

# POPULAR MECHANICS

MAGAZINE

WRITTEN SO YOU CAN UNDERSTAND



**COLOR TV IS HERE**

*See page 129*

Try Your Hand at Modeling the  
**USS *MIDWAY*** — page 206

**WHAT OWNERS THINK OF  
REAR-ENGINE CARS**

Copyrighted material





LOOK WHAT **WE** DID  
TO OUR SINK TOP...

*with Simple Tools and*

**FORMICA**

It's easy and it's fun to replace a worn out sink top with genuine Beauty Bonded Formica. A new Formica surface can be rolled down with Formica Contact Bond Cement and an ordinary rolling pin.

Your work can have a finished professional look because the Formica you use is exactly the same material famous for color, beauty and long wear—not a new material for amateurs.

**FREE** We've prepared an instruction booklet complete with step-by-step pictures. A copy is yours free for the asking. Just write Formica, 4596 Spring Grove Ave., Cincinnati 32, Ohio.



DEMAND THIS CERTIFICATION

*This mark certifies genuine*  
REMOVE WITH SOAP AND WATER

Beauty Bonded  
**FORMICA**  
Pays in Performance

Seeing is believing. If this wash-off identification is not on the sheet, it's not Formica.





# NOW - A SUPER BATTERY

*With power  
to spare*



—for cold weather starting— for all accessories

**T**HE new Double Eagle 125 is packed with power—more than you'll ever need—for heater, radio and other accessories. With up to 67% more starting power than other batteries of its type, it gives you faster, surer starting on cold winter days.

Its new porous rubber and Fiberglas insulation is highly resistant to acid, heat and vibration, holds the material on the plates for longer battery life. And — 3½

times more solution above the plates means filling only 3 times a year in normal use.

The super-powered Double Eagle 125 has a blue-and-yellow polystyrene case — lighter but stronger! Ask your dealer about this great new battery now. It costs a little more — but its sure-fire dependability is more than worth it.

Goodyear, Battery Dept., Akron 16, Ohio

*NEW SUPER-POWERED*  
**GOODYEAR**  
DOUBLE EAGLE BATTERY

Double Eagle—T. M. The Goodyear Tire & Rubber Company, Akron, Ohio

This One



ND4C-QSA-1YZT

JANUARY 1954

1

Copyrighted material



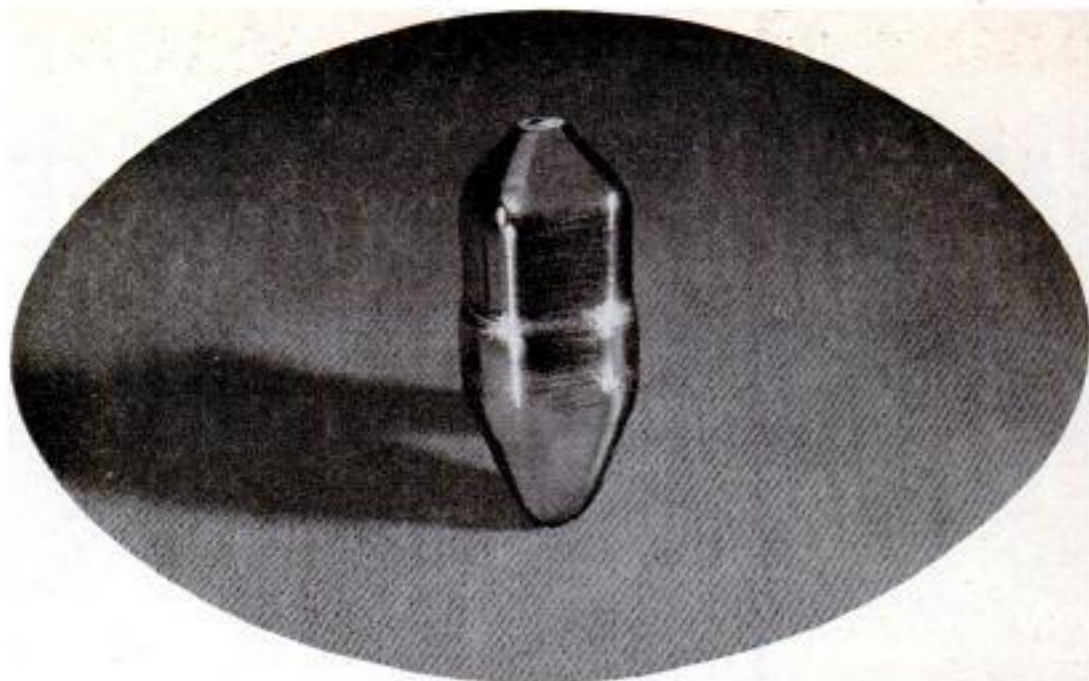

Germanium crystal grown at Bell Telephone Laboratories (half size). It is sliced into hundreds of minute pieces to make *Transistors*. Transistor action depends on the flow of positive current-carriers as well as electrons, which are negative. Arsenic—a few parts per 100,000,000—added to germanium produces prescribed excess of electrons. With gallium added, positive carriers predominate. Latest junction type *Transistor* uses both kinds of germanium in the form of a sandwich.

## THEY GREW IT FOR TRANSISTORS

Heart of a *Transistor*—Bell Telephone Laboratories' new pea-size amplifier—is a tiny piece of germanium. If *Transistors* are to do their many jobs well, this germanium must be of virtually perfect crystalline structure and uniform chemical composition. But it doesn't come that way in nature.

So—Bell scientists devised a new way to grow the kind of crystals they need, from a melt made of the natural product. By adding tiny amounts of special alloying substances to the melt, they produce germanium that is precisely tailored for specific uses in the telephone system.

This original technique is another example of the way Bell Laboratories makes basic discoveries—in this case the *Transistor* itself—and then follows up with practical ways to make them work for better telephone service.

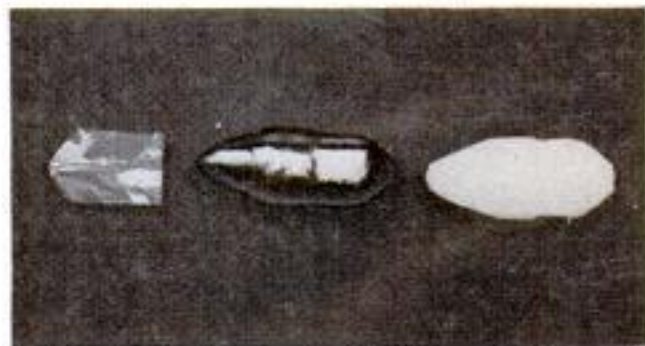

Section of natural germanium, left, shows varying crystal structure. At right is sectioned single crystal grown at Bell Laboratories.

BELL TELEPHONE LABORATORIES



IMPROVING TELEPHONE SERVICE FOR AMERICA PROVIDES CAREERS FOR CREATIVE MEN IN SCIENTIFIC AND TECHNICAL FIELDS



# Popular Mechanics Magazine

Registered in U. S. Patent Office and Canada

H. H. WINDSOR, Founder

H. H. WINDSOR, JR., Editor and Publisher



## this month's cover

**COLOR TV IS HERE!** For years we've been hearing miraculous claims for color television—but it's always been sometime in the nebulous future. This month, color TV is a reality. Starting with the Tournament of Roses on New Year's Day, when cameras will capture all the breathtaking hues of the colorful spectacle, networks will beam color telecasts regularly. Full-color TV has been held up by conflicting systems, but now manufacturers have agreed on a single broadcasting system, though they may use different types of equipment. Best part of the agreement is that your black-and-white set won't be outmoded. You can still see the color telecasts in black and white on your present receiver. Chances are, though, you'll be wanting a color set soon, for the colors are as vivid as they appear on our cover, where a cameraman is making a pretelecast color check. For a full report on color TV today, turn to page 129

Published monthly by Popular Mechanics Company, 200 E. Ontario St., Chicago 11, Ill. H. H. Windsor, Jr., President; Wm. Harrison Frazier, Exec. Vice-pres.; D. F. Windsor, vice-president and secretary-treasurer; H. H. Windsor III, vice-president; Clover L. Perkins, advertising manager; Alan M. Deyoe, circulation manager. Single copy in the United States and Canada, 35 cents; subscription rates in the United States and possessions, Canada, possessions and countries of the Pan-American Postal Union, 1 year \$5.50; 2 years, \$9.00; 3 years \$14.00. To all other countries add \$1.00 a year over United States prices for overseas postage. If you plan to move, notify us at least 30 days in advance so you will not miss an issue. Give both your old and new addresses. Entered as Second Class Matter, September 15, 1903, at the Post Office at Chicago, Illinois, under Act of March 3, 1879. Entered as Second Class Matter at Post Office Dept., Canada. Registered as Second Class Matter at the Post Office at Mexico, D. F., Mexico, June 20, 1950. Copyright 1953 by Popular Mechanics Company. Copyright under International Copyright Union. Copyright in France. All rights reserved under Pan-American Copyright Union. Printed in the United States of America.

Volume 101 JANUARY 1954 Number 1

Address all communications to:  
200 East Ontario Street, Chicago 11, Illinois

Managing Editor.....Roderick M. Grant  
Assistant Managing Editor.....Wayne Whittaker  
Shop Notes and Crafts Editor.....James R. Ward  
Radio-Television, Electronics Editor.....Frank L. Brittin  
Associate Editor, Aviation.....Aubrey O. Cookman, Jr.  
Associate Editor.....Clifford B. Hicks  
Associate Editor, Automotive.....Arthur R. Railton  
Associate Editor, Shop Notes and Crafts.....Wayne C. Leckey  
Assistant Editor, Shop Notes.....W. Clyde Lamney  
Assistant Editor, Crafts.....Frank N. Stephany  
Assistant Editor, Makeup.....John C. Dalen  
Automotive Correspondent.....Leo Donovan  
Art Director.....Frank Beatty

### Assistant Editors

Leonard F. Hilts  
Jay W. Hedden  
Elliott H. McCleary  
Eastern Editor.....Richard F. Dempewolf  
Empire State Bldg., Room 2906, New York City 1  
Western Editor.....Thomas E. Stimson, Jr.  
London Manager.....Douglas W. Wedderspoon  
Eagle House, Jermyn St., London S. W. 1, England  
Director, Bureau of Information.....Allan Carpenter  
200 E. Ontario St., Chicago 11

## IN THIS ISSUE

<b>Look How Your Mail Gets There!</b> - - - -	<b>97</b>
<b>Perpetual Motion Just Isn't</b> - - - -	<b>108</b>
<b>The Battle of the Sagebrush Busters</b> - - -	<b>114</b>
<b>Deep-Sea Sentinels Guard Our Harbors</b> - -	<b>124</b>
<b>Color Television Is Here</b> - - - - -	<b>129</b>
<b>Owners Report on Three Rear-Engine Cars</b> -	<b>134</b>
<b>Sensitive House</b> - - - - -	<b>148</b>
<b>Oh, for the Life of a Human Mole!</b> - - -	<b>152</b>
<b>Relax!</b> - - - - -	<b>162</b>
<b>Salmon Fishing on the Night Shift</b> - - -	<b>169</b>
<b>Radio, TV and Electronics</b> - - - - -	<b>177</b>

## For the Craftsman

<b>Room Divider Features Writing Desk</b> - - -	<b>181</b>
<b>Extension Cords</b> - - - - -	<b>188</b>
<b>Aluminum as a New Craft Material</b> - - -	<b>197</b>
<b>Try Your Hand at Modeling the Midway</b> - -	<b>206</b>
<b>How Your Brakes Work</b> - - - - -	<b>213</b>
<b>Jigsaw From Small Engine</b> - - - - -	<b>219</b>
<b>Milling-Machine Setups</b> - - - - -	<b>224</b>
<b>Farm Trailer Made From Auto Chassis</b> - -	<b>230</b>
<b>Clinic for Homemakers</b> - - - - -	<b>240</b>

Other items, and manufacturers of available products described, are listed on pages 16, 18 and 20





THE LE MANS 24-HOURS (France) saw Champion-equipped cars take the first seven places at record times for this event.



SEBRING 12-HOUR RACE was won by top U. S. road-racing team of John Fitch-Phil Walters in a Cunningham.

## Again in International Racing CHAMPIONS POWER THE WINNERS!

LE MANS GRAND PRIX GERMANY GRAND PRIX MONTE CARLO INDIANAPOLIS GRAND PRIX PORTUGAL PAN-AMERICAN  
RIO DE JANEIRO GRAND PRIX SEBRING MILLE MIGLIA GRAND PRIX ENGLAND GRAND PRIX HOLLAND GRAND PRIX ITALY  
GRAND PRIX FRANCE GRAND PRIX PARIS GRAND PRIX PAU GRAND PRIX COMMINGES GRAND PRIX DES SABLES D'OLONNE  
GRAND PRIX SWITZERLAND GRAND PRIX LABAULE GRAND PRIX RHEIMS GRAND PRIX SICILY GRAND PRIX BELGIUM  
GRAND PRIX NAPLES GRAND PRIX TURIN GRAND PRIX MARSEILLES GRAND PRIX MONACO SAO PAULO GRAND PRIX



THE GRAND PRIX OF BRITAIN—another victory for the Ferrari team—Ascari in 1st—all team cars using Champions.



THE GRAND PRIX OF EUROPE (France) in which the Ferrari team again triumphed with Mike Hawthorne the victor.

Wherever power, performance and dependability are essential, Champions are the first selection because they are engineered and designed to make any engine—including yours—deliver its best. See your Champion dealer—today!

WORLD'S FAVORITE

# CHAMPION

SPARK PLUGS

CHAMPION SPARK PLUG COMPANY, TOLEDO 1, OHIO

POPULAR MECHANICS



# GOOD NEWS! THIS BEAUTIFUL VINYL-PLASTIC TILE FLOORING RESISTS GREASE, ACID, ALKALI YET COSTS YOU LESS!

## MATICO ARISTOFLEX

The New Low-Cost Tile  
Flooring Made of Vinyl—  
The Wonder Plastic!

Costs Less To Begin With! Aristoflex—in economical standard gauge — is produced especially by MATICO to meet the needs of homeowners everywhere. It resists dirt, grease, acid and alkali... stays sparkling clean with occasional damp moppings... is quiet and comfortable underfoot... comes in 13 radiant Coronation Colors... lasts for years and years. Best of all, Aristoflex costs less than any other flooring of comparable quality... gives you far more for your money. See Aristoflex at your friendly MATICO dealer — he's listed in your local classified telephone directory!



install  
**ARISTOFLEX yourself**  
**SAVE STILL MORE!**

Yes, you can save \$25, \$30 or more on every room by installing Aristoflex yourself. It's easy, too, with MATICO's tested install-it-yourself method—special tool kit—and illustrated instruction booklet. And you can install Aristoflex in any room from basement to attic because it's rugged vinyl-plastic throughout — there's no felt backing to wear off or deteriorate.



**MASTIC TILE CORPORATION  
OF AMERICA**

Member: Vinyl Flooring Institute  
Joliet, Ill. • Long Beach, Calif.  
Newburgh, N. Y.





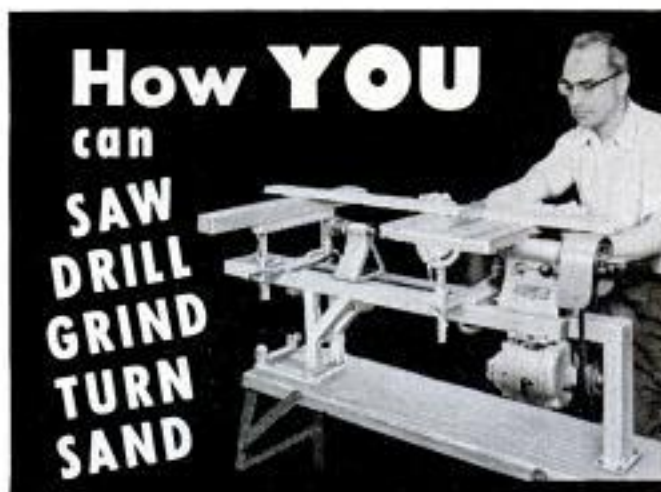

**How YOU**  
can  
**SAW**  
**DRILL**  
**GRIND**  
**TURN**  
**SAND**

with **SUPERSHOP**

**5 BIG POWER TOOLS IN 1**

- 8" TILTING TABLE SAW
- 1/2" DRILL PRESS
- 8" SANDER
- 30" LATHE
- 5" GRINDER

When you DO-IT-YOUR-SELF with SUPERSHOP you save money and you have fun. You can build a house or a garage — handle BIG jobs. The 8 inch saw cuts 2 1/2 inches deep. Heavy tubular steel frame. 100% Ball Bearing. Lifetime accuracy. Save \$65.05—buy direct from factory. Take advantage of our FREE trial plan. You can buy on EASY TERMS. Write for FREE How-To-DO-It Catalog.



**DRILL PRESS**



**SANDER**



**LATHE**



**GRINDER**

Write for **FREE** How-To-Do-It Catalog.

WRITE FOR  
YOUR COPY  
SEND POSTCARD

FACTORY  
TO YOU

**\$79<sup>95</sup>**

EASY PAY PLAN

**POWER TOOLS INC.** 155A Yates Ave. Beloit, Wis.

in this corner.....

**THE EDITORS**



**USS Midway Project**

In this issue our Craft Editors present a new project for the thousands of ship-model hobbyists—detailed plans for construction of a model of the USS *Midway*,



Paul Strayer with his miniature of the USS *Midway*

famed aircraft carrier. Paul Strayer, originator of the plans, is first of all an artist in oil, best known for his magazine illustrations and cover paintings and for his marine



Strayer's oil painting of *Midway* shows jet takeoff

paintings. But he is also a great ship-model builder, often constructs a painstakingly accurate miniature of a famous sailing vessel or warship as a prelude to painting its portrait. We picture him here with the *Midway* model he built. The oil painting of the *Midway*, also Strayer's, depicts a Grumman F9F-6 Cougar jet fighter being catapulted from the carrier's deck. The *Midway* model project begins on page 206 of this issue.

(Continued to page 12)



# 5 reasons why ACCOUNTANCY



**offers you MORE MONEY... and SUCCESS!**

**REASON #1.** If you were an expert accountant right now, chances are you would find yourself among the highest-paid of all professional men and women. Even back in "depression years," surveys showed that accountants earned more on the average than men in other major professions.

**REASON #2.** The demand for accountants is great—everywhere. All businesses must have trained accountants to cope with ever-growing requirements. It's a profession offering wide opportunity—always—to the man who knows.

**REASON #3.** You can fit into any business, anywhere in the country—because accounting principles are universal. Think what this means in terms of security and independence!

**REASON #4.** Accountancy is open to all. Any man or woman of good intelligence, who enjoys figure work and is willing to follow LaSalle's systematic "problem method" plan, can rapidly qualify for a highly profitable, enjoyable lifetime career... and he doesn't have to finish his training before beginning to "cash in."

**REASON #5.** Without losing a day from your present work, you can prepare in spare hours at home, at low cost, under LaSalle's step-by-step "Problem Method" of "learning by doing." This famous plan accounts for LaSalle's remarkable record of having trained nearly 10 per cent of all Certified Public Accountants in the U. S. . . . and of having put many thousands of others into high-paying careers.

Send today for Free Sample Lesson and "Accountancy, the Profession That Pays." Learn about the five great fields of opportunity . . . and LaSalle's time-tested plan for helping men and women to rapid advancement, higher income, greater prestige and professional standing. The coupon below will bring this information to you—without cost or obligation.

**MAIL THE COUPON—NOW**

**GET FREE SAMPLE LESSON**



**LaSalle Extension University**

**A Correspondence Institution**

Dept. 164 H, 417 S. Dearborn St., Chicago 5, Ill.

Please send me, free of all cost or obligation, a sample lesson in Accounting . . . also, your 48-page illustrated book, "Accountancy, the Profession That Pays."

Name..... Age.....

Address.....

City, Zone, State.....

**LASALLE**  
417 S. Dearborn St.,  
CHICAGO 5, ILL.

JANUARY 1954

7



# OPPORTUNITY OUTLOOK FOR

## AUTOMOTIVE

**AUTOMOBILE MECHANIC.** Many openings for beginners. High turnover. Average straight-time earnings from \$1.31 to \$2.15. 2 years high school desirable. Excellent training available through I.C.S. Free catalog.

**DIESEL MECHANIC.** Prospects for experienced men highly favorable. Limited openings for helpers and apprentices. I.C.S. training helping many qualify. Also helps supplement experience. Big future.

## AVIATION

**AERONAUTICAL ENGINEERING.** Employment still high. Best insurance against layoff is good training. Guided missiles open new field. High starting salaries for qualified newcomers. I.C.S. offers basic courses.

**AIRCRAFT ENGINE MECHANIC.** Unlimited opportunities. Best jobs going to trained men. Draft eligible men can train now for good Air Force ratings. I.C.S. training leads to CAA certification. Course includes electrical hydraulic systems.

**AIRCRAFT DRAFTING.** Still a critical occupation. Trained men command high pay. Drafting department is springboard for big money planning and designing jobs. I.C.S. course rates high.

### What I.C.S. Can Do For You

1. Help you qualify quicker for better job. Bigger pay.
2. Give you new self-confidence.
3. Save you time and expense. No out-of-date or unnecessary material to study.
4. Keep your employer informed of your progress (if you wish).

## BUILDING

**ARCHITECTURE.** High pay. Professional status. I.C.S. training plus experience recognized by most States. I.C.S. graduates among leaders in the field.

**ARCHITECTURAL DRAFTING.** Excellent way to enter field. Start as draftsman. Advance as ability becomes recognized. I.C.S. offers two approved courses.

**BUILDING CONTRACTOR.** Current and long-range outlook good. Chance for tradesman to start business of his own. Knowledge of estimating and superintendence essential. I.C.S. course complete, up to date, low in cost.

**READING BLUEPRINTS.** Men who can read blueprints usually promoted first. Six I.C.S. courses. Architect's. Electrical. Structural (including steel, concrete). Free catalog describes each.

**ELECTRICIAN.** Long-range outlook good. Hourly wages from \$2-\$3. Unions, States set job qualifications. Both approve I.C.S. training.

## BUSINESS

**BUSINESS ADMINISTRATION.** Growing need for engineers, technicians with business training. Management openings. Top salaries. I.C.S. executive training meets requirements of hundreds of up-and-coming men. Special refresher courses. Many companies are using I.C.S. courses to train foremen, salesmen, young executives. Write for free catalog. Check coupon.

**CERTIFIED PUBLIC ACCOUNTANT.** Heavy competition. Big demand for C.P.A.'s. Employment gains expected in 1954. C.P.A.'s average \$10 more per week than other accountants. I.C.S. course helps meet qualifications of most State boards. Includes Federal Tax, Business and Commercial Law.

### Why I.C.S. Is Best for You

1. I.C.S. offers 277 success-tested courses, 1438 different texts.
2. I.C.S. texts are used by U. S. Armed Forces Institute, Marine Corps Institute, Coast Guard Institute, as well as by colleges and universities.
3. I.C.S. courses are used by 4330 businesses and industries to train employees.
4. I.C.S. has spent five million dollars keeping texts up to date.

**ACCOUNTING.** Bachelor's degree or diploma from recognized school required for best jobs. Experience in accounting offers excellent background for top business positions. I.C.S. offers comprehensive course for beginners and bookkeepers requiring further training. Catalog brings you complete information. Mark and mail coupon.

**BOOKKEEPING.** Many more openings in 1954-55. High school required by most employers. Weekly earnings average \$53-\$70 for hand operators, \$45-\$62 for machine operators. Opportunities for advancement. Study at home, in your spare time, with I.C.S. Wide selection of courses, combining bookkeeping with other subjects. Short course for managers of small businesses.

**STENOGRAPHY AND TYPING.** Excellent prospects through 1955. High school preferred. Additional training desirable. High demand has improved starting rates in most areas. Home study available through I.C.S.

**SECRETARIAL.** Long-run trend upward. Shortage of secretaries puts extra premium on training, allows newcomers to pick field of interest. Many openings in government service. Excellent home study course offered by world famous I.C.S.

**RETAIL BUSINESS MANAGEMENT.** Competition great for top jobs. Men with sound training given priority. Knowledge of merchandising, advertising, sales management essential. High salaries plus bonuses. For complete information send for I.C.S. catalog. See coupon.

**CREATIVE SALESMANSHIP.** General tightening of business will put new emphasis on creative salesmanship. Forward looking men already enrolling for refresher courses and new I.C.S. course in Creative Salesmanship. Texts prepared by experts, have full endorsement of leaders.

## CHEMISTRY

**CHEMICAL ENGINEERING.** Employment prospects for new graduates reach new high, particularly in Eastern States, Midwest, Texas and California. Monthly salaries of \$800 to \$1000 not uncommon. Best opportunities for men with approved schooling. I.C.S. course used by many companies to train new chemical engineers. Free catalog. Complete information. Send coupon.

### Advantages of I.C.S. Method

1. You earn while you learn. No time lost "going to school."
2. Study in your spare time, at work, at home or in between.
3. Set your own pace—never hurried or held back by others.
4. Study when convenient—no missed classes due to illness, business or social engagements.
5. Individual, personalized instruction. You correspond directly and privately with your instructor.

## CIVIL, STRUCTURAL ENGINEERING

**CIVIL ENGINEERING.** 15,000 new openings expected by 1960. Salaries for beginners, \$3000. For managers, over \$10,000. Many of nation's leading civil engineers were I.C.S. trained. Courses recommended by public agencies, private companies.

**STRUCTURAL ENGINEERING.** Outlook depends on building activity—good through mid-fifties. Need greatest in steel industry, railroad, and public utilities. I.C.S. texts used by many engineering schools. No finer home study course. Send coupon for details.

**SURVEYING & MAPPING.** Excellent foundation for student engineers. No experience needed. I.C.S. course qualifies you for surveying corps or topographic draftsman's job.

**HIGHWAY ENGINEERING.** Limited opportunities. Training essential to qualify for State highway jobs. I.C.S. course is standard in majority of States. Course includes airport layout and runway construction.

## DRAFTING

**DRAFTSMEN.** Aircraft. Architectural. Electrical. Mechanical. Structural. Sheet Metal. Mine. Favorable prospects. Top jobs going to trained men. Train at home. I.C.S. success-tested courses. Drawing equipment. Diploma awarded. Low cost. Rapid progress. Free catalog and sample lesson showing famous instruction service. Check coupon.

## ELECTRICAL

**ELECTRICAL ENGINEERING.** Excellent outlook for those now starting training. Earnings high—from \$235 a month for beginners to \$1000 a month for chief engineers. Complete or special I.C.S. courses—only training of its kind for both college and non-college employees. Coupon brings free book.

**ELECTRICAL MAINTENANCE.** Industrial electricians in short supply. Excellent opportunities for men with broad general knowledge of electric circuits, apparatus. High pay. Future security. Fifty lesson I.C.S. course gives necessary background training.

**ELECTRO POWER & LIGHT.** Huge industry-wide expansion still underway. New managers, superintendents being drawn from ranks. Need for technical plus commercial training. I.C.S. offers ten different courses including steam, hydro-electric, overhead power lines. Send coupon for free catalog and full details.

### There's a Difference!

One important value is that I.C.S. gives you the bedrock facts and theory, plus practical application. No skimping. Instead of just becoming good, you become expert with an expert's knowledge of fundamentals.

That is the big difference between I.C.S. and other teaching methods.

## HIGH SCHOOL

**I.C.S. COURSES.** Twenty-two different courses on high school and college subjects. Also special, made-to-order courses for those requiring fewer subjects. Lessons prepare you for State equivalency examinations. Certificates awarded. Rapid progress. Cost surprisingly low. Credit for subjects already completed. Full particulars on request. Send coupon.



# 1954



Here's a list of opportunities now open to YOU. International Correspondence Schools can help you forge ahead in any one of these fields. Check the course in which you are interested on the coupon printed below. Clip the coupon and mail for "How to Succeed" book and full information. No obligation whatever. But don't delay — mail it TODAY.

## 5 Reasons Why You Should Mail Coupon TODAY

1. It brings you two free books by return mail.
2. It puts you in touch with the world's largest training school.
3. It proves to everyone (including yourself) that you are determined to make good.
4. It starts the pattern that has led thousands to richer, fuller lives.
5. It costs you absolutely nothing. Nor are you obligated in any way.

### MECHANICAL AND SHOP

**MECHANICAL ENGINEERING.** Largest branch of engineering and still growing. Good job opportunities. 2000 needed annually for replacement alone. Interesting, rewarding work. I.C.S. courses written by top men. No previous education required. You teach yourself from special textbooks.

**INDUSTRIAL SUPERVISOR.** Key positions in industry today. Most companies now have training programs for industrial supervisors. Many use I.C.S. texts. Smartest men do not wait for company. They enroll themselves.

**FOREMANSHIP.** Growing importance of foreman reflected in higher pay scale, more responsibility. I.C.S. course recognized as standard for industry. Easily adapted to needs of individual or group. You learn while you earn.

**MACHINE SHOP.** Many opportunities for new workers. Quick advancement for skilled men and women. Additional training can mean promotion to tool or die maker. I.C.S. offers excellent course in Machine Shop Practice.

**TOOL DESIGN.** Limited field. Highly competitive. Very high earnings. Top working conditions. Men planning to enter this field must devote much time to training in tool designing, drafting, mathematics. I.C.S. graduates have advanced to broader, more responsible jobs in tool engineering.

**INDUSTRIAL INSTRUMENTS.** Small, fast-growing field. Good opportunities for trained newcomers. High school desirable. I.C.S. combines all needed training into new course in Industrial Instrumentation. Free catalog with complete details.

**TOOLMAKING.** Highest paid machine-shop occupation. Stepping-stone for supervisor jobs. Long-run prospects good for employment. Requires rounded experience plus special training. Hundreds find I.C.S. course best in field.

### RADIO, TV, COMMUNICATIONS

**PRACTICAL RADIO-TELEVISION ENGINEERING.** Opportunity trend upward due to TV, electronics. Also new opportunities in industry. I.C.S. course prepared by leading technicians. Excellent foundation course for men entering Armed Forces.

**TELEVISION TECHNICIAN.** High-level technical positions await men with training. One of few schools with complete, up-to-date course. I.C.S. offers work in camera, studio, transmitter techniques. Also manufacture, sale and installation of TV equipment.

**RADIO OPERATION.** Rising volume of government openings. Airlines and military demands high. Typical earnings: \$180-\$300 a month. I.C.S. courses prepare for Civil Service examinations.

**ELECTRONICS.** Rapid growth in both government and industry. Excellent opportunities for qualified technicians. Manufacturing, Research, Defense. Unparalleled chance to learn and serve at same time. Investigate I.C.S.

**RADIO-TV SERVICING.** Critical shortage of trained specialists. Opportunity for you to start your own profitable business. Especially bright future. Not too late to learn. No previous training required. I.C.S. method has proved successful in over 1000 cases of recent graduates. Send for full particulars.

### RAILROAD

**DIESEL LOCOMOTIVE.** Marked trend toward Diesel equipment on all major railroads. Technical knowledge speeds advancement, though promotions based on seniority for the most part. Good pay. Security. I.C.S. courses adopted by over 300 leading railroads.

### POWER

**DIESEL.** Large, growing employment. Best prospects for trained specialists. Excellent home training available through I.C.S. Four courses. Railroad. Marine. Trucks. Free, illustrated catalog. Just mark and mail the coupon.

### TEXTILE

**TEXTILE MANUFACTURING.** Great shortage of college trained technical and supervisory personnel. Many overseers I.C.S. trained in carding, spinning, weaving, warping, throwing, finishing, dyeing, cotton, synthetics, wool.

### ART

**COMMERCIAL ART.** Good demand for top-notch commercial artists. Payments up to \$1200 per illustration. Best opportunities in metropolitan areas. Brisk demand everywhere for lettering artists and sign painters. Send for beautiful, new art catalog.

## 2 FREE BOOKS

The coupon below will bring you Free Book about course in which you are interested. Also "How to Succeed," a 36-page gold mine of advice telling Why People Fail... How to Pick Your Goal... How to Develop Hidden Talent, etc. No cost — no obligation. Take advantage of today's new job opportunities. Mail this coupon TODAY.



I.C.S., Scranton 9, Penna.

## INTERNATIONAL CORRESPONDENCE SCHOOLS

ICS

BOX 5608-L, SCRANTON 9, PENNA.

Without cost or obligation, send me "HOW TO SUCCEED" and the booklet about the course BEFORE which I have marked X:

- |  |  |   |  |
|--|--|---|--|
| <p><b>ART</b></p> <ul style="list-style-type: none"> <li><input type="checkbox"/> Commercial Art</li> <li><input type="checkbox"/> Magazine Illustrating</li> <li><input type="checkbox"/> Fashion Illustrating</li> <li><input type="checkbox"/> Cartooning</li> <li><input type="checkbox"/> Sketching and Painting</li> <li><input type="checkbox"/> Show Card and Sign Lettering</li> </ul> <p><b>AUTOMOTIVE</b></p> <ul style="list-style-type: none"> <li><input type="checkbox"/> Automobile, Mechanic</li> <li><input type="checkbox"/> Auto Elec. Technician</li> <li><input type="checkbox"/> Auto Body Rebuilding and Refinishing</li> <li><input type="checkbox"/> Diesel-Gas Engines</li> </ul> <p><b>AVIATION</b></p> <ul style="list-style-type: none"> <li><input type="checkbox"/> Aeronautical Engineering Jr.</li> <li><input type="checkbox"/> Aircraft Engine Mechanic</li> <li><input type="checkbox"/> Airplane Drafting</li> </ul> <p><b>BUILDING</b></p> <ul style="list-style-type: none"> <li><input type="checkbox"/> Architecture</li> <li><input type="checkbox"/> Arch. Drafting</li> <li><input type="checkbox"/> Building Contractor</li> <li><input type="checkbox"/> Estimating</li> <li><input type="checkbox"/> Carpenter and Mill Work</li> <li><input type="checkbox"/> Carpenter Foreman</li> <li><input type="checkbox"/> Reading Blueprints</li> <li><input type="checkbox"/> House Planning</li> <li><input type="checkbox"/> Plumbing</li> </ul> | <p><input type="checkbox"/> Heating</p> <p><input type="checkbox"/> Painting Contractor</p> <p><input type="checkbox"/> Air Conditioning</p> <p><input type="checkbox"/> Electrician</p> <p><b>BUSINESS</b></p> <ul style="list-style-type: none"> <li><input type="checkbox"/> Business Administration</li> <li><input type="checkbox"/> Certified Public Accountant</li> <li><input type="checkbox"/> Bookkeeping and Accounting</li> <li><input type="checkbox"/> Office Management</li> <li><input type="checkbox"/> Stenography and Typing</li> <li><input type="checkbox"/> Secretarial</li> <li><input type="checkbox"/> Federal Tax</li> <li><input type="checkbox"/> Business Correspondence</li> <li><input type="checkbox"/> Letter-writing Improvement</li> <li><input type="checkbox"/> Personnel and Labor Relations</li> <li><input type="checkbox"/> Advertising</li> <li><input type="checkbox"/> Retail Business Management</li> <li><input type="checkbox"/> Managing Small Business</li> <li><input type="checkbox"/> Ocean Navigation</li> <li><input type="checkbox"/> Sales Management</li> <li><input type="checkbox"/> Short Story Writing</li> <li><input type="checkbox"/> Creative Salesmanship</li> <li><input type="checkbox"/> Traffic Management</li> </ul> <p><b>CHEMISTRY</b></p> <ul style="list-style-type: none"> <li><input type="checkbox"/> Electrical Engineering</li> <li><input type="checkbox"/> Chemistry</li> <li><input type="checkbox"/> Analytical Chemistry</li> </ul> | <p><input type="checkbox"/> Petroleum-Nat'l Gas</p> <p><input type="checkbox"/> Pulp and Paper Making</p> <p><input type="checkbox"/> Plastics</p> <p><b>CIVIL, STRUCTURAL ENGINEERING</b></p> <ul style="list-style-type: none"> <li><input type="checkbox"/> Civil Engineering</li> <li><input type="checkbox"/> Structural Engineering</li> <li><input type="checkbox"/> Surveying and Mapping</li> <li><input type="checkbox"/> Structural Drafting</li> <li><input type="checkbox"/> Highway Engineering</li> <li><input type="checkbox"/> Reading Blueprints</li> <li><input type="checkbox"/> Construction Engineering</li> <li><input type="checkbox"/> Sanitary Engineering</li> </ul> <p><b>DRAFTING</b></p> <ul style="list-style-type: none"> <li><input type="checkbox"/> Aircraft Drafting</li> <li><input type="checkbox"/> Architectural Drafting</li> <li><input type="checkbox"/> Electrical Drafting</li> <li><input type="checkbox"/> Mechanical Drafting</li> <li><input type="checkbox"/> Structural Drafting</li> <li><input type="checkbox"/> Sheet Metal Drafting</li> <li><input type="checkbox"/> Ship Drafting</li> <li><input type="checkbox"/> Mine Surveying and Drafting</li> </ul> <p><b>ELECTRICAL</b></p> <ul style="list-style-type: none"> <li><input type="checkbox"/> Electrical Engineering</li> <li><input type="checkbox"/> Electrician</li> <li><input type="checkbox"/> Electrical Maintenance</li> </ul> | <p><input type="checkbox"/> Electrical Drafting</p> <p><input type="checkbox"/> Electric Power and Light</p> <p><input type="checkbox"/> Lineman</p> <p><b>HIGH SCHOOL</b></p> <ul style="list-style-type: none"> <li><input type="checkbox"/> High School Subjects</li> <li><input type="checkbox"/> Mathematics</li> <li><input type="checkbox"/> Commercial</li> <li><input type="checkbox"/> Good English</li> </ul> <p><b>MECHANICAL AND SHOP</b></p> <ul style="list-style-type: none"> <li><input type="checkbox"/> Mechanical Engineering</li> <li><input type="checkbox"/> Industrial Engineering</li> <li><input type="checkbox"/> Industrial Supervision</li> <li><input type="checkbox"/> Foremanship</li> <li><input type="checkbox"/> Mechanical Drafting</li> <li><input type="checkbox"/> Machine Design-Drafting</li> <li><input type="checkbox"/> Machine Shop Practice</li> <li><input type="checkbox"/> Tool Design</li> <li><input type="checkbox"/> Industrial Instrumentation</li> <li><input type="checkbox"/> Machine Shop Inspection</li> <li><input type="checkbox"/> Reading Blueprints</li> <li><input type="checkbox"/> Toolmaking</li> <li><input type="checkbox"/> Gas-Electric Welding</li> <li><input type="checkbox"/> Heat Treatment-Metallurgy</li> <li><input type="checkbox"/> Sheet Metal Work</li> <li><input type="checkbox"/> Sheet Metal Pattern Drafting</li> <li><input type="checkbox"/> Refrigeration</li> </ul> <p><b>POWER</b></p> <ul style="list-style-type: none"> <li><input type="checkbox"/> Combustion Engineering</li> <li><input type="checkbox"/> Diesel-Electric</li> <li><input type="checkbox"/> Electric Light and Power</li> <li><input type="checkbox"/> Stationary Steam Engineering</li> <li><input type="checkbox"/> Stationary Fireman</li> </ul> <p><b>RADIO, TELEVISION COMMUNICATIONS</b></p> <ul style="list-style-type: none"> <li><input type="checkbox"/> Practical Radio-TV Eng'ing</li> <li><input type="checkbox"/> Radio Operating</li> <li><input type="checkbox"/> Radio and TV Servicing</li> <li><input type="checkbox"/> Television-Technician</li> <li><input type="checkbox"/> Electronics</li> <li><input type="checkbox"/> Telephone Work</li> </ul> <p><b>RAILROAD</b></p> <ul style="list-style-type: none"> <li><input type="checkbox"/> Locomotive Engineer</li> <li><input type="checkbox"/> Diesel Locomotive</li> <li><input type="checkbox"/> Air Brakes</li> <li><input type="checkbox"/> Car Inspector</li> <li><input type="checkbox"/> Railroad Administration</li> </ul> <p><b>TEXTILE</b></p> <ul style="list-style-type: none"> <li><input type="checkbox"/> Textile Engineering</li> <li><input type="checkbox"/> Cotton, Rayon, Woolen Mfg.</li> <li><input type="checkbox"/> Carding and Spinning</li> <li><input type="checkbox"/> Warping and Weaving</li> <li><input type="checkbox"/> Loom Fixing</li> <li><input type="checkbox"/> Throwing</li> <li><input type="checkbox"/> Finishing and Dyeing</li> <li><input type="checkbox"/> Textile Designing</li> </ul> |
|--|--|---|--|

Name \_\_\_\_\_ Age \_\_\_\_\_ Home Address \_\_\_\_\_

City \_\_\_\_\_ Zone \_\_\_\_\_ State \_\_\_\_\_ Working Hours \_\_\_\_\_ A.M. to P.M. \_\_\_\_\_

Occupation \_\_\_\_\_ Canadian residents send coupon to International Correspondence Schools Canadian, Ltd., Montreal, Canada, . . . Special tuition rates to members of the U. S. Armed Forces.

MAIL  
THIS  
COUPON  
FOR  
TWO  
FREE  
BOOKS



## Our 40th Year

NRI training is thorough, practical, up-to-date. When you enroll with NRI you benefit from our 40 years of successful experience training men at home.

*J. E. Smith*

President  
National Radio Institute  
Washington, D. C.



# I'll Train You RADIO-

## You Practice Broadcasting with Parts I Send



As part of my Communications Course I send you parts to build low-power Broadcasting Transmitter at left, and other equipment. Use it to get practical experience. You put this station "on the air," perform procedures demanded of station operators. An FCC Commercial Operator's License can be your ticket to a bright future. My Course trains you to get your license. Mail Coupon now!



## Television Is Today's Good Job Maker

Television now reaches from coast-to-coast. More than 25 million Television sets are already in use and require servicing; thousands more sets are being sold every week. About 200 TV stations are now on the air with hundreds more being built. This means new jobs, more jobs, better pay for trained men. The time to act is NOW! Start learning Radio-Television servicing or communications.

## You Practice Servicing with Parts I Send

Nothing takes the place of PRACTICAL EXPERIENCE. NRI training is based on LEARNING BY DOING. You use parts I send to build many circuits common to Radio and TV. You build the modern radio at right. Use Multi-tester you build to make money fixing sets. Many students make \$10, \$15 a week extra fixing neighbors' sets in spare time, starting soon after enrolling. All equipment I send is yours to keep.



## Make Extra Money in Spare Time While Learning

Keep your job while training. Many NRI students make \$10, \$15 and more a week extra fixing neighbors' Radios in spare time. The day you enroll I start sending you special booklets that show you how to service sets. Multi-tester you build helps discover and correct Radio troubles, gives PRACTICAL EXPERIENCE on circuits common to radio and TV. Mail coupon today.

## I Trained these Men at Home



Laborer  
Finds  
Success in  
Radio-TV

"I was a laborer with no future. Now I have a position that pays well. My spare time servicing pays good money, too. Thanks to NRI."—Robert Ford, Johnstown, Pa.



Switched  
to TV  
Servicing

"I recently switched from studio work and am now holding a position as TV service technician. Enjoy my work more and more."—Norman Ward, Ridgefield Park, N. J.



Paid for  
Course, Car  
in Spare  
Time

"By the time I graduated I had paid for my course, a car and testing equipment. I can handle any job in Radio-TV."—E. J. Streitenberger, New Boston, Ohio



\$10 to \$15  
Week  
Spare Time

"Four months after enrolling, was able to service Radios . . . averaged \$10 to \$15 a week spare time. Now have full time business."—W. Weyde, Brooklyn, N. Y.



Employed as  
Transmitter  
Operator

"A former employer recommended NRI training to me. Now employed as transmitter operator in Harrisburg."—Albert Herr, New Cumberland, Penna.



# AT HOME for Good Jobs in TELEVISION

**There is Success-Good Pay-Security for You in America's Fast Growing Industry**



## NRI Training Leads to These Jobs in RADIO-TELEVISION

### BROADCASTING

Chief Technician  
Chief Operator  
Power Monitor  
Recording Operator

### SERVICING

Home and Auto Radios  
Television Receivers  
P.A. Systems

### MANUFACTURING

Design Technician  
Service Manager  
Tester  
Research Assistant

### SHIP AND HARBOR RADIO

Chief Operator  
Radiotelephone Operator  
Assistant Operator

### GOVERNMENT RADIO

Operator in Army, Navy, Marine Corps  
Airways Operator  
Forestry Dispatcher

### AVIATION RADIO

Transmitter Technician  
Airport Transmitter Operator

### TELEVISION

Pick-up Operator  
Television Technician  
Remote Control Operator  
Service and Maintenance Technician

### POLICE RADIO

Transmitter Operator  
Receiver Serviceman

DO YOU want good pay, a job with a bright future, security? Would you like to have a profitable business of your own? If so, find out how you can realize your ambition in the fast-growing RADIO-TELEVISION industry. Even without Television, the industry is bigger than ever before. Just think, over 115 million home and auto Radios, 3000 Radio Broadcasting Stations, plus 25 million Television sets and about 200 Television Broadcasting Stations. Expanding use of Aviation and Police Radio, Micro-wave Relay, Two-way Radio for busses, taxis etc., are making opportunities for Servicing and Communications technicians and FCC Licensed Operators.

## My Training Includes Television

You get practical experience by working on circuits common to both Radio and Television. My graduates are filling jobs, making good money in both Radio and Television. Many NRI trained men start their own Radio and Television servicing business with capital earned in spare time. Let me show you how you can be your own boss; earn \$10 to \$15 a week extra even while still learning. Now is the time to get ready for success in Radio-Television. Coupon below brings you Actual Lesson and 64-page book.

## Find Out What Radio-Television Offers You

What will YOU be doing one year from today? Decide now that you are going to know more and earn more. ACT NOW. Send the coupon below NOW for my FREE DOUBLE OFFER. You get Actual Servicing Lesson. Also my 64-page Book, "How to Be a Success in Radio-Television." Read what my graduates are doing, earning, see equipment you practice with at home. Mail coupon now. Send in envelope or paste on postal. J. E. SMITH, President, Dept. 4AA, National Radio Institute, Washington 9, D. C. Our 40th Year.

**Actual Lesson and 64-page Book BOTH FREE**

The ABC's of SERVICING

**MAIL THIS NOW!**

MR. J. E. SMITH, President, Dept. 4AA  
National Radio Institute, Washington 9, D. C.

Mail me Sample Lesson and 64-page Book, FREE. (No salesman will call. Please write plainly.)

Name..... Age.....

Address.....

City..... Zone..... State.....

**VETS** write in date of discharge.....

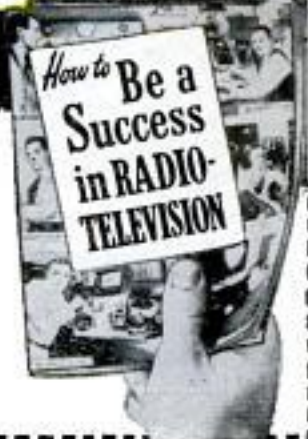

Control Operator, Station WEAN

"Received my License and worked on ships. Now with Station WEAN. NRI Course is as complete as any radio course can be."  
—Raymond E. Arnold, Rumford, L. I.

Available to **VETERANS** under G. I. Bills





# BIG NEWS!

Both Inch-Pound and Foot-Pound Models of Amazing **PROTO Torquer** Now Available!

Announced in January! Over 30,000 bought by March 31!! That's the whirlwind success story of the sensational PROTO torque-limiting wrench. In addition to foot-pound models, you can now buy *inch-pound* styles with all of the features that made the Torquer famous overnight. Thousands of jobs can now be handled with the various inch-pound and foot-pound capacities, different drive sizes and plain or ratchet head styles available. Whether used for repair, assembly, inspection or installation work, the super-fast Torquer pays for itself in time saved. Buy the model you prefer from your PROTO dealer today! Send 10¢ for 68-page catalog of entire line to

**PLOMB TOOL COMPANY**

2255Z Santa Fe Ave.,  
Los Angeles 54,  
Calif.

Head of Plain Head Model

Ratchet Head Model

## Fastest Torquer in the World!

- \* Automatic Torque-Limiting Release
- \* NO Dials, Scales or Pointers to Watch or Break
- \* Ratchet Head Models Save Time
- \* Use in Dark, Noisy or "Blind" Locations
- \* Enclosed Precision Spring and Accurate Micrometer-Type Adjustment
- \* All-Steel Trouble-Free Construction

5383



Eastern Factory: Jamestown, N.Y.  
Canadian Factory: London, Ont.

(Continued from page 6)

### Oh! For the Life—

Of a human mole. In this instance, the mole is our New York editor, Dick Dempe-wolff. When our editors research and write



an article, we expect them to live the part. This Dick did, as he proves in this picture portraying himself, with a grin of simulated happiness, emerging from an underground pipe. For his story, turn to page 152.

### To the Editor

No doubt you have received many compliments on your October issue. However, I want to add mine from the technical press because I believe you are contributing a great deal to the general home-building picture by broadcasting this factual information to the public.

Your presentation is particularly impressive to me as to its importance, because you have, in the most part, presented your subject through the facts, rather than glamorizing the home-ownership and home-building pictures, as is being done by some of the consumer magazines.

Your editorial recipe is similar to that of PRACTICAL BUILDER, and we welcome this October issue because we believe it will help everyone in the home-building industry who has a legitimate stake in that business.

Sincerely yours,  
James M. Lange,  
Executive Editor,  
*Practical Builder*,  
5 South Wabash Ave.,  
Chicago 3

### Electronic Termite Detector

Ever hear a termite lurching? They're noisy eaters, according to an Oklahoma City man who detects them with a tiny microphone and an electronic amplifier. The sensitive "mike" picks up the sound

(Continued to page 14)



# INVENTORS

**L**earn how to protect your invention. The U. S. Patent Laws provide that any new and useful art, machine, article of manufacture, or composition of matter, or any new and useful improvement thereof, may be patented if the act of invention is involved. Therefore, every inventor with a valuable invention should take advantage of the Patent Laws and proceed for patent protection in order to safeguard his rights.

A patent gives the inventor the exclusive right to prevent others from making, using, or selling the invention claimed in the patent for a period of seventeen years.

The Patent Laws were enacted for the benefit of the inventor to give him protection for the features of his invention which are patentable. These features must be properly and concisely set forth and claimed in a formal application for patent, in order to comply with the requirements of the Patent Laws. For that reason, unless the inventor is familiar with patent matters, he should engage a competent registered patent attorney or agent to represent him. We are registered to practice before the U. S. Patent Office and are prepared to serve you in the handling of your patent matters.

A specially prepared booklet entitled "Patent Guide for the Inventor", containing detailed information with respect to patent protection and procedure, together with a "Record of Invention" form will be promptly forwarded to you without obligation upon request.

---

## CLARENCE A. O'BRIEN & HARVEY JACOBSON

*Registered Patent Attorneys*

41-A DISTRICT NATIONAL BUILDING

WASHINGTON 5, D. C.



# NEWS FROM SCIENCE ABOUT YOUR HAIR



**V-7**  
— new  
grooming discovery  
outdates messy oils

Not an animal, vegetable or mineral oil, V-7 in new Vitalis Hair Tonic is a completely new greaseless grooming agent.

**PROOF**  
you don't need  
grease to  
correct dryness



New research on human hair shows that even very dry hair regains its normal moisture content faster with new Vitalis than with any leading cream or oil hair tonic.

**KEEPS YOUR HAIR NEAT ALL DAY  
—GREASELESSLY**

Even hard-to-manage hair stays neatly in place with Vitalis. No gummy film or "oil-slick" look.

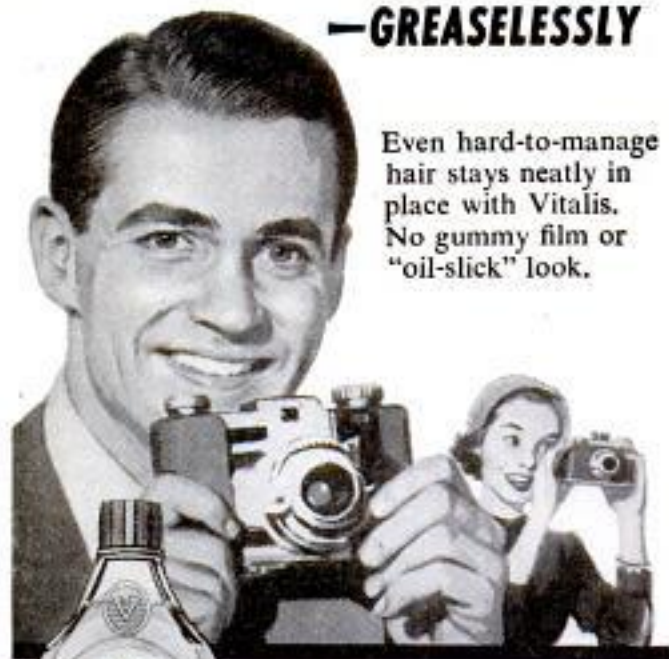

New, finer  
**VITALIS®**  
Hair Tonic with V-7  
*Product of Bristol-Myers*

(Continued from page 12)

made by the insects as they rub against the wood and break the fiber with their heavy jaws. The sound is carried through a long wire connected to a powerful radio amplifier, boosted, and relayed to the operator, who listens with a set of dictaphone



ear tubes. A loudspeaker can be connected to make the sound audible to everyone in the room. Termite exterminator W. E. Fisk picked up the idea for the detector while reading about undersea recordings of noises made by fish. The instrument was made by Ed Cones, a local radio technician.

## Workshop Club

Arthur C. Miller of Evansville, Ind., tells us he has organized a home-workshop club "to help underprivileged children." In the picture, he writes, "we are finishing up our



first project of 36 lawn chairs for our local Children's Home. . . . Our next project is to buy those kids a set of woodworking power tools they can use this winter when they can't get outside."



# How I foxed the Navy

by Arthur Godfrey



The Navy almost scuttled me. I shudder to think of it. My crazy career could have ended right there. Who knows, I might still be bumming Chesterfields instead of selling them.

To be scuttled by the Navy you've either got to do something wrong or neglect to do something right. They've got you both ways. For my part, I neglected to finish high school.

Ordinarily, a man can get along without a high school diploma. Plenty of men have. But not in the Navy. At least not in the U. S. Navy Materiel School at Bellevue, D. C., back in 1929. In those days a bluejacket had to have a mind like Einstein's. And I didn't.

"Godfrey," said the lieutenant a few days after I'd checked in, "either you learn mathematics and learn it fast or out you go. I'll give you six weeks." This, I figured, was it. For a guy who had to take off his shoes to count

above ten, it was an impossible assignment.

I was ready to turn in my bell-bottoms. But an ad in a magazine stopped me. Here, it said, is your chance to get special training in almost any subject—mathematics included. I hopped on it. Within a week I was enrolled with the International Correspondence Schools studying algebra, geometry and trig for all I was worth.

Came week-end liberty, I studied. Came a holiday, I studied. Came the end of the six weeks, I was top man in the class. Within six weeks I had mastered two years of high school math, thanks to the training I'd gotten.

I.C.S. made the impossible—easy!

## GET EXPERT GUIDANCE 2 FREE BOOKS

Free, illustrated catalog on career that interests you. Also 36-page, pocket-size guide to advancement, "How to Succeed." Just mail the coupon!

I. C. S., Scranton 9, Penna.

### INTERNATIONAL CORRESPONDENCE SCHOOLS



BOX 5609-L, SCRANTON 9, PENNA.

Without cost or obligation, send me "HOW TO SUCCEED" and the booklet about the course BEFORE which I have marked X:

- |  |  |   |  |   |
|--|--|---|--|---|
| <p><b>ART</b></p> <p><input type="checkbox"/> Commercial Art</p> <p><input type="checkbox"/> Magazine Illustrating</p> <p><input type="checkbox"/> Fashion Illustrating</p> <p><input type="checkbox"/> Cartooning</p> <p><input type="checkbox"/> Sketching and Painting</p> <p><input type="checkbox"/> Show Card and Sign Lettering</p> <p><b>AUTOMOTIVE</b></p> <p><input type="checkbox"/> Automobile, Mechanic</p> <p><input type="checkbox"/> Auto Elec. Technician</p> <p><input type="checkbox"/> Auto Body Rebuilding and Refinishing</p> <p><input type="checkbox"/> Diesel—Gas Engines</p> <p><b>AVIATION</b></p> <p><input type="checkbox"/> Aeronautical Engineering Jr.</p> <p><input type="checkbox"/> Aircraft Engine Mechanic</p> <p><input type="checkbox"/> Airplane Drafting</p> <p><b>BUILDING</b></p> <p><input type="checkbox"/> Architecture</p> <p><input type="checkbox"/> Arch. Drafting</p> <p><input type="checkbox"/> Building Contractor</p> <p><input type="checkbox"/> Estimating</p> <p><input type="checkbox"/> Carpenter and Mill Work</p> <p><input type="checkbox"/> Carpenter Foreman</p> <p><input type="checkbox"/> Reading Blueprints</p> <p><input type="checkbox"/> House Planning</p> <p><input type="checkbox"/> Plumbing</p> | <p><input type="checkbox"/> Heating</p> <p><input type="checkbox"/> Painting Contractor</p> <p><input type="checkbox"/> Air Conditioning</p> <p><input type="checkbox"/> Electrician</p> <p><b>BUSINESS</b></p> <p><input type="checkbox"/> Business Administration</p> <p><input type="checkbox"/> Certified Public Accountant</p> <p><input type="checkbox"/> Bookkeeping and Accounting</p> <p><input type="checkbox"/> Office Management</p> <p><input type="checkbox"/> Stenography and Typing</p> <p><input type="checkbox"/> Secretarial</p> <p><input type="checkbox"/> Federal Tax</p> <p><input type="checkbox"/> Business Correspondence</p> <p><input type="checkbox"/> Letter-writing Improvement</p> <p><input type="checkbox"/> Personnel and Labor Relations</p> <p><input type="checkbox"/> Advertising</p> <p><input type="checkbox"/> Retail Business Management</p> <p><input type="checkbox"/> Managing Small Business</p> <p><input type="checkbox"/> Ocean Navigation</p> <p><input type="checkbox"/> Sales Management</p> <p><input type="checkbox"/> Short Story Writing</p> <p><input type="checkbox"/> Creative Salesmanship</p> <p><input type="checkbox"/> Traffic Management</p> <p><b>CHEMISTRY</b></p> <p><input type="checkbox"/> Chemical Engineering</p> <p><input type="checkbox"/> Chemistry</p> <p><input type="checkbox"/> Analytical Chemistry</p> | <p><input type="checkbox"/> Petroleum—Nat'l Gas</p> <p><input type="checkbox"/> Pulp and Paper Making</p> <p><input type="checkbox"/> Plastics</p> <p><b>CIVIL, STRUCTURAL ENGINEERING</b></p> <p><input type="checkbox"/> Civil Engineering</p> <p><input type="checkbox"/> Structural Engineering</p> <p><input type="checkbox"/> Surveying and Mapping</p> <p><input type="checkbox"/> Structural Drafting</p> <p><input type="checkbox"/> Highway Engineering</p> <p><input type="checkbox"/> Reading Blueprints</p> <p><input type="checkbox"/> Construction Engineering</p> <p><input type="checkbox"/> Sanitary Engineering</p> <p><b>DRAFTING</b></p> <p><input type="checkbox"/> Aircraft Drafting</p> <p><input type="checkbox"/> Architectural Drafting</p> <p><input type="checkbox"/> Electrical Drafting</p> <p><input type="checkbox"/> Mechanical Drafting</p> <p><input type="checkbox"/> Structural Drafting</p> <p><input type="checkbox"/> Sheet Metal Drafting</p> <p><input type="checkbox"/> Ship Drafting</p> <p><input type="checkbox"/> Mine Surveying and Drafting</p> <p><b>ELECTRICAL</b></p> <p><input type="checkbox"/> Electrical Engineering</p> <p><input type="checkbox"/> Electrical</p> <p><input type="checkbox"/> Electrical Maintenance</p> | <p><input type="checkbox"/> Electrical Drafting</p> <p><input type="checkbox"/> Electric Power and Light</p> <p><input type="checkbox"/> Lineman</p> <p><b>HIGH SCHOOL</b></p> <p><input type="checkbox"/> High School Subjects</p> <p><input type="checkbox"/> Mathematics</p> <p><input type="checkbox"/> Commercial</p> <p><input type="checkbox"/> Good English</p> <p><b>MECHANICAL AND SHOP</b></p> <p><input type="checkbox"/> Mechanical Engineering</p> <p><input type="checkbox"/> Industrial Engineering</p> <p><input type="checkbox"/> Industrial Supervision</p> <p><input type="checkbox"/> Foremanship</p> <p><input type="checkbox"/> Mechanical Drafting</p> <p><input type="checkbox"/> Machine Design-Drafting</p> <p><input type="checkbox"/> Machine Shop Practice</p> <p><input type="checkbox"/> Tool Design</p> <p><input type="checkbox"/> Industrial Instrumentation</p> <p><input type="checkbox"/> Machine Shop Inspection</p> <p><input type="checkbox"/> Reading Blueprints</p> <p><input type="checkbox"/> Toolmaking</p> <p><input type="checkbox"/> Gas—Electric Welding</p> <p><input type="checkbox"/> Heat Treatment—Metallurgy</p> <p><input type="checkbox"/> Sheet Metal Work</p> <p><input type="checkbox"/> Sheet Metal Pattern Drafting</p> <p><input type="checkbox"/> Refrigeration</p> | <p><b>POWER</b></p> <p><input type="checkbox"/> Combustion Engineering</p> <p><input type="checkbox"/> Diesel—Electric</p> <p><input type="checkbox"/> Electric Light and Power</p> <p><input type="checkbox"/> Stationary Steam Engineering</p> <p><input type="checkbox"/> Stationary Fireman</p> <p><b>RADIO TELEVISION COMMUNICATIONS</b></p> <p><input type="checkbox"/> Practical Radio—TV Eng'ring</p> <p><input type="checkbox"/> Radio Operating</p> <p><input type="checkbox"/> Radio and TV Servicing</p> <p><input type="checkbox"/> Television—Technician</p> <p><input type="checkbox"/> Electronics</p> <p><input type="checkbox"/> Telephone Work</p> <p><b>RAILROAD</b></p> <p><input type="checkbox"/> Locomotive Engineer</p> <p><input type="checkbox"/> Diesel Locomotive</p> <p><input type="checkbox"/> Air Brakes <input type="checkbox"/> Car Inspector</p> <p><input type="checkbox"/> Railroad Administration</p> <p><b>TEXTILE</b></p> <p><input type="checkbox"/> Textile Engineering</p> <p><input type="checkbox"/> Cotton, Rayon, Woolen Mfg.</p> <p><input type="checkbox"/> Carding and Spinning</p> <p><input type="checkbox"/> Warping and Weaving</p> <p><input type="checkbox"/> Loom Fixing <input type="checkbox"/> Throwing</p> <p><input type="checkbox"/> Finishing and Dyeing</p> <p><input type="checkbox"/> Textile Designing</p> |
|--|--|---|--|---|

Name \_\_\_\_\_ Age \_\_\_\_\_ Home Address \_\_\_\_\_

City \_\_\_\_\_ Zone \_\_\_\_\_ State \_\_\_\_\_ Working Hours \_\_\_\_\_ A.M. to P.M. \_\_\_\_\_

Occupation \_\_\_\_\_

Canadian residents send coupon to International Correspondence Schools Canadian, Ltd., Montreal, Canada. . . . Special tuition rates to members of the U. S. Armed Forces.



## WHERE-TO-BUY-IT INDEX

Source of supply appears after items commercially available

### AUTOMOTIVE

Seen at the Paris auto show.....	106
Chrysler stylists bring out two experimental models.....	113
More 1954 "Debutantes" — Pontiac, Chevrolet, Lincoln, Mercury.....	120
Detroit Listening Post.....	122
Porsche sports car gets boost in horsepower and speed.....	140
Detroit didn't build these "cars".....	146
Passengers enter tiny Italian automobile through door in nose.....	176

### AVIATION

2000 M.P.H. goal for "Stiletto" (Douglas Aircraft Co., Santa Monica, Calif.).....	102
Air Force flying lung and its user easily carried by two men.....	104
Biggest transport helicopter cruises 150 miles per hour (Piasecki Helicopter Corp., Morton, Pa.).....	119
Twin-boom helicopter to become ambulance for navy personnel (Kaman Aircraft Corp., Bloomfield, Conn.).....	140

### HOUSE AND HOME

Rubber strip on bottom of garage door keeps out rain and snow (United Products Co., 900 N. 43rd St., Milwaukee 8).....	103
Binding strip (Cyemba Sales Corp., 120 Wall St., New York City 5).....	142
Juice pipes (Biltwell Brush Co., 225 S. Church St., Rockford, Ill.).....	142
Phone kit (Leavitt Mfg. Co., 208 E. 25th St., New York City 10).....	142
Portable bed rail (Misco Products, Box 564, Rockford, Ill.).....	142
Adjusting towel bar (Gerity-Michigan Corp., 10 S. Superior St., Toledo 4, Ohio).....	143
Card rack (Maclean Associates, 722 Citizens Bldg., Cleveland 14, Ohio).....	143
Carpet needle (Albin Enterprises, 1401 W. 8th St., Los Angeles 17).....	143
Dual faucet pedals (Crane Co., 836 S. Michigan Ave., Chicago).....	143
Thermostat heater (Titan Mfg. Co., 701 Seneca St., Buffalo 10, N. Y.).....	143
Low-slung chair for television viewing folds into hassock (Parkko Mfg. Co., 4655 Park Blvd., San Diego, Calif.).....	158
Interlocking rubber tiles fit together like jigsaw puzzle (R. L. Mitchell Rubber Co., 2114 San Fernando Road, Los Angeles 63).....	161
Adjustable table permits typing, writing or sewing in bed (Arthur C. Hokanson, R. I., Box 259, Cassopolis, Mich.).....	116
Reel for extension cord has built-in electric outlet (House of Ideas, Racine, Wis.).....	167
Glareproof tilted blackboard mounts bulletin board on back (Claridge Equipment Co., 4608 W. 20th St., Chicago 50).....	168
Toddler's chair serves at home and in car (Malbee Enterprises, Box 111, Elmont, N. Y.).....	168
Mirror panels and grooved molding make quick wall covering (Creative Workshop, 7 Parker St., Watertown, 72, Mass.).....	173
"Electric Wallpaper" cemented to ceiling supplies heat for room (United States Rubber Co., Rockefeller Center, New York City 20).....	174
Double-glazed window without metal edge.....	175

### INDUSTRY

Plastic balloons save oil.....	104
Mechanical brain prints answers in easy-to-read numbers (Streeter-Ames Co., 4101 N. Ravenswood Ave., Chicago).....	119
Plastic truck tank carries 3460 gallons of liquid.....	151
Bombardment with electrons toughens plastic bottles (General Electric Research Laboratory, Schenectady, N. Y.).....	175

### MILITARY AND NAVAL

Inflated life raft in hold of sinking trawler saves ship.....	141
Mobile power-tool unit aids front-line troops.....	151
Single transmission line carries 30 TV channels.....	159
Flying radar stations to be "eyes" for U. S. defense forces.....	174

### SCIENCE

Tilting X-ray examination table suspends patient by heels.....	103
Scientist uses "mud pies" to explain changes in earth.....	133
Artificial atom chip.....	151
Atomic "preserver" kills food bacteria.....	159
Chemical shotgun shell absorbs moisture.....	160
Coating protects metals against 5000-degree temperature (B. F. Goodrich Co., Ind. Prod. Div., Akron, Ohio).....	160
Long-distance gauge checks faraway storage tanks (Shand and Jurs Co., 8th and Carlton, Berkeley, Calif.).....	161
Metal-powder process forms strong castings (Chrysler Corp., Amplex Div., Detroit 31, Mich.).....	168
Delayed-action nitrogen.....	260
Sound waves clean bearings.....	268

### TRANSPORTATION

Personalized markers identify freight cabooses.....	105
Semitrailers ride railroad flatcars in fast-freight system.....	112
Truck cab sliced in half to make lumber loading easier.....	154
Two-section German bus uses bellows-type connection.....	160
Change freight-car wheels to fit different gauges.....	176

### MISCELLANEOUS

Cigarette-making machine (Sears, Roebuck & Co., Chicago 7).....	102
Motor from paratrooper bike powers miniature motorcycle.....	103
Clamp fastened to automobile wheel gives needed traction.....	104
Paint dispenser mixes any color (Martin-Senour Co., 2620 S. Quarry, Chicago).....	141

(Continued to page 18)

# 2¢ POSTCARD PUTS YOU IN Big-Money SHOE BUSINESS!



## STARTING OUTFIT FREE!

Start a **big-money** shoe business without spending a cent! We furnish **everything** you need to build a steady business that brings in cash every month! We send a starting outfit to you **Free!** Men who qualify receive the \$35.00 professional outfit above without a penny's cost! It's surprisingly **EASY!** Take orders for just 2 pairs a day in spare time and by the end of the month you'll have earned up to \$217.00! You also get a chance to win valuable free prizes!

### People Must Buy From YOU!

Customers are **everywhere**, because **EVERYBODY** wears shoes! Show friends, relatives, neighbors, people where you work how they can "walk on air" in Mason's famous Velvet-eez Air Cushioned Shoes bearing the Good House-keeping Seal. What comfort! They'll be delighted to know they get from you the **EXACT** style, size, and width they order because you draw from our huge stock of 200,000 pairs. You offer 160 dress, sport and work shoe styles for men, women, in sizes 2½ to 15, widths AAAAA to EEEE, including special shoes for different occupations. You actually run the best "shoe store" business in your town! Because our TV-advertised shoes are **not** sold in stores... people must buy and **keep** buying these fine, **extra**-feature shoes from you! Start earning exciting cash profits **right away**. Send for your Free Starting Outfit **Now!** **MASON SHOE MFG. CO., Dept. MA-279, Chippewa Falls, Wis.**

## Send for FREE SELLING OUTFIT!

**MR. NED MASON**  
**MASON SHOE MFG. CO., Dept. MA 279**  
 Chippewa Falls, Wisconsin

Please rush my Free Selling Outfit so I can start making up to \$217 EXTRA a month and more **RIGHT AWAY!**

NAME.....

ADDRESS.....

TOWN..... STATE.....



# INVENTORS

If you believe that you have an invention, you should find out how to protect it. The first step is to have a search made of the prior pertinent U. S. patents. If a report on this search indicates that the invention appears patentable you can apply for a patent, and the specifications and claims should be prepared.

The firm of McMorrow, Berman & Davidson, with offices in Washington, D. C., is qualified to take the necessary steps for you. We can make a preliminary search on your invention, advise you whether we think it can be patented, and prepare your application for patent.

Unless you are fully familiar with the U. S. Patent Laws, we recommend that you engage the services of a Registered Patent Attorney to protect your interests. The patent laws are *your* laws. A patent gives you the right to prevent others from making, using or selling the invention claimed in your patent for a period of 17 years.

Use these patent laws for your protection. Investigate whether your invention can be patented. If you have what you believe to be an invention, we suggest that you have this firm make a search for you.

*Send for a copy of our Patent Booklet entitled "How To Protect Your Invention," containing information about patent protection and patent procedure. Along with this we will also send you an "Invention Record" form, for your use in writing down and sketching details of your invention. We will mail them promptly. No obligation. They are yours for the asking.*

## McMORROW, BERMAN & DAVIDSON

Registered Patent Attorneys

PATENTS • COPYRIGHTS • PATENTS

135-X VICTOR BUILDING, WASHINGTON 1, D. C.





# Put Your Finger ON Any Car Trouble

**IN A JIFFY!**

**Handy New Guide Lists 2,000 Causes of Faulty Operation, Noises, Break-downs**

**SAVE TIME AND WORK** on any auto repair job by being able to "put your finger" on exactly what's causing the trouble—right from the start! New, indexed **TRUBLE-SHOOTER GUIDE**—prepared by the Editors of the world-famous **MOTOR'S Repair Manuals**—lists 2,000 specific causes of car and truck troubles; helps you find the one you're after **FAST**. Book fits right in your pocket for instant reference. Spiral binding lets book stay open while you work. Cross-section **PICTURES** also included.

If car has Fan Belt noise—turn to Fan Belt Section for 3 specific things that can be wrong. **MOTOR'S TROUBLE-SHOOTER** helps you track down noises, knocks, misses, breakdowns—faulty operation from radiator to rear end. Covers engines, clutches, brakes, ignition, new automatic transmissions, etc. Gives quick help to beginners as well as experienced repair men!

**Try Book for 7 Days—without obligation!**  
**SEND NO MONEY**—Mail Coupon—When postman delivers book, pay him \$1, plus postage and C.O.D. charges. (Or send \$1 with coupon, and we pay shipping charges.) If not delighted, return book in 7 days for full refund. **MOTOR Book Dept., Desk FR, 250 W. 55th St., New York 19, N. Y.**



### HOW TO SPOT —

87 Automatic Transmission Troubles. 8 Causes of Connecting Rod Noise. 87 Checks for Poor High-Speed Performance. Lack of Power. 82 Causes for Engine "Misses." 17 Checks for Pre-ignition or Spark Knock. 45 Causes of Excessive Oil Consumption. 14 Causes of Crankshaft Noise. 73 Checks for Clutch Troubles. 66 Causes of Rear-Axle Trouble. 150 Checks for Front Suspension and Steering Troubles. 81 Causes of Brake Trouble. 27 Checks for Faulty Springs and Shock Absorbers. 84 Different Types of Wheel Troubles. **AND MUCH, MUCH MORE!**

- New "Dope" On Automatic Transmissions Covers:
- **HYDRAMATIC**
- **BUICK DYNAFLOW**
- **CHEVROLET POWERGLIDE**
- **PACKARD ULTRAMATIC**
- **STUDEBAKER AUTOMATIC**

**MOTOR Book Dept., Desk FR, 250 West 55th St., New York 19, N. Y.**

Rush me **MOTOR'S** work-saving **TRUBLE-SHOOTER**. I will pay postman \$1 on delivery, plus 43c postage and actual Gov't. C.O.D. charges for each copy ordered. Unless completely satisfied, I may return book in 7 days and my money will be promptly refunded.

Name.....  
 Address.....  
 City..... Zone..... State.....

**SAVE 43c POSTAGE, C.O.D. CHARGES.** Check if you send \$1 with coupon, then we pay shipping charges. Same refund guarantee.

(Continued from page 16)

Single sportsman's gun has four sets of barrels (Simmons Gun Specialties Co., 504 E. 18th, Kansas City, Mo.).....141

Daredevils play donkey ball.....144

Cabinet converts leaves into compost in 30 days.....145

Easily operated lifeboat radio transmits on SOS frequencies (Mackay Radio & Telegraph Co., Marine Div., 60 Broadway, New York City).....145

Galvanic rod in radiator prevents scale deposits.....145

"Sweet" chemical fed to cows.....145

Small portable camera photographs fingerprints at scene of crime.....158

Breath-controlled television set entertains police victims (Lion Mfg. Corp., 2640 W. Belmont, Chicago).....159

English hearing aid mounts on spectacles.....160

"H bomb" vault has 18-ton door.....165

Flashlight batteries supply power for portable turntable.....166

Versatile drawing table quickly assembled from kit (Tectonic Services, Inc., 2074 E. 36th St., Cleveland 15, Ohio).....166

Drive-in movie theater features screen for each automobile.....167

Portable luggage carrier folds into small carrying case.....167

"Sea Cow" foghorn.....173

Midget fire extinguisher (Pyrene Mfg. Co., 540 Belmont Ave., Newark, N. J.).....173

Radiator warming shelf.....175

Tricycle built for fire.....175

Rice-bran oil.....176

Miniature pen (Parker Pen Co., Janesville, Wis.).....248

Texas butterfly branding.....248

White House weathermaker.....254

Padlock sealed with metal strip (Corbin Cabinet Lock Div., New Britain, Conn.).....286

## Craftsman and Shop Notes Index

**AUTOMOTIVE**

Driver and automobile brakes must team up for safety.....196

Rolled towel across back eases traveling fatigue.....204

Location of car in parking area revealed by flag on antenna.....211

Rear window of car kept clear by concealed defroster.....212

Warning buzzer prevents driving with emergency brake set.....223

**BOATS AND BOATING**

Plastic webbing replaces canvas as lift on jump-rail window.....187

Wax dressing helps preserve outboard starting rope.....211

Avoiding motor corrosion.....211

**FARM**

Auto pistons used as anchors for fence and gateposts.....201

Egg-crate fillers provide "pots" for seedlings started indoors.....211

Poultry-house feeders supplied by hopper on overhead track.....229

Four gates in fenced pasture permit field rotation.....236

**HOUSE AND HOME**

Breadboard has adjustable guide for cutting uniform slices.....190

Handy washing-machine switch.....190

Solving Home Problems.....194

Toaster bracket supports doors.....200

Bleach cleans stained vase.....201

Shower curtains hang better when weighted with sinkers.....204

Sawdust cleans chinaware.....204

Metal foil in picture window reflects light and heat.....212

New furnace adjustment assures even heating.....212

Magnet holds wooden pencils.....236

**OFFICE, SHOP AND STORE**

Pencil eraser spreads paste.....187

Anchoring rolls of screen wire.....190

Chalk line in bow aids lettering.....192

Flooring strip aids squaring.....196

Steaming stamps from envelopes.....211

Portable welding-rod holder.....229

**PAINT AND PAINTING**

Hardboard painted and finished the same as hardwood.....193

Hand rest on wire brush provided by half of ball.....199

Wall-paneling filler.....200

Modified spray-width valve allows quick adjustment.....229

**PHOTOGRAPHY**

Wet-cell floodlight.....205

Petroleum jelly deepens tones when copying matte prints.....217

Thermometer in darkroom hose indicates water temperature.....217

Light-tight darkroom heater uses Bunsen burner.....217

Repairing camera bellows and shutter curtains.....218

Wax for ferrotype plates.....218

**TOOLS**

Adjustable stock support for table saw utilizes ball-bearing casters.....223

Miniature brake for light-gauge sheet metal.....223

"Wrench" improvised in shop adjusts voltage regulator.....233

Folding screwdriver (Hunter Tool Co., Whittier, Calif.).....234

Wire-twisting mechanism (Ralph C. Robinson Co., Box 494, North Sacramento 15, Calif.).....234

(Continued to page 20)

**IMPORTANT NOTICE**—It is the intention of this magazine to provide its readers with information regarding the latest developments in the mechanical arts. We take no responsibility as to whether the disclosures contained in our articles are covered by patents and advise readers to investigate this subject before making, using, or selling any of the products, machines, or processes described in order to avoid possible liability for patent infringements.



# LEARN ELECTRICITY AND ELECTRONICS

ON REAL EQUIPMENT  
IN THE GREAT SHOPS  
OF **COYNE**

**RADIO-TELEVISION**  
A GREAT BOOMING INDUSTRY

**Largest, Oldest  
Best Equipped  
School of its Kind!**

Thousands of successful men have been trained at Coyne over past 54 years. There is no substitute for Coyne's wealth of experience.



The tremendous growth of this new field is almost unbelievable. TV has been given the "go-ahead" in 1227 new communities, with 1845 new stations to be built. Unusual opportunity to get in on ground floor. RADIO-TELEVISION and ELECTRONICS are vital to our Defense Program. And they offer a world of opportunities for a real future when the emergency is over. Train quickly on actual equipment at Coyne by practical-technical methods. Get big Free Book today.

## ELECTRICITY-

### The Power Behind Our Industrial Program

A great opportunity field and vital to Defense. Thousands of trained Electrical and Electronics men needed in good jobs and a real future. Why be satisfied with a "no future" job? Get Free Book that tells how thousands have prepared quickly for Electricity and Electronics at Coyne.

### TRAIN QUICKLY AT COYNE FOR VITAL FIELDS

ELECTRICITY-RADIO-TELEVISION-ELECTRONICS-VITAL in Industry and Armed Forces. TRAIN QUICKLY for better rating, if drafted—vital job in Industry, if not. Trained men whether 17 or up to 43 needed. Prepare now for steady, well paid, essential jobs in A FIELD THAT ALSO OFFERS A REAL FUTURE WHEN THE EMERGENCY IS OVER.

### START NOW—PAY LATER

Enroll now, pay most of tuition later. Monthly payment plan especially designed for K-Vets. If you need part-time work to help out with living expenses while at Coyne, we'll help you get it. Special tuition plan for men of Draft Age.

### APPROVED FOR VETERANS



B. W. COOKE



**1** You are TOLD the how and why of each job.



**2** You're shown how to do typical jobs by trained instructors.



**3** You DO practical job YOURSELF on equipment.

### Mail Coupon for Big Free Book

Whether you prefer Electricity or Television-Radio, train on actual equipment, at Coyne. Fill in and mail coupon TODAY. Paste it on a postcard if you wish. A big fully illustrated booklet and complete details will come by return mail. No salesman will call.

B. W. COOKE, President



## COYNE SCHOOL

A TECHNICAL TRADE INSTITUTE  
CHARTERED NOT FOR PROFIT  
Established 1899  
500 S. Paulina Dept. 14-72H  
Chicago 12, Illinois

ELECTRICITY ★ TELEVISION ★ RADIO ★ REFRIGERATION ★ ELECTRONICS

B. W. COOKE, President  
COYNE SCHOOL  
500 S. Paulina St., Chicago 12, Ill.  
Dept. 14-72H

Send your BIG FREE BOOK and details of your training offer. This does not obligate me and no salesman will call. I am interested in:

ELECTRICITY     TELEVISION-RADIO

NAME .....

ADDRESS .....

CITY.....STATE.....



# It's Easy with CRAFTPLAN Patterns!

## RACKS, CABINETS, KITS for SEWING, KNITTING SUPPLIES

All patterns and details needed to make 22 useful items — Priscilla sewing cabinet, little cobbler's bench, novelty sewing boxes, sewing lamp, spool, thread, scissors holders, etc. . . . . \$1



### 27 SHELVES SHADOW BOXES

Shelves for displaying figurines, knickknacks, to rack for souvenir teaspoons and shamrock design for bust vase. Designs with real class. Easy to make. 19 shelves. 8 shadow boxes. . . . . \$1.50



### COSTUME JEWELRY

482 full-size patterns novel lapel pins, brooches, monograms, name pins, initials for personalizing costumes, etc. . . . . \$1



## BIBBB

### THINGS TO MAKE FOR CHILDREN

20 of the finest children's room projects you have ever seen. Make them for your kids and to sell. . . . . \$1



### 5 Distinctive ALPHABETS

Ready-to-trace letters, figures, etc., five distinctive alphabets, 2 and 3 in. high. Enables you to do all kinds of lettering. (487 patterns) . . . . . \$1.50



### Personalized, House, Lawn Markers

Full-size patterns 17 novel silhouettes, plus alphabet and numbers. Make swell personalized gifts, addition to own home. . . . . \$1

### 7 EASY-TO-MAKE DOG HOUSES...50c

Santa Claus & Baby Deer . . . . . \$1

KITCHEN CABINET UNITS . . . . . \$1

Matching Sectional Bookcase Units 50c



### 13 EASY-TO-BUILD BENCHES

Sturdy, well-designed benches cabinet, folding, portable, etc. . . . . \$1

5 Homemade Workshop Machines. Plans on Jig-saw, drill, belt sander, wood lathe, circular saw. . . . . \$1

### FAST ACTION TOYS

Everything you need to make 15 toys that compare favorably with those in stores. Legs of toy shown work in realistic manner as it is pushed along. . . . . \$1



### WEATHERVANES

18 full-size patterns . . . . . \$1

Plans on 15 HANDSOME TABLES . . . . . \$1



### 14 ANIMATED WEATHERVANES

(full size patterns) Action windmills provide all kinds of lifelike action: farmer milking cow, fighting rooster, Indian paddling canoe, seal balancing ball, etc. . . . . \$1



17 pieces FINE LAWN FURNITURE . . . . . \$1



### 22 full-size patterns unusual LAWN NOVELTIES

. . . . . \$1.50

### Colorful FLOWER BOXES

Full-size patterns, 14 nifty little boxes for plants. Color schemes, full instructions included. . . . . \$1



### 19 patterns MUSICAL NOVELTIES

Use inexpensive Swiss musical movements. . . . . \$1



### 16 Different BOOK ENDS

Full-size patterns wonderful assortment of easy-to-make book ends. . . . . \$1

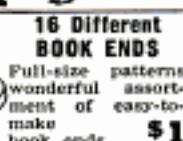

### YEAR ROUND AWNINGS 50c

### 27 BIRD HOUSES, FEEDERS

Details on everything from simple wren house to elaborate home for martins. Designed for easy cleaning. . . . . \$1



### 15 Outdoor Fireplace Plans

... simple fireplace from 60 bricks to deluxe job with multiple units. . . . . \$1



### 57 NOVEL TRELLISES

32 DESIGNS HOME BARS Built-in, cellarettes, portable. . . . . \$1

### \$6.00 WORTH OF PLANS FOR \$5.00

If price of plans you order is \$5.00, we'll include without extra charge another dollar's worth of plans of your selection. If price of plans selected is \$10.00 you may select \$2.50 worth of free plans (\$12.50 value for \$10).

### UNCLE SAM

Full-size pattern popular mailbox support, 66 in. high. . . . . \$1

### Money-Back Guarantee

Thousands of satisfied customers. To order these easy-to-use plans, simply check items wanted, clip ad and mail with currency (U.S. or Canadian bills) or check TODAY!

**CRAFTPLANS** 1321 S. Michigan Ave. Dept. 228, Chicago 5

(Continued from page 18)

- Four-corner miter clamp (Cincinnati Tool Co., Cincinnati 12, Ohio) . . . . . 234
- Block handling tool (Lay-Level, Inc., Box 99, Toledo 99, Ohio) . . . . . 234
- Precision hand grinder (Precise Products Co., 1328 Clark St., Racine, Wis.) . . . . . 235
- Pocket saw (Pixley Co., 5336 Glenwick Lane, Dallas, Tex.) . . . . . 235
- Carpenter's and mason's level (Creative Plastics Corp., Stony Brook, N. Y.) . . . . . 235
- Inspection instrument (Eder Instrument Co., 2293 Clybourne Ave., Chicago) . . . . . 235
- Magnetic locator (Dresden Mfg. Co., 2375 Walnut Ave., Long Beach, Calif.) . . . . . 235
- Machinist's vise holds thin work by use of auxiliary jaws. . . . . 236

## WOODWORKING

- Straightening warped doors . . . . . 193
- Plan of the month—dining table commode . . . . . 201
- Wooden drying rack folds into cabinet. . . . . 201

## WORKSHOP HINTS

- Free-cut saw blade improvised . . . . . 190
- Renew your scissors . . . . . 191
- Discarded oil can stores drills . . . . . 192
- Hot lead cuts hole in glass . . . . . 196
- Piece of hose speeds sawing in difficult places . . . . . 199
- Shaker-type seasoning can dispenses abrasives . . . . . 200
- Scrub-brush sanding block ideal on uneven surfaces . . . . . 200
- Plumb bob improvised from solder and cord . . . . . 200
- Band of inert tube on block makes bench brush . . . . . 204
- Improvised pipe wrench . . . . . 204
- Tighten electric motor bushings by knurling in lathe . . . . . 222
- Stop block for saw or shaper has clamp attached . . . . . 229
- Winding small coil springs between lathe centers . . . . . 232
- Handy workbench tool "pocket" . . . . . 232
- Machine vibration dampener . . . . . 232
- Broken drills removed with slotted tool . . . . . 236
- Rejuvenate steel brushes . . . . . 236

## MISCELLANEOUS

- Rod driven without bending when inserted in pipe . . . . . 190
- Rawhide lacing cut uniformly with hatchet and knife . . . . . 192
- Sand trap for water-pump line . . . . . 192
- Adhesive tape anchors badge to hunter's lapel . . . . . 196
- Envelope corner as bookmark . . . . . 199
- Foam-rubber pad on palette helps prevent cramped hand . . . . . 212
- Kite hauls line over chimney to simplify rigger's job . . . . . 223
- Mason's line held tight by slotted rubber hose . . . . . 232

## Radio-Television, Electronics

- TV programs recorded on tape . . . . . 177
- Portable radio "test bench" for convenient service . . . . . 178
- Radio frequency calibrator (Bud Radio, Inc., 2118 E. 55th St., Cleveland 3, Ohio) . . . . . 180
- TV antenna coupling device (RCA Victor Div., Radio Corporation of America, Camden 2, N. J.) . . . . . 180
- Electronic leak detector (Fisher Research Laboratory, Inc., Palo Alto, Calif.) . . . . . 180
- Ultra-sensitive volt-ohm-microammeter (Simpson Electric Co., 5200 W. Kinzie St., Chicago 44) . . . . . 180

## Scents Go to Work

Near-permanent scents of every type—from freshly baked bread to magnolia blossoms—are becoming available for business and industry. Soon you'll pick up a match folder containing the advertisement of a meat packer. As you strike the match a mouth-watering aroma of hickory-smoked ham will tease your nostrils. Mail circulars from northwoods resorts will give off the fragrance of pine forests, and your new shoes may have the clean, fresh smell of cedar bark. The pleasant odor is due to a plastic compound developed by Kenneth Spraker, a Deerfield, Ill., perfumer. Previously, no scent could be made that would last after long exposure to air. Spraker devised an acetate-plastic base which could be impregnated with perfume oils. In liquid form before use, the plastic will harden in a few minutes upon exposure to air. The flexible, transparent semisolid gives off a scent almost indefinitely. It can be brushed, sprayed or poured on objects, or cast into thin sheets, then die-cut and applied to the object to be scented.



# GET INTO AUTOMOTIVE DIESEL AND ALLIED MECHANICS

by Shop Method Home Training

**JOBS LIKE THESE ARE OPEN TO YOU AS A TRAINED ENGINE MECHANIC... CHOOSE THE FIELD YOU LIKE BEST!**

### Get complete training

- Diesel Fuel Injection
  - Automotive Motor Tune-up
  - Diesel Engine Maintenance
  - General Garage Mechanics
  - Agricultural Implements
  - Auto Engine Rebuilding • Auto Elec. Service
  - Public Utilities • Parts Dealers
  - Bus & Truck Lines • Industrial Maintenance
  - Contracting & Excavating
  - Business of Your Own
- AND MANY other similar openings

### EARN WHILE YOU LEARN

With our practical Master Shop-Method Home Training, you study at home in your spare time. You receive Spare Time Work Lessons, which show you how to earn while you learn... for extra money and experience. You Learn by DOING.

### YOU RECEIVE AND KEEP ALL THIS MATERIAL:

- |                       |                        |
|-----------------------|------------------------|
| Basic Lesson Texts    | Engine Service Manuals |
| Diesel Installation   | Engine Repair          |
| Operation—Maintenance | Drive Systems          |
| Diesel Chart Manual   | Diesel Electric Power  |
| Spare Time Lessons    | Thermodynamics         |

### TOOLS AND EQUIPMENT

**INVESTIGATE!  
SECURE FULL  
INFORMATION**

**WE GIVE  
YOU TOOLS  
OF YOUR  
TRADE**



### Master All Phases!



Get Master Shop-Method Home Training from an Established Resident School with its own Training Shops and Laboratories—and almost 50 years of Successful Experience in Training Men.

### We Bring National Schools To You

National Schools trains you for all opportunities in the dynamic, fast-growing Automotive-Diesel and Allied Industries. You get complete training for this great Industry.

Thousands upon thousands of autos, trucks, tractors, ships, trains, farms and factories are dependent upon engine power! Trained engine mechanics are needed in the Armed Forces as well as in civilian production. This huge field needs trained men for servicing, repairing, installing, operating and manufacturing equipment. The pay is good, the future excellent! National Schools offers you a practical, all-embracing Automotive-Diesel Mechanics Course that qualifies you for your choice of many good jobs.

Your National Course covers Gasoline and Special Fuel Engines; Diesels, High Speed and Heavy Duty; Semi-Diesels; Allied Mechanics.

This course also offered in Spanish and Portuguese

**BOTH  
RESIDENT AND  
HOME STUDY  
COURSES  
OFFERED**

**APPROVED FOR  
VETERANS AND  
NON-VETERANS**

**NATIONAL SCHOOLS** LOS ANGELES 37 CALIFORNIA  
IN CANADA: 811 W. HASTINGS ST., VANCOUVER, B.C.  
**TECHNICAL TRAINING SINCE 1905**

**GET FACTS FASTEST!  
MAIL TO OFFICE NEAREST YOU!**

(mail in envelope or paste on postal card)

**NATIONAL SCHOOLS, Dept. DB-14**  
4000 S. Figueroa Street LOS ANGELES 37, CALIF. or 323 West Polk Street CHICAGO 7, ILLINOIS

Send FREE Auto-Mechanics book and FREE sample lesson. No obligation, no salesman will call.

NAME \_\_\_\_\_ BIRTHDAY \_\_\_\_\_ TD \_\_\_\_\_

ADDRESS \_\_\_\_\_

CITY \_\_\_\_\_ ZONE \_\_\_\_\_ STATE \_\_\_\_\_

Check here if interested in Resident School Training at Los Angeles.  
VETERANS: Give Date of Discharge \_\_\_\_\_

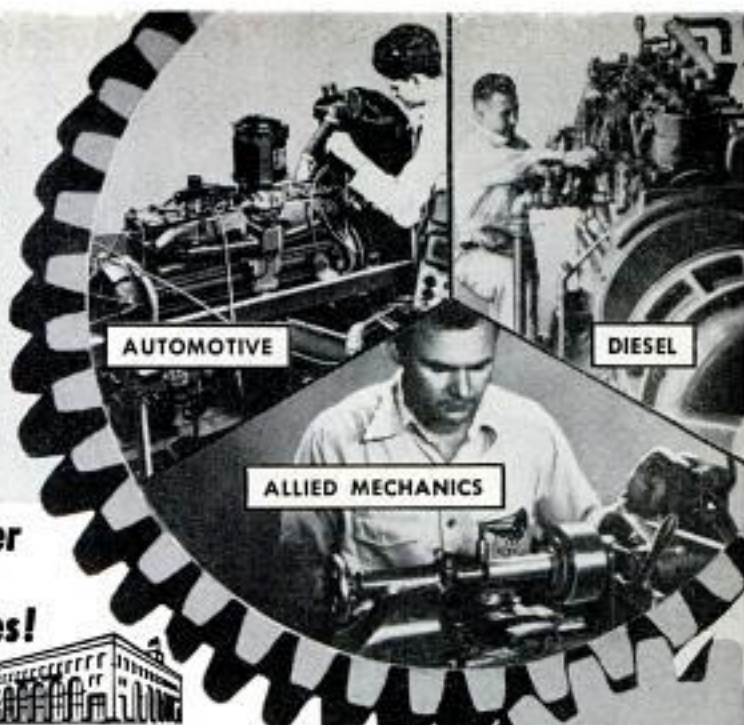

### Free Book and Sample Lesson Show You How

Send today for National Schools' new, illustrated Book of Opportunity in Automotive, Diesel and Allied Mechanics, and an actual sample lesson. No cost - no obligation. Use the coupon now - we'll answer by return airmail.



# Inventors

The following are the usual preliminary steps to take toward patent protection.

You are advised first, to make a disclosure of your invention. Date, sign and have this document witnessed by two or more persons who are capable of understanding your invention. The "Evidence of Invention" form mentioned below, we offer as a convenience in making your disclosure and in starting action leading toward patent protection.

Mail your disclosure to the registered patent attorney or agent whom you select to assist you, together with a letter authorizing him to conduct a

preliminary search among previously granted U. S. patents for similar types of invention. He then prepares for you a report on the probable patentability of your invention and, if the report is favorable, recommends the further course you should take.

This firm is registered to practice before the U. S. Patent Office and is available to assist you in the preparation and prosecution of patent applications. We shall be glad to send you without obligation, the "Evidence of Invention" disclosure form mentioned above and our instructive booklet, "Patent Protection for Inventors".

VICTOR J. EVANS & Co. *Merlin M. Evans*  
REGISTERED PATENT ATTORNEY  
930-A MERLIN BUILDING, WASHINGTON 6, D. C.

## EXPANDING AMERICA Needs DRAFTSMEN Now!



LEARN AT HOME AND GET  
ON THE SURE ROAD TO  
**BIG MONEY**

Today more than ever Draftsmen are needed. America must produce better war and peace time equipment if America's well-being and prosperity is to continue. Draftsmen command big part or full time wages . . . own tremendous money earning businesses.

**VALUABLE EQUIPMENT  
SENT TO YOU**

Everything you need to train at home supplied. Professional set of drafting instruments, all drafting equipment needed and portable drafting table all furnished on **PAY AS YOU LEARN PLAN**. RUSH name today for **FREE Book**.

CHRISTY TRADES SCHOOL, 4432 N. Kedzie, Dept. DB-2303, Chicago

## FALSE TEETH KLUTCH holds them tighter

KLUTCH forms a comfort cushion; holds dental plates so much firmer and snugger that one can eat and talk with greater comfort and security; in many cases almost as well as with natural teeth. Klutch lessens the constant fear of a dropping, rocking, chafing plate. 35c and 60c at druggists . . . If your druggist hasn't it, don't waste money on substitutes, but send us 10c and we will mail you a generous trial box.

KLUTCH CO. Box 5493A ELMIRA, N. Y.

### TASOPE PHOTO-ENGRAVING PLANTS



Material Cost  
Of This Cut 34c  
Selling Price  
\$1.00 And Up

Establish your own profitable PHOTO-ENGRAVING business. Make cuts for newspapers, printers, and advertisers. Make etched name plates, plaques etc. Instructions furnished, no experience necessary. Sold direct from factory since 1931. First five hundred cuts sold locally or by mail will pay for plant and pay you well for your time. Write for **FREE catalog**.  
TASOPE DEPT. PM1, AURORA, MO.

WANT TO  
**Write Stories**  
**FREE BOOK** tells how you learn at home  
Articles  
Mysteries?



Would you be willing to spend a few hours a week learning to write so you may earn \$100-\$1200 a year part-time? Or many thousands full-time? **FREE book**, "Art of Writing Salable Stories" tells how to get started writing short stories, radio-TV scripts, articles, business items. Many students earn while learning (Graham Doar sold one story to Post, CBS Radio and NBC-TV). Endorsed by famous authors, scores of successful graduates; approved for veterans. Send today for **FREE book** (no salesman will call).  
**PALMER INSTITUTE OF AUTHORSHIP, Since 1917**  
1680 N. Sycamore Hollywood 28, Calif. Desk T-14



**NOW... GET EVERYTHING YOU  
NEED TO LEARN AND MASTER**

# TELEVISION

**RADIO-ELECTRONICS  
...AT HOME!**

**Use REAL commercial-type equip-  
ment to get practical experience**

Your future deserves and needs every advantage you can give it! That's why you owe it to yourself to find out about one of the most COMPLETE, practical and effective ways now available to prepare AT HOME for America's billion dollar opportunity field of TELEVISION-RADIO-ELECTRONICS. See how you may get and keep the same type of basic training equipment used in one of the nation's finest training laboratories... how you may get real STARTING HELP toward a good job or your own business in Television-Radio-Electronics. Mail the coupon today for complete facts—including 89 ways to earn money in this thrilling newer field.

**D. T. I., ALONE, INCLUDES BOTH MOVIES and HOME LABORATORY** In addition to easy-to-read lessons, you get the use of HOME MOVIES—an outstanding training advantage—plus 16 big shipments of Electronic parts. Perform over 300 fascinating experiments for practical experience. Build and

**Get information packed  
publication FREE!**

keep real commercial-type test equipment shown at right.

**MODERN LABORATORIES**

If you prefer, get all your preparation in our new Chicago Training Laboratories—one of the finest of its kind. Ample instructors, modern equipment. Write for details!

**MILITARY SERVICE**

If you're subject to military service, the information we have for you should prove very helpful. Mail coupon today.

**89 WAYS  
TO  
EARN  
MONEY  
IN TELEVISION  
RADIO-ELECTRONICS**

**ACT NOW! MAIL COUPON TODAY!**

**DEFOREST'S TRAINING, INC.** Dept. PM-1-K  
2533 N. Ashland Avenue, Chicago 14, Ill.

I would like your valuable information-packed publication showing how I can get started toward a good job or my own business in Television-Radio-Electronics.

Name..... Age.....  
Street..... Apt.....  
City..... Zone..... State.....



**Build and keep this BIG DTI  
engineered TV set—easily  
converted to U.H.F.**

**Here's the REAL THING!**

**SET UP YOUR OWN  
HOME LABORATORY**



Multimeter



Oscilloscope

HOME  
MOVIES



**DEFOREST'S TRAINING, INC.**  
AFFILIATED WITH  
**DEVRY Technical INSTITUTE**  
CHICAGO 14, ILLINOIS



## WHAT SECRET POWER DID THIS MAN POSSESS?



**BENJAMIN FRANKLIN**  
(A Rosicrucian)

**WHY** was this man great? How does anyone—man or woman—achieve greatness? Is it not by mastery of the powers within ourselves?

Know the mysterious world within you! Attune yourself to the wisdom of the ages! Grasp the inner power of your mind! Learn the secrets of a full and peaceful life!

Benjamin Franklin—like many other learned and great men and women—was a Rosicrucian. The Rosicrucians (NOT a religious organization) first came to America in 1694. Today, headquarters of the Rosicrucians send over seven million pieces of mail annually to all parts of the world. Write for YOUR FREE COPY of "The Mastery of Life"—TODAY. No obligation. No salesmen. A non-profit organization. Address: Scribe C.H.F.

**THIS BOOK FREE!**



**The ROSICRUCIANS**  
SAN JOSE • (AMORC) • CALIFORNIA

SEND THIS COUPON

Scribe C.H.F.  
The ROSICRUCIANS (AMORC)  
San Jose, California  
Please send me the free book, *The Mastery of Life*, which explains how I may learn to use my faculties and powers of mind.

Name \_\_\_\_\_

Address \_\_\_\_\_

City \_\_\_\_\_

MAKE EXTRA MONEY

## PLASTICS LEARN AT HOME

LEARN HOW TO MAKE fast-selling PLASTIC NOVELTIES FURNITURE JEWELRY



There are RICH OPPORTUNITIES for MEN and WOMEN with "know-how" in Plastics. Interstate's new Plastics course tells and shows how to make hundreds of fast selling items out of Plastics. Gives complete training in fabrication, casting, lamination, molding, internal carving, etc., in simple, easy, step-by-step language and pictures. Plastics and Fabricating Kits for 23 valuable Plastic Items come with training at no extra cost. **START A PLASTICS BUSINESS OF YOUR OWN.** No other industry holds such promise for the future. You can make big money manufacturing novelties, toys, signs, etc., in your own home in spare or full time. Don't wait! Learn NOW how Interstate's Plastics Training qualifies you for success in the Plastics field.

PLASTICS AND SUPPLIES FURNISHED FOR 23 VALUABLE PROJECTS

**INTERSTATE TRAINING SERVICE**  
Dept. C-3-A Portland 13, Oregon

## STUDY AT HOME LAW FREE BOOK!

**Prepare for the Bar!**

Write today for a copy of our FREE book, "The Law-Trained Man," which gives the bar rules in your state and tells how ambitious men and women since 1890 have been preparing at home in spare time for the practice of law by studying the famous Blackstone bar-training course. All needed instruction material is furnished including big 16-volume law library. Law diploma awarded. Moderate tuition; easy monthly terms. Write for FREE book today!

**BLACKSTONE SCHOOL OF LAW**  
225 N. Michigan Ave., Dept. 58, Chicago 1, Illinois

## SHINE WITHOUT 'POLISH'



**Cars Gleam Like Mirror**

NEW  
MEN! WOMEN! So easy a child can do it! Amazing "Dry" Polisher puts mirror-like shine on car WITHOUT 'POLISH'. No messy pastes, liquids, sprays. Simply glide over car. PRESTO! Looks hard, lustreous, long-lasting protective Wax Coating. Take orders! Earn money!

**SAMPLES FOR TRIAL**

Sample offer sent immediately to all who send name at once. Just a postcard will do. SEND NO MONEY—just your name. KRISTEE CO., Dept. 673, Akron 8, Ohio

## CASTING SECRETS REVEALED

Big money! Cast 1000's of plaques, figurines, etc. with X.L. rubber molds. No exper., little capital req. X.L. rubber pts. \$2.50, pts. \$4 (postage extra). Models, rubber for 3 molds, \$1.50 ppd. U. S. only. Send 25c (refundable) for 40 pp fact catalog.

**HUGE PROFITS! MORE MONEY!**

PLASTIC ARTS STUDIO, Dept. 3,  
3403 S. Madison St., Muncie, Ind.

## SUCCESS • BIG PAY in Aviation MASTER A & E MECHANICS urgently needed

Maximum training in minimum time! Thorough, practical instruction backed by more than 25 years of aviation technical experience. Training authorized under G.I. Bill.

Write today!  
Illustrated Catalog  
Registrar, Dept. 99,  
Miami 30, Florida



**TRAIN IN MIAMI -- AIR CAPITAL OF THE WORLD**



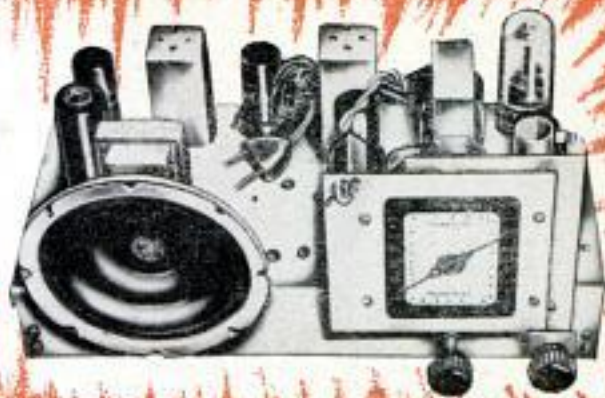

TRAIN FASTER—TRAIN BETTER—TRAIN EASIER  
 IN 10 MONTHS—OR LESS—FOR  
**RADIO-TELEVISION**

Our 21st Year Training Men for Greater Incomes and Security in Radio-Television

I SEND YOU  
**18 BIG KITS**

of Radio-Television parts and equipment. Much of your training will be actual construction and experimentation . . . the kind of truly PRACTICAL instruction that prepares you for your Radio-Television career.



Frank L. Sprayberry  
 President  
 Sprayberry Academy  
 of Radio

**NEW! NO OBLIGATION PLAN**

You Have No Monthly Payment Contract to Sign  
 Pay For Your Training as You Earn and Learn

You can get into Radio-Television, today's fastest growing big money opportunity field, in months instead of years! My completely new "package unit" training plan prepares you in as little as 10 months or even less! *No monthly payment contract to sign—thus NO RISK to you!*

This is America's finest, most complete, practical training—gets you ready to handle any practical job in the booming Radio-Television industry. Start your own profitable Radio-Television shop . . . or accept a good paying job. I have trained hundreds of successful Radio-Television technicians during the past 21 years—and stand ready to train you, even if you have no previous experience! Mail coupon and get all the facts—FREE!

**Valuable Equipment Included  
 With Training**

The new Sprayberry "package" plan includes many big kits of genuine, professional Radio-Television equipment. You perform over 300 demonstrations, experiments and construction projects. You build a powerful 6-tube 2-band radio set, multi-range test meter, signal generator, signal tracer, many other projects. All equipment and lessons are yours to keep . . . you have practically everything you need to set up your own profitable Radio-Television service shop.

**Earn Extra Money While You Learn!**

All your 10 months of training is IN YOUR HOME in spare hours. Keep on with your present job and income while learning. With each training "package" unit, you receive extra plans and "Business Builder" ideas for spare time Radio-Television jobs. New television stations everywhere, open vast new opportunities for trained Radio-Television Technicians—and those in training. If you expect to be in the armed forces later, there is no better preparation than practical Sprayberry Radio-Television training.



**YOU BUILD** the Television set and the powerful superhet radio receiver shown above IN ADDITION to the other test units shown here. (Many are not illustrated.)

Approved for Veterans under the G. I. Bill

**SPRAYBERRY ACADEMY OF RADIO** 111 NORTH CANAL ST.  
 Dept. 10-E, Chicago 6, Ill.

**MAIL COUPON  
 TODAY!  
 NO OBLIGATION**

**SPRAYBERRY ACADEMY OF RADIO, Dept. 10-E**  
 111 North Canal St., Chicago 6, Ill.

Please rush to me all information on your 10-MONTH Radio-Television Training Plan. I understand this does not obligate me and that no salesman will call upon me. Be sure to include 3 books FREE.

Name..... Age.....  
 Address.....  
 City..... Zone..... State.....

I invite you to get all the facts —

**FREE TO YOU 3 BIG  
 RADIO-TELEVISION BOOKS**

Rush coupon for my three big Radio-Television books: "How to Make Money in Radio-Television," PLUS my new illustrated Television Bulletin PLUS an actual sample Sprayberry Lesson—ALL FREE. No obligation and no salesman will call. Mail coupon NOW!







**Helpful For Tune-Ups**  
 "I think that MOTOR's Auto Repair Manual is tops. I find it most helpful for tune up of carburetors and distributors."  
 Clarence W. McCulley  
 Coatesville, Penna.



**Gets Better Job . . . Thanks to Manual**  
 "I have become foreman of my garage—thanks to help of your Manual."  
 Elmer Henster,  
 Wisconsin



**Eliminates Guesswork**  
 "There is no other source so compiled on cars and trucks. MOTOR's repair Manual takes the guesswork out of most every problem."  
 S. V. Patterson  
 Rockford, Ill.

**Tough Jobs Now Easier**  
 "I have found out that tough jobs all come easier if the manual is referred to before starting the job."  
 Ray Jelen  
 Cleveland, Ohio



**Amazed Self and Friends**  
 "I amazed myself and my friends, too. Now do auto repair jobs that stumped me before."  
 Michael Ballesky  
 Newark, N. J.



**Book Does Man's Job**  
 "We have been using your book on Auto Repair for the past year and feel like it is a third man around the shop."  
 F. M. Scott  
 Stamwood, Wash.



**ANYONE—BEGINNER OR EXPERIENCED**

# "Now I Can

It's a cinch to do any job, quickly, easily, right—with Brand-



COVERS 872 MODELS—  
 ALL THESE MAKES

- |           |            |
|-----------|------------|
| Buick     | Lafayette  |
| Cadillac  | La Salle   |
| Chevrolet | Lincoln    |
| Chrysler  | Mercury    |
| Crosley   | Nash       |
| De Soto   | Nash       |
| Dodge     | Rambler    |
| Ford      | Oldsmobile |
| Frazer    | Packard    |
| Henry J   | Plymouth   |
| Hudson    | Pontiac    |
| Kaiser    | Studebaker |



Crystal-clear Tune-Up photos, diagrams and pictures trace mysterious "can't start" troubles. (Note: All these pictures have been greatly reduced in size.)

USED BY  
 U. S. ARMY  
 NAVY  
 MARINES



Adjusting a Chevrolet brake . . . the way an expert does it—quickly and easily.

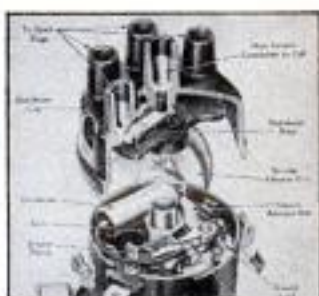

Diagrams, tables and text take the "mystery" out of all ignition systems.

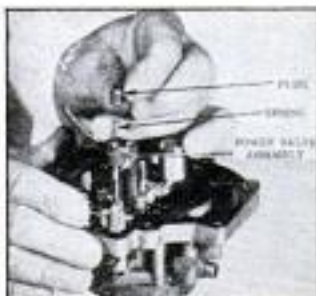

You get illustrated repair procedures for all types of carburetors.

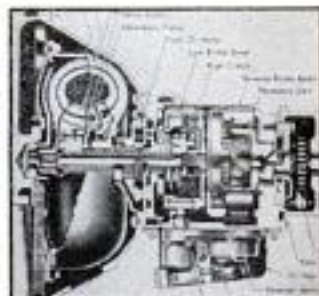

Buick Dynaflo. Book has 2500 pictures. ALL automatic transmissions fully covered.

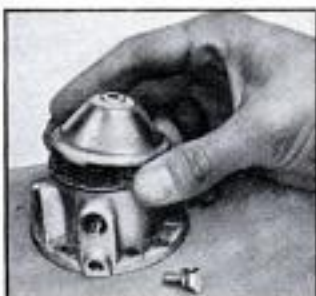

Fuel pumps can cause trouble. Pictures show exactly how to take them apart, fix them.



How to fix Hydra-Matic transmission. Pictures show tools to use, how to use them.





#### Has Paid for Itself Time and Again

"It sure doesn't take schooling to read it. It's easy to see pictures of every part. Has paid for itself time and again."

Paul R. Pempfer, Wis.



#### Helps Him Do Any Job

"I have found my MOTOR Manual a wonderful help. It has put me in a position to do every job."

S. L. Sharpless  
Los Angeles, Cal.



#### No Trouble Learning

"Instructions so clear I have had no trouble learning anything about any car. Now working as mechanic in big plant."

Sam Ordóñez, Calif.

#### Paid for Itself on First 2 Jobs

"MOTOR's Manual paid for itself on the first 2 jobs and saved me valuable time by eliminating guesswork."

W. Schrop, Ohio



#### So Complete and Easy to Understand

"So complete, easy to understand — have done jobs with Manual I would not have attempted without it."

C. L. Vaxerstrom, Mich.



#### Other Mechanic Worked Half A Day—He Does Job in Half An Hour

"I fixed a motor in 30 minutes after another mechanic worked on it half a day."

C. Auberry, Tenn.



## MECHANIC CAN SAY WITH CONFIDENCE:

# Fix Any Car!"

## New MOTOR'S AUTO REPAIR MANUAL! Prove it in 7 days FREE!

**N**OW you can tackle any repair job, and do it quickly, easily, right—the first time! BRAND NEW Edition of MOTOR's AUTO REPAIR MANUAL shows you how—with crystal-clear pictures and step-by-step directions you can easily follow. **COVERS EVERY CAR BUILT SINCE 1935!**

No guesswork. This giant guide tells you where to start; what tools to use. Leads you easily and quickly through the entire operation. Covers everything from a simple carburetor adjustment to a complete overhaul on 872 car models!

Put this famous manual to the test—*your own test*. Try it on any auto repair job during a **FREE 7-Day Trial** of the book. Make it save time, work, money — without risking a penny!

#### Everything You Need to Know

**BIG, NEW REVISED Edition** has **MORE REPAIR INFORMATION THAN EVER!** Over 850 giant pages, 2,500 "This-Is-How" pictures—clear drawings, diagrams, cut-away photos—make every step **EASY**. Over 200 "Quick Check" charts—more than 37,000 essential repair specifications. Over 227,000 service and repair facts. Instructions and pictures so **COMPLETE**, so **CLEAR** — you **CAN'T** go wrong!

Even a green beginner can do a good job. If you're a top mechanic, you'll profit by the time-saving procedures you'll discover.

#### The "Meat" of Over 189 Official Shop Manuals

The editors have put together the "Know-How" from over 189 Official Shop Manuals; "boiled it down" into one profusely illustrated, easy-to-understand guide—the very latest edition of this world-famous Manual that is the "Bible" of auto men everywhere.

Includes **ALL** Automatic Transmissions (including Dual Range Hydramatic). Covers the newest Carburetors, Engines (including new Buick and Dodge V-8's) . . . Chokes . . . Fuel Pumps . . . Oil Filters . . . Starting Motors . . . Generators . . . Distributors . . . Clutches . . . Universals . . . Axles . . . Brakes . . . Power Steering . . . Shock Absorbers, etc.

Factory specifications and Adjustment Tables. Tune-up Charts. Tables of Measurements and Clearances. Overhauling and Replacement Facts — **AND MUCH MORE.**

Used by Armed Forces, hundreds of thousands of auto service men! Now **YOU'LL** want to try it, too — on this amazing **UNCONDITIONAL GUARANTEE!**

#### Try Book for a Week FREE

**SEND NO MONEY.** Pay nothing to postman. Test book in your own garage or shop. It's **GUARANTEED** to pay for itself in 7 days. If it doesn't, just return the book and owe nothing. Rush coupon for your **FREE Trial** copy of this great money-saving Manual. **MOTOR Book Dept. Desk 1A, 250 West 55th St., New York 19, N. Y.**

Try Book FREE on ANY Auto Repair Job!



### MAIL COUPON NOW FOR 7-DAY FREE TRIAL

**MOTOR Book Dept., Desk 1A, 250 West 55th Street, New York 19, N. Y.**

Rush to me at once! (Check box opposite book you want).

**MOTOR'S New AUTO REPAIR MANUAL.** If okay, I'll remit just \$1.00 in seven days, then \$2.00 monthly for two months and a final payment of 95c (plus 35c delivery charges) one month after that. (Otherwise, I'll return the book postpaid in seven days. (Foreign price: Remit \$5.00 cash with order.)

**MOTOR'S New TRUCK AND TRACTOR REPAIR MANUAL.** (Described at left.) If okay I will remit \$2.00 in seven days, and \$2.00 monthly for three months, plus 35c delivery charge with final payment. Otherwise, I will return book promptly. (Foreign price: Remit \$10.00 cash with order.)

Print Name.....Age.....

Print Address.....

City & Zone No.....State.....

**SAVE 35c** delivery charge by enclosing **WITH** coupon check or money order for full payment of \$5.95 for Auto Repair Manual for \$8.00 for Truck and Tractor Manual. Same 7-day return-for-refund privilege applies.

#### Same FREE 7-Day Offer on MOTOR'S TRUCK and TRACTOR REPAIR MANUAL



Covers **EVERY** job on **EVERY** gasoline-powered truck and farm tractor made from 1939 thru 1953. 2267 pictures, 960 big 8½ x 11 inch pages, 300,000 facts. Used by Armed Forces. Check proper box in coupon for **FREE 7-day trial.**



## NOW YOU CAN BUILD IT WITH CONCRETE BLOCKS

**10 DAYS FREE TRIAL EXAMINATION!**

This practical guide shows every step from how-to-plan to how-to-build with one of the most abundant and economical building materials known to man. Over a hundred pictures and cut-away diagrams show exactly what to do and what not to do. Tells how to plan, place corner block, make foundations easily, how to paint for special purposes. A picture story of everything in building any type of structure with concrete blocks, easily and inexpensively.

Here's how little this book costs you . . . or if you don't keep it after 10 days trial, return it and you owe nothing. **\$3.25**

Here's how to apply Mortar

### CARPENTRY FOR EVERYONE



A clear explanation of modern carpentry construction including framing, roof constructions, general carpentry work, exterior and interior finish of buildings, building forms and working drawings, and farm buildings. Covers everything you need to know about lumber, tools, joints and splices, floors, stairs, partitions, rafters, etc. Gives short cuts and tricks used by the master carpenter. Easy to understand. 504 pages, 580 illustrations. **\$2.50.** Use 10 day no-cost trial coupon below.

### BRICKLAYING — WIRING — PLUMBING

**Bricklaying Skill and Practice** shows by clear explanations and actual on-the-job illustrations, simplifies the construction of everything from fireplaces to complete buildings. **\$3.25**

**Electric Wiring**—New book covers job-tested methods of residential and farm wiring, code changes. Show-how for amateur, valuable reference for tradesman, estimator, contractor. **\$4.25**

**How to Design and Install Plumbing**—Hundreds of how-to-do-it pictures, full-sized blueprints for most every plumbing job. 349 illustrations, 422 pages. **\$4.25**

### OTHER YOU-CAN-DO-IT BOOKS IN COUPON BELOW

Mail this coupon today—10 days trial at no cost to you

American Technical Society, Dept. B-119  
848 East 58th Street, Chicago 37, Illinois

Please rush me the following books I'm checking below to examine at home. If I'm not convinced these books will help me save thousands of dollars by doing my own building and planning, I may return the books and owe nothing.

- |         |                          |   |        |
|---------|--------------------------|---|--------|
| Examine | <input type="checkbox"/> | CONCRETE BLOCK CONSTRUCTION FOR HOME AND FARM . . . . . | \$3.25 |
| at home | <input type="checkbox"/> | CARPENTRY . . . . .                                     | \$2.50 |
|         | <input type="checkbox"/> | BRICKLAYING . . Skill and Practice . . .                | \$3.25 |
|         | <input type="checkbox"/> | HOW TO DESIGN AND INSTALL PLUMBING . . . . .            | \$4.25 |
| at no   | <input type="checkbox"/> | ELECTRIC WIRING—  |        |
| cost.   | <input type="checkbox"/> | Residential and Farm . . . . .                          | \$4.25 |
|         | <input type="checkbox"/> | How to Insulate Home & Farm Bldgs. . .                  | \$3.25 |
|         | <input type="checkbox"/> | Steel Square . . . . .                                  | \$2.50 |

Name \_\_\_\_\_

Address \_\_\_\_\_

City \_\_\_\_\_ State \_\_\_\_\_

Ten day no-cost-trial. If I keep books, will remit by check or money order.

Send C.O.D. Same return privilege—money refunded, I'm enclosing \$\_\_\_\_\_ now to save postage—same return privilege—money refunded.

## ITALIAN ACCORDIONS AT LOWEST WHOLESALE PRICES

**"PAY AS YOU PLAY"**

Small Down Payment  
As Little As

**\$10** per month

**DIRECT from Importer to You!**

**SATISFACTION GUARANTEED**, or your money back! NOW you can save up to 50% by direct purchase from America's leading distributor of famous genuine ITALIAN ACCORDIONS. TRADE-INS ACCEPTED. Send for **FREE Illustrated Catalog!**

**5-DAY FREE TRIAL**

**ACCORDION MANUFACTURERS & WHOLESALE OUTLET**

2003 West Chicago Ave. Dept. R 14, Chicago 22, Ill.

## Now Many Wear FALSE TEETH With More Comfort

**FASTEETH**, a pleasant alkaline (non-acid) powder, holds false teeth more firmly. To eat and talk in more comfort, just sprinkle a little **FASTEETH** on your plates. No gummy, gooey, pasty taste or feeling. Checks "plate odor" (denture breath). Get **FASTEETH** at any drug counter. **FREE!** Write for generous sample to 55 Wall St., Binghamton, New York.

## ENGINEERING DEGREE IN 27 MONTHS

**INDIANA TECHNICAL COLLEGE**

**B. S. DEGREE**, Aeronautical, Chemical, Civil, Electrical, Mechanical and Radio Engineering (inc. TV and Electronics). Drafting. 1-yr. G.I. Gov't approved. Low rate. Earn board. Large industrial center. Students from 48 states, 21 countries. Demand for graduates. Enter March, June, September, December. Write for catalog. 1614 E. Washington Boulevard, Fort Wayne 2, Indiana.

**FUN TO DO . . . PROFITABLE TOO!**

## LEATHERCRAFT

Textile Painting • Shellcraft  
Beadcraft • Metal Tooling  
Lamp Shade Making  
Other Crafts

Send for **BIG, FREE**

**Catalog Today!**



Complete supplies, everything you need

**KIT KRAFT**, Dept. 24, 7373 Melrose Ave., Hollywood 46, Calif.

**FREE BOOK**

## SAVE WITH Pre-Packaged Flower & Bulb Collections

Save up to 40% by buying Spring Hill 105th Anniversary collections. Thrilling varieties, big quantity production, assembly-line packaging, and low, low prices—no wonder Spring Hill collections are so popular. Send for free catalog. 48 colorful pages packed with flower, bulb, fruit, and tree offers. All guaranteed.

**SPRING HILL NURSERIES**, Dept. L-25, Tipp City, Ohio





**UKRAINE 1918** — Complete set of 3 stamps. SET NO. 1

**ESTONIA 1940** — Last 3 stamps issued in free Estonia (above). Beautiful pictures honor 100th birthday of postage stamp. SET NO. 2

**LITHUANIA 1934** — 3 Stamps (above) picture flyers that crashed on transatlantic flight. SET NO. 3.

**SOMALI COAST 1947** — 6 glamorous African scenes—beaches, palm trees, tents in wonderful colors. SET NO. 4

**HITLER STAMPS** — Complete set of 6 in great demand; hard to get. SET NO. 5

# PRIZED FOREIGN STAMPS

## only 15¢ per Set!

*Now!* Big Bargain in Foreign Stamps! All in Brilliant Colors! All Different! All Valuable Hard-to-Get Sets!



**VATICAN CITY 1944** — Complete set of 3 stamps. SET NO. 6

**SAN MARINO 1930** — Airmail set of 3 with views of smallest, oldest republic. SET NO. 7



**CZECHOSLOVAKIA 1949** — Semipostal set of 2 with Red Cross surtax. SET NO. 8

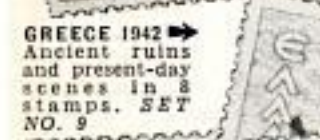

**GREECE 1942** — Ancient ruins and present-day scenes in 8 stamps. SET NO. 9



**RUSSIA** — Behind the Iron Curtain scenes inside Russia. Two giant size stamps, 3-colored. SET NO. 10

More People Get Stamps from LITTLETON than from Any Other Concern in The World

**YES!** It's true. You can take your pick of any of these exciting sets of Prized Foreign Stamps—not for the 25¢, 35¢, or 50¢ Catalog price you'd expect to pay—**BUT FOR ONLY 15¢ PER SET!**

READ the descriptions of each stamp set. SEE the fascinating pictures and foreign markings. Imagine the added interest and beauty of these stamps in wonderful colors. Then circle (in the coupon below) the numbers of the sets you want.

### MAIL COUPON NOW

Don't delay! These Prized Foreign Stamps will go fast. We'll also send other interesting offers for your inspection — **PLUS A FREE** copy of our exciting "How to Collect Stamps." Illustrated with pictures; expert advice on where and how to get stamps, trade stamps, etc. Rush coupon **AT ONCE** to: **LITTLETON STAMP CO., Dept. PM-1, Littleton, N. H.**

**FREE!**



**SAVE 50¢ CASH AND GET ... Free**

A Handy Magnifying Glass **PLUS A SET of 4 German Inflation Stamps** When You Buy **ALL 10 SETS** of These Prized Foreign Stamps—**for only \$1!**

If you take **ALL 10 SETS** of prized stamps on this page for only \$1 (saving 50¢ cash!) we will send you **FREE** a handy magnifier to detect tiny stamp details **AND** a set of 4 unusual Inflation Stamps — issued in pre-war Germany (face value **Twenty MILLION Marks!**) But hurry; supply is short! Check box in coupon.



**LITTLETON STAMP CO., Dept. PM-1, Littleton, New Hampshire**

I enclose \_\_\_\_\_ Rush me the Prize Foreign Stamp sets I have circled below. **ONLY 15¢ PER SET.** Also send me **FREE** your helpful and informative "How to Collect Stamps."

1 2 3 4 5 6 7 8 9 10

I want to **SAVE 50¢** and get 3 Gifts **FREE.** Send me **ALL 10 SETS** for only \$1 (enclosed) — **PLUS** the Magnifying Glass, **AND** the set of 4 German Inflation Stamps, **AND** "How to Collect Stamps."

Print **NAME** \_\_\_\_\_

Print **ADDRESS** \_\_\_\_\_

City \_\_\_\_\_ State \_\_\_\_\_

**YOUR MONEY BACK IF NOT COMPLETELY SATISFIED!**



Men Between 18 and 55  
 Mail Coupon Now for my **TWO**  
**NEW FREE BOOKS**  
 About Present-Day and Future  
**OPPORTUNITIES in WELDING**

**Train at Home, in Spare Time, for a Good Future—a Job or Business of Your Own**



**E. P. SORENSEN**  
 E. P. Sorensen, famous trainer of men for industry, stands back of your welding instruction all the way through, and offers placement service when you finish.

Jobs in this field pay \$2.25 to \$2.50 an hour and more, with extra benefits, such as paid vacations, insurance, and pension plans. My graduate Raymond Masak, indeed, makes \$6,000 to \$7,500 a year, and many others are also doing splendidly. So get my two new FREE books about the booming opportunities in welding, and investigate for yourself how you may be able to cash in.

**It's the Coming Trade**

Here is the point: Welding is fast replacing the old-fashioned methods of cutting, joining, repairing and processing metals. As a result, in industries of all kinds, welders are desperately needed—as the classified ads in any major newspaper will show. Also, in your garage, or on the farm, there are opportunities to open a business of your own, and be rid of straw-horses forever. Men trained the practical way I train them are making good. Maybe you can, too. Certainly, you owe it to yourself to clip the coupon now, and find out.

Important in every important industry today



MAIL COUPON TODAY FOR **TWO** FREE BOOKS

**UEI** has trained men for industry since 1927

E. P. Sorensen, Pres.  
**UTILITIES ENGINEERING INSTITUTE, Dept. WC-5,**  
 2523 Sheffield Ave., Chicago 14, Ill.  
 Yes! Rush free books on Welding. No obligation.

NAME \_\_\_\_\_ Apt. \_\_\_\_\_  
 ADDRESS \_\_\_\_\_  
 CITY \_\_\_\_\_ Zone or County \_\_\_\_\_ STATE \_\_\_\_\_  
 ( ) Check here for special information if under 17.



**Wild Life Films**

Exciting, dramatic action in the natural habitat of animals of forest and plains. 8 mm or 16 mm in beautiful color or B & W. Also 2" x 2" color slides. Write for free illustrated literature.

**WILD LIFE FILMS**

5151 Strohm Ave., Rm. 2A, No. Hollywood, Calif.

**High School at Home**

**Many Finish in 2 Years**

No classes. No time wasted going to and from school. Progress as fast as your time and abilities permit. Standard H. S. texts supplied. Thousands enroll each year in this 57-year-old school. Send for FREE descriptive booklet.

**AMERICAN SCHOOL, Dept. H145**  
 Drexel at 58th St., Chicago 37, Ill.  
 Without obligation, please send FREE descriptive booklet.

Name \_\_\_\_\_  
 Address \_\_\_\_\_

**HEARING BAD?**

If so, you will be happy to know how we have improved the hearing and relieved those miserable head noises, caused by catarrh of the head, for thousands of people (many past 70) who have used our simple Elmo Palliative Home Treatment in the past 16 years. This may be the answer to your prayer. **NOTHING TO WEAR.** Here are **SOME** of the symptoms that may likely be causing your catarrhal deafness and head noises: Head feels stopped up from mucus. Dropping of mucus in throat. Hawking and spitting. Mucus in nose or throat every day. Hearing worse with a cold. Hear — but don't understand words. Hear better on clear days. Worse on rainy days. Head noises like crickets, bells, whistles, clicking, escaping steam or many other sounds. If your condition is caused by catarrh of the head, you, too, may likely enjoy such wonderful relief as many others have reported. **WRITE TODAY FOR PROOF AND 30 DAY TRIAL OFFER.**



**THE ELMO COMPANY**  
 DEPT. 4PM1 DAVENPORT, IOWA

**A "GOOD HAND" HELPS YOU SUCCEED!**  
**LEARN TO WRITE WELL**

Handwriting quickly improves with our easy-to-understand picture lessons! Put your spare time to good use; send today for  **FREE BOOKLET**, "How to Become a Good Penman," or check volumes wanted below at \$1 each:  Business Writing  Artistic Writing  Card Writing  Bird & Design Flourishing  Engraving Alphabets. COMPLETE SET \$4.50. Ask for price list of penman's supplies.

Beautifully written, plus special pen-point for shaded writing. **OUR 33rd YEAR**  
**TAMBLYN SCHOOL OF PENMANSHIP**  
 S.A. Ziller, Pres., 442 Ridge Bldg., Kansas City, Mo., USA

**ALPHABET PATTERNS**  
**A** MULTI-PURPOSE Alphabet Patterns—numerous craft uses. 14 distinctive alphabets—numerals—monograms. Over 500 individual patterns. 1/2" to 4" high. Only **\$1.00** Postpaid.  
**WALKER STUDIO** Dept. AP-1, 4343 Lindell, St. Louis 8, Mo.

**STUDY AT HOME**

**WITH AN EDUCATIONAL INSTITUTION**  
 Courses in **ARTS AND SCIENCES:** Philosophy; Education; Letters; Public Health; Medical Jurisprudence; Psychology; Sociology; Physics; Chemistry; Geology; Pol. Science; Theology; Law; Business and Commerce; Accounting; Mathematics; Statistics; Agriculture. **ENGINEERING:** Electrical, Civil, Mechanical, Drafting, Architectural, Steam, Diesel, Aeronautical, Radio, Structural, Mining, Industrial, Petroleum, Refrigeration, Chemical. Send for free catalog. McKinley-Roosevelt Incorporated, 4610-K32, Sheridan Rd., Chicago 40, Illinois

**HELPFUL BOOKS**  
 Send post card asking for **FREE** catalog  
 Popular Mechanics Press, 200 E. Ontario, Dept. 601, Chicago 11

**LEARN LOCKSMITHING**  
 Learn this fascinating, profitable trade from experts in your spare time at home! Age or physical handicap no disadvantage. Year around, steady income. Full or part time. Practical, illustrated lessons. You can make money even while learning! All materials and special tools supplied without extra charge.  
**INSTITUTE OF LOCKSMITHING, Dept. P-50**  
 15 PARK AVENUE RUTHERFORD, N. J.  
 Lic. by N.J. State Board of Education  
 Approved for Veterans

**Learn BAKING At Home**  
 Baking is one of America's high industries in wages. Nearly depression-proof. Thorough basic home course lays sound foundation. If you have aptitude, write for **FREE** BOOKLET, "Opportunities in Commercial Baking."  
**NATIONAL BAKING SCHOOL**  
 835 Diversey Parkway Dept. 1351, Chicago 14



# START YOUR OWN BUSINESS!

## ELECTRICAL APPLIANCE REPAIRING

**SECURITY — INDEPENDENCE |  
WORK SHORT HOURS**

There are millions of electrical equipment units in daily use . . . in factories, homes, office buildings and on farms. Skilled electrical technicians are needed to keep this equipment in good running condition. Learn at home in spare time.

You can now **BE TRAINED** to fill this **BIG NEED** . . . a need that grows day by day because of new electrical inventions for home and factory.

If you are mechanically inclined, can hold and use tools, we can give you the training and time-saving kits that will enable you to . . . **Command More Money at Work . . . A Better Paying Job Elsewhere . . . Or A Business Of Your Own!**

The **ELECTRONIC KIT**, a multi-purpose trouble detector, and other valuable Shop Method Training is sent to you! All instruction material is written in simple, easy-to-understand language, chock full of hundreds of detailed photos and drawings. Used by servicemen the country over.

We show you how to quickly locate the trouble, how to fix it and what to charge. **ALSO**, how to solicit business and keep business coming to you.

Get Full Facts on how you can get this training at home in your spare time and pay for it out of your earnings while learning!

**IN YOUR OWN KITCHEN, BASEMENT, OR GARAGE**

You don't need elaborate fixtures or expensive equipment to be a successful repairman. Work as many hours as you wish. The Electrical Appliance Technician is his own boss!

**\$5.00 - \$6.00 HOUR**

often charged for making ordinary repairs. We show you how to repair refrigerators, vacuum cleaners, washing machines, motors, etc., etc.

**AGE IS NO BARRIER**

Nor is a minor physical handicap. Work is light, pleasant and **PROFITABLE**.

**FREE BOOK**

On America's fastest growing industry

**CHRISTY TRADES SCHOOL, Dept. D-2603  
4432 N. Kedzie Ave., Chicago 25, Ill.**

Gentlemen:  
Please rush me your **FREE ILLUSTRATED BOOK** about Electrical Appliance Servicing, facts on your Electronic Kit and Special form for paying later from earnings while learning.

NAME \_\_\_\_\_ Age \_\_\_\_\_

ADDRESS \_\_\_\_\_

CITY \_\_\_\_\_ Zone \_\_\_\_\_ State \_\_\_\_\_



**EARN WHILE YOU LEARN!**



Only had your course a few short weeks and have already made \$800.00. Going to quit my job paying \$250.00 straight salary to operate my own business.—J. D. S., St. Louis, Mo.  
I work day times at the shipyard and after 4:00 P. M. I operate from my cellar and garage. I average \$10.00 to \$15.00 clear every day.—Waiter Hanby, Brockton, Mass.



**SEND COUPON TODAY**





# FREE 5-Day Trial

## How to Make Your Own CABINETS, BOOKCASES and WALL SHELVES



**NOW — You Can Build the Things You Want at Big Cash Savings — Without Expensive Tools**

**YOU** don't have to be an experienced craftsman—you don't even have to understand blueprints. The amazing new **GIANT-SIZE BIG HOME-PROJECT CRAFTSMAN MANUAL** shows you step-by-step, with easy-to-understand illustrations how to make your own useful things for your home and earn or save hundreds of dollars. Here are detailed drawings so simple, that even a child can understand and follow. This **HUGE** new atlas-book guides you every step of the way on any of the 77 up-to-date projects you decide to make.

### Big Money-Market for Every Project Made

These hand built pieces of furniture whether they are a Chest, Cupboard, or Night Table bring many, many dollars in the market. Yes, you too, can share in the profits to be made in this lucrative field. Cash in on this golden opportunity of getting into a hobby that really pays off in gold dust.

### Enrich Your Own Home

The 27 styles of cabinets alone, shown in this wonder-book can produce outstanding results for your home—watch your friends gasp when they see the practical bookcases (19 styles) and magazine racks you can make. You'll find yourself turning out modern cabinets, book shelves, hanging racks, chests and dozens of other things you need, "just like magic."

### Follow Expert Advice

Scores of experts including furniture designers, woodworking instructors, master craftsmen and cabinet makers put their heads together to give you a book that will enable you to make the things you always dreamed of having.

Clear-cut photos guide you as you work. The complete drawings and dimensions shown make every job so easy you will marvel at how quickly you can turn out these fine pieces.

**SEND NO MONEY** Risk Nothing—**READ ON 5-Day FREE TRIAL**

Just fill in coupon and mail. Use **CABINETS, BOOKCASES AND WALL SHELVES** for 5 days FREE. If not delighted, return the book within 5 days and owe nothing or keep it and send only the low price of \$3.95 (plus postage). **Order NOW!**

**CRAFTSMAN PUBLISHING, Dept. PM4, 115 Worth St., New York 13, N. Y.**

**5-Day FREE TRIAL COUPON**

**CRAFTSMAN PUBLISHING, Dept. PM4, 115 Worth Street, New York 13, N. Y.** Mail **NOW**

Please send me **CABINETS, BOOKCASES AND WALL SHELVES**. If not delighted, I will return the book within 5 days and owe nothing, otherwise I will keep it and send you only \$3.95 (plus postage).

Name.....

Address.....

City & Zone..... State.....

**SAVE.** Send payment (check or money order) NOW and We pay postage. Money back if not delighted.

**MAKE THESE THINGS**

Wardrobe Chests, Dresser, Night Table, Breakfast Cupboard, Phonograph Record Cabinet, Modern Chest Units, Sewing Cabinet, Book Shelves, Wall Shelves and dozens of other pieces.

**630 PHOTOS & DRAWINGS BIG BOOK 9" x 12"**



# Ball-Bearing SPEED WHEELS



JUVENILE WHEELS (No bearing, solid tires)			
5" .....	45¢	6" .....	65¢
7" .....			
(Semi-pneumatic tire, ball bearing)			
8x1.25 .....	\$1.85	10x1.25 .....	\$2.20
8x1.75 .....	1.95	10x1.75 .....	2.30
8x2 .....	2.20	10x2.00 .....	2.65
12x1.75 .....			
12x3.45 .....			
INDUSTRIAL WHEELS			
Lug Base, Semi-Pneumatic tire			
6x2 SW .....	\$3.45	10x2.00 .....	\$6.10
6x2.00 .....	4.00	10x2.75 .....	5.15
8x2.00 .....	5.20	12x2.00 .....	6.90
8x2.50 .....	5.40	12x3.00 .....	9.20
16x4.00 .....			
15.15 .....			
Smooth Base, Pneumatic tire and tube			
8x3.00 .....	\$11.00	12x4.00 .....	\$12.10
10x2.75 .....	6.80	4.00x8 .....	13.10
10x3.50 .....	10.55	14x4.50 .....	13.40

Available Now — **CASTERS**  
Write for circulars on all wheels.  
No c.o.d. orders. Prices F.O.B. our plant.

**JIM BROWN TOY COMPANY**  
1095 HOME AVENUE PM-154 AKRON 10, OHIO

## YOU CAN MAKE A FORTUNE!

Raising Fabulous **CHINCHILLAS**... The most luxurious fur known to man. Clean—takes you only minutes a day! Fantastic profit possibilities for your future security. This new rising industry can never be crowded in your lifetime! It can make you rich!

Don't hesitate, send name and address today for big **FREE** booklet.

"Dixieland Acres" Chinchilla Ranch  
Dept. P-1, 133 Shamrock Rd., Asheboro, N. C.

## Secrets of VENTRILOQUISM Now Revealed!

Easy to learn in 60 to 90 days with our Home Study Course. **RESULTS GUARANTEED.** Make Money! Be Popular! Have Fun! Our Opportunity! Radio, Television, Stage Appearances! For **FREE** information regarding price and terms, **WRITE.** You must state your age, Dummy Catalog 27c.

**FRED MAHER SCHOOL OF VENTRILOQUISM**  
Kensington Station  
Box 36, Studio A  
Detroit 24, Michigan

## WITH RUPTURE-EASER®

**You Can Walk, Run, Swim, Dance**

**No Fitting Required**

Soft, flexible and washable. Flat foam rubber groin pad holds rupture firmly in place. No steel or leather bands. For men, women, children. Give measurement around lowest abdomen. State side. Postage prepaid except on C.O.D.'s. Delay may be dangerous. **Order today!** Money-back guarantee.

**PIPER BRACE CO.**  
811 Wyandotte Dept. PM-14 Kansas City 5, Mo.

Right or Left Size **\$3.95**  
Double **\$4.95**

## For your NARROW FOOT!

**AAA**

Sizes 6 to 16

Men with narrow feet! Enjoy a perfect fit at no extra cost. We specialize in narrow widths only. **AAA** to **B**, sizes 6 to 16. Write **TODAY** for **FREE** information about wide style variety.

**Write for FREE Catalog**

**NARROWS Inc. N-91, BROCKTON, MASS.**



# CAR BURNING OIL?

## Engineer's Discovery Stops it Quick

### Without A Cent For Mechanical Repairs!

If your car is using too much oil—if it is sluggish, hard to start, slow on pickup, lacks pep and power—you are paying good money for oil that's burning up in your engine instead of providing lubrication. Why? Because your engine is leaking. Friction has worn a gap between pistons and cylinder wall. Oil is pumping up into the combustion chamber, fouling your motor with carbon. Gas is exploding down through this gap, going to waste.

#### SAVE \$50 TO \$150 REPAIR BILL

Before you spend \$50.00 to \$150.00 for an engine overhaul, read how you can fix that leaky engine yourself, in just a few minutes, without buying a single new part, without even taking your engine down. It's almost as easy as squeezing toothpaste or shaving cream out of a tube, thanks to the discovery of a new miracle substance called Power Seal. This revolutionary, new compound combines



the lubricating qualities of Moly, the "greasy" wonder metal, with the leak-sealing properties of Vermiculite, the mineral product whose particles expand under heat. (Up to 30 times original size.)

Just squeeze Power-Seal out of the tube into your motor's cylinders through the spark plug openings. It will spread over pistons, piston rings and cylinder walls as your engine runs and it will PLATE every surface with a smooth, shiny, metallic film that won't come off! No amount of pressure can scrape it off. No amount of heat can break it down. It fills the cracks, scratches and scorings caused by engine wear. It closes the gap between worn piston rings and cylinders with an automatic self-expanding seal that stops oil pumping, stops gas blow-by and restores compression. No more piston slapping; no more engine knocks. You get more power, speed, mileage.

This genuine plating is self-lubricating too for Moly, the greasy metal lubricant, reduces friction as nothing else can! It is the only lubricant indestructible enough to be used in U. S. atomic energy plants and jet engines. It never drains down, never leaves your engine dry. Even after your car has been standing for weeks, even in coldest weather, you can start it in a flash, because the lubrication is in the metal itself. That's why you'll need amazingly little oil; you'll get hundreds, even thousands of more miles per quart.

#### TRY IT FREE!

You don't risk a penny. Prove to yourself that Power-Seal will make your car run like new. Put it in your engine on 30 days' Free Trial. If you are not getting better performance out of your car than you thought possible—if you have not stopped oil burning and have not increased gas mileage—return the empty tube and get your money back in full.

Power-Seal is absolutely harmless; it cannot hurt the finest car in any way. It can only preserve and protect your motor.

**RUDSON AUTOMOTIVE INDUSTRIES**  
Dept. 214, 24 East 67th Street  
New York 21, N. Y.

JANUARY 1954



#### POWER SEAL MAKES WORN OUT TAXI ENGINE RUN LIKE NEW

Here are the Test Engineer's notarized figures showing the sensational increase in compression obtained in a 1950 De Soto taxi that had run for 93,086 miles. Just one POWER SEAL injection increased pep and power, reduced gas consumption, cut oil burning nearly 50%.

	Cyl. 1	Cyl. 2	Cyl. 3	Cyl. 4	Cyl. 5	Cyl. 6
BEFORE	90 lbs.	90 lbs.	105 lbs.	90 lbs.	80 lbs.	100 lbs.
AFTER	115 lbs.	115 lbs.	117 lbs.	115 lbs.	115 lbs.	115 lbs.

#### BEST INVESTMENT WE EVER MADE, SAYS DRIVER-OWNER

"We simply inserted the POWER SEAL per instructions and made no other repairs or adjustments. Compression readings were taken before and after and showed a big improvement in both cars. As a result the engine gained a lot more pickup and power which was especially noticeable on hills. What impressed us most was the sharp reduction in oil consumption. In one cab, we've actually been saving a quart a day and figure we have saved \$11.20 on oil alone since the POWER SEAL was applied a month ago. In the other cab, oil consumption was cut practically in half. We have also been getting better gas mileage. All in all, POWER SEAL turned out to be just about the best investment we ever made. It paid for itself in two weeks and has been saving money for us ever since, to say nothing of postponing the cost of major overhauls that would have run into real money." *Town Taxi, Douglasson, N. Y.*

#### SEND NO MONEY!

Simply send the coupon and your Power-Seal injection will be sent to you at once C.O.D. plus postage and handling charges. Or, to save the postage and handling charges, simply enclose full payment with the coupon. For 6-cylinder cars order the Regular Size, only \$4.95. For 8-cylinder cars order the Jumbo Size, \$7.95. Power-Seal is now available only by mail from us. Send the coupon at once.

**RUDSON AUTOMOTIVE INDUSTRIES, Dept. 214**  
24 East 67th St., New York 21, N. Y.

Please send me ..... tubes of the amazing new POWER SEAL.

Regular Size, for 6-cyl. cars, \$4.95     Jumbo Size, for 8-cyl. cars, \$7.95

On arrival, I will pay the postman the price indicated above plus postage and delivery charges. I must see an immediate improvement in the pep and power of my car, less oil consumption, greater gas mileage, reduced engine noise, easier starting, faster pickup, within 30 days, or you will refund my full purchase price.

Name .....

Address .....

City ..... Zone ..... State .....

Save More! Send cash, check, or money order with coupon and we pay all postage charges. Same money-back guarantee.

IN CANADA: 6355 PARK AVE., MONTREAL 15, P. Q. — ADD 55 CENTS



# C. T. C. TRAINING IN DRAFTING

PREPARES FOR  
PROMOTION  
•  
MORE MONEY  
•  
SUCCESS



"Here I am at work making good money as a draftsman. I'm glad I sent the coupon to Chicago Tech for that Free Trial Lesson and found out how easy it is to learn Drafting in spare time at home. Today, I feel secure in my job. What's more, I feel I'm slated for promotion and more pay."

## LEARN IN SPARE TIME—AT HOME!

(or at the College in Chicago)

A few hours of pleasant home study every week—that's all. All the tools you need; drawing outfit included. This tested method—developed over 49 years of C.T.C. progress—prepares men quickly for good positions in industry.



### FREE INFORMATION—SEND COUPON

To prove to you how easy it is to learn Drafting at home, we will send you this FREE TRIAL LESSON. Mail coupon or send post card today.

## CHICAGO TECHNICAL COLLEGE

A-252 Tech Bldg., 2000 So. Michigan Ave.  
Chicago 16, Illinois

Mail me FREE Lesson with information about big opportunities in DRAFTING.

Name \_\_\_\_\_ Age \_\_\_\_\_

Address \_\_\_\_\_

City \_\_\_\_\_ Zone \_\_\_\_\_ State \_\_\_\_\_

## ENGINEERING DEGREE IN 27 MONTHS

### Big Demand for Graduates

**Aeronautical, Chemical, Civil, Electrical, Mechanical and Radio Engineering (inc. TV and Electronics)**

Hundreds of young men are earning B. S. ENGINEERING DEGREES annually in this recognized institution — year around operation. New terms start quarterly. Many students earn a major part of their college expenses in this large industrial center.

Low tuition. Competent instruction. Thorough, intense, practical program. Modern, well-equipped laboratories including new physics laboratory and modern wind tunnel. Individualized instruction emphasized.

Government approved for G.I.'s. Engineering preparatory courses. Students from 48 states and 21 foreign countries. Enter March, June, September, December. Send coupon for free catalog and full information. Enroll now.

SEND COUPON TODAY

## INDIANA TECHNICAL COLLEGE

514 E. Washington Boulevard  
Fort Wayne 2, Indiana

Please send me free information on B.S. Engineering Degree in 27 months as checked.

Aeronautical,  Chemical,  Civil,  Electrical,  
 Mechanical,  Radio-Television

Name \_\_\_\_\_

Address \_\_\_\_\_

## Super All Channel TV RECEPTION Powerful IN ALL DIRECTIONS

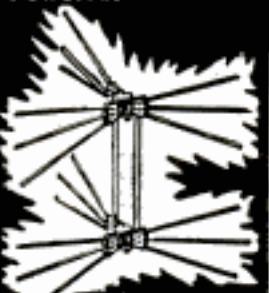

### Rocket DIRECTRONIC MOTORLESS TV ANTENNA

- 360° Electronically Switched Beam
- No Motors
- No Roof
- Orientation
- No Electric Power
- No Ghosts
- Flick of Switch Clears Picture Instantly

In the city or in an ultra-fringe area, the Directronic will outperform ordinary antennas. Only the Motorless 360° Directronic TV Antenna offers "around the compass" reception WITHOUT Rotors. Clarity of picture well amaze, it's so bright, so sharply defined. AX-599 "Serviceman's Army" contains Hi-Pac molded insulator of extremely high tensile strength, 18 hi-tensile aluminum alloy elements, 1 set of connecting stubs (3), Universal U-Clamps for masts to 1 1/2", Directronic Beam Selector, 75 feet of Tri-X Cable.

Do not remit more than complete purchase price. 25% deposit on C.O.D. orders, please. Money-back guarantee.

NATIONAL ELECTRONICS OF CLEVELAND 3, OHIO  
301 DELCO BLDG. CLEVELAND 3, OHIO

## AVIATION Pays You More With a Schooling at PARKS

### NOW! A&E MECHANIC LICENSE COURSE

45-week course, all phases aircraft & engines.

Start Jan. 4, 1954

**FLIGHT COURSES**—Private, Commercial, Instrument, Instructor, Multi-Engine.

**DEGREE COURSES**—B.S. degree in 3 yrs. from Saint Louis University — Aero. Engineering, Maint. Engineering, Aero. Administration.

All Parks Schooling Approved for Veterans  
Write Today.

## PARKS COLLEGE ARNOLD HALL EAST ST. LOUIS, ILL.

## "How to Make Money with Simple Cartoons"



A book everyone who likes to draw should have. It is free; no obligation. Simply address

FREE BOOK

CARTOONISTS' EXCHANGE  
Dept. 91D Pleasant Hill, Ohio

## REAL ESTATE BE A BROKER

PAY BIG! SEND FOR FREE, BIG, ILLUSTRATED CATALOG NOW! Graduates report making substantial incomes. Start and run your own business quickly. Men, women of all ages, learn easily. Course covers Sales, Property Management, Appraising, Loans, Mortgages, and related subjects. STUDY AT HOME or in classrooms in leading cities. Diploma awarded. Write TODAY for free book! No obligation.

FREE BOOK TELLS HOW

Approved for World War II and Korean Veterans  
WEAVER SCHOOL OF REAL ESTATE (Est. 1938)  
Suite 300 Law Bldg. Dept. PM Kansas City, Mo.

## LEATHERCRAFT THE "HE-MAN" HOBBY



Make Leather Items for Gifts, to Sell, or for Your Own Use

Get started now. LARSON Beginners' Kits of ready-cut projects require no tools or experience. Free instructions included. Make belts, gloves, moccasins, billfolds, woolskin animals and mittens, other attractive leather items. Also America's most complete stock for advanced hobbyists and professional craftsmen. SEND 10c TODAY for big illustrated catalog. J. C. LARSON CO., 820 So. Tripp Ave. Dept. 3127, CHICAGO 24, ILLINOIS



# THEY MAILED THIS COUPON

... and look what I did for them!



"My arms increased 1 1/2"; chest 2 1/2"; forearm 1 1/2".  
—C.W., W. Va.



"Gained 2" in neck; 1 1/2" in biceps. Never felt better in my life."  
—J.S., Calif.



T.M., Atlas Cup Winner. "I'm proud of the way you made me an Atlas Champion."



A.H.,—Kans.—Atlas Cup Winner.

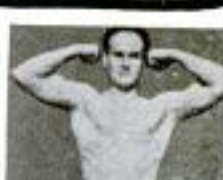

"I surprise my friends by out-lifting them."  
D.P., Ind.



"When I started your course I weighed only 141. Now weigh 170."  
—T.K., New York.



"Here's my photo showing just how I look today. I owe it all to you."  
—W.D., New York.



"Have put 3 1/2" on chest (normal), 2 1/2" expanded."  
—F.S., N.Y.



CHARLES ATLAS,  
115 East 23rd St., New York 10, N. Y.

**You MAIL THE COUPON BELOW AND I'll Prove I Can Make YOU a New Man!**

**My Secret Method Has Done Wonders For Thousands—Here's What I'll PROVE It Can Do For YOU—In Just 15 Minutes A Day!**

JUST MAIL the coupon below. Read my free book. And then give me 15 minutes a day. That's all I ask. I'll prove you can have the kind of body that your friends will admire. *There's no cost if I fail!*

I don't care how old or young you are, or how-ashamed of your present physical condition you may be. If you can flex your arm I can add SOLID MUSCLE to your biceps—in double-quick time! I can broaden your shoulders, strengthen your back; add inches to your chest, give you a vise-like grip, make those legs of yours powerful; shoot new strength into your backbone, exercise those inner organs, cram your body full of vigor and red-blooded vitality!

scal specimens—my way. No gadgets or contraptions. You simply use the DORMANT muscle-power in your own God-given body—watch it increase double-quick into solid MUSCLE.

"Dynamic Tension" is easy! Only 15 minutes a day in your own home. You can use "Dynamic Tension" almost unconsciously every minute—walking, bending over, etc.—to BUILD MUSCLE and VITALITY. You'll be using the method which many great athletes use—fighters, wrestlers, baseball, football players, etc.

**FREE Illustrated 32-Page Book Not \$1 or 10c—but FREE**

SEND NOW for my famous book, "Everlasting Health and Strength." (Over 3 1/2 MILLION fellows have sent for it already.) 32 pages, packed with actual photographs, valuable advice. Shows what "Dynamic Tension" has done for others. answers many vital questions. Page by page it shows what I can do for YOU.

This book is a real prize for any fellow who wants a better build. Yet I'll send you a copy absolutely FREE. Just glancing through it may mean the turning point in your whole life! Rush coupon to me personally: CHARLES ATLAS, Dept. 8A, 115 East 23 St., N.Y. 10, N.Y.

Send me—absolutely FREE—a copy of your famous book, "Everlasting Health and Strength"—32 pages, crammed with actual photographs, answers to vital health questions, and valuable advice. I understand this book is mine or it does not obligate me in any way.

Walter Age 18  
Case print or write plainly  
Cedar Street  
Halls Zone No. State N.Y.  
(if any)  
YOU USE COUPON BELOW

*Charles Atlas*

Awarded the title of "The World's Most Perfectly Developed Man" in an international contest.



**SILVER CUP GIVEN AWAY**  
Over a foot high! Will be given to pupil who makes greatest physical improvement in next 3 months.

CHARLES ATLAS, Dept. 8A,  
115 East 23rd St., N. Y. 10, N. Y.

Send me—absolutely FREE—a copy of your famous book, "Everlasting Health and Strength"—32 pages, crammed with photographs, answers to vital health questions, and valuable advice. I understand this book is mine to keep, and sending for it does not obligate me in any way.

Name.....Age.....  
(Please print or write plainly)  
Address.....  
City.....State.....

**ARE YOU SKINNY?**  
Weak, run down? Always tired? Nervous? Constipated? Fat and flabby? Want to lose or gain weight? WHAT TO DO ABOUT IT is told in my FREE BOOK.

**WHAT'S MY SECRET?**  
"DYNAMIC TENSION!" That's the ticket! The identical natural method that changed me from a 97-lb. weakling to the world's champion! Thousands are becoming marvelous phys-







**YOU  
can  
acquire**

**LAW NIGHTS AT HOME!  
L. B. DEGREE**

LaSalle's famous Law Library—used as reference in many Law libraries and Law offices—has enabled thousands to master Law surprisingly fast, in spare hours at home, for business and professional advancement.

These 14 remarkable volumes, compiled by leading professors and lawyers, cover the whole basic field of Law in condensed, orderly, simplified manner.

You advance rapidly with this great library, plus special lectures furnished. We guide you step-by-step with personalized Problem Method of instruction . . . you *learn by doing*—handling legal problems—not by memorizing rules.

Send for two FREE 48-page booklets, "Law Training for Leadership," and "Evidence," answering questions about Law and its value to you, and telling how LaSalle Law graduates are winning rapid advancement in business and public life. Mail coupon below. No obligation.

**LA SALLE EXTENSION UNIVERSITY  
A Correspondence Institution**

417 S. Dearborn St. Dept. 164L Chicago 5, Ill.

Send me your two FREE booklets described above, without obligation.

Name.....Age.....

Street.....

City, Zone & State.....

**OPPORTUNITY  
FLORIDA**  
*for you in*

**YOU ARE IN DEMAND...**

Whether you are highly skilled or completely untrained, there's opportunity for you in Florida today.

**WANTED...MEN AND WOMEN!**

Secretaries...office clerks... nurses... hotel employees... truck drivers... waiters and waitresses... hotel detectives... night watchmen... and over 150 other positions...

Don't delay! Send \$1.00 today for information on who to contact for work in Florida.

**Col. CHAS. G. GROTE** Personnel Consultant  
Dept. PM, P.O. Box 2281, Miami, Fla.

**INVENTORS**

IF YOU WISH TO PROTECT YOUR INVENTION, You should take steps to protect it by a U. S. Patent. Write me for "INVENTION RECORD" form

**CARL MILLER**  
REGISTERED PATENT ATTORNEY

WOOLWORTH BLDG., 35th FLOOR, 14A  
NEW YORK CITY

**PATENTS**  
**C. A. SNOW & CO.**  
REGISTERED PATENT ATTORNEYS  
WRITE FOR INFORMATION TO  
428 SNOW BUILDING, WASHINGTON 1, D. C.

**INVENTORS**

Whether an invention is patentable can be substantially determined by a search of the U. S. Patent records. Without obligation, write for information explaining the steps you should take to secure a patent.

**JOHN N. RANDOLPH**

Registered Patent Attorney  
201 Columbian Building, Washington 1, D. C.

**YOU CAN BUILD A VIOLIN  
FOR PLEASURE OR PROFIT**



Now you can build a rich toned mellow viola modeled after a famous "Strad." **YOU CAN MAKE A STRADIVARIUS VIOLIN** contains 8 full scale plans plus complete instructions. You work directly from the plans with no confusing scale of dimensions to translate. Detailed instructions for each step including varnishing and stringing—even shows how to build your own tools. Cloth bound. Order today from  
**POPULAR MECHANICS PRESS . . . \$3.50**  
200 EAST ONTARIO STREET, CHICAGO 11, ILLINOIS

**INVENTORS**

Send for **REGISTERED PATENT ATTORNEY**  
**PATENT INFORMATION** Book and **INVENTOR'S RECORD** without obligation  
**GUSTAVE MILLER**  
14-PM WARNER BUILDING  
WASHINGTON 4, D.C.

**PATENT ATTORNEY & ADVISOR**  
U. S. NAVY DEPT. 1930-1947  
**ASSOCIATE EXAMINER**  
U.S. PAT. OFF. 1922-1929  
**PATENT LAWYER**

**INVENTIONS  
WANTED**

If you want to market, or sell, your invention for cash or royalties. Write for our Free Booklet. Send no drawings. We also welcome hearing from firms, or private capital, wishing to review inventions in any field. We will be glad to send notice of our clients' inventions.

**GLOBAL MARKETING SERVICE**  
1404 Mitchell Street Dept. PD Oakland 1, Calif.

**INVENTORS**

I shall be pleased to furnish you, upon request, with full information relative to patent procedure—without any obligation on your part.

**PATRICK D. BEAVERS**  
Registered Patent Attorney  
934 Columbian Building Washington 1, D. C.

POPULAR MECHANICS





**TURN RIGHT**

# Get on the Road to a Better Job-Brighter Future with **RIGHT** Training — then You Can Really GO!

**AMERICAN SCHOOL, Dept. G145, Drexel at 58th, Chicago 37, Ill.**

Without obligation, please send FREE and postpaid, full particulars about the subject checked below.

- |  |   |   |
|--|---|---|
| <input type="checkbox"/> Accounting              | <input type="checkbox"/> Drafting—Building Trades | <input type="checkbox"/> Plastics Engineering |
| <input type="checkbox"/> Air Conditioning        | <input type="checkbox"/> Drafting—Machine Trades  | <input type="checkbox"/> Plumbing—Practical   |
| <input type="checkbox"/> Architecture & Building | <input type="checkbox"/> Electrical Engineering   | <input type="checkbox"/> Private Secretary    |
| <input type="checkbox"/> Automotive Technician   | <input type="checkbox"/> Electricity—Practical    | <input type="checkbox"/> Refrigeration        |
| <input type="checkbox"/> Better Foremanship      | <input type="checkbox"/> Electronics—Industrial   | <input type="checkbox"/> Retail Merchandising |
| <input type="checkbox"/> Bookkeeping             | <input type="checkbox"/> High School Courses      | <input type="checkbox"/> Salesmanship—Outside |
| <input type="checkbox"/> Business Management     | <input type="checkbox"/> Machine Shop Operations  | <input type="checkbox"/> Sheet Metal Work     |
| <input type="checkbox"/> Contracting             | <input type="checkbox"/> Mathematics & Slide Rule | <input type="checkbox"/> Tool Making          |
| <input type="checkbox"/> Diesel Technician       | <input type="checkbox"/> Mechanical Engineering   |   |

NAME \_\_\_\_\_ OCCUPATION \_\_\_\_\_  
HOME ADDRESS \_\_\_\_\_ AGE \_\_\_\_\_  
CITY \_\_\_\_\_ STATE \_\_\_\_\_

**START NOW** by checking, filling in and mailing this coupon.  
**You'll get full information — No cost, No obligation!**

• Today, make the BIG decision of your life. Choose the career you want and take the first easy step toward your goal. Learn how you can get the training that can put you in the bigger pay class and give you security in the years ahead. Find out how, in spare time at home, you can qualify for work you prefer, and higher pay. Or if you are already in the work you like, find out how you can win quicker promotion and a larger income.

### **Backed by 57 Years of Training Know-How**

Since 1897 American School has helped many thousands of ambitious people toward success by providing specialized training for

commercial and technical advancement. Its study program for you has been prepared by experts in the subject you select and the school will give you guidance every step of the way. In time you might otherwise waste and at a cost you can afford you can prepare at home and really GO on the right road.

### **Don't Delay YOUR Start**

Give serious thought to the list of training courses listed above. Pick the opportunity that interests you, check it and add your name and address. (Check more than one if you are undecided which appeals most.) Then clip and mail the coupon. Full information will be supplied without cost or obligation.

**PRACTICAL, EFFECTIVE HOME STUDY TRAINING SINCE 1897**

**AMERICAN SCHOOL, Dept. G145, Drexel at 58th, Chicago 37, Ill.**

**THE SOONER YOU START, THE SOONER YOUR GOAL CAN BE REACHED**



# WANTED MILLION DOLLAR IDEAS

AS  
SIMPLE  
AS

JELL-O   
BAND-AID Adhesive Bandages  
PAPER CLIPS   
ZIPPER   
KLEENEX  
GILLETTE   
SAFETY RAZOR

## AMAZING NEW BOOK TELLS HOW YOU CAN FIND IDEAS...How to Sell Them

THE world is actually waiting to pay fortunes to men and women who fill all kinds of needs. No matter whether you have technical skill, mechanical aptitude—or no skill at all—vast opportunities await you. You have but to know how to find them, and how to make use of them. This book will prepare you. Remember what Abraham Lincoln said, "I will study to prepare myself, and my opportunities MUST come." If you will use the secrets disclosed in this book, the road to wealth lies before you!

**How to Develop Your Hidden Power**  
Success—big success—is not a rarity by any means. Hundreds of thousands of men and women throughout history have discovered the secret of attaining confidence and wealth. But once they have found it, they usually keep it secret or pass it on only to their families. There is no room for secrecy today! America NEEDS to have more people enjoy Financial Security and Self-Confidence. This book reveals the way it can be done by any person of ordinary intelligence, no matter what his or her background or present position may be! Is Capital Needed? NO! Is Your Job a Handicap? NO! Is Religion, Race or Family Situation a Handicap? NO!



READ IT FREE FOR 10 DAYS

Simon and Schuster, Dept. E  
20 W. 47 Street, New York 36, N. Y.

Please send me "How to Attain Financial Security and Self-Confidence." I will deposit with the postman \$2.95 plus few cents postage. If I am not delighted in 10 days, I'll return book for full refund.

Name.....

Address.....

City.....

State.....

City.....

State.....

City.....

State.....

City.....

State.....

City.....

State.....

City.....

State.....

City.....

State.....

City.....

State.....

City.....

State.....

City.....

State.....

City.....

State.....

City.....

State.....

City.....

State.....

City.....

State.....

City.....

State.....

City.....

State.....

City.....

State.....

City.....

State.....

City.....

State.....

City.....

State.....

City.....

State.....

City.....

State.....

City.....

State.....

  
Harold Shafer  
who made a  
great success  
of Glass Wax,  
Snowy Bleach.

  
Nelson Harris,  
only 33 when  
he sold "Tom  
Home Perma-  
ment" for \$20  
million.

  
Leo Godowsky  
and Leo Mannes,  
young camera  
enthusiasts.  
Created Kodachrome film  
and made fortunes.

## BE A HIGH-PAID MAN IN YOUR COMMUNITY WITH THIS LONG NEEDED INVENTION

Earn up to \$10,000 or more per year! Nothing to invest! Be your own boss!

U.S. Pat.  
D. 153853-  
D. 153854

A worldwide product needed by every home, business and farm... priced to sell quickly at long profit! Automatic Red Comet goes into action as soon as fire starts... smotherers fire without human aid. It's a sales 'natural'!



### FREE SALES KIT

Demonstrator units, sales literature, etc., furnished you FREE. Handsome leather-type kit. Tried and proved, it will make you an independent businessman. ACT NOW! Someone in your community will be appointed soon. Write for details, today!



## RED COMET, INC.

Dept. 334-H, R.C. Bldg., Littleton, Colo.



## SEND FOR THIS FREE!

Make money. Know how to break and train horses. Write today for this book FREE, together with special offer of a course in Animal Breeding. If you are interested in Galting and Riding the saddle horse, check here ( ) Do it today—now.

BEERY SCHOOL OF HORSEMANSHIP  
Dept. 1101 Pleasant Hill, Ohio

## THE KEY TO POWER

Life is law and never luck!

Create the future you desire by learning to control your subconscious mind. Free booklet. Write to

### KEY TO POWER

Dept. PM, 7321 Beverly Blvd. Los Angeles 36, Calif.

## MONEY in DONUTS

Make new pressureless donuts. Start in kitchen. No smoke. Sell stores. Cash daily. No experience necessary. Free recipes. No obligation. Write! MARTIN RAY CO., 3605 SO. 15th AVENUE, MINNEAPOLIS 7, MINN.

## BECOME AN EXPERT IN

# TRAFFIC

Traffic men earn \$4,000 to \$10,000 and up. Thousands of firms need experts on rates, tariffs, regulations. We train you thoroughly in spare time at home for executive traffic jobs. Personal training under traffic authorities. Placement counsel and help. Write for free 48-page book "Traffic Management—the Fast Growing Profession."

LASALLE Extension University, 417 So. Dearborn St.  
A Correspondence Institution Dept. 1647 Chicago 5, Ill.

## Say You Saw It in Popular Mechanics



## INSURED TIRE SERVICE POPULAR BRANDS

FREE INSURANCE POLICY given with each used tire sold. We guarantee the amount of service you pay for.

Tube Given Free with Each Used Passenger Tire Upon Request

SPECIAL! 10% off on orders for two or more used tires

YOU CAN'T LOSE!!

Super Quality — Rugged Performance — 15 Months Insured Service			
600x16	\$4.55	670x15	\$5.25
650x15	4.95	670x16	5.35
650x16	5.45	700x15	5.40
700x16	5.55	710x15	5.45
760x15	5.45	760x16	5.95
820x15	6.45	820x16	6.45
850x17	4.75		

Supreme Quality, Nothing Finer — 30 Months Insured Service			
450x20	5.95	450x21	6.25
600x16	6.65	650x16	6.75
650x16	6.85	670x15	6.95
700x16	7.75	700x15	6.75
750x16	12.50	710x15	6.50
550x17	5.75	760x15	6.95
525x18	5.45	820x15	7.50
640x15	5.75	475x19	5.75
700x15(0)	10.45	750x16(0)	15.95
800x20	10.95	900x20	10.95
1000x20	11.75	1000x20	20.45
1100x20	12.50	1100x20	26.75
1000x22	11.95	1000x22	19.80
1100x22	12.75	1100x22	24.75
1200x20	14.50	1200x20	23.50
1100x24	21.50	1100x24	32.75

MIDLAND  
TIRE SALES

Speedy shipments on Mail Orders. F.O.B. Chicago. Insurance policy sent with each order. Deduct 10% on orders for 2 or more used tires. Send CHECK or MONEY ORDER.—No COD's. 449 W. 37th St., Dept. PM-18, Chicago 9, Ill.

POPULAR MECHANICS

Copyrighted material

## MECHANICAL DENTISTRY

A profession offering unlimited opportunities. Most modern and complete course embracing every branch from Plate to Porcelain Work, which prepares you to work for Dentists or start your own business. Individual instruction—practical training in day or night school. No books—no classes. Catalog upon request. McCARRIE SCHOOL OF MECHANICAL DENTISTRY, 207 N. Broad Street Dept. 25 Philadelphia 7, Penna.

## New Low Cost Electric Water Heater Gives You



## HOT WATER AUTOMATICALLY From Your Present Tank!

- No dirt, grime, soot, flame!
- SAFE! Every part UL approved!
- Install in 10 Minutes, or less!
- No new tanks or plumbing!
- Works automatically, saves fuel.

New, UL approved LECTROMATIC changes gas, coal or oil-burning water heater into modern ALL-ELECTRIC unit! Turns on automatically when water is heated. To install, simply shut off water. Remove plug from water tank. Screw move plug from water tank. Plug into 110 volt outlet.

Complete—Ready to Plug In — Only \$19.95

LECTROMATIC into opening (as shown), then PLUG IN 110 volt outlet. Uses 1250 watts. Plenty of hot water all day long. Uses only 1/4-c.c. electricity per gal. of hot water. Temp. adjustable from 100 to 180 degrees. Only \$19.95 C.O.D. plus shipping or send check or money order for \$19.95 now and we pay shipping. (Also 220 V., 2000 W. model \$21.95). Money back in ten days if not delighted. Pull one year guarantee! ORDER NOW!

COLLOID EQUIPMENT CO., INC. Dept. PM-1, 10 MURRAY STREET NEW YORK 7, N. Y.



# \$15.20 an hour!

This is the average earning reported by Presto salesman WILLIAM F. WYDALLIS. "The sky's the limit" on Presto profits because of America's serious need for this new fire extinguishing discovery.



WILLIAM F. WYDALLIS

"Most specialty salesmen are always on the lookout for a 'natural.' The 'natural' of this decade is the PRESTO FIRE EXTINGUISHER... because it is handy in size, simple to operate, and in the right price range.

"For every hour I have devoted to the Presto, I find that I have earned an average of \$15.20 an hour. I am now convinced that extraordinary money can be made in this safety field. I am devoting more of my time to this product now since I have discovered that the earnings on this item are greater than any item I have handled in the past."

William F. Wydallis  
Van Wert, Ohio

WOULDN'T YOU like to be making the kind of money William F. Wydallis is making? His story (printed at right) is just one example of the brilliant success that Presto salesmen are meeting everywhere! A Florida salesman earned \$600 in one month. An Ohio man earned \$2100 in 2 months. A New York salesman earned \$1500 in one month. A New Hampshire salesman added the Presto as a *sideline* and picked up an extra \$1800 in 20 months.

### Almost Two Million Sold!

PRESTO contains an amazing new chemical "Chlorobromomethane" or "C.B." developed as a secret defense against fire during the war.

In comparing the effectiveness of "C.B." in fighting various kinds of fires an authoritative testing laboratory states: "It has been proved that 'C.B.' is about 1.5 to 6 times as effective as other common extinguishing agents on an equal weight basis."

This extra effectiveness of "C.B." means that Presto can be made light and handy enough for even a woman or child to use. Just a twist of the knob... and flames disappear! "Sells on sight" to civil defense workers, owners of homes, cars, stores, farms, service stations, boats, motorcycles, factories, offices and to stores for re-sale.

### Why Large Presto Profits Are So Easy

Everyone is terrified at the very thought of FIRE! Every year fire kills more than 11,000 people. Most people who see Presto in action want one or more — ESPECIALLY WHEN THE PRICE IS ONLY \$3.98 EACH!

You can demonstrate Presto in a few minutes, and every sale will net you \$1 or more. We refill your demonstrator free... and we give you dramatically powerful printed sales material to "talk from"... free certificates testifying that Presto is GUARANTEED FOR 20 YEARS.

YOU DON'T NEED TO INVEST A PENNY. Just collect and keep \$1 or more every time you write an order—we collect the balance and deliver the extinguisher. (Or if you wish, you can buy from us at extra-low wholesale prices and then make up to \$2.18 profit per unit supplying both dealers and retail customers — we'll send you free details.)

### Start Now — Mail Coupon

Get started in this rich new field now. Don't "put it off"! Every day you hesitate may cost you \$10, \$15, or even \$50 you could otherwise be making. Mail the coupon at right NOW for everything you need to get started right away!

MERLITE INDUSTRIES, Dept. 51, 114 East 32 Street, New York 16, N. Y.

Best Selling Months Just Ahead! Don't Delay — Mail Coupon Now!

MERLITE INDUSTRIES, Dept. 51  
114 East 32 Street, New York 16, N. Y.

Please send me illustrated sales literature, liberal profit plan, order blanks—everything I need to get started making good money introducing the Presto Fire Extinguisher in my locality.

CHECK HERE IF YOU WISH TO ORDER A REGULAR PRESTO TO BE USED AS A DEMONSTRATOR (\$2.50). Pays for itself many times over in increased sales. Can be returned as often as you like for FREE re-fill. You needn't enclose any money now—we'll send Demonstrator C.O.D. (Or if you wish to save money, enclose \$2.50 and we'll pay postage.) Money back if not delighted.

Name.....

Address.....

Zone No. (if any)..... State.....

City.....

IN CANADA: Moga Co., Ltd., 371 Dowd Street, Montreal 1, P.Q.

Folks Are Amazed when you Tell Them This New Kind of Protection Costs Only \$3.98

ADVERTISED IN LIFE



### Only Presto Has All These Features!

- Ends Fire as Fast as 2 Seconds
- Chemical Contents 1.5 to 6 Times More Effective than Others on an Equal Weight Basis
- Weighs Less Than 1 Lb.
- Easily Held in One Hand—Even by a Child
- Needs No Inspection or Re-Charging — Does Not Corrode or Deteriorate
- Costs Only \$3.98—Yet Out-Performs Bulky Extinguishers Costing Several Times as Much
- Automatic Pressure — No Pumping
- Guaranteed for 20 Years — Certificate is Packed with Every Presto





**START AS HIGH AS  
\$3,795.00 A YEAR**

**Veterans Get Special Preference  
Get Ready Now for Next Examinations  
in Your Vicinity**

**City Mail Carriers, Post Office Clerks**

Clerks and Carriers now get \$3,270.00 the first year of regular employment and automatically increase \$100 a year to \$4,070.00. Open to Men—Women, 18 to 50. Clerks and Carriers can be promoted to other positions paying as high as \$8,437.00.

**Railway Postal Clerks**

Railway Postal Clerks get \$3,470.00 the first year of regular employment, being paid on the first and fifteenth of each month. (\$144.58 each pay day.) Their pay is automatically increased yearly to \$4,270.00. Advance may be had to Chief Clerk at \$6,565.00 a year. (\$273.54 each pay day.) Men 18-50 only.

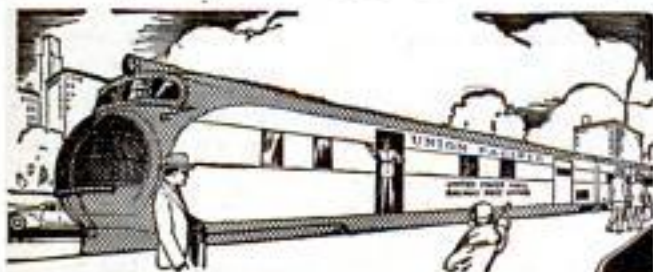

**3 Days On—3 Days Off—Full Pay**

Railway Postal Clerks on long runs usually work 3 days and have 3 days off duty or in the same proportion. During this off duty their pay continues just as though they were working. They travel on a pass when on business. When they grow old, they are retired with a pension.

**Many Other Positions**

Many other positions are obtainable. Rural Carriers — Stenographers — Typists — Patrol Inspectors — Meat Inspectors — etc. Those wishing these positions should qualify at once.

**Get Free List of Positions**

Fill out the following coupon. Tear it off and mail it today —NOW—at once!

Although not government controlled, this can result in your getting a big paid government job.

**FRANKLIN INSTITUTE, Dept. H-84, Rochester 4, N. Y.**

Rush to me, entirely free of charge (1) a full description of U. S. Government Jobs; (2) Free copy of illustrated 36-page book, "How to Get a U. S. Government Job" with (3) List of U. S. Government Jobs; (4) Tell me how to qualify for one of these jobs.

Name \_\_\_\_\_

Street \_\_\_\_\_

City \_\_\_\_\_ Age \_\_\_\_\_

**Use This Coupon Before You Mislay It. Write or Print Plainly.**

**LOW OVERHEAD—LARGE VOLUME SALES & SMALL PROFITS  
BRING YOU THESE "LOWEST PRICES!"  
WHAT GOOD IS A TIRE WITHOUT A TUBE?  
TUBE FREE WITH EVERY TIRE AT NO EXTRA COST**

**WHY PAY MORE!**

AN ESTABLISHED POLICY OF CAREFUL SELECTION ASSURES YOU, MANY HAPPY MILES. BE WISE—TRY ONE—YOU'LL BUY MORE! WE WELCOME COMPETITION. NO ONE CAN TOUCH OUR QUALITY & PRICE!

**YOU GET WHAT WE ADVERTISE**

GOOD USED TIRES — NOT RECAPS — NOT RETREADS

**WINTER SPECIALS—SEND THIS AD**

EVERYBODY MAY TAKE **10% off** ON EVERY TIRE

**20 MONTHS WRITTEN GUARANTEE**

600-18 \$3.42	820-15 \$4.82	600-20 \$6.52	32x8 (8) \$8.02
650-16 4.12	700-13 3.82	890-20 7.02	32x8 (10) 9.02
700-16 4.32	670-15 3.82	700-20 7.92	900-20 13.22
650-15 3.72	710-15 4.12	750-20 8.02	1000-20 13.12
780-15 4.32	850-17 4.32	825-20 13.02	1100-20 13.02

Specialists in Truck Tires—Selected for Toughest Jobs—Tops in Value

EXTRA SPECIAL—30 MONTH WRITTEN GUARANTEE—FREE TUBE	600-15 \$5.12	475-19 \$4.72	700-15 (6) \$8.52	700-20 \$10.82
600-16 (6) 6.32	640-15 4.82	750-16 (8) 10.82	750-20 (10) 13.32	
650-16 5.62	670-15 5.32	700-17 9.82	750-20 (8) 11.02	
650-16 (6) 7.22	710-15 5.42	750-17 11.62	825-20 18.02	
700-16 6.12	760-15 5.82	750-15 10.52	900-20 17.02	
750-16 (6) 8.62	800-15 6.32	825-18 12.62	1000-20 17.52	
825-18 4.62	820-15 6.32	800-20 8.52	1100-20 17.02	
850-17 4.62	670-15 6.22	820-20 9.22	1100-22 18.32	
850-15 4.92	760-16 7.12	32x8 (8) 11.02	1100-22 18.22	
700-15 5.22	700-16 (6) 7.32	32x8 (10) 13.12	1100-24 19.62	

ALL WHITE WALLS \$1.00 extra (Military treads)—750x20—\$14.02

Thousands of tires shipped all over U.S.A. All tires shipped F.O.B. Phila. Send Check or M.O. with this ad. Dept. 2.

**STANDARD 834 N. Broad St., Philadelphia 30, Pa.**

**RUPTURED?**  
**Get Relief This Proven Way**

Why try to worry along with trusses that gouge your flesh—press heavily on hips and spine—enlarge opening—fail to hold rupture? You need the Cluthe. No leg—straps or cutting belts. Automatic adjustable pad holds at real opening—follows every body movement with instant increased support in case of strain. Cannot slip whether at work or play. Light. Waterproof. Can be worn in bath. Send for amazing FREE book, "Advice To Ruptured" and details of liberal truthful 60-day trial offer. Also endorsements from grateful users in your neighborhood. Write:

**CLUTHE SONS, Dept. 31, Bloomfield, New Jersey.**

**TURN FUN INTO MONEY**

BOOKLET TELLS HOW—H. I. A. is helping thousands to cash in on their hobbies by turning them into profitable home industries. Send \$1.00 for year's membership, descriptive booklet and credentials. Dept. H-3, Home Industries Assn. 1727 K St. N. W., Wash. 4, D. C.

**FREE Big NURSERY CATALOG**  
with 999 special offers

Send for America's most unusual nursery catalog. Special dollar-saving collections. Old favorites... rare varieties. 48 value-packed pages. Roses, mums, bulbs, fruit, shrubs, etc.—all guaranteed, all gov't inspected. Write today.

105th YEAR

Spring Hill Nurseries, Dept. L-21, Tipp City, Ohio

**BOYS BUILD YOUR OWN CRYSTAL RADIO**

It's easy and lots of fun to build your own crystal radio set. You need no batteries or tubes when you use a "Melomite" Crystal and detector. Wonderful performance. "Melomite" crystal and detector with instructions and plans for building your own Crystal radio set—All for only 60c post-paid. Rush your order today, immediate delivery.

**ALVA ALLEN RADIO, Dept. PM-51, Clinton, Mo.**

**GIANT BALLOONS**

Surplus U. S. Gov't. (new—overage) NEOPRENE weather target balloons. For FUN or PROFIT. Great sport in the backyard; or for parties, picnics, dances, fairs. MONEY-MAKERS. Use these balloons to attract crowds to civic events, conventions, exhibitions, trade shows. TERRIFIC for high school and college PROMS. All sizes—see approx. inflated sizes. Postage prepaid on prepaid orders.

3 ft. dia. 49c—6 ft. dia. 99c—13 ft. dia. \$1.59

20 ft. dia. \$1.95

\* Calif. residents please add sales tax.

**WAR ASSETS DIV. VOLUME SALES CO.**

Dept. M-1-54 3930 Sunset Blvd., Los Angeles 29, Calif.



**TRAIN FOR GOOD PAY IN A FIELD THAT ISN'T CROWDED!**



**NOW!** you can  
**LEARN ELECTRIC MOTOR REPAIR**  
 ... A good-paying, modern profession



**OPPORTUNITIES EVERYWHERE!**

Don't drift into a rut! Don't train for something that everybody and his brother are studying! Consider the facts. . . . The average small home has at least 11 electric motors! Big homes have many more—in phonographs, recorders, oil burners, refrigerators, washers, fans, clocks, mixers, cleaners, air conditioners, etc., etc. Millions more in office, industrial, mining, and transit equipment. Be the well-paid expert who can keep them working!

**FREE STUDY GUIDE**

A unique Study Guide booklet of 500 practical motor study questions—priced and sold separately at 25¢—is yours FREE with your request to examine **ELECTRIC MOTOR REPAIR** book. Makes learning easier—speeds up the work! See coupon.



**... for only \$6**  
**FOR THE COMPLETE TRAINING**

Every day, more and more electric motors and motor control systems are being used BOTH in industry and in home appliances. The expert who can install and keep them working properly is a valuable man in this Electrical Age. The pay is surprisingly good. The field is tremendous—and growing rapidly. Trained men find opportunities everywhere for full or part time work. **ELECTRIC MOTOR REPAIR**, the big 560-page training course book teaches you the work step by step—quickly and easily—at home in spare time. There is no other book like it. Ideal for beginners or for actual bench use in busy shops. Thousands already in use in leading vocational schools, shops, and for home study.

**SHOWS YOU HOW . . . Every Step of the Way!**

Based on what you can learn quickly at home from **ELECTRIC MOTOR REPAIR** you can train for prompt, profitable installation, servicing, repairing and complete rewinding of practically any motor in use today. You learn fast! You learn right! Every subject is clearly explained by text AND ALSO by more than 900 illustrations and diagrams. You not only read what to do—you SEE how it is done. Quick reference guides tell you how to handle specific jobs. When a certain motor comes in for repairs, just look it up. **ELECTRIC MOTOR REPAIR** tells you what to do—and exactly how to do it.

**ELECTRIC MOTOR REPAIR** is designed for use right at the service bench. Unique Duo-Spiral Binding divides the book into two sections so that both text and related diagrams can be viewed together. An instructor standing by your side could hardly do better! **ELECTRIC MOTOR REPAIR** covers the entire field—from alternating- and direct-current motors and generators, etc., to mechanical and electrical and electronic control systems. Right down the line, it explains trouble diagnosing, repair, rewinding and maintenance in a way you can easily understand.

**PRACTICE FROM IT 10 DAYS AT OUR RISK!**

You don't risk a cent! Use coupon for 10-day examination of this famous home training book.



**LEARN FAST . . . No Lessons to Wait for!**

If sold as a course and sent to you in lesson form, **ELECTRIC MOTOR REPAIR** would be a bargain at 10 times the price. You get it all at once. You learn rapidly. Here are just a few of the subjects covered!

- Split-Phase Motors
- Capacitor Motors
- Repulsion-type Motors
- Polyphase Motors
- Alternating-Current Motor Control
- Direct-Current Armature Winding
- Direct-Current Motors
- Direct-Current Motor Control
- Universal, Shaded-pole, and Fan Motors
- D-C Generators, Synchronous Motors and Generators
- Electronic Motor Control . . . and essential motor data

**10-DAY EXAMINATION COUPON**

Dept. PM-14, RINEHART BOOKS, Inc., Technical Division, 232 Madison Ave., New York 16, N. Y.

Send me the 560-page **ELECTRIC MOTOR REPAIR** home-training book for 10-day FREE EXAMINATION. At the end of 10 days, I will either return book to you postpaid in good condition or send you the sum of \$6.00 in full payment. Include FREE Study Guide which is mine to keep whether I buy the book or not.

Name \_\_\_\_\_  
 Address \_\_\_\_\_  
 City, Zone, State \_\_\_\_\_  
 Your Employer's name & address \_\_\_\_\_

(Outside U.S.A. \$6.50 each only—same return privilege)





**"I DOUBLED MY INCOME—  
Am My Own Boss—  
in CUSTOM  
UPHOLSTERY"**



**Leonard Schroeder, Former Low Paid  
Accountant—Increases Earnings 110%**

"I was an accountant earning \$40 a week before getting UTS training in upholstery. As soon as I graduated, I got a much bigger paying job with a firm specializing in custom upholstery work. Now I've better than doubled my income operating my own business and have an ever-growing number of new and satisfied customers."

**WHAT DO YOU WANT? Your Own Business—A Better Job—Substantial Sparetime Earnings—A Better Future? They're all waiting for you in the Big-Opportunity Field of Custom Furniture Upholstery.**

**AT HOME** in spare time, you can do what Leonard Schroeder and other UTS graduates have done — easily, quickly! Trained upholsterers are scarce. You can earn as you learn to make good money all year 'round at home, in your own shop, or in a well-paid job. The practical N.Y. State-Approved UTS course teaches you custom furniture upholstery, reupholstery, slipcovers, furniture finishing, repairs, PLUS 3 BIG EXTRAS—window cornice, cushion and drapery making. You get—FREE 4 BIG OUTFITS of all tools, complete frames and materials to make beautiful upholstered furniture and slip covers that are yours to keep or sell! FREE book, "Your New Way to A Successful Career" tells how you prepare at home for this big pay, big opportunity trade. **WRITE TODAY!** Also training in N. Y.; Upholstery Trades School, Dept. CA-305, 721 B'war, N. Y. 3.

**YOU MAKE**



**SLIPPER CHAIR**  
**CLUB CHAIR**  
**OTTOMAN**  
**PLUS SLIP COVERS**  
Yours to keep or sell

**SEND FOR BIG FREE BOOK**

UPHOLSTERY TRADES SCHOOL, Dept. CA-305  
721 Broadway, New York 3, N. Y.  
Send me your FREE book on:  
 Home Study     In School Training

Name \_\_\_\_\_  
Address \_\_\_\_\_  
City \_\_\_\_\_ Zone \_\_\_\_\_ State \_\_\_\_\_  
 Check here if Korean Veteran



**AUTO BODY  
AND FENDER  
REPAIR**

**Men!**

**Reading This  
Message Could Be  
the Most Important  
40 Seconds In Your Life**

From every indication Auto Body and Fender Repair work will continue to be one of America's Big Income fields. Here at U.E.I. we're training men for it—a proven plan that combines spare-time, home study and actual shop practice. Men from coast to coast have successfully completed the U.E.I. course in Auto Body and Fender Repair—many earned money while learning—many now have their own shops. What about you? Isn't this the time for you to see what this big-pay field offers you? Do this: Mail the coupon below and we'll send you our big, descriptive book, "Opportunities." It's Free—Mail the Coupon.

**UTILITIES ENGINEERING INSTITUTE, Chicago 14, Illinois  
Founded 1927**

**UTILITIES ENGINEERING INSTITUTE,**  
2523 Sheffield Ave., Dept. XC-26, Chicago 14, Illinois  
Please send, Free, Your Book "Opportunities".

NAME (print) ..... AGE.....  
ADDRESS .....  
CITY..... (Zone).... STATE.....  
 Check here for information if you are under 17.



**WANTED MAN  
WITH CAR  
TO RUN STORE  
ON WHEELS**



**USE OUR  
CAPITAL  
NO SALES EXPERIENCE NEEDED**

The biggest opportunity ever, to quickly establish a money-making, lifetime business, now awaits you as a McNeas Dealer. Sell things farmers need and use up. Serve same families year after year. Pleasant work—no bosses—easy to do. We supply capital to work on. Also provide offers—advertising—premiums and trade secrets that bring sales.

First to apply get best trading areas. Don't wait—write us today for McNeas proposition. Tell us county and state you want to serve. Ask for free McNeas Book.  
**The McNESS CO., 105 Clark St., Freeport, Ill.**

**STUDY INDUSTRIAL DESIGN**

You can train at Art Center School in California with practicing-professionals for upper-level jobs in INDUSTRIAL DESIGN. Recent graduates have been added to the staff at General Motors, Chrysler, Raymond Loewy, Henry Dreyfuss, etc. Majors in transportation, general product design, structures, community development, furniture design, packaging, display, 4-year degree courses. Learn to combine imaginative design with technical proficiency, coordinate utility and beauty. Stimulating environment. Field trips. Advantages of mild Southern California climate and nearby holiday spots. Fully accredited. Coed. Placement service. Write for catalog.

**ART CENTER SCHOOL, Edward M. Adams, Director  
5253 WEST THIRD STREET, LOS ANGELES 5, CALIFORNIA**



**Make BIG MONEY!  
RAISE CHINCHILLA RABBITS!**  
Cash Markets Supplied for Your Production  
**FREE - Illustrated Booklet - WRITE TODAY!**  
ROCK HILL RANCH, SELLERSVILLE 36, PA.  
World's Largest Breeder of Chinchilla Rabbits

**BRASS NAME PLATES  
or KEY TAGS**

**40c each**

YOUR NAME  
STREET/AND NUMBER  
CITY AND STATE  
PHONE NUMBER

Half actual size  
QUANTITY PRICE - SAME STAMPING  
3 for \$1.00  
8 for \$2 - 15 for \$3 - 25 for \$4 - 50 for \$6  
LARGER QUANTITIES ON REQUEST

**TAGCO, P. O. BOX 203 X, PLEASANT VALLEY, N. Y.**

**FOR BIG MEN ONLY!**

**SIZES 10 to 16    WIDTHS AAA to EEE**



We SPECIALIZE in large sizes only—sizes 10 to 16, widths AAA to EEE. Loungers; Dress Oxfords; Moccasins; Cushion Crepe; High and Low Work Shoes; Slippers, Rubbers; Over-shoes; Sox. You get top quality at popular prices. Fit and wear **GUARANTEED.** Sold by mail only. Over 50,000 satisfied customers. Write for **FREE Style Book TODAY!**

**KING-SIZE, Inc.**  
407, Brockton, Mass.

**SEND FOR  
FREE  
CATALOG**





# NO EXPERIENCE NECESSARY!

# LEARN TELEVISION AT HOME

# IN YOUR SPARE TIME!

L. C. Lane, B.S., M.A.  
President: Radio-Television Training Association  
Executive Director: Pierce School of Radio & Television

Super-Het Radio Receiver

Public Address System

C-W Telephone Transmitter

AC-DC Power Supply

Giant Screen TV Receiver

Combination Voltmeter-Ammeter-Ohmmeter

RF Signal Generator



21 IN.

You build all this equipment and more! Everything yours to keep.

## VETERANS! CIVILIANS!

## PREPARE FOR A BRIGHTER FUTURE AS A TRAINED TV TECHNICIAN!

Thousands of new jobs in TV are opening up in every state as new stations go on the air. You too can take your place in America's booming TELEVISION and Electronics industries... enjoy the success and happiness you always wanted. Keep your present job while I prepare you at home for a life-time career as a trained TV Technician. You "learn-by-doing" with the actual parts and equipment I send you... the same successful methods that have helped hundreds of men - many with no more than grammar school training - master television!

### ENOUGH EQUIPMENT TO SET UP YOUR HOME LABORATORY!

As part of your training, I give you ALL the equipment you need to prepare for a BETTER PAY TV job. You build and keep a professional GIANT SCREEN TV RECEIVER complete with big picture tube (designed and engineered to take any size up to 21-inch)... also a Super-Het Radio Receiver, RF Signal Generator, Combination Voltmeter-Ammeter-Ohmmeter, C-W Telephone Transmitter, Public Address System, AC-DC Power Supply. Everything supplied including all tubes.

### GOOD SPARE TIME EARNINGS!

Almost from the very start you can earn extra money while learning, repairing Radio-TV sets for friends and neighbors. Many of my students earn up to \$25 a week... pay their entire training from spare time earnings... start their own profitable service business. Act now! Mail coupon and find out for yourself what a TV career can do for you!

## VETERANS!

MY SCHOOLS FULLY APPROVED TO TRAIN VETERANS UNDER NEW G.I. BILL! If discharged after June 27, 1950 - CHECK COUPON! Also approved for RESIDENT TRAINING in New York City... qualifies you for full subsistence allowance up to \$160 per month.

### EXPERT FM-TV TECHNICIAN TRAINING!

My FM-TV Technician Course can save you months of training if you have previous Armed Forces or civilian radio experience! Train at home with kits of parts, plus equipment to build BIG SCREEN TV RECEIVER, and FREE FCC Coaching Course! ALL FURNISHED AT NO EXTRA COST!

### NEW! PRACTICAL TV CAMERAMAN & STUDIO COURSE!



(For men with previous radio & TV training)  
I train you at home for an exciting big pay job as the man behind the TV camera. Work with TV stars in TV studios or "on location" at remote pick-ups! A special one-week course of practical work on TV studio equipment at Pierce School of Radio & TV, our associated resident school in New York City, is offered upon your graduation.

### FREE FCC COACHING COURSE!

QUALIFIES YOU FOR HIGHER PAY! Given to all my students AT NO EXTRA COST after TV Theory and Practice is completed. Helps you qualify for the TOP JOBS in Radio-TV that demand an FCC License! Full training and preparation at home for your FCC License.

### OPTIONAL: TWO WEEKS TRAINING IN NEW YORK CITY AT NO EXTRA COST

You get two weeks, 50 hours, of intensive Laboratory work on modern electronic equipment at our associated school in New York City—Pierce School of Radio and Television. And I give you all this AT NO EXTRA COST whatsoever, after you finish your home study training in the Radio-FM-TV technician course and FM-TV Technician Course.

### RADIO-TELEVISION TRAINING ASSOCIATION

52 East 19th Street, New York 3, N. Y.  
Licensed by the State of New York. Approved by the VA

### MAIL COUPON TODAY!

MY 4 FREE AIDS SHOW YOU HOW AND WHERE TO GET A BETTER PAY JOB IN TELEVISION! See for yourself how my simple, practical methods make success easy.



### NO SALESMAN WILL CALL!

Mr. Leonard C. Lane, President  
RADIO-TELEVISION TRAINING ASSOCIATION  
52 East 19th St., New York 3, N. Y. Dept. M-1B

Dear Mr. Lane: Mail me your NEW FREE BOOK, FREE SAMPLE LESSON, and FREE aids that will show me how I can make BIG MONEY IN TELEVISION. I understand I am under no obligation and no salesman will call.  
(PLEASE PRINT PLAINLY)

NAME \_\_\_\_\_ AGE \_\_\_\_\_

ADDRESS \_\_\_\_\_

CITY \_\_\_\_\_ ZONE \_\_\_\_\_ STATE \_\_\_\_\_

#### I AM INTERESTED IN:

- Radio-FM-TV Technician Course **VETERANS! Check here**  
 FM-TV Technician Course **for Training under NEW**  
 TV Cameraman & Studio Course **G.I. Bill**



In 10 Minutes of **FUN** a day I changed myself from this Bloodless, Pitiful **SKINNY SHRIMP** →



TO THIS Ken Grimm BEFORE mailing coupon



Ken GRIMM AFTER MAILING COUPON

**NEW MUSCULAR RED-BLOODED HEAD-TO-TOE HE-MAN!**

Now, Buddy YOU Mail the Coupon below as I did! May be LAST CHANCE before \$1 price goes back!

GET ALL THESE PICTURE-PACKED COURSES **FREE** if you mail coupon NOW!

I just **GAINED 35 NEW LBS.** OF SHAPELY POWER-PACKED **MUSCLES!**

You can do the same as I and THOUSANDS have.

You can add 10 inches to your CHEST 6 inches to each ARM and the rest in proportion as I did.

**NO!** friend you don't have to be SKINNY, WEAK or FLABBY any more just mail NOW the FREE

coupon below as I did. Besides getting ALL 5 Courses (pictured on this page) FREE (Millions Have Been Sold for \$1.) You'll ALSO get FREE a big BOOK of PHOTOS of STRONG MEN and BOYS who were WEAKLINGS like you BEFORE mailing coupon. This Thrilling Book Will Also Tell You



**HOW YOU CAN WIN A BIG 15" TALL SILVER CUP as I just did and how to WIN \$100.**



**LAST CHANCE — ALL FREE COUPON!**

1. Photo Book of STRONG MEN  
2. MUSCLE METER 3. FIVE COURSES

Dept. PM-41

Tell Me How To WIN \$100, etc.

"Seven Courses granted in World for Building All-Around HE-MEN!"  
—W. F. Kelley  
Physical Director

JOWETT INSTITUTE OF PHYSICAL TRAINING  
220 FIFTH AVENUE, NEW YORK 1, N. Y.  
Dear George: Please mail to me FREE Jowett's Photo Book of Strong Men and a Muscle Meter, plus all 5 HE-MAN Building Courses: 1. How to Build a Mighty Chest. 2. How to Build a Mighty Arm. 3. How to Build a Mighty Grip. 4. How to Build a Mighty Back. 5. How to Build Mighty Legs—Now all in One Volume "How to Become a Mighty HE-MAN." ENCLOSED FIND 10c FOR POSTAGE AND HANDLING (no C.O.D.'s)

NAME \_\_\_\_\_ AGE \_\_\_\_\_  
ADDRESS \_\_\_\_\_  
CITY \_\_\_\_\_ ZONE \_\_\_\_\_ STATE \_\_\_\_\_

**Over \$450<sup>00</sup> Profit!**

**I SOLD 67 D-FROST-O-MATICS IN JUST 5 DAYS SPARE TIME!**



**Get the EXTRA MONEY YOU want this Easy Way!**

**Amazing D-FROST-O-MATIC Makes Any Electric Refrigerator Self-Defrosting!** Bill Carney is just one of thousands of alert men, all over America, who have found money-making "magic" showing housewives how amazing D-FROST-O-MATIC ends messy, time-wasting hand defrosting forever. Bill Carney's record is exceptional—but our sure-fire FREE TRIAL PLAN can pay YOU up to \$210.00 a week on just five easy sales a day! You just plug in D-FROST-O-MATIC, tell the housewife "Try it before you buy it". When she sees how D-FROST-O-MATIC saves time... work... food... and money **SHE WON'T LET YOU TAKE IT OUT.**

**RUSH NAME TODAY... for PROFIT Details and FREE TRIAL PLAN!**

"Anyone Can Sell Them"

"You just place them in homes. D-FROST-O-MATIC does the rest. My profit has been several times over what I hoped for."  
—Bill Carney, Mo.

More than 29,000,000 prospects waiting! Rush your name and address today. We'll airmail exciting facts, proof and sure-fire Free Trial plan. No obligation. Send your name and address today.

**D-FROST-O-Matic, Dept. K-6**  
173 W. Madison St., Chicago 2, Illinois  
In Canada: **SILVEX CO., Ltd.**  
371 Dowl Street, Montreal 1, Quebec

**BUILD LUGGAGE AT HOME WE SELL YOUR PRODUCTS!**

**ONLY NEW HOME MONEY-MAKING PLAN IN YEARS!**

Make Luggage and cases for traveling, photographers, musicians, salesmen, electronics, tools, portables, 1001 other items. Also repair Luggage. No special equipment needed. **BIG Profits.** We supply complete instructions—everything! Write for free details and Business Plan. **ABARSI CASECRAFT, Dept. H5, 805 W. Sunset Blvd., Los Angeles 12, Calif.**

**IMPROVE YOUR PENMANSHIP**

*Write Like This*

YOUR penmanship can be improved in 3 hours or corrected to your satisfaction in 10 hours' practice with my **DEFINITE HAND CONTROLS**. New way!

**WRITE OZMENT** BOX 665 34-N. ST. LOUIS, MISSOURI

**Complete OUTLINE FREE!**

**Learn ACCOUNTING Business Administration**

Bookkeeping, secretarial and allied subjects at home in your spare time or attend nationally approved resident school. Write for **FREE Success Book** giving complete details on courses, plans, rates and employment opportunities. G.I. approved.

**Hills BUSINESS UNIVERSITY AND EXTENSION SCHOOL**  
619 W. MAIN ST. OKLAHOMA CITY 2, OKLAHOMA

**LEARN WATCH REPAIRING**



**AT HOME.** By our modern and original system of instruction you can learn every part of the **WATCH REPAIRING TRADE AT HOME.** Prepare yourself for a well-paying position or start in business after completing our course of instruction. Good watch repairers are in demand and generally earn very good salaries. For particulars apply to the **WISCONSIN SCHOOL OF WATCH REPAIRING**  
759 N. Milwaukee St., Milwaukee 2, Wis.

**\$750 BUILDS 4 ROOMS & BATH!**

**WHY PAY RENT?**

For Seven Hundred Fifty Dollars and 30 days of your spare time, you can build yourself this Beautiful Home. Living Room 11x15, Front bedroom 9x11, Back bedroom 10x12, Kitchen 9x11, Bath 5x8, Hall 3x4. Wind out steel casement windows. Concrete block stuccoed. Step-by-step illustrated instructions, blueprint and material list \$1.00 ppd. No COD. Moneyback guarantee. Economy Home, Dept. C Box 645 Columbus 16, Ohio





# GET INTO RADIO-TELEVISION

## ELECTRONICS by Shop-Method Home Training

### GOOD JOBS AWAIT THE TRAINED RADIO-TV TECHNICIAN

There is a place for you in the great Radio-Television-Electronics industry when you are trained as National Schools will train you at home!

Trained technicians are in growing demand at good pay—in manufacturing, broadcasting, television, communications, radar, research laboratories, home Radio-TV service, and other branches of the field. National Schools Master Shop-Method Home Training, with newly added lessons and equipment, trains you in your spare time, right in your own home, for these fascinating opportunities. OUR METHOD IS PROVED BY THE SUCCESS OF NATIONAL SCHOOLS TRAINED MEN, ALL OVER THE WORLD, SINCE 1905.

### EARN WHILE YOU LEARN

Many National students pay for all or part of their training with spare time earnings. We'll show you how you can do the same! Early in your training, you receive "Spare-time Work" Lessons which will enable you to earn extra money servicing neighbors' and friends' Radio and Television receivers, appliances, etc.



Signal Generator

Audio Oscillator

T. R. F. Receiver

### National Schools Training is All-Embracing

National Schools prepares you for your choice of many job opportunities. Thousands of home, portable, and auto radios are being sold daily—more than ever before. Television is sweeping the country, too. Co-axial cables are now bringing Television to more cities, towns, and farms every day! National Schools' complete training program qualifies you in all fields. Read this partial list of opportunities for trained technicians:

- Business of Your Own • Broadcasting
- Radio Manufacturing, Sales, Service • Telecasting
- Television Manufacturing, Sales, Service
- Laboratories: Installation, Maintenance of Electronic Equipment
- Electrolysis, Coil Systems
- Garages: Auto Radio Sales, Service
- Sound Systems and Telephone Companies, Engineering Firms
- Theatre Sound Systems, Police Radio
- And scores of other good jobs in many related fields.

### TELEVISION TRAINING

You get a complete series of up-to-the-minute lessons covering all phases of repairing, servicing and construction. The same lesson texts used by resident students in our modern and complete Television broadcast studios, laboratories and classrooms!



## MASTER ALL PHASES!



Get Master Shop-Method Home Training from an Established Practical Resident School with its own Training Shops, Laboratories, Studios — almost 50 Years of Successful Experience in Training Ambitious Men.

**We Bring National Schools To You!**



Superheterodyne Receiver

You also receive this Multitester

### LEARN BY DOING

You receive and keep all the modern equipment shown above, including tubes and valuable, professional quality Multitester. No extra charges.

### FREE! RADIO-TV BOOK AND SAMPLE LESSON!

Send today for National Schools' new, illustrated Book of Opportunity in Radio-Television-Electronics, and an actual Sample Lesson. No cost—no obligation. Use the coupon now—we'll answer by return airmail.

APPROVED FOR VETERANS AND NON-VETERANS  
Check coupon below

Both Resident and Home Study Courses Offered!



## NATIONAL SCHOOLS

Los Angeles 37, California • Established 1905  
In Canada: 811 W. Hastings Street, Vancouver, B.C.

### GET FACTS FASTEST! MAIL TO OFFICE NEAREST YOU!

(mail in envelope or paste on postal card)

NATIONAL SCHOOLS, Dept. RB-14

4000 S. Figueroa Street or 323 West Polk Street  
Los Angeles 37, Calif. or Chicago 7, Ill.

Send FREE Radio-TV Electronics book and FREE sample lesson. No obligation, no salesman will call.

NAME \_\_\_\_\_ BIRTHDAY \_\_\_\_\_ 19 \_\_\_\_\_

ADDRESS \_\_\_\_\_

CITY \_\_\_\_\_ ZONE \_\_\_\_\_ STATE \_\_\_\_\_

Check here if interested in Resident School Training at Los Angeles. VETERANS: Give Date of Discharge \_\_\_\_\_



# WHAT ALL AUTO MECHANICS WANT TO KNOW

1664 PAGES



This Big Practical Book gives full information with working diagrams covering the principles, construction, ignition, service and repair of modern cars, trucks and buses.

### Diesel Engines, Hydramatic & Fluid Drives Fully Explained.

A complete Guide of 1664 pages, with over 1500 illustrations showing inside views of working parts, with instructions for service jobs.

### IT PAYS TO KNOW

How to fit pistons—How to locate engine knocks, How to fit connecting rod bearings—How to service main bearings—How to recondition valves—How to time valves—How to adjust fan belts—How to adjust carburetors and chokes, How to rebuild a clutch—How to service automatic transmissions—How to service brakes—How to adjust steering gear—How to cope with ignition troubles—How to service distributors—How to time ignition—How to "tune up" an engine.

to rebuild a clutch—How to service automatic transmissions—How to service brakes—How to adjust steering gear—How to cope with ignition troubles—How to service distributors—How to time ignition—How to "tune up" an engine.



**\$4 COMPLETE - PAY \$1 A MO.** TO GET THIS ASSISTANCE FOR YOURSELF SIMPLY FILL IN AND MAIL COUPON TODAY.

Step up your own skill with the facts and figures of your trade. Audels Mechanics Guides contain Practical Inside Trade Information in a Handy Form. Fully illustrated and Easy to Understand. Highly Endorsed. Check the book you want for 7 DAYS FREE EXAMINATION. Send No Money. Nothing to pay postman.

## MAIL ORDER



**Check NOW!**

You Can Look Over Any Guide In Your Own Home — Start the Easy Payments If Satisfied

**MAIL THIS TODAY**



AUDEL, Publishers, 49 W. 23 St., NEW YORK 10, N. Y.

Please send me postpaid for FREE EXAMINATION books marked x below. If I decide to keep them I agree to mail \$1 in 7 days on each book or set ordered and further mail \$1 monthly on each book or set until I have paid price, otherwise I will return them.

- AUTOMOBILE MECHANICS GUIDE, 4 \$4
- TRUCK & TRACTOR GUIDE, 1299 Pages 4
- DIESEL ENGINE MANUAL, 575 Pages 2
- MACHINISTS HANDY BOOK, 1650 Pages 4
- WELDERS GUIDE, 400 Pages 1
- BLUE PRINT READING, 416 Pages 2
- MATHEMATICS & CALCULATIONS, 700 Pages 2
- SHEET METAL PATTERN LAYOUTS, 1100 Pages 4
- SHEET METAL WORKERS HANDY BOOK, 388 Pgs. 1
- MECHANICAL DRAWING GUIDE, 160 Pages 1
- MECHANICAL DRAWING & DESIGN, 480 Pages 2
- AIRCRAFT WORKER, 240 Pages 1
- TELEVISION SERVICE MANUAL, 384 Pages 2
- RADIOSMAN'S GUIDE, 914 Pages 4
- ELECTRONIC DEVICES, 216 Pages 2
- ELECTRIC MOTOR GUIDE, 1000 Pages 4
- ELECTRIC WIRING DIAGRAMS, 272 Pages 1
- ELECTRICIANS EXAMINATIONS, 250 Pages 1
- ELECTRIC POWER CALCULATIONS, 425 Pages 2
- HANDY BOOK OF ELECTRICITY, 1440 Pages 4
- ELECTRIC DICTIONARY, 9000 Terms 2
- ELECTRIC LIBRARY, 7000 Pages (12 Book Set) 18
- MARINE ENGINEERS HANDY BOOK, 1258 Pgs. 4
- SHIPFITTERS HANDY BOOK, 250 Pages 1
- REFRIGERATION & Air Conditioning, 1280 Pgs. 4
- MILLWRIGHTS & MECHANICS GUIDE, 1200 Pgs. 4
- POWER PLANT ENGINEERS GUIDE, 1500 Pages 4
- ENGINEERS & FIREMANS EXAMS, 525 Pages 1
- PUMPS, Hydraulics & Air Compressors, 1658 Pgs. 4
- ENGINEERS LIBRARY (3 Book Set) 9
- MECHANICAL DICTIONARY, 950 Pages 4
- GARDENERS & GROWERS GUIDES (4 Book Set) 6
- CARPENTERS & BUILDERS GUIDES (4 Book Set) 6
- PLUMBERS & Steamfitters Guides (4 Book Set) 6
- MASONS AND BUILDERS GUIDES (4 Book Set) 6
- PAINTERS & DECORATORS MANUAL, 450 Pgs. 2
- HOUSE HEATING GUIDE, 1000 Pages 4
- OIL BURNER GUIDE, 384 Pages 1

Name \_\_\_\_\_  
 Address \_\_\_\_\_  
 Occupation \_\_\_\_\_  
 Employed by \_\_\_\_\_ P1

# 317 DIFFERENT FOREIGN STAMPS only 25¢



- \$9.50 value includes:
- **STALIN DEATH STAMP** — special black-bordered issue!
- **NEW ZEALAND** — 98-year-old proof of Queen Victoria. Sold for \$5 at auction.
- **ISRAEL** — complete sheet of first issues.

You get all 3 scarce items shown (alone worth \$7.00)—plus **LUNDY**, fantastic Puffin issue from the only private kingdom in the world; **BERLIN BEARS**, epl. set for Russian Zone; **SPAIN**, 3 Iberia Airmails; **FRANCE**, 3 re-issues of 194-year-old rarities—plus hundreds more! Grand total of 317 different stamps—reg. \$9.50 value—for just 25¢ to introduce our Bargain Approvals. Included **FREE**, "Midget Encyclopedia of Stamps"—plus Stamp Dictionary and Identifier. Send 25¢ today. Money back guarantee. **ASK FOR LOT FO-11**

**ZENITH CO., 81 Willoughby St., Brooklyn 1, N. Y.**

**UP TO 6 MILES MORE PER GALLON**  
 Reported by Hundreds Using  
**MIRACLE ACTION TUR-B-LIZER**

Carburetor specialists say Tur-B-lizer is best patented improvement they have seen. Tested in millions of miles of driving in cars, trucks and tractors. Easily installed. Send \$3.00 for six cylinder type, \$4.50 for eight cylinder type. Try Tur-B-lizer for 30 days, if you are not enthusiastically satisfied as claimed by hundreds of users, your money will be promptly refunded.

Mechanics-Salesmen: Make big money selling and installing. Write for full facts.

**UNIVERSAL TUR-B-LIZER CO.**  
 621 E. STATE ST. MILWAUKEE 2, WISC.

## Become a MENTAL SUPERMAN

OVERNIGHT! Floor everybody! Revolutionary "MEMO-PROP" does all your thinking! It's uncanny! Unprecedented! **FREE LITERATURE!** BIJOU STUDIO, BOX 1727ME, HOLLYWOOD 28, CAL.

**'How to Make Money with Simple Cartoons'**

A book everyone who likes to draw should have. It is free; no obligation. Simply address **FREE BOOK**

**CARTOONISTS' EXCHANGE**  
 Dept. 91A Pleasant Hill, Ohio

**Want a HOME?**

Before you choose, be sure to GET THE FACTS about Schult mobile homes. Write or wire Dept. 3201

**SCHULT TRAILERS**

SCHULT CORP., ELKHART, IND.

**WORLD'S LOWEST PRICED ADDING MACHINE** Vest Pocket Size **FREE TRIAL \$2.95**

IDEAL FOR BUSINESS AND PERSONAL USE — GUARANTEED ACCURATE. Not a toy. Operates with only a finger flick. Adds, subtracts, multiplies, divides. Counts up to one billion. Pays for itself over and over. Ideal Gift — for **TOTAL COST** Business, Income Tax and School use. **SEND NO MONEY BACK GUARANTEE.** Send name **MONEY** and address. Pay postman only \$2.95 plus postage. (Send full cash if outside U.S.) Beautiful rich-looking Leatherette Case included at no extra cost. Money back in 10 days if not delighted. **AGENTS WANTED.**

**CALCULATOR MACHINE CO., (Mfrs.)**  
 Dept. PM 41 Glenview, Illinois



**"What's he got  
that I haven't got?"**

LOOK at the successful men you know. "What have they got" that you haven't?

Very little, probably. In most ways these men are no brighter or naturally more capable than average. Many of them probably have no more formal education or better natural aptitudes than you.

But that little extra they have is important. They have the special knowledge and ability for which business is glad to pay well—they know the what, why and how of business. They have also the confidence and aggressiveness which come from knowing that they know and can apply their knowledge.

You may add that extra—may get that same profitable knowledge and ability—that same confidence and aggressiveness—if you are willing to pay the price in earnest, necessary study. For LaSalle has spent over 40 years developing, testing and proving, with over a million student members, spare-time success training in certain specialized business fields. What scores of thousands of men and women—many just like you—have done, you should be able to do.

You need not leave your home or interrupt your job; you need pay comparatively little money. But you must be ambitious and willing to study seriously. And soon after you start training, the results will begin to show up in your own confidence and in your work. For what you learn at home tonight is so practical that often you can apply it on the job tomorrow.

How much do you want success—more money, a promotion or a new job, prestige and responsibility? If you really want it, you will use this coupon to find out what LaSalle training can do for you. It costs only a postage stamp, but a coupon like it has been the starting point to real success for scores of thousands—and can be for you.



**LASALLE EXTENSION UNIVERSITY  
A Correspondence Institution**

Dept. 164-R • 417 S. Dearborn • Chicago 5, Ill.

I want to know how LaSalle can help me win success in the field I have checked below. Please send me your free 48-page booklet about that field and your success training in it—plus "Ten Years' Promotion in One," a book which has helped many men.

- |  |   |
|--|---|
| <input type="checkbox"/> Higher Accountancy  | <input type="checkbox"/> Salesmanship                     |
| <input type="checkbox"/> C.P.A. Coaching     | <input type="checkbox"/> Traffic Management               |
| <input type="checkbox"/> Bookkeeping         | <input type="checkbox"/> Foremanship                      |
| <input type="checkbox"/> Law: LL.B. Degree   | <input type="checkbox"/> Industr'l Management             |
| <input type="checkbox"/> Business Management | <input type="checkbox"/> Stenotypy<br>(Machine Shorthand) |

Name.....Age.....

Address.....

City, Zone and State.....

**LASALLE**

{ Dept. 164-R, 417 So. Dearborn St. }  
{ Chicago 5, Ill. }

**EXTENSION UNIVERSITY**  
*A Correspondence Institution*



# BECOME AN Electrical Engineer



- Major in Power or Electronics
- Earn B. S. Degree in 36 months

Over 50% of the nation's industrial leaders began their careers with engineering training. Today, the demand for young, trained Electrical Engineers and Technicians is constantly expanding. Eight separate programs give you a wide range of career opportunities.

## Plan Your Career From these Courses in Electrical Technology

### ENGINEERING COURSES

Electrical Engineering — Bachelor of Science Degree  
Save a valuable year through optional year 'round study.

Electronics major ..... 36 months

Power major ..... 36 months

### TECHNICIAN COURSES

Electro Technician ..... 12 months

Electronics Technician ..... 12 months

Radio Technician ..... 12 months

Radio and Television Technician ..... 18 months

### SERVICE COURSES

Electrical Service ..... 6 months

Radio and Television Service ..... 12 months

Terms open April, July,  
September, January

Approved for veterans.  
Prior Military, Practical  
or Academic training  
evaluated for advanced  
credit. Faculty of spe-  
cialists. 50,000 former  
students. Annual enroll-  
ment from 48 states and  
23 overseas countries.  
50th year. Non-profit.  
Residence Courses only. Send coupon for facts.

**MECHANICAL TECHNOLOGY  
COURSES** — Also available,  
Service Technician courses 6  
to 18 months — Heating,  
Refrigeration, Welding, Air  
Conditioning and Mechanical  
— Mechanical Engineering  
with a major in Design, Met-  
al Fabrication or Plant Engi-  
neering.

Also, general 3-month pre-  
paratory course.



## MILWAUKEE SCHOOL OF ENGINEERING

MILWAUKEE SCHOOL OF ENGINEERING  
Dept. PM-154, 1025 N. Milwaukee  
Milwaukee 1, Wisconsin  
Send:  Free 160-Page Catalog  
 "Your Career" Booklet

I am interested in .....  
name of course

Name ..... Age .....

Address .....

City ..... Zone ..... State .....

If veteran, indicate date of discharge .....



## SKYMASTER <sup>Palm Size</sup> RADIO

250 MILE DAYTIME RECEPTION,  
1000 MILES RECEIVED  
AT NIGHT

Not a toy! This powerful vac-  
uum tube miniature kit covers  
standard broadcast band 550  
to 1600 KC. Hearing aid  
battery, all parts, fit in case.  
A PERSONAL radio for home,  
office, camp, etc. Photo dia-  
grams included. **PERFORM-  
ANCE AND ALL PARTS  
FULLY GUARANTEED.** Bat-  
tery plus EXTRA "A" BAT-  
TERY, \$1.50. 1500 OHM  
ALNICO MAGNET powered  
earphone only \$1.45. C.O.D.  
orders acceptable with \$1 de-  
posit within U. S. and pos-  
sessions.



**\$6.75**  
postpaid

(Factory assembled \$8.95)

**PRECISION RADIO ELECTRONICS**  
Placerville, Calif. **DEALERSHIPS AVAILABLE**

## 60 POWER TELESCOPE \$3.98

VARIABLE EYEPIECE 20x-40x-60x—BRASS BOUND

**NEW!** Three telescopes in one, 3 different  
magnifications, 20 power for ul-  
tra-bright images with 40 and 60 power  
for extra long range. Guaranteed  
to bring distant objects, peo-  
ple, sports events, ships,  
moon, stars, etc. 60  
times as close.  
Made in U.S.A.



Most power-  
ful for anywhere  
near the money. 5 sec-  
tions. Closes to  
1 ft. long. Contains  
4 ground and polished  
lenses. Also used as a pow-  
erful compound microscope. Di-  
rections included. Mass production  
enables us to offer this instrument at  
amazing price of \$3.98 complete. Money  
back guarantee. We pay postage. Get yours now. As A Microscope

**CRITERION CO.**  
DEPT. PMB 19  
331 CHURCH ST.  
HARTFORD 3, CONN.

## WHAT'S YOUR FIELD OF INTEREST?

Whatever it is, specialized magazines will help you get ahead.  
Look over current copies of those covering your field through  
our easy-to-get-acquainted service. Choose from 4,387 publica-  
tions covering all fields—business, trades, agriculture, professions,  
insurance, real estate, music, writers, educational, hobbies,  
sports, etc. Current List FREE.

Commercial Engraving Publ. Co., 34AB North Ritter, Indianapolis 19, Ind.

## Broken or Loose FALSE PLATE?

Fix it Yourself EASILY in a Few Minutes

Your plates may become broken or loose just when  
you need them most. With FIX-IT-KIT you can repair  
your own broken plates. Also tightens loose fitting  
plates, easily. Get permanent comfort with profes-  
sional material. Complete instructions. Satisfaction  
guaranteed or your money refunded. Order Now at a  
new low price only \$2.98 postpaid — or sent C.O.D.

DENT-FIX DENTAL PRODUCTS, Box 674, Dept. PM-1, Kansas City 8, Mo.

## Do You Make These Mistakes in English?

MANY PERSONS say "between you and I" instead  
of "between you and me"—or use "who" for "whom."  
Every time you speak or write you show what you are.  
Mistakes in English reveal lack of education, refine-  
ment. Real command of English will help you reach  
any goal.

Only 15 minutes a day with Sherwin Cody's fa-  
mous invention—and you can actually SEE your  
English improve. It teaches by HABIT—makes it  
easier to do it the RIGHT way.

**FREE BOOK.** Lack of language power may be costing you thou-  
sands of dollars every year. See what Mr. Cody's method can do  
for you; it costs nothing to find out. Write now for free book,  
"How You Can Master Good English in 15 Minutes a Day."  
Sherwin Cody Course in English, 581 Central Drive, Port Wash-  
ington, N. Y.







**"Opened Door to Popularity"**

"I was able to play many pieces in a short time. Family and friends certainly surprised. Course opened door to popularity, wider circle of friends. Recently I entered amateur contest—won First Prize."—Peter H. Kozyra, Manitoba, Canada.



**Plays Banjo in a Short Time**

"Enjoy your lessons for the Tenor Banjo! am progressing rapidly. Lessons are so simple, anyone can understand! yet so thorough I have learned to play by note in little more than a month!" — Andrew Schneider, Hanna, Wyoming.



**Course Inspires Music Circle**

Shown above is Miss Mildred Cade, of Houston, Texas. She and a number of her friends are so enthusiastic about the U. S. School of Music's quick easy way of learning that they've ALL taken it up.



**"Can't Thank Your School Enough"**

"Never studied music before. Your method is easy; being your own teacher is best. After 4 lessons, I could play a few pieces. Now play any piece I like. Can't thank you enough." —Rose Boyer, Blackwell, Mo.

# THOUSANDS NOW PLAY

## who never thought they could!

**THIS FAMOUS WAY MAKES IT EASY AS A-B-C TO LEARN — EVEN IF YOU DON'T KNOW A SINGLE NOTE NOW**

**Y**OU think it's difficult to learn music? That's what thousands of others have thought! Just like you, they long to play some instrument — the piano, accordion, violin, guitar, saxophone or some other favorite. But they denied themselves the pleasure—because they thought it took months and years of tedious study to learn!

### Learn in Spare Time at Home

And then they made an amazing discovery! They learned about a wonderful way to learn music at home—without a private teacher—without tedious study—and in a surprisingly short time. They wrote to the U. S. School of Music for the facts about this remarkable short-cut method. And the facts opened their eyes! They were amazed to find how easy it was to learn!

### 900,000 Students!

The result? over 900,000 men and women have taken up music at home this simple A-B-C way. Now, all over the world, enthusiastic music-lovers are enjoying the thrilling satisfac-

tion of creating their own music. They have found the key to good times, and popularity.

### Costs Only Few Cents a Lesson

And that's what you can do, right now. **NO TEDIOUS PRACTICING OF BORING SCALES AND EXERCISES!** Even if you don't know a single note now, you'll "start right in on pieces." This builds up your skill and confidence so rapidly that soon you'll be able to play **ALL** your favorite songs and compositions **by note**. It's all so clearly explained — so **EASY** to understand — that even children "catch on" at once.

Why not let this famous home study method bring the many pleasures of music into **YOUR** life! New friends. Extra money from playing or teaching. Greater listening pleasure. Possibly a brilliant career. Best of all, the deep **personal** satisfaction of being able to make your own music—provide your own entertainment.

### FREE BOOK and Free Lesson-Sample

Let us **PROVE** that what we say is true. See for yourself why our School has been so successful for 56 years. Mail the coupon and we'll gladly send you our valuable 36-page **FREE BOOK** — and also a **Free Lesson-Sample** you can try out right at home. No obligation; no salesman will call on you. **U. S. SCHOOL OF MUSIC, Studio 301, Port Washington, N. Y.** (Special Reduced prices on instruments to our students.)



### CHOOSE YOUR FAVORITE INSTRUMENT

Now it's easy to learn — by note — Piano, Guitar, Piano Accordion, Violin, Hawaiian Guitar, Mandolin, Trumpet, Cornet, Saxophone, Tenor Banjo, Organ, Ukulele, Clarinet, Trombone, Flute, Piccolo, Modern Elementary Harmony. Write your choice in coupon.

### Becomes Famous Band Leader



The Champagne Music of **LAWRENCE WELK'S** orchestra is enjoyed by millions. He writes: "I got my start with a U. S. School Course. How easy it is to learn to read notes and play an instrument this 'teach - yourself' way! You did so much for me that I've enrolled my two daughters."



### Mail this for FREE BOOK

**U.S. SCHOOL OF MUSIC, Studio 301 Port Washington, N. Y.**

Please send me **FREE** Book and Lesson-Sample. No salesman will call upon me. I'm interested in playing (name instrument).

I do  I do NOT—have instrument now.

Name \_\_\_\_\_ (Please Print)

Address \_\_\_\_\_

City \_\_\_\_\_ Zone \_\_\_\_\_ State \_\_\_\_\_



not everyone does as well, but E. O. Lockin, who started a business of his own, reports...

for 12 months I've averaged

**\$800 PER MONTH INCOME**

—most of it clear profit for me!

● Mr. Lockin expresses his grateful thanks for the opportunity to make a decent living on his own. Many men have discovered how to be independent, to be free of bosses and layoffs. L. A. Eagles grossed more than \$200 his first week. R. E. Traynor says, "I made \$62 gross in one day." Others report gross up to \$12,000 per year.

How much you make depends largely on you. You need no special skill, no large investment.

**No shop necessary.**

Our **ELECTRIC RUG WASHER** cleans rugs, carpets right on floor... helps to show their natural color and beauty. So efficient and safe, used by largest hotels and railroads.

You take no risk. Machines fully guaranteed. Mail coupon today for complete information including how to start making big profits in YOUR OWN BUSINESS.

**VON SCHRADER MFG. CO., RACINE, WIS.**

You, too, can start your own business. No special skill, no large investment required. Mail coupon today for interesting **FREE** book.

**VON SCHRADER MFG. CO.,**  
1110 "R" Pl., Racine, Wisconsin

Send at once (no obligation) your **FREE** booklet containing information about your **ELECTRIC RUG WASHER** and how I can start my own permanent, profitable business.

Name \_\_\_\_\_

Address \_\_\_\_\_

City \_\_\_\_\_ Zone \_\_\_\_\_ State \_\_\_\_\_

ADDRESS  
**POSTCARDS**  
AT HOME  
MAKE MONEY!! SPARE—FULL TIME  
write LINDO, WATERTOWN, MASS.

LOOK! **A MILLION THRILLS!**



33 Models  
**\$9.95 UP**

High Power  
**BINOCULARS**  
**30 DAY FREE TRIAL**

Finest Precision Optics  
Featherlight  
Guaranteed Savings  
Money Back Guarantee  
Easy Pay Plan

Compare Before You Buy!  
Dealer Name on Request.

**FREE BOOK & COLOR CATALOG**

**BUSHNELL Binoculars** Bushnell Bldg., Dept. M81  
Pasadena 1, Calif.

FREE BOOK AND COLOR CATALOG

**Free!**

NAME \_\_\_\_\_ CITY \_\_\_\_\_  
ADDRESS \_\_\_\_\_ STATE \_\_\_\_\_

## 100 YEAR OLD U.S. STAMPS



We will send "On Approval" all United States stamps, even those over 100 years old. We will also send "On Approval" all foreign stamps in singles and sets, including such famous issues as Coronations, Roosevelts, etc. Ours is the only stamp house able to render such service. Just send 10c for our introductory bargain of 50 different U.S. stamps and fascinating stamp literature.

**GLOBUS STAMP CO.**

268 — 4th Ave. New York 10, N.Y. Dept. 213

## PORTABLE GARAGE

• Folds compactly • Keeps rain, snow, dust, salt air, sun or sleet away • Constructed of vinyl plastic • Fits all makes • Enclose check or money order for \$6.95 or \$8.95 plus 35c Postage or sent C.O.D. 10-Day Money Back Guar.



**MARDO SALES CORP.**

480 Lexington Ave. Dept. G-1400 New York 17, N. Y.

## GROW MINIATURE TREES

Grow authentic, LIVE dwarf trees!  
Fascinating hobby! Fabulous profit!

SEND FOR FREE SEED & INSTRUCTIONS!

**MINIATURE NURSERY CLUB**  
Dept. S-1, Box 3964, Victory Center,  
North Hollywood 24, California

**RADIO** Engineering. All phases radio & electronics theory & practice; television; FM; broadcasting; servicing; aviation, marine & police radio. Prepare for high pay; 18-month course. Graduates in demand by major companies. Enter Jan., March, June, Sept. Regular campus life. Write for catalog. **VALPARAISO TECHNICAL INSTITUTE, Dept. D, Valparaiso, Ind.**

## RUPTURE!

An amazing Air-Cushion Invention allows body freedom at work or play. Light, neat, cool, sanitary. Durable, cheap. Day and night protection helps Nature support weakened muscles gently but surely. No risk. **Sent on Trial!** Write NOW for free Booklet and **Proof of Results.** All correspondence confidential.

Brooks Company, 373-C State St., Marshall, Mich.



Success Requires Training! **LEARN**  
**AIR CONDITIONING**  
and **REFRIGERATION**

This great, modern industry is alive with opportunities for trained men. Installation, maintenance and servicing of home and industrial equipment is a well-established, paying trade and business. Now mechanically inclined men can get practical instruction in spare time at home, plus quick shop practice at U.E.I. (founded 1927).

**IMPORTANT FACTS FREE — Write today**

Find out all about these interesting opportunities without obligation. Send a postcard or short note right now.

**UTILITIES ENGINEERING INSTITUTE, Dept. C-8**  
2525 SHEFFIELD AVENUE CHICAGO 14, ILLINOIS



# LEARN TO MOUNT BIRDS and ANIMALS



## SPORTSMEN • MEN, BOYS—

Here is something **NEW** — something **MARVELOUS**. Act **NOW**.  
Learn **TAXIDERMISTRY** at home. Save your wild-game trophies.

### HAVE A HOME MUSEUM

Here is the **GRANDEST HOBBY** in the world for hunters, anglers, sportsmen. **DOUBLE** your interest in hunting and fishing. Save your marvelous trophies. Mount **Birds, Animals, Heads, Fish**, all kinds of beautiful specimens, wild or tame. Tan leathers and fine furs. It is grand to be a **TAXIDERMIST**. You become well known and famous.



### WILD-GAME NOT NEEDED

Mount common specimens, squirrels, crows, fish, frogs, plovers. Make useful and humorous groups. A highly interesting hobby. You will be amazed and delighted.

### TAN SKINS

Learn easily the **KROME-TAN METHODS**. Make sole, rawhide, harness leather, and **TAN SKINS** and furs. Create beautiful rugs. Decorate your home, and **MAKE FINE PROFITS** doing work for others.

### CRAFT-TAXIDERMISTRY!

Make wild-game and domestic specimens into alluring **CRAFT-ART**, like the lamp shown above. You can devise a vast variety of alluring creations. **Easily learned**. Decorate with mounted specimens, **book-ends**, **door-stops**, **hat-racks**, **match and pen-holders**, and **scopes of delightful and USEFUL** home articles and gifts. We teach you an **easily** both wild-game and also craft taxidermy. Investigate **NOW**.

### Rush Coupon TODAY!

The beautiful book will go to you by **RETURN MAIL**. Nothing like its strange and amazing art ever seen before. It is **FOR SPORTSMEN and NATURE-LOVERS**, and it is **FREE** if you send the **COUPON NOW**. Hunters, Men, Boys. Mail the coupon **THIS MINUTE**. You will **WIN**, new interests.

**NORTHWESTERN SCHOOL OF TAXIDERMISTRY**  
2501 Elwood Bldg., Omaha 2, Nebr.

### FUN • PROFITS

**THINK** of the fun and joy of mounting and saving your own hunting trophies. Right in your home, will be the prizes of your fine hunting and outing trips. It's simply great!

### SPARE-TIME PROFITS

All of your sportsmen friends will be proud of you and your work. **THEY WILL URGE YOU TO MOUNT THEIR SPECIMENS**. They will be delighted to pay you liberally. Many students earn splendid profits while learning. **YOU can now be a Taxidermist, for pleasure and profits.**

### 300,000 Students

Many of our vast number of students are employed in the **BIGGEST and FINEST MUSEUMS**, which endorse our school. No higher recommendation can be had in America. **WE CAN TEACH TAXIDERMISTRY TO YOU**, men, boys, and women. Yes, more than 300,000 are members of this fine school, and endorse it enthusiastically. Here is your opportunity, long awaited. Send the **COUPON** without fail.

### GET THE FREE BOOK

This new, strange, unique **FREE BOOK** will open a new world of fine pleasure to you. Write for it **NOW**. **IT TELLS THE WHOLE STORY**. 44 pages, over 100 photos of wild-game, and stories of success that will thrill you. Shoot fewer specimens, double your fun, and help conserve the wild-game.

Send the **COUPON THIS MINUTE**. State your **AGE**.

**Send  
for  
Free  
Book**

### Mail Coupon Now

**Northwestern School of Taxidermy,**  
2501 Elwood Building, Omaha 2, Nebr.

Please Rush the **FREEBOOK** to Me. I am interested. Please send the **FREE BOOK ON TAXIDERMISTRY** and tell me about how I can **BECOME A FINE TAXIDERMIST**.

Without obligation on my part, explain how I can **double my interest** and fun in hunting, outdoor life.

Name.....

Address..... Age.....



## AMERICAN TECHNICAL SOCIETY (Founded 1898)

**Offers You the Opportunity to Prepare for Higher Earnings in Building and Contracting**



**THESE 9  
HOW-TO-DO-IT  
VOLUMES  
ON APPROVAL**

**SEND  
NO MONEY  
•  
MORE THAN  
4000 PAGES  
•  
2750  
PICTURES**

Examine this Up-to-Date Edition for 10 days. See how these nine books supply easily understood self-training that will help you get a better job and make more money, or start a profitable business for yourself. Have these books handy for use in solving all sorts of building problems.

### PAY-RAISING INFORMATION

Learn to draw plans, estimate, do all-new construction and modern remodeling to meet fast-growing demand. More than 4000 pages of practical, pay-raising information with 2750 helpful illustrations, on such subjects as blueprint reading, concrete forms, masonry, carpentry, steel square, electrical wiring, plumbing, heating, painting and hundreds more.

In our more than 50 years we have never offered more complete building information. **SEND THE COUPON TODAY.**

(A year's consulting privileges with our staff given with these books without extra cost.)

**AMERICAN TECHNICAL SOCIETY—Publishers Since 1898**  
Dept. G119, Drexel Ave. at 58th St., Chicago 37, Ill.

I would like to examine your 9-Volume Set of Building, Estimating, Contracting Books. I will pay the delivery charges only, but if I choose I may return them express collect. If after 10 days' use I prefer to keep them, I will send you \$3 plus postage and pay the balance at the rate of only \$4 a month until \$34.80 has been paid.

Name \_\_\_\_\_

Address \_\_\_\_\_

City \_\_\_\_\_ State \_\_\_\_\_

Please attach letter giving employer's name and address (if self-employed give business man's name as reference). Men in service please give home address.

**TOOTHACHE?** TOOTH GUM  
TOOTH DROPS  
POULTICE  
Ask your Druggist for **DENT'S**

## IT PAYS to know— WATCHMAKING

Why spend all your life at dull or backbreaking work? Watchmaking is light, clean, fascinating. Ideal for handicapped. Lifelong livelihood. Learn the quick Sweazey way at home or Chicago school. Modern methods, step-by-step. No previous experience needed. Send for FREE sample lesson. No obligation.

### APPROVED FOR VETERANS

Chicago School of Watchmaking also offers personal attendance courses in advanced horology, engraving, jewelry repairing, diamond and stone setting. Successfully taught since 1908.

### CHICAGO SCHOOL OF WATCHMAKING

2330 Milwaukee Ave., Dept. 114, Chicago 47, Ill.  Veteran  
Send me FREE sample lesson  Home study  Resident school

Name \_\_\_\_\_

Address \_\_\_\_\_

City \_\_\_\_\_ Zone \_\_\_\_\_ State \_\_\_\_\_

**more jobs  
than graduates**

**ENGINEERS**  
Interesting opportunity! If you pay you to write Box D 1 including a complete history of terms and education.

Demand for our engineering graduates exceeds supply. Effective placement! Study in this world-famed college . . . established 1884. New term starts quarterly. Approved for Korean Vets.

### Bach. Sc. degree in 27 months

Bachelor of Science in Mechanical, Civil, Electrical, Chemical, Aeronautical, Radio (Television), Administrative Engineering; Business Administration and Accounting. Also 36-weeks certificate courses in Surveying, Drafting, Secretarial Science. Intensive program: technical fundamentals accented.

Small classes; personalized instruction. For earnest, mature students whose time and budget require accelerated courses and modest costs. Preparatory courses.

Beautiful campus in friendly college town. Well-equipped, new and modernized buildings and labs. Enter March, June, Sept., Jan. Write Jean McCarthy, Director Admissions, for Catalog and View Book.



## FREE! TOO FOREIGN STAMPS

All genuine, unpicked, unsorted — just as received from Europe, Asia, Africa, Near East, Far East — from everywhere! Plus a beautiful souvenir of World's Rarest Stamp and our valuable "Stamp Collector's Guide". Other valuable offers also included for your FREE inspection!

Send 10c for postage and handling to:  
**GARCELON STAMP CO., DEPT. 1PM**  
CALAIS, MAINE



**Finish HIGH SCHOOL AT HOME**  
**Complete 4 Yrs. in 12 Months**  
Learn More! Earn More! Enter professional or technical schools. Advance Socially. Live a Happier, Fuller Life. Individual Courses or complete schedule. **WRITE FOR SCHOOL BULLETIN.**  
**ACADEMY FOR ADULTS**  
30 W. Washington, Dept. PM-104, Chicago, Ill.

**500 TRICKS** **MAGIC TRICKS**  
**IT'S FUN TO DO MAGIC**  
Be popular! Amaze—mystify—entertain! For 30 years Douglas has satisfied customers all over the world. Now, you can enjoy this fascinating hobby. Only 10c brings our Catalog—500 Tricks, containing brand new tricks for pocket, parlor, stage. Join in the fun—send 10c today!  
Douglas Magicland, Dept. A, Dallas, Texas

### Say You Saw It in Popular Mechanics

Mitchell B-25 **BUILD A FAMOUS TWIN ENGINE BOMBER**  
Invader B-26  
With a **MONOGRAM Speedee-Bilt Kit**

Completely Finished Balsa and Plastic Parts • Only \$2.95 Each

Give yourself a thrill fellow. Build one of these famous bombers with the finest model building kit you ever saw. Now twin-engine planes easier to build than single-engine jobs in the past. Prefabricated balsa fuselage—famous all-balsa Monofoil wings, completely airfoiled—34 detailed molded plastic parts including props and pilots, in each kit.

**MONOGRAM MODELS, Dept. 11, 3421 W. 48th Place, Chicago 32**

**Easiest to build.**  
The B-25 Mitchell flown by Gen. "Jimmy" Doolittle and the B-26 Invader used in Korea. Famous names with famous names! Get one for yourself, if no dealer near you order from address below. Each kit \$2.95, plus 35c for packing and shipping. Both kits for \$6.25 postpaid. You save 35c.



**MEN-WOMEN**  
*GROW*  
**TROPICAL**

# ORCHIDS

**IN YOUR LIVING ROOM!**  
**BIG PROFITS--SPARE OR FULL TIME**

**ALL THESE**  
Also CYMBIDIUMS,  
LAELIAS, EPIDENDRUMS  
and many others

**YEAR 'ROUND**

**No Green House**

**ANY CLIMATE**  
Maine to California



**CYPRIPEDIUMS**  
(Greens, Pinks,  
Yellows)



**CATLEYAS**  
(Lavenders,  
Yellows,  
Whites)



**ODONTOGLOSSUMS**  
(Yellows, Browns, Rose)

**FILL YOUR HOME with ORCHIDS**  
—EVERY MONTH OF THE YEAR

Successful family of home growers now reveal their secrets for your pleasure and profit. Learn the exciting facts about raising beautiful Orchids at home... how to grow dozens of varieties in every rainbow color... have Orchids in full bloom every month of the year! Many grow without soil, getting food from the air. NO GREENHOUSE NEEDED. Start on table or window ledge.

**Home Growers Coast to Coast Benefit from Schirmers' Help**

"Received my Orchid plants and have 2 very beautiful flowers in full bloom." L. S., Utah

"A wonderful course, written so anyone can understand it." J. G., Michigan

"You have explained each step so clearly I don't see how anyone could go wrong." M. S., Louisiana

"Am very proud of my Course and plants. Our florist says he will buy my Orchids." R. P., Arkansas

"I'll always be grateful to Mr. and Mrs. Schirmer. My entire family is happy." M. M., N. Y.

"I can sell all the Orchids I can produce." M. H., Idaho

"Our Orchid plants are a constant source of joy." J. P., Colorado

**THRILLING HOBBY—EXCITING HOME BUSINESS**

Imagine the delight of watching gorgeous Orchids burst into bloom in your living room! The big lavender corsage Orchids you see in every flower shop—also many others in all sizes and colors. Orchids for your own enjoyment, or to sell at good profits.



**LOUIS and GLADYS SCHIRMER, SUCCESSFUL HOME-GROWERS SAY: "We'll Show You How We Raised Orchid Plants Worth A Fortune—Starting At Home in Spare Time"**



**FINE PROFITS—ANY LOCATION—RETAIL—WHOLESALE—MAIL ORDER**

Learn how to market your Orchids for profit, no matter where you live—small town, big city, or on a farm. Millions sold by mail order, coast to coast. Tropical Flowerland's "Quick-Profit Plan" helps you get started at once.

**FUN FOR ALL THE FAMILY.** It's great fun to grow Orchids. And the whole family can help—from teen-agers up. Mr. Schirmer himself is over 60—was nearly 50 when he and Mrs. Schirmer first started to grow Orchids for profit.

**LEARN HOW ORCHIDS MULTIPLY.** Learn how one plant may become many, each as valuable as the first! Flower production and plant stock should both increase steadily—year after year.

**FREE Airmail Coupon Now—Send No Money!**

**COMPLETE INSTRUCTIONS & Blooming-Size Orchid Plant Sent for You to Examine at Home without Risk!**

Airmail coupon today for amazing offer of Complete Home Course and a real blooming-size Orchid plant for you to examine at home without risk! Nearly 300 large-size pages, filled with "show-how" draw-

ings and photos—many in full color. Shows you how to grow 30 different kinds of Orchids at home, and market them for extra income—spare or full time. Send no money—just the coupon.



**TROPICAL FLOWERLAND, Dept. 311**  
4622 Wilshire Blvd., Los Angeles 5, Calif.

Please rush FREE details on your offer of Louis & Gladys Schirmers' Instructions which show me how to grow Orchids at home. The Instructions will include a real blooming-size Orchid plant and valuable "Quick-Profit Plan"—all sent for me to examine at home without risk. This request does not obligate me in any way.

Name \_\_\_\_\_

Street \_\_\_\_\_

Town \_\_\_\_\_ Zone \_\_\_\_\_ State \_\_\_\_\_

**TROPICAL FLOWERLAND, Dept. 311** 4622 Wilshire Blvd. Los Angeles 5, Calif.



own your own business! earn up to  
**\$75 A DAY CLEAR PROFIT**  
 in your back yard or basement!

**MAKE CONCRETE BLOCKS With Amazing New  
 LOW PRICED GENERAL BLOCK MACHINE**

**NOW! Big Building Boom**

**Profits Within Your Reach**

You don't need much cash to cash in on the building boom! New high speed, low cost General Block Machine produces up to 1,000 concrete blocks a day for homes, factories, buildings, garages. Your profit markup is 100% to 150%! Fool-proof, easily operated, sturdy steel machine can make any size from 4" to 12". These superior 3-core blocks meet all building code requirements for foundation, chimney, corner, sash and many other types of blocks. Works indoors or out. Sand, cement and water available anywhere! Simple operating instructions and mixing formulae for cement and cinder blocks supplied FREE. Get full details, no obligation!



R.L.T. of  
 New York  
 City Reports:  
 "My General  
 Block Machine  
 PAID FOR ITSELF IN FIRST  
 2 WEEKS!"

Thousands now in use  
 the world over!  
 Write for FREE details  
 TODAY

**EXTRA!**

Amazing illustrated book gives floor plans for 6 sensational concrete block bungalows. Tells how to lay blocks, lay out building lines, mix concrete, build steps, porch and concrete floors all at great savings. Written by experts. Can save many times the cost of the machine! Get it now! No strings attached.

HOW TO  
 BUILD  
 YOUR OWN  
 CONCRETE  
 BLOCK  
 HOME  
 Only 17 pages!

Book sent free if you buy machine. \$1 refunded if you buy later.

**GENERAL ENGINES COMPANY**

Dept. M-14, 307 HUNTER STREET, GLOUCESTER, N. J.

**FREE CATALOG**

**WORLD  
 RADIO LABORATORIES**

"The World's Largest Distributor of  
 Amateur Radio Transmitting Equipment."

Jam packed with bargains—  
 everything in Radio, TV, and  
 Hi-Fi—for Handyman, Ham,  
 Experimenter or Serviceman!

- Pay Only 10% Down
- Easy Terms
- Liberal Trade-Ins
- Save Over 50% on Used Equipment
- Over 600 guaranteed reconditioned items.



**WORLD RADIO LABORATORIES**

3415 W. Broadway—Council Bluffs, Iowa

Leo I. Meyerson

PERSONALIZED SERVICE

**MAIL HANDY COUPON**

WORLD RADIO LABORATORIES, INC. Dept. PM 12  
 3415 W. Broadway—Council Bluffs, Iowa 3'x4' U.S.  
 Free 1954 Catalog  Used Eq't List  Radio Map 25c

NAME \_\_\_\_\_  
 ADDRESS \_\_\_\_\_  
 CITY \_\_\_\_\_ STATE \_\_\_\_\_

**HOW TO MAKE Your Old Boat NEW**

**How to build your own  
 FIBERGLASS BOAT**

These Two Manuals Tell You How To:  
 • Protect your old boat permanently with Liquid Castoglas • Form resilient plastic skin tougher than steel, lighter than aluminum • Make hulls leak-proof, weather-proof • Lay fiber mat and glass cloth for new boats • Build your own non-rusting, non-corroding tanks, compartments • Repair pipes, etc. • Skid-proof decks • Illustrated step-by-step instructions show how

**YOU CAN DO-IT-YOURSELF**  
 easily and save one-half to two-thirds of cost. Send 25c for these two practical books. Satisfaction guaranteed. Limited edition, so order today.

DEALERS: WRITE FOR PROPOSITION

MARINE DIV.  
 DEPT. MA-2

**THE CASTOLITE COMPANY**  
 Mfg. Chemists—WOODSTOCK, ILL.



**BOTH FOR 25c**

**LAW**

Men and women **STUDY AT HOME** for Business Success and **LARGER PERSONAL EARNINGS**, 44 years expert instruction—over 114,000 students enrolled. LL.B. Degree awarded. All text material furnished. Easy payment plan. Send for **FREE BOOK**—"Law and Executive Guidance"—**NOW!**

**AMERICAN EXTENSION SCHOOL OF LAW**

Dept. PM-70, 664 N. Michigan Ave., Chicago 11, Illinois

**FREE WILL'S SEED CATALOG**



Get our big new 1954 CATALOG **FREE** . . . One of our finest! 62 colorful pages of select hardy Northern grown flowers, vegetables, fruits, berries, trees, shrubs, evergreens, farm seed and Pioneer Hybrid Corn. Early hardy varieties. Special low mail order prices for early orders. Mail card or letter for **FREE** copy.

**OSCAR H. WILL & CO.**

**BISMARCK, NO. DAKOTA**

BOX 600-BG

**Learn CARTOONING**

at home in spare time . . . the quick easy Landon Picture Chart way. Teaches how to originate—today's big need. Scores of successes. Send for **FREE** Picture Chart (to test ability) and full details.

Landon School of Cartooning, 5401 CTS Bldg., Cleveland 14, O.



**LEARN Modern Appliance and  
 Electrical Servicing**

Revolutionary New Method shows you how—at home—in YOUR SPARE TIME! We send you complete Home Training Kits and Latest Engineered Test Equipment. You can actually earn **BIG MONEY WHILE LEARNING!** Many men are making \$2.50—\$3.00 and more PER HOUR! RUSH name and address for big **FREE** book and full details—**WRITE TODAY!**

**ADVANCE TRADES INSTITUTE, Dept. 141**  
 5944 NO. NEWARK AVE. CHICAGO 31, ILL.

**Learn LANDSCAPE  
 GARDENING**

**FOR PLEASURE OR PROFIT**  
 • **TO START YOUR OWN BUSINESS**  
 • **TO IMPROVE YOUR PROPERTY**

A thorough interesting and constructive home training for both those who wish to become **LANDSCAPERS, DESIGNERS, & GARDENERS**, and those who wish to learn for their **OWN USE AND PLEASURE.**

**OPPORTUNITIES**  
 An uncrowded field. Healthful out-of-door work for both men & women. Prepare now, Send for **FREE** Information

**NATIONAL LANDSCAPE INSTITUTE**  
 Dept. P-1, 310 So. Robertson, Los Angeles 48, Calif.



**Yours for the asking—  
No charge—no obligation**

# "How to Become a Mail Order Millionaire"

Read how Gilbert on a "peanut" investment built up to \$350.00 A DAY. Learn how Zimmerman started a mail order business on a buck private's pay and spiraled \$16.80 into a big yearly income. See how a Chicago clerk quit a \$75.00 job and now makes \$22,000 a year in his own Mail Order business. Read how a southern boy made a fortune selling war-surplus parachutes which he bought as he went along. All Free! Send name on coupon for a copy of this fascinating reprint of "How to Become a Mail Order Millionaire" from *Mechanix Illustrated* plus details on the L.W. Mail Order Survey.



## Start on a SHOESTRING!

The real-life stories of success in Mail Order read like fairy tales. If I had not personally known these people their stories would be hard to believe. Yet they are not only true, but they represent just a few of the hundreds of "little operators" who have been swept into big money by Mail Order.

**GAINES.** I personally guided his start when he invented an automatic parts presser. He started with one little ad in one magazine. Four years later he retired — with enough real estate to keep him in cash income the rest of his life.

**VAN MARK.** I worked with him for six years. I met him when he was a wagon man for a tea and coffee house, knocking on doors. He went into Mail Order on nothing—made money from the start —ended up six years later with savings of \$50,000 and an income of \$5000.00 a year for life without further work.

**DUGGAN.** A few years ago he was a truck driver. Started fooling with Mail Order in a spare room in his spare time. Last year he said, "I don't know how much I'm worth—after you get the first million you quit keeping track."

**MRS. NIXON.** Started a small Mail Order business at home—just to keep occupied. It looked good and she came to me for advice. I showed her how to expand. In two years the business got so big her husband resigned his job to help manage it.

**FOXMAN.** Foxman worked as a book writer at \$70 a week. He had idle time in the evenings—ran an ad offering something he didn't have—got so many orders he had to find a source of supply. He made \$18,000 the first year. He gives me credit for "showing the way."

**JORGENSEN.** Consulted me about a specialty product. On my advice he ran one ad to "test" its saleability. That ad brought sales of \$50,000. In his first year he did a business of nearly a half million dollars. His original investment was less than a thousand.

These things I have seen. These people I have helped to the realization of their dreams — these and hundreds of others. My own fortune was made in Mail Order. And now my secrets can be yours.

**L. W.**

Have you ever thought of running a profitable little sideline right from your home? Has it occurred to you that you are just as capable as anyone else of making money on a product or service that can be sold by mail? Have you ever looked into the Mail Order business as it's run (on tiny investments) by innumerable small operators?

Forget about Sears and Ward's! Read about the "little fellows" . . . clerks, teachers, vets, mechanics, salesmen and others . . . who are packing Mail Order items in bedrooms, spare rooms, attics, garages, cellars . . . dumping them in the Post Office . . . and quietly banking the fistful of Money Orders, cash and checks delivered to them daily by the mailman.

An annual business of almost a billion dollars is done by "little fellows" who advertise and sell just one item! The Department of Commerce of the United States says, "A number of the most successful obtain incomes as high as \$40,000 to \$50,000.00."

It's an incredible story . . . a story of a business that's wide-open for newcomers . . . with opportunities for income far-and-away greater than you can ordinarily hope to attain by holding down a job. And in Mail Order you can stay as small as you wish—run your deal as a \$50 or \$75 weekly sideline—or consider jacking it up into really big figures as a full time operation.

Glance at the examples at left. These true stories are far from unusual. Multiply them by the hundreds and you begin to get an idea of what can be done . . . what is being done . . . in the phenomenal Mail Order field.

Yet, if you were to jump blindly into Mail Order your chances would be slim. A peculiar brand of "know-how" is vital in this little - known, little - understood business. This is fortunate for you. If any Tom, Dick, or Harry would "click" in Mail Order, the field would have been overloaded years ago.

But now you have the opportunity to learn the authentic secrets of successful Mail Order operation. They are revealed for the first time, step by step, in an extraordinary new Survey . . . the L.W. Confidential Mail Order Letters.

This Survey is not a course—not a book—not a group of lessons. It is a simple guide that anyone can follow. It shows you how to pick the right product for Mail Order. It shows you exactly how to start a profitable business fast, with cash or Money Orders in the envelopes you receive. It shows how to buy your product out of the very money you get in the mail, so you don't have to tie up cash in large supplies of your product. It gives you actual examples of ads and letters, analyzed to show how and why they make money. It demonstrates the months to start, the time to expand, the best way to get prospects' names. It reveals from A to Z the confidential facts that have made fortunes for Mail Order operators who use them.

Mail the coupon today, or simply send your name and address on a postcard. No salesman will call. We will mail, postage prepaid, a Free copy of "How to Become a Mail Order Millionaire" and along with it will give you complete facts about the L.W. Mail Order Survey. Read the facts. Then decide whether you would like to spend spare time or full time in a profitable, fascinating Mail Order enterprise. If you think you would like to follow the footsteps of hundreds of others who are now making good money in this way, you can get your L.W. Survey and begin at once.

Please don't decide to write us "a little later." Send your name now, before you forget. This one little act might be the first step to a future of independence and wealth.

**The L. W. MAIL ORDER SURVEY, Dept. 11  
805 LARRABEE ST., LOS ANGELES 46, CALIF.**

**The L. W. MAIL ORDER SURVEY, Dept. 11  
805 Larrabee St., Los Angeles 46, Calif.**  
Mail me a free copy of "How to Become a Mail Order Millionaire" and details about the L. W. SURVEY. It is understood there is no charge at any time, and that I am not under the slightest obligation. After reading, I will decide whether I want to use the L. W. Confidential Letters to help me start a Mail Order business at home.

NAME \_\_\_\_\_  
ADDRESS \_\_\_\_\_  
CITY \_\_\_\_\_ Zone \_\_\_\_\_ STATE \_\_\_\_\_



# SHORTHAND IN 6 WEEKS

WRITE 120 WORDS PER MINUTE  
Age No Obstacle

Famous Speedwriting Shorthand. No symbols, no machines. Uses ABC's. Easiest to learn and use. Qualify at home in spare time or through classroom instruction. Fast preparation for a better position and a sound, substantial future. Nationally used in leading offices and Civil Service; also by executives, students, etc. 120 words per minute. 50% FASTER than Civil Service requirements. Over 200,000 graduates. Typing available.



Writes 120 Words Per Minute in a Few Weeks With Speedwriting

"I enrolled for the Speedwriting Course and mastered it within a few weeks at less than an hour a day. Shortly after starting, I was writing shorthand at 120 words a minute. Anyone who knows the alphabet can master speedwriting easily." Henry Stepp, Beauty, Kentucky.

The very low cost will surprise you  
**31st Year**

Schools in over 400 cities in U. S., Canada, Cuba and Hawaii.

Write for FREE Booklet to:

## Speedwriting

Dept. 1501-4, 55 W. 42 St., N. Y. 36

Say You Saw It in Popular Mechanics

**Grow with diesel**  
and SCIENTIFIC MOTOR TUNE-UP  
—One of America's Fastest-Growing Big-Pay Industries!

Get ready now . . . Make a place for yourself in the mighty Diesel industry. Be there to take advantage of the opportunities ahead. The U.E.I. Plan for learning Diesel is simple, practical and is based upon the principle of learning-to-do-by-doing. Includes Auto Engine Tune-Up. You get fundamentals through spare-time home-study, followed by actual shop practice on modern Diesel engines. Experienced instructors guide you step-by-step — you learn the HOW and WHY of Diesel operation, service and maintenance. Get all the facts—mail the coupon and we'll send you a free copy of "Earning Power in Diesel." Mail coupon today!



**UTILITIES ENGINEERING INSTITUTE**

Dept. DC-35, (Founded 1927) Chicago 14, Ill.

UTILITIES ENGINEERING INSTITUTE, Dept. DC-35  
2521 Sheffield Ave., Chicago 14, Illinois

Please send me, without obligation, your free book, "Earning Power in Diesel."

NAME (print).....AGE.....

ADDRESS .....

CITY..... Zone..... State.....

Check here for information if you are under 17

## Shrinks Hemorrhoids Without Surgery

Science Finds Healing Substance That Relieves Pain—Shrinks Hemorrhoids

Science has found a healing substance that shrinks hemorrhoids, stops pain promptly, ends bleeding — without surgery. Doctors report actual shrinking of hemorrhoids. Sufferers say, "Hemorrhoids have ceased to be a problem." The secret is Bio-Dyne® — already widely used for healing injured tissue. This substance is now available in a hemorrhoid ointment called Preparation H\*. Ask your druggist for Preparation H. Money back guarantee.

\*Trade Mark

## Want a COLLEGE EDUCATION in Engineering or Liberal Arts — on an economical plan?

More than 50 colleges now offer you a remarkably practical plan of "Learn while you earn". It no longer requires a lot of cash to obtain a college education in Engineering or Liberal Arts. These colleges help secure a part-time job in the field you desire while studying for a college degree in that field. Thousands of men are doing just this, today! Industry and other fields want to help you gain that efficient "know-how". They need you now. Get even further aid. Send \$1.00 TODAY for a copy of our easy-to-follow, complete data booklet entitled "College For Everyone". No C.O.D.'s please.

COLLEGE AIDS P. O. Box 157 E, Pasadena 8, Calif.

## Learn DRAFTING At Home

Tremendous opportunities in this field. Our simplified method trains you for a top paying position. Text books, drafting outfit, and instruments furnished. 3 courses in one. Low tuition. Free information.

ROTH TECHNICAL INSTITUTE  
Dept. M1, Box 2283 Youngstown, Ohio

PLEASE  
SEND ME



for the  
time checked.  
I am enclosing . . .

1 year \$3.50

2 years \$6.00

name

address

city

zone

state

C-14

Hand this order to your newsdealer or send it to

**POPULAR MECHANICS**  
200 East Ontario St. Chicago 11, Ill.



# Take your Short Cut to HIGH-PAY JOBS or BE YOUR OWN BOSS IN Television

**TRAIN FOR SUCCESS AS A TV TECHNICIAN IN YOUR SPARE TIME AT HOME—EARN WHILE YOU LEARN!**

Are you looking for employment opportunities with a FUTURE? What are your chances for promotions or raises in your present job? BETTER YOURSELF... train NOW for profitable jobs in the booming Television Industry. Thousands of top jobs are awaiting the Trained TV Technician. HERE IS YOUR BIG OPPORTUNITY IF YOU ACT NOW!

**MANY UTL TRAINEES MAKE \$25 A WEEK**

**IN SPARE TIME**, while still in training. The money they earn for repairing TV sets and radios for neighbors... assisting service shops and distributors, more than paid for the training, and permitted them to enjoy many of the luxuries in life. UTL SHOWS YOU HOW!

**NO EXPERIENCE NECESSARY**

**YOU ARE READY TO TRAIN AS YOU ARE!**

You don't have to know the first thing about electricity or television at the start, to master UTL Training. Step-by-step instructions TELL you how—thousands of pictures, diagrams and charts SHOW you how! The finest equipment GIVES you the Know-how! Age or experience is not important... just your AMBITION.

**Be Your Own Boss  
No Money Down!**

Start your own profitable service business immediately after graduation, without putting one cent down for equipment, stock, parts, and tubes. Get the amazing details! ACT NOW... OFFER LIMITED TO FIRST COME, FIRST SERVED.

**NOTE TO MEN PAST 40:**

If you find it difficult to get ahead, here is your opportunity to be independent and have your own thriving business.



**ALL PROFESSIONAL TOOLS AND EQUIPMENT FURNISHED, COMPLETE!**

UTL sends you everything you need for successful Home Training. These BIG KITS, which you keep, convert any table into a fascinating experimental laboratory. Enjoy doing hundreds of thrilling experiments and interesting demonstrations. Build professional equipment to use in your career, including a volt-ohm-milliammeter, a complete superheterodyne receiver, a cathode-ray oscilloscope and other valuable units. Practice servicing on TV receiver units!



**UTL has Successfully Trained Thousands**

Amazing Training Program has caused graduates to say UTL training was responsible for their getting ahead so fast... trainees report UTL training is the easiest thing they have ever done! Training is professional and efficient... you are treated as a person, on an individual basis.

**TRAIN AT HOME** set your own pace. Practice with parts and equipment sent you. UTL instructors give you full assistance. Your training is remarkably EASY. Upon completion, you...

**TRAIN IN UTL LAB.** for 160 hours of INTENSIVE, ADVANCED TV EXPERIENCE! You operate modern equipment found only in a lab; do interesting trouble-shooting assignments; get the professional touch by knowing accepted TV circuits, equipment and standards!

**JOB PLACEMENT SERVICE and BUSINESS PLAN IS AVAILABLE** when you complete your training. Excellent record. Find out for yourself!

**STUDIO TRAINING**

UTC Television Studio Techniques training paves the way to glamorous jobs in TV Studios and Stations. Non-technical! Absolutely NO EXPERIENCE required! Be a cameraman, actor, director, audio man, writer, artist, or choose from other fascinating positions. TRAIN AT HOME for exciting work "behind the scenes" in producing shows! At no extra cost, get 160 HOURS STUDIO TRAINING in UTC's professional studios. Get EASY training that will thrill you with its simplicity. Make good pay in the job of your choice! UTC offers job placement service. Get the facts on what television studio training offers you!

**FREE FREE FREE!**

Exciting big 48-page book is jam-packed with information on how to get high pay jobs in TV; how easy it is to train; how to build up prestige and income at the same time; how to take advantage of your opportunities.



**UNITED TELEVISION LABORATORIES**  
19th & MAIN • LOUISVILLE, KENTUCKY

**DON'T DELAY-MAIL THIS TODAY**

UNITED TELEVISION LABORATORIES, Inc., Dept. M54J  
19th and Main Streets, Louisville 3, Kentucky  
Send me the big, valuable 48-page book of Opportunities, FREE! I understand I am under no obligation.

Name \_\_\_\_\_  
Address \_\_\_\_\_  
City \_\_\_\_\_ Zone \_\_\_\_\_ State \_\_\_\_\_  
Married \_\_\_\_\_ Single \_\_\_\_\_ Age \_\_\_\_\_

PLEASE SEND DETAILED INFORMATION ON:

- TV Technical Training
- Owning my own business
- Television Studio Techniques
- How to get a high-pay job in TV



# FOR YOUR TECHNICAL AND VOCATIONAL TRAINING

Come to the  
**UNIVERSITY OF HOUSTON**

One of America's large and most modern universities. Select from these fascinating fields:  aeronautics  air conditioning & refrigeration  auto body and paint  auto mechanics  auto upholstery & trim  diesel  drafting  electricity  electronics  machine shop  photography  radio  stationary engineering  television  welding  woodworking  furniture upholstery.

**PREPARE FOR YOUR FUTURE NOW** . . . with very latest methods and equipment, at modern U. of Houston College of Technology. Entrance: high school diploma, or over 18 and ability to profit from instruction. Beautiful campus—250 wooded acres in Houston, Texas—city of tomorrow. Full college activities, sports, social life. Day or night, short or longer courses. Co-op work-study programs . . . earn part of tuition and expenses with part-time job in your own career field, while you learn. Personal vocational counselling. Diploma on completion and all credits apply towards Bachelor of Applied Science Degree. Job placement assistance, Feb., June, Sept. semesters. Mail ad now for Free fully-illustrated brochure. No obligation. Mark X before choice of subject. Do it today!



ADMINISTRATION BUILDING  
**University of Houston, College of Technology**  
Dept. 114 — HOUSTON 4, TEXAS

## GREER SHOP TRAINING

2220 So. Michigan Blvd.  
Chicago 16, Illinois

**Leader in Practical Training for 50 Years**

Gain success by learning a trade offering security and high pay—go into business for yourself.

**Get the "Know-how" at Greer**

You learn in our new, large, modern shops by working with latest tools and equipment of the trade — tear down, inspect, repair and rebuild . . . under supervision of experts. Greer founded 1902. Over 51,000 successful grads. Part time, full time, day and evening. E-Z terms. Mail coupon today.

**CLIP COUPON . . . MAIL TODAY**  
Greer Shop Training—2220 South Michigan  
Chicago 16, Illinois Desk 213

Please send information about trade checked:

- |   |   |
|---|---|
| <input type="checkbox"/> Body, fender Repair              | <input type="checkbox"/> Auto Mechanics   |
| <input type="checkbox"/> Welding—Arc, gas                 | <input type="checkbox"/> Diesel Mechanics |
| <input type="checkbox"/> Refrigeration & Air-conditioning | <input type="checkbox"/> Tool & Die       |
| <input type="checkbox"/> Machinist                        | <input type="checkbox"/> Piano tuning     |

APPROVED FOR CIVILIANS  and G.I.'s   
(check which)  
**ATTENTION: HIGH SCHOOL GRADUATES.**  
Write for information on 2 year DIESEL-AUTOMOTIVE ENGINEERING COURSES.

Name \_\_\_\_\_

Address \_\_\_\_\_

City \_\_\_\_\_

State \_\_\_\_\_

Age \_\_\_\_\_



A FEW MORE TIRES YEAR AFTER YEAR WE HAVE INSURED YOU ALWAYS SAID "IT'S DAMN-FAMILY SAFE" GEROUS TO PAY LESS!"

**GOOD YEAR Firestone**

GOODRICH, U. S. ROYAL, ARMSTRONG & OTHERS | A FREE TUBE with every good and finest grade tire.

**PASS. CAR TIRES \$4** (no recaps & GUARANTEED). **TRUCK TIRES \$11**

BLATTS WORLD-FAMOUS FINEST. (NOT RECAPS.)	32 MONTHS GOLDEN RULE	GUARANTEE
600-16 \$5.05	700-16 \$5.85	800-15 \$5.95
600-16(G) 5.90	700-16(G) 7.14	820-15 5.95
650-16 5.64	750-16 8.78	650-15 4.95
650-16(G) 6.79	550-17 4.25	700-15 5.25
480-21 5.15	850-16 5.78	600-18 6.00
475-19 4.84	WHITEWALLS \$1.50 EXTRA	625-18 4.25

FLEET OWNERS	RE-ORDER YEAR AFTER YEAR, NOT RECAPS.	TRUCK TIRES 32 MONTH GUARANTEE
700-15(G) \$8.73	700-17 \$9.83	1000-20 \$17.95
750-15 11.73	750-17 11.23	1100-20 17.97
750-15(H) 10.65	600-20 8.64	1000-22 17.97
825-15 12.53	32-6 10.96	1100-22 18.20

We select your tires, as if our future depended on it. Buy in Confidence, our Finest Safe, Slightly Used Tires.

**MILITARY TREAD MUD-GRIP 32 MONTH GUAR. NO RECAPS.**  
750-20 H. Duty Rugged \$16.64  
900-16 H. Duty Rugged \$14.24  
600-16 H. Duty Rugged 9.94



**FACTORY RETREAD SNOW TIRES 30 MO. GUARANTEE "New Tire Traction."**  
GOODYEAR, FIRESTONE & OTHERS  
670-15(600-16) \$7.95 | 710-15 \$9.95 | 800-15 \$9.90 | 820-15 \$9.90 | 700-15 \$9.90

**BLATT** 11th & SPRING GARDEN ST., PHILA., PA. Send ck or M.O. ORDER RUSHED  
order from your nearest store 2827 N.W. 7th AVE., MIAMI, FLA.

**DAN LURIE**  
"America's Most Muscular Man"—on television's "Big Top."



**FAMOUS DAN LURIE**

## BARBELLS

with 4 courses—low factory prices

50 lb. set...\$ 8.48 | 150 lb. set...\$20.48

100 lb. set... 13.98 | 200 lb. set... 25.98

Write for order by Mail: 50% with order, bal. C.O.D. Free Catalog Extra wia. 13c per lb., F.O.B. plant

**DAN LURIE BARBELL CO.**

1701-M-1 Pitkin Ave., Dept. 459-A, Brooklyn, N. Y.

## MEN AND WOMEN TRAINED AT HOME FOR PROSPEROUS BUSINESS IN UPHOLSTERING

Tools, Supplies, everything necessary to get started sent. Illustrated training shows how — progress rapidly. No previous experience necessary. Make over old furniture, sell for many times cost to you. Establish full or part time money making business. Free booklet explains plan. Send name, address to

**COMMERCIAL TRADES INSTITUTE**  
1400 GREENLEAF, DEPT. U2-1, CHICAGO 26, ILL.



## Cartoon the EASY way!

**ORDER THIS KIT TODAY!**

Make your own cartoons for fun and profit. No skill needed. Photo template with cut-out spaces and holes lets you make over 200 different cartoons. Kit also includes illustrated instructions, helpful hints book and information on selling. Only \$1.95 C.O.D. in USA plus c.o.d. postage. Send check or M.O. and we pay postage. Order today—no rush time for circulators. J. HOUSTON MAUPIN, Dept. 50, Tipp City, Ohio

**NEW**

for the LEATHERCRAFTSMAN

**Fiebing's DYEING and REFINISHING KIT**

... including nine basic leather preparations and daubers for the application of richly distinctive colors and finishes to hand-crafted leather articles. . .

**GET FREE FIEBING'S Handbook on How to DYE and REFINISH LEATHER**

**ASK YOUR DEALER or write direct FIEBING CHEMICAL CO.**  
516 South 2nd St. • Milwaukee 4, Wisconsin



Now! Earn \$5..\$8..\$10..up to \$12<sup>50</sup> per Hr.

SPARE TIME!

# Sensational New HOME-BUSINESS!

## AMAZING NEW PRINTING SECRETS CAN BE YOURS

For Pleasure & Profit. Once you learn the closely guarded printing secrets of Screen-Print there's virtually no limit to how much "extra money" you can earn. SPARE-TIME WORK—For FULL-TIME PROFITS. Screen-Printing is the most fascinating Home-Business ever! Learn in a few days and start making money immediately. Even earn while you learn—it's amazing!

## LEARN AN "EXTRA TRADE"

**MEN! WOMEN!** Learn Screen-Printing and make up to \$300 per week—even working for someone else. Learn Screen-Printing and you learn an "extra trade."

PRINT WITHOUT A PRINTING PRESS!

OR ANY SPECIAL EQUIPMENT

SCREEN PRINT  
TRADE MARK REG.

## WHAT IS SCREEN PRINTING?

It's a revolutionary new method of printing—WITHOUT an expensive printing press. This amazing new development lets you print quantities of 25, 50, 100, 500 or even 1,000 in many cases, FOR LESS THAN YOU CAN PRINT ON A \$5,000 PRINTING PRESS. Just put anything under a screen and take out beautiful products of printing—no expensive plates or "cuts" needed. No big overhead. Never has such an opportunity been offered the spare-time person who wants to make "Extra Income" in his home. This amazing NEW INDUSTRY can mean huge spare time profits for you.

### PRINT IN COLORS—EVEN NEW FLUORESCENT COLORS

There's no limit to the number of colors you can use. It's easy to print in luminescent, "glowing" fluorescent colors, too. (These "brilliant" new inks can ONLY be printed satisfactorily by the Screen-Print method.) Screen-Print lets you print on paper, cardboard, leather, glass, wood, plaster, fabrics—anything!

### NO ART NECESSARY—EASY TO LEARN

Anyone (young or old) can be a Screen-Printing expert—he doesn't have to be a "Rembrandt" either. Beautiful printing can be produced WITHOUT doing any art work whatsoever—simple tracing is all that's necessary in most cases. Simplified photo method ELIMINATES ALL HAND WORK. No camera needed.

### One of America's FASTEST GROWING BUSINESSES!

Hundreds are already profiting handsomely with Screen-Print. This New method may revolutionize the printing business, as we know it today! Get the facts NOW!

### A BUSINESS OF YOUR OWN

Be your own boss. Operate from the corner of your kitchen or garage. Build a successful future with a few cents worth of materials. Screen-Printing is the opportunity to establish a spare-time business without sacri-

ficing job or pay check—have 2 INCOMES INSTEAD OF ONE.

"I already make 75% of my expenses doing Screen-Printing only spare-time" says Mr. E. L., Ontario.

### THERE'S \$555 IN ADVERTISING!

Here's your chance to GET INTO ADVERTISING—one of the largest paying businesses in America. Most Screen-Printing is used for advertising purposes. Materials cost you 10%—you can earn 90%—few businesses offer this high profit.

### HUGE DEMAND! ENORMOUS PROFITS!

Millions of shops, stores, theaters, markets—almost any business needs Screen-Printing done for them. It's possible to even do your business by mail. No house-to-house selling either. You can make \$10 to \$20 profit on each dollar of cost on some jobs. Here's...

### YOUR "Chance of a Lifetime" OPPORTUNITY to

"cash-in" on a new printing method not generally known. We supply everything you need! From easy step-by-step instructions—secrets plus materials enough to make money immediately. A complete ready-made BUSINESS PLAN guides you every step of the way. This all can be yours—at our risk. Space here does not permit telling you all the terrific opportunities of Screen-Print. Don't waste a minute—mail coupon NOW! TODAY!—and get all the FREE FACTS and ACTUAL SAMPLE.



PRINT colorful ADVERTISING DISPLAYS at home!

You've seen thousands of them in stores, gas stations, theaters, markets—everywhere! Many of these displays are printed by Screen-Printing in brilliant "eye-catching" colors.



PRINT expensive SIGNS, BANNERS, POSTERS, LABELS, etc. at home!

EVERY BUSINESS, large or small, needs these items—they order them almost daily. It's possible to specialize in Screen-Printing banners alone and get all the orders you can take care of.



PRINT beautiful CLOTH, FABRICS, GLASSES, NOVELTIES, etc. at home!

Because you can Screen-Print on any kind of material, there are thousands of uses. Print lamps, glassware, ties, calendars, draperies, wall paper, flags, dress materials, balloons, bows, etc. Orders come from gift shops, manufacturers, markets, department stores, etc.

FREE

MY BOOKLET AND ACTUAL SAMPLE OF SCREEN-PRINTING. TELLS ALL THE FACTS ABOUT MY HOME-BUSINESS OPPORTUNITY PLAN.



Mr. C. J. Nowak  
GENERAL MANAGER



FREE BOOKLET AND REAL SAMPLE MAIL TODAY!

Screen-Print Co., Dept. 21  
1010 So. Los Angeles Street  
Los Angeles 15, California  
Dear Mr. Nowak: Please rush me booklet, facts, sample and entire Home-Business Plan. All this is Free. No salesman will call. I am under no obligation now or ever.

Name \_\_\_\_\_  
Address \_\_\_\_\_  
City \_\_\_\_\_ Zone \_\_\_\_\_ State \_\_\_\_\_





## Garlinghouse HOME PLANS

America's Pioneer Home Plan Service **for Better Living**

### 5 LATEST PLAN BOOKS—1 TO 4 BEDROOM SIZES

- **"RANCH AND SUBURBAN"**  
128 ranch plans most practical for town and country.....50c
- **"DELUXE SMALL HOMES"**  
Our largest selection—155 modern, time-tested designs...\$1.00
- **"HOMES IN BRICK"**  
Many of these 115 tested designs of medium and large homes are in color.....\$1.00
- **"YOUR NEW HOME PLANS"**  
2nd Edition. 64 pages (16 in color) of excellent plans for modern families.....50c
- **"BLUE RIBBON HOMES"**  
2nd Edition. 63 pages of homes proved popular by actual sales. Many in color.....50c

Select your new home from the hundreds of photographs and colored drawings in these five books. All sizes and styles are shown along with accurate description and floor plan of each. Complete working plans, specifications, lumber and mill lists are available for every design at low cost which is listed with each design. The moderate price of these plan sets is your best investment when building, since you know in advance what you are getting, thus avoiding misunderstandings. Complete plan sets when ordered will be sent by return mail (24-hr. service) on a money-back guarantee if unused plans are returned in five days.

All 5 above books for \$3.00, Postpaid—  
Our Complete Home Plan Library — 18 books and over  
1,250 Home Designs — Only \$8.00, a \$2.50 Saving.

**ORDER YOUR BOOKS TODAY**

All Books POSTPAID. No C.O.D.'s Please

**L. F. GARLINGHOUSE CO., INC., Box PM-20 TOPEKA, KANSAS**

## DIESEL MECHANICS NEEDED

### BIG PAY—GOOD FUTURE

Virtually all heavy power equipment is rapidly going DIESEL, creating big paying, steady jobs—through good times or bad—for properly trained men.

Back during the DEPRESSION... there was a big demand for Bailey Trained Diesel mechanics.

We can QUICKLY TRAIN YOU to enter this big pay field... no previous experience or special education necessary!

With our method of training you don't spend years pouring over books, figures, charts or graphs—you learn by repairing and operating big Diesel engines, under the guidance of experienced and friendly instructors.

This method of training gives you the experience and confidence that enables you to move right into the BIG PAY JOBS without spending years-as-a mechanic's helper. We help you find part-time jobs while in school—full-time jobs after graduation. Mail coupon for complete information.

### BAILEY Technical SCHOOLS

Veteran Approved

1626 S. Grand St. Louis 4, Mo.

NAME.....AGE.....

STREET.....

TOWN.....ZONE.....STATE.....

## MAKE MONEY 90 WAYS IN PHOTOGRAPHY



A profitable, action-packed career or steady, sparetime income can be yours in photography. Start earning at once as you learn to make money 90 ways with your camera. Our famous, low-cost LEARN-BY-DOING method and PERSONAL guidance train you quickly, easily at home! Big FREE book gives all the exciting details. Write TODAY! Our 44th year. Also Resident Courses.

Approved for Veterans.

**NEW YORK INSTITUTE OF PHOTOGRAPHY**

Dept. 49, 10 West 33 Street, New York 1, N.Y.

Send for FREE BOOK

## NEW! CHEAP! OIL BURNER

AMAZING HEAT INVENTION



**\$14.75 for Stoves**  
**\$29.50 for Furnaces**

FITS IN ANY COAL STOVE, RANGE, BOILER OR FURNACE. No more shoveling Coal or Ashes. This Universal Unit makes one of the quickest, hottest, cheapest fires known. Sold on a 60 day Money-Back Guarantee. Send No Money. You will receive Agents Prices and full details by sending your name to

**NORTHWEST MFG. CO., 10-A Main, Mitchell, South Dakota**



## DELICIOUS NEW HAMPSHIRE MIDGET WATERMELON

SIZE OF GRAPEFRUIT 15c PER LB.

FOR EASY REFRIGERATOR STORAGE

1951 All-American Gold Medal Winner. Delicious flavor, deep red, very early and hardy. Makes two good servings. Packet only 15c. FREE WILL'S BIG NEW 1954 CATALOG — 71st year.

**OSCAR H. WILL & CO. Box 600-5G Bismarck, No. Dakota**

## LEARN REAL ESTATE BUSINESS

Be A Broker Study At Home  
BROKERS EARNINGS OFTEN EXCEED \$10,000 PER YEAR

For a HIGH INCOME. Lifetime career become a Real Estate Broker. No other profession offers men and women from 18 to 65 such rich rewards in so short a time. Seavy Home Study Course is written so simply anyone with grammar school education can easily master real estate operation. Covers all subjects thoroughly. Special emphasis on HOW TO CLOSE SALES. Diploma awarded. The low cost will surprise you. Start now, be running your own profitable business quickly. Send for free illustrated folder TODAY. No obligation.

**SEAVY REALTY INSTITUTE**

1750 Colorado Blvd. • Los Angeles 41, California • Dept. PM

## WONDER RAT GLUE BOARDS

A SURE WAY TO GET RID OF RATS and MICE

Catch Rats and Mice Like Flies on Fly Paper. No Springs — No Poisons.

\$9 PER DOZEN SAMPLE BOARDS \$1 EACH



**STAR EXTERMINATING CO., 2958 Nostrand Ave., Brooklyn 29, N.Y.**

## Wheels



## Wheels

7" Disc Wheel 3/4" Tire 3/4" sleeve.....45c ea.  
8" Disc Wheel 1 1/4" Tire 1 1/4" sleeve.....70c ea.  
7" Disc Wheel 1" Tire 1 1/2" ball bearing.....80c ea.  
8" Disc Wheel 1 1/4" Tire 1 1/2" ball bearing.....\$1.00 ea.  
8" Disc Wheel 1.50 semi-pneum. Tire 1 1/2" B.B.....\$1.35 ea.  
8" Disc Wheel 2" semi-pneum. T. 1 1/2" B.B.....\$1.50 ea.  
10" Disc Wheel 1.75 semi-pneum. T. 1 1/2" B.B.....\$1.50 ea.  
10" Disc Wheel 2.75 semi-pneum. Tire 3/4" B.B.....\$3.50 ea.  
12" Disc Wheel 1.75 semi-pneum. T. 1 1/2" B.B.....\$1.85 ea.

Above wheel prices includes hub cap. Plus Postage, C.O.D.'s accepted.  
AXLES—Sizes 5/16 in., 3/8 in., 1/2 in.—Cut to size—End holes drilled.

**UNITED WHEEL STAMPING CO.**  
12131 S. PEORIA STREET PM-1 CHICAGO 43, ILLINOIS



Let CORTINA Show You A SHORT-CUT To.....



MORE MONEY



A NEW CAREER



CULTURAL ENJOYMENT



TRAVEL FUN

MAIL COUPON FOR

**FREE**

2-SIDED, NON-BREAKABLE

**RECORD**



Just Listen — Pick up many phrases in the first 15 minutes!

START SPEAKING

**SPANISH OR FRENCH**

GERMAN • ITALIAN • RUSSIAN

• JAPANESE or BRAZILIAN

**ALMOST OVERNIGHT!**

With a Second Language—You're a Big Step Ahead of the Other Fellow; Job Opportunities Here and Abroad

MAIL coupon below. We'll send you this double-faced, non-breakable sample record plus a sample Cortina Lesson. BOTH FREE!

Just listen as your native instructor speaks to you on the record. At the same time, let your eye run over the words in the sample Cortina Lesson. Almost before you realize it, you'll be "chatting" easily in your new language—with a perfect accent!

**Easiest Way to Learn a New Language**

- You learn by listening — just as a child learns.
- You learn to speak with a perfect accent — because that's all you hear. You can't go wrong.
- You don't learn "verbs and syntax." You learn CONVERSATION. That's the only way to learn a living language.

**A Wonderful Time to Start**

Now is the perfect time to learn a new language. American business abroad is booming; travel is running into billions. Good paying, interesting jobs are open both here and overseas. And because so few Americans speak a foreign language — you can pretty well write your own ticket.

**Mail Coupon NOW**

There are no "strings" to this

Speak with Perfect Accent — By listening to native instructors (on the record) you naturally acquire his fine accent.



offer. Start speaking a new language right away. See how easily a complete mastery of the language can be yours—through the Cortina Method.

But hurry! Offer may end soon. Rush coupon with 25c to help cover cost of special packaging, shipping. We'll also send you a FREE 32-page book describing the full Cortina Course. No obligation.

**CORTINA ACADEMY**

(Originator of the Phonograph Method)  
Dept. 641, 136 W. 52 Street, New York 19, N. Y.

MAIL AT ONCE FOR *Free* RECORD

CORTINA ACADEMY, Dept. 641 (Established 1882)  
136 W. 52 Street, New York 19, N. Y.

Please send me free sample record and lesson in (check one)

- SPANISH  FRENCH  RUSSIAN  GERMAN  
 ITALIAN  JAPANESE  BRAZILIAN

and complete information about the full Cortina course. Enclosed is 25c (stamps or coin) to help cover the cost of special packaging, shipping.

Name \_\_\_\_\_

Address \_\_\_\_\_

City \_\_\_\_\_ Zone \_\_\_\_\_ State \_\_\_\_\_



Go after the **BIG MONEY**

in **ELECTRICAL** Repair and Maintenance

Keeping industrial and domestic electrical machinery "going"—that's a big-pay job for thousands of men—big today—and ever-growing, in this electrical age! Get into this promising line—grow with it into bigger opportunities and get really worthwhile pay. Let this big, practical, Electrical Maintenance and Repair Library show you how—as it has hundreds of other men.

5 volumes 2101 pages 1834 illustrations Starts at beginning, and takes you step-by-step through every phase of connecting, altering, testing, repairing all types of equipment. How to install motors, generators, rewind motors; inspect, repair starters; locate trouble, test induction motors, and MUCH MORE! One entire volume crammed with trouble-shooting charts. Simple diagrams make everything crystal-clear. Gives best on-the-job practices of experts. Will help to put you in big-pay class and rate you an EXPERT electrical worker.



**FREE 10-DAY TRIAL**

Send no money. Just mail coupon. Easy payments.

McGraw-Hill Book Co., Dept. PM-1  
327 West 41st St., New York 18, N. Y.

Send me for FREE 10-Days' Examination the Electrical Maintenance and Repair Library. If not satisfied I will return books. Otherwise, I will send \$5.00, plus delivery, then and \$5.00 a month for 4 months, until total of \$25.00 is paid.

Name \_\_\_\_\_  
Home Address \_\_\_\_\_  
City & State \_\_\_\_\_ PM-1  
WE PAY DELIVERY if you enclose \$5.00 first payment WITH coupon. Same return privilege for full refund.

**FIND OUT FREE!**

**HAVE YOU GOT WHAT IT TAKES?**

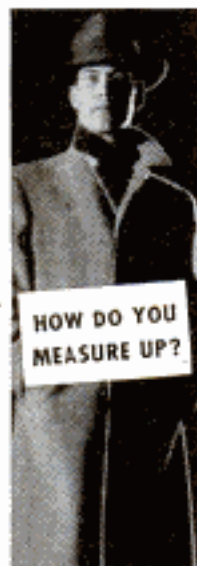

SUCCESS  
HOME STUDY  
WILL TO WIN  
CHARACTER  
HEALTH

to be a **FINGER PRINT EXPERT** or **TRAINED INVESTIGATOR?** Send for free IAS Qualification Questionnaire. If in our opinion your answers indicate that you "have what it takes," then you will receive absolutely free the famous "Blue Book of Crime" . . . plus full details on how to train at home in Crime Detection and Finger Printing! IAS graduates are key men in over 800 Police Bureaus. See if YOU can train for this exciting, steady, "good pay" work! No obligation. No salesman will call. Write today, stating age.

**INSTITUTE OF APPLIED SCIENCE**  
1920 Sunnyside Ave., Dept. 1351, Chicago 40, Ill.

**INSTITUTE OF APPLIED SCIENCE**  
1920 Sunnyside Ave., Dept. 1351, Chicago 40, Ill. \*

Gentlemen: Without obligation or expense on my part, send me your qualification questionnaire. I understand that upon receipt of my answers you will immediately advise me if you think they indicate that I have a chance to succeed in criminal investigation or finger print work. Then I will receive FREE the "Blue Book of Crime," and information on your course and the 800 American Identification Bureaus employing your students or graduates.

Name \_\_\_\_\_  
Address \_\_\_\_\_ RFD or Zone \_\_\_\_\_  
City \_\_\_\_\_ State \_\_\_\_\_ Age \_\_\_\_\_

**PRESTO! ANYONE CAN MASTER GLAZE**



Car Owners! Meet Master Glaze—the sensationally different luster for new and used cars! Not a wax—not an oil polish—not a paint!—nothing that "smears" over the surface.

**MASTER GLAZE** is a unique discovery—a creamy liquid—quick and easy to apply! Gives a hard, glass-like surface. Even gasoline cannot dull it! Lasts six months to a year! Amazing luster—beautiful, sparkling clean and brilliant! Doesn't finger-mark—doesn't smear! A match box full glazes an entire car. Seals the pores—protects! **NOTHING LIKE IT!**

**AGENTS**

An unusual opportunity! Quick, flashy demonstrator. Big profits. Good territory. Write today!

**FREE SAMPLE**

Just send your name and address to **MASTER GLAZE CO., 7720-780 W. Harwood Ave., Milwaukee, Wis.**

Better Than Your Own

**SHOE STORE AT HOME**



110 Comfort Styles Bring You Extra Spare Time Cash!

No investment, no experience needed. Just show magic cushion comfort to friends, neighbors, co-workers. Advance commissions to \$4.00 a pair, plus Cash Bonus. Paid Vacation, \$25.00 Reward Offer. Outstanding values for men, women, children. Money back guarantee. Shoe samples supplied without cost. Write TODAY for FREE new 84 page Catalog and full details.

Crepe Sole Hit With DOUBLE Cushioned Comfort

TANNERS SHOE CO., 360 Boston 10, Mass.

Say You Saw It in **POPULAR MECHANICS**

Secrets of Press Photographers

**FREE** Illustrated new book by Joseph Costa, America's foremost press photographer.

Learn the secrets press photographers use in shooting sports, fires, floods, etc. Tells how to put story-telling impact in your pictures. 25¢ at photo dealers—FREE if you write to

KALART, PLAINVILLE, CONN., DEPT. PM-1

**Watch Repairing Pays Big Money Learn at home**

Send for Free Sample Lesson

Watch repairers in big demand. You train step-by-step in 10 easy lessons. You learn to take a watch apart—repair and put in perfect working order. We furnish all tools, and a 15 jeweled watch. Practice movement with first lesson.



Turn spare time into cash—perhaps a business of your own. A licensed school. Students 18 to 65 have profited by our training. Low cost.

Write Today for All the Facts—No Obligation

**ILLINOIS SCHOOL OF WATCH REPAIRING**  
2870 Elston Ave., Dept. PM-13, Chicago 18, Ill.





# IMPORT PAYS BIG!

## HERE'S PROOF!

As startling first-hand proof I will send you an actual import from overseas. AT MY COST—something to see and use. Just mail me 25¢ in coin and I will rush you this imported Melson Automatic cigarette lighter—made to retail in the U.S. at \$2. This magnificent import will convince you of the tremendous profits being made in World Trade... right now!



**Big Profits by Mail Order!** Learn how you, too, may have money and orders come right to your door in envelopes delivered by your mailman. No canvassing — no face to face selling — do it all by mail. Foreign imports are the source of terrific profits in the mail-order business. The "Old World" offers almost unbelievable bargains, and they are quickly snapped up by millions of mail-order buyers throughout the U. S. Look in national magazines and see ads featuring *hundreds* of such imports. Fine brassware from India. Glassware from Sweden. Woolens from England. Many other products which are bringing *cash profits in the mail* to advertisers — day after day and year after year.

### Mellinger Students Go After This Profitable Business in a Big Way

You would be delighted to read the letters I receive from students who are taking advantage of this unusual mail-order opportunity. For instance, Mr. L. E. Roska says that the handbags he is importing from Guatemala will be featured in Vogue magazine. Mr. A. J. Rotols says: "My wife and I are already planning a world tour—as soon as our daughters are married and our son in college. We want to meet the friends we have made through our correspondence all over the world."

### START AT ONCE WITHOUT CAPITAL

Huge profits possible without previous experience. My training includes shipment to you of many sample imports from 'round the world. When you hold these exquisite gift items in your hand you feel the thrill of shopping in Old World bazaars. You almost imagine yourself visiting native workshops—watching craftsmen whose skills have been handed down from father to son out of the ancient past. Foreign lands offer an exciting variety of unusual products. Exquisite handmade petit point from Austria. Unique hand-carved clocks from the Black Forest of Germany. Scintillating cultured pearls from the Orient. Purses of Alligator hide from South America. All of these and more—yes, *thousands* of items, in great demand in this country by individuals, stores and shops, are available to you as a World Trader. Think of the big savings on your own purchases of clothing, tools, gems, antiques, watches, cameras, silks toys, etc.

### GRASP THIS OPPORTUNITY TODAY!

Send for your Melson Automatic Cigarette Lighter now. I will include full details that show you how to learn my secrets of Big-Profit World Trade — complete instructions that put you on the road to a profitable mail-order business of your own. Or an opportunity to travel abroad for profit and pleasure. You can have the complete details **FREE** without ordering the lighter if you wish, but I would like to send you the Melson Lighter as an actual demonstration of Import Values. Either way, rush the coupon Now. Air-mail reaches me overnight.

### AIRMAIL THIS COUPON NOW

The Mellinger Co., Dept. 251  
1717 Westwood, Los Angeles 24, Calif.

Mr. Mellinger: Show me the big profits to be made through World Trade, especially in mail order from my own home.

- I enclose 25¢ in coin. Send me one Melson Cigarette Lighter and your plan that shows me how to learn the secrets of World Trade.
- Just send your **FREE** World Trade Plan.

PLEASE PRINT

Name \_\_\_\_\_  
 Address \_\_\_\_\_  
 Town \_\_\_\_\_ Zone \_\_\_\_\_ State \_\_\_\_\_

### New World Trade Boom Offers BIG PROFIT OPPORTUNITY

to ambitious Men and Women everywhere. I'll show you how you may import thousands of useful or unusual products at low foreign prices for Department Stores, Gift Shops, etc., in your locality who pay high U. S. prices. Also how you may operate a profitable world-wide mail-order Import-Export business from home, whether you live in a big city, or a small town.

*B. J. Mellinger*  
—Exporter-Importer

**MAKES \$2500.00 PROFIT ON FIRST ORDERS...** "Sales up to this time are \$10,000, leaving about 25% profit (India Brass artwares samples sent without charge). Only takes part time. I plan to expand."

A. E. PIXA, Ohio

"We operate a profitable **WORLD TRADE BUSINESS FROM OUR HOME**

... Thanks to Mellinger."  
Mr. and Mrs. H. F. Beke, N. Y.



**\$680 PROFIT ON ONE EXPORT ORDER.** "Two months after enrolling received first order for \$6,800 in Sound Projector equipment from Philippines. Made 10% commission."

Jay A. Welsh  
California



**START ON THE ROAD TO BIG PROFITS TODAY!**

The Mellinger Co., Dept. 251  
1717 Westwood, Los Angeles 24, Calif.



# Sell WORK UNIFORMS Make BIG MONEY

Need money? Here's a quick, easy, pleasant way to earn lots of it—spare time or full time. Just show the huge, unlimited selection of **TOPPS EMBROIDERED WORK UNIFORMS**—to garages, service stations, factories, institutions, stores, every business man in your community. Sales are easy—profits are big because you show more styles, more fabrics, more colors, more sizes, more of everything than any competition can match.

## TOPPS THEM ALL!

You can't miss making sales and money. And the profits are worth the time . . . and how! One man made \$800 profit on a single sale! You show the biggest, best, most-economical uniform line in America **MADE EVEN BETTER** by exclusive features like these.



### ORLON

Uniforms of DuPont ORLON that look and feel like wool, but wear like iron. Crease-resistant, acid-proof, wash them at home. A sure seller. Many other fabrics not available in stores **PLUS** all sizes, all colors, all styles — more than any competition can match.

### PANORAMIC LINE

—The TOPPS Line spreads out over 3 feet. Swatches are man size. Prospect can see everything at a glance. It's eye-stopping, sales-compelling.

### NEW EMBROIDERY IDEAS

—Biggest, finest selection of lettering styles, designs, trade marks in all the world. Or we'll custom make it to suit individual requirements.

**OUTFIT FREE!** Get in the great new TOPPS "Panoramic" Line now. See how fast the sales pour in . . . see how fast your profits mount up. Start spare time if you wish—you'll earn enough money to make TOPPS your career! Write today.

**TOPPS, Dept. 611, Rochester, Indiana**

I SHOW YOU HOW TO

# MAKE MONEY AT ONCE

START YOUR OWN BUSINESS IN 2 WEEKS—AT HOME IN SPARE TIME

## METALIZE BABY SHOES

IF YOU ACT NOW, I will show you how to start earning extra money immediately—in spare time or full time. **AND I SHOW YOU HOW** to start your own profitable business. With my complete course and easy-to-understand illustrated instructions containing trade secrets of ALL metalizing processes **PLUS** beautifully processed sample metalized baby shoe **AND** all my tested and proved methods of operating a successful metalizing business. I show you how to start **YOUR OWN** profitable, fascinating business right in **YOUR OWN HOME**. Absolutely no experience needed. For **PROOF** send coupon today for **FREE** details of my **MONEY MAKING PLAN** for you and be convinced.

# FREE!

**MONEY MAKING PLAN**

Full Details Without Obligation

MAIL COUPON TODAY!

**KIKTAVI CO., Dept. PM-541**  
7217 So. Broadway, Los Angeles 3, Calif.  
Send me **FREE** details of your **MONEY MAKING PLAN**, without obligation.

NAME \_\_\_\_\_  
STREET \_\_\_\_\_  
CITY \_\_\_\_\_ ZONE \_\_\_\_\_ STATE \_\_\_\_\_

### THIS WIRE HAS NOT BEEN OVERSEAS

This high quality two conductor communication wire offered in No. 18 and No. 22 gauge is ideal for intercoms, lead-ins, telephones, indoor and outdoor speaker extensions, doorbells, signal and burglar alarm systems, shot string, etc., etc. **SAMPLES ON REQUEST.**

## U.S. GOV'T CLOSEOUT



# Wire

U. S. Signal Corps  
Communication Wire

TWISTED TWO CONDUCTOR \$5.00  
No. 18 STRANDED per 1000 ft.  
\$7.50 per 1000 ft. TWISTED TWO CONDUCTOR No. 22 STRANDED

NEW WAR SURPLUS

**Won't Last Very Long at These Prices**

**Stock Up Now — Subject to Prior Sale — Order Today**

**W-110-B — TWO CONDUCTOR #18 STRANDED** (four 5 cc. and three copper strands) rubber covered plus weatherproof cotton braid and twisted, 5,280 feet per steel reel. Only \$3.50 per thousand feet on 5,280 foot reels or \$18.25 per reel.  
**W-110 — TWO CONDUCTOR #22 STRANDED** and twisted (one copper and six steel strands) in your choice of rubber or plastic insulation, 10,000 feet per steel reel. Only \$3.50 per thousand feet on 10,000 foot steel reel or \$35.00 per reel.  
(Note: Steel strands are incorporated for extra tensile strength and are tinned and treated for efficient conductivity.)  
Wt. per 100 ft. #18 wire, 25 lbs. Wt. per 100 ft. #22 wire, 11 lbs.  
All these wires below market prices, our stock will not last long! Take advantage of this exceptional closeout on **STOCK UP NOW!**

Prices F.O.B. Chicago. Include approx. postage on orders paid for in advance. C.O.D. orders enclose 25% balance with C.O.D.

**U. A. S. Corp.** Dept. PM-1, 5637 W. 63rd Pl. Chicago 38, Illinois

## AMAZING NEW POCKET SIZE RADIO

Really Works—Small as a Pack of Cigarettes!



**FITS IN ANY POCKET OR PURSE—GETS LOCAL RADIO STATIONS WITH CLEAR BELL-LIKE TONE—NO STATIC OR INTERFERENCE! NEEDS NO TUBES, BATTERIES OR COMPLICATED HOOKUPS! NO AC PLUG INS! Nothing to wear out. Thousands of users—many report years of service. Uses new crystal diode and H-Q coil. SELF-CONTAINED SPEAKER PHONE. Just the tiny radio to take with you ANYWHERE YOU GO—ON TRIPS, VISITING, ETC.—for real fun and enjoyment—ANY TIME. **SEND ONLY \$1.00****

(bill, ck., mo.) and pay postage \$3.99 C.O.D. postage or send \$4.99 for p.p. delivery. COMPLETE READY TO LISTEN. MIDWAY CO., Dept. PPM-1, Kearney, Nebr.

# FREE!

Latest 52 page 3 color economy priced, illustrated Binocular Catalog plus interesting Binocular Facts. Over 82 models from 3 continents. Binoculars, Telescopes, spotting and rifle scopes. \$14.95—\$270.00. Rush name for **FREE** Catalog. **UNITED BINOCULAR CO., Dept. A-7108, 9043 S. Western Ave., Chicago 20, Ill.**



Dealers Wanted

## Guide to HOME REPAIRS



## Pays for Itself 100 Times Over

Beat the high cost of home upkeep. Save hundreds of dollars every year on carpentry, electrical, painting, plumbing and other jobs around the house with **Popular Mechanics GUIDE TO HOME REPAIRS**. Simplified how-to-do-it instruction and 646 pictures make all jobs, inside and out, easy. Covers construction, remodeling, modernizing, repairing that you can do yourself at small cost. 192 page cloth bound book only \$2.50 postpaid. Order today under our money back guarantee.

**POPULAR MECHANICS PRESS, Dept. PM16**  
200 EAST ONTARIO STREET CHICAGO 11, ILLINOIS

## COLLECT STAMPS!



**GET THIS NEW VALUABLE CATALOG!** Published by world's largest stamp firm. Beautifully illustrated. Hundreds of items and offers to save you money. U. S. postage & airmail stamps complete! amazing bargains in "clearance sale" items; kits for beginners; "How to Collect Stamps," etc. Special offers also included for your consideration. Get your copy now! Send name, address and 10c—**TODAY!**

**H. E. Harris & Co., Dept. PM-14A, Boston 17, Mass.**  
**THE WORLD'S LARGEST STAMP FIRM**

## SAVE TIME & MONEY WITH NAME LABELS

YOUR NAME & ADDRESS  
Printed like this on Gunned Labels

(Twice This Size)

Stick them on books, packages, letters, envelopes, umbrellas, camera, luggage, etc. and get loaned and lost articles back!  
300 Labels • Gift-Boxed • \$1.00

**MAKE MONEY EASILY!** Sell for us. Big profits! Write for Sales Kit and full information.

**WRITEWELL CO. • Dept. SM-42 • BOSTON 15, MASS.**

POPULAR MECHANICS



**I have a good proposition for men or women who would like to make an extra \$125.00 a month for spare time**



These 15 Utensils and covers are all interchangeable. They fit into each other so as to make up 23 different cooking combinations for "Waterless Cooking." The four egg cups make a 19-piece set that covers 99% of all cooking needs.



**By Frank W. Strong**

**I won't make any fancy promises of \$50.00 a day. And I'm not after any of your money. What I can do is show you a simple plan by which you can pick up enough extra money every week to help make up for the money you're losing in higher taxes and higher costs of living. And I supply your working outfit free—no charge and no deposit. Just your name is all I need. Read my proposition. It is honest and down to earth. And it won't cost you anything to try it.**

TODAY almost everyone needs extra money. Increased taxes and increased living costs are making your dollar worth less and less, so you have to have more and more dollars just to keep even. There are lots of good ways to make extra money. I don't say my way is the best. I do say it's one of the easiest and most pleasant. It even leads to making new friends. It doesn't call for house-to-house canvassing, either. Let me explain:

I am Sales Manager for a very big manufacturing company. We make Stainless Steel Cooking Utensils. We do an enormous business with hotels, restaurants, hospitals, and institutions. We also make utensils for the Army, Navy and Air Force.

As a result, we have very low manufacturing costs. We can sell a set of Stainless Steel Cookware for home use for about what it costs some companies to make it! In fact, for years we did sell to one Sales Organization who resold our cookware house to house under their own name. They got \$120.00 for the same set that our people sell for approximately half of that.

You've probably heard of salesmen who give dinner parties in homes and then take orders from the ladies who attend. These salesmen have to get a high price because it costs money to give parties—he has to make his share—and his supervisor has to make his. The sales organization adds a profit and the manufacturer has to make his. So there are about four or five profits added to the actual manufacturing cost.

About two years ago I got to figuring. There are five good reasons why Stainless Steel is the kind of cookware that should be in every home. 1. It washes as easy as a drinking glass. No scouring, scraping or scrubbing. 2. It doesn't rust or corrode—and it doesn't stain. 3. It doesn't affect the taste of food. 4. Carlton Ware enables you to prepare food by the method called "waterless cooking" which keeps more of the natural minerals and vitamins in your food and makes the food taste better. 5. Buy it once and you're all through buying for life. You can't wear it out.

You see, Stainless Steel is not a coated or plated metal, like chromium plate on the bumper of your car. That chromium plate can chip or wear off and exposes the raw steel underneath. Then the steel rusts. But our kind of Stainless Steel is stainless all the way through. It can't chip, crack, peel, or wear off. You could use a set the rest of your lifetime and then give it to your children and it would still be good for their children.

Well, I figured that if the price was low enough every family could afford Stainless Steel Carlton Ware. So I worked out this plan! We would sell a complete set of 15 pieces at a figure that would include our profit. Then you add your profit and re-sell this set to your friends and neighbors for just about half of the usual price charged on the "party plan." They are glad to get such a bargain and they feel that you've done them a real favor.

The plan becomes like an endless chain. When a woman gets her first piece of Carlton Ware she gets so thrilled with its better cooking and easy cleaning that she talks and talks. She can't wait to demonstrate it to her friends and tell them all about it. She's so proud of its silvery sheen that she just "bubbles over." So just by letting your own friends in on a good thing, before you know it their friends call you up and ask

if you can get the same low prices for them. Then their friends call you and their friends' friends. It goes on and on!

To make an extra \$125.00 a month, you only have to deliver seven sets and that's easy. Mrs. Montell in Pennsylvania took orders for \$1400.00 worth in her first month. And Mrs. William Hanchow wrote, "Got my set Saturday—I already have 17 customers."

Now, I'll let you in on another part of my plan. If you take only ten set orders a month for six months my company pays your expenses for a winter vacation in Florida. We maintain a beautiful resort in the Florida Keys just so our sales representatives can enjoy a Florida vacation at company expense.

Get all the information right now. I'll not only be glad to send Free Information, I'll also send you a complete demonstrating outfit that you can show to your friends and neighbors. And I'll give you exact instructions by which you can write up orders without ever trying to "sell" and without making any house-to-house calls.

Everything I send you is free. When you qualify, I'll even furnish you with a complete 15-piece set of Carlton Ware to use in your own kitchen and show to your friends. It's an extra bonus I give to encourage good earnings on your part.

Send your name today in confidence. You'll be glad you wrote. This ad may not appear in this magazine again, so don't take any chances on losing out. Send the coupon or just send your name on a postcard. I won't send any salesmen to call on you and you won't be under the slightest obligation.

**Frank W. Strong**

*Carlton of Carrollton, 3341 High St., Carrollton, Ohio*

**Frank W. Strong, Carlton of Carrollton  
3341 High St., Carrollton, Ohio**

Dear Mr. Strong: Please send me free and without any obligation a complete selling and demonstrating outfit with exact instructions for making an extra \$125 a month. I don't want to do any house-to-house selling, but I will show your products to my friends and give them the advantage of the low prices.

Name .....

Address .....

City..... Zone..... State.....

I am already selling Cookware and am interested in getting a line that can be sold at a lower price. Please send me your Distributor's proposition.



# TURN SPARE HOURS INTO CASH



Few Hours Evenings and Week Ends Can Pay up to

**\$1650**

A DAY AND MORE!

## Every Car Owner Wants Sensational "Wipe-to-Clean" Plastic AUTO SEAT COVERS

Here's big money! Just show car owners America's most sensational Auto Seat Cover values. Newest materials; exciting variety of colors and styles. Superb tailoring means perfect fit for every model, old or new. Amazing low prices . . . bring you big profit orders. New line includes popular "wipe-to-clean" plastics (just a few strokes with a damp rag cleans like new) . . . BAMBOO, FIESTA, PLAIDS, many more. Get YOUR OWN \$50.00 SET OF SEAT COVERS AS BONUS!

### Big FREE OUTFIT — Send No Money

Rush name and address on coupon below. Send no money. We'll rush complete new FREE SALES OUTFIT including many actual samples. Start earning from first day. No experience needed. Just make a few pleasant calls a day on car owners in your town. Hurry . . . RUSH COUPON TODAY for FREE OUTFIT.

KEY PRODUCTS, Dept. 441, 800 N. Clark St., Chicago 10

KEY PRODUCTS, Dept. 441, 800 N. Clark St., Chicago 10, Ill.

Rush MONEY MAKING auto seat cover sales outfit, including actual samples—all FREE.

Name \_\_\_\_\_  
 Address \_\_\_\_\_  
 Town \_\_\_\_\_ State \_\_\_\_\_

## I'll Send You This Handsome SAMPLE CASE—FREE!



Make up to **\$15.00** in a Day!

Your Own Tailored Suits Without 1¢ Cost

If you want to make more money, spare time or full time, rush the coupon below today for this big, valuable tailoring Sample Case packed with 150 beautiful, big-value suit and overcoat samples. Just show the samples and last-minute styles to friends, fellow-workers, others. Take their orders for fine made-to-measure clothes—and pocket BIG CASH PROFITS in advance. No experience, no tailoring knowledge needed—and no money needed, ever. WE SUPPLY EVERYTHING FREE . . . sample case, sample suitings, equipment, complete instructions. Start making money first day!

Use Spare Evenings . . . Weekends . . . Make Money . . . Get Suits!

It's easy to make money taking orders in just spare time—lunch-time, evenings, weekends. When men see the fine fit, quality and value of our suits—THEY ORDER! So we make it easy for you to get your own personal suits and overcoats without paying even one penny. Don't wait! Rush coupon with your name, address, and age for FREE Sample Case.

**STONE-FIELD CORP., Dept. F-816**  
 532 S. Throop Street, Chicago 7, Ill.

**STONE-FIELD CORP., Dept. F-816**  
 532 S. Throop St., Chicago 7, Ill.

Please rush ABSOLUTELY FREE the valuable Sample Case with suit fabrics and style display. Include instructions, money-making plans and details for getting my own suits without paying one cent.

Name \_\_\_\_\_ Age \_\_\_\_\_  
 Address \_\_\_\_\_  
 City \_\_\_\_\_ State \_\_\_\_\_



I Have Given

**\$195,000**  
 to Puzzle Fans

Now I'm ready to pay out another Giant Jackpot of \$25,000 to some more lucky people. Will you sell me a few hours of spare time if I guarantee to pay you \$12,000 if you win First Prize in my New and excitingly different puzzle game just starting? No 25-word essays to write . . . no big dictionaries to toil over . . . no weird pictures to figure out! Without obligation or the risk of a penny, I'll send you ABSOLUTELY FREE complete contest instructions, entry puzzle charts and rules. I'll also put your name down to receive all my future Big Prize Money puzzle contest offers. Send postcard or letter TODAY with your name and address to:

**G. F. GEMEROY** 232 Mutual Life Bldg.  
 Seattle, Washington

**ELECTROPLATE**  
 ANY OBJECT IN HOME, SHOP, GARAGE OR STAY  
 YOUR OWN WELL PAYING ELECTROPLATING BUSINESS

NO TANKS USED  
 NEW SIMPLIFIED METHOD

TOOLS: OPERATIONAL HOUSE AND B. ARTICLES, BOND P. BARY SHEET, AUTO PANS, 4 1/2 DIA. W/100/111

It's easy to electroplate any object. Complete kit and instructions on plating metal and non-metal objects, with nickel, copper, chrome, gold, etc., plus full data on obtaining all the business you desire and make BIG MONEY full or spare time. ONLY \$9.95. SEND NO MONEY—everything sent C.O.D. plus postage—OR send \$5.00 now and receive it postpaid. Money back in 7 days if not satisfied.

**M. Z. NATIONAL SALES CO., 144-K Henry St., N. Y. 2, N. Y.**

**BUY IT GET UP TO 40% OFF** **WHOLESALE!** **FREE**

Start a Buying Service At Home, SPARE TIME, GET BIG NAME MERCHANDISE FOR SELF AND CLIENTS UP TO 40% LESS THAN REG. PRICE. SALES EASY AS YOU CAN SEE. Sizable Discounts, STILL MAKE FAT COMMISSIONS. Post Card Brings Free Copy

**AMERICAN BUYERS SERVICE**

631-R Linden Ave., Buffalo 16, N. Y.

**COMPLETE KIT** For Handbag Repairmen, Hobbycrafters

Whether it's your business or your hobby, the Monal Kit's amazing assortment of handbag locks, turn locks, hook locks, lift locks, snap locks, strap handle holders and clips, has everything you need. \$4.95 prepaid. Send 10 cents (Refunded with Order) for graphic photo of every item in the kit.

**MONAL CO., 102 WESTWOOD AVE. CRANSTON 5, R. I.**

**Telephones**

**Desk Stand Style**  
 Slightly used and in excellent condition. Many Valuable Uses—  
 Inter-house phones **\$2.75**  
 Loud Speakers  
 Microphones  
 Educational purposes  
 Toys, etc. **Postpaid**  
 Come complete, ready to use, in U.S.A.  
 Wiring Diagrams Furnished. Two complete for only \$5.00.

**TELEPHONE LAMP KITS**  
 Including Telephone, lamp, nipples, push switch, cord & plug together with illustrated instructions \$6.50 postpaid (shade not included).

**MICROPHONE Dept. X-1002**  
 1760 W. Lunt Ave., Chicago 26, Ill.



**MEN-WOMEN!**

**BUILD A BIG PROFIT HOME BUSINESS...**

**FLOK KRAFT**

SILVERWARE CABINETS

with **NEW**

**Suede Paint!**



**NELS IRWIN**  
—DIRECTOR OF INSTRUCTION

the **NEW WONDER FINISH** that **COVERS EVERYTHING**

... Plastic, Fabric, Metal, Plaster, Wood, Rubber... any Surface!

**MAKE \$500 to \$1000 PER HOUR and more!**



TURNTABLES



LAMPS



AUTO TRUNK INTERIORS



AUTO DASHBOARDS



GLASS



SHOES



RADIOS



TOYS

**Read What Others Say About Flok-Kraft Suede Paint...**

"Received the flok-kraft outfit and everyone that saw it is very enthused. I only had it about thirty minutes and got an order for a hundred dollar job." Mr. C. H. Maryland.

"... I have received my order of Flok and Adhesives and believe me, I'm very pleased and happy as I've made myself MORE than the cost of my supplies already, and I've still got more jobs to do." Cpl. G. W., S. Carolina.

"Got \$52.50 for those 7 trunk interiors for about 4 hours work. \$7.50 per trunk." J. O., Mo.

"... pleased with your course and I'm being swamped with work to do." W. F.,

**Yours to Examine Without Risk**

Examine in your own home — then decide. The complete instructions, the full starting kit of materials and equipment plus full details on how you may open your own business — spare or full time — EVERYTHING will be sent to EXAMINE AT OUR RISK.

**FLOK-KRAFT IN INDUSTRY**

This amazing miracle finish is of inestimable value for use on hundreds of manufactured products. Flok-Kraft offers you a way to big, extra money, assisting manufacturers in many lines as well as filling a big demand among home owners.

**FREE!** Booklet, Sample, Plan!



**SEND NO MONEY—Just Name and Address**

COAST INDUSTRIES, Dept. 21  
1004 S. Los Angeles St., Los Angeles 15, California  
Please rush me FREE details, sample, etc., I understand that everything you send is free and that I'll be under no obligation now or ever.

NAME \_\_\_\_\_  
STREET \_\_\_\_\_  
CITY \_\_\_\_\_ STATE \_\_\_\_\_

**Coast Industries** Dept. 21 1006 S. Los Angeles St. Los Angeles, California



# INVISIBLE REWEAVING

## Make Big Money At Home!

**BEFORE**



**AFTER**



**WOMEN (AND MEN, TOO) FIND FINANCIAL SECURITY . . . . AT HOME!**

The demand is endless. Laundries, cleaners, tailors, department stores, homes — everybody needs professional reweaving service. And skilled craftsmen are scarce! You can learn to make cuts, moth holes, burns, tears DISAPPEAR from coats, suits, dresses, all fabrics almost like magic! . . . EARN UP TO \$10.00 IN AN HOUR AT HOME!

**The ORIGINAL, Complete Professional Course . . .**

You need no special education, experience or ability. Age doesn't matter. Learn all the secrets of this fascinating profession in a few short weeks — then start earning at once!

**FREE** Get Thrilling Details Now!

Make no mistake! This is a complete, professional course . . . with professional equipment . . . written by experts. Not a gadget. Not a condensed, unsatisfactory short-cut. FABRICON offers the ORIGINAL home-study course . . . first, best, most-complete in the field. It qualifies you for professional work . . . and for professional earnings! Write for complete details FREE.

**FABRICON CO.**

8342 S. Prairie Ave., Dept. 321  
Chicago 19, Ill.

### MEN!

Invisible Reweaving offers as much or more promise for profit to men . . . as it does to women. Over half our successful students have been men. Men can learn to do the work as well and as quickly as women. Actually, Invisible Reweaving is the perfect "team" business — for man and wife . . . or even the entire family! Write today.

**FREE**  
**100** BRITISH  
EMPIRE  
STAMPS



**Guaranteed Worth at Least \$2.00 . . . SENT TO MAKE NEW FRIENDS!**

Get these valuable exciting stamps from the far corners of the World: Pitcairn Is. (settled by mutineers), Falkland Is. (only postoffice in Antarctic Circle), Tanganyika, Ceylon, South Africa, many others. Price in Standard Catalog guaranteed at least \$2! Supply limited—rush coupon and 10c to help pay postage and handling. We'll also include other exceptional values for your inspection.

**KENMORE STAMP CO.**  
Dept. XH-292, Milford, New Hampshire

Kenmore Stamp Co., Dept. XH-292, Milford, N. H.  
Rush me FREE 100 British Empire Stamps and Booklet "How to Recognize Rare Stamps". I enclose 10c to help pay postage and handling.

NAME \_\_\_\_\_  
ADDRESS \_\_\_\_\_  
CITY \_\_\_\_\_ STATE \_\_\_\_\_

### Also FREE!

... valuable illustrated booklet "How to Recognize Rare Stamps", tells where and how to seek, identify and sell rare stamps. May lead you to stamps worth many dollars!



Flower Coasters  
and Tiles

**PRESERVE Real FLOWERS  
in NEW CRYSTAL PLASTIC**



"Pours like water . . .  
Sets like glass"

**NEW BOOK Shows How:**

• to permanently preserve real flowers, photos, coins, shells, star fish, butterflies, etc., in Castolite. • Create exquisite jewelry • Cast beautiful figurines, plaques, candlesticks, other lovely things for gifts or to sell. Comes crystal clear or may be dyed for brilliant color effects. Can be sawed, drilled, carved.

**YOU CAN DO IT—AT HOME WITHOUT EXPERIENCE.** Illustrated step-by-step instructions show how to get started, what to make, to have fun, make money. Free with book, new manual "How to Make Jewelry" and proven "Home Success Plan." Send 25c to **CASTOLITE, Dept. A-1, Woodstock, Ill.**

25c



**FREE 156 PAGE  
1954 B-A CATALOG**

Complete guide to Everything in Radio, TV and Electronics for Dealers, Servicemen, Schools, Amateurs, Broadcasters, Public Utilities, Engineers, Experimenters, Factories and Laboratories.

**BURSTEIN-APPLEBEE CO., 1012 MCGEE ST., KANSAS CITY, MO.**

### Now.. MAKE YOUR OWN GOLD MONOGRAMS!

Easy, fun for anyone! Distinctive monograms, signatures, drawings, quickly imprinted on leather, cloth, paper, plastic, felt, wood, crockery, painted or varnished surfaces with this new, all-purpose electric fountain pen. Heats in seconds . . . handy fountain pen size. See write-up in Nov., 1953, Popular Mechanics. Complete with transformer and 600-in. roll of gold paper. Specify 110 or 220 volts. AC only. Send cash with order or C.O.D. Postage paid on cash order. . . each **\$9.95**



**OSBORN BROS. SUPPLY CO. 223 W. Jackson Blvd., Dept. P  
Chicago 6, Illinois**

### SEND ME



every month so I am sure to see each new issue. Here's

- \$3.50 for 1 year  
 \$8.00 for 3 years

name \_\_\_\_\_  
address \_\_\_\_\_  
city \_\_\_\_\_ zone \_\_\_\_\_ state \_\_\_\_\_ B-14

Hand this order to your newsdealer or send it to  
**POPULAR MECHANICS**  
200 East Ontario St. Chicago 11, Ill.



# WILL YOU SMOKE MY NEW KIND OF PIPE 30 Days at My Risk?

By E. A. CAREY

All I want is your name so I can write and tell you why I'm willing to send you my pipe for 30 days smoking without a cent of risk on your part.

My new pipe is not a new model, not a new style, not a new gadget, not an improvement on old style pipes. It is the first pipe in the world to use an ENTIRELY NEW PRINCIPLE for giving unadulterated pleasure to pipe smokers.

I've been a pipe smoker for 30 years—always looking for the ideal pipe—buying all the disappointing gadgets — never finding a single, solitary pipe that would smoke hour after hour, day after day, without bitterness, bite, or sludge.

With considerable doubt, I decided to work out something for myself. After months of experimenting and scores of disappointments, suddenly, almost by accident, I discovered how to harness four great natural laws to give me everything I wanted in a pipe. It didn't require any "breaking in". From the first puff it smoked cool—it smoked mild. It smoked right down to the last bit of tobacco without bite. It never has to be "rested". AND it never has to be cleaned! Yet it is utterly impossible for goo or sludge to reach your tongue, because my invention dissipates the goo as it forms!

You might expect all this to require a complicated mechanical gadget, but when you see it, the most surprising thing will be that I've done all this in a pipe that looks like any of the finest conventional pipes.



The claims I could make for this new principle in tobacco enjoyment are so spectacular that no pipe smoker would believe them. So, since "seeing is believing", I also say "Smoking is convincing" and I want to send you one Carey pipe to smoke 30 days at my risk. At the end of that time, if you're willing to give up your Carey Pipe, simply break it to bits—and return it to me—the trial has cost you nothing.

Please send me your name today. The coupon or a postal card will do. I'll send you absolutely free my complete trial offer so you can decide for yourself whether or not my pipe-smoking friends are right when they say the Carey Pipe is the greatest smoking invention ever patented. Send your name today. As one pipe smoker to another, I'll guarantee you the surprise of your life, FREE. Write E. A. Carey, 1920 Sunnyside Ave., Dept. 1041, Chicago 40, Illinois

**E. A. CAREY, 1920 Sunnyside Ave.,  
DEPT. 1041, CHICAGO 40, ILLINOIS**

Please send facts about the Carey Pipe. Then I will decide if I want to try it for 30 Days at YOUR RISK. Everything you send is free. No salesman is to call.

Name \_\_\_\_\_

Address \_\_\_\_\_

City \_\_\_\_\_ Zone \_\_\_\_\_ State \_\_\_\_\_

## LEARN MEAT CUTTING AT NATIONAL Pay After Graduation



The steady dependable trade of Meat Cutting taught easily in 8 short weeks. YOU LEARN BY DOING under actual meat market conditions in big modern school at Toledo.

For beginners or men with experience. Get a profitable store of your own. Remember, PEOPLE MUST EAT! Big pay jobs. Free employment help. Thousands of successful graduates.

Buying, cutting, percentage, pricing, advertising, selling, etc. A complete retail meat education. National School established over 25 years. Get National training NOW. Pay your tuition in easy weekly payments

after you graduate. Send coupon for FREE 52 page school catalog — TODAY. G.I. approved.

**National School of Meat Cutting, Inc., Dept. 50-A, Toledo 4, Ohio**

Send me your FREE school catalog on National Training at Toledo in Meat Cutting, Meat Merchandising and Self Service Meats. No obligation. No salesman will call.

Name \_\_\_\_\_ Age \_\_\_\_\_

Address \_\_\_\_\_

City \_\_\_\_\_ State \_\_\_\_\_

Approved for training Korean Veterans



**Learn TELEVISION RADIO ELECTRONICS**



**EARN Big Money**

The new Christy Shop-Method Home Training makes everything interesting, easy. The **only complete Electronics course**. Covers Radar, Sonar, Electronics, Radio and Television. No previous knowledge needed. You learn by actually working on equipment you study about. Makes learning fun. Speeds your progress. Helps you understand quicker and remember longer.

**19 BIG TRAINING KITS INCLUDED**

You build your own Multi-Tester, Oscillator, Signal Tracer, Oscilloscope, Signal Generator, Electronic Timer, Regenerative Radio, Television Receiver (optional), and many other test units. Check circuits, locate and correct troubles, etc. Earn while you learn by repairing television and radio sets for friends and neighbors.

**SEND FOR FREE BOOK and SAMPLE LESSONS NOW!**

**CHRISTY TRADES SCHOOL, INC.,**

Dept. T-103  
4432 N. Kedzie Avenue,  
Chicago 25, Illinois



**WHOLESALE ELECTRIC GUITARS—HEARING AIDS**

Accordions, amplifiers, double-necks, triple-necks, pick-up mikes, mandolins, non-electric instruments, etc. 1954 MODELS WHOLESALE. FREE CATALOG. FREE home study course with instruments. Specify catalog, musical instruments or hearing aids.

**CARVIN CO.** Box 28 P.M. 1  
Baldwin Park, Calif.



**MIRACLE TOMATO Yields 2 BUSHELS To a Vine**

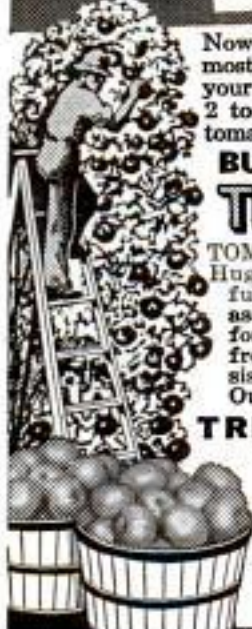

Now—You can grow the world's most amazing Tomato right in your own garden and get from 2 to 3 bushels of delicious, ripe tomatoes from every vine.

**BURGESS CLIMBING TRIP-L-CROP**

TOMATO grows 16 to 20 feet high. Huge, meaty, solid fruit, wonderful flavor. Some weigh as much as 2 pounds each. Unsurpassed for canning and slicing. Blight free—drought and disease-resistant. Grows in any garden. Outyields all other varieties.

**TRIAL PACKET 10c**  
Postpaid. Order Today  
**3 Packets for 25c**

Write for **FREE** complete Catalog listing many unusual Seeds, Plants and Bulbs.

**BURGESS SEED & PLANT CO.**  
117 B. Galesburg, Mich.

**GET "New Car" POWER!**



• Stop Burning Oil! **\$3.95**  
• Restore Compression! post-paid

A small amount of Fisher's Compression SEAL in each cylinder bore gives you the economics of smooth, powerful "new car" performance and reduced oil consumption. Old, tired engines may not need expensive overhauling. Only takes minutes to apply—yet gives you 10,000 more miles of low-cost driving pleasure.

**SATISFACTION GUARANTEED!**

Full purchase price refunded immediately, if not completely satisfied. No solvent baths necessary. Order today! Information. Dealers inquire.

Sorry, no COD's. Free **FISHER'S** 4756 S. Central, Dept. PM-1  
Los Angeles 11, Calif.

**HE-MAN VOICE!**

**STRENGTHEN** your voice this tested scientific way. Yes—you may now be able to improve the **POWER** of your speaking and singing voice . . . in the privacy of your own room! Self-training lessons, mostly silent. No music required.



**FREE BOOK** Write TODAY for Eugene Feuchtinger's great booklet "How to Develop a Successful Voice." It's absolutely FREE! You must state your age. Booklet mailed postpaid in plain wrapper. No salesman will call. Send your name and age **RIGHT NOW!** Perfect Voice Institute, 210 S. Clinton St., Studio AW-2, Chicago 6, Ill.

**ANALYZE HANDWRITING**

**MORE INCOME.** Prestige. Success. Fascinating uncrowded profession-business, full or spare time. **FREE** illustrated lesson & Year Book shows how men and women in home, business and professions analyze handwriting to understand people. **MAKE MONEY.** FREE lesson and information about unusual opportunities if over 21.



**I. G. A. S., Inc., 901 Wilhoit Bldg., Springfield, Mo.**

**TOOLS WHOLESALE**

**MAKE EXTRA MONEY**

Start Your Own Business. Sell tools to your friends, neighbors, Part Time-Full Time. **A MILLION DOLLAR INVENTORY AT YOUR FINGERTIPS.** Send \$1.00 for Dealer's Card and Wholesale Catalog.

Stanley, Millers Falls, Plumb, Dixon, Wiss, and others at 30% to 50% off.

**SILVO HARDWARE CO., Dept. M, 108 Market St., Phila. 6, Pa.**

**AUTO RACING BOOKS AT NEW LOW PRICE**

**Automobile Racing — Fifth Edition by Ray F. Kuns.** This is a book for auto racing fans. It covers construction and specifications of racing cars and tells and shows how you can build your own. It also contains regulations for midget auto racing and describes roadster racing in California. A number of Indianapolis races are described and pictured. Formerly \$1.00 per copy. Now just..... **50c**

**Automobile Racing — Fourth Edition by Ray F. Kuns.** Includes eight working drawings and complete building instructions for standard midget racers as well as drawings for midget road cars. Miller Ford V8 front-drive racers are illustrated and described and other big-time data given. Large, clear pictures give inside information. Was \$1.00—Now only **50c**

**POPULAR MECHANICS PRESS** 200 E. Ontario St. Chicago 11, Ill.



# DRAW ME!

Here's how you can win a full 2-year art scholarship worth \$295<sup>00</sup> by making one drawing!



Would you like a chance to prove your ability? Here it is! The prize is a complete 2-year course from Art Instruction, Inc., world's greatest home study art school. This 39-year old institution has taught America's most successful artists. Now imagine you enrolled in its famous course—learning the art profession from over 40 nationally-known artists. Your drawing of this girl could win you that training—free! Why not start your drawing now?

**Amateurs Only!** Our students not eligible. Make copy of girl 5 ins. high. Pencil or pen only. All drawings must be in by Feb. 28, '54. None returned. Winner notified.

## ART INSTRUCTION, INC., Studio 1134

500 S. 4th St., Minneapolis 15, Minn.

Please enter my attached drawing in your February contest.  
(PLEASE PRINT)

Name \_\_\_\_\_ Age \_\_\_\_\_  
Address \_\_\_\_\_ Apt. \_\_\_\_\_  
City \_\_\_\_\_ Zone \_\_\_\_\_  
County \_\_\_\_\_ State \_\_\_\_\_  
Phone \_\_\_\_\_ Occupation \_\_\_\_\_

## Can A Man My Age Become a Hotel Executive



### Even Though He Has No Previous Hotel Experience?

**Calvin W. Schaeffer Succeeds  
As Manager of Resort Hotel**

"After retiring as a Lt. Commander from the U. S. Navy, I considered many fields of endeavor. I decided upon the hotel field and enrolled for Lewis Training. I am now Manager

of a resort hotel. I can look forward to a bright future."

## "How I Stepped Into a BIG PAY Hotel Job"

### Don E. Ulmer Becomes Hotel Manager As A Result of Lewis Training



"After I received my Lewis diploma, I accepted a position at a resort hotel. This position was obtained for me by the Lewis Placement Service. At the end of the season, I was appointed Manager of another hotel. Thanks to Lewis Training."

## STEP INTO A WELL-PAID HOTEL POSITION

Important positions, ever-increasing opportunities await trained men and women in essential hotels, motels, clubs, apartment house projects. Lewis graduates are "making good" as managers, assistant managers, stewards, executive housekeepers, hostesses and in 55 other types of well-paid positions. Previous experience proved unnecessary in this business, where you're not dropped because you are over 40. Lewis Training qualifies you at home, in spare time or through resident classes in Washington.

FREE book describes this fascinating field. It tells how you are registered FREE in Lewis National-Placement Service. Mail coupon today! Lewis Hotel Training School, XA-317, Washington 7, D. C.

## COURSE APPROVED FOR ALL VETERAN TRAINING

LEWIS HOTEL TRAINING SCHOOL,  
Room XA-317, Washington 7, D. C.

**38<sup>th</sup>**  
SUCCESSFUL  
YEAR

Send me, without obligation, the Free Book, "Your Big Opportunity." I want to know how to qualify for a well-paid position.

Home Study  Resident Training

Name \_\_\_\_\_  
(Print Name & Address)

Address \_\_\_\_\_

City \_\_\_\_\_ Zone No. \_\_\_\_\_ State \_\_\_\_\_

Check here if eligible for Veteran Training



## NOW YOU CAN PICK YOUR JOB & BIG PAY FUTURE IN ALLIED NATION WIDE COOPERATIVE PLAN

INDUSTRY CRITICALLY NEEDS ALLIED TRAINED MEN TO FILL IMPORTANT JOBS

**TOOL ENGINEER  
TOOL-DIE DESIGNER  
MACHINE DESIGNER  
Industrial ENGINEER  
DRAFTSMAN  
MASTER MACHINIST  
TOOL & DIE MAKER**

Shortages of Draftsmen, Designers, Tool Engineers, Machinists, Tool and Die Makers are so widespread that you can pick a key job and look forward to rapid promotions, better pay, job security, success and achievement. There are more good paying jobs than trained men to fill them.

Program is integrated so that you can learn at home in your spare time or study at the Institute in Chicago. Enroll in short courses or study progressively for a degree of Bachelor of Tool Engineering.

send for **FREE BOOKS**

**ALLIED SCHOOL of MECHANICAL TRADES**  
1338-42 S. Michigan Ave. Chicago 5, Illinois

ALLIED SCHOOL of MECHANICAL TRADES  
1338-42 S. Michigan Ave.- Dept. PM-1, Chicago 5, Ill.

Gentlemen:  
Send me without obligation your FREE BOOKS explaining Allied's Courses of Instruction and Nation-Wide Industrial Co-op Plan.

I am interested in Resident Training  Home Study   
I am eligible for the G.I. Bill  I am not eligible

Name \_\_\_\_\_  
Address \_\_\_\_\_  
City \_\_\_\_\_ State \_\_\_\_\_

**312 DIFFERENT STAMPS**  
INCLUDING NEW BIRD & FLOWER TRIANGLE SETS



25¢

NEW COMPLETE SET of 6 multi-colored Flower TRIANGLES PLUS the COMPLETE AIRPOST TRIANGLE SET of 6 Gorgeous Bird Stamps of Croatia. These are only part of the collection of 312 ALL DIFFERENT UNUSUAL STAMPS of the world that is yours for only 25c to INTRODUCE OUR BARGAIN APPROVALS. A 40-PAGE STAMP DICTIONARY & GUIDE will be sent FREE with your order.  
STAMPEX CO., 116 PM Nassau St., New York 38, N. Y.

**SEE HOW EASY IT IS Step by Step!**



## BE AN ARTIST -- booklet free

Learn commercial art, cartooning, designing, illustrating. Free booklet shows how you can earn while you learn; describes enormous demand for artwork; artists' earnings; home study advantages; outlines course. This is our 39th year—we have trained thousands to draw for pleasure and profit. Course includes 2 art outfits. Life Class Book, book "How to sell your work." Mail coupon today. Career or Hobby Course. No salesman will call.

**WASHINGTON SCHOOL OF ART, Studio 121N**  
Washington 5, D. C.

Send free booklet  Send Free Talent Test

Name \_\_\_\_\_ Age \_\_\_\_\_  
Address \_\_\_\_\_  
City, Zone, State \_\_\_\_\_

## Handy Mail Order List

Little Library of Useful INFORMATION

5 for \$1.00  
12 for \$2.00  
25¢ Each

- Here at amazingly low cost is the practical help and information you have always wanted. Articles in previous issues of Popular Mechanics have been classified according to subject and are now available in these handy reprint booklets.
- How to Use Measuring Tools—Micrometers, Calipers, etc.—106.
  - Power Driven Saws—74.
  - Drill Presses, Grinders, Etc.—79.
  - Wood, Metal Turning—Lathes—81.
  - Filing Machine, Hacksaw, Cutoff Wheel, Shaper—82.
  - Lathe Tools You Can Make—101.
  - Workbenches—Tool Cabinets—47.
  - Spray Painting—94.
  - Iron Pattern to Casting—91.
  - Tool and Saw Sharpening—92.
  - Sharpening Drills, Wood Bits—90.
  - Successful Wood Turning—32.
  - How to Read Blueprint—71.
  - Metal Turning Lathe Kinks—99.
  - Operating a Metal Lathe—100.
  - Heat Treating, Hardening—102.
  - Working With Glass—103.
  - Servicing Elec. Motors—75.
  - Electromagnets & Solenoids—44.
  - Transformer Construction—41.
  - The Boy Electrician—43.
  - Soldering and Brazing—17.
  - Iron and Spot Welding—5.
  - Electroplating With Nickel, Chromium, Cadmium, Etc.—86.
  - Plating Leather, Wood, etc.—87.
  - Lower Your Fuel Costs—31.
  - Curing Leaky Basements—45.
  - Fitting Home Game Room—55.
  - Indoor and Outdoor Fireplaces—88.
  - Backyard Gardening—39.
  - Lawn and Garden Novelties—72.
  - Trellises, Pergolas, Fences—76.
  - Lawn and Garden Furniture—77.
  - Playground Equipment—73.
  - How to Use Your Drill Press—125.
  - Making Sewing Trays—53.
  - Knots and Ropework—105.
  - Sanders—80.
  - House Wiring—89.
  - Hanging Wallpaper—38.
  - Built-in Fixtures—76.
  - Bird Houses—7.
  - Magazine Racks—49.
  - Clock Cases—50.
  - Book Ends—52.
  - Small Tables—54.
  - Smoking Stands—56.
  - Decks—58.
  - Book Cases—59.
  - Action Toys—66.
  - High Flying Kites—67.
  - Telescopes—20.
  - Metal Craft—28.
  - Small Looms—37.
  - Working With Plastics—61.
  - Simple Home Improvements—104.
  - Ridding Home of Insect Pests—107.
  - Children's Room Furniture—51.
  - Jigsawed Novelties—57.
  - Doll House & Doll Furniture—60.
  - 25 Shelves You Can Make—64.
  - Novelties Turned on Lathes—62.
  - Inlay Pictures—Veneering—63.
  - Wood, Soap Carving—65.
  - Windmills & Weather-vanes—68.
  - Lamps from Wood, Metal—69.
  - Rustic Furniture—18.
  - Wood Finishing—40.
  - How to Fix Electrical Appliances—111.
  - Painting Your House—117.
  - Build Your Own Relays—123.
  - Rowboats, Small Dinghy—83.
  - Small Sail Boats—84.
  - Two Outboard Runabouts—85.
  - Build Own Canoe, Kayak—30.
  - Build Class-E Ice Yacht—22.
  - Auto Kinks, Shortcuts—10.
  - Lawn and Garden Equipment—124.
  - Motor-Driven Midget Cars—34.
  - Stop Auto Elect. Troubles—95.
  - Photo Printers and Dryers—25.
  - Photo Darkroom Equipment—96.
  - Trick and Table Top Photos—97.
  - Home Movie Equipment—118.
  - Poultry Houses—108.
  - Guns and Decoys—109.
  - Re-Silvering Mirrors—70.
  - Chemical Experiments—93.
  - Log Cabins, Tourist Houses—14.
  - Using Basic Tools—120.
  - Farm and Garden Tractors—8.
  - Building Extra Attic Rooms—23.
  - Attractive Basement Rooms—24.
  - Gem Cutting—42.
  - Photo Enlargers—1.
  - Photo Kinks—98.
  - Cleaning Formulas—11.
  - Taxidermy—9.
  - Photo Lighting—119.
  - Training Dogs—35.
  - Small Furnaces—38.

Check Titles Wanted, Clip, Mail with Remittance to  
POPULAR MECHANICS PRESS, Dept. 23, 200 E. Ontario, Chicago 11

**YES! SEND**



directly to my door every month

I am enclosing  
 \$3.50 for 1 year  
 \$8.00 for 3 years

name \_\_\_\_\_  
address \_\_\_\_\_  
city \_\_\_\_\_ zone \_\_\_\_\_ state \_\_\_\_\_ A-14

Hand this order to your newsdealer or send it to  
**POPULAR MECHANICS**  
200 East Ontario St. Chicago 11, Ill.





C1

# COLORCRETE

Drab or dirty masonry—concrete, stucco, etc., becomes gleaming white. Or there's a range of sparkling colors—ivory, cream, pink, blue, green, and 25 more. Colorcrete is fused to masonry surfaces under pneumatic pressure. Stays put and stays beautiful. Highly water resistant. Used for more than a quarter century.

## There's Profit-Appeal in Stucco Spraying

The business of applying Colorcrete is a community enterprise, with special appeal to men of limited capital. Equipment is compact, simple to operate, practically wear-proof. Work is easy, interesting and rich in profit potentials. Broad opportunities for development. We supply all equipment and full instructions.

No experience or special ability needed. Write or wire today for the Opportunity Book.

**COLORCRETE INDUSTRIES, INC.**  
570 Ottawa Ave.  
Holland, Mich.



### PUMP WATER FAST!

DRAIN WASH TUBS, CELLARS, CISTERNS  
IRRIGATE—FILL TANKS—DRAW WELL WATER

Pumps 2800 GPH. 420 GPH at 75' High or 1600 GPH from 25' well. Sturdy, Rustproof Alloy Metal. Six Blade Impeller. Uses any 1/8 to 1/2 H.P. Motor. Will not leak or clog. Fits any garden hose. Immediate Money Back Guarantee. Send Check, M.O., or C.O.D.

**895**

**MOORE MANUFACTURING CO.**  
SWEDSBORO 1 NEW JERSEY

### LOCKSMITHING & Key Making

PRACTICAL UP-TO-DATE COURSE—ONLY \$4.95

Easy-to-learn modern information for self-instruction. How to work on locks, decode, make masterkeys, repair, install, service, etc. For every handyman, home owner, carpenter, mechanic, service station operator, fix-it shop, hardware dealer, gunsmith. 53 plain illustrated lessons. FULL PRICE ONLY \$4.95. SEND NO MONEY. We'll ship postpaid. Satisfaction guaranteed or refund.

Just pay postman plus C.O.D. postage. Or send \$4.95 with order.

**NELSON-HALL CO., 210 S. Clinton Ct., Dept. AW-2, Chicago 5, Ill.**

Save Money on **TV Purchase, Repair and Service**

**ALL ABOUT TELEVISION**

You can actually save \$50 to \$100 when you buy a TV set. You can save that much more every year on service with Popular Mechanics All About Television to guide you. Do 9 out of 10 service jobs yourself. Complete simplified instruction and 220 pictures show you how. No previous experience or knowledge of electronics required. Cloth bound edition only \$3.00 postpaid. Money back if not pleased. Paper covers 75 cents at newsstands.

**POPULAR MECHANICS PRESS, Dept. PM11, 200 E. Ontario St., Chicago 11**

## SAY YOU SAW IT IN POPULAR MECHANICS

### Enjoy the Fascinating Story of the Horseless Carriage in

It's thrilling, fascinating, informative. From the very first gasoline-propelled buggy to the cars of today and the atomic auto of the future. The first cars—the men who made them—the scrambled start and development of the fabulous auto industry—the story of auto racing. 366 thrilling action pictures—old-time cars—racing cars—early auto advertising—automotive oddities. Listing of 2050 U. S. autos included. Ideal gift book. Cloth bound, only \$3.00 by mail. Money back if not pleased. Paper covered edition \$1.00 at newsstands.



**POPULAR MECHANICS PRESS, Dept. PM15, 200 E. Ontario St., Chicago 11**

# EARN BIG MONEY!

## BREED RARE TROPICAL FISH

### IN YOUR HOME

**NEW! HOME-BUSINESS OPPORTUNITY!**

**FOR FIRST TIME Secrets Can Be Yours!**

**UP TO \$7.50 PER HOUR SPARE TIME POSSIBLE**

**KISSING FISH**

**SEA HORSE**—shown giving birth to 350 young. Retail for \$4 to \$15 pair.

**FIGHTING FISH**—lays about 300 eggs at a time. Retail, about \$4.50 pair.

**ANGEL FISH**—Gross-fal, exotic. Lays about 350 eggs at one time. Big profit maker.

**BREED THOUSANDS IN YOUR GARAGE, LIVING ROOM, CLOSET, BASEMENT—ANYWHERE!** Now, for the first time you can learn all the little known secrets of Breeding Rare Tropical Fish (jealously guarded by breeders). Earn fabulous profits in little used space in your home, and enjoy one of the most fascinating and beautifully exotic of all hobbies.

**HELP US FILL HUGE DEMAND**—Terrific demand everywhere. Supply America's newest, biggest-booming hobby. 20 million hobbyists already. Architects, offices, hospitals, schools, photographers—almost every kind of business demands these beautiful creatures. Get into this brand new big paying business now. Nature does the work—you make the profits.

**FABULOUS PRICES FOR RARE VARIETIES.** Some sell for \$100 to \$1000 pair, but of course this is exceptional. Most varieties sell for \$5 to \$20 pair. Breed them by the hundreds—even thousands.

**OVER 500 EGGS LAID AT ONE TIME.** Think of it. Yes, some varieties lay even more eggs at one spawning and spawn several times a year. Yet in one small living room aquarium you may keep up to 1000 babies at one time—amazing profit possibilities.

**NO COMPETITION FROM LARGE COMPANIES.** Nearly all present Tropical Fish Breeders are very small. They cannot meet the present terrific demand all over the U. S. They're earning big money now because they know the secrets.

**NO SELLING—BUILD A MAIL ORDER BUSINESS.** Our National Advertising is designed to flood you with orders with names of people who wish to purchase Tropical Fish in your area and all over the U. S.

**NO EXPERIENCE—NO EXPENSIVE EQUIPMENT NEEDED** BECAUSE we show you how.

**WE SUPPLY EVERYTHING YOU NEED**—all the revealing secrets for success—all necessary materials—everything you need to start breeding immediately.

**LOOK WHAT OTHERS ARE SAYING!**

"Business prospects tremendous" J.K., Ga.  
"Earned \$125.00 first week" T.S., Calif.  
"Dealers want all I can breed" J.F., Oregon, "Big money and how"  
T.V., Fla. "Exactly what I've been looking for" A.S., New York, "Pays off large dividends" E.D., New York, "No limit amount to be earned" M.G., Oregon, "Fascinating business" D.F., Texas.

**FREE!** "How to Succeed" BOOKLET, Breeding BROCHURE RE-PRINTS and all DETAILS!

**TROPICAL FISH BREEDERS OF AMERICA**  
Dept. B-1, Los Angeles 15, California

Dear Sir:  
Please rush all free details about this new industry opportunity.

Name \_\_\_\_\_ Age \_\_\_\_\_  
Address \_\_\_\_\_  
City \_\_\_\_\_ State \_\_\_\_\_



# Guaranteed to Save You Money!



CONSIDER THE COST of a typical carpentry, electrical, plumbing or other repair job. Consider how much you'd save each year if you did these jobs yourself! Well, *Better Homes & Gardens HANDYMAN'S BOOK* shows you how. It's guaranteed to save you money—and lots of it!

THE HANDYMAN'S BOOK shows you the easy way to do 1600 home-maintenance jobs—expertly. Shows you the easy way—the way that saves you time and money. Shows you how to do improvements and decorating jobs as well as repairs. Instructions are easy to follow—and are made even clearer by 1600 helpful, step-by-step illustrations.

Yes, we guarantee that *Better Homes & Gardens HANDYMAN'S BOOK* will save you money. Buy it wherever books are sold—including hardware stores. Or order by mail. Use coupon today. Money-back guarantee.

### BETTER HOMES & GARDENS

404 Meredith Bldg., Des Moines 3, Iowa

Please send me the HANDYMAN'S BOOK. I enclose  check OR  money order for \$3.95. (Canada \$4.50). If not entirely satisfied, I may return book in 10 days and my money will be refunded.

Name \_\_\_\_\_  
Address \_\_\_\_\_  
City \_\_\_\_\_ State \_\_\_\_\_

## GROW Living MIDGET TREES!

EARN \$10.00 PER HOUR!

- AT HOME
- IN SPARE TIME
- NO EXPERIENCE NEEDED



It's new! Amazing! At last, the secret of growing miniature (MIMID) trees can be yours. FULL GROWN, dwarf trees—only a few inches high. Beautiful miniature fir, orange, oak, Chinese elm, peach, pine, cypress—any kind! ALL BLOOM and even BEAR FRUIT. All perfect healthy specimens—but miniature in size! Make costly home decorations and expensive centerpieces. (SOLD FOR OVER \$1,500 EACH) Big demand. Costs only pennies—takes only minutes per week. IT'S EASY! Fun! A new fascinating hobby—a new fabulous \$\$\$\$ business. Send for free secret plan details and real seed.

### HELP US FILL HUGE DEMAND!

These trees are being demanded by STORES CLUBS • HOTELS • FLORISTS • HOUSEWIVES • INTERIOR DECORATORS • COLLECTORS • HOBBYISTS—A Big Money Opportunity FOR YOU.

FREE! GENUINE SEED AND PLAN!



NATIONAL NURSERY GARDENS, Dept. M1  
8463 South Van Ness  
Inglewood 4, Calif.  
Rush me FREE plan and seed IMMEDIATELY!

Name \_\_\_\_\_  
Address \_\_\_\_\_ Zone \_\_\_\_\_  
City \_\_\_\_\_ State \_\_\_\_\_

## The Most Fascinating Book About the Automobile Ever Printed!

Popular Mechanics

# AUTO ALBUM

The Motor Car in Picture and Story from 1769 to 1952



### You'll Find...

the Answers... the Fascinating Stories... in the AUTO ALBUM

Who built the first horseless carriage?

Who obtained the first U.S. patent on an automobile?

Where did the name "automobile" come from?

Are you familiar with the workings of the Stanley Steamer... the "electrics"... the famous Ford Model T?

Do you know when the first Indianapolis race was won... by whom... at what speed?

Do you know the story of Henry Ford, Barney Oldfield, Ransom Olds, Walter Chrysler, W. C. Durant and other automotive giants?

### 166 Illustrations Including 94 Old-Time Cars — 22 Auto Ads of By-Gone Days!

Here is a book you can't help enjoying and wanting, whether or not you have, or ever will own an automobile. It is the fascinating, thrilling and informative story of the horseless carriage from the first gasoline-propelled buggy to a forecast of the atomic car of the future.

Popular Mechanics AUTO ALBUM by Throm and Crenshaw presents America's first cars and the pioneering men who made them; the scrambled start and the development of the fabulous auto industry; the story of automobile racing; the growth of the Nation's highways. It is a book that just had to be published.

### To Read... to Enjoy... to Remember!

More than one-half of the book is pictures, most of them action pictures, from photos of old-time cars in operation. Other pictures show race cars from 1911 to 1951; early auto advertising, picturing 32 cars priced from \$375 to \$6000; tri-cycle autos, wind wagons, auto cycles and other automotive oddities. A roll call of horseless carriages is included — the names of more than 2000 cars made in the United States.

### Gift Book of the Year

Get the fascinating AUTO ALBUM for yourself today. Send it as a gift to friends and business associates. Order on coupon below. Money refunded if you are not entirely pleased.

Cloth Binding



## Use Coupon to Get AUTO ALBUM

POPULAR MECHANICS PRESS, 200 E. Ontario, Chicago 11

Send at once postpaid \_\_\_\_\_ copies of Popular Mechanics AUTO ALBUM at \$3.00 each.  Remittance enclosed.  Send COD. I will pay postman plus charges. I understand books are returnable in 7 days for full refund if I am not pleased.

Name \_\_\_\_\_  
Address \_\_\_\_\_  
City \_\_\_\_\_ Zone \_\_\_\_\_ State \_\_\_\_\_



# NEW "PAINT PEN"

## PAINT STRIPING TOOL Works like a Fountain Pen Stripes with Paint instead of Ink!

This amazing new "PAINT PEN" is a Paint Striping Tool that makes it easy to do expert striping on furniture, bikes, model planes, autos, signs, toys, linoleum, wall board, etc. Makes plain, painted walls look like tile. Paint straight, curved, circular or evenly spaced parallel lines the same way a professional painter does. Simply fill Tubular Glass Paint Fountain with any color paint and wheel tip feeds paint evenly. Tips interchangeable—jaws split apart for easy cleaning. Tool complete with tip for 1-16 inch stripe only \$1.00 postpaid. Other complete tools with 1-64, 1-32, 3-64, 5-64, 3-32, 1-8 in. tips, \$1.50 ea. Extra tips, 75c ea. Complete KIT with 7 tips, \$5.00. Also 1-4 in. tip only, \$1.50. C.O.D.'s postage collect. Here's the handiest tool in your whole painter's kit. Get yours today.



Paint  
STRAIGHT,  
CURVED OR  
PARALLEL LINES

### Home Craftsmen

Just the tool you've been waiting for! New Paint Striping Tool gives "professional" results every time, yet simple and easy to use as a fountain pen. Adjustable guide keeps lines straight as an arrow. Just as easy to make curves or free hand designs. Adds new beauty and finished look to everything you paint. Send \$1 now!

Only  
**\$1.00**

**WENDELL MFG. CO., Dept. 3-A**  
4234 LINCOLN AVENUE, CHICAGO 18, ILL.

**DEALERS**  
PAINT STRIPING TOOL  
packed in display cartons  
of 1 doz. Fact, profitable  
seller. Write for illus-  
trated circular, discounts

**AUTO DEALERS  
TOY STORES  
WRITE US  
FOR  
DEALER  
PRICES  
ON YOUR  
LETTER-  
HEAD**

## 70 MILES PER GAL. GAS CHILD'S AUTO WITH MOTOR

Sturdy, Safe for kids 5  
to 15 Years. Also pulls  
Mowers, Carts and Pow-  
er Takeoff drives Pumps,  
Saws, etc. Write for lit-  
erature. **ESHELMAN**,  
Dept. CM-61, 1110 Light  
St., Balto., Md. 7070  
Hollywood Blvd., Los  
Angeles 28, Cal.



## 100 BEST Woodworking Projects



**SELECTED FOR YOU BY POPULAR MECHANICS EDITORS**  
Enjoy the fun—the pride—of making things. Get  
100 BEST WOODWORKING PROJECTS, complete with  
simplified instruction, plans, diagrams and more than  
400 how-to-do-it pictures. Make all kinds of furniture,  
baby carriages, clocks, lamps, book shelves, fireplaces  
and other useful articles at little or no cost. Send  
only \$2.00 with name and address. Money back if  
not pleased.

POPULAR MECHANICS PRESS, Dept. PM6, 200 E. Ontario St., Chicago 11

Say You Saw It in Popular Mechanics

# STOP BURNING OIL!

LOSING POWER  
WASTING \$\$\$



When your car "eats-up" oil, loses that get-up-and-go power, has poor gas mileage, it's a sure sign that you have worn rings, pistons, and cylinder walls in your engine. This is robbing you of driving pleasure and valuable \$\$\$ to the tune of \$250 every 10,000 miles in oil, gas, and repair bills.

### WHAT CAN YOU DO ABOUT IT?

You can either have an expensive overhaul job done or offset this wear with a

## RING-RE-NU MOTOR RECONDITIONER KIT

It's the inexpensive, proven answer to a worn engine. This terrific 1-2 combination restores power and zip to your car without expensive repair work, reduces oil burning, slashes gas consumption, brings back that "new car" performance to your car.

### HERE'S HOW THIS DOUBLE VALUE KIT PERFORMS!

- 1. PVR COMPOUND**—is a hard hitting engine reconditioner that removes sludge, tars, sticky greases from a tired, worn engine. Pour in carburetor, idle engine. Leaves rings, valves, pistons whistle clean, ready for...
- 2. RING-RE-NU**—the amazing compound which when squeezed by tube on your pistons forms a tough, pliable, self-expanding seal on rings and pistons to compensate for wear.

**RESULT!**—You get power-packed, economical driving pleasure. Good for 10,000 plus miles. Adds years to the life of your car. Guaranteed not to harm the finest engine. Takes only 30 minutes to install.

### Read ACTUAL PROOF From One of 100,000 Satisfied Users!

Cadillac Owner, E. L. G., Lawrence, Mass. writes — "My Cadillac was burning 2 qts. of oil every 100 miles. I have now travelled 400 miles since installing the kit. Haven't used one drop of oil. Further my gas consumption has been cut in half. I'm more than pleased with results — best investment I ever made."

### NOTE! DON'T BUY HALF A TREATMENT!

Ring-Re-Nu is more than just a seal—it's a complete 1-2 combination. PVR to clean your engine, RING-RE-NU to seal in that "new car" power.  
1 tube kit \$4.95 ppd. treats all cars except large 8 cyl. autos which require special 2 tube kit at \$8.95 ppd. sold with money back guarantee. (C.O.D.'s accepted. \$1 deposit required, bal. and postage on arrival.) For economical, power-packed, new car performance—rush order to:



Only  
**\$4.95**

Free folder available on request

## RICHIE DISTRIBUTING, INC.

11916 MADISON AVENUE • DEPT. A1 • CLEVELAND 7, OHIO

RING-RE-NU... GOOD FOR YOUR CAR—GOOD FOR YOUR POCKETBOOK

I MADE  
**\$14 PER DAY**  
While still learning!  
T. E. H.—WEST VIRGINIA

I MADE  
**\$800 IN 3 MONTHS**  
While taking your course!  
F. V.—NEW YORK

## Get into the ELECTRIC APPLIANCE REPAIR & SERVICE BUSINESS

**OPEN YOUR OWN SHOP**  
As soon as you enroll, I send you my New Book "How to Open Your Own Business" at no extra cost. PTS training is more than a home study course in electric appliance repair and service. It gives you the "know how" on the operation of your shop from a business standpoint: What to charge, how to get customers. Everything possible is done to start you on the road to success.

**SPARE OR FULL TIME**  
You can actually increase your income while still learning—spare or full time  
**ACT NOW**  
Want a good-paying business—a job in a fast-growing industry? Send now for your **BIG FREE BOOK**—"My Plan for your Success." Get started **NOW**  
**EASY TO LEARN**  
Men of all ages, yes, even the man of 69 can get into this expanding field. A **REAL OPPORTUNITY** for the practical man who wants the **BETTER THINGS IN LIFE**. The easy PTS Home Study Plan prepares you for greater earnings **NOW!**

I SEND YOU A  
**BIG KIT of TOOLS at No Extra Cost**

**WE TEACH YOU:**  
Electric motors, house wiring, refrigerator, auto ignition, automatic washers, garbage disposals, fluorescent lights, irons, cleaners, etc., at home.  
**FULL OR SPARE TIME**

**SEND FOR THIS FREE BOOK**



### MAIL THIS COUPON TODAY

**PACIFIC TRAINING SCHOOL** H. T. ARMSTRONG  
7219 So. Broadway, Dept. P-541 Los Angeles 3, Calif.  
Please send me, without obligation, your free booklet and details.

Name \_\_\_\_\_  
Address \_\_\_\_\_  
City \_\_\_\_\_ Zone \_\_\_\_\_ State \_\_\_\_\_



# Start a profitable manufacturing business in spare time

with your own home  
as your headquarters



**R**IGHT at this moment there is a tremendous demand for new business enterprises in a branch of the plastics industry. Fortunately, this is a type of manufacturing business that does not require heavy or expensive machinery, rented space for storage, production or sales. A portable hand machine does the work wherever electric current is available, and the working area can be in almost any part of your home.

The opportunity that is open to you today, is to meet this growing demand in a new industry by establishing yourself as the manufacturing agent in your own trading area. Several hundred of our machines are already in use in both large and small communities. Some are even being operated successfully by women whose family duties make it necessary for them to be at home during the day, but whose family income is not enough to meet rising expenses. Most are being operated by men. Many started in spare time just to pick up an extra five or ten dollars for an evening's work. They found the work so profitable that some have now given up former jobs to devote full time to a business of their own.

One of our manufacturers gets all of his business by mail. Orders and money come to him in envelopes and he sends his products out the same way. Another delivers his entire output to stores in the vicinity. An-

other does a wholesale business supplying other manufacturers who do the selling. Still another works with advertisers in the manufacture of plastic advertising novelties and specialties.

The operation of the machine is simple and easy for anyone to learn. It does not require any knowledge of chemistry, mechanics, or electricity. And what some say is best of all, a manufacturing business like this enables a person to make good money without any house to house canvassing. The machine turns out from \$5.00 to \$15.00 worth of work per hour and it can be operated for as short or long a time as you wish.

We have prepared a simple step by step instruction manual that not only tells how to operate the machine, but also tells how to get the business coming in at a profitable clip right from the start. We will lend a copy of this book to any serious minded man or woman with the

understanding that a copy will be given them free if and when they purchase a machine—or the copy we lend can be returned if you decide not to go into the business. Reading it will not cost you anything.

If you are interested in a nice little home business that can bring in an extra \$60 or more for ten or twelve hours work in spare time, send your name. All information on the book and machine will be sent free, postage prepaid and no salesman will call to bother you. You read about it in the privacy of your own home without outside pressure and then decide whether you'd like to take the next step. Address your envelope to me in person. Send me the coupon below. Or, if you prefer send your name on a post card and ask for "Free information on starting a manufacturing business at home." Either way, send your name today and find out about this wonderful new fast growing money-making business.

RAYMOND E. BRANDELL

1512 Jarvis Ave., Dept. L-10-A, Chicago 26, Ill.

Raymond E. Brandell, 1512 Jarvis Ave., Dept. L-10-A, Chicago 26, Ill.

Dear Mr. Brandell: Please send information showing how I can start a profitable manufacturing business in my home in spare time. All the information you send will be mailed to me free of charge and no salesman is to call on me. I am not under any obligation to go ahead with the business and there is no charge for this information now or any other time.

Name \_\_\_\_\_

Address \_\_\_\_\_

City \_\_\_\_\_ Zone \_\_\_\_\_ State \_\_\_\_\_

POPULAR MECHANICS



**WORLD'S  
BEST  
WANT AD  
MEDIUM**

# CLASSIFIED Advertisements



Advertisements in this section \$1.00 per word, each insertion, minimum 10 words, payable in advance.

To be inserted under proper classification, copy must be in our office the

20th of the second month preceding date of issue

F. W. Johnson, Manager, Classified Advertising

Popular Mechanics Magazine, 200 East Ontario Street, Chicago 11, Illinois

## YOU'LL PROFIT

By reading and answering the classified ads in this section. Hundreds of opportunities for you to make and save money

### AUTOMOBILES. MIDGET CARS

**GERMAN** Automatic toy car manufacturer: list of addresses \$1.00 A to Z export import industrial directory, 65,000 addresses—English index \$3.00 postpaid. Special lists \$1.00. Burke Associates, Manchester 1, Mass.

**200 MILES** Per gallon claimed by inventor of patented carburetor. Complete details and drawings \$2.00. Extremely interesting. Behling, Box 955, Dept. 1, Inglewood, Calif.

**WEAK** Starting, pep, mileage, try Super-ignition. \$4.50. EG, Elmford, N. Y.

**AUTO Owners** guide! All makes—models, prices, technical data, part replacements, etc. See advertisement (Felber's Guide) page 290.

**NON-Profit** organization offers automobile literature—Old, new and foreign; dealer books; repair manuals; glossy photographs; free motor magazines. Write today; get on free mailing list. Auto Maniacs, Stockbridge, Mich.

**TWENTY** Ways to make money with your car. Complete plans \$1.00 prepaid. Particulars stamp. Strickland's, Box 447, Longmont, Colorado.

**FORD Owners**—Stop clutch chatter, without new clutch. Simple instructions—\$1.00. Box 4065, Denver 9, Colo.

**HI-Mileage** speed equipment from the world's largest supplier. Dual manifolds, finned heads, electric doors, lowering sets, chrome panels, thousands of items for all cars. 1954 catalog 25c (illustrated literature free). Wholesale to garages. Newhouse Automotive Industries, Los Angeles 22.

**ADJUST** Tappets the easier, better "two position" professional way. Complete instructions one dollar. Brewer, Woodland Park, Colorado.

**PHOTOGRAPHS**, World's finest automobiles. List, sample, 25c. Box 1028, Minneapolis, Minnesota.

### AUTO SUPPLIES AND EQUIPMENT

**GENUINE** Motor treatment, Lachapelle's (patented). For only \$3.00 delivered. Restores older motors. Restores compression, power. Saves gas, oil, repair bills. New motors will last longer. Money back guarantee. You can't lose. Free circular. Write Joe Dillon, Authorized Warehouse and Agents Distributor, Box 323-R Bridgeport, Ohio. Exclusive distributorships, agencies open.

**FIBERGLAS** Automobile bodies. Build your own. Maurice Lannon's Fiberglass "How" book—\$2.50. Information, materials catalog, 10c. Airmailed, 35c. Gem-O-Lite, Box 6867A, North Hollywood, California.

**SAVE Money!** Stop burning excess oil with Dana's Engine Treatment. \$3.00 postpaid. Dana's, R.F.D. 1, Coupeville, Wash.

**WHOLESALE** Automobile supplies. Catalog 25c. Refundable. Charles Wholesale, Batesville, Arkansas.

**MOTORIST** Save gasoline vacuumating overrich mixtures. For free particulars, how you install on your car for introducing, write Vacuumatic, Dept. 2053, Wauwatosa, Wis. Salesmen wanted.

**MOTORIZED** Vehicles. Illustrated circular dime. Craftsmann Books, Box 1153, Milwaukee 1, Wis.

**PROFESSIONAL** Automotive gauges—Surplus stock of famous Gale Hall instruments, brand new, original cartons! Compression gauges, originally \$10.75, only \$2.98 plus 40c postage! Precision engine analysis vacuum gauges, originally \$12.50, now only \$4.58 plus 40c postage! Catalog of other bargains sent free with first order! N. E. Surplus Sales, Dept. PMA-1, 67 High Street, Newburyport, Mass.

**BUY Wholesale** nationally advertised auto supplies, thousands other products at big discount. Free "Wholesale Plan." American Buyers', 629-D Linden, Buffalo 16, New York.

**BARGAIN** Offer! Surplus stock of Gale Hall's original gasoline economy and motor condition gauges, designed for dashboard mounting. Brand new, original cartons! Directions and connections included. Originally \$7.50, now only \$2.98! Deluxe all-chrome model, originally \$12.95, now \$4.98! (Add 40c each for postage.) Order now! N. E. Surplus Sales, 67-PM1 High Street, Newburyport, Mass.

**CONVERTIBLE** Top tailoring, California padded top construction. Secrets revealed in new manual. Detailed text and illustrations. \$2.00 postpaid. G & G Publications, Box 425, Temple City 1, Calif.

**FREE** Quotations! Racing, rodding, re-styling requirements. Wholesale-retail. All Price, 64 Afton, PM-1, Rochester 12, New York.

**A Better** motor for \$3.00. Write Ferns Products, 8120-B Walnut Dr., Los Angeles 1, Calif., for free data.

**SOMETHING** New! "Battery Guard." Indicating light mounted on car dash shows whether or not battery needs water. Five minute installation, any car. No drilling dash. \$1.50 complete. Guaranteed. Order c.o.d., cash, check, m.o. or ask for details. Loran Products, 124 Morton St., Rochester 9, N. Y.

**MAGICARPET** Gives your car the traction of an army tank in snow, ice, mud or sand. Flexible steel mesh. \$1.98 pair postpaid. Guaranteed. Phil Products, Box 589, Evanston 1, Illinois.

**WHAT'S** New? Crumbliss super coil! Also hundreds of special automotive tools. Catalog. White's, Catawissa, Penna.

**SAVE** Your life with amazing new "Torsion-Flex" Sway-Billisers! Stops sway, skid, slide. Postal brings free illustrated literature, gift offer. Sway-Billiser, 5434-A Higgins Road, Chicago 30.

**TIME** That spark with the actual position of the piston. Use Time-Rite—Avoid timing mark errors. Guaranteed. Timing chart free. Time-Rite, 140 Darst Road, Ferguson 21, Missouri.

**ELECTROPLATE** Auto parts, novelties, mirrors. Easy, inexpensive home processes. Free booklet. Tyco Metals, Box 13231-BO, Houston 19, Texas.

**VAPOR** Injector, cools and peps up engines. Saves you money on gas and oil. Gives high test performance using regular gasoline. Ten days trial, refund. \$8.00 complete. Send make and year of car, tractor or truck. Tenco, Box 212, Clermont, Iowa.

**USE** Your spotlight, make automatic. Complete plans newly developed system. \$1.00. Experilabs, Earick Rd., Rt. #6, Mansfield, Ohio.

**CONVERTIBLE** Tops—Black, tan, custom made \$27.95. Send make, year and model. Florida Top Shop, 7325M Old St. Augustine Rd., Jacksonville, Florida.

**MIDGIT-Frigit** the patented, insulated car convenience with spigot for coffee, ice water, etc., fits under any dash. Pulls out for beverage bar and snack shelf. Retail \$19.95 postpaid. Satisfaction guaranteed. Free details from Midgit Frigit, 5001 Georgia Avenue, West Palm Beach, Florida.

**CARBURETOR** Flanges for vacuum controlled valve oilers, water injectors, vacuum gauges, etc. Send \$1, make and model car. Flanges, 253-E Angeleno, Burbank, Calif.

**MODEL T** Ford parts, engine and chassis. Parts for other make old models too. Special parts made to order. We also buy surplus items. B. S. Wisneski, Inc., Milwaukee 7, Wis.

**GM71** Discarded injector parts wanted. Bares, 7120 Carnegie, Cleveland, Ohio.

**CHEVROLET** Owners: Stop tappet noise with Kaye Tappet Silencers. Quality product. Easy to install. Complete set \$5.95. Kaye Products, 2067 B S. Layton Blvd., Milwaukee, Wis.

**NEW** And used guaranteed parts for civilian and army cars and trucks. Largest stock in America. Mail orders. Pioneer Auto and Truck Parts Co., 734 W. 13th Ave., Denver, Colorado.

**SAVE**—California custom accessories headquarters. Buy direct from original designers. Electric push button door-trunk conversions, bull noses, custom grilles, speed dress-up equipment, 40 page catalog, hundreds of photos. Send 25c to Eastern Auto, 3319A South Grand, Los Angeles 7, Calif.

**"WATER** Injection." Free descriptive, illustrated, information. Neher Industries, LaVerne, California.

**BRUSH** Plating outfits connect to a battery. No tanks or shop required. Free particulars. Gunmetal Co., Ave. J., Decatur, Ill.

**CAR** Burning oil? Losing compression? Try Clifford's Compression Seal. \$2 postpaid. Clifford's Engineering, 1329 Seventh, Aurora, Illinois.

### AUTO TRAILERS

**AVAILABLE** In kits. Trailers, boats, coach for pick-up trucks. Trailers blueprints. Catalog 10c. Comstock Trailers, 585-K, Parsons, Kansas.

**ALUMINUM** Camp trailer kit. Campers, hunters, fisherman. Sleeps four. Compact, folding. 560 lbs. Literature 10c. Master Camper, West Sayville, N. Y.

**THREE** Room trailer 24x36" print \$1.00. Trailer Building, quarter. Both \$1.00. Craftsmann Books, Box 1153, Milwaukee 1, Wisconsin.

**BUILD** Your own trailer! Plans for all kinds. Illustrated catalog 10c. Jim Dandy, 125-M, Wausau, Wisconsin.



**EXCEPTIONAL** Expanding eight foot trailer. Accommodates family of five. Build yourself. Literature 10c. Fra-Mar Company, Jones Avenue, Wilmington, Mass.

**CATALOG**—Largest in Midwest. New-est items. Send 10c. Hanna Trailer Supply, 615 W. Layton Ave., Milwaukee, Wisconsin. Dept. MP.

### MOTORCYCLES, BICYCLES, MOTORSCOOTERS AND SUPPLIES

2½ H.P. Whizzer \$18.50; midget car \$15.00; Doodlebug motorscooter \$37.50; homemade motorscooters \$6.00. Send 25c (35c first class mail) for catalog #24 (jammed with sensational bargains in wheels, motors, motorscooters, midget cars, motorbikes, construction plans, etc. Gail, 1313 Jefferson, Toledo, Ohio.

**NEW** In U.S.A. Famous Lambretta scooter. Exclusive territory for southeast area. Salesmen, agents, dealers, factory representatives. Write Box 298, Ft. Lauderdale, Florida.

**NEW** Wasp 4 cycle bicycle engine kits. Ready to install in bike. Cauffield Motor Industries, Temperance, Michigan.

**LEATHER** Jackets repaired, free circular. Zip-Jack, 708 East Tremont Avenue, Bronx, New York.

**"BUZZZZ"**—The motorcycle magazine. International coverage. Thoroughly illustrated. Yearly \$2.00. Sample 20c. 5424-A Sawyer, Chicago 25.

**RECONDITIONED** Motorcycles and motors. Chromium accessories. Complete stock Indian parts. Expert rebuilding. Fast service. Indian Motorcycle Sales, Kansas City 27, Mo.

**CZEK** Motorcycle \$25; midget motorcycle \$20; Doodlebug motorscooter \$30; Whizzer bike motor \$10; two cylinder Maytag engine \$4. Four airplane tires \$3. Mailorder only. Send 25c for catalogue Number 56, just out, listing these and hundreds of other bargains in new and used midget cars, motorscooters, home-builders parts, plans, etc. (35c by first class mail). Midget Motors Directory, Athens, Ohio.

### AVIATION

**PROPELLERS**, Plans, supplies. For air boats, snow sleighs. Immediate delivery. Catalog 25c. Banks-Maxwell, Box 3301E, Ft. Worth, Texas.

**QUALIFY** For high paying mechanic and pilot jobs with our guaranteed exam. Copies. Free details. Acme Flight School, Meacham Airport, Ft. Worth, Texas.

**FREE**: Monthly aircraft, electronic, gadget list. Dick Rose, Everett, Wash.

**LIGHTPLANE** Circular, illustrated, 20c. Craftsmann Books, Box 1153, Milwaukee 1, Wisconsin.

**PROPELLERS**, Plans for snow sleighs, air boats. Lowest prices, fastest service. Literature. Gano Propeller, Box 3284A, Ft. Worth, Texas.

### BATTERIES, GENERATORS

**EDISON** Nickel odorless storage batteries. 12 to 600 ampere hour. Any voltage. Long guarantee. Literature. Hawley Smith Co., Croton Falls 1, N. Y.

### ELECTRICAL SUPPLIES

**REPLACE** Motor brushes yourself—Drills, saws, motors, mixers, vacuums, hair clippers, driers, etc. Send make and model or exact brush dimensions. Average cost \$1.00 c.o.d.. Brushes, Box 547, Inglewood, Calif.

**LAMP** Supplies—Wholesale, any amounts. All parts for repairing and building lamps. Catalogue 15c. Brown Lamp Co., Box 501—Wellston Sta., St. Louis 12.

**MOTOR** Rewinding supplies. Wire. Insulation. Morton Electrical Service, Round Lake, Ill.

**ELECTRIC** Pencil: Engraves all metals \$1.50. Beyer Mfg., 10511-H Springfield, Chicago 43.

**LAMPS**—25c Brings bargain catalog showing all parts for repairing, building. Contains instructions for electrifying vases, oil lamps, etc. Gyro Lamps, 5402P Clark, Chicago 40.

### WELDING, SOLDERING, PLATING

**"BUILD-UR-OWN"** a.c. welder and a.c. power plant with a good used engine and low cost Hobart generator. Welds anywhere and supplies 5KW stand-by power for any emergency. Write Hobartweld, Box M-143, Troy, Ohio.

**ACETYLENE** Welding outfits. New \$49.00, used \$29.00; arcwelders \$49.50. Dept. PM, Eagle Welding, 5085 Broadway, Chicago 40, Illinois.

**CROMIT** British wonder powder chrome plates most metal \$1.00 postpaid. Gardner-Merrick, P.O. Box 431, Manhattan Beach, Calif.

**ELECTRIC** Torch \$9.95, welders \$29.50. Morris, 1070 Inner Drive, Schenectady 3, N. Y.

**SAVE** Time. The must for all acetylene welding and cutting torch owners. It's the new special made cart with rubber tired wheels to accommodate large and small size oxygen and acetylene tanks. Free details. Stoltzfus Welding, Elverson, #2, Penna.

**SELF-Training** System. Radiator repairing, cleaning, rearing. How to equip small shop at low cost. Supply sources, trade secrets. Instructions. Radiator Service, McBain, Mich.

**ELECTRO** Plating equipment—New and used. Complete assemblies. All sizes for all types of plating. Baby shoe metallizing sets. Mounts, supplies, instructions. Free catalog. Hollywood Bronze Supply, 1624-C E. First Street, Los Angeles 33, Calif.

**GOLD** 24kt \$5.95. Silver, nickel, copper electroplating outfits plus booklet on plating and formulas, \$4.95 each. Wholesale chemical supplies. Capitol, 4213 Queensbury Road, Hyattsville, Maryland.

**WELDERS**—Electric, various models, \$28.50 to \$235.00, direct from manufacturer. Free literature. Champion Welder Mfg., 193MP Centre St., New York 13, N. Y.

**A.C. Welders**, 4 sizes. Lowest prices. Free literature. Holgerson's Service, Canton 1, Kans.

### MACHINERY, TOOLS, SUPPLIES

**SHEBEL** Saw filer. Files all saws. Circular. A. P. Shebel, 730 S. 2nd St., Milwaukee 4, Wis.

**BIG** Factory catalog! Buy direct. Save middleman's profits; hundreds of labor saving tools and equipment at tremendous savings. Send 10c. Master Mechanic Mfg., Dept. 2E, Burlington, Wis.

**PRECISION**, Chuck and arbor. Drill runout eliminated. Free trial. Send no money with order. No c.o.d. Free literature. \$3.98 pp. With same ½" diameter shaft motor, you can drive equipment and do precision drilling. 0 to ½". Best Tools Inc., Box 92 Berwyn, Illinois.

**ATTENTION** Machinists and tool and diemakers. We carry a complete stock of Starrett, Lufkin and Brown & Sharpe precision tools. Send 15c in stamps for one catalog. Specify brand. Acme Hardware Co., 1013 W. 63rd St., Chicago 21.

**POWER** Tools, equipment, wholesale prices. Free bulletin. Homecrafters Cooperative, Grand Rapids 6, Michigan.

**ALLEN** One ton power bench type punch press. \$125. Circular. Allen, Dept. PMB, Clinton, Missouri.

**NEW** Mail electric drills—½", \$15.00; ¼", \$25.00. Jacobs chucks. Wilt Surplus, 7829 S. Racine, Chicago 20, Ill.

### ENGINES, MOTORS, DYNAMOS

**INVALUABLE** Motor winders handbook. Simplifies complicated reconnecting. Jed-nak, Clinton, Penna.

**ALTERNATING** Current generators. 750 watt \$38.50. 5000 \$185. Motors ½ horse, \$15; ¾, \$22; 1, \$35. Butler, 1885 Milwaukee, Chicago 47.

**WHIZ** Electric motor. Small flashlight cell operates. Parts plus instructions 25c. Eltro, Dept. PM, Babylon, N. Y.

**AUTOMATIC** Order for electric motors, \$ for \$1.00. United States Petroleum Co., Dept. 5, Clifton, New Jersey.

**WINDING** Data, listing 225 motors, single and three phase, \$1.00. Motor Data Co., Box 7631, Kansas City 28, Mo.

### BOATS, OUTBOARD MOTORS

**BUY** Wholesale nationally advertised outboards, thousands other products at big discount. Free "wholesale plan." American Buyers, 628-D Linden, Buffalo 16, N. Y.

**RECONDITIONED** Marine inboard and outboard motors, boats, supplies. Complete stock, all marine equipment. Send only 25c for illustrated catalog and will include free current list of reconditioned motors. Masters, Dept. 9, 210 W. Chicago Ave., Chicago 10, Illinois.

**CRACKER** Box plans \$7.50 set. Marine hardware at discounts. Literature free. Glen Designs, Box 568, Compton, Calif.

**MARINE** Conversions. Request deluxe catalog with photographs of our products 25c. Gershel Engineering, Oceanside, N. Y.

**P38 BELLY** Tanks \$9.95. Free picture. Anzio Boat, 89, Merced, California.

**PERMANENT** Boat protection with liquid Castoglas! Forms resilient plastic skin, tougher than steel, lighter than aluminum. Leak-proofs any boat. Won't rust, corrode. Free folder. Dept. MA-101, Castolite, Woodstock, Illinois.

**BOAT** Kits, plans, hardware. Catalog 15c. Boatbuilders Marine, 55-M Sorrento, Allston, Mass.

**BOAT** Kits. Build your own boat. Easy to follow instructions. Literature free. Paramount Boat Company, 2202 N. Raynor, Joliet, Illinois.

**SEA** Legs boat kits, prices from \$39. Improved 12' utility boat, racy new 14' runabout, featherweight new 8' skiff. Pre-assembled frames, brass wood screws furnished. Parts pre-cut from marine type plywood, select Philippine mahogany. Illustrated instructions. Write for free literature on all models. Penny Woodcraft Industries, Ottawa Avenue, Dept. C-19, Defiance, Ohio.

**BUILD** A 20 foot sailing catamaran. Very fast, stable and fun. Also other boat plans and patterns, power and sail up to 42 feet, literature free. Book "How to Build Boats," \$1.00. Widd Hauber, 2451 18th Ave., No. St. Petersburg, Fla.

**PLYWOOD** Boat plans 21 for \$1.00. Catalog boat building plans 25c. The Rudder, 15 Murray Street, New York 7.

**AIR** Boat, snow sleigh plans, kits. Catalog 25c. Banks-Maxwell, Box 3301N, Ft. Worth, Texas.

**FIBERGLAS** Your boat for permanent waterproofing. Easy to apply. Full instructions. Guaranteed materials at wholesale prices. Complete kits as low as \$15.75. Buy direct and save. For complete price list write Ajax Plastic Company, P.O. Box 1323, Ft. Worth, Texas.

**FIBERGLAS** Permanent boat coating. Maurice Lannon's Fiberglass "How" book—\$2.50. Complete catalog 10c. Airmailed 35c. Gem-O-Lite, Box 6867B, North Hollywood, California.

**BOAT** Patterns, kits, 8'-50'. Descriptive literature and illustrated boat construction book 50c. Germain Boat Company, West Saginaw 3, Michigan.

**MARINE** Conversions—Willys to Cadillac. Catalogue and conversion hints free. Barr Marine Products, 2706 Castor Avenue, Philadelphia 34, Penna.

**MARINE** Conversions for Ford and Jeep engines. Catalog 10c. Lehman Manufacturing Company, 972D Broad Street, Newark 2, New Jersey.

**CONVERT** Fords and Jeeps to 100% marine engines with Osco's world famous Convo-Kits. Deluxe catalogue 25c (coin). Oscomotors, 3627B Lawrence, Philadelphia 40, Penna.

**NEW**, Used, rebuilt marine motors. Marine conversions, fittings. Free catalog. Stokes Marine Supply, Dept. 24, Coldwater, Michigan.

**PLANS**: Inboard-outboard runabouts, cruisers, sail, Wood, plywood, welded steel. Advise requirements. John B. Clark, N.A., 329 Kenmore, Bay Village, Ohio.

**BUILD** Marine engines with Federal conversion kits. Federal Marine Motors, 9011 Cottage Grove Ave., Chicago 19, Illinois.

**FULL** Size, cut-to-shape boat patterns, blueprints, 7½-38 feet. New 1954 illustrated "Build a Boat" catalog of 50 naval architect-designed cruisers, runabouts, sloops, skiffs, outboard boats, sailing, racing, houseboats, 25c. Marine hardware catalog, \$1.00. "How to Build Boats" book, \$1.75. PolyWog Houseboat Plans, \$12. Cleveland Boat Blueprint Co., Dept. A-66, 9400 Steinway, Cleveland 4, Ohio.



**JOHNSON** Outboard specialists. Used parts for all models at substantial savings. Prompt quotations. Specify model serial. Crandall-Hicks, 910 Commonwealth, Boston, Mass.

**BOAT** Kits, plans and patterns for America's fastest and finest outboard racers and runabouts, fishing boats, hunting skiffs, dinghies, canoes. Illustrated literature 25c. Schneider Boat Co., Dept. PM, 1913 W. Vliet, Milwaukee 5, Wis.

**BUILD** Beautiful fiberglass-plastic boats without using molds. New patented method. Write Speedcraft, 2450 Emerson, off Square Lake Road, Pontiac, Michigan.

### ATHLETIC EQUIPMENT. BODY BUILDING COURSES

**160#s** QUALITY Barbell sets; personal course \$24.00. EG, Elmford, N. Y.

**GREAT** Strength easily obtained. Send \$1.00 for complete course and apparatus. Noticeable results guaranteed in 7 days, or \$1.00 refunded. Joseph Dryer, Box 5527, Chicago 80.

**BARBELLS.** Exercise equipment. Courses. Free booklet. Good Barbell Co., Reading, Penna.

### SPORTING GOODS. GUNS, FISHING TACKLE. ARCHERY. TRAPPING

**HOLLOWGLASS** Fishing rods. Save over half. Buy complete kits. Casting, spinning fly and boat. \$4.95 to \$7.95. Assemble yourself. Full instructions. Makit Rod Company, 429 Fulton, Ft. Worth, Texas.

**SAVE 50%** On finest bows, arrows, equipment, bowhunting outfits. Free catalog and "How to Hunt with Bow and Arrow" booklet. Send 10c. Malibu Archery, 3156-RJ 8th St., Los Angeles 5, Calif.

**IMPORTED** Daggers, throwing, pocket, hunting knives, etc. Free catalog. J. D. Clinton, 94 Church, Mt. Clemens 2, Mich.

**TENTS** (Direct from manufacturer). Camping equipment, sleeping bags, air mattresses. Low prices. Free 80 page catalogue. Mor-San Sales, 10-21R 50th Ave., Long Island City 1, New York.

**BUY** Wholesale nationally advertised sporting goods, thousands other products at big discount. Free "wholesale plan." American Buyers', 627-D Linden, Buffalo 16, N. Y.

**CASTING** Plugs—Catch fish or money back. S. R. Blackstone, 344 West Dayton St., Madison 3, Wis.

**TAN** Fur hides. Instructions \$1.00. Hicks, 128 Pioneer Rd., Watsonville, Calif.

**GUNS** Galore! Western, Kentuckies, Winchester, Mausers, Colts, Lugers. Big bargain catalog 50c. Ed Agramonte, Yonkers 20, N. Y.

**FREE** Fishing catalog—132 pages. Over 3000 hard to find fishing specialties. Netcraft Company, Dept. PM1, Toledo 13, Ohio.

**FREE** Catalogue: Imported hunting knives, binoculars, guns. Sportsmen, 1324 Wilshire, Los Angeles 17, California.

**SPORTER** Stocks, semi-finished for Arisaks, Enfields, Mausers, Springfield, etc. Catalog 10c. Banks-Maxwell, Box 3301L, Ft. Worth, Texas.

**AMMUNITION** Priced below wholesale. 200 calibers, guns. Catalog 10c. Firearms, 1517 Gardner, Hollywood 46, Calif.

**JAP** Rifle altering American shells \$6.00. Catalog 5c. TP Shop, West Branch 11, Mich.

**GOLFERS** Save! 1954 equipment catalog 20c. Pro-Golf Shop, Waseca, Minn.

**5000** BARGAINS. Firearms, binoculars, war relics. Catalog 50c. Smith Firearms, Rummel, N. J.

**SHOTGUNS,** Rifles, Revolvers, 500 modern, obsolete. Also cartridges. Each list 10c coin. Ed Howe, 52 Main, Coopers Mills, Maine.

**120** PROFUSELY illustrated pages antique pistols, swords, daggers, armor, etc. 50c. Robert Abels, M860 Lexington Ave., New York 21.

**CAST** Iron molds—For casting fishermen's sinkers. Free illustrated booklet. Reading Instrument Co., Box 78, Reading, Penna.

**FREE** Catalog: flies, lures, mustad hooks, fly tying, lure, spinner, rod making materials, nylon coils. Supreme Mfg. Company, Amarillo, Texas.

### TAXIDERM Y

**TAXIDERM Y** Supplies, books, instructions. Everything! Catalog 10c. Vandye's, Wessington Springs 12, S. Dak.

**MODERN** Taxidermist Magazine, Greenfield Center 2, N. Y. Devoted entirely to taxidermy, photos, articles, methods. Trial year's subscription, \$1.00.

### BINOCULARS, TELESCOPES, MICROSCOPES, MAGNIFIERS

**20X** TELESCOPE \$1.00! Coated lens. Vision hazy for lenses need cleaning (this you can do). Regularly \$8.95. Closeout \$1.00 plus 25c postage. United, 9043-A S. Western, Chicago 20.

**SAVE 25%!** Get interesting facts. Free 52 page binocular, telescope catalog. \$3.95 to \$250.00! United, 9043 S. Western, A-7008, Chicago 20. Dealers wanted.

**BINOCULARS,** Telescopes, microscopes. Terrific values \$3.98 up. Request free money saving catalog. Criterion, Hartford, Conn. Dept. P 19.

**AMAZING** Prices, binoculars, telescopes, microscopes. Free trial. Folder, "Binocular Selecting," also pricelists free. Prentiss Importers, Mercury Bldg., West Los Angeles 25, Calif.

**LOWEST** Prices, all sizes binoculars, telescopes, microscopes. \$X20 \$32.00. Free catalogue. Joe's Binocular Sales, 4827 Second Blvd., Detroit 1, Michigan.

**GIANT** 100X Ready to use day and night telescope. Steel and brass tubing construction. Hardwood tripod. \$7.95 f.o.b. factory. 400X giant telescope easily made. Brass focusing tube, erector, 5 lenses, instructions. \$3.95 postpaid. Carl Jamer, Manorville, N. Y.

**IMPORTED** Large three-section nickel plated pocket telescope \$1.00. Mallory, Box 1031-M, Tacoma 1, Wash.

**GIANT** Astronomical telescope complete with six ft. tripod. 45X, 75X, 100X eyepieces. \$15.00. Satisfaction guaranteed. Suffolk Science Service, Riverhead, N. Y.

**400X** TELESCOPE Easily made. Erector, focusing tube, 5 lenses and instructions. \$3.75. Suffolk Science, Riverhead, N. Y.

**BINOCULAR** Specialists, all makes repaired. Authorized Zeiss, Hensoldt dealer. Tele-Optics, 5514 Lawrence, Chicago 30, Illinois.

**SPECIALISTS.** Used, new microscopes. Prepared slides. Supplies. Telescopes. Free illustrated catalog. Nassau Optical, 9 W. Greenwich, Roosevelt, N. Y.

**WAR** Surplus bargains, binoculars, telescopes, sextants, millions of lenses, prisms, reticles, eyepieces, objectives, etc. Mail 10c for big "Catalog CH." Send \$1.00 for Stock CH-10-piece lens kit and big instruction booklet. Edmund Scientific Corp., Barrington, N. J.

**REFLECTING** Telescopes. 60X, completely assembled \$29.75. Guaranteed observatory clearness. Free information. Skyscope, 475 Fifth Avenue, New York 17.

**MAKE** Your 6" telescope reflector. Glass, abrasives, instructions—\$9.50. F. Cameron, Box 65, Inwood 96, N. Y.

**REFLECTOR** Telescope kits from \$6.25. All parts designed and built at our Hoboken factory. Mirror cells, diagonals, focusing mounts, tripods, tubing, oculars. Fully guaranteed. Send for free illustrated catalog. Our only sales showroom, Esco Products, 134 West 32 St., Rm. 204-A, New York 1.

### PETS—DOGS, BIRDS, RABBITS, HAMSTERS, ETC.

**FREE** Dog book! Illustrated with rib-tickling cartoons. Your name, address on postcard brings you "How to Feed and Care for Me." written so your dog understands it. Plus free Ken-L-Ration, Ken-L-Biskit, Ken-L-Meal coupons. Write Ken-L-Products, Dept. A-1, Box 515, Park Ridge, Illinois.

**RAISE** Chinchillas. More profitable than rabbits. Written instructions. Free extra female with each pair. For limited time only. Order today. Hollywood Chinchilla Ranch, 7280 Sunset Blvd., Hollywood 45, Calif.

**CHINCHILLAS** Book, breeding and care. Ludwig Ranch, Mohnton 10, Penna.

**ANGORAS,** Chinchillas, White Giants! World's most profitable rabbits! Catalog free. Grinstead's, Edwardsville, Illinois.

**PARRAKEET** Newspaper, monthly, sample 10c. Box 46, West Bend, Wisconsin.

**RABBITS**—Best home enterprise. Booklet free. Tayco Rabbitry, Hapeville, Ga.

**RACCOONS,** Minks—Bred females. Baby skunks. Catalog 25c. Shady Fur Farm, Springfield, Minnesota.

**GROW** Mushrooms. Cellar, shed, and outdoors. Spare full time, year round. We pay \$3.50 lb. We paid Habbit \$4,165.00 in few weeks. Free book. Washington Mushroom Ind., Dept. 171, 2954 Admiral Way, Seattle, Washington.

**HAMSTERS**—Golden; young, \$4.00 pair; fully developed, \$5.00 pair. Request prices on rare albinos. Adirondack Hamstery, Prospect 2, New York.

**RAISE** Rabbits. Make money. Send 25 cents for market information, housing plans, prices for starting stock. A. Johnson, Box 694, Kansas City, Mo.

**RAISE** Rabbits and Guinea pigs. Profitable occupations. Interesting booklets 10c. Winfield Harrison, Fitzgerald, Ga.

**RABBITS**—Purebred New Zealand Whites. Best commercial breed. Two does and one buck, \$10.00. Safe delivery guaranteed anywhere. Shipped express collect. Order from Wilson's Rabbitry, Greer 1, South Carolina.

**GUINEA** Pigs. Wonderful moneymakers. Booklet free. Taylors, B426A, Hapeville, Georgia.

**ALBINO,** Panda and Golden Hamsters, \$2.75 and up. Write for booklet. Engle's Hamstery, 1228 So. 17th, Terre Haute, Indiana.

**AMERICAN** Rabbit Journal, Box PM, Warrenton, Mo. Year \$1; sample 15c.

**BEAUTIFUL** Pure white pedigreed police puppies. Ansonia Kennels, Moose, N. Dak.

**NATURALIST'S** Catalog 10c. Chameleon 75c. Hamsters \$2.75 pair. 200 mealworms \$1.20. Quivira Specialties, Topeka 51, Kansas.

**PARRAKEETS,** Talking pigmy parrots, all colors \$7.00 each. Monkeys, all kinds. Demused skunks, pigmy skunks, raccoons. Thompson Wild Animal Farm, Clewiston, Fla.

**CHINCHILLAS,** \$325 pair. Free literature. Far-West Chinchilla, 1446 Jones, San Francisco, Calif.

**SALE.** Breed tame red squirrels. Dewey H. Balch, Castleton, Vt.

**CHINCHILLAS**—Pedigreed South American. Use spare room or cellar. No odors. Profitable. Stewart Chinchilla Ranch, Washingtonville, N. Y.

**ST. Bernards,** Boxers, "Weimaraners," Hof Kennels, 5136 Cascade Rd. S.E., Grand Rapids 6, Mich.

**CHINCHILLAS**—Registered, high scores, reasonable. Herb Miller, 1911-N, Lubbock, Texas.

**1000** BRED Mink booklet, plans 20c. Lake Ontario Ranch, Gravel Road, Webster, N. Y.

**CHINCHILLAS** Rented, offspring bought. R. Rau, Route 2, Jeannette, Pennsylvania.

**DOLLAR-Maker** rabbits! Cash markets. Write today! Ramshead Ranch, Gibbsboro 3, New Jersey.

**FOR** Sale: A few outstanding Coonhounds, Beagle, and Rabbits. Prices from \$15.00 to \$40.00. Free literature. Trial Dures Thomas, Box 268, Albertville, Alabama.

**HAMSTERS,** Golden and Panda. Literature free. Charles E. Bowser, Smokerun, Penna., Dept. H.

**HAMSTERS**—Cages and equipment. Free illustrated details. Lakeview Hamster Colony, Newfield, New Jersey.

**EARTHWORM** Raising pays worthwhile profits! Illustrated booklet explains raising, feeding, packing, marketing. 25c. Ozark Worm Farm-J, Willow Springs, Mo.

**STANDARD** Rabbit Journal, B-241-M, Milton, Penna. Year \$1.00, sample dime, beginner's manual 25c.

**MAKE** Big money! Raise Chinchilla rabbits. Cash markets supplied. Write today! Rockhill Ranch, Sellersville 15, Penna.

**MINK** Raising information free. Complete. Lake Superior Mink Farm, Superior, Eel, Wisconsin.

**CHINCHILLAS** (No rabbit.) Easily raised anywhere. Profitable. Big future. Terms. Hibner Chinchillas, Ithaca, Mich.



**SPORTSMEN:** 200 Pointers, setters, straight cooners, combination hunters, rabbit and fox hounds. Reasonable. List free. Ramsey Creek Kennels, Ramsey, Ill.

**RAISE** Highly-profitable Angora and New Zealand rabbits. Particulars free. White's Rabbitry, Jackson, Michigan.

**RAISE Mink:** Free booklet, pen plans, inside secrets, feed, care. Mink are money makers. Investigate today. Lawrence Molgard, Brigham City 12, Utah.

#### PLANTS, SEEDS, NURSERY AND GARDEN SUPPLIES

**MULTIFLORA** Rose, the living self-repairing fence, ornament, erosion control, windbreak, snow fence, etc. Rapid grower. Raise from seed. Free planting guide, write Woodlot Seed Company, Norway 4, Michigan.

**FRUIT Trees!** Stark Bro's sensational new "Dwarfs." Also standard size, exclusive patented, trade-marked varieties produce abundant, larger, better apples, peaches, pears. All fruit faster growing, quicker bearing. Also beautiful ornamental trees and shrubs. Get giant new colorphoto catalog free. Stark Bro's, Dept. 30014, Louisiana, Missouri.

**TREES** And shrubs—Raise your own from seed for shade, windbreak, snow fence, ornament, erosion control. Free planting guide—price list. Write Woodlot Seed Company, Norway 4, Michigan.

**WE** Sell on the installment plan. Best varieties peach and apple trees, low as 12c; grapevines 5c; shrubs 13c; evergreens 15c. Berries and plants. Catalog free. Benton County Nursery, Box 542, Rogers, Arkansas.

#### FARMS, FARM LANDS, REAL ESTATE

**FLORIDA,** Best low price 75x110 lot in south Florida, easy terms, close to courthouse, school, 5 churches, hospital, civic center, all stores, three fishing piers, ball-park, golf course, hunting area, all year bathing. 112 page Florida fishing guide sent free. Cuthbert, Box 722, Stuart, Fla.

**SUNNY** California land bargains as low as \$5.00 per acre. Low down payments—low monthly payments. Write for free information. Land Department, Suite 105, 1340-A No. Highland Ave., Hollywood 28, California.

**FARM-Ranch** opportunities. Favorable conditions. Washington, Minnesota, Montana, Idaho, Oregon, North Dakota. Literature, farm descriptions. Specify which state. J. W. Haw, 119 Northern Pacific Ry., St. Paul 1, Minn.

**\$5.00 MONTHLY** Buys 5 acres, excellent fishing and hunting; good land; price \$120.00. Free list, Box 425-P, Carthage, Mo.

**FLORIDA—Homesites,** business sites and acreage in Potterfield's Garden areas. High dry land about 40 miles from Tampa and St. Petersburg close to wonderful hunting and fishing. Tracts as low as \$595.00 for three acres, only \$10.00 down, \$10.00 month. Information write G. B. Potterfield Owner, Dept. V, Charleston, W. Va.

**FARM** And business catalog free! Big edition. Hundreds of bargains from \$1000 up. Maine to Florida. West's, M-1, Pittsburgh 17, Penna.

**TOWN—10 Acres.** Others listed. \$5 monthly. Write Armstrong, 34, Shook, Missouri.

**SELLING** Attractive homes like rent. Request list. Perry, Briarhill, Penna.

**FREE** List farms, auto courts, homes, Missouri Ozarks. Johnson Realty-PM, Marshfield, Missouri.

**CALIFORNIA** Ranch lands, \$10 to \$25 acre. Easy terms. Free catalog. Write Pacific Lands, 1621BW Cahuenga, Hollywood 28, Calif.

**INFORMATION** On where to buy cheap land. Many terrific bargains in land, averaging from \$3 to \$5 an acre. Inside facts on buying up woodlands, farmlands, etc. New booklet gives details. Send \$1 to Gotham Publishing Co., P.O. Box 321, Wall Street Station, New York 5, N. Y.

**WRITE** For information about Public Lands Digest, Dept. 30, Box 361, T&C, Sacramento 21.

**STROUT'S** Farm catalog. Farms, homes, businesses, 33 states, coast-to-coast, 3298 bargains described. Mailed free. World's largest: 53 years service. Strout Realty, 7-M So. Dearborn St., Chicago 3, Ill.

**FLORIDA'S** Choicest lakefront lots. Eustis-DeLand highway. \$10 monthly without interest. Free literature. Roepke, Eustis, Florida.

**FLORIDA—New** development adjoining Ocala National Forest in Lake County. Best fishing, hunting. Nice homesites \$345 at \$10 monthly. Folder free. Howard Vernor, DeLand, Florida.

**\$5.00 PER** Acre, Missouri land. Warranty deed. Free list. John Calvert, Plant City, Florida.

**FLORIDA—Beautiful** retirement homesites near gulf coast. Excellent hunting, fishing in 9 fresh and salt water rivers, 11 bays and gulf. \$250 at \$10 monthly. Free literature. A. M. Mathews, Box 1405, Asheville, N. C.

**HOMESITES \$400—** Convenient payments. California's finest garden section. On Morro Bay's scenic shores. Wonderful fishing, boating, bathing. Fertile soil, softest water, temperate climate, congenial community. Free literature. Richard Otto, Department M, San Luis Obispo, Calif.

**FLORIDA** Choice lakefront lots available. Best fishing, hunting. Terms. Grace Parker, Paisley, Florida.

#### POULTRY, FARM SUPPLIES

**TECHNICAL** And commercial advices, world-wide informations. Poultry Documentation Service, Pelee Island 11, Ontario, Canada.

**RAISE** Turkeys the new way. Write for free information explaining how to make up to \$3000 in your own backyard. Address—National Turkey Institute, Dept. 3, Columbus, Kansas.

**KNOW** How to raise poultry for profit. Read Poultry Industry. Every issue packed with helpful hints and practical suggestions. Latest articles on breeding, feeding and management. Subscribe now, 1 year 50c, 3 years \$1.00. U. S. funds or checks payable at a New York or Boston bank. Poultry Industry, Dept. PM, 376 Boylston St., Boston 16, Mass.

**POULTRY** Farmers, broiler growers, turkey raisers read the new American Poultry Journal for latest ideas and greater profits. 12 months, 50c. Special offer, 4 years, \$1.00. American Poultry Journal, 182 North Wabash, Chicago.

#### PROFITABLE OCCUPATIONS

**REVEALING** Vocational aptitude test especially designed for mailing. Receive personal detailed report. Enjoy financial success and happiness. How much is your future worth? Send just \$5. Vocational Testing Service, Box 272, Ridgewood, N. J.

**MAGAZINE** Subscriptions. Biggest commissions. Bonus. Qualified Publications, 451J Kingston, Brooklyn 25, N. Y.

**ALASKA** Jobservice "directory." Alaskan jobs, highway map, job contracts, pay scales, homesteading, fur farming, application blank, foreign contract, sample, physical examination required. Civil and defense work. Send \$2.00 postpaid, (c.o.d. \$3.87), airmail and special handling \$3.00. No other fee. Money refunded in 7 days if not satisfied. Alaskan Jobservice, PM, Waseca, Minn.

**FOREIGN** Jobs—Tax free. Save \$10,000 to \$20,000. Truck drivers \$1100, laborers earned \$255 weekly. Men and women, welders, mechanics, professional to \$1200. South America, Alaska, South Pacific, Europe, Asia. Fare paid. Get our "Foreign Opportunity Directory" with foreign contract, sample, application blank, information on job contracts, construction news, etc. Send \$2 postpaid (c.o.d. \$2.87) airmail \$3.00. No other fee. Money refunded in 7 days if not satisfied. Foreign Opportunities, PM, Waseca, Minn.

**LEARN** Metalizing baby shoes, gifts, etc. Bronze, gold, silver. Polio free. Kiktavi, 7217-MK South Broadway, Los Angeles 3.

**NEED** More money to live on? Increase your weekly income \$20 to \$25 or more in spare time. Supply Rawleigh Products to consumers. Also openings for full-time dealers. Write Rawleigh's, Dept. A-DD-PPM, Freeport, Ill.

**FLORIDA** Jobs—Florida needs you. You can live and work on Florida's fabulous gold coast. Hundreds of interesting, good paying jobs now open. Skilled and unskilled workers badly needed. For complete information send your name, address and \$1 to Florida Personnel Institute, Dept. A, Box 2058, Miami 12, Florida.

**HONOLULU** Help wanted columns airmailed \$1.00. Sterling's, #3 Campbell Block, Honolulu, Hawaii.

**\$1300.00 MONTHLY** For truck drivers, \$1400.00 monthly for carpenters, electricians, plumbers, mechanics, \$1200.00 for clerks and laborers. Replacement hiring now being done. Full information and complete foreign listings, with current information on Spain job, \$1.00. Women's listings, \$1.00. 25,000 men and women needed for new stateside project! Complete information and other domestic listings, \$1.00. Dept. 3-A, Opportunities Unlimited, 1110 Commerce Bldg., St. Paul, Minn.

**HOME** Mail order beginners. Sources, methods, information. Details, plus 10,000 word instruction book, 25c. Carnahan Bros., 5582-A Nelson, Cypress, Calif.

**SOUTHERN** California is booming! Grow with it. Get big job and opportunity report showing job openings, business opportunities, actual companies now hiring, pay scales, living conditions, etc. For accurate, last-minute information about this fabulous area, send \$1.00 to Tower Distributors, Dept. 404, 15136 Vermont, Paramount, Calif.

**WANT** A diesel job? New opportunities to increase income. Higher pay. More money. We can help you qualify. Tools. Shop method home training. Write today! Diesel, Tractor, Heavy Equipment Division, Interstate Training Service, Dept. B3A, Portland 13, Oregon.

**"HOW** To Make Money With Simple Cartoons"—A book everyone who likes to draw should have. It is free; no obligation. Simply address Cartoonists' Exchange, Dept. 91CP, Pleasant Hill, Ohio.

**SEND** For big, new 1954 illustrated catalog that will show you how to turn your spare time into cash—making quick-selling, highly profitable lamps. Every home a prospect. Hundreds doing it, you can, too. No experience or special tools required. Catalog No. 7 contains 56 pages filled with shades, shade frames, figurines and bases, oil lamp converters, boring compound, and dozens of similar items. Also all kinds of sockets, cords, pipes, harps, finials, bases, and hundreds of other parts—everything you need. Special 8-page section shows 6 beautiful lamps in kit form, ready to assemble. You buy wholesale, sell at retail. Make big profits. Send 25c today for new 1953 catalog and wholesale price list, you'll be glad you did. The 25c will be refunded on your first order. Gearon Co., Dept. 500-B1, 27 S. Desplaines, Chicago 6, Ill.

**FOREIGN** And Latin American employment. 1954 "Foreign Service Directory" gives up-to-minute facts on military and civilian construction, government jobs, major oil listings, aviation, transportation, steamship lines, mining, importers, exporters, how-when-where to apply, application forms, hot list firms hiring. \$1.00 postpaid. Global Reports, Box 883-P, Hollywood 28, Calif.

**\$10,800 PROFITS!** Your own mailorder business! No risk! Success plan free! Treasury, 709 Webster, New Rochelle L-19, N. Y.

**WELDING** Pays big money. Learn easily at best equipped school in country. Non-profit school with low cost training. G.I. approved. Write Hobart Trade School, Box M-142, Troy, Ohio.

**BUY** Wholesale thousands nationally advertised products at big discount. Free "Wholesale Plan." American Buyers', 628-P Linden, Buffalo, N. Y.

**MUSHROOMS** Grown boxes barrels. Manureless process 50c. Spawn \$1.00. Gordons, 553 William, Winnipeg, Manitoba.

**FREE!** "301 Profitable Small Businesses!" Amazing shoeing plans! Work home! Start sparetime! Deumant Surveys, Kenmore 23-PM, N. Y.

**MEN** Earn \$1,500.00 per month on foreign projects. Men wanted now on foreign, Latin America and far north projects. Truck drivers, \$3.55 hour. Clerks, \$3.00 hour. Electricians, \$4.00 hour. Carpenters, \$3.70 hour. Laborers, \$3.00 hour. Most all trades wanted. Up to 70 hours week with time and one half for all over 40 hours. Transportation paid. 8 to 24 month contract. New treaty with Spain, South Korea will start new bases at once. Get in on start. Full information of over 20 sheets 9 1/2 x 11 listing over 200 firms now hiring, conditions, wages, hours, contract requirements, application form, etc., also latest issue of our monthly bulletin listing new contracts and coupon worth \$1.00 on subscription. All for \$1.00. Airmail \$1.24. Edward O. Burns, 911 N. Lancaster Avenue, Dept. 6, Dallas, Texas.



**ALASKA!** Last American frontier. \$1.00 brings 1954 business directory and government map. Military and civilian construction; homestead and highway facts; mining, aviation, fur farming, grazing, timber, travel directions. List of firms hiring. How to apply. Alaska Opportunist, Box 92-P, Hollywood 28, Calif.

**GROW** Plants, flowers. Details free. Shiffer, Box 129, Millersburg, Penna.

**FOREIGN** Jobs. Contracts underway and soon starting in Africa, South America, Canada, England, Europe, South Pacific, Middle East, Mexico and Alaska. Send \$1.00 for foreign job news, information, application forms, etc. DCS Foreign Job News, Dept. 268-SZ, Bridgeport, Ill.

**BECOME** Patent firm representative. Spare time, mail order. Experience unnecessary. Work done main office, you collect commissions. Industrial Patent Reports, Box 6296, Washington 15, D. C.

**LOS** Angeles job opportunities—For office, factory and professional workers, skilled and unskilled labor. Information on living conditions and copy of big daily paper with classified ads for hundreds of men and women. Only \$1.00. Money returned if not satisfied. P.O. Box 1188, Hollywood 28, Calif.

**SECRET** Investigation. Experience unnecessary. Investigators particulars free. George Wagoner, 125M West 86th, New York 24.

**OVERSEAS** Jobs. Big pay, transportation, expenses. Clerical, professional, mechanical workers. Most all trades. Latest listings airline, construction, manufacturing, oil, steamship companies, government agencies, many other opportunities. Up to date information on securing employment, contracts, income tax, application forms. \$1.00. Overseas Jobs, Box 325-A17, Baton Rouge, La.

**MAKE** Finest costume jewelry. Over 100% profit. Easy instructions, wholesale catalog 20c. Bergen Arts, 128M Main Street, Hackensack, N. J.

**SELL** Popular Mechanics and all other magazine subscriptions. Free catalog, supplies. Subscription Service Company, Dept. B, P.O. Box 2070, Birmingham, Ala.

**OVERSEAS:** Contracting, engineering and oil companies; big pay, no U.S. taxes, cheap living costs. Send \$1 for list showing where to apply. ForeignJobs, Box 166, Washington 4, D. C.

**CONSTRUCTION** Job list. Published monthly. \$1.00. Dempster's Construction Scout News, Dept. 268-SY, Bridgeport, Ill.

**PARTNERSHIPS**—Don't lose your shirt getting into or getting out of a business partnership. Our copyrighted booklet, price \$2.00, may save you. It points out the uncertainties. Particulars free. Fox Business Publications, Box 1265-A, Peoria, Ill.

**EVERYBODY** Likes candy. Learn to make professionally at home. Interesting work. Tools and supplies. Our 44th. year. Ragsdale Candies, D6, East Orange, New Jersey.

**START** Operating profitable advisory service! ProspeX, Box 6404-V, Jacksonville 5, Florida.

**TYPISTS**—Profitable home business. Complete copyrighted information, 50c. Gaunt, 827-W Irving Park, Chicago, Ill.

**\$500,000** BY Mail from home. Free folder. Publicity, Kalamazoo, 65DD, Mich.

**JOB** Opportunities overseas! Some paying skilled \$340 weekly, drivers \$275, laborers \$255. Transportation, overtime. 23 firms seeking applications from construction men, clerks, etc. Plus, 269 projects underway in 53 countries. 44 page manual, application forms, everything. \$1. JobService D-16, Box 30, Billings, Montana.

**ALASKAN** Jobs! Over 150 new construction projects with names, addresses companies hiring. Thousands needed. Highest wages. Military, private construction, mining, fishing, lumbering, aviation, railroads, homesteading. Skilled, unskilled workers. Salary information. Alaskan map included. \$1.00 complete. Alaskan Opportunities (PM), Box 362, Kenmore, Washington.

**\$40.00 WEEKLY.** Made growing mushrooms. Dominion patent 331,583. Free spawn with order. North American, 169P Yonge, Toronto, Canada.

**GROW** Mushrooms. Cellar, shed, and outdoors. Spare, full time, year round. We pay \$3.50 lb. We paid Babbitt \$4,165 in few weeks. Free book. Washington Mushroom Ind., Dept. 99, 2954 Admiral Way, Seattle, Wash.

**JOB** On ships and yachts, excellent pay. Foreign travel. Davenport's, Dept. 3, Box 1354, G.P.O., New York 1, N. Y.

**MAKE** Flexible molds! Cast plaques, bookends, figurines! Free sample! H. Tooker, 630-M Chestnut, Hamilton, Ohio.

**FREE** Book "505 Odd, Successful Businesses." Work home. Expect something odd! Pacific, Oceanside, Calif.

**BE** The Popular Mechanics representative in your neighborhood and earn big profits in your spare time. Write Popular Mechanics Magazine, Room 408M, 200 E. Ontario St., Chicago, Ill.

**BUY** Wholesale thousands nationally advertised products. Save money! Make money! Postcard brings details. Kemah Company, 5017-J Washington, Houston 7, Texas.

**FOREIGN** Employment construction work. If interested in foreign projects with high pay write Foreign Service Bureau, (Dept. P.M.), Metuchen, New Jersey.

### BOOKS, PERIODICALS, PICTURES, POSTCARDS

**ILLUSTRATED** Comic books. Grownups love 'em. Vest pocket size. 24 for \$1.00. All different! "Vim" Rogers, Box 14738, Cimarron Station, Los Angeles 9, Calif.

**SCIENCE** Fiction magazines, back numbers. Free list. Haslam's, 742 Central, St. Petersburg, Fla.

**USED** Pocket novels. 8 for \$1.00. Stamp brings list. Trunkat, Glenshaw 1, Penna.

**BACK** Number magazine specialist. Specific requests. Ellis Chalfin, 410 East 17th Street, Brooklyn, New York.

**POPULAR** Novels, 3 for \$1.00. Pocket books, 8 for \$1.00. Catalog 10c. Miller, 5253-M Page, St. Louis, Mo.

**FREE** Catalog. Sensational adult reading. Fascinating revealing subjects. Speedy Press, 2281 Kenwood, San Jose 2, Calif.

**BOOKHUNTERS!** Scarce, unusual, miscellaneous books supplied. Atlantic Book Service, Cedar Street, Charlestown 29, Massachusetts.

**SPARETIME** Profits taking subscriptions, all magazines. Wholesale catalog free. Cassell Agency, Westfield 2, New Jersey.

**BOOKS** On all subjects. Schaengold Book Co., 1000 Keith Bldg., Cincinnati 2, Ohio.

**JOIN** The book swap club. Information. Book Exchange, 1911 Peppertree Lane, San Bernardino, Calif.

**BOOKHUNTERS!** Unusual, scarce, gay, serious miscellaneous books. Catalog free. The Mail Order Bookstore, 1336 S.W. Hall St., Portland, Oregon.

**BOOKS** Just published, fiction, non fiction. Lists. Armstrong, 6 Rockland, Melrose, Mass.

**BOOKS** Found! Any author, old or new. Rush titles wanted; no obligation. International Bookfinders, Box 3003-PM, Beverly Hills, California.

**FREE** Catalogue. Special interesting books. Powers, 1324 Wilshire, Hollywood 17, California.

**NATIONAL** Geographic Magazines, 1888-1952. Periodical Service, Box 465-PM, Wilmington, Delaware.

**BOOKHUNTERS!** All subjects. Send wants! Jaher Book Service, 620-P East 17th Street, New York 57.

### GAMES, TOYS, NOVELTIES

**GREAT** Fun. Commodore invisible writing ink kit complete, postpaid \$1.00. Send mysterious messages. Mongol Chemical, West Nyack 2, N. Y.

**CARD** Table tennis. A new game. Write Olympic, Fairfield, Maine.

### MAGIC TRICKS, PUZZLES, JOKER NOVELTIES

**FREE** Catalog. Best magic, practical jokes. Top Hat Magic, Evanston, Illinois.

**BE** A magician. Large professional magic catalog of latest tricks, 35c. Ireland, C-109 North Dearborn, Chicago 2.

**LEARN** Ventriloquism. 3c stamp brings particulars. Smith, 801 Bigelow, Peoria 5, Ill.

**SPECIAL** Magic section, Hollow Tree Magazine, Lawrence, Kansas. Sample 10c.

**BASEBALL** Puzzle. Deductive logic type. Difficult. 50c. G. Lupfer, 5107 Cato, Bedford, Ohio.

**REAR** View mirror attachment for glasses. Free details and gift. Starling Co., 2206M Starling Ave., New York City 62.

**JUMBO** Catalogue! Tricks! Puzzles! Funmakers! 10c. Rick's, P.O. Box 260, Chicago 90.

**200** ELECTRIC Stunts, 110 volts, \$1.00. Kutting Sons, Los Altos, Calif.

**WOODEN** Nickel, catalog, trick, 25c. Fun'n Magic, 423-P North St. Marys, San Antonio, Texas.

**NEW** Magic catalogue and magic circulars 10c. New joke lists 5c. Magic Factory, Minneapolis 2, Minn.

**WE** Supply every noted magician. Large professional catalog \$1.25. Holden's, 120 Boylston Street, Boston, Mass.

**500** TRICKS, Douglas famous 120-page catalog, only 10c. Fastest service to magicians for 30 years. Send 10c today. Douglas Magician, Dept. 1, Dallas, Texas.

**2500** TRICK Catalogue (512-pages), pocket, parlor, stage. World's finest magic. Catalogue \$2.00 (dollar trick included free). Kanter's, M-1311 Walnut, Philadelphia 7.

**VENTRIL** OUISM Selftaught. My quick, easy instructions, 25c. Ventriloquist, Calallen, Texas.

**90** PAGE Novelty-magic catalog with novelty, 25c. Allen, Dept. PMT, Clinton, Missouri.

**PROFESSIONAL** Catalog, 175 pages, 25c. Williams, 900 Plymouth, Ellwood City, Penna.

**ENTERTAIN** With magic—Hobby or profession. Write Marsh's, 237 W. 11th, Columbus, Ohio.

**BIG** Fun kit! Tricks, jokes, novelties, books. Real gay stuff. Howls galore. \$1.00. Johnson, 414 McRae, Wilmington, N. C.

**NOVELTY** Fun cards—Better than a show. Guaranteed to make you laugh. All different. Fifty cents. Aarons, 10742 So. Michigan, Chicago 28, Ill.

### STAMP COLLECTING

**HIGH-Grade** approvals—U.S. postage, commemoratives, revenues. Send want lists. Altopa, 2624 North Albany, Chicago 47.

**TERRIFIC** Collection—Unsurpassed bargain! Animal stamps from Imit. Iceland fish. Gold mining in British Guiana. Map, coat of arms of Nyassaland. Croatian imperforate set. Red Cross airmails from Spain. Beautiful flowers in natural colors, from Congo, Colombia, San Marino, etc. Triangles from many countries. Multi-colored stamps of Cape Verde. New, big set from Uruguay. Reproduction of first U.S. stamp. Stamps honoring landing of Columbus. All these, plus more than a hundred others, for only 50c, to introduce our bargain approvals. Money-back guarantee on this breathtaking, unusual collection. Write today. Wolverine Stamp Service, Dept. C-1, Fruitport, Mich.

**SPEND** Pennies! Not dollars! Thousands of fascinating stamps to choose from our 1c and 2c approvals. No premiums. Just honest value! Pat Knowles, 5902 Van Nuys, Van Nuys, California.

**U.S.** Mint 797 SPA sheet 10c to U.S. approval applicants. D. Kelly, 153M-74th St., Brooklyn 9, N. Y.

**FREE** U.S. \$1.00 presidential plus German peace issue. Approvals. Write Bala Stamps, Bala-Cynwyd, Penna.

**PROFITABLE** Surprise: Asia. 111 diff. 20c. China, Hejaz, Israel, Japan, Manchukuo, Siam. Robert Boger, 3401 Oakmont Ave., Philadelphia 38, Penna.

**SOMETHING** New, something different, something terrific! Try our books of 1000 different and see for yourself. Mostly 1c and 2c, but Scott's catalog number and price under each stamp. Big discounts. Modern Stamp Co., Dept. A-4, Ferryburg, Michigan.

**FREE** U.S. commemorative price list. Ray Worth, 321 S. Cicero, Chicago 44, Ill.

**BUSINESS** And professional men! For the better U.S. approvals, write, New-Way Stamp, Lawrence 6, Mass.

**PHOTOSTATS.** 25c Each, cash with order. Returned postpaid. Golub, 8835 23rd Ave., Brooklyn 14, N. Y.

**FREE** Valuable mystery gift. Approvals. Raymax, 37-Z Maiden Lane, New York City 8.



U.S. Illustrated price list free. Lush, 6422 Ellsworth, Detroit, Mich.

**POLAR** Bear triangle, giant George Washington, six colored Ecuador, Arctic triangle, first American commemorative, Corsica, Devils Island, others. Everything free with approvals. Capital Stamps, Little Rock 2, Ark.

25 **PORTUGUESE** Colonies, mystery gift, 10c. Smithco, Northeast, Box 6618, Kansas City 23, Mo.

25 **BRITISH** Colonies 10c. Illustrated approvals show how to build magnificent collection cheaply. Stoll Stamp Service, 2632 Burnett, Louisville 10, Ky.

**PINE** Approvals. Fast, personal service. What countries do you prefer? I'll send their stamps. Skinner, 438 Locust, Long Beach 12, California.

100 **FOREIGN**, 20 U. S. commemoratives, 10c with approvals. Weckerling, 608A South 6th, Raton, New Mexico.

200 **LONG** United States commemorative \$1.00. John Winn, Bolivar 1, Mo.

300 **DIFFERENT** Given free with approvals. Particulars. Windsor Stamps, 8334 South Cornell Ave., Chicago 17.

**FIRST** U.N. set; among world's prettiest. Only 10c. Welles, Box 1246-R, Church Street Station, New York City 38.

**TWO** \$5.00 U.S. stamps plus 20 different U.S. approvals. Send 10c to Irwin Stamp Co., Box 11P, Brooklyn 30, N. Y.

12,000 **PENNY** Approvals waiting for you. Many from exotic countries, pictorials, airmails, new issues. Tilbury, Box 862, Newark 1, N. J.

\$4.50 **PACKET**. With high values. One dollar. Free to serious approval applicants. A. Beanie, 555 Markham St., Toronto 4, Canada.

**MINT** Commemorative 3c United States stamps. 1948 to 1953 inclusive. For sale 6c each postpaid. O. H. Johnson, Box 92, Sharon, Pennsylvania.

**PENNY** Approvals by country. M. H. Hoerning, 15, Farmington, Ark.

**WHOLESALE** Job lots for dealers and exchangers. Particulars free. Progressive, 270 Burkhardt, Cincinnati 15, Ohio.

**SENSATIONAL** Offer! 300 different Austria \$1.00. Approvals. Norge, Hoboken, N. J.

**SAVE** Money! Buy stamp packets. World-wide selection. Bargain price lists free. Webb, 2200 Quintara, San Francisco 16, Calif.

**DEALERS** - Wholesale list. Postage 3c. Frank, 5031 Queensberry, Baltimore 15, Maryland.

**UNITED** States 1893 Columbian commemoratives, 6 varieties \$1.25. Four Flags, 993 Third, Niles, Michigan.

40,000 **DIFFERENT** World, \$975.00; 30,000, \$595.00; 20,000, \$195.00; 10,000, \$47.00; 5,000, \$15.00; 3,000, \$6.00; 2,000, \$3.00. Gould's, Box 631, San Francisco 1, Calif.

**PHILIPPINES** - 25 Different 10c. Approvals. Moffet's, 921 College, Rock Hill, S. C.

**NEW** Stamp magazine. Full year 50c. Box 1654, Washington 13, D. C.

**MINT** Five pound British Colony stamp, guaranteed genuine, face value \$25. Just 25c to introduce our approvals. Viking, 11-Z Northern Blvd., Great Neck, N. Y.

**COLONIAL** Collection free - Magnificent collection. British, French, American and other colonies. Flowers, animals, commemoratives, triangles, pictorials, high values all free plus Philatopic Magazine. Send 5c for postage. Empire Stamp Company, Dept. PM, Toronto, Canada.

**RARE** Octagonal stamp. Giant triangle. gorgeous diamond, also mammoth and midget stamps given to foreign approval buyers. Gifts with purchases including Scott's International \$6.00 album, also latest Scott catalogues. Plymouth, Dept. A9, Bell, California.

123 **DIFFERENT** United States-\$1.00. Approvals. Utechts, 1143D North Keeler, Chicago 51.

**AMAZING** Rare bargain-Finest pictorial collection. 40 world religions, 25 battle scenes, 25 world maps, 25 famous personages, 20 art and artists, 20 ships, 10 South Sea islands, 10 locomotives; totalling 183 pictorial stamps. Biggest illustrated selection plus 100 worldwide, all for \$1.00. Only to adults requesting approvals. Canada Stamp Co., 1907 Main St., Dept. 218, Niagara Falls, N. Y.

**ABSOLUTELY** Free! 50 different unusual stamps and other premiums to approval applicants. Newton Schrodt, Box 92, Sullivan, Illinois.

**APPROVAL** Buyers can receive late issues free. Details. Wilvanan Stamps, Box 472J, Sistersville, R. I.

100 **DIFFERENT** U.S. 25c. approvals. Buckeye, Box 53, Mansfield 2, Ohio.

**FUME** 27-32 Mint, 5c. Illustrated price lists. Approvals. Norbert W. Payne, Box 227-P, Orchard Park, New York.

**FREE**: All countries collection lists. Bargains. Fraser, 1093 "D", Springfield, Ore.

**GERMANY** Colonies, offices, states. Mostly 1/2-1/5 catalogue. Twelve page list 3c. Myers, VanZandt, Little Neck, N. Y.

**SUPERIOR** Worldwide mission mixture. Amazing variety! Half pound \$1.48. Bay Nielsen, 4407B Catherine, Montreal 6, Can.

**HANDSOME** New Zealand 1943 Elizabeth and Margaret Rose triangles only 10c to approval applicants. George Richie, 1539 Sixth, Alameda, Calif.

**MINT** San Marino commemorative triangles 10c. Dolinco, 31 Park Row, New York City 36.

**CANADA** Complete Queen Elizabeth set, coronation, 10c. Attractive approvals. Rheume, 6591 11th Ave., Montreal 36, Canada.

**FREE**: 5 Hungary bird triangles to new approval applicants. Moulblow, Box 278T, East Northport, N. Y.

U. S. Commemoratives: 1950 (11), 10c; 1951 (6), 6c; 1952 (13), 12c. Approvals? S. Penniston, Norborne, Mo.

50 **DIFF. U.S.A.**, 100 diff. foreign 10c. Approvals. Kem, Box 11, Puente, Calif.

**FREE**: 25 Different Switzerland, with swell approvals. Kardell, Box 2058-B, Santa Fe, New Mexico.

**YOUTH** And Canada mint plate blocks both for 25c. Approvals. Lou Allmendinger, Warner, N. H.

368 **MIXED** U. S. Old and new 25c. Monjar, Cincinnati 14, Ohio.

U. S. 150 Different commemoratives, etc. 35c. C. P. Steger, Steger, Ill.

**FREE**: United States price list. Patrick Agencies, 3650 Central, Indianapolis 5, Indiana.

200 **DIFFERENT**, including Roosevelt triangle. 10c to approval applicants. M. Avalon Stamp Company, Springfield, Mass.

**FREE** - Bi-color triangles! Half-price approvals. Brunning, Donaldson Ave., Rutherford, N. J.

**FREE**, Greek airmail set with approvals. Stanley Bazan, 801 Literary Road, Cleveland 13, Ohio.

105 **DIFFERENT**, Triangles, giant and midget stamps. 15c. Approvals. Bilislands, Box 1101P, Spokane 10, Wash.

**APPROVALS?** U.S. or foreign? Mint? Used? Hotchkiss Stamps, Montpelier, Vermont.

**JAMAICA** Mixture \$2.00. Catalog value 25c. Anthony Daley, Buckland, Conn.

100 **DIFFERENT** British Empire 10c with approvals. Sadler, 9013 Central, Kansas City 14, Mo.

100 **DIFFERENT** France 10c. Approvals. Aronson, 91 Marion, Brookline 46, Mass.

**EXCHANGE** 100 Different foreign, 10c. Ireland, 807 14th St. Southeast, Cedar Rapids, Iowa.

**RARE** U.S. stampless covers over 100 years old, \$1.00 each, 3 for \$2.00. Arkin, 1133 Broadway, New York 10, N. Y.

**UNBEATABLE!** 200 Different, unusual non-Scott stamps, revenues, etc. \$1.00. Philsdelines, 19 Belsize, Toronto, Canada.

**MINT**, Unused, United States approvals. Patrick Agencies, 3650 Central, Indianapolis 5, Indiana.

110 **AMERICAS**, Also British, U.S., Europe each 10c. Bristol Stamps, Collinsville, Conn.

**MINT** Army Navy set 50c. Twelve mint commemoratives 50c. Fine approvals sent to serious collectors. Charles Mekeel, 2101 East Market, York, Penna.

50c **PACKET** Given approval customers! Gaines, 716-A South Sixteenth, Mattoon, Illinois.

**GREATEST** Free offer - Croatia exile government air set; gorgeous birds, natural colored triangles. Also albums, supplies. All to our approval buyers. Bell Stamp Service, Dept. 8-3, Bell, California.

500 **DIFFERENT** Manchukuo (cataloguing over \$2.00), 25c with approvals. Great Western Stamps, Box 245, Rivera, Calif.

500 **DIFF.** 25c. New customers. Wilcox, Box 292, Bremerton, Wash.

**TRIANGLES**, Mint sets, giant Mexican, 10c. Hogan's, 17517 Bradgate, Cleveland 11, Ohio.

**FREE** Packet and packet list. Gerteisen, Box 226, Lincoln 1, Nebraska.

**FREE** Sample-Interesting, informative, illustrated! National Stamp News, Anderson, South Carolina.

**STAMP** Wallet containing small German collection 5c with approvals. Amberg, 537M 35th, Union City, N. J.

500 **MIXED** U.S., 10c. List. Blanchard, Box 307, Medina, Ohio.

**ZOO** Parade - 10 different bi-colored stamps depicting queer Civet from Liberia, Bay-thighed Diana monkey, Sudan camel, Hedge-hog rabbit, squirrel, Fox, Finch, Golya, Gullpan including big triangles. Regular \$1.00 value only 10c to approval applicants. Roseland Stamp Co., Dept. 10-E, Spring Lake, Michigan.

23 **DIFFERENT** Triangles 25c with approvals. Pix-Stamps, Box 8643, Hollywood 46, California.

**LOOKING** For bargains? Try our 1c and 2c approvals in books of 1000. First try will satisfy. Clark Stamp Co., Dept. P-2, Muskegon Heights, Mich.

**CIPEX** Souvenir sheet plus 25 different U.S., 10c. Approvals accompany. Village Stamps, 90-39P 214 St., Queens Village 28, N. Y.

500 **MIXED** Stamps and surprise packet for 10c with approvals. Fahsing, Dept. PM, Atascadero, California.

**ADULTS** 100 Different Hungary large commemoratives 50c with approvals. Ward, 241 South Winchester, Campbell, Calif.

300 **STAMPS**, Triangle, airmail, pictorials, etc., 25c. 500 mixed U.S. 25c. Carlton's, Tujunga, Calif.

**FREE** Scott's international album. Other premiums. Particulars with approvals. Raymax, 35-Z Maiden Lane, New York 38.

100 **BRITISH** Empire-All different, plus valuable illustrated book "How to Recognize Rare Stamps." Only 10c! Other offers included. Kenmore, Milford 8-ZH, N. H.

**FREE** Complete set of famous Americans, flags, parks and presidentials to approval buyers. Send 5c for 15 of the above stamps plus full particulars. Tribort Stamp Company, 145 Nassau Street, Dept. 101, New York 38, N. Y.

**APPROVALS**, 80,000 Low priced foreign! Grabin, Box 1111, Sioux City 2, Iowa.

15-1-2c **APPROVALS**, Povilauskas, 212 E. 3 St., New York 9, N. Y.

U.S. 150 Different, including 75 commemoratives and airm. \$1.00. Farmer, 4913 Rosewood, Hollywood, Calif.

U.S. Specials! Flag set complete, mint, \$1.00; U.P.U. airmails complete, used, 30c. Want lists filled. Brooks, 23529 East 23rd Street, Brooklyn 29, New York.

792 **DIFFERENT** From 36 stamp companies. Approvals, \$8.00. Names 1000 stamp collectors \$5.00. King, 22 Alexander, Kamloops, Can.

**FREE** Infi animals, approvals. Gannon, 703 E. Artesia, Longbeach 5, Calif.

**FREE** Russia 942-4 catalog 39c with approvals. Reilly's Stamps, 3107 East 26th Street, Los Angeles 23, California.

**BETTER** Stamps? Try our quality approvals. North Andover Stamp, North Andover, Mass.

**SENSATIONAL** Clearance bargain lists sent free. Beacon Sales, Maynard, Mass.

**SENSATIONAL** U.S. Confederate states catalogue free. Stone, 45-P Bromfield, Boston 8, Mass.

63 **ALL** Different U. S. stamps. Includes 50 year olds, commemoratives, airmails and \$5.00 stamp. Only 10c. Approvals. Willett Co., Box 511-L, Port Chester, New York.

**QUEEN** Elizabeth British Colonials. Used. References. Moffitt, 43 S.W. 20th Rd., Miami, Florida.

83 **COLOR** Foreign flags, 15c to approval buyers. Seabrook Stamps, Washington 10, D. C.

**GOOD** Quality mixture, 30c per 100; 1/4 pound, \$1.00. Foreign cover included. Thomas Bannigan, Box 211, Rutherford, New Jersey.



**FREE!** Unique illustrated catalog listing hundreds stamp assortments, weight mixtures, packets, collector's supplies. Bargain-crammed! Latest releases! No approvals included. Tower, 1630 Melrose, Chicago 13.

**SEND** For bargain worldwide approvals. Free set. Marge, Box 6, Hanover, Penna.

**FREE!** Obsolete U.S. occupation set. To approval applicants only. Riedell, Greensburg, Penna.

**100 DIFFERENT** Air mail 40c. Ask for mammoth packet list free. Econopackets, Box 168, Riverside 9, Calif.

**111 STAMPS** From 111 countries \$1.11. John Bosse, 536 Rush St., Chicago 11, Ill.

**EXCHANGE** Your duplicate stamps. Send 100-200 different foreign and dime. Receive all different. Patterson, 5622 Broadway, Lancaster 14, New York.

**50 DIFF.** Uruguay for 10c to approval applicants. Elco Stamp Co., 682 Pearl St., Benton Harbor, Mich.

**FREE,** 4 Germany pictorial sets. Approvals. Pleasure Stamps, 1865P—52nd, Brooklyn 4, N. Y.

**SENSATIONAL!** Set each Honduras, Martinique, Guadeloupe, Guiana, also \$2.-00,000 stamp. Brunel, over 100 different others. Everything 10c with approvals. Whitehead, 315P South 5th Ave., Canton, Illinois.

**50,000 STAMP** Grabbags 25c each. Anderson, 630B Bingham, Reading, Penna.

**SPECIAL!** Nudes collection; approvals—5c. Atlas, 2830-M Eisenhower, Racine, Wis.

**PENNY** Approvals that satisfy. Robert Meed, 245 Kosciuszko St., Brooklyn 21, N. Y.

**SENSATIONAL—** Twenty-five different colorful pictorial complete sets plus desirable bonus packet, everything only 20c. Bargainful approvals accompany. Dresel, Box 270-H, New York 25, N. Y.

**FREE** 119 Foreign stamps including Africa, Australia, Pakistan, China, India, Russia and Scandinavia. Send 10c for postage and handling. With approvals. Niagara Stamp Co., Niagara-on-the-Lake 81, Canada.

**25 DIFFERENT** Japan free to approval applicants. Collier, Box 4243, Atlanta 2, Ga.

**15 GIANT** Stamps dime with approvals. Free premiums. Heritage Hobbies, 52½ Balmforth, Danbury, Conn.

**65 ALL** Different U. S. stamps. Includes 5 year olds, commemoratives, airmails and \$5.00 stamp. Only 10c. Approvals. Willett Co., Box 511-L, Port Chester, New York.

**50 DIFFERENT** Worldwide 3c! Approvals. Vinny Jo, Box 3062, Seattle 14, Wash.

**PREMIUM** Packet 10c with bargain priced approvals. Websters, Jamesburg, N. J.

**OLD** U. S. on approval. Low prices. MacG., 2905 Observatory, Cincinnati 8, Ohio.

**FOREIGN** Unhinged approvals at lowest possible prices. We pay all postage. LaLiberte, Box 724, Brockton, Mass.

**BIRDS,** Butterflies, flowers—25 different 25c, with approvals. Southwest Stamps, Box 117, Long Beach 1, Calif.

**BETTER** Grade U.S. or foreign approvals. Ocean Stamp Co., Box 64-M, Brooklyn 29, N. Y.

**WORLD** Wide, all different. 100, 10c; 500, 75c; 1000, \$1.75; 2000, \$3.25; 5000, \$13.75. Philatelic House, Rockville Centre, N. Y.

**FREE** Triangles with approvals. Philatelic House, Rockville Centre, N. Y.

**5 TRIANGLES** 2c With approvals. Choice Stampco, Box 424, Miami 3, Fla.

**1000 FINE** Mixed U. S. stamps 25c. Wright, 723 Washington, Hagerstown, Md.

**WONDERFUL** Offer — 7 complete mint sets only 10c with approvals. Reich (M26), 1033 Lawrence, Chicago 40.

**START** Your own stamp business. Send for free circular. Donald Shepard, Box 1147, Chicago.

**100 DIFFERENT** World 10c. Free gift. Bellet, Mapledale, Hazel Park, Mich.

**50 DIFFERENT** U. S. commemoratives 25c. Durham, 1021 N. Granger St., Saginaw, Michigan.

**312 MIXED** U. S. only 10c to "Gold Nugget" approval applicants! Nothing like them. Kessel's, Folsom, California.

**ALBUM!** Capacity over 1,000 stamps! Only 10c! Stampmart, Hartford 1, Conn.

**CANADA—100** Different, 25c with approvals. Crown Stamps, Box 331, Toronto, Canada.

**BIG** New U. S. catalog—Only 10c! Published by world's largest stamp firm. Completely illustrated. Bargain lists and approvals included. Harrisco, 202 Transit Bldg., Boston 17, Mass.

**ZOUNDS!** Exciting strange countries packet. Free with approvals! Saxon, Vista, California.

**DIFFERENT** 500, 35c; 1000, \$1.00; 2000, \$2.75; 5000, \$11.00, with approvals at wholesale to clear. K. S. Holmes, London, Canada.

**96 PAGE** Illustrated U. S. price list. Send 10c, cost of mailing. DeLisle, 154 S. Second St., San Jose, Calif.

**850 MIXED** U. S. old, new, 25c. Lists. Weatherby, Medina, Ohio.

**AMAZING** Offer! 200 United States stamps—including commemoratives, airmails, high denominations to \$1.00. Only 10c to approval applicants! Illustrated bargain lists free. Mystic Stamp Co., Dept. 80, Camden, New York.

**225 STAMPS** For only 10c! This mammoth value includes airmails, pictorials; stamps from strange countries cataloguing up to 25c each! Also approvals. Mystic Stamp Company, Camden 80, New York.

**1000 MIXED** United States. Guarantee over 140 different stamps. \$1.10 insured. Quaintance, Box 178P, Upper Sandusky, Ohio.

**50 DIFFERENT** Argentine 10c. Approvals. Reuter, 611 W. 40th Pl., Los Angeles 37.

**WOW!** 203 All different Germany 15c. Zeppelins, semi-postals, airmails, high values. Big bargain lists and approvals included. Jamestown Stamp, Dept. 512, Jamestown, N. Y.

**UNITED** States approvals. Select copies. Used, mint. Kingsbury, So. Woodbury 2, Vermont.

**100 DIFFERENT** Spain 25c. Penny approvals included. Reed, Box 980, Chicago 90, Ill.

**FREE!** Powerful magnifying glass for 5c post. Bargain lists and approvals. Jamestown Stamp Co., Dept. 207, Jamestown, New York.

**STAMPS** Wanted. Collections, duplicates, surplus stock, mint and used. Good grades only. Buy outright if bargain. What have you? Write us details. Vanroy Shirk, Lebanon, Penna.

**WORLD'S** Largest stamp (7½x14 inches). A real curiosity! Retail for \$50, only 3c to approval applicants. Tatham Stamp Co., Springfield 30, Mass.

**OLD** Scarce U.S. seconds on approvals. Slight imperfections, lowest prices. Herndon, Clintonhill Sta., Newark 8, N. J.

**UNITED** States—40 different 10c; 40 different commemoratives 25c. No approvals. Seidenberg, Appleton 244, Wis.

**UNITED** States—58 different including 8 airmails, 15 commemoratives, 10c. Approvals. Sunset, Box 47, South Gate, Calif.

**27 HITLER** Stamps from five Nazi-dominated countries. Historically valuable collection only 5c. Request approvals. Gulfstream, "PM" Hillside, N. J.

**80,000 DIFFERENT** — On approval Books, world-wide. Cole, 43-A Rinewalt, Buffalo 21, N. Y.

**TRADE** Your extra stamps. Join our stamp club. \$1.00 for two years. Free information. Valley Stamps, Box 87, New Cuyama, Calif.

**PACKETS**. World different 2,000, \$3.00; 3,000, \$5.00; 5,000, \$15.00; 10,000, \$47.00; 20,000, \$200.00; 30,000, \$610.00; 40,000, \$1,220.00; 50,000, \$2,180.00; 60,000, \$4,220.00; 70,000, \$8,040.00; 80,000, \$12,360.00. Russell Smoky Mountain, Box 2011D, Natural Bridge Station, St. Louis 15, Mo.

**327 DIFFERENT** Stamps 25c! Including early Canada, Newfoundland, British Colonies, Vatican, Red Russia, Hitler heads, Indian states, animals, airmails, French Colonies, rarities, unusuals. Every stamp different. Rare bargain with approvals. Money back guarantee. Niagara Stamp Co., Niagara-on-the-Lake 61, Canada.

**COLOSSAL** Stamp zoo 10c. Jungle beasts, wildlife, domestic animals—Fifteen different, including, rhinoceros, elephant, snake, tiger, zebu, kangaroo, koalabear, emu, kookabura, bull, horse. Extraordinary accompanying approvals. Niagara Stamp Company, Niagara-on-the-Lake 51, Can.

**NEW** Zealand triangles. Queen Elizabeth, 10c with approvals. Seminole Stamps, Box 1138-P, Coral Gables 34, Florida.

## COINS, TOKENS, CURRENCY

**GOLD** U.S. coins bought 50% above face value. Baevitz, 229-04 Hillside Ave., Bellerose, N. Y.

**105 DIFFERENT** Foreign bills—\$1.00. Free list. Dwight Musser, Dunbar, West Virginia.

**FREE!** Foreign coin, banknote and coin collectors illustrated catalog to approval service applicants. Send 3c postage. Tatham Coinco, Springfield 30, Mass.

**INDIAN** Cent with bargain lists 10c. Hutchinson, 3463 "I" Street, Philadelphia 34, Penna.

**WANTED—**1894-8 dime pay \$500.00. Certain 1913 nickel \$1,000.00. 1901-8 quarter \$20.00 to \$150.00. Hundreds of others. Know their true value. Complete illustrated catalogue 25c. Worthycoin Corporation, (D-325), Boston 8, Mass.

**\$10.00** FOR Certain Lincoln pennies, Indianheads \$30.00. Send dime for booklet listing prices paid. Lincoln Coins, D-29, Glendale, Arizona.

**GET** Profit and pleasure in collecting old coins. Send 10c for 56-page illustrated coin catalog. You'll be delighted with it. Send for it now. B. Max Mehl, 370 Mehl Building, Fort Worth, Texas. Largest rare coin establishment in U. S. Established 54 years.

**THIRTY** Liberty nickels \$3.00, fifteen different \$2.00. Sayers, 1000 East Unaka, Johnson City, Tennessee.

**OLD** Money wanted. Will pay fifty dollars for nickel of 1913 with liberty head (no buffalo). We pay cash premiums for all rare coins. Send 4c for large coin folder. May mean much profit to you. Numismatic Co., Dept. 20, Fort Worth, Texas.

**OLD** Stamps wanted. I will pay \$100.00 each for 1924 1c green Franklin stamps, rotary perforated eleven (up to \$1,000 each unused). Send 10c for large illustrated folders showing amazing prices paid for old stamps, coins. Vernon Baker, PM-41, Elyria, Ohio.

**35 DIFFERENT** Foreign coins. \$1.00. Claud Denney, 3633 Colonial, Dallas 15, Texas.

**40 DIFFERENT** Coins, \$1.00. 66 coins and bills \$1.00. Oddehon, Box 482, St. Louis, Mo.

**CONFEDERATE** And Southern bank notes, 3 different, \$2.00. 50 mixed Indian pennies, \$2.00. Ben's Coin Shop, 31 N. Clark, Chicago 2.

**JAPANESE** Invasion notes 1c to \$1000.00 set \$1.00. 100pp. illustrated catalogue, 25c. Shultz, Salt Lake City 10, Utah.

**UNITED** States coins! Bargains! Sullivan's, 127-F East Fourth, St. Paul 1, Minn.

**WORLD'S** Greatest magazine for coin collector's and wooden nickel 10c. Lawrence Brothers, Anamosa, Iowa.

**UNITED** States Rare Coin Value Guide. 48 pages 50c. Fortunes in rare coins. Ideal, 4464-P Geary, San Francisco 18, California.

**WHAT** Are your coins worth? Fell's amazing new International Coin Book, 1954 edition, tells you how to identify and learn exact value, history, and country of origin, of every coin you own, buy, sell, trade! Hundreds of detailed illustrations, thousands of fascinating facts, for amateur and professional collectors in 1 giant volume reference guide. Pay postman just \$2.50 plus postage for handsome cloth-bound edition, or enclose \$2.50—Save postage. Order now, satisfaction or money back. Fell Publishers, 386-B-1 Fourth Avenue, New York 16, New York.

**COIN** Collector's Magazine. Over 1000 pages per year. Sample copy 30c; \$3.00 per year. Hewitt, 7320-J Milwaukee, Chicago 31.

## ANTIQUES, RELICS, INDIAN GOODS, CURIOS

**1903** AUTOMOBILE With original county license. Make offer. Shelburne, 818 Broadway, Hannibal, Mo.

**ROYAL** English daggers \$12 dozen. Arkin, 4195-MP Third Ave., New York 57, New York.

**FREE!** Indian relic catalog. Nirscher's, 111 South 31st, Belleville, Illinois.

**ARROWHEADS.** Location given, four \$1.00, 24—\$5.00. Bird points, two \$1.00, dozen—\$5.00. Fine stone axe plus celt \$7.45, good \$4.95. Book-relic catalog 10c. Tilton Relics, Topeka 51, Kansas.



INTERESTING reproduction of old Oregon map used by early explorers. \$1.00. Moise Penning, Klamath, California.

**QUWITZSCHUERBELLERAIN**—Selling several hundred historical firearms, 30,000 Indian relics, collectors cartridges, coins, Confederate money, antiques. 400 bayonets, swords, Revolutionary, Civil War; flintlocks, muskets, blunderbusses, snaphaunces, matchlocks, revolvers, frontiers, Kentuckies, stagecoach carbines, Winchester, Ramrods, powderhorns, blunderbusses, bullet moulds, pepperboxes, steer-deer-buffalo horns, Arrowheads, spearheads, tomahawks, discoidal, gorgets. Violin wood, bo-wood, daguerrotypes, ambrotypes, gun parts. Agates, lapidary supplies, minerals, fossils, gold dollars. Send 35c for profusely illustrated catalog. Heike, (Abbotstown) Wenona, Illinois.

**SPECIAL**—10 Indianhead cents 87c; 6 prehistoric arrowheads \$1.46; scalper \$2.88; hammerstone \$2.65; pestle \$8.88; bayonet \$1.98; canteen \$1.95; geode, pyrite, galena, molybdenite, ricolite, hematite, muscovite, turquoise, fossils, gastropod, 48c each. Heike, (Abbotstown) Wenona, Illinois.

6 EXTRA Fine bird arrowheads \$2.00. 4 fine Indian arrowheads. \$1.00. Good grooved tomahawk \$2.00. List free. Lear's, Glenwood, Arkansas.

**ANTIQU** Firearms, pistols, percussion flintlock, list 25c. Westbrook, 738 Royal St., New Orleans, La.

4 PERFECT Arrowheads \$1.00. Flint knife 50c. Hide scraper 50c. Stone axe \$3.00. Perfect pipe \$3.00. Flint hoe \$1.00. List 10c. H. Daniel, Lamar, Arkansas.

4 SELECTED Arrowheads \$1.00. List 5c. H. Talburt, Calico Rock, Ark.

#### PRECIOUS STONES, MINERALS

**URANINITE**, The rock that lives. Principal source of uranium. Curio extraordinary! Certified specimen, beautifully mounted, \$2.00. Schools, homes, prospectors. Uraninite-carnotite \$3.50. Join Future Chemists of America. Membership participation, education, profit, fun. Particulars free. Parkway Laboratory, 1004 d, Second Ave., Pittsburgh 19, Penna.

**GEMOLOGY** Books! Catalog 10c. Atlantic Books, Cedar Street, Charlestown 29, Massachusetts.

**INDUSTRIAL** Mineral prospecting pays big when you hit! Free instructions. Stratex Instruments, 1861E Hillhurst, Los Angeles 27.

**FUN** With rocks! Rockhound's own monthly magazine featuring mapped trips, gem cutting, silverwork, minerals. 9,000 already enjoy it, so will you. Only \$3.00 year. Gems and Minerals, Box 716P, Palm-dale, Calif.

**FIND** Tungsten, mercury, uranium with Mineralight. Free brochure. Write Dept. PM8 Ultra-Violet Products, South Pasadena, California.

**JADE**, Agates, gems, gem cutting machines, supplies. Free list. North West Gems, 2819 North Warner, Tacoma 7, Washington.

**SAPPHIRE**, Topaz, tourmaline, garnet, peridot. 5 uncut gem specimens, \$1.00. O'Brien's, 1116M Wilcox, Hollywood 38, Calif.

**GEMSTONES**. Mineral specimens. Every variety. Lowest prices. Postcard brings free booklet. Plummer's, 4730 Point Loma Ave., San Diego 7, Calif.

**TEN** New Mexico minerals \$1.50, six fluorescents \$1.00, fool's gold 25c. Free literature. Minerals, Winston, New Mexico.

#### HOBBIES AND COLLECTIONS

**EXCITING** Hobby: collect authentic military patches, insignias, campaign ribbons, navy rates, etc. 57 assorted \$1.00. Free gift. Pruitt, Dept. M-1, 12 West 27th, New York City.

**MATCHBOOK** Collectors—Latest set and lists 25c. Yeingst, Parkway Road, Harrisburg, Penna.

**UNUSED** Match book covers from famous hotels and gambling casinos in Las Vegas. 15 colorful covers, all different, only \$1.00. Supply is limited. Pasadena Novelty Co., 468 Cypress, Pasadena 3, Calif.

**WANTED** Cigarette, tobacco, cards. Write Charles Bray, East Banker, Penna.

**NAZI**, Soviet, medals, campaign ribbons. Big packet. Lists. \$1.00. Medcrafts, 1923 34th St. S.W., Calgary 2, Canada.

**WEATHER** Instruments. Amateur and weather bureau types. Free catalog. Science Associates-Weather, Philadelphia 8, Penna.

**BOOKBINDING** As a hobby. Large 28 page materials and tools catalog will be sent upon receipt of 25c to cover cost of handling and mailing. House of Gane, Box PM, 1335 W. Lake St., Chicago 7, Ill.

**HOBBIES** Catalog and cyclopedia of model railroads, boats, ships, historical vehicles, handicrafts and model tools, 187 pages, 300 manufacturers, illustrated. \$2.00 purchase price refunded with twenty dollar order pro rata. Aircraft Sales Co., Box 235, Quincy 69, Mass.

**UNUSED** Matchbook covers—100 different \$1.00. 36-page catalog 25c. Charles Edelman, 1311C East 84, Cleveland 3, Ohio.

**INVENTING** Can be an interesting and profitable hobby. Write for complete particulars. Institute of American Inventors, Dept. 40-E 631-E St. N.W., Washington 4, D. C.

**CLEARANCE** Sale—Army patches 3c up; catalogue 10c; 32 different emblems \$1. Hobbyguild, 550-A Fifth Ave., New York City.

#### CAMERAS, PHOTO SUPPLIES

**OWN** A new camera. With carrying case and films only \$2. Alts, 6106 University Ave., Chicago 37, Illinois.

**BUY** Wholesale nationally advertised cameras, photo supplies, thousands other products at big discount. Free "Wholesale Plan." American Buyers', 629PP Linden, Buffalo 16, N. Y.

**PHOTOGRAPHY** For pleasure or profit. Learn at home. Practical basic training. Long established school. Free booklet. American School of Photography, 835 Diversey Parkway, Dept. 3432, Chicago 14, Illinois.

**OIL** Coloring photographs—A fascinating hobby or profitable sideline for those with artistic talent. Learn at home. Easy simplified method. Free booklet. National Photo Coloring School, 835 Diversey Parkway, Dept. 3442, Chicago 14.

**AMATEUR** Photographers. Big profits with your camera. Lee, 4011-C, Tulsa 9, Oklahoma.

**WILD** Life films. Exciting, dramatic action in the natural habitat of animals of forest and plain. 8mm. or 16mm. in beautiful color or B & W. Also 2" x 2" color slides. Write for free illustrated literature. Wild Life Films, 5151AM Strohm Ave., North Hollywood, California.

**WHOLESALE** Photographic supplies. Cameras, films, projectors, enlargers. Write for free catalog. Capitol Photo Supplies, 2428 Guadalupe, Austin, Texas.

**BASS** Says: Trading since 1910. Used but good as new buys: 8mm. B.&H. Sportster \$52.50; 16mm. Keystone A-7, F:2.5 lens \$37.50; Voigt. 35mm. Vito II, flash shutter, Skopar F:3.5, like new \$38.50; Kodak Reflex F:3.5 lens, like new \$38.50; Contax 1, F:2 Sonnar \$37.50; 3 1/2 x 4 1/4 Speed Graphic, Skopar F:4.5 Ibsor shutter, \$52.50. Satisfaction guaranteed. Bass Camera Co., Dept. AG, 179 W. Madison St., Chicago 2.

#### PHOTO FINISHING

**35MM** Specialists—Fine grain developing. 20 exposures 95c, 36 exposures \$1.40. Individual handling. Free prices and mailers. Tops Photo Service, Lyons, New York.

**CUSTOM** Jumbo album prints! 8 exposure 35c; 12, 36c. Special! 35mm 36 exp. \$1.00. Free mailer. Flash Photo, Box 36M, Brooklyn 4, N. Y.

**TOP** Quality with Magni size prints in albums, 8 exposure roll, 35c; 12 exposure roll, 50c; reprints 3c. Lee's Film Service, P.O. Box 1021, Battle Creek, Mich.

6 OR 8 Picture roll 35c. 12 or 16 picture roll 55c. Each roll developed and printed in handy album pack. Send coin with roll. No c.o.d.'s. Mailing containers sent free. Deluxe Film Service, Box 1268-A, Shreveport, Louisiana.

**SPECIAL**—8 Jumbos 25c; 12, 45c with this ad. Western, PM14, Box 298, San Francisco 1, Calif.

**ENLARGEMENTS**, 8x10 Oil colored \$2.00. Miniatures. Free price lists. George Brewer, 5864-D Hollywood Blvd., Hollywood 28, California.

**GIANT** Size deckle album prints. 8 exposure roll, 35c, 12 exposure 50c. Send money. Free mailers. Dow's Photo Co., P.O. Box 2077, Ft. Worth, Texas.

**TWO** Prints each good negative, 8 exp. 35c; 12 exp. 50c; 16 exp. 65c. Reprints 4c. Mayfair Photo Service, Box 617-K, Toledo, Ohio.

**ENLARGEMENTS**! Eight 5 x 7's or five 8 x 10's, \$1.00. Wilart Enlargers, Box 967, Little Rock, Ark.

**TOP** Quality. Fast service. 8 jumbos 35c in beautiful Super Pak Album. 16 contacts 40c. Reprints—Jumbos 4c; contacts 3c. Satisfaction guaranteed. Write for free mailers and circulars. Fast-X-Photo, Box A, Jersey City, N. J.

12 JUMBOS 35c, 8 Jumbos 25c, 16 jumbos 50c from roll or negatives with this ad. S. Skrudland, Lake Geneva, Wis.

**GUARANTEED** Quality. Fast service. Eight jumbos in beautiful super pak plastic ring binder albums only 35c. Send for free mailers and particulars of our complete photo finishing service. Grand Fotos, G.P.O. Box 1410, New York 1, N. Y.

**BEAUTIFUL** Enlargement in album from each good picture on roll. 8 exposure, 40c; 12 exposure, 50c; 16 exposure, 65c. Cut Rate Photos, Dept. B-4, Janesville, Wis.

**TWO** Beautiful prints from each picture on 8 exposure roll 35c. Many years of satisfied customers. Quick service. Lens Photos, Dept. J-4, Janesville, Wis.

#### MOTION PICTURES AND SOUND EQUIPMENT

**BARGAINS** 16MM. sound features and shorts. Bedner, 5300 So. Talman, Chicago.

**16MM.** Movie subjects. New 300' 16mm. sound releases, \$11.95. Bargain prices on hundreds used 16mm. sound, silent prints. Dime brings 32-page, 1954 catalog. Blackhawk Films, 1231 Eastin Bldg., Davenport, Iowa.

**8MM.** Movie subjects. New 150' films, \$2.98. Dime brings 32-page, 1954 catalog. 50' 8mm. Prevue film and catalog, 50c. Blackhawk Films, 1230 Eastin Bldg., Davenport, Iowa.

**EARN** Up to \$15.00 daily with your movie projector! Details free! Metcalf, 16806 Glenroy, Chicago 43.

**16MM.** Sound projectors—Excellent used units, all makes, \$119.95 up; some \$39.95. Dime brings 32-page catalog equipment, films. Blackhawk Films, 1229 Eastin Bldg., Davenport, Iowa.

**WOW!** We've got everything! Collector's items, new releases. Free catalog. Vanity Productions, Dept. 10, 93 Seneca Street, Seattle 1, Washington.

**"ENTIRE** Life Story of Christ." 8mm., 16mm., sound and silent, purchase or rent, state projector. Hemenway Film, 31P Church St., Boston 16, Mass.

**5000** NEW-Used 8-16mm. silent-sound films. International-B, 2120 Strauss, Brooklyn 12.

**RENT** 16MM. sound films, 50c reel. Large selection; free catalog. Film Service, 128 Chestnut St., Roselle Park, N. J.

**8-16MM.** Silent-sound films. Complete rental library. All latest subjects. Free catalogue, sample film 10c. Garden Film, 317 West 50th, New York 19.

**MOVIE** Camera film: 8mm. roll \$1.50, 16mm. 100' \$3.00. Free processing. Better Films, 742 New Lots, Brooklyn, N. Y.

**TAPE** Recorders, tapes, accessories. Unusual values. Dressner, 624-M East 20th Street, New York City 9.

**GUARANTEED** Fresh 8mm. roll, magazine; 16mm. roll, magazine movie films. Color, b&w. Free catalog. ESO-R, 47th Holly, Kansas City 2, Missouri.

**8MM., 16MM.** U. S. National parks in color. Free list. Ideal Service Supply, 4644 Geary Blvd., San Francisco 18, California.

**BELL & Howell** 16mm. sound projectors. Castle sound films, splicers, reels, other supplies. Free catalog. Ideal Service Supply, 4644 Geary Blvd., San Francisco 18, Calif.

#### MUSIC AND MUSICAL INSTRUMENTS

**LEARN** Piano, singing, songwriting. Valuable catalogue 20 other self-taught instruments 10c. Write: Music Teachers' Associates, 26 Potters Lane, Great Neck, N. Y.

**NEW** Songwriters can sell their songs for cash! Get free facts. No obligation. Meadowlark Music School, 203 Summer Road, Colorado Springs, Colo.

**SWISS** Musical movements, assorted tunes, \$1.70. Helax, 218 West 72nd Street, New York City.



**LEARNING** Violin or viola? Here's a little pamphlet which can make a big difference in your playing thru emphasis on tone quality. Just send one dollar to M. L. Stayner, P.O. Box 1393, Salt Lake City 10, Utah. Thirty day refund period.

**GROW** Mushrooms. Cellar, shed, and outdoors. Spare, full time, year round. We pay \$3.50 lb. We paid Babbitt \$4,165.00 in few weeks. Free book. Washington Mushroom Ind., Dept. 175, 2954 Admiral Way, Seattle, Washington.

**FREE** Songwriters kit. Write your melodies without music knowledge. Name band singer records. Postcard brings details and kit. Harmony Unlimited, 3409-B Grand Ave., Oakland, Calif.

**MAGNUS** Push button harmonica. Accordion effects. 7 1/2 in. Postpaid \$2.00. Moeller's, 3209 Crystal, Chicago.

**SWISS** Musical movements. First quality. \$2.50. Spielman, 131 West 42nd, New York 36.

**GUITAR** Playing a new way. Ten times the music for one tenth the effort. Different tuning, easy fingering. Simplified music. Instruction \$1.00. Will Hughes, Box E2, Depoe Bay, Ore.

**SUCCESS** Assured through simple device. Valuable information free. Publisher, Box 6346, Philadelphia 39.

**\$5.00 SERVICE** Lead, copies, records. Al Music, 245 W. 51st, New York.

**PIANO** Technic simplified, \$1.00. Kazaks, 234 East 56th Street, New York 22.

**MUSIC** Printed. Specializing in small quantities for song writers. Skoumal Music Service, 319 E. State, Rockford, Ill.

**MUSIC** Arranged. Songs printed. Frank Wildt, Music Publisher, Lancaster, Penna.

**SONGWRITERS:** Your song expertly arranged for piano. Send lead and \$8.00 to Zarlengo Music, 1454 Welton Street, Denver, Colorado.

**UKULELE.** Play by ear, easily. Instructions 50c. Details free. Pete Eby, Box 81, Perry, Oklahoma.

**FREE** Record of your song. Your words, my melody. Free information. Johnny Mack's Melody Mart, 1094 West 39th Street, Dept. A, Los Angeles 37.

**YOUR** Voice made loud, clear and powerful with my diaphragm exerciser. Inexpensive. Write, Inventor Co., 34V, Box 663, St. Louis, Mo.

**ACCORDIONS** And other musical instruments wholesale. Music Center, Plymouth, Ind.

**POEMS** Wanted for musical setting. Send poems. Free examination. Five Star Music Masters, 630 Beacon Bldg., Boston, Massachusetts.

**SONGWRITERS!** Outstanding, ethical offer. Hibbeler, C-5, 2157 N. Avers, Chicago 47.

**SONGWRITERS!** Let me help you. Stamp for booklet. Mark Rubens, 146-D West 79 St., New York 24, N. Y.

**COLLABORATION** Offer. Newark Publications, GPO Box 1226, Syracuse, N. Y.

**SONGWRITERS!** Protect your ideas! Hold all songs, poems! Write for safe correct procedure first! Song Service, Dept. P, 323 W. 56th St., New York 19, N. Y.

**POPULAR** Songs. How to write and sell them. Write for free booklet Successful Songwriting. Gateway Songs, Box 2470, Hollywood 28, Calif.

**SONGWRITERS!** Send poems, songs. Music Service, 243 West 72nd St., PM, New York 23.

**POEMS** Wanted to be set to music. Free examination. Send poems. McNeil, Master of Music, 510-PM S. Alexandria, Los Angeles, California.

**WANTED!** Poems for musical settings. Write Songwriters' Service, Clifton, N. J.

**WRITE** Songs. Big money and reputation. Write for information. J. Gordon Pub. Co., 4700 South California Avenue, Chicago.

**1953 ACCORDIONS** Wholesale. Free catalog. American Accordion Center, 5329 Belmont, Chicago.

**POEMS** Wanted for musical setting. Send poem for immediate consideration and free rhyming dictionary. Richard Brothers, 24 Woods Building, Chicago 1.

**WANTED:** Songpoems, lyrics. To be set to music. Work done by Hollywood professional artists. Recordings made. Quarterly magazine. Write for free sample. Inside Music, 3653 1/2 Hollywood Blvd., Dept. K-6, Hollywood 28, Calif.

**SONGPOEMS** Wanted. Mail to: Tin Pan Alley, Inc., 1650 Broadway, New York 19, N. Y.

## RADIO AND TELEVISION

**BUILD** A transistor radio yourself! Kit contains all necessary parts including the new junction-type transistor. Complete with instructions and headphone. \$11.95 cash, check, money order. Morley-Turner, 23 Capen Street, Medford, Mass.

**MAKE** Simple, tubeless, batteryless distance-getting crystal radio. Crystal and illustrated instructions 25c postpaid. Allen, 427-P, Clinton, Missouri.

**F.C.C.** Commercial operator license quickly. Grantham, 6064 Hollywood Blvd., Hollywood 28, California.

**BUILD** 15 Radios—Only \$19.95 complete. Free radio tester, tools, soldering iron. No experience required. Money-back guarantee. Order direct or send for descriptive literature. Free valuable radio and TV repair guide on request. Progressive Electronics, 497 Union Ave., Dept. PM13, Brooklyn 11, N. Y.

**INSTRUCTION** Booklet for new twin crystal set and crystal set with signal strength meter 30c. Potential Radio Company, 446 Crown Street, Brooklyn, N. Y.

**INSTRUCTIONS,** Simplified radio repairing, only \$1.00. Slate's Radio Service, Corsicana, Texas.

**LOUD** Crystal, catwhisker, radio plans, catalog: 25c. Amoroses, Route Four, Richmond, Virginia.

**LOUDER** Crystal radio. Complete kit \$1.00. Malloy, Box 1031-M, Tacoma 1, Wash.

**BUILD** Your own top quality TV set. We supply complete equipment, tools, instructions as part of America's finest home-study TV course. Be a high-paid TV technician. Install, repair, service all makes of sets. Many excellent jobs now open. Or start your own business. Get full facts free. Write: Commercial Trades Institute, Dept. CT2-1, 1400 Greenleaf Ave., Chicago 26, Ill.

**PICTORIAL** Construction plans. Free list. Alena, Box 24, Astoria 6, New York.

**SENSATIONAL** Television development! Instantly eliminates annoying commercials. Sample \$2.95. Franklin, 2156-A, Los Angeles 54.

**COMPLETE** Schematic, illustrated instructions for simplest one tube 110VAC capacity relay, 50c postpaid. Draws no idling power. Ideal for trick locks, scare-em gadgets, burglar alarms, operating window displays. Printed, not mimeographed. Technix Labs, 568V Riley, Buffalo 8, New York.

**YAKITY-Yak** eliminates television commercials. Operates from your favorite chair. \$2.98 postpaid. Electronic Tube-Mart, 8709 114th Street, Richmond Hill, N. Y.

**FREE.** Get on our radio and electronics mailing list. A.R.I., Box 1438, Denver, Colorado.

**SH-H-HUSH** Annoying television commercials from easy chair. Flick switch, sound stops; flick again, sound resumes. Easy installation directions enclosed. Guaranteed. \$2.50 postpaid. Agents wanted. Sh-h-hush, Box 89, Cincinnati 31, Ohio.

**AMAZING** Newly developed, permanently fixed crystal detector with warranty guarantee and complete plans for building crystal radios only \$1.00 postpaid. Allen, 427-PM10, Clinton, Missouri.

**STOP** Radio television noise immediately. Patented filter plug eliminates interference from household appliances, fluorescent lights, motors, oil-burners. Clear reception. No c.o.d.'s. Try 7 days. Moneyback guarantee. \$1.00. Electronic Tube-Mart, 87-09 114th Street, Richmond Hill, N. Y. Dept. PK-12.

**CLEARCO** Crystal radio kit \$1.50; pre-assembled \$1.75. Free catalogue. Clearco Crystal Co., Box 1857, Milwaukee, Wis.

**CRYSTAL** Radio experimenters. Write Leslie Hulet, R4, Lakewood, New Jersey.

**LIMITED** Quantity surplus double headphones. High quality, slightly used, \$7.95 value. Special now \$2.95 postpaid. Guaranteed. Allen, Dept. PMH, Clinton, Mo.

**COLOR** Television! Enjoy multi-color filter screen now. Easily attached. Send \$2 for your screen size. Satisfaction guaranteed. Dealers opportunity. Zingo Products, Johnstown 7, New York.

## BUSINESS OPPORTUNITIES

**BIG** Money. Amazing new home business. Pearl finish baby shoes. Free plan. Pearl Art, 7218 Bear, Bell 1, Calif.

**LIST** Your name in "big mails." Get opportunities, catalogs, samples. One issue 10c, three issues 25c. Walter Rix, P.O. Box 6521, Cleveland 1, Ohio.

**GROW** Mushrooms. Cellar, shed, and outdoors. Spare, full time, year round. We pay \$3.50 lb. We paid Babbitt \$4,165.00 in few weeks. Free book. Washington Mushroom Ind., Dept. 175, 2954 Admiral Way, Seattle, Washington.

**LUCRATIVE** Fascinating business, learn china repairing at home. Make invisible, strong repairs. Service antique shops, private customers. Course \$5.00. Gussack, 12310 Magnolia Blvd., North Hollywood, California.

**200 TESTED** Plans for home business, details free. Paul Greene, 115 Hyde Park Ave., Tampa, Fla.

**LET** Others sell for you. Earn steady from home. Full setup service from idea to success. Free information. Hermes Company, 152-H West 42, New York.

**EARTHWORM** Breeding! Bait, soil! Easy, profitable! Get unusual story. "An Earthworm Turned His Life." Free. Write Earthmaster System, Dept. 14 A, El Monte, California.

**MONEYMAKING** Home mailorder business. Free details. Service Bureau, Box 596, Toronto, Canada.

**COLOR** Concrete with chemicals. Marble-glass cement benches, pottery, garden ornaments. Home — shop. 10c yards sample, pictures. Hollywood Cementcraft, 8527-R Wonderland, Hollywood 46, Calif.

**MAKE** Them! Eat them! Sell them! Pralines, the good Southern pecan candy. Details free! A. Dadson, 4815 Belinole Drive, Houston, Texas.

**MAKE** Tough durable plastic of waste—easily. Makes attractive, resilient floors, walls, built-ins. Stucco. Build good home for half. Bays Laboratory, Oklahoma City 9.

**\$100.00 MONTHLY** Sparetime sharpening lawnmowers at home. Get business through hardware. No experience necessary. Send for free instruction book and business plan. Vernon Foley Company, Columbia Heights, Minn.

**RAISE** Orchids—At home. Big profits. Fascinating. Year 'round any climate. No greenhouse. Instructions, including blooming-size orchid plant, sent for no-risk examination. Free details. Flowerland, 4622-DT, Wilshire, Los Angeles 5.

**IMPORT-Export!** Opportunity, profitable, world-wide, mail-order business from home, without capital; or travel abroad. Established world trader ships instructions for no-risk examination. Experience unnecessary. Free details. Mellinger 701, Los Angeles 24.

**ADVERTISING** Book matches—Cash in on big demand; sell union label matches. Cuts for all businesses and political parties. Free powerhouse selling kit, low prices, protection guaranteed on repeat orders. Cash commissions. Superior Match Co., Dept. MX-154, 7330 Greenwood, Chicago.

**NEWEST** Spare, full-time home business. \$5 to \$10 hour possible. Paint with suede—The finish with touch and eye-appeal. Beautify auto dashboards, signs, radios, toys, figurines, lamps—1001 others. Complete, step-by-step instructions sent for no-risk examination. Free details. Coast, 1004-HZ So. Los Angeles St., Los Angeles 15.

**"10 WAYS** To Travel and Make Money." Copyrighted instructions \$1. Willmack, 14838 Winchester, Harvey, Illinois.

**GIFT** Shops: Make money selling leather bags, skirts, other typical Guatemalan products. Free catalog. Write airmail. Mapilon, Box 268, Guatemala, C.A.

**OWN**, Operate, route—"Wishing Wells." Place these new \$8.50 skill games on counters in cafes, luncheonettes, clubs, etc., collect coins weekly. Write, Legalsbaro, Box 929, Long Beach 1, California.

**LIQUID** Rubber, make flexible molds. Free sample. Chaney, 1130 E. 16th St., Jacksonville 6, Fla.

**FREE!** "301 Profitable Small Businesses!" Amazing shoestring plans! Work home! Start sparetime! Deumant Surveys, Kenmore 23-PM, N. Y.



**START A buying service, buy wholesale thousands nationally advertised products. Make big profits selling at sizable discounts. Postcard brings details. American Buyers, 627-P Linden, Buffalo, N. Y.**

**FOR Your successful business plans write C. Millheiser, Fayetteville, Arkansas.**

**START Your own business on credit. Your own boss. 1658 of our dealers sold \$5,000 to \$27,500 in 1953. We supply stocks, equipment on credit. 200 home necessities. Sales experience unnecessary. Pleasant profitable business backed by world-wide industry. Write Rawleigh's, Dept. A-U-PPM, Freeport, Ill.**

**EARN \$50 Weekly in spare time. Lifetime vitamin business. Details free! Emm-Bee, Dept. PMJ, Box 992, New York 8, N. Y.**

**NEED Money? Want independence. Be your own boss. Start home mail order business on shoestring. Free information. Cox, Saugus 10, Mass.**

**HOW And where to obtain capital. Particulars free. Star Service, Wapakoneta, Ohio.**

**EXPORT Business easy made! Substantial income from home. No merchandise. Our full setup service includes everything. Not an instruction course. Write: Hermes Exports, 152 West 42, New York.**

**WANTED! Home producers, by manufacturers in our clearing house service. Become a subcontractor, casting plastic products for these companies. Thousands of easy-to-make items required for consumer and industrial use. Cash in at home, without previous experience. Plastic Service Associates, Dept. 1-PM, East Boston 28, Mass.**

**FREE Electroplating information. Money making plans. Send postcard for your copy. Highly paid, interesting, uncrowded field. Plater M. Hyde, 327 West 120th Street, Los Angeles 61, California.**

**FISHWORMS. Breeders 100, \$1.00. Manual \$1.00. Postpaid. Literature free. Duxdok, Kent, Ohio.**

**START Home mailorder business. Details. Gedgard, Box 798-E, New York 1, N. Y.**

**WHAT'S Your field of interest? Whatever it is, specialized magazines will help you get ahead. Examine current copies of those covering your field through our easy-to-get-acquainted service. Choose from 4,387 covering all fields—business, trades, agricultural, professions, insurance, real estate, music, educational, hobbies, sports, etc. Current list free. Commercial Engraving Publishing Company, 34C North Ritter, Indianapolis 19, Indiana.**

**LOOK Over this method in mail order. Has produced daily for years. Income steady. Literature free. Shore Enterprises, Box 218 C, Neptune, N. J.**

**HOMEWORKERS Wanted: Mailing publications. Sample, details and big instructive manual only 25c. Dispensa, 2020 Harbor Ave., Ashtabula, Ohio.**

**EARN Money at home, making rhinestone jewelry. Free catalog. Ebert, Box P183, East Orange, New Jersey.**

**NEW Plastic mending tape. Just press on! Repairs clothing instantly. Lightning seller. Samples sent on trial. Kristee, 100, Akron, Ohio.**

**BUSINESSMEN—Industrialists, ask us about Florida. The State of Florida will welcome the chance to give you complete, dependable facts about Florida's many investment opportunities for business and large and small industry. Highly favorable tax situation. Write, telling about your interests and your specific requirements. You'll be put in touch with communities that offer what you want plus delightful year-round living. Write today: State of Florida, Industrial Development Division, 4314C Caldwell Building, Tallahassee, Fla.**

**LEARN Sewing machine repair, electrify, sell. How to make big money at home spare time. New zigzag machines, etc., wholesale. Details free. Taylor Service, Hamilton, Ohio.**

**EARN Money with typewriter, sewing machine! Details free. Edwards, 3915-PM, 12th, Des Moines 13, Iowa.**

**WE Love our mailman—He leaves over \$1,000.00 monthly in our rural mailbox. My college professor husband drafted a scientific home mailorder method. We bought a Texas ranch, live as we always wanted. Now we sell the Ranch Mailorder Method. Operates anywhere. Inquire: Eveningshade Ranch, Helotes, Texas.**

**BE Notary public. Rate higher. Details free. Stationers, Helotes, Texas.**

**EARN \$2.00 Hour! I do, making sandals. Young's, 1308-PM, South First, Arcadia, California.**

**MAKE Money at home as renewal headquarters for all magazines. Liberal commissions. No experience—No capital needed. Supplies furnished. Write for free catalog. McGregor Magazine Agency, Dept. 500 B, Mount Morris, Ill.**

**IMPORTING Is profitable! Details free. Warner's, Box 6, Fort Scott, Kansas.**

**MAKE Perfumed stationery. Profitable local—Mail order business. Free sample, details. Riens Press, 24-R North Seventh, Newark 7, New Jersey.**

**START A business at home permanentizing baby shoes. Complete plan embodied in prospectus for 10 cents in coin. Send today. Jay, 192-A N. Clark, Chicago.**

**POPCORN And potato chip equipment. Leo, Box 933-A, Springfield, Ohio.**

**MAILORDER—Operate profitable home business using free advertising method reaching millions. Revealing information free. H. P. Seidel, 7070 Hollywood Blvd., Hollywood 28, California.**

**MAKE Perfume and other profitable products. Catalogue free. International, 6347 Parnell-PM-1, Chicago 21, Illinois.**

**BARGAINS. Big monthly tabloid paper lists hundreds bankrupt, closeout, wholesale bargains. Many bargains 15c-20c on retail dollar! Lists sources 100,000 items wholesale. 6 months, \$1.00; 1 year \$2.00, regular \$3.00. Tower, Box 391-ST, Lynn, Mass.**

**MEN, Women! Make money at home or build your own mailorder business spare time. Free booklet reveals secrets. Write: Spaadco Surveys, 412 Portland, Rochester 5, New York.**

**CO-PUBLISH Interesting mailorder publications. Two samples, literature, full details, 25c. McAlister Publications, 3464 Farmville, Memphis 12, Tenn.**

**UNPAINTED Figurines. Weaver's Statuary, 1524-A Second Avenue, Altoona, Pennsylvania. Catalog.**

**OWN A garden golf business. Experience unnecessary. Brockway, Seaside, Oregon.**

**MAKE Perfumes and cosmetics at home. Write Carey Laboratories, 1914 Chouteau PM-1, St. Louis 3, Missouri.**

**SELL By mail. New 10,000 word booklet shows how. At home. Sparetime. Small capital. 25c guaranteed. Vernon-Hall, Box 193M, Abington, Penna.**

**SELL Popular Mechanics and all other magazine subscriptions. Free catalog, supplies. Subscription Service Company, Dept. A, P.O. Box 2070, Birmingham, Alabama.**

**\$40.00 DAILY With inexpensive sawshop equipment. Zapart, 586-PM Manhattan, Brooklyn 22, N. Y.**

**OWN A profitable home business. Free brochure on practical plans. Lorimer's, Box 2429, Greensboro, N. C.**

**BUY Wholesale thousands items. Lists free. Cottage Industries, Omaha 12, Nebr.**

**TO \$40.00 Weekly. Spare time, home operated, mailorder business. Successful "beginner's" plan. Everything supplied. Lynn, 10420-M National, Los Angeles 34, Calif.**

**MILLIONS Have been made in California real estate. State licenses protect salesmen and saleswomen so investigate this high paying easy business. No college or high school needed and there is no age limit if over 21. Send for Bulletin No. 14 today; include your name, address and fee of \$1.00. California Real Estate Bureau, 1400—30th Avenue, San Francisco 22, Calif.**

**\$28,500 SALES In two weeks! Amazing radio-mail order method. Free details. Broadcast Service, 1412-H Great Northern Building, Chicago 4, Illinois.**

**MAKE Money from old coat hangers. \$1.00. Baxter, 4972 San Rafael, Compton, Calif.**

**YOUR Ideas should pay. Let us manufacture and market your pet gadget for you. Ideal Machine and Tool, 4114 Olive, St. Louis 8, Mo.**

**THERE'S Money in earthworms. Details 25c. Earthworm Gardens, Dept. PM1, Box 428, El Monte, California.**

**SAVE Money when you buy home or farm. Priceless information, only \$1. W. Wells, 323E 6th, Escondido, Calif.**

**DON'T Wait. Live center United States opportunities. Oil, farming, business. Habiger Agency, Russell, Kansas.**

**BUILD Luggage and cases at home. We sell your products. No special tools or equipment needed. Free details. Casecraft, 805-A2 Sunset Blvd., Los Angeles.**

**START Sparetime home mailorder business. Pays big profits. Amazing instructive book, 25c. Moneyback guarantee. Tomlin Service, 550 Ocean, Portland 5, Maine.**

**20 YEARS Experience. Business, sales, mail order consultant. Your problems solved. Send problem with \$2.00. Morael, Box 7-M, Rockaway Park 94, New York.**

**SENSATIONAL Television development! Instantly eliminates annoying commercials. Free details. Franklin, 2156-B, Los Angeles 54.**

**\$500,000 BY Mail from home. Free folder. Publicity, Kalamazoo, 65DF, Mich.**

**SENSATIONAL Home plastic business. Men and women make big money, spare or full time. Also valuable liquid marble information. Free catalog. Write: Bing Products, PM-154, Watertown 72, Mass.**

**LEARN Mailorder. Money-making opportunity. Work home. Literature free. Addison, 1840-T Addison, Chicago 13.**

**NEW In U.S.A. Famous Lambretta scooter. Exclusive territory for southeast area. Salesmen, agents, dealers, factory representatives. Write, Box 298, Ft. Lauderdale, Florida.**

**EARN Big money with few hours' work each week in your own mailorder business. Free details. Mailford Company, Dept. PM-14, Southampton, New York.**

**FREE Catalog, samples. Printing at wholesale prices. Dealers wanted. Sutton Printing, Box 833-B, Waycross, Georgia.**

**\$7.50 PROFIT Each sale! Free details. Far Hills, Box 544-MD, Dayton 2, Ohio.**

**BUY It wholesale! Manufacturers, distributors offer 850,000 items. Literature free. Olsen, 1231-A East Third St., Duluth 5, Minn.**

**3,658 GOVERNMENT-Owned inventions available, free use. Details, 25c. Box 123-B, Allenhurst, N. J.**

**MOLD Making liquid rubber; quarter pint sample with instructions, \$1.00 postpaid. Plastercraft Supply Company, 3051 St. Clair Ave., Cleveland 14, Ohio.**

**MONEY Opportunities big mail listing 10c. Box 970A, Milwaukee, Wis.**

**FREE Instructions "Metalizing Baby Shoes," mountings. Fosters, 1520 Ardmore, Chicago 26.**

**\$200 WEEKLY Reported! No selling. Free booklet. T. J. Surface, Roanoke 4, Virginia.**

**MAKE Money by mail order. Free catalogue shows how. Details free. Opportunities Unlimited, Dept. 6, Box 1578, Boston, Mass.**

**MAKE Perfume. Sell on smell. Mail order or local. Wilson made \$7200.00 first year. Free sample, plan revealed. McCann, 1612 Johnson, Amarillo, Texas.**

**BUILD Ornamental iron railings for big profit. Complete instructions \$1.00. Befro, Box 45, Fond du Lac, Wis.**

**SELL Wrist watches. Free literature. Kelley, Box 207, Rapid City, South Dakota.**

**FREE Magazine. Hundreds homework offers. Siegel, Box 183PM, New York 2.**

**PROFITABLE Repair shop. 11254 N.W. 7th Ave., Miami, Florida.**

**BOOKKEEPERS, Increase earnings operating sensational bookkeeping service. Kern, 4942 Vineland, North Hollywood, Calif.**

**YOU Can become notary public. Details free. Magnolia Press, Box 1272-P, Burbank, Calif.**

**BE A sewing machine repair agent. Good money, pleasant interesting work. Complete professional course in servicing and overhauling all makes. \$4.95 postpaid. No c.o.d. Humes Sewing Machine Co., 12405—87 St., Edmonton, Alberta, Can.**

**OPERATE Escalator mailorder system, selling our products or any products. Fastest, most revolutionary mailorder system known. Write: Selbyco, Decatur 162, Ill.**

**MAILORDER. Operate profitable home business. Free details. Guymon Direct Sales, Dept. 25, Box 535, Guymon, Okla.**

**FREE Directions for casting plaster novelties using our latex rubber for molds. Lowest prices. Major Chemical & Latex Co., 25 Allerton St., Boston 9, Mass.**

**ELECTRO-Plating. Profitable home business. Auto parts, novelties, giftwares, baby shoes, mirrors. Easy, inexpensive home processes. Free booklet. Tyco Metals, Box 13231-ML, Houston 19, Texas.**



**\$46 FROM** Square foot plywood; jigsaw necessary. Write: Woodarts, Bridgewater, Mass.

**\$300 WEEK Possible!** Sensational new hand cleaner. Manufacture-distribute. Operate from corner of basement or garage. Your very own private, exclusive, money-making business. Easy. Free plan! Write today. Keenelo, 2445 Larimer, Denver 5, Colorado.

**\$2000 MONTHLY**—Easy, instructions free. Sundberg, 1552 Essex, Willow Run, Michigan.

**\$5.00 MONTH Up.** Establish a permanent California address for your mail order business here in downtown Los Angeles. Confidential. Replies forwarded immediately and efficiently. Established here 10 years. Ellery Office Service, 1244 S. Grand Ave., Los Angeles 15, Calif.

**WORK At home.** Mail to automobile owners. Big earnings. Everything furnished. Eastern, Box 142-F, Dorchester 24, Mass.

**CONVERT** Hand mowers to power mowers. Do it now, this winter. Sell the Handy-Dandy conversion kits. Easily installed on 16 to 20" mower. Use any small gasoline or electric motor. Quick delivery. Kits purchased with or without engines. Also new garden cultivator. Takes less than a minute to change attachments: Weed whacker, lawn mower, snow plow, and rotary tiller. Discount to dealers. Le Claire Manufacturing Company, Le Claire, Dept. P.M., Iowa.

**FREE Folder.** Make big money by mail the sure way that pays. New, different. Fullmer, 92H Greenwood, Pocatello, Idaho.

**MAKE Money** selling by mail; instructive booklet 25c. Manhattan House, P.O. Box 51-M, Saint Albans 12, N. Y.

**EARN More money.** 137 Elite plans. Free information. Jorine, Snyder Lake, Troy 4, N. Y.

**MADE \$24,500** Using money making plans from world's oldest mailorder publication. Scherer Magazine, Canfield 1, Ohio. Year \$1.00. Sample 25c.

**UNUSUAL** Homework opportunity, sparetime, men, women. Angora House, PM, Springfield, Illinois.

**MAKE Rubber stamps,** repair dolls; learn silk screen printing; invisible reweaving. Catalogue (60 ideas) free. Universal, Box 1076-A, Peoria, Ill.

**\$25 WEEKLY** Working two hours daily at home. Lycke, Box 2471-A, Cleveland 12, Ohio.

**START Your own profitable home mail-order business!** We supply everything! Write today! Studio Products, Box 564-A, Glendale 5, Calif.

**WHOLESALE** Of sensational nationally advertised appliances, silverware, watches, cameras, etc. Start your own business. Full details. Send 50c for catalogue. International Sales Co., 175 Fifth Ave., New York 10, N. Y.

**LIVING Miniature ("Ming") trees** only 10 to 20 inches tall. Grow at home. Big profits! Spare time opportunity. Fascinating! Amazing! Write for free seed and plan. National Nursery, Dept. PC, Inglewood 4, California.

**BREED** Rare tropical fish at home. Earn big money! Learn secrets! Help fill huge demand. Amazing opportunity! Free plan. Tropicals, 1008-P Los Angeles St., Los Angeles 15.

**INCOME** From local information. No selling. Write Neherco, La Verne, Calif.

**RESILVERING** Mirrors, formula 50c; two-way lookout mirrors, (No one sees you), 50c; coppered mirrors, 50c. All \$1.00. Nelko-Mir, Box 3462-J, Chicago 54.

**FIGURINE** Molds and many others, liquid rubber, statuary plasters, flock finishes, Glo-candle wax, etc. Illustrated catalog and "Plastercraft" manual free. Blue Rapids Supply, Blue Rapids, Kansas.

**START Home manufacturing business.** Make cleaners, soaps, polishes, cosmetics. Free literature. Kemix, Park Ridge, Ill.

**MAKE Money** spare or full time, casting metal toys and novelties. Big wholesale and chain store demand for autos, soldiers, ashtrays, banks, etc., keeps manufacturers busy. Production moulds furnished for up to 100 and more castings per hour. No experience or special place necessary. Write for information and illustrations of patterns needed. Metal Cast Products Co., Dept. A, 1696 Boston Road, New York 60, N. Y.

**MAKE Flexible molds!** Cast plaques, bookends, figurines! Free sample! H. Tooker, 630-R Chestnut, Hamilton, Ohio.

**NEW Exceptionally profitable plans,** ideas for home operated mail business. Rush name. Miller, 1772-P Carylon Road, East Cleveland 12, Ohio.

**RECAST** Old batteries into new. Latest achievements. Battery Laboratories, Minneapolis.

**GOOD** Paying business silvering mirrors, plating autoparts, reflectors, bicycles, bathroom fixtures, etc., by late method. No tanks or shop required. Outfit furnished. Free booklet. Gunmetal Co., Ave. H, Decatur, Illinois.

**BUY Wholesale.** Thousands articles, Supply directory, 10c. Idealso, Park Ridge, Illinois.

**EARN Extra money!** "Homeworker Magazine" tells how. Sample 25c. Size more. Box 7, 4917 Kostner, Chicago 30.

**EXTRA Money**—No selling, operate vendors. Amazing profits, details free. Silver King, Suite 220, 622 Diversey, Chicago 14.

**OPERATE** Profitable mail order business. Write Walter Service, 4150-A East 112th, Cleveland 5, Ohio.

**DOLLARS** In personalized baby record books. Sell by mail. Use same literature we do. No-Co-Ro, Oakland 6, Calif.

**MINK** Raising information free. Complete. Lake Superior Mink Farm, Superior, EEL, Wisconsin.

**COPUBLISH** Leading m.o. paper. Latest copy. Mail Sale Advertiser, details, dime. Vanroy Shirk, Lebanon, Penna.

**COLORGLAZED** Concrete pottery made without molds. Patented method. Cemetery products, novelties, tiles. Basement leak-sealing. Money-making projects. Booklet, details free. Men only. National Potteries Company, Grand Rapids, Minnesota.

**FREE Book** "505 Odd, Successful Businesses." Work home. Expect something odd! Pacific, Oceanside, Calif.

**137 PLANS** For starting home business. Details: Elite Co., 220 Grand St., New York 13.

**FIX Typewriters.** Free booklet describes our modern, inexpensive home-study course. Factory methods taught. Write Typewriter, Building 1, Tarentum, Penna.

**MONEY** In new greaseless doughnuts. Start in kitchen. No smoke. Sell stores. Free recipes. M. Ray Company, 3605 South 15th Ave., Minneapolis 7, Minn.

**START A** lettershop on a shoestring! Sales \$56,000. Started \$36.00. Information? Merritt, Box 13, Basking Ridge, N. J.

**NATURAL** Molding latex. Tinsel, flock, supplies. Extra thick. Free sample. W. Woolley, 115-A Donald, Peoria, Ill.

**EARN Big money** by mail. Depression-proof income. Circular 10 cents. Complete starting deal \$3.00 postpaid. Reho, Box 21A, Whitsett, Penna.

**VENDING** Machines—No selling. Operate a route of coin machines and earn amazing profits, 32-page catalog free. Parkway Machine Corporation, Dept. 72, 715 Ensor St., Baltimore 2, Md.

**FLEXIBLE** Rubber moulds for plaster and Marble figurines. Sample and large illustrated catalog 25c. refunded on first order. K-C Novelties, Dept. 73, Easthampton, Mass.

**HAVE Home mail business**—Get \$10 orders in every mail. Keep \$3.00. Everything furnished. Hutchinson, 401-A Adams, Dorchester 22, Mass.

**BOOKKEEPERS.** Keep books, small firms spare time. Manual latest technique by C.P.A., \$3.00. Modern Business, Box 406, Youngstown 1, Ohio.

**LEARN** Refrigeration mechanics. Complete illustrated course. Free booklet. Mechanics School, 7217-PM South Broadway, Los Angeles 3.

**SPARE** Time business. No investment. Details free. Howell, 1320 St. Andrew, New Orleans 13, La.

**BRONZED** Baby shoe supplies, instructions, mountings. Metal bookends, \$1.50 pair. Free catalog. National Bronze Supply, Box 56, Los Angeles 32, Calif.

**PERFUMERS;** Cut costs, 500 fragrances, supplies. Box 3267, San Diego, Calif.

**QUICK Money!** Repairing car batteries. At home! Easy, too! Batteryman, Grand Junction, Colorado.

**"HOW To Build Your Own Mailorder Business,"** 25c. Guaranteed. E. Merrill, Coldbrook Road, Bangor, Maine.

**\$10,800 PROFITS!** Your own mailorder business! No risk! "Success Plan" free! Treasury, 709 Webster, New Rochelle-LB-1, New York.

**BUY Wholesale** thousands nationally advertised products. Save money! Make money! Postcard brings details. Kemah Company, 5017-P Washington, Houston 7, Texas.

**CATALOG** Of top mail order plans and folios, proven and tested. Stamp please. Lindholm Service, P.O.B. 2604, St. Ann Station, Minneapolis, Minn.

### MONEYMAKING OPPORTUNITIES

**FREE!** "301 Profitable Small Businesses!" Amazing shoestring plans! Work home! Start sparetime! Deumant Surveys, Kenmore 23-PM, N. Y.

**TYPEWRITER** Owners. Make handsome profits. Get details today. Groves Company, 662, Hastings 8, Nebraska.

**EARN Money** evenings, copying and duplicating comic cartoons for advertisers. Adservice, Argyle 1, Wisconsin.

**BEAUTIFUL** Feather pictures. 200% profit! Free sample. Apartado 9036, Mexico 1, D. F.

**START A** buying service, buy wholesale thousands nationally advertised products. Make big profits selling at sizable discounts. Postcard brings details. American Buyers, 630-P Linden, Buffalo, N. Y.

**\$10,800 PROFITS!** Your own mailorder business! No risk! Success plan free! Treasury, 709 Webster, New Rochelle, PM-19, N. Y.

**"HOW To Make Money With Simple Cartoons"**—A book everyone who likes to draw should have. It is free; no obligation. Simply address Cartoonists' Exchange, Dept. 91CM, Pleasant Hill, Ohio.

**START A** profitable subscription business in spare time! We need men and women (young or old) as representatives for all leading national magazines. Liberal commissions paid for new and renewal subscriptions. Start earning money in this pleasant work at once! Clip this ad and send with your name and address to: International Circulation Distributors, Dept. PM, Hearst Magazines, 230 W. 35th St., New York 19, N. Y.

**ADDED** Income selling by mail. Roblin Sales, 1001 Curtiss, Downers Grove, Ill.

**GROW** Mushrooms. Cellar, shed, and outdoors. Spare, full time, year round. We pay \$3.50 lb. We paid Babbitt \$4,165.00 in few weeks. Free book. Washington Mushroom Ind., Dept. 173, 2954 Admiral Way, Seattle, Washington.

**OPERATE** Cafe, diner, without penny invested. Will help you locate. Free details. Restaurant Arts, 51-M, Fremont, Ohio.

**SELL** Stamps. I guarantee profit. Return envelope. Fairbrook, 13321 Blossom, Flushing, N. Y.

**MAKE Money** at home. Write. Falcon House, Winnebago 2, Ill.

**CHINCHILLAS:** Profitable. Raise in spare room, cellar. Ross Chinchilla Ranch, 749 Rincon, El Sobrante 11, California.

**EARN \$50 Weekly** operating home mail business. Write. Lewis Barlett, Richland, Georgia.

**SECRET** Investigation. Experience unnecessary. Investigators particulars free. George Wagoner, 125M West 86th, New York 24.

**1930 DEPRESSION** Forced me to invent my own business—a minimum-cost, high-potential home mailorder. Lucky design paid immediately, over \$1,000 every month since! Over half net! This original design, "Selective Mailorder," is United States Postal Service approved. Now mapped out to guide mailorder beginners. Literature free. Eveningshade Ranch, Helotes 14, Texas.

**HOW** To earn up to \$500 for each script, writing for television. New, different! Particulars free! Wonderful Products, Box 2113, Santa Fe, N. M.

**BUY** Bankrupt, closeout bargains! Toys, novelties, household items, specialties, etc. Many 15-25c on the dollar! Also 100,000 items wholesale. Free details. Box 591, Lynn 8, Mass.

**CHURCHES,** Women's clubs, receive \$100.00 to \$500.00 and 24-card tables. Unique plan. Pine Hill, New Jersey.

**500% PROFIT.** No equipment. Complete laminating and goldstamping outfit, easy instructions, 12 sales and mailorder plans, terrific money accumulation project, all \$1.00. Argentum, Box 6346, Philadelphia 39.



**CASH-In.** Get into mail order business. 68 page book reveals business secrets, effective advertising, what to sell, beginners advice. Numerous tested and original money-making plans. Over 40,000 words. We'll include other helpful literature free. Rush 25c to: Par Products, 2185 Bolton St., New York 62, N. Y.

**BE Appointed, outfitted, Notary Public.** Thousands needed. Men. Women. World's lowest cost. Box 3025, Dallas 1, Texas.

**CYPRESS** Knee lamp kits \$3.95, postage 50c. Cy Products, Dept. 1-A, Lafayette, La.

**THOUSANDS** Articles—Wholesale source information 10c. Dennis, #4, 1402 Kearny, San Francisco, Calif.

**SPARETIME** Profits taking subscriptions, all magazines. Wholesale catalog free. Cassell Agency, Westfield 2, New Jersey.

**DON'T** Be Mr. Average Man. Operate your own business. Very desirable, non-perishable, no chemicals or liquids, highly profitable. Can you recognize real opportunity? Postcard will bring details. Protecto Products Company, Box #543, Oak Park, Illinois.

**NEW 7"x11"** Ultra-blue signs. 7c, retail 50c. Sample free! Lowy, 812 Broadway, Dept. 774, New York 3.

**400 RADIO** Stations active. Free radio advertising. Pay commission only on orders received. Free information. Mishek, 2, Waseca, Minn.

**OPERATE** A home mail order business. Fascinating. Profitable work. Complete instruction, \$6.00. Augustus A. R. Stephens, P.O. Box 548, Oakland 4, Calif.

**BIG** Profits in spare time! I'll send assortment full-size samples fine foods, household necessities to ambitious men-women who need money. Friends, neighbors buy eagerly. Send no money. Just write Blair, Dept. 31MA-2, Lynchburg, Va.

**COST** Of things going up faster than your income? You can make more full or part time as a Rawleigh dealer. Write for full particulars. Rawleigh's, Dept. A-RK-PPM, Freeport, Ill.

**\$500,000** BY Mail from home. Free folder. Publicity, Kalamazoo 65DE, Mich.

**EARN \$50.00** Daily making mats, shoes and mud guards from old tires. 8 and 8 Patents Inc., 1307 North Clark St., Chicago 10, Ill.

**SELL** Titania gems; \$9.75 carat wholesale. More brilliant than diamonds. Free catalogue. Diamonite, 1404-M Mitchell, Oakland 1, California.

**50,000** ARTICLES Wholesale. Source directory, dime. Nelko, Box 3462-DR, Chicago 54.

**SCHOOL** Seniors—Sell classmates America's most beautiful graduation name cards. Largest selection. Highest commission. Outsell all others. Free sample kit. Printercraft, Dept. M, 1509 Maple Street, Scranton 3, Penna.

**READ** Progressive Mailtrade, the magazine that tells how to make money by mail. Dime brings sample and special offer. Progressive Mailtrade, Box 357, Sheboygan, Wisconsin.

**FREE** Book "505 Odd, Successful Businesses." Work home. Expect something odd! Pacific, Oceanside, Calif.

**137** PLANS To make money, local mail-order. Details: Elite Co., 220 Grand St., New York 13.

**PUBLISH** Your own magazine. Hand-some 52 page format, well edited, illustrated. Cost low as \$1.00 month. Brings you prestige, profits. 25c brings sample, details. National, Ord, Nebr.

**MAKE** Money at home by mail. Fast, easy. Liebig Industries, Beaver Dam 4, Wisconsin.

**FOREIGN** Employment construction work. If interested in foreign projects with high pay write Foreign Service Bureau, (Dept. P.M.), Metuchen, New Jersey.

**GENERAL** Contest Bulletin. Issued monthly. Sample, 10c. 1609½ East 5th, Duluth, Minn.

**MAKE** To \$4.50 hour doing common pen lettering. National Artists, 801½-A North Marsalis, Dallas 3, Texas.

**BUY** Wholesale thousands nationally advertised products. Save money! Make money! Postcard brings details. Kemah Company, 5017-L Washington, Houston 7, Texas.

**MAKE** Money at home, it's easy. I'll show you how and help you. Write: Allen, Box 4A, Houma, Louisiana.

**WINNING** Prize contests is fabulous, confidential, home opportunity! Send stamp! National Contest Bulletin, Box 2685-P, Miami 16, Florida.

#### FORMULAS, PLANS, ETC.

**PRODUCT** Analysis, manufacturing formulas, processes developed. Moderate fees. Plastics, Box 1574, Boston 4, Mass.

**ANY** Formula \$5.00. Satisfaction guaranteed. Jack, Consulting Chemist, 5138 Gainor, Philadelphia 31.

**LIFETIME** Business! Manufacture extremely profitable chemical products! Descriptive information free! Thermolab, Peoria 4, Ill.

**500** MONEY Making formulas, 25c postpaid. Allen, Dept. FMC, Clinton, Missouri.

**FORMULAS;** All kinds. Latest, best. Literature free. Kemixal, Park Ridge, Ill.

**GENUINE** Manufacturing formulas. Latest. Literature free. Nelko, 3462-P Merchandise Mart, Chicago 54.

**REAL** Manufacturing formulas. Lists free. Cummings, Chemist, Gordon Ave., Syracuse 4, N. Y.

**ANY** Formula \$3.00. Chemical Instruction Sheet—catalog 10c. J. Belfort, 216 W. Jackson, Chicago 6.

**FREE** Formula catalog. Anything analyzed \$35. Western Chemical, Salem, Ore.

**LABORATORY** Tested formulas. Catalog free. Pont Chemical Company, Terre Haute 2, Indiana.

**MODERN** Formulas for many new and unusual business-building products. Fifty years supplying the best. Literature free! Liscomb Miller, Chemist, Tampa, Florida.

#### PLASTICS

**NEW** Liquid casting plastic. Clear, colors. Embed flowers, insects, coins. Saw, drill, carve. Send 25c for Castolite Creations Manual and proved success plan showing how to make money at home. Castolite, Dept. A-101, Woodstock, Ill.

**FIBERGLAS,** Polyester, Plexiglas, Acetate, Vinylite. Casting, coating plastics. Maurice Lannon's Fiberglass "How" book now ready, \$2.50. Fast service, best prices. Catalog 10c. Airmailed 35c. Gem-O-Lite, Box 6867P, North Hollywood, California.

**PLASTICS** Home-craft course for men and women. Tells and shows how to make hundreds of fast selling plastics products. All plastics and materials for 23 projects included in course. No special tools needed. Course pays for itself. Write for free booklet. Interstate Training Service, Dept. D-3-A Portland 13, Oregon.

**PLEXIGLAS** Sheets—Cut to size. Clear. All thicknesses. Standard outdoor translucent colors. McClarin Plastics, P.O. Box 168H, Hanover, Penna.

**PLASTICS,** Cements, dyes, findings, carvings. Wholesale prices. 64 page catalog free "Trace and Carve" pattern book for carving and coloring fish, birds, animals, only 35c. Taylor & Art, Inc., 1710 East 12th Street, Oakland 6, California.

**LEARN** Plastics at home. Complete kit—\$5.98 postpaid. Dime brings sample plastic, three experiments, full details. Plastic Projects, Box 5151, Detroit 35, Mich.

**PLEXIGLAS** Closeout—Masked, square foot— $\frac{1}{8}$ —\$1.20,  $\frac{1}{4}$ —\$1.90,  $\frac{1}{2}$  tubing 15c ft. List 10c. Plastics, Box 602A1, Janesville, Wis.

**PLASTIC,** Sheets, rods, tubes, etc. Free list. Plastic Supply Co., 2901 N. Grand Blvd., St. Louis 7, Mo.

**PLEXIGLAS,** Lucite. Any size sheets. Square foot (12 x 12) cost, 1/16", \$1.18; 1/8", \$1.55; 3/16", \$1.90; 1/4", \$2.25. Add 15% for postage. Minimum order \$3.00. Almac Plastics, 600 Broadway, New York City.

#### CHEMISTRY

**ILLUSTRATED** Catalog: Chemistry, mineralogy, biology 20c. Tracey Laboratories, Evanston, Illinois.

**CHEMICAL** Set makes water, snow, glow in darkness. Blue, green, orchid colors. Resembles glow of fireflies, deep sea fish. Harmless. Free literature. Varniton Company, 416 N. Varney Street, Burbank, Calif.

**COMPLETE** Catalog, bargain lists, 20c. Laboratory Sales, Box 161-A, Brighton, Mass.

**SECOND** Improved printing, "Spectacular Chemical Experiments" manual. Not mimeographed. Contains complete formulas, set-ups, instructions, special data, on thermites, fulminates, explosive powders, etc. Still \$1.00 postpaid. Chemi-Technix Laboratories, 568CM Riley, Buffalo 8, New York.

**AMAZING** New book of science. Experiments, formulas and catalogue of laboratory supplies. Only 25c. National Scientific Co., Dept. 16, 2204 W. North Ave., Chicago 47, Illinois.

**NEW** Idea chemical and apparatus outfits for home experimenting. Photo-scales, microscopes, chemicals, biological and laboratory supplies in small quantities. Catalog 25c. Established 1931. John H. Winn, 124A West 23rd Street, New York, N. Y.

**CHEMICALS** And apparatus for industrial, analytical, and private laboratories. Catalog 25c. Dept. M-50, Biological Supply Co., 1176 Mt. Hope Ave., Rochester 20, N. Y.

**SPECTROSCOPE** For quick chemical analysis \$3.00. Kutting Sons, Los Altos, Calif.

#### AGENTS WANTED

**STICKERS:** Name and address labels. Agents wanted. 817 East St., Pittsburgh 12, Penna.

**NEW** and unusual merchandise. E. Elier, 1000 Sutter St., San Francisco 9, Calif.

**APPLIANCES,** Cameras, radios, toys, typewriters, watches. Large coded wholesale catalogue! Cam Company, 6806PM—20th Ave., Brooklyn 4, N. Y.

**BUY** Wholesale thousands nationally advertised products at big discount. Free "Wholesale Plan." American Buyers, 629-P Linden, Buffalo, N. Y.

**LIFETIME** Vitamin business! Sell sensational food supplement! Steady repeat profits. Full or part-time. Write for free sales plan. National Health Products, Dept. PMJ, 150 Broadway, New York 38.

**MAKE** Up to 150% profit selling finest line everyday greeting cards. New \$1.00 assortments, 21-card boxes, make-it-yourself kits, 100 fast-sellers. Extra gift bonuses! Assortments on approval. Stationery samples free! Creative Cards, 2505 Cermak, Dept. 502-H, Chicago 8.

**AGENTS-Salesmen:** Sell beautiful hand-colored plastic enlargements and sensational new personalized photo compacts, rings, bracelets, lockets, etc. Experience unnecessary. 40% advance commissions. We deliver, collect. Wonderful sideline—Better full time. Free sample outfit. Novel Portrait Co., 3343 North Ave., Chicago, Ill.

**REPRESENT** The new Ar-Lee Gem, retractable ball pen. Top quality, firm imprints, High commissions. Send two dollars. Sales kit, Refundable first order. Ar-Lee Imprints, 37E East 51st St., Brooklyn 3, N. Y.

**PRINTING,** Salesbooks, envelopes. Free illustrated catalog. Erseo, Dept. PM, Bronx 72, N. Y.

**BUY** Wholesale. 25,000 items. Catalogue 25c. Matthews, 1472-B4 Broadway, New York City 36.

**FOG-Stop** windshield cloth. Instantly removes blurry mist, frost, sleet, snow. Stops windshield fogging. Samples sent on trial. Kristee 50, Akron, Ohio.

**BE** A money maker. Use your home as magazine headquarters. Liberal commissions. No experience—No capital needed. Everything furnished. Write for free catalog. McGregor Magazine Agency, Dept. 500 A, Mount Morris, Ill.

**MAKE** \$25-\$100 Fast for yourself or organization. Sell friends big value \$1.00, \$1.25 all-occasion greeting card assortments. Leading 21 card boxes, Valentine, Easter cards. Gift wrappings, stationery, gifts. 100 items! Experience unnecessary. Samples on approval. Free \$1.00 gift for promptness. Hedenkamp, 361 Broadway, Dept. PM-30, New York.

**MEXICAN** Feather pictures. Sell on sight; 200% profit! Free details. Sample 20c stamps. No colns. SylviaP, Apartado 9026, Mexico City.

**300% PROFIT.** Millions prospects. Take orders for plastic sealing of cards, photos, papers. Sample, details free. Plastiseal Company, Dept. M3, 45-05 30th Ave., Long Island City 3, N. Y.

**MAKE** Money introducing world's cutest children's dresses. Big selection, adorable styles. Low prices. Complete display free. Rush name. Harford, Dept. L-2341, Cincinnati 25, Ohio.



**MEXICAN Feather pictures.** High profits! Fast sellers! Adelphi, Box 57-B, Bellerose 26, N. Y.

**300% PROFIT** For you. Selling most proofing solution concentrate. Guaranteed protection. Sensational value. Friendly Products Co., Dept. PM154, Box 665, Youngstown 1, Ohio.

**RUN A spare-time greeting card and gift shop at home.** Show friends samples of our new 1954 all-occasion greeting cards and gifts. Take their orders and earn up to 100% profit. No experience necessary. Costs nothing to try. Write today for samples on approval. Regal Greetings, Dept. 41, Ferndale, Michigan.

**SELL Unusual greeting cards, wrappings, novelties.** Make \$50, \$75, \$100 more. Win Dormeyer meal maker, Toastmaster, other famous products as bonus. Write for feature all occasion assortments on approval, free samples exclusive name imprinted stationery, free color catalog, selling guide. New England Art Publishers, North Abington 133-C, Mass.

**BIG Profits** selling ties, \$2.00 values, \$6.50 dozen. Free catalog. Empire Cravats, 611A Broadway, New York 12.

**MAKE Big money** selling Sunshine's exclusive everyday cards. Nationally famous assortment sells on sight for \$1.00. Many others. Imprinted stationery, gift wraps, novelties, deluxe 21 card assortment, etc. Send postcard today for sample kit on approval. Sunshine Art Studios, Inc., Dept. PM-1, Springfield 1, Mass.; Pasadena 3, Calif. (East of Rockies address Springfield office).

**GET An easy to play cowboy guitar** for selling only 50 packets of Garden Spot seeds at 10c packet. No extra charge. Sent postpaid, instructions included. Lancaster County Seed Company, Dept. 298, Paradise, Penna.

**FREE!** "How to Make Money with Greeting Cards" booklet. Samples on approval. Organizations! Ask for fund-raising plan. Writewell, PM-41, Boston 15, Mass.

**STRANGE Dry window cleaner.** Sells like wild. Replaces messy rags, liquids. Simply glide over glass. Samples sent on trial. Kristee 51, Akron, Ohio.

**AMAZING Bath sponge.** Washes back easily. Suds as it washes. Uses soap scraps. Big profit. Whirlwind seller. Write for free sample offer. Magica Products, Wollaston 70, Mass.

**NEW In U.S.A. Famous Lambretta scooter.** Exclusive territory for southeast area. Salesmen, agents, dealers, factory representatives. Write, Box 298, Ft. Lauderdale, Florida.

**COUNTY Agency.** Power mowers, Cordwood-chain saws. Prepaid. Sell on terms. Farmco-51, Excelsior Springs, Mo.

**BUY Nationally advertised merchandise** direct from manufacturers, distributors and save! 850,000 items offered. Also big profit opportunities. Literature free. Olsen Publications, 1231-A East Third St., Duluth 5, Minn.

**BALL Pens \$10 gross, d.e.s.c. blades \$4.75 M.** novelty flashlights with batteries \$2.25 dozen, assorted ruffled plastic aprons \$1.40 dozen up, needlebooks with threader \$6.25 gross, YoYo tops \$12 gross. Lutzker, 871 East 170th, New York City.

**A Dress-lingerie shop in your home.** No investment. Good commissions. Write for sample book. Modern Manner, 260PA Fifth Avenue, New York.

**JAPAN Trade directory, 1954.** 400 pages, \$3.00 prepaid. Hoffman, 2842<sup>1</sup>/<sub>2</sub> Madison, Passaic, N. J.

**EXTRA Money every week.** I'll send you full-size Blair household products. Show them to friends and neighbors. You can make big extra profits. Write Blair, Dept. 31MA-1, Lynchburg, Va.

**FREE Hosiery!** Introduce sensational hosiery by giving every man and woman free trial pair to prove how good they are! Amazing nylon stockings guaranteed against runs and snags. New miracle one-size nylon two-way stretch socks. Contain no elastic yet fit any size foot. Never sag. Comfortable like second skin. Actually guaranteed one full year. Earn to \$3 hour in spare time. Mail postcard for free sample stocking and money-making outfits. Absolutely no obligation. Kendex, Babylon 83, N. Y.

**MAN Wanted—Are you dissatisfied with your work?** Would you like a business of your own? If so, write Rawleigh's, Dept. A-OO-PPM, Freeport, Ill.

**BEST Source for Nylons.** Rich Supply, 215 W. 98th, New York 25.

**SENSATIONAL Television development!** Instantly eliminates annoying commercials. 100% profit. Franklin, 2156-W, Los Angeles 54.

**EASY Extra income—**Sell sensational new scorch resistant silicone ironing board covers. Good Housekeeping approved. Terrific \$1.98 seller! Send for free complete selling kit. Menell Products, Dept. P-P.O. Box 431, Midtown Station, New York 18, N. Y.

**SAVE 50-75% On household appliances.** Free particulars. Wholesale catalog. Nueblings-P. Stickerville, N. J.

**SELL:** Watches, jewelry, household, gift items, national named brands. Guaranteed. Illustrated catalog and confidential wholesale price list 25c, refundable. H. Distributors, Palatine 5, Ill.

**SCHOOL Seniors—**Have fun and spending money! Be popular with your classmates. Send postal for details. Craftcards, Box 235-L, Pittsburgh 19, Penna.

**TWO In one screwdrivers.** Money maker. Sample 88c. Ideal Service, 4644 Geary, San Francisco 18, California.

**WINDOW Sign letters.** Samples free. West Coast Sign Letter Service, P.O. Box 897, Escalon, Calif.

**GOLD Or silver letters, numbers.** Windows, doors, trucks. 1" to 8". 500% profits. Free samples. Atlas, 544-T West 79th, Chicago 20.

**EASY Handwork** makes fast-selling useful articles. Sample free. Sunmade Company, Brockton 64, Massachusetts.

**MAKE Extra money.** Sell front door name plates to friends, neighbors. Retail \$1.98; you make \$1.00! Free selling kit. Modern Engraving Co., P.O. Box 194, Boston 14, Mass.

**YOUR Own business—**Used suits \$1.50, overcoats 65c, mackinaws 35c, shoes 12<sup>1</sup>/<sub>2</sub>c, ladies coats 30c, dresses 15c. Enormous profits. Catalog free. Moro, 558-AA Roosevelt, Chicago 7.

**AGENTS:** Stamping names on key protectors. Sample 25c. Stamping outfits, checks, social security and name plates. Hart Mfg. Co., 303 Degraw St., Brooklyn, N. Y.

**AGENTS—300% Profit** selling genuine gold window letters; stores and offices. Free samples. Metallic Sign Letter Co., 431-D North Clark, Chicago.

**EXCELLENT Sideline** for printing and advertising salesmen. Decalcomania name plates in small quantities. Great demand. Also, make money with our line of automobile initials and sign letters. Free samples. "Ralco" XL-Roxbury, Boston 19, Mass.

**\$1.00 PROFIT** Selling \$2.95 photo enlargement deal. Allen Studio, Riegler Bldg., Little Rock, Ark.

**BUY Wholesale** thousands nationally advertised products at big discount. Free "Wholesale Plan." American Buyers, 630-D Linden, Buffalo, N. Y.

**BIG Money** making opportunity. Exclusive line work uniforms. Jackets, pants, shirts, coveralls, advertising embroidered. Every business prospect. Outfit free. Master Div., Dept. 150, Ligonier, Ind.

**ADVERTISING Book matches—**Cash in on big demand; sell union label matches. Cuts for all businesses and political parties. Free powerhouse selling kit, low prices, protection guaranteed on repeat orders. Cash commissions. Superior Match Co., Dept. M-154, 7530 Greenwood, Chicago.

**CALENDARS.** Advertising novelties, matches. All styles, including religious, varnished, 12 sheet, girls. Hundreds of advertising novelties, book matches, etc. Fleming Calendar Co., Sales Division, 6539 Cottage Grove, Chicago 37, Ill.

**MONEY Making opportunity!** Take big profit orders for world famous patented varieties fruit trees. Also flowering shrubs, roses, vines. Big sales outfit free. Stark Bros., Desk 30114, Louisiana, Missouri.

**\$10,000 PROFIT** Selling printing, matches, specialties! Arrow dealer tells how he did it in giant free sales outfit. You can do it too—Without experience. Write Arrow Press, 515-B Fourth Ave. So., Minneapolis, Minn.

**SALESMEN—\$50.00** In a day definitely assured, selling brand new item going to every type of food and beverage store, factories, laboratories, hospitals, etc. Samples furnished. Utility Durawear, 53 West Jackson Blvd., Dept. PM-1, Chicago, Illinois.

**GARAGE Equipment** manufacturer seeks salesmen calling on garages. Investment for demonstrators only. Protected territories. Exceptional opportunity. Box 316, Berkeley City 21, Mo.

**IS \$210 A week** worth a postcard to you? Then rush card with name and address for special free trial plan that sells amazing new automatic refrigerator defroster like hot cakes! Write to Mr. Lewis, D-Proct-O-Matic Corp., Dept. K-102, 173 W. Madison, Chicago 2, Illinois.

**SELL Educational** service. Schools. Thousand month—opportunity. Professor Martin, Orient, So. Dak.

**AD Matches!** Sell amazing designs—20, 30, 40 and 240-light book matches. Bigger spot cash commissions; every business a prospect. Low prices for high quality. Repeats. Start without experience; men, women; full, part time. Buy nothing! Sales kit furnished. Match Corp., Dept. PM-49, Chicago 22, Illinois.

**ANYONE** Can sell famous Hoover uniforms for beauty shops, waitresses, nurses, doctors, others. All popular miracle fabrics—Nylon, dacron, orlon. Exclusive styles, top quality. Big cash income now, real future. Equipment free. Hoover, Dept. A-100, New York 11, N. Y.

**SELL Miracle orlon** embroidered work uniforms. Looks, feels like wool; wears 3 times longer and washes like cotton. Huge 3-foot wide "Panoramic" line makes sales easy. Amazing profits. Outfit free. Topps, Dept. 531, Rochester, Indiana.

**BIG Money, your own business.** Wonder Glaze, Bay Port 7, Mich.

**NAMEPLATES** For homes, desks. Biggest profits. Free samples. Carlton-Whitney, West Springfield, Mass.

**DISTRIBUTORS—**Large profits. Terrific repeat orders. Unique Italian brooms. Write Peacock, 400 Montgomery Street, San Francisco, California.

**AMAZING Discovery.** Master Glaze, puts brilliant glass-like surface on cars. Free sample, information. Big commissions. Master Glaze, Dept. 783, 7720 Harwood, Milwaukee, Wis.

**GET New shirt outfit free; make \$90.00** weekly on 5 average orders a day. Famous quality made-to-measure dress and sport shirts at \$3.95 up sell fast to all men. No experience needed. Pull or part time. Write Packard Shirt Co., Dept. 582, Terre Haute, Ind.

**MAKE Money** with fast-selling Bostonian shirts. Spare time, full time. Sales kit, actual sample fabrics, free. Bostonian, 89 Bickford, Dept. D-10, Boston 20, Mass.

**NEW Jobs** open in selling. Send name, address for five free issues of Opportunity Magazine's money-making guide, listing hundreds of companies who'll pay you well, full or part-time. No experience needed. Opportunity, 28 E. Jackson, Dept. 17, Chicago 14, Ill.

**MEN! Money!** Miracle Spray-A-Tint tints windshields, gives marvelous glare-protection, plus new 1954 look! Sprays on in jiffy. Reduces glare from sun, snow, headlights, etc. Lasts for years. Auto, truck owners buy on sight! Profits 100% up! Spray-A-Tint, Dept. PM-11, Consumers Bldg., Chicago 4, Illinois.

**RICH Opportunity** for men in their 50's. Healthful, pleasant occupation. No investment needed. 150 of our men made \$500 to \$3,000 in one month; many just beginners. Heckman made \$104 first 2 hours; Crowley made \$224 first day; exceptional earnings. Openings available. (If you live in Canada write President, Dept. PM, 23 Industrial St., Leaside, Ontario.) In U.S.—President, Dept. PM, Box 711, Fort Worth 1, Texas.

**NEW In U.S.A. Famous Lambretta scooter.** Exclusive territory for southeast area. Salesmen, agents, dealers, factory representatives. Write, Box 298, Ft. Lauderdale, Florida.

**\$185.00 WEEKLY** Interest you? Millions prospects. Details 10c. Sycamore, 13-PMJ, Oak Park, Illinois.



**MEN** Wanted to sell our established line of nationally known men's hygienic products to physicians and druggists. Extremely long profits. Many ready customers waiting for our salesmen. Free price list upon request. Send \$2.00 for salesman's sample kit including actual samples and prices of merchandise to be sold. Federal Premium Supply, 4307-J Lawrence Ave., Chicago 30, Illinois.

**BUY** Wholesale thousands nationally advertised products. Save money! Make money! Postcard brings details. Kemah Company, 5017-N Washington, Houston 7, Texas.

### EDUCATIONAL AND INSTRUCTION

**IDEAL** Mail order home study course. Particulars free. A. Spencer, Mokena, Ill.

**GROW** Mushrooms. Cellar, shed, and outdoors. Spare, full time, year round. We pay \$3.50 lb. We paid Babbitt \$4,165.00 in few weeks. Free book. Washington Mushroom Ind., Dept. 174, 2954 Admiral Way, Seattle, Washington.

**WELDING** Training pays at Hobart Welding School, Box M-141, Troy, Ohio. VA contract. Best equipment. Catalog free.

**HIGH** School—No classes. Study at home. Spare time. Diploma awarded. Write for free catalog HF-39, Wayne School, 2527 N. Sheffield, Chicago 14, Ill.

**WANT** A diesel job? New opportunities to increase income. Higher pay. More money. We can help you qualify. Tools. Shop method home training. Write today! Diesel, Tractor, Heavy Equipment Division, Interstate Training Service, Dept. B3-A, Portland 13, Oregon.

**LEARN** Priceless secrets of technical metaphysics. Easy to learn. Only school of its kind. Write: Premier College of Technical Metaphysics, 2532 McKenzie St., Vancouver, B. C., Canada.

**PIANO** Tuning pays. Learn this profitable profession at home. Our Tunometer and mechanical aids make learning easy. No knowledge music necessary. Diploma granted. Largest and oldest school—55th year. G.I. approved. Write for booklet, Niles Bryant School, 78 Bryant Bldg., Washington 16, D. C.

**TERRIFIC** New self-help book Cyclegram teaches science of life cycles in minutes, promotes success in love, business, health. 64-pages, retails \$1, wholesale introductory special 2 for \$1. Cyclegram, Box 301B, South Pasadena, Calif.

**SIGN** Painting—Learn quickly by easy method. Complete \$2.00. Particulars free. John Blackwell, Inverness, Florida.

**HEATING** And ventilating engineering, home study. Midwest Engineering School, 10923 Hilcrest, Hickman Mills, Missouri.

**CAN** A man my age become a hotel executive even though he has no previous hotel experience? Would you like to step into a well-paid position as hotel or club manager, purchasing agent, social director or assistant manager, etc.? The success of Lewis graduates from 20 to 50 proves you can—Though you have no experience in hotel work. Louis M. Reny says: "I took the Lewis Course after leaving the Air Force. Before graduation I had accepted a position through your Placement Department. Now assistant manager of a Washington, D. C. hotel. All this could not have happened without the help of the Lewis Training School." Our free book explains how you can qualify for a well-paid position in leisure time; how you are registered free of extra cost in Lewis National Placement Service. Write today. Course approved for Veteran Training. Lewis Hotel Training School, Desk KA-324, Washington 7, D. C.

**IT'S** Fun learning a language by Linguaphone. At home, in leisure time, quickly, easily master French, Spanish, German, Russian—29 languages by Linguaphone World's Standard Conversational Method. You listen, you hear men and women speak, you understand, you speak. Save time, money. Gain job, school, travel, cultural opportunities. Write for free book. Linguaphone Institute, 8301 RCA Building, New York 20.

**GET** Any government job you want. Complete preparation. Free catalog listing all jobs. Federal, 304P Chestnut Street, West Hempstead, N. Y.

**SECRET** Investigation. Experience unnecessary. Investigators particulars free. George Wagner, M125 West 86th, New York 24.

**UPHOLSTERY**—Profitable business. Job opportunities; excellent sparetime earnings quickly while training at home with practical N. Y. state approved UTS course. You learn professional furniture upholstery; slip cover, cushion, window cornice, drapery making. You make beautiful upholstered furniture, slip covers while learning. Course includes free all tools, frames, materials. Free illustrated book. Write today. Also resident training. Upholstery Trades School, Dept. CA-1402, 721 Broadway, New York 3.

**SHORTHAND**, \$3.00. Free lesson. Bowlers, 233 W. 42nd, New York City.

**CORRECT** Your thinking and change your life! Write Christian Way of Life, Box 1, Main Office, Louisville 1, Kentucky.

**OIL** Coloring photographs—A fascinating hobby or profitable sideline for those with artistic talent. Learn at home. Easy simplified method. Free booklet. National Photo Coloring School, 835 Diversey Parkway, Dept. 3432, Chicago 14.

**COMPLETE** Your high school at home in spare time with 57-year-old school. Texts furnished. No classes. Diploma. Information booklet free. American School, Dept. X145, Drexel at 58th, Chicago 37, Illinois.

**PHOTOGRAPHY** For pleasure or profit. Learn at home. Practical basic training. Long established school. Free booklet. American School of Photography, 835 Diversey Parkway, Dept. 3441, Chicago 14, Illinois.

**SUCCESS** Books. Powerful principles. List free. Davidson Co., Box 1232, Escalado, California.

**1954 GOV'T** Jobs! Start high as \$316.00 month. Men—women, 18-55. Qualify now! 30,000 jobs open. Experience often unnecessary. Get free 36-page book showing jobs, salaries, requirements, sample tests. Write: Franklin Institute, Dept. J-24, Rochester, N. Y.

**FINGERPRINTING** Course, \$12.00. Free details. Alabama School of Fingerprinting, 414 South 10th Street, Bessemer, Alabama.

**LEARN** Drafting—Write for free booklet, "Drafting Opportunities in Industry." Cesco Industrial Training Services, 1704-A Frederick, Fort Worth 7, Texas.

**LEARN** Shorthand at home. Successfully taught system for 24 years. Easily understood. No long tedious studying. Write Maude E. Frank Secretarial School, Ridge Building, Kansas City, Missouri.

**BECOME** A doctor of psychology or metaphysics. Learn secret of contentment, happiness. Win degree of Ph.D. or MsD. Solve mental worries. Free book. College of Universal Truth, 5038-C Broadway, Chicago.

**UPHOLSTERING** For profits—Instructions \$1.00. Information free. Custom Upholstering, D-6, Oxford, Penna.

**WINDOW** Display money making home course. Pan-America Art School, 321 West 56th, New York 19.

**SMASH** Worries, fears and problems with our "Thought and Behavior Control" home-study method. Many helped. Rush request for amazing free lecture in plain wrapper. Personal Psychology, Inc., Box 1924-E, Louisville 1, Ky.

**UPHOLSTERING** — Train at home for prosperous business. Tools, supplies sent. Illustrated training shows you—previous experience unnecessary. Establish full or part time business. Free booklet explains plan. Write Commercial Trades Institute, 1400 Greenleaf, Dept. U2A-1, Chicago 26.

**LEARN** To make miniature photo copies of any picture. Details free. John Doran, 1356-25 Street, Des Moines, Iowa.

**BE** Independent, learn auctioneering. Literature free. Pennell, 802 West Magnolia, San Antonio 1, Texas.

**STUDY** For degree of Doctor of Psychology (Ph.D.), Doctor of Metaphysics (Ms.D.) or Doctor of Divinity (D.D.). Write College of Divine Metaphysics, Dept. PM, 2811 North Illinois Street, Indianapolis, Indiana.

**CORRESPONDENCE** Courses, educational books, bought, sold, rented. Lists free. Magnolia Press, Box 1272-P, Burbank, Calif.

**PENMANSHIP** Courses. Improve your writing quickly. Learn shaded writing. Greeting cards—Name cards, elegantly written. Free literature. Tevis, A-25, Chillicothe, Mo.

**HIGH** School diploma at home. Licensed teachers. Approved materials. Southern States Academy, Box 144, MX Station E, Atlanta, Georgia.

**INCREDIBLE!** Become mental superman overnight! Free booklet! Bijou, Box 1727-MC, Hollywood 28, California.

**MIDLAND** Linotype School. Charles City, Iowa. Civilian and Veteran Courses. Free placement. Established 1909.

**BE** A real estate broker. Study at home or in classrooms in leading cities. Write for free book today. G.I. approved. Weaver School of Real Estate, 304 Law Bldg., Kansas City, Missouri.

**EARN** While you learn. Auto and diesel mechanics master this top paying trade. Many graduates earn \$100 a week and up. Approved for Korean veterans. For free information write Dept. No. 256, Nashville Auto-Diesel College, Nashville 3, Tenn.

**BOOKKEEPERS!** Increase your earnings! Operate your own simplified "Dollar-A-Week" bookkeeping and tax service. Full or spare time. Details free. No obligation. Ellis, Box 200, Cedar Grove, North Carolina.

**MEDICAL** Laboratory technicians in great demand. We train you in your own home. Catalogue free. Imperial Technical Institute, Box 973-J, Austin, Texas.

**INVESTIGATOR** Training. Phillips Secret Service System, 1917-B North Kenneth, Chicago 39.

**USED** Correspondence courses and books sold and rented. Money back guarantee. Catalog free. (Courses bought.) Lee Mountain, Pisgah, Alabama.

**GOVERNMENT** Position! Home training for examination, \$9.95. Refunded if don't pass. Write, Ozment Instructions, 34-CS, St. Louis, Mo.

**SIMPLIFIED** Analytics teach algebra instantly; \$1.00, guaranteed. Ziembeck, 6123 Orchard, Dearborn, Mich.

**UNIVERSITY** Degrees by residence and correspondence. Golden State University, Hollywood, Calif.

### PLAYS, STORIES, MANUSCRIPTS

**WRITE** For pay—Cash checks of \$1 to \$100 offered daily. Learn professional writers' secrets at home. Free details. Cummings Institute, Box 17006, Studio A-11, Los Angeles 17, Calif.

**HOW** To write short stories, mysteries, articles. Learn at home for career or extra part-time income. Graham Deor sold one story to Post, CBS radio and NBC-TV. Professional writers show you how. Send today for free lesson. Palmer Institute of Authorship, Desk TM-14, 1680 N. Sycamore, Hollywood 28, Calif.

**BEGINNING** Writers: Get \$1 to \$20 checks daily writing simple children's stories, articles, poetry in your sparetime. Experience unnecessary. Our instructions reveal how. Details free. W. Herman, 7016 Euclid, Cleveland 3, Ohio.

**NO** Luck finding a book publisher? Write for free Booklet PM. Vantage Press, 120 W. 31, New York.

### BUSINESS SERVICE

**TUCSON** Postmark! Confidential! Letters 25c plus postage. Hugh McInroy, 2614 N. Goyette Ave., Tucson, Arizona.

### SPECIAL SERVICES

**GHOST** Writer. Articles, letters. E. Eller, 1600 Sutter St., San Francisco 9, Calif.

**"VALLEY** Of the Sun." Prompt returns. 20c; postcards 7, \$1. Ratner, 3008 W. El Caminito Dr., Phoenix, Ariz.

**EXACT** Duplicate copies made of birth certificates, diplomas, and any printed matter \$1.00 each. Black and white only. Not photostatic. John Lycke, 1010 Bath St., Santa Barbara, Calif.

**PROMPT**, Reliable information on any subject. Questions on matters of fact answered, \$2.00 each. Gordon Research, Box 1427, Chicago 90.

**INFORMATION** On any matter. Ferguson Research Specialists, 118-14 141 St., South Ozone Park 36, N. Y.

**LETTERS** Remailed from Gaspee Peninsula, Canada and Newark, New Jersey. Send 25c. N. Bryker, Gaspee, Quebec, Canada or K. Saxton, 242 Mill St., Belleville, N. J.

**MAKE** Your will now! Will form, instructions and seals \$1 postpaid. 3 for \$2. Pacific Research, Box 907, Phoenix, Ariz.



BALTIMORE, Maryland and historic Gettysburg, Pennsylvania, letters mailed 25c, postcards 15c, Baltimore classifieds airmailed \$1.00. Ordermat, 225 Broadway, Hanover, Penna.

LETTERS Remailed. Write for rates. Remail Service, 4560 North 14th Street, Omaha, Nebraska.

### CARTOONING, COMMERCIAL ART, SHOWCARD WRITING, SIGN PAINTING

"HOW To Make Money With Simple Cartoons"—A book everyone who likes to draw should have. It is free; no obligation. Simply address Cartoonists' Exchange, Dept. 91C, Pleasant Hill, Ohio.

9 ALPHABET, 3 Numeral pattern sets and raised wood letter catalog, \$1.00. Sign Letter Distributors, P.O. Box 101, Mineola, N. Y.

LEARN How to write showcards quickly, easily. No special skill needed. Profitable lifetime business of your own. Details free. Sherwood Publishing Co., Irvington 15, N. J.

CHALK Talks. Laugh producing program, \$1.00. Catalog 10c. Balda The Cartoonist, Oshkosh, Wisconsin.

### ADVERTISING AGENCIES, LETTER WRITERS, FOR ADVERTISERS

FREE! 1954 Advertisers Rate and Data Directory, 52 pages! E. H. Brown Advertising Agency, 20 N. Wacker, Chicago 6.

FREE! 1954 Advertiser's Guide. Rates, ideas, publicity service. BT Nationwide Advertising Service, 2108 Payne, Cleveland, Ohio.

FREE Copy, layout service. Mailorder ad, 1,700,000 nationwide circulation, \$27.30 incl. 24-word classified, 20 big Sunday newspapers, \$30.00. Advertising ratebook free. Chicago Advertising Agency (established 1909), Chicago 4.

RADIO Stations seek mail order items to sell on commission basis. Stirling Associates, 210-K Fifth Avenue, New York 10.

MAILING Lists, most any classification. 1000 names \$5.00. 1000 your circulars mailed with ours \$4.00. 5000 your circulars printed and mailed \$12.95. Write Dixie Mailers, King, North Carolina.

ADVERTISE: 24 Words, 100 Canadian newspapers \$5.50. Lists free. Advertising Bureau, 10511-C Springfield, Chicago 43.

ADS Placed in out of town newspapers and magazines. Low rates. Catalogue free. Ideas that pay. Baker Advertising Agency, Successors Ankrum Agency, 189 W. Madison, Chicago 2.

ADVERTISERS! Reach nearly 18,000,000 readers. 25 Sunday national key newspapers, 18 words, \$59.00. "Terrific pullers." 20 popular newspapers, \$11.50. Free booklet. Special—One inch display 2-321.198 circulation, \$51.10. Newark's Advertising Agency, (Established 1893), 217-7th Ave., New York 11.

### RUBBER STAMPS AND OFFICE SUPPLIES

FREE Catalog and printing samples. 2 lines 45c, 3-45c, 4-80c. 1000 2 color business cards \$3.00, 100 white envelopes \$1.00 or 1000 for \$6.10, postpaid. Esco 14 Print, 8 Holt, Dayton 7, Ohio.

RUBBER Stamps. Send for catalog. Excello, Box 500, Shreveport, Louisiana.

RUBBER Stamps—3 lines \$1.00. U.S. postpaid. Catalog—South Coast Press, 2128 Mt. View, San Bernardino, California.

10 BALLPOINT Pens \$1.00 postpaid. Cheaper than refills. Money back guarantee. Sorry no c.o.d.'s. Calpen Company, P.O. Box 2164, San Francisco 19, Calif.

3 LINES, 75c. Catalog free. Raymond McVaine, Box 86-PM, Brooklyn 30, N. Y.

3 LINES, \$1.00. Past service! Catalogue. Johnson Press, Box 6-A, New York City 26.

### TYPEWRITERS, DUPLICATORS, OFFICE DEVICES

TYPEWRITERS, All kinds, wholesale prices. Miller, Box 505-P, Poteau, Okla.

VARIETYPER. Electric typewriters, \$110. Sachs, 119 W. 23 (PM), New York 11, N. Y.

RECONDITIONED Typewriters, duplicating, printing devices, \$25.00 up. Supplies. Appliances. DixieGraph, King, N. C.

### PRINTING, MULTIGRAPHING, MIMEOGRAPHING GUMMED LABELS

1000 BUSINESS Cards \$2.95, samples. Scull's, 121 West 25th Avenue, Dept. B4, Wildwood, New Jersey.

100 BILLHEADS, 8 1/2 x 11 Letterheads, or envelopes \$1.00 postpaid. Gillingham, Milford, Conn.

DISTINCTIVE Raised print business cards. 29 type styles. Free samples, type chart and price list. Write A. O. Gerwig, Box 335, Columbus 4, Ohio.

ATTRACTIVE Printing, labels, stickers. Inexpensive. Samples. Fame, 291 Ellis, San Francisco 2, Calif.

DISTINCTIVE Printing, Samples, prices. Klifford, 545 North Oakland, Pasadena 4, California.

100 ENVELOPES. Printed 2-colors \$1.25. Box 523, Rochester 2, N. Y.

ENVELOPES 6 3/4, 1M \$4.00 f.o.b. Abernethy, 1423A Edwards, New York 61, N. Y.

PRINTING. Write for samples. Clifford Boals, Box 90, Kensington, Ohio.

MIMEOGRAPHING. Mailing, addressing. Reasonable. Mimeographers, 7404-58 Pl. Summit, Illinois.

125 8 1/2 x 11 LETTERHEADS And 125 6 3/4 envelopes \$2.50 postpaid. 250 of each \$4.50. Going Print Shop, Box 1544A, Muskogee, Oklahoma.

BUSINESS Cards, printing, Reasonable prices. Free catalog. Lites, 5352-PM Princeton, Chicago 9.

GUMMED Labels, stationery. Free list. Reed, Box PM-135, Spiro, Okla.

JOB Printing, Letterheads, envelopes, circulars. Printing, 21 Barclay, Portsmouth, Virginia.

100 8 1/2 x 11 LETTERHEADS. Carefully printed, \$1.00 postpaid. Envelopes same. Race Printers, Hudson, New York.

BEAUTIFUL Two color raised print business cards. Dignified, appealing. Send for samples, prices. J. Hampton, 601 1/2 N. Main, Wichita, Kans.

1000 THERMOGRAPHED Business cards, case, \$3.75. Electric Shaver, \$3.95. Johnson, 1129-A State, Harrisburg 33, Pennsylvania.

LETTERHEADS, Envelopes, billheads or statements 75c per 100 postpaid. DiBenedetto's Printers since 1924, Box 171, Chelsea, Mass.

1000 3/4 x 2 GUMMED Labels neatly printed with your name, business, address, \$1. Other printing. Samples free. Cramer, 1010 East Morgan, Martinsville, Indiana.

100 ENVELOPES. Printed 2-colors \$1.25. Box 523, Rochester 2, N. Y.

MIMEOGRAPHING — Letters, forms, bulletins, anything. Samples. Brennen, 1404 Carolina, Middletown, Ohio.

1000 PROCESSED Engraved business cards \$3.95 delivered. The Guild, 2702 Georgia Avenue, Washington, D. C.

MIMEOGRAPHING 8 1/2 x 11, 250 White \$3.25 postpaid. Guaranteed. Arnolds, Box 524e, Sacramento 2, California.

100 8 1/2 x 11 LETTERHEADS, 100 6 3/4 Envelopes, \$2.00, 250 each, \$3.75. 500 business cards \$1.95; 1000, \$2.50. Standard copy. Postpaid. Allen, Dept. PMP, Clinton, Missouri.

100 PRINTED Envelopes or letterheads \$1.00. Two colors \$1.50. Salesbooks. Broadbrook, Botsford, Conn.

MIMEOGRAPHING — Anything! 200, 8 1/2 x 11, \$2.00; 500, \$4.00; 1000, \$6.00. Guaranteed. Free samples. Quinn Sales, P.O. Box 967, Little Rock, Ark.

TWO Color 8 1/2 x 11 letterheads, 500, \$3.50. Samples. D'Yarmett Printing, Newark, Ohio.

MIMEOGRAPHING — Letters, price lists, formulas, instructions. Lowest prices. Lem's Letter Shop, 5710 Stanton, Detroit 8.

500 3/4 x 2 1/4 FOUR Line gummed stickers 50c. Red border \$1.00. Moritz Printery, Saginaw, Mich.

BUSINESS, Personal stationery. Catalogs free. Howprint, 723-M Eunice, Webster Groves 19, Missouri.

### PRINTING OUTFITS AND SUPPLIES

MAKE Your own self-molding printing cuts. Flexirubber, Argyle 1, Wisconsin.

PRESSES, Type, cabinets, supplies. List for stamp. Lincoln Press Company, 220-Z Hartwell, Fall River, Mass.

CAST Your cuts, rubber stamps. Catalog presses, supplies, paper 10c. Custom, Box 211-P, Springfield, Missouri.

HAND Presses, small paper cutters, type cases, etc. Visit our store. Van Dillen Inc., 74 Beekman St., New York City.

DO Your own printing. Save money. Simple rules. We supply everything. Print for others; good profit. Raised printing like engraving too. Have home shop. Details free. Kelsey Presses, V-11, Meriden, Connecticut.

PRINTING Presses, type, supplies. Lists 3c. Turnbaugh Service, Loysville, Penna.

### PATENT ATTORNEYS

"INVENTOR'S Guide" and "Record of Invention" free on request. Frank P. Lederhann, Registered Patent Attorney, 154 Nassau Street, New York City.

INVENTORS—If you believe you have an invention, you should find out how to protect it. The firm of McMorrow, Berman & Davidson with offices in Washington, D. C., is qualified to take the necessary steps for you. Send for copy of our patent booklet "How to Protect Your Invention." We will also send you an "Invention Record" form. No obligation. They are yours for the asking. McMorrow, Berman & Davidson, Registered Patent Attorneys, 1343 Victor Building, Washington 1, D. C.

INVENTORS—If you consider your invention to be something of importance, take steps to protect it with a United States Patent which gives you the right to exclude others from making, using and selling your invention as claimed. "Patent Protection for Inventors" outlines steps to take to secure patent protection. Mailed promptly without obligation. Victor J. Evans & Co., Merlin M. Evans, Registered Patent Attorney, 931-A Merlin Building, Washington 6, D. C.

ALL Latin America, patents, trademarks, pharmaceutical licenses. Box 830, Lapaz, Bolivia.

PATENTS—Irving L. McCathran, 315 McLachlen Bldg., Washington 1, D. C. Registered Patent Attorney.

REGISTERED Patent attorney offers services. Sanders, 6430 Evans, Chicago 37, Ill.

INVENTORS: When you are satisfied that you have invented something of value write me, without obligation, for information as to what steps you should take to secure a patent. Write Patrick D. Beavers, Registered Patent Atty., 935 Columbian Bldg., Washington 1, D. C.

PATENTS. "Proof of Invention" free. E. E. Vrooman, Registered Patent Attorney, 507 McKim Building, Washington 5, D. C.

INVENTORS: Without obligation, write for information explaining the steps you should take to secure a patent. John N. Randolph, Registered Patent Attorney, 203 Columbian Bldg., Washington 1, D. C.

C. A. Snow & Co.—M427, Snow Building, Washington 1, D. C. Registered Patent Attorneys. Write for information.

INVENTORS — For "Invention Record" form, contact Carl Miller, Registered Patent Attorney, Woolworth Building, New York.

INVENTORS: Learn how to protect your invention. Unless the inventor is familiar with patent matters, he should engage a competent registered patent attorney or agent to represent him. We are registered to practice before the U.S. Patent Office and prepared to serve you in handling your patent matters. "Patent Guide for the Inventor" containing detailed information concerning patent protection and procedure with "Record of Invention" form will be forwarded to you upon request—without obligation. Clarence A. O'Brien & Harvey Jacobson, Registered Patent Attorneys, 41B-A District National Building, Washington, D. C.

### FOR INVENTORS

INVENTORS—Send for free patent information book and inventor's record. Registered Patent Attorney, Associate Examiner, Patent Office 1922-29; Patent Attorney & Advisor, Navy Department 1930-47. Gustave Miller, 14A Warner Building, Washington 4, D. C.

PATENT Searches \$5.00. Complete reports airmailed within 48 hours. Free invention protection forms. Write Miss Ann Hastings, P.O. Box 176, Washington 4, D. C.



**INVENTORS:** Learn how to protect your invention. Unless the inventor is familiar with patent matters, he should engage a competent registered patent attorney or agent to represent him. We are registered to practice before the U.S. Patent Office and prepared to serve you in handling your patent matters. "Patent Guide for the Inventor" containing detailed information concerning patent protection and procedure with "Record of Invention" form will be forwarded to you upon request—without obligation. Clarence A. O'Brien & Harvey Jacobson, Registered Patent Attorneys, 41A-A District National Building, Washington, D. C.

**PERPETUAL Motion** impossible without overcoming friction. Bulletin 12, \$1.00, describes simple, cleverly contrived, magnetic arrangement for overcoming friction. Numerous ideas included. Cash for your ideas printed. Bulletin 11 still available. Ideas, 310-A Harlem, Glenview, Ill.

**43 THINGS** to do before applying for patents. Free information. Fred G. Roth, 657 East 26th Street, Brooklyn 10, N. Y.

**PATENT Searches \$5.00.** 48-hour service. Free record of invention. Write Raymond L. Smith, Patent Searcher, 622 Sheraton Building, Washington 5, D. C.

**MODELS.** Novelty products, photographed. \$5.00. Hollywood Portrait Studios, 200-A Columbus Avenue, New York 23.

**PATENT Searches \$5.00.** 48-hour airmail service. Record of invention forms free. Patent drawings prepared. Write Patent Engineering Service, 711 14th Street, N.W., Washington 5, D. C.

**INVENTORS.** "Thirty Years Experience with Inventions and Inventors" is an education in dealing with lawyers, patent attorneys, patent brokers and financiers worth thousands of dollars. Don't mortgage your home until you have read this copyrighted book. Price \$5.00. Full information free. Claudius Nielsen, Consulting Engineer, P.O. Box 4703-A, Detroit 19, Mich.

**MY 7th Invention** paid \$750,000. Others paid well. I learned the hard way what inventors should know, must avoid. My new book tells all, can save you thousands, help you make fortune. Only \$1. Refunded if not delighted. Write "Inventor," Post-office Box 5, Station B, Omaha, Nebraska.

**PATENT Searches, \$5.00,** including patent copies. Same reliable search as conducted for patent attorneys. Free protection forms. Patent Service Institute, 945-A Pennsylvania Avenue, Washington 4, D. C.

**CASH** for your idea, 280 manufacturers need inventions, patented or unpatented. List free. Invention Bureau, 208M Clinton, Oak Park, Ill.

**INVENTORS —** For "Invention Record" form, contact Carl Miller, Registered Patent Attorney, Woolworth Building, New York.

**MAKE Money** from your ideas, gadgets, patents. Get "Inventors Guide." Helpful book tells you how. Send \$1.00, includes list of needed inventions. We have buyers. Inventors Creative Service, 354 South Spring, Los Angeles 13, Calif.

**SEARCHES—**Put your patent searches in the hands of a registered patent attorney or agent, as he qualifies to give a worthwhile patentability report. Record of invention form upon request and information on patent protection. Patrick D. Beavers, Registered Patent Attorney, 936 Columbian Bldg., Washington 1, D. C.

**INVENTORS:** If you have an invention for sale, patented or unpatented, write Institute of American Inventors, Dept. 40A, 631-E St. N.W., Washington 4, D. C.

**INVENTORS:** Information on patent procedure furnished on request, without obligation. John Randolph, Registered Patent Attorney, 202 Columbian Building, Washington 1, D. C.

**I Sell patents.** Established 1900, Charles A. Scott, 773PM Garson Avenue, Rochester 9, N. Y.

**INVENTORS—**If you believe you have an invention, you should find out how to protect it. The firm of McMorrow, Berman & Davidson with offices in Washington, D. C., is qualified to take the necessary steps for you. Send for copy of our patent booklet "How to Protect Your Invention." We will also send you an "Invention Record" form. No obligation. They are yours for the asking. McMorrow, Berman & Davidson, Registered Patent Attorneys, 1342 Victor Building, Washington 1, D. C.

**INVENTORS—**This firm is registered to practice before the United States Patent Office and is available to assist you in the preparation and prosecution of your patent application. "Patent Protection for Inventors" booklet containing detailed information and steps to take toward patent protection will be sent upon request. No obligation. Victor J. Evans & Co., 932-A Merlin Building, Washington 6, D. C.

"**INVENTOR'S Guide**" and "Record of Invention" free on request. Frank P. Ledermann, 154 Nassau Street, New York 38, N. Y.

### INVENTIONS WANTED

**INVENTORS:** If your invention is adaptable to our business we will contract on cash or royalty basis. If not, we will try to place. Write today. Kessler Sales Company, Dept. 51, Fremont, Ohio.

**INVENTIONS Promoted.** Best handling. Reasonable cost. Write for free particulars. Superior Inventions Agency, 240 South Beverly, Beverly Hills, Calif.

**CASH Buyers** for ideas and inventions. Write National Inventors Institute, 4697 East 131st St., Cleveland 5, Ohio.

**IDEAS, Inventions sold.** Broker Service, 2408 West Washington, Charleston, W. Va.

**MARKETING Aid —** Nation wide. Patented, patent pending. Booklet free. Market Contacts, 719-A2 Magnolia, Tupelo, Miss.

**INVENTIONS Promoted.** Patented or unpatented. Established 1911. Write Adam Fisher Company, 61 Enright, St. Louis, Mo.

**INVENTIONS Wanted.** Patented, pending only. Inventors Patent Exchange, Hartford 1, Conn.

**INVENTIONS Wanted.** Patented; unpatented. Tremendous manufacturers lists. Global Marketing Service, 1404 Mitchell, Oakland 1, California.

**INVENTIONS Wanted.** Patented or patent pending. 23 years experience promoting inventions. National Service Bureau, 3120 Meramec, St. Louis 18, Mo.

### PATENTS FOR SALE

**COIN Operated shoe shine machine,** cleans, applies polish, shines. B. C. Ashley, 3922 Dover, Houston, Texas.

**PATENTS For sale.** Household goods. Dr. Robertis, Cross City, Fla.

**INVENTORS:** Test the commercial value of your patented or unpatented inventions, quickly and inexpensively. Write for free information. Institute of American Inventors, Dept. 40-B, 631-E St. N.W., Washington 4, D. C.

### MANUFACTURING

**MODELS —** Small lot manufacturing. Metals, plastics, etc. Milburn, Burlington, Kentucky.

### MODELS, MODEL SUPPLIES

**1954 CAR Models.** 1/25 scale, all metal, chrome trim. Send for catalog. Ajax Co., Dept. PM-14, 2637 Division, Chicago 22.

**BRASS Gears** and model supplies for the inventors. Send 10c for catalog. Pierce Model Works, Tinsley Park, Ill.

**NEW Completely revised** giant 88-page 1954 "O" gauge catalog for model railroads. Scale and tinplate. Fully illustrated. Hundreds of car kits all types, steam locomotives, diesels, specialty items and parts galore. Catalog cost of 75c refunded with first \$5.00 order. All-Nation Hobby Shop, 182 N. La Salle St., Dept. A, Chicago 1, Ill.

**RAILROAD Road bed —** Green sponge curved or straight track, 10c per section. Minimum \$2.00 prepaid. Bob's Hobbies, 1214 37th Northwest, Canton, Ohio.

**LIVE Steam engine,** 10 1/2" high, ready-to-run. \$3.95 postpaid. Catalog 35c. Merlo, 50-18 94th Street, Elmhurst 73, N. Y.

**POWER Models.** Unusual steam, gasoline and traction engines, fittings, metals. Anniversary catalog 50c. Chas. Cole, Ventura, Calif.

**STEAM Locomotives,** 1 1/2", 1", 3/4", 1/2", 1/4" scales. Castings, rail, steam fittings! Thorough drawings with instructions. Catalog 50c. Little Engines, Wilmington, California.

**BUILD Historic ships, vehicles.** 50c to \$9.00 kits. Illustrated catalog 10c. Ideal Models, 21 West 18th Street, New York 11.

**SHIP And other scale models.** Most complete line in New England. Kits, fittings, plans, books, tools, engines, motors. Illustrated catalog 25c. James Bliss & Co., Inc., Dept. SM, 342 Atlantic Ave., Boston 10, Mass.

**SHIP And yacht model fittings; blueprints.** Send 25c for illustrated catalog No. 28—listing hundreds of items. A. J. Fisher, 1002-1 Etowah Ave., Royal Oak, Mich.

**BALSA Wood,** Grade AAA. Free sample, price list. Sig Mfg. Co., Montezuma, Iowa.

### HOME CRAFTSMEN

**DOWELLING Jig** works on any surface \$2.95. Bevel disc for jointing any edge. Lee, Box 22PM, Rochester 17, N. Y.

**16 NEW Lawn chairs,** 22 picnic tables, benches, trellises, etc. All 38 plans with necessary full size patterns, \$1.00. Mastercraft 13M, 7041 Olcott, Chicago 31, Ill.

**ASSEMBLE Jewelry, gifts.** Free catalog, details. Novelcrafts Co., 25 Adrian Ave., New York 63, N. Y.

**WHOLESALE Leather list free.** Tinnin Leather, 213 East Walnut, Columbus, Ohio; 4014 Olive, St. Louis, Missouri.

**14 LARGE Whatnot patterns** \$1.00. Joannes, Box 141, Omaha 7, Nebraska.

**FREE Leathercraft catalogue** showing ready-to-assemble kits in full color, lacing instructions, doodle pages, wallet designs, index of all craft tools. Complete stock of leathers, lowest prices. Write Tandy Leather Company, Box 397M, Tulsa, Okla.

**JIGSAW Owners attention!** Start earning money at home cutting out wooden novelties and souvenirs. Write H. Cook, Dept. A, 4467 S. Normal Ave., Chicago 9, Illinois.

**90 ALL New, full size lawn ornament** and novelty patterns, up to 20" high. Only \$1.00. Mastercraft 12M, 7041 Olcott, Chicago 31, Illinois.

**BUY Wholesale** nationally advertised power, hand tools, thousands of other products at big discounts. Free "Wholesale Plan." American Buyers', 628-PP Linden, Buffalo 16, N. Y.

**LEATHERCRAFT.** Tremendous stock of leather, tools, supplies, and kits. In leather business over forty years. Send 10c for big catalog. Sax Bros., 1111 No. 3rd, Dept. PMI, Milwaukee 3, Wisconsin.

**LEATHERCRAFT.** Everything needed by beginners, advanced hobbyists and professional leatherworkers. Largest stock of supplies in U. S. Moderate-priced tooling leathers, top quality calfskins, tools, supplies, kits. Send 10c for big catalog. J. C. Larson Co., 820 S. Tripp, Dept. 3850, Chicago 24.

**METAL—**Rounds, flats, sheets. Small order inquiries invited. Tools, Will's Crafts Service, Box 3923, Detroit 27, Michigan.

**101 FULL Size patterns.** Smart, new, gifts, novelties, lawn figures, shelves, action windmills, alphabets. Plus "Make Money Jig Sawing." Only \$1.00. Mastercraft 15M, 7041 Olcott, Chicago 31, Illinois.

**ALUMINUM.** Brass, copper sheet, rod. Price list free. Arnott's, Box 294, Aber Road, R. D. #1, Verona, Penna.

**BIRDHOUSES.** 20 Proven plans for attractive homes and feeders. \$1.00. Bird-box, Dept. M-1, 159 Clyde, Baltimore 27, Md.

**KNOCKDOWN Cedar chests.** Lumber and veneers. Free price list. Giles & Kendall Company, Huntsville, Ala.

**LEATHERCRAFT Spring punch.** Makes oval lacing holes 3/32", 1/4". Write A. Mullin, 972 Harless Ave., San Jose, California.

**PETER Pan, Snow White, Seven Dwarfs, Cinderella, Red Riding Hood, etc.** Full size patterns 16" to 24" high. All for \$1.00. Mastercraft 17M, 7041 Olcott, Chicago 31, Ill.

**PINE Root** for beautiful driftwood lamp, \$1.00 plus postage c.o.d. Instructions included. Gover's Sales, Sheridan, Michigan.

**PROFITABLE Jigsaw patterns.** Folder, Pauls, 2233A North 35th, Milwaukee 8, Wis.

**WOODWORKERS.** Unique bench clamp. \$1.00 postpaid, 761 Washington St., Venice, Calif.

**93 ORIGINAL Idea jig saw patterns** \$1.00. Professional drawing, quality printing. Full size shelves, toys, lawn ornaments, novelties. Walker Studio, V1-PM, 4343 Lindell, St. Louis 8, Mo.

**GRANDFATHER Clocks,** weight driven movements. Wills Bros., 237 South Ellwood Ave., Baltimore 24, Maryland.



**BRASS** Rods. List free. Miller, 388 East 34 St., Brooklyn 3, N. Y.

**HOOKED** Rug workers. Guaranteed bur-lap marker \$1.00. Jet, Box 188, Boston 30, Mass.

**VIOLINMAKERS**, Amateurs, professionals, fine tone European wood. Materials, instructions, tools, patterns. Illustrated catalogue. 10c refundable. Premier Violin Supplies, Dept. VZ, 430 South Broadway, Los Angeles 13, California.

**ZONA** Razor and homecraft saws, 4½" blade \$1.00 and 6" blade \$1.50. For all fine work. Cuts metal, too. Arizona Products, 9307 North 9th Avenue, Phoenix, Arizona.

**MAKE** Professional signs. Die-cut transfer letters. Layouts. Guaranteed. Sample lettering. Details 10c. C & E Specialties, Chippewa Falls, Wisconsin.

**LAMP** Size cypress knee \$1.00. Cy Products, Dept. 1, Lafayette, La.

**FURNITURE** Handles. Solid brass. Free literature. Colony House, Box 1892, Huntington, West Virginia.

**UNPAINTED** Hydrocol plaques and figurines. Many original pieces not advertised before. Latest African masks, etc. Moulds for sale and made to order. Illustrated copy 25c. Harrington House of Hobbies, Box 163, Maywood, Illinois.

**PLASTICS** Home-craft course for men and women. Tells and shows how to make hundreds of fast selling plastics products. All plastics and materials for 23 projects included in course. No special tools needed. Course pays for itself. Write for free booklet. Interstate Training Service, Dept. D-3-A, Portland 13, Oregon.

**FREE** Do-it-yourself leathercraft catalog. Tandy Leather Co., Box 791-FF, Fort Worth, Texas.

**WROUGHT** Iron ash trays, lamps, tables. Full size plans, no welding necessary. Send \$1.00. Home Craft, Box O, Pelican Rapids, Minnesota.

**LEATHERCRAFT** Supplies. Pre-cut kits, tools, etc., large stock. Catalog 10c. refunded first order. Whitman Saddle Mfg. Co., 1725 Powers St., Cincinnati 23, Ohio.

**STEEL** Floor flanges. Grothe Manufacturing Company, 9002 Madison Avenue, Cleveland 2, Ohio.

**100** FULL Size jig saw patterns up to 20" high, only \$1.00. Pattern Service, Medway 9, Mass.

**846** FROM Square foot plywood; jigsaw necessary. Write: Woodarts, Bridgewater, Mass.

**129** NEW Full size jigsaw patterns. Unusual novelties, gifts, lawn figures up to 22 inches high, action (merry-go-round) windmill, toys, useful gadgets. Artist drawn. \$1. Craftplans, 1331-A South Michigan, Chicago 5.

**CRAFT** Leathers, supplies, lacing, kits, tools. Send 25c for latest catalog. Jonas Handicraft Co., 30 Frankfort Street, New York 38, N. Y.

**FREE** Information. Money-making full size patterns. Professional designs. Furniture, gift shop items. Write Jigsawers, 117 Worth, New York 13.

**SPECIAL** Offer. 102 full size jig saw patterns only \$1.00. Lynds, 71 Park, Natick, Mass.

**35** LAWN And garden ornament patterns. Full size, ready cut, colors indicated. \$1.00 postpaid. Lincoln Craft Studio, Columbia, Conn.

**HOW** To refinish your own furniture. Krafters, Box 86, Hubbard, Ohio.

**LEATHERCRAFT**—New stylecraft folder free. New kits illustrated. Filigree belts, billfolds, purses, etc. Send 25c new catalog. Refunded first order. Apache Leather Co., 2804 East Washington St., Phoenix, Arizona.

**LEATHER**, Tools, lacings, supplies. Free catalog. National Handicraft, 199 William St., New York 7.

**"TOPS"** In everything for leathercraft. Lowest prices. Genuine "Craftool" stamps. Catalog 10c. Crown Leather Company, 22 Spruce Street, New York 38.

**KNOCKDOWN** Cedar chests and lumber. Free price list. Bedford Lumber Company, Shelbyville, Tennessee.

**LEATHERCRAFT**, Metal tooling, textile painting, beadcraft, shellcraft. Many other crafts. Send for free, big, illustrated catalog today! Kit Kraft, Hollywood 46, Calif.

## MAKE IT YOURSELF

**YOUR** Workshop incomplete without Easy Plater. Free catalogue, booklet. Easy Plater, Box 293 PM6, Red Lion, Penna.

**ADMIRAL** New refrigerator cabinets. \$27.50. Metro, 44 North Albany, Chicago.

**YOU** Cast anything with metal. Free literature. Castings, Box 124, Lynwood, Calif.

**BUILD** Inexpensive concrete blockmaker. Motor-hand. Then, make blocks for 5 room house for \$95. Write: C. Lee, Mountain View, Oklahoma.

**SLIDING** Door units. All hardware, instructions, drawings supplied. Knockdown wooden parts, doors, accessories available. Drawings alone \$1.00. Write Greenlee Products, Hollywood, Fla.

**BUILD** Streamlined plywood kitchen cabinets. Plans, photos, instructions, 50c. Playcabinets, 4617 Johnson, Western Springs, Ill.

**HOMES** Built for practically no cost. Details ten cents. Tom-Bilt Homes, Box 481-M1, Fitzgerald, Georgia.

**MAKE** Your own stone-veneer. Economical, easily made, quickly applied. Looks like genuine stone. Formulas, illustrations, patterns \$1.00. Alburg, Box 17, Carrollton, Mich.

**CONCRETE** Block homes. 32 page booklet on how to build. \$1.00. H. C. Lightfoot, Civil Engineer, Richboro 1, Penna.

**HEATER** For shop, etc. \$10 builds it. Fuel cost \$10 to operate all winter. Plans \$1.50. Super Home Models, \$2. Both \$3. Twain Associates, Box 446, Hannibal, Mo.

**CONVERT** Your hand lawnmower to electric power. Tested performance. Complete plans \$2.00. Convert-A-Mower Co., Box 169, Syracuse 1, New York.

**PATENTS** For free use. List and instructions \$1.00. Glen-Lea Company, Box 164, Valley Stream, New York.

**GRANDFATHER** Clock easily built. Big savings. See ad on page 275.

**BUILD** Luggage and cases at home. We sell your products. No special tools or equipment needed. Free details. Casecraft 805-P2 Sunset Blvd., Los Angeles.

**MODERNISTIC** 3 Bedroom dream home. Build it yourself \$985. Plans, material lists, simplest step-by-step instructions. Financing methods. Cash in on building boom's enormous profits. \$1.00. C. E. Langford, Building Contractor, Box 353, Lemon Grove, California.

**BUILD** Copyrighted concrete block duplex \$1300. Livingroom, kitchenette, bedroom, bath, each side. Blueprint, instructions, material cost list \$1.00. Bailey Builders, 915 Pyramid Building, Little Rock, Arkansas.

**BUILD** A treasure and metal detector. Lightweight, sensitive, inexpensive. Complete kits, free literature. Dept. 1, Electronic Applications, Box 4975, Washington 8, D. C.

**BUILD** Your own tractor. Free information. Eltraco, D-1, Camptonville, California.

**MELT** Iron for castings. Free literature. Urats Burner, Box 92, Globe, Ariz.

**BUILD** 3 Bedroom rancher. Large rooms. Fireplace. Only \$1200. Plans \$1.00. Minkoff, Box 32, Flushing, N. Y.

## WATCHES, OLD GOLD, JEWELRY

**WRIST** Watch special. Wrist alarm \$18.95; self winding \$24.95, calendar \$7.50, chronograph \$5.98. Clark, 9521 Hoff St., Philadelphia 15, Penna.

**HIGHEST** Cash paid for old gold, broken jewelry, gold teeth, watches, diamonds, silverware, spectacles, platinum. Free information. Satisfaction guaranteed. Rose Smelting Company, 29-A East Madison, Chicago.

**TWO** New books show how to make jewelry at home and how to sell what you make. Send 25c for "How to Make Costume Jewelry" and "A Success Plan For You." Castolite, Dept. AJ-101, Woodstock, Ill.

**WATCHMAKERS'** Tools, materials, supplies, watches. Catalog. Gales, Box 1000, Chicago 90, Ill.

**HIGHEST** Prices paid for old gold, silver, platinum, diamonds, watches, gold teeth, spectacles. Cash immediately. Goods returned if offer unsatisfactory. United Smelting Works, (The Old Reliable), 6-B East Monroe, Chicago 3.

**CUCKOO** Clock repair. Beach's Clinic, 4055 S.E. Taylor, Portland 15, Ore.

**RHINESTONES**. Jewelry settings, camoes, sequins, beads. Send 10c for illustrated catalog. J & M Novelties, Dept. CA-3, Griffith, Ind.

**FIX** Watches for pay or pastime. Free sample lesson. Chicago School, Dept. PM-1, 2330 Milwaukee Ave., Chicago 47, Ill.

**WATCH** And clock repairing books for hobbyists. Free information. North American, Dept. 14-A, 2320 N. Milwaukee, Chicago 47, Illinois.

**10** HIGH-Grade Swiss ladies' and gents' wristwatches needing minor repairs. \$18.00. Write for prices. B. Lowe, Holland Bldg., St. Louis 1, Mo.

**WATCHMAKERS'** Journal for watchmakers, hobbyists, collectors. Sample copy 20c. Box 3218, Daytona Beach, Fla.

**5000** JEWELRY Styles you can easily make yourself. Rhinestones, pins, earrings, etc. Lowest prices guaranteed. Instructions and catalog 10c. Barry's, 165 Ardsley Court, Newark, N. J.

**WATCHMAKERS'** — Jewelers' complete informative catalogue 20c. Bengale Company, Culver City, California.

**JEWELRY** Making can be a profitable hobby—Send 20c for our latest illustrated catalog. Milady-Fair Co., G.P.O. Box 1328, New York City.

## TOBACCO, SMOKERS' SUPPLIES

**PIPE** Smokers! Cigar smokers! Free illustrated catalog saves up to 50% on choice imported, domestic pipes, cigars, tobaccos, supplies. Write Wally Frank, Dept. 231, 150 Nassau St., New York 38, N. Y.

## RAZORS, BLADES, SHARPENING

**55** YEARS Shaving before I found comfortable way. Yours for \$1. Dr. Roberts, Cross City, Fla.

## FOR THE HOME

**HEAT** Homes efficiently. Prints marked. Bill of material listed. Details free. Garver Company, Vermilion, Ohio.

**FOAM** Rubber furniture cushions. Factory seconds. 50% discount. Prices free. Perma-Foam, 140-C Main Street, East Orange, New Jersey.

## OF INTEREST TO WOMEN

**MONEY** For you—Quickly, easily. Everybody is waiting to see gorgeous, newest dresses for Easter, spring. Show your friends. No investment. No experience necessary. Free style kit. Melville Co., Dept. 8347, Cincinnati 25, Ohio.

**GROW** Mushrooms. Cellar, shed, and outdoors. Spare, full time, year round. We pay \$3.50 lb. We paid Babbitt \$4,165.00 in few weeks. Free book, Washington Mushroom Ind., Dept. 176, 2954 Admiral Way, Seattle, Washington.

**EMBROIDER** Stamped linens. Buy direct from manufacturer and save. Send for free catalog. Merrilee, Dept. 450, 22 West 21st St., New York 10, N. Y.

**LADIES** Charming hostess apronettes. Different colors and style. Beautiful. Each \$3.50. Archer, Arcadia, Mich.

**MAKE** Big money at home! Invisible reweaving pays \$10.00 profit an hour spare time. Make tears, cuts, holes disappear from fabrics. Constant demand from laundries, cleaners, homes assures steady earnings. Details free. Fabricon, Dept. C, 6342 S. Prairie, Chicago 19, Ill.

**DOES** Your child read well? Get quick results worth \$200.00 to over \$1,000.00 in your own home. Guaranteed course costs only \$20. Herbert Sage School, 611 North 50th St., Seattle, Washington.

**FREE** Samples, new-purpose, fragrant cloth to homeworkers, gift designers. Write Delight M. Company, 4043 Kimball, Chicago 18.

**NYLONS** 5c Pair, anklets 12c pair, socks 9c, print 17c, panties 12c, dresses \$1.95, slips 47c, undershirts 17c, rugs 70c, robes \$1.65, spreads \$2.65, \$70.00 watches—\$18.95, jewelry sets \$1.25, pens 8c, combs 1c, aspirin \$1.00-1.000 brushes 9c, razor blades 5-3c, electric razors \$2.00. Complete stock list, picture catalogue, 25c if sent immediately. Sibert's, Chattanooga 4, Tenn.



**GOOD Money in weaving.** Weave rugs at home for neighbors on \$69.50 Union Loom. Thousands doing it. Booklet free. Union Looms, 133 Post St., Boonville, N. Y.

**PROFITABLE Home business.** Make fast-seller chenille monkey trees, dolls, flowers. Terrific holiday demand. Information free. Velva, Bohemia 16, N. Y.

#### FOR SALE—MISCELLANEOUS

**WORK Clothes.** Used, professionally laundered; coveralls, \$1.75; pants, \$1.25; shirts, 75c. Send cash, check or money order; indicate sizes. Plymouth Surplus Sales, Gloversville, N. Y. Add 50c postage and handling. Satisfaction guaranteed.

**HEARING Aid batteries,** wholesale. Free list. Habs, Box 51, York, Penna.

**SAVE Money on army, navy and factory surplus.** Write today for new 60-page illustrated catalog. Tennusa Sales Co., Dept. C, 1451 Market, Chattanooga, Tenn.

#### WANTED—MISCELLANEOUS

**GRINDER And saw filer.** Box 574, Pearl River, N. J.

**OLD Toy coin banks.** Big prices. Gordon Grimes, 2000 Marber, Long Beach 15, Calif.

**QUICKSILVER,** Platinum, silver, diamonds, indium. Write. Wholesale Terminal, Norwood, Massachusetts.

**SCRAP Mercury (quicksilver)** containers supplied—Tantalum, bismuth, tungsten. Metallurgical Products Company. Established 1909, 35th and Moore Sts., Philadelphia 45, Penna.

#### PERSONAL

**LETTERS Remailed, 4 for \$1.** Write Jacobo M. Arends, Box 123, Aruba Netherlands Antilles.

**X-RAY Mind.** Stupendous mental power. Details 6c. Krishnar Institute, 1912 Lincoln Park West, Dept. PM-1, Chicago 14.

**MAIL Order newstand.** Sells single copies of 700 periodicals, listed in Magazine News. Copy 10c. Jay Wilcox, GCPO, Box 1403, New York 17, N. Y.

**MASSACHUSETTS,** Connecticut, Rhode Island remails 25c. Anne Katrenak, Box 53, Webster, Massachusetts.

**LETTERS Remailed 25c.** Buckley, 1237 Winter Street, Ft. Wayne, Indiana.

**LETTERS Remailed San Francisco** postmark 25c. Private receiving-forwarding address available. Shanks, Box 3110, San Francisco 19, California.

**RANCH Country remails.** 25c each. Crown, Box 71D, Kerrville, Texas.

**BORROWING By mail.** Loans \$50 to \$600 to employed men and women. Easy, quick. Completely confidential. No endorser. Repay in convenient monthly payments. Details free in plain envelope. Give occupation. State Finance Co., 323 Securities Bldg., Dept. L-14, Omaha 2, Nebraska.

**LETTERS Remailed, historic Philadelphia,** 25c. Bond, 441 W. Norris St., Philadelphia, Penna.

**LETTERS Remailed 25c each,** 5 scenic cards \$1, remailed free. Homer, 13247 Sayre, San Fernando, California.

**BE A memory wizard.** Amaze your friends and boss. Memory Institute, Box 261-L, Staten Island #1, New York.

**MEXICAN Law.** General Practice Attorney, 1203 Arizona St., El Paso, Texas.

**LETTERS Remailed from historic Durango,** Mexico, air mail \$1.00 each. Croze, Apartado No. 1, Durango, Dgo., Mexico.

**MIAMI, Miami Beach:** Letter remailed 25c; local classified pages airmailed \$1.00. Confidential, Box 306, Miami 2, Fla.

**LETTERS Remailed 25c.** Personal address service available. Write for rates. McLaughlin, 800 Stewart, Columbus 6, O.

**AROUND The world remailing,** Chicago 25c. Business and personal address. Letters relay from other cities 75c. Full details 10c. C. Macks Mailorder, 5656 N. Hermitage, Chicago 26, Ill.

**LETTERS Remailed 25c.** Private receiving-forwarding address available. Hicks Service, 5216 Just Street, N.E. 303, Washington 19, D. C.

**"HOW Can I find out?"** You can! Information confidentially developed. Any matter, person, problem. Worldwide. Officially licensed. Established 1922. William Herman, 170 Broadway, New York City.

#### MISCELLANEOUS

**8x10 HANDPAINTED Oil picture** of yourself, \$5.00. Send photo with color of eyes and hair. Frank Lewis, 3411 Ormond Street, Tuscaloosa, Alabama.

**HAIRCUT As you like it.** Booklet explains. 25c. Mastrolia, 32-20BX 89th Street, Jackson Heights 69, New York.

**RECEIVE Magazines, samples, catalogues.** Mails from everywhere. Offers, hundreds. Get listed 25c. Rorick, Box 86, Cincinnati 26, Ohio.

**25 TO 50% Discount:** Appliances, giftware, cameras. Catalogue 50c refundable. Dart, 3812 Atlantic Ave., Brooklyn 24, N. Y.

**MAGNETS—Permanent Alnico.** Never loses magnetism. Excellent for map and bulletin board work. Many uses. 12 for \$1.00. Pritt Co., Dept. MM-1, 12 West 27th, New York City.

**BUY Wholesale thousands nationally advertised products** at big discount. Free "Wholesale Plan." American Buyers, 631-D Linden, Buffalo, N. Y.

**LEATHERCRAFT** For pleasure or profit. Make easy-to-assemble purses, belts, gloves, woolskin toys, 100 other items for gifts or to sell. Send 10c today for big catalog. Largest leathercraft stock in U.S. J. C. Larson Co., 820 S. Tripp, Dept. 3551, Chicago 24.

**DISCOVER Gold!** How to make simple tests for gold. Complete instructions 25c. Box 52, Culver City, Calif.

**BE The Popular Mechanics representative** in your neighborhood and earn big profits in your spare time. Write Popular Mechanics Magazine, Room 403M, 200 E. Ontario St., Chicago, Ill.

**ATOMIC Bomb!** History, pictures of Los Alamos, birthplace of atomic bomb. \$1.00 postpaid. Box 759, Los Alamos, New Mexico.

**OUTDOOR Toilets, cesspools, septic tanks cleaned,** deodorized with amazing, safe, harmless powder. Easy, economical to use. Saves digging, pumping. 150,000 customers guarantee satisfaction. Details free. Burson Laboratories, Dept. O-36, Chicago 22, Illinois.

**HELP Poor circulation, nervous tension.** Free folder, Gyro-Belt, Upper Darby 7, Pennsylvania.

**CLEAN Your three piece living room set** for \$2.95. Easy. Money back guarantee. Rayko, 2628 Madison, Granite City, Ill.

**GERMAN Address lists.** Anything manufactured \$1.00. Burke Associates, Manchester 1, Mass.

**YES, There is a publication** that describes new inventions from manufacturers. Write for details. David A. Lee, Publishers, Box 53, Norfolk 1, Virginia.

**FAMOUS Model power mower.** Assemble your own power mower, gasoline or electric. Now available in low-priced parts kit—Exact duplicate of models of famous make mower. Thousands sold at \$119.75. Trims lawns to carpet smoothness, yet sturdy enough to cut 10-foot growth of weeds or brush. No special tools required. This enjoyable home project can save you real dollars. Write for complete information: 7528 Oakwood, Rt. 7, Omaha, Nebraska.

**BIG Savings on nationally advertised products.** Information free. George Boyd, 140 West 42nd St., New York, New York.

**200 ONE-Evening Projects** that you can start and finish in one evening! Popular Mechanics editors have assembled 200 projects to be made with only simple hand tools, in a few hours time. Each project costs only 1c. Order your copy today, \$2.00. Popular Mechanics Press, Dept. EP-2, 200 E. Ontario, Chicago 11, Ill.

**CIGARETTES—Roll 200 mild, tasty,** guaranteed to please for 75c. Details free. Pete Moberly, Box 857, Owensboro, Ky.

**"SQUEESIT" Catsup dispenser.** Unbreakable, washable. Shape of tomato. Holds full catsup bottle. \$1.10. Ivanhoe Company, Box 41A, Poughkeepsie, N. Y.

**AUTHENTIC Desert treasure map,** complete directions except exact location, \$2. John Boulton, Box 28, San Francisco, Calif.

**ENDLESS Energy "Secrets of Tiredness,"** \$1.00. Eldetic Foundation, Fairhope, Ala.

**RARE Specialty devices catalog.** Limitless possibilities. Gen. Store, Tazewell, Virginia.

**SUPERSHARP Precision pocket knife,** 25c. Carlson's, 2523 Aqueduct, New York 68, N. Y.

**FREE List for post card.** Soaps, blades, lotions, and other masculine necessities at large savings. Sullivan, Box 5655, Chicago 90, Ill.

**SMASH Worries, fears and problems** with our "Thought and Behavior Control" home-study method. Many helped. Rush request for amazing free lecture in plain wrapper. Personal Psychology, Inc., Box 1924-M, Louisville 1, Ky.

**OVER 2500 Uses.** Sobo, world's most remarkable adhesive; non-inflammable, odorless. Sobo makes it possible to discontinue using inflammable and messy cements, glues and pastes. If your dealer is out of Sobo, send \$1.00. Solomon's, 31 Thomson, Long Island City, N. Y.

**1954 FLORIDA Guide,** employment, retirement, small business, travel, recreation, sports and farm opportunities. \$1.00. P. P. Jaycees, Eau Gallie, Florida.

**GOLD Prospecting catalogue—** Listing maps, pans, mineral books, gold machine blueprints. Gold panning lesson free. Old Prospector, Box 729D1, Lodi, Calif.

**300 BIG Mails guaranteed.** Samples, plans, offers, propositions, 12 months listing. \$1.90 refundable. Wright Publications, 2270 Hubbard, Memphis 8, Tenn.

**INCREDIBLE! Become mental superman overnight!** Free booklet! Bijou, Box 1727-MC, Hollywood 28, California.

**300 PROJECTS You can make—**In Popular Mechanics 32-page Blueprint catalog. Send 3c stamp for copy. Popular Mechanics Press, Dept. 106, 200 East Ontario St., Chicago 11, Ill.

**LOCATE Hidden treasure,** distinguish minerals from metals with the Model 100 Detector. Weighs 5 pounds, extremely sensitive. Factory assembled \$79.90 or kit form \$39.90. Free literature. Dept. P, Electronic Applications, Box 4975, Washington 8, D. C.

**SELECTIVE Metal and mineral detector.** Revolutionary design. Distinguishes metals from black magnetic sands. Readily detects metals under salt water. Also Geiger counters. Free literature. Gardiner Electronics Company, 2018 N. Dayton, Phoenix, Arizona.

**YOUR Leather jacket renovated expertly.** Free circular. Berlew Mfg. Co., Dept. 3, Freeport, N. Y.

**INSTALL Your own fixtures,** make most of your own electrical repairs and save hundreds of dollars with Popular Mechanics' Electric Fix-It Book, \$2.00. No matter if you want to install fluorescent fixtures, test circuits, repair appliances or do any one of many electrical repairs, this new book tells and shows you how, step-by-step. Popular Mechanics Press, Dept. EP-2, 200 E. Ontario, Chicago 11, Ill.

**TREASURE Finders for gold, silver and minerals.** Money back guarantee, best available. Also Geiger counters for uranium prospectors, free information. Write Goldak Company, 1541 West Glenoaks, Glendale 1, Calif.

**STUDY For game warden, park, fish, forestry, lookout, guide, wildlife conservation, immigration and highway patrol service.** Details free. Write Delmar Institute, C5, Whittier, Calif.

**TREASURE—M-Scope Geiger counters,** mineral locators. Why buy something inferior when you can buy the best at a lower price? Backed by years of experience. Fully guaranteed by factory. Detects minerals, metals, gold, silver, coins. Payment plan available. Proven superior performance. Free 16 page illustrated booklet. Fisher Research Lab., Inc., Palo Alto, California.

**CLOGGED Drains opened** by new powerful chemical called Sursolvent. Removes grease, soap, tree roots, etc., without expensive digging and electric rodding machines. Simple to use. Mix with water and pour down sink. Postal brings free details. Electric Sewer Cleaning Co., Allston 34, Mass.

**GOLD, Silver, metal detectors.** Geiger counters for uranium. Mineralights. Sensational new fully guaranteed models. None finer. Information free. Detector Co., 5420 Vineland Ave., North Hollywood, California.

**SAVE Thousands of dollars.** Build your own home. Book and plans for Popular Mechanics Ranch-Type House ready now! Six rooms and carport for \$5000; add breezeway, garage, extra bedroom \$2500. No experience needed. Book shows you how. Get copy today. Step-by-step instructions, hundreds of photos, drawings. Mail \$3.50 to Popular Mechanics Press, Dept. 101, 200 E. Ontario, Chicago 11, Ill.



**LOOK BETTER!  
FEEL BETTER!**

USE A  
**Vibrosage**

**ELECTRIC MASSAGER**

- Professional-Type
- 4 Scientifically Designed Applicators
- Sanitary

A few minutes daily use of VIBROSAGE gives that stimulating, healthful aid to circulation... relief from aches and pains. Four applicators assure maximum effectiveness for scalp, face and body. Operates on 110 volt, 60 cycle A.C. Five day trial—money-back guarantee! If your dealer cannot supply you, send \$8.50 check or money order, for pre-paid shipment. Or, send \$2; pay postman balance plus postage and C.O.D. charges.

**BEAUTY APPLIANCE CORP., Dept. V524-A, RACINE, WIS.**

**SPORTS AND PROFESSIONAL**

**DIVING**

**EQUIPMENT**

"IF IT'S FOR DIVING

**DESCO MAKES IT!"**

\* World's largest manufacturers of Diving Equipment

**CATALOG DIVING EQUIPMENT & SUPPLY CO.**

ON REQUEST 234 N. BROADWAY MILWAUKEE 2, WIS.

**POWER MOWERS & KITS**

**FREE PLANS**

LOW FACTORY PRICES DIRECT TO YOU



Wheel Direct Drive

Build your own quality mower with our LOW COST KITS, Parts, Engines. Free Plans guide you. 3 and 4 Wheel Kits, complete. Parts precision finished, ready to use. Write TODAY for Free Plans, Low Prices, Parts List and Guarantee.

**3-WHEEL KIT NO. T-800**



America's Finest Power Mowers completely assembled in 3 and 4 wheel models. Belt or direct drive. 18" and 20" sizes. Nationally known make engine. Latest improved features, sturdy construction and money back guarantee fully described in color folder. Write today.

▼ **TRIANGLE MANUFACTURING CO., Box M-26, Fort Scott, Kansas**

**HELPFUL BOOKS**

Send post card asking for **FREE** catalog

Popular Mechanics Press, 200 E. Ontario, Dept. 601, Chicago 11



JANUARY 1954

**The WONDERS of LIQUID PLASTICS**

**MANUFACTURE WITHOUT TOOLS OR MACHINERY!  
WE PAY YOU \$5.00 AN HOUR!**

No previous experience or special ability required! NO TOOLS OR MACHINERY required... the entire process is about as easy as pouring water out of a glass! The WONDERS OF LIQUID PLASTICS make all this possible! Many of the products made with our liquid plastics are so beautiful and attractive that we have created an unusual demand for this type of merchandise! That's why we will pay you \$5.00 an hour (materials extra) to make the items shown here and in our catalog for us!

**UNLIMITED POSSIBILITIES**

Work with LIQUID IVORY, LIQUID GLASS, LIQUID MARBLE, LIQUID EBONY, LIQUID PORCELAIN, LIQUID WOOD, LIQUID GEMSTONE and many other LIQUID PLASTICS and in a matter of minutes turn them into an endless and valuable procession of beautiful imbedded jewelry, novelties, ornaments, statuettes, bookends, lamps, pensets, lighters, ashtrays, keychains, figurines, curios, SOUVENIRS, art and gift products, fishing lures, BOATS, GADGETS, galore, exquisite GEMS! Make gears, locks, dials, forms, handles, dials, knobs, MACHINE PARTS, models of inventions, pistol grips... the list is endless! The only LIMITATION is your IMAGINATION! Liquid Plastics are the blessing of every creative and ambitious person... with these materials ANYONE can create and manufacture by the THOUSANDS and at a tiny fraction of what it would cost by any other method! Just send 25c and we will send you our book, "HOW TO MANUFACTURE WITHOUT TOOLS OR MACHINERY," included with our big 64 page catalog describing all the materials mentioned above; also details of our \$5.00-an-hour offer! Do it today... we want you to share in these wonderful opportunities as soon as possible!

**PLASTICAST CO., (Dept. C)**

P.O. Box 6737 (Write to) P.O. Box 987 Chicago 80, Ill. other address) Palo Alto, Calif.



GEARS



FISHING LURES



PEN SETS



HANDLES KNIVES - DIALS



STATUES FIGURINES



JEWELRY GEMS



NOVELTIES GADGETS

**PLASTIC LAMINATING**



This remarkable Plastic Laminating Machine will earn \$18.00 an hour right in your kitchen! Big profits laminating Business, Social Security, Identification, Credit CARDS of all kinds, photos, passes, clipboards etc. Price complete (illustrated) \$35.00 plus postage. Others higher. Literature free. **PLASTICAST CO.** (Address in ad above)

**Prints Postal Cards!**

**FREE** Use on 30 Day Trial! Send name today for facts and **FREE** Illustrated Book of unique advertising plans and money-making ideas for your business. Learn how others are boosting sales with post card ads... easy with Cardmaster.



**Cardmaster Co., 1920 Sunnyside, Dept. 1341 Chicago 40, Ill.**

**Catalog of 3200 Novelties, Gadgets, Jokes & Tricks**

Send 10c for amazing catalog of novelties, joke articles, funmakers, tricks, gadgets, live animals, scientific supplies, hobbies, planes & boats, unusual seeds, time-savers, cameras, optical goods, projectors, movies, lucky jewelry, religious goods, disguises, masks, musical instruments, stamps, coins, puzzles, fortune tellers, radios, auto & bike accessories, telescopes, magnifiers, compasses, banks, smokers' items, artist supplies, printing sets, engines, motors, shockers, knives, billfolds, guns, rifles, sports, books, games, plants, pennants, emblems, etc. Send name, address and 10c to:

**JOHNSON SMITH & CO.**  
Dept. 765 Detroit 7, Mich.

**Here's 10c. Rush me New Catalog!**

Johnson Smith & Co., Dept. 765, Detroit 7, Mich.

Name \_\_\_\_\_

Address \_\_\_\_\_



**NEW** way to  
enjoy **SPORTS**  
movies, television

**MADE IN  
GERMANY**

**CLIP  
THIS  
AD**

**SAVE  
\$7.00**



**DELUXE MODEL  
NOW ONLY**

**\$2.98**

*Now...*

**GET CLOSE-UP VIEWS ALL  
DAY...WITHOUT FATIGUE!**

Here for the first time—Germany's famed **SPEKTOSCOPIES** — a revolutionary concept in binoculars. Wear them like ordinary eye-glasses — hour after hour — without fatigue. Featherweight — only 1 oz. You'll hardly FEEL them! Yet here is a new, truly powerful optical design that gives you greater range than many expensive opera or field glasses and a far greater field of view than some selling for many times more! Has **INDIVIDUAL** eye focusing for clear, sharp viewing, whether you're looking at a play in the first row or a seashore scene miles away! **SPEKTOSCOPIES** are ideal for indoors, outdoors or distant scenes or close-up viewing. Special low price — \$2.98, a saving of \$7.00 or more!

**Try at Our Risk — No Obligation!**

Enjoy at our risk for 5 days. You must be delighted! Otherwise, your \$2.98 will be refunded with no questions asked! Limited supply forces us to place a limit of 2 per customer. Send check or m.o. for prompt, free delivery. COD's sent plus postage. Use convenient coupon below!

**● NOTICE!**

**FAVORABLE EXCHANGE RATE MAKES THIS VALUE POSSIBLE!** This is the first time this type of optical instrument has ever sold for less than \$10.00. The favorable rate of exchange and Germany's need for dollars make it possible. We're the exclusive distributors of **SPEKTOSCOPIES** in the U.S.A. Order today!

**INTERNATIONAL BINOCULAR CO.**

Dept. 6-A-90, 352 Fourth Ave., New York 10, N.Y.

Your Name \_\_\_\_\_

Address \_\_\_\_\_

Town \_\_\_\_\_ Zone \_\_\_\_\_ State \_\_\_\_\_

**BE YOUR OWN BOSS**

*Make Hundreds of \$ Spare or Full Time Work*

You can make  
simply and  
cheaply



**BUSTS**



**GARDEN URNS**



**NOVELTIES**



**TILE**



**STATUARY**

**NO EXPERIENCE NEEDED**

Here is the ideal business with no previous experience or large investment required and no high-priced equipment to buy. A business that will return dollars for the pennies you invest.

**YOU CAN CAST ANYTHING**

With *Flexible Mold Making and Ornamental Casting*, an amazing fact-packed book, you learn how you can cast practically any article in concrete, plaster, imitation marble or any other casting material using a marvelous new process. You can make ash trays, novelties, garden and lawn ornaments and hundreds of other highly profitable items that cost you but a few cents and sell for as much as \$5.00 and more. Why you can even make true-to-life full-sized busts of your neighbors and friends.

**NO EXPENSIVE MOLDS TO BUY**

Why buy high-priced molds from others? Learn how you can make your own molds quickly, easily and inexpensively with materials that can be used over and over. You get copyrighted formulas, complete instructions and detailed how-to-do-it photographs as well as complete sources of supply for the few inexpensive materials you need. This is the only book printed in America today that contains instructions for making profitable papier-mache casts.

**MONEY BACK GUARANTEE**

Start on your road to extra income and independence today. Send only \$3.00 for your copy of *Flexible Mold Making and Ornamental Casting*. Complete satisfaction guaranteed or your money refunded within seven days.

**POPULAR MECHANICS PRESS, Dept. 46**

200 E. ONTARIO ST., CHICAGO 11, ILL.

**Save Hundreds of Dollars  
On Home Repairs . . . .**

**Add to Your Home's Beauty and Comfort  
. . . Increase Its Selling Price**

Here is the last word in dependable, money-saving help for the homeowner. *Guide to Home Repairs*, written by the editors of *Popular Mechanics*, gives you the know-how you need to repair and maintain plumbing; install and repair wiring; paint and decorate; install insulation, etc.

**192 Pages  
646 Illustrations**

**\$2.50**

**Step-by-Step Instructions  
Tell How — Pictures Show How**

First you read how to do it in the famous *Popular Mechanics* "Written So You Can Understand It" style and then hundreds of photos, drawings and diagrams show you how it is done. Nothing is left to the imagination. Now you can lay floor tile and linoleum, repair doors and windows, tuckpoint, repair and install gutters, etc. Order your copy today. If it isn't entirely satisfactory you may return it in seven days for a full refund.



**POPULAR MECHANICS PRESS, Dept. HR-1**

200 E. Ontario St., Chicago 11, Ill.

Send at once my copy of *Guide to Home Repairs*. My remittance for \$2.50 is enclosed. If it isn't satisfactory I may return it in 7 days for a full refund.

NAME \_\_\_\_\_

ADDRESS \_\_\_\_\_

CITY \_\_\_\_\_ ZONE \_\_\_\_\_ STATE \_\_\_\_\_

Check here for C.O.D. shipment. (U.S.A. only). Postage extra.



**If YOU have hidden talent, your future is secure!**

Now: America's 12 Most Famous Artists

# TEST YOUR ART TALENT!

Yours FREE if you act today! Thousands paid \$1.00 to take this revealing test. Now, to meet the ever-increasing demand for artists needed for higher-paying jobs, this same Talent Test is yours without charge or obligation. Here's your chance-of-a-lifetime to find out if you have that real, hidden talent which can open up an exciting, glamorous, well-paying career in magazine illustration and advertising art. This is one field with no age limits, seniority, or prejudices, nothing to hold you back, when you are a talented artist. If you like to draw, you owe it to your future to take this Talent Test now.

Quantity limited. Write today!



**FREE!**

This exciting test, printed on 8 large pages of drawing paper, has over 50 illustrations. It tests you seven ways to show your sense of design, composition, form, observation, imagination, originality and picture sense. Yours if you act today!

## FAMOUS ARTISTS COURSE

Studio 6A4, Westport, Connecticut

Send me with no obligation the Famous Artists Talent Test

Mr. \_\_\_\_\_  
 Mrs. \_\_\_\_\_ Age \_\_\_\_\_  
 Miss \_\_\_\_\_ (please print)  
 Address \_\_\_\_\_  
 City \_\_\_\_\_ Zone \_\_\_\_\_ State \_\_\_\_\_

Norman Rockwell  
 Jan Whitcomb  
 Stevan Dohanos  
 Harold Von Schmidt  
 Peter Helck  
 Fred Ludakens  
 Al Parker  
 Ben Stahl  
 Robert Fawcett  
 Austin Briggs  
 Doug Kingman  
 Albert Dorne

## REAL ESTATE BE A BROKER

**PAYS BIG! SEND FOR FREE, BIG, ILLUSTRATED CATALOG NOW!** Graduates report making substantial incomes. Start and run your own business quickly. Men, women of all ages, learn easily. Course covers Sales, Property Management, Appraising, Loans, Mortgages, and related subjects. **STUDY AT HOME** or in classrooms in leading cities. Diploma awarded. Write TODAY for free book! No obligation. Approved for World War II and Korean Veterans. **WEAVER SCHOOL OF REAL ESTATE** (Est. 1936) Suite 300 Law Bldg. Dept. PMB Kansas City, Mo.



**"TROUT STORY"** See and read all about:  
 Trout Farming for Profit;  
 Trout Fishing for Fun and Profit;  
 Trout Hatchery Operation.

**NEW IDEAS — VENTURE — INVESTMENT**  
 Write now — Enclose \$1 for this interesting and valuable picture story:

**BERKSHIRE TROUT FARM, Inc., Dept. PM**  
 125 PARKWAY ROAD BRONXVILLE, N. Y.

SAY YOU SAW IT IN  
 POPULAR MECHANICS

## AUTO 1954

The International Yearbook of Auto Design and Production

- Over 300 illustrations of the latest Foreign and U.S. sports, family and luxury cars! Complete specifications of each car clearly arranged!
- Unprecedented in size, scope and practical value. Impartial directory of auto production in 11 countries.
- Special Feature! "The History of Auto Racing." A must for racing and sports car enthusiasts, for everyone in the automotive field. Only \$6.00 at all bookstores or from Tudor Pub. Co., 221 4th Ave., N. Y. 3.

# RUPTURED

**Relief  
 or Your  
 Money  
 Back!**

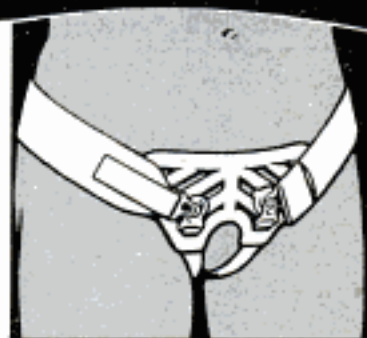

You risk nothing to find out why thousands of rupture sufferers can now work and play in comfort with the help of the patented Web Truss.

*No matter what truss you are wearing* our free booklet on rupture care will help you. Write for it today.

**WEB TRUSS CO.**  
 DEPT. M-54, HAGERSTOWN, MD.



## AIRMAIL STAMPS! - 10c

Here's your miniature collection of imported airmail stamps from all over the world. Extra: free 16 page treatise on airmail.



Whether you are just starting out or a seasoned stamp collector, you will want to get off to a flying start with this miniature collection of beautiful, valuable airmail stamps from the world over. Our staff has spent long hours obtaining this unusual offering. Frankly, we're going overboard to give you this high value because we want you to know about us and our vast assortments of all kinds of stamps. We are now celebrating our 14th year of satisfied customers—so you can do business with us with confidence! We haven't too many of the special miniature airmail collections available—we suggest you send us your order without delay.

FREE: with every order—a new 16 page treatise on the romance of airmail, complete with illustrations of important airmail stamps.

JAMESTOWN STAMP COMPANY  
DEPT. #725 JAMESTOWN, N. Y.

Send me a complete miniature collection of world-wide airmail stamps—plus the free 16 page airmail treatise. I enclose 10c to help cover the cost of the stamps. I understand there is no postage or handling charge.

Name \_\_\_\_\_  
Address \_\_\_\_\_  
City \_\_\_\_\_ State \_\_\_\_\_

MAIL  
TODAY

## What to Make with CONCRETE

Even little concrete jobs cost big money—mostly for labor. Get Popular Mechanics WHAT TO MAKE WITH CONCRETE and save all the labor cost while making your home or farm ship-shape. Book shows all—tells all—how to make the right mixture, plan, apply and gives 50 professional short cuts. Hundreds of pictures. Only \$2.00 postpaid. Order today. Money back if not pleased.

POPULAR MECHANICS PRESS, Dept. PM9, 200 E. Ontario St., Chicago 11



Build Your Own Fireplace, Driveways, Walks, Etc.



## LIKE TO DRAW?

Trained Animators needed in Hollywood and TV cities

You may have talent for a career in animated cartooning—and that talent can earn you \$75-\$300 weekly! Hollywood studios and TV producers are

looking for trained animators, willing to pay good salaries. And our course is the easy way to develop your talent—at home, in your spare time, keeping your present job! Only course of its kind in America. Beginners, amateurs, professionals may enroll. Written, illustrated, and taught by top experts. Mail the coupon below today!

PM-1

ANIMATED CARTOONING SCHOOL OF AMERICA

P.O. Box 2109  
Hollywood 28, Calif.

Please send me complete information on your animated cartooning course and your FREE gift offer.

Name \_\_\_\_\_

Address \_\_\_\_\_ Age \_\_\_\_\_

City, Zone, State \_\_\_\_\_

## BUILD THIS HOUSE Yourself



## The Famous Popular Mechanics House

The picture below is from an actual photograph of the Build-It-Yourself House with breezeway and garage, as built by Jack Brownson, 23-year-old veteran, in Aurora, Illinois.

## Mail Coupon for New Book and Plans!

Build It Yourself or Have It Built—Save Hundreds of Dollars!

### PLANS YOU CAN READ AND FOLLOW

Plans consist of ten working-size blueprints—floor plans, elevations, construction notes, framing, joints, lumber and mill list, specifications, plumbing and wiring diagrams. Every measurement is marked—every detail made clear as ABC. Book has 100 pages—three-fifths are photographs and drawings. Some sections in color, showing just how your house will look when finished.

BIG BOOK  
8 1/2 x 11 inches



Designed by Popular Mechanics and Famous Architects. Every Detail Simplified and Explained. No Previous Experience Needed!

Can you use everyday tools as well as the average Popular Mechanics reader? Then you, too, can easily build this modern house in any of its five designs, doing every part of the job yourself. The new Popular Mechanics Book, "Your Home—How to Build It Yourself" will show you how.

### Space for Living and Family Growth

This beautiful, modern house is 1 1/2 stories, with basement, living room, kitchen, dining nook, two bedrooms, bath, plenty of closets and space for two additional bedrooms on second floor. The house itself is 35' 9" x 28' 11"; breezeway 20' 10" x 8'; garage 20' 10" x 12'.

### The House That Has Everything

Designed for easy construction and the most living space for the least cost, the Build-It-Yourself House is also most attractive and suitable for any community and most income groups. The basic plan is adaptable to four other exterior designs.

### Get Book and Plans Now—Build When You Can

You may never have thought about actually building a house yourself, but now that building restrictions have been lifted, it is easier than you think. So order book and plans today. Even if you engage a contractor to build for you, you will need the plans. And you certainly will want the book which can easily save you hundreds of dollars, whether you build this or any other house.

## MAIL COUPON FOR BOOK AND PLANS

POPULAR MECHANICS PRESS, Dept. 16  
200 E. Ontario St., Chicago 11

I enclose \$\_\_\_\_\_. Send me the items checked at once.

- Your Home and How to Build It Yourself.....\$ 3.00  
 Complete set of plans for Popular Mechanics Home... 12.50  
 Book and plans at reduced price..... 14.00  
 Duplicate sets of plans..... 5.00

Name \_\_\_\_\_

Address \_\_\_\_\_

City \_\_\_\_\_ Zone \_\_\_\_\_ State \_\_\_\_\_



# PLYMOUTH SAVE MONEY!

Owners



Learn How to Make Your  
Car Run Better . . . Last  
Longer . . . and Save Hundreds of Dollars!

Get this book, written especially for you, without one penny of risk and get more out of your car. Mail coupon for MANUAL FOR PLYMOUTH OWNERS today. When the book comes, skip through the pages and see how your investment in one of America's most popular automobiles can be even a better investment than you thought. If you don't agree, send the book back and you'll get your money back.

## A Popular Mechanics Book Written Just for You

Not a re-hash of service manuals. A complete new Popular Mechanics book written for the Plymouth owner by an outstanding automotive authority with the full cooperation of Plymouth engineers and service directors. It will save you money on repairs and service; make your Plymouth last longer; give you safe, economical and trouble-free motoring. And this is true whether you take your Plymouth to a regular service station or service it at home.

## Prevents Trouble. Cuts Down on Repair Bills

Nothing like this manual anywhere. It covers all phases of operation, service and maintenance. It has entire chapters on the individual parts of your Plymouth—battery, ignition, starter, generator, regulator, lighting, fuel system, engine, lubrication, gasoline quantities, cooling systems, transmission, differential, rear axle, brakes, wheel alignment, tire care, body maintenance, trouble shooting on the road, etc. It covers your Plymouth, new and older models, step by step—bumper to bumper—showing you how parts operate; what can go wrong; how repairs and adjustments should be made and how to avoid all types of troubles.

## Money Back if Not Satisfied

Mail the coupon today. Send only \$3.50 or you can pay postman. Money back guarantee protects you.

Order on this Handy Coupon

POPULAR MECHANICS PRESS  
200 E. Ontario St., Chicago 11, Ill.

Send Manual for Plymouth Owners at once. If not satisfactory I will return it within 5 days and you will refund full purchase price.

Remittance for \$3.50 enclosed.  Send C.O.D.

Name \_\_\_\_\_

Address \_\_\_\_\_

City \_\_\_\_\_ State \_\_\_\_\_

## Official, Authoritative, Practical Information

Written by C. E. Packer, formerly service school instructor and auto show lecturer for automobile manufacturers, Member Society of Automotive Engineers, Special Services Editor of Automobile Digest, contributor to leading magazines, author of some of the biggest selling books on Automotive subjects. Prepared with the full authority and active cooperation of the Plymouth Division of the Chrysler Corporation.

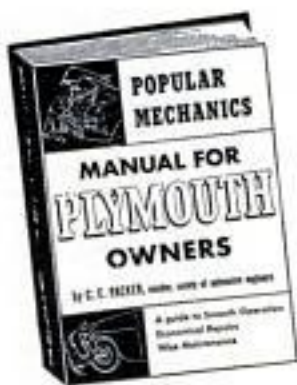

288 Pages. Hundreds of How-  
To-Do-It Illustrations and  
Diagrams

The entire book follows Popular Mechanics famous easy-to-read and easy-to-understand style. While primarily intended for the Plymouth owner, to help him get more out of his car at lower cost, it can be worth its weight in gold to the auto mechanic and service station operator who works, not only on Plymouths, but on all other makes as well, to which the information in the book can be easily applied.

# FREE

SEND FOR  
THE

# 1954

# ALLIED

268  
value-packed pages

# TV & RADIO CATALOG

WORLD'S MOST COMPLETE

Save on everything in TV and RADIO



Everything for Experimenters,  
Builders, Amateurs, Servicemen,  
Engineers and Soundmen

Send for ALLIED's big 268-page value-packed buying guide to *everything* in TV and Radio! Largest selections of custom TV chassis, TV accessories, FM and AM radios, High-Fidelity Sound, Amateur supplies, P.A. Systems, recorders, test instruments, builders' kits, industrial electronic supplies—plus the world's largest stocks of electronic parts, tubes, tools and books. Get *everything*—get more for your money—send today for your FREE 1954 ALLIED Catalog.

NEW HOME OF ALLIED RADIO



ultra modern facilities  
TO SERVE YOU BEST

SEND FOR  
FREE CATALOG

# ALLIED RADIO

ALLIED RADIO CORP., Dept. 5-A-4  
100 N. Western Ave., Chicago 80, Illinois

Rush FREE 1954 ALLIED 268-Page Catalog

Name \_\_\_\_\_

Address \_\_\_\_\_

City \_\_\_\_\_ Zone \_\_\_\_\_ State \_\_\_\_\_



WORLD'S  
LARGEST  
STOCKS





SELL JUST **ONE**  
**SENTRY SAFE A DAY**  
AND YOU CAN EARN  
**\$8,000 A YEAR!**

ONLY 5% of the people own a personal safe to protect their valuables from fire, theft and loss! Cash in on this untapped market with SENTRY—the world's finest small safe. Prospects everywhere—householders, professional men, farmers, small businessmen. Set your own price, take a big mark-up, and still undersell all competition. Just one SENTRY sale a day can bring you \$8,000 a year. Choice, exclusive territory. Drop shipment if desired. Send for full details.

Write to Dept. PM-1



**BRUSH-PUNNETT CO.**  
545 WEST AVE., ROCHESTER 11, N. Y.



Popular Mechanics Book for Pleasure or Profit  
**23 BOATS You Can Build**

Build the boat you have always wanted. Build it for fun or to sell at a profit. Get Popular Mechanics 23 BOATS YOU CAN BUILD—row boats, canoes, sail boats, power boats and other craft including a 25 foot cabin cruiser. Book includes more than 500 photos, plans, diagrams and working drawings, plus step by step instructions that anyone can follow. Only simple tools needed. Material list of lumber, hardware, fittings, etc., included. Order today under money-back guarantee. Only \$2.00 postpaid.

POPULAR MECHANICS PRESS, Dept. PM3, 200 E. Ontario St., Chicago 11

**SAVE \$65 ON THIS LUXURIOUS \$100 CONTOUR CHAIR 34.95 FOR**

Everything Needed Complete To Put It Together In One Evening

Scientifically correct design for restful, healthful, relaxing. Adjusts for perfect sitting or reclining comfort. Proved beneficial to heart, nerves, etc. Most popular chair in the home. Firestone foam rubber and washable, pliable genuine Duran upholstery. Would cost \$100 or more in any store. Shipped all ready to put together in less than one evening by anyone who can use a screwdriver. No cutting, no drilling, no skill needed. A woman can do it. Order now! Everything needed for only \$34.95, f.o.b. Balto. Slate color wanted; forest green, sapphire, blue, lipstick red, walnut brown. Enclose \$5 deposit, balance C.O.D. Money back guarantee. Return in 10 days. Order now.

**Bestcraft, Dept. 56, Mathieson Bldg., Baltimore 2, Md.**  
Make Money selling and Assembling Contour Chairs for friends

Genuine FOAM RUBBER

**Say You Saw It in Popular Mechanics**

**BUILD your own TV Set**

YES, actually build a valuable TV Set right at home. At the same time learn all about installing, repairing, servicing—and get ready for a Big-Pay Job in America's fastest-growing, most exciting industry. The CTI TV Train-at-Home Plan is preparing hundreds for bigger pay TODAY—and a brighter Future TOMORROW. No experience needed. We supply easy-to-understand instructions—made clear with hundreds of charts, diagrams, photos—plus TWENTY KITS of Parts, Professional Equipment and Tools. Get a TV Set to ENJOY. Get set to ENJOY a TV Future. Make money in spare time while taking Course. THOUSANDS SUCCEEDING! So can You. Send today for big FREE Book, "You Can Succeed in Television."



COMMERCIAL TRADES INSTITUTE

Dept. T2-1, 1400 Greenleaf Ave., Chicago 26, Ill.

Make Your Own **POWER TOOLS**

Enjoy Fun and Profit With a Low Cost Motorized Shop!



Drill Press from Pipe Fittings

3 Different Drill Presses You Can Make



Table Saw With Tilting Arbor

All Types of Saws—Circular, Jig and Others



Four-Wheel Band Saw

Band Saws—Two, Three and Four-Wheel

Save Hundreds of Dollars on an Up-to-Date Shop Make All of These

- Jig Saw from Old Sewing Machine
- Two, Three and Four-Wheel Band Saws
- Drill Presses from Old Auto Parts and Pipe
- Precision Drill Press for Model Makers
- Swing Saw
- Power Hacksaw
- 10-inch Table Saw With Tilting Arbor
- Disk and Spindle Sander
- Power Scroll Saw
- Thickness Planer—10 Inch
- Wood Shaper from Pipe and Plywood
- Disk Sander, 12 Inch, With Tilting Table
- Motorized Hand Plane
- One-Motor Workshop
- Electric Filing Machine
- Heavy Duty Grinder
- Flexible Belt Sander
- and others—60 Power Tools in All.

Over 250 Photos, Diagrams and Working Drawings

New Popular Mechanics Book Shows How to Make 60 Tools from Scrap, Discarded Parts!

Get SIXTY POWER TOOLS AND HOW TO BUILD THEM, the sensational new book in the Popular Mechanics Craftman Series. Build your own lathe, drill press, sander, circular and band saw and other power tools at a cost of only a few dollars each. Use old auto parts, pipe, wood and odds and ends that cost little or nothing. Every detail of construction is given in plain language you can understand and follow in this timely how-to-do-it book.

200,000 Copies of Earlier Edition Now in Use

More than 200,000 copies of the earlier book "Forty Power Tools You Can Make" have been sold. This is a brand new book with new material and new machines—SIXTY POWER TOOLS AND HOW TO BUILD THEM. Hundreds of pictures and plans show every step to follow in making the power tools you want. Actual photos of finished machines included. Note partial list of power tools you can make below.

Examine for 7 Days • Your Money Back if Not Pleased

Mail the coupon today with only \$2.50 or we will send book C.O.D. Your money back if you return the book. You'll be amazed with the practical tools you can make and how little they cost. With this book you can have a complete motorized workshop and save hundreds of dollars. Mail coupon today.

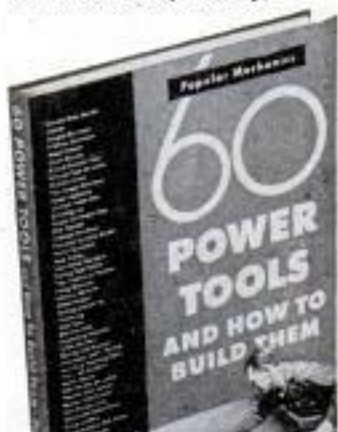

Use This Coupon • Mail it Today!

POPULAR MECHANICS PRESS, Dept. PT-4, 200 E. Ontario St., Chicago 11

Send me SIXTY POWER TOOLS AND HOW TO BUILD THEM.

Remittance for \$2.50 enclosed. Send postpaid.

Send C.O.D. (U.S.A. only). I will pay postman.

I understand I may return book within 7 days if not satisfactory and you will refund full purchase price.

Name \_\_\_\_\_

Address \_\_\_\_\_

City \_\_\_\_\_ Zone \_\_\_\_\_ State \_\_\_\_\_



## New Amazing Invention—"Magic Art Reproducer"

# DRAW

# ANY PERSON

# NO LESSONS! NO TALENT!

## IN ONE MINUTE

Anyone Can Draw  
With This Amazing  
New Invention—  
Instantly!



Complete  
For Only **\$1.98**  
De Luxe  
Model

You Can Draw Your Family, Friends, Anything  
From REAL LIFE—Like An Artist Even if  
You CAN'T DRAW A Straight Line!

Yes, anyone from 5 to 80 can draw or sketch or paint anything now . . . the very first time you use the "Magic Art Reproducer" like a professional artist—no matter how "hopeless" you think you are! Anything you want to draw is automatically seen on any sheet of paper instantly! Then easily and quickly follow the lines of the "picture image" with your pencil . . . and you have an accurate original drawing that anyone would think an artist had done. Also make drawings larger or smaller as you wish. Anyone can use it on any desk, table, board, etc.—indoors or outdoors! No other lessons or practice or talent needed!

**HAVE FUN! BE POPULAR!** Everyone will ask you to draw them. You'll be in demand! After a short time you may find you can draw well without the "Magic Art Reproducer" because you have developed a "knack" and feeling artists have—which may lead to a good paying art career.

Also Excellent for  
Every Other Type  
of Drawing!

- Human Figures •
- Outdoor Scenes, landscapes, buildings •
- Still life, vases, bowls of fruit, lamps, furniture, all objects •
- Copy photos, other pictures, portraits, etc. •
- Copy blueprints, designs, decorations, for woodwork, machines, for needlework, crocheting, knitting •
- Copy all cartoons.

**SEND NO MONEY!**  
Free 10-Day Trial!

Just send name and address. Pay postman on delivery \$1.98 plus postage. Or send only \$1.98 with order and we pay postage. You must be convinced that you can draw anything like an artist, or return merchandise after 10-day trial and your money will be refunded.

Dealers, Jobbers write for prices and details.

## FREE!

"How to Easily Draw Artists' Models"

This valuable illustrated guide is yours free with order of "Magic Art Reproducer." Packed with pictures showing all the basic poses of artists' models with simple instruction for beginners of art. Includes guidance on anatomy, techniques and figure action.

Create Your Own Designs for All Hobbies! Reproduce on anything.



Outdoor Scenes, landscapes, buildings.



**NORTON PRODUCTS, Dept. 5801K, 296 B'way, N. Y. C. 7**

## PUMP WATER FAST!

DRAIN WASH TUBS, CELLARS, CISTERNS. Famous #7 pumps 2800 GPH. 420 GPH at 75' high or 1600 GPH from 25' well. Sturdy, rustproof Alloy Metal. Six Blade impeller. Uses any 1/4 to 1/2 H.P. Motor. Will not leak or clog. Fits any garden hose. Immediate money back guarantee. Send Check, Money Order, or C.O.D. **\$8.95**

IRRIGATE, FILL TANKS, DRAW WELL WATER. Heavy duty #8 Pumps 7000 GPH. 1000 GPH 75' high—3000 GPH from 25' well. Rust-proof Alloy Metal. 8 blade impeller. 1" inlet—1" outlet. Standard Pipe Threaded. Money back guarantee. Send check, **\$11.95** Money Order, or C.O.D.

Free Catalogue—Gear Pumps—Deep and Shallow Well Pumps.

**MOORE MANUFACTURING CO.**  
SWEDSBORO 6 NEW JERSEY

Say You Saw It in  
**POPULAR MECHANICS**



## TRAILER COACHES

Here's everything you want to know about trailers, with plenty of pictures and plans and instructions for building three different types. Covers also, history of trailers, trailer parks, camps and overnight-stops information, furniture, furnishings, materials and engineering data. If you want to build a trailer, live in a trailer, or just want to know more about trailers, get this book. Only \$1.50 postpaid. Rush order to:

**Build it Yourself!**

Complete Trailer Book and Construction Data for 10, 16 and 22 Foot Trailers—Only \$1.50

### Partial Contents

Trailer Parks—Living in a Trailer—Towing a Trailer—Floor Plans—Service—Classifications—Balance—Dollies—Jacks—Weight Distribution—Construction—Working Drawings for a Two-Place, Standard Travel and Standard Dwelling Trailers. Size 8 1/2 x 11 1/4 inches.

POPULAR MECHANICS PRESS • Dept. 350, 200 E. Ontario St., Chicago

## HELPFUL BOOKS

Send post card asking for FREE catalog

Popular Mechanics Press, 200 E. Ontario, Dept. 601, Chicago 11



## WAR SURPLUS BARGAINS

**\$500,000.00 INVENTORY for QUICK LIQUIDATION**

Surplus items—hundreds of them for home, shop, factory, farm and outdoor use. New items, used items, reconditioned items—all at tremendous savings—all priced for quick sale.

**Page After Page of Values**

This big catalog shows page after page of amazing money saving values. Write for your copy today. Send 10c to cover postage, mailer, etc. Write today! **SEND TODAY FOR YOUR COPY**

**10c**

## FIELD TELEGRAPH TRANSMITTER & RECEIVER SET

Complete; includes transmitter with pair of head phones, sending telegraph key, buzzer, double throw switch. Original cost of this instrument to English government well over \$100.00. Ship. wt. 20 lbs. each. Allow sufficient postage or will be shipped express charges collect. Two 4 1/2 volt C batteries needed in each set. Batteries 45c each extra. Wire needed to connect for operation. No. 428. Complete set of two... **\$15.00**  
One set ..... **\$7.95**



## STARK'S

509 So. State St.  
Dept. PM-154  
CHICAGO 5, ILL.



# What Kind Of A Man Are You?

Weak, frail, without energy and ambition? If you are undeveloped, run-down, with all sorts of complaints hindering you, whether a victim of physical excesses, overwork, worry, drugging, alcoholism, tobacco, over-stimulation or youthful errors, then it is high time for you to act.



## STRONGFORTISM

The world-renowned modern science has fulfilled its mission in America and Europe for hundred thousands of just such men and women, who adopted the principles of this real revelation and who found supreme health, strength and organic stability.

### STRONGFORT

If you need such help, write for the free enlightening booklet "PROMOTION AND CONSERVATION OF HEALTH, STRENGTH AND MENTAL ENERGY." For an immediate Airmail reply, please enclose \$1.00 for expenses.

**LIONEL STRONGFORT INSTITUTE**  
MUNICH 50 · BAVARIA · DEPT. 7W  
Germany, American Zone

How to make the most of your home woodworking equipment

## POWER TOOL WOODWORKING FOR EVERYONE

By R. J. De CRISTOFORO

Basing his book on famous SHOPSMITH, an expert tells you everything that can be done with multi-purpose and individual tools. Detailed instructions for the table saw, jointer, drill press, lathe, jig-saw, band saw, abrasive machines, shaper; how to adjust and use each tool, and perform every woodworking operation. Suggested work projects and hundreds of time- and money-saving hints. 560 photographs and drawings. \$4.95 at bookstores, or mail coupon below.

### FREE 10-DAY TRIAL COUPON

McGRAW-HILL BOOK COMPANY PM-1  
330 West 42nd St., New York 36  
● Please send me "POWER TOOL WOODWORKING FOR EVERYONE" for 10 days' examination on approval. In 10 days I will send \$4.95, plus a few cents delivery, or return the book postpaid. (We pay delivery if you remit with this coupon; same return privilege.)

Name .....  
Address .....  
City ..... Zone ..... State .....

# NEW! ALL ABOUT TELEVISION



## Service Your TV Set Yourself and Save Hundreds of Dollars . . . Save on the Purchase of a New Set!

Here's the brand new book that tells and shows you how 9 times out of 10 you can service your TV set yourself and save the \$5 to \$25 fee charged by professional repairmen for service calls.

### Make Most Repairs Yourself

Here are famous step-by-step instructions by John Derby, famous television engineer, which make it possible for you to locate trouble quickly and repair it in the matter of minutes. Hundreds of "show-how" photos, drawings and diagrams actually show you just how to go about making most TV repairs.

### Actual Photos Show You How

A special illustrated section contains actual photographs of imperfect TV pictures. By comparing the picture on your set with those in the book you immediately identify the trouble and then by following Derby's instructions you make the adjustment or repair which will give you perfect reception once again.

Find out how to install your own antenna at a savings of as much as \$20 . . . how to replace burned-out picture tubes . . . how to get the best reception in outlying areas . . . how to save money when buying a new set . . . what to look for when you purchase a TV set.

### Go "Behind the Scenes"

Go with Derby into TV studios and see stars in action . . . see how television shows are produced and what goes on "behind the scenes."

No other TV book on the market is so comprehensive and so chock-full of valuable information.

### Money Back Guarantee

Send just \$3.00 for your copy of "All About Television." Read it for seven full days and unless you agree that it can save you hundreds of dollars and enable you to service your TV set yourself just slip it back in its wrapper and return it to us for a full refund.

## Order on this Handy Coupon

POPULAR MECHANICS PRESS  
200 E. Ontario Street, Chicago 11, Ill.

Remittance for \$3.00 enclosed. Rush postpaid my copy of "All About Television." Unless it is entirely satisfactory I may return it within seven days for a full refund.

NAME \_\_\_\_\_

ADDRESS \_\_\_\_\_

CITY \_\_\_\_\_ ZONE \_\_\_\_\_ STATE \_\_\_\_\_

Send C.O.D. (Postage extra)



**AT LAST... A NEW  
AUTOMATIC**

# Underground Sprinkler System

**EVERY HOME-OWNER CAN AFFORD!**

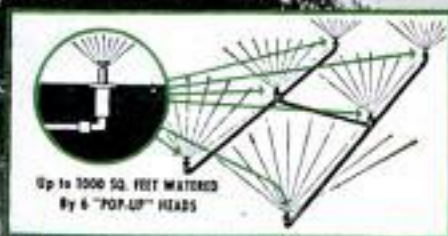
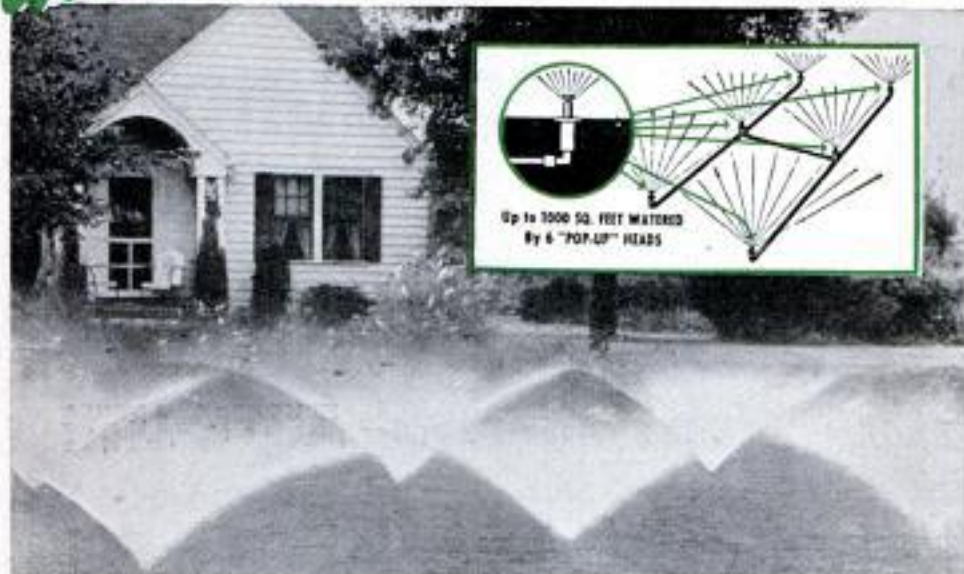

AS LOW AS  
**\$59<sup>50</sup>**  
COMPLETE

**EASY TO INSTALL  
IN A FEW HOURS**

**without damage to  
Lawn or Garden**

**ORDINARY WRENCH  
ONLY TOOL NEEDED**

EVERSPRAY INSTALLED AT NORTH ACRES GARDENS, ANDERSON, INDIANA

## SALES GOING CRAZY COAST TO COAST!

### Salesman Demonstrates EVERSPRAY on Prospect's Own Lawn—in Less than 10 Minutes!

Salesmen! Get in at the very beginning of the season. Make 1954 the biggest money year you've ever known. You can't miss with EVERSPRAY and here's why. EVERSPRAY is a real underground Sprinkler System. It's built exactly like those you see on million dollar estates. Yet it's priced so low that even the owner of the most modest home can afford it! It's a system that ends forever the drudgery of hand sprinkling. EVERSPRAY never gets out of order—nothing to rust, rot, or wear out—never needs repairs—doesn't cost a penny for upkeep. At trifling cost, it gives the home-owner the beautiful lawn he has always dreamed of, but could never have until now.

### NOTHING ELSE LIKE IT

EVERSPRAY is not an untried gadget. It is a proved and tested Sprinkler System that appeals instantly to every home-owner. And it's one of those terrific money-making fast-sellers that appeals to top-flight Salesmen—men accustomed to selling "big-ticket" Home Improvement Products.

Any man who calls himself a Salesman can really clean up with EVERSPRAY because every home-owner is a prospect. He wants what you can give him with EVERSPRAY—the beautiful lawn he has always wanted—a lawn that is the envy of everyone who sees it. Best of all, the owner installs EVERSPRAY himself—or you can do it for him and collect an extra fee for this extra service. As H.C. Lewis of Great Bend, Kansas writes: "The three

EVERSPRAY DIVISION, 2001-09 W. Carroll Ave., Dept. 11, Chicago 12, Ill.

EVERSPRAY Systems we installed were up to your promises in every way and water even a greater area than said. One man and myself assembled and installed all 3 systems in 1 afternoon!"

### \$60 A DAY—WITH "JACK POT" PYRAMID PLAN

In the New Automatic EVERSPRAY you've got your hands on the biggest Spring, Summer and Autumn seller ever offered Salesmen. When most lines are dying because of hot weather, EVERSPRAY is hitting the very peak of the Big Money selling season! Our sure-fire "Jack-Pot" Pyramid Sales Plan turns your first sale into TEN or more. Then EXTRA orders start pouring into your hands automatically—with little effort on your part. It's a "push-over" for any good salesman. You make \$20.00 on every order, a net of \$60.00 on only 3 sales a day!

### FREE! MAIL COUPON FOR FULL PARTICULARS

Limited space does not permit my giving you full details here. But I'll rush complete information to you by return mail if you'll send me the coupon now. Don't lose a minute in getting the facts. Time is precious, so act promptly. Fill in and get the coupon in the mail right now. It may well prove to be the most profitable step you have taken in your entire selling career. —John Oakman, Sales Mgr.

### Only EVERSPRAY gives Home Owners these EXCLUSIVE Features:

**ELECTRONIC, AUTOMATIC** Device turns water ON at pre-determined hour then shuts water OFF automatically. Waters lawn regularly even when owner is on vacation.

**"POP-UP" Spray Heads** and all other parts made of SOLID BRASS. Six heads water up to 1000 sq. ft. of lawn. Finger-tip adjustment gives any desired spray—from fine mist to heavy rain.

**AUTOMATIC DRAIN VALVE** makes entire System absolutely "Freeze-Proof" even in zero weather.

**SPECIAL ALLOY SOLID COPPER PIPING.** Timetested underground. This "just-right" temper permits laying pipe underground in straight lengths for maximum pressure and water flow.

**F. H. A. APPROVED.** Customer can buy for as little as \$2.00 per month.

### Be a USER-AGENT And Get Your EVERSPRAY FREE

**Home Owners!** The very moment your own EVERSPRAY starts sprinkling, your friends and neighbors will want to know where THEY can get one, too! Just send us their orders on our User-Agent Plan and quickly get back in profits three to four times the cost of your own EVERSPRAY. Check coupon if you are interested in this Plan.

### DISTRIBUTORS WANTED

A few Big-Profit County Franchises still available. Plenty of leads provided from our Advertising in National Magazines. Please write me a letter stating what territory you want, what item or items you now handle, how many men in your present Sales Crew and any other information you care to give me. I will hold all information in strict confidence.

JOHN OAKMAN, Sales Mgr.  
EVERSPRAY DIVISION, Dept. 11  
2001-09 W. Carroll Ave., Chicago 12, Ill.

**FREE!**

- I am a Home Owner. I am interested in EVERSPRAY for my own use.  As a User-Agent.
- I am a Salesman. Please rush full details about EVERSPRAY and the new 1954 selling opportunity now open in my territory.
- I am a Distributor. See letter attached regarding territory I desire.

NAME.....









ADDRESS.....

CITY..... ZONE..... STATE.....

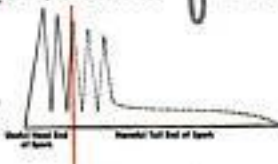

# How a tiny Auto-Lite *Resistor* helps give you better car performance!



When you replace old  worn out spark plugs with new **AUTO-LITE Resistor**  Spark Plugs the tiny 10,000 ohm  resistor filters out harmful end of spark  permitting a wider gap  setting to deliver a  super spark for quick  starts smoother  performance and double  life

*You're always right with...*

**AUTO-LITE**  
*Resistor*  
**SPARK PLUGS**



Tune in "Suspense!" ... CBS Radio Mondays ... CBS Television Tuesdays

Copyrighted material



# POPULAR JANUARY 1954 MECHANICS

WRITTEN SO YOU CAN UNDERSTAND IT  
VOL. 101 NO. 1

**By Sea Jug and Camel,  
Dog Sled and Helicopter . . .**

## LOOK HOW YOUR MAIL GETS THERE!

SHELL HUNTERS prowling Miami's palm-fringed beach recently picked up a pickle bottle washed ashore by strong east winds. Inside, they discovered a packet of letters with a note asking the finder to drop them in a letter box. Underneath was a pack of cigarettes and a silver dollar for the favor.

This new twist on the old message-in-a-bottle technique became a legitimate part of the United States postal system a few years ago. It was invented by two merchant marine captains in order to get crew and passenger mail ashore without slowing

down. Letters from Captain C. E. Milbury's ship, *Arizona Sword*, bear the printed cachet "Sea-Jug-Post, mailed at sea—in the sea, via sea jug." Letters from the *SS Mexico*, skippered by "postmaster" Captain O. H. Martinson, carry a "Via Pickle Bottle" cancellation.

The system was simple. When his ship was due east of Miami, each skipper collected mail from those on board and put it in an empty gallon jar ballasted with sand or cement so it could stand up in the water. The jug was fitted with a sealed top from which poked a tiny flag saying: "U. S. Mail

Letter mailed via official "Sea-Jug-Post" floated to Florida shore in a bottle. Note cachet and cancellation  
Photo courtesy Miami Postmaster S. Valliere and Miami Chamber of Commerce

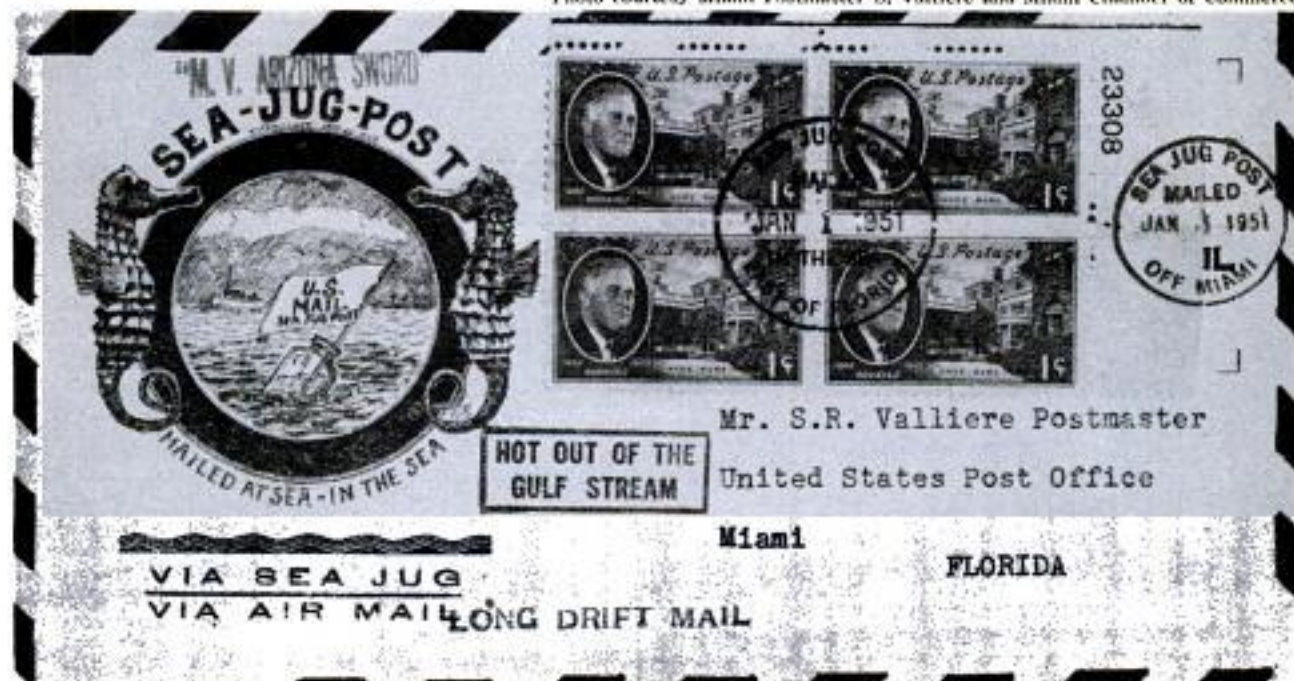





Standard Oil Co. of New Jersey photo  
Clerk inside a new Highway Post Office sorts mail while the two-unit vehicle moves down a country road

—Sea Jug Post.” The jar was tossed overboard and drifted away to be picked up by fishermen, cruisers or swimmers on the near-by beaches.

“Letters mailed by jug seem to reach their destination far sooner than those saved for mailboxes in foreign countries,” one of the skippers explains. The unique mail became an established service operating in conformity with postal regulations for as long as the skippers plied that run.

Tricky as it is, Sea Jug Post is only one of many queer ways in which the mail you post today may be delivered. If your letter is bound overseas, anything that moves is a suitable carrier for it. Near the town of Sodankyla, Finland, under the Arctic Circle, the post goes on small sleds hauled by reindeer.

In the Philippines, your letter rides an oxcart; in Ceylon it goes via elephant. Fancy, two-wheeled horse-drawn carts carry the post in Pakistan; so do camel carts, built like flatbed trucks. In northern Scandinavia your letter may be shoved around the route in chair sleds with baby-carriage handles.

If these contraptions seem weird, you should see some of the streamlined carts the Post Office Department is testing right now. In half a dozen big cities, letter carriers, the foot soldiers of the department, are moving down the streets in or behind some 25 two, three and four-wheeled experimental go-buggies.

In several suburbs, letters ride on three-wheeled “Thrif-Ts,” tiny motor cars. The postman sits in the one-passenger front seat, which he shares with a center steering

Drawings based on CARE photos show how CARE packages are delivered by mail around the world. From top to bottom: By elephant in India, oxcart in the Philippines, reindeer and sled in Finland, horse-drawn cart in Pakistan and by camel-drawn truck in Ceylon





Standard Oil Co. of New Jersey photo

**Highway Post Office, pivoted in middle, swings onto the road. Over 100 of these vehicles now roam highways**

wheel. In one version, his bag of mail rides in the trunk above the two wheels in front of him. Just as odd is the three-wheel Autoette, with tiller instead of steering wheel, making experimental deliveries in Washington, D. C. In other suburbs "mounted" postmen are testing a four-cylindrical "putt-putt" with a square-cut body and a right-hand drive so the carrier can get out the door beside the wheel and step onto the curb.

Where go-buggies are impractical, plans call for other tricks. In Washington, Houston, Milwaukee, Miami and some smaller cities, mail is rolling in a wide variety of pushcarts—some like two-wheeled caddy carts for toting golf clubs; others resembling basket carriers in supermarkets.

A post office spokesman reports some curious reactions to all this. In downtown areas, where heavy volume calls for a four-wheeled, rubber-tired affair with a big boxlike compartment capable of holding 90 pounds of mail, the postman finds himself the victim of jibes such as: "Well, well, can we warm you a bottle?" and "Whose little darling are you airing?"

In spite of the ribbing, carriers are slashing up to two hours from their route time with some of the new vehicles. Older men with foot and leg injuries that would be aggravated by ever-increasing loads find them valuable. Since 1945 the number of pieces of annual mail has risen 31 percent to a total of 50,000,000,000. The weight has jumped 72 percent to a staggering 12,000,000,000 pounds annually, requiring 500,000 men to handle it and vast ingenuity to speed it on its rounds.

Oddly, one of the most streamlined means of scooting urban mail between main office and substation today is one of the oldest. Underneath New York City, 27 miles of eight-inch pneumatic tubes circle Manhattan Island to zip the mail along at

30 miles per hour in big 21-pound steel cylinders carrying 400 letters each. The system was laid down in 1897 and still moves 5,000,000 letters a day. Air pressure shoots the cylinders through the underground tubes, servicing 21 stations on the east and west sides of the city. Despite the speed of the cylinders, they shoot out at destinations unharmed into nets. Nerve center of the system is in the city's big General Post Office, where some 95,000 projectiles are loaded and sent out every day. Occasionally a projectile jams in the line. Then the men step up air pressure to pop it loose.

When postal officials bucked the first postwar traffic jams they figured the best answer was to jump over the whole mess. So, since 1946, in Chicago, New York and Los Angeles, helicopters have been skylifting your letters from airports and from the lawns behind outlying stations to platforms on the roofs of main post offices in town. More and more privately contracted whirly birds will be hovering over cities and suburbs to drop bundles of mail or make pickups via special hook-type devices as time goes on.

One of the trickiest uses of the postal eggbeater, though, is made by the Navy to deliver mail to men aboard picket submarines at sea. The helicopter hovers low above the sub and from the hatch a cylindrical object plummets into the sea. Made from a disposable container, it is attached by rope to a flotation buoy. Inside are papers, magazines and letters. A good "drop" will see the container plop into the sea 20 feet in front of the sub's bow, where it is retrieved with boat hooks.

Most people think of air mail as something just more speedy and efficient than regular post. But there are isolated places where, if it weren't for planes, people wouldn't get letters at all. Big PBY planes shuttle mail, fruit, meat, cigarettes and





U.S. Coast Guard photo

At a lonely loran station in the Pacific, a sack of mail is unloaded from the gun blister of a PBY. Right, mail from suburbs is unloaded from helicopter at heliport, a painted square on roof of Chicago's post office

candy to some 200 isolated officers and men of the Coast Guard who run our chains of loran stations in South Pacific islands. Another such air-mail route is Bud Branham's, out of Rainy Pass, Alaska. On the first Monday of each month, Bud takes off on the 125-mile jaunt to Anchorage. Along the way he "sits down" on lakes and waterways at fishing or trapping villages on the Cooke inlet. At each stop, mail and freight is toted on Bud's back. He wears hip boots to wade his cargoes back and forth. Besides incoming mail, on the return trip, he may bring in drugs for a sick trapper in Tyonek, rugs for the schoolma'am in Skwentna, clothes for the cleaner, gossip and messages from "outside" for everyone.

A tremendous amount of America's mail must find its way into remote hinterlands and the newest mass method for handling it is the unique \$17,000 Highway Post Office, a double-jointed superbus. Actually,

it is a bus and trailer. The front end contains an "office" patterned after railroad mail cars, with sorting bins, counters and pouch racks. The rear half is for storing bulk mail. More than 100 of these roving monsters already carry mail into isolated hill towns, and plans call for a fleet of 5000.

Unfortunately, some of our back roads are too rough, narrow and remote even for these rugged carriers. In such places, carrying mail is purely a matter of American ingenuity and determination. During winter, a tractor-drawn sled bulldozes the mail through snowdrifts in northern Wyoming. Across the Idaho highlands in winter, a propeller-driven snowmobile whisks sacks of letters across frozen plateaus at 85 miles per hour. But where mail routes tunnel into deep, roadless canyons and climb tiny trails into spiring mountains, a postman has to be a combination of tough outdoorsman, mechanical wizard and good Samaritan.

Plane with a carrier-type cable snatches mail from Bering Sea ice field during expedition by Coast Guard. Nylon cable with the "give" of rubber but without the rebound was used to pick up the 75-pound mail parcels

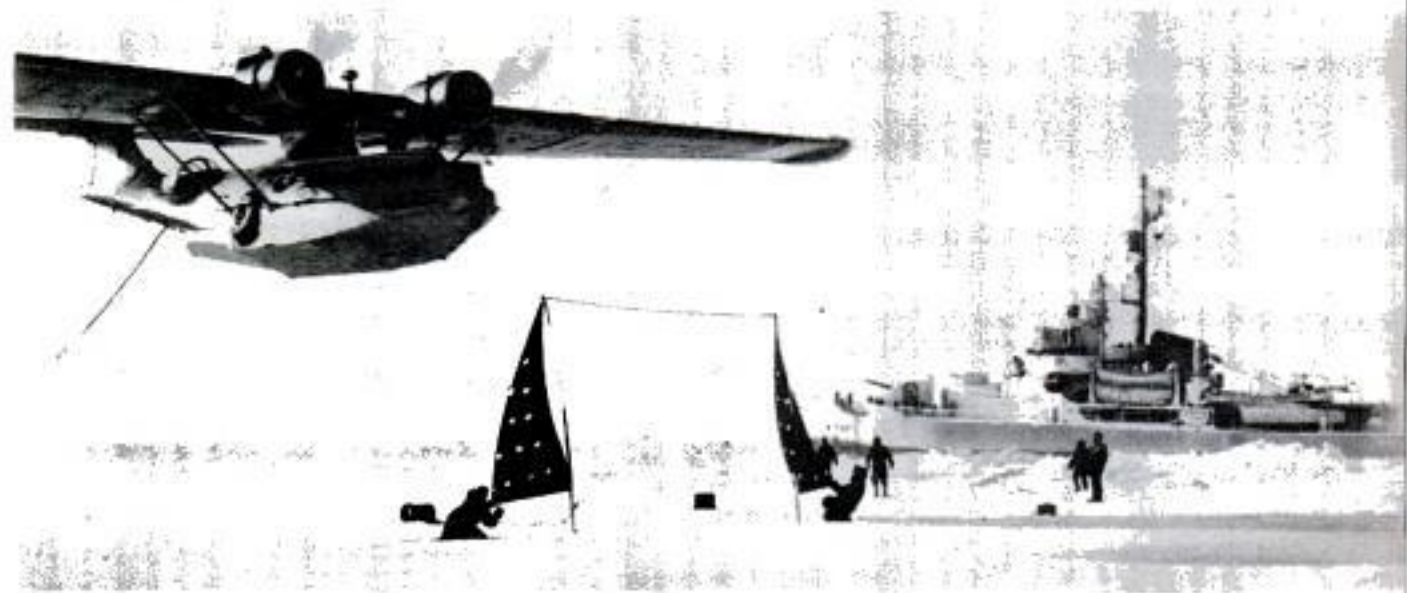





Boat on Snake River mail run plows through 93 miles of rapids. Canyon dwellers meet mailman along river

In the wilds of Idaho, for instance, from December through March, Lloyd Van Sickle runs a frigid, sky-bound mail route between Drummond and Squirrel, on a trail below the white crests of the Grand Teton Mountains to serve some 60 snowed-in farmers and cattlemen. The trail is often buried in 10 and 12-foot snowdrifts. So Van Sickle uses a team of 15 sled dogs and the mail rides on an Eskimo-type sled that is usually loaded down with a supercargo of necessary supplies for the isolated families on the run. Like Bud Branham, this north-country courier also brings in news from outside and, thus, is one of the most looked-for mailmen in the country.

Plenty of United States mail travels between Garden Valley and Lowman, Idaho, in the back packs of mountaineers equipped with snowshoes or skis. Many rural routes in Alaska get snowshoe service.

In a world of jet planes and guided missiles, mail by snowshoe and dog team seems incongruous. Unfortunately, there still are plenty of places where foot power, mules and horses are more practical than anything with wheels or propellers.

For more than 16 years Alex Worrells, route carrier between Rice Station and Noland, Ky., has run his 27-mile stint over incredible roads through the back hills in a horse-drawn buggy fitted out with

(Continued to page 284)

Shown at right are some of the experimental carts for Uncle Sam's carriers

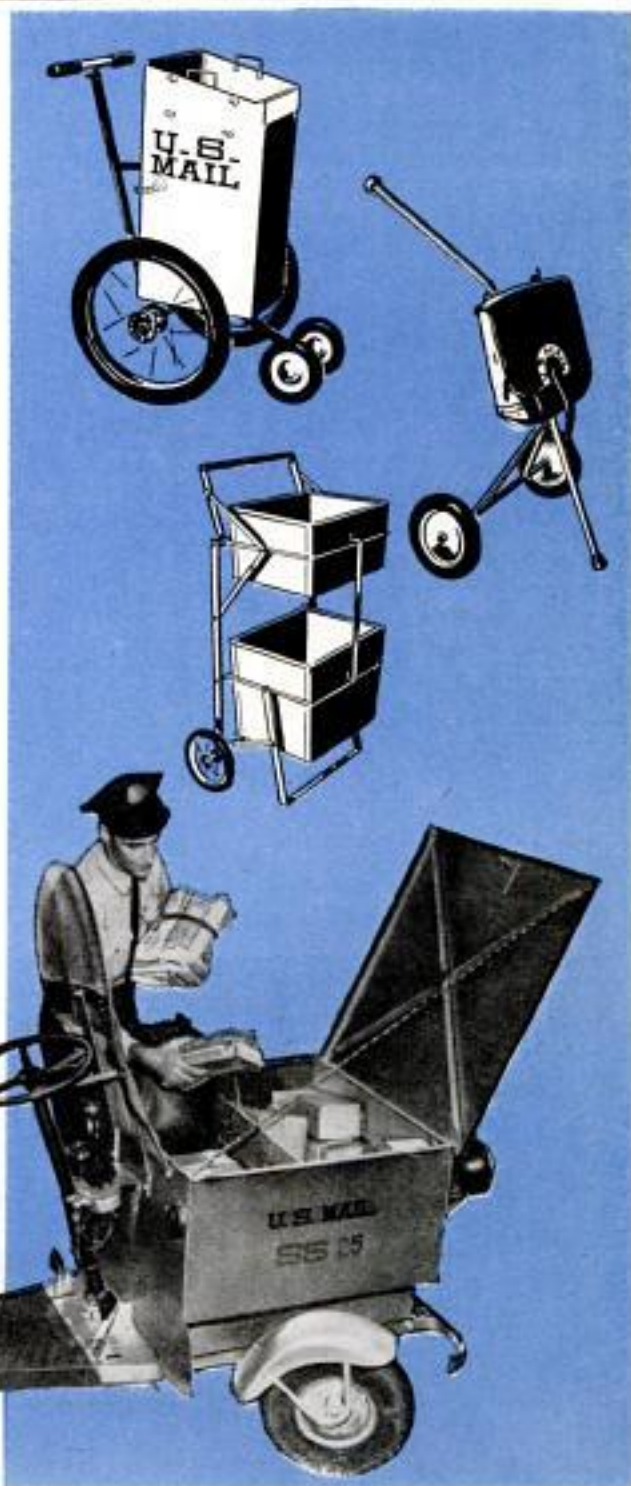



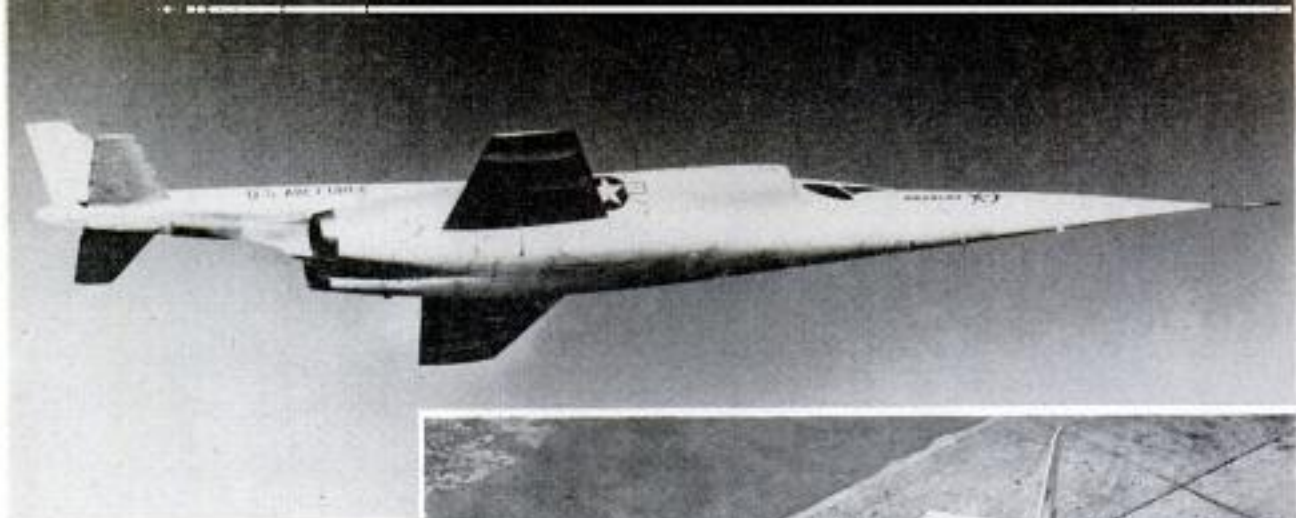

## 2000 M.P.H. Goal For "Stiletto"

Stiletto-shaped, a 66-foot-long Air Force research plane is expected to fly at speeds of 2000 miles per hour at very high altitude. The jet-powered Douglas craft has an extremely long, tapered nose and straight, stubby wings spanning a little more than 22 feet. Instead of armament, the X-3 carries 1200 pounds of research instruments. More than 850 pin-hole orifices dot the fuselage, wings and other air foils of the plane, part of the system for measuring pressures at virtually every point on the aircraft. Temperature recordings are made at 150 points. Strain gauges are spotted at 185 points to measure loads on the frame, most of which is titanium.



Douglas Aircraft Co. photos

## Cigarette-Maker Rolls Regular or King Size Five at a Time



Five cigarettes at a time are produced by a cigarette-making machine that comes in two models. The de luxe edition has built-in cutting blades, the other a manual cutting blade. It turns out both regular and king-size cigarettes, and the diameter of the cigarette can be adjusted to preference. With the machine you can "roll your own" at a cost of about nine cents a pack.

Information not listed on articles in the index, starting on page 16, frequently is listed in the WHERE-TO-FIND-IT LIST, which is available to readers without charge. A copy of this list may be obtained simply by sending a postcard or letter to the Bureau of Information, *Popular Mechanics Magazine*, 200 East Ontario Street, Chicago 11



## Tilting X-Ray Examination Table Suspends Patient by Heels

Patients fastened to an X-ray table that tilts in a 180-degree arc can be fluoroscoped as they are changed from a head-up to a horizontal to a feet-up position. Uninterrupted observation is possible as the patient is turned. Unneeded are cumbersome shrouds and compression-band attachments, which interfere with fluoroscopy. The feet-up position is especially useful when inspecting the spinal column and digestive tract. The unit mounts an X-ray camera so that the examining doctor can record on film what he has just seen in the fluoroscope. Incorporated in the camera is a novel photo-timing device which automatically terminates an X-ray exposure when a proper film density has been reached, eliminating guesswork and retakes. The new diagnostic unit was developed by General Electric.



## Motor From Paratrooper Bike Powers Miniature Motorcycle



Five-year-old Randie Lou Reynolds of Albuquerque, N. M., scoots around the neighborhood on a miniature replica of her father's motorcycle. Reynolds secured the 97-c.c. one-cylinder motor from an English paratrooper bike. Other parts came from a child's bicycle and a tricycle, a piece of copper tubing and a shower rod, auto wrist pins and a sun-visor bar. A governor holds Randie Lou's speed to 15 miles per hour, but a top speed of 35 m.p.h. is possible.

## Rubber Strip on Bottom of Garage Door Keeps Out Rain and Snow

Overhead garage doors fitted with a flexible rubber weatherstrip are sealed against the elements when closed. Nailed to the bottom of the door, the strip keeps out rain, snow, sleet and drafts. Uneven surfaces under the door are sealed by the strip, which eliminates the bang when the door is closed and prevents the door from freezing to the floor.

☐ Almost half of California's cotton crop is now sprayed with chemicals which remove the leaves before harvest.

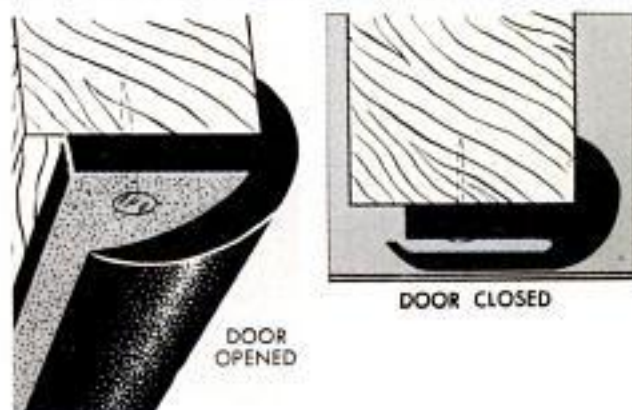



## Air Force Flying Lung and Its User Easily Carried by Two Men



Movement of lung-disease victims by air or ambulance is simplified with the use of a new lightweight "flying lung." Developed at the U.S. Air Force School of Aviation Medicine, the portable respirator operates off either a plane's electrical system or a 24-volt battery. It is six feet long, less than two feet deep and with a patient inside is easily carried by two men.

## Plastic Balloons Save Oil

Microscopic plastic balloons floating on top of crude oil may solve the evaporation problem in large storage tanks. Filled with nitrogen gas, the resin balloons nudge each other into a tight, floating pack one inch thick. This layer is said to cut evaporation as much as 90 percent. Each year an estimated \$60,000,000 worth of stored oil is lost by evaporation.

## Clamp Fastened to Automobile Wheel Gives Needed Traction

Cars are freed from snow and mud by a pair of clamps which fit around the rear tires and clamp to the wheel rims. The new devices can be installed or removed in seconds without the use of tools and without

soiling gloves or hands. A simple lock fastens them to the rear wheels of Fords, Chevrolets, Plymouths and several other automobile models using size 670 tires. Pressing a release unfastens each clamp.

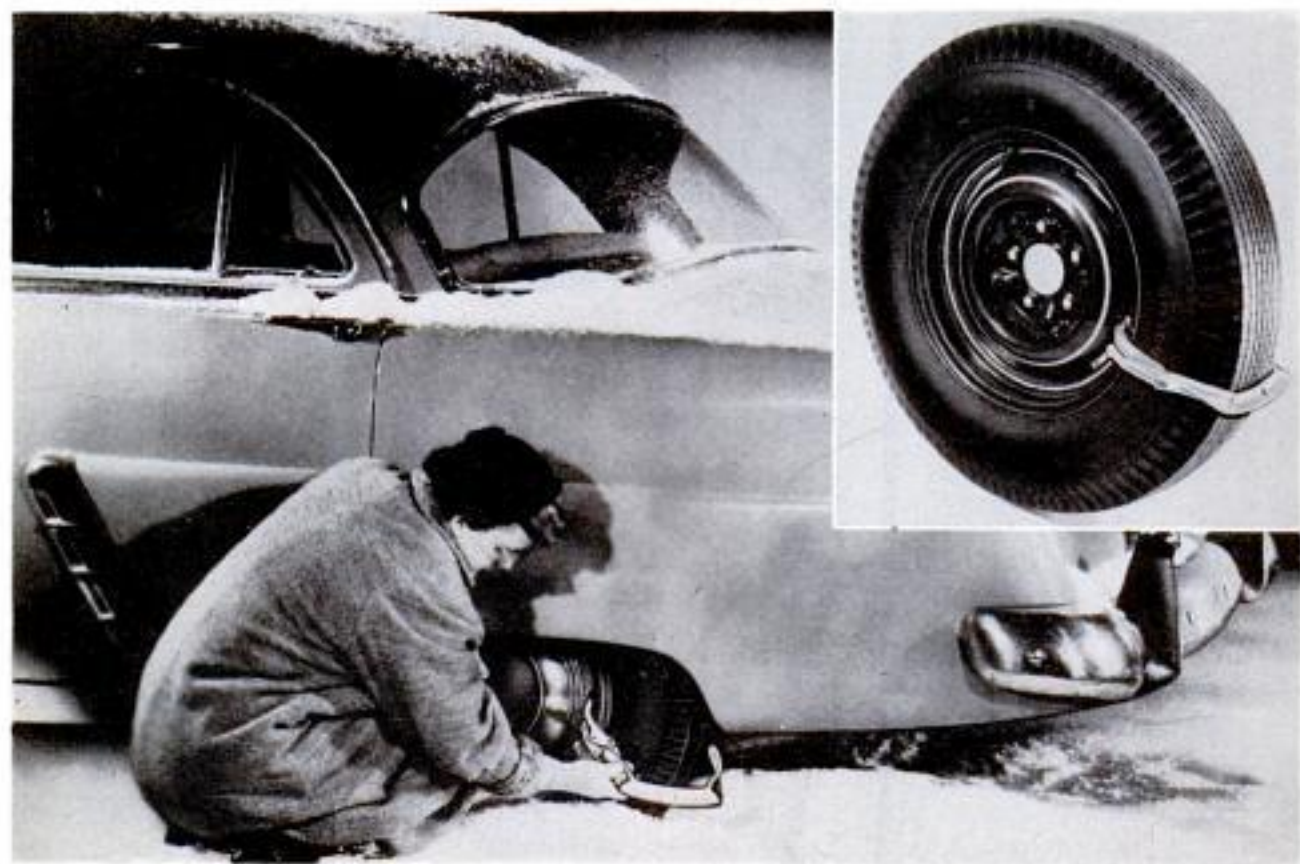





Wooden cross, studded with coffee can tops, and yellow and black auto license plates label these cabooses

## *Personalized Markers Identify Freight Cabooses*

YEARS AGO the freight crews on the St. Louis Southwestern Railway had a problem. When night fell and crews returned from town, even with flashlights it was difficult to locate the proper caboose—their headquarters on wheels. Lined up on the caboose track, all the “crummies,” as they’re called by railroaders, look alike, even to the crews. Checking the car serial numbers took a great deal of time. Finally someone came up with the idea of identifying each by a distinctive marker or sign, perched prominently on the roof. Ingenious crews took up the challenge and competed in designing unusual, personalized markers for their cabooses. Now the railroad’s yards at Tyler, Tex., and Pine Bluff, Ark., are liberally sprinkled with cars bearing individualistic standards, some highly humorous. They range from baby shoes and plumbing materials to signs and traffic markers.



Brightly painted fuller ball is a familiar tag

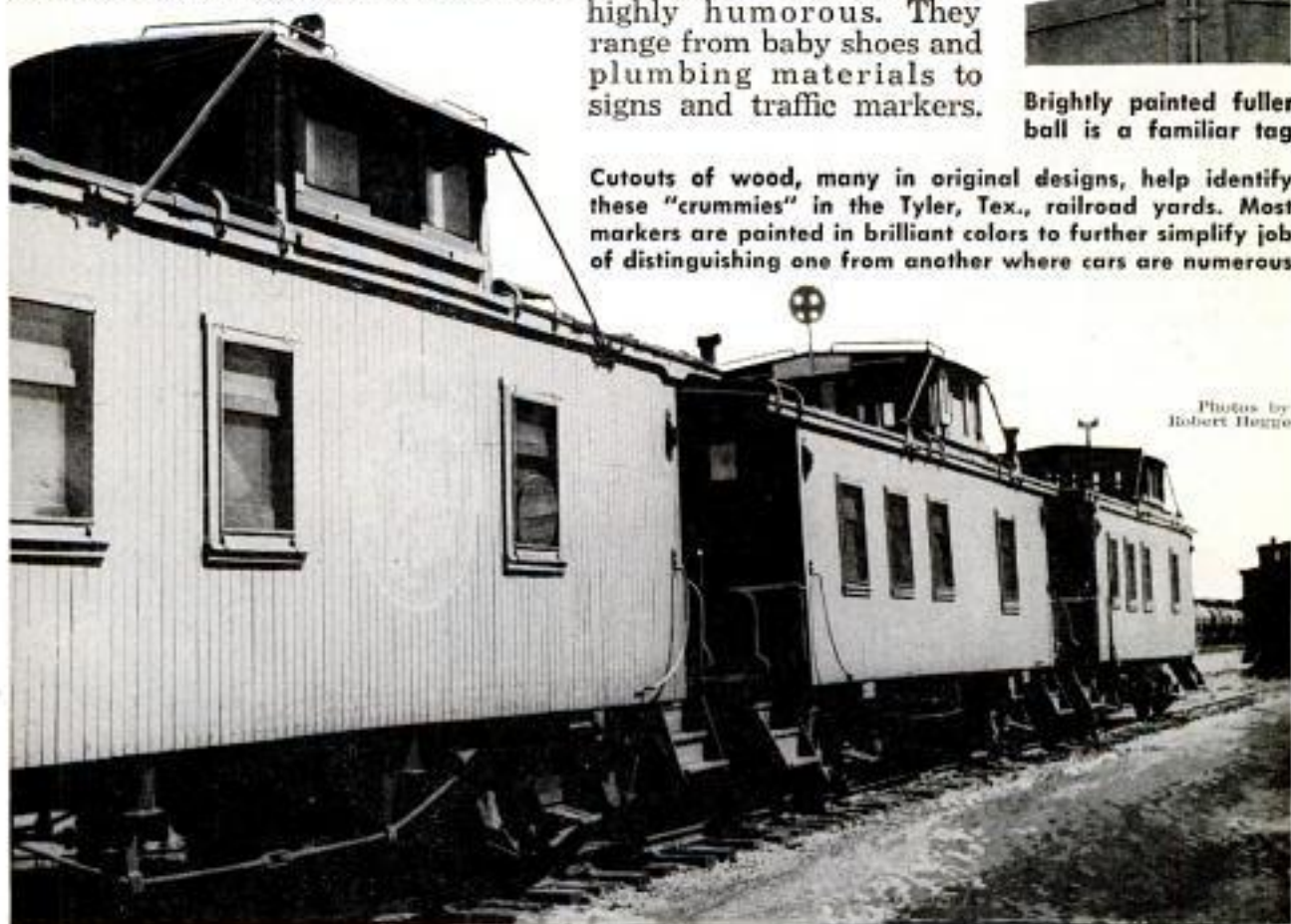

Cutouts of wood, many in original designs, help identify these “crummies” in the Tyler, Tex., railroad yards. Most markers are painted in brilliant colors to further simplify job of distinguishing one from another where cars are numerous

Photos by Robert Hogue





France's Renault Fregate convertible was a top attraction. It has an overhead-valve, four-cylinder engine

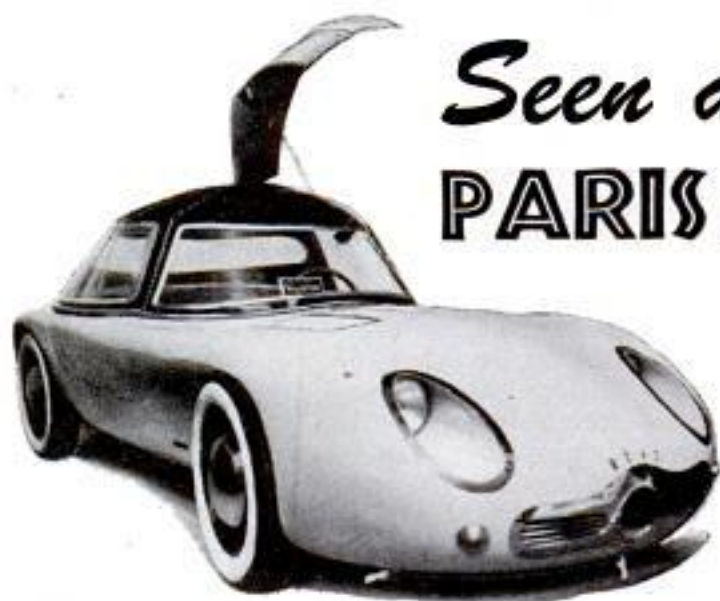

With a body of lightweight plastic, the Morocco-built Reac has won several North African races. Roof and windows can be detached from the body to convert it into a roadster

## *Seen at the* **PARIS AUTO SHOW**



Among the British cars was the Austin-Healey 100, a four-cylinder speedster that set a record of 142 m.p.h. on the Bonneville Salt Flats



Among the numerous American cars exhibited at the Paris show was the Henry J, which is closer in size than most U.S. cars to Europe's average

Left, the Marathon two-seater is another car with a plastic body. It was made in France and is extremely lightweight with very sleek lines



Below, Chrysler showed a special Ghia-bodied car at the exhibition, as well as its regular line of cars. This model has the 185-horsepower Chrysler engine



Above, an example of the sleek Italian styling, the Nardi sports car has two cylinders and a top speed of over 100 m.p.h.



Below, Spain's Pegaso 102 boasts a body by Saoutchik. Designed as a high-speed sports car, it has a big 250-horsepower V8 engine

Below, the Bristol 403 has a rather unconventional front end, but one based on careful wind-tunnel tests for high-speed efficiency. It exceeds 100 miles per hour with a minimum of effort. Engine produces 100 hp.



Right, weighing only 1430 pounds, the French Panhard 54 is made mostly of aluminum. Its two-cylinder, air-cooled engine gives it a top speed of over 80 m.p.h. The body panels, engine and chassis castings are of aluminum



Above and right, another French car at the show was the Salmson sport coupe. It has a four-cylinder, double-camshaft engine. The rear window extends up into the roof. Its overhanging hood makes it look like a shark





# PERPETUAL MOTION

By Robert E. Paquin

**THE CHAIN THAT RUNS FOREVER.** Here's just one of several similar inventions. It's an endless chain mounted on pulleys. Free-rolling idler wheels on one side of this marvelous machine make that side of the chain longer than the other side. Since the chain is obviously off balance, says the inventor, it therefore follows that this added weight on the right will pull the chain around and—presto, we have perpetual motion. Why doesn't it work? Figure it out yourself before reading further. Explanation: part of the weight of the right side of the chain is supported by the idling wheels at the points where the chain curves round them. This offsets the extra weight of the right side of chain

**THE SPINNING RING.** One of the simplest ideas of all, and it's bound to work, says the inventor. A metal ring is held in position by two idler wheels which have free-rolling bearings. The ring is supported at such an angle that it has a continual tendency to roll downward, causing it to spin merrily on forever. You can try it if you wish, but it just won't work. Why? Explanation: the force exerted by the two idler wheels to hold the ring in this position cancels out the gravitational force which tends to turn the ring, and the ring doesn't spin

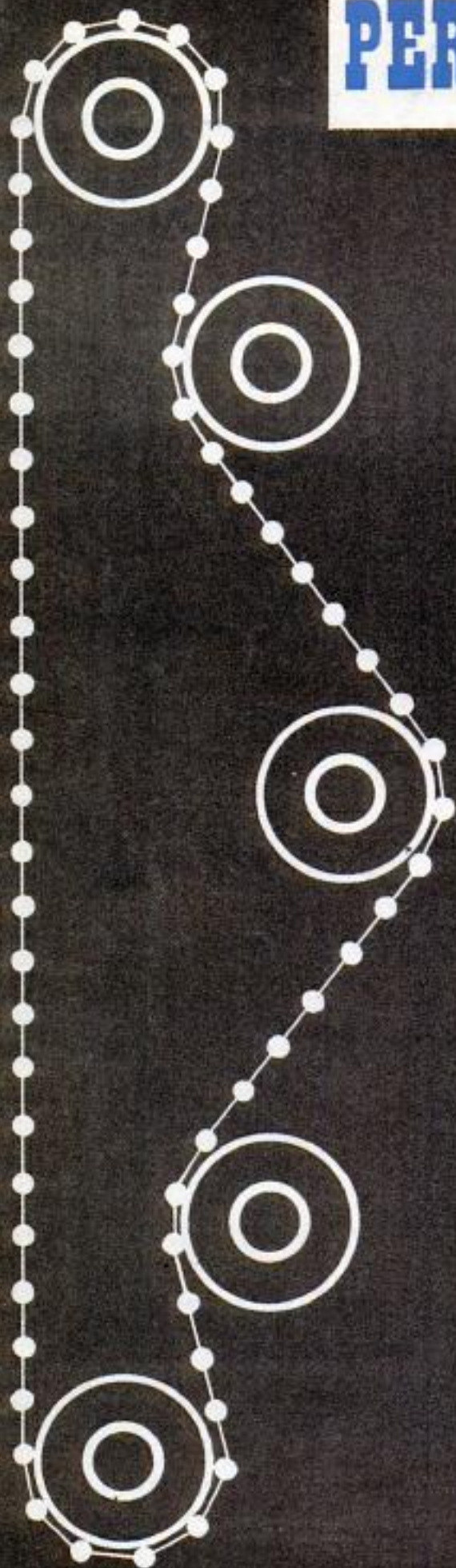



# JUST ISN'T

**T**HE HISTORY of perpetual-motion machines is replete with motors that won't "mote" and engines that won't "eng." Fortunes have been spent to make possible the impossible. We present here some of the more common types of perpetual-motion devices. In many cases, the inventor's explanation of why the machine will work seems quite plausible, but always he overlooks some principle of physics that stops his machine dead in its tracks. Can you tell why the device won't work before reading the explanation? ★ ★ ★

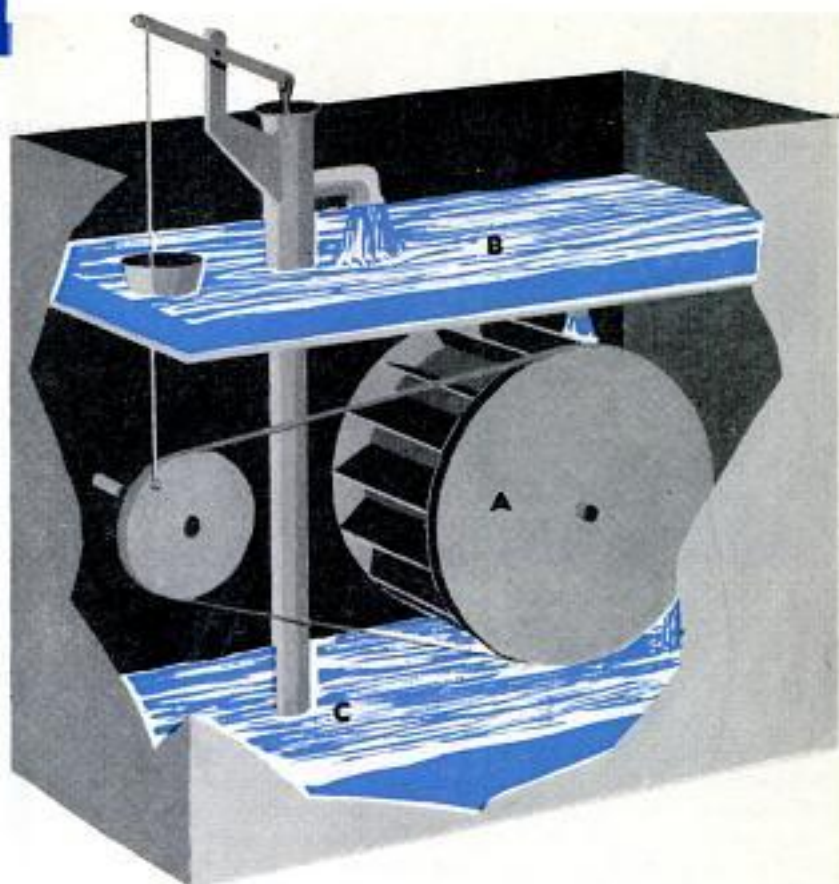

**THE PUMPING WATER WHEEL.** There have been a good many variations of this idea. A water wheel "A" is operated by water dropping through a hole in the top reservoir "B." The wheel drives a pump to lift water from the bottom reservoir "C." The water is lifted up to the top reservoir, finds its way through the opening and turns the water wheel. Works fine according to the inventor. Now you figure out why it won't. Explanation: Friction won't permit the apparatus to lift as much water as falls, so all the water eventually ends up in reservoir "C"

**THE WATER CYCLE.** You may laugh at this one but a good many inventors have tried it. The apparatus consists of a large vessel of water "A" with a tube extending from the bottom, back up at "B" and around until the end is over the vessel. Now when you put water in the vessel, says the inventor, it will push its way up tube "B," and since the weight of the water in the large vessel greatly exceeds the water in the tube, the water will flow right on up and eventually fall back into the vessel. This will continue forever (or at least until someone explains why it won't work). Explanation: Best summed up in the old phrase, "Water seeks its own level." The water will rise in the tube only to a point equal to the level of the water in the large reservoir

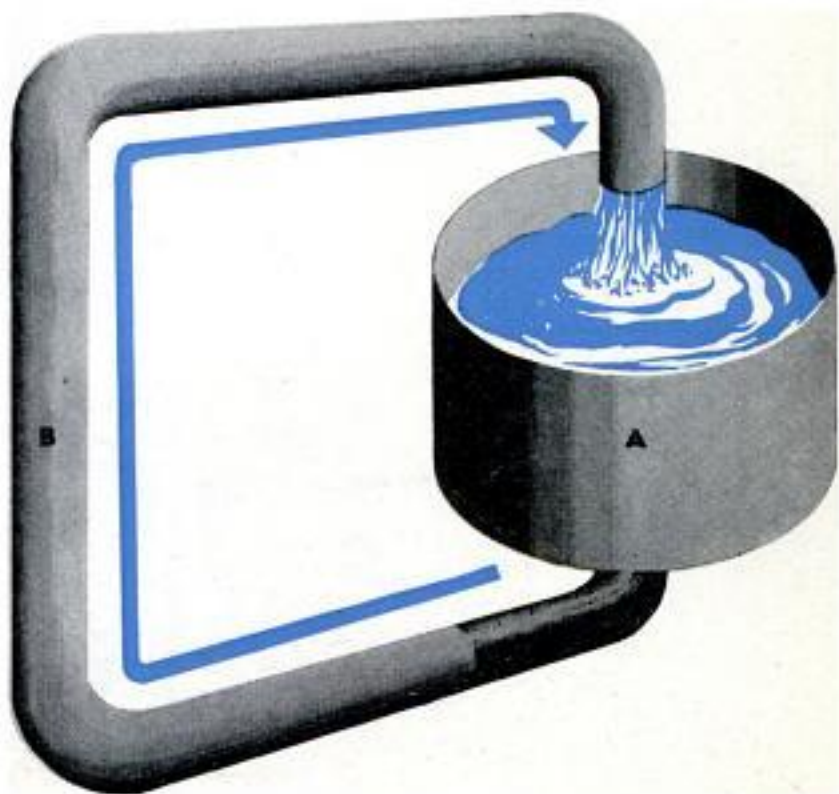



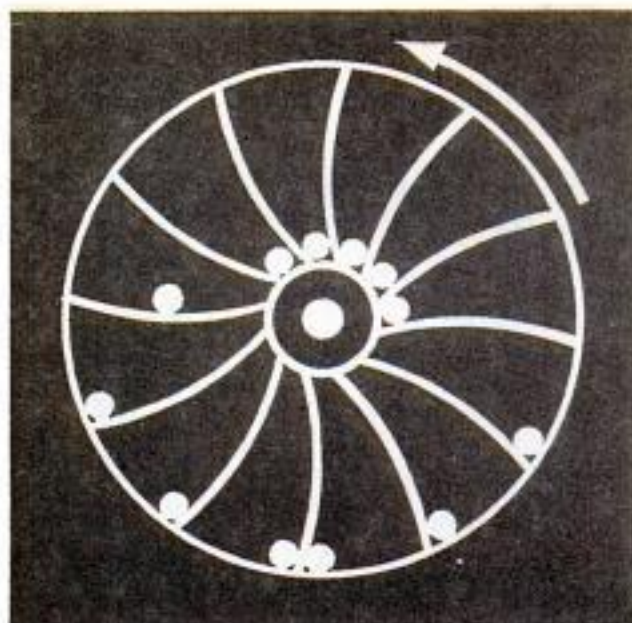

**THE CAGE AND BALLS.** This is a leverage problem. The invention consists of a cage divided into pockets, each of which contains a heavy ball. The drawing shows the apparatus in cross section. Because the balls at the left are farther from the hub than those at the right, the wheel should turn in a counter-clockwise direction. As it turns, more balls roll toward the rim to keep it spinning. Well, why won't it work? Explanation: This one has to be disproved mathematically, but the idea is that despite the illusion of greater leverage on the left, the total force exerted downward on each side is exactly the same and the wheel will reach a state of equilibrium

**THE BUOYANT SPHERES.** Here's a good one. In this rig, the left column, "B," is filled with water. At the bottom is a puddle of mercury, "A." The mercury, being heavier than the water, stays at the bottom of the apparatus. In the slanting column at the right are hollow iron spheres. The total weight of the spheres pushes the bottom one through the puddle of mercury and into the upright column. The hollow sphere floats up through the column of water, strikes the line of spheres and pushes the top one over to the ramp, and eventually it reaches the slanting column again. On the way over, it partially rotates a paddle wheel to perform useful work. Sounds rather logical, doesn't it? Explanation: As the bottom ball is forced up into the column of water, it raises the weight of the water-plus-balls, forcing the mercury back up the other column. This prevents another ball from entering the column. Another failure

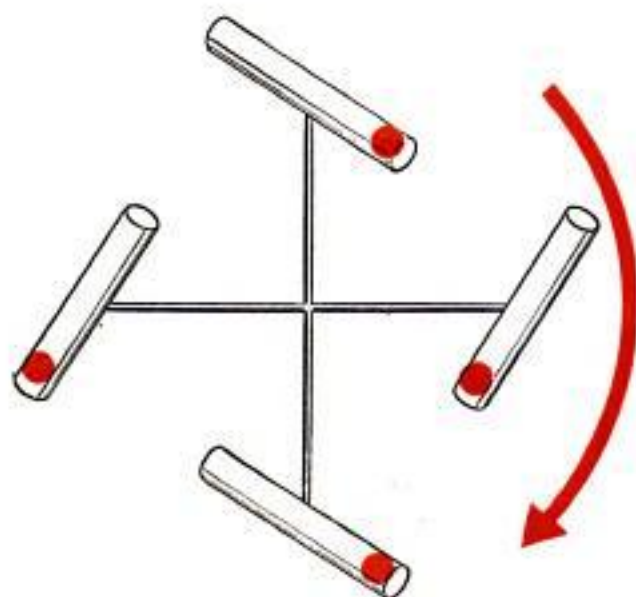
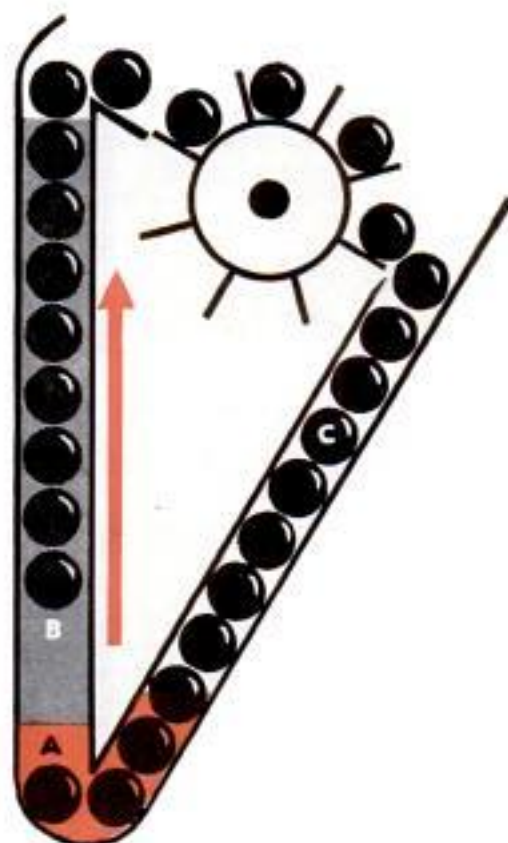

**MORE ROLLING BALLS.** In this one, hollow cylinders, capped at both ends, are fastened at an angle to the crossbars. Inside each of the cylinders is a steel ball. Since there are three balls on the right side of the center and only one on the left, the wheel should turn in the direction of the arrow. As the cylinder on the left reaches the top, the ball will roll to the other end to keep the wheel turning. Sounds reasonable. Why won't it work? The explanation: Imagine the vertical arm completely removed. The remaining arm will swing in a counterclockwise direction. Now imagine the horizontal arm removed. The vertical one will swing in a clockwise direction. At one point in the revolution, these two forces will balance and the blame thing just won't turn



**PIVOTING BALLS.** There are variations on this one by the hundreds. You can get the idea at a glance. As the wheel revolves, the weights are thrown out to the right, where they have greater leverage and therefore keep the wheel spinning. Each successive weight adds its thrust. Try building one, and you'll soon find out that the apparatus grinds to a halt. Explanation: there are more weights on the left side, balancing the increased leverage of the weights on the right. The wheel soon reaches a state of equilibrium

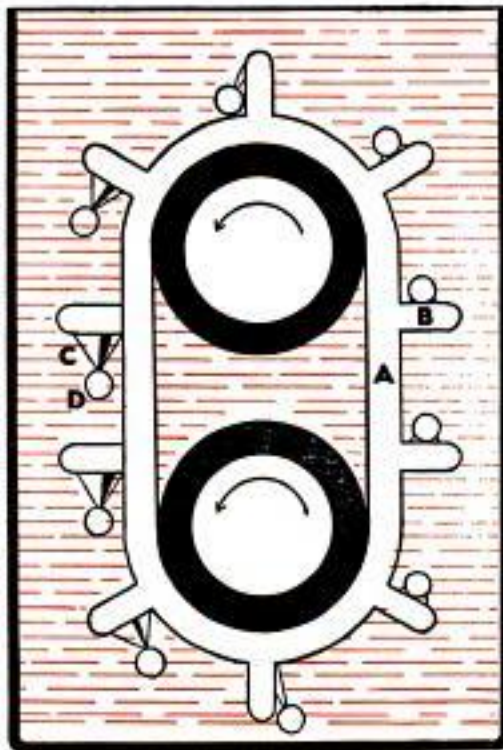
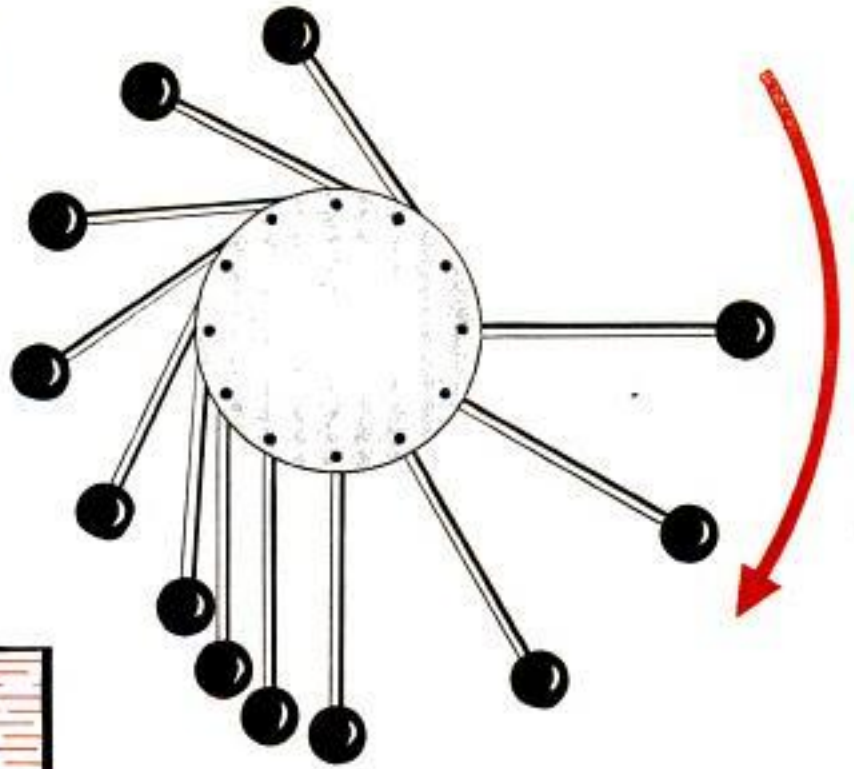

**THE WEIGHT OF AIR.** This one is highly theoretical. A hollow ring of rubber "A" has hollow projections "B" which extend outward like shelves. Fastened to each shelf is a thin rubber membrane "C" to which is fastened a metal ball "D." At the right side of the assembly, the metal balls lie on the projections after having deflated the air from the thin membranes. At the left side, the air has been drawn into these membranes, and the wheels should turn. We've put the apparatus in a vacuum to make it a little easier to understand. Why won't this one work? Explanation: The weight of the trapped air is so negligible that it cannot overcome the impeding force of friction, no matter how fine the bearings. It poses well for a time exposure

**THE CREEPING SPONGES.** There's a lot of ingenuity wasted on this idea. A continuous band of sponges "A" is confined between conveyor belts. To the outside belt is fastened a band of weights, "B." The inventor says that capillary action will draw water up the vertical band of sponges, causing the band to move in the direction of the arrow. Weights pressing down on the slanted column of sponges will squeeze out the water and the whole apparatus will continue to revolve. This idea is all wet. Why? Explanation: Water in the sponges on the right is not instantly removed as each sponge emerges from the water. Thus these sponges are also partially hydrated and there are more of them. It's a standoff

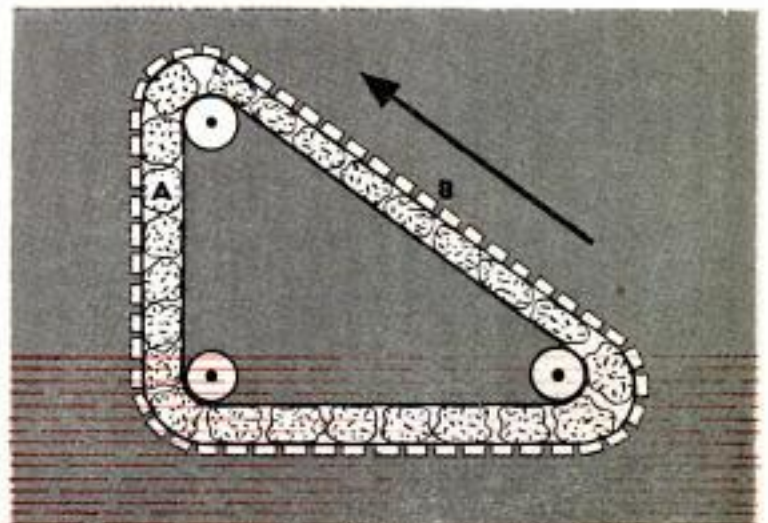



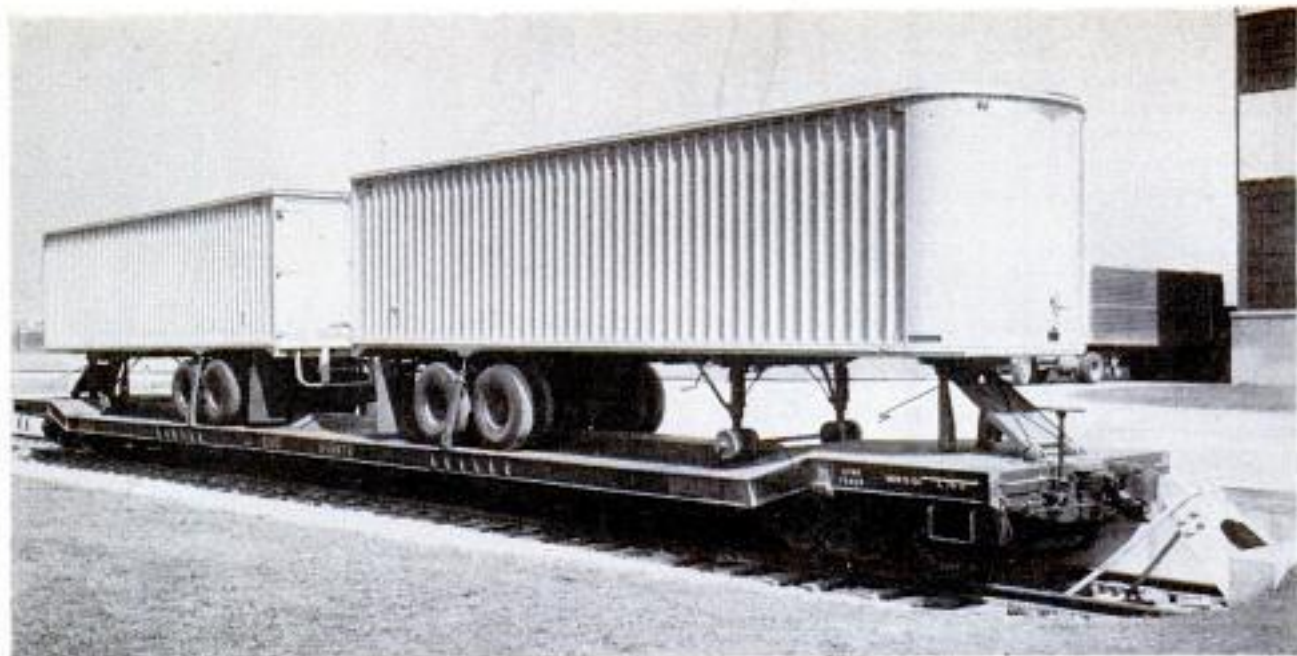

Long flatcar totes two trailers. Shock absorbers permit stanchions to move  $4\frac{1}{2}$  inches, reducing shock to cargo

## Semitrailers Ride Railroad Flatcars in Fast-Freight System

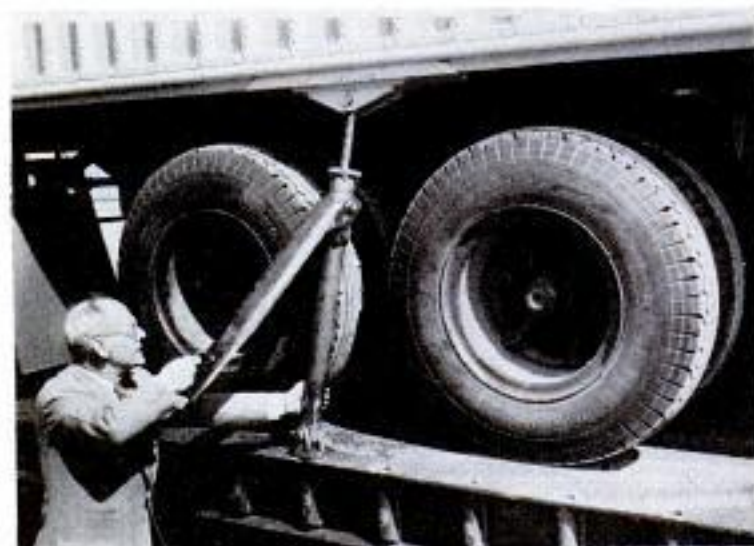

Adjustable struts anchor the trailer to the special flatcar

IN THE NEAR FUTURE, many semitrailers may ride on railroad flatcars instead of rolling down the highways. General Motors has worked out a system which may take thousands of semitrailers off the highways and speed freight deliveries. In the new system, the trucker picks up his load at a shipper's dock and delivers the loaded trailer to the railroad. A big lift truck maneuvers it aboard a special 75-foot-long flatcar designed to carry two trailers. The flatcar moves the trailer to its destination, where another truck picks it up and delivers the cargo. The plan is considered applicable over 300-mile intercity routes.

Big hydraulic lift trucks maneuver the semitrailers on and off the cars at the railroad loading docks





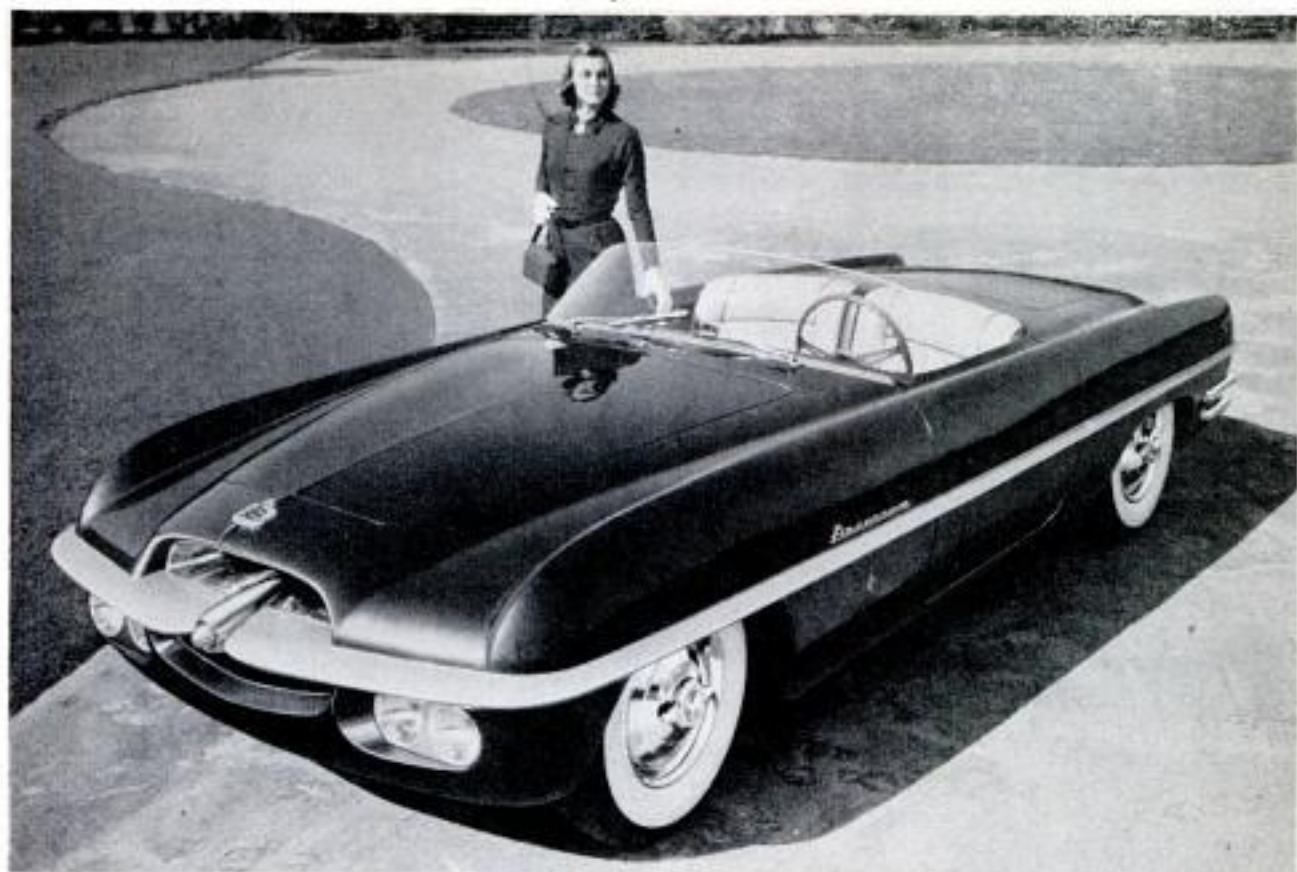

Only 34 inches high, the Dodge Firearrow has four low-mounted headlights, one large radiator air intake

## Chrysler Stylists Bring Out Two Experimental Models

TWO CHRYSLER divisions, Dodge and De Soto, are showing special models or "dream cars" that may herald things to come in tomorrow's styling. Both bodies were made in Italy by Ghia; the Adventurer is Chrysler-designed, Firearrow Italian-designed.

The Dodge prototype, called the Firear-

row, is a low, two-seat roadster. The De Soto Adventurer is a closed coupe that seats four. Both are examples of the uncluttered Italian styling so often imitated these days. The Dodge has a V-shaped rub rail running around it. The De Soto is virtually without ornamentation.

De Soto's Adventurer has a recessed rear floor. Below the door one of two polished exhaust pipes is visible





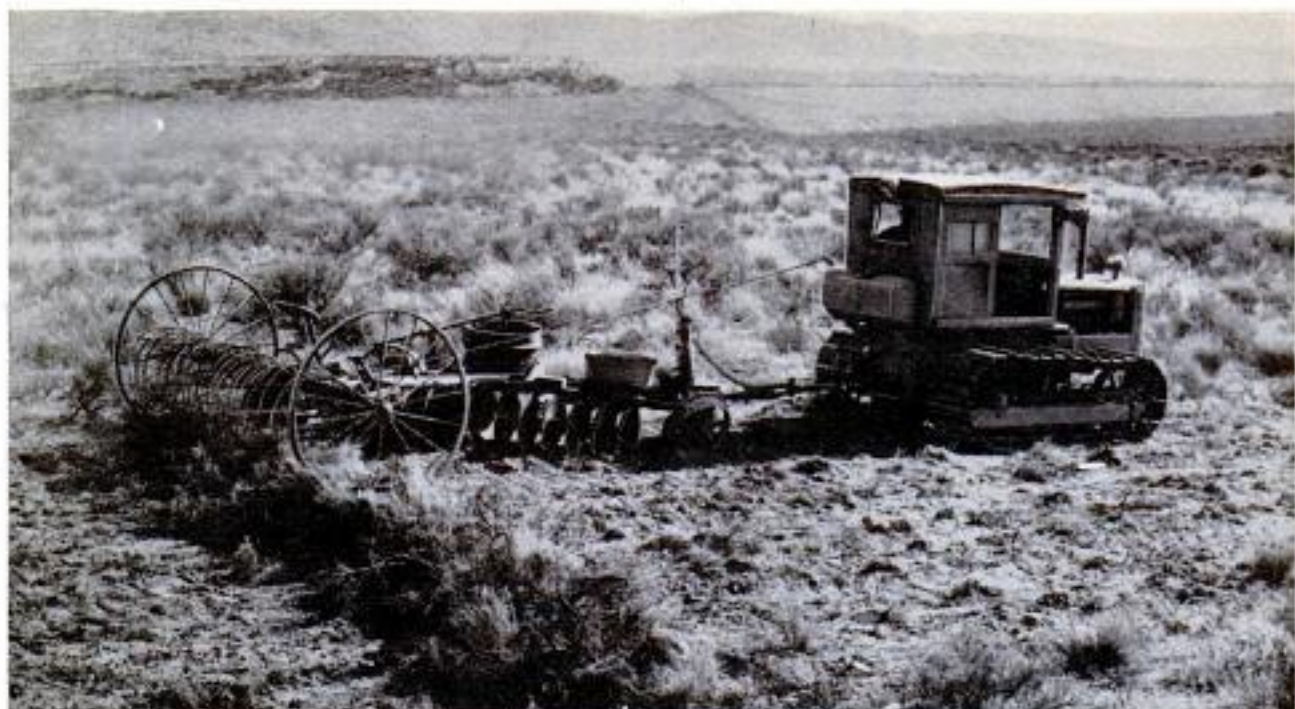

U.S. Bureau of Reclamation photo

Ingenious farmer in Yakima Valley combined a disk and rake to grub out and pile sagebrush in one operation

# The Battle of the Sagebrush

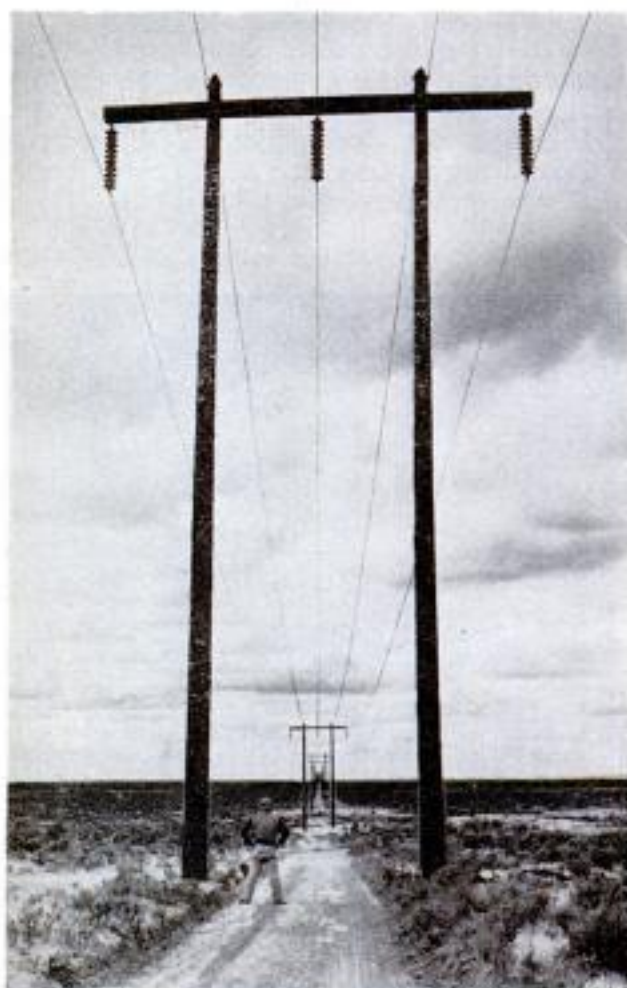

**M**ARK TWAIN once summed up the West's sagebrush situation: "As a vegetable, sagebrush is a distinguished failure. Nothing can abide the taste of it but the jackass and . . . the mule." Twain would be pleased if he could see what is happening today.

Westerners are currently gunning for sagebrush with the same vigor they showed years ago in warring on horse thieves. In fact, the situation is such that it recently inspired one Western columnist to lament that "the sagebrush is going the way of the buffalo, the trumpeter swan and the passenger pigeon." This is a slight exaggeration. There are still more than 90,000,000 acres of sagebrush in the West!

For the most part, sagebrush is just about as worthless as Twain said it was. Not only worthless, but it makes growth tough for worth-while forage.

During a four-month summer-grazing season, 100 acres of average sagebrush land will feed only one cow. But rid that same land of sagebrush and reseed it to crested wheatgrass and it will take care of 10 cows.

Through overgrazing, some range lands that were once hip-deep in grass have been almost completely taken over by sage-

**Power lines now cross the purple sage. Power means dams, dams mean water, water means less sagebrush**





First harvest: The year before, this land was covered with worthless sagebrush. Now it's good farm land

# Busters

By Rafe Gibbs

brush. In fact, there is more sagebrush in the West today than when Twain sounded off about it.

That's what bothered members of the Rotary Club at Lakeview, Ore., one Wednesday noon in 1948. Their county—Lake—sprawls over 5,000,000 acres. Half of this acreage is in sagebrush. What could be done about it?

The Rotarians staged for ranchers demonstrations of brush clearing with specially adapted plows and flame throwers, then

With the oldtime mattoxe a man was lucky to clear half an acre from sunup to sundown







"Stump jumper" for "brush bustin'" has disks mounted in pairs. Each pair can ride right over a big rock

offered annual prizes of grain drills for the ranchers making the best showing in rehabilitating their ranges. So far, about 20,000 acres of land in Lake County have been cleared of sagebrush and reseeded to grass. That's not a very big dent in 2,500,000 acres but it's a start and, as one Rotarian put it, "We're now able to feed 1800 more cows. Add that up in T-bones."

Biggest pay-off, however, has been the fact that other organizations in the West have been inspired to adopt the campaigning tactics of the Lakeview Rotary Club.

Cutting a big swath through sagebrush in

national forests the last few years has been the U.S. Forest Service. Land cleared and reseeded to date—506,843 acres. Now scheduled for sage-to-grass transformation—3,289,599 acres.

But the Forest Service, like the Lakeview Rotarians, is also interested in inspiring individual ranchers to clear their ranges of sagebrush. It has been highly effective with its Dixie National Forest project in southern Utah.

Some ranchers had been contending that the Forest Service picked only selected, small and lush spots for its demonstration

In areas where sagebrush is fairly dense it can be burned out, then the soil seeded with hardy grasses

U.S. Forest Service photo





plots. That was a challenge to the men in green and they came back in 1947 with plans to reseed a single, 23,000-acre area known as the Pines, on Paunsaugunt Plateau. "Paunsaugunt" is Ute for "home of the beaver," but the beaver had long since left. Pickings had become too slim.

"Sure, the natural grass was grade-A," said one old-timer, "but getting a stand with reseeding is something else. Rainfall most years isn't much over 12 inches. And rocky—you can walk for miles some places without stepping on dirt. The Forest Service is going to look awful silly trying to grow grass here."

And for a while the Forest Service men thought so, too. They started tearing into the sagebrush and rocks with one-way wheatland plows. Three plows broke the first day.

Then the Service imported from Australia a plow called the "stump jumper" and redesigned it for sage-busting. "Cookies" (Australian farmers) apparently got the idea for the plow from watching kangaroos travel across rugged terrain. When a kangaroo comes to a difficult obstacle, he jumps it. The plow works the same way. Disks are mounted in pairs on independent arms controlled by springs. When a rock or stump is encountered, the disks in its path rise up and ride over it. But the obstacle has to be a pretty tough one before the plow will let it pass.

On some of the rockier ridges, however, even the stump-jumper was stumped. Forest Service mechanics then came up with the Dixie harrow or drag. Large, loose pipes with spikes twist and roll through the brush, tearing it down and at the same time smoothing the earth.

"The job was as tough a one as I ever got involved in," says Forest Ranger Bert Tucker, "but we've got the grass before us now and the ranchers back of us."

Typical of the Pines-area ranchers is Konroy Henri, a Navy veteran who returned to ranching on 830 acres of sage-studded land.

"The Forest Service spread looks mighty good," he says. "On one choice, 690-acre patch the stock carrying capacity has been increased 15 times by reseeding.



Farmer uses a homemade rake to windrow the sagebrush. Then he comes along with an improvised flame thrower and burns it



Homesteading veteran in Idaho has his own system for "busting out" sagebrush. He uses a rail weighted down with a heavy log. Here's another homemade rig. This one has sharp blades that slice off the brush below the ground. It will cut 40 acres a day

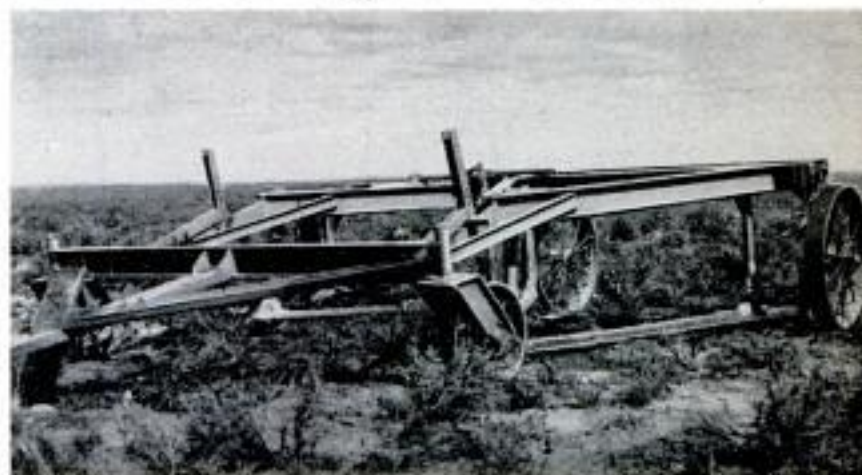





**This farmer is literally "in clover" now that he's cleared the sagebrush and water has come to his land**

I'm starting to reseed my range, and don't plan to stop until I've got 600 acres of new grass."

What has happened in the area has interested all Utah—particularly its women. The Utah Federation of Women's Clubs is now promoting trips to the scene of the Forest Service's triumph. And it has long been said out in the range country that "when the women get behind the wheel the men will start turning it."

Giving the men further inspiration is the Production and Marketing Administration, which has been paying part of the costs of clearing sagebrush and reseeding the land, and the Soil Conservation Service. Ranchers in SCS districts can rent heavy sage-removing equipment from the SCS at maintenance and operation costs.

Another organization due credit in the clearing of much sagebrush from Western

acres is the Bureau of Reclamation. Last year the Bureau celebrated its 50th anniversary and figured it had brought irrigation to 2,190,000 acres. Most of those acres were in sagebrush before the water came and most of them had to be cleared by individuals who moved onto the land.

Even today it is difficult to find commercial equipment suitable for removing sagebrush. The Forest Service's stump-jumper or "brushland plow," for instance, is not on the commercial market. Comments O. L. Kime, Bureau of Reclamation engineer at Burley, Idaho:

"Perhaps the reason why the farm-machinery industry has neglected to develop a machine for clearing sagebrush is that it is not a continuous seasonal operation. Once the brush is removed and crops are started, the brush never reappears."

(Continued to page 258)

**Huge wheatland plow is among the most effective weapons against sage. It cuts a swath of brush 30 feet wide**  
U.S. Bureau of Reclamation photo





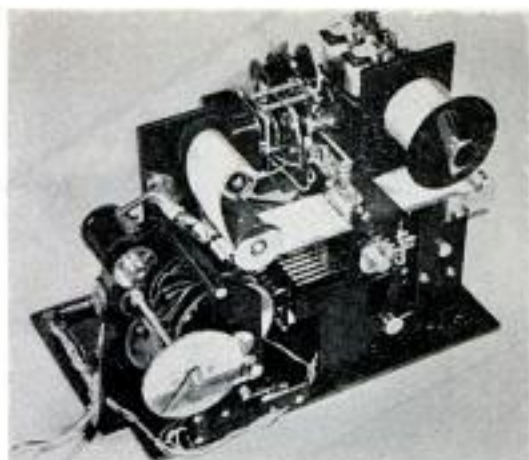

## Mechanical Brain Prints Answers in Easy-to-Read Numbers

There are no graphs or punched strips of tape to be interpreted with a new mechanical brain that prints the numerical answers for anybody to read. The machine, called an Analog Data recorder, can record temperature, take weight, measure the length of an object, give the light intensity, voltage, pressure, stress strain and revolutions per minute. It measures and records almost any physical quantity that can be converted into a corresponding voltage. This multiple recorder can be operated re-

motely, printing its data on tape, cards or tickets. Controls can be set for automatic operation, such as the taking of temperature or pressure at specified intervals; or it can be manually operated. The electronic engineers who developed the compact recorder in the laboratories of the Streeter-Amet Company in Chicago report the versatility of the machine is virtually unlimited. It will even do addition, subtraction, multiplication and division by utilizing various components.

## Biggest Transport Helicopter Cruises 150 Miles Per Hour

Weighing 15 tons and believed to be the world's largest transport helicopter, the new Piasecki YH-16 will carry 40 fully equipped troops, 32 litter patients or three

Jeeps. It has a 78-foot fuselage and cruises at nearly 150 miles per hour. Supplies, including guns and ammunition, can be carried in a sling beneath the fuselage.

Dwarfing two other multiplace helicopters, the YH-16's over-all length is 134 feet and its height is 25 feet







Pontiac introduces a new line in 1954—it's the Star Chief series, shown at left. The Star Chief models are bigger and more de luxe. Wheelbase is 124 inches, 2 inches longer than on other Pontiacs; overall, Star Chief is 213 inches long, 11 inches longer than others of the line. You can spot it by the stars on the rear fenders. Other style changes include a new grille and chrome striping

## Pontiac

Right, Pontiac also has a new air-conditioning system that is entirely front-mounted as shown here. The normally trunk-installed evaporator is placed inside the right front fender. Another idea is a mechanical seat adjustment that permits you to move the front seat up or down as well as horizontally

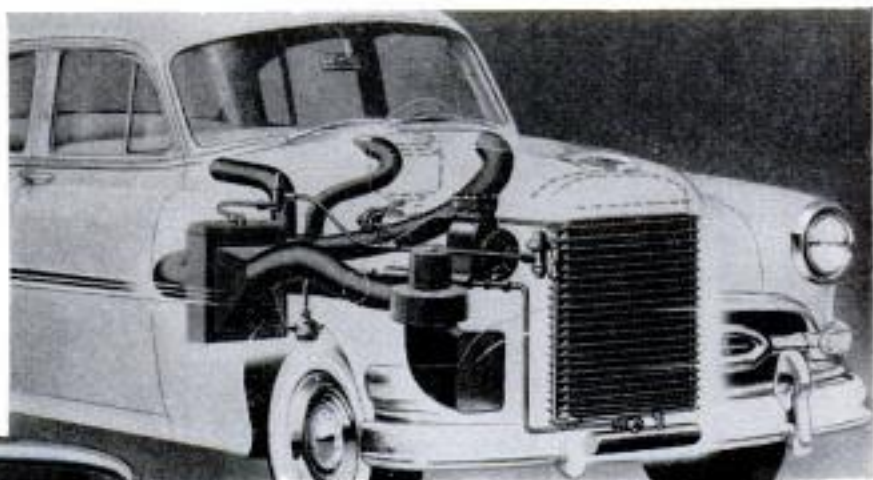

## More 1954

Chevrolet has a new front grille, but only few other exterior changes. The wider grille gives the car a lower look. Mechanically, there are more obvious changes. The 115-horsepower Blue Flame engine is now in the gearshift models; a 125-horsepower engine is used with Powerglide. Mufflers are almost twice as long for improved silencing

## Chevrolet

New this year with Chevrolet is the option of an electric front-seat adjustment and electric front-window lifts. There are 13 body models available in three series, with 13 two-tone color combinations. Powerglide is now optional on all models and interiors are emphasizing two-tone color treatments





Lincoln, after its win in Mexico for the second year in a row is making no important changes in its 205-horsepower V8 engine. Improvements this year include a better spark control, new vacuum-controlled four-barrel carburetor and redesigned hydraulic tappets. The bumper-guard air scoop and the three vertical bars in grille are new



## *Lincoln*



From the side, several decorative changes are apparent on the 1954 Lincoln. The forward-jutting bumper guards and wrap-around bumpers combine with new side moldings to make the car look longer. The gravel-shield design is new as are the taillights

## **“Debutantes”**

Mercury is unveiling a surprise model in its Sun Valley hardtop, shown at the right. It has a portion of its roof made of transparent plastic. A great car for sightseeing in the mountains or in big cities! Front grille is new



## *Mercury*



Mercury's biggest news is the overhead-valve V8 engine with 161 horsepower. High compression, with a short stroke, it is said to have economy plus performance. A four-barrel carburetor is also new as is ball-joint front suspension. Side view of hardtop, left, shows how rear fender now extends over taillight



# Detroit Listening Post



By Leo Donovan

**C**ARS GET BETTER every year and that's as it should be. Customers insist on such progress, although a few precious sentimentalists would still buy Model T Fords, Marmons, Bugattis, Hupmobiles and even Tucker Torpedoes, given the chance.

Constant improvement certainly contributes to sales. Some of these improvements, of course, are "corrections of last year's mistakes," as C. F. "Boss" Kettering has so aptly observed.

**But today we hear criticism directed at engineers for having given cars too much performance, too much convenience and comfort.**

Engineers are having to defend such developments as faster acceleration, greater horsepower, power steering and braking. They point out that while it is important to build cars to minimize crash injuries, it is even more important to build cars that make it easier for the driver to stay out of accidents. Charles A. Chayne, vice president of General Motors, said the driver has better control of his car today because of increased acceleration, visibility, power steering and braking.

On the other side of the argument, Paul H. Plaisdell, national safety expert, said he thought the one-arm driver soon may be eclipsed by the one-finger driver as a highway menace. Power steering makes such a menace possible, he said.

Another viewpoint was submitted to the National Safety Council by safety leaders in Michigan. They state that faster speeds make essential 100-percent driver attention, yet such physical aids as power steering tend to give the driver a sense of security that might lead to inattention.

The general manager of Studebaker Corp. of Canada has also suggested that the auto industry take another look at itself. In 10 years, he said, these high-horsepower cars will still be able to go as fast, yet their tires, brakes and other parts will be dangerously worn. What happens then?

**Buick has pulled a fast one on the smart boys around Detroit. It was expected that**

**only the Roadmaster would be completely new, with wrap-around windshield. Now it turns out that the whole line will be all-new bodywise. And, of course, the V8 goes into the Special this year.**

Don't look for the long-rumored Lincoln Continental until 1956. And unless you're very rich and influential, don't expect to own one! Hints have it that it will gleam in splendor with production limited to fewer than 3000 copies a year. That will put it in a very restricted class indeed. How much it will cost is unknown, but a conservative guess is upwards of \$7000. With such restricted output, the competition to buy should put it in a far more exclusive category than any of the present "prestige" cars.

Speaking of performance and speed, the 1954 Dodge V8 averaged more than 101 miles per hour (including time out for pit stops) for 48 consecutive hours on the Bonneville Salt Flats to set a new stock-car record. It also travelled 108.36 miles per hour on the straightaway to become the fastest standard American car ever clocked by AAA officials.

You can expect Ford to come forward with a sleek sportster to rival the Chevrolet Corvette before the end of 1954. By then, the market for such cars will have been tested by the plastic Corvette and if it shows promise there will be others in it, too, you can bet on that.

**Suburbanites are expected to be the target for the dealers' sales drives in 1954. They hope to make more and more two-car families among the 30,000,000 persons now classified as suburbanites, most of whose breadwinners commute or drive to the city daily.**

That's the reasoning behind the contemplated "executive coupe" which will provide the man with a small car to drive to the station or office while the wife has the family car for the kids and shopping.

Nash is getting ready to announce its new offering in this field—although it refuses to label it a "second" car. That is the NKI—the small vehicle built to Nash design and specifications in England and brought over here for sale at a price said to be the "lowest in the industry." It has a wide, three-person seat in front and a "convenience" or jump seat in the back for packages or, on short trips, for the youngsters. It is expected to be announced early in 1954.

It looks as though you can cross the V6 engine off the list as far as Plymouth is concerned, at least. One very high Chrysler official was heard to say that you couldn't compete "uphill" with a V6 against a V8 and that when competition required it, Plymouth would have its V8 power plant.



READ ABOUT  
THE '54 CARS

IN

BUBBLES

*Cadillac*

CHEVROLET

*Chrysler*

DODGE

*DeSoto*

FORD

HUDSON

KAISER

*Lincoln*

*Mercury*

*Nash*

*Packard*

*Plymouth*

*Pontiac*

OLDSMOBILE

*Studebaker*

*Willys*

# February

## YOU'LL SEE

# Our Big 1954 Special Section ON AUTOMOBILES

*including*

- Over 45 pages on automobiles
- All the '54 models on parade
- 8-page color album of Classic Cars
- The world's greatest road race
- How to buy a used car
- What to look for on the '54 cars
- Specifications of the new models
- What makes an automobile go?
- American motorists tell what they want

*On the newsstands January 29th*

JANUARY 1954

123

Copyrighted material





Net tender drops buoys and nets into water while another vessel prepares to tow completed sections away

## *Deep-Sea Sentinels* **GUARD OUR HARBORS**

By Dick Frederic

**I**N SUBTERRANEAN ROOMS beneath the coastal hills around certain vital United States harbors, a new surge of activity is in progress. Week-end warriors of the Naval Reserve, standing side by side with "regulars" in the somber gloom, watch patterns of green light dance across oscilloscope screens. Each wiggle tells about some object that is moving through the water out beyond: A submarine is preparing to dive, a depth charge has exploded, a ferry is plowing its regular course. Each writes its distinctive pattern across the scopes.

In other underground rooms, men with earphones listen to an eerie bedlam of noises from all over the ghostly depths of the harbor entrance—the grunting and croaking of fish, crackling shrimps, the

whoosh of big and little propellers, the thrum of ship engines. The sharp "ping—clunk" of the signals echoes back from moving hulls and monitors track the course and speed of every vessel in the harbor. Harbor radar scopes flicker, radios crackle, galvanometers silently scrawl jagged lines on reels of paper.

At a semicircular table resembling a huge protractor, men determine an instantaneous fix for any suspicious vessel out there, simply by swinging a pair of swivel cross-arms to known positions on the table. And out in a big central control room, earphone plotters at a vast Lucite harbor map sketch the course and progress of every ship in the area through information fed to them by each electronic watchdog in a modern harbor-defense web so complex that a fish



would have a tough time sneaking through it undetected. Anything that did get through would run head-on into a nightmare of mine groups, harbor nets and patrol gunboats back-stopping the whole business.

Russia's marine strength today lies in a powerful fleet of more than 300 submarines. If war came, we could be pretty sure these silent marauders would try to nose into our harbors, torpedo our shipping and atom-bomb our coastal cities if they had the bombs to do it. That's why, in laboratories and in secretly designated harbors here and there, the Navy's "bad-dream department" is perfecting three-dimensional harbor defense capable of pin-pointing



"Heralds," like this one, are placed in row at bottom of harbor entrance and are actually sonar instruments. Their "pings" are monitored at control post



MONITOR CAN DISTINGUISH WHAT'S COMING BY INTERPRETING PICTURE ON HIS SCREEN. SAMPLES ABOVE SHOW A FEW OF DOZENS OF PICTURES MADE BY UNDERWATER SOUNDS TRANSMITTED BY HERALDS

MONITOR AT H.E.P.C. CAN HEAR "PING" AND ECHO TRANSMITTED TO HIM BY HERALD; ALSO WATCHES PICTURE OF SOUNDS ON OSCILLOSCOPE SCREEN

HERALD ON BOTTOM OF HARBOR ENTRANCE SENDS OUT HIGH-FREQUENCY SOUND WAVES, PICKS UP ECHO WHEN "PING" BOUNCES OFF OBJECTS, AND TRANSMITS BOTH SOUNDS TO HARBOR ENTRANCE CONTROL POST

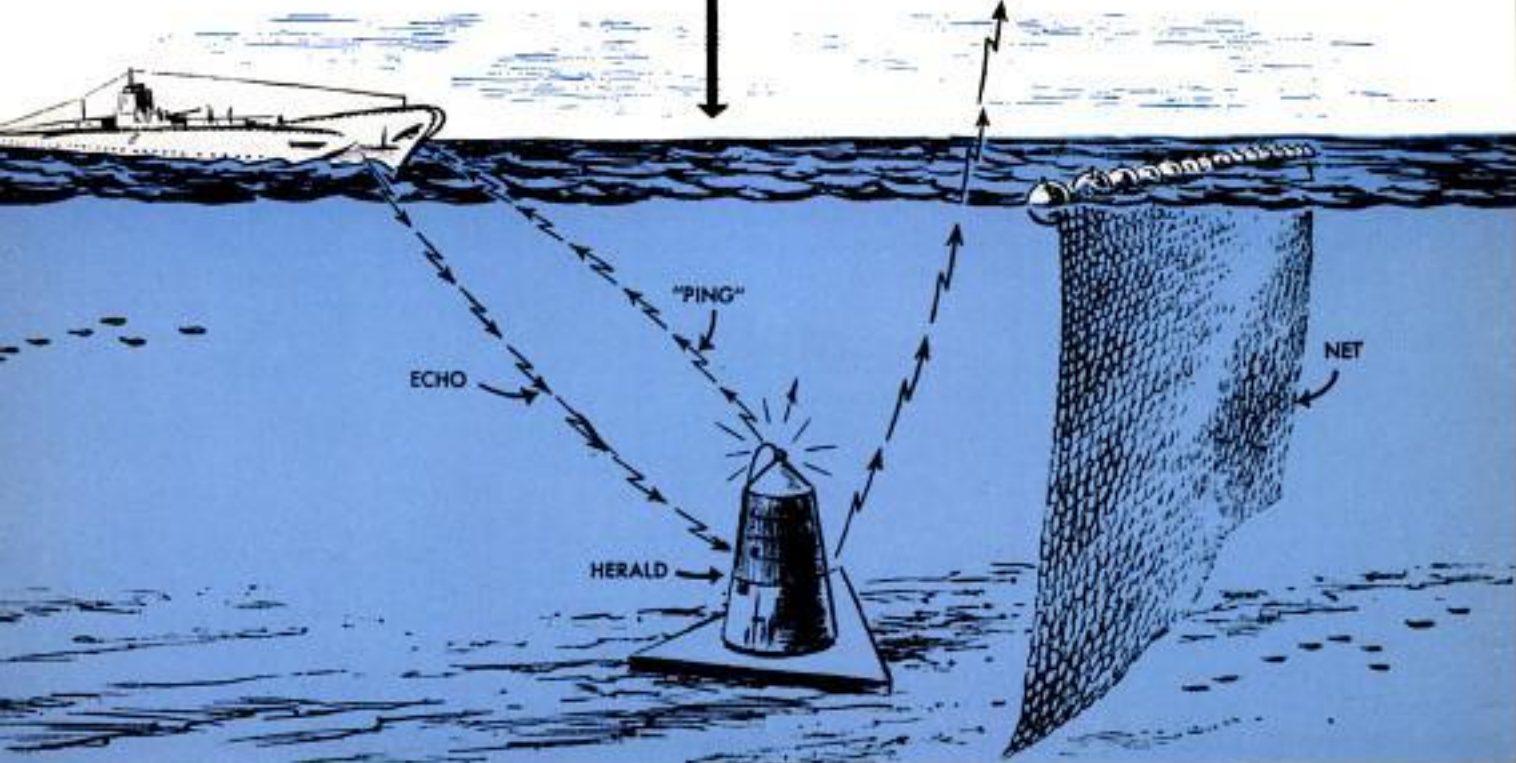



potential surface or subsurface intruders, determining what and who they are and blasting them before they even reach the harbor entrance.

Electronic brain of the system is the harbor-entrance control post (HECP)—that underground maze of chambers. Here all the signals from the vast array of robot eyes and ears lurking out on the bottom of the harbor entrance filter through monitoring equipment in flickers of light or sound that men can translate into vital intelligence. In effect, it's like human eyes, ears and fingers sending impulses through the nerves to the brain, where they are interpreted into mental images.

"An ideal HECP," explains one harbor-defense skipper, "might be laid out in semi-circular form—like half a pie. The big room in the hub houses the harbor plot where all information is assembled. Chambers encircling it contain the control or monitoring equipment for each set of robot guardians that are watching, listening or waiting out there on the sea bottom."

To see how it works, imagine that a submerged enemy sub is sliding silently through black water towards the entrance of a vital harbor. It is night. Not a ripple betrays his presence to the 24-hour watch in the lookout signal towers atop the bluffs overlooking this harbor.

The sub may still be miles from the entrance when the first watchdog detects him. Far out beyond the harbor, lying on the bottom, are long, overlapping strands of armored copper cable over which he must pass. These are "magnetic loops," so sensitive they detect the slightest change in the earth's magnetic field. A steel hull moving through the water sets up its own magnetic field and, back in a room in HECP, this variation is instantly recorded by a stylus, in a series of jagged lines on graph paper. Since the sub passed over only one particular loop in the long chain of five or six that span the harbor entrance in a long arc, the monitor knows: First, there's a ship coming; second, its general position.

Radio and communication lines buzz as the alert goes out. Sharp-eyed lookouts find no sign of surface craft in the reported area. Hence, the crew already suspects a sub.

Out there in the black depths, the unsuspecting sub skipper has only begun to snare himself. His craft now skims the top of a metal box—one of many jutting from the ocean bottom on weighted tripods like a long row of fence posts. They are hydrophones, or underwater "mikes."

No sound escapes these eavesdroppers of the deep. Back at HECP, where monitors listen in shifts 24 hours a day, every whisper in the sea comes through their earphones in a cataract of sound. "A school of

shrimp swimming by a hydrophone comes across like an amphitheater full of people cracking peanut shells," one man explains.

The whoosh of the enemy sub's propellers comes clearly over the line from the hydrophone nearest to it. Now, HECP knows it has a sub and, since the men know the exact location of the phone that picked up the noise loudest, they have narrowed the sub's position.

Ahead of him, in the depths, another guardian has gone into operation—the "heralds" (Harbor Echo Ranging and Listening Device.) These massive affairs look like small lighthouses on heavy triangular bases. They're spotted around the ocean floor inshore from the hydrophones. They house special harbor sonar—the radar of the deep—and, like most of these detection instruments, are lowered in place by harbor-defense crews from net tenders, harbor workboats or lighters.

Using high-frequency sound waves instead of radio waves, and linking electronics and magnetism, this "Davey Jones Radar" combines listening gear and ranging equipment. It sends out a sharp "ping" that spears through the ocean until it fades out in the distance or bumps into something, like the hull of a ship or submarine. When that happens, an echo bounces back to the herald, is picked up and transmitted to the monitor listening in at HECP. The monitor hears both the "ping" and the echoing "clunk." The time interval between them tells the distance of the approaching object. And, since the direction of the sound beam is known, a bearing can be taken on the sub. His progress across the harbor entrance can now be plotted with deadly accuracy on the big Lucite board in central control.

By now, HECP will have dispatched harbor-patrol craft to depth charge the enemy sub. But what if they miss? He's not likely to slip away undetected. Behind the heralds, an audio-reception system, similar to the hydrophone ring, is picking up his noises. If he comes up for air, the big rotating "fans" of harbor radar will pick him up and he'll be a blip on the scopes in HECP. If he gets past the heralds, he's really in trouble. Beyond them are the mine fields.

Modern mines are a far cry from the old spherical monsters that exploded when a ship bumped their horns, though this "Model T" of the mine department is still in business. More subtle and deadly are the controlled mines, triggered from ashore, and the ground mines that can be exploded by a fantastic combination of impulses. The magnetic field of a ship will "pull the cord" on a magnetic mine. The acoustic mine is a fiend with an ear—a sim-



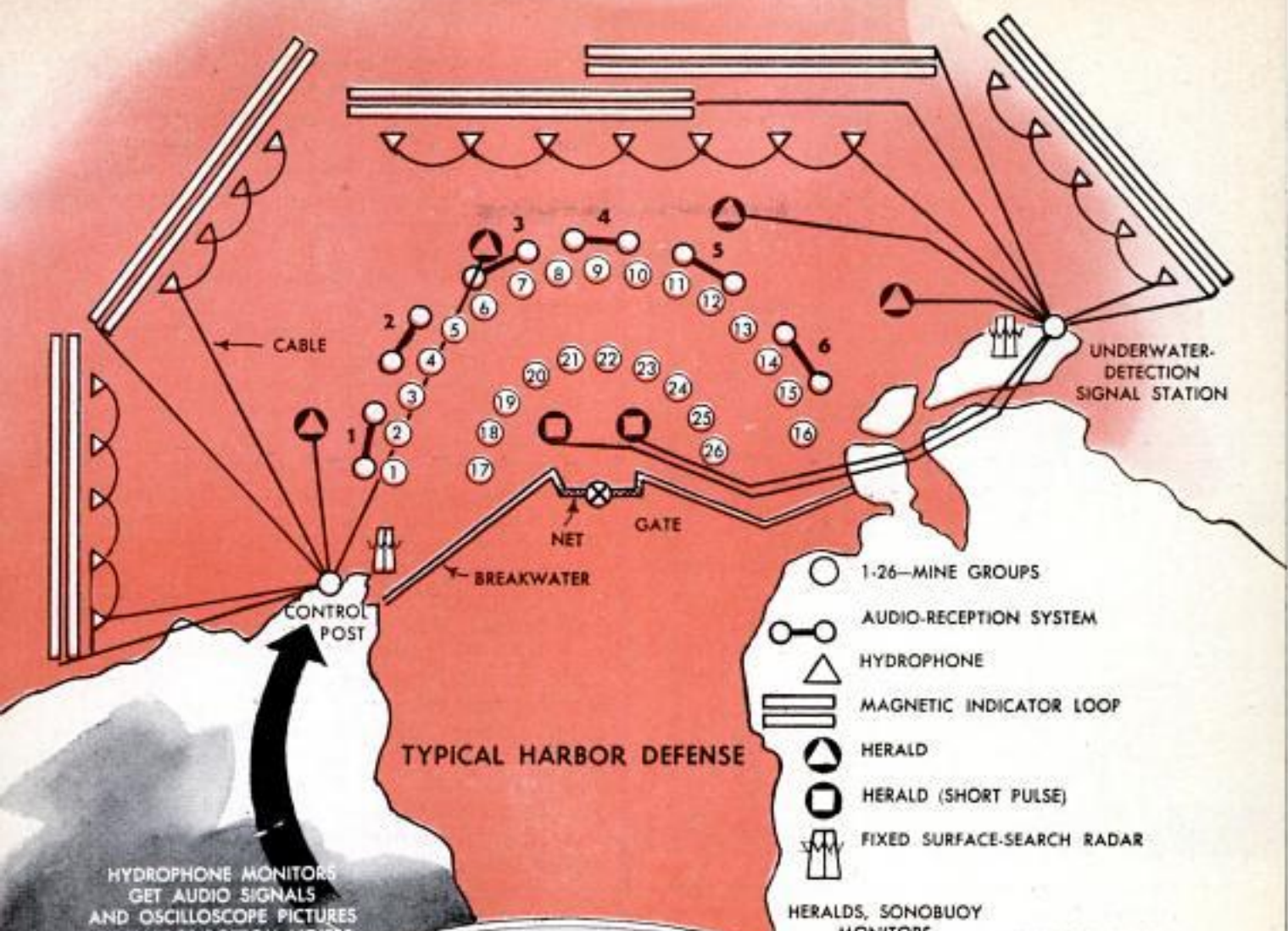

HYDROPHONE MONITORS GET AUDIO SIGNALS AND OSCILLOSCOPE PICTURES OF HARBOR-BOTTOM NOISES

TRANSMITTER ROOM

HERALDS, SONOBUOY MONITORS

HARBOR RADAR SWEEP MONITORS

MINE CONTROL

CENTRAL CONTROL

OFFICES

GALVANOMETERS RECORD ON STYLUS SIGNALS FROM MAGNETIC LOOPS ON OCEAN FLOOR

PLOTTING TABLE FOR FIX

HARBOR-ENTRANCE CONTROL POST





Mass of steel rings is a harbor net strong enough to stop a torpedo. It's made of  $\frac{1}{4}$ -inch steel wire

Minelayer lowers a controlled mine toward bottom of harbor. This type is exploded by remote control

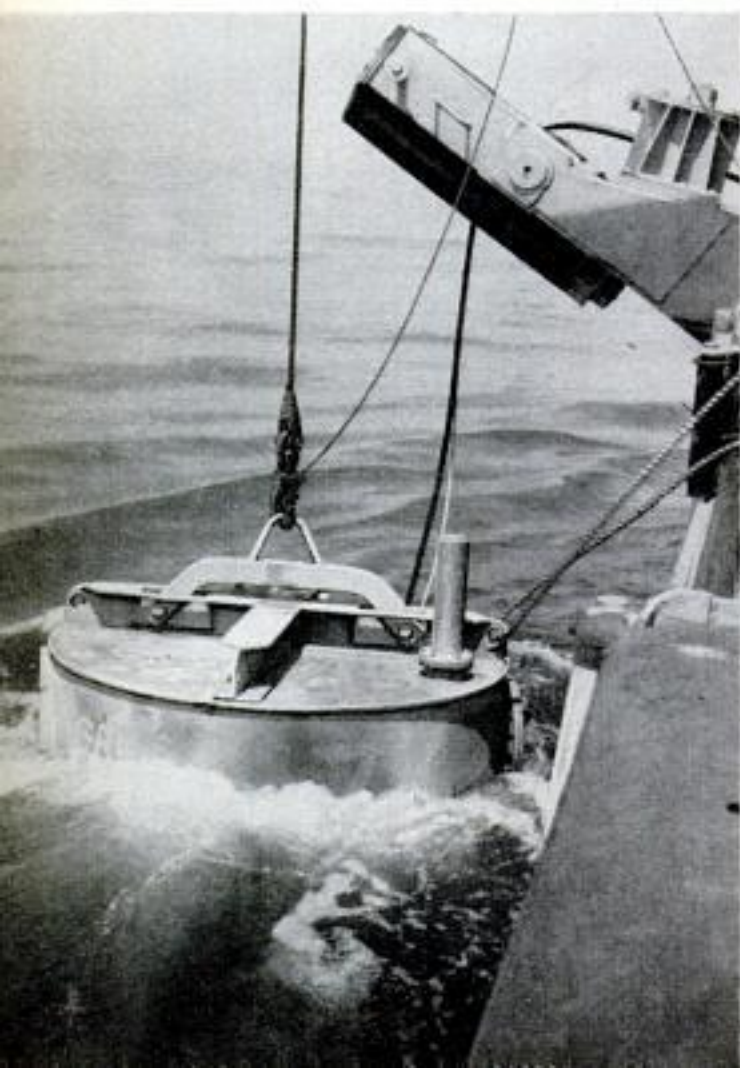

ple hydrophone that can be cocked for a special ship noise, like the turning of a screw or the beat of a particular type engine. Let the noise get loud enough—and wham!—On a pressure mine, a tiny diaphragm is faintly depressed by a hull pressing into the water overhead. But it's enough to throw the switch.

Working in combination, these triggering systems can be scrambled into a fantastic number of actions, one backstopping or booby-trapping another. And they may all lie harmless in the bottom of a harbor until someone ashore pulls the switch that cocks their triggers.

Chances are 10 to 1 that our enemy sub would end his voyage here, if he got this far. By now, Navy planes would have been alerted and would be circling his position waiting for a periscope to show.

But suppose he crept through that minefield hazard. Another set of heralds will be watching his movement through the field—and beyond them, the sub skipper will find himself up against a tough net capable of stopping both him and his torpedoes.

Establishing and maintaining such an elaborate harbor defense is a whopping job. To do it, the Navy has established several Naval Reserve Harbor Defense Units, where week-end warriors go out with veterans on the unique workboats that lower the massive equipment to the sea bottom, patrol the nets and keep the robot sentinels operating.

The men who do this work are a race apart. Big, rugged and ingenious, they follow the first assault waves, locking up waterways as they are taken. "Harbors, safe for fleet anchorage and repair, must be provided in forward areas," Commander S. E. Taylor points out. Typical of the men he leads, Taylor is a ruddy-faced, salt-bitten mariner heading operations at one of our harbors. Behind him lies a lifetime of rugged experience in defending harbors all over the world, under all conditions.

"The logistics of the job," he says, "is staggering. The tremendous bulk and weight of nets, buoys and electronic gear means that often there's no room for everything in the initial convoys. If ships carrying our gear are sunk, we improvise with what we've got."

A simple "boom" might do a perfect job blocking a river, for instance. This is just a barrier made up of baulks, or wooden floats, with timbers bolted between them. It can be enough to stop a small ship long enough to give it the works with shore batteries. Sometimes "star cutters"—big 18-inch steel spikes—are attached to the timbers. Purpose: to tear the bottom out of any small craft that tries to cross the boom.

(Continued to page 270)



Here's the control room during a color telecast. Screen at left is a black-and-white reproduction of flower scene in center, which is on the air. Engineer can switch either of the other two scenes on the air



# COLOR



## TELEVISION IS HERE

**By Michael Day**

**S**TEP THROUGH the door marked "restricted" on the 18th floor of the CBS Madison Avenue (New York) studios, or through a hidden portal in the soundproof glass partition of NBC's specially designed "Colonial Theater" on Broadway, and you'll find yourself in a flickering world of color. The only light comes from rows of TV-monitor screens. Some are alive with scenes in full color, playing across the glowing phosphors like miniature movies

in Technicolor. Others duplicate the same pictures in black and white.

Green graph patterns tremble on oscilloscope screens as technicians manipulate scores of dials and switches on the panels before them. Hushed voices of earphoned producers, technical directors and video-control men drone back and forth in weird, technical lingo as they issue orders over an intercom system to cameramen, actors and stagehands outside on the set:



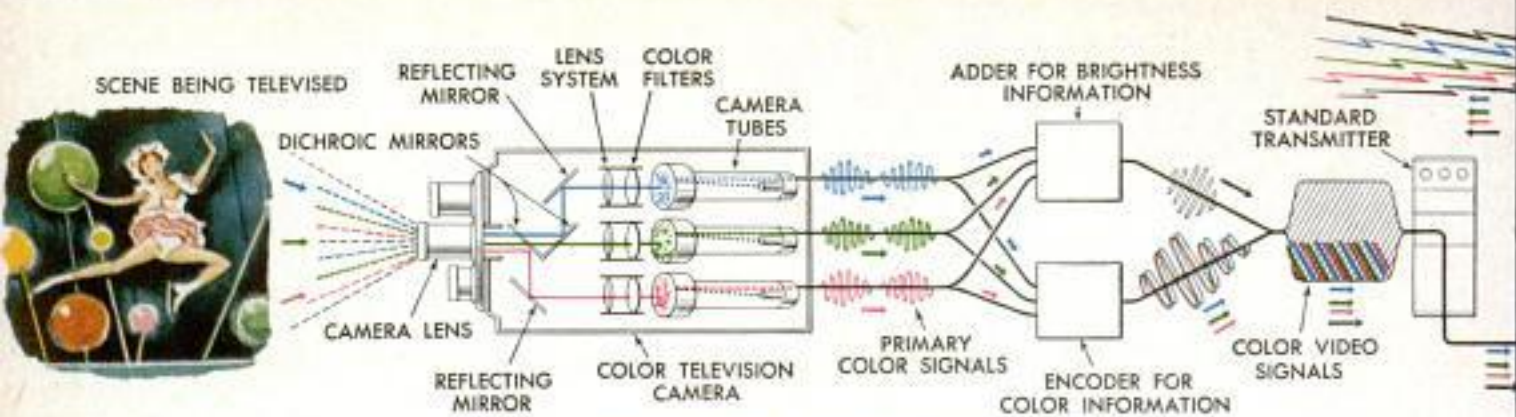

## RCA COLOR TELEVISION

In RCA system, full-color image is focused on special mirrors which reflect one color, allow other two colors to pass. Color images then are focused on three camera tubes, which produce three color signals. Samples of signals are combined to add black-and-white signal. Process is reversed during reception



Before a telecast, each camera must be "tuned in" for delicate shadings of flesh tones. Here a cameraman focuses on a girl beside a color wheel to adjust camera for perfect color pickup

"Too much red on number three . . . there's a 'kick' in that vase lip on number two preview; move it back . . . we pick up convergence on number two; how's your registration? . . . gamma check on number four, please . . ."

These are the control rooms for the new coast-to-coast color telecasts. Both NBC and CBS have been telecasting color shows around the East Coast—and NBC has even microwaved color shows to the West Coast—for many months. Starting with the Rose Bowl game on New Year's Day, NBC expects to send out several network shows weekly in color. Most of their 70-odd primary stations have already agreed to put in the \$22,000 color-conversion equipment, and more are expected to follow. If the shows look just as black and white as usual on your set, that's because you happen to have a black-and-white set. If you'd been watching the same channel on one of the handful of existing color sets owned largely by TV and advertising executives, you'd have seen the show in a dazzling array of brilliant hues.

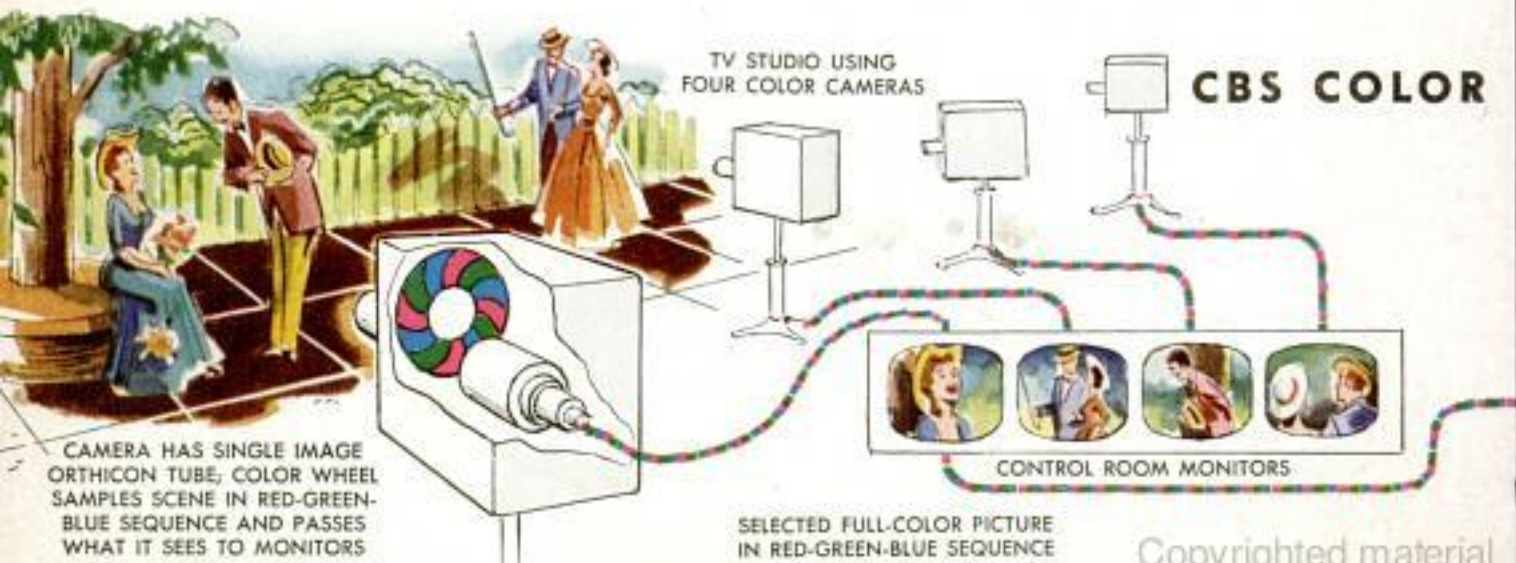



## COMPATIBLE COLOR BROADCAST SIGNALS

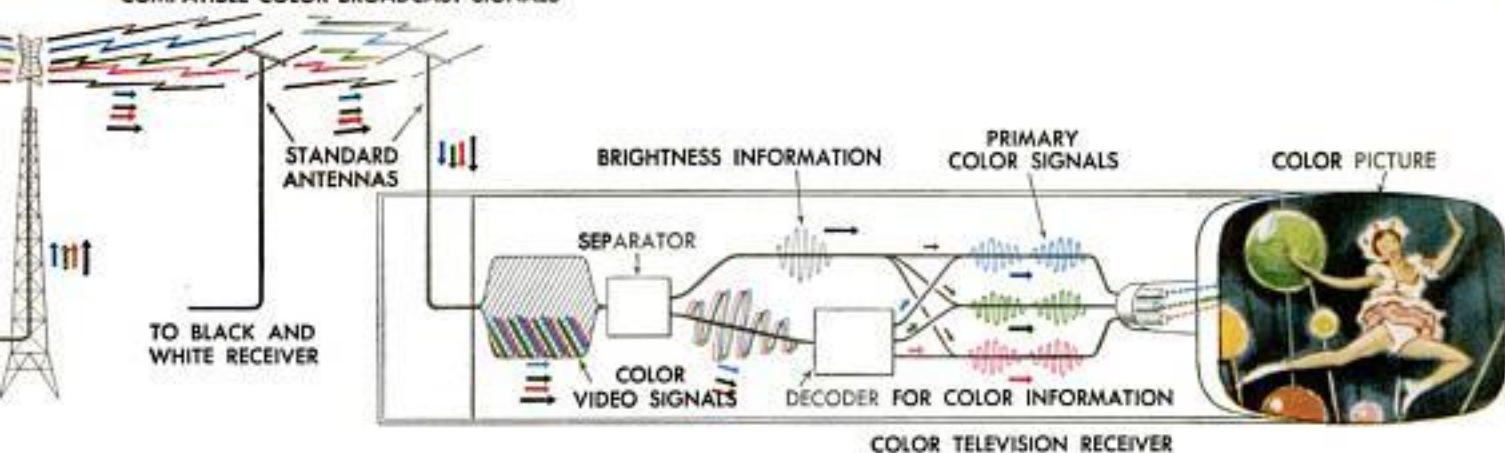

COLOR TELEVISION RECEIVER

Actually, those same color signals were streaming down your own antenna the whole time. And, while your set can't translate the signals into color on its black-and-white screen, it still can produce a perfect black-and-white picture from the same telecast—no matter whose network is beaming the show.

According to the big networks, color TV is here to stay. By the end of this year, 50,000 color sets will be operating. But don't get too excited unless, as one set manufacturer puts it, "you're in the mink-coat-and-foreign-car category." The first sets will cost about \$1000, and most will go to potential advertisers and engineers. As mass production and simplification sets in, the price tag is expected to move down, but it may be several more winters before the price levels off at what manufacturers guess will be about 100 percent higher than black and white today. For awhile, replacing a picture tube will cost as much as a whole black-and-white set (about \$250). Since color circuits are more complicated, repairs will cost proportionately more. You'll be able to convert your old set, if

Dr. Frank Stanton, president of CBS, shows heart of CBS system, the Chromacoder. This electronic panel converts sequence signals, representing colors, into simultaneous signals for the air



In CBS system, camera sees through a rapidly rotating color wheel. Signals from the camera are in a red-green-blue sequence. After passing through control room, signals go to Chromacoder which converts them into three simultaneous signals for transmission. On the air, signals of CBS and RCA systems are identical

## TELEVISION

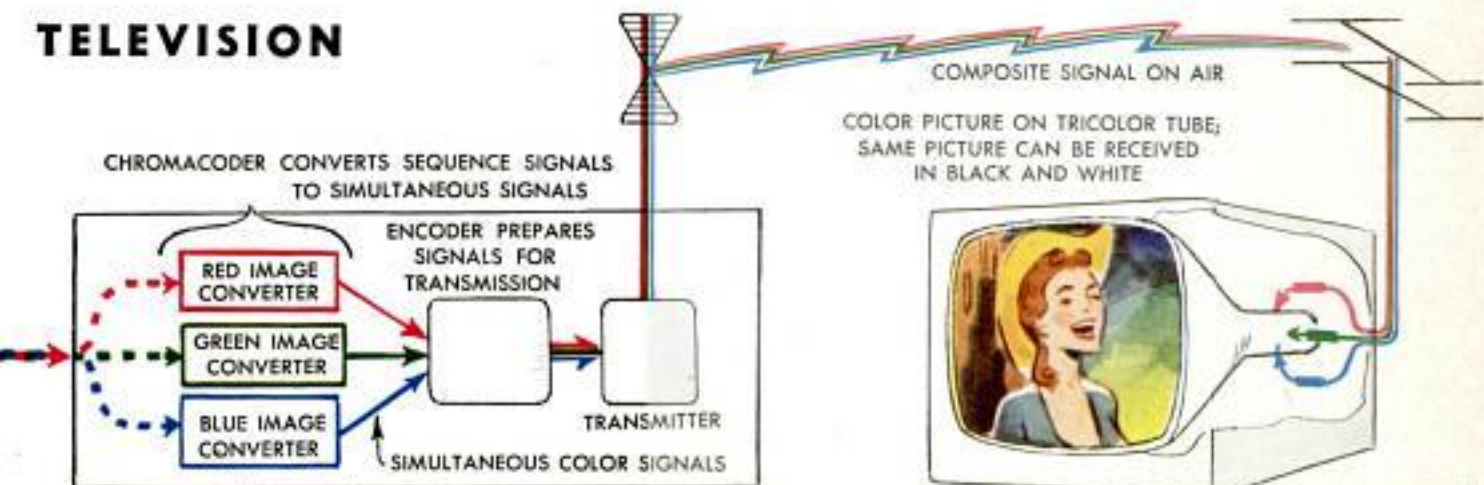



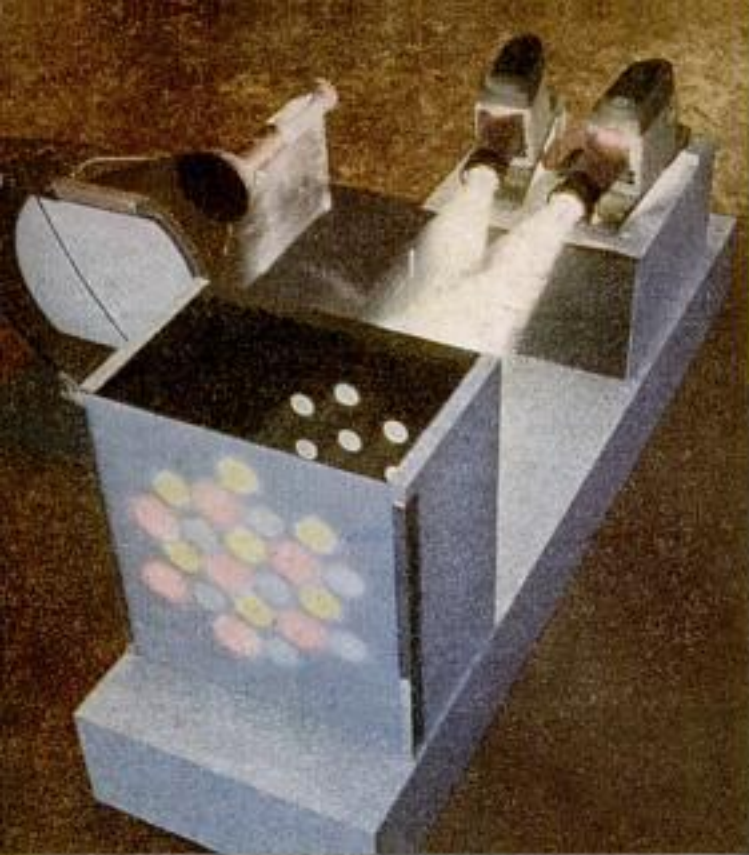

RCA demonstrator shows in large scale how beams pass through mask to affect phosphors on the screen

you want, but even that will cost between \$500 and \$800. About the only part of your present equipment that works equally well for color reception is the antenna—if it's well designed. In spite of all this, color is definitely in your very near future. The first big handicap has been hurdled.

Until recently, color had bogged down in a battle of "systems" (see *Popular Mechanics*, January 1950). One big stickler was



Engineer checks light prior to telecast. Poor lighting can turn blues to reds, give flesh a green tone

that not all the systems could be picked up in black and white on the 25,000,000 standard sets now in American homes, unless people bought special adapters. To protect billions of public dollars, the industry refused to commercialize color TV until all its members could come up with "compatible" standards. This meant that a program must be seen in color on color sets, but must also be seen in black and white on present sets, without adapters, and regardless of the type of equipment used to telecast the show.

For two years, the NTSC (National Television Systems Committee), made up of representatives from each network, has

(Continued to page 274)

Diagram shows how each of the 250,000 microscopic holes in aperture mask permit each of the electron beams to affect only the proper phosphor. When eye sees these glowing phosphors it combines them into full-color scene, such as unretouched photo at left

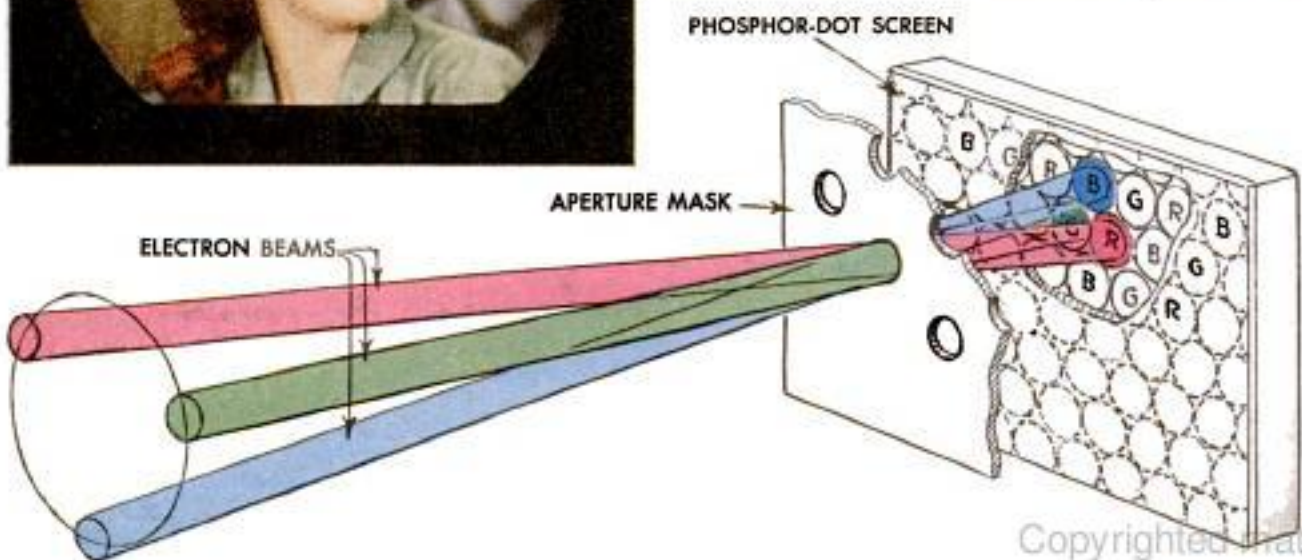



## Scientist Uses "Mud Pies" To Explain Changes in Earth

"MUD PIES" are helping explain changes in the earth's crust to geology students at The Johns Hopkins University. Maker of the mud pies is Dr. Ernst Cloos, who uses this method to illustrate in half an hour the changes which took place in the surface of the earth over millions of years. In effect, the mud pies are flexible models of the earth's surface. On a table with a hole in the center are two rectangular pieces of tin which overlap slightly. The outer ends of the tin sheets are fastened to the table. Over the tin Dr. Cloos spreads a "pie," about two inches thick, of moist clay. A rod under the table, when operated by a ratchet, moves up through the hole and begins lifting the two sheets of tin. As the center of the pie rises, something of course has to give. Minute fractures occur on the surface, just as fracture zones have appeared in the earth's crust over millions of years. Eventually the entire surface gives way to form a crevasse. Why is the pattern of such fractures important? When a vein of ore or oil is interrupted by a fracture, the geologist can determine where the stratum is likely to be found on the far side of the fracture. In another demonstration, Dr. Cloos forces a mud pie against a metal rod which represents an immovable barrier. In this way, he demonstrates what happens when softer sections of the earth's crust move against harder ones. Overlapings occur, such as the "folds" which can be found in the Appalachian area.



Sequence above shows how a "mud pie" is lifted in the center until fractures occur. Below, Dr. Cloos sprays clay with atomizer in demonstration of the earth's folds





# The OWNERS REPORT on

**LIKES:** 5. I add 0 quarts of oil in 1000 miles. I change oil every 1000 miles.  
6. Here is what I like about my rear-engined car: *Maneuverable and easy to park. Less tiresome to drive & more comfortable on a trip (I am over 6 feet tall) than the "big" cars! Easy to service. Rugged in operation. Cheap to run.*

LORAIN, OHIO,  
PHYSICIAN

**DISLIKES:** 7. Here are my specific complaints: *Utter lack of quick acceleration above 40 m.p.h. No power on steep grades at high speeds. As a four-passenger car, it is cramped, but adequate for our two children.*  
8. I hate its roadability.

EVANSVILLE, IND.,  
WELDER

CAMBRIDGE, MASS.,  
RESEARCHER

**LIKES:** 6. Here is what I like about my rear-engined car: *Easiest car to drive (including 11 U.S. cars) I have owned. Can take any car on speed and acceleration, especially on winding roads. No leaning on corners.*

**DISLIKES:** 7. Here are my specific complaints: *It is very noisy and this cannot be gotten around. The result is that long trips are more tiring than they need be. Luggage space restricted, car difficult to enter and leave.*

ITHACA, N.Y.,  
STUDENT

NORRISTOWN, PA.,  
AUTOMOTIVE ENGINEER

**LIKES:** 5. I add  $\frac{1}{2}$  quarts of oil in 1000 miles. I change oil every 2000 miles.  
6. Here is what I like about my rear-engined car: *It can go anywhere. It holds the road well, One feels in this small car as though one were personally motorized and not riding.*

**DISLIKES:** 7. Here are my specific complaints: *Complete lack of body insulation. Muffling could be improved. Standard heater is useless. Side mirror necessary for rear visions.*

DARIEN, CONN.,  
CIVIL ENGINEER



# THREE REAR-ENGINE CARS

The true test of a car begins when the owner takes the wheel. Popular Mechanics sent questionnaires to 1000 owners of rear-engine cars. Here is what they say

By Floyd Clymer

**WHAT IS BETTER:** engine in front or engine in the rear? It's an endless argument!

We're all familiar with the front-engine car. To find out about the less familiar rear-engine design, *Popular Mechanics* asked 1000 American owners of Volkswagens, Porsches and Renaults to tell you about their cars.

How do they feel about the rear engine after thousands of miles of driving? Only a scant one percent say they won't buy another rear-engine model! The majority are most enthusiastic. Let's see what they have to say.

"No heat from engine being in front. No antifreeze or radiator worries with air-cooled engine."—Binghamton, N. Y., Volkswagen owner.

"Weight in rear aid to traction."—Islip, N. Y., Volkswagen owner.

"No drive-shaft troubles. Better traction. I have taken roads that only a Jeep could negotiate."—Spring Valley, N. Y., Volkswagen owner.

"Logical to have engine in rear and eliminate long drive shaft which wastes power."—Los Gatos, Calif., Porsche owner.

"If any American manufacturer ever produced a rear-engine car it would sell like hotcakes."—Edmonds, Wash., Renault owner.

## Volkswagen Comments

What do the owners have to say about their particular make of car? Like most foreign-car owners, they are enthusiastic.

"Economy above all! Good forward visibility, nice ride, no road shock felt in steering, terrific gearbox," writes a Volkswagen owner from Bloomfield, N. J.

Other owners agree with him. Economy of operation is the best-liked feature (see *Percentage Poll*, page 138). That is understandable



## VOLKSWAGEN

With its hood swooping abruptly downward, the VW is affectionately called "Beetle" by some of the responding owners



## PORSCHE

Lively, sleek and expensive, the Porsche is acclaimed by a large number of owners as "the finest automobile ever built"

## RENAULT

France's most popular car, the Renault is water cooled, unlike the air-cooled German cars above. This is a 1954 model







Clymer points to the belt that drives the cooling fan of the rear-engine, air-cooled Volkswagen he tested



Spare tire, gas tank and some luggage space is under the hood of the VW. Below, the rear engine gives fine traction, Clymer reports, even on rough, sandy roads

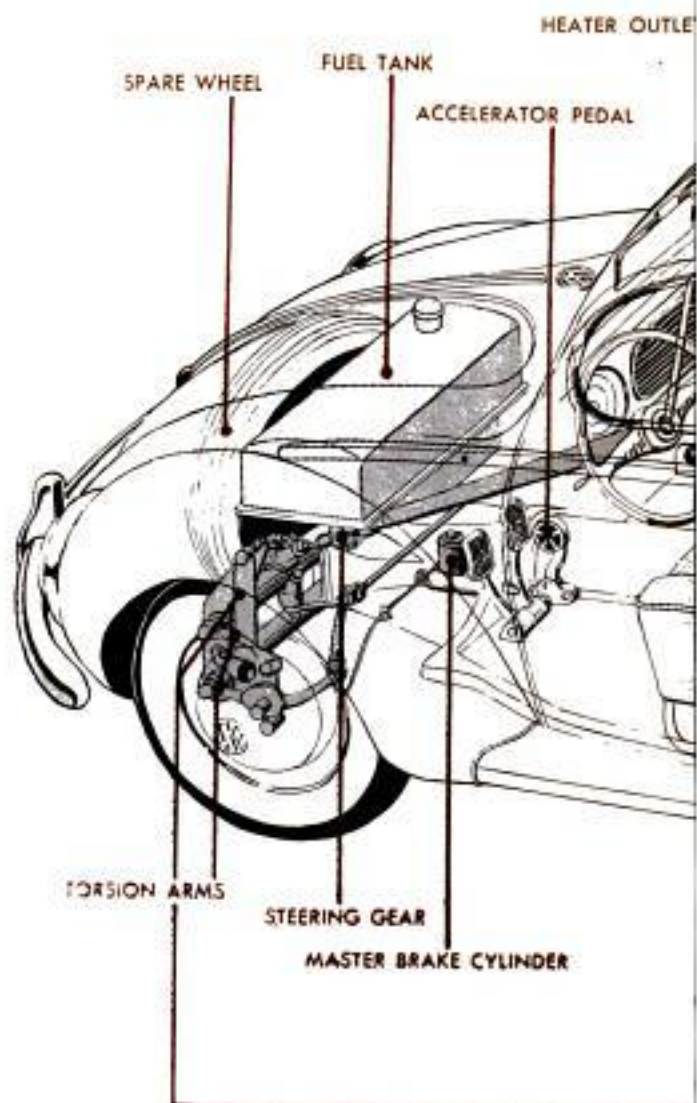

Phantom sketch shows major parts of the Volkswagen

since Volkswagen owners average 37 miles per gallon in country driving, 32 miles per gallon in the city.

But there are other good features, say the VW owners. Safety is one of them.

"I like freedom from sideway due to torsion-bar spring. Also the comfort, economy, sure traction on slippery roads. Easy parking."—West Cornwall, Conn., purchasing agent.

"Excellent traction on wet pavement. Structurally rigid. Sensitive steering. Four-wheel independent suspension."—Lansing, Mich., draftsman.

"Had an accident with my first VW. Its special safety glass is excellent. In accident, two heads went through the windshield. The glass broke up into harmless small pieces. No damage to heads!"—South Ozone Park, N. Y., foreman.

"Quiet, smooth engine at cruising speed (65 m.p.h.). Excellent cornering, easy maintenance."—Detroit, Mich., telephone worker.

"Exceptional engineering, functional design and low upkeep. Riding comfort excellent."—Jersey City, N. J., instructor.



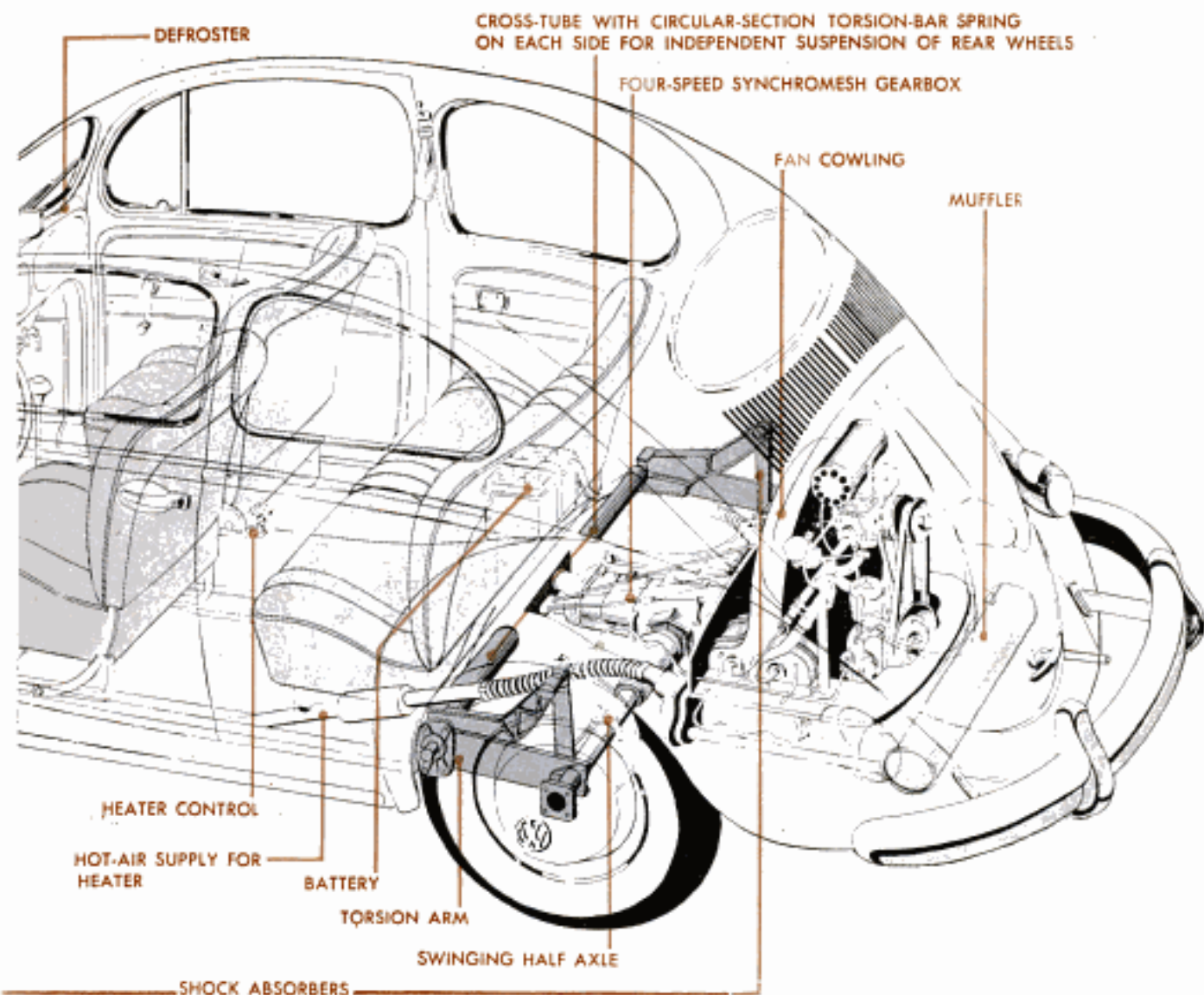

"Rear engine gives a far cooler ride over a long distance in hot weather. Lower horsepower is no disadvantage since I can maintain a higher constant speed than with my larger U.S. car, which has six times the horsepower."—Paterson, N. J., auditor.

"I wanted an economical second car. Now I prefer driving it instead of my large U.S. car."—Lorain, Ohio, physician.

"The air-cooled engine has really freed me from summer and winter radiator worries."—New York City photographer.

"Four hours at 65 m.p.h. with temperature over 100 degrees and motor could still be touched."—Jamaica, N. Y., student.

A great many owners wrote that they have rediscovered the "fun of driving" with their Volkswagen.

"The joy of driving has certainly come back to me since I bought my VW."—Buffalo, N. Y., owner.

#### Volkswagen Complaints

Biggest complaint of the VW owners was the poor rear visibility. Next came the lack of high-speed acceleration.

"Poor vision over shoulder to either side. Do not like divided rear window."—Chi-

cago, Ill., clerk. (The 1954 VW has one-piece window.)

"Over 40 m.p.h. acceleration is painfully slow."—Evansville, Ind., welder.

"I believe a danger exists in the lack of acceleration on today's highways."—Manhasset, N. Y., salesman.

"Horsepower output is good in the lower ranges, but long hills leave a lot to be desired."—Racine, Wis., sales engineer.

"No reserve power for passing."—Highland Park, N. J., salesman.

"A little underpowered, but easy to remedy with twin carburetor kit."—Lexington, Mass., photographer.

Other complaints were less frequent:

"Engine noisy when one rides in back seat."—Lakeville, Conn., housewife.

"Inadequate protection against front and rear body damage from bumpers of larger cars."—Uniondale, N. Y., engineer.

"Lack of fuel and oil gauge. Low sloping front deck easily pock-marked by flying stones."—Huntington, N. Y., engineer.

"I would rather have gearshift on steering post. Luggage space should be larger."—Port Washington, N. Y., locksmith.



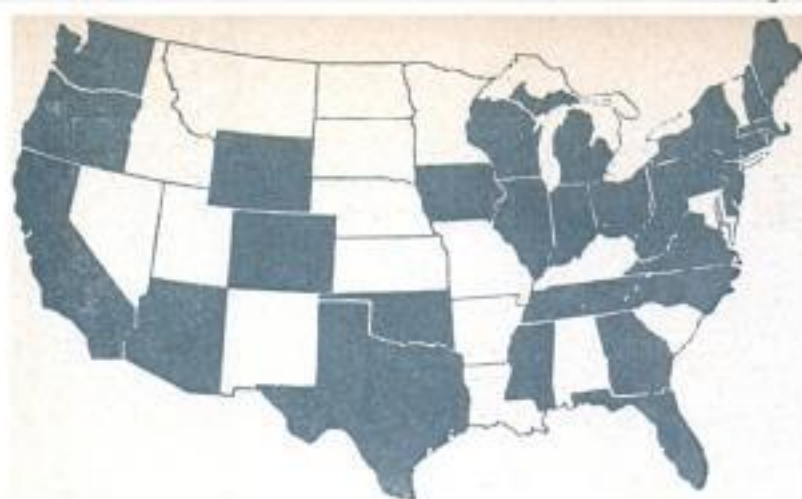

Owners from the 30 shaded states took part in the survey on rear-engine cars

## Percentage from PM Poll of Owners of Rear-Engine Cars

### PERFORMANCE RATINGS

	Porsche	Volkswagen	Renault
<b>Average miles per gallon</b>			
city .....	26.4	32.1	37.1
country .....	32.2	37.4	43.9
<b>Roadability</b>			
excellent .....	95%	91%	76%
good .....	5%	9%	22%
unsatisfactory .....	0%	0%	2%
<b>Handling</b>			
excellent .....	95%	97%	89%
good .....	4%	3%	11%
unsatisfactory .....	1%	0%	0%
<b>Structural rigidity</b>			
excellent .....	94%	95%	55%
good .....	4%	5%	41%
unsatisfactory .....	2%	0%	4%
<b>Acceleration from standstill</b>			
excellent .....	87%	40%	28%
good .....	13%	54%	64%
unsatisfactory .....	0%	5%	8%
<b>Acceleration from 40 m.p.h.</b>			
excellent .....	78%	21%	23%
good .....	21%	66%	62%
unsatisfactory .....	1%	13%	15%
<b>Traction on wet or icy pavement</b>			
excellent .....	65%	75%	73%
good .....	22%	20%	23%
fair .....	8%	4%	4%
poor .....	5%	1%	0%

### BEST-LIKED FEATURES OF THE PORSCHE

(in order of popularity)

1. Roadability and handling qualities
2. Engine and sports-car performance
3. Economy of operation
4. Engineering quality and workmanship
5. Exterior and interior styling

### COMPLAINTS ABOUT THE PORSCHE

(in order of frequency)

1. Engine noisy
2. Bumpers too low and too weak
3. Valve trouble
4. Tendency to "spin out" in fast cornering
5. Difficulty of getting in and out of body
6. Inadequate luggage space

### BEST-LIKED FEATURES OF THE VOLKSWAGEN

(in order of popularity)

1. Economy of operation
2. Roadability and handling characteristics
3. Engine location
4. Engineering and workmanship
5. Air-cooled engine

### COMPLAINTS ABOUT THE VOLKSWAGEN

(in order of frequency)

1. Poor rear visibility
2. Insufficient horsepower, acceleration above 40
3. Bumpers too low and too weak
4. Rear seat too small
5. Engine noisy

### BEST-LIKED FEATURES OF THE RENAULT

(in order of popularity)

1. Roadability and handling characteristics
2. Economy of operation
3. Engine location
4. Convenient maintenance

### COMPLAINTS ABOUT THE RENAULT

(in order of frequency)

1. Too small
2. Engine noisy
3. Bumpers too low and too weak
4. Inadequate horsepower

### MISCELLANEOUS

	Porsche	Volkswagen	Renault
Owners with no complaints at all.....	29%	33%	20%
Would buy another of this make?			
yes .....	88%	88%	63%
possibly .....	11%	10%	16%
no .....	1%	2%	21%
Also own a U.S. car?			
yes .....	60%	43%	63%
Have trouble getting parts and service?			
yes .....	17%	10%	21%
occasionally .....	39%	16%	13%
no .....	44%	74%	66%

### WOULD BUY ANOTHER REAR-ENGINE CAR

(responses of all owners)

Would buy another.....	90%
Might buy another.....	9%
Would not buy another.....	1%

### OVER-ALL RATING BY OWNERS

	Porsche	Volkswagen	Renault
Excellent .....	95%	88%	59%
Good .....	3%	11%	33%
Average .....	1%	0%	6%
Poor .....	1%	1%	2%

### Porsche Comments

Economy is not so important to owners of the Porsche, it being an expensive, carefully assembled sports car that costs well over \$3000 (the Volkswagen, its "bargain basement" brother, lists for about \$1600). Most Porsche owners list roadability and performance as the points they like the most about the car. Economy of operation rates third. The average gasoline mileage

was very high: 32.2 miles per gallon in the country; 26.4 in the city.

"Fantastic performance, economy, road holding, ease of handling and comfort. No service expense. It just runs and runs."—Bremerton, Wash., photographer.

"Will outrun most any United States car, regardless of horsepower. On winding roads it handles far better."—Los Angeles attorney.





Dashboard of the VW is simple. Owners complained of no gas gauge. Hole near shift lever is heat outlet



Designed for the mechanical minded, the Porsche has a more complicated dash, but no fuel-gauge either

"Effortless at 75 and 80 m.p.h. Absolutely no roll on curves. Excellent aerodynamic body."—Detroit, Mich., engineer.

"Unbelievably short braking distance at any speed."—Crestwood, N. Y., food broker.

"Since owning the Porsche, other cars seem obsolete."—Berkeley, Calif., naval officer.

"Air-cooled engine is built like a fine watch—as is the complete car."—Writes a Dallas, Tex., furniture manufacturer.

"The car provides a feeling of being in complete control. Absence of leaning on corners gives a safe feeling I don't find in Detroit products."—Cambridge, Mass., researcher.

"I would like to shake hands with the old-fashioned craftsman who did such a wonderful job on this car."—Iowa City, Iowa, engineer.

"Most fun to drive."—Fitchburg, Mass., sales executive.

"The only 'car of the future' made today."—Marion, Iowa, salesman.

"Amazing economy at speeds above 60."—Decatur, Ill., student.

#### Porsche Complaints

Generally the owners of the Porsche had little to complain about. Most frequent gripe was the engine noise. Other complaints included low, weak bumpers, tendency to spin in fast cornering, small luggage space, difficulty of getting in and out and valve trouble.

"Noisy. Needs acoustical insulation between rear seat and engine. Bumpers should be heavier."—Claremont, N. H., engineer.

"Car was noisy. I corrected it by insulating the belly pan and motor

(Continued to page 262)



Four-cylinder, air-cooled Porsche engine fits neatly into the "trunk." It has two carburetors, gets expert factory tune up. In front is spare tire, gas tank and little luggage space







## Twin-Boom Helicopter to Become Ambulance for Navy Personnel



Convertible to use as an aerial ambulance, the Navy's new Kaman HOK-1 is believed to be the world's first twin-boom helicopter. It normally will serve as a four-place utility craft. To save space aboard aircraft carriers and other ships, HOK-1's rotor blades can be aligned parallel to each other and to the longitudinal axis. Its Continental engine delivers 500 horsepower on take-off and 450 horsepower during cruising. Another Kaman helicopter being built for the Navy, the smaller HTK-1, has been equipped with floats so that it can take off and land on land, water, marshland, snow or ice. Seating three, it has a 240-horsepower Lycoming engine.

## Porsche Sports Car Gets Boost in Horsepower and Speed

Power and speed are increased in the latest Porsche sports-car racer. Horsepower has been boosted to 80 and maximum

speed from about 110 to 125 miles per hour. The body is a few inches lower than the previous model of the same type.







Shotgun and the sets of over-under barrels fit into a handy gun bag for easy carrying by the sportsman



Hunter selects the set of barrels which will give him the desired combination of gauges and chokes

### Single Sportsman's Gun Has Four Sets of Barrels

Trap and skeet shooters have virtually any choice of gauge and choke they want in a single gun equipped with four matching sets of barrels. The over-under barrels are available in 12, 20, 28 and 410 gauges

and in various lengths and chokes. Each set of barrels has a ventilated rib sight. If the sportsman desires, he can buy the gun complete with one set of barrels and add other sets later.

### Inflated Life Rafts in Hold of Sinking Trawler Save Ship

To the Coast Guard rescuers, the plight of the trawler *Dixie B* seemed hopeless. The 64-foot vessel had gone hard aground off the North Carolina coast and was sinking. If pulled off the sandbar she would sink beyond hope of salvage—if left on, she would be ripped apart by the waves. And there was more water pouring into the

hold than could be removed by portable pumps. Finally one coastguardsman thought up a scheme which saved the ship. Two 7 by 13-foot inflatable life rafts were placed in the hold and inflated, raising the level of the vessel 18 inches. Pumped out at low tide, the *Dixie B* was towed back to port without further incident.

### Paint Dispenser Mixes Any Color

Select any color out of a choice of thousands, fix the indicated setting on an automatic paint-mixing machine and within seconds the desired paint is produced. With the mechanical mixer, a paint dealer need stock only 12 colors and finishes to produce custom-color paint in flat enamel, satin-gloss and high gloss. With older systems, a formula was obtained from the color chart and the operator measured out the indicated quantities.







# WHAT'S NEW FOR Your Home

**1. JUICE PIPES** inserted in pie crust prevent fruit juices from boiling through. Made of heat-resistant glass, the sanitary stacks insure a crisp pie crust with all the juice retained inside the pie—where it belongs. The little glass pipes are no trouble to use and can be easily cleaned for repeated use



**2. PORTABLE BED RAIL** protects sleeping child from rolling off bed or davenport, ends bruising falls. Folding prongs slip under mattress or sofa cushions. Designed especially for travel and visits, the compact guard changes a standard bed or sofa into a safe crib, keeps awake, bouncing babies from tumbling to floor



**3. PHONE KIT** attaches to back of telephone or rests on desk top. An automatic index includes phone numbers and addresses, and a push-button tally counts the number of calls made in a month. Two perpetual calendars, one monthly and one yearly, an attached pencil and a convenient memo pad complete the set

**4. BINDING STRIP** allows you to bind your own rugs, using only a hammer and metal shears. The edge of the rug is pressed down upon a row of spikes protruding from the base of the metal strip. The side of the strip is then bent over the edge of the carpet to produce a firm binding. Fabric covering of strip matches rug







**5. CARPET NEEDLE** for making deep-pile rugs at home is automatic and driven by a hand crank. The compact needle permits speedy outlining with yarn of patterns traced on canvas, and can be adjusted to provide piles of three heights. You can sew backward or forward by simply reversing the crank rotation



**6. DUAL FAUCET PEDALS** at base of lavatory control hot and cold water flow. Both hands are free for washing, excessive use of water is reduced and water flow is more easily adjusted. The supply valve can be mounted on the wall underneath the lavatory on new or existing installations of bathroom equipment



**7. THERMOSTAT HEATER** turns itself on and off as temperature varies. Thermostat is suspended in air for instant response to small temperature changes. Warning light prevents you from forgetting that the heater is plugged in even when fan and coils are not operating. Handle on top makes unit easily portable

**8. ADJUSTING TOWEL BAR** doubles as a drying rack for stockings and other light clothing. An extension bar pulls out of each end of the hollow rod to extend the total length from 24 inches to 46 inches. The telescoping fixture helps to keep the bathroom neat-appearing even after nightly laundry

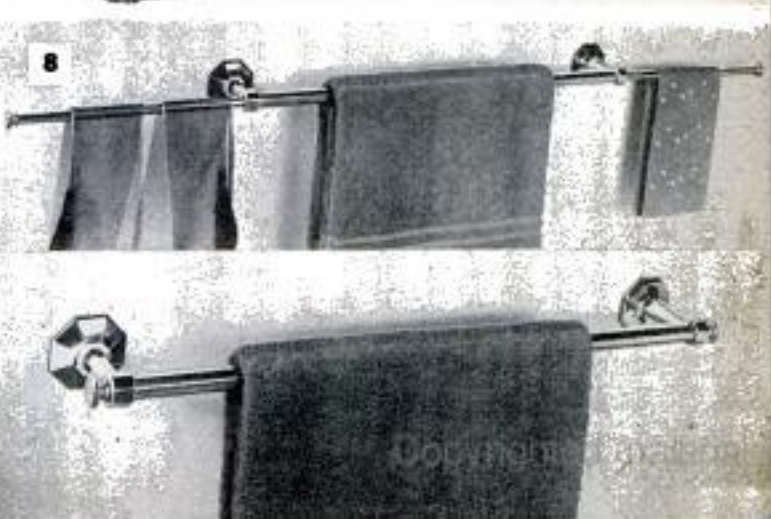

**9. CARD RACK** with a capacity of over 60 playing cards keeps canasta, samba or rummy hand in full view of the player. Three slots in the transparent plastic holder keeps cards on graduated levels, making every card visible and easy to reach. Handicapped players find the new holder useful for any card game







## ***Daredevils Play Donkey Ball***

THERE IS a thrill per second in the familiar games of basketball and baseball when the players use such frisky and uncooperative means of transportation as the donkeys pictured on this page. The light-colored burro at the top of the page is appropriately named Atom Bomb. Donkey ball originated in mining camps years ago when the hard-working

miners "relaxed" on Sunday afternoons by playing baseball on the backs of their faithful burros. Traveling donkey-ball troupes were popular in the 1930s, but today there are less than a dozen troupes left. They travel from town to town and recruit local daredevils to play the game, usually for charity benefits. Old-timers argue whether a donkey can be taught to respond to orders; most of them agree that he can't.

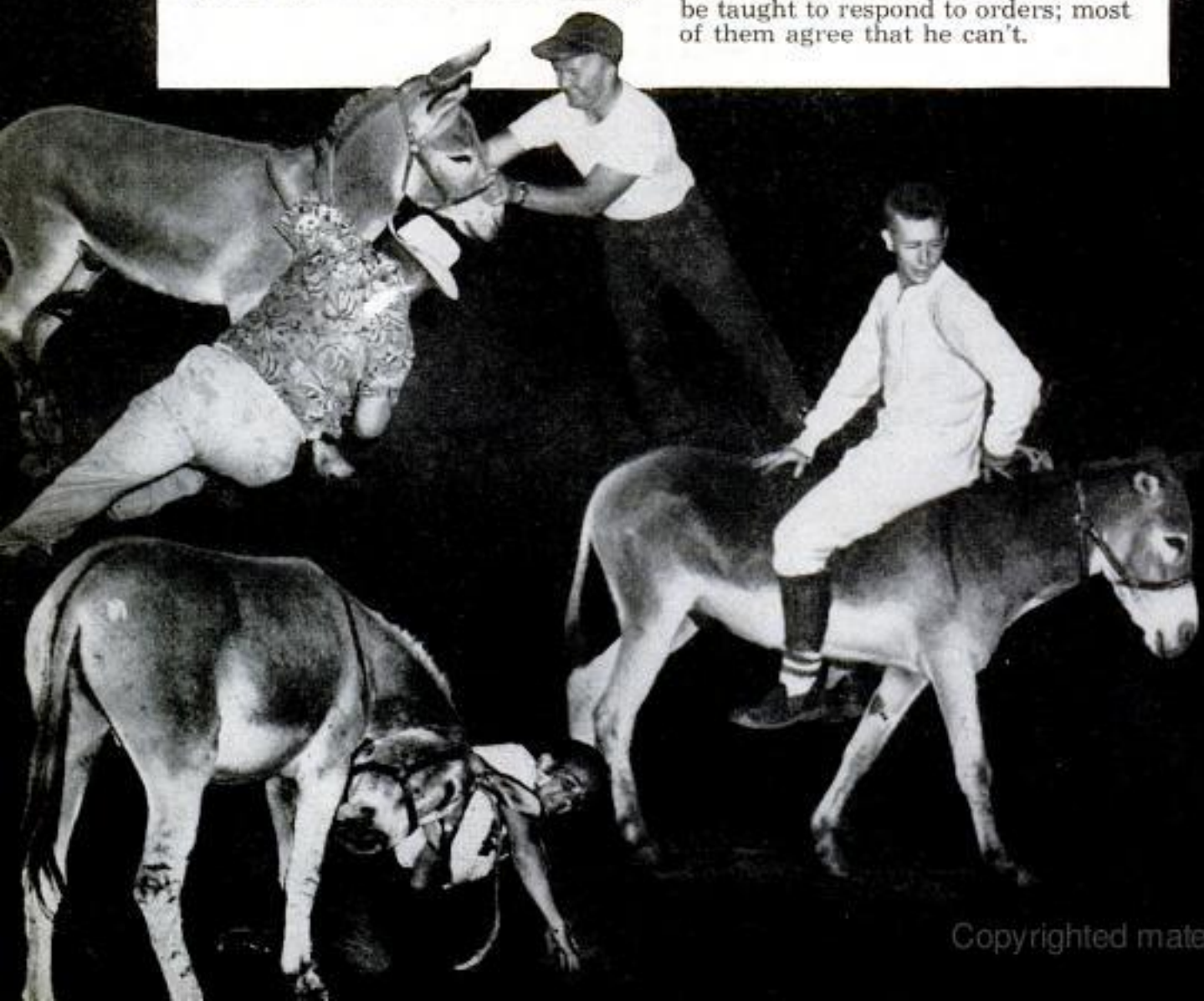





### Galvanic Rod in Radiator Prevents Scale Deposits

Scale deposits that choke a car's cooling system are prevented by inserting a galvanic-type protection rod in the radiator reservoir. The rod consists of copper and zinc plates assembled like the plates in a battery. The hot water in the radiator activates a galvanic field that makes the scale-forming salts inert.



### Easily Operated Lifeboat Radio Transmits on SOS Frequencies

Anyone can operate a portable lifeboat radio that receives and transmits on international distress frequencies. The portable unit, complete with collapsible mast and antenna wire, weighs only 56 pounds. If dropped in the water, it will float for an indefinite time.

### Cabinet Converts Leaves Into Compost in 30 Days

Gardeners can now convert old leaves, grass, kitchen garbage and other waste into soil-building fertilizer in 30 days with an automatic composter. No working or spading is required. You simply place the raw materials in the cabinet, add an activating chemical compound and the resultant humus falls through a grating into a drawer at the bottom. Entirely odorless, the cabinet is screened to bar flies and insects and has a double-wall construction.

### "Sweet" Chemical Fed to Cows

Milk can be kept sweet by feeding cows menadione, a harmless chemical that slows the action of bacteria. Tests at Florida State University showed that raw milk from treated cows remained sweet for 96 hours at 68 degrees Fahrenheit. Ordinary milk soured after 24 hours. Pasteurized milk from menadione-fed cows remained sweet 20 percent longer than pasteurized milk from untreated cows. One pound of menadione, from which vitamin K is formed, supplies 50 cows for one year.





**INVALID'S CAR** is driven by Englishman Sidney Jones who is unable to sit up because of a spinal injury. He drives while lying on his back. Powered by batteries, the electric car will do 12 miles per hour and go 30 miles on a charge of batteries

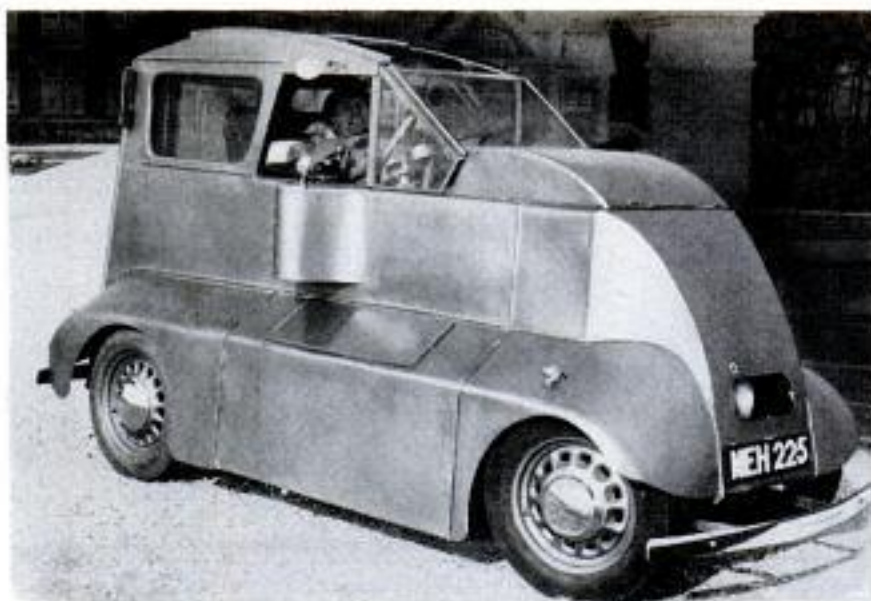

**ELECTRIC CAR**, built by Gaver Powers, Florida engineer, contains parts of an old electric auto, an X-ray outfit and a pin-ball machine. One charge of its 14 batteries takes it 60 miles at a speed of 30 miles per hour

# Detroit



**HORSE CAR** is also electric, powered by storage batteries. The robot horse actually walks, trots, runs or gallops and it pulls the wagon behind it on a level road. When the hill gets steep, a belt drive on the rear wheels helps. It was built by a Cleveland war-surplus dealer





➤ **SLEIGH CAR** needs no snow or ice. A Delaware auto-parts dealer uses it for city deliveries. He mounted the antique sleigh on the chassis of a motor scooter

**PROPELLER "CAR"** is almost an airplane without wings. The engine is mounted on the rider's back. It drives the propeller, pushing man and bike forward



## Didn't Build These "Cars"

**ARTIST'S CAR**, designed and built by a Paris decorator, is also unlike any Detroit product. It has strangely angular lines, a transparent dome and no seats. The driver has to sit on a thick carpet on the floor

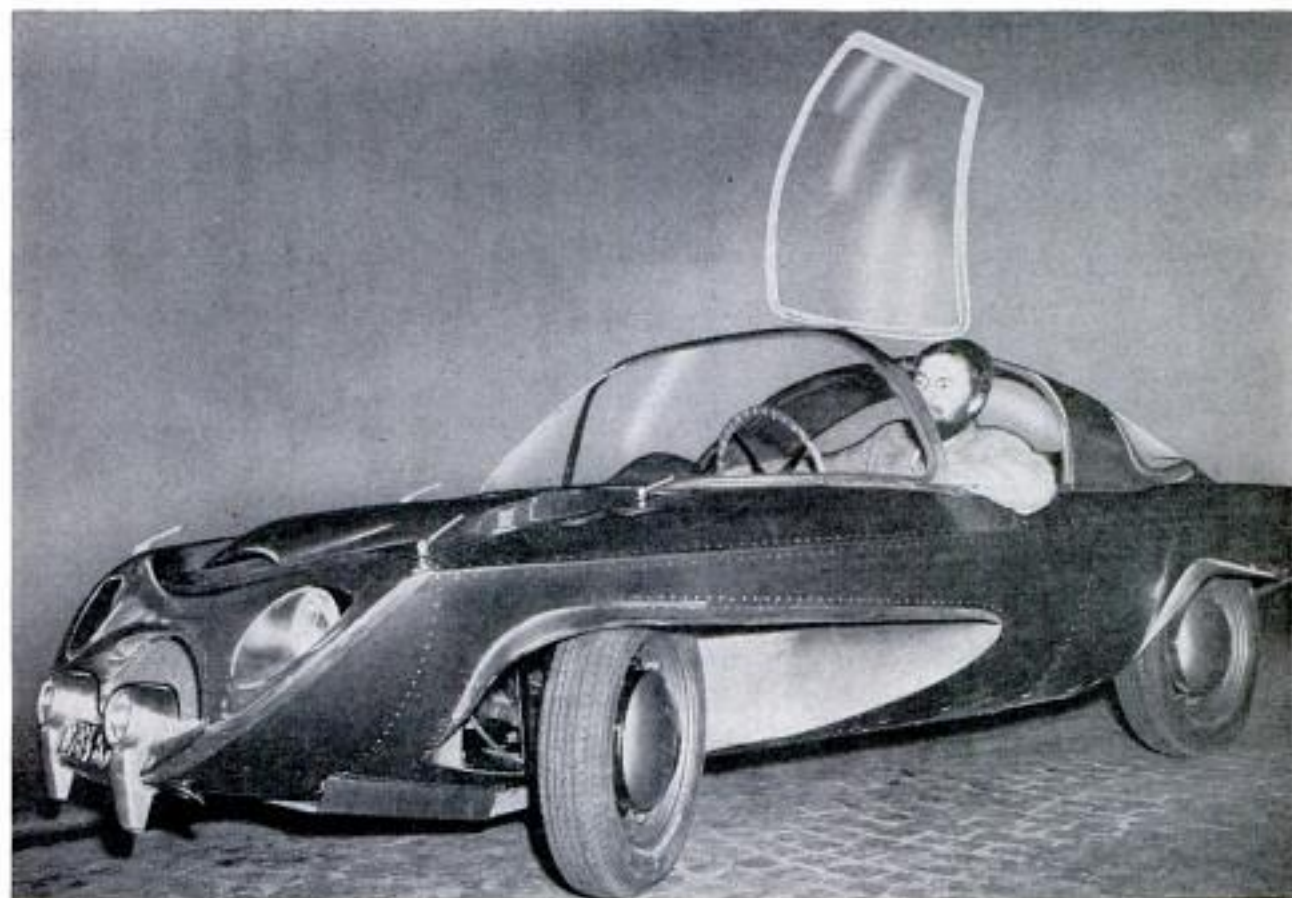



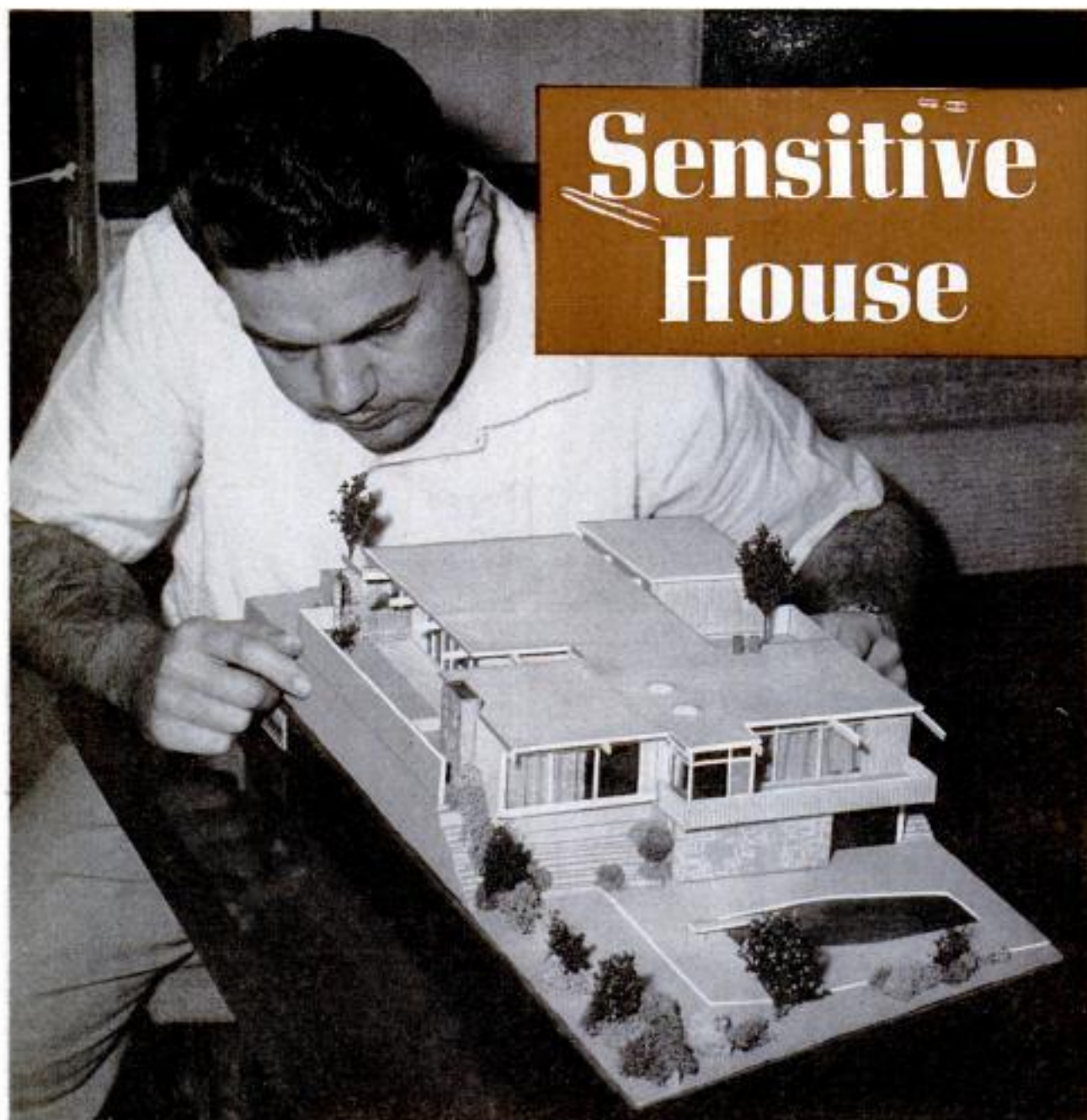

# Sensitive House

Jerry Tamkin displays model of his home with swimming pool at rear. Plastic skylights are for the kitchen

*By Ewart Thomas*

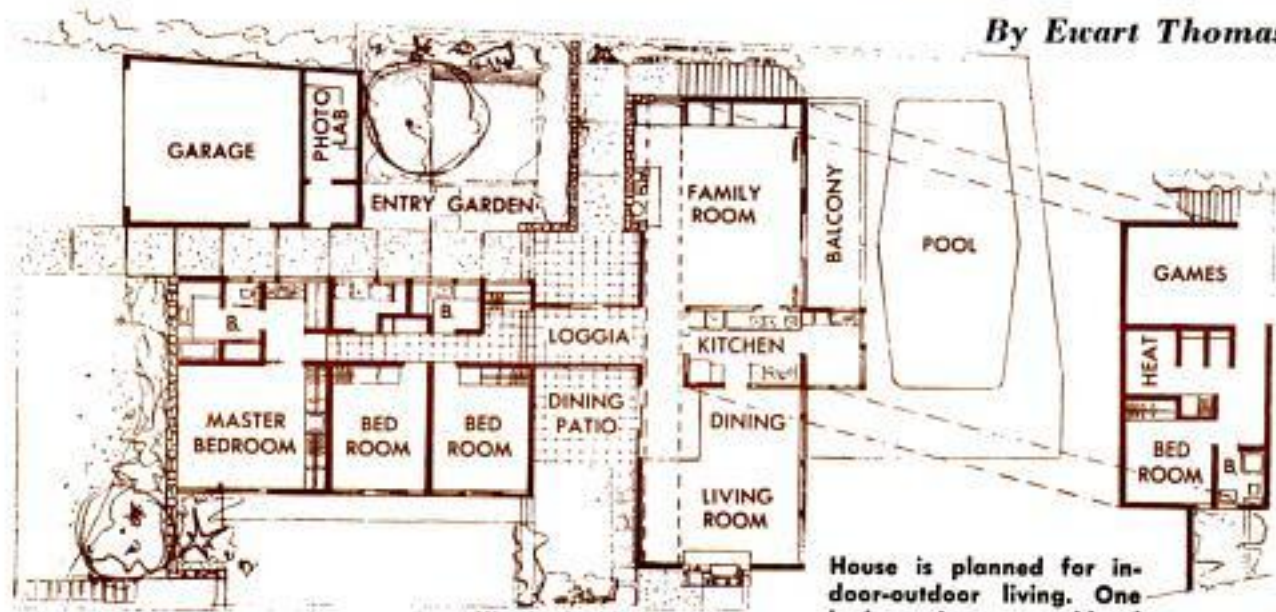

House is planned for indoor-outdoor living. One bedroom is on ground level





Tamkin tests efficiency of fire-detecting unit at alarm "station" in garage. Each room has one unit



Radio-operated mechanism in garage opens or closes doors when signal is received from approaching car

A "RADAR" burglar screen, a sliding front door that has neither hinges nor handle, and a master control panel at the head of his bed are features of a home built by Jerry Tamkin in Los Angeles.

The burglar screen consists of a wire that extends around the outside of the house and that actuates alarm buzzers if an intruder approaches the wire.

Tamkin's motor-driven front door slides to one side when the door key is placed in the lock on an adjoining wall. A button inside the entrance as well as one on the bedroom control panel likewise opens or closes the door.

Tamkin calls his residence the "Home of



Below, remote-control panel in master bedroom. Above, sliding front door opens when key is placed in lock

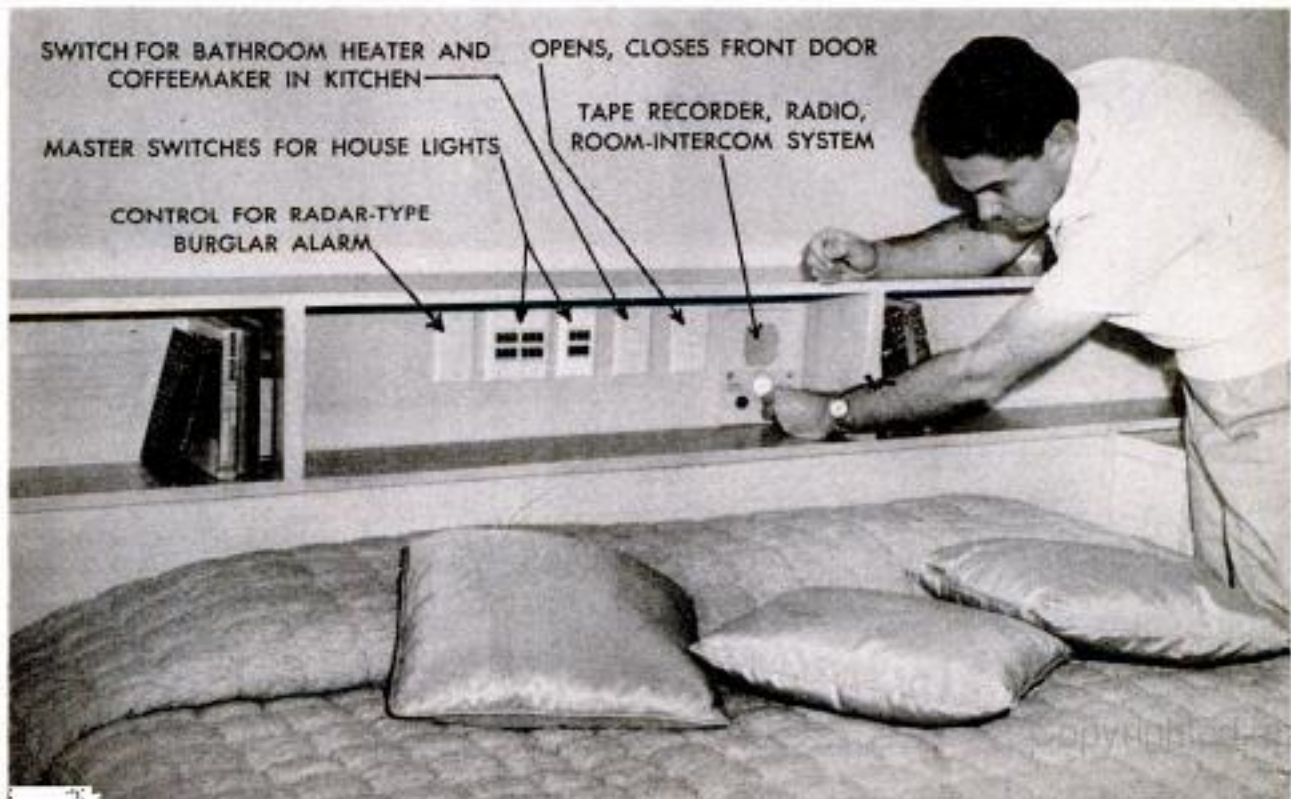





Entry garden leads to front door. Clay pipes are chimneys from fireplace and adjoining barbecue in den



Above, storage wall in den. Below, built-in range and broiler



Imagination" because he built into it all the newest devices on the market plus many of his own ideas. From the bedside control panel he can switch on or off the principal outside and inside lights, turn on the burglar alarm, start the electric percolator in the kitchen, turn on the bathroom heater and operate the front door. The panel also has switches for a tape recorder, radio, and a room-intercom system by which he can talk to people in any room or at the front entrance.

A storage wall in his large den provides space for a television receiver, tape recorder and a combination phonograph and radio whose music is piped to outlets in the principal rooms of the house. The storage wall also contains a movie projector and aquarium and has folding doors that conceal a built-in desk complete with interphone, telephone and lighting controls. Traverse window draperies in the den are pulled open or closed by means of a small electric motor.

The house is equipped with an automatic fire-alarm system that has sensitive detectors concealed in the ceiling of each room. The garage door is operated by means of a special radio mounted in Tamkin's car. In the kitchen is a dumbwaiter that is used for lowering snacks to the recreation area and pool on a lower level. ★ ★ ★



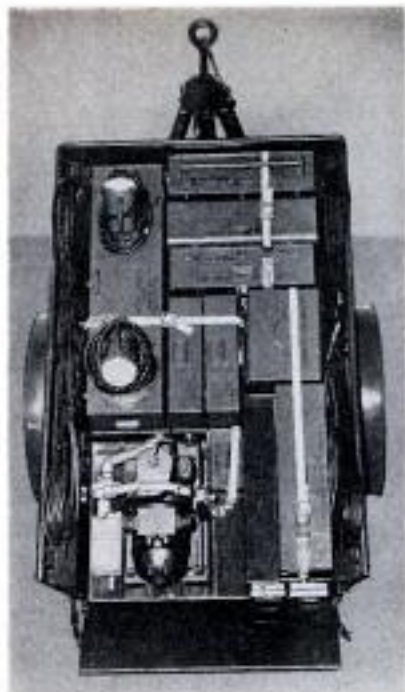

## Mobile Power-Tool Unit Aids Front-Line Troops

Already tested in Korea by Army Engineers, a portable electric-tool unit housed in a Jeep trailer is light enough to be dropped from a plane to troops near the front. A standard Army gasoline engine powers the 220-volt, 2½-kilowatt generator. Included are chain saws, circular saws, one ¼-inch drill, one 1¼-inch drill, two

impact wrenches, a grinder, an electric hammer and floodlights. Total weight with trailer is 1370 pounds; the electric generator and any two of its tools can be carried easily by two men if the trailer is stopped by rough terrain or enemy fire. Army engineers used the set in Korea to construct bunkers and assemble steel fuel tanks.

## Plastic Truck Tank Carries 3400 Gallons of Liquid Chemicals

One of the largest one-piece molded structures ever made, a 3400-gallon plastic transport tank is now being used in commercial trucking. It weighs only 7025 pounds, 3600 pounds less than the steel tank it replaces. The P. B. Mutrie Motor Transportation, Inc., Waltham, Mass., is using it to haul formaldehyde and similar liquid chemicals. The oval tank is nearly 22 feet long, over six feet wide.



## Artificial Atom Chip

For the first time the neutral V particle, a bit of the atom's nucleus, has been produced artificially. At Brookhaven National Laboratory, the giant cosmotron atomic accelerator, operating at 2,200,000,000 volts, yielded two examples of these V particles, so called because of the shape of their vapor trails. Only two examples were found on about 4000 photographs taken. Similar particles have been noted in cosmic rays.



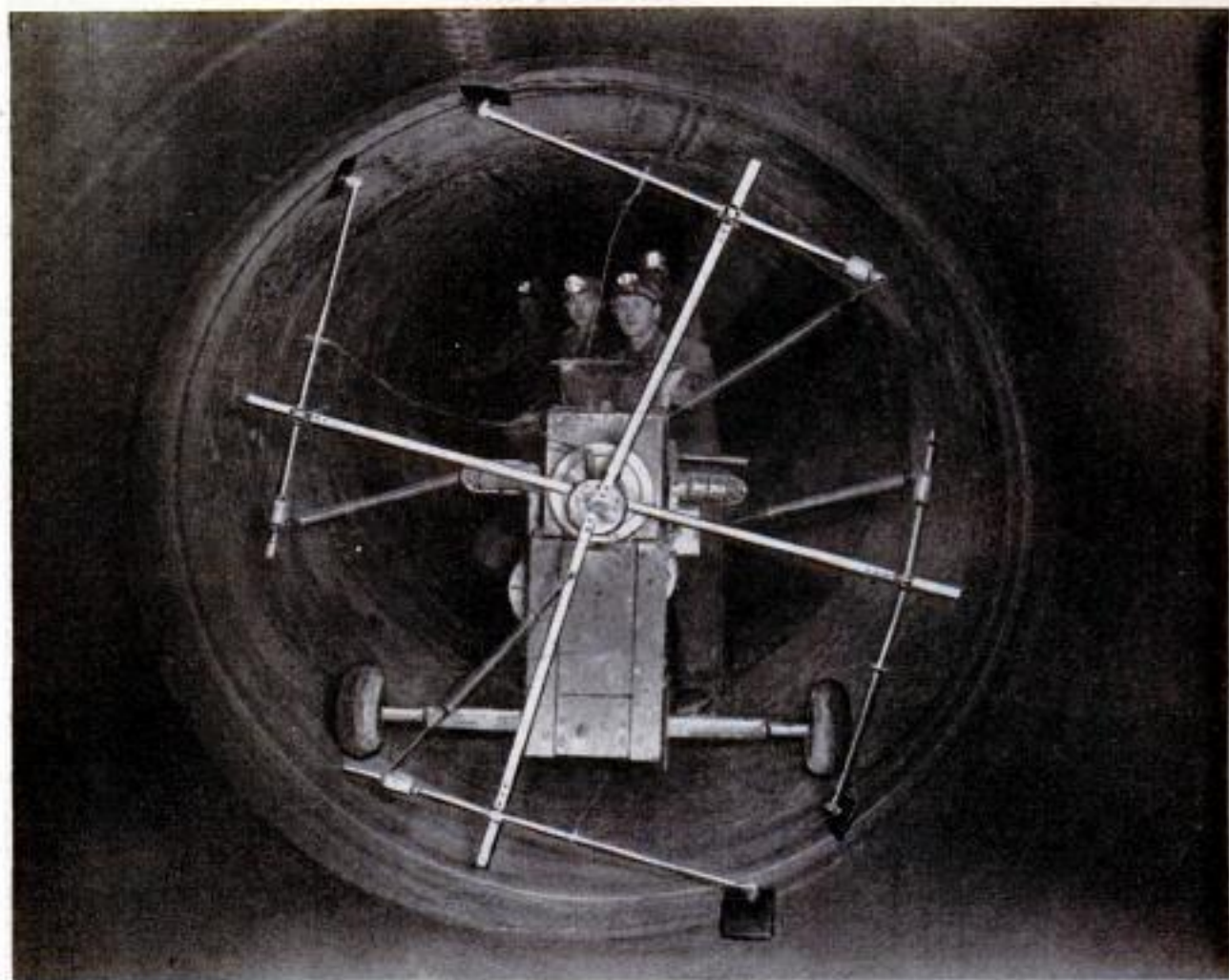

Trowel arms of pipe liner rotate like windmill arms while cement is sprayed from whirling multijet nozzle

## ***Oh, for the Life of a Human Mole!***

**By Richard F. Dempewolff**

**D**EEP UNDER the ground, crews of rugged men are worming their way through thousands of miles of dank pipe lines beneath city and countryside. Depending on the size of the pipe, they wriggle, squirm or lope along on their feet and knuckles like chimpanzees. Through the tight squeeze of a 16-inch water main, they

ride belly-flop on miniature "go buggies" propelled by outstretched fingertips working against the sides or bottom of the pipe. And some men, lying prone, buzz through the narrow underground labyrinths aboard tiny, rubber-tired trains of electric cars.

Their job, one of the most unique professions, has carried these human ferrets

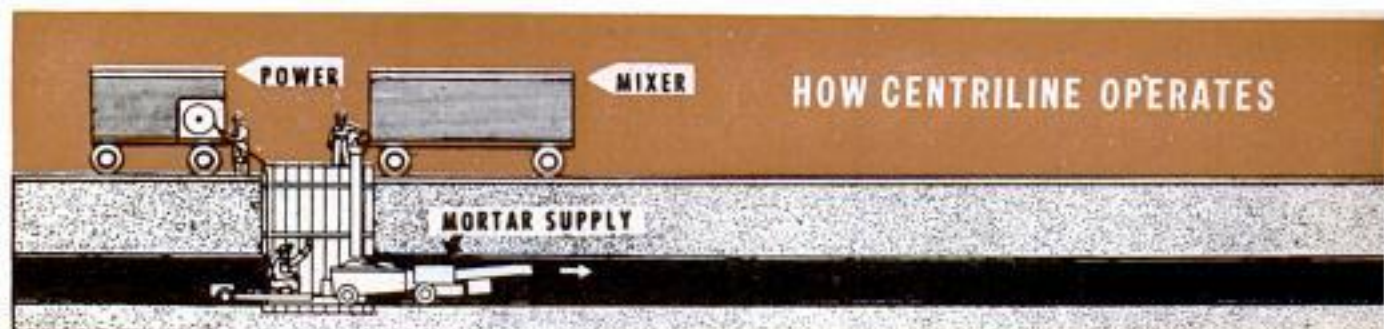



100 feet deep in the bowels of London, through a pipe so big that a six-footer standing on another six-footer's shoulders wouldn't bump his head. They have squeezed under rivers through pipe narrower than their own shoulders. Their odd little trains have carried them scuttling head-on into some spine-tingling surprises.

The object of all this burrowing usually has to do with the precious water that most of us take for granted. Turn on the tap and down comes your shower. But, supposing some morning it oozed out in a thin trickle? And what if the fireplug out front produced a rusty dribble when you needed a flood? That's what would happen if the thousands of miles of 4 to 148-inch mains carrying water from mountain reservoirs to your kitchen sink were left to shift along for themselves.

If you could peer into the black gloom of a big iron or steel pipe that had been in service for 30 years, you'd soon see why. Lumpy, barnacle-shaped corrosion deposits, called tubercles, crowd in around the inside wall of the pipe and gradually choke off the flow of liquid, killing pressure and often eating tiny holes through the pipe wall. In a 30-inch pipe of such vintage, even though population growth has increased water needs, an original gushing torrent of 140,000,000 gallons per day would have trickled out to 65,000,000, requiring pumps to force up enough pressure to service the same territory.

For years, men have forced scraping machines through such pipes to clean out tuberculation. But with each cleaning, the blobs of corrosion form faster, and in some cases, big pipes finally must be scraped every few months to do their job at full capacity.

Actually, men have known for a long time how to protect pipe insides from coming apart. Back in 1836 a French scientist



Pipe worker riding contoured "buggy" worms his way into a 16-inch pipe with automatic liner. He will come out feet first

discovered that by lining metal pipes with a thin layer of hydraulic cement, tubercles stopped forming, corrosion halted, and the line would carry full capacity indefinitely. Such a cement-lined water main was buried in New Jersey in 1845. Someone dug it up for new construction a few years ago and found to his amazement that, after a century of use, it was still in excellent shape.

It's easy to line new pipe in short sections before it's buried. Some of it comes that





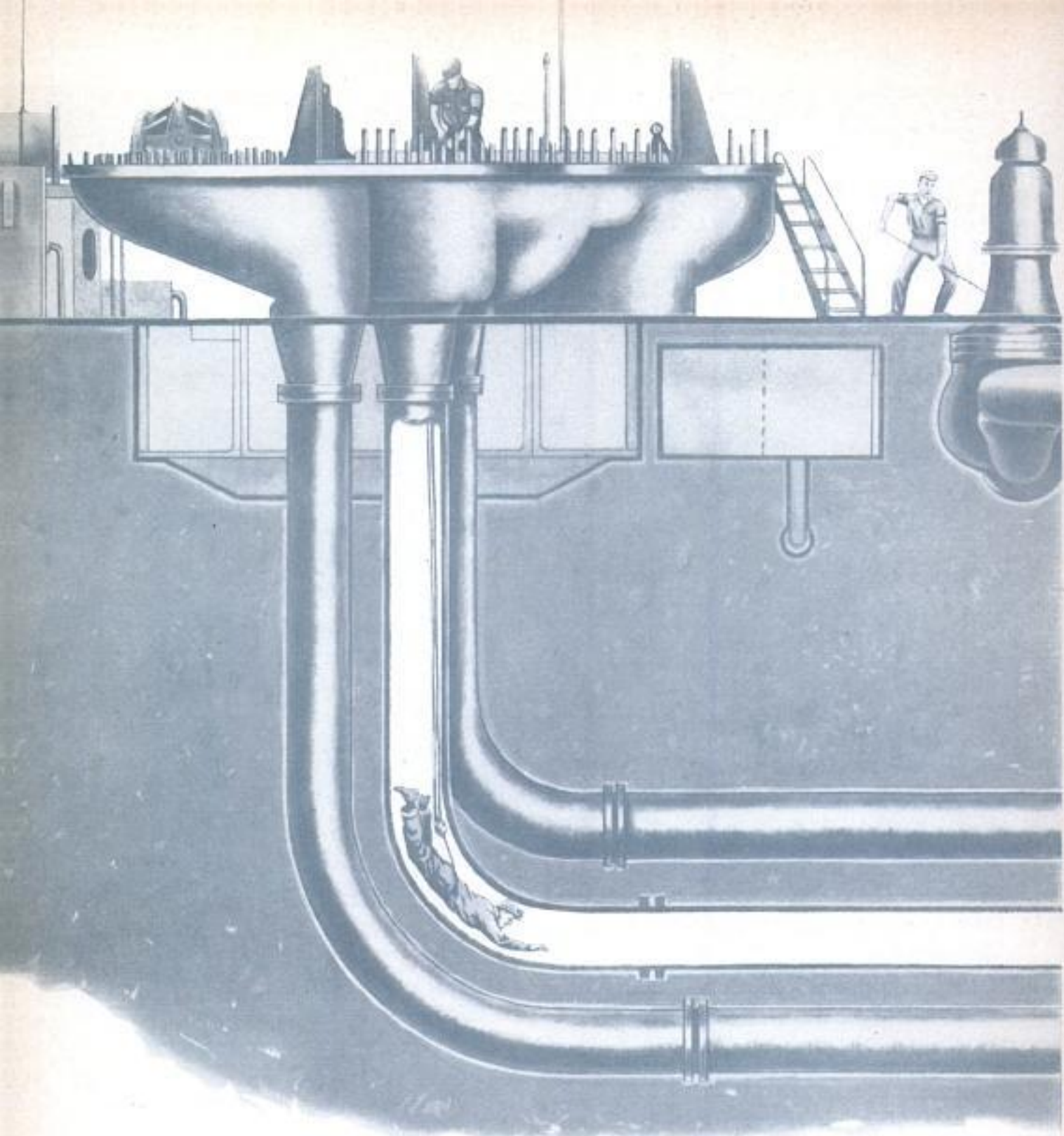

way today. But what about the miles of pipe already in the ground, which grows tubercles because it didn't have a cement lining when it went in?

Recently, engineers have come up with some clever answers. One of the cleverest is a system developed and put into operation by the Centrline Corporation. Mechanical star of the show is a fantastic little electric mole that comes in varying sizes to fit pipe of varying diameters. It crawls through underground tubes spraying cement from a whirling multijet nozzle in its tail that "revs up" to 1000 revolutions per minute. Behind the nozzle, long, skinny arms slowly rotate delicately sprung

trowels that put a precise finish on the new lining. Cement is flipped out with such force that it will even stick to wet pipe walls. Thickness of the lining is determined by the speed of the machine's whirring drive motors.

Some of these liners carry men on their backs. Others burrow alone, completely remote-controlled, pushing a lining through pipes at some 800 feet per day. Already they have ferreted their way through some 3,000,000 lineal feet of buried pipe here and abroad, spewing new and virtually permanent life into them at costs that are a small fraction of the price of new pipe. A remarkable thing about the lining is that it



Cutaway diagram shows how human moles were used to retrieve 50 steel turbine blades that had broken and fallen into the pipe line of a turbogenerator. Photo at right shows only the feet of Earl Parker as he is lowered by block and tackle into the 19-inch vertical steam line. He and co-worker Ken Powell had to creep through two vertical right-angle turns 20 feet down in the pipe line. Both men are six footers. They found all of the broken turbine blades and a grateful company made a movie of job

Courtesy of Consolidated Edison Company of New York

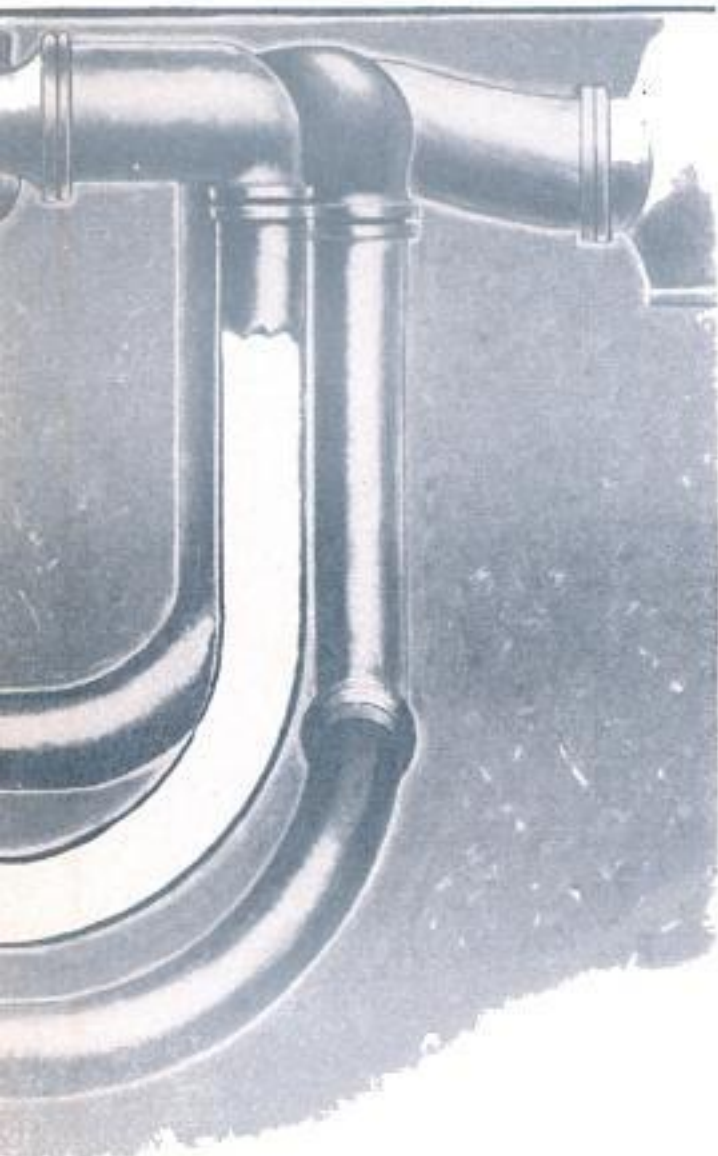

will cover leaks and holes as big as your hand. In tests, lining covering a six-inch hole in a steel pipe held up under more than 300 pounds of water pressure.

It takes more than one machine to line an old pipe, of course. The line must be opened and cleaned. Men go through to see that all obstructions are cleared. Water must be cleaned out. Once the grotesque lining machine goes in, it has to be fed a constant supply of cement. Then, afterward, special crews tunnel through to make sure the lining is perfect before the pipe is sealed and fluid gushes through it. All this requires a wide assortment of tricky contraptions and a crew of human moles to run



them. Each of the pipe-lining units at Centrline is packaged neatly in a semitrailer, self-contained and ready to move in on any pipe that needs new innards. A built-in mixer in the rear of the trailer turns out cement to supply the hungry liner via hose, electric car or hand-propelled carts. A generator up front whirls up the 50,000 watts needed to run the mixer, the winches and the heavy little electric trains and cars that buzz along deep down in the pipe below the street. The center section carries all the mechanical gear to and from location and holds a day's supply of cement and sand on the job.

To show *Popular Mechanics* how it works, Centrline invited us to crawl and coast around with them inside dark tubes that twisted tortuously beneath the streets of Cleveland, Ohio, and Norfolk, Va. In Cleveland, Charlie Smiley's team of veterans was working its way toward a river through a 36-inch water main—big enough for men to move around in with cement carts. The Norfolk job was 16-inch watermain that Earl Parker's boys could barely squeeze into when they belly-whopped on little underslung carts with curved bottoms that fitted the contour of the pipe with a clearance of about one inch.

Before an old pipe can be lined, it must be cleaned. In Norfolk, Joe Fielder, colorful old veteran with the National Watermain Cleaning Company, was busy "shooting" the line ahead of the Centrline crew. In Cleveland, Joe Quigley was doing the same thing.





Pipes are cleaned with a "go devil" which has hoelike blades and is flushed through pipe (below) to scrape interior clean



Below, to prove cement will bend without cracking, Centriline engineers depressed 72-inch mortar-lined steel pipe 13 inches

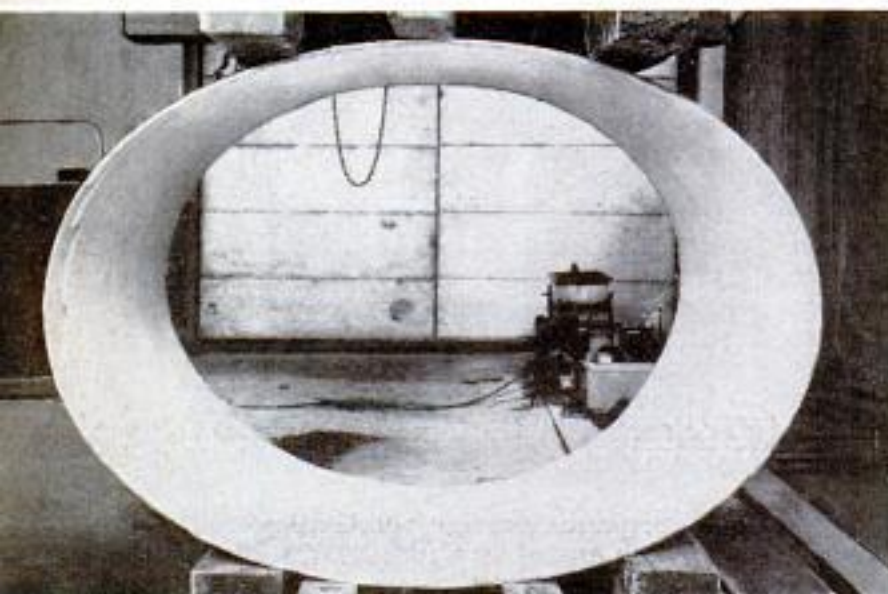

At intervals varying from 500 to 1000 feet along the line, men dug excavations, bolted huge rotating pipe cutters on the main and removed 10-foot sections called "nipples." Things the men call "go devils" do the cleaning job. These machines look like a string of steel bushel baskets, dangling one above the other on a cable like nested Christmas bells. Each "cleaning head" bristles with scrapers, resembling little steel hoes, which are bolted to big discs. Into the opening goes the machine, its spring-steel hoe edges pointed outward against the pipe wall. Nipples are winched back into place, fastened with Dresser couplings and full city-water pressure pours into the pipe behind the big go-devil. Perforated pistons on its front end catch water pressure from behind, and off it goes down the pipe, grinding and scraping the walls down to their skin. Huge tubercles and chunks of rust pile up in front of the monster as they break loose and are washed ahead through the perforations in the go-devil's pistons. An incredible quantity of stuff will gush in a roaring cascade from the yawning excavation that is left open at the end of the line.

"In a 2½-mile stretch of pipe in Louisville," reminisces Joe Fielder, "we cleaned out 76 tons of junk from a line in one shot."

If everything goes well, the cleaner, with 1200 gallons of water a minute pushing it, rumbles along beneath the ground at 60 to 80 feet a minute—about the speed of a slow walk. But everything doesn't always go well. "She'll take almost any degree of turn in a pipe," Joe reveals. "But obstructions can trip her up. Lead for instance, piled up in the line from a sloppy joint, will roll her up like a candy ball." When this happens, the spring steel of the go-devil can get wedged in the pipe so thoroughly that it must be cut out.

To keep track of their underground monsters, Fielder and Quigley follow them above ground by sound as they grind through the pipe. When the men lose the rumbling machine in deeper pipe, a broomstick sounding rod—one end pressed to the ground and the other to an ear—helps them keep track of its progress. It's not al-



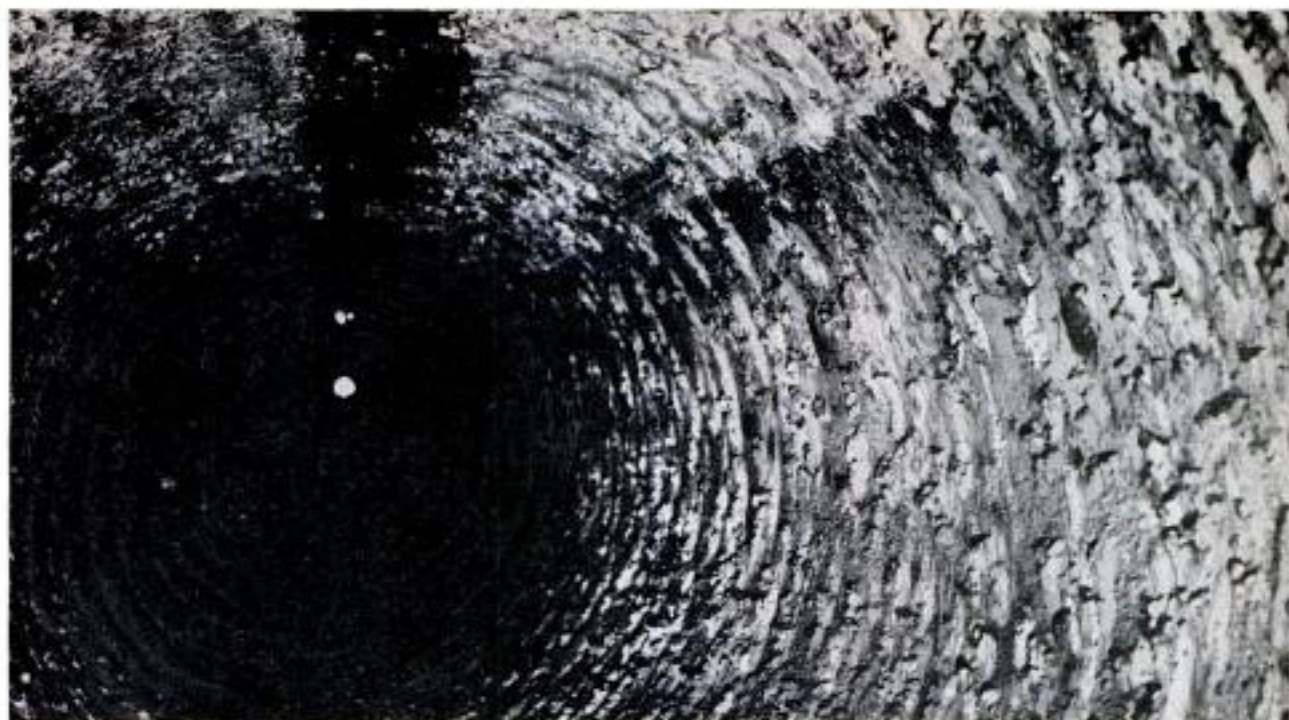

Before cleaning—interior of 48-inch steel pipe heavily encrusted with deposits that slow flow of water

ways a snap to stroll along above a galloping go-devil. Fielder tells about the time he shot 25 miles of pipe at one crack in Texas, running and stumbling across the prairies all day long as a crew of men cut a swath through the tangled mesquite ahead of him with machetes.

Once a line is cleaned, Centriline's crews move in. Men crowd the excavations, removing nipples again. In smaller pipe, like the 16-inch in Norfolk, a self-propelled machine called a "ferret" whisks down the long tube, trailing the cable that feeds power to it from the generator on the trail-

er, plus a steel cable that will be used to winch the squeegee through from the other end. The latter contraption looks like two disc wheels with rubber tires. As it drags down the pipe, it scrapes up water in low spots, pushing it out to the opening. Then the lining machine goes in. The long-nosed affair is hitched to a tiny electric engine that moves it slowly through the pipe. A hose line feeds the mortar to it from the mixer unit up on the street. Between engine and liner, a man lies prone on a tiny buggy, making a train about 21 feet long.

(Continued to page 250)

After cleaning with a go devil and lining with mortar, the pipe shown at top of page looks like this





## Truck Cab Is Sliced in Half to Facilitate Loading of Lumber



One-man delivery of small orders of building materials is speeded by an island-type truck designed by an Oregon lumber-yard owner. The cab of the 1-ton Dodge truck was sliced just off center and the truck bed extended to the front bumper. The bed is only 32 inches from the ground, making loading less strenuous. Extending full length, the bed is 20 feet long on the right.

## Small Portable Camera Photographs Fingerprints at Scene of Crime

Fingerprints are gathered in record time by a portable camera with built-in lighting. Its narrow nose fits on small ledges, on undersurfaces and other usually inaccessible spots. Flashlight batteries power four tiny bulbs around the lens hood. Pressure on a guide-block cover first turns on the light and then trips the shutter to make an exposure on  $2\frac{1}{4}$  by  $3\frac{1}{4}$ -inch film. Coins, stamps and portions of printed material can be photographed.



## Low-Slung Chair for Television Viewing Folds Into Hassock



Contoured for comfortable sitting, a low, plastic-covered chair designed for television watchers can also be folded into a hassock. It doesn't interfere with the vision of those seated behind on ordinary-sized chairs and couches. The adult size has a headrest that can be folded out of sight. A beach-lounging model of the chair has a Zipper-covered hollow bottom for towels and suits.

☐ Just the fuel carried by a jet bomber weighs more than a World War II bomber did when fully loaded for combat.



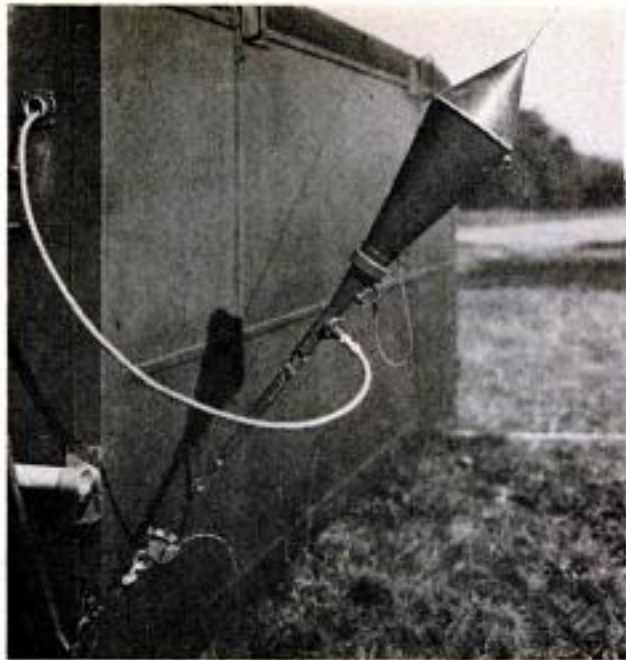

### Single Transmission Line Carries 30 TV Channels

Wide uses are forecast for a transmission line developed by the Army Signal Corps that consists of a single wire, special insulation and funnel-shaped terminals. Up to 30 separate television programs can be carried on the surface of the simple, inexpensive line. A new radar method uses the wire in eliminating costly, bulky wave guides and simplifying the problem of feeding power to rotating antennas. Microwave-relay techniques are improved by the wire's efficient transmission of energy from sender to antenna.



### Atomic "Preserver" Kills Food Bacteria

Scientists at the University of Chicago are testing radioactivity as a means of preserving foods. The "preserver" is a cobalt tube placed in an atomic reactor and made radioactive. It is installed in a lead chamber and sealed with lead plugs which are lifted by a rope and pulley. The fresh foods are sealed in the tube for periods ranging from a minute to several hours. Then they are tested to determine the effect of radiation.

### Breath-Controlled Television Set Entertains Polio Victim

Being encased in an iron lung doesn't stop an Illinois polio victim from tuning in her favorite television shows, for she controls the set with her breath. A small unit beside her head contains two telephone mouthpieces which funnel air

against delicately counterbalanced vanes, which actuate switches. A gentle puff into one mouthpiece changes the channel; the other mouthpiece controls the sound, consecutively turning it on and off. A mirror above her head reflects the TV image.







### English Hearing Aid Mounts on Spectacles

Attached behind the ear to a spectacle frame, the earpiece for an English hearing aid is held securely and inconspicuously. A gimbal mounting with swiveling support holds the bone-conductor earpiece firmly against the bone. A short, tiny cable leading to the amplifier passes inside the wearer's shirt collar.



### Chemical Shotgun Shell Absorbs Moisture

Atmospheric moisture which condenses inside a shotgun barrel is absorbed by a new shell which is filled with a chemical. The shell is slipped into the chamber of the gun between hunting periods to keep the barrel free from rust and corrosion. Machined from aluminum, it is a duplicate of a real shell.

### Coating Protects Metals Against 5000-Degree Temperature

Metals treated with a new spray-on material developed by the B. F. Goodrich Company can withstand temperatures up to 5000 degrees Fahrenheit. A  $\frac{1}{16}$ -inch coating of the new insulation, called Pyrolock,

protects metal for as long as 10 seconds against flame temperatures hotter than the melting point of the metals. It was developed for the Defense Department for use in the rocket and guided-missile field.

### Two-Section German Bus Uses Bellows-Type Connection

Consisting of two sections coupled with a bellows-type joint, a large German bus carries 120 persons. When used as a metropolitan bus, it has a two-man crew with the conductor riding at the rear. All pas-

sengers board the bus through the rear door and exit through either of the forward doors. When built for longer runs, the bus has adjustable sleeping seats, radio, tape-recorded music and refreshments.





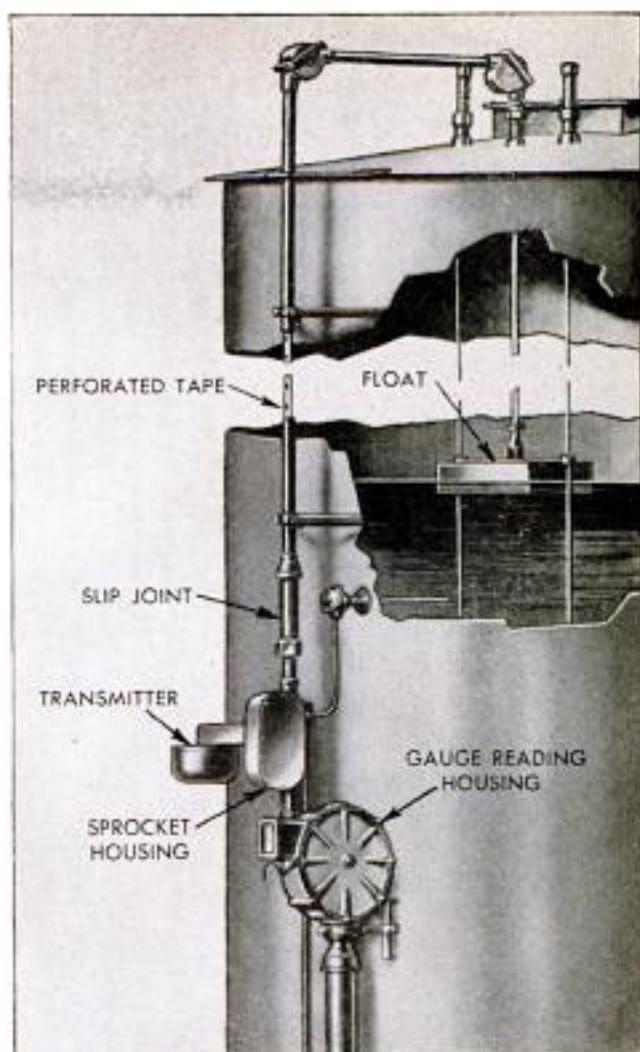
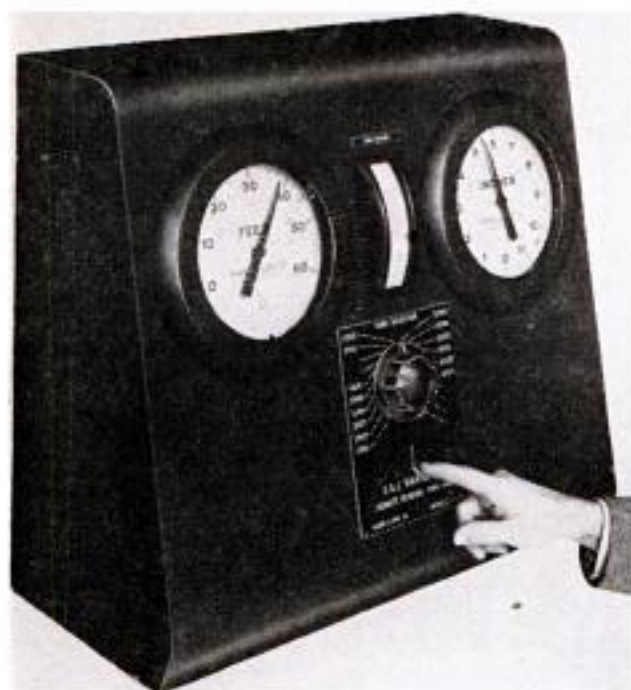

## Long-Distance Gauge Checks Levels in Faraway Storage Tanks

Seated in a New York skyscraper, an engineer now can measure the contents of storage tanks located in Houston, Tex., or Los Angeles, Calif. He dials the number of any storage tank, then reads instruments which report the height of the liquid to the fraction of an inch. The new remote-gauging system operates on any telegraph, teletype, telephone, radio or microwave circuit. First developed for the remote reading of tanks in the petroleum industry, the system can be used in other industries

and for measuring the water level of lakes and reservoirs as an aid in flood control, irrigation and power production. The basis of the system is a perforated steel tape connected to a float that rests on top of the liquid in the tank. A ratchet mechanism keeps track of the movement of the tape. It operates an electronic device that furnishes impulses to the transmitter, thereby sending out a report of the liquid level inside the tank. The transmitter can be adapted to radio or telephone circuits.

## Interlocking Rubber Tiles Fit Together Like Jigsaw Puzzle

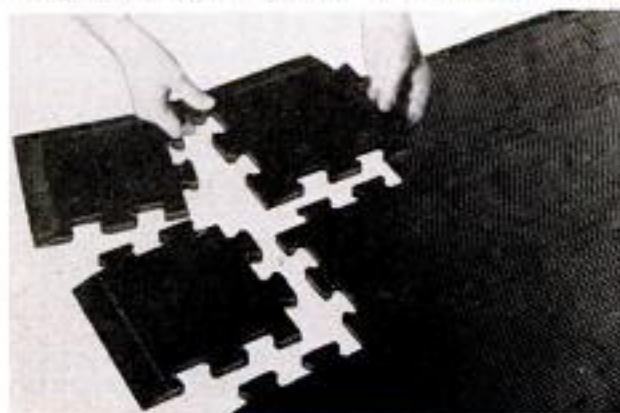

No mastic is required in laying rubber floor tiles that have interlocking edges. The tiles fit together like pieces of a jigsaw puzzle. They are available in two sizes—eight inches square and 24 inches square, and in thicknesses of  $\frac{1}{4}$  and  $\frac{1}{2}$  inch. The flooring can be laid from wall to wall or assembled with a beveled border. Suitable for installation below grade and on cement floors, the material requires no adhesive. One advantage of the flooring is that it can be picked up and relaid in another location if desired.



# RELAX!

By Dr. Donald A. Laird

**A**S THE IRISH laborer exclaimed, "'tis hard work doing nothing, that it is."

The artist's model has nothing to do—just strike a pose and keep muscles tensed to hold it. Keeping in a more-or-less fixed position is hard work because of static tenseness. It is called static, not because sparks are given off but because there is a lack of motion.

The small boy who has to sit through a ponderous sermon gets the wiggles because of static tenseness. Activity is needed to restore the dynamic equilibrium. People who attend long meetings, such as conventions, get bothersome temporary attacks of static tenseness. At a ball game, a seventh-inning stretch really should be taken about every other inning.

A person driving an automobile any length of time is likely to notice static tenseness in the leg and foot on the gas pedal. Painful cramps in the calf of the leg are not rare.

Persons in many occupations can arrange materials and equipment so they can shift position or move around occasionally. Being able either to sit or stand at work is a simple example. Another example was given in a patent issued in 1887 when women were wearing flowing skirts with bustles underneath. The invention was a combined bustle and stool—fine for watching a parade from the front row!

How can an individual detense from static tenseness in connection with so-called mental work?

Eye muscles provide a good example of the usefulness of intentionally shifting the tenseness as a relaxing aid. There are three pairs of muscles which control the eyeball's movements. As with most voluntary muscles, the muscles of each pair are ar-

Buckingham Palace sentry learns to "pump" calf muscles to relieve tenseness while standing at attention

POPULAR MECHANICS

Copyrighted material



ranged in opposition. When the lower muscle pulls the eye down to look at the desk top, the upper muscle has to stretch. It is pull-and-give in that fashion with all three pairs all the while we are awake.

There are four or five jumps of these pulling-and-giving eye muscles as you read one line of print. There can be a considerable total of these darting shifts during the course of a day.

These muscles are in balanced equilibrium when the eyes are looking slightly above a horizontal line. Nature wants the eyes to look up slightly. If you watch the movements of the eyeball as a person slowly closes his eyelids, you will see the eyeball automatically turn upward.

Yet most occupations require a downward look. This causes continuous tenseness because it keeps half the muscles shortened and the other half elongated. This occurs even while reading a magazine or watching the traffic while driving an automobile.

Eye muscle tenseness can be balanced several times a day by turning the eyes upward. Raise the eyes and look at the right corner of the ceiling, and hold them in that position for a few seconds. Lower them.

Now raise them to look at the left corner

of the ceiling. Repeat this four or five times, alternating right and left. The eyes can be either open or closed during this detensing. They should always be closed, however, if there is a bright light on the ceiling.

When close eye work is being done, tenseness is increased in a small muscle inside the eye which automatically focuses the lens. If this tenseness is continued long enough, it may cause this focusing muscle to become trembly (a spasm), blurring the vision momentarily.

If your work requires reading or equivalent use of the eyes for any length of time, pause a couple times each hour to look out the window at the most distant object you can locate. Spend two or three minutes looking into the distance.

Such detensing from close eye work can also be combined with detensing the muscles that move the eyeball—look to the far right in the distance, then to the far left and far up.

All other muscles can be relaxed at the same time. Just let your jaw and back and stomach relax, and slump as you look into the distance.

Mental work provides another example of static muscular tenseness. Very little energy is used for the brain work itself—

**Good news for office workers! Author says they should move about occasionally or put their feet on the desk**







Closing the eyes or looking far into distance relaxes focusing muscles of eyes, preventing blurred vision

only about four calories an hour. But brain work tires the person physically because of static tenseness, as if the thinking were being done by all the muscles.

Experiments by Dr. G. L. Freeman have shown that when a person starts some mental work there is a sharp increase in static muscular tenseness. And if the person is interrupted while doing the mental work, his muscle tenseness is raised again.

Artists' models, soldiers standing at attention, brain workers and others who are

Another eye exercise: Arrows show path of vision as eyes look up to left, then down, then up to right



required to hold a position (even continuous sitting), should follow two rules to minimize static tenseness.

1. Shift the position slightly every 10 or 15 minutes. The movement is relaxing because it offsets static tenseness.

The soldier at attention, for instance, is taught to shift his weight to his left leg for a time, then back to his right. A shift of this sort can be made without the reviewing notables observing any change.

The mental worker or industrial worker can make greater shifts. The typist can put one foot on top of the other, or lean slightly backwards for a few minutes, or stretch out her legs, or run an errand.

The mental worker can put his feet on the desk. Three out of four executives do!

2. "Pump" or flex the calves of the legs to speed up the return of blood to the heart.

All sedentary workers, whether they sit or stand at their work, should pump the calves of their legs several times a day or put their feet on the desk (or even stand on their heads!) to relieve the congested circulation in their lower legs. Dental students are taught to pump this way:

Just tense the calf of the right leg and hold it squeezed for a few seconds, then let it relax as fully as possible. Then do the same with the other leg while the right remains relaxed.

Remember, big tensions are just an accumulation of little ones. Relax away the little ones to avoid the big ones. ★ ★ ★



## "H BOMB" VAULT HAS 18-TON DOOR

NOT EVEN the blast of a hydrogen bomb, it is said, could destroy the new vault in the Ohio State House. Its rock, concrete and steel construction make it indestructible by any known force. Four time locks and two separate combination locks are encased in the massive 18-ton door, behind which are stored over \$1,000,000,000 in bonds. If anyone is accidentally locked inside the vault a fresh-air vent prevents him from suffocating and an emergency hatch allows him to leave the huge safe.

Right, vault door. Bottom of page, massive escape hatch. Below, inlet for fresh air





## Adjustable Table Permits Typing, Writing or Sewing in Bed



Permitting a bedridden person to type, manage correspondence or operate a portable electric sewing machine while sitting upright or lying on his back, an adjustable bed table makes for efficiency and comfort. The table top may be moved up or down the steel-tube frame and set at one of three different angles by the adjusting knob at the side. The lightweight frame rests solidly on each side of the bed to maintain a stable surface.

## Flashlight Batteries Supply Power for Portable Turntable

Powered by two ordinary flashlight batteries and a clock-type motor, a portable turntable is said to revolve continuously for five to six weeks. Outwardly, the self-contained unit resembles a circular metal candy box; the cover revolves on a central spindle-motor mechanism mounted on the bottom section. Useful for window displays and in photography, it will carry a 6½-pound load.

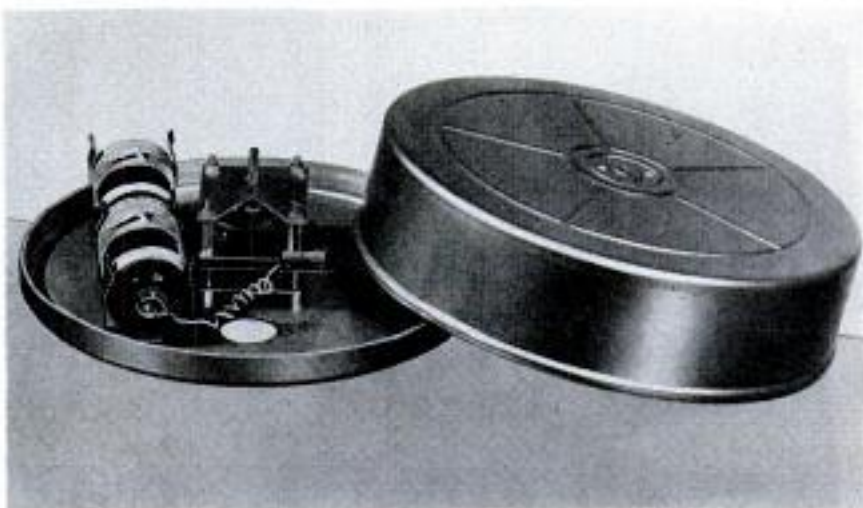

## Versatile Drawing Table Quickly Assembled From Kit

Shipped disassembled, a pine-plywood drawing table can be put together by anyone with a hammer and a screwdriver. The edge of the

table top closest to the draftsman is only 30 inches from the floor, permitting the use of an ordinary chair, though the top can be raised to standard height, fixed at a

sloping or level position anywhere within the range of adjustment, or tilted toward either side. A large reference shelf, open at the front, can also be reached through a slot in front of the draftsman. Hinged on the right side of the table is a palette table with two sliding shelves for supply storage. The disassembled table can be stored in a carton three inches thick by three by six feet.





## Drive-In Movie Theater Features Screen for Each Automobile

Every car has an individual screen in a drive-in movie theater devised by Tom Smith, of Urbana, Mo. Screens are arranged in a circle with the projection booth in the center, the image being flashed on the rear of the screens. Smith won't tell how the projector directs separate beams to the individual screens, but says the system will eventually have screens for 150 to 200 cars. Clearer, unobstructed images are its chief advantages.



## Reel for Extension Cord Has Built-In Electric Outlet

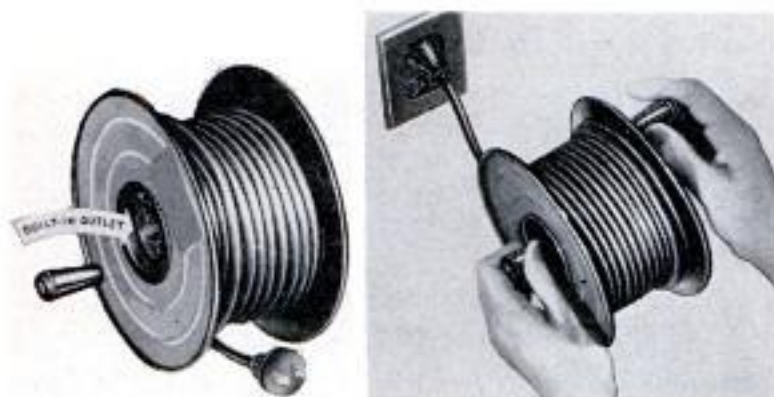

Wound on a small reel, an electrical extension cord is virtually tangleproof. Built into one side of the reel is an electric outlet, permitting the user to unwind only as much wire as he requires and still have access to a plug. Twenty-five feet of wire are wound on the reel, which is 6 $\frac{3}{4}$  inches in diameter.

Far left, "portable plug" is in side of reel. Left, cord rolls neatly on drum

## Portable Luggage Carrier Folds Into Small Carrying Case

Luggage weighing more than 150 pounds has been carried by a "portable porter" invented by Albert Roubeck of New York City. A traveling wholesaler, Mr. Roubeck devised the adjustable, folding dolly to move his luggage without dependence on porters at hotels and terminals. The four-wheeled dolly, made of Duralumin, is 18 inches long and 3 inches wide when closed, adjusting to 13 inches in width when fully opened. It has straps and four suction cups

that screw into the corners of the dolly to hold luggage in place. The carrier and its leather traveling case together weigh less than three pounds.







## Toddler's Chair Serves at Home and in Car

Energetic toddlers can be anchored to "home base" in a collapsible chair that does four-way duty as a car seat, nursery chair, TV seat or sanitary training unit. Made of hardwood, the chair folds up at the squeeze

of a spring-held bar. Rubber-covered hooks hold it to the back of the car seat and a strap keeps the youngster from slipping out while traveling. The seat is hinged, with a plastic well beneath.

## Glareproof Tilted Blackboard Mounts Bulletin Board on Back

Glare from natural or artificial light is eliminated by a reversible blackboard that is mounted at an angle. The blackboard can be lifted out of its frame easily and flipped over to bring a cork-faced bulletin board to the front. Space behind the board can be used for the storage of papers, art materials, chalk, books and other school supplies. The height of the blackboard can be adjusted to accommodate school children of any age.

## Metal-Powder Process Forms Strong Castings

Able to withstand high stresses, a new metal is so ductile that it can be twisted two full turns without cracking. Gears, cams, and other finished machine parts of high strength can be formed from the metal. A mixture of iron powder is fed into a briquetting press and formed into the exact shape and size of the part. Then the briquette is heat-treated to fuse the metal particles and finished-sized again in a press, eliminating costly machining.







Hundreds of fishing boats dot the mouth of the Columbia River night after night during the salmon run

## ***SALMON FISHING on the Night Shift***

**By Tom Riley**

Pulling in a floater gill net. It rains most nights

**S**CIENTISTS are predicting that the heavily populated world of the future will depend more and more on ocean foods for sustenance. Doing quite well already are the night fishermen of the Columbia River.

The mouth of the Columbia, separating Oregon and Washington on the Pacific Coast, is a rainy, storm-ridden spot, treacherous for the largest ocean-going ship. It is also the hub of United States salmon fishing, where most of the King Chinook, Silverside, Blueback, Chum and Steelhead—each a variety of salmon—are prepared in the canneries lining the shores.

The fishermen work mainly at night for the simple reason the wily salmon can see and dodge their nets in the daytime. During a heavy salmon run, these men dot the black, windswept waters with such a multitude of lights from boats and net buoys that visitors driving by on the shore highways wonder what city it can be.

Even in the seven-mile width of the Columbia's mouth, the traffic problems are enough to make a policeman shudder. Literally hundreds of boats are there during the salmon runs, roaring through the darkness, stormy or calm, to take their turns in floating the 1500-foot-long nets down a







So what do the night netters do during their day off? They go fishing in the annual Astoria Salmon Derby

THICK PART OF SALMON'S BODY PREVENTS IT FROM PUSHING THROUGH NET AND GILLS CATCH IN NET TO PREVENT IT FROM BACKING OUT. OTHER FISH AND SMALL SALMON PASS THROUGH

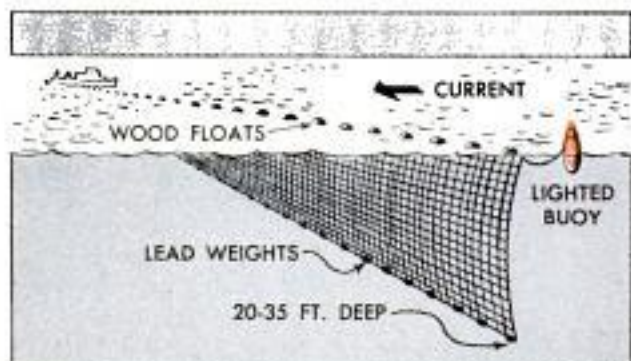

WITH A LIGHTED BUOY AT ONE END AND A BOAT FAST TO THE OTHER, A 1500-FOOT "FLOATER" IS DRIFTED DOWN THE RIVER CROSSWISE TO THE CURRENT

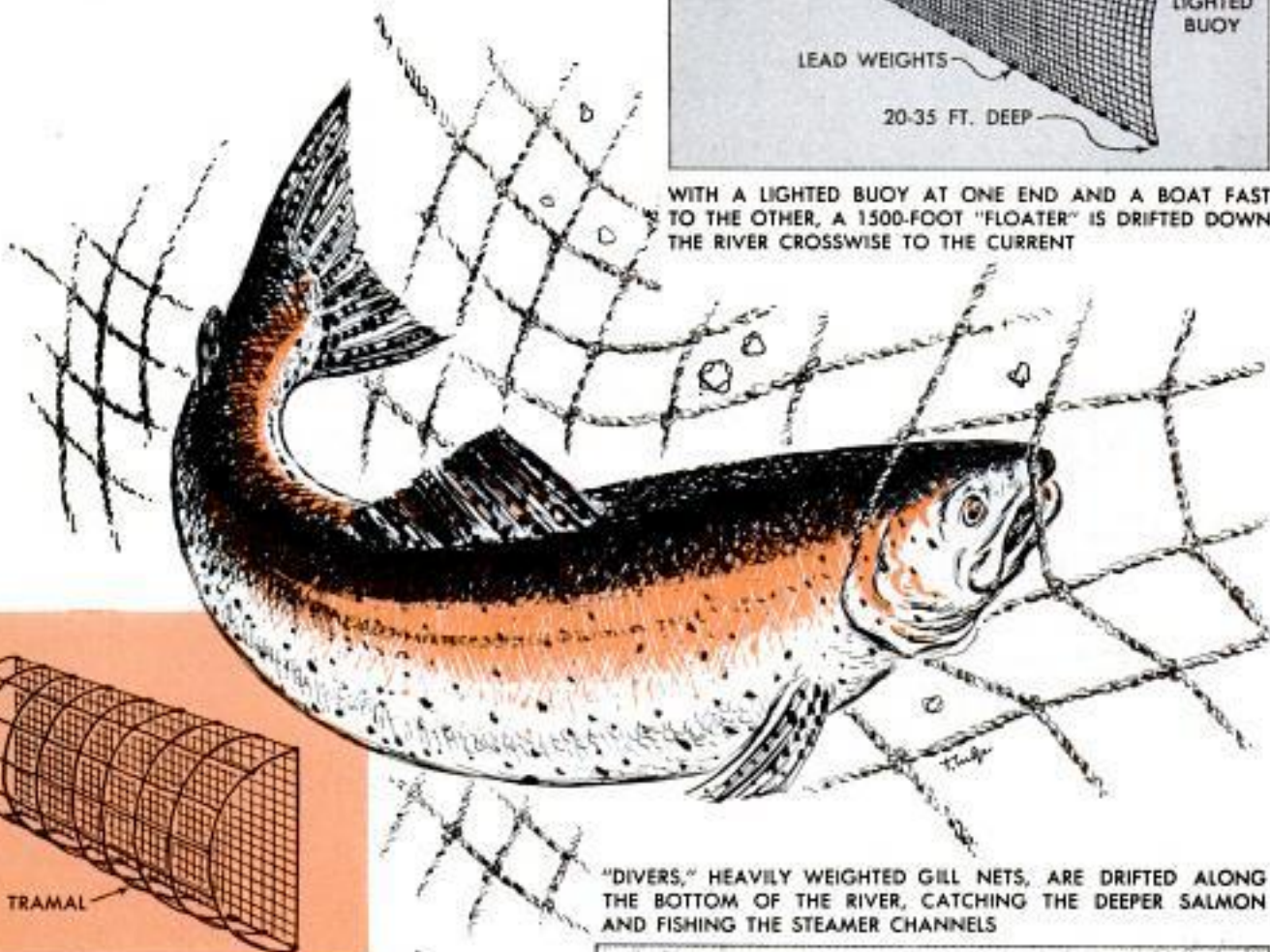

"DIVERS," HEAVILY WEIGHTED GILL NETS, ARE DRIFTED ALONG THE BOTTOM OF THE RIVER, CATCHING THE DEEPER SALMON AND FISHING THE STEAMER CHANNELS

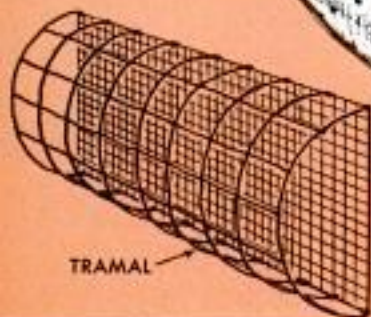

TRAMAL

A TRAMAL NET IS SOMETIMES ADDED. BILLOWING BEHIND GILL NET, ITS LOOSE, LARGE 34-INCH MESH ENTANGLES SALMON TOO LARGE TO BE CAUGHT IN GILL NET

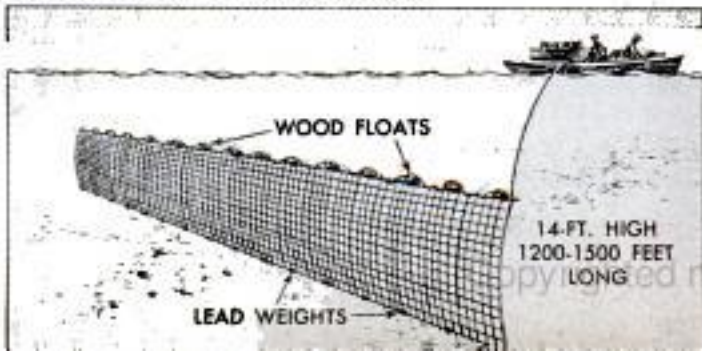



10-mile "drift." One close behind another, they slip their bulky nets past miles of dangerous sandbars and jetties and under busy steamers puffing up the river channels to Portland.

Scientists call the salmon the romantic fish of the sea, because he leaves the ocean to spend his last days at the exact spot where he was born. After four years of wandering through the Pacific Ocean, feeding on shrimp and smelt and growing to between 20 and 80 pounds, he returns in huge schools or runs to the mouth of the Columbia. The salmon then swims up the river to leave the school at one of the tributaries, to return to the very gravel bar where his life began. There he mates, the eggs are spawned and his life is over.

How each salmon can find the mountain stream of his birth is still a mystery. That he does is known, and the practical fishermen gather their bountiful harvest at the river's mouth. They close down their net fishing a part of each run to allow enough salmon to race by to spawn.

Back at the turn of the century, the then-untouched salmon fishing of the Columbia attracted fishermen from all over the world. These hardy men from Norway, Sweden and Finland and from the Mediterranean—Greece, Italy and Portugal—brought with them seven or eight proven designs of rough-weather boats. The result has been that the best features of all have been blended together into one of the most seaworthy small craft ever built—the Columbia River salmon boat. Usually a 26-footer, it has a round-bottomed hull, because the river's mouth is far too rough for fishing from a V-bottom craft. It is a "bow picker" (the nets are handled from a bow cockpit), and the roomy bow is claimed to have developed from an ancient Scandinavian design. Most of the fishermen have favored the boat as a double-ender, the pointed stern from a Mediterranean design. Some are using a square-sterned version today, thus having a modern transom that gives more speed with a large motor but less seaworthiness in bad weather.

Speedy motors are a great help to the night netters. In the past, their boats were powered with one and two-cylinder in-board engines—because those heavy-duty gas engines were the most reliable on a wet night and reliability is an all-important feature at the mouth of the Columbia, where an engine failure in the darkness would mean being carried to clutching sandbars and breakers that tear up the largest of ships.

But those "one lungers" were slow and meant 12 to 16 cold hours a night on the river, half the time on the trips to the start of the drifts. The powerful 4 and 6-cylinder



To halt rot, nets are "bluestoned"—soaked in a copper sulphate solution—in large wooden tubs at the right

gasoline marine engines of the last 10 years have fully proved their reliability to these fishermen, especially since the war-developed ignition waterproofing. Their 26-footers are now roaring through the black water to the start of a drift in a half hour.

A single floater or diver net, the two types used on the Columbia, costs from \$800 to \$1100. Both are gill nets, made of the strongest linen line available; and both catch the salmon when the fish pushes his head through the seemingly flimsy netting. His thick body prevents his passing on through and his gills prevent his backing out. The floaters are 1200 to 1500 feet long and up to 35 feet deep, with wood floats supporting the upper edge at the river's surface and with lead weights on the lower edge to hold the net vertical. A buoy containing a waterproof battery and light is attached to one end, and the net is spread out its full width at right angles to the current. The boat is kept fast to the far end and drifting alongside as the net bobs down the river. The diver nets are similar, except that they have additional lead weights on the lower edge, a carefully balanced number of weights to sink the net





Part of the mouth of the Columbia River, showing how it is congested with boats and nets during the run

Crowded deck of a salmon boat. Fish are stored in hold below the hatch to keep them out of the way



just enough to drift it along the bottom of the river. Many of them know their Columbia so well they can drift a net down the bottom of the main channels while steamers ply back and forth above it.

The Columbia has an all-sand bottom, but tree stumps and other snags are continually lodging in the sand to hook and rip the expensive nets. Whenever this happens, the next morning a heavy snag scow moves out to the spot. Owned by the fishermen's association at Astoria, Ore., it contains a powerful winch and diving equipment. The diver goes to the bottom to attach a cable to the snag, which is then jerked out by the scow.

The boats are not as spotless on hull and deck as a yacht, but they are kept in better operating condition. The nets are "bluestoned"—soaked in a 1:3 solution of copper sulphate and water—once a week during fishing weather to prevent their rotting from the salty waters. When not in use, the nets are carefully dried and any tears in the linen mesh repaired. These nets will withstand only four months of use, so it doesn't pay to use them when the salmon are not running strong.

The salmon are unpredictable. The fall run of huge Chinooks will often mill in the ocean off the mouth of the Columbia for weeks, seemingly in no hurry at all. Then, for some obscure reason, all will move with a rush over the bar and disappear up the river, the peak of the run lasting only one frenzied night for the fishermen. Actually, these night netters make the most of their year's income on just a few, rain-ridden nights—but they work on those nights.

★ ★ ★



## Mirror Panels and Grooved Molding Make Quick Wall Covering



With easy-to-handle panels and molding strips, one person can completely cover a wall with mirrors in an afternoon. The full-wall mirror makes the average room seem much larger. The grooved molding strips measuring  $1\frac{1}{2}$  inches wide and either 16 or 18 inches long, are attached to the wall first, then the mirror panels are simply slipped in from the front. The grooves are cut so they do not require sliding the panels in from the side. The panels measure 16 by 18 inches. They also can be attached to the wall with a special cement, eliminating the moldings to produce a solid wall of mirrors.

## "Sea Cow" Foghorn

When fog blankets the Isle of Helgoland in the North Sea, a powerful noisemaker goes into action to warn ships. Called the "sea cow" because its signal is like the lowing of cattle, the device produces sound by electrical means. Twenty feet high and made of steel, it contains eight apertures from which sound emerges.

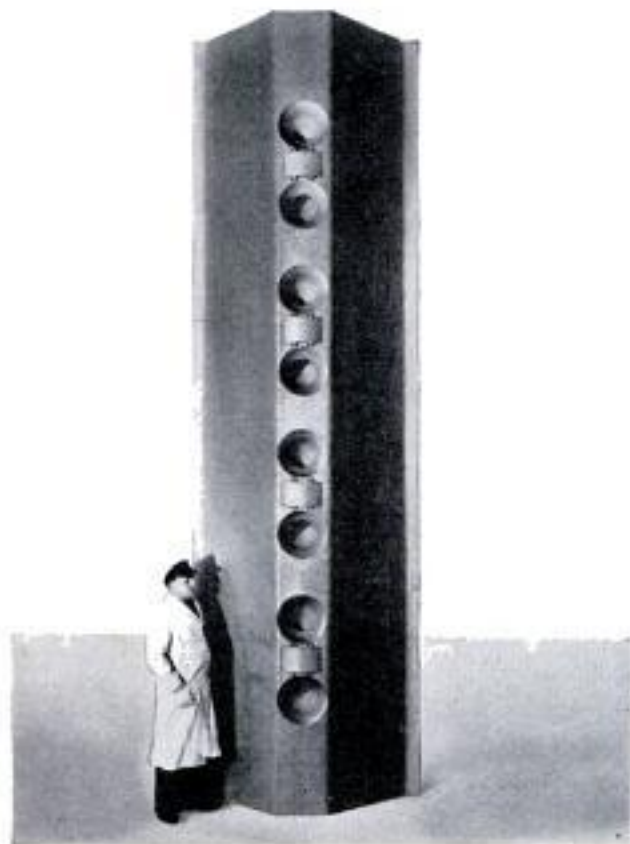

## Midget Fire Extinguisher

Fires can be extinguished from a distance of 25 feet with a push-button extinguisher powered by compressed air. The container is recharged by filling the shell with fluid and adding air from the hose of any filling station. Suitable for home workshops and automobiles, the small, stainless-steel extinguisher contains a fluid which smothers flames of all types, including those originating from flammable liquids.







Lockheed Aircraft Co. photo

## Flying Radar Stations To Be "Eyes" for U.S. Defense Forces

Like magic spyglasses, new flying radar stations will carry the military services' most powerful "search" radar to high altitudes for maximum effectiveness in spotting surface and air targets. Radar beams scan on a straight line and cannot bend over the horizon. The aircraft are special versions of Super Constellation transports. Housed in an eight-foot-high hump on top

of the fuselage is a height-finder radar antenna and mushrooming from the bottom is a bowl-shaped radome. Each plane has facilities for a crew of 31 and carries a complete electronic maintenance shop to permit in-flight repairs during long patrol flights. They will be used to give early warning of approaching air targets and by the Navy to screen United States fleets.

## "Electric Wallpaper" Cemented to Ceiling Supplies Heat for Room

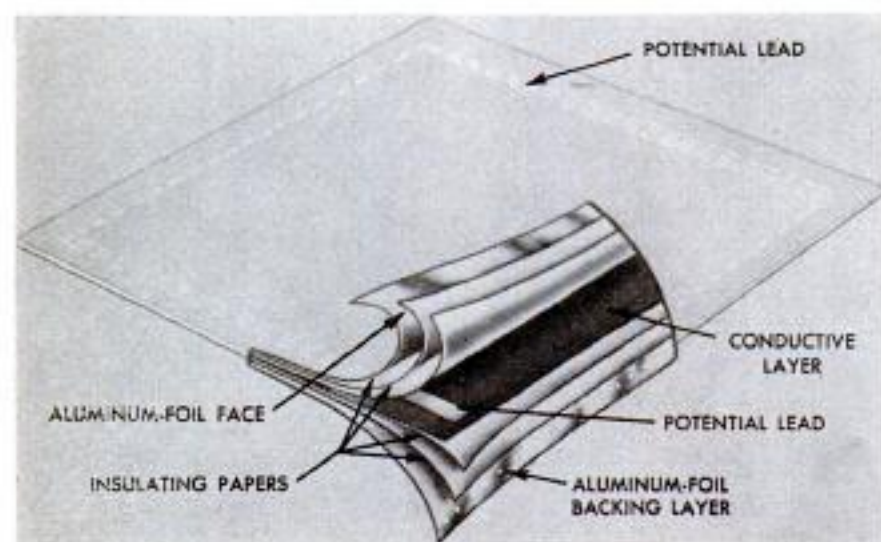

Electric heating panels which cement to the ceiling like wallpaper are designed for partial or complete home heating. Only  $\frac{1}{10}$ -inch thick, the panels consist of a sheet of electrically conductive rubber sandwiched between layers of electrical insulating paper, plastic and aluminum foil. Since the rubber itself is conductive, there are no wires in the panels. A potential lead connects the rubber sheet to the source of the current. Surface temperature of the panel is a uniform 100 degrees, warm enough so that the entire ceiling does not need to be covered. Where the cost of electricity is 1½ cents per kilowatt or below, cost of operation is said to compare favorably with other methods.

Research men have found evidence that antibiotics in feed speed animal growth by stimulating bone development.



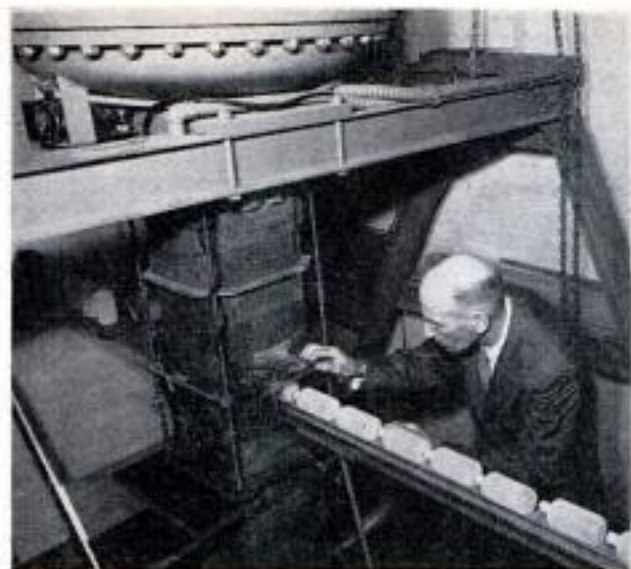

### Bombardment With Electrons Toughens Plastic Bottles

Brief bombardment with electrons can toughen plastic bottles enough to withstand steam sterilization, General Electric scientists have found. Otherwise the polyethylene containers, used for packaging pharmaceuticals and fluids such as blood plasma, melt into a shapeless mass when subjected to extreme heat or steam. Only a few seconds bombardment from a million-volt X-ray machine is needed for the complete toughening process. The electrons can also "cure" plastic dishes so they will keep their shape in hot water.

### Tricycle Built for Five

Baby-sitting can be pleasant, believes one Italian miss. With four young charges and a small dog seated before her in a wrong-way rumble seat, she's off to see the sights of Rome. At other times the "rubberneck buggy" serves as a pedaled pushcart for packages and produce.



JANUARY 1954



### Double-Glazed Window Without Metal Edge

Insulating windows are now being made without the customary metal edging and separating strips. The two panes of glass are electrically fused on all edges, forming a permanent, airtight seal. It is primarily designed for homes, apartments and other buildings requiring relatively small size panes. The two layers of glass are separated by a  $\frac{3}{16}$ -inch air space. All air between the panes is removed and replaced with specially dried air.

### Radiator Warming Shelf

Restaurants in Florence, Italy, don't allow food to cool once it's taken from the oven. Instead, it's placed on a warming shelf built into a radiator beside the diner. As a result, no matter how long the customer dawdles over his meal, food remains piping hot.





## Passengers Enter Tiny Italian Automobile Through Door in Nose

See [@for info: address](#)



Two passengers fill a tiny Italian car to capacity. The car, called the Iso, has a door in its nose and a steering column that swivels forward as the door opens to permit easy access. The tiny engine burns only a gallon of gasoline every 120 miles yet will drive the car at speeds up to 55 miles per hour. Another unusual feature of the car is the extremely narrow tread of the rear wheels. The hand-shift gearbox has four forward speeds and one reverse.

## Change Freight-Car Wheels to Fit Different Gauges

Moving freight from one European country to another has long presented a problem because railroads are built on a variety of gauges. Today, on the Franco-Spanish border, wheels are switched on the freight cars instead of reloading the freight. Each freight car simply is raised on electric jacks, the wheels removed, another set of wheels of the proper gauge installed and the freight car is ready to roll to its destination with little delay.

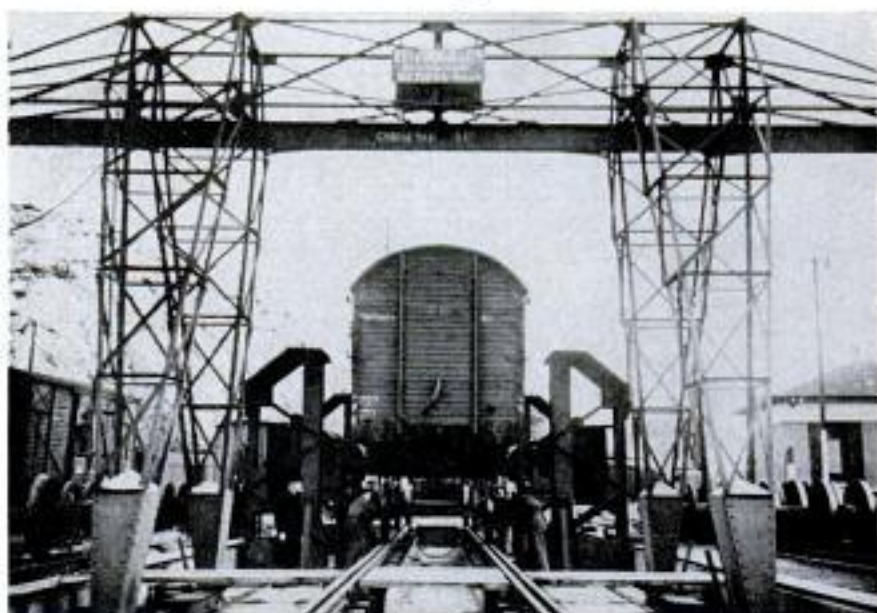

## Rice-Bran Oil

Oil extracted from rice bran by a new process can be used for cooking, lubrication, and as an ingredient of candles and varnish. As a cooking oil, the clear, bland extract is resistant to becoming rancid and does not pick up food flavors and odors. Foods fried in rice oil contain less fat than when they are fried in other oils. The oil is a good industrial lubricant because of its high penetration ability, and may also find use in cosmetics, soap and antirust compounds.

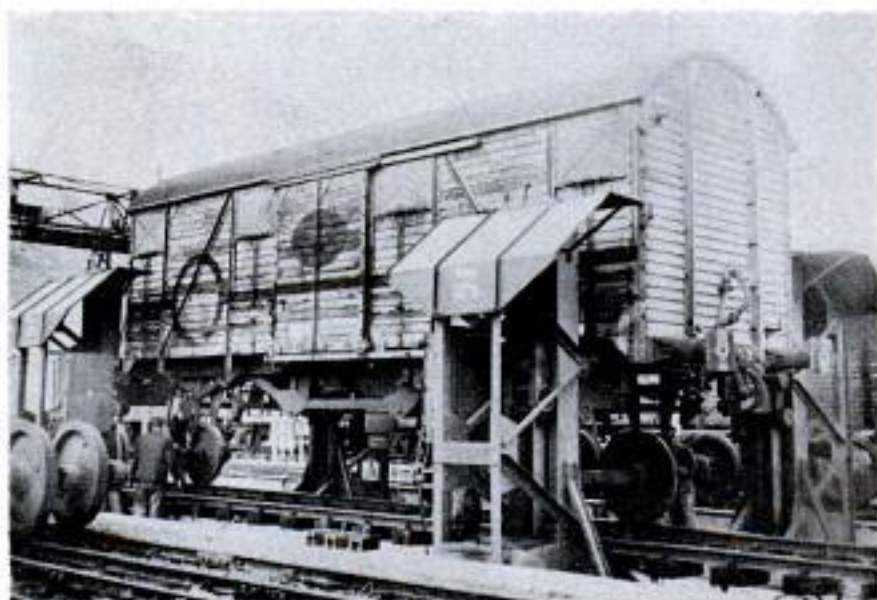



# Radio Television Electronics

## TV PROGRAMS RECORDED ON TAPE

By Thomas E. Stimson, Jr.

COMPLETE television programs are now being recorded on tape. Half-inch tape takes the place of film in a new video recorder perfected for the industry by the Bing Crosby Enterprises in Hollywood.

Electric impulses from an iconoscope camera or from a TV circuit are registered magnetically on nine channels of a tape at the same time the accompanying sound is recorded on an additional channel. The program thus recorded may be viewed at once, or stored for later use.

The system is claimed to replace the Kinescope camera now used for recording TV programs for later broadcasting. The video tape recorder eliminates film development process required with camera film, and provides a motion picture claimed to have no flair, very little loss of definition, and almost complete gray scale. Recordings will be available to TV-transmitting stations in 1954.

Techniques radically new to the recording field are employed. Instead of recording a single track down the length of tape as is done in sound work, all tracks are employed simultaneously. These are recorded by a multiple head in a solid-block assembly; the stack of heads having their gaps precisely in line. The half-inch tape is standard acetate-base type coated with magnetic iron oxide. The sound channel is recorded by a wide-deviation FM system and playback is through a frequency-counter type of discriminator. This sound system is claimed to be one of the finest ever assembled.

The operator in photo A is making a magnetic record on half-inch tape of the video (picture) and sound channels of a TV program. When completed, it can be played back immediately, or held for future rebroadcast. Photo B shows the video recording, video playback, and sound circuits of this new video tape recorder. In commercial installations all of these circuits will be contained in the stand assembly on which the tape recorder itself is mounted. A test pattern, photo C, that was recorded on the tape, is being played back on the regular TV-receiving tube for checking purposes.







# PORTABLE RADIO "TEST BENCH"

By Harry F. Leeper

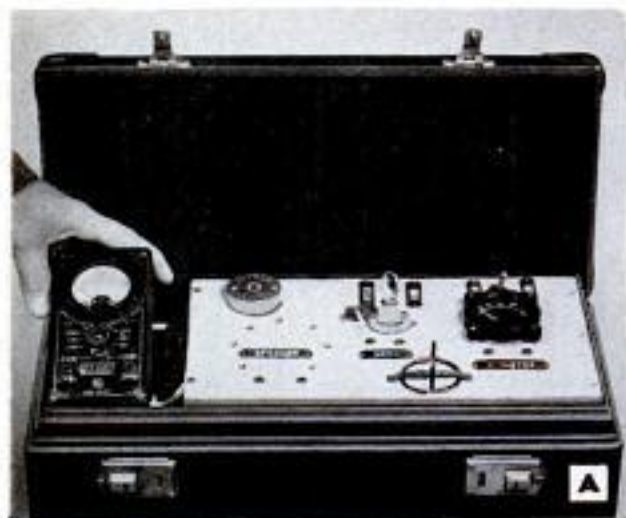

INSTEAD OF having various pieces of small testing and service equipment scattered over the test bench, why not mount such units in a portable kit? Such a kit becomes a portable "test bench" that will save the student or experimenter many unnecessary steps. Many servicemen can arrange their small testing units in the same compact form for use on outside jobs.

The units illustrated were arranged to mount in the top tray of a standard fiber tool kit having outside dimensions as follows: 18-in. long, 11½-in. high and 8-in. wide. These dimensions are not too critical.

Several services are available from this assembly; there is a triplex outlet for soldering iron, testers and radio or TV set. The a.c. voltmeter keeps line voltage in sight while operating the set under test. The neon lamp tester is for continuity or

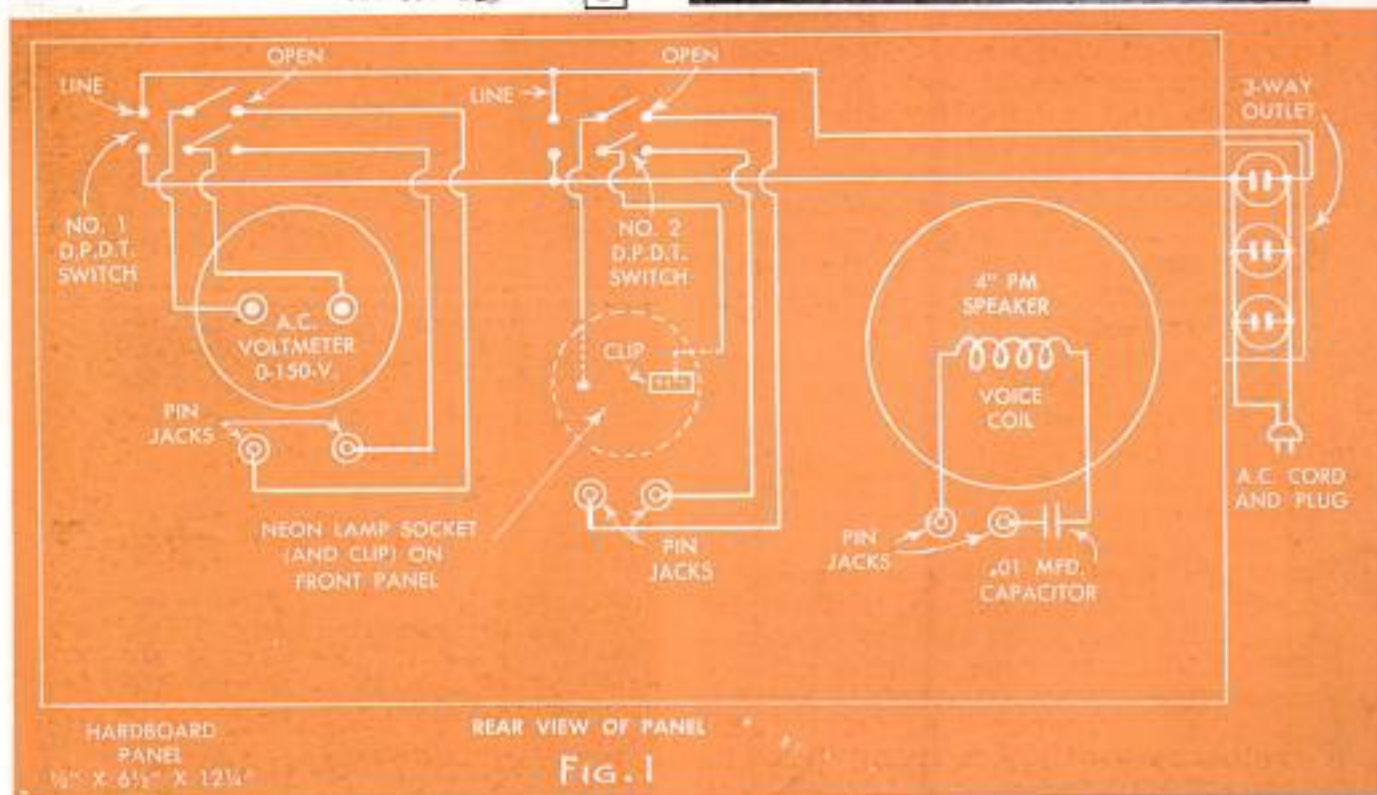
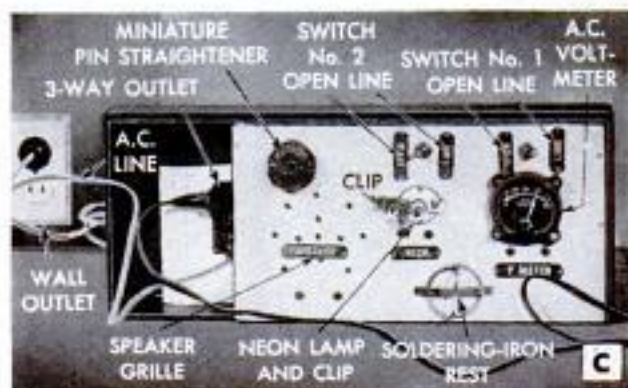
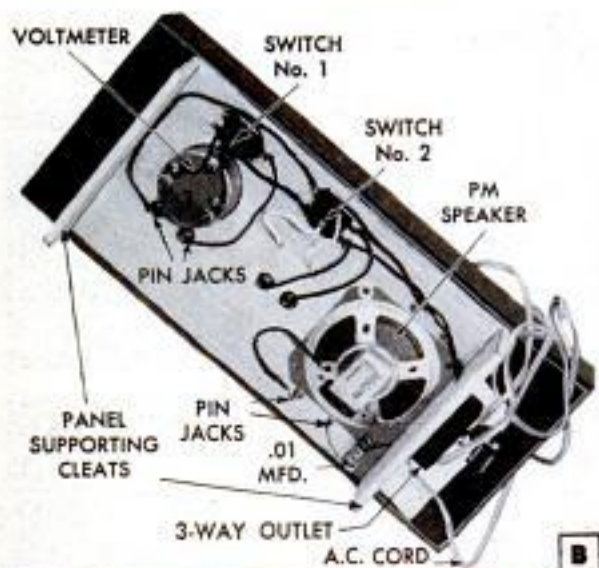



# FOR CONVENIENT SERVICE



voltage tests. A spare speaker of the small 4-in. PM type, is mounted so as to be easily available by means of pin jacks. A miniature-tube pin straightener, and a rest for the soldering iron, complete the assembly.

Photos A and B show the various units mounted in the kit tray, and wired as indicated in diagram Fig. 1. The  $\frac{1}{4}$ -in. plywood panel is  $12\frac{1}{4}$ -in. long and  $6\frac{1}{2}$ -in. wide, with supporting cleats to fit into the kit tray. The voltmeter is an 0-150-volt a.c. type; switches Nos. 1 and 2 are double-pole, double-throw, bat-handle types. A  $\frac{1}{4}$ -watt neon lamp and candelabra-type socket, and a .01 mfd. 600-volt fixed capacitor, together with 6 pin jacks and the 3-way outlet with line cord and plug, complete the list of parts. Ordinary No. 20 insulated hookup wire is used for wiring. As the instrument panel is only  $12\frac{1}{4}$ -in. long, sufficient space is left for a standard pocket-size volt-ohmmeter, as shown in photo A.

Photo C shows the line cord plugged into a wall outlet with the meter switch No. 1, thrown to line. When the meter switch is thrown to "open," as in photo I, the meter is disconnected without disturbing the line plug in the wall outlet. The meter may then be used with test leads for other purposes, such as for testing a radio off-on switch as indicated in photo D.

Photo E shows how the spare speaker may be substituted for the set speaker where an open circuit in either a radio or

(Continued to page 256)

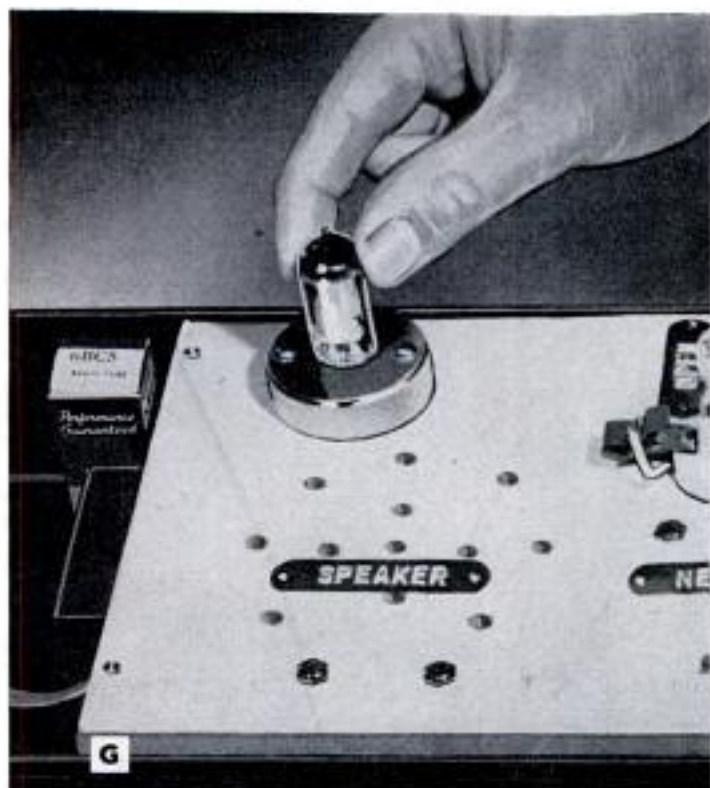
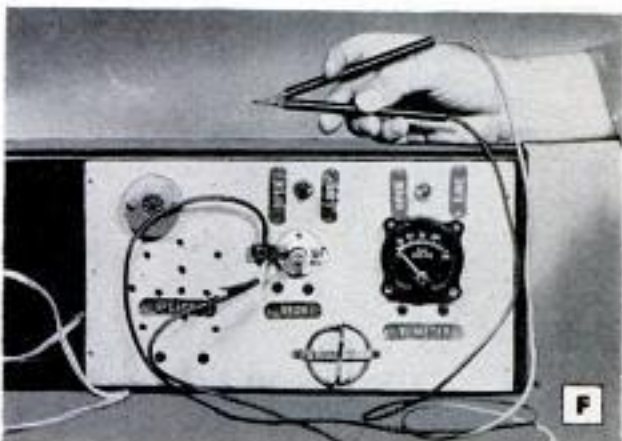
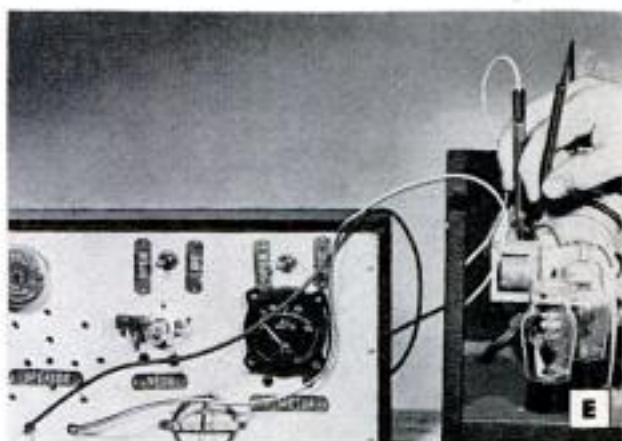
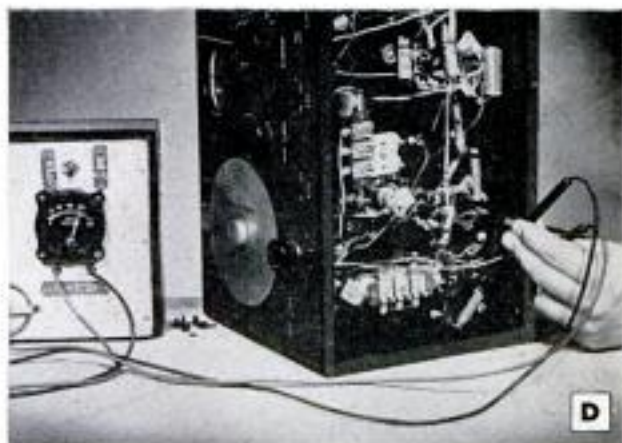





A



B



C

## Radio and Electronics Today

WRIST RADIO is now made possible through the use of tiny transistors and other miniature components. The one shown on the wrist of Lt. John H. Willis, Signal Corps officer at Fort Monmouth, N. J., in photos A and B, owes its small size to printed circuits and transistors, with their low-power battery requirements. This tiny receiver has been picking up broadcasts from New York City. Fort Monmouth is approximately 40 airline miles from mid-town Manhattan.

One of the most important accessories in every amateur radio station is a frequency calibrator. It provides a simple, accurate means of checking transmitter operating frequencies to avoid out-of-band operation. The Bud FCC-90 unit, photo B, consists of a stable 100-kc. crystal oscillator.

Quick, inexpensive installation of secondary TV sets in the home is made possible by the small RCA coupling device shown in photo C. It permits operation of two TV sets on the same antenna. The coupler is attached to the antenna line, and a separate transmission line is run from the top of the coupler to the No. 2 set.

Photo D illustrates the use of a tiny electronic device for detecting leaks in pipes or valves. The operator merely touches the pipe or valve with the protruding pickup on this midget M-Scope detector and the leak, unmistakable in sound, is heard.

An ultra-sensitive 100,000-ohms per volt, volt-ohm microammeter is shown in photo E. This Simpson model 269, a.c.-d.c. test instrument is ideal for voltage measurements in high-resistance circuits in TV receivers and other electronic equipment. It is claimed to replace vacuum-tube voltmeters for many such tests in TV and other service work.

Very few radio sets have been built into cowboy saddles. The one shown in photo F was designed for a rodeo by Motorola.



D



E



F





## Room Divider Features Writing Desk

By John Bergen

WANT TO GET that separate-room feeling from your dining-living room area and still make the most out of available floor space? Then here's the piece of furniture you've been looking for. It's a modern, movable room divider that serves as a partition wall to separate the dining area from the living room. In addition, it has two otherwise space-stealing pieces built right in—a convenient writing desk and a generous-sized china cabinet. The china cabinet, which faces the dining room, incorporates three shelves covered with

sliding glass doors, four spacious drawers and four cabinets. On the living-room side of the unit, there is a low storage cabinet on each side of the writing desk and two bookshelves above. Both ends of the room divider are finished so it can be used in the center of the room or against either wall.

Figs. 1 and 2 clearly show the difference between the two sides of the divider. Overall construction is detailed in the sectional views, Fig. 3, and the pull-apart perspective, Fig. 6. The upper and lower sections of the divider are built as individual pieces



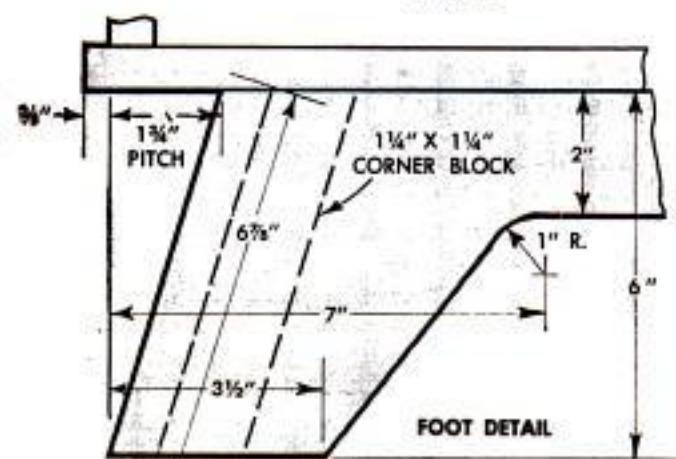
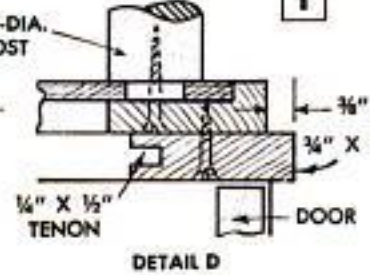
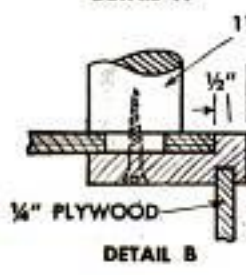
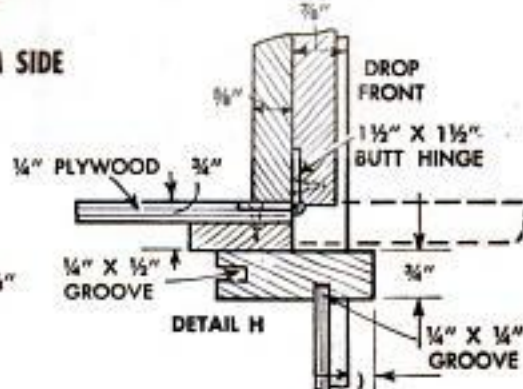
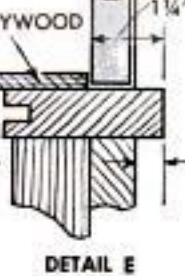
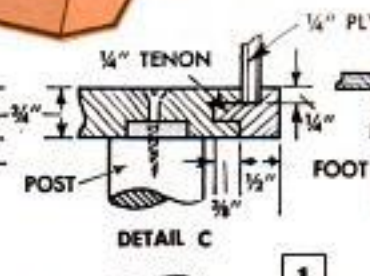
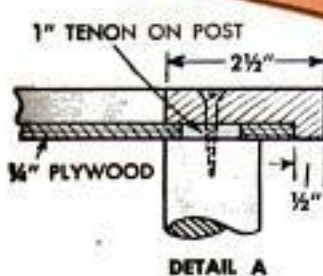
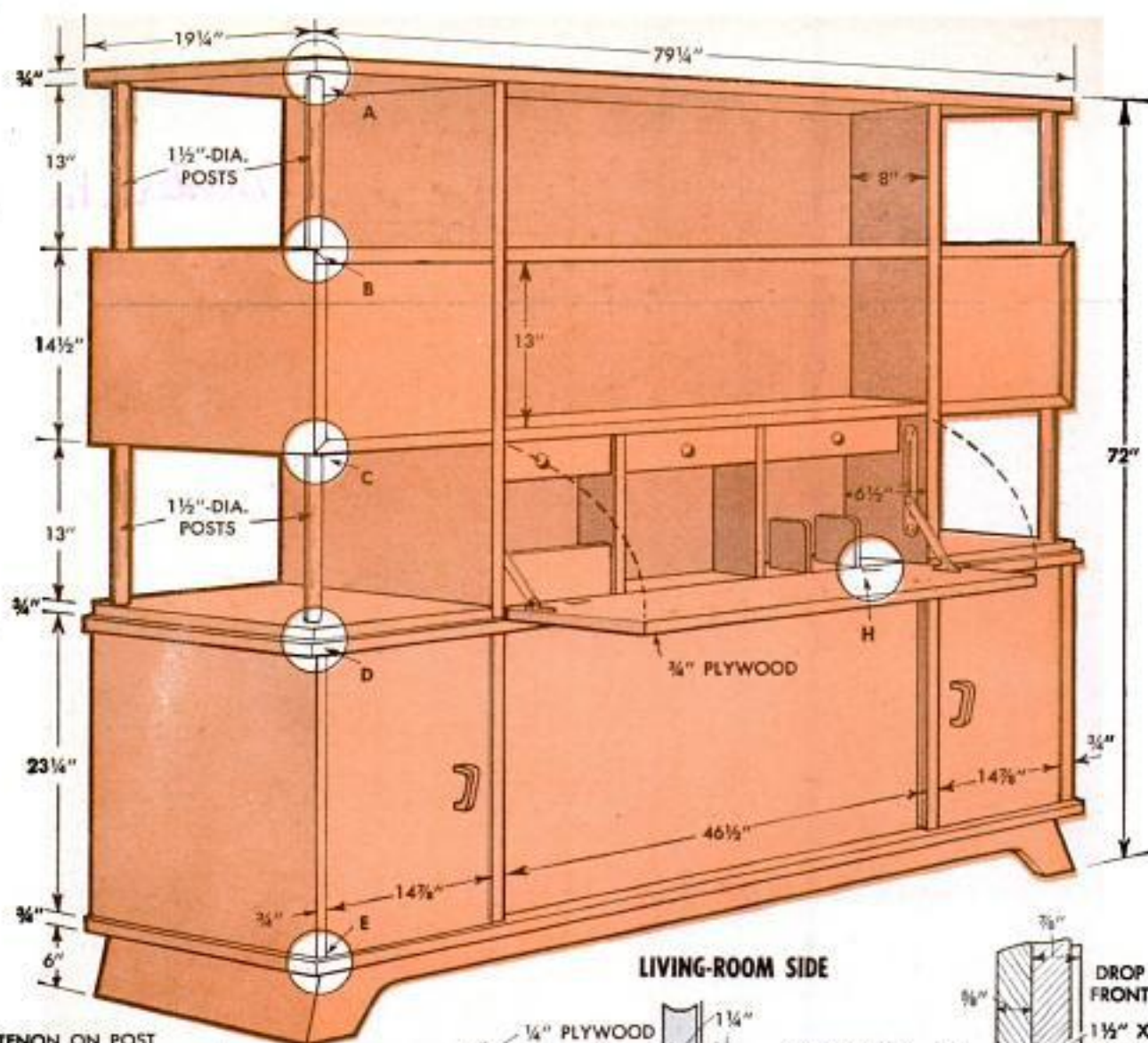

LIVING-ROOM SIDE

and then fastened together with wood screws driven upward through the top frame of the lower unit and into the bottom-frame rails of the upper unit.

The base of the lower unit is made of 3/4-in. hardwood. The legs, or feet, are cut as in the lower left-hand detail, Fig. 1, and assembled with corner blocks as in Fig. 6. The bottom frame, which rests directly on the base, is of 3/4 x 2 1/2-in. stock mitered at the corners. The front and rear rails are grooved along the inside edges to take tenons cut on the ends of the center cross members, and the rear rail of the frame is grooved to take the bottom edge of the 1/4-in.-plywood back panel. The top frame is made in the same way as the bottom frame except that it is grooved on the underside to receive the top edge of the back panel.



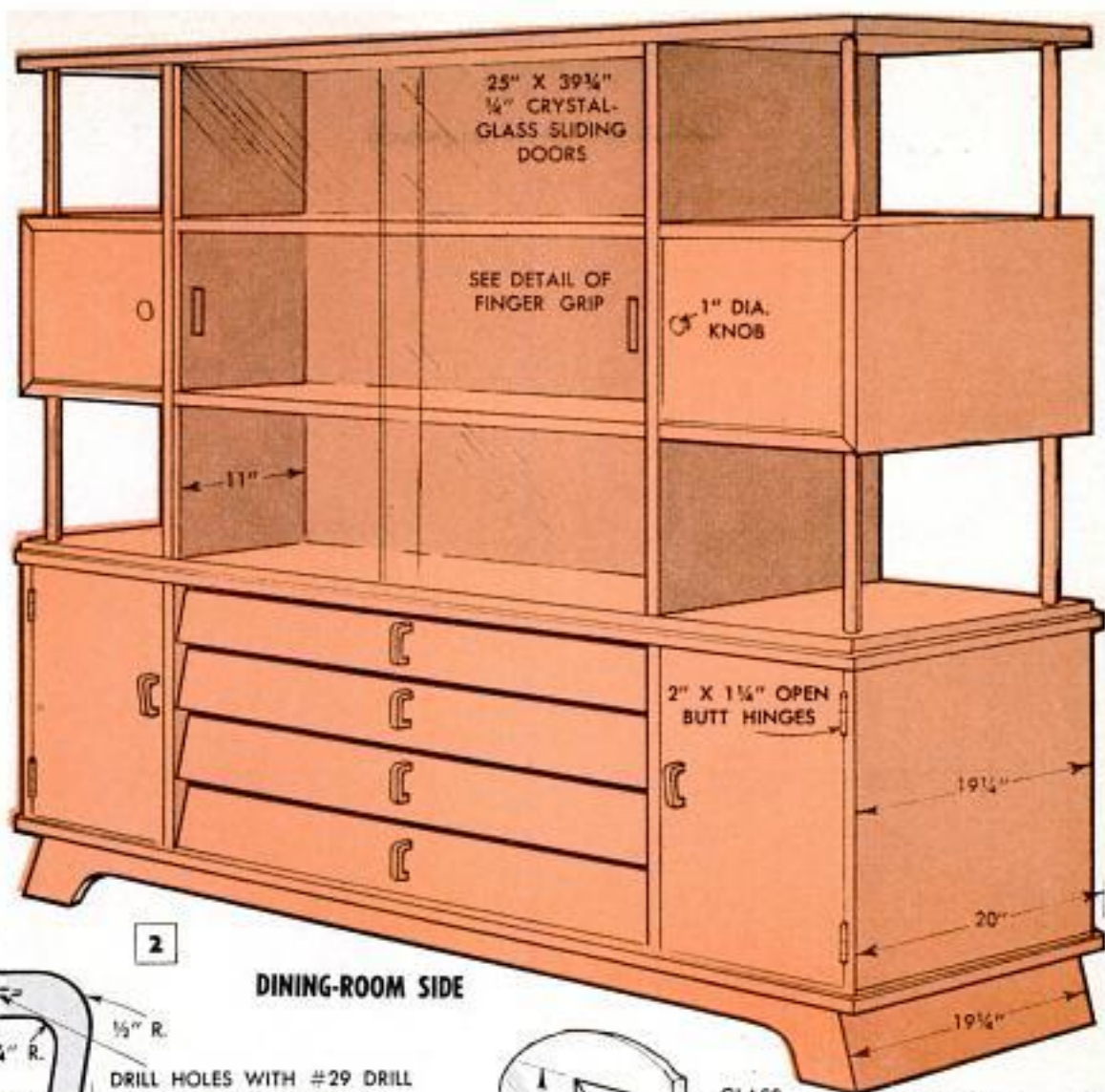

2

DINING-ROOM SIDE

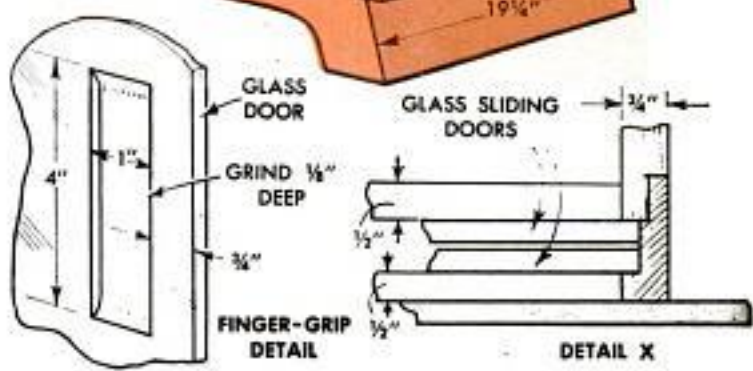
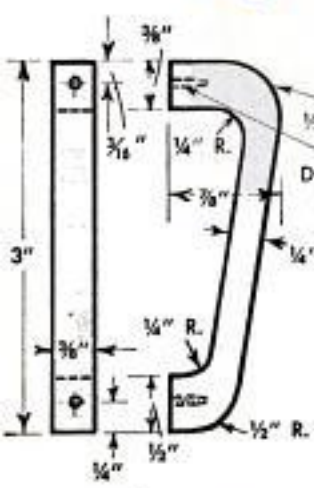

Both grooves are located 3/8 in. from the outer edge of the rear frame rails.

The cabinet portion of the lower unit consists of two end panels and two partitions framed as in Fig. 5. The drawer frames are installed between the partitions, the ends of the rails being fitted in the notched uprights of the partition frames. Figs. 5 and 6 clearly show the construction and installation of the drawer frames and the plywood or hardboard dust panels. The drawers are made as in Fig. 2, detail I, and Fig. 5.

The side cabinets contain a 1/4-in.-plywood bottom shelf and a 3/4-in.-plywood center shelf. Each cabinet is fitted with two doors to permit access from either the dining-room or living-room side of the unit. All the doors and drawers of

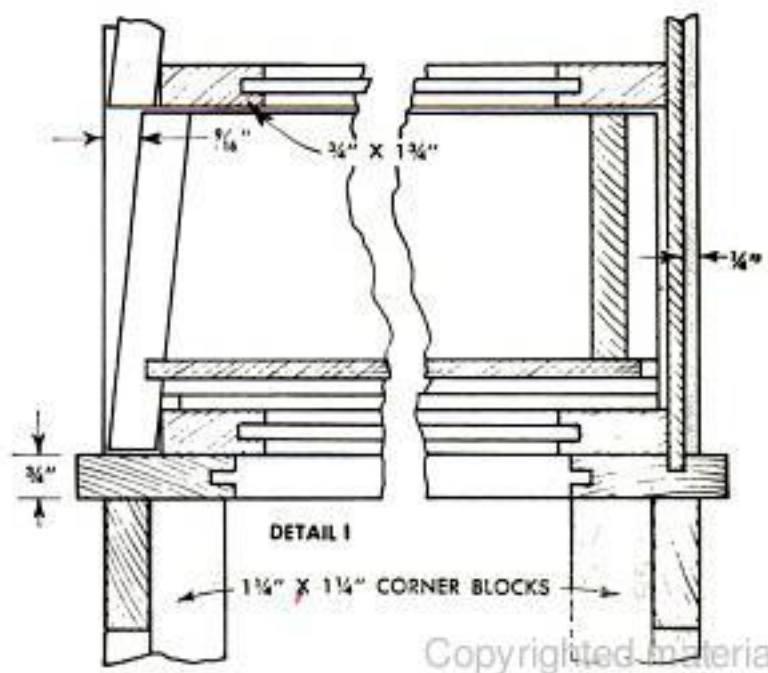



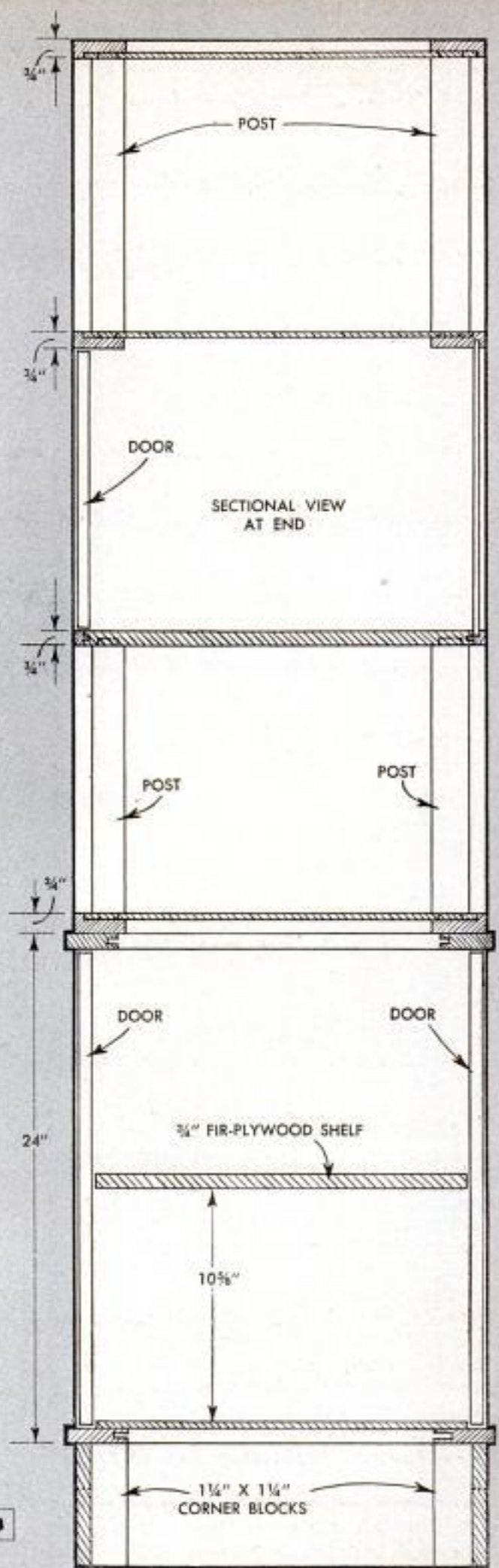
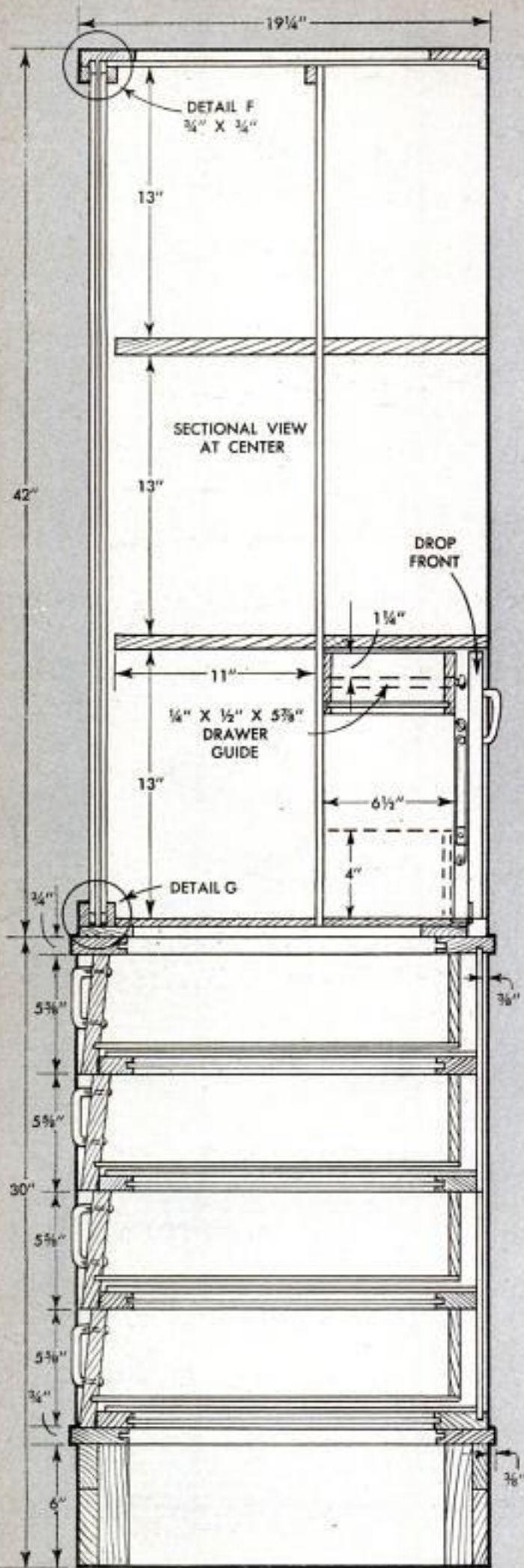

3



the lower unit are fitted with pulls cut from brass as in Fig. 2.

Construction of the upper unit can be seen from the two finished views, Figs. 1 and 2, and the pull-apart perspective, Fig. 6. Note also the various details in Fig. 1 and the sectional views, Fig. 3. The bottom frame for the upper unit, Fig. 6, is made similarly to the lower-unit frames except that the rails and end members are faced with a  $\frac{3}{4}$  x  $\frac{7}{8}$ -in. molding which is rabbeted, as shown, to take a  $\frac{1}{4}$ -in. plywood panel.

The center section of the upper unit, which contains the china cabinet on one side and the writing desk and bookshelves on the other, is assembled between two  $\frac{3}{4}$ -in.-plywood end panels. The panels are grooved on the inside surface for the two bookshelves and two china shelves. These are of  $\frac{3}{4}$ -in. plywood and are separated by a vertical panel of  $\frac{1}{4}$ -in. plywood, the edges of which are set in  $\frac{1}{4}$ -in. vertical grooves in the end panels and a  $\frac{1}{4}$ -in. groove in the bottom-frame panel. As shown in Fig. 1, the vertical grooves are located 8 in. from the edge on the bookshelf side of the unit. On this side, the end panels are faced with  $\frac{3}{4}$ -in. molding, while on the china-cabinet side they are faced with molding cut as in Fig. 2, detail X, to receive the ends of the sliding glass doors.

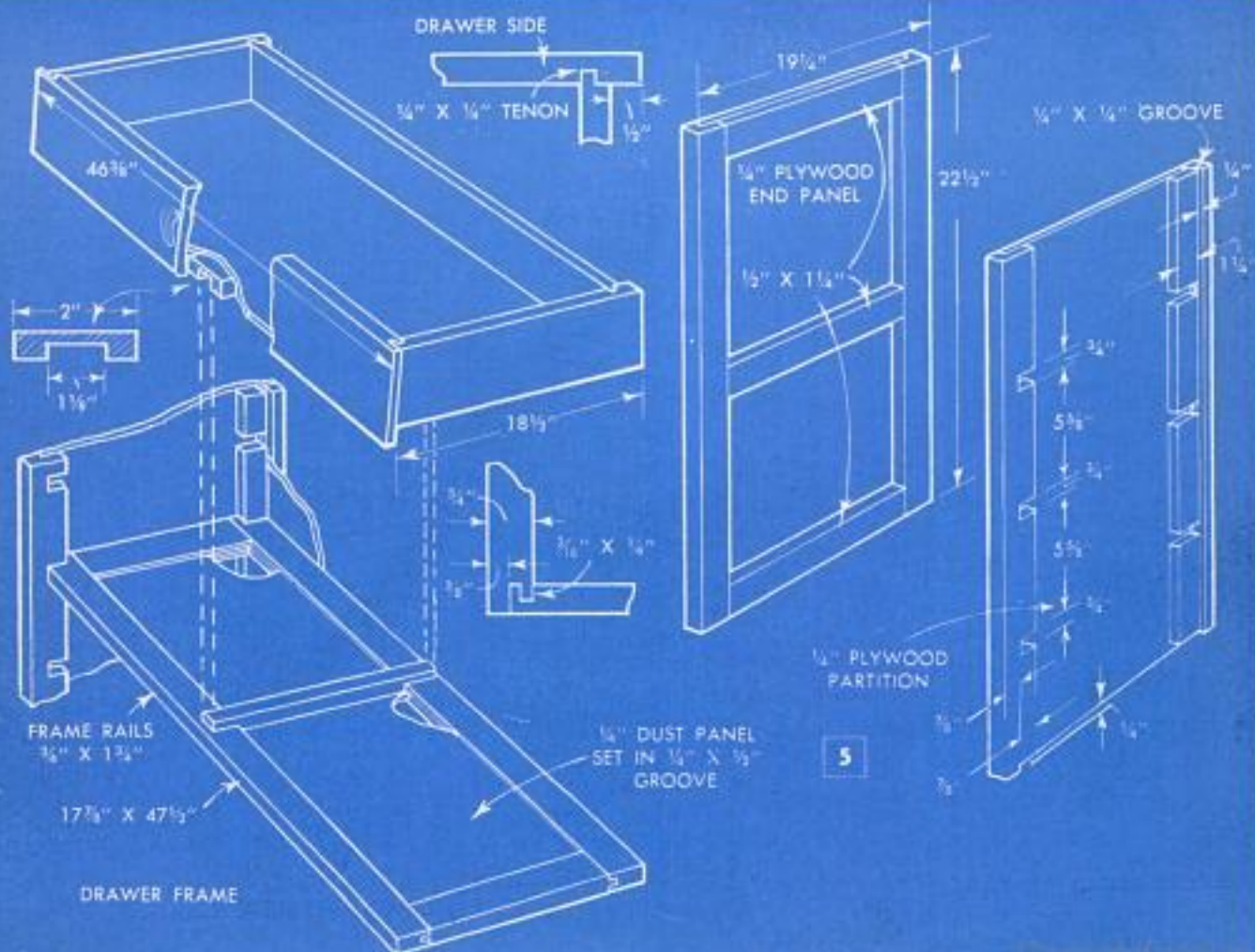
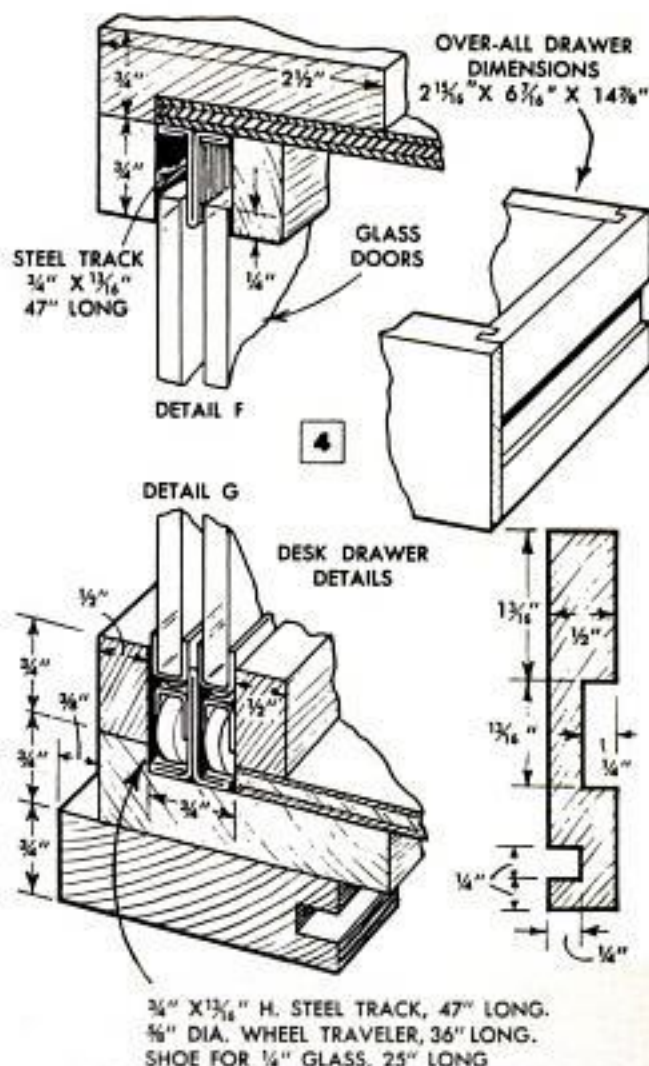



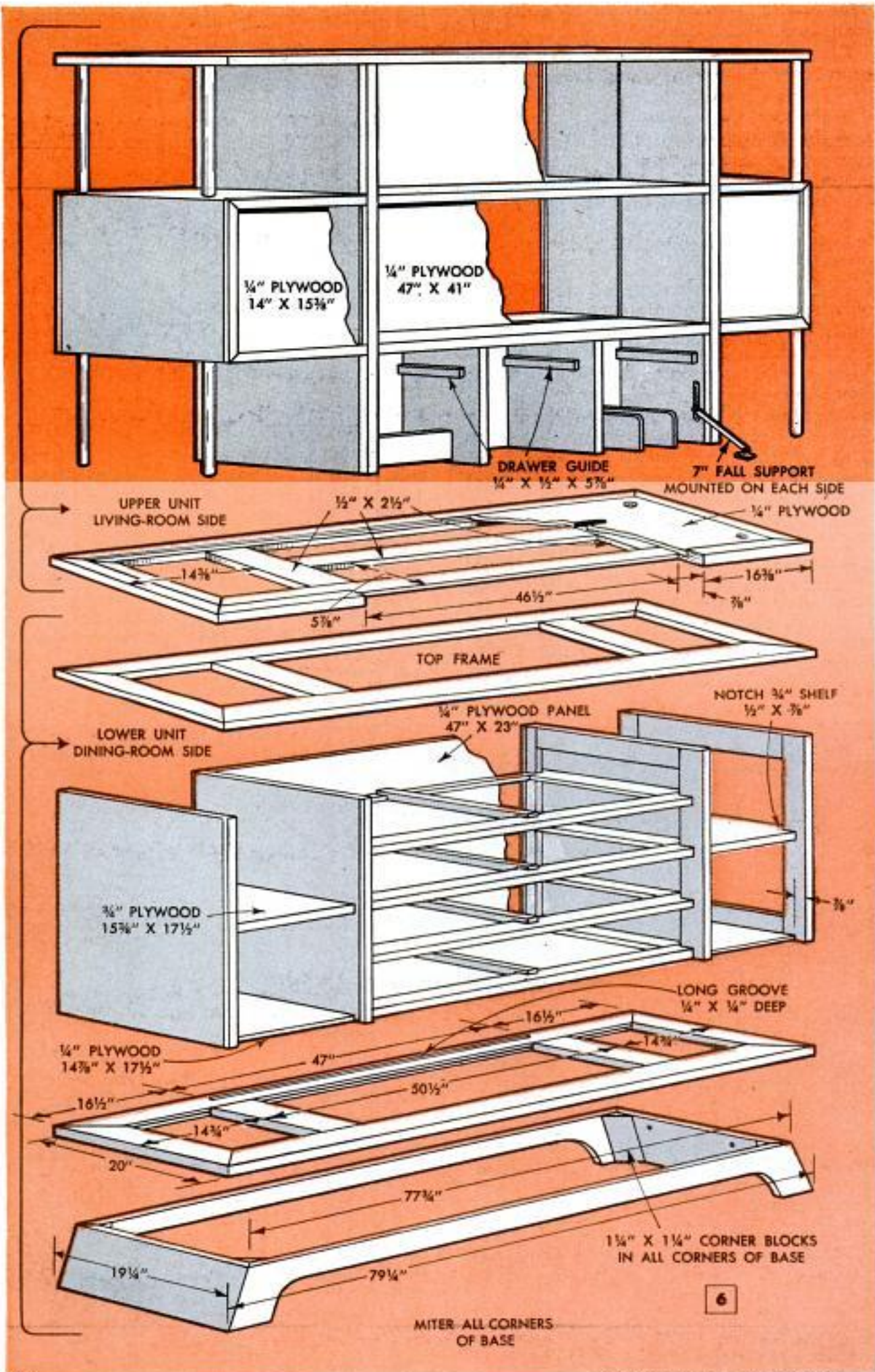



The pair of whatnot shelves and cabinet at each end of the upper unit are assembled as in Fig. 1, details A, B, C and D, 1½-in.-dia. posts being used to support the cabinets and the top frame of the unit. Although the bottoms of both cabinets are of ¾-in. plywood, the tops, sides and back panels are of ¼-in. plywood. The center-section end panels are grooved on the outside exactly opposite the inside grooves, the two grooves in each panel being ¾ in. wide. The lower groove takes the ¾-in.-plywood cabinet bottom while the upper one receives the ¼-in.-plywood cabinet top along with a ½-in. cleat. The corner joint of the top with the side panel also is reinforced with a ½-in. cleat. The molding used to face the plywood parts of the cabinet is mitered at the corners. The top frame is made in the same way as the other frames except that it is rabbeted on the underside for a ¼-in.-plywood panel, Fig. 1, detail A, and Fig. 3.

The three drawers of the writing desk are fitted between two ¾-in.-plywood separators and the center-section end panels. The drawers are made of ½-in. stock as in Fig. 4, the drawer sides being grooved for the side-mounted guides. Front and side pieces of the drawers are grooved for a ¼-in.-plywood bottom panel, the grooves being run ¼ in. from the lower edges of the pieces. The separators mounted on the bottom of the desk between the partitions are of ¼-in. plywood.

The drop front of the desk is of ¾-in. plywood hinged to the desk bottom with mortised butt hinges. Fig. 1, detail H, shows how the drop front clears the top of the lower unit to provide a writing surface flush with the bottom of the desk. A 7-in. fall support is mounted on each side.

To keep the china dust-free and add beauty to the dining-room side of the divider, the front of the china cabinet is fitted with crystal-glass doors. Details F and G in Fig. 4 show how the ¼-in. sliding doors are installed. At the tops of the doors, a steel track is mounted between two ¾-in. cleats, detail F. At the bottoms of the doors, the lower track, wheel traveler and shoe also are installed between ¾-in. cleats. However, an extra ¼-in. depth is gained by utilizing the groove which is formed by stopping the bottom-frame panel ¾-in. from the shoulder on the bottom rail. The ½-in. clearance at the tops of the glass doors is necessary so they can be lifted in place on the track after assembly.

Each door is fitted with a finger grip ground ⅛ in. deep in the surface of the glass. As grinding the finger grips is difficult to do without breakage, it is by far the best procedure to have them ground by the glass dealer. ★ ★ ★



### Pencil Eraser Spreads Paste

When a regular paste brush is not at hand, library paste may be applied and spread with a pencil having a slip-on eraser of the type shown. The flat, flexible surfaces of the wedge-shaped eraser spread the paste uniformly and the "brush" is easily washed clean for regular use.

### Plastic Webbing Replaces Canvas As Lift on Jump-Rail Window

Leather and canvas are used generally to make the lifts for jump-rail boat windows, but both materials are subject to mold and mildew because they absorb moisture. To avoid this, replace the lifts in the windows aboard your small boat with the new plastic chair webbing, sold in many hardware stores. It is available in a wide range of colors to match the boat's interior, and is mildew resistant.—George Brook Taylor, Daytona Beach, Fla.

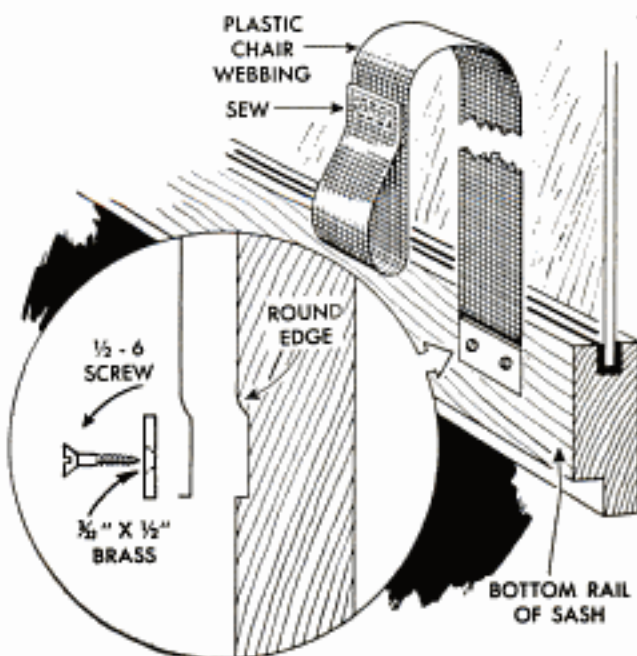



# EXTENSION



**A**ROUND YOUR HOME and workshop, the extension cords are as useful and valuable as any of the tools you own. Because so much depends on them, they deserve the same care as do your tools. Furthermore, if neglected, the extension cords can be numbered among the most dangerous items in the shop.

Extension wires trailing over the floor have caused more accidents than can be counted. The detail in Fig. 1 shows one good method of avoiding such a condition. The extension cord is strung through metal rings on a wire runner overhead. With this device, the cord can be pulled safely across the shop and yet be out of the way at all times.

Your extension cords should be checked occasionally for bad connections and broken wires. One way to do this is to turn on the radio at a spot between stations. Then, with the extension cord carrying current, roll it between your hands, and push and pull the cord at the points where it joins the plug and socket as well as at any suspected trouble spot. If the radio sputters during the test, the spot being checked needs repair. A typical source of trouble is indicated at A in Fig. 2, where the unsoldered strands of wire have frayed

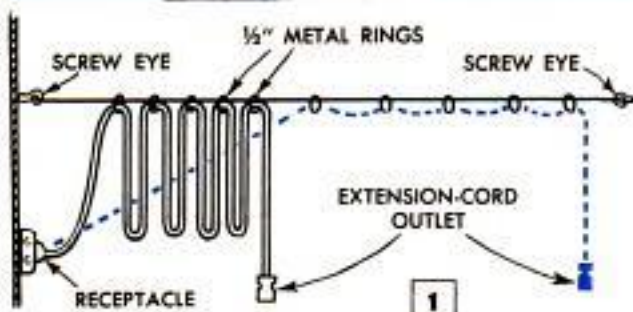

Above, the extension cord is wired or taped to metal rings about 3 ft. apart when extended. This method keeps cord out of the way no matter where it is used

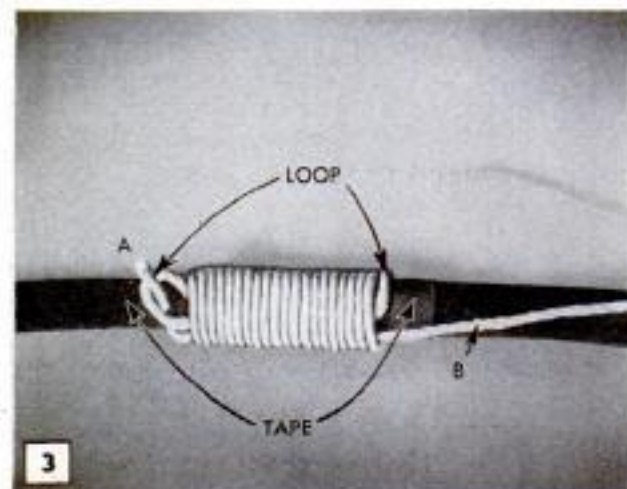
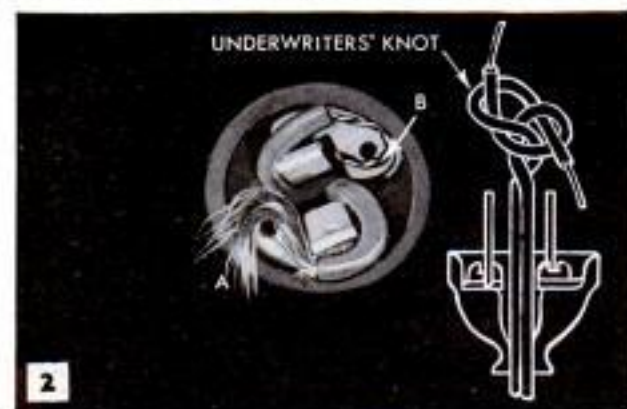



# CORDS By Ed Packer

so the connection is poor. The proper condition of the wire is shown at B, where the strands of wire have been soldered before being wrapped around the terminal screw. Note the underwriter's knot in the same figure. When installing plugs, use such a knot inside of the plug to keep the wires from being pulled loose.

A neglected break in the insulation can cause a serious shock or a short circuit, and should be repaired immediately. A cord used in the shop is not easy to keep taped because of oil and grease, so the repair shown in Fig. 3 is useful. The broken area is taped, and the tape is held in place by a cord wrapping. A loop of cord is laid lengthwise on the wire and then the loop wrapped with cord. The end of the wrapping is brought through the loop at A. Then a pull on B, will tuck the end at A securely under the wrapping.

There are several ways of improving an extension cord's contact in the outlet. As in Fig. 4, the prongs can be notched with side cutters, which roughens the surface. Another method, Fig. 5, is to twist the prongs slightly, since bent contacts will wedge more tightly into the receptacle. The contact surfaces of a receptacle should be kept clean for best results. Fig. 6 shows how to clean them by sandpaper rolled over a large nail.

Finally, for convenient storage and handling, every extension cord should have a winding reel. Figs. 7 to 9 show two such reels that are made easily from hardboard. The dimensions of the sides of the smaller one are  $3\frac{1}{2} \times 5$  in., and the large one is  $6 \times 12$  in. The small reel accommodates 20 ft. of light cord, and has a night light which tells when power is coming through the line. The capacity of the large reel is 50 ft. of heavy cord, and it is made doubly handy by the receptacles mounted on it. ★ ★ ★

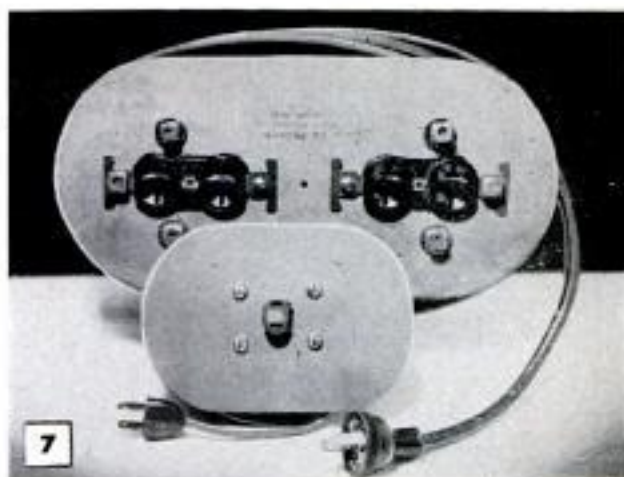

Reels are assembled from hardboard sides using copper tubing as spacer sleeves. 3-way outlet on small reel takes night light which acts as "on" indicator

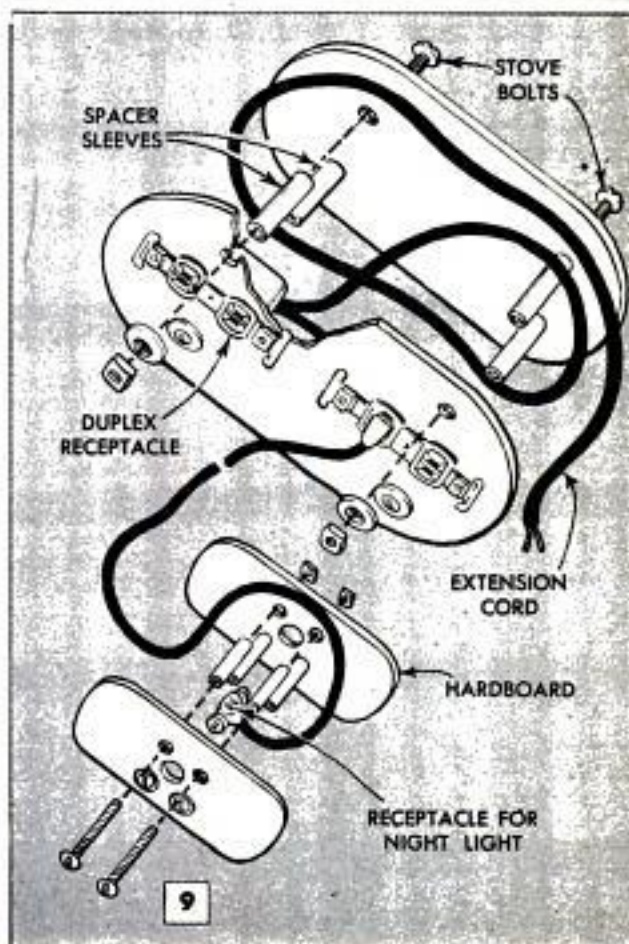
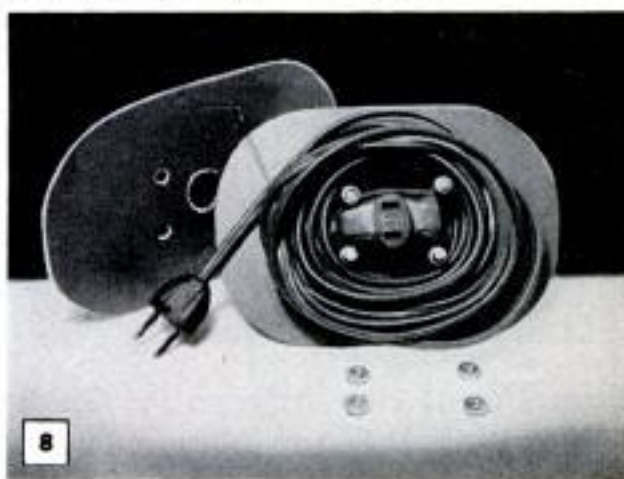





### Breadboard Has Adjustable Guide For Cutting Uniform Slices

For the woman who bakes bread at home, or buys unsliced bread, this adjustable bread-slicing guide will permit cutting uniform slices. A piece of light sheet metal, 2 x 14 in., is bent into a U-shape and fastened with wood screws to the edge of a 1 x 4 about 14 in. long. A T-shaped piece of 1/4-in. plywood is slotted and held to the board with a wing nut. This piece is kept in line by two 1/4-in.-plywood strips. The bread is placed on the board, under the metal band and the guide is adjusted for the desired thickness of slice. The knife is held against the sheet-metal band for accurate slicing.—O. A. Nelson, Seattle, Wash.

### Rod Driven Without Bending When Inserted in Pipe

You will find that a long electrical ground rod frequently will bend while being driven into hard or stony terrain unless you have a helper at hand to hold it. When one man is obliged to handle the job alone, such bending can be prevented if a suitable length of small pipe is forced a few inches into the ground first, and then the ground rod inserted in it. After the rod has been driven to a depth of several feet, the pipe can be removed and the task completed without further difficulty.

### Free-Cut Saw Blade Improvised

A hollow-ground circular-saw blade can be modified for use as a free-cut type, by grinding off the crosscut teeth in each section of the blade, leaving only the raker tooth. A combination blade also readily adapts itself to this modification, but it is necessary to alternately set the raker teeth to allow them to cut freely. This modification will work well, but has definite limitations. The saw should not be run at too high a speed, nor should the work be forced into it.



Robert Micals, Freehold, N. J.

### Anchoring Rolls of Screen Wire

One hardware dealer, faced with the problem of tying up rolls of screen wire for storage at the end of the season, saved himself time by anchoring the loose end of the roll with hog rings, as shown. These rings, which come



bent as pictured in the inset, can be pushed into the mesh with little difficulty, and can be withdrawn just as easily when the screen wire must be unrolled.

G. E. Hendrickson, Argyle, Wis.

### Handy Washing-Machine Switch

To save my wife the bother of disconnecting the washing machine five or six times during a washday, I fastened an improvised switch to the wall near the machine, as shown in the illustration. The switch consists of an ordinary pull-chain socket mounted on an angle-steel bracket and connected to the wall outlet by means of a short cord. The plug of the washing machine is then inserted in a female receptacle which is screwed into the socket.

Martin Mantell, Hazleton, Pa.

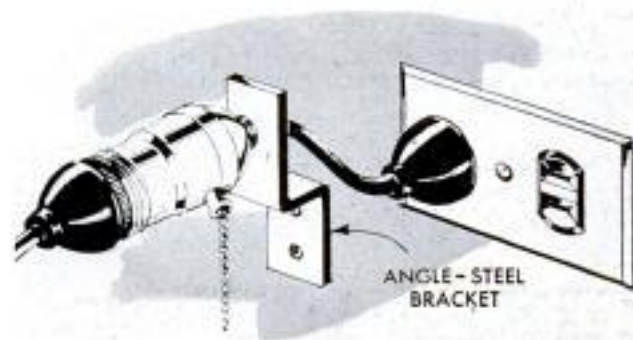





# RENEW YOUR SCISSORS



Dull, bent scissors that you've been intending to throw away can be put back into service with a few simple repairs. Start by cutting off original rivet



Clean rust from scissors with dampened steel wool and polish blades with fine sandpaper or emery cloth. Adding drop of oil helps to obtain a "satin" finish

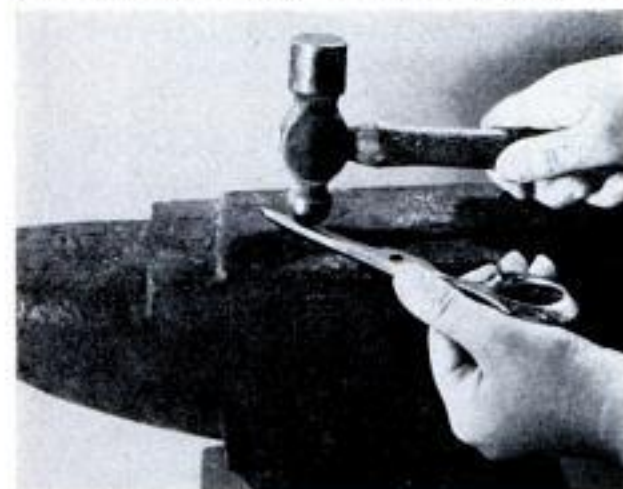

Polish one surface of bent blade until bright, heat gently until yellow tinge appears and place on anvil, concave side down. Straighten by hammering lightly



Temporarily assemble scissors. If tips are uneven when closed, file rivet holes either toward or away from cutting edge and redrill holes for larger rivet

New rivet can be made from head and shank of round-headed screw. Assemble scissor blades with rivet, spring and washer and peen over end of screw shank

Scissors may be sharpened by filing or grinding on fine-grit wheel. Draw blade across wheel so bevel is same as original, one pass usually being sufficient





## Rawhide Lacing Cut Uniformly With Hatchet and Knife



If a sharp knife and a hatchet or ax are available, you have the tools for cutting leather shoelaces. Start the lace by cutting a strip 2 or 3 in. long parallel to the edge. Then strike the hatchet, ax or even another knife blade into a flat surface. Holding the started lace tightly against the side of the hatchet, force a knife into the surface against the lace, with the cutting edge of the knife blade slanted toward the piece of leather. Hold the piece flat to the surface and pull steadily to make an even lace. The knife should be sharp, or the leather will have a tendency to bunch up against the blade.—N. C. Darling, Orleans, Mass.

## Sand Trap for Water-Pump Line

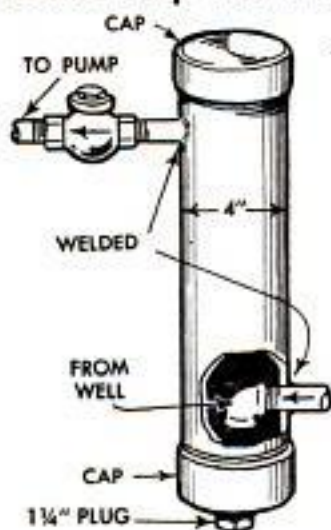

A length of 4-in. pipe, 15 in. long, will make an excellent sand trap for a water line fed by a well pump. The pipe is threaded at both ends and capped, with the bottom cap drilled and tapped for a 1/4-in. pipe plug. One hole is cut near the top end of the pipe and another is cut near the bottom on the opposite side, both

being large enough to insert pipe nipples of the size used for the line from the pump. The lower pipe nipple is fitted with an elbow turned so the opening faces the bottom of the trap. Both nipples are welded in

place. The trap is connected in the line between the well and the pump with a check valve on the pump side of the trap, as shown. When the water is pumped through the trap, sand will fall to the bottom as the water is forced down by the elbow. Several times a year, or as often as required, the pipe plug in the bottom is removed and the sand drained out.

G. W. White, Severn Park, Ont., Can.

## Chalk Line in Bow Aids Lettering

When laying out signs on windows and doors, the difficulty of holding a short chalk line can be eliminated by using the whip-bow chalk line shown in the diagram. The line is attached permanently to one end of a flexible dowel. The other end of the dowel is slotted to receive the line when the bow is bent. A knot in the free end of the line holds it in the slot.



The line is attached permanently to one end of a flexible dowel. The other end of the dowel is slotted to receive the line when the bow is bent. A knot in the free end of the line holds it in the slot.

## Discarded Oil Can Stores Drills

When a battered spout renders an oil can useless, save the bottom to use as an oiltight container for short drills, punches and other small tools. Partially filled with oil, the can will protect the tools from rust. When set near the job it is handy for dipping drills to lubricate them when drilling. The wide base of most oil cans makes them ideal for this use, because they are not tipped over easily even when empty.

H. Leeper, Canton, Ohio.



POPULAR MECHANICS



# Straightening WARPED DOORS

Wooden doors, especially those made from tongue-and-groove lumber, often warp diagonally so that opposite corners are too far "in" or "out." Such warping can be neutralized by means of simple diagonal braces installed on the inside of the door, where they are visible only when the door is open. One form of brace consists of a 2-in. board,  $\frac{3}{4}$  to 1 in. thick, tapered to 1 in. at the ends. The taper is formed by planing the outer edge of the brace. The underside is planed either concave or convex, depending on the warp of the door, as shown in the right-hand detail. When the X-brace shown in the left-hand detail is used, one arm of the X is flat against the door, and the other bridges it. The bridging piece exerts an upward pull on the warped corners of the doors, bringing them back into line.

CORNERS A AND B ARE PULLED TOWARD REAR, OR INSIDE, SURFACE OF DOOR

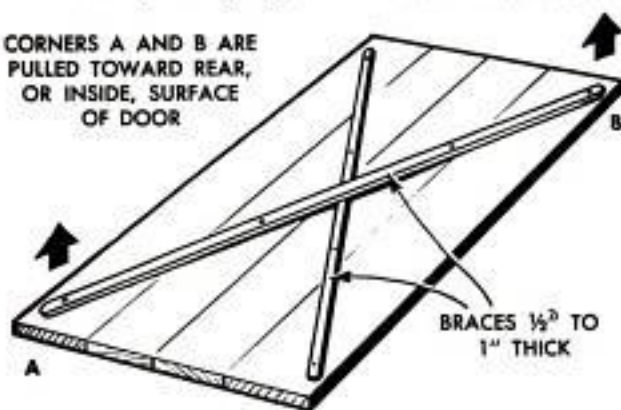

Above, crossed braces are applied to the inside of a warped closet door. Outermost brace exerts pull on top outer corner and bottom inner corner of door

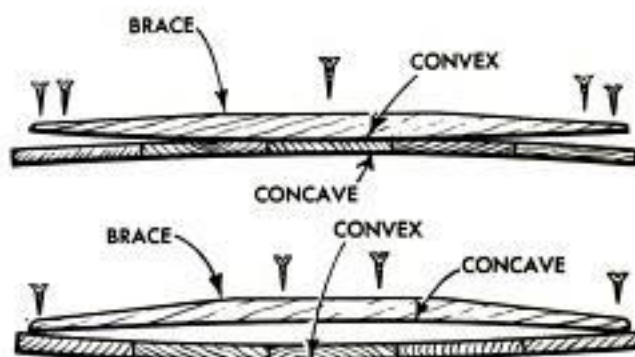

DIAGONAL DOOR SECTIONS

## Hardboard Painted and Finished the Same as Hardwood

Hardboard is painted or finished in the same manner as any hardwood, following the instructions of the manufacturer of the particular finish to be applied. As with wood, the surface must be cleaned of dirt, grease and other foreign matter before finishing. Dirt is removed with a mild soap-and-water solution, and grease with carbon tetrachloride or naphtha. After cleaning, wait until the surface is completely dry before applying the finish. Any rough spots caused by cutting, handling or fastening should be smoothed with fine sandpaper. Next, a sealer or primer that is intended for use with the particular finish is applied. The primer, used as a base for the finish coats, is pigmented so as to have opacity as well as sealing qualities. Sealers, on the other hand, are sometimes used as the only finish. Penetrating sealers, which are an excellent means of finishing hardboard

work surfaces, are of this type. They are easily applied, fast-drying and require only occasional washings to keep them in condition. Hardboard also can be stained with good results. The best stain to use is the nongrain-raising type, which may be applied by brush, spray, dipping or wiping. The stain should be covered with a protective coating of varnish, clear lacquer or clear sealer. Another method of staining is to use colored penetrating sealer or to mix a small quantity of dry pigment or color-in-oil in clear penetrating sealer. The mixture is applied heavily, then the excess is wiped off.—Masonite Corporation.

☞ When sewing snap fasteners on clothes, attach the stud first. Rub chalk on its tip and press against the other side of the garment. The resulting mark will show where the socket of the snap should be sewn.



# Solving Home Problems



**HANDY SPICE CABINET** recessed in kitchen wall is closed with neat door hinged to open downward. Cabinet is simple box,  $3\frac{1}{2}$  in. deep by  $5\frac{1}{2}$  in. high, which is inserted and fastened between wall studs

**THE HANGING HAT BOX** shown below, is a real closet-space saver that can be made in a few minutes from a small cardboard box. Top flaps are cut off and V-cut made in bottom is bent to form tab

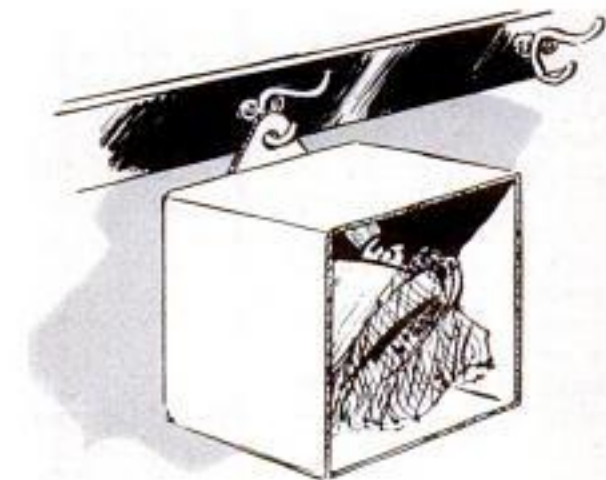

**DUPLEX RECEPTACLE** fastened to back of bed headboard, left, is ideal for plugging-in an electric clock, radio or electric blanket. Cord from surface-mounted receptacle is run to the baseboard outlet





**IF SEWING THIMBLE** is misplaced, a suitable substitute can be improvised by taping a coin to tip of finger. Although not as efficient as thimble, coin allows you to push needle through the fabric



**WHEN RING DROPS** part way down sink drain, easiest way to retrieve it is with tweezers. If latter are not available, wrap piece of paper toweling in tight spiral and use to pick up the ring as shown above



**PAINT SPOTS** on linoleum floor that are too dry to be removed with turpentine, often can be "sanded" off with fine steel wool. Work carefully to protect linoleum, then wax and polish

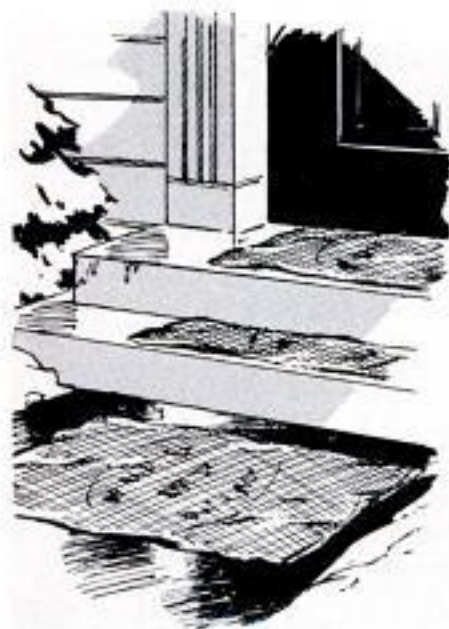

**BURLAP SACKS** spread over icy steps and walks, above, provide nonslip surface and eliminate nuisance of ashes or sand being tracked into house. Dampen sacks first so they will freeze in place on icy surface

**RIGHT, OILSTONE MOUNTED** in kitchen-cabinet knife drawer permits quick whetting of blades as knives are removed. Cement oilstone to wooden block and mount flush with edge of drawer which is notched for blade





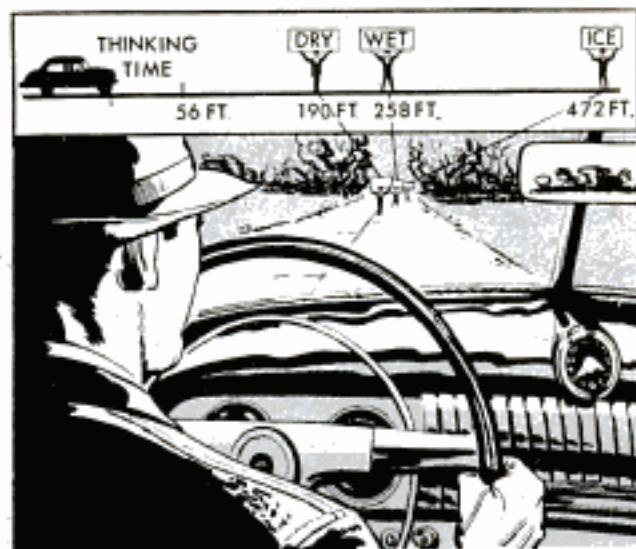

## Driver and Automobile Brakes Must Team Up for Safety

"Look at my tire marks! The wheels were locked! What more could I do?" How often have you heard these statements at the scene of an automobile accident? Such a driver has no knowledge of the limitations of his brakes, nor of the tremendous force of momentum. A modern passenger car traveling at 60 m.p.h. covers ground at the rate of 88 ft. per second. At the conservative open-highway speed of 50 m.p.h. on dry pavement your car will travel 190 ft. before you can bring it to a full stop, even when the brakes are in good condition. This distance increases to 258 ft. on wet pavement, and stretches to 472 ft. on icy pavement. With most automatic transmissions and overdrives, the car can be slowed or stopped only by the brakes, because there is no braking compression from the engine that is transferred to the driving wheels. A good safety habit to acquire is to allow a car length between you and the car ahead, for every ten miles an hour of speed on dry pavement, a length and a half on wet surfaces and three lengths when driving on ice. Close to 30% of the cars tested in one safety checkup had faulty brakes. Do not buy cheap linings or questionable brake fluid. Many of the cheaper linings will not stand one "panic" stop from 70 m.p.h. At present there is no accepted quality standard on brake lining set up by any independent source, such as the S.A.E., as there is for brake fluids. And one in three brands of brake fluid does not meet the S.A.E. specifications for the heavy-duty fluid required in modern automobiles. A serious misconception is held by many drivers that power brakes will stop a car more quickly. The power brake makes it easier to apply pedal pressure, but does not stop the car in a shorter distance. Too much pressure may cause trouble.

## Hot Lead Cuts Hole in Glass

When faced with the need to bore a hole in a pane of glass, one craftsman used a dam of putty and molten lead to do the job. He shaped a pocket in the putty with the point of a pencil and poured the molten lead into the pocket. The lead cut a hole through the glass approximately the same diameter as the hole in the putty. *Caution:* No moisture should be present on either the glass or putty.



John A. Comstock, Wellsboro, Pa.

## Adhesive Tape Anchors Badge To Hunter's Lapel

To avoid the possible loss of an identification badge, one hunter inserts the pin of the badge through his coat lapel and also through a small square of adhesive tape stuck on the back of the lapel, as shown. The tape anchors the badge securely and yet may be removed easily when the badge is taken off. This same idea is practical also for those attending conventions and other gatherings where identification badges are worn.

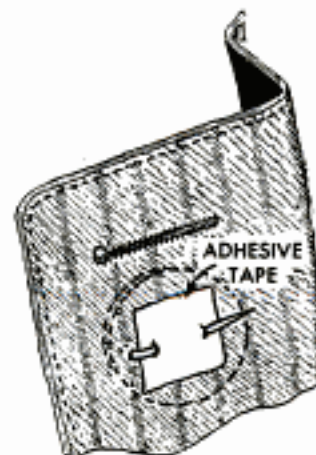

## Flooring Strip Aids Squaring

Should it be necessary to square off a large number of pieces of lumber, one way of doing it quickly and accurately is to screw a strip of tongue-and-groove flooring to the side of a sawhorse. The strip of flooring is fastened groove up and parallel to the top edge of the sawhorse. In use, a carpenter's square is set in the groove and held against the work by the hand that holds the pencil, while the other hand steadies the work.

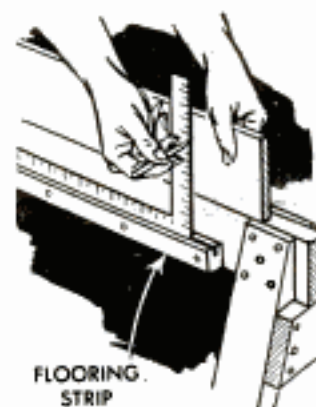



SN 56

# ALUMINUM

## Makes Its Debut

### As a New Craft Material

**T** IRED OF WORKING solely with wood? A fascinating new experience awaits you in working with do-it-yourself aluminum—a new, easily worked craft material that offers the home craftsman unlimited possibilities in creating attractive, smart-looking pieces of modern furniture. The many advantages of aluminum are familiar to most craftsmen, but up to now, this material has been fairly difficult to work. Now, thanks to the Reynolds Metals Company, a special homecrafter's aluminum is available which can be worked with ordinary hand and power woodworking tools.

Do-it-yourself aluminum is available in standard sizes and shapes, including rod and bar stock, various sizes of angle, tubing, embossed or mill-finished sheet and the popular aluminum foil. In addition, there are a variety of aluminum fasteners such as sheet-metal screws, machine screws, wood screws, rivets and nails. As you can see from the right-hand photos on this page, the sheet may be cut with ordinary scissors or tin snips, the tubing, rod or bar stock with a handsaw or coping saw, burrs removed with a pocketknife and holes drilled with wood bits. The home-shop circular saw, jigsaw, jointer, drill press and other power tools also can be used. Because of the thinness of the sheet and the tubing walls, it is recommended that a fine-tooth blade be used to

This handsome barbecue cart is a striking combination of aluminum angle, tubing and sheet. Shelves of  $\frac{1}{4}$ -in. hardboard and a pair of semi-pneumatic wheels complete unit

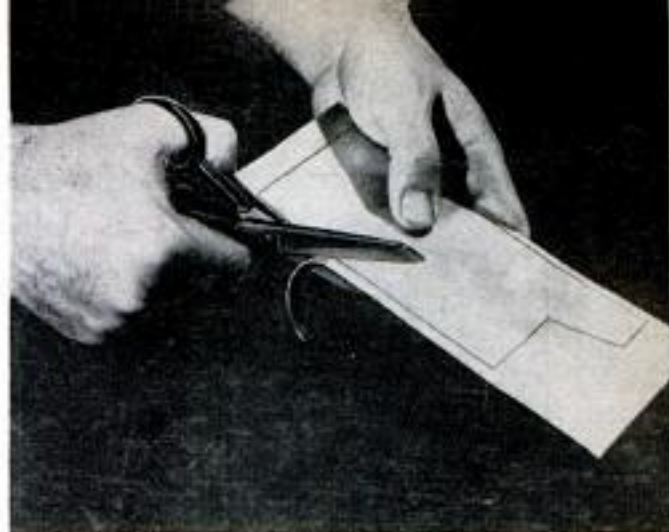

Plain or embossed aluminum sheet is cut readily with pair of ordinary household scissors

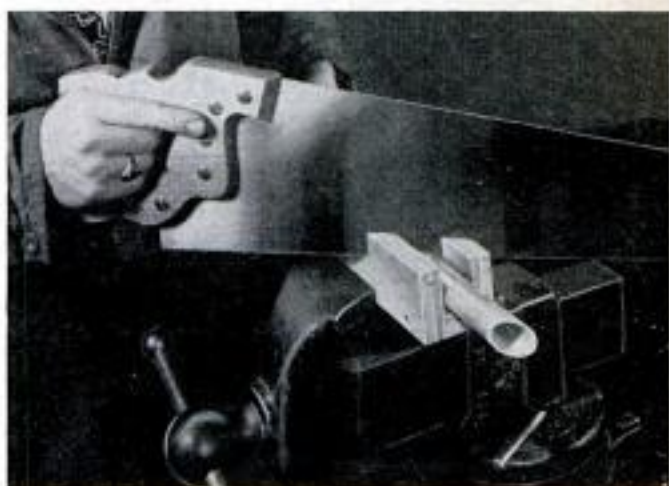

Above, a length of tubing is clamped in vise between wooden blocks and cut with handsaw



Burrs can be removed from edges of tubing with pocketknife, above. Aluminum sheet is bored with expansive wood bit, as below

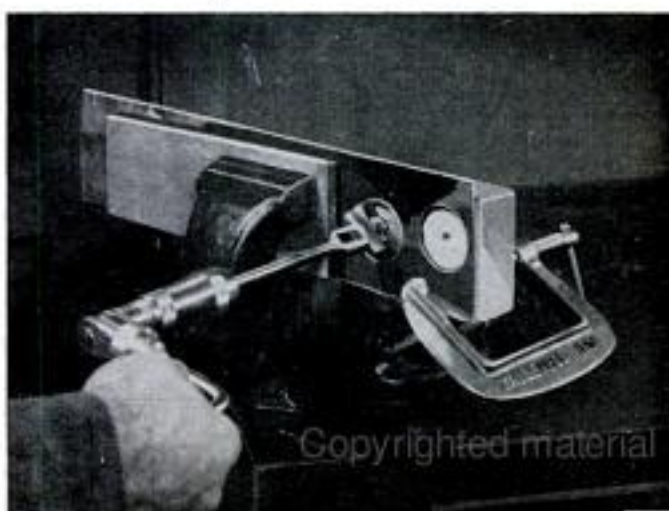



## Steps in making aluminum screens

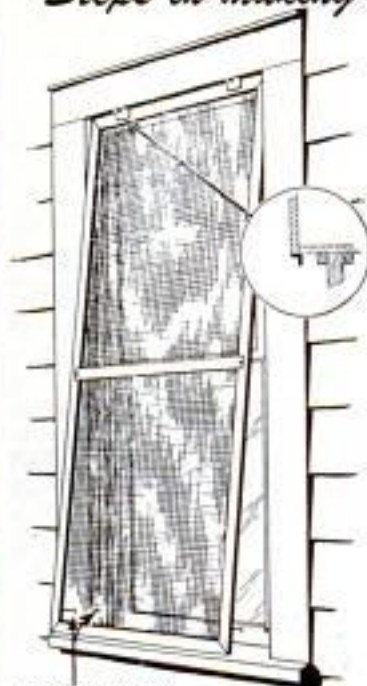

SCREEN HOOK AND EYE



FRAME MEMBERS MITERED WITH HACKSAW



METAL CLIPS LOCK MITERED CORNERS

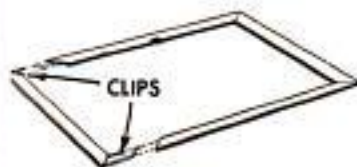

HOW METAL CLIPS LOCK CORNERS

BRACE ADDED AT CENTER OF FRAME

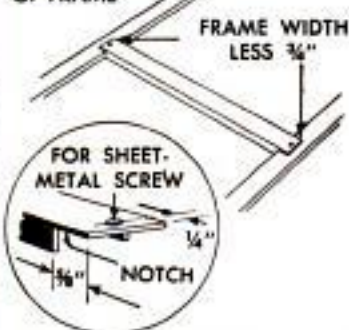

ALUMINUM FRAME SECTION



SPLINE DRIVEN IN GROOVE ANCHORS SCREEN WIRE

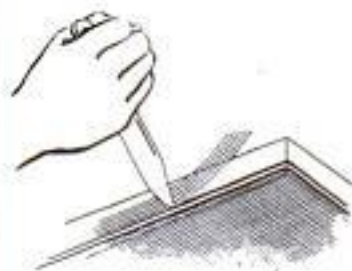

EXCESS TRIMMED OFF WITH KNIFE

saw the material. These pages picture some of the countless attractive things that can be made from this new material, and plans and instruction booklets giving you further information are available from the dealer who handles this product.

One of the real moneysaving features of this material, is newly designed extruded moldings which allow you to make your own screen and storm sash. The series of drawings above show how screens can be made. The frame members are mitered at the corners and assembled with clips, the screen wire is stretched across the frame and the wire is driven into the frame grooves all the way around. Then a wire spline is driven into the groove over the screen wire to hold it in place. Plastic storm windows are made in much the same way using the same molding. ★ ★ ★

Modern magazine rack, left, combines embossed aluminum sheet with black-painted tubing. For some really eye-catching furniture, note sketches at the right. Here, aluminum is used with hardboard or plywood





DESK



ARM CHAIR

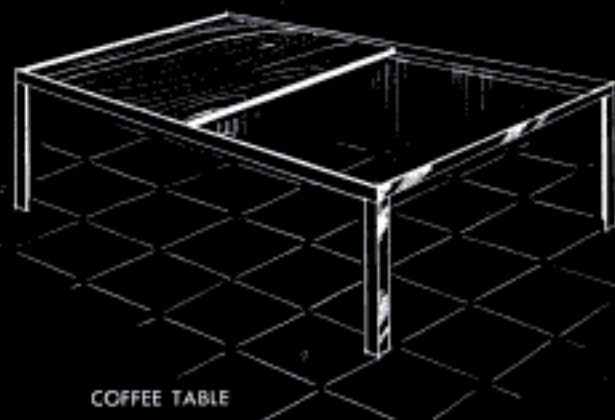

COFFEE TABLE



MODULAR CABINET

## Envelope Corner as Bookmark

The corner of an old envelope often makes a more satisfactory bookmark than the usual card or paper stuck between the pages. Cut off a lower corner from the envelope and slip it over the upper corner of the page to be marked. This marker will not project above the corners of the book and, therefore, does not interfere when placing the book on a shelf that provides little or no clearance over the top of the book.

Henry A. Miller, Kent, England.



## Hand Rest on Wire Brush Provided by Half of Ball

Much of the strain on wrist and finger muscles that results when painters use a wire brush to remove old paint, can be avoided if the back of the brush is equipped with a hand rest. One method is to cement one half of a sponge-rubber ball to the back of the brush. The ball will fit up into the palm of the hand, providing a resilient rest.

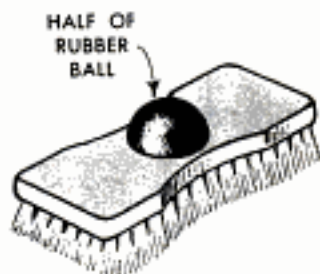

## Piece of Hose Speeds Sawing In Difficult Places

Making cuts with a handsaw that require short strokes and guiding of the blade with both hands can be facilitated by an extra handhold improvised from a piece of garden hose. Slit a 5-in. section of the hose lengthwise and slip it over the edge of the blade to form a grip for the left hand. This will enable you to apply more pressure to the saw and also to obtain better control of the blade.

Victor Lamoy, Upper Jay, N. J.

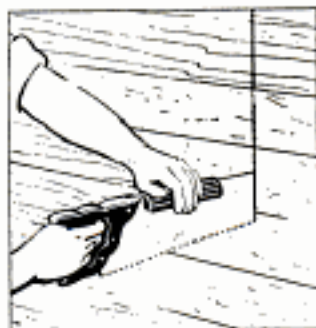

☐ The annoyance of searching through your purse or handbag for the house key can be avoided if the key is placed in an empty spectacle case, which is easy to find.





### Plumb Bob Improvised From Solder and Cord

A plumb bob suitable for use around the house is made easily from a length of wire solder. Flatten one end of the solder, band the flat end around a fine cord and, pinch it tight with pliers. This makes a bob that can be used against a wall when hanging wallpaper or large pictures. A number of these plumb bobs can be made to use for individual drops from a cord stretched between two points, as in the case of spacing fence posts.

Watt Baker, Charlotte, N. C.

### Wall-Paneling Filler

After wall paneling has been installed, the nail holes can be filled with a mixture of fine, sifted sawdust and shellac. Since the shellac dries quickly, it is best to work with small amounts of the mixture. After the filled spots have dried, sand them.

### Scrub-Brush Sanding Block Ideal on Uneven Surfaces

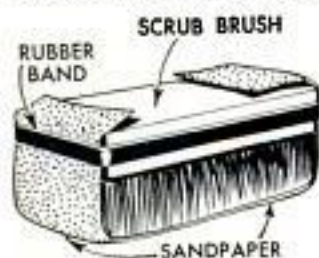

The sanding of irregular surfaces will be no problem if you wrap the sandpaper around a scrub brush and use it as you would a sanding block.

The bristles of the brush permit just enough "give" to allow the sandpaper to follow any curvatures in the surface. A rubber band secures the sandpaper.

### Toaster Bracket Supports Doors

A metal bracket fastened to some of the older, non-automatic toasters will prevent damage to table and cloth caused by the hot door dropping open. The length of the bracket and its location will depend on the individual toaster. The bracket is mounted so that the handles of the doors rest on it when the doors are open. The bracket is also useful for winding up the cord when the toaster is stored away.

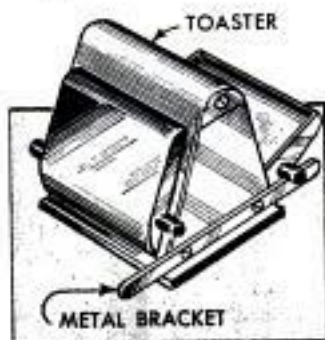

Arthur Trauffer, Council Bluffs, Iowa.

### Shaker-Type Seasoning Can Dispenses Abrasives

Rottenstone, pumice and other abrasive powders used around the home workshop for polishing are kept ready for instant use if stored in the small shaker-type cans in which seasonings such as paprika are packed. The "sprinkler" top makes it easy to dispense just the right amount of abrasive required. And since shaker cans are usually provided with separate covers, the abrasive can be kept free of moisture and foreign substances.

R. F. Donovan, Guttenberg, N. J.



Opening a partially used can of paint will be easier if a little petroleum jelly is applied to the cover rim each time the can is sealed. For best results, remove any paint drippings left in the rim of the can before applying the petroleum jelly.



WIM '55

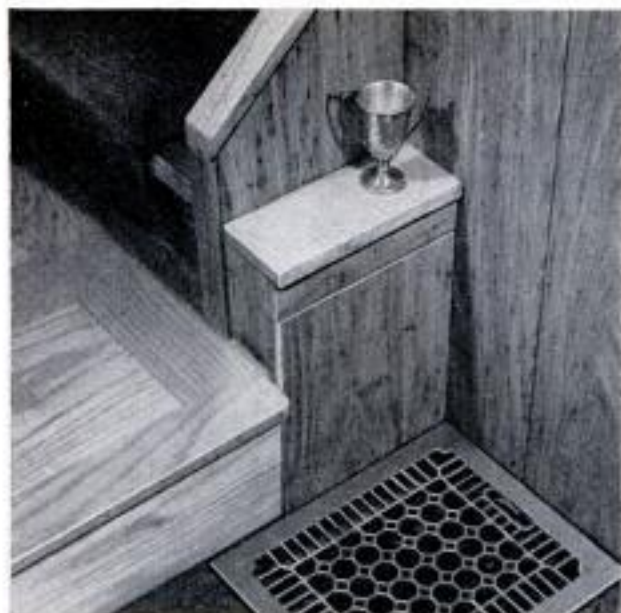

## Wooden Drying Rack Folds Into Cabinet

When not in use, this wooden drying rack is slipped out of sight into its own neat-looking cabinet which becomes an attractive whatnot shelf. Situated next to a radiator or hot-air register, it utilizes the heat to dry gloves, stockings and other small articles of clothing. The rack is formed of  $\frac{3}{8}$ -in. dowels, which are glued at one end in blind holes drilled in a piece of 1-in. stock. The other ends of the dowels are glued in holes in the underside of a second piece of 1-in. stock that becomes the top of the cabinet when the rack is closed. Another length of stock is screwed at right angles to the top piece, thus forming the top section of the cabinet front. A  $\frac{1}{8}$ -in. strip is attached to the inside of the

latter, forming a lip to hold the top in place when the cabinet is closed. A cleat is fastened to the back of the cabinet so the lower end of the rack will engage the cleat to hold the rack in a horizontal position. A  $\frac{1}{2}$ -in. strip is fastened across the fronts of the dowels. This is located to bear against the inside of the cabinet front and prevents the rack from sliding out when in the open position. The top of the cabinet projects  $\frac{1}{4}$  in. at the front to provide a finger grip for lifting the rack from its cabinet. The latter is of simple box construction made to suit the particular installation, which also determines to some extent the dimensions of the rack itself.

Walter E. Burton, Akron, Ohio.

## Auto Pistons Used as Anchors for Fence and Gateposts

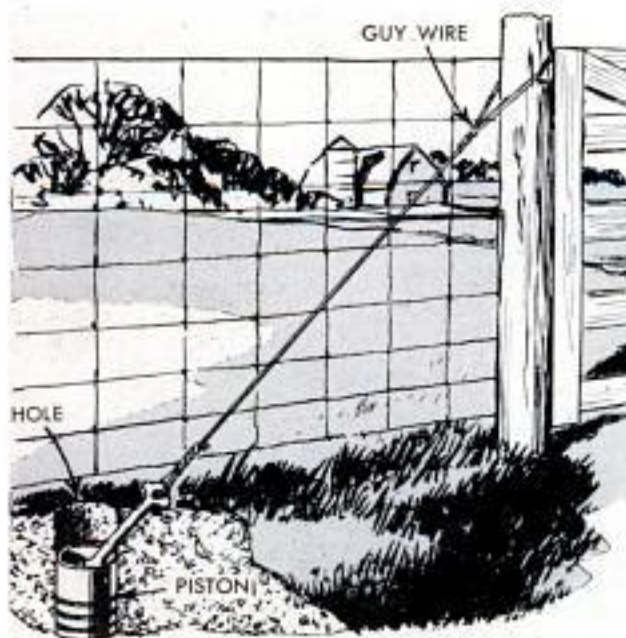

Set in a hole dug by a posthole digger, an automobile piston can be used as an effective anchor for corner and gate fence posts. The piston is inserted in the hole several inches below ground, and then a channel is cut on the side of the hole toward the post to be supported. The connecting rod of the piston is laid in this channel and the guy wire from the top of the post is attached to it and tightened. Dirt is tamped over the piston to complete the job.

## Bleach Cleans Stained Vase

Stain that accumulates in a narrow-necked flower vase where it is difficult to get at with a cloth or brush can be removed with a mild solution of ordinary laundry bleach. After such a cleaning, the vase should be rinsed thoroughly in hot water to remove all traces of the bleach.



# PLAN of the MONTH...



W T M '55

Combining the advantages of minimum storage space with a maximum seating capacity, the table featured in this month's plan by John Bergen is large enough to seat 10 people, yet folds into a cabinet only 21½ in. deep. The secret of the table's flexibility lies in the leaf supports, which telescope by means of dovetail slots and keys. A dovetail bit of the proper size, chucked in a drill press, can be used to rout the dovetail slot, as well as shape the key. However, both slot and key can be cut with a circular saw, using a sharp chisel to clean out the bottom of the slot. The key can be made an integral part of the slide by cutting each member from one piece. Note that the table top, which is the same size as each leaf, is permanently attached to the outboard "leg" of the table by wood screws. A drawer in the cabinet provides a convenient storage space for table linens and silverware

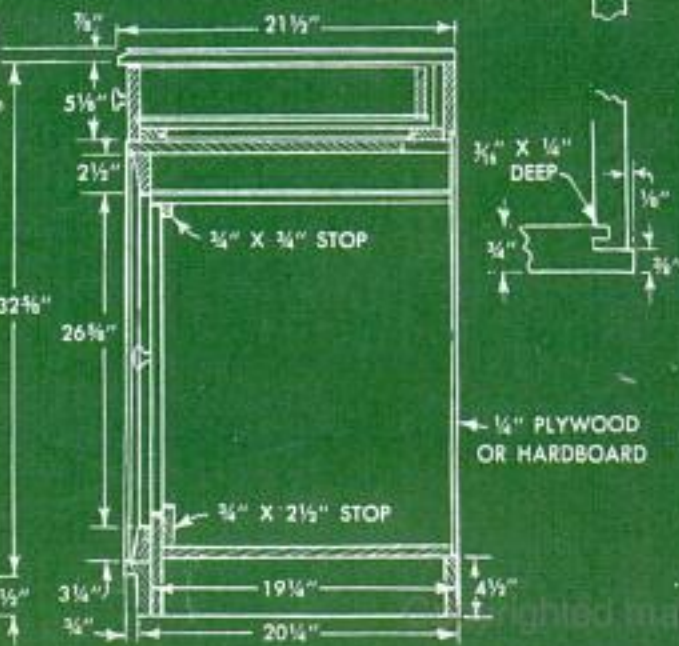
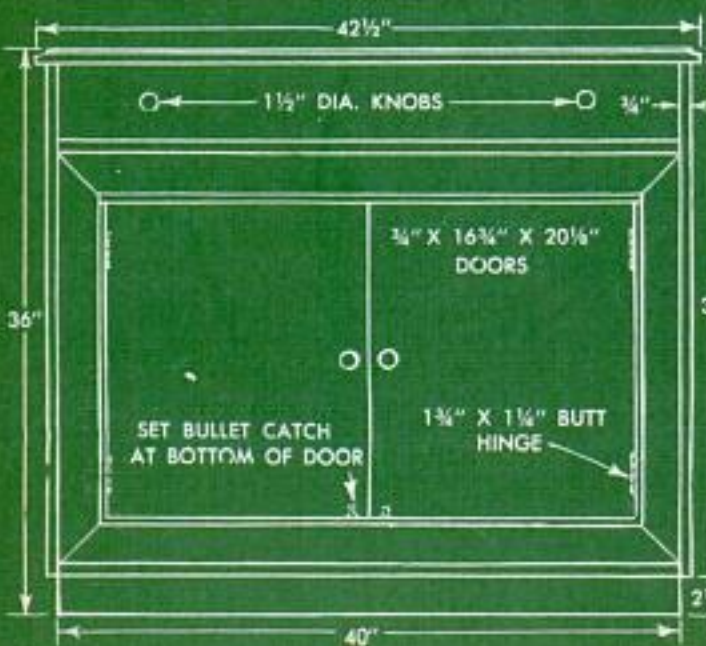
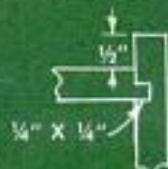
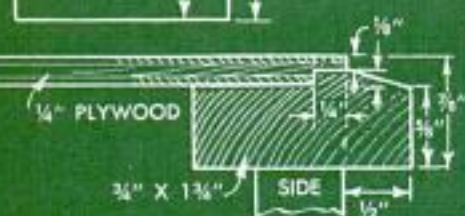
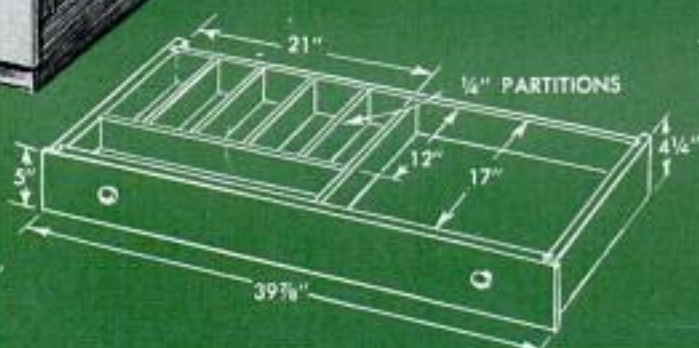
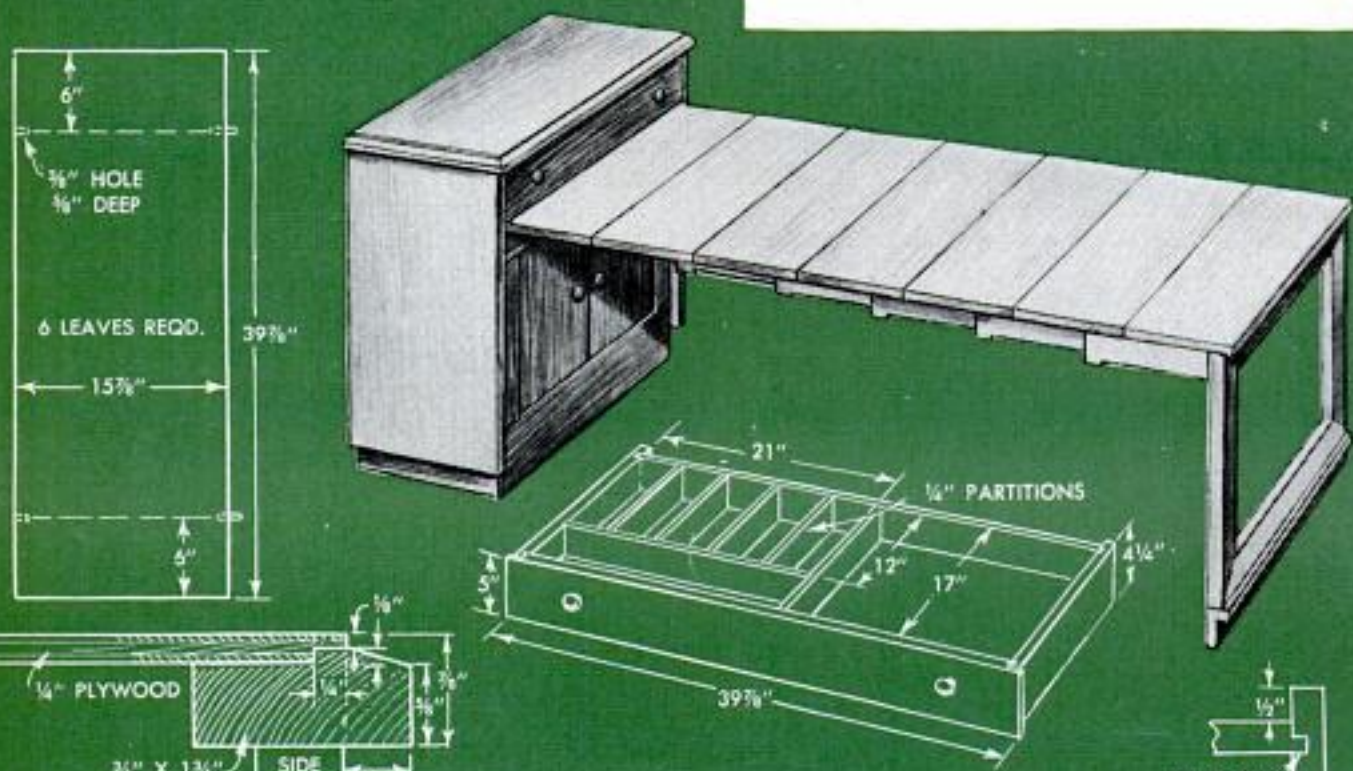



# Dining Table Commode

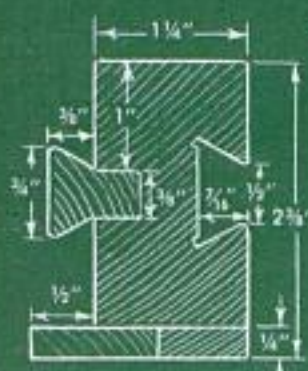
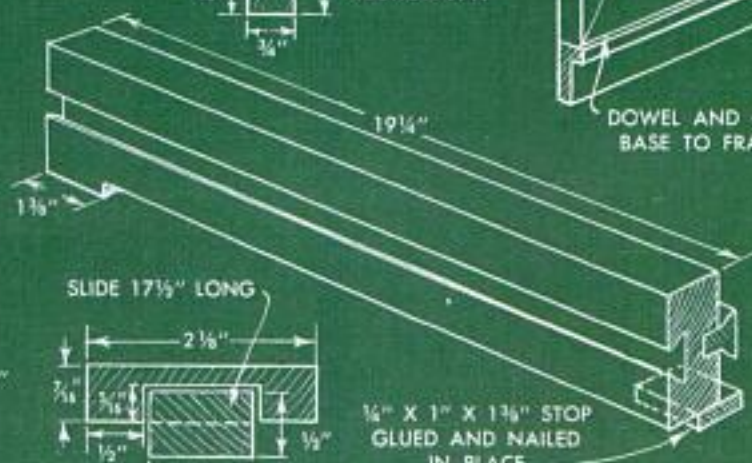
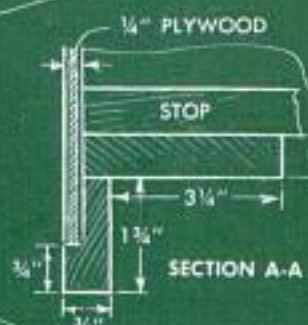
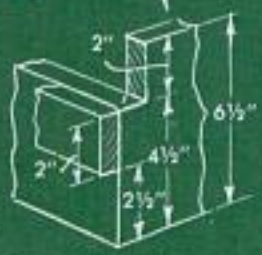
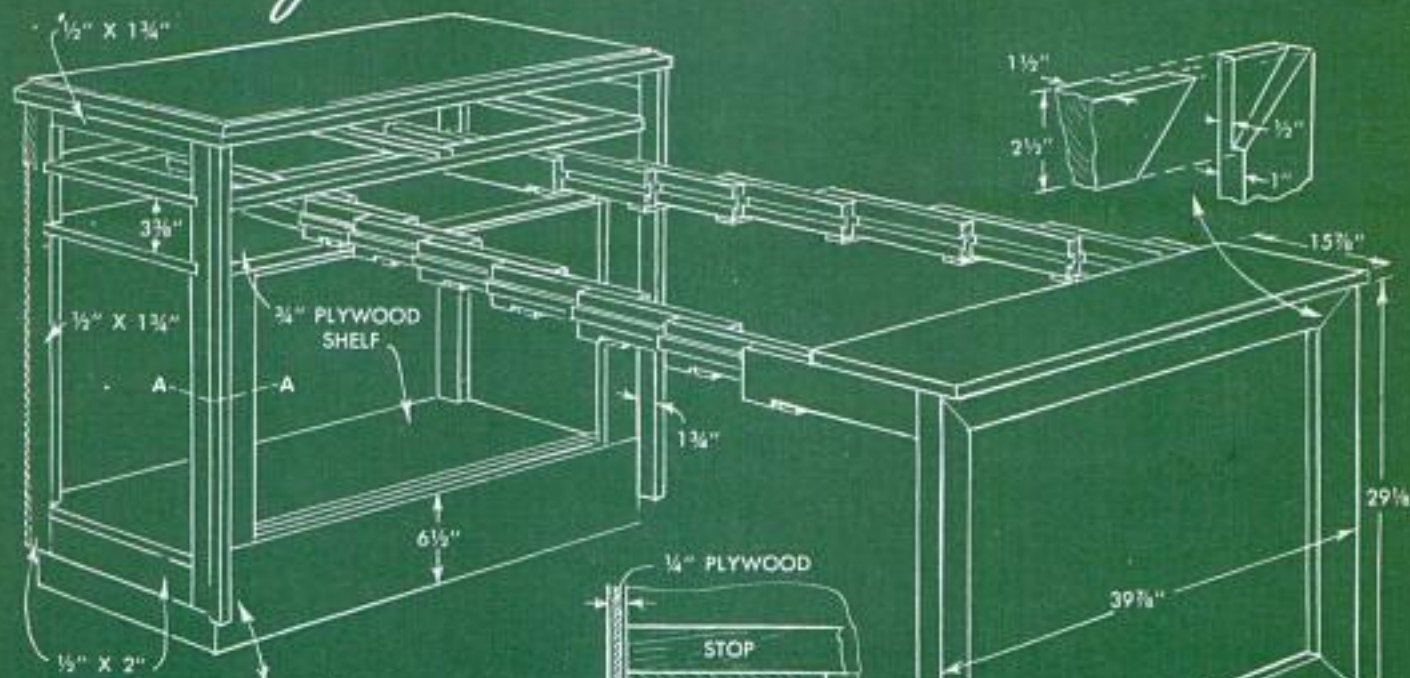

$\frac{1}{4}$ " X  $1\frac{1}{2}$ " X  $1\frac{3}{4}$ " STOP GLUED AND NAILED IN PLACE

CAN BE MADE IN ONE PIECE

WAX SLIDE MEMBERS THOROUGHLY WITH PARAFFIN AFTER ASSEMBLY USE HARD MAPLE FOR SLIDES

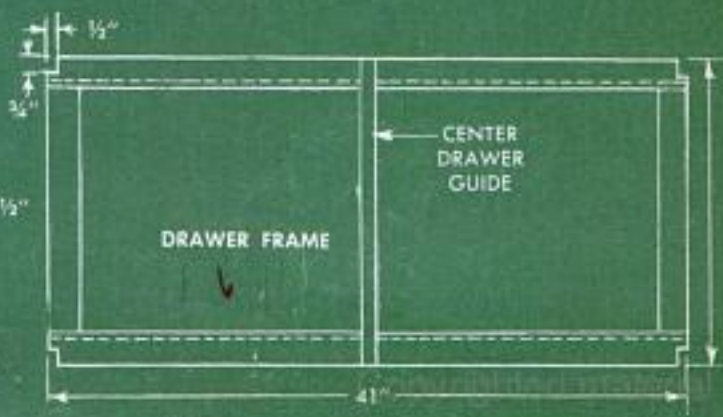





### Rolled Towel Across Back Eases Traveling Fatigue

To avoid backache caused by sitting for long periods of time, as on a train, bus or car ride, one traveler uses an ordinary bath towel. A large-size towel is folded in half, across the short way, then wrapped into a tight roll. The rolled towel is placed across the small of the back, and by occasionally moving it up or down, changes the muscle tension enough so that back fatigue is kept to a minimum. The towel is carried easily in a suitcase and is inconspicuous as compared to a pillow.

S. S. Rubira, Jr., Phoenix, Ariz.

### Sawdust Cleans Chinaware

Irregular corners inside china and glassware can be cleaned with a mixture made by mixing a pinch or two of fairly fine sawdust with the scouring powder or other cleaning agent used for this job. Drop the mixture inside the item to be cleaned, and swab it around with a bit of cloth wrapped on the end of a stick. The sawdust particles will conform to the shape of the object and carry the cleaner into the smallest crevices to remove the dirt.



### Improved Pipe Wrench

In an emergency, a wrench for turning pipe or tubing can be improvised by using an ordinary adjustable wrench and a three-cornered file. With a sharp cold chisel, notch the pipe deeply enough to take the edge of the file and tighten the wrench snugly over the file and pipe. Use a firm even pull.

Frank Butrick, Jr., Alma, Mich.

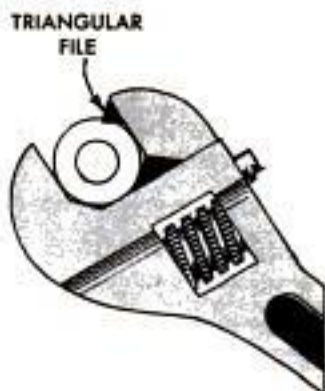

### Shower Curtains Hang Better When Weighted With Sinkers

Fishing sinkers on the bottom edge of a plastic shower curtain will prevent the lightweight material from billowing and blowing around the person using the shower. The sinkers on the curtain shown in the sketch are 1½ in. long and of the pinch-on type. Space them about 1 ft. apart and pinch with pliers. Be careful not to cut the plastic by pinching too hard.

Theo. Kleinrock, Brooklyn, N. Y.

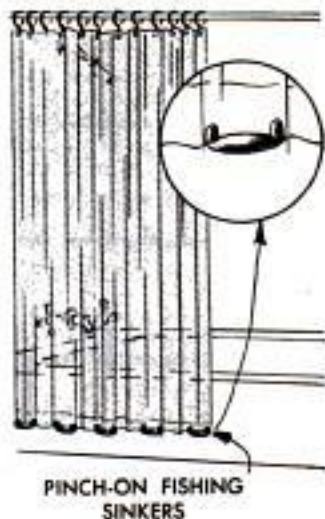

### Band of Inner Tube on Block Makes Bench Brush

For dusting the sawdust and shavings from your workbench, a "rubber bristle" brush can be made by stretching a section of inner tube over a plywood handle. Because it is wide and flexible, the brush will clean the bench in a few strokes. Such a brush would be useful also around the house for sweeping up broken glass, plaster dust and other materials which are difficult to sweep with an ordinary broom.

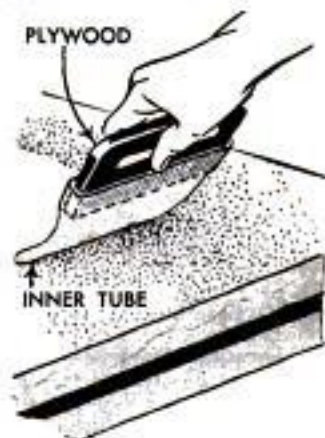



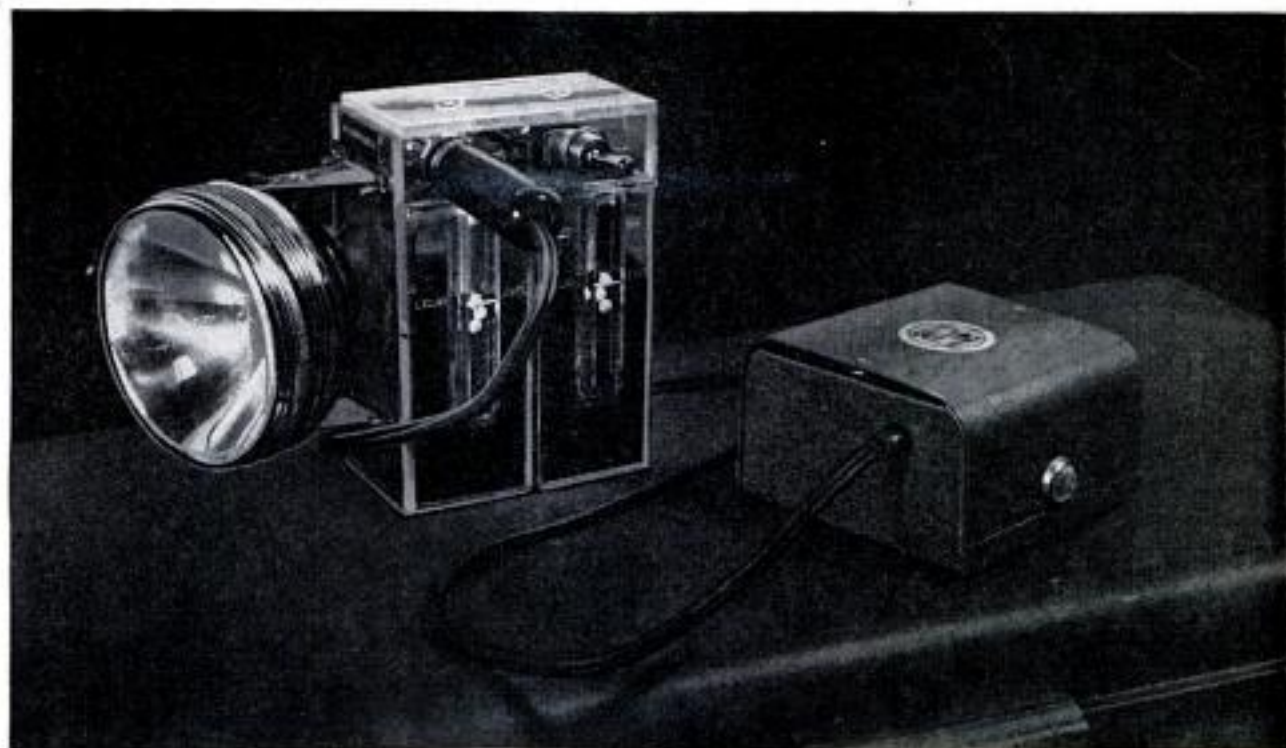

## Wet-Cell Floodlight

UTILIZING a wet-cell storage battery as a source of power, this portable floodlight eliminates the need for the supply of dry-cell batteries required by conventional flashlights. The battery has a plastic case and is the type used for photo-strobe lights. The bulb and reflector unit for the floodlight are salvaged from a swivel-head flashlight, the bracket of the swivel head being fastened to a sheet of  $\frac{1}{8}$ -in. plastic. The latter is cut to fit over one end of the battery case, projecting 1 in. above the top. The flat-headed machine screws used to hold the bracket are countersunk so the sheet of plastic can be cemented flush against the battery case. Two holes are drilled in the projection of the plastic sheet to allow the wires from the light to be connected to the battery and toggle switch. Then strips of the  $\frac{1}{8}$ -in. plastic are cut to provide a 1-in. extension around the top of the battery case. One side strip is drilled to receive the switch and a phone jack which is used to plug in a battery charger. Extension tubes of  $\frac{1}{8}$ -in.-i.d. plastic are fitted into the battery openings and cemented directly beneath holes drilled in a plastic plate, to allow refilling the cells with distilled water. It is suggested that a  $3\frac{1}{2}$ -volt bulb be used, as this type of battery supplies 4 volts. The sheet plastic and cement are obtainable at most hobby stores. The phone jack and plug, toggle switch and wiring are available at a radio-supply house, while the battery and charger may be purchased in a photographic store.

John L. Hoke, Washington, D. C.

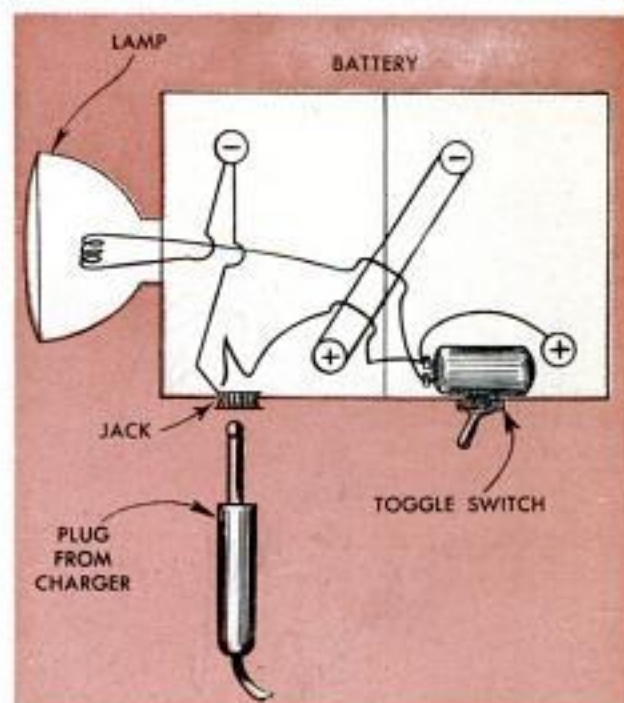



Rep: WTM '55

# Try Your Hand at

## FULL-SIZE PATTERNS

Actual-size patterns of the various lifts that comprise the hull of the *MIDWAY*, as well as patterns for the fittings, are available for tracing directly on your wood to simplify construction of model

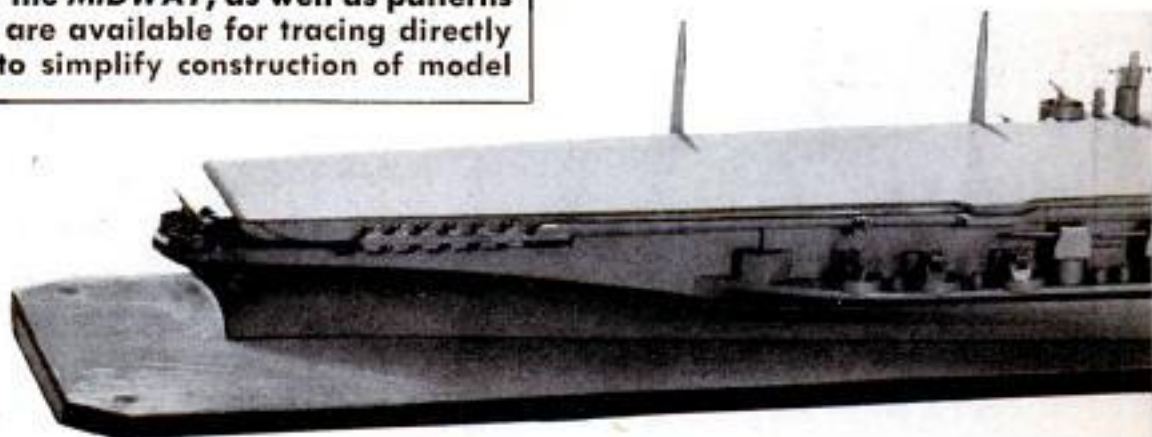

## PART I

By Paul Strayer

Below, aerial view shows how actual ship dwarfs tugs. Symbol of power and strength, the mighty *Midway* knifes along at a speed of 34 knots, to provide a formidable striking force in defense of our shores  
Official United States Navy photograph



FROM HER BATTLE-READY flight deck down to the vigorous speed lines of her immense hull, this water-line scale model of the mighty 55,000-ton USS *Midway* faithfully reproduces one of the most powerful warships afloat. The modelmaker who thrills to the sight of sleek naval craft will be proud to add this beautiful model to his collection of fighting ships.

**The hull proper:** The hull of the USS *Midway* is divided into four basic parts: the hull proper, the sponson piece, the notched piece and the cover board for the notched piece. If possible, select a piece of white (sugar) pine for the hull proper, measuring 24 in. long, 3½ in. wide and 15/16 in. thick. Usually a local pattern shop will sell you enough sugar pine for your model. Basswood can be used as a substitute as well as mahogany. Pass up balsa wood, ponderosa pine and fir as they are unsuitable for carving. If working with ready-drawn hull patterns which save making your own, you are all set to trace them right on the work. If not, the first step is to enlarge to full size the patterns given on page 210. Note in the case of the hull and sheer patterns, that only half patterns are necessary, as both port and starboard lines of the ship are of the same contour. A pattern also is needed for tracing the hull outline at the water line.

Before the deck and water-line



# Modeling the *MIDWAY*

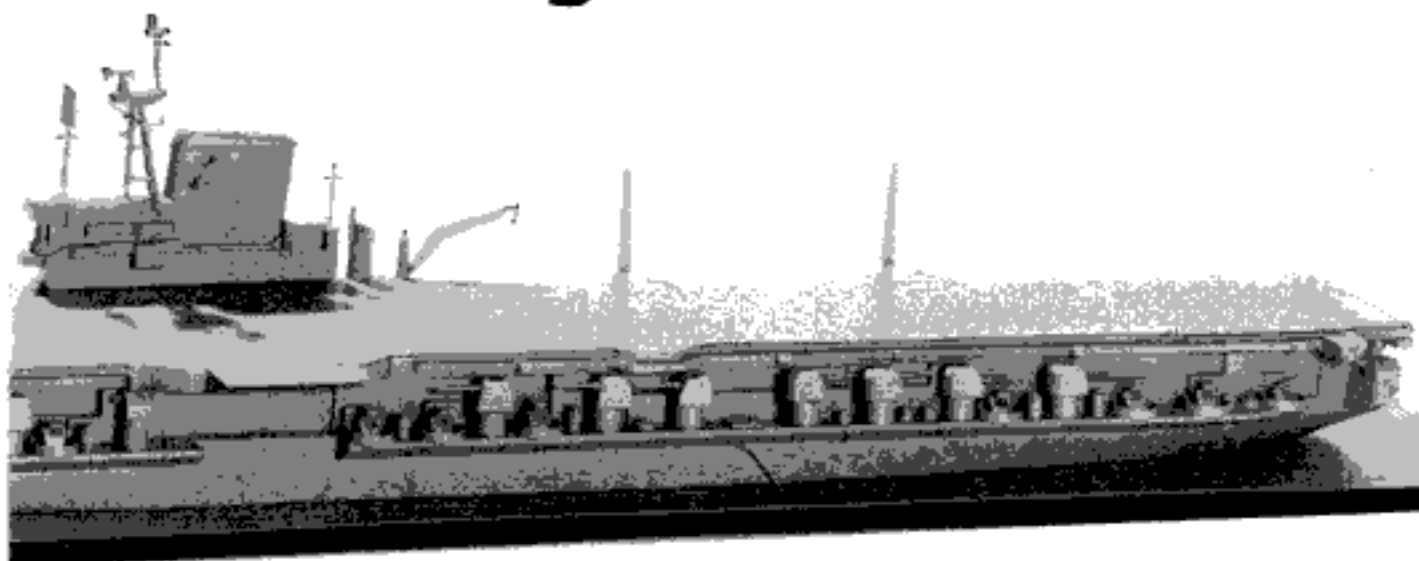

patterns can be traced on the hull block, you must draw centerlines all around the block—top, bottom, sides and ends. These lines are used to position the patterns for tracing. In tracing, place each respective pattern on the centerline and trace around one side, then flip the pattern over to draw the opposite side, keeping it registered exactly with the centerline. Trace the deck pattern on top of the block and the waterline pattern on the bottom, taking care that the latter is positioned to coincide at the bow with the cutwater as it curves backward at this point.

Mark off the over-all length of the hull by drawing around the four faces of the block, fore and aft. Place the sheer pattern in position and trace around it on opposite sides of the block, keeping the pattern registered with the crosslines at the bow and stern. We are now ready to draw transverse lines all around the block. These establish the points at which the contour templates are held during the carving of the hull. In cutting the sheer profile of my

model, I set the circular saw to the various depths required and made a series of cuts  $\frac{1}{8}$  in. or so apart. Then, with a chisel, I cut away the waste and finished up with a wood rasp and sandpaper, taking care to keep the surfaces level.

Now you can concentrate on the bow and stern profiles. The stem shape or cutwater of any ship is as characteristic as the profile of a person's face and, therefore, it must be shaped with utmost care. You will note there is a subtle convex curve above a concave curve. This reverse curve is most pleasing and harmonizes perfectly with the semicircular plan of the bow. In sawing the stem and stern profiles, avoid sawing too closely to the actual lines. Final finishing is done after the hull is shaped. The deck outline may be cut with a coping saw, bandsaw or jigsaw. It also may be shaped with a drawknife. Again remember not to saw too closely to line, reserve some wood for final finishing.

The hull is ready for shaping. First, however, you must re-establish the template

## The Mighty Midway

*Commissioned too late to participate in the history-making naval actions of World War II, the mighty Midway and her sister ships, the Coral Sea and the Franklin D. Roosevelt, represent the most powerful carrier units of the United States Navy. Immense ships, they measure 968 ft. in over-all length by 136 ft. maximum beam. Their armament, unlike that of conventional carriers of the Essex class, is carried, for the most part, on sponsons which extend from the sides of the ship. Most of the measurements for Mr. Strayer's 24-in. water-line model were taken from the government model on display at the Museum of Science and Industry in Chicago*



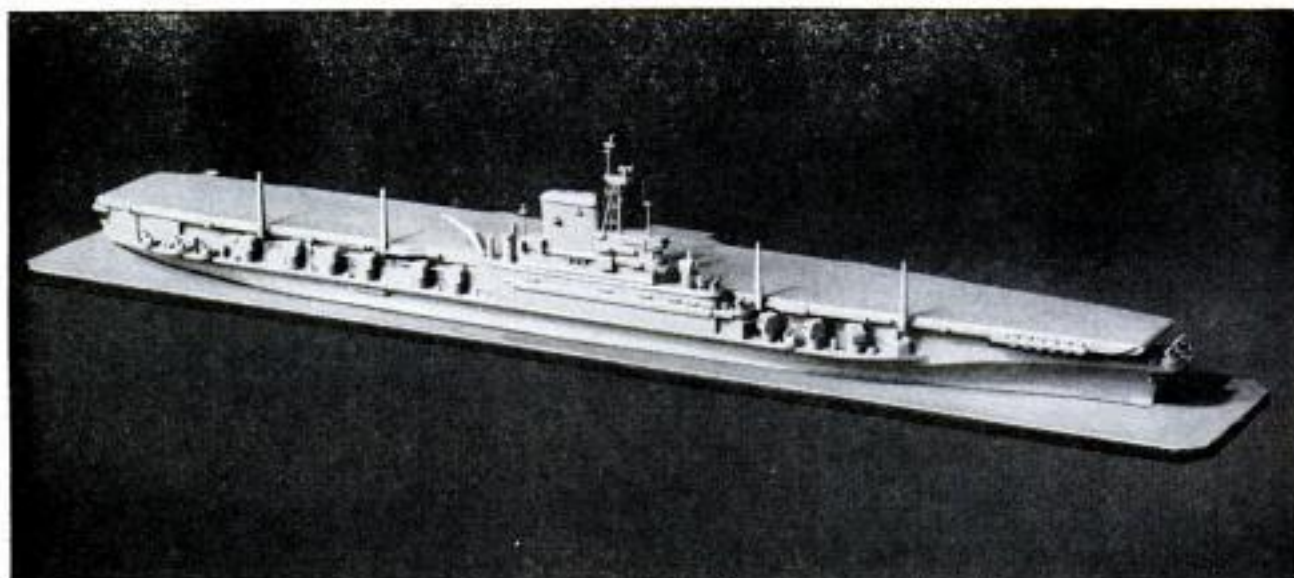

Above, starboard view of completed water-line model



How hull looks when carved according to templates



Stern view showing sponson piece in place on hull



Above, underside view (looking aft) showing overhanging sponson. Below, starboard view shows sponson topped with notched piece. Cover board fits on top



station lines on the hull proper. As these lines are still intact on the bottom, they can be carried easily up the sides of the rough-sawed hull. These lines should be numbered 1 to 12 from the bow aft and from 1S to 8S from a point just aft of midships to the stern. The carving templates are presented actual size on page 209, ready for tracing directly on cardboard. Number each template to correspond with the station numbers. Inasmuch as the center section of the hull is flat, the hull can be held conveniently for carving in a bench vise. In carving the hull, begin at the center and work fore and aft, both sides, using a chisel and gouge. Work carefully, taking only shallow cuts and checking frequently each particular station point with its respective contour template. Watch to see that each template is held vertically in checking the progress of the carving. Pay particular attention and use great care in shaping the region beneath the bow, where the curves are deep, and use utmost care in shaping the area in the vicinity of the bow quarter. As you view the stern from aft, you'll note that it appears to have a triangular shape. After carving the hull down to general but accurate form, bring it down to final lines with various grades of sandpaper.

**The sponson piece:** The sponson piece is the member which distinguishes the carriers of the *Midway* class from those of the *Essex* class which formed the major striking force of the carrier fleets of World War II. The sponson piece is cut from the same kind of wood as the hull, and measures 18 in. long, 4 in. wide and  $\frac{1}{4}$  in. thick. As before, draw a centerline along the top, down the ends and on the bottom of the piece. Then trace around the sponson pattern and cut the wood to shape, taking care that the ends are cut squarely and cleanly. Now with the sponson piece centered on the hull, place the fore end of the sponson in



the recess marked X. Tack the sponson lightly in place, leaving the brads projecting a bit so the piece can be removed for shaping. Turn the model upside down and carefully draw a line on the underside of the sponson, following the shape of the hull. When this is done, withdraw the brads and remove the piece. Now take the paper pattern for the sponson and trace around it on the top surface of the board. Thus we have an outline on both the top and bottom of the sponson. Next a guide line is drawn along opposite edges of the sponson at a point  $\frac{1}{32}$  in. down from the top surface. This serves as a point from which the angle or flare of the edge is maintained in shaping the sponson. The shaping is brought from the guide line down to the hull outline drawn on the underside of the sponson piece. Work carefully to see that these lines are closely maintained. The ends of the sponson should be faired smoothly into the hull. Filler, such as wood putty, will enable you to shape the subtle, difficult joints with a riffle file.

**The notched piece:** This piece measures 20 in. long, 3 in. wide and  $\frac{1}{2}$  in. thick. It is somewhat complex in shape with its recesses, projections and half-heights. After the notched piece is cut to shape, it is fastened in place with small brads. A second member, called a small forecastle, butts flush against the fore end of the notched piece. This piece may be added later, and is located as indicated in the plan drawing to be shown in Part II.

**The cover-board piece:** The cover board forms the top or ceiling of the notched piece. It is cut from  $\frac{1}{16}$ -in. material and forms a part of the flight deck. Two small dowels are used to hold the cover board in place on top of the notched piece. Here, the cover board is temporarily bradded to the notched piece and dowel holes are drilled through both pieces at one time. The dowels are driven part way into the notched piece and sanded off flush with the top surface of the cover board. The dowels register the cover board perfectly so that it may be removed and replaced accurately when necessary.

To be continued next month

The 20 individual templates required to check the contour of the hull when carving are made by tracing the outlines given below directly on cardboard. Each numbered line represents the contour of the hull at the corresponding station line as indicated at the right. Make each template about 3 in. long to provide a sufficient base to keep the template at right angles to the hull when checking the carving. Proper depth of carving at each station is reached when template contacts the hull at the sheer line.

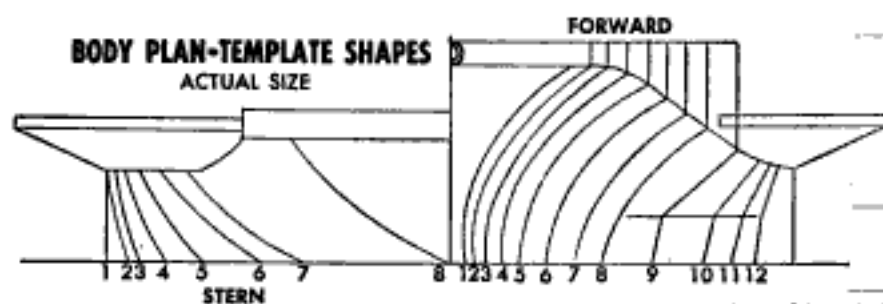

JANUARY 1954

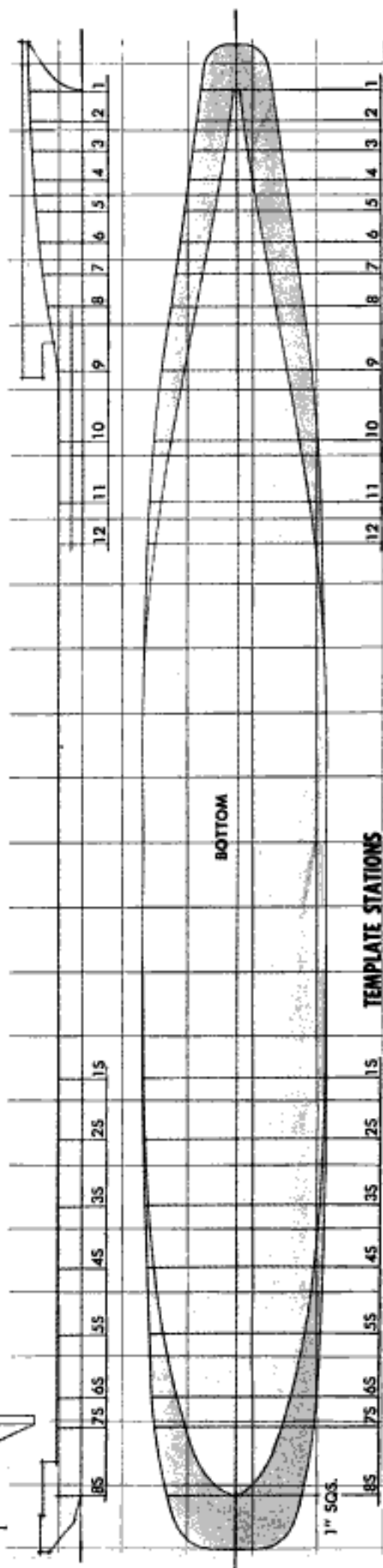

209



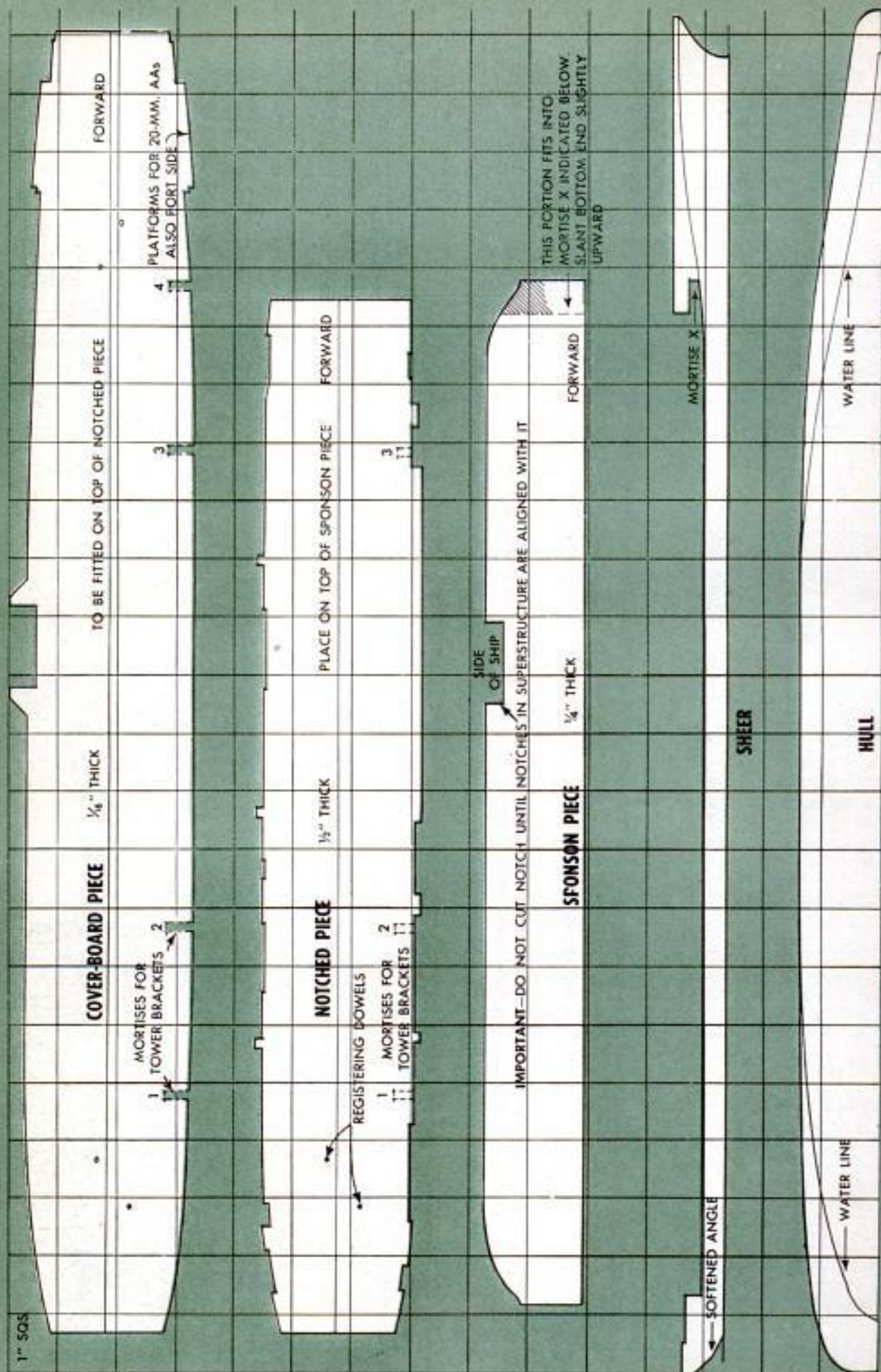



## Location of Car in Parking Area Revealed by Flag on Antenna

Made from brightly colored material, a small pennant which can be fastened to the top of the radio antenna of your car will enable you to spot it more easily when parked in a large, unattended parking area. Cut the pennant 8 to 12 in. long and about 3 in. wide, and tack it to a spring-type clothespin. Rolled and stored in the glove compartment, the pennant will take up negligible space and yet always will be available when needed.

Harold Cripe, Racine, Wis.

## Steaming Stamps From Envelopes

Collectors who wish to remove stamps from old envelopes can do the job quickly by steaming them in a wire strainer set in the top of a teakettle. To keep the stamps from curling after removal, place them between weighted blotters to dry.

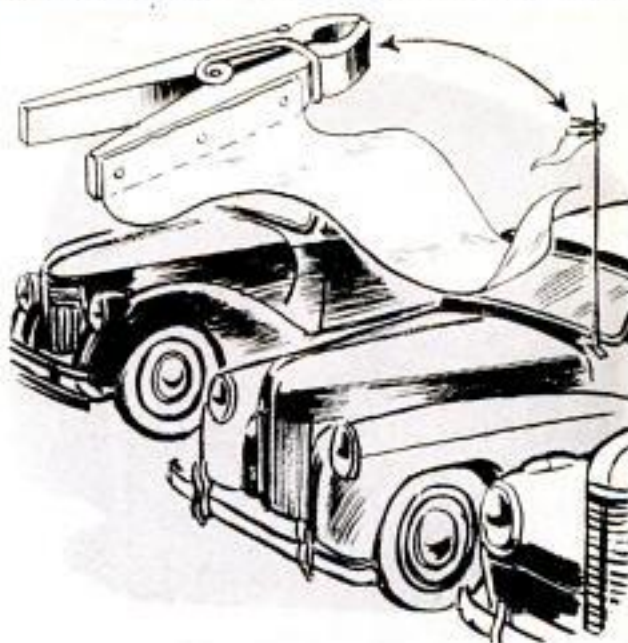

## Egg-Crate Fillers Provide "Pots" for Seedlings Started Indoors

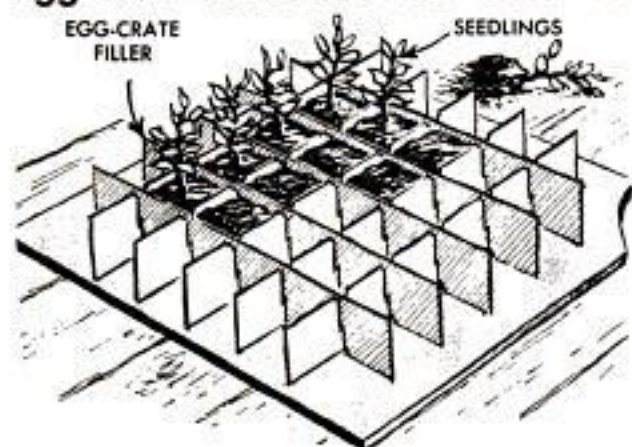

Egg-crate fillers make ideal "pots" for starting seeds indoors early in the spring. Set the filler on a base of sheet metal, hardboard or in a shallow pan. The latter is desirable, as it permits moisture to be added from underneath the soil and packing of surface soil is thus avoided. In the latter case, give the filler two coats of spar varnish to prevent disintegration of the cardboard. When seedlings reach transplanting size, the filler is easily peeled away leaving each plant in its own block of earth which can be readily transferred to the garden. Marguerite McLees, Moose Jaw, Sask., Can.

## Wax Dressing Helps Preserve Outboard Starting Rope

The useful life of an outboard-motor starting rope can be doubled by frequently dressing it with beeswax, which greatly decreases normal chafing and wear. It is best done during the warm part of the day when the wax will be softer and more readily applied.

## Avoiding Motor Corrosion

To prevent the formation of rust and corrosion which gathers on power heads and exposed bolts of outboard motors that are used in salt water, spray the motor with a solution consisting of the greaselike rust preventive sold by most oil companies, 1 part, and carbon tetrachloride, 3 parts. After dissolving the compound thoroughly, apply with a common fly sprayer. When set, the coating will withstand considerable contact with water, and even with gasoline, before losing its protective qualities.





## Foam-Rubber Pad on Palette Helps Prevent Cramped Hand



To avoid a cramped thumb and hand caused by gripping a palette for a long period of time while holding a handful of brushes, one artist uses a piece of sponge rubber fastened to the underside of the palette. The foam rubber is cut to the shape shown in the sketch, and glued with rubber cement to the bottom of the palette.

Lance Werner, Cleveland, Ohio.

## New Furnace Adjustment Assures Even Heating

A new method of adjusting the controls of a forced warm-air furnace provides greater comfort and economy during the winter months, and prevents the extreme fluctuations that sometimes occur during the fall and spring. The new method entails running the blower most of the time, but at a reduced speed. This allows an almost constant circulation of air, and in changeable weather when the outside temperature suddenly rises, permits the air to dissipate the extra heat more rapidly. Thus a

### Free How-To-Make-It Index

Write the Bureau of Information, *Popular Mechanics Magazine*, 200 East Ontario Street, Chicago 11, for your free copy of the latest index to all the how-to-do-it sections of *Popular Mechanics*

more constant temperature is maintained inside the house.—National Warm Air Heating and Air Conditioning Association.

## 145 Public Square - Cleveland 14, Ohio Rear Window of Car Kept Clear By Concealed Defroster

A blower unit of the type sold for replacement in car heaters can be installed under the package shelf of your automobile to serve as a defroster for the rear window. A round hole for the air outlet is cut in the package shelf and covered with wire screening, thus leaving the shelf unobstructed. The blower unit is fastened to the inside of the trunk, and a flexible air hose is led to the opening on the package shelf. A switch should be mounted on the instrument panel to give the driver control of the unit.—Ed Packer, Chicago.

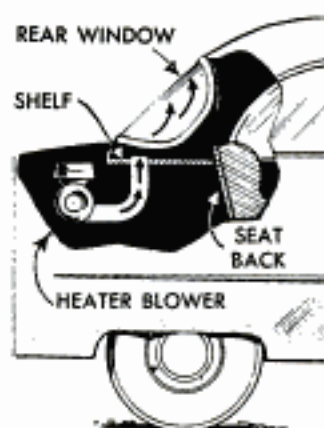

## Metal Foil in Picture Window Reflects Light and Heat

Aluminum foil, widely used for a variety of purposes, was utilized by one homeowner to reflect the blinding hot rays of the afternoon sun that shone through a large picture window on the west side of the house. Besides keeping the temperature down an appreciable amount, the foil prevents the sun from fading the drapes, rugs and furniture. The foil may be purchased in different widths and in both heavy and light-gauge thickness. Because it is metal, careful handling will allow it to be removed and stored for use the following year.

John L. Hoke, Washington, D. C.







## HOW YOUR BRAKES WORK

**N**O PART OF a modern passenger car is called on more frequently to absorb sudden high stress and frictional heat than the brake system. A mechanically minded motorist can do much to make sure his brakes will give maximum trouble-free service once he understands the principles on which the brake system operates. The majority of passenger cars are equipped with hydraulic brakes, which operate on the principle that pressure applied to a closed column of an incompressible fluid will be transmitted to all surfaces with equal force. The principle is utilized in automobile brakes by employing a master cylinder to develop the pressure, and four wheel cylinders which transmit this pressure to brake shoes bearing against the drums. In a typical brake system, Fig. 1, the master cylinder is mounted beneath the floor of the car, and is connected to brake pedal by means of mechanical linkage.

**Master cylinder:** The master cylinder consists of a pressure chamber, a fluid reservoir located above the pressure chamber and a combination filler cap and breather

plug on the reservoir which permits atmospheric pressure to act on the brake fluid in the reservoir. A piston in the pressure chamber compresses the fluid ahead of it when force is applied through the brake pedal. As the pedal is depressed, the piston and cup assemblies move forward in the master cylinder, closing off the compensating port, Fig. 2, A, and forcing the fluid through the check valve into the brake lines. Actual braking pressure is not built up until all the shoes are in contact with the drums. Additional pressure then increases the braking action. When pressure on the pedal is released, a spring returns it independently of the master cylinder. Meanwhile, the piston spring forces the piston to follow the push rod back until stopped by the stop plate. The spring also holds the primary cup firmly against the piston and keeps the check valve in place. In each wheel, Figs. 3 and 4, the retracting springs on the shoes pull them away from the drum and force the pistons and cups in the wheel cylinders back to the release position. This, in turn, forces the fluid back

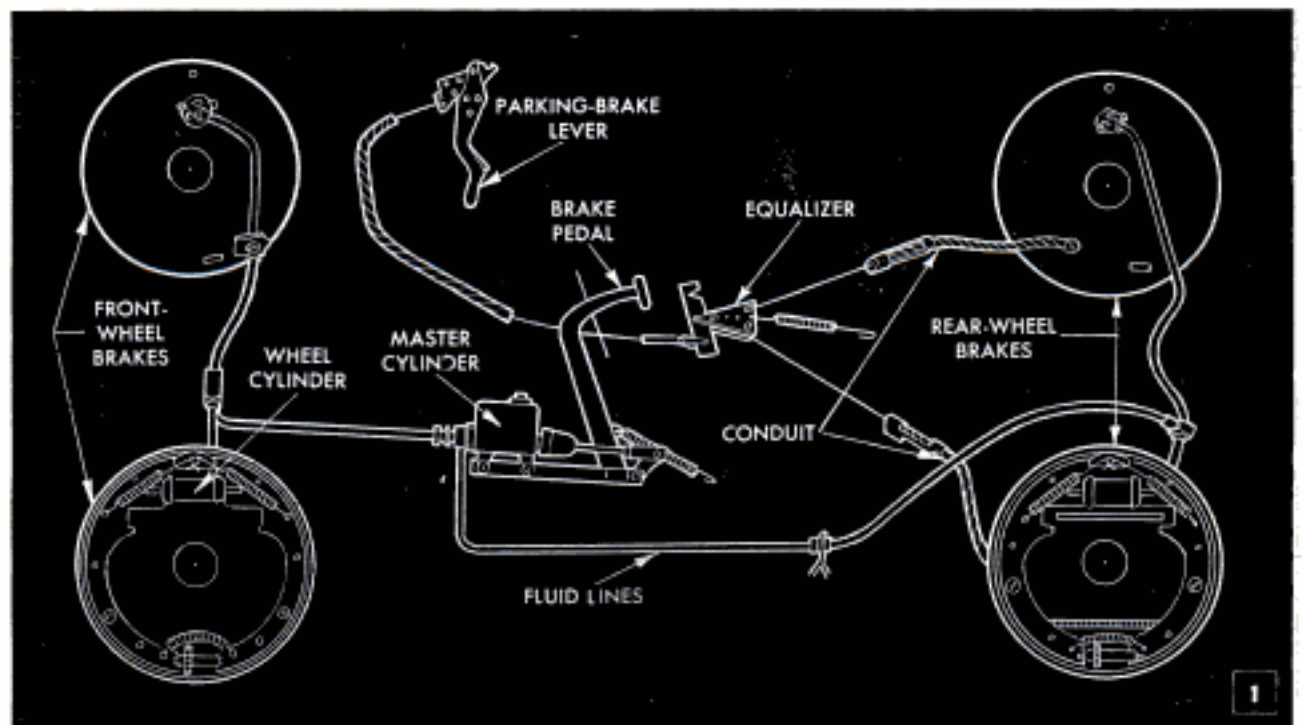



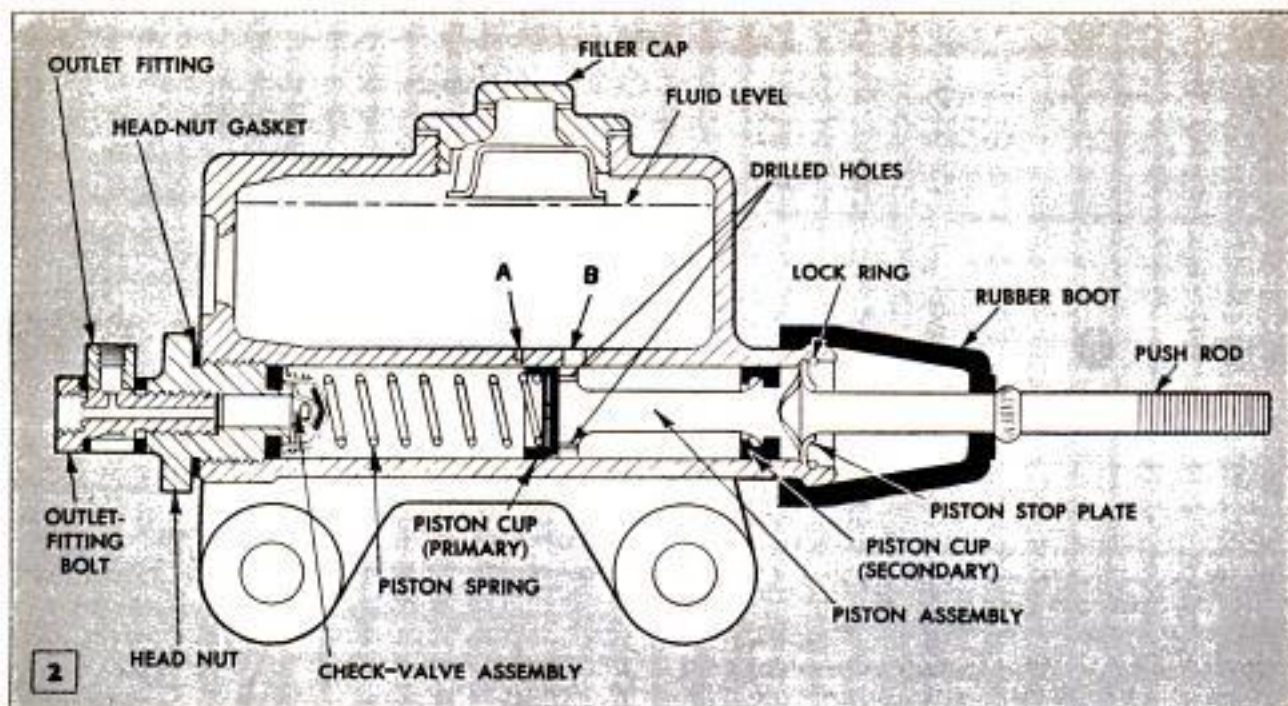

through the lines to the master cylinder. When the line pressure equalizes with the piston-spring pressure, the check valve closes. Depending on the model of the car, this action maintains a fluid pressure of from 8 to 16 lb. in the lines and wheel cylinders. This constant pressure prevents air from leaking into the system. As shown in Fig. 2, a secondary cup is fitted over the rear of the piston. This secondary cup acts as a seal to prevent the fluid from leaking out the back when fluid from the reservoir passes through vent B into the recessed area of the piston behind the primary cup. When the brake is released, the piston and cups in the master cylinder move back so rapidly that a partial vacuum is created in the pressure chamber. This vacuum is relieved by drawing fluid into the pressure chamber through small holes drilled in the face of the piston and over the lip of the primary cup. The primary cup must clear

port A when the brakes are released, or the compensating action will not take place and the brakes will drag. Correct adjustment of the brake pedal positions the primary cup.

**Wheel cylinder:** When the brake fluid, under pressure, enters the wheel cylinder, Fig. 5, it forces the cups out against the pistons which in turn transmit the force through connecting links to the shoes causing them to bear against the brake drum. Only after all shoes on all wheels are in contact with the drums will pressure be built up in the system. This assures simultaneous action of all brakes.

**Parking brakes:** Depending on the make and model of car, parking brakes, Fig. 1, are operated either by a hand or foot-operated lever, located just below the instrument panel. In most cars this lever is connected by conduit cables to the brake shoes on the rear wheels only. A single cable runs

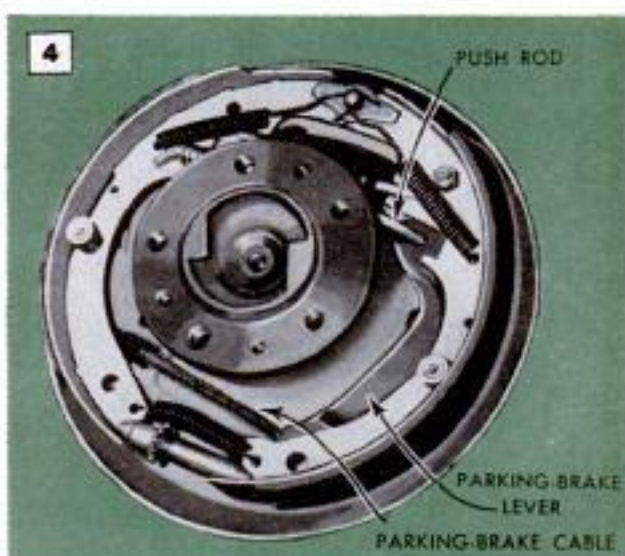
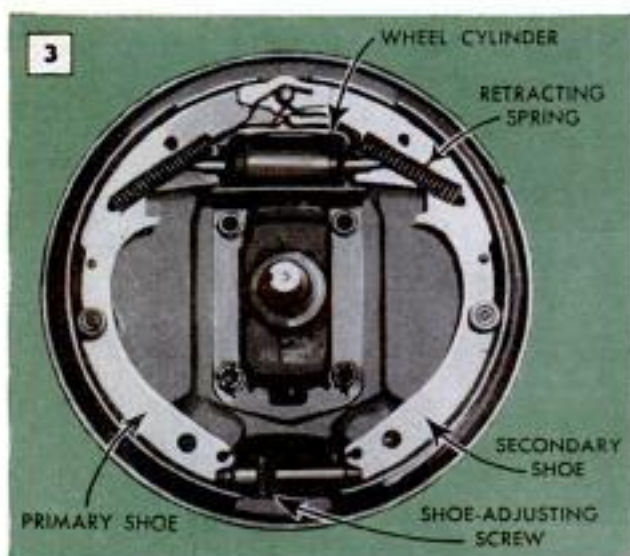



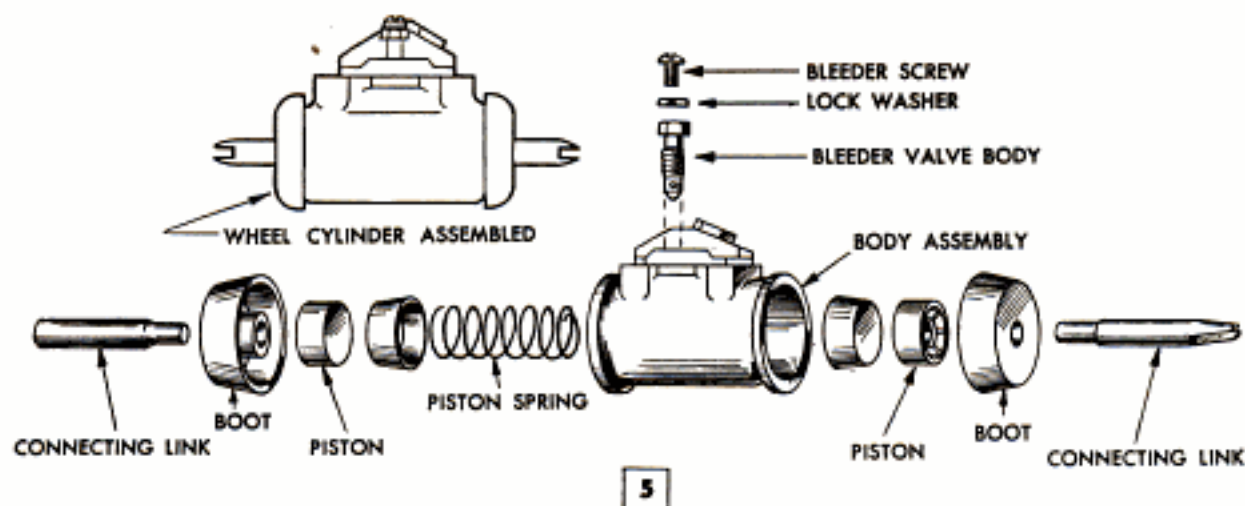

5

from the parking-brake lever to an equalizer. Other cables lead from the equalizer to each of the rear-wheel brakes. Each cable fastens to the free end of the parking-brake lever which pivots at its top end on the secondary brake shoe, Fig. 4. A push rod, joining the secondary and primary brake shoes, is mounted horizontally just below the wheel cylinder. When the parking-brake lever is operated, the cables apply an equalized pull to each of the push-rod levers, which actuate the push rods and force the brake shoes against the drums.

**Bleeding hydraulic system:** Air in the hydraulic system will cause a "spongy" pedal and inefficient brakes. Air will enter if the fluid level in the master-cylinder reservoir is too low. Worn parts in the system may result in leakage, and air frequently enters the system when some part of the brake mechanism is removed for repair. Air should be removed from the hydraulic system by bleeding and refilling. Fig. 7 illustrates the filler-jar method of bleeding. All parts of the brake system must be assembled when bleeding the lines. To bleed the system, remove the filler cap from the master cylinder, first making sure the top of the cylinder is perfectly clean. Then insert the neck of a standard filler-jar full of clean brake fluid into the cylinder opening. Next, remove the bleeder screw from the wheel-cylinder bleeder valve, Fig. 5. Attach a bleeder hose to the bleeder valve. Place the other end of the hose in a container partially filled with brake fluid, making sure the end of the hose is below the surface of the liquid. Open the bleeder valve about  $\frac{3}{4}$  of a turn and have someone press the brake pedal down slowly and then release it slowly. When air bubbles cease to show in the fluid in the container, you can be reasonably sure that air has been bled out of the cylinder and line. Tighten the bleeder valve, remove the bleeder hose and replace the screw. Repeat this procedure at each wheel. When the bleeding

On cars having two cylinders per wheel, each cylinder has one spring and half the parts shown above

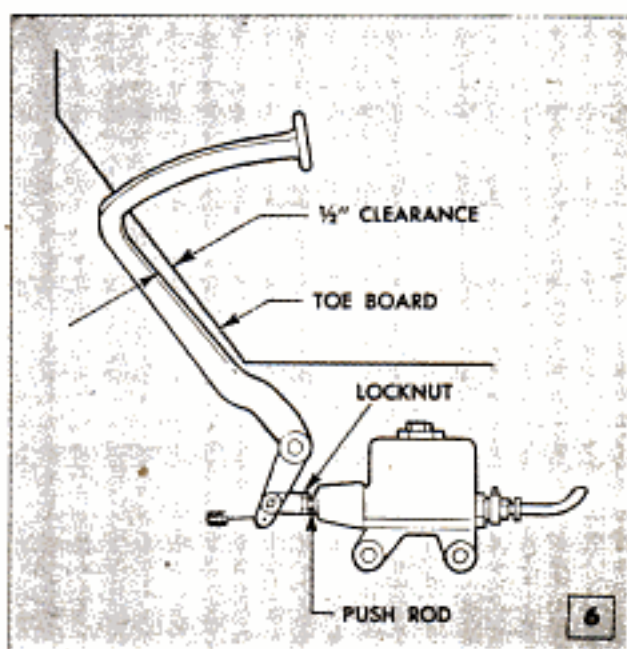

The clearance between brake-pedal arm and toe board is shown above. In filler-jar method of bleeding brakes, below, jar is attached to master cylinder

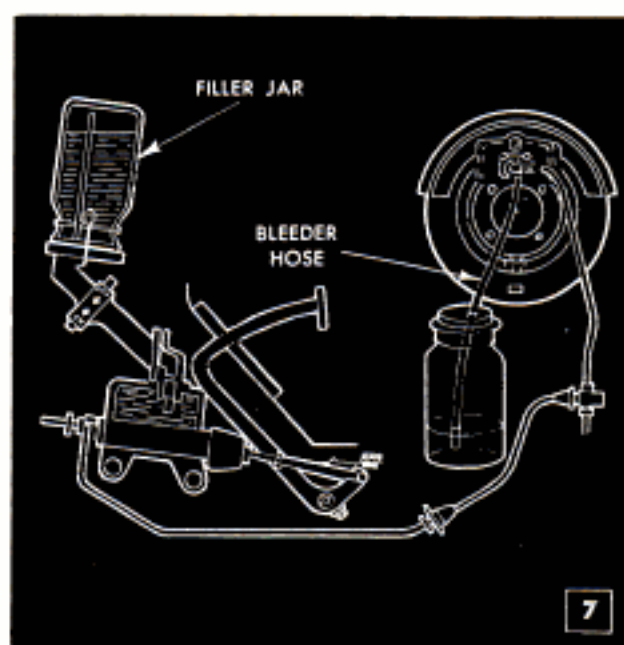

7



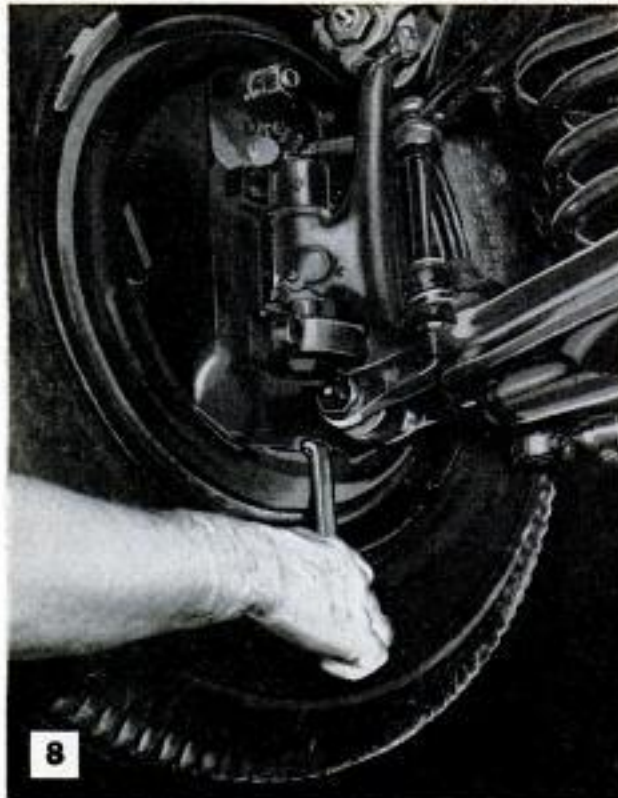

operation is completed, make sure the master-cylinder reservoir is filled to the proper level.

**Maintainance:** Some cars have a pedal stop incorporated in the master-cylinder casting, others have an adjustable stop in the linkage. These stops hold the brake-pedal arm about  $\frac{1}{2}$  in. below the toe board, Fig. 6. In addition, there must be  $\frac{1}{2}$  to  $\frac{3}{4}$  in. of free pedal movement, that is, the pedal can be pushed down freely  $\frac{1}{2}$  in. or more with no resistance except that of the pull-back spring. This will assure that the piston in the master cylinder can move back to clear the compensation port.

**Adjusting brakes:** First, check the brake pedal for proper master-cylinder clearance, and look on the inside surface of each wheel for traces of leaking brake fluid. If the emergency brake does not release completely, disconnect the emergency brake-cable conduits from the backing plates and slide the conduits along the cable. Clean

the cables with emery cloth, wipe clean and lubricate sparingly. Replace the conduits. Next, jack up each wheel in turn. If there is an eccentric on the rear shoe (this pertains to the Bendix-type brake), adjust it until the wheel starts to drag, then back off until the wheel turns freely. Repeat this procedure by expanding the adjusting screw with a brake wrench or screwdriver, Fig. 7. Lockheed-type brakes usually have an adjustment on each shoe, and these are adjusted in the same way. Check all nuts and bolts on the backing plate to make sure they are tight, Fig. 8. On the Lockheed-type brake, if the anchor bolts are loose, tighten the locknuts while holding the anchor bolts with another wrench. If these anchor bolts turn, it is usually necessary for a mechanic to reset them, using a dummy drum or special gauges. After adjusting the brakes, road-test the car to make sure all wheels brake evenly. ★ ★ ★

### TROUBLE-SHOOTING HINTS

EFFECT	Pedal Goes to Floor	Car Pulls to One Side	Spongy Pedal	Brakes Fade
<b>POSSIBLE CAUSES</b>	Worn linings Loss of fluid Air in system Brakes need adjusting Worn master cylinder Clevis pin missing from pedal linkage	Grease or brake fluid on linings Bad linings Primary and secondary shoes reversed Clogged hydraulic line Wheel cylinder sticking Loose backing plate	Air in system Wrong brake fluid Worn lining Drums worn too thin Anchor pin adjustment incorrect Wrong lining thickness Master cylinder filler-cap vent clogged Brake drum distorted	Worn lining Poor lining contact Wrong lining Drums worn too thin Expansion of drums from heavy braking



## Light-Tight Darkroom Heater Uses Bunsen Burner

For chilly nights in the darkroom, here's an odorless, safe and light-tight heater that doubles as a stove for warming chemicals. The heating unit is an old Bunsen burner, although the jet from a hot-water heater will do as well. The burner is placed inside a 1-lb. coffee can fastened to an inverted piepan, which serves as a nontip base. Six  $\frac{1}{2}$ -in. ventholes are cut in the lower edge of the can and made light-tight by metal strips soldered behind them. Several large holes are cut in the lid of the coffee can, one being directly over the flame from the burner. This lid is then welded to the end of a length of downspout. Slits are cut into the edge of the other end of the downspout, and the tabs thus formed are bent inward. Cut a metal baffle, with a diameter 1 in. less than the downspout, with three ears equally spaced. Install the baffle inside the upper end of the downspout by bending the ears over the edge, making sure there

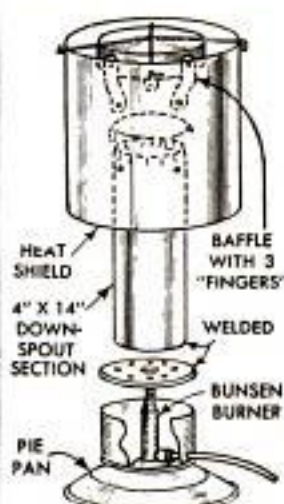

is  $\frac{1}{2}$ -in. clearance all around. Remove the lid and metal sealing strip from another coffee can. Fasten the strip to the inside edge of the rim of the lid. This will be the stove cover, which is fastened to the downspout body by three metal strips, or fingers, 1 in. x  $2\frac{1}{2}$  in., using sheet-metal screws. A length of 8 or 10-in. stovepipe with a crossed-wire support near the upper edge makes an efficient heat shield to prevent accidentally touching the hot stove body.

Clinton R. Hull, Costa Mesa, Calif.

## Thermometer in Darkroom Hose Indicates Water Temperature

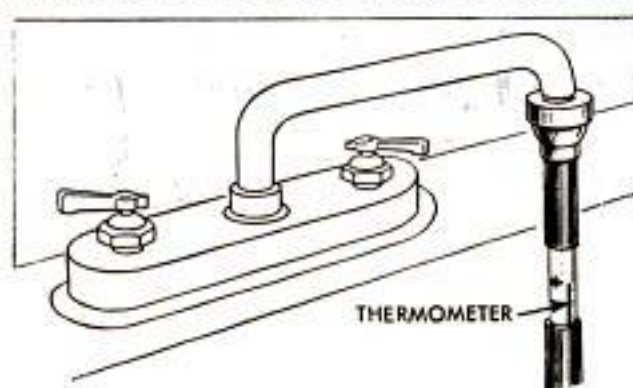

To keep a close temperature check on the water used in washing negatives and prints, install a thermometer in the hose leading from the darkroom mixing faucet to the print washer or developing tank. Cement the glass tube from an ordinary outdoor thermometer inside a short length of plastic tubing, using a strong waterproof cement. Then cut the hose near the faucet and insert the tubing into the hose as shown. When the thermometer is in place, turn on the water and, with a second thermometer, carefully adjust the water to washing temperature. After the water has run for a few minutes, use red fingernail polish to mark the plastic tube at the mercury level of the thermometer cemented

inside. Then, whenever you wish to bring the water to washing temperature, simply adjust the faucets until the mercury level is aligned with the mark on the tubing.

John J. Rea, Urbana, Ill.

## Petroleum Jelly Deepens Tones When Copying Matte Prints

Since matte photographic prints are dull in finish and lack any really deep black, they have less range of tone than glossy prints. For this reason they make poor copies and photoengravings. This can be remedied to some extent by rubbing a film of transparent petroleum jelly on the surface of the print. This will deepen the black tones by eliminating some of the surface reflections, and give the print a more brilliant appearance, producing better copies and engravings.

Virginia Hanson, Los Angeles, Calif.

## What About Used Cars!

You take no chances in buying a used car if you know where and what to check. Read the factual article in next month's issue and learn how to purchase a used car with confidence





## Repairing Camera Bellows and Shutter Curtains

Tiny holes and other defects that develop in camera bellows and shutter curtains can be repaired effectively by coating them with a mixture in which rubber cement provides a base for an opaque color pigment. While there are a number of flexible adhesives and pigments which, with a little experimentation, may be used successfully for this purpose, the combination of dry lampblack mixed with a synthetic rubber-resin cement will be easy to prepare and provide very satisfactory results. The pigment and the rubber cement should be mixed thoroughly, using lacquer thinner to thin the cement if necessary, as shown above left. A thin coating is then applied uniformly over the defective areas with a small brush. If the finish on the inside of the shutter curtain has flaked off, it's a good idea to recoat both the inside and out-

side surfaces, as shown in the center photo. The mixture is easily brushed on practically any type of camera bellows, shown above right, and provides a smooth, nontacky surface once the solvent in the cement has evaporated. In covering large holes, a piece of black cloth that has been saturated with the cement may be used as a patch. On the other hand, a new flexible paint on the market will be found ideal for renewing the finish and sealing leaks on leather bellows. It will not crack or peel from repeated bending and can be applied over patches.

### Wax for Ferrotypes Plates

Paraffin dissolved in lighter fluid makes an excellent solution for waxing ferrotypes plates. A lighter-fluid can provides a handy dispenser for applying the solution.

## Popular Mechanics Bookshop



### Railroad Album

Every railroader—the real one, the armchair Casey Jones or the model enthusiast—will welcome this book. It's a picture history of the iron horse from the Tom Thumb of 1830 to the streamlined train of tomorrow, with a commentary that changes history into lively entertainment. Price, \$3.00



### Toys You Can Make

This book is a double measure of enjoyment: fun for Pop as he makes the toys, and a boisterous time for the kids when they play with them. Complete plans for toys for every age from tots to teens. Projects include kiddie video, a "giggle getter" airplane and a motorized carousel. Price, \$2.00



### What to Make

The latest edition of Popular Mechanics' famous collection of top-notch projects—more than 500 things to make. Here is a book for the beginner as well as the experienced craftsman. Included are such projects as glassware, lamps, furniture and a big model of the SS United States. \$2.00

All books available from Popular Mechanics Book Department, 208 E. Ontario St., Chicago 11



This jigsaw is standard size and has a 1½-in. stroke. It uses regular straight-end blades in the common sizes from fine to coarse. Large table tilts 45 deg. in two directions

SN 55

By J. Vincent Webster

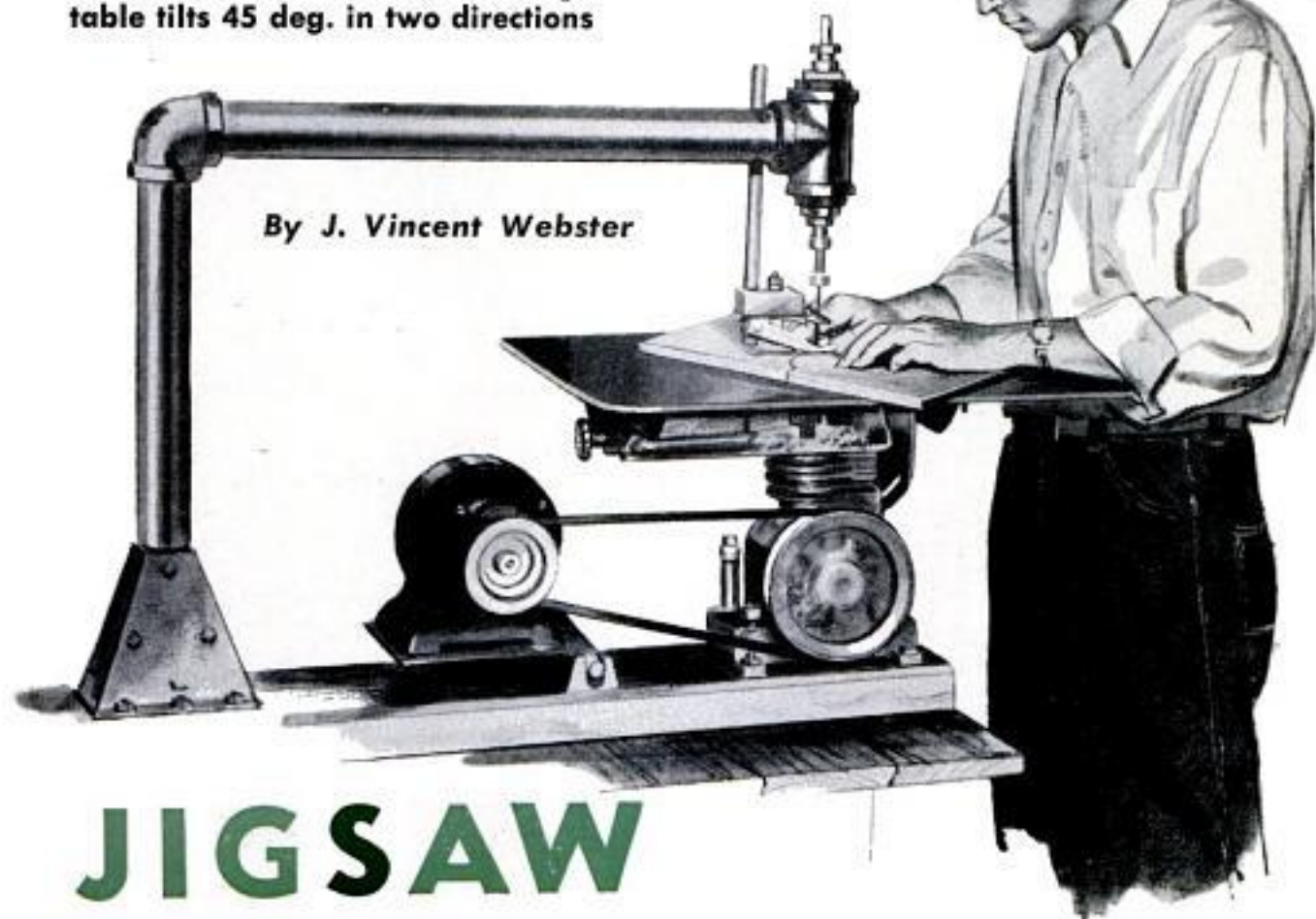

## JIGSAW

### FROM SMALL ENGINE BLOCK

A SMALL GASOLINE engine stripped down to the block and crankshaft assembly becomes the sturdy driving mechanism of this 24-in. jigsaw. Any engine of the vertical air-cooled type having a 1½-in. stroke can be utilized. Also it is possible to use an old single-cylinder refrigerator or air compressor of the vertical type. All other parts are made from stock materials. The overarm is assembled from 2-in. pipe and fittings, the pipe tee at the outer end of the arm serving as a housing for the spring-tension mechanism and upper blade guide.

Strip the engine or compressor of all parts except the crankshaft, connecting rod and piston. Replace the engine flywheel with a 5-in. V-pulley. Drill a ½-in. hole through the top of the piston for insertion

of the ½-in. rod on which the lower blade chuck is mounted. Both upper and lower blade chucks can be purchased ready-made as repair parts for commercial jigsaws. The lower end of the ready-made chuck is drilled so that it can be slipped over the end of the rod, or plunger, and locked in place with a setscrew. In some cases it may be necessary to shoulder the upper end of the ½-in. rod so the chuck can be fitted. It also is possible to make a suitable blade chuck by simply slotting the end of the ½-in. rod with a fine hacksaw blade to a depth of about ½ in. Then sweat-solder or weld a ½-in. shaft collar to the upper end of the rod. Drill and tap straight through the shaft and collar at right angles to the slot for ¼-in. setscrews. Hollow setscrews turned into the holes will hold the blade



securely in position. The upper blade chuck also can be made in this manner if desired. On some engines and compressors the top end of the piston will not permit a nut to be used on the end of the plunger, as in the lower left-hand detail on page 221. In this case it will be necessary to drill and tap the top end of the piston, and then turn the threaded end of the rod into the hole. Tightening the upper nut will hold the rod in place. In either case, thread the end of the rod  $\frac{1}{2}$ -13 N.C. (National Coarse).

Now, measure the height of the engine or compressor block from the bottom of the base to the top. The height of the engine used in the original jigsaw is about  $9\frac{1}{8}$  in. and dimensions of all other related parts are based on this height. If the height of the compressor or engine you have at hand varies from this height, then it will be necessary to alter dimensions of other parts accordingly. An example of this is the arm upright, the length of which is given in the details as  $17\frac{1}{4}$  in. If the engine or compressor you have varies from the height of the original, the length of the upright will have to be changed to assure that the table and arm are at the correct height when the units are assembled. Be sure to check before you cut parts to size.

When assembling the upper chuck guide, upper left-hand detail on this page, it's a good idea to use brass pipe plugs for the upper and lower bushings carrying the  $\frac{1}{2}$ -in. plunger. Drill the holes through the plugs  $\frac{7}{16}$  in. in dia. and ream to  $\frac{1}{2}$  in. Use polished steel shafting for the plunger. Also, it's best to use 1-in. brass pipe for the upper chuck guide. This is slotted  $\frac{9}{32}$  in. wide to clear the  $\frac{1}{4}$ -in. steel crosspin which rides in the slot and prevents the plunger from turning. By using brass plugs for bushings and brass pipe for the chuck guide, compatible wear surfaces will be provided for both the plunger and pin.

The sector, or trunnion yoke, center detail at the right, is made by cold-bending  $\frac{1}{8}$ -in. flat steel. Note the assembly of these parts in the cutaway view on the opposite page. The complete assembly consists of the front and rear sectors, or segments, the yoke, the lower blade guide and its angle-steel support, and two angle-steel brackets to which the segments are bolted. As will be noted, the table is bolted to the brackets when the assembly is complete. Again it is necessary to carefully check the dimensions before cutting parts. Bolt holes in the yoke should be located from the cylinder head of the engine or compressor. The clearance hole, which must be at least  $\frac{1}{4}$  in. larger in dia. than the piston, should be located likewise. The latter can be cut through with a plumber's hole saw if no circle cutter is available. The blade-guide

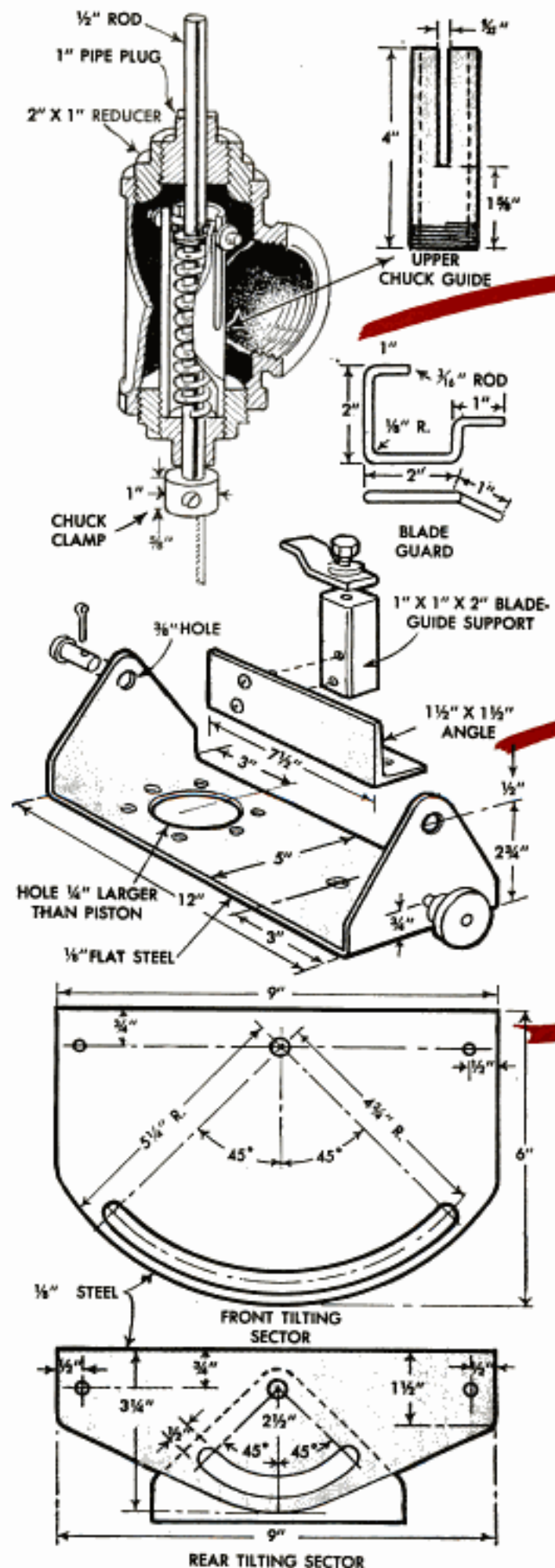







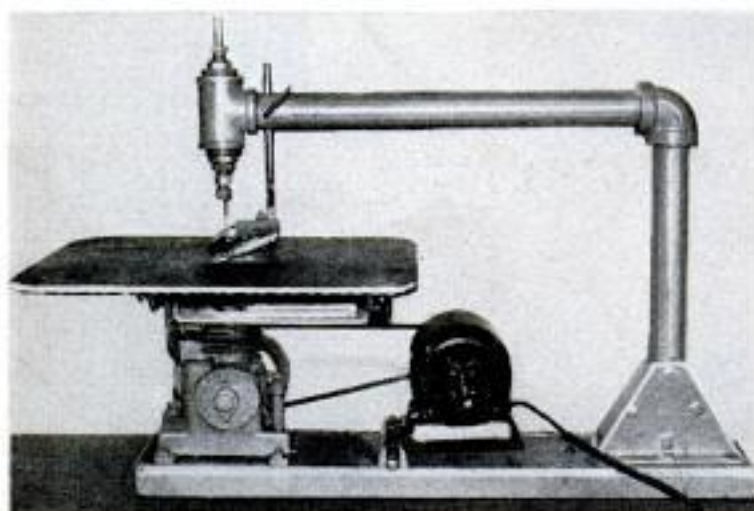
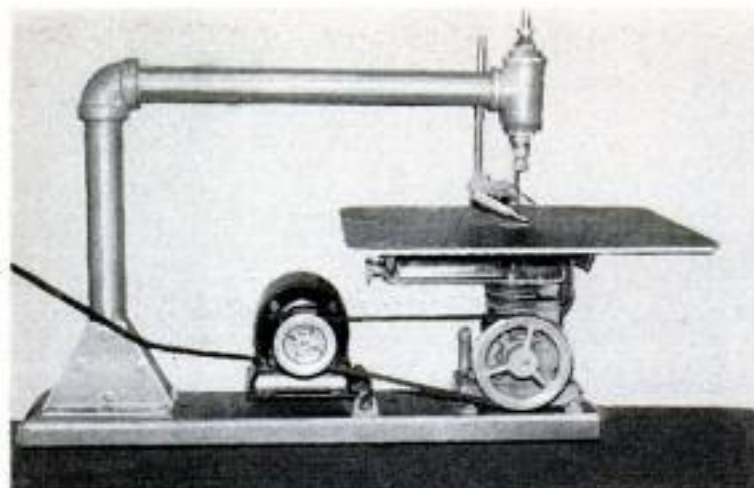

Right and left-hand views of the completed jigsaw. Although the swing, or blade-to-frame capacity of the saw is given as 24 in., this may vary slightly due to irregularities in the length of the pipe threads. Capacity can be increased to 30 inches

support is a 2-in. length of 1-in.-square steel with tapped holes for  $\frac{1}{4}$ -in. machine screws. This part is mounted on a steel angle, the latter being bolted to the yoke where it serves the dual purpose of a support for the lower blade guide and also as a stiffener for the overhanging portion of the yoke.

On the original jigsaw the manifold pad of the stripped engine permitted the use of a front sector, or segment, of the size given. In some cases, due to the design of the engine block, both segments will have to be made the same size. In either case the table should pivot on keyed pins, rather than bolts. Note the  $\frac{3}{8}$ -in. pivot pin in the center detail on page 220. Cut the curved slots in the segments  $\frac{1}{2}$  in. wide and use  $\frac{3}{8}$ -in. locking bolts fitted with wing nuts, or use a small handwheel, or palm wheel, as in the lower center detail on page 221.

Bolt the flat-steel brackets to the vertical member of the overarm and then bolt the assembly to the hardwood base. Tie a small weight to a cord and grip the free end of the cord in the upper blade chuck. Then

use this improvised "plumb bob" to locate the position of the engine or compressor. First, place the assembly on a table and level it. Then locate the engine with the lower blade chuck centering directly under the suspended weight. Mark the location of the bolt holes on the wooden base; drill the holes and bolt the engine in place.

If a counterbore for cutting the shouldered blade opening in the table is not available, cut the hole through with a 2-in. hole saw. Then cut a hole through a small piece of  $\frac{1}{8}$ -in. flat steel with a  $1\frac{1}{2}$ -in. hole saw, and screw this piece to the bottom of the table with the holes concentric to form the shoulder which supports the insert. The latter can be made from  $\frac{1}{4}$ -in. hardboard or fiber. It also is possible to make the table from  $\frac{3}{8}$  or  $\frac{1}{2}$ -in. plywood.

The pressure-foot assembly, which includes the upper blade guide, is dimensioned in the upper details on page 221 and shown fully assembled in a separate detail on the same page. It is carried on a  $\frac{1}{2}$ -in. rod which slides in a hole drilled through the overarm. The guide is held in any position by means of an L-shaped locking screw turned into a tapped hole in the overarm. When assembling, be sure that the bottom of the open slot in the pressure foot does not

touch the back of the blade when the foot is raised to its highest position. Engagement of the parts will cause breakage of the blade. Use a  $\frac{1}{4}$ -hp. 1750 r.p.m. motor for the drive. The motor should be mounted on a floating rail as indicated in the details and also in the photos above. Use a  $2\frac{1}{2}$ -in. V-pulley on the motor. ★ ★ ★

### Tighten Electric Motor Bushings By Knurling in Lathe

When new parts are not readily available, worn bearings on electric motors of fractional hp. sizes can be tightened by knurling them in the lathe. These motors have a sleeve bushing that can be pressed or driven out of the end housing. With the bushing held lightly on a mandrel, the outside surface is knurled, leaving  $\frac{1}{16}$ -in. clearance at each end to allow easy reinsertion. The knurling raises the surface a few thousandths of an inch and when the bushing is forced back into the housing the inside diameter will shrink enough to cause a tighter fit on the shaft.—E. J. Gilkerson, Columbus, Ohio.



Because the roller on a conventional stock support tended to pull the length of lumber to one side when the support was not exactly in line with the saw table, one carpenter built his own, utilizing ball-bearing casters. The casters roll easily in any direction, allowing complete control of the stock being sawed. The pedestal of the support is a 12 x 18-in. base to which is fastened a 2-in. pipe flange to hold a 24-in. length of 2-in. pipe. A 24-in. length of 2 x 4, fitted with a 1½-in. pipe flange, holds a number of ball-bearing casters. An 18-in. length of 1½-in. pipe is screwed into the flange, and the unit is then slipped into the 2-in. pipe column. Near the upper end of the 2-in. pipe a hole is drilled and tapped to receive a ⅜-in. steel rod, which is threaded and bent L-shape. This serves

## Adjustable Stock Support for Table Saw Utilizes Ball-Bearing Casters

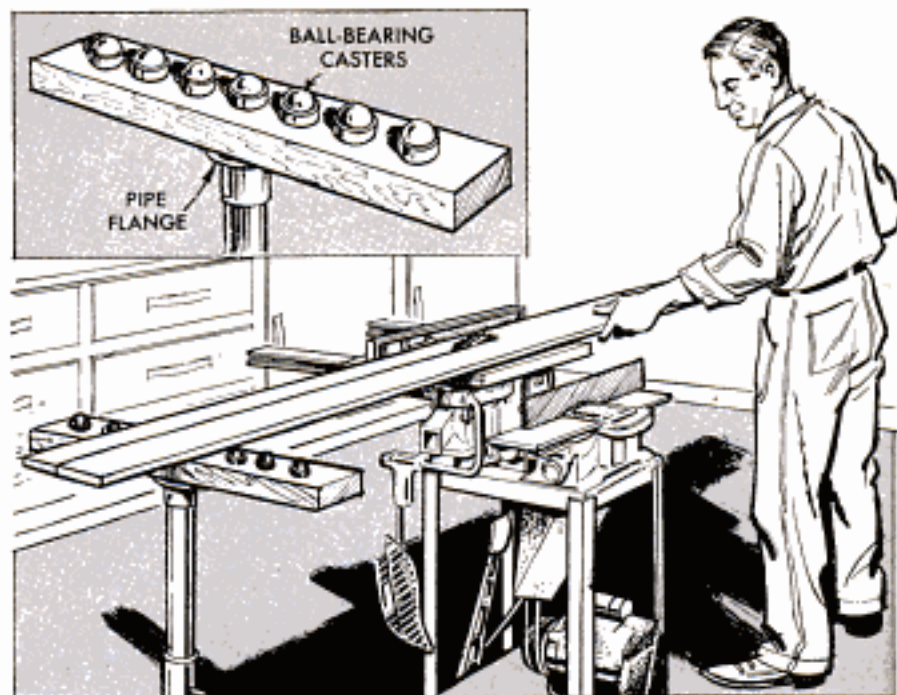

as a lock for the adjustable column of the support.

Fred J. Lingham, Lockport, N. Y.

## Warning Buzzer Prevents Driving With Emergency Brake Set

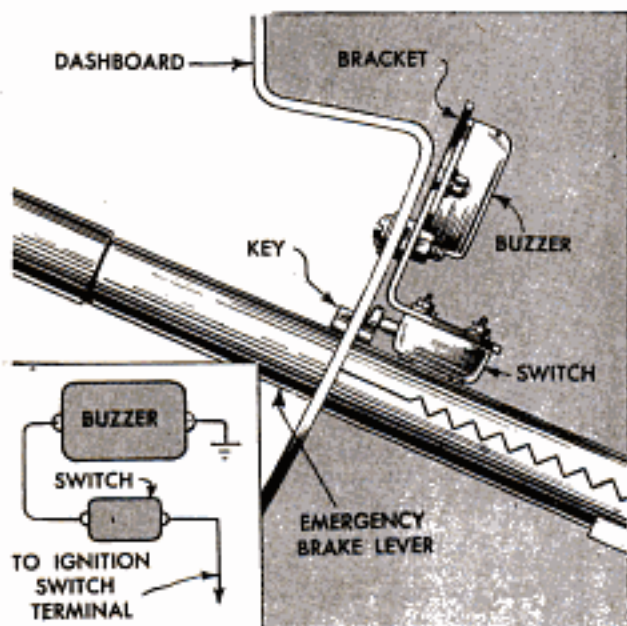

If you have the habit of setting your emergency brake when you park, this warning device will tip you off immediately if you start to drive away without releasing it. Hooked in series with the ignition switch, a warning buzzer sounds when the key is turned on and the brake is engaged. A small doorbell buzzer is secured to the fire wall or dashboard and hooked up with a spring-loaded, off-on switch of the type that is normally on. The arrangement in the sketch uses a "key," made from a piece of ⅜-in. aluminum rod, which floats in a hole in the dash and depresses the switch when the brake handle is in a released position. Depending on the model of car and the type of brake, the key can be a longer screw or a piece of metal fastened to the brake handle.

Sidney V. Worth, Brooklyn, N. Y.

## Kite Hauls Line Over Chimney to Simplify Rigger's Job

When one rigger had the job of replacing the control wires on the damper of a spark arrester near the top of a 120-ft. chimney, he simplified the job by flying a kite over the chimney. When the kite string was above the stem of the T-bar control of the damper, a light line attached to the tail of the kite was used to draw the flying line down over the T-bar stem. Progressively

heavier lines were then tied to the string and drawn up and over the T-bar until a block and tackle was in place. The rigger was then hoisted up in a boatswains chair, carrying the control lines with him. Several men hung their combined weight on the final line to make sure the damper stem would support the man and chair.

Preston Taylor, Detroit, Mich.





Outboard support gives maximum rigidity and must be used for all heavy cuts in iron or steel. The overarm is always used for spindle-mounted cutters

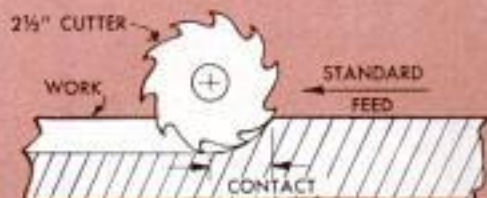
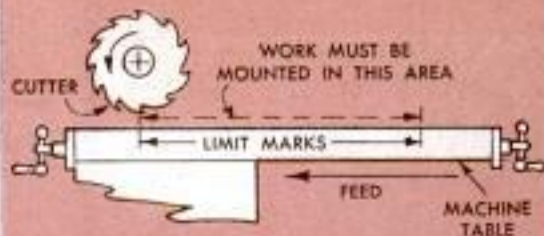

# MILLING-MACHINE SETUPS

## *with plain and side mills*

By Sam Brown

THE COMMON RUN of work on a small milling machine usually is done with two types of cutters—the plain mill and the side mill. A plain mill has cutting teeth only on the periphery, or rim, while the side cutter has both rim teeth and side teeth. These two cutters form a hard-working team with which it is possible to do a wide variety of milling operations.

**General setup:** A common setup for milling with the cutter mounted on the milling-machine spindle is pictured in Fig. 1. Here the work is supported in a milling vise bolted to the machine table, and the outboard support is attached to prevent any tendency of the overarm to vibrate when

a heavy cut is being made. The overarm is not used when making light cuts in steel, or in nonferrous metals and plastics. When the outboard support is used, the milling vise must be placed the long way of the machine table so that it will clear the support. Standard feed is used, with the work moving against the rotation of the cutter. This means that the direction of work travel is from right to left.

**Cutters:** Plain milling cutters less than  $\frac{3}{4}$  in. wide generally have straight teeth. Wider cutters have spiral teeth, Fig. 2, and are furnished both right and left hand. The shearing cut of the spiral mill leaves a smooth surface and eliminates the "ham-

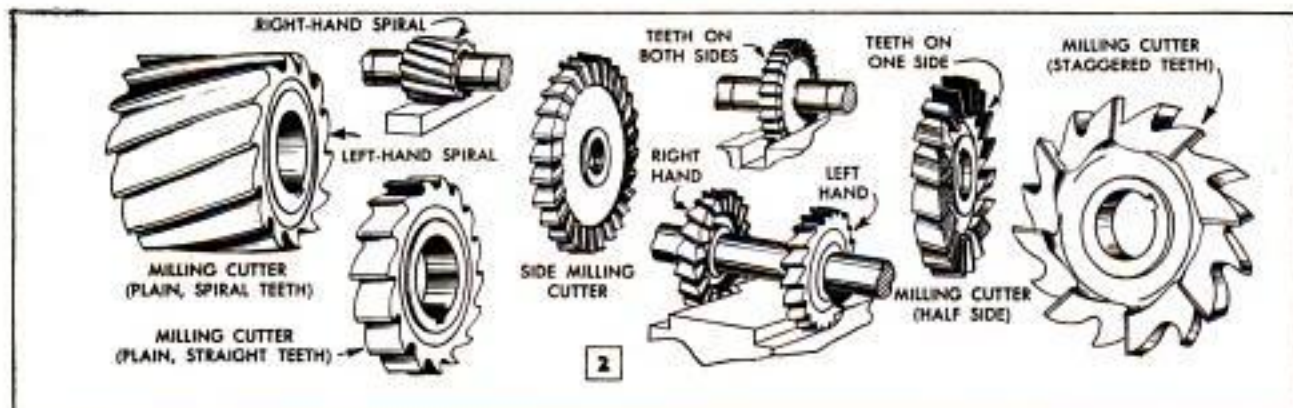



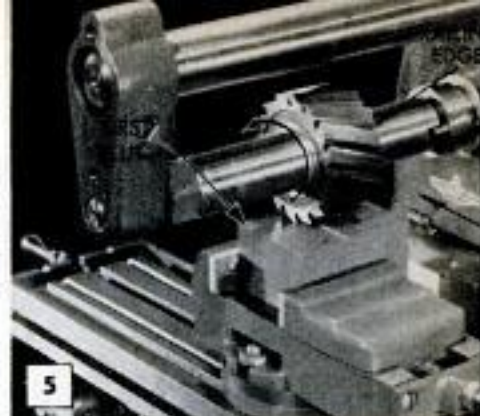

**SURFACING, OR SLABBING**, as it is called in the shops, is main job of the plain milling cutter. Whenever possible, select a cutter that is wider than the stock so that the cut can be made in one pass. However, if a narrow cutter must be used, the shoulder should be formed with the trailing edge as in Fig. 6. Otherwise the cutter may dig in and jam

**MILLING AN EDGE** is done with a spiral mill as in Fig. 7. Work is held in vise and if longer than space between limit marks, it must be moved to continue cut. A spiral cutter can be stopped at any point without leaving mark on work. However, it is necessary to make sure that the work is relocated at precisely the same height in the milling vise

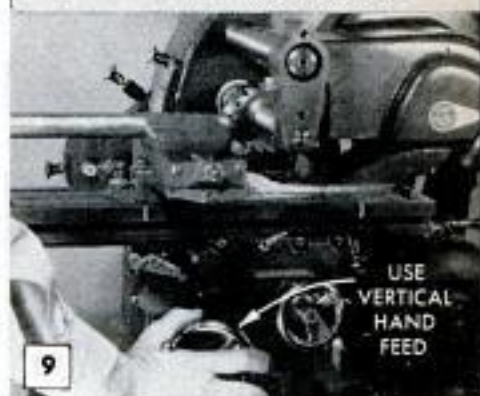
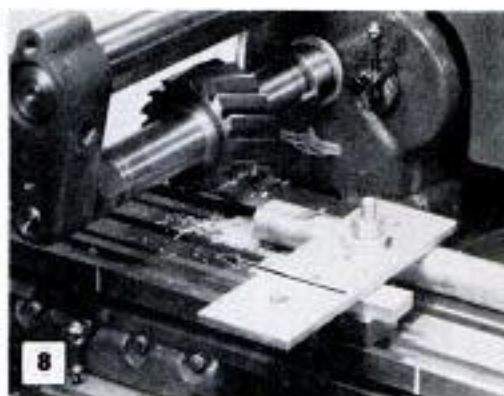
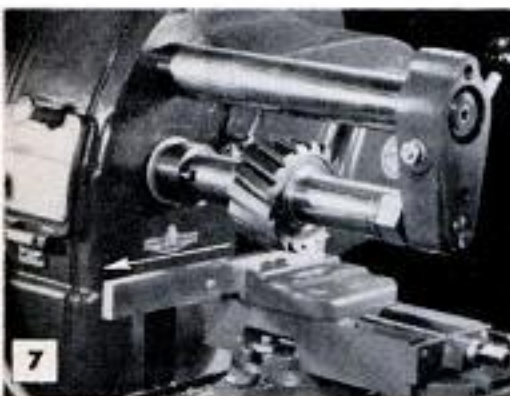
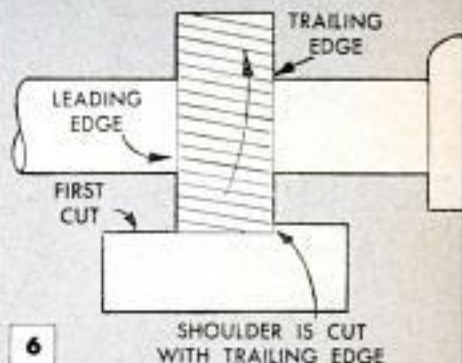

**MILLING FLAT ON A SHAFT** with the cutter running in from the end is a simple operation. Work can be mounted in the vise or clamped directly to the machine table with a clamping fixture as in Fig. 8. Care must be taken to clamp the work securely in one of the V-grooves in the table, as otherwise it may shift even under a light cut. Successive cuts are made, using automatic stop to stop feed of the machine table

**SQUARING AN END** is one of the few milling operations where the work must be mounted at the left of the cutter. Use the vertical hand feed as shown in Fig. 9. Work can be any length that the vise will support. Squaring usually is done with successive cuts to avoid undue strain on the vise, especially if the end of the work has been cut at an angle. Feed up for the roughing cut and down for the finish cut, Fig. 10

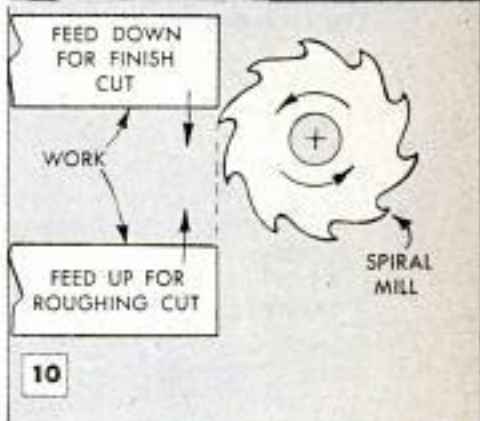

mering" action of the straight-toothed cutter in certain materials. Side mills of conventional pattern have straight teeth. A variation is the side cutter with staggered teeth, Fig. 2, which gives a shearing cut due to the angle of the cutting edge on each individual tooth. Both side and plain mills can run right or left. Nearly all bench milling machines are designed for counter-clockwise rotation as viewed from the operator's position. Because of the direction of rotation, the right-hand spiral cutter is favored by most machinists, as it leads into the work. Average diameter of cutters for use on small machines is 2½ to 3 in.

**Plain milling:** This operation usually is

referred to in the shops as slabbing, or surfacing. Plain milling, or surfacing operations with a spiral milling cutter are shown in Figs. 3 to 10 inclusive. In surfacing operations, as in other work, it is best to determine the length of the cut beforehand and then mount the work within the limits of the machine-table travel. Note the limit marks in the photo, Fig. 1, and also in the upper detail of Fig. 1. Cutters of small diameter usually give a smooth cut in surfacing due to the greater number of teeth in contact. Note the variation in the center and lower detail in Fig. 1. When the work is wider than the cutter, Fig. 5, successive cuts must be used. Using right hand



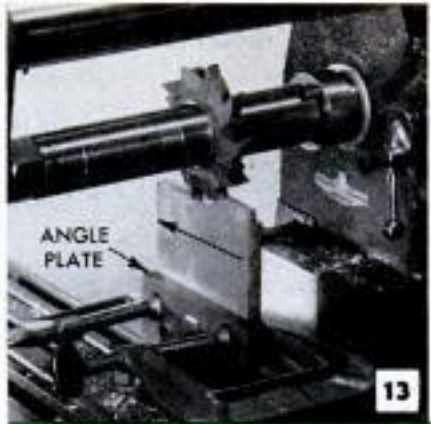

**FLAT ON SHAFT** has square shoulder when worked with a side mill. Fig. 11 shows cut on square stock, while Fig. 12 shows same cut on round stock. Successive cuts are made at full depth until required length of flat is obtained. Use outboard support whenever possible

**MILLING AN EDGE** can be done either with broad, shallow cuts or with successive narrow side cuts as in Fig. 14. As a rule it is best to clamp stock to an angle plate as in Fig. 13, rather than rely on the vise, especially where the work projects more than 1 in. above jaws

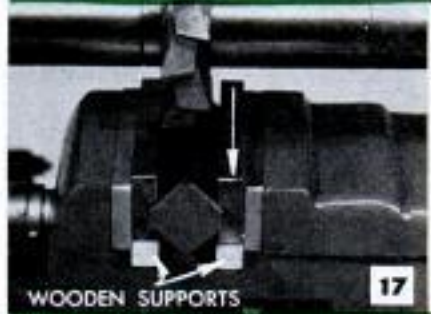
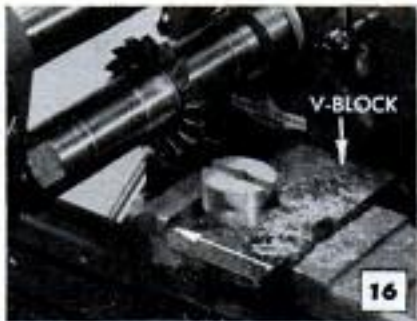
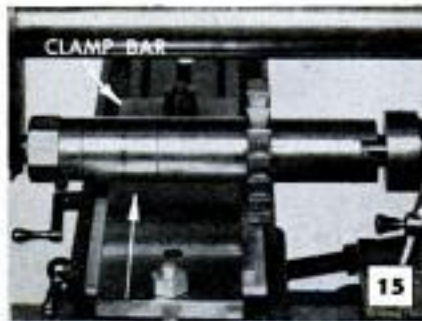
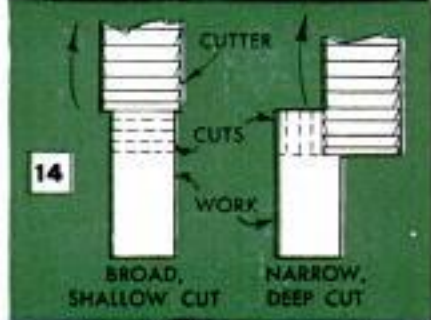

**STEP MILLING**, Fig. 15, is the common term for shouldering or rabbeting operations. Step is run with a side cutter, either in a single cut to depth or with successive, narrow cuts to the required depth. Clamp bar over the work requires a 3-in. cutter for clearance

**SLOTING** usually is done with saws or straight-toothed side mills, Fig. 16, provided the latter are the correct width. Mounting the work sometimes poses a problem. Frequently it is possible to slot long stock by setting up as in Figs. 9 and 10 and using same feeds

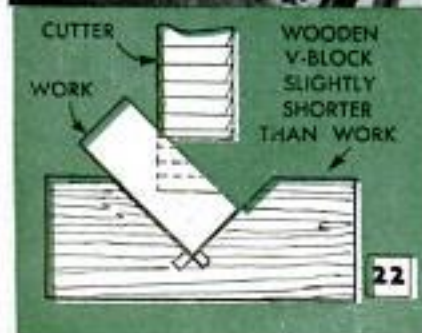
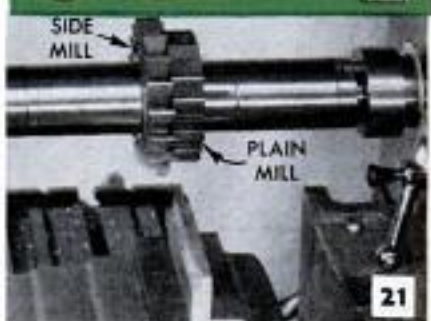
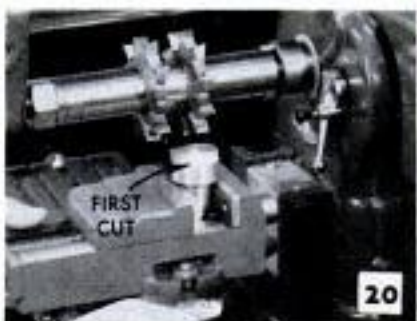
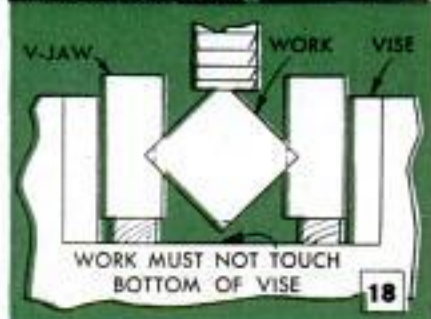

**SETUPS FOR GANG MILLING AND STRADDLE MILLING** are pictured in Figs. 20 and 21. In gang milling the side and plain mills are placed side by side on the spindle to make a combination surfacing and step cut. In straddle milling cutters are placed on the spindle with a collar

**VEE-CUT** is made with the work clamped lengthwise in vise and supported by a hardwood V-block as in Figs. 19 and 22. It's important to note that the V-block supports the work at the correct height, while the vise jaws hold it in position for making successive cuts



# Speed, Feed and Cut

## FOR 2½" and 3" DIAMETER CUTTERS

BASED ON 4 SPINDLE SPEEDS  
AND 4 TABLE FEEDS

60	} REVS. PER MIN.	.003	} INCHES PER REV.
130		.006	
228		.012	
450		.025	

MATERIAL	SPEED (R.P.M.)	WORK FEED PER REV. = I.P.M.		DEPTH OF CUT — REMARKS
ALUMINUM MAGNESIUM	450	.012	5½	Step cuts or grooving to ½" wide by ¼" deep with stagger tooth mill. Surfacing cuts up to ¼" deep.
SET PLASTICS	450	.012	5½	Cuts readily at 450 r.p.m. or higher speeds. .025 feed can be used if desired. Cuts up to 1½" wide by ¼" deep.
THERMO PLASTICS	225	.025	5½	Coarse cutters (not over 16 teeth) needed to avoid softening of work. Stagger tooth side mill is excellent.
	450	.025	11	
YELLOW BRASS	130	.025	3¼	Side mill, ¼" x ¼"; surfacing, 1/16". Coarse teeth and spiral work best and prevent hogging and chatter.
	225	.012	2¾	
CAST IRON (SOFT)	60	.025	1½	Always use .025 feed. Side mill cuts to ½" wide by ⅛" deep; surfacing to 1/16 x 1¼. 60 r.p.m. best for 3" mills.
	130	.025	3¼	
SOFT STEEL	60	.025	1½	Harder to mill than cast iron but .025 feed can be used with slotting cuts to ⅜" deep. Surfacing, about 1/32".
	130	.012	1¾	
MACHINE AND LOW CARBON STEEL	60	.012	¾	Resists penetration of broad cutters. Surfacing, 1/32". Often faster to walk across work with narrow deep cuts.
		.025	1½	
MALLEABLE IRON	60	.025	1½	Requires low speed but permits big chip. Spiral and stagger tooth cutters work smoother than straight teeth.
HARD STEEL	60	.006	¾	Reduced feeds often necessary but should be avoided if a narrower or shallower cut can be made with faster feed.
		.012	¾	

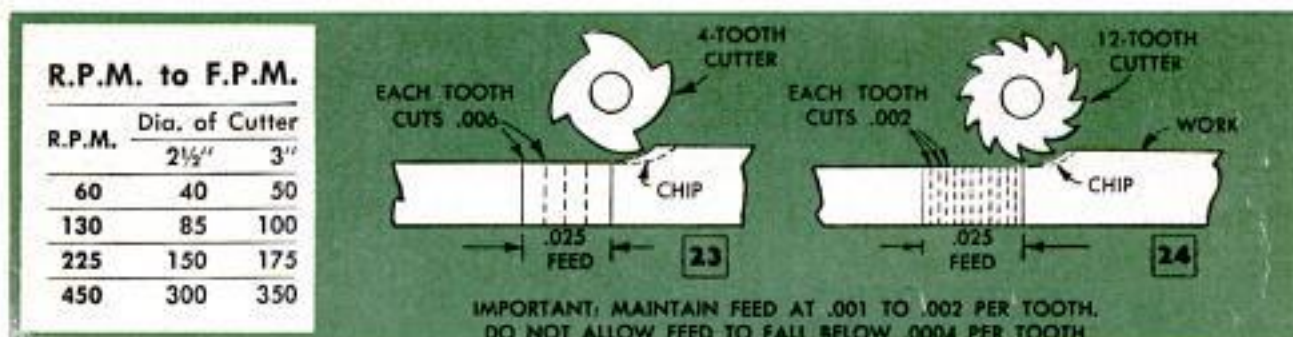

rotation and a right-hand spiral cutter, the first cut is made on the outside. In this way the shoulder is cut with the trailing edge, reducing friction to the minimum.

The operation of squaring an end, Figs. 9 and 10, is one of the few instances where the cut is made with the work mounted at the left of the cutter. Use the vertical hand feed and feed up (climb feed) for the roughing cut and down for the finish cut.

**Use of side mill:** Various operations with side mills are shown in Figs. 11 to 22 inclusive. These illustrations are more or less self-explanatory. Note in Figs. 17, 18, 19 and 22, the use of hardwood supporting blocks and shims. If care is used in cutting the blocks to exact size, extremely accurate work can be done by these simple methods. For side milling, the stagger-toothed side mill generally is superior to the side mill with straight teeth. When making straight cuts it's a good idea to tighten the gib lock just sufficiently to cause a slight drag. This steadies the machine table and generally

eliminates any tendency to chatter. Another step that's important when setting up the work is to make sure that it is in full contact either with the vise or the surface of the machine table, depending on how it is set up. Generally this can be accomplished by tapping the work lightly with a soft hammer as in Fig. 4.

**Speeds and feeds:** When milling soft metals and plastics, the cutters usually can be operated by direct drive at comparatively high speeds. The back gears and intermediate speeds generally give satisfactory results on cast iron, but steel always takes the lowest back gear, especially when 2½ or 3-in cutters are used. Due to the comparatively large diameter of the spindle-mounted cutters considerable power is required, even in light cuts. With a 2½-in. cutter, cast iron usually can be worked at a surface speed of 85 f.p.m. (feet per minute) which means that the cutter speed will be about 130 r.p.m.

Most materials should be worked with



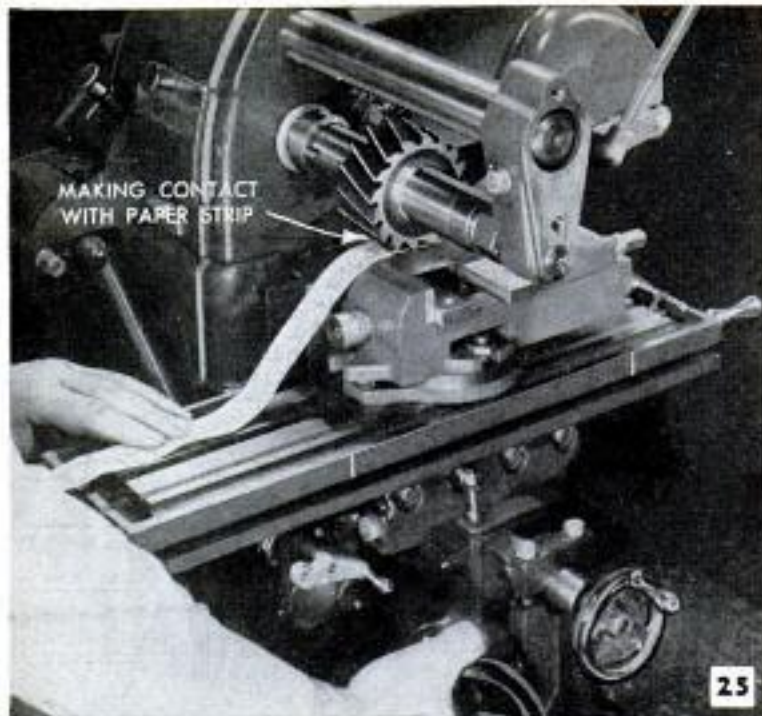

ORIGINAL THICKNESS	.658
WANTED	.625
STOCK TO BE REMOVED	.033

MIKED AT	.634
WANTED	.625
UPFEED FOR FINISH CUT	.009



ROUGHING CUT ABOUT .025



ZERO THE VERTICAL FEED

the coarsest feed, which is about .025 per revolution. However, using a 4-tooth mill, Fig. 23, the .025 feed results in a .006 chip, while the same feed with a 12-tooth cutter gives a .002 chip, Fig. 24, which is more within the capacity of the bench machine. As most plain side mills have 14, 16 or 18 teeth, the .025 feed is a good value for nearly all materials. Extremely fine feeds must be avoided, as a fine feed-per-tooth powders the metal and dulls the cutter quickly due to the abrasive action.

**Measuring:** A good example of preliminary measuring requirements for a precision job are shown in Figs. 25 to 28 inclusive. This is the initial surfacing cut on the V-block shown in Fig. 19. In the rough the stock measured slightly over  $\frac{5}{8}$  in. or about .658. The requirement for thickness is assumed to be .625, or  $\frac{5}{8}$  in. The first roughing cut of about .025 reduces the thickness to .634 on the mike, Fig. 27. The vertical micrometer collar is then zeroed, Fig. 28, after which an upfeed of .009 sets the work for the finish cut. Note the calculations set down at the right of Fig. 26. Where the surface of the work is smooth, the initial contact between cutter and work usually is made by the paper-strip method, Fig. 25. This is easy to carry out. When the paper is gripped to the point where it tears, the contact usually is considered sufficiently close for average calculations. Precision work generally requires square mounting and for this reason it's advisable to check the index marks on the vise by squaring from the spindle as shown in Figs. 29 and 30. Special care in this phase of the setup will assure accurate cuts whether with or across the work. ★ ★ ★

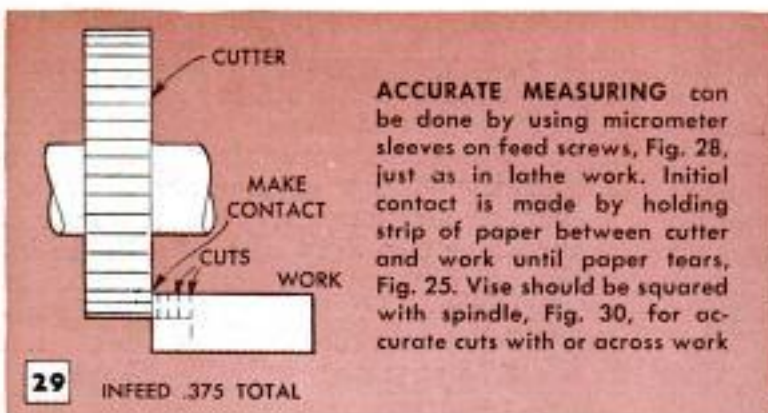

INFEEED .375 TOTAL

**ACCURATE MEASURING** can be done by using micrometer sleeves on feed screws, Fig. 28, just as in lathe work. Initial contact is made by holding strip of paper between cutter and work until paper tears, Fig. 25. Vise should be squared with spindle, Fig. 30, for accurate cuts with or across work



30



## Modified Spray-Width Valve Allows Quick Adjustment

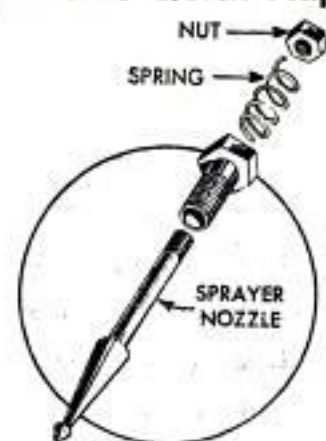

The spray-width adjustment valve on a paint spray gun may be modified to a quick-acting one that is controlled by thumb pressure. In this way, the spray pattern may be changed momentarily by pressing on the valve, which will return to its original setting

when pressure is released. To alter the valve, unscrew the packing gland, remove the valve and have the valve reshaped like the one illustrated. Install this new fitting in the gun, using the old packing gland. Depending on the type of gun, some valves may be modified by turning the sprayer nozzle, while other guns will require machining a completely new fitting.

John E. Walden, Delaware, Ohio.

## Stop Block for Saw or Shaper Has Clamp Attached

The advantage of this one-piece, cut-off stop block lies in the fact that the clamp and block need not be handled separately. The stop block is made by recessing a short length of 2 x 4 to receive the fixed pad of a C-clamp. Two holes are drilled in the pad and it is fastened to the block with wood screws. Because it is one piece, the stop block can be quickly and easily removed from the fence of one machine and moved to another, thus requiring only one clamp for several machines.

Milt Evans, Palmdale, Calif.

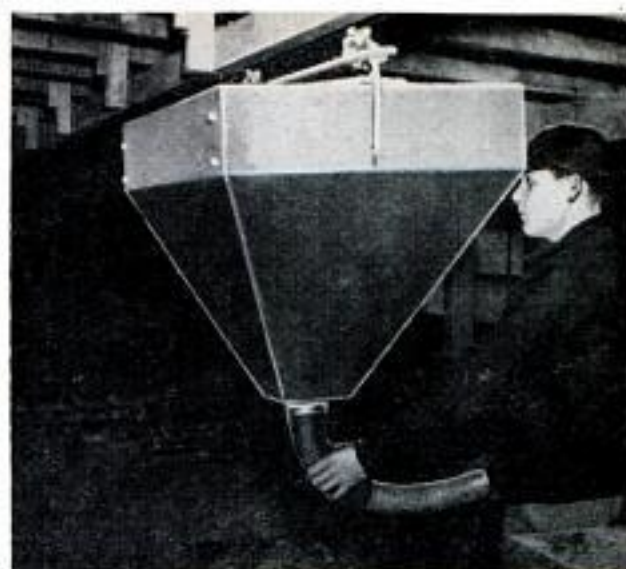
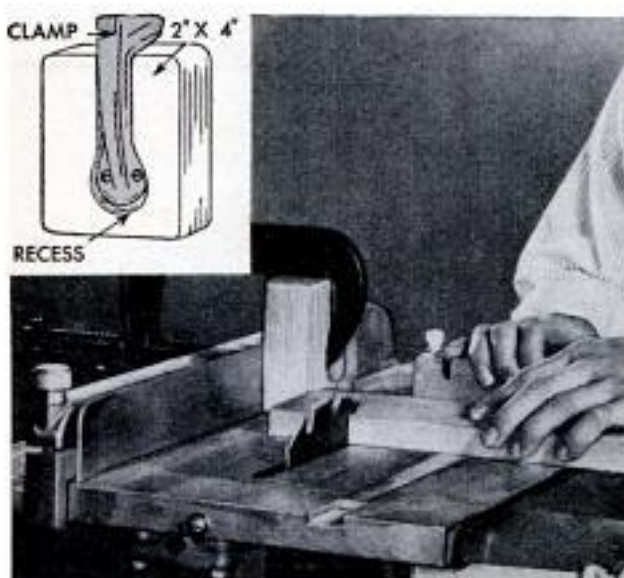

## Poultry-House Feeders Supplied By Hopper on Overhead Track

Suspended from an overhead track running the full length of the poultry house, this traveling hopper holds 200 lb. of feed for supplying half of the 80 feeders used in the building. Two loadings of the hopper, which supplies the feeders through a flexible tube attached to the bottom, makes possible completing in 10 minutes an operation that formerly required eight trips carrying 50-lb. buckets of feed. Constructed of sheet steel, the hopper is suspended on short lengths of chain beneath trolley-type door hangers that run in tubular track of the kind used for heavy barn and garage doors. The track is attached to 2 x 4 supports that are nailed to rafters or joists overhead. Flow of feed from the hopper is shut off by hooking the flexible spout to one side of the hopper.—S. R. Winters, Orlando, Fla.

## Portable Welding-Rod Holder

Easily welded together from short lengths of 1½-in. pipe and pieces of scrap steel, this portable holder will carry a generous supply of welding rods of various sizes. The base of the holder is cut from a piece of ¼-in. steel plate and the handle is a length of ½ x ½-in. flat steel. The pipes are cut to 8-in. lengths and welded to the base. The number of pipes will depend on the variety of sizes required by the individual welder. Pipe other than 1½ in. may be used.

C. Wayne Close, Sycamore, Ohio.

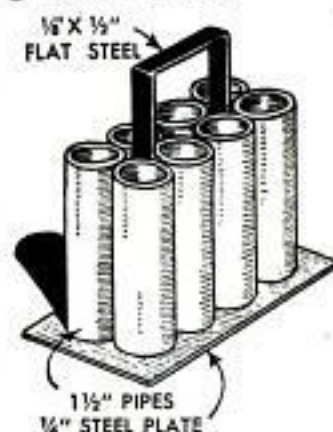





# FARM TRAILER

## *made from auto chassis*

By David F. Costello

FARMERS LIKE the easy maneuverability and handy loading height of short-coupled tractor trailers, such as this one which is built on a wheelbase of only 6 ft. The front and rear channel-steel bolsters are elevated on pipe uprights to clear the wheels. This construction permits a short turning radius and a bed width of 6 ft. 3 in. on standard-tread front axles salvaged from Ford Model-A cars. In the assembly of the chassis, the tie rod of the rear axle is braced to the reach to hold the wheels in the straight-ahead position. Note that a 3 x 3-in. wooden reach is used for greater flexibility. Select straight-grained hardwood, preferably oak or hickory, for this member. The construction and assembly of the steering gear is shown in the detail at the right and also on the opposite page. Although not indicated, the clamping plates can be welded to the I-beam axle if desired. Some adjustment of both tie rods may be necessary to assure that the wheels track properly. The bolsters consist of 5-in. steel channels supported on 18-in. lengths of 2-in. pipe, the lower ends of which are welded and braced to the front and rear axles. Cross members, spaced between the bolsters, are made by bolting one 2 x 4 flatwise to the edge of another. Truss rods bolted to the channels pass under these members and support the center of the bed. Hardwood 2 x 6s are bolted to the top of the channel-steel bolsters as in the cutaway view of the bed. Construction of the bed offers considerable latitude. You can build the type shown, or make it longer and wider to suit a specific purpose. Use oversize tires as pictured. Sideboards are cleated and held in place by stakes which fit in sockets cut in the bed. The rear step is supported by steel rods and braces.

★ ★ ★

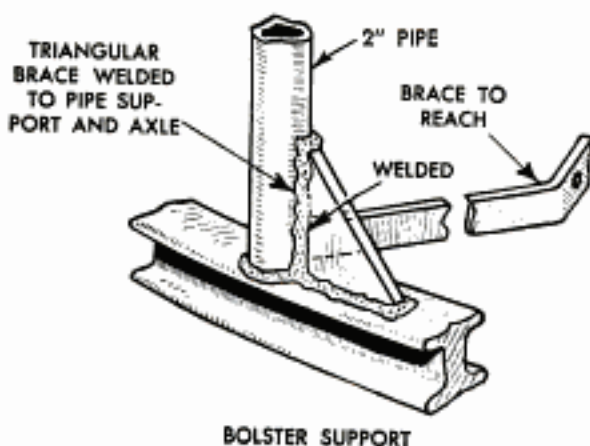
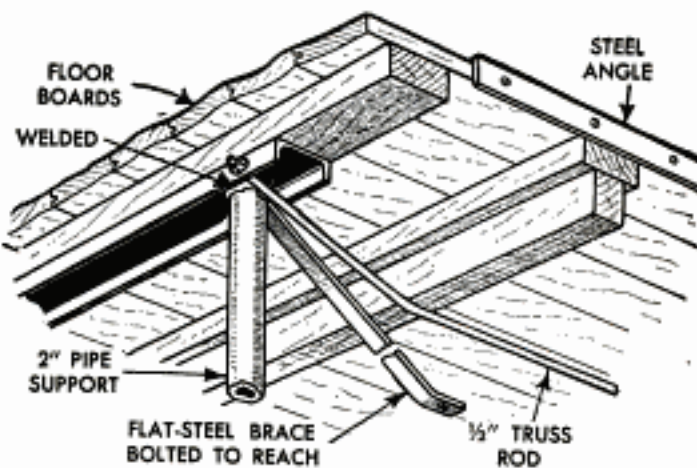
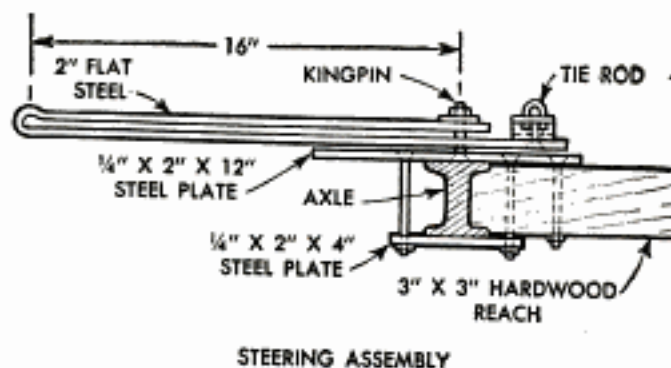
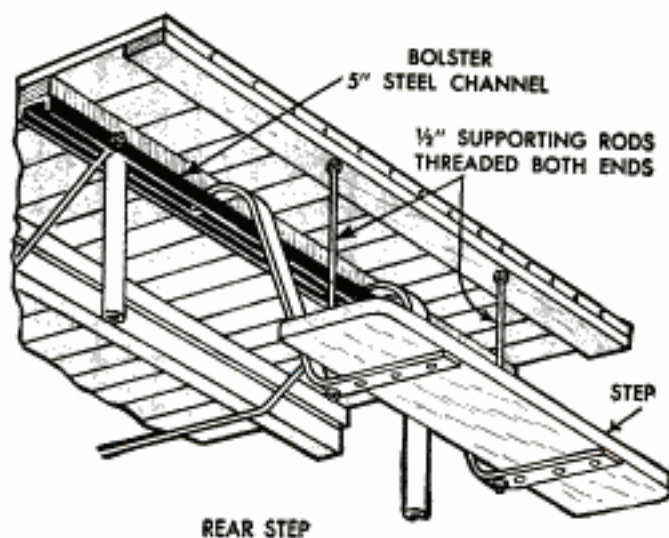



Although only a flat bed is pictured and detailed, provision is made for mounting sideboards and a rear endgate. Use two 1 x 12s for each sideboard and the endgate, joining the boards edge-to-edge with hardwood cleats. Use paint or creosote on wooden parts

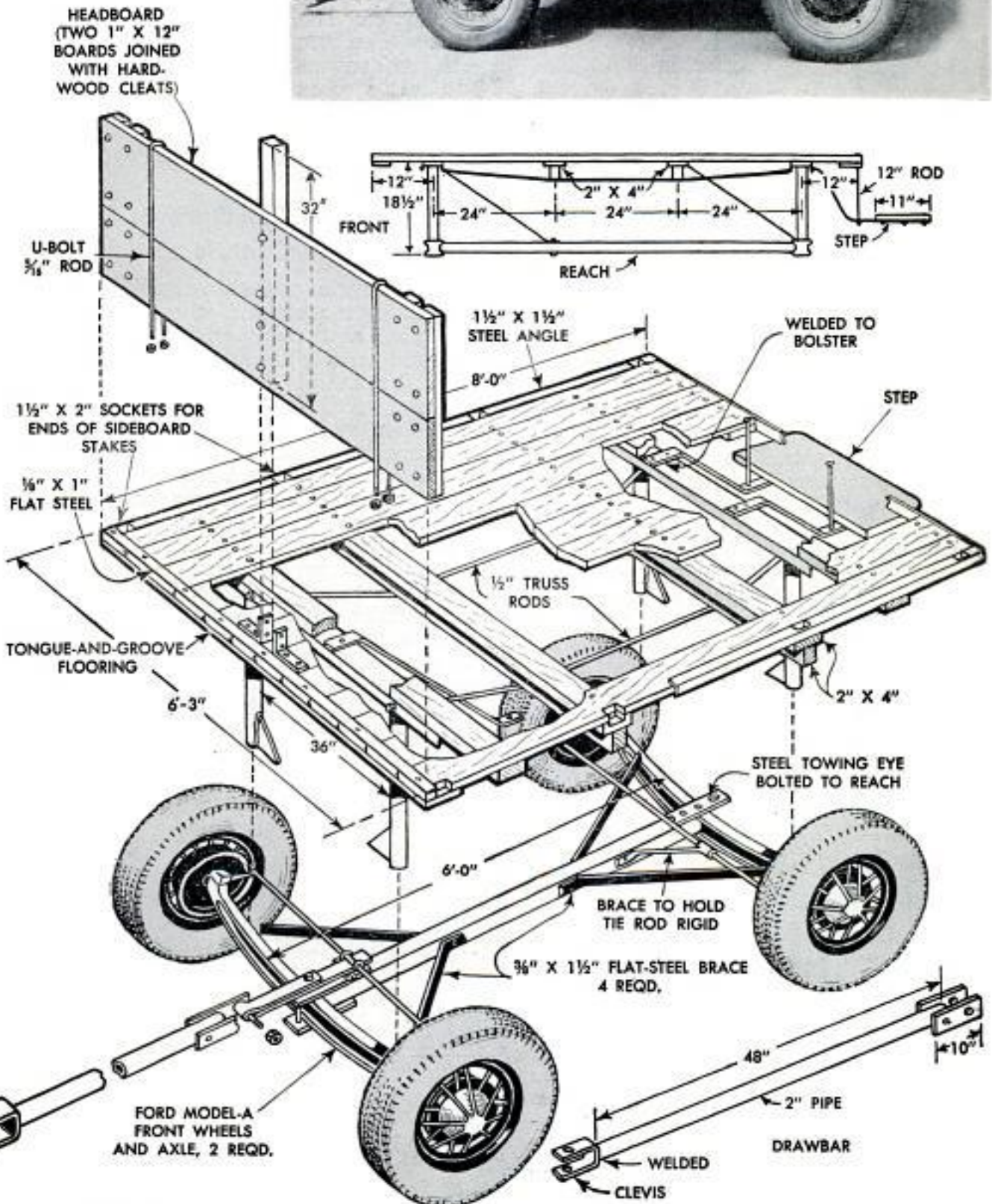
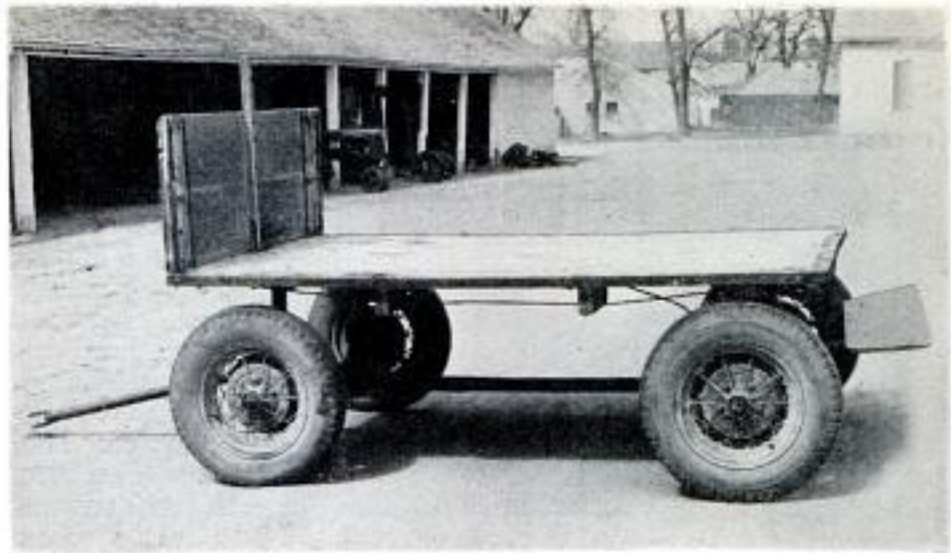



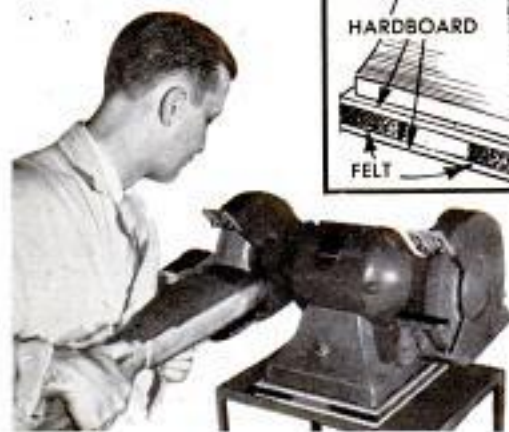

### Machine Vibration Dampener

When operated at high speeds, bench-type power tools often set up high-frequency vibrations, and also a resonance that may be objectionable in some locations. In many cases, vibration may be so pronounced that it is difficult to do accurate work. This is especially true where the work can be only partially supported by a table or rest and must be held and guided by hand. To remedy the condition one craftsman mounts his drill press, lathe and bench grinder on a simple sandwich-type vibration dampener, consisting of two pieces of  $\frac{3}{16}$ -in. hardboard with strips of  $\frac{1}{2}$ -in. felt between. Parts of the dampener are cut slightly larger than the base of the machine. Flathead machine bolts are used to attach the assembled dampener to the machine base. Countersink the bolt holes so that the heads of the bolts will not touch the bench top. When necessary to attach the tool to a bench or stand, separate bolts are used, each one passing through the lower piece of hardboard and through a hole drilled in the bench top.

### Mason's Line Held Tight By Slotted Rubber Hose

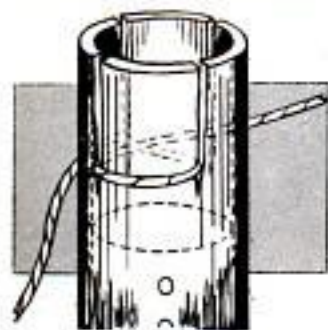

Bricklayers, masons and others who use a tightly stretched line for aligning and leveling, can eliminate tying and untying the cord by using a length of rubber hose slipped over a round stake. The hose is allowed to project about two inches above the top of the stake and is cross-sawed to make four notches. The line is pulled tight, slipped into the slots and wound around as shown.

### Handy Workbench Tool "Pocket"

If you like your tools hung or mounted at the back of your workbench, a "pocket" of plywood scraps will make a handy holder. Folding rules, putty knives and other hard-to-hang items can be stored within quick reach. The pocket can be made any convenient size, but



should not be made too large, because smaller tools will drop down inside out of sight.—Robert C. Barnes, Joplin, Missouri.

### Winding Small Coil Springs Between Lathe Centers

Tiny coil springs, used in cigarette lighters, working models and other fine mechanisms, are not readily available, but can be wound on a lathe by using two small chucks. A mandrel 6 in. long is made of No. 18 music wire, about 1 in. of which is chucked in the headstock chuck. The tailstock chuck is tightened just enough to allow the mandrel to turn freely. Bend the end of a piece of No. 8 music wire so that it catches in one of the spaces between the jaws of the headstock chuck. Turn the lathe by hand until several turns of wire are made on the mandrel. Then, using power, run the lathe at slow speed and wind the spring to the desired length. Use a fairly long piece of No. 8 wire, so there is enough to allow you to keep it at an even tension, then cut it off after the spring is wound. The spring should be tempered to a blue color.—E. J. Gilkerson, Columbus, Ohio.

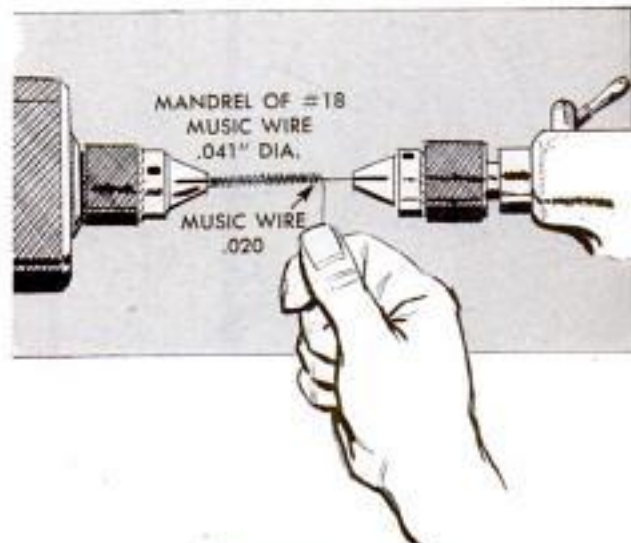



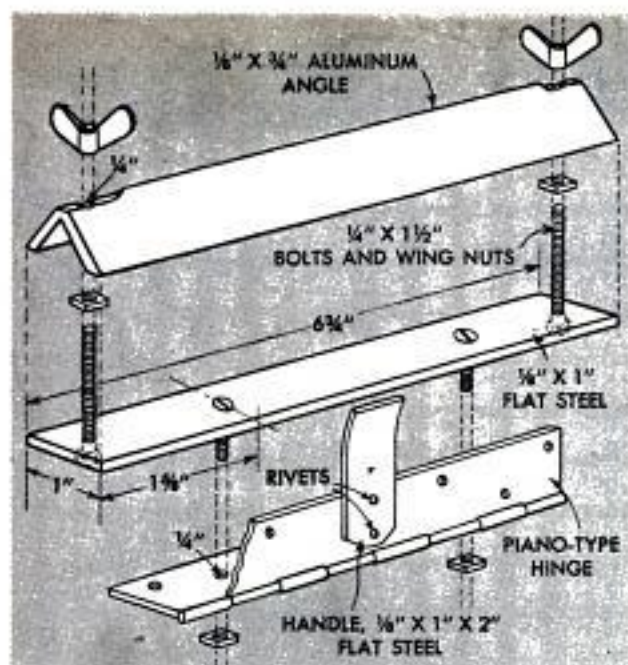

## Miniature Brake for Light-Gauge Sheet Metal

ANY MODELMAKER, hobbyist or craftsman who has occasion to work with the lighter gauges of metal, will find dozens of uses for this miniature sheet-metal brake. The base of the brake is a piece of flat steel drilled for four  $\frac{1}{4}$ -in. screws, as shown in the detail. The two inside holes are countersunk for flat-headed machine screws which hold a piano-type hinge to the base. The two outside holes are fitted with  $\frac{1}{4}$  x  $1\frac{1}{2}$ -in.-roundheaded machine screws, held to the base with nuts. The  $\frac{1}{8}$  x  $\frac{3}{4}$ -in. angle used in the original was aluminum. However, steel can be used, but will be somewhat more difficult to work. A flat is filed across the heel of the angle at each end, and

two  $\frac{1}{4}$ -in. holes are drilled to align with the end holes in the base. The legs of the angle are filed so their edges are parallel to the face of the base. Wing nuts are turned on the  $\frac{1}{4}$ -in. bolts that hold this angle to the base, facilitating quick adjustment. The handle for the brake is a 2-in. length of  $\frac{1}{8}$  x 1-in. flat steel, riveted to the middle of the hinge. Two holes may be drilled in the handle for attaching an extension arm. In use, the piece of sheet metal to be bent is placed on the base, the wing nuts are tightened to clamp the angle on the sheet and the hinge is swung up by means of the handle to give the desired angle of bend.—Carl S. Bates, Chicago.

## "Wrench" Improved in Shop Adjusts Voltage Regulator

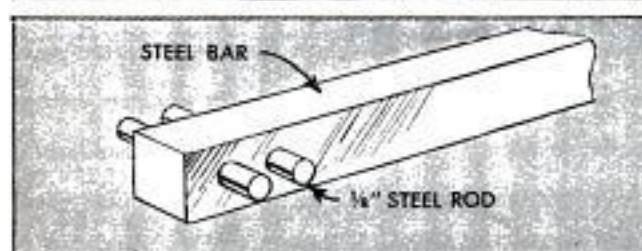
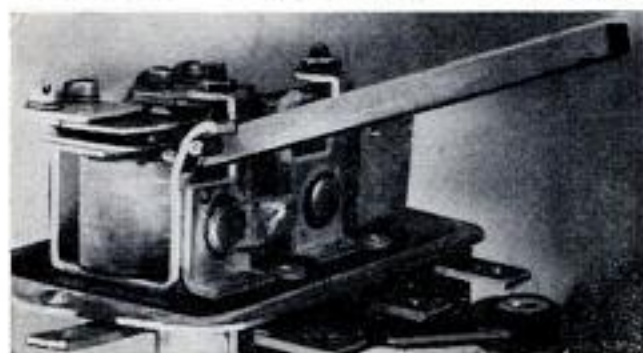

Although special tools may be purchased for the job, some machinists prefer to make their own tools for bending the spring support of a voltage regulator in order to raise or lower amperage. One such tool devised for this purpose was made from a length of  $\frac{1}{4}$ -in.-sq. steel bar, 5 in. long, and a scrap piece of  $\frac{1}{8}$ -in. steel rod. Two  $\frac{1}{8}$ -in. holes were drilled in the bar, one being about  $\frac{1}{8}$  in., the other about  $\frac{7}{16}$  in. from the end, after which pins cut from the rod were inserted. They were cut so they extended approximately  $\frac{1}{16}$  in. from each side of the bar. The pins are held in place by upsetting the metal around the edges of the holes with a centerpunch.

☞ To patch holes in roof gutters, coat the damaged area with roofing cement and apply a patch cut from building paper.



# SHOPPING FOR TOOLS



**1. BLOCK HANDLING TOOL** provides that extra hand so often needed by masons when laying cinder and concrete blocks. Tool is designed to slide easily into the block openings and has case-hardened jaws that grip the block securely, enabling the user to carry it from a distance and place it in position on the wall. Has two spirit levels

**2. FOUR-CORNER MITER CLAMP** is designed to put equal pressure on the four corners of a mitered frame simultaneously. Angle corner blocks are of aluminum alloy and are drilled and tapped for  $\frac{1}{4}$ -in. threaded rods. Large adjusting nuts have knurled rims so that they can be spun into position quickly. Comes in 8, 12, 18 and 24-in. sizes

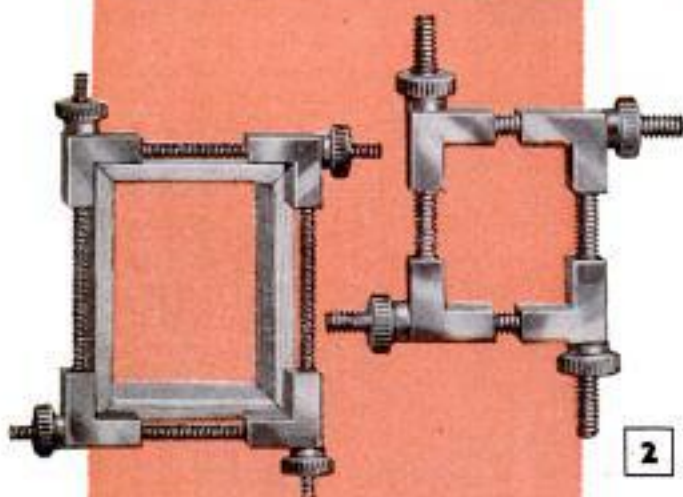

**3. A WIRE-TWISTING MECHANISM** built into pliers of a special design makes it easy to spin two wires into a neat twist in a matter of seconds. Wire ends are gripped in plier in usual manner and a sleeve is pushed forward with thumb to lock jaws. Then the pliers are released and a pull on the knob spins them as in lower photo

**4. FOLDING SCREWDRIVER** has three separate bits that close into a sturdy handle like the blades of a pocketknife. Can be used as an offset screwdriver as pictured, or a regular screwdriver simply by opening the blade straight out to an overall length of 8 in. As an offset driver it works anywhere there is a clearance of  $2\frac{3}{4}$  in.

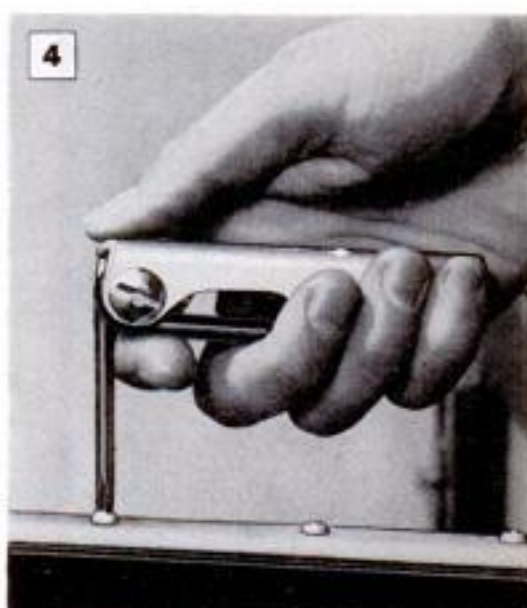
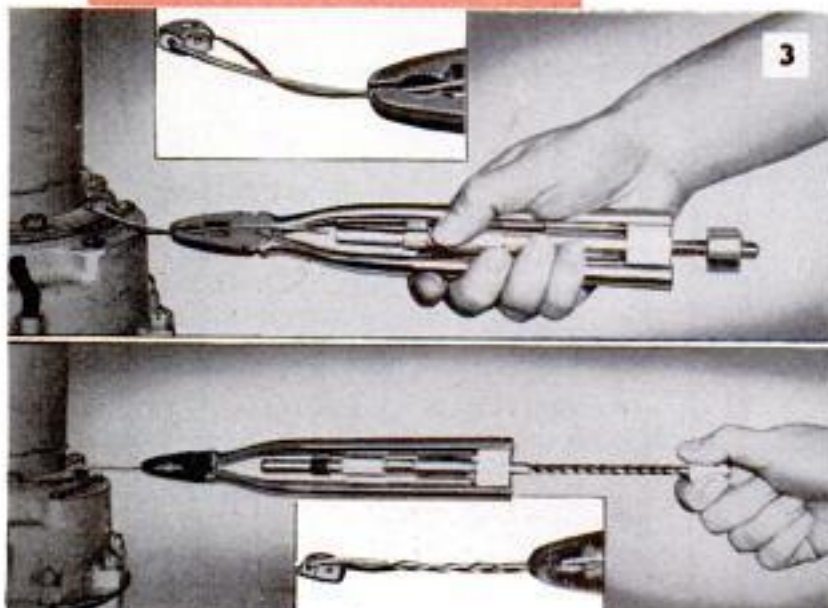



**5. PRECISION HAND GRINDER** has speed and power to operate carbide midget milling cutters and other rotary tools for grinding, finishing and polishing metals. Can be used freehand or mounted on lathe or drill press in a special holder for internal or external grinding. Specially designed motor operates at 45,000 r.p.m. and has built-in overload protection. Features sealed ball bearings

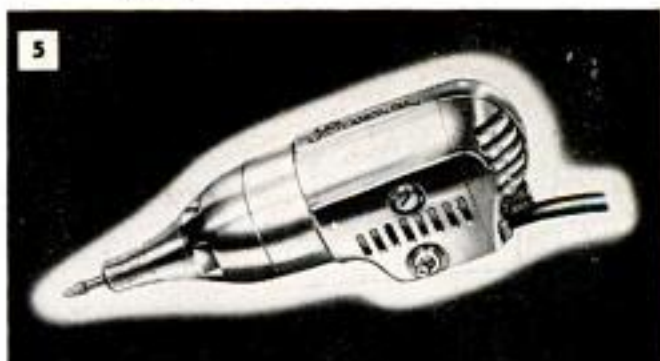

**6. MAGNETIC LOCATOR** finds nails in tires, locates lost parts in the shop and enables the user to spot position of studs in a plastered wall. A small disk pivoted in a clear-plastic tube supports a permanent magnet which reacts to presence of ferrous metals within  $\frac{3}{8}$  in. of pointed end. Nails used to attach lath or plasterboard to studs make it easy and simple to spot the studs



**7. INSPECTION INSTRUMENT** contains a special optical system mounted in a flexible tube which can be inserted in any opening  $\frac{1}{2}$  in. or larger. Reflecting lens system forms an image at eyepiece. Dark areas, such as those in cored castings, are illuminated by built-in light. Tube may be curved and maneuvered into desired position by means of a handwheel on handle of instrument

**8. CARPENTER'S AND MASON'S LEVEL** has a frame made from plastic having accurate working surfaces and exceptional lightness and strength. Openings at ends give a comfortable handhold for placement of the level either vertically or horizontally. Solid webs in the center sections support the level glasses and at the same time afford protection against breakage. Comes in 24-in. length



**9. POCKET SAW** consists of a wire-type blade with spiral cutting teeth. A steel ring attached to each end of the 20-in. blade serves as a handle. Handles many emergency needs of campers, fishermen, woodsmen and hobbyists. Cuts in any direction in any kind of wood, hard or soft. Can be operated as pictured, or can be made into a bow saw by fitting a bow fashioned from a tree limb

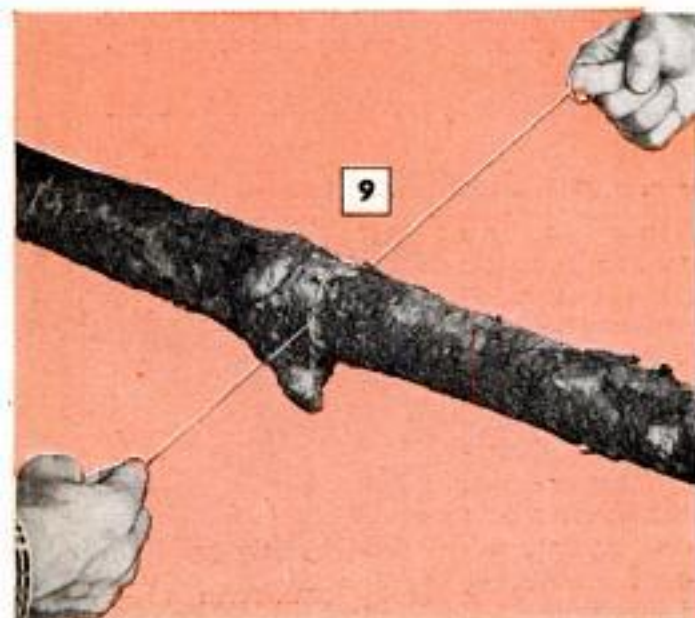





### Magnet Holds Wooden Pencils

A convenient and novel pencil holder for the kitchen can be made from a small horseshoe magnet. The magnet is fastened to the wall or to the side of a kitchen cabinet at a handy location with a strip of wood and four screws. Steel screws or thumbtacks provide metal ends for the pencils. Thumbtacks can be pressed into the rubber erasers, whereas the use of screws requires cutting off the brass eraser ferrule and drilling out a portion of the pencil lead.

H. G. Frommer, Milwaukee, Wis.

### Machinist's Vise Holds Thin Work By Use of Auxiliary Jaws

When milling, drilling or planing thin work held in a drill vise, shouldered auxiliary jaws of soft metal will save considerable set-up time. The jaws are machined from aluminum blocks and a shallow shoulder is milled in the face of each one. When milling the shoulders, clamp the blocks together in the vise and true-up the whole assembly on the milling machine bed, to make sure of the accuracy of set-ups when using these jaws.

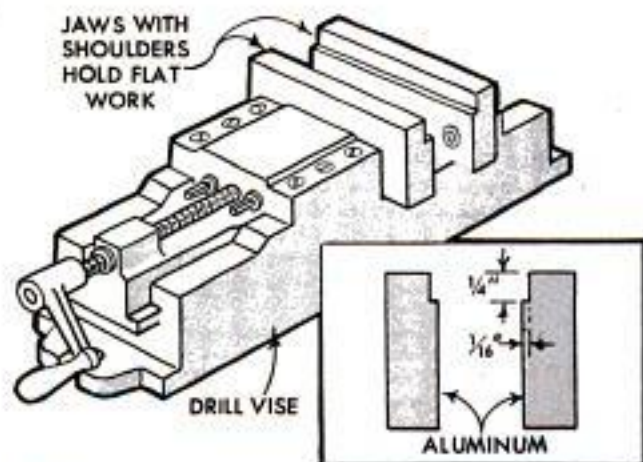

### Broken Drills Removed With Slotted Tool

To solve the problem of removing center drills broken off in the work, one machinist devised a tool by modifying a larger-size drill. He ground a slot, slightly wider than the diameter of the broken drill, in the shank, or body, of the larger drill. In use the larger drill fits around the broken piece and cuts away enough metal to clear the end of the broken section. It is then fairly simple to grasp the end of the broken drill to pull it out.

Thomas J. Kilb, Springfield, Mass.



### Four Gates in Fenced Pasture Permit Field Rotation

Fencing a pasture into four fields, that can be combined in a variety of ways, is done by installing four gates at the intersection of the fences. A large center post is installed at the intersection, to which all four gates are latched. An alternate method, using a water tank common to all four fields, requires four center posts. With either method, three fields can be combined to form one large pasture, plus one small field, or adjacent fields can be used to divide the pasture into two fields. The many variations allow frequent pasture rotation by merely opening and closing gates.

R. A. Meeks, Mannville, Alberta, Can.

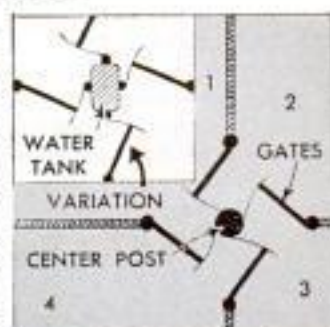

### Rejuvenate Steel Brushes

Steel-wire brushes become dull after prolonged use because the ends of the bristles become rounded. To restore the sharpness of the bristles, brush them a few times across the side of a rotating grinding wheel.





## DE LUXE DRESSING TABLE YOU CAN BUILD AT HOME



### Color-Toned with *Rez*

Wouldn't this dressing table look lovely in your bedroom? Mirror-top folds shut, keeps table looking neat. Wrought-iron legs add a smart touch. There's storage space for tall bottles, too. Build-it-yourself plans include cushioned bench.

Rez is used in finishing the wood portions of the unit. Rez

—which primes, seals and gives you the natural wood finish decorators recommend.

Rez Color Tones bring you these ultra-modern *natural* shades: *Redwood, Cedar, Sage, Driftwood* and *Mahogany*. *White Rez* can be used for 1-coat blond finish. Just put it on and wipe with a cloth. *Clear Rez* beautifies grain in the original wood color.

You can paint like a professional with Rez. Brushes or

wipes on like water . . . can't leave streaks or brush marks.

Rez *protects* wood, too. It seals out moisture, checks warping and swelling. Ends the nuisance of "sticking" drawers, doors and windows.

So many places to use Rez! Paneling, siding, flush doors, fencing, furniture . . . wherever you want a modern natural wood finish. See the beauty of Rez Color Tones soon. Ask your dealer for color samples!

*Laux Rez: Reg. U. S. Pat. Off.*



### MAIL COUPON AND 25¢ CASH FOR PLANS

MONSANTO CHEMICAL COMPANY, Merchandising Division  
1700 South Second Street, St. Louis 4, Missouri  
Enclosed find 25 cents (25¢) for which please send plans and specifications for De Luxe Dressing Table (Monsanto Rez Moderns, Plan No. 11).

Name.....

Street.....

City..... Zone..... State.....

SERVING INDUSTRY...WHICH SERVES MANKIND



# Here's a family project that's good for a lifetime

**Developing—Printing—Enlarging!** Here's much more than just another hobby for dad, or a pastime for junior. Here is a project for the whole family. A project whose rewards in pictures are good for a lifetime. You don't even need a darkroom for developing and printing.

And enlarging will be one of the most satisfying activities you've ever tried. Here is some moderately priced Kodak equipment.

Your Kodak dealer will be glad to show you more. He has all the latest dope and "doings" for beginners and experts.



**A complete enlarger for only \$57.50.** Kodak Hobbyist Enlarger comes complete with  $f/6.3$  lens. "Cold" light protects negatives. New-design lamp house insures sparkling enlargements up to 7 times. Easy-load, rotary, glassless negative carrier. Easel extra.



**Makes superb salon-quality prints.** Kodak Fluorolite Enlarger has integrating-sphere light source for even illumination plus unusual printing speed and contrast. Focuses and elevates simultaneously. Lighttight paper-storage base. \$99.50, without lens and easel.



**Everything you need for \$9.75.** Kodacraft Photo-Lab Outfit contains basic essentials for developing and printing pictures. Includes rocker-type trays, roll-film tank, printing frame, printing paper, thermometer. Comes complete with illustrated instructions.



**Times your work.** Kodak Timer covers all intervals up to 60 minutes. Spring-wound; has both minute and second hands. Can be stopped and restarted without re-setting hands. Special feature: handy tilting base. \$7.95.



**Washes film or prints automatically.** Kodak Automatic Tray Siphon converts an ordinary tray into effective washer. Attaches to water tap. Water is siphoned out at same speed it enters. Wonderful for kitchen or bathroom. \$4.50.



**Protect light-sensitive materials.** Kodak 2-Way Safelight (left) swivels on socket for direct or indirect lighting. Second filter (extra) allows 2-way light. \$4.50. Kodak Adjustable Safelight Lamp (right) attaches almost anywhere. \$8.75.

*Prices include Federal Tax where applicable and are subject to change without notice*





**Accurate weight scale.** Kodak Chemical Scale weighs up to  $3\frac{3}{4}$  ounces or 175 grains (avoirdupois), or 130 grams (metric). Chemical-resistant housing. Hair-lined window makes easy reading. \$14.50.



**Dries prints without curling.** Kodak Blotter Roll with corrugated backing allows free circulation of air for rapid drying. Capacity, 80 prints of average size. 6 feet long,  $11\frac{1}{4}$  inches wide. \$2.88.



**For contact printing.** Kodacraft Printing Frame includes glass plate, mask for 9 popular negative sizes. Accepts paper up to  $4\frac{1}{4} \times 5\frac{1}{2}$  inches. Corner loading assures accurate positioning. \$1.65.



**Zips off the water.** Kodak Rubber Squeegee quickly removes superfluous water from flat surfaces. Ideal for quality ferrotyping, or Kodak Dye Transfer Process. 10-inch blade. \$3.75.



**3-in-1 funnel.** Kodak Combination Funnel is made in two plastic sections. Can be used 3 ways as illustrated. Largest intake diameter, 5 inches. 2-inch and  $\frac{1}{4}$ -inch spouts. \$.85.

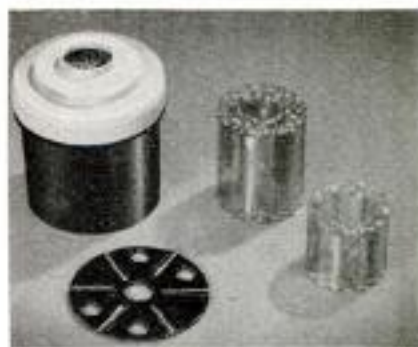

**Easy roll-film developing.** Kodacraft Roll-Film Tank can be used in lighted rooms (after loading). Faster drying "apron" method allows immediate development of successive rolls. \$2.53.

## Another good friend of the family— KODACHROME SLIDES

For an evening of thrills, you can't beat beautiful Kodachrome slides in glorious full color. Show them with one of the fine-quality Kodaslide projectors or viewers described below. Their optical systems help project your slides sharper and brighter, making every colorful detail stand out.



**Inexpensive fan-cooled projector.** Kodaslide Highlux III Projector. 300 watts. Brilliant optical system. Built in its case. \$56.50. Highlux II (no fan) is only \$36.50.



**Rock-bottom price.** Kodaslide Merit Projector features slide-feeding in top, prevents jarring. 5-inch  $f/3.5$  lens. 150-watt lamp. 10-foot cord. \$26.10.



**Show slides in lighted rooms.** Kodaslide Table Viewer 4X combines screen and projector in one convenient unit. It enlarges color slides 4 times. \$37.50.

Your Kodak dealer will be glad to demonstrate this equipment for you. Make him headquarters for all your photo needs.

**Eastman Kodak Company, Rochester 4, N. Y.**

Copyrighted material





## Care and Feeding of Engines

BY S. P. CORP

### FLIRTATIOUS SPEEDOMETER

When your speedometer becomes noisy and waves at you, it's time to inspect the head and the cable. To test for tightness in the head, disconnect the cable casing up under the instrument panel and pull cable out of casing. Then insert upper end of cable back into the speedometer head and spin it between your thumb and finger. If cable turns hard, the head should be removed for internal repairs.

Next, inspect cable for breaks, worn spots, or kinks. Hold both ends of cable as shown and turn it slowly. A kinked cable will "flop" and you need a new one. Check casing carefully and replace it if distorted or broken. Remove any sharp bends. Before putting cable back in casing, spread a thin layer of high-temperature grease over the lower two-thirds of the cable. As cable is installed, entire cable will be lubricated.

Make sure that cable enters the socket in the worm gear by turning cable until connection is made. Be sure upper end of cable is seated in speedometer socket before connecting upper end of casing to speedometer head.

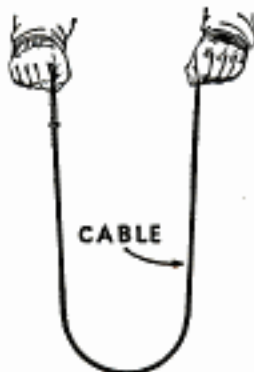

### CROSS TIRES EVERY 5000 MILES

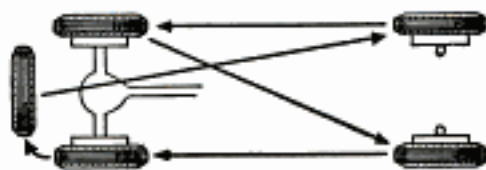

Your tires will last longer if you cross them every 5000 miles, as shown above, to counteract the uneven wear which occurs when a tire is left on the same wheel continuously. As tires are rotated, remove any metal or foreign material imbedded in the treads. If treads are worn smooth, replace them for winter driving and thus reduce the danger of skidding. Be sure to have any cuts repaired, as water or dirt penetrating to the cords can cause rapid deterioration of the tire.

### WRITE FOR FREE BOOKLET

"MORE POWER, Less Oil, Less Gas," is a free illustrated manual of car care which may save you a lot of money. It tells all about Sealed Power KromeX Full-Flow Ring Sets and the famous MD-50 Steel Oil Ring with the Full-Flow Spring, which does the best possible job of oil control, even in badly tapered and out-of-round bores. To get your free copy, write a card to Sealed Power Corporation, Dept. G-1, Muskegon, Michigan.



## Clinic for Homemakers



As a service to our readers in solving the hundreds of problems pertaining to a home—inside or out—the editors of *Popular Mechanics* invite you to present your problems to The Clinic Editor for help and advice. Address your questions to The Clinic Editor, *Popular Mechanics Magazine*, 200 East Ontario Street, Chicago 11, Ill.

### Crackle Finish

Q—How does one apply the so-called crackle finish? I've always understood that it is a finishing process requiring special materials and is done in several steps. I'd like to try it. What comes first? Can the finish be applied to both wood and metal? Is spray equipment required? Does the process require heat?

J. B., Colo.



A—At one time the crackle finish was quite extensively used on table tops, radio cabinets, instrument panels and the like. However, changes in design and materials made its use impractical and for this reason it is seldom recommended at the present time. It is still possible to produce a fairly suitable crackle finish by using ordinary slow-drying (brushing) lacquers in two colors. For best results the two coats should be sprayed on. The base color, such as Chinese red, is applied first and allowed to set partially. Then the darker-colored top, or crackle coat is sprayed on. In drying, the top coat breaks, or crackles, into an irregular pattern exposing the base color. Another method effective on metal, is the use of what is known as "crystal" lacquer, a special slow-drying material which on drying produces an all-over crystal pattern very similar to frost patterns on a window pane. It is available in colors and also in clear. For best results it should be applied by spraying rather than brushing. No heat is required as the materials dry at room temperatures.

### Refinishing Meat Block

Q—I have a heavy meat block, or cutting block, which is now covered with knife marks due to prolonged use. The block is about 10 x 12 in. and consists of several hardwood strips glued together, or joined in some manner, and supported on four short legs. How does one remove the knife marks and refinish the block? I tried planing with a hand plane, but this does not work satisfactorily as the grain in adjacent strips seems to run in opposite directions.—B. Y., Ore.

A—If the plane iron is very sharp and set to lift a paper-thin shaving you can remove the knife marks quite easily even though cutting against the grain. However, you may be able to do a better job by using a cabinet scraper and working with the grain in two directions. Rarely are the knife marks more than  $\frac{1}{16}$  in. deep but of course, cleaver marks may cut in as much as  $\frac{1}{8}$  in. In either case

(Continued to page 242)



Announcing **TYNEX** ... a new  
trade-mark for Du Pont nylon bristles



GET FULL  
PAINT  
PICK-UP



SMOOTH  
EVEN  
FLOW



choose brushes  
with bristles of Du Pont

**TYNEX**

nylon

To assure you of highest-quality bristles when you buy paintbrushes, Du Pont has adopted the trade-mark "Tynex" for bristles of genuine Du Pont nylon.

"Tynex" nylon bristles help make painting easier and faster. Brushes with long, tapered, well-tipped "Tynex" bristles pick up a full load of paint ... flow it on smoothly and evenly. Home painters know from experience that "Tynex" bristles are easy to clean with any commercial cleaner ... won't break off ... last three to five times as long as other types of bristles.

"Tynex" has been granted the Good Housekeeping Guarantee Seal. Leading brush manufacturers are now using the trade-mark "Tynex" to identify genuine Du Pont nylon bristles in all types of paintbrushes. So next time you buy brushes, look for the word "Tynex" on tags and brush handles. It's your guarantee of work-saving, long-lasting bristles of Du Pont nylon!



BETTER THINGS FOR BETTER LIVING  
... THROUGH CHEMISTRY



"Handy" SANDY says:



Use these  
**GOOD  
SHORT-CUTS**  
to save work!

**Drawer sticking slightly?** Fix it quickly: rubber cement a piece of Fine Flint Paper by CARBORUNDUM, sand side out, to the shiny spot where it's binding. Work drawer in and out 'til it's free — then peel off the Flint Paper. The sanded spot is concealed . . . no "touch up" needed, so it's better than sanding the drawer itself. Look for CARBORUNDUM® Brand Flint Paper at your hardware store or lumber dealer. Five useful grades: Extra Fine, Fine, Medium, Coarse, Extra Coarse.

**What? Shaving cream in your tool kit?** Sure — it's a smart way to "lubricate" wood screws. Just stick the threads in the end of the tube before driving them into your wood.

**Paper or plastic garment bags** will last longer if you reinforce the upper edges with sturdy FLEXBAC® Masking Tape by CARBORUNDUM. Use it on the corners and around the edge, overlapping the top and sides. If you seal the seams with FLEXBAC Masking Tape, too, you'll make them really air-tight — keep the vapors in, moths out. Ask for FLEXBAC Masking Tape by the brand name. It's flexible, tough, goes on easily and stays put.

**Save work** next time you glue a mitered joint. Before gluing, wrap strips of FLEXBAC Masking Tape around the outer edges of the joint. The excess glue that squeezes out will then be on the tape . . . and tape and glue will peel off quickly, cleanly after the job is done. Saves extra sanding and cleaning.

**Use your power drill** to polish inside surfaces of holes — with a simple attachment you can make in a few minutes. Take a ¼" rod and slit one end to a depth of 1". Insert a strip of Abrasive Paper or Emery Cloth (CARBORUNDUM® Brand, of course) in the slot and wind it around the rod spirally — in a clockwise direction. Lock t'other end in your drill chuck and you're ready for business.

**Safety tip:** Don't cut yourself with dull knives and tools. Keep 'em sharp and smooth with handy CARBORUNDUM® Brand Sharpening Stones and avoid dangerous slipping. Your favorite hardware or lumber dealer has a complete assortment you can choose from. One for the kitchen and one for your workshop is a mighty good safety rule.

**"HOW TO SAND"**, useful pamphlet by CARBORUNDUM, is yours free for the asking. Gives you all the info you need to refinish furniture, plus tips on many other sanding jobs. Write for your copy—a postcard addressed to me will put it in your hands promptly.



**"Handy" SANDY**  
**CARBORUNDUM**

REGISTERED TRADE MARK

Niagara Falls, New York

(Continued from page 240)

It will be necessary to remove stock to a point slightly below the depth of the marks in order to eliminate them entirely. This done, sand the surface until it is smooth to the touch, then dampen it slightly to raise the grain and after it is dry, sand again. Although linseed oil is sometimes used to finish cutting blocks, this is not recommended unless you can be certain that the oil is absolutely pure. It is better to use pure olive oil, making several applications and allowing time for absorption between coats.



#### Ink Stain

**Q**—Recently I sanded the hardwood floor in one room but before a finish could be applied I had the misfortune to spill ink, which of course spattered over a considerable area. I have tried several ways of removing the ink stain without success. A strong solution of washing powder helped some but the stain still shows. Most of it seems to be embedded in the grain of the wood. Can it be removed entirely?—O. B., Miss.

**A**—Use of any of the common ink eradicators should remove most of the stain, but if the floor is of oak you may have some trouble getting the ink entirely out of the grain. Rather we think it would be better to rely on a mild solution of oxalic acid. Prepare the solution in an earthen jar or bowl by dropping several oxalic-acid crystals, or granules, into ½ gal. of clean water which has been poured into the bowl. Never pour water onto the acid crystals. Apply the solution to the affected area with a cloth swab. Let it dry and note results. If discoloration still shows, strengthen the solution and apply again. In some cases a third application may be necessary to remove the stain entirely. Then wash with clean water and when dry, sand the surface lightly to remove the raised grain caused by wetting the wood. **Caution:** Avoid handling the acid crystals, or granules, with the bare hands. Wear rubber gloves and avoid inhaling the fumes from the acid solution both when preparing and applying it. Destroy any unused portion of the solution.

#### Patching Cracks in Wall



**Q**—There are a number of narrow cracks in my basement wall. These run diagonally from the top of the wall to the lower course of blocks. The wall has been plastered. The cracks are only about ¼ in. wide but some loose material has fallen out in places. Should I fill with a cement mortar?—T. E., Mass.

**A**—You can probably make a satisfactory repair with cement mortar. However, it cannot be considered wholly permanent because of the possibility that the blocks may shift slightly later on. Should this occur, the newly repaired cracks may open again. Clean all loose material from the cracks and undercut the edges with a cold chisel so that the new mortar will "key" securely in the opening. Then mix prepared cement mortar fairly stiff and press into the cracks with a small trowel. Use considerable pressure to assure that the mortar is forced into all irregularities of the opening throughout its length. Strike the mortar off flush with the surface and smooth lightly with the trowel. After the mortar has partially set, trim the bristles of a whisk broom square across, and use the broom to "stipple" a pattern on the troweled surface of the mortared joint to match the surrounding surface. Touch the fresh mortar only lightly with the ends of the bristles and shift the broom so that the imprints overlap irregularly.



# CHAN NEL LOCK

The finest line of tools you  
can buy!



YOU'LL find a complete selection of pliers in the Channellock line — a plier for every job . . . at work and in the home. Don't take a substitute when you shop for pliers — Only Champion DeArment make Channellock . . . patented features assure you of the finest line of tools you can buy.



THE PLIER DESIGN THAT OBSOLETEES ALL OTHERS

CHAMPION DEARMENT TOOL CO.  
MEADVILLE, PENNSYLVANIA



**No. 407 GRIPPING  
PLIER**



Length 7". Capacity  $\frac{1}{8}$ " to  $\frac{5}{8}$ ". Two adjustments. Knurled grips.

This No. 407 plier is primarily intended for battery work. The self-gripping feature insures a positive grip on acid corroded and mutilated terminal nuts. Its adjustable feature also makes it indispensable for many other kinds of work. Polished steel finish.

**No. 410 GRIPPING  
PLIER**



Length  $9\frac{1}{2}$ ". Capacity  $\frac{3}{16}$ " to  $1\frac{1}{8}$ ". Four adjustments.

Our No. 410 is a heavy-duty self-gripping plier which will hold work of any shape with a positive pipe wrench grip. Will exceed a pipe wrench in usefulness because of its light weight and streamlined design. Polished steel finish.

**No. 417 GENERAL  
UTILITY PLIER**



Length 7". Capacity  $\frac{7}{8}$ ". Three adjustments. Knurled grips.

The No. 417 is a heavy-duty plier with a gripping power many times greater than the ordinary slip-joint plier. Polished steel finish. Its superiority can only be appreciated by actual use.

Ask your hardware dealer to show you the complete **CHAN NEL LOCK** line

**The NEW No. 420 PUMP  
PLIER**



Length  $9\frac{1}{2}$ ". Capacity  $1\frac{3}{4}$ ". Five adjustments.

The wide range of adjustments of the No. 420 Pump Plier makes it adaptable to a multitude of uses. New strength has been added by the patented design of the tension edge. Interlocking channels and lugs prevent slipping. Wide base lugs provide maximum cross section strength.

**SELECT THE PLIER YOU NEED**

**No. 424 IGNITION  
PLIER**



Length  $4\frac{1}{2}$ ". Capacity  $\frac{1}{2}$ ". Four adjustments.

This No. 424 ignition plier incorporates the Channellock adjustment feature in order to eliminate wear on the joint bolt and lengthen the life of the tool. A midget plier. Polished steel finish.

**No. 307 BATTERY PLIER  
LAP JOINT**



Length 7". Capacity  $\frac{1}{4}$ " to  $\frac{5}{8}$ ". Blue finish.

**No. 317 $\frac{1}{2}$  LONG  
NOSE PLIER  
with Side-Cutter**



Length  $7\frac{1}{2}$ ". Polished steel finish. Knurled grips. No. 3017 $\frac{1}{2}$  same model without side cutter. Point,  $\frac{3}{32}$ " round.

**No. 326 LONG NOSE  
PLIER  
with Side-Cutter**



Length 8". Polished steel finish. Knurled grips. No. 3026, same model without side-cutter. Point  $\frac{3}{32}$ " round.

**No. 337 DIAGONAL  
CUTTING PLIER  
Lap Joint**



Length 7". Weight 6 lbs. per doz. Polished steel finish. Knurled grips.

**No. 348 $\frac{1}{2}$  LINEMEN'S  
PLIER  
Rounded Nose**



Polished steel finish. Knurled grips. Side-cutter.

No.	Size
346	6"
347	7"
348 $\frac{1}{2}$	8 $\frac{1}{2}$ "

Only **CHAMPION DEPARTMENT MAKES** **CHAN NEL LOCK**

Copyrighted material



**No. 3048 1/2 LINEMEN'S  
Bevel Nose**

Polished steel finish.  
Knurled grips. Side-  
cutter.

No.	Size
3046	6"
3047	7"
3048 1/2	8 1/2"



**No. 356 END CUTTER**

Length 6". Polished  
steel finish.



**No. 366 FLAT-NOSE  
PLIER**

**with Side-Cutter**

Length 6". Polished  
steel finish. Knurled  
grips. No. 3066, same  
model without side-  
cutter.



**No. 378 LONG REACH  
DUCK-BILL  
PLIER**

Length 8". Polished  
steel finish.



**No. 3078 LONG REACH  
NEEDLE-NOSE  
PLIER**

Length 8". Polished  
steel finish.



**No. 436 DIAGONAL  
CUTTING PLIER  
Box Joint**

Length 6". Polished  
steel finish. Knurled  
grips. No. 435, same  
model 5" long.



**HE WILL HAVE ONE FOR EVERY JOB**

**No. 437 DIAGONAL  
CUTTING PLIER  
Box Joint**

Length 7". Polished  
steel finish. Knurled  
grips. A popular plier  
with automobile and  
airplane mechanics.



**No. 447 CURVED  
DIAGONAL  
CUTTING PLIER  
Lap Joint**

Length 7". Polished  
steel finish.



**No. 516 SLIP-JOINT  
PLIER  
Thin Nose**

Length 6". Polished  
steel finish. Knurled  
grips.



**No. 537 SLIP-JOINT  
PLIER  
with Side-Cutter**

Length 7". Polished  
steel finish. Knurled  
grips.



**No. 568 ANGLE-NOSE  
PLIER  
Slip-Joint**

Length 8". Polished  
steel finish. Knurled  
grips.



**"SUPERIOR" PLASTIC  
GRIPS FOR PLIERS**

Made of tough, durable plastic  
material. Easy to install, full  
instructions with each pair.  
Plier loss reduced as light blue  
color makes pliers easy to locate  
Gives maximum handle-grip  
comfort.





**No. 27 1/2  
BRICK HAMMER**



Drop Forged — Black Enamel Finish  
Adze Eye

Hickory Handle

No.	Size
27 1/2	#2/0—10 oz.
27 1/2	#0—18 oz.
27 1/2	#1—24 oz.
28 1/2	#1—24 oz.

**No. 88 LONG NECK  
ELECTRICIAN'S  
HAMMER**



Designed specially for working over conduit and nailing junction boxes. Full Polished, Black Neck. Weight, 16 oz.

**No. 451 1/2  
"Our Pride"  
NAIL HAMMER**



Special Analysis Steel. Properly heat-treated to insure maximum durability for claws, face and body. Square face provides wider striking surface at edge of face and enables easier driving of nails close to abutting surface and in corners. Claws are clean-cut and sharp for easy gripping of nails of all sizes. Lacquered handle is moisture proof, full octagon, nonslipping, and easy on the hands. Weight, 16 oz.

**FOR HIGHEST QUALITY TOOLS BUY CHAN NEL LOCK**

**H**ERE are a few of the many items in the complete Champion-DeArment Channel-lock line. On these pages you see the result of three quarters of a century experience in producing highest quality tools. Send for our Catalog PM-1 for complete information on the full Champion DeArment line of fine tools.

**BALL PIEN  
HAMMERS**



**No. 20**  
Full Polished Finish  
(Painted Neck)  
**No. 20 1/2**  
Black Enamel Finish  
Dropped Forged  
Hickory Handle  
This hammer available from 2 oz. to 3lb.

**BRICK CHISELS  
AND SETS**



Drop Forged — Black Enamel Finish

No.	Size
52 Single Bevel	3"
	3 1/2"
	4"
53 Double Bevel	3"
	3 1/2"
	4"

**No. 140  
WRECKING BAR**



Forged from High-grade Hexagon Tool Steel... Heat Treated for Maximum Strength... Tips Hardened to Resist Wear... Pry End Carefully Ground... Claw End Separately Forged and Ground Just Like a Nail Hammer Claw... Clean... Sharp... "Nipper-Grip" Claw for Easy Gripping of Nails of All Sizes. Distinctively Painted Red and Black Lacquer. 18, 24 and 30 inch lengths.

**No. 148  
HEAVY DUTY NIPPERS**



This "Heavy Duty" Nipper is specially designed for Concrete Form Builders, Carpenters, Mechanics, Farmers and for Miscellaneous work. It will easily cut large nails, small spikes, form tie wires, reinforcement wire, etc. Drop forged from special analysis steel, and designed to give greatest leverage and strength. The stops prevent dulling of cutting edges and provide adjustment when edges have worn. Polished head. Painted "T" handles. Cutting edges hand filed. Available in 8, 10 & 14 inch lengths.



# Presenting America's **NEWEST** and **FINEST**

STYLED BY  
**HARLEY EARL**  
DESIGNERS



Only **\$87.50**  
Less Motor, Guard,  
Stand . . . slightly higher  
west of Rockies.

## The Great New *Atlas* 3021 8" TILT/ARBOR, BALL BEARING CIRCULAR SAW

Here's a brand new saw that'll do everything you've ever expected of an 8" circular . . . **FASTER, SMOOTHER, EASIER** and **MORE ACCURATELY** than you'd have believed possible. It's designed for efficiency . . . engineered to exacting standards for smoothest operation and long service . . . built for rigidity and styled along the most modern structural lines. Never before such value . . . **STUDY THESE FEATURES.**

- NEW** MODERN STRUCTURAL DESIGN . . . for accurate work.
- NEW** PUSH-PULL DUAL CONTROL . . . one handwheel for blade height, angle.
- NEW** LARGER ARBOR AND SEALED-FOR-LIFE BEARINGS.
- NEW** FAMOUS ATLAS DOUBLE-LOCKING, LIFT-OFF FENCE.
- NEW** DUAL V-BELT DRIVE . . . full power for every job.
- NEW** GRIP-FORM MITER GAUGE . . . greatest working ease and accuracy.
- NEW** BIG, EASY-TO-READ TILT GAUGE . . . accurate settings in seconds.
- NEW** STRUCTURAL DESIGN MECHANISM . . . greater rigidity, accuracy, ease of operation.
- NEW** CLEAR-VISION SAFETY GUARD . . . with tough transparent Tenite. Optional.
- NEW** PYRAMID DESIGN STAND . . . extra rigid, scientifically balanced. Optional.

Write for **FREE LITERATURE** and name of nearest **FRANCHISED ATLAS DEALER**

with



*Atlas Press Company*

124 N. PITCHER ST., KALAMAZOO, MICHIGAN

**you can DO so much MORE so much BETTER**





Used and Endorsed by  
**LEADING OUTDOORSMEN**  
Everywhere!



## Your 3 **Coleman** "OUTING PALS"



**Coleman Folding Camp Stove** gives you big hot meals or a tasty snack, quick and easy, wherever you go. Cooks like a gas range. Lights instantly. Easily regulated burners. Folds up and carries like a suitcase. New durable copper-brazed fuel tank;

rust-resistant finish. 2 and 3-burner models. Ask your dealer for demonstration.

**Coleman Floodlight Lantern** means more hours of fun outdoors. Floodlights 100-ft. area. Lights instantly. 8 to 10 hours service from one filling. Safe; stormproof. Coleman Reflector makes it a powerful spotlight. Single and double mantle models. See it lighted.

**NEW Coleman Folding Picnic Table and Carrying Case** sets up in a jiffy on strong legs. All steel. Big 28-in. square top. 26½-in. high. Folds into carrying case with legs and stools inside, plus extra space for other equipment.

See all three Coleman "Outing Pals" at Hardware, Sporting Goods and Department stores.

Mail  
Coupon  
for Free  
Outdoor  
Book



(FOLDING STOOLS EXTRA)

The Coleman Company, Inc., Dept. 205-PM  
Wichita 1 Kansas

Send me free copy of the Coleman outdoor book,  
"How to Have More Fun on Every Outing."

Name \_\_\_\_\_

Address \_\_\_\_\_

City \_\_\_\_\_ State \_\_\_\_\_



Dallas Morning News

### Texas Butterfly Branding

Butterfly breeder Carl Anderson of Dallas, Tex., keeps track of his insects with a traditional Western method — branding. Anderson, who raises monarch butterflies as a hobby, paints a number on the butterflies with check-protector ink and then turns them loose. Postcards are sent to interested people throughout the country, who are asked to report any branded butterflies. Most of the reports come from the Dallas region.

### Miniature Pen

So small it must be filled with an eye dropper, a new fountain pen weighs only an eighth of an ounce. Half as long as a king-size cigarette when closed for carrying, it actually writes and carries its own ink supply.

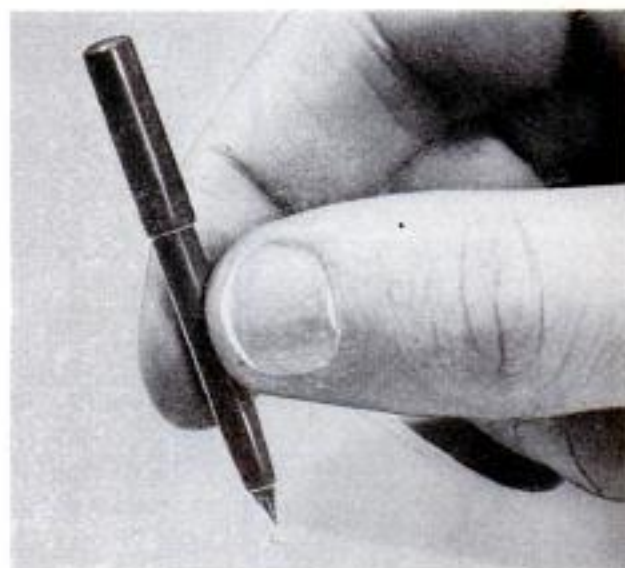



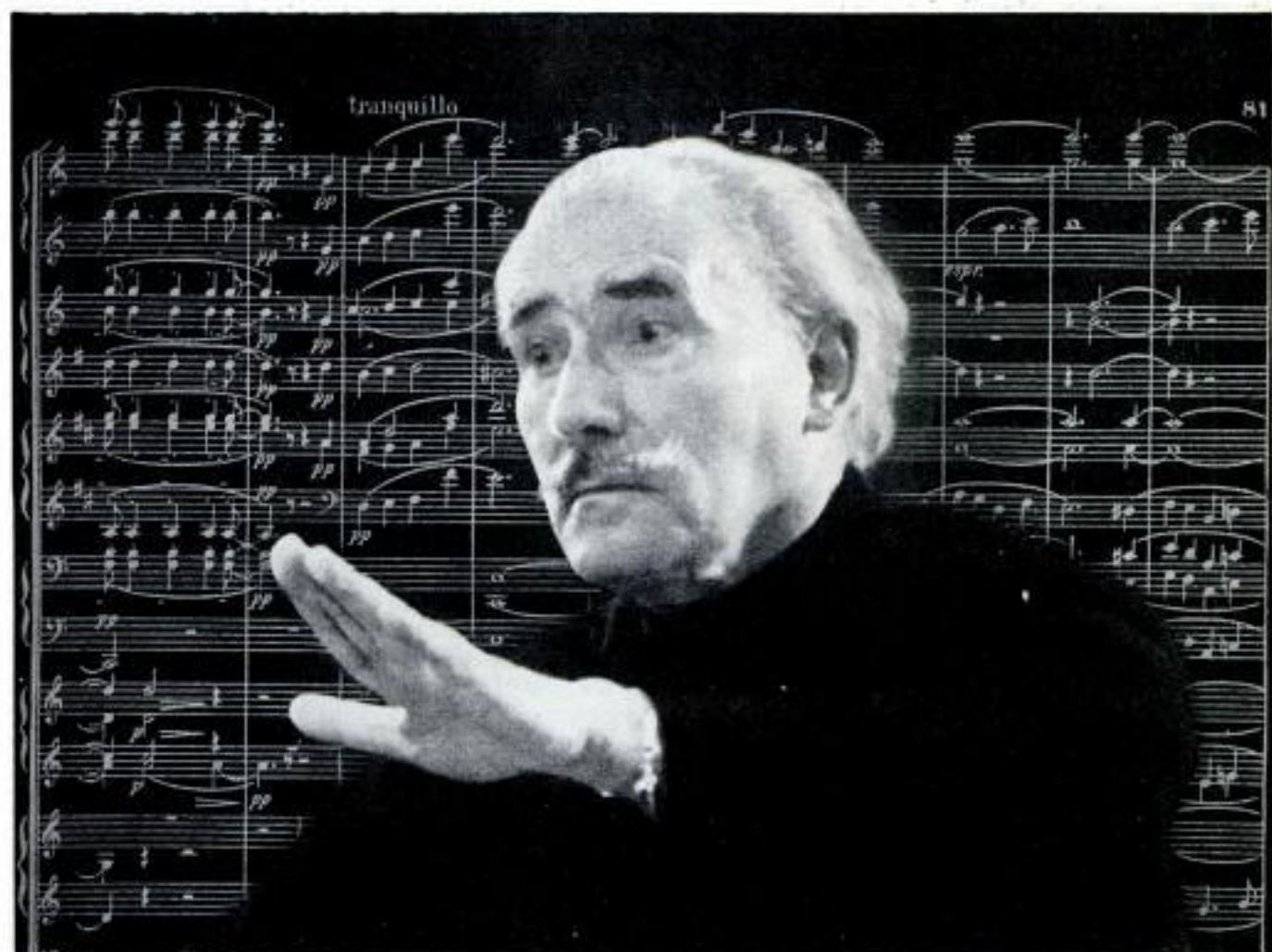

Arturo Toscanini conducting "Death and Transfiguration," Opus 24, by Richard Strauss

## RCA High Fidelity brings you every musical note!

RCA Victor High Fidelity is the result of a half century of leadership in recorded music, in phonograph research and in the development of radio and motion picture sound equipment. It is a great new dimension in sound created by the perfect union of recorded music and the phonograph.

A genuine high fidelity instrument re-creates the full range of tones and overtones of the original composition—exactly as the composer intended.

"Victrola"® phonographs, Victor rec-

ords, and "intermatched" high fidelity equipments for those who want to assemble their own units—all are designed to work perfectly together to bring all of the brilliance of the original performance into the home.

The nation-wide interest in high fidelity reflects the public's growing taste for the highest quality in recorded and broadcast music. Developments by RCA scientists and engineers now make it possible for you to enjoy this new, musical experience.



® **RADIO CORPORATION OF AMERICA**

*World leader in radio — first in television*



# 168 TYPES AND SIZES

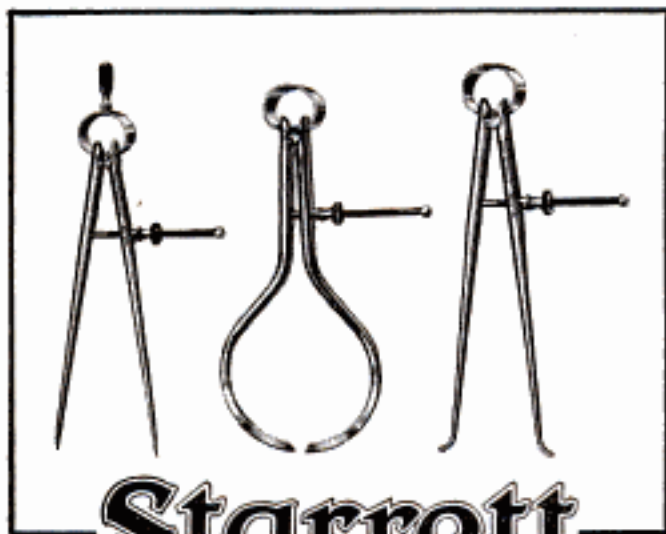

## Starrett

### CALIPERS AND DIVIDERS

Made of finest quality steel, nicely tempered for lasting accuracy, Starrett Calipers and Dividers have the perfection of design, finish and workmanship that lends added sureness and accuracy to skilled hands. The complete line of 168 types and sizes from 2 inches up to 36 inches includes spring, firm joint, lock joint, hermaphrodite, thread and transfer calipers and dividers. See them at your Starrett Tool Distributors.

#### SEND FOR IT — ONLY 10¢

Starrett "Tools and Rules" Book  
50 page booklet shows the right tools for any precision measuring job. 100 pictures plus helpful reference tables. Send only one dime. Address Dept. AP.



THE L. S. STARRETT COMPANY · ATHOL, MASS., U.S.A.



MECHANICS' HAND MEASURING TOOLS AND PRECISION INSTRUMENTS  
DIAL INDICATORS • STEEL TAPES • PRECISION GROUND FLAT STOCK  
HACKSAWS, BAND SAWS and BAND KNIVES

### Oh, for the Life of a Human Mole!

(Continued from page 157)

To look at the pipe opening you'd never suspect that a man could fit in, but actually these fellows, with arms stretched out in front of them, have squeezed into 14-inch lines.

In his rigid position, the rider can't do much but observe the operation. His buggy is remote-controlled from a panel up on the street. And when he comes to the pipe opening, feet first, he must be pulled out by teammates. A woman watching this operation from the sidewalk one day let out a horrible scream, the men report. "She thought we'd found a corpse in the line."

To really see what happens, larger pipe like the 36-inch main that Charlie Smiley's crew was lining provides a better view. Creep 500 to 1000 feet back in one of these overgrown mole holes and you find yourself in another world. Up ahead, the headlight on the humming lining machine flickers across rotating trowel arms, and silhouettes the line of men spaced some 50 feet apart. You see them like shadows relaying the tiny mortar buggies from the pipe opening, where they pick up cement, back to the liner where they are discharged into the hungry hopper. Empties are passed back over the top of the full ones coming in. In cramped quarters, the job takes plenty of energy. "It separates the men from the boys," is how Smiley puts it. "Ordinarily," he explains, "in this and larger pipe, we now use a little electric mortar buggy that a man drives back and forth at four or five miles per hour. At the lining machine, he discharges his load into a charging machine behind the liner. This reservoir keeps the liner supplied while the mortar-buggy man scuttles back for another load."

Down in the eerie regions of a long pipe there's no communications problem. Sound carries along like it would on a telephone wire, since it has no place else to go. A whisper carries 1000 feet. At that distance voices echo back and forth as though men were side by side. Miner's lamps on the men's caps flicker far up in the black hole. Sounds of trucks on the surface thunder sullenly, as their big tires thump over pavement seams. Some of the odd pipe noises can give even a veteran the willies.

Joe Quigley tells about the time he was followed by one of his men when he went down to inspect a big pipe. "I didn't know he was there," says Joe. "Suddenly, 1000 feet back in the pipe, he fell in some water with a tremendous splash. I was sure someone had opened a valve and I was due for drowning. I set a running record that day."

(Continued to page 252)





*Sparking*  
Every  
**CHEVROLET**  
Since 1916



**ABOVE**—This restored 1916 Chevrolet Baby Grand was quite a car in its day. Its 4-cylinder AC-equipped engine developed 24 hp.

**BELOW**—The thrilling Chevrolet Corvette, with AC-sparked 150-hp. engine, has been named "The First All-American Sports Car."



**And Original Equipment on Nearly as  
Many New Cars as All Other Makes Combined**

From the Baby Grand right down to the brand-new Corvette, AC Spark Plugs have been Chevrolet's constant companions.

Today's ACs have insulators of patented *CORALOX*, the greatest spark plug advancement in the past forty years. *CORALOX* resists the formation of oxide and carbon deposits much more effectively than any previous insulator. Elimination of these common causes of plug "shorting" and misfiring can—

- INCREASE ENGINE POWER BY AS MUCH AS 10%
- SAVE UP TO ONE GALLON OF GASOLINE IN TEN

You, too, can enjoy the gas-saving, power-boosting advantages of AC Spark Plugs—no matter what make or model car you drive.



AC SPARK PLUG DIVISION

GENERAL MOTORS CORPORATION



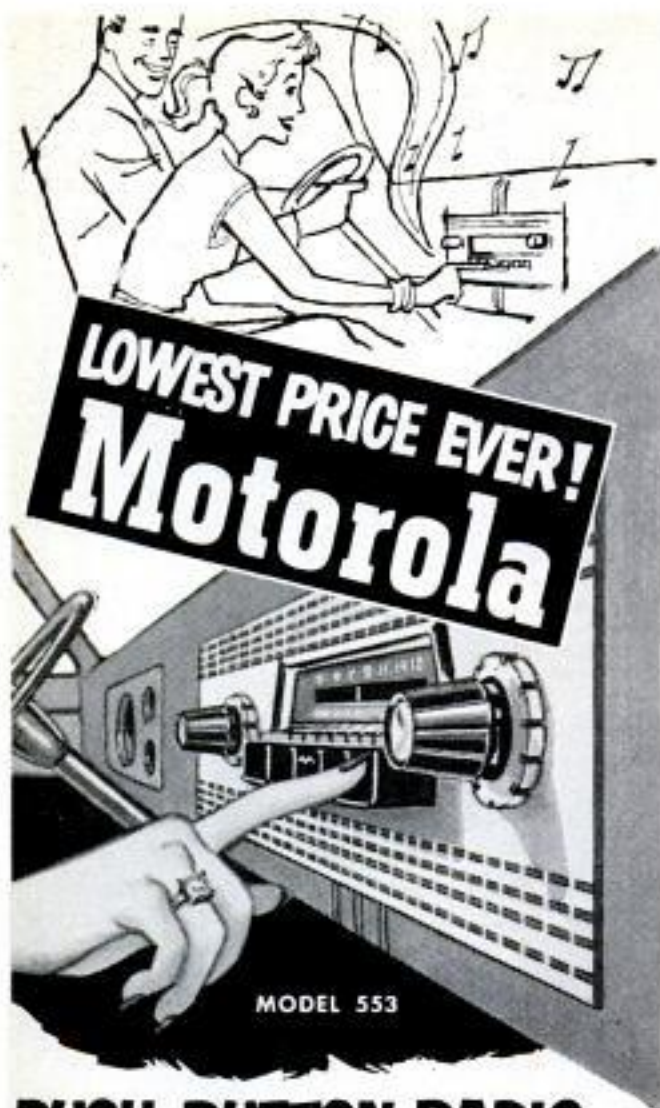

## PUSH BUTTON RADIO

ONLY \$54<sup>95</sup>

Now—you can have real driving pleasure with a Motorola push-button radio at a sensationally low price—only \$54.95! It's easy to install in your car. New larger speaker gives new depth of tone never believed possible in a set so compact!

Five station push-to-lock control locks in the station; razor-sharp selectivity; full automatic volume control reduces fading. Low battery drain! So easy to install, it can be put in your car while you wait.



Water is one hazard the men respect, with reason. "We were lining two parallel 36-inch mains in an eastern city recently," Smiley recalls, "One was finished and we were 500 feet up the other. Some official opened the gate valve on what he thought was the finished line. Instead he released a flood into the one we were in. We knew it instantly. A rush of air came past. There was noise like a waterfall. Yelling men crawled over each other in a mad dash for the exit. The last man made the nipple opening with the roaring water close at his heels.

Like steel riggers, some men actually freeze, or get "pipe happy" in the gloomy recesses now and then. The men describe it as a kind of momentary panic. It happened once to Ray Briere, a rugged young man on Earl Parker's gang. Briere was working his way through a long stretch of 16-inch pipe, hand cleaning the line as he inched his buggy along with his fingertips. Far inside the pipe his strength gave out. Men yelled encouragement to him, but he wasn't having any. "Just leave me alone. I can't move. I'm staying here," he said. They finally went in and hauled him out, struggling and protesting.

In spite of his experience, Briere is one of the toughest and best pipe men in the business today. On one job, he was belly-whopping through a small pipe on a winch-hauled buggy and went head-on into a long dip filled with water. For almost two minutes, men at the opening yelled to him and got no reply. Finally the buggy broke through on the other side of the trap. Briere came out wet and sputtering and mad. Without knowing how long he would be submerged when he saw that water coming at him, he held his breath and went under with the buggy.

Tricky jobs at Centrline are standard. Not the least tricky was the mile of 22-inch pipe in a western canyon that climbed at a fantastic angle up the canyon wall. On such a grade, the electric buggies couldn't haul the liner, so winches at the top pulled it along. High-speed winches hauled the mortar buggies back and forth. The operator, lying between the 1800-pound liner and the equally heavy charger, was 4000 feet from the canyon bottom when suddenly the cable holding his train snapped. For almost a mile, he rocketed downward inside that black tube, until the entire train whammed to a stop against a closed gate valve at the bottom. The machinery crumpled and wedged so fast inside the pipe that the entire section had to be cut out. Miraculously, the operator sustained a few broken bones and nothing more. That was

(Continued to page 254)



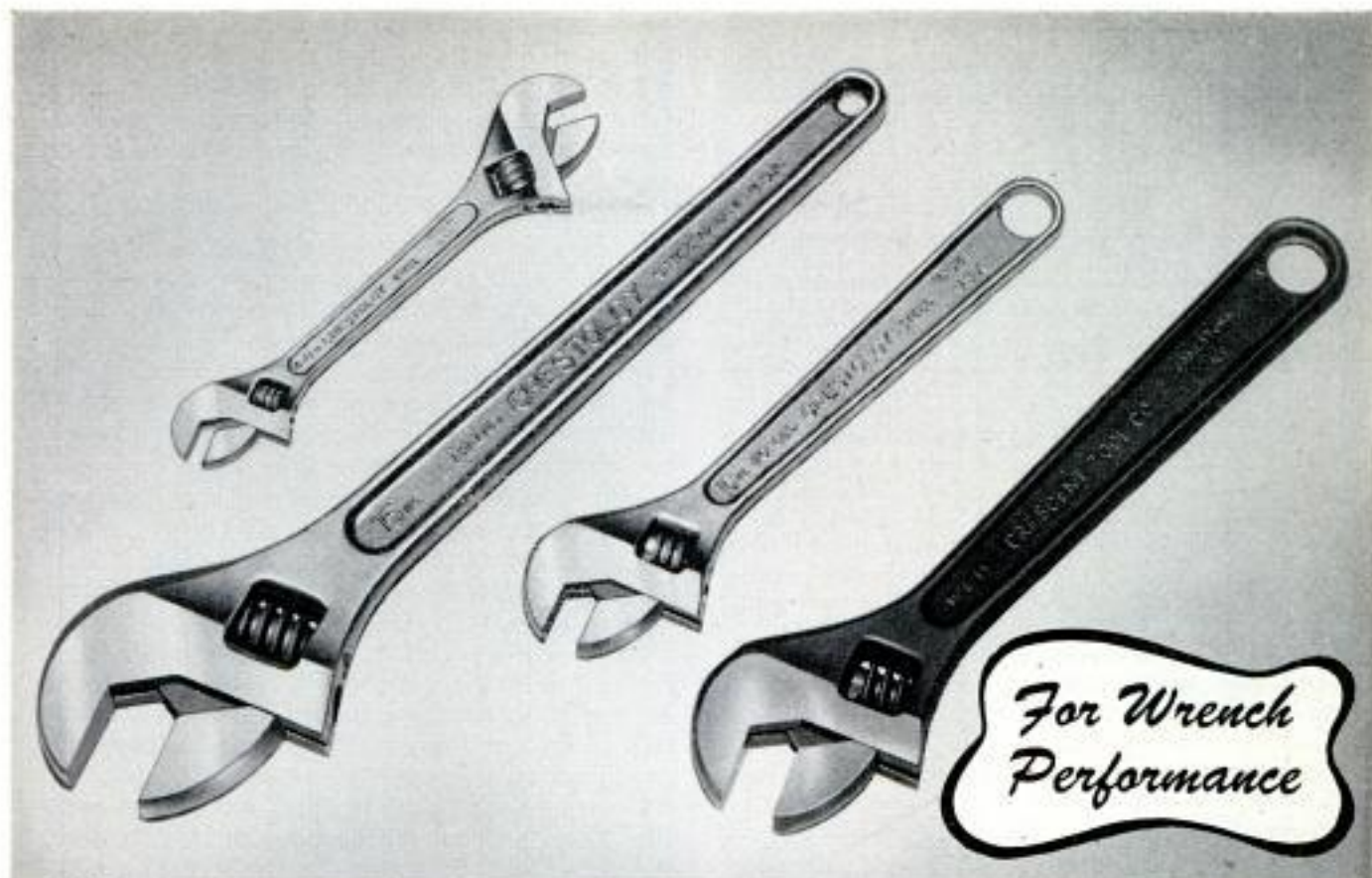

## Choose **CRESCENT** or **CRESTOLOY**

● Since more Crescent and Crestoloy Adjustable Wrenches are sold today than any other brand, an explanation of the differences in these two famous Crescent tools may be appropriate.

**CRESTOLOY** Wrenches are forged from a special alloy steel permitting thinner, trimmer design with greater strength and less weight than conventional types. They are available in Single End patterns, 4" to 24" size. Double-end in four models combining 4-6; 6-8; 8-10; 10-12 inch sizes.

The 15", 18" and 24" sizes, available in Single End pattern only, are distinguished by their tapered handles. There is no stronger or finer Adjustable Wrench than **CRESTOLOY**.

**CRESCENT** Wrenches are forged from selected carbon steel and specially heat-treated to increase their toughness and durability. Due to their lesser cost and relatively great strength, they are widely used in industrial and service operations where thinness is not essential. Available in Single End Patterns, 4" to 18".

Both Wrenches represent the best in design and workmanship, and carry the same guarantee.



### GET YOUR FREE COPY!

This new 20-page booklet provides many useful how-to-do-it ideas for both amateurs and professional mechanics, as well as basic information on the proper selection, use and care of hand tools. 93 illustrations. Write today.

**CRESCENT TOOLS**

*Give Wings to Work*

*Sign of the Artisan  
Symbol of Excellence*

Crescent is our trade-mark, registered in the United States and abroad, for wrenches and other tools. Sold by leading distributors and retailers everywhere and made only by **CRESCENT TOOL COMPANY, JAMESTOWN, NEW YORK**



**PIONEER WORK SAVERS**  
NOW BETTER THAN EVER—GREAT NEW 1954

**SHAW**  
"DU-ALL"

## Garden and Small Farm Tractors

Plow .. Cultivate .. Mow .. Rake .. Bulldoze ..  
Saw Wood..Make Many Other Hard Jobs Easy

### Sturdy 1½ to 5 H.P. Walking Tractor



Best for all around garden and lawn work. Variable speeds, adjustable wheel widths, individual gang tool controls. 3 speed and reverse automotive gears on 3 and 5 H.P.

models. Superb traction, deep plowing, easy handling. All wanted tools and attachments.

### Rugged, Low Cost 2½, 5, 8 H.P. Streamliner

Powerful, practical, streamlined, comfortable. Pulls 8, 10, 12 inch plows, cultivates between 38 in. rows, bulldozes, mows lawns, operates belt attachments. 3 speeds and reverse automotive transmission. Friction brakes. ¼ to 7 M.P.H. Nothing else like it in a tractor that will do the work.



### Powerful 8 & 12 H.P. Riding Tractor



Low cost power for truck gardens, small farms. Handles 10, 12, 14 in. plows. Works astride or between 42 inch rows. Automotive transmission, 3

speeds and reverse. All wanted tools and power take off attachments.

### Inexpensive New Garden Tiller-Lawn Mower

Nine inch rotor pulverizes 12 inch swath 6 inches deep, makes perfect seed bed. does all cultivating between narrow rows. Rotor quickly replaced with single wheel for lawn mowing, hauling, power take off work.

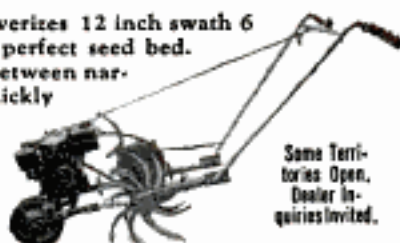

Some Territories Open. Dealer Inquiries Invited.

See the Shaw Dealer for Demonstration

**MAIL COUPON FOR FREE CATALOG**

**SHAW MANUFACTURING CO.**  
4501 Front St., Galesburg, Kansas  
668-G N. 4th St., Columbus, Ohio

Please send me Free Catalog and Prices on Shaw Du-All Garden and Small Farm Tractors.

NAME \_\_\_\_\_

ADDRESS \_\_\_\_\_

probably the most serious accident in Centriline's 14 years of operating history. And it's rare that even minor accidents occur. "People take care of themselves down there," says Smiley. "It's not worth taking chances."

No one at Centriline needs to go into pipe less than 16 inches in diameter. These smaller jobs are performed by the "Tate process." Cement is pumped into the pipe and a bullet-shaped cylinder is dragged through the line, spreading and pressing the mortar to the pipe wall. Spring steel arms on the front end of the cylinder keep it centered in the pipe.

But there are pipes other than water mains that carry these men down into pretty predicaments. Not long ago, Joe Reidlinger, a Centriline pipe man, was working on a team with veteran superintendent Charlie Erskine in a 30-inch-tile drain beneath a Florida airport. Way up the drain he suddenly came face to face with a five-foot alligator. It didn't faze Joe. He backed away quietly, got a rope and went back in. After a two minute tussle, he had roped the 'gator's jaws, trussed it up, and hauled the thing out to fresh air for everyone to see. Before the men were through, they had also flushed a family of foxes from under that airport.

Probably one of the trickiest Centriline jobs materialized when the Consolidated Edison Company of New York yelled for help. Turbine blades from one of their big generators had broken off and fallen into a 19-inch steam line that fed the monster. They had heard (erroneously) that Centriline used midgets to crawl up pipes, and their eyes popped when Earl Parker and Ken Powell—two lanky six footers—showed up. One was lowered feet first by a rope into the deep chasm under the generator. The other went in head-first to check the job. They had to make two vertical right-angle turns that meant practically doubling up 20 feet down in the narrow hole. But they found all the turbine blades, and "Con Ed" officials were so impressed they made a movie of the whole job.

Whether it's water main, steam-turbine lines, oil line or gas line there isn't much in the way of gloomy pipes that these men can't handle. ★ ★ ★

## White House Weathermaker

Comfort of the President and his household will be assured by a new electronic control panel which regulates temperature and humidity in the White House. The complex board monitors 106 thermostats in the modernized executive mansion.



Try My "FAMILY FORMULA" For  
GETTING YOUR COMPLETE WORKSHOP

Build your one-motor  
**DELTA SHOP** this ideal way—  
**A TOOL AT A TIME!**



FIRST I BOUGHT THE  
BASIC SAW AND STAND



... and that gave me the tool to do the sawing operations that are needed on every job. The DELTASHOP'S big tilting blade saw does many other important operations, too—such as cutting grooves, decorative moldings, etc.—and its accuracy helps me do work like a professional.

Saw and stand, less motor \$109<sup>80</sup>

LATER, MY WIFE GAVE ME  
THE COMPANION JOINTER-PLANER



To do any finished-looking job you must plane the edge of a board right after you rip it. The Delta jointer planes boards up to 4" wide . . . does operations such as tapering and rabbeting, too.

Jointer, complete \$49<sup>15</sup>

THE DRILL PRESS WAS A  
GIFT FROM MY FOLKS



In addition to doing accurate drilling, the Delta drill press made it possible to make mortises, do routing, carving, sanding, polishing, make beautiful shaped edges . . . actually it's a "master of all trades."

Drill Press . . . \$57<sup>50</sup>

MY KIDS JOINED FORCES TO  
GIVE ME THE SANDER



This handy, low cost tool is perfect for finish-sanding jobs—has many other uses, too.

Sander . . . \$17<sup>55</sup>

Ask about the DELTASHOP "tool-at-a-time" plan today—at your Delta dealer, department store or nearby hardware store. Then start building your complete workshop this easy, low-cost way. Delta Power Tool Division, Rockwell Manufacturing Company, 502A N. Lexington Avenue, Pittsburgh 8, Penna.

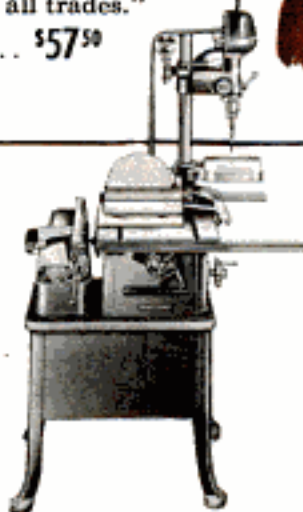

Prices slightly higher west of the Rockies

**DELTA** QUALITY POWER TOOLS

Another Product by

**Rockwell**



DELTA QUALITY  
MAKES THE DIFFERENCE







# Mystify your friends

... by using  
these **WIZARDS** with **WOOD!**

Give a professional finish to everything you make... an "everlasting" bond to everything you mend. Mail coupon for leaflets about the miracles you can perform with Firzite, Satinlac and Weldwood Glue.

**The Wood Glue you can rely on**

To make things or fix things, use **Weldwood Glue** for all wood-to-wood bonds. Makes joints stronger than the wood itself. Mixes easily with water. Stain-free, rot-proof... highly water-resistant!

**WELDWOOD®**  
PLASTIC RESIN GLUE

**For blond or pickled effects—**

White Firzite produces those magical "woods" effects—on hard wood or soft, plywood or solid lumber. For light pastel tones, tint White Firzite with Colors-in-Oil. (On fir plywood stain jobs, tame that wild grain with Clear Firzite.)

**White FIRZITE®**

**Gets that Natural-Wood Finish**

On furniture, panelling or woodwork, there's nothing like Satinlac. Brings out natural grain and color beauty of any plywood or solid wood. Avoids that "built-up" look. "Water-clear," easy to brush or spray, dries ready for next coat in 2 or 3 hours.

**SATINLAC®**

**United States Plywood Corporation**  
Dept. 292, 55 West 44th St., New York 36, N.Y.

Send me free leaflets on Weldwood Glue, Firzite and Satinlac.

NAME \_\_\_\_\_

ADDRESS \_\_\_\_\_

## Portable Radio "Test Bench" For Convenient Service

(Continued from page 179)



TV speaker is suspected. The 7-prong miniature-tube pin straightener is shown in photo G; there is also room for a 9-pin straightener at the right if desired. Photo H shows the convenient soldering-iron rest.

Photos F and J illustrate the use of the 1/4-watt neon lamp in the candelabra socket. The clip is a Fahnestock type arranged for one of the test leads. It is connected to one terminal of the lamp socket by means of a flexible wire brought through the panel from d.p.d.t. switch No. 2 as indicated in Fig. 1. This wire may be detached to permit a pair of test leads to be inserted as shown in photos F and J. The lamp may then be used in series with the line voltage for continuity testing. With the flexible wire replaced and switch No. 2 in the open position, test leads may be plugged into the pin jacks below the lamp socket and the lamp used to detect voltage, or the absence of same.

\*\*\*

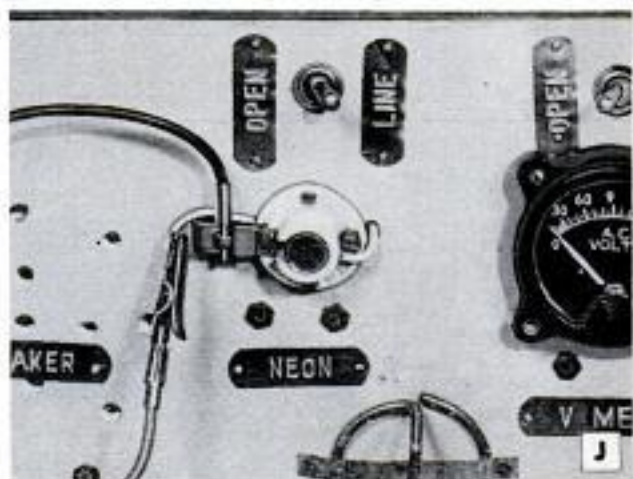



*See* How Little It Costs  
to Build a Ready-Cut

*Liberty Home*

Ranch - type home,  
64 feet wide, with  
three bedrooms



**\$3128**

Freight-Paid  
Prices  
As Low  
As  
\$2608



### What "Liberty" Owners Say

#### Ahead \$2,000 to \$3,000

"We have moved into our 'Liberty' home and are more pleased with it every day. I think I would be safe in saying we are ahead \$2,000 to \$3,000 by buying your Liberty Home and doing the work ourselves."

#### Saved \$4,000 to \$6,000

"Compared to a local contractor's price to build a home equal to my 'Liberty,' I will be saving \$4,000 to \$6,000; so you can see why I have such enthusiasm for Liberty Homes."

*Save 30% to 40%*

Don't pay several hundred dollars more than necessary when you build a home! Buy direct from our mill at our low, factory, freight-paid price. We ship you the lumber cut-to-fit, ready to erect. Paint, glass, hardware, nails, etc., all included in the price. Plans furnished—also complete building instructions. No wonder our customers write us that we saved them 30% to 40%. Architecturally approved construction. (Not prefabricated.)

### Visit a Liberty Home!

Many thousands of Liberty Homes have been built in all parts of the country. If you would like to visit and inspect the model that suits you best, write us and we will give you its location.

### Handsome Big CATALOGUE

Pictures wonderful homes in colors at money-saving prices. Designs to suit everyone. Send 25c for catalogue today.

**BIG BOOK**  
of  
House Plans  
in Colors  
**25¢**

### LEWIS MANUFACTURING CO.

1241 Lafayette

Bay City, Mich.

## FREE Garden Tractor CATALOG

Big heavy-duty models—low cost utility models. All attachments including plow, sickle bar, cultivator, mower. Safety reverse. Quick starting. Rugged construction. Write for free catalog.

Quick Mfg., Inc., 3257 E. Main St., Springfield, O.

**Springfield** GARDEN TRACTOR



## IDEAL LAWNMOWER SHARPENER

### BOOST YOUR INCOME

You can earn extra cash with the Model 300 Ideal Lawnmower Sharpener. Used and recommended by leading manufacturers and service shops, the Ideal has everything you need, nothing else to buy. Grinds reel and bed knife, also reconditions. Get started now in this highly profitable business. Write for catalog today.



**The Fate-Root-Heath Co.**  
Dept. PM-1, Plymouth, Ohio



**WHAT  
DO YOU WANT?**

**A GOOD BUSINESS  
OF YOUR OWN?**

**A HIGH PAY  
SPARE-TIME  
JOB?**

*Then* **FOLLOW THIS  
PROVED SUCCESS PLAN!**

Here is your chance to be your own boss, secure financial independence, build a future for yourself and your family in a profitable business in your own garage or basement. J. S. of Michigan writes, "I figure my profits (last season) at over \$1,000.00." Mr. C. H. R. of Ohio says, "This season I have taken in \$3,688.20." J. P. of Pennsylvania writes "I spent only 40c for a newspaper ad and have done nearly \$500.00 worth of business." Another owner writes, "I have had 4 mowers a day brought to me since last May . . . and do the grinding evenings at an average of \$2.50 each." Think of it! That's \$10.00 an evening in spare time. If you want to get ahead, make big money, be your own boss. Act Now. Write today for full details of our proved success plan.



**ONLY ON THE UNIVERSAL LAWN MOWER GRINDER**

can the inside face and edge of the stationary blade, and all reel blades, be ground to proper clearance

**ALL IN ONE SET-UP**

**WITHOUT REMOVING ANY BLADE FROM THE MOWER**

. . . that's why this business is simple, easy, and interesting. No experience or long hours of study are necessary. A leading National Magazine says, even an inexperienced worker can do a good job. We furnish complete instructions, everything you need to get started . . . But you must take the first step. Just fill in and mail the coupon below. Do it right now.

**ROGERS MFG. CO., DEPT. M-14, LINDSEY, OHIO**

**SEND THIS COUPON NOW**

**ROGERS MFG. CO., Dept. M-14, Lindsey, Ohio**

Please send me full details about the profit possibilities of Lawn Mower Sharpening.

NAME \_\_\_\_\_

ADDRESS \_\_\_\_\_

CITY \_\_\_\_\_ STATE \_\_\_\_\_

**The Battle of the Sagebrush Busters**

*(Continued from page 118)*

For many years, the removal of sagebrush required a grub hoe or mattox—a sort of cross between a pick and hoe—a strong back and gallons of liniment.

Then one day a team of horses, dragging an iron rail into place for the Union Pacific's new line, became frightened by a rattlesnake and raced across the sagebrush. The rail knocked down brush in its path and that gave a settler who has long gone unnamed an idea.

That night he "borrowed" a rail from the Union Pacific, hitched a couple of spans of mules to it and began clearing his land. For many years thereafter, many other rails were borrowed from railroads throughout the West. Railroad officials never complained seriously, because the sooner the land got into crops the sooner the railroads had freight to haul.

The "railers" did complain, though. To get the land cleared, they had to go over and over it. Said one early settler: "Trouble was the brush was sometimes tougher'n the mules."

About 12 years ago, Westerners began to use extensively big Wheatland-type plows, which cut a 30-foot swath through the land. The plows run into trouble, however, in rocky land.

One of the most ingenious recent developments is the handmade outfit of Ray Sherwood at Twin Falls, Idaho. His machine is designed like a cultivator, with thin, sharp blades for cutting the sagebrush off two to four inches below the earth. Tractor drawn, the device will cut sagebrush off 40 acres a day—providing the land isn't rocky. Sherwood has also developed an improved rake which windrows the brush.

Sherwood moves along the rows of brush in a truck with an improvised flame thrower. For a complete job, he's been charging neighbors \$9 an acre—and the neighbors have been happy to pay the price.

Burning of brush as it stands has been done in some areas for as little as 35 cents an acre. If the burn is good, no other seedbed treatment prior to drilling is required. But the brush must be unusually dense if this type of clearing is to be successful.

And now comes the airplane spewing chemicals. Reports the Forest Service: "Studies in the Beaver Rim area near Lander, Wyo., reveal that 75 percent and higher kills of big sagebrush can be obtained with as little as one pound of 2,4,5-T ester per acre, or 2 pounds of 2,4-D ester per acre. These herbicides were most effective

*(Continued to page 260)*



Send for Your  
**FREE**  
Copy of the NEW 1954  
**MIDWEST**  
**TELEVISION and**  
**RADIO Catalog**

# MIDWEST *Presents*

For 1954 a Completely NEW LINE of  
**21" and 27" TELEVISION**

CONSOLES  
TABLE MODELS

and  
**COMPLETE  
CHASSIS**

at  
**LOW FACTORY  
PRICES**



YOUR CHOICE OF EITHER 12 CHANNEL  
VHF or All-Channel VHF-UHF Models

Buy your Television or Radio Direct from the Midwest Factory . . . on  
30 DAYS TRIAL . . . Easy Terms . . . and at LOW FACTORY PRICES.  
For 34 years Midwest, the world's largest and oldest exclusive Factory-  
To-You radio and television manufacturer, has served hundreds of thou-  
sands of satisfied customers all over the world.



**EASY TERMS**  
— • —  
**30 DAYS  
TRIAL**



## FACTORY-TO-YOU

Also—Powerful New 1954 World-Ranging  
**MIDWEST Series 16 RADIOS**  
In Beautiful Consoles and Complete Chassis

All models  
available in  
your choice  
of mahoga-  
ny, walnut  
finish or  
blond lined  
oak.

Once again Midwest  
offers its famous series  
16 five band AM-FM  
radio chassis and the  
magnificent new Sym-  
phony Grand Radio-  
Phonograph with 3-  
Speed Automatic Inter-  
mix Record Player.  
Also, a complete line of  
clock radios, table  
radios, and portables.



WRITE IN NAME AND ADDRESS (PLEASE  
PRINT) ON COUPON OR 2c POSTCARD

MIDWEST RADIO & TELEVISION CORP.  
Dept. H-25, 909 BROADWAY • CINCINNATI 2, OHIO  
Please send me your new FREE 1954 Catalog.

NAME \_\_\_\_\_

ADDRESS \_\_\_\_\_

CITY \_\_\_\_\_

ZONE \_\_\_\_\_ STATE \_\_\_\_\_

**MIDWEST RADIO & TELEVISION CORP.**

DEPT. H-25, 909 BROADWAY, CINCINNATI 2, OHIO



## HOW to CHOOSE a DRILL

Before you buy, make sure you get  
all these up-to-date features . . .

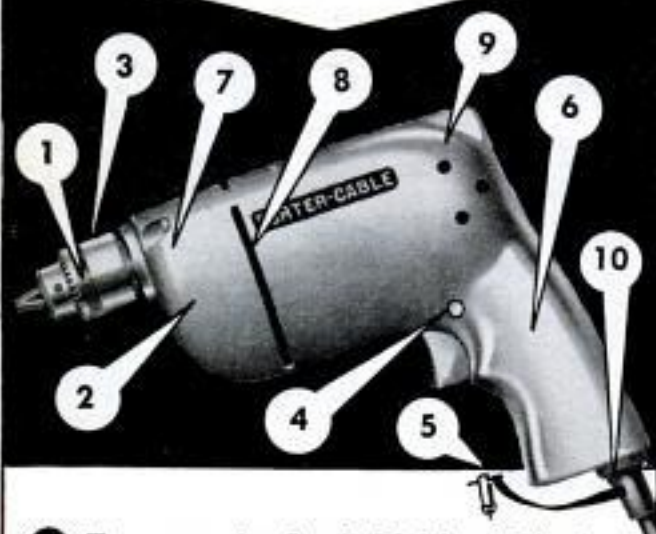

- 1 True-centering Jacobs Multicraft Chuck.
- 2 Compound reduction gears assure smooth operation, longer life.
- 3 Drills within  $\frac{1}{8}$ " of vertical surface.
- 4 Trigger lock under right thumb for instant control.
- 5 Convenient chuck key strap included.
- 6 Longer, more comfortable full-hand pistol grip.
- 7 Spindle ball bearing absorbs radial and thrust loads.
- 8 Air vents never blocked by left hand.
- 9 Brushes easily accessible for quick change.
- 10 Strain reliever prevents cord pulling out.

PLUS speed and power to drill 1" bar stock  
in 2 min.—1" hardwood board in  $1\frac{1}{4}$  min.

Everything you want in this  
new  $\frac{1}{4}$ " DRILL by

ONLY  
\$29.<sup>95</sup>  
MODEL 1E1

**Porter-Cable**  
Quality Electric Tools

See it at your Porter-Cable dealer's or mail coupon  
for new folder "How To Choose A Drill".

Porter-Cable Machine Co.  
2441 No. Salina St., Syracuse, N. Y.

Name \_\_\_\_\_

Street \_\_\_\_\_

City \_\_\_\_\_ State \_\_\_\_\_

In Canada: STRONGRIDGE, LTD., London, Ont.

in this area when applied in three to five gallons of diesel-oil carrier about the time the native bluegrasses started blooming. Herbicide treatments, which gave the best control of big sagebrush, did not result in severe damage to other shrubby species or to perennial grasses."

Over in the Columbia Basin of Washington recently, airplane operators were given the job of spraying 20,000 acres of sagebrush. In one day alone, two planes sprayed approximately 5000 acres. With the grub hoe or mattox, two men did well to clear an acre a day.

In reseeding of rangeland after the brush is gone, the big question in the West for many years has been the type of grass to plant. Sixteen years ago, A. Perry Plummer, range ecologist in charge of Utah reseeding studies for the Intermountain Forest and Range Experiment station at Ogden, Utah, was given the job of finding the answer.

Plummer experimented with more than 700 grass and shrub species hailing from Siberia to Africa. More than 60 were found to have some place in artificial revegetation of the intermountain area. In areas with more than 14 inches of rain, intermediate wheatgrass and tall wheatgrass, both from Siberia, were found to be highly productive. But in areas with less than 14 inches of rain, crested wheatgrass soon proved a favorite.

"Successful plantings have been made in areas with rainfall as low as five inches," said Plummer. "Major difficulty is getting the grass started, but once established it will persist."

His main experiments were conducted on a patch of land near Ephraim, Utah, that was entirely bald except for thistles and sagebrush. Many ranchers in the area scoffed at his first grass-growing efforts. One rancher leaned from his saddle to snort:

"I'll give you a dollar for every blade of grass you grow on that land."

Plummer's lament: "I should have taken him up. I'd be a billionaire today—or at least have a billion or so owed to me." ★ ★ ★

### Delayed-Action Nitrogen

Nitrogen in granular form makes it possible to apply a full year's supply at one time without danger to a garden. The same materials which make Bakelite are put together in a slightly different way to make the fertilizer, called "uramite." Urea and formaldehyde combine to give a granular material that, in moist garden soil, slowly makes nitrogenous food available to plants.



## D. C. GENERATORS

ITEM #91



Type R-1, rated 300 Amps.—30 Volts. Mfd. by Jack & Heintz, Gov't. Acq. Cost \$380.00.

Shpg. wt. 55 lbs. Dimensions 16" x 10" x 7". F.O.B. Chicago. . . . **35.00**

ITEM #90—Type P-1, rated 300 Amps.—28 Volts. 2500 R.P.M. Mfd. by General Electric, Ford, Delco-Remy and Westinghouse. Gov't. Acq. Cost \$300.00. Shpg. wt. 55 lbs. Dimensions 15" x 9" x 6". F.O.B. Chicago. . . . **22.50**

ITEM #176—Type L-3. Rated 25 amps., 24 volts. Manufactured by Leece-Neville Co. Shpg. wt. 30 lbs. Dimensions 12" x 6 1/2" x 5 1/4". F. O. B. Chicago. **16.50**



## FOUR-WAY, OPEN CENTER CONTROL VALVE

ITEM #126 with built-in adjustable relief valve. Factory set at 1000 P.S.I., spring loaded neutral position, for use with one double acting cylinder. In neutral position cylinder is locked and pump unloaded. Fully balanced plunger type, smooth, positive, easy operation. Can be used as single unit or mounted in series of any combinations desired. Has 3/4" pipe thread inlet and outlet. 1/2" pipe thread cylinder ports. Newly manufactured to our specifications. Ship. wt. 8 1/4 lbs. An outstanding buy! F.O.B. Chicago. . . . **21.50**



## CENTRIFUGAL PUMP

GENERAL MOTORS

—ALLISON

200 GALLONS

Per Minute

- For Draining Basements • Fire Fighting • Irrigation • Fuel Transfer • Swimming Pools • Home water Systems • Dewatering

ITEM #130

For high volume commercial, home and industrial use. Standard 2 1/2" pipe thread inlet, twin 1 1/4" pipe thread outlets. Ball bearing supported 3/4" shaft. Easy priming rotation, counter-clockwise facing shaft. Gov't. acq. cost \$145.00. Complete with full instructions. Ship. wt. 35 lbs. F.O.B. Chicago. . . . **39.50**

Will deliver 200 gals. per min. against 65 ft. head using 3.2 H.P. at 3500 R.P.M.

## EXTRA HEAVY DUTY Double Action HYDRAULIC CYLINDER



ITEM #224. 3 1/4" bore, 24" stroke, will lift 3250 lbs. with 1000 P.S.I. line pressure. 1/2" pipe thread ports —1 3/8" stress-proof ground, polished & plated solid steel shaft. Overall length closed 36". 3/4" steel wall cylinder barrel clevis mounting at base and shaft. Features—Tie rod construction. Honed barrel. Ship. wt. 50 lbs. F.O.B. Chicago. . . . **39.60**

TO PLACE PHONE ORDERS CALL WEBSTER 9-3793

GOV'T. SHOP BY MAIL AND SAVE

# SURPLUS AND OTHER BARGAINS

MANY ITEMS JUST RELEASED

## PORTABLE POWER CABLES

Manufactured By General Electric & Western Electric

ITEM #193—Ideal for radio equipment, grounding cables, power tools, battery chargers, electric generator sets, searchlights flexible jumpers and general power supply. Individually export packed, net weight 120 lbs. gross 190 lbs.

Neoprene covered flexible—2 conductor, 1/0 wire size. Each cable is 75 feet long, and equipped with 1-male and 1-female Hubbell plug. Conforms to requirements of Federal Bureau of Mines and I.P.C.E.A.

Specifications. Regular price \$135.00 Per 75 feet. **47.50** F.O.B. Chicago

## NOW . . . SAVE \$161.00 on this \$250.00 VALUE 350 WATT A. C. PORTABLE ELECTRIC LIGHT PLANT

Compact Electric Plant suited for small homes, cabins, campers, hunting and fishing camps, trailers and small electrical home appliances. Source of electricity for portable or stand-by use for homes, farms, hatcheries, radio stations, factories. Built by Hobart Mfg. Co. to exacting specifications of the U. S. Army. Ball-bearing, generator, fan cooled. Equipped with standard 1 1/2" shaft with keyway for direct or pulley drive. Built-in Self-Exciter Foot Mounted. Gov't. Acquisition Cost: \$325.00. Dim. 21"x13" Dia. Ship. wt. 290 lbs. **89.00** F.O.B. Chicago

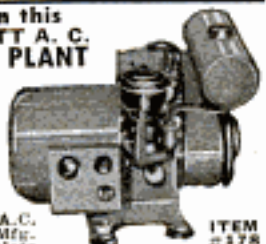

## A. C. ELECTRIC GENERATORS

Power these electric generators with your own gasoline engine, power take-off, or electric motor, and save the difference.

ITEM #G-3—3000 Watts, 120 Volt, 60 Cycle, 1200 R.P.M. single and three phase, for two or three wire circuits. Excellent source of electricity for portable or stand-by use for homes, farms, hatcheries, radio stations, factories. Built by Hobart Mfg. Co. to exacting specifications of the U. S. Army. Ball-bearing, generator, fan cooled. Equipped with standard 1 1/2" shaft with keyway for direct or pulley drive. Built-in Self-Exciter Foot Mounted. Gov't. Acquisition Cost: \$325.00. Dim. 21"x13" Dia. Ship. wt. 290 lbs. **155.00** F.O.B. Chicago

ITEM #G-75—7500 Watts, 120 Volt, 60 Cycle, 1800 R.P.M. single and three phase current, for 2 or 3 wire circuits electric generator, double ball-bearing construction, standard 1 1/2" shaft with keyway, and included at no extra price, 2-groove six inch pulley for belt drive. Direct connected Self-Exciter Foot Mounted. Gov't. Acquisition Cost: \$545.00. Dim. 34"x11 1/2". Ship. wt. 420 lbs. Price Slashed To: **269.00** F.O.B. Chicago



## HYDRAULIC SPEED REDUCER with FINGER TIP CONTROL

USE FOR: Reamer Drives • Midget Cars • Feed Mills • Canning Machines • Conveyors • Lathes • Milling Machines • Motor Boats • Cream Separators • Garden Tractors • Pumps

Variable output speeds from 0 to input speed available by moving control handle. Locking handle maintains setting. Use input power of 1/2 to 1 1/2 H.P. This Westinghouse-Oil Gear Unit consists of a variable displacement hydraulic pump feeding a fixed displacement hydraulic motor. Adjustable relief valves set at factory for 100 lph pounds of torque may be reset up to 180 lph pounds. Independent reverse control allows full output power and speed selection in either direction of rotation. Shafts measure 5/8" diam., include keyway. Input rotation is counter-clockwise facing shaft. Recommended input speed not to exceed 750 R.P.M. Over-all dimensions, 7 1/2" x 7 1/2" x 11 1/2". Gov't. acquisition cost \$428.00. Shpg. wt. 31 lbs. Complete with 2 qts. of oil and full instructions. F.O.B. Chicago. **54.50**

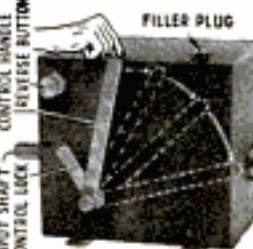

## PESCO GEAR TYPE HYDRAULIC PUMP

COMPACT—POWERFUL—RELIABLE Especially designed for belt drive from fan belt, power take-off, drive pulley, electric motor or small gas engine. Equally suitable for direct coupling. Pedestal type mounting with two bolt holes for 3/4" hold-down bolts. Standard 1/2" pipe thread inlet and outlet ports. Delivers 4.5 GPM at 1000 Psi at 2800 R.P.M. with 3 HP. Will actuate one item #G, 3" bore, 24" stroke cylinder in 10 seconds. Hardened steel wears turn in dense oilite bronze bearings. Rotation—clockwise facing shaft. Guaranteed trouble-free service. Ship. wt. 6 lbs. F.O.B. Chicago. . . . **22.50**



## D. C. ARC WELDER

NEW MODEL 353

ITEM #65 For Stationary or Portable Use. HEAVY DUTY RANGE to 250 AMPS.

- Ideal for
- Farm
  - Garage
  - Factory
  - Workshop



Welds Anything From Auto Frames To Tractor Frames

- Dial Type Rheostat Control
- Use 1/16" to 1/4" Rod
- Generator-type Welder
- Reactor Coil for Smooth Even Arc
- Use 7 1/2 H.P. Electric Motor or 10 H.P. Gasoline Engine
- Run at 2500 R.P.M.
- Available with Either Flat Belt or Double V Pulley
- Complete Operating Instructions

Shipping wt. 107 lbs. \$350.00 value. **99.50** F.O.B. Chicago. . . . Deluxe Model—with "Magic Terminal" for low amperage range welding. (Between 30-100 amps.) **119.50** F.O.B. Chicago. . . .

## CONTINENTAL "RED SEAL" 1 1/2 H.P. ENGINE

ITEM #97—Power for lawn mowers, garden tractors, pumps, generators, compressors, tillers, rakes, plows, feed mills, milking machines and motor scooters.

Brand new Continental "Red Seal" 1 1/2 H.P. gasoline engine, Model AA-7, single cylinder, 4 cycle, with 8:1 gear reducer. Shipping weight 60 lbs. A \$74.00 value. Order now. Limited quantities. **47.50** F.O.B. Chicago. . . .



## Brand New! Just Released! BLACKHAWK HAND-HYDRAULIC PUMP

ITEM #82. Perfect for Hydraulic Presses, Snow Blows, Farm Wagons, Jacks, and Farm Plows. A few easy strokes of the 20" handle and you can lift 5000 lbs., using Item 355 — Hydraulic Cylinder. Blackhawk Model P-151—complete with built-in oil tank and release valve. Rated 1200 lbs. per square inch. Dim. 9"x7"x6". Ship. wt. 35 lbs. Worth much more. F.O.B. Chicago. **22.50**



## Brand New—DOUBLE ACTION HYDRAULIC CYLINDER

ITEM #355 — 2 1/2" bore and 7 1/2" stroke, 1 1/2" stainless steel piston rod. Lift capacity 5000 lbs., using 1000 lbs. pump pressure. Manufactured by Delco-Remy Division of General Motors Corporation. Clevis mounting on base and piston rod for 7/16" bolt. Overall length closed 21". Distance between centers 19". Supplied with fittings to 3/4" pipe thread. Brand new—in original carton. F.O.B. Chicago. **16.00**

ITEM #355A— Same unit, but supplied with built-in spring to provide cushion effect on power stroke and rapid return. **17.00** F.O.B. CHICAGO.



## FREE WINTER EDITION

1954 CATALOG, 52 PAGES, check-out of unsurpassed War Surplus Equipment Bargains for farm, home, factory and workshop.

ORDER DIRECT FROM AD — SEND PAYMENT OR PURCHASE ORDER TODAY — SATISFACTION GUARANTEED

# GROBAN SUPPLY CO. 1139 SO. WABASH AVE., CHICAGO 5, ILL. DEPT. PM1



**FREE****GET THE WORLD'S LEADING  
TV & RADIO CATALOG****ALLIED'S 1954  
ELECTRONICS BUYING GUIDE****268  
VALUE-  
PACKED  
PAGES****SAVE ON  
EVERYTHING  
IN TV AND  
RADIO****Everything for Experimenters, Builders,  
Amateurs, Servicemen, Engineers  
and Soundmen . . .**

Get ALLIED'S big 268-page Catalog featuring the world's largest selections of latest top-quality electronic equipment at lowest, money-saving prices. See the newest in custom TV chassis, TV accessories, FM and AM radios, High-Fidelity sound, Amateur equipment, P.A. systems, recorders, test instruments, builders' kits, industrial electronic supplies—plus thousands of parts, tubes, tools and books. Get more for your money—send today for your **FREE 1954 ALLIED Catalog!**



NEW HOME OF ALLIED RADIO

ultra-modern facilities TO SERVE YOU BEST

**ALLIED RADIO****SEND FOR  
FREE  
CATALOG**

ALLIED RADIO CORP., Dept. 5-AA-4  
100 N. Western Ave., Chicago 80, Illinois  
 Rush **FREE** 1954 ALLIED 268-Page Catalog

Name \_\_\_\_\_

Address \_\_\_\_\_

City \_\_\_\_\_ Zone \_\_\_\_\_ State \_\_\_\_\_

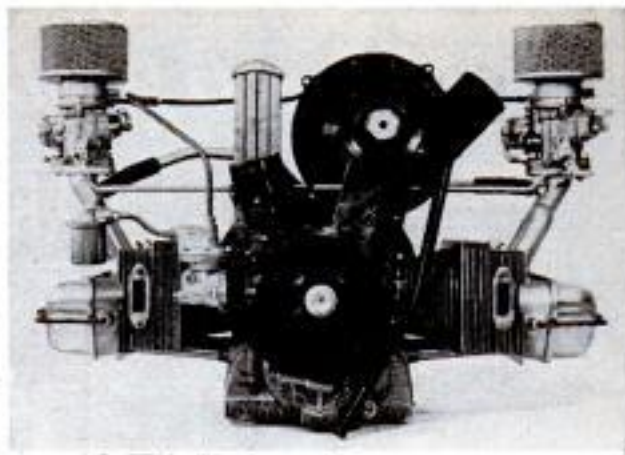

Out of the car, the Porsche engine looks tiny. Two carburetors, circular fan and oil cooler are visible

**The Owners Report on Three  
Rear-Engine Cars**

(Continued from page 139)

compartment with glass fiber."—Milwaukee, Wis., executive.

"Have had some valve trouble. The front end gets out of line easily."—Boston, Mass., internal-revenue agent.

"Road clearance in front is too low."—Car bottoms on medium-grade driveway."—Detroit, Mich., owner.

"Can't park this car just anywhere. No protection as its bumpers are too light and too low."—Los Angeles, Calif., executive.

Many Porsche owners stated that they had to learn to drive the rear-engine car. This is primarily due to difference in weight distribution over a front-engine design.

"Not a car for the beginner driver. Peculiar cornering characteristics."—Libertyville, Ill., executive.

"Dangerous for inexperienced driver."—Fitchburg, Mass., sales executive.

"On wet pavement the car is a little skittish."—Los Gatos, Calif., realtor.

"Marked breakaway of rear wheels on wet roads."—Los Angeles, Calif., physician.

"No gasoline gauge. Car hard to get in and out of. Rear seat useless. Definitely a two-passenger car."—Portland, Ore., timberman.

"Weaves or follows a wavy path. This is reported inherent in the car. They do not know how to fix it."—Centralia, Ill., engineer.

"Car can be 'whipped' by inept handling—meaning rear will skid and slide."—Scarsdale, N. Y., teacher.

"Rear seats are called 'occasional,' but 'emergency' is a better term."—Kirkland, Wash., aircraft-design engineer.

"Surface coat of paint chips too easily. Primer coat is tough as copper plating.

(Continued to page 264)





# Powerful **New** Jig Saw with Built-in Rotary Motor **Only \$23<sup>50</sup>**

**Compare it! Try it!**

**Dollar-for-Dollar,  
DREMEL MOTO-JIG SAW  
Out-performs Them All!**

- Cuts 1½" wood, ¾" plywood, metal, plastic, etc.—will even cut a 2x4!
- New **ROCKER ACTION PRINCIPLE** prevents blade whipping or buckling, eliminates breakage! This revolutionary improvement obsoletes old-style blade tension springs, permits use of finest, fastest-cutting blades in jig saw history!
- **Safe for children!** Blade is completely guarded against finger injuries!
- 4-way blade holder saws any direction, takes any length stock! Table raises and lowers so you can use every tooth in the blade!—Tilts 45°.



Pat. Pend.



Here's jig saw magic to amaze you! Here's a powerful tool driven by a real rotary motor (not a vibrator) that cuts through wood as fast as you can feed it! Sturdy, compact, and agile, it takes 90° turns at top speed, cuts the most intricate scrolls yet is rugged enough for major household repair jobs! Use it to make lawn furniture, valances, knickknacks, toys. It's ideal for adults, safe for children—an all-family tool! The new Dremel Moto-Jig Saw is so superior to others anywhere near its price class that we challenge you to match it against others costing many dollars more. You'll agree it's the greatest value in jig saw history!



**Hobby Project or Household Repair . . . Do it with Dremel—and Save!**



**CUTS SCROLLS LIKE MAGIC—SANDS AS IT SAWS**

**BLADE  
FACES  
4 WAYS**

**SAFE!  
AS A  
HANDSAW**

**JUST  
GUIDE IT!**

**Only  
\$6<sup>85</sup>**  
with 3 new blades

**ANOTHER LONG-TIME FAVORITE WITH CRAFTSMEN!**

## DREMEL *Electric* MOTO COPING SAW

A genuine craftsman's tool with dozens of household and workshop uses. Lightweight . . . easy to operate . . . perfect for knickknacks, corner shelves, intricate scroll work. Cuts through ¾" wood, plastics, rubber and asphalt tile, etc. Perfectly safe for children—women love to use it too! Has only two moving parts, never needs oiling. Unique 4-way blade holder permits cutting any direction—no limit to length of stock it can handle.



Jig saw plans and 6 project patterns **FREE**.

SEE YOUR FAVORITE DEALER. Dremel Tools are sold at better dealers everywhere. If yours can't supply you, order direct on a five-day trial, money-back guarantee. Remit in full and we ship postpaid. Or, send only \$2, now, pay postman balance plus postage and C.O.D. fee.

**DREMEL MANUFACTURING CO.**

**Dept. 114-A**

**RACINE, WIS.**



Valve guides too long, must be end-milled to cure hanging."—Claremont, N. H., engineer.

### Renault Comments

Best-liked features of the Renault were its roadability and handling, with economy of operation next. The Renault is bought more often as a second car, than the two other rear-engine cars surveyed. Sixty-three percent also owned American cars (percentages for the others were: Volkswagen 42 percent; Porsche 59 percent).

"Inexpensive to buy and to operate—a good 'second' car."—Shelburne, N. H., lawyer.

"Traction unequalled. Economy unbelievable (40 miles per gallon). Good braking and cornering."—Manhattan Beach, Calif., owner.

"Weight over rear axle has proved its value. Have never been stuck in the 25 months since I bought it, even in snow and ice, although I drive it daily."—Seattle, Wash., aircraft worker.

"I have never driven a car that had such an uncanny ability to hold the road on the sharpest curves."—Seattle, Wash., radio man.

"Balance and road-holding ability is far greater than any of over 40 cars I have owned."—St. Petersburg, Fla., owner.

"Easy to park."—Wayne, Mich., airways worker.

### Renault Complaints

But, since nothing is perfect, there were complaints. Some of the more typical:

"Too small. Other cars back into me. Heater inadequate. Had to put in a gasoline heater."—Babylon, N. Y., bus driver. (Incidentally, this same owner listed smallness and the ability to get into tight places as what he liked best about his Renault!)

"Needs a little more room in rear. Would like to see a Renault the size of the Volkswagen. Needs larger rear window. Better plugs."—Johnston, R. I., teacher.

"Little too small for comfort. Damp or rainy weather makes hard starting. Local mechanics not fond of working on car."—Harriman, Tenn., banker.

"Poor ignition system, somewhat erratic at low speed and heavy pull. I have had the Renault completely undercoated and its acoustic characteristics entirely changed."—Long Branch, N. J., engineer.

"Gas inlet too near engine block. Dangerous when engine is hot."—Washington, D. C., student.

"Quite a bit of road noise." Lakebay, Wash., electronics technician.

"Rear-engine hood is so made that a hard

(Continued to page 266)

### IT SMELLS GRAND



WANT AROMA WITH "LIFT"? MAN, HERE'S HOW

### IT PACKS RIGHT



AND IT PACKS SO NEAT IT RATES A BOW

### IT SMOKES SWEET



IT'S THE PIPE-BLEND CHAMP YOU MUST ALLOW

### IT CAN'T BITE!

SIR WALTER RALEIGH'S BLEND OF CHOICE KENTUCKY BURLEYS IS EXTRA-AGED TO GUARD AGAINST TONGUE BITE. AND SIR WALTER RALEIGH NEVER LEAVES A SOGGY HEEL IN YOUR PIPE. STAYS LIT TO THE LAST PUFF.



*It costs no more to smoke the best!*



- CEILINGS CRACKED?
- NEED MORE ROOM?
- BUILDING A GARAGE?

# Use UPSON PANELS

*do it yourself, save money, get better finished job!*



## Recover cracked ceilings in a day

**Upson Kuver-Krak Ceilings.** Apply Upson Ceilings on furring strips right over your old cracked plaster ceilings. They stay anchored from the back with ingenious Upson Floating Fasteners. (See insert). There are no visible nailholes. In just a matter of hours the job is finished. No dirt, no mess. And you have a beautiful, *permanent* and crackproof ceiling. See your lumber dealer. Insist on Upson.



## Add beauty to extra room with Striated Panels

**Upson Striated Panels.** Panel-finish your attic or basement with Upson Panels. And, to add a beautiful modern touch, finish one wall with smart Upson Striated Panels. A contrasting wall adds a professional decorator touch to your room. There's nothing tricky about Upson Striated Panels, either. They're easy to apply, won't crack, shatter, splinter. Take paint beautifully, withstand extra hard jolts. See your lumber dealer.



## It's easy to build your own garage

**New Upson All Weather Sheathing.** Costs surprisingly little. And the superior weather resistant qualities of this super-strong 6-ply Sheathing make it perfect for siding. Cover a garage, utility shed, in no time. Easy to apply, nail direct to studs. No paint required or one coat covers beautifully. Offers good insulation value. See your lumber dealer. Insist on Upson All Weather Sheathing.

*Mail coupon for FREE details*

### OTHER UPSON PRODUCTS

- Strong-Bilt Walls
- Ceiling Tiles
- 1/4" Panels
- Easy Curve Panels
- Peg-It Panels
- 3/8" Panels
- Cut-Out Letters

# UPSON

PROVEN QUALITY YOU CAN TRUST

# PANELS



The Upson Company  
471 Upson Point, Lockport, N. Y.

Please send me FREE details on

Upson Ceilings  Upson Striated Panels  All Weather Sheathing

(Name of other product) \_\_\_\_\_

NAME \_\_\_\_\_

ADDRESS \_\_\_\_\_

CITY \_\_\_\_\_ STATE \_\_\_\_\_



Make \$20 to  
\$30 a Week  
**EXTRA  
MONEY**



## MACHINE SAW FILING PAYS UP to \$3 or \$4 an HOUR

• Turn your spare time into CASH—sharpening saws with a Foley Automatic Saw Filer pays up to \$3 or \$4 an hour. You will find you can make \$20 to \$30 a week in your spare time as a starter.

You can work in your basement or garage—no experience necessary. "The first saw I sharpened with my Foley Filer came out 100%"—writes Clarence E. Parsons. No canvassing—"I advertised in our local paper and got in 93 saws"—says M. L. Thompson. The Foley is the only machine with which you can file all hand saws, also band saws and cross-cut circular saws.

## SEND FOR FREE BOOK "MONEY MAKING FACTS"

Shows how you can get business from home owners, farmers, carpenters, schools, factories, etc. With a small investment, no overhead, no stock of goods to carry, you can get right into a cash business,—and possibly later on develop into a full-time repair shop. Send coupon today for Free Book. No salesman will call.

"Each saw I filed got me six more and business has been picking up that way since a year ago. If it keeps up I will have to buy another Foley Saw Filer."  
William C. Baldwin

"I have done 4 or 5 thousand saws in my spare time in the 4 1/2 years since I got the outfit, and they are all coming back with repeat orders." Len Crego

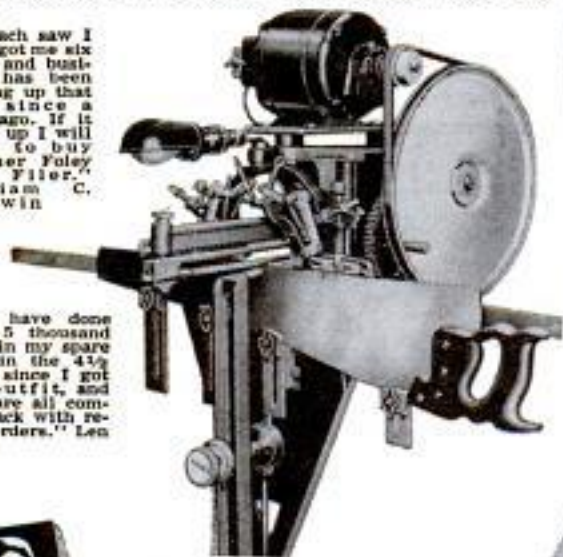

Send Coupon for **FREE BOOK**

FOLEY MFG. CO., 116-4 Foley Bldg.  
Minneapolis 18, Minnesota

Send **FREE BOOK**—  
"Money Making Facts"

Name.....  
Address.....

rain can drown it out." — Miami, Fla., musician.

"Have to watch greasing in service stations as Renault has many fittings not common to U.S. cars."—Bothell, Wash., investigator.

"Finish is poor, protection against rusting virtually nonexistent."—Wellesley, Mass., mechanical engineer.

"Engine should be mounted with more cushioning to eliminate so much vibration now transmitted through body."—Culver City, Calif., retailer.

**And now for my own tests:**—I've driven all three of the rear-engine cars in this survey.

**Volkswagen**—In addition to several hundred miles in Europe, I recently drove a Volkswagen from New York City to Springfield, Mass., and return. While around Springfield, I put the car through its paces on some back roads that were rough and sandy. The car has amazing performance and in sand it has excellent traction, due to the engine weight in the rear of the car.

The car is well balanced and handles exceptionally well on curves and over rough roads. The steering is rather quick compared to American cars, but I rate this as a good feature.

I've long been an advocate of air-cooling and I can see no reason for millions of automobiles on our highways lugging around a radiator, water pump and a lot of extra weight that is unnecessary. I've found it impossible to overheat a Volkswagen engine under any condition. It remained cool with no loss of power during all of the tests I made.

In the days of U.S. air-cooled cars, Franklin dealers made many demonstrations in hot weather and on the desert, driving the cars in low and second gears to prove that air-cooling is advantageous. Air-cooling is a boon to owners residing in cold climates.

Outstanding features that I liked about the Volkswagen are the economy, the reserve gasoline tank, the excellent paint and workmanship on the body and the fact that the engine mounted in the rear practically eliminates gasoline fumes. The VW has an oil cooler as standard equipment, which is highly desirable, and only 45 minutes are necessary for removal of the complete power plant.

There is a noticeable engine noise, which is common in an air-cooled engine because it has no water jacket around the cylinders to help reduce engine noise, as in a liquid-cooled engine. Insulation, and possibly undercoating, would reduce the noise.

**Porsche**—I've driven several different

(Continued to page 268)





### 20" JIG SAW

With completely built-in motor. Table tilts to 45°. Built in blower. Blade turns to rip. Available with mitre gauge and rip fence.....

**\$41<sup>50</sup>**



### 10" TILTING TABLE BAND SAW

All cast tool of rugged aluminum alloy. 10 by 10 table top. Has excellent locking mechanism.....

**\$49<sup>95</sup>**



### 6" JOINTER-PLANER

Professional model with latest cutting head. Cuts 1/2 inch deep and 6 inches wide. Removable guard..

**\$86<sup>50</sup>**



Professionals and Amateurs alike rely on  
**Shopmaster**  
The Most Complete Line of Power Tools in America!



### 12" DRILL PRESS BENCH MODEL

Equipped with Jacobs Chucks, three-spoke feed wheel. Shaper attachments available.....

**\$49<sup>95</sup>**



### 8" TILTING ARBOR SAW

Heavy duty construction. Sealed-for-life ball bearings. Table size 13 by 16. Complete with mitre gauge and rip fence.....

**\$51<sup>95</sup>**



### 9 IN 1 UNIVERSAL TOOL

Has sturdy workbench stand. Adapts quickly to Circle Saw, Drill Press, Sander, Shaper, Router, Lathe, Jointer, Grinder, or Buffer. All in one tool.....

**\$269<sup>50</sup>**



### DUAL CIRCLE SAW-JOINTER

New combination dual purpose tool, complete with motor that switches easily from one tool to other. Complete with motor.....

**\$154<sup>60</sup>**



### COMBINATION BELT AND DISC SANDER

Ruggedly constructed. Table tilts to 45°. Entire sander tilts to vertical position. Has belt tension knob and lock.....

**\$54<sup>00</sup>**

Prices slightly lower in Zone 1

**SEND FOR**

**Free**  **Catalog**



**Shopmaster**  
RM. 10G, 1214 S. 3RD ST.  
MINNEAPOLIS, MINNESOTA





do-it-yourself  
**IDEAS**  
to give you  
more room



**CORNER CLOSET**

Build across corner of room. Attractive Ra-Tox Folding Door gives complete closure for handy storage of household items, hobby materials, tools or toys.

**PROJECTED CLOSET**

If there's no corner to spare, build out from wall. Ra-Tox Folding Door forms sides and front... travels on curved overhead track for 100% accessibility.



**WALL TO WALL WARDROBE**

To have everything in easy reach and view... build an "open wide" wardrobe. It's economical and easy to enclose one end of room or alcove with a Ra-Tox Door.

Ra-Tox Folding Doors are woven of beautiful Northern Basswood, in colors or natural finish. They are quickly installed, sturdy and long lasting.

Send 10c for folder and plans for four space-saving closets. See Ra-Tox Doors at your lumber or building materials dealer.

**THE HOUGH SHADE CORPORATION**  
1066 Jackson • Janesville, Wisconsin  
IN CANADA: Canadian Ventilating Shades, Ltd.  
481 Reid Street • Peterborough, Ontario

easy to build with



Porsche models in many and varied tests. The Porsche, being a sports car, is in demand by a select group that appreciates its handling characteristics and unbelievable power and speed from such a small engine.

It definitely has outstanding advantages for mountain driving and on winding roads or highways, as well as for top speed. The acceleration is terrific and even though the displacement of the engine is small, it will actually outrun many of our large cars having two or three times more engine capacities. The obvious reason for such performance is the unusually low over-all weight per horsepower of the car.

**Renault**—I was pleased with the tests I made of the Renault 750 (mostly in Europe.) The ride is unbelievably smooth, when you consider that it is an ultrasmall car. While driving through the Swiss and French Alps, I saw hundreds of these little rear-engined jobs—slowly but surely climbing the high mountain passes, and many of them with luggage piled high in a carrier mounted on top of the roof.

Renault economy is outstanding and they are preferred by many owners of larger cars as second cars. While top speed is not exceptional, the car apparently has a definite place in various automotive markets throughout the world. It is held in high esteem in Europe and holds first place in sales of cars made in France. ★ ★ ★

**Sound Waves Clean Bearings**

Delicate bearings for aircraft gyroscopes are cleaned by a washing machine that shakes dirt free with sound waves. The bearings are placed in a beaker containing a cleaning fluid; high-intensity sound waves pierce the beaker to vibrate the tiny parts and loosen dirt. One speck of dust could ruin the costly gyroscopes, designed for use in the latest jet planes.





# power

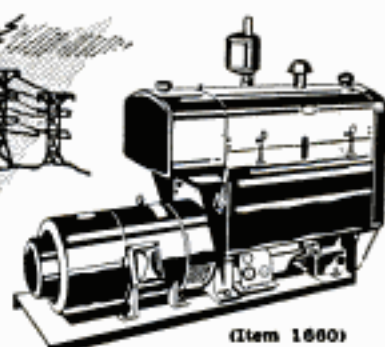

(Item 1600)

when, where  
you need it!

**STANDBY or CONTINUOUS DUTY**  
by **MASTER MECHANIC** at lowest factory-to-you prices

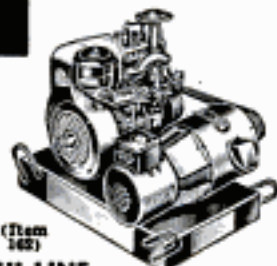

(Item 142)  
**HI-LINE**  
**6000 WATT PLANT**  
(Item 162) Push Button Start 115-230 v. 60 cyc. AC. A brute of a power plant with a rugged 14 HP Wisconsin engine. Plenty of electricity for ranges, water heaters, freezers, pumps, machinery, etc. Affords both 110 and 220 volts. Ideal where heavy current is needed. Wt. 390 lbs. Easily worth \$985.50 With self-starter. **\$645.00** Factory price. Same plant but with Crank Start (Item 166) **\$585.00** Generator and control box only, belt driven. Use your own engine or tractor. Wt. 240 lb. (Item 163) **\$345.00** Factory price.

**GIANT 2000-2500 WATT PLANT**



(Item 31)

(Item 31) 110/120 volt, 60 cyc. AC. A favorite plant among farmers and contractors. Skid mounting has advantage of easy portability. Double V belt drive permits engine to be easily disconnected for other uses. Exclusive dynamically balanced armature—heavy windings develop up to 5000 watts overload for motor starting. Powered by an easy starting Briggs or Wisconsin 6 HP engine—complete with all accessories. Big outlet box and voltmeter—no wiring necessary. Provides ample current for operating lights, refrigerator, freezer, pumps, fuel systems, power tools. **\$299.50** Wt. 230 lbs. Same plant with elec. self-starter (Item 179) **\$359.50** **GENERATOR ONLY** and control box. Drive it with engine, jeep or tractor. **\$169.50** (Item 31A). **POWER-FLO 3000-3500 Watt Plant** (Item 198) 110-220 v. 60 cyc. AC. Triple V-belt drive. 8 HP Wis. engine. Electric self-starter. Wt. 310 lbs. **\$399.50**

**MASTER SHOP COMPRESSOR**



Big and rugged. This stationary compressor provides 8 c.f.m.—plenty of air for industrial uses, powered by heavy duty repulsion induction 34 HP, 115/230 v. motor. Factory type twin cylinder compressor designed for continuous operation. Mounted on heavy 22 gal. steel tank. Complete with unloader type automatic switch, pressure relief valve, check valve gauge, shut-off valve, and 20 ft. heavy duty air hose. (Item 200H) Reg. retail \$319.50 **\$179.95** Factory price.



**Be prepared to operate essential equipment!**  
In your home, farm or business—it's vital that many different modern devices continue to run—even when power lines are down. A freezer without power lets high cost meats and foods spoil, an oil burner lets the house become freezing cold, electric farm equipment, milking machines, separators, etc. go dead—everywhere the lights go out. And without regular power in new locations, the builder contractor cannot use his time saving power tools, chain saws, compressors or pumps. You can be prepared to meet any of these emergencies or regular power needs at amazingly low cost with a **MASTER MECHANIC Light Plant**. Low direct factory prices from the world's largest direct selling light plant factory on a wide range of models from 350 to 25,000 watts, assures you a high quality, durable plant—whatever your power needs—at tremendous savings!

## MASTER PORTABLE LIGHT PLANTS



**LITTLE GIANT 350 WATT PLANT**  
Imagine—35 compact pounds of portable power that goes with you anywhere—easier to carry than an outboard motor. Provides plenty of current for lights, portable radios, 1/4" drills, small power saws, electric shavers, etc. Perfect for hunters, campers, contractors' service trucks, wreckers, etc. 350 Watts, 115 v. Dc. Ruggedly constructed with 1 1/2 HP price \$224.75. (Item 273) **\$99.75** Special at the terrific factory price of only...



**ELECTRA-LITE 600-700 WATT**  
Push Button Start 115 v. 60 cyc. AC. Powered by a rugged 2 HP, easy starting Briggs gas engine. No wiring necessary: just plug in and operate. Plenty of current for any oil burner, freezer, brooder, emergency lights, etc. which require up to 700 w. Complete with voltmeter and built-in winding to charge 8 v. auto batteries. Item 24. Wt. 55 lbs. Reg. \$275.00 value. **\$143.50** Factory price.



**1000-1200 Watt Plant (Item 45)** same as Item 24 but larger generator & engine. **\$199.50**

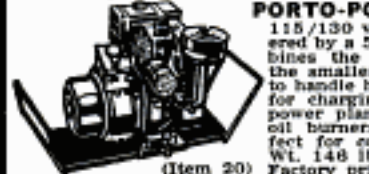

**PORTO-POWER 1500-1750 WATT PLANT**  
115/130 v. 60 cyc. AC. Push Button Start. Powered by a 5.10 HP Briggs engine. This plant combines the compactness and easy portability of the smaller plants above, but has a high output to handle heavier starting loads. Built-in winding for charging 12 v. batteries. An ideal standby power plant for operating lights, sump pumps, oil burners and communications systems. Perfect for contractors and line crews. (Item 20) Wt. 148 lbs. **\$279.50** Factory price.



**700-800 Watt Plant (Item 44)** same as Item 24 but larger engine. **\$169.95**

We make fully automatic controls for all light plants. Write for details **WE MAKE ALL SIZES UP TO 25,000 WATTS.**

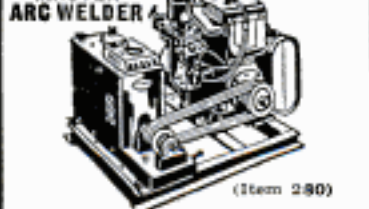

**POWER MASTER ARC WELDER**  
(Item 280)  
Now! a portable, rugged, self-powered industrial type welder with terrific performance, yet at a price hundreds of dollars less than you'd expect. High capacity DC welding unit enables you to tackle any job with confidence—easily handles anything up to 2" plate using from 1/16" to 1/4" rods. Built-in stabilizer and dual control simplifies any welding job from 30 to 250 amps. Welder is powered by 14HP 2 cylinder air cooled Wisconsin industrial engine with triple V-belt drive. Mounted on a welded steel chassis—easily transported on trailer or pick-up truck. Ideal for shop, factory or farm welding. Complete with instructions and guarantee. Wt. 480 lbs. Compares with welder costing \$1200. (Item 280) Factory Special **\$449.50**

## HEAVY DUTY D-C ARC WELDER



Use as portable or shop welder. Up to 300 amps. Senior model. Made for years of trouble-free continuous service. Will handle light or heavy jobs. Easily welds up to 3/4" plate using 1/4" rods. Built-in air cooling system. Arc is easy to strike and hold because of specially designed arc stabilizer. Hi-lo switch and dial control gives wide range of welding heats. Runs welder at 3500 rpm with tractor, jeep or 14 HP gas engine or 7 HP elec. motor. Complete with instructions, guar. and triple V-belt or flat pulley. You can pay more, but you can't buy a better welder. (Item 38). Wt. 110 lbs. **\$99.75** \$400 value at. **DUAL CONTROL MODEL** same as above but with built-in dual rheostat for low heat soldering, brazing, welding. Special. **\$119.50** **WELDING KIT**. Two 10 ft. leads, welding helmet, electrode holder, ground clamp. Sold only with welder at. **\$10.50** See our other ad on Page 271

**11-12 KW Diesel Light Plant**  
Item 1600. Diesel Master illustrated above. 115/230 v. AC single or 3 phase. 1800 rpm. direct connected. Electric self-starting. Engineered for permanent power where continuous low cost, heavy duty service is important. Wt. 1350 lbs. Reg. list \$3650.00 **\$1895.00** Factory Price. **10-11 kw. GAS DRIVEN PLANT**  
115-230 v. 60 cyc. AC. single or 3 phase, powered by a 4 cylinder Wisconsin air cooled engine. Belt driven. Constructed similarly to Hi-line 6 KW shown above at left, but much larger. (Item 217) with crank start. Wt. 900 lb. **\$1075.00** Factory price. Same plant with **\$1145.00** elec. self-starter.

## DYNA-POWER 3500 WATT PLANT



(Item 23)  
115 volt 60 cyc. AC. Built-in battery charger. Powered by a sturdy 8 HP air-cooled Wisconsin engine. A powerful plant built for continuous duty, yet compact and portable. Integral positive drive—an exclusive Master Mechanic engineering feature. Ideal for farms, ranches, country estates, resorts, etc. High output makes it an excellent unit for larger contractors, fire departments, communication systems, Civil Defense, etc. (Item 23) Wt. 279 lbs. **\$379.50** Factory price. **MASTER-LITE 2500 WATT PLANT** 110-220 v. 60 cyc. AC. Similar to above. Powered by 5.10 HP Briggs engine. **\$329.50**

## MASTER AIR COMPRESSOR



Tank Tested up to 500 lbs. per sq. in.  
(Item 200) High pressure type for large volume of air for heavy duty service. For paint spraying, inflating truck and auto tires, greasing and the hundreds of other jobs done by compressed air. Piston type 2" bore compressor with built-in air filter. Master built with hi-strength alloys and precision bearings. Lifetime, stainless steel tank, 12"x24", 2100 cu. in. cap. Safe up to 500 lb. Equipped with automatic switch that starts and stops motor to maintain desired pressure (up to 150 lbs.) and check valve, safety valve, gauge, shut-off valve, 20 ft. air hose and tire chuck. Beautifully balanced on ball bearing wheels and rubber tires. Don't take chances with used or surplus equipment. Our compressors are factory new and are guaranteed **SAFE**. Low factory prices. With 1/2 hp., 110 v. AC motor. (Reg. \$175) **\$109.50** (Item 200p) With 1/2 hp motor. Reg. \$199.50. (Item 200Ap) **\$129.50**

Send check or M.O. Prices f.o.b. Factory. 10 day Money back guarantee. SEND 10c for... **BIG 1954 Catalog**  
**MASTER MECHANIC MFG. CO., DEPT. EE Burlington, Wis.**



# Personalize

## YOUR CAR

DAY or

NIGHT



FENDER OR DOOR



(4/5 actual size)

(Pat. applied for)

## MONO-LAMP

- EASILY INSTALLED IN MINUTES
- COMPLETE INSTRUCTIONS

This attractive chrome-nickel plated die-cast day and night insignia will add that touch to your car as identifying as your own finger print. In shining red and blue squares alternating with black as the background, your own initials in gold plate have that rich embossed look under the interchangeable molded plexiglass blocks. At night your initials illuminate whenever your car lights are on, as the Mono-Lamp becomes a part of your lighting system. All necessary parts including bulb, wiring, screws and instructions come with the Mono-Lamp and are guaranteed, except bulb, for one full year. Just \$3.95 each, prepaid. \$4.95 Gold Plated.

*The Mono-Lamp makes a fine gift. Fill out order blank and mail today. Be sure to print initials desired in squares at bottom of coupon.*

**G. & S. MACHINE CO., MONO-LAMP DIV.**

10725 Briggs Avenue • Cleveland 11, Ohio

Please send me  Mono-Lamps at \$3.95 each

I enclose

(check)

(Money Order)

Send C.O.D. (Postage & handling charges extra.)

Name \_\_\_\_\_

Address \_\_\_\_\_

City \_\_\_\_\_ State \_\_\_\_\_

Initials desired:

Ohio residents add 12c per unit for Sales Tax

## Deep-Sea Sentinels Guard Our Harbors

(Continued from page 128)

To protect an island airstrip, it would be foolish to ring the whole island with nets, mines and tricky expensive gear. So harbor defenders may just protect the thing that's most vital—the gasoline supplies, which are generally in barges offshore. Torpedo nets hung on buoys around a couple of barges are relatively cheap and effective.

Even doing this much in an action-packed forward area can present problems and develop into amusing fiascos. Taylor recalls one barren Pacific airstrip so small there was no room to store his gear. "We scouted the shoals," he says, "and found a coral plateau covered with about four feet of water at high tide. Apparently a satisfactory place to keep our stuff. We put a cable fence around it, dropped all our gear inside and called it Warehouse Number One. The big round net buoys, floating in the coral, were all you could see. It was fine until a big storm broke the cables and the buoys "kited" off across the ocean in all directions. The whole crew went out in boats, rafts and lifejackets, chasing them. We retrieved some, but the rest got away. For months afterward we kept getting reports of 'floating mines' from our ships in the area—my buoys."

Handy tools in harbor defense are the big steel nets, draped from buoys like huge curtains from shore to shore and from surface to bottom at river and harbor entrances. Today, these huge circlets of steel mesh come in all kinds of tricky variations—indicator nets, submarine nets and torpedo nets. Ingenious variations are forever being tried by harbor defense men.

"During World War II," Taylor reveals, "someone got an idea that a net might be made, not to stop ships, but to set off an alarm when a ship broke through it. Among the trickiest was the XLI (extra light indicator). It was a mesh of stuff like coat-hanger wire. Fine wire across the top supported it on plastic floats. It came collapsed in one thick strand bound by blocks of salt. Work ships simply payed it out like cable. The salt melted, and the mesh unfolded to the bottom like a window shade."

Most familiar, though, are the heavy submarine and torpedo nets, made of heavy wire wrapped around itself and formed into circular grommets that are interlaced to form a mesh. These rugged affairs will stand the tremendous impact of torpedoes. In the last war, they protected not only harbors, but also kept drydock locks from

(Continued to page 272)



## EXTENSION CORD



(Item 16) Heavy duty, made of Buna rubber insulated #14-2 conductor, stranded wire enclosed in a treated braided jacket. So tough that you can drive over it. Use indoors or out. Resists oil, grease or water. Extends electrically up to 400 ft. without voltage drop. Complete with heavy rubber plug and outlet. (Item 16) 40 ft. (wt. 2 1/2 lbs.) Usually \$4.50

**\$1.99**  
Special. . . . . 2-40 ft. & 1-20 ft. (total 100 ft.) (Item 16c) **\$4.95**  
100 ft. length (1 piece)

(Item 18p) **\$4.95**  
**RUBBER EXTENSION CORD** #16, 2 conductor stranded wire, extremely flexible, ideal for hedge trimmers, lawn mowers, power tools, etc. Tough and rugged, withstands any abuse. Complete with rubber plug and outlet. 40 ft. (Item 17a) wt. 2 1/2 lbs. Regularly \$4.95 **SPECIAL \$2.49**  
Combination 2-40 ft. & 1-20 ft. (total 100 ft.) (Item 17b) **\$5.95**  
100 ft. length (1 piece)  
(Item 17c) **\$5.95**  
Wire only. No fittings. 100 ft.  
(Item 17d) **\$5.00**  
**NEOPRENE CABLE** #14-2 (Item 18b) Heavy duty, very flexible, 20 year quality. Wt. 9 lbs. 100 ft. Complete with rubber plug and outlet. A terrific buy at only **\$8.95**  
**NO. 12-2 POWER CABLE.** Very flexible rubber covered, special outside shield for grounding power tools, etc. 50 ft. (Item 19b) wt. 8 lbs. **\$6.95**  
100 ft. (Item 200) **\$12.95**

## AUTOMATIC HOT WATER HEATER



(Item 76) Modern electric hot water heater. Its air tank with threaded openings 1" or 1 1/2". Works just like heater costing \$100 or more. Goes on and off automatically to heat water to desired temperature—using electricity only when needed. Takes only 1/4 to 1/2 cent of electricity per gallon of steaming hot water. Heater element and thermostat. **\$14.95**  
Wt. 8 lb. Reg. \$49.50  
Heater only for manual temperature control. **\$7.95**  
Wt. 3 lbs. . . . .

## Variable Speed Selector



Heavy duty, made by **8-F GOODRICH** for industrial use. Provides instant speed changes for any drive. For machine tools, dryers, printing, conveyors, production lines, hoists—any operation requiring variable speed. Ideal for midge auto. Exp. to a reliable "trouble free" planetary system. No hydraulic power losses or creeping. Infinite range, smooth operation, easy installation (data included). 3 sizes: 1/2-1 hp. wt. 36 lbs.; 1-2 hp. wt. 58 lbs.; 3-5 hp. wt. 105 lbs. Reg. list \$288, \$352 and \$352. Our prices . . . **\$79.50, \$89.50 and \$114.50.**

## FIRE EXTINGUISHER



(Item 39) Fully charged (at 1000 lb. P.S.I. or more) with CO2 (carbon dioxide), the proven miracle fire-fighting chemical that smotheres oil, gasoline and electrical fires. Place it in your garage and home. Heavy ICC approved steel cylinder, valve, and 3000 lb. gauge that shows available remaining pressure. **REFILLABLE** at nominal cost. Hose included for emergency tire inflator or air blast. Wt. 4 lb. **\$19.50 Value. Special. \$6.95**

## BUY DIRECT FROM FACTORY



## SAVE MIDDLEMAN'S PROFITS

### HOBBY GRINDER CUTTING TOOLS and STONES

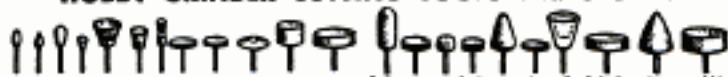

The perfect accessory kit to increase the scope of your hobby grinder. Has a dozen different burrs, cutters, flutes, reamers, routers, etc. Cutters are of finest, hardened tool steel on 3/32" shafts. Holds a keen edge for a long time. Packed in a handy index base. Item 342. Wt. 1 lb. Factory price **\$1.95**

### MASTER SAFTI-FUSE

Flip-on fuses that restore electrical service by merely pressing a button. This amazing permanent safety fuse protects all your electrical circuits against dangerous overloads (the cause of most fires). Just screw them in—in place of your old fuses—and forget all future worries. Automatically interrupts any dangerously overloaded circuits. To restore service—just flip the button. Uncond. guaranteed **SAFE**. U. L. approved. Eliminate danger of shock from old-fashioned fuses and enjoy automatic, permanent protection. Available in 15, 20 and 30 amp. sizes—please specify. All sizes 4 for **\$5.25—\$1.35 ea.**

### RIGHT ANGLE DRIVE and SPEED REDUCER

for 1/4" Electric Drills  
A precision built drive which converts right angle drilling in confined spaces as between joists or shelves. 2 to 1 reduction gear will drill with ease up to 1" holes in wood using 1/4" shank bits. Makes impossible drilling jobs easy and accurate. Also ideal for power buffing and sanding. Can be used in either direction—to increase or decrease speed. Twice speed of drill for sanding metal—half speed of drill for sanding wood or polishing. Eliminates danger of damaging finishes caused by too high a speed. Fits practically all 1/4" electric drills—simply transfer drill chuck to right angle drive. Item 243. Wt. 1 lb. **\$4.95**  
Factory Special. . . . .

**HEAVY DUTY RT. ANGLE DRIVE** for 1/2" DRILLS. Has 2 to 1 speed ratio. Easily handles large auger bits and will drill up to 3" in wood. Ideal for plumbers—drilling for pipe installations in confined places—or electricians drilling between joists. Attaches easily to most electric drills with 1/2-20 threaded spindle. Precision cut gears; main and rear bearings on each spindle to assure perfect alignment. Item 308. Wt. 2 lbs. **\$19.95**

### COMBINATION TAPER DRILL AND COUNTERSINK

The first real improvement in drills for the wood working industry in over a century. This 3 in 1 drill bores a tapered hole which corresponds to the contour of a wood screw. This enables every thread on the screw to hold tightly right down to the tip. Ordinary drills bore straight holes which allow only part of the threads to come in contact with the wood. Get increased holding power out of your screws; make better, longer-lasting joints. In addition you can countersink the hole, if desired, thus saving an extra operation. Merely send the drill hole right down to the collar and you will get a perfectly countersunk hole without extra effort. Set of 5 most commonly used sizes in handy kit; accommodates 7, 8, 10 and 12 screws; Item 246. Wt. 2 lbs. **\$3.75**

### JET FLOW BLOWER

Tremendous air movement (1700 CFM) and quiet operation make this double inlet 10" turbine blower unbestable for heating, cooling, drying and air conditioning. Ideal for attic or barn ventilation, converting gravity heating to forced air; spray booth exhausts, etc. Operates with any 1/4, 1/2 or 1/2 HP motor. Oversized, long-life bearings. Includes variable speed motor pulley and belt. Dimensions: 19" h.l.x 8"x16 1/2". Outlet opening 13"x 11 1/4". Wt. 45 lbs. Item 245. Regularly \$54.50. **\$27.50**  
Factory Spec. . . . .  
**HEAVY DUTY 1/4 HP motor** for above blower. **\$16.95**  
See our other ad on page 269

A complete set of highest quality abrasive wheels and stones permanently bonded to hardened steel 1/4" & 1/16" shafts. One dozen different stones—of every conceivable shape made to match any grinding job. Packed in a handy index base. Item 341. Wt. 1 lb. **\$2.95**  
Factory price. . . . .

### 6 FT. FLEXIBLE SHAFT

A sensational all-around power tool kit that includes a precision-built heavy duty 6 ft. flexible shaft complete with all the necessary accessories for doing a hundred different jobs. Fits any 1/4, 1/2 or 3/4" shaft on any 1/4, 1/2 or 3/4 HP electric motor. Also works fine with gas engine, or with shaft chucked in drill press or lathe. Shaft unit has heavy duty 3/4" piano wire core encased in tough rubber housing. Handle and arbor have rugged industrial type precision type ball bearings for years of service. Accessories included are: rubber backer plate, lamb's wool bonnet, 6 sanding discs, 8 drill bits, wire brush and drill chuck. Ideal for all grinding, metal polishing, drilling, finishing, repairing, etc. Does countless jobs impossible with ordinary tools. Complete kit (Item 240a) Wt. 13 lbs. **\$19.95**

6 Ft. Flexible Shaft only (Item 240. Wt. 10 lb.) **\$15.95**

### POTTER'S WHEEL

Power Driven—Foot pedal speed control  
New compact modern design. Precision built to meet exacting requirements of professional artists—the finest wheel ever built. Heavy and sturdy for quiet accurate operation. Mechanism fully enclosed for safety and to exclude clay and moisture. Foot controlled variable speed drive provides instant, smooth speed range of 30 to 150 rpm. Equipped with adjustable arm rests. Easy to operate—even for handicapped persons. Reversible 10" throwing head—back side recessed for casting plaster bats. Larger 18" dia. throwing table; wedging wire attached, removable water cup inside. Heavy prelubricated bronze bearings. Use any 1/4 HP motor (not incl.). Shipped fully assembled—just mount wheel and motor on table or sheet of 1/2 plywood. Self storing—tip up on edge. Wt. 45 lbs. List price \$125.00 (Item 47) **Factory price. . . \$64.95**  
1/2 HP 115 v. AC motor for Potter's Wheel, Wt. 27 lbs. **\$16.95**  
Item 258. . . . .

### 29 PC. SPEED DRILL SET

Superb, high quality, imported drills of chrome vanadium speed steel designed for superior performance. Normally you'd expect to pay much more for these precision made, drill bits. Perfect for all drilling in steel, cast iron and other metals. Also excellent for wood or plastics. Set of 29 drills from 1/16" to 1/2" by 1/64s in an indexed steel box. Wt. 4 lbs. (Item 311d) **Special. . . \$11.95**  
Same set with 1/2" shanks **\$12.95** for 1/4" drills. (Item 311e)

### HEATING & VENTILATING FAN

(Item 10) Easily installed in furnace pipes. Forces even heat to all rooms. Over range removes kitchen smoke and odors. Powerful, continuous duty motor. 110-120v. AC. Mount in wall or ceiling to ventilate any area. Quiet, super efficient fan moves huge volume of air. (400 to 600 CFM.)  
8" Fan, wt. 5 lb. . . . . **\$6.85**  
9" Fan, wt. 6 lb. . . . . **\$7.85**  
10" Fan, wt. 7 lb. . . . . **\$8.85**  
12" Fan, wt. 8 lb. . . . . **\$9.85**  
**HEAVY DUTY FAN.** Semi-enclosed motor, suitable for spray booths, restaurant exhausts, poultry houses, etc.  
10" Fan, wt. 8 lb. (Item 10E) **\$11.95**  
12" Fan, wt. 10 lb. (Item 10D) **\$12.95**

## MASTER SNO-BLOW



**NO PUSHING**  
Tractor shown with Snow Blow Attachment (Item 206)  
**SELF-PROPELLED**  
It's a snow-blower  
It's a power sickle  
It's a cultivator  
It's a rotary tiller  
It's a plow  
It's a rotary mower  
Where can you get a power tool that does so many jobs? Works for you the year round. Does terrific job of cleaning snow from walks, drives, etc. without backbreaking work. Also prepares deep mellow seed beds, cuts weeds, lawns, etc. The Master Gardener performs better—does more than tractors costing twice as much. Converts in minutes to Tiller, Power Sickle, etc. Basic, self-propelled 2 hp. tractor, Briggs **\$119.50**  
Snow Blow. . . . . **\$39.50**  
Cultivator. . . . . **\$8.75**  
Rotary Tiller. . . . . **\$42.50**  
Disc Harrow. . . . . **\$15.50**  
Furrowing Tool. . . . . **\$8.75**  
Plow. . . . . **\$15.00**  
Rotary Lawn Mower. . . . . **\$42.50**  
Sickle Bar Mower. . . . . **\$42.50**  
Lawn Mower Hitch. . . . . **\$4.50**  
Freight prepaid to most areas. Easy payment plan available.

## AUTOMATIC 6 VOLT COMPRESSOR



The ideal compressor for operating load blast air horns on cars or boats, and for use as tire inflating equipment on service trucks or jeeps. Inflates tires in seconds. Compact! Can be installed in small space under hood, in trunk, etc. High air output, (4 CFM). Operates on standard 6 or 12 volt storage battery current. Built-in 1/2 HP electric motor, Solenoid switch, 6"x24" air tank, pressure gauge, safety valve, shut-off valve, automatic on and off switch. (Runs only when air is needed.) Wt. 39 lbs. Item 355 Reg. \$129.50  
Our Special. . . . . **\$54.50**

## 37 pc. SOCKET SET



Highest quality, guaranteed non-breakable sockets made by Husky. Beautifully matched chrome alloy. Absolutely the best. Complete range of 17 sockets from 1/4" thru 1 1/2" (1/4" drive) and 7/16" thru 1-1/16" (1/2" drive), 1 extension, reversible ratchets, ratchet bit, sliding "T" handle, "L" handle, 1/2" speeder, 5 pc. alloy combination wrench set, 8 pc. Allen wrench set, and a doghouse tool box. We challenge anyone to match this value. Easily worth \$41.95, Wt. 14 lb. (Item 59) **\$16.95**

## 44 PC. SOCKET SET

(Item 59E) Same unconditionally guaranteed, non-breakable sockets as above—but with added sizes. Complete range of 21 sockets from 1/4" thru 7/16" (1/4" drive) & 7/16" thru 1-1/16" (1/2" drive). Two extensions, reversible ratchets, ratchet bit, sliding "T" handle, all angle coupling, 1/2" speeder, 1/2" breaker, 5 pc. high chrome alloy combination wrench set and 8 pc. offset wrench set in big doghouse tool box with ample room for other tools. Reg. \$49.50 **\$21.95**  
Wt. 16 lb. . . . .

## 52 PC. SOCKET SET

(Item 205) Contains a complete set of sockets in 1/2" drive, 3/4" drive and 1 1/4" drive, plus all necessary extensions, handles, speeders, reversible ratchets, etc.; all uncond. guaranteed against breakage. Beautifully matched chrome thin wall alloy sockets in a sturdy hand-some steel box. Wt. 17 lbs. List price \$62.00  
Factory Special. . . . . **\$27.95**

Send check or M.O. Prices L.o.b. Factory. 10 day Money back guarantee. SEND 10c for . . . **BIG 1954 Catalog**  
**MASTER MECHANIC MFG. CO., DEPT. 4E Burlington, Wis.**





### This oil-pumper needs Tough-but-oh-so-Gentle Piston Rings

Oil pumping is just the start of expense and trouble—the first danger signal from worn-out piston rings. The longer you let those rings stay in, the more oil you use, the more power you lose, and the bigger your repair bill.

As your engine gets older, it runs hotter because of accumulations in the cooling system. Cylinders wear tapered and out-of-round—need more oil on the walls.

It requires a special type of piston rings—replacement rings—to deliver this extra oil, under full control, without waste. Hastings makes replacement rings exclusively, devotes all its research on the highways and in the laboratory, to the particular replacement problems of each make and type of engine.

That's why Hastings Rings stop oil-pumping, check cylinder wear, restore engine performance—in re-ring, re-bore and re-sleeve installations.

So go to your motor specialist at the first sign of oil-pumping or performance drop-off. If rings are the trouble, ask him to install a Hastings Steel-Vent replacement set. Truly the best money you can spend on your car! Hastings Manufacturing Company, Hastings, Michigan; Hastings Ltd., Toronto; Piston Rings, Spark Plugs, Oil Filters, Casite, Drout.

#### TOUGH-but-oh-so-GENTLE

TOUGH on oil-pumping  
GENTLE on cylinder walls



**HASTINGS** STEEL-VENT PISTON RINGS  
*Regular or Chrome Faced*

being rammed by attacking enemy ships. "It's always a race to keep one jump ahead of the enemy," says Taylor. "You build a net, and they find a way around it. Then you fix that, and they look for another way."

Shining example was the explosion boat (E Boat) developed by the Italians in World War II. These explosive-laden outboards hydroplaned right over the net buoys. The motor flipped up on a hinge as they went, then snapped back in place on the other side. The pilot dove out, after aiming his craft at the nearest ship inside the harbor. Later the Nazis made similar craft that were radio-controlled. Star-cutter booms helped stop them, but the men went even further.

"We tried to develop a tricky affair called a 'sausage' or 'table cloth' net," says Taylor. "This was a sort of snare that spread out flat on the water, supported by kapok-filled hose and 18-inch balls for flotation."

"Our new electronic wizards will help," he says. "There are too many ways to breach nets. Some of our enemies can think up slick tricks—like the Italians did in Alexandria Harbor. One night this sub skipper came up to the submerged net. Four men with aqua lungs crawled out through the tubes and, with compressed air jacks, hoisted the net high enough off the bottom to let the sub through. The sub sank several ships in the harbor that night—even though it never got back out.

"But," points out the commander, "it was a different story in Sidney Harbor, when the Japs released midget subs. There, we had some magnetic loops that warned us what was up. We dropped depth charges and got them."

The secret of success in harbor defense is to get there first with the most. Hence the latest and trickiest developments are on the top secret list and we won't hear about them until after they've done a job and the enemy has found a way to breach them.

"You can bet they'll go to incredible ends," says Captain A. C. Burrows, head of Harbor Defense for the Navy's Undersea Warfare Division. "The Japs were fantastic in their efforts during the last war. They didn't plan on going home like we did. In Ulithi Harbor, they swam under cartons and orange crates—right through our defenses, carrying explosives with them. They were human torpedoes. There were swarms of them and some got through. They slapped their homemade mines against the sides of ships with considerable effectiveness. It's tough work, but challenging. Our new schools start from the ground up, so applicants no longer need previous training for Harbor Defense." ★ ★ ★



**DO IT YOURSELF**

Anything you do, this glue does better!

**NEW! WELDWOOD PRESTO-SET GLUE**

**USE IT EVERYWHERE, FOR EVERYTHING!**

BONDS WOOD TO WOOD	REPAIRING ART OBJECTS
BONDS WOOD TO COMPO BOARD	SPORTING GOODS UPKEEP
BONDS CLOTH TO WOOD	SHOP WORK
BONDS PAPER TO CLOTH	ALBUM COLLECTIONS
BONDS PAPER TO PAPER	HOBBY WORK

Perfected at last! A ready-to-use *white glue* worthy of the famous Weldwood name! Sets fast, bonds like magic! The perfect all-around glue for home, hobby, shop. Doesn't spoil or stain! Ask for Presto-Set glue with the blue and white label at your lumber, paint or hardware dealer's. If he is not yet stocked, send us 25¢ for a full size tube.



In 25¢ and 45¢ tubes, pint and quart bottles.



**FREE!** Leaflet of many uses. Write **UNITED STATES PLYWOOD CORP.** Dept. 33, P.O. Box 205, N. Y. 46, N. Y.

**ANOTHER WIZARD WITH WOOD: WELDWOOD Plastic Resin GLUE**  
The water resistant powder glue—America's largest selling wood glue.



Trade where you see this sign

**DRAINS Cellars, Laundry Tubs; CIRCULATES Oil; IRRIGATES Gardens**

Original "Type P" Pump has 2400 GPH capacity. 360 GPH 75' high, or 1500 GPH from 25' well. Use any 1/8 to 1/2 HP motor. DOES NOT CLOG. 1" Intake; 3/4" outlet.  
Postpaid if cash with order. (West of Miss. add 50c.) Motor coupling included. **MONEY BACK GUARANTEE**  
Also Gear Pumps in all sizes.  
**LABAWCO PUMPS, BELLE MEAD 7, N. J.**



**\$6.95**

**KING MIDGET AUTO**

Operate it for 75c per week. Amazing performance. Surprising comfort. All steel construction. Ready to run or assemble it yourself with our bolt together parts. Rider Agents wanted. Send 25c for detailed literature or \$1 (refunded first order) for actual assembly book and service manual filled with photos, drawings, specifications, etc.  
**MIDGET MOTORS MFG. CO., ATHENS, OHIO**



WORLD'S LOWEST PRICED 2 PASSENGER AUTO

JANUARY 1954

send for **FREE CATALOG**

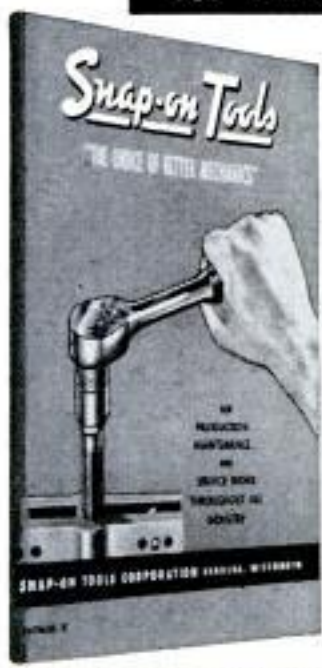

America's Foremost **money-making MECHANICS' TOOLS**

It's easy to own the same "pay-off" tools used and endorsed by America's top-earning mechanics throughout the automotive, aviation and industrial fields! Snap-on tools help you handle every repair job faster, easier, better. And they LAST... pay for themselves over and over again! Start building your own tool set now with basic Snap-on units—add others any time. Genuine Snap-on tools are never sold in stores—direct to users only. Mail coupon for free catalog.



Snap-on Tools Corporation  
8062-A 28th Ave., Kenosha, Wis.

Send me free catalog. Occupation \_\_\_\_\_  
Name \_\_\_\_\_  
Address \_\_\_\_\_  
City \_\_\_\_\_ Zone \_\_\_\_\_ State \_\_\_\_\_



# FREE PLAN BOOK



12 pages of things to make with

# DURON

the Hardboard of 1001 uses



TOOL CHEST



DOG BED



CLOTHES HAMPER



MAGAZINE RACK

Yes, it's all yours, *FREE!*  
This big (10-in. x 8-in.)  
12-page book of make-'em-  
yourself plans for many  
useful things. All *easy to make*  
with DURON, the hardboard  
of 1001 uses. Works like  
wood, yet free from grain-  
raising, knots, splints.  
Both sides satiny-smooth.  
Paints beautifully. Ask your  
building supplies dealer  
for your **FREE DURON Plan**  
Book; or write Dept. PM-1.,  
300 W. Adams, Chicago 6.

\*T. M. Reg. U. S. Pat. Off.

... many more easy-to-follow plans specially  
designed by **POPULAR MECHANICS**  
**MAGAZINE** in this DURON make-'em-  
yourself book!

**UNITED STATES GYPSUM**

The Greatest Name in Building



CBS color camera at right is about the same size and  
shape as conventional black-and-white camera at left

## Color Television Is Here

(Continued from page 132)

worked to set up specifications that would  
make the big dream come true. Finally last  
October FCC members saw the results.

On color receivers produced by 13 differ-  
ent manufacturers, NBC's Nanette Fabray  
sang before a multihued background;  
dancers in colorful costumes whirled across  
vivid color sets. Pretty girls flipped swirl-  
ing red skirts to show brilliant green slips  
beneath. Then, CBS took its show outdoors  
to prove how well its color cameras worked  
on remote pickup. In a program called  
"Autumn in New York," the lenses panned  
garden colors, climbed to dizzying sky-  
scrapers in midtown, browsed through a  
sidewalk cafe to zoom in on dishes of pink  
lobster, bright, delicious-looking salads  
and plates of sweet red berries. The Allen  
B. Du Mont Laboratories flashed close-up  
and distant shots of brilliantly colored  
scenes across the phosphors. And all the  
while, regular black-and-white sets beside  
the color screens faithfully reproduced  
everything coming in on all the channels.

As for those 13 different color sets, they  
looked exactly like black-and-white re-  
ceivers, but the cabinets were larger by  
half. For the present, color screens are 14  
inches (producing a 12½-inch-wide pic-  
ture), but 21-inchers are in the works.

In many recent color demonstrations,  
technicians have hovered over sets, tinkering  
and making adjustments, leading ob-  
servers to wonder if every color set would  
come equipped with a built-in electronics  
engineer. Last November 1, when NBC  
microwaved Bizet's opera "Carmen" in  
superb, delicately shaded colors, news and  
magazine reporters were loaned color sets  
and permitted to tune them in unassisted.

How do they work? Remarkably well. A  
typical set has five or six knobs. Four are

(Continued to page 276)



RELIEVES  
HEADACHE  
NEURALGIA  
NEURITIS PAIN

**FAST**



**Here's Why...**

Anacin® is like a doctor's prescription. That is, Anacin contains not one but a combination of medically proved active ingredients. Anacin is specially compounded to give FAST, LONG LASTING relief. Don't wait. Buy Anacin today.



**CUT BUILDING COSTS 2/3!  
Make Your Own Concrete  
BLOCKS and BRICKS  
To Use or Sell**

New superior moulds make absolutely square, true, easy-to-lay blocks which will pass any building code. Production is fast... easy. One durable \$30 machine will make four 5"x8"x12" blocks per minute—1,000 a day. Pays for itself in one day! Sell blocks for big profit... or save 2/3 building cost for yourself. POST CARD BRINGS FREE FOLDER.

**ECONOMY MFG. CO.**  
DEPT. P STONE MOUNTAIN, GA.



**BUILD FINE GRANDFATHER CLOCK NOW**

The simple sensible Red-Red Way as thousands have — HAVE HALF-SHOP TESTED PLANS "SPIRIT OF THE CENTURY" Narrow waist 83" tall or stately straight side "SPIRIT OF AMERICA." EASY-TO-FOLLOW photo-graphic PLANS tell all—plus BROCHURE of heavy brass weight Westminster, tube chime, movements, porcelain dial, 3/4" solid mahogany case kits. Send \$1.00 today — Both plans \$1.50 NOW. KUENPEL CHIME CLOCK CO., 27 Kuempel Bldg., Minneapolis 16, Minn.

SAY YOU SAW IT IN POPULAR MECHANICS

Protect your home against  
power interruptions  
with an...

**ONAN Emergency  
ELECTRIC PLANT**

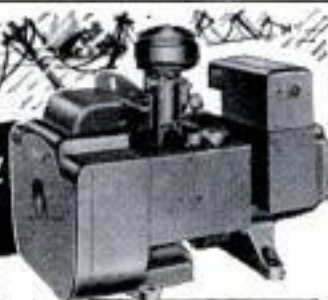

Provides dependable stand-by electricity for heating system, pumps, freezer, lights, appliances. Keeps home safe, livable. Automatic start and stop. Find out how little it costs!

Write for Folder!

**A SIZE FOR EVERY NEED**

1,000 to 50,000 watts.  
Compact, quiet-running,  
easy to install. Gasoline  
engine powered.

**D. W. ONAN & SONS, INC.**  
8573 University Ave. S. E. • Minneapolis 14, Minnesota

**4-IN-HAND**

(four files in one)

A "must" for the homecrafter



Flat file and rasp on one side; half round rasp and file on other side. (8", 9" or 10" length.)

FLAT surface or curved; deep cut or light—you get quick, sure stock removal on wood, plastics or soft metal with this unique four-faced rasp-file. And its utility is well seconded by its facility... flip it over, endwise or sidewise, and instantly you have the face best suited for the job.

A woodworker writes: "This is a fine correcting tool... if I can't cut or saw a thing right I make it so with the 4-IN-HAND. It removes the offending material in a jiffy."

**GET IT FROM YOUR HARDWARE  
OR TOOL SUPPLY HOUSE**

in either Nicholson or Black Diamond brand

You'll notice the evidences of the 4-IN-HAND's high quality. And while you're about it, why not lay in an auxiliary complement of regular files for your "Do It Yourself" projects? The dealer will gladly help you make a wise selection.

**NICHOLSON FILE COMPANY**

22 Acorn St., Providence 1, R. I.  
(In Canada: Nicholson File Company of  
Canada Ltd., Port Hope, Ontario)



**NICHOLSON  
FILES** FOR EVERY PURPOSE



NATIONALLY FAMOUS PATHFINDER  
**AUTO LIGHTING ACCESSORIES**

for **ADDED SAFETY...**  
**EXTRA CONVENIENCE!**

**"JET-LITE"**



**FULLY  
 AUTOMATIC  
 TRIPLE  
 WARNING SIGNAL**

for **SUPER-SAFE Driving!**  
 A real "traffic light" in miniature for your car! 3-way warning instantly signals following cars when you **STOP... GO... SLOW DOWN**—helps prevent collisions. Easily installed on trunk of car—**no holes to drill!** Beautifies any car with its handsome streamlined, chrome plated body and colorful lights. Theft-proof, weather-proof. Complete with all parts and instructions for easy installation.

- Automatically shows **RED** when you step on Brake
- Automatically shows **AMBER** when you release accelerator
- Automatically shows **GREEN** when you step on the Gas

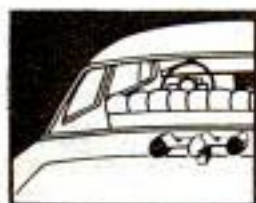

No. JL 600

**\$595**  
 POSTPAID

**"HANDEE-LITE"**

**PORTABLE SPOTLIGHT of 1001 USES!**

De luxe chrome plated spotlight for every night-driving emergency! No installation—just plug into Cigar Lighter socket. GE "Sealed-Beam" bulb throws brilliant light 500 feet. Modern streamlined design with built-in switch and adjustable stand. Complete with 10-foot cord and special lighter socket plug.

No. HL 600  
**\$595**  
 POSTPAID



**"PORTA-LITE"**

**PUTS THE "SEE" in "EMERGENCY"!**

Compact, rugged model for instant, powerful light whenever and wherever you need it! Special plug fits into lighter socket—no installation needed. Baked blue enamel finish, powerful sealed-beam bulb. E-Z-grip handle acts as adjustable stand—leaves both hands free. Ready to use, including 10-foot cord and plug.

No. PL 400  
**\$395**  
 POSTPAID



**ORDER TODAY ON MONEY-BACK GUARANTEE!**

**VISIONITE PRODUCTS CO.**  
 3544 W. Roosevelt Road • Chicago 24, Ill.  
 SEND POSTPAID  No. JL 600 JET-LITE  
 HL 600 HANDEE-LITE  PL 400 PORTA-LITE  
 Enclosed is  Check  Money Order (Amt.) \$\_\_\_\_\_

Name \_\_\_\_\_  
 Address \_\_\_\_\_  
 City \_\_\_\_\_ Zone \_\_\_\_\_ State \_\_\_\_\_

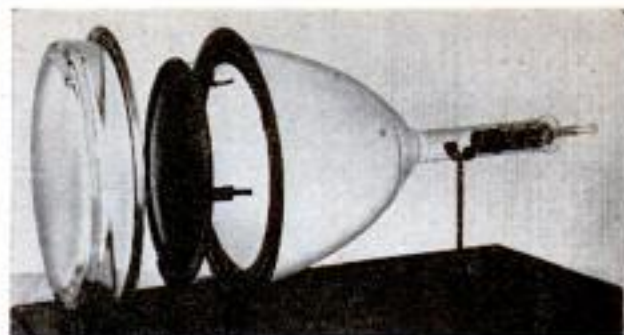

Newest CBS tube is shown at top. It is simpler and less expensive than the former color tube at bottom

the familiar ones on your standard black-and-white (monochrome) set: channel selector, brightness, contrast and focus control. One new one is the "chrome control." Turn it all the way left, and color fades to a bland, washed-out mess resembling a badly over-exposed color transparency. At far right, color jumps out in a dense intensity and brilliance, startling but hardly "true" color. In between lie the subtle shadings to suit your taste.

There's also a "convergence control," a delicate adjustment for aligning the three color signals coming into the tube so that they strike the tube face in perfect register. If this adjustment is off, people on the screen may suddenly develop green or red ears or grow purple halos.

Actually, TV color signals are identical to black and white. But instead of a single signal carrying a single picture there are three signals riding together, carrying three separate images. One shows all the red values in the scene being shot, another all the green, a third all the blue.

Each network has its own special cameras and gear for breaking down the scene into these three colors. What the NTSC has set up is not a new "system" but a set of standards. "It's like standardizing railroad tracks," explains NBC chief engineer O. B. Hanson. "Any railroad can streamline its cars and engines. But all must fit the same gauge track. Like railroad cars, each network can run its own equipment, as long as it fits the same standards."

When the signal leaves the transmitter,

(Continued to page 278)





# No More Wrist Strain!

- Only Atkins handsaws have the famous *Perfection Handle*—a basic design change to permit faster, easier cutting with no wrist strain!

Atkins *Perfection Handle* applies cutting pressure on a straight line from the elbow, through the wrist, to the middle of the cutting edge. There's no wrist action... less fatigue... the cut runs perfectly true!

**WHEN YOU BUY A SAW, BUY A GOOD ONE—ATKINS!**

# ATKINS

ATKINS SAW DIVISION

Borg-Warner Corporation • Indianapolis 9, Indiana



Hack Saws                      Back Saws  
Mitre Saws                  Coping Saws  
Compass Saws              Keyhole Saws  
Pruning Saws               Nests of Saws  
• Mechanic-Kut Circular Saws

## If you can drive a nail you can install beautiful hardwood paneling like this

Visit your local lumber dealer now! Let him show you how you can enjoy the warmth and beauty of *real* wood paneling at a cost you wouldn't think possible.

Choose from rich looking mahogany, oak, birch, Korina,<sup>®</sup> knotty pine and many others. Start this week end—you need no special skill.

No need to waste time, work and money on imitations that try to look like wood. Weldwood hardwoods are the *real thing!* Furthermore, *they're guaranteed for the life of your home!* Look for the Weldwood label.



## Weldwood<sup>®</sup>

REAL WOOD PANELING

United States Plywood Corporation

World's Largest Plywood Organization  
Weldwood Building, 55 West 44th Street, New York 36, N.Y.  
U.S.-Mengel Plywoods, Inc., Louisville, Ky.



**KORINA<sup>®</sup>** the beautiful blond hardwood from our plant in the Belgian Congo. Costs only \$80.64 for a 16' x 8' wall. Other Weldwood hardwood paneling (birch) as low as \$11.00 per 4' x 7' panel.

United States Plywood Corporation  
Box 61, New York 46, N. Y.

PM-1-54

Please send 20-page, full-color book with 32 ideas for "Beautiful Homes—with Weldwood". Enclosed is 10¢.

NAME.....

ADDRESS.....

CITY..... STATE.....



## WEEK-END DECORATORS!

### Peel off old paint

FOR A BETTER JOB



Why try to paint over a cracked, checked or broken finish . . . when it's so easy to "peel it off" with Klean-Strip? This modern remover leaves the surface clean, smooth and dry — ready for a

better, longer-lasting paint job. Non-inflammable Klean-Strip works fast on all type finishes. Needs no afterwash or neutralizing . . . saves labor and materials. Buy it when and where you buy paint.

**Made by The Klean-Strip Co., Inc.**  
2340 S. Lauderdale, Memphis 6, Tenn.  
**KLEAN-STRIP TAKES OFF ANY FINISH**

With our simple pattern  
you build this

## LEAN-TO STORAGE SHED

AT MINIMUM  
COST

**MAKE it at home . . . and  
SAVE..with HOMASOTE**

Now have that storage shed you need so badly—for tools, bicycles, hose, bulky objects. With simplified Easi-Build\* Pattern #89, you do a professional job—without blueprints. The pattern takes the mystery out of building . . . specifies all materials required . . . shows how to cut each piece to exact size . . . how to assemble the finished shed . . . The major material used is *weatherproof* Homasote—America's oldest and strongest insulating-building board. Saws and nails easier than wood; takes paint, stain or Sand Finish. Mail coupon today for pattern and Homasote literature.

\*T. M. Reg. Easi-Build Pattern Company

HOMASOTE COMPANY, Dept. 14, Trenton 3, N. J.  
I enclose 50¢ for which send me Pattern #89.

NAME .....

ADDRESS .....

CITY..... STATE.....

My lumber dealer is.....

it is the same for all networks—three color signals riding in close frequency to black-and-white and sound signals.

All this electronic information is picked up by your home color receiver. The black-and-white signal tells the set how much brightness is in the picture. Impulses for each of the three color images are separated and zipped to three electron guns (one for green information, one for red and one for blue) at the base of the big tri-color tube. The inner face of this tube, pioneered by RCA and recently modified by CBS, is coated with up to 750,000 dots of red, green and blue phosphor, mechanically arranged in 250,000 tiny triads. Behind this surface a perforated screen or "shadow mask" with 250,000 microscopic holes is so perfectly registered over the triads that the three electron beams angling through them hit only the right phosphors. The green beam, piercing a tiny hole in the mask, hits the green phosphor of a triad and makes it glow. The red beam, angling in from another direction through the same perforation, is masked from the blue and green dots but "tickles" the red one.

Thus, each beam lays down its own image in its own color. Since the dots are so tiny and closely packed, your eye melts them together into one picture in true-to-life color.

In the host of vital circuits between scene and screen, startling things occasionally happen to the colors. If the three guns are out of alignment, you get a cascade of color flecks instead of the picture. One or more colors have been known to drop out until emergency equipment could be brought into play.

Though controls on present sets are simple, you may find yourself diddling with dials a lot more to get the picture you want. Color signals are more sensitive to interference than monochrome and an accurate shade may stubbornly elude capture.

Vance Hallack, producer in charge of color for NBC, wryly recalls that during the 1950 FCC demonstrations, transmission engineers fought bitterly all day with the receiver engineers, each blaming the other for the poor color coming through. "Finally, during a break," he says, "I sent out for green bananas and substituted them for yellow ones in a fruit bowl on the set. Soon as we started up again, a receiver man called up, screaming:

"'What's with the green bananas?'

"'Don't know what you're talking about,' I told him. 'They're yellow on *our* monitors.' That kept him quiet for half an hour. Then he called again and said: 'Got your

(Continued to page 280)



## A PERFECT PICTURE OF YOUR BEST BET—BULLDOG COUPLERS!

Model No. 1-C for light-duty trailers, capacity 2500 lbs. 1 1/4" ball with nut included. \$6.36 Fed. Tax incl.



Manufacturers of TORQ-LESS AXLES, BULLDOG COUPLERS and BULLDOG FARM JACKS. Write for Brochure 131 on complete line.

**HAMMER BLOW TOOL COMPANY**  
"As old as the Industry"  
WAUSAU, WISCONSIN

## SHEET METAL BRAKES

Angles, flanges, Pittsburgh locks, 24 G. steel, heavier aluminum. Cam locking, mount on bench, truck or floor stand. Truss braced steel. Express collect. 30" 45 lbs., \$28.50. 36" 75 lbs., \$33.00. 48" 100 lbs., \$48.00. Portable stands, 32" hi., 35 lbs., \$7.00. 15", 40 lbs., capacity 16 gauge, \$21.50. IRON BENDER forms hooks, angles, eyelets, etc. Capacity 1/2" x 2", 5/16" x 1 1/2". All steel. \$9.50. 30" CURVE FORMER. Forms straight and tapering pipes 2" to 2 ft. in diameter. 20 gauge, express collect \$9.50 (Immediate delivery. Order direct, cash or C.O.D., or send for folder)

VYKE BRAKE CO., P-2439 15th St., Denver 11, Colo.

## A NEW YEAR

of satisfaction can be yours with a Gerstner Chest. Free Catalog.  
**GERSTNER TOOL CHESTS**  
454 Columbia St. Dayton 7, Ohio

## STOP JERKY STARTS! with an AUTOMATIC CLUTCH

END BELT SLIPPAGE—Get smooth pickup for your power mower, scooter or garden tractor with only throttle control.  
PREVENT STALLING engine, cut belt wear, gain no-load idling. Quickly and easily installed on 1/2", 3/4", 1" shafts. Every clutch factory tested.  
See dealer or write for Folder M14.

**V-PLEX CLUTCH DIVISION • Hagerstown, Indiana**

## MODERN LAWN MOWER SHARPENER

Service departments of leading Lawn Mower manufacturers use the Modern Lawn Mower Sharpener. One lever moves lawn mower into grinding position. Gasoline and oil remain in engine while sharpening, no dismantling of wheels, roller or handle. The Modern is a precision bed knife grinder—no extra grinder to buy. Imitated but never equaled—Compare before you buy. If it isn't a Modern it can't be Modern (Prices subject to change without notice)

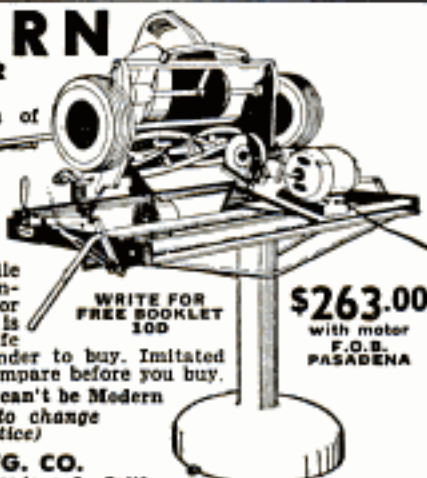

WRITE FOR FREE BOOKLET 100 \$263.00 with motor F.O.B. PASADENA

**MODERN MFG. CO.**  
160 N. Fair Oaks - Pasadena 1, Calif.

# PALMGREN HOBB-E TOOLS

## ROTARY INDEX MILLING TABLE

Turn drill press into vertical miller. Mill, Grind, Index, Rabbet, Mortise and Rout curved or straight. PALMGREN "Hobb-E" ROTARY TABLE is a precision machine, accurately graduated. Bolts to table. No. 83—8" Table, 4" Cross Feeds, 360° Rotary Feed. \$54.50



No. 82—Without Rotary Feed. \$39.75

## ANGLE VISE

Set up hard angle jobs in 5 seconds. Drill, grind, mill, round, square or irregular pieces quickly and accurately. Save time, money and errors. PALMGREN ANGLE VISE has 2 1/2" Jaws. 1 Plain, 1 Grooved. Accurately machined and graduated. \$11.75



Complete with Swivel Base

## MILLING ATTACHMENTS

Mill it on YOUR LATHE! Now! You can make T-slots, Dovetails, Keyways—Recess, Grind, Square Shafts, Saw at Angles, etc. Fits any Lathe. Graduated for rotary and vertical feeds. Attaches to tool post in 10 seconds. No. 150—1 1/2" Jaws. Fits 1" Post. \$18.75  
No. 250—2 1/2" Jaws. Fits 1 1/2" Post. \$24.75  
No. 400—4" Jaws. Fits 2" Post. \$39.75



## ADJUSTABLE ANGLE PLATE

Every Hobbyist should have one for jobs difficult to hold in vise. No delay, less spoilage on complicated angles in drilling, milling, grinding or layout work. No. 256 B has 6"x6" surface plate, 8 bolt slots. Adjustable to full 90°. Accurate graduations. Mounted on Swivel Base. \$14.35



No. 249B—9"x9 1/2" Plate Mounted on Swivel Base. \$32.75

## BENCH DRILL PRESS VISE

A fine "Hobb-E" tool. Base bolts to work bench for general work. Vise is dovetailed and removable for use on drill press by loosening thumb screw. Unit rotates 360° horizontally. Adapter has steel rib which locks vise in position. No. 12 Removable Jaws 2 1/2" wide. 1 Plain \$12.95  
1 Grooved.

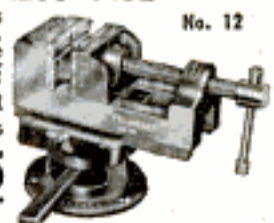

If your Dealer cannot supply you, write us.

## ORDER NOW! SEND COUPON TODAY!

CHICAGO TOOL & ENGINEERING CO.,  
8338 South Chicago Ave., Chicago 17, Ill.

Enclosed find \_\_\_\_\_ for items checked below.  
 PALMGREN "Hobb-E" ANGLE VISE.  PALMGREN "Hobb-E" ANGLE PLATE  PALMGREN "Hobb-E" ROTARY TABLE.  PALMGREN MILLING ATTACHMENT.  PALMGREN "Hobb-E" BENCH DRILL PRESS VISE.  
 Send Circular No. 20134.

NAME \_\_\_\_\_  
ADDRESS \_\_\_\_\_  
TOWN \_\_\_\_\_ ZONE \_\_\_\_\_ STATE \_\_\_\_\_



# FEARLESS FOSDICK

by AL CAPP



KEEPS HAIR NEAT — BUT NOT-UGH! - GREASY! LOW AS 29¢

yellow bananas—but your apples are blue.’”

Hallack, and his counterpart at CBS, Jerry Danzig, still shudder over some of the whimsies of the new medium. The minute anyone steps into a shadow his face may turn a hideous green, purple or other unlikely shade on receiver screens. A blue dress may go dirty red.

The shade problem makes “remotes” a tough job, too. Last year when NBC ran a sneak preview of the Penn-Columbia football game, everything was fine until the last quarter. “Then,” says Vance, “the sun went below the stadium rim and the final quarter came through in a greenish black and white.”

Indoors or out, color TV requires more light than monochrome. RCA, NBC's parent company, says three times more; CBS says six times. Art-museum guards, in charge of a Picasso painting in one scene, were sure the oils would melt and run on the priceless picture. They didn't, but everyone trembled.

Hurdles still confronting color are technical and economical. Most TV executives are confident they'll all be solved in a relatively short time with the brains and effort being applied today.

Already, with all its whimsies, color is cutting dollar corners in a few areas. “We can paint our scenery with light instead of paint,” Hallack points out. “We built a gray cyclorama for the studio. By playing lights through varicolored gels, we can give an audience 500 different backgrounds per hour if we want. That way a set can be varied all night at no cost. We can paint objects and costumes with colored spots, too—everything but flesh tones.”

Flesh is the key to all color TV and it's giving technicians some headaches right now. At NBC, cameramen “tune in” on what they call Gamma Chips—three bars of shading, one black, one white and one a flesh tone—providing full color range. When these are right on the monitors, everything comes out right, they claim. To make sure, they run further tests on color bars.

Finally, they tune in on Marie MacNamara—a pleasant chore. Marie is a natural auburn-haired beauty who has been tuned in on by RCA color cameras daily for 2½ years. “Her natural skin tones are perfect and her hair, one of the hardest colors to telecast correctly, is among the toughest tests we have,” Hallack explains.

Radical simplifications in technique and equipment are being announced every month. CBS claims that its new Colortron tube is a simplification of the shadow-mask

(Continued to page 282)



# PIPE JAWS FOR YOUR BENCH VISE

**\$2.65**

POSTPAID

A QUALITY SHOP TOOL FITS ANY MAKE OR SIZE VISE

Transforms any ordinary bench vise into an effective pipe vise instantly. Holds up to 2 1/2 inch pipe either vertically or horizontally. As effective as the most expensive pipe vise. Save at least \$25. Ideal for hobbyist, householder, farmer, garages, service stations, and machine shops

SEND CASH, CHECK OR MONEY ORDER — NO C.O.D. 10-DAY MONEY BACK GUARANTEE

**BANITE CO., BANITE BLDG., BUFFALO 4, N. Y.**

## MAKE UP TO \$5 AN HOUR WITH

# EASISHARP



Big profits in your spare time sharpening scissors. We show you how to start making money immediately. This is your chance now to have your own business with Easisharp. Sharpen a pair of scissors in less than two minutes! A child can operate it. Weighs only 10 lbs. Every home, barber, tailor, dressmaker — everybody uses scissors and all need sharpening two to four times a year. Don't let some one else get ahead of you. Write immediately to

**MONEY MAKING SALES PLAN FREE**

**SERR-EDGE MACHINE CO., 9731 Lorain Ave., Cleveland, Ohio**



# MAGNETS

GENUINE ALNICO—NEVER WEAKENS

**225 lb. PULL**

**AMAZING, PERMANENT MAGNETS—WILL NOT WEAKEN! NON-ELECTRIC** Retrieve guns, tackle, tools and other steel items from lake, river, plating tanks, drains or other hard-to-reach spots. Recover drills, taps, etc. from sweeping. Clear alley of harmful tacks, nails. Many other uses. Pays for itself quickly. **GUARANTEED.** Try any magnet one week. Money refunded if you are not well pleased.

No. M-725 (Weights 54 oz.) Has pull of 225 lbs. on steel block. \$15.00  
 No. M-975 (Weights 49 oz.) Has pull of 175 lbs. on steel block. \$10.50  
 No. M-650 (Weights 41 oz.) Has pull of 150 lbs. on steel block. \$ 8.50  
 No. M-500 (Weights 35 oz.) Has pull of 50 lbs. on steel block. \$ 4.00  
 No. M-30 Hobbyist assortment of six small magnets. . . . . \$ 1.50

Send Money Order or Check. We pay postage. No C.O.D.'s.  
**MIAMI MAGNET COMPANY, 3240 N. W. 27th Ave., Miami 42, Fla.**



# PAGE Garden Tractors

1954 line now ready — low prices!

Ruggedly built riding and walking models, 2 to 6 HP. All gear drive with reverse, no belts or chains. Plow, till, harrow, disc spray, remove snow, do dozens of other farm and home chores. Also new "Bantam" one-wheel model.

Fully Guaranteed  
 Low prices — easy terms

Free Catalog Shows over 60 attachments!

PAGE does every job faster — cheaper!

**PAGE** 1904 S. 81st Street MILWAUKEE, WISC.

# Floor Surfacing Contractors NEEDED!



- ★ BIG PAY
- ★ FULL or PART TIME
- ★ AGE No Barrier
- ★ Minimum Investment

## Highly Respected Profession Offers You Unusual Opportunity to BE YOUR OWN BOSS

Thousands of men of all ages have found financial security and happiness in a phase of the building and remodeling industry that has become as necessary as the hammer and nails. The pay scale is high for those who are willing to work; many earn \$50 a day and more. No great physical stamina required—men from 18 to 80, even with physical handicaps, enjoy this pleasant year 'round indoor work where earnings are limited only by the amount of time you devote to it. The American Floor Surfacing Machine Co., a 50-year-old pioneer firm and leader in the industry, shows you how to quickly make good in this stable business. No schooling, no special talent or skills required. Only small investment in sander gets you started. Send coupon for "money-making booklet" entitled "Opportunities in Floor Surfacing"—enclose 25c in coin or stamps to cover handling.



# AMERICAN FLOOR MACHINES

SEND ↓

The American Floor Surfacing Machine Co.  
 535 So. St. Clair St.  
 Toledo 3, Ohio

Here is 25c in stamps or coin for booklet "Opportunities in Floor Surfacing", telling me how I can start my own floor sanding business.

Name.....

Street.....

City..... State.....



75th Anniversary

**STILL  
THE BEST!**

**75 YEARS OF  
STRENGTH**

# LE PAGE'S GLUE

For 75 years, Le Page's has been a household name. Whenever folks used glue for making or mending, they used Le Page's. They found Le Page's was good glue — ready to use, stronger, more reliable than any other glue made.

Today, we produce specialized adhesives for every purpose. But there is still nothing better than the original Le Page's Glue — time tested — the finest you can use!



LE PAGE'S, INC., Gloucester, Mass.

Regular Price of a  
Slide Rule \$4 and up



## Slide Rule

# 92c

and this coupon  
Add 8c Postage

If you can use a pencil you can use a slide rule. For bookkeepers, accountants, salesmen (figuring commissions, cost, etc.), farmers, housewives, etc. For Armed Forces highly important. Men's most useful tool. Easy to calculate instantly. Multiplying, proportions, division, roots, etc. "High Vision" Clear View Slide. Full 10" Rule. A, B, C, D, C1 and K scales. **FREE** 28-page instruction book on how to get correct answers instantly without pencil or paper.

Gene Loewy, 545 5th Ave., Dept. 43-H, N.Y. 17

Limit three rules to each coupon

type that suddenly makes possible mass production of one item that posed manufacturing sticklers six months ago. The tube will be in pilot production next month. By next September 15,000 are expected to roll out each month.

RCA's big three-tube color camera that does everything in one operation, but is a cumbersome \$65,000 affair, already is obsolete. At RCA's Princeton labs, technicians are shooting successful color with a camera the size of a standard black-and-white job. Three miniature Vidicon tubes no bigger than two-cell flashlights do the work. The same men are also dollying a brand new single-tube camera that works like a tricolor receiver tube in reverse.

One of the hottest color developments, quietly being perfected in Paramount's laboratories, is a receiving tube known as the "Chromatron." Owned by Dr. E. O. Lawrence (who invented it) and Paramount pictures (who financed its development), this tube may speed the arrival of lower-cost color sets.

Instead of using three electron beams, perforated masks and thousands of phosphor dots, the Lawrence-type tube has a single gun—like a black-and-white tube. Across its screen are 900 vertical lines of red, green and blue phosphor. The gun fires red, green and blue signals at the screen in an ultrarapid sequence through a grid of vertical wires. As each tiny color impulse flies between a pair of wires, it passes through a magnetic field that bends it toward the right phosphor.

Other startling things are in the works. A big headache for advertising men has been the fact that color films don't work well on color TV. Now they won't need film. Brig. Gen. David Sarnoff just announced that RCA's Princeton scientists have perfected a method for storing color signals on half-inch magnetic tape. It does away with all chemical processing. A color "show" can be stored indefinitely and played back anytime—or the tape can be "wiped" and reused.

"Magnetic tape recording of video signals," says the General, "should make possible a simple means by which a TV-set owner can make recordings of television pictures in the home. And they can then be 'performed' over and over."

Nobody believes that color will completely replace black and white. There wouldn't be much point in seeing wrestling bouts or horse races in color. Dr. DuMont has pointed out that Technicolor didn't replace black-and-white movies. "Neither," he says, "can it happen in TV. There will always be plenty of monochrome shows to watch." ★ ★ ★



**DOES EVERYTHING A PIPE-  
WRENCH WILL DO, AND MORE!**

**THE AMAZING  
RATCHETING CHAIN  
WRENCH**



Takes the place of 4 pipe wrenches. Gets into tight places where a pipe wrench cannot be used... capacity  $\frac{3}{8}$ " to  $4\frac{1}{2}$ ". For jobs around the home, garage or service station.



A must for farmers, steam-fitters, plumbers, electricians.

Grips anything round or hex, in corners or up against a wall.

**AT HARDWARE, PLUMBING, AND AUTO SUPPLY DEALERS OR WRITE DEPT. P.M.**

**Owatonna Tool Co., Owatonna, Minnesota**

**Build your own JET ENGINE!**



SEND NO MONEY

Order these plans today

1. JET PROPELLED BICYCLE. Assemble your own. Photo and instructions, \$1.00.  
2. HOW TO MAKE EXPERIMENTAL JET ENGINES. Seven sheets drawings with information and instructions \$2.95.  
3. BOTH OF ABOVE in one order \$3.75. SEND NO MONEY. Order both at once \$3.75 C.O.D. in USA plus c.o.d. postage. Send check or money order and we pay postage. Get other information too. Rush Order.

**J. HOUSTON MAUPIN, Dept. 55, Tipp City, Ohio**

SEND FOR YOUR PLANS TODAY ONLY 10c

**HYDRAULICS**

Build-Your-Own Dozer, Hay-Fork, Loader, Hoist, etc. Dime brings DUNBAR'S Hydraulic PLAN with all hydraulic essentials necessary and big Catalog listing 1500 items including many Hydraulic-kits, Arc Welder-kits and War Surplus. Send today.



EVERYTHING IN HYDRAULICS

**DUNBAR MFG. CO., INC.**

10318-B5 Aurora Avenue, Seattle 33, Washington

**AMMUNITION**

for a fraction of regular cost



Reload a whole carton for the cost of a few rounds of factory ammunition. Shotgun shells, rifle and pistol cartridges can be reloaded safely and easily with an inexpensive set of famous IDEAL Reloading Tools. Send for free literature.

**THE LYMAN GUN SIGHT CORP.**  
Middlefield, Conn.

JANUARY 1954

**NEW HOME TOOLS FOR Craftsmen!**



**SYNCRO'S DOUBLE ARC MOTION DOUBLES Sanding Action**

Deluxe Model in Metal Carrying Case \$22.95 No. 504

**\$19.95**

Syncro's exclusive Double Arc Motion combines the best features of orbital and straight-line sanding for a satin-smooth finish. Try the Syncro No. 504 before you buy any Sander. Perfect for polishing, too. With new BUILT-IN Reactance Type Electric Motor, \$19.95. Deluxe No. 504 in metal case \$22.95 at dealers or postpaid!

**Amazing SAFE JIG SAW CUTS 1" WOOD!**



No. 201 \$24.95 MOTOR INCLUDED

Most powerful, largest of its kind! SAFE—does not pull fingers toward blade. QUIET—ideal for apartments. No Radio or TV interference. Adjustable "any length cut" arm. With BUILT-IN New Reactance Type Electric Motor, \$24.95, at dealers or postpaid.

UL  
SYNCRO POWER UNITS GUARANTEED AGAINST BURN OUT DURING YOUR OWNERSHIP OR REPLACED FREE!

Those Who Know Buy

**SYNCRO QUALITY ELECTRIC TOOLS**

U.S.A. Models: 60 Cycle, 110-120 Volt AC. Other Voltages, Cycles available.

USE COUPON FOR CIRCULAR OR DIRECT ORDER

SYNCRO CORPORATION, Dept. D-14, OXFORD, MICHIGAN, U.S.A.

SANDER ORDER. I enclose \$\_\_\_\_\_ Send No. 504 Sander postpaid.

With Case, \$22.95  Without Case, \$19.95

SAW ORDER. I enclose \$24.95. Send No. 201 postpaid.

FREE CIRCULAR. Send New Syncro Products Circular.

(All Syncros Sold on 10 DAY MONEY BACK TRIAL!)

WRITE NAME, ADDRESS BELOW — MAIL TODAY!



# Fishermen!

3 BOOKS  
AND FISHING  
CALENDAR

FREE!



WANT TO CATCH MORE FISH  
... BE A BETTER FISHERMAN!

- ① Interested in Spin Fishing? Helpful tips on "How to Outfish That Good Old Cane Pole".
  - ② Like to Bait Cast? Learn how to ... "Hook, Hold and Handle The Big Ones".
  - ③ Like to Fly Fish? "No Limit on Fun Fly Fishing for Bass, Trout and Pan Fish".
- Books Show Right Fishing Tackle For Catching More Fish — Spinning — Bait Casting — Fly Fishing.
- ④ Pocket Fishing Calendar ... by Joe Godfrey ... shows best days to fish in '54. Mail Coupon!

## Shakespeare

WONDERRODS • REELS • LINES • BAITS

### SHAKESPEARE COMPANY

Dept. PM1, Kalamazoo, Michigan

Please send me 3 BOOKS and 1954 POCKET FISHING CALENDAR — FREE

Name \_\_\_\_\_

Address \_\_\_\_\_

City \_\_\_\_\_ State \_\_\_\_\_



### Here now for 1954

"Home Is Where You Take It" with America's leading all-steel insulated mobile home, the new HOWARD for 1954! Time-tested from Alaska to Florida, now better by far—for you and your car. For details write HOWARD Industries, Box 2188 ... Dept. 21, Saginaw, Mich.

## Howard MANSION COACH

HOWARD INDUSTRIES INC., SAGINAW, MICHIGAN

## Look How Your Mail Gets There!

(Continued from page 101)

a canopy like a miniature covered wagon to keep off the intense sun.

Worrells' is lucky to have roads. One of the toughest routes in the country is a 38-mile trail from the Big Creek, Idaho post office, on an air strip, to the Middle Fork of the Salmon River. The trail follows the rocky stream bed through a deep canyon. Tin mailboxes of mountain folk along the creek are serviced twice a week by L. E. Curtis and his two pack horses who take two days picking their way up trail to deliver a week's inbound "air mail." The first night is spent in a cabin along the creek, the second at a ranch on the Fork.

Few people think of a postman as the pilot of a boat. Yet several mail routes are famous waterways demanding mailmen who are far more than just letter carriers. Perhaps the most exciting mail route in the country is the Snake River run—93 miles of treacherous rapids curling through Hell's Canyon—deepest and narrowest cut on the continent—from Johnson's Bar to Lewiston, Idaho. Up in the Canyon live some 350 cattlemen, sheep ranchers and prospectors with no established means for getting in or out except via the torrential river. And that's the way their mail goes.

Until 1938, mail delivery up the canyon was spasmodic and unpredictable. Only a few pilots would run it when the river was "right." That year, a rugged mechanic named Kyle McGrady quit work in a Lewiston garage, bought himself a tough-bottomed freight boat and began to ply the Snake on a regular weekly schedule—feeling his way around rocks and sandbars as he crept up and plummeted down the rapids. McGrady would ride the river when it was "right" or "wrong," servicing the 50-odd mailboxes along the shores. He smashed as many as three propellers per trip. His first boat crashed on the rocks and blew up under him before one year of duty. But grateful canyon dwellers helped him buy another and for 12 years McGrady bucked the Snake, carrying not only mail but cattle, medicine, boots, canaries and everything up to a year's supply of groceries for his clientele. He ferried sick people out (one appendicitis case and scores of mothers-to-be) and brought them back. In one 18-month period, he never missed a single weekly mail trip.

Knowing the hazards of the run, McGrady's wife worried in bad weather. To ease her mind, the river mailman kept a cage of homing pigeons aboard his craft. When the last rapids had been navigated

(Continued to page 286)





### Double-Lever Action Locks Jaws with TON-GRIP

Look INSIDE the most useful tool in the world! Only Double-Lever action could provide **Ton-Grip**. See how a squeeze of the hand locks jaws to work! Won't slip. Can hold, twist, bend, pull, ratchet, cut! How you'll USE it! 7" and 10" only \$1.85 to \$2.60. At your hardware dealer.

Manufactured Only By

**PETERSEN MFG. CO., Dept. M-1, DeWitt, Nebr.**

### "Do-It-Yourself" Begins With How

"How to Work With Tools and Wood" makes the basic do-it-yourself skill easy for handyman or homeowner. Fully illustrated, only \$2.00 postpaid. Order from Stanley Tools, 314A Elm Street, New Britain, Conn. In Canada, write to Stanley Tool Co. of Canada 314A Stanley Street, Roxton Pond, Quebec.



**THE TOOL BOX OF THE WORLD**  
Hardware • Electric Tools • Steel Strapping • Steel

**STANLEY**

LOOK AT THESE

**WEN**

*Values!*



A STRAIGHT LINE ACTION

*Electric*

# SANDER-POLISHER

Has 1001 uses around the home or shop! Sands wood satin smooth—easily, quickly. 14,400 strokes per minute on ordinary 110-120 Volt A.C. Sands rust off metal, removes paint, polishes furniture, your car, bright metal—*anything!* Even gives a good massage. And it's *light* (only 2½ lbs.)—*quiet* (like electric razor) and *bandy* to use. Well made, fully guaranteed. Sturdy plastic case—colors black, red or green.



## VARIABLE SPEED HYDRAULIC POWER TRANSMISSION



It has Infinite Speeds 0 to 550. Reverse, Automatic Overload Protection; Adjustable Torque up to 180 inch pounds. 3/8" Input and Output Shafts. It will handle 1/2" to 1 1/2" H.P. Motor. Case measures 7 1/2" long, 7" high, 6 1/2" wide. **VALUE OVER \$300.** Shipping Wt. 25#. On C.O.D. Orders we require a 10% only deposit. **\$54.50** Fab. Chicago

DIRZIUS MACHINE SHOP "J" 1423-25 So. 52nd Ave., Cicero 50, Ill.

## make your own Gems 29.50 F.O.S.

The Gem Maker comes complete with all necessary equipment, including a super-charged diamond blade for sawing, and all wheels for grinding, shaping and polishing; also complete instructions. The complete equipment as shown, less motor and belt, for only \$29.50, f.o.b., Burlington, Wisconsin. Write today for information and literature.



**B&I MANUFACTURING CO.**  
Dept. 5 Burlington, Wis.

## PLYWOOD BOAT KITS

(Freight Included) 12 FT. \$9700  
14 FT. \$12900



Build these 12 or 14-ft. sport runabouts from readycut parts. Kits include all hardware, etc., to complete the boat shown. Send for free folders of all models as low as \$33.00 freight included.

**TAPT MARINE WOODCRAFT**

Dept. J, 636 39th Ave., N. E., Minneapolis 21, Minn.

## WEN 250 WATT "QUICK-HOT" ELECTRONIC SOLDERING GUN

3 seconds on 120 Volt A.C. readies Gun for all soldering requirements 50-250 Watts. With special tip, becomes marvelous plastic tile cutter, too. Multi-useful!

Only \$12.95



At your Dealer's or write

**WEN PRODUCTS, INC.**

5808 NORTHWEST HIGHWAY, CHICAGO 31, ILL.  
(Export Sales, Scheel International, Inc., Chicago)



"About your raise, Smithers. Using this Aladdin wide-mouth will save you hundreds!"

**Aladdin**  
VACUUM BOTTLES  
and LUNCH KITS

10 OUNCE  
PINT  
QUART

ALADDIN INDUSTRIES, INCORPORATED, Nashville, Tennessee

**The easy way to paint!**

*Speedy Sprayer*

Favorite of home owners and craftsmen for 20 years! SPEEDY SPRAYER gives your work that professional paint finish everyone admires. Sprays paint, enamel, varnish, lacquer, etc. . . . 4 to 7 times faster than hand brushing! Lightweight, portable, uses any 1/4 H.P. motor. Improved diaphragm principle assures clean, oil-free air. You'll find dozens of time and money saving uses for SPEEDY SPRAYER, including spraying insecticides 2-4-D and DDT. Complete outfit, without motor, only \$36.50.

At leading hardware, lumber, and auto supply dealers.  
FREE—write for handy booklet "How to Spray."

**W. R. BROWN CORPORATION**  
2635 N. Normandy • Chicago 35, Ill.

ONLY  
**\$36.50**  
LESS  
MOTOR

on the return trip, he'd write a note estimating his arrival time in Lewiston, slip it in a leg capsule on one of the birds and release it with the news.

Today the run McGrady established is covered by a big 52-foot boat powered by twin diesels. Her shallow-draft hull, drawing only 22 inches, is specially designed for riding the Snake's shifty bottom. For the past three years this boat, the *Wenaha*, has been the official Snake River mailboat, piloted by Capt. Oliver McNabb of the Inland Navigation Company. Mail leaves the Lewiston dock each Wednesday morning at dawn and reaches the end of the route 10 hours later. McNabb and the *Wenaha* are generally back for supper next day.

Perhaps the most catch-as-catch-can mail "routes" in the United States are the speed runs made on the Great Lakes by several boats operating out of Soo and along the Detroit River. These high-powered craft, rigged up as floating post offices, chase after big lake steamers and transfer mail back and forth while both craft move along at 10 miles per hour. A mail bucket comes slithering down the high sides of the big steamer to the pitching mailboat. Outgoing mail from the ship is removed and letters for the crew put in the bucket which is then hauled up.

One of these blunt-prowed, square-sterned boats, the *G. F. Becker*, plies a 13-mile run up and down the Detroit. Her interior is lined with pigeonholes, each marked with the name of a lake ship. More than 2,000,000 letters and packages a year are delivered to the big steamers on the run, and only heavy fog or impossible weather sees her miss a connection.

In spite of jet planes and a streamlined century, the mailman is still doing a yeoman service to live up to the Post Office creed: "Neither snow, nor rain, nor heat, nor gloom of night stays these couriers from the swift completion of their appointed rounds." ★★★

### Padlock Sealed With Metal Strip

Burglars can't open a new, small padlock without breaking a seal. A lock pick or a key cannot be inserted when the sealing strip is intact.



Originally designed to protect cargo in transit, the padlock can be used around the home, in warehouses and on isolated buildings. A glance at the seal tells whether a locked door has been opened.



**DRILL SAW REAM CUT**

**INTERNATIONAL**  
**HI-SPEED COPE SAW DRILL BIT**



**DRILL, SAW, REAM . . . metal, pipe, wood, plastic, Transite, etc.** Use with any electric drill, slow drill press, lathe or milling machine. Drills own starting hole—upper part of bit is used to cut, saw or ream circles, ovals, squares or scrolls. Easy to operate. Ideal for carpenters, mechanics, electricians, plumbers, hobbyists, many others. Abrasive resistant, high speed steel. Flutes ground from solid. Will withstand severe continuous use without breaking. Resharpens at no charge. Takes place of up to \$50 in tools. 1/2" diameter, 2" cutting sections, total length 3 1/2". Available in three types—All Purpose, Wood, Heavy Metal. Specify type needed. Set of 3, \$11.50. Details on request. Shipped same day. Money-back guarantee. Dealer inquiries invited. **ORDER NOW! SEND CASH, CHECK OR MONEY ORDER.**

Manufactured and distributed by  
**INTERNATIONAL TWIST DRILL CORP.**  
 618 Wyandotte, Rm. 632, Kansas City 5, Mo.

**only \$3.95**  
 POST PAID

# Weld anywhere

with this amazing **LOW COST**  
**HOBART "Husky-Boy"**

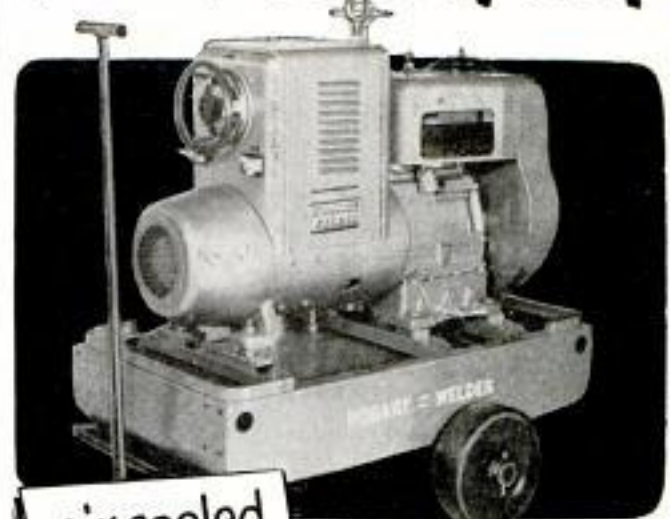

**air-cooled engine drive arc welder**

**Gets the BIG PAY jobs**

Cash in on those profitable emergency repair jobs with the lightweight, easily portable, "Husky Boy" 200 amp. arc welder. For in or out of shop welding you'll get years of dependable service at a low investment cost. Wheels and handles available at slight extra cost.

**AC Welding AC Power**  
 With the Hobart "Build Your Own" you can do repair and construction work away from power lines. Make big savings by hooking this AC-AC generator up to your own gasoline engine, truck or tractor.

**Be Your Own Boss!**  
 Open a welding business of your own and make hundreds of dollars a month with the Hobart 300 amp. electric drive welder. This all-purpose welder can't be beat for completeness of equipment, economy of operation and welding range.

**HOBART School trains you quickly**  
 You can learn welding quickly and easily in this modern, non-profit school. Complete of partial courses. Best equipment, thorough training, experienced instructors. Ask for free booklet.

Enroll NOW!  
 G. I. Bill Approved.  
**HOBART BROTHERS Co.** Box M-14, Troy, Ohio  
 Phone 21223 "One of the World's Largest Builders of Arc Welding Equipment"

**Hobart Brothers Co. Box M-14, Troy, Ohio**

Send complete details on items checked.

"Husky Boy"  Generator Only  Weldors Trade School  Electric Drive DC Welder  Hobart Vest Pocket  Welding Lessons Book, \$1.  Hobart Welding Guide

NAME \_\_\_\_\_

ADDRESS \_\_\_\_\_

CITY \_\_\_\_\_ STATE \_\_\_\_\_

## BOAT KITS

Models from 12 ft. Runabout  
 39.25 complete

- Assemble your own boat
- No experience necessary
- Save 1/2 to 2/3 "factory built" prices
- Prices include freight and paint



Free Catalog of all models

Marine Hardware & complete accessories

**LUGER INDUSTRIES** Kit Division 3207 FREMONT AVE. SO. MINNEAPOLIS 8, MINN.

## BATTERIES! - START

—a factory at home and re-cast junk batteries into new; latest achievement. We supply complete instructions and everything needed. Large daily profits!

BATTERY LABORATORIES, Dept. PM, Minneapolis 4, Minn.

## Reduce RADIO NOISES

**NEW CLEAR-TONE LINE-NOISE ELIMINATOR**  
 SIMPLY PLUG Radio or Appliance cord into Noise Eliminator and plug into wall socket. Enjoy reception FREE from noisy distracting noises. Send No Money, pay postman \$1.25 each (2 for \$2.00) plus postage or send cash and we'll mail postpaid. Try 5 days, money back if not delighted. Many hundreds of satisfied users. Send for yours today. Merit Sales, Dept. R-30, 800 Edmondson Ave., Baltimore 28, Md. \$2.00

## TREASURE -- \$10,000

New locator detects metals, valuable minerals and buried treasure. Money-back guarantee of superiority.

Also geiger counters. Govt. reward of \$10,000 for uranium discovery. Write for FREE information.  
**THE GOLDAK COMPANY**  
 1542 W. GLENDAKS BLVD., GLENDALE 1, CALIF.

## GET THIS STRAIGHT you can't beat an EMPIRE LEVEL

For improved accuracy, better visibility, less breakage, use the new Empire 9" aluminum Torpedo pocket level with machined bottom groove and protected, easy-reading vials. See your dealer today for all-purpose Empire Levels.



**EMPIRE LEVEL MFG. CO.** | 10930 W. Potter Rd., Dept. PM Milwaukee 13, Wisconsin



# CUT PERFECT GROOVES WITH *Warren* WASHERS ON YOUR SAW BLADE!

You Just **DIAL** the Cut Wanted

over **250,000** sets in use!



**NOT ONE—NOT TWELVE—BUT 40 DIFFERENT CUTS!**

Warren Washers—engineered to cut clean, accurate, parallel grooves with your present power saw. 40 micromatic adjustments—just dial the desired width. Actually strengthens blade, eliminates vibration—leave on saw for straight cuts. No burning or chewing. Over 250,000 satisfied users in 48 States and many foreign lands. Be sure to get genuine Warren Washers... they're guaranteed!

**FREE!** Send for free descriptive booklet. Arbor sizes  $\frac{1}{2}$ ",  $\frac{3}{8}$ ",  $\frac{3}{4}$ ", 1". See your dealer or write direct.

**WARREN WASHERS CO.**

Dept. 21, Box 98, North End Station, Detroit, Mich.

**ONLY \$4.95 SET**

**Made \$2,600 LAST SEASON**

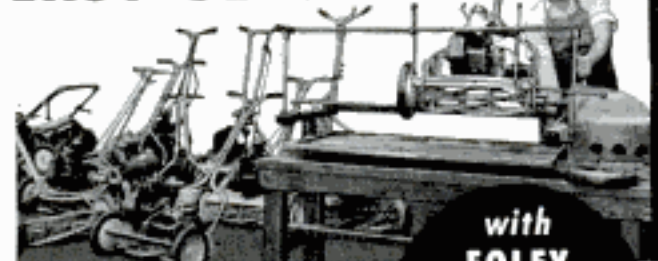

with **FOLEY LAWN MOWER SHARPENER**

**99c Profit On Each Dollar!**

It costs less than 1c per mower for electricity and material. The Foley sharpens all blades and cutter bar together just like lawn mower manufacturers do it. Start in spare time in basement or garage. The Foley handles up to 3 or 4 mowers per hour—prices run \$1.50 to \$3.00 for hand mowers—\$5.00 to \$8.00 for power mowers.

**FREE—VALUABLE ILLUSTRATED BOOK** shows how to sharpen all leading makes of power mowers. Foley prices are low—easy payment plan lets you pay for machine with profits. **FREE PLAN** tells how to start. Send coupon today—no salesman will call.



**SEND FOR FREE**

**BOOK**

**FOLEY MFG. CO., 107-4 Foley Bldg., Minneapolis 18, Minn.** Send **FREE BOOK** and **FREE PLAN** on Foley Lawn Mower Sharpening business.

Name \_\_\_\_\_

Address \_\_\_\_\_



5-HP Gravely Tractor powers 21 tools—does every lawn, garden, and field job easier, better! All-gear drive, Reverse. New "Power vs Drudgery" Booklet **FREE**. Write for it today!



**GRAVELY**

BOX 163, DUNBAR, W. VA.

**FIELD-TESTED FOR 32 YEARS**



**Free!**

1954 CRAFTSMAN Power Tool Catalog! Get yours NOW from the Hardware Department of your Sears Retail Store. **Sears, Roebuck and Co.**

**BUY IT WHOLESALE!** FREE! GET UP TO 40% OFF! THE WHOLESALE PLAN! Start a Buying Service At Home, SPARETIME. GET BIG-NAME MERCHANDISE FOR SELF AND CLIENTS UP TO 40% LESS THAN REG. PRICE. SALES EASY AS YOU CAN GIVE VISIBLE DISCOUNTS. STILL MAKE FAT COMMISSIONS. Post Card Brings Free Copy.

**AMERICAN BUYERS SERVICE**

631-RA Linden Ave., Buffalo 16, N.Y.

GET THIS **Slip-on Coach** in KIT form and assemble yourself, fits all makes of Pick-up Trucks, easy to slip-on or take off. Trailer Kits, Build-it-yourself blueprints for all types of house and camp trailers. Catalog 10c.

**COMSTOCK TRAILERS, Dept. K, Parsons, Kansas**

**Find HIDDEN TREASURES** **GEIGER COUNTERS** (as shown) for Uranium Detection, **TREASURE DETECTORS** for gold, silver, etc. Lightweight, ultra sensitive. Best at any price. Also mineralights. **INFORMATION FREE** • **Detectron Co.** 5420 Vineland, North Hollywood, Calif

**HULL AUTO COMPASSES ARE EASIEST TO INSTALL** • Greater accuracy and a patented, more positive means of compensating against magnetic interference have long kept Hull Auto Compasses first with America's motorists. Now, choice of a new vacuum cup mounting bracket with special adhesive, or the original clamp type, gives greater-than-ever ease of installation. Write for local dealer's name, free literature



**HULL MFG. CO.** P.O. Box 246, D1 WARREN, OHIO



# BRIKCRETE



## Local Manufacturers Have Broad Opportunities

Brikcrete manufacturers operate compact, self-contained plants under franchise privileges in protected territories. Each is an independently owned unit in a country-wide chain, using local materials and local labor to supply the world's most modern masonry for local building needs.

Brikcrete is rich in sales appeal because it is ahead in design, style, size, color, economy. Easily the preferred masonry. But because local production eliminates economic wastefulness, Brikcrete can be sold at a lower-than-lumber price. Yet still allow a generous profit margin.

Brikcrete offers much to men looking for a community enterprise on a nominal investment. We supply complete equipment; easy terms when desired. Liberal cooperation. Write today for Brikcrete Book No. 2—while territory is still open.



**BRIKCRETE ASSOCIATES, INC.**  
4679 Division Avenue, S.  
Grand Rapids 8, Mich. 82

## MONEY for MEN ALL DATA FREE

THE PLASTEX Industry needs manufacturers on small scale and for big production of Lamp and Clock Stands, Art Goods and Novelties in Plastex and Marble imitation. Experience unnecessary. 1/2¢ material makes regular 10¢ store sellers. Rubber moulds furnished for speed production. Small investment brings good returns. We are now placing big Chain Store Orders with manufacturers. Ambitious men have chance for real prosperity. Our Free booklet will interest and benefit you.

**PLASTEX INDUSTRIES, Dept. A**  
3400 Third Ave. New York 56, N. Y.

## Print Your Own

Cards, stationery, circulars, tags, labels, photo and movie titles, advertising, etc. Save money. **Print for Others, Good Profit!** Easy rules sent. Raised Printing like Engraving, too. Sold direct from factory only. Write for free catalog of outfits and all details. **KELSEY PRESSES, M-37, Meriden, Conn.**

## MACMILLAN RING FREE Xtra Heavy Duty is the ONLY motor oil to GUARANTEE:

- to prevent Valves and Hydraulic Lifters from sticking
- to reduce Engine Ping...or Your Money Back!

For further information write: **R. S. MACMILLAN, PRES.**  
530 West 6th St., Los Angeles, Calif.

## NEW, EXCLUSIVE LOK-BLOK LOCKS BLADE IN HANDLE

Now **TWIST & IMPACT PROOF!**

Plus many other great features and unsurpassed quality...yet cost no more than ordinary drivers!

At All Leading Dealers  
UPSON BROS., INC., Rochester 14, N. Y.



**HOLD-E-ZEE**  
The Original Automatic Grip SCREWDRIVERS

# TIME SAVING TIPS

## ALL YOU NEED IS A TUBE OF DU PONT DUCO CEMENT

REG. U. S. PAT. OFF.



**WHEN HANDLES COME OFF**, put 'em back on to stay with "Duco" Cement. It's a must in the tool room.



**LOOSE REAR-VIEW MIRROR?** It'll hold fast if you put it in its place with strong Du Pont "Duco" Cement.



**REPAIRS CHAIRS.** Strong "Duco" Cement puts loose rungs in so they'll stay. Makes chairs sturdier.



**LOSING YOUR GRIP?** Anchor loose golf-club grips with "Duco" Cement. Good for tennis-racket grips, too.



**FOR THE BIRDS.** Build an attractive birdhouse. You can make it strong and neat with "Duco" Cement.



**COAT STRIPPED THREADS** with "Duco" Cement for new gripping power. Perfect for emergency repairs.



**KEEP BUGS OUT** by mending small tears in screens with strong, transparent, waterproof "Duco" Cement.



**WATERPROOF MATCHES** for camping trips. Dip them in easy-to-use "Duco" Cement, and wipe smooth.



NEW EASY-SEAL TOP HAS HANDY APPLICATOR TIP



BETTER THINGS FOR BETTER LIVING... THROUGH CHEMISTRY



**WINTER OR SUMMER  
DO EVERY OUTDOOR JOB  
FASTER—EASIER—BETTER**

WITH A **GEORGE** GARDEN TRACTOR

**\$119.50**  
F.O.B. Sullivan, Ill.

Illustrated:  
2 wheel, 2 HP GEORGE Garden Tractor, Briggs or Clinton Engine

**SEND TODAY**  
Write for free copy of illustrated George garden tool folder. See how a George garden tractor can do every outdoor chore.  
George Garden Tool Div.  
P.M.-1  
Sullivan, Illinois

Your George garden tractor is a multi-purpose, year-round work saver. In price, it compares with a power mower. In use, the George garden tractor is incomparable. Complete range of attachments for tilling gardens... mowing lawns... cutting weeds... removing snow. A George tractor is ideal for every purse and purpose.

**GEORGE GARDEN TOOL**  
Div. of Community Industries Ass'n

# Warm, Dry Floors

With **Amazing ZONOLITE®**  
**INSULATING CONCRETE**

**Blocks Condensation,  
Prevents Heat Loss!**

Building or remodeling a house, garage or farm structure? Here's a way to be sure of *warm, dry floors* all year 'round! One inch of Zonolite concrete insulates as well as 12 to 16 inches of ordinary concrete! **LIGHTWEIGHT... easy to mix. You can do it yourself!** A good investment in any building for comfort, fuel savings; for increased profits from farm stock.

See your building supply dealer for FREE estimate on how much Zonolite Concrete Aggregate you'll need for your job.

Zonolite Company, Dept. 193-14  
135 S. LaSalle St., Chicago 3, Ill.

Please rush free "How-to-do-it" manual. No obligation.

Name.....

Address.....

City.....Zone.....State.....

## IDEAL FOR

Basementless Houses



Garages



Farm Buildings



**ZONOLITE**  
(BRAND)  
**VERMICULITE  
AGGREGATES**

# READY CUT HOMES

**\$2150 AND UP DIRECT FROM MILL**

**YOU SAVE** the items which help make today's building cost expensive: high labor cost, contractor's profit and overhead, insurance, architect's fees. Cut-to-Fit eliminates usual lumber and material waste, also costly mistakes. Anyone can assemble. Simple, easy-to-follow plans furnished and each part numbered. Complete with all lumber, roofing, nails, glass, hardware, paint, doors, windows. Freight paid. Low-cost building plans sold separately if desired. 57 Homes and Floor Plans.



**5 EASY PAY PLANS  
COLOR CATALOG**

Send **25c**



**INTERNATIONAL MILL & TIMBER CO.**  
Dept. P.M. 14 Bay City, Mich.



# GEARS

**In Stock - Immediate Delivery**  
Gears, speed reducers, sprockets, thrust bearings, flexible couplings, pulleys, etc. A complete line is carried in our Chicago stock. Can also quote on special gears of any kind. Send in your blueprints and inquiries.

Send for Complete Catalog No. 10  
**CHICAGO GEAR WORKS**  
440-50 N. Oakley Blvd., CHICAGO 12, ILL.



## NEW, IMPROVED CALCULATOR FOR WOODWORKERS only 25c

Instantly gives information on lumber, nails, concrete mixes, painting materials, etc. Convenient, simple to read. Just set dial for nail specifications, to convert linear to board feet, find bit sizes for screws, compare characteristics of woods. 6" diameter heavily varnished cardboard. Send 25c, no stamps, please to Greenlee Tool Co., 2101 Columbia Avenue, Rockford, Illinois.

# AUTO OWNERS GUIDE

For all makes and models of American postwar cars (1945 to 1954) "Pelber's Latest Guide Book" lists weights, lengths, widths, etc., Oil, water, fuel capacities, etc., Tire, battery, bulb sizes, etc., Wheel bases, h.p., pistons, etc. Also included is official FOB prices. Over 30,000 facts, only publication of its kind, only \$1.00 pp. Printing Consultants, Pub. Box 636, Newark 1, N. J.

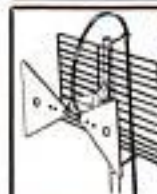

## UHF BUTTERFLY ANTENNA KITS

**Install Your Own UHF Antenna**

Each Kit contains 1 UHF Antenna as shown—1 6 Ft. sectional mast—50 Ft. Guy wire—50 Ft. UHF Lead wire—4 screw eyes—6 stand offs—1 guy wire clamp.

Everything required for the average installation. Send Check or Money Order

**\$12.95** PREPAID **MAJESTIC MAIL ORDER CO.**  
203 S. Locust St. Marengo, Illinois

# 2 OR 4 WHEEL DRIVE FOR JEEPS IN SECONDS



## AMAZING NEW WARN HUB

gives your 4-wheel drive Willys 2-wheel pop, power, speed, extra mileage, passenger car performance—as well as 4-wheel power and traction! Change from 2-wheel to 4-wheel or back in seconds by turning fingertip control on hubs. Warn hubs reduce wear on front axle assembly and front tires, eliminate shimmy, increase gas mileage up to 6 miles per gal. Unconditional Money Back guarantee. \$65.00 pair prepaid. ALSO AVAILABLE: Warn Standard Hub for Willys \$20.00 pr., Dodge \$23.00 pr. and Warn Automatic Hub for Willys \$120.00 pr. At Dealers or direct.

**WARN MFG. CO., RIVERTON Box 4064-A2, Seattle 88, Wash.**



## EDUCATIONAL KITS MAKE "TINY ATOM" MOTOR USEFUL



CHOICE OF  
3 KITS

Vial containing all parts for applying power to toys and models by belt, direct connection, spur gear or worm drive.  
Kit K-1300.....\$1.00



New Wilson Kit K-4000 contains a "Tiny Atom" Motor (1½-3 volt) plus all the components (gears, pinions, pulleys, shafts, etc.) necessary to run models, toys, flashers, turntables, signs, model autos, trucks, boats and locomotives. Adaptable to direct or radio control. Highly educational. Precision built to last in service. Price.....\$5.00  
(Similar kit without motor K-3700.....Price \$3.00)

For quick delivery see your local dealer — or order direct



Remit to Dept. M with order and we pay postage in U.S.A. No C.O.D. shipments.

**WILSON'S OF CLEVELAND**

425 Lakeside Ave., N.W. • Cleveland 13, Ohio

## DINSMORE AUTO COMPASS



ONLY COMPASS  
FACTORY  
APPROVED  
BY AUTO  
MANUFACTURERS

Enjoy traveling with America's finest auto compass. Accurate — dependable — trouble-free. Quickly and conveniently mounted on any car. Always insist on a DINSMORE — it's the only compass approved by auto manufacturers. Send for free folder "Pants, Knives, Compasses" and name of nearest dealer. **DINSMORE INSTRUMENT COMPANY**  
1802-21 Keise St., Flint, Michigan Illuminated

Only  
\$549

## BUILD YOUR OWN ARC WELDER FROM AIRCRAFT GENERATOR

For Light or Heavy Work  
WE SHOW YOU HOW to build this new powerful welder without rewinding. Uses most any surplus aircraft generator. Produces 75-300 amps. EASY TO BUILD. COMPLETE PLANS 35c. Send today & we'll include FREE our Big War Surplus and Electrical Catalog.



LEJAY MFG. CO. 1247 LeJay Bldg., Minneapolis, Minn.

## Take The "PAIN" Out of PAINTING!



Basements . . . Fences . . . Furniture . . .

## USE A BECKER CO<sub>2</sub> SPRAY GUN

Take It Anywhere! No Compressor . . . No Electric Cords Needed. Sprays: Paints, Oil, Varnishes, Insecticides, etc.

Men! Women! Here's the easy way to lick those tough, tedious, tiresome paint jobs. Becker Spray Gun is fun to use, requires no electricity or compressors—pressurized by low-cost CO<sub>2</sub> cartridges each sprays up to 21 sq. ft. containerful. Used 5 years successfully in industry.

SEE YOUR DEALER! If he cannot supply, order direct for postpaid. Extra cartridges 10 for \$1.

**SULLIVAN-BECKER CO.**  
Dept. 114-A Kenosha, Wis.



ONLY  
\$19.95  
with box of  
10 cartridges

# BUILD YOUR OWN POWER TOOLS

## Exclusive GIL-BILT Build-It-Yourself Features

- No machining—build easily with hand tools only
- No blueprint reading — step-by-step pictorial plans, full scale patterns, actual photographs
- Sturdy wood, steel, and aluminum construction
- Capacity and performance of commercial tools selling from \$60 to \$210.00
- Proven design—nationally advertised and sold for 6 years. Satisfied customers around the world

SAVE  
\$50  
OR MORE

## GIL-BILT 10-INCH TILT/ARBOR SAW

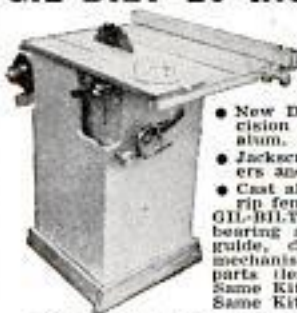

- 27x28 in. table, 13½ in. capacity in front of blade
- 10 in. blade cuts 3¼ in. deep, tilts full 45 degrees
- Floor model 34" high, table always stays level

- New Departure ball bearing arbor, 3½" precision shaft turned down for 3¼" bore blades, alum. housing, shipped ready to run
- Jackscrew and 4½ in. dia. handwheel lowers and raises blade
- Cast aluminum miter gauge and self-aligning rip fence guide

GIL-BILT Metal Parts Kit includes Plans, ball bearing arbor, miter gauge and bar, rip fence guide, cast insert, lock knob, jack screw mechanism and handwheel, and all other metal parts (less blade).....\$22.95  
Same Kit with 10" Combination Blade \$28.90  
Same Kit with 8" Combination Blade \$24.90

## GIL-BILT BELT SANDER

- 84 sq. in. sanding surface. Over 4 times the effective area of a 10 in. disc sander
- Belt operates in either vertical or horizontal position, does all sanding operations
- Driver drum and pulley turn on sealed New Departure ball bearings; tension drum turns on Chrysler Oilite bronze bearings
- Spindle and tension mechanisms of cast aluminum, completely machined and assembled
- Belt travels 1800 ft. per min. Over a MILE of straight sanding action every three minutes. Saves more "elbow grease" than any other tool

GIL-BILT Metal Parts Kit includes Plans, ball bearing spindle, 4 in. driver drum, 3 in. tension drum, tension mechanism, table tilt segments, rubber tires, cloth sanding belt, and all other metal parts \$16.95



## GIL-BILT 12" BANDSAW



- Cuts to center of 24 inch circle
- Handles stock up to 6 inch thick
- 18x18 inch table tilts 45 degrees
- Lower wheel and drive pulley runs on sealed New Departure Ball Bearings; Upper wheel runs on two 5½" bore Oilite Bronze bearings

- Upper wheel tension and tilt mechanism of cast aluminum, completely assembled
- Upper and lower blade guides. Each has ball thrust bearing, self-lub bronze jaws
- Rigid cast aluminum wheels fully machined ready-to-install. Heavy rubber tires
- Uses standard 78 inch blades up to ¾ in. wide
- Fully enclosed mechanism for utmost safety

GIL-BILT Metal Parts Kit includes Plans, rubber tires, aluminum wheels, ¾ in. blade, ball bearing spindle, tilt mechanism, blade guides, table tilt segments, and all other metal parts.....\$23.95

## GIL-BILT 18" BANDSAW

- Cuts to center of 36 inch circle
- Maximum height under top guide 12 inches
- 26x28 in. table tilts 45 degrees
- Floor model. Motor and all moving parts fully enclosed

- Heavy ¾" ball bearing drive shaft, Oilite bronze bearings in upper wheel
- Rigid cast aluminum wheels precision machined, 18½ in. dia. with rubber tires
- Upper and lower blade guides. Each has ball thrust bearing, self-lub bronze jaws
- Upper wheel tension mechanism of aluminum and steel, completely assembled

GIL-BILT Metal Parts Kit includes Plans, rubber tires, aluminum wheels, 1½ in. blade, drive shaft and bearings, tension mechanism, blade guides, table tilt segments, and all other metal parts.....\$37.95

## NO DEALERS — ONE LOW PRICE

For shipment as to 600 miles, add 2%; over 600 add 10%. Amount in excess of actual postage will be refunded. Send cash check or money order for complete kit. Return in 10 days for refund of purchase price if not satisfied.

ALSO AVAILABLE—Plans and Metal Parts Kit for 8" Tilt/Table Saw. Order any of above plans at \$1.00 each, buy kit later less cost of plans. Plans sent postpaid anywhere in the world, or write for FREE Descriptive Catalog.

## GILLIOM POWER TOOLS

P. O. Box 1-PA, Lambert Field, St. Louis 21, Mo.

COMPLETE  
PLANS  
only  
\$1.00  
EACH



**Keeping a gouge sharp  
is easy...**



with a  
**NORTON INDIA Gouge Slip**

The gouge has a curved edge and requires a stone formed to fit the curve. Rotate the gouge from side to side as illustrated. Then turn the stone over and using the narrow end give the inside of the gouge a few deburring strokes, keeping the inside face flat on the stone. Get FS-76 at your hardware store or direct, \$2.25.

Are the rest of your tools sharp? If not, send 10¢ for the "How to Sharpen" Book to Behr-Manning Corp., Troy, N. Y., Dept. PM-1.



**BEHR-MANNING**  
division of NORTON Company

▲COATED ABRASIVES ▲SHARPENING STONES ▲PRESSURE-SENSITIVE TAPES

## AMAZING NEW KIT OF HARD TO GET BRASS FITTINGS

A \$17.50 Value  
For Only  
**\$6.00**



Keep it running with **MUELLER UNIVERSAL BRASS FITTING REPAIR KIT**. After extensive research we believe this kit contains the essential fittings for the repair of all types of tube lines (copper, steel, aluminum, Bundy, flex, etc.) used on Aircraft, Automobiles, Farm Machinery, Motor Boats, Oil Burners, Compressors, All Types of Engines, Machinery, Pumps, Spraying Equipment, Refrigeration, House Trailers, Hydraulic Press and Machinery, Tractors, Power Mowers, Plumbing, Heating, Air Conditioning, etc.

This kit contains over a hundred brass fittings and lists for \$17.50. For a limited time as an introductory offer this kit can be purchased for \$6.00 prepaid.

Fill out and mail the blank below along with your check or money order.

-----

**MUELLER SALES**

5157 W. Montrose Ave., Chicago 41, Ill.

Gentlemen:

Kindly send me \_\_\_\_\_ kit (s) at \$6.00 each prepaid. Enclosed find check or money order.

Name \_\_\_\_\_

Street \_\_\_\_\_

City \_\_\_\_\_ State \_\_\_\_\_

# STOP FREEZING



Your furnace can go full blast, but if wind comes in around windows, transoms, and baseboards, you can still freeze.

## Mortite WEATHERSTRIPPING

is pliable and cord-like. It's easy for anybody to press in place with the fingers. Stops heat leaks and keeps out cold and wind. Hundreds of pluggers-upper uses the year around. Get at stores

—29c, 98c, \$1.25. Slightly higher west of Rockies and Canada. Write for circular. J. W. MORTELL CO. 522 Burch St., Kankakee, Ill.



Thousands  
In Use

### SMALL! POWERFUL!

America's finest low cost tractor. Ruggedly built. Easy to operate. No belts, no chains. Borg-Warner clutch, trans. and diff. 14:1 to 1 reduction. 49% more drawbar pull than ordinary tractors. 8-1/4 H.P. engine—gasoline or kerosene. 20 quick change implements.

Write for complete details.  
**ENGINEERING PRODUCTS CO.**  
915-K-1 Niagara Ct.  
Waukesha, Wis.

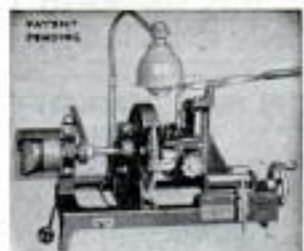

### Start a NEW BUSINESS!

or Add to your present  
Repair Business

### SHARPEN DULL PIPE WRENCHES

PIPE TAPS & DIES  
"GUM" CIRCULAR SAWS

Write for Information

**J. C. MOORE INDUSTRIES**  
BOX M 276 FREDONIA, PA.



### Treasure - Minerals - COINS

Easily located with new Light-weight M-Scope Detector. Superior performance, lowest price, monthly payment plan.

FREE LITERATURE  
**FISHER RESEARCH LAB., INC.**  
PALO ALTO CALIF.



## Saves Paint Brushes BRUSH CONDITIONER

Softens hard as rock brushes, makes them like new. Keeps stored brushes soft, safe and always ready for use. Vapor action penetrates brushes and dissolves binding oils in paints and finishes. Written up in November Popular Mechanics. GUARANTEED. Unit with pt.

vapor liquid, ppd. . . . . \$3.35

2 Complete Units, ppd. . . . . \$5.90

2 Pts. Vapor Liquid, ppd. . . . . \$1.70

Send for FREE "Brush Cleaning Hints"

**WISCONSIN LAB. INC.**

P.O. Box 200, Dept. P, Deussman, Wis.



**SAVE \$60 and MORE!**



It's the only one on the market with 8" tilt-arbor saw and sander, industrial type lathe, vertical and horizontal drill presses. 5 big power tools in one and no heavy lifting to change set-ups. Plana Centric Home Workshop rips, crosscuts, miters, dados, bevels, drills, countersinks, sands, planes, routs, turns wood and plastics, grinds, polishes, does every job in the woodworker's dictionary. Heavy construction, professional quality, all steel and cast iron parts, precision performance. Only \$139.95. Write for complete details in free illustrated brochure.

Yalands Precision Tool Company, PM1-54, 20 Boylston Street, Boston, Mass.

**First COMPLETE  
5-in-1 HOME WORKSHOP  
in history with  
8" TILT ARBOR SAW  
& SANDER—\$139.95**

**BUDGET TERMS**

**RICH CARBURETOR  
ROBS MOTORIST**



Car owners who are wasting money, getting poor gas mileage due to over-rich mixtures, will be pleased to learn how to save gasoline by VACU-MATING OVER-RICH MIXTURES. Vacu-Matic fits all cars, trucks and tractors. Automatic and operates on the supercharge principle. Easily installed in a few minutes.

**SALESMEN WANTED! Big Profits**

For FREE particulars, how you can install one on your own car for introducing, just send your name and address on a postcard to VACU-MATIC, 7617-19 W. State St., WAUWATOSA, WIS.

**MAGNETS** OF ALL TYPES — 10c UP  
AMAZINGLY POWERFUL!  
5 ounce bar magnet—\$1.50.  
Our leader, 1 lb. magnet lifts 25 lbs.—\$9.95. New alloy—will not weaken!  
Useful for lifting valuables from tanks, lakes, or rivers easily! 7 small magnets \$1.25 with list of many shop and home uses. Satisfaction guaranteed.  
R. EYRICH, 1091 N. 48 STREET, MILWAUKEE-8, WISC.



**BRONZE FOUNDRY**

Schools and Home Workshops

Make your own castings of aluminum, copper, bronze, silver. Foundry sets are available in three sizes including 2400 Deg. F. blast furnaces. \$22.50; \$29.50; and \$42.00. f.o.b. Kansas City. Free Circular.

KANSAS CITY SPECIALTIES CO. P. O. Box 5022, Dept. P-1 KANSAS CITY, MO.

**2 DRILLS in 1**

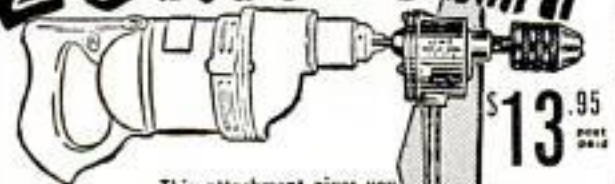

**\$13.95** post paid

This attachment gives you two drills in one. It converts any 1/4 inch electric drill to 1/2 inch capacity. Reduction gears reduce the drill speed 5 to 1, the average speed of a 1/2 inch drill, and thereby increases the power. Absolutely indispensable for all shop work and home craftsmen.

**G. M. CO. MANUFACTURING, INC.**  
1308 43rd AVE.  
LONG ISLAND CITY 1, NEW YORK

Send check or Money Order  
Satisfaction guaranteed  
Order yours now

**WOODCRAFTSMEN'S**



**ENCYCLOPEDIA**

144 PAGES of information, illustrations and bargains on every conceivable wood working item you need at money saving prices.  
**only 15¢**

CRAFTSMAN WOOD SERVICE CO., CHICAGO 8, ILL.

**CONTENTS**

Rare and fancy woods, domestic and imported woods, panels, matched plywoods, veneers, multicolored inlay bandings, beautiful natural color inlays and overlays. Embossed mouldings, carved ornaments, hundreds of scroll saw patterns, woodworking tools and equipment, cabinet hardware and fittings, more than 1500 items, HOW-TO-DO IT information, projects and ideas. Send for your copy today, the biggest 15c worth ever offered.

**MAIL THIS COUPON**

**CRAFTSMAN WOOD SERVICE CO.**  
Dept. A1 • 2729 S. Mary St. • Chicago 8, Ill.

Gentlemen: Enclosed find 15c. Please send me your big book No. 20.

NAME \_\_\_\_\_  
ADDRESS \_\_\_\_\_  
CITY \_\_\_\_\_ STATE \_\_\_\_\_

**TODAY**



**YOU CAN START A \$40 A DAY BUSINESS IN YOUR SPARE TIME**



Andy Phillips says: "My BELSAW Sharp Smith gives me big profits at low expense — I can run 35 to 40 circular saws in an 8-hour day — that makes me \$40 cash."

"I also get BIG EXTRA PROFITS... up to \$4 an hour... by grinding planer and jointer knives — there's always a demand for this kind of work."

You can start this REPEAT CASH business in your own home or garage while you are working at your regular job. Easy to operate, no experience needed. "Pays for itself from just 65 jobs." — Harvey Jensen

For as little as \$15 down payment, you can get your BELSAW SHARP SMITH rushed to you.

**FREE book tells how**

YOU can start making money the very day your BELSAW SHARP SMITH arrives. Earns \$4 to \$5 an hour in your SPARE TIME sharpening and setting circular saws for builders, lumber yards, factories... Plus BIG EXTRA CASH, precision grinding planer and jointer knives, plane irons, wood chisels and drill bits. Hundreds of jobs in your own neighborhood. No extra equipment needed, no canvassing. Send today for your Free copy of "Life-Time Security."



**BELSAW MACHINERY CO**

3705 Field Building

Kansas City 2, Mo.

**Enjoy New Driving Comfort with the Sensational**



**PNEUMATIC**

**SPRING BOOSTER**



Front AIR LIFTS are specifically designed to give you new driving comfort. They dampen the suspensions, cushion the bumps and eliminate costly repairs.

You'll appreciate the ease with which you can drive the roughest roads and the severest turns with AIR LIFTS to steady your car.

For comfort, stability and safety install AIR LIFTS in your FRONT coil springs. To assist your rear springs... if you are carrying overloads... use REAR AIR LIFTS. Installation is simple... nothing to dismantle... economical and guaranteed.



See Your Dealer Today or Write to:



**AIR LIFT CO.**  
2330 W. Main Street  
LANSING, MICHIGAN

**ALLEN 1-TON POWER BENCH TYPE PUNCH PRESS**

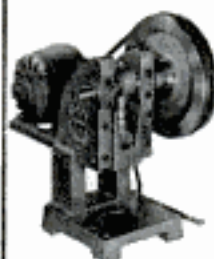

A RUGGED, RELIABLE PRESS FOR SMALL WORK

Cuts cost and saves money on stamping, forming, drawing, etc. Overall height—17 1/2" Base size—8 1/2" x 8 1/2" Die bed—5 1/2" x 8 1/2" Ram face—1 1/2" x 3 1/2" Ram stroke—3/4" Positive 3/4" ram adjustment. Sturdy, single pin, non-repeat hand lever clutch. V-belt drive. Total weight 105 lbs.

**30-DAY MONEY-BACK GUARANTEE**

Full year warranty against defects. Send your order today. Price \$125.00 L.o.b., Clinton, Mo. (Includes motor bracket, V-belt, motor pulley, less motor).

Alva F. Allen, Dept. PM, Clinton, Mo.

**DON'T BE CAUGHT WITH A DEAD BATTERY**



Amazing "New Life" battery rejuvenator stops build-up of plate sulfates... keeps battery automatically charged. Use lights, heater, radio, as much as you like. Get faster starting! Greater power! RECHARGING IS UNNECESSARY! Only one treatment needed! Money back guarantee. Rush \$1.00 to:

JSM PRODUCTS CO. • 1118-C Castleton Rd., Cleveland 21, OHIO

**"HOW TO BUILD A FIBERGLASS CAR BODY"**

This New Book contains up to the minute information on styling, mold-making, construction and materials. Only \$2.00 postpaid. Complete Stock of Fiberglass Materials and Marco Resin for Cars and Boats

**ALLIED PRODUCTS ENGINEERING CORP.**

4707 CRENSHAW BLVD., DEPT. A, LOS ANGELES 43, CALIF.



**SILVER SOLDER TORCH & KIT \$7.95**

JOINS ALL METALS PERMANENTLY Do your own repairing. KIT includes one tube silver solder paste and 10 3-in. lengths silver solder alloy. Hottest ALCOHOL TORCH known. 2700° F. flame. Operates in any position, indoors or out. Pint of special fuel included. Complete outfit ready for use \$7.95 postpaid. TORCH alone with pint of special fuel \$6.85. KIT alone \$1.65. Instructions included.

AMERICAN PRODUCTS CORP., 422 S. Dearborn, Dept. 3-A, Chicago

**"SNOOPER" GEIGER COUNTER**



Supersensitive! Only 1 1/4 lbs. Fits pocket—uses flashlight battery. Find a fortune in uranium. Order Now! Send \$5.00, balance C.O.D. MONEY BACK GUARANTEE, FREE CATALOG—scintillator and larger uranium and metal detectors. DEALERS WANTED.

2995

**PRECISION RADIATION INSTRUMENTS**

COMPLETE

2235 PM S. LA BREA, LOS ANGELES 16, CALIF.

**POPULAR MECHANICS SAY YOU SAW IT IN**



**The Modern PLASTIC for lasting Home Repairs**

PERMANENTLY mends cracks or holes in wood, tile, stone or plaster. Sticks and stays put—Does not chip, shrink or fall out. Easy to use. Economical. Mold it, chisel it, polish or paint it. If unobtainable from your lumber, paint or hardware dealer, the big 4-lb. can will be sent you postpaid (in U.S.) for only \$1.25. Full money-back guarantee, order now.

**DONALD DURHAM CO.**

203 School St., Des Moines, Iowa



# "Speedy" Alka-Seltzer

BRAND

Reg. U.S. Pat. Off.



**FIRST AID** for  
HEADACHE  
COLD MISERIES

TRADE MARK

**FIRST AID**

for

**ACID INDIGESTION**  
ENJOY INSTANT ALKALIZING  
ACTION



Made by  
**MILES LABORATORIES, INC., ELKHART, IND.**

ON DISPLAY AT  
ALL DRUG STORES  
U. S. and Canada

*Say You Saw It in Popular Mechanics*



**BUY THE FINEST**  
**Metal Boxes**  
... FOR EVERY  
SHOP USE

• Designed to meet exacting requirements of tool experts in every phase of automotive, radio, electrical, and industrial work. Unmatched for lightness, strength, beauty, durability. See them at your hardware dealer now or write for free catalog.

**WATERLOO VALVE SPRING  
COMPRESSOR CO., WATERLOO, IOWA**



**3 Bedroom Home**  
**1990<sup>00</sup>** Model 101

(Plus freight and sales tax if any.)

**PRE-CUT  
AND  
PANELIZED  
FOR  
EASY  
ERECTION**



Erect this home in 2 days with the help of a few friends—move in—then finish it at your leisure. Exterior walls fabricated with sheathing, builders' felt and asbestos shingles applied, in choice of colors. Windows installed, interior partitions assembled, erection drawings and specifications furnished and all lumber marked for easy erection.

**Send \$1.00 for PLANS  
and material list to:**

Choice Territories Still  
Open For Representatives

**LUMBER FABRICATORS, INC.**  
ECONOMY DEPT. **A** FORT PAYNE, ALA.



**FILE SAWS THE RIGHT WAY**  
SUPER FILER No. 9  
USED AS JOINTER

SO EASY with this new filing jig and jointer anyone can now sharpen any handsaw like new! When file hits hardened steel rollers teeth are finished and EXACTLY THE SAME HEIGHT. All teeth cut and saw runs true and smooth. Jig and instructions \$2.95 postpaid. FREE FOLDER.



**SHARPEN YOUR CIRCULAR SAWS**  
The RIGHT WAY on your own saw table. Sharpens rip, cutoff, hollow ground and combination blades—6" to 10". Saws stay round with correct bevel. Precision made, easy to use. GUARANTEED. Only \$8.95. Includes \$3.00 Grinding wheel.  
"TRU-CIRCLE" saw set automatically sets teeth at 10° or more.  
\$2.95  
AT DEALERS OR POSTPAID  
**A. D. McBURNEY, Dept. A-37, 5908 Hollywood Blvd., Hollywood 28, Calif.**



ace  
of  
**Aces**

in  
**LOW  
COST**

**transportation**

*Cushman* is the top card in the transportation deck for speed, power—low cost operation. Ride it to work, for sport, school, on errands, deliveries. You're set to go! No traffic or parking worries either. And total operating cost **LESS THAN A PENNY A MILE!** See your nearest Cushman dealer for **FREE** demonstration.



Up to  
**75**  
miles  
per  
gallon

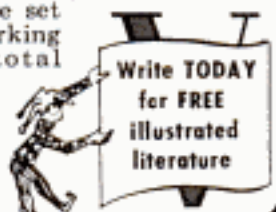

**CUSHMAN MOTOR WORKS, INC.**

915 No. 21st St., Lincoln, Nebraska

**BUILD  
IT**

**FIX  
IT  
with**

**AMBROID**

- Ready-to-use
- Fast drying
- High tensile strength
- Transparent
- Waterproof

**IT STAYS STUCK**

Dries entirely by evaporation of the solvent. Quick setting—no distortion. Ideal for assembling, repairing, home crafts, electrical work, factory, workshop or household use. Send postcard for free literature.



Try Ambroid in your business, too. For over 40 years recognized as the leading industrial adhesive of its type.

Art galleries, museums, and leading industrial concerns, rely on AMBROID

**TRY A TUBE TODAY**—At most hardware stores and hobby shops. If your dealer cannot supply you, send 30c for big 2 oz. tube, postpaid. Money back guarantee.

**AMBROID**

303 FRANKLIN ST.  
BOSTON 10, MASS.

**EXECUTIVE INTERCOM SYSTEM**



Normally sold for \$49.95. Two ultramodern French phones with desk cradles! Completely self-contained. Handsome contemporary design. Lifetime construction. Built-in double buzzer system. Operated anywhere by ordinary flashlight batteries (2 in each cradle) completely concealed. Excellent fidelity, range, clarity. Used interoffice, on ranches, between buildings. Black satin finish. Quality never approached at 4 times price. Two phones, two cradles (4 batteries inc.) postpaid \$19.95. Double wire, postpaid 3c per ft. Calif. resid. add 3% tax. 10-day money back guar. Send check or m.o.

**FREE—OPTICAL CATALOG**

From the Akron optical dept. 44-pg. catalog of microscopes, telescopes, fine optics at popular prices.

**THE AKRON** 65 Akron Bldg.

4379 Sunset Blvd. Los Angeles 27, Calif.



**\$ Free Course! Big Profits! \$ Flocks & Sandblasts**

**Dual Purpose Spray Gun!** Uses only 25 lbs. Air Pressure  
• Thousands of uses in Home, Shop, Industry. Makes Auto Interiors Clean & New. Lines drawers, Marproofs lamp bases, Refinishes any object. All in colorful Flock. Etch & Frost windows, glassware, etc. Removes Paint & Rust from Autos, Tools. Guaranteed! Send \$29.75 or write for free information. Flocking supplies!

Only \$29.75 Complete

**BLASTO SPRAY GUN MFG.**  
Dept. PM-1, 7007 Haas Avenue, Los Angeles 47, Calif.

**SET-UP - KNOCKDOWN SAWHORSE with Jiffy BRACKETS**



No nails or bolts... use 2x4's for legs. 2x4 or wider for crossbar. Rugged, sturdy, easy to move, saves storage space. Sold by hardware and building material dealers, or order direct.

**GRAND HAVEN STAMPED PRODUCTS CO., Grand Haven, Mich.**

**Clark EXPANSIVE BIT**

**CUTS BETTER • COSTS LESS!**  
Accurate, fast; cuts smooth holes in hard or soft wood. Chrome vanadium steel blades, all chrome body. No. 250, 1/2"-1 1/2", \$1.89; No. 251, 3/8"-3", \$2.19. **GUARANTEED.** At your dealer or write Dept. PM-1

**ROBERT H. CLARK COMPANY • Beverly Hills, California**

**MORE JOBS EASIER QUICKER With Gear-Driven "RED-E" GARDEN TRACTORS**



**NO BELTS! NO CHAINS!**  
Proven For Over 30 Years

**NEW 1954 MODELS**

Thousands of satisfied users say "RED-E" has solved their tractor problems. You, too, will like its smooth, powerful, easy-to-operate, gear-driven action—with power turning clutch for 4 1/2 and 6 H.P. WALKING MODELS and automotive type differential for 8 1/2 H.P. RIDING MODEL. Our 2 and 3 H.P. Walking Models low as \$169.00. Attachments for plowing, sowing, cultivating, wood-sawing, snow-plowing, etc. **EASY TERMS—Factory-To-You discount. Write for FREE Catalog.**

**Buy Direct from Manufacturer and SAVE**  
**WRITE FOR FREE CATALOG**

**RED-E TRACTOR CO., Richfield 442, Wisconsin**



**GIGANTIC  
SAVE-TO-70%**

**MAIL SALE**

**WAR SURPLUS  
EXCESS INVENTORY  
BANKRUPT STOCK**

**POWER PLANTS & GENERATORS**

Note: all AC plants are 115-v 60-c.

- Plants 25 KW A-C...\$1190
- Plants 5 KW A-C...\$595
- Plants 3 KW A-C...\$349
- Plants 2 KW A-C...\$289
- Plants 1 KW A-C...\$189
- Plants 3 KW 115-v D-C...\$169
- Plants 1.5 KW 32-v D-C...\$72
- Plants .6 KW 32-v D-C...\$64
- Generator 3 KW 115-v A-C...\$149
- Generator 2 KW 115-v A-C...\$139
- Generator 1 KW 115-v A-C...\$104
- Generator .6 KW 115-v A-C...\$79
- Generator 3 KW 115-v D-C...\$49

Save to 70% - See our catalog.

**WATER PUMPS & SYSTEMS**

- Centrifugal 3/4" 1" \$19.95
- Rotary. Bronze, rubber paddle. Self priming. Pressure to 30 lbs. 5/8" \$14.75; 3/4" \$19.50; 1" \$25.
- Rotary. Bronze-nylon roller. Self priming. Pressures to 100 lbs. 1/2" \$17; 3/4" \$24; 1" \$32.
- Auto Water System. Lifts to 22 ft. 110-v 300 gals. per hr. 40 lb. pres. Compact. Easy to install...\$70

**SUPER CLOSEOUT BARGAINS**

- Famous make \$200 Tape Recorder \$149.00
- Winch, 1500-lb. cap. 1-4 ratio...\$19.95
- Mechanics Tool Chest, deluxe...\$19.75
- Gas Chain Saws, leading make...\$199.00
- Electric Chain Saws...\$89.25
- Rural Magneto Phones...\$9.95
- Tarpaulins, finest new Army type 10 oz. 8x10, \$8.80; 10x12, \$13.20; 20x20, \$43.95
- Engineers Boots, Reg. \$14...\$8.76
- Electric Drill, 1/2" 110-v...\$26.95
- Electric Drill, 1/4" 110-v...\$16.89
- Drill Set, 29-Piece, 1/16" to 1/2" \$8.98
- Air Corps 8-v Searchlight...\$4.39
- Revolver, 9-shot H and K 8" \$28.95
- City Wall Telephones...\$4.99

Hundreds items, many less than mfg. cost.

**OUR 30-YEAR POLICY** • EVERYTHING GUARANTEED TO SATISFY • WE PAY ALL SHIPPING CHARGES IN U. S.

**BURDEN PAYS ALL  
SHIPPING CHARGES**

**Watches—Optical—Precision Units**

- Fully guaranteed tax-paid top-quality leading makes—Save to 50%!
- Binoculars, 7x50 coated with case...\$42.95
- Binoculars, 8x25 coated with case...\$29.75
- Microscope, 3-turret 100-300-300X...\$9.95
- Engineers Hand Level Army type...\$2.19
- Surveyors Tripod Level & Rod...\$37.95
- Weather Unit, barometer, hygrometer, thermometer...\$12.50
- Car Altimeter, 0-10,000' (Taylor)...\$9.00
- Wrist Watch, 17-jew. "Executive" Gen. sine Enicar. Specify men's or ladies' \$18.15
- Engr. Stop Watch, precision 1/10 sec...\$12.95
- Inspection Magnifier, 2"x4" lens...\$2.80
- DeLuxe Auto Compass, illum. type...\$5.49
- Hand Tally Register, records 0-999...\$4.95
- Drawing Sets, finest 13-pc. in case...\$9.78

**HYDRAULIC EQUIPMENT**

- Savings to 80%. Build loaders, diggers, presses, etc. Marvellous values.
- Pump, 1000 lb. 12 gal. 500 RPM...\$45.50
- Cylinders, 1-way 3"x8" \$11.95; 2-way 2"x10" \$22.85; 2-way 3"x24" \$39.90.
- Valves, hand control, 1 or 2-way...\$18.00
- Gauges, 1000 lb., 1500 lb. or 2000-lb...\$3.49

**AIR COMPRESSOR UNITS**

- Paint, clean, for tires, control terminals, etc. Build your own or ready built units.
- DeLuxe Kit, Tank, compr., gauge, valves, paint gun, regulator, fittings, etc. "How To Build" instructions. \$70 value...\$45
- Economy Kit, same, smaller tank, no regitr, paint gun...\$32
- Components, Compressors, \$20. Tanks \$8.78. Auto. Press. Switch \$4.95. Gauges (60 lb.) \$1.89. Pop-Off Valve \$1.95. Paint Gun \$9.95. Dust Gun \$1.29.



Many air items, see catalog.

**SPECIAL For The Month!**

**Gov't. AIR  
TANK UNIT**



**FILL TIRES . . .  
SPRAY LIQUIDS**

- Large 10"x18" hi-strength tank, 400 lb. test. Complete with gauge, hose, tire chuck, liquid spray nozzle, Schrader in-pit valve, etc.
- Use to fill auto tires, spray liquids, clean clogged pipes, spray paint, blow dirt out of machinery, etc. Fill with hi-pressure air at any filling station. Holds pressure indefinitely. Satis. Guar. New cost over \$30. Sale, ppd...\$14.95

**ARMY PARTS CLEANER**

- Amazing air-solvent cleaner. Makes dirty greasy parts shiny bright in secs. For garages, factories, farm, etc.
- Heavy galv. tank 25x20x20". Air jet valve, hose, hyd. lid raiser. Cost over \$100. Ppd. \$29.95.



**GENERATOR—3000W—115V**

- Dir. Current ball brg. compound-wound Delco unit. 1" dia. shaft 2800 RPM. Ideal for portable tools, lights, boats, etc. Guar. List over \$195. Prepaid...\$49.50



**TRACTOR WEED SPRAY OUTFITS**

- Finest stainless steel 20' 7-row boom, tractor pump, push button control, hose, gauge, etc. Only 41 available. List \$225. Ppd. \$129.50



**ORDER FROM AD or write for big  
FREE CATALOG** 1000's of items! Motors, sporting goods, hand and electric tools, clutches, clothing, watches, tarps, winches, etc. Write for your copy of Free Catalog—today!

**BURDEN SALES COMPANY**  
815 "O" ST. LINCOLN, NEBRASKA

**FISHERMEN**  
SEND FOR  
**FREE CATALOGUE TODAY!**  
FULLY ILLUSTRATED  
FULLY DESCRIPTIVE  
ALL PRICES LISTED

**Make Your Own SINKERS!  
JIGS! SQUIDS! CASTING  
AND SPINNING LURES!**

It's fun, It's easy with Sweet's  
**ALUMINUM MOLDS**  
Molds for fresh and salt water  
fishmen. Handled and hinged  
for easy, fast operation. Over 100  
types, 500 sizes. Write for free  
catalogue.

AS LOW AS  
**\$2.95**  
PER MOLD

**SWEET'S MOLDS**  
Tonawanda 16, N. Y.

**INTRODUCTORY OFFER!**  
**MONEY-BACK GUARANTEE**

**CORKY** . . . The all-new cleaner, preservative, polish for aluminum storm sash and doors.

**\$1.59 VALUE ONLY 98¢ POST-PAID**

**CORKY** makes aluminum storm sash and doors shine like new! . . . and last years longer!  
Send 98c in cash, money order or stamps to  
**THE McALPINE COMPANY, Creve Coeur, Mo.**

**YOU CAN'T AFFORD TO BE WITHOUT  
AN AMPCO UNIT ON YOUR CAR\***

**INSTALL AN IMPROVED . . .**

**AMPCO VAPOR LUBRICATOR**

**FOR THE LIFE OF AN ENGINE**

for better upper cylinder lubrication

Pays for itself in a few months in actual cash savings because you can: Increase your gas mileage from 2 to as high as 6 miles per gallon\*\*—Increase your oil mileage some 600 additional miles\*\*—Increase power up to 12 more brake Horse-Power\*\*—Improve valve and hydraulic lifter action\*\*. To you, as a car owner, this all means: (1) Elimination of sticky valves (2) Overcoming hydraulic lifter failure (3) Faster starting in any weather (4) Increased engine power (5) Reduction of carbon, gum, and acid deposits (6) Elimination of engine "ping" caused by deposits (7) Friction-free ring action. All this equals extended engine life—savings in gasoline and oil—cut in maintenance costs.

\*\*Field test reports proving these results are available.  
\*\*AMPCO carries unconditional guarantee of improved engine performance.

AMPCO unit shipped complete with detailed instructions for simple installation on intake manifold.

Install an AMPCO yourself, or ask your friendly mechanic. When ordering, be sure to state year, make, and model of your car or truck. Order your AMPCO lubricator unit today. Makes an ideal Christmas gift, too. Gives your car new power—new smoothness—new efficiency—and, at the same time, saves gas and oil.

**AMPCO VAPOR LUBRICATOR Model ST-100—\$12.00 plus Installation Kit**

**SPECIFY YEAR, MAKE AND MODEL WITH ORDER**

**\$5.75\*** — Pontiac 6, Chrysler 6, De Soto 6, Dodge 6, Chevrolet, Ford 6, Plymouth, Nash, exc. Statesman

**\$11.75\*** — Cadillac after '49, Buick 70 from '52, Hudson Hornet (duals), Packard '53, Olds Super 88 & 98 from '52, Lincoln from '53, Chrysler V-8

**\$7.75\*** — All Others.

\*Price includes one quart of Ampco-Approved Oil. Send check or money order, then complete unit shipped prepaid, or send \$2.00 deposit and complete unit shipped, balance C.O.D.

**ADVANCE MOTOR PRODUCTS CO. Dept. PM 1  
WHITMAN, MASSACHUSETTS**



**PLANE IT TRUER,  
PLANE IT FASTER**  
WITH THE AMAZING **NEW**



**ROTO  
AUTO-PLANE**



for Doors



for Windows



for Every  
Planing  
Use

The Fast, Precision, Low-Cost Planer  
FITS ANY 1/4-INCH DRILL

The answer to your planing problems. For planing windows, doors, hard wood, soft wood, plywood, plastic, or masonite, or for smoothing or jointing, the ROTO "AUTO-PLANNER" planes it truer and faster. Cuts with, against, or across the grain with equal ease. Depth of cut is adjustable. Automatically planes at 90° angle. Can cut at any angle desired.

A precision tool especially designed for the lower speed 1/4-inch drills. Spiral cutter eliminates grain deflection and wavy cuts. It's deep-hardened and ground for durability and keen edge. Long-surfaced, self-lubricating bearings assure long life.

**12<sup>95</sup>**

If your dealer does not yet stock it, send cash, check or Money Order for prepaid Shipment.

THE ROTEX CO.  
837 West Davis  
Dallas, Texas

**Rotex**  
DRILL ATTACHMENTS

## Ball Bearing Construction Throughout

A Drill of  
Better Quality,

**Mall**



1/4"  
Model 143T  
**\$38<sup>00</sup>**

### THESE FEATURES MEAN LASTING DEPENDABILITY

- Dynamic motor runs on ball bearings and hardened steel gears.
- Housing is light-weight die cast aluminum alloy.
- Equipped with heavy cord, geared chuck, and key.
- Weighs only 4 lbs. complete for easy one hand operation.
- Comfortable pistol grip and trigger switch for best control.
- Spindle speed of 2500 free rpm. U.L. approved.



Powers dozens of  
work-saving attach-  
ments.

40 Branches and Thousands of Dealers, Coast to Coast

**MALL TOOL COMPANY** 7805 S. Chicago Ave.  
Chicago 19, Illinois

Send me more information about MALL drills.

Name .....

Address .....

EU-77

# BOOKS ARE BETTER THAN EVER!

(and so is TV)

We had a hunch (about the time a lot of other publishers were gloomily predicting the end of the printed word because of TV) that nobody, but nobody, was going to sit around forever staring at the little lighted screen in their living room. We reasoned that after the novelty had worn off, people would be anxious to get back to their hobbies, workshop projects, home maintenance and repairs, and to continue to broaden their interest in this scientific and mechanical world of ours.

To prove our confidence, we even joined forces with some of the "enemy" as we continued to produce worthwhile books in these fields. For instance, we got the feeling that it was just too bad that the excellent science programs of Mr. Wizard (Don Herbert) had to vanish from the record at the conclusion of his weekly half-hour television program.

We got Don Herbert to put down on paper some of his best tricks and experiments. The result was *Mr. Wizard's Science Secrets*, a book that started walking off the shelves literally as fast as we could get it to the stores. A first printing was exhausted within a few weeks . . . now we're out with the third printing (a total of 75,000 copies).

The book is an excellent gift for any bright youngster. He'll be able to mystify his friends (and learn a lot about science, too) after he reads how he can turn "wine" into water, pop popcorn



with radiant energy, blow up a balloon inside a bottle, make his own telephone and telegraph systems, cause water from a faucet to bend mysteriously, make mothballs dance, etc., etc. Mr. Wizard tells not only how to do these tricks, but why. It was this that led Wilbur L. Beauchamp, professor of education at the University of Chicago, to pronounce his judgment: "It's a good book."

We think we have another best seller in *Dorsey Connors' Book: Gadgets Galore!* Miss Connors has written an excellent book, hard to label except by the blanket term, "Ideas." Some of them represent the best that she has presented on her television

show over WNBO-NBC (Channel 5). Others are brand new. Altogether they make up a collection of intriguing ideas for household short cuts, homemade gifts, etc. In an ordinary wire coat hanger, Miss Connors sees: a mail caddy . . . an earring bar . . . a rack for cups . . . a beverage holder for garden parties . . . an extra shelf . . . a newspaper or book rack . . . an outdoor grill fork . . . an omelet stirrer . . . a muffin toaster. In her capable hands an aspirin tin, a stone from discarded jewelry and a little gift paint become a Marie Antoinette pill box; while four handkerchiefs and a length of bright ribbon work into a fancy party apron. *Gadgets Galore!* is an excellent gift for any woman, whether bachelor girl or homemaker. And the handy man of the house will find much to interest him, too, in this fascinating book.

Another television star who's doing a book for us is Walt Durbahn, genial proprietor of "Walt's Workshop," a program which has a large following among home-workshop craftsmen. Walt's book, *Carpentry for the Home Craftsman*, is eagerly awaited by this group.

So TV continues to have stars and sponsors, and we continue to produce books that are sold . . . and read . . . and used. The books are as easy to obtain as your favorite program. Simply go into your favorite bookstore . . . or write



**POPULAR MECHANICS PRESS**  
200 East Ontario Street, Dept. 12, Chicago 11, Illinois

POPULAR MECHANICS

Copyrighted material



**SURPLUS! New Release! Original Gov. Cost \$350.00**

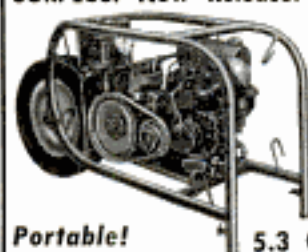

## AIR COMPRESSOR

200 lb. Pressure, 2 Horsepower  
**Finest Industrial Compressor ever built! Now only \$129.00** pre-paid

**Portable!** 5.3 C.F.M. Handles largest industrial and commercial applications

Made by World-famous manufacturers to rigid specifications. A BUY for Contractor, Farm, Garage, Service station, Factory, Shop. Two independent air outlets—one for high pressure (up to 200 lbs.)—the other controlled by regulator from 0 to 80 lbs. Large face gauge. Safety release valve. Automatic unloader keeps pressure constant without stopping engine. Hollow frame acts as reservoir assuring ample supply of oil-free air with absolutely no pulsation! Unexcelled for: Spraying; Greasing; Tire inflation; Blowing out heating and refrigeration lines; Small pneumatic tool operation; Insecticide dusting and spraying; Flocking; Undercoating!

### SPECIFICATIONS:

- |  |  |
|--|--|
| <p><b>—COMPRESSOR—</b></p> <ul style="list-style-type: none"> <li>• Mfg. by BENDIX WESTINGHOUSE</li> <li>• Twin cylinder</li> <li>• 4 Rings on each piston for added compression—capable of pumping 1100 lbs. p.s.i.</li> <li>• Forced pressure lubrication assures oil to every moving part</li> <li>• Ball bearing construction</li> <li>• Capacity 5.3 cu. ft.</li> </ul> | <p><b>—ENGINE—</b></p> <ul style="list-style-type: none"> <li>• Mfg. by BRIGGS &amp; STRATTON</li> <li>• Kick or rope start</li> <li>• 2 HP, 4 cycle air cooled</li> <li>• Splash lubrication system</li> <li>• 2 qt. gas tank</li> <li>• Float feed carburetor with adjustable idle speed and automatic governor</li> <li>• 3 piston rings</li> </ul> |
|--|--|

Also Available! Same unit with 1 HP Electric Motor, 110-220 volts, 60 cp. Sent prepaid. **\$129.00**

**IMMEDIATE DELIVERY! SUPPLY LIMITED! FULLY GUARANTEED!**

**FREE CATALOG of Motor and Electrical Bargains**  
 ROBERTS ELECTRIC CO., Dept. 131, 849 W. Grand, Chicago 22, Ill.

# FREE CATALOG

Over 300 books on Fishing, Hunting, Home Repairs and Improvements, Bricklaying, Welding, Home Workshop, Power Tools, Hobbies, Crafts, Home Building, Trades, Making Money at Home, Furniture Making, Woodworking, Carving, Photography, Art, Drawing, Mechanisms, Engineering, Refrigeration, Plumbing, Radio-TV, Electricity, Automobiles, Farming, Livestock, Gardening, Decorating, Painting, many, many more. Send for yours today.

POPULAR MECHANICS PRESS, 200 E. Ontario St., Chicago 11

# All About TELEVISION



**How to Replace Tubes Install Antennas Make Adjustments**



POPULAR MECHANICS PRESS  
 200 E. Ontario St., Chicago 11, Ill.

Send at once my copy of All About Television. Remittance for \$3.00 enclosed. If it isn't entirely satisfactory I may return it in 7 days for a full refund.

NAME \_\_\_\_\_  
 ADDRESS \_\_\_\_\_  
 CITY \_\_\_\_\_ ZONE \_\_\_\_\_ STATE \_\_\_\_\_  
 Send C.O.D. (U.S.A. only). Postage extra.

JANUARY 1954

# NEW!

CATALOG NO. 108

1954 EDITION

Complete LINE OF

## AUTOMOTIVE PARTS AND ACCESSORIES

For All Cars, Trucks, Hot Rods, and Custom Cars

Hi-Speed Equipment

See Your Gas

See Your Gas

See Your Gas

**J.C. WHITNEY & CO.**  
 1917-B-2 Archer Ave., Chicago 16, Ill.

**World's Largest Selection... Everything for Your Car, Truck, Custom-styled Car, Hot Rod**

# YOU SAVE UP TO 50%!

**50,000 Items ... all at WHOLESALE PRICES!**

It's ready now... the only complete buying guide to everything you need for your car, truck, custom-styled car, or hot rod... at rock-bottom wholesale prices! Thousands of hard-to-find parts... equipment and replacement parts for cars from 1920 to brand new 1954 models! New Hollywood accessories not offered in stores; high-speed parts to soup up your engine; custom-styling equipment to give your car that "expensive" look. Speedy shipment, guaranteed satisfaction, and money-saving wholesale prices!

**FREE** if you mail coupon today, we'll send valuable Check Chart that shows you how to know if your car is safe... may save you hundreds of dollars in repair bills... **YOURS FREE** when you mail coupon for Catalog.

**MAIL THIS COUPON TODAY!**  
 Get your J. C. Whitney Catalog NOW! Mail coupon with 25c to help pay postage and handling. We'll credit the 25c on your first \$5.00 minimum order, and the Catalog will be FREE TO YOU! Mail Coupon TODAY!

**J. C. WHITNEY & CO.**  
 1917 B-2 Archer Ave., Chicago 16

Here are just a few of our 50,000 items



- Auto radios
- Hi-Speed Equipment
- Mufflers, pipes
- Engines, parts
- Transmissions
- Custom-Style Acc.
- Tires, tubes
- Tools
- Springs, shocks
- Ignition parts

**J. C. WHITNEY & CO.**  
 1917 B-2 Archer Ave., Chicago 16, Illinois

Rush giant 1954 Catalog of auto parts and accessories at wholesale prices. I enclose 25c to cover part of cost, which will be credited to me on my first \$5.00-or-more order.

Name \_\_\_\_\_  
 Address \_\_\_\_\_  
 City \_\_\_\_\_ State \_\_\_\_\_



now! *Beauty* for the housetops



WARD  
PATRON-VANE  
CONICAL

Styled for beauty . . .  
engineered for top performance.  
Insist on Ward Tele-vane TV  
antennas for new or  
replacement installations.  
Ask your TV service man about  
Tele-vanes today!

**THE WARD  
PRODUCTS CORP.**

Division of  
The Gabriel Co.  
1148 Euclid Ave.  
Cleveland, Ohio

The Ward Products Corp., Div. The GABRIEL Co.  
Dept. PM 154, 1148 Euclid Ave., Cleveland 15, Ohio  
Send me free folder describing the complete line of  
Ward Tele-vane TV Antennas.

Name \_\_\_\_\_  
Address \_\_\_\_\_  
City \_\_\_\_\_ State \_\_\_\_\_

# Life-long

## 10 YEAR BATTERY\*

### A EUROPEAN INVENTION

Gives 2,000 Amps  
Instant Power Output

**A WINTER AND  
SUMMER BATTERY**

Actual tests and records prove that  
below zero conditions or boiling tempera-  
tures have no effect on the electric  
receptive power of this famous Battery.

**BETTER THAN GOVERNMENT SPECIFICATIONS**

Life-Long Batteries (same type as used by the U. S. Army, Air Force and Navy  
Submarines) recently were proven to be better than Government requirements.  
For example: A production Life-Long Battery for passenger car use was sub-  
mitted to strict U. S. Army Signal Corps tests for use in the Arctic weather. Life-  
Long out-performed all tests, even delivered power at a temperature 20  
degrees further below zero than was necessary.

**SPECIAL LIFE-LONG FEATURES**  
Silver Nuclear Cells; Galvic Grids; instant starting in any type  
of weather; acid-proof non-corrosive lead bushing on termi-  
nal; silver-plated plates with capillary action for safety; Un-  
calculated metallic bearing litharges; self-javeling device; con-  
trols low-gravity electrolyte; micro-calibrated cell connectors;  
measured resistance safety fuse; requiring least amount of  
water; approved by insurance companies.

**SELF-RECHARGING**  
Unequal life expectancy and outstanding recuperative characteristics of  
LIFE-LONG Batteries make it possible to sell at the popular price of—6 volt,  
\$29.95; 12 volt available for \$34.95.

**LOWEST PRICE FOR QUALITY!**  
Battery naturally doesn't last for life but it is the only BATTERY  
WITH A TEN YEAR GUARANTEE. It pays you to change it to  
your new car. Figure the difference. Check the quality . . .  
the performance. Hundreds of  
testimonial letters prove Life-  
Long Battery to out-perform,  
outlast others by over 300%.

**SPECIAL DEALER AND  
DISTRIBUTOR ZONES AVAILABLE**

**LIFE-LONG BATTERIES, 6V and  
12V, are manufactured for all cars,  
trucks, boats and industrial use.**

**LIFE-LONG BATTERY MFG. CO.**  
11766 W. Pico Blvd., Dept. M-1  
Los Angeles, Calif.  
San Francisco, Chicago, Cleveland, Dallas

**LIFE-LONG BATTERY CO.**  
11766 W. Pico Blvd., Los Angeles, Calif.  
Please ship LIFE-LONG BATTERY at once  
& wob (\$29.95 including tax)  
12 volt (\$34.85 including tax)

for \_\_\_\_\_  
Make & Model, Year of Car  
 I enclose cash, check, or money  
order, you pay shipping cost.  
 I enclose \$5 deposit, will pay  
balance and shipping costs C.O.D.  
Name \_\_\_\_\_  
Address \_\_\_\_\_  
City \_\_\_\_\_ Zone \_\_\_\_\_ State \_\_\_\_\_

**A BANG UP VALUE  
Satisfaction  
Guaranteed**



Made Up of  
**PROTO-S.K.  
SNAP-ON**  
and other  
top  
brands.

21 Piece Socket Set,  
1 1/2" drive. All NEW  
SOBPLUS. This set  
has everything. 15  
sockets 7/16" to 1 1/8", 1 1/2"  
Reversible ratchet, Heavy Metal  
Box, 1 1/2" drive speed handle, two  
extensions, breaker  
handle. A \$39.00 List Val-  
ue. Only . . . . . **\$15.95** Prepaid

Also Available—19 Piece 3/8" drive socket set. Socket ranges 1/4"  
to 1/2" Same as above. List Value \$27.00. Only **\$11.95** prepaid.

Check or Money Order  
**CONSUMERS HARDWARE CO.** Dept. PM-1, 6323 Santa Fe Ave.  
Huntington Park, Calif.

## SUPER DRILL GRINDER



Sharpens round shank drills from  
3/32" to 1/2" in diameter, up to 6"  
long. Grinds old drills like new in  
4 different point angles, using  
hand or power grinding wheels.  
Money-back guarantee. Only \$2.95  
At Dealers or Postpaid

**A. D. McBURNEY** Dept. A-37  
5908 Hollywood Blvd. Hollywood 28, Calif.

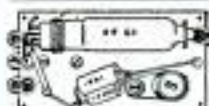

## RADIO CONTROL YOUR MODELS

DEVICE MIDGET 1" Radio control consists of license free transmitter &  
Receiver Radio & a control equipment, long range for 1/2 mile, Boat, Air  
Models. All these with easy assembly with our parts & plans. . . \$9.98

Detailed Information & Radio Catalogue . . . 24c  
Book - "RADIO CONTROL OF MODEL AIRCRAFT" \$3.98

ONLY \$9.98 RADIOMODELS BOX 36 DEPT. PM BALTIMORE & MARYLAND

SAY YOU SAW IT IN POPULAR MECHANICS

# Guide for HOME ELECTRICIANS

Now You Can Install Fixtures, Make Most of Your Own  
Electrical Repairs and Save Hundreds of Dollars

Now you can do almost any  
electrical job that comes up  
around your home and pocket  
really worthwhile savings.

### Read How — See How

No matter if you want to in-  
stall fluorescent fixtures, test  
circuits, repair appliances, or  
do any one of the many elec-  
trical repair jobs that come  
up, Popular Mechanics' new  
ELECTRIC FIX-IT BOOK tells  
and shows you how, step-by-  
step.

### 7-Day Money Back Guarantee

Use this book in your home for  
7 days and return it for a full  
refund if it isn't more than  
satisfactory.

### Partial Contents

Rewire Your Home for  
Modern Lighting—Make  
a Shelf-Light—Service  
Electrical Home Equip-  
ment—Make Porch and  
Table Lamps—Install  
Fluorescent Fixtures—  
Repair a Vacuum Clean-  
er—Make Home Ap-  
pliances Last Longer—  
Etc.



**POPULAR MECHANICS PRESS, Dept. EF-1**  
200 E. Ontario St., Chicago 11, Ill.

Gentlemen:  
Send postpaid my copy of ELECTRIC FIX-IT BOOK. Remittance for  
\$2.00 is enclosed. Unless it is entirely satisfactory I may return it  
within 7 days for a full refund.

NAME \_\_\_\_\_

ADDRESS \_\_\_\_\_

CITY \_\_\_\_\_ ZONE \_\_\_\_\_ STATE \_\_\_\_\_

Send C.O.D. (U.S.A. only). Postage extra.





## OVERHAUL YOUR MOTOR in 10 minutes

**STOP BURNING OIL. STOP PISTON SLAP**

15,000 Mile Performance Guarantee!

**1st Step - CLEANSE WITH "MOTOR PURGE"**-In the FIRST step of the famous

Motor Renew Kit treatment, the "Purge" formula cleans, quiets and power robbing carbon, gums and varnish. Pour this miracle solvent into the cylinders, run your motor and watch the combustion residue billow out of your exhaust pipe.

**2nd Step-RENEW WITH "COMPRESSION SEAL"**-RESTORE COMPRESSION... GET NEW POWER, SPEED AND ECONOMY with "Compression Seal"! As the SECOND step of the Renew treatment, squeeze this self expanding mineral compound into your cylinder where it can fill worn spots (which cause compression leaks) between cylinder walls and pistons. Thus it restores compression... cuts oil-gas waste and eliminates costly engine overhaul and ring jobs.

**100% MONEY BACK GUARANTEE!**

Free Auto Manual with each order. Kit treats all cars and trucks.

\$6.95 Postpaid (or send \$1 deposit, bal. C.O.D.)

Write "RENEW KIT," Dept. PMR-1

10407 W. Washington Blvd., Culver City, Calif.

## The QUICK-WAY TO SHARPEN CIRCULAR SAWS



Now you can do it yourself—save time and money. The new QUICK-WAY Index Plate Circular Saw Sharpener makes your own power table a precision saw sharpener. Guarantees accurate grinding and spacing of every tooth. Complete unit only \$16.50 postpaid, including patented Index Plate block for mitre and \$3.00 grinding wheel... Nothing else to buy!

Send check, cash or money order. We pay postage.

Model 6-12P  
\$16.50 Postpaid

**QUICK-WAY Saw Company**  
11 Riverside Corning, N.Y.

## DE WALT OWNERS!

EXTENSION ARBOR INCREASES RIPPING range to 28 1/2" on late models... 24" on earlier models. Greater depth in DADOING. Unlimited capacity in SHAPING! Increases GRINDING scope. Many other uses. Complete unit incl. ARBOR, SPACER & GUARD E.S. TENSION. Install in 1 min. GUARANTEED. Money-back 10 day trial. \$9.95 ppd. \$2 dep. on C.O.D. Dealer inquiries invited.

CAMPBELL & LEE, Dept. PM-1  
1460 N. Evergreen, Burbank, Calif.

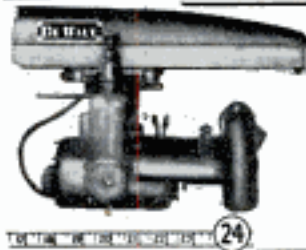

DE WALT MODEL 24

## HELPFUL BOOKS

Send post card asking for FREE catalog

Popular Mechanics Press, 200 E. Ontario, Dept. 601, Chicago 11

## "HANDY TIPS FOR HANDY MEN"

BOOK OF HINTS to make home repairs and hobby projects easier. Send 25 cents in coin to: THE BLACK & DECKER MFG. Co., Dept. H1M, Towson 4, Maryland.

## WAR SURPLUS GIGANTIC SALE SAVE UP TO 85%

**NEW HI-SPEED DRILLS**  
30 ea. 1/60-1/2 for \$3.25  
10 ea. 1/4-1/2 for \$3.00  
5 ea. w/1/4" shank \$2.50  
7 ea. 5/16-1/2 Wood Drills \$2.50

**HELIOS MICROMETER**  
0-1 Lock Nut... \$10.50  
1-2 Lock Nut... \$15.00

Check or M.O. 25% Dep. on C.O.D.—F.O.B. L.A.

**METRO PRECISION TOOL CO.** 1507 S. La Cienega, Los Angeles 35, Calif., Dept. M1

**VERNIER CALIPERS**  
Helios 6 inch, w/case \$11.00  
Precision 6 inch... \$6.95  
Case Extra... \$1.00

**Build Your Own ARC WELDER**

New D. C. Generators P.I. w/diagram \$21.00

Generators R.I. w/diagram... \$25.00

## YOU'LL CATCH BIGGER FISH

and have more fun catching them after you read Popular Mechanics HOW TO TEMPT A FISH! Here is the experience of veteran guides and fishermen brought to you for hours of enjoyable reading. Many pages of brilliant full color Kodachrome plates. Covers every phase and style of fishing—even tells where to find the big ones and what baits to use. Hundreds of lures and tips to make every trip more enjoyable. Endorsed by leading sportsmen throughout the country. 128 pages. 325 lbs.

**POPULAR MECHANICS PRESS \$2.00**

200 E. Ontario Street, Chicago 11



## MICRO VEST-POCKET RADIO UNIQUE TWO TUBE PERSONAL SET

Micro is a marvel of miniature engineering and was designed for those who desire a good performing, practical pocket radio at low cost. Using only its built-in antenna system Micro tunes in all local stations with perfect selectivity and plenty volume. Tested in New York City, Philadelphia, Baltimore, Los Angeles, Denver and Kansas City the results were truly amazing for so tiny a receiver. In small towns, having one or more stations, results were equally as good.

**CIGARETTE PACKAGE SIZE MICRO EASILY OUT-PERFORMS ALL OTHERS OF EQUAL SIZE AND PRICE**

"Believe It or Not" Micro's attractive case contains a miniature tuning condenser, volume control, built-in variable antenna system, two powerful mini-size tubes just 1/4" diameter and the latest in miniature long-life batteries.

SEND ONLY \$1.00 NOW... Pay Postman Balance C.O.D.

Micro is supplied in fully finished pre-fab form that anyone can easily assemble in just one evening. Large, clear picture plans assure even the young radio hobbyist perfect results. Complete Micro Kit, less earset and batteries, ONLY \$6.95. Batteries \$1.50 per set. Flesh color tiny hearing aid earset shown in photo supplied at wholesale cost of \$5.25 or use any regular size earphone.

Order To-Day! If you do not agree Micro is the finest pocket-radio you have ever seen then return it once for full refund plus your postage.

**ELECTRONIC MINIATURES LAB NORTH CAROLINA**

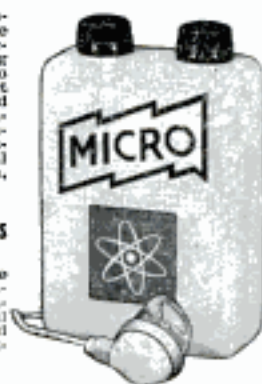

## SAVE UP TO \$40\* on fuel each year—with the



the "MAGIC" BRAIN that lets you wake up to a warm house!

ONLY \$12.95 **PARAGON Nightrol**

Here's how the Nightrol works for you!

Every Morning. Automatically turns up heat before you awake. Lets you dress in warm comfort.

Every Night. Automatically turns heat down 6° to 10°. Keeps home cooler for greater comfort while you sleep. Saves up to \$40 on fuel each year.



\*According to Government Surveys. Install it yourself! It's easy! Timer plugs directly into convenient electric outlet. Set back unit attaches directly into thermostat. Then set it and forget it... that's all there is to it. Approved by U.L. as a safe appliance for the home.

ENJOY ECONOMICAL AUTOMATIC HEAT CONTROL... MAIL COUPON TODAY

PARAGON ELECTRIC CO., Dept. PM102, Two Rivers, Wis.  
 Please send me complete information on Paragon Nightrol.  
 Please send me a Paragon Nightrol. Enclosed is check or money order for \$12.95.

Name.....

Address.....

City.....Zone.....State.....

© 1953



POPULAR MECHANICS

# FAMOUS LITTLE LIBRARY OF USEFUL INFORMATION

Complete Set of 126 BOOKS only \$17.95

25 BOOKS	\$3.75
12 BOOKS	\$2.00
5 BOOKS	\$1.00

SINGLE BOOK 25c

Here at amazingly low cost is the practical help and information you have always wanted. Articles in previous issues of Popular Mechanics have been classified according to subject and are now available in these handy reprint booklets.

Check titles wanted, clip ad, mail today.

## HOME WORKSHOP

Power-Driven Saws—74: How to build. Drill Presses, Plane, Grinders—79. Sanders—80: Details on 8 machines. Wood & Metal-Turning Lathes—81. Filing Machine, Hacksaw, Cutoff Wheel, Shaper—82: Full details on these. Metal Lathe Tools—101: How to build. Workbenches and Tool Cabinets—47. Spray Painting—84: Proper methods. From Pattern to Casting—91: How castings are made in sand molds. How to Use a Circular Saw—135. Jigsaw Technique—136: How to use. Bandsaw Know-How—137: Techniques.

## HOME IMPROVEMENTS

Painting Your House Inside and Out—117. Simple Home Improvements—104: Save money. Building Extra Rooms in Your Attic—23: Add to the value of your home. Basement Playrooms—24: Build an attractive playroom in your basement. House Wiring—89: How-to-do-it. Curing Leaky Basements—45. Fitting Home Game Room—55. Built-in Fixtures—78: Several. Lower Your Fuel Cost—31: Practical kinks that will save you hundreds of dollars. Hanging Wallpaper—38: Hints and tricks. Ridding the Home of Insect Pests—107. Constructing Indoor & Outdoor Fireplaces—58: Details on stone fireplaces.

## CRAFTWORK • HOBBIES

Games and Puzzles—131: Have fun at home. Model Planes You Can Build—129: Several. Fun With Your Model Railroad—127. How to Make Novelty Jewelry—126. Working with Plastics—61: Novelties, etc. 25 Shelves You Can Make—64: Wall shelves, etc. Novelties Turned on Lathe—62: Dishes, etc. Projects in Plastics—112: How to use. Inlay Pictures—Veneering—63. Whittling and Wood Carving—65: Methods. Action Toys—66: 21 easy-to-make toys. Marionettes—113: How to make and use. High Flying Kites—67: How to build. Windmills & Weather-vanes—68. Lamps in Wood, Metal, Plastic—69: Several. Bows and Crossbows—115: How to make. Playground Equipment—73: 8 projects. Metal Craft—28: Simple instructions. Weaving and Recaning—37: Full details. Gem Cutting—42: How to cut and polish.

## USING TOOLS

How to Use Your Drill Press—125. Correct Measurements—106: How to obtain.

Tool and Saw Sharpening—92: Tricks and hints. Technique of Using Drills and Wood Bits—90. Successful Wood Turning—32. How to Read Blueprints—71: Tells you how. Metal Turning Lathe Kinks—99. Operating a Metal Turning Lathe—100. Heat Treating and Case Hardening—102. Working with Glass—103: Cutting, etc. Using Basic Tools—120: Tips and hints.

## WELDING • SOLDERING

Rewinding & Servicing Electrical Motors—75: Repairing and rewinding motors. Electrical Appliances, How to Fix—111. Electromagnets & Solenoids—44. Transformer Construction—41: Directions. The Boy Electrician—43: Five projects. Soldering & Brazing—17: Tells how to. Arc & Spot Welders—5: How to use & build. Build Your Own Relays—123: Instructions. Home Burglar Alarms, Secret Locks and Time-Setting Systems—128. Welding with Arc and Gas—134: Tips.

## AUTOMOBILE BOOKS

House Trailers—121: Build it yourself. Automobile Kinks and Shortcuts—10. Building Trailers—Small Teardrop and Utility—27: Can be built in your spare time. Motor-Driven Midget Car & Scooter—34. Curing Auto Electrical Troubles—95.

## BUILD A BOAT

14 Ft. Outboard Runabout—2: How to build. Rowboats, Bicycle Boat, Small Dinghy—83. Small Sail Boats—84: For young sailors. Two Outboard Runabouts—85: 14 ft. & 12 ft. Build Your Own Canoe, Kayak, Surfboard—30: Complete building details. Fast Class-E Ice Yacht—22: Build your own.

## GARDENING HELPS

Lawn and Garden Equipment—124. Handy Farm Implements—114: How to build. Tractor Attachments—116. Backyard Gardening—39: Helpful hints. Lawn & Garden Novelties—72: Easy to build. Trellises, Pergolas, Fences—76. Lawn & Garden Furniture—77. Colored Concrete Garden Furniture—6. Farm & Garden Tractors—8: How to build.

## PHOTOGRAPHY

Home Movie Equipment—118: How to use. Photo Lighting—119: Helpful information. Photo Enlargers—1: Complete plans. Photo Printers & Dryer—25: Describes three. Photo Darkroom Equipment—96. Picture Projector, Trick & Table Top Photography—97: Tips on how to make. Photo Kinks—98: Money-saving ideas.

## FURNITURE MAKING

Furniture Upholstery and Repair—122. Rustic Furniture—18: How to build. Children's Room Furniture—51. Book Ends—52: Good selection from 10 designs. Small Tables—54: Interesting styles. Desks—53: Many varied designs. Smoking Stands—56: Seven designs given. Plain & Novelty Wood Finishing—40. Book Cases—59: Eight designs. Magazine Racks—49: Ten attractive racks. Clock Cases—50: Several types. Serving Trays for Every Occasion—53.

## MISCELLANEOUS

Cleaning Formulas—11: Make your own. Re-Silvering Mirrors—70: How to do it. How to Build a Concrete Block Machine—110: Make your own block machine. It's Easy to Tie Knots—105. Chemical Experiments—93: Several. Taxidermy—9: How to mount small animals. Log Cabins and Tourist Cottages—14. Magic for Everybody—29: Simple tricks. Trapping Small Animals—33: How to trap. Training Your Dog—35: Tricks and obedience. Small Furnaces—36: For melting copper, etc. Electroplating with Copper, Nickel, Chromium, Lead, Zinc, Cadmium—86. Plating Non-Metallic Objects—Plating with Gold, Silver, Alloys—87. Telescopes—20: Design and construction. Poultry Houses—108: How to build. Guns & Decoys—109: Clean guns, make decoys. For Better Business—130: Timely tips. For Better Business—132: Saves time. For Better Business—133: For smooth operation.

USE THIS HANDY ORDER COUPON NOW!

POPULAR MECHANICS PRESS  
200 E. Ontario St., Chicago 11, Ill.  
I enclose \$\_\_\_\_\_ (U.S. currency may be mailed if carefully wrapped) for "Little Library" booklets numbers:

24 Books	12 Books	5 Books	1 Book
\$3.75	\$2.00	\$1.00	25c

NAME \_\_\_\_\_

ADDRESS \_\_\_\_\_

CITY \_\_\_\_\_ ZONE \_\_\_\_\_ STATE \_\_\_\_\_



# STOP CHANGING MOTOR OIL!

End this needless expense forever with

**RECLAIMO** Today's most advanced OIL RE-REFINING filter FOR CARS, TRUCKS, TRACTORS.

Continuously cleans and RE-REFINES motor oil as you drive by utilizing motor heat — keeps oil in high grade lubricating condition at all times.

### "RECLAIMO"

- REMOVES SOLIDS (by filtration)
- REMOVES WATER (by distillation)
- PREVENTS Excess fuel dilution
- PREVENTS Acid and Sludge Formation
- ADDS Thousands of Miles to Engine Life

**MAINTAINS** Stable Viscosity **ELIMINATES** All Oil Changes  
 FREE 32-page book "OIL FACTS" with bonafide \$1,000.00 offer on page 30. Gives you the complete "Reclaimo" story and details of our extraordinary 90-DAY NO-RISK TRIAL OFFER. Write for your copy today!

## RECLEAN FILTER CO.

5083 Elston Ave., Dept. M-2, Chicago 30, Ill.  
 Wm. Schwalge, U.S. Pats. 1757223, 1834654, 2068473.

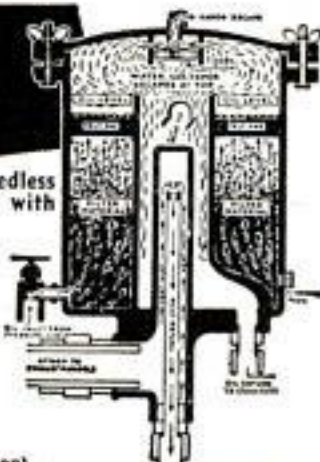

DEALERS WANTED

U. S. BUREAU OF STANDARDS, Bul. 86 States, "Oil does not wear out mechanically."

## PARTS FOR MILITARY TRUCKS

and JEEPS 4 & 6 WHEEL DRIVE. WRITE FOR PARTS CATALOG STATING MAKES

## American AUTO PARTS CO. INC.

1830 LOCUST — DEPT. PM  
 KANSAS CITY, MISSOURI



### SAMSON FIBER-GLASS BOWS

THEY DON'T BREAK  
 THE WHOLE FAMILY  
 CAN USE THE SAME BOW

CATALOG - Five Bow-Arrows Materials 54  
 HANDBOOK - Illustrated Instructions on  
 Making & Shooting Archery Tools 73c

L. E. STEMMER CO., Box 3  
 MANORVILLE, L. I., NEW YORK  
 Making Bows & Arrows for over 80 years

## LAWN ORNAMENT-NOVELTY PATTERNS

28 Lawn Ornament Patterns, 25c. Other Patterns: 15-20" high; Dutch Girl, Dutch Boy, Pirate, Bull Terrier, Mexican Girl, Mexican Boy, Dwarf, Penguin, Flower Girl, 15c each. 25 Novelty Patterns, 30c. All 62 Full Size Patterns, \$1.00.  
 Strother Pattern Service, Dept. D0-8, Box 128, Bellington, W. Va.



## PIXA-GLO

"NOVEL" GLOWING DESIGNS FOR "NIGHT DRIVING PROTECTION."

ATTACH TO TRUNK OR CAR BUMPER. EA. PIC. OVER

20 SQ. IN., 2 FOR \$1.00 P.P.D.

COMES IN RED OR BLUE  
 P.O. Box 163  
 I. H. MERRITT CO. Forest Hills, N. Y.

**WELD** **BRAZE**  
**SOLDER** **CUT**



4WAY ONLY \$14.75 f.o.b. factory

### WELDER

Complete with Twin Carbon Arc Torch and accessories... to handle all metal-craft work.

Acclaimed by thousands of Homeowners, Mechanics and Hobbyists as the welder of 1001 uses. Easily operated from properly wired 110 volt AC or DC line. The ideal gift with a life-long use... Order today on 10 day money back guarantee.

FOUR-WAY WELDER CO., Dept. F2-A  
 2326 S. Michigan Ave. • Chicago 16, Ill.

# I Made \$15 PER HOUR..

with my SUPER-SHOP

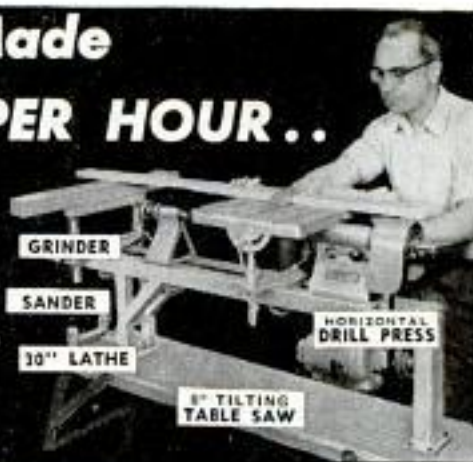

Every hour spent with SUPER-SHOP has been worth \$15 to me. Making it yourself is fun. SUPERSHOP is a complete, precision-built workshop. 100% ball bearing. Rugged tubular steel frame. Big capacity. 8 inch saw. Factory to you only \$79.95. Free trial. Easy pay plan. FREE catalog.



VERTICAL DRILL PRESS

Write for FREE Catalog on Money Saving SUPERSHOP

POWER TOOLS INC. 155 Yates Ave. BELOIT, WISCONSIN

"THE NAME THAT MADE BOAT KITS FAMOUS"

## U-MAK-IT BOAT KITS

MOST COMPLETE LINE

8 TO 23 FEET

PRAMS—ROWBOATS—OUTBOARDS



18 FT.—21 FT.—23 FT.  
 Outboard & Inboard Cabin Cruisers

### BIG ILLUS. CATALOG

44 PAGES, shows construction details. Incl everything to build your own—hardware, engines, conversions, paint & color chart. Also Fibreglas covering for all Kit Boats, ideal for Cabin Roofs.

SEND 35c COIN TODAY  
 703P—WHITTIER ST.  
 Bronx 59, N. Y. City

U-MAK-IT PRODUCTS





# DRIVE 500,000 MILES WITHOUT NEED OF A MAJOR OVERHAUL

and at the same time get more power  
and better fuel mileage  
**ENGINEERS HAVE PROVEN  
THIS POSSIBLE**



They have shown that the combustion process produces more than a gallon of water in vapor or steam for every gallon of fuel burned. Most of this vapor and other impurities are removed in the form of exhaust vapors. (Ever notice the water that drips from your exhaust pipe?) Some of these vapors blow by the pistons and enter the crank case where they cause RUST, VARNISH, ACIDS and SLUDGE.

## INSTALL POWER VENTILATION ON YOUR CAR

Now you can increase the overall operating efficiency of your car with amazing, newly developed Moto-Vent. Moto-Vent gives you POSITIVE POWER VENTILATION which removes the water vapors, sulphur and other highly corrosive materials that enter crank case. Not just another "gimmick" or "gadget" but a precision engineered instrument designed to give better engine performance, add life to your car and save you money. Moto-Vent feeds these oil and water vapors back into the combustion chambers where they give you water injection and overhead lubrication preventing back pressure, overheating, sticky valves and rings, sludge and carbon formation. Moto-Vent actually reconditions your motor as you drive at no extra cost to you.

### EASY TO INSTALL — DO IT YOURSELF

Fits all cars, trucks, tractors, old or new. Moto-Vent is installed between oil breather and intake manifold in less than half hour. Once installed it requires no further attention, service or replacement. Because you will get better mileage and won't have to change oil as often, Moto-Vent will pay for itself many times each year.

### SEND NO MONEY—FREE 30 DAY TRIAL OFFER

Simply send us your name and address. Pay postman only \$4.95 plus charges on delivery. All fittings and easy to follow installation chart included. If you send payment with order, we will ship postpaid. Try Moto-Vent for 30 days. If you are not completely satisfied, return it for full refund. Send your order today.

**PRECISION PRODUCTS CO., Dept. 10, HARVARD, ILL.**

# Something NEW under the SON!



**TILL WITHOUT TOIL  
WITH BOLENS  
M-E MUSTANG  
ROTARY TILLER**

Do 5 gardening jobs in 1 operation: FLOW • DISC HARROW • AERATE • CULTIVATE. Tines Guaranteed against Breakage.

Bolens offers a complete line of Rotary Tillers in 3 hp, 4½ hp and 6 hp. AVAILABLE WITH WORK SAVING PLUG-IN ATTACHMENTS.



### MAIL COUPON TODAY!

#### BOLENS PRODUCTS DIVISION

Food Machinery and Chemical Corporation  
265-1 South Park Street, Port Washington, Wisconsin

I am interested in:

- TILLERS                       MOWERS  
 TRACTORS                     CHAIN SAWS

Name \_\_\_\_\_

Address \_\_\_\_\_

City \_\_\_\_\_ Zone \_\_\_\_\_ State \_\_\_\_\_



How to save money on all plumbing jobs — using approved methods.



How to select materials and fixtures.

## Save on Plumbing Costs

When You Build · When  
Making Improvements  
Repairs · Maintenance.

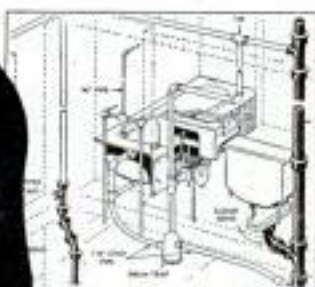

How to plan and lay out plumbing installations.

## Do All Kinds of Jobs Yourself With Home Plumbing Guide

Got a leaky faucet; a clogged drain; a noisy hammering water pipe? Want to add a bathroom to your home, install a new kitchen, or even build a home? Then you need Popular Mechanics' HOME PLUMBING GUIDE. It shows how you can do every kind of plumbing job yourself and can easily save you hundreds of dollars. Savings on even a small job will pay for this practical book many times over. It covers plans and layouts, installation, maintenance and repair of all home plumbing systems; tells you what materials to get and use and how to do a proper job with approved methods.

### Over 500 Pictures and Diagrams and Hundreds of Money-Making Tips

Simple everyday jobs, bigger remodeling and improvement jobs and complete installations are made clear and simple and easy to follow. Few, other than the simplest tools are required and some of these can be rented. Pipe, materials and fixtures are available from mail order houses, hardware dealers and supply houses. Don't pay high prices for work you can do yourself. Get the HOME PLUMBING GUIDE. You will be amazed how the practical text and hundreds of how-to-do-it pictures simplify jobs you thought might be difficult.

### Mail Coupon. Money Back if You Want It

Get the HOME PLUMBING GUIDE today. Only \$3.50. Read it. Study it. Put the vital information it contains into practice. Then if you are not satisfied return the book for a complete refund of your money. Order today.

### 15 Ways to Save Money in Your Own Home

- All about modern home plumbing
- How to use plumbing tools in your home
- Getting acquainted with pipe
- Pointers on planning home plumbing systems
- Installing and maintaining the home drainage system
- Your own private sewage disposal system
- The causes of drainage troubles and how to cure them
- Home water lines and how to install them
- Valves and faucets and what to do with them for best and most economical service
- Your own private water supply system
- All about water heaters and automatic supply
- Methods and advantages of water conditioning
- Water system troubles and how to prevent and cure them
- How to install plumbing fixtures and take care of them for longer life



### Mail Coupon Today for Money Back Home Trial

**POPULAR MECHANICS PRESS, Dept. HPG-1  
200 East Ontario Street, Chicago 11, Ill.**

Send Popular Mechanics HOME PLUMBING GUIDE in cloth binding at once. I understand I may return the book in 7 days for full refund of my money.

- Remittance for \$3.50 enclosed. Send postpaid.  
 Send C.O.D. (U.S.A. only) I will pay postman plus charges.

Name \_\_\_\_\_

Address \_\_\_\_\_

City \_\_\_\_\_ Zone \_\_\_\_\_ State \_\_\_\_\_



## BUILD YOUR OWN ARC WELDER OR LIGHT PLANT



**D-C GENERATOR**  
 \$15.50 used, good cond.  
 Instruct. incl. for Combs welder & light plant, 200 amps, 28 Volts, 2500 to 4000 H.P.M. Or Brand New.....Price \$21.50  
 PRICE F.O.B. K. C. MO.

CONVERTS TO ARC WELDER 100-250 AMP.  
 OR LIGHT PLANT CAP. LOAD 5000 WATTS

Stock #511 A.C.-D.C. Generator, Mfg. by General Electric, Rated 1250 Watts, 10.5 Amps, 115V, A.C., 200 Amps, 30V, D.C. Converts to dependable 115V, A.C. Light plant and D.C. Battery Charger. Gov't. cost, \$100.00, instructions incl. Wt. 50 lbs. Used, good condition.....**\$25.50** NEW **\$35.50**

**BOMB INTERVOLMETER**, Applicable for 24V, D.C. and 115V, A.C. To Operate lights, displays, photography, etc. Can be set to release at fixed time interval or split timing. Size 5"x9"x1 1/2". \$50.00 value, Brand New.....**\$8.95**

**CUNO OIL FILTER—BRAND NEW** Aircraft type. Filters oil without cartridge replacements. Just turn handle and cartridge is clean. Std. 3/4" inlet & outlet ports. **\$4.95** post-instructions incl.....

Send check or M. Order. Prices f.o.b. KCMo Except when marked postpaid U.S.A.

GENERAL SALVAGE CO., Dept. 714, 2922 E. 27 St., Kansas City, Mo.

**BEAM ROTATOR MOTOR** New, Reversible, geared motor, applicable for 110V, A.C. or 24 V. D. C. Powerful geared motor for TV aerials, Ham, FM antennas, etc. Approx. 9 H.P.M., free swing. Instructions incl. Stock #A331 **\$7.95** \$50.00 value.

**RHEOSTAT #R-27** Heavy duty for regulating the voltage on the converted P. J., R-L, Welder, & A.C.-D.C. type **\$6.95** post Gen. .... \$25.00 paid

**VALUABLE GEARS BARGAIN SPEED REDUCER**, 5-1 or 10-1 ratio 90 degree angle 1/2" splined shaft with 3 mounting holes rated **\$5.95** 2 H.P. .... (Add 50c Postage)

Complete outfit — rotator, bearings, directional indicating unit, weatherproof wiring — the works. Complete directions, easy installation. Nationally advertised, quality stock, drastically reduced for quick, close-out sale. Positively guaranteed, you get a 10-day free trial.

TV Close-Out Bargain

# ANTENNA ROTATORS

**\$12.95** 10 DAY FREE TRIAL

SLASHED TO LESS THAN 1/2 PRICE!

Complete outfit — rotator, bearings, directional indicating unit, weatherproof wiring — the works. Complete directions, easy installation. Nationally advertised, quality stock, drastically reduced for quick, close-out sale. Positively guaranteed, you get a 10-day free trial.

With non-indicating unit **\$12.95**

With indicating unit **\$16.95**

SUPPLY IS LIMITED, and we're not kidding. If you want this once in a blue moon bargain — ORDER TODAY. Send no money, we ship C.O.D. Specify unit desired, \$16.95 or \$12.95.

K. W. SALES CO. Box 111-3, Tipton, Indiana



## ARMSTRONG LATHE TOOLS

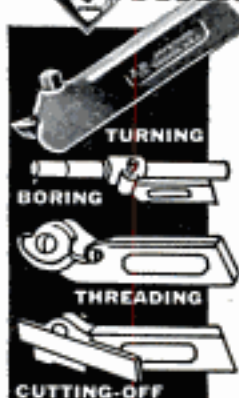

There is a correct ARMSTRONG TOOL HOLDER for every operation on Lathes, Planers, Slotters and Shapers. Shown at left are:

1. **Turning Tool**—for roughing, finishing and fillet work.
2. **Boring Tool**—for boring and internal threading.
3. **Threading Tool**—for thread cutting.
4. **Cutting-off Tool**—for lathe cutting-off work.

ARMSTRONG Lathe Tools are designed to give greater strength, maximum clearance and correct cutting angle. They are the most efficient and economical lathe tools you can buy. Write for Catalog

OVER 250 SIZES AND TYPES **ARMSTRONG BROS. TOOL CO.** 5268 W. ARMSTRONG AVE. • CHICAGO 30, ILL.

## How to Build Your Own GARAGE



Save as Much as 50% of Usual Construction Costs

Get Popular Mechanics' brand new book **How to Build Your Own Garage** by Wayne Leckey, Assistant Shop Notes Editor, and find out how you can build your own garage at savings of 50% of usual cost. Leckey tells in famous step-by-step instructions and shows in big, clear photos, drawings and diagrams how to perform every building operation from laying the concrete to installing the final trim. There are 25 designs. Brick, frame, and concrete block fully covered. Send \$3.50 for your copy. 7-day money back guarantee.

POPULAR MECHANICS PRESS, 200 E. Ontario, Chicago 11, Ill.

## BUILD YOUR OWN POWER MOWER



With Parts We Furnish

Why break your back mowing field or lawn? Now anyone can save time, money and effort by building their own Power Mower. Build it to fit your needs, in a short time without special tools.

**PULLS ITSELF, STEERS ITSELF**

WRITE FOR FREE BUILDING INSTRUCTIONS—NO OBLIGATION

T & H Mfg. Co., 811 E. 31 St., Dept. P1, Kansas City, Mo.

## Look... 3000 MILES of TELEPHONE WIRE at 1947 PRICES!

### 7th ANNIVERSARY SALE

We were the original National dealer in surplus telephonic equipment and have specialized continually in phone equipment since 1947.

During our Anniversary Sale... our wire is rolled back, to 1947 PRICES. At today's cost phone wire per 1,000 ft. is approximately \$32.50 wholesale. Buy 1 mile (5,280 ft.) for \$16.00. COMPARE THIS PRICE!

**ALL PURPOSE—ALL WEATHER** Designed for tough usage by U.S. Signal Corps, perfect for telephone companies, industry, engineering projects, ranches, etc.

W10B #18 gauge, 2-conductor, each cond. copper-steel constructed rugged insulated for weatherproofing.

Send Check or M.O. • No C.O.D.'s • All Prices F.O.B. Sacramento • California Buyers Add 3% Tax

**LORIS SALES P.O. Box 1896 B-1 SACRAMENTO, CALIFORNIA**

GR. I Unused, excellent condition, mile reels (5,280 ft.) 160 lbs. \$16.00. 1/2 mile reels (2,640 ft.) 80 lbs. \$9.00.

GR. II Unused, good condition. Mile reels, \$11.50. 1/2 mile \$6.50.

W-130 #22 gauge, New 2-conductor, copper-steel, plastic insulation wire, 10,560 ft. reels \$34.50. 3,500 ft. reels... \$16.00.

**EASY TO INSTALL TELEPHONES, RING AND TALK UP TO 20 MILES**

EE-8 Army Field Telephones, factory reconditioned—like new... per pair \$42.50.

EE-91 Field telephones, factory checked... per pair \$34.50.

ORDER BY AIRMAIL TO-DAY—it won't last at these prices—

Write for free folder—MANY LOW-COST PHONES FOR THIS SPECIAL SALE.

**AS LOW AS... \$11.50 Per Mi.**



Completed Popular Mechanics Ranch Type House and exact scale pictorial room and suggested furnishing layout. To right of dotted line is BASIC HOUSE. Expansion to the left. Designed for easy building in two convenient steps.



Basic house includes living room, dining area, two bedrooms, kitchen, bath, utility room and car port. Can be built for about \$5000.

More than 100,000 families have built their own homes in the past few years, doing all of the work, or most of it themselves. Right now, one of every five homes being built is at least partially owner-built. This proves that you too, if you can use hammer and saw, can build your own home and save more than one-half of the cost.



Add When You Need More Room



Build the Basic House First



When expanding you add garage and breezeway, and car port becomes third bedroom. About \$2500.

Get this Newest Popular Mechanics "Build-It-Yourself" Book and Building Plans and Save Many Thousands of Dollars

Book gives complete step by step instruction in simple language. Hundreds of pictures, actual photos and diagrams, showing every phase of construction, guide you from start to finish. Ten working size blueprints give floor plans, elevations, notes on construction, framing, lumber list, specifications, plumbing and wiring diagrams.

part of it. And at the same time, save in labor costs, more than he spends for material.

Order Book and Plans Now

Use the handy coupon below to order your copy of the RANCH-TYPE HOUSE BOOK AND PLANS. Read the book; study the plans and then you will be prepared to go right ahead when you are ready to build. Even if you have the house mainly built by others, you can still enjoy a tremendous savings by using the instructions and blueprints from Popular Mechanics.

Read How and See How — Simplified Instruction

You read "how-to-do-it" in the book. You see how it looks in actual pictures. You follow the plans for dimensions and details. You make use of labor-saving kinks and special methods developed especially for the project.

No Previous Building Experience Required

Any ordinary handy man, using only simple tools, can build this house with little or no assistance and enjoy every



Build this Popular Mechanics RANCH HOUSE Yourself! Save Over One-Half

Beat the High Cost of Home Owning It's Easier Than You Think

Here is a dream home that can become a reality without too much worry about money. Build this beautiful Ranch Type Home yourself. Simply follow the Popular Mechanics RANCH TYPE HOUSE BOOK AND PLANS. You can save \$7,000 to \$10,000 and have one of the most desired homes of these times. You can build it all now—or part of it—and add garage, breezeway and another bedroom later on without affecting the basic house.

Modern Design • Fully Finished • All-Season Build this Home Anywhere and Save

Designed for Popular Mechanics by John P. Whelan, famous West Coast architect and designer of homes and entire villages. It's a year round house, 81 feet long and 29 feet wide. Fully insulated. Finished outside and inside with durable plywood and requires no plastering. Brick "island wall" and big fireplace in living room. Heating, unique ventilating system and latest development in electric wiring included. A dream home that can easily come true and a home that can grow with the family.

Reduced size illustrations from book. Building roof truss on floor for easy construction. Mrs. Tom Riley, Portland, Oregon, shingles the roof on her Popular Mechanics Ranch Type House



Use This Handy Order Coupon

POPULAR MECHANICS PRESS

200 E. Ontario St., Chicago 11, Ill.

Send at once my copy of the Ranch-Type House Book and Plans as checked below:

- |  |  |
|--|--|
| <input type="checkbox"/> Remittance enclosed         | <input type="checkbox"/> Send C.O.D. (postage extra) |
| <input type="checkbox"/> Ranch Type House Book       | \$ 3.50  |
| <input type="checkbox"/> Set of 10 Blueprints        | 13.50  |
| <input type="checkbox"/> Book and Blueprints         | 15.00  |
| <input type="checkbox"/> Duplicate Set of Blueprints | 5.00   |

Name \_\_\_\_\_

Address \_\_\_\_\_

City \_\_\_\_\_ Zone \_\_\_\_\_ State \_\_\_\_\_



**JOB LOT TRADING 53 Vesey St. NYC**

**COMBINATION STETHOSCOPE**

GOVT. SURPLUS — NEVER USED  
High Chrome Finish



**\$2.95** Postpaid  
REGULARLY \$12.00

A professional instrument for detecting delicate mechanism defects.

SCIENTISTS  
ENGINEERS  
STUDENTS

13" Long

**"ARISTO" SLIDE RULE**



**\$6.95** Postpaid  
REG. \$16.00

**PATTERN OF SCALES**  
FACE: K, DF, CF, CIF, CI, C, D, L.  
BACK: LLO, A, B, S, T, C, LL3, LL2, LL1.  
Instruction Book Included

The divisions & figures are clear and well defined. Water resistant . . . Leatherette case included . . . The very finest precision instrument of its kind. Made by Dennert & Pape of Hamburg, Germany. No C.O.D.'s. Send Check or Money Order to Dept. PM 3



**TRANSFORMER WELDER \$19.95 FOR QUINCY**

Complete with everything. Ready to plug in. 110 volts AC. 15-30 Amps. 3 heats. Welds metal from 1/16" to 1/4" using 1/16" to 3/32" standard rods. Guaranteed unconditionally. 10-day trial. No C.O.D. Does everything welders costing up to \$75.00 do. Buy direct and save.

ESSAY MFG. CO., INC., Dept. 25, Quincy 69, Mass.



**SURPLUS SALE**

**\$39.50** NEW TOOL POST GRINDERS  
REGULAR PRICE \$125.00

1-6 H. P. MOTOR  
TAKES WHEELS UP TO 1 1/2" x 4"  
EXTRA QUIET EXTERNAL GR  
INTERNAL \$29.50

MONEY BACK GUARANTEE  
EDWARD J. NOLAN, PULASKI, NEW YORK

**NEW ILLUSTRATED AUTOMOBILE DICTIONARY**

A handsome 214-page manual on current models of foreign and domestic cars. Illustrates major parts and gives name of each in 5 languages — English, French, German, Italian and Spanish. \$9.50 postpaid. (Free descriptive circular on request.) Write Dept. 1PM, AUTOCESSORIES, LTD., Division of Arnolt Corporation, Warsaw, Indiana.

**FREE CRAFT CATALOG**



120 PAGES... Craft Supplies, Tools, Designs, Instruction Books from America's Largest, Most Complete Handcraft Stock.

Send for your free copy NOW!

GRIFFIN CRAFT SUPPLIES

5626-A Telegraph Ave • Oakland 9, Calif.

**KROIL LOOSENS RUSTY FROZEN PARTS**



12,000 industrial plants now use Kroil for emergencies like frozen bolts, pipe threads, bearings, etc. Kroil creeps into millionth inch spaces to dissolve rust and dried grease . . . guaranteed to loosen stuck-together metal parts or money back—gallon \$3.85 f.o.b. Factory or send \$1.50 for two 8 oz. spout cans postpaid.

**KAND LABS.**, 1032 Thompson Lane, NASHVILLE 11, TENN.

The New Model 770-A

The FIRST Pocket-Sized

**VOLT-OHM MILLIAMMETER**  
USING THE NEW "FULL-VIEW" METER

71% MORE SCALE AREA!!



Yes, although our new FULL-VIEW D'Arsonval type meter occupies exactly the same space used by the older standard 2 1/2" Meters, it provides 71% more scale area. As a result, all calibrations are printed in large easy-to-read type and for the first time it is now possible to obtain measurements instead of approximations on a popular priced pocket-sized V.O.M.

**Features:** Compact — measures 3 1/4" X 5 1/4" X 2 1/4". Uses "Full View" 2% accurate, 850 Microampere D'Arsonval type meter. Housed in round-cornered, molded case. Beautiful black etched panel. Depressed letters filled with permanent white, insures long-life even with constant use.

**Specifications:** 6 A.C. VOLTAGE RANGES: 0-15/30/150/300/1500/3000 Volts. 6 D.C. VOLTAGE RANGES: 0-7.5/15/75/150/750/1500 Volts. 2 RESISTANCE RANGES: 0-10,000 Ohms — 0-1 Megohm. 3 D.C. CURRENT RANGES: 0-15/150 Ma., 0-1.5 Amps. 3 DECIBEL RANGES: -6 db to + 18 db, + 14 db to + 38 db, + 34 db to + 58 db.

The Model 770-A comes complete with self-contained batteries, test leads and all operating instructions. . . . . **\$15.85**

**SOLD ON EASY PAYMENTS AT THE NET CASH PRICE**

MOSS ELECTRONIC DISTRIBUTING CO., INC.  
Dept. B-91, 3849 Tenth Ave., New York 34, N. Y.

Please rush 1 Model 770-A VOLT-OHM MILLIAMMETER. I am enclosing \$3.85 as down payment, and agree to pay balance at the rate of \$4.00 per month.

(No interest or carrying charges added.)

Name \_\_\_\_\_  
Address \_\_\_\_\_  
City \_\_\_\_\_ Zone \_\_\_\_\_ State \_\_\_\_\_

**PLANS! BEAUTIFY YOUR GARDEN**

3 Distinctive Lawn Chair Plans for ONLY \$1.25  
40" high Dutch Windmill Detailed Plan, ONLY \$7.95  
Send 10c for Illustrated Catalog.  
● DUTCH WINDMILLS  
● LIGHTHOUSES  
● LAWN CHAIRS  
● BIRD HOUSES  
● LAWN FIGURES  
CRAFTSMAN'S MODEL CO. Dept. P-60 DELAFIELD, WIS.

SAY YOU SAW IT IN POPULAR MECHANICS

**TRIPLE ELECTRODE LUTHY AERO SPARK PLUGS**  
with ALUMINUM OXIDE INSULATORS

Just what your car needs—for extra "zip and go" and lasting power. THREE TIMES LONGER LIFE.

Give better performance and last longer because of these features:

- 3 POINT ELECTRODES. Tapered points for hotter spark and 3 times longer life.
- "LUM-OX" INSULATORS. Used exclusively in the LUTHY AERO SPARK PLUG. First used in combat aircraft during World War II. Keep plugs cool by fast thermal conduction. Highly resistant to mechanical shock, too.
- CHROME PLATED. For resistance to rust.
- NO GAP SETTING NECESSARY. Every set perfectly engineered for your make and model at the factory.



Pat. App. For  
SET OF 6 \$5.34  
SET OF 7 \$7.12  
Postpaid

**LUTHY AERONAUTICAL SALES COMPANY**  
302-3 COOPER ST., JACKSON, MICH.  
CANADIAN ADDRESS: BOX 394, HAMILTON, ONTARIO

Send me a set of \_\_\_\_\_ plugs. Enclosed is \$ \_\_\_\_\_  
 Check here for C.O.D.  
Name \_\_\_\_\_  
Address \_\_\_\_\_  
Year of car \_\_\_\_\_ Make and Model \_\_\_\_\_



# WELD IT YOURSELF! IN A JIFFY!

**Weld, Cut, Braze, Solder  
IRON, STEEL, BRONZE, BRASS,  
ALUMINUM & OTHER METALS**

Tool and Equipment breakdowns are always annoying and costly. Don't let them bother you. Get a Dynamic Arc Welder. You can do expert work on your very first job. Welders operate from any properly wired 110 V. AC line. The handiest "tool" in your workshop. A Dynamic Welder will save its low cost of only \$38.50 F.O.B. in both time and money.

**DYNAMIC INDUSTRIAL type  
transformer Arc Welder  
75 amp. output for Industrial  
or Workshop use.**

**DYNAMIC  
WELDER CO.**

Dept. D2-A, 15 E. 23rd St.  
Chicago 16, Ill.



## EASY PAY PLAN

Low down pay-  
ment. Pay as you  
weld. Sold on  
money-back guar-  
antee. Send for  
details. Complete  
outfit only

**\$38.50**

f.o.b. factory

**Free Details and "How to Weld"**

## STEP UP PERFORMANCE OF YOUR OUTBOARD



**WRITE FOR OUTBOARDER'S BIBLE—**  
our 1954 catalog. It's FREE! Contains  
much valuable information on how  
to get MORE SPEED, for racing or  
pleasure, from motors of 7½ to 50  
HP; better performance and load car-  
rying capacity from any motor old or  
new. Easily understood recommendations enable  
you to choose a propeller virtually custom-built  
for your motor and boat combination—much more  
rugged and damage resistant than the original.  
Write NOW. Michigan Wheel Co., Dept. P-61  
Grand Rapids 3, Mich.

**AT ALL HARDWARE STORES**

**FULLER'S famous  
"FOUR-IN-ONE" Screwdriver**

- No. 2 Recessed for cross head screws;
- ¼" Diameter for fine work;
- 3/16" for electrical work;
- ½" Diameter for regular work;
- heavy aluminum chuck.

**UNBREAKABLE HANDLE  
HI-CARBON STEEL!**



**ONLY \$1 set**

**FULLER TOOL CO., Inc. 3522 Webster Ave., N. Y. 67**

Export Sales Dept., John H. Graham Co., 105 Duane St. • New York, U. S. A.

## Get Our Big "HARD-TO-GET" Items Manual of

For home craftsmen, wood workers, industrial art departments,  
furniture repair men, hobbyists, cabinet makers, etc.

A few of the items we sell: Inlays, fancy cabinet wood, lumber,  
Ebony, Holly, Dimension cut lumber, lignum vitae, Carving Blocks,  
Turning Squares, 120 kinds of veneers. Abrasive papers, archery  
woods, bill-board clamps, binswings, bed fasteners, blueprints,  
Chair braces, brass chain, brass fencing, Craftsmen books, candle-  
stick holders, candlestick sockets, card table hardware, casters, Chair  
cane, ceramic tiles, clamp nails, crib hardware, Dowels and dowel  
pins, dowel centers, drawer rollers, felt, Flok finishes, foam rubber,  
furniture clamps, complete professional finishing materials, Folding  
tablelegs, hand tools, furniture pulls, modern and period, chest  
and ornamental hardware, all types of hinges and locks, small box  
hardware, Inlaid picture kits, inlaid card table tops, leather working  
tools, Micarta, revolving Lazy Susans, musical movements, moulded  
wood carvings, Metalcraft material, Moto Sander, nut bowl hardware,  
Picture frame moldings, Free Cut Wood Fix, perforated steel panels,  
plaster standards, plastics and plexiglass, internal carving bits,  
plastic polishing compounds, Electric routers, sanders, foot rheo-  
stats, hand drills, sprayers, revolving fixtures for television tables,  
chairs, etc. Fibre rush, screw hole buttons, spiral saw blades, sliding  
door track, sharpening stones, home owners specialties, 109 woods,  
ski woods, platform rocker springs, Table leaf supports, tack rags,  
thermometer cards, turned furniture legs, typewriter fixtures. Com-  
plete upholstery supplies, Veneer presses, wood burning pens, wood  
working instructions, black and copper wrought iron hardware,  
zipper wire.

Send fifty cents today (refunded on 1st order) for your copy of the  
Country's leading Catalog, "Constantine Manual for Craftsmen" to:  
**ALBERT CONSTANTINE & SON, Inc., Dept. PM-19**  
797 East 135th St. New York 54, New York

# Now You Can Upholster Any Piece of Furniture!

## Upholster—Restyle Any Piece of Furniture Yourself

John Bergen, custom furniture  
designer, tells and shows you  
how to transform old out-of-  
date furniture into brand new  
smart-looking comfortable fur-  
niture in his new book **ALL  
ABOUT UPHOLSTERING.**

## No Experience Needed

Bergen tells you every step to  
follow in amazingly clear easy-  
to-understand step-by-step in-  
structions and then shows you  
how in hundreds of big, clear  
drawings and photos. You read  
and see how to strip the old  
frame, install new webbing and  
springs, apply burlap, install  
stuffing and padding, fit the  
muslin cover and the final fab-  
ric and install trim.

## Use New Materials—Methods

Now you can have furniture  
upholstered with foam rubber,  
sagless springs and other new  
materials that add so much to  
comfort and durability and are  
so costly when included in new  
furniture.

## Save 50% of Usual Cost

Don't pay a small fortune for  
new furniture when you can  
make your old furniture better  
than new! Why pay high prices  
to have someone else upholster  
and restyle your old furniture  
when you can do it yourself for  
cost of materials alone? It's  
easy and it's fun.

## Special Chapter on Slipcovers

Learn how to make custom-  
made slipcovers with profes-  
sional look and fit. Find out  
how you can realize tremen-  
dous savings by investing a  
few spare-time hours and the  
cost of a few yards of fabrics.

## 7-Day Money Back Guarantee

Send for your copy of **ALL  
ABOUT UPHOLSTERING** to-  
day. Read and use it for 7 days.  
If it isn't entirely satisfactory  
return it for a full refund.



## USE THIS HANDY ORDER COUPON

**POPULAR MECHANICS PRESS, Dept. AAU  
200 E. Ontario St., Chicago 11, Illinois**

Gentlemen:

Please send my copy of **ALL ABOUT UPHOLSTERING.**  
Enclosed is my remittance of \$3.50. If I am not com-  
pletely satisfied with the book I will return it for a  
full refund after 7 days.

Name \_\_\_\_\_

Address \_\_\_\_\_

City \_\_\_\_\_

Zone \_\_\_\_\_ State \_\_\_\_\_



## BARRON Drill Press TOOLS



### ROTARY PLANER

Planes • Rabbits  
Tenons • Panels  
Routs • Bevels

Only \$8.50 COMPLETE

FOR WORKSHOP AND INDUSTRIAL USES...

Over 40 precision built woodworking tools and accessories... Hi-Speed Router Bits—Rotary Surface Sanders & Drum Sanders—Safety Shaper Cutters—Dovetail Cutters—Large Auxiliary Metal Tables—All Metal Shaper Fences—Spindle Adapters—Handy Bench Vises. Many other items indispensable for accurate, useful, versatile workshop use. Every tool sold on complete satisfaction or your money back. See your Barron Dealer. Ask for special folder — "24 Extra Uses for Your Drill Press."

FREE Workshop Guide & Catalog

BARRON TOOL CO. INC.  
364 Architects Bldg., Detroit 1, Mich.



Dealers or Representatives Needed for nationally advertised line of Spark Plugs — Oil Filters — Auto Specialties — Liberal Proposition — Full or Part Time — Experience Not Necessary — Write Today

ENGINE PRODUCTS MFG. CO.

5801 E. Beverly Blvd., Dept. 118, Los Angeles 22, Calif.

WAR SURPLUS

BARGAINS galore for workshop, farm and home. Pumps, Power Tools, Hydraulics, Magnet Wire, Gauges, Meters, Mechanical Books, Portable Welders and Welding Supplies. MONEY BACK GUARANTEE. Send for FREE CATALOG today.

LEJAY CO.: 247 LeJay Bldg., Minneapolis, Minnesota

## ONE-MAN SAWMILL LOW \$50.00 DOWN AS...



Take BELSAW Portable Sawmill right to the trees—turn out valuable lumber for home and farm—sell to local yards—make up to \$50 a day custom sawing for neighbors. BELSAW lasts a lifetime. No crew needed. Power with tractor or auto engine. Beginners get excellent results. Send today for FREE BOOK, "HOW TO MAKE LUMBER".

BELSAW MACHINERY CO.  
1118 Field Bldg. Kansas City 11, Missouri



\$2.95 OR 2 FOR \$5.00!

TESTED AND GUARANTEED  
Write for free list on all types of telephones. Shipments F.O.B.

TELEPHONE ENGINEERING CO.  
Dept. B-2 Simpson, Pa.

Do a Real Professional-Like Job Yourself and SAVE

## HOW to PAINT With Brush and Spray

Covers All Painting Methods and Materials

You can do professional-like painting and finishing jobs yourself and save about two-thirds of the cost. Sam Brown, noted craft authority, makes it so easy for you in his book, HOW TO PAINT WITH BRUSH AND SPRAY. Order your copy now and enjoy this tremendous saving. It covers exterior painting, wall and interior decorating, furniture finishing, concrete painting — every type of painting with brush, spray gun, roller and other methods. Tells what finish is best; what materials to use, etc. No previous experience needed. Fully illustrated. Order by mail. Only \$2.50. Money back if not pleased.

POPULAR MECHANICS PRESS, Dept. PM18  
200 E. ONTARIO ST., CHICAGO 11, ILL.



41 NEW MODELS for 1954

## Custom-Craft BOAT KITS

RATED "TOPS" BY THE EXPERTS in DESIGN, STYLING, PERFORMANCE

See the World's finest, most complete line before you decide! 41 exciting new models for '54; Dinghies, Skiffs, Inboards, Outboards, Cruisers plus the only Pontoon or "class" Racers available anywhere. Priced from \$49 up. You get more with Custom-Craft. MORE exclusive features, MORE beam and depth, precision pre-cut solid mahogany parts plus brass screws on all models. They're easier to assemble, too! See Custom-Craft before you buy!

SEND 25¢ for BIG, NEW 1954 KIT CATALOG

1954 Catalog PLUS booklet "Boat Selection, Operation & Maintenance" \$1.00. (Refundable)

DEALER INQUIRIES INVITED



## World's Finest Designs Modern BOAT PLANS

With FULL-SIZE PAPER PATTERNS EASIER TO BUILD, SAVES TIME, MONEY

Over 150 modern plans and patterns with material lists and building procedure. Racing classes, cruisers, inboards, outboards, sailboats, 6 to 36 ft. All materials, fittings, etc. available at "Package" prices. Big savings! Design Catalog tells all!

SEND 35¢ for 1954 DESIGN CATALOG

Design Catalog PLUS boat building handbook, \$1.00

## ARMOR-GLASS CUSTOM-CRAFT'S NEW SUPER XXX FIBREGLASS

You've read about this remarkable product everywhere. Makes hulls watertight permanently, stops leaks, adds terrific strength to the hull. Eliminates annual painting forever.

SEND 10¢ for Literature and "How-to-measure and Order Form", or send \$1.00 for valuable booklet describing, showing and explaining how to use Armor-Glass for boats, auto bodies and dozens of other ideas. Tells all, shows all!

CUSTOM-CRAFT • DEPT. 7 • BUFFALO 7, N. Y.

Our 663rd Advertisement

## REAL DIESEL ENGINE

\$3.95 • for planes, boats, midget cars • 7500 RPM; 1/7 HP; hL 3 1/2"; wt. 5 oz. • precision machined for smooth operation

You just can't beat this price for a precision diesel engine! Streamlined, compact, easy to install. Thousands of satisfied users all over the world. Fast delivery if you ORDER TODAY! Send \$3.95 plus 25c postage.

GOTHAM HOBBY CORP. Dept. P, 107 E. 126th St. New York 35, N. Y.



## The SPEEDY STITCHER

Sews quick and strong, making new or repairing all sorts of leather and canvas articles — boots, shoes, coats, gloves, belts, saddles, golf bags, ski, football, Baseball, Skating, Hunting, Fishing, Camping bags, grain bags, burlap, etc.



Each stitcher comes ready to use with a reel of waxed thread and 3 needles, assorted sizes. Needles are carried in handle. A handy tool for home or on hunting, fishing or camping trips.

Price Postage prepaid \$1.00.  
LYMAN BRADFORD CO.  
Box No. 201 KINGSTON, MASS.



## SAVE MIDDLEMAN'S PROFITS ...buy DIRECT from C&H

### LIGHT PLANTS



1000-1200 w AC, 115 v, 60 cyc. Powered by rugged 2 1/2 hp easy-starting Continental gas engine. No wiring. Just plug in, ready to go. Complete with 12 v starting winding. Easily connected for push-button battery starting. Fully guaranteed, easily worth \$325. Your Factory Price only \$194. Other bargain price models in stock, 300, 1500, 2500, 5000 w etc. SEND FOR FREE BOOKLET WITH VITAL FACTS ON HOW TO SELECT PROPER SIZE FOR YOUR JOB.

### BOOSTER FANS



Fit any 8" to 12" furnace pipe. Mounting frame, 7" blade, 110v motor, 80 cyc, 1550 rpm with 6' cord. Silent operation. Easy to install. Warm those rooms with long runs. List \$11.95. Our price . . . \$6.95; two for \$11.95; three for \$14.95. Buy one for each room! REGISTER FAN for hot or cold air with bracket ready to mount: motor, 7" blade, 6' cord ONLY . . . \$7.50; two for \$12.95; three for \$16.95.

Here are only a few big \$\$\$ savings! More in our catalog!

Air Compressor	Electric Motors	Hand Truck	Rubber Cable
Air Tank	Electric Switches	Hydraulic Cylinder	Rubber Wheels
Block & Tackle	Elevator	Hydraulic Saw Tables	Shower Sprays
Blowers	Drawing	Hydraulic Stackers	Starters
Bomb Trailer	Elevator Incline	1 Beam Trolley	Tools
Buzz Saw	Fans, Exhaust	Lawn Mower	Transformers
Compressor	Fans, Heat	Sulky	Whiting Hoist
Accessories	Booster	Magnetic Starter	Wilton Vise
Clutches	Gas Engines	Mail Chain Saw	Winch, Electric
Conveyors	Generators	Mail Grinder	Winch, Hand
Delta Tools	Grinders	Pumps	Fire Extinguisher
Drop Cords	1/2 Ton Wagon	Reduction Gear	4 Wheel Trailer
Electric Hoists	Hale Fire Pump		

Get this catalog! 72 pages packed with useful charts, information, more than 1100 tool and equipment items at money-saving, factory-to-you prices. Send 25c (refund with first order) or write on company letterhead for free copy.

## C&H ELECTRIC MACHINE Co. Inc.

434-B W. Juneau Ave., Milwaukee 3, Wisconsin

### HI PRESSURE STEEL TANKS

Ideal for Air Compressors, Liquids, Gases, Hydraulics, etc.



NEW steel air tanks, rated 500 lbs. per square inch pressure, 1/4" pipe thread openings on each end.

ACCESSORY KIT includes: 500 lb. air gauge, 1/4" safety valve, 18" flexible tubing with fittings, 4-way cross, 3 nipples, tire chuck, and 20 ft. 2 ply air hose with fittings.

Tank Only	With Accessory Kit
12"x24", wt. 18 lb. . . . . \$11.50	22 lb. . . . . \$17.95
6"x45", wt. 10 lb. . . . . \$ 8.50	14 lb. . . . . \$14.95
6"x24", wt. 5 lb. . . . . \$ 4.50	9 lb. . . . . \$10.95

H1—High Pressure Cylinder, 2"x9", 3,000 lb. test with stainless steel release valve and 3,000 lb. gauge, wt. 3 lbs. . . \$5.50

Special Prices in Lots of 100, 500, 1000!

Send Check or Money Order Today! Shipment same day. Money Back Guarantee. F.O.B. Burlington, Wis.

A. C. TANK CO., Box 389, BURLINGTON, WIS.

## FREE BOOK CATALOG

Everything—shop tools, hunting, fishing, making money at home, concrete work, welding, mail order, plastics, painting, carpentry, photography, boat building, gardening, auto repair, hobbies, home building—is listed in the new 40-page 1953 catalog of easy-to-understand Popular Mechanics books. Write for your free copy now! Dept. CT2.

Popular Mechanics Press, 200 E. Ontario, Chicago 11



**D.C. WELDER**  
REGULAR VALUE \$350.00  
BUY WHOLESALE \$85.00

Special Price Only \$85.00 f.a.b.

PAYS FOR ITSELF IMMEDIATELY

BRAND NEW! BELT DRIVEN! Ideal for field use where electricity isn't available. 1,001 uses for farm, shop, factory. Operates at 3000 RPM off any tractor, engine, etc. WELDS,

CUTS, BRAZES tractor frames to light sheet metal. COMPARE FEATURES. Straight or reverse polarity. Reactor-type series winding for EVEN arc. Rheostat for pin-point heat control. Over-size ball bearings. 2-Groove V pulley.

ACCESSORIES AT A BUY! Two 15-ft. cables. Ground Clamps. 300 amp. electrode holder. Arc't electrodes. Helmet. Simplified instructions. COMPLETE GIFT (ship. wt. 95 lbs.) only \$99.50 f.o.b. FULL 1-YEAR GUARANTEE. You can't go wrong. Send for our

**FREE LIMITED OFFER! 10-DAY FREE TRIAL!**

Use it for 10 days. Be 100% satisfied or money back!

... CATALOG of Welders, Motors, Electrical BUYS!

ROBERTS ELECTRIC CO., Dept. 130, 849 W. Grand, Chicago 22, Ill.

## Save on all PLUMBING JOBS

When You Build · When Making Improvements · Repairs · Maintenance

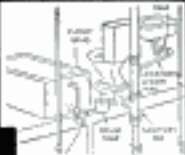

How to plan plumbing installations, select materials and fixtures.

Get POPULAR MECHANICS Home Plumbing Guide



How to save money on all plumbing jobs using approved methods.

Easy to Do Professional-Like Jobs and Save Over One-Half

### 15 Ways to Save Money

- All about modern home plumbing
- How to use plumbing tools
- Getting acquainted with pipe
- Planning home plumbing systems
- Installing and maintaining home drainage systems
- Private sewage disposal systems
- Causes and cures of drainage troubles
- Installing home water lines
- Private water supply systems
- Water Heaters
- Water Conditioning
- Water system troubles and cures
- Installing and caring for fixtures
- What to do with valves and faucets

Over 500 How-to-do-it Pictures Guide You



Get the Popular Mechanics HOME PLUMBING GUIDE. It shows how you can do every kind of plumbing job yourself and save from a few to hundreds of dollars. Covers plans, layouts, installation, maintenance and repair. Shows what materials to get and use, where to get them and how to do a proper job with approved methods. Few, other than the simplest tools are required and some of these can be rented. Don't pay high prices for work you can do yourself. Get the HOME PLUMBING GUIDE for only \$3.50. You will be amazed how jobs you thought difficult are simplified.

Clip This Ad and Mail. Money Back if Not Pleased

Invest only \$3.50. Use the book for 7 days. Then if you are not satisfied return it for full refund of your money. Sent C.O.D. (U.S.A. only) if you prefer.

POPULAR MECHANICS PRESS, Dept. HPG-10, 200 E. Ontario St., Chicago 11

SAY YOU SAW IT IN POPULAR MECHANICS

## OWN A... FORD?

### FIX IT YOURSELF!

Popular Mechanics Magazine has just published a new Owners Manual covering all 1941 to 1952 models of Ford cars . . . So accurate mechanics use it . . . so simple a woman can understand it.



Save money on your Ford car repairs. Prevent trouble. Enjoy care-free driving. Increase trade-in value. Avoid major repairs by fixing minor troubles before they get serious. Get sparkling performance at all times. Has 272 pages, more than 350 photos, diagrams, tables, charts, breakdown drawings, plus clear, non-technical directions that make all repairs simple as A B C. Written by Ed Packer with the assistance of the Ford Motor Company. Shows you how to diagnose all Ford troubles by feel, sound, sight, smell and performance. Simple trouble shooting. Permanent repairs. Emergency repairs. Plus, "How to get value from garages."

### MONEY BACK IF IT DOESN'T SAVE MORE THAN IT COSTS!

One minor repair will save the cost ten times over. Read it. Then you decide. If you don't see that you'll save more than the cost, send it back for refund. SEND NO MONEY. Send postcard. Ask for the Ford Manual. Postman will deliver C.O.D. for \$3.50 plus postage. Or, save postage by sending \$3.50 with order. Send today. Save its cost on your next repair.

POPULAR MECHANICS PRESS  
200 E. Ontario, Dept. 90, Chicago 11, Illinois



# EVERY ELECTRIC DRILL A PORTABLE JIG SAW & CIRCULAR SAW!

THESE TWO AMAZING SAWS HAVE THE SAME FEATURES, DO THE SAME WORK AS OTHER SAWS COSTING \$50 & UP!

ARCO SAW

No. 455  
"ARCO-SAW"  
\$12.50  
with Blade.

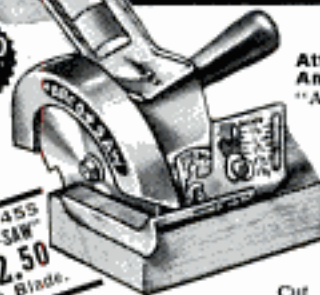

## "ARCO-SAW"

Attaches in One Minute to Any 1/4" Electric Drill.

"ARCO-SAW," the only saw attachment to whiz thru 2x4's in one cut, cuts 8-times faster than handsawing. Just tighten Safety-Yoke & Clamp around drill and run this powerful saw with one hand. Build anything from a bookcase to a bungalow!

Cut any depth up to 1 3/4" with Depth Gage. Cut any angle with Bevel Gage. Follow a line with Rip Gage or Visual Guide.

New 5" Safcut Blade zips thru heavy lumber. You'll find "ARCO-SAW" with its tough steel gears practically indestructible.

BLADES—5" Safcut, Rip, Crossover, or Combination. \$1.75

## "ARCO JIG-SAW"

Does work of Jig, Keyhole, Coping, Rip, Band and Hacksaw!

EXCLUSIVE AIR-JET BLOWS AWAY SAWDUST.

Here for the first time is a Portable Jig Saw that attaches in 1 minute to any 1/4" drill. Cuts intricate patterns, circles—no matter how large—in plywood, wallboard, plastics, metals—even lumber up to 2x4's! Cuts openings without boring starting hole.

Right Angle Drive makes "ARCO JIG-SAW" easy to handle. Safety Yoke & Clamp give you a vibration-free unit. Wide Shoe-Plate. Converts to Table Model with No. 401 "ARCO STAND"—Sturdy casting with clamp. . . . \$2.75

No. 505—Six extra Blades for wood, metals, plastics, etc. . . . \$1.95



AT BETTER HARDWARE STORES EVERYWHERE

No. 500  
"ARCO JIG-SAW"  
\$10.95  
complete with blade.

90-DAY FACTORY GUARANTEE.

DEALERS Write for nearest jobber.

BUY THE BEST—see your hardware dealer now! If not available, try "ARCO" Tools on our 10-DAY MONEY BACK GUARANTEE. Send us check or M.O. (Postpaid). C.O.D.'s—postage extra.

ARROW METAL PRODUCTS CO.

Dept. PM-1, 140 WEST BROADWAY, NEW YORK 13, N. Y.

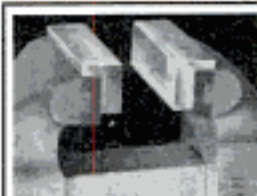

## BENCH VISE SOFT JAWS NEW! PLASTIC! MAGNETIC!

Adapt your bench vise for all-around service with a set of "SOF-JAWS". They slip on or off in a jiffy. "SOF-JAWS" protect the surfaces of wood, metal or plastic objects; insulate objects carrying electric current from contact with the vise. Made of malleable plastic that won't chip or crack; forms to irregularly shaped objects, but quickly returns to original shape. Deeply embedded permanent "ALNICO" magnets hold the "SOF-JAWS" securely on the vise jaws. \$2.50 per set. Satisfaction guaranteed. Send check or M.O.

SOF-JAW CO., 16890 Garfield Ave., Detroit 19, Michigan

Make Money Selling Eshelman Power Mowers Riding Tractors & Rotary Tillers

RAKES  
PLOW  
CULTIVATES  
HARROWS  
HAULS  
SPRAYS  
SAWS  
DOZER  
MOWS  
CUTS  
ROLLS  
TILLS  
SNOW PLOW

ESHELMAN FOR Better LAWNS And GARDENS



Women Can Operate It. Free Catalog. Write

ESHELMAN Dept. 51  
119 Light St.,  
Baltimore, Md.  
333 N. Michigan Ave.,  
Chicago - 1, Ill.  
7070 Hollywood Blvd.,  
Los Angeles 28, Cal.

3.50 8 H.P.  
WALKING TRACTORS  
Low as \$69

## MILLING MACHINE VISE



Heavy duty Milling Machine Vise. Swivel Base, graduated 0-90° Left and Right. Dimensions overall height 3 1/2". Jaws 1 1/2" x 1 1/2" wide, open 3", furnished with crank Handle. Small but mighty. Can be used on bench type machines, as well as larger sizes. Keyway in base fitted with keys. Shipping weight 27 lbs. Steel replaceable jaws, machined acme threaded operating screw.

MULTIPLEX MFG. CO., Berwick, Penna.

Say You Saw It in Popular Mechanics



## TRU-PERIMETER HEATING

The leading hot water baseboard heating. For new homes or old. Folder on request to Dept. PM1, Warren Webster and Company, Camden 5, N. J.

**Webster**  
TRU-PERIMETER FORCED HOT WATER  
BASEBOARD HEATING

JANUARY 1954

## WAR SURPLUS AND OTHER BARGAINS SAVE UP TO 90%

### LOW VOLTAGE CIRCUIT TESTER

Made for U.S. Ordinance to rigid specification. Portable steel carrying unit, self-contained trouble shooting device makes complete & rapid check of generator battery circuit incl. any circuit & voltage regulators. Battery voltage, regulators, cut-out settings & generator performance easily determined. Any 6 or 12 volt system. Great for garages, mechanics, truck fleet owners, boat & marine mechanics. Every set checked out in our lab & in perfect condition. Shpg. Wt. 20 lbs. Approx. GOVT COST \$175. NEW. Complete with instruction book.

Anniversary Special . . . \$29.75 . . . WHILE THEY LAST!



### GEAR HEAD MOTOR

Use to turn antenna, open or close doors and windows, barbecue, displays, etc. Approx. 1 RPM. Set for 140° turning with limit switches that can be removed for full 360° turning. Operates on 24 Volt DC, 1/2" shaft dia 3" wide, 10" long. Wt. 4 lbs. High speed 7000 RPM. 1/10 HP motor, micro-switches, reduction gears, mounting brackets—a bonanza for hobbyists. Approx. GOVT. Cost. \$90. In perfect condition, now just \$3.50. Mfd. by Barber-Colman Company

MICROMETERS Chrome plated, precision engineered, carefully toolled to give long life. All new 0-1" cap. \$2.25 ea., 1-2" cap. \$3.50.

### NEW IMPROVED MODEL MAUSER-TYPE PRECISION 1/1000" VERNIER CALIPERS

Quick, handy, accurate. 6" Vernier Calipers. Glass hardened, lapped measuring surfaces. Fine engraved scales—1/1000" and 1/10 mm for inside, outside & depth measurements. Friction thumb release. Larger capacity. Two giv adjustments. Reg. \$25. Anniversary Special only \$6.95. Leather case \$1 extra.

SENSITIVE ALTIMETER IN 10 FT. INCREMENTS 0 to 35,000 ft. (inches of Mercury). Tested and inspected in our own instrument lab. Guaranteed perfect. Ready to install. \$12.95.



### D. C. GENERATORS—\$14.95

The generators listed below will weld plate steel or better. They all can be used as a combination welder and light plant. Generators (like NEW). Pl. Perfect. 200 Amps. 28 Volts. 2500 to 4500 RPM. Wt. 53 lbs. Approx GOVT Cost \$350.—\$14.95. Electric Auto-Life. 200 AMP. 24 Volt. 2500 RPM. Makes a handy arc welder. Wt. 53 lbs. Approx GOVT Cost \$450. NEW \$20.

R1 Jack & Heintz. Rated 300 Amps, 30 Volts. Wt. 60 lbs. Approx GOVT Cost \$450. Guaranteed perfect. \$23.50

MAKE YOUR OWN ARC WELDER Complete make-up package consisting of one NEW Auto-Life Pl. Generator, one giant toggle switch, one voltage regulator and a wiring diagram chart showing conversion of Aircraft Generator to Arc Welder. Special — WHILE THEY LAST— \$29.50

Send 25¢ for big catalog. Bargains for everyone. Check, Money Order or Cash. 25% deposit on C.O.D. orders. Prices F.O.B. Culver City, Calif., Unless otherwise stated.

AIRBORNE SALES CO., INC., Dept. PM154  
8501 Stellar Dr., Culver City, Cal.



## SURPLUS TOOL SAVINGS!

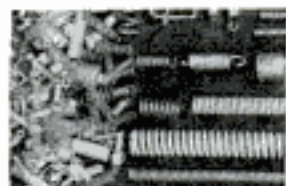

Assorted **5 Lbs. \$2.98**

All types included, large and small, in lengths from 3/4" to 6". All in original condition. Many uses in shop, office or home. Shipped postpaid. Order No. 1 B.

Heavy Duty 60:1 GEAR BOX



List Price \$46.50  
**\$4.98**

Bronze worm gear drive, sealed in grease—never needs oiling. Double end 1/2" input shaft, 1/2" output shaft. Precision built—hundreds of uses. Shipped postpaid. Order No. 3 B.

JOBBER'S LENGTH DRILL SET

in Huit Index Case **\$9.50**

Brand new—complete set of 29 drills from 1/16" to 1/2" in Huit indexed metal case with folding index drill holders. Shipped from stock, postpaid. Order No. 2 B. SET WITHOUT INDEX CASE... **\$7.49** Order No. 2 BW.



1 TON WINCH with CABLE

Originally \$125—Our Price Only **\$9.95**

Just purchased from U. S. Gov't. Ratchet type on heavy steel base for easy mounting. Power enough to lift a ton or more. Manual or automatic lock—Independent stop. 16 feet 3/8" cable. For shops, garages, boat docks, trucks, etc. P.O.B. Detroit—Order No. 4 B.



RESINOID BOND GRINDING WHEELS

Save 85%! The perfect wheel for welders, machine shops, hobbyists—works fast. New, shipped immediately postpaid. 8" diameter, 3/8" bore. Order No. 5 B.



1 1/4" Thick... **\$1.10** 3/4" Thick... **\$1.20** 1/2" Thick... **\$1.35**

Write for Our Free Catalog

ORDER BY NUMBER FROM **T&T TOOL CO.** 7667 GRAND RIVER DETROIT 4, MICH.

NEW 1954

# Do-It-Yourself LUMBER CATALOG



FEATURING AMERICA'S FINEST FURNITURE AND CABINET LUMBER FOR THE HOME SHOP CRAFTSMAN

Now you can buy your "Do-It-Yourself" Lumber in small quantity orders of \$20 or more. Send for new 32-page, net price catalog which contains detailed information on 16 species of Furniture Lumber, Plywood, Dowels, Turning Squares, etc., as used by the home craftsman.

● For complete catalog, send 15c to cover handling and mailing costs. Mimeographed Price List sent free.

**HARDWOOD CORPORATION OF AMERICA**

E. L. DIVISION  
Box 1091, Dept. M  
Asheville, N. C.

I enclose 15c for "Do-It-Yourself" lumber catalog.

Name \_\_\_\_\_  
Address \_\_\_\_\_  
City \_\_\_\_\_ Zone \_\_\_\_\_ State \_\_\_\_\_

## DO MORE PLANING JOBS WITH LOW COST BELSAW

Exclusive MONEY-MAKING features:

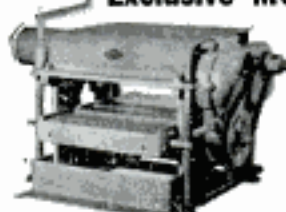

- Full 12 3/4 in. x 6 in. capacity
- Power feeds at 24 ft. a minute. (Easily adjusted for lower feed rate)
- Machined cast iron bed; adjustable rolls, total bed length 42 in.
- Provides for Grinding Knives in the Cutterhead.
- Attachments for Jointing, Rabbeting, Tongue, Groove, Matching.

Belsaw Multi-Duty Planer for cabinet shops, builders, lumber yards, woodworking plants and spare time work shops... Now you can convert low cost rough and random size lumber into high priced cabinet finished stock... Easy to make flooring and popular patterns. Belsaw quickly returns cost with savings on raw material... profits on finished stock.

Send Today for FREE literature on Belsaw, the LOW COST, high speed production planer.

**BELSAW MACHINERY CO**

1010 Field Bldg.

• Kansas City 11, Missouri

LOW DOWN PAYMENT EASY TERMS

## STOP RADIO & TV NOISES INSTANTLY!

NEW ELECTRONIC DESIGN

Bell-Tronic line filter eliminates noisy interference caused by motor appliances, autos, oil burners, etc. Simply plug radio or TV cord into filter and filter into wall socket. Send \$1. Add 25c for P.P. & Handling. No C.O.D. Try 5 days. Money back guarantee.

**\$1.00**



TUBE WHOLESALERS CO.

Box 364, Dept. PM3, Rockville Centre, N. Y.



MAKE YOUR OWN FOUNTAINS, LAKES, RIVERS, WINDOW DISPLAYS

With New Miniature Water Pump Here's real action for window displays, Xmas tree layouts, or the home lab. Pump only 4 3/4" high—3 1/4" wide. Threaded for pipe, or uses 3/8" rubber tubing. 110 A.C. 60 Cycle. 1/250 H.P. Furnished completely ready to work—your satisfaction absolutely guaranteed or your money back. ppd. **\$9.95** MOORE MANUFACTURING COMPANY Swedesborg 15, N. J.

WORLD'S BEST SMALL TRENCHERS



Portable DITCH-WITCH digs 2" to 6" clean, even ditches to 36" depth in all types of soil. Complete unit—self propelled—outdigs 8 men. Four rugged models.

Write for illustrated literature. THE CHARLES MACHINE WORKS 620 B Street Perry, Oklahoma

## Say You Saw It in POPULAR MECHANICS

What Every Farmer Should Know About Taking Care of Farm Animals



The Most Popular Veterinary Guide Ever Printed

This practical and helpful VETERINARY GUIDE FOR FARMERS prepares the farmer to perform many routine veterinary tasks—provides quick information that can often save the life of an animal—prevents disease in herds—saves money on the farm in a hundred different ways.

Written in plain understandable language. It covers symptoms, causes of disease and prevention, and treatment of cattle, swine, sheep, horses and poultry and warns when to call in the professional veterinarian. Names, terms and phrases made clear in a separate section. Over 100,000 copies of this book are in use on American farms. 275 pages. Fully illustrated. Only \$3.95. Order today under money-back guarantee.

POPULAR MECHANICS PRESS, Dept. PM13  
200 E. Ontario St. Chicago 11, Ill.

POPULAR MECHANICS



# ASSEMBLE IT YOURSELF — SAVE MONEY!

## Automatic COMPRESSOR UNIT With 22 Gallon Tank

Unusual value compressor, assemble it yourself and save \$35.55. Heavy duty compressor with outstanding features: 1/2 hp. heavy duty capacitor motor, 110 volt, A.C. 2" bore, 1 3/4" stroke, 125 lbs. pressure capacity, 2.8 cu. ft. Stainless steel valves, 3 piston rings, aluminum piston, brass valve retainers. Comes complete with rubber tired wheels, 10 ft. cord and plug, 20 ft. non-corrosive air hose, tire chuck, air intake filter, dustproof crankcase. Positive lubrication, balanced crankshaft, fan-cooled pulley, automatic pressure switch, safety valve and check valve. Simple instructions included for assembling. Assemble it yourself and save. Ship. weight 150 lbs. NOTHING EXTRA TO BUY.

Regular  
\$175 value

Shipped  
Unassembled  
**\$72<sup>95</sup>**

Shipped  
Assembled  
**\$98.50**

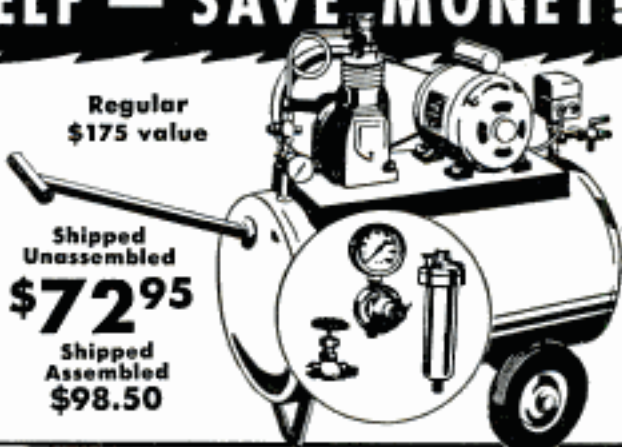

BRAND NEW



## Regular \$135 value PORTABLE SPRAY OUTFIT WITH 1/3 H.P. HEAVY DUTY MOTOR

Outstanding value. Professional type paint sprayer mounted on 7 1/2 in. by 25 in. tank. 1/3 h.p. 110V AC motor, 10 foot cord with plug, V belt drive. Heavy duty piston type compressor with 2 compression rings, 1 oil ring, 2 in. bore, 1 3/4" stroke. Displacement 2.86 c.f.m. at 60 lbs. pressure. Complete with safety valve, internal atomizing gun with fan, round and angle spray nozzles, quart cup, 35 to 40 lb. working pressure automatically maintained. Oil and water extractor, 20 ft. non-corrode hose, leakproof fittings, carrying handle. Assemble it yourself and save \$20. Instructions for easy assembling included. Wt. 90 lbs. NOTHING EXTRA TO BUY.

Shipped  
Unassembled  
**\$47<sup>95</sup>**

Shipped  
Assembled  
**\$67.50**

### FREE CATALOG

Send for free catalog of compressors, paint sprayers, light plants, motors and many other money saving items. Tanks of all sizes, stainless and carbon steel.

Prices F.O.B. Chicago. Order from this ad. On Money Back Guarantee. Send check or money order.

## WELLWORTH TRADING CO.

1832 S. Wabash Avenue, Dept. D-154, Chicago 16, Ill.



**Assemble Your Own DIVING LUNG**  
We furnish the parts and instructions. Complete outfits \$39.95 and \$49.95. Write for descriptive literature.

**Assemble Your Own Portable EMERGENCY OXYGEN OUTFIT**  
Complete parts and instructions furnished. Outfits from as low as \$9.50 up to \$59.50. Write for literature.

• Air & Oxygen Tank. For Diving Lungs, etc. 205 cu. in. capacity. 1800 psi. Hydro. tested, current dating. ICC-3A1800. Reconditioned. Wt. 12 3/4 lb. F.O.B. St. L. \$10.95

Ed. Aguado Trdg. Co., Dept. B, Box 4525 Plaza Sta., St. Louis, Mo.

**FREE Catalog!**  
Underwater swimming equipment. Write today!

### PROTECT YOUR WORK FROM VISE TEETH MARKS

Our smooth aluminum plates attach easily to vise-jaws with patented spring clamps and hold work firmly. Uncond. Guar. Available in four popular vise-jaw lengths: 2 1/2", 3", 3 1/2", 4".

**Robbins Mfg. Co.**  
1240 So. Prairie Ave.  
Hawthorne, Calif.

**\$2.<sup>95</sup> PER PAIR**



### TOOLS AT FACTORY PRICES

Save up to half on Fully Guaranteed New Tools

1/2" Square Drive Universal Socket, Hot Forged, Chrome Plated, Spring Loaded	<b>\$1.15</b>
Set of 7 sizes: 1/4" to 1 1/2"	<b>\$8.50</b>

**MATCHED SETS**

1/2" Drive: 12 sockets, 3/16" to 3/8"; T-handle, flexhandle, 2 extensions, steel box.	<b>\$5.00</b>
3/4" Drive: 8 sockets, 1/4" to 3/4"; reversible ratchet, flexhandle, speeder, universal joint, 4 extensions, steel box.	<b>\$12.00</b>
1/2" Drive: 11 sockets, 3/8" to 1 1/2"; reversible ratchet, flexhandle, speeder, universal joint, extension, steel box.	<b>\$15.00</b>
3/4" Drive: 16 sockets, 1/4" to 2"; reversible ratchet, flexhandle, T-bar, 2 extensions, steel box.	<b>\$40.00</b>

56-page catalog free with order, or send 10c for catalog only. Send money-order, check or currency to —

### MECHANICS TOOL CLUB

5319 HORTON STREET  
OAKLAND 8, CALIF.

## At Last! A PORTABLE Motor-Welder



**Motor-Weld Model 1A**  
—Recommended for Hobby and Home work. Comes as illustrated above. Plugs into any 110 Volt AC or DC Line. Amperage Output is 50 to 70 Amps. Size: 11" deep, 4 1/2" high, 13" wide. Shipping Weight 45 lbs. Price F.O.B. Chicago, Ill. Less Accessories \$49.95. Complete with Accessories \$54.75. Fast Battery Charger Attachment \$5.00 Extra.



**Porto-Weld Model 2A**  
—Amperage Output: 50 to 140 Amps. Input: 110-220V AC or DC. Line Draw: 24 Amps. on Each of Two 110V Circuits or 24 Amps. on a 220V Single or 3 Phase Line. Straight or Reverse Polarity. 5 Welding Heats. Size: 12 1/2" x 18 1/2" x 15". Shipping Weight 56 lbs. Price F.O.B. Chicago, Ill. Less Accessories... \$85.00. Complete with Accessories \$98.00. Fast Battery Charger Attachment \$5.00 Extra. \*Accessories include—300 Amp. Electrode Holder, Helmet, Ground Clamp, Sander, Buffer, Sample Electrodes, V-Pulley, 8" Welding & Ground Cables, and Instruction Booklet.

**9 TOOLS IN 1**

- ✓ WELDS
- ✓ BRAZES
- ✓ GRINDS
- ✓ SANDS
- ✓ POLISHES
- ✓ BUFFS
- ✓ BRUSHES
- ✓ POWER UNIT
- ✓ CHARGES BATTERIES

**HAS SELF-CONTAINED MOTOR GENERATOR JUST LIKE BIG PLANT UNITS**

MOTOR WELD is the only known motor-generator type unit that has its Large Amperage Output, is self-contained, yet has light-weight "Pickup" Portability and sold at transformer price levels. Low cost, economical operation. No special wiring—just plug into any 110 volt AC or DC line (any cycle) and it's ready to use! Its portable POWER UNIT can be used to operate saws, grinders, etc. Other models (100-225 amp.—Cart Models, etc.) available.

Send for FREE Literature  
**10-DAY FREE TRIAL**  
**90-Day Warranty**  
**On All Machines**

Send remittance with order: will ship C.O.D. (\$15 deposit)

**GENERATOR SALES CO. • 1627 N. Damen Ave. • Dept. L • Chicago 47, Ill.**



# Schupack's Amazing Tool Bargains! All Brand New! Save up to 100%!

**FLEXIBLE SHAFT — ONLY \$4.95** Post-Paid



Fits all electric drills & hand power tools. 35 1/2" long. Oilite bearings. Core of specially wound, high carbon steel wire in flexible steel casing. Will accept modular tool shafts up to 1/2" dia. For lathes, electric drills, etc.

**SURPRISE VALUE 100 PIECES FOR \$1.00** Post-Paid

**FOR ELECTRIC GRINDERS**



Grinding Wheels, Cut-off Wheels, Sanding Discs, Mounted Stones, Sharpening and Honing Stones, Rotary Cutting Burs, Abrasive Cartridges, Mandrels, and many other items.

**75 MOUNTED WHEELS & MINIATURE CUTTERS \$4.50** Post-Paid



Regular \$11.00 value. For cutting and grinding on wood, metal or plastic. Includes 26 mtd. wheels and points on 3/32" shanks; 24 miniature cutters on 3/32" shanks; 25 short shank min. cutters. Will fit all electric drills and hand grinders.

**3 ROLLS ABRASIVE CLOTH — Only \$5.45** Post-Paid

For less than the price of one, 50 yds. per roll. 1 1/2" wide—3.20 grit; 3/4" wide—2.40 grit; 5/8" wide—50 grit.

**2 CIRCULAR SAWS ON 2 MANDRELS — \$1.50** Post-Paid

**ALL AT ONE LOW PRICE**



1" diameter saws on 1/2" Mandrels. For cutting wood, plastic, or soft metals. Order as usual. Send Check or Money Order.

**20 ABRASIVE ROLLS, \$1.00** Post-Paid



cloth, and 1/2" mandrel for grinding, sanding, deburring metal, plastic, wood or rubber. ONLY.

**4 GRINDING WHEELS WITH ARBOR \$1.75** Post-Paid



3 grits—fine, med., coarse. 2—4" gr. wheels; 1—3" gr. wheel; 1—1 1/2" gr. wheel, 1 arbor for above to fit 1/4" drill and all chucks. A \$4.50 value.

**HIGH SPEED DRILLS**

**7 High Speed Drills \$1.00** P.P.

15 Drills \$2.00 P.P.

7 Popular sizes—up to 1/4" Brand new. Set #10. Drills from 1/4" to 5/8" Dia. . . . \$1.95

**15 Assorted Drills** From 1/16" to 1/2" high speed, and carbon. Set #17. Only . . . . . Ppd. **\$3.95**

**10 Twist Drills** Brand New. From 1/4" to 1-1/64". High speed, and carbon steel. Set #18. Ppd. **\$10.95** Only . . . . .

**5 All New Drills** From 1/2" to 1-1/64". High speed, and carbon. Set #19. Ppd. **\$7.50** Only . . . . .

**12 Assorted Drills** High speed & carbon steel, from 1/8" to 1/2". Set #21. **\$3.60** Ppd.

**8 Assorted Drills** High speed & carbon steel, from 1/4" to 1-9/64". Set #22. Ppd. **\$9.50**

**Woodworkers' Drills \$2.00** P.P. U.S.A.



4 drills, from 5/16" to 1/2" with 1/4" shanks. Brand new, popular sizes. Set #14.

**5 Woodworkers' Drills** From 1/4" to 3/8". Set #15. Only . . . . . Ppd. **\$3.50**

NEW ILLUSTRATED CATALOG 10c

**12 MOUNTED WHEELS and points on 1/4" SHANK. \$2.95** Post-Paid



For grinding on plastic, wood, soft and hard metals. Regular list value \$8.40.

**12 MTD. WHEELS ON 1/4" SHANK. . . . . \$3.60**

**18 MOUNTED POINTS ON 3/32" SHANK. . . . . \$2.50**

**ADAPTER CHUCK** With 2 interchangeable collets, opening from 3/32" to 0, on 1/2" mandrel. Price each only. **\$1.50** Post-Paid



**4 HIGH SPEED SLITTING SAWS ONLY \$2.95** Post-Paid



From 1 1/2" to 3" dia. 3/8" to 1" arbor hole. For cutting hard and soft metals, wood, or plastic. Any thickness. A regular \$8.00 value.

**112 PIECE ASSORTMENT FOR ELECTRIC GRINDER \$3.95** Post-Paid

\$10.00 VALUE — ONLY



Here's what you get! Mounted Stones on 1/2" mandrel, Drum Sander, Sanding Discs for sander, Rotary Cutters, Wire Scraper, Electric Brushes, Circular Saw Buffing Wheel, Grinding Wheel, Rubber Polishing Wheel, Cut-off Wheel, Rubber Cylinder-Mandrel to fit above tool, and! Sanding Discs, Sharpening Stone, etc.

**18 ROTARY CUTTERS \$5.85** Post-Paid

Value \$13.50



Assorted sizes cutter on 1/4" or 3/32" shank. Will fit all hand grinders. Ideal for cutting wood, metal, or plastic. Guard new.

**12 MINIATURE CUTTERS \$1.00** Post-Paid



FOR CUTTING WOOD, PLASTIC, or METAL. Actual size. Aust. shape on 3/32" shank. For the makers, some workmen, etc.

**36 SHORT SHANK MINIATURE CUTTERS. . . . . \$1.00**

SCHUPACK SUPPLY CO., 7331 COTTAGE GROVE AVE., DEPT. M-50 CHICAGO 19, ILL. SEND CHECKS OR M. O. NO COD'S PLEASE

**20 "SEE THRU" DRAWERS!**

LOWEST COST — HANDIEST STORAGE



**MODEL J-20 . . . . . \$7.95**

Useful in every shop, lab., home, office, etc. For Radio, T.V. or ignition work. KEEPS SMALL ITEMS HANDY. No other cabinet can compare in price, construction strength. "SEE-THRU" durable plastic drawers can't spill accidentally. Strong welded steel cabinet. Drawers 5 3/4" L x 2 3/4" W x 1-7/16" D divide into 2 or 3 LENGTHWISE or CROSSWISE compartments. Sent complete, postpaid. Money back if not satisfied within 10 days. Free catalog on other sizes.

J-24, 24 drawers 5 9.95  
J-32, 32 drawers 12.95  
J-64, 64 drawers 24.95

Contents always fully visible, clean, dustproof, organized and orderly indexed.

MFG. BY AKRO-MILS, INC., 818 E. MARKET, AKRON 5, O.

**NEW! EXCITING! JET EXHAUST CUT-OUT**



Now your car can sound off those exciting, dynamic tones — easily controlled mechanically from your dashboard. Channel your exhaust through special pipes or muffler without removing your original muffler. Easily installed. **MONEY BACK GUARANTEE.**

Send \$1.25 (postpaid) check, cash, money order (add \$1.00 for postage outside of U.S.A.) to: Fur Sales, Dept. PM, 1840 S. Michigan Ave., Chicago 16, Ill. Dealer inquiries invited.

**POWER HACKSAW \$55.75** LESS MOTOR

F.O.B. Benton Harbor



• Rugged cast iron construction. Wt. 56 lbs. bronze bearings. Draw cut. Auto. return lift. Auto. shut-off. Vise swivels 45°. Cap. 4"x4".

Send for full details and name of nearest dealer.

Dept. PM-14  
**EXCEL MACHINE TOOLS BENTON HARBOR, MICHIGAN**

**AUTOMATIC AIR COMPRESSOR**



1/2 H.P. heavy duty capacitor motor, 115-V, 60 Cy. AC. . . . . \$23.80  
X2 Quincy 3 CFM, 100-150 lb. compressor . . . . . \$20.50  
Furnas automatic adjustable pressure switch . . . . . \$6.50  
Tank #26, rubber tired wheels and handle . . . . . \$17.00  
Adjustable pressure regulator and gauge . . . . . \$6.00  
Moisture filter — \$3.25 V-belt drive \$2.75  
Hose and tire chuck \$2.50 • Safety valve . . . . . \$1.50  
Check valve & copper tubing . . . . . \$3.75  
Small parts shipped parcel post prepaid at above prices.

Complete 1/2 HP unit assembled, ready to use—Plus Special FREE \$12.00 value Quart External Atomizing Spray Gun with every unit . . . . . \$33.00 **\$79.00 FOR CHICAGO**

Save \$10.00 — 1/2 HP outfit knocked down, you assemble, free spray gun, \$12.00 value. **\$69.00 FOR CHICAGO**

Same as above with larger 1/2 HP motor—free spray gun, knocked down unit **\$79.00**

1/2 H.P. **\$69.00** FREE \$12.00 QUART GUN

• SK-75 — 3/4 HP Motor 12x24 Stainless Steel Tank, wheels, all accessories, large 4 CFM compressor, free gun. . . . . \$123.50 FOR  
• SK-100 — 1 HP Motor 15x30 Tank Twin Cylinder 9 CFM compressor, All Access. You assemble. Free Gun. . . . . \$169.50 FOR

**C. MARSHALL SALES** Dept. P-1 Chicago 47

3546 W. Fullerton Ave.

**VOLUME BLOWERS FOR HEATING, VENTILATING, EXHAUSTING**

Blowers for forced drafts, heating boosters, exhausters, coolers, dryers and dust collectors, 110 volt A.C., 50/60 cycle motors.

\*75 CFM Blower, 3 inch wheel. . . . . \$10.75  
\*125 CFM Blower, 4 inch wheel. . . . . \$14.75  
\*200 CFM Blower, 4 1/2 inch wheel. . . . . \$19.50  
400 CFM Blower, 5 inch wheel. . . . . \$32.50  
600 CFM Blower, 6 inch wheel. . . . . \$38.50  
1000 CFM Blower, 8 inch wheel. . . . . \$52.00  
1500 CFM Blower, 9 inch wheel. . . . . \$72.00

\*These blowers with motors shipped Post Paid. Larger sizes are FOB.

Write for CIRCULAR: Listing Motors; ALL SIZES: Fans and Air Compressors — ALL SIZES.

**16 TO 1 SPEED REDUCERS**

For Dia. 1/2" Table — Barbecue Spits — Toy Auto Gear Box — Experimental Uses, Etc. Gears Enclosed in Aluminum Housing. Bronze Gear, Hardened Worm, Input Shaft 1/4 in. Output Shaft 3/8 in. Speed Reducer **\$5.95** Post Paid

#R 161. . . . .





**NEW SURPLUS WINCH HOIST**

Ideal for use in garages, machine shops, boat yards, farms, trucks, etc. Has 2500 lb. lift capacity through a 24 to 1 gear ratio. Has bronze worm gear drive. 18 feet of 7/16" high tensile strength steel cable. Originally made for use as Navy Bomb Hoist. **3250**

**SURPLUS 5 TON HOIST**

A real heavy duty hoist. Mfd. by the Seattle Chain & Rig. Co. Hand operated. Has 2 speeds - one for rapid lifting and one for heavy duty. Drum size is 8-3/8" wide x 5" dia. at center. Complete with hand brake and crank type handle. A \$100 Value **7350**



**CONTROL QUADRANT**

Kids love it to play "Space Man". Ideal for remote controls on boats, machinery, etc. Has four levers mounted in precision frame. One lever fitted with a ratchet type position lock. Another with a 7/16" curved gear rack with a pinion gear and knob for precise control. Originally used on aircraft. **195**

**4-WAY LAMP**

A handy lamp for desk, work bench, chart table, engine room, etc. May be used on 6 - 12 - 24 or 110 volt current by simply changing the bulb. Has 3 foot shaft with four movable joints to adjust light. **395**

**PROP PITCH MOTOR**

One of the best all-around heavy duty motors. Does the job of bigger, bulkier more expensive motors and you can operate it on as little as 15 Volts DC. Will handle rotation of heavy beam antenna, farm equipment, etc. Cold weather will not FREEZE it up. Rated at 2 HP but will develop tremendous power through a 10,000 to 1 gear reduction. Easily adapted to AC current by using any standard current converter. **1975**



**SAVE UP TO 85% ON WAR SURPLUS FROM WORLD FAMOUS 'GADGETEER'S' HEAVEN**

**SMISS PATTERNED NEEDLE FILES**  
Ideal for model makers, technicians, repairmen, etc. Here is a set of finest quality needle files. Made of the toughest file steel, specially hardened and accurately machined for precision filing. **349**

**SAVE ON HYDRAULICS AT PALLEY'S**

Here at Palley's we carry the WORLD'S LARGEST supply of special Hydraulic Equipment. Our huge stocks of Hydraulic Cylinders alone feature over 20,000 units in 61 sizes and types. We also stock thousands of accessories such as Hydraulic Pumps, Transmissions, Valves, Tanks, Filings, Hose, etc.

**HYDRAULIC CYLINDERS**  
No. 29 - Double Action Cylinder Gives 20,000 lbs. lift with a 1500 PSI line pressure, or will give 40,000 lbs. thrust on an intermittent 3000 lb. line pressure. Has a 4" bore, 3-1/2" diameter piston shaft, 18 inch stroke, 30-1/2" length. Ideal for presses, road, farm and shop equip. Cost Gov't \$390. **2995**

No. 3 - Double Action Cylinder - Bore is 1", Shaft 1/2". Stroke adjustable from 2-1/2" to 4" with internal sleeve stops. Length overall 8-1/2". Will raise 1500 lbs. continuous - 3000 lbs. intermittent. Will lift or push up to 1500 pounds. **575**

No. 66 - Double Action Cylinder. Bore 2-1/4", Shaft 1", Stroke 4-1/2". Length 13-1/4". L.Hrs 4000 lbs. with 1500 lbs. pressure. **1150**

No. 53 - Double Action Cylinder. Bore is 2-3/8", shaft 1 1/2", stroke 1 1/2", length 26". Gives 6643 lbs. lift with 1500 lbs. line pressure. **2050**

**HYD. HAND PUMP**  
Has operating pressure of 2000 PSI. Capacity of 3.5 cu. inches per complete cycle. Our special price ONLY. **1275**

**HYD. ACCUMULATOR**  
A-5 VICKERS - Built to stand 2000 PSI. Has had Hydrostatic test. **2450**

A-2C - Has 3" dia. x 18" long. Holds up to 2000 PSI. **1075**

V-12 - FOUR WAY VALVE - Piston type. Neutral position. Pressure balanced. Built-in relief valve for limit of cylinder stroke. Open center is **NEW 1750** neutral position. Parts are 5/8" AC tube. **USED 1275**

**TRAINING RIFLE 598**  
A DUMMY RIFLE. Lightweight. Has hardwood stock. Movable bolt. Genuine leather adjustable straps. Click type trigger. Leaf sight. Ideal for kids.

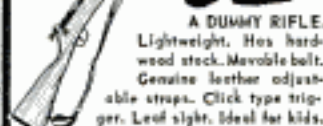

**P-1A PESCO GEAR PUMP**  
Capacity, 11GPM at 1500 RPM or 1500 PSI. Pressure limit is 1500 PSI continuous, with intermittent maximum of 1875 PSI for 15 seconds. Normal operating speed is 3750 RPM with an intermittent maximum speed of 4500 RPM. Rotates right-hand only. **Now 895**



**NEW! PUMP FOOT MOUNT**  
Contains 2 first-line, high speed bearings. Mount plate has 4 holes - 2" from the center to center. Has spline shaft one side, key slotted 1/2" shaft on other side. **1050**

**Large Base FOOT MOUNT** - For a pump up to 10 HP. Four mount holes are 3-1/2", center to center. Shaft is 3/4" dia., slotted. **1495**

**VICKERS HYDRAULIC TRANSMISSION**  
Self-contained, constant torque at all speeds with variable volume, reversible piston pump which supplies piston hydraulic motor. Has 2 H.P. Automatic pressure dash pot for smooth control. Power output RPM - 0 to 1/3 input RPM in both directions. Input RPM 1800 continuous, 4000 intermittent. Ideal for Lathes, Dupli-licator setup on Mills, Conveyors, Small Cars, Drives, etc. **4250**

**4" SPLINE SHAFTS** for input and power take-off on above. Pair \$2.50

**INPUT & TAKE-OFF PLATE ASSEM.** To adapt Trans. to pulley drive. Has 1/2" keyway shaft. 2 first-line, shielded high speed bearings in each unit. Per Set - **\$20.00**

**SURPLUS ELECTRONICS & RADIO MIX**

A Jumbo Surprise Package containing control, coils, switches, wire and a variety of other valuable radio and electronic devices. A BARGAIN BUY! **225**

**RADIO ANTENNA REEL**

For tuning beam antenna. Powered by 1/8 HP, 24V, GE motor, engaged to gear reduction only when electrical contact is made. Operated in either direction. Ideal for auxiliary power take-off. 150 RPM at take-off. Used for opening & closing doors, etc. A tremendous value. **NEW 875**

**USAF THROAT MICROPHONE**  
Genuine USAF type T-30. Gives distinct voice reproduction for aircraft or amateur radio broadcasting. Consists of two microphones, mounted on rubber neoprene elastic neck band. Operates between 100 & 300 ohms. **139**

**SIGNAL CORPS TEL. KEY**  
The new model J5A with ball type, flame-proof metal key. perfectly balanced to permit positive contact with minimum effort. An ideal adjustment for "ham" or professional use. A BUY at... **NEW 189**

**NAVY SOUND-POWER PHONE SET**  
Used by the Navy for flight deck and gunnery control. An ideal emergency communication system because they require no power supply. Perfect for office-to-shop house-to-garage or barn, or any point-to-point within 1/2 mile radius. These sets are fully sound powered. A set includes 2 phones on chest plate, two headsets, button switches, 35' of cable. **995**

**DC METERS VOLTMETERS**  
0-30 0-240 30-0-30  
0-60 0-480 50-0-50  
0-120 0-300 40-0-60  
120-0-120  
**495 EACH**

All Voltmeters & Ammeters are NEW and have 2" face (except 0-300 which is Used and has 3" face) Manufactured by Westinghouse, G.E., & Weston.

NOTE: External SHUNTS are required on DC AMMETERS.  
SHUNTS - with meter . . . \$1.35  
SHUNTS - without meter . . . \$1.65

**NEW AMMETER 0-30 ONLY 495 EA.**

**UNIVERSAL JOINT**  
Rotates with full flexibility from 90 to 180 degree angle. Body is solid bronze. Drive shaft is 29/32" dia. steel. Joint is Ball and Socket type. Ideal for use on boats and heavy machinery. **595**

**RIGHT ANGLE DRIVE**  
Has direct 1 to 1 ratio through 90° level gears. Drive & take-off shafts are 3/8" diameter. Gears are self-lubricating hi-speed steel. Ideal for use on power tools, flex drives, etc. Size 3/16" x 25/16" 1/4". Many other types Gear Boxes and flexible Drive Shafts in stock. See Catalog! **225**

**1954 Edition of WORLD'S MOST AMAZING BARGAIN CATALOG!**

**320 PAGES - FULLY ILLUSTRATED**  
Larger than ever before. Packed with SENSATIONAL VALUES in WAR SURPLUS, FACTORY CLOSE-OUTS and GENERAL MERCHANDISE! Included are thousands of items in Hand & Power Tools; Hydraulic Cylinders, Pumps, Motors, etc.; Hardware; Industrial Tools; Cameras and Photo Supplies; Outdoor and Sporting Equipment; Microscopes, Binoculars, Telescopes, etc. Foam Rubber, Aircraft Parts, Electrical Motors, Blowers, etc. Gadgets plus many, many more hard-to-find items.

**Only 50¢** Order Your Copy Today! We refund your 50¢ on your first order of \$1.00 or more.



**PALLEY SUPPLY CO.** 2263 E. VERNON AVE., DEPT. PM-1 LOS ANGELES 58, CALIF.  
Order From This Ad. Pay by M.O. or check, P.O.'s acceptd. from D&S firms. 1/2 deposit with C.O.D.'s. All Prices FOB Los Angeles.



# More for Your Money

If there is any one reason why South Bend Lathes are so popular it is because they represent the maximum value per dollar of cost. We invite comparison feature-by-feature with any other make, and are confident you will find South Bend gives you more for your money. Send coupon for catalog.

## TIME PAYMENTS

You can buy any South Bend Machine Tool on time payment terms. Pay 10% down and balance in 12 or 18 months. Light Ten Tool-room Lathe illustrated \$73.10 down. Down payments on other sizes start at \$21.10.

## How to Run a Lathe

Every lathe operator needs this helpful handbook on lathe operation and care. Exceptionally complete. 128 pages — 365 illustrations. Price 50¢ postpaid.

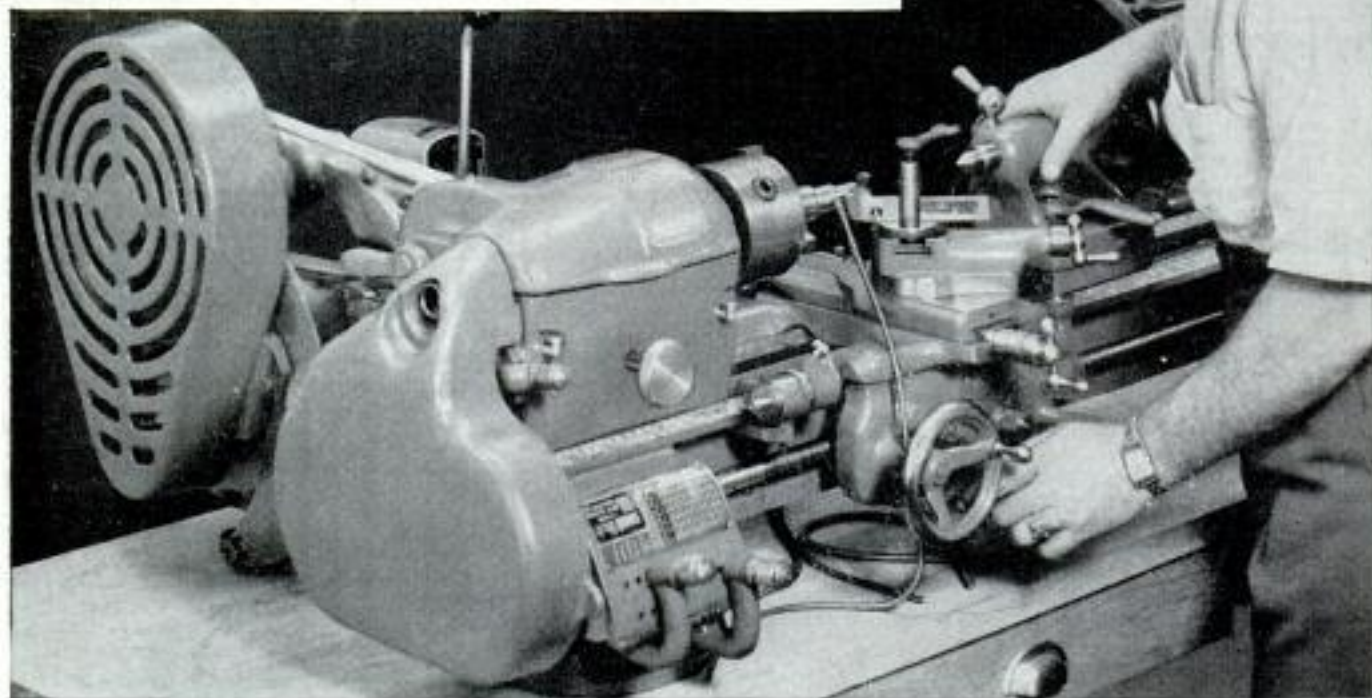

Can I get it?  
When? How?

Yes—you can get most any South Bend product immediately from our distributor's stocks in principal cities. Items not stocked, shipped promptly from factory.

Three ways to order:

1. See or telephone nearest distributor.
2. Order by mail from your distributor.
3. If no distributor is nearby, order direct from factory.

South Bend machine tools with accessories may be purchased on convenient terms up to 12 months.

SEND INFORMATION  
CHECKED:



9" and 10"  
BENCH LATHES



10" to 16-24"  
FLOOR LATHES



DRILL  
PRESSES

TOOL  
GRINDERS

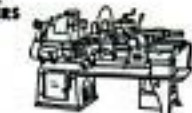

1/2" & 1" Collet  
TURRET LATHES



7"  
BENCH SHAPERS

Name \_\_\_\_\_ Company \_\_\_\_\_

Street \_\_\_\_\_ City & State \_\_\_\_\_



Building Better Tools Since 1906 • SOUTH BEND LATHE • South Bend 22, Indiana



# We'll **train** & establish you in Your Own Business ... even if now employed

We are enlarging this 24-year-old world-wide chain of Duraclean dealerships. Many excellent locations are still available in the U.S.A., Canada, and other countries. If you are reliable and diligent, this is an opportunity to increase your income... and have the freedom, financial independence, and prestige of YOUR OWN business.

These are full time dealerships... but you can start

in spare time and have a profitable, lifetime business when your present job ends. A Duraclean dealer will train and assist you. He'll reveal his successful, proven methods and sales plans. He'll work with you.

Alert dealers can average \$5 hourly gross profit on service they render plus \$3 on EACH service-man at National Price Guide charges. This business is easy to learn... quickly established.

No shop needed

Machine becomes carrying case

## You Become an Expert in cleaning and protecting Rugs and Upholstery



24 Years of Proven Success

**DURACLEAN** cleans by absorption. It eliminates scrubbing... soaking... shrinkage. Aerated foam, created by electric Foamovator, restores the natural lubrication of wool and other animal fibers in rugs and upholstery. Dirt, grease and many unsightly spots vanish. Fabrics and floor coverings are cleaned with a new consideration for their life and beauty.

This modern process avoids strong soaps and machine scrubbing! This eliminates unnecessary wear and the breaking of fibers. Fabric life is increased.

**DURACLEANING** is done in the home. Customers like this convenience. Fabrics dry in a few hours. Rug pile again stands erect and even. Brilliant colors revive. Furnishings become clean, fresh and enlivened.

**DURAPROOF** is another year-round service rendered in the home, office or institution — without removing furnishings. It protects upholstery, rugs, furs, clothing and auto interiors against damage by moths and carpet beetles. U. S. Government says "Moths are present in practically every household... No section of country seems free from such infestations." **DURAPROOF** kills moths and carpet beetles... it makes materials non-eatable to both. **DURAPROOF** is the ONLY moth-proof service backed by an International Money Back, 4-Year Warranty.



## Easy to Learn • No Overhead Expense

### Permanent, Growing Market

Service is rendered IN homes, offices, hotels, theaters, institutions and to revive used-car upholstery for auto dealers. There is need for these services in almost every building. Duraclean dealers operate from their home, an office or shop, as they prefer. It's easy to learn... we quickly train you. Rendering service yourself, at first, prepares you to train and supervise service men.

### Repeat and Voluntary Orders

Demonstrations win new customers. **DURACLEAN** Dealers find REPEAT and VOLUNTARY orders a major source of income. Customers, enthused with results, tell friends and neighbors. Furniture and department stores and others turn over rug and upholstery cleaning and mothproofing to **DURACLEAN** Dealers. We show you 27 ways to get new customers.

### Two-Way Profit

You enjoy big profits on BOTH materials and labor — after paying service men and salesmen. This is a year-round large-profit business. You have the cooperation of a 24 YEAR OLD organization interested in your success. If you want to become the owner of a **DURACLEAN** Service business, you should inquire now. TODAY, while territory is still available.

### What Dealers Say

- W. Looklebill: We've had 20 years of pleasant dealings. I'm 65 but am setting my sights for 20 more years.  
Gerald Merriman: \$700 cleaning... only 13 working days.  
P. D. Freidinger: 70% of our business is repeat.  
A. Ullman: Every demonstration has been a sale.  
Ellsworth: Your advertising certainly has paid dividends.  
M. Lassanske: My original investment was returned in about two months. I am not sorry in any way that I started my business 'on a shoe string.'  
R. Kimbrough: Finished First White House of Confederacy and am to Duraclean the Governor's Mansion.  
Margaret Turner: Took in \$106 in 15 or 18 hours.  
L. Johnson: Each customer leads to 3 or 4 more.  
T. Komori: We have 1,000,000 yen contract Duracleaning for U. S. Army in Japan.

### EASY TERMS

A moderate payment establishes your own business—pay balance from sales. We furnish electric machines, folders, store cards, introduction slips, sales book, demonstrators and enough material to return your TOTAL investment. Your business can be operating in a few days. Mail coupon today! No obligation.

**Duraclean Co.** 4-161 Duraclean Bldg., DEERFIELD, ILLINOIS

### Nationally Advertised

Your services are Nationally Advertised in Life, McCall's, Better Homes & Gardens, Ladies Home Journal, House & Garden, Maclean's (Canada's largest magazine), etc. See full-column ad in Jan. McCall's on newsstands Dec. 23.

### FREE Booklet

Our first letter and illustrated booklet will explain everything—the two modern, urgently needed services, waiting market, how business grows, your large profit, easy terms and PROTECTED territory. Send Coupon TODAY!

## "OWN a Business" Coupon

**DURACLEAN CO., 4-161 Duraclean Bldg., Deerfield, Illinois**

With no obligation to me, send booklet and letter giving full details. Tell me how I may OWN a growing business of my own built upon satisfied customers.

Name \_\_\_\_\_

Address \_\_\_\_\_

City \_\_\_\_\_ State \_\_\_\_\_



Bed bumpy?



Oatmeal lumpy?



Wife grumpy?



Nerves Jumpy?



Climb into your

**REO**

and relax!

Step in through that almost yard-wide door (a full 30"), spread yourself on that comfortably cushioned seat (foam rubber in all tractor models)...for steering without peering, check that new-angle steering wheel, the new positive-power 103° arc electric windshield wiper...and not only that—lend an ear to the potent purr of that perfect power plant...that GO upgrade...run your rig through traffic like a swivel-hipped halfback on the loose...And all the while you're relaxing in that comfortable REO cab, cozy as a caliph after curfew.

**REO MOTORS, INC.,** Lansing 20, Michigan

Manufacturer of Commercial & Military Trucks • Buses • Power Lawn Mowers  
Children's Wheel Goods & Play Ground Equipment • Inboard Engine Kits  
for Small Boats • Replacement Engines for Trucks • Industrial Engines



Copyrighted material