

POPULAR MECHANICS

MAGAZINE

WRITTEN SO YOU CAN UNDERSTAND IT

REGD. TRADE MARK, GREAT BRITAIN, No. 4-0426

Building Canada's Colossus
—Page 96

What It's Like—Living in a Trailer

Six Pages of
CHRISTMAS GIFT IDEAS

For the Craftsman
Build a Sail for Ice Skating

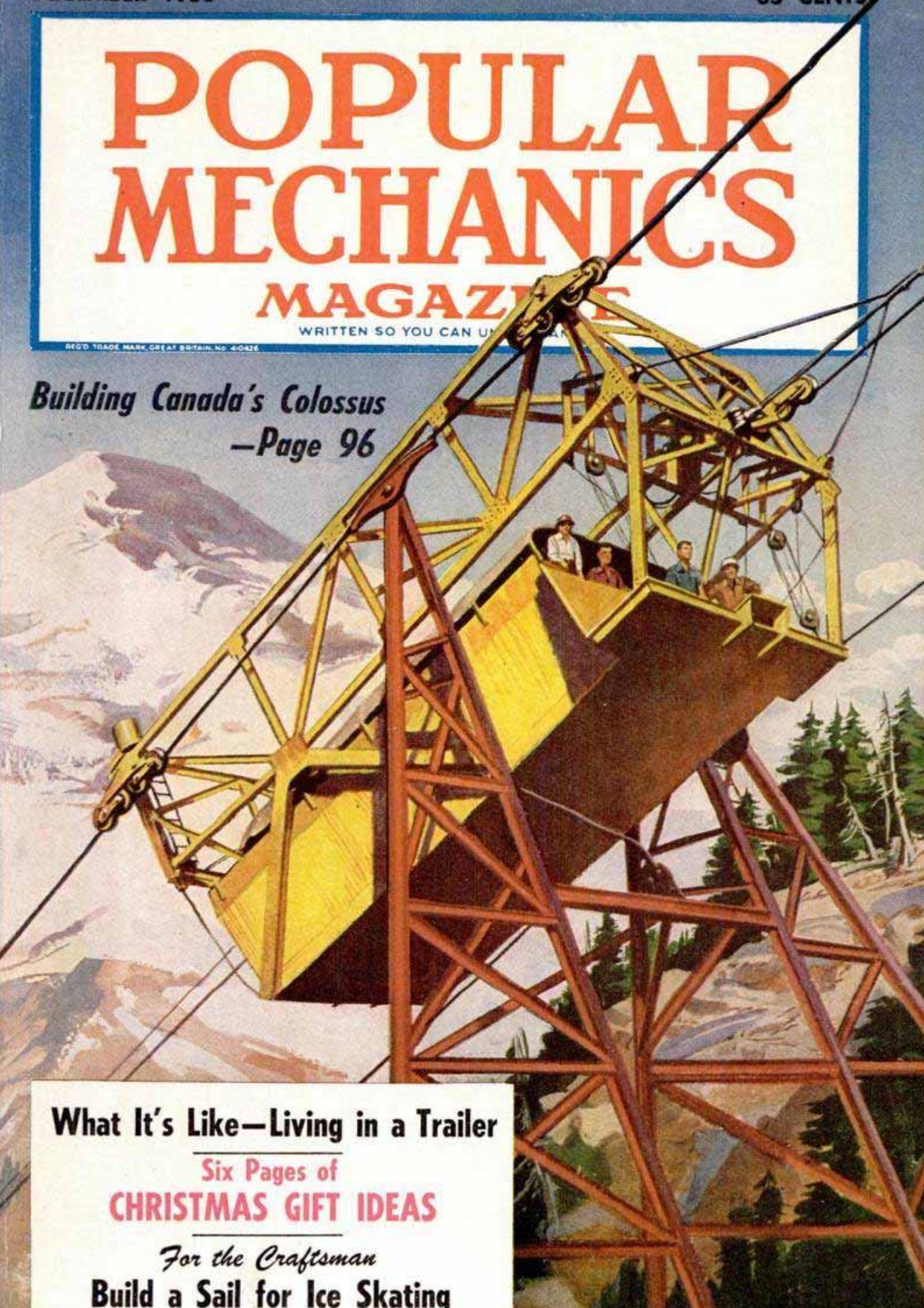

GET A SMOOTHER, QUIETER ENGINE... MORE PUNCH ON THE PICK-UP...with the **MARVEL INVERSE OILER**



Install it and see! Your car takes a new lease on life, when vital upper cylinder areas are lubricated automatically by the Marvel Inverse Oiler.

Operating off the intake manifold, this completely automatic oiler feeds to the upper cylinder areas in exact proportion to engine load and speed.

Install it. Fill it. Adjust it. And forget it! There's no maintenance worry with the Marvel Inverse Oiler. Fully automatic operation and full quart capacity give you 1000 miles of carefree motoring on each filling.

Here's how Fully Automatic Operation Improves your car's performance!

Notice how the Marvel Inverse Oiler feeds oil just exactly as your engine needs it. Throttle open, under load or speed...more oil. Throttle closed, less oil.



EMEROL

MANUFACTURING CO., INC.

Dept. 122

242 West 69th Street
New York 22, N. Y.

Use only **MARVEL Mystery Oil** in the Marvel Inverse Oiler

Time-tested secret formula gives you everything you want in an upper cylinder oil. Especially blended and refined to keep sludge-forming components in emulsion, and prevent oil rupture.

Marvel Mystery Oil reduces cylinder wall and piston wear. It keeps piston rings at their proper wall tension. Prevents excessive wear on intake valves, and keeps exhaust valves from sticking.



Don't let your battery let you down



When winter winds come whirling in, a good battery is something to be thankful for. So don't ever be caught alive with a dead battery. How do you make sure? First chance you get, stop in at your Goodyear dealer's. Have your battery checked free with the portable, accurate, Goodyear All-Purpose Tester. That's the way to catch battery troubles before they start. And don't forget to ask about the Goodyear Dry Proof Double Eagle Batteries, too.

Goodyear, Battery Dept., Akron 16, Ohio

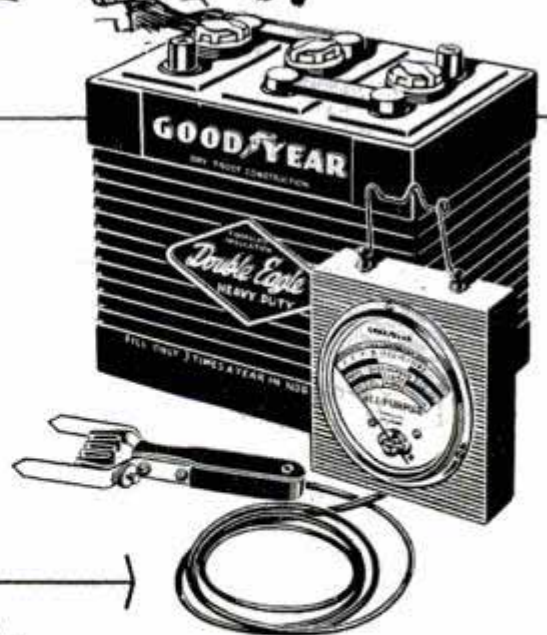

Double Eagle—T. M. The Goodyear Tire & Rubber Company, Akron, Ohio

GOODYEAR

DRY PROOF • DOUBLE

This One



Don't be satisfied with an ordinary radio...

get a hallicrafters



and Hear it All!

Now, at prices no higher than you'd expect to pay for ordinary radio, you can have all the thrills of short-wave reception, plus tops in regular broadcasts, too. You hear London, Paris, Rio, Moscow—hear ships at sea and planes in the air—police and military broadcasts—and you hear them *direct* with a Hallicrafters.

Hear amateur broadcasts from all over the world, and get in on the fun of the world's greatest hobby. And you'll hear them on the sets that these critical experts choose for themselves . . . Hallicrafters. For many years Hallicrafters has been first choice with amateurs, just as governments all over the world, including our own, have chosen Hallicrafters for critical communications.

Hallicrafters prices start at \$59.95

Write today for full information.

Model S-53A. The finest small communications receiver built and ideal where maximum performance is required in small space. Covers Broadcast Band 540-1630 kc plus four short-wave bands covering 2.5-31 and 48-54.5 Mc.

Electrical bandsread for easy tuning. Two i-f stage. Switches for automatic noise limiter, code reception and high-low tone. Phono jack for records. Headfones tip jacks on rear and built-in PM speaker. Temp. compensated to reduce fading due to frequency shift.

Satin black steel cabinet with brushed chrome trim. 12 $\frac{7}{8}$ " x 7" x 7 $\frac{3}{4}$ " deep. Ship. wt. 19 lbs. Piano hinge top. Seven tubes plus rectifier. For 105/125 V. 50/60 cycle AC..... **\$99⁹⁵**

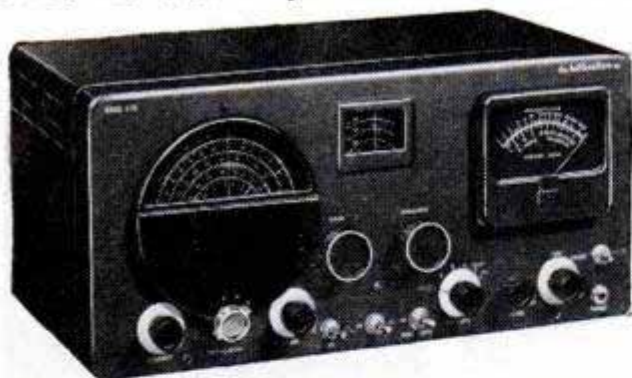

Model S-76. Double conversion receiver. Value packed communications receiver with Broadcast Band 538-1580 kc plus three short-wave bands covering 1720 kc-34 Mc.

Electrical bandsread tuning control with calibrated dial to separate stations on crowded bands. Double superhet with 50 kc second i-f and giant 4-inch "S" meter. Five position selectivity, one r-f, two conversion, two i-f stages, temperature compensated. Phono input jack. 3.2 or 500 ohm outputs. Socket for external power or remote control.

Satin black steel cabinet with chrome plastic trim rings. 18 $\frac{1}{2}$ " x 8 $\frac{7}{8}$ " x 9 $\frac{1}{2}$ " deep. Ship. wt. 41 lbs. Piano hinge top. Nine tubes plus voltage regulator and rectifier.

For 105/125 V. 50/60 cycle AC..... **\$199⁹⁵**
Use R-46 speaker.

hallicrafters

4401 West Fifth Avenue, Chicago 24, Illinois
Hallicrafters Ltd., 51 Camden Street, Toronto, Canada

World's Leading Exclusive Manufacturer
of High Fidelity and Communications Equipment,
Radio and Television

Popular Mechanics Magazine

Registered in U. S. Patent Office and Canada

H. H. WINDSOR, *Founder*

H. H. WINDSOR, JR., *Editor and Publisher*

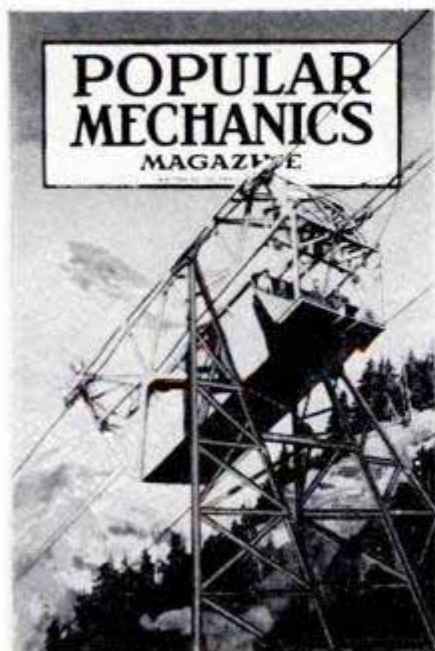

this month's cover

LIKE TO RIDE one of the most thrilling "skylifts" ever built? You won't find this one at Coney Island, but in the Canadian Rockies 400 miles north of Vancouver, B. C., where a huge power plant is being carved deep in the base of a mountain. The turbines will spin up 1,650,000 horsepower which will crackle into the largest aluminum smelting plant on earth. The skylift carries men and machines 2600 feet up the side of a mountain. On its first journey the cable car ran smack into a jutting crag of rock. The passengers calmly blasted away a piece of mountain and proceeded on their way. To harness the water power, engineers have had to reverse the flow of a 125-mile chain of lakes, forcing the water back through a 10-mile tunnel to a mountain peak. From here the water will plunge down a half-mile manmade hole in the mountain to the powerhouse below. You'll find the fascinating story on page 96

Published monthly by Popular Mechanics Company, 200 E. Ontario St., Chicago 11, Ill. H. H. Windsor, Jr., president; Wm. Harrison Pettridge, exec. vice-pres.; D. F. Windsor, vice-president and secretary-treasurer; H. H. Windsor III, vice-president; Clover L. Perkins, advertising manager; Alan M. Deyoe, circulation manager. Single copy in the United States and Canada, 35 cents; subscription rates in the United States and possessions, Canada, Philippines and countries of the Pan-American Postal Union, 1 year \$3.50; 2 years, \$6.00; 3 years \$8.00. To all other countries add \$1.00 a year over United States prices for overseas postage. If you plan to move, notify us at least 30 days in advance so you will not miss an issue. Give both your old and new addresses. Entered as Second Class Matter, September 15, 1903, at the Post Office at Chicago, Illinois, under Act of March 3, 1879. Entered as Second Class Matter at Post Office Dept., Canada. Registered as Second Class Matter at the Post Office at Mexico, D. F., Mexico, June 20, 1950. Copyright 1953 by Popular Mechanics Company. Copyright under International Copyright Union. Copyright in France. All rights reserved under Pan-American Copyright Union. Printed in the United States of America.

Volume 100

DECEMBER 1953

Number 6

Address all communications to:
200 East Ontario Street, Chicago 11, Illinois

Managing Editor.....	Roderick M. Grant
Assistant Managing Editor.....	Wayne Whittaker
Shop Notes and Crafts Editor.....	James R. Ward
Radio-Television, Electronics Editor.....	Frank L. Brittin
Associate Editor, Aviation.....	Aubrey O. Cookman, Jr.
Associate Editor.....	Clifford B. Hicks
Associate Editor, Automotive.....	Arthur R. Railton
Associate Editor, Shop Notes and Crafts.....	Wayne C. Leckey
Assistant Editor, Shop Notes.....	W. Clyde Lamme
Assistant Editor, Crafts.....	Frank N. Stephany
Assistant Editor, Makeup.....	John C. Dalen
Automotive Correspondent.....	Leo Donovan
Art Director.....	Frank Beatty
Assistant Editors	
Leonard F. Hilts	Elsie L. Domin Elliott H. McCleary Jay W. Hedden
Eastern Editor.....	Richard F. Dempewolf Empire State Bldg., Room 2906, New York City 1
Western Editor.....	Thomas E. Stimson, Jr.
London Manager.....	Douglas W. Wedderspoon Eagle House, Jermyn St., London S. W. 1, England
Director, Bureau of Information.....	Allan Carpenter 200 E. Ontario St., Chicago 11

IN THIS ISSUE

Fireman, Save My Child! - - - - -	65
Christmas Shopping Section - - - - -	74
Colossus in the Wilderness - - - - -	96
They Call It Automatic Farming - - - - -	110
Decorative Panels From Wood Chips - - - - -	116
Who Says Animals Are Dumb?—Part II - - - - -	122
Subways for a City's Floods - - - - -	129
Trailers Are Stay-at-Homes Now - - - - -	136
Radio, TV and Electronics - - - - -	145

For the Craftsman

Modernizing Old Furniture - - - - -	149
Playroom Phonograph - - - - -	153
Ride the Wind With a Skate Sail - - - - -	165
How to Make Panel Doors - - - - -	178
Punches for Sheet Metal and Cardboard - - - - -	183
Using Wrenches the Right Way - - - - -	187
Portable Saw From Vacuum-Cleaner Motor - - - - -	193
Finishes for Metalwork - - - - -	197
Shopping for Tools - - - - -	202
Clinic for Homemakers - - - - -	208

Other items, and manufacturers of available products described, are listed on pages 12, 14 and 16

NEW! ALUMINUM STORM WINDOWS EASIER TO MAKE THAN WOODEN ONES!

Make and repair countless other things
around your home with amazing new

REYNOLDS Do-It-Yourself ALUMINUM



No Special Tools . . .
No Special Skills Required!

This amazing new kind of material opens up a brand new field for the home owner and hobbyist. It has the beauty and strength of regular aluminum. But Reynolds *Do-It-Yourself* Aluminum, made by the makers of Reynolds Wrap, is specially engineered for amazing workability. You can cut it with scissors, drill it, bend it, shape it and plane it, using ordinary hand or power tools. And it's so easy to use that even an amateur can become an expert overnight!

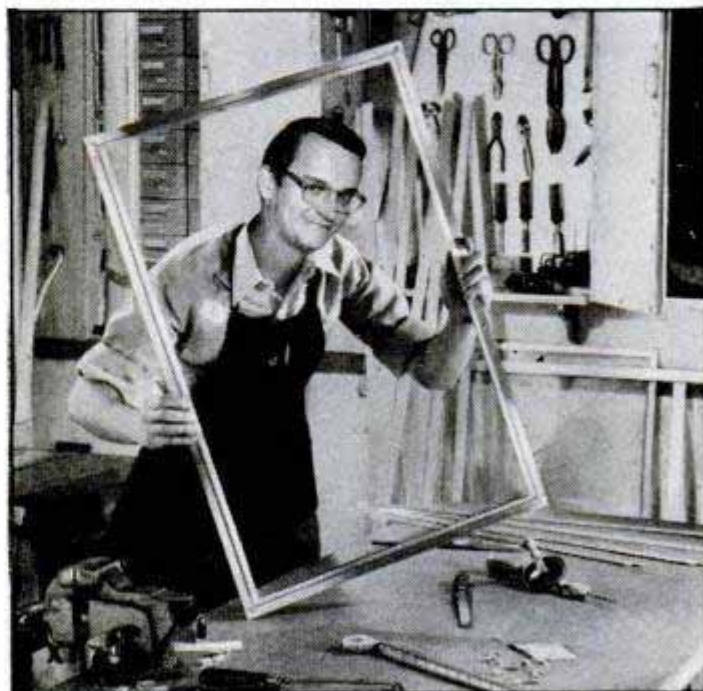

Wally Cox, TV's Mister Peepers (Sunday nights, NBC-TV) shows one of the aluminum storm windows you can make with Reynolds *Do-It-Yourself* Aluminum. These storm windows . . . so much easier to make than wooden ones . . . are permanent, rustproof, attractive, can be made with either glass or plastic panes.



END TABLES like this, made easily and quickly with new Reynolds *Do-It-Yourself* Aluminum, are smart, modern . . . cost very little.



WALL PROTECTOR made in an hour using Reynolds *Do-It-Yourself* Embossed Aluminum Sheets is just as handsome as it is practical.



FISHING NET and light, strong fishing rod cases are simple projects with Reynolds *Do-It-Yourself* Aluminum, make fine Xmas gifts.



HOUSE NUMBERS add an expert decorator's touch to any house, are easy to make with Reynolds *Do-It-Yourself* Aluminum.

ORDINARY HAND OR POWER TOOLS WORK FINE
ON THIS FABULOUS NEW MATERIAL



SAW IT PLANE IT DRILL IT BEND IT CUT IT

CAUTION: Regular aluminum may harm tools . . . use only Reynolds *Do-It-Yourself* Aluminum. Each piece has Seal attached.

Look for this Self-Service
rack containing
REYNOLDS
Do-It-Yourself
ALUMINUM
at hardware and lumber
supply dealers everywhere

Tubes • rods • bars • plain
sheets • embossed sheets
angles • fasteners • screen
and storm window sections
window hardware • plastic
sheet • trim moulding

APPROVED BY:

Atlas • Delta • Disston • DeWalt
Black & Decker • Stanley
Skil Corporation and other
Leading Tool Makers



FREE BOOKLET is available with instructions and projects for Reynolds *Do-It-Yourself* Aluminum. See your dealer or write Reynolds *Do-It-Yourself* Aluminum at address below.



REYNOLDS DO-IT-YOURSELF ALUMINUM • 2502 South Third Street, Louisville 1, Kentucky



Texaco Tips

on car care

How to help keep front wheel bearings in top shape

Front wheel bearings may burn out if they're not lubricated every 10,000 miles. See your Texaco Dealer for a front wheel bearing check-up. If necessary, he will remove the old grease, clean the grime out of the bearings and apply heavy duty Marfak lubricant. It's care like this that helps keep your motoring trouble-free—and safer.



How to get that "cushiony" ride

Get Marfak lubrication for your car's chassis — and you'll get cushiony driving ease for 1,000 miles or more! This "stretch test" shows why. Given this treatment, an ordinary grease would fall apart. Not Marfak! It's extra-tough and stretchy. This means Marfak clings to chassis points of friction and wear far longer — resists jar-out, squeeze-out and wash-out, too. Start enjoying that cushiony feeling today. Get Marfak lubrication from your Texaco Dealer, the best friend your car has ever had.

THAT "CUSHIONY" FEELING
LASTS LONGER WITH



THE TEXAS COMPANY
TEXACO DEALERS
in all 48 states

Texaco Products are also distributed in Canada and in Latin America

TUNE IN: METROPOLITAN OPERA radio broadcasts every Saturday afternoon. See newspaper for time and station.



Sealing Savvy

YOU CAN SEAL ABOUT EVERYTHING WITH

PERMATEX FORM-A-GASKET®

Leakproof against water, oil, gasoline, most chemicals, heat and cold.



SAVE CORRODED CYLINDER HEADS!

Clean out corrosion. Build up with Form-A-Gasket #1. When set, reassemble with Form-A-Gasket #3.

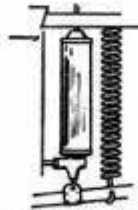

SEALS CAR WINDOW CLOSERS!

Seal automatic window closer cylinders with Form-A-Gasket #2; it allows later removal of cap.

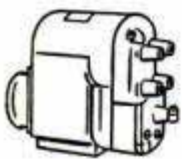

KEEPS MAGNETO DUST FREE!

On farms and other dusty areas, seal magneto caps and covers with Aviation Form-A-Gasket #3.



SEALS ELECTRIC MOTORS!

Keep motors dry by coating the motor windings and sealing the cover flanges with Form-A-Gasket #2.



RESCUE DROPPED PARTS!

Use Form-A-Gasket #2 on a long shank screwdriver with a thin strip of cloth around it. Makes it easy to pick up small parts you can't reach.



**MEND CAR
WEATHER STRIPPING!**
Aviation Form-A-Gasket #3 holds stripping in place. Also good for car floor mats.

3 TYPES

- No. 1** Sets quickly, dries hard
- No. 2** Sets slowly, remains pliable
- No. 3 (Aviation)** Brushable liquid (brush in can), sets to a paste; remains tacky.

All three belong in your shop!



PERMATEX COMPANY, INC., Brooklyn 35, N.Y.

Over 50 Chemical Products for Better Automotive Maintenance

in this corner.....

THE EDITORS



This month the world salutes again the Wright brothers on the fiftieth anniversary of their first powered flight at Kitty Hawk, N. C. To show in a graphic way how far we have come since Kitty Hawk, we present on pages 92 to 95 in this issue two drawings by the noted artist, Leydenfrost, one pin-pointing the 54 giant passenger planes en route across the Atlantic at one moment of this year, the other a map showing the major historical events and records in these first 50 years of flight.



For years one of our frequent overseas contributors has been Hans F. Kutschbach of Bad Grund/Harz, in the British zone of Germany. Reminiscing on this fiftieth anniversary of the Wright brothers' first flight, Mr. Kutschbach tells us he was a fellow student of the famous Anthony



Fokker and learned to fly in the same biplane in which the now noted German aircraft builder first flew in 1911. The photograph shows Kutschbach at the stick of the plane at Doitzheim near Wiesbaden.

Next Month, the Rear-Engines

What do American owners of European-made rear-engine automobiles think of their cars? To find out, we have polled drivers of the Porsche, Volkswagen and Renault. A report based on these questionnaires, along with Floyd Clymer's study of the three automobiles, will appear in the January issue. Don't miss it!

To the Editor:

I enjoy Floyd Clymer's write ups on cars, and consider he gives a fair opinion on each make, but I cannot see myself ever getting

(Continued to page 8)

This **FREE SAMPLE LESSON** will prove you can become an expert **BOOKKEEPER... ACCOUNTANT** OR **C.P.A.**



This well-paid
LaSalle-trained
Accountant's
success could
be yours.

FREE SAMPLE LESSON

We offer you this free sample lesson so that you can *prove to yourself* that you CAN master Accountancy—quickly, thoroughly—in spare time at home.

You will see exactly how LaSalle's famous "Problem Method" works... how you are led step-by-step through actual accounting work—*learning by doing* and not by study of theory alone. First you tackle easy problems, then more difficult ones—until soon you master them all. And at every step you have the close personal guidance of LaSalle's large staff of C.P.A. instructors.

HIGHER ACCOUNTANCY

By the LaSalle Problem Method..

• Practical Accounting

Assignment 1

THE BALANCE SHEET



QUOTING from the "Journal of Accountancy," the authoritative organ of the professional accountants of the United States:
"...the accounting profession is probably the best paid in the world. If there be a profession in which the average compensation is higher, it is not known to us."
"There is need for accountants. There is ample compensation for accountants. There is no prospect that the supply will overtake the demand within the lifetime of even the youngest of us."

LaSalle Extension University
A Correspondence Institution
CHICAGO

THIS SAME LESSON HAS STARTED HUNDREDS OF THOUSANDS toward well-paid accounting careers—in business, government, and as C.P.A.'s. Even without previous knowledge, progress is rapid—earning power climbs fast. This sample lesson shows why.

If you have been envying the high incomes and good jobs enjoyed by thousands of men and women Accountants today... incomes ranging from \$4,000 to \$10,000 and more per year... why not launch such a career for yourself?

Do you doubt that you can?

Then let us send you—without cost or obligation—the same Lesson Number One with which LaSalle has started several hundred thousand

men and women toward successful accounting careers. We want you to see for yourself how this remarkable method, originated by LaSalle, makes Accountancy simple, interesting, practical, and certain... how it leads you step-by-step to a complete mastery of Accounting—and on up to the coveted degree of Certified Public Accountant if you so aspire.

It doesn't matter whether you've had previous bookkeeping experience, or whether you don't know a debit from a credit. Whether you wish to qualify as an expert bookkeeper, advanced accountant, cost accountant, auditor, government accountant, income tax specialist, or public accountant... you'll find in LaSalle's Problem Method the exact plan to prepare you rapidly and inexpensively—in spare hours at home—without losing a day from your present job.

So right now, today... if you are an adult, employed, and earnestly ambitious for rapid advancement in this highest-paying of all professions... send your name and address on the coupon below. We'll send the free sample lesson—plus our 48-page book outlining today's career opportunities and how you can qualify for them. A coupon like this has started many thousands toward greater success. It can do the same for you. Mail it today!

**Nearly 10%
of all C.P.A.'s
in the U.S. have
been trained by the
LaSalle Problem
Method**

GOOD-PAY JOBS IN 5 BIG FIELDS

If you were an expert accountant right now, chances are you would find yourself among the highest-paid of all professional men and women. Surveys show that accountants earn more than those in other major professions.

There are five big fields of opportunity open to Accountancy-trained men and women... opportunities that are wide open and highly inviting, offering maximum income and job security in good times or bad. And under LaSalle's "Problem Method" you can start earning while still learning—either in spare-time or full-time employment... or in business for yourself with no capital required.

Get the latest information by sending for our 48-page book, "Accountancy, the Profession That Pays"... plus free sample lesson. The coupon at right will bring both to you without cost or obligation. LaSalle Extension, 417 S. Dearborn St., Chicago 5, Ill.

Clip Coupon... Mail TODAY!

LaSalle Extension University... A Correspondence Institution
Dept. 1264H, 417 S. Dearborn Street, Chicago 5, Illinois

YES, I want to see how LaSalle's "Problem Method" works... how I can qualify for high-pay Accountancy positions. Send Free Sample Lesson—also your 48-page book, "Accountancy, the Profession That Pays"... all without cost or obligation.

Name..... Age.....

Street Address.....

City, Zone & State.....

Present Position.....



NEWS FROM SCIENCE ABOUT YOUR HAIR



V-7

—new
grooming discovery
outdates messy oils

Not an animal, vegetable or mineral oil, V-7 in new Vitalis Hair Tonic is a completely new greaseless grooming agent.

PROOF

you don't need
grease to
correct dryness



New research on human hair shows that even very dry hair regains its normal moisture content faster with new Vitalis than with any leading cream or oil hair tonic.

KEEPS YOUR HAIR NEAT ALL DAY —GREASELESSLY

Even hard-to-manage hair stays neatly in place with Vitalis. No gummy film or "oil-slick" look.



New, finer
VITALIS[®]
Hair Tonic with V-7
Product of Bristol-Myers

(Continued from page 6)

one of them. . . . It might interest you to know that a Ford V8 costs about \$5,700 in your money and I am afraid that in this country they are no longer the family car for the workingman as they were before the war. . . . I look forward each month to the new copy [of *Popular Mechanics*] because I know that for the next week or so all my spare time will be a pleasure.

G. R. Pullan,
Auckland, New Zealand.

Mile-a-Minute Delta:

John B. Vella of Sliema, Malta, sends us this photograph of a model delta plane built by himself and designed, with Vella's help, by his brother Wilfrid. Construction



took two weeks, and Vella writes: "The trial test went as follows: Speed, first test over 60 miles per hour. Most effective elevator response over 35 miles per hour. Performance, excellent stability at all speeds flown on 50-foot lines. Powered by a 3.5-cubic-centimeter diesel engine."

☆☆☆

K.L.M. Royal Dutch Airlines has turned down a permit to land airplanes at Mala-Mala Airport in South Africa. Reason: Several lions and a lioness with newborn cubs are at home on the runway, and any aircraft landing there must wait until guards shoo the animals out of the way.

To the Editor:

You provided a very one-sided picture of the passing of the steam locomotive: "What Comes After the Iron Horse" (Sept. 1953).

(Continued to page 10)

ARE THESE MISTAKES HOLDING YOU BACK?

If you're not getting ahead as fast as you'd like, check these possible reasons. Find out why you're not a success and what you can do about it.

YES NO

- Do you put things off? To get anywhere you have to make a start.
- Do you really want to succeed? Isn't there something you want enough to work for it? Marriage, a new home, money for your family—all depend on your advancement.
- Are you unwilling to give up temporary pleasures? Some people think more of a good time now than of promotion and higher pay later on.
- Are you too lazy to plan ahead? You've got to manage your life, plan for success and stick to it.
- Are you afraid of responsibility? In a bigger job you'll have to make decisions, act, be somebody.
- Are you short on courage? It takes grit and determination to set a course and stick to it.
- Is your education limited? The good jobs go to men who know—men with sound training in their field. I. C. S. offers you that training.
- Do you think you can't afford specialized training? College may be too expensive, but home study lets you earn while you learn, at 1/10 the cost.
- Do you hesitate to find out where to get training? If you shy off from taking the first step, you'll never achieve success.

One out of three who read this page and check their shortcomings will do something about it. Two will stay in the rut. One will plan for self-improvement and stay with it till he gets there. Are you the one?

I. C. S. has helped train nearly 6 million men and women for better jobs. Among its 391 courses there's one that can help you succeed. I. C. S. lessons are clear, direct, authoritative. They give you bedrock facts and theory with practical application. Studying at home you can progress at your own speed, have the advantage of individual instruction. Choose the course you need from the list below, and *mail the coupon today!* We'll send you full information plus free book, "How to Succeed."

I.C.S.—the lifetime Christmas gift

I. C. S., Scranton 9, Penna.

INTERNATIONAL CORRESPONDENCE SCHOOLS

ICS

BOX 5604-L, SCRANTON 9, PENNA.

Without cost or obligation, send me "HOW to SUCCEED" and the booklet about the course BEFORE which I have marked X:

- | | | | | |
|--|---|--|---|--|
| <p>ART</p> <ul style="list-style-type: none"> <input type="checkbox"/> Commercial Art <input type="checkbox"/> Magazine Illustrating <input type="checkbox"/> Fashion Illustrating <input type="checkbox"/> Cartooning <input type="checkbox"/> Sketching and Painting <input type="checkbox"/> Show Card and Sign Lettering <p>AUTOMOTIVE</p> <ul style="list-style-type: none"> <input type="checkbox"/> Automobile, Mechanic <input type="checkbox"/> Auto Elec. Technician <input type="checkbox"/> Auto Body Rebuilding and Refinishing <input type="checkbox"/> Diesel—Gas Engines <p>AVIATION</p> <ul style="list-style-type: none"> <input type="checkbox"/> Aeronautical Engineering Jr. <input type="checkbox"/> Aircraft Engine Mechanic <input type="checkbox"/> Airplane Drafting <p>BUILDING</p> <ul style="list-style-type: none"> <input type="checkbox"/> Architecture <input type="checkbox"/> Arch. Drafting <input type="checkbox"/> Building Contractor <input type="checkbox"/> Estimating <input type="checkbox"/> Carpenter and Mill Work <input type="checkbox"/> Carpenter Foreman <input type="checkbox"/> Reading Blueprints <input type="checkbox"/> House Planning <input type="checkbox"/> Plumbing | <ul style="list-style-type: none"> <input type="checkbox"/> Heating <input type="checkbox"/> Painting Contractor <input type="checkbox"/> Air Conditioning <input type="checkbox"/> Electrician <p>BUSINESS</p> <ul style="list-style-type: none"> <input type="checkbox"/> Business Administration <input type="checkbox"/> Certified Public Accountant <input type="checkbox"/> Bookkeeping and Accounting <input type="checkbox"/> Office Management <input type="checkbox"/> Stenography and Typing <input type="checkbox"/> Secretarial <input type="checkbox"/> Federal Tax <input type="checkbox"/> Business Correspondence <input type="checkbox"/> Letter-writing Improvement <input type="checkbox"/> Personnel and Labor Relations <input type="checkbox"/> Advertising <input type="checkbox"/> Retail Business Management <input type="checkbox"/> Managing Small Business <input type="checkbox"/> Ocean Navigation <input type="checkbox"/> Sales Management <input type="checkbox"/> Short Story Writing <input type="checkbox"/> Creative Salesmanship <input type="checkbox"/> Traffic Management <p>CHEMISTRY</p> <ul style="list-style-type: none"> <input type="checkbox"/> Chemical Engineering <input type="checkbox"/> Chemistry <input type="checkbox"/> Analytical Chemistry | <ul style="list-style-type: none"> <input type="checkbox"/> Petroleum—Nat'l Gas <input type="checkbox"/> Pulp and Paper Making <input type="checkbox"/> Plastics <p>CIVIL, STRUCTURAL ENGINEERING</p> <ul style="list-style-type: none"> <input type="checkbox"/> Civil Engineering <input type="checkbox"/> Structural Engineering <input type="checkbox"/> Surveying and Mapping <input type="checkbox"/> Structural Drafting <input type="checkbox"/> Highway Engineering <input type="checkbox"/> Reading Blueprints <input type="checkbox"/> Construction Engineering <input type="checkbox"/> Sanitary Engineering <p>DRAFTING</p> <ul style="list-style-type: none"> <input type="checkbox"/> Aircraft Drafting <input type="checkbox"/> Architectural Drafting <input type="checkbox"/> Electrical Drafting <input type="checkbox"/> Mechanical Drafting <input type="checkbox"/> Structural Drafting <input type="checkbox"/> Sheet Metal Drafting <input type="checkbox"/> Ship Drafting <input type="checkbox"/> Mine Surveying and Drafting <p>ELECTRICAL</p> <ul style="list-style-type: none"> <input type="checkbox"/> Electrical Engineering <input type="checkbox"/> Electrician <input type="checkbox"/> Electrical Maintenance | <ul style="list-style-type: none"> <input type="checkbox"/> Electrical Drafting <input type="checkbox"/> Electric Power and Light <input type="checkbox"/> Lineman <p>HIGH SCHOOL</p> <ul style="list-style-type: none"> <input type="checkbox"/> High School Subjects <input type="checkbox"/> Mathematics <input type="checkbox"/> Commercial <input type="checkbox"/> Good English <p>MECHANICAL AND SHOP</p> <ul style="list-style-type: none"> <input type="checkbox"/> Mechanical Engineering <input type="checkbox"/> Industrial Engineering <input type="checkbox"/> Industrial Supervision <input type="checkbox"/> Foremanship <input type="checkbox"/> Mechanical Drafting <input type="checkbox"/> Machine Design-Drafting <input type="checkbox"/> Machine Shop Practice <input type="checkbox"/> Tool Design <input type="checkbox"/> Industrial Instrumentation <input type="checkbox"/> Machine Shop Inspection <input type="checkbox"/> Reading Blueprints <input type="checkbox"/> Toolmaking <input type="checkbox"/> Gas—Electric Welding <input type="checkbox"/> Heat Treatment—Metallurgy <input type="checkbox"/> Sheet Metal Work <input type="checkbox"/> Sheet Metal Pattern Drafting <input type="checkbox"/> Refrigeration | <p>POWER</p> <ul style="list-style-type: none"> <input type="checkbox"/> Combustion Engineering <input type="checkbox"/> Diesel—Electric <input type="checkbox"/> Electric Light and Power <input type="checkbox"/> Stationary Steam Engineering <input type="checkbox"/> Stationary Fireman <p>RADIO, TELEVISION COMMUNICATIONS</p> <ul style="list-style-type: none"> <input type="checkbox"/> Practical Radio—TV Eng'ring <input type="checkbox"/> Radio Operating <input type="checkbox"/> Radio and TV Servicing <input type="checkbox"/> Television—Technician <input type="checkbox"/> Electronics <input type="checkbox"/> Telephone Work <p>RAILROAD</p> <ul style="list-style-type: none"> <input type="checkbox"/> Locomotive Engineer <input type="checkbox"/> Diesel Locomotive <input type="checkbox"/> Air Brakes <input type="checkbox"/> Car Inspector <input type="checkbox"/> Railroad Administration <p>TEXTILE</p> <ul style="list-style-type: none"> <input type="checkbox"/> Textile Engineering <input type="checkbox"/> Cotton, Rayon, Woolen Mfg. <input type="checkbox"/> Carding and Spinning <input type="checkbox"/> Warping and Weaving <input type="checkbox"/> Loom Fixing <input type="checkbox"/> Throwing <input type="checkbox"/> Finishing and Dyeing <input type="checkbox"/> Textile Designing |
|--|---|--|---|--|

Name _____ Age _____ Home Address _____

City _____ Zone _____ State _____ Working Hours _____ A.M. to P.M. _____

Occupation _____

Canadian residents send coupon to International Correspondence Schools Canadian, Ltd., Montreal, Canada. . . . Special tuition rates to members of the U. S. Armed Forces.

"How \$2⁹⁵ Saved Me a Hundred!"

...says James McParland of New York City

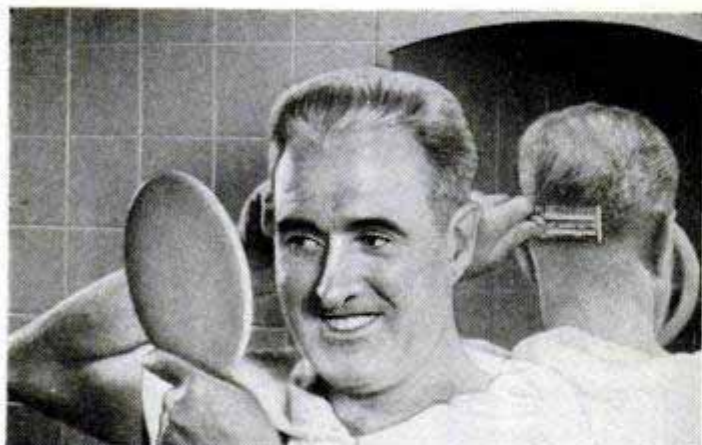

Playtex[®] HOME Hair Cutter*

"Yes, just \$2.95 for a Playtex Home Hair Cutter and our family saved almost a hundred dollars last year in haircut money. And, with Playtex, I'm my own best barber. The first haircuts came out fine. And we were delighted how they improved every time we used the Playtex. Now we get all our haircuts just the way we like them . . . and for only 3¢ apiece!"



Do as hundreds of thousands of families are doing...cut, trim, style hair exactly the way *you* like. Easy as ABC! Dial-adjusted Stainfree floating blade is the secret. Steel guard makes Playtex Hair Cutter 100% safe—foolproof!

\$2⁹⁵

in stainfree steel—complete with 4 blades, nylon cleaning brush, easy-to-follow picture directions, in clear-view travel case. De Luxe gold-plated model, \$5.

At leading drug and department stores.

PRECISION PRODUCTS DIVISION
International Latex Corporation Dover, Delaware

© 1953 *U.S.A. and Foreign Patents Pending

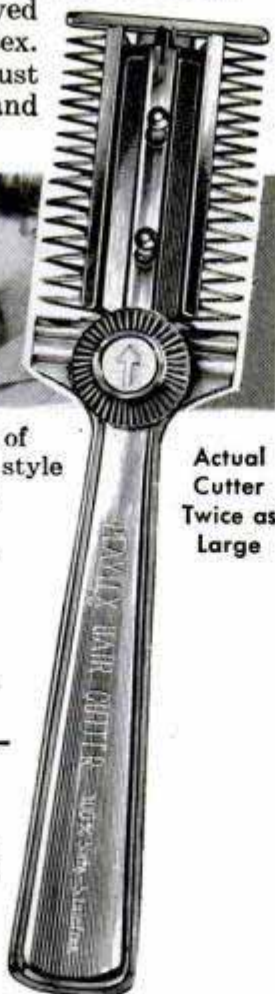

Actual
Cutter
Twice as
Large

(Continued from page 8)

Why didn't you include in your panel of experts someone who is engaged in the actual manufacture of steam locomotives? Asking a manufacturer of diesels or electric locomotives about the future of the steam locomotive was like asking Vishinsky if he thinks there is any future for capitalism. . . .

Wm. A. Novak,
Maywood, Calif.

EDITOR'S NOTE:—There is no locomotive manufacturer currently building the conventional steam locomotive. The only railroad adding steam locomotives in the last year was Norfolk & Western, which built the engines in its own shops. In the last 12 years 16,226 new diesels were put into service while the number of steam locomotives operating dropped from 39,624 to 21,747; in 1952 only 17 new steam locomotives were installed, while 2,227 diesel and electric locomotives were added. Diesels today handle 65 percent of all freight, over 70 percent of all passenger traffic and over 75 percent of yard and switching operations. There are at least 24 major railroads which do not own a steam locomotive. We felt that the steam locomotive's interests were represented by the two railroads participating in the panel, which utilize steam, electric, diesel and turbine locomotives.

To the Editor:

I read with interest sometime back, an article in *Popular Mechanics* [Aug. 1953] about the gas turbine-driven truck that is being road tested at the present time, in the western part of our country.

The article stated that noise and fuel consumption are two of the problems yet to be solved. There is no doubt in anyone's mind, I believe, but what the engineers will one day solve these problems. But at the same time, I can't help but wonder what our engineers could do with steam to power these huge trucks if they were to put their brains to work on this type of power plant. I believe that they could make today's methods of using steam look primitive in a very short time and at the same time take away some of the terrible noise which the present-type power plants make.

I wish we could get them (engineers) interested. I think we all would be grateful if they would.

Kenneth L. Orris,
Maumee, Ohio.

ⓄTires cushioning the landings of the Douglas-built Navy rocket plane that has broken speed and altitude records are no larger than those on a Crosley automobile.

You Practice **SERVICING** with Kits I Send You

Nothing takes the place of PRACTICAL EXPERIENCE. That's why NRI training is based on LEARNING BY DOING. You use parts I send to build many circuits common to Radio and Television. With my Servicing Course you build the modern Radio shown at left. You build a Multitester and use it to help make \$10, \$15 a week fixing sets in spare time while training. All equipment is yours to keep. Coupon below will bring book of important facts. It shows other equipment you build.

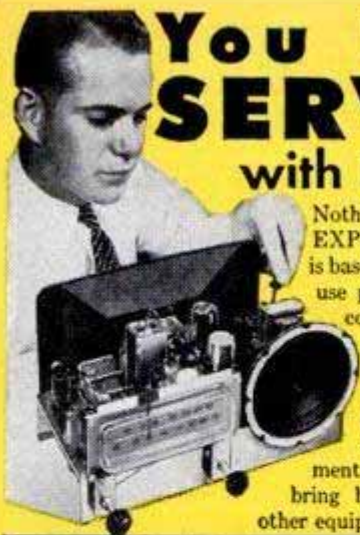

You Practice **BROADCASTING** with Kits I Send You

As part of my Communications Course I send you parts to build low-power Broadcasting Transmitter at left. Use it to get practical experience. You put this station "on the air" . . . perform procedures demanded of broadcasting station operators. An FCC Commercial Operator's License can be your ticket to a bright future. My Communications Course trains you to get your license. Mail coupon. Book shows other equipment you build for practical experience.

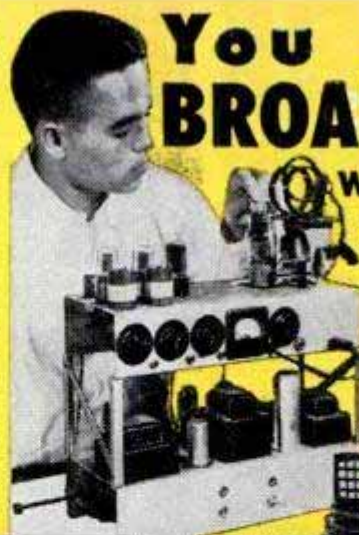

I Will Train You at Home in Spare Time to be a **RADIO-TELEVISION** Technician



TELEVISION Making Jobs, Prosperity

25 million homes have Television sets now. Thousands more sold every week. Trained men needed to make, install, service TV sets. About 200 television stations on the air. Hundreds more being built. Good job opportunities here for qualified technicians, operators, etc.



J. E. SMITH, President National Radio Institute Washington, D. C. Our 40th Year

America's Fast Growing Industry Offers You Good Pay, Success

Training PLUS opportunity is the PERFECT COMBINATION for job security, advancement. When times are good, the trained man makes the BETTER PAY, gets PROMOTED. When jobs are scarce, the trained man enjoys GREATER SECURITY. NRI training can help assure you and your family more of the better things of life. Radio is bigger than ever with over 3,000 broadcasting stations and more than 115 MILLION sets in use, and Television is moving ahead fast.

N.R.I. Training Leads to Good Jobs Like These

I TRAINED THESE MEN

 "Am transmitter-studio operator at KPAT. Most important day of my life was when I enrolled with NRI."—Elmer Frewaldt, Madison, S. Dakota.

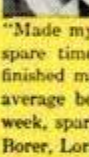
 "Made my first \$100 from spare time work before I finished my course. Now I average better than \$10 a week, spare time."—Frank Borer, Lorain, Ohio.

 "I've come a long way in Radio and Television since graduating. Have my own business on Main Street."—Joe Travers, Asbury Park, New Jersey.

 "I didn't know a thing about Radio. Now have a good job as Studio Engineer at KMMJ."—Bill Delzell, Central City, Nebraska.



BROADCASTING: Chief Technician, Chief Operator, Power Monitor, Recording Operator, Remote Control Operator. **SERVICING:** Home and Auto Radios, Television Receivers, FM Radios, P.A. Systems. **IN RADIO PLANTS:** Design Assistant, Technician, Tester, Serviceman, Service Manager. **SHIP AND HARBOR RADIO:** Chief Operator, Radio-Telephone Operator. **GOVERNMENT RADIO:** Operator in Army, Navy, Marine Corps, Forestry Service Dispatcher, Airways Radio Operator. **AVIATION RADIO:** Transmitter Technician, Receiver Technician, Airport Transmitter Operator. **TELEVISION:** Pick-up Operator, Television Technician, Remote Control Operator.

Start Soon to Make \$10, \$15 a Week Extra Fixing Sets

My training is practical, complete; is backed by 40 years of success training men at home. My well-illustrated lessons give you basic principles you need and my skillfully developed kits of parts "bring to life" things you learn from the lessons. I start sending you special booklets that show you how to fix sets the day you enroll. Multitester you build with my parts helps you discover and correct set troubles, helps you make money fixing neighbors' sets in spare time while training. Many make \$10, \$15 a week extra this way.

Mail Coupon — Find Out What Radio-Television Offer You

Act now to get more of the good things of life. I send actual lesson to prove NRI home training is practical, thorough. My 64-page book "How to be a Success in Radio-Television" shows what my graduates are doing and earning. It gives important facts about your opportunities in Radio-Television. Take NRI training for as little as \$5 a month. Many graduates make more than the total cost of my training in two weeks. Mail coupon now to: J. E. SMITH, President, Dept. 3NA, National Radio Institute, Washington 9, D. C. Our 40th year.

AVAILABLE to all qualified VETERANS UNDER G.I. BILLS

Good for Both—FREE

MR. J. E. SMITH, President, Dept. 3NA National Radio Institute, Washington 9, D. C. Mail me Sample Lesson and 64-page Book, FREE. (No salesman will call. Please write plainly.)

Name.....Age.....
Address.....
City.....Zone.....State.....
VETS write in date of discharge

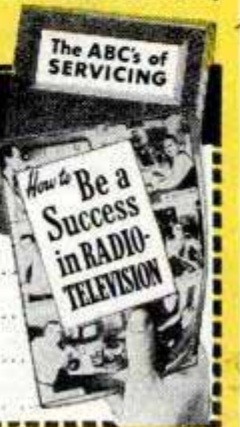

Mail Today—Tested Way to Better Pay

HOW TO FIX ANY PART OF ANY CAR

QUICKLY--EASILY--RIGHT!

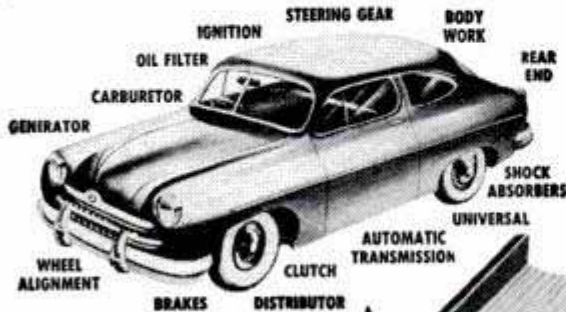

FREE 7-DAY TRIAL

Whether you're a beginner or an expert mechanic — now you can "breeze through" any "fix-it" job from simple carburetor adjustment to complete overhaul. Just look up job in index of MOTOR'S Brand-New 1953 Auto Repair Manual. Follow simple step-by-step directions, clear pictures. Presto—the job is done!

No guesswork! MOTOR'S MANUAL takes you from "scratch" — shows WHERE to start, WHAT tools to use Covers EVERY job on EVERY car built from 1935 thru 1953!

Everything You Need to Know "Boiled Down" from 189 Official Shop Manuals

NEW, REVISED, ENLARGED. 1953 Edition contains the "meat" from over 189 OFFICIAL shop manuals — simplified for YOU. 37,000 essential repair specifications on 907 car models. Over 850 big pages. More than 2500 "this-is-how" pictures. 227,000 service and repair facts. Leads beginners every step of the way. Time-saving factory repair procedures for experts. Instructions and pictures so clear you CAN'T go wrong. Used by U. S. Army and Navy.

Try Book FREE 7 Days

SEND NO MONEY! Pay postman nothing. Make Manual show you what it's got. Unless you agree this is the greatest time and work saver you've ever seen—return book in 7 days and pay nothing. Mail coupon today for MOTOR Book Dept., Desk 112, 250 W. 55th St., New York 19, N. Y.

MOTOR'S AUTO REPAIR MANUAL

Covers 907 Models All These Makes

Buick	La Salle
Cadillac	Lincoln
Chevrolet	Mercury
Chrysler	Nash
Crosley	Nash
De Soto	Rambler
Dodge	Oldsmobile
Ford	Packard
Frazer	Plymouth
Henry J	Pontiac
Hudson	Studebaker
Kaiser	Terraplane
Lafayette	Willlys

Same FREE Offer On MOTOR'S Truck and Tractor Manual

Covers EVERY job on EVERY popular make gasoline truck, tractor made from 1939 thru 1953. FREE 7-Day Trial. Check proper box in coupon.



MAIL COUPON NOW FOR 7-DAY FREE TRIAL

MOTOR BOOK DEPT. Desk 112, 250 W. 55th St., New York 19, N. Y.

Rush to me at once (check box opposite book you want!)

MOTOR'S New AUTO REPAIR MANUAL. If O.K., I will remit \$1 in 7 days, \$2 monthly for 2 months and a final payment of 95c (plus 35c delivery charges) one month after that. Otherwise I will return the book postpaid in 7 days. (Foreign price, remit \$8 cash with order.)

MOTOR'S New TRUCK & TRACTOR REPAIR MANUAL. If O.K., I will remit \$2 in 7 days, and \$2 monthly for 3 months, plus 35c delivery charges with final payment. Otherwise I will return book postpaid in 7 days. (Foreign price, remit \$10 cash with order.)

Print Name..... Age.....

Address

City..... State.....

Check box and save 35c delivery charge by enclosing WITH coupon entire payment of \$5.95 for Auto Repair Manual (or \$8 for Truck & Tractor Repair Manual.) Same return-refund privilege.

WHERE-TO-BUY-IT INDEX

Source of supply appears after items commercially available

AUTOMOTIVE

Parking-lot guard operated by coin eliminates need for attendants (Park-O-Matic, Inc., Detroit, Mich.)..... 73
 Mercedes-Benz is roomier with better vision than former model 73
 1954 Nash line..... 80
 DeSoto V8 offers added horsepower and new transmission.... 80
 Studebaker offers station wagon in 1954..... 81
 Here come the Corvettes!..... 82
 Detroit Listening Post..... 88
 Rail-riding Plymouth 105
 Homemade horseless carriage built in 1900 rattles again..... 108

AUTOMOTIVE ACCESSORIES

Circular road map fits on steering wheel for ready reference.. 108
 Battery tester-analyzer can forecast failures (Auto-Test, Inc., 411 W. 8th St., Neillsville, Wis.)..... 120
 Quickly installed spotlight grips automobile windshield..... 120
 Emergency telescopic flasher elevates for visibility (McDonald and Arneson, 225 Springs Rd., Vallejo, Calif.)..... 120
 Clamp-on spring steel band serves as nonskid chain (Automatic Non-Skid Chain Co., 350—5th Ave., New York City 1)..... 120
 Back toaster for cilly drivers (Howard Hollander, 115 Central Park West, New York City)..... 220
 Finned brake drum adds life to linings (Copperweld Steel Co., Glassport, Pa.) 220

AVIATION

Production fighter tops speed of sound (North American Aviation, Inc., Los Angeles 45, Calif.)..... 81
 PM glider, 1909 model..... 84
 Milestones of aviation..... 92
 Air traffic fills Atlantic skies..... 94
 French air oddities..... 115
 Marine flies rocket plane to altitude of nearly 16 miles..... 127
 Model airliner's "Venetian blind" wings permit vertical take-off 128
 Airplane distance finder (Federal Telecommunications Laboratories, Inc., Nutley, N. J.)..... 134

CONSTRUCTION

Aluminum skyscraper 86
 Grinding "giraffe" polishes concrete ceilings without scaffolding (Concrete Grinding Corp., 300 Straight St., Paterson, N. J.)..... 91
 Room-a-day is the story of 59-room prefab building (Mobil-home Corp. of America, Box 3306, Bakersfield, Calif.)..... 133
 Lightweight cooked concrete handles like wood (United States Plywood Corp., 55 West 44th St., New York City 36)..... 135

FARMING

Miniature trailer with fold-down ramp hauls tractors (Sunderman Mfg. Co., Box 85, Sioux Falls, S. D.)..... 109
 Handle on post tightens barbed-wire gate (E-Z-Tite, Box 3135, St. Louis 5, Mo.)..... 134
 Wire winder operates off tractor tires (H. D. Hume Co., Mendota, Ill.) 144
 Clamp on cow prevents tail-swishing..... 216

HOUSE AND HOME

Coffee kit (House of Leather, Box 38, Bloomington, Ill.)..... 75
 Motorized spit (Brevet Products Corp., 508 Broome St., New York City) 75
 Photo lampshade (Coast O'Maine Studio, R. S. Vennerbeck Co., Inc., Boothbay Harbor, Me.)..... 76
 Dishwashing sprayer (Regnille Tool & Engineering Co., 923 E. Garfield Ave., Milwaukee 12, Wis.)..... 76
 Wall clock (Art Specialty Co., 7112 Washington Ave., Racine, Wis.) 76
 Multipurpose lamp (Carleton Associates, Box 444, Fairfield, Conn.) 77
 Home-freezing kit (Sydney-Thomas Corp., 2055 Reading Road, Cincinnati, Ohio) 77
 Electric trivet (Bay Giftwares, Whitefish Bay 17, Wis.)..... 77
 Water-powered mixer (Aqua-Matic Products Co., Poole St., Oceanside, N. Y.)..... 77
 Pigment tubes give homeowner choice of 1322 paint colors (Bennett's, 65 West First South St., Salt Lake City 10, Utah) 90
 Wall coating resists fire (Dow Chemical Co., Midland, Mich.)..... 108
 Hinged blade of snow shovel adapts to shoveling or pushing (Gardex, Inc., Michigan City, Ind.)..... 128
 Joshua tree veneer (O. A. Metzger, 228 North 1st Ave., Arcadia, Calif.) 135
 "Safety pin" skewer holds six frankfurters (I. K. Lockey, Box 157, Sumatra, Fla.)..... 228
 Automatic control for dehumidifiers (Minneapolis-Honeywell Regulator Co., 2755—4th Ave. S., Minneapolis, Minn.)..... 252

MILITARY AND NAVAL

Portable garage with "buggy top" doors shelters Army vehicles (Evans Products Co., Plymouth, Mich.)..... 128
 Vest holds 117 batteries to power walkie talkie..... 134
 Dry-land destroyer-escort teaches recruits drill procedures..... 135

OFFICE, SHOP AND STORE

Five instruments combined by plastic draftsman's tool (Ambi Corporation, 162-54—14th Ave., Whitestone 57, N. Y.) 72
 Merry-go-round spins cake for decorator (Duchess, Inc., 24th & Grove, Oakland, Calif.)..... 132
 Wrap-around glass fiber blanket insulates any size pipe (Owens-Corning Fiberglas Corp., Toledo 1, Ohio)..... 234
 Illuminated pencil 246
 Magnet for magnetizing (Alger Tool Co., Box 1212, Lansing 4, Mich.) 252

(Continued to page 14)



INVENTORS

Learn how to protect your invention. The U. S. Patent Laws provide that any new and useful art, machine, article of manufacture, or composition of matter, or any new and useful improvement thereof, may be patented if the act of invention is involved. Therefore, every inventor with a valuable invention should take advantage of the Patent Laws and proceed for patent protection in order to safeguard his rights.

A patent gives the inventor the exclusive right to prevent others from making, using, or selling the invention claimed in the patent for a period of seventeen years.

The Patent Laws were enacted for the benefit of the inventor to give him protection for the features of his invention which are patentable. These features must be properly and concisely set forth and claimed in a formal application for patent, in order to comply with the requirements of the Patent Laws. For that reason, unless the inventor is familiar with patent matters, he should engage a competent registered patent attorney or agent to represent him. We are registered to practice before the U. S. Patent Office and are prepared to serve you in the handling of your patent matters.

A specially prepared booklet entitled "Patent Guide for the Inventor", containing detailed information with respect to patent protection and procedure, together with a "Record of Invention" form will be promptly forwarded to you without obligation upon request.

CLARENCE A. O'BRIEN & HARVEY JACOBSON

Registered Patent Attorneys

31-M DISTRICT NATIONAL BUILDING

WASHINGTON 5, D. C.

**"Cake" - not wood
mellows
your smoke**

**and the
exclusive
honey lining
cakes Yello-Bole
imported briar far faster
than any pipe at any price!**

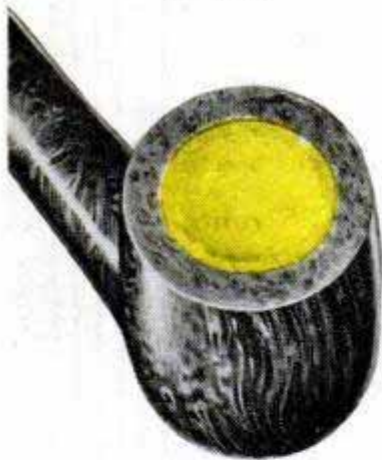

The yellow in Yello-Bole is real honey —and honey cakes faster! This great Yello-Bole exclusive builds up "cake" from the first puff . . . holds the cake fast to fine imported briar. One pipeful — and you're smoking cool and sweet. No break-in. *No tongue sting!* It's the pipe that takes the cake!

PROOF?

**Yello-Bole is the world's
largest selling pipe . . . BY FAR!**

YELLO-BOLE

**\$1.00
TO
\$2.50**



(Continued from page 12)

PHOTOGRAPHY

Tripod attachment permits wide variety of positions (Burke and James, Inc., 321 S. Wabash Ave., Chicago)..... 73
Projector (Eastman Kodak Co., Rochester 4, N. Y.)..... 74
Aerial photos aid log counters..... 121
Oversize camera produces large photograph in one minute (Polaroid Corp., Cambridge 39, Mass.)..... 144
Camera designed for rapid-sequence shots (Willoughbys, 110 West 32nd St., New York City 1)..... 216

SCIENCE

Five-by-five atomic pile aids research workers..... 71
Mammoth solar furnace "burns" at 3000 degrees..... 85
Mountain-top laboratory for cosmic-ray research..... 89
Rare metal germanium harvested from vegetables..... 132

SPORTS AND RECREATION

Golfball feeder (Parco Company, 82 Beaver St., New York City 5)..... 75
Electric reel (Electric Reel Co., Route 1, Box 29, Firebaugh, Calif.)..... 75
Quiet outboard motor has noise cushions (Evinrude Motors, 4143 North 27th, Milwaukee, Wis.)..... 91
Two-piece German ski comes apart for carrying convenience (California International Co., 9490 Brighton Way, Beverly Hills, Calif.)..... 109
Convertible skate..... 246

TOYS

Powerful slingshot (Bullshot Sales Co., Box 12132, Los Angeles 26, Calif.)..... 74
Shuffleboard set (Dimco-Gray Co., 211 E. 6th St., Dayton 2, Ohio)..... 76
Coaling station (Lionel Corp., Irvington, N. J.)..... 78
Toy chest (Jeff Elliot Craftsmen, Station C., Flushing 67, N. Y.)..... 78
Bulldozer (New London Metal Processing Co., 82 Union St., New London, Conn.)..... 78
Electric tractor (Product Miniature Co., Inc., 2240 South 54th St., Milwaukee 14, Wis.)..... 78
Lumber kit (Alice Werner, Dept. PM, 1659 Bridge St. N.W., Grand Rapids 4, Mich.)..... 78
Building set (Monsanto Chemical Co., 445 Park Ave., New York City)..... 79
Bucket loader (Charles W. Doeppe Mfg. Co., 1917 Emerald Ave., Rossman, Ohio)..... 79
Electric auto (Mystic River Sales Co., Mystic, Conn.)..... 79
HO model (Athearn Mfg. Co., 11929 S. Western, Los Angeles 44, Calif.)..... 79
Kit produces "3D" figures from series of flat parts (Empire Hobby Industries Corp., 722 Coney Island Ave., Brooklyn 18, N. Y.)..... 90
Folding box solves Christmas train-storage problem the year 'round (Train-A-Way, Carlisle, Pa.)..... 90

MISCELLANEOUS

Quick-change drying cartridge removes moisture from gas (Ansul Chemical Co., Marinette, Wis.)..... 72
Mining machine with many functions multiplies ore production..... 72
Chemicals check oak wilt..... 73
Belt watch (Robert Watch Co., 580-5th Ave., New York City)..... 74
Fountain-pen set (Parker Pen Co., Janesville, Wis.)..... 74
Photo playing cards (Dunhill Playing Cards, 3550 White Plains Road, New York City 67)..... 77
Wheeled frame helps wounded soldiers regain use of legs.... 91
Ring around the stage..... 106
Garbage becomes humus..... 109
Chemical toughens cotton fibers..... 128
Portable emergency light..... 134
V-shape "boat" puts concrete lining into irrigation trenches. 144
Imported grass stays green..... 214

Craftsman and Shop Notes Index

AUTOMOTIVE

Plastic shoe bag in car trunk eliminates packing problem.... 152
Inner-tube strap holds articles on automobile front seat.... 156
Skid chains put on easily..... 169
Corroded carburetor cleaned by mild acid solution..... 185
Prevent engine overheating after a complete overhaul..... 195

FARMING

Extra-wide, farm-implement gate easily handled..... 185
Portable, general-purpose shelter is easily towed on skids.... 185
Overhead plumbing in barn simplifies floor cleaning..... 186
Hardware cloth on combine reel prevents fouling..... 191
Fan cools dairy barn at milking time..... 192
Tractor-lift arms used to load corn shocks..... 192
Oil ignited in drain tile thaws frozen hydrant..... 192
Combined taillight and flagstaff guards implements on highway..... 196
Milk-can lids removed with wringer roller..... 204

HOLIDAY TIPS

Christmas-card display rack adds festive touch..... 156
Candles to Christmas trees with paper and foil..... 157
Christmas ideas..... 173

HOUSE AND HOME

Repairing toaster elements..... 156
Clothespin provides handle for razor blade..... 157
Foiling household chores..... 158
Solving Home Problems..... 162
Friction block holds door open..... 164
Spatter shield on stove burner improvised from metal container..... 172

(Continued to page 16)



Picture yourself going places

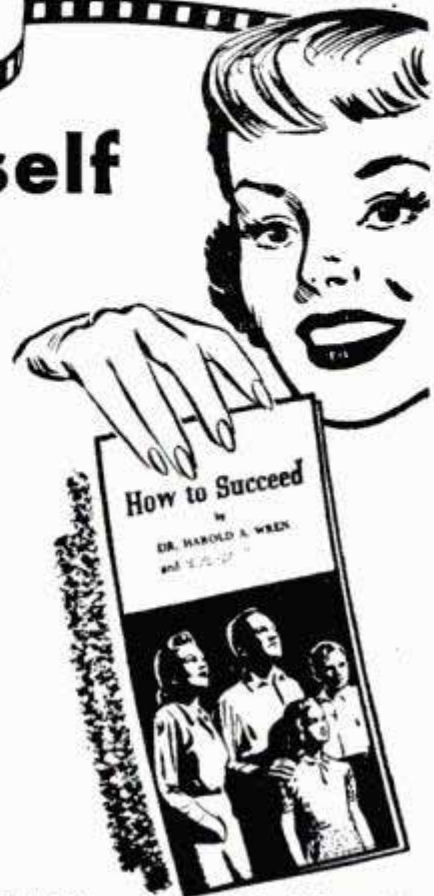

You've done it often. Call it day-dreaming if you like, but you've seen yourself in a bigger job - giving orders and making decisions - driving off in a smart new car - buying your family a fine home.

There's nothing wrong with dreams. But how about making them come true? *You can do it*, if you're willing to try!

Look around you. The men who are going places are the *trained men*. They've learned

special skills that bring them better jobs and higher pay. It's the men *without* training whose dreams never come true.

What are you going to do about it? Just wait and wish? If you really *want to succeed*, you can get the training you need by studying at home in your spare time. International Correspondence Schools offer you a course in just about any field you choose, giving you the practical plus the bedrock facts and theory. No skimming or skimping! And you'll be earning while you learn. Students report better jobs and more pay within a few months.

Look over the list of subjects in the coupon below. Pick out the one that interests you most - the one that holds the greatest future for you. Then mark the coupon, and mail it today. *Find out* what I. C. S. can do for you. It costs only a stamp or postcard, but it's the first step if you want to go places!



SMARTEST THING HE EVER DID

"I noticed that the trained men held the better jobs. That's when I decided to take an I. C. S. course. Enrolling with I. C. S. was one of the smartest things I ever did. The position as Plant Engineer I hold today is largely due to the 'know-how' derived from my I. C. S. texts. I. C. S. can help any man who will study."

L. P. S., Elkhart, Ind.

FREE BOOK

"How to Succeed." 36 pages packed with worthwhile success tips. Step-by-step plan of action. Pocket size edition. Absolutely free. Send coupon below.

I.C.S. - The Lifetime Christmas Gift

I. C. S., Scranton 9, Penna.

INTERNATIONAL CORRESPONDENCE SCHOOLS



BOX 5606-L, SCRANTON 9, PENNA.

Without cost or obligation, send me "HOW to SUCCEED" and the booklet about the course BEFORE which I have marked X:

- | | | | | |
|--|---|--|---|--|
| <p>ART</p> <ul style="list-style-type: none"> <input type="checkbox"/> Commercial Art <input type="checkbox"/> Magazine Illustrating <input type="checkbox"/> Fashion Illustrating <input type="checkbox"/> Cartooning <input type="checkbox"/> Sketching and Painting <input type="checkbox"/> Show Card and Sign Lettering <p>AUTOMOTIVE</p> <ul style="list-style-type: none"> <input type="checkbox"/> Automobile, Mechanic <input type="checkbox"/> Auto Elec. Technician <input type="checkbox"/> Auto Body Rebuilding and Refinishing <input type="checkbox"/> Diesel-Gas Engines <p>AVIATION</p> <ul style="list-style-type: none"> <input type="checkbox"/> Aeronautical Engineering Jr. <input type="checkbox"/> Aircraft Engine Mechanic <input type="checkbox"/> Airplane Drafting <p>BUILDING</p> <ul style="list-style-type: none"> <input type="checkbox"/> Architecture <input type="checkbox"/> Arch. Drafting <input type="checkbox"/> Building Contractor <input type="checkbox"/> Estimating <input type="checkbox"/> Carpenter and Mill Work <input type="checkbox"/> Carpenter Foreman <input type="checkbox"/> Reading Blueprints <input type="checkbox"/> House Planning <input type="checkbox"/> Plumbing | <ul style="list-style-type: none"> <input type="checkbox"/> Heating <input type="checkbox"/> Painting Contractor <input type="checkbox"/> Air Conditioning <input type="checkbox"/> Electrician <p>BUSINESS</p> <ul style="list-style-type: none"> <input type="checkbox"/> Business Administration <input type="checkbox"/> Certified Public Accountant <input type="checkbox"/> Bookkeeping and Accounting <input type="checkbox"/> Office Management <input type="checkbox"/> Stenography and Typing <input type="checkbox"/> Secretarial <input type="checkbox"/> Federal Tax <input type="checkbox"/> Business Correspondence <input type="checkbox"/> Letter-writing Improvement <input type="checkbox"/> Personnel and Labor Relations <input type="checkbox"/> Advertising <input type="checkbox"/> Retail Business Management <input type="checkbox"/> Managing Small Business <input type="checkbox"/> Ocean Navigation <input type="checkbox"/> Sales Management <input type="checkbox"/> Short Story Writing <input type="checkbox"/> Creative Salesmanship <input type="checkbox"/> Traffic Management <p>CHEMISTRY</p> <ul style="list-style-type: none"> <input type="checkbox"/> Chemical Engineering <input type="checkbox"/> Chemistry <input type="checkbox"/> Analytical Chemistry | <ul style="list-style-type: none"> <input type="checkbox"/> Petroleum-Nat'l Gas <input type="checkbox"/> Pulp and Paper Making <input type="checkbox"/> Plastics <p>CIVIL, STRUCTURAL ENGINEERING</p> <ul style="list-style-type: none"> <input type="checkbox"/> Civil Engineering <input type="checkbox"/> Structural Engineering <input type="checkbox"/> Surveying and Mapping <input type="checkbox"/> Structural Drafting <input type="checkbox"/> Highway Engineering <input type="checkbox"/> Reading Blueprints <input type="checkbox"/> Construction Engineering <input type="checkbox"/> Sanitary Engineering <p>DRAFTING</p> <ul style="list-style-type: none"> <input type="checkbox"/> Aircraft Drafting <input type="checkbox"/> Architectural Drafting <input type="checkbox"/> Electrical Drafting <input type="checkbox"/> Mechanical Drafting <input type="checkbox"/> Structural Drafting <input type="checkbox"/> Sheet Metal Drafting <input type="checkbox"/> Ship Drafting <input type="checkbox"/> Mine Surveying and Drafting <p>ELECTRICAL</p> <ul style="list-style-type: none"> <input type="checkbox"/> Electrical Engineering <input type="checkbox"/> Electrician <input type="checkbox"/> Electrical Maintenance | <ul style="list-style-type: none"> <input type="checkbox"/> Electrical Drafting <input type="checkbox"/> Electric Power and Light <input type="checkbox"/> Lineman <p>HIGH SCHOOL</p> <ul style="list-style-type: none"> <input type="checkbox"/> High School Subjects <input type="checkbox"/> Mathematics <input type="checkbox"/> Commercial <input type="checkbox"/> Good English <p>MECHANICAL AND SHOP</p> <ul style="list-style-type: none"> <input type="checkbox"/> Mechanical Engineering <input type="checkbox"/> Industrial Engineering <input type="checkbox"/> Industrial Supervision <input type="checkbox"/> Foremanship <input type="checkbox"/> Mechanical Drafting <input type="checkbox"/> Machine Design-Drafting <input type="checkbox"/> Machine Shop Practice <input type="checkbox"/> Tool Design <input type="checkbox"/> Industrial Instrumentation <input type="checkbox"/> Machine Shop Inspection <input type="checkbox"/> Reading Blueprints <input type="checkbox"/> Toolmaking <input type="checkbox"/> Gas-Electric Welding <input type="checkbox"/> Heat Treatment-Metallurgy <input type="checkbox"/> Sheet Metal Work <input type="checkbox"/> Sheet Metal Pattern Drafting <input type="checkbox"/> Refrigeration | <p>POWER</p> <ul style="list-style-type: none"> <input type="checkbox"/> Combustion Engineering <input type="checkbox"/> Diesel-Electric <input type="checkbox"/> Electric Light and Power <input type="checkbox"/> Stationary Steam Engineering <input type="checkbox"/> Stationary Fireman <p>RADIO, TELEVISION COMMUNICATIONS</p> <ul style="list-style-type: none"> <input type="checkbox"/> Practical Radio-TV Eng'ring <input type="checkbox"/> Radio Operating <input type="checkbox"/> Radio and TV Servicing <input type="checkbox"/> Television-Technician <input type="checkbox"/> Electronics <input type="checkbox"/> Telephone Work <p>RAILROAD</p> <ul style="list-style-type: none"> <input type="checkbox"/> Locomotive Engineer <input type="checkbox"/> Diesel Locomotive <input type="checkbox"/> Air Brakes <input type="checkbox"/> Car Inspector <input type="checkbox"/> Railroad Administration <p>TEXTILE</p> <ul style="list-style-type: none"> <input type="checkbox"/> Textile Engineering <input type="checkbox"/> Cotton, Rayon, Woolen Mfg. <input type="checkbox"/> Carding and Spinning <input type="checkbox"/> Warping and Weaving <input type="checkbox"/> Loom Fixing <input type="checkbox"/> Throwing <input type="checkbox"/> Finishing and Dyeing <input type="checkbox"/> Textile Designing |
|--|---|--|---|--|

Name _____ Age _____ Home Address _____

City _____ Zone _____ State _____ Working Hours _____ A.M. to P.M. _____

Occupation _____

Canadian residents send coupon to International Correspondence Schools Canadian, Ltd., Montreal, Canada. . . . Special tuition rates to members of the U. S. Armed Forces.

THOUSANDS NOW PLAY

who never thought they could!



WOULDN'T TAKE \$1000 FOR COURSE

"The lessons are so simple that anyone can understand them. I have learned to play by note in a little more than a month. I wouldn't take a thousand dollars for my course." *S.E.A., Kansas City, Mo.

PLAYS AT DANCES

"The Piano course I'm taking is the 3rd course with your school. Previously I took Saxophone and Clarinet. Since then I've played a lot of dance jobs." *E. A., Lake View, Iowa.



PLAYS ON RADIO

"I can't keep from telling you that I have a good position playing from KTHS, Hot Springs, Ark., every morning." *J. S., Okla.



**You, too, can play any instrument by
this EASY A-B-C METHOD**

YOU think it's difficult to learn music? That's what thousands of others have thought! Just like you, they longed to play some instrument. But they denied themselves the pleasure — because they thought it took months and years of tedious study to learn.

And then they made an amazing discovery! They learned about a wonderful way to learn music at home—without a private teacher—without tedious study—and in a surprisingly short time. They wrote to the U. S. School of Music about this remarkable short cut method. A free Lesson-Sample actually showed them how easy it was to learn.

The result, over 900,000 people have studied music at home this simple, A-B-C way. They have found the key to good times, popularity and profit.

And that's what you can do right now. Simply mail the coupon. Get the proof that you, too, can learn to play your favorite instrument—quickly, easily, in spare time at home. Just read the fascinating illustrated Book — examine the free Lesson-Sample. Tear out the coupon now, before you turn the page. Instruments supplied when needed, cash or credit. U. S. SCHOOL OF MUSIC, Studio C3012, Port Washington, N. Y. 55th Successful year. (Established 1898.)

*Actual names on request. Pictures by professional models.

FREE! Book and Lesson-Sample

U. S. SCHOOL OF MUSIC, Studio C3012
Port Washington, N. Y.

Send me Free Book and free Lesson-Sample. No salesman is to call upon me. I'm interested in playing (name instrument).....

I do I do NOT—have instrument now.

Name.....
(please print)

Address.....

(Continued from page 14)

Tacks through terminal nuts prevent damage to carpet.....	176
Rubber hose snubs door spring.....	181
Exterminating black ants.....	191

METALWORKING

Self-supporting shelf brackets made of welded pipe.....	161
Reflector for shop light made from kettle.....	164
Plan of the month—wrought-iron furniture.....	170

OFFICE, SHOP AND STORE

Long extension rule improvised from tongue-and-groove boards.....	152
Saw blade hold-down aids glass cutting.....	160
Rust preventive for tools.....	160
Plastic egg-storage tray used in mixing artist's colors.....	176
Drop cord kept on empty spool.....	186
Hand truck equipped with crane lifts heavy loads.....	186
Raised cash-register keys are timesaver in store.....	191
Gauge gives scale reductions directly on layout.....	192
Wrecking tool for plasterboard from discarded car spring.....	201
Brake stops T-square slipping on large inclined boards.....	201
Square held on sawhorse leg.....	204

PAINT AND PAINTING

Lacquer thinner has many uses.....	152
Proper mixing of paint important to good job.....	156
Repairing cracks in plaster.....	164
Wood stained with fabric dye.....	164
Patching plaster applied with small brush.....	172
Foil speeds paint color change.....	172
Wet-paint signs supported by pin card holders.....	204

PHOTOGRAPHY

Refrigerator water coolers used as developing trays.....	182
Enlarger doubles as printer.....	182
Blue filter on enlarger gives softer contrast.....	182

TOOLS

Jig for building picket fence.....	172
Mason's two-way level (Handy Mason's Level, 371 E. Becker St., Milwaukee 7, Wis.).....	202
Rotating drill holder (Wayne Products Co., 2757 Hawthorne, Franklin Park, Ill.).....	202
Motor-driven sander (Dremel Mfg. Co., Racine, Wis.).....	202
Storage container (Empire Oil Co., 4800 S. California Ave., Chicago 32).....	202
Cartridge-actuated power driver (Velocity Power Tool Co., 201 N. Braddock Ave., Pittsburgh 8, Pa.).....	203
Sliding "trowel" (Kakest Co., Curwensville, Pa.).....	203
Tool holder (Brookfield, Inc., 755 Boylston St., Boston, Mass.).....	203
Portable bender (Iron Bender Sales Co., 6547 West Blvd., Inglewood 3, Calif.).....	203

TOYS AND NOVELTIES

Ride 'em cowboy.....	174
Rack for table-tennis balls made from cigar box.....	176
Modeling-clay substitute cooked in kitchen.....	181
Miniature license holder used as luggage identification tag.....	181

WORKSHOP HINTS

Pivoted paddle holds sandpaper for sharpening pencils.....	152
Distorted cotter pin reshaped with screwdriver and pliers.....	152
Rubber tubing holds screw for easy starting.....	156
Cotter-pin holes aligned quickly by notch filed on bolt.....	160
Table insert used as wrench to adjust blade chuck.....	160
Sharpen rasp with grinding wheel.....	160
Oiler made from bobby pin.....	160
Tape holds small parts.....	161
Reducing tap breakage.....	184
Cut-off tool hollow ground to form curved chip.....	185
Adjustable ripping fence extends saw capacity.....	186
Chips "floated" from tapped hole by using light grease.....	186
Cutting circular gaskets.....	196
Hard-rubber stoppers frozen for easy machining.....	196
Lathe-carriage stops altered for multiple operations.....	204
Brackets hinged above bench support machinist's chest.....	204

MISCELLANEOUS

Clean soiled playing cards.....	156
Floor lamp becomes modern torchere.....	161
Ice pick aids nailing of stud.....	164
Rack for rubbers and galoshes.....	169
Dry cells stored in refrigerator.....	172
Open loop holds tools.....	172
Outboard-motor drain deflector protects against corrosion.....	176

Radio-Television, Electronics

Wide-screen 16-mm movies (Bell & Howell Co., 7100 McCormick Rd., Chicago 45).....	145
One-tube loudspeaker set for junior builders.....	146
Remote-controlled TV-radio-phonograph (Crosley Div., Avco Mfg. Corp., 1329 Arlington St., Cincinnati 25, Ohio).....	148
Dampness preventer for TV sets (Damp-Chaser, Inc., Box 520, Hendersonville, N. C.).....	148
Tuner brings in 16 channels (Radio Corporation of America, RCA Victor Div., Camden, N. J.).....	148
UHF twin corner reflector TV antenna (Channel Master Corp., Ellenville, N. Y.).....	148

IMPORTANT NOTICE—It is the intention of this magazine to provide its readers with information regarding the latest developments in the mechanical arts. We take no responsibility as to whether the disclosures contained in our articles are covered by patents and advise readers to investigate this subject before making, using, or selling any of the products, machines, or processes described in order to avoid possible liability for patent infringements.

INVENTORS

If you believe that you have an invention, you should find out how to protect it. The first step is to have a search made of the prior pertinent U. S. patents. If a report on this search indicates that the invention appears patentable you can apply for a patent, and the specifications and claims should be prepared.

The firm of McMorrow, Berman & Davidson, with offices in Washington, D. C., is qualified to take the necessary steps for you. We can make a preliminary search on your invention, advise you whether we think it can be patented, and prepare your application for

patent.

Unless you are fully familiar with the U. S. Patent Laws, we recommend that you engage the services of a Registered Patent Attorney to protect your interests. The patent laws are *your* laws. A patent gives you the right to prevent others from making, using or selling the invention claimed in your patent for a period of 17 years.

Use these patent laws for your protection. Investigate whether your invention can be patented. If you have what you believe to be an invention, we suggest that you have this firm make a search for you.

Send for a copy of our Patent Booklet entitled "How To Protect Your Invention," containing information about patent protection and patent procedure. Along with this we will also send you an "Invention Record" form, for your use in writing down and sketching details of your invention. We will mail them promptly. No obligation. They are yours for the asking.

McMORROW, BERMAN & DAVIDSON

Registered Patent Attorneys

PATENTS • COPYRIGHTS • PATENTS

135-W VICTOR BUILDING, WASHINGTON 1, D. C.

WHAT SECRET POWER DID THIS MAN POSSESS?

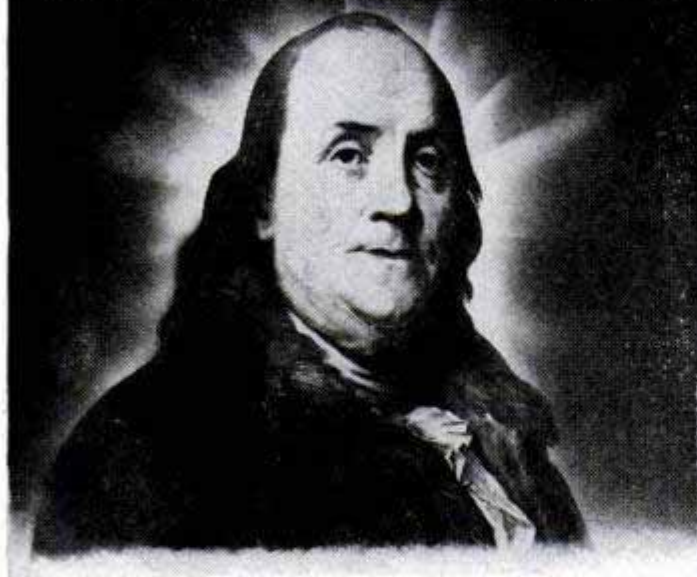

BENJAMIN FRANKLIN
(A Rosicrucian)

WHY was this man great? How does anyone—man or woman—achieve greatness? Is it not by mastery of the powers within ourselves?

Know the mysterious world within you! At-tune yourself to the wisdom of the ages! Grasp the inner power of your mind! Learn the secrets of a full and peaceful life!

Benjamin Franklin—like many other learned and great men and women—was a Rosicrucian. The Rosicrucians (NOT a religious organization) first came to America in 1694. Today, headquarters of the Rosicrucians send over seven million pieces of mail annually to all parts of the world. Write for YOUR FREE COPY of "The Mastery of Life"—TODAY. No obligation. No salesmen. A non-profit organization. Address: Scribe B.T.Y.

THIS BOOK FREE!

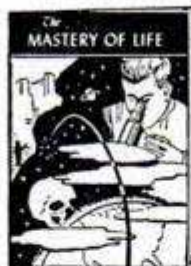

The ROSICRUCIANS

SAN JOSE • (AMORC) • CALIFORNIA

—SEND THIS COUPON—

Scribe B.T.Y.
The ROSICRUCIANS (AMORC)
San Jose, California
Please send me the free book, *The Mastery of Life*, which explains how I may learn to use my faculties and powers of mind.

Name _____
Address _____
City _____

WRITTEN ALL TIME SERVICE GUARANTEE
17 JEWEL SHOCK RESIST NEW WATCH

WAS \$50.00 under O.P.A.
OUR PRICE ONLY **\$14.95**
Plus \$1.50 tax

YOU SAVE \$35.00



WEAR AT OUR RISK

Guaranteed Inca-Bloc. Shock-Protected Damp-resist. Dust Resist construction. Anti-magnetic. Proved in Army, Air, and Navy service. Has sweep second hand, radium dial, genuine imported 17-jewel Swiss lever movement. You save sensationally on new de-luxe watches sold with WRITTEN ALL TIME SERVICE GUARANTEE, because we buy out distress and surplus stocks. Order now. Wear 10 days. Money back if not delighted. Order men's style—\$14.95, plus \$1.50 tax. Or ladies' style, \$15.95 plus \$1.60 tax. Send only \$1 down payment with order, pay balance on arrival. Or enclose full payment plus tax, and we pay postage. Handsome expansion band included free if you order now.

MEADE CO. DEPT. 45, 175 FIFTH AVENUE
NEW YORK—10, NEW YORK

Learn to **MOUNT BIRDS**

Tan SKINS, Make Up FURS
Be a Taxidermist. We teach you at Home. Mount Birds, Animals, Pets, Game Heads, Fish. Save your hunting trophies; decorate home and den. **MAKE MONEY**. Mount and Krometize for others. Big spare-time profits.

FREE BOOK 100 game pictures, 48 pages. Hunters, get this wonderful book. It's Now Free. Send postcard TODAY. State AGE. NORTHWEST TAXIDERMIST SCHOOL, Dept. 2572, Omaha, Nebraska

THE KEY TO POWER

Life is law and never luck!

Create the future you desire by learning to control your subconscious mind. Free booklet. Write to

KEY TO POWER

Dept. PM, 7321 Beverly Blvd. Los Angeles 36, Calif.

Learn **ACCOUNTING** Business Administration

Bookkeeping, secretarial and allied subjects at home in your spare time or attend nationally approved resident school. Write for FREE Success Book giving complete details on courses, plans, rates and employment opportunities. G.I. approved.

Hills BUSINESS UNIVERSITY AND EXTENSION SCHOOL
619 W. MAIN ST. OKLAHOMA CITY 2, OKLAHOMA

Operation "EASY STREET"

Take the Red Comet road to Big Profits

Earn up to \$10,000 or more per year!

Nothing to invest! Full or part time!

Make year-round profits selling famous Red Comet automatic fire extinguishers. Easy to sell! Every home, farm, business a prospect. Advertised Post, Collier's, Country Gentleman. Priced to sell quickly—a sales "natural"!



U.S. Pat. D 153853 D 153854

FREE SALES KIT

Demonstrator units, sales literature, etc., furnished you FREE. Handsome leather-type kit. Tried and proved over 21 years, it will make you an independent business man. Someone in your community will be appointed soon. Write for details today!

RED COMET, Inc.

Dept. 385G, R.C. Bldg., Littleton, Colo.



THESE MEN ARE GETTING PRACTICAL TRAINING

IN TELEVISION-RADIO

On Real:

**TELEVISION SETS
RADIO RECEIVERS
F.M.**

(Frequency Modulation)

ELECTRONICS

RECORD CHANGERS

AUTO RADIOS

PUBLIC ADDRESS Systems

(Right—Instructor helping students check the wiring and trace circuits of television receivers)



AND

ELECTRICITY

—ELECTRONICS

On Real:

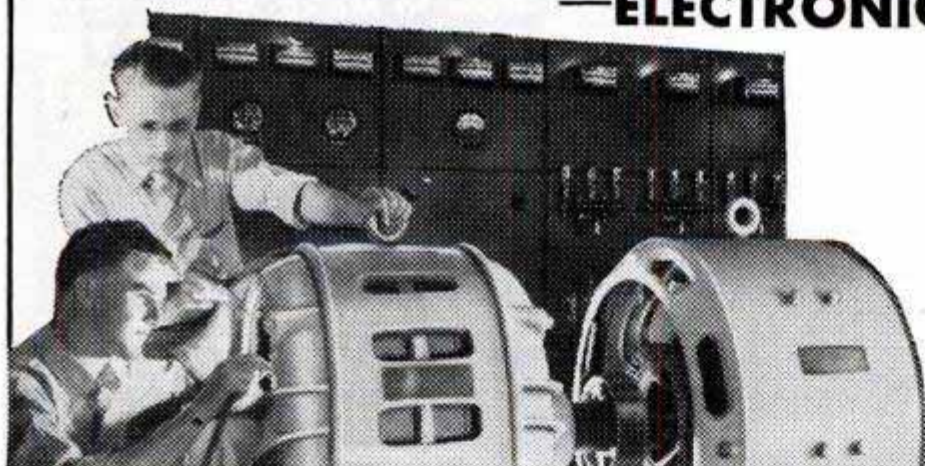

**A.C. and D.C. MOTORS
GENERATORS
SWITCHBOARDS
CONTROLLERS
WIRING JOBS
APPLIANCES
ELECTRONIC UNITS**

(Shown at left—Instructor explaining operation and testing of a large Motor Generator in our A.C. Department.)

Train in the great SHOPS of COYNE For These Opportunity Fields!

Trained men needed whether 17 or up to 45. Prepare quickly at Coyne for better rating, if drafted—a vital job in industry, if not, in A FIELD THAT ALSO OFFERS A REAL FUTURE IN THE YEARS AHEAD.

FINANCE PLAN Enroll now, pay most of tuition later. Special plan for men of draft age.

WE TRAIN YOU IN CHICAGO. At Coyne you learn on real, full-size equipment. Trained instructors show you how, then you do practical jobs yourself. No previous experience or advanced education needed.

CLIP COUPON NOW for big new illustrated Coyne book. Check whether interested in TELEVISION-RADIO or ELECTRICITY or both. No obligation; no salesman will call. Get vital facts now!

B. W. COOKE, President

COYNE
SCHOOL

A TECHNICAL TRADE INSTITUTE
CHARTERED NOT FOR PROFIT
Established 1899
500 S. Paulina Dept. 93-72H
Chicago 12, Illinois

TELEVISION ★ RADIO ★ ELECTRICITY ★ REFRIGERATION ★ ELECTRONICS



**Mail Coupon for
BIG FREE BOOK!**

**APPROVED
FOR
VETERANS**

B. W. COOKE, President
COYNE SCHOOL
500 S. Paulina St., Chicago 12, Ill. Dept. 93-72H

Send BIG FREE book and details of your training offer. This does not obligate me and no salesman will call. I am interested in:

TELEVISION-RADIO ELECTRICITY

NAME

ADDRESS.....

CITY.....STATE.....

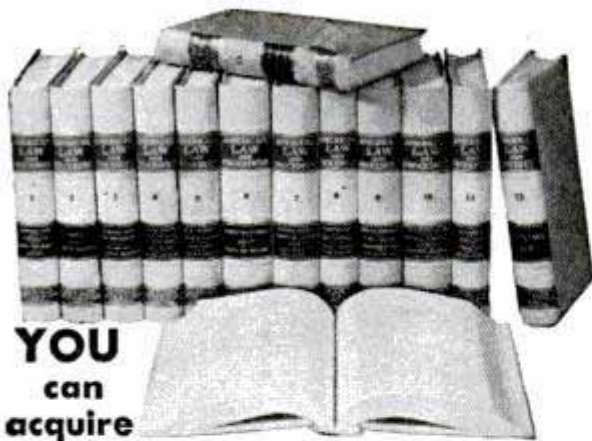

YOU
can
acquire

LAW NIGHTS AT HOME!
L. L. B. DEGREE

LaSalle's famous Law Library—used as reference in many Law libraries and Law offices—has enabled thousands to master Law surprisingly fast, in spare hours at home, for business and professional advancement.

These 14 remarkable volumes, compiled by leading professors and lawyers, cover the whole basic field of Law in condensed, orderly, simplified manner.

You advance rapidly with this great library, plus special lectures furnished. We guide you step-by-step with personalized Problem Method of instruction . . . you learn by doing—handling legal problems—not by memorizing rules.

Send for two FREE 48-page booklets, "Law Training for Leadership," and "Evidence," answering questions about Law and its value to you, and telling how LaSalle Law graduates are winning rapid advancement in business and public life. Mail coupon below. No obligation.

LA SALLE EXTENSION UNIVERSITY
A Correspondence Institution

417 S. Dearborn St. Dept. 1264L Chicago 5, Ill.

Send me your two FREE booklets described above, without obligation.

Name..... Age.....

Street.....

City, Zone & State.....

LIVE and WORK on
FLORIDA'S GOLD COAST!

With industry and resort experiencing acute growing-pains—*You are in Demand!* Whether you are highly skilled, or completely untrained, there's opportunity for you in South Florida today.

WANTED... MEN and WOMEN!
Secretaries... office clerks...
nurses... hotel employees...
truck drivers... waiters and
waitresses... hotel detectives...
night watchmen... and over
150 others...

Don't delay! Send \$1.00 today for information on who to contact for work on the Florida Gold Coast.

Col. CHAS. G. GROTE Personnel
Consultant
Dept. PM. P. O. Box 2281, Miami 13, Fla.

MAKE EXTRA
MONEY

PLASTICS

LEARN
AT HOME

LEARN HOW
TO MAKE
fast-selling
PLASTIC
NOVELTIES
FURNITURE
JEWELRY



There are RICH OPPORTUNITIES for MEN and WOMEN with "know-how" in Plastics. Interstate's new Plastics course tells and shows how to make hundreds of fast selling items out of Plastics. Gives complete training in fabrication, casting, lamination, molding, internal carving, etc., in simple, easy, step-by-step language and pictures. Plastics and Fabricating Kits for 23 valuable Plastic items come with training at no extra cost. **START A PLASTICS BUSINESS OF YOUR OWN.** No other industry holds such promise for the future. You can make big money manufacturing novelties, toys, signs, etc., in your own home in spare or full time. Don't wait! Learn NOW how Interstate's Plastics Training qualifies you for success in the Plastics field.

PLASTICS AND SUPPLIES FURNISHED
FOR 23 VALUABLE PROJECTS

INTERSTATE TRAINING SERVICE
Dept. C3N Portland 13, Oregon

RUPTURED?

Get Relief This Proven Way

Why try to worry along with trusses that gouge your flesh—press heavily on hips and spine—enlarge opening—fail to hold rupture? You need the Cluthe. No leg-straps or cutting belts. Automatic adjustable pad holds at real opening—follows every body movement with instant increased support in case of strain. Cannot slip whether at work or play. Light. Waterproof. Can be worn in bath. Send for amazing FREE book, "Advice To Ruptured" and details of liberal truthful 60-day trial offer. Also endorsements from grateful users in your neighborhood. Write:

CLUTHE SONS, Dept. 31, Bloomfield, New Jersey.



How to Make Money in
PHOTOGRAPHY

If you are OVER 17—good pay, fascinating work await you in photography! Start making money quickly in sparetime—step into your own studio or exciting job. LEARN-BY-DOING method trains you at home! Write TODAY for FREE catalog. Also Resident Training. 44th Year! GI Approved. **NEW YORK INSTITUTE OF PHOTOGRAPHY**
Dept. 49, 10 W. 33 St., New York 1, N.Y.



Say You Saw It in Popular Mechanics

Secrets of VENTRILOQUISM
Now Revealed!



Easy to learn in 60 to 90 days with our Home Study Course, **RESULTS GUARANTEED.** Make Money! Be Popular! Have Fun! Big Opportunities! Radio, Television, Stage Appearances! For FREE Information regarding price and terms, WRITE. You must state your age. Dummy Catalog 25c. **FRED MAHER SCHOOL OF VENTRILOQUISM**
Box 36, Studio J Kensington Station
Detroit 24, Michigan

IT'S FREE!

New, exciting booklet . . .
"THE INVISIBLE WORLD and
THE WONDERS OF CHEMISTRY"



Big, precision built Sciencecraft microscopes are equipped with velvet touch focusing adjustment, 90 degree inclination joints, fully adjustable mirrors, and spring stage clips. Accurately ground and polished optical glass lenses are carefully synchronized to insure perfect resolving power and definition. Now available! New, improved triple objective turret microscope. Exclusive index gives complete coverage of large subjects. Magnification 50-150 and 300 diameters. Priced as low as \$8.95 . . . Explore the exciting world of science. Send for your free booklet today.

The Porter Chemical Company
43 Prospect Avenue, Hagerstown, Maryland



GET INTO AUTOMOTIVE DIESEL AND ALLIED MECHANICS by Shop Method Home Training

**JOBS LIKE THESE ARE OPEN
TO YOU AS A TRAINED ENGINE
MECHANIC... CHOOSE THE
FIELD YOU LIKE BEST!**

Get complete training

- Diesel Fuel Injection
- Automotive Motor Tune-up
- Diesel Engine Maintenance
- General Garage Mechanics
- Agricultural Implements
- Auto Engine Rebuilding • Auto Elec. Service
- Public Utilities • Parts Dealers
- Bus & Truck Lines • Industrial Maintenance
- Contracting & Excavating
- Business of Your Own
- AND MANY other similar openings

EARN WHILE YOU LEARN

With our practical Master Shop-Method Home Training, you study at home in your spare time. You receive Spare Time Work Lessons, which show you how to earn while you learn...for extra money and experience. You Learn by DOING.

YOU RECEIVE AND KEEP ALL THIS MATERIAL:

- | | |
|---|-----------------------------|
| Basic Lesson Texts | Engine Service Manuals |
| Diesel Installation Operation—Maintenance | Engine Repair Drive Systems |
| Diesel Chart Manual | Diesel Electric Power |
| Spare Time Lessons | Thermodynamics |

**TOOLS AND EQUIPMENT
INVESTIGATE!
SECURE FULL
INFORMATION**

**WE GIVE
YOU TOOLS
OF YOUR
TRADE**

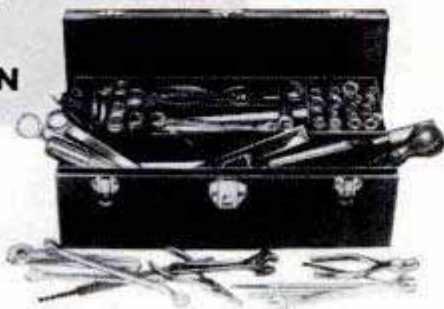

**Master
All
Phases!**



Get Master Shop-Method Home Training from an Established Resident School with its own Training Shops and Laboratories—and almost 50 years of Successful Experience in Training Men.

We Bring National Schools To You

National Schools trains you for all opportunities in the dynamic, fast-growing Automotive-Diesel and Allied Industries. You get complete training for this great industry.

Thousands upon thousands of autos, trucks, tractors, ships, trains, farms and factories are dependent upon engine power! Trained engine mechanics are needed in the Armed Forces as well as in civilian production. This huge field needs trained men for servicing, repairing, installing, operating and manufacturing equipment. The pay is good, the future excellent! National Schools offers you a practical, all-embracing Automotive-Diesel Mechanics Course that qualifies you for your choice of many good jobs.

Your National Course covers Gasoline and Special Fuel Engines; Diesels, High Speed and Heavy Duty; Semi-Diesels; Allied Mechanics.

**APPROVED FOR
VETERANS AND
NON-VETERANS**

This course also offered in Spanish and Portuguese

**BOTH
RESIDENT AND
HOME STUDY
COURSES
OFFERED**

NATIONAL SCHOOLS LOS ANGELES 37 CALIFORNIA
IN CANADA: 193 HASTINGS ST., VANCOUVER, B. C.
TECHNICAL TRAINING SINCE 1905

**GET FACTS FASTEST!
MAIL TO OFFICE NEAREST YOU!**

(mail in envelope or paste on postal card)

NATIONAL SCHOOLS, Dept. DB-123
4000 S. Figueroa Street LOS ANGELES 37, CALIF. or 323 West Polk Street CHICAGO 7, ILLINOIS

Send FREE Auto-Mechanics book and FREE sample lesson. No obligation, no salesman will call.

NAME _____ BIRTHDAY _____ 19 _____

ADDRESS _____

CITY _____ ZONE _____ STATE _____

Check here if interested in Resident School Training at Los Angeles.
VETERANS: Give Date of Discharge _____

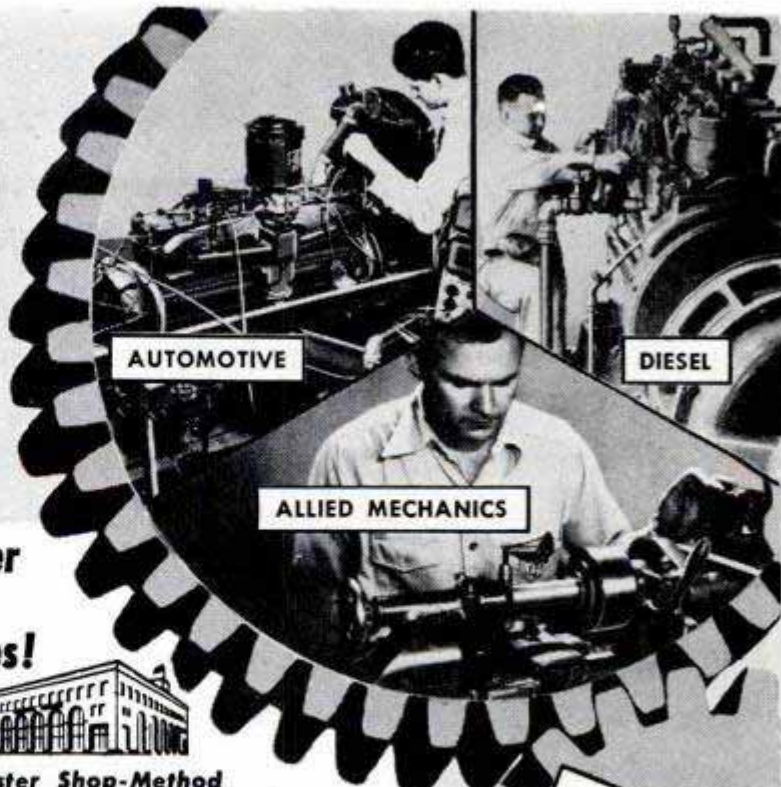

Free Book and Sample Lesson Show You How

Send today for National Schools' new, illustrated Book of Opportunity in Automotive, Diesel and Allied Mechanics, and an actual sample lesson. No cost — no obligation. Use the coupon now — we'll answer by return airmail.

Inventors

The following are the usual preliminary steps to take toward patent protection.

You are advised first, to make a disclosure of your invention. Date, sign and have this document witnessed by two or more persons who are capable of understanding your invention. The "Evidence of Invention" form mentioned below, we offer as a convenience in making your disclosure and in starting action leading toward patent protection.

Mail your disclosure to the registered patent attorney or agent whom you select to assist you, together with a letter authorizing him to conduct a

preliminary search among previously granted U. S. patents for similar types of invention. He then prepares for you a report on the probable patentability of your invention and, if the report is favorable, recommends the further course you should take.

This firm is registered to practice before the U. S. Patent Office and is available to assist you in the preparation and prosecution of patent applications. We shall be glad to send you without obligation, the "Evidence of Invention" disclosure form mentioned above and our instructive booklet, "Patent Protection for Inventors".

VICTOR J.
EVANS & Co. *Merlin M. Evans*
REGISTERED PATENT ATTORNEY
830 - P MERLIN BUILDING, WASHINGTON 6, D. C.



DRAFTING
pays **BIG MONEY!**

Draftsmen earn more, enjoy pleasanter working conditions. Get into DRAFTING and Blue-Printing, the starting point of all production. Trained Draftsmen are needed everywhere. Machines can never replace the draftsman.

LEARN AT HOME IN SPARE TIME

Revolutionary new method teaches you quickly the hows and whys of Mechanical, Structural, Machine, Architectural, etc. Drafting. You are sent professional drafting instruments, drafting equipment, portable drafting table, etc., at no extra cost. You learn by making actual drawings.

BIG MONEY... ADVANCEMENT OPPORTUNITIES offered trained draftsmen. Drafting is light, pleasant work, paying big salaries. Is a stepping stone to top managerial jobs. The draftsman plans the World of Tomorrow. That is why drafting is such interesting work.

OWN YOUR OWN DRAFTING FIRM

The investment requirement is small, the earning possibilities great. Many draftsmen eventually branch out into manufacturing the products they created. Learn of the opportunities in Drafting.

MAIL THIS COUPON TODAY!

CHRISTY TRADES SCHOOL, Dept. DB-2203
4432 N. Kedzie Ave., Chicago 25

Mail at once your big FREE book on Drafting and Blue-Printing. Tell me how your Home Training and Professional Drafting Instruments, Portable Drafting Table, Drafting Equipment, etc. can be had on a PAY AS YOU LEARN plan.

NAME _____ Age _____

ADDRESS _____ CITY _____ STATE _____

LEARN WATCH REPAIRING



AT HOME. By our modern and original system of instruction you can learn every part of the **WATCH REPAIRING TRADE AT HOME.** Prepare yourself for a well-paying position or start in business after completing our course of instruction. Good watch repairers are in demand and generally earn very good salaries. For particulars apply to the **WISCONSIN SCHOOL OF WATCH REPAIRING** 759 N. Milwaukee St., Milwaukee 2, Wis.

'How to MAKE MONEY with Simple CARTOONS'



A book everyone who likes to draw should have. It is free; no obligation. Simply address **FREE BOOK**

CARTOONISTS' EXCHANGE

Dept. 912A Pleasant Hill, Ohio



Before You Buy Your Trailer—READ...

TRAILER TOPICS MAGAZINE

It brings you the latest in Trailer Coaches—Equipment—Accessories—Trailer Trips—Trailer Parks and many other interesting monthly features at only—\$3.00 for 2 years.

(6 MONTH TRIAL SUBSCRIPTION \$1.00)

TRAILER TOPICS MAGAZINE (Room 1573)

28 East Jackson Blvd., Chicago 4, Ill.

Prepare Now... in spare time at Home ... for a New,

PROFITABLE, INTERESTING FUTURE

in TELEVISION RADIO - ELECTRONICS

RADIO CHIEF OF ILE DE FRANCE
FRENCH LUXURY LINER PRAISES D. T. I.

Radio Chief—Jean Desmas Says:

"DeForest's Training, Inc., of Chicago, is known not only throughout Europe, but also in many parts of the world as one of America's finest Television, Radio and Electronics training centers."



JACK DEMPSEY

Former World's Heavyweight Champion
TELLS WHY HE'S PROUD
TO BE WITH **D.T.I.**

- I have been greatly impressed with D.T.I.'s wonderful spirit of friendliness and sincere determination to help its students make good in Television-Radio-Electronics.
- I admire its remarkable 20 year record of helping men build brighter futures.
- I also admire the business policy of its management and the thoroughness of its large faculty of instructors.
- Never have I heard young men praise a school as enthusiastically as do the students and graduates of D.T.I. They are its best boosters.

Prepare At Home Or In Our Chicago Laboratory!

See for yourself how readily you may prepare at home, or in our modern Chicago laboratories, for a better job or business of your own in one of America's fastest-growing fields—TELEVISION-RADIO-ELECTRONICS.

If you train at home you get (1) the use of a 16-mm. movie projector and 16 reels of animated movies to help you learn important points faster... easier, (2) modern lessons and (3) sixteen shipments of electronic parts enabling you to get valuable practical experience from over 300 projects—including building and keeping the electronic equipment shown below. And upon completing training, you have the optional privilege of building and keeping a big 21 INCH TV Set. (D.T.I. offers another home training in Television-Radio-Electronics, but without the TV set.) Get the full story. Mail coupon today!



LAUD D. T. I.'s HOME MOVIES IN CONGRESS

D.T.I.'s remarkable home training benefit of visual training MOVIES has been praised from the floor of the House of Representatives in Washington, D. C. and recorded in The Congressional Record.



HOME MOVIES

If subject to military service, the information we have for you should prove very helpful. Mail coupon today.



MILITARY SERVICE



DEFOREST'S TRAINING, INC.
AFFILIATED WITH
DEVRY Technical INSTITUTE
CHICAGO 14, ILLINOIS

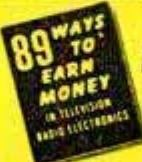

MAIL COUPON TODAY!

DE FOREST'S TRAINING, INC. PM 12-J
2533 N. Ashland Ave., Chicago 14, Ill.

I would like your valuable information-packed publication showing how I can get started toward a good job or my own business in Television-Radio-Electronics.

Name _____ Age _____
Address _____ Apt. _____
City _____ Zone _____ State _____

LET ME PROVE I Can Make YOU a New Man!

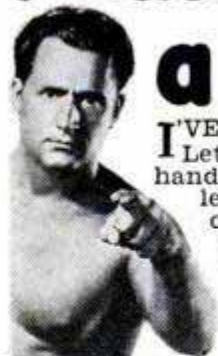

Charles Atlas—winner of title "World's Most Perfectly Developed Man"

I'VE done it for thousands of other fellows. Let me prove I can add solid inches of handsome, rippling muscles to YOUR arms, legs, shoulders, back . . . make you an outstanding specimen of strength and self-confidence. My secret of "Dynamic Tension" does it in just 15 minutes a day. You'll be amazed at the results and so will your friends.

FREE — My 32-Page Illustrated Book Is Yours — Not for \$1 or 10c — But FREE

32 pages packed with valuable advice, actual photographs of fellows who became new men almost overnight . . . with "Dynamic Tension." Book can mean turning point of your life.

It's yours—**ABSOLUTELY FREE!** Send for it TODAY. Address me personally: **CHARLES ATLAS, Dept. 812, 115 East 23rd St., N. Y.**



5 INCHES OF NEW MUSCLE

"My arms increased 1 1/2"; chest 2 1/2"; forearm 3/8"; C. S., W. Va. "Have put 3 1/2" on chest (normal) and 2 1/2" (expanded)."
F. S., N. Y.

CHARLES ATLAS, Dept. 812, 115 East 23rd St., New York 10, N. Y.

Send me—absolutely FREE—your famous book, "Everlasting Health and Strength"—32 pages, crammed with photos, answers to vital questions, valuable advice. I understand book is mine to keep, and sending for it does not obligate me in any way.

Name _____ Age _____
(Please print or write plainly)
Address _____
City _____ State _____



GREER SHOP TRAINING

2230 So. Michigan Blvd.
Chicago 16, Illinois

Leader in Practical Training for 50 Years

Gain success by learning a trade offering security and high pay—go into business for yourself.

Get the "Know-how" at Greer

You learn in our new, large, modern shops by working with latest tools and equipment of the trade — tear down, inspect, repair and rebuild . . . under supervision of experts. Greer founded 1902. Over 51,000 successful grads. Part time, full time, day and evening. E-Z terms. Mail coupon today.

CLIP COUPON . . . MAIL TODAY
Greer Shop Training—2230 South Michigan
Chicago 16, Illinois Desk 213

Please send information about trade checked:
In our Chicago Shops: Auto Mechanics
 Body, fender Repair Diesel Mechanics
 Welding—Arc, gas Tool & Die
 Refrigeration & Air-conditioning
 Machinist Piano tuning
 APPROVED FOR CIVILIANS and G.I.'s

ATTENTION: HIGH SCHOOL GRADUATES.
Write for information on 2 year DIESEL-AUTOMOTIVE ENGINEERING COURSES.

Name _____
Address _____
City _____
State _____ Age _____



SUCCESS • BIG PAY in Aviation MASTER A & E MECHANICS urgently needed

Maximum training in minimum time! Thorough, practical instruction backed by more than 25 years of aviation technical experience. Training authorized under G.I. Bill.

Write today!
Illustrated Catalog
Registrar, Dept. 99,
Miami 30, Florida



TRAIN IN MIAMI -- AIR CAPITAL OF THE WORLD

STUDY LAW FREE AT HOME BOOK!



Prepare for the Bar!

Write today for a copy of our FREE book, "The Law-Trained Man," which gives the bar rules in your state and tells how ambitious men and women since 1890 have been preparing at home in spare time for the practice of law by studying the famous Blackstone bar-training course. All needed instruction material is furnished including big 16-volume law library. Law diploma awarded. Moderate tuition; easy monthly terms. Write for FREE book today!

BLACKSTONE SCHOOL OF LAW
225 N. Michigan Ave., Dept. 58, Chicago 1, Illinois



LEARN LOCKSMITHING

Learn this fascinating, profitable trade from experts in your spare time at home! Age or physical handicap no disadvantage. Year around, steady income. Full or part time. Practical, illustrated lessons. You can make money even while learning! All materials and special tools supplied without extra charge.

INSTITUTE OF LOCKSMITHING, Dept. P-49
15 PARK AVENUE RUTHERFORD, N. J.
Lic. by N.J. State Board of Educ.
Approved for Vets

Finish HIGH SCHOOL AT HOME

Complete 4 Yrs. in 12 Months

Learn More! Earn More! Enter professional or technical schools. Advance Socially. Live a Happier, Fuller Life. Individual Courses or complete schedule. **WRITE FOR SCHOOL BULLETIN.**

ACADEMY FOR ADULTS

30 W. Washington, Dept. PM-123, Chicago, Ill.

Say You Saw It in Popular Mechanics

LEFAX POCKET SIZE TECHNICAL DATA BOOKS \$1.25 each

Printed on loose leaf, six hole, 6 3/4"x3 3/4" bond paper, each book contains about 140 pages of technical data, presenting condensed, accurate and essential data for the student, engineer, technical worker and business man.

- | | | |
|-------------------------------|--------------------------|------------------------------|
| Architecture | Phys. & Thermodyn. Data | Transformers, Relays, Meters |
| Home Heating Illumination | Phys. & Org. Chemistry | Hydraulics |
| Electrician's Data | Metals | Surveying |
| Builder's Data | General Chemistry | Mechanical Drawing |
| Lumber Data | Reinforced Concrete | Machine Design |
| Air Conditioning | Building Constr. | Machinists' Data |
| General Math. | Radio | Piping Data |
| Math. Tables | Television & FM | Surveying Tables |
| Physics | Electricity, AC | Trig-Log Tables |
| Chemical Tables | Electricity, DC | Metallurgy |
| Mechanics of Materials | AC Motors and Generators | Analytic Chemistry |
| Power Trans. Mach'y. | | Highway Engineering |
| Thermodynamic Tables & Charts | | |

Write for FREE catalogs (over 2000 listings). See for yourself how helpful LEFAX can be to you. Send \$1.25 for each book (or \$6 for any five books listed above), to

LEFAX DEPT. PM-17 PHILADELPHIA 7, PA.

I'll Train **YOU** at Home in Your Spare Hours for Big Pay Job • Your Own Business • Exceptional Opportunity in

RADIO-TELEVISION

ON *New* NO-OBLIGATION PLAN!



**I Send You
18 BIG
KITS**

**OF RADIO-
TELEVISION
EQUIPMENT**



**Approved for
Veterans Under
the G. I. Bill**

**You Have NO MONTHLY
PAYMENT CONTRACT**

**to sign... you pay for your training
as you learn and earn... ENROLL NOW!**

Be Ready in Little as 10 MONTHS!

Now you can get into Radio-Television, today's fastest growing big money opportunity field, in months instead of years! My completely new "package unit" training plan prepares you to qualify as a Radio-Television Technician in as short a time as 10 months, or even less! I offer you my training with no monthly payment contract to sign—thus NO RISK and NO OBLIGATION for you! This is America's finest, most modern and really practical training.

Includes FM... UHF Television and all the most recent developments. My training gets you ready to handle any practical job in the booming Radio-Television industry. Start your own profitable Radio-Television Service Shop... or accept a fine paying job. I have trained hundreds of successful Radio-Television technicians—and I can train you regardless of lack of previous experience. Mail coupon and get all the facts—FREE!

VALUABLE EQUIPMENT INCLUDED WITH TRAINING

Much of your Sprayberry Training is actual construction, demonstration and experimentation. You get priceless practical experience this way. You build the 6 tube Sprayberry Short Wave and Broadcast Training Radio Receiver, the Sprayberry Television set, multi-range test meter, signal generator, signal tracer, cathode ray oscilloscope and many other projects. All this equipment is yours to keep. You have practically everything you need to set up your own profitable Radio-Television shop. All lessons and books I send you remain your own property.

OUR 21st YEAR TRAINING MEN FOR RADIO-TELEVISION

Earn Extra Money While You Learn

All your Sprayberry Training is given IN YOUR OWN HOME during your free time. Keep on with your present job and income while learning Radio-Television. With each Sprayberry "Package Training Unit" I include money-making plans and special "Business Builders" for spare time Radio-Television service jobs. New Television stations opening everywhere open big money opportunity for men to install UHF antennas—I tell you how! If you expect to be in the Armed Forces later, there is no better preparation than Radio-Television. Mail coupon below... get facts FREE. *No salesman will call.*

**FREE TO YOU 3 BIG RADIO-
TELEVISION BOOKS**

I invite you to get all the facts—

I want you to have ALL the facts—without cost! Rush coupon for my three big Radio-Television books! "How to Make Money in Radio-Television" PLUS my new illustrated Television Bulletin PLUS an actual sample Sprayberry Lesson—ALL FREE. No obligation and no salesman will call. Mail coupon!

SPRAYBERRY ACADEMY OF RADIO
Dept. 10-D, 111 North Canal Street
Chicago 6, Illinois

**Mail
Coupon
Today!**

**IF YOU ARE
EXPERIENCED IN RADIO**

Men already in Radio who seek a short intensive 100% TELEVISION Training with FULL EQUIPMENT INCLUDED are invited to check and mail the coupon at the right.

**NO OBLIGATION
No Salesman
Will Call**

SPRAYBERRY ACADEMY OF RADIO
Dept. 10-D, 111 N. Canal St., Chicago 6, Ill.

Please rush to me all information on your 10-MONTH Radio-Television Training Plan. I understand this does not obligate me and no salesman will call. Include 3 books FREE.

Name..... Age.....

Address.....

City..... Zone... State.....

Are you Experienced? No Experience

EARN MORE IN DRAFTING



More Opportunities for Employment and Promotion

"Here I am at work making good money as a draftsman. I'm glad I sent the coupon to Chicago Tech for that Free Trial Lesson and found out how easy it is to learn Drafting in spare time at home. Today I feel secure in my job because the draftsman's work comes first on any new project. And, in addition, draftsmen can't be replaced with machines. What's more, I feel I'm slated for promotion and more pay, because I see so many draftsmen advancing to high-pay jobs."

LEARN IN SPARE TIME — AT HOME!

(or at the College in Chicago)

A few hours of pleasant home study every week—that's all. No interference with your present job. All the tools you need; drawing outfit included. With Chicago Tech's help, you train yourself step by step. This tested method—developed over 49 years of C.T.C. progress—prepares men quickly for good positions in industry.



FREE INFORMATION—SEND COUPON

To prove to you how easy it is to learn Drafting at home by the Chicago Tech method, we will send you this FREE TRIAL LESSON. No charge for this lesson, now or later. Fill out and mail coupon, or send post card today.

CHICAGO TECHNICAL COLLEGE

S-251 Tech Bldg., 2000 So. Michigan Ave., Chicago 16, Illinois

Mail me FREE Lesson with information about big opportunities in DRAFTING.

Name _____ Age _____
 Address _____
 City _____ Zone _____ State _____

ENGINEERING DEGREE IN 27 MONTHS

Big Demand for Graduates

Aeronautical, Chemical, Civil, Electrical, Mechanical and Radio Engineering (inc. TV and Electronics)

Hundreds of young men are earning B. S. ENGINEERING DEGREES annually in this recognized institution — year around operation. New terms start quarterly. Many students earn a major part of their college expenses in this large industrial center.

Low tuition. Competent instruction. Thorough, intense, practical program. Modern, well-equipped laboratories including new physics laboratory and modern wind tunnel. Individualized instruction emphasized.

Government approved for G.I.'s. Engineering preparatory courses. Students from 48 states and 21 foreign countries. Enter December, March, June, September. Send coupon for free catalog and full information. Enroll now.

SEND COUPON TODAY

INDIANA TECHNICAL COLLEGE

5123 E. Washington Boulevard
 Fort Wayne 2, Indiana

Please send me free information on B.S. Engineering Degree in 27 months as checked.

- Aeronautical, Chemical, Civil, Electrical,
 Mechanical, Radio-Television

Name _____
 Address _____

PLASTIC LAMINATING



This remarkable plastic laminating machine will earn \$18 an hour right in your home! Big profits guaranteed laminating CARDS of all kinds, Business Cards, Social Security Cards, Identification Cards, Credit Cards, photos, passes, driver's licenses, newspaper clippings, souvenirs, etc. The perfect way to preserve all sorts of valuable PAPERS permanently. Demand for such a service is staggering. Operate profitable business at home . . . we show you how! Price complete (illus.) only \$35 plus postage. Write now. Free sample and literature.

PLASTICAST CO. P.O. Box 987, Palo Alto, Calif.
 DEPT. C P.O. Box 6737, Chicago 80, Ill.



FREE 11 HITLER STAMPS

Eleven colorful Hitler stamps—all different, all sought-after—sent FREE to secure names for our mailing list. We'll also include other interesting offers for your inspection—PLUS a FREE copy of our helpful, fascinating "How to Collect Stamps." Supply limited, so rush name, address, and 10c to help cover postage and handling costs. Address:

Littleton Stamp Co., Dept. 12-PM, Littleton, N.H.

IMPROVE YOUR PENMANSHIP

Write Like This

YOUR penmanship can be improved in 3 hours or corrected to your satisfaction in 10 hours' practice with my DEFINITE HAND CONTROLS. New way!

WRITE OZMENT BOX 665 34-N, ST. LOUIS, MISSOURI

Complete OUTLINE FREE!

BUILD LUGGAGE AT HOME WE SELL YOUR PRODUCTS!

ONLY NEW HOME MONEY-MAKING PLAN IN YEARS!

Make Luggage and cases for traveling, protographers, musicians, salesmen, electronics, tools, portables, 1001 other items. Also repair Luggage. No special equipment needed. BIG Profits. We supply complete instructions—everything. Write for free details and Business Plan. ABARSI CASECRAFT, Dept. H5, 805 W. Sunset Blvd., Los Angeles 12, Calif.

CASTING SECRETS REVEALED

Big money! Cast 1000's of plaques, figurines, etc. with X.L. rubber molds. No exper., little capital req. X.L. rubber pts. \$2.50, qts. \$4 (postage extra). Models, rubber for 3 molds, \$1.50 ppd. Send 25c (refundable) for 40 pp fact catalog.



HUGE PROFITS! MORE MONEY!

PLASTIC ARTS STUDIO, Dept. 3, 3403 S. Madison St., Muncie, Ind.

INSURED TIRE SERVICE POPULAR BRANDS



FREE INSURANCE POLICY given with each used tire sold. We guarantee the amount of service you pay for.

Tube Given Free with Each Used Passenger Tire Upon Request

SPECIAL! Deduct 10% on orders for 2 or more used tires

YOU CAN'T LOSE!!

Super Quality — Rugged Performance — 15 Months Insured Service	
600x16 \$4.55	670x15 \$5.25
650x15 4.95	670x16 5.35
650x16 5.45	700x15 5.40
	700x16 5.55
	760x15 6.45
	550x17 4.75
Supreme Quality. Nothing Finer — 30 Months Insured Service	
450x20 5.95	450x21 6.25
600x16 5.85	600x20 10.95
650x16 5.85	650x20 11.75
700x16 7.75	700x20 12.50
750x16 12.50	710x15 6.50
550x17 5.75	710x16 6.50
525x18 5.45	750x20 12.50
640x15 5.75	475x19 5.75
	825x20 21.50
	750x16.8 15.95
	900x20 19.95
	1000x20 20.45
	1100x20 26.75
	1000x22 19.50
	1100x22 24.75
	1200x20 23.50
	1100x24 22.75

MIDLAND TIRE SALES

Speedy shipments on Mail Orders. F.O.B. Chicago. Insurance policy sent with each order. Deduct 10% on orders for 2 or more used tires. Send CHECK or MONEY ORDER.—No COD's. 449 W. 37th St., Dept. PM-17, Chicago 9, Ill.

MORE MONEY \$ \$ \$ a BETTER JOB



YOU'RE in the biggest competition—yes, the biggest battle in the world—that of making a living. You have to work for a living—so does everyone else. Competition for

promotion is keen—people all around you are looking for more money—a better job—and so are you.

You can get a head start. Other men have—and in a short time you should be able to out-distance those who have no progress plan, make more money—have a better job—a more certain future.

Few people prepare themselves for that promotion—that better job and more money. Not many are making any special effort to learn outside of the time they put in each day on their work. They're taking the long, hard road to success. *How about you?* Are you, too, taking that same old, winding road—with its many disappointments and heartbreaks?

Here at LaSalle we have been training ambitious men and women for success for more than 40 years—enrolled hundreds of thousands of students—and our files overflow with grateful letters from students who have attained success and earnings far beyond their fondest dreams.

Perhaps we can help you—at any rate it will be well worth a three cent stamp to mail the coupon below. **DO IT NOW!** Just check the field of your choice and we'll send you full information on that field without obligation—plus "Ten Years' Promotion in One"—a book which has helped many men. It may be the turning point in your life to a successful career, and more money.

Your Competition is Keen



LASALLE EXTENSION UNIVERSITY

A Correspondence Institution
417 So. Dearborn St.

DEPT. 1264-R

CHICAGO 5, ILL.

I am interested in preparing myself for a better job and more money. Please send me your free 48-page booklet on the training course I have checked below—plus "Ten Years' Promotion in One."



- | | |
|--|--|
| <input type="checkbox"/> Higher Accountancy | <input type="checkbox"/> Traffic Management |
| <input type="checkbox"/> C.P.A. Coaching | <input type="checkbox"/> Foremanship |
| <input type="checkbox"/> Bookkeeping | <input type="checkbox"/> Industrial Mgt. |
| <input type="checkbox"/> Law: LL.B. Degree | <input type="checkbox"/> Stenotypy |
| <input type="checkbox"/> Business Management | <input type="checkbox"/> (Machine Shorthand) |
| <input type="checkbox"/> Salesmanship | |

Name _____ Age _____

Street Address _____

City, Zone and State _____

LASALLE EXTENSION UNIVERSITY
A Correspondence Institution
Dept. 1264-R Chicago 5, Ill.

**CLIP AND MAIL
THIS COUPON TODAY!**

This year...be sure you get the famous MILE-O-METER!

Let your family know that you want the famous Mile-O-Meter this Christmas! Thousands of men did just that last year . . . and were "surprised" with the valuable and useful gift they wanted most! You'll join them in saving money every mile you drive . . . it's what you need to get more miles per gallon, avoid highway breakdowns, and insure top engine performance. Simple to install on the dash of any car—no holes to drill—all directions and fittings included. The chrome and black Mile-O-Meter actually pays for itself over and over again . . . tell your family today!



Beautifully gift packaged. Mailed anywhere within 24 hours. Add 35c for Special Delivery. Money-back guarantee!

SEND DELUXE STANDARD
MILE-O-METERS AT \$ _____

\$14.95

Deluxe Illuminated

\$9.95

Standard

We pay postage!

NAME _____

ADDRESS _____

CITY _____ ZONE () STATE _____

Check Enclosed Money Order Enclosed Send C.O.D.

GALE HALL ENGINEERING, INC. DEPT. 399
NORTH HAMPTON, NEW HAMPSHIRE

UNLIMITED OPPORTUNITIES IN ENGINEERING DEGREE IN 27 MONTHS

Study Engineering in this world-famed school. Established 1884. Demand for our graduates exceeds supply. Approved for Korean Vets.

Bachelor of Science Degree in Mechanical, Civil, Electrical, Chemical, Aeronautical, Radio (Television) Engineering; Business Administration and Accounting. Also 36-weeks certificate courses in Surveying and Drafting.

Personalized Instruction. Accelerated courses. Non-essentials eliminated. For ambitious, earnest students. Earn your degree in the shortest possible time. Preparatory courses. Placement service.

Extensive Campus. Well equipped, new and modernized buildings; up-to-date labs. Low cost. New terms start quarterly. Enter January, March, June, September.

Mail Coupon Today

TRI-STATE COLLEGE

4123 College Avenue, Angola, Indiana

Please send me free catalog and special information. I am particularly interested in courses as checked:

- Mechanical Civil Electrical Chemical Aeronautical
 Radio (Television) Business Administration Accounting
 Short Diploma Courses

Name _____

Address _____

EARN \$10 PER HOUR GROWING MIDGET TREES!
AT HOME! - SPARE TIME! - NO EXPERIENCE NEEDED!
It's New! Amazing! FULL GROWN living dwarf trees — only 12 INCHES HIGH! Elm, orange, oak, cypress—any kind! All BLOOM and even BEAR FRUIT. Perfect, healthy specimens, but miniature! Make costly home decorations and beautiful expensive centerpiece (sold for over \$1,500 each). It's easy! Fun! A new fascinating artistic HOBBY — a new fabulous BUSINESS! Real seed and sensational new growing secret plan details. BOTH FREE!

FREE! GENUINE SEED AND PLAN

HOW TO LEARN GROWING SECRETS
FREE SEEDS

NATIONAL NURSERY GARDENS, Dept. M12
8463 SO. VAN NESS, INGLEWOOD 4, CALIFORNIA

SHORTHAND in 6 WEEKS

Famous Speedwriting Shorthand. 120 wpm. No symbols; no machines; uses ABC's. Easiest to learn; write and transcribe. Low cost. 200,000 taught by mail. For business and Civil Service. Typing available. 31st year. Write for FREE booklet to:

Speedwriting

Dept. 1512-3, 55 W. 42 St., New York 63

OWN WORLD'S FINEST CRYSTAL RADIO
Complete Kit Only **\$9.95** Money Back Guarantee
Plays anywhere. Needs no batteries or electric current. Excellent performance guaranteed. Germanium crystal diode can get stations over 500 miles away. Head phones, aerial kit included. Nothing else to buy. Assembled in minutes. Popular 5"x4 1/2"x6 3/4" personal size. Send \$2.00 deposit now, we'll mail C.O.D. plus postage. Satisfaction guaranteed.
IDEAL FOR CHRISTMAS GIFTS!
JAEGER & CO.
P.O. BOX K246 SKOKIE, ILL.

TOOLS WHOLESALE

MAKE EXTRA MONEY

Start Your Own Business. Sell tools to your friends, neighbors. Part Time-Full Time.
A MILLION DOLLAR INVENTORY AT YOUR FINGERTIPS.
Send \$1.00 for Dealer's Card and Wholesale Catalog
SILVO HARDWARE CO., Dept. M, 108 Market St., Phila. 6, Pa.
Stanley, Millers Falls, Plumb, Disston, Wiss, and others at 30% to 50% off.

REAL ESTATE BE A BROKER

PAYS BIG! SEND FOR FREE, BIG, ILLUSTRATED CATALOG NOW! Graduates report making substantial incomes. Start and run your own business quickly. Men, women of all ages, learn easily. Course covers Sales, Property Management, Appraising, Loans, Mortgages, and related subjects. **STUDY AT HOME** or in classrooms in leading cities. Diploma awarded. Write TODAY for free book! No obligation. Approved for World War II and Korean Veterans
WEAVER SCHOOL OF REAL ESTATE (Est. 1936)
Suite 300 Law Bldg. Dept. PM Kansas City, Mo.

FREE BOOK TELLS NOW

Become an Expert Body and Fender Repair Man

The new 1953 edition of "The Key to Metal Bumping" is now out. 120 pages with 73 illustrations, show the Fairmount method of body and fender repair. Read this Manual written by Frank T. Sargent, the well-known authority on metal bumping, and you can become an expert in this high paying art. Order your copy today and be on your way to success. Mailed, prepaid, for \$1.00.
FAIRMOUNT TOOL & FORGING, INC.
10609 Quincy Avenue, Cleveland 6, Ohio

THE KEY TO METAL BUMPING

HERE'S A READY-MADE FUTURE FOR YOU

MILLIONS OF HOMES IN U.S.
HAVE 6-12 SMALL APPLIANCES
& MILLIONS MORE SOLD EVERY
YEAR - MILLIONS
NEED REPAIR NOW
WITH THE NEED
INCREASING
DAILY!

Start Your own Business IN

ELECTRICAL APPLIANCE REPAIRING

EARN WHILE YOU LEARN

Only had your course a few short weeks and have already made \$800.00. Going to quit my job paying \$250.00 straight salary to operate my own business. — J. D. S., St. Louis, Mo.

Make \$15.00 Saturdays and more. Am only able to operate in my spare time. It is just what a mechanical minded man needs. — G.O.P., Thomasville, Ga.



IN YOUR OWN KITCHEN, BASEMENT OR GARAGE

Learn at home in your spare time this fascinating big paying profession.

If you are mechanically inclined, can hold and use tools, we can give you the training and time saving kits that will enable you to . . . Command More Money At Work . . . A Better Paying Job Elsewhere . . . Or A Business Of Your Own!



3 EASY STEPS

- 1 We send you the "CHRISTY" Electronic Kit. A multi-purpose trouble tracer. Indicates current consumption, shorts, breaks, etc.
- 2 We teach you Electrical Appliance Repairing with cross indexed illustrated Manuals. The Easy-To-Remember-Way.
- 3 We show you How to Get Business and Keep Business Coming to you.



WE GIVE YOU THIS ELECTRONIC KIT TROUBLE FINDER



New Shop Method Home Training teaches you both the technical and practical side of Electricity by having you work with your hands, Building, Testing, Repairing. All instruction manuals are written in easy-to-understand language chock full of hundreds of detailed photos and drawings.

We show you how to quickly locate the trouble, how to fix it and what to charge. ALSO, how to solicit business and keep business coming to you!

\$5.00 TO \$6.00 AN HOUR

Often charged for making ordinary repairs. We show you how to repair refrigerators, vacuum cleaners, washing machines, motors, etc.

SEND FOR FREE BOOK!

CHRISTY TRADES SCHOOL, Dept. D-2503
4432 N. Kedzie Ave., Chicago 25, Ill.

Please send me FREE Illustrated Book on Electrical Appliance Repairing and special form for paying later from earnings.

NAME _____ Age _____

ADDRESS _____

CITY _____ Zo. e. _____ State _____



It's easy to . . . OWN a Business!

. . . Even if NOW Employed

You can profitably operate in spare time while building a full time business with servicemen.



Clean & Mothproof Rugs & Upholstery

- \$5 Hourly Profit
- No Shop Needed
- No Experience Needed
- Nationally Advertised
- War-proof business

If you are honest and willing to work, you can become financially independent in a growing lifetime business of your own. Alert dealers can average \$5 hourly gross profit on service they render and \$3 on EACH of their servicemen. Nationally Advertised services rendered on location in homes, offices, clubs, institutions, etc. Recommended by leading furniture and department stores.

DURACLEAN (illustrated above) cleans by absorption! Eliminates scrubbing . . . soaking . . . shrinkage. Dirt, grease and many unsightly spots vanish as if by magic. Wool fibers come to life . . . matted pile rises . . . colors revive. Upholstery and floor coverings last longer.

DURAPROOF (not illustrated) is another year 'round service. Kills moths and carpet beetles. Makes material resistant to both. Protects furnishings, clothing, and auto interiors. Only such service backed by international money-back, 4-year warranty.

Dealer sales increased during last war due to calls from customers of other cleaners who were unable to give service because short of help . . . a war-proof business.

Easy to learn. No shop needed. Operate from your own home. We furnish enough materials to return your **TOTAL INVESTMENT**. 22 years of proven success. Easy terms. Start part or full time. Write **TODAY** for **FREE** booklet and full particulars while territory is available.

DURACLEAN CO.

3-16D Duraclean Bldg.
Deerfield, Illinois

Develop Hidden Earning Power

STUDY LAW

at home! LL.B. Degree

Qualify yourself in spare time for advancement, greater earnings, business success. Now, more than ever, legal ability is in demand! Easy-to-understand step-by-step lessons and text material furnished -- invaluable for permanent reference. Over 40 years expert instruction. 114,000 students enrolled. Easy payments. Find out now, at no cost, how study of law can help you. Write today for **FREE** Book "Law and Executive Guidance."

AMERICAN EXTENSION SCHOOL OF LAW
Dept. PM-69, 664 N. Michigan Ave., Chicago, Ill.

DAN LURIE
"America's Most Muscular Man"
—on television's "Big Top."

FAMOUS DAN LURIE



BARBELLS

with 4 courses—low factory prices
50 lb. set... \$ 8.48 | 150 lb. set... \$20.48
100 lb. set... 13.98 | 200 lb. set... 25.98

Write for Order by Mail; 50% with order, bal. C.O.D. Free Catalog Extra wts. 13c per lb., F.O.B. plant

DAN LURIE BARBELL CO.

1701-M-12 Pitkin Ave., Dept. 359-M, Brooklyn, N. Y.



Wild Life Films

Exciting, dramatic action in the natural habitat of animals of forest and plains. 8 mm or 16 mm in beautiful color or B & W. Also 2" x 2" color slides. Write for free illustrated literature.

WILD LIFE FILMS

5151 Strohm Ave., Rm. 2M, No. Hollywood, Calif.

Broken or Loose FALSE PLATE?



Fix it Yourself EASILY in a Few Minutes

Your plates may become broken or loose just when you need them most. With **FIX-IT-KIT** you can repair your own broken plates. Also tightens loose fitting plates, easily. Get permanent comfort with professional material. Complete instructions. Satisfaction guaranteed or your money refunded. **Order Now** at a new low price only **\$2.98** postpaid — or sent C.O.D.

Make Plates Like New
DENT-FIX DENTAL PRODUCTS, Dept. PM-12
P.O. Box 674

Kansas City 8, Missouri



UP TO 6 MILES MORE PER GALLON

Reported by Hundreds Using
MIRACLE ACTION TUR-B-LIZER

Carburetor specialists say Tur-B-lizer is best patented improvement they have seen. Tested in millions of miles of driving in cars, trucks and tractors. Easily installed. Send \$3.00 for six cylinder type, \$4.50 for eight cylinder type. Try Tur-B-lizer for 30 days. If you are not enthusiastically satisfied as claimed by hundreds of users, your money will be promptly refunded.

Mechanics-Salesmen: Make big money selling and installing. Write for full facts.

UNIVERSAL TUR-B-LIZER CO.

621 E. STATE ST. MILWAUKEE 2, WISC.

Say You Saw It in Popular Mechanics

2 OR 4 WHEEL DRIVE FOR JEEPS IN SECONDS



AMAZING NEW WARN HUB

gives your 4-wheel drive Willys 2-wheel pep, power, speed, extra mileage, passenger car performance—as well as 4-wheel power and traction! Change from 2-wheel to 4-wheel or back in seconds by turning fingertip control on hubs. Warn hubs reduce wear on front axle assembly and front tires, eliminate shimmy, increase gas mileage up to 6 miles per gal. Unconditional Money Back guarantee. \$65.00 pair prepaid. **ALSO AVAILABLE:** Warn Standard Hub for Willys \$20.00 pr., Dodge \$23.00 pr. and Warn Automatic Hub for Willys \$120.00 pr. At Dealers or direct.

WARN MFG. CO., RIVERTON Box 6064-A2, Seattle 88, Wash.

AUTO BODY MEN
Expt. comb. paint and metal; excel. cond., high earnings; Olds. dir. Norman Motors, 1013 Chicago-av., Evanston. University 4-4109.

AUTO BODY-FENDER MAN
Ideal working conditions; to 17. Woodbury 4-4222.

AUTO BODY-FENDER MAN
Expt. and good help. Apply. Good pay. 3339 WASHINGTON.

AUTO BODY-FENDER MEN WANTED
IMMEDIATELY. MUST BE EXPERIENCED. HIGH PAY. 3339 WASHINGTON.

AUTO BODY-FENDER MAN
U.S. mech. exp. 3339 WASHINGTON.

AUTO BODY-FENDER MAN
To work on cars and trucks. Lincoln 9-5833.

AUTO BODY MEN
Expt. comb. paint and metal; excel. cond., high earnings; Olds. dir. Norman Motors, 1013 Chicago-av., Evanston. University 4-4109.

AUTO BODY-FENDER MAN
Ideal working conditions; to 17. Woodbury 4-4222.

AUTO BODY-FENDER MAN
Expt. and good help. Apply. Good pay. 3339 WASHINGTON.

AUTO BODY-FENDER MEN WANTED
IMMEDIATELY. MUST BE EXPERIENCED. HIGH PAY. 3339 WASHINGTON.

AUTO BODY-FENDER MAN
U.S. mech. exp. 3339 WASHINGTON.

AUTO BODY-FENDER MAN
To work on cars and trucks. Lincoln 9-5833.

AUTO BODY MEN
Expt. comb. paint and metal; excel. cond., high earnings; Olds. dir. Norman Motors, 1013 Chicago-av., Evanston. University 4-4109.

Learn This Craft—Earn Big Money

Look at the Help Wanted ads in your paper. The billion-dollar auto repair trade needs trained men NOW! The demand is big . . . pay is big . . . opportunities are great. You have a chance to grow with this growing trade, perhaps set up your own profitable shop.

CASH IN ON YOUR SPARE TIME!

You can begin your Auto Body & Fender Training at home in spare time with the proven UEI plan. You learn about appearance reconditioning, metalwork, painting, welding, other practical phases without leaving your present job. Then get actual practice in our large, well-equipped shops, repairing wrecked cars under the guidance of skilled instructors. Get **FREE** book and all the facts by sending coupon NOW!

UTILITIES ENGINEERING INSTITUTE 2523 Sheffield Ave., Dept. XC-25
Auto-Crafts Div. Chicago 14, Ill.

MAIL TODAY FOR FREE FACTS

UEI
has been training men for industry since 1927.

Auto-Crafts Div.
UTILITIES ENGINEERING INSTITUTE
2523 Sheffield Ave., Dept. XC-25, Chicago 14, Ill.
YES! Rush **FREE** Book and full facts on Auto Body & Fender Repair Training.

Name..... Age.....
Address.....
City..... Zone or County..... State.....
| Check for special information if under 17.

GET INTO RADIO-TELEVISION

ELECTRONICS by Shop-Method Home Training

GOOD JOBS AWAIT THE TRAINED RADIO-TV TECHNICIAN

There is a place for you in the great Radio-Television-Electronics industry when you are trained as National Schools will train you at home!

Trained technicians are in growing demand at good pay—in manufacturing, broadcasting, television, communications, radar, research laboratories, home Radio-TV service, and other branches of the field. National Schools Master Shop-Method Home Training, with newly added lessons and equipment, trains you in your spare time, right in your own home, for these fascinating opportunities. OUR METHOD IS PROVED BY THE SUCCESS OF NATIONAL SCHOOLS TRAINED MEN, ALL OVER THE WORLD, SINCE 1905.

EARN WHILE YOU LEARN

Many National students pay for all or part of their training with spare time earnings. We'll show you how you can do the same! Early in your training, you receive "Spare-time Work" Lessons which will enable you to earn extra money servicing neighbors' and friends' Radio and Television receivers, appliances, etc.



Signal Generator

Audio Oscillator

T. R. F. Receiver

Superheterodyne Receiver

You also receive this Multitester

MASTER ALL PHASES!

Get Master Shop-Method Home Training from an Established Practical Resident School with its own Training Shops, Laboratories, Studios — almost 50 Years of Successful Experience in Training Ambitious Men. We Bring National Schools To You!

LEARN BY DOING

You receive and keep all the modern equipment shown above, including tubes and valuable, professional quality Multitester. No extra charges.

FREE! RADIO-TV BOOK AND SAMPLE LESSON!

Send today for National Schools' new, illustrated Book of Opportunity in Radio-Television-Electronics, and an actual Sample Lesson. No cost—no obligation. Use the coupon now—we'll answer by return airmail.

This course also offered in Spanish and Portuguese.

APPROVED FOR VETERANS AND NON-VETERANS Check coupon below

Both Resident and Home Study Courses Offered!

NATIONAL SCHOOLS

LOS ANGELES 37, CALIFORNIA • ESTABLISHED 1905
IN CANADA: 193 E. HASTINGS STREET, VANCOUVER, B.C.

GET FACTS FASTEST! MAIL TO OFFICE NEAREST YOU!

(mail in envelope or paste on postal card)

NATIONAL SCHOOLS, Dept. RB-123

4000 S. Figueroa Street or 323 West Polk Street
Los Angeles 37, Calif. Chicago 7, Ill.

Send FREE Radio-TV Electronics book and FREE sample lesson. No obligation, no salesman will call.

NAME _____ BIRTHDAY _____ 19 _____

ADDRESS _____

CITY _____ ZONE _____ STATE _____

Check here if interested in Resident School Training at Los Angeles. VETERANS: Give Date of Discharge _____

National Schools Training is All-Embracing

National Schools prepares you for your choice of many job opportunities. Thousands of home, portable, and auto radios are being sold daily—more than ever before. Television is sweeping the country, too. Co-axial cables are now bringing Television to more cities, towns, and farms every day! National Schools' complete training program qualifies you in all fields. Read this partial list of opportunities for trained technicians:

- Business of Your Own • Broadcasting
- Radio Manufacturing, Sales, Service • Telecasting
- Television Manufacturing, Sales, Service
- Laboratories: Installation, Maintenance of Electronic Equipment
- Electrolysis, Call Systems
- Garages: Auto Radio Sales, Service
- Sound Systems and Telephone Companies, Engineering Firms
- Theatre Sound Systems, Police Radio
- And scores of other good jobs in many related fields.

TELEVISION TRAINING

You get a complete series of up-to-the-minute lessons covering all phases of repairing, servicing and construction. The same lesson texts used by resident students in our modern and complete Television broadcast studios, laboratories and classrooms!



Last Week I Made \$259.92



RAY BARTA

with Science's New Midget Miracle,
PRESTO Fire Extinguisher

So reports RAY BARTA of Wisconsin. Many others
"cleaning up" — so can YOU!



Science's
New Midget
Miracle
"PRESTO"

AMAZING new kind of fire extinguisher. Tiny "Presto" (about size of a flashlight!) does job of bulky extinguishers that cost 4 times as much, are 8 times as heavy. Ends fires fast as 2 seconds. Fits in palm of hand. Never corrodes. **Guaranteed for 20 years!** Sells for only \$3.98!

Show it to civil defense workers, owners of homes, cars, boats, farms, etc., and to stores for resale—make good income. H. J. Kerr reports \$20 a day. C. Kama, \$1,000 a month. Write for **FREE Sales Kit**. No obligation. **MERLITE INDUSTRIES, Inc.**, Dept. 512, 201 East 16th St., New York 3, N. Y. **IN CANADA: Mopa Co., Ltd.**, 371 Dowd St., Montreal 1, P.Q. (If you want a regular Presto to use as a demonstrator, send \$2.50. Money back if you wish.)



SEND
NO MONEY
•
MORE THAN
4000 PAGES
•
2750
PICTURES

9 BIG COMPLETE BOOKS BUILDING, ESTIMATING, CONTRACTING

Examine this Up-to-Date Edition for 10 days. See how these nine books supply easily understood training that will help you to get a better job and make more money, or start a profitable business for yourself. Think what a BIG help it will be to have them handy for use in solving all sorts of building problems.

Learn to draw plans, estimate, do all-new construction and modern remodeling to meet fast growing demand. More than 4000 pages of practical, pay-raising information with 2750 helpful illustrations, on such subjects as blueprint reading, concrete forms, masonry, carpentry, steel square, electrical wiring, plumbing, heating, painting, and hundreds more.

In our more than 50 years we have never offered more complete building information. Send the coupon TODAY.

(A year's consulting privileges with our engineers now given with these books without extra cost.)

AMERICAN TECHNICAL SOCIETY—Publishers Since 1898
Dept. G919, Drexel Ave. at 58th St., Chicago 37, Ill.

I would like to examine your 9-Volume Set of Building, Estimating, Contracting Books. I will pay the delivery charges only, but if I choose I may return them express collect. If after 10 days' use I prefer to keep them, I will send you \$3 plus postage and pay the balance at the rate of only \$4 a month until \$34.80 has been paid.

Name _____
Address _____
City _____ State _____
Please attach letter giving employer's name and address (if self-employed give business name and reference). Men in service please give home address.

LOW OVERHEAD—LARGE VOLUME SALES & SMALL PROFITS
BRING YOU THESE "LOWEST PRICES."
WHAT GOOD IS A TIRE WITHOUT A TUBE?
TUBE GIVEN WITH EVERY TIRE AT NO EXTRA COST

WHY PAY MORE!
20 YEARS AT THIS ADDRESS
AN ESTABLISHED POLICY OF CAREFUL SELECTION ASSURES YOU, MANY HAPPY MILES. BE WISE—TRY ONE—YOU'LL BUY MORE! WE WELCOME COMPETITION. NO ONE CAN TOUCH OUR QUALITY & PRICE!

GOOD USED TIRES — NOT RECAPS — NOT RETREADS
YOU GET WHAT WE ADVERTISE
FALL SPECIALS — SEND THIS AD
MAIL ORDERS PROMPTLY FILLED
Thousands of satisfied customers.
20 MONTHS WRITTEN GUARANTEE

600-16	\$3.72	820-15	\$5.02	600-20	\$6.62	32x6(8)	\$8.22
650-16	4.22	700-15	4.02	650-20	7.22	32x6(10)	9.52
700-16	4.82	670-15	4.12	700-20	8.12	900-20	13.72
650-15	3.82	710-15	4.32	750-20	8.12	1000-20	13.22
760-15	4.62	550-17	3.92	825-20	13.52	1100-20	13.22

EXTRA SPECIAL—30 MONTH WRITTEN GUARANTEE—FREE TUBE	600-16	\$5.12	475-19	\$5.52	700-15 (G)	\$7.72	700-20	\$10.32
600-16 (G)	6.32	640-15	4.72	750-16 (H)	8.72	750-20 (I)	14.72	
650-16	6.42	670-15	5.02	700-17	9.82	750-20 (J)	12.32	
650-16 (6)	6.52	710-15	5.42	750-17	10.72	825-20 (K)	17.72	
700-16	6.22	760-15	5.62	825-15	12.92	900-20	17.02	
750-16 (G)	6.72	800-15	6.72	600-20	8.42	1000-20	18.02	
525-18	5.22	820-15	6.62	650-20	10.32	1100-20	18.12	
550-17	4.22	670-16	6.12	32x6(8)	11.72	1000-22	17.12	
650-15	5.02	550-15	5.42	32x6(10)	13.02	1100-22	17.12	
700-15	5.52	700-16 (F)	7.52	750-15	10.02	1200-20	22.22	
All White Walls	\$1.00 extra	Military treads	750-20	10.72				

Thousands of tires shipped all over U.S.A. All tires shipped F.O.B. Phila. Send Check or M.O. with this ad, Dept. 2.
STANDARD 834 N. Broad St., Philadelphia 30, Pa.

SEND FOR THIS FREE!

Make money. Know how to break and train horses. Write today for this book **FREE**, together with special offer of a course in Animal Breeding. If you are interested in Gaiting and Riding the saddle horse, check here () **Do it today—now.**

BEERY SCHOOL OF HORSEMANSHIP
Dept. 11012 Pleasant Hill, Ohio

\$750 BUILDS 4 ROOMS & BATH!
WHY PAY RENT? For Seven Hundred Fifty Dollars and 30 days of your spare time, you can build yourself this Beautiful Home. Living Room 11x15, Front bedroom 9x11, Back bedroom 10x12, Kitchen 9x11, Bath 5x8, Hall 3x4. Wind out steel casement windows, Concrete block, stuccoed. Step-by-step illustrated instructions, blueprint and material list \$1.00 ppd. No COD. Moneyback guarantee. Economy Home, Dept. C Box 645 Columbus 16, Ohio

STUDY INDUSTRIAL DESIGN

You can train at Art Center School in California with practicing professionals for upper-level jobs in INDUSTRIAL DESIGN. Recent graduates have been added to the staff at General Motors, Chrysler, Raymond Loewy, Henry Dreyfuss, etc. Majors in transportation, general product design, structures, community development, furniture design, packaging, display, 4-year degree courses. Learn to combine imaginative design with technical proficiency, coordinate utility and beauty. Stimulating environment. Field trips. Advantages of mild Southern California climate and nearby holiday spots. Fully accredited. Coed. Placement service. Write for catalog.

ART CENTER SCHOOL, Edward M. Adams, Director
5353 WEST THIRD STREET, LOS ANGELES 5, CALIFORNIA

ITALIAN ACCORDIONS AT LOWEST WHOLESALE PRICES

5-DAY FREE TRIAL

"PAY AS YOU PLAY"
Small Down Payment
As Little As
\$10 per month

DIRECT from Importer to You!
SATISFACTION GUARANTEED, or your money back! NOW you can save up to 50% by direct purchase from America's leading distributor of famous genuine ITALIAN ACCORDIONS. TRADE-INS ACCEPTED
Send for FREE Illustrated Catalog!

ACCORDION MANUFACTURERS & WHOLESALE OUTLET
2003 West Chicago Ave. Dept. R-123, Chicago 22, Ill.

**World's Greatest Hobby
For Men and Boys!
Get This Free Book. It
Tells How You Can Learn to**

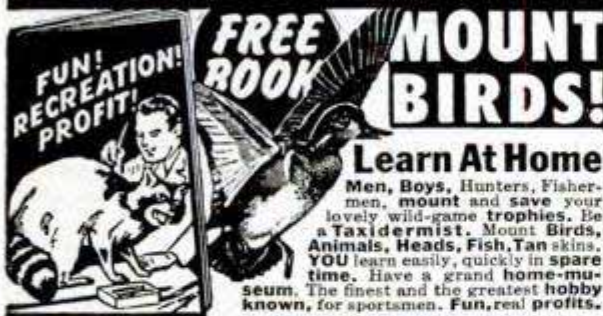

Learn At Home
Men, Boys, Hunters, Fishermen, mount and save your lovely wild-game trophies. Be a Taxidermist. Mount Birds, Animals, Heads, Fish, Tan skins. YOU learn easily, quickly in spare time. Have a grand home-museum. The finest and the greatest hobby known, for sportsmen. Fun, real profits.

FREE BOOK

Yes, FREE. Beautiful strange, valuable Book, telling all about Taxidermy. Contains over 100 beautiful game-pictures. And it's yours FREE, if you rush your request. You can mount all kinds of wild-game, and common specimens too. We can positively TEACH YOU. So GRASP this opportunity. RUSH letter or postal for this amazing FREE BOOK. Don't delay. State your AGE. N. W. SCHOOL OF TAXIDERMY, 2512 Elwood Bldg., Omaha 2, Neb.

AVIATION Pays You More With a Schooling at PARKS
NOW! A&E MECHANIC LICENSE COURSE
45-week course, all phases aircraft & engines.
Start Jan. 4, 1954

FLIGHT COURSES—Private, Commercial, Instrument, Instructor, Multi-Engine.

DEGREE COURSES—B.S. degree in 3 yrs. from Saint Louis University — Aero. Engineering, Maint. Engineering, Aero. Administration.

All Parks Schooling Approved for Veterans
Write Today.

PARKS COLLEGE ARNOLD HALL EAST ST. LOUIS, ILL.

Become a **MENTAL SUPERMAN**

OVERNIGHT! Floor everybody! Revolutionary "MEMO-PROP" does all your thinking! It's uncanny! Unprecedented! FREE LITERATURE! BIJOU STUDIO, BOX 1727MD, HOLLYWOOD 28, CAL.

TASOPE PHOTO-ENGRAVING PLANTS



Establish your own profitable PHOTO-ENGRAVING business. Make cuts for newspapers, printers, and advertisers. Make etched name plates, plaques etc. Instructions furnished, no experience necessary. Sold direct from factory since 1931. First five hundred cuts sold locally or by mail will pay for plant and pay you well for your time. Write for FREE catalog.

Material Cost Of This Cut 3/4c Selling Price \$1.00 And Up

TASOPE DEPT. PM12, AURORA, MO.

Tool and Die Design Training

\$8,000 to \$15,000 YEARLY INCOME!

ACME training has been fully proved in practice through its fine resident schools. Acme graduates report outstanding promotions, resulting in higher salaries. Progress is sure and easy through Acme's famous "COPE" System. Prepare yourself IN YOUR SPARE TIME for a secure position of responsibility and high earnings, and qualify at a time when you will have every opportunity to rise to a position in the \$8-15,000 per year salary bracket. Be successful — Go Farther Faster!

Detailed information upon request.

ACME SCHOOL OF DIE DESIGN

(Correspondence Division, Dept. M)
8 N. JEFFERSON STREET DAYTON 2, OHIO

**BECOME AN
Electrical Engineer**



● Major in Electronics or Power
● Earn B. S. Degree in 36 months

Over 50% of the nation's industrial leaders began their careers with engineering training. Today, the demand for young, trained Electrical Engineers and Technicians is constantly expanding. Eight separate programs give you a wide range of career opportunities.

**Plan Your Career From these
Courses in Electrical Technology**

ENGINEERING COURSES

Electrical Engineering — Bachelor of Science Degree
Save a valuable year through optional year 'round study.
Electronics major 36 months
Power major 36 months

TECHNICIAN COURSES

Electronics Technician 12 months
Radio Technician 12 months
Radio and Television Technician 18 months

SERVICE COURSES

Electrical Service 6 months
Radio and Television Service 12 months

MECHANICAL TECHNOLOGY COURSES — Also available.

Service Technician courses 6 to 18 months — Heating, Refrigeration, Welding, Air Conditioning and Mechanical — Mechanical Engineering with a major in Design, Metal Fabrication or Plant Engineering.

Also, general 3-month preparatory course.

Terms open January, March, June, October

Approved for veterans. Prior Military, Practical or Academic training evaluated for advanced credit. Faculty of specialists. 50,000 former students. Annual enrollment from 48 states and 23 overseas countries. 50th year. Non-profit.

Send handy coupon for complete information. (Residence Courses Only)



MILWAUKEE SCHOOL OF ENGINEERING

MILWAUKEE SCHOOL OF ENGINEERING
Dept. PM-1253, 1025 N. Milwaukee
Milwaukee 1, Wisconsin

Send free pictorial "Your Career Booklet"



I am interested in name of course

Name Age

Address

City Zone State

If veteran, indicate date of discharge



HERE'S YOUR BIG OPPORTUNITY!

TELEVISION

TECHNICIANS EARN BIG PAY!

21 IN.



NO
 experience
 needed...
 I'll train
 you
AT
HOME
 in your
SPARE
TIME!
EARN WHILE
YOU LEARN!



VETERANS!

MY SCHOOLS FULLY APPROVED TO TRAIN VETERANS under new G.I. bill! If discharged after June 27, 1950—**CHECK COUPON!** Also approved for **RESIDENT TRAINING** in New York City at Pierce School of Radio and Television... qualifies you for full subsistence allowance up to \$160 per month. Write for details.

YOU GET ALL 4 FREE!

GOOD SPARE TIME EARNINGS! Almost from the very start you can earn extra money while learning, repairing Radio-TV sets for friends and neighbors. Many of my students earn up to \$25 a week... pay their entire training from spare time earnings... start their own profitable service business. *Act now! Mail coupon and find out for yourself what a TV career can do for you!*

OPTIONAL: TWO WEEKS TRAINING IN NEW YORK CITY AT NO EXTRA COST! You get two weeks, 50 hours, of intensive Laboratory work on modern electronic equipment at our associated school in New York City—Pierce School of Radio and Television. And I give you all this **AT NO EXTRA COST** whatsoever, after you finish your home study training in the Radio-FM-TV Technician Course and FM-TV Technician Course.

RADIO-TELEVISION TRAINING ASSOCIATION
 52 EAST 19th STREET, NEW YORK 3, N. Y.

Licensed by the State of New York • Approved by the VA

CIVILIANS! VETERANS! PREPARE FOR A BRIGHTER FUTURE AS A TRAINED TV TECHNICIAN! Thousands of new jobs in TV are opening up in every state as new stations go on the air. You too can take your place in America's booming TELEVISION and Electronics industries... enjoy the success and happiness you always wanted. Keep your present job while I prepare you at home for a life-time career as a trained TV Technician. You "learn-by-doing" with the actual parts and equipment I send you... the same successful methods that have helped hundreds of men—many with no more than grammar school training—master television!

ENOUGH EQUIPMENT TO SET UP YOUR HOME LABORATORY!

As part of your training, I give you **ALL** the above equipment you need and more to prepare for a **BETTER PAY TV** job. You build and keep a professional **GIANT SCREEN TV RECEIVER** complete with big picture tube, takes any size up to 21-inch... also a Super-Het Radio Receiver, RF Signal Generator, Combination Voltmeter-Ammeter-Ohmmeter, C-W Telephone Transmitter, Public Address System, AC-DC Power Supply. Everything supplied including all tubes!

EXPERT FM-TV TECHNICIAN TRAINING! My FM-TV Technician Course can save you months of training if you have previous Armed Forces or civilian radio experience! Train at home with kits of parts, plus equipment to build **BIG SCREEN TV RECEIVER**, and **FREE FCC Coaching Course!** **ALL FURNISHED AT NO EXTRA COST!**

FREE FCC COACHING COURSE! Important for **BETTER PAY JOBS** requiring FCC License. You get this training **AT HOME** and **AT NO EXTRA COST**, Top TV jobs go to FCC licensed technicians.

NEW! PRACTICAL TV CAMERAMAN & STUDIO COURSE! (For men with previous radio and TV training) I train you at home for an exciting high pay job as the man behind the TV camera. Work with TV stars in TV studios or "on location" at remote pick-ups! A special one-week course of practical work on TV studio equipment at Pierce School of Radio & TV, our associate resident school in New York City, is offered upon your graduation.

LEARN ALL ABOUT COLOR TV! I give you the latest principles and practical training in TV COLOR!



MAIL THIS COUPON NOW! No Salesman Will Call!

Mr. Leonard C. Lane, President
RADIO-TELEVISION TRAINING ASSOCIATION
 52 East 19th Street, New York 3, N.Y., Dept. M-12A
 Dear Mr. Lane: Mail me your **NEW FREE BOOK**, **FREE SAMPLE LESSON**, and **FREE aids** that will show me how I can make **BIG MONEY IN TELEVISION**. I understand I am under no obligation and no salesman will call.

(PLEASE PRINT PLAINLY)

NAME _____ AGE _____

ADDRESS _____

CITY _____ ZONE _____ STATE _____

I AM INTERESTED IN:

- Radio-FM-TV Technician Course
- FM-TV Technician Course
- TV Cameraman & Studio Course

VETERANS!
 Check here for
 Training under
NEW G.I. Bill

Capra Gems

more dazzling than diamonds

Free Booklet Shows
How You
Can Own
A CAPRA GEM
For 1/30 The Cost
Of A Diamond!



Get full facts, FREE, on the most amazing discovery by modern science — CAPRA GEMS. A miracle of science described in recent issues of *Saturday Evening Post* and *Reader's Digest*. They're more dazzling than diamonds, yet cost much less. CAPRA GEMS' refractive quality is actually higher than diamonds! Brilliantly beautiful, dazzling CAPRA GEMS are hand cut, hand polished and hand selected . . . priced within the reach of all who love fine gems. A 1-carat diamond stone costs you approximately \$1000. A comparable choice selected, 1-carat CAPRA GEM is yours for \$24, federal tax included . . . and can be bought in small easy payments.

GET THE FACTS NOW

Valuable illustrated booklet shows a wide selection of men's and women's rings. Gives full details, including prices and settings . . . shows all CAPRA GEMS actual size. Limited supply, so send today without delay. No charge, no obligation. Get all the facts on CAPRA GEMS . . . more dazzling than diamonds.

SEND NO MONEY

CAPRA GEMS, INC., Dept. PM-12, P.O. 5145, Phila. 41

Name _____

Address _____

City _____ Zone _____ State _____

FIX WATCHES

FOR PAY OR PASTIME Cash in on growing opportunities. Study at home or in person with Chicago School of Watchmaking. No experience needed. Write!

CHICAGO SCHOOL OF WATCHMAKING

2330 Milwaukee Ave., Dept. 1123, Chicago 47, Ill. Veteran
Send FREE information on Home Study Resident School

Name _____

Address _____

City _____ Zone _____ State _____

LOOK!



A MILLION THRILLS!

High Power
BINOCULARS
30 DAY FREE TRIAL

Finest Precision Optics
Featherlight
Guaranteed Savings
Money Back Guarantee
Easy Pay Plan

Compare Before You Buy!
Dealer Name on Request.

33 Models
\$9.95
UP

FREE BOOK & COLOR CATALOG

BUSHNELL Binoculars Bushnell Bldg., Dept. M72
Pasadena 1, Calif.

FREE BOOK AND COLOR CATALOG

NAME _____ CITY _____

ADDRESS _____ STATE _____

INVENTORS

IF YOU WISH TO PROTECT YOUR INVENTION, You should take steps to protect it by a U. S. Patent. Write me for "INVENTION RECORD" form

CARL MILLER

REGISTERED PATENT ATTORNEY

WOOLWORTH BLDG., 35th FLOOR, 123A
NEW YORK CITY



PATENTS

C. A. SNOW & CO.

REGISTERED PATENT ATTORNEYS
WRITE FOR INFORMATION TO
428 SNOW BUILDING, WASHINGTON 1, D. C.

INVENTORS

Whether an invention is patentable can be substantially determined by a search of the U. S. Patent records. Without obligation, write for information explaining the steps you should take to secure a patent.

JOHN N. RANDOLPH

Registered Patent Attorney

201 Columbian Building, Washington 1, D. C.

HELPFUL BOOKS

Send post card asking for FREE catalog

Popular Mechanics Press, 200 E. Ontario, Dept. 601, Chicago 11

INVENTORS

Send for
PATENT INFORMATION
Book and

INVENTOR'S RECORD
without obligation

GUSTAVE MILLER
123-PM WARNER BUILDING
WASHINGTON 4, D.C.

REGISTERED PATENT
ATTORNEY

Patent Attorney & Advisor
U. S. NAVY DEPT. 1930-1947

ASSOCIATE EXAMINER
U.S. PAT. OFF. 1922-1929

PATENT LAWYER

INVENTIONS WANTED

If you want to market, or sell, your invention for cash or royalties, Write for our Free Booklet. Send no drawings. We also welcome hearing from firms, or private capital, wishing to review inventions in any field. We will be glad to send notice of our clients' inventions.

GLOBAL MARKETING SERVICE

1404 Mitchell Street

Dept. PD

Oakland 1, Calif.

INVENTORS

I shall be pleased to furnish you, upon request, with full information relative to patent procedure—without any obligation on your part.

PATRICK D. BEAVERS

Registered Patent Attorney

934 Columbian Building Washington 1, D. C.

MEN WANTED!



Make \$15-\$20 in Few Hours Spare Time—up to \$210⁰⁰ a Week FULL TIME—with Amazing D-FROST-O-MATIC!

Millions of housewives want this sensational new Automatic Refrigerator Defroster! No more messy hand defrosting! Just plug in D-FROST-O-MATIC and refrigerator is defrosted automatically every night! Sales easy, sure when you leave D-FROST-O-MATIC on FREE TRIAL—housewives won't let you take it out! Saves money, food, time, work! **Big profits for you**—up to \$210.00 a week full time—\$15 to \$20 in just a few spare hours! Start spare time and build big, prosperous business . . . quickly, easily!

SELLY of California started in his spare time and now sells 1500 D-Frost-O-Matics a month!

Rush Name Today for Profit Details and FREE TRIAL PLAN!

More than **29,000,000** prospects waiting! Rush your name and address today. We'll airmail exciting facts, proof and sure-profit Free Trial plan. No obligation. Write today.

D-FROST-O-MATIC, Dept. J-6
173 W. Madison Street, Chicago 2, Ill.

In Canada—Write Silvex Co., 371 Dowd St., Montreal 1, Que.

How to Make Money with Simple Cartoons

A book everyone who likes to draw should have. It is free; no obligation. Simply address **FREE BOOK**

CARTOONISTS' EXCHANGE
Dept. 912D Pleasant Hill, Ohio

LEARN TO THROW THE BOOMERANG

A Fascinating Sport and Unique Gift

Flight Tested—Guaranteed to Return Golden Red, Jade Green or Natural with Story and Instructions **\$2.00 ea.**

CARVED by Postpaid
COL. JOHN M. GERRISH
4409-M S.W. Parkview Lane, Portland 1, Ore.

SEND FOR YOURS TODAY

BECOME AN EXPERT IN TRAFFIC

Traffic men earn \$4,000 to \$10,000 and up. Thousands of firms need experts on rates, tariffs, regulations. We train you thoroly in spare time at home for executive traffic jobs. Personal training under traffic authorities. Placement counsel and help. Write for free 48-page book "Traffic Management—the Fast Growing Profession."

LASALLE Extension University, 417 So. Dearborn St.
A Correspondence Institution Dept. 1264T Chicago 5, Ill.

CUSSIN'

WON'T START YOUR COLD OR WET MOTOR...

KAR-START WILL!

Amazing device helps start cold or wet car engines instantly! 5 times more spark from plugs for sure-fire starts. Will not damage points. Simply installed—3 quick connections. Long lasting. If your dealer can't supply, order direct. Only \$5.95 postpaid. Buy Kar-Start today. Money back if not delighted. Write for free bulletin.

SCHAUER MANUFACTURING CORP., 4532 ALPINE AVE.
CINCINNATI 36, OHIO

Get Kar-Start and GO!

COME TO THE UNIVERSITY OF HOUSTON

FOR YOUR

TECHNICAL AND VOCATIONAL TRAINING

ONE OF AMERICA'S LARGE AND MOST MODERN UNIVERSITIES

Select from these fascinating fields

- | | |
|---|---|
| <input type="checkbox"/> Aeronautics | <input type="checkbox"/> Industrial mechanics |
| <input type="checkbox"/> Air conditioning and refrigeration | <input type="checkbox"/> Drafting |
| <input type="checkbox"/> Automobile trades | <input type="checkbox"/> Machine shop |
| <input type="checkbox"/> Body and paint | <input type="checkbox"/> Welding |
| <input type="checkbox"/> Mechanics | <input type="checkbox"/> Woodworking |
| <input type="checkbox"/> Upholstery and trim | <input type="checkbox"/> Photography |
| <input type="checkbox"/> Diesel | <input type="checkbox"/> Radio |
| <input type="checkbox"/> Electricity | <input type="checkbox"/> Stationary Engineering |
| <input type="checkbox"/> Electronics | <input type="checkbox"/> Television |

PREPARE FOR YOUR FUTURE NOW . . . with the very latest methods and equipment, at the modern University of Houston School of Technology. For entrance: high school diploma, or over 18 and ability to profit from instruction. Beautiful campus—250 wooded acres in Houston, Texas—the city of tomorrow. Full college activities . . . sports . . . social life. Day or night, short or longer courses. Cooperative work and study programs . . . earn part of tuition and expenses with part-time job in your own career field, while you learn. Personal vocational counselling. Diploma or B.A.S. degree on completion—and job placement assistance. Feb., June, Sept. semesters. G.I. approved. —V. A. on campus. Send for Free illustrated brochure now!



EZEKIEL W. CULLEN BUILDING

University of Houston, School of Technology
Dept. 1C3—HOUSTON 4, TEXAS

Without cost or obligation, please send me fully-illustrated brochure and full particulars. I am interested in subject marked X above.

Name.....Age.....

Address

City.....State.....

own your own business! earn up to
\$75 A DAY CLEAR PROFIT
 in your back yard or basement!

**MAKE CONCRETE BLOCKS With Amazing New
 LOW PRICED GENERAL BLOCK MACHINE**

**NOW! Big Building Boom
 Profits Within Your Reach**

You don't need much cash to cash in on the building boom! New high speed, low cost General Block Machine produces up to 1,000 concrete blocks a day for homes, factories, buildings, garages. Your profit mark-up is 100% to 150%! Fool-proof, easily operated, sturdy steel machine can make any size from 4" to 12". These superior 3-core blocks meet all building code requirements for foundation, chimney, corner, sash and many other types of blocks. Works indoors or out. Sand, cement and water available anywhere! Simple operating instructions and mixing formulae for cement and cinder blocks supplied FREE. Get full details, no obligation!



EXTRA!

Amazing illustrated book gives floor plans for 6 sensational concrete block bungalows. Tells how to lay blocks, lay out building lines, mix concrete, build steps, porch and concrete floors all at great savings. Written by experts. Can save many times the cost of the machine! Get it now! No strings attached.

R.L.T. of
 New York
 City Reports:
 "My General
 Block Machine
**PAID FOR ITSELF IN FIRST
 2 WEEKS!**"
 Thousands now in use
 the world over!
 Write for FREE details
TODAY

**HOW TO
 BUILD
 YOUR OWN
 CONCRETE
 BLOCK
 HOME**
 Only 1 Prepaid

**SEND \$1 — Refunded
 if you buy machine!**

GENERAL ENGINES COMPANY

Dept. M-123, 307 HUNTER STREET, GLOUCESTER, N. J.

**AMAZING NEW
 ASTRO-SCOPE* & TRIPOD**
POWERFUL! ACCURATE! COMPLETE!

IDEAL FOR

- Astronomers
- Students
- Hobbyists
- Scouts
- Sportsmen
- Plane Spotters
- Target Spotters
- Mountain Climbers
- Sea & Land Observers



\$8.95
 POST-PAID

Sky High Value at a Down-To-Earth Price! Amazing New Astro-Scope* Combination — another Big "CRITERION FIRST" — A brilliant variable 20x, 45x, 75x, power adjustable eyepiece, 3 foot telescope, brass bound, with 4 precision lenses that will bring distant objects, moon, stars, ships and people 75 times closer. Can also be used as powerful compound microscope. All aluminum tripod with non-slip rubber tips. Universal mount makes easy, smooth adjustment to any position. FREE — 108-page book "DISCOVER THE STARS." A marvelous complete all-purpose instrument ready to use, in a Christmas Gift Package all for the amazing price of \$8.95.

Money Back Guarantee

*Reg. U.S. Pat. Office

Send Check or Money Order
 DEPT. PMA 3

CRITERION CO. HARTFORD 3, CONN.

331 CHURCH ST.

Super
TELESCOPE

Aluminum
TRIPOD

Hi-Power
MICROSCOPE

Astronomy
BOOK

**MAKE YOUR OWN FOLDING TABLES
 IN MINUTES**

WITH
**TABLECRAFTERS'
 TUBULAR STEEL
 FOLDING
 TABLE LEGS**

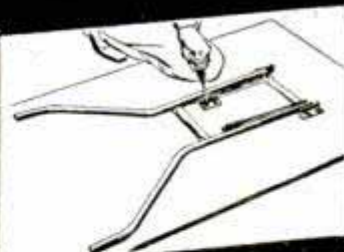

Screw leg assemblies to your table top. Guide holes assure accurate assembling. Sturdy, rustproof legs have safety lock... won't collapse... fold easily for storage. For hobby, work, banquet, buffet, game tables.

**\$995 COMPLETE
 KIT FOR
 ONE TABLE**

If you send check or money order, we pay postage. Special discounts to institutions.

Dep't G-12

TABLECRAFTERS 1114 York Rd., Abington, Pa.

**Want a
 HOME?**



Before you choose, be sure to GET THE FACTS about Schult mobile homes. Write or wire Dept. 3212
SCHULT CORP., ELKHART, IND.

**SCHULT
 TRAILERS**

YOUR OWN PRINTING BUSINESS



Start in spare time at home. Everyone uses printing. Print Xmas cards, letterheads, church and club circulars, advertising. Do hundreds of jobs, quickly and easily, with an ADANA world-famous, low-cost machine using regular printer's type. Follow simple instructions—produce professional work. Write for free literature and samples.

ADANA LTD., 56 Adelaide St. E., Toronto, Canada

Catalog of 3000 Novelties 10c

Send 10c for amazing catalog of novelties, live animals, scientific supplies, hobbies, funmakers, planes & boats, looms, magic tricks, joke articles, unusual seeds, gadget timesavers, cameras, optical goods, projectors, movies, lucky jewelry, religious novelties, disguises, musical instruments, stamps, coins, puzzles, fortune tellers, radios, auto & bike accessories, telescopes, magnifiers, compasses, banks, smokers' gadgets, artists' supplies, printing sets, engines, motors, shockers, knives, billfolds, guns, rifles, sports, books, games, plants, etc. Send name, address & 10c to:

JOHNSON SMITH & CO., Dept. 694, Detroit 7, Michigan

NOW LEARN TV-RADIO Servicing AT HOME!

EARN WHILE YOU LEARN! No previous training needed. New, simplified lessons with complete parts kits. Build your own TV set! A leading school, approved for Korean vets. Also Residential Course (day & eve. classes). Send for FREE sample lessons and full details on a PROFITABLE, thrilling career. Write Dept. B12

CRESCENT SCHOOL

500 PACIFIC ST.

BROOKLYN 17, N. Y.

BRASS NAME PLATES

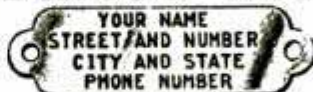

or KEY TAGS

40c each

Half actual size
 QUANTITY PRICE — SAME STAMPING
 3 for \$1.00
 8 for \$2 — 15 for \$3 — 25 for \$4 — 50 for \$6
 LARGER QUANTITIES ON REQUEST

TAGCO, P. O. BOX 203 X, PLEASANT VALLEY, N. Y.

Learn BAKING At Home

Baking is one of America's high industries in wages. Nearly depression-proof. Thorough basic home course lays sound foundation. If you have aptitude, write for FREE BOOKLET, "Opportunities in Commercial Baking."
NATIONAL BAKING SCHOOL
 835 Diversey Parkway Dept. 1359 Chicago 14, Ill.



Famous 15 and 17 Jewel
BULOVA WATCHES \$16.95 PLUS TAX

PRACTICALLY WHOLESALE TO YOU

UNLIMITED SERVICE GUARANTEE

**WHY PAY \$59.50?
 SAVE \$42.55**

Also Choice of • **BENRUS**
 • **GRUEN** • **WALTHAM**
 or • **ELGIN WATCHES**

You get these unredeemed SERVICE guaranteed Bulova and other movements in latest style Yellow Gold Cases at this sensationally low price because we bought out huge surplus STOCKS of leading New York and Md. Jewelers. Order now while they last. Specify make, preferred and whether men's or ladies'. Only \$16.95 plus \$1.70 tax. Order right now.

FREE TRIAL OFFER! WEAR AT OUR RISK! Money back guarantee in 10 days if not delighted.

SEND ONLY \$1 with order. Pay balance C.O.D., plus postage. Or enclose \$16.95 plus \$1.70 tax, we pay postage.

Handsome Expansion extra cost. AIRMAIL XMAS DELIVERY GUARANTEED. **MARYLAND DISTRIBUTORS, Dept. 561** 501 E. Baltimore St. Baltimore 2, Md. Write For Free Watch and Diamond Ring Catalog — Practically Wholesale Prices.

UNLIMITED Service Guaranteed 17 Jewel Swiss WRIST WATCH

Worn by Army, Navy & Marines.

WHY PAY \$50? Here \$14.95 Plus \$1.50 tax.

New Incublock, Shock-Protected Water & Dust Tight



Band with orders at no extra cost. AIRMAIL XMAS DELIVERY GUARANTEED. **MARYLAND DISTRIBUTORS, Dept. 561** 501 E. Baltimore St. Baltimore 2, Md. Write For Free Watch and Diamond Ring Catalog — Practically Wholesale Prices.

Here's to FIRST AID
FOR
COLDS

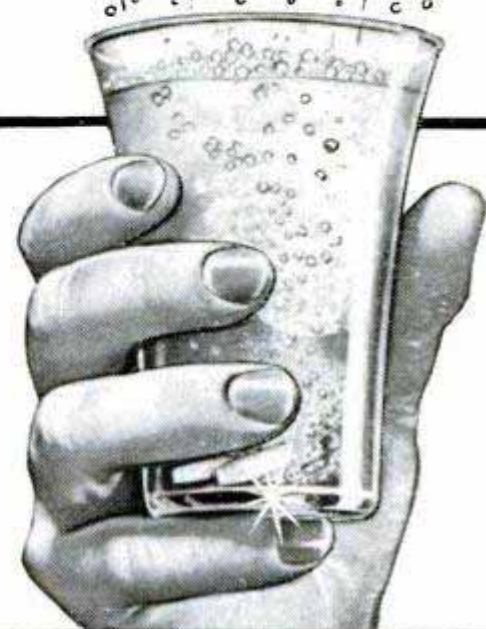

Alka-Seltzer
 BRAND Reg. U. S. Pat. Off.

SPEEDY RELIEF FOR THESE COLD DISCOMFORTS
ACHE-ALL-OVER MISERY
FEVERISH FEELING • HEADACHE
SORE THROAT OF A COLD



Also Use *Alka-Seltzer* for
ACID INDIGESTION
HEADACHE
MUSCULAR ACES
 On Display at ALL DRUG STORES
MILES LABORATORIES, INC., ELKHART, IND.

PLYWOOD BOAT KITS

(Freight Included) 12 FT. \$9700
 14 FT. \$12900



Build these 12 or 14-ft. sport runabouts from readycut parts. Kits include all hardware, etc., to complete the boat shown. Send for free folders of all models as low as \$32.00 freight included.

TAFT MARINE WOODCRAFT
 Dept. J, 636 39th Ave., N. E., Minneapolis 21, Minn.



MECHANICAL DENTISTRY

To make Crowns, Plates, Bridgework, etc., for Dentists. Easy practical way to learn mechanical dentistry at home in spare time. FULL EQUIPMENT OF TOOLS AND MATERIALS INCLUDED WITH COURSE. Low tuition. Easy terms. Write for FREE BOOK about this money making profession that is not affected by machine age.

MCCARRIE SCHOOL OF MECHANICAL DENTISTRY
 207 N. Broad St., Dept. 24, Philadelphia 7, Pa.

PORTABLE GARAGE

\$6.75 Plastic Vinyl
USE IT ANYWHERE



• Folds compactly • Keeps rain, snow, dust, salt air, sun or sleet away • Protects your car's finish • Durably constructed of vinyl plastic • Springtite elasticized bottom, holds securely in all kinds of weather • Fits all makes • Direct from manufacturer • Enclose check or money order for 6.75, plus 25c postage or sent C.O.D. 10-Day Money Back Guarantee.

MARDO SALES CORP.
 480 LEXINGTON AVE., DEPT. G-606, NEW YORK 17, N. Y.

60 BALLOONS \$2
 THAT MAKE **GIANT CIRCUS ANIMALS**

Some from 3 ft. to 4 ft. Easy to make GIANT CIRCUS ANIMALS—instructions included. 3 1/2 ft. Giraffe, a yard full of 12" kittens. Make a big SANTA CLAUS, a set of REINDEER, Seal, Kangaroo. FREE with \$4.00 order a balloon squawker. FREE with \$6.00 order 50 plastic toys. "A Complete Rodeo." Add 10c for postage.

52 PARTY BALLOONS \$100
 In assorted colors & sizes.

50 PLASTIC TOYS \$100
 A complete Rodeo.

CIRCUS BALLOONS, Dept. PM-12, Scarsdale, N. Y.

See Your House Before You Build \$4.95
HOYT RUST Scale Kit



Make exact model on your plan. A few hours fun will prevent costly mistakes. Colors, finishes, furniture, appliances, instructions, patented clasps included in Kit M-33. Postpaid for \$4.95 with order. Or write for description.

HOYT RUST, 173 Marion Street, Denver 18, Colo.

FREE

to start
you in
a...



FABULOUS BUSINESS of YOUR OWN Part or Full Time

Thousands of men and women will attest to the money making power of this great catalog. It is specially designed for a highly profitable business of your own... without investing in stock... and is jam packed with amazing values.

Here you will find merchandise of the highest quality, styling and popular acceptance, with famous brand names in every category. Hundreds upon hundreds of items include Appliances, Binoculars, Cameras, Clocks, Costume Jewelry, Cutlery, Diamonds, Dolls, Fishing Tackle, Houseware, Luggage, Pearls, Pens and Pencils, Radios, Wallets, Watches and many more... all beautifully illustrated.

The new 68 page 1953-54 edition is just off the press. Write for your FREE copy today. You'll be astounded how simple it is to build a business the Temple way.

Clip and Mail Today!

TEMPLE COMPANY, INC.

804 Sansom Street, Phila. 6, Pa. Dept. P.
Please rush Temple's 1953-54 Catalog and Confidential Price Book. No obligation.

Name
Address
City..... Zone..... State.....

Learn CARTOONING

at home in spare time... the quick easy Landon Picture Chart way. Teaches how to originate—today's big need. Scores of successes. Send for FREE Picture Chart (to test ability) and full details.

Landon School of Cartooning, 5312 CTS Bldg., Cleveland 14, O.



I'll Send You This Handsome SAMPLE CASE - FREE



and Show You How to Make
Up to \$15.00 in a Day

Mail coupon for this Free Tailoring Sample Case packed with 150 beautiful, big-value suit and overcoat fabrics. Take orders from friends, fellow-workers, others, for fine quality, made-to-measure clothes. Pocket big cash profits in advance. Because wearing our suits and overcoats brings more orders, we make it easy for you to get your own clothes without 1c cost. No experience is needed. **SATISFACTION GUARANTEED.**

SEND NO MONEY. Just fill out and mail coupon—today!
**PIONEER TAILORING CO., Congress & Throop Sts.
DEPT. D-1116 CHICAGO 7, ILLINOIS**

**PIONEER TAILORING CO., Dept. D-1116
Congress & Throop Sts., Chicago 7, Ill.**

Dear Sir: I WANT A MADE-TO-MEASURE SUIT TO WEAR AND SHOW, without paying 1c for it. Rush details and Sample Kit of actual fabrics, ABSOLUTELY FREE.

NAME..... AGE.....
ADDRESS.....
CITY..... STATE.....

WRIST CIGARETTE LIGHTER

Fits wrist
like a fine
watch



for
GIFT
Giving

America's most unique and practical double feature lighter arrangement. Beautiful high quality, imported, gleaming chrome finish wrist cigarette lighter, mounted on matching full wrist or 2-pc. expansion band. Just attach lighter on one side and your watch on the other side. Men and women owners marvel its perfect performance. Just press once and lid opens; press again and... it lights—*never fails!* Strikingly different and popular! Also unique for GIFT-giving! And, ONLY \$4.95 ppd., plus FREE miniature table lighter (shown). No C.O.D.'s. Money-back guarantee. *Indicate choice of band in order!*



OCIP Imports 424 S. Los Angeles St.
Los Angeles 13, Calif.

ENGINEERING DEGREE IN 27 MONTHS

INDIANA TECHNICAL COLLEGE

B. S. DEGREE, Aeronautical, Chemical, Civil, Electrical, Mechanical and Radio Engineering (inc. TV and Electronics). Drafting, 1-yr. G.I. Gov't approved. Low rate. Earn board. Large industrial center. Students from 48 states, 21 countries. Demand for graduates. Enter December, March, June, September. Write for catalog. 16123 E. Washington Boulevard, Fort Wayne 2, Indiana.



Print Your Own

Cards, Stationery, Advertising, labels, circulars, photo and movie titles, church work, tags, etc. Save money. Sold direct from factory only. Raised printing like engraving, too. **Print for Others, Good Profit.** Have a home print shop. Easy rules supplied. Pays for itself in a short time. Write for free catalog of outfits and all details.

Kelsey
EXCELSIOR
Presses

KELSEY PRESSES, N-37 MERIDEN, CONN.

STOPS FOGGY WINDSHIELDS NEW Chemical Mitt



Amazing Discovery! Autoists wild over new FOG-STOP Windshield Cleaner. Simply glide over windshield chemically-treated Mitt—at once glass sparkles crystal clear. Blurry mist, frost, sleet, snow disappear like magic. *Stops fogging. Sells like wild!*

SAMPLES FOR AGENTS Sample offer sent immediately to all who send name at once. Hurry. Postcard will do. **SEND NO MONEY—just your name.**
KRISTEE CO., Dept. 672, AKRON 8, OHIO

MAKE CRIME YOUR BUSINESS

ON THE SIDE OF THE LAW!

Help fight crime!... Earn steady good pay as a Finger Print Expert or Investigator. I.A.S. trains you—by easy, low-cost home study lessons. Learn this exciting work in spare time. Write for full details now!

OVER 800 POLICE BUREAUS...

Employ I.A.S.-trained men... proof of what I.A.S. can do. Write today (state age) for details. No obligation. No salesmen will call.

INSTITUTE OF APPLIED SCIENCE

(A Correspondence School Since 1916)

1920 Sunnyside Ave., Dept. 1359 Chicago 40, Illinois



FULLY GUARANTEED TIRES COST LESS!

Nationally famous FIRESTONE, GOODRICH, U. S. ROYAL, GOODYEAR, and other makes. Every tire selected and inspected for your safety.

FREE TUBE ON REQUEST WITH PASSENGER TIRES

WHITE WALLS OR SNOW TIRES \$1 EXTRA

HIGH GRADE TIRES GUARANTEED 12 MONTHS

600x16	4.14	700x16	5.14	32x6(8)	8.84	825x20	14.24
650x16	4.54	670x15	4.74	32x6(10)	10.84	900x20	13.34
650x15	4.34	650x20	7.84	750x20(8)	8.54	1000x20	14.14
700x15	4.64	700x20(8)	8.34	750x20(10)	9.94	1100x20	16.14

AAA PREMIUM GRADE GUARANTEED 18 MONTHS

550x15	5.48	700x15	5.98	760x15	5.58	750x20(10)	14.98
600x16	5.28	700x16	6.78	550x17	5.48	825x20	18.68
600x16(6)	6.58	700x16(6)	7.98	600x20	9.78	900x20	18.98
640x15	5.68	750x16(6)	8.98	650x20	10.88	1000x20	19.98
650x16	5.78	800x15	6.88	700x20	12.88	1000x22	21.98
650x16(6)	6.98	820x15	7.48	32x6(8)	10.48	1100x20	20.98
650x15	5.98	710x15	6.09	32x6(10)	12.48	1100x22	21.98
670x16	6.18	550x18	5.98	750x20(8)	12.98	1100x24	23.98

PENNA'S LARGEST STOCK

MILITARY SPECIAL AA Guaranteed 12 Months—
 900x16 10.69 1000x20 19.98
 750x20 10.98 1100x20 21.98

NEW TREAD GUAR. 24 MOS.
 600x16 8.98
 600x16(6) 9.98
 700x15(6) 15.95
 750x20(8) 24.98

Largest stock of used tires in the East. Thousands of satisfied customers. Write for Free Catalogue. MONEY ORDER OR CHECK WITH ORDER. NO C.O.D.'s

PYRAMID TIRE CO.
 1333-35 North 5th St. Dept. M., Phila. 22, Pa.

Learn to MOUNT BIRDS and Animals

LEARN BY MAIL
 At Home, in Spare Time
HUNTERS, SPORTSMEN, save your TROPHIES. Be a taxidermist. Mount ducks, deer, pets, Tan skins.
FREE BOOK tells you how to art. 100 FREE game-pictures. Grand and wonderful. Quickly learned by men or boys. FUN AND PROFIT. Send for FREE BOOK. State AGE.
N. W. SCHOOL OF TAXIDERMY, Dept. 2592 Omaha, Nebr.

MOTORCADE BARGAIN FROM DETROIT

8 FEET OF CARS!
 End-to-end these cars, trucks, trolleys, planes reach almost 8 ft. Fifty true 3-dimensional colorful plastic scale models. Order Now!

50 CARS FOR \$1

YOUNG PRODUCTS, Dept. 5076, 2605 Elmhurst, Detroit 6, Mich

Learn Deep Professional Secrets of Engineering
SCIENCE • INVENTION
 HELP RELIEVE DANGEROUS SHORTAGE IN THESE FIELDS
 Formula in this document has achieved outstanding success for many. College degree not necessary.
 Document written in non-technical language
THIS DOCUMENT CAN AFFECT YOUR FUTURE
 SEND NOW! \$2.75 POSTPAID — CASH, MO., COD
 Panoramic Research 4421 N.14th St. Phoenix Arizona

ELECTRIFY your SEWING MACHINE

BE AN AGENT \$9.00 NEW LOW PRICE!

Kit comes fully wired, installed in a jiffy. Fits all machines!
 You get ALL NEW PARTS:
 • Motor & Bracket
 • AC-DC 115v 60c
 • Multi-speed foot control
 • Cord set & block
 • Easy instructions
 • Steel pulley & belt

FREE . . . Reg. \$2.95 chrome SEW-LITE given with every kit

10 DAY FREE TRIAL—MONEY BACK GUARANTEE!
 Send \$5 deposit, pay postman balance plus postage.
 Please state whether wheel on your machine turns toward you or away from you. Shipping wt. 6 lbs.
 Order carrying case to fit your machine at new low price—\$9.50 plus postage. State the type machine you have. We also sell sewing machines.
BEDFORD SEWING MACHINE CORP.
 106 Fifth Ave., Brooklyn 17, N. Y. ST3-9589

WHAT ALL AUTO MECHANICS WANT TO KNOW

1664 PAGES

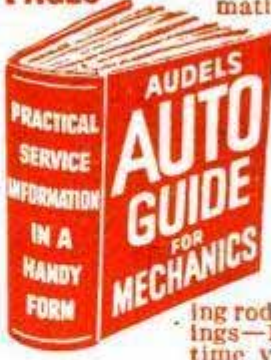

This Big Practical Book gives full information with working diagrams covering the principles, construction, ignition, service and repair of modern cars, trucks and buses.

Diesel Engines, Hydramatic & Fluid Drives Fully Explained.

A complete Guide of 1664 pages, with over 1500 illustrations showing inside views of working parts, with instructions for service jobs.

IT PAYS TO KNOW

How to fit pistons—How to locate engine knocks, How to fit connecting rod bearings—How to service main bearings—How to recondition valves—How to time valves—How to adjust fan belts—How to adjust carburetors and chokes, How to rebuild a clutch—How to service automatic transmissions—How to service brakes—How to adjust steering gear—How to cope with ignition troubles—How to service distributors—How to time ignition—How to "tune up" an engine.



\$4 COMPLETE • PAY \$1 A MO.
 TO GET THIS ASSISTANCE FOR YOURSELF SIMPLY FILL IN AND MAIL COUPON TODAY.

Step up your own skill with the facts and figures of your trade. Audels Mechanics Guides contain Practical Inside Trade Information in a Handy Form. Fully illustrated and Easy to Understand. Highly Endorsed. Check the book you want for 7 DAYS FREE EXAMINATION. Send No Money. Nothing to pay postman.

MAIL ORDER

AUDEL, Publishers, 49 W. 23 St., NEW YORK 10, N. Y.

Please send me postpaid for FREE EXAMINATION books marked x below. If I decide to keep them I agree to mail \$1 in 7 Days on each book or set ordered and further mail \$1 monthly on each book or set until I have paid price, otherwise I will return them.

- AUTOMOBILE MECHANICS GUIDE, 1800 Pages \$4
- TRUCK & TRACTOR GUIDE, 1299 Pages . . . 4
- DIESEL ENGINE MANUAL, 575 Pages . . . 2
- MACHINISTS HANDY BOOK, 1650 Pages . . . 4
- WELDERS GUIDE, 400 Pages . . . 1
- BLUE PRINT READING, 416 Pages . . . 2
- MATHEMATICS & CALCULATIONS, 700 Pages. . . 2
- SHEET METAL PATTERN LAYOUTS, 1100 Pages 4
- SHEET METAL WORKERS HANDY BOOK, 388 Pgs. 1
- MECHANICAL DRAWING GUIDE, 160 Pages . . . 1
- MECHANICAL DRAWING & DESIGN, 480 Pages 2
- AIRCRAFT WORKER, 240 Pages . . . 1
- TELEVISION SERVICE MANUAL, 384 Pages . . . 2
- RADIOMANS GUIDE, 914 Pages . . . 4
- ELECTRONIC DEVICES, 216 Pages . . . 2
- ELECTRIC MOTOR GUIDE, 1000 Pages . . . 4
- ELECTRIC WIRING DIAGRAMS, 272 Pages . . . 1
- ELECTRICIANS EXAMINATIONS, 250 Pages. . . 1
- ELECTRIC POWER CALCULATIONS, 425 Pages. 2
- HANDBOOK OF ELECTRICITY, 1440 Pages. . . 4
- ELECTRIC DICTIONARY, 9000 Terms . . . 2
- ELECTRIC LIBRARY, 7000 Pages (12 Book Set) 18
- MARINE ENGINEERS HANDY BOOK, 1258 Pgs. 4
- SHIPFITTERS HANDY BOOK, 250 Pages . . . 1
- REFRIGERATION & Air Conditioning, 1280 Pgs. 4
- MILLWRIGHTS & MECHANICS GUIDE, 1200 Pgs. 4
- POWER PLANT ENGINEERS GUIDE, 1500 Pages 4
- ENGINEERS & FIREMANS EXAMS, 525 Pages . . . 1
- PUMPS, Hydraulics & Air Compressors, 1658 Pgs. 4
- ENGINEERS LIBRARY (3 Book Set) . . . 9
- MECHANICAL DICTIONARY, 950 Pages . . . 4
- GARDENERS & GROWERS GUIDES (4 Book Set) 6
- CARPENTERS & BUILDERS GUIDES (4 Book Set) 6
- PLUMBERS & Steamfitters Guides (4 Book Set) 6
- MASONS AND BUILDERS GUIDES (4 Book Set) 6
- PAINTERS & DECORATORS MANUAL, 450 Pgs. 2
- HOUSE HEATING GUIDE, 1000 Pages . . . 4
- OIL BURNER GUIDE, 384 Pages . . . 1

Check NOW!

You Can Look Over Any Guide In Your Own Home — Start the Easy Payments If Satisfied

MAIL THIS TODAY

Name _____
 Address _____
 Occupation _____
 Employed by _____ P12

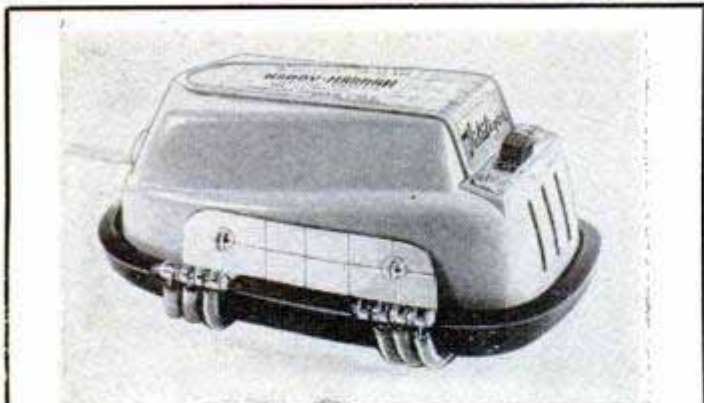

VITALIZER

**A Professional Type
ELECTRIC VIBRATOR
For Use in the Home!**

At last—a really fine Vibrator that's within the reach of everyone! Now you can enjoy the wonderful Swedish rotary-type massage that makes tired, aching muscles feel so good and is so good for you!

● Just slip VITALIZER over your hand. Thousands of vital massage pulsations pass through your finger tips to arms, legs, body, scalp . . . help stimulate circulation, relieve fatigue, tone up muscles.

● VITALIZER is lightweight, beautifully designed, precision-engineered for years of service and enjoyment. Pleasant, easy to use—and amazingly low in price for a quality massage instrument.

● Only \$9.95, plus 50c insured postage and handling. AC only. 6' cord. Fully guaranteed, of course. Order now!

HUGH CLAY PAULK

304 Kansas Ave. Dept. 5-11 Topeka, Kansas

SAY YOU SAW IT IN POPULAR MECHANICS

DIESEL MECHANICS NEEDED

BIG PAY—GOOD FUTURE

Virtually all heavy power equipment is rapidly going DIESEL, creating big paying, steady jobs—through good times or bad—for properly trained men.

Back during the DEPRESSION . . . there was a big demand for Bailey Trained Diesel mechanics.

We can QUICKLY TRAIN YOU to enter this big pay field . . . no previous experience or special education necessary!

With our method of training you don't spend years pouring over books, figures, charts or graphs—you learn by repairing and operating big Diesel engines, under the guidance of experienced and friendly instructors.

This method of training gives you the experience and confidence that enables you to move right into the BIG PAY JOBS without spending years—as a mechanic's helper. We help you find part-time jobs while in school—full-time jobs after graduation. Mail coupon for complete information.

BAILEY Technical SCHOOLS

Veteran Approved

1626 S. Grand St. Louis 4, Mo.

NAME AGE
STREET
TOWN ZONE STATE

.22 RIFLE BARGAIN CARBINE STYLE

(BRAND NEW!)
34 inches long
4 lbs., 3 oz.



\$14.95

Exclusive with UNITED! From Germany, home of some of the world's finest hunting and military guns, come these superb rifles. Factory was founded in 1865 in Thuringin, Germany's great arsenal and home of the famous Mauser Gun Works. Today, the plant has been moved to the American Zone and these rifles are made to rigid UNITED requirements. Bears the famous UNITED "Seal of Quality" BECAUSE this featherweight model is rugged in every detail. One screw take down assembly. Shoots Longs, Shorts and Long Rifles (regular and high powered). Has automatic ejector with self adjusting sporting rear sight and blade front sight. Sturdy Beech stock. Barrel has SIX lands. Blued thruout. CHROME plated smooth working bolt action. Amazing accuracy at 100 yard range. Ammunition is available anywhere and replacement parts can easily be had if ever needed. Low cost skilled labor makes possible our sensational bargain price. Supply is limited as yet, so quick action is urged. **10 DAY NO RISK TRIAL.** Use for 10 days. If not fully satisfied return for full refund! Remit \$14.95. Rifle shipped express. Transportation collect. C.O.D.'s require \$2.00 deposit. **UNITED ARMS Co., United Building, 9043 S. Western Ave., Dept. HOB-365, Chicago 20. Mail Orders Only. None sold to minors. STATE AGE!**



Dealers or Representatives Needed for nationally advertised line of Spark Plugs — Oil Filters — Auto Specialties — Liberal Proposition — Full or Part Time — Experience Not Necessary — Write Today

ENGINE PRODUCTS MFG. CO.

5801 E. Beverly Blvd., Dept. 109, Los Angeles 22, Calif.

CUCKOO CUCKOO CUCKOO

Now you can build Cuckoo clocks in your own home just like those imported from the Black Forest. All Necessary parts available at low cost. Build a profitable business quickly. Big demand for these clocks everywhere. Send \$1.00 (refundable on first order) today for fully illustrated instruction booklet and price list.

THE HOUSE OF REICH

Dept. PM-1 7522 W. 63rd Terrace Merriam, Kans.

BUY IT GET UP TO 40% OFF **WHOLESALE!** **FREE** **THE Whole-Sale PLAN!**

Start a Buying Service At Home, SPARETIME. GET BIG-NAME MERCHANDISE FOR SELF AND CLIENTS UP TO 40% LESS THAN REG. PRICE. SALES EASY, AS YOU CAN GIVE SIZEABLE DISCOUNTS. STILL MAKE FAT COMMISSIONS. Post Card Brings Free Copy

AMERICAN BUYERS SERVICE

631-R Linden Ave., Buffalo 16, N.Y.

RADIO Engineering. All phases radio & electronics theory & practice; television; FM; broadcasting; servicing; aviation, marine & police radio. Prepare for high pay; 18-month course. Graduates in demand by major companies. Enter Jan., March, June, Sept. Regular campus life. Write for catalog. **VALPARAISO TECHNICAL INSTITUTE, Dept. D, Valparaiso, Ind.**



TAIL PIPE EXTENSION

Protect your bumper from discoloration and rust. Install this heavy duty chrome-plated extension on your exhaust. Will fit all cars. \$1.50 ppd.

JET PRODUCTS P.O. Box 2005 Inglewood 4, Calif.

What Every Farmer Should Know About Taking Care of Farm Animals

The Most Popular Veterinary Guide Ever Printed

This practical and helpful **VETERINARY GUIDE FOR FARMERS** prepares the farmer to perform many routine veterinary tasks—provides quick information that can often save the life of an animal—prevents disease in herds—saves money on the farm in a hundred different ways.

Written in plain understandable language. It covers symptoms, causes of disease and prevention, and treatment of cattle, swine, sheep, horses and poultry and warns when to call in the professional veterinarian. Names, terms and phrases made clear in a separate section. Over 100,000 copies of this book are in use on American farms. 275 pages. Fully illustrated. Only \$3.95. Order today under money-back guarantee.

POPULAR MECHANICS PRESS, Dept. PM13 200 E. Ontario St. Chicago 11, Ill.

SANTA'S HELPER



© The Borden Co.

• ELMER'S GLUE-ALL dries clear. It's ideal for sealing packages, making fancy gift boxes, paper ornaments, pasting window decorations . . . and mending broken toys the morning after.

ELMER'S GLUE-ALL

IF IT'S *Borden's* IT'S GOT TO BE GOOD!



GIANT BALLOONS

Surplus U. S. Gov't. (new—overage) NEOPRENE weather, target balloons. For FUN or PROFIT. Great sport in the backyard; or for parties, picnics, dances, fairs. MONEY-MAKERS. Use these balloons to attract crowds to civic events, conventions, exhibitions, trade shows. TERRIFIC for high school and college PROMS. All sizes are approx. inflated size. Postage prepaid on prepaid orders. 3 ft. dia. 49c—6 ft. dia. 99c—13 ft. dia. \$1.59 20 ft. dia. \$1.95

• Calif. residents please add sales tax.

WAR ASSETS DIV. VOLUME SALES CO.

Dept. M-12-53 3930 Sunset Blvd. Los Angeles 29, Calif.



12 FOOT BOAT KIT
ONLY \$59.00
F.O.B. DEFIANCE, OHIO

The season's best boat kit buy! Pre-assembled frames, all parts cut to size and shape for speedy assembly. Write today for FREE brochure.

PENNEY WOODCRAFT INDUSTRIES

Ottawa Ave., Dept. PM-12 Defiance, Ohio

Become a Doctor of PSYCHOLOGY

Win the degree of Ps.D. Learn the secret of contentment, happiness. Solve mental worries. Experience the revelation of truth. Chartered college. Individual help. Write for FREE book. **COLLEGE OF UNIVERSAL TRUTH, 5038-B Broadway, Chicago.**



FINE BOWS and ARROWS
SELECTED RAW MATERIALS

Catalog 5c Send for it
HAND BOOK—Illustrated
Instructions on Making and
Shooting Archery Tackle—75c
L. E. STEMMLER CO.
Manorville (Box 3) L. I. N. Y.

NEW

... for the LEATHERCRAFTSMAN

Fiebing's DYEING and REFINISHING KIT

... including nine basic leather preparations and daubers for the application of richly distinctive colors and finishes to hand-crafted leather articles. . .

and including **FIEBING'S Handbook on How to DYE and REFINISH LEATHER**

ASK YOUR DEALER or write direct
FIEBING CHEMICAL CO.

516 South 2nd St. • Milwaukee 4, Wisconsin

FREE

SEND FOR
THE

1954

ALLIED

268
value-packed pages

TV & RADIO CATALOG

WORLD'S MOST COMPLETE

Save on everything in TV and RADIO

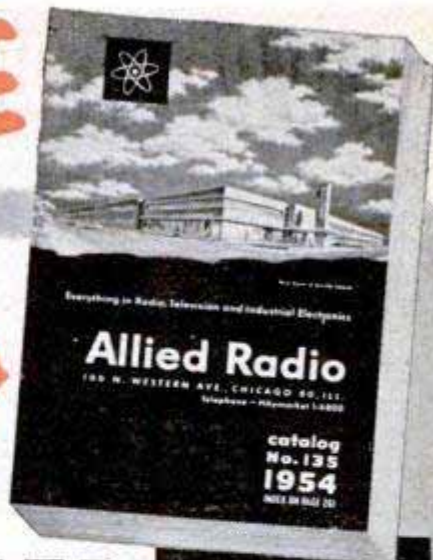

Everything for Experimenters, Builders, Amateurs, Servicemen, Engineers and Soundmen

Send for ALLIED's big 268-page value-packed buying guide to *everything* in TV and Radio! Largest selections of custom TV chassis, TV accessories, FM and AM radios, High-Fidelity Sound, Amateur supplies, P.A. Systems, recorders, test instruments, builders' kits, industrial electronic supplies—plus the world's largest stocks of electronic parts, tubes, tools and books. Get *everything*—get more for your money—send today for your **FREE 1954 ALLIED Catalog.**

NEW HOME OF ALLIED RADIO



SEND FOR
FREE CATALOG

ultra modern facilities
TO SERVE YOU BEST

ALLIED RADIO

ALLIED RADIO CORP., Dept. 5-M-3
100 N. Western Ave., Chicago 80, Illinois

Rush **FREE 1954 ALLIED 268-Page Catalog**

Name _____

Address _____

City _____ Zone _____ State _____



**WORLD'S
LARGEST
STOCKS**

NEW PAINT PEN

PAINT STRIPING TOOL Works like a Fountain Pen Stripes with Paint instead of Ink!

This amazing new "PAINT PEN" is a Paint Striping Tool that makes it easy to do expert striping on furniture, bikes, model planes, autos, signs, toys, linoleum, wall board, etc. Makes plain, painted walls look like tile. Paint straight, curved, circular or evenly spaced parallel lines the same way a professional painter does. Simply fill Tubular Glass Paint Fountain with any color paint and wheel tip feeds paint evenly. Tips interchangeable—jaws split apart for easy cleaning. Tool complete with tip for 1-16 inch stripe only \$1.00 postpaid. Other complete tools with 1-64, 1-32, 3-64, 5-64, 3-32, 1-8 in. tips, \$1.50 ea. Extra tips, 75c ea. Complete KIT with 7 tips, \$5.00. Also 1-4 in. tip only, \$1.00. COD's postage collect. Here's the handiest tool in your whole painter's kit. Get yours today.



Paint
STRAIGHT,
CURVED OR
PARALLEL LINES

Home Craftsmen

Just the tool you've been waiting for! New Paint Striping Tool gives "professional" results every time, yet simple and easy to use as a fountain pen. Adjustable guide keeps lines straight as an arrow. Just as easy to make curves or free hand designs. Adds new beauty and finished look to everything you paint. Send \$1 now!

Only \$1.00
WENDELL MFG. CO., Dept. 312
4234 LINCOLN AVENUE, CHICAGO 18, ILL.

DEALERS
PAINT STRIPING TOOL
packed in display cartons
of 1 doz. Fast, profitable
seller. Write for illustrated
circular, discounts

SEE HOW
EASY IT IS
Step by Step!



Be an Artist! Draw & Paint for Money (and fun!)

Prepare at home to become a well-paid professional artist—or a well-trained hobbyist. Our 39th year—thousands of successful graduates. Write for Talent Test and illustrated booklet, "Art for Pleasure & Profit." Both FREE. No salesmen will call.

WASHINGTON SCHOOL OF
Studio 1212K Washington 5, D. C.

ART

Handy Mail Order List

Little Library of Useful INFORMATION

5 for \$1.00
12 for \$2.00
25¢ Each

Here at amazingly low cost is the practical help and information you have always wanted. Articles in previous issues of Popular Mechanics have been classified according to subject and are now available in these handy reprint booklets.

- How to Use Measuring Tools—Micrometers, Calipers, etc.—106.
- Power Driven Saws—74.
- Drill Presses, Grinders, Etc.—79.
- Wood, Metal Turning—Lathes—81.
- Filing Machine, Hacksaw, Cutoff Wheel, Shaper—82.
- Lathe Tools You Can Make—101.
- Workbenches—Tool Cabinets—47.
- Spray Painting—94.
- From Pattern to Casting—91.
- Tool and Saw Sharpening—92.
- Sharpening Drills, Wood Bits—90.
- Successful Wood Turning—32.
- How to Read Blueprint—71.
- Metal Turning Lathe Kinks—99.
- Operating a Metal Lathe—100.
- Heat Treating, Hardening—102.
- Working With Glass—103.
- Servicing Elec. Motors—75.
- Electromagnets & Solenoids—44.
- Transformer Construction—41.
- The Boy Electrician—43.
- Soldering and Brazing—17.
- Arc and Spot Welders—5.
- Electroplating With Nickel, Chromium, Cadmium, Etc.—86.
- Plating Leather, Wood, etc.—87.
- Lower Your Fuel Costs—31.
- During Leaky Basements—45.
- Fitting Home Game Room—55.
- Indoor & Outdoor Fireplaces—58.
- Backyard Gardening—39.
- Lawn and Garden Novelties—72.
- Trellises, Pergolas, Fences—76.
- Lawn and Garden Furniture—77.
- Playground Equipment—73.
- How to Use Your Drill Press—125.
- Making Serving Trays—53.
- Knots and Repwork—105.
- Sanders—80.
- House Wiring—89.
- Hanging Wallpaper—38.
- Built-in Fixtures—78.
- Bird Houses—7.
- Magazine Racks—49.
- Clock Cases—50.
- Book Ends—52.
- Small Tables—54.
- Smoking Stands—56.
- Desks—58.
- Book Cases—59.
- Action Toys—66.
- High Flying Kites—67.
- Telescopes—20.
- Metal Craft—28.
- Small Looms—37.

- Working With Plastics—61.
- Simple Home Improvements—104.
- Ridding Home of Insect Pests—107.
- Children's Room Furniture—51.
- Jigsawed Novelties—57.
- Doll House & Doll Furniture—60.
- 25 Shelves You Can Make—64.
- Novelties Turned on Lathe—62.
- Inlay Pictures—Veneering—63.
- Wood, Soap Carving—65.
- Windmills & Weather-vanes—68.
- Lamps from Wood, Metal—69.
- Rustic Furniture—18.
- Wood Finishing—40.
- How to Fix Electrical Appliances—111.
- Painting Your House—117.
- Build Your Own Relays—123.
- Rowboats, Small Dinghy—83.
- Small Sail Boats—84.
- Two Outboard Runabouts—85.
- Build Own Canoe, Kayak—30.
- Build Class-E Ice Yacht—22.
- Auto Kinks, Shortcuts—10.
- Lawn and Garden Equipment—124.
- Motor-Driven Midget Cars—34.
- Stop Auto Elect. Troubles—95.
- Photo Printers and Dryers—25.
- Photo Darkroom Equipment—96.
- Trick and Table Top Photos—97.
- Home Movie Equipment—118.
- Poultry Houses—108.
- Guns and Decoys—109.
- Re-Silvering Mirrors—70.
- Chemical Experiments—93.
- Log Cabins, Tourist Homes—14.
- Log Basic Tools—120.
- Farm and Garden Tractors—8.
- Building Extra Attic Rooms—23.
- Attractive Basement Rooms—24.

Check Titles Wanted, Clip, Mail with Remittance to

POPULAR MECHANICS PRESS, Dept. 23, 200 E. Ontario, Chicago 11

Protect your home against
power interruptions
with an ...

ONAN Emergency ELECTRIC PLANT

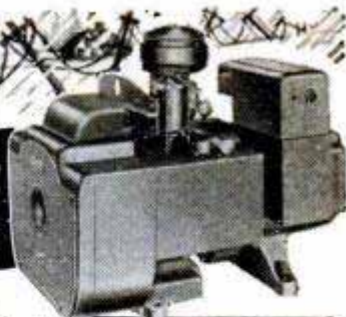

Provides dependable stand-by electricity for heating system, pumps, freezer, lights, appliances. Keeps home safe, livable. Automatic start and stop. Find out how little it costs!

Write for Folder!

A SIZE FOR EVERY NEED
1,000 to 50,000 watts.
Compact, quiet-running,
easy to install. Gasoline
engine powered.

D. W. ONAN & SONS, INC.
8572 University Ave. S. E. Minneapolis 14, Minnesota



AUTO-SHOCKO Have some REAL FUN with your car. AUTO SHOCKO gives anyone who touches the outside surface of your car a HARMLESS but VERY EFFECTIVE shock. When the Shocko switch is on, the entire outer surface of the car becomes charged. You can also charge your buddy's car by touching your bumper to his. He won't be able to get into his car until you turn off your switch. Can also be left on while car is parked to keep vandals from scratching or damaging your car. Will not run down your battery. AUTO SHOCKO is the best FUN MAKER you will ever own. Easily installed in a few minutes. Available for both 6 and 12 volt systems (please specify). Complete with AUTO SHOCKO unit, wire, switch, etc. Price \$9.95 ppd., or COD plus postage. \$1 deposit required on COD orders. Dealer inquiries invited. MORBARCO MFG. CO., Dept. P-2, 192 Arlington, Lawrence, Mass.

EASY TO ASSEMBLE BOAT KITS 30 MODELS

NEW 18 FT. OUTBOARD CABIN CRUISER

Other models 8 to 23 Ft. Rowboats, Outboards, Inboards



NEW CATALOG Only 35c. SEND COIN TODAY
U-MAK-IT PRODUCTS 703P-WHITTIER ST. Bronx 59, N. Y. City

HELPFUL BOOKS

Send post card asking for FREE catalog
Popular Mechanics Press, 200 E. Ontario, Dept. 601, Chicago 11



Cartoon the EASY way!

ORDER THIS KIT TODAY!

Make your own cartoons for fun and profit. No skill needed. Plastic template with cut-out spaces and holes lets you make over 200 different cartoons. Kit also includes illustrated instructions, helpful hints book and information on selling. Only \$1.95 COD in USA plus c.o.d. postage. Send check or M.O. and we pay postage. Order today—or rush dime for circulars. J. HOUSTON MAUPIN, Dept. 50, Tipp City, Ohio

GET "New Car" POWER!



• Stop Burning Oil! \$3.95 post-paid
• Restore Compression!

A small amount of Fisher's Compression SEAL in each cylinder bore gives you the economies of smooth, powerful "new car" performance and reduced oil consumption. Old, tired engines may not need expensive overhauling. Only takes minutes to apply—yet gives you 10,000 more miles of low-cost driving pleasure.

SATISFACTION GUARANTEED!

Full purchase price refunded immediately, if not completely satisfied. No solvent baths necessary. Order today! Information. Dealers inquire.

FISHER'S 4756 S. Central, Dept. PM-12 Los Angeles 11, Calif.

HEARING - BAD ?

If so, you will be happy to know how we have improved the hearing and relieved those miserable head noises, caused by catarrh of the head, for thousands of people (many past 70) who have used our simple Elmo Palliative Home Treatment in the past 16 years. This may be the answer to your prayer. **NOTHING TO WEAR.** Here are **SOME** of the symptoms that may likely be causing your catarrhal deafness and head noises: Head feels stopped up from mucus. Dropping of mucus in throat. Hawking and spitting. Mucus in nose or throat every day. Hearing worse with a cold. Hear — but don't understand words. Hear better on clear days. Worse on rainy days. Head noises like crickets, bells, whistles, clicking, escaping steam or many other sounds. If your condition is caused by catarrh of the head, you, too, may likely enjoy such wonderful relief as many others have reported. **WRITE TODAY FOR PROOF AND 30 DAY TRIAL OFFER.**



THE ELMO COMPANY
DEPT. 4PM9 DAVENPORT, IOWA



FREE 156 PAGE 1954 B-A CATALOG

Complete guide to Everything in Radio, TV and Electronics for Dealers, Servicemen, Schools, Amateurs, Broadcasters, Public Utilities, Engineers, Experimenters, Factories and Laboratories.

BURSTEIN-APPLEBEE CO., 1012 McGEE ST., KANSAS CITY, MO.

WATCHMAKING

Learn at home • FREE sample lesson
CHICAGO SCHOOL OF WATCHMAKING
2330 N. Milwaukee Avenue Dept. 1123A Chicago 47, Ill.

SAY YOU SAW IT IN POPULAR MECHANICS

FUN INTO MONEY

BOOKLET TELLS HOW—H. I. A. is helping thousands to cash in on their hobbies by turning them into profitable home industries. Send \$1.00 for years membership, description booklet and credentials.

Home Industries Assn. 1727 K St. N.W., Wash. 6, D. C.

New Low Cost Electric Water Heater Gives You

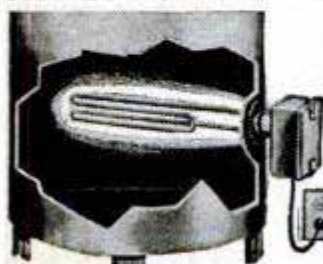

HOT WATER AUTOMATICALLY

From Your Present Tank!

- No dirt, grime, soot, flame!
- **SAFE!** Every part UL approved!
- Install in 10 Minutes, or less!
- No new tanks or plumbing!
- Works automatically, saves fuel.

New, UL approved LECTROMATIC changes gas, coal or oil-burning water heater into modern ALL-ELECTRIC unit! Turns on automatically when needed, shuts off automatically when water is heated. To install, simply shut off water. Remove plug from water tank. Screw

Complete—Ready to **\$19.95**
Plug In — Only

LECTROMATIC into opening (as shown), then PLUG IN 110 volt outlet. Uses 1250 watts. Plenty of hot water all day long. Uses only 1/4-1/2¢ electricity per gal. of hot water. Temp. adjustable from 100 to 180 degrees. Only \$19.95 C.O.D. plus shipping or send check or money order for \$19.95 now and we pay shipping. (Also 220 V., 2000 W. model \$21.95). Money back in ten days if not delighted. Full one year guarantee! **ORDER NOW!**

COLLOID EQUIPMENT CO., INC. Dept. PM-12, 19 MURRAY STREET
NEW YORK 7, N. Y.

MEN - WOMEN!

FLOK KRAFT BUILD A BIG PROFIT HOME BUSINESS...

Suede Paint!

the NEW WONDER FINISH that **COVERS EVERYTHING**

Make \$500 to \$1000 per Hour & More



... Plastic, Fabric, Metal, Plaster, Wood, Rubber... any Surface!

READ WHAT OTHERS SAY ABOUT FLOK-KRAFT SUEDE PAINT

"Got \$52.50 for about 4 hrs. work." J. O., Mo.

"Getting orders faster than I will be able to handle in spare time" W. R., Wyo.

"... pleased with your course and I'm being swamped with work." W. F., Pa.

SECRETS OF NEW INDUSTRY NOW YOURS
At last, secrets of this amazing miracle finish can be yours! Huge profits waiting to be tapped in tremendous new field. Flok-Kraft gives a velvety, luxurious surface to radios, lamps, toys, signs, store displays, figurines, auto dash boards—a thousand and one items to be seen on every hand easily and quickly beautified, enriched, increased in value with Flok-Kraft. Make old objects beautiful—saleable, make new things worth much more with this soft, rich covering that can be applied to any surface, even if old or worn.

BIG PROFITS RIGHT AWAY—LEARN IN FEW HOURS
Make to \$5.00—yes! even \$10.00 and more per hour. Fully detailed Flok-Kraft instructions—complete and easy to understand—every point explained—shows you how to start on the road to big money, full or spare time.

WE FURNISH EVERYTHING YOU NEED TO START
You also get complete Flok-Kraft kit of materials and equipment that enables you to start at once. Add to your income from your regular job or begin to build a successful business of your own and do it all, right in a corner of your basement, garage, service porch, kitchen or living-room.

GRASP THIS LIFETIME OPPORTUNITY TODAY
I'll arrange to send you the complete outfit—everything you need to start—for leisurely, no-risk examination right in your own home. You owe it to yourself to investigate. Fill out and mail the coupon below for FREE details: Sample, Plan, etc. Do it today! Everything I send you now is FREE of charge and post-paid. Airmail is faster.

Coast Industries, Dept. 2C
1004 S. Los Angeles St., Los Angeles, Calif.

YOURS TO EXAMINE WITHOUT RISK!

Examine in your own home—then decide. The complete instructions, the full starting kit of materials and equipment plus full details on how you may open your own business—spare or full time—EVERYTHING will be sent you to EXAMINE AT OUR RISK.

FLOK-KRAFT AND DEFENSE

This amazing miracle finish is of inestimable value for use on hundreds of defense products. Flok-Kraft offers you a way to big, extra money, assisting manufacturers in many lines as well as filling a big demand on the home front.

MAIL COUPON NOW!

COAST INDUSTRIES, Dept. 2C
1004 S. Los Angeles St., Los Angeles 15, California
Gentlemen:
Please rush me FREE details, sample, etc., I understand that everything you send is free and that I'll be under no obligation now or ever.

NAME _____
STREET _____
CITY _____ STATE _____



FREE!
Booklet,
Sample,
Plan!

FREE 1954 CATALOG

WORLD RADIO LABORATORIES

"The World's Largest Distributor of Amateur Radio Transmitting Equipment."

Jam packed with bargains—everything in Radio, TV, and Hi-Fi—for Handyman, Ham, Experimenter or Serviceman!

- Pay Only 10% Down
- Easy Terms
- Liberal Trade-Ins
- Save Over 50% on Used Equipment
- Over 600 guaranteed reconditioned items.



WORLD RADIO LABORATORIES
3415 W. Broadway—Council Bluffs, Iowa

Leo I. Meyerson

PERSONALIZED SERVICE

MAIL HANDY COUPON

WORLD RADIO LABORATORIES, INC. Dept. PM 12
3415 W. Broadway—Council Bluffs, Iowa 3'x4' U.S.
 Free 1954 Catalog Used Eq't List Radio Map 25c

NAME _____
ADDRESS _____
CITY _____ STATE _____

Sample IMPORTS

FROM FOREIGN LANDS—Exciting, useful sample, products from France, Germany, India, etc., sent to you. Established Import-Export firm offers men or women FREE plan for big profit, world-wide, mail-order business at home; or travel abroad. No capital or previous experience needed. Overseas bargains bring high U. S. prices. Write today for FREE plan!

Mellinger, Dept. 25C, 1717 Westwood, Los Angeles 24, Cal.

FREE!

GET ALL THESE
5 PICTURE-PACKED
COURSES
Plus "Amazing Secrets"
PHOTO BOOK
If you mail coupon NOW!
Millions have been sold
at \$1.



Quit being a **BAG OF BONES**
Weakling Like I Was →
IN **10** MINUTES OF
FUN A DAY
YOU Can DO ALL I did!



I gained 25 Terrific Lbs. of
**HANDSOME POWER-PACKED
MUSCLES** all over!

I Improved My **HE-MAN**
Looks 1000%.

I Won **NEW STRENGTH-POPULARITY**
NO! I don't care how skinny or flabby you
are. I'll make you **OVER** by the **SAME**
method I turned myself from a wreck to the
strongest of the strong. **DEVELOP YOUR
520 MUSCLES.**

YES! You'll see **INCHES** of
mighty muscles added.
From head to heels you'll
gain **SIZE, POWER, SPEED.**

Mail Coupon
NOW YOU CAN WIN A BIG
15" TALL SILVER CUP and \$100 as I just did **TODAY!**

LAST CHANCE COUPON — 5 COURSES FREE!
JOWETT INSTITUTE, Dept. PM-312
220 Fifth Avenue, New York 1, N. Y.
Dear George: Please mail to me prepaid FREE Jowett's Photo
Book of Strong Men, a Muscle Master, plus all 5 Muscle Building
Courses, "How to Become a Mighty He-Man." ENCLOSED FIND 10c for
postage and handling (no C.O.D.'s).

NAME _____
(Please print plainly, include Zone Number)
ADDRESS _____
CITY _____ ZONE & STATE _____

WANTED MAN WITH CAR

**NO TIME LIKE NOW TO
GET IN McNESS BUSINESS**

It's no trick to make good money when you use your car as a McNess "Store on Wheels." Farmers buy everything they can from McNess Men because McNess Products are tops in quality, represent extra values. Attractive business-getting prizes and premiums; also money-saving deals to customers make selling McNess daily necessities a snap.



WE SUPPLY CAPITAL—START NOW!

There's no better work anywhere. Pays well, permanent, need no experience to start, and we supply capital to help you get started quick. You begin making money first day. Write at once for McNess Dealer Book. It's FREE. Tells all—no obligation. (15)

THE McNESS CO., 101 Clark St., Freeport, Ill.



TELEPHONES

Desk Stand style

Slightly used and in excellent condition.

Many Valuable Uses—

- Inter-house phones
- Loud Speakers
- Microphones
- Educational purposes
- Toys, etc.

\$1.95

Postpaid
Come complete, ready to use in U.S.A.
Wiring Diagrams Furnished. Please add
75c each shipping and handling cost.

MICROPHONE Dept. X-902
1760 W. Lunt Ave., Chicago 26, Ill.

HELPFUL BOOKS

Send post card asking for FREE catalog

Popular Mechanics Press, 200 E. Ontario, Dept. 601, Chicago 11

AMAZING NEW POCKET RADIO

Really Works—Small as a Pack of Cigarettes!



FITS IN ANY POCKET OR PURSE—GETS LOCAL RADIO STATIONS WITH CLEAR BELL-LIKE TONE—NO STATIC OR INTERFERENCE! NEEDS NO TUBES, BATTERIES OR COMPLICATED HOOKUPS! NO AC PLUG INS! Nothing to wear out. Thousands of users—many report years of service. Uses new crystal diode and HI-Q coil. SELF-CONTAINED SPEAKER PHONE. Just the tiny radio to take with you ANYWHERE YOU GO—ON TRIPS, VISITING, ETC.—for real fun and enjoyment—ANYTIME. **SEND ONLY \$1.00**

(bill, ck., mo.) and pay postman \$3.99 C.O.D. postage or send \$4.99 for o.p. delivery. COMPLETE READY TO LISTEN. MIDWAY CO., Dept. PPM-12, Kearney, Nebr.

Wheels Wheels Wheels Wheels

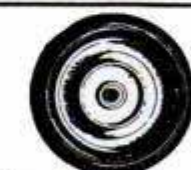

- 7" Disc Wheel 3/4" Tire 3/4" sleeve..... 45c ea.
 - 8" Disc Wheel 1 1/4" Tire 1/2" sleeve..... 70c ea.
 - 7" Disc Wheel 1" Tire 1/2" ball bearing..... 80c ea.
 - 8" Disc Wheel 1 1/4" Tire 1/2" ball bearing..... \$1.00 ea.
 - 6" Disc Wheel 1.50 semi-pneum. Tire 1/2" B.B..... \$1.35 ea.
 - 8" Disc Wheel 2" semi-pneum. T. 1/2" B.B..... \$1.50 ea.
 - 10" Disc Wheel 1.75 semi-pneum. T. 3/4" B.B..... \$1.50 ea.
 - 10" Disc Wheel 2.75 semi-pneum. Tire 3/4" B.B..... \$3.50 ea.
 - 12" Disc Wheel 1.75 semi-pneum. T. 1/2" B.B..... \$1.85 ea.
- Above wheel prices includes hub cap. Plus Postage, C.O.D.'s accepted.
AXLES—Sizes 5/16 in., 3/8 in., 1/2 in.—Cut to size—End holes drilled.

UNITED WHEEL STAMPING CO.
12131 S. PEORIA STREET PM-12 CHICAGO 43, ILLINOIS

STOP BURNING OIL!

K. O. ENGINE WEAR!

With This Terrific 1-2 Combination...

Ring-Re-Nu and P.V.R. Compound

• Your car gets new pep, new power with amazing RING-RE-NU and P.V.R. Compound. Eliminate costly over-haul, cut oil and gas waste this easy way — simply pour hard-hitting P.V.R. Compound into your carburetor — cleans engine of tars, gums, and varnish—then squeeze heavy-duty RING-RE-NU into cylinders — restores compression and "new car" power! stops oil burning! — good for 10,000 plus miles. Guaranteed harmless to the finest engine.

• Read one of thousands of enthusiastic reports! CADILLAC OWNER, E.L.G., Lawrence, Mass., writes: "My Cadillac was burning 2 qts. of oil every 100 miles. I have now travelled 400 miles since installing Ring-Re-Nu and P.V.R. Compound. Haven't used one drop of oil. Further, my gas consumption has been cut in half. I'm more than pleased with results."

• For reduced oil burning — for lower gas consumption — for power-packed economical performance — ORDER Ring-Re-Nu. Only \$4.95 postpaid. (C.O.D.'s, \$1.00 deposit, bal. plus post, on arrival). Takes only 30 minutes to install. Send \$4.95 with year and make of car.

(Free Folder Available on Request)



RICHIE DISTRIBUTING, INC.

11916 Madison Ave., Dept. A12 Cleveland 7, Ohio

DO IT YOURSELF with LEATHER

SAVE WITH TANDY'S YOU-MAKE-IT KITS

Thrifty Americans are earning extra money and enjoying a fascinating hobby by hand-tooling and assembling Tandy Leathercraft Kits for re-sale at a BIG PROFIT.



Start with

TOM THUMB PURSE KIT

Contains pre-cut 8-oz. genuine cowhide with gusset and zipper assembled, ready to carve (size 4" x 2" x 1½") Only 50¢ ppd. \$4.50 per doz., and receive FREE 64-page instr. Book and Leathercraft CATALOG



NATIONWIDE — A TANDY STORE NEAR YOU

TANDY LEATHER CO. Since 1919

P. O. Box 791-GP, Fort Worth, Texas

Watch Repairing Pays Big Money Learn at home



Watch repairers in great demand. Train step-by-step in 10 easy lessons. We furnish all tools and 15 jewel watch and practice movement. Turn spare time into cash. A licensed school. Low cost. Send for FREE book today.

ILLINOIS SCHOOL OF WATCH REPAIRING

2870 Elston Ave., Dept. PM-123, Chicago 18, Ill.

IMPORTED BRITISH ORDNANCE Hunting KNIFE!

and Sheath

Brand New—from big game hunters in Africa, Alaska, Asia and Europe we have heard what a wonderful hunting knife this special British ordnance design makes. We have purchased the small remaining supply known to exist in the world. This is the actual knife of finest Sheffield steel with ribbed, balanced contour handle made in England for the exclusive use of the British Commando units of WW II. It has proven to be ideal for skinning out game, also for handling big saltwater fish, muskies, etc. Excellent serviceman's gift. Shipped in original commando metal-tipped sheath for belt or boot. 12" overall. Send check, cash or M.O. Sorry no C.O.D.'s. For U.S., A.P.O. or F.P.O. airmail add 80¢ per knife. Dealers inquire. Calif. resid. add 3% state tax.



\$3.95
EACH
postpaid

PASADENA FIREARMS CO.

52 Sports Bldg., 972 E. Colorado St. Pasadena 1, Calif.

NEW way to enjoy SPORTS movies, television

MADE IN GERMANY

CLIP THIS AD

SAVE \$8.00



NOW ONLY \$1.98

Now... GET CLOSE-UP VIEWS ALL DAY...WITHOUT FATIGUE!

Here for the first time—Germany's famed SPEKTOSCOPIES — a revolutionary concept in binoculars. Wear them like ordinary eye-glasses — hour after hour — without fatigue. Featherweight — only 1 oz. You'll hardly FEEL them! Yet here is a new, truly powerful optical design that gives you greater range than many expensive opera or field glasses and a far greater field of view than some selling for many times more! Has INDIVIDUAL eye focusing for clear, sharp viewing, whether you're looking at a play in the first row or a seashore scene miles away! SPEKTOSCOPIES are ideal for indoors, outdoors or distant scenes or close-up viewing. Special low price — \$1.98, a saving of \$8.00 or more!

Try at Our Risk — No Obligation!

Enjoy at our risk for 5 days. You must be delighted! Otherwise, your \$1.98 will be refunded with no questions asked! Limited supply forces us to place a limit of 2 per customer. Send check or m.o. for prompt, free delivery. COD's sent plus postage. Use convenient coupon below!

● NOTICE!

FAVORABLE EXCHANGE RATE MAKES THIS VALUE POSSIBLE! This is the first time this type of optical instrument has ever sold for less than \$10.00. The favorable rate of exchange and Germany's need for dollars make it possible. We're the exclusive distributors of SPEKTOSCOPIES in the U.S.A. Order today!

INTERNATIONAL BINOCULAR CO.

Dept. 6-N-90, 352 Fourth Ave., New York 10, N.Y.

Your Name _____

Address _____

Town _____ Zone _____ State _____

Mutual Funds

Investors MUTUAL, INC.

An open-end management type mutual fund diversifying its investments among common stocks, preferred stocks and bonds.

Investors SELECTIVE FUND, INC.

An open-end management type mutual fund diversifying its investments among bonds, preferred stocks, and other senior securities.

Investors STOCK FUND, INC.

An open-end management type mutual fund diversifying its investments among common stocks and other equity securities.

Face-Amount Certificate Company

Investors
SYNDICATE OF AMERICA, INC.

A face-amount certificate company issuing installment certificates of 6, 10, 15 and 20 year maturities and single payment face amount certificates.

This is not an offer to sell these securities. They are subject to the registration and prospectus requirements of the Federal Securities Act. Information about the issuer, the securities and the circumstances of the offering is contained in the prospectus which must be given to the buyer. Copies of the prospectus relating to the shares of capital stock or certificates of the above companies may be obtained from the national distributor and investment manager:

Investors Diversified Services, Inc.

211 Roanoke Building Minneapolis 2, Minnesota

Send me the prospectus relating to the company I've checked:

- Investors Mutual, Inc.
- Investors Selective Fund, Inc.
- Investors Stock Fund, Inc.
- Investors Syndicate of America, Inc.

NAME _____

ADDRESS _____

CITY _____ STATE _____

Say You Saw It in Popular Mechanics



HANDS TIED?

—because you lack a

HIGH SCHOOL DIPLOMA

• You can qualify for an American School Diploma *in spare time at home!* If you have left school, write or mail coupon for FREE booklet that tells how. No obligation of any kind.

OUR 56TH YEAR

AMERICAN SCHOOL, Dept. V945
Drexel at 58th, Chicago 37, Illinois
Please send FREE High School booklet.

NAME _____

ADDRESS _____

CITY & STATE _____

The Most Fascinating Book About the Automobile Ever Printed!

Popular Mechanics

AUTO ALBUM

The Motor Car in Picture and Story from 1769 to 1952



You'll Find..
the Answers... the Fascinating Stories . . . in the AUTO ALBUM

Who built the first horseless carriage?

Who obtained the first U.S. patent on an automobile?

Where did the name "automobile" come from?

Are you familiar with the workings of the Stanley Steamer . . . the "electrics" . . . the famous Ford Model T?

Do you know when the first Indianapolis race was won . . . by whom . . . at what speed?

Do you know the story of Henry Ford, Barney Oldfield, Ransom Olds, Walter Chrysler, W. C. Durant and other automotive giants?

166 Illustrations Including 94 Old-Time Cars — 22 Auto Ads of By-Gone Days!

Here is a book you can't help enjoying and wanting, whether or not you have, or ever will own an automobile. It is the fascinating, thrilling and informative story of the horseless carriage from the first gasoline-propelled buggy to a forecast of the atomic car of the future.

Popular Mechanics AUTO ALBUM by Throm and Crenshaw presents America's first cars and the pioneering men who made them; the scrambled start and the development of the fabulous auto industry; the story of automobile racing; the growth of the Nation's highways. It is a book that just had to be published.

To Read . . . to Enjoy . . . to Remember!

More than one-half of the book is pictures, most of them action pictures, from photos of old-time cars in operation. Other pictures show race cars from 1911 to 1951; early auto advertising, picturing 32 cars priced from \$375 to \$6000; tri-cycle autos, wind wagons, auto cycles and other automotive oddities. A roll call of horseless carriages is included — the names of more than 2000 cars made in the United States.

Gift Book of the Year

Get the fascinating AUTO ALBUM for yourself today. Send it as a gift to friends and business associates. Order on coupon below. Money refunded if you are not entirely pleased.



Cloth Binding

Use Coupon to Get AUTO ALBUM

POPULAR MECHANICS PRESS, 200 E. Ontario, Chicago 11

Send at once postpaid — copies of Popular Mechanics AUTO ALBUM at \$3.00 each. Remittance enclosed. Send COD. I will pay postman plus charges. I understand books are returnable in 7 days for full refund if I am not pleased.

Name _____

Address _____

City _____ Zone _____ State _____

**New! 2 in 1 Combination!
Pocket-Size**

**50 POWER MICROSCOPE
and
10 POWER TELESCOPE**

**Only \$4.50
ppd.**



Useful Telescope and Microscope combined in one amazing, precision instrument. Imported! No larger than a fountain pen. Telescope is 10 Power. Microscope magnifies 50 Times. Sharp focus at any range. Handy for sports, looking at rare objects, just plain snooping. Wonderful Xmas gift. Send check or M.O. Satisfaction Guaranteed!
Order Stock #30,059-H.....\$4.50 ppd.

GET FREE CATALOG #H—World's largest variety of Optical Items. Bargains galore... War Surplus — Imported — Domestic! Microscopes, Telescopes, Hand Spectroscopes, Prisms, Lenses, Reticles, Mirrors and dozens of other hard-to-get Optical items. Ask for **FREE CATALOG #H**.

EDMUND SCIENTIFIC CORP., Barrington, N. J.

FREE! 100 FOREIGN STAMPS

All genuine, unpicked, unsorted — just as received from Europe, Asia, Africa, Near East, Far East — from everywhere! Plus a beautiful souvenir of World's Rarest Stamp and our valuable "Stamp Collector's Guide". Other valuable offers also included for your **FREE** inspection!

Send 10c for postage and handling to
**GARCELON STAMP CO., DEPT. PM12
CALAIS, MAINE**



MASTER MIND!



Learn Short-Cut Mathematics

Juggle figures, do baffling number tricks. Make people gasp at your marvelous lightning-quick mind. Multiply 4 figures by 4 figures without using old-fashioned multiplication! Big cloth-bound volume; fully illustrated course.

Sharpen up Your Brain Power

Includes worked out problems, answers, etc. Sensational bargain, only \$2.95, postpaid or COD plus postage. Satisfaction guaranteed or refund. Order this amazing "Short-Cut Mathematics" today!

**NELSON-HALL CO., 210 S. Clinton St.
DEPT. MX-2 CHICAGO 6, ILL.**

**\$2.95
Complete**

SEND ME



every month so I am sure to see each new issue. Here's

- \$3.50 for 1 year
 \$8.00 for 3 years

name _____

address _____

city _____ zone _____ state _____ B-123

Hand this order to your newsdealer or send it to

**POPULAR MECHANICS
200 East Ontario St. Chicago 11, Ill.**

Mr. Fisherman!

**YOU need
"Goin' Fishin'!"**



• You haven't LIVED until you have read the hottest fishing book ever published for fishermen by 20 top-name authors... all the game fish spectacularly reproduced in full color... a riot of tall-tale fish cartoons in color... **THE FISHING HALL OF FAME**... Maps of Fish Hot Spots... 1,000 Better Places To Fish... Florida... Alaska... Pacific Coast... Atlantic... Great Lakes Region... Rockies... Texas, etc. All the best fishing gear on parade. **ALL THIS FOR A DOLLAR. FREE!** New secret method to catch more game fish. If tackle dealer cannot supply, write direct.

**Joe Godfrey • Dept. III • Goin' Fishin' Everywhere
422 South Dearborn St. • Chicago 5, Ill.**

SAVE \$65 ON THIS LUXURIOUS \$100 CONTOUR CHAIR 34.95 FOR
Everything Needed Complete To Put It Together In One Evening



Genuine FOAM RUBBER for perfect sitting or reclining comfort. Proved beneficial to heart, nerves... most popular chair in the home. Firestone foam rubber and washable, pliable genuine Duran upholstery. Would cost \$100 or more in any store. Shipped all ready to put together in less than one evening by anyone who can use a screwdriver. No cutting, no drilling, no skill needed. A woman can do it. Order now! Everything needed for only \$34.95, f.o.b. Balto. State color wanted: forest green, sapphire, blue, lipstick red, walnut brown. Enclose \$5 deposit, balance C.O.D. Money back guarantee. Return in 10 days. Make Money Selling and Assembling Contour Chairs. **Bestcraft, Dept. 52, Mathieson Bldg., Baltimore 2, Md.**

Say You Saw It in Popular Mechanics

WAR SURPLUS BARGAINS

WAR SURPLUS BARGAINS

\$500,000.00 INVENTORY for QUICK LIQUIDATION

Surplus items—hundreds of them for home, shop, factory, farm and outdoor use. New items, used items, reconditioned items—all at tremendous savings—all priced for quick sale.

Page After Page of Values

This big catalog shows page after page of amazing money saving values. Write for your copy today. Send 10c to cover postage, mailing, etc. Write today!

SEND TODAY FOR YOUR COPY

10c

FIELD TELEGRAPH TRANSMITTER & RECEIVER SET

Complete! Includes transmitter with pair of head phones, sending telegraph key, buzzer, double throw switch. Original cost of this instrument to English government well over \$100.00. Ship. wt. 20 lbs. each. Allow sufficient postage or will be shipped express charges collect. Two 4 1/2 volt C batteries needed in each set. Batteries 45c each extra. Wire needed to connect for operation. No 438. Complete set of two... **\$15.00**
One set\$7.95



STARK'S

**509 So. State St.
Dept. PM-1253
CHICAGO 5, ILL.**

CASH IN ON ROTO-SPLAY

ROTATING DISPLAY-TURNABLE
OPERATES WITHOUT ELECTRICITY

- No Wiring • No Winding
- No Fire Hazard

"GOLDMINE FOR MEN WHO CALL ON MERCHANTS"

One of the fastest sellers ever to hit the U. S. So valuable Sears Roebuck bought for their own store use—so have Rexall, Woolworth, Eastman Kodak. And no wonder! ROTO-SPLAY is a moving turntable that can be put in windows, on counters or shelves. No springs to get out of order. No cords or plugs, so it can be put anywhere for displaying merchandise. Think of it—8 weeks of MOVING DISPLAY for the cost of two 10c flashlight batteries. Most small merchants want two or three—big stores buy quantities at our low price! You can make \$10 to \$15 and up on every such sale. A fast working salesman should sell 30 to 40 a day! Merchants know that moving displays sell merchandise. So your sales are easy. Get the facts quick. Write at once and make a "clean-up" while you can be first. Facts are FREE. Send your name and address today—sure!



only
\$9⁹⁵

Runs Night and
Day for 5 to 8
Weeks on Two 10c
Flashlight Bat-
teries.

MAXILUME COMPANY

125 W. HUBBARD ST. DEPT. RS-812 CHICAGO 10, ILL.

Now YOU can PICK your JOB and BIG PAY Future in Allied's Nation Wide Industrial Co-op Plan

INDUSTRY CRITICALLY NEEDS
ALLIED TRAINED MEN TO FILL
IMPORTANT JOBS

- TOOL ENGINEER
- TOOL-DIE DESIGNER
- MACHINE DESIGNER
- Industrial ENGINEER
- DRAFTSMAN
- MASTER MACHINIST
- TOOL & DIE MAKER

Shortages of Draftsmen, Designers, Tool Engineers, Machinists, Tool and Die Makers are so widespread that you can pick a key job and look forward to rapid promotions, better pay, job security, success and achievement. There are more good paying jobs than trained men to fill them.

Program is integrated so that you can learn at home in your spare time or study at the Institute in Chicago. Enroll in short courses or study progressively for a degree of Bachelor of Tool Engineering.

send for **FREE**
BOOKS

ALLIED SCHOOL of MECHANICAL TRADES
1338-42 S. Michigan Ave. Chicago 5, Illinois

ALLIED SCHOOL of MECHANICAL TRADES
1338-42 S. Michigan Ave.—Dept. PM-12, Chicago 5, Ill.
Gentlemen:

Send me without obligation your FREE BOOKS explaining Allied's Courses of Instruction and Nation-Wide Industrial Co-op Plan.

I am interested in Resident Training Home Study

I am eligible for the G.I. Bill I am not eligible

Name _____

Address _____

City _____ State _____

Sell Auto Seat Covers



Make Spare Hours Pay Up To
\$16⁵⁰ A DAY
AND MORE

Sensational New Plastic Materials
... LOW PRICES... Get Orders EASY!

BIG OUTFIT
FREE
Write Today!

Just show America's greatest line of finest quality Auto Seat Covers to motorists in your town. Take easy orders... make big money every day. New line includes exciting new, long wearing, easily cleaned plastic materials in gay, beautiful colors. Superb tailoring and perfect fit. All this plus LOW PRICES gets orders for the asking. Earn big money spare hours or full time. No experience needed... we supply everything. **GET OWN SEAT COVERS AS BONUS!** Rush name and address (SEND NO MONEY) for big sales outfit FREE. Write TODAY!

KEY PRODUCTS, Dept. 4312, 800 N. Clark St., Chicago 10, Ill.

MAKE MONEY IN YOUR OWN SHOP WITH Plastics

Want to earn extra money—make your own Christmas gifts of professional-looking accessories? Perhaps you've never realized it before, but any hobbyist can do it who have use of the average home shop equipment. And now you can buy raw materials direct from a commercial supplier—real Plexiglass in sheets, rods and tubing. A whole new wondrous world of enjoyment awaits you. Immediate delivery. Write now for price list.

PHIPPS & BIRD, Inc., P.O. Box 2V, Richmond 5, Va.



EXCELLENT XMAS GIFT!

\$2.95 OR 2 FOR \$5.00

Complete, tested and guaranteed. Write for free list on all types of Telephones. Shipments FOB Simpson.

TELEPHONE ENGINEERING CO.

Dept. BB Simpson, Pa.

MAKE A "Stradivarius"

VIOLIN

—For Pleasure
—For Profit
—For Your Own Use

BOOK AND PLANS ALL YOU NEED

You Can Do It at Little Cost!
It's Easy! It's Fun!

Here is the "top" of all home crafts projects. Make a violin—a replica of a famous "Strad"—the original of which sold for \$80,000.00. Joe Reid who has made hundreds of fine violins makes the job so easy—so inexpensive—in his new book, "You Can Make a 'Stradivarius' Violin." You don't need any tools. Reid shows you how to make all the tools you need from old table knives, worn out files, sheet metal, etc. Eight full-size plans, 16x23 inches, folded into the book give you every detail in actual size.

Violins Bring High Prices

Make a violin and you probably will never want to sell it. But good tone modern violins bring terrific prices, yet the materials cost comparatively little. With Reid's plans and step-by-step instructions you can make such a violin for yourself. 15 chapters guide you in selection of wood, fashioning the belly, back, sides, mold, lining, neck, scroll, purfling. Other chapters cover varnishing, finishing, stringing. Others show how to make tools and clamps at little or no cost.

Order Book Today.

Money Back if Not Satisfied.

Make your own violin for pleasure or profit. Get book and plans now. Clip this ad and mail with check, money order or cash for only \$3.50 or we will ship C.O.D. Money back in 7 days if not satisfied.

FULL SCALE PLANS INCLUDED

Working plans, drawn to full scale, are included in a special pocket inside the book where they may be withdrawn for quick and easy reference.

POPULAR MECHANICS PRESS



Complete Instructions

8 Actual Size Plans
How to Make the Tools You Need
Where to Get the Materials

You trace or work direct from actual size plans. No measurements to translate or confuse you. You see the entire violin in the plans. You read the how-to-do-it instructions in the book.

\$3.50 Cloth Bound

ORDER FORM IN BACK

Dept. 30
200 E. Ontario St., Chicago

New! ALL PLASTIC QUICKIE KITS



ALL
FOUR
ONLY
\$316

1904 OLDS 69¢
1914 REGAL 89¢
1911 MAXWELL 69¢ Famous Antique
1913 MERCER 89¢
Autos you can assemble in 5 minutes
NO SANDING - NO CARVING
FOR COLLECTORS OF ALL AGES
At your Hobby, Toy and Department
Store OR SEND DIRECT - All 4 Kits for
\$3.16 plus 25¢ for postage and handling.

SCRANTON HOBBY CENTER **Lil' OLD TIMERS**
Dept. L 14 • 329-331 Adams Ave., Scranton 10, Pa.

NO TANKS USED
NEW SIMPLIFIED METHOD

SUCCESS IN THE
ELECTROPLATING
BUSINESS



ELECTROPLATE

ANY OBJECT IN HOME, SHOP, GARAGE OR START
YOUR OWN WELL PAYING ELECTROPLATING BUSINESS.

NOW, using NEW plating kit.

It's easy to electroplate any object. Complete kit and instructions on plating metal and non-metal objects, with nickel, copper, chrome, gold, etc., plus full data on obtaining all the business you desire and make BIG MONEY full or spare time. ONLY \$5.95. SEND NO MONEY—everything sent C.O.D. plus postage—OR

send \$5.95 now and receive it postpaid. Money back in 7 days if not satisfied.
M. Z. NATIONAL SALES CO., 113-U West 42 St., N. Y. 36, N. Y.

TOOLS,
SILVERWARE,
HOUSEHOLD
ARTICLES,
JEWELRY,
BABY SHOES,
AUTO PARTS
& TOOL
ARTICLES

MICRO-VOX WIRELESS MICROPHONE

With built-in transmitter for operating through any radio (without wires) within 50 feet as a PA system, Baby Listener, Detectophone, etc. Supplied complete ready to use with simple instructions. Shpg. wt. 3 lbs.
No. 20A920.....\$6.50 (Plus Parcel Post)

FREE CATALOG 156 pages of everything
in Radio and Electronics.

BURSTEIN-APPLEBEE CO. 1012-14 McGEE, KANSAS CITY, MO.

Shrinks Hemorrhoids Without Surgery

Science Finds Healing Substance That
Relieves Pain—Shrinks Hemorrhoids

Science has found a healing substance that shrinks hemorrhoids, stops pain promptly, ends bleeding — without surgery. Doctors report actual shrinking of hemorrhoids. Sufferers say, "Hemorrhoids have ceased to be a problem." The secret is Bio-Dyne® — already widely used for healing injured tissue. This substance is now available in a hemorrhoid ointment called Preparation H*. Ask your druggist for Preparation H. Money back guarantee. *Trade Mark

MEN - WOMEN RAISE

ORCHIDS

IN YOUR
LIVING
ROOM!

YEAR 'ROUND

No Greenhouse Needed

Any Climate, Maine to California

BIG PROFITS!

Spare or Full Time. Loads
of Fun for all the Family!



Fill your home with gorgeous Tropical Orchids. Thrill to the gorgeous beauty of your very own huge purple Cattleyas like those you see in nearly every flower shop. Exquisite Cymbidiums, sometimes with 30 or more blooms on each stalk. Hundreds of others—many grow without soil, getting food from the air. Yellow Orchids, greens, blues, pinks, browns, every rainbow color. No greenhouse needed. Start on card table in your living room. Any climate, Maine to California.

Successful Home Grower SHOWS YOU HOW



LOUIS SCHIRMER Orchidist

Louis Schirmer, successful home grower, shows you step-by-step how he and Mrs. Schirmer started with a few plants at home, developed a big-profit business, and grew an Orchid collection now worth a fortune. Learn how Orchids multiply — how one plant may become many, each as valuable as the first. No big investment.

No overhead. Takes few minutes a week. Big-profit orders come from individuals, florists, hotels, clubs, etc. Popular year-round gift. Millions sold by Mail-Order. Schirmer shows you how!



You can grow
gorgeous Cattleya Orchids
like this in your own home!

Home Growers Coast to Coast
Benefit from Schirmer's Help

"A wonderful course, written so anyone can understand it!"
J. G. Mueger
"I can sell all the Orchids I can produce!"
M. H. Johns

Complete Instructions and Living
Orchid Plants Sent for You to
Examine at Home Without Risk

Complete Directions—secrets of the experts — in simple language, jam-packed with "show-how" drawings, gorgeous full color pictures of Orchids. Also a real blooming-size Orchid plant from the Schirmer's own Gardens. Everything you need to start is yours to examine at home, without risk. FREE—full details. Learn how you may become an Orchid Grower. Send no money! Write today. Airmail is quickest.

TROPICAL FLOWERLAND DEPT. 31 C
4622 Wilshire, Los Angeles 5, Calif.

HOW TO
RAISE ORCHIDS
AT HOME



MAIL COUPON NOW!

Tropical Flowerland Dept. 31 C
4622 Wilshire, Los Angeles 5, Calif.

Rush me complete free details on your offer of Louis Schirmer's Instructions which show me how to grow Tropical Orchids at home. The instructions will include a blooming-size Orchid Plant and valuable home Profit-Plan. This request does not obligate me in any way.

Name _____
Address _____
City _____ Zone _____ State _____



HAIRVAC

New Massage Instrument Keeps Hair, Scalp, Clean and Healthy

Removes embarrassing dirt and dandruff . . . promotes hair health with electrical massage. Vibrating rubber fingers loosen, vacuum suction removes, harmful scalp wastes. Soothing, enjoyable rotary massage—3000 pulsations per minute—tones up scalp, stimulates circulation, distributes vital natural oils, makes scalp tingle for hours. VISKON patented disposable filter—easily inserted and removed—traps dirt and dandruff . . . Immediate visible proof of Hair-Vac's effectiveness. USE HAIRVAC DAILY to keep hair handsome, glossy, better looking . . . scalp clean, healthy, invigorated.

Hand-size, easy to use, convenient at home or away. Wonderful with a wave; no resetting ever necessary. No water, soap, oil—nothing to dull the natural beauty of your hair. Already in use in thousands of homes. UL-approved. AC only. Complete with 100 filters, only \$14.95, postpaid. Order by mail today—check, money order or C.O.D. Immediate delivery. Guaranteed, of course.

H. C. PAULK

304 Kansas Ave., Dept. H-40, Topeka, Kansas

Do you work all day with

COLD FEET?

NOW,

at last, a new, modern, low priced electric foot warmer that will keep you healthy, happy and comfortable



Check stand cashiers, secretaries, assembly line workers, housewives, office workers, theatre cashiers, machine operators, telephone operators, and many others throughout the country are now singing the praises of the Electro Mat. There is no further need to work all day with cold feet. Many colds, causing absenteeism and irritability, can be directly traced to cold feet. *Safe and Economical*

Size 14" x 21"
light-weight,
portable

Consumes less power than a 75 watt light bulb. Mail your check or money order today for ONLY

\$6.95

F.O.B. Factory

PETERSON RUBBER MAT CO.
5508 N. Halifax Arcadia, California

Please send me ___ Electro Mats at \$6.95 each

IMPORTANT SAVING:

If 6 or more ordered, price is only \$5.95 each.

C.O.D. Enclose \$1.00 deposit with order.

Prepaid

Name _____

Address _____

City _____ State _____

PLEASE PRINT CLEARLY

NEW! ALL ABOUT TELEVISION

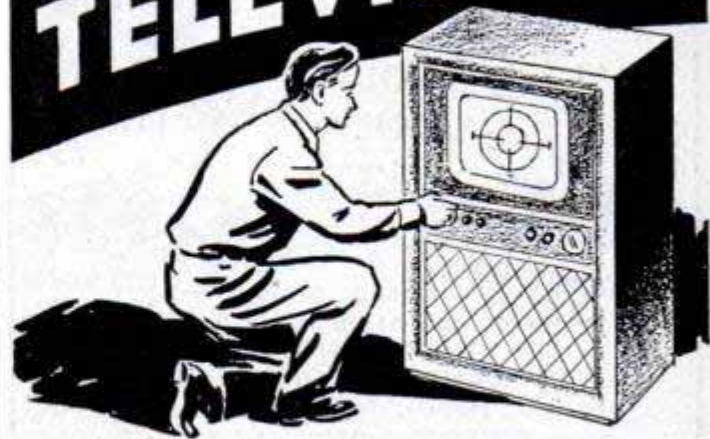

Service Your TV Set Yourself and Save Hundreds of Dollars . . . Save on the Purchase of a New Set!

Here's the brand new book that tells and shows you how 9 times out of 10 you can service your TV set yourself and save the \$5 to \$25 fee charged by professional repairmen for service calls.

Make Most Repairs Yourself

Here are famous step-by-step instructions by John Derby, famous television engineer, which make it possible for you to locate trouble quickly and repair it in the matter of minutes. Hundreds of "show-how" photos, drawings and diagrams actually show you just how to go about making most TV repairs.

Actual Photos Show You How

A special illustrated section contains actual photographs of imperfect TV pictures. By comparing the picture on your set with those in the book you immediately identify the trouble and then by following Derby's instructions you make the adjustment or repair which will give you perfect reception once again.

Find out how to install your own antenna at a savings of as much as \$20 . . . how to replace burned-out picture tubes . . . how to get the best reception in outlying areas . . . how to save money when buying a new set . . . what to look for when you purchase a TV set.

Go "Behind the Scenes"

Go with Derby into TV studios and see stars in action . . . see how television shows are produced and what goes on "behind the scenes."

No other TV book on the market is so comprehensive and so chock-full of valuable information.

Money Back Guarantee

Send just \$3.00 for your copy of "All About Television." Read it for seven full days and unless you agree that it can save you hundreds of dollars and enable you to service your TV set yourself just slip it back in its wrapper and return it to us for a full refund.

Order on this Handy Coupon

POPULAR MECHANICS PRESS

200 E. Ontario Street, Chicago 11, Ill.

Remittance for \$3.00 enclosed. Rush postpaid my copy of "All About Television." Unless it is entirely satisfactory I may return it within seven days for a full refund.

NAME _____

ADDRESS _____

CITY _____ ZONE _____ STATE _____

Send C.O.D. (Postage extra)

POPULAR MECHANICS

Make \$20 to \$30 a Day
with this new **ONE MAN**

MAIL ORDER BUSINESS

DO PLASTIC LAMINATING AT HOME!

Would you like to get orders and cash from your mailman—then in space of hours make and ship the things people ordered from you? If you have spare time and a little spare room in kitchen, garage, or basement, get the facts about the newest and most fascinating of all home operated businesses. For the first time a simplified machine brings the fabulous profit of **Plastic Sealing and Plastic Laminating** within the reach of the small operator. Any one can learn to operate the machine with a few minutes practice—then

with our **Magic Mail Plan** can get mail orders pouring in daily with cash in every envelope. No canvassing—no selling. We even supply the circulars you mail to bring back cash and orders. Don't waste a minute. Rush your name. We'll send you, **FREE** and postpaid, pictures, prices, details, all the facts you need to start. Mail coupon or send name on postcard. No charge.

WARNER ELECTRIC CO., 1512 Jarvis Av.
DEPT. L-1012 - CHICAGO 26, ILLINOIS

Make Thousands of Beautiful Art Creations

**COSTUME JEWELRY • CIGARETTE BOXES
TRAYS • CANDLESTICKS • COASTERS
LAMP BASES • BOOK ENDS...ALL IN
SPARKLING COLORED PLASTIC**



WARNER ELECTRIC CO., 1512 Jarvis Av.
Dept. L-1012, Chicago 26, Ill.

At no cost to me, please rush complete details postage prepaid. I am under no obligation.

Name _____

Address _____

City _____ Zone _____ State _____

THIS MAN . . .

. . . is taking out of the machine a Plastic Sealing Job—ordered by mail—only 11c in material cost brings back \$2.58 in cash by mail. Capacity of machine: \$25.00 profit per hour of operation.

HE-MAN VOICE!

STRENGTHEN your voice this tested scientific way. Yes—you may now be able to improve the **POWER** of your speaking and singing voice . . . in the privacy of your own room! Self-training lessons, mostly silent. No music required.

FREE BOOK Write TODAY for Eugene Feuchtinger's great booklet "How to Develop a Successful Voice." It's absolutely FREE! You must state your age. Booklet mailed postpaid in plain wrapper. No salesman will call. Send your name and age **RIGHT NOW!** Perfect Voice Institute, 210 S. Clinton St., Studio MX-2, Chicago 6, Ill.



MAKE \$5 PER HOUR WITHOUT A PRINTING PRESS

PRINTING

REVOLUTIONARY
NEW SCREEN METHOD

PRINT colorful signs, posters, banners, fabrics, wall paper, show cards—ANYTHING! Print on any surface. NO printing press or special equipment is needed with this amazing "approved" new printing secret. 300% profit on nearly every job. Easy to learn. —NO EXPERIENCE or art ability necessary. Exceptional opportunity. Complete illustrated detailed plan and color sample FREE—Write.

SCREEN-PRINT COMPANY, Dept. 2C
1010 So. Los Angeles St., Los Angeles 15, Calif

FREE
complete "BIG MONEY"
Plan and
SAMPLE!



EARN AT HOME
SPARE or FULL Time

100 BEST Woodworking Projects

SELECTED FOR YOU BY POPULAR MECHANICS EDITORS
Enjoy the fun—the pleasure—of making things. Get **100 BEST WOODWORKING PROJECTS**, complete with simplified instruction, plans, diagrams and more than 400 how-to-do-it pictures. Make all kinds of furniture, baby carriages, clocks, lamps, book shelves, fireplaces and other useful articles at little or no cost. Send only \$2.00 with name and address. Money back if not pleased.

POPULAR MECHANICS PRESS, Dept. PM6, 200 E. Ontario St., Chicago 11



Here it is—the Amazing, Scientific **BARREL OF FUN TRICK!**

Milarious! Sensational!
Fun Galore! It's Crazy!
You roll out the Barrel . . . Watch it come back, then hand it to your friends . . . Ask them to try it. Watch the fun as they roll out the barrel. Only YOU can control its movements.

A Barrel Full of Laughs! You'll be the most popular person at any party, the center of attraction at any gathering with this exciting new trick. Be among the first to own one—you can put on a whole show with **BARREL OF FUN!** Order Today! Complete with instructions, PPD., only **\$1.00**

AARON'S 10742 So. Michigan, Dept. PM-12A, Chicago 28, Ill.

\$2600 MORE A YEAR

in your spare time laundering venetian blinds at home. Expand to full time. New portable machine. Free booklet. Write today to
VENETIAN BLIND LAUNDRY EQUIPMENT CO., Inc.
442 N. Seneca Dept. 10-T Wichita, Kansas

Malayan THROWING DAGGER

BALANCED TO STICK! \$1.98 postpaid

MALAYAN HUNTING KNIFE used for killing game. Exciting Target Sport. Easy to learn! Fun indoors or outdoors!

EASY TO THROW!

MONEY BACK GUARANTEE

Fun, Thrills, Excitement!
Indoors—outdoors. Learn this Sport! Easy to throw accurately with our clear instructions. Beautiful, heavy-duty 10" knife. Tempered steel. Tough, rawhide-bound handle. Rare souvenir, unusual bargain. Limited quantity. At dealers or send \$1.98

WHOLESALE IMPORT CO. Dept. K, 604 Marengo, Alhambra, Calif.

★ GET ON "UNCLE SAM'S" PAYROLL ★

START AS HIGH AS \$3,795.00 A YEAR

MEN - WOMEN
PREPARE NOW FOR 1954 EXAMINATIONS

Mail Clerks and Carriers, Rural Carriers, Stenographer-Typists, Clerks, Messengers, and many others.

36-Page book on Civil Service FREE
Mail Coupon TODAY
ACT NOW

FRANKLIN INSTITUTE (Not Government Controlled)
Dept. G-83, Rochester 4, N. Y.

Sirs: Rush to me, without charge, copy of 36-page book, "How to Get a U. S. Government Job," list of positions, and full particulars telling how to qualify for them.

Name _____
Street _____
City _____ Age? _____

MASTER GARDENER



NO PUSHING
It's a snow-blower
It's a power sickle
It's a cultivator

Tractor shown with Snow Blow Attachment (Item 206)

It's a rotary tiller
It's a plow
It's a rotary mower

Where can you get a power tool that does so many jobs? Works for you the year 'round. Does terrific job of cleaning snow from walks, drives, etc. without backbreaking work. Also prepares deep mellow seed beds, cuts weeds, lawns, etc. The Master Gardener performs better—does more than tractors costing twice as much. Converts in minutes to Tiller, Power Sickle, etc. Basic, self-propelled 2 hp. tractor, Briggs \$119.50 or Clinton engine... \$139.50
Snow Blower... \$39.50
Cultivator... \$8.75
Rotary Tiller... \$2.75
Disc Harrow... \$15.75
Furrowing Tool... \$8.75
Plow... \$15.00
Rotary Lawn Mower... \$42.50
Sickle Bar Mower... \$42.50
Lawn Mower Hitch... \$4.50
Freight prepaid to most areas. Easy payment plan available.

HEAVY DUTY D-C ARC WELDER

Use as portable or shop welder. Up to 300 amps. Senior model. Made for years of trouble-free, continuous service. Will handle light or heavy jobs. Easily welds up to 3/4" plate using 1/4" rods. Built-in air cooling system. Arc is easy to strike and hold, because of specially designed arc stabilizer. Hi-lo switch and dial control gives wide range of welding heats. Run welder at 2600 rpm. with tractor, jeep or 14 hp gas engine or 7 hp elec. motor. Complete with instructions, guar. and triple V belt or flat pulley. You can pay more, but you can't buy a better welder. (Item 38) Wt. 110 lbs. \$400 value at... **\$99.75**

DUAL CONTROL MODEL same as above but with built-in dual rheostat for low heat soldering, brazing, welding. Special... **\$119.50**

WELDING KIT. Two 10 ft. leads, welding helmet, electrode holder, ground clamp. Sold only with welder at... **\$10.50**

Write for prices on A.C. Arc Welders.

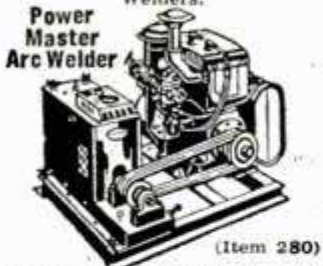

Power Master Arc Welder

(Item 280)

Now! a portable, rugged, self-powered industrial type welder with terrific performance, yet at a price hundreds of dollars less than you'd expect. High capacity DC welding unit enables you to tackle any job with confidence—easily handling anything up to 2" plate using from 1/16" to 1/4" rods. Built-in stabilizer and dual control simplifies any welding job from 30 to 250 amps. Welder is powered by 14 HP 2 cylinder air cooled Wisconsin industrial engine with triple V-belt drive. Mounted on a welded steel chassis—easily transported on trailer or pick-up truck. Ideal for shop, factory or farm welding. Complete with instructions and guarantee. Wt. 80 lbs. Compares with welder costing \$1200. (Item 280) Factory Special... **\$499.50**

YOUR OWN EMERGENCY POWER AT DIRECT FACTORY PRICES

PORTABLE LIGHT PLANTS



(Item 24)
700-800 Watt Plant (Item 44) same as Item 24 but larger engine... **\$169.95**

1500-1700 Watt Plant (Item 20) Similar to Item 24, but has three times more capacity. Wt. 73 lbs. Factory price... **\$279.50**

GIANT 2000-2500 WATT PLANT

110-120 V. 60 cye. A.C. Absolutely the best made—exclusive dynamically balanced armature; heavy windings develop up to 5000 watt overload for motor starting. Skid-mounted—portable. Powered by easy starting Briggs or 6 hp. Wisconsin engine—complete with all accessories; engine easily disconnected for other uses. Big outlet box, voltmeter, no wiring necessary. Ample current for all purposes. Factory warranty and complete instructions included. (Item 31) Wt. 210 lbs. Reg. price \$585.00. Special at **\$299.50**

Generator Only and control box... \$169.50

3000-3500 WATT PLANT (Item 198) 110-220 v. 60 cye. A.C. Belt drive Wis. Engine. Push button start. Wt. 370 lbs. Heavy duty **\$399.50**

Generator only for belt drive, Wt. 115 lbs. (Item 198A) \$239.50

MASTER-LITE 2500 Watt Plant 110/120 v. 60 cye. A.C. A powerful plant, ruggedly constructed and yet designed for easy portability. Can be started by rope or built-in 12 v. electric push button starter. Built-in winding to charge battery. Powered by a big 5.10 HP Briggs engine, complete with all accessories. Includes control box, voltmeter, and handy plug-in power receptacle. An ideal plant for permanent or stand-by service. Wt. 225 lb. Reg. price \$645.00. Factory Price (Item 21) **\$329.50**

3500 Watt Plant (Item 23) 115 v. 60 cye. A.C. Push Button Start. Direct Drive. Wt. 270 lbs. Factory Price... **\$379.50**

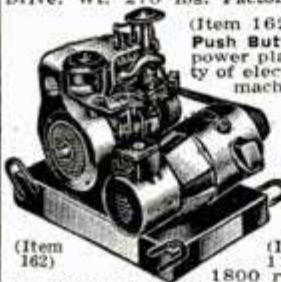

(Item 162)
HI-LINE 6000 WATT PLANT
Push Button Start. 115-230 v. 60 cycle A.C. A brute of a power plant with a rugged 14 hp. Wisconsin engine. Plenty of electricity for ranges, water heaters, freezers, pumps, machinery, etc. Affords both 110 and 220 volts. Ideal where heavy current is needed. Wt. 590 lbs. Easily worth \$995.00. With self starter. Factory price... **\$645.00**

Same plant but with Generator and control box only, belt driven. Use your own engine or tractor. Wt. 240 lbs. (Item 163) Factory price... **\$345.00**

DIESEL LIGHT PLANT
(Item 1660) Diesel Master 11-12 kw. 115/230 v. AC. Single or 3 phase. 1800 rpm. direct connected. Electric Self-starting. Engineered for permanent power where continuous low cost, heavy duty service is important. Wt. 1350 lbs. Reg. list \$3650.00. **\$1895.00**

10-11 kw. GAS DRIVEN PLANT. 115-230 v. 60 cye. AC. Single or 3 phase, powered by 4 cylinder Wisconsin air cooled engine. Belt driven. Constructed similarly to Hi-Line 6 KW shown above but much larger. (Item 217) (with crank start) Wt. 900 lb. Factory price **\$1075.00**

Same plant with elec. self-starter... **\$1145.00**

We make fully automatic controls to operate any of the above light plants. Write for details.

HEATING & VENTILATING FAN



(Item 10) Easily installed in furnace pipes. Forces even heat to all rooms. Over range removes kitchen smoke and odors. Powerful, continuous duty motor, 110-120v. AC. Mount in wall or ceiling to ventilate any area.

Quiet, super efficient fan moves huge volume of air. (400 to 600 CFM).
8" Fan, wt. 5 lb. **\$6.85**
9" Fan, wt. 6 lb. **\$7.85**
10" Fan, wt. 7 lb. **\$8.85**
12" Fan, wt. 8 lb. **\$9.85**

HEAVY DUTY FAN. Semi-enclosed motor, suitable for spray booths, restaurant exhausts, poultry houses, etc.
10" Fan, wt. 8 lbs. (Item 10E) **\$11.95**
12" Fan, wt. 10 lbs. (Item 10D) **\$12.95**

MASTER AIR COMPRESSOR

(Item 209) High pressure type for large volume of air for heavy duty service. For paint spraying, inflating truck & auto tires, greasing, & the hundreds of other jobs done by compressed air. Piston type. 2" bore compressor with built-in air filter.



Master built with high strength alloys and precision bearings. Stainless steel tank, 12"x24", 2100 cu. in. cap. Heavy duty automatic switch starts and stops motor to maintain desired pressure (up to 150 lb.). Has check valve, safety valve, gauge, shut-off valve. 20 ft. air hose and tire chuck. Beautifully balanced on ball bearing wheels and rubber tires. Low factory prices.

Tank Tested up to 500 lbs. per sq. in.

6 FT. FLEXIBLE SHAFT

A precision built, heavy duty tool with amazing flexibility. Replaces a dozen individual tools—drills, buffs, grinds, sands, saws—handles jobs in impossible places. Fits any 3/8" motor shaft or use with drill press, grinder, lathe, gas engine, etc. Heavy duty 3/8" piano wire core encased in tough rubber housing. Handle and arbor have rugged industrial type precision ball bearings for years of service. Arbor takes all 1/2", 20 standard threads. Use with any 1/4, 1/2 or 1/2 hp motor. Wt. 10 lbs. Reg. \$29.95. **\$15.95**



With 1/2 hp. motor, 110v. AC motor. Reg. \$175. (Item 209p)..... **\$109.50**

With 1/2 hp. motor, Reg. \$199.50 (Item 209Ap)..... **\$129.50**

2 hp. Briggs Gas Engine. Reg. \$199.50. (Item 209Bp)..... **\$119.50**

37 Pc. SOCKET SET



Highest quality, guaranteed non-breakable sockets made by Husky. Beautifully matched chrome alloy. Absolutely the best. Complete range of 17 sockets from 1/4" thru 1 1/2" (1/4" drive) and 7/16" thru 1-1/16" (1/2" drive). 1 extension, reversible 1/2" ratchet, adapter bit, sliding "F" handle, "L" handle, 1/2" speeder, 5 pc. alloy combination wrench set, 8 pc. Allen wrench set, and a big doghouse tool box. We challenge anyone to match this value. Easily worth \$41.95. Wt. 14 lb. (Item 59)..... **\$16.95**

44 Pc. SOCKET SET
(Item 59C) Same unconditionally guaranteed, non-breakable sockets as above—but with added sizes. Complete range of 21 sockets from 1/4" thru 7/16" (1/4" drive) & 7/16" thru 1-1/16" (1/2" drive). Two extensions, reversible 1/2" ratchet, 3 drift punches, sliding "F" handle, all angle coupling, 1/2" speeder, 1/2" breaker, 5 pc. high chrome alloy combination wrench set and 8 pc. offset wrench set in big doghouse tool with ample room for other tools. Reg. \$49.50. **\$21.95**

52 Pc. SOCKET SET
(Item 205) Contains a complete set of sockets in 1/2" drive, 3/8" drive and 1/4" drive, plus all necessary extensions, handles, speeders, reversible ratchets, etc.; all uncond. guaranteed against breakage. Beautifully matched chromed thin wall alloy sockets in a sturdy handsome steel box. Wt. 17 lbs. List price \$62.90. **\$27.95**

JET FLOW BLOWER



Tremendous air movement (1700 CFM) and quiet operation make this double inlet 10" turbine blower unbeatable for heating, cooling, drying, and air conditioning. Ideal for attic or barn ventilation, converting gravity heating to forced air; spray booth exhausts, etc. Operates with any 1/4, 1/2 or 1/2 HP motor. Oversized, long life bearings. Includes variable speed motor pulley and belt. Dimensions 19" hi. x 8 x 16 1/2". Outlet opening 13"x11 3/8". Wt. 45 lbs. (Item 245). **\$27.50**

Reg. \$54.50. Special. **\$27.50**

HEAVY DUTY 1/4 HP motor for above... **\$16.95**

EXTENSION CORD



(Item 16) Heavy duty, made of Buna rubber in insulated #14-2 conductor, stranded wire encased in a treated braid jacket. So tough that you can drive over it. Use indoors or out. Resists oil, grease or water. Extends electricity up to 400 ft. without voltage drop. Complete with heavy rubber plug and outlet. Comb. 2-40 ft. & 1-20 ft. (total 100 ft.) (Item 16c) **\$4.95**

Variable Speed Selector



Heavy duty, made by B. F. GOODRICH for industrial use. Provides instant speed changes for any drive. For machine tools, dryers, printing, conveyors, production lines, hoists — any operation requiring variable speed. Ideal for midget autos. Employs reliable "trouble free" planetary system. No hydraulic power losses or creeping. Infinite range, smooth operation, easy installation (data included). 3 sizes: 1/2-1 hp. wt. 36 lbs.; 1-2 hp. wt. 55 lbs.; 2-3 hp. wt. 105 lbs. Reg. list \$228, \$252 and \$352. Our prices... **\$79.50, \$89.50 and \$114.50.**

Send check or M.O. Prices f.o.b. Factory. 10 day Money back guarantee. SEND 10c for... **BIG 1954 Catalog**

MASTER MECHANIC MFG. CO., DEPT. 79D Burlington, Wis.

**WORLD'S
BEST
WANT AD
MEDIUM**

CLASSIFIED Advertisements



Advertisements in this section 85 cents per word, each insertion, minimum 10 words, payable in advance. To be inserted under proper classification, copy must be in our office the 20th of the second month preceding date of issue
F. W. Johnson, Manager, Classified Advertising
Popular Mechanics Magazine, 200 East Ontario Street, Chicago 11, Illinois

YOU'LL PROFIT

By reading and answering the classified ads in this section. Hundreds of opportunities for you to make and save money

AUTOMOBILES. MIDGET CARS

ALL-Car Auto Club offers automobile literature—Old, new and foreign; dealer books; service manuals; glossy photographs; free motor magazines. Write today; get on free mailing list. Auto Maniacs, Stockbridge, Mich.

FORD Owners—Stop clutch chatter, without new clutch. Simple instructions—\$1.00. Box 4065, Denver 9, Colo.

HI-Mileage-speed equipment from the world's largest supplier. Dual manifolds, finned heads, electric doors, lowering sets, chrome panels, thousands of items for all cars. 1954 catalog 25c (illustrated literature free). Wholesale to garages. Newhouse Automotive Industries, Los Angeles 22.

ADJUST Tappets the easier, better "two position" professional way. Complete instructions one dollar. Brewer, Woodland Park, Colorado.

TEN Cents per year, keeps chrome on your car shining like new. Inquire: Sunset, Yreka, Calif.

FIBERGLAS Automobile bodies. Build your own, Gem-O'-Lite's own "how" book \$2.50. Information, materials catalog 10c. Airmailed 35c. Gem-O'-Lite, Box 6867A, North Hollywood, California.

PHOTOGRAPHS, World's finest automobiles. List, sample, 25c. Box 1028, Minneapolis, Minnesota.

AUTO SUPPLIES AND EQUIPMENT

BARGAIN Offer! Surplus stock of Gale Hall's original gasoline economy and motor condition gauges, designed for permanent dashboard mounting. Brand new, original cartons! Directions and connections included. Original price \$7.50, now only \$3.98 plus 40c postage! Deluxe all-chrome model, originally \$12.95, now only \$5.98 plus 40c postage! Order now! N. E. Surplus Sales, Dept. PM-12, 67 High Street, Newburyport, Mass.

PROFESSIONAL Automotive gauges—surplus stock of famous Gale Hall instruments, brand new, original cartons! Compression gauges, originally \$10.75, only \$2.98 plus 40c postage! Precision engine analysis vacuum gauges, originally \$12.50, now only \$4.58 plus 40c postage! Catalog of other bargains sent free with first order! N. E. Surplus Sales, Dept. PMA-12, 67 High Street, Newburyport, Mass.

GENUINE Motor treatment, Lachapelle's (patented). For only \$3.00 delivered. Restores older motors. Restores compression, power. Saves gas, oil, repair bills. New motors will last longer. Money back guarantee. You can't lose. Free circular. Write Joe Dillon, Authorized Warehouse and Agents Distributor, Box 323-P, Bridgeport, Ohio. Exclusive distributorships, agencies open.

QUICKER Starts, better mileage, full power acceleration. Hove's Du-L-Spark adapter plates. Ford, Mercury \$1.50; Chevrolet \$2.00. Free catalog. Hove Engineering, 1503 Hennepin, Minneapolis 3, Minn.

ELECTROPLATE Auto parts, novelties, mirrors. Easy, inexpensive home processes. Free booklet. Tyco Metals, Box 13231-BG, Houston 19, Texas.

HOTROD Jetflame tailpipe. Plans, \$1.00. Autoen, Box 71D, Kerrville, Texas.

G. E. Engine heaters ½ price. Installed in water jacket, connected to any electric outlet in your garage, they keep engine warm all night, make starting easy, coldest morning. Only \$4.45 for Chevrolet heater unit regularly \$9.95. Only \$3.95 for G. E. heater regularly \$8.95 for all other cars except Packard, Nash 600, Studebaker 6. Add 50c for postage. B. S. Wisneski, Milwaukee 7, Wis.

FIBERGLAS—Plastics for bodies and hardtops. Complete building instructions. New low prices. Nationally known suppliers. Industrial Plastics, 4425 Linden, Oakland 8, Calif.

MOTORIST—Save gasoline vacuumating overrich mixtures. For free particulars, how you install on your car for introducing, write Vacuumatic, Dept. 2051, Wauwatosa, Wis. Salesmen wanted.

UP To 6 miles more per gallon, increased pep, smoother acceleration reported by hundreds using Tur-B-Lizer gasoline saver. Six cylinder single manifold cars \$3.00, eight cylinder, \$4.50. Money back guarantee. Tur-B-Lizer, 621 E. State, Milwaukee 2, Wis.

DE-SLUDGE Your car in 20 minutes with Shayne "7-11" Solvent. Also cleans carburetors, radiators, cuts ethylene glycol, etc. 16-oz. can \$2.00. Special discount in case lots to fleet owners, trucking companies, etc. Satisfaction guaranteed or money back. Write for free particulars. Agents wanted. Shayne Products, 1200 N. Ashland, Chicago, Ill.

USE Your spotlight, make automatic. Complete plans newly developed system, \$1.00. Experilabs, Earick Rd., Rt. #6, Mansfield, Ohio.

CONVERTIBLE Tops—Black, tan, custom made \$27.95. Send make, year and model. Florida Top Shop, 7325M Old St. Augustine Rd., Jacksonville, Florida.

\$50 DAILY! Amazing atomic powder polishes cars quickly! Details free! Three car can \$1, 3 cans \$2. Star Dust, 405-B Madison Street, Fort Wayne, Ind.

MIDGIT-Frigit the patented, insulated car convenience with spigot for coffee, ice water, etc., fits under any dash. Pulls out for beverage bar and snack shelf. Retail \$19.95 postpaid. Satisfaction guaranteed. Free details from Midgit Frigit, 5001 Georgia Avenue, West Palm Beach, Florida.

FREE Quotations! Racing, rodding, restyling requirements. Wholesale-retail. All Price, 64 Afton, P-12, Rochester 12, New York.

YEAR Guaranteed spray-on auto polish \$2.50; pre-polish cleaner \$2.50; transparent chrome protector—Remove with gasoline \$1.50; spray-on anti-static for plastic seat covers \$1.75; Swiss electric shaver \$5.95, cash, prepaid. Genesee Distributors, 1906 Barth, Flint, Michigan.

CARBURETOR Flanges for vacuum controlled valve oilers, water injectors, vacuum gauges, etc. Send \$1, make and model car. Flanges, 253-E Angeleno, Burbank, Calif.

VAPOR Injector, cools and peeps up engines. Saves you money on gas and oil. Gives high test performance using regular gasoline. Ten days trial, refund. \$8.00 complete. Send make and year of car, tractor or truck. Tenco, Box 212, Clermont, Iowa.

AUTOMOBILE Log book, enables you to keep accurate account of your automobile expenses, gasoline mileage, and distances traveled. Fits in glove compartment. A five year log book! \$1.00 postpaid. J. Belik Publications, Box 207, Coronado 18, Calif.

BUY Wholesale nationally advertised auto supplies, thousands other products at big discount. Free "Wholesale Plan." American Buyers', 629-DD Linden, Buffalo 16, New York.

CAR Insurance only \$1.00; guaranteed lubrication if equipped with Pro-Caps one minute installation, set of 25 only \$1.00 postpaid. A. Creed, 123PS Warner Bldg., Washington 4, D. C.

MODEL T Ford parts, engine and chassis. Parts for other make old models too. Special parts made to order. We also buy surplus items. B. S. Wisneski, Inc., Milwaukee 7, Wis.

REFLECTING Bumper tape, prevents accidents. Red and silver. 5 ft. package \$1 postpaid. Reflecto, Box 232, Ravenna, Ohio.

GM71 Discarded injector parts wanted. Bares, 7120 Carnegie, Cleveland, Ohio.

CHEVROLET Owners: Stop tappet noise with Kaye Tappet Silencers. Quality product. Easy to install. Complete set \$5.95. Kaye Products, 2067 B S. Layton Blvd., Milwaukee, Wis.

NEW And used guaranteed parts for civilian and army cars and trucks. Largest stock in America. Mail orders. Pioneer Auto and Truck Parts Co., 734 W. 13th Ave., Denver, Colorado.

CORD Parts, literature. Sell, swap. Greenlee, Box 1036-P, Anderson, Indiana.

CRANKSHAFT Grinder, hand operated. Makes bearings fit without taking engine apart. \$3.75. Literature. L. D. McGee, 719 Cascade St., Wenatchee, Wash.

SAVE—California custom accessories headquarters. Buy direct from original designers. Electric push button door-trunk conversions, bull noses, custom grilles, speed dress-up equipment. 40 page catalog, hundreds of photos. Send 25c to Eastern Auto, 3319A South Grand, Los Angeles 7, Calif.

"WATER Injection." Free descriptive, illustrated, information. Neher Industries, LaVerne, California.

BRUSH Plating outfits connect to a battery. No tanks or shop required. Free particulars. Gunmetal Co., Ave. J., Decatur, Ill.

CAR Burning oil? Losing compression? Try Clifford's Compression Seal. \$2 postpaid. Clifford's Engineering, 1329 Seventh, Aurora, Illinois.

AUTO TRAILERS

TRAILER Building, illustrated, 20c. Craftsmann Books, Box 1153, Milwaukee 1, Wis.

BUILD Your own trailer! Plans for all kinds. Illustrated catalog 10c. Jim Dandy, 125-M, Wausau, Wisconsin.

CATALOG—Largest in midwest. Newest items. Send 10c. Hanna Trailer Supply, 615 W. Layton Ave., Milwaukee, Wisconsin. Dept. MP.

EXCEPTIONAL Expanding eight foot trailer. Accommodates family of five. Build yourself. Literature 10c. Fra-Mar Company, Jones Avenue, Wilmington, Mass.

AVAILABLE In kits. Slip-on coach for all pickups. Boat kits. Trailer blueprints. Catalog 10c. Comstock Trailers, 585-K Parsons, Kansas.

COMET Trailer homes. 14 ft. \$1150. Otho DeWitt, Almont, Mich.

MOTORCYCLES, BICYCLES, MOTORSCOOTERS AND SUPPLIES

QUALITY Chrome plate service. Motorcycling, 813 Ohio Street, Wichita Falls, Texas.

MOTORIZED Vehicles. Illustrated circular dime. Craftsman Books, Box 1153, Milwaukee 1, Wis.

\$50.00 FOR Your bicycle on new NSU German motorcycle. \$288 up. Literature 25c. Walraven Motors, Marion, Ohio.

NEW Wasp 4 cycle bicycle engine kits. Ready to install on bike. Cauffiel Motor Industries, Temperance, Michigan.

"BUZZZZ"—The motorcycle magazine. International coverage. Thoroughly illustrated. Yearly \$2.00. Sample 20c. 5424-A Sawyer, Chicago 25.

RECONDITIONED Motorcycles and motors. Chromium accessories. Complete stock Indian parts. Expert rebuilding. Fast service. Indian Motorcycle Sales, Kansas City 27, Mo.

CZEK Motorcycle \$25; midget motorcycle \$20; Doodlebug motorscooter \$30; Whizzer bike motor \$10; two cylinder Maytag engine \$4. Four airplane tires \$3. Mailorder only. Send 25c for catalogue Number 56, just out, listing these and hundreds of other bargains in new and used midget cars, motorscooters, home-builders parts, plans, etc. (35c by first class mail). Midget Motors Directory, Athens, Ohio.

AVIATION

SNOW Sleigh, air boat, propellers, lowest prices, literature. Universal, Box 3123, Ft. Worth.

PROPELLERS, Plans, supplies—For snow sleighs, air boats. Immediate delivery. Catalog 25c. Banks-Maxwell, Box 3301E, Ft. Worth, Texas.

LIGHTPLANE Circular, illustrated, 20c. Craftsman Books, Box 1153, Milwaukee 1, Wisconsin.

PROPELLERS, Plans for snow sleighs, air boats. Lowest prices, fastest service. Literature. Gano Propeller, Box 3284A, Ft. Worth, Texas.

ELECTRICAL SUPPLIES

MOTOR Rewinding supplies. Wire. Insulation. Morton Electrical Service, Round Lake, Ill.

TIMER Control. Automatic or manual 24 hour cycle. Use on fans, refrigerator defroster, light circuits, etc. Specifications; 115 v. 60 cy., genuine Telechron motor, steel case. Mounts on standard wall or outlet box. Retail \$21.50. Close out price \$6.75 each while supply lasts. Cash or check. Holcomb & Hoke, Indianapolis, Ind.

NEW Tool strips insulation from all wires, cable. \$2.95. E. V. Barber Company, Box 4525, Ecorse 29, Michigan.

FREE Catalog. Welders, welder-kits, hydraulics, hydraulic-kits, generators, motors, pumps, winches, boats, boat-kits, appliances, 1500 items including war surplus. Dunbar Mfg., 10318-B Aurora, Seattle, Washington.

LAMP Supplies—Wholesale, any amounts. All parts for repairing and building lamps. Catalogue 15c. Brown Lamp Co., Box 501—Wellston Sta., St. Louis 12.

MOTOR Winders, free bulletins. Winding and testing equipment. Motor Industries, Quincy, Illinois.

SUPER Special. Kit of 100 insulated resistors. 1/2 and 1 watt, assorted values from 50 to 2,000,000 ohms. Send \$1.50 plus 20c postage. International Instrument Development Co., Box 31, Brooklyn 11, N. Y.

LAMPS—25c Brings bargain catalog showing all parts for repairing, building. Contains instructions for electrifying vases, oil lamps, etc. Gyro Lamps, 5402P Clark, Chicago 40.

ELECTRIC Pencil: Engraves all metals \$1.50. Beyer Mfg., 10511-H Springfield, Chicago 43.

FREE Surplus catalog. You need it, we have it. Everything in hydraulics, pumps, winches, welders and supplies. Mechanical books. Prices you can afford. LeJay, 47, Minneapolis, Minn.

WELDING, SOLDERING, PLATING

SAVE Time. The must for all acetylene welding and cutting torch owners. It's the new special made cart with rubber tired wheels to accommodate large and small size oxygen and acetylene tanks. Free details. Stoltzfus Welding, Elverson, #2, Penna.

BUILD-UR-OWN a.c. welder and a.c. power plant with a good used engine and low cost Hobart generator. Welds anywhere and supplies 5KW stand-by power for any emergency. Write Hobartweld, Box M-1233, Troy, Ohio.

SELF-Training System. Radiator repairing, cleaning, recoring. How to equip small shop at low cost. Supply sources, trade secrets. Instructions. Radiator Service, McBain, Mich.

WELDERS, Instant start, 110v. \$29.50. Morris, 1070 Inner Drive, Schenectady, N. Y.

ELECTRO Plating equipment—New and used. Complete assemblies. All sizes for all types of plating. Baby shoe metallizing sets. Mounts, supplies, instructions. Free catalog. Hollywood Bronze Supply, 1624-C E. First Street, Los Angeles 33, Calif.

GOLD 24kt \$5.95. Silver, nickel, copper electroplating outfits plus booklet on plating and formulas, \$4.95 each. Wholesale chemical supplies. Capitol, 4213 Queensbury Road, Hyattsville, Maryland.

ACETYLENE Welding outfits new \$49; used \$29; arcwelders \$49.50. Eagle Welding, Dept. PM, 5085 Broadway, Chicago 40, Ill.

WELDERS—Electric, various models, \$28.50 to \$235.00, direct from manufacturer. Free literature. Champion Welder Mfg., 193MP Centre St., New York 13, N. Y.

A.C. Welders, 4 sizes. Lowest prices. Free literature. Holgerson's Service, Canton 1, Kans.

MACHINERY, TOOLS, SUPPLIES

PRECISION 5" Sine plate \$24.95. Heath, 2130 Roblyn, St. Paul, Minnesota.

BEVELDISC Sander, makes jointing easy. Lee, Box 22PM, Rochester 17, N. Y.

FREE Booklet! Learn how you can quickly level points for all types of construction work with amazing new precision one-man leveling instrument. Only \$12.95! Write Levelall, 84N Park St., Rockland, Mass.

\$1.00 BUYS A 13 piece drill set, standard long length—All sizes 1/16" to 1/4", complete with plastic carrying case. We pay postage. Modern Tools, Box 614, Wantagh, Long Island, N. Y.

SPECIAL Tools for woodworking machines, also metal turning attachment for Shopsmith. Free lists. Dixiang, 7301-F N.W. 10th Ave., Miami 38, Florida.

ATTENTION Machinists and tool and diemakers. We carry a complete stock of Starrett, Lufkin and Brown & Sharpe precision tools. Send 15c in stamps for one catalog. Specify brand. Acme Hardware Co., 1013 W. 63rd St., Chicago 21.

POWER Tools, equipment, wholesale prices. Free bulletin. Homecrafters Cooperative, Grand Rapids 6, Michigan.

ALLEN One ton power bench type punch press. \$125. Circular, Allen, Dept. PMB, Clinton, Missouri.

NEW Mall electric drills — 1/4", \$15.00; 1/2", \$25.00. Jacobs chucks. Wilt Surplus, 7829 S. Racine, Chicago 20, Ill.

ENGINES, MOTORS, DYNAMOS

SMALL Motors 110 a.c. and 32 d.c. for driving sewing machine, small power and hobbycraft tools, grinders, polishers, number of home and shop uses. \$7.95 postpaid anywhere. No c.o.d. Humen Sewing Machine Co., 12405—87 Street, Edmonton, Alberta, Canada.

REBUILT Gasoline engines \$17.00 to \$37.00. Cauffiel Motor Industries, Temperance, Michigan.

INVALUABLE Motor winders handbook. Simplifies complicated reconnecting. \$4.98. Jednak, Clinton, Penna.

ALTERNATING Current generators. 750 watt, \$38.50; 5000, \$185. Motors 1/2 horse, \$15; 3/4, \$22; 1, \$35. Butler, 1885 Milwaukee, Chicago 47.

WINDING Data, listing 225 motors, single and three phase, \$1.00. Motor Data Co., Box 7631, Kansas City 28, Mo.

BOATS, OUTBOARD MOTORS

CRACKER Box boat plans, \$7.50 set. Marine hardware at discounts. Literature free. Glen Designs, Box 568, Compton, California.

MARINE Conversions—Willys to Cadillac. Catalogue and conversion hints free. Barr Marine Products, 2706 Castor Avenue, Philadelphia 34, Penna.

BOAT Kits: Sail, power. Fittings. Catalog 15c, refundable. Boatbuilders Marine, 55-M Sorrento, Allston, Mass.

PLYWOOD Boat plans 21 for \$1.00. Catalog boat building plans and copy boating magazine, special price for both, 50c. The Rudder, 15 Murray Street, New York 7.

CURE That leaking boat with Fiberglass-plastic covering. Ends caulking and painting. Nationally approved process. Complete instructions. New low prices. Industrial Plastics, 3807 Harrison, Oakland 11, California.

BUY Wholesale nationally advertised outboards, thousands other products at big discount. Free "wholesale plan." American Buyers, 628-DD Linden, Buffalo 16, N. Y.

FIBERGLAS Permanent boat coating. Gem-O-Lite's own "how" book \$2.50. Complete catalog 10c. Airmailed 35c. Gem-O-Lite, Box 6867B, North Hollywood, California.

MARINE Conversions for Ford and Jeep engines. Catalog 10c. Lehman Manufacturing Company, 972D Broad Street, Newark 2, New Jersey.

CONVERT Fords and Jeeps to 100% marine engines with Osco's world famous Convo-Kits. Deluxe catalogue 25c (coin). Oscomotors, 3627B Lawrence, Philadelphia 40, Penna.

NEW, Used, rebuilt marine motors. Marine conversions, fittings. Free catalog. Stokes Marine Supply, Dept. 24, Coldwater, Michigan.

PLANS: Inboard-outboard runabouts, cruisers, sail, Wood, plywood, welded steel. Advise requirements. John B. Clark, N.A., 329 Kenmore, Bay Village, Ohio.

BUILD Marine engines with Federal conversion kits. Federal Marine Motors, 9011 Cottage Grove Ave., Chicago 19, Illinois.

JOHNSON Outboard specialists. Used parts for all models at substantial savings. Prompt quotations. Specify model serial. Crandall-Hicks, 910 Commonwealth, Boston, Mass.

FULL Size, cut-to-shape boat patterns, blueprints, 7 1/2-38 feet. New 1954 illustrated "Build a Boat" catalog of 50 naval architect-designed cruisers, runabouts, sloops, skiffs, outboard boats, sailing, racing, houseboats, 25c. Marine hardware catalog, \$1.00. "How to Build Boats" book, \$1.75. PolyWog Houseboat Plans, \$12. Cleveland Boat Blueprint Co., Dept. A-66, 9400 Steinway, Cleveland 4, Ohio.

BOAT Kits, plans and patterns for America's fastest and finest outboard racers and runabouts, fishing boats, hunting skiffs, dinghies, canoes. Illustrated literature 25c. Schneider Boat Co., Dept. PM, 1913 W. Vliet, Milwaukee 5, Wis.

BELLY Tanks, \$9.95. Free picture. Buck's Auto Wrecking, Merced, California.

BUILD Beautiful fiberglass-plastic boats without using molds. New patented method. Write Speedcraft, 2450 Emerson, off Square Lake Road, Pontiac, Michigan.

SPORTING GOODS, GUNS, FISHING TACKLE, ARCHERY, TRAPPING

IMPORTED, Stilettoes, daggers, springers, throwing knives, hunting knives, etc. Free catalog. J. D. Clinton, 94 Church Street, Mt. Clemens 2, Michigan.

GUNS! Guns! Guns! Mausers, Lugers, Kentuckies. New-used hunting bargains. Antique arms. Illustrated catalog 50c. Ed Agramonte, Yonkers 2G, N. Y.

GOLFERS. New combination golf cart and 14 club bag. \$39.50. Free information. Fribil, 626 Gem, Tulare, California.

FREE Catalogue: Imported hunting knives. Sportsmen, 1324 Wilshire, Los Angeles 17, California.

HYBRID Redworm wiggler bait or growing your own. Special prices. Quantity lots. Prices. Literature free. Hanna, 3806 Brooklyn, Kansas City, Mo.

LEARN To trap all furbearers. Big catalog free. Stamp appreciated. Hawbaker's, Fort Loudon, Penna.

BUY Wholesale nationally advertised sporting goods, thousands other products at big discount. Free "wholesale plan." American Buyers', 627-DD Linden, Buffalo 16, N. Y.

PLENTY Cash paid. Modern, antique guns, gold coins. Describe completely. Charlie Dutz, Box 284, Lincoln 5, Ill.

MOLDS For fisherman's sinkers, jigs, squids, casting and spinning lures. Sweet's Molds, Tonawanda 1, N. Y.

5000 BARGAINS, Firearms, binoculars, war relics. Catalog 50c. Smith Firearms, Runnemeade, N. J.

SHOTGUNS, Rifles, Revolvers, 500 modern, obsolete. Also cartridges. Each list 10c coin. Ed Howe, 52 Main, Coopers Mills, Maine.

120 PROFUSELY illustrated pages antique pistols, swords, daggers, armor, etc. 50c. Robert Abels, M860 Lexington Ave., New York 21.

CAST Iron molds—For casting fishermen's sinkers. Free illustrated booklet. Reading Instrument Co., Box 78, Reading, Penna.

CAMPING Equipment, sleeping bags, tents. Low prices. Free 80 page catalogue. Mor-San Sales, 10-21R 50th Avenue, Long Island City 1, New York.

FREE Catalog: flies, lures, mustad hooks, fly tying, lure, spinner, rod making materials, nylon coils. Supreme Mfg. Company, Amarillo, Texas.

ATHLETIC EQUIPMENT, BODY BUILDING COURSES

GREAT Strength easily obtained. Send \$1.00 for complete course and apparatus. Noticeable results guaranteed in 7 days, or \$1.00 refunded. Joseph Dryer, Box 5527, Chicago 80.

BARBELLS. Exercise equipment. Courses. Free booklet. Good Barbell Co., Reading, Penna.

TAXIDERMY

MODERN Taxidermist Magazine, Greenfield Center 2, N. Y. Devoted entirely to taxidermy, photos, articles, methods. Trial year's subscription, \$1.00.

BINOCULARS, TELESCOPES, MICROSCOPES, MAGNIFIERS

AMAZING High power telescope kit—Including tubing, fittings, 5 ground, polished lenses, instructions. \$2.95 postpaid. Brings objects 21 times closer! Hobbycraft, 7109 Princeton, Chicago 21.

GIANT 100X complete, ready to use day and night telescope. Steel and brass tubing construction. Hardwood tripod. Same quality lenses as \$15.00 telescope. Cheaper than buying a kit. Our price \$7.95 f.o.b. factory. Carl Jamer, Manorville, N. Y.

BINOCULARS, Telescopes, microscopes, terrific value. \$3.98 up. Request free money saving catalog. Criterion, Hartford, Conn. Dept. P 18.

GIANT 100X to 400X telescopes easily made. Complete kits from \$2.00 up. Free money saving price list. Suffolk Science Service, Riverhead, N. Y.

WAR Surplus bargains, binoculars, telescopes, sextants, millions of lenses, prisms, reticles, eyepieces, objectives, etc. Mail 10c for big "Catalog CH." Send \$1.00 for Stock CH-10-piece lens kit and big instruction booklet. Edmund Scientific Corp., Barrington, N. J.

GIANT Astronomical telescope complete with 6 ft. tripod. 45X, 75X, 100X eyepieces. Sun projector lens. \$15.00. Money back guarantee. Suffolk Science Service, Riverhead 3, N. Y.

SPECIALISTS. Used, new microscopes. Prepared slides. Supplies. Telescopes. Free illustrated catalog. Nassau Optical, 9 W. Greenwich, Roosevelt, N. Y.

AMAZING Prices, binoculars, telescopes, microscopes. Free trial. Folder, "Binocular Selecting," optical catalog free. Prentiss Importers, Mercury Bldg., West Los Angeles 25, Calif.

REFLECTING Telescopes, 60X, completely assembled \$29.75. Guaranteed observatory clearness. Free information. Skyscope, 475 Fifth Avenue, New York 17.

MAKE Your 6" telescope reflector. Glass, abrasives, instructions—\$9.50. F. Cameron, Box 65, Inwood 96, N. Y.

BINOCULARS. Lowest prices. 8x30. \$32.00 guaranteed telescopes, microscopes. Free catalog: All sizes. Joe's Binocular Sales, 4827 Second Blvd., Detroit 1, Mich.

SAVE Money—Get interesting facts! Free 52 page three color catalog. 80 different models. United Binoculars, 9043 S. Western, A-5608, Chicago 20.

REFLECTOR Telescope kits from \$6.25. All parts designed and built at our Hoboken factory. Mirror cells, diagonals, focusing mounts, tripods, tubing, oculars. Fully guaranteed. Send for free illustrated catalog. Our only sales showroom, Esco Products, 134 West 32 St., Rm. 204-A, New York 1.

PETS—DOGS, BIRDS, RABBITS, HAMSTERS, ETC.

GOLDEN Hamsters, \$2.75 pair. Write for folder. Engle's, 1228 So. 17th, Terre Haute, Ind.

RABBITS. Best home moneymakers. Booklet free. Tayco Rabbitry, Hapeville, Georgia.

RABBITS—Purebred New Zealand Whites or American Chinchillas. Two does, 1 buck for \$10.00. Safe delivery guaranteed anywhere. Shipped express collect. Order from Wilson's Rabbitry, Greer, South Carolina.

WANTED: To buy registered Airedale dog. Large male or female. B. B. Carlton, Gadsden, Alabama, R. 1.

CHINCHILLAS For profit. Best prices. Herb Miller, 1911-N, Lubbock, Texas.

NATURALIST'S Catalog 10c. Lizard 85c. Hamsters \$2.75 pair. 200 mealworms \$1.20. Quivira Specialties, Topeka 51, Kansas.

HAMSTERS—Golden and Albino. Fine Christmas gifts. Free information. Anderson's Hamstery, 35 Oneida, Pontiac, Michigan.

RAISE Guinea pigs. Very profitable. Booklet 10c. Winfield Harrison, Fitzgerald, Ga.

1000 BRED Mink booklet, plans 20c. Lake Ontario Ranch, Gravel Road, Webster, N. Y.

CALENDAR 25c. Refund first order. Hobbies, chickens, ducks, geese, rabbits, novelties, mailed in Jan. Warner Poultry Farm, Box 1085, Bridgeport 1, Conn.

BEAUTIFUL Pure white police puppies. Ansonia Kennels, Mose, N. Dak.

HAMSTERS—Golden; young, \$3.00 pair; fully developed, \$4.00 pair. Request prices on rare albinos. Adirondack Hamstery, Prospect 2, New York.

CHINCHILLAS, Mink raising list. Robert Lasky, 12,217 Memorial, Detroit, Mich.

CHINCHILLAS Rented, offspring bought. R. Rau, Route 2, Jeannette, Pennsylvania.

DOLLAR-Maker rabbits! Cash markets. Write today! Ramshead Ranch, Gibbsboro 3, New Jersey.

FOR Sale: A few outstanding Coonhounds, Beagle, and Rabbithounds. Prices from \$15.00 to \$40.00. Free literature. Trial. Dures Thomas, Box 268, Albertville, Alabama.

HAMSTERS, Golden and Panda. Literature free. Charles E. Bowser, Smokerun, Penna., Dept. H.

HAMSTERS—Cages and equipment. Free illustrated details. Lakeview Hamster Colony, Newfield, New Jersey.

EARTHWORM Raising pays worthwhile profits! Illustrated booklet explains raising, feeding, packing, marketing. 25c. Ozark Worm Farm-J. Willow Springs, Mo.

STANDARD Rabbit Journal, B-241-M, Milton, Penna. Year \$1.00, sample dime, beginner's manual 25c.

MAKE Big money! Raise Chinchilla rabbits. Cash markets supplied. Write today! Rockhill Ranch, Sellersville 15, Penna.

MINK Raising information free. Complete. Lake Superior Mink Farm, Superior, EEl, Wisconsin.

CHINCHILLAS (No rabbit.) Easily raised anywhere. Profitable. Big future. Terms. Hibner Chinchillas, Ithaca, Mich.

SPORTSMEN: 200 Pointers, setters, straight cooners, combination hunters, rabbit and fox hounds. Reasonable. List free. Ramsey Creek Kennels, Ramsey, Ill.

RAISE Highly-profitable Angora and New Zealand rabbits. Particulars free. White's Rabbitry, Jackson, Michigan.

RAISE Mink: Free booklet, pen plans, inside secrets, feed, care. Mink are money makers. Investigate today. Lawrence Mologard, Brigham City 12, Utah.

PLANTS, SEEDS, NURSERY AND GARDEN SUPPLIES

FRUIT Trees! Stark Bro's sensational new "Dwarfs." Also standard size, exclusive patented, trade-marked varieties produce abundant, larger, better apples, peaches, pears. All fruit faster growing, quicker bearing. Also beautiful ornamental trees and shrubs. Get giant new colorphoto catalog free. Stark Bro's, Dept. 30064, Louisiana, Missouri.

TREES And shrubs—Raise your own from seed for shade, windbreak, snow fence, ornament, erosion control. Free planting guide—price list. Write Woodlot Seed Company, Norway 4, Michigan.

MULTIFLORA Rose, the living self-repairing fence, ornament, erosion control, windbreak, snow fence, etc. Rapid grower. Raise from seed. Free planting guide, write Woodlot Seed Company, Norway 4, Michigan.

GREEN Hawaiian TI plant cutting. \$1.00. Grows in water. Box 1951, Hilo, Hawaii.

WE Sell on the installment plan. Best varieties peach and apple trees, low as 12c; grapevines 5c; shrubs 13c; evergreens 15c. Berries and plants. Catalog free. Benton County Nursery, Box 542, Rogers, Arkansas.

GROW Christmas trees. Ornamental landscape evergreens. Profitable. Quality planting stock at wholesale on quantity. Free list. Planting guide. Suncrest Evergreen Nurseries, Dept. PM, Johnstown, Penna.

FARMS, FARM LANDS, REAL ESTATE

FLORIDA Homesites, business sites and acreage in Potterfields Garden Acres. High dry land about 40 miles from Tampa and St. Petersburg close to wonderful hunting and fishing. Tracts as low as \$595.00, for three acres, only \$10.00 down, \$10.00 month. Information write G. B. Potterfield, Owner, Dept. V, Charleston, W. Va.

MAMMOTH Free listings Ozark properties. \$3 to \$100 per acre. Terms \$5 to \$35 monthly. Personal selections. Write Mr. Armstrong, Shook 34, Missouri.

SELLING Village homes like rent. Request list. Perry, Briarhill, Penna.

HOMESTEAD Land. New pamphlet on free government land. Send \$1.00. Chase Distributors, 4312 Home Ave., Berwyn, Ill.

WRITE For information about Public Lands Digest, Dept. 30, Box 361, T&C, Sacramento 21.

SAVE Money when you buy home or farm. Priceless information, only \$1. W. Wells, 323E 6th, Escondido, Calif.

STROUT'S Farm catalog. Farms, homes, businesses, 33 states, coast-to-coast. 3298 bargains described. Mailed free. World's largest; 53 years service. Strout Realty, 7-M So. Dearborn St., Chicago 3, Ill.

FLORIDA'S Choicest lakefront lots. Eustis-DeLand highway. \$10 monthly without interest. Free literature. Roepke, Eustis, Florida.

6 ROOM Bungalow, 12 acres, 2200 feet poultry houses, double garage, all conveniences, excellent condition, extras. Southern New Jersey. \$6900.00. Robert Einson, 441 W. Norris St., Philadelphia 22, Penna.

FLORIDA Gold coast quarter acre ranch type homesites, predevelopment sale. Act now. \$15 down and monthly, no interest, low homestead taxes, \$30,000 homes both sides. Box 722, Stuart, Fla.

FLORIDA, Central, lake-front subdivision near Tavares. Lots 10% down, \$25.00 month. Write John D. Rapalje, Box 792B, Tavares, Fla.

FLORIDA—New development adjoining Ocala National Forest in Lake County. Best fishing, hunting. Nice homesites \$245 at \$10 monthly. Folder free. Howard Vernor, DeLand, Florida.

\$5.00 PER Acre, Missouri land. Warranty deed. Free list. John Calvert, Plant City, Florida.

FARM-Ranch opportunities. Favorable conditions. Washington, Minnesota, Montana, Idaho, Oregon, North Dakota. Literature, farm descriptions. Specify which state. J. W. Haw, 119 Northern Pacific Rv., St. Paul 1, Minn.

\$5.00 MONTHLY Buys—5 acres; excellent fishing and hunting; good land. Price \$120.00. Free list. Box 425-P, Carthage, Mo.

FLORIDA—Beautiful retirement homesites near gulf coast. Excellent hunting, fishing in 9 fresh and salt water rivers, 11 bays and gulf. \$250 at \$10 monthly. Free literature. A. M. Mathews, Box 1406, Asheville, N. C.

HOMESITES \$400—Convenient payments. California's finest garden section. On Morro Bay's scenic shores. Wonderful fishing, boating, bathing. Fertile soil, softest water, temperate climate, congenial community. Free literature. Richard Otto, Department M, San Luis Obispo, Calif.

CALIFORNIA Ranch lands. 50c to \$5 acre minimum bid. Farm-ranch-hunt-fish-retire. 10c brings illustrated land catalog, outline maps. Tax Land Sales, Box 2350 BW, Hollywood 28, Calif.

FLORIDA Choice lakefront lots available. Best fishing, hunting. Terms. Grace Parker, Paisley, Florida.

POULTRY, FARM SUPPLIES

RAISE Turkeys the new way. Write for free information explaining how to make up to \$3000 in your own backyard. Address—National Turkey Institute, Dept. 3, Columbus, Kansas.

KNOW How to raise poultry for profit. Read Poultry Industry. Every issue packed with helpful hints and practical suggestions. Latest articles on breeding, feeding and management. Subscribe now, 1 year 50c, 3 years \$1.00. U. S. funds or checks payable at a New York or Boston bank. Poultry Industry, Dept. PM, 376 Boylston St., Boston 16, Mass.

POULTRY Farmers, broiler growers, turkey raisers read the new American Poultry Journal for latest ideas and greater profits. 12 months, 50c. Special offer, 4 years, \$1.00. American Poultry Journal, 182 North Wabash, Chicago.

PROFITABLE OCCUPATIONS

MUSHROOMS Grown boxes, barrels. Manureless process 50c. Spawn \$1.00. Gordons, 553 William, Winnipeg, Manitoba.

WELDING Pays big money. Learn easily at best equipped school in country. Non-profit school with low cost training. G.I. approved. Write Hobart Trade School, Box M-1232, Troy, Ohio.

\$1300.00 MONTHLY For truck drivers, \$1400.00 monthly for carpenters, electricians, plumbers, mechanics, \$1200.00 for clerks and laborers. Replacement hiring now being done. Full information and complete foreign listings, with current information on Spain job, \$1.00. Women's listings, \$1.00. 25,000 men and women needed for new stateside project! Complete information and other domestic listings, \$1.00. Dept. 3-L, Opportunities Unlimited, 1110 Commerce Bldg., St. Paul, Minn.

GUINEA Pigs. Home business. Booklet free. Taylors, B426A, Hapeville, Georgia.

\$400.00 PROFIT Per month possible for \$1.00 investment for one catalogue book and net wholesale sheet which consists of all household appliances, watches and jewelry. Get in on the bonanza deal for the Christmas rush. Extraordinary deal for all small businessmen. Frank's Wholesale House, 19-23 White St., Paterson, N. J.

ALASKAN Jobs! Over 150 new construction projects with names, addresses companies hiring. Thousands needed. Highest wages. Military, private construction, mining, fishing, lumbering, aviation, railroads, homesteading. Skilled, unskilled workers. Salary information. Alaskan map included. \$1.00 complete. Alaskan Opportunities (PM), Box 362, Kenmore, Washington.

\$40.00 WEEKLY, Made growing mushrooms. Dominion patent 331,583. Free spawn with order. North American, 169P Yonge, Toronto, Canada.

RAISE Chinchillas—Genuine South American (not rabbits). NCBA registered breeding stock. Mated pairs and singles. Future unlimited. Inquiries and visitors welcome. Mineral Springs Chinchilla Ranch, 48 Sodus St., Clyde 20, New York.

SELL Popular Mechanics and all other magazine subscriptions. Free catalog, supplies. Subscription Service Company, Dept. B, P.O. Box 2070, Birmingham, Alabama.

HOME Mail order beginners. 10,000 word instruction book, 25c. Carnahan Bros., 5582-A Nelson, Cypress, Calif.

FREE! "301 Profitable Small Businesses!" Amazing shoestring plans! Work home! Start sparetime! Deumant Surveys, Kenmore 23-R, N. Y.

JOB On ships and yachts, excellent pay. Foreign travel. Davenport's, Dept. 3, Box 1354, G.P.O., New York 1, N. Y.

FOREIGN Employment. Top pay. U. S. companies need personnel for foreign assignments. Now! For immediate valuable information, how to apply, application forms, etc., send \$1.00. Receive free with this offer "Opportunities in Booming Brazil." Worldwide Job News, Box 271, Temple City, California.

CONSTRUCTION Job list. Published monthly. \$1.00. Dempster's Construction Scout News, Dept. 268-SW, Bridgeport, Ill.

FOREIGN Jobs. Contracts underway and soon starting in Africa, South America, Canada, England, Europe, South Pacific, Middle East, Mexico and Alaska. Send \$1.00 for foreign job news, information, application forms, etc. DCS Foreign Job News, Dept. 268-SX, Bridgeport, Ill.

OVERSEAS Jobs. Big pay, transportation, expenses. Clerical, professional, mechanical workers. Most all trades. Latest listings airline, construction, manufacturing, oil, steamship companies, government agencies, many other opportunities. Up to date information on securing employment, contracts, income tax, application forms. \$1.00. Overseas Jobs, Box 335-A16, Baton Rouge, La.

CONFIDENTIAL Reports. Highest paying jobs in 28 countries, including United States, Alaska, South America, Europe, Middle East. Many average \$1450.00 monthly. Skilled, unskilled, laborers, trades, supervisory, clerical wanted. Only \$2, including one year registration-advisory service. Complete satisfaction guaranteed. National Services, Box 2954-PB, St. Louis 17, Missouri.

MAKE Rhinestone costume jewelry. Over 100% profit. Wholesale catalog plus instructions 20c. Bergen Arts, 128M Main Street, Hackensack, N. J.

"**HOW** To Make Money With Simple Cartoons"—A book everyone who likes to draw should have. It is free; no obligation. Simply address Cartoonists' Exchange, Dept. 912CP, Pleasant Hill, Ohio.

FOREIGN And Alaska latest list contractors openings \$1. Quinn, 1218 South Clayton, Denver, Colo.

\$10,800 PROFITS! Your own mailorder business! No risk! Success plan free! Treasury, 709 Webster, New Rochelle L-18, N. Y.

WANT A diesel job? New opportunities to increase income. Higher pay. More money. We can help you qualify. Tools. Shop method home training. Write today! Diesel, Tractor, Heavy Equipment Division, Interstate Training Service, Dept. B3N, Portland 13, Oregon.

SEND For big, new 1953 illustrated catalog that will show you how to turn your spare time into cash—making quick-selling, highly profitable lamps. Every home a prospect. Hundreds doing it, you can, too. No experience or special tools required. Catalog No. 7 contains 56 pages filled with shades, shade frames, figurines and bases, oil lamp converters, boring compound, and dozens of similar items. Also all kinds of sockets, cords, pipes, harps, finials, bases, and hundreds of other parts—everything you need. Special 8-page section shows 6 beautiful lamps in kit form, ready to assemble. You buy wholesale, sell at retail. Make big profits. Send 25c today for new 1953 catalog and wholesale price list, you'll be glad you did. The 25c will be refunded on your first order. Gearon Co., Dept. 500-B12, 27 S. Desplaines, Chicago 6, Ill.

FOREIGN And domestic jobs. Up to \$12,000. Alaska, South America, Central America, Far East, U. S. Where-how to apply. Latest listings world-wide jobs, red hot. "Foreign Opportunity Directory" gives civilian and defense construction, oil companies, aviation, transportation, mining, steamship companies, employment agencies. All kinds of workers needed. Application blank included with directory. \$1.00 postpaid, (c.o.d. \$1.87), air mail \$2.00. Alaska special job list \$1.00 postpaid. Specify listing. Foreign Opportunities, Waseca, PM2, Minn.

SECRET Investigation. Experience unnecessary. Investigators particulars free. George Wagoner, 125M West 86th, New York 24.

MEN Earn \$1,500.00 per month on foreign projects. (See Reader's Digest, December 1952 issue, page 21.) Men wanted now on foreign, Latin America and far north projects. Truck drivers, \$3.55 hour. Clerks, \$3.00 hour. Electricians, \$4.00 hour. Carpenters, \$3.70 hour. Laborers, \$3.00 hour. Most all trades wanted. Up to 70 hours week with time and one half for all over 40 hours. Transportation paid. 8 to 24 month contract. New treaty with Spain, South Korea will start new bases at once. Get in on start. Full information of over 20 sheets 9½x11 listing over 200 firms now hiring, conditions, wages, hours, contract requirements, application form, etc., also latest issue of our monthly bulletin listing new contracts and coupon worth \$1.00 on subscription. All for \$1.00. Airmail \$1.24. Edward O. Burns, 911 N. Lancaster Avenue, Dept. 6, Dallas, Texas.

GENUINE Leather wallets easily made. Experience, tools unnecessary. Kit \$1.00. Miles Crafts, 3220P Fish Avenue, New York 69, New York.

PARTNERSHIPS—Don't lose your shirt getting into or getting out of a business partnership. Our copyrighted booklet may save you. Write for particulars. Fox Business Publications, Box 1265-A, Peoria, Ill.

CASH In on coming income tax boom. Learn how to prepare tax returns. Experience unnecessary. Write Union Institute, Lakewood 2-F, N. J.

GLITTERBIRDS Make beautiful Christmas decorations, favors! Kit 25c. Sell completed glitterbirds for \$1.00. Miles Crafts, 3220P Fish Avenue, New York 69, N. Y.

ALASKA Directory—Jobs. High wages. Labor \$2.95 hr., plumbers \$4.00, carpenters \$3.34, truck drivers \$3.37, etc. Homestead facts. Job list. Application blank with directory. \$1.00 postpaid. "Foreign Opportunity Directory." Foreign job list. \$1.00 postpaid, c.o.d. \$1.87, air mail \$2.00. Specify listing. Alaskan Opportunities, Waseca, Minn.

JOBS In Florida—Florida needs you. You can live and work on Florida's fabulous gold coast. Hundreds of interesting, good paying jobs now open. Skilled and unskilled workers badly needed. For complete information send your name, address and \$1 to Florida Personnel Institute, Box 2058, Miami 12, Florida.

\$500,000 BY Mail from home. Free folder. Publicity, Kalamazoo, 65DA, Mich.

BUY Wholesale thousands nationally advertised products at big discount. Free "Wholesale Plan." American Buyers', 628-R Linden, Buffalo, N. Y.

GOOD Paying part time business resilvering mirrors. E-Z method formula \$1.00. Glasscrafters, Dept. 1, 2866 E. 79 St., Chicago 49, Ill.

RAISE Pheasants on \$100 week plan. Little capital and space can make you independent. Free details. Great Central System, Columbus 1, Kansas.

FOREIGN And Latin American employment. 1953 "Foreign Service Directory" gives up-to-minute facts on military and civilian construction, government jobs, major oil listings, aviation, transportation, steamship lines, mining, importers, exporters, how-when-where to apply, application forms, hot list firms hiring. \$1.00 postpaid. Global Reports, Box 883-P, Hollywood 28, Calif.

GROW Mushrooms. Cellar, shed, and outdoors. Spare, full time, year round. We pay \$3.50 lb. We paid Babbitt \$4,165 in few weeks. Free book. Washington Mushroom Ind., Dept. 99, 2954 Admiral Way, Seattle, Wash.

MAKE Flexible molds! Cast plaques, bookends, figurines! Free sample! H. Tooker, 630-M Chestnut, Hamilton, Ohio.

FREE Book "505 Odd, Successful Businesses." Work home. Expect something odd! Pacific, Oceanside, Calif.

ALASKA! Last American frontier. \$1.00 brings 1953 business directory and government map. Military and civilian construction; homestead and highway facts; mining, aviation, fur farming, grazing, timber, travel directions. List of firms hiring. How to apply. Alaska Opportunist, Box 92-P, Hollywood 28, Calif.

BE The Popular Mechanics representative in your neighborhood and earn big profits in your spare time. Write Popular Mechanics Magazine, Room 408M, 200 E. Ontario St., Chicago, Ill.

BUY Wholesale thousands nationally advertised products. Save money! Make money! Postcard brings details. Kemah Company, 5017-J Washington, Houston 7, Texas.

FOREIGN Employment construction work. If interested in foreign projects with high pay write Foreign Service Bureau, (Dept. P.M.), Metuchen, New Jersey.

EVERYBODY Likes candy. Learn to make professionally. Our 43rd year. Ragsdale Candies, D6, East Orange, New Jersey.

BOOKS, PERIODICALS, PICTURES, POSTCARDS

GERMANY Export-import-industrial directory, 65,000 addresses. English index \$9.00 postpaid. Burke Associates, Manchester 1, Mass.

HUNDREDS Of valuable free publications: Building, Farming, Hobbies, Sports, Health, Foods, Gardening, Travel, Education, Industry, Pets, Trades. Details: Universal Guide to Free Literature, Box 971A, Escondido, California.

BOOKS. All subjects! Promptly supplied! Plymouth, Box 365-I, Far Rockaway, N. Y.

SHORT Method arithmetic, 125 pages, 50c; Master Mechanic home study course 50c. Stein's, 526 So. State, Chicago 5, Ill.

BOOKS Found! Any author, old or new. Rush titles wanted; no obligation. International Bookfinders, Box 3003-PM, Beverly Hills, California.

CYCLEGRAM 64-Page \$1 book teaches science of life cycles. Sample 50c. Cyclegram, Box 301, South Pasadena, Calif.

BOOKHUNTERS! Scarce, unusual, miscellaneous books supplied. Atlantic Book Service, Lawrence Avenue, Charlestown 29, Massachusetts.

FREE Catalogue. Special interesting books. Powers, 1324 Wilshire, Hollywood 17, California.

BIG Catalogue; 1500 bargains, send 10c. Books, 3100 Ocean Parkway, Brooklyn 35.

NATIONAL Geographic Magazines, 1888-1952. Periodical Service, Box 465-PM, Wilmington, Delaware.

BOOKHUNTERS! All subjects. Send wants! Jaher Book Service, 620-P East 178 Street, New York 57.

MAGIC TRICKS, PUZZLES, JOKER NOVELTIES

FREE Catalog. Best magic. Practical jokes. Top Hat Magic, Evanston, Illinois.

200 ELECTRIC Stunts, 110 volts, \$1.00. Kutting Sons, Los Altos, Calif.

NEW Trick. Do immediately after purchase. 55c. Keller, Box 686, Jamaica 31, New York.

WOODEN Nickel, catalog, trick, 25c. Fun'n Magic, 423-P North St. Marys, San Antonio, Texas.

NEW Magic catalogue and magic circulars 10c. New joke lists 5c. Magic Factory, Minneapolis 2, Minn.

LEARN Magic! New simplified instructions. \$2.00. Gateway Press, 414 Second Ave., So. Clinton, Iowa.

REAR View mirror attachment for glasses. \$1.00 post paid. Starling Co., 2206M Starling Ave., New York City 62.

EASY Professional magic for beginners. Amazing trick and illustrated catalogue 35c. Kaye Enterprises, PM-7, Box 8084, Newark, N. J.

"VENTRILQUIISM Selftaught"—Complete book 25c. Greenview, Box 61-BC, Whitestone 57, New York.

JUMBO Catalogue! Tricks! Magic! Fun-makers! 10c. Rick's, Box P260, Chicago 26.

YOU Win! Exciting new pocket size game of skill for checker, chess and game players. Play one opponent or more at once! Key moves enable you to win every time! Amazes! Astounds! People call you a wizard! Send only \$1.00. Aaron's, 10742 So. Michigan, Chicago 28, Illinois.

WE Supply every noted magician. Large professional catalog \$1.25. Holden's, 120 Boylston Street, Boston, Mass.

500 TRICKS, Douglas famous 120-page catalog, only 10c. Fastest service to magicians for 30 years. Send 10c today. Douglas Magicland, Dept. 1, Dallas, Texas.

2500 TRICK Catalogue (512-pages), pocket, parlor, stage. World's finest magic. Catalogue \$2.00 (dollar trick included free). Kanter's, M-1311 Walnut, Philadelphia 7.

224 CATALOG, Magic, illusions, sensational escapes, spiritualism. Also big mystery book. Illustrated, prepaid. Send one dollar. Heaney Magical Co., Oshkosh, Wisconsin.

VENTRILQUIISM Selftaught. My quick, easy instructions, 25c. Ventriloquist, CalAllen, Texas.

90 PAGE Novelty-magic catalog with novelty, 25c. Allen, Dept. PMT, Clinton, Missouri.

PROFESSIONAL Catalog, 175 pages, 25c. Williams, 900 Plymouth, Ellwood City, Penna.

ENTERTAIN With magic—Hobby or profession. Write Marsh's, 237 W. 11th, Columbus, Ohio.

BIG Fun kit! Tricks, jokes, novelties, books. Real gay stuff. Howls galore. \$1.00. Johnson, 414 McRae, Wilmington, N. C.

STAMP COLLECTING

FREE 50 Different with approvals. Sue's Stamps, Box 31, Toledo 14, Ohio.

SEND For bargain worldwide approvals. Free set. Mange, Box 6, Hanover, Penna.

FREE Illustrated folder—Stamps, albums, accessories. S. Billey, Castle Rock, Minnesota.

FREE Russia, 596 mint catalog 50c to approval applicants. Reilly's Stamps, 3107 E. 26th St., Los Angeles 23, Calif.

FREE! Obsolete U.S. occupation set. To approval applicants only. Riedell, Greensburg, Penna.

FIFTY Different Spain 5c with approvals. Ione Peterson, Route One, Fulton, N. Y.

FREE! Scotts International Albums, Parts 1, 2, or 3. To regular customers foreign approvals. Hal Buck, 935 Waterloo Road, Stockton, California.

INDONESIA Famous American bicolored, complete. Only 10c. Approvals. Welles, Box 1246-R, Church Street Station, New York City 8.

PHANTOM Plane airmails, genuine flown copies from French West Africa (C12-14) handsome, mammoth stamps, with high catalog value, plus packet stamps from 50 different countries. All for 25c! Interesting approvals. Modern Stamp Co., Dept. A-3, Ferrysburg, Michigan.

100 DIFFERENT Air mail 40c. Ask for mammoth packet list free. Econopackets, Box 168, Riverside 9, Calif.

1,000 STAMPS For you to look at—Big, attractive approval books of beautiful stamps. Pick and choose to suit yourself, at 1c to 5c each! Let us show you the economical way to a large, worthwhile collection. Wolverine Stamp Service, Dept. C-3, Fruitport, Mich.

TRIANGLES, Airmails, bicolored, U.S.A. stamp centenary, Columbus, Trieste, Garibaldi, fortresses, large historical pictorials, 3c to approval buyers. Fortune Stamp Company, PMM-1, Washington 10, D. C.

INDONESIA—10 Mint bicolored dazzling pictorials. Just 5c to introduce our famous approvals. Viking, 11-Z Northern Blvd., Great Neck, N. Y.

U. S. Approvals, mint, used! Square Deal Teal, 663 Beach, Rochester 12, N. Y.

CIPEX Souvenir sheet plus 25 different U.S., 10c. Approvals accompany. Village Stamps, 90-39P 214 St., Queens Village 28, N. Y.

FINEST U.S. mixture \$1.25 pound. Haggard, 2616 Normandy, Mishawaka, Ind.

FREE Scott catalog and other premiums. Approval applicants write for details. Newton Schrodt, Box 92, Sullivan, Illinois.

51 DIFFERENT From 51 countries, 10 cents. Schmidlin, Dept. PM, Russiaville, Indiana.

UNITED States approvals. Used. Mint. Vic's Stamps, 7026 East SanMarcus, Compton, California.

111 STAMPS From 111 countries \$1.11. John Bosse, 536 Rush St., Chicago 11, Ill.

FINE Foreign stamps on approval. Laddy, Evanston Bldg., Minneapolis 2, Minn.

UNUSUAL Stamp packet! Only 10c with approvals. Plymouth, Box 365-J, Far Rockaway, N. Y.

COMMEMORATIVES—25 Different U.S. commemoratives 25c with approvals. Amster, 1714 East 7th Street, Brooklyn, N. Y.

EXCHANGE Your duplicate stamps. Send 100-200 different foreign and dime. Receive all different. Patterson, 5622 Broadway, Lancaster 14, New York.

\$5.00 CATALOGUE Value stamps only 50c. Norge Company, Ho-Ho-Kus, N. J.

85 DIFFERENT Portugal and bargain list of 700 collections by countries 25c. Gandy Company, St. Albans 12, N. Y.

ITALY—100 Different 10c with approvals. DeRespini, G.P.O. Box 771P, New York 1.

U.S. Mint specials! 1934 national parks, complete \$1.50; flags, complete \$1.00. Price list free. Brooks, 2352 East 23rd Street, Brooklyn 29, N. Y.

67 DIFFERENT U.S. stamps 10c with approvals. Oehlmen, Hebron, Indiana.

50 DIFF. Uruguay for 10c to approval applicants. Elco Stamp Co., 682 Pearl St., Benton Harbor, Mich.

AUSTRIA—Packets, sets, singles. Lists 10c. H. E. Faville, Box 2005, Madison 5, Wis.

FREE, 4 Germany pictorial sets. Approvals. Pleasure Stamps, 1865P—52nd, Brooklyn 4, N. Y.

FREE! Surprise packet to approval applicants. Pioneer, Box 414, Pasadena 18, Calif.

FREE Gift. Bargain approvals included. Cavanagh, 4410 Banner, Long Beach, Calif.

SAVE 50% On stamps. Send \$1.00 for trial offer. Receive 100 stamps free. Shere's Stamp Supply, Byron, Illinois.

MOZAMBIQUE, Latest, beautifully colored fishes, butterflies, (10 mint stamps) given approval buyers. William Deems, Ravenswood, West Virginia.

U. S. Foreign stamps, coins. Free lists. Slikes, 1831 E. Allegheny, Philadelphia 34, Penna.

CANADA Plate blocks. Send dollar for five blocks. Helen Parr, 75 Young, Hamilton, Canada.

FINE Foreign approvals. Europe, French Colonies, British Colonies, Latin, American. Frank Moret, 1001A Sidney, St. Louis 4, Mo.

MAGNIFICENT Lot! Includes stamps of flowers, butterflies, animals, triangles, fishes, waterfalls, etc. Everything 10c with approvals. Wilvanan Stamps, Box 472, Slatersville, R. I.

SENSATIONAL! Set each Honduras, Martinique, Guadeloupe, Guiana, also \$2,000,000 stamp. Brunei, over 100 different others. Everything 10c with approvals. Whitehead, 315P South 5th Ave., Canton, Illinois.

50,000 STAMP Grabbags 25c each. Anderson, 630B Bingaman, Reading, Penna.

FREE Complete set of famous Americans, flags, parks and presidentials to approval buyers. Send 3c for 15 of the above stamps plus full particulars. Triboro Stamp Company, 145 Nassau Street, Dept. 112, New York 38, N. Y.

300 DIFFERENT Given free with approvals. Particulars. Windsor Stamps, 8834 So. Cornell Ave., Chicago 17.

299 DIFFERENT Worldwide stamps 25c, plus Hitler heads, British Colonies and attractive stamps on foreign cover. Everything complete 25c to adults requesting approvals. Canada Stamp Co., 1907 Main St., Dept. 118, Niagara Falls, New York.

SPECIAL! Nudes collection; approvals—5c. Atlas, 2830-M Eisenhower, Racine, Wis.

FREE. 5 Hungry triangles. Approvals. Wiley, 3280 Cherry, Beaumont, Texas.

FREE! \$1. Pack with each purchase. Details 10c. Moore, Box 1782, Los Angeles 53.

PENNY Approvals that satisfy. Robert Moed, 245 Kosciusko St., Brooklyn 21, N. Y.

15 GORGEOUS Large U.S. commemoratives for just 3c postage. Approvals. Lou Allmendinger, Warner, N. H.

FINE Approvals. Fast, personal service. What countries do you prefer? I'll send their stamps. Skinner, 438 Locust, Long Beach 12, California.

130 DIFFERENT United States commemoratives—\$1 with fine approvals. Goodman, Box 133, Bloomfield, New Jersey.

2000 DIFFERENT; World \$2.75; 3000, \$5.00; 5000, \$10.50; 10,000 mounted \$39.90. Albert Ptacek, Route 1-P, Ottawa, Illinois.

SENSATIONAL—Twenty-five different colorful pictorial complete sets plus desirable bonus packet, everything only 20c, bargainful approvals accompany. Dresel, Box 270-H, New York 25, N. Y.

QUEEN Elizabeth coronation mint 10c. Dolins, 31 Park Row, New York City 38.

FREE 119 Foreign stamps including Africa, Australia, Pakistan, China, India, Russia and Scandinavia. Send 10c for postage and handling. With approvals. Niagara Stamp Co., Niagara-on-the-Lake 81, Canada.

FREE! 3 Hungary diamond stamps, plus 3 Sanmarino triangles, to new approval applicants. Moulblow, Box 278D, East Northport, N. Y.

25 DIFFERENT Japan free to approval applicants. Collier, Box 4243, Atlanta 2, Ga.

15 GIANT Stamps dime with approvals. Free premiums. Heritage Hobbies, 52½ Balmforth, Danbury, Conn.

65 ALL Different U. S. stamps. Includes 5 year olds, commemoratives, airmails and \$5.00 stamp. Only 10c. Approvals. Willett Co., Box 511-L, Port Chester, New York.

HANDSOME New Zealand 1943 Elizabeth and Margaret Rose triangles only 10c to approval applicants. George Richie, 1539 Sixth, Alameda, Calif.

50 DIFFERENT Worldwide 3c! Approvals. Vinny Jo, Box 3062, Seattle 14, Wash.

EIGHT Beautiful mint sets 12c. Approvals. Burgett Stamps, Lima, Ohio.

SPAIN, 100 Different, 10c to approval applicants. Morrel, 203 Fenimore St., Brooklyn 25, N. Y.

20,000 DIFFERENT World, \$195.00; 10,000, \$47.00; 5000, \$15.00; 3000, \$6.00; 2000, \$3.00. Gould's, Box 631, San Francisco 1, Calif.

PREMIUM Packet 10c with bargain priced approvals. Websters, Jamesburg, N. J.

OLD U. S. mixture 10c. Price list. Rothberg, X123PM, Braintree 84, Mass.

OLD U. S. on approval. Low prices. MacG., 2905 Observatory, Cincinnati 8, Ohio.

FOREIGN Unhinged approvals at lowest possible prices. We pay all postage. LaLiberte, Box 724, Brockton, Mass.

50 BRITISH Empire—All different, plus illustrated book "How to Recognize Rare Stamps." Only 10c with approvals. Kenmore, Milford G-8, N. H.

BIRDS, Butterflies, flowers—25 different 25c, with approvals. Southwest Stamps, Box 117, Long Beach 1, Calif.

500 STAMPS, All different, 50c. Edd. Stoka, 10511 S. Peoria St., Chicago 43, Ill.

GIVEN Free U. S. \$1.00 presidential plus German peace issues. Approvals. Write Bala Stamps, Bala-Cynwyd, Penna.

BETTER Grade U.S. or foreign approvals. Ocean Stamp Co., Box 64-M, Brooklyn 29, N. Y.

FISHERMAN'S Treasure set of lovely mint Mozambique stamps. Each with tropical fish in brilliant natural colors. Only 5c. Approvals. Hathaway, Box 145PM, Garden City, N. Y.

U. S. And Confederate states price list free. Stone, 45 Bromfield, Boston 8, Mass.

GIGANTIC Collection free. Includes triangles, early United States, animals, commemoratives, British Colonies, high value pictorials, etc. Complete collection plus big illustrated magazine all free. Send 5c for postage. Gray Stamp Company, Dept. PM, Toronto, Canada.

100 DIFFERENT France 10c. Approvals. Aronson, 91 Marion, Brookline 46, Mass.

WORLD Wide, all different, 100, 10c; 500, 75c; 1000, \$1.75; 2000, \$3.25; 5000, \$13.75. Philatelic House, Rockville Centre N. Y.

FREE Triangles with approvals. Philatelic House, Rockville Centre, N. Y.

DEALERS: Sales guaranteed; display packets; samples \$2.00. S. Penniston, Norborne, Missouri.

LION Triangle, 28 others, 3c. K & S, 303 Clinton Ave., Newark, N. J.

WOW! 7972 Different worldwide stamps from 36 stamp companies with approvals \$3.00. Names 1000 stamp collectors \$5.00. King, 32 Alexander, Kamloops, B.C., Can.

SPECIAL 100 Different Switzerland 25c with approvals. Ward, 241 South Winchester, Campbell, Calif.

5 TRIANGLES 2c With approvals. Choice Stampco, Box 424, Miami 3, Fla.

TEN Beautiful Croatian stamps 10c with approvals. Denney, 2118 Dublin Road, Oklahoma City 14, Oklahoma.

1000 FINE Mixed U. S. stamps 25c. Wright, 723 Washington, Hagerstown, Md.

500 MIXED U. S. 25c; 1000, 40c; 50 different, 10c; 50 different commemoratives, 25c. Brookside Stamps, Box 133, Mendon, Mass.

TWO Mint U. S. plate blocks only 25c with approvals. Wern, 333 N. Michigan, Chicago 1, Illinois.

BAHAMAS 132-34 Mint, 5c. Approvals. Illustrated price lists. Norbert W. Payne, Box 227, Orchard Park, New York.

WONDERFUL Offer — 7 complete mint sets only 10c with approvals. Reich (M26), 1033 Lawrence, Chicago 40.

FREE! Unique illustrated bargain catalog of mixtures, packets, accessories. Many pages, values galore for any collector! Latest releases! No approvals. Tower, 1630 West Melrose, Chicago 13.

BRITISH Colonies, cat. value \$10.00, \$1.00. Approvals. Gannon, 703 E. Artesia, Long Beach 5, Calif.

START Your own stamp business. Send for free circular. Donald Shepard, Box 1147, Chicago.

100 DIFFERENT World 10c. Free gift. Bellet, Mapledale, Hazel Park, Mich.

UNBEATABLE! Nauru, Brunei, Ceyman, Nyasaland, Liberia, Sarawak, Borneo, over 100 different. Everything 10c with approvals. Albert Ptacek, Route 1-P, Ottawa, Illinois.

50 DIFFERENT U. S. commemoratives 25c. Durham, 1021 N. Granger St., Saginaw, Michigan.

312 MIXED U. S. only 10c to "Gold Nugget" approval applicants! Nothing like them. Kessel's, Folsom, California.

APPROVALS? U. S. or foreign? Mint? Used? Hotchkiss Stamps, Montpelier, Vermont.

ALBUM! Capacity over 1,000 stamps! Only 10c! Stampmart, Hartford 1, Conn.

CANADA—100 Different, 25c with approvals. Crown Stamps, Box 331, Toronto, Canada.

BIG New U. S. catalog—Only 10c! Published by world's largest stamp firm. Completely illustrated. Bargain lists and approvals included. Harrisco, 202 Transit Bldg., Boston 17, Mass.

ALBUM, 100 Diff. stamps, 3 premiums, 20c. Smithco, Northeast, Box 6618, Kansas City 23, Mo.

WORLDWIDE Stamp mixture, 5 ounce package, \$1.25. Veteran Frank Stroskey, 223 Market St., Perth Amboy, New Jersey.

ZOUNDS! Exciting strange countries packet. Free with approvals! Saxon, Vista, California.

DIFFERENT 500, 35c; 1000, \$1.00; 2000, \$2.75; 5000, \$11.00. with approvals at wholesale to clear. K. S. Holmes, London, Canada.

96 PAGE Illustrated U. S. price list. Send 10c, cost of mailing. DeLisle, 154 S. Second St., San Jose, Calif.

850 MIXED U. S. old, new, 25c. Lists. Weatherby, Medina, Ohio.

AMAZING Offer! 200 United States stamps—including commemoratives, airmails, high denominations to \$1.00. Only 10c to approval applicants! Illustrated bargain lists free. Mystic Stamp Co., Dept. 80, Camden, New York.

GERMANY Colonies, offices, states. Mostly 1/2-1/5 catalogue. Twelve page list 3c. Myers, VanZandt, Little Neck, N. Y.

BARGAINS Galore. Low priced approvals. Schur, Box 245, Buffalo 12, N. Y.

225 STAMPS For only 10c! This mammoth value includes airmails, pictorials; stamps from strange countries cataloguing up to 25c each! Also approvals. Mystic Stamp Company, Camden 80, New York.

1000 MIXED United States. Guarantee over 140 different stamps. \$1.10 insured. Quaintance, Box 178F, Upper Sandusky, Ohio.

50 DIFFERENT Argentine 10c. Approvals. Reuter, 611 W. 40th Pl., Los Angeles 37.

WOW! 203 All different Germany 15c. Zeppelins, semi-postals, airmails, high values. Big bargain lists and approvals included. Jamestown Stamp, Dept. 512, Jamestown, N. Y.

FREE To approval applicants—Israeli, British, French Colonies, Latin American. U. S. packet. Hobbies, 1463 Drexel, Miami Beach 39, Florida.

UNITED States approvals. Select copies. Used, mint. Kingsbury, So. Woodbury 2, Vermont.

100 DIFFERENT Spain 25c. Penny approvals included. Reed, Box 980, Chicago 90, Ill.

FREE! Powerful magnifying glass for 5c post. Bargain lists and approvals. Jamestown Stamp Co., Dept. 207, Jamestown, New York.

200 DIFFERENT Including Roosevelt triangle, 5c to approval applicants. M. Avalon Stamp Company, Springfield, Mass.

STAMPS Wanted. Collections, duplicates, surplus stock, mint and used. Good grades only. Buy outright if bargain. What have you? Write us details. Vanroy Shirk, Lebanon, Penna.

WORLD'S Largest stamp (7½x14 inches). A real curiosity! Retail for 50c, only 3c to approval applicants. Tatham Stamp Co., Springfield 30, Mass.

OLD Scarce U.S. seconds on approvals. Slight imperfections, lowest prices. Hernefield, Clintonhill Sta., Newark 8, N. J.

UNITED States—40 different 10c; 40 different commemoratives 25c. No approvals. Seidenberg, Applieton 944, Wis.

FREE. Scott's International Album, other premiums. Details with approvals. Raymax, 35-Z Maiden Lane, New York City.

FREE. Valuable mystery gift. Approvals. Raymax, 37-Z Maiden Lane, New York City.

UNITED States—58 different including 8 airmails, 15 commemoratives, 10c. Approvals. Sunset, Box 47, South Gate, Calif.

PENNY Approvals by country. M. H. Hoerning, 15, Farmington, Ark.

27 HITLER Stamps from five Nazi-dominated countries. Historically valuable collection only 5c. Request approvals. Gulfstream, "PM" Hillsdale, N. J.

60,000 DIFFERENT — On approval! Books, world-wide. Cole, 43-A Rinewalt, Buffalo 21, N. Y.

OPPORTUNITY, Gorgeous lot with triangles, giants, midgets, flags, airmail and railroad stamps. Also Brunei, Mongolia, Sarawak, etc. Everything only 10c to approval applicants. Evden, Valley Stream 12, N. Y.

AUSTRALIA, 47 All different 10c. Anderson, Box 45, Seaside Heights, N. J.

TRADE Your extra stamps. Join our stamp club. \$1.00 for two years. Free information. Valley Stamps, Box 87, New Cuyama, Calif.

500 MIXED U.S., 10c. List. Blanchard, Box 307, Medina, Ohio.

COLORFUL Surprise 10c; special offers, U.S., foreign, approvals. Bristol Stamps, Collinsville, Conn.

500 MIXED Stamps and surprise packet for 10c with approvals. Fahsing, Dept. PM, Atascadero, California.

PACKETS. World different 2,000, \$3.00; 3,000, \$6.00; 5,000, \$15.00; 10,000, \$47.00; 20,000, \$200.00; 30,000, \$610.00; 40,000, \$1,220.00; 50,000, \$2,180.00; 60,000, \$4,220.00; 70,000, \$8,040.00; 80,000, \$12,360.00. Russell Smoky Mountain, Box 2011D, Natural Bridge Station, St. Louis 15, Mo.

327 DIFFERENT Stamps 25c! Including early Canada, Newfoundland, British Colonies, Vatican, Red Russia, Hitler heads, Indian states, animals, airmails, French Colonies, rarities, unusuals. Every stamp different. Rare bargain with approvals. Money back guarantee. Niagara Stamp Co., Niagara-on-the-Lake 61, Canada.

25 DIFFERENT British Colonies 10c. Completely illustrated folders. Many free sets for customers. Stoll Stamp Service, 2632 Burnett, Louisville 10, Ky.

COLOSSAL Stamp zoo 10c. Jungle beasts, wildlife, domestic animals—Fifteen different, including rhinoceros, elephant, snake, tiger, zabu, kangaroo, koalabear, emu, kookabura, bull, horse. Extraordinary accompanying approvals. Niagara Stamp Company, Niagara-on-the-Lake 51, Can.

NEW Zealand triangles. Queen Elizabeth. 10c with approvals. Seminole Stamps, Box 1138-P, Coral Gables 34, Florida.

COINS, TOKENS, CURRENCY

TWENTY Different Liberty head half dollars, \$19.50. U. S. price list 10c. Johnson's, 644 E. Valerio, Santa Barbara 3, Calif.

WANTED—United States \$50, \$4; 1815, 1819, 1822. \$5 gold pieces. Mail it in. State your price. Marcell's, 4520 University Ave., San Diego 5, Calif.

GOLD U.S. coins bought 50% above face value. Baevitz, 229-04 Hillside Ave., Bellerose, N. Y.

LARGE Cent over 100 years old, plus flying eagle cent, only \$1.00. Rhodoco, 105 Windsor, Reading, Penna.

105 DIFFERENT Foreign bills—\$1.00. Free list. Dwight Musser, Dunbar, West Virginia.

OLD Money wanted. Will pay \$100.00 for 1894 dime, S. mint. \$50.00 for 1913 liberty head nickel (not buffalo). Big premiums paid for all rare coins. Send 4c for large coin folder. May mean much profit to you. Numismatic Co., Dept. 20, Fort Worth, Texas.

J. S. Large cents, 2 different, \$1. Half dimes, 2 different, \$1. Delmaco, Box 1123, Wilmington, Del.

FOREIGN Coins 10 different 25c. Foreign bills 10 different 15c. Lists. Oliver Arnold, Macon, Missouri.

WHAT Are your coins worth? Amazing Fell's new 1953 United States coin book. Everything on every single coin minted—Worth, value, how to sell, speculating, investment; other valuable facts. Cloth-bound. 150 illustrations. Send no money. Pay postman only \$1.50 (plus postage) or \$1.50 postpaid (refundable). Order now! Fell Publishers, 386-U 212 4th Ave., New York City 16.

\$15 PAID For 89 Lincoln cents. Details free. Macon Coin Co., Box 44, Macon, Mo.

\$1,000.00 NOTE Only \$1.00. 100 page illustrated catalogue 25c. Shultz, Salt Lake 10, Utah.

FREE! Foreign coin, banknote and coin collectors illustrated catalog to approval service applicants. Send 3c postage. Tatham Coinco, Springfield 30, Mass.

COIN Collector's Magazine. Largest independent, over 1000 pages per year. Sample copy 30c; \$3.00 per year. Hewitt, 7320-J Milwaukee Ave., Chicago 31.

INDIAN Cent with bargain lists 10c. Hutchinson, 3463 "I" Street, Philadelphia 34, Penna.

SCARCE 1931-S cent only \$1.25; ancient Roman coin \$1.00; Whitman coin albums, three for \$1.00 postpaid. Ben's Coin Shop, 31 North Clark, Chicago 2.

GET Profit and pleasure in collecting old coins. Send 10c for 56 page illustrated coin catalog. You'll be delighted with it. Send for it now. B. Max Mehl, 370 Mehl Bldg., Fort Worth, Texas. Largest rare coin establishment in U. S. Established 53 years.

66 COINS And bills \$1.00. Oddehon, Box 482, St. Louis, Mo.

WORLD'S Greatest magazine for coin collectors and wooden nickel 10c. Lawrence Brothers, Anamosa, Iowa.

WANTED—1894-S dime pay \$500.00. Certain 1913 nickel \$1,000.00. 1901-S quarter \$20.00 to \$150.00. Hundreds of others. Know their true value. Complete illustrated catalogue 25c. Worthycoin Corporation, (D-325), Boston 8, Mass.

ANTIQUES, RELICS, INDIAN GOODS, CURIOS

GENUINE Horseshoe \$1; 6, \$5. Hagler, 2838 Sharon, Dallas 8, Tex.

ARROWHEADS. Location given, four \$1.00; 24, \$5.00. Bird points, two \$1.00; dozen, \$5.00. Book-relic catalog 10c. Tilton Relics, Topeka 51, Kansas.

PROCRASTINATING?—Am selling several hundred historical firearms. 30,000 prehistoric relics, collectors cartridges, coins. Revolutionary, Confederate, Civil War flintlocks, muskatoons, revolvers, blunderbusses, Winchester, carbines, buffalo rifles, pepperboxes, Kentuckies, frontiers, 400 bayonets, swords, bullet molds, ramrods, gun parts. Powderhorns. Blo-horns, bo-wood, deer-steer-buffalo horns. Arrowheads, tomahawks, hammerstones, spearheads, dauguerrotypes, violin wood, agates, minerals, fossils, gold dollars. Catalog profusely illustrated, 35c. Heike, (Cabin-creek), Wenona, Illinois.

6 EXTRA Fine bird arrowheads \$2.00. 4 fine Indian arrowheads. \$1.00. Good grooved tomahawk \$2.00. List free. Lear's, Glenwood, Arkansas.

ANTIQUA Firearms, pistols, percussion flintlock, list 25c. Westbrook, 738 Royal St., New Orleans, La.

4 PERFECT Arrowheads \$1.00. Flint knife 50c. Hide scraper 50c. Stone axe \$3.00. Perfect pipe \$3.00. Flint hoe \$1.00. List 10c. H. Daniel, Lamar, Arkansas.

4 SELECTED Arrowheads \$1.00. List 5c. H. Talburt, Calico Rock, Ark.

PRECIOUS STONES, MINERALS

INDUSTRIAL Mineral prospecting pays big when you hit! Free instructions. Stratex Instruments, 1861E Hillhurst, Los Angeles 27.

LAPIDARIANS. Uncut gem materials. Agate, agatized wood, jasper, moonstone, opal, petrified wood. Mixed assortment \$1.00 per pound. Merlin Hayes, Jackson, Wyoming.

ALUMAG Gems! The world's most beautiful synthetic gemstone. Bluewhite, 58 facets, hand cut and polished. Harder than Zircon or Rutile. \$12.00 carat. Satisfaction or full refund. Rogers Jewelers, 291 Grant, Buffalo, N. Y.

GENUINE Rough white diamonds, mined South Africa; (for experimental settings, tools); 50-150 stones weighing one carat \$8.90; 1/2 carat \$4.90. Postpaid on receipt check, money order. Quotations furnished other sizes, colors, qualities. United Rough Diamond Co., 516 Fifth Ave., N. Y.

FUN With rocks! Rockhound's own monthly magazine featuring mapped trips, gem cutting, silverwork, minerals. 9,000 already enjoy it, so will you. Only \$3.00 year. Gems and Minerals, Box 716P, Palm-dale, Calif.

FIND Tungsten, mercury, uranium with Mineralight. Free brochure. Write Dept. PM8 Ultra-Violet Products, South Pasadena, California.

COLLECTORS, Two dollars bring twelve beautiful genuine specimens from gemland Brazil. Five dollars bring perfectly cut ten carat Braziltopaze. Airmail bills or check. Jean Bach, 413 Praia Icarai, Niteroi, Brazil.

GEMOLOGY Books! Catalog 10c. Atlantic Books, Lawrence Avenue, Charlestown 29, Massachusetts.

JADE, Agates, gems, gem cutting machines, supplies. Free list. North West Gems, 2819 North Warner, Tacoma 7, Washington.

SAPPHIRE, Topaz, tourmaline, garnet, peridot. 5 uncut gem specimens, \$1.00. O'Brien's, 1116M Wilcox, Hollywood 38, Calif.

GEMSTONES, Mineral specimens. Every variety. Lowest prices. Postcard brings free booklet. Plummer's, 4720 Point Loma Ave., San Diego 7, Calif.

TEN New Mexico minerals \$1.50, six fluorescents \$1.00, fool's gold 25c. Free literature. Minerals, Winston, New Mexico.

HOBBIES AND COLLECTIONS

EXCITING Hobby; collect authentic military patches, insignias, campaign ribbons, navy rates, etc. 57 assorted \$1.00. Free gift. Pritt, Dept. M-12, 12 West 27th, New York City.

50 DIFFERENT Army embroidered patches \$1. Other bargains. Insignia Mart, 703A Broadway, New York 3, N. Y.

AUTOGRAPHS, Wonderful Christmas gift for youngsters, 5c each. Magellan, Revere, Boone, etc. Box 642, Miami 4, Fla.

SHIP Photographs. Passenger, cargo, tankers, naval. Nearly 1,000 different. New illustrated catalog just out. Send 25c to Carphos, #3 Edgehill, Little Rock, Ark.

NAZI, Soviet, campaign ribbons. Big packet, lists, \$1.00. Medcrafts, 1923 34th St. S.W., Calgary 2, Canada.

UNUSED Matchbook covers—100 different \$1.00. 36-page catalog 25c. Charles Edelman, 1311C East 84, Cleveland 3, Ohio.

INVENTING Can be an interesting and profitable hobby. Write for complete particulars. Institute of American Inventors, Dept. 40-E 631-E St. N.W. Washington 4, D. C.

CLEARANCE Sale—Army patches 3c up; catalogue 10c; 32 different emblems \$1. Hobbyguild, 550-A Fifth Ave., New York City.

8 HOTEL Baggage labels 50c. Copleston, 1555 Odell, New York 62, N. Y.

CAMERAS, PHOTO SUPPLIES

PHOTOGRAPHY For pleasure or profit. Learn at home. Practical basic training. Long established school. Free booklet. American School of Photography, 835 Diversey Parkway, Dept. 345B, Chicago 14.

WILD Life films. Exciting, dramatic action in the natural habitat of animals of forest and plain. 8mm, or 16mm. In beautiful color or B & W. Also 2" x 2" color slides. Write for free illustrated literature. Wild Life Films, 5151AM Strohm Ave., North Hollywood, California.

BUY Wholesale nationally advertised cameras, photo supplies, thousands other products at big discount. Free "Wholesale Plan." American Buyers', 629-RR Linden, Buffalo 16, N. Y.

WHOLESALE Photographic supplies. Cameras, films, projectors, enlargers. Write for free catalog. Capitol Photo Supplies, 2428 Guadalupe, Austin, Texas.

DISCOUNT To 40%—Cameras, projectors, tape recorders, lenses. Quotations given on your specific needs. Classified Camera, 2375-D E. 65th St., Brooklyn, N. Y.

BASS Says: Trading since 1910. Used but good as new buys: 8mm. B.&H. Sportster \$52.50; 16mm. Keystone A-7, F:2.5 lens \$37.50; Voigt. 35mm. Vito II, flash shutter, Skopar F:3.5, like new \$38.50; Kodak Reflex F:3.5 lens, like new \$88.50; Contax I, F:2 Sonnar \$87.50; 3 1/4 x 4 1/4 Speed Graphic, Skopar F:4.5 Ibsor shutter, \$52.50. Satisfaction guaranteed. Bass Camera Co., Dept. AG, 179 W. Madison St., Chicago 2.

PHOTO FINISHING

SAME Day service. Double-sized prints from 8 exposure roll, 40c. Satisfaction guaranteed. Enclose 4 dimes with each roll. Ma-Lo Studio-7, Box 238, Jefferson City, Mo.

GIANT Size deckle album prints, 8 exposure roll, 35c, 12 exposure 50c. Send money. Free mailers. Dowl Photo Co., P.O. Box 2077, Ft. Worth, Texas.

TOP Quality with Magni size prints in albums. 8 exposure roll 39c, 12 exposure roll 59c, reprints 5c. Lee's Service, P.O. Box 1021, Battle Creek, Mich.

FREE Mailers—Attractive packaging. Contact prints 4c. Jumbos 5c. Western Photo, Dept. PM123, Box 298, San Francisco 1, Calif.

KODACOLOR Prints by Eastman for Christmas. Special handling. Send Kodacolor negatives. Send 2x2 color transparencies and 25c for making each Kodacolor negative. Prints 3 1/2 x 5, 37c; 5x7, \$1.75; 8x10, \$4.00. Order by Dec. 10th. Free catalogue and mailer. Pascolor, Box 86, Rochester 1, N. Y.

OVERSIZE Prints no extra charge, 8-exposure roll, 30c. 12-exposure, 45c. 16-exposure, 55c. Reprints oversize 4c. Finest quality. Mail Order Photo Service, Box 297, Watertown, Wisconsin.

PHOTO Xmas cards 20 for \$1.10. Techni-Foto, Dept. Pm, Lorain, Ohio.

TWO Prints each good negative, 8 exp. 35c; 12 exp. 50c; 16 exp. 65c. Reprints 4c. Mayfair Photo Service, Box 617-K, Toledo, Ohio.

ENLARGEMENTS! Eight 5 x 7's or five 8 x 10's, \$1.00. Wilart Enlargers, Box 967, Little Rock, Ark.

CUSTOM Photo finishing guaranteed. 8 exposures 35c; 12, 50c. Bound in beautiful plastic ringed album. Special! 35mm., 36 exposure \$1.00. Free mailer. Flash Foto, Box 36M, Brooklyn 4, N. Y.

6 OR 8 Picture roll 35c, 12 or 16 picture roll 55c. Each roll printed and developed. Handy album pack. If you fail to get pictures on your film a new roll will be sent you without extra cost. Send coin with roll. No c.o.d.'s. Mailing containers sent free. DeLuxe Film Service, Box 1268-A, Shreveport, Louisiana.

TOP Quality. Fast service. 8 jumbos 35c in beautiful Super Pak Album. 16 contacts 40c. Reprints—Jumbos 4c; contacts 3c. Satisfaction guaranteed. Write for free mailers and circulars. Fast-X-Foto, Box A, Jersey City, N. J.

12 JUMBOS 35c, 8 Jumbos 25c, 16 jumbos 50c from roll or negatives with this ad. S. Skrudland, Lake Geneva, Wisc.

GUARANTEED Quality. Fast service. Eight jumbos in beautiful super pak plastic ring binder albums only 35c. Send for free mailers and particulars of our complete photo finishing service. Grand Fotos, G.P.O. Box 1410, New York 1, N. Y.

BEAUTIFUL Enlargement in album from each good picture on roll. 8 exposure, 40c; 12 exposure, 50c; 16 exposure, 65c. Cut Rate Photos, Dept. B-4, Janesville, Wis.

PHOTOS Copied—20 wallet-size deluxe prints \$1.00. Original picture returned. Send any size photo or negative. Federal Wallet-Size Photo Co., Dept. PM, P.O. Box 2448, Kansas City 6, Mo. (No c.o.d.'s please.)

TWO Beautiful prints from each picture on 8 exposure roll 35c. Many years of satisfied customers. Quick service. Lens Photos, Dept. J-4, Janesville, Wis.

MOTION PICTURES AND SOUND EQUIPMENT

NEW Holmes 16mm. sound projector. Special \$279. Ideal Service, 4644 Geary, San Francisco 18, California.

16MM. And 8MM. films of gorgeous models for sophisticated adults. Community Productions, Dept. 20, 210 Fifth Avenue, New York 10.

35MM. Films for sale. George's, 2122 Atchison, Whiting, Ind.

3500 PERFECT Used subjects, all complete. 200' 8mm, \$2.75; 350' 16mm silent \$3.75; sound \$8.00. Postpaid. Choose. Free lists. Dept. M, Abbe Films, 503 5th Ave., New York 17.

EARN Up to \$15.00 daily with your movie projector! Details free. Metcalf, 10806 Glenroy, Chicago 43.

TREMENDOUS List of documentaries. 16mm sound. Army, Navy, Air Force combat films. Also health, medical, safety, instructional, industrial, automotive. 350', \$2.75; 700', \$5.00. Lists. Abbe Films, 503 5th Ave., New York 17.

NEW Movie bargains! 50' 8mm. Prevue film, 59c. 300' 16mm. silent film, (value \$9.75), \$1.98, our title choice. Blackhawk 8mm. films, children's films, railroads, collector's items, hunting, fishing, 150', \$2.98; Bible stories, 300', \$7.98. New, used 16mm. sound, silent bargains, too! Six used 100' 16mm. reverse-image Panoram musicals, \$3.49. Good used 16mm. sound projectors, all leading makes, \$129.95, some \$99.95. Big catalog free. Blackhawk Films, 1228 Eastin Bldg., Davenport, Iowa.

BARGAINS Used 400' 16mm silent \$3.50, sound \$7.50, features, Westerns, \$33.50, musicals, adventure, \$42.50. Sound RCA projector \$115.00, DeVry \$165.00. 8mm 200' assorted films \$2.95. Reels, cans: 400' 29c; 800' 59c; 1200' 89c; 1600' 99c. Cameras, lenses. Trades accepted, bought. Film library. Mogull's, 112 W. 48, New York 36.

"ENTIRE Life Story of Christ." 8mm., 16mm., sound and silent, purchase or rent, state projector. Hemenway Film, 31F Church St., Boston 16, Mass.

5000 NEW-Used 8-16mm. silent-sound films. International-B, 2120 Strauss, Brooklyn 12.

RENT 16MM. sound films. 50c reel. Large selection; free catalog. Film Service, 128 Chestnut St., Roselle Park, N. J.

8-16MM. Silent-sound films. Complete rental library. All latest subjects. Free catalogue, sample film 10c. Garden Film, 317 West 50th, New York 19.

MOVIE Camera film: 8mm. roll \$1.50, 16mm. 100' \$3.00. Free processing. Better Films, 742 New Lots, Brooklyn, N. Y.

TAPE Recorders, tapes, accessories. Unusual values. Dressner, 624-M East 20th Street, New York City 9.

GUARANTEED Fresh 8mm. roll, magazine; 16mm. roll, magazine movie films. Color, b&w. Free catalog. ESO-R, 47th Holly, Kansas City 2, Missouri.

8MM., 16MM. U. S. National parks in color. Free list. Ideal Service Supply, 4644 Geary Blvd., San Francisco 18, California.

BELL & Howell 16mm. sound projectors. Castle sound films, splicers, reels, other supplies. Free catalog. Ideal Service Supply, 4644 Geary Blvd., San Francisco 13, Calif.

MUSIC AND MUSICAL INSTRUMENTS

INSTANT Piano playing! New method assures instant results! Praised by thousands! No piano needed; Study home—Play anywhere! Write now! \$2 postpaid. "Instant Piano." Dept. #102, Parkville Sta., Brooklyn 4, N. Y.

FREE Record of your song. Your words, my melody. Free information. Johnny Mack's Melody Mart, 1094 West 39th Street, Dept. A, Los Angeles 37.

YOUR Voice made loud, clear and powerful with my diaphragm exerciser. Inexpensive. Write, Inventor Oz, 34V, Box 665, St. Louis, Mo.

WOODMAN Musical slide rule. Easy. Accurate. For transposing music, writing scales and chords, arranging band music. Rule and exercise book \$4.00. L. E. Woodman, Rolla, Missouri.

SWISS Musical movements. First quality. \$2.50. Spielman, 131 West 42nd, New York 36.

NOW A guitar you can play, because it's tuned that way. There is no difficult fingering to do. Play all melodies, harmonize many keys. Make music that is easy to listen to. Instructions \$1.00. Will Hughes, Box E2, Depoe Bay, Oregon.

MUSIC Arranged. Songs printed. Frank Wildt, Music Publisher, Lancaster, Penna.

PIANO By ear \$1.25. Wells, 39 Dales Ave., Jersey City 6, N. J.

ACCORDIONS And other musical instruments wholesale. Music Center, Plymouth, Ind.

I Get my songs published! Information. Williams, 342-28th, North Kansas City 16, Missouri.

POEMS Wanted for musical setting. Send poems. Free examination. Five Star Music Masters, 630 Beacon Bldg., Boston, Massachusetts.

SONGWRITERS! Outstanding, ethical offer. Hibbler, C-5, 2157 N. Avers, Chicago 47.

ANYONE Can play the Block-flute! Entertaining and relaxing! "C" soprano Block-flute \$6.50 prepaid. Professional discount. Art Hersch, P.O. Box 24, Lakewood, New Jersey. Inquiries invited. Any instrument.

SONGS And music printed. Specializing in small quantities for song writers. Skoumal Music Service, 319 E. State, Rockford, Ill.

ACCORDIONS And concertinas, save 50% and up. New and used. All brands. Wholesale to every one. Please specify. Free accordion or concertina catalogue. Del Principe, 29 South Cicero, Chicago 44, Illinois.

SWISS Musical movements, finest make. assorted tunes \$1.70. Direct imports. Helax Co., 218 West 72nd Street, New York City.

SONGWRITERS! Let me help you. Stamp for booklet. Mark Rubens, 146-D West 79 St., New York 24, N. Y.

COLLABORATION Offer. Newark Publications, GPO Box 1228, Syracuse, N. Y.

POEMS Wanted for musical setting. Send poems. Free examination. Crown Music Company, 1476 Broadway, New York City 36.

SONGWRITERS! Protect your ideas! Hold all songs, poems! Write for safe correct procedure first! Song Service, Dept. P. 333 W. 56th St., New York 19, N. Y.

POPULAR Songs. How to write and sell them. Write for free booklet Successful Songwriting. Gateway Songs, Box 2470, Hollywood 28, Calif.

SONGWRITERS! Send poems, songs. Music Service, 243 West 72nd St., PM, New York 23.

POEMS Wanted to be set to music. Free examination. Send poems. McNeil, Master of Music, 510-PM S. Alexandria, Los Angeles, California.

WANTED! Poems for musical settings. Write Songwriters' Service, Clifton, N. J.

WRITE Songs. Big money and reputation. Write for information. J. Gordon Pub. Co., 4700 South California Avenue, Chicago.

SONGPOEMS Wanted. Mail to: Tin Pan Alley, Inc., 1650 Broadway, New York 19, N. Y.

POEMS Wanted for musical setting. Send poem for immediate consideration and free rhyming dictionary. Richard Brothers, 24 Woods Building, Chicago 1.

SELF Taught courses: Piano, singing, songwriting and other instruments. Song collections. Music Teachers' Associates, 26 Potters Lane, Great Neck, N. Y.

1953 ACCORDIONS Wholesale. Free catalog. American Accordion Center, 5329 Belmont, Chicago.

WANTED: Songpoems, lyrics. To be set to music. Work done by Hollywood professional artists. Recordings made. Quarterly magazine. Write for free sample. Inside Music, 5653 1/2 Hollywood Blvd., Dept. K-6, Hollywood 28, Calif.

RADIO AND TELEVISION

LEARN Radio repairing. Simple, easy method \$1.00. Slate's Radio Service, Corsicana, Texas.

SEND \$3 Crystal radio set complete. Box 2929, Odessa, Texas.

RADIO Tubes, surplus radio equipment, bargains. Ask for list. Kay Electronics, Box 25, Hollis, New York.

AMAZING Newly developed, permanently fixed crystal detector with warranty guarantee and complete plans for building crystal radios only \$1.00 postpaid. Allen, 427-PM10, Clinton, Missouri.

NEW TV catalog free. Loaded with bargains for TV servicemen, technicians, installers. Finest new TV antennas, motorless directronics, multi-channel yagis, UHF antennas, converters, motors, boosters, parts, instruments, hundreds of quality accessories at money-saving prices. Get your catalog now! National Electronics, 3012 Delco Bldg., Cleveland 3, Ohio.

SAVE \$30 To \$40! U.H.F. all-channel outside TV antenna with reflector, installation instructions. This antenna picks up any U.H.F. station. Gives top performance! Only \$5.75! Starlit Antenna Co., 7120 Fenkell, Detroit 38, Michigan. Send check or money order. Save c.o.d. charges.

WHAT Is Ekeradio? Subminiature battery radio, broadcast and shortwave. Story carried by the Associated Press, national magazines. This powerful Ekeradio, headset, batteries, antenna, ready to play is only \$29.95. Dealers needed in every state. Send your order now. Ekeradio, Box 247M, Pasadena, California.

CONDENSER Checker kit \$5.95. Plans \$1. Bullocks, 1910 Montgomery, St. Louis, Mo.

TVeto Silences annoying television, radio commercials! Operates from your viewing chair. Attach it yourself to any set; it's easy, harmless! Money back guarantee. \$2.95 postpaid. TVeto, Box 444A, Arcadia, California.

CRYSTAL Radio kit, \$1.50; phone, \$1.75; fixed crystal, 60c; guaranteed. Clearco Crystal Co., Dept. 9, Des Moines 11, Iowa.

BUILD 15 Radios—Only \$19.95 complete. Free radio tester, tools, soldering iron. No experience required. Money-back guarantee. Order direct or send for descriptive literature. Free valuable radio and TV repair guide on request. Progressive Electronics, 497 Union Ave., Dept. PM12, Brooklyn 11, N. Y.

SIMPLEST One tube capacity relay yet out! Draws no idling power. Ideal for trick locks, scare'em gadgets, burglar alarms, operating window displays. Complete schematic, illustrated instructions, 50c postpaid. Printed, not mimeographed. Technix Laboratories, 568RS Riley, Buffalo 8, New York.

STOP Radio television noise immediately. Patented filter plug eliminates interference from household appliances, fluorescent lights, motors, oil-burners. Clears reception. No c.o.d.'s. Try 7 days. Moneyback guarantee. \$1.00. Electronic Tube-Mart, 87-09 114th Street, Richmond Hill, N. Y. Dept. PK-12.

24 PAGE Plans "18 long distance crystal sets" 25c, including "Radiobuilder," catalog. Laboratories, 328-C Fuller, Redwood City, California.

CLEARCO Crystal radio kit \$1.50; preassembled \$1.75. Free catalogue. Clearco Crystal Co., Box 1857, Milwaukee, Wis.

MAKE Simple, tubeless, batteryless distance-getting crystal radios. Crystal and illustrated instructions 25c postpaid. Allen, 427-P, Clinton, Missouri.

CRYSTAL Radio experimenters. Write Leslie Hulet, R4, Lakewood, New Jersey.

LIMITED Quantity surplus double headphones. High quality, slightly used, \$7.95 value. Special now \$2.95 postpaid. Guaranteed. Allen, Dept. PMH, Clinton, Mo.

DIAGRAMS: Radio \$1.00, television \$2.00. Give make and model. Diagram Service, Box 672-PM, Hartford, Conn.

TALKIE Crystalphone — Nearest thing to a real walkie talkie. Talk and receive radio programs. Instructions 50c. Talkie Crystalphone, Valley Road, Box 27, Clark-Rahway, N. J.

COLOR Television! Enjoy multi-color filter screen now. Easily attached. Send \$2 for your screen size. Satisfaction guaranteed. Dealers opportunity. Zingo Products, Johnstown 7, New York.

BUSINESS OPPORTUNITIES

MAKE Tough durable plastic of waste—Easily. Makes attractive, resilient floors, walls, built-ins, stucco. Build good home for half. Bays Laboratory, Oklahoma City 9.

HOW To raise needed funds. Free details. Enterprise Bureau, Syracuse 2-P, N. Y.

HOW And where to obtain capital? Free details. Star Service, Wapakoneta, Ohio.

THERE'S Money in small machinery rentals; man or woman can operate from home; small or large towns; equipment offered. No cash down; details free. Rader, Box 8456, Kansas City 14, Missouri.

SELL Wrist watches. Free literature. Kelley, Box 207, Rapid City, South Dakota.

LEARN Mailorder. Moneymaking opportunity. Work home. Literature free. Addison, 1840-R Addison, Chicago 13.

MAILORDER Business book. Full information for the beginner. Write Brown's Agency, Box 491, Tacoma, Wash.

FREE Magazine. Hundreds homework offers. Siegel, Box 183PM, New York 2.

\$200 WEEKLY Reported! No selling. Free booklet. T. J. Surface, Roanoke 4, Virginia.

PROFITABLE Repair shop. 11254 N.W. 7th Ave., Miami, Florida.

LUCRATIVE Fascinating business. Learn china repairing at home. Make invisible strong repairs. Service antique shops, private customers. Course \$5.00. Gussack, 12510 Magnolia Blvd., North Hollywood, California.

START Home mailorder business. Details. Gedgard, Box 798-B, New York 1, N. Y.

FREE Mailing lists! Directory gives over 300 sources furnishing over 380,000 classified mail order prospects without charge. Write for full information. Research House, 3810 Merrill, West Palm Beach, Fla.

DOLLAR Maker "tips" means your own business. Details free. Oglesby Co., Aurora, Mo.

CONSTRUCTION Men, your opportunity to get into a full time, non-competitive specialty construction business. An investment is necessary but returns more than justify it. To qualify, you should have construction experience, preferably plastering, and real sales sense. This dealership is for a patented revolutionary method of forming an actual brick surface, highly recommended by architects and contractors. This is not an imitation or nailed-on siding but is real brick in a beautiful new form. There is no charge for the dealership. For details, write Quikbrik, 7306 Puritan Avenue, Detroit 38, Michigan.

SELL Popular Mechanics and all other magazine subscriptions. Free catalog, supplies. Subscription Service Company, Dept. A, P.O. Box 2070, Birmingham, Alabama.

HOW To set up and run a mirror shop! Resilvering mirrors. Making chipped glass nameplates. Electroplating salts and rectifiers. John Sprinkle, V60, Marion, Ind.

WHAT'S Your field of interest? Whatever it is, specialized magazines will help you to greater success. Look over current copies of those covering your field through our easy-to-get-acquainted service. Choose from 4,387 publications covering all fields—Business, vocational, agricultural, sports, hobbies, etc. Write for current list. It's free. Commercial Engraving Publishing Company, 34C North Ritter, Indianapolis 19, Indiana.

LIQUID Rubber, make flexible molds. Free sample. Chaney, 1130 E. 16th St., Jacksonville 6, Fla.

JOB Opportunities in New York City! What could you earn in world's business center? Skilled, semi-skilled, professional, executive, overseas. Will mail latest, largest New York Sunday classified section. Only \$1.00. Robert S. Smith, 107 Early Street, Morristown, New Jersey.

OWN, Operate, route "wishing wells." Place these new \$8.50 skill games on counters in cafes, luncheonettes, clubs, etc. Collect coins weekly. Write, Legalsharo, Box 929, Long Beach 1, California.

EARTHWORMS: Health and profits. Details 25c. Earthworm Gardens, Dept. PM12, Box 428, El Monte, California.

PACKAGED Food mailorder business. Home operated. Everything supplied. Successful proven plan. Free details. Frazar Foods, Desert Springs 10, California.

MAKE Perfumes and cosmetics at home. Write, Carey Laboratories, 1914 Chouteau, PM-12, St. Louis 3, Missouri.

BOOKKEEPERS, increase earnings operating sensational bookkeeping service. Kern, 4942 Vineland, North Hollywood, Calif.

FREE! "301 Profitable Small Businesses!" Amazing shoestring plans! Work home! Start sparetime! Deumant Surveys, Kenmore 23-R, N. Y.

MAIL Order secrets revealed. \$1. Grande, Box 145, Parris Isle, S. C.

MAKE Profitable products. Formula catalogue free. Inscoc, 6347 Parnell, PM-12, Chicago 21, Illinois.

START Your own business on credit. Your own boss. 1658 of our dealers sold \$5,000 to \$27,500 in 1952. We supply stocks, equipment on credit. 200 home necessities. Sales experience unnecessary. Pleasant profitable business backed by world-wide industry. Write Rawleigh's, Dept. L-U-PPM, Freeport, Ill.

EARN \$50 Weekly in spare time. Lifetime vitamin business. Details free! Emm-Bee, Dept. PM2, Box 992, New York 8, N. Y.

LEARN Piano tuning at home in five weeks. Big demand. Earn \$6 hour full or spare time. Write: Empire School, 606E University, Champaign, Illinois.

INDUSTRIALISTS—Businessmen. Investigate Florida. Rapidly-growing Florida offers innumerable opportunities for business and large and small industries and a highly favorable tax situation. Write State of Florida, telling type of business you're seeking and specific requirements. You'll be put in touch with communities where opportunities exist and where you'll enjoy Florida's wonderful year-round climate. Free, complete information will be sent you. Write today: State of Florida, Industrial Development Division, 4314B Caldwell Building, Tallahassee, Florida.

COUNTRY Life profitable, secure, happy. 100 tested plans. Inquire. Hermes, 152-L West 42, New York.

YOU Can become notary public. Details free. Magnolia Press, Box 1272-P, Burbank, Calif.

CANDID Wedding photography pays well. Complete instructions with 24 actual photos. \$1.60 postpaid. Candid Photography, 1818 E. Jarvis St., Milwaukee 11, Wis.

IMPORT-Export! Opportunity, profitable, world-wide, mail-order business from home, without capital; or travel abroad. Established World Trader ships instructions for no-risk examination. Experience unnecessary. Free details. Mellinger 70C, Los Angeles 24.

JOIN Depression-proof mail business. Enjoy increased income. Explanatory literature 25c. Marbill Mail Trade, 6660-A Winch St., North Burnaby, B. C., Canada.

\$200.00 WEEKLY Making mats, mud guards, shoes from old tires. Amazing illustrated literature, 10c. Refundable. S and S Patents Inc., 1307 P North Clark St., Chicago 10, Ill.

MEXICO! Curios wholesale! Excellent gift shop items! Illustrated pricelist 3c stamp. Filmer, 910 Marion, Pharr 10, Texas.

EARN Money! Amazing plans! Easily mastered at home. Details free. Bruns, 216-B West Jackson Boulevard, Chicago 6, Illinois.

GENUINE Silverplating liquid. Cloth rubon. \$1.50. NuSilver, 508-PM11, Aurora, Illinois.

DON'T Be Mr. Average Man. Operate your own business. New field, sensational sales potential, highly profitable. Very desirable, non-perishable, no chemicals or liquids. High-grade proposition for men not afraid of earning \$10,000 and up annually. Can you recognize real opportunity? Postcard will bring details. Protecto Products Company, Box #543, Oak Park, Illinois.

BE A sewing machine repair agent. Good money, pleasant interesting work. Complete professional course in servicing and overhauling all makes. \$4.95 postpaid. No c.o.d. Humen Sewing Machine Co., 12405—87 St., Edmonton, Alberta, Can.

FIGURINES Unpainted. Catalog. Weaver's Products, 1524-M 2nd Avenue, Altoona, Pennsylvania.

EARN Money at home, making rhinestone jewelry. Free catalog. Ebert, Box p183, East Orange, New Jersey.

BUY Wholesale! Appliances, watches, jewelry, etc. Catalog free! Buda, Box 124, Oneida, N. Y.

MAKE Perfume. Catalog free. International, 6347 Parnell-PM-12, Chicago 21, Illinois.

OPERATE Escalator mailorder system, selling our products or any products. Fastest, most revolutionary mailorder system known. Write: Selbyco, Decatur 162, Ill.

MAKE 155 Gifts, novelties, jewelry, from sea shells, fish scales, plastics. Beautifully photographed instruction book (6th edition) \$1.25. Wholesale supply catalog 20c. Giftcrafts, Box 4550-PX, Coral Gables, Florida.

SAVE 50%! Buy wholesale. Postcard brings details. Regal, Box 173, Royal Oak, Mich.

LOOK Over this method in mail order. Has produced daily for years. Income steady. Literature free. Shore Enterprises, Box 218-C, Neptune, N. J.

\$40.00 DAILY With inexpensive sawshop equipment. Zapart, 586 Manhattan, Brooklyn 22, N. Y.

WHOLESALE! Hundreds nationally known appliances, silverware, aluminum-ware. 50% off. Picture catalog 10c. Supply, 1402 North 21st, Birmingham 4, Ala.

BUILD Luggage and cases at home. We sell your products. No special tools or equipment needed. Free details. Casecraft, 805-A1 Sunset Blvd., Los Angeles.

MAILORDER. Operate profitable home business. Free details. Guymon Direct Sales, Dept. 25, Box 535, Guymon, Okla.

BUY 150,000 Articles wholesale. Directory 10c. Publishers, Box 1486-P12, Detroit 31.

LEARN Sewing machine repair, electrify, rent, trade, sell. Make up to \$150 week spare time setup. Motor kits, zigzag machines, etc., wholesale. Free particulars. Taylor Service, Hamilton PM-12, Ohio.

MAKE Money at home. Easy; pleasant; profitable. Paton, Box 55-E, New York 23, N. Y.

EARN \$2.00 Hour! I do, making sandals. Young's, 1308-PM South First, Arcadia, California.

EARN Amazing profits following our instructions; selling nationally advertised watches, etc. Enclose 25c, refundable; receive multi-colored salesman's catalog and confidential price list. Result Sales Co., 580 Fifth Ave., New York.

RAISE Orchids—At home. Big profits. Fascinating. Year 'round any climate. No greenhouse. Instructions, including blooming-size orchid plant, sent for no-risk examination. Free details. Flowerland, 4622-DS, Wilshire, Los Angeles 5.

NEWEST Spare, full-time home business. \$5 to \$10 hour possible. Paint with suede—The finish with touch and eye-appeal. Beautify auto dashboards, signs, radios, toys, figurines, lamps—1001 others. Complete, step-by-step instructions sent for no-risk examination. Free details. Coast, 1004-HY So. Los Angeles St., Los Angeles 15.

FREE Directions for casting plaster novelties using our latex rubber for molds. Lowest prices. Major Chemical & Latex Co., 25 Allerton St., Boston 9, Mass.

FEATHER Bird pictures from Mexico. Real money makers. Your own business. Sample offer; beautiful picture with hand carved cedar frame and glass \$2.50 value, \$1.00 post paid. Free details. Specialty Products Co., 301 New Market Ave., South Plainfield, N. J.

ELECTRO-Plating. Profitable home business. Auto parts, novelties, giftwares, baby shoes, mirrors. Easy, inexpensive home processes. Free booklet. Tyco Metals, Box 13231-ML, Houston 19, Texas.

WANTED! Home producers, by manufacturers in our clearing house service. Become a subcontractor, casting plastic products for these companies. Thousands of easy-to-make items required for consumer and industrial use. Cash in at home, without previous experience. Plastic Service Associates, Dept. 12-PM, East Boston 28, Mass.

EVERY Home needs Hotair Sprinkler. Attached to cookstove. Worth a fortune, sells \$3.50. Even Temp, Thornburg, Ark.

MONEY Bulletin magazine shows how to make money in home mail business. Sample 10c. 3 months 25c, year \$1.00. Dispenza Co., 2020 Harbor Ave., Ashtabula, Ohio.

\$200 WEEK Possible! Sensational new hand cleaner. Manufacture-distribute. Operate from corner of basement or garage. Your very own private, exclusive, money-making business. Easy. Free plan! Write today. Keenelo, 2445 Larimer, Denver 5, Colorado.

MAKE Money at home mailing literature offering fast selling books and merchandise. Everything supplied at low cost. Rush name. Thomas Jerdon, Hermansville, Maryland.

LET Others sell for you. Earn steady from home. Full setup service from idea to success. Free information. Hermes Company, 152-H West 42, New York.

WILL Establish you in business with our capital. Part-time or fulltime. No investment or experience needed to start. Winona Monument Co., Winona, Minn.

START Spare-time fixit shop at home. Hardware dealers get saws and lawnmowers to sharpen on commission. Make extra \$100 monthly. Free booklet tells how. Victor P. Foley Company, Columbia Heights, Minnesota.

PERMANIZE. Ceramize, porcelainize, metalize baby-shoes, crochet items, hundreds of keepsakes. No baking, no firing. Fantastic profits. Details for 25c. No equipment to buy! Jay Sales, Dept. 3-M, 192 N. Clark, Chicago.

ADVERTISING Book matches—Cash in on big demand; sell union label matches. Cuts for all businesses and political parties. Free powerhouse selling kit, low prices, protection guaranteed on repeat orders. Cash commissions. Superior Match Co., Dept. MX-1253, 7530 Greenwood, Chicago.

\$2000 MONTHLY—Easy, instructions free. Sundberg, 1552 Essex, Willow Run, Michigan.

EASY Capital money. For retail, mail-order business. You can raise thousands quickly! Unique method. How? Write, enclose dime. Dougherty, Box 88, Van Nuys, Calif.

BARGAINS—Lists hundreds terrific bankrupt, closeout, merchandise bargains every month. Also sources 100,000 items wholesale. Many 15-25c on retail dollar! 6 issues, \$1.00. Money back if 1st issue unsatisfactory. Bargains, Box 591-DA, Lynn, Mass.

\$26,500 SALES In two weeks! Amazing radio-mail order method. Free details. Broadcast Service, 1412-G Great Northern Building, Chicago 4, Illinois.

\$500,000 BY Mail from home. Free folder. Publicity, Kalamazoo 65DC, Mich.

BECOME Co-publishers of interesting mail order publications. Two samples with literature and full details 25c postpaid. McAllister Publications, 3464 Farmville, Memphis, Tenn.

\$5.00 MONTH Up. Establish a permanent California address for your mail order business here in downtown Los Angeles. Confidential. Replies forwarded immediately and efficiently. Established here 10 years. Ellery Office Service, 1244 S. Grand Ave., Los Angeles 15, Calif.

DO Mailing at home. Get orders in every mail. Keep every cent. Everything furnished. Genmerco, Box 142-M, Dorchester 24, Mass.

MOLD Making liquid rubber; sample pint, with instructions, \$2.00 postpaid. Plastercraft Supply Company, 3051 St. Clair Ave., Cleveland 14, Ohio.

WORK At home. Mail to automobile owners. Big earnings. Everything furnished. Eastern, Box 142-F, Dorchester 24, Mass.

NOTARY Public commands more money. Be one. Stationers, Helotes, Texas.

START A buying service, buy wholesale thousands nationally advertised products. Make big profits selling at sizable discounts. Postcard brings details. American Buyers, 627-R Linden, Buffalo, N. Y.

CONVERT Hand mowers to power mowers. Do it now, this winter. Sell the Handy-Dandy conversion kits. Easily installed on 16 to 20" mower. Use any small gasoline or electric motor. Quick delivery. Kits purchased with or without engines. Also new garden cultivator. Takes less than a minute to change attachments: Weed whacker, lawn mower, snow plow, and rotary tiller. Discount to dealers. Le Claire Manufacturing Company, Le Claire, Dept. P.M., Iowa.

FREE Folder. Make big money by mail the sure way that pays. New, different. Fullmer, 92H Greenwood, Pocatello, Idaho.

MAKE Money selling by mail; instructive booklet 25c. Manhattan House, P.O. Box 51-M, Saint Albans 12, N. Y.

EARN More money. 137 Elite plans. Free information. Jorine, Snyders Lake, Troy 4, N. Y.

START Small business. Stir your imagination with over 100 business plans. Free information. Shore Enterprises, Box 91-C, Little Ferry, N. J.

MADE \$24,500 Using money making plans from world's oldest mailorder publication. Schemer Magazine, Canfield 1, Ohio. Year \$1.00. Sample 20c.

OWN A garden golf business. Experience unnecessary. Brockway, Seaside, Oregon.

UNUSUAL Homework opportunity, sparetime, men, women. Angora House, PM, Springfield, Illinois.

MAKE Rubber stamps, repair dolls; learn silk screen printing; invisible reweaving. Catalogue (60 ideas) free. Universal, Box 1076-A, Peoria, Ill.

HAVE New York address with mail service \$2 month. 516 Fifth Ave., Suite 1004, New York.

\$25 WEEKLY Working two hours daily at home. Lycke, Box 2471-A, Cleveland 12, Ohio.

START Your own profitable home mail-order business! We supply everything! Write today! Studio Products, Box 564-A, Glendale 5, Calif.

WHOLESALE Of sensational nationally advertised appliances, silverware, watches, cameras, etc. Start your own business. Full details. Send 50c for catalogue. International Sales Co., 175 Fifth Ave., New York 10, N. Y.

LIVING Miniature ("Ming") trees only 10 to 20 inches tall. Grow at home. Big profits! Spare time opportunity. Fascinating! Amazing! Write for free seed and plan. National Nursery, Dept. FC, Inglewood 4, California.

BUY It wholesale! Manufacturers, distributors offer \$50,000 items. Literature free. Olsen, 1231-A East Third St., Duluth 5, Minn.

BREED Rare tropical fish at home. Earn big money! Learn secrets! Help fill huge demand. Amazing opportunity! Free plan. Tropicals, 1008-F Los Angeles St., Los Angeles 15.

INCOME From local information. No selling. Write Neherco, La Verne, Calif.

RESILVERING Mirrors, formula 50c; two-way lookout mirrors, (No one sees you), 50c; coppered mirrors, 50c. All \$1.00. Nelko-Mir, Box 3462-J, Chicago 64.

FIGURINE Molds and many others, liquid rubber, statuary plasters, flock finishes, Gio-candle wax, etc. Illustrated catalog and "Plastercraft" manual free. Blue Rapids Supply, Blue Rapids, Kansas.

START Home manufacturing business. Make cleaners, soaps, polishes, cosmetics. Free literature. Kemix, Park Ridge, Ill.

MAKE Money spare or full time, casting metal toys and novelties. Big wholesale and chain store demand for toys, soldiers, ashtrays, banks, etc., keeps manufacturers busy. Production moulds furnished for up to 100 and more castings per hour. No experience or special place necessary. Write for information and illustrations of patterns needed. Metal Cast Products Co., Dept. A, 1696 Boston Road, New York 60, N. Y.

NEW Exceptionally profitable plans, ideas for home operated mail business. Rush name. Miller, 1772-P Carlyon Road, East Cleveland 12, Ohio.

MAKE Flexible molds! Cast plaques, bookends, figurines! Free sample! H. Tooker, 630-R Chestnut, Hamilton, Ohio.

RECAST Old batteries into new. Latest achievements. Battery Laboratories, Minneapolis.

GOOD Paying business silvering mirrors, plating autoparts, reflectors, bicycles, bathroom fixtures, etc., by late method. No tanks or shop required. Outfit furnished. Free booklet. Gunmetal Co., Ave. H, Decatur, Illinois.

BUY Wholesale. Thousands articles. Supply directory, 10c. Idealco, Park Ridge, Illinois.

EARN Extra money! "Homeworker Magazine" tells how. Sample 25c. Sizemore, Box 7, 4917 Kostner, Chicago 30.

EXTRA Money—No selling, operate vendors. Amazing profits, details free. Silver King, Suite 220, 622 Diversey, Chicago 14.

OPERATE Profitable mail order business. Write Walter Service, 4159-A East 112th, Cleveland 5, Ohio.

DOLLARS In personalized baby record books. Sell by mail. Use same literature we do. No-Co-Ro, Oakland 6, Calif.

MINK Raising information free. Complete. Lake Superior Mink Farm, Superior, EE1, Wisconsin.

COPUBLISH Leading m.o. paper. Latest copy. Mail Sale Advertiser, details, dime. Vanroy Shirk, Lebanon, Penna.

COLORGLAZED Concrete pottery made without molds. Patented method. Cemetery products, novelties, tiles. Basement leak-sealing. Money-making projects. Booklet, details free. Men only. National Potteries Company, Grand Rapids, Minnesota.

FREE Book "505 Odd, Successful Businesses." Work home. Expect something odd! Pacific, Oceanside, Calif.

START Venetian blind laundry. Profitable lifetime business. New machine. Free booklet. F. C. Co., 442 N. Seneca, Wichita 12, Kansas.

137 PLANS For starting home business. Details: Elite Co., 220 Grand St., New York 13.

MAKE Perfume. Sell on smell. Mail order or local. Wilson made \$7200.00 first year. Free sample, plan revealed. McCann, 4019-21 Rio Grande, Amarillo, Texas.

FIX Typewriters. Free booklet describes our modern, inexpensive home-study course. Factory methods taught. Write Typewriter, Building 1, Tarentum, Penna.

LEARN Metalizing baby shoes, gifts, etc. Bronze, gold, silver. Folio free. Kiktavi, 7217-PM South Broadway, Los Angeles 3.

MONEY In new greaseless doughnuts. Start in kitchen. No smoke. Sell stores. Free recipes. M. Ray Company, 3605 South 15th Ave., Minneapolis 7, Minn.

POPCORN And potato chip equipment. Long Eakins Company, 5360 High, Springfield 99, Ohio.

START A lettershop on a shoestring! Sales \$56,000. Started \$36.00. Information? Merritt, Box 13, Basking Ridge, N. J.

NATURAL Molding latex. Tinsel, flock, supplies. Extra thick. Free sample. W. Wooley, 115-A Donald, Peoria, Ill.

EARN Big money by mail. Depression-proof income. Circular 10 cents. Complete starting deal \$3.00 postpaid. Reho, Box 21A, Whitsett, Penna.

FREE Details! Home operated mailorder business. Successful beginner's plan. Everything supplied. Lynn, 10420-M National, Los Angeles 34, California.

VENDING Machines—No selling. Operate a route of coin machines and earn amazing profits. 32-page catalog free. Parkway Machine Corporation, Dept. 72, 715 Ensor St., Baltimore 2, Md.

FLEXIBLE Rubber moulds for plaster and Marble figurines. Sample and large illustrated catalog 25c. refunded on first order. K-C Novelties, Dept. 73, Easthampton, Mass.

UNUSUAL Opportunity. Sell by mail—Books, merchandise. Complete setup. Write Sherron, Box 343P, Bloomfield, N. J.

ESCAPE Wage slavery. Easily. Operate your own profitable lifetime business. Free literature. Corley, H186 Ackerman, Clifton, New Jersey.

HAVE Home mail business—Get \$10 orders in every mail. Keep \$8.00. Everything furnished. Hutchinson, 401-A Adams, Dorchester 22, Mass.

BOOKKEEPERS, Keep books, small firms spare time. Manual latest technique by C.P.A., \$3.00. Modern Business, Box 406, Youngstown 1, Ohio.

FREE Booklet—"How to Make Money by Raising Fishworms." Please include 25c for postage and handling. Flint River Worm Farm, Reynolds 5, Georgia.

LEARN Refrigeration mechanics. Complete illustrated course. Free booklet. Mechanics School, 7217-PM South Broadway, Los Angeles 3.

BIG Profits, manufacture night glowing varnish. Chemicals, formula, \$1.00. Ceramic Products, Box 6321, Birmingham 7, Ala.

SPARE Time business. No investment. Details free. Howell, 1320 St. Andrew, New Orleans 13, La.

SAVE Postage. Register your name with us. Receive mail dealers best offers without writing them. Only 25c. Falcon House, Winnebago, Ill.

WANT Profitable hobby? Try weaving potholders. Card brings particulars. Morgan's Hobby Supplies, Dept. C, Indiana, Penna.

BRONZED Baby shoe supplies, instructions, mountings. Metal bookends, \$1.50 pair. Free catalog. National Bronze Supply, Box 56, Los Angeles 32, Calif.

IMPORTING, Exporting! Profitable details free. Warner's, Box 6, Fort Scott, Kansas.

PERFUMERS; Cut costs, 500 fragrances, supplies. Box 3267, San Diego, Calif.

PROFITABLE Home mail business. Details free. Service Bureau, Box 596, Toronto, Canada.

FISHWORMS. Breeders 100—\$1.00. Manual \$1.00. Postpaid. Literature free. Dixdok, Kent, Ohio.

QUICK Money! Repairing car batteries. At home! Easy, too! Batteryman, Grand Junction, Colorado.

"HOW To Build Your Own Mailorder Business," 25c. Guaranteed. E. Merrill, Coldbrook Road, Bangor, Maine.

BUY Wholesale thousands nationally advertised products. Save money! Make money! Postcard brings details. Kemah Company, 5017-P Washington, Houston 7, Texas.

SUNNY California land bargains as low as \$5.00 per acre. Low down payments—Low monthly payments. Write for free information. Land Department, Suite 105, 1540 N. Highland Ave., Hollywood 28, Calif.

\$10,800 PROFITS! Your own mailorder business! No risk! "Success Plan" free! Treasury, 709 Webster, New Rochelle LB-1, New York.

EARN Money with typewriter—Sewing machine! Details free. Edwards, 3915-PM, 12th, Des Moines 13, Iowa.

SUCCESSFUL Money-making plans. Home or mail-order. Details free. Stowell's, Woodstock, N. Y.

BUY Nylons direct from mill. Good profits. Quick delivery. Write for jobbers prices. Joy Hosiery Mills, Delawanna 38, New Jersey.

SELL By mail. New 10,000 word booklet shows how. At home. Sparetime. Small capital. 25c. Satisfaction guaranteed. Vernon-Hall, Box 193M, Abington 11, Penna.

CATALOG Of top mail order plans and folios, proven and tested. Stamp please. Lindholm Service, P.O.B. 2504, St. Ann Station, Minneapolis, Minn.

CLEAN Watches for profit. Solvent and directions \$3. General Chemicals, Box 827, Pittsfield, Mass.

WE Pay \$5.00 for some names. Make steady income sending us names. We buy thousands. Pacific, Box 73136, Los Angeles 3.

\$46 FROM Square foot plywood; jigsaw necessary. Write: Woodarts, Bridgewater, Mass.

MONEYMAKING OPPORTUNITIES

"CASH-In." Get into mail order business. 68 page book reveals business secrets, effective advertising, what to sell, beginners advice. Numerous tested and original money-making plans. Over 40,000 words. We'll include other helpful literature free. Rush 25c to: Par Products, 2185 Bolton St., New York 62, N. Y.

SELL Used auto parts. Wrecking cars and selling parts is fun and profitable. Be your own boss. I started with \$25.00. Send \$1 for detailed information. B. M. Giberson, R.F.D. #1, Millville, N. J.

YOUR Own mailorder business. Details free. Write John Franco, 108-62 53 Ave., Corona 68, N. Y.

SELL To stores, offices, factories. Magic marker 69c. 8 colors. Writes instant-dry. Waterproof, indelible on any surface. Special introductory agents offer 2 for \$1.00. Dept. PM-11, Speedy Products, Richmond Hill 18, N. Y.

EARN \$50 Weekly operating home mail business. We show you how. Write Lewis Barlett, Richland, Georgia.

FREE! "301 Profitable Small Businesses!" Amazing shoestring plans! Work home! Start sparetime! Deumant Surveys, Kenmore 23-R, N. Y.

EARN Money evenings, copying and duplicating comic cartoons for advertisers. Adservice, Argyle 1, Wisconsin.

TRIM Hair without barber. Miracle clipper sells on sight. Keeps hair neat. Samples sent on trial. Kristee 181, Akron, Ohio.

FREE Folder "E" is full of moneymaking and moneysaving ideas for everybody. Write for it now. Giftory, Box 12, Cincinnati 13, Ohio.

UPHOLSTERING For profits. Complete instructions, \$1.00. Custom Upholstering, D-4, Oxford, Penna.

MAILORDER'S Greatest magazine. Sample 5c. Sell 7 merchandise items with postcards 5c. R. Barr, Box 861MA, Milwaukee, Wisconsin.

VALUABLE State franchise open new invention. Unique mail box signal. Sold through retail outlets. Unlimited possibilities, small mdse. investment. Tell-O-Mail, Inc., P.O. Box 1, Grants Pass, Ore.

MONEYMAKING Opportunities. home-work. Free literature. Wiese, 1516 Franklin, Waterloo, Iowa.

"HOW To Make Money With Simple Cartoons"—A book everyone who likes to draw should have. It is free; no obligation. Simply address Cartoonists' Exchange, Dept. 912CM, Pleasant Hill, Ohio.

BUY Nationally advertised merchandise direct from manufacturers, distributors at big savings! 850,000 items wholesale. Order only one or any number. Big profits buying for others at real savings, using their money. Other fine opportunities. Literature free. Olsen Publications, 1231-A East Third St., Duluth 5, Minn.

EARN \$50.00 Daily making mats, shoes and mud guards from old tires. S and S Patents Inc., 1307 North Clark St., Chicago 10, Ill.

BE Appointed, outfitted, notary public. Thousands needed. Men, women. World's lowest cost. Box 3025, Dallas 1, Texas.

\$10,800 PROFITS! Your own mailorder business! No risk! Success plan free! Treasury, 709 Webster, New Rochelle, PM-18, N. Y.

FREE! Complete mailorder business! Terrific profits! No investment. Write today. VitaMins, 2908-PM Beverly Boulevard, Los Angeles 57.

HOW To earn up to \$500 for each script, writing for television. New, different! Particulars free! Wonderful Products, Box 2113, Santa Fe, N. M.

FREE! 60 Wholesale catalogs free! Sherry's, Box 11-M, Miami 37, Florida.

\$500,000 By Mail from home. Free folder. Publicity, Kalamazoo 65DB, Mich.

START A buying service, buy wholesale thousands nationally advertised products. Make big profits selling at sizable discounts. Postcard brings details. American Buyers, 630-R Linden, Buffalo, N. Y.

JOB Opportunities overseas! Some paying skilled \$340 weekly, drivers \$275, laborers \$255. Transportation, overtime. 23 firms seeking applications from construction men, clerks, etc. Plus, 269 projects underway in 53 countries. 44 page manual, application forms, everything. \$1. Job-service D-16, Box 30, Billings, Montana.

LEARN Professional candy making, profitable home business. Details free. Pate, Kissimmee, Florida.

MAKE \$2600.00 A year spending 5 hours a week. Start at home. New machine. Small investment. Free booklet. A.X. Co., 442 N. Seneca, Wichita 12, Kansas.

STOP Shopping! See our complete catalog of spare time opportunities. Free. Rush postal. Lewis Enterprises, P.O. Box 2367, Portland 14, Oregon.

101 WAYS To make \$1,000 at home. Details free. Business Surveys, 365 S. Fairfax, Los Angeles 48, Calif.

DIME Brings our nationally advertised opportunity packet. Rinehart, 235 Baltimore, Hanover, Penna.

SELL Titania gems; \$9.75 carat wholesale. More brilliant than diamonds. Free catalogue. Diamonite, 1404-M Mitchell, Oakland 1, California.

50,000 ARTICLES Wholesale. Source directory, dime. Nelko, Box 3462-DR, Chicago 54.

SCHOOL Seniors—Sell classmates America's most beautiful graduation name cards. Largest selection. Highest commission. Outsell all others. Free sample kit. Printercraft, Dept. M, 1509 Maple Street, Scranton 5, Penna.

READ Progressive Mailtrade, the magazine that tells how to make money by mail. Dime brings sample and special offer. Progressive Mailtrade, Box 357, Sheboygan, Wisconsin.

FREE Book "505 Odd, Successful Businesses." Work home. Expect something odd! Pacific. Oceanside, Calif.

137 PLANS To make money, local mail-order. Details: Elite Co., 220 Grand St., New York 13.

PUBLISH Your own magazine. Hand-some 52 page format, well edited, illustrated. Cost low as \$1.00 month. Brings you prestige, profits. 25c brings sample, details. National, Ord, Nebr.

MAILORDER—Operate profitable home business using free advertising method reaching millions. Revealing information free. H. F. Seidel, 7070 Hollywood Blvd., Hollywood 28, California.

MAKE Money at home by mail. Fast, easy. Liebig Industries, Beaver Dam 4, Wisconsin.

FREE Folder! Make money at home. Samuel Tell, Guaynabo, Puerto Rico.

FOREIGN Employment construction work. If interested in foreign projects with high pay write Foreign Service Bureau, (Dept. P.M.), Metuchen, New Jersey.

GENERAL Contest Bulletin. Issued monthly. Sample, 10c. 1609½ East 5th, Duluth, Minn.

101 WAYS To make \$1000 at home. Details free. Business Surveys, 365 So. Fairfax, Los Angeles 39, Calif.

BUY Wholesale! Nationally advertised products. Tremendous discounts. Particulars free. Econ-O-Mart, Box 535B, Morristown, New Jersey.

MAKE To \$4.50 hour doing common pen lettering. National Artists, 801½-A North Marsalis, Dallas 3, Texas.

GET Facts—\$4.00 merchandise, \$2.00 treatise 100 money makers, \$6.00 value \$2.00. Kohne, 506 West 45th, Chicago 9.

ROSARIES—Make your own! For gifts, fun, profit! See complete line of religious goods, gold-filled and sterling rosary parts. Medals, books, statues, novelties. Big group of make-it-yourself items. Send 10c for new wholesale illustrated catalogue just off the press, bigger than ever! Greylock Creations, Box 1048-PM, Pittsfield, Mass.

BUY Printing and office supplies wholesale. 10,000 items. Details free. Royal, Box 368-A, Cleveland 27, Ohio.

BUY Wholesale thousands nationally advertised products. Save money! Make money! Postcard brings details. Kemah Company, 5017-L Washington, Houston 7, Texas.

MAKE Money at home, it's easy. I'll show you how and help you. Write: Allen, Box 4A, Houma, Louisiana.

BUILD Fireplaces—The very best, for yourself and others. Scientific principle, different. Heats wonderfully well, does not smoke, no metal shells or dampers, build of rock, brick, etc. Instructions with working model \$4.85. Master Fireplaces, 730 State St., Bellingham, Wash.

WINNING Prize contests is fabulous, confidential, home opportunity! Send stamp! National Contest Bulletin, Box 2685-P, Miami 16, Florida.

FORMULAS, PLANS, ETC.

MODERN Formulas for many new and unusual business-building products. Fifty years supplying the best. Literature free! Liscomb Miller, Chemist, Tampa, Florida.

OVER 100 Profitable assorted formulas! 50c. Plus unusual gift! Corlin's, 4741 Bernard, Chicago 25, Illinois.

OUR Laboratory tested formulas and plans put you in business. Free information. Write Stark Co., Grafton, Wis.

PRODUCT Analysis, manufacturing formulas, processes developed. Moderate fees. Plastics, Box 1574, Boston 4, Mass.

500 MONEY Making formulas, 25c postpaid. Allen, Dept. PMC, Clinton, Missouri.

FORMULAS; All kinds. Latest, best. Literature free. Kemixal, Park Ridge, Ill.

GENUINE Manufacturing formulas. Latest. Literature free. Nelko, 3462-P Merchandise Mart, Chicago 54.

REAL Manufacturing formulas. Lists free. Cummings, Chemist, Gordon Ave., Syracuse 4, N. Y.

ANY Formula \$3.00. Chemical Instruction Sheet—catalog 10c. J. Belfort, 216 W. Jackson, Chicago 6.

FREE Formula catalog. Anything analyzed \$35. Western Chemical, Salem, Ore.

LABORATORY Tested formulas. Catalog free. Pont Chemical Company, Terre Haute 2, Indiana.

ANY Formula. Jack, Consulting Chemist, 5138 Gainor Road, Philadelphia 31, Penna.

PERFUME Manufacturing formulas. Fragrance Research Foundation, 1513 Oxford Way, Oklahoma City, Oklahoma.

PLASTICS

"WORKING With Plexiglas," 70 page illustrated instructions with material catalog \$1.00 postpaid. Plastic's, Box 1812, Salt Lake City 10, Utah.

NEW Liquid casting plastic. Clear, colors. Embed flowers, insects, coins. Saw, drill, carve. Send 25c for Castolite Creations Manual and proved success plan showing how to make money at home. Castolite, Dept. P-101, Woodstock, Ill.

PLASTICS Home-craft course for men and women. Tells and shows how to make hundreds of fast selling plastics products. All plastics and materials for 23 projects included in course. No special tools needed. Course pays for itself. Write for free booklet, Interstate Training Service, Dept. D3N, Portland 13, Oregon.

MANUFACTURERS Of a complete line of internal carvings. Special introductory offer; \$1.00, jewelry set and keychain. Crystal Floral Company, Bound Brook, New Jersey.

FIBERGLAS, Polyester, Plexiglas, Acetate, Vinylite; casting, coating plastics: My own Fiberglass "how" book now ready, \$2.50. Fast service, best prices. Catalog 10c. Airmail 35c. Gem-O'-Lite, Box 6867P, North Hollywood, California.

PLASTIC, Sheets, rods, tubes, etc. Free list. Plastic Supply Co., 2901 N. Grand Blvd., St. Louis 7, Mo.

PLEXIGLAS Sheets—Cut to size. Clear. All thicknesses. Standard outdoor translucent colors. McClarin Plastics, P.O. Box 168, Hanover, Penna.

LEARN Plastics at home. Complete course—\$5.98 postpaid. Dime brings sample plastic, three experiments, full details. Plastic Projects, Box 5151, Detroit 35, Mich.

PLEXIGLAS, Lucite. Any size sheets. Square foot (12 x 12) cost, 1/16", \$1.18; 1/8", \$1.55; 3/16", \$1.90; 1/4", \$2.25. Add 15% for postage. Minimum order \$3.00. Almac Plastics, 600 Broadway, New York City.

CHEMISTRY

CHEMISTRY: Brand-new, step-by-step, painstakingly designed course for all ages. Not a toy. Not a plaything. Cultural. Practical. Fascinating. Constructive. First lesson 25c. Parkway Laboratory, 1004 Second Ave., Pittsburgh 19, Penna.

CHEMICAL Set makes water glow in darkness. Blue, green, orchid colors. Resembles glow of fireflies, deep sea fish. Harmless Christmas gift. Free literature. Varniton Company, 416 N. Varney Street, Burbank, California.

ILLUSTRATED Catalog: Chemistry, mineralogy, biology, 20c. Tracey Laboratories, Evanston, Illinois.

NEW Idea chemical and apparatus outfits for home experimenting. Photo-scales, microscopes, chemicals, biological and laboratory supplies in small quantities. Catalog 25c. Established 1931. John H. Winn, 124A West 23rd Street, New York, N. Y.

AMAZING New book of science. Experiments, formulas and catalogue of laboratory supplies. Only 25c. National Scientific Co., Dept. 16, 2204 W. North Ave., Chicago 47, Ill.

SECOND Improved printing, "Spectacular Chemical Experiments" manual. Not mimeographs. Contains complete formulas, set-ups, instructions, special data, on thermites, fulminates, explosive powders, etc. Still \$1.00 postpaid. Chem-Tech Laboratories, 568CL Riley, Buffalo 8, New York.

CHEMICALS, Supplies. Catalog, 15c. Laboratory Sales, Box 161-A, Brighton, Mass.

CHEMICALS And apparatus for industrial, analytical, and private laboratories. Catalog 25c. Dept. M-50, Biological Supply Co., 1176 Mt. Hope Ave., Rochester 20, N. Y.

SPECTROSCOPE For quick chemical analysis \$3.00. Kutting Sons, Los Altos, Calif.

AGENTS WANTED

BIG Profits in spare time! I'll send free assortment full-size samples fine foods, household necessities to ambitious men—women who need money. Friends, neighbors buy eagerly. Send no money. Just write Blair, Dept. 31LY, Lynchburg, Va.

LIFETIME Vitamin business! Sell sensational food supplement! Regular \$3.00 size (month's supply) \$1.50 postpaid. Money back guarantee. National Health Products, Dept. PM2, 150 Broadway, New York 38.

STRANGE Dry window cleaner. Sells like wild. Replaces messy rags, liquids. Simply glide over glass. Samples sent on trial. Kristee 126, Akron, Ohio.

BARGAINS, Terrific savings, job lots, close-outs! Also save up to 50% on dry-goods, clothing, hosiery, notions, drugs, toiletries, gifts, jewelry, television, etc. 2000 items. Send 25c for wholesale bargain catalog with special get acquainted offer which includes free \$1.00 merchandise certificate. Reliable Jobbers, 311-B North Desplaines, Chicago.

SAVE 50-75% On household appliances. Free particulars. Wholesale catalog. Nueblings-P, Sicklerville, N. J.

SELL: Watches, jewelry, household, gift items, national named brands. Guaranteed. Illustrated catalog and confidential wholesale price list 25c, refundable. H. Distributors, Palatine 5, Ill.

SCHOOL Seniors—Have fun and spending money! Be popular with your classmates. Send postal for details. Craftcards, Box 235-L, Pittsburgh 19, Penna.

MEXICAN Feather pictures. Sell on sight; 200% profit! Free details. Sample 20c stamps, no coins. Sylvia P, Apartado 9036, Mexico City.

BUY Wholesale. 25,000 items. Catalogue 25c. Matthews, 1472-B3 Broadway, New York City 36.

PRINTING—Salesbooks, business cards, stationery. Free samples, wholesale prices. Sutton Printing, Box 853-A, Waycross, Georgia.

ATTENTION Jobbers, wagon men, church groups, etc. Sell Silver Grill. Amazing new magnesium alloy silver cleaner cleans immediately, automatically. Large profit. Send 75c for sample, information. Portland Specialty Sales, Portland, Michigan.

MAKE Money spare time plus new car as encouragement bonus. No house-to-house canvassing required. Amazing 60 gauge nylons 3 pairs guaranteed 3 months or replaced free. Write Wilknit, 17311 Wash., Greenfield, Ohio.

MAIL Order dealers wanted for specialty used daily by 30,000,000 people. Mail order plan, sales letter and sample free. Get in on the ground floor. Write today. Malomatic Service, Dept. 1, 26 Court St., Brooklyn 1, N. Y.

FREE Hosiery! Introduce sensational hosiery by giving every man and woman free trial pair to prove how good they are! Amazing nylon stockings guaranteed against runs and snags. New miracle one-size nylon two-way stretch socks. Contain no elastic yet fit any size foot. Never sag. Comfortable like second skin. Actually guaranteed one full year. Earn to \$3 hour in spare time. Mail postcard for free sample stocking and money-making outfits. Absolutely no obligation. Kendex, Babylon 73, N. Y.

TWO In one screwdrivers. Money maker. Sample 88c. Ideal Service, 4644 Geary, San Francisco 18, California.

MAGAZINE Subscriptions—Highest commissions, bonus. Qualified Publications, 451 R. Kingston, Brooklyn 25, N. Y.

BIG Profits selling ties (\$2.00 values), \$6.50 dozen. Free catalog. Empire Cravats, 611A Broadway, New York 12.

RURAL Agents, 20" wood-chain saw. Cuts everything. Winter demand. Easy terms. Farmco-PM, Excelsior Springs, Mo.

BIG Money selling Walker's famous tooth powder. James Walker, Jr., 633 S. Plymouth Court, Dept. 11, Chicago 5, Ill.

WINDOW Sign letters. Samples free. West Coast Sign Letter Service, P.O. Box 697, Escalon, Calif.

BUY Bankrupt, closeout bargains! Toys, novelties, household items, specialties, etc. Many 15-25c on the dollar! Also 100,000 items wholesale. Free details. Box 591, Lynn 3, Mass.

BUY Wholesale thousands nationally advertised products at big discount. Free "Wholesale Plan." American Buyers, 629-R Linden, Buffalo, N. Y.

AMAZING Process permanently seals snapshots, cards, etc. in plastic. Earn extra money taking orders. Send 60c and 2 snapshots for sample work and particulars. Refundable. Variety Sales, Box 11533M, Los Angeles 48, Calif.

JAPAN Trade directory, 1954. 400 pages, \$3.00 prepaid. Hoffman, 248P Madison, Passaic, N. J.

BALL Pens \$10 gross, d.e. s.e. blades \$4.75 M, novelty flashlights with batteries \$2.25 dozen, assorted plastic ruffled aprons \$1.40 dozen up, needlebooks with threader \$6.25 gross. Lutzker, 871-D East 170th, New York City.

LEARN Where millions in profits from Bible sales have gone! Receive free proven sales course, catalogues and whole story on how you can get these profits! Joseph W. Cain, Wholesaler, Box 5065A, San Antonio 1, Texas.

GOLD Or silver letters, numbers. Windows, doors, trucks. 1" to 6". 500% profits. Free samples. Atlas, 544-T West 79th, Chicago 20.

MEXICAN Feather pictures. High profits! Fast sellers! Adelphi, Box 57-B, Bellersore 26, N. Y.

MAKE Money introducing world's cutest children's dresses. Big selection, adorable styles, low prices. Complete display free. Rush name. Harford, Dept. L-1341, Cincinnati 25, Ohio.

EASY Handwork makes fast-selling useful articles. Sample free. Sunmade Company, Brockton 64, Massachusetts.

FOG Stop windshield cloth. Instantly removes blurry mist, frost, sleet, snow. Stops windshield fogging. Samples sent on trial. Kristee 124, Akron, Ohio.

101 WAYS To make \$1,000 at home. Details free. Business Surveys, 365 S. Fairfax, Los Angeles 49, Calif.

SENSATIONAL New plan! Large wholesaler of appliances, cameras, watches, etc. will start you in new type of business. No selling. Free details. Cam Company, 6806PM-20th Ave., Brooklyn 4, N. Y.

MAKE Extra money. Sell front door name plates to friends, neighbors. Retail \$1.98; you make \$1.00! Free selling kit. Modern Engraving Co., P.O. Box 194, Boston 14, Mass.

ABSOLUTELY Free—Sales kit. Yours for the asking. Send postcard today requesting kit showing new line, belt buckles with your name or personal initials, cap badges, choice 3000 different emblems. Write Hook-Fast, Box 1425PM, Providence, R. I.

YOUR Own business—Used suits \$1.50, overcoats 65c, mackinaws 35c, shoes 12½c, ladies coats 30c, dresses 15c. Enormous profits. Catalog free. Moro, 558-AA Roosevelt, Chicago 7.

CALIFORNIA Sweet smelling beads. Sensational sellers. Free particulars. Mission, 2328PM West Pico, Los Angeles 6, Calif.

AGENTS: Stamping names on key protectors. Sample 25c. Stamping outfits, checks, social security and name plates. Hart Mfg. Co., 303 Degraw St., Brooklyn, N. Y.

AGENTS—300% Profit selling genuine gold window letters; stores and offices. Free samples. Metallic Sign Letter Co., 431-D North Clark, Chicago.

\$50 WEEKLY Selling finest razor blades, other items. Free details. Edisons, Box 274, Far Rockaway, N. Y.

EXCELLENT Sideline for printing and advertising salesmen. Decalcomania name plates in small quantities. Great demand. Also, make money with our line of automobile initials and sign letters. Free samples. "Ralco" XL-Roxbury, Boston 19, Mass.

\$1.00 PROFIT Selling \$2.95 photo enlargement deal. Allen Studio, Riegler Bldg., Little Rock, Ark.

BEST Source for wholesale nylons. 25 years dependable service. Fields Hosiery, 99-G Chauncy, Boston, Mass.

NEW And unusual merchandise. E. Eller, 1000 Sutter St., San Francisco 9, Calif.

BUY Wholesale thousands nationally advertised products. Save money! Make money! Postcard brings details. Kemah Company, 5017-K Washington, Houston 7, Texas.

SALESMEN—DISTRIBUTORS

SALESMEN—\$50.00 In a day definitely assured selling brand new item going to every type of food and beverage store, factories, laboratories, hospitals, etc. Samples furnished. Utility Durawear, 53 West Jackson Blvd., Dept. PM-12, Chicago, Illinois.

BIG Money making opportunity. Exclusive line work uniforms. Jackets, pants, shirts, coveralls, advertising embroidered. Every business prospect. Outfit free. Master Div., Dept. 721, Ligonier, Ind.

\$10,000 PROFIT Selling printing, matches, specialties! Arrow dealer tells how he did it in giant free sales outfit. You can do it too—Without experience. Write Arrow Press, 515-A Fourth Ave. So., Minneapolis, Minn.

IS \$210 A week worth a postcard to you? Then rush card with name and address for special free trial plan that sells amazing new automatic refrigerator defroster like hot cakes! Write to Mr. Lewis, D-Frost-O-Matic Corp., Dept. J-102, 173 W. Madison, Chicago 2, Illinois.

FREE Sample—New process, cleans, polishes, protects car finishes and chrome. Agents wanted. Wonder Glaze, Bay Port 7, Mich.

IMPORTED Wood slab coffee tables from Hawaii. Unusual, beautiful. Picture, information 25c. Robert Jones, Spring Lake, Mich.

PLASTICKON Changeable letters automatically adhere to glass and other smooth surfaces, yet they are not sticky and leave no marks when removed. Earnings of \$40.00 daily not unusual. Send 50c for samples. Plastickon, Huron 3, Ohio.

AD Matches! Sell amazing designs—20, 30, 40 and 240-light book matches. Bigger spot cash commissions; every business a prospect. Low prices for high quality. Repeats. Start without experience; men, women; full, part time. Buy nothing! Sales kit furnished. Match Corp., Dept. PM-48, Chicago 22, Illinois.

ADVERTISING Book matches—Cash in on big demand; sell union label matches. Cuts for all businesses and political parties. Free powerhouse selling kit, low prices, protection guaranteed on repeat orders. Cash commissions. Superior Match Co., Dept. M-1253, 7530 Greenwood, Chicago.

EXCLUSIVE Franchises for the world's best seller! You'll be amazed when I show you where millions in profits from Bible sales have gone. Proven sales course, catalogues. Whole story free. Joseph W. Cain, Wholesaler, Box 5065M, San Antonio 1, Texas.

NEW Advertising glass insert drink mixers, advertiser's message can't wear off. Other revolutionary items also. Details free. Sample kit; dollar, refundable first order. Murray Ackerman Advertising Service, 1016C-50 Street, Brooklyn 19, New York.

MEN Wanted to sell our established line of nationally known men's hygienic products to physicians and druggists. Extremely long profits. Many ready customers waiting for our salesmen. Free price list upon request. Send \$2.00 for salesman's sample kit including actual samples and prices of merchandise to be sold. Federal Premium Supply, 4307-J Lawrence Ave., Chicago 30, Illinois.

BUY Wholesale thousands nationally advertised products at big discount. Free "Wholesale Plan." American Buyers, 630-DD Linden, Buffalo, N. Y.

PROVEN Profits: Magica, back sponge. Patented. Seventeen inch polystyrene handle. Suds as it washes. Soap saver. Sensational sales. Magica Products, Wollaston 70, Mass.

BUY Wholesale thousands nationally advertised products. Save money! Make money! Postcard brings details. Kemah Company, 5017-N Washington, Houston 7, Texas.

EDUCATIONAL AND INSTRUCTION

YOU For president of collection agency. We have helped hundreds get their names on office doors. Franklin Credit, Roanoke 7, Virginia.

BLUEPRINT Reading—Train at home. Learn to read blueprints with confidence in 10 easy lessons. Write today Belton School, 1059 N. Lawndale Ave., Chicago 51, Ill.

LEARN Priceless secrets of technical metaphysics. Easy to learn. Only school of its kind. Write: Premier College of Technical Metaphysics, 2532 McKenzie St., Vancouver, B.C., Canada.

WINDOW Display money making home course. Pan-America Art School, 321 West 56th, New York 19.

FINGERPRINTING Course \$12.00. Free details. Alabama School of Fingerprinting, 414 South 10th Street, Bessemer, Alabama.

FOR An extremely profitable lifetime business, operate a collection agency. Quickly learned. Write Cole Associates, Syracuse 2, N. Y.

WELDING Training pays at Hobart Welding School, Box M-1231, Troy, Ohio. VA contract. Best equipment. Catalog free.

USED Correspondence courses and educational books bought, sold, rented. Catalog free. Educational Exchange, Summer-ville, Ga.

STUDY For degree of Doctor of Psychology (Ps.D.), Doctor of Metaphysics (Ms.D.) or Doctor of Divinity (D.D.). Write College of Divine Metaphysics, Dept. PM, 2811 North Illinois Street, Indianapolis, Indiana.

UPHOLSTERING—Train at home for prosperous business. Tools, supplies sent. Illustrated training shows how—previous experience unnecessary. Establish full or part time business. Free booklet explains plan. Write Commercial Trades Institute, 1400 Greenleaf, Dept. U2A-12, Chicago 26.

IT'S Fun learning a language by Lingua- phone. At home, in leisure time, quickly, easily, master French, Spanish, German, Russian, Japanese—29 languages by Lingua- phone Conversational Method. Save time, work, money. Send for free book. Lingua- phone Institute, 8312 Mezz., Rockefeller Plaza, New York 20.

UNITED States Constitution! All amendments! Pocket size! 50c. Plus unusual gift. Corlin's, 4741 Bernard, Chicago 25, Illinois.

TELEGRAPH Codes easily learned with Simplex teaching machine. Free particulars. Harris, 9534-P Lemturner, Jacksonville 8, Florida.

CORRESPONDENCE Courses, educational books, bought, sold, rented. Lists free. Magnolia Press, Box 1272-P, Burbank, Calif.

WORK For "Uncle Sam"! Start high as \$316.00 month. Men—women, 18-55. Qualify now! 30,000 jobs open. Experience often unnecessary. Get free 36-page book showing jobs, salaries, requirements, sample tests. Write: Franklin Institute, Dept. H-24, Rochester, N. Y.

MINISTER'S—Laymen's religious courses. Free bulletin! Midwest Bible School, 517 Merchants Bank Building, Indianapolis, Indiana.

COMPLETE Your high school at home in spare time with 55-year-old school. Texts furnished. No classes. Diploma. Information booklet free. American School, Dept. X945, Drexel at 58th, Chicago 37, Ill.

EASILY Make, sell rubber artificial plants. Huge profits. Free sample. Rubber, 711 Vine, Hollywood, Calif.

LEARN Drafting and design at home. Spare time. Simplified method. Prepare yourself for a good paying position. Text books and complete drafting equipment furnished. Free booklet. Roth Technical Institute, Dept. M12, Box 2283, Youngstown, Ohio.

PENMANSHIP Courses. Improve your writing quickly. Learn shaded writing. Greeting cards—Name cards, elegantly written. Free literature. Tevis, A-25, Chillicothe, Mo.

BEST Buy in education, 100 subjects, lists free. Davidson Co., Box 1232, Escondido, California.

SECRET Investigation. Experience unnecessary. Investigators particulars free. George Wagner, M125 West 86th, New York 24.

MECHANICAL Engineering. Unusual home study opportunity. Midwest Engineering School, 10923 Hillcrest, Hickman Mills, Missouri.

WANT A diesel job? New opportunities to increase income. Higher pay. More money. We can help you qualify. Tools. Shop method home training. Write today! Diesel, Tractor, Heavy Equipment Division, Interstate Training Service, Dept. B3-N, Portland 13, Oregon.

YES! You must do it now! You must tap unused powers today or fall flat on your face under life's disciplines tomorrow. Our "Human Behavior Control" formula fills this fitness requirement for many. Rush your request for details. Personal Psychology School, Box 1924-E, Louisville 1, Ky.

INCREDIBLE! Become mental superman overnight! Free booklet! Bijou, Box 1727-MC, Hollywood 28, California.

PIANO Tuning pays. Learn this profitable profession at home. Our Tonometer and mechanical aids make learning easy. No knowledge music necessary. Diploma granted. Largest and oldest school—55th year. G.I. approved. Write for booklet. Niles Bryant School, 78 Bryant Bldg., Washington 16, D. C.

THINKING Correctly will change your life! Write Christian Way of Life, Box 7, Main Office, Louisville 1, Ky.

LEARN Linotyping. One of the highest paid, most fascinating trades. Least unemployment. Jobs all over U. S. Fully GI approved. Free catalog. Chicago Linotype School, 637 S. Dearborn, Chicago 5.

HIGH School diploma at home. Licensed teachers. Approved materials. Southern States Academy, Box 144, MX Station E, Atlanta, Georgia.

PREPARE For career in private investigation or public law enforcement work. Write for free booklet. National Detective Academy, 8038 North 30th Drive, Phoenix, Arizona.

MIDLAND Linotype School. Charles City, Iowa. Civilian and Veteran Courses. Free placement. Established 1909.

BE A real estate broker. Study at home or in classrooms in leading cities. Write for free book today. G.I. approved. Weaver School of Real Estate, 304 Law Bldg., Kansas City, Missouri.

EARN While you learn. Auto and diesel mechanics master this top paying trade. Many graduates earn \$100 a week and up. Approved for Korean veterans. For free information write Dept. No. 256, Nashville Auto-Diesel College, Nashville 3, Tenn.

BOOKKEEPERS! Increase your earnings! Operate your own simplified "Dollar-A-Week" bookkeeping and tax service. Full or spare time. Details free. No obligation. Ellis, Box 200, Cedar Grove, North Carolina.

MEDICAL Laboratory technicians in great demand. We train you in your own home. Catalogue free. Imperial Technical Institute, Box 973-J, Austin, Texas.

INVESTIGATOR Training. Phillips Secret Service System, 1917-B North Kenneth, Chicago 38.

USED Correspondence courses and books sold and rented. Money back guarantee. Catalog free. (Courses bought.) Lee Mountain, Pisgah, Alabama.

LEARN Drafting. Fastest method. Low cost pay-as-you-learn plan. Drafting equipment furnished. Top grade industrial instructors. Free catalog. Cesco Industrial Training Services, 1704-A Frederick, Fort Worth 7, Texas.

GOVERNMENT Position! Home training for examination, \$9.95. Refunded if don't pass. Write, Ozment Instructions, 34-CS, St. Louis, Mo.

MAKE Movies a career, paying hobby, learn 3-D, TV films at home. Free catalogue. Motion Picture Institute, Birmingham 6, Mich.

SIMPLIFIED Analytics teach algebra instantly; \$1.00, guaranteed. Ziembeck, 6123 Orchard, Dearborn, Mich.

MASSAGE Course, also principles of osteopathy, naturopathy, chiropractic, etc. \$2.00. Healthway, Box 5610, St. Ann 14, Missouri.

UNIVERSITY Degrees by residence and correspondence. Golden State University, Hollywood, Calif.

PLAYS, STORIES, MANUSCRIPTS

MANUSCRIPT Typing: expert and expeditious. Editing. Manuscript Service, 1533 East Boulevard, Cleveland 6, Ohio.

BEGINNING Writers: Get \$1 to \$20 checks daily writing simple children's stories, articles, poetry in your sparetime. Experience unnecessary. Our instructions reveal how. Details free. W. Herman, 7016 Euclid, Cleveland 3, Ohio.

NO Luck finding a book publisher? Write for free Booklet PM. Vantage Press, 120 W. 31, New York.

WRITE For pay—Cash checks of \$1 to \$100 offered daily. Learn professional writers' secrets at home. Free details. Cummings Institute, Box 17006, Studio S-11, Los Angeles 17, Calif.

SPECIAL SERVICES

INFORMATION On any matter. Ferguson Research Specialists, 116-14 141 St., South Ozone Park 36, N. Y.

BE A notary public. Apply, Keena, 1312 Jefferson, Grand Rapids, Mich.

PROMPT. Reliable research on any subject. Questions on matters of fact answered, \$2.00 each. Gordon Research, Box 1427, Chicago 90.

CARTOONING, COMMERCIAL ART, SHOWCARD WRITING, SIGN PAINTING

IMPORTED West German precision Lot-ter geared head drawing instrument sets. \$7.50 up. Send for free brochure. Empire Engineering Supply Company, Box 114, Canal Street Station, New York City 13, N. Y.

14 ALPHABET Patterns. Monograms, numerals, $\frac{1}{2}$ "-4" high. Walker Studio A-12PM, 4343 Lindell, St. Louis 8, Mo.

"HOW To Make Money With Simple Cartoons"—A book everyone who likes to draw should have. It is free; no obligation. Simply address Cartoonists' Exchange, Dept. 912C, Pleasant Hill, Ohio.

PAINT Signs and show cards. Learn at home. Biggest complete course with 324 illustrations (18 in colors) \$5 postpaid. Descriptive circular free. E. C. Matthews, 2325 Cass, St. Louis 6, Mo.

ANIMATED Cartooning. Amateurs, professionals. Big demand by TV and motion pictures. Excellent pay. Animated Cartooning School of America, P.O. Box 2109, Hollywood 28, California.

CHALK Talks. Laugh producing program, \$1.00. Catalog 10c. Balda The Cartoonist, Oshkosh, Wisconsin.

FREE Sample cartooning lesson. No obligation. Box 10074M, Knoxville 16, Tenn.

ADVERTISING AGENCIES, LETTER WRITERS, FOR ADVERTISERS

OPPORTUNITY Seekers. 500 names, guaranteed, \$2.00. Ideal Service, 4644 Geary, San Francisco 18, California.

NATIONAL. Stork and newly weds mailing lists. Eugene Pyles, Aspers, Penna.

MAILING Lists, most any classification. 1000 names \$5.00. 1000 your circulars mailed with ours \$4.00. 5000 your circulars printed and mailed \$12.95. Write Dixie Mailers, King, North Carolina.

600 CIRCULARS Mailed with others \$1.00. 1000 buyers names 25c. R. Barr, Box 861MB, Milwaukee, Wisconsin.

GET Thousands of dollars worth of national advertising for your new product, for only a few dollars. Williams Agency, 1117-C-2 Investment Bldg., Pittsburgh 22, Penna.

ADVERTISE: 24 Words, 100 Canadian newspapers \$5.50. Lists free. Advertising Bureau, 10511-C Springfield, Chicago 43.

ADS Placed in out of town newspapers and magazines. Low rates. Catalogue free. Ideas that pay. Baker Advertising Agency, Successors Ankrum Agency, 189 W. Madison, Chicago 2.

ADVERTISERS! Reach nearly 18,000,000 readers. 25 Sunday national key newspapers. 18 words, \$59.00. "Terrific pullers." 20 popular newspapers. \$11.50. Free booklet. Special—One inch display 2,-821,198 circulation. \$51.10. Newmark's Advertising Agency, (Established 1893), 217-7th Ave., New York 11.

RUBBER STAMPS AND OFFICE SUPPLIES

PLEXIGLAS Deskplates for executives, staff. \$4.50. Brauner, Merrick 54, N. Y.

NAME Stamps for Christmas. 3 lines \$1.00. U.S. postpaid. Catalog. South Coast Press, 2128 Mt. View, San Bernardino, California.

WISE UP! Write for quantity prices! 3 line pocket stamp \$1.00, 4 line rubber stamp \$1.00. Free stamp and quality printing catalog. Esco 123 Print, 8 Holt, Dayton 7, Ohio.

3 LINES, \$1.00. Fast service! Catalogue. Johnson Press, Box 6-A, New York City 26.

LINE 25c; 2-45c; 3-65c. Stamp Works, Auburn, Nebraska.

TYPEWRITERS, DUPLICATORS, OFFICE DEVICES

FREE Check protector, value \$1.00, plus sensational new offer to mimeographers, with big opportunities mail for 25c. Ajax, P.O.B. 6346, Philadelphia 39.

RECONDITIONED Typewriters, duplicating, printing devices. \$25.00 up. Supplies. Appliances. DixieGraph, King, N. C.

FREE! Literature Protectograph, check-writer. Model Service, Box 777A, St. Louis 1, Mo.

PRINTING OUTFITS AND SUPPLIES

PRESSES, Type, cabinets, supplies. List for stamp. Lincoln Press Company, 220-Z Hartwell, Fall River, Mass.

MAKE Your own self-molding rubber printing cuts. Plexirubber, Argyle 1, Wisconsin.

CAST Your cuts, rubber stamps. Catalog presses, supplies, paper 10c. Custom, Box 211-P, Springfield, Missouri.

HOBBY Printers—Join American Amateur Press Association, 822 South Orleans, Tampa, Florida.

MAKE Your own cuts. New, simple process. Low cost. Literature free. Walp, P.O. Box 4308, Mobile, Ala.

HAND Presses, small paper cutters, type cases, etc. Visit our store. Van Dillen Inc., 74 Beekman St., New York City.

DO Your own printing. Save money. Simple rules. We supply everything. Print for others; good profit. Raised printing like engraving too. Have home shop. Details free. Kelsey Presses, V-11, Meriden, Connecticut.

PRINTING Presses, type, supplies. Lists 3c. Turnbaugh Service, Loysville, Penna.

PRINTING, MULTIGRAPHING, MIMEOGRAPHING GUMMED LABELS

BEAUTIFUL Art printed circulars—5,000, $5\frac{1}{2} \times 3\frac{1}{4}$, \$8.95. $8\frac{1}{2} \times 11$ offset \$22.95. Free samples other printing bargains. Dixieprint, King, N. C.

MIMEOGRAPHING—Letters, forms, bulletins, anything. Samples. Brennen, 1404 Carolina, Middletown, Ohio.

SALESBOOKS, Labels, calendars, samples for 50c. Write, O'Tool, Hammondsville, Ohio.

BEAUTIFUL Two color raised business cards. Dignified, appealing. Send for samples, prices. J. Hampton, 601 $\frac{1}{2}$ N. Main, Wichita, Kans.

MIMEOGRAPH Duplicating, cartooning, advertising. Samples free. Woods, Lafayette Station, P.O. Box 7052, Norfolk, Virginia.

500 LETTERHEADS, billheads or statements, \$3.50 ppd. Gillingham, Milford, Conn.

100 $8\frac{1}{2} \times 11$ LETTERHEADS, 100 $6\frac{3}{4}$ Envelopes, \$2.00. 250 each, \$3.75. 500 business cards \$1.95; 1000, \$2.50. Standard copy. Postpaid. Allen, Dept. PMP, Clinton, Missouri.

100 LETTERHEADS And 100 envelopes \$1.25 postpaid. DiBenedetto's, Box 171, Chelsea, Mass.

ALL Sizes gummed labels, lowest prices. Samples free. Cramer, 1010 East Morgan, Martinsville, Indiana.

100 PRINTED Envelopes or letterheads \$1.00. Two colors \$1.50. Salesbooks. Broadbrook, Botsford, Conn.

1000 EMBOSSED Business cards \$3.00 postpaid. Free samples. Printing prices. Lites, 5352-PM Princeton, Chicago 9.

ATTRACTIVE Printing, labels, stickers. Inexpensive. Samples. Fame, 291 Ellis, San Francisco 2, Calif.

MIMEOGRAPHING—Anything! 200, $8\frac{1}{2} \times 11$, \$2.00; 500, \$4.00; 1000, \$6.00. Guaranteed. Free samples. Quinn Sales, P.O. Box 967, Little Rock, Ark.

100 LETTERHEADS Or envelopes \$1.00. Printing, 21 Barclay Ave., Portsmouth, Virginia.

TWO Color $8\frac{1}{2} \times 11$ letterheads, 500, \$3.50. Samples. D'Yarmett Printing, Newark, Ohio.

PRINTING That pleases. Send copy for estimate. Samples, prices. Mercury Press, Box 69M, Marengo, Iowa.

MIMEOGRAPHING—Pricelists, letters, instructions. Free samples, prices. Loyal Brush, 3712 Walnut, Kansas City 11, Mo.

MIMEOGRAPHING—Letters, pricelists, formulas, instructions. Lowest prices. Lem's Letter Shop, 5710 Stanton, Detroit 8.

500 $\frac{3}{4} \times 2\frac{1}{4}$ FOUR Line gummed stickers 50c. Red border \$1.00. Moritz Printery, Saginaw, Mich.

BUSINESS. Personal stationery. Catalogs free. Howprint, 723-M Eunice, Webster Groves 19, Missouri.

PATENT ATTORNEYS

INVENTORS—If you consider your invention to be something of importance, take steps to protect it with a United States Patent which gives you the right to exclude others from making, using and selling your invention as claimed. "Patent Protection for Inventors" outlines steps to take to secure patent protection. Mailed promptly without obligation. Victor J. Evans & Co., Merlin M. Evans, Registered Patent Attorney, 831-P Merlin Building, Washington 6, D. C.

PATENTS—Irving L. McCathran, 315 McLachlen Bldg., Washington 1, D. C. Registered Patent Attorney.

INVENTORS—If you believe you have an invention, you should find out how to protect it. The firm of McMorro, Berman & Davidson with offices in Washington, D. C., is qualified to take the necessary steps for you. Send for copy of our patent booklet "How to Protect Your Invention." We will also send you an "Invention Record" form. No obligation. They are yours for the asking. McMorro, Berman & Davidson, Registered Patent Attorneys, 1341 Victor Building, Washington 1, D. C.

INVENTORS: Learn how to protect your invention. Unless the inventor is familiar with patent matters, he should engage a competent registered patent attorney or agent to represent him. We are registered to practice before the U. S. Patent Office and prepared to serve you in handling your patent matters. "Patent Guide for the Inventor" containing detailed information concerning patent protection and procedure with "Record of Invention" form will be forwarded to you upon request—without obligation. Clarence A. O'Brien & Harvey Jacobson, Registered Patent Attorneys, 31B-K District National Building, Washington, D. C.

INVENTORS: When you are satisfied that you have invented something of value write me, without obligation, for information as to what steps you should take to secure a patent. Write Patrick D. Beavers, Registered Patent Atty., 935 Columbian Bldg., Washington 1, D. C.

PATENTS. "Proof of Invention" free. E. E. Vrooman, Registered Patent Attorney, 507 McKim Building, Washington 5, D. C.

INVENTORS: Without obligation, write for information explaining the steps you should take to secure a patent. John N. Randolph, Registered Patent Attorney, 203 Columbian Bldg., Washington 1, D. C.

C. A. Snow & Co.—M427, Snow Building, Washington 1, D. C. Registered Patent Attorneys. Write for information.

"INVENTOR'S Guide" free. Frank P. Ledermann, Registered Patent Attorney, 154 Nassau Street, New York.

REGISTERED Patent attorney offers services. Sanders, 6430 Evans, Chicago 37, Ill.

CANADA—Ramsay Company Registered, 273 Bank Street, Ottawa, Canada.

INVENTORS—For "Invention Record" form, contact Carl Miller, Registered Patent Attorney, Woolworth Building, New York.

FOR INVENTORS

INVENTORS—If you believe you have an invention, you should find out how to protect it. The firm of McMorro, Berman & Davidson with offices in Washington, D. C., is qualified to take the necessary steps for you. Send for copy of our patent booklet "How to Protect Your Invention." We will also send you an "Invention Record" form. No obligation. They are yours for the asking. McMorro, Berman & Davidson, Registered Patent Attorneys, 134-Z Victor Building, Washington 1, D. C.

INVENTORS: Learn how to protect your invention. Unless the inventor is familiar with patent matters, he should engage a competent registered patent attorney or agent to represent him. We are registered to practice before the U. S. Patent Office and prepared to serve you in handling your patent matters. "Patent Guide for the Inventor" containing detailed information concerning patent protection and procedure with "Record of Invention" form will be forwarded to you upon request—without obligation. Clarence A. O'Brien & Harvey Jacobson, Registered Patent Attorneys, 31A-K District National Building, Washington, D. C.

THE Truth about patents with instructions for developing profitable inventions. \$1.00 postpaid. N. W. Halsey, Box 65, Jackson Heights, N. Y.

INVENTORS—This firm is registered to practice before the United States Patent Office and is available to assist you in the preparation and prosecution of your patent application. "Patent Protection for Inventors" booklet containing detailed information and steps to take toward patent protection will be sent upon request. No obligation. Victor J. Evans & Co., 832-P Merlin Building, Washington 6, D. C.

INVENTORS, Idea bulletin number 11 now out with excellent ideas to be developed in shop, home or on paper \$1.00. Thinkers, cash awards for ideas printed in our bulletins. Ideas, 310 Harlem Ave., Chicago, Ill.

FROM One inventor to another: Have licensed over 60 of my own inventions. I can help you market yours. Also thorough patent searches and commercial evaluations. Free information. Jacquelin Harvey, Jr., Research Engineer, Realty Bldg., Washington 5, D. C.

PATENT Searches \$5. 48-hour service. Free record of invention. Write Raymond L. Smith, Patent Searcher, 622 Sheraton Building, Washington 5, D. C.

PATENT Searches \$5. 48-hour airmail service. Record of invention forms free. Patent drawings prepared. Write Patent Engineering Service, 711 14th Street, N.W., Washington 5, D. C.

PATENT Searches \$5. Complete reports airmailed within 48 hours. Free invention protection forms. Write Miss Ann Hastings, P.O. Box 176, Washington 4, D. C.

GOT My patent the hard way. Knew nothing. Learned plenty, paid plenty. My Gamecraft product now sold nationally. "Story of a Patent" details my experiences, itemizes every cost. Chart calculates your total patent cost within \$50! Don't gamble. Know ahead. Save about \$200.00. Patent story information free. Gamecraft, Red Lion, Penna.

PATENT Searches, \$5.00, including patent copies. Same reliable search as conducted for patent attorneys. Free protection forms, 48 hour service. Patent Service Institute, 945-A Pennsylvania Avenue, Washington 4, D. C.

CASH For your idea, 280 manufacturers need inventions, patented or unpatented. List free. Invention Bureau, 208M Clinton, Oak Park, Ill.

INVENTORS — For "Invention Record" form, contact Carl Miller, Registered Patent Attorney, Woolworth Building, New York.

MAKE Money from your ideas, gadgets, patents. Get "Inventors Guide." Helpful book tells you how. Send \$1.00, includes list of needed inventions. We have buyers. Inventors Creative Service, 354 South Spring, Los Angeles 13, Calif.

SEARCHES—Put your patent searches in the hands of a registered patent attorney or agent, as he qualifies to give a worthwhile patentability report. Record of invention form upon request and information on patent protection. Patrick D. Beavers, Registered Patent Attorney, 936 Columbian Bldg., Washington 1, D. C.

INVENTORS: If you have an invention for sale, patented or unpatented, write Institute of American Inventors, Dept. 40A, 631-E St. N.W., Washington 4, D. C.

INVENTORS: Information on patent procedure furnished on request, without obligation. John Randolph, Registered Patent Attorney, 202 Columbian Building, Washington 1, D. C.

I Sell patents. Established 1900. Charles A. Scott, 773PM Garson Avenue, Rochester 9, N. Y.

INVENTORS—Send for free patent information book and inventor's record. Registered Patent Attorney. Associate Examiner, Patent Office 1922-29; Patent Attorney & Advisor, Navy Department 1930-47. Gustave Miller, 93A Warner Building, Washington 4, D. C.

INVENTIONS WANTED

INVENTIONS Promoted successfully. Best handling. Reasonable cost. Write for free particulars. Superior Inventions Agency, 240 So. Beverly Drive, Beverly Hills, California.

CASH Buyers for inventions, patented or patentable. National Inventors Institute, 4097 East 131st St., Cleveland 5, Ohio.

FINALLY A publication devoted to describing new inventions to manufacturers. Insert your ideas. Reasonable rates. Post card brings details. David A. Lee and Company, Publishers, Box 142, Hampton, Va.

MARKETING Aid — Nation wide. Patented, patent pending. Booklet free. Market Contacts, 719-A2 Magnolia, Tupelo, Miss.

INVENTORS: Hundreds of manufacturers have requested our assistance in locating marketable new products. Complete information free. Institute of American Inventors, Dept. 40-D, 631-E St. N.W., Washington 4, D. C.

INVENTIONS Promoted. Patented or unpatented. Established 1911. Write Adam Fisher Company, 61 Enright, St. Louis, Mo.

INVENTIONS Wanted. Patented, pending only. Inventors Patent Exchange, Hartford 1, Conn.

INVENTIONS Wanted. Patented; unpatented. Tremendous manufacturers lists. Global Marketing Service, 1404 Mitchell, Oakland 1, California.

INVENTIONS Wanted. Patented or patent pending. 23 years experience promoting inventions. National Service Bureau, 3120 Meramec, St. Louis 18, Mo.

PATENTS FOR SALE

WASTE Oil and liquid fuel burner. Patent number 268,803 for sale, manufacture for me, or royalty basis. 3525 N.E. 2nd St., Minneapolis, Minnesota.

5 WAY Boot jack. Invention and patent. Illness. Must sell. David O'Blusteel, 144 Allen St., Buffalo 1, N. Y.

PATENTED Sign letter, cheap to mfg. Large sales prospect. Write, 3023 State Avenue, Des Moines, Iowa.

INVENTORS: Test the commercial value of your patented or unpatented inventions, quickly and inexpensively. Write for free information. Institute of American Inventors, Dept. 40-B, 631-E St. N.W., Washington 4, D. C.

MANUFACTURING

MODELS — Small lot manufacturing. Metals, plastics, etc. Milburn, Burlington, Kentucky.

MODEL Making, experimental and machine work in metal, wood and plastics. Free estimate. Futuraire Engineering, Box 8, Parkville Sta., Brooklyn, N. Y.

MODELS, MODEL SUPPLIES

POWER Models. Unusual steam, gasoline and traction engines, fittings, metals. Anniversary catalog 50c. Chas. Cole, Ventura, Calif.

LIVE Steam engine, 10½" high, ready-to-run, \$5.95 postpaid. Catalog 35c. Merlo, 50-18 94th Street, Elmhurst 73, N. Y.

LIVE Steam locomotive catalogue of supplies, rough castings and blueprints for ten engines. Send 25c to Yankee Shop, Box 275C, Danvers, Mass.

1953 CAR Models. 1/25 scale, all metal, chrome trim. Send for catalog. Ajax Toy Co., Dept. PM-13, 2637 W. Division St., Chicago 22.

BUILD Western vehicles 50c to \$2.25. Illustrated catalogue 10c. Frontier, 221 San Fernando Road, Los Angeles 31, Calif.

SOMETHING New. Four scenic ship model kits for framing or shadow box. Carve and paint yourself. Photos and description 10c. Richard Orr, Ship Studio, No. Easton, Mass.

SELL Half scale live steam locomotive. Gebott, 9717 Dayton, Seattle, Wash.

STEAM Locomotives, 1½", 1", ¾", ½", ¼" scales. Castings, rail, steam fittings! Thorough drawings with instructions. Catalog 50c. Little Engines, Wilmington, California.

BUILD Historic ships, vehicles. 50c to \$9.00 kits. Illustrated catalog 10c. Ideal Models, 21 West 18th Street, New York 11.

SHIP And other scale models. Most complete line in New England. Kits, fittings, plans, books, tools, engines, motors. Illustrated catalog 25c. James Bliss & Co., Inc., Dept. SM, 342 Atlantic Ave., Boston 10, Mass.

SHIP And yacht model fittings; blueprints. Send 25c for illustrated catalog No. 28—listing hundreds of items. A. J. Fisher, 1002-1 Etowah Ave., Royal Oak, Mich.

ILLUSTRATED Lionel catalog, 10c; American Flyer, 10c; H. O. gauge, 10c. Ben's PM Dept., 134 North Dearborn, Chicago 2.

BALSA Wood. Grade AAA. Free sample, price list. Sig Mfg. Co., Montezuma, Iowa.

HOME CRAFTSMEN

KNOCKDOWN TV stool. Colonial style, rush seating. Circular free. Nelson Rapids Co., 1934 Nelson Ave., Grand Rapids 7, Michigan.

89 FULL Size jig saw patterns of beautiful shelves, ornaments, toys, novelties. Plus "How, Where to Sell." Only \$1.00. Mastercraft 124M, 7041 Olcott, Chicago 31, Illinois.

GUN Wall cabinets, complete or partly assembled quality precut kits. Free leaflets. Johnson Woodworking-14, Saugerties, N. Y.

FREE 48 Page leathercraft catalog including easy-to-follow instructions on lacing, wallets, etc. Get started in this easy fun-to-do-hobby today. Tandy's leathercraft prices are lowest! Write Tandy Leather, Box 397-M, Tulsa, Okla.

SMALL Motors 110 a.c. and 32 d.c. for driving sewing machine, small power and hobbycraft tools, grinders, polishers, number of home and shop uses. \$7.95 postpaid anywhere. No c.o.d. Humen Sewing Machine Co., 12405—87 Street, Edmonton, Alberta, Canada.

101 FULL Size patterns. Smart, new, gifts, novelties, lawn figures, shelves, action windmills, alphabets. Plus "Make Money Jig Sawing." Only \$1.00. Mastercraft 125M, 7041 Olcott, Chicago 31, Ill.

LEATHERCRAFT—Spring punch makes oval lacing holes 3/32", 1/8". Free information. A. Mullin, 972 Harliss Ave., San Jose, California.

FURNITURE Finishing made easy. Professional type supplies. Illustrated catalog and simplified manual 50c. Colorall, 493 Cedar Lane, Teaneck, N. J.

90 ALL New, full size lawn ornament and novelty patterns, up to 20" high. Only \$1.00. Mastercraft 122M, 7041 Olcott, Chicago 31, Illinois.

FOR Sale, unpainted plaster novelties, plaques. Free folder. Plasterine Novelties, 105 Frost Parkway, Tiffin, Ohio.

129 NEW Full size jigsaw patterns. Unusual novelties, gifts, lawn figures up to 22 inches high, action (merry-go-round) windmill, toys, useful gadgets. Artist drawn. \$1. Craftplans, 1321-A South Michigan, Chicago 5.

16 NEW Lawn chairs, 22 picnic tables, benches, trellises, etc. All 38 plans with necessary full size patterns, \$1.00. Mastercraft 123M, 7041 Olcott, Chicago 31, Ill.

CRAFT Leathers, supplies, lacing, kits, tools. Send 25c for latest catalog. Jonas Handicraft Co., 30 Frankfort Street, New York 38, N. Y.

ALUMINUM, Brass, copper sheet, rod. Price list free. Arnott's, Box 294-B, Aber Road, R.D. #1, Verona, Penna.

FREE Information. Money-making full size patterns. Professional designs. Furniture, gift shop items. Write Jigsawers, 117 Worth, New York 13.

GRANDFATHER Clocks, weight driven movements. Wills Bros., 237 South Ellwood Ave., Baltimore 24, Maryland.

LAMP Size cypress knee \$1.00. Cy Products, Dept. 1, Lafayette, La.

PLASTICS Home-craft course for men and women. Tells and shows how to make hundreds of fast selling plastics products. All plastics and materials for 23 projects included in course. No special tools needed. Course pays for itself. Write for free booklet. Interstate Training Service, Dept. D3N, Portland 13, Oregon.

LEATHERCRAFT. Tremendous stock of leather, tools, supplies, and kits. In leather business over forty years. Send 10c for big catalog. Sax Bros., 1111 No. 3rd, Dept. PM12, Milwaukee 3, Wisconsin.

LEATHERCRAFT Supplies. Pre-cut kits, tools, etc., large stock. Catalog 10c, refunded first order. Whitman Saddle Mfg. Co., 1725 Powers St., C-12, Cincinnati 23, Ohio.

ALUMINUM Nails, 1", 1½", 2", 2½", 3", \$2.25 per pound or assorted, postpaid. Barrs, 7800 Perry Highway, Pittsburgh 37, Penna.

ONLY New money maker in years—Secrets of luggage making revealed. We sell your products. Casecraft, 805-M1 Sunset Blvd., Los Angeles.

93 ORIGINAL Idea jig saw patterns \$1.00. Professional drawing, quality printing. Full size shelves, toys, lawn ornaments, novelties. Walker Studio, PM-V12, 4343 Lindell, St. Louis 8, Mo.

BIRDHOUSES. 20 Proven plans for attractive homes and feeders. \$1.00. Bird-box, Dept. M-12, 159 Clyde, Baltimore 27, Md.

LEATHERCRAFT For pleasure or profit. Make easy-to-assemble purses, belts, gloves, woolskin toys, 100 other items for gifts or to sell. Send 10c today for big catalog. Largest leathercraft stock in U.S. J. C. Larson Co., 820 S. Tripp, Dept. 3750, Chicago 24.

14 ALPHABET Patterns. Monograms, numerals, 1/2"-4" high. Walker Studio PM-A12, 4343 Lindell, St. Louis 6, Mo.

52 PATTERNS And plans for Christmas novelties, toys, interior and exterior decorations \$1.00. C & E Specialties, Chippewa Falls, Wisconsin.

PROFITABLE Occupation or hobby. Hand weaving loom plans. \$1. Bill Carter, 864 W. 19th St., Chicago 8.

SPECIAL Offer. 102 full size jig saw patterns only \$1.00. Lynds, 71 Park, Natick, Mass.

35 LAWN And garden ornament patterns. Full size, ready cut, colors indicated. \$1.00 postpaid. Lincoln Craft Studio, Columbia, Conn.

BRASS Rods, list free. Miller, 388 East 34th Street, Brooklyn 3, New York.

BLEACH Furniture blond. Kit \$1, complete with instructions. Send for free booklet. National Chemicals, Dept. 112, 3601 Bainbridge Ave., New York 67, N. Y.

HOW To refinish your own furniture. Krafters, Box 86, Hubbard, Ohio.

BUY Wholesale nationally advertised power, hand tools, thousands other products at big discounts. Free "Wholesale Plan." American Buyers', 628-RR Linden, Buffalo 16, N. Y.

SILVERSMITHING For beginners. Free illustrated directions for changing flat sheets of metal into hollow forms. Write for leaflet M. Craft Service Department, Handy & Harman, 82 Fulton Street, New York 38, N. Y.

LEATHERCRAFT—New stylecraft folder free. New kits illustrated. Filigree belts, billfolds, purses, etc. Send 25c new catalog. Refunded first order. Apache Leather Co., 2804 East Washington St., Phoenix, Arizona.

LEATHER, Tools, lacings, supplies. Free catalog. National Handicraft, 199 William St., New York 7.

LEATHERCRAFTERS: Illustrated catalog shows everything you need 10c. Art Leather, 411 Joseph Ave., Rochester 5, N. Y.

"TOPS" In everything for leathercraft. Lowest prices. Genuine "Craftool" stamps. Catalog 10c. Crown Leather Company, 22 Spruce Street, New York 38.

KNOCKDOWN Cedar chests and lumber. Free price list. Bedford Lumber Company, Shelbyville, Tennessee.

LEATHERCRAFT, Metal tooling, textile painting, beadcraft, shellcraft. Many other crafts. Send for free, big, illustrated catalog today! Kit Kraft, Hollywood 46, Calif.

200 ONE-Evening Projects that you can start and finish in one evening! Popular Mechanics editors have assembled 200 projects to be made with only simple hand tools, in a few hours time. Each project costs only 1c. Order your copy today. \$2.00. Popular Mechanics Press, Dept. EP-2, 200 E. Ontario, Chicago 11, Ill.

BIG Savings leather—Now, for first time, you can buy full sides of top grain cowhide at our special, amazingly low "tannery-to-you" prices. For details, write Dept. 1. W. D. Byron & Sons, Williamsport, Md. Fine cowhide tanners since 1832.

WORKSHOP Tips, by the hundred, in the new ten thousand word woodworking workshop manual, cover many details for starting, improving, and operating. Act fast. Also get five "How to Do It" books, or patterns, direct from manufacturers. All for \$3.00. U. S. funds accepted. Make It Yourself Club, 189 Church Street, Toronto, Canada.

PLANS—Children's davenport and chair \$1.00; platform rocker 50c. Pennebakers, Creston, Iowa.

100 FULL Size jig saw patterns up to 20" high, only \$1.00. Pattern Service, Medway 9, Mass.

\$46 FROM Square foot plywood; jigsaw necessary. Write: Woodarts, Bridgewater, Mass.

\$500 FROM \$75.00 Worth pine boards. Hammer and saw only. Enclose \$1.00 for plans, plus how to sell. Thanks. Cooke, Stoddard, Wisconsin.

HOMES You can build for \$4500 to \$7046. Books that take you through every step. Popular Mechanics Famous Concrete Block House, \$2.00. Your Home and How to Build It Yourself, \$3.00. Ranch Type House You Can Build, \$3.50. Also full-size/1 builder's plans for each home at nominal price. Popular Mechanics Press, Dept. 102, 200 E. Ontario, Chicago 11, Ill.

MAKE IT YOURSELF

BUILD Copyrighted concrete block duplex \$1300. Livingroom, kitchenette, bedroom, bath, each side. Blueprint, instructions, material cost list \$1.00. Bailey Builders, 915 Pyramid Building, Little Rock, Arkansas.

YOUR Workshop incomplete without the Easyplater. Also electrochemistry sets, hobby items. Free catalogue. Easyplater, Box 293D, Red Lion, Penna.

BUILD Automatic clothes dryer, \$50.00. Complete plans \$1.00. Nunley Enterprises, Dept. A1, 3390 Wiley, San Leandro, Calif.

BUILD A table model power hack-saw. Cuts patterns in wood, metal, plastic. Spare parts. Hand tools. Plan \$1.00. A. Harvey, Thornwood, New York.

INSCRIBE Gifts. 23K goldfoil 50c. Arndt, 1017-PM Bay, Eureka, Calif.

BUILD Luggage and cases at home. We sell your products. No special tools or equipment needed. Free details. Casecraft 805-P1 Sunset Blvd., Los Angeles.

BUILD Your own concrete blockmaker. Easy. Inexpensive. Motor or hand. Make block per minute. Write C. Lee, Mountain View, Oklahoma.

MAKE Your own sliding door units. All hardware, instructions, drawings supplied. Prices start at \$7.00. Knockdown wooden parts, doors and catches available. Send for list. Greenlee Products, Hollywood, Fla.

TRACTOR, Garden, two, four wheel drive. You build car parts. Information, Tractor, 14493 Arrow, Fontana, California.

HEAT 24x60 Shop, barn, etc., for as little as \$10 per winter with oil heater made from oil drum. Plans, instructions, \$1.50. Home deluxe model \$2.00. Both \$3.00. Twayne Associates, 446, Hannibal, Missouri.

BLUEPRINTS, 12"x24"x15". Toy garage \$2.39. Sample 25c. Woode-Versept, 725 Dickinson, Grand Rapids, Michigan.

BUILD A treasure and metal detector. Lightweight, sensitive, inexpensive. Complete kits, free literature. Dept. 1, Electronic Applications, Box 4975, Washington 8, D. C.

BUILD Your own tractor. Free information. Eltraco, D-I, Camptonville, California.

MELT Iron for castings. Free literature. Ursutz Burner, Box 92, Globe, Ariz.

"CONCRETE Block Homes." 32-page booklet, on how to build. \$1.00. H. C. Lightfoot, Civil Engineer, Richboro 1, Penna.

BUILD 3 Bedroom rancher. Large rooms. Fireplace. Only \$1200. Plans \$1.00. Minkoff, Box 52, Flushing, N. Y.

MAKE Your own stone veneer. Economical. Easily made. Quickly applied. Looks like genuine stone. Formulas, illustrations, patterns. Send \$1.00. Alburg, Box 17, Carrollton, Michigan.

WATCHES, OLD GOLD, JEWELRY

JEWELRY Wholesale direct to you. Egin, other national brands. 50% discount. Write, catalog 10c. Brockway Plan, 1145 High, Topeka, Kansas.

TWO New books show how to make jewelry at home and how to sell what you make. Send 25c for "How to Make Costume Jewelry" and "A Success Plan For You." Castolite, Dept. PJ-101, Woodstock, Ill.

WATCH And clock repairing books for hobbyists. Free information. North American, Dept. 13-M, 2320 N. Milwaukee, Chicago 47, Illinois.

RHINESTONES. Jewelry settings, cameos, sequins, beads. Send 10c for illustrated catalog. J & M Novelties, Dept. CP-3, Griffith, Ind.

WATCHMAKERS Journal contains instructive articles for watchmakers and beginners. \$1.00 year. Sample copy 20c. Dean Co., Box 3218, Daytona Beach, Fla.

FREE Wholesale catalog jewelry findings, supplies, chains, etc. Unsurpassed values! Fine finishes brass, gold, silver. Religious medallions, fraternal emblems, armed forces insignia. Real money makers! Caraday, Box 71, Ryder Station, Brooklyn 34, N. Y.

5000 JEWELRY Styles you can easily make yourself. Rhinestones, pins, earrings, etc. Lowest prices guaranteed. Instructions and catalog 10c. Barry's, 165 Ardsley Court, Newark, N. J.

WATCHMAKERS'—Jewelers' complete informative catalogue 20c. Bengale Company, Culver City, California.

JEWELRY Making can be a profitable hobby—Send 20c for our latest illustrated catalog. Milady-Fair Co., G.P.O. Box 1328, New York City.

CASH For old gold, broken jewelry, gold teeth, watches, platinum, diamonds. Popular Refinery Co., C. C. Hurley, Mgr., 216 East Ontario St., Chicago 11, Ill.

UNREDEEMED Diamond, 1-carat, \$295. 30-day refund. Free catalog. Broff's Diamond Loan Association, 411 Smithfield, Pittsburgh, Penna.

10 HIGH-Grade Swiss ladies' and gents' wristwatches needing minor repairs. \$18.00. Write for prices. B. Lowe, Holland Bldg., St. Louis 1, Mo.

HIGHEST Prices paid for old gold, silver, platinum, diamonds, watches, gold teeth, spectacles. Cash immediately. Goods returned if offer unsatisfactory. United Smelting Works, (The Old Reliable), 39-B South State, Chicago 3.

TOBACCO, SMOKERS' SUPPLIES

STOP Cigarette burns. Ashtray with clever mechanism slides cigarette into ashtray. \$1.00, 4 for \$3.80. Blue, green, amber, crystal. W. Spangler, 308 E. King, York, Penna.

100 5" CORONA Cigars \$4.75. Ideal Supply, 1903 Nebraska, Tampa, M. Florida.

RAZORS, BLADES, SHARPENING

100 HIGHEST Quality blades \$1.00. Sample 10c. \$20 electric shavers \$4.95. Paul Hollman, 7004 Merrill, Chicago 49, Ill.

200 DOUBLE Edge razor blades \$1.25, guaranteed. Bart Sales Company, 886 Frederick Blvd., Akron 20, Ohio.

XMAS Special ball pen. 100 double edge razor blades; guaranteed \$1.00. Payne, 5426 5th Ave., Los Angeles 43, Calif.

FOR THE HOME

HEAT Homes efficiently. Prints marked. Bill of material listed. Details free. Garver Company, Vermilion, Ohio.

RID Your home of termites. Guaranteed. Free details. Wynne Co., 426 Transportation Bldg., Cincinnati 2, Ohio.

PERSONALIZED Engraved door knockers, Christmas. \$5.95. Brauner, Merrick 54, N. Y.

FOAM Rubber furniture cushions. Factory seconds. 50% discount. Prices free. Perma-Foam, 140-C Main Street, East Orange, New Jersey.

OF INTEREST TO WOMEN

NERVOUS, Worried, can't relax, need rest, sleep—Try Delighted pillow cards in the pillow. Sample available. Write Delight N Company, 4042 Kimball Ave., Chicago 18.

NYLONS 8c Pair, anklets 12c pair, socks 9c, print 17c, panties 12c, dresses \$1.95, slips 47c, undershirts 17c, rugs 70c, robes \$1.65, spreads \$2.65, \$70.00 watches—\$18.95, jewelry sets \$1.25, pens 8c, combs 1c, aspirin \$1.00-1,000 brushes 9c, razor blades 5-2c, electric razors \$2.00. Complete stock list, picture catalogue, 25c if sent immediately. Sibert's, Chattanooga 4, Tenn.

GOOD Money in weaving. Weave rugs at home for neighbors on \$69.50 Union Loom. Thousands doing it. Booklet free. Union Looms, 153 Post St., Boonville, N. Y.

PROFITABLE Home business. Make fast-seller chenille monkey trees, dolls, flowers. Terrific holiday demand. Information free. Velva, Bohemia 16, N. Y.

FOR SALE—MISCELLANEOUS

GERMAN Pocket knife. Quality through-out. Ideal for yourself. Makes perfect gift. \$3.50 postpaid. Satisfaction guaranteed. Hepner, Box 1905E, Huntington, W. Va.

HEARING Aid batteries, wholesale. Free list. Habs, Box 51, York, Penna.

SAVE Money on army, navy and factory surplus. Write today for new 60-page illustrated catalog. Tennusa Sales Co., Dept. C. 1451 Market, Chattanooga, Tenn.

WANTED—MISCELLANEOUS

QUICKSILVER, Platinum, silver, diamonds, indium. Write. Wholesale Terminal, Norwood, Massachusetts.

GRINDER And saw filer. Box 574, Pearl River, N. Y.

SCRAP Mercury (quicksilver) containers supplied—Tantalum, bismuth, tungsten. Metallurgical Products Company. Established 1909. 35th and Moore Sts., Philadelphia 45, Penna.

PERSONAL

FOOL Your friends. Enclose one dollar and we will send you ten beautiful post cards of Florida. You address them and return to us, and we will mail them on your specified date. Address Mailing Service, Box 225, Gibsonton, Florida.

LETTERS Remailed 25c each. Private Pronto Service, P. O. Box 118, Miami Beach, Fla.

LOS Angeles remails, 25c. Classifieds, \$1. Ogle, Box 13168, Los Angeles 25, Calif.

BIBLE Reveals time of end. Free. Write: Harvest, Jefferson City, Missouri.

REMAIL Carmel, Monterey Peninsula 50c. Informational letter \$1.00. Peninsula Service, Box 892, Seaside, Calif.

SAN Juan, Puerto Rico, Miami, Florida, New York City. Remails 25c each. Mailit, Box 613, Wantagh, N. Y.

"X-RAY Mind." Entire course. Adults. Inquire. Send dime. Krishnar Institute, 1912 Lincoln-Park-West, 242-82, Chicago 14.

REMAIL From world famous Santa Claus, Ind., postoffice. Your stamped Christmas greetings, 12 for \$1.00, letters and singles, 25c. Send to Kermit Talbott, Evanston, Indiana.

LETTERS Remailed from historic Durango, Mexico, air mail \$1.00 each. Croze, Apartado No. 1, Durango, Dgo., Mexico.

REMAIL Service from Ephrata, Penna., 65 E. Franklin, 25c.

LETTERS Remailed, 25c each. \$2.00 monthly. J. Foster, 830 Terry St., Cincinnati 5, Ohio.

BORROW By mail from Postal Finance Co. Employed men and women can easily obtain \$50 to \$600 fast, entirely by mail. Repay in small monthly payments. Friends, relatives, employer, tradespeople will not know you are applying for loan. Advise occupation, amount wanted. Postal Finance Co., 200 Keeline Bldg., Dept. 7-Z, Omaha, Nebraska.

DETROIT 31, Michigan, Box 425, Myers. Remailings 25c. Confidential services reasonable.

JACKSONVILLE, Florida. Letters remailed 25c. Harris, 9534-P Lemturner, Jacksonville 8, Fla.

LETTERS Or Christmas cards remailed from Havana, Cuba—"The Paris of the Americas." Air mail 2, \$1.00. Ordinary mail 3, \$1.00. Under Cuban postage. Carlos Gonzalez, Apartado 1076, Habana, Cuba.

PARIS—Letters reairmailed \$1. Lucas, 50 Rue du Four, Paris 6, France.

LETTERS Remailed San Francisco postmark 25c. Private receiving-forwarding address available. Shanks, Box 3110, San Francisco 19, California.

LETTERS Remailed from principal cities of America, 25c per letter. Mixon, Box 2048, Los Angeles 53, California.

PLAY A joke on your friends. Christmas cards and letters remailed from London, England, 3 for one dollar. Oren Crothers, Whitehall, Saham Toney, Norfolk, England.

1000 PRACTICAL Advices how to: plan, enjoy travel (worldwide), vacations, save money, trouble: \$100. Informations, books, Jarry, Travel Consultant, Box 268-MK, Wall Street, New York 5.

MEXICAN Law. General Practice Attorney, 1203 Arizona St., El Paso, Texas.

MIAMI, Miami Beach: Letter remailed 25c; local classified pages airmail \$1.00. Confidential, Box 306, Miami 2, Fla.

DALLAS Remails 25c. Other services. Hagler, 2838 Sharon, Dallas 8, Texas.

LETTERS Remailed 25c. Personal address service available. Write for rates. McLaughlin, 800 Stewart, Columbus 6, O.

SAN Antonio re-mail 25c. Local information \$1.00. Re-Mail, Box 1918, San Antonio, Texas.

AROUND The world remailing, Chicago 25c. Business and personal address. Letters relay from other cities 75c. Full details 10c. C. Macks Mailorder, 5656 N. Hermitage, Chicago 26, Ill.

LETTERS Remailed 25c. Private receiving-forwarding address available. Hicks Service, 5216 Just Street, N.E. 303, Washington 19, D. C.

CHICAGO Mailing address, centrally located, lowest rates. International Mailtrade, 125 South Market Street, Chicago, Illinois.

"HOW Can I find out?" You can! Information confidentially developed. Any matter, person, problem. Worldwide. Officially licensed. Established 1923. William Herman, 170 Broadway, New York City.

MISCELLANEOUS

RECEIVE Magazines, samples, catalogues. Mails from everywhere. Offers hundreds, larger listing 35c. Rorick, Box 86, Cincinnati 26, Ohio.

GOLD Prospecting catalogue—Listing maps, pans, mineral books, gold machine blueprints. Gold panning lesson free. Old Prospector, Box 729D1, Lodi, Calif.

SUCCESS Is yours through your own atomic mind power! 9c brings literature. Gosomar Research, 90 West Broadway, New York City 7.

WEATHER Instruments. Amateur and weather bureau types. Free catalog. Science Associates-Weather, Philadelphia 8, Penna.

MAGNETS—Permanent Alnico. Never loses magnetism. Excellent for map and bulletin board work. Many uses, 12 for \$1. Pritt Co., Dept. MM-12, 12 West 27th, New York City.

LARGE New crop pecans. Write for prices, any quantity. A. F. Hamburg, Foley, Ala.

PERFECTIONAL Spinning lariats. Patented Honda. Easily handled. Texas skip, bronze Honda, each \$5.00. Postpaid. F. T. Villmer, 929 Francisco St., Los Angeles, Calif.

STAIN Removal booklet. Any fabric. Details free. M. Kent, 1796 University Ave., New York 53, N. Y.

WOW! This French-type perfume really sells. 60% off! Free sample. Elliot-Stuart, Ltd., 4616A Hollywood Blvd., Hollywood 27, Calif.

300 BIG Mails guaranteed. Samples, plans, offers, propositions, 12 months listing. \$1.00 refundable. Wright Publications, 2270 Hubbard, Memphis 8, Tenn.

RECEIVE Mails, magazines, samples. Your name in numerous mailing lists 20c. Greenwood, Box 1116-K, New York 8.

INSTRUCTIONS For building Radio Treasure Finder, \$1.00. Wyss, 104½ Francis, St. Joseph, Mo.

FREE Details. 30 different 10c items. Walter Mondschein, Box 222, Chicago 90.

LEATHERCRAFT. Everything needed by beginners, advanced hobbyists and professional leatherworkers. Largest stock of supplies in U. S. Moderate-priced tooling leathers, top quality calfskins, tools, supplies, kits. Send 10c for big catalog. J. C. Larson Co., 820 S. Tripp, Dept. 3451, Chicago 24.

INCREDIBLE! Become mental superman overnight! Free booklet! Bijou, Box 1727-MC, Hollywood 28, California.

BUY Wholesale thousands nationally advertised products at big discount. Free "Wholesale Plan." American Buyers, 631-D Linden, Buffalo, N. Y.

HORRORSCOPES. Hilarious horoscopes. Good for laughs at parties. All 12 months only 25c. P. J. Publications, 16 Underwood Rd., Wyncote, Penna.

FAT Men! Big men! Tall men! We fit the hard-to-fit. Free clothing catalog. Cushner's, 2122 West Pratt Street, Baltimore, Maryland.

DAY And nite mailboxes sign, all reflecting, same both sides, 18 letters lifetime aluminum. \$1.75 postpaid. Reflecto, Box 232, Ravenna, Ohio.

BUY Wholesale thousands of nationally advertised appliances, giftware, watches, cameras, dolls, etc. Catalog 50c, refundable with order. Dart Sales, 3812 Atlantic Ave., Brooklyn 24, N. Y.

FIRE Alarm detectors for homes and buildings. Complete engineered system: Three detectors, 100 feet wire, bell, switches, instructions \$18.95. Additional detectors \$4.50 each. Gar Company, Cranston, R. I.

DRIVEWAY Marker, lifetime aluminum, reflects same as roadside billboards. 24 in. long. \$1.25 postpaid. Reflecto, Box 232, Ravenna, Ohio.

EASILY Home-made windmill gives plenty power. Guaranteed instructions, \$1. Ziembak, 6123 Orchard, Dearborn, Mich.

300 PROJECTS You can make—In Popular Mechanics 32-page Blueprint catalog. Send 3c stamp for copy. Popular Mechanics Press, Dept. 106, 200 East Ontario St., Chicago 11, Ill.

B & B Photo Christmas cards are the finest. Satisfied, repeat customers in 49 states. 25 large cards and envelopes \$1.69 postpaid. Send for order blanks and samples today or send negative with check. B & B Studios, Box P945, Wilmington 99, Delaware.

WHOLESALE Aluminum Venetian blinds. Prices on request. Delta Distributors, Moreauville, La.

BUILDERS, Contractors, home owners. Buy that safe now. Wall and floor safes. Write for information. Ernie Scott, 7905 Birchdale, Chicago 35, Illinois.

HOSTS Apron. A wonderful gift for someone who has everything. Covered with witty expressions and humorous cartoons. Rush \$2.00. Host, Box 1918, San Antonio, Texas.

LOCATE Hidden treasure, distinguish minerals from metals with the Model 100 Detector. Weighs 5 pounds, extremely sensitive. Factory assembled \$79.90 or kit form \$39.90. Free literature. Dept. P, Electronic Applications, Box 4975, Washington 8, D. C.

SELECTIVE Metal and mineral detector. Revolutionary design. Distinguishes metals from black magnetic sands. Readily detects metals under salt water. Also Geiger counters. Free literature. Gardiner Electronics Company, 2018 N. Dayton, Phoenix, Arizona.

TREASURE Finders for gold, silver and minerals. Money back guarantee, best available. Also Geiger counters for uranium prospectors, free information. Write Goldak Company, 1541 West Glenoaks, Glendale 1, Calif.

STUDY For game warden, park, fish, forestry, lookout, guide, wildlife conservation, immigration and highway patrol service. Details free. Write Delmar Institute, C5, Whittier, Calif.

TREASURE—M-Scope Geiger counters, mineral locators. Why buy something inferior when you can buy the best at a lower price? Backed by years of experience. Fully guaranteed by factory. Detects minerals, metals, gold, silver, coins. Payment plan available. Proven superior performance. Free 16 page illustrated booklet. Fisher Research Lab., Inc., Palo Alto, California.

CLOGGED Drains opened by new powerful chemical called Sursolvent. Removes grease, soap, tree roots, etc., without expensive digging and electric rodding machines. Simple to use. Mix with water and pour down sink. Postal brings free details. Electric Sewer Cleaning Co., Allston 34, Mass.

GOLD, Silver, metal detectors. Geiger counters for uranium. Mineralights. Sensational new fully guaranteed models. None finer. Information free. Detectors Co., 5420 Vineland Ave., North Hollywood, California.

70 BIBLE Lessons, 25c. Bulletin, Box 87, Cathedral Station, N. Y.

YOUR Leather jacket renovated expertly. Free circular. Berlew Mfg. Co., Dept. 8, Freeport, N. Y.

INSTALL Your own fixtures, make most of your own electrical repairs and, save hundreds of dollars with Popular Mechanics' Electric Fix-It Book, \$2.00. No matter if you want to install fluorescent fixtures, test circuits, repair appliances or do any one of many electrical repairs, this new book tells and shows you how, step-by-step. Popular Mechanics Press, Dept. EF-2, 200 E. Ontario, Chicago 11, Ill.

**A "Must" Book for Boys of All Ages and
the Greatest Gift Book of All Time!**

**POPULAR
MECHANICS**

BOY MECHANIC

Give the
Boy Mechanic
for Christmas
and other Gift
Occasions

FREE Any Name Stamped
in Gold on Cover

Any name you wish will be stamped in gold on the
cloth bound front cover **FREE** if you remit with order

NEW!

Fascinating! Educational!

How to Make Things That Work and Go!

This is it, fellows! Here's the exciting book you have been waiting for. Get the brand new Popular Mechanics **BOY MECHANIC** for yourself or be sure you get it soon for a gift. You know it's the fellow who can do things—make things that "work" and "go" who is the kingpin in every school and neighborhood. Enjoy this popularity yourself. Learn what to do—what to make—how to make it—with the **BOY MECHANIC**. Have fun with outdoor projects and gadgets; models of every type; your own scientific experiments and instruments; all kinds of craft work with wood, metals, plastic, etc; easy to make toys for yourself and others.

Something for Every Place, Time and Season

Think of it! More than 500 wonderful ideas you can use, selected by Popular Mechanics editors. Projects for the home workshop; in camp; on land and water and in the air. Projects for summer and winter and in between. More than 1100 pictures and diagrams show you exactly what to do and how to do it. It's a big, fascinating and helpful book that will give you hours and hours of fun and show you how to make so many of the things you have always wanted.

**A Grand Big
Book!**

**Beautifully Bound
in Library Cloth and
Personalized With
Your Name in Gold
on the Cover**



**POPULAR MECHANICS PRESS, Dept. 111
200 E. Ontario Street, Chicago 11, Ill.**

Send me at once _____ copies of the **BOY MECHANIC**
at \$2.95 each.

- Remittance enclosed. Stamp name in gold and
send postpaid.
 Send COD. I will pay postman plus delivery
charges.

Name _____

Address _____

City _____ State _____

Print name on this line for gold stamping. Use margin
for additional names.

308 Pages

Packed with fascinating pictures and practical how-to-do-it information on outdoor projects, models and model making, spare time crafts, workshop fun, simplified science, toys, etc.

1100 Pictures

Photographs, Drawings, Diagrams, Plans and Construction Details. The most elaborately illustrated "What to Make" book ever printed.

**Rush Coupon
Today!**

Be the first in your neighborhood to get the **BOY MECHANIC** by mailing the coupon today. Only \$2.95 postpaid. And we'll stamp your name (or any other name if a gift) on the cloth bound cover in gold **FREE** if remittance accompanies order. Be sure to **PRINT** name for gold stamping and mail order today.



**Model Airplanes, Railroads,
Ships, in Model Section**



**Fascinating Tin Craft,
from Indoor Crafts**

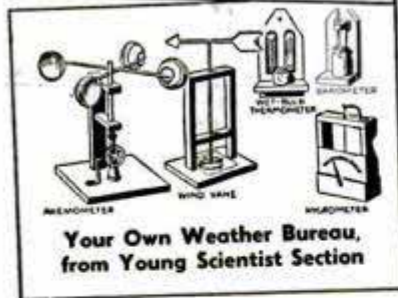

**Your Own Weather Bureau,
from Young Scientist Section**

Some of More Than 500 Articles in Boy Mechanic

Build a Soap Box Derby Racer — Coasting in a Sidewalk Jeep — Aero Driven Ice Boat — Eight Repair Kinks for Your Bicycle — Sea Scout Dinghy — Control Line Flying Model Planes — Model Racing Yacht — Model Railway Small-Space Track Layout — Leathercraft — Tin Can Craft — Useful Articles from Hammered Copper — Jackknife Animal Carving — Easy to Make Hand Puppets — Art With the Typewriter — Dog Quonset Hut — Bird Houses and Cages — Home Laboratory Short Cuts — Your Own Weather Bureau — Toy Electric Motors You Can Make — Fun With Common Gases — 100 Power Microscope — Six-in-One Puzzle — Magnetic Theatre — Turkey Hunt Dart Game. And hundreds of others.

Save on all PLUMBING JOBS

When You Build - When Making Improvements - Repairs - Maintenance

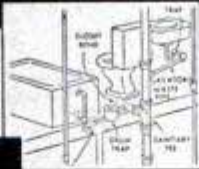

How to plan plumbing installations, select materials and fixtures.

How to save money on all plumbing jobs using approved methods.

Easy to Do Professional-Like Jobs and Save Over One-Half

Get the Popular Mechanics HOME PLUMBING GUIDE. It shows how you can do every kind of plumbing job yourself and save from a few to hundreds of dollars. Covers plans, layouts, installation, maintenance and repair. Shows what materials to get and use, where to get them and how to do a proper job with approved methods. Few, other than the simplest tools are required and some of these can be rented. Don't pay high prices for work you can do yourself. Get the HOME PLUMBING GUIDE for only \$3.50. You will be amazed how jobs you thought difficult are simplified.

Clip This Ad and Mail. Money Back if Not Pleased

Invest only \$3.50. Use the book for 7 days. Then if you are not satisfied return it for full refund of your money. Sent C.O.D. (U.S.A. only) if you prefer.



Get POPULAR MECHANICS Home Plumbing Guide

- 15 Ways to Save Money**
 All about modern home plumbing
 How to use plumbing tools
 Getting acquainted with pipe
 Planning home plumbing systems
 Installing and maintaining home drainage systems
 Private sewage disposal systems
 Causes and cures of drainage troubles
 Installing home water lines
 Private water supply systems
 Water Heaters
 Water Conditioning
 Water system troubles and cures
 Installing and caring for fixtures
 What to do with valves and faucets

Over 500 How-to-do-it Pictures Guide You

POPULAR MECHANICS PRESS, Dept. HPG-10, 200 E. Ontario St., Chicago 11

End getting stuck forever!

For only \$8.95

No more tow charges or delays



Shur-Out gets you out of Snow, ice, mud or sand . . . instantly

Chains and other devices won't work unless you have them on before you get stuck. With Shur-Out your worries are over . . . when your car slips into snow or mud, fasten your big, rugged malleable iron Shur-Out on each rear wheel in minutes, and you're on your way immediately. No attachments necessary, no help needed, hands or clothing won't get soiled! Lasts for years . . . perfect for gifts.

SEND FOR YOUR SET TODAY!

Only \$8.95 wrench included. Unconditionally guaranteed! Shipped prepaid, send check or money order. C.O.D.'s accepted. Specify tire size with order.

ON IN A JIFFY, CAN'T SLIP OFF!

Works on any car. Long arm hooks over inside wheel rim, other arm against tire. Allen wrench tightens for fool-proof grip.



SHELLY PRODUCTS CO.

P. O. Box 664
 Aurora, Illinois

YES! SEND

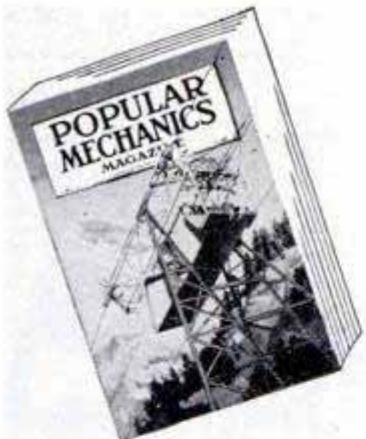

directly to my door every month

- I am enclosing
 \$3.50 for 1 year
 \$8.00 for 3 years

name _____
 address _____
 city _____ zone _____ state _____
 A-123

Hand this order to your newsdealer or send it to

POPULAR MECHANICS
 200 East Ontario St. Chicago 11, Ill.

THE MIGHTY MIDGET



GUARANTEED WORLDWIDE RECEPTION ON 3 SHORTWAVE BANDS! PLUS STANDARD BROADCAST

Without any special aerial, you can pull in Radio Moscow, London, Paris, Berlin, South Africa — ships at sea, aircraft, police — plus standard broadcast with new power and clarity! By the makers of U. S. Navy receivers. Hear this sensational radio value! \$59.95

Also hear "The World Master". Compares favorably with shortwave receivers selling for \$300 and up! Only \$129.95!

Write for complete details and name of nearest National dealer.





NEW MOSSBERG CATALOG

To make your Christmas selection easy

Complete lineup of rifles, shotguns, telescope sights and spotting scope, — all at low Mossberg prices— each readily obtainable at your dealer's.

Clip and fill in coupon now so you'll have plenty of time to pick a "Mossberg"

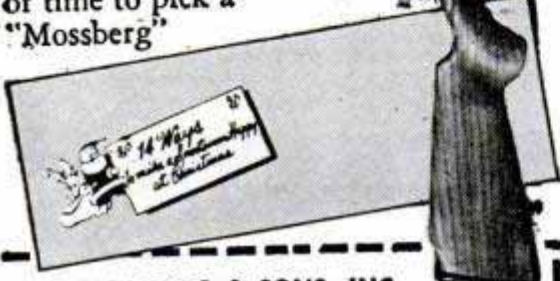

O. F. MOSSBERG & SONS, INC.
39712 St. John St., New Haven 5, Conn.

Send me without delay your new Christmas catalog of Mossberg Firearms available at my dealer's.

Name.....

Street.....

City..... (Zone)..... State.....

It's New—Amazing—Astounds Everybody MAGICAL BLOCK

A penny held in a spectator's hand changes to a dime!

Yes—that's right! When you cover the penny with this MAGIC BLOCK, it will disappear! A dime will take its place! Here is a trick that's really different! Fun for all ages—children, grownups too. Works every time! People will gather around, wondering how you do it! Carry it in your pocket—have fun everywhere you go! Easy to do.

Order today! Complete with instructions, postpaid, only **\$1.00**

AARON'S, 10742 So. Michigan Ave., Dept. PM-12B, Chicago 28, Ill.

Monogram SPEEDEE-BILT New Models FUN TO ASSEMBLE ALL PARTS FINISHED



PANTHER JET

THUNDERBOLT

Navy and Air Force Planes With Full Armament

At Hobby Stores or by Mail.

If no dealer near you send \$1.25 for one kit, postage and packing. \$2.25 for two. Save 25c on two. Delivery guaranteed.

Here are the two newest models in the famous Speedee-Bilt flying model series. Only \$1 each for Panther Jet F9F and Thunderbolt P-47. Easiest models to build. Build one complete and fly it in an evening. Use Jetex engine for the jet job. Power rubber supplied for the Thunderbolt. Kits contain built-up Monofoil wing, pre-fab fuselage, finished wood parts and 14 molded plastic parts including prop, pilot, canopy, machine guns, rockets, and other parts. Catalog of other models in each kit. Write today.

MONOGRAM MODELS, Dept. 19, 3421 W. 48th Place, Chicago 32



How to save money on all plumbing jobs — using approved methods.



How to select materials and fixtures.

Save on Plumbing Costs

When You Build · When Making Improvements
Repairs · Maintenance

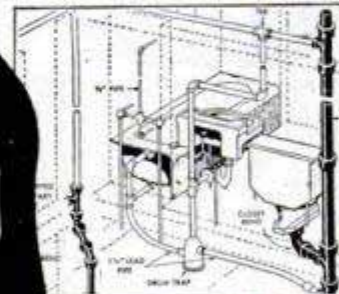

How to plan and lay out plumbing installations.

Do All Kinds of Jobs Yourself With Home Plumbing Guide

Got a leaky faucet; a clogged drain; a noisy hammering water pipe? Want to add a bathroom to your home, install a new kitchen, or even build a home? Then you need Popular Mechanics' HOME PLUMBING GUIDE. It shows how you can do every kind of plumbing job yourself and can easily save you hundreds of dollars. Savings on even a small job will pay for this practical book many times over. It covers plans and layouts, installation, maintenance and repair of all home plumbing systems; tells you what materials to get and use and how to do a proper job with approved methods.

Over 500 Pictures and Diagrams and Hundreds of Money-Making Tips

Simple everyday jobs, bigger remodeling and improvement jobs and complete installations are made clear and simple and easy to follow. Few, other than the simplest tools are required and some of these can be rented. Pipe, materials and fixtures are available from mail order houses, hardware dealers and supply houses. Don't pay high prices for work you can do yourself. Get the HOME PLUMBING GUIDE. You will be amazed how the practical text and hundreds of how-to-do-it pictures simplify jobs you thought might be difficult.

Mail Coupon, Money Back if You Want It

Get the HOME PLUMBING GUIDE today. Only \$3.50. Read it. Study it. Put the vital information it contains into practice. Then if you are not satisfied return the book for a complete refund of your money. Order today.

15 Ways to Save Money in Your Own Home

- All about modern home plumbing
- How to use plumbing tools in your home
- Getting acquainted with pipe
- Pointers on planning home plumbing systems
- Installing and maintaining the home drainage system
- Your own private sewage disposal system
- The causes of drainage troubles and how to cure them
- Home water lines and how to install them
- Valves and faucets and what to do with them for best and most economical service
- Your own private water supply system
- All about water heaters and automatic supply
- Methods and advantages of water conditioning
- Water system troubles and how to prevent and cure them
- How to install plumbing fixtures and take care of them for longer life



Mail Coupon Today for Money Back Home Trial

POPULAR MECHANICS PRESS, Dept. HPG-1
200 East Ontario Street, Chicago 11, Ill.

Send Popular Mechanics HOME PLUMBING GUIDE in cloth binding at once. I understand I may return the book in 7 days for full refund of my money.

- Remittance for \$3.50 enclosed. Send postpaid.
- Send C.O.D. (U.S.A. only) I will pay postman plus charges.

Name.....

Address.....

City..... Zone..... State.....

POPULAR MECHANICS

Save Hundreds of Dollars On Home Repairs . . .

Add to Your Home's Beauty and Comfort
. . . Increase Its Selling Price

Here is the last word in dependable, money-saving help for the homeowner. *Guide to Home Repairs*, written by the editors of *Popular Mechanics*, gives you the know-how you need to repair and maintain plumbing; install and repair wiring; paint and decorate, install insulation, etc.

**Step-by-Step Instructions
Tell How — Pictures Show How**

First you read how to do it in the famous *Popular Mechanics* "Written So You Can Understand It" style and then hundreds of photos, drawings and diagrams show you how it is done. Nothing is left to the imagination. Now you can lay floor tile and linoleum, repair doors and windows, tuckpoint, repair and install gutters, etc. Order your copy today. If it isn't entirely satisfactory you may return it in seven days for a full refund.

192 Pages
646 Illustrations
\$2.50



**POPULAR MECHANICS PRESS, Dept. HR-1
200 E. Ontario St., Chicago 11, Ill.**

Send at once my copy of *Guide to Home Repairs*. My remittance for \$2.50 is enclosed. If it isn't satisfactory I may return it in 7 days for a full refund.

NAME _____

ADDRESS _____

CITY _____ ZONE _____ STATE _____

Check here for C.O.D. shipment. (U.S.A. only). Postage extra.

**PLEASE
SEND ME**

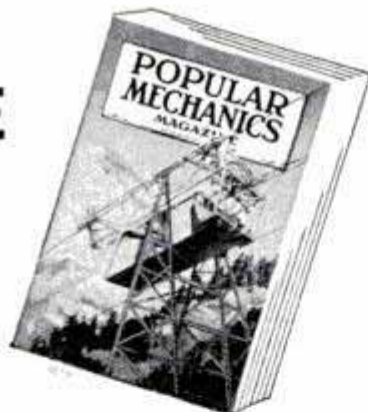

for the
time checked.

I am enclosing . . .

1 year \$3.50

2 years \$6.00

name _____

address _____

city _____ zone _____ state _____

C-123

Hand this order to your newsdealer or send it to

**POPULAR MECHANICS
200 East Ontario St. Chicago 11, Ill.**

THE NEW MODEL 170-A

TV TUBE TESTER AND CONTINUITY INDICATOR

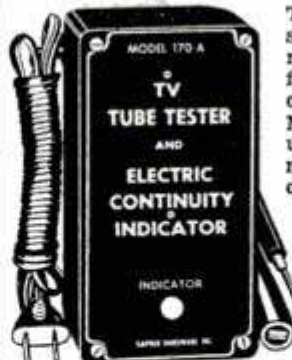

The majority of inoperative tubes stop functioning due to open filaments, inter-element shorts and other faults which can be located by the continuity and leakage method. The Model 170-A will test ALL the tubes used in your TV set for open filaments, inter-element shorts, burned out tubes, etc. A safeguard resistor included in the circuit network of the Model 170-A limits the output to approximately one one-thousandth of an ampere. This insures positive safety for the non-technical user and also eliminates the possibility of ever burning out a tube under test.

The Model 170-A is capable of testing EVERY type of tube used in any and ALL TV sets (including picture tubes).

ADDED FEATURE:

Also included, detailed instructions for using Model 170-A as **ELECTRIC CONTINUITY TESTER**. Check electric toasters, fuses, heating irons, broilers, heating pads, clocks, fans, fluorescents, other bulbs, etc.

Housed in molded bakelite case. Complete with test leads and detailed easy-to-understand instructions and tube charts. Only

\$4.95

**SHIPPED ON APPROVAL
NO MONEY WITH ORDER — NO C. O. D.**

Kapner Hardware, Inc.
Dept. A-91, 2248 Second Ave., N. Y 29, N. Y.

Please RUSH one Model 170-A. If completely satisfied I agree to pay \$4.95 within 10 days. If not, instrument will be returned (no explanation necessary).

Name _____

Address _____

City _____ Zone _____ State _____

FREE PREMIUM

Check here if you remit \$4.95 with order, and we will include 6 Key Chains with Tube Tester — all post paid. Money-back guarantee, of course!

HELPFUL BOOKS

Send post card asking for FREE catalog

Popular Mechanics Press, 200 E. Ontario, Dept. 601, Chicago 11

A FEW MORE "FAMILY SAFE" TIRES YEAR AFTER YEAR WE SAY — "IT'S DANGEROUS TO PAY LESS!"

CHOOSE! "EXTRA DISCOUNT?" or our EXTRA SAFE SERVICE?

GOOD YEAR **Firestone**

GOODRICH, U. S. ROYAL, ARMSTRONG & OTHERS | 1 FREE TUBE with every good & finest grade tire.

PASS. CAR TIRES \$4 no recaps & GUARANTEED. **TRUCK TIRES \$11**

BLATT WORLD-FAMOUS Finest. (NOT RECAPS.)		32 MONTHS GOLDEN RULE		GUARANTEE	
600-16	\$5.05	700-16	\$5.85	640-15	\$4.72
600-16(6)	5.90	700-16(6)	7.16	670-15	5.06
650-16	5.64	750-16	8.78	700-15	5.35
650-16(6)	6.79	550-17	4.25	760-15	5.63
475-19	4.84			WHITEWALLS \$1.50 EXTRA	
				525-18	4.25

FINEST HEAVY DUTY TRUCK TIRES 32 MONTH GUARANTEE

FLEET OWNERS RE-ORDER YEAR AFTER YEAR. NOT RECAPS.	
700-15(6)	\$8.73
750-15	11.73
750-16(8)	10.65
825-15	12.53
700-17	\$9.83
750-17	11.23
600-20	8.64
32-6	10.96
700-20	\$10.76
750-20	13.22
825-20	18.69
900-20	16.49
1000-20	\$17.95
1100-20	17.97
1000-22	17.97
1100-22	18.25

We select your tires, as if our future depended on it. Buy in Confidence, our fine Slightly Used Tires

MILITARY TREAD
32 MONTH GUAR. NO RECAPS

750-20 H. Duty	\$16.64
900-16 H. Duty	14.24
600-16 H. Duty	9.94

FACTORY RETREAD SNOW TIRES 30 MO. GUARANTEE "New Tire Traction."
GOOD YEAR, FIRESTONE & OTHERS
670-15|600-16|710-15 800-15 650-16 \$9.90
\$7.95 \$7.95 \$7.60-15 820-15 700-15

BLATT 11th & SPRING GARDEN ST., PHILA., PA. Send ck or M.O. ORDER RUSHED
order from your nearest store 2827 N.W. 7th AVE., MIAMI, FLA.

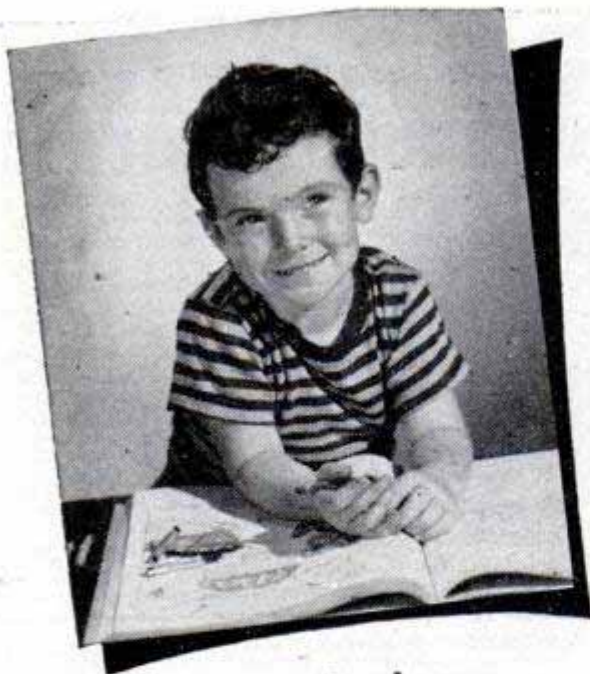

indoor photos
made easy with

Victor LIGHTING

our instruction booklet FREE

JAMES H. SMITH & SONS CORP.
Dept. T12, Griffith, Indiana

Say You Saw It in Popular Mechanics

AUTO RACING BOOKS AT NEW LOW PRICE

Automobile Racing — Fifth Edition by Ray F. Kuns.

This is a book for auto racing fans. It covers construction and specifications of racing cars and tells and shows how you can build your own. It also contains regulations for midget auto racing and describes roadster racing in California. A number of Indianapolis races are described and pictured. Formerly \$1.00 per copy. Now just..... **50c**

Automobile Racing — Fourth Edition by Ray F. Kuns.

Includes eight working drawings and complete building instructions for standard midget racers as well as drawings for midget road cars. Miller Ford V8 front-drive racers are illustrated and described and other big-time data given. Large, clear pictures give inside information. Was \$1.00—Now only **50c**

POPULAR MECHANICS PRESS

200 E. Ontario St.
Chicago 11, Ill.

Now You Can Upholster Any Piece of Furniture!

Upholster—Restyle Any Piece of Furniture Yourself

John Bergen, custom furniture designer, tells and shows you how to transform old out-of-date furniture into brand new smart-looking comfortable furniture in his new book **ALL ABOUT UPHOLSTERING**.

No Experience Needed

Bergen tells you every step to follow in amazingly clear easy-to-understand step-by-step instructions and then shows you how in hundreds of big, clear drawings and photos. You read and see how to strip the old frame, install new webbing and springs, apply burlap, install stuffing and padding, fit the muslin cover and the final fabric and install trim.

Use New Materials—Methods

Now you can have furniture upholstered with foam rubber, sagless springs and other new materials that add so much to comfort and durability and are so costly when included in new furniture.

Save 50% of Usual Cost

Don't pay a small fortune for new furniture when you can make your old furniture better than new! Why pay high prices to have someone else upholster and restyle your old furniture when you can do it yourself for cost of materials alone? It's easy and it's fun.

Special Chapter on Slipcovers

Learn how to make custom-made slipcovers with professional look and fit. Find out how you can realize tremendous savings by investing a few spare-time hours and the cost of a few yards of fabrics.

7-Day Money Back Guarantee

Send for your copy of **ALL ABOUT UPHOLSTERING** today. Read and use it for 7 days. If it isn't entirely satisfactory return it for a full refund.

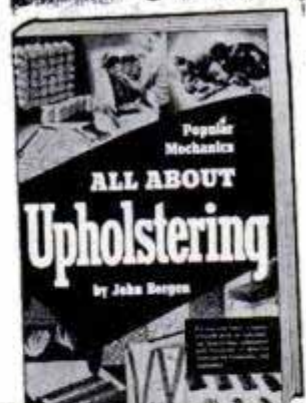
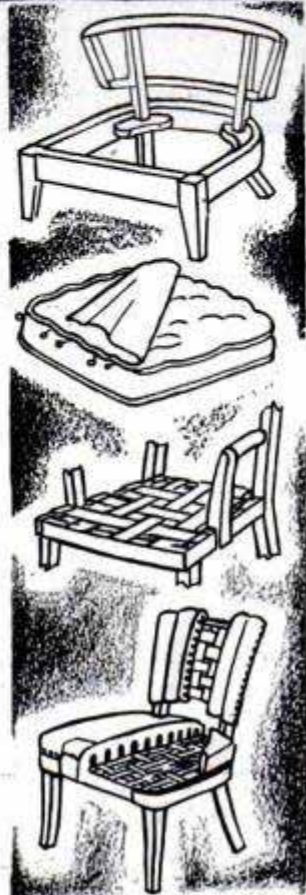

USE THIS HANDY ORDER COUPON

POPULAR MECHANICS PRESS, Dept. AAU
200 E. Ontario St., Chicago 11, Illinois

Gentlemen:

Please send my copy of **ALL ABOUT UPHOLSTERING**. Enclosed is my remittance of \$3.50. If I am not completely satisfied with the book I will return it for a full refund after 7 days.

Name _____

Address _____

City _____ Zone _____ State _____

LEARN MEAT CUTTING AT NATIONAL

Pay After Graduation



The steady dependable trade of Meat Cutting taught easily in 8 short weeks. YOU LEARN BY DOING under actual meat market conditions in big modern school at Toledo.

For beginners or men with experience. Get a profitable store of your own. Remember, PEOPLE MUST EAT! Big pay jobs. Free employment help. Thousands of successful graduates.

Buying, cutting, percentage, pricing, advertising, selling, etc. A complete retail meat education. National School established over 25 years. Get National training NOW. Pay your tuition in easy weekly payments

after you graduate. Send coupon for FREE 52 page school catalog — TODAY. G.I. approved.

National School of Meat Cutting, Inc., Dept. 50-Y, Toledo 4, Ohio

Send me your FREE school catalog on National Training at Toledo in Meat Cutting, Meat Merchandising and Self Service Meats. No obligation. No salesman will call.

Name _____ Age _____

Address _____

City _____ State _____

Approved for training Korean Veterans



TRAILER COACHES

Here's everything you want to know about trailers, with plenty of pictures and plans and instructions for building three different types. Covers also, history of trailers, trailer parks, camps and overnight-stops information, furniture, furnishings, materials and engineering data. If you want to build a trailer, live in a trailer, or just want to know more about trailers, get this book. Only \$1.50 postpaid. Rush order to:

POPULAR MECHANICS PRESS • Dept. 350, 200 E. Ontario St., Chicago

Build it Yourself!

Complete Trailer Book and Construction Data for 10, 16 and 22 Foot Trailers — Only \$1.50

Partial Contents

Trailer Parks—Living in a Trailer—Towing a Trailer—Floor Plans—Service—Classifications—Balance—Dollies—Jacks—Weight Distribution—Construction—Working Drawings for a Two-Place, Standard Travel and Standard Dwelling Trailers. Size 8 1/2 x 11 1/4 inches.

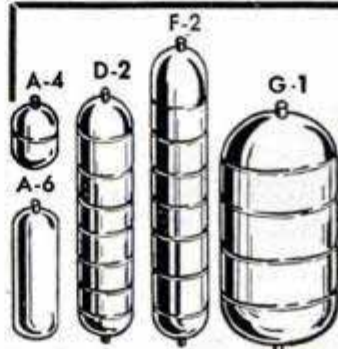

STEEL AIR TANKS

Steel pressure tanks suitable for compressors, pneumatic units, gases, hydraulics, and liquids. Rated at 500 lbs. per square inch pressure. 1/4" standard pipe thread openings on tank ends as shown.

	Size	Wt. Lbs.	Volume	Price
A-4A Carbon Steel—New	7 1/2" x 5 1/4"	1 1/2	104 cu. in.	\$1.50
A4 Stainless Steel—New	7 1/2" x 5 1/4"	1 1/2	104 cu. in.	2.50
A-6 Carbon Steel—New	14 1/2" x 5 1/2"	3 1/4	280 cu. in.	3.50
D-2A Carbon Steel—New	24" x 6"	5	500 cu. in.	4.50
D-2 Stainless Steel—New	24" x 6"	5	500 cu. in.	7.50
F-2A Carbon Steel—New	45" x 6"	11	1000 cu. in.	8.50
F-2 Stainless Steel—New	45" x 6"	11	1000 cu. in.	9.50
F-1 Stainless Steel—New	18" x 10"	12	1000 cu. in.	9.50
G-1 Stainless Steel—New	24" x 12"	18	2100 cu. in.	12.50

Prices F.O.B. Chicago. Include approx. postage on orders paid for in advance. C.O.D. orders enclose 25%, balance sent C.O.D.

U. A. S. Corp. Dept. PM12, 5637 W. 63rd Pl. Chicago 38, Illinois

SAY YOU SAW IT IN POPULAR MECHANICS

What to Make with CONCRETE

Even little concrete jobs cost big money — mostly for labor. Get Popular Mechanics WHAT TO MAKE WITH CONCRETE and save all the labor cost while making your home or farm ship-shape. Book shows all—tells all — how to make the right mixture, plan, apply and gives 50 professional short cuts. Hundreds of pictures. Only \$2.00 postpaid. Order today. Money back if not pleased.

POPULAR MECHANICS PRESS, Dept. PM9, 200 E. Ontario St., Chicago 11



Build Your Own Fireplace, Driveways, Walks, Etc.

Learn the Secrets BREED RARE tropical fish

KISSING FISH

KIND OF FISH	EGGS OR YOUNG PRODUCED AT ONE BIRTH	APPROX. RETAIL PRICE OF FULL-GROWN FISH
Swordtail	20 to 100	\$3.00 to \$4.00 Pr.
Red Betta	70 to 200	3.00 to 4.00 Pr.
	150 to 100	8.00 to 11.00 Pr.

Proof of tremendous profits!

... IN YOUR HOME... SPARE ROOM, BASEMENT, GARAGE... ANYWHERE!
EARN BIG MONEY—SPARE TIME

New "Chance of Lifetime" opportunity! Start your own spare or full time business once you know the revealing breeding secrets. It's fascinating! It's Fun! Breed EXOTIC and graceful "Angel Fish", BEAUTIFUL "Gourami" that are 12 DIFFERENT COLORS, "Fighting Fish" THAT FIGHT UNTIL DEATH; "Danio" that are STRIPED LIKE A ZEBRA; TRANSPARENT FISH — hundreds of expensive varieties. Some fish lay 300 to 600 eggs at one time. (Some very rare fish have sold for over \$75 a pair.) Get into PARTNERSHIP WITH NATURE and let nature multiply your profits for you. NO EXPENSIVE EQUIPMENT — NO EXPERIENCE NECESSARY. WE SUPPLY EVERYTHING YOU NEED. HELP FILL HUGE DEMAND from stores, offices, theaters, hotels, etc. New plan lets YOUR MAILMAN BRING YOU ORDERS. Investigate TODAY.

FREE! Colorful "How To Do It" success BOOK-LET, REPRINTS, breeding BROCHURE and ALL DETAILS. Rush coupon today!

RUSH this Coupon TODAY!

Tropical Fish Breeders of America, Dept. D 12
1010 S. Los Angeles St.,
Los Angeles 15, California

Dear Sir:
Please rush me all Free Details.

Name _____

Address _____

City _____

State _____

Your Age _____





Honestly now—
would you prefer
a shrinking
violet?

The advertisers in this magazine all claim their products are "tops." They are full of pride in their brand names.

Every so often you meet someone who objects to what he calls the "boastfulness" of advertising, but *most* of us Americans like it.

We like it because we know that deep *pride* in things well made goes way back into the factories and is reflected in the fine products we have to choose from when we go to buy the things we use in our homes—or on our persons.

We like it because we know that pride is a spur to make better merchandise; and that it is the driving power that keeps men striving each to outdo the other in new ideas, new and better ways of doing things. The end result is a steady stream of new and better means to make life comfortable; more and better jobs for us to earn the means of buying them.

We will take the *Proud* ones—and let some other land cultivate the shrinking violets.

Brand Names Foundation

INCORPORATED

A non-profit educational foundation • 119 West 57th Street, New York 19, N. Y.

BOOKS ARE BETTER THAN EVER!

(and so is TV)

We had a hunch (about the time a lot of other publishers were gloomily predicting the end of the printed word because of TV) that nobody, but nobody, was going to sit around forever staring at the little lighted screen in their living room. We reasoned that after the novelty had worn off, people would be anxious to get back to their hobbies, workshop projects, home maintenance and repairs, and to continue to broaden their interest in this scientific and mechanical world of ours.

To prove our confidence, we even joined forces with some of the "enemy" as we continued to produce worthwhile books in these fields. For instance, we got the feeling that it was just too bad that the excellent science programs of Mr. Wizard (Don Herbert) had to vanish from the record at the conclusion of his weekly half-hour television program. We got Don Herbert to put down on paper some of his best tricks and experiments. The result was *Mr. Wizard's Science Secrets*, a book that started walking off the shelves literally as fast as we could get it to the stores. A first printing was exhausted within a few weeks . . . now we're out with the third printing (a total of 75,000 copies).

The book is an excellent gift for any bright youngster. He'll be able to mystify his friends (and learn a lot about science, too) after he reads how he can turn "wine" into water, pop popcorn with radiant energy, blow up a balloon inside a bottle, make his own telephone and telegraph systems, cause water from a faucet to bend mysteriously, make mothballs dance, etc., etc. Mr. Wizard tells not only *how* to do these tricks, but *why*. It was this that led Wilbur L. Beauchamp, professor of education at the University of Chicago, to pronounce his judgment: "It's a good book."



We think we have another best-seller in *Dorsey Connors' Book: Gadgets Galore!* Miss Connors has written an excellent book, hard to label except by the blanket term, "Ideas." Some of them represent the best that she has presented on her television show over WNBO-NBC (Channel 5). Others are brand new. Altogether they make up a collection of intriguing ideas for household short cuts, homemade gifts, etc. In an ordinary wire coat hanger, Miss Connors sees: a mail caddy . . . an earring bar . . . a rack for cups . . . a beverage holder for garden parties . . . an extra shelf . . . a newspaper or book rack . . . an outdoor grill fork . . . an omelet stirrer . . . a muffin toaster. In her capable hands an aspirin tin, a stone from discarded jewelry and a little gilt paint become a Marie Antoinette pill box; while four handkerchiefs and a length of bright ribbon work into a fancy party apron. *Gadgets Galore!* is an excellent gift for any woman, whether bachelor girl or homemaker. And the handy man of the house will find much to interest him, too, in this fascinating book.

Another television star who's doing a book for us is Walt Durbahn, genial proprietor of "Walt's Workshop," a program which has a large following among home-workshop craftsmen. Walt's book, *Carpentry for the Home Craftsman*, is eagerly awaited by this group.

So TV continues to have stars and sponsors, and we continue to produce books that are sold . . . and read . . . and used. The books are as easy to obtain as your favorite program. Simply go into your favorite bookstore . . . or write



GET WILDROOT CREAM-OIL CHARLIE!



GIRLS WON'T GO WITH A GUY WHO HAS MESSY HAIR! KEEP YOUR HAIR NATURALLY WELL GROOMED WITH WILDROOT CREAM-OIL. IT'S NON-ALCOHOLIC, NON-GREASY. CONTAINS LANOLIN, SO MUCH LIKE THE NATURAL OILS OF SCALP AND HAIR. TRY A BOTTLE OR HANDY TUBE TODAY
29¢ and 59¢



IT NEVER FAILS!

SO DON'T FAIL TO SEND YOUR NAME WITH THIS AD AND 10¢ FOR A GENEROUS BOTTLE OF WILDROOT CREAM-OIL TO WILDROOT, DEPT. W, BUFFALO 11, N.Y.

POPULAR MECHANICS PRESS
200 East Ontario Street, Dept. 12, Chicago 11, Illinois

FIRST

*to meet demands
of today's
high powered engines*

Gives you

QUICK STARTS

DOUBLE LIFE

SMOOTHER

PERFORMANCE



First Resistor-Type Spark Plug APPROVED AS ORIGINAL EQUIPMENT by leading car manufacturers.

AUTO-LITE SPARK PLUGS—PATENTED U.S.A.

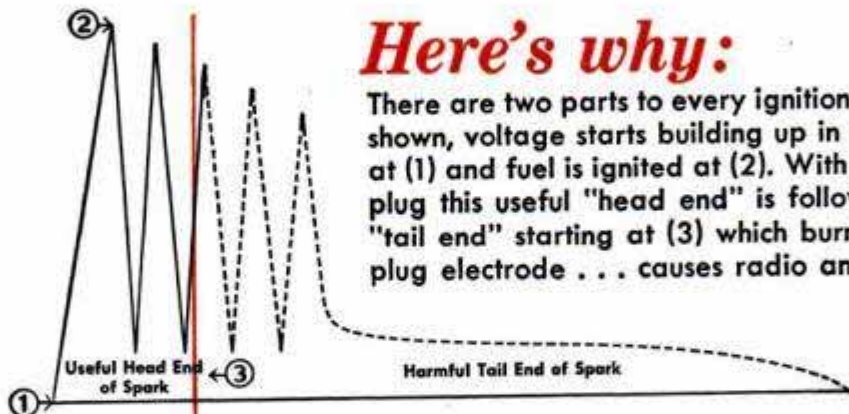

Here's why:

There are two parts to every ignition spark. In the chart shown, voltage starts building up in the ignition system at (1) and fuel is ignited at (2). With an ordinary spark plug this useful "head end" is followed by a harmful "tail end" starting at (3) which burns away the spark plug electrode . . . causes radio and TV interference.

With the ignition engineered Auto-Lite Resistor Spark Plug there's this difference. The built-in resistor controls the spark. Voltage starts building up in the ignition system at (1), delivers a super-spark to ignite the fuel at (2) for quick starts and smoother performance. But it filters out the harmful "tail end" spark from (3) on to eliminate radio and TV interference . . . protects electrodes to double spark plug life.

Tune in

"SUSPENSE!"

CBS Radio Monday

CBS Television Tuesday

Auto-Lite RESISTOR Spark Plugs are one of a complete line of spark plugs

By Richard W. Emery

IT COULDN'T HAPPEN to you. That is, it probably won't. But it could happen to someone else, when you were the one they yelled to for a little help. And rescuing someone who has trapped himself may turn out to be a major project.

In most cities, rescue jobs go to the firemen. Fire stations keep a batch of special tools for tough rescues and firemen train in their use. A rescue may be fairly simple, like salvaging Junior when he has stuck his foot in a drainpipe. Or it may be complex, like unpinning a man from a tangle of gasoline-splashed wreckage.

Mostly, the rescue jobs where an amateur might do some good are of the type which look, at first glance, like a very fine joke on the victim. They are the home-front booby-trap type. But such accidents can be painful and dangerous. They can happen

POPULAR DECEMBER 1953 MECHANICS

WRITTEN SO YOU CAN UNDERSTAND IT
VOL. 100 NO. 6

at times or places where firemen can't be quickly reached. On camping trips, on lonely highways, on pleasure boats hours from port, pinning-type accidents can be deadly.

Almost always, there is some common-sense solution to a rescue problem. If a study of successful rescues indicates only one rule of thumb, it is this: before you act, take time to think. There may be more than one solution to the rescue problem and one may be better than the other!

Fireman Save my Child!

Firemen were called to free the foot of this 12-year-old movie-goer who stuck it between seats





Firemen use pry bar to raise iron manhole cover in which frightened boy has finger stuck in small hole

A simple example is the procedure, well known among fishermen, of removing a fishhook which has snagged in someone's skin. At first thought, it would seem that the hook must be pulled back out—a rough and painful remedy because of the barb.

Usually the hook can be pushed farther, so that its point and barb emerge through the skin. There the barb can be nipped off with wire-cutters or pliers. Then the hook is retracted easily.

"Discuss methods freely with others—if there are any at the scene," suggests a fire captain with years of rescue experience. "Try to attack it from the best side. Look at all sides. Try to think of some second way to free the person; there may be some quick, sure method just waiting to be thought of."

A swimmer with knife rescues a skin-diver whose identification bracelet got caught in strands of rope. Diver was trying to salvage lost anchor

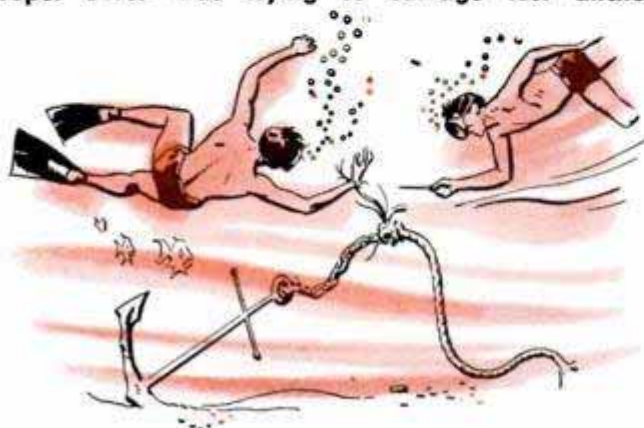

The manhole cover is lifted over the boy's head to drain blood from his hand and reduce the swelling

Youngsters frequently trap themselves by poking their feet into narrow places—water-meter pipes, for example. Frantic parents have struggled to extract Junior's foot, and despaired, only to see firemen release Junior in a few minutes by pulling the foot out of the shoe which is wedged in the pipe.

An old man fell in front of a heavy bus and the front tire of the bus came to rest, pinning the man's foot. No jack powerful enough to raise the front of the bus could be brought quickly to the scene. Firemen blocked up the front axle and released the air from the bus tire. The man's foot was moved without further injury.

Fright can blind a whole household of adults to the most obvious, immediate solution to a rescue problem. Recently firemen raced to a home to free a woman's hand from a washing-machine wringer. Arriving, they found the woman screaming beside the machine, her hand still being mangled by the machine. Three other housewives ran back and forth, also screaming.

"Not one of them had thought to pull the electric cord and shut off the machine, or to strike the machine's tripping lever," the firemen reported. "Even ordinarily level-headed people can go panicky like that, especially if someone in their own family gets trapped."

Many rescues involve youngsters who have stuck a finger into a steel pipe, or



The boy asks: "Do you have to cut off my finger?" Firemen are using soapsuds and detergent on finger

bottle neck, or some other trap—and discovered the finger wouldn't come back out. Steel washers pushed past the second knuckle, and worn briefly there by small-fry, have a way of staying put because the finger swells. Salt-and-pepper shakers are favorite traps for small fingers.

Elevating the trapped hand reduces or prevents swelling. Ice or cold cloths may do the same. Soapsuds or oil then may speed rescue of the imprisoned finger. If the finger is trapped in a bottleneck, as a means of breaking the air-seal you may have to break the bottle. First wrap it with adhesive tape to prevent shattering.

Hospitals use slick little rotary saws to remove rings and similar metal objects from fingers. The blade is hand-turned against the ring while a thin metal guard protects the finger.

Some of the oddest "pinning" accidents are what firemen call repeaters. The same thing happens over and over, as the years roll by. One of these is the "splinter test" trap.

It happens when an amateur carpenter bores a hole through one wall of a partition, using a dull bit against grainy, tough wood. He jabs the bit through the last part of the cut, pulls the bit out, and runs a finger into the hole to see if he has removed all the wood from the cut.

On the far side of the hole, ratchet-like splinters prevent him from pulling his finger out. The rescue on this one usually calls



The soapsuds worked and the finger slipped out of the hole. It is Exhibit A to all near-by small fry

for sawing out a portion of the opposite side of the partition, or a disk around the pinned finger.

Small boys get themselves caught in such unlikely things as empty oil drums, brick chimneys, sections of sewer pipe, concrete storm drains and old-fashioned flour bins. Experts proceed on the idea that by reversing the movements which got him into his fix, the boy can get out. Gravity is a complication. If the boy's cramped position has made his legs go to sleep, for instance, that may complicate the rescue.

Often the first thing to do is to quiet down the relatives, so that you can talk quietly

A mother's screams brought riot call for boy stuck in incinerator chimney. Firemen scooped out ashes, had boy flex knees and they pulled him out of firebox

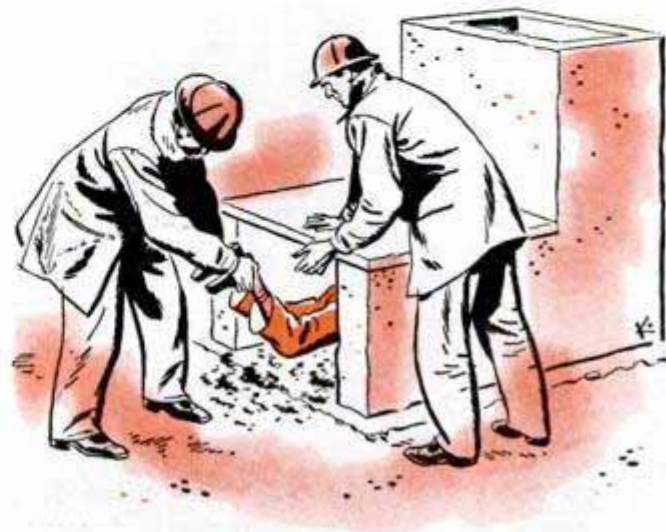

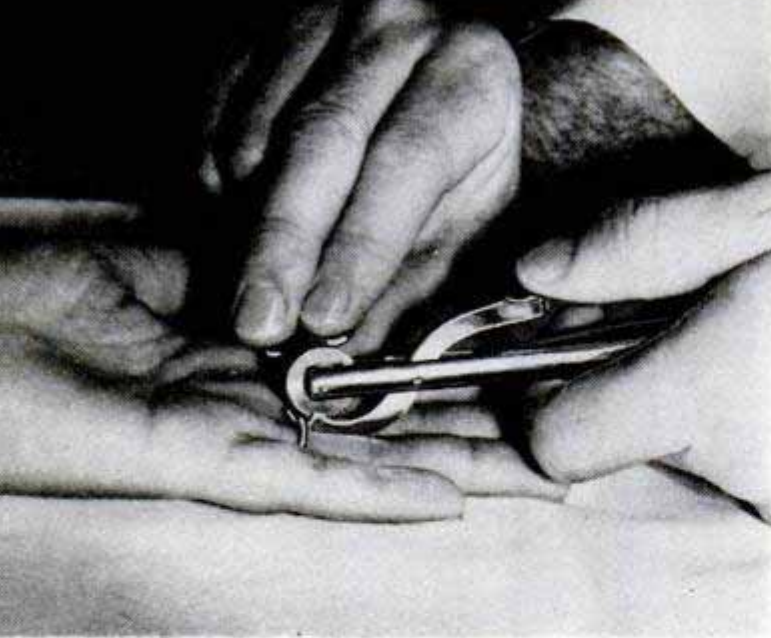

This hospital tool is used to remove a ring from finger. The right hand turns small rotary hacksaw while pressure of thumb at right presses the cutter against ring. Finger is protected by a metal shield

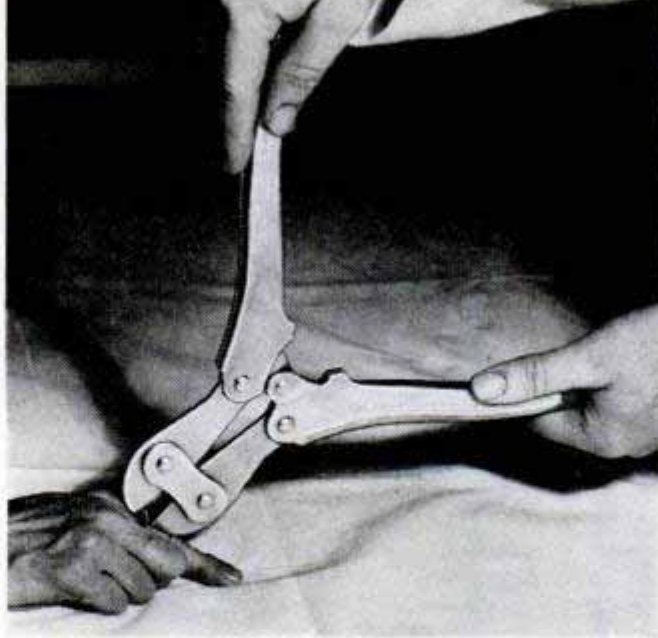

Rings, barbed wire and fish-hook barbs are also removed with powerful bolt cutters such as the pair shown above. Such tools are standard equipment in hospitals and must be handled with considerable care

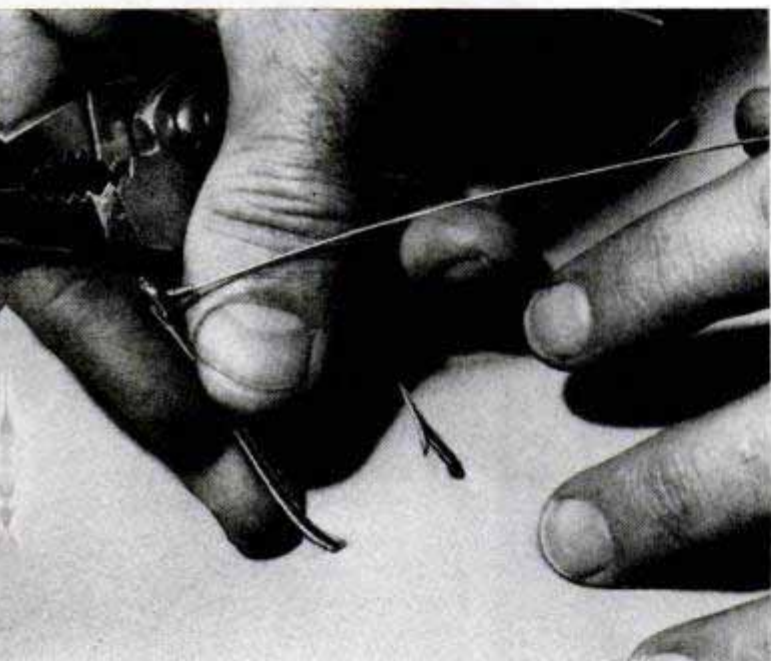

Here's a quick way to remove a fish hook embedded in a finger: turn hook through the skin and clip off the barb. Below, winding string on finger is help in removing stuck washer, one turn at a time

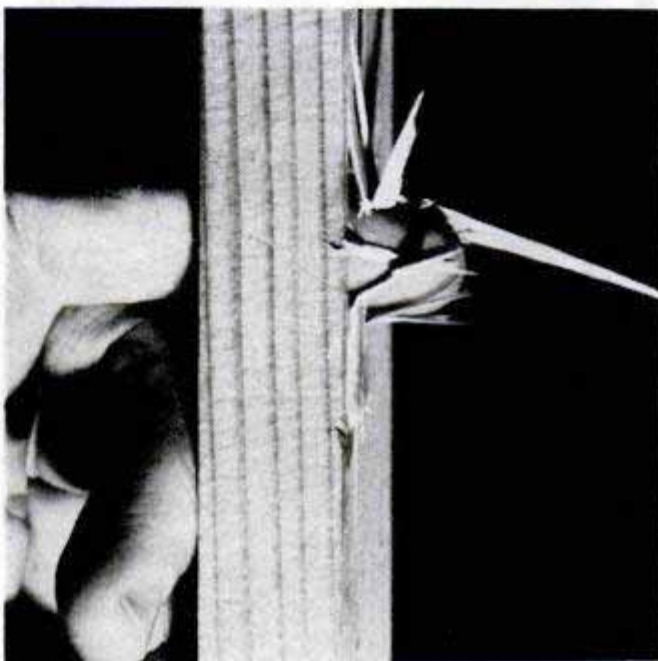

Many a carpenter has tested newly drilled hole and caught his finger in splinter trap. Finger can be removed by sawing disk around hole. Below, a metal cylinder can be ejected by filling with cold suds

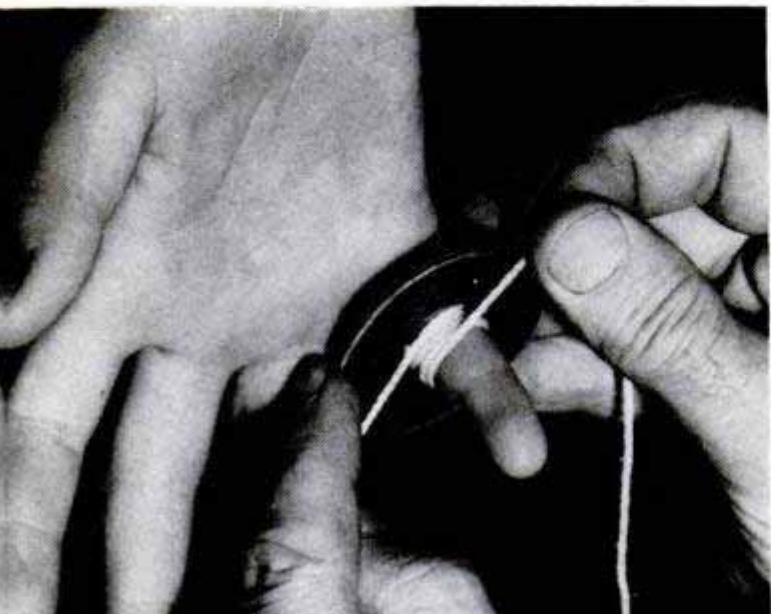

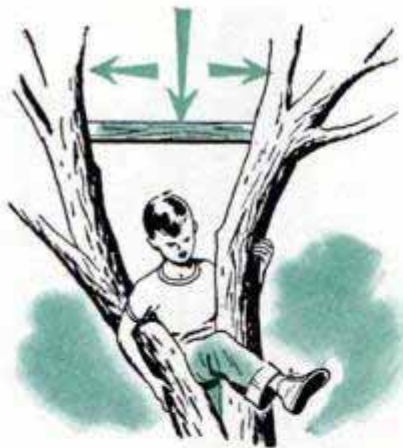

Junior's leg, trapped in tree crotch, is best freed by wedging block of wood between limbs and pressing it down as breeze flexes and widens crotch

Below, as last resort in this finger-stuck-in-bottle rescue the bottle is wrapped with adhesive tape to minimize the shattering, and hit with hammer

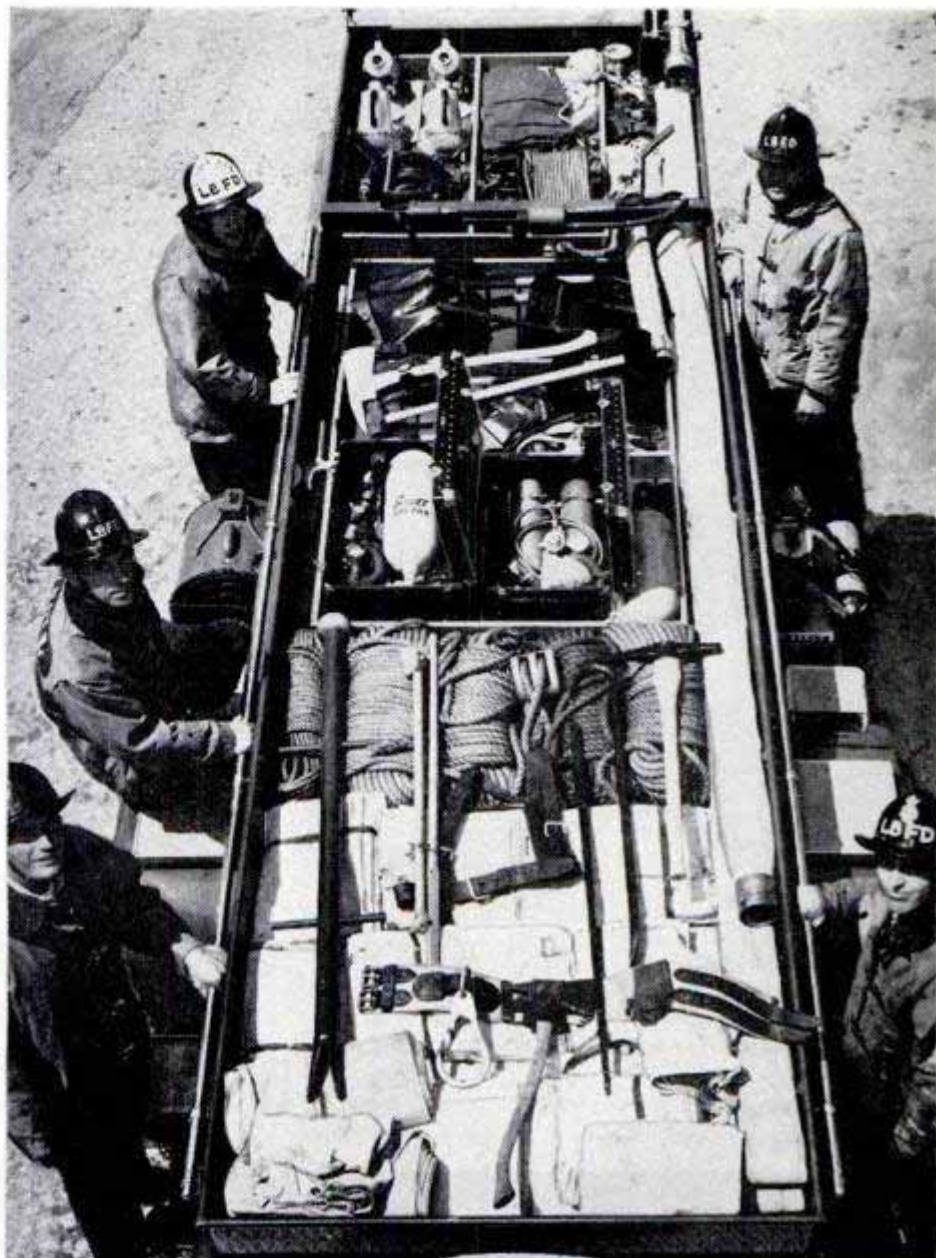

Special tools displayed by firemen for rescue work at Long Beach, Calif.

to the boy and get his confidence. If he relaxes, it may be possible simply to lift him out. He may be so terrified that he can't try to help. Give him hope and encouragement—and you may be able to rescue him without hacksaw, tin snips or pry bar!

The mechanical principle of leverage can be used to free victims of some types of mishaps. Even a small person can bring tremendous power to bear against an object by using a plank or pipe or bar as a lever. An automobile jack can be used to raise heavy objects, or to pry heavy things apart.

In all rescue operations, fright is an opposing factor. The victim is frightened; everyone around him is frightened. The rescuers must try to look confident, because that look is contagious. Here's our fire captain on that point:

"I've seen firemen, even nurses, go to pieces in an emergency. You've got to keep control. We teach our men to stop a moment and take several deep breaths if

they get in a 'blind' on a rescue job. The appearance of confidence is catchy—just the sight of the ambulance man's white coat helps to restore calm at an accident scene.

"If people have no relation to the incident, they'll have greater panic. Give them a job to do. Encourage the person you're trying to help. Talk to him. Remember that a person learning to swim can be 'talked' stroke by stroke along the surface; but turn your back on him, and he'll drown!"

Thinking things out, despite a tough situation, has saved the life of many a man trapped alone without hope of outside aid.

A fisherman set sail alone in a sailboat from a West Coast port, bound for Tahiti. His boat was caught in a hurricane off the coast of Mexico. At midnight, a huge wave shook him loose from his place at the stern and threw him feet first and barefooted along slippery planks of the cabin deck. One prong of a big fish spear was driven through his foot, emerging above the instep.



Lever action gives this door opener plenty of the necessary squeeze, far exceeding strength of a man

At a teen-age party, prankster clamped a pair of old handcuffs on girl; police had to find a key



Tin-roof opener works on the same principle as the familiar can opener; just jab it in and rock along

In the darkness, with his boat threshing in heavy seas, the fisherman found that he could not reach forward far enough to unlash the spear handle. Neither could he pull his foot loose from the barbed steel. All night long he notched at the hardwood handle of the spear with a short knife. When the knife finally cut through, he dragged his speared foot forward to a tool locker, filed the barbs from the spear and pulled the steel out of his foot. He managed then to ride out the storm and reached shore for necessary medical attention. ★ ★ ★

These firemen are rushing a handy rescue tool to scene of disaster—an all-purpose battering ram



Five-by-Five Atomic Pile Aids Research Workers

A MINIATURE atomic pile used by researchers at an atomic-power laboratory operated by General Electric is housed in a cube of graphite measuring five feet on each side. A handy source of the atomic particles called neutrons, it can be used in many fields of fundamental research. The reactor can also be utilized to analyze minute amounts of chemicals, and to make radioactive isotopes. Test samples are lowered into a narrow shaft surrounded by a cylindrical graphite block. Encircling the blocks are 20 rods on which are "strung" small disks of an alloy of uranium and aluminum. Control of the reaction is accomplished with rods and sheets of cadmium which can be lowered into the fuel assembly. The pile is in a cell surrounded by a thick concrete wall. The operator controls the lifting and lowering mechanism from a panel.



Technician at control board can increase or decrease activity of pile by movement of shields. Test samples are analyzed by recording activity of pile before and after samples are lowered

Safety rods, below, are held by electromagnets which drop them into place in case of emergency. Cutaway, left, shows part of control mechanism and test cylinder encased by graphite blocks

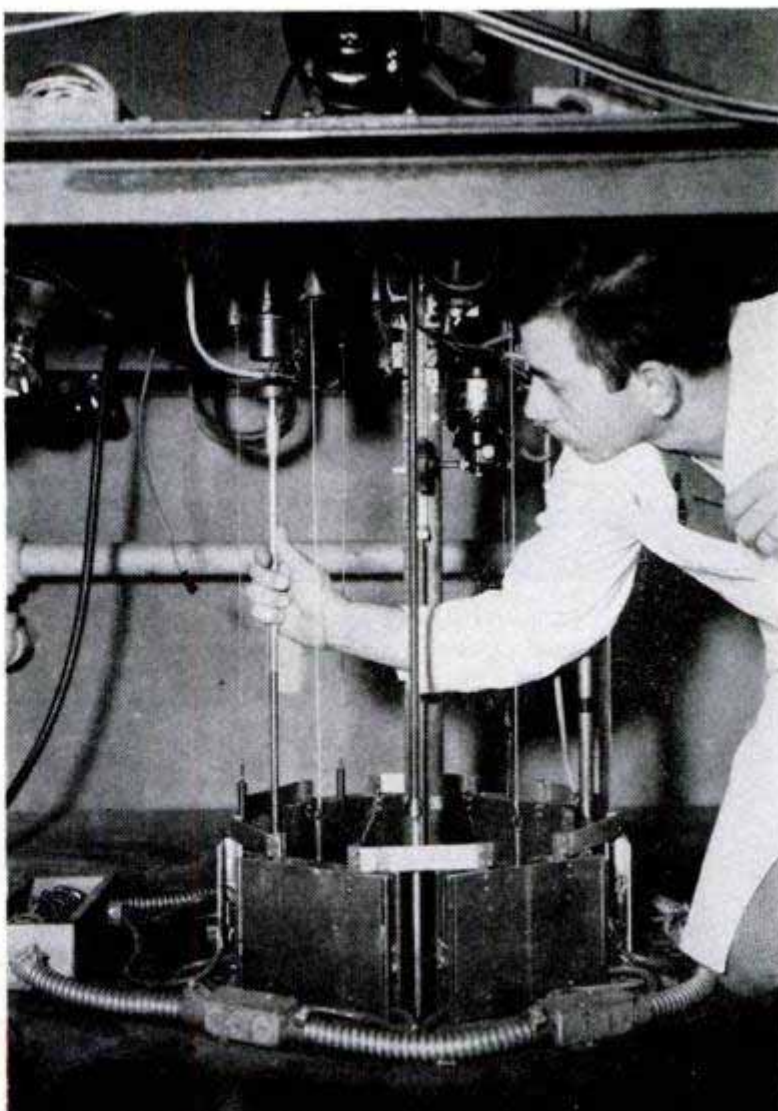
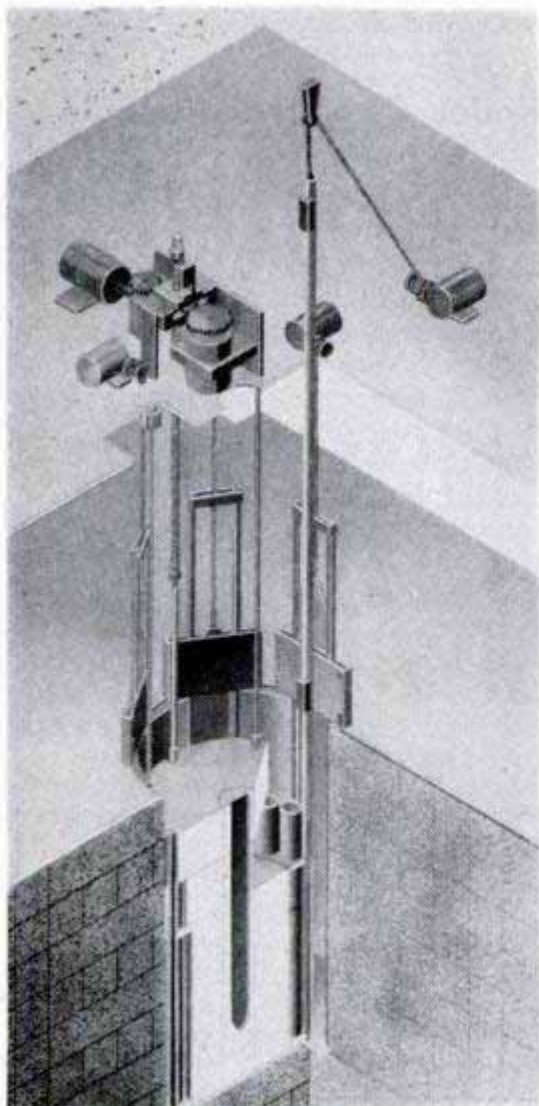

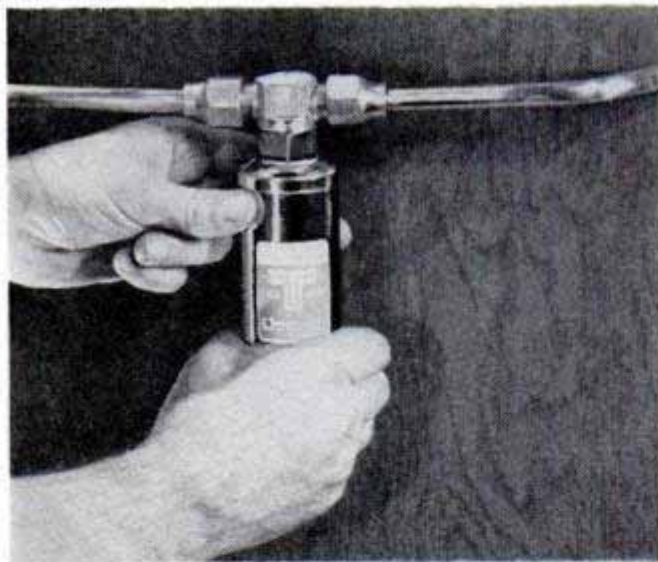

Quick-Change Drying Cartridge Removes Moisture From Gas

Moisture in refrigerant gas is removed efficiently by a T-shaped appliance that is quickly installed at any point on the gas-carrying line. Tiny spheres of moisture-absorbing material absorb the moisture as the gas percolates around them. The canister containing the drying agent can be replaced when saturated without removing any pipe fittings. It is simply unscrewed from the T-fitting and a fresh canister installed. The device is designed for use in commercial refrigeration systems.

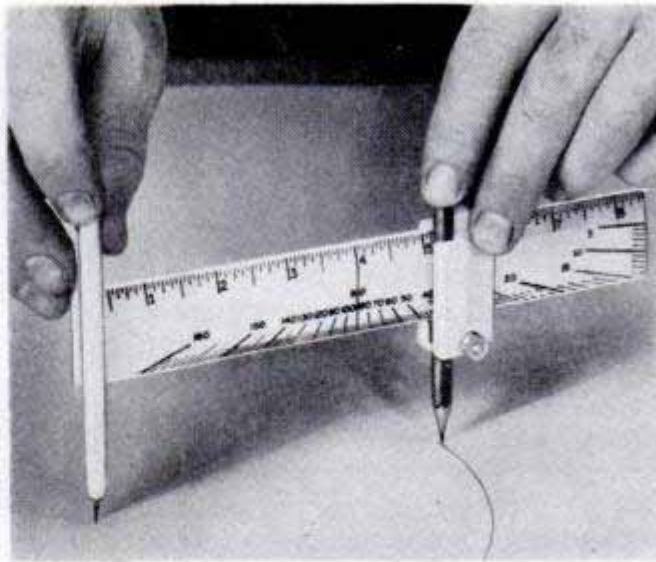

Five Instruments Combined By Plastic Draftsman's Tool

Craftsmen, draftsmen, artists and students find wide uses for a compact five-way tool. Made of plastic, it consists of a straightedge with ruler and protractor markings, a pencil holder which slides the length of the ruler but can be fixed at any point and a post at one end with a steel needle on the bottom. As a compass, it makes circles up to 17 inches in diameter. When the instrument is turned upside down, it becomes a T square, and can also be used as a marking gauge.

Mining Machine With Many Functions Multiplies Ore Production

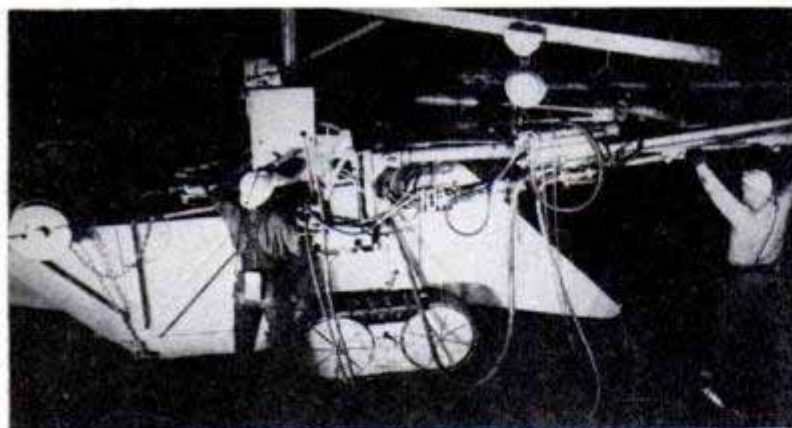

Boom containing rock-drilling equipment is mounted in minutes. [With boom removed, machine scoops up rock, hauls it away



Ore production at a Washington mine has been boosted from 15 to 100 tons per man a day with a machine which drills blast holes, scoops up the broken ore and hauls it away. Rock drills and jibs are mounted on a special assembly that is removable in one piece by a portable crane applied to the machine for this purpose. Pick and shovel work is eliminated by a loading scoop on the front, which fills the large ore compartment. The machine then backs away, hauls the ore to an unloading area, and dumps it by releasing a door in the bottom. Built at a cost of \$13,000, the unit replaces equipment valued at \$100,000.

Human Moles

They work deep under the city, crawling and squirming through pipes narrower than their shoulders. Their job is to clean out the miles of pipe that serve a city. A feature next month tells of these amazing men and their weird machines

Mercedes-Benz Is Roomier With Better Vision Than Former Model

Considerably more space for passengers is offered in the new Mercedes-Benz. The model, Type 180, has 22 percent more available space than its predecessor in the same price class. Window area has been increased about 40 percent, and the lines of the car show a marked similarity to some American cars. The four-cylinder engine yields about 27 miles per gallon.

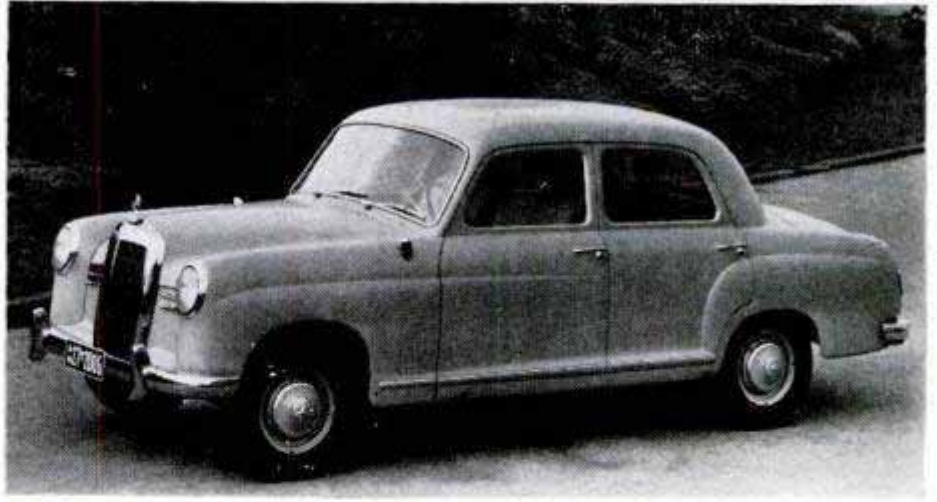

Tripod Attachment Permits Wide Variety of Positions

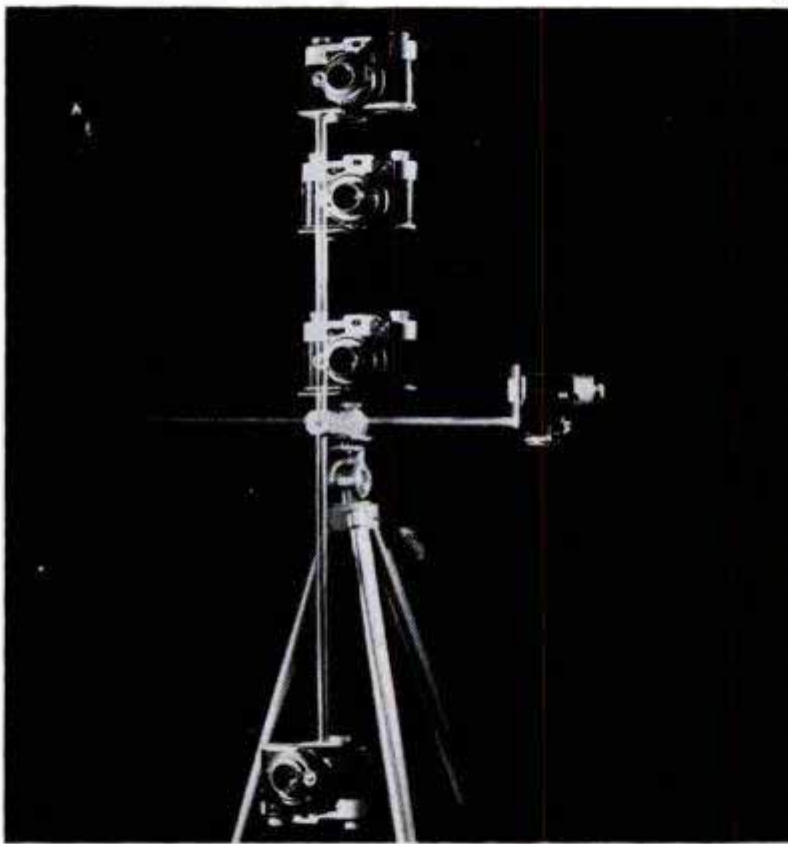

Photographers can vary the position of their cameras almost endlessly with a swinging tripod attachment. The device increases the height of the tripod and permits taking pictures from a vertical or horizontal position, or from any point in between. A lock screw keeps the camera steady in all positions.

Chemicals Check Oak Wilt

Shade and forest trees are saved from destruction by eight different chemicals designed to check oak wilt. In tests, up to 75 percent of afflicted saplings and seedlings recovered and resumed apparently normal growth. The chemicals seem to change the growth processes of the trees and allow them to live despite the presence of the fungus. The disease is now spreading in many parts of the nation.

Parking-Lot Guard Operated by Coin Eliminates Need for Attendants

Combining the action of a midget railroad-crossing barrier and a modified parking meter, a parking-lot device ends the need for attendants. The motorist simply drops a coin in a slot and the barrier rises. The car drives over an air hose which causes the barrier to lower again. A similar machine is placed at the exit. Machines for private lots are opened by use of a magnetized card.





PROJECTOR for silent home movies is quiet, casts a sharp image and never needs to be oiled. Lifetime lubrication is sealed around bearings and nylon gears. Lamp is 750 watts, cannot be turned on unless fan is operating. The weight of 16 mm. projector is 19 pounds

BELT WATCH for men or women has a snakeskin snap cover and can be worn on a belt, placed upright on a night table or carried in a pocket or purse. One of the new designs presented by Swiss watchmakers, the timepiece is not easily damaged when worn at the waist

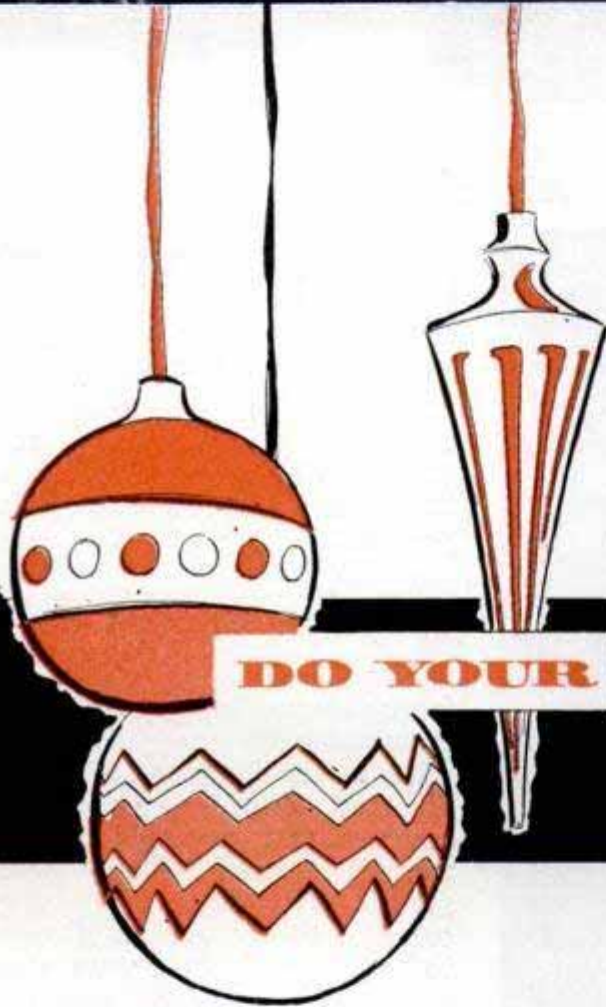

DO YOUR

Christmas



FOUNTAIN-PEN SET for car enthusiasts features accurate metal replica of a famous automobile mounted between pen holders

POWERFUL SLINGSHOT with three rubber bands instead of two shoots arrows, stones or pellets, can kill small game and is accurate enough to be used for target practice

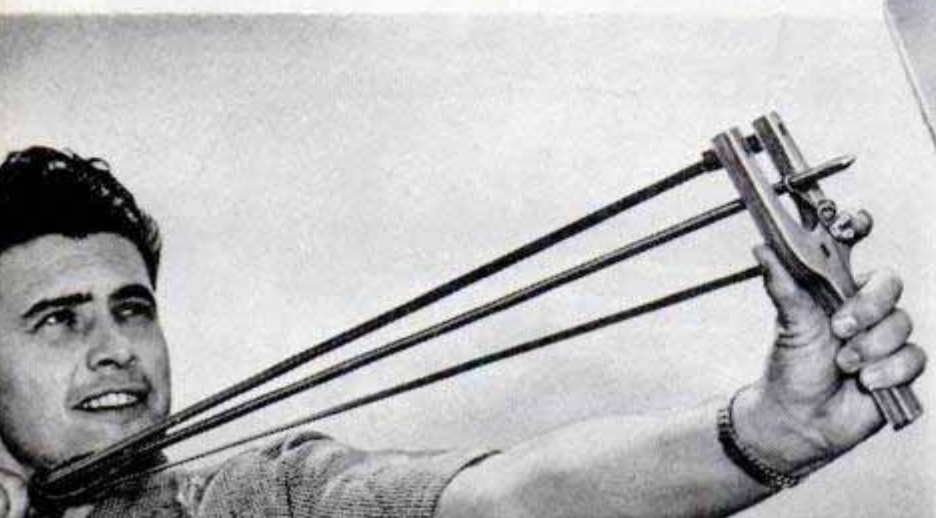

SPIT driven by electric motor frees the outdoor chef from the tedious job of turning and basting. Horizontal adapter allows a set of four skewers to turn independently

ELECTRIC REEL for surf and boat fishermen has a small electromagnet that applies tension to spool when line slackens. Tiny flashlight battery in reel furnishes power

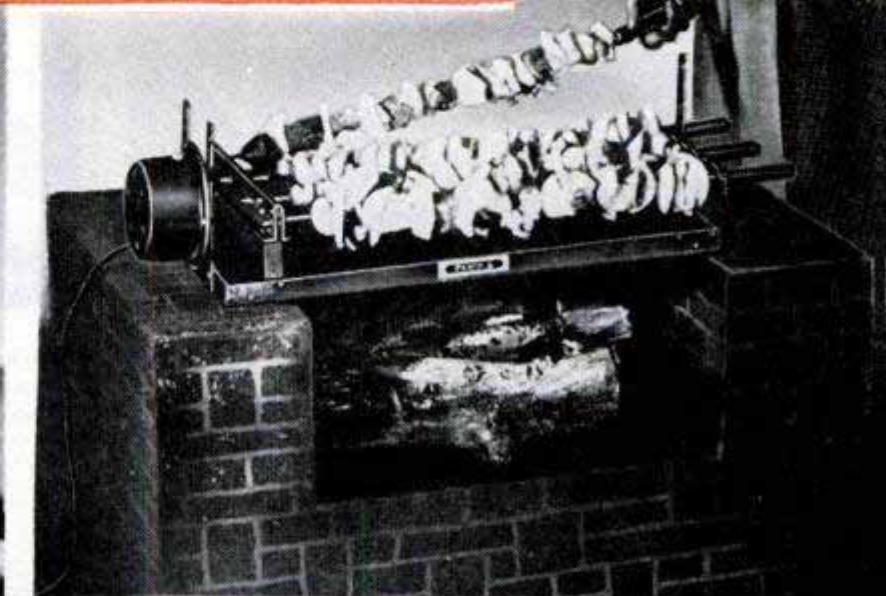
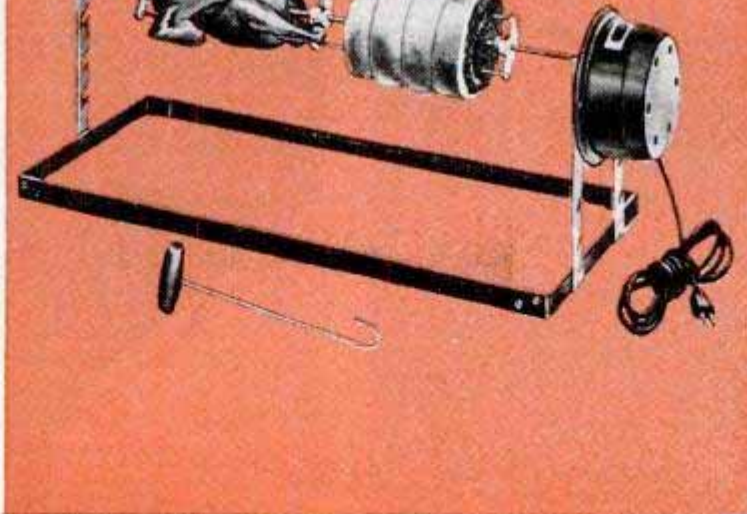

Shopping Here

For the man— and
the outdoorsman—
in the family

Six pages of timely new Christmas gift ideas for the home, the youngsters, and the man of the family

COFFEE KIT assures the traveler of a perfect brew even when he is far from home. A plastic carrying case contains the pot, four cups and spoons, a small vacuum bottle for cream and canisters for coffee and sugar. The fast-percolating electric coffeemaker has a six cup capacity

GOLFBALL FEEDER contains 15 balls for practice shooting in the house or on the lawn. Each time the golfer depresses the delivery tube with his club a ball rolls out and seats itself on the rubber tee. Baseboard won't skid on floor, anchors to turf by means of wooden pegs

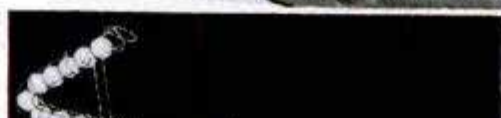

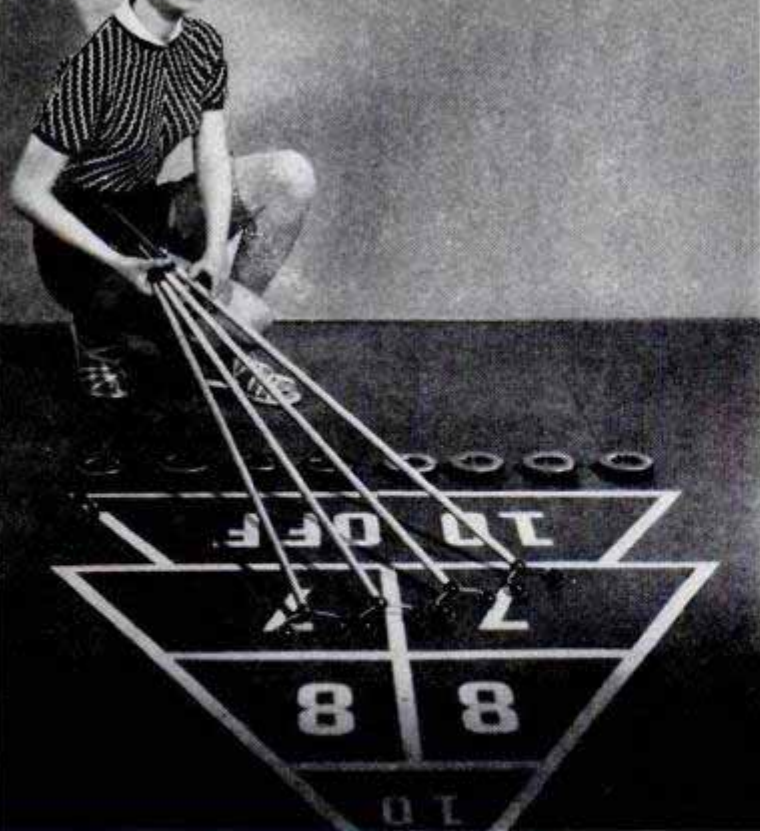

SHUFFLEBOARD SET two-thirds regulation size is just right for recreation rooms and driveways. Four aluminum cues and eight disks comprise the set

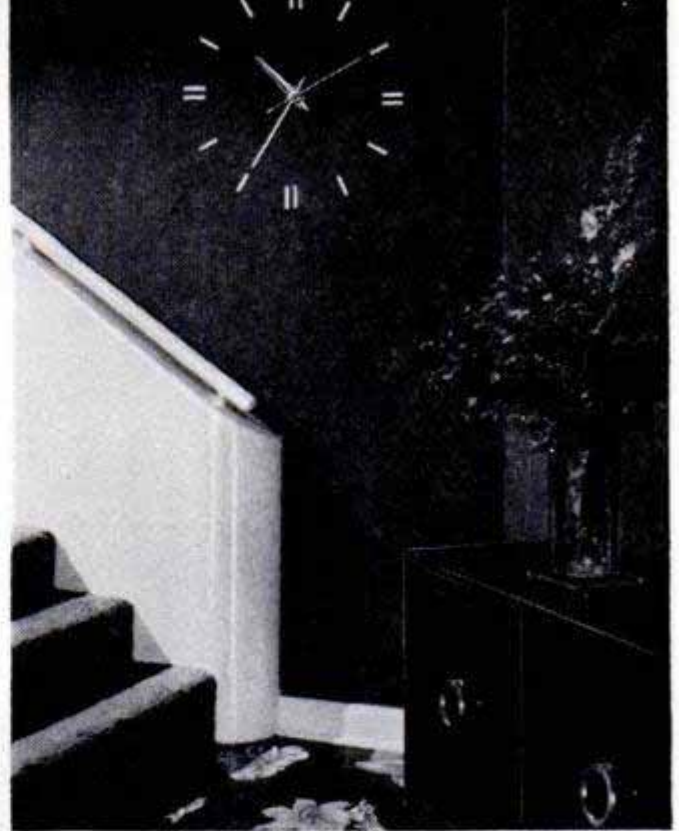

WALL CLOCK driven by hidden works is assembled from kit which includes template and full directions. Works are covered by a disk or installed behind wall



DO YOUR

Christmas

DISHWASHING SPRAYER mixes detergent with water from faucet to clean dishes in one third the usual time. Thumb lever opens detergent reservoir or closes it when only rinse water is needed. Device won't rust



PHOTO LAMPSHADE is illustrated with enlargements of favorite pictures, black and white or hand-colored. Printed on extra-heavy photographic paper made translucent and durable by a plastic treatment, pictures appear to have depth and reality when lamp is turned on. Snapshots, large glossy prints or transparencies may be reproduced on shade

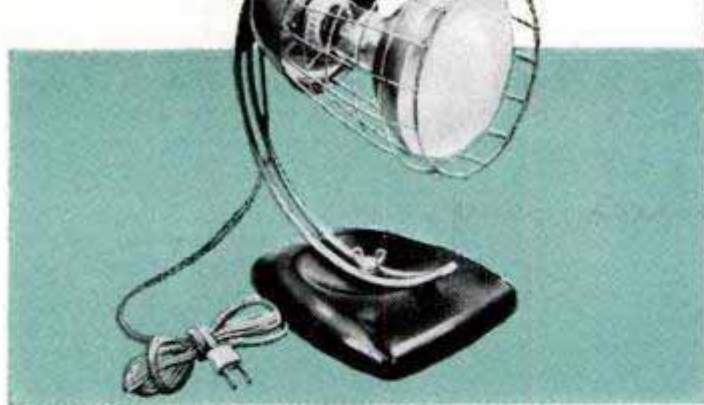

MULTIPURPOSE LAMP gives you a sun tan, a heat treatment or enough light for indoor picture-taking by using ultraviolet, infrared or photoflood bulbs



HOME-FREEZING KIT supplies everything for the beginner, including cartons, plastic bags and boxes, aluminum foil and instruction book



ELECTRIC TRIVET keeps food hot after it has reached the table. The decorative hot plate won't harm table finish. Handle remains cool

Shopping Here

For the **HOME—**
and the woman
who runs it

PHOTO PLAYING CARDS contain black-and-white reproductions of personal caricature or snapshot. Caricatures are drawn by company artists from enclosed photographs. The service is handled entirely by mail



WATER-POWERED MIXER connected to faucet blends fruit juices and mixes beverages, topping and batter. Stainless-steel blades in base revolve at high speed to mix liquid efficiently. Container is of plastic



COALING STATION for model trains is operated by remote control. Contents of dump car are emptied into an elevator and carried to overhead bin which then releases its load

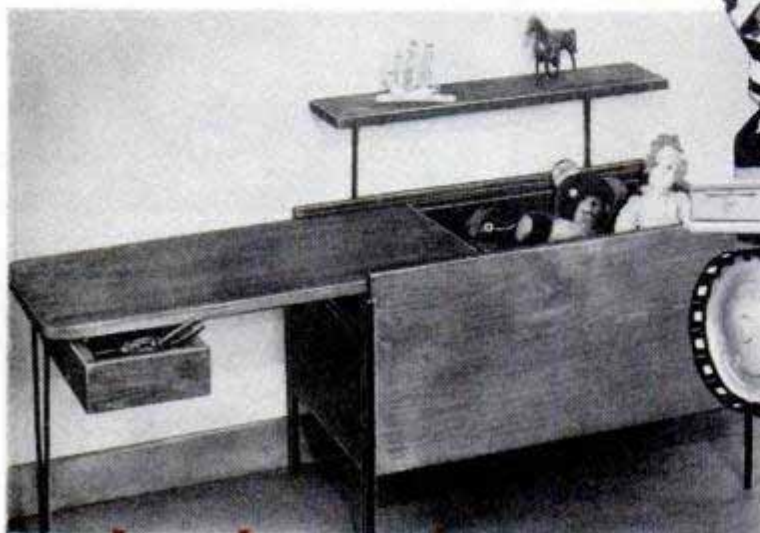

TOY CHEST has a sliding top that can be pulled out to form a work table or play table. Attached to sliding top is an extra leg and a small tool drawer

BULLDOZER is a scale model of the real thing, one of the largest playthings that is available to mechanically minded boys



DO YOUR

Christmas



ELECTRIC TRACTOR directed from control box turns in its tracks, crawls over obstacles, shifts into two forward or reverse speeds at touch of button

LUMBER KIT contains everything needed to build toys or authentic models of furniture and buildings. Miniature boards, beams and dowels, glue, sandpaper and a saw are provided for the young modelmaker

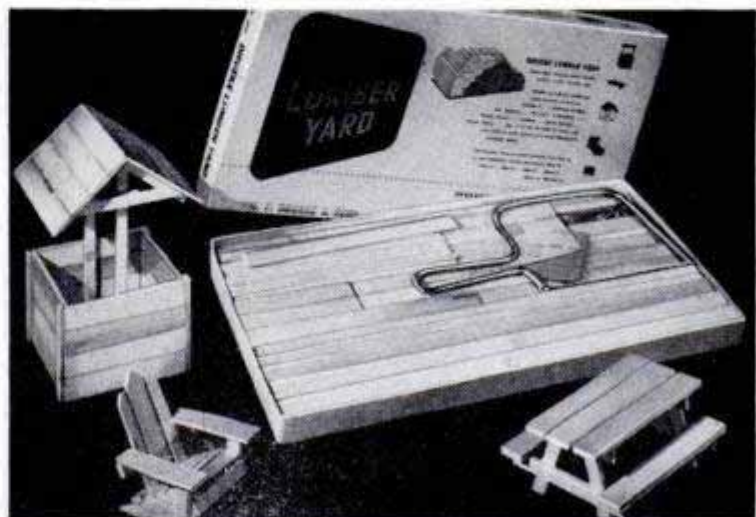



BUCKET LOADER scoops up sand or gravel and puts it in an earth hauler. A crank operates the loading screw, sand buckets, and the rubber conveyor belt

BUILDING SET enables children to build fort or playhouse big enough to walk into. Building planks are $\frac{3}{4}$ -inch plywood notched at the ends so that boards can fit into each other

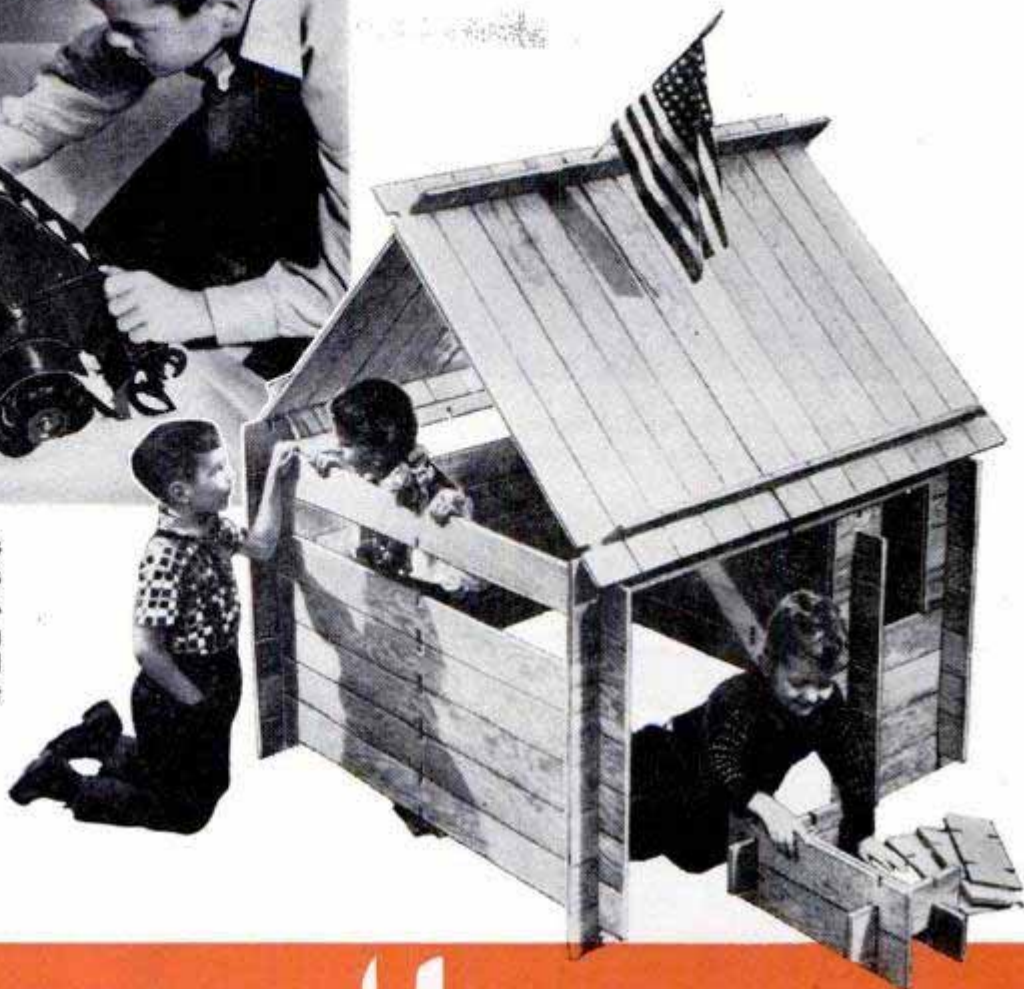

Shopping Here

For the youngsters

ELECTRIC AUTO powered by battery needs charging only once a day, attains a speed of five m.p.h. Gearshift for forward and reverse speeds, lights, brake and horn add reality

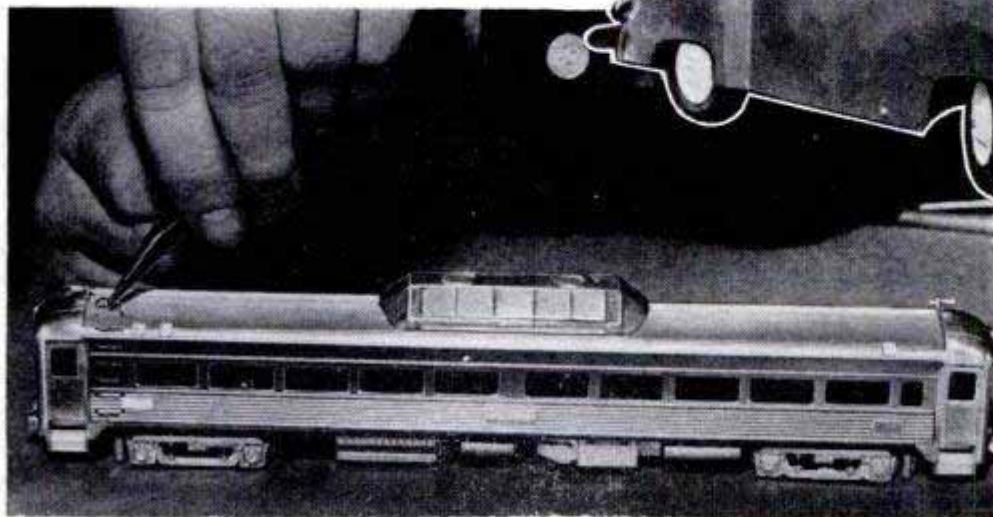

HO MODEL of self-propelled diesel car now in service on major railroads includes pre-painted parts, electric motor

1954 Nash Line

For 1954 Nash continues to expand its Rambler line by introducing a four-door sedan. It has a 108-inch wheelbase, eight inches longer than other Ramblers. Its L-head engine produces 90 horsepower. Standard for the smaller Ramblers is 85 horsepower; with Hydramatic, 90 horsepower. Seats in the sedan recline and fold to make a bed. The only styling change is the addition of chrome teeth in the air intake below the windshield. Statesman 1954 models have 110-horsepower engines featuring dual carburetors, aluminum head and 8.5:1 compression. Ambassador models have 130 horsepower and 7.6:1 compression. The Le Mans 140-horsepower engine is optional on the Ambassador. Continental spare-tire mounts are standard on the Rambler, optional on others.



Above, a four-door, slightly longer sedan joins the Rambler line for 1954. Below, the only exterior change in the Ambassador is a concave front grille



DeSoto V8 Offers Added Horsepower and New Transmission

DeSoto for 1954 features a fully automatic transmission, increased horsepower and all-new interiors. Exteriors are only slightly changed, with a new grille, bumpers and taillight clusters. PowerFlite, the new transmission, combines a torque con-

verter and a two-speed planetary unit. There is only one automatic shift from starting gear to direct drive. Over-all torque-multiplication is 4.47 to 1, highest in the industry. The Fire Dome V8 engine develops 170 horsepower, up 10 from 1953.

DeSoto has given its 1954 models a longer look by redesigning its chrome trim. Interiors have added luxury



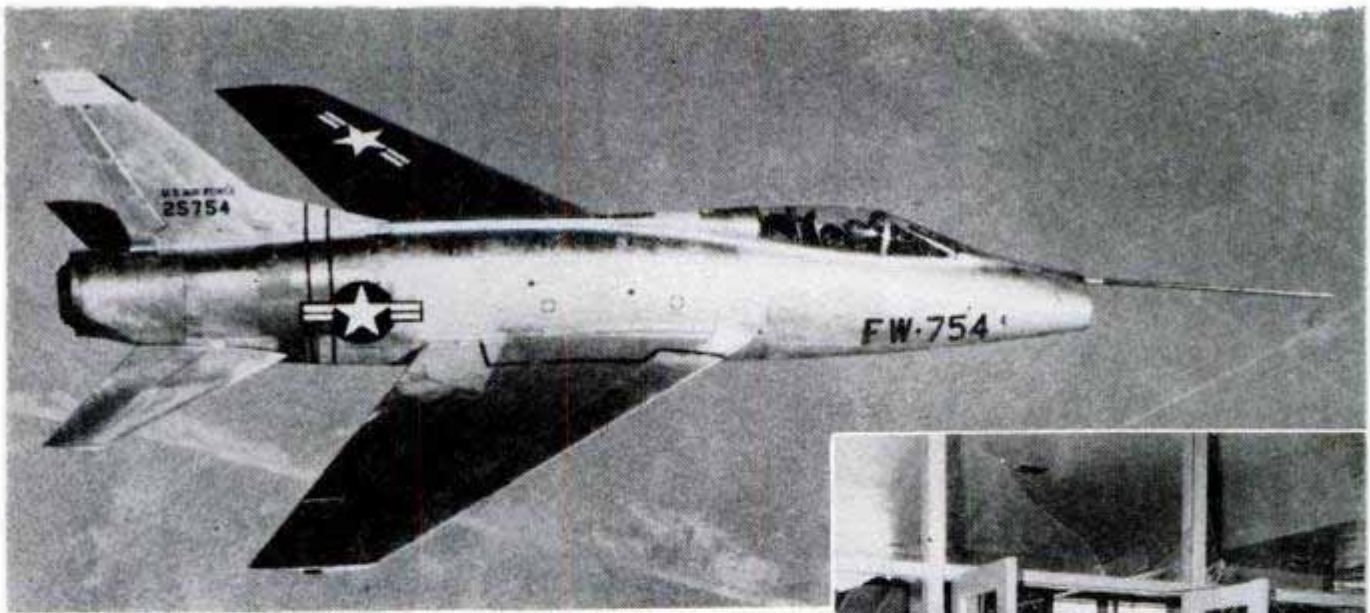

North American Aviation photo

Production Fighter Tops Speed of Sound

Introduced by its manufacturer as the world's fastest jet fighter, the Air Force's F-100 Super Sabre roared through three speed runs averaging about 760 miles per hour. Quarter-inch plate glass in an airport building (shown at right) was shattered by the terrific shock wave created by one supersonic run. The F-100 is in production as successor to the F-86 Sabre. Both its wing and tail are swept back 45 degrees. Titanium, the new metal that resists heat and corrosion, is used throughout the F-100's construction.

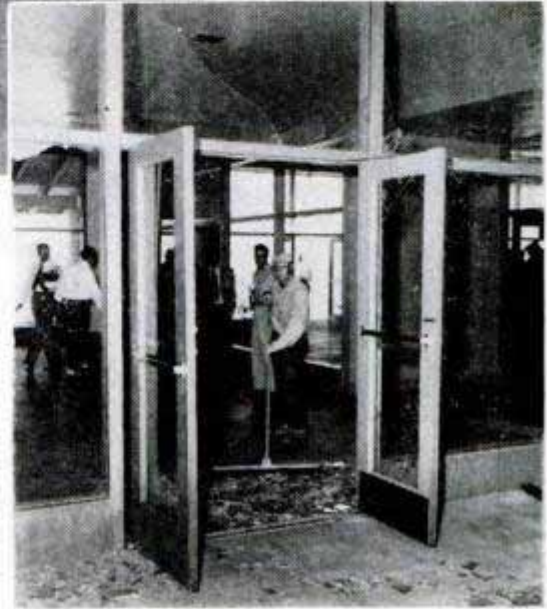

Studebaker Offers Station Wagon in 1954

The 1954 Studebaker line includes the company's first station wagon—the Conestoga. Style changes from 1953 are slight: new front grille, larger bumper guards and hood ornament. Sedans (not the sports line) have a chrome rub rail running along the body. Both V8 and 6-cylinder engines have 7.5:1 compression ratios and larger brakes. Overload springs on the Conestoga give passenger-car comfort with small loads, ample support on larger loads.

Below, the new Studebaker Conestoga retains the sleek look. Right, center armrest in back seat is removable on 1954 coupes





Around the high-speed curve at Milford come nine plastic Corvettes, each doing about 100 miles per hour

HERE COME THE CORVETTES!

CCHEVROLET has come up with a pair of firsts: It is the first modern United States manufacturer to mass-produce a sports car; second, it is the first to mass-produce a plastic car.

By the end of January 1954, plastic Corvettes will be coming off the line at a rate of 1000 each month. Small potatoes, indeed, is such a production figure to a company that builds 250 steel cars and trucks every 30 minutes, but there's nothing small about its impact on the industry.

When the mass-produced Corvettes were first shown to the press there were some surprised skeptics. Confirmed sports-car enthusiasts were frank to praise the car after a few spins around the Milford proving ground. Although not billed as a

Corvette floor is this huge plastic underbody. Weight: only 75 pounds. Entire body weighs 411 pounds, 300 less than it would if of steel

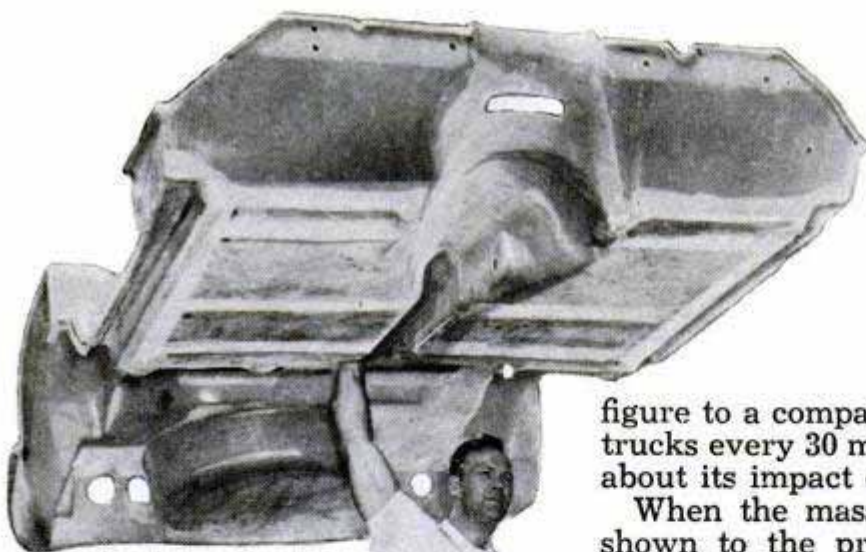

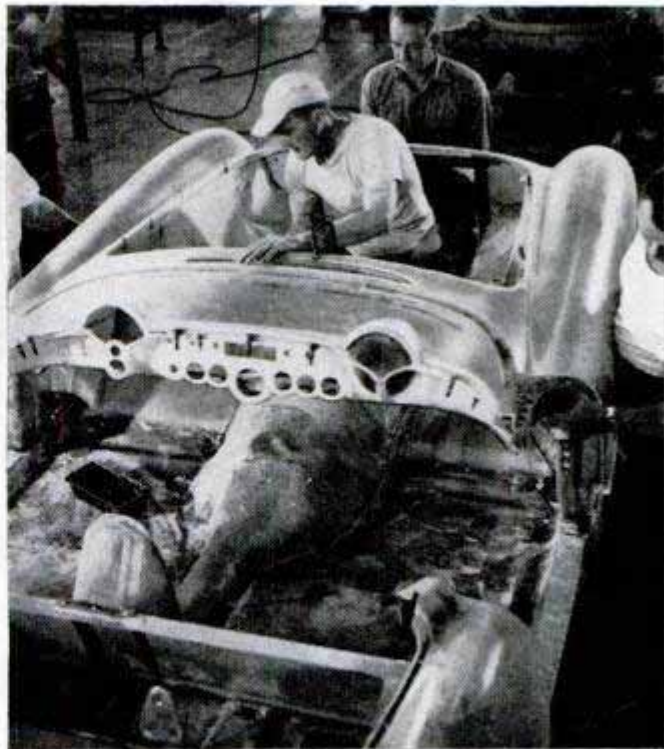
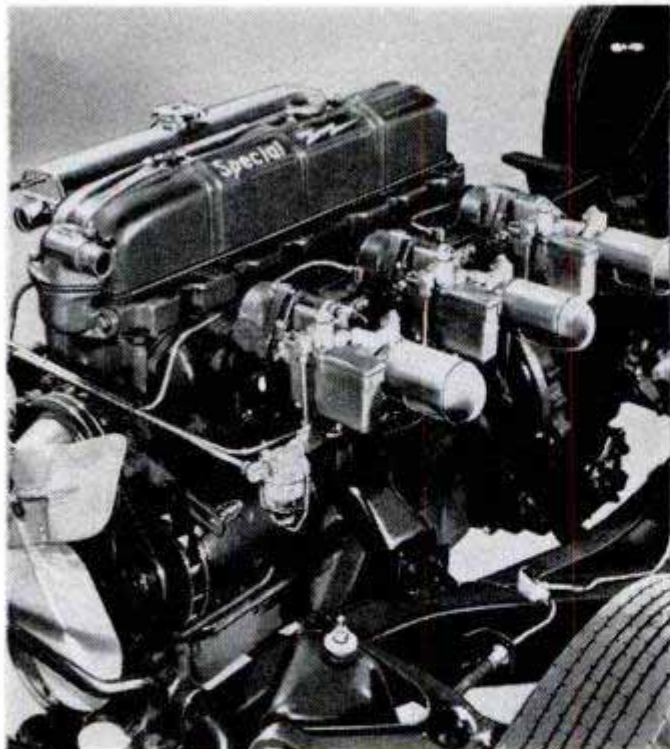

Engine has three carburetors. Top right, front section is fitted to underbody. Plastic parts are bonded together. Right, plastic body is so strong no separate bumper is required either front or back

competition car, the Corvette handles, accelerates and corners like one. Of course, it will not please the purists among the sports-car clan. Biggest complaint: it will be sold only with Powerglide, the automatic transmission—anathema to the sports-car enthusiast.

By using plastic, Chevrolet got into production years sooner and with a tooling cost of only \$500,000, compared with \$4,500,000 for steel. The plastic is thicker than steel and much sturdier. A hammer blow that would dent steel bounces harmlessly off the plastic. If it does break through, the damage is localized, can be repaired in an hour.

The engine is a souped-up Chevrolet six, developing 150 horsepower. Compression ratio is 8:1. Powerglide has been modified to provide full-throttle upshift at 55 miles per hour. High-lift cams and dual exhaust boost performance. Wheelbase is 102 inches. Frame, springs and shocks were specially designed for the Corvette. Steering ratio is a fast 16 to 1. Acceleration: from 0 to 60 in 11.4 seconds. Top speed: over 100. Price: \$3490.



Right, major plastic parts of Corvette. Only metal body part is gas-tank flap

April 1909 p. 386

Way back in 1907 Popular Mechanics was telling its readers how to build their own glider. This drawing, revived from the old "build-it-yourself" story, was reprinted in our September 1953 issue to advertise the new PM Album of Aviation. Its republication brought pangs of nostalgia to Ralph H. Hall of Seattle, who wrote us the following letter accompanied by these photographs of his "early American" PM glider.

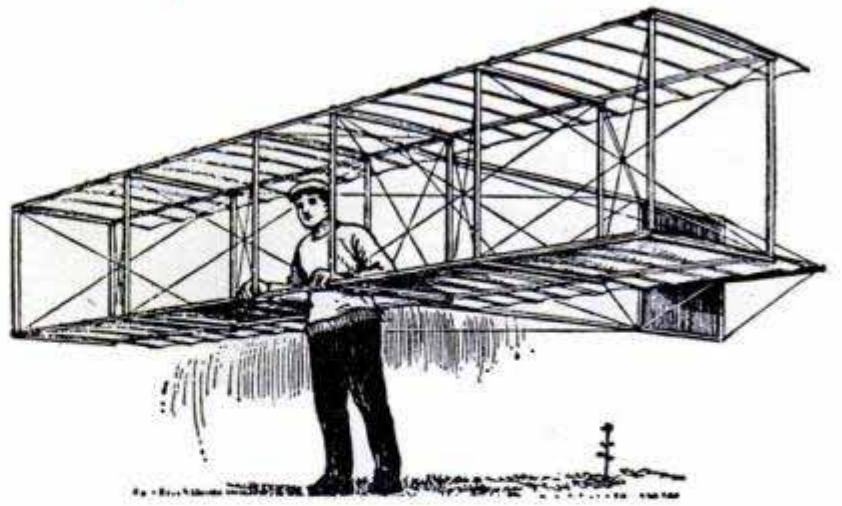

PM Glider, 1909 Model

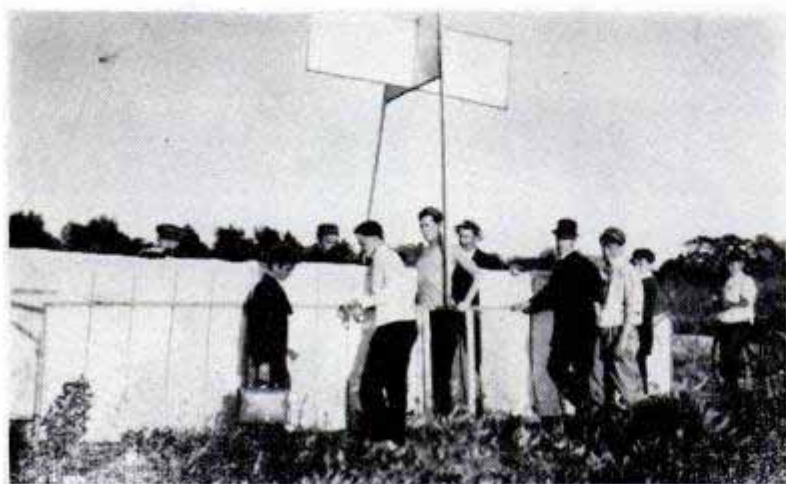
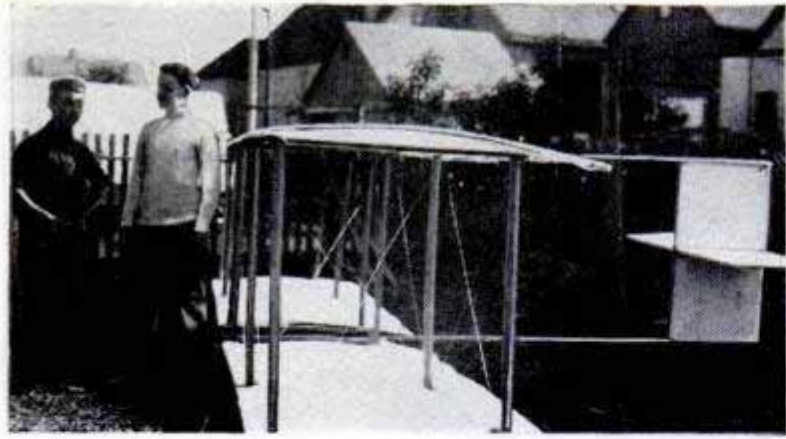
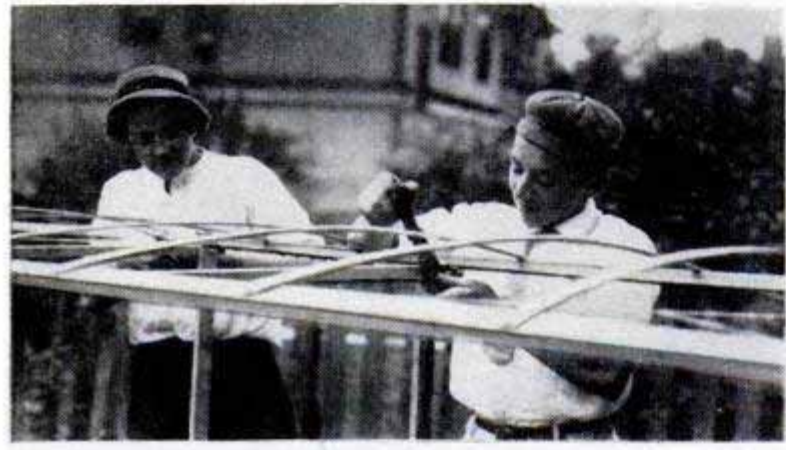

To the Editor:

While thumbing through the September 1953 issue of Popular Mechanics I encountered an advertisement that had a vaguely familiar appearance. I answered the original advertisement sometime in 1909. And from the plans my pal and I constructed the poor man's glider. As proof thereof, enclosed are snapshots of the two amateur builders and flyers working on their "bird."

I recall that both of us leaped from a tremendous and precipitous cliff just outside of Milwaukee, Wisconsin. Strangely enough, I cannot recall that we returned the "scraps" to the family backyard on conclusion of the experiment. I should like to see that "cliff" again. I wonder just how high it was. Since then I have been a passenger in military planes in Europe during World Wars I and II, across the Pacific and all over Japan and Korea during the recent fracas. None of these flights provided the thrill or anticipation of that leap in the Pop Mechanics contraption.

The taller chap [center photo] is Edward V. Oehler, now a vice president of the Briggs & Stratton Corporation in Milwaukee. I am the short boy in the cap, now a retired Army lieutenant-colonel living in Seattle.

Hope you get as much kick out of these pictures as I did. You should, since their reprinting was inspired by your article on aviation.

Ralph H. Hall
Seattle 2, Wash.

Mammoth Solar Furnace 'Burns' at 3000 Degrees

TRAPPED SUNSHINE melts glass and liquefies steel at a research station in the eastern French Pyrenees mountains. A 10-ton flat mirror is moved about to catch the rays of the sun and bounces the beams to a fixed parabolic mirror made up of 3500 individual concave plates. The huge 12-ton "burning glass" causes the rays to converge in a solar oven placed between the two mirrors. The resulting heat reaches a temperature of 3000 degrees Centigrade. The individual plates in the curved mirror are adjusted by a simple hand control to vary the concentration of the burning rays.

According to the French National Center of Scientific Research, the apparatus is the largest solar furnace in the world. Designed by scientist Felix Trombe, who became interested in the idea while conducting research in rare metals, the furnace was built during a period of three years in an old fort at Mont Louis. The installation is located 5200 feet above sea level.

Experiments conducted at the research station indicate excellent possibilities of the solar furnace as a source of power. The scientists look forward to a day when electric generating plants fueled by sunshine will furnish heat, light and power for home and industry.

Glowing end of glass rod, right, marks point in oven where sun's rays converge. Huge flat mirror, below, catches sunshine, bounces it to curved mirror which beams it into oven

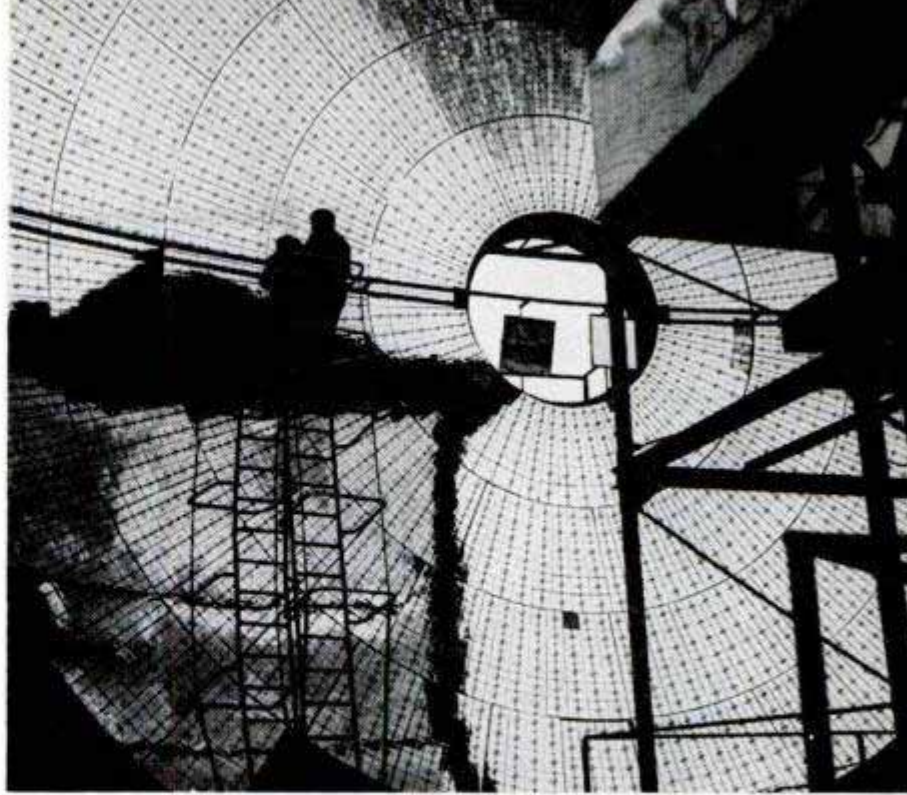

Polishing the 3500 individual concave mirrors is a daily task

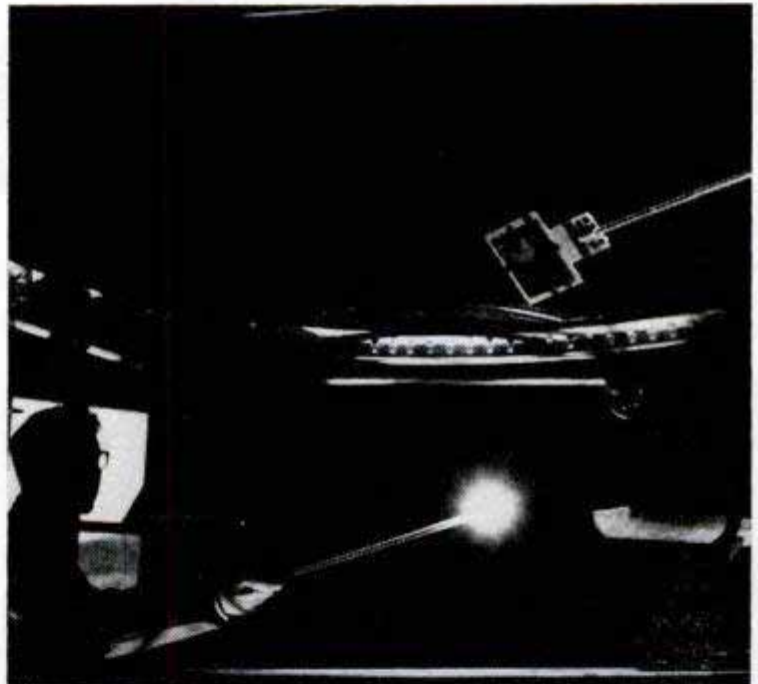

ALUMINUM SKYSCRAPER



Six-by-twelve-foot exterior panels already fitted with windows are bolted to metal brackets by crew inside the building. Workmen on floor above position the panels. No taping or caulking of joints is needed

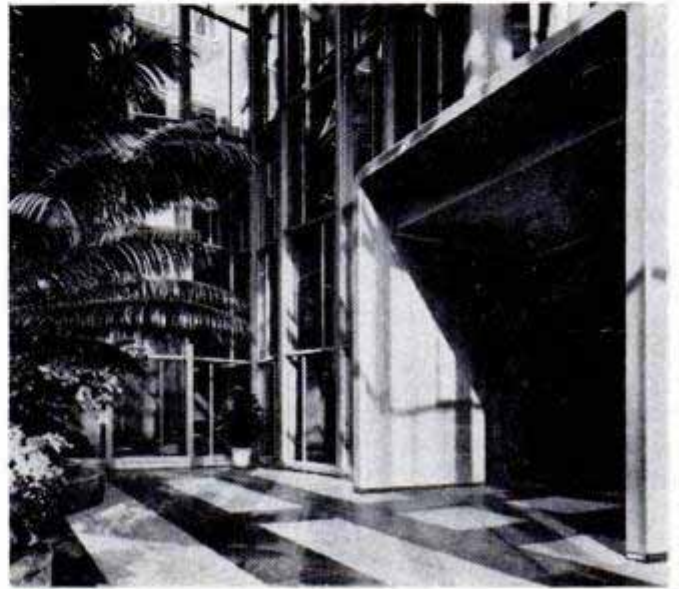

Glass-walled main entrance rises $4\frac{1}{2}$ stories alongside the main tower. Two huge cantilever beams which jut out from the fifth floor of the tower support the weight of the structure from the top. Floor is marble

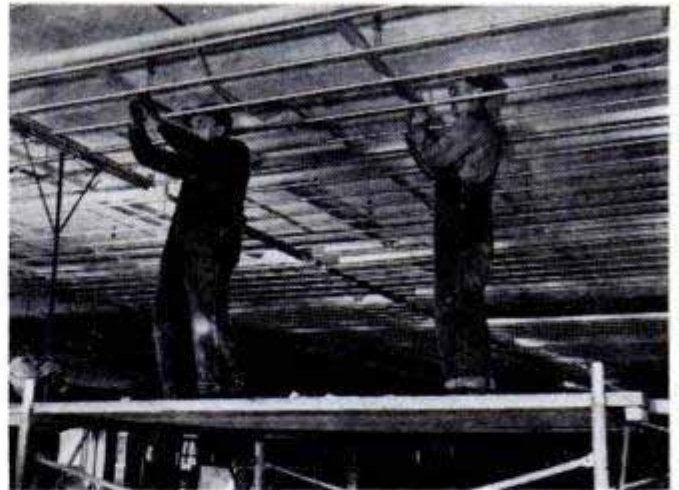

Grids of aluminum pipe suspended from true ceiling provide all heating, half the cooling. Below, thin panels are stamped out like cookies by hydraulic press

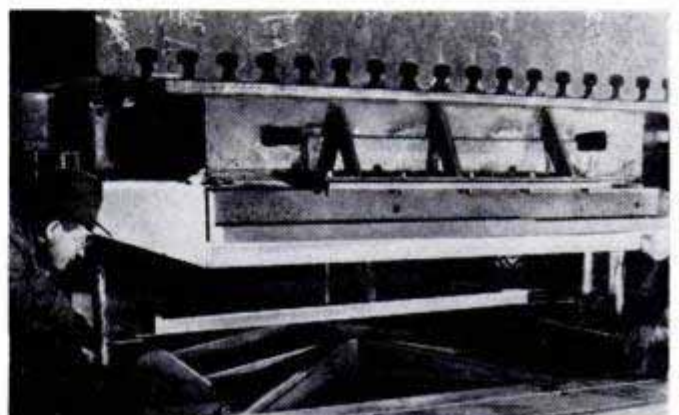

AMERICA'S FIRST aluminum skyscraper, the 410-foot, 30-story Alcoa building in downtown Pittsburgh, is also said to be the lightest building of its size in the world. Use of aluminum saved space and cut the need for structural steel by 30 to 50 percent.

Perforated aluminum panels in the ceilings, topped by a glass-fiber blanket, deaden sound and mask grids of aluminum pipes which heat and cool the offices. Lights are hooked to aluminum conduits. Circulated air travels through aluminum ducts.

A skinlike outer wall is made up of stamped aluminum panels only an eighth of an inch thick. After metal holding clips were bolted to the horizontal beams the one-story-high panels were easily hoisted and bolted into place by a small crew working inside the building. The inner wall consists of four separate layers of perlite concrete sprayed from a pneumatic nozzle onto slotted aluminum lath and metal reinforcing bars. Such methods resulted in a strong, modern, low-cost structure. ★ ★ ★

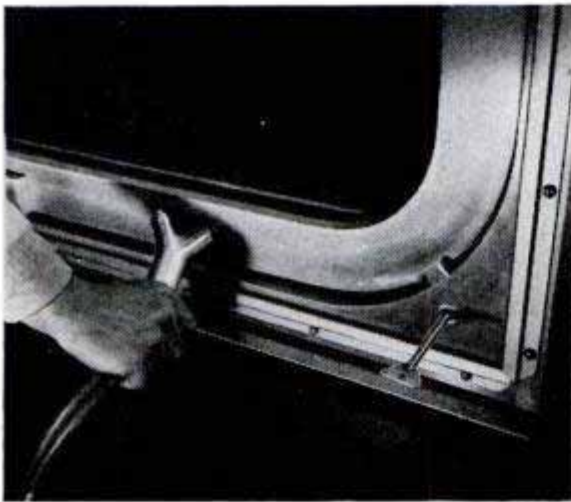

Y-shape tool deflates and inflates a rubber gasket before and after cleaning. Key at right locks window. Below, window is reversed for washing. Compressor on cart supplies air hose

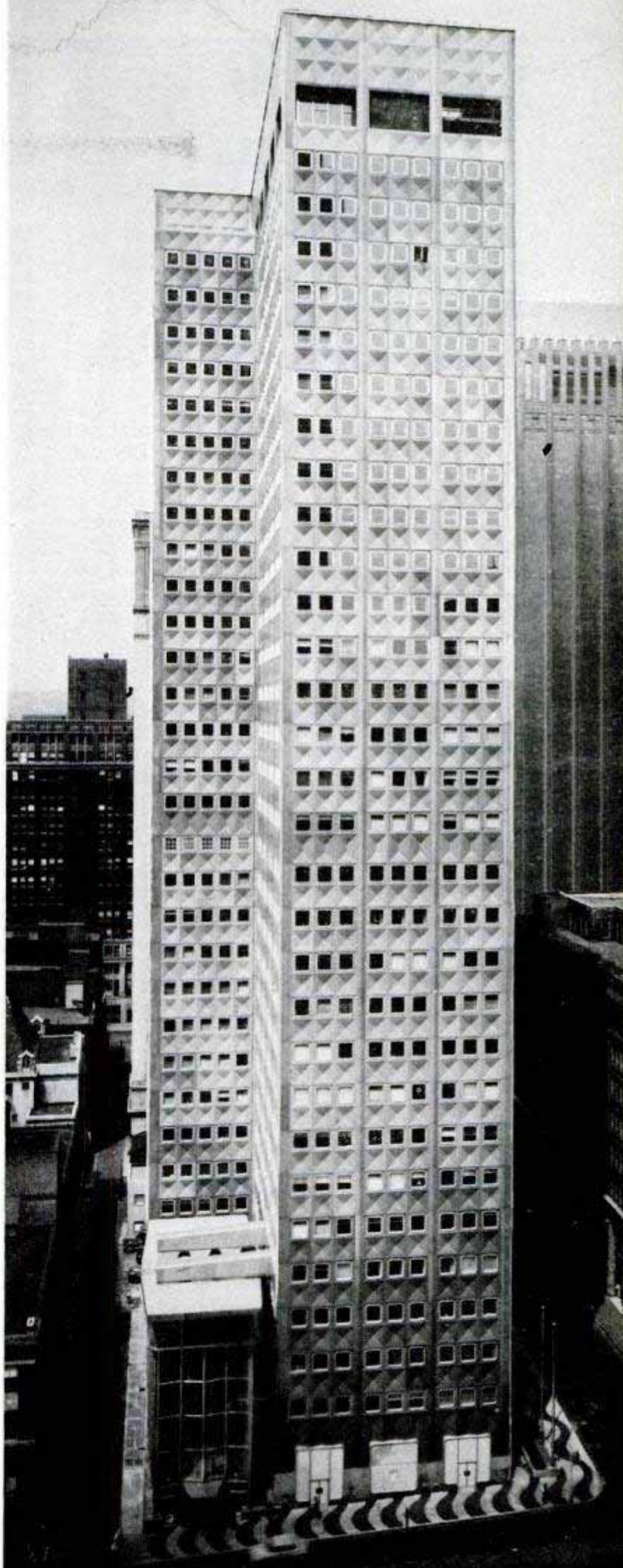

Detroit Listening Post

By Leo Donovan



LOW-SLUNG and high-powered, a snug little sedan is definitely being planned by at least one of the Big Three in Detroit. The car is referred to as an "executive coupe" because it is to be built for the executive who drives to the office every day.

So much criticism has been made of the extravagance of the breadwinner driving downtown in a car with five empty seats, that the plan is to approach a "two car" economy through what amounts to a "one and one-half car" doorway.

Production of the two or three-seater is at least two years away, but it is no mid-winter night's dream—it's on the way.

The "explosion" of our cities into the suburbs has made cars more essential than ever. Transportation to these outlying areas offers a market of the future, especially for cars designed not to carry whole families but only two or three persons.

The new, smaller car will not be a cheap car. Its power plant will have a higher compression ratio than most present models. It will be on a 102-inch wheelbase and will be highly maneuverable, sensitive to the throttle and well-balanced for high speeds on better, wider thoroughways of the future.

It definitely will be a closed model, not a convertible. You can take this on the word of an executive who said he felt too conspicuous in the wide-open Corvette.

Before the 1954 models are very old, probably before press previews of the 1955 cars roll around, buyers will begin to get some long-awaited price cuts as a result of technological progress. Several spokesmen for producers foresee a combination automatic-transmission-and-power-steering package next year at the current price of the transmission alone.

Chevrolet is moving steadily forward with its plans for a V8 engine, persistent gossip says. Forged camshafts may be replaced by shell-molded camshafts so accurately cast that millions of dollars in machining costs eventually may be saved.

The 1954 models have, in the main, made little more than "identification" changes in their exterior body lines over 1953. But there is a definite newness about the interiors. Women shoppers especially notice a much wider variety of color combinations and fabrics this year. Undoubtedly, the tricks Kaiser Motors first introduced in color styling of interiors are being adopted by other manufacturers.

Natural wool, mohair from Texas goats and easily-soiled cotton fabrics are being replaced by nonstaining and longer-wearing synthetics. Not only are nylon and Orlon fabrics appearing in greater varieties of colors, but also Dacron, Saran, Kuralon, Perlon and other less familiar test-tube fibers are making an appearance in combinations that harmonize with exteriors.

General Motors' experiments with plastic-body production in its Corvette line have failed to indicate any future possibility of impregnating the plastic with color to eliminate the need for exterior paint. The plastic can be colored—there is no trick to that. But the problem is that the color does not have the deep, brilliant shine the public demands. All colors come out rather muddy, engineers say. So the Corvette has a conventional paint job over its plastic body and the problem of chipping paint still persists.

While body engineers generally agree that it will be a long time before plastic replaces sheet steel in body panels, they now predict a much earlier adoption of the glass-fiber material than originally estimated—and in many more uses.

The use of plastic in the Corvette reduces its weight by about 300 pounds from a similar vehicle with a steel body. That is worthwhile, but the really big saving is in tooling. E. N. Cole, Chevrolet engineer largely responsible for the quick appearance of the Corvette, estimates tooling for the Corvette body in steel would have cost about \$4,500,000 compared with only \$500,000 for the tools, dies, jigs and fixtures in plastic production.

Chevrolet's pioneering in the plastic-body field (which Kaiser announced last June it also would enter) will be followed by a third major producer. The nameless (for the present) manufacturer plans to market a limited number of plastic-bodied sedans in 1954.

Auto-sales executives are convinced that the super-de luxe models will be the big sellers in 1954. The day of the standard, stripped-down model apparently is now over. The trend applies to trucks as well. GMC Truck and Coach Division has invested \$500,000 in new tooling to provide extra chrome moldings and trim panels in the new commercial-vehicle line.



Scientist melts snow to obtain drinking water. In the future, men may use steam from volcano to heat camp

Mountain-Top Lab for Cosmic-Ray Research

ON THE 14,006-foot summit of Mt. Wrangell, a dormant volcano in Alaska, a scientific expedition has established an observatory for cosmic-ray research. The mountain-top station, a venture of New York University and the University of Alaska, consists of two Jamesway huts, shelters made by covering a wooden framework with an insulated fabric. Supplies are flown to the station in a plane equipped with a ski-wheel combination landing gear. The scientists are attempting to find the connection, if any, between cosmic rays and other radiations.

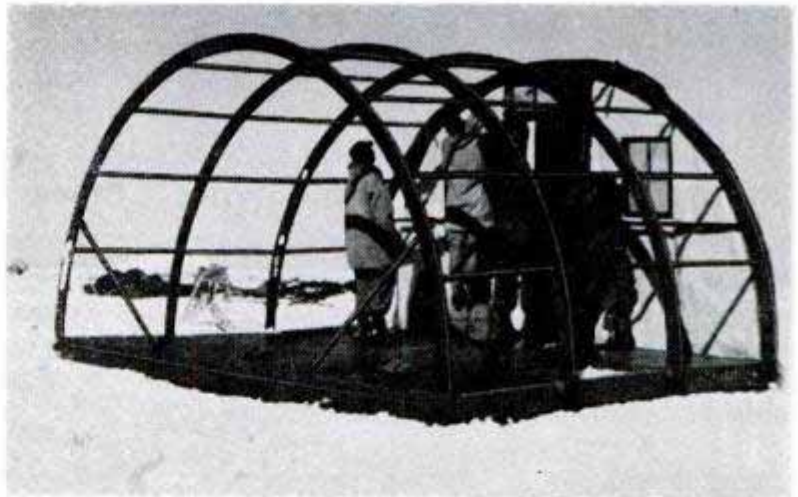

Research party erects framework of one of the two Jamesway huts. Over this prefabricated wooden frame goes insulating fabric

Top-of-the-world station consists of a couple of huts on the bleak mountain. One serves as a laboratory



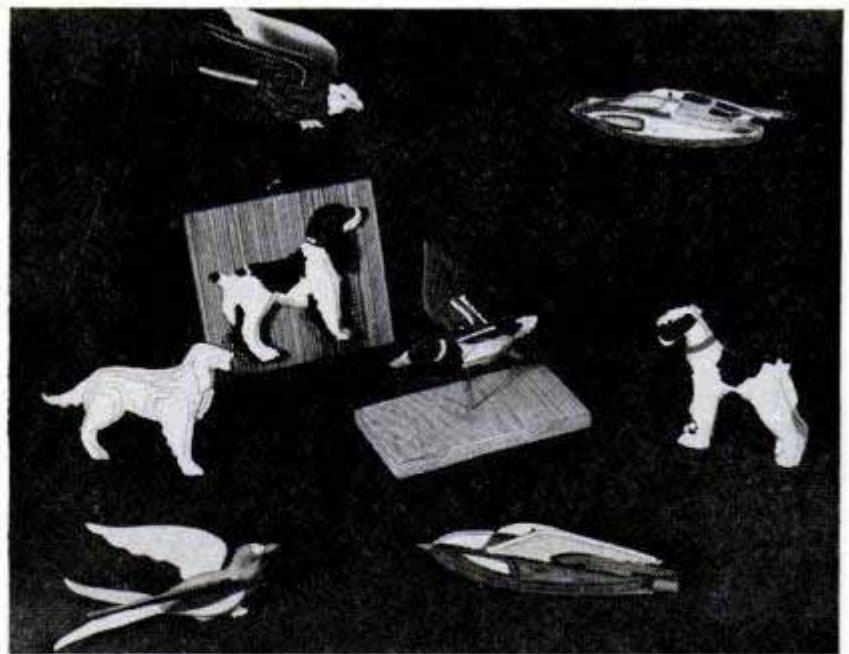

Kit Produces "3-D" Figures From Series of Flat Parts

With a new craft kit, youngsters can build full, rounded figurines from pre-cut flat parts. In the kit are three rectangular boards stamped with die-cut patterns. The child punches out the middle part of a dog, for example, and then cements succeeding parts on each side until the dog is complete. The figure then is sanded lightly, coated with a special liquid and painted with oil paint or water colors. Kits are available to make dogs, birds and rocket ships. The figures measure about 4½ inches high and can be mounted on plaques.

Pigment Tubes Give Homeowner Choice of 1322 Paint Colors

Any of 1322 colors of paint, in addition to several hundred "deep tones," can be secured at paint stores which supply the customer with base paint and separate tubes of pigment. Preparing to paint, the customer empties the tubes of colorant into

the white or gray-base paint, stirs it thoroughly, and the desired color results. Enamel, flat, semigloss, floor enamel and outside house paint can be supplied in this manner. Precise color matching is assured the customer.

Folding Box Solves Christmas Train-Storage Problem the Year 'Round



Young engineers can keep their Christmas trains readily available, yet neatly stored away inside a new plywood box. The box measures four feet wide, six feet long and six inches deep. It is hinged in the center so it folds into a covered box measuring four by three feet. The train accessories are permanently mounted within the box and are folded into it when the box is stored away. Coasters on the bottom permit the box to be pushed underneath a bed or into a closet storage area.

Wheeled Frame Helps Wounded Soldiers Regain Use of Legs

Patients at the Veterans Administration Hospital in Long Beach, Calif., learn to walk again with a "self-reliant walker" designed by Nathan Hack. It helps a wounded or polio-afflicted vet regain the use of his legs by providing a wheeled support. The frame is indented to fit snugly over the side of a bed, where the patient can get right into it.



Quiet Outboard Motor Has Noise Cushions

Power without the proverbial "putt-putt" noise is achieved by Evinrude's new 7.5-horsepower outboard motor, the Aquasonic Fleetwin. It weighs only 49 pounds, 17 pounds more than the company's three-horsepower motor, yet it delivers more than twice as much power. Twin resilient mountings soak up the engine pulsations before they reach the hull and the propeller thrust is absorbed against companion cushions in the lower housing. Silencers "tune out" annoying sounds.

Grinding "Giraffe" Polishes Concrete Ceilings Without Scaffolding

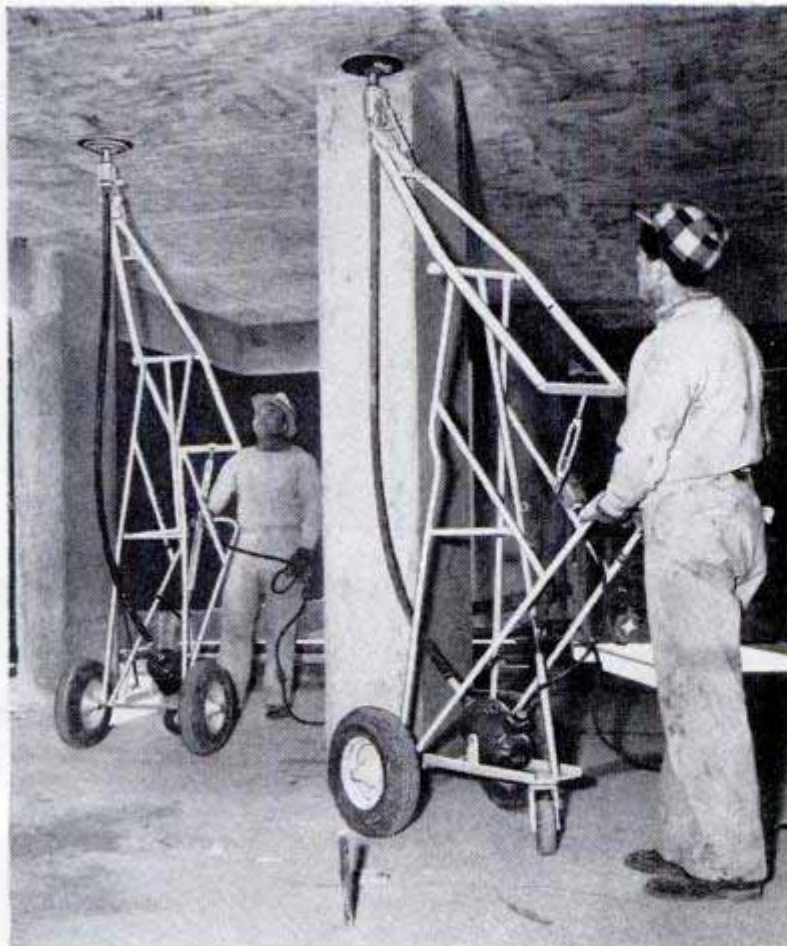

Dubbed the "giraffe," a grinding tool polishes concrete ceilings up to 11 feet high, whisking away any ribs, fins, board marks or nails that may be left when forms are removed. An electric motor mounted at the base of the wheeled unit drives a flexible shaft which turns the grinder disk. Since no scaffolding is needed, the tool speeds grinding operations and lessens the need for masks and goggles because the operator is not directly beneath the grinder. The unit weighs 148 pounds, is only 28 inches wide and is powered by a $\frac{3}{4}$ -horsepower motor run by standard current.

Sources of supply for available products described in this issue are listed in the monthly index starting on page 12. Sources of further information on other articles shown in the magazine will be found in the WHERE-TO-FIND-IT LIST, which is available to you without charge from the Bureau of Information, *Popular Mechanics Magazine*, 200 East Ontario St., Chicago 11. Write for your free copy

Milestones of Aviation

THIS MONTH the world is observing the Fiftieth Anniversary of Powered Flight and paying tribute to the men—from the Wright brothers on—most responsible for its remarkable progress. In a half century the airplane has helped to shrink the size of the globe, in travel time, until now no place on earth is more than two flying days from any other place. Thousands of big transports and airliners daily ply the sky lanes, moving goods and people safely and swiftly over routes tens of thousands of miles long. Along with these great benefits to commerce and industry, the airplane's ever-increasing speed, range, carrying capacity and mobility have forced drastic changes in the strategy of war. As part of the magazine's salute to aviation's fiftieth birthday, the editors of *Popular Mechanics* have mapped the 37 flights they believe have contributed most significantly to flying's development. The exploits of the airmen of many nations are represented. Artist Alexander Leydenfrost on this specially drawn map has indicated the sites or routes of their famous flights, with small drawings of the planes they flew. At the bottom of the opposite page is a key to the map with brief identifications of the flights. The full details of these accomplishments are familiar to air-minded people all over the world. ★ ★ ★

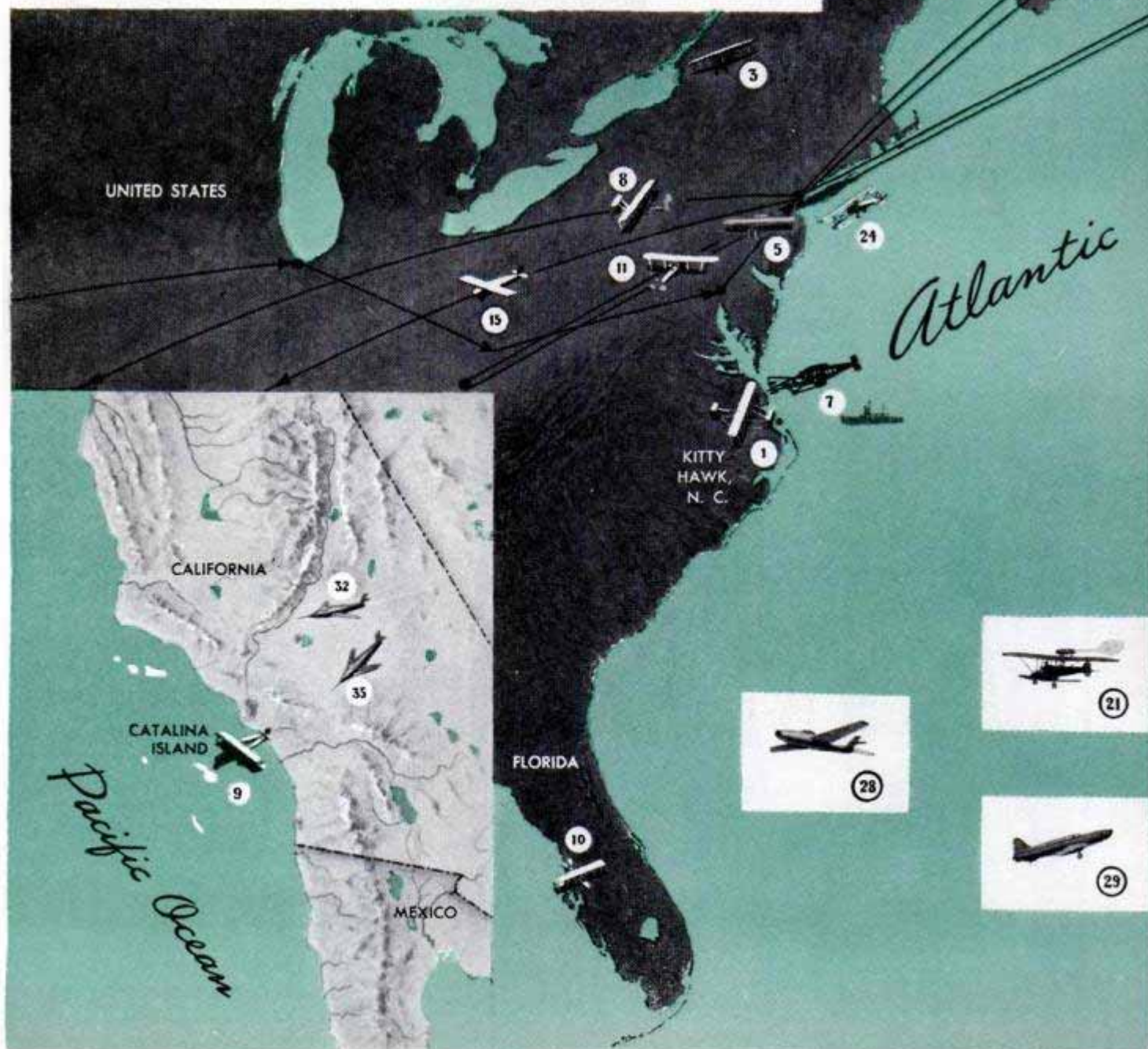

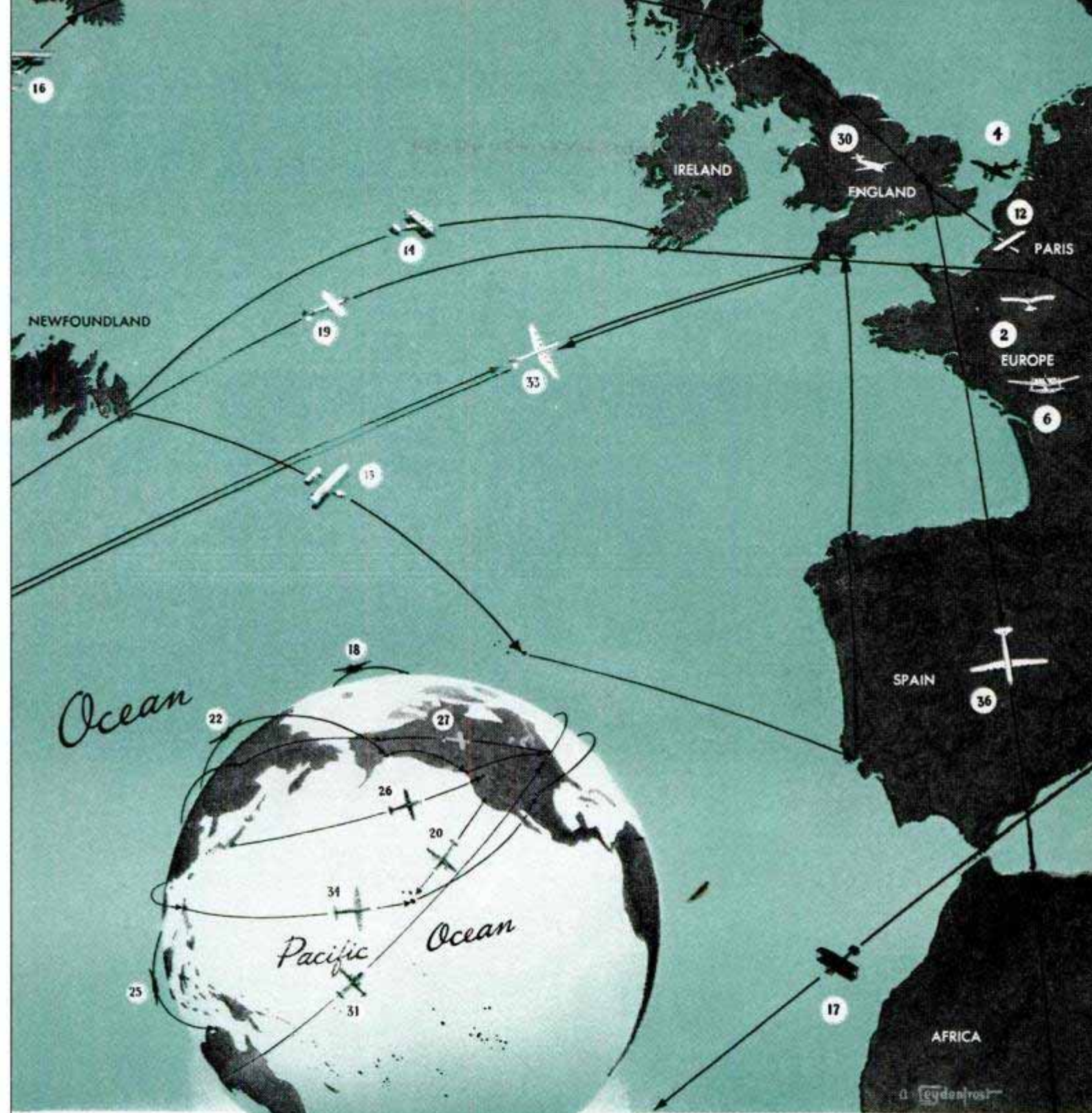

1. First sustained, controllable flight of a heavier-than-air machine, Orville and Wilbur Wright, Kitty Hawk, N. C., Dec. 17, 1903.
2. First flight in Europe, by Alberto Santos-Dumont, Paris, 1906.
3. First U. S. aeronautical trophy won by Glenn H. Curtiss for a flight exceeding one kilometer (3280 ft.), Hammondsport, N. Y., 1908.
4. First flight across English Channel, Les Baraques to Dover, by Louis Bleriot, 1909.
5. First flight higher than one mile, Richard Brookins (6176 ft.), Atlantic City, N. J., 1910.
6. First seaplane flight, Henri Fabre, Port de la Mede, France, 1910.
7. First ship-to-shore flight, from USS Birmingham, at Hampton Roads, Va., by Eugene Ely, 1910.
8. First transcontinental flight, New York to Long Beach, Calif., by Calbraith Rodgers, 1911 (49 days).
9. Over-ocean round-trip flight from California mainland to Catalina Island and return by Glenn L. Martin, 1912.
10. First scheduled airline, St. Petersburg-Tampa, Fla., Tony Janus pilot, 1914.
11. Army pilots start scheduled U.S. mail route, New York-Washington, 1918.
12. First London-Paris airline service, 1919.
13. First trans-Atlantic crossing by air, U.S. Navy NC-4, New York to Southampton, England, 1919.
14. First nonstop trans-Atlantic air crossing, Newfoundland to Ireland, Capt. John Alcock, Lt. A. W. Brown (England), 1919.
15. First nonstop flight across U.S., New York-San Diego, Lts. Oakley Kelley and John Macready, 1923.
16. Around-the-world flight by two U.S. Army planes, starting from Seattle, Wash., 1924 (175 days).
17. Flight from Spain to Argentina, by Ramon Franco, 1926.

18. First airplane flight over North Pole, Lt. Cmdr. Richard Byrd, Floyd Bennett, 1926.
19. First nonstop solo trans-Atlantic flight, New York-Paris, by Charles A. Lindbergh, 1927.
20. California to Hawaii flight, by Lts. Lester Maitland and Albert Hegenberger, 1927.
21. Rocket-propelled plane flown by Fritz von Opel, at Frankfurt, Germany, 1929.
22. Soviet flight from Moscow to New York, via Siberia, Alaska and Seattle, Wash., 1929 (12,500 miles).
23. First flight over South Pole, Cmdr. Richard Byrd, Bernt Balchen, from Bay of Whales, 1928.
24. First demonstration of "blind" flying, by Lt. James H. Doolittle, Long Island, N. Y., 1929.
25. Flight from London to Port Darwin, Australia, by Sir Charles Kingsford-Smith, 1930.
26. Nonstop flight Japan-U.S. (Wenatchee, Wash.), by Clyde Pangborn and Hugh Herndon, 1931.
27. Around-the-world solo flight, starting from New York, by Wiley Post, 1933 (seven days, 18 hours).
28. Jet-propelled aircraft flies in Germany, 1939.
29. Aircraft with both jet and piston-engine power flies in Italy, 1940.
30. Jet-powered fighter flies in England, 1941.
31. Record nonstop flight of 11,235 miles (without refueling) by U.S. Navy crew in Lockheed Neptune, Perth, Australia to Columbus, Ohio, 1946.
32. First flight faster than sound (761 miles per hour at sea level), by U.S. Air Force Bell X-1, Capt. Charles Yeager, pilot, Muroc, Calif., 1948.
33. Automatic robot airplane (C-54) flies round trip from Wilmington, Ohio, to England, and return, 1948.
34. Nonstop around-the-world flight (four mid-air refuelings) by U.S. Air Force crew in Boeing B-50, starting from Ft. Worth, Texas, 1949 (94 hours).
35. Speed of 1238 miles per hour (1051) and altitude of 83,235 feet (1953) attained by U.S. Navy Douglas Skyrocket at Muroc, Calif.
36. Jet-powered airline service begins, London-Johannesburg, South Africa, 1952.

Air Traffic Fills Atlantic Skies

IN CONTRAST to the lonely sky through which Lindbergh winged his way to Paris 26 years ago, at a single instant during 1953's peak-travel period there were nearly 3000 passengers en route across the Atlantic in 54 luxurious airliners. As part of its observance of the 50th year of powered flight, *Popular Mechanics* had illustrator Alexander Leydenfrost "freeze" Atlantic air traffic at that moment for this drawing. The 10 lettered vessels, operating at fixed points, are maintained by six nations as weather observation and transmittal

stations and for rescue work. The broken lines are the boundaries of ocean air traffic control areas. For this drawing the International Air Transportation Association pin-pointed the location and gave the identity of every airliner plying the ocean air lanes at that specific second. This year, according to IATA, an estimated 525,000 passengers will have flown the Atlantic, marking the first time in history that the air-traffic total has exceeded the estimated combined first and second-class surface travel across the ocean.



MAIN AIRPORTS AND ALTERNATES

LORAN STATION

CONSOL STATION

M. M. O.



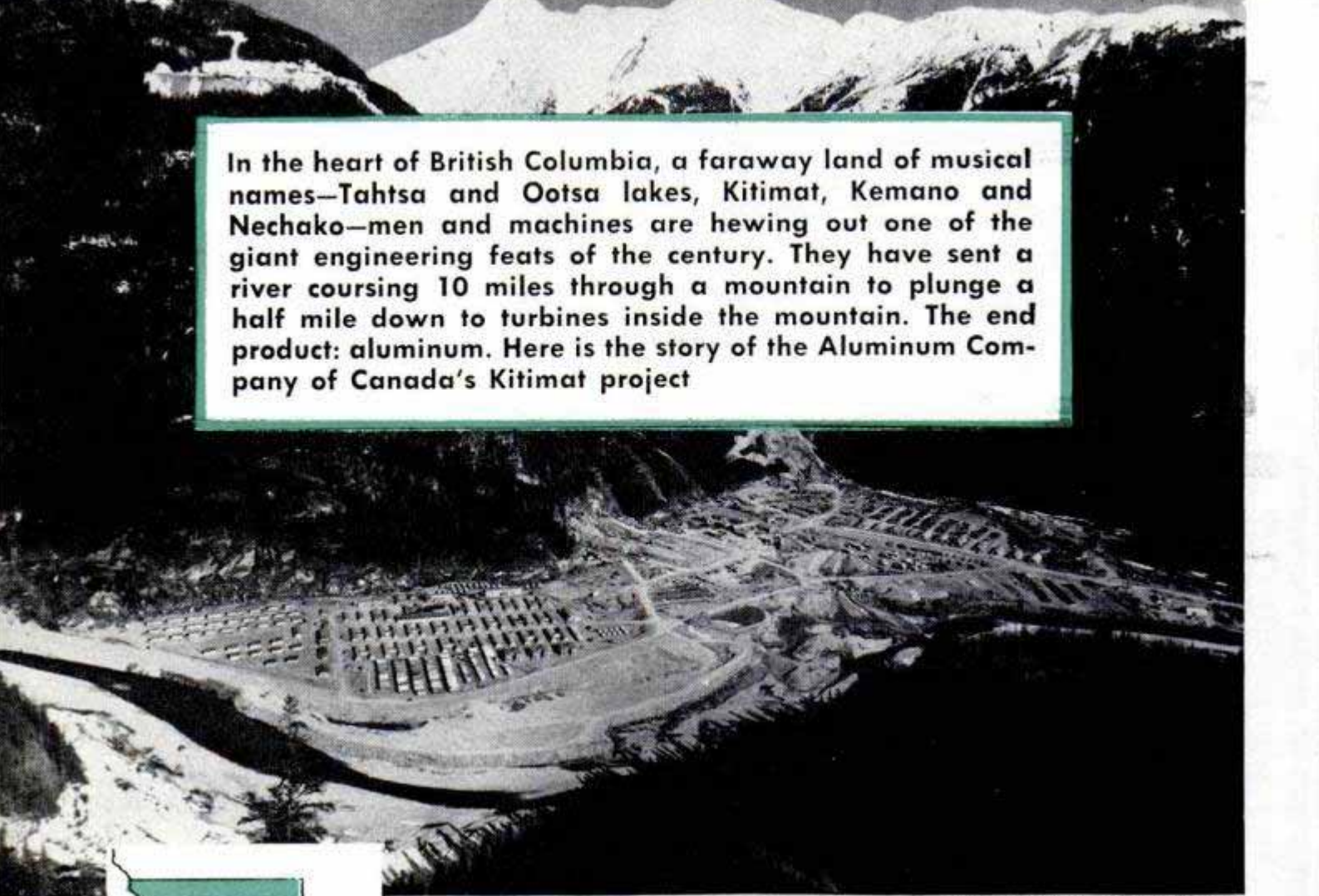

In the heart of British Columbia, a faraway land of musical names—Tahtsa and Ootsa lakes, Kitimat, Kemano and Nechako—men and machines are hewing out one of the giant engineering feats of the century. They have sent a river coursing 10 miles through a mountain to plunge a half mile down to turbines inside the mountain. The end product: aluminum. Here is the story of the Aluminum Company of Canada's Kitimat project

Aluminum Company of Canada photo

Headquarters for the project is Kemano, at the foot of "powerhouse mountain"



COLOSSUS in the WILDERNESS

By Richard F. Dempewolff

Crawler tractors punched through the vital power-line access road

International Harvester Company photo

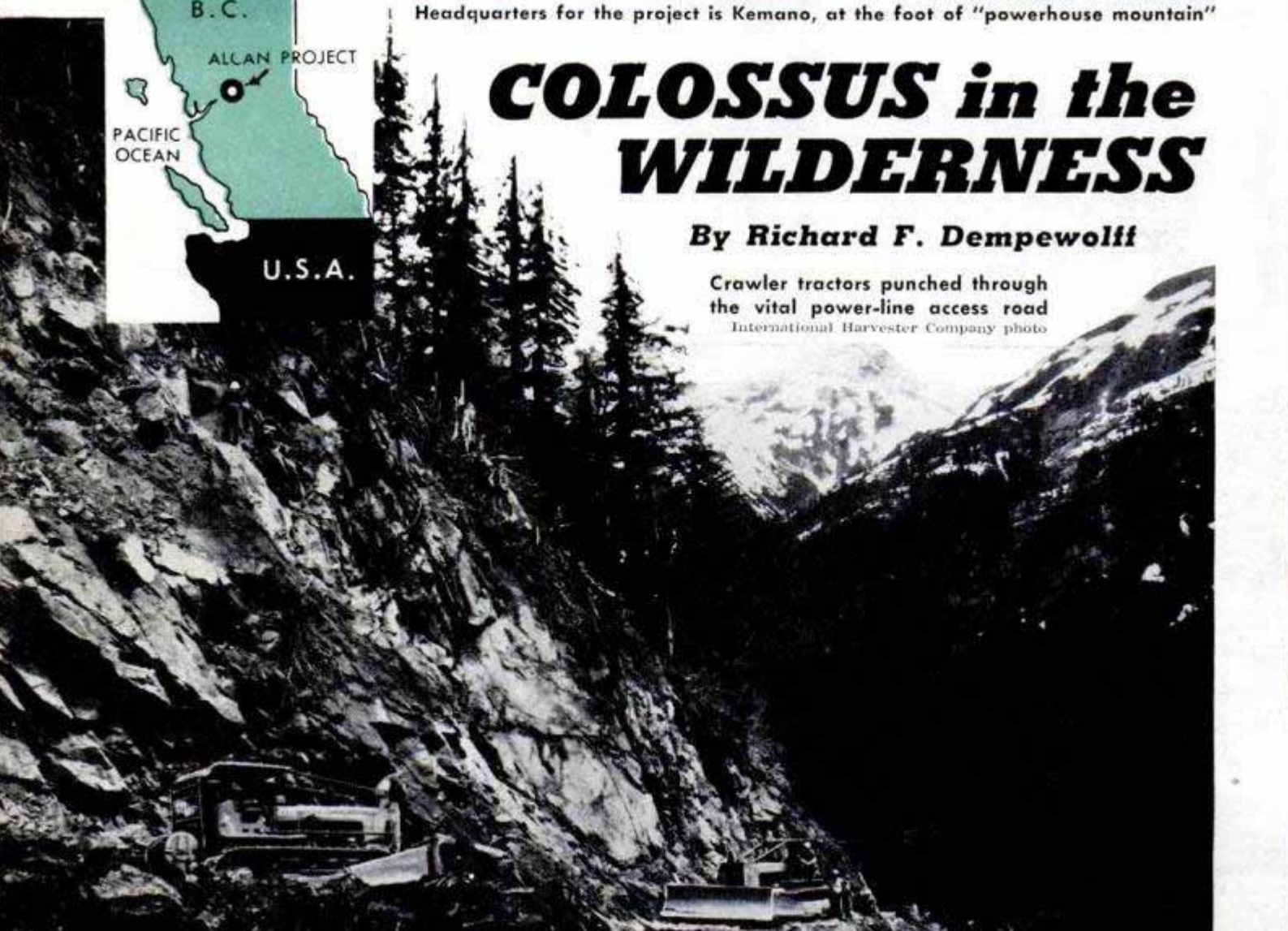

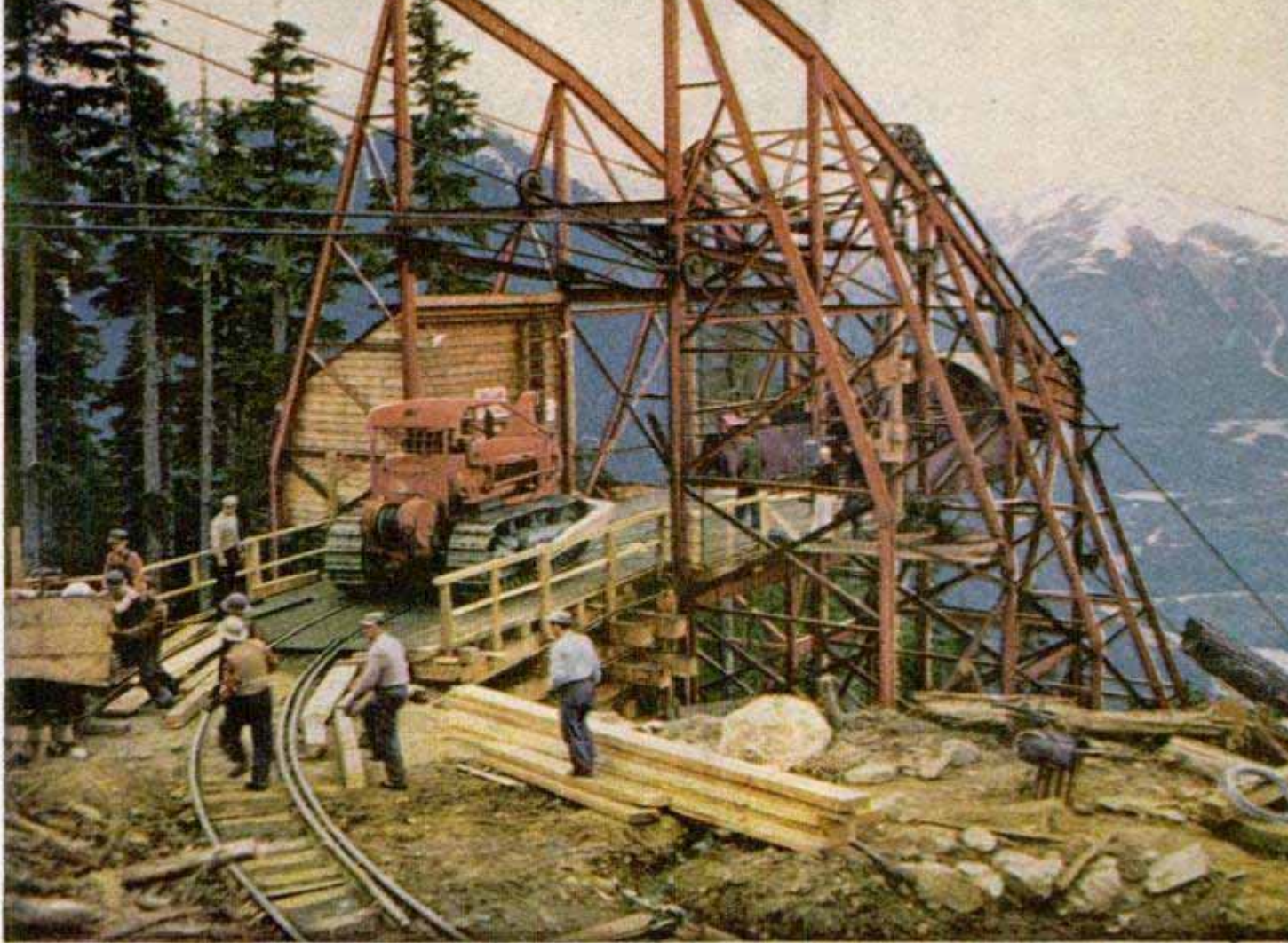

International Harvester Company photo

Arriving at the 2600-foot level on the aerial tramway, a powerful TD-24 backs off to the tunnel entrance

IN THE BLACK BELLY of the mountain at Kemano, 400 miles north of Vancouver, B. C., an underground army of shouting, sweaty men, in aluminum "tin hats," works under glaring floodlights. In caverns and tunnels of jagged rock, they're splashing through underground brooks and mud, scrambling over chunks of broken rock as big as an average garage, and clambering from level to level on rough wooden ladders. Some jolt around on roaring machines or on cars that heave precariously along rough-laid track as they haul away the rock debris.

Deep in the Canadian Rockies, these men are somersaulting the flow of a 125-mile chain of mountain lakes, forcing it backward through a 10-mile tunnel to the core of a mighty peak. Here it will cascade down a half-mile man-made hole to a subterranean powerhouse they are carving inside the mountain's base.

The turbines it spins will turn up a potential 1,650,000 horsepower—equal to the combined top output of Shasta, Bonneville and Wilson dams. And all that power will leap across a mile-high range of peaks on a line of steel and aluminum towers, jutting from "postage stamp" crags, to the largest aluminum-smelting plant on earth. Its ingots—550,000 tons of them a year—will one day sail down the fjord and into homes and industry everywhere, in the form of useful products.

Floodlights bathe work crew inside the 25-foot-diameter rock tunnel that will carry water 10 miles to the huge subterranean powerhouse at Kemano

Aluminum Company of Canada photo

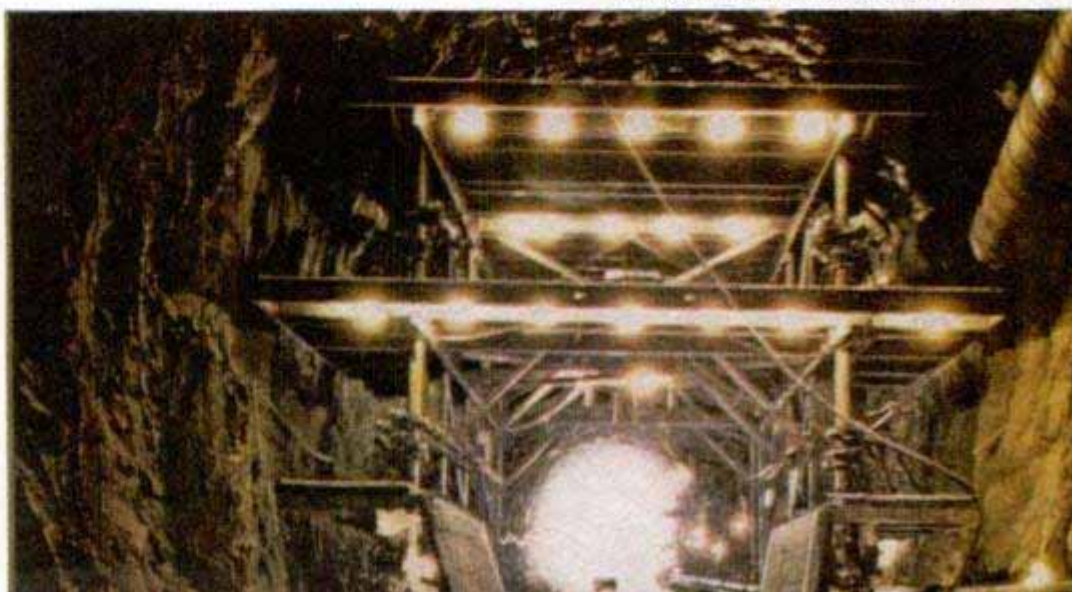



Aluminum Company of Canada photo

Over 300 feet high, the ramparts of the rock-filled Kenney Dam hold back a 900,000,000-cubic-foot inland sea

Why go to all that fuss to locate a huge aluminum factory in a rugged, inaccessible wilderness when space is available in civilization? Aluminum smelting takes huge amounts of cheap power. So much that ingots are often called "packaged electricity." The juice required to make a ton of aluminum from bauxite ore would run your house for eight years. Hence, when the

Aluminum Company of Canada decided to expand their production a few years ago, they didn't look for more ore—they hunted for fast water, boiling down from great heights. Their search brought them to a tiny Indian village called Kitimat (for which the project is named) at the head of a long, navigable fjord winding inland from the Pacific Ocean, 70 miles southeast of

Diagram of the vast Kitimat development whose giant turbines will turn up a potential 1,650,000 horsepower

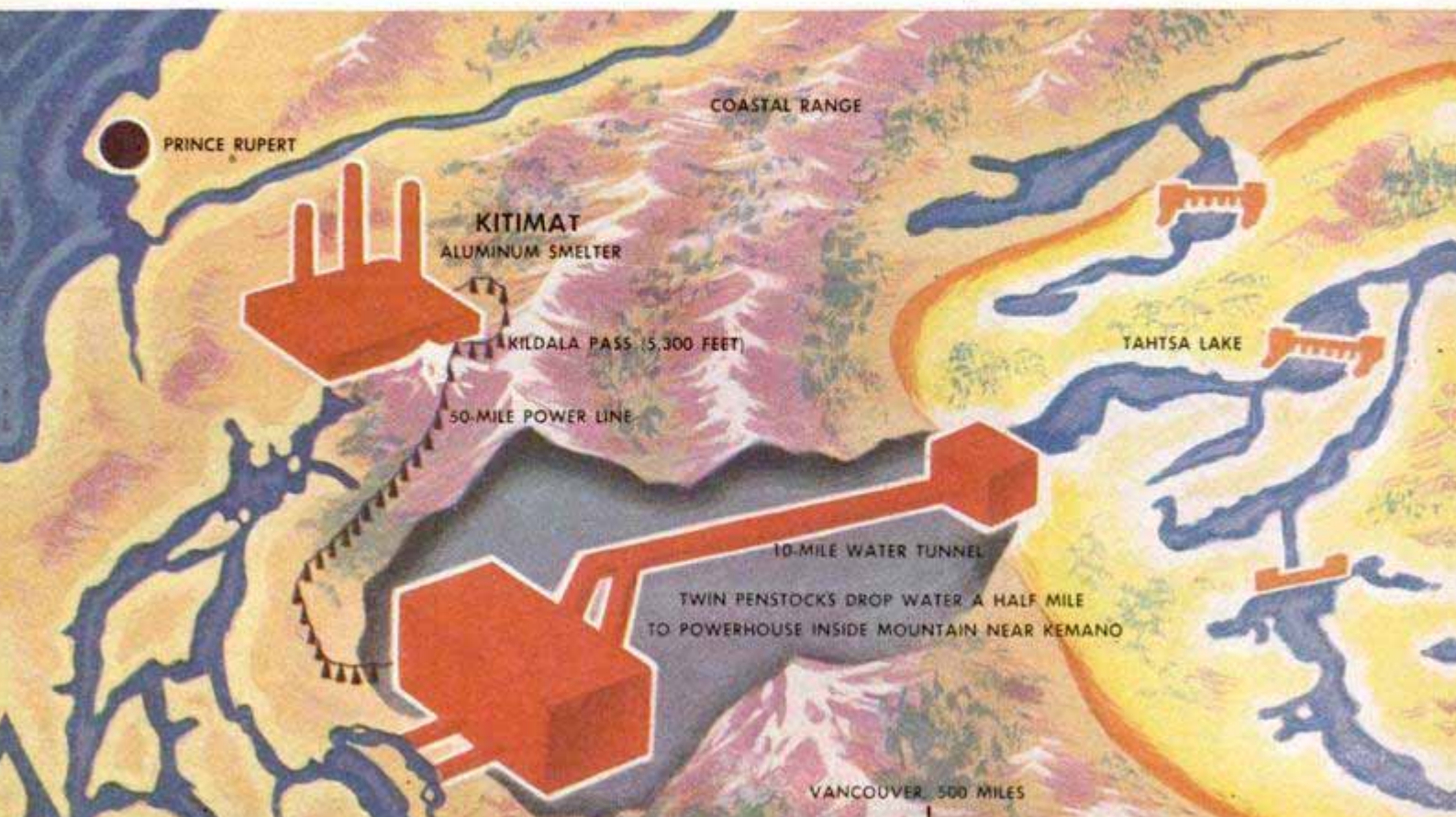

Prince Rupert. Beyond the mountains east of Kitimat, a chain of 12 lakes nestle in a 5,000-square-mile bowl-shaped plateau nearly 3,000 feet high on wooded uplands. The lakes drain off in gently flowing rivers toward the northeast—away from Kitimat and the sea. It was hardly a sight to stir a cataract hunter. But in those lakes, engineers saw a mighty slumbering giant that could be put to work by reshaping geography on a monstrous scale.

First job was to reverse the flow of those vast lakes (Tahtsa and Ootsa, the two largest, stretch for 125 miles) so their waters would plunge 2800 feet to sea level on the precipitous west side of the big basin—instead of dribbling eastward. To do it, a giant plug was needed to stop up the gorge of the Nechako River where it split the peaks in the northeast rim of the mountains.

The ramparts of the rock-filled Kenney Dam that today holds back a 900,000,000-cubic-foot inland sea, was completed by 1,000 men in less than six months. It is 1,550 feet long and 317 feet up to the 40-foot-wide crown atop its sloping sides.

Mammoth Euclid trucks, husky bulldozers and other heavy machines were flown,

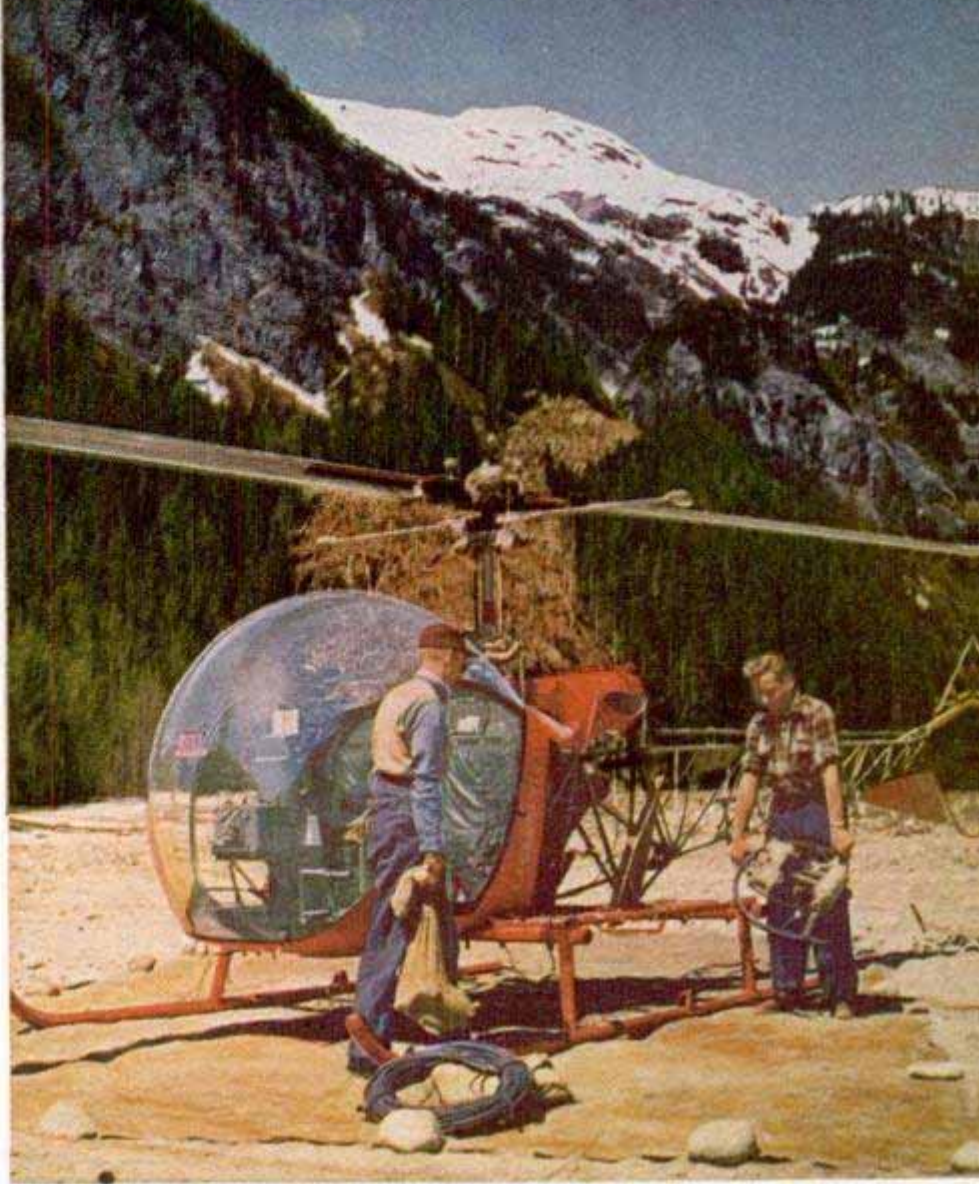

Aluminum Company of Canada photo

Loading a helicopter with equipment for erecting power-line towers

Clearing snow around a test-tower location on top of Glacier Creek Pass. The helicopter about to land is carrying inspectors to the site

International Harvester Company photo

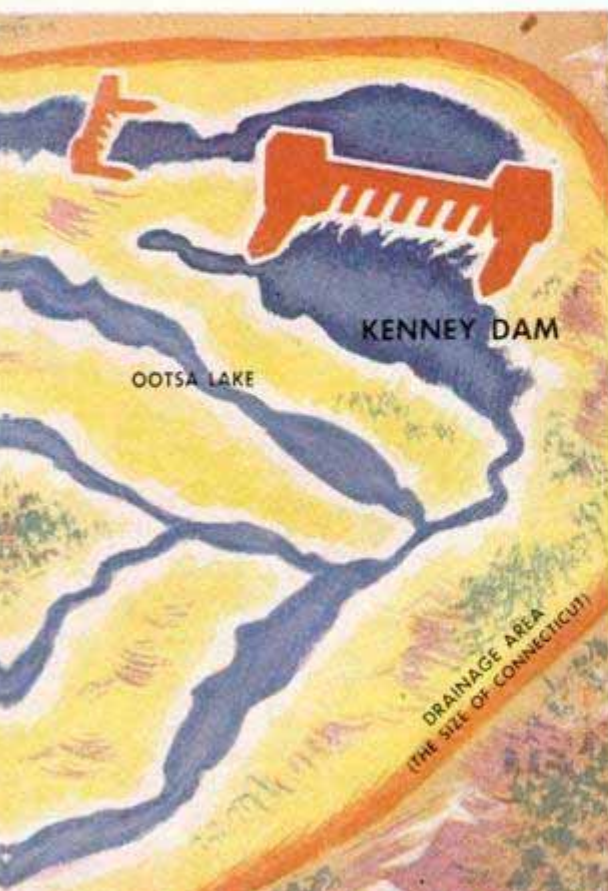



Bulky pieces of construction equipment were moved up the slope, at a 30-degree angle, in this nine-ton cable car

Fuel had to be flown by helicopter to tractors and other machines working far into the rugged mountains

Aluminum Company of Canada photo



hauled or driven up those crags over a hair-raising 60-mile access road carved from the cliffs in record time. With the precision of a trained army, men and machines flipped the forces of nature head over tail. Clattering drills echoed through the chasms as a yawning 32-foot tunnel was bored through the mountain rim to divert the Nechako from its bed at the dam site. Two hundred tons of dynamite was tamped into 300-foot holes in a near-by granite peak. Under the greatest explosion in Canada's history, the entire face of the mountain crumbled. Chunks of rock up to 20 tons cascaded earthward, where giant shovels scooped them up at one bite and dumped them into a stream of 40 trucks that scooted from dam site to quarry in 12-minute round trips. Every 45 seconds, another 20 tons of rock cascaded down the hill. As each load tumbled, huge hydraulic guns sluiced the tumbling rock to clean and wet it for the clay that would bind it.

Some 40 mammoth scrapers scurried back and forth over the mounting pile of rock and clay at 10-minute intervals. A yellow mechanical demon, resembling an overgrown saber-toothed cultivator, ploughed the sticky gumbo ahead of the compactors. From the tip of each curved-steel tusk gouging the soil, a jet of water shot into the clay, making it more plastic for the rollers.



Forty dump trucks shuttled back and forth on 12-minute round trips with rock loads blasted from the slope

Engineers like to tell how they were warned by an old trapper not to use the first clay deposit they found. "The beavers don't use it for the winter houses," he explained. "It's no good."

Samples shipped to Toronto laboratories, according to the tale, proved extremely poor and porous. A new deposit up the river yielded impervious clay—which, the old timer allowed, the beavers used, too.

Following a year of preparation, work on Kenney Dam began in May, 1952. In November, the 114-ton gates of the diversion tunnel slammed shut with a resounding clang. A concrete plug was poured in the temporary hole. A river's flow was turned end over end, and the lakes fattened and rose in their mountain-rimmed saucer.

With the lakes locked up, the next job was to back the overflow off the other side of the plateau and let it plunge down to the bottom of that abyss 2,800 feet below. But the water, in its fall, would never spatter the landscape and be lost in countless cataracts.

Instead, it would be guided 10 miles through the mountain in a tunnel big enough to handle a two-lane highway. A quarter mile from the outer slope of the mountain, the water would suddenly plunge down two penstocks, jabbing through the rocks at a 48° angle for a drop

Big hydraulic guns sluiced each rock load during the dumping to wet it for the clay that would bind it



Once a Sacramento river boat, the Delta King was grounded to become a hotel for 400 Kitimat workers



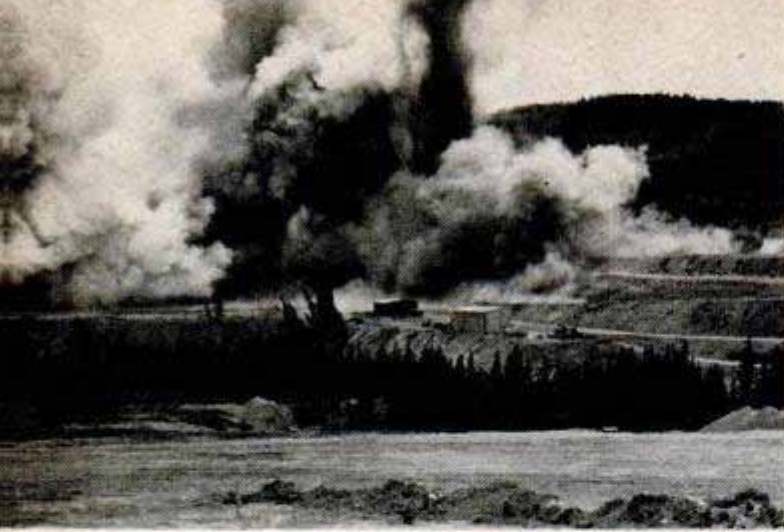

Tamped into 300-foot holes, more than 200 tons of dynamite, the largest amount ever shot in Canada, blasted out the hillside in the Kenney Dam area



After being positioned for the shovels by TD-24s, the huge rocks were dumped into big Euclid trucks like the one in the background and scooted away to the quarry



Fast, close teamwork between shovel and truck crews made it possible to construct the giant Kenney Dam in less than six months. One thousand men worked on the project. Below, improvisation a daily need; here crawler and earthmover become a ferry

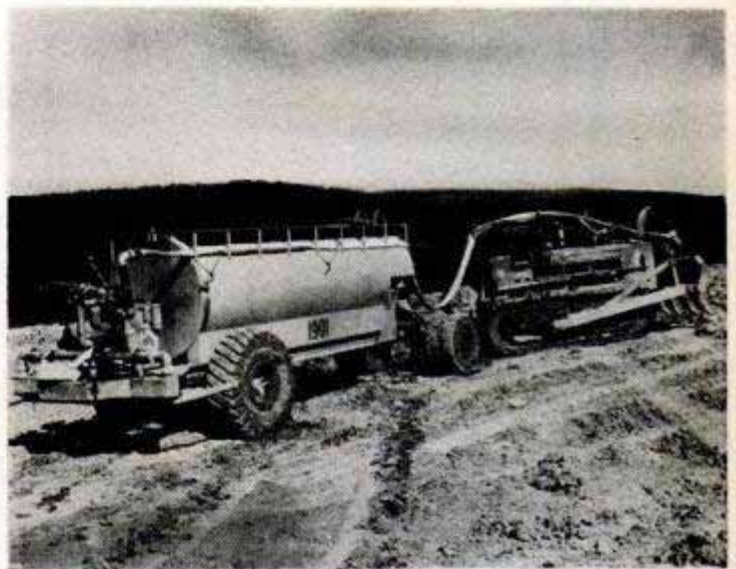

Water from tank towed by TD-24 is pumped through ducts in rippers attached to bulldozer blades and into the mealy clay, making it more plastic for the compacters. Below, this doesn't look much like the greasing pit in your local garage, but big logs serve the same purpose

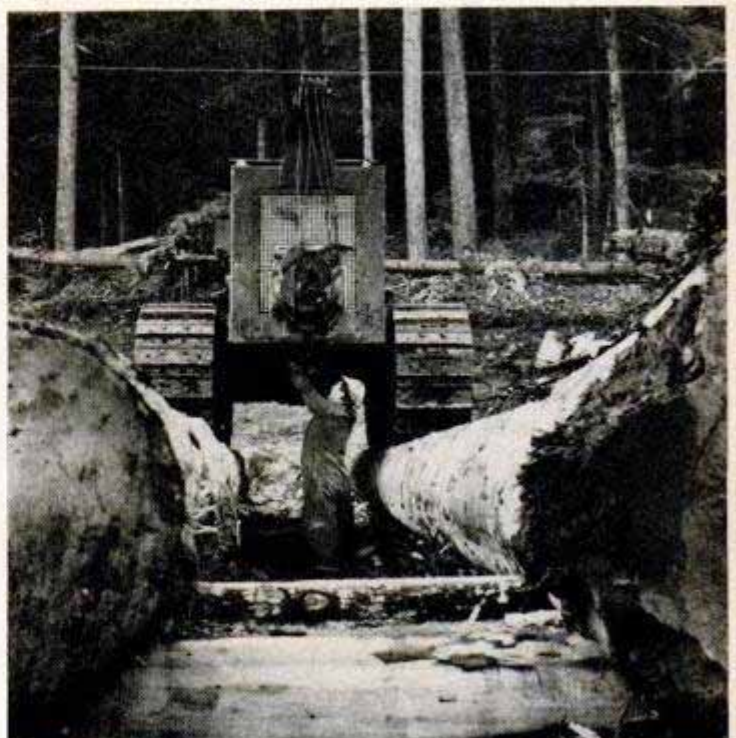



Tractors were the workhorses of the projects. Here one drags ski-mounted machinery to a 5300-foot summit

16 times the height of Niagara. Two Empire State Buildings, from footings to TV antenna tip, would not reach the distance of that mighty plunge. The water will hit the bottom with a force of 1000 pounds per square inch. That is the power that will drive the turbines in the cavernous powerhouse 100 feet high, 80 feet wide and 5 blocks long, carved out of granite a quarter mile inside the mountain.

Putting the powerhouse inside the mountain protects it from the rock or snow slides that tumble down the precipitous slopes, prevents it from trembling under the impact of the fantastic cataract dropping on it from the sky, and makes it invulnerable to air attack in case of war.

Five thousand men of the Morrison-Knudsen Construction Company marched in to storm the mountain and riddle its innards. One group attacked the granite wall at the eastern shore of Tahtsa Lake. Eleven miles away, on the west side of the mountain, another crew camped precariously half a mile up the slope on a tiny level plateau, where they began to bore a tunnel in to drive the penstock holes downward. Far down the valley, 1300 men ground their way into the mountain's base to blast out the powerhouse. Working with dynamite, bulldozers and trucks, they started at roof level and gouged their way down. For months, the clatter of jackhammers bounced off the surrounding peaks. Tortuous roads curled dizzily up the ridges to every level that could possibly be reached in a wild country where caribou and bear could be shot from the seat of a giant "cat" as the vehicle lumbered along on the job.

To carry massive rock-breaking monsters, bulldozers and other ponderous machines to the crew working 2600 feet up on the

Power-line towers like this, carrying 300,000 volts of electricity, link Kemano and Kitimat, 50 miles apart

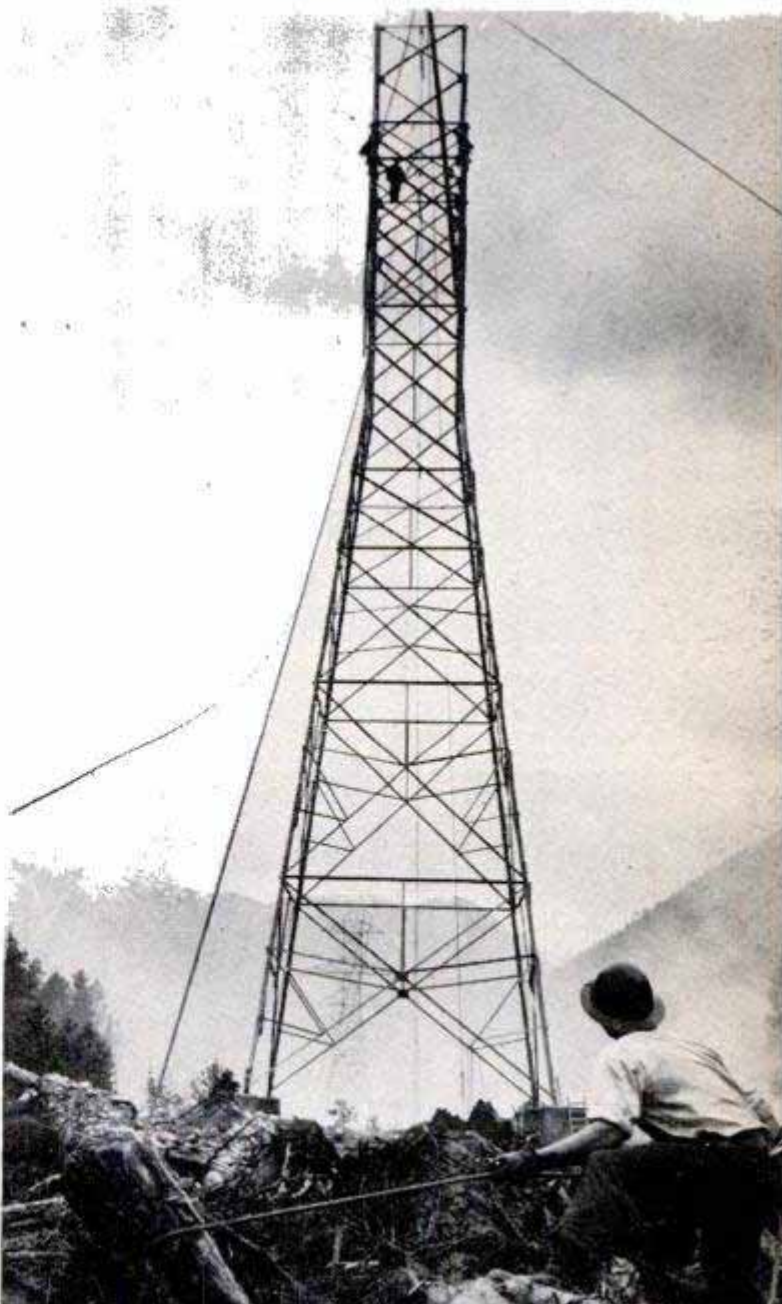



Working in damp tunnels and caverns of jagged rock, drilling crews pushed along at a rate of nearly 300 feet per week in some places. About 260,000 cubic yards of rock were blasted for the underground powerhouse

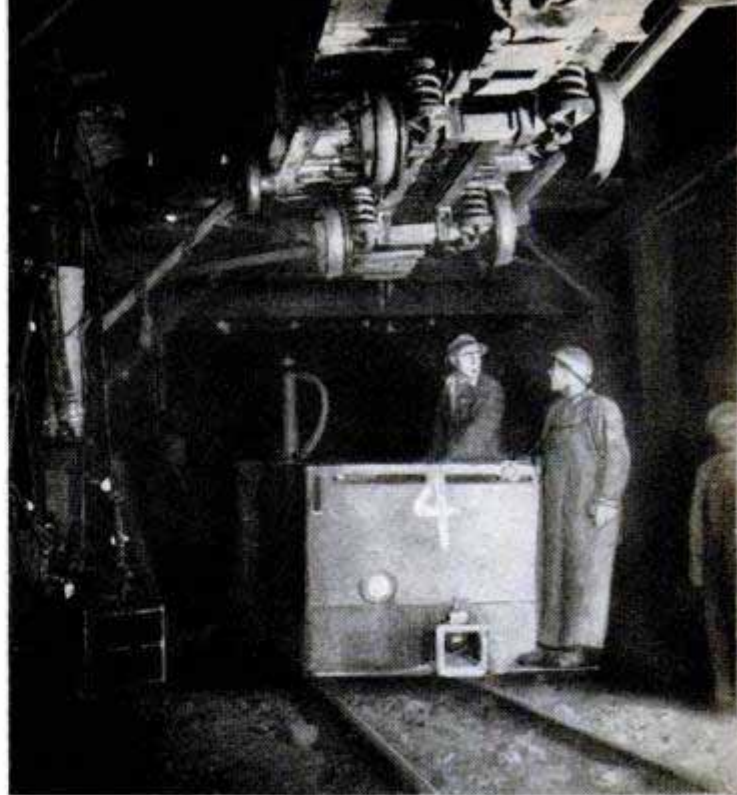

Called the "cherry picker," the gadget above solves the problem of moving waste quickly during tunnel boring. As each car is loaded, it is plucked from the track and set down at the rear end of the train



Mucker working its way through the tunnel. Below, dozing rocks inside powerhouse cavern. The exhaust "scrubber" unit shown eliminates most harmful gases



western slope, the men rigged a 5500-foot cable tramway, capable of lifting a TD-24 dozer to the tunnel mouth with the ease of a pulley clothesline handling wash. Climbing at 30 degrees, it will carry 20 tons or 60 men and its schedule calls for 16 hours a day of duty.

The "skylift" has caused moments of palpitation. On its first journey with a big TD-24 cat, the tractor's weight put such a sag in the cables that the car came hard against a jutting crag half way up the mountain. A passenger solved the problem by drilling a hole in the crag, packing it with dynamite and touching off the "shot."

To date, the rock chewers have been driving their bits and chippers through the mountain at a rate of 30 feet per day. At the main tunnel, driving in at Tahtsa, work moves a little faster and a record of 282 feet was hung up in a week. Huge chunks of granite waste are hauled from the heading by a train of little cars that roll in and out on rough-laid tracks. At the heading, a steel monster loads the first car. When it's full, the giant steel claw of an overhead traveling crane reaches down, plucks the car from the track and sets it down at the rear of the train as the empties move forward. The men call this gadget the "cherry picker." When the train is loaded, it's pulled from the hole to a raised track outside. Here, arms on each car ride a rail that lifts the arm, dumps the car sideways and the muck rumbles down the dump.

(Continued to page 232)



Rail-Riding Plymouth

EX-RAILROADER Truman Crowell of Torrington, Conn., has found a way to put his 1941 Plymouth on rails. 'Most any Sunday, "Old 386" can be seen scooting along a little-used, 29-mile stretch of the Suncook Valley Railroad, with Truman at the controls and brother Russell conducting. Attached to the front and back of the auto are section cars, loaded with ballast, which keep the auto tires on the rails. Tires are deflated to 15 pounds pressure, and fold down around the inside of the rail, acting as flanges. Originally, the front wheels fitted exactly on top of the rails, but each of the rear-wheel rims had to be machined back to bring the rear wheels into line. The perfected "railmobile" can clip along at 20 to 30 miles per hour.

Above, section cars fasten to front and rear bumpers by special drawbars. Signal flags classify the vehicle as a "light extra"



Derailment, above, results from a broken drawbar on the lead section car. Note iron ballast. Below, Conductor Russell Crowell flags auto traffic to a stop as "Old 386" moves through crossing. "Railmobile" runs on extra set of wheels not used on highway





Saucer roof of theater rests on ring of steel posts around its edge. Workshops and offices are housed in wings

Ring Around the Stage

ON THE SPRAWLING lawns of the University of Miami's campus, a circular building squats like a gigantic mushroom cap, kicked off its stem by a clumsy giant. It looks as though it had skittered across the green and wedged itself between two curved wings that jut from it on each side.

The building is a unique auditorium, measuring 100 feet across its inverted saucer-shaped roof. You won't see a single post inside the structure. The 283-ton dome of reinforced concrete is held in place by a three-inch steel band circling its edge like the rim of a wagon wheel. As the wheelwrights used to shrink-fit iron rims on wood spoked wheels, so the builders of the university's Ring Theater pulled up on the iron band around the dome by heating it, then taking up on 28 turnbuckles spaced around the circle. As long as there is proper tension on the steel band, the 8000-

square-foot dome of five-inch concrete can't sag or collapse. It sits on the exterior wall like a lid on a sugar bowl. The outside wall of the theater is really no wall at all, but a circle of steel columns. Between them are hung big double doors made up of horizontal steel slats that open or close like Venetian blinds to let Miami breezes through—or keep Miami hurricanes out.

The Ring Theater is no architectural whimsey. Designed by Robert M. Little and Marion I. Manley, it was carefully planned, first, to weather a 250-mile-per-hour hurricane. Second, its unique style makes it one of the most versatile theaters in the world. Inside its great circle, audiences can watch theater-in-the-round, a fast-growing form of show in which the audience completely surrounds the stage.

But supposing the producers want to stage a conventional show on a standard stage? Or a horseshoe-type production?

Diagram shows seating variations, Ring Theater sitting between its curved wings and connecting galleries

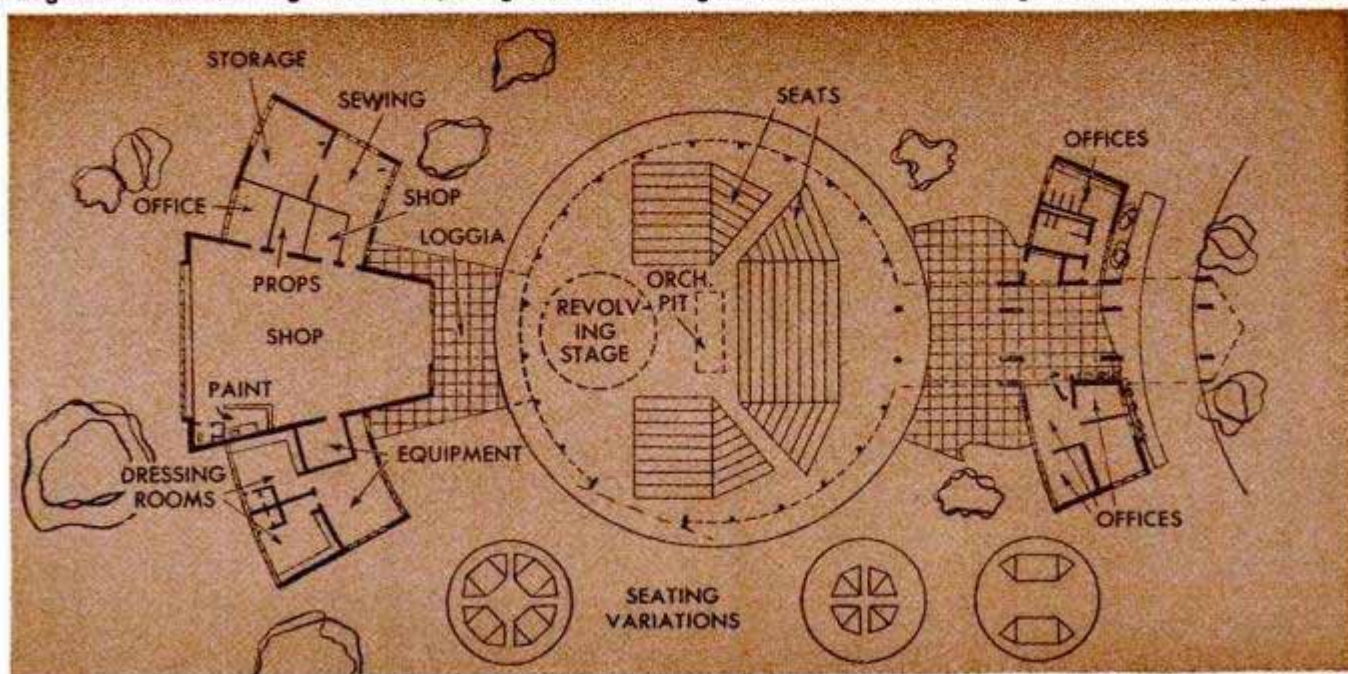

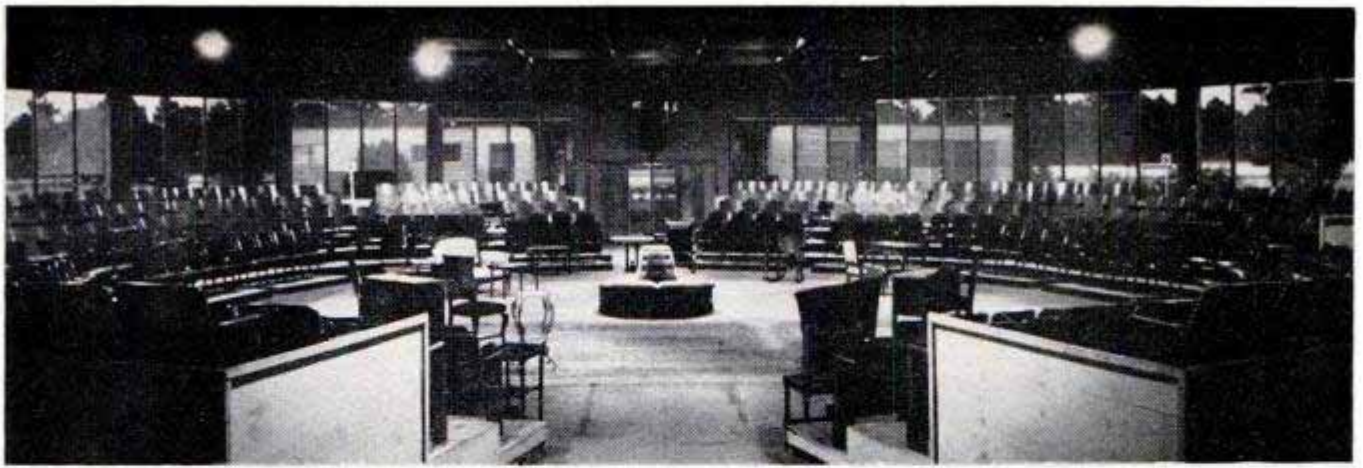

Audience completely enfolds stage for theater-in-the-round. Stage lights are directly above stage in grid

Nothing to it at the Ring. The bleacher-type seats, accommodating nearly 1000 people, are built in pie-shape sections on retractable aircraft-wheel carriages. To shift seating arrangements, men trot from section to section, jacking down the caster wheels. The double-doored jalousie walls of the theater are opened and the seating sections are dollied in and out of the building on their own rollers until any desired pattern is achieved. Then they're jacked down again. On a curved track across the dome, a standard stage arch can be drawn in front of the audience like a curtain and the actors can perform in the regular Broadway manner.

The circular form of the building, however, lends itself especially to theater-in-the-round, which has advantages for enthusiasts.

(Continued to page 218)

Hydraulic jacks on casters lift frame of seat section off floor so it can be moved



DECEMBER 1953

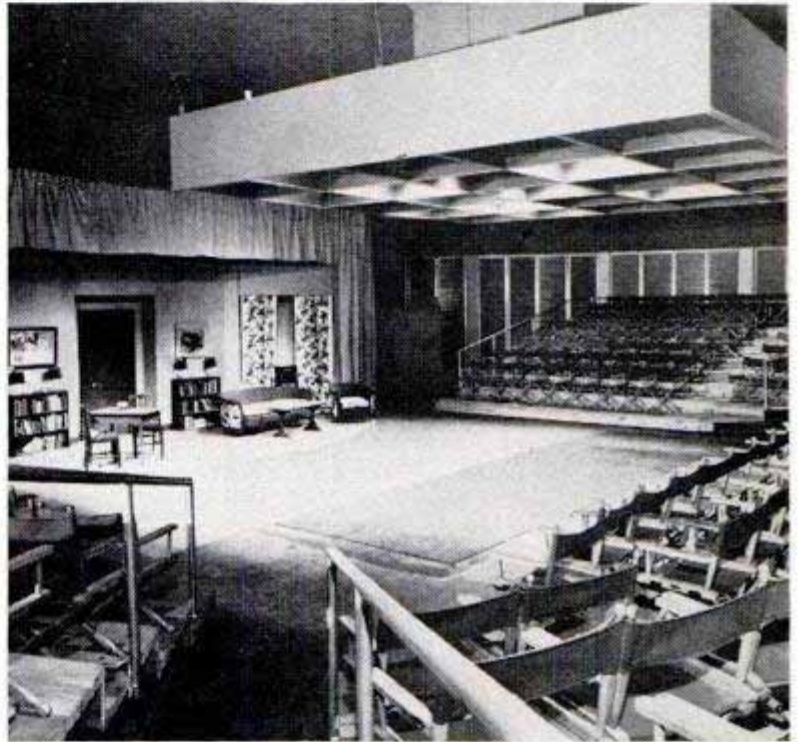

Revolving stage mounted on surplus Army gun turret is built into one side of theater for conventional staging of plays

Vast dome of reinforced concrete five inches thick was poured in a plywood mold. A steel rim holds unsupported dome in place



Circular Road Map Fits on Steering Wheel for Ready Reference

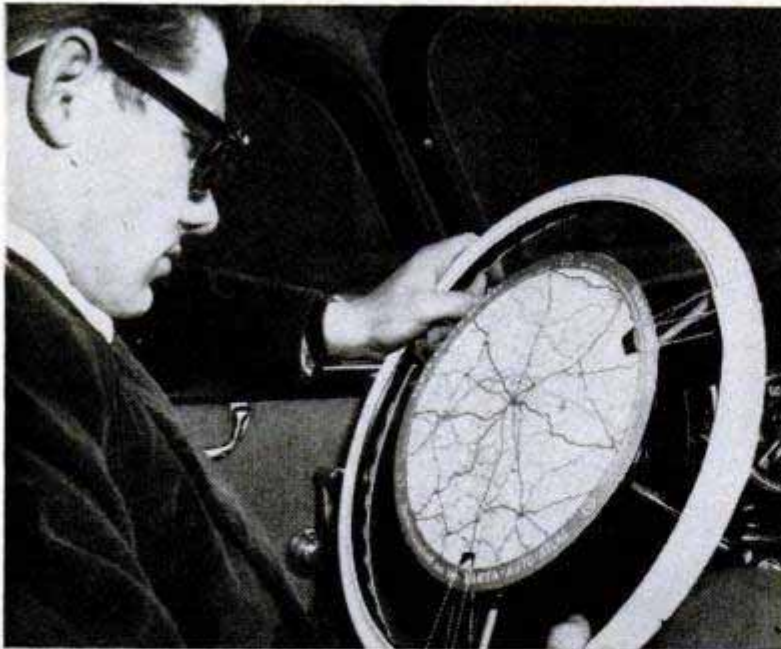

Drivers follow their routes easily with a circular road map, developed in Germany, that slips on the steering wheel. Three rubber bands hold it in place and it is quickly removed when a new map is needed. All Germany is being mapped in this form for the convenience of motorists.

Wall Coating Resists Fire

Acoustical tile and wallboard are made fire-resistant by a new plastic coating. When flame strikes a treated wall or ceiling, the coating swells up and covers the surface with a protective layer of char which insulates the board itself from the flame.

Homemade Horseless Carriage Built in 1900 Rattles Again

How long will a good automobile last? William Braley of Clifton, Ohio, has found that the car he built over 50 years ago still has plenty of spunk. Reclaimed by Springfield garage owner T. J. Goss, it is once again putt-putting down the highway. When Braley built the car in 1900, with the aid of a local blacksmith, many of the parts were forged by hand. The car weighed between 1000 and 1200 pounds, and in one run averaged 50 miles per hour over 7½ miles of gravel road. For the initial run the car was powered by a one-cylinder water-cooled French De Dion engine, but the four-cylinder air-cooled Braley handmade motor was installed in 1903. Braley sold the car in 1909, saw it once in 1915, but lost track of it. Finally abandoned, it remained for years in an old garage with its engine in a

bushel basket. When Goss bought the car he replaced damaged gears and fabricated new parts. Minor improvements included the installation of cylinder sleeves. After putting it in running condition, he exhibited it at an antique-car show. There William Braley rediscovered the durable automobile he had built half a century before.

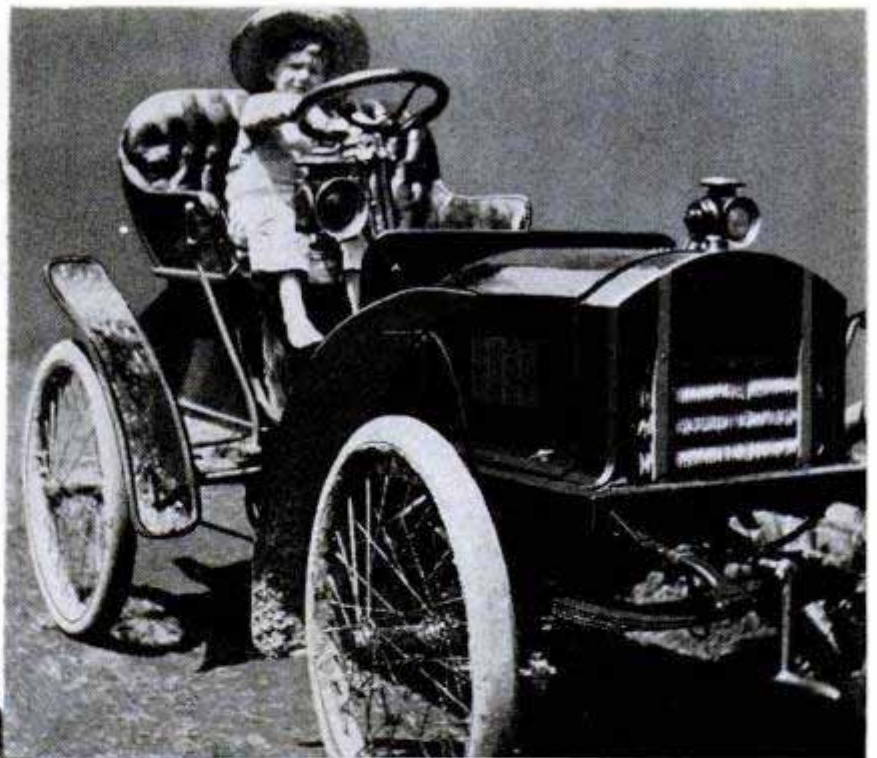

Fifty years ago Braley's young son posed at the wheel of his father's homemade car. A different grille, spoke wheels, running boards, big headlamps and Braley's handmade engine have since been added. Left, Braley and present owner T. J. Goss take the car for a spin



Two-Piece German Ski Comes Apart for Carrying Convenience

Broken into two sections for carrying, a German ski is easy to pack or transport. A ball-spring locking device prevents it from coming apart when in use, yet permits assembling or disassembling in a few seconds.

Fully tested, the ski is said to have the correct amount of spring required by good skiers. Each pair comes complete with steel edges, leather carrying case, bindings and metal ski poles.

Miniature Trailer With Fold-Down Ramp Hauls Tractors

Tractors can be hauled to the shop for repairs or moved from a field to a far distant one on a simple, two-wheeled trailer. The tractor simply is driven up a small ramp until the front wheels rest securely in a cradle on the trailer. The ramp then is swung upward to lock the wheels in place. The trailer, made of tubular steel, has a 36-inch tread and accommodates all row-crop tractors.



Garbage Becomes Humus

Municipal garbage and other organic refuse can be converted into humus, valuable in increasing soil fertility, according to research workers at the University of California. The composting method—called aerobic or oxygen-requiring—creates no bad odors and requires no decomposition agents or chemicals. The microorganisms which cause decomposition already are present in the refuse. Heaps of refuse must be turned to aerate them. From 12 to 21 days are required to convert municipal refuse into humus.





Mechanical harvester crawls through an orchard. Steel fingers snatch up prunes or nuts in a seven-foot swath

This year a good many farmers are field-testing strange new implements. They're so enthusiastic

They Call It **AUTOMATIC FARMING**

By Thomas E. Stimson, Jr.

ON HIS WAY to town recently, a startled farmer slammed on his brakes, pulled off the road and gazed popeyed at a man apparently soaring 12 feet off the ground through an orchard. What the farmer couldn't see because of the trees was the self-propelled "steel squirrel" on which the man was riding.

The steel squirrel is just one example of

some mighty strange new machines rambling through American fields and orchards. Other examples: A flame cultivator that burns away the weeds and leaves the cotton crop untouched, a new harvester with mechanical fingers which pick up every nut or prune lying on the ground and a mechanical hoe directed by an electronic brain.

After crop is picked up it moves along a cross conveyor and up an elevator where blower ejects foreign matter

A. D. Goodwin & Son drawing

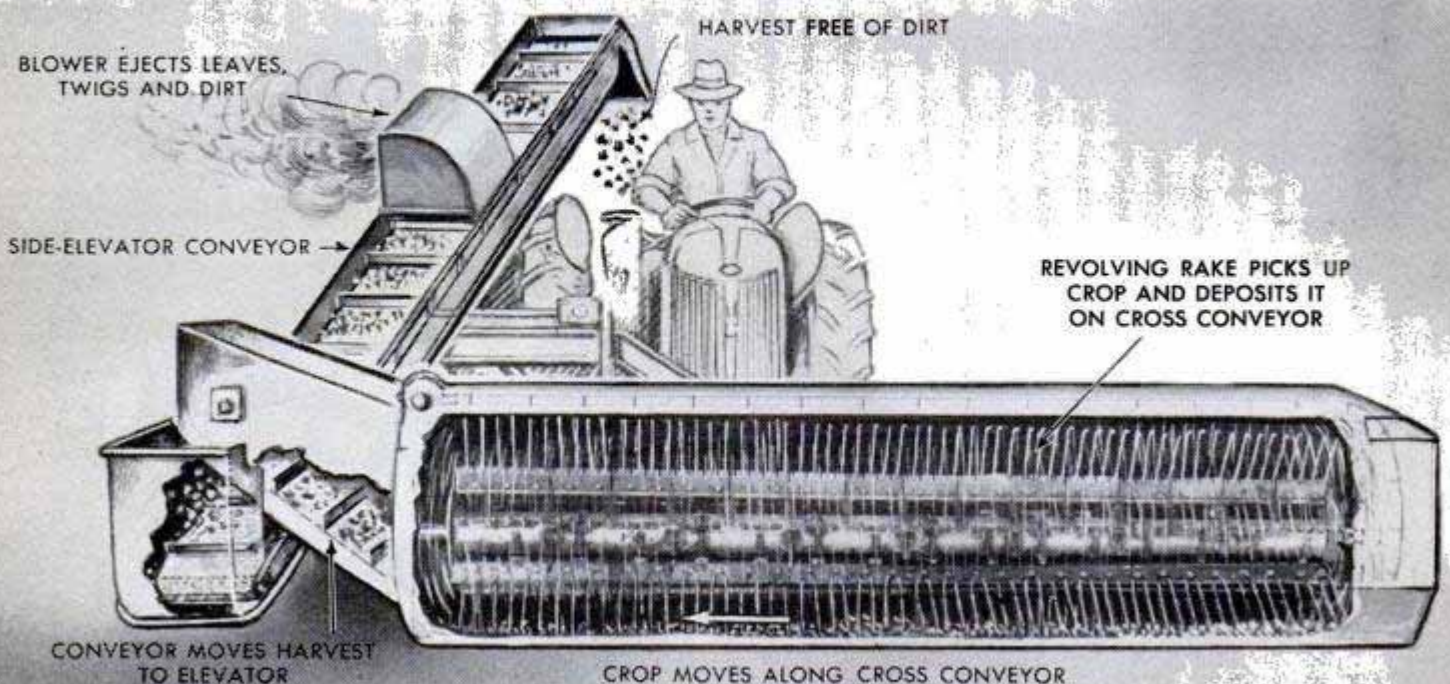

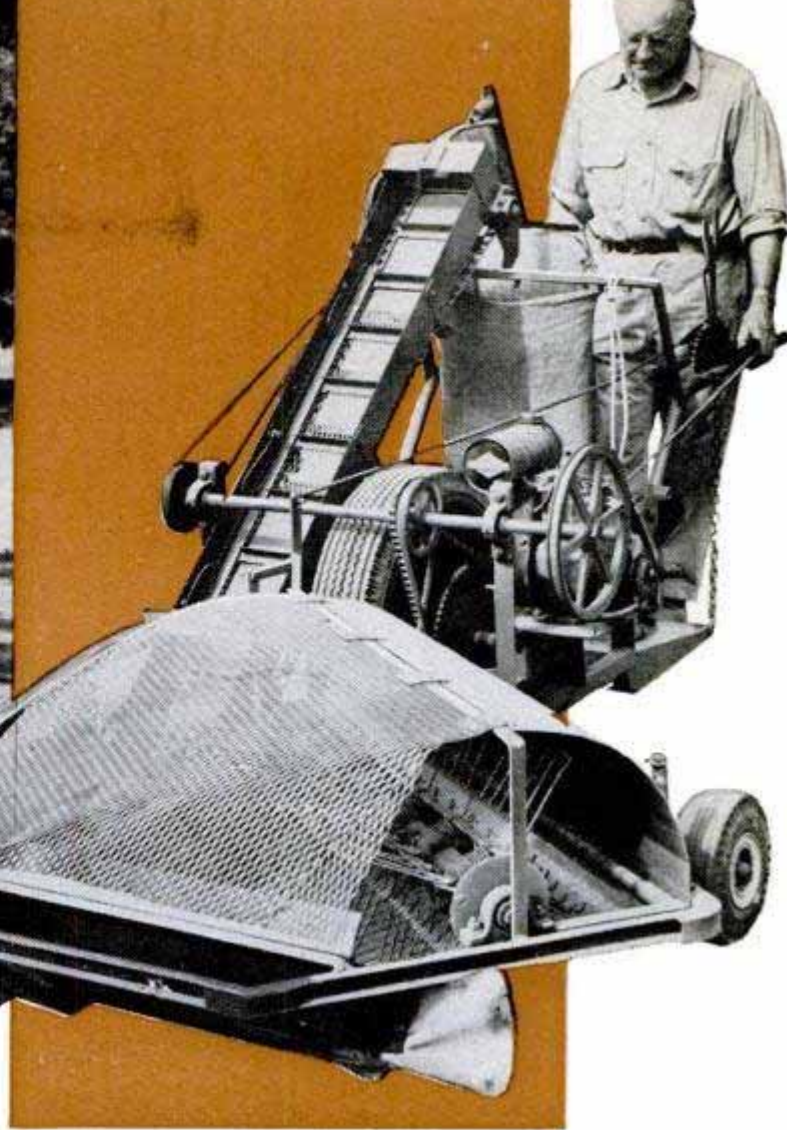

Smaller version of the mechanical harvester is powered by a gasoline engine, picks up the crop along a three-foot swath and deposits it in sacks

Some of these odd implements have been invented by farmers themselves; others have been developed by special engineering groups. But regardless of who invented them, the men who are testing the machines are enthusiastic about the results. One farmer, after putting a new implement through its paces, said flatly "I'd call it automatic farming."

The steel squirrel is a little self-propelled

Spring-loaded fingers, mounted in groups, revolve to rake up crop and whirl it onto moving belt in machine



vehicle with a tiny tower on which the operator rides. By manipulating hand and foot controls he can flit from tree to tree, turn in a 30-inch circle and raise or lower the tower. At his elbow are compressed-air outlets to which he attaches pneumatic shears and other air-driven tools. One man, according to tests, can do the work of two men on ladders. When not roaming through an orchard, the vehicle can be used as a mobile air compressor for spray painting and other odd jobs.

The flame cultivator is a harrow attachment for a tractor, equipped with a butane tank and pairs of butane burners. It cultivates the soil and sears and kills all the young weeds while leaving the sturdier cotton plants unharmed. It's fast and efficient in the field.

The nut harvester uses spring-loaded wire fingers to sweep up the crop from the ground. It picks up every nut in a seven-foot swath, sifts out the dirt and lumps of soil, blows away any leaves and twigs and delivers the cleaned crop to a bin. The harvester can be pushed by any farm tractor. It's suitable for gathering walnuts, almonds, pecans, filberts, tung nuts and prunes. Eleven of the machines do all the



"Steel squirrel" is a self-propelled perch for orchard workers. Below, it's small enough to move easily between trees. Operator guides it by foot and hand controls, has compressed air at hand for pneumatic tools



picking on a 5000-acre pecan orchard in New Mexico, replacing almost 100 laborers. A smaller hand-operated model is powered by a small gas engine and snatches up the crop along a three-foot path.

Undergoing field trials this year is the mechanical hoe, equipped with electric eyes and activated by an electronic brain. It thins a row crop to the desired number of plants per foot, and later in the season does much of the weeding. The electric eyes "see" the difference between plants and weeds, and the hoe chops away all the weeds between the rows and even between the plants. Several of the units can be mounted on one tractor. The electronic hoe is especially suitable for weeding young sugar beets and cotton.

Such mechanical farm hands are steadily reducing the amount of "stoop labor" drudgery associated with some kinds of planting, cultivating and harvesting. The ultimate aim is to put almost all of agriculture on a production-line basis that will eliminate most hand labor. That goal isn't as far off as it might seem.

Roy Bainer, head of the agricultural engineering department on the Davis campus of the University of California, says that no big problems remain today as far as the mechanization of field and row crops. There are lots of odd jobs that still are done by hand, to be sure, but in most cases it's only a question of sitting down and devising a machine for any particular task.

Bainer cites rice as one crop in which hand labor no longer is used at all, in California at least. In Japan it takes 900 man-hours of hand labor per acre to bring rice to maturity and harvest it. In California, the rice crop costs only 15 man-hours of labor per acre. The rice is planted, fertil-

Strange cotton topper moves along on three wheels





Crew tosses heads of lettuce on a wheel-mounted endless belt which carries them quickly to waiting trucks

ized and weeded by aircraft, then harvested with combines. One man, with machines, does the work of 60 Japanese.

In cotton it's becoming a similar story. Close to 80 percent of the 1953 California cotton crop was machine-picked. All of it was sown by machine, much of it cultivated by tractor-drawn equipment, most of it fertilized automatically by nutrient solutions in the irrigation water, and all of it dusted with insecticides by tractor equipment or aircraft. It was defoliated by chemicals dropped from aircraft to make machine harvesting easier. In some areas where

cotton grows as tall as a man it was topped by mechanical rotating knives, to force growth into the lateral branches.

Ten years ago the Western sugar-beet crop required 120 man-hours of labor per acre to plant, cultivate and harvest. Today the same operations are performed at a labor cost of only 25 man-hours per acre. In this short period of time the whole sugar-beet operation has been almost completely mechanized.

The big surge toward mechanization has been spurred by the fact that farm labor is vanishing rapidly. Seventy-five percent

Topper has four rotating knives which chop off the tops of tall plants, forcing growth into lower branches

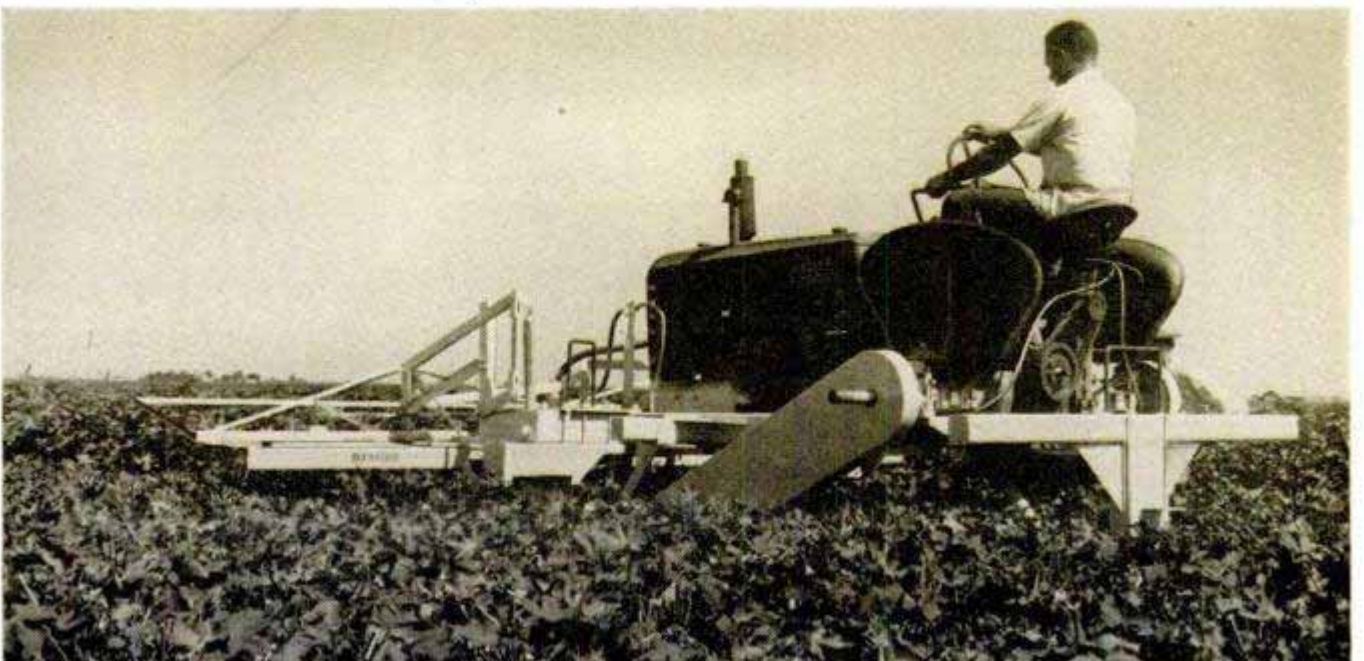

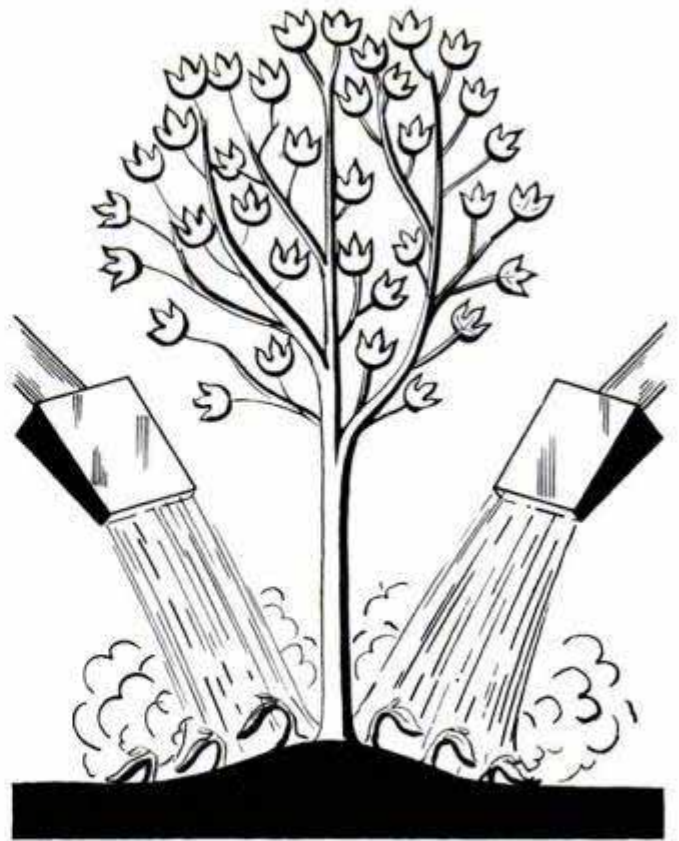
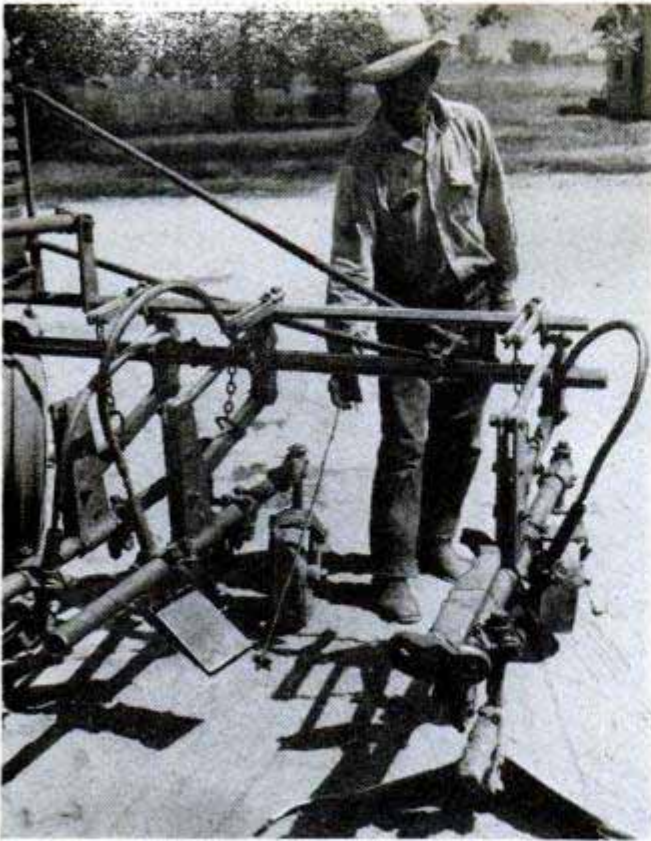

Operator ignites flame cultivator. Diagram shows how it sears weeds without damaging stronger cotton plants

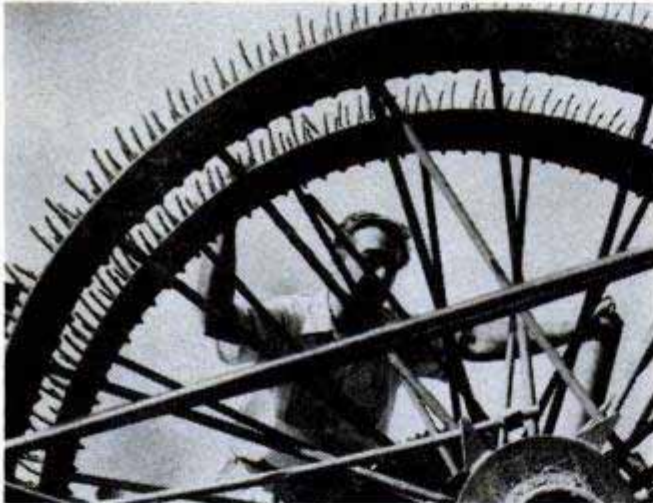

of the total population lived and worked on the farm when this country was young; less than one fourth of the population is engaged in agriculture today and the percentage still is going down. Fewer persons are producing more and more food, working with machines instead of with hands.

Research and instruction groups such as the Davis engineering department are playing an important part in this trend toward automatic farming. Bainer and his staff of 30 men sometimes take a new machine invented by an enterprising farmer and test it exhaustively; sometimes they

(Continued to page 212)

↑Huge spiked wheels are forced into ground to pick up sugar beets and deposit them in a bin. Below, from high perch of this strange machine, operator spots and flame-kills patches of dodder in alfalfa fields





French Air Oddities

THREE UNUSUAL planes distinguish new French aircraft design. In one built for close support of ground troops and antitank roles, the Potez 75, the pilot sits in an open cockpit and the observer rides in an enclosed cabin in the nose. A twin-boom pusher, it cruises at about 150 miles per hour. The prototype of a new transport, the Hurel-Dubois 31, features a very narrow wing with an exceptional span—nearly 148 feet—for the over-all size of the airplane. Specially shaped lifting struts and very-high-lift flaps add to its unusual appearance. It is the forerunner of a medium-size transport, carrying 36, that will operate out of small fields. The designer claims the HD-31's operating expenses will be 40 percent lower than those of existing transports. France enters the convertible aircraft field with the SO-1310 Farfadet, with jet units turning the rotor and the propeller. The Farfadet is fitted with a newly developed three-blade rotor 36 feet 8 inches in diameter. Compressed air is fed from the jet engine through the blades, ejecting at the tips, thus driving the rotor. For horizontal flight, the rotors are placed in autorotation and the main lift effort is transferred to the wings, which have a 20-foot span.

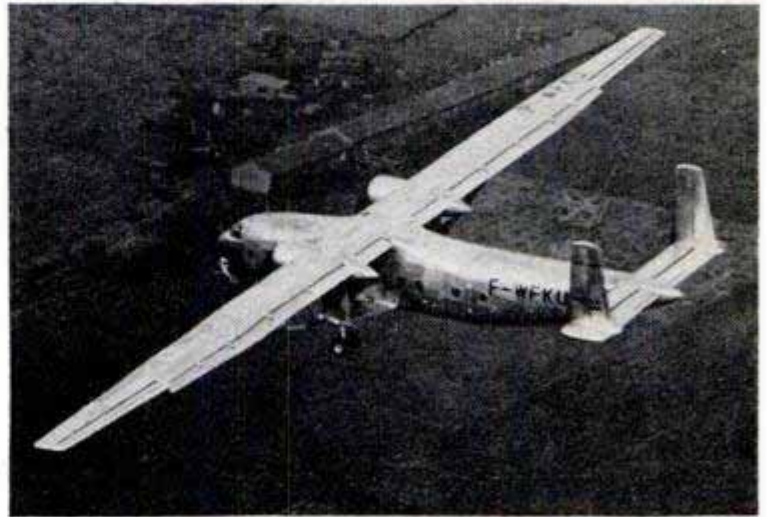

Cruising speed of the HD-31, above, will be about 170 miles per hour. High lift struts support its very-wide-span wing



Designed for low flying in support of troops, the Potez 75 above is heavily armored against small-arms fire. Built by Sud-Ouest, convertiplane below will help speed development of a 20-30-passenger commercial model already in design stage





Pressed cedar chips form panels and doors behind Hughes. Desk and lamp stand are treated with white putty

DECORATIVE

By Ewart Thomas

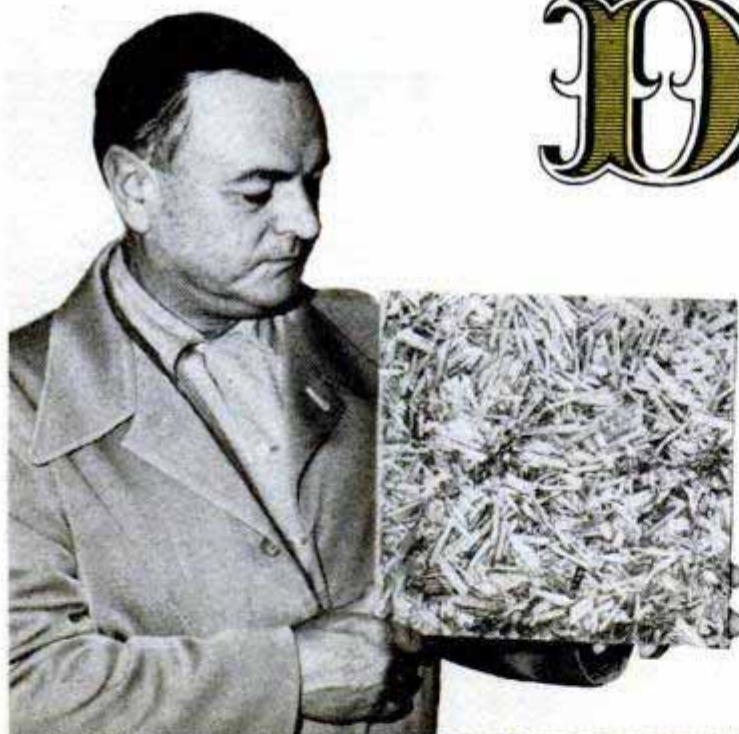

WASTE WOOD that formerly was burned is being converted into unique decorative panels that are in big demand for homes and stores on the West Coast.

In a Sacramento restaurant, in North Hollywood homes and in other places you'll find walls with a textured appearance unlike anything you've ever seen.

The material looks like a lot of wood chips that have been pressed together, and that is precisely what it is.

Used mainly for decorative effects, the panels have roughly the same properties as has ordinary lumber. The material can be nailed, sawed, turned in a lathe and cut up into furniture. It sells for around 40 cents per square foot, from half to a third the cost of some decorative plywoods and veneers.

The panels come from a factory in North Sacramento, Calif., where the process for manufacturing them was



Samples, left, contain cotton stalks (top) and bolts, cedar chips with white and colored putty

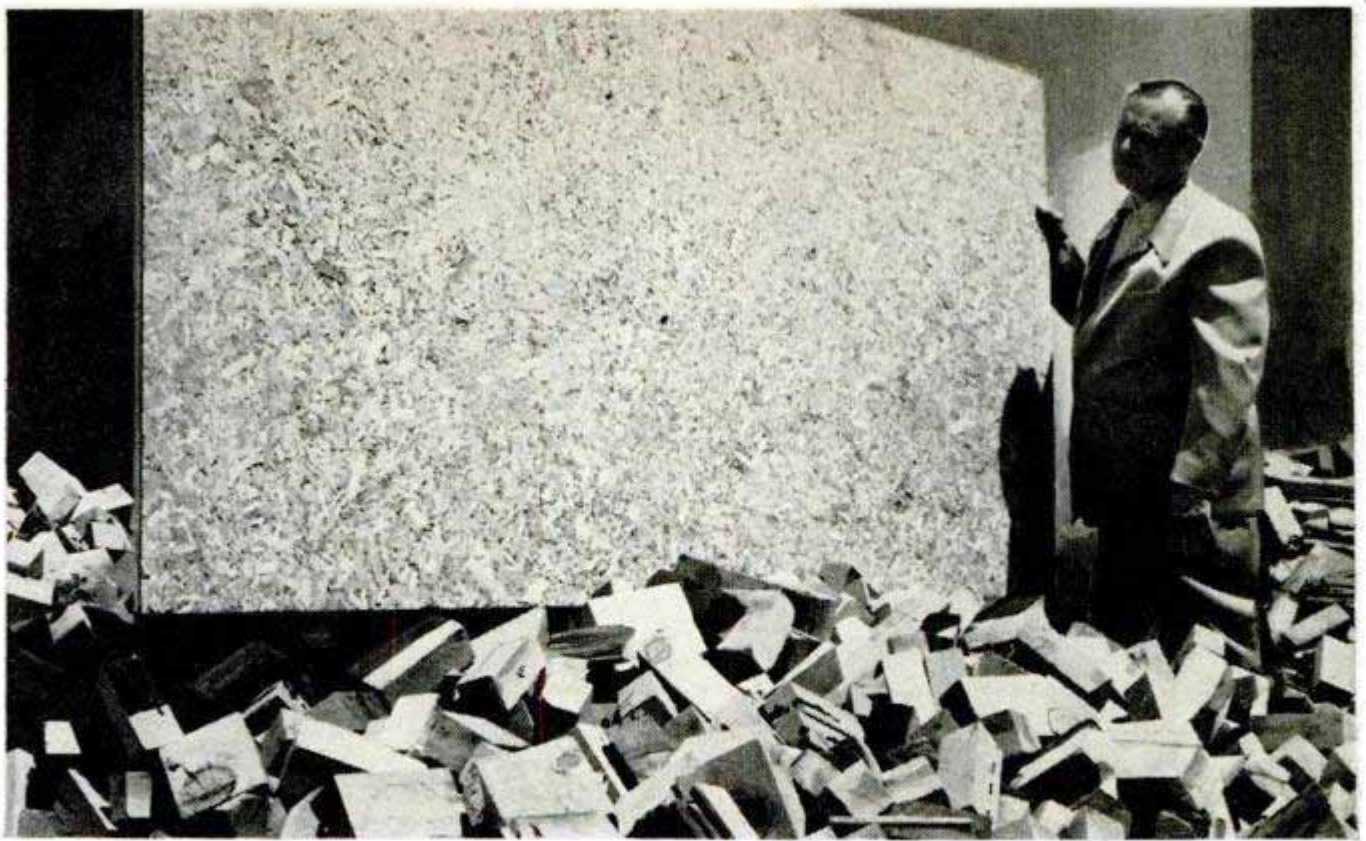

Attractive, durable pressed-chip panel was made from imperfect cedar blocks like those in foreground

PANELS from WOOD CHIPS

developed over a 10-year period by Fred Hughes, research chemist and engineer. Waste wood culled from woodworking operations is shoveled into one end of the factory; finished panels of Hu-wood go onto trucks at the other end of the plant a half hour later.

To manufacture panels from cedar chips, Hughes uses the imperfect cedar blocks discarded by a local pencil factory. For panels of pine, fir or other woods he takes the odds and ends that unavoidably are wasted by near-by factories in making boxes, furniture and other items. Wood with knots, wormholes and other imperfections can be used.

The manufacturing process is simplicity itself. The waste wood goes first into a "hogging" machine that reduces it to splinters and chips from a quarter of an inch to two inches long. These wood particles then are treated with a plastic binder and are fed to a depth of several inches into a metal tray that is slightly larger than four feet wide by eight feet long.

The tray then goes into a big press where the chips are compacted under heat and pressure for several minutes. The layer of chips is compressed into a panel three quarters of an inch thick. Meanwhile, the plastic binder solidifies the panel. Three trays at a time go into the press, each producing a panel.

When removed, each panel slides on rollers to saws that trim it to the dimensions of 4 by 8 feet. Next the panels are fed through a sanding machine that grinds a smooth, finished surface on one side. A sealing lacquer is sprayed on and the panels are stacked for shipment. That's all there is to the operation.

But it isn't as simple as it sounds. One of Hughes'

Pressure pipe made from sawdust can be tapped and threaded, is designed to convey corrosive chemicals





Samples are sections cut from slab doors made by sandwiching wood chips between plywood veneers. Center sample is pressed rice-hull insulation

achievements was to provide a way for the chips to slide into position when placed in the press, providing an interlocking effect and relieving all dimensional stresses. Otherwise the panels would have weak spots and lumpy surfaces. Controlled slippage permits turning out panel after panel having the same characteristics of appearance and strength.

Hu-wood floats as do other woods and it picks up some moisture unless sealed. It does not swell up and come apart, as do some plywoods. It can be manufactured in various thicknesses and in various densities. It is somewhat fire-retardant and can be given additional fire-resisting qualities by adding chemicals in manufacture.

Smooth-finish panel results when surface is impregnated with water putty and sanded down. Tinted putty gives desired color—here, a light pink



Other chemicals can be used to make it fungus-proof. DDT has been added to the mix, experimentally, to create panels that are lethal to flies and some other insects.

As an offshoot of his decorative panels, Hughes has manufactured wood blocks $\frac{3}{16}$ to $\frac{5}{16}$ inch thick for use as flooring. Somewhat similar in appearance to the chip boards and containing a percentage of rubber for resilience, the blocks measure nine inches on a side.

So far the Hu-wood factory has been operated only on a research and pilot-plant basis. To date about 500,000 square feet

of product has been produced. Production is at the rate of about 5000 square feet per day. Hughes points out that his operation requires a minimum of labor, none of which needs to be skilled, and that one of his plants can be placed wherever quantities of waste wood are available.

As an example, he cites one woodworking factory that is forced to reject or waste one third of the wood that it buys, using this waste as fuel for its boilers. The amount of wood that is burned per day, Hughes figures, could be converted into 450 panels of Hu-wood having a retail value of \$5760. Its value as fuel is only \$90.

Not only can manufacturing waste be used by the process, but much of the debris that is discarded in rough lumbering also could be converted into panels by compression molding. Limbs that are slashed off in the forest, stumps, and even bark have been tested successfully.

Hughes turns out panels having a different appearance by using chopped stalks of cotton plants as a surface material. He gets still another effect with cotton bolls and ginning debris used as the surface layer.

His standard wood-chip panels have a slightly rustic appearance because of the small surface voids and spaces between the chips. To create an entirely different surface he

wipes water putty, white or tinted to a desired color, into the surface of a panel and then sands the panel to a smooth finish. After a coat of lacquer the panel has a smooth, hard surface for table tops.

Odd attractive inlays not otherwise practical can be obtained with his process. One type has palm leaves on the surface with a background of the usual wood chips. Treated palm leaves are simply laid on the bottom of a tray in the factory and the tray is filled with wood chips in the usual way. When taken from the press the finished panel contains the palm leaves permanently embedded in its surface. Flat inlays of rare woods, cut to any desired pattern, similarly can be pressed into the surface of a panel. This technique is particularly effective in making doors.

Hughes is also experimenting with slab doors that are made by laying a sheet of plywood on the bottom of a tray, adding wood edges and a filler of wood waste, bark, or even rice hulls, then placing another sheet of plywood on top. This "sandwich" becomes a single, permanent slab in the press.

Similarly, shaped components for furniture can be made in a single operation, using expensive veneers for the surfaces and a filler consisting of various waste products.

Hughes is even manufacturing pipe from sawdust and disintegrated wood particles. Pressed to a high density and lined with a protective coating, the pipe can withstand internal pressures of up to 150 pounds per square inch and is suitable for carrying various acid or caustic solutions. It costs about half the price of other pipes used for these purposes and can be manufactured in sizes ranging from two to eight inches inside diameter. By means of a different technique the same products can be used in pipe as large as 20 inches. The material can be tapped and threaded. Lengths can be joined with standard drive-collar fittings when used as conveyance pipe, or with synthetic-rubber rings when used in pressure systems.

★ ★ ★



Machine at left feeds cedar chips treated with plastic into moving tray. In the press, tray serves as form for finished panel

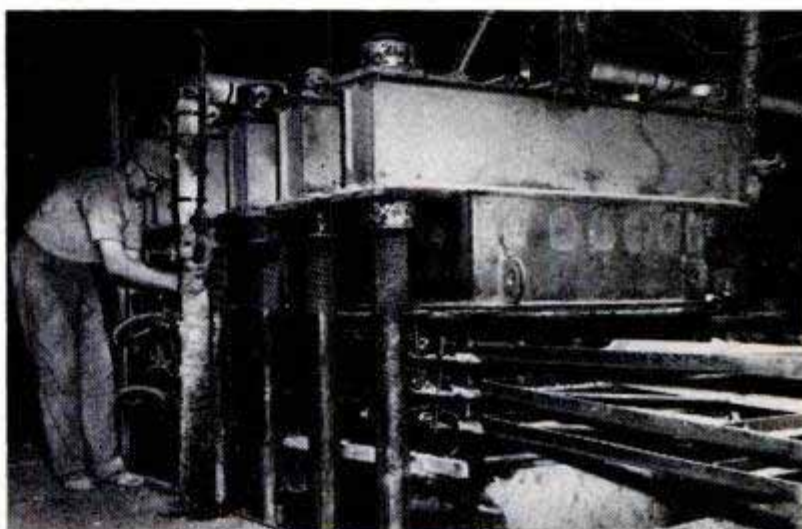

Three trays of chips are fed into press at a time. Within a few minutes they are transformed into panels complete except for trimming and sanding. Below, trimmed panel is fed through sanding machine that puts a smooth surface on one side of the panel

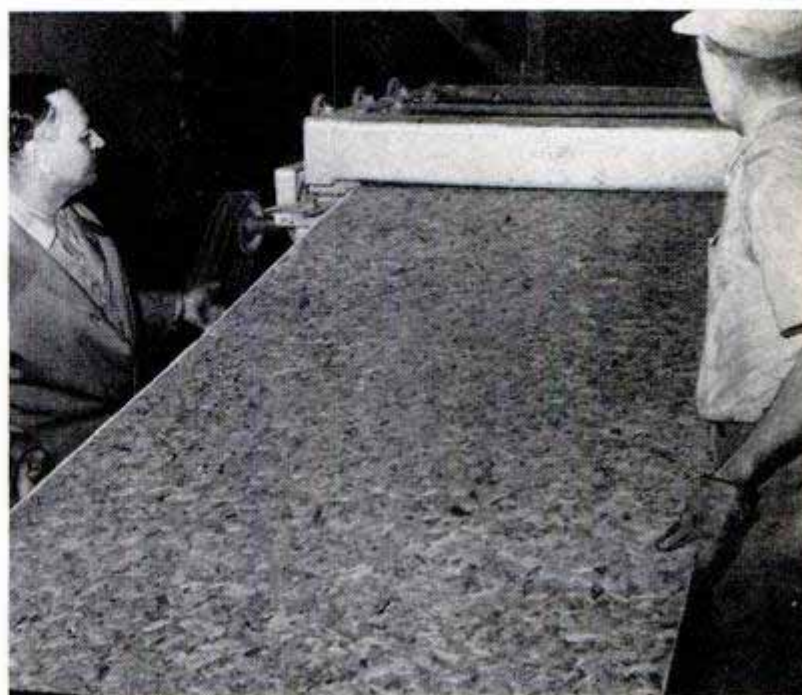



Battery Tester-Analyzer Can Forecast Failures

At a glance, a new battery tester-analyzer tells you the condition of your car battery and charging unit. Equipped with two contact prongs and a grounding clamp, the unit can be used to test individual cells; under load conditions the device can indicate internal damage and foretell failure. It can also be used to indicate need of charge, the rate of charge and to take a voltage reading.

Quickly Installed Spotlight Grips Automobile Windshield

There's little effort involved in mounting a German auto spotlight that is held to the windshield by suction. The direction of its off-center beam is changed by rotating the lamp on its suction-plate base. If desired, it can be removed from the fixture and used as a hand lamp. Vacuum is created between the suction plate and the windshield by tightening screws around the edge of the rubber-ringed disk.

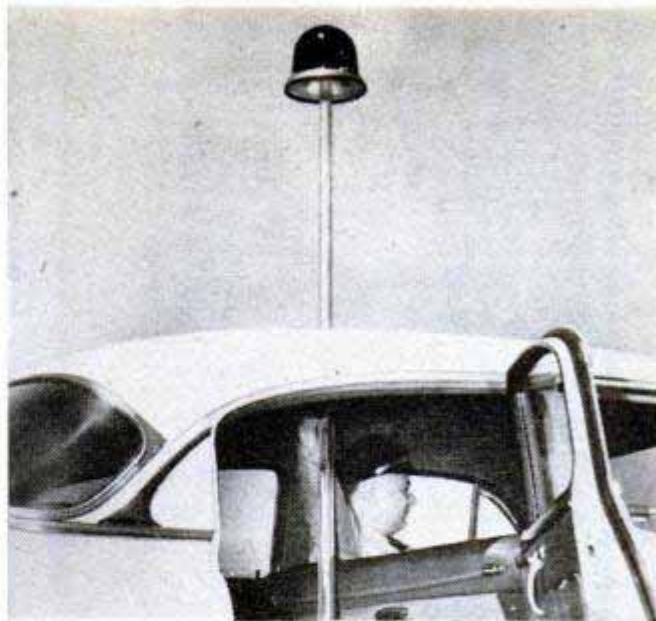
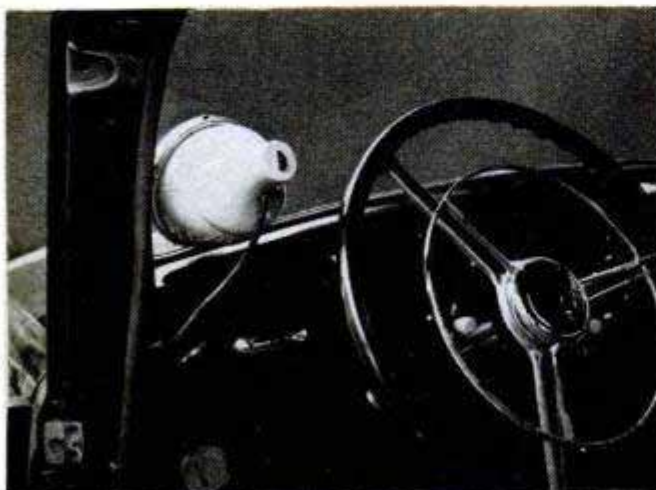

Emergency Telescopic Flasher Elevates for Visibility

Controlled from inside the car, a telescopic flasher light provides police and other emergency vehicles with a high-level warning that can be seen from a great distance. Four bulbs inside the glass housing flash alternately, providing warning in all directions. The light is normally kept in the down position on the car roof. In an emergency, it can be elevated several feet while the car is operating at high speed. A quick locking device holds the extended shaft in any position.

Clamp-On Spring Steel Band Serves as Non-Skid Chain

Easy to put on, a spring-steel band with a single chain attached serves as an emergency nonskid chain. It is expandable and the ends touching the wheel are rubberized to prevent scratching. The band fits all types of wheels.

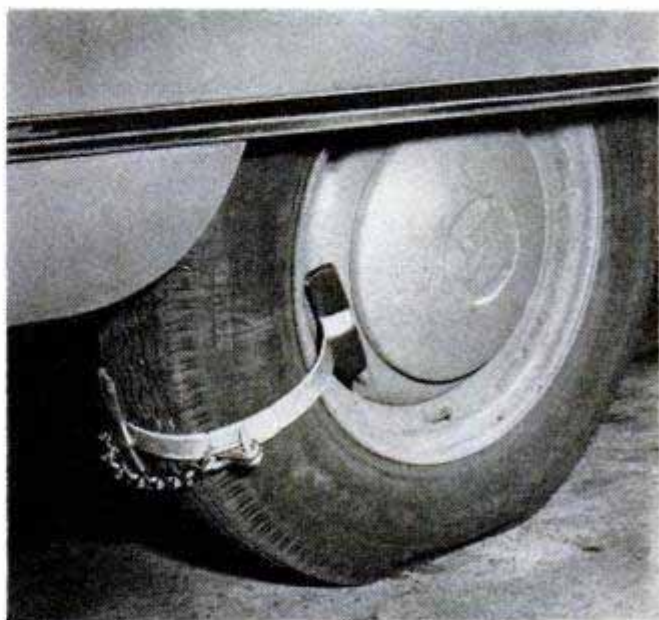

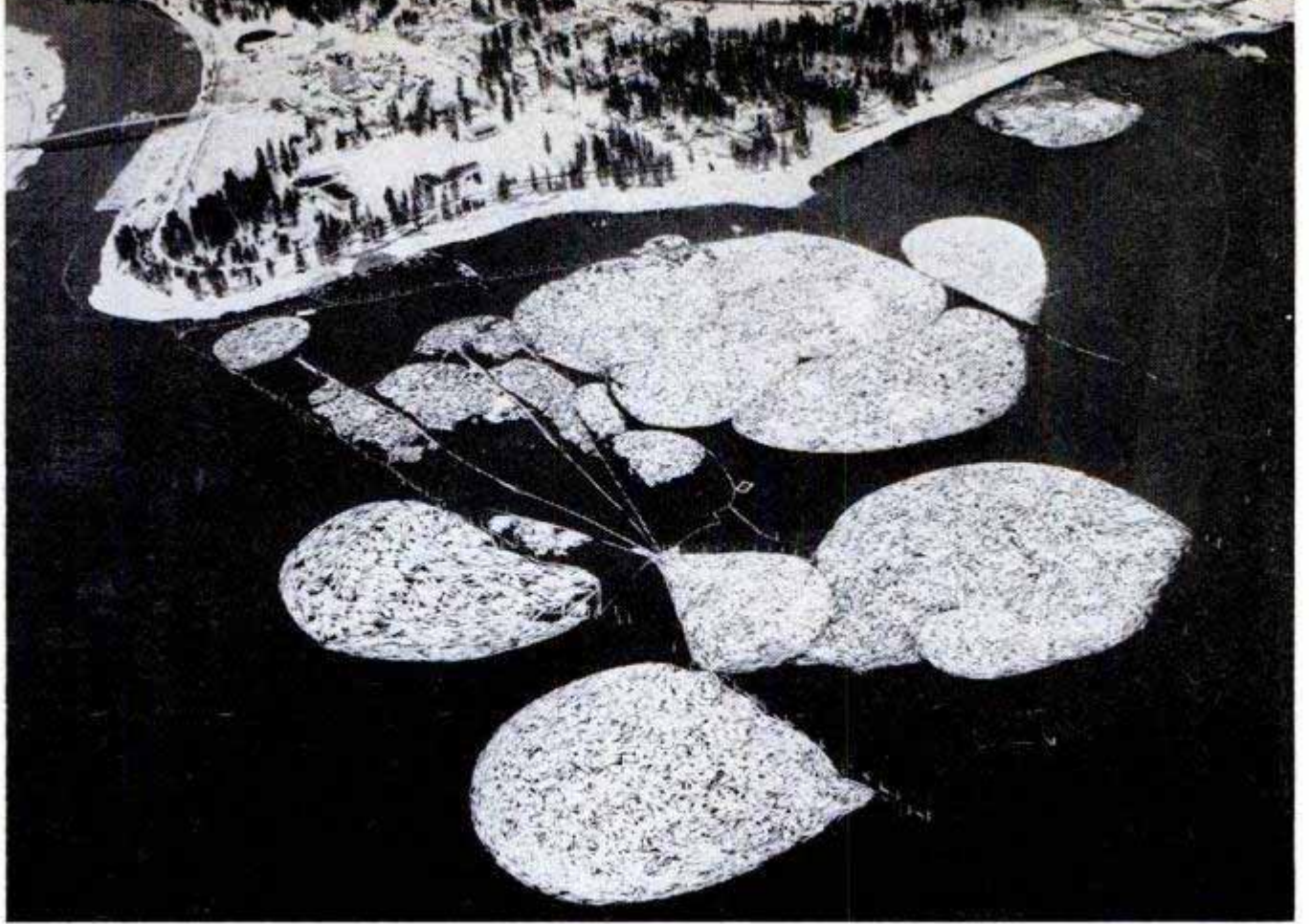

Aerial Photos Aid Log Counters

Aerial photographs of a manmade log jam on Lake Coeur d'Alene, Idaho, enabled loggers to take a January inventory while seated around a hot stove. Ordinarily, each log would have to be measured by men walking about on the wet, icy, bobbing timber. Instead, a photographer was sent aloft to take aerial

shots of each boom. Ten percent of the logs were measured by hand to get an average. Scalers then huddled around enlarged photographs, counted the logs and multiplied the total by the board-foot average. Above is shown the captive timber, encircled by nooses of cable. Below is a close-up of 6005 logs





Keller cocks the lever and Sureshot fires the ball at the basket. Inset, he follows up for the rebound, too!

WHO SAYS ANIMALS ARE DUMB?

By Clifford B. Hicks

THE AVERAGE VISITOR to the little farm near Hot Springs, Ark., comes away with his head spinning and the feeling he's walked out of another world. After watching chickens play baseball and rabbits shoot baskets, he's ready to swear that psychologists Keller and Marian Breland could very easily teach a cow to jump over the moon.

The Breland system of animal training through scientific reinforcement is deceptively simple and surprisingly effective. The two psychologists use no punishment in any form. They simply "reinforce" the

animal or bird by rewarding it with food for any random movement that even suggests the goal of the training. All their "students" are well fed—the feed simply is rationed out over the training period.

Two hilarious examples of this type of training are Casey-at-the-Bat and Sureshot.

Casey (there are about 125 Casey chickens across the country now belting home runs) is conditioned to peck at a rubber-covered wire loop. To begin the training, Keller reinforces the chicken with a few grains of feed whenever she even wanders close to the loop. Soon she associates the

loop with the feed, and he waits until she pecks at the ring before giving her any more reinforcement. As soon as she absorbs this basic idea, he puts her on the floor next to the "diamond"—a slanted board much like a pinball game, with humorous baseball figures spotted strategically about the playing field. Attached to the lower end of the board is a child's baseball bat, actuated by a solenoid.

When Casey is placed near the diamond, she struts over to the batter's box, braces her feet and jerks on the rubber-covered ring. This touches off the solenoid, which swings the bat against a rubber baseball. If it's a poor hit, or a "fowl," the ball strikes one of the figures, then rolls back down to the batting position. If it's a well-hit liner, it zips right past all the players and strikes a tripping bar on the outfield fence. Bzzzt, grain drops, Casey scrambles for her reinforcement, then struts back to bat again.

The training itself is simple: all the Brelands have to do is condition Casey to pull the ring and the mechanism does the rest. But the behavior patterns which develop in the chicken are fascinating. Casey gradually begins to throw "body English" into her line drives. The moment she swings the bat she runs alongside the board, peering anxiously at the ball as it moves between the players, leaning this way and that to "help" it around them. When one of the players stops the ball, she dashes desperately back to bat. One of the Caseys, while I was watching, rapped out a solid liner that shot past all the players but one. The center fielder made a spectacular stop. It made Casey so mad she leaped to the top of the board and pecked the ball on up to the outfield fence!



Assistant teaches cat to high-jump. Bit of liver is placed on platform, which is raised each time Tabby reaches it. Another method is to tie a bit of liver on a string, hang it from ceiling, and swing it like a pendulum. When cat gets liver, string is raised

Favorite stunt of this rooster is to pull the trigger of a popgun, spraying powder over the audience

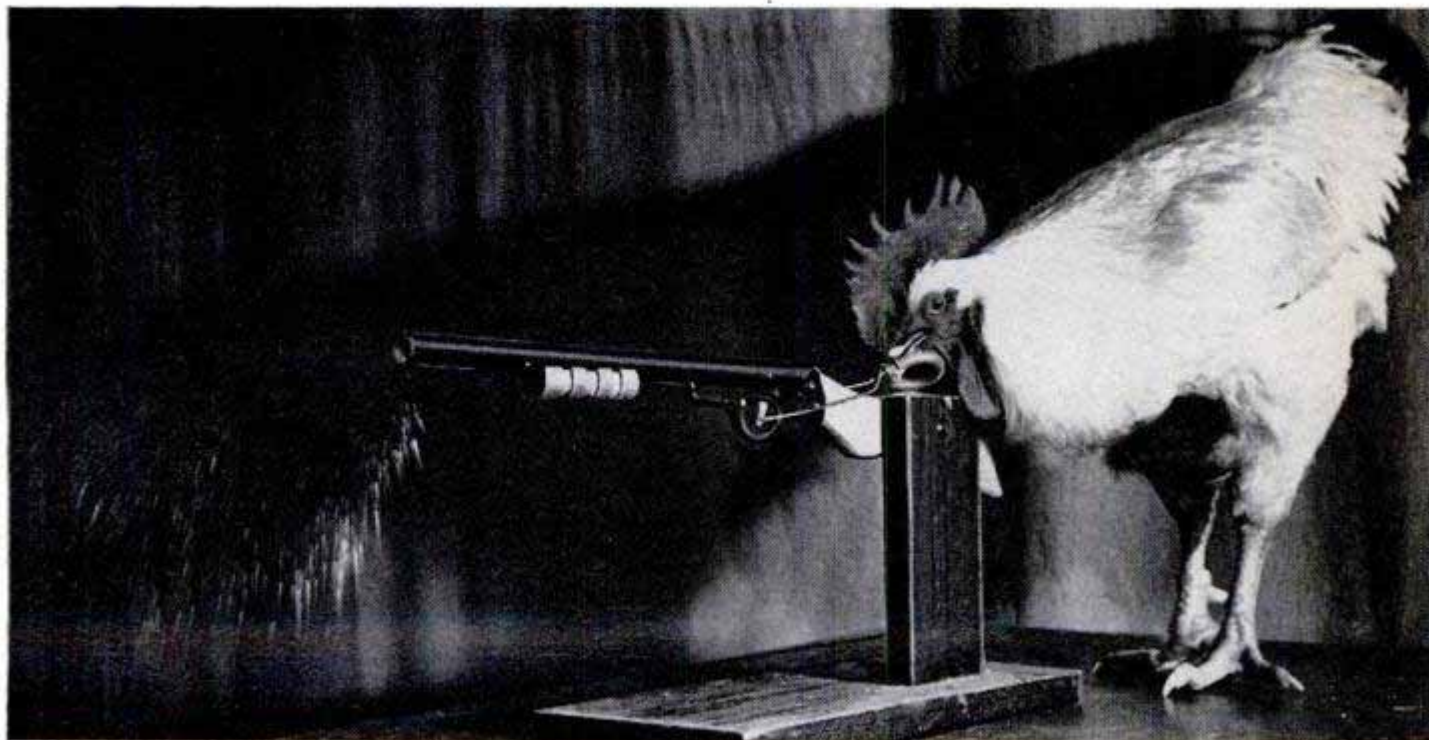

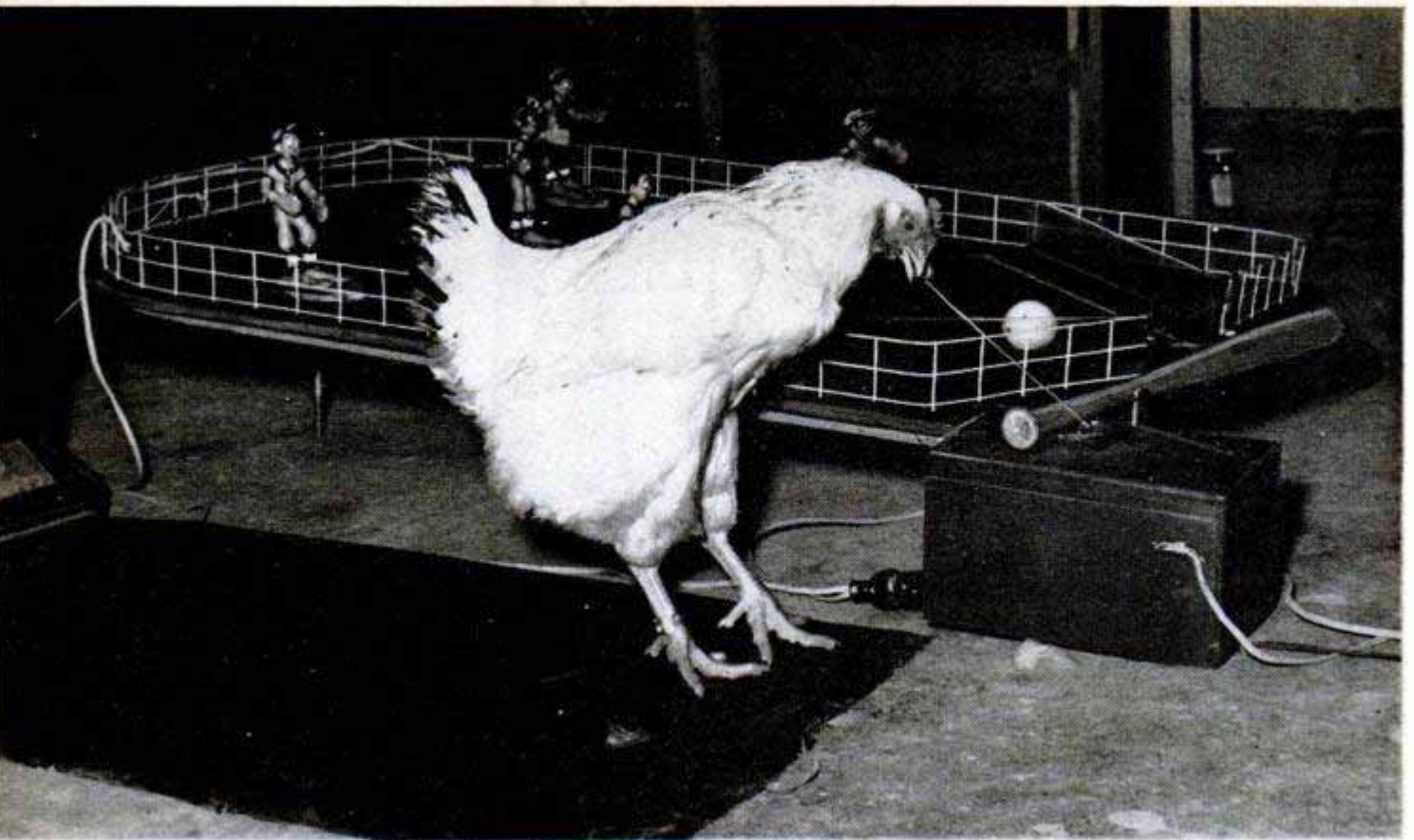

There'll be joy in Mudville tonight, for the mighty Casey slams out another homer, then claims "his" reward

"Putty" poses on teetering chair. He'll perch here without flicking a muscle for minutes until released
Jack and Jill Studio photo



It's an amazing sight to see half a dozen Caseys lined up on the floor, all training feverishly for the big leagues. If you walk out of the room and return a few minutes later, you'll find them all as intent on their batting techniques as they were when you left.

Casey is an automatic act—the audience merely watches the spectacle. On the other hand, Sureshot, the basketball-playing rabbit, is touched off by the spectator, who places a little ball in a socket and pushes back a lever. When Sureshot hears the click of the cocked lever he hops happily over, grabs the tip with his teeth and gives a strong tug. A spring snaps and the ball arches high into the air with Sureshot watching anxiously. If the ball strikes the backboard and drops through the basket, a buzzer sounds and he gets his reinforcement. If the ball misses the basket, he waits impatiently for someone to recock the lever so he can try again.

One of the most remarkable of all the birds is the chicken that plays the old-time pea-and-shell game. The exhibitor places three walnut shells, a pea and the hen on a table. He shuffles the pea and the walnuts about, his hands moving so fast that every spectator is utterly confused as to the location of the pea. When he stops, the hen walks regally over, looks at the three shells for a moment, then decisively pecks one of them. Invariably the pea is under the shell.

The trick? Through a period of intensive

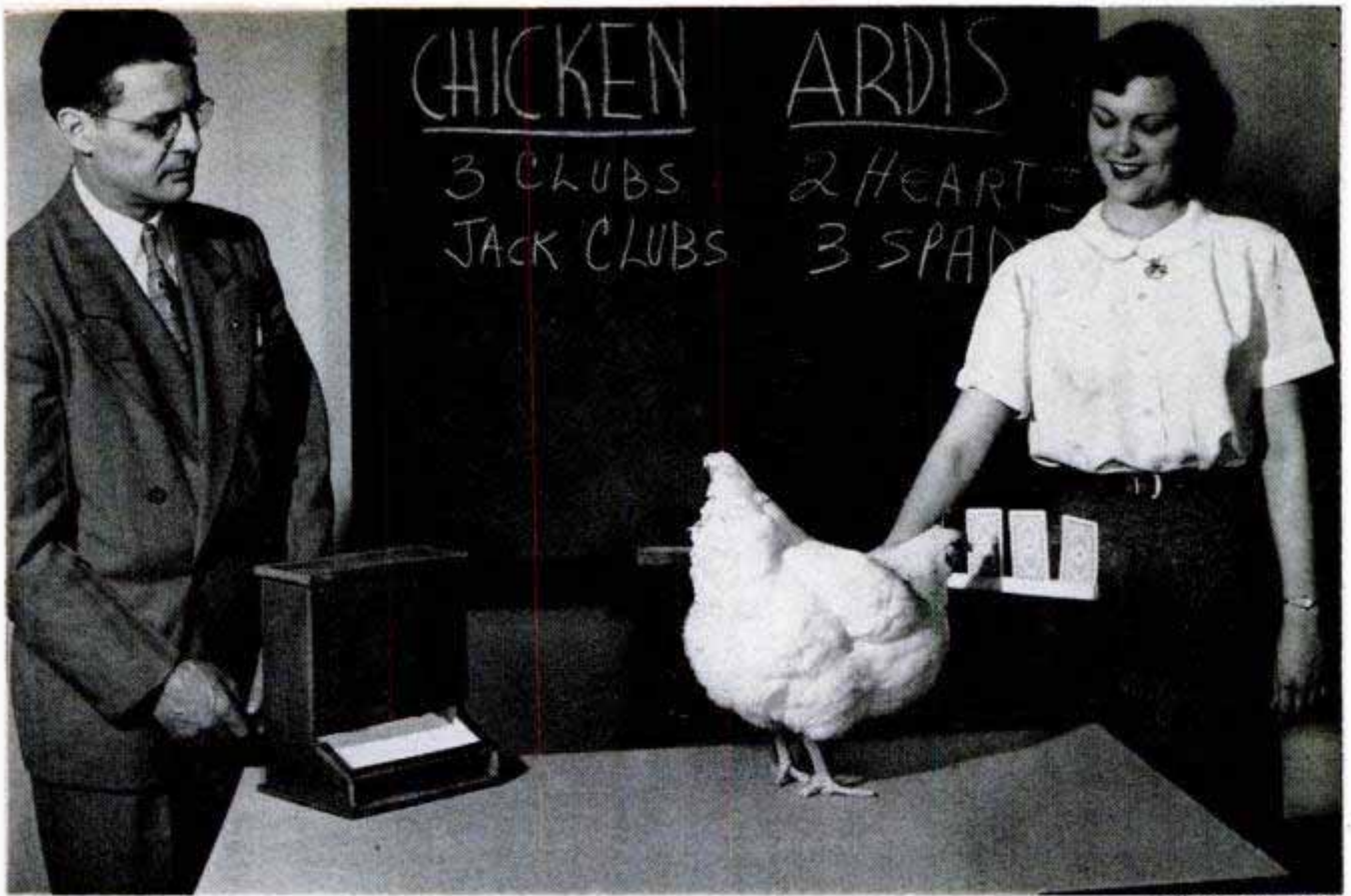

General Mills photo

Clucking cardsharp carefully selects one card from three held by opponent, who takes her choice of the remaining two. Each player ends up with a poker hand, and hen invariably wins. The trick? Brelands won't tell

reinforcement and "localization" the Brelands actually have taught the chicken to distinguish the wrinkle pattern on one of the shells. All the handler must do is make sure the pea comes to rest under the key shell, regardless of the position of that shell in the line.

A somewhat similar and even more mystifying trick is the poker-playing hen. This remarkable fowl is placed on a table and a volunteer from the audience is escorted to the stage. Three cards then are placed in a wooden rack, which is held so the volunteer can see the faces of the cards but the hen can see only the backs. Because of this "unfair advantage" the chicken is given first choice, and pecks at one of the cards. This is removed and the volunteer selects his card. The procedure is repeated until both hen and volunteer have full poker hands. Invariably the chicken wins.

The mysterious part of this trick is that no signals pass between the handler and the hen, and no one can detect any marks on the cards, which can be inserted at random in the holder by the volunteer himself. It's such an effective trick that the Bre-

lands, usually very open about their training methods, refuse to divulge the secret. Meanwhile, humans are losing a lot of poker hands to fowls when you consider that there are 50 of these clucking card sharps roaming the countryside with feed salesmen.

Although training by reinforcement—immediate and positive—is the major method the Brelands use, they may occasionally employ what they call "inhibition of

Patriotic duck beats drum incessantly until rewarded. Brelands have trained several fowls to put on complete half-hour shows by themselves

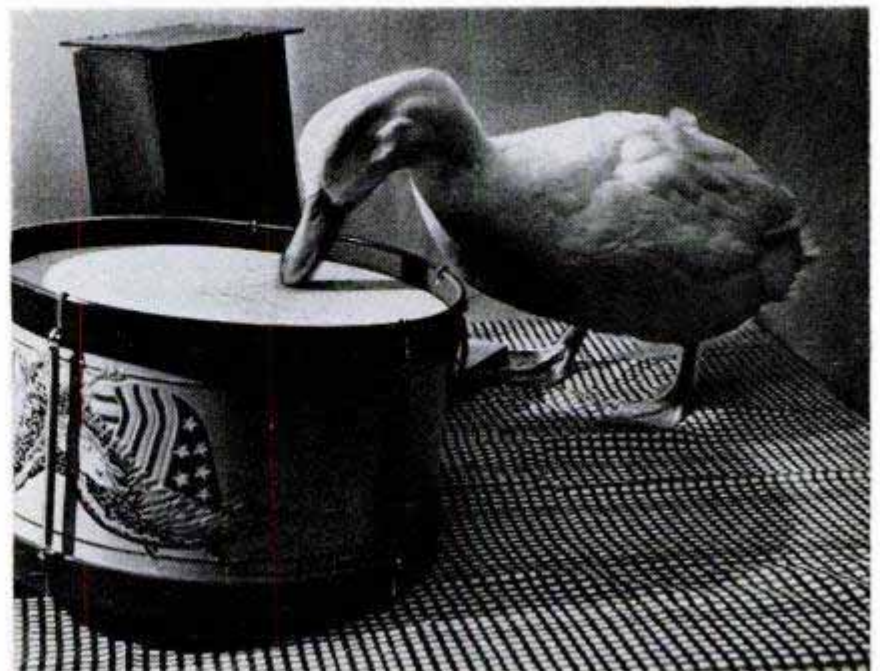



Brelands' daughter conditions chicks to tiny rubber rings. Chicks then will be given away to children who "fish" them out of bowl

Mathematical wizard solves problems chalked on blackboard by pecking arrow to correct answer. Breland helps a little, of course!



response" to train an animal to do a particular trick. "Putty," their own mongrel farm dog, is a ludicrous example of this technique. You can mold Putty into any weird position—both front feet over his neck, one eye closed, hind legs shooting out at wild angles and tail arched over his back—and he'll stay motionless for as long as you like. One favorite trick is to prop him on his nose in the corner with his tail pointing straight as a gun barrel toward the ceiling, and leave him there for a couple of minutes.

"Anyone can teach a dog to be a Putty, and it's quite easy if the dog is one of the hunting breeds," states Keller. "Hunting dogs have an innate tendency to 'freeze.'"

He makes the training sound simple. "Just before starting each training period, show affection for the dog. Otherwise he may not like the training period and eventually may refuse to come when you call. After fondling the dog for a few minutes, order him to 'stay' and hold him forcibly in a sitting position for one or two seconds. Soon he'll hold the position even when you remove your hands. After he's learned to stay, insist that he

(Continued to page 222)



Douglas Aircraft Company photo

During its climb, the Skyrocket used about a ton of fuel per minute. It has a 25-foot wingspan, is just over 40 feet long

Marine Flies Rocket Plane to Altitude of Nearly 16 Miles

ASCENDING higher than man had ever been before—nearly 16 miles above the earth—Marine Lt. Col. Marion E. Carl flew a rocket-powered research plane to 83,235 feet above the California desert. It bettered the previous mark by more than a mile. The record will not be recognized as official by the Federation Aeronautique Internationale, since present rules require the aircraft to take off under its own power. Col. Carl's plane, the Douglas Skyrocket, was released from the belly of a Superfort at 35,000 feet in order to economize on fuel. Carl climbed at an ever-increasing angle that reached 40 degrees when his fuel supply was exhausted at 75,000 feet. The craft's momentum carried it on up to 83,235 feet in about five seconds. Col. Carl took about 10 minutes to glide down, landing dead-stick at about 150 miles per hour. The pressurized Skyrocket also holds the unofficial speed record of 1238 miles per hour.

Pressure suit worn by Col. Carl inflates automatically if the cockpit pressure system fails

Department of Defense photo

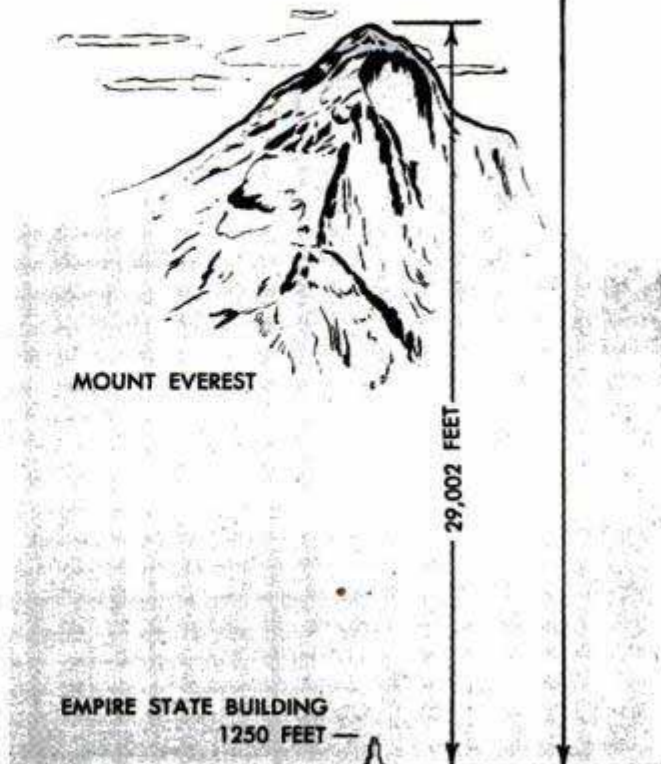

83,235 FEET

Portable Garage With "Buggy Top" Doors Shelters Army Vehicles

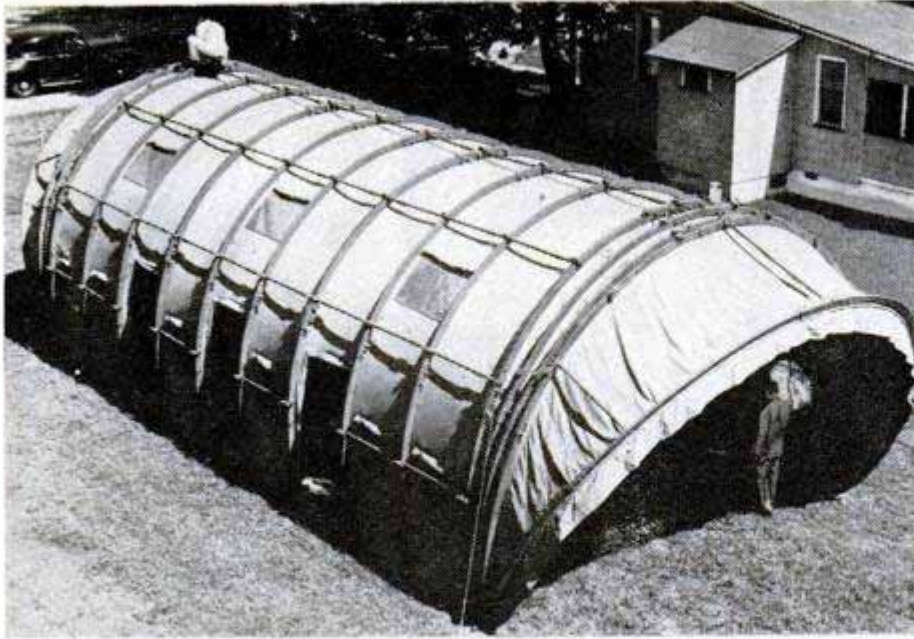

Big enough to accommodate the largest tank or truck, a portable garage developed for the Army protects vehicles and crews in the field during repair work. The shelter, resembling a Quonset hut, is 66 feet long, 21 feet wide and 15 feet high at the center. Arches made of magnesium alloy form the framework to which a canvas cover is fastened. The covering has plastic skylights, portholes and zippered doors. At each end is a unique "buggy top" door.

Model Airliner's "Venetian Blind" Wings Permit Vertical Take-Off

With wings resembling Venetian blinds, tomorrow's airliner may take off straight up and yet not be a helicopter. A model being studied by the National Advisory Committee for Aeronautics has multiple wings that can be tilted to the rear for take-off, then straightened for forward flight. The engines and propellers, mounted at the leading edge of one of the wings, will not tilt with the wing.

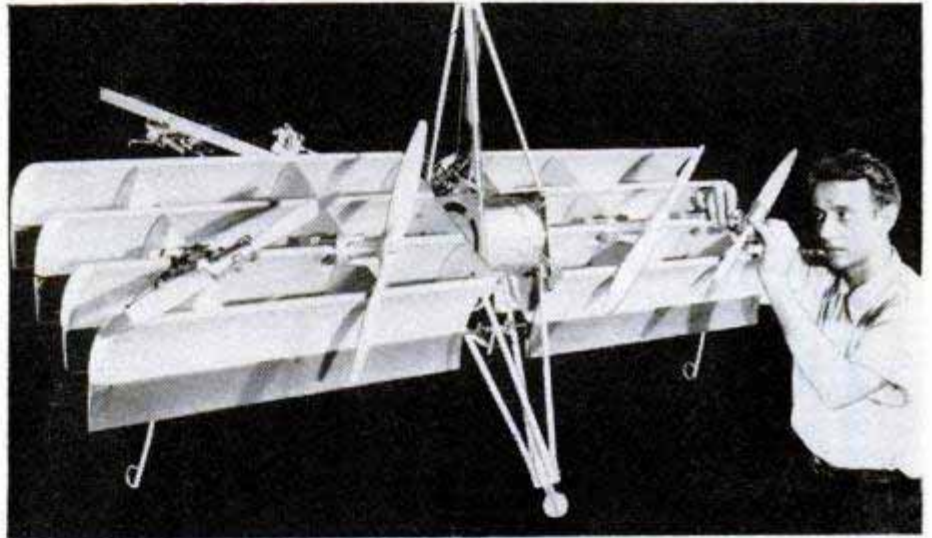

Hinged Blade of Snow Shovel Adapts to Shoveling or Pushing

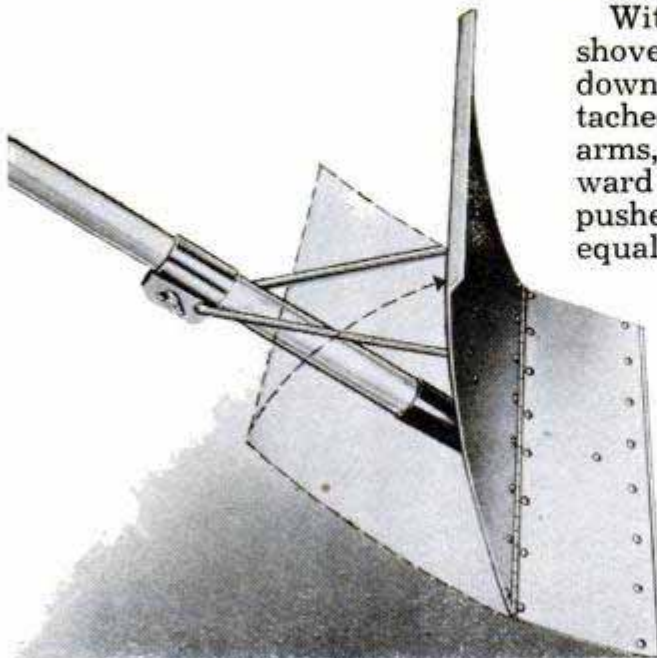

With a simple, quick adjustment, a versatile snow shovel is converted into a snow pusher. By moving down a wing-nut collar on the handle, which is attached to the back of the blade by two supporting arms, the upper two-thirds of the blade moves forward on a piano hinge to become an efficient snow pusher. Converting the pusher back to a shovel is equally simple.

Chemical Toughens Cotton Fibers

Cotton fibers are fortified against mildew and bacteria by a new chemical treatment that also gives them greater strength after exposure to wet and dry heat. The basic chemical, acrylonitrile, is also an important ingredient in fibers such as Orlon, Dynel, Acrilan and X-51. Additional treatments have given yarns and fibers extra "stretch" and greater resistance to scuffing.



Los Angeles Times photo

Sections of pipe 12 feet high await their addition to Los Angeles' storm-drain system—the world's largest

SUBWAYS for a CITY'S FLOODS

By Robert H. Forbes

AT THE GENERAL election that swept Ike into the White House, citizens of metropolitan Los Angeles put themselves in hock to float \$179,000,000 worth of bonds, final results of which hardly any of them will ever see! The whopping bond issue was required for additions to their area's network of modern underground "cata-

combs"—some as large as subway tunnels. Already the underground river system is the largest in the world.

What is more, the catacombs will be badly needed only at two or three-year intervals, for they are buried storm sewers designed to carry away infrequent but torrential rains.

During the big 1938 flood many motorists were trapped. Some took it less gracefully than this newspaper man

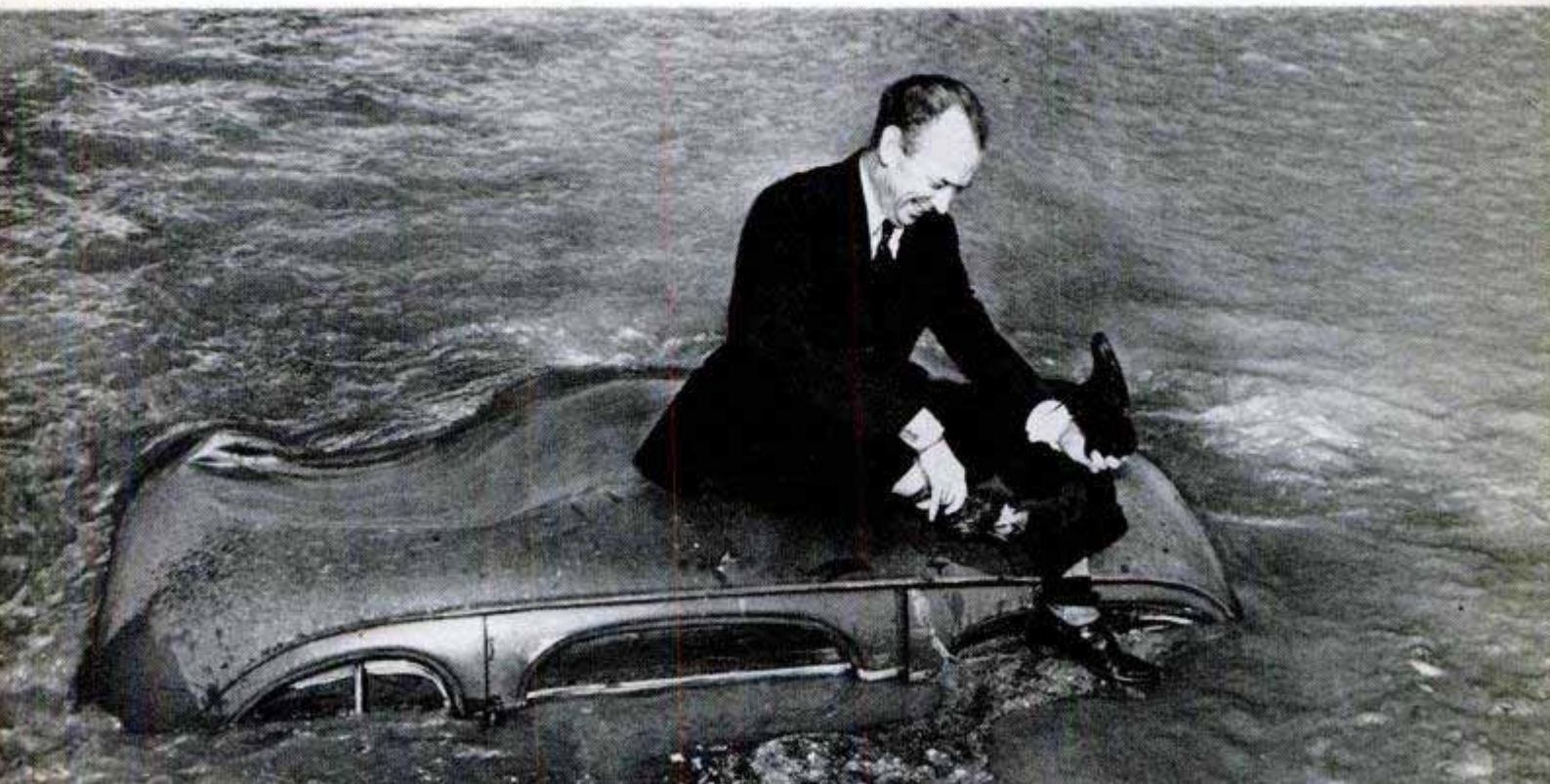



Villain of motion picture *He Walked by Night* sought refuge after his movie crimes in Los Angeles sewers

Record-breaking rainfalls have washed the mountains overlooking the city. One world's record was established at Opid's Camp, just behind famed Mount Wilson, where 1.02 inches of rain fell in one minute.

Camp LeRoy, in the Santa Anita Canyon, holds a United States' record for 24-hour precipitation; over 26 inches of water pelted down there in one day of January 1942. During the record-breaking downpour in the canyon, a total of more than 37 inches of water fell on the camp in three days.

Rain from such record showers spills over into the city, too. Streets become awash with water curb-deep. People who build homes in the picture-postcard Los Angeles highlands may find their residences washed downhill or covered with water-borne debris.

The skies over Los Angeles opened up to unload a few years of rain all at once in March 1938. The torrent taxed the partially completed system of drains in one section with a discharge rate of 99,000 cubic feet per second at the Pacific Coast Highway and Los Angeles River. The cascade of water at this point was equal to 6480 gasoline tank cars per minute spilled in the usually dry river.

Imagine the drenching for the whole city!

Workman removes slurry from densely compacted concrete pipe resulting from centrifugal spinning process
American Pipe and Construction Co. photo

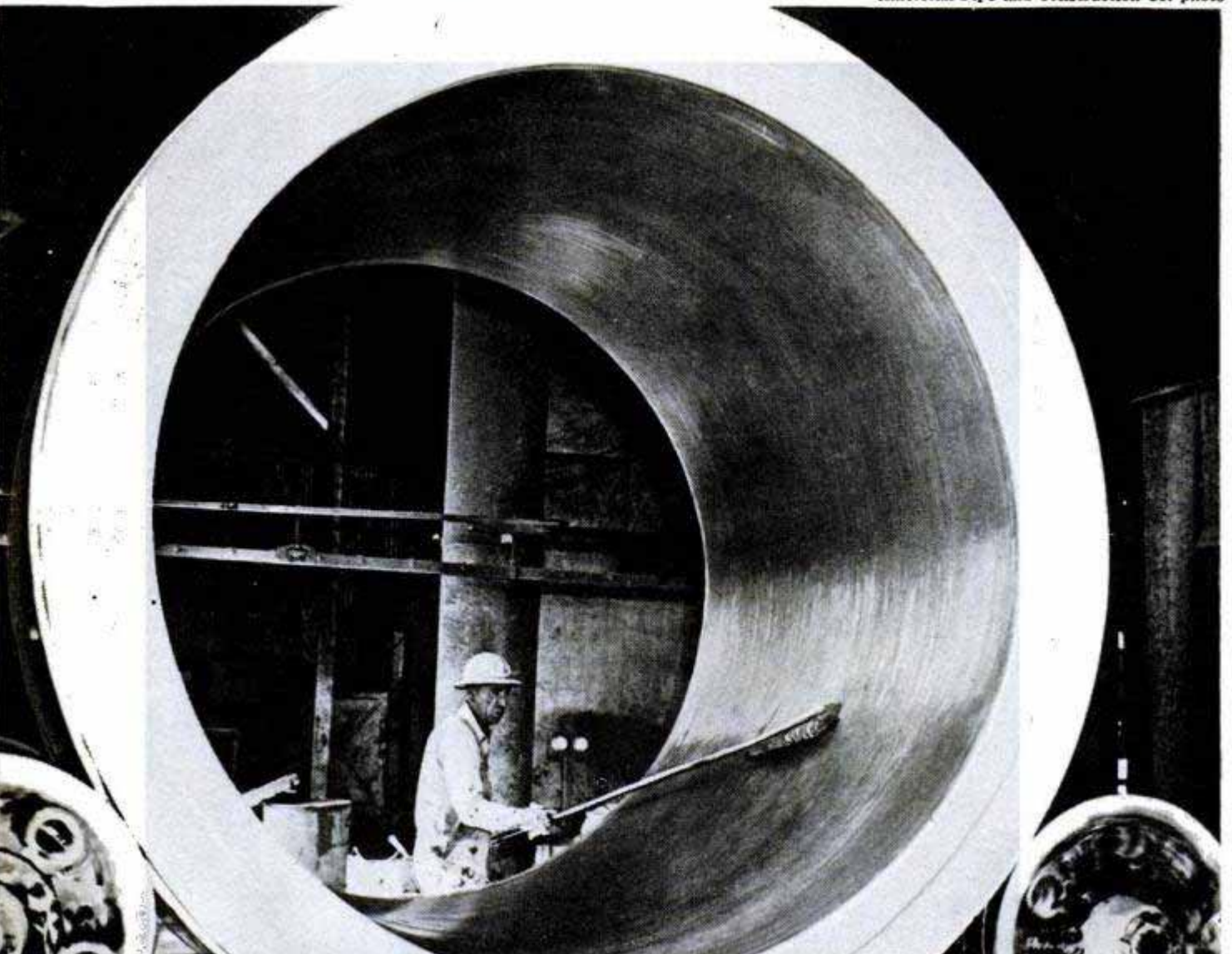

Storm sewers, although not everywhere in sufficient numbers, are under every part of Los Angeles and most of its county's 44 other mainland communities. Drains total thousands of miles in length, according to George Hartley, engineer of the county storm-drain division.

Huge Los Angeles, although nineteenth in the world population, is second only to London in area. The British metropolis spreads over 693 square miles and greater Los Angeles is next with 451 square miles. New York City and environs cover only 319 square miles.

Los Angeles' storm-drain network might appear to be ideal for bomb shelters, since reinforced concrete has proved to be good protection against atomic explosions. But an investigating commission's report to city engineer Lloyd Aldrich pointed out major drawbacks. The drains are not deep enough to offer much protection. They might also be brimming with water at a critical time, the biggest objection. If reservoir dams around the city are broken by bombs, the storm drains would quickly flood and, if the drains were full of refugees, a calamity would result.

Larger sewers are not such bad places

for human habitation, however. Hoboes have a summer resort in the Los Angeles River ends of many drains. But knights of the road usually have to find "jungles" elsewhere in the winter months when southern California might suffer a cloudburst.

When a Hollywood movie producer discovered the catacombs beneath his feet, he filmed a cops-and-robbers epic under a street near his studio. *He Walked By Night*, starring Richard Baseheart, was about a policeman-killing thief who fled to a storm drain after his crimes, only to reappear in a totally different part of the city and baffle detectives.

Young boys of suburban Los Angeles like to tell their less-venturesome elders about subterranean-exploration trips taken on their bikes in big storm drains. By removing the handlebars of the bicycles, the boys can lower them into the long gutter-level openings of excess-water sewers and then ride for miles under the heaviest traffic. When it's time to come out, they somehow take the correct turns and head their wheels toward the river, where the tunnels end. The idea is not recommended. The authorities say their catacombs are no place for play. ★ ★ ★

Los Angeles boys prepare to embark on a bike trip through the city's sewers—not a recommended sport

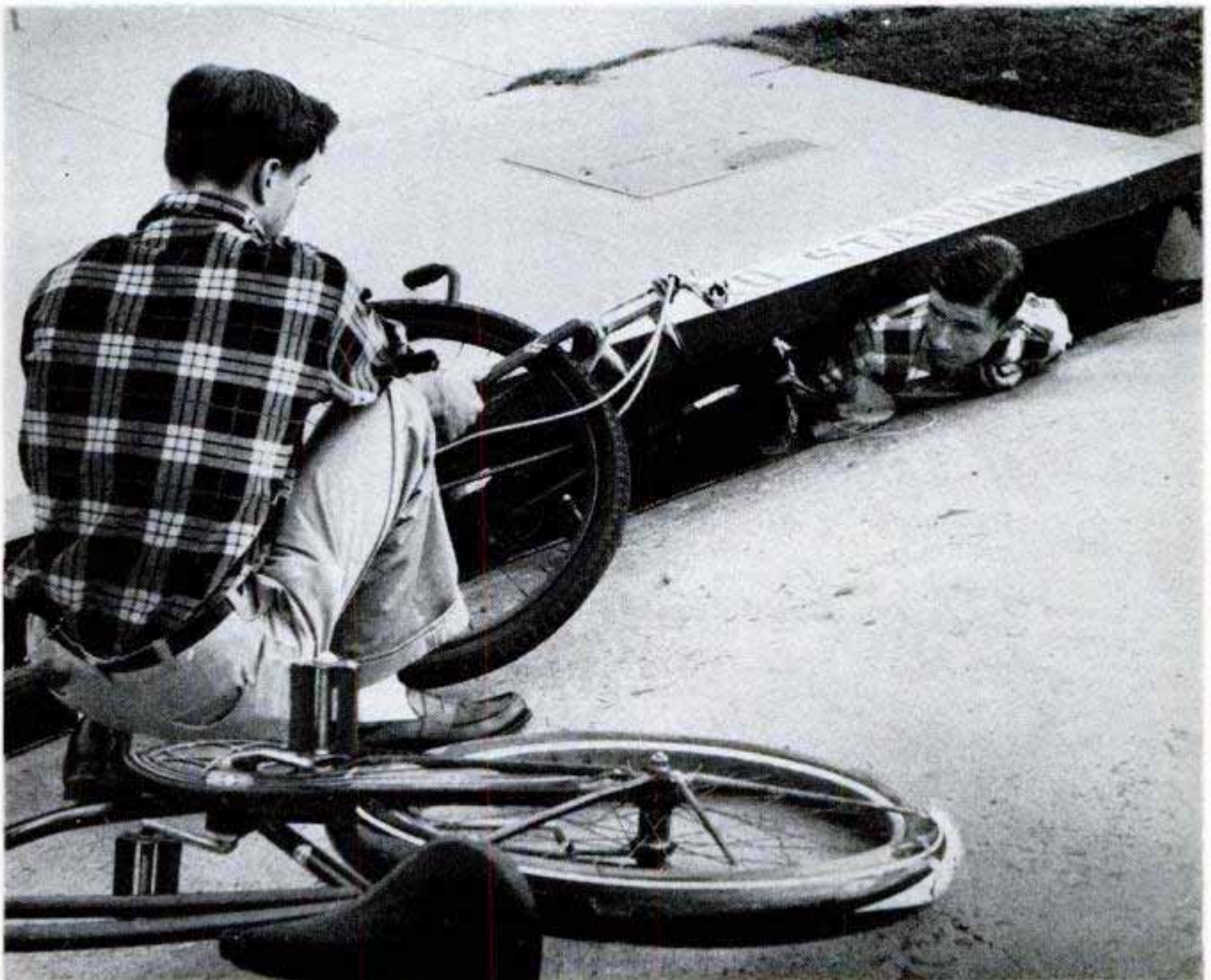



Merry-Go-Round Spins Cake for Decorator

Pastry artists now have a new tool—a motor-driven cake turntable which permits them to circle a wedding cake with loops and flowers in one continuous operation. The turntable is connected to a variable-speed motor controlled by a foot pedal. The

platform can be raised or lowered gently by using a hand-operated hydraulic lift. Seat and arm rest are adjustable, and wheels give the rig mobility. With the old method, the baker placed the cake on a Lazy Susan which was revolved by hand.

Rare Metal Germanium Harvested From Vegetables

Germanium, the rare, \$350-a-pound metal, may be harvested profitably from vegetation, according to Dr. Hans Brauchli of Johns Hopkins University. The chemist has been working on the theory that vegetation growing in certain areas where the underground water has a high germanium

content would absorb some of the metal. He has reduced such vegetation to ash and found that the germanium content is as high as five percent. This corresponds to the .001 percent found in the most promising "bonanzas" of certain coal mines today. The rare metal is used in transistors.

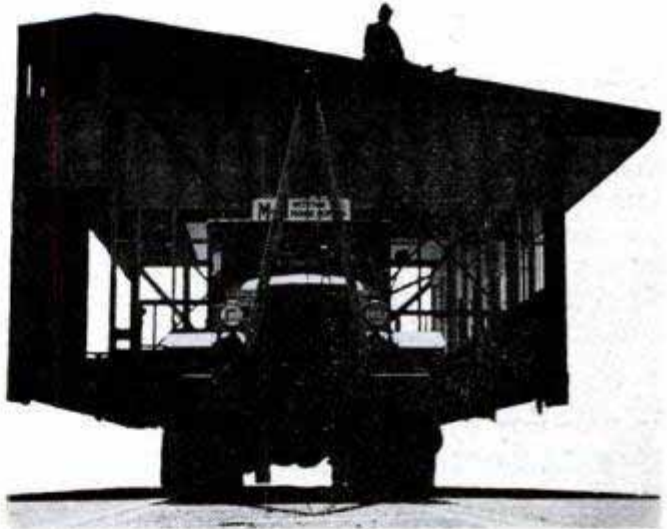

Room-a-Day Is the Story Of 59-Room Prefab Building

WHEN A California oil company wanted a 59-room office building in a hurry, it asked a maker of prefabricated homes to do the job.

Designed to be built in 38 separate sections on an assembly line, the 34,000-square-foot building was finished in 57 working days—faster than a room a day. Three sections rolled off the line every two days, completely assembled, plastered and painted—ready to be moved to the site.

As the sections were completed, they were loaded on derrick-equipped trucks and hauled to the site outside Bakersfield, Calif. None of them cracked en route from the factory in Bakersfield to the building site. Lowered in place by the derricks on the trucks, the sections were bolted together to form a building with a front 291 feet long and three arms extending 157 feet to the rear. The building provides complete facilities for drafting, filing, record storage and a paleontology laboratory.

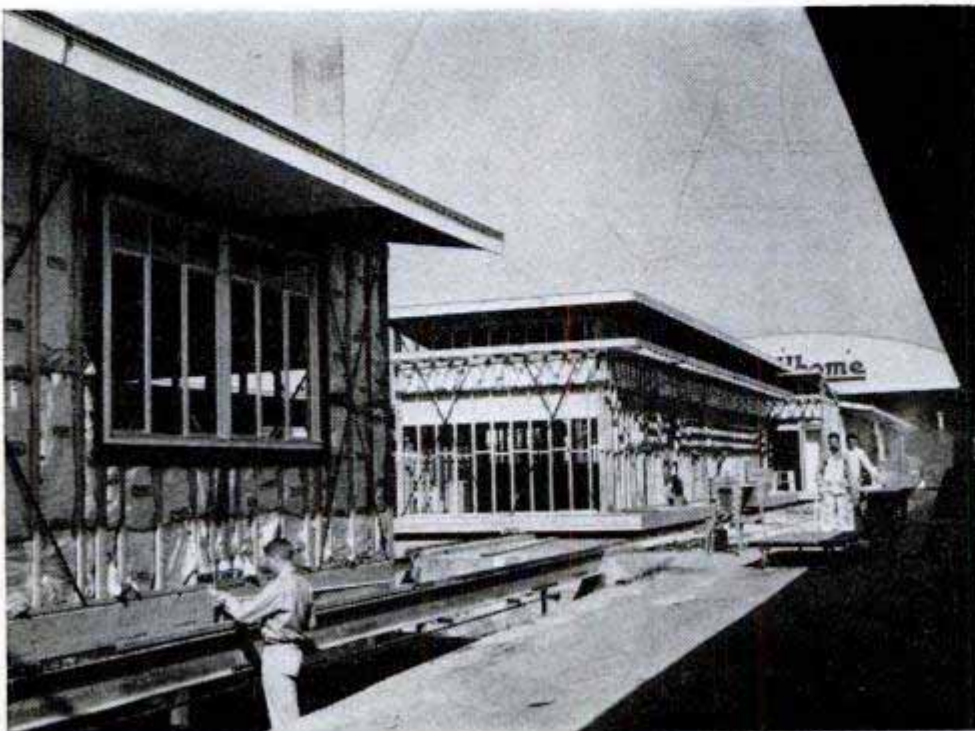

Top, 90 days after the lot was cleared, this expansive office building was ready to use. It is 291 feet long. Air photo shows over-all size and shape of the tremendous prefab building

Above, loaded on a truck, one of the 38 sections is hauled to the building site. Derricks on the truck lift the sections into position

Left, sections move along the assembly line like new cars. Three sections were finished every second day. Exterior walls are stuccoed



Vest Holds 117 Batteries To Power Walkie Talkie

Batteries operate more efficiently when warm, so the Army has developed a method of keeping their temperatures up even in subzero weather. A flexible rubber vest contains 117 pockets with a tiny dry cell in each one and when worn under a heavy overcoat it uses body heat to keep battery temperatures at a point that assures efficient operation. The batteries are the power supply for a compact portable radio designed to provide short-range, two-way communication in combat areas.



Portable Emergency Light

When Louisville, Ky., police failed to find an emergency light suited to their needs, they designed and made their own. Raised to a height of 5½ feet, the battery-powered blinker can be seen clearly by approaching drivers. The emergency lights formerly used were frequently bowled over by motorists.

Handle on Post Tightens Barbed-Wire Gate

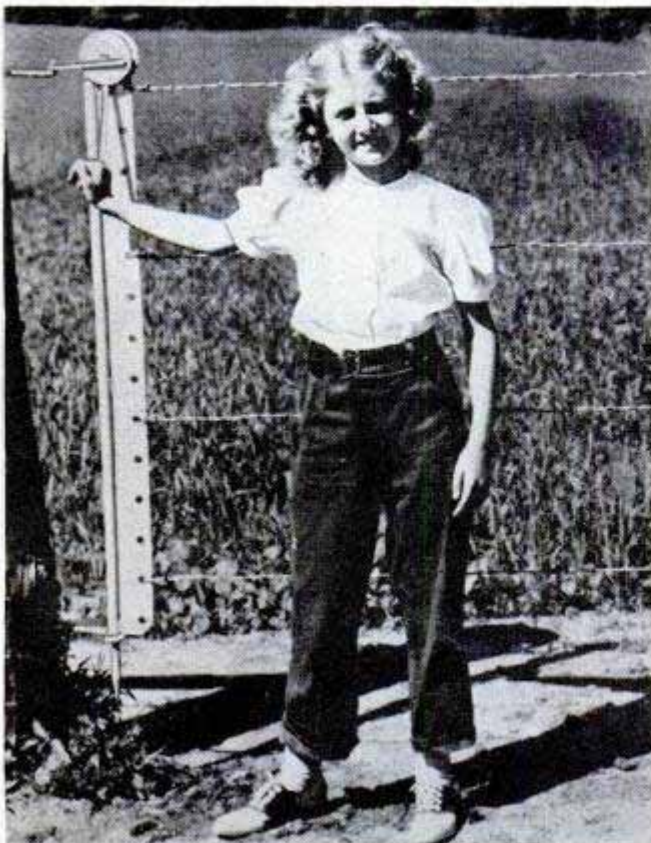

Gates made of barbed wire are kept taut, yet are opened or closed easily with a steel gatepost equipped with a tightener. Welded onto a steel stake, which is stuck into the ground to keep the gate upright when open, is a flat metal plate perforated along the edge to hold a number of wires in any position. At the top of the gatepost is a circular tightener equipped with a handle. A U-bolt pivoting off-center on the tightener wheel hooks to the anchor post and tightens the gate as the handle is pulled downward and locked in position.

Airplane Distance Finder

Pilots can pin-point their flying position within a tenth of a mile by using a new radio distance finder. A transmitter in the plane sends out impulses which are picked up by a receiver on the ground and retransmitted to the plane. A measuring circuit in the plane receiver translates the time required for the impulses to return into miles and tenths of miles. The device is effective up to 100 miles.

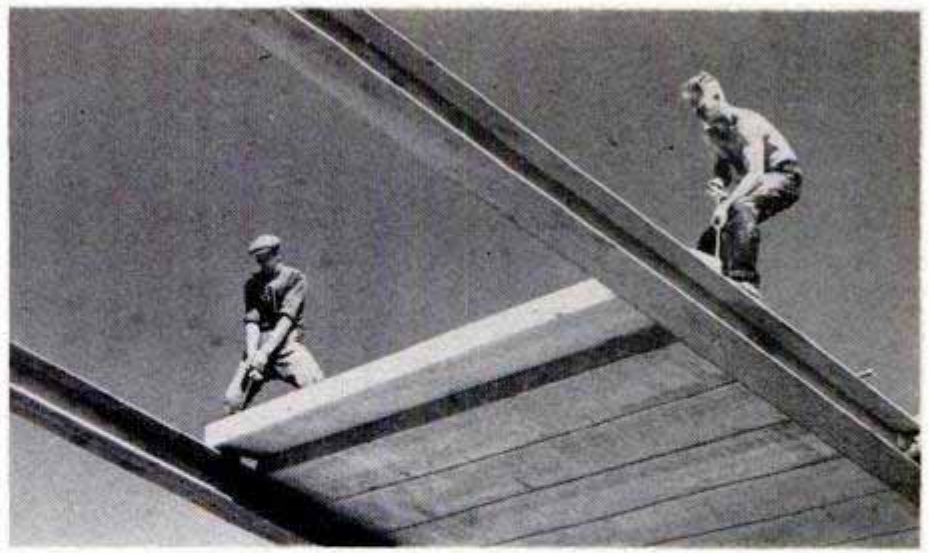

Lightweight Cooked Concrete Handles Like Wood

Cooked concrete, one-fifth as heavy as ordinary concrete, can be worked like wood. Slabs, available in 20-in widths in lengths up to 18 feet and in thicknesses from 2 to 10 inches can be cut with an axe or hatchet, sawed, drilled or nailed. Structurally strong, the slabs are self-supporting and require no insulation as they have 10 times the insulating value of concrete. Although the material is light in weight—it

floats in water—it barely warms up when exposed to flame for more than an hour. Developed in Sweden, it is used in 50 percent of all the new buildings erected there. The manufacturing process involves placing a mixture of sand, cement, aluminum powder and certain chemicals in a mold where the ingredients react chemically and rise like bread before they are placed in an oven and baked.

*Patent held by:
INTERNATIONELLA
SIPORTEX AB,*

Dry-Land Destroyer-Escort Teaches Recruits Drill Procedures

U. S. Navy photo

One of the most useful ships in the U. S. Navy has never even been afloat. It's the USS *Recruit*, a mockup destroyer-escort at the Naval Training Center in San Diego, Calif. The dry-land craft is used to teach recruits the fundamentals of mooring and the procedures to follow during drills. Measuring 221 feet long and 24 feet through the beam, the mockup has classrooms below deck.

Joshua Tree Veneer

Window-shade panels, Venetian blinds and lamp shades are now made from the translucent veneer of the Joshua tree. The veneers are produced by a special process, since the wood cannot be removed in the ordinary manner. Stained to any desired color, the veneer makes a novel covering for walls and furniture.



*ACRRLAN
GATE
79,
STC
Swe*

When we tell you some 2,000,000 Americans are living in trailers, don't assume we've become a nation of nomads. For these fancy homes may be equipped with wheels, but

Trailers are Stay-at-Homes Now

By Arthur R. Railton

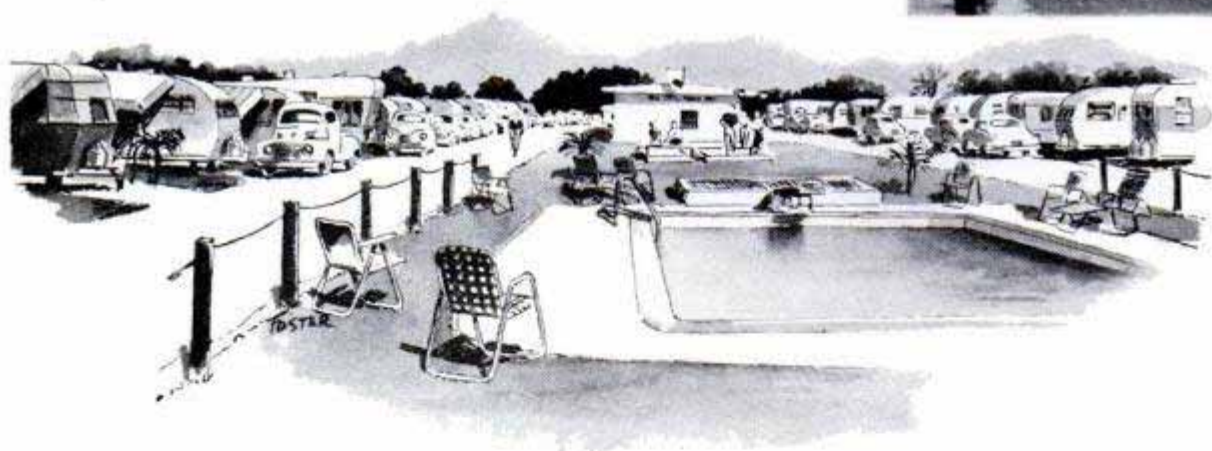
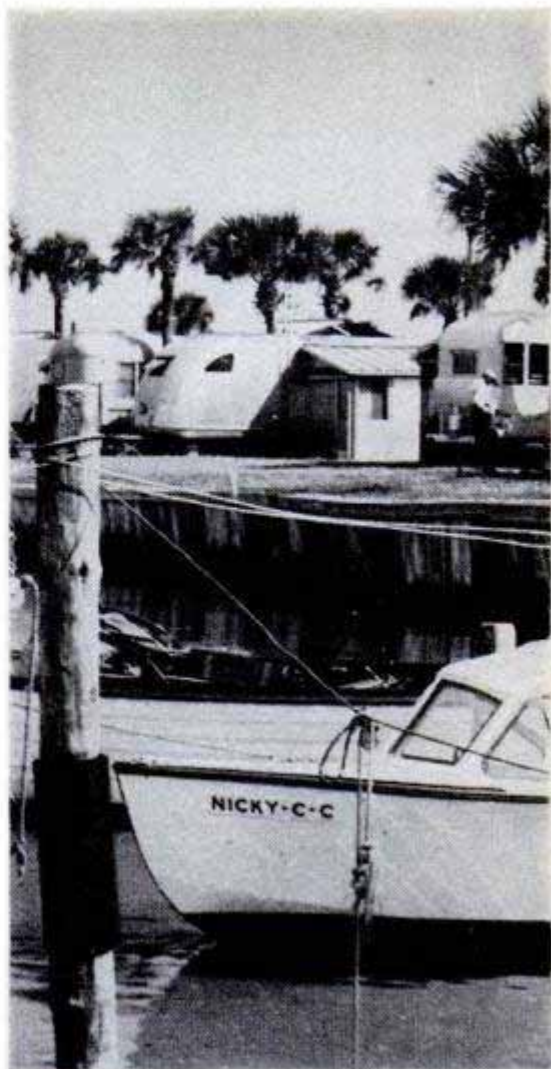

Trailer parks like beautiful Squaw Peak at Phoenix, Ariz., provide such luxuries as private swimming pools

TRAILERS DON'T TRAIL so often these days. Diluted is the gypsy blood once so much a part of trailer living. Trailerites stay put most of the time, moving only once or twice a year, if at all.

While trailers have lost some agility, they have taken on comforts. They have become more like homes, less like caravans. In fact, recent years have brought so many changes that about the only item an old "tin-can tourist" would recognize is the hitch—and even that is different.

They even have a new name. Now they are mobile homes—homes on wheels with everything the anchored-to-the-ground house has except open space.

To find out about trailer life, *Popular Mechanics* assigned the writer, his wife and two small sons to live in one for a couple of weeks. It was our first taste of trailer life.

We moved into a huge, handsome Liberty 41-footer with two bedrooms. It was in one of Florida's best known parks: the Parsley Trailer Park on the Gulf north of St. Petersburg. The combination of a fine trailer and a wonderful park made trailer life most inviting. We learned some things about trailer living that we had not known before. We learned enough to know that it's an utter waste of effort to feel sorry for families who live in trailers. In most cases they should be envied!

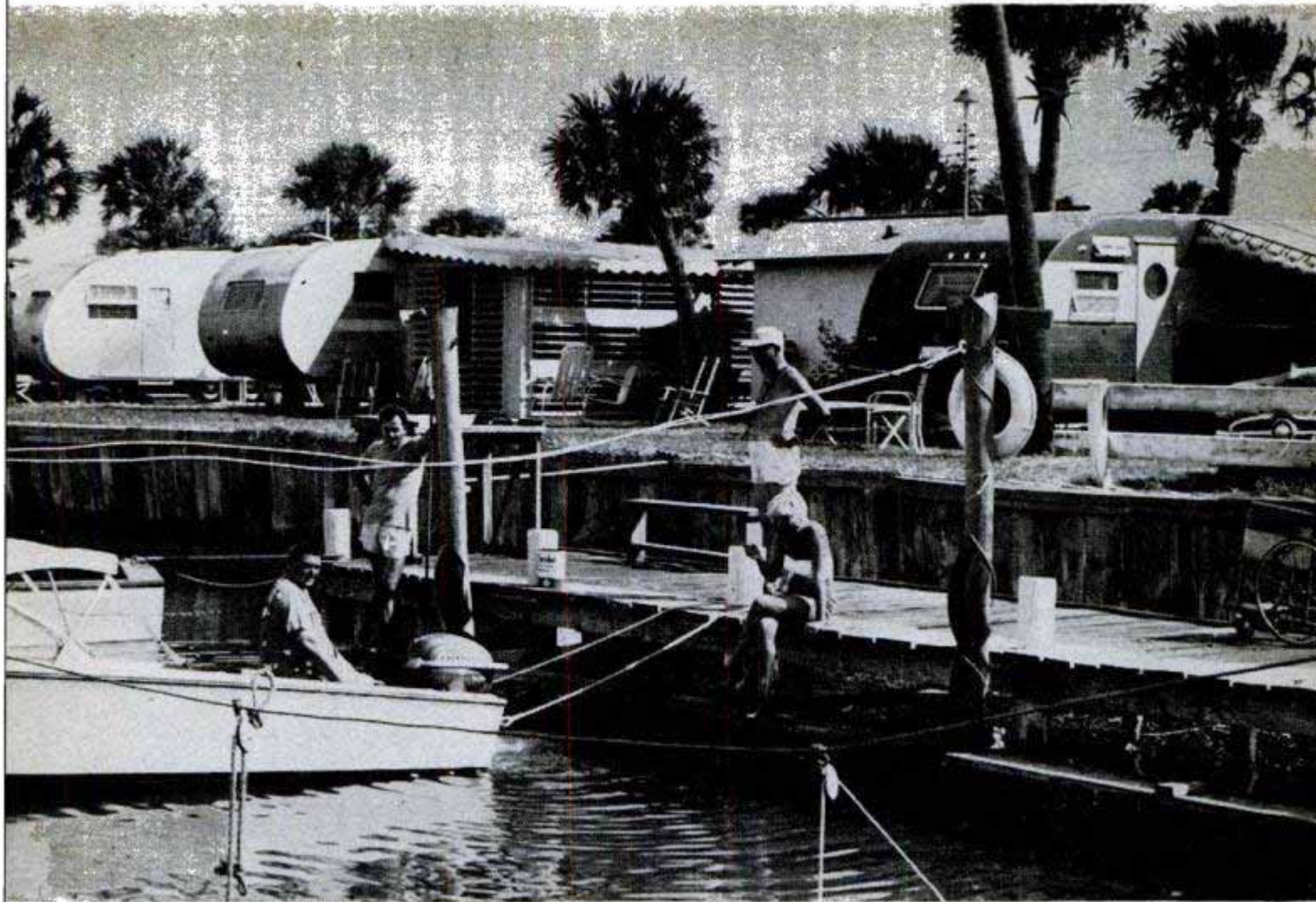

Florida has 1100 trailer parks. Parsley's, on the Gulf near St. Petersburg, is a sportsman's paradise

There are two popular misconceptions about trailer folks. The first is that they live in trailers because they can't afford to live elsewhere. The second is that they were forced into trailers by a housing shortage.

Trailerites are, on the average, a prosperous group. Their annual income is \$1100 above the national average. (We noticed plenty of Cadillacs in our trailer park!)

During and just after the war, many

families did move into trailers because of the housing shortage. But today that is not the reason for the trend toward trailer living. By the end of 1953 more than 2,000,000 persons will be living in 700,000 mobile homes in the United States. In 1952, 83,000 trailer coaches were sold at a total cost of \$320,000,000—the biggest year in the short but phenomenal life of an industry only 22 years old.

Left, a 1953 trailer has a front porch! Right, retired couples say trailer life is economical and relaxing





CABANAS

Cabanas are becoming more popular each year. Trailer can be seen at right. Below, cabana construction is usually permanent

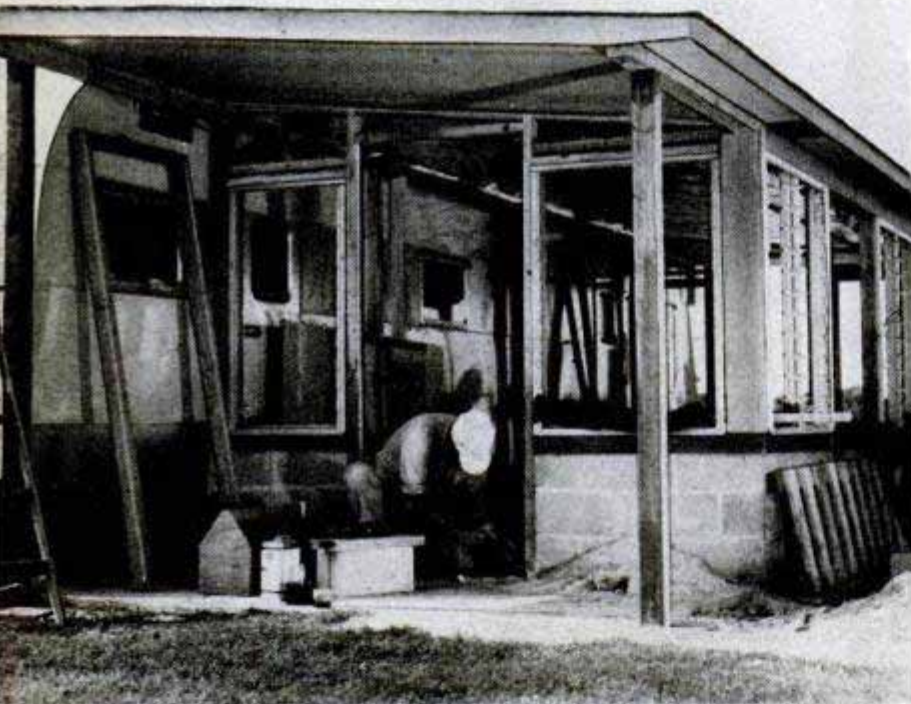

Today's trailer has one or more separate bedrooms. Although small, they are handsomely furnished as the sketch below shows

Why would anyone buy a trailer, you ask, especially when they cost up to \$6000? The principal reason is mobility, of course. This is true even though the average trailer moves rarely. The trailer owner knows that if he wants to move, it's no problem. If he wants to change jobs, he's not dissuaded by the complications of selling and buying a house, of packing and unpacking. He just hitches up his trailer and moves.

Another big reason for owning a trailer is that it involves less work for both the man and woman. Housework is a breeze. In an hour, the whole house can be cleaned. Women love trailer living for that reason. Most trailers have aluminum siding and that means no rust or paint problem. If painting is necessary, its a week-end job at most. There is no interior painting or wallpapering. Dust-collecting ledges are virtually nonexistent. All woodwork is smooth and streamlined for quick cleaning.

Economy is a big factor in trailer buying, of course. Space in the better trailer parks costs only about \$25 a month. The lush resort parks charge only \$40 or less. Utilities amount to another dollar or two. Fuel bills are small because the cubic space is small and well insulated.

Economy, too, is the big reason why retired couples are becoming trailerites in large numbers. Pensions, caught in the squeeze of inflation, go farther in a trailer. Surveys show that the annual cost of heat and upkeep is about a quarter

Children's bedrooms often have bunk beds in keeping with the ranch-house tradition

INDIAN TRAILER CORP.
122 E 63RD ST
CHICAGO

INDIAN

BEDROOMS

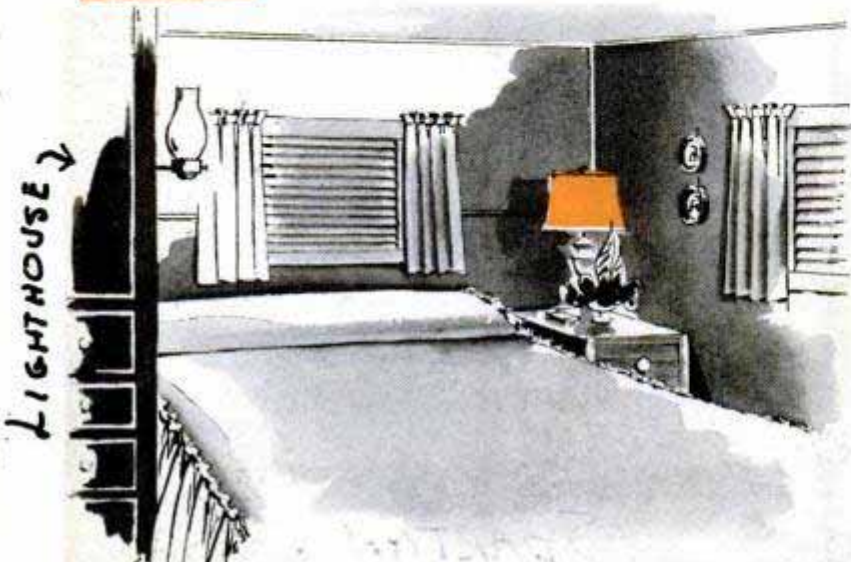

LIGHTHOUSE



of that in the usual frame house.

Yet there is more than economy responsible for the movement of retired couples into trailers. Sociability is another big factor. There is no place less lonesome than a trailer park. Everybody talks to everybody else. Everybody shares the other fellow's problems. As one man remarked: "If you don't know how to do a job, don't let that stop you. Just start it and you'll get all the advice you need."

However, some retired couples do have trouble adjusting to trailer life. There are a few difficult months while they realize that they have given up the old familiar furniture they lived with for so long. Women especially complain about this. But once they get over that hurdle, they're usually trail-erites for life. "We wouldn't go back to that big house if you gave it to us," one woman told me.

Trailer parks run organized recreational programs. There are hobby groups, movies, bingo games and dancing. Shuffleboard is the traditional trailer-park sport and the courts are busy from early morning until late at night.

Why have trailers become so popular? Why haven't they disappeared as more housing became available? The reason is obvious: They are no longer stripped-down, primitive shelters on wheels. You don't give up a thing except space when you move into a trailer.

Obviously, they are smaller than a house (although a 48-footer has almost as much room as a small home). But the space that is sacrificed is not living space—the sacrifices involve the extra room which you kept for storage, for odds-and-ends you no longer use or for getting-away-from-the-family. These spatial luxuries you have to give up in trailer living. That means, for most families, that you are forced to get rid of piles of junk you never used anyway!

If you think trailer life is primitive, answer this: Does your home have a garbage-disposal unit, an air conditioner, wall-to-wall carpeting, a completely automatic range, continuous hot water, thermostatic heating? If it does, it is not primitive. You can have all those conveniences in a trailer at a price that is lower than that of

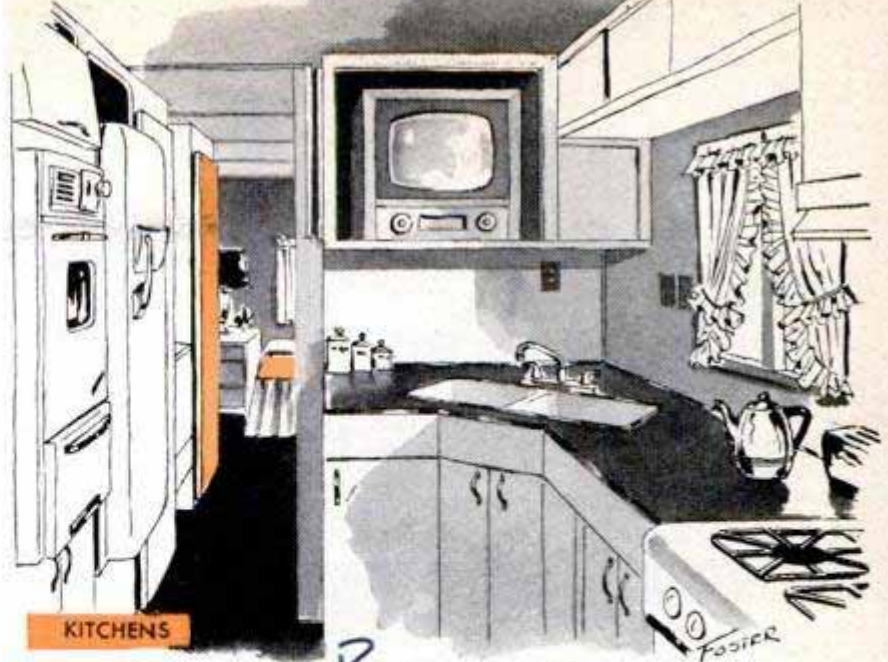

Kitchens are streamlined and some even have TV. Oven, broiler and refrigerator are built into the wall at left in this model



Above is one example of the corridor style of kitchen design, while below is a U-shaped style with work space on both sides





National's 44-footer features functional, modern Raymond Loewy design. It is all metal. Left, the 28-foot Lighthouse Duplex has an upstairs bedroom



Ventoura's two-story coach, right, is 41 feet long, 12 feet high. It has two upstairs bedrooms, one downstairs

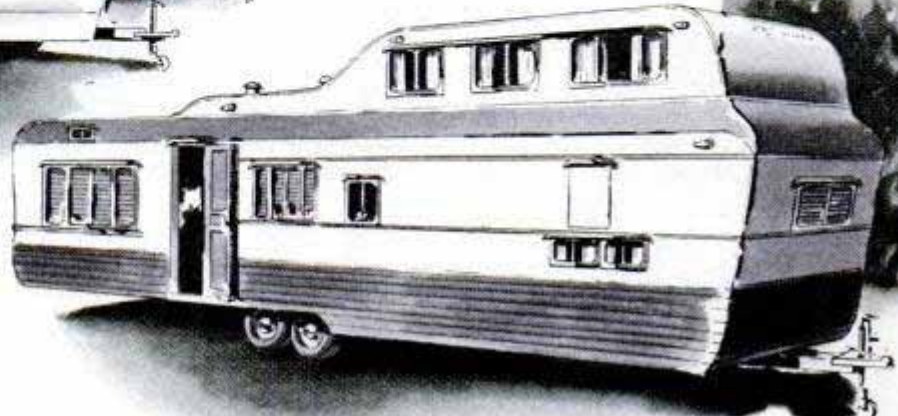

Below, Trotwood's 22-footer is easy to haul—an ideal trailer for the wanderer



Above, Spartan uses airplane methods to build a strong, streamlined trailer with large picture windows front and rear. The sides are riveted aluminum

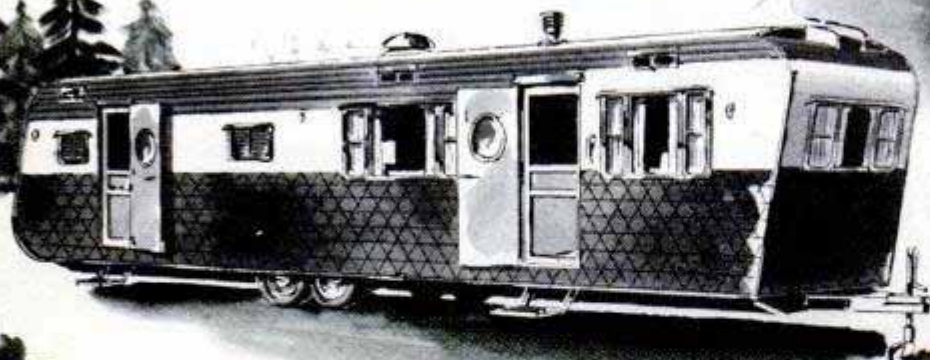

Left, a 41-foot Liberty like the one used by the author and family. It has a vented attic for better insulation. Below, the Overland Twin Liner—a 50-foot trailer that splits into two small units



FOSTER'S

many small homes today. And what is more, you get furniture as well. All you have to buy are dishes and linens and you can move right in.

Of course, you want a modern bathroom and kitchen. You get them in a trailer. The bathroom of today's trailer has a normal-size bathtub, a wash basin, a flush toilet (which may have a garbage-disposal unit incorporated in it) and a standard medicine cabinet. The kitchen has more cabinet space than the average house kitchen. It has an automatic range, a refrigerator, exhaust fans, electric water heater and streamlined sink. Some even have freezers, automatic laundries and other extras.

Trailer heating is another field where improvements have been made. Forced hot-air heat is standard. Fresh air is brought into the trailer from the outside and heated before being discharged into the rooms. The air inside is always fresh even if the windows are kept shut. Heating ducts run under the floor, warming it so that it is comfortable to your bare feet in winter and also adding a radiant-heating effect.

In summer, the insulated roof and sidewalls keep the trailer as cool as the average house. There is

Column at right shows a representative group of floor plans. Below, cutaway of double-deck, three-bedroom Ventura trailer

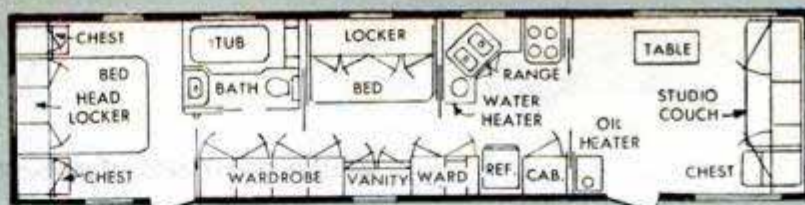

Liberty's 41-footer uses the conventional two-bedroom layout

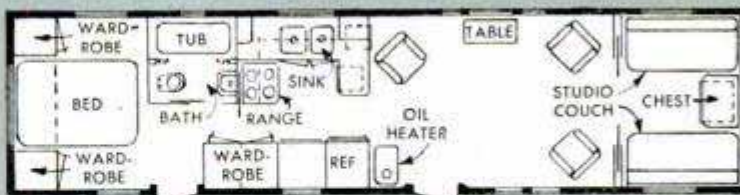

Prairie Schooner builds a 37-footer with a bedroom at each end

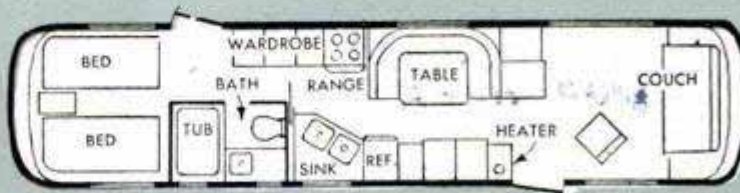

Spartan's twin-bedroom 37-footer has a big dinette, roomy bath

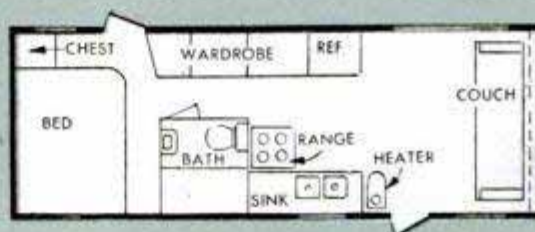

Stewart's compact 27-footer trailer has a full bath, one bedroom



Boles-Aero 22-foot travel trailer uses shower stall as bathroom



Tour-It's 15-foot model is compact, designed for vacation trips

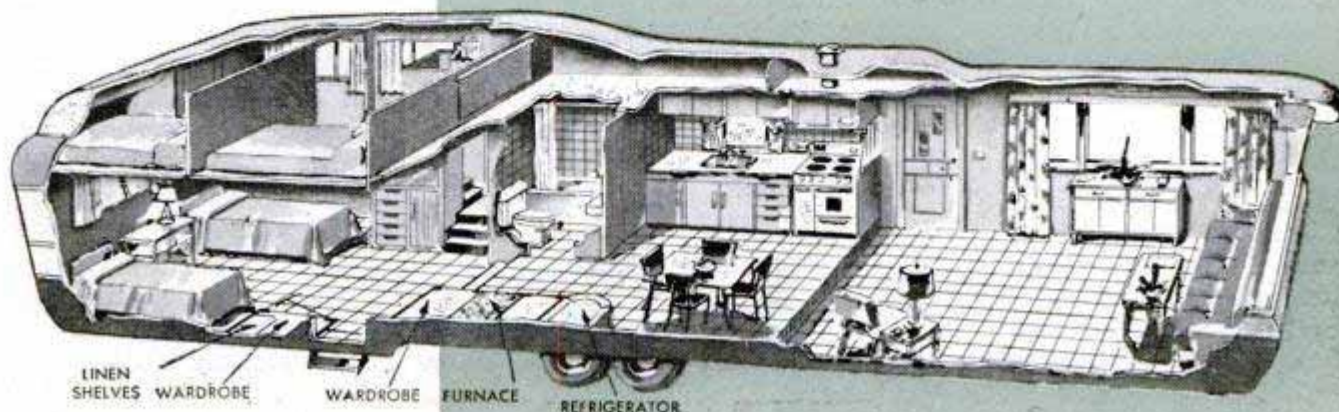



DINETTES

Duo 43-2

Dinettes are getting increased attention in mobile homes these days. Eating in the living room is on the way out. These four examples show how manufacturers are providing adequate dining space in and near the kitchen



SEYMOUR PLATT

cross ventilation in every room and the slightest breeze keeps you comfortable. If you park your trailer where it is extremely hot, you can air condition it at a fraction of the cost of air conditioning a standard house. In some models, the air conditioners are built into the furniture. In others, the units are mounted on the roof or window.

Living rooms are as handsome as those in the newest homes. The only way they differ is in width. All are a standard eight feet wide. Some run up to almost 20 feet long. Wall-to-wall carpeting is common. Built-in television sets are also popular this year. Picture windows are standard and in parks like Parsley Park in Florida there is good reason for having such a window.

There once was a time in trailer history when the living room doubled as a bedroom and dining room. You opened a studio couch and went to bed. In the morning you pulled a table out of the wall and ate breakfast, all in the same room. It's different to-

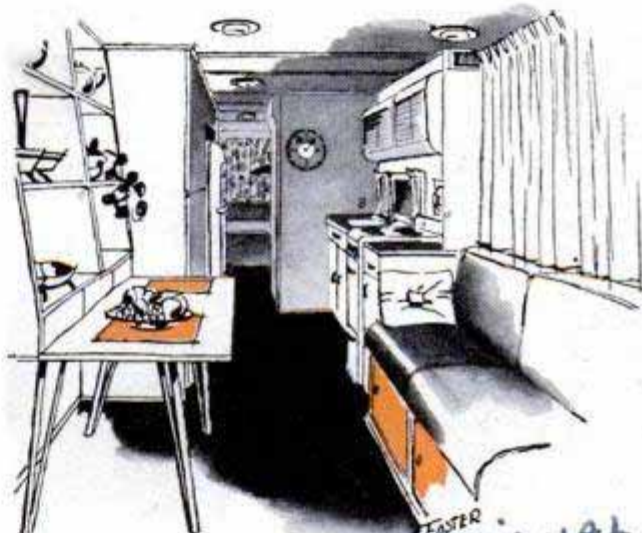

NATIONAL

day. Trailers still have sofa beds, but they are usually reserved for guests. Normal today is a large master bedroom with a full-size double bed. Many trailers have second bedrooms, some even have a third.

Dining alcoves, rooms or built-in breakfast nooks are standard in most models now.

Just about essential for the permanent trailer dweller is a nonmobile room called a cabana. This can be lush or modest. It is a large, enclosed room built adjacent to the trailer. When you leave, you sell it to the trailer-park operator who rents or sells it to the next customer. Some of them are put together with bolts and can be taken down when you move and set up at the next stop.

The cabana is the social room of the trailer. Cooking, eating, bathing and sleeping are done inside, but entertaining and relaxing are done in the cabana.

What about pulling a trailer over the

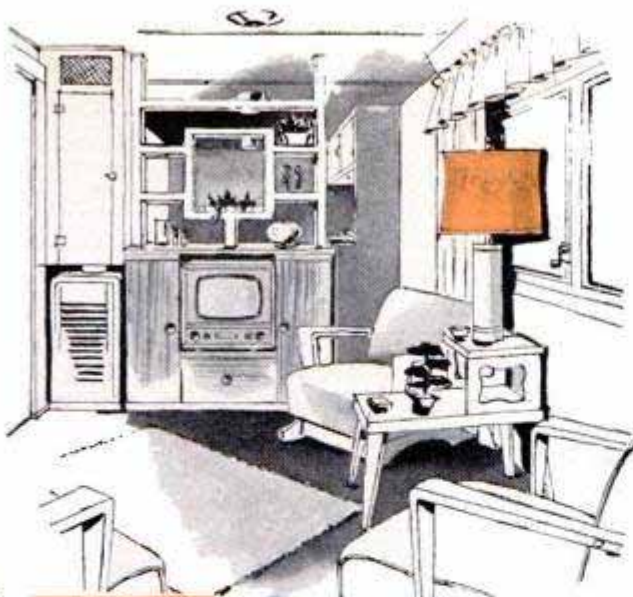

LIVING ROOMS

PLATT-?



1607 WOOD CHALET 21 FT.

Living-room designs are fairly standard. The eight-foot width limits furniture arrangement. The sofa is usually placed across the front end. Built-in television is common. Accordion walls are an innovation

SCHULTZ CORP.
1830 SO. MAIN, BURLINGTON, VT.



SCHULTZ

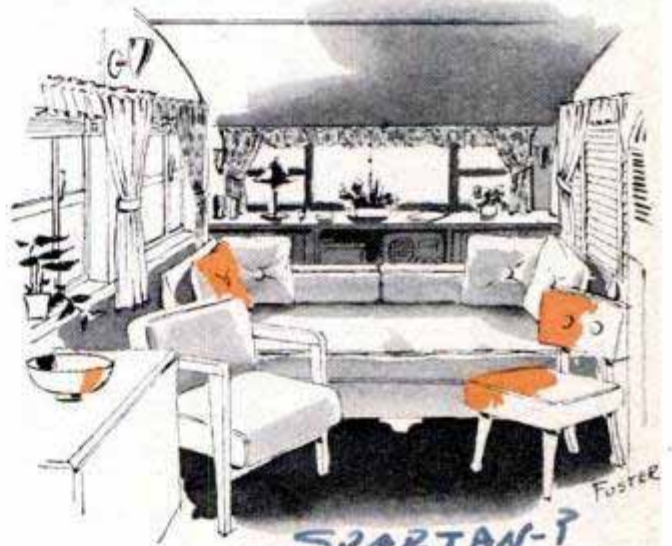

SPARTAN-?

Below, trailers became real homes when the bathroom was added. Here, the bath is alongside the bedroom

highway? Aren't these 40-foot "monsters" as hard to handle as a freight car? Owners say not. After you have been towing one for a few hours, you almost forget it is behind you. Or, if you wish, you can forget it completely and hire a hauling company to pick up the trailer, pull it to your next stop and set it up ready for you to arrive at your leisure. You don't even have to own a car to be a trailerite today!

If you intend to spend a lot of time on the highway with your trailer, you'll do well to consider a small, vacation model. These come in sizes from 12-footers up to 22-footers. They are not mobile homes—they are camps on wheels. Usually they have no bathrooms, but all the other conveniences are there.

One trailer manufacturer has found a novel solution to the problem of the vacation trailer. He builds a trailer in two sections. At your home location you couple

(Continued to page 230)



BATHROOM

PEERLESS MFG. CO.
4300 BLUFFSON RD.
- WATKINS -

Oversize Camera Produces Large Photograph in One Minute



Weighing 40 pounds, a huge working model of the Polaroid Land camera makes a 9 by 8-inch photograph in one minute. Built to use the 20-exposure roll film developed for Air Force aerial photography, the oversize camera is for exhibition purposes only. The same type of film and developing system is used as on the smaller model after which it was patterned. Carefully scaled up from its smaller counterpart, the camera measures 20½ inches high and 11½ inches wide. The film develops within the camera as it advances through the self-contained chemicals to emerge as a positive print.

V-Shape "Boat" Puts Concrete Lining Into Irrigation Trenches

Irrigation ditches are lined with concrete by a V-shape "boat" which lays and packs a uniform coating of concrete as it is pulled through the trench. The ditch is presized with a V ditcher, the boat's hopper filled with concrete from a truck mixer, and the lining process begins. As the boat moves along, it packs the concrete tightly against the earthen banks to form an efficient and easily cleaned waterway. By raising or lowering the guides along the sides of the boat, different-size ditches are lined. The resulting trenches reduce seepage which builds up the surface water table.



Wire Winder Operates Off Tractor Tires

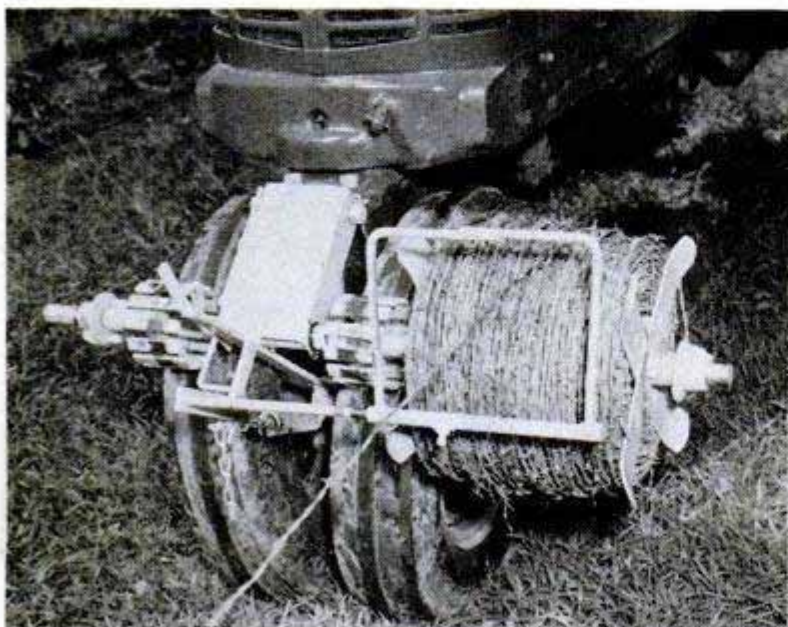

With a tractor attachment, a farmer can roll up or unroll fence wire. Handling either barbed or smooth wire, the winder has drive spools which are held by a spring against the tractor tires to maintain tension on the wire at all times. The farmer always drives the tractor forward, regardless of whether he is picking up or unwinding the wire. Available in styles to fit most tractors, the winder can be mounted on either the right or left side of the wheel. It will lay out or pick up as much as 80 rods of wire in three minutes. An antibacklash brake prevents the wire from snarling or kinking as it is handled.

Wide-Screen 16-mm Movies

NOW YOU CAN HAVE wide-screen 16-MM movies with stereophonic sound in your living room, rumpus room, schoolroom or church. A single anamorphic or "squeeze" lens attachment, photo A, is used for both shooting and projecting the movies.

The projected picture, photo B, is of normal brilliance picture and fills a curved screen 2.5 times as wide as it is high. This expanse covers more nearly the normal field of vision of the human eye. The peripheral, or side, as well as the "straight ahead" vision of the viewer is brought into play, and a strong sense of depth and participation in the scene is created without the use of special glasses. The illusion is further heightened by three dimensional, or stereophonic sound, which emanates from the part of the screen where the action takes place.

This Bell & Howell 16-mm. system is also intended for use in making industrial films. Diagram Fig. 1, illustrates how the "squeezed" picture spreads out during projection as it passes through the lens attachment, photo A.

To produce stereophonic sound, Fig. 2, a modified version of this firm's model 202 magnetic recording projector is used to record the magnetic sound tracks and project the film. Two different sound tracks are recorded side by side on a single strip of magnetic material bonded to the edge of the film. The sound is then played back through separate amplifier-speaker systems located at opposite ends of the curved screen.

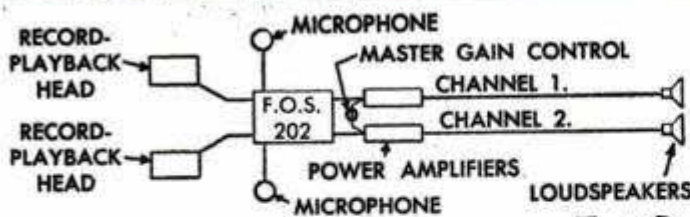
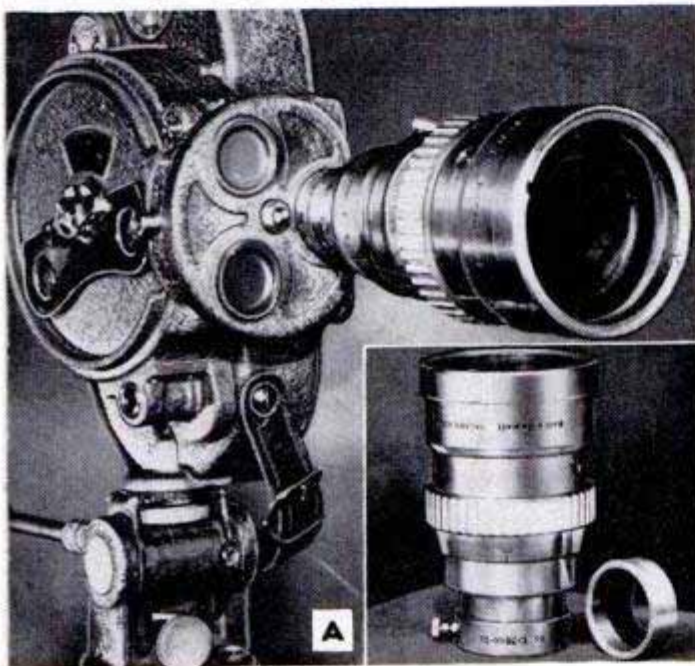
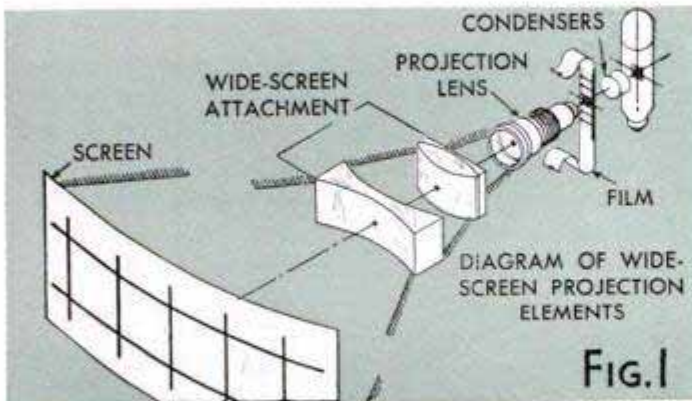

BLOCK DIAGRAM—PROPOSED STEREOPHONIC SOUND SYSTEM

FIG. 2

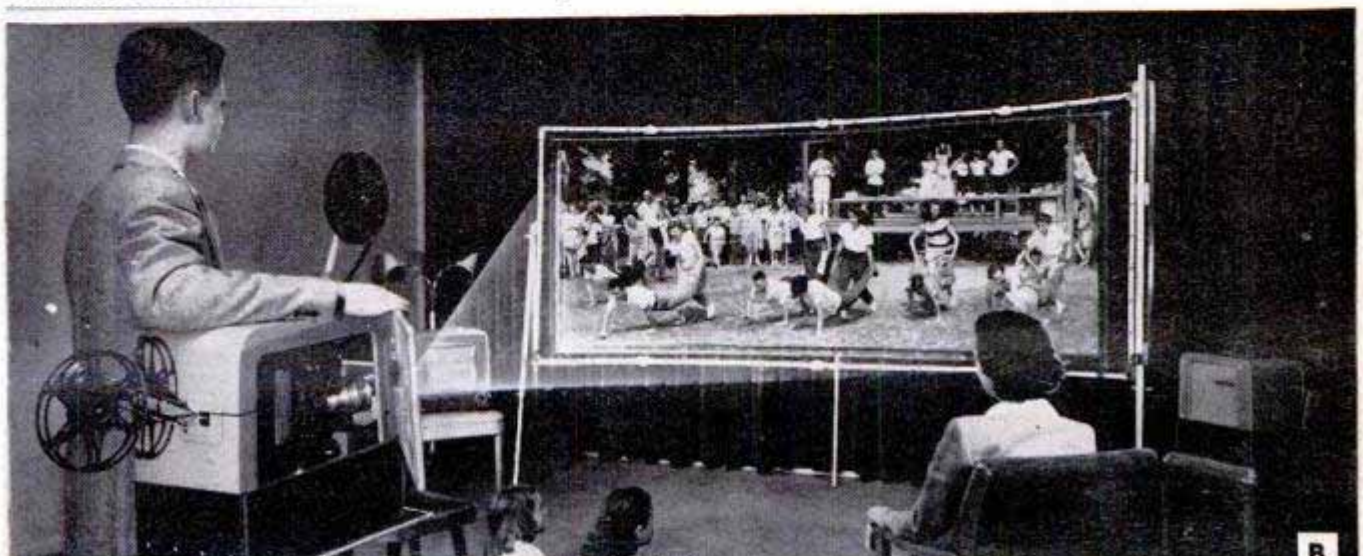

ONE-TUBE LOUDSPEAKER SET

By Lothar Stern

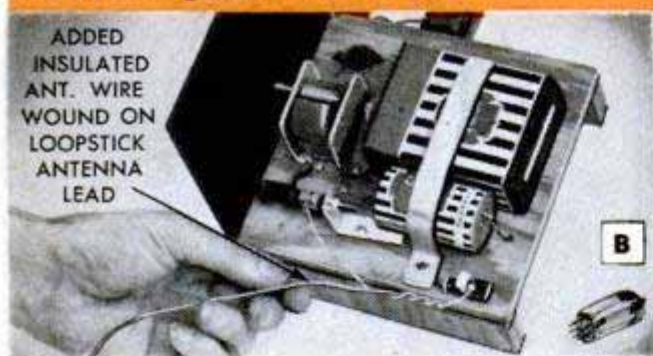
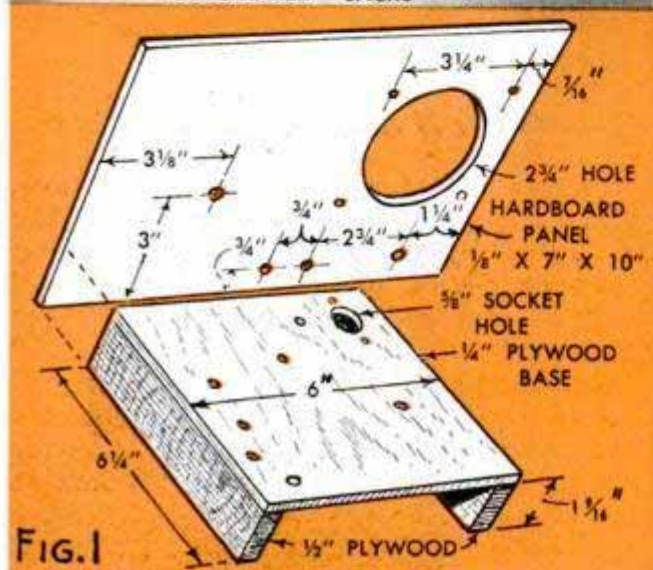

SAFE, SIMPLE AND SENSITIVE are the words which best describe this one-tube receiver designed especially for junior radio experimenters. It provides sufficient volume to drive a loudspeaker, and it employs only a few simple parts that are available from all radio-parts houses. Safety is insured by the use of dry-cell batteries; simplicity is achieved by the use of a wooden chassis and a hardboard panel. Sensitivity is the result of a simple but efficient circuit which provides maximum amplification from the radio signal present at the antenna.

This little one-tuber makes an excellent project for beginners, who can build it in one evening during the holidays. Only a few tools and a small soldering iron are necessary. A battery-operated broadcast receiver of this type can also be used as a stand-by receiver in the event of a power failure, or other emergency, which would make line-operated receivers useless.

All base and panel details are clearly shown in Fig. 1. If headphone reception alone is desired, the loudspeaker and the output transformer may be omitted, thus cutting the number of parts and cost to an absolute minimum if you happen to have a good pair of 2000-ohm headphones on hand. The plywood for the chassis base should not be thicker than 1/4-in. in order to permit the tube socket terminal lugs to protrude from the bottom for easy access when soldering circuit leads to them. Two small angle brackets are used to mount the variable-tuning capacitor (C1) on the chas-

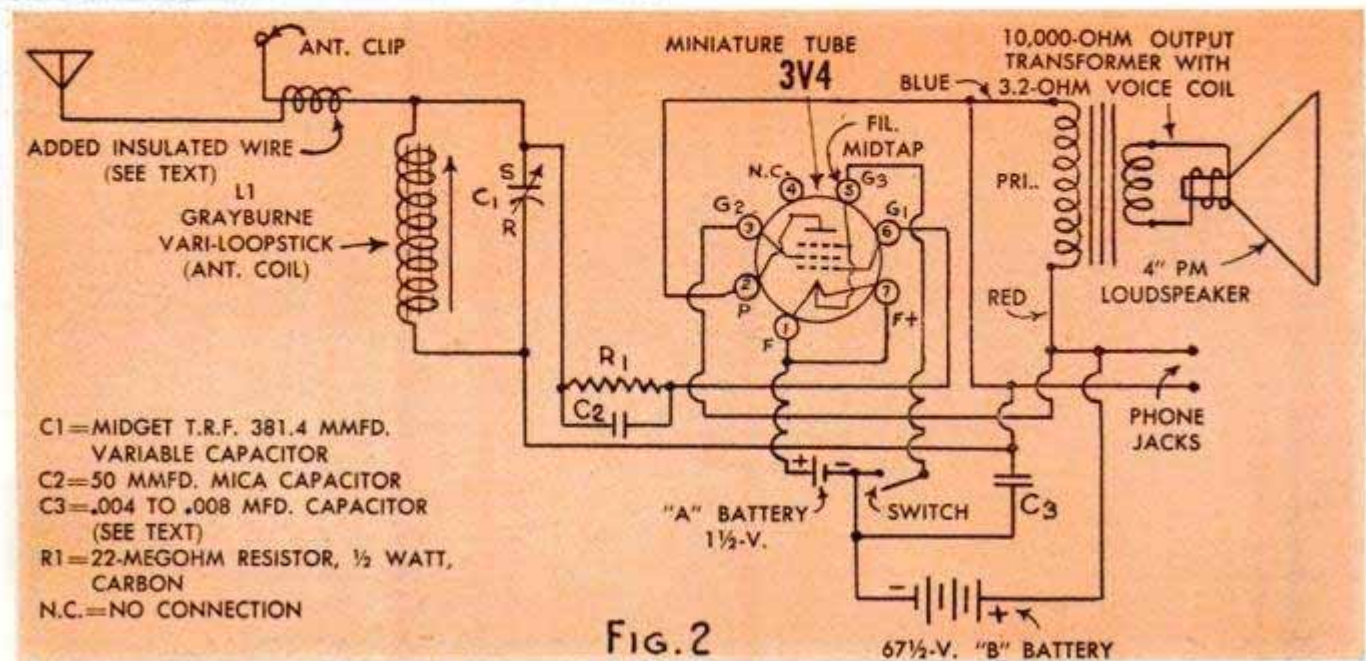

for JUNIOR BUILDERS

sis base. A soldering lug is placed underneath one of the capacitor-mounting screws as a common tie point. Brads or screws fasten panel to base.

Small holes drilled in the base permit passing the hookup wires from the components mounted on top of the chassis to those on the bottom. The schematic-circuit diagram is given in Fig. 2; the pictorial wiring diagram, Fig. 3, shows all parts in their relative positions and every connecting lead. Photos A, B, C, D and E should be studied carefully as they are close-up views of the completed set. Check each connecting lead with the pictorial wiring diagram and you will soon learn to double check your wiring with the schematic diagram as they both agree in every detail. Please note that there is a stator (S) lug on each side of variable capacitor C1. These lugs make the connection to the stator (stationary) plates. The rotor plates are common with the condenser frame. No external ground wire is required.

The bracket holding the dry-cell batteries was made from a strip of thin aluminum; any similar metal strip will do. The B-battery connectors are standard pressure-clip types; the connections to the 1½-V. A-battery are soldered directly to the negative and positive end terminals, the bottom of the battery case being the negative side. All wiring should be done with rosin-core wire solder, and No. 20 solid copper wire with push-back insulation. Particular care should be taken in soldering the leads to the tube socket. The tube

(Continued to page 226)

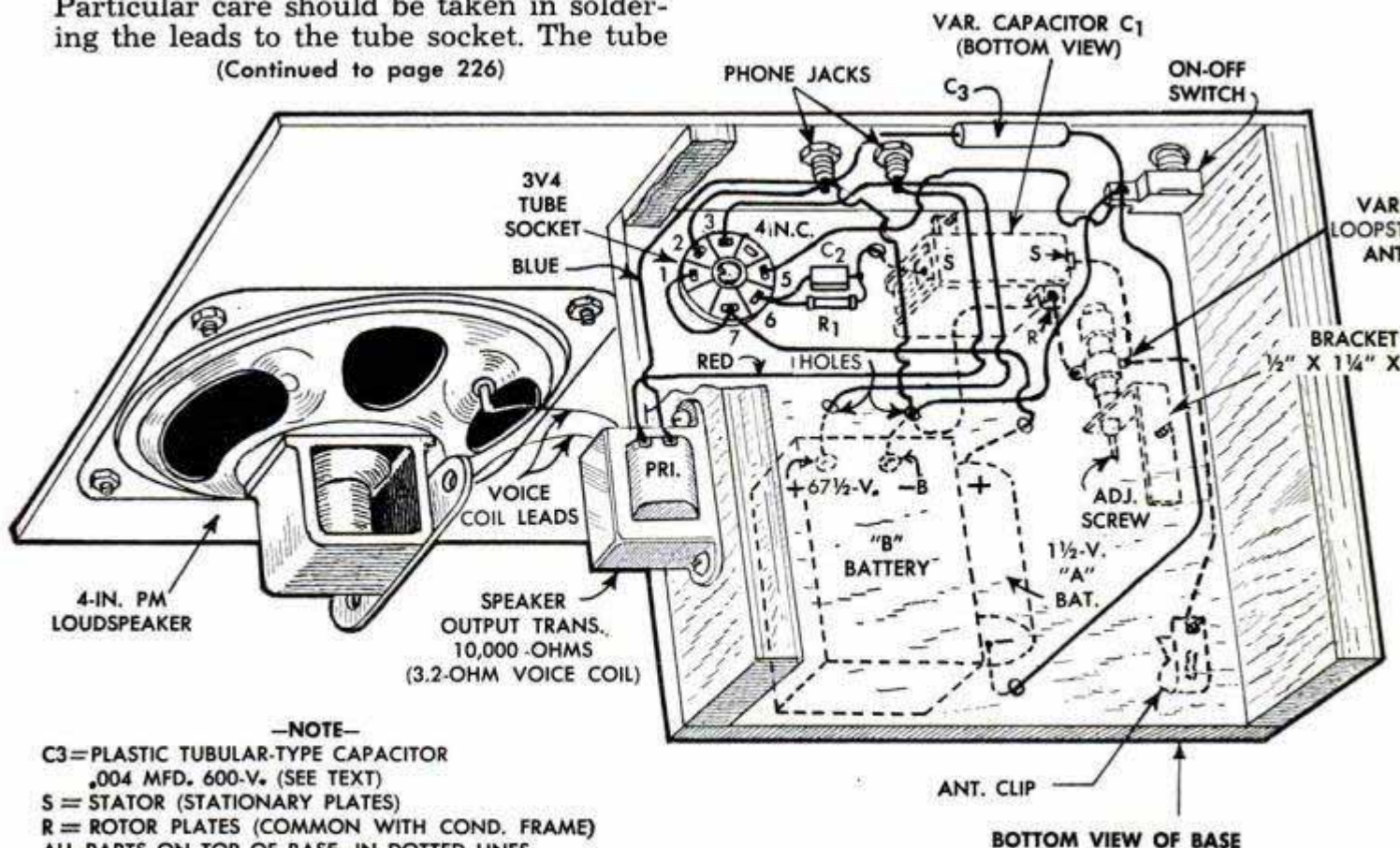
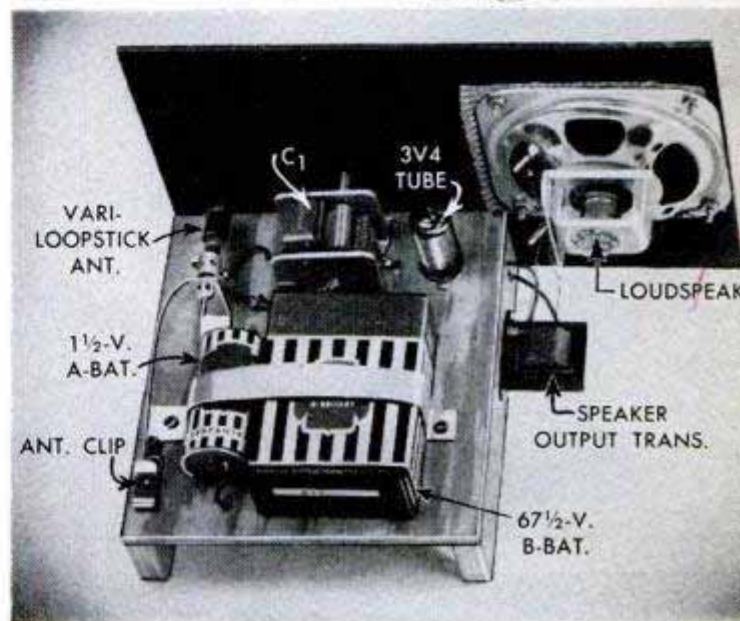
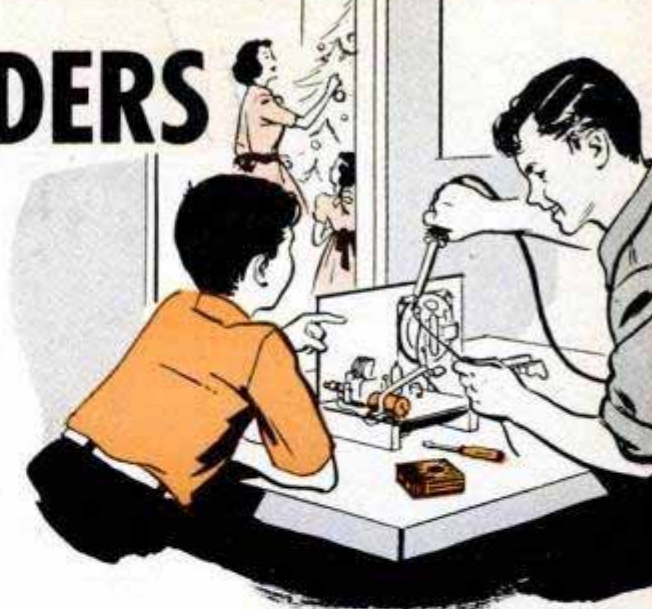

—NOTE—

- C3=PLASTIC TUBULAR-TYPE CAPACITOR .004 MFD. 600-V. (SEE TEXT)
- S = STATOR (STATIONARY PLATES)
- R = ROTOR PLATES (COMMON WITH COND. FRAME)
- ALL PARTS ON TOP OF BASE—IN DOTTED LINES
- N.C.=NO CONNECTION

BOTTOM VIEW OF BASE

Fig.3



A

TELEVISION TODAY

REMOTE CONTROL gives the young lady in photo A complete supervision over this advanced combination all-channel TV set, AM-FM radio and a three-speed record player from a single chairside-control signal unit. The picture console is at the right, the chairside cabinet at left is the remote-control signal unit and the cabinet at center provides generous record storage.

A device that has been employed extensively to protect pianos from dampness, is now available for the same purpose to television-set owners. It is claimed to cut down TV failures and service expense commonly encountered in damp locations. The method of installation is illustrated in photo B. It is claimed to give continuous protection without attention.



B

The TV-tuner unit shown in photo C is one of the latest to emerge from television's electronic laboratories. It is claimed to automatically bring in 16 TV stations, reaching into the ultra-high-frequency (UHF) channels. The new tuner is designed to meet the need created by the TV-station expansion program. The new tuner instantly "clicks" the receiver into proper alignment automatically for the best possible reception on all channels.

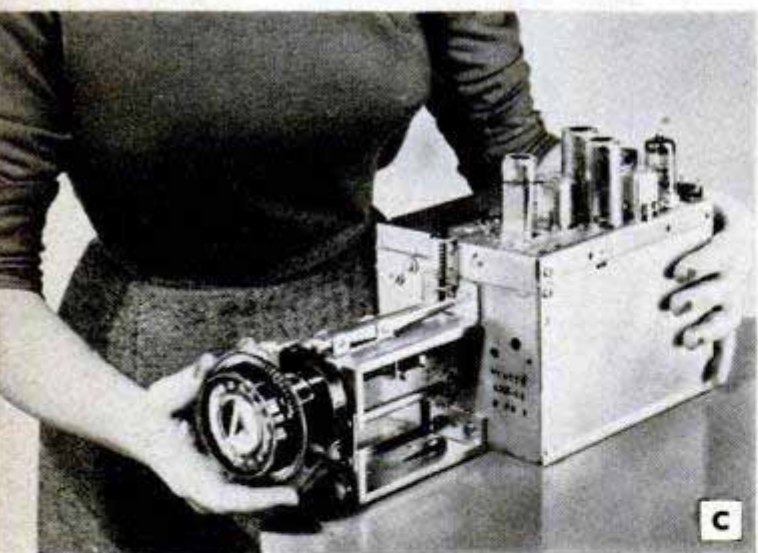

C

An idea for a demountable music wall is illustrated in photo D. A single speaker serves the TV set, built-in record player and receiver. There is also plenty of space for all three sizes of record albums. It may be made of fir plywood and finished in a neutral blend to harmonize with other modern room furnishings.

Now that UHF stations are beginning to join the established VHF television group in many localities, one of the uppermost problems is selecting the proper type of UHF antenna. In certain locations where receiving conditions present problems a high-gain UHF-antenna system will be necessary. The twin corner reflector antenna system shown in photo E is claimed to be an all-channel UHF array that provides up to 16 DB gain, owing to its stacked design.



D

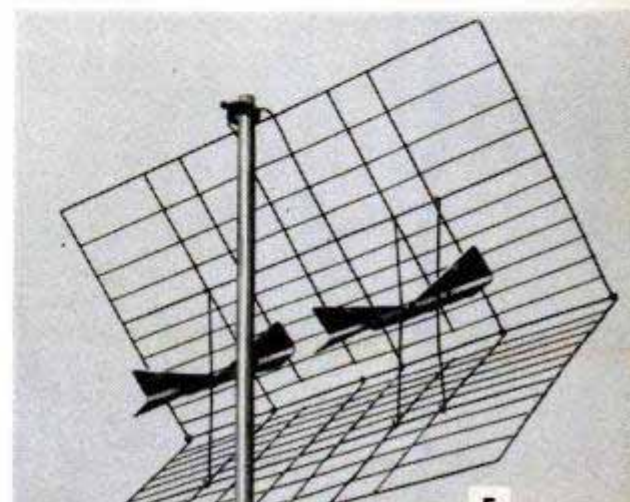

E

*Modern
Furniture*

MODERNIZING OLD FURNITURE

A few hours of carpentry and an application of grained plastic veneer transformed this old record player into a useful and attractive buffet

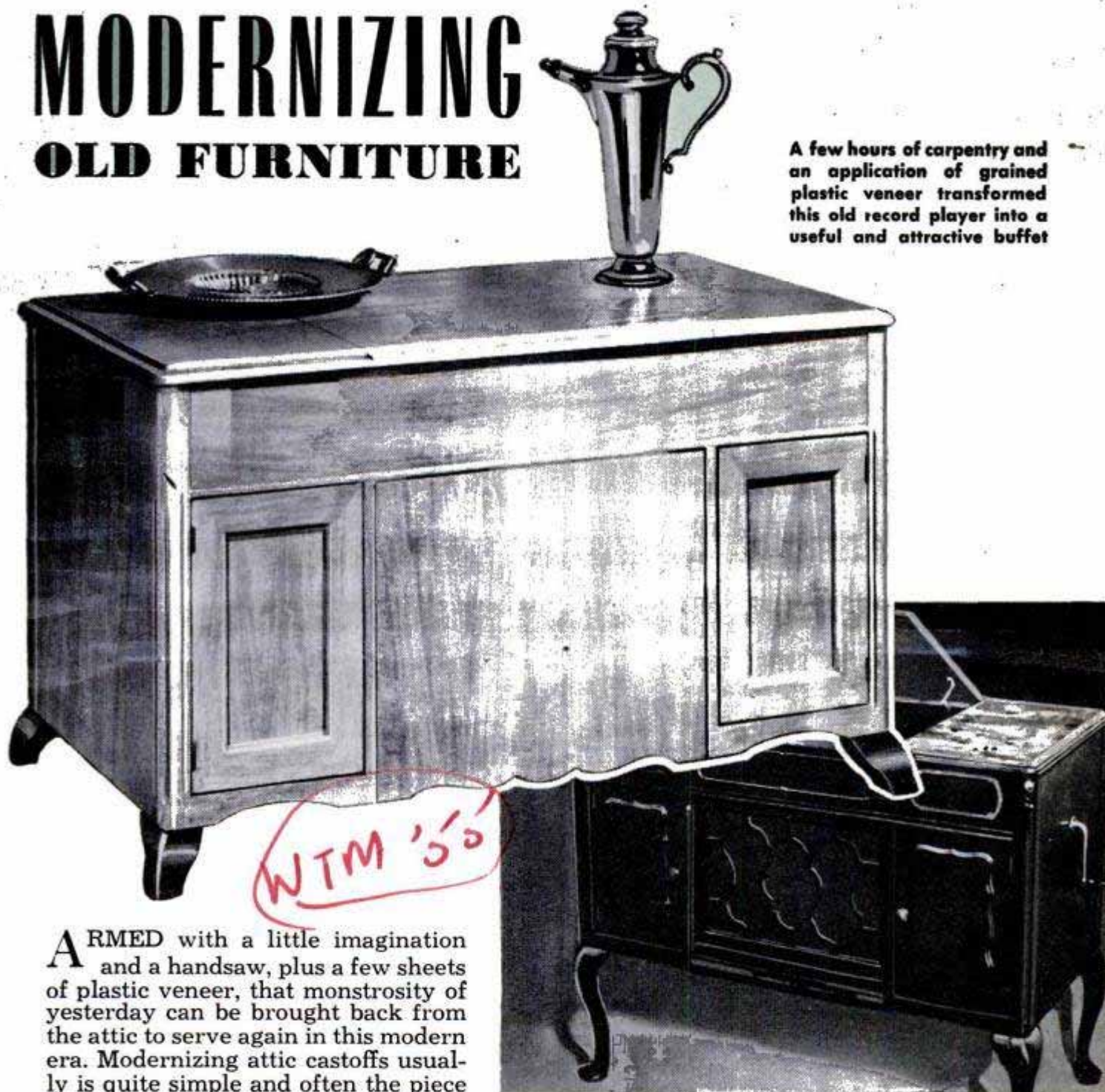

ARMED with a little imagination and a handsaw, plus a few sheets of plastic veneer, that monstrosity of yesterday can be brought back from the attic to serve again in this modern era. Modernizing attic castoffs usually is quite simple and often the piece can be made to serve an entirely different purpose than that for which it was originally designed. The old record player pictured above is a good example of the transformation that can be brought about in a few hour's time. It took only a minimum of careful carpentry and a facelifting with plastic veneer to produce the attractive serving buffet you see in the upper photo.

What happened? First, the player

"works" were removed and the cabriole legs sawed off at approximately the center of the upper curve, or knee. Then the open grille was covered with a piece of $\frac{1}{8}$ -in. plywood, the lower edge being scroll-cut in the pattern indicated. To continue the scroll across the full width of the lower rail, a shallow cut was made in the original rail below each door. Finally, the doors were reversed on the hinges in order to



locate the panel overlays on the inside. Then all surfaces were sanded smooth in preparation for the application of the plastic veneer. Application of the veneer should be done carefully in accordance with the manufacturer's instructions. As a last step, the altered legs are coated with a semigloss black enamel.

Another similar project is pictured above in before-and-after views. In this case only

the backboard and the carved overlays were removed. A portion of the carved knee of each cabriole leg was cut away to provide for the application of a straight front rail, which is simply a narrow strip of plywood glued and nailed to the original rail. The top and legs were enameled in semigloss black. Only the doors, front rail and end panels are plastic-veneered. In this case the wood-grain veneer is applied so that the grain runs vertically on all surfaces. Select a light-colored veneer with a pronounced grain for this project.

Any design, new or old, can be restored to usefulness with plastic veneers. This end table is typical

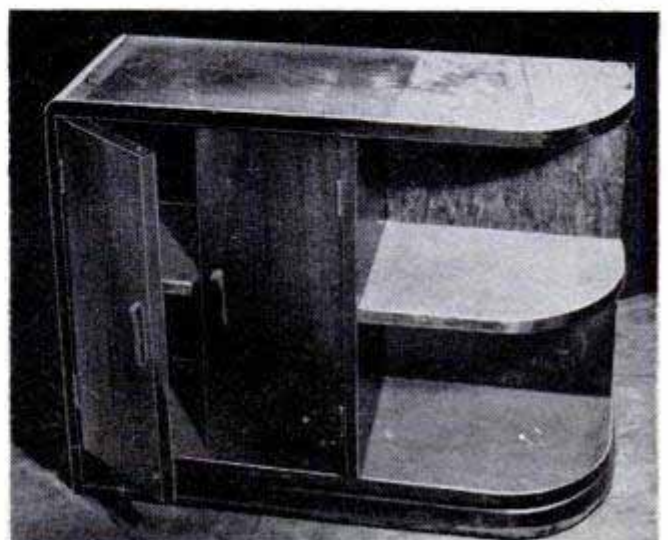
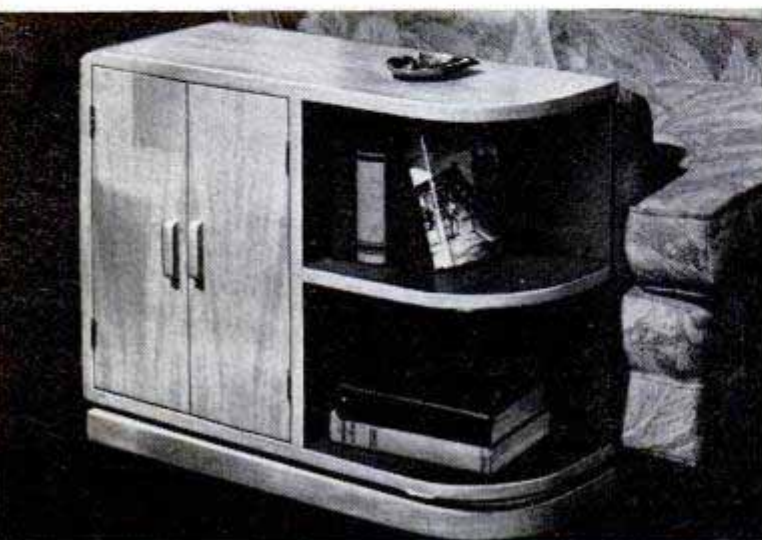

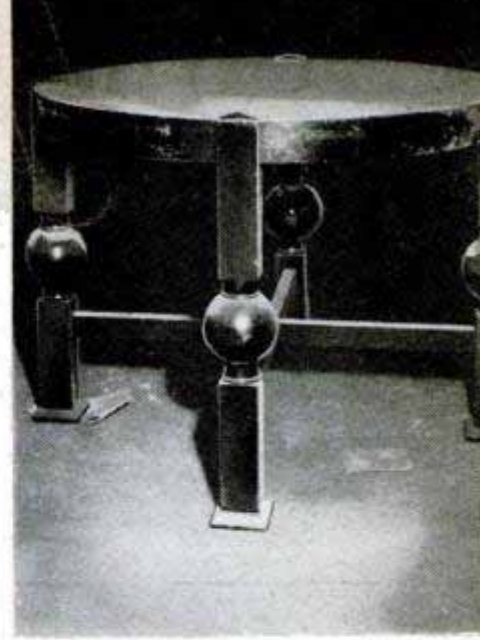

Sawing off the legs and covering circular top with rose-colored marble veneer salvaged this old table

The modern end table pictured below required no structural changes, only a thorough cleaning and sanding to remove dirt and grime and smooth the old finish. In this case both the back and front are veneered as both are exposed when the piece is in normal use. This piece, although of modern design, is typical of many older pieces that will require very little change in design detail. Many older types of tables will lend themselves to modernization with veneer alone. Others require only minor changes in structural details which is easily done with household hand tools. In many instances, a leather or marble top combined with a careful use of enamels can transform an old table into one that is attractively modern and useful. A good example is the marble-topped coffee table

pictured above. The photo at the right shows what it was made from. The plastic veneer also comes in a beautiful Breche Rose Marble and this was used on the top and curved rail of the restoration you see at the left. The legs were sawed off and the short sections were coated with semigloss black enamel.

The old oak sideboard, or dresser, pictured below gets about the same treatment as the player cabinet on page 149 except that to accent the overhanging serpentine drawer section the veneer was applied with the grain running horizontally. The backboard, along with its mirror, was removed and the short cabriole legs were cut off just above the knees. All hardware was removed before applying the veneer. Then new pulls were attached and the rails, edges of the top and the corner posts were finished with a black enamel. The finished credenza is shown in the lower left-hand photo. ★ ★ ★

Photos and information courtesy Transvener Sales Co.

Minor alterations plus plastic veneer transform sideboard

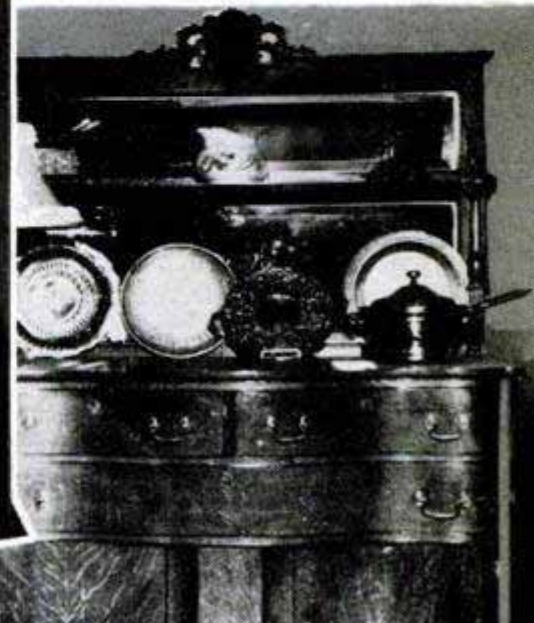

Plastic Shoe Bag in Car Trunk Eliminates Packing Problem



A plastic shoe bag fastened inside the trunk of your car will eliminate the headache of finding room for shoes in suitcases when packing for a motoring trip. A length of curtain rod, or other rod stock, is bent to a U-shape. The top crossbar is just high enough to be held in place by two S-hooks fastened to the back support of the car seat. The flange ends of the rods are secured to the deck of the trunk. The plastic shoe bag is then hung onto the rods.

R. E. Hensley, Chico, Calif.

Lacquer Thinner Has Many Uses

Besides its intended purpose of reducing lacquer to desired brushing or spraying consistency, lacquer thinner also serves as a solvent of many uses. For example, paintbrushes, except those used with water-soluble paints, can be softened and cleaned by soaking them for a day or two in a closed container partially filled with lacquer thinner. Then the loosened paint is worked out with a wire brush or by stroking the brush against any rough surface. After this, the brush is rinsed in clean thinner. To re-use the solvent, store it in a tightly sealed container and, when the paint has settled to the bottom of the container, drain off the clear solvent. In addition, lacquer thinner used together with fine sandpaper or steel wool, is an effective rust remover. The solvent also is helpful

in loosening "frozen" machine screws or bolts. To do this, place a few drops of thinner on the threads and allow to soak for a few minutes, repeating if necessary.

Ralph E. Moore, Wenatchee, Wash.

Distorted Cotter Pin Reshaped With Screwdriver and Pliers

A cotter pin that has been distorted in removal, can be straightened again with a pliers and screwdriver. Firmly grasp the open end of the cotter pin with the pliers, insert the screwdriver blade between the arms and open them with a twisting motion. The ends of the arms are now close together and the pin easily can be replaced in the hole.

Andy Vena, Philadelphia, Pa.

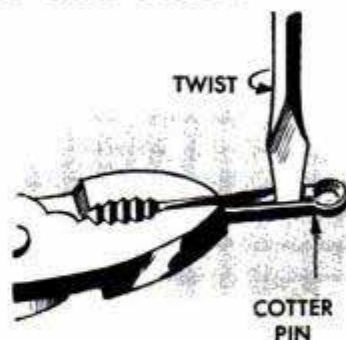

Long Extension Rule Improved From Tongue-And-Groove Boards

A length of discarded tongue-and-groove flooring will provide an emergency adjustable-extension rule for making long comparative measurements such as on masonry or excavation work. The piece of flooring is ripped down the center into two lengths which are fitted together, tongue in groove, and held with a rubber band cut from an old inner tube.

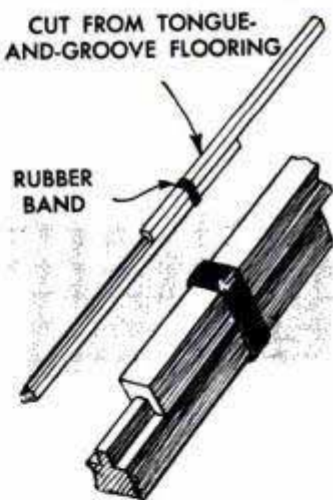

Pivoted Paddle Holds Sandpaper For Sharpening Pencils

Sandpaper for sharpening artist's and draftsman's pencils is kept at hand on a slotted panel that pivots out of the way under the drawing board. The paddle is made of plywood and slotted to hold the ends of the sandpaper. The latter may be replaced easily by slipping out the old piece and inserting a new one.

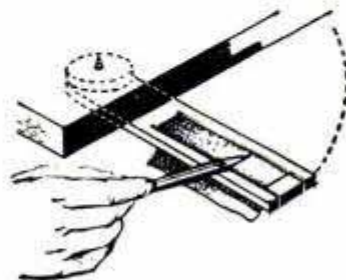

PLAYROOM

WTM '53

PHONOGRAPH

By Mrs. Henry Clark

SAVING wear and tear on the regular living-room radio-phono combination is only one feature of this playroom phonograph. What's even more important, it makes a wonderful Christmas present that will be used daily throughout the year. The playroom unit is simply an old-fashioned phonograph which is modified somewhat and installed in a new upright cabinet.

First, the phonograph mechanism is removed from the old cabinet. Player head, arm, pivot, throat and speaker are reused without change except for shortening the

The little girls, listening to their windup phonograph, below, find plenty of storage space in the modern cabinet for their favorite records and albums



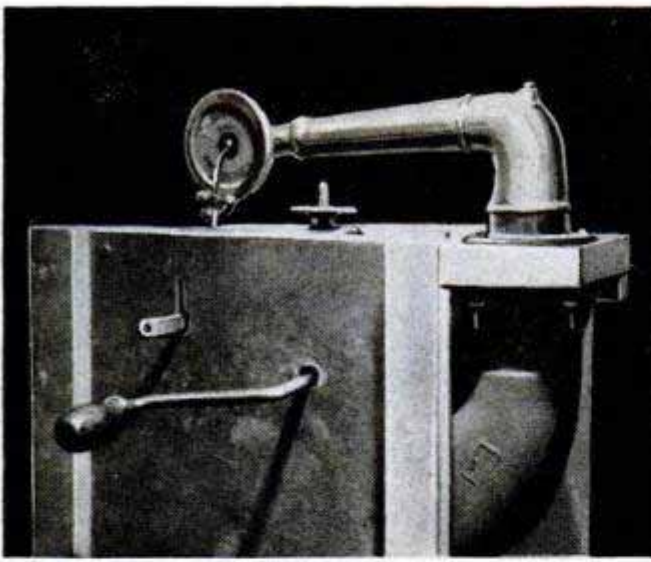
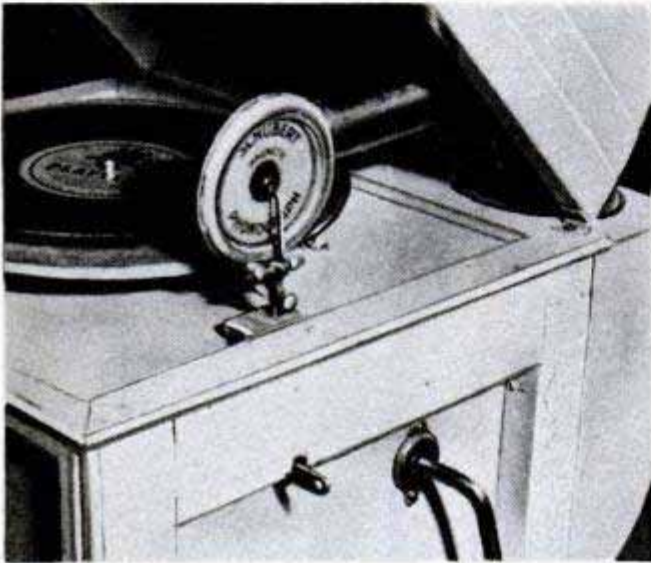
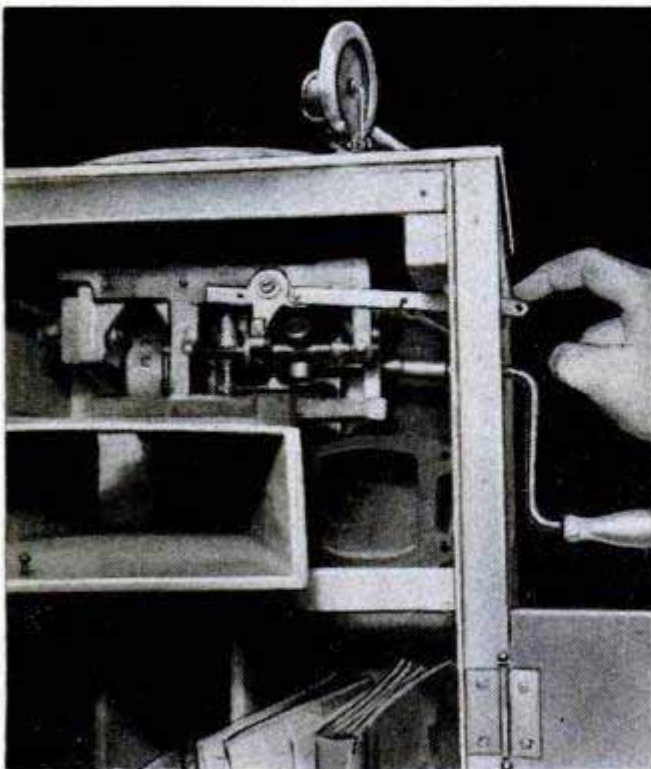

Photo above clearly shows speaker extension on back of cabinet. Player head, below, rests on rubber pad



When the lever arm is pressed into "stop" position, below, friction pad is forced against brass disk. Small block engages lever to hold it in place



speaker to suit the new cabinet. The original turntable, however, is discarded and replaced with a 1/4-in.-plywood disk.

The spring motor, shown in the upper right-hand detail on the opposite page, is altered to make the original speed-control lever serve as a start-stop lever. The felt friction pad is adjusted to jam the brass friction disk when the lever is in the down, or off, position, thus stopping the motor. When the lever is moved to the up position, the friction pad is released from the disk to start the motor. Note in the details that a coil spring provides tension for the lever and that the end of the lever extends through a slot cut in the side of the cabinet. A small block extends beyond the edge of the slot to engage the lever and keep it in the down position.

The cabinet is built of hardwood applied to a wooden framework. The particular phonograph mechanism used may require varying the cabinet dimensions to a certain extent, but this can be done without difficulty. Begin construction by fastening the hardboard side panels to the legs, mounting the panels on the inside surface. The panel on the right-hand side of the cabinet is slotted for the stop-start lever and drilled to receive the motor-winding handle.

The sides of the cabinet are joined together with cleats which form the rests for the bottom panel and supports for the speaker. After the bottom panel and speaker have been installed, a slotted hardboard grille is mounted in front of the speaker and the record-cabinet door is hung. Both the grille and the door are finished with mitered molding, either 1/8-in. stock being used as an overlay or heavier stock being rabbeted for the edges of the hardboard.

The back panel is cut out for the speaker extension and the latter is hung from a wooden block which supports the player arm. This block is butted against the rear edge of the phonograph table and reinforced with cleats screwed to the underside of the table and the block. Additional support may be gained by notching both the rear edge of the table and the right-hand rear leg to take the inner edge of the block. The speaker extension is concealed with a hardboard or cardboard cover.

The phonograph table and motor are supported by two cleats fastened to the sides of the cabinet. A lid is made by nailing sheet metal over two wooden sidepieces as indicated and notched at the rear to clear the player arm. The hinged lid is supported in the open position by a wooden or flat-steel brace which is pivoted to the inside of the lid with a roundheaded screw. The cabinet door may be decorated with overlay strips, a jigsawed C-clef or other design and the cabinet painted. ★ ★ ★

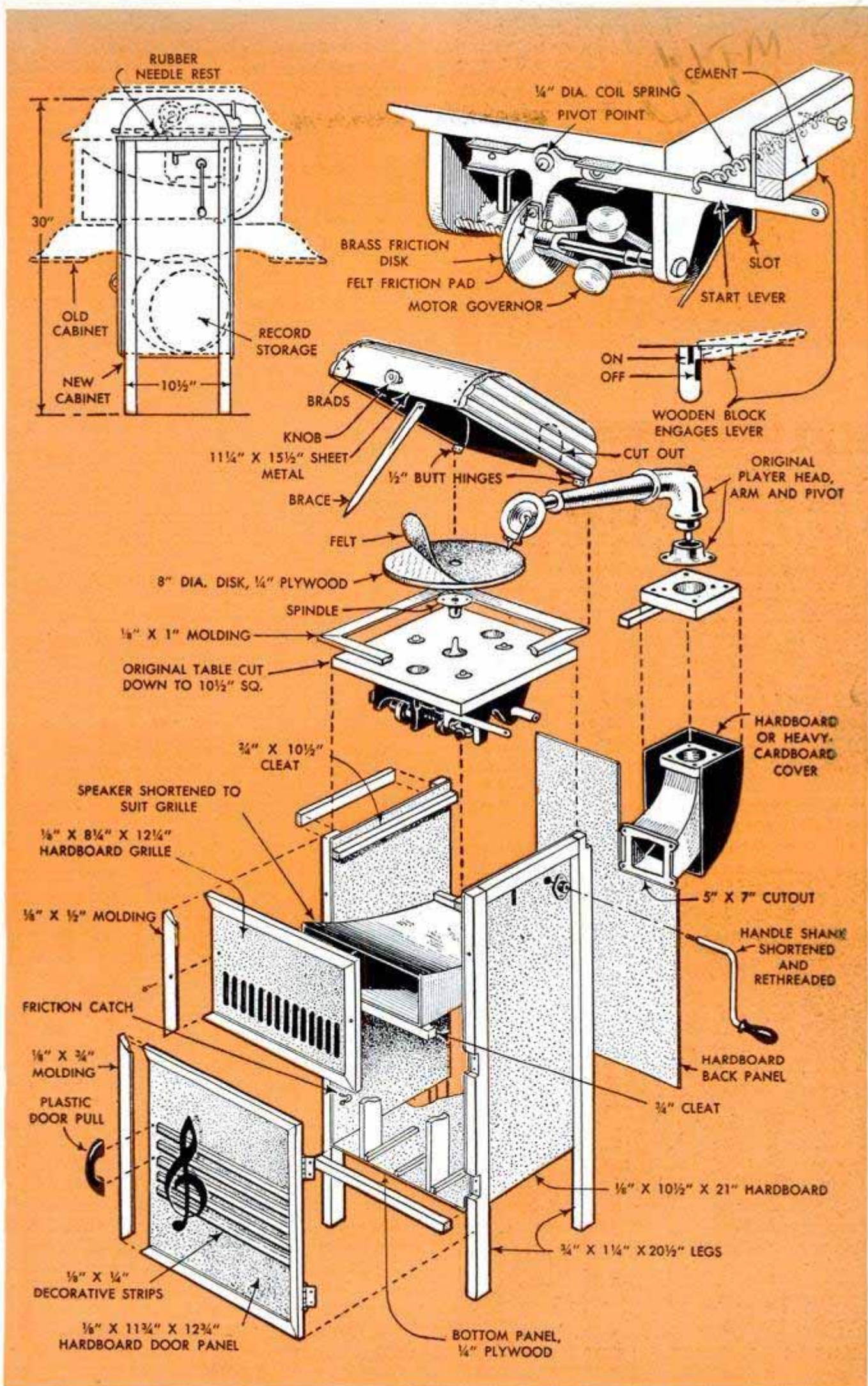

Christmas-Card Display Rack Adds Festive Touch

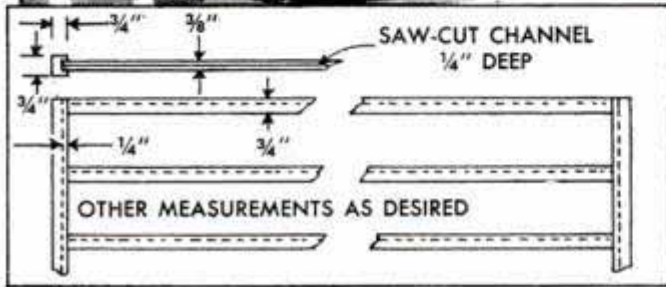

The cards you receive this Christmas can be displayed very attractively in the rack shown in the illustration. And the rack, festooned with holly and loaded with gay cards will add a festive, holiday touch to the room in which it is placed. The rack is made of $\frac{3}{4}$ x $\frac{3}{4}$ -in. stock, and is an easy one-evening project. A $\frac{1}{4}$ -in. deep saw cut is made in each of the crossbars and the cards are inserted in this cut. All the necessary dimensions are given in the detail.

E. E. Gearhart, Bucyrus, Ohio.

Rubber Tubing Holds Screw For Easy Starting

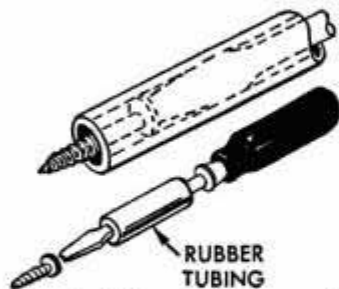

A small piece of rubber tubing slipped over the shank of a screwdriver will save time when it is necessary to drive screws in places that are difficult to reach. The tubing will grip the screw for starting, holding it securely against the screwdriver blade until it is driven in.

John Comstock, Wellsboro, Pa.

Repairing Toaster Elements

When the wire or ribbon element of a toaster or similar electrical appliance breaks, place the broken ends together,

sprinkle a little borax on them and turn on the current. The resulting electrical spark will fuse the two broken ends and the element will be restored to operation.

Inner-Tube Strap Holds Articles On Automobile Front Seat

Purses, gloves and other articles a driver habitually places on the front seat of the car can be kept on the seat and within reach if tucked under a rubber strap. The strap is made by cutting around the circumference of an inner tube

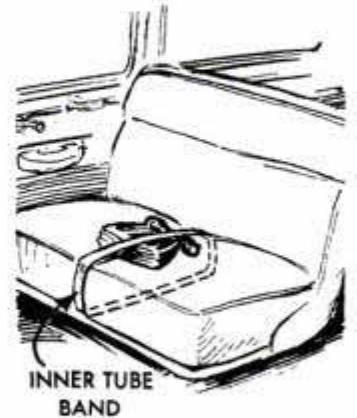

which is placed around the seat cushions. When not in use, the band may be left in position since it does not interfere with the use of the seat.

Proper Mixing of Paint Important to Good Job

The mixing of your paint before starting on a job can well make the difference between a poor paint job and a good one. If this step is hurried, and the heavy pigments at the bottom of the can are not thoroughly mixed with the surface liquid, it is possible that unsatisfactory coverage and



slow drying will result. To be sure of getting full value from your paint, follow these simple mixing steps: 1. Pour surface oil into an empty, clean container. 2. Stir up pigment thoroughly from the bottom. 3. Pour oil back gradually, stirring as you do. 4. Stir and pour from can to can.

Clean Soiled Playing Cards

Soiled linen playing cards can be cleaned by wiping them with a cloth which has been dipped in soap suds and wrung almost dry. When the dirt has been removed, dry the cards carefully. Playing cards made of other materials may be cleaned by placing in a pie tin and sprinkling liberally with talcum. Then rub them with a soft dry cloth.—Blanche Campbell, Las Vegas, Nev.

Candles to Christmas Trees With Paper and Foil

Shimmering Christmas-tree table decorations that reflect the holiday spirit are easily made from ordinary candles. The smallest of the three trees shown is shaped around a birthday-cake candle. Circles cut from paper doilies are pasted on five disks cut from colored-paper napkins, each disk being $\frac{1}{4}$ in. smaller than the one below it. The disks are slit as shown in the detail, slipped over the candle and fastened with cellulose tape. The star on top of the tree is cut from gold foil glued to cardboard and fastened to the candle with a short piece of stiff wire. The two larger trees are made in the same manner as the small one, the larger disks varying $\frac{1}{2}$ in. in size. Colors can be alternated for a more interesting effect and stiff paper used to support the disks and doilies.

Helen Lemberger, Chicago.

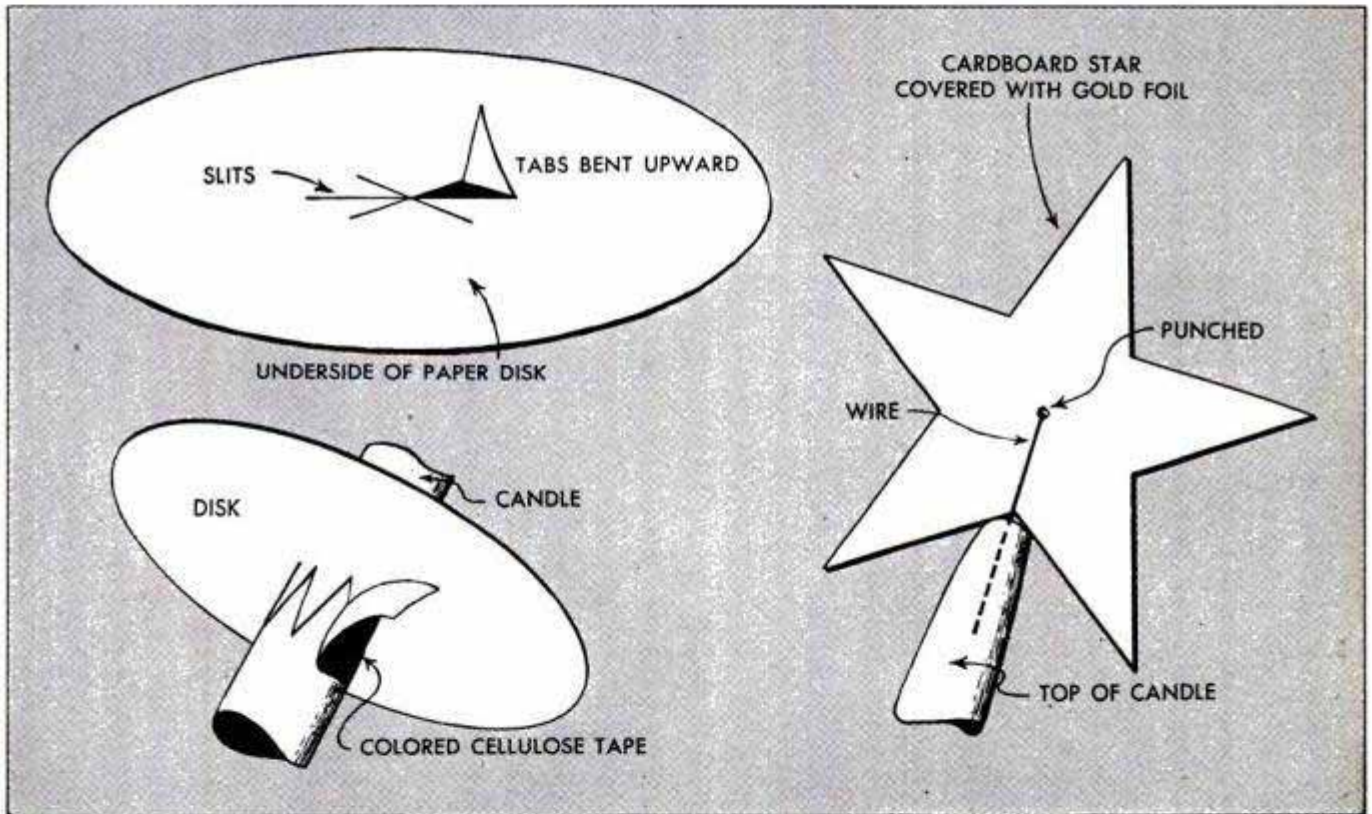

Clothespin Provides Handle for Razor Blade

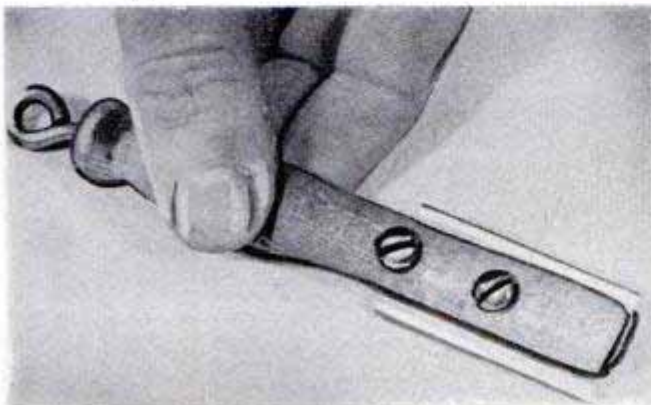

Fitting an ordinary razor blade with a clothespin handle provides a handy cutting tool that is useful both in the home and in the shop. Two holes are drilled in the clothespin for small bolts. One passes through the center of the razor blade, and the other engages the notch at one end. The cutter is stored out of reach of inquisitive youngsters by driving a small screw eye into the end of the clothespin and hanging it from a nail.

John J. Rea, Urbana, Ill.



FOILING HOUSEHOLD CHORES

WITH a surprising number of new-found uses around the home, aluminum foil is fast becoming commonplace. Although you're no doubt familiar with this versatile product, here are some practical applications of aluminum foil that may not have come to mind. An old stand-by, 1, is wrapping yams, squash and other vegetables for baking. They can be served right in their foil wrappers. Lining pots, pans and oven racks with foil, 2, saves scouring after frying or broiling. In the bedroom, dresser tops can be protected from spilled perfume by slipping foil under doilies, 3. To keep odors of onions, cheese, fish, etc. from permeating the





7

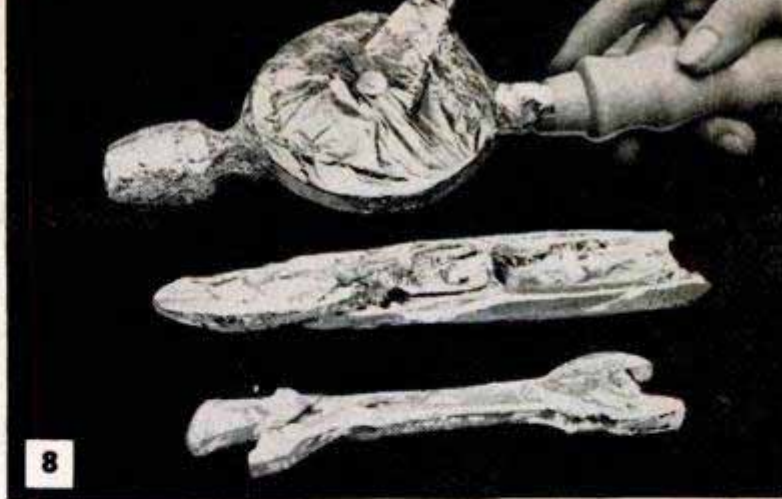

8



9



10



11

refrigerator, wrap the food in aluminum foil, 4. Damp washcloths and toothbrushes may be wrapped in the foil for packing, 5. Silverware can be brightened by boiling in a water-filled pan, the silverware touching a piece of foil placed in the bottom of the container, 6. Foil wrapped around medicine-bottle caps prevents dangerous mistakes, 7. It also can be used to keep small tools from rusting, 8, the tools being thoroughly oiled before wrapping. Left-over foods retain their moisture and flavor when wrapped in foil, 9. Foil also can be used to decorate coat hangers, 10, and make novelty candle holders, 11. Paper plates lined with foil form neat throwaway ash trays or coasters, 12. The foil provides novel gift wrappings, 13. ★ ★ ★



12



13

Saw Blade Hold-Down Aids Glass Cutting



The biggest problem when cutting glass is to keep the straightedge from slipping, so that a single pass can be made with the cutter to assure a uniform score. When the homeowner has a number of pieces of glass to be cut, this can be simplified by attaching a saw blade to the wall or backboard of his workbench, just high enough to allow placing the end of a yardstick under it. A blade from a bucksaw is suggested in the illustration, but a common handsaw held by cleats will serve as well. With the glass placed on the bench and the end of the yardstick held under the blade, pressure on the opposite end of the stick will force it against the teeth of the blade and keep it from slipping. This allows the workman to hold the stick with one hand, while making a single sweep with the glass cutter.

Oiler Made From Bobby Pin

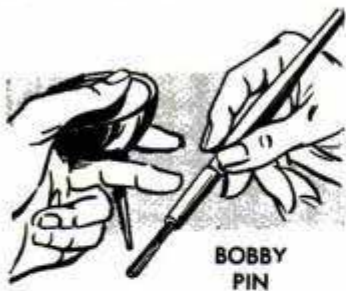

it can be applied. The oil is then released by tapping the end of the penholder.

Rust Preventive for Tools

An effective rust preventive for tools to be stored, or tools that are seldom used, can be made by mixing paraffin, 2 oz., in carbon tetrachloride, 1 pt. The mixture is applied with a brush and, when dry, leaves a waxlike film on the tool that will not attract dust or grime as oil or some other

preventives do. Also, it is less messy to handle and easy to wipe off when the tool is to be used again.

Harvey Muller, Danboro, Pa.

Cotter-Pin Holes Aligned Quickly By Notch Filed on Bolt

A notch filed in the end of a bolt will considerably lessen the difficulty of aligning a cotter-pin hole in the nut. File the notch parallel to the cotter-pin hole in the bolt. When the nut is tight, place the cotter key in the hole and check its

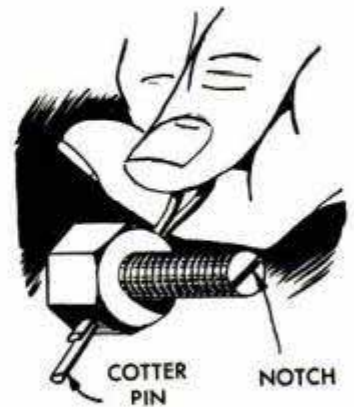

position against the notch. This will tell quickly how much the nut must be turned to bring the holes in alignment.

Table Insert Used as Wrench To Adjust Blade Chuck

The slotted insert on a jigsaw table provides a handy wrench for tightening the blade chuck screws. The insert is convenient, since in most cases, it must be removed when the saw blade is changed. A light twist is sufficient to tighten the screw.

Richard Hanscom, Elmhurst, Ill.

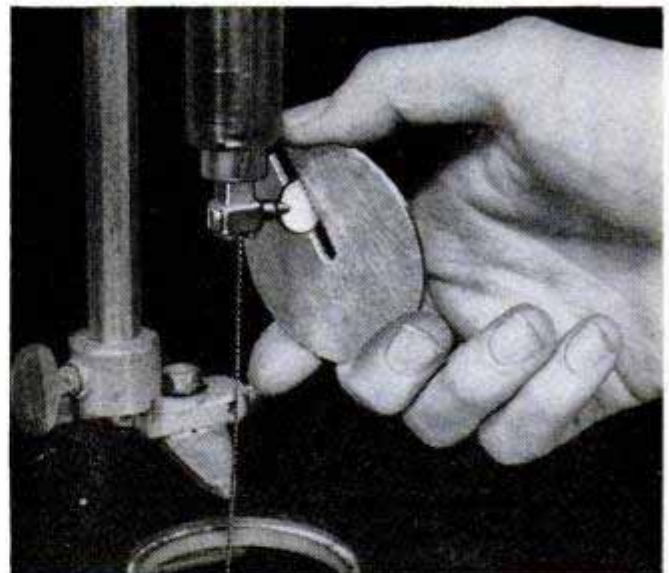

Sharpen Rasp with Grinding Wheel

When a coarse rasp becomes dull it can be sharpened with a hand grinder. Hold the grinder at an angle of 20 deg. to the file and sharpen one row of teeth at a time, being careful to grind very little from the top of each tooth. The wheel is held at an angle to provide clearance for the teeth.

Charles Homewood, Los Angeles, Calif.

FLOOR LAMP BECOMES MODERN TORCHERE

An old-fashioned floor lamp with its wide, fringed shade and poor lighting characteristics is easily converted to a modern indirect-lighting torchere with little cost and labor. The first step is to disassemble the old lamp, removing the shade and socket. Usually there will be a length of fixture pipe extending above the lamp standard. This must be cut and rethreaded or replaced with a shorter length cemented in place, leaving just enough threads exposed for screwing on the new socket. It is suggested that at this time the cord be replaced, using the old cord to pull the new one through. Then a 3-way socket and decorative shell are screwed on the pipe, their size depending on the size of the lamp standard. A translucent reflector bowl is fastened in place, a bulb installed and the lamp is complete. The lamp standard may be refinished in a lighter tone to match the modern motif by removing the old finish and bleaching the wood with a prepared bleach.—Max Alth, Yonkers, N. Y.

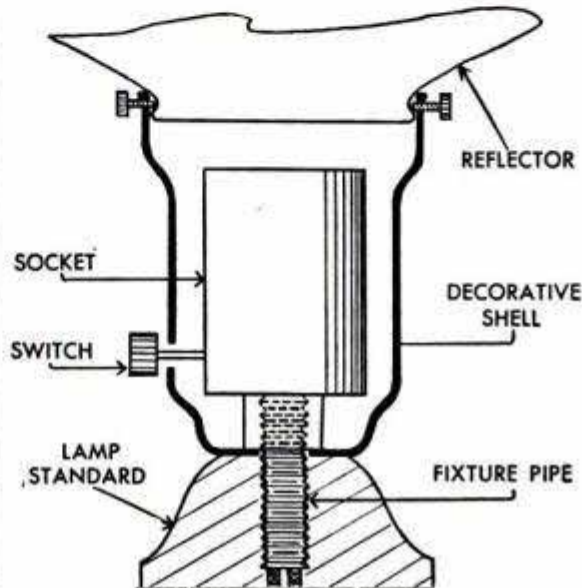
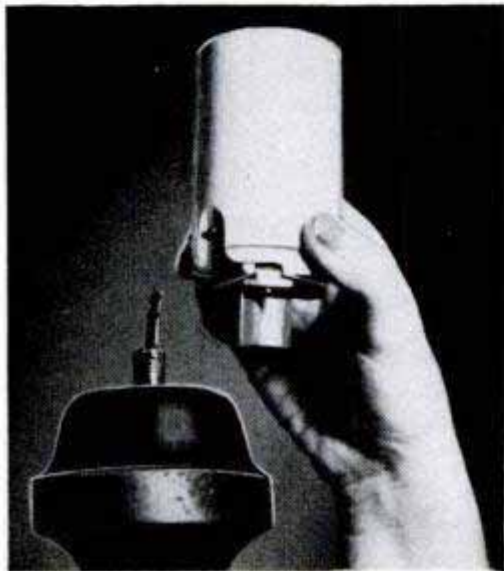

Self-Supporting Shelf Brackets Made of Welded Pipe

Self-supporting shelf brackets for use in storerooms and other places where the walls are not adaptable to ordinary shelves, or are not strong enough to support anything but a light load, can be made by welding 1½-in. pipe as shown in the detail. The original brackets were made for 1 x 12 shelf boards, but could be of any convenient size. The brackets are fastened to the wall at one point on each upright, just under the top-shelf brace, using a lag screw or a toggle bolt. This fastening serves only to keep the shelves from swaying, as the brackets are propped against the wall and held in position by the "toe."

G. R. Slaughter, Winnipeg, Man., Can.

Tape Holds Small Parts

Place small parts which are removed during a repair job on a strip of cellulose tape which has been attached to the workbench with the sticky side up. This will prevent them from being lost and also will indicate the order in which the parts were removed, thus facilitating reassembly.

Howard E. Moody, Upper Jay, N. Y.

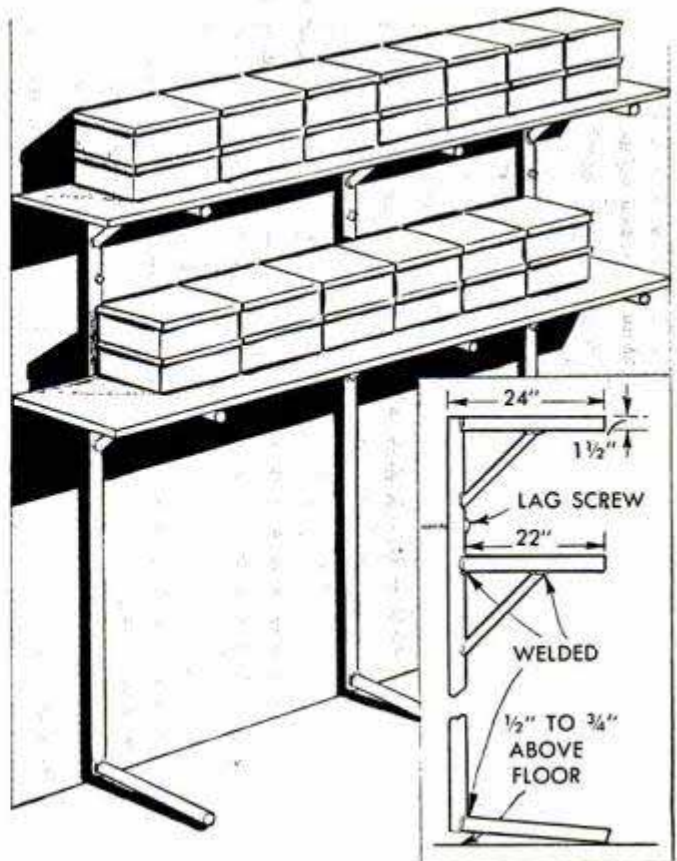

Solving HOME PROBLEMS



CHILDREN LEARN to operate slide fasteners at an earlier age if buttons are stitched to tabs of fasteners. Button gives youngster larger finger grip

WIPING EXCESS PAINT from roller is simplified by slotted wooden block slipped over side of pan. Edge of block is cut to conform to shape of roller

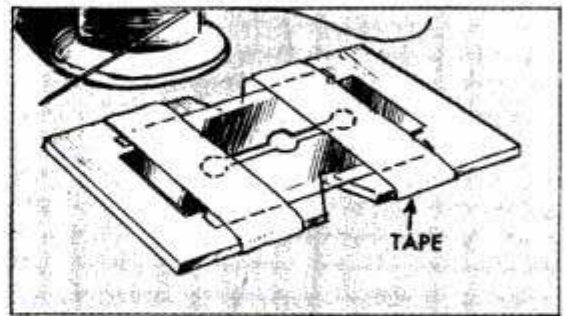
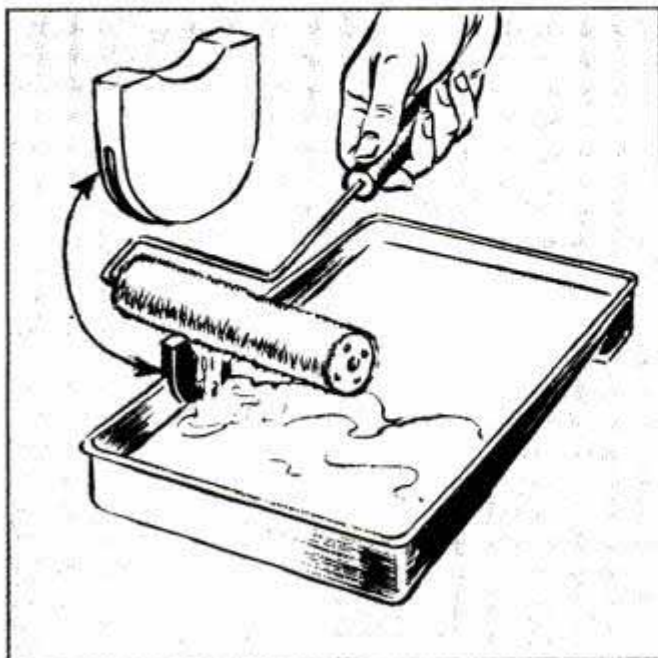

RAZOR BLADE used for cutting sewing thread is shielded by taping it to notched piece of cardboard. Notch on each side is deep enough to expose portion of blade edge

FRAGILE TIP of glass eye dropper is protected from breakage by slipping an extra rubber bulb, or tip, over it. The rubber shield also helps keep the eye dropper clean

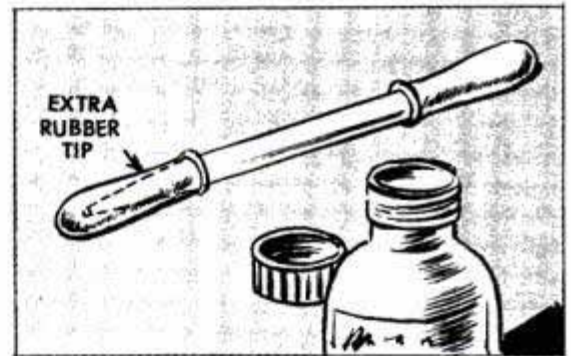

WOODEN OR PLASTER BOOK ENDS can be prevented from sliding apart if a piece of corrugated cardboard is taped to the bottom of each book end. The cardboard extends under books and their weight holds it in place

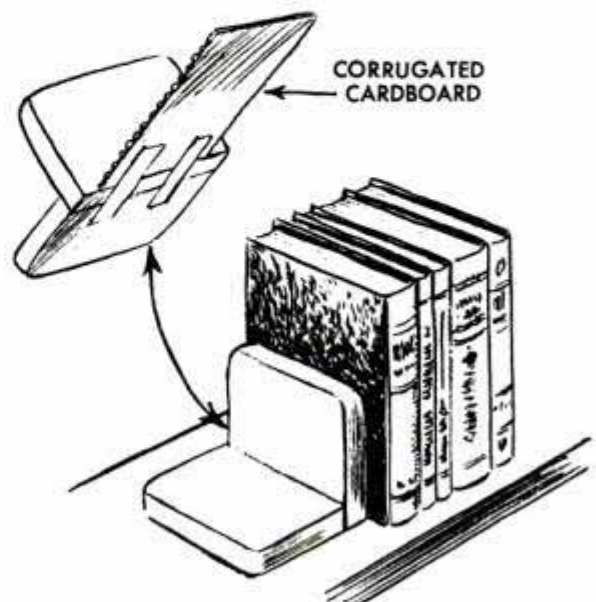

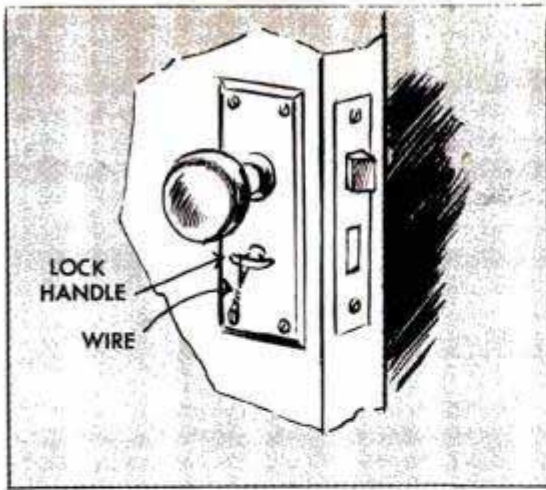

CHILDREN CAN'T LOCK themselves in the bathroom if lock handle is wired in open position. Anchor wire to escutcheon screw



COLLECTORS can remove choice stamps from envelopes neatly and with less danger of damaging the stamp by applying lighter fluid to inside of the envelope. If the envelope is of heavy paper, roughen surface with eraser before swabbing on lighter fluid

WHEN PLACING A SIGN in a window to rent a room or sell furniture, hold the sign snugly against the pane by slipping a piece of wood into the sash lift

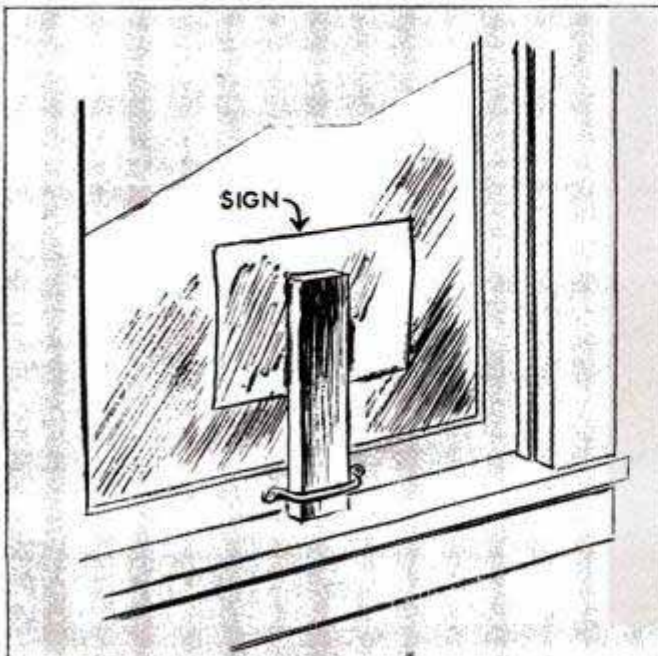

HANGING HEAVY FRAMED PICTURES is easier if an ordinary fork is placed over the picture hook as shown in the detail below. In this way, the fork handle guides the picture wire to engage the hook





Reflector for Shop Light Made From Kettle

A discarded aluminum or stainless-steel kettle can be converted into an excellent reflector for a shop light. A hole is cut in the bottom of the kettle as shown, to fit the light fixture, and the handles of the kettle are cut off with a hacksaw. The threaded ring on the fixture is used to hold the shade in place, as it would any other shade. Care should be taken to see that the shade is insulated from the fixture, so that there is no danger of shock when the shade is touched.

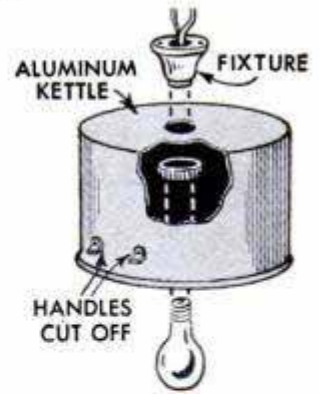

Victor H. Lamoy, Upper Jay, N. Y.

Wood Stained With Fabric Dye

Recent research has proven that it is practical to use dyes of the all-fabric type to stain unpainted woodwork and furniture. Since only a limited number of colors in oil stains are available for wood, this new method gives the advantage of an extensive color selection, and also has the advantage of extremely easy application. To stain wood, first prepare the dye as you would for fabric, following the manufacturer's directions. Then apply it to the piece to be stained with either a brush or a cloth. When the dye is thoroughly dry, brush on a coat of white shellac. After ample drying time has been allowed, rub the shellac down lightly with fine sandpaper, and apply a finishing coat of clear varnish. This finish then may be protected with the usual wax or furniture polish.—Tintex Home Economics Bureau, New York City.

Friction Block Holds Door Open

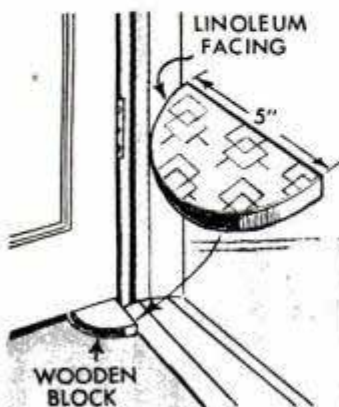

Taking advantage of the slight play in the hinges of the door itself, this friction doorstop relies on the weight of the door to hold it in place. The stop consists of a wooden block faced with linoleum, the combined thickness being slightly greater

than the space between the bottom of the door and the floor. In use, the doorstop is wedged under the door at the hinged edge.

Ice Pick Aids Nailing of Stud

The job of holding 2 x 4 studding in place for toe nailing can be simplified considerably with the use of an ice pick. Simply force the pick into the floor plate at the base of the stud on the side opposite the one in which the nail is to be driven.

Repairing Cracks in Plaster

When repairing cracks in a plastered wall, the large cracks must be cleaned out and cut more deeply to key the patch. The wrong and right way to cut out the crack is shown in the sketch. The V-cut allows the patch to loosen and fall out, while the undercut, inverted-wedge type of cut will lock the patch permanently into the old plaster. Before applying the plaster, thoroughly wet the edge of the area to be patched with water, using a paintbrush or sponge. This keeps the plaster and laths from taking moisture out of the patch.

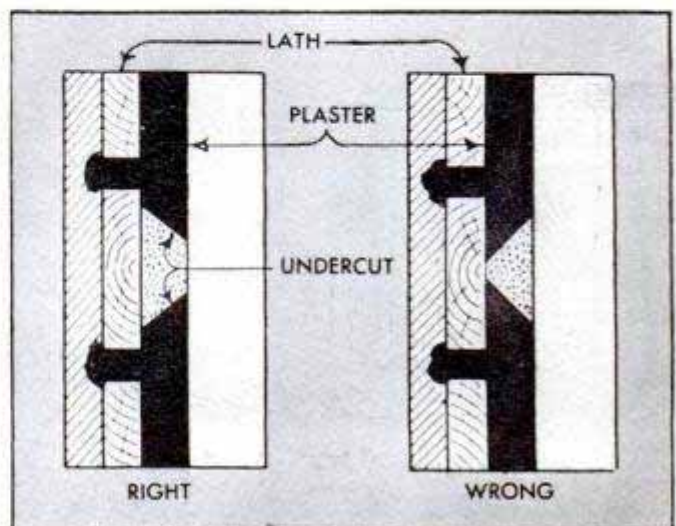

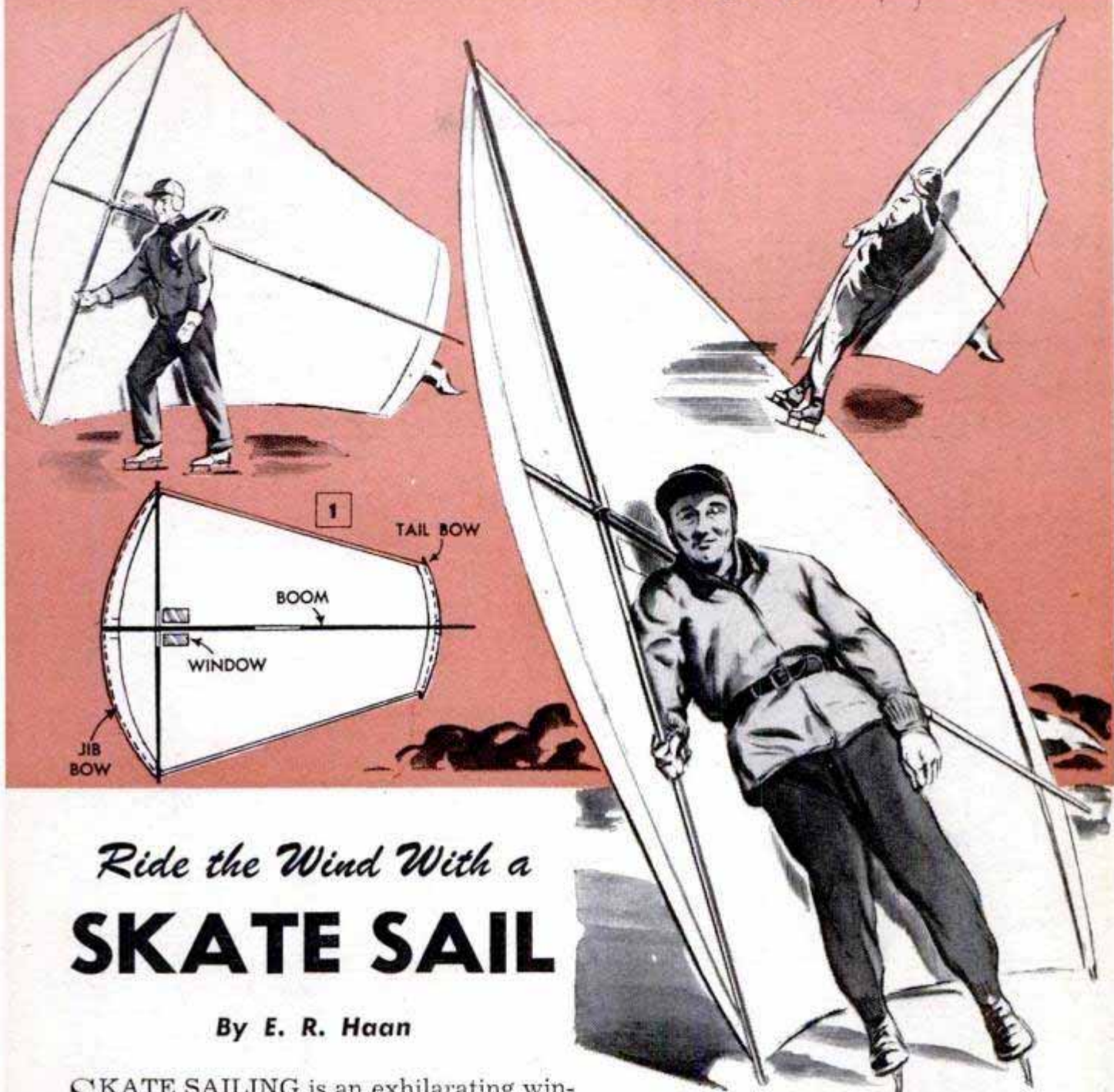

Ride the Wind With a **SKATE SAIL**

By E. R. Haan

SKATE SAILING is an exhilarating winter sport that is gaining in popularity every year because it is easy to learn and fun to do. You don't have to be an expert skater to learn to handle a sail, and it takes very little time to become proficient at steering a course both with and against the wind. All you need to begin having fun is a sharp pair of skates, a sail and an open expanse of ice, $\frac{1}{2}$ mile or more long.

Basic points of skate sailing: In skate sailing, the boom rests on the skater's windward shoulder, as in Fig. 1, so that the sail is balanced. The boom should slope downward slightly from the shoulders toward the back. Both feet are kept on the ice about 5 in. apart, with the foot nearest the sail a little ahead of the other one. The body is kept straight and almost rigid, so that it can pivot with the skates. The wind keeps the boom snugly on the skater's shoulder, allowing him to lean against the

sail and giving a degree of stability not possible in regular skating. It enables him to ride over bumps and rough spots and over patches of soft snow up to $1\frac{1}{2}$ in. deep. The weight is kept on the heels, with an upward pull on the toes for best control.

Selecting a skate sail: A sail of the shape shown in Fig. 1 has been found best for maneuverability in varying wind conditions. Its size should be suited to the user's weight and height. Relation of sail area to a user's weight is given in Fig. 8. When a person's height is less than average for his weight, the next smaller size that provides sufficient clearance above the ice should be used. A sail that is too large becomes uncontrollable in winds over 20 m.p.h.

Skates to use: Beginners in skate sailing should use the skates to which they are

Illustrations courtesy Skate Sailing Ass'n of America

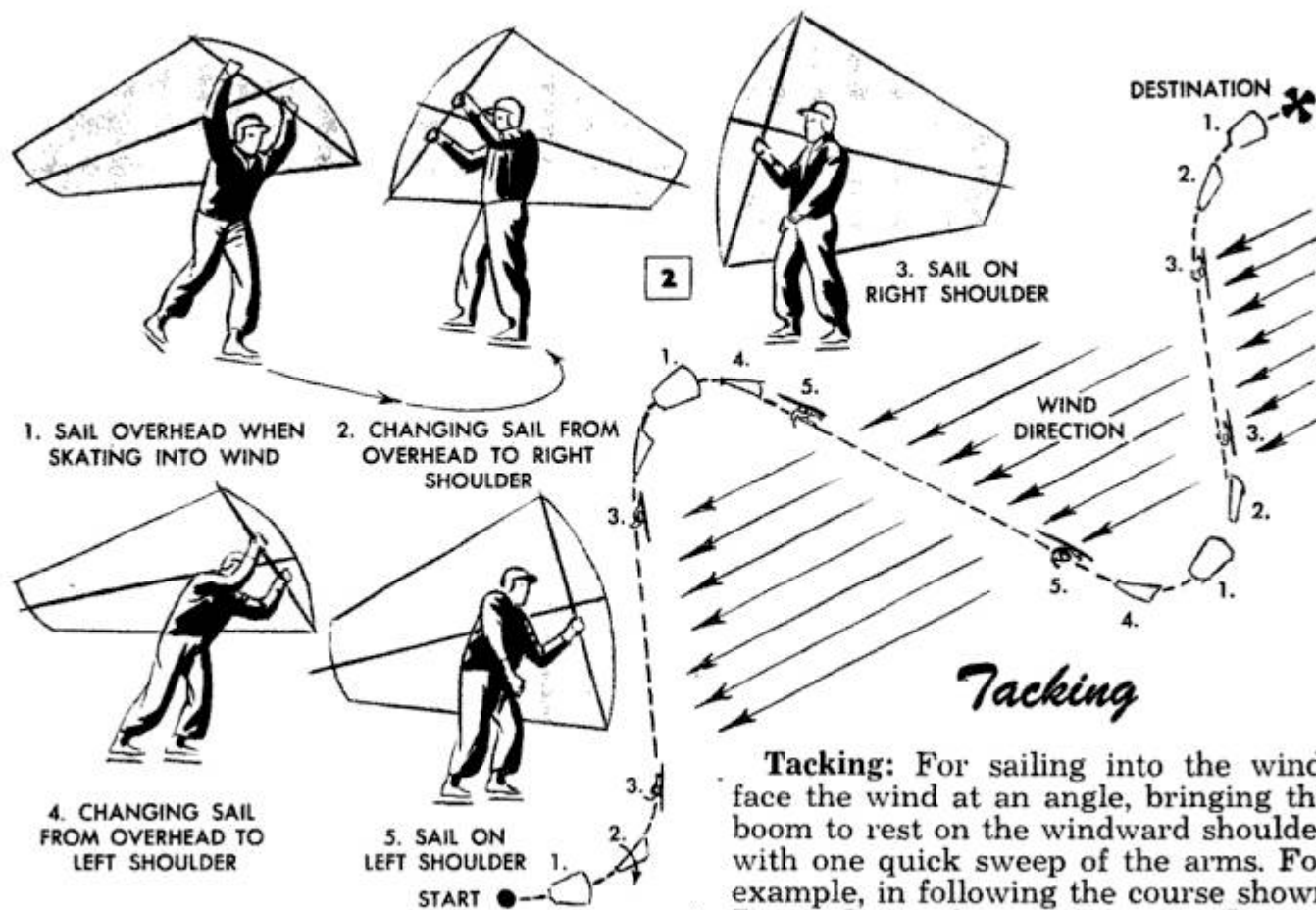

Tacking

Tacking: For sailing into the wind, face the wind at an angle, bringing the boom to rest on the windward shoulder with one quick sweep of the arms. For example, in following the course shown in Fig. 2, bring the sail from the floating position down toward your right side, continuing until the sail is vertical. As the sail catches the wind, lean firmly against it. Then the top of the sail will tilt slightly into the wind, and the bottom away from it. Since this deflects the wind downward, it tends to lift the sail and relieve its weight from the shoulder.

Retain the grasp on the mast with your right hand just below the boom. It doesn't take long to learn to hold the sail with one arm entirely free. The shoulder is the pivot point on which the sail is swung to keep it at the desired angle. Should you find yourself going too fast, bring the sail to the horizontal floating position and make a gliding turn into the wind. To change direction on tack toward the right, bring the sail over your head and down on the left side through the positions shown in Fig. 2. The skater has full visibility ahead and on the left, and the windows in the sail provide him with ample visibility to the right.

Across and downwind: To sail crosswind, hold the sail diagonally to the wind direction, as in Fig. 3. To go downwind, follow a zigzag course as in Fig. 4, holding the sail a little more toward your back, but never directly at right angles to the wind. Each time a turn is made, transfer the sail from one side to the other as already described, except for one important difference: don't hold the sail in the horizontal overhead position, but keep its tail down close to the ice behind you, so that the wind cannot whip it out of control. Holding the sail at

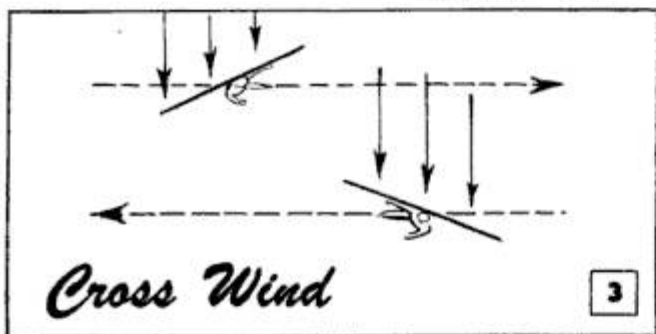

accustomed, and the skates kept very sharp. Then, after developing some sailing skill, you may prefer 18-in. racing skates, which provide better riding over rough ice and also enable the user to keep a straight course more readily.

Getting out on the ice: Try out a skate sail for the first time when there is a fair wind, and select a smooth expanse of ice on which to begin. Give other skaters a "wide berth" and skate out into the wind with the sail held horizontally over the head at arm's length. Grasp the mast with both hands as shown in Fig. 2, since the sail, when held in this fashion, does not catch the wind, but "floats" above you.

If the wind is behind you as you go out, keep the back of the sail down to deflect it. This will prevent the sail from blowing down in front of you. The sail is held in the horizontal floating position also when turning from one tack to another. If the sail becomes uncontrollable at any time, let it go. It is easier to retrieve it later than to attempt to fight the power of the wind.

Down Wind

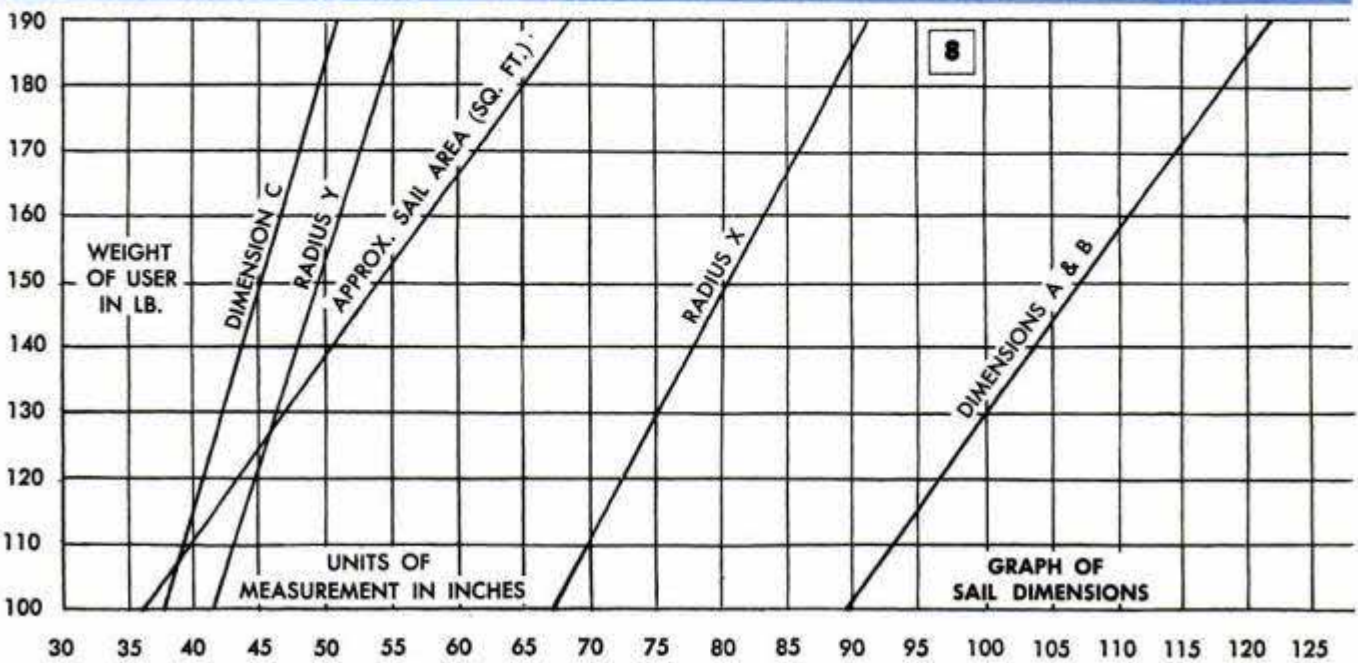
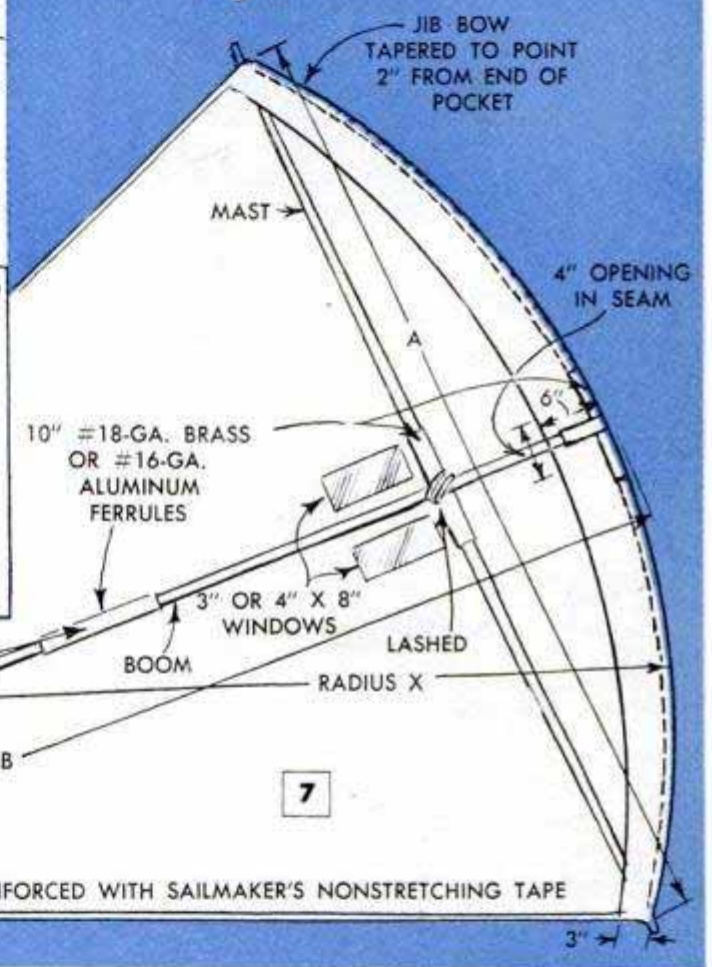
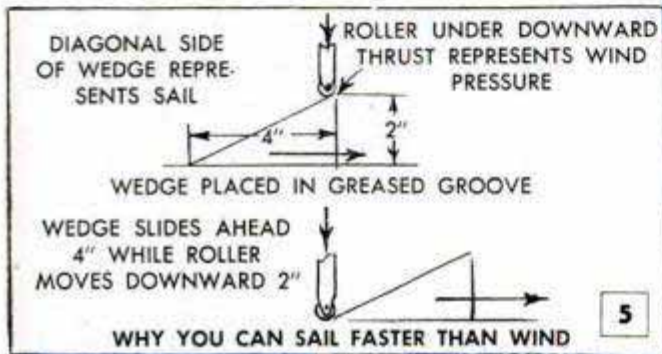
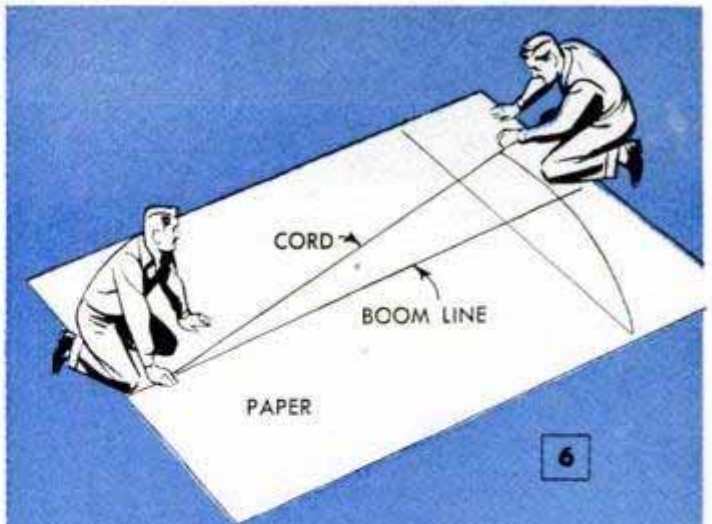
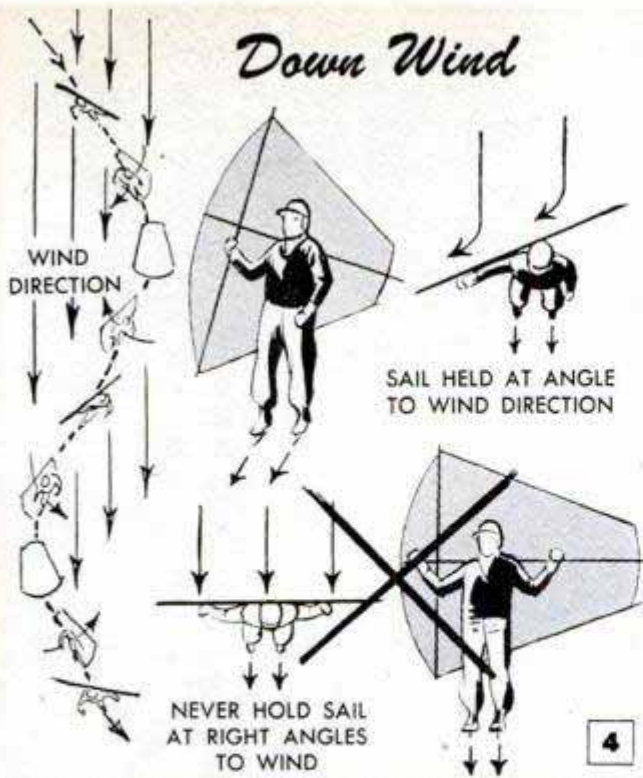

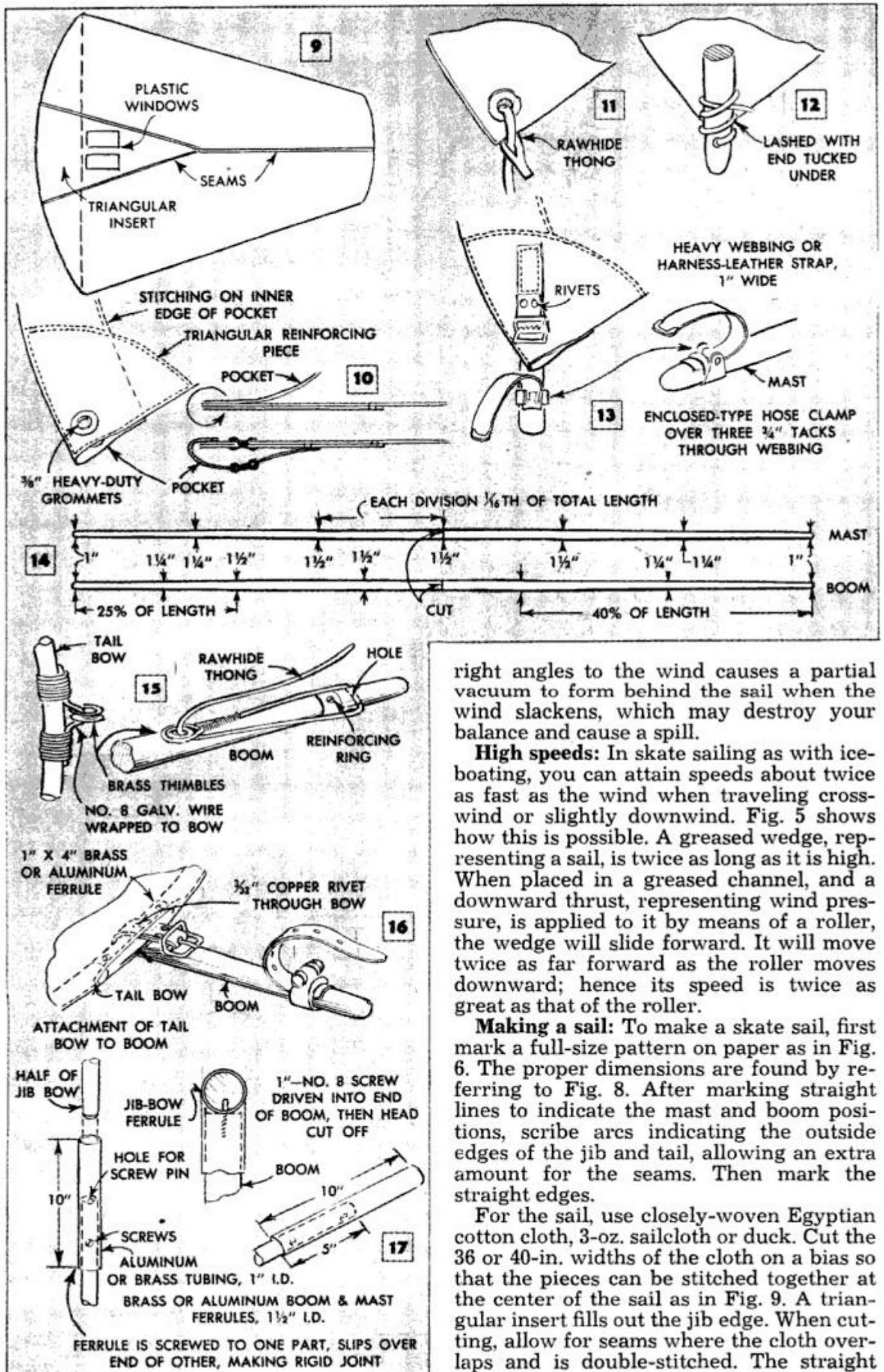

right angles to the wind causes a partial vacuum to form behind the sail when the wind slackens, which may destroy your balance and cause a spill.

High speeds: In skate sailing as with ice-boating, you can attain speeds about twice as fast as the wind when traveling cross-wind or slightly downwind. Fig. 5 shows how this is possible. A greased wedge, representing a sail, is twice as long as it is high. When placed in a greased channel, and a downward thrust, representing wind pressure, is applied to it by means of a roller, the wedge will slide forward. It will move twice as far forward as the roller moves downward; hence its speed is twice as great as that of the roller.

Making a sail: To make a skate sail, first mark a full-size pattern on paper as in Fig. 6. The proper dimensions are found by referring to Fig. 8. After marking straight lines to indicate the mast and boom positions, scribe arcs indicating the outside edges of the jib and tail, allowing an extra amount for the seams. Then mark the straight edges.

For the sail, use closely-woven Egyptian cotton cloth, 3-oz. sailcloth or duck. Cut the 36 or 40-in. widths of the cloth on a bias so that the pieces can be stitched together at the center of the sail as in Fig. 9. A triangular insert fills out the jib edge. When cutting, allow for seams where the cloth overlaps and is double-stitched. The straight

edges of the sail are reinforced by sewing on sailmaker's nonstretching tape. Two 3 x 8 or 4 x 8-in. windows of transparent-plastic material are sewed into the sail at the points shown.

The bow pockets at the jib and tail should be faced with fairly heavy duck on the spar side for strength. They should be about 6 in. wide at the center and 3 in. wide at the ends, which are open. Both pockets have openings in the center of the seams as indicated in Fig. 7, so that the bows can be joined to the boom. Before sewing the inside edge of the jib pocket to the sail, sew on the corner-reinforcing pieces and grommets for rawhide thongs, Fig. 10. Figs. 11 and 12 show how the thongs are lashed to the ends of the mast. If you prefer, heavy webbing or harness-leather straps with buckles can be used to hold the sail to the mast ends, Fig. 13. However, sewing thick fabric and leather together is a job for a shoe repair shop.

Mast, boom and bows: After the cloth part of the sail has been completed, make and fit the mast, boom and jib bow. Each of these consist of two pieces joined together by means of brass or aluminum ferrules as in Figs. 7 and 17. The tail bow is one piece. The jib bow tapers to $\frac{3}{8}$ in., and the ends extend about 1 in. beyond the ends of the pocket. The mast and boom are made of spruce, $1\frac{1}{2}$ in. thick, tapered to 1 in. at the ends, as in Fig. 14. For tapering, use a block plane or a spokeshave. The boom extends 10 or 12 in. beyond the tail, and both ends of the mast project about 2 in. beyond the sail.

The tail bow, if lashed, is provided with a heavy wire yoke that carries a brass or aluminum thimble to which the thong is attached as in Fig. 15. If straps are used at the tail bow, they are attached as in Fig. 16. The tips of the bows should be rounded so they will slip easily into the pockets. The mast and boom are sanded smooth and then coated with spar varnish.

Assembling the sail: To assemble the sail, lay it out flat with the pocket side up. The two sections of the jib are first inserted, one from each end, and are joined at the center. Then the mast is laid in place, but is not attached to the sail. The forward end of the boom is slipped into place, so that it joins the jib bow. Then the top and bottom of the sail are joined to the mast ends at about half the required tautness. The tail bow is inserted and stretched tightly, and the fastenings at the mast ends also are drawn up snugly so that the sail will be "drum" tight. The mast is always located between and sail and the boom, and the two are bound together tightly where they cross by lashing with a rawhide thong or a web strap. ★ ★ ★

Rack for Rubbers and Galoshes



Wet galoshes and rubbers worn by all members of the family can be stored and dried on this handy rack which is placed just inside the back door of your home. A length of 2 x 6-in. lumber is used for the base, with two pieces of 1 or 2-in. stock nailed to the underside to serve as feet. Dowels cut from old broom or mop handles, are forced into holes drilled into the base. The dowels can be of various heights, to suit the size of footwear to be hung on them.—I. M. Fenn, Chicago.

Skid Chains Put on Easily

A device to simplify attaching snow chains to your car can be made from a wire coat hanger. The straight bar of the coat hanger is snipped out and bent into a V, and the ends twisted to form hooks. To put the chains on, slip the puller through a spoke opening in the wheel. Stretch out the chain in front of the wheel, hook the puller to the chain, and drive the car forward until the wheel makes one complete revolution. Then fasten the chains.

Stanley J. Meyer, Hamilton, Ohio.

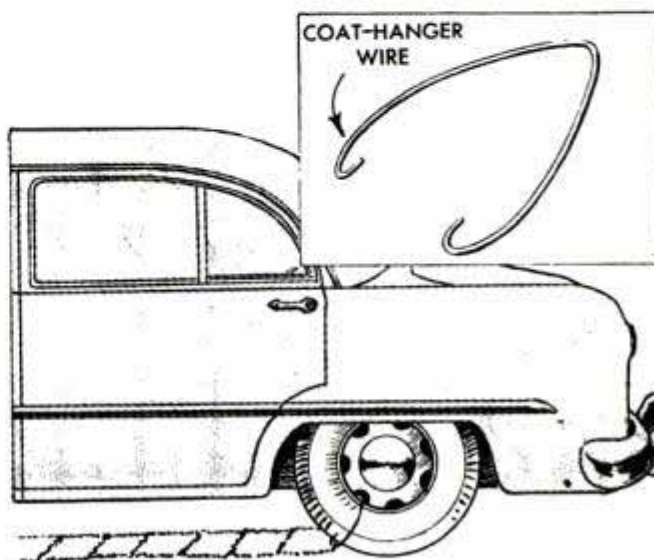

PLAN of the MONTH...

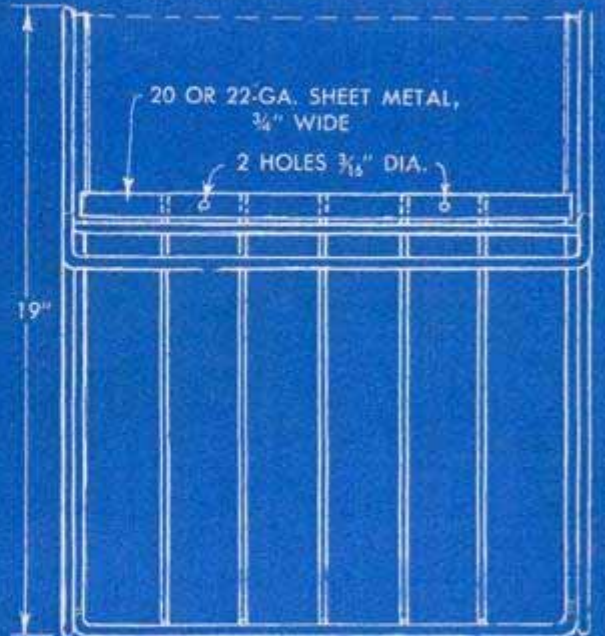

PLAN

FRAME MEMBERS ARE $\frac{3}{8}$ " DIA. COLD-ROLLED STEEL

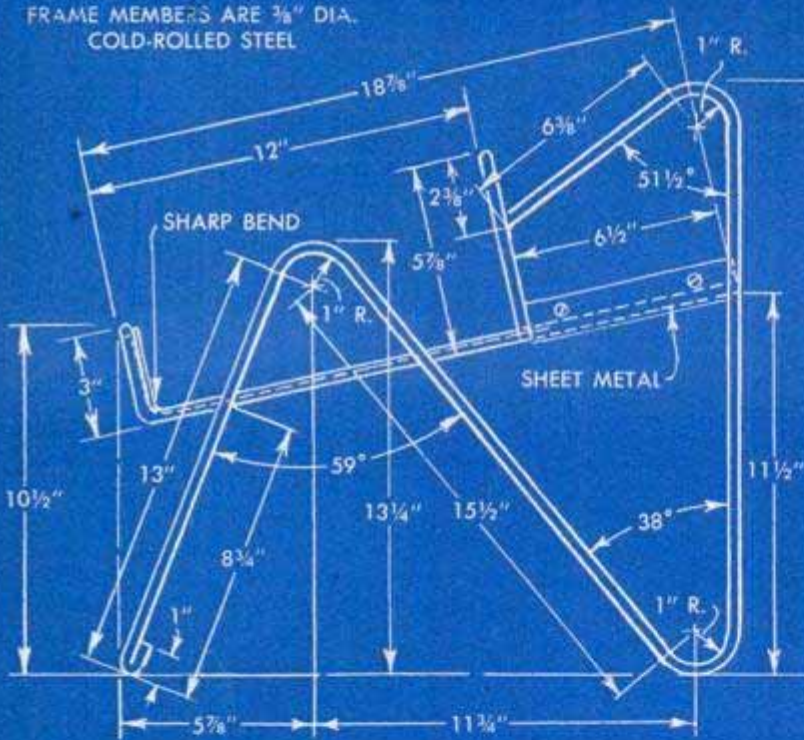

SIDE VIEW

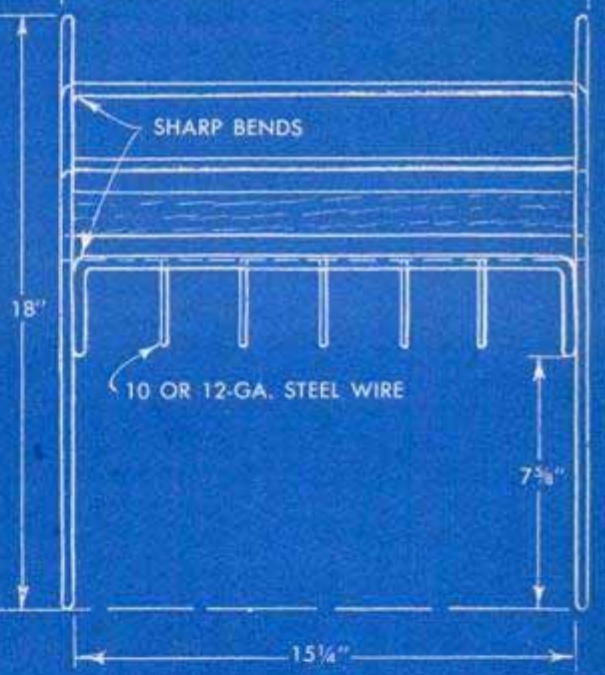

FRONT

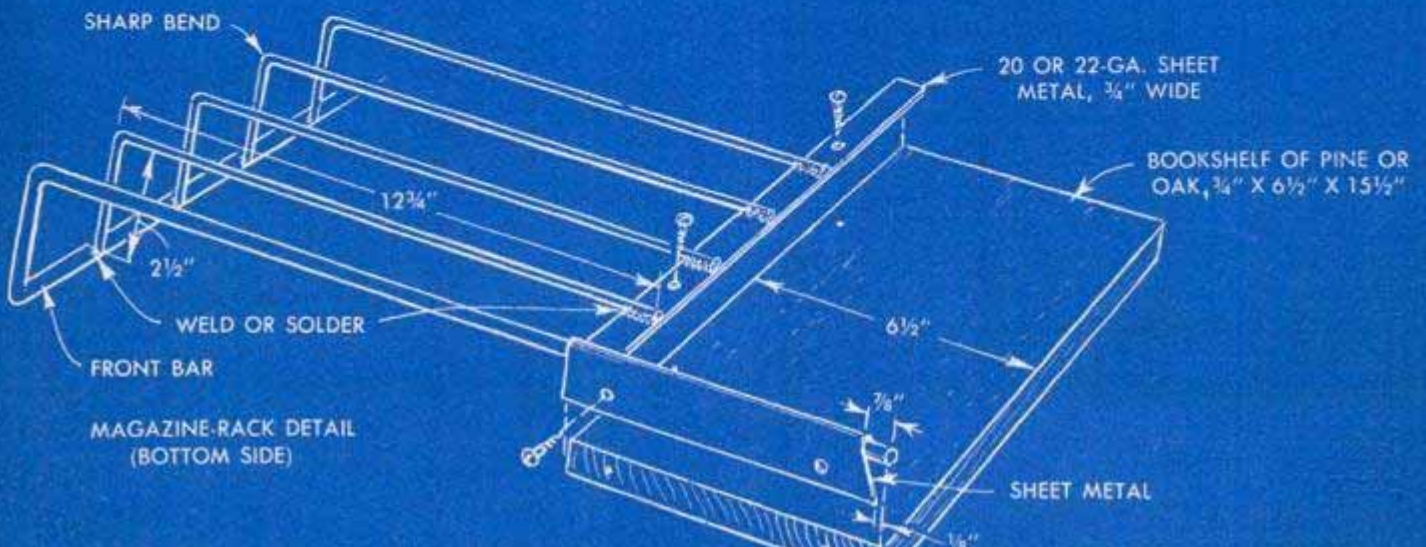

Wrought-Iron Furniture

MATERIAL LIST

WALL BOOKRACK

Pine or Oak Lumber

3 pcs.— $\frac{1}{2}$ " x $6\frac{1}{2}$ " x 15"—Shelves

Sheet Metal, 20 or 22 ga.

16 pcs.— $\frac{1}{2}$ " x $1\frac{1}{4}$ "—Shelf supports

Cold-Rolled Steel Rod

2 pcs.— $\frac{1}{4}$ " dia. x $50\frac{1}{4}$ "—Shelf supports

4 pcs.— $\frac{1}{4}$ " dia. x 13"—Side brackets

2 pcs.— $\frac{1}{4}$ " dia. x 6"—Shelf brackets

4 pcs.— $\frac{1}{4}$ " dia. x $13\frac{1}{8}$ "—Top and bottom

4 pcs.— $\frac{1}{4}$ " dia. x $15\frac{7}{8}$ "—Side

18 pcs.—16-ga. steel wire, $3\frac{3}{4}$ "—Gallery

MAGAZINE AND BOOKRACK

Pine or Oak Lumber

1 pc.— $\frac{3}{4}$ " x $6\frac{1}{2}$ " x $15\frac{1}{4}$ "—Book shelf

Sheet Metal, 20 or 22 ga.

2 pcs.— $1\frac{3}{4}$ " x $6\frac{3}{8}$ "—Shelf brackets

1 pc.— $\frac{3}{4}$ " x $14\frac{7}{8}$ "—Rack bracket

Cold-Rolled Steel Rod

2 pcs.— $\frac{3}{8}$ " dia. x $62\frac{7}{8}$ "—Legs

1 pc.— $\frac{3}{8}$ " dia. x 59"—Rack frame

1 pc.— $\frac{3}{8}$ " dia. x $27\frac{3}{4}$ "—Bookrack rail

1 pc.— $\frac{3}{8}$ " dia. x 16"—Bookrack rail

WTM
155

Modern
Furniture

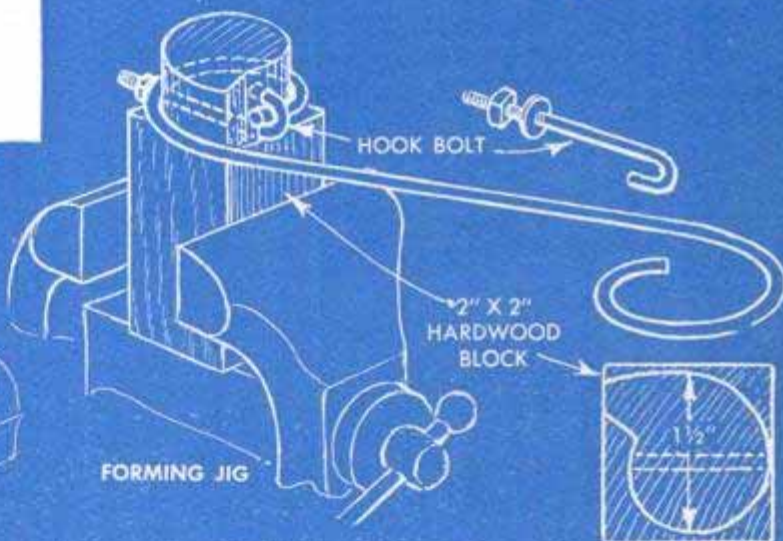
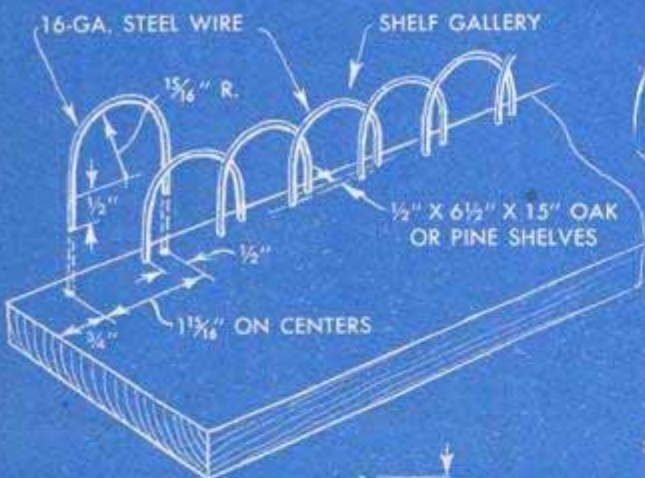
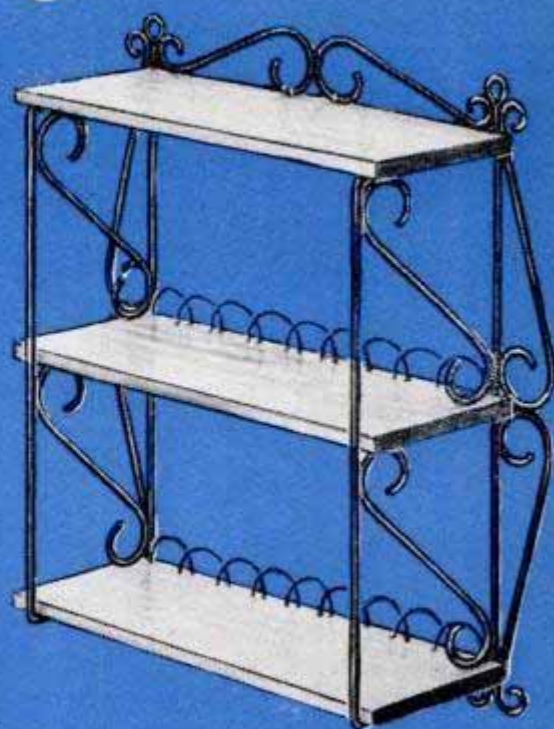

TAB FOR FASTENING
WROUGHT IRON TO
SHELVES

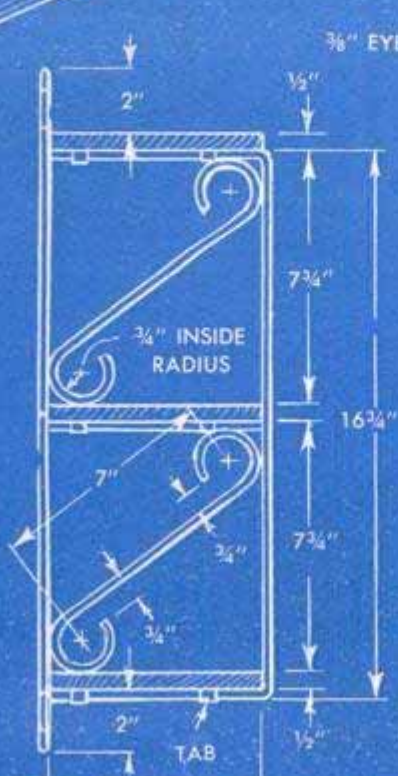

Spatter Shield on Stove Burner Improvised From Metal Container

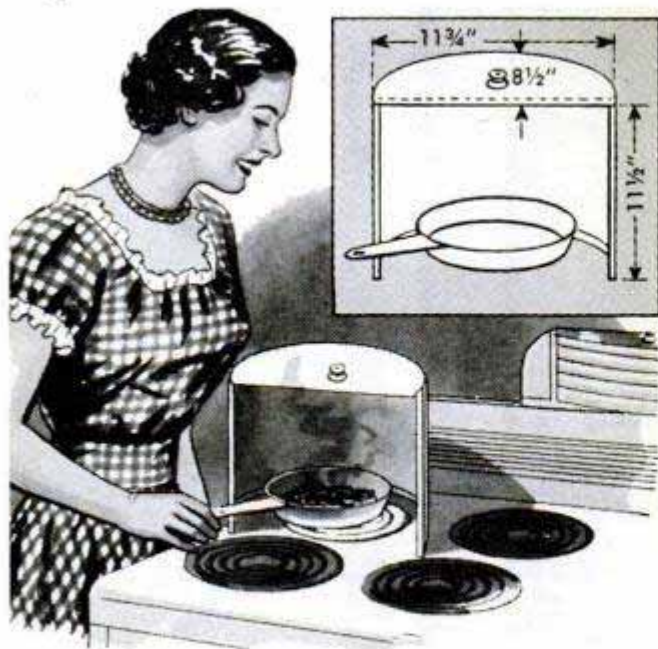

When frying food, there is always a spattering of grease on the stove top, and very often on the walls around the stove. A spatter shield that will keep your walls clean can be made from a large metal container such as a lard or shortening can. Cut it in half and bend back the metal edges to eliminate the sharp edges. A glass, plastic or wooden knob is fastened to the top of the shield.—Martin Mantell, Hazleton, Pa.

Open Loop Holds Tools

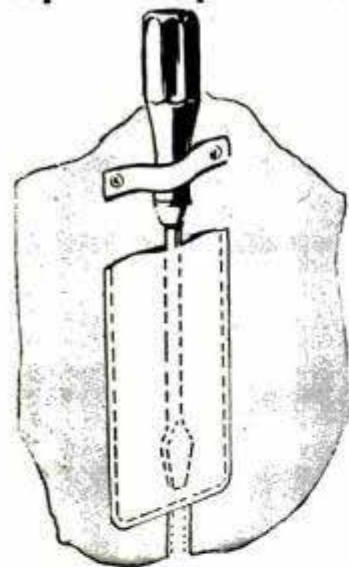

When you carry a long screwdriver or other tool in your rule pocket, sew or rivet a loop an inch or two above the pocket. This will prevent the tool from flopping back and forth or from falling out, and will not interfere when the pocket is used for the rule.—G. E. Hendrickson, Argyle, Wis.

Patching Plaster Applied With Small Brush

You can do a neat job of filling fine cracks in rough plastered walls before painting by using a small stiff paintbrush to apply the patching plaster. A 2-in. brush will be found satisfactory for this purpose. If a water-base paint is to be used, mix a little of it with the plaster. With this meth-

od it often is possible to conceal the cracks with one coat of paint. When patching smooth-finished walls, allow the plaster to dry and then sand smooth before painting.

Arthur A. Stevens, Canby, Ore.

Jig for Building Picket Fence

A jig that will automatically space the pickets the proper distance apart and maintain the proper slope is a real timesaver when building a fence. A board equal to the width of the opening between the pickets is selected, and a V-shaped wooden block, designed to rest on the top rail of the fence, is nailed to one face. A movable head is pivoted to the top of this board to align the tops of the pickets. Use a level to true up the first picket.

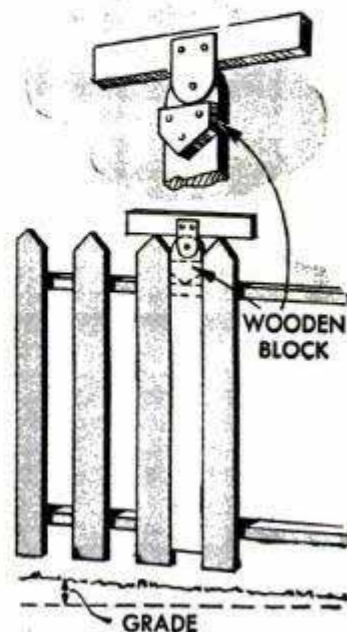

N. C. Darling, Orleans, Mass.

Foil Speeds Paint Color Change

When using a roller and roller pan to apply a number of different colors of paint, several sheets of aluminum foil speed the job of changing colors by eliminating the need for cleaning the pan. Press a sheet of aluminum foil into the pan and smooth it over the edges. When ready to change colors, pour out the paint and remove the foil.

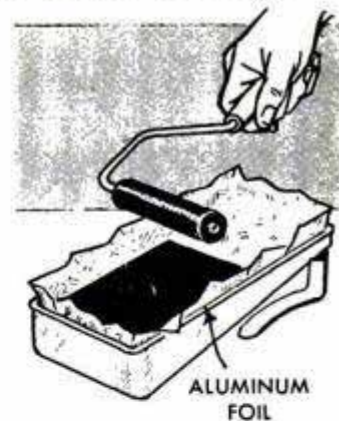

Dry Cells Stored in Refrigerator

Since heat and low humidity tend to deteriorate dry-cell batteries, they will last longer if stored in the refrigerator. When removed from the refrigerator for use, the batteries should be allowed to stand and "thaw out," in order to deliver maximum power. Flashlights, with the dry cells in them, should not be put into the refrigerator because of the danger of corrosion. They should be kept in a cool place.

CHRISTMAS *Ideas*

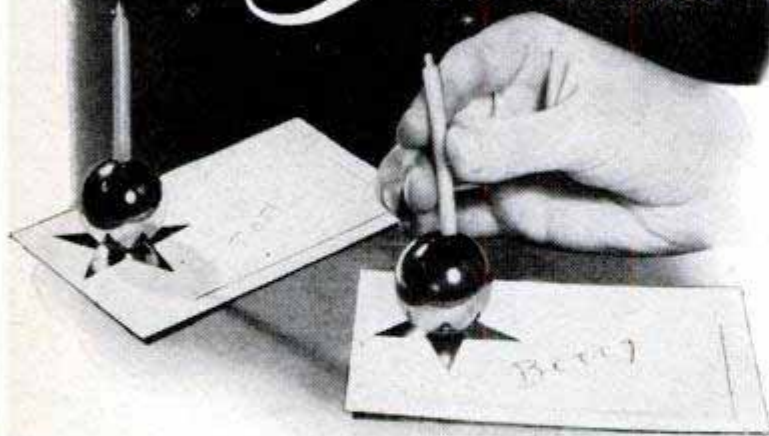

Christmastime is party time and there's nothing quite like decorative place cards to dress up the festive table. To make the cards pictured above, paste a large metallic star—gold, silver, red or green—to the upper left-hand corner of a plain card. Then remove the cap from a small tree ornament and "cement" the ornament to the star with melted wax. Insert red or green birthday candle in neck opening of the ornament and print guest's name on the card

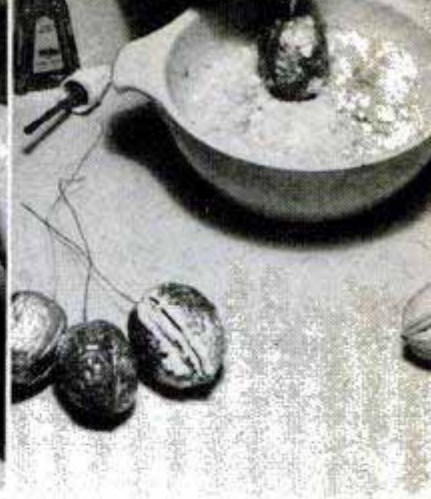

Empty walnut shells covered with artificial snow provide novel tree ornaments. Wrap a length of fine wire around a scrap of paper and place the wrapped end inside one half of the walnut shell, as in the upper left-hand photo. Then cement other half of shell to first half. Finally, coat shell with quick-drying paint or fingernail polish and dip in artificial snow

Neat little "candy" canes for your tree can be fashioned quickly from pipe cleaners, as below. Divide package of cleaners in half, leaving half of them their natural white color and coating others with red fingernail polish. When colored cleaners dry, twist a red cleaner with each white one to form spiral. Then bend to shape of a cane handle



You can use ordinary soap flakes, above, to simulate snow on the branches of your Christmas tree. Mix 1 cupful of flakes with $\frac{1}{2}$ cupful of water and whip to a creamy consistency with an egg beater. Then apply mixture to tree branches with paintbrush. Before coating entire tree, experiment on a small sprig to be sure the effect will be satisfactory

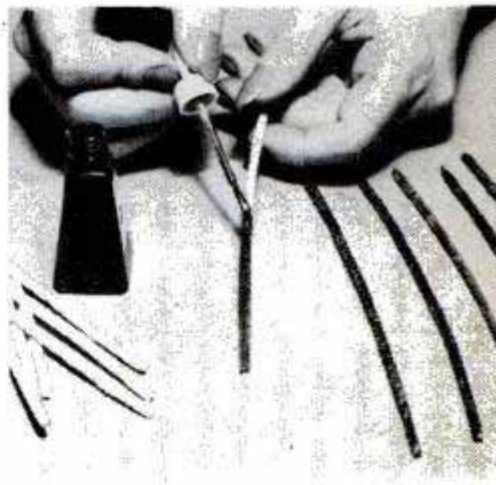
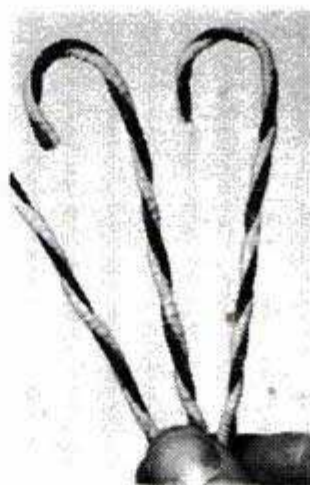

Decorative Christmas bells are made from scraps of colored candles as shown below. Melt the candles and pour wax into bell-shaped molds—several small glasses are excellent. Then remove hardened "bells" from the molds and pierce each one with a hatpin. String colored beads on fine wire, fasten ends of wire to hatpins and bind wires around ribbon bow



The young cowpoke of the family can gallop along with his favorite TV idol on this faithful wooden pinto

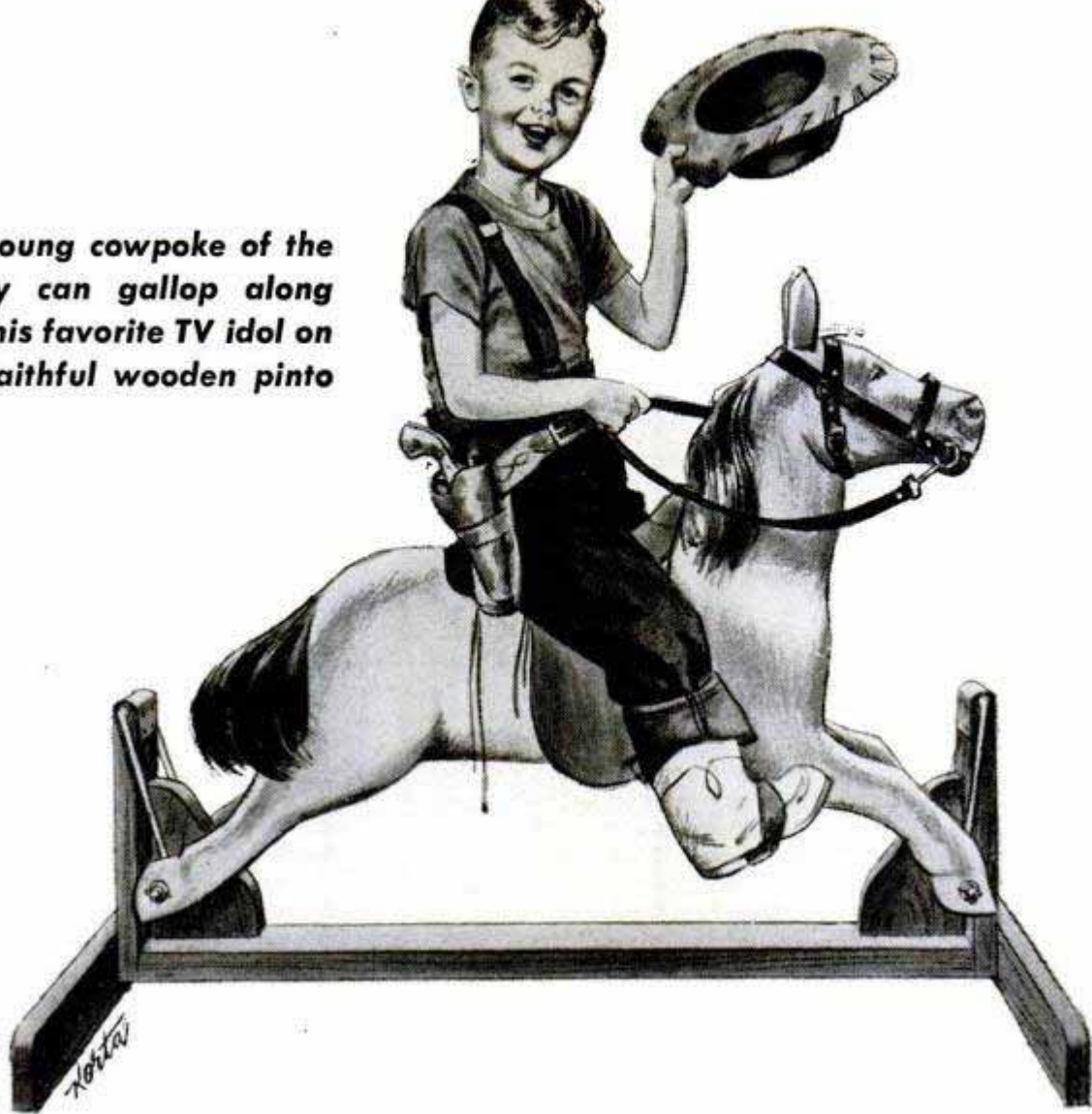

RIDE 'EM COWBOY

By
Dick Hutchinson

LONG A FAVORITE toy, the rocking horse has grown in popularity through TV westerns. To live the exciting action of stagecoach days, the modern cowhand of the family generally saddles up astride the piano bench or the arm of an easy chair. Imagine the thrill of being able to mount this fine stallion to help round up cattle rustlers, train robbers and other badmen of the western plains. You've still got time to tether this fine mount to the tree on Christmas morning, and can make it even more complete by placing a full cowboy regalia near by.

The "3D" body of the horse is built up of several layers of white pine, the outer ones being carved to the proper contour. Following the plans on the next page, the body and head pieces are cut out on a bandsaw. The head is assembled with glue and finishing nails, and then sanded roughly to shape on a sander. Next the body is put together, also with glue and finishing nails, and then the legs, made from 1-in. oak for sturdiness, are cut out and sanded to rough shape.

The swings which support the horse are

made of $\frac{3}{8}$ -in. rod that is heated and bent to shape in a vise. Set the bushings in the horse's feet and place the hangers in position in the bushings. Now the legs are glued and nailed to the body, with the feet fitted over the swings at the same time.

The whole body is brought to shape with a rasp. Fill and sand until the entire surface is smooth. The completed horse is given a coat of shellac, and then either painted or finished in felt flocking. The latter method produces a very realistic coat. First mix an enamel about the color of the flock you are going to use, and apply it to the horse with either a spray gun or a brush. When the enamel is tacky, the flock is sifted on and then pressed down with the fingers. Brush off lightly with a bench brush, let dry, and then brush again.

Hemp rope may be combed out for the hair of the mane and tail. A $\frac{1}{4}$ -in. slot is cut along the top of the neck, and clumps of the hair glued into it for the mane. For the tail, scrape away the flock at the point at which it is to be attached, coat the surface with glue and then staple the tail in place. The stand is made of oak. ★ ★ ★

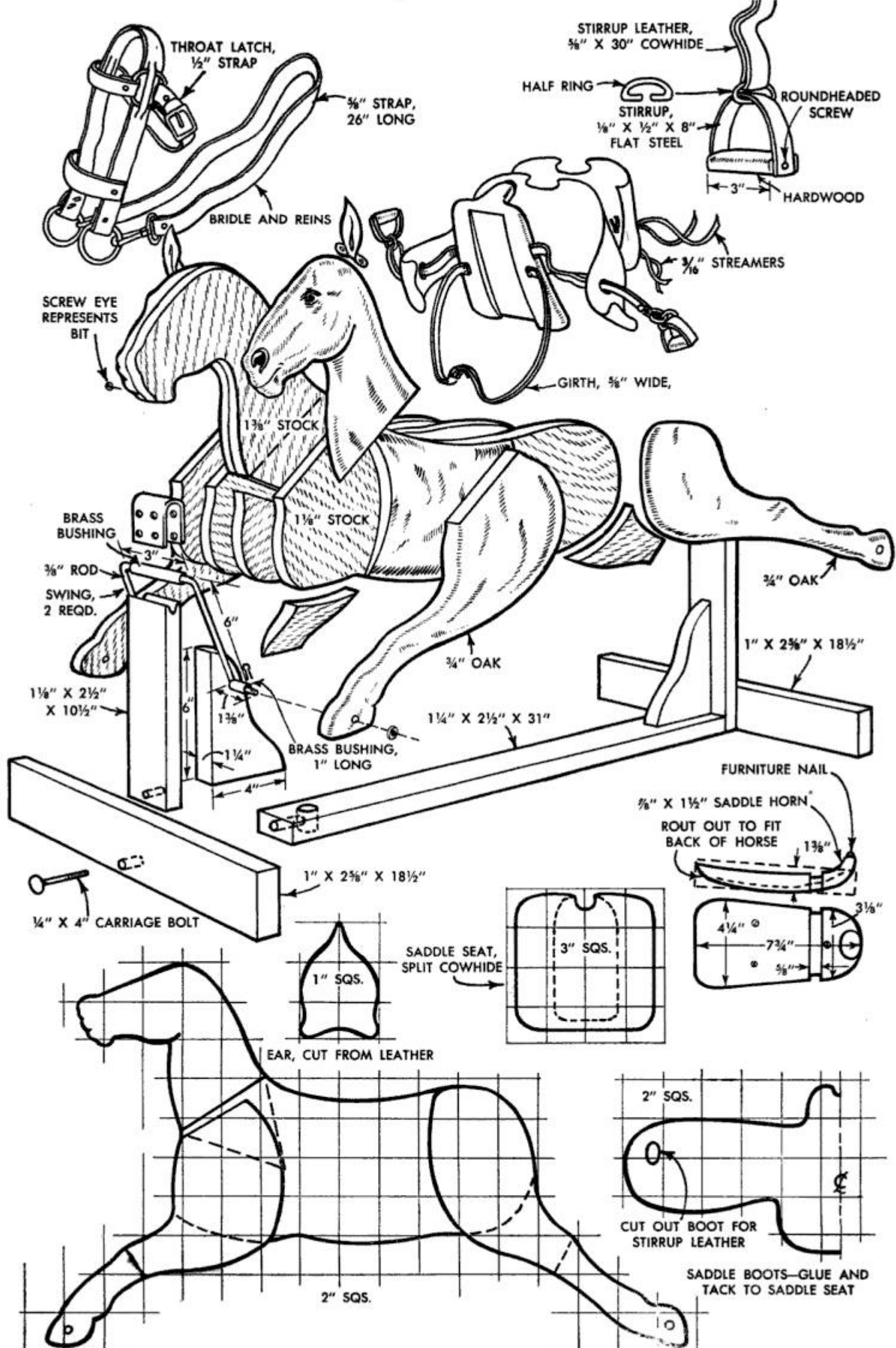

Plastic Egg-Storage Tray Used In Mixing Artist's Colors



Artists will find that a plastic egg tray of the type used to store eggs in a refrigerator is excellent for mixing small amounts of paint. Such trays are available at most ten-cent stores. The wells in the trays provide small individual mixing bowls and have the advantage of being easy to clean.

Hugh Lineback, Stillwater, Okla.

Rack for Table-Tennis Balls Made From Cigar Box

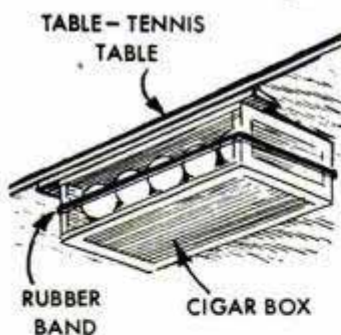

A generous supply of table-tennis balls is kept ready for action when stored in this cigar-box rack, which is fastened to the underside of the table top or a near-by shelf. The front of the box is

removed and the top is tacked shut. A large rubber band is drawn around the box to keep the balls from rolling out. Note in the detail that a thin strip of wood is inserted above the front edge of the rack. This tilts

Build the Midway!

Only the magic of modelmaking could transform your workbench into a shipyard for building one of the world's most powerful warships. All of her imposing 968-ft. length is concentrated in a finely detailed 2-ft. model, the story of which will start next month. You'll enjoy working out the rakish lines, unusual armament and streamlined superstructure of this famous fighting ship

the box forward just enough to keep the balls at the front where they are within easy reach of the players.

Tacks Through Terminal Nuts Prevent Damage to Carpet

When stair carpeting is moved, as it must be occasionally to prevent uneven wear, the edges frequently are damaged and torn during the removal of the tacks.

To prevent this damage, one building owner used longer tacks when laying the carpet and drove them through terminal nuts taken from dry cells. Then, when relocating the carpeting on the stairs, withdrawing the tacks was simple, since the claw of the hammer fitted under the head of the terminal nut. The terminal nuts should be used only where there is no danger of tripping over them.

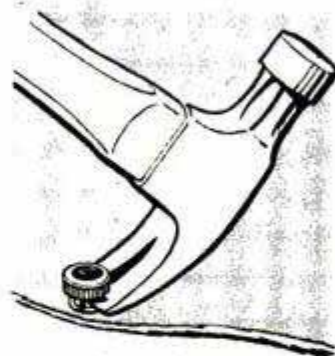

Outboard-Motor Drain Deflector Protects Against Corrosion

On some older type outboard motors the cooling water drains directly onto the exhaust housing, causing a constant corrosion, especially in water containing salt or of a high mineral content. To prevent this, drill a $\frac{5}{16}$ -in. hole into the present drain and tap it with a $\frac{1}{8}$ -in. pipe thread. Install a 2-in. length of copper tubing which has a male fitting with a $\frac{1}{8}$ -in. pipe thread. Then bend the tubing so the water drains away from the motor, as in the photo.

Clinton R. Hull, Costa Mesa, Calif.

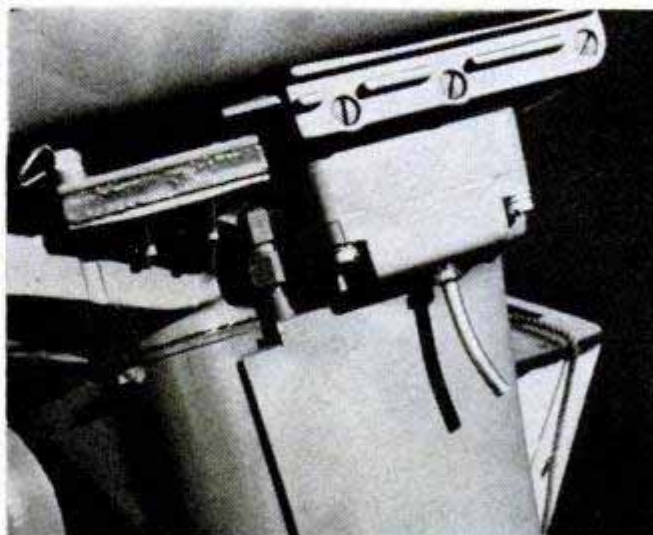

One way of thawing a frozen lock on a car door is to hold a hot-water bottle containing boiling water against it.

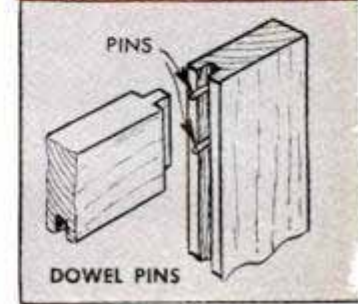
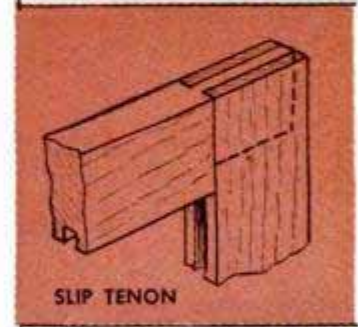
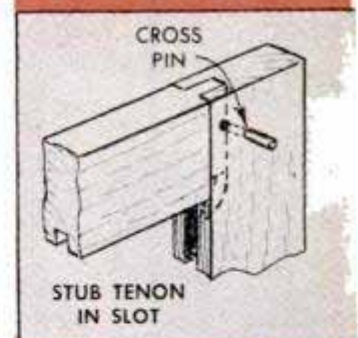
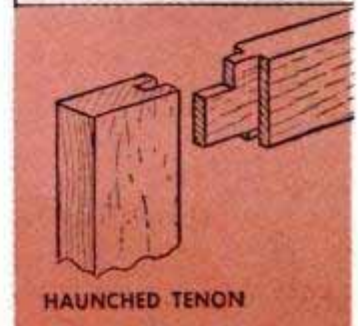
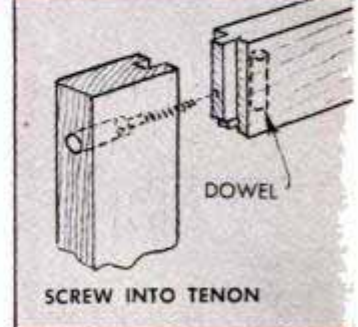
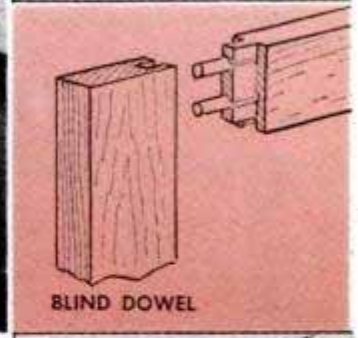
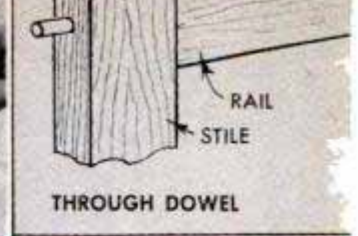
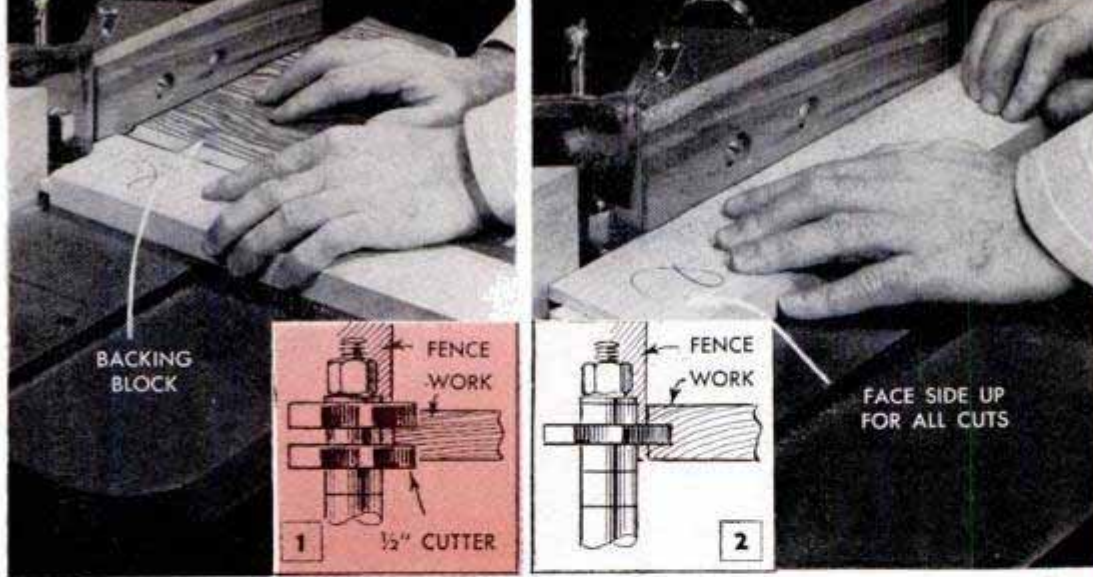

HOW TO MAKE PANEL DOORS

WTM
255

By Sam Brown

WITH A wide variety of applications from the kitchen cabinets to full-size entryways, recessed-panel doors present a finished professional-looking appearance. This is especially true when the stiles and rails are molded and coped to fit together neatly. If your shop is equipped with a single-spindle shaper, you'll be surprised how easily this can be done. In most cases, special shaper cutters are required for any specified type of molding. A full set consists of four cutters, two of which run the molding on the edges of the stiles and rails and a second pair which shape the matching cope cut in the rails. This is illustrated clearly in the series of details directly below Fig. 3. Half of a full set of cutters; that is, one molding cutter and one cope cutter, can be used for both molding and coping as in Fig. 4, and a few shapes can be cut with but a single cutter.

Square molding: Because this type of molding retains the original square shape of the stock, no special cutters are needed, the regular straight knives supplied in any stock assortment of cutters being used. The stub tenon on the rails is made with two cutters separated by a 1/4-in. spacer, Fig. 1, while the molding is formed automatically when the panel groove is cut, as in Fig. 2. Although a cut 1/4 in. deep usually is sufficient for the panel groove, many craftsmen prefer to make this groove 3/8 in. deep to permit using a longer stub tenon and thus achieving greater strength. It is also recommended to make the groove slightly deeper than the length of the tenon to allow room for excess glue. The tenon-cutting setup shown in Fig. 1, which consists of two 1/2-in. cutters and a 1/4-in. spacing collar, can be conveniently changed for making the cope cut. To do this, a 1/2-in. collar is substituted for the lower 1/2-in. cutter, automatically positioning the single 1/4-in. cutter used for the panel groove at the proper height, Fig. 2.

When the complete set of cutters is used, the work is shaped with either the face side up or down during the entire operation. The depth of cut, which is governed by the fence setting, is the same for both the molding and cope cuts. An efficient and safe method for feeding the work into the cutters, especially when

Although stub tenon and groove formed by making cope and molding shaper cuts frequently are sufficient, stronger joints can be made in a number of ways. Note the seven popular methods given in the details at the right

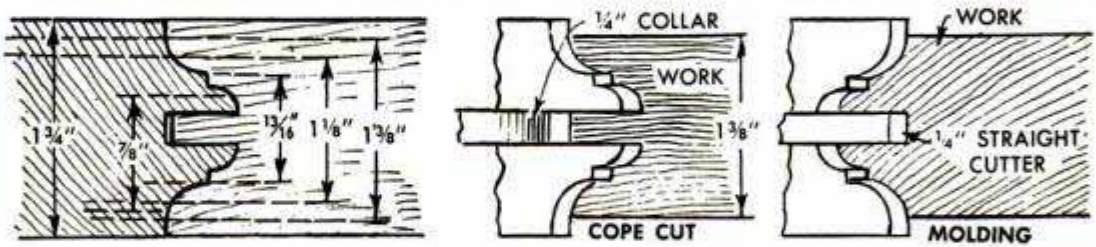
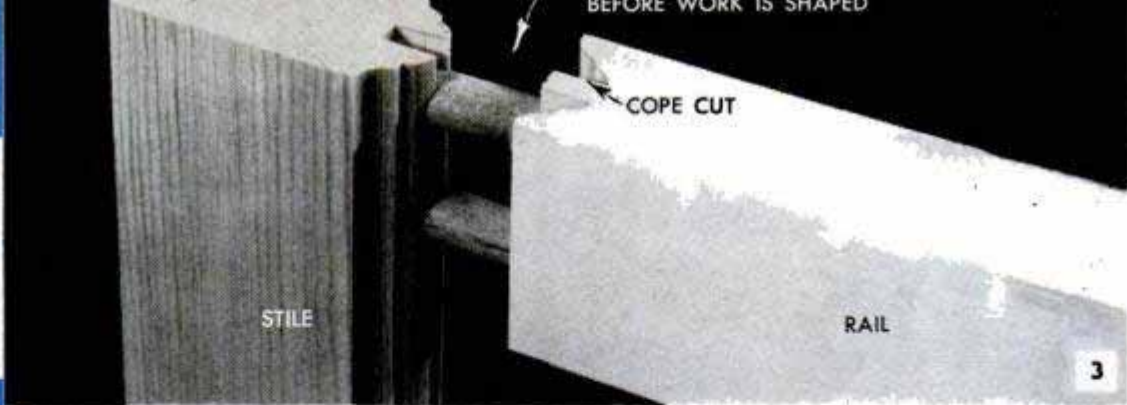
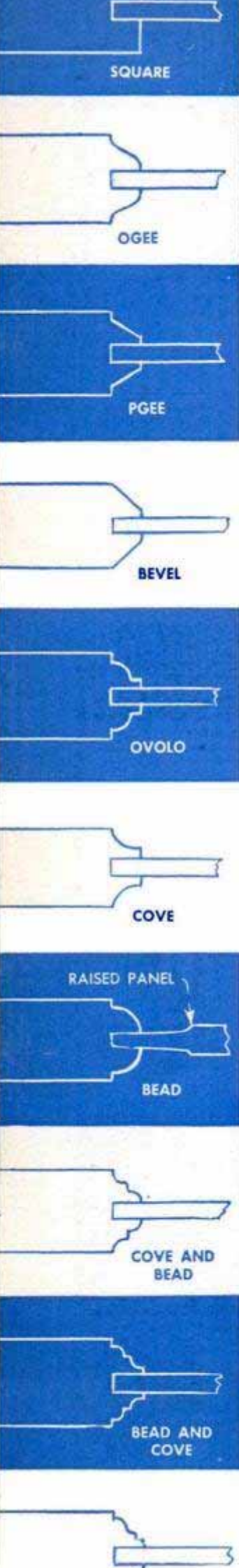

Details at left show various types of molding. Complete set of shaper cutters for making both cope and molding cuts is shown above. Note dimensions for 1 3/4-in. stock

making cope cuts, is to use a wooden backing block, as pictured in Figs. 1 and 5. The block may be a piece of 3/4-in. plywood about 12 in. sq. with the front edge faced with a wooden strip held in place with brads. The strip provides a backing for the cut and also a gripping edge for the operator's thumb when the work is fed into the cutters as in Fig. 5. It is necessary, of course, that the faced edge of the plywood be at right angles to the edge guided along the fence.

Door joints: Lightweight doors usually are satisfactory if assembled only with the 3/8-in. stub tenon formed in the shaping operation. However, additional reinforcing can be obtained by using any of the various joints pictured in the series of drawings along the right-hand side of page 177. The stub-tenon-in-slot joint is one of the more popular because it requires only straight shaper work, differing from the square molding only in that special long shaper knives are used to cut 3/4 in. deep. Blind doweling, also shown in Fig. 3, is a practical method of joinery for the average worker, while the haunched-tenon joint has a reputation for providing maximum strength.

Cove and bead molding: Fig. 5 shows a typical coped-and-molded doorframe with cove and bead molding. The cope cut always is made first, as in Fig. 5; then, when the molding is cut, Fig. 6, the slight splintering at the ends of the cope cut is removed. A good routine is to run

Forming ogee molding with one cutter, as below, is simple inexpensive setup. The same cutter can be used to cope the rails as well as cut the molding

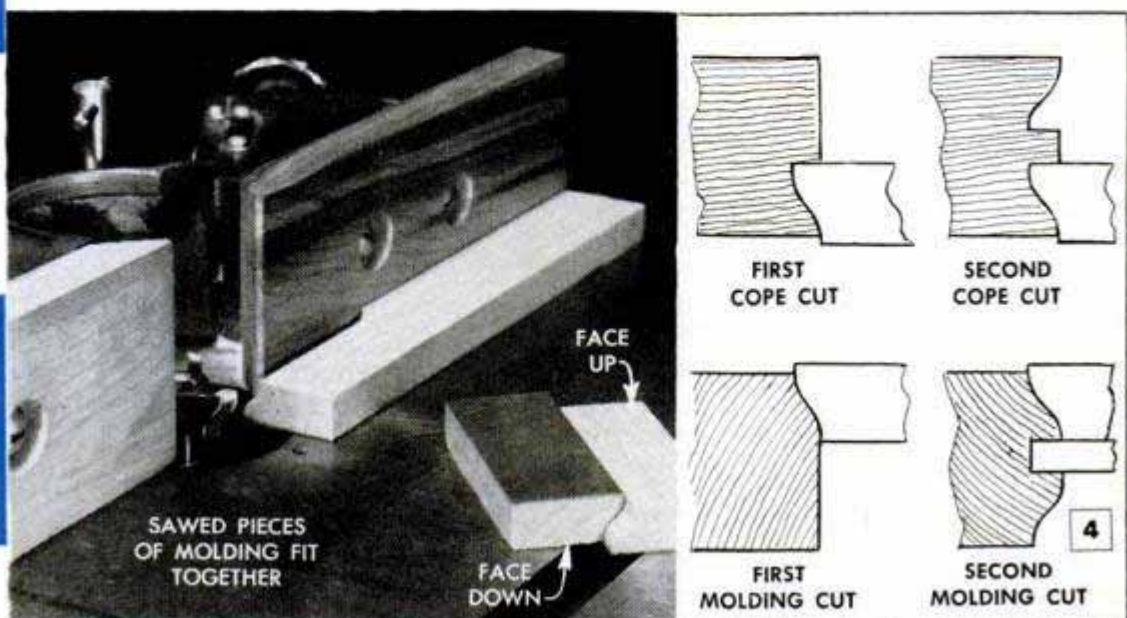

test cuts for both the molding and cope. Assemble the test joint, and if the fit is satisfactory, as in Figs. 9 and 10, proceed by making the cope cuts on the actual work. In any setup of this type, the fence setting remains the same for both the cope and molding cuts and, in many instances, the cutters are matched so that the spindle height setting remains the same throughout.

Long tenons: When assembly is to be made with long tenons, the tenons are marked and rough-cut on the bandsaw or circular saw, the idea simply being to get rid of some of the excess wood. The tenon is then cut to net thickness and coped by using a single cope cutter, Fig. 8. It is necessary to turn the work over to cope the opposite side. A single pass will form a tenon up to 2 in. long provided that some of the excess wood has been cut away. As the cope cutter runs completely under the work, it is necessary to mount the cutter so the end of the shaper spindle does not extend beyond the top of the cutter. There are various methods of accomplishing this; two of the most common methods being the use of either the stub spindle or the threaded cutter, as in Fig. 7. Note that the cope cut can be made with one cutter simply by turning over the work. The molding cut can be made similarly, enabling you to do a good job with only half a cutter set. Before making the molding cuts in the stile, it is necessary to use the dado head on the circular saw to cut the deep full-length groove for the rail tenons and the door panel. Special care must be taken to center this groove along the length of the stile.

Reversible moldings: Certain moldings, such as those detailed at the bottom of the page, have a reversible shape and fit together perfectly when one section of the molding is turned over and placed against the other part, as in Fig. 4. This means that a doorframe can be molded and coped with just one special cutter as shown in the setups for the ogee molding, Fig. 4, and the detail below Fig. 10. The fence setting remains the same for all cuts but the spindle height must be varied when changing from the molding to the cope cut. The straight cutter for the panel groove can be combined with the molding cutter, as in Fig. 11, or the groove can be run as a separate cut. Other examples of the single-cutter setup are shown in Fig. 11. These include the ogee, 45-deg. bevel and reverse ogee on 3/4-in. stock. In all cases, the cutter can be

Long tenons are rough-cut with a handsaw or circular saw and then shaped as pictured at the right. Work must be turned over to cope the opposite side

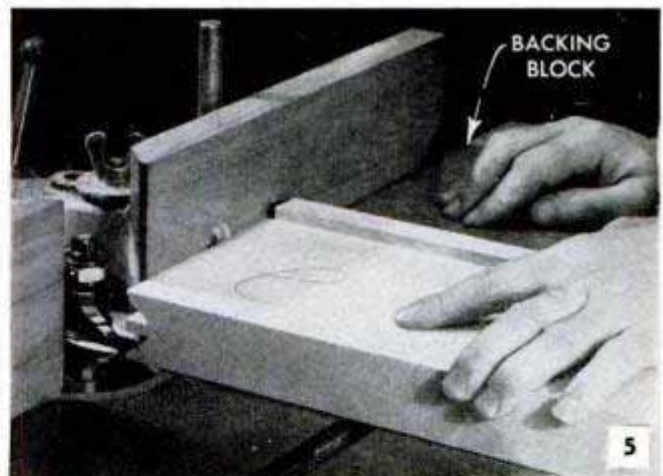

COPE CUT IS ALWAYS MADE FIRST

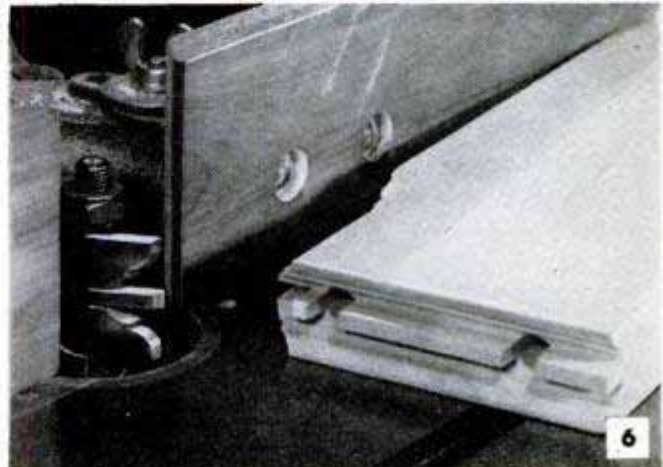

MOLDING IS RUN ON ALL PIECES

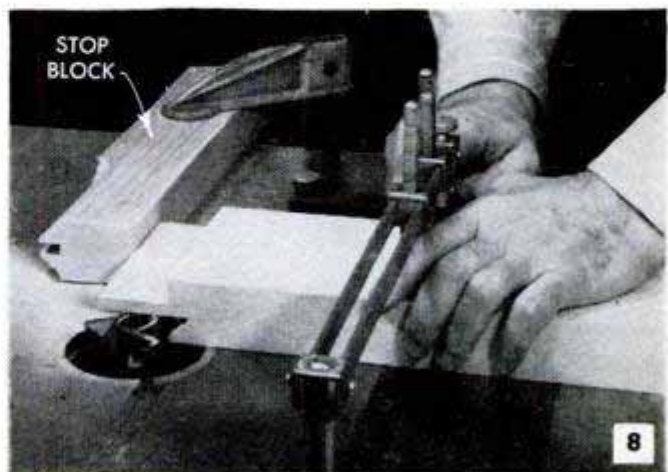
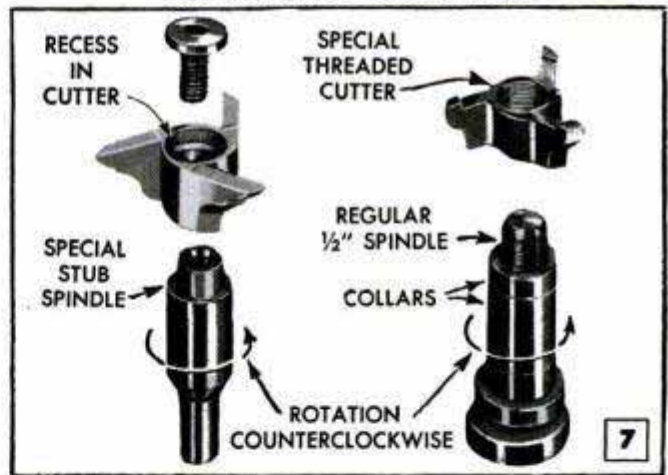

COPING A LONG TENON





1 3/8" STOCK WITH
OGEE MOLDING

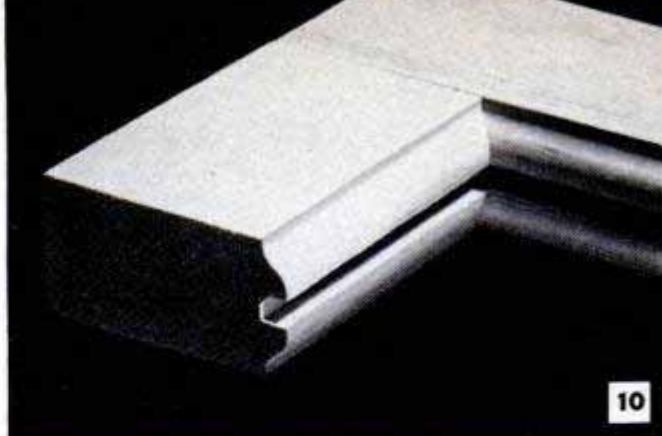

10

Ogee molding on 1 3/8-in. stock is typical of door work where ends of the rails are coped to fit the molding on the stiles. Note joint in right-hand photo

reversed, if desired, instead of turning over the work. This is shown in the upper series of details which pictures the ogee molding cut. Note in the three right-hand details in Fig. 11, that a set of two cutters would be required as normal equipment for working 1 1/16 or 1 3/8-in. stock.

Raised panels: Most doors are assembled with 1/4-in.-plywood panels. If raised panels are desired, they can be cut by using a special shaper cutter, Figs. 12 and 13, or by sawing with a hollow-ground blade tilted 4 or 5 degrees. Whether the shaper or the circular saw is used to shape the edges of the panels, it is best to use a high fence to help support the work. The spring hold-in pictured in Fig. 12 and shown in use in Fig. 13, is made by slotting one end of the length of hardwood. The hold-in is clamped to the shaper table so the slotted edge bears against the flat surface of the work. Height of the fence may be increased by clamping



OGEE ON 3/4" STOCK

a board to the original fence or bolting it in place, Figs. 12 and 13, countersinking the bolt heads. The auxiliary fence, of course, must be cut out to clear the shaper cutter.

Door layout: Probably the most troublesome problem to the beginner in sash-and-door work is layout; that is, how long to saw the rails to compensate for molding and joints. This becomes easy, however, if a rough drawing is made as in the upper detail of Fig. 14. Then, starting with the required width and applying the various simple additions and subtractions indicated, all the necessary dimensions can be calculated quickly. When determining the width of the molding, always measure an actual sample, as the width varies from cutter to cutter, and also when part instead of the full cutter shape is used. ★ ★ ★

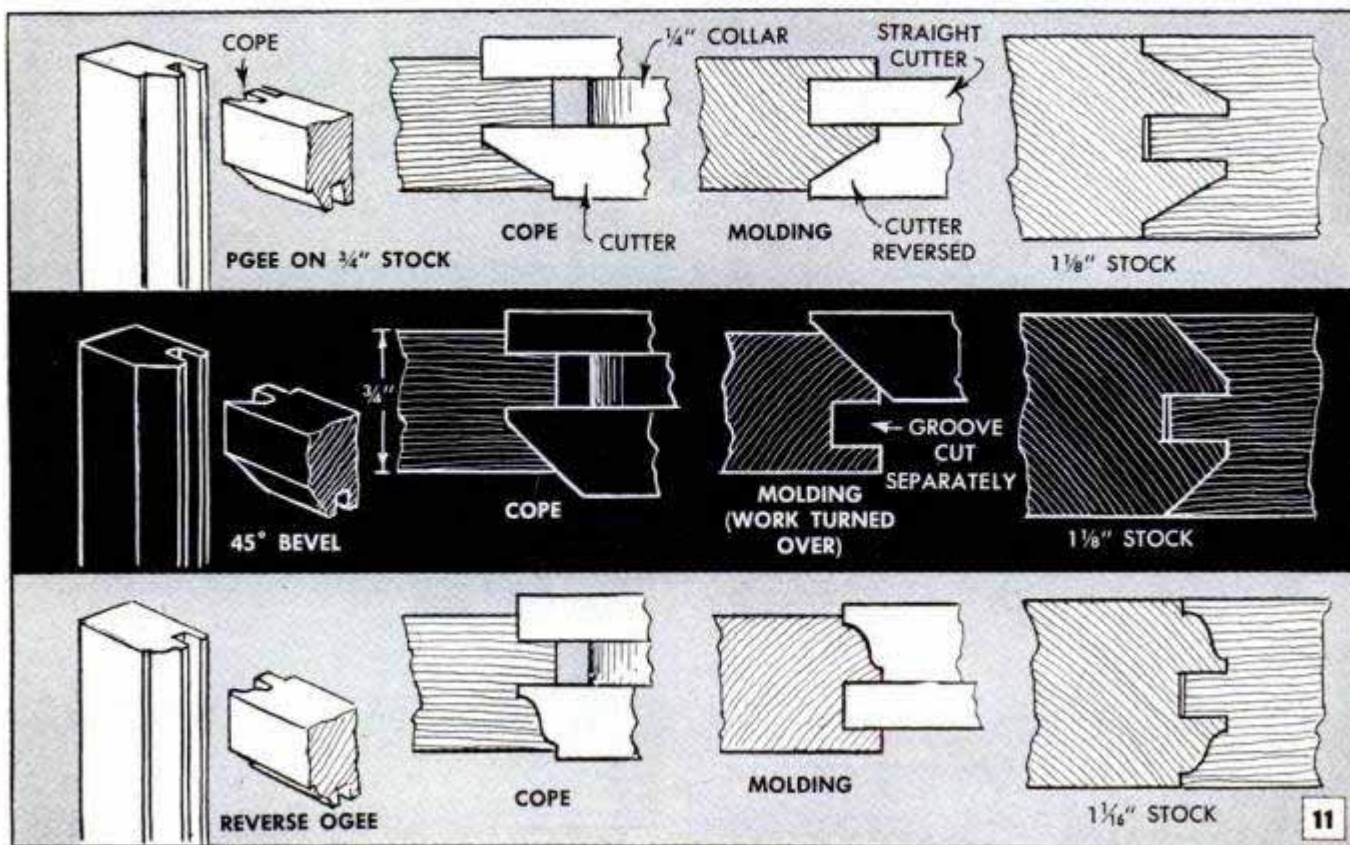

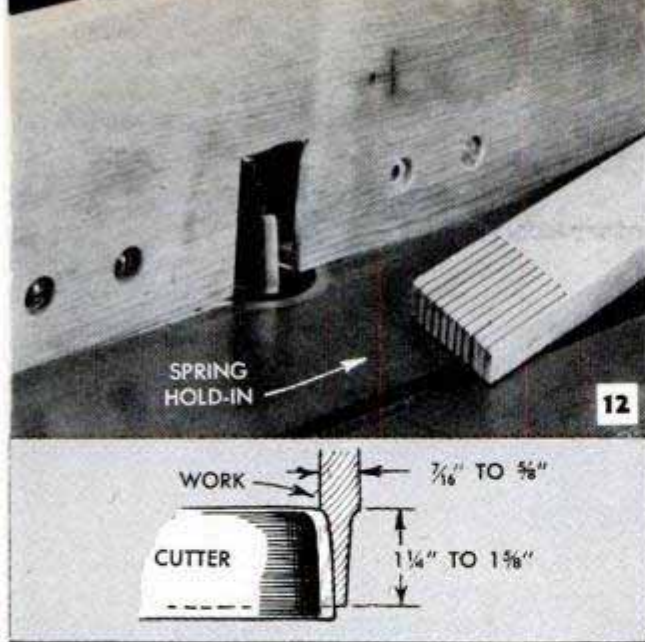

Raised panels are made by shaping edges on circular saw or with special shaper cutter as detailed above

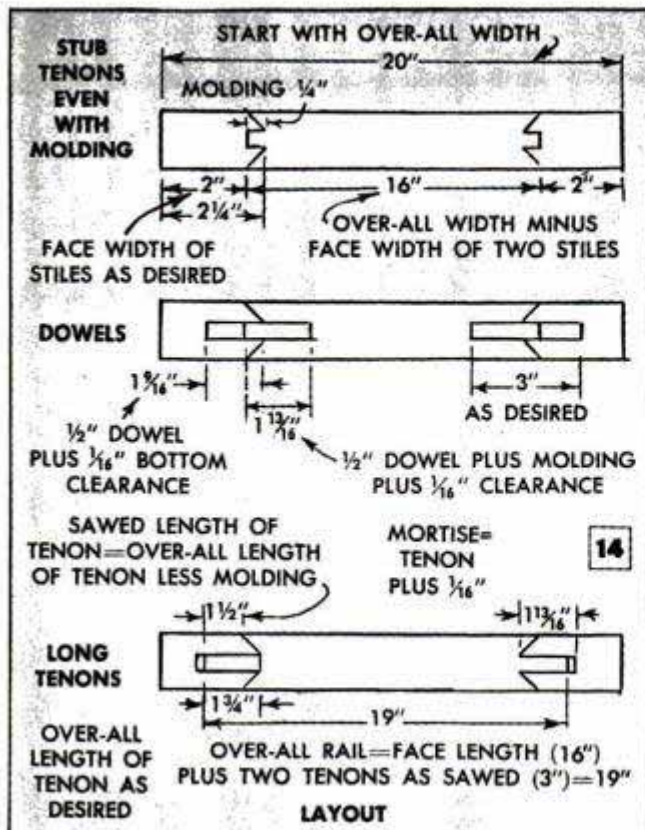
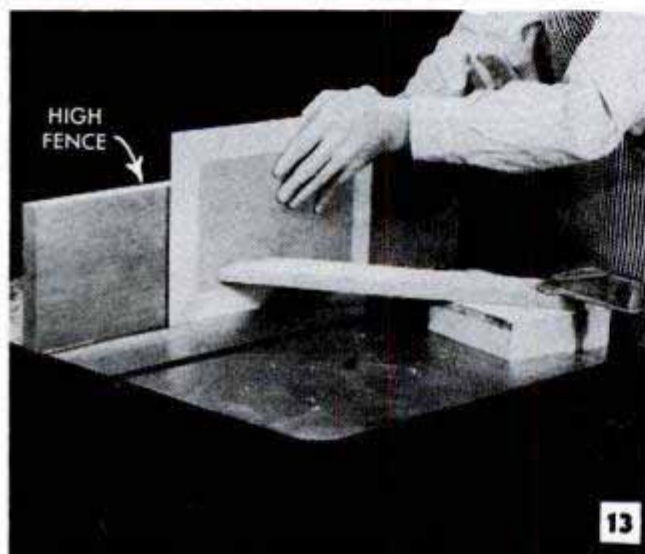

Miniature License Holder Used As Luggage Identification Tag

The miniature license-plate holders many people carry with their automobile keys make excellent identification tags for use on brief cases and other types of luggage. Instead of throwing away last year's tag, pry open the metal tabs, remove the license numbers and insert a small card with your name and address on it. An inexpensive key chain may be used to secure the tag through the handle-grip posts on the piece of luggage.



H. G. Frommer, Milwaukee, Wis.

Modeling-Clay Substitute Cooked in Kitchen

An inexpensive modeling material, allowing both children and adults a chance for artistic expression, is made easily from water, cornstarch and ice-cream salt. Two cups of salt are boiled in one cup of water, into which is stirred one cup of cornstarch that has been thinned to the consistency of thin gravy. When the mixture cooks to a semisolid condition, roll it out on waxed paper to cool. For variety, work in a small amount of vegetable coloring to a portion of it. In its moist condition the "clay" can be kept for weeks by wrapping in waxed paper and storing in a crisper bag in the refrigerator. This material will get quite hard after air-drying for several days. During the drying, pinch shut and smooth over any cracks which appear.—Mrs. Gertrude Springer, Cloverdale, Mich.

Rubber Hose Snubs Door Spring

A piece of small-dia. rubber hose or tubing slipped over a screen-door spring will prevent possible injury if the spring should break or become unhooked. Cut the hose long enough to cover the spring and hooks, loosen the spring and slide it into the hose. Then hook it back into place. In this way, the hose or tubing forms a rubber sheath to dampen and absorb the backlash of the spring if it should break.

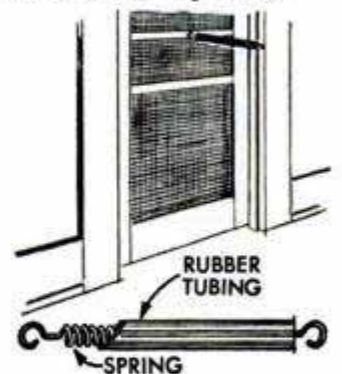

Louis Booker, Louisville, Ky.

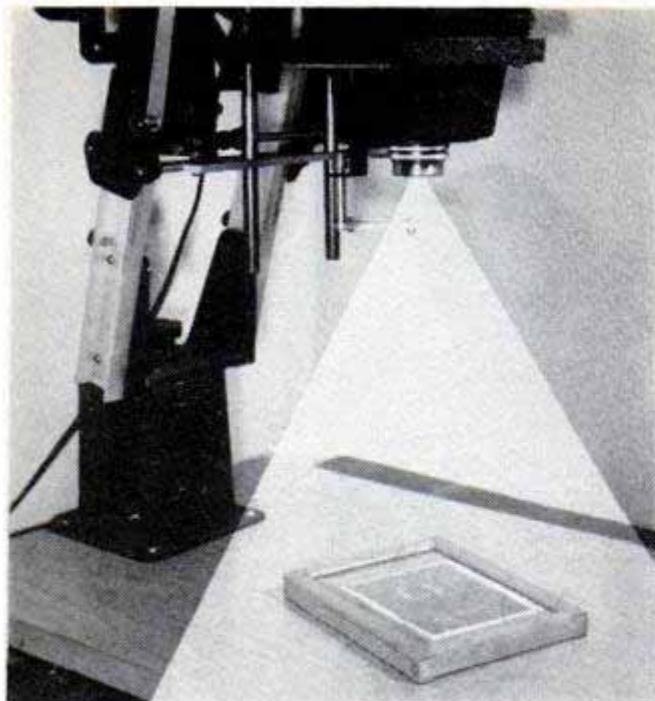

Enlarger Doubles as Printer

When you run short of contact paper, contact prints can be made by switching over to your enlarger and using enlarging paper. The negative and enlarging paper are held in the printing frame as before and placed on the bed of the enlarger. As enlarger paper is slower than contact, a trial exposure of 10 seconds at f:16 should be made.

Virginia Hanson, Los Angeles, Calif.

Blue Filter on Enlarger Gives Softer Contrast

Photographic prints made on enlarging paper with a cold-light enlarger have a softer contrast because of the greater amount of blue light in the fluorescent bulb. A blue filter used on a condenser-type enlarger will, for the same reason, give a softer contrast to prints.

Robert C. Florian, Chicago.

Refrigerator Water Coolers Used as Developing Trays

Furnished with identifying labels, several glass or plastic water trays of the type used in home refrigerators will provide a set of photo-developing trays. Each tray holds more than a gallon of liquid and can accommodate 18 film hangers up to and including the 4 x 5-in. size. Each tray has a push-button faucet.—S/Sgt. Eugene H. Lechler, M.C.A.S., Cherry Point, N. C.

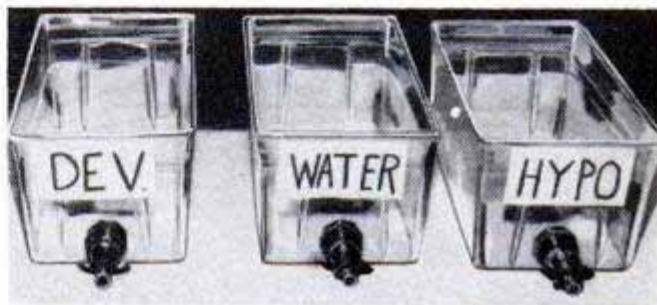

Popular Mechanics Bookshop

Do Your Christmas Shopping Here

Here are gifts that can solve two of your shopping problems. One will provide countless hours of amusement—and education—to any child. The other will bring back a good many laughs and memories to adults. Order now and they'll arrive in plenty of time for Christmas.

For Children

TO EVERY CHILD there comes a time when Santa changes from a person into a spirit; when the child is "just too old" for kiddies' toys and not quite old enough to know what he really wants. Here's a book that spans the age group from the nursery set right into the teens. TV's famous Mr. Wizard explains in text and photos 150 experiments that can be performed with articles found around the home. Hour upon hour of pleasure awaits the child as he makes his own toys and thereby solves Nature's fascinating riddles. What's more, he learns as he plays. \$3.00.

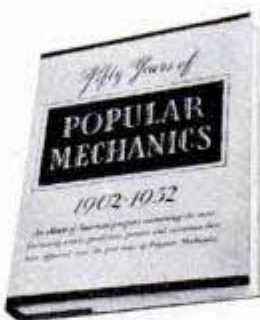
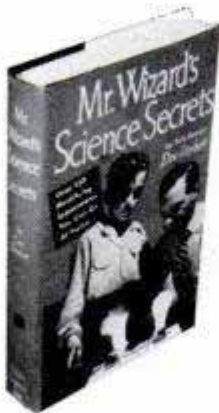

For Adults

AND HERE'S a solution to a perennial problem: what to give the person who "has everything." Within the pages of this book anyone can find a good many smiles, and memories of "the good old days" when the most important thing on earth was Barney Oldfield's latest race or that amazing phenomenon, pictures that actually moved! Here's a 50-year record of the way we've lived, worked and played, illustrated with a fine collection of photos from every decade. Whether you thumb through the book for one minute or three hours, you'll thrill again to the thrills of yesterday. \$5.00

Both books available from Popular Mechanics Book Department, 208 E. Ontario St., Chicago 11

PUNCHES

for sheet metal and cardboard

By Carl S. Bates

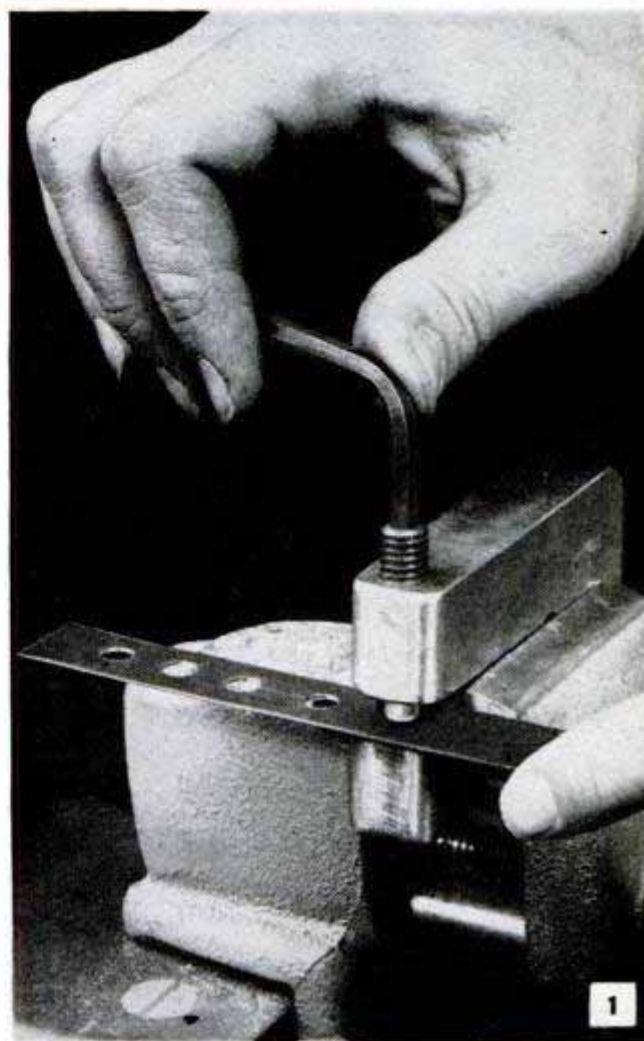
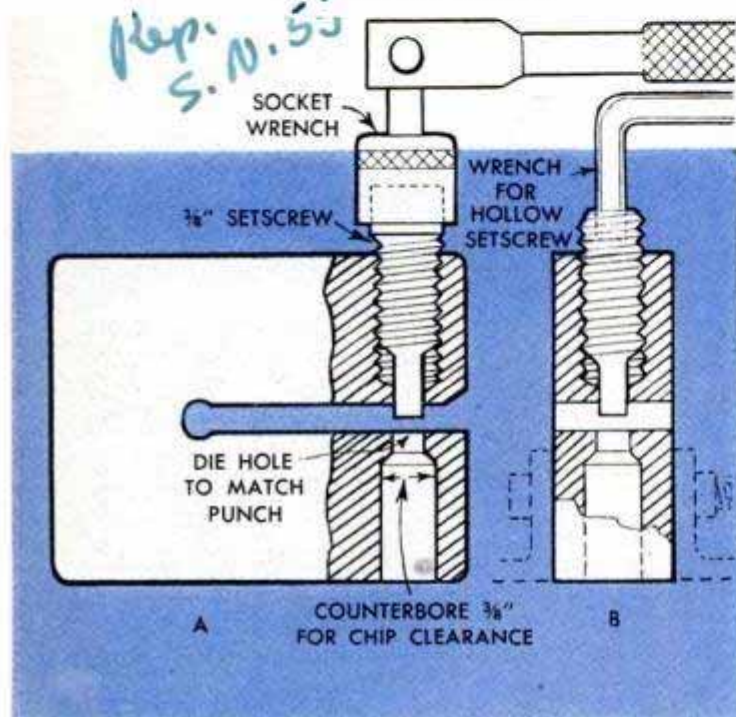

FOR ACCURACY, holes in sheet metal should be punched rather than drilled. Drilling the holes by sandwiching the metal between two pieces of hardwood and drilling through all three thicknesses is never quite satisfactory, especially where a layout is involved. It is difficult to locate the drill bit on the layout centers and unless the bit has been precision-ground the hole is almost sure to be slightly oversize.

When the work requires clean, round holes with sharp edges, simple hand punches that operate on the screw-press principle give the best results on sheet metals of varying thicknesses. The detail above shows the construction of the simplest type, and the photo, Fig. 1, pictures it in use. As detailed, the punch gives only one hole size, but of course, screw punches and insert dies of varying sizes could be used in the same frame. However, as a rule it is easier to make a number of individual units of one-hole size than it is to make insert dies and separate punches of several sizes for use in the same frame. As will be seen from details A and B, suitable punches can be made from ordinary setscrews of the hol-

low and square-headed types. Forming the cutting punch on the end of the setscrew is done by first rough-grinding by hand to remove the threads for a distance of about 1/2 in. from the end of the setscrew. Then drill and tap a block of 1/2 x 1-in. steel for the setscrew. Clamp the block to the grinder tool rest with one face as close to the side of the wheel as possible. Then raise the tool rest until the tapped hole is on the center line of the wheel, or slightly below it. Turn the screw into the tapped hole and adjust the block so that the wheel will take a very light cut as the setscrew is turned in slowly. The advance of the threads carries the rounded end of the setscrew across the face of the wheel, grinding the end concentric. Turn the screw in the required distance and then back it out to clear the wheel. Check the diameter at the end and if it is slightly over the required dimension, tap the holder lightly with a hammer to shift it slightly inward on the tool rest. Then repeat the grinding procedure. Several passes may be necessary to bring the punch to the required diameter. When grinding in this manner be careful not to

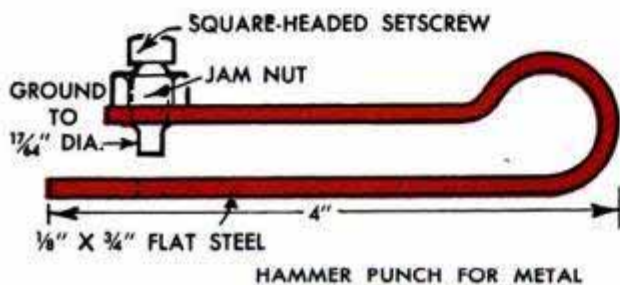

HAMMER PUNCH FOR METAL

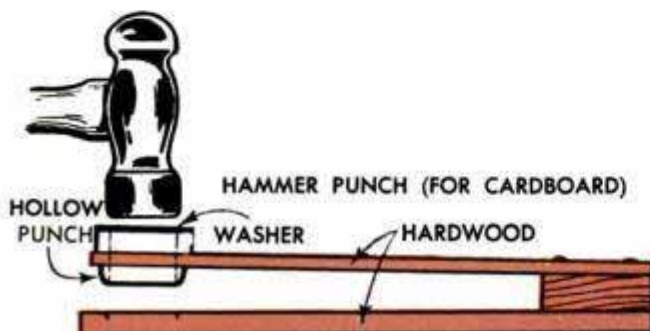
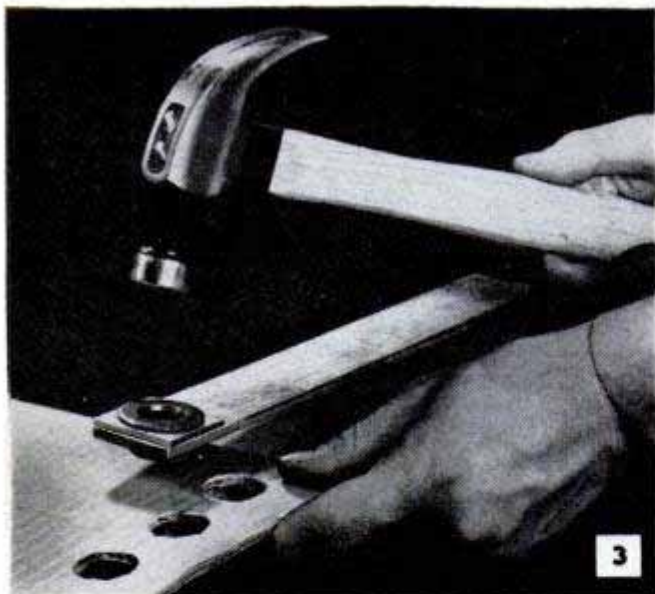

overheat the setscrew and draw the temper, making it useless as a punch.

When a $\frac{3}{8}$ -in. setscrew is used as the punch, the frame can be made from a piece of $\frac{3}{4}$ -in. tool steel about 2 in. wide and $3\frac{1}{2}$ in. long. Note in the details A and B that the piece is slotted to a clearance hole. The exact width of the slot is not important. If a milling machine is not available, two hacksaw blades placed side by side on the saw frame will do the trick. In either case the clearance hole must be drilled before slotting. If the slot is cut by hand, true the cut with a file so that both faces are smooth.

The next step is to drill the die hole through both arms of the frame. Follow with a tap hole for the $\frac{3}{8}$ -in. thread in the upper frame, and a $\frac{3}{8}$ -in. chip-clearance hole drilled in the bottom arm. Note that both the tap hole and the chip-clearance hole do not break through into the slot. Next, tap the hole in the upper arm for the setscrew, using a bottom tap. It will be noted that these separate drilling operations produce what is in effect a double counterbore with the smaller-diameter hole serving as a guide for the punch in the upper arm, and as the actual die in the lower arm.

For thin sheet metal a hammer actuated punch, Fig. 2, is practical and somewhat faster in operation. The punch itself is made from a square-headed setscrew in the same manner as described. The frame is a length of flat steel bent back on itself as in the detail, Fig. 2. An eye is formed in the bend to accentuate the normal spring action in returning the upper arm to a position parallel with the lower arm after each hammer blow. The punch is held rigidly in the upper arm by means of a jam nut and the hole forming the die is drilled in the lower arm, the hole centering under the punch.

The cardboard punch, Fig. 3, operates in the same manner as the hammer punch for metal, except that the frame is made from three pieces of hardwood and the hollow punch is made from a short length of steel tubing. An inside bevel is ground on one end of the punch to form a cutting edge and a washer welded to the opposite end provides a striking surface. In the assembly the punch is simply forced into a hole drilled through the upper arm. ★ ★ ★

Reducing Tap Breakage

Tap breakage can be kept to a minimum in hard metal by using drills larger than those listed on a tap-drill chart. For holes less than $\frac{1}{2}$ in. use a drill $\frac{1}{64}$ in. larger than listed. For holes larger than $\frac{1}{2}$ in. use a drill $\frac{1}{32}$ in. oversize.

C. Wayne Close, Sycamore, Ohio.

Here's a portable, large-capacity hog shelter which is towed by means of eyes welded on the ends of the skids. The two skids and the crossbeams joining them are 6-in. steel I-beams. The frame is of welded construction, utilizing angle iron from an old windmill tower. The angles were heated and bent to form a radius where roof and walls join. The building is 12 x 20 ft. and 8 ft. high at the ridge. Five rib sections were used to support the roof. The 2 x 10-ft. sheets of corrugated aluminum forming the skin were bolted to the ribs. One sheet was folded over the ridge, extending a foot on each side. The aluminum sheeting, plus the rib-type welded construction, results in a lightweight

Portable General-Purpose Shelter Is Easily Towed on Skids

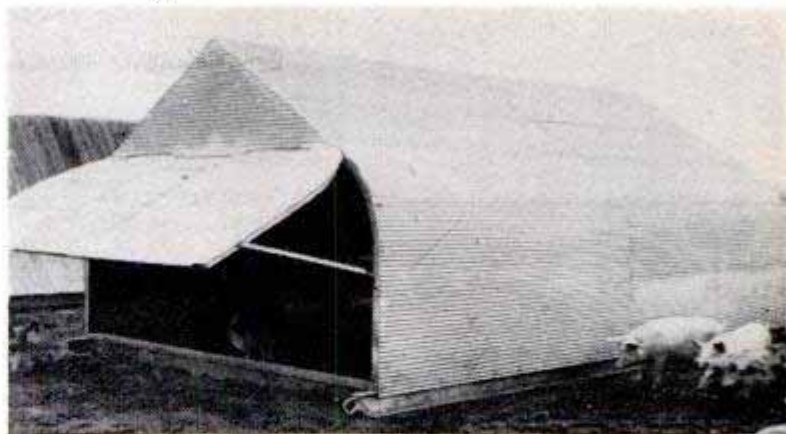

building that can be readily towed to any desired location.

Arthur Trauffer, Mt. Pleasant, Iowa.

Cut-Off Tool Hollow Ground to Form Curved Chip

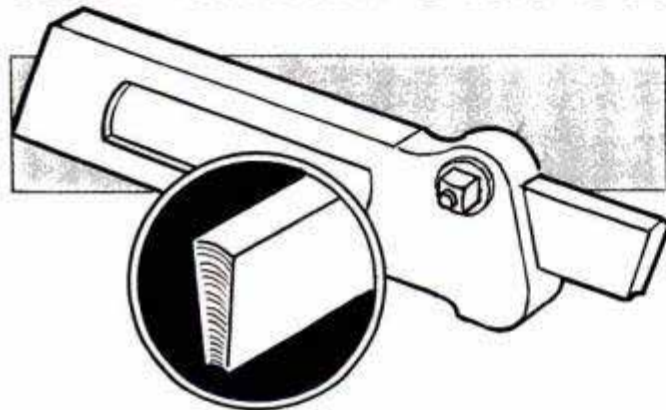

When cutting off large-diameter work in the metal-turning lathe, the straight chips have a tendency to curl tightly and wedge in the groove, causing the tool to bind as the cut deepens. This often results in tool breakage and damage to the work. The trouble generally can be avoided if the cutting edge of the tool is hollow ground as indicated. The new cutting edge forms a chip that is slightly curved across its width and lifts readily without wedging.

C. W. Woodson, Chicago.

Extra-Wide Farm-Implement Gate Easily Handled

Although measuring 16 ft. long and 6 ft. high to allow passage of large implements, this farm gate actually is lightweight and easy to handle. The steel-pipe framework is reinforced by welding lengths of flat bar stock across the corners. The tightly stretched, welded-wire fabric is wrapped around each end and tack welded to the frame. The fabric is wired to the frame at the top and bottom. Short lengths of pipe welded to the end of the frame serve as sockets to rest on the pintle hinge pins screwed into the fence posts. The hinge pins illustrated, are the type that are threaded.

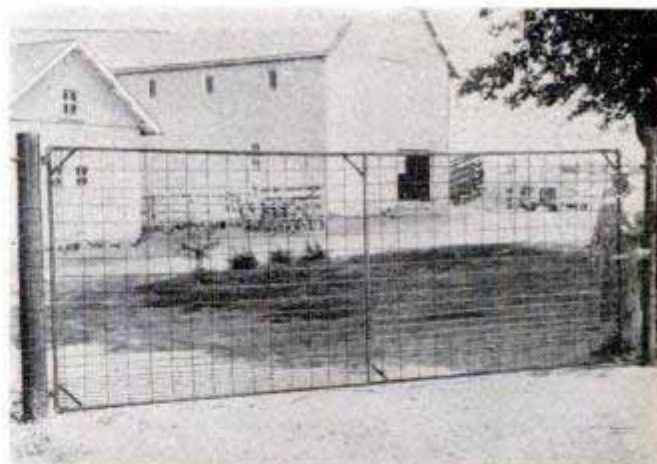

Corroded Carburetor Cleaned by Mild Acid Solution

Deposits of corrosion in the float chamber of a carburetor built up through the action of water on the casting can be removed in all except the very worse cases. First, scrape and blow out as much of the corrosion as possible. Then plug all holes and fill the carburetor to the height of the corrosion with a mild solution of sulphuric acid, such as battery acid. A stronger solu-

tion of the acid will eat away the corrosion more rapidly, but it must be watched closely to prevent damage to the casting. An ideal solution is one which will not quite float the bulb of the hydrometer. Such a solution will clean the average float chamber in 20 min. After cleaning, rinse the carburetor thoroughly with clear running water and reassemble.

Hand Truck Equipped With Crane Lifts Heavy Loads

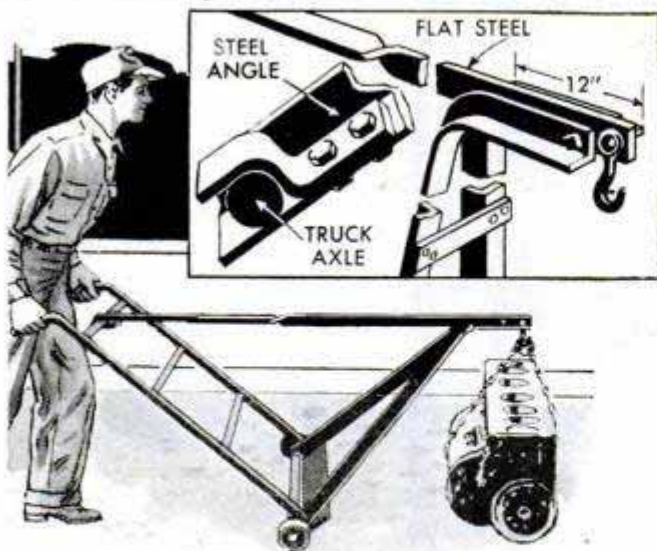

The moving of heavy and awkward objects can be simplified by the use of this crane which is attached to a handtruck, and can be removed when the truck is used for normal operations. The length of flat steel used as the crane arm is bent at one end to hook over the top crosspiece of the truck while a hook is attached to the other end. The crane arm is supported by two lengths of angle steel which are bent and bolted to the arm just in back of the hook. These support arms are fitted with brackets which slip over the axle of the truck. A short length of chain for wrapping around some items makes a convenient accessory for this tool.

Chips "Floated" From Tapped Hole By Using Light Grease

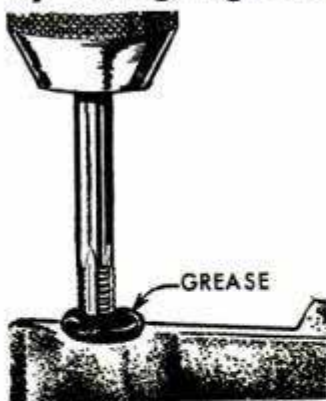

When running threads into blind holes, chips often jam the tap, causing it to break. To prevent tap breakage and produce a cleaner thread, one mechanic fills the hole to be tapped with light grease. Then, as the tap enters, pressure is

built up, forcing the grease out between the flutes of the tap and the chips with it.

Walter E. Burton, Akron, Ohio.

Overhead Plumbing in Barn Simplifies Floor Cleaning

Instead of running a water pipe over his barn floor, or up through it, making the floor difficult to clean, one farmer ran the pipe in along the ceiling and down the wall

to shoulder height. A sill cock installed at this point made it possible to use a length of garden hose to direct the water wherever needed.

Drop Cord Kept on Empty Spool

An effective way of handling and storing your drop cord is to use an empty metal lamp-cord spool, obtainable from an electrical appliance or hardware store. Drill a $\frac{1}{4}$ -in. hole in one side of the spool, insert the end of the cord through it and attach a male plug. Any length of cord may then be unreeled from the spool.

John W. Byrd Jr., Jacksonville, N. C.



Adjustable Ripping Fence Extends Saw Capacity

This adjustable ripping fence, in conjunction with a plywood table extension, greatly increases the capacity of any small table saw, allowing it to rip wide pieces, such as plywood sheets. For the rough adjustment, the bolts through the outside parallel bar are set into a series of holes drilled in the front and back edges of the extension table. These holes are on a line at right angles to the saw blade, and spaced exactly the same distance apart on both edges. The fence was made of oak scraps, two pieces being screwed together L-shape to form the actual fence. The four pieces were clamped and drilled together to assure keeping the sides parallel. In use the fence is adjusted to any measurement by the quick-adjusting thumb nut.

Val F. Rebhahn, San Francisco, Calif.

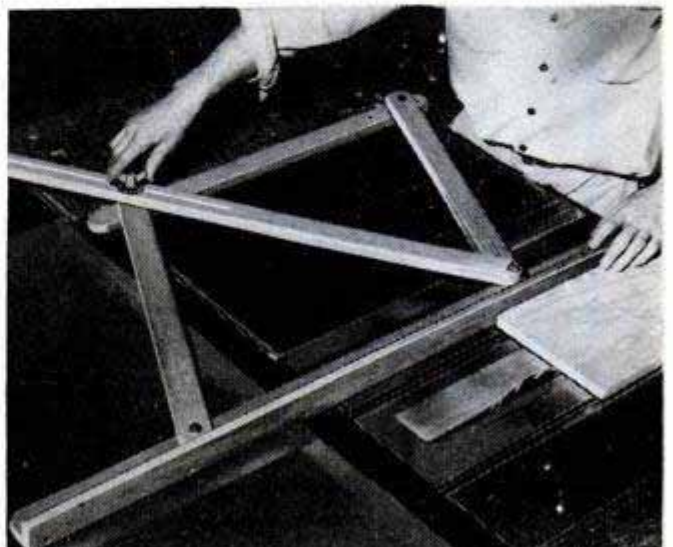

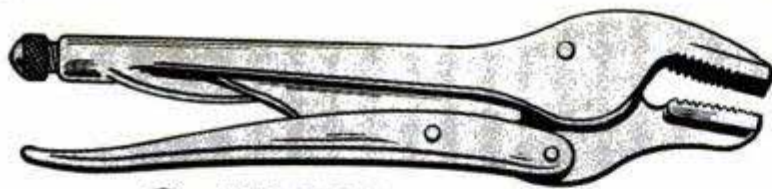

(A) LEVER-ACTION WRENCH

1

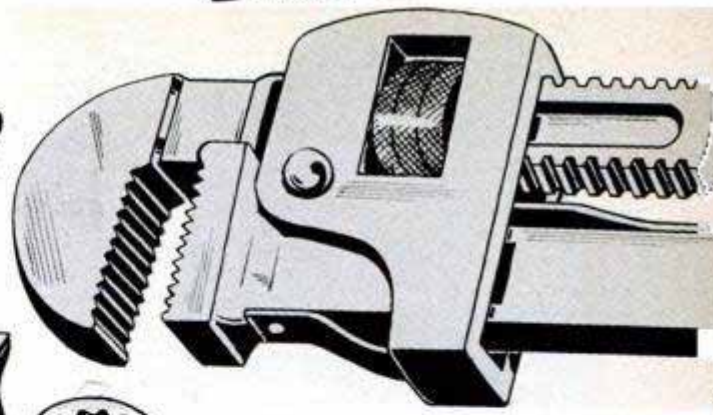

(B) PIPE WRENCH

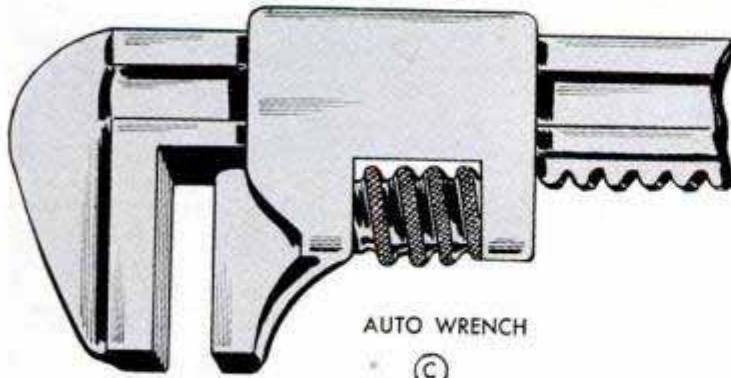

AUTO WRENCH

(C)

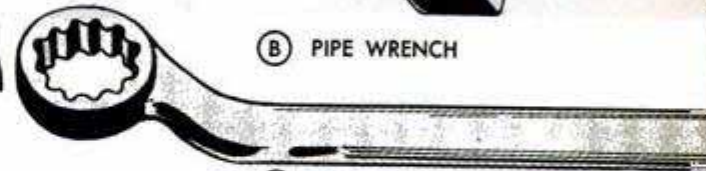

(D) BOX WRENCH

USING WRENCHES *The Right Way*

By E. R. Haan

BY PUTTING INTO USE a few simple tricks that experienced mechanics practice regularly you can get more work out of wrenches with less effort and without damaging the tools. Wrenches are either adjustable or have fixed jaws, and each type has many variations. Some are for all-around use; others are designed for specific jobs. Figs. 1 and 3 show a number of commonly used wrenches.

Adjustable flat-jaw wrenches: Every homeowner frequently has use for an adjustable flat-jaw wrench. Auto wrenches, detail C, Fig. 1, have certain advantages but are in much less use than adjustable wrenches, detail A, Fig. 3. These

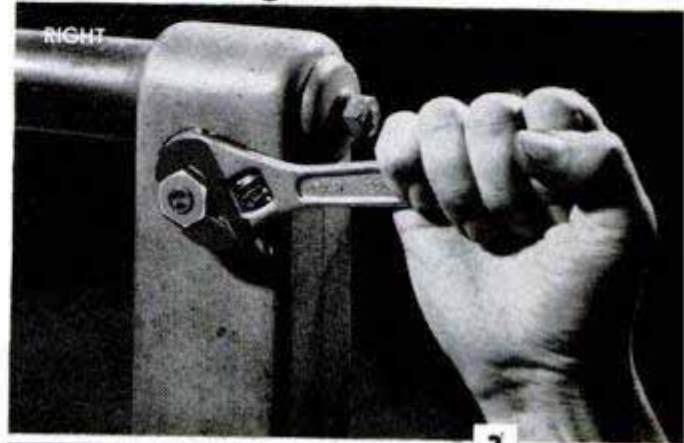

There's a right way to put pressure on the handle of an adjustable wrench. In emergency you can use light pressure as in lower photo

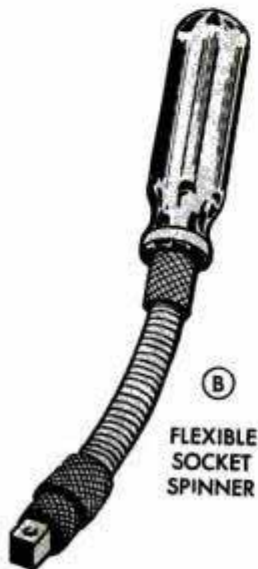

(B) FLEXIBLE SOCKET SPINNER

3

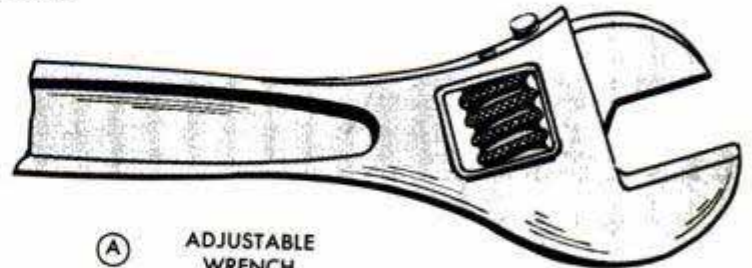

(A) ADJUSTABLE WRENCH

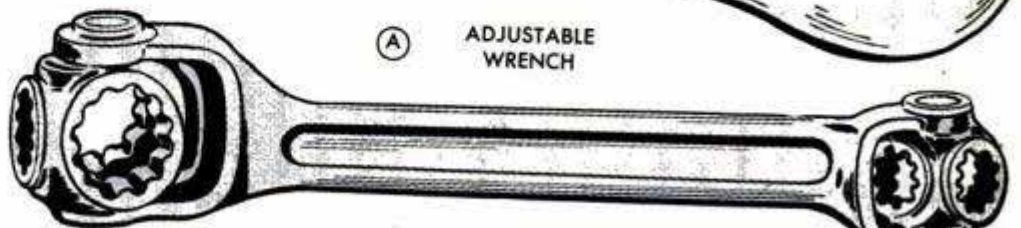

(C) MULTISOCKET WRENCH



(D) NUT DRIVER (INTEGRAL SOCKET)



(E) RATCHET BOX WRENCH

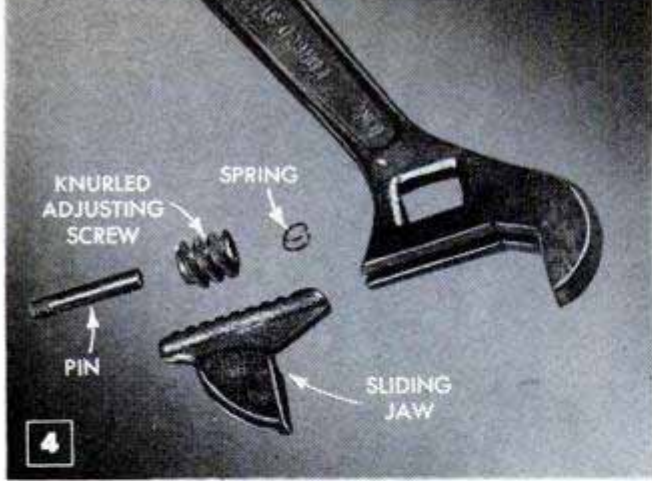

Disassembled, an adjustable wrench looks like this. A short coil spring maintains tension on the movable jaw. When the jaw becomes loose, stretch the spring

Wrenches with badly damaged jaw faces can be made serviceable again by grinding the jaws so that the spacing between them is equal to the next nut size

SOCKET DRIVERS

SOCKET TYPES

USUAL ANGLE 15°

SIZES OF OPEN-END WRENCHES (DIMENSIONS IN INCHES)					
OPENING	$\frac{1}{4} \times \frac{3}{16}$	$\frac{3}{8} \times \frac{7}{16}$	$\frac{1}{2} \times \frac{9}{16}$	$\frac{5}{8} \times \frac{11}{16}$	
LENGTH	4 $\frac{3}{8}$	5	5 $\frac{3}{4}$	6 $\frac{1}{2}$	
OPENING	$\frac{3}{8} \times \frac{3}{4}$	$\frac{1}{2} \times \frac{13}{16}$	$\frac{3}{4} \times \frac{7}{8}$	$\frac{15}{16} \times 1$	$1 \frac{1}{16} \times 1 \frac{1}{8}$
LENGTH	7 $\frac{3}{4}$	8 $\frac{1}{4}$	8 $\frac{3}{4}$	10	11 $\frac{1}{4}$

are much more efficient and also are far easier to handle on most work. They vary from 4 to 16 in. in length, the smallest one opening to $\frac{1}{2}$ in., and the largest one to approximately 2 in. The 6, 8 and 10-in. sizes, which open to about $\frac{3}{4}$, $\frac{7}{8}$ and $1\frac{1}{8}$ in. respectively, are the most popular.

In using any type of adjustable wrench it should be placed on the work so that the stationary jaw takes the greatest strain. The right and wrong ways are shown in Fig. 2. Adjust the jaws so they just slide over parallel flats of the nut without excessive clearance. Too much clearance allows the jaws to ride over corners, which tends to round them, and may also cause the wrench to slip off the work, resulting in bruised fingers.

Excessive play in an adjustable wrench often can be minimized by first removing the threaded pin on which the "worm" or knurl turns. This loosens the other movable parts including the movable jaw, the worm and a small coil spring as in Fig. 4. Stretch the spring, reinsert it into the cupped end of the worm and then reassemble the wrench, tightening the pin and prick-punching its end to lock it in place.

Open-end wrenches: An open-end, fixed-jaw wrench, details A, B and C, Fig. 7, has two advantages over an adjustable wrench. First the jaws, being stationary, do not require constant readjustment. Second, as the jaws are usually inclined at a 15-deg. angle from the body center line, the wrench can be turned over to change the angle of the handle when tightening or loosening a nut in close quarters, detail D, Fig. 9.

Ordinary open-end wrenches come in sets but can also be obtained separately. Each wrench has jaws at both ends. The ends are referred to as heads and the jaw widths vary so that each individual wrench takes two nut sizes. Body lengths vary with jaw sizes as indicated in the table, Fig. 7. Lengths are standardized within certain

limits so that excessive leverage cannot be applied to the work. Most open-end wrenches have rather wide jaws as in detail A, Fig. 7. Better ones of tough alloy steel often have thin, pear-shaped heads, detail B. Some open-end wrenches have the head at one end set at an angle from 60 to 90 deg. as in detail C.

Open-end wrenches with battered, nicked or spread jaws often can be made serviceable again by filing or grinding the jaws, which then should be enlarged to the next standard-size opening. The jaw faces should be perfectly flat and parallel. If you do this by grinding as in Fig. 5, be sure to dip the wrench end into water constantly in order to avoid drawing the temper.

Box and combination wrenches: Box wrenches for hexagon nuts, detail D, Fig. 1, come in practically the same sizes as open-end wrenches. The heads are round and are usually offset from 10 to 45 deg. from the handle for greater handling convenience. On the inside of the heads there are twelve notches permitting a nonslip grip on all corners of a nut or bolt head. The earlier type of box wrenches, which are hexagon shaped inside, do not have the range of adjustment as do modern 12-point box wrenches, but still are being used for small assembly work.

Combination wrenches have one open end and one box end. The reason for this arrangement is that the box end is safer for loosening nuts or for final tightening, while the open end is more convenient to slip on and off a nut while turning it.

Socket wrenches and nut drivers: Socket wrenches are similar to box wrenches but have a deeper reach in recessed places where other wrenches cannot be used. Nearly all socket wrenches consist of a driver to which the interchangeable sockets or drive heads are attached. Details A to F of Fig. 6 show various types of drivers. Detail G shows a regular-length socket and

Hook-type spanner wrench is being used to adjust door closer. Spanners are made in several types

Lever-action wrench is easily adjusted to the size of work. Compressing the handles locks the jaws

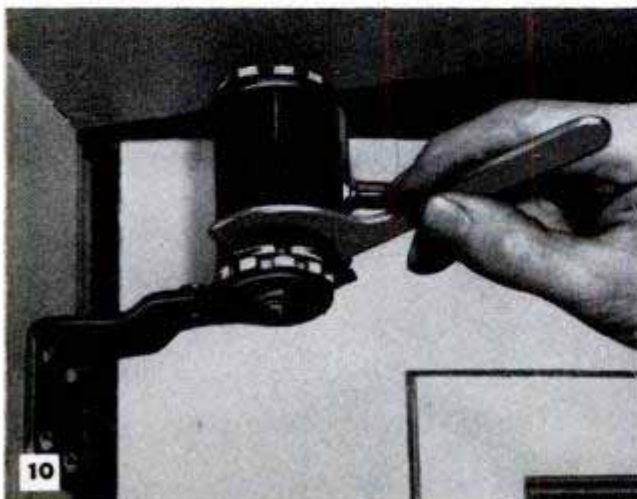

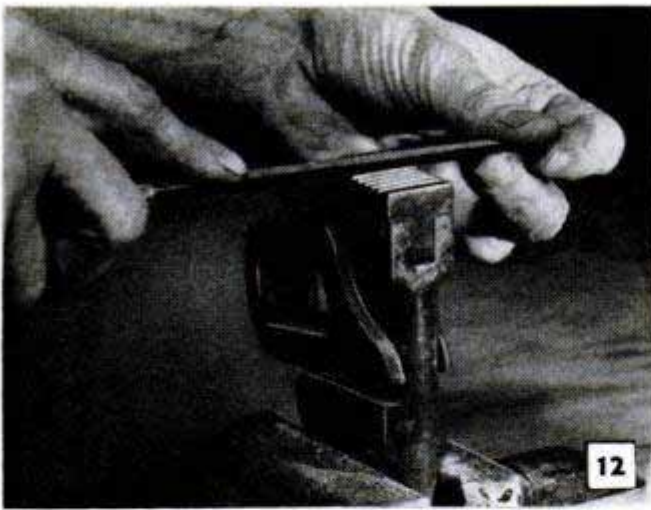

Serrated pipe-wrench jaws can be resharpened by filing or grinding. Teeth are filed to uniform length

also one that is extra deep. Sockets for both square and hexagon-shaped nuts and bolt heads are available. The work openings may be square or grooved like box wrenches. The 6 and 12-point heads, or sockets, are for hexagon nuts, and the 8-point heads for square nuts. Some drive heads are combined with universal joints as in detail H, permitting the drive tool to be held at various angles. The universal joint may be a separate adaptor unit be-

tween the drive tool and the head. Small socket wrenches and spinners that are used like screwdrivers, details B and D, Fig. 3, are called nut drivers. Multisocket wrenches, detail C, Fig. 3, also are available.

Ratchet wrenches: Box and socket wrenches may be of the ratchet type. A ratchet permits the handle to be moved back and forth while driving a nut in one direction only. This eliminates slipping a wrench off and on the nut for each stroke, and is especially handy where the stroke is limited. Ratchet box wrenches have heads integral with the body as in detail E, Fig. 3. These have to be turned over to turn a nut in the opposite direction. A reversible ratchet, detail F, Fig. 6, is used for drive sockets. It also will take an extension or universal joint. A pin or small lever reverses the ratchet.

Spanner wrenches: Threaded rings often have notches or holes near the edges to permit tightening or loosening them with hook-type spanner wrenches shown in Fig. 8. Such wrenches may have one hook or a round pin, an adjustable hook, or two hooks diametrically opposite each other. Sometimes the faces of threaded rings are drilled, in which case fixed or adjustable face-pin spanners, also shown in Fig. 8, are used. Important dimensions of spanners are the length and diameter of the pins and their spacing. Fig. 10 pictures a hook-type spanner in use.

Setscrew wrenches: Socket setscrews having hexagon-shaped holes in the body, rather than square or hex heads, often are used on motors and other machinery, especially to hold pulleys on shafts. L-shaped wrenches to fit standard setscrews of this type also are shown in Fig. 8.

Using wrenches properly: Before exerting any pressure on a wrench, make sure that it fits the nut, or other work, as snugly as possible. This will prevent rounding corners of the nut, and also keep the wrench from slipping off. If the work is gripped at the jaw tips, they may spread or break, and may also slip off the nut. Pull a wrench toward you as in detail E, Fig. 9, rather than pushing it, which may result in injury to the hand if the wrench should slip, or the work suddenly break loose. If you must push a wrench, apply pressure with the palm of the open hand as in detail F. Don't increase the leverage of a wrench by slipping a length of pipe over it as in detail A. This may break a bolt, strip the thread or even break the wrench. For the same reason don't hammer on a wrench as in detail B to jar a nut loose. If hammering is necessary, use a striking wrench, detail C. Don't use wrenches as hammers or pry bars.

Lever-jaw wrenches: Fig. 1, detail A, and

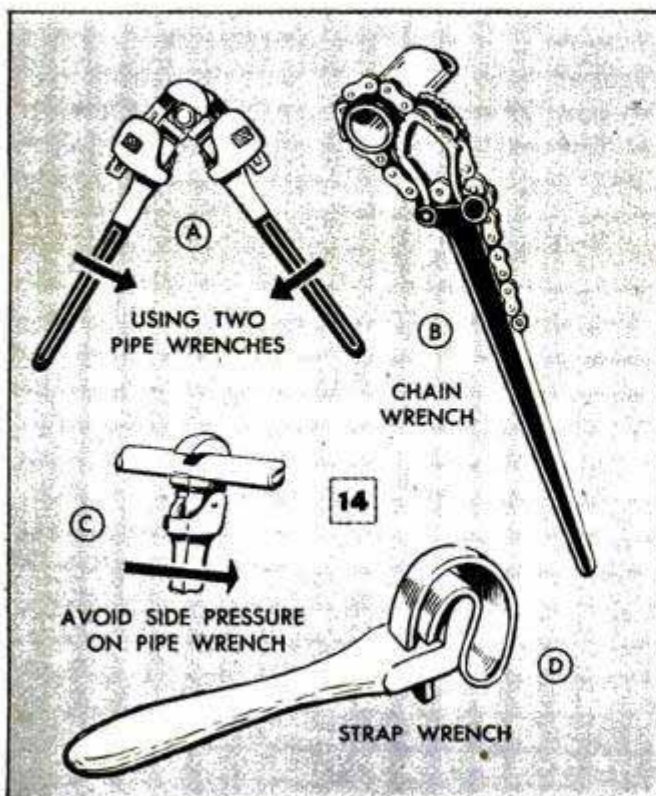
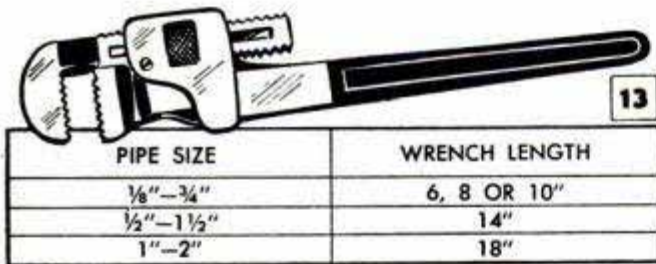

also Figs. 10 and 11 show a lever-action wrench. The jaws are adjusted on the work by turning the thumbscrew while the lever handle is held open just beyond the locking point. Then the handle is closed to lock the jaws on the work. Such a wrench can serve as a small pipe wrench. However, as its sharp teeth bite into metal, it should not be used where marks are objectionable.

Pipe wrenches: For pipe fitting, or wherever round work must be gripped to prevent it from turning, you need one or two pipe wrenches, detail B, Figs. 1 and 13. The table in Fig. 13 indicates the proper size wrench to use for various diameters. For average requirements a 10 and 18-in. pipe wrench will be found satisfactory. Two pipe wrenches often are needed, one to hold pipe while turning a fitting on or off with the other, as in detail A, Fig. 14. Pipe too large for a pipe wrench is gripped with a chain wrench, detail B.

When adjusting a pipe wrench on pipe, you adjust the movable jaw so that when pressure is applied on the handle, the teeth on the jaws will bite into the pipe but will not crush it. A pipe wrench should not be pushed sideways as in detail C. This may damage the wrench. Avoid using a pipe wrench on any surface that you do not wish to mar, as on chromium-plated pipe tubing, or nuts. Use a strap wrench, detail D, for such purposes. If a pipe wrench is the only tool available, then insert pieces of cardboard between the work and the wrench jaws.

When the sharp teeth of a pipe wrench become dull and the wrench loses its holding power, you can sharpen the teeth with a fine, 8-in. triangular file, Fig. 12. This may also be done with a grinding wheel, dressed to the same angle as the teeth. The level of the teeth should be maintained so that they will be parallel to each other through their length and also to those of the other jaw.

Special wrenches: There are numerous other types of wrenches designed for special purposes in various professional fields as well as for assembly work in industrial plants. In general, the basic methods of handling them are similar to the methods used on ordinary wrenches. ★ ★ ★

Exterminating Black Ants

To exterminate a hill of black ants, one farmer soaked a large sponge in gasoline, placed it on top of the hill and then inverted a dishpan over it. If the hill is too large to be covered by the pan, a washtub may be used in place of it. When trapped beneath the pan, the gas fumes were concentrated sufficiently to destroy most, if not all, of the ant colony within a 24-hr. period.



Raised Cash-Register Keys Are Timesaver in Store

When a heavy turnover of a single item in a store sale is anticipated, considerable time can be saved by fitting keys representing the price of the article with dowel caps as shown. This enables the clerk to locate the keys with a quick glance or, if far enough apart, by feel alone. The caps are made from short pieces of dowel that are drilled at one end to fit over the keys, after which they are taped in place. Numbers that correspond with the respective keys are then lettered on the caps.

Hardware Cloth on Combine Reel Prevents Fouling

To prevent his combine reels from becoming fouled in viney crops, or in crops infested with bindweed, one farmer modified his reel as illustrated. He removed the wooden cross blades and attached hardware cloth to the arms of the spider. Each piece was fastened to the axle of the reel with a length of baling wire and secured to the arms of the reel with tacks.

J. R. Kennedy, McCool, Miss.

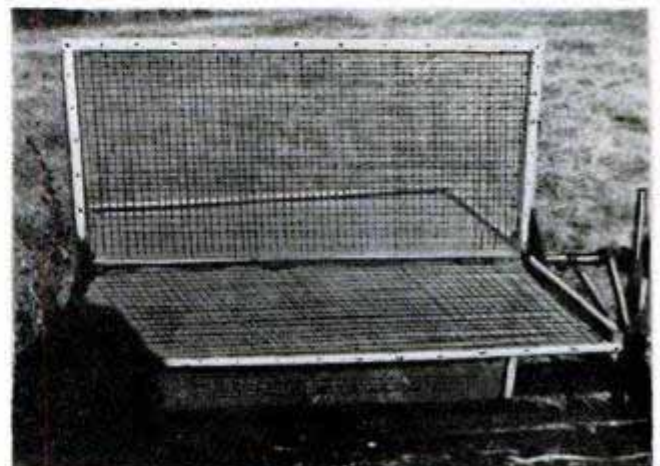

Tractor-Lift Arms Used to Load Corn Shocks



When feeding corn fodder in the shock to cattle, one farmer simplifies the job of loading the shocks by utilizing a tractor scoop to lift the whole shock onto a wagon as shown. This was made possible by removing the scoop part and bolting an A-shaped extension to the ends of the lift arms. The extension, held vertically by lightweight cable, is made from 2 x 4s that are joined at the top by a long bolt. A swivel hung from this bolt holds a six-tined grapple fork having a trip rope.—Ed Mercer, Madison, Wis.

Truck-Radiator Fan Cools Dairy Barn at Milking Time

To remove heated stagnant air from a small dairy barn at the end of a sultry day, one farmer improvised a highly efficient fan by utilizing the six-bladed unit from a dismantled truck engine. The fan, V-pulley and bracket assembly are welded or bolted to a heavy U-shaped bracket of flat steel. This bracket is bolted to a shelf attached to the inside of the barn wall in a position to center the fan over an opening cut in the wall at a point just below the ceiling. The motor, driving the fan through a V-belt as pictured, also is bolted to the shelf. Located in this position the fan quickly removes warm air from the first floor of the building and displaces it with cooler air from the outside.

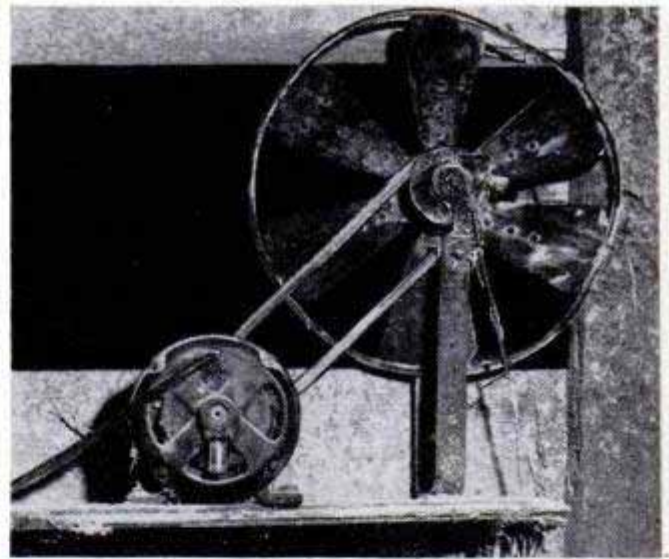

Gauge Gives Scale Reductions Directly on the Layout

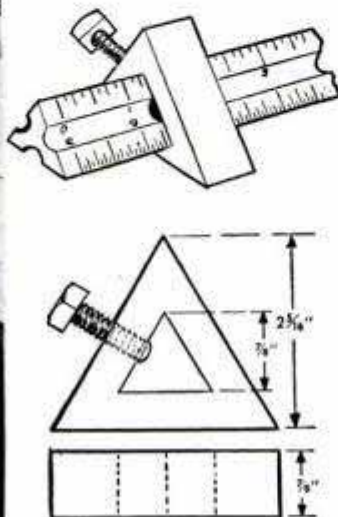

An aluminum stop fitted on a draftsman's triangular scale permits the user to lay off and score stock to scale measurements without the necessity of transferring the measurements in the usual manner. Hardened metal scoring points are fitted at both ends of the scale so that it can be used to mark gauge lines on both metal and wood. The 1-in. graduation on the triangular scale also permits the unit to be used as a regular marking gauge. The sliding stop is made from aluminum to the dimensions given and is drilled and tapped for a small set-screw, the threaded end of which should be ground to a radius slightly less than that of the flutes in the sides of the scale.

Richard Dickover, Chicago.

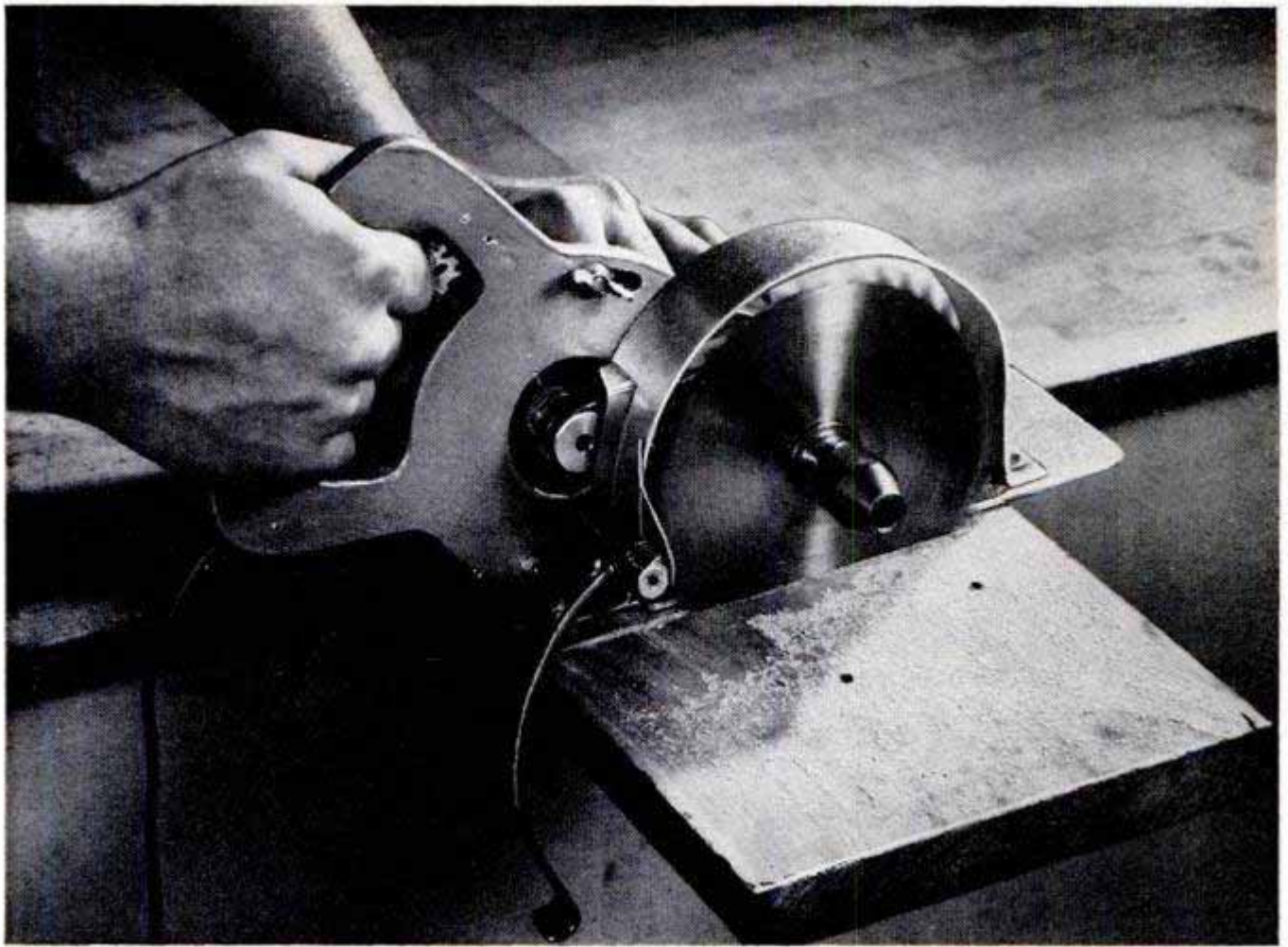

PORTABLE POWER SAW

FROM VACUUM-CLEANER MOTOR

THIS PORTABLE SAW doubles as a drill that will bore holes as large as $\frac{5}{16}$ in. in metal and 1 in. in hardwood. A vacuum-cleaner motor of the flange-mounted type provides power to drive a 6-in.-dia. saw blade through two $\frac{1}{4}$ -in. V-belts of the type used on sewing machines. A 6-in. blade cuts through a standard 2 x 4 easily. Before cutting or machining any stock according to the details on the following page, have the motor, belts, drill chuck of $\frac{3}{8}$ -in. capacity and the oilless sleeve bearings at hand. As shown in the center left-hand detail, a bicycle hub can be used as a spindle housing if desired. This will contain ball bearings which take both lateral and radial thrust. However, its length will permit the use of only a single-groove pulley rather than the more efficient two-groove pulleys as shown in the top detail. Note that the motor is flange-mounted on the plywood frame to the rear of the saw arbor and drives from a 1-in. pulley to a 2-in.-dia. pulley on the arbor. Recondition the motor by replacing worn sleeve bearings and brushes, and if necessary, true up the commutator. Check to see that the

brush holders are in good condition and clean the motor thoroughly.

Note that the length of the $\frac{1}{2}$ -in. saw arbor is not given. This must be determined from the drill chuck at hand as the length of the thread required to close it may vary somewhat. As will be seen from the detail, the chuck also serves as the arbor nut to hold the saw blade in place. The bearing housing is assembled from a length of steel tubing and two steel washers, one being welded to each end of the tube to form a flange. Note that the flange at the inner end of the housing is welded to the tube at a point $\frac{1}{2}$ in. from the end of the tube which is inserted in a hole drilled in the plywood frame. Both flanges are drilled to take $\frac{3}{16}$ -in. bolts for attaching the outboard handle and also for attaching the housing to the frame. The oilless sleeve bearings, or bushings, should be a light drive fit inside the housing. Now cut a triangular piece of $\frac{1}{2}$ -in. plywood, laying it off from a base line with the short side measuring about 15 in. and with the long side at a 30-deg. angle from the base line. This will give you the rough blank for the frame. Lay out and saw

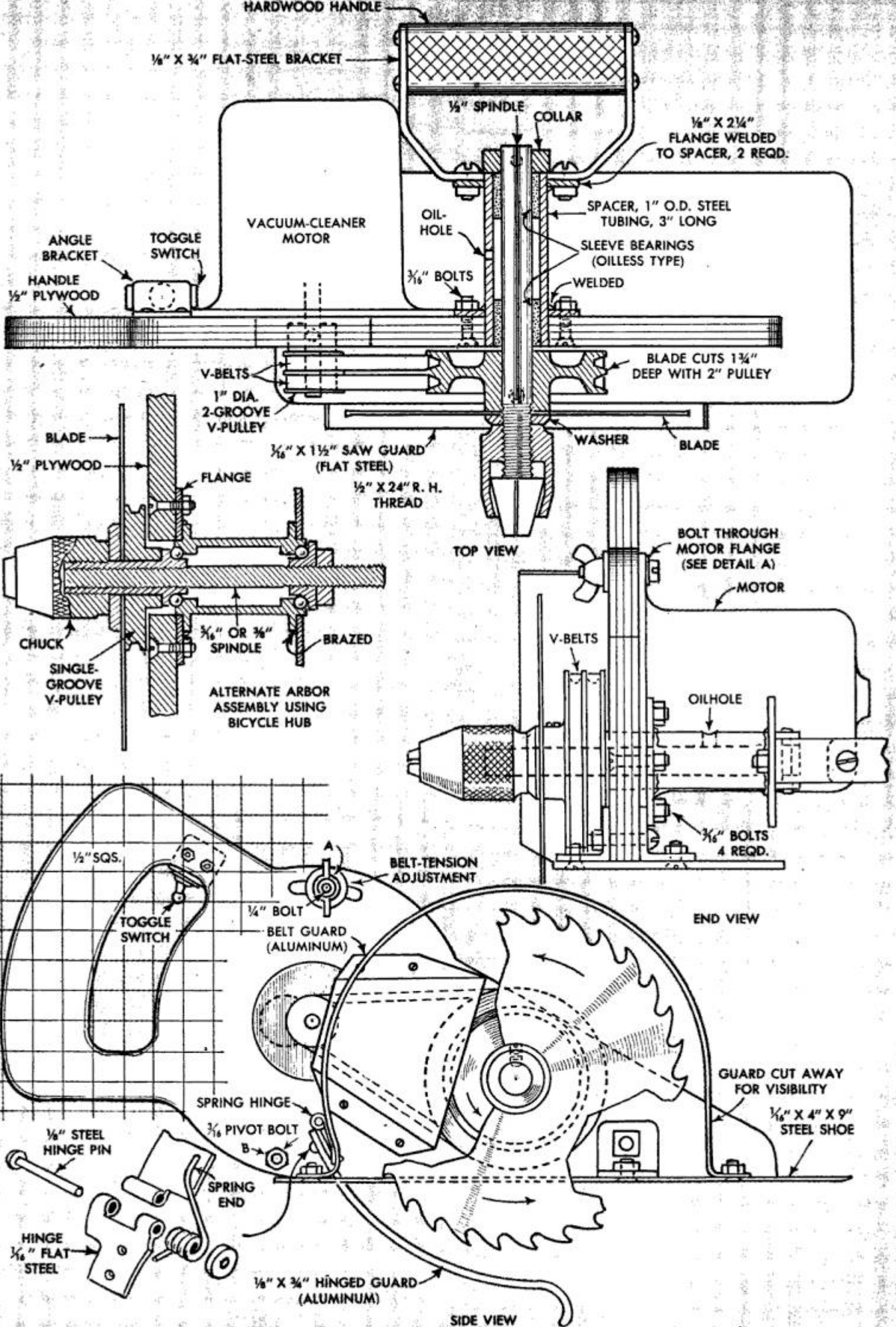

the handle to shape from the squared portion of the lower detail. Then locate and bore a 2-in. hole for insertion of the motor shaft in the position indicated in the detail. The size of the hole can vary somewhat but it is necessary that the motor flange pivot on the lower bolt, B, so the belt can be tightened by loosening the thumb screw, A, and shifting the bolt in the slot. After centering the shaft in the 2-in. hole, drill holes for bolts A and B, and elongate the upper hole to form a slot about 1½ in. long. Mark the outline of the motor flange on the frame, making sure that the flange clears the finger opening in the frame. Then cut the frame to a rounded contour at the point where the motor is fitted. The remainder of the waste is cut away later to give approximately the shape shown. No dimensions are given for the frame, as the sizes of motors and flanges will vary and the frame must be made to suit the motor at hand.

The center-to-center distance between the motor shaft and the saw arbor is determined by the length of the belt and this can be measured only with the belts on the pulleys. Turn a two-groove drive pulley from machining aluminum or mild steel to fit the motor shaft. Space the grooves so the belts run with about ⅜-³²-in. clearance between the edges. Then turn the arbor pulley to 2-in. outside diameter with a two-groove rim, the grooves corresponding in size to those in the motor pulley. Note that both pulleys have projecting hubs which are drilled and tapped for hollow setscrews. With these parts made you can then determine the length of the saw arbor. Before cutting the arbor, or spindle, to length, thread the end for the drill chuck and make a trial assembly with the pulley, saw blade and chuck in normal position. Then bolt the housing in place, slide the arbor through the bearings and slip a shaft collar on the outer end. Mark the arbor and cut off to length. This completes the assembly ready for the motor switch, saw guard and shoe. If the unit is to be used extensively for drilling holes, the outboard handle for the left hand is essential. It is pictured in the photo above and shown in the upper detail on the opposite page. The belt guard, lower detail, is made from light sheet aluminum and is attached to the frame in the position shown. Its purpose is to prevent sawdust from getting into the pulley grooves. The shoe is attached to the frame with two angle brackets, cut from ⅛ x 1-in.

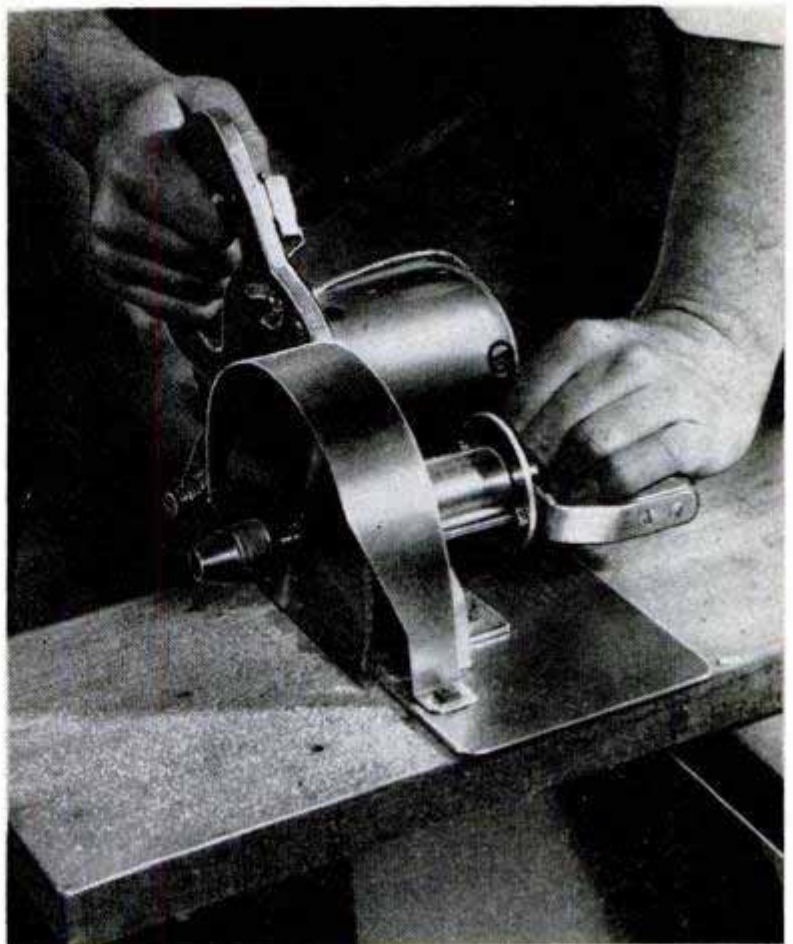

Saw cuts through 1½-in. stock easily. Guard is cut away so gauge line on stock can be seen from above. Note drill chuck

steel angle, one bracket being placed on each side of the frame as shown in the end view. Note in the lower detail (side view), that the hinged guard is shown swinging in an open-ended slot in the shoe. However, if desired, the shoe can be notched and the guard attached so that it swings outside the shoe as in the photo on page 193. This simplifies the construction to some extent.

★ ★ ★

Prevent Engine Overheating After a Complete Overhaul

An automobile engine often will overheat after it has been overhauled because rust and scale, which has been in solution in the cooling system, hardens and sets in the empty radiator and block. The best method to avoid this is, of course, to have the engine and radiator thoroughly cleaned and flushed by a professional shop. But if this is not possible, keep the rust and scale to a minimum by flushing the engine beforehand with clear water, then if the radiator is removed, fill it at least half full of water. This can be done by leaving the bottom hose on and standing the radiator upright. If the petcocks in the block are not opened, the water will stay in the block up to the level of the water pump, while the engine is being overhauled.

D. W. Brentlinger, Richmond, Calif.

Oil Ignited in Drain Tile Thaws Water Hydrant



To thaw a frozen outdoor hydrant, one farmer drops a large bell tile over the hydrant, pours crankcase drainings over the inner walls and ignites it. The oil will burn slowly for a time and as the walls of the tile prevent rapid dissipation of the heat, the hydrant is thawed quickly without damage. A common tile, which is porous and will absorb the oil, also can be used.

Combined Taillight and Flagstaff Guards Implements on Highway

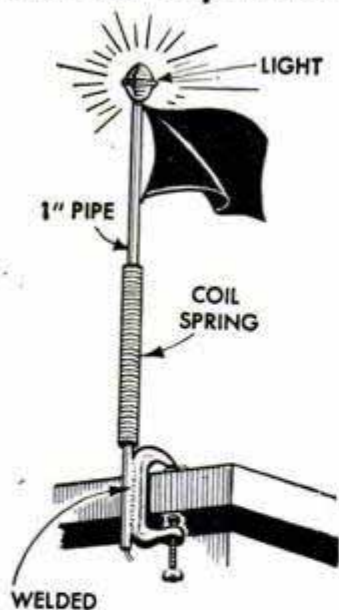

Faced with the problem of transporting large and heavy farm implements on a busy highway, often at night, one farm operator devised this detachable taillight and flagstaff unit. Due to its novel construction it gives motorists ample warning of the presence of slow-moving equipment. Both the red daytime flag and the red

warning light are carried at the top of a flexible staff which consists of a length of $\frac{1}{2}$ -in. pipe, the lower end of which is welded to a heavy coil spring. The lower end of the spring is welded to a short length of $\frac{1}{2}$ -in.-i.d. tubing which in turn is welded to the back of a C-clamp as pictured. The

lamp cord is fed through the tubing, spring and pipe to the light at the top of the staff. When the unit is clamped to the rear of the implement, the motion of the latter imparts an erratic waving movement to the staff which is sure to attract attention.

A. M. Wettach, Mt. Pleasant, Iowa.

Hard-Rubber Stoppers Frozen For Easy Machining

To overcome the difficulty of altering the size or shape as well as drilling holes in hard-rubber stoppers, technicians of one research laboratory immerse the stoppers in a freezing mixture of dry ice and acetone. This causes the stoppers to become so hard they can be machined like wood or metal when placed in a lathe or drill press.—Leroy J. Hebert, Arlington, Mass.

Cutting Circular Gaskets

When you need a small, round gasket quickly and there's no regular equipment at hand with which to cut it, use a hand brace and an expansive bit. If the gasket required is in the form of a flat ring, cut the outer diameter first. Then tack the disk to a flat surface and set the bit to cut the inner diameter. A few sweeps of the brace and you'll have the gasket you want, cut neatly to size. Any of the regular gasket materials can be cut in this manner in an emergency.—O. A. Nelson, Seattle, Wash.

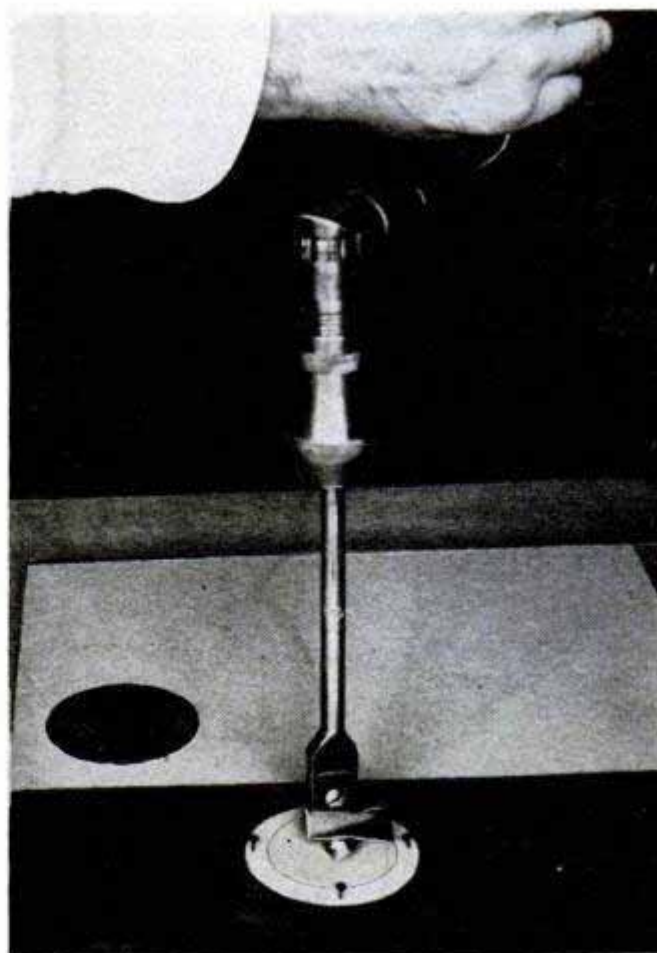



1

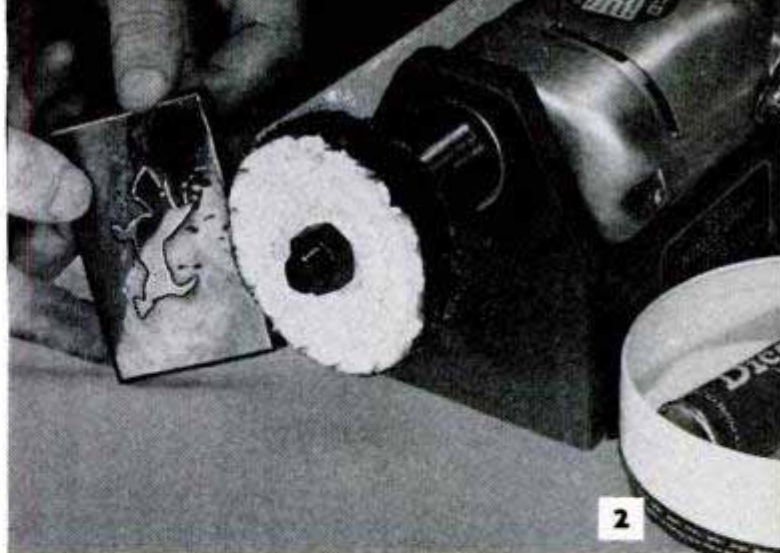

2

FINISHES

for your

Metal Work

WHEN YOU SAND surfaces of wood in preparation for finishing, the finishing process is just beginning. But when you use abrasives on projects made from art metals the job is practically done. Top coatings, such as metal lacquer, are used only to protect the luster of the polished metal surfaces.

Polishing: Polishing in some form is a part of all metal craftwork. The degree of polish can range from soft satin to mirror-bright. Craft metals usually have a fairly good finish to begin with and it will save a lot of extra work if you handle the metal carefully and protect the surfaces from fingerprints. Probably the best and simplest way to do this is to cement heavy paper to both sides of the metal sheet. Then the layout can be made on the paper. If the job involves cutting on the jigsaw, sandwich the metal between pieces of thin stock taped tightly together at the edges. By protecting the original finish in this way, you can produce a fairly high polish with 3/0 steel wool used dry. A wet rub with 3/0 or 4/0 steel wool and soapy water, Fig. 1, produces a somewhat higher luster on most craft metals. On circular pieces rub with a circular motion. On square or rectangular pieces rub with a straight back-and-forth stroke.

For higher lusters up to mirror-bright, the next step is "color" buffing, Fig. 2. This operation often is referred to as "coloring," as the high polish has the effect of changing the color of the metal. It is done with the fine abrasives such as rouge, rottenstone,

BUFFING SPECIFICATIONS

Metal	Cut	Color
Aluminum	Tripoli	Lime or stainless *
Copper and Brass	Tripoli	Red rouge
Magnesium	Tripoli	Dry lime
Pewter	Fine pumice	White rouge
Steel	Emery or stainless *	Stainless *

* Stainless is finest grade of aluminum oxide and silicon-carbide abrasives in a white composition

3

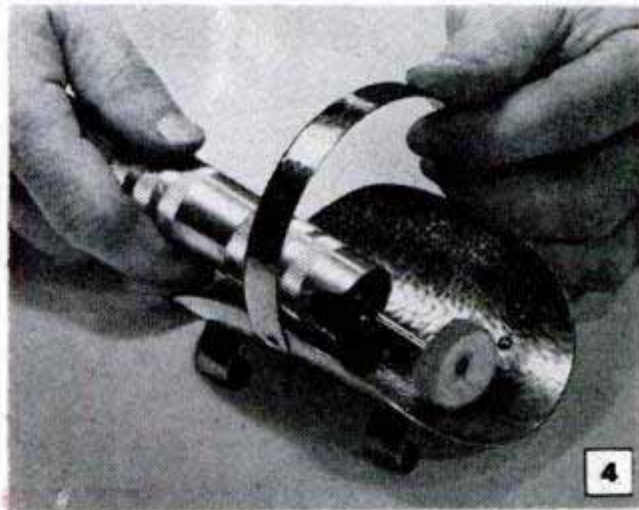

4



5

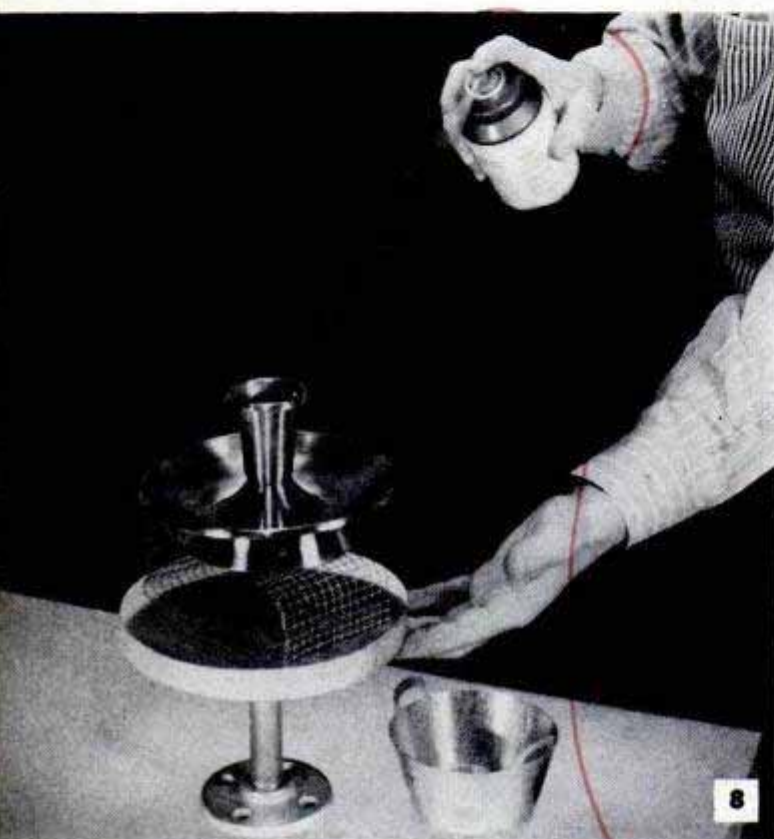
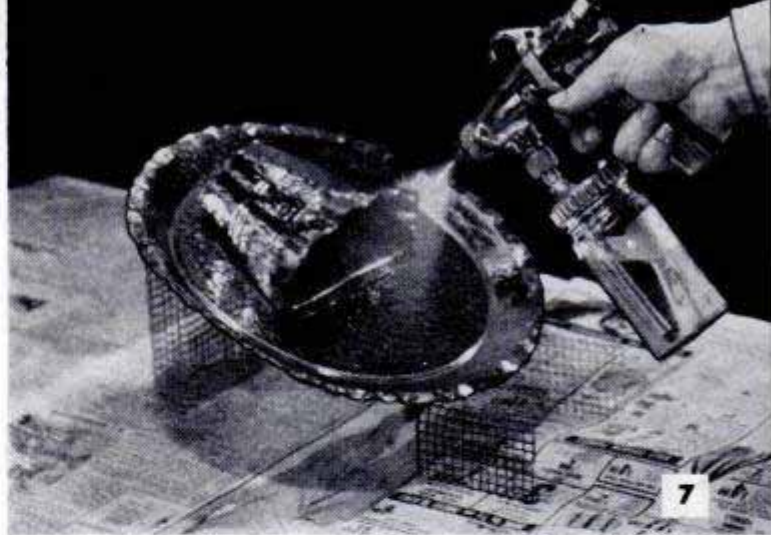

Top coating prevents tarnishing and discoloration. Wax, metal lacquer and plastic finishes are easy to apply as in the two photos above and at the left

lime or crocus. The table of buffing specifications, Fig. 3, list the selections ordinarily used. A common procedure is to begin buffing with one of the coarser abrasives, such as tripoli, and finish with rouge or crocus. Abrasive compounds such as those listed are commonly used in stick form, making it easy to charge the buffing wheel simply by holding the end of the abrasive stick against the rim while the wheel is rotating. A separate wheel must be used for each grade of abrasive. Small buffing wheels of the type supplied for use with a flexible shaft, Fig. 4, are especially effective on curved work and on surfaces difficult or impossible to reach with a large wheel. Although buffing produces a high luster on most craft metals, many metalcrafters prefer the steel-wool finish as the extremely



KIRYDON, INC.
2601 N. Broad St.
Phila. 32, Pa.

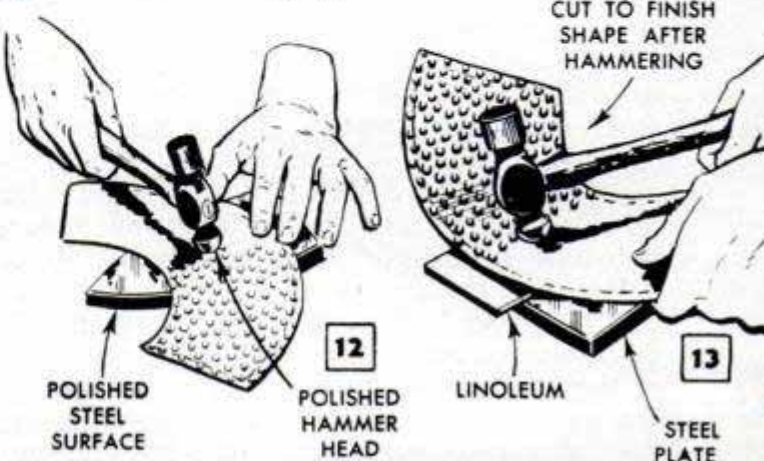

RE-MARK AND CUT TO FINISH SHAPE AFTER HAMMERING

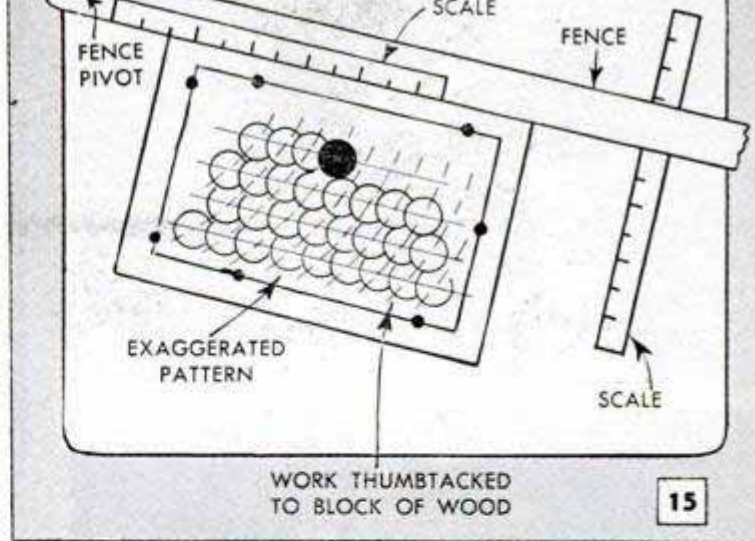

Spot finish is attractive on machine parts such as slides and worktables. Photo above and detail at right show how to set up job on drill press

fine scratch pattern left on the surface makes it appear brightly polished, yet is sufficiently irregular to break up light reflection. A simple method of polishing trimmings is pictured in Fig. 5.

Top coatings: Polished metals will not remain bright unless the surface is protected against the moisture always present in the air. The simplest protective coating is ordinary furniture wax of the paste type. Apply with the fingers as in Fig. 6, permit it to set until it feels slightly tacky to the touch, then polish briskly with a soft cloth. The wax, properly applied, gives most polished metals a soft, burnished appearance that is very attractive.

Although water-white metal lacquer can be applied by brushing, use of a spray gun gives best results. Another excellent liquid top coating is acrylic plastic spray which comes in a handy pressurized can, Fig. 8. This material should be applied in the thinnest possible coating. Always use a heat-proof metal lacquer on ash trays and lamp shades, or on any work subjected to temperatures of 180 deg. or more. A ground coat of metal lacquer should be applied to all work which is to be decorated with low-bake enamels, Fig. 9. Work which has been buffed should always be thoroughly cleaned to remove all traces of wax before lacquering.

Mechanical Textures: Common mechanical textures are produced by hammering, spotting and spinning. The simplest and most popular is done by hammering, the patterns being worked on the metal before cutting to finish size. The head of the hammer, whether ball peen or any other shape, must be perfectly polished, as any scratches or other imperfections on the surface of the head will be impressed in the surface of the work. The close ball-peen pattern, Fig. 10 is easiest to do, as it is worked over a polished metal surface, Fig. 12. Here the

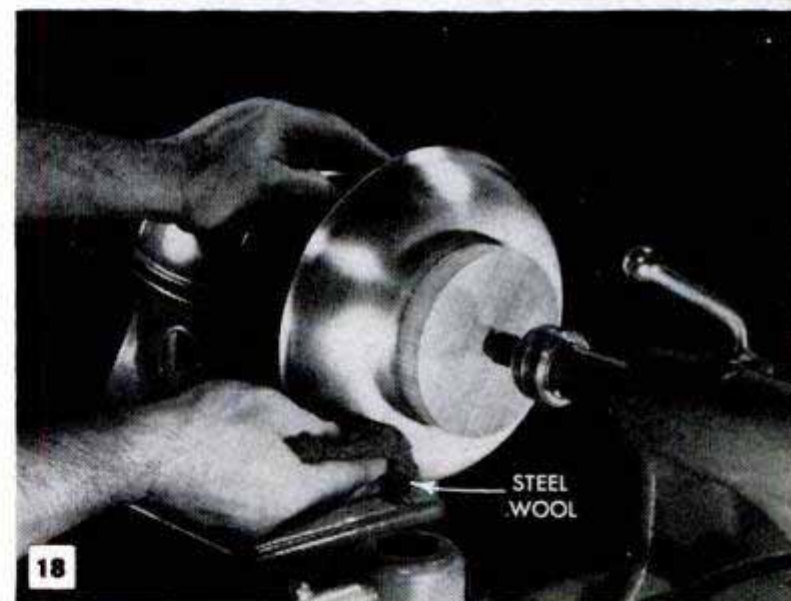
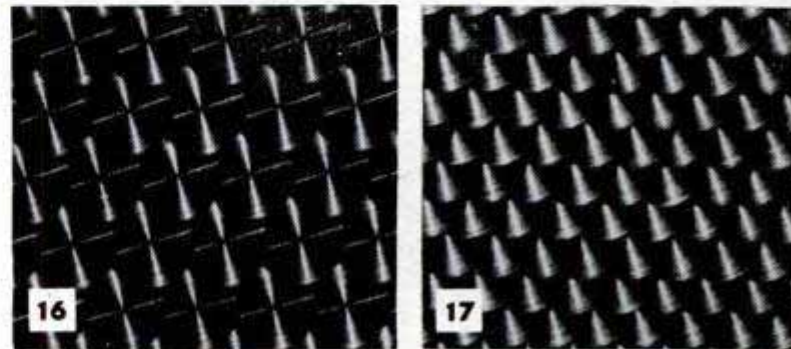

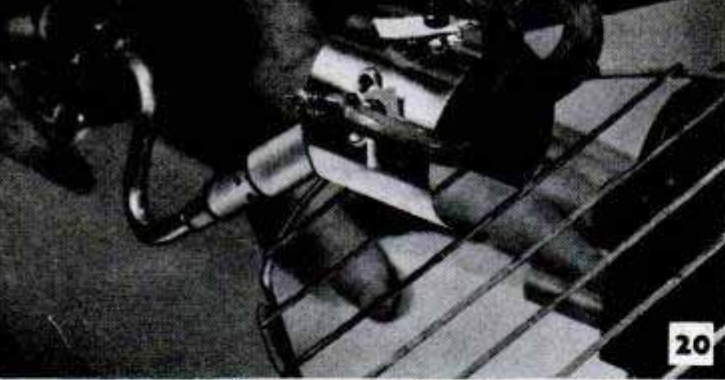

20



21



22



23



24



25

Ornamental iron usually gets a pigmented top coating which covers and protects the metal. Colors can range from flat-black lacquer to bright-colored enamels

hammer blows must overlap and form an irregular pattern of raised facets on the surface. Hammer blows should be light and uniform to avoid thinning and drawing the metal. The open ball-peen pattern is somewhat more difficult as the hammer blows must be carefully controlled to give a uniform pattern. Open peening is done on a soft, yielding surface such as that afforded by a piece of linoleum laid over a flat-steel backing plate, Fig. 13.

Spot finishing—or “engine” turning, as it is sometimes called—produces glittering circular facets on polished metal. It is often used as a decoration on machine parts, such as slides and worktables. Figs. 14 and 15 show the setup for spot finishing on a drill press, using a special table and a pivoted guide. Two sample patterns are pictured in Figs. 16 and 17. The size abrasive specified in Fig. 14 usually gives best results on steel, but on softer metals a somewhat finer abrasive may be used. Although not essential, the pivoted fence gives somewhat better results as its use gives a sweep to the pattern that is more attractive. A spun finish can be done either with steel wool as in Fig. 18, or with abrasive cloth as in Fig. 19.

Oxidized copper: One of the most popular



26

and attractive finishes on copper is produced by swabbing a liver-of-sulphur solution on the surface, Fig. 22, and then highlighting with steel wool as in Fig. 23. The finished work with the high-lighted pattern is shown in Fig. 24. If work to be finished by oxidizing has become discolored from annealing or soldering, Fig. 20, it should be dipped in an acid pickle, Fig. 21.

Finishing ornamental iron: The most popular and durable finish for ornamental iron is a pigmented lacquer or paint. Flat-black lacquer probably is best for plain black work and for a high-lighted hammer finish. In this latter case, the hammered surfaces are lacquered black and then sanded lightly, producing a finish similar to that in Fig. 11. If the work is to be in color, Figs. 25 and 26, then use a full-gloss enamel.

Chemical solutions: A liver-of-sulphur solution for an oxidized finish on copper or brass is made by dissolving a lump of liver of sulphur (potassium sulphide) approximately $\frac{1}{2}$ in. in dia. in a glass of pure water. Apply to the work by immersion or by swabbing with steel wool. The black-brown color appears in about 20 to 30 sec. After the desired color is obtained rinse the work in running water. Avoid touching the metal. Dry thoroughly and then high-light with 3/0 steel wool.

A mild acid solution for pickling (cleaning) copper, brass, nickel silver, silver and pewter is made as follows: To 15 parts water in an earthenware or glass container, add slowly 1 part of commercial sulphuric acid and 1 part commercial nitric acid. Immerse the work on a copper wire or apply with a cloth swab. A 10-sec. dip is usually sufficient.

A solution for frosting aluminum is made by dissolving 1 part household lye (sodium hydroxide) in 4 or 5 parts of cold water. Pour the water into a glass or earthenware container and add the lye. Immerse the work or apply with a cloth swab. The solution attacks aluminum violently and will etch the surface silvery white overlaid with a black smutlike coating in about 40 to 50 sec. The work is then rinsed in water and dipped in a 25-percent solution of nitric acid to remove the black coating. Rinse the work again, allow it to dry and protect with a coat of metal lacquer.

Caution: Solutions for pickling and frosting are both corrosive and toxic. Handle with extreme care. Wear rubber gloves and avoid inhaling the fumes. Always add acid to water; never water to acid. The liver-of-sulphur solution is harmless. ★ ★ ★

☐ If a nail is heated before driving it into plaster, there is less chance of it causing the plaster to crack.



Wrecking Tool for Plasterboard From Discarded Car Spring

Especially useful when salvaging soft materials, such as plasterboard, this wrecking tool can be made from one of the short leaves of a discarded automobile spring. Heat a spot 2 or 3 in. from one end and bend it about 30 degrees. Grind a knife-edge notch in the end of the bent portion to be used for pulling nails. Because the spring is flat and wide, rather than narrow, as is the usual wrecking bar, there is less tendency to dig into plasterboard and other soft materials when removing nails.

M. J. Berg, Wausau, Wis.

Brake Stops T-Square Slipping On Large Inclined Boards

Draftsmen who work on large inclined drawing boards frequently have trouble keeping the larger types of T-squares from slipping down. One way to solve this problem, without damaging the face of the board,

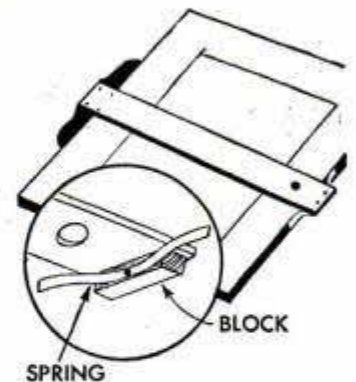

is to install a simple brake on the end of the square. A small block is fastened to the underside of the square on the portion which extends over the end of the board. A piece of light spring steel, such as from an old clock spring, is screwed to the block, as shown. The spring holds the square firmly, yet allows it to be moved easily.—Frank M. Butrick, Jr., Alma, Mich.

SHOPPING FOR TOOLS



1

1. STORAGE CONTAINER for paint rollers solves the cleaning and storing problem. Comes complete ready for use with 1 qt. of a special cleaning solution. Roller is placed in the container, which holds it centered. Solution in container removes paint residues

3. ROTATING DRILL HOLDER fits in the top of the drill-press column. Does not interfere with adjustment or operation of the machine, yet keeps drills always at hand. Stepped adapter fits 1½ or 2¾-in. column. Made of aluminum. Holds set of 29 drills

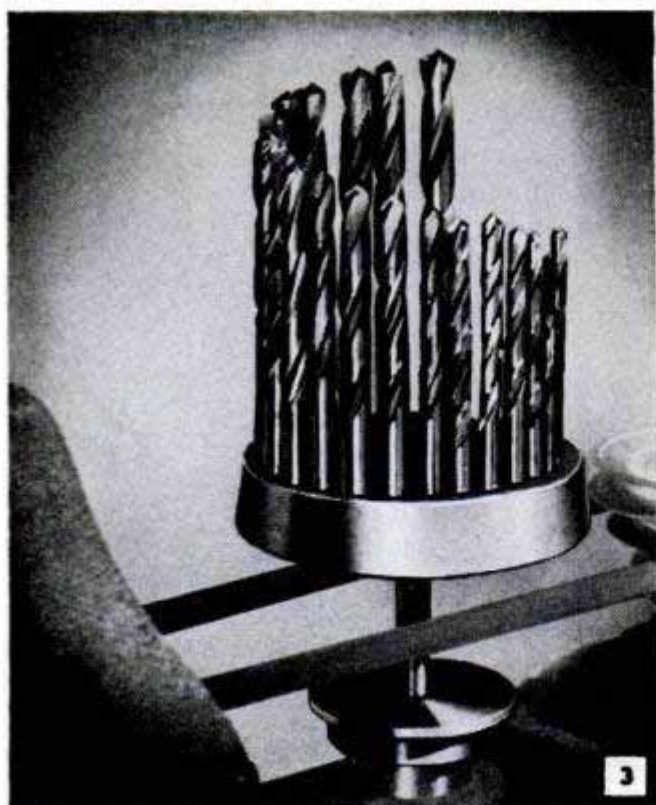

3

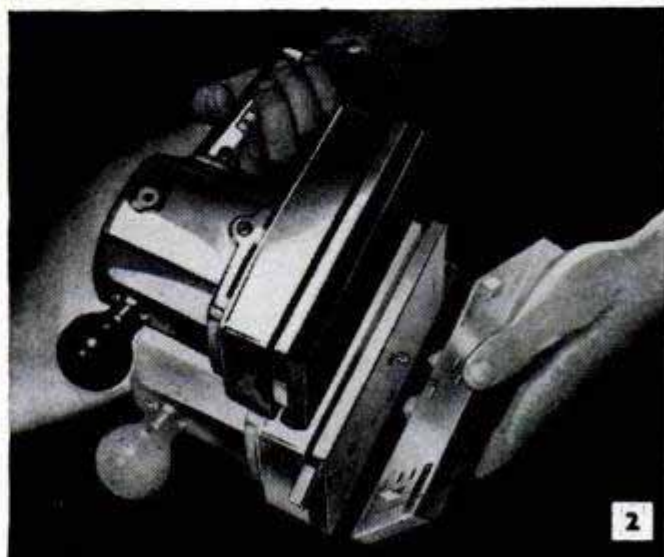

2

2. MOTOR-DRIVEN SANDER features a sanding pad which moves in a straight line. Action of pad eliminates laps, orbital swirls and other abrasive patterns on work. Sander is furnished with two abrasive holders so that change in grit size can be made quickly

4. MASON'S TWO-WAY LEVEL straps to the back of the hand, enabling the user to level each brick or block as it is laid. Use of the device practically eliminates the necessity of constantly checking the work with a conventional level. Speeds up intricate work



4

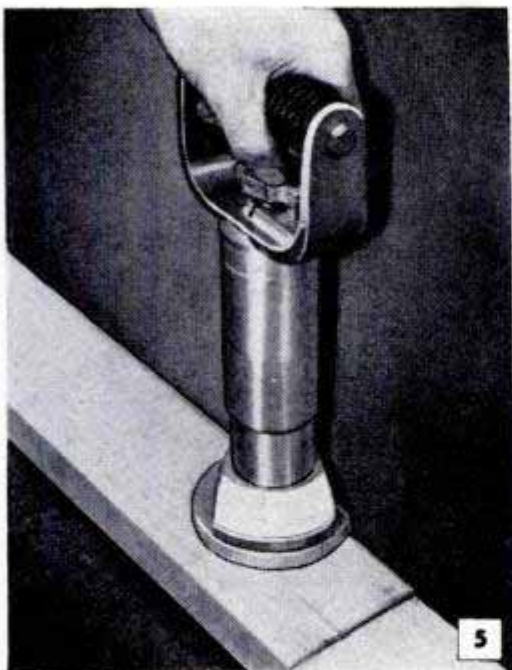

5. CARTRIDGE-ACTUATED POWER DRIVER for setting studs in concrete or steel has a permanently attached shield having a hinged section which can be lifted when working close to a wall. Interchangeable barrels permit driving either $\frac{1}{4}$ or $\frac{3}{8}$ -in. studs with same firing unit. Spring-loaded safety arm and center-fire cartridges avoid accidental discharge and assure correct load for job

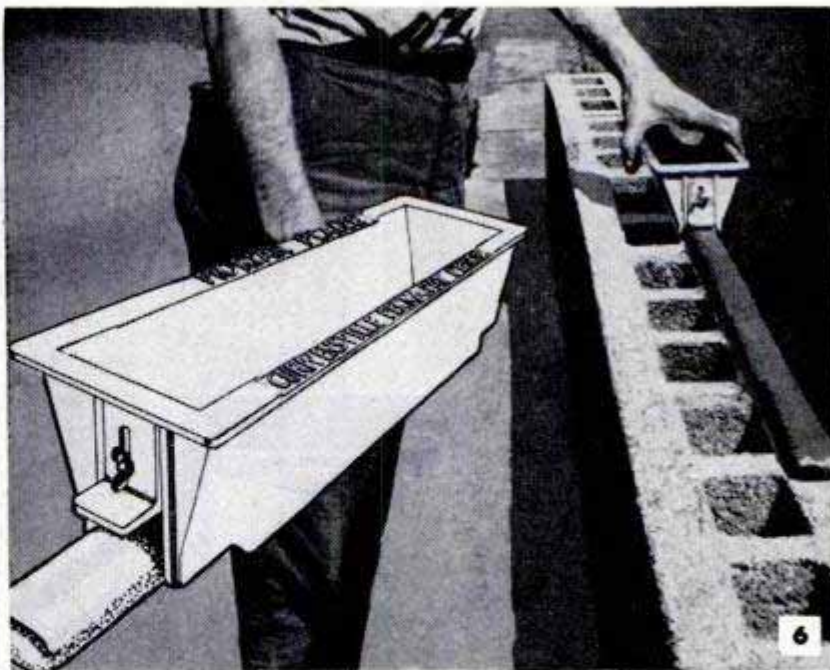

6. SLIDING "TROWEL" lays mortar to a uniform depth in concrete-block wall construction. Even flow of mortar is controlled by gates which are adjustable to give varying thicknesses of the mortar strip. Consists of hopper with flaring sides the lower edges of which project and serve as guides. Can be used on both sides of blocks. One filling of hopper is sufficient for four to six blocks

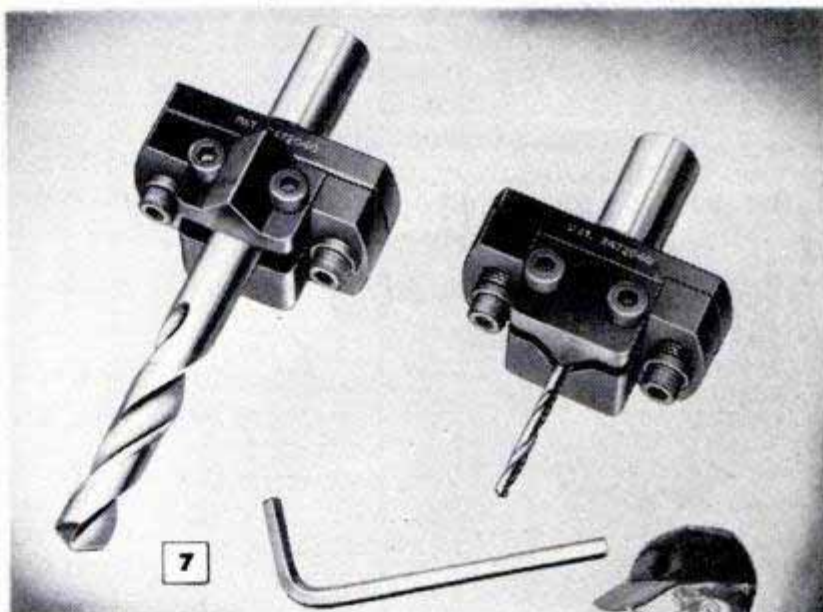

7. TOOL HOLDER centers twist drills, counterbores, reamers and similar tools having shank diameters from $\frac{1}{64}$ to $\frac{1}{2}$ in. without the use of bushings. Precision grinding of parts assures accuracy within .0005. Movable and fixed jaws are designed to prevent creeping or shifting of tool when it is being tightened in the holder. Reduces setup time

8. PORTABLE BENDER handles pipe up to 2 in. in dia. and tubing to $1\frac{1}{2}$ in. in dia. Magnetic stop switches give positive forward and reverse control of bending mechanism. Bends to 190 deg. are made with standard bending dies and the push-button controls start and stop bending operation. Unit comes complete on trailer as pictured



Wet-Paint Signs Supported By Pin Card Holders



Pin card holders are ideal for supporting small signs on freshly painted surfaces. All that's necessary is to bend the pins at right angles and clip the loops over the edge of the sign as indicated. The pins then can be stuck in a newly painted surface without marring it visibly.

Milk-Can Lids Removed With Wringer Roller



Finding that his milk cans were being damaged by knocking open the lids with an ordinary hammer, one dairy owner fashioned efficient rubber hammers from discarded washing-machine wringer rollers. He modified them by cutting away all but a few inches of

the rubber near the end of the rollers. The steel cores of the rollers serve as handles and provide sufficient weight.

Square Held on Sawhorse Leg

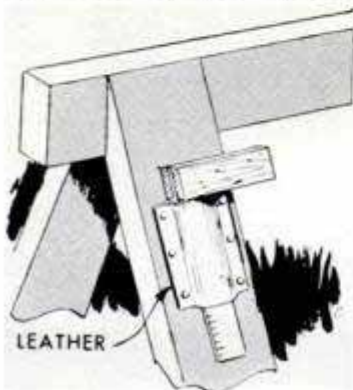

To hold a try-square within easy reach when using sawhorses, one carpenter tacked a piece of leather to one of the legs to provide a "holster" for the tool when not in use. Cut in a rectangular shape, the piece

is attached so the center arcs away from the side of the leg sufficiently to permit insertion of the square as shown. If the leather is not available, a piece of canvas, heavy cloth or even sheet metal may be used.

Brackets Hinged Above Bench Support Machinist's Chest

Cramped for working space on his bench top, one machinist attached a pair of swinging brackets to the wall above the bench to support his tool chest at a convenient height. Each bracket is

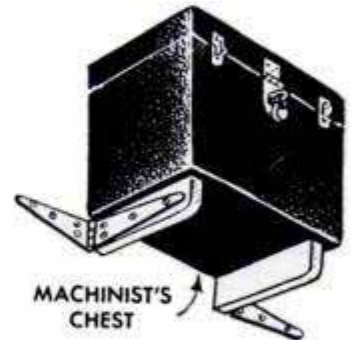

made by screwing one leaf of a strap hinge to a strip of hardwood, the length of each strip being approximately equal to the depth of the chest. The other hinge leaf is attached to the wall with screws, using lead screws anchors if the wall is of masonry. It's important to locate the brackets so the strips are level when swung outward. Brackets of this type fold flush with the wall when not in use.

Lathe-Carriage Stops Altered For Multiple Operations

To convert a lathe-carriage stop for multiple operations, one machinist attached three adjustable stops to a steel disk, which then was mounted as shown on the face of the bed clamp. The disk, which pivots on a bolt turned into the hole for the original stop, has a diameter large enough to allow any two of the stops to clear the carriage while the third is in use. Holes for the stops were spaced an equal distance apart, drilled and then tapped to take setscrews of three different lengths. The face of the bed clamp was marked to coincide with one of the stop holes and a registering hole drilled to house a spring-loaded ball catch. This engages the holes as the disk is rotated.

H. K. Chapman, Englewood, Calif.

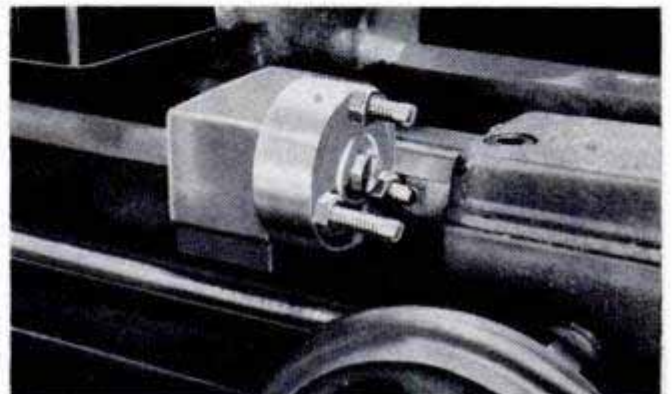

How to fix up your bathroom with Armstrong's M-67 Monowall



- 1.** Large, colorful panels of M-67 Monowall® can help turn an old-fashioned bathroom into a bright, easy-to-clean room in less than two days. Begin by marking a level guide line around the walls.

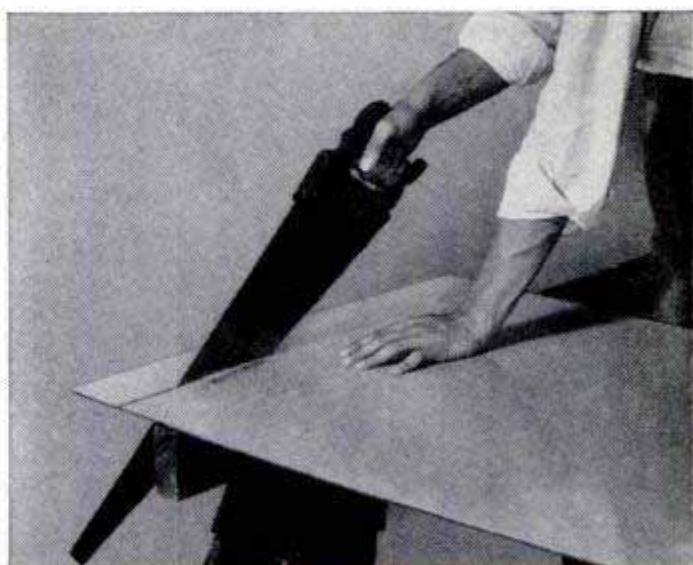

- 2.** Then you cut Monowall to fit all wall surfaces. Handy-sized sheets of Monowall cut like wood but will not crack, chip, or peel. Decorative metal channels are used for corners and joints.



- 3.** Spread Armstrong's Panelboard Cement on the back of the Monowall and apply a sealer coat to the walls. Then press Monowall into place, using metal channels to join panels.

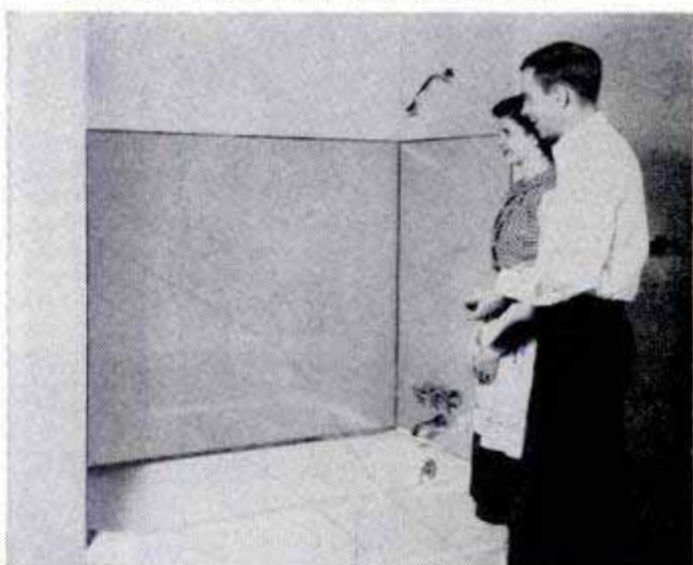

- 4.** You'll be proud of the results. Monowall's M-67 plastic finish resists all kinds of stains and hard wear, is a cinch to wipe clean. Your wife will want Monowall in the kitchen next.

M-67 Monowall's ten beautiful colors and three smart styles will suggest plenty of handsome decorating schemes for your bathroom, kitchen, or laundry. For full details, see your local building materials dealer.

FOR FREE BOOKLET: "How to Install Armstrong's M-67 Monowall," write Armstrong Cork Company, 4112 Watch Avenue, Lancaster, Pennsylvania.



ARMSTRONG'S M-67 MONOWALL



Easy-to-use materials for printing pictures—ideally suited for beginners. **Kodacraft Printing Kit**, \$4.95.



Essentials for developing and printing pictures, including roll-film tank. **Kodacraft Photo-Lab Outfit**, \$9.75.



Complete developing, printing equipment incl. metal printer. **Kodacraft Advanced Photo-Lab**, \$14.95.



For efficient print drying. Stops tendency of prints to curl. Use it over and over. **Kodak Blotter Roll**, \$2.88.



Easy to use. Simple to load in dark. Takes 620-120 and 127 roll films. **Kodacraft Roll-Film Tank**, \$2.53.

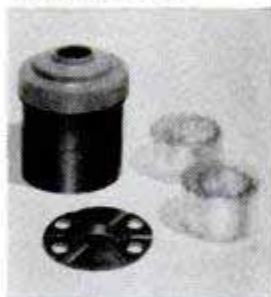

For simultaneous development of two rolls of 828 or 135 film. **Kodacraft Miniature Roll-Film Tank**, \$2.53.

Save time—Shop here for the photo fans on your Christmas list

These two pages give you some idea of the many useful and inexpensive gift ideas at your Kodak dealer's. Visit him soon. He'll be glad to help you choose just the right gift for every photo fan on your shopping list.



For accurate darkroom temperature control. You have choice of four **Kodak Thermometers**, from \$1.55.

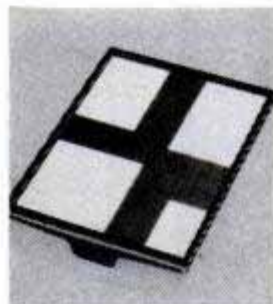

New-type printing frame of steel construction. Includes a set of masks. **Kodacraft Printing Frame**, \$1.65.



Converts tray to efficient, trouble-free washer for prints or films. **Kodak Automatic Tray Siphon**, \$4.50.



Tilting base, minute and split-second hands, large dial. Intervals up to 60 minutes. **Kodak Timer**, \$7.95.



Chemical-resistant plastic housing protects all working parts. **Kodak Chemical Scales**, \$14.50.



Includes three cups for darkroom work with both papers and films. **Brownie Darkroom Lamp Kit**, \$1.75.



New darkroom safelight provides direct or indirect illumination—or both. **Kodak 2-Way Safelamp**, \$4.50.



Can be used either from a drop cord or in a wall plug. Includes safelight filter. **Kodak Darkroom Lamp**, \$5.75.



For wall, shelf, bench. Includes switch, cord, safelight filter. **Kodak Adjustable Safelight Lamp**, \$8.75.



For determining correct printing time—saves both paper and time. **Kodak Projection Print Scale**, \$1.15.



Cool, circline fluorescent lamp, integrating-sphere lamphouse are prominent features in each enlarger. **Kodak Hobbyist Enlarger (left)**, \$57.50, complete with f/6.3 lens. **Kodak Fluorolite Enlarger (right)**, \$99.50 (lens extra).



Lenses for the Fluorolite Enlarger range from 50mm. f/4.5 "Ektanon" to 4-inch f/4.5 "Ektar." From \$15.00.

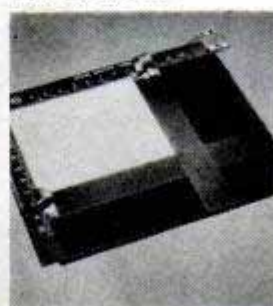

For accurate masking of enlargements with any vertical enlarger. **Kodak Masking Easel**, 11 x 14. \$15.00.



View-type camera—permits one-to-one close-ups. **Kodak Fluorolite Camera Combination**, \$69.50 (less lens).



Expertly made Kodak Field Cases make cameras easy to carry, offer sound protection together with smart appearance. Include fine-quality leather cases (left), and durable simulated leather (right). **Kodak Field Cases**, from \$2.65.

Automatically trips shutter, permits photographer to get into picture. **Kodak Auto-Release**, \$3.86.

Provides dependable "flash" for most internally synchronized cameras. **Kodak Standard Flashholder**, \$8.25.

B-C (battery-condenser) flash insures longer battery life, sure synchron. **Kodak B-C Flashholder**, \$10.40.



For quick, easy multiple lighting, with Lumac-lad reflector. **Kodak Flashholder Extension Unit, Model I**, \$11.00.

Condenser-type power for dependable "flash." **Kodak B-C Flashpack**, \$2.95 (without 22 1/2-volt battery).

Sensational new battery-condenser flash system. **Kodak Ektalux Flashholder (Standard Bracket)**, \$29.75.

Holds your camera and flash extension unit on most flat or tubular surfaces. **Kodak Flexi-clamp**, \$4.95.

For use with new Brownie Hawkeye Camera, Flash Model. Very easy to attach. **Kodalite Flashholder**, \$4.00.

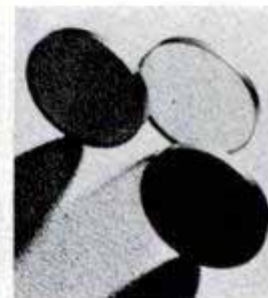

Permits close-range picture taking with most fixed-focus cameras. **Kodak Close-up Attachment**, \$1.63.

Now, a filter designed for inexpensive box cameras — emphasizes clouds. **Kodak Cloud Filter**, \$1.85.

It's easy to get extreme close-ups with both still and movie cameras with **Kodak Portra Lenses**, from \$2.65.

Shades camera lens and reduces sky flare — attaches to adapter ring. **Kodak Lens Hood**, from \$1.75.

Popular yellow (K2), red (A), and green (X1) filters to fit most cameras. **Kodak Wratten Filters**. From \$1.75.



Two compartments hold 4 filters, adapter ring, lenshood. **Kodak Combination Filter Cases**, \$4.25, \$4.95.

New-type slide-feeding mechanism, cool operation, elevating device. **Kodaslide Merit Projector**, \$26.10.

Two superb new slide projectors. **Kodaslide Highlux III Projector (left)**, 300-watt; quiet fan; blower, carry case, \$56.50. **Highlux II (right)** gives brilliant 200-watt projection. Converts to Highlux III. \$36.50. Carry case, \$7.50.

2x2 projector and screen in a single unit. Usable in fully lighted room. **Kodaslide Table Viewer 4X**, \$37.50.

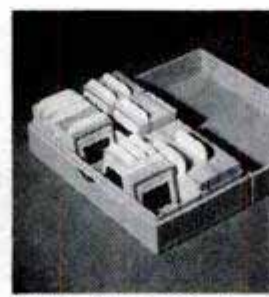

Projector, screen, changer in one unit. **Kodaslide Table Viewer, Model A**, \$97.50.

Compartments for 240 cardboard or 96 glass slides. **Kodaslide Compartment File**, \$3.94.

Holds 360 2x2-inch or 160 stereo slides. **Kodaslide Flexo File**, \$1.25.

Materials for mounting 50 color transparencies in glass. **Kodak Slide Kit**, \$3.63.

Prices include Federal Tax where applicable and are subject to change without notice.

Kodak



Care and Feeding of Engines

BY S. P. CORP

ENGINE EFFICIENCY

One of the prime causes of engine inefficiency is piston ring wear. Worn rings waste oil, waste gas, drag down power. At the first sign of blue smoke from the exhaust, consider reringing.

However, engine efficiency also suffers to a lesser degree from other conditions such as if tail pipe is bent or plugged with mud, so that the exhaust is obstructed. Likewise if you have a V-8 engine with a heat control valve between banks, see that it operates freely. Most engines have a heat control valve in the manifold system. This must operate freely for engine efficiency.

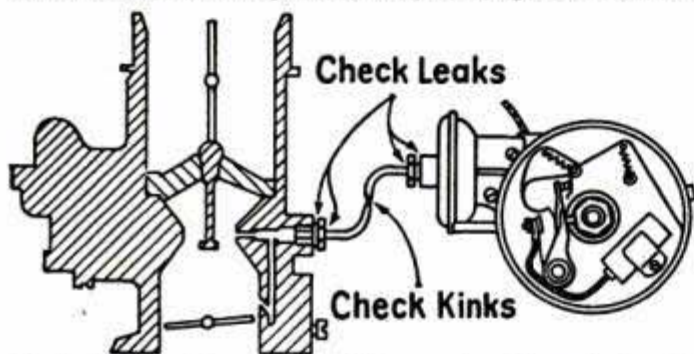

If timing is off, engine efficiency is affected. At 10 mph in high gear gradually push accelerator down until you reach 25 mph. Listen for a slight ping between 15 and 20. If not heard, advance timing.

COLD WEATHER HINTS

It is important to know engine temperature in cold weather. Check the accuracy of your temperature indicator by removing unit from engine and immersing bulb in a container of hot water. Use a thermometer to check water temperature. Now watch the gauge on the dash. Thermometer reading and gauge should agree.

To check for proper cooling and water circulation, place a cover over the radiator and run engine at a fast idle until needle reaches top of gauge. Place a thermometer in top tank of radiator and see whether gauge and thermometer agree. They should.

GET THIS FREE MANUAL

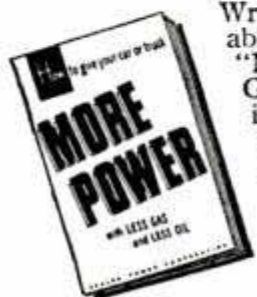

Write for your free copy of the valuable illustrated manual of car care, "MORE POWER, Less Oil, Less Gas." It may help you save money in several ways. When you need new piston rings, insist on a Sealed Power KromeX Ring Set with the famous MD-50 Steel Oil Ring, the only ring with the Full-Flow Spring. Sealed Power Corporation, Dept. G-12, Muskegon, Michigan.

Clinic for Homemakers

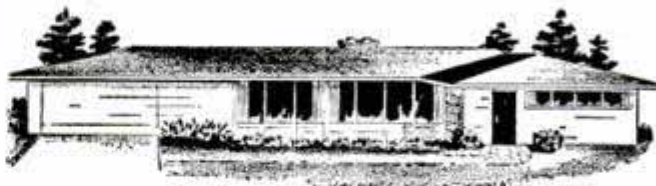

As a service to our readers in solving the hundreds of problems pertaining to a home—inside or out—the editors of *Popular Mechanics* invite you to present your problems to The Clinic Editor for help and advice. Address your questions to The Clinic Editor, *Popular Mechanics Magazine*, 200 East Ontario Street, Chicago 11, Ill.

Soundproofing



Q—I live in a first-floor apartment and we are greatly annoyed at times by footsteps, the piano and radio and other sounds from the apartment above. I understand that the ceilings in my apartment are of plasterboard. I'm thinking about soundproofing and have been told that it will be necessary to remove the plasterboard ceiling. Is this correct, or is there some other way?

—J. T., Mass.

A—Installing soundproofing between floors in the regular way is expensive, especially in older construction. We could not recommend it as we believe the cost will be out of proportion to the benefit derived. It would be necessary to remove the plasterboard from the ceilings, a considerable job in itself in addition to the waste of material and the inconvenience you would experience while the work is being done. Rather we would suggest that you consider the installation of acoustical tile, or tileboard. This material comes in 12-in. squares and in ½ and ¾-in. thicknesses and can be installed over the plasterboard with a special adhesive. The tiles have a fairly high noise-reduction coefficient, can be cleaned with a brush or damp cloth and can be painted without affecting their sound absorption qualities.

Wall Condensation

Q—What causes condensation in the walls of a building? How is it prevented? Why does it cause trouble in newer buildings, but not in older structures?—C. Y., Tenn.

A—So many of our readers encounter this problem that we are repeating our answer to a question published some time ago. Space does not permit an extended discussion, but perhaps the basic cause of wall condensation can be outlined briefly. Because of what is known as vapor pressure, air containing moisture escapes through walls and ceilings of the house when the outside temperature is lower than that inside the building. Heat loss through an uninsulated wall tends to prevent a lowering of the temperature within the wall to the condensation point, or dew point. For this reason such walls remain comparatively dry. When walls were first insulated with sawdust and other fine material, the insulating properties of these materials greatly retarded, but did not entirely

(Continued to page 210)



Willard Announces the only battery in the world with

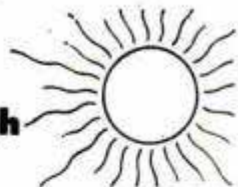

Climate Control

...The All-New Willard Weathermaster

Just turn this Key...



**Climate Control increases battery life in any climate...
Saves power in hot weather... Gives extra power in cold weather**

Wherever you live—North, South, East or West—you'll want the revolutionary new Willard Weathermaster with Climate Control. Best for hot weather driving... best for cold weather starting... it's two

tremendous batteries in one. It's the first and only battery in the world that automatically adjusts its power-out-put to meet your climate—at the turn of a key. See it... try it... buy it from your nearby Willard Dealer.

Every Willard Battery is backed by a written guarantee. Willard prices start at **\$16.65**... less a liberal trade-in allowance for your old battery.

For the name of your nearest Willard Dealer call Western Union by Number. Ask for Operator 25. Or, look under "Batteries" in the Yellow Pages of your phone directory.

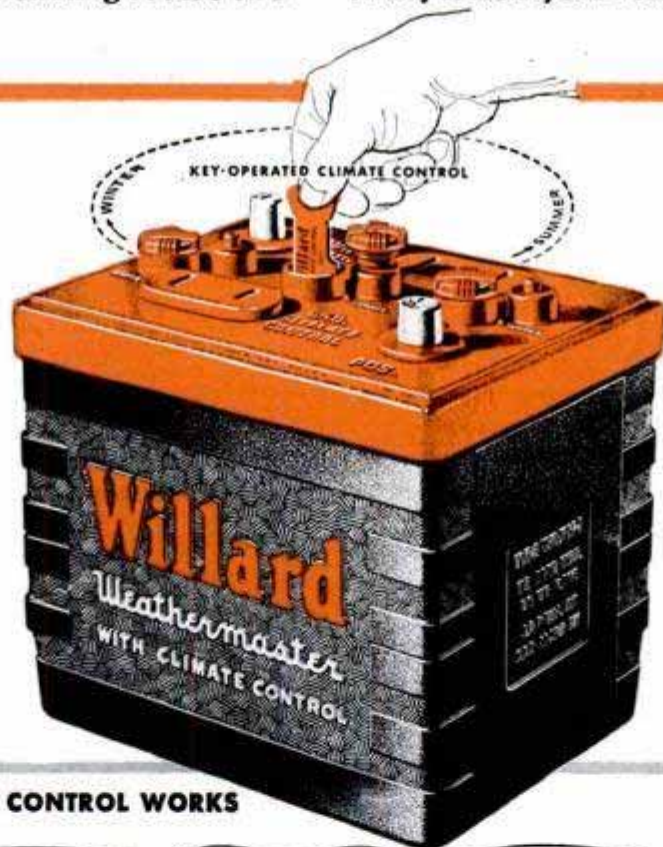

- NEW One-Piece Top
- NEW Mechanical Separators
- NEW Metalex Grids
- NEW Stronger Case
- NEW Stepped-Up Power
- GENUINE Willard "Safety-Fill"

WILLARD STORAGE BATTERY CO.

Factories in: Cleveland
Los Angeles • Dallas
Memphis • Portland
Allentown • Toronto

HOW WILLARD CLIMATE CONTROL WORKS

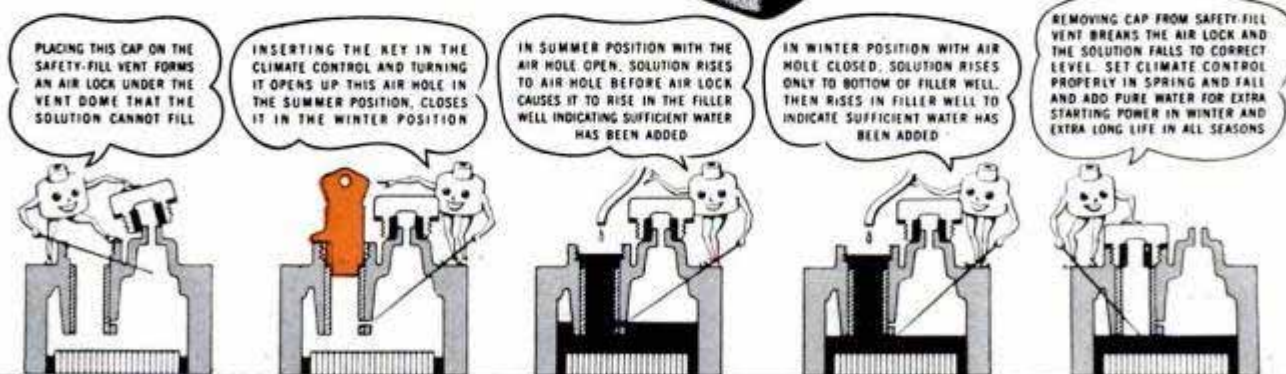

FINE WOOD DESERVES



a fine
**OIL
FINISH**



Archer
Pol-mer-ik
LINSEED OIL

- PROTECTS
- PRESERVES
- FINISHES

AMONG ITS 101
Handy Uses

- Refinishing Antiques
- Glazing Windows
- Protecting Tool Handles
- Preserving Paint Brushes
- Protecting Ladders

**Is there a painter
in the house?**

Archer Pol-mer-ik is the choice of most professional painters for paint reducing and brush conditioning. And with good reason . . . for Pol-mer-ik's special heat processing rearranges and locks together the oil molecules, giving you a tougher, more durable paint film than ordinary linseed oil. Paints reduced with Pol-mer-ik brush out easier . . . level better . . . establish a smoother surface that collects less dirt, and gives you a longer-lasting job! For better results, use Archer Pol-mer-ik whenever you paint!



FREE!
101 MONEY-SAVING IDEAS

Get your copy today. Shortcuts and pointers from the "pro's", based on practical experience. Free—no obligation. Just drop a card to: Archer-Daniels-Midland Co., 603 Roanoke Building, Minneapolis, Minn.

Yes, for preserving fine woods . . . and for an unending variety of other daily uses both indoors and out . . . you'll find Archer Pol-mer-ik the *handiest* single item in your home or shop.



(Continued from page 208)

prevent, the passage of heated, moisture-laden air through the walls and ceilings. This slowing up of the process of air and heat transfer usually resulted in a gradual lowering of the temperature within the walls to a point where the water vapor in the air condensed and formed beads of moisture, or frost, depending on the temperature. Manufacturers have developed various insulating materials having "built in" vapor barriers. Barriers also come in separate sheet forms for direct application to the studding under the plaster. These barriers are fully effective only if they are installed in accordance with the manufacturer's instructions. In homes without barriers, reducing the humidity in the rooms will lessen the possibility of trouble. Applying two coats of oil-base or rubber-base paint to the walls will help, as these paints are fairly effective barriers.

Raised Shingles

Q—We have a new home, less than two years old, and just recently we've noticed that the butts of the shingles have turned upward, some of them as much as 1/2 in. or more. Some courses of shingles appear to be affected nearly all the way across, while those above and below seem to be flat. In some cases the affected area, or strip, extends only part way across. What causes this, and is there a remedy?—O. F., Ind.



A—There are several causes but according to your description the most likely one is the use of roof boards that were not thoroughly seasoned. As soon as the boards are covered by the shingles they dry slowly and the wider ones will shrink appreciably across the width during this period. The course of shingles that happens to be nailed to a wide board with the row of nails entering near the upper and lower edges, will buckle when the board shrinks across the width. This buckling, even though it is slight, raises the butts of the next course of shingles and would give the effect you describe. Unfortunately there is no simple remedy but, of course, in time the shingles will flatten to some extent so that the defect will not be so noticeable.

Furring Siding

Q—I have just built a home for myself and am planning to build another, using the same plan. I used an insulating sheathing under cedar siding, but now I notice that paint is beginning to peel from the siding. I suppose this is due to condensation of moisture on the back of the siding boards. I'd thought of using furring strips under the siding, leaving openings at the top and bottom of the wall. Is this idea practical?—A. J., S. Dak.



A—The idea you propose may have some merit so far as ventilating the area back of the siding is concerned, but we wonder if you have thought about the structural weakness that could result from this procedure. We'd rather recommend that you stick to conventional wall construction in the new home you plan to build. Install a vapor seal under the plaster or plasterboard on the room side of all exterior walls. In the house already built we suggest that you consider painting all exterior walls, on the room side, with either a rubber or oil-base paint. Two coats form a fairly effective vapor seal. Wallpapers can be applied over the painted surface if you prefer this type of wall decoration.



All the family wants...

What Dad's Gift Can Give!

Price, \$229 delivered (saw blade and custom-built motor included). Easy terms available to fit your budget. Now on sale in department stores, hardware stores, mill supply houses.

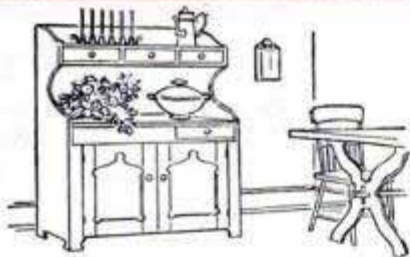

MOM wants beautiful new furniture to dress up her home!



JUNIOR AND SIS want juvenile furniture that spells play fun!



DAD wants to enjoy doing his own money-saving home repairs!

5 Woodworking Exclusives...

yours with AMF DeWalt® "Power Shop"

- 1. 12 POWER TOOLS IN 1**—all run on *one* direct-drive motor!
- 2. 3-DIMENSION FLEXIBILITY**—makes it simplest and safest to learn—easiest to operate!
- 3. SAWS THE EXPERTS' WAY**—blade moves, material doesn't. You *see* what you do—no guesswork!
- 4. PROFESSIONAL PRECISION**—home workshop version of same machine preferred by experts for over 30 years!
- 5. COMPLETE HOME WORKSHOP**—does everything in woodworking—makes every cut and joint!

Save 80% on fine furniture, home improvements and maintenance! Send for *free* booklet today!



IN CANADA: DeWalt Canada Limited, Guelph, Ontario

AMF DeWalt "Power Shop"

AMF DE WALT, Dept. PM-12-53, Lancaster, Pa.

- Please send me *free*, fully illustrated woodworking booklet showing the many ways the AMF DeWalt "Power Shop" will save me money.
- Send me the name and address of my nearest AMF DeWalt dealer.

Name _____

Address _____

City _____ Zone _____ State _____

Tune in **OMNIBUS** Sunday afternoons for America's most unusual TV entertainment. See local paper for time and channel.

NEW for Your Workshop!

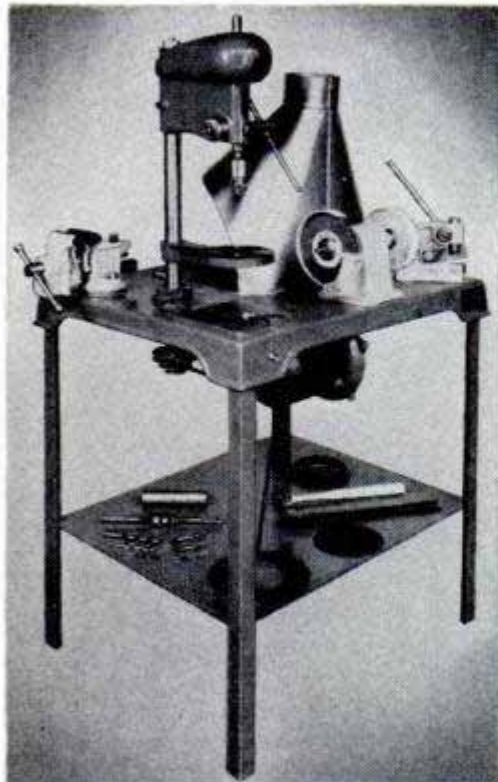

**Original
•
Complete
•
Ready
to
Use!**

**Only
\$269.50**

F.O.B.
Lancaster, Pa.
Ship. Wt. 240 lbs.

The Champion **FORGE SHOP**

Works Iron, Sheet Metal,

Aluminum, Brass for

**Homeshop, Farm, Factory
Estates, Repair Shops, etc.**

Includes: 1/3 h.p. Motor; 15" x 20" Forge with air blast regulator; electric blower; 3 1/2" machinists vise; 14" two speed radial bench drill press; Grinder & Polisher with emery, cut-off, polishing and wire wheels; 3" lever operated Shear; Hammer; Fire Tong; Tap Wrench; Set of 1/4", 3/8", 1/2" taps and drill bits to match; 1/2" steel burr; complete assembly & instruction book.

**Make your own furniture, signs,
railings, trellises, repairs, etc.**

See the **FORGE SHOP** today at your hardware store or Hobby Shop—OR write for Free Catalog to Champion Blower & Forge Co., Dept. P, Lancaster, Penna.

Name _____

Street _____

City _____

State _____

They Call It Automatic Farming

(Continued from page 114)

start from scratch and pool ideas to develop equipment which can do a necessary job. When they've tried out a new machine in the field and worked out all the bugs, they make the implement available to any interested manufacturer. Their principal concern is to help the farmer solve his equipment problems.

Agriculture is such a broad field that a good many of the mechanical problems have absolutely nothing in common. Not long ago the Davis research group was called on to devise a smokeless heater to protect citrus groves against frost. The need was a new heater that could replace standard types which create enormous clouds of smoke and soot. The research group came up with a fine solution—a return-stack heater that produces so little smoke that all other types are now banned in many communities. Then the group jumped from heaters to a far different problem: how to eliminate the stray bits of wire and pieces of metal that sometimes find their way into baled hay. This problem was solved by devising a magnetic separator—a device on the baler that automatically ejects any hay in which a metal object is detected.

For asparagus growers, Bainer and his staff have developed a new mechanical harvester that may change the whole technique of growing the vegetable. One machine can do all the harvesting for 80 acres of asparagus. It's under test this year.

One recent problem at Davis was to find a better way of separating sticks and chaff from dry beans. Some machines now on the market do the job fairly well, but none efficiently removes the small lumps of clay that also are picked up with the crop. The new machine solves this problem. It uses a new approach—the differential in skin friction between beans and trash—to make 100-percent separation. It's now being manufactured commercially.

Another Davis innovation, demonstrated this year to apricot growers, is a mechanical cutter and stoner that washes the apricots, cuts the fruit in halves and removes the seeds preparatory to sun drying.

The poultry industry grades eggs according to weight by means of simple equipment. Why can't fruit be graded not only according to size but also color? Bainer says this question has already been pretty well answered. Now under final test is a lemon sorter perfected by Bainer and his staff that automatically grades the fruit according to its color. An electronic eye

(Continued to page 214)

What every Automobile man should know about

Power Steering

The fastest-growing innovation in automotive history is Power Steering—and the leader in Power Steering is SAGINAW, world's largest producer of steering gears. Saginaw Power Steering is now available on all General Motors cars and three other well-known makes. Nearly 600,000 new cars have been equipped with it—more than all other types combined. So naturally, many people wonder:



This assures the "feel of the road" SAFETY ZONE which distinguishes Saginaw Power Steering from ordinary types.

However, as soon as *more* than three pounds pull is needed, the resistance of the wheels causes the ball-nut and screw assembly to act as a jack. If the turn is to the *left*, this forces the whole steering shaft, including the valve spool, imperceptibly *toward* the driver, as shown in Diagram 2. This changes the course of the oil, so it now flows to the front of the power cylinder and forces the piston backward. Power assistance is thus applied to the pitman arm, to help turn the wheels to the left. At the same time, oil pressure on the valve plungers tends to move the steering shaft and spool back to neutral position, which cuts off the flow of oil to the power cylinder.

When the steering wheel is turned to the *right*, the spool moves slightly *away* from the driver. The oil flows to the opposite end of the power cylinder and forces the piston to assist in turning the front wheels to the right.

The whole system also acts in reverse to resist any force, such as a blowout, which tends to twist the wheel from the driver's hands. When a road shock is transmitted through the pitman arm, the resulting movement of the valve spool admits oil to the proper side of the power cylinder to counteract the shock. Note, too, that a by-pass valve is provided which opens in case of pump failure, so there is no resistance to manual steering.

IF YOU'D LIKE TO LEARN MORE—we'll be delighted to send you "THE FACTS ABOUT POWER STEERING."

6. HOW DOES SAGINAW POWER STEERING OPERATE?

Basically, it is simply a highly efficient recirculating Ball Nut Steering Gear with a built-in hydraulic assist. This consists of a pump which delivers oil at 750 pounds per square inch, a reservoir, a double-acting hydraulic cylinder, and an ingenious spool-type control valve, as shown in simplified Diagram 1.

The spool valve, part of the steering shaft, is a grooved cylinder machined to a sliding fit within the grooved valve housing. The spool revolves with the steering shaft, can slide forward or backward about .060" and still retain the high-pressure oil. Whenever *less* than three pounds pull on the steering wheel is needed, the valve remains in "neutral" position, as shown in Diagram 1, and the circulating oil by-passes the power cylinder. *No hydraulic force whatever is applied to the steering mechanism*, and the car remains completely under manual control.

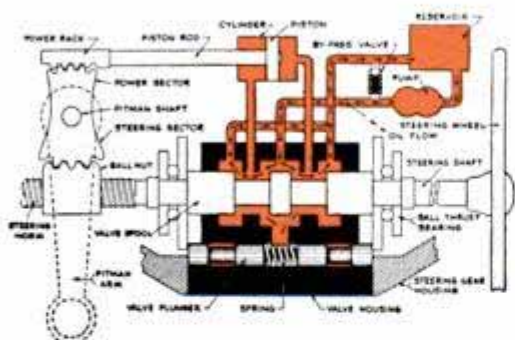

Diagram 1

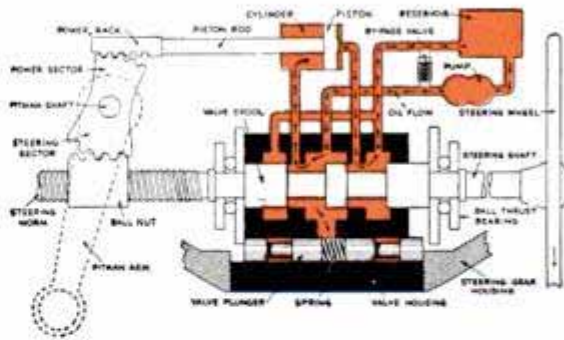

Diagram 2

Saginaw

POWER STEERING

Saginaw Steering Gear Division
General Motors Corporation
Saginaw, Michigan (Dept. M)

Please send a free copy of "The Facts About Power Steering."



NAME _____
 ADDRESS _____
 CITY _____ ZONE _____ STATE _____

Practical Gift Idea!



Available in beautiful hardwood chests or colorful plastic rolls. Choice of 6, 10, or 13 bit assortments. Made of special heat-treated steel, accurately tempered, hardened full length to stay sharp longer. Brightly polished. Gift-package of 13 bits in solid walnut chest now available from most Irwin dealers. Price: \$15.50. Other sets as low as \$6.50.

IRWIN auger bit set in beautiful hardwood chest

Definitely on the practical and useful side. Wood-boring tools to treasure for years to come by home handyman, hobbyist, professional woodworker. And downright modest in cost, too. So — put an Irwin Auger Bit Set on your list of gifts to buy. A special someone will be happy you did. Sold only through independent hardware dealers. The Irwin Auger Bit Co., Wilmington, Ohio.

IRWIN ALL-PURPOSE EXPANSIVE BITS: America's most versatile wood-boring tools. Easily adjusted to desired size. Two types, small and large sizes. Boring range from $\frac{5}{8}$ " to 3". Ideal for the home handyman who wants a practical range of auger bit sizes combined in one efficient tool. As low as \$2.40.

IRWIN SCREW DRIVER SET: Another practical gift idea being featured by many Irwin dealers. Set of 5 drivers with genuine tenite plastic handles in colorful red and ivory gift box. Drivers heat treated, accurately balanced, highly polished. Gift set of 5 only \$2.49.



the original solid center auger bit

Screw drivers
Screw driver bits

IRWIN

inspects each fruit, compares it to an index color and automatically diverts ripe lemons to one bin for immediate marketing, green lemons to another bin for warehouse storage. Soon it will be tried on apples and olives.

Bainer foresees the day when all packing operations including sorting and packaging will be virtually automatic. In addition to the color-grading machine there'll be one that grades fruit according to size. The principle has been worked out already. An individual fruit can be graded as small, intermediate or large simply by the size of a shadow it casts, under a strong light, on a light-sensitive surface.

Not all research is completely successful. Once Bainer invented a novel way of shelling walnuts by actually exploding the shells away from the meats. Each nut passed under a saw that cut through the shell. Then it passed a nozzle from which a metered amount of illuminating gas was injected through the saw cut, and finally a spark gap threw a spark, igniting the gas and blowing up the walnut. The routine worked to perfection—but couldn't compete with more conventional shellers! One of the latest developments in this field is the splitting of shells with high-voltage electricity—in effect, striking them with lightning.

The major problems in farm mechanization that remain to be solved, Bainer says, are in tree and vine crops. Such crops involve far different operations than row crops. Some problems already have been solved, such as the steel squirrel that puts a man into any part of a tree he desires. Handling of picked fruit in boxes, in the field, has been speeded through pallets and fork-lift trucks, similar to conventional industrial equipment. These are steps forward but they don't represent the ultimate, which would be some kind of a machine that would quickly strip a tree of its ripe, soft fruit without harming the tree or bruising a single fruit. That sounds impossible right now, but don't bet against such a possibility! ★ ★ ★

Imported Grass Stays Green

Grass that will remain a brilliant green during conditions of drought and cold has been discovered by scientists at the University of California in Los Angeles. Imported from Queensland, Australia, it is known as "McCoy Grass." Grown in a test plot, it maintained its vivid color during the summer under irregular watering and during winter months when the temperature dipped to 25 degrees Fahrenheit.

**Man with
stapler beats
man with
hammer 4 to 1**



...and cuts fastening costs 60%.

This race between two carpenters took place in a wood products shop—the man at left fastening latticework with ordinary hammer-and-nails, the other working 4 times faster with a Bostitch H4 Stapling Hammer.

The shop foreman reports that one $\frac{3}{4}$ " staple is more rigid than two $\frac{3}{4}$ " nails. The staple won't loosen because its legs diverge inside the wood, bracing against each other when under strain.

The carpenter can drive a staple all the way home with one blow, leaving his other hand free to hold the work. He gets greater "reach"

from one position. No "mouthing" of nails, either!

Over 800 Bostitch staplers trim time and costs on thousands of different fastening jobs in factory, office and building trades. To fit the right stapler to the job, Bostitch has 325 Economy Men in 123 U. S. and Canadian cities.

If you buy equipment for your company, call the Economy Man nearest you. If not, tear out this page and take it or route it to the man who does.

The Economy Man will tell you honestly if stapling can save you time and money. Look up "Bostitch" in your phone book or write us.

**FASTEN IT BETTER
AND FASTER WITH**

BOSTITCH®
STAPLERS AND STAPLES

BOSTITCH, 552 Mechanic Street, Westerly, R. I.

- Would like an Economy Man to analyze our fastening problems.
- Would like to have FREE BULLETIN telling how stapling can cut costs on fastening jobs checked below.

I want to fasten:

- wood
- plastics
- cartons
- leather
- rubber
- light metals
- fabric
- roofing

Name _____

Company address _____

City _____ Zone _____ State _____



YOU can make this
 low cost **TUBINETTE**
 with
MASONITE
PRESWOOD

Now! Make your utility room more attractive. Build this laundry tub cabinet that doubles as a sorting table. It's easy—when you work with strong, smooth Masonite Tempered Presdwood®. Won't snag the finest fabrics. Not affected by water, steam or heat. Easy to cut and fit. Can be painted in attractive colors.

Free plan also tells how to make enclosure for water heater—including storage space for ironing board and laundry supplies. There are scores of ways to use these dense, grainless, all-wood hardboard panels around the home. Send coupon today.

See your local building materials dealer for
MASONITE PRESWOOD PRODUCTS

A type and thickness for every job!

- Standard Presdwood—1/8", 3/16", 1/4" and 5/16" thick.
- Tempered Presdwood—brown, 1/8", 3/16", 1/4" and 5/16" thick. Black in all but 5/16".
- Temprtle®—1/8".
- Tempered Duolux—both sides smooth! 4-ft. and 5-ft. widths, 1/8", 3/16" and 1/4" thick.
- Leatherwood—1/8".
- Panelwood—3/16" and 1/4" thick.

Better Hardboards for Better Home Projects

MASONITE®
CORPORATION

Dept. PM-12, Box 777, Chicago 90, Illinois.
 "Masonite" signifies that Masonite Corporation is the source of the product

Please send me free plan on the TubINETTE

Name.....

Address.....

City.....Zone.....

County.....State.....

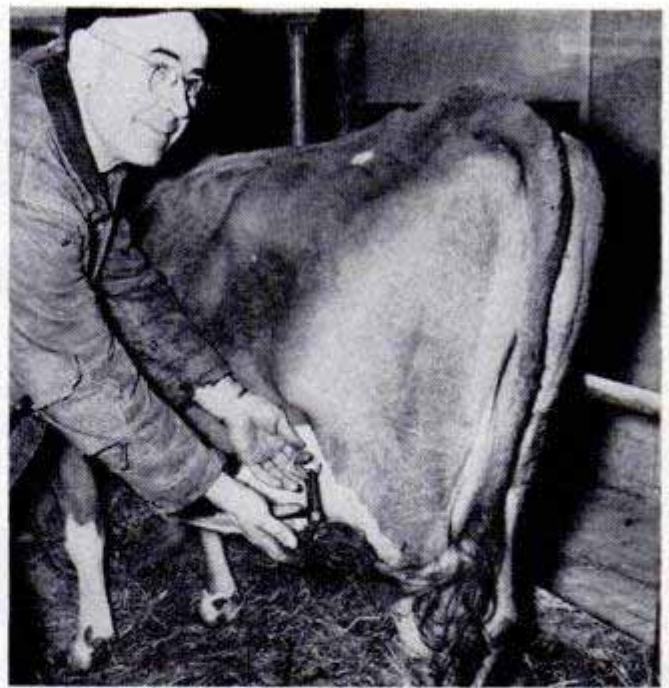

Clamp on Cow
Prevents Tail-Swishing

Cows no longer will swish their tails in Frank M. Kaneski's face. Kaneski, a farmer near Duluth, Minn., has invented a "tail tie" which protects him from flicks of the tail while he's milking his cows. Secured to the flabby skin along the cow's flank is a metal ring, similar to a bull ring. When it's time to milk the cow, Kaneski slips one end of a clamp on the ring and uses the other end to hold the cow's tail.

Camera Designed
For Rapid-Sequence Shots

Two plungers atop a 35-millimeter camera enable the photographer to take pictures in extremely rapid sequence. One plunger advances the film and cocks the shutter automatically. The other takes the picture. There is no need for the photographer to lower the camera from his eye while taking many shots in succession. All operating parts recede when the camera is closed.





"...and bring Daddy some Bonney wrenches"

Daddy's been prompting *this* lad. Not a bad idea, either. A word to the right person *now* will pay off at Christmas.*

Any man wants wrenches he can be proud of. That means Bonney wrenches—mechanics themselves call them America's finest.

Your Santa Claus can buy Bonney wrenches wherever fine tools are sold—in open stock or complete sets.

Bon-E-Con tools, also, carry the famous Bonney guarantee. They're tools any man would value—at prices anyone can afford.



* Confidentially, men, it would be smart to leave this page where the right person can't miss it!

Ring Around the Stage

(Continued from page 107)

"Here the audience no longer watches a play," explains Fred Koch, Jr., drama-department chairman. "It is enfolded by it."

When Miami's Ring Theater is producing this type of play, the last seats in the house are only 10 rows from the stage. "The close-up, born in Hollywood," says Koch, "now emerges into the world of flesh and blood. It flows into a third dimension."

This is fine, but it poses problems for designers and technicians on a limited budget. How do you light such a stage without blinding the audience? Where do you hide your stage-handling equipment? How do you arrange for a central stage and still operate like a conventional theater when you want? Ingenious stunts at Miami solve these enigmas. Men working house lights, for instance, prowl a circular catwalk, suspended from the dome 17 feet inside its outer perimeter and 14 feet above the floor. Stage lights, made from surplus Navy signal lamps, are installed directly above the stage in individual cubicles of a huge hanging grid that looks like an overgrown egg crate. Lenses are high up in the cubicles so the audience can't see the source of light, which is directed straight down on the stage. A booth above the entrance wing houses electrical controls for all theater lights. Stage manager and electrician yammer back and forth over an intercom system throughout a show. The orchestra is sunken from sight in a big pit shielded by a low canvas wall.

As for the conventional stage, it was Technical Director Gordon Bennett who came up with the answer for that. From Army surplus he bought a coast-artillery gun turret which he installed under the rear sector of the theater. On top of it, workmen mounted a 30-foot-diameter revolving platform. Divided into pie-shape sets, this stage supports three scenes at a time, which are rotated to face the audience as needed. It works as neatly as the million-dollar rig in Radio City, New York and, with the proscenium arch drawn across the front, looks like any conventional theater.

Total cost of the unique Ring Theater was only \$110,000—a cheap price to pay for the realization of a ten-year dream for the University of Miami's drama staff. It's a far cry from the circus tent on the student parking lot that first served as a playhouse and inspired the theater-in-the-round idea at the school. "We could seat 120 under that carnival hood," the men recall. "And if it hadn't been for a high wind and rot in the canvas, we might still be struggling along and turning away customers." ★ ★ ★



Graflex Prize-winning Photo by Charles Hoff

Get Out
of the
"Snapshot
Class!"

GRADUATE TO A...

Graphic

● If you've ever snapped a picture with a folding camera, you can shoot with a Pacemaker Graphic. And make far better pictures, too, for there's not a challenge these rugged cameras can't meet. That's why they're the overwhelming favorite of press photographers—men who live by the lens. Have your Graflex dealer show you both the Speed and Crown Graphics—each in three sizes. And see the Century Graphic, now only \$108 with coated f/4.5 lens. Many dealers offer budget terms as low as \$2.00 weekly.

Graflex Inc., Dept. 87-A
Rochester 8, New York

Please send the new FREE 48-page booklet.

Name _____

Street _____

City _____

County or Zone _____ State _____

GRAFLEX® *Price-Winning
Camera*

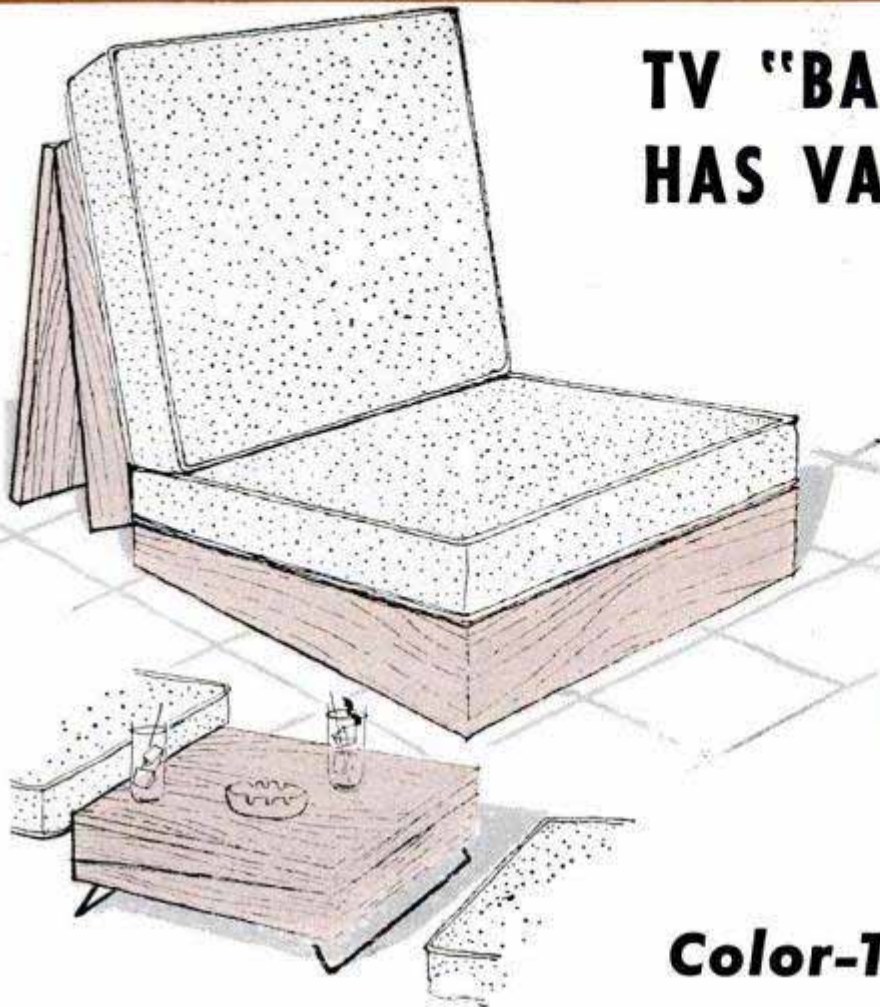

TV "BACK-REST" SEAT HAS VARIETY OF USES

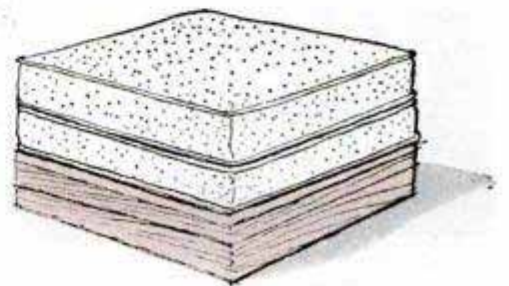

Color-Toned with **Rez**^{LAUX}

Modern . . . unusual . . . easy to build at home. This TV seat folds to become a coffee table. Add cushions and it's an ottoman! You'll enjoy making it . . . use it for years. Write for detailed plans today.

Rez is used in finishing the wood portions of the unit. Rez—which primes, seals and gives

you the natural wood finish decorators recommend.

Rez Color Tones bring you these ultra-modern *natural* shades: *Redwood, Cedar, Sage, Driftwood* and *Mahogany*. *White Rez* provides a 1-coat blond finish. Just put it on and wipe with a cloth. *Clear Rez* beautifies grain in original wood color.

You can paint like a professional with Rez. Brushes or wipes on like water . . . can't

leave streaks or brush marks.

Rez protects wood, too. It seals out moisture, checks warping and swelling. Ends the nuisance of "sticking" drawers, doors and windows.

So many places to use Rez! Paneling, siding, flush doors, fencing, furniture . . . wherever you want a modern natural wood finish. See the beauty of Rez Color Tones soon. Ask your dealer for color samples!

Laux Rez: Reg. U. S. Pat. Off.



SERVING INDUSTRY...WHICH SERVES MANKIND

MAIL COUPON AND 25¢ CASH FOR PLANS

MONSANTO CHEMICAL COMPANY, Merchandising Division
1700 South Second Street, St. Louis 4, Missouri
Enclosed find 25 cents (25¢) for which please send plans and specifications for TV "Back-Rest" Seat (Monsanto Rez Moderns, Plan No. 10).

Name.....

Street.....

City..... Zone..... State.....

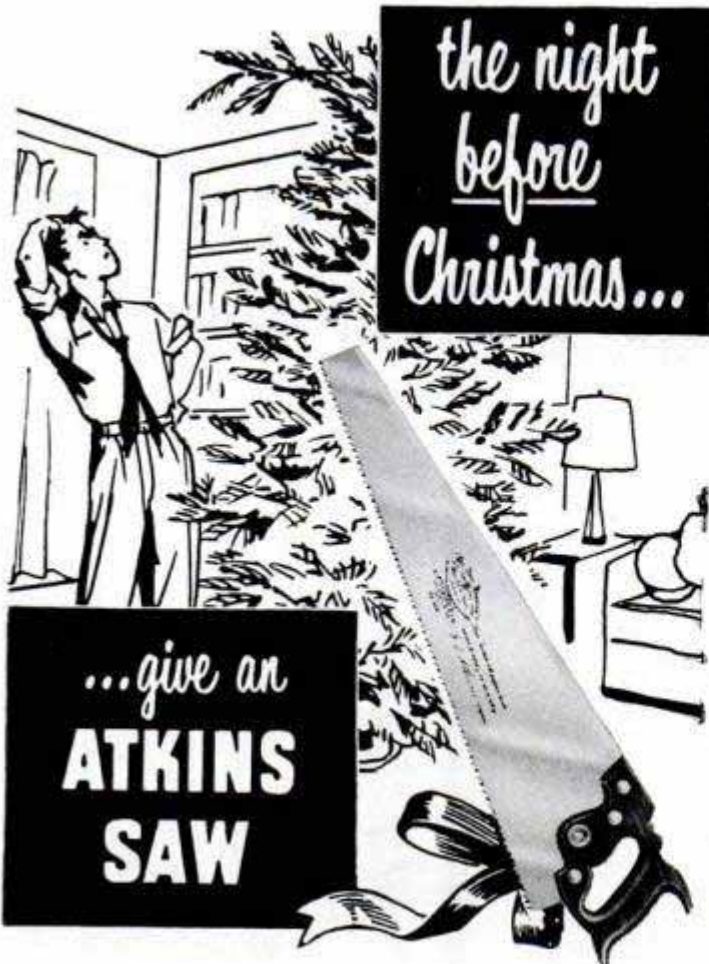

CHOOSE A TYPE THAT'S RIGHT
PRICE-WISE • PURPOSE-WISE

For men who want the best, choose the Atkins *Silver Steel* "400." The blade is tempered, balanced, taper ground. The Perfection Handle relieves wrist strain—takes the work out of sawing. Costs more—but worth it!

... if your friend is handy around the house, give him an Atkins *Silver Steel* 65! It cuts fast and accurately—stays sharp! The cost is average—the value high!

... if he is a once-in-a-while carpenter who wants a saw that cuts easily—pick the Atkins P-4! A low-cost saw of very good quality.

Ask for Atkins...at hardware stores
or building supply dealers

ATKINS



Atkins Saw Division • Borg-Warner Corp., Indianapolis 9, Indiana

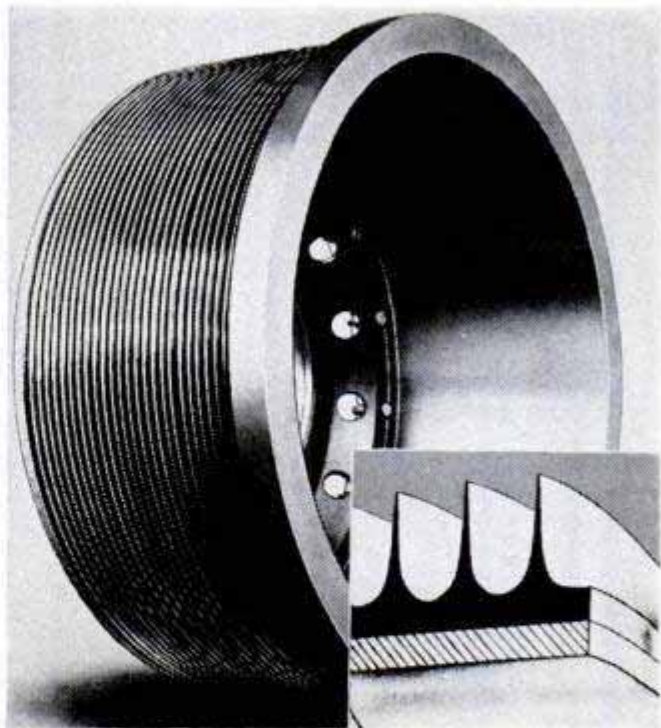

Finned Brake Drum Adds Life to Linings

Welded to an alloy-steel brake drum, a band of copper grooved to form sharp fins disperses heat due to friction fast enough to make linings last about four times longer than normally. Designed for use on trucks, busses and other heavy road equipment, the brake drum itself outlasts the conventional cast-iron drum by a ratio of more than six to one.

Back Toaster for Chilly Drivers

Motorists can toast their backs on chilly days with a new heating pad that plugs into the car's cigarette lighter. The pad is equipped with a plastic harness so it can also be used on motorcycles, jeeps and speedboats. One side of the pad radiates medium heat, the other side higher heat. Outdoorsmen can use the pad by connecting it to a carton of six-volt batteries.



CHRYSLER CORPORATION'S "deep-breathing V8"

NEWEST, MOST ADVANCED CAR ENGINE

Compact, low-friction engine inhales and utilizes air and fuel more efficiently . . . gives you greater performance and safety, even on steepest mountain roads.

What's happened to automobile engine design?

At Chrysler Corporation, something spectacular! America's most advanced car engine, the V8 hemispherical combustion chamber design, is already turning gasoline into power more cleanly, more efficiently, than any other power plant for passenger cars.

This extraordinary engine, which is now being enjoyed by Chrysler, DeSoto and Dodge V8 owners, actually *breathes* deeper through the wider, straighter fuel passages. Valves are larger, open wider. Spark plugs fire directly above pistons. So efficient is performance that the engine doesn't "carbon-up" with resultant power loss.

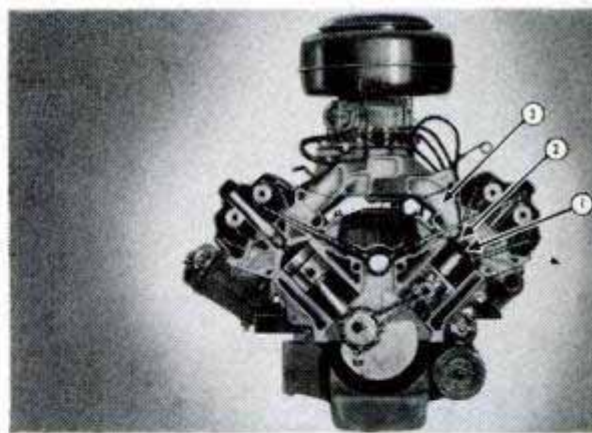

Cutaway view of Chrysler-built V8 engine showing (1) dome-shaped chamber, (2) bigger, high-lift valves, (3) wide fuel channel.

The new engine is another example of how practical imagination puts *more value and worth* into Chrysler Corporation cars. To get the "feel" of this Chrysler-built V8, call a Chrysler, De Soto or Dodge dealer for a demonstration . . . today!

Chrysler Corporation produces Plymouth, Dodge, De Soto, Chrysler & Imperial cars and Dodge Trucks, Chrysler Marine & Industrial Engines, Oilite Metal Powder Products, Mopar Parts and Accessories, Airtemp Heating, Air Conditioning, Refrigeration, and Cycleweld Cement Products.

You will enjoy Medallion Theatre—
dramatic entertainment for the whole family on CBS-TV.

Practical imagination that brings you the good things first. *This deep-breathing, high efficiency engine has enough reserve power to handle with ease rugged terrain like that found on Nevada's Route 50.*

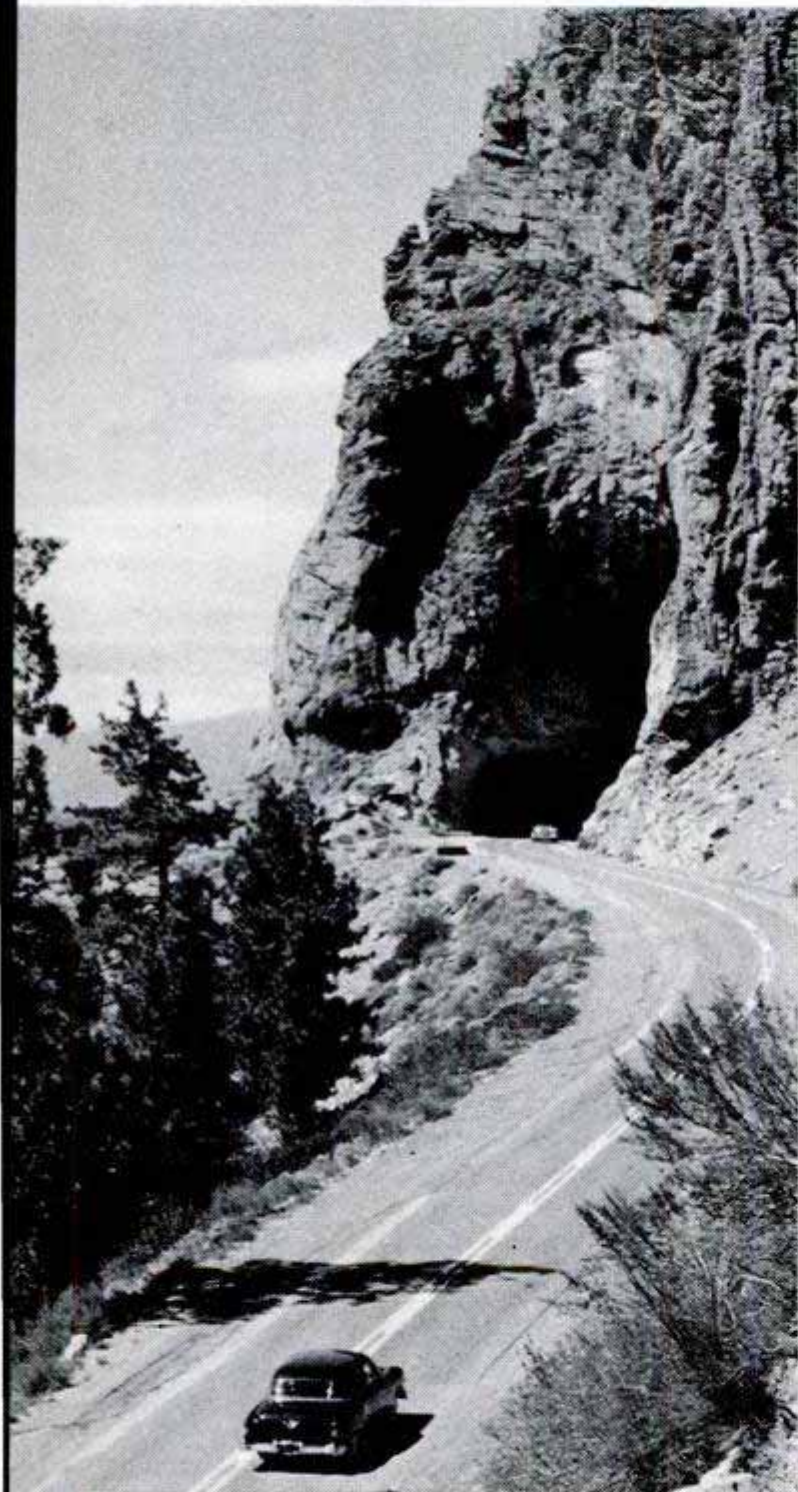



YOUR LIFE MAY DEPEND ON USING THE RIGHT BRAKE FLUID

Just keeping enough fluid in the brake system is NOT the answer if you want good brakes . . . and SAFETY!

There are many brake fluids which can be dangerous . . . some, freezing point too high or boiling point too low . . . no water absorption . . . no rust protection . . . no lubricating qualities . . . ingredients which cause distortion of rubber parts and formation of sticky gums . . . and . . . some that won't properly mix with fluid presently in brake system.

Don't Take Chances . . . INSIST ON

BOWES BRAKE FLUID



Certified to meet or exceed
SAE Specifications

**IF YOU WANT TO STOP IN TIME . . .
SEE YOUR BOWES DEALER
FOR SAFE
BRAKE FLUID!**

BOWES "SEAL FAST" CORP., INDIANAPOLIS 7, IND.

Who Says Animals Are Dumb?

(Continued from page 126)

remain in any position by holding him there until you give the releasing command. Pretty soon you can tie him in knots and he'll make no effort to untie himself."

Since the dawn of history, Keller points out, man's two household pets have been the cat and dog. Dogs are taught quite complex tricks, but few people succeed in training a cat to perform more than an elementary stunt or two. Why? To the Brelands, any behavior question demands an answer, and they have recently undertaken a research program on cats. A graduate psychologist from the University of Arkansas has been doing some of this work at the Breland laboratory. The preliminary studies show that a cat won't accept "remote reinforcement" like a dog. You can train a dog to travel a mile or more and perform an involved routine (round up the sheep, bring in the cows) to earn a reward. A cat, on the other hand, apparently needs reinforcement right under its nose before it will respond.

The Brelands have discovered that cats can be trained to do a wide variety of tricks if the reinforcement is immediately at hand. For example, they have trained a run-of-the-farm Tabby to be a high-jumper. The cat, on signal, will leap six feet straight up in the air. Looks like a bouncing ball.

Wrestling pigs are among the funniest of animals the Brelands have trained. They grapple with huge enjoyment in a miniature ring. Keller first made each pig realize it would be reinforced if it pushed another out of the ring. From that point the porkers trained themselves. Although the pigs remain the best of friends outside the ring, they have developed their own specialties inside. They shove, push, attack from the flanks and teeter on the apron to an orchestration of grunts and squeals. One little porker, initially at a disadvantage, learned to run around the very lip of the ring, then give an extra-fast jump when an opponent charged from the flank. The poor opponent invariably plunged on through the ropes.

Keller designs many of the tricks to take advantage of an odd instinct or peculiar behavior pattern in the animal. Just for fun, the Brelands decided many months ago to "imprint" a goose (attach it psychologically) to their baby daughter. No training is involved in imprinting an animal or bird. You merely deceive it by rearing it in association with some creature other than its own species. A goose is just about the easiest animal or fowl to imprint. Each day the Brelands placed a gosling in a little pen

(Continued to page 224)

THRILLING POWER



PUTS YOU MILES AHEAD IN FUN

As powerful as it looks . . . more comfortable to ride than anything in its field. The "Golden Anniversary 74 OHV" is truly the undisputed ruler of highways and byways. No other two wheeler offers so much pleasure and safety. It's the one motorcycle every rider wants to own. See it! Thrill to a test ride at your dealer's today. Ask about his easy-payment plans. For your copy of the action-packed ENTHUSIAST Magazine and illustrated literature, send 10¢ to Harley-Davidson Motor Company, Department P, Milwaukee 1, Wisconsin.

GOLDEN ANNIVERSARY



HARLEY-DAVIDSON

HYDRA-GLIDE®

beside the baby's playpen. This continued for several months until the goose was full grown and the child had begun to walk. By then the goose was convinced beyond any doubt that it was a child, too, and imitated the little girl to perfection. It played with the baby's toys, tried to enter into the children's games. Today wherever the child goes, a tremendous goose chases after.

Although the Brelands have been training animals commercially since 1947, they consider that most of their past work has been research. Now they're ready to try new ideas.

For example, they're branching into animated displays for store windows, using animals instead of mechanical figures. They state emphatically that the behavior of a highly conditioned animal is as predictable as the swing of a pendulum. Animals, they say, will repeat a routine far longer and with fewer failures than most mechanical displays. The Brelands also hope to branch out into television programs and the filming of famous animal stories.

Another idea, and one of their favorites, is to work out a coin-operated zoo. Zoos, it seems, are costly to maintain. This idea would bring in revenue while still permitting anyone to see the animals free. Here's the way a coin-operated zoo would work: You could walk up to the monkey cage or

the hippopotamus tank and watch the animals just as you do now. However, if you wanted to see two monkeys do a sprightly waltz while another played the piano, or watch the hippopotamus dive from a three-foot perch with a tremendous splash, you'd simply insert a penny, nickel or dime into a reinforcing mechanism.

Training turkeys to play with electric trains and pigs to jump from eight-foot towers is more or less routine with the Brelands now. What excites them most is their research is basic behavior patterns. There are several "schools" of psychology today, they point out, but all schools agree there is a definite correlation between animal and human behavior patterns.

When you acknowledge this fact, a good many questions suddenly pop into your head—some of them with deep philosophic overtones. If you can train an animal to do phenomenal tricks, what happens when you set about scientifically reinforcing a child? Can humans be so strongly conditioned that, like the Breland animals, certain of their actions are completely predictable, even inevitable? And if you go this far (as the Brelands do), can a teacher or statesman "reinforce" groups of people so strongly that they are almost certain to react favorably, thereby creating a real opportunity for human betterment? ★ ★ ★

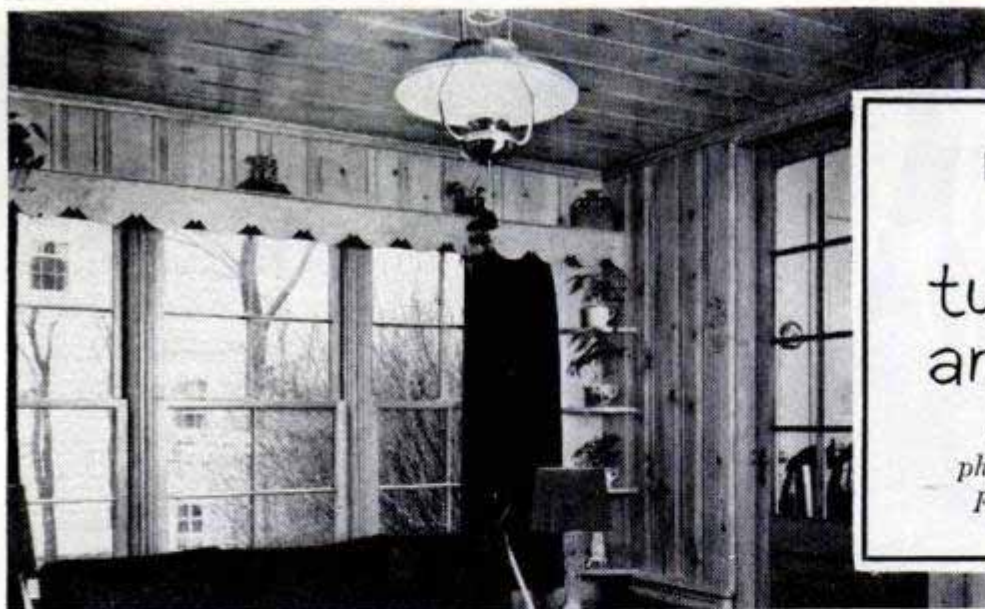

**put your porch
to work**

turn it into
an extra room!

*complete detail drawings,
photographs and directions in
FREE IDEA PACKET 247*

The handsome woods of the Western Pines* changed an open porch into this cozy room!

Western Pine horizontal log siding forms the wainscot, vertical paneling with molded edge continues up to the paneled ceiling.

You'll find the Western Pines cut clean

and accurately with hand or machine tools. Their even texture and smooth surface take all finishes without grain-raising.

See these versatile woods at your local lumber dealer — he'll be happy to help you select them.

the Western Pines (***IDAHO WHITE PINE**
***PONDEROSA PINE**
***SUGAR PINE**

Send for FREE IDEA PACKET 247 — including the booklet, "Enchanting Homes of Western Pines" — to WESTERN PINE ASSOCIATION, Dept. 247-N, Yeon Building, Portland 4, Oregon.

NOW
a power tool that's

Really New!



JUST TURN TO RIP
No need to disassemble and reassemble when changing from cross-cutting to ripping. Just turn head 90° . . . you're all set to rip!

BUILT-IN
BLOWER

TABLE
TILTS
TO 45°

NEW SHOE
HOLD-DOWN
DESIGN

FULL-ROTATING
ARMATURE AC
MOTOR

MASTER-VIEW
CONTROLS

SHOPMASTER'S

Sensational **20" JIG SAW**
with **Self-Contained Motor**

Think of it—this rugged 20-inch jig saw has its own built-in motor! Not a solenoid or a vibrator, but a full-rotating armature, powerful AC motor.

A rugged, professional power tool that cuts up to 2½" stock with ease, this newest of all power tools makes precision woodworking actually easy. Shopmaster's EXCLUSIVE COMBINATION MITRE GAUGE AND RIP FENCE accessory sees to that!

Want to rip? Just turn saw head 90°. It's that simple. Truly the most outstanding QUALITY power tool value on the market today!



**Just plug
it in**

(Exclusive combination mitre gauge and rip fence available at slight extra cost.)

\$39⁹⁵ Motor included

Slightly higher in zone 2

**OTHER FAMOUS
SHOPMASTER
TOOLS**

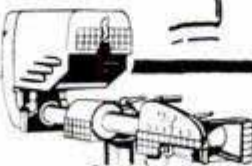
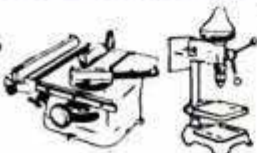

**FAMOUS UNIVERSAL
COMBINATION TOOL**

WRITE FOR FREE CATALOG
There's a Shopmaster power tool for every need. Write today for catalog of complete line.

SHOPMASTER, INC. Room 10F
1214 South 3rd St. • Minneapolis, Minn.



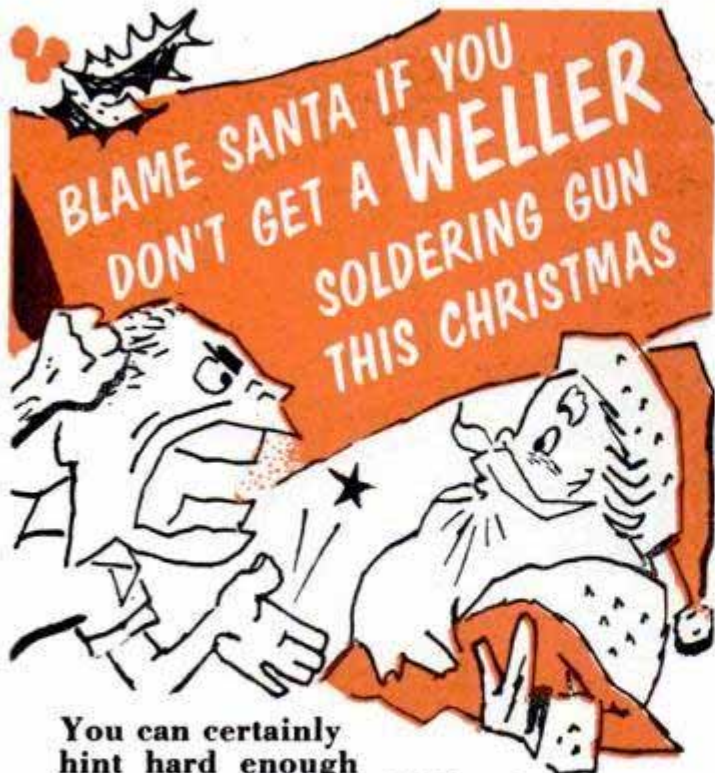

You can certainly hint hard enough telling everybody a Weller Soldering Gun tops your "want" list because it makes all kinds of homcraft and hobby jobs easier, faster and better. So if you don't get one, it's because the old guy kept it for sled repairs and his toy factory. Even at the North Pole, there are endless uses for the new Weller Soldering Guns!

While you're thinking about it... they're gift wrapped for Christmas and a sure-fire idea for giving, too!



INSTANT HEAT—saves time and current
2 SPOTLIGHTS—eliminate shadows
SPECIAL TIPS—for cutting, smoothing and soldering



Cuts plastic tile



Seals freezer packages



Removes hard putty



Solders and repairs

Weller SOLDERING GUNS
 816 Packer Street, Easton, Pa.
 AT BETTER HARDWARE STORES EVERYWHERE

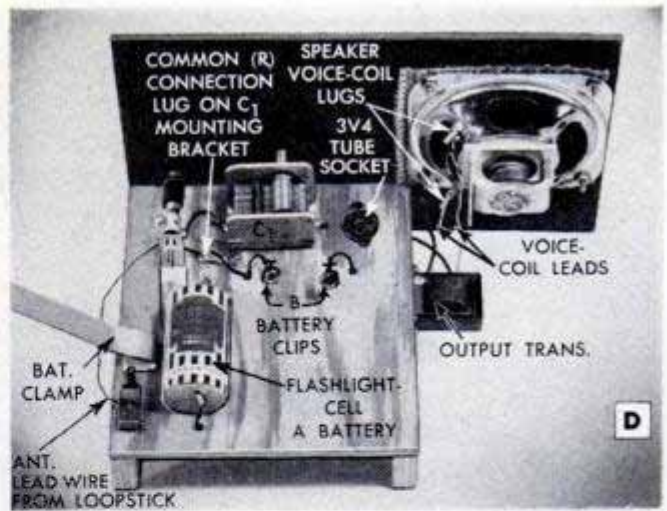

One-Tube Loudspeaker Set for Junior Builders

(Continued from page 147)

lugs are spaced very close together and the excessive use of solder could cause a short circuit between the terminals.

All components are standard and available to radio students and experimenters. The variable capacitor C1 is a single-gang unit with a capacity range from 11.2 to 381.4 mmfd. The exact capacity is not critical; any type of broadcast-band variable can be used as the loopstick antenna coil is variable. This antenna coil has a single winding and a variable iron core; it is known as a Vari-loopstick and it is especially suitable for a simple set of this type where maximum gain is essential. The mounting bracket comes with the coil.

The value of fixed capacitor C3 is critical and it must be carefully chosen for best results. In the model, a .004 mfd. gave the best volume and sensitivity. If the capacity is too high the sensitivity and volume will be less than the maximum obtainable. If too low the set will oscillate (whistle) as you tune in stations.

Best results are obtained with a good long outdoor antenna; however for strong

(Continued to page 228)

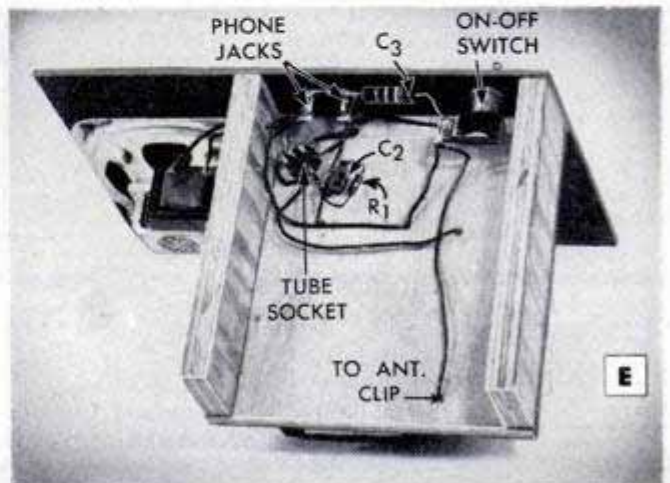

**GIFT FOR
YOUR MAN**

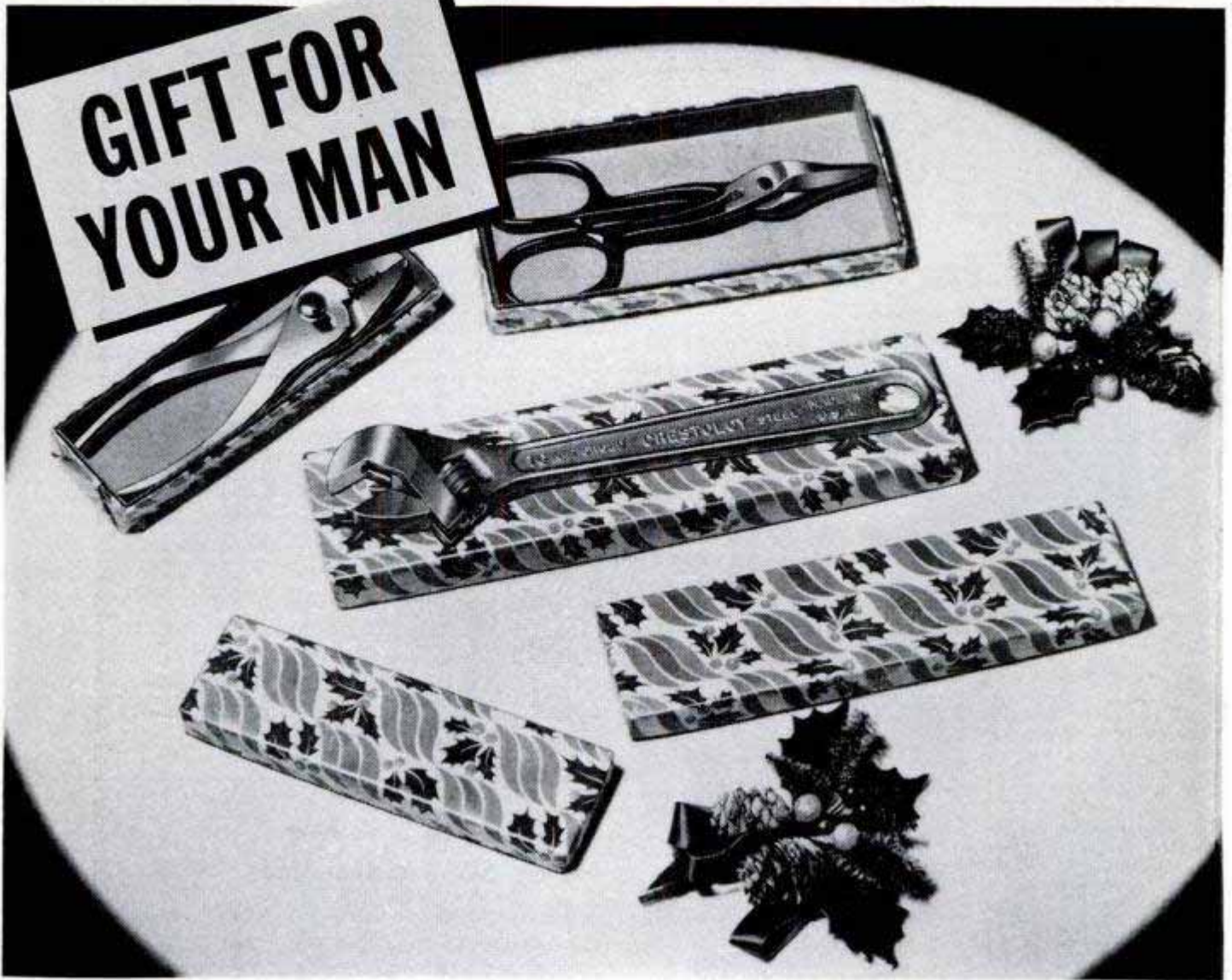

★ No finer gift for the mechanic, home workshop fan or householder! You can't buy finer tools anywhere, and your local hardware dealer has these popular Crescent Tools *gift wrapped* in colorful, Christmas boxes. See him soon while his Crescent stock is complete.

**CRESCENT TOOLS
available in Gift Boxes**

AC16	Six inch Crestoloy Wrench... Retail value.....	\$2.00
AC18	Eight inch Crestoloy Wrench... Retail value.....	\$2.30
AC110	Ten inch Crestoloy Wrench... Retail value.....	\$3.00
L26	Six inch slip joint, thin nose Plier... Retail value.....	\$1.20
T47	Seven inch combination Snip... Retail value	\$2.60

CRESCENT TOOLS

Give Wings to Work

*Sign of the Artisan
Symbol of Excellence*

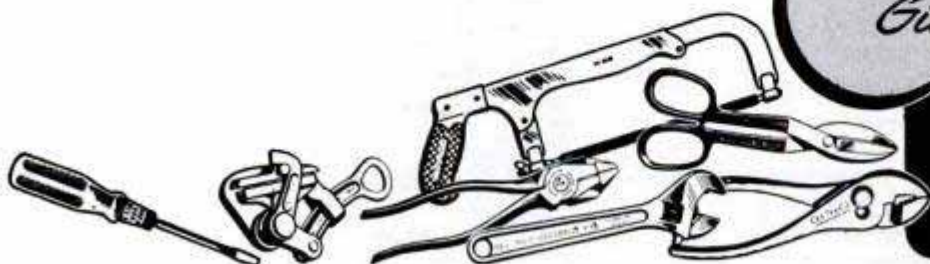

Crescent is our trade-mark, registered in the United States and abroad, for wrenches and other tools. Sold by leading distributors and retailers everywhere and made only by **CRESCENT TOOL COMPANY, JAMESTOWN, NEW YORK**



Tell them you want **STANLEY TOOLS** for Christmas

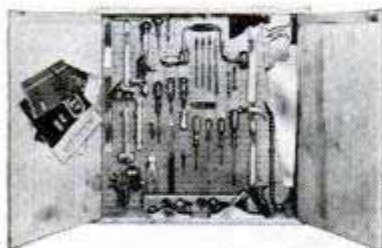

"Suburban" Set No. 981—
Knotty pine chest holds 34 tools—
for handyman or hobbyist.
\$99.50. Other chests and sets
from \$25.75

When your family or
friends ask what you
want for Christmas, tell
them Stanley Tools! You
know Stanley Tools are
practical and they'll give
years of service.

STANLEY TOOLS are de-
signed to please experts,
yet are priced for the
handyman. Only a few of
the wide selection are
shown here.

Bench Plane No. 4—Better
Plane for Better Work. Per-
fect balance—cutter fully ad-
justable. \$8.25.



Nail Hammer No. 51½—
Balanced for easy driving.
Beveled claws grip and pull
nails and brads easily. \$2.90
(Western price
slightly higher)



INDIVIDUAL
STANLEY TOOLS
AVAILABLE IN
GIFT BOXES

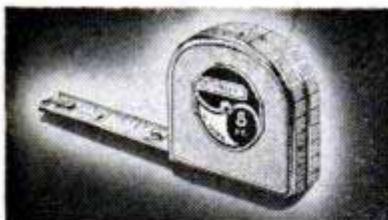

"Pull-Push" Rule No.
1208W—Large black num-
bers on 8 ft. white blade. Tops
for Christmas stocking. \$1.19

"Yankee" Push Drill No.
41—Push to drill holes in
wood or plastic. Chromium
plated. 8 drill points in
handle. \$5.65



"Yankee" Handyman Spi-
ral Screw Driver No.
233H—Drives and draws
screws easier, faster—also
drills small holes. Rugged
ratchet construction. \$4.75.



STANLEY TOOLS
New Britain, Connecticut

THE TOOL BOX OF THE WORLD

STANLEY **STANLEY**
TOOLS HARDWARE
ELECTRIC TOOLS
STEEL STRAPPING
STEEL

locals an indoor type can be used. You will note a short wire on the loopstick that is connected to the clip. If a 10 or 15-ft. indoor antenna is used, connect it to this clip. Scrape the enamel off the wire to insure good connection at the clip. When the outdoor antenna, which gives maximum results, is used it should be terminated in a length of flexible insulated lead-in wire which should be coupled to the loopstick-antenna lead by winding several turns of the insulated wire around the loopstick lead as indicated in photo B. This form of capacitive coupling improves selectivity. The exact number of turns for best results is found by experimenting, usually only a few turns are required. The tuning-dial plate is a standard 3½-in. 0-100 type cemented to the front panel. Heavy paper or cardboard can be substituted. The front panel can be decorated with colored decals if desired. Before plugging the tube in the socket, be sure that all wiring is correct and the A and B-batteries properly connected. Detailed student-material list R-423 is available from Popular Mechanics Radio and Electronics department upon receipt of ordinary letter postage. ★ ★ ★

"Safety-Pin" Skewer Holds Six Frankfurters

Back-yard chefs can roast up to six frankfurters at once over an open fire with a skewer that works like a safety pin. The pointed end of the skewer is punched through the frankfurters. The wire then is sprung over a hook, holding the franks under tension. The skewer is 34 inches long.

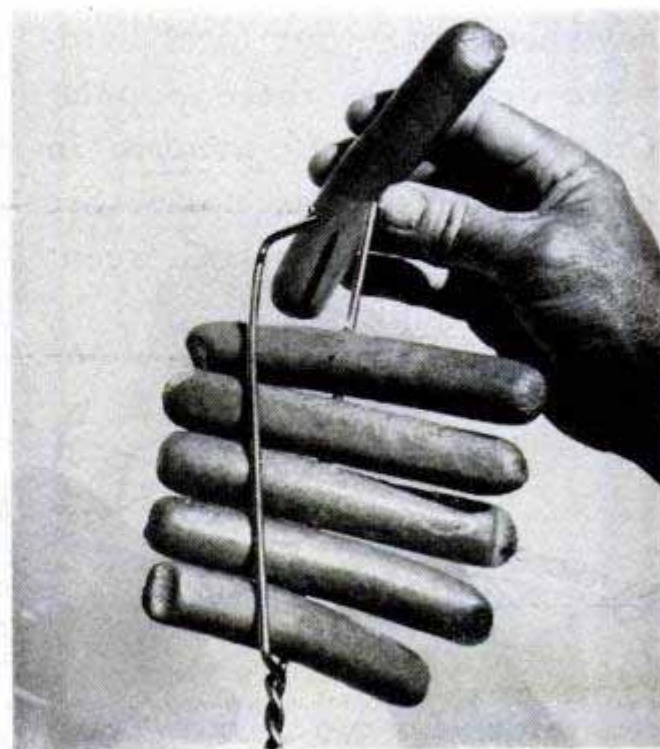

GET IT OR GIVE IT!

Build the One-Motor **DELTA'SHOP**

A TOOL AT A TIME

Now you can get the wonderful one-motor DELTASHOP on a year-around gift plan.

You can start with the saw this Christmas and add the other tools throughout the year. Ask your family to start you on the Deltashop "Add-a-Tool" gift plan this Christmas, or start yourself and let the family take it from there.

Here's how it works:

A GIFT FORMULA FOR YOUR COMPLETE WORKSHOP

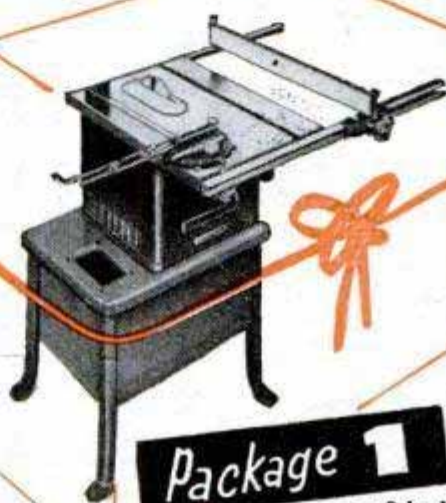
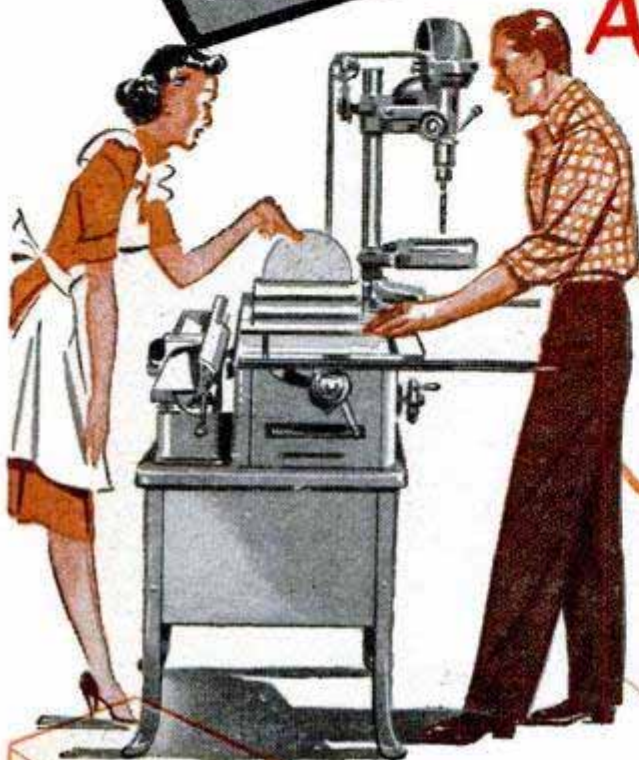

Package 1

The circular saw and stand for Xmas. A Delta Home-craft quality saw—with an 8-inch tilting blade—handles every sawing job for your "do-it-yourself" home projects.

Saw and stand only . . . \$109.80

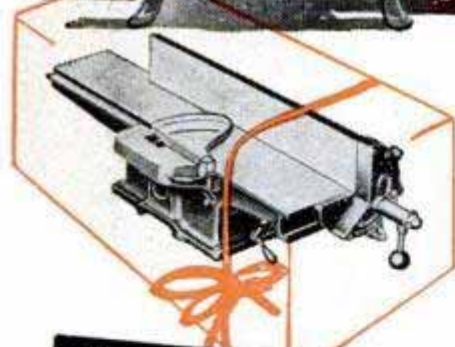

Package 2

The jointer is the next natural gift—a fine tool that puts a true "finish" edge on a board and planes stock 4 inches wide.

4' Jointer, only . . . \$49.15

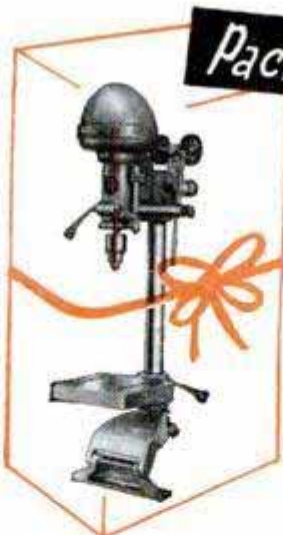

Package 3

Comes the drill press for the birthday or Father's Day—a Home-craft 11" drill press, none finer. Does a multitude of jobs; no shop complete without one.

11" Drill Press, only...\$57.50

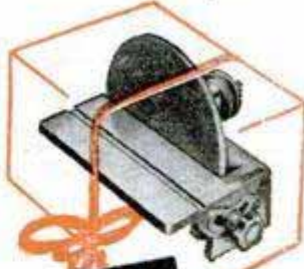

Package 4

Finally the sander, a most versatile tool—puts a professional finish on wood surfaces; also can be used to grind, buff, polish—a real handyman tool.

8½" Disc Sander, only . . . \$17.55

You get these packages for the same total price as the complete DELTA'SHOP

The DELTASHOP is a complete home-workshop that does 95% of home do-it-yourself projects, occupies only a 3-foot square, and pays for itself quickly by savings on home repairs and improvements. Keep it anywhere, move it anywhere, use it anywhere, indoors or out.

Make it a "must" to see this remarkable tool demonstrated—at your local Delta dealer, department store, or your nearby IRHA hardware store.

Also send for catalog of famous Delta "How to do it" books. Delta Power Tool Division, Rockwell Manufacturing Company, 502M North Lexington Avenue • Pittsburgh 8, Pennsylvania.



DELTA QUALITY MAKES THE DIFFERENCE

Prices slightly higher west of the Rockies

DELTA QUALITY POWER TOOLS

Another Product of **Rockwell**



AMAZING TOOL for ELECTRICAL WIRING

Wherever there is an Electrical Connection there is a USE for this PRECISION ENGINEERED, PROFESSIONAL WONDER TOOL

CRIMPS
Solderless TERMINALS and CONNECTORS

In one simple, easy operation this wonder tool crimps terminals and connectors for safe connections. Supply of Terminals and Connectors included with Tool free.

SPLICES WIRE

Makes quick, firm splice in damaged wire, preparing it for connector and crimping. Completed splice with connector is firm, neat and safe.

CUTS WIRE

Makes a sharp, clean bite through wire and insulation, leaving no loose, scraggly conductor strands.

STRIPS WIRE

Cuts through insulation, and when loose fabric is pulled off, leaves wire strands clean and bright and of proper length.



**EXTRA FEATURE
SHEARS BOLTS**

Bolt snaps off clean, leaving no damage to threads — no burrs to file, Cuts steel or brass bolts.

Thousands in Use

Electricians, garage and service station mechanics, maintenance men by thousands depend on this wonder tool for all wiring work. It is made of high quality tool steel and is needed by every home craftsman. Satisfaction guaranteed or money back. Send check or money order for \$3.95. Post Paid.

American Pamcor, Inc.
1315-D American Bldg.
Cincinnati 2, Ohio



CRIMPS



SPLICES



CUTS



STRIPS

FREE
with Tool
Terminals and
Connectors
in assorted
sizes.

formerly
\$5.00
Reduced to
\$3.95
POST PAID

LIBERTY

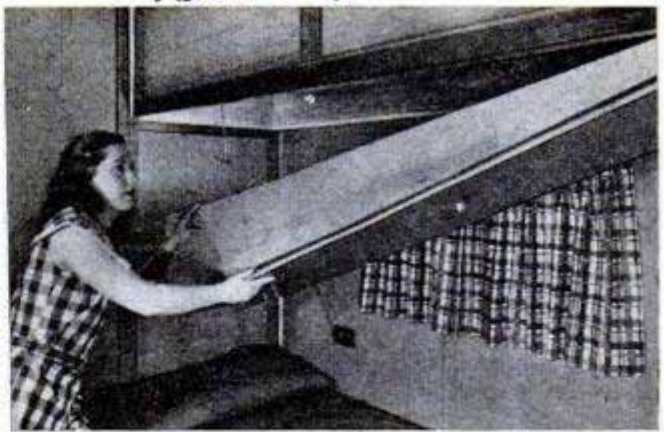

Trailer designers are always coming up with clever uses for waste space like this overhead cedar chest

Trailers Are Stay-at-Homes Now

(Continued from page 143)

the two together to form a roomy, 50-foot home. At vacation time, you uncouple the 25-foot kitchen-bath-bedroom unit and take it with you, leaving the master bedroom and living room behind.

Latest innovation in trailers is a model with a folding front porch. It has a wrought-iron railing, a porch light and a canopy.

Trailers are so important in the American scene that when the University of Chicago set up a research project in retirement problems, the educators turned to the trailer. A brand-new trailer park at Melbourne, Fla., houses the retired couples as the Chicago sociologists study the adjustment problems that arise when active folks retire.

So what are you waiting for? Next time you pass a trailer park, stop in, step up on the front porch and ask if you can look around. You'll find trailerites love company. You'll be in for some surprises when you see what's happened to trailers lately.

★ ★ ★

Trailer air conditioning is new. Some companies are building units into corner tables or other furniture



ZIMMER

POPULAR MECHANICS

Tom McCahill says—

TOM McCAHILL, well known, free-lance automotive journalist whose test reports of American and European cars appear regularly in *Mechanix Illustrated* magazine.

“The finest automobile engine in the world
is no better
than its weakest
spark plug!”



“I’ve been around automobiles for a long time and have road-tested practically every make of hack put together on these shores or across the pond. You learn a lot about any engine when you start dishing out the punishment. But there’s one thing you discover quickly—the finest engine in the world is no better than its weakest spark plug.

“Spark plugs may look small and unimportant but, brother, if you want that mill of yours to unleash all its horses make sure you have the best spark plugs money can buy. That’s where Champions take the spotlight. I’ve had stock Champions go on delivering the mail in car tests that were downright brutal.

Furthermore, I’ve watched Champion-equipped cars cream everything in sight in the world’s great speed, endurance and reliability runs—from Indianapolis “500” to the LeMans 24-Hours.

“So take a tip from your Uncle Tom, and get set for winter driving by putting dependable Champion Spark Plugs in your car. They’re your best assurance of positive starting and worry-free motoring when, ‘the north wind doth blow and we shall have snow’.”



Stop in at the service station or garage displaying this poster!

AMERICA'S FAVORITE

CHAMPION

SPARK PLUGS



CHAMPION SPARK PLUG COMPANY, TOLEDO 1, OHIO

Colossus in the Wilderness

(Continued from page 104)

If all goes well, the subterranean work for Kitimat will be completed by the time you read this.

Meanwhile, 50 miles westward at Kitimat, pile drivers are pounding poles into the waters of the fjord to complete a \$7,000,000 pier for the ships that bring the raw alumina in from foreign ports. A 70-acre site for the gigantic smelter is being cleared and filled. So is a townsite that someday may house 50,000 residents. Crews are living in the Delta King, an old stern wheeler that was towed up the fjord and beached. She sleeps 400 men in mahogany-trimmed comfort, provides her own utility services, and her saloon makes a recreation and movie hall.

Why couldn't the smelter and town have been put on the Kemano River at the foot of powerhouse mountain? There wasn't a piece of flat ground at Kemano big enough to house the plant, much less the people.

That's why a centipede of towers must crawl from Kemano to Kitimat across 50 miles of mile-high ragged peaks through Kildala Pass, carrying 300,000 volts of electricity on its back through stout 2½-inch aluminum cables strong enough to carry an ice casing weighing 40 pounds to the foot.

Of all the jobs in Project Kitimat, the transmission line has proven toughest. Never in history has anyone tried to send that much power over such staggering terrain. The steel and aluminum towers must cling to abutments, leap across gorges and step firmly across the top of a glacier. Tower sites are often no bigger than eagle aeries, clinging to sides of 5000 foot cliffs.

Test towers were first built on the eerie heights, to gather ice and be buffeted by gales—so that men could see how they'd withstand the rugged weather.

High on the crags, 12 by 12-foot platforms of wood were built. Helicopters, built on skids that could carry loads on each side, skylifted men and materials to their mountain perches, setting them down on the postage-stamp platforms. It's a hero's work for the whirlybird pilots. The canyons they fly are fraught with treacherous up and down drafts that buffet the craft mercilessly, threatening to bash them against jagged mountain walls. The roosts they light on are often encased in swirling clouds of mist, or whipped by winds so strong that tower crews stationed on them can't live in tents. Living quarters are tiny shacks, bolted to the rock of the mountainside on dynamited ledges.

(Continued to page 234)

IT SMELLS GRAND



HERE'S THE SEASON'S FRAGRANCE HIT!

IT PACKS RIGHT



THERE'S LOTS OF FUN IN LOADING IT!

IT SMOKES SWEET



AND MAN—WHAT PLEASURE WHEN IT'S LIT!

IT CAN'T BITE!



SIR WALTER RALEIGH'S BLEND OF CHOICE KENTUCKY BURLEYS IS EXTRA-AGED TO GUARD AGAINST TONGUE BITE. THE LARGE SIZE CANISTER OF SIR WALTER RALEIGH—IN A BEAUTIFUL YULETIDE PACKAGE—MAKES THE PERFECT CHRISTMAS GIFT!

IDEAL GIFT THE ENTIRE FAMILY CAN ENJOY...

DREMEL *Electric* MOTO-SAW!



**CUTS SCROLLS LIKE MAGIC
... SANDS AS IT SAWS**

**SAFE AS A
HANDSAW**

**INDISPENSABLE
FOR HOBBY OR
WORKSHOP USE**

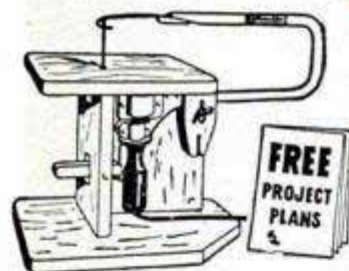

FREE PLANS

Have fun and save money. Make your own Jig-Saw stand. Complete, easy-to-follow plans furnished free with each Moto-Saw —also patterns for making six useful projects.

**7,200
CUTTING STROKES
PER MINUTE**

**Only
\$6⁸⁵**
with 3
Saw Blades

**FUN FOR BOYS
FROM 8 TO 80!**

Here is a genuine craftsman's tool with dozens of household and workshop uses. It is perfect for all sorts of coping and jig saw work, making window valances, knickknacks, hobby projects, etc. Highspeed, reciprocating-type motor easily cuts asphalt and rubber tile, also masonite and formica—wood up to 3/4". Perfectly safe for children—so easy to handle that women love to use it. Has only two moving parts, never needs oiling. A high quality tool used by craftsmen, tile layers, and carpenters.



**EASILY CUTS INTRICATE
SCROLLS—OTHER DESIGNS**



**JUST THE THING FOR
ACCURATE MODEL MAKING.**

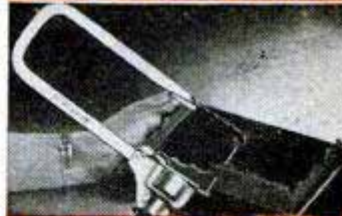

**INDISPENSABLE FOR DETAIL
SAWING OF ALL KINDS.**

THESE HAVE BEEN SANTA'S FAVORITES FOR MANY YEARS

DREMEL *Electric* MOTO-TOOLS

Grind • Carve • Engrave • Drill • Rout • Sharpen • 1001 Uses

**FASTEST, MOST POWERFUL TOOL IN ITS CLASS
—APPROX. 27,000 R.P.M.**



KIT NO. 2 Includes Model 2 Moto-Tool and 23 Accessories (High-Speed Steel Cutters, Grinding Wheels, Polishers). Packed in sturdy steel case..... **\$25.95**

KIT NO. 1 Includes Model 1 Moto-Tool and 34 Accessories (Steel Cutters, Grinding Wheels, Polishers, etc.) Packed in attractive steel case..... **\$19.50**

MOTO-TOOL NO. 2 Offers more convenience and long life features for the money than any other hand grinder. Thousands of satisfied users. Moto-Tool No. 2 (With 1 emery wheel point)..... **\$17.85**

Most practical tool a man can own—more powerful than any similar tool you can buy. Works well in wood, plastics, and metal. For home maintenance jobs you'll wonder how you got along without it. For model making it's a must. And for general shop operations it saves time and money. Compare it, try it, buy it. You be the judge.

Check These Important Features: Oilless sealed bearings • Dynamically balanced armature • Shockproof, Bakelite housing • Dust-filtered air cooling system • Sturdy 110-120 V., A.C.-D.C. motor • Wt. only 13 oz. • A precision tool widely used in industry for many years.



SEE YOUR LOCAL DEALER: Dremel Tools are sold at better dealers everywhere. If your dealer can't supply, order direct on a five-day trial, money-back guarantee. Remit in full, and we will ship postpaid. Or, send only \$2.00 now, pay postman balance plus postage and C.O.D. fee.

DREMEL MANUFACTURING CO.

Dept. 113-M

RACINE, WISCONSIN

Make this **PET** CHRISTMAS!

Give him one of these wonderful new worksavers!

New Shopmate

THE COMPLETE MOTORIZED HOME POWER SHOP

Lathe • Grinder • Bench Saw • Sander-Polisher
Vertical Drill Press • Horizontal Drill Press
Portable Drill • Router

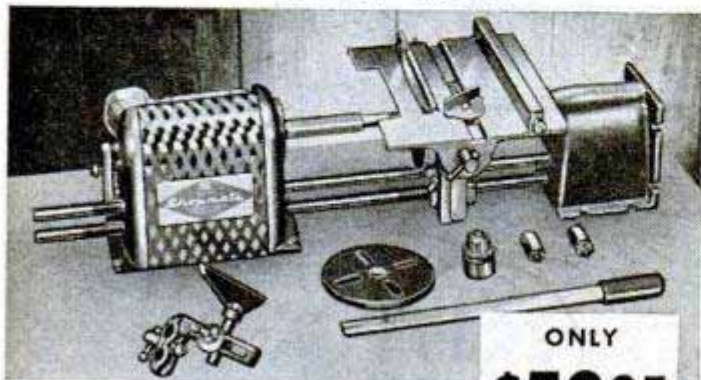

ONLY
\$59.95

POWER UNIT
INCLUDED

Never before a complete motorized home power shop at such a low price!

With the all-new PET Shopmate you'll do precision wood turning on a sturdy lathe. Cut wood accurately on a real bench saw. You'll sand and polish wood or metal; sharpen tools. Vertical or horizontal drill press ready for use any time. Use as a router to cut grooves, make moldings. Powerful portable drill easily detached from lathe for use anywhere.

Ask your dealer to show you the new PET Shopmate—America's first complete motorized home power shop.



Accurate bevel gauge in use. Rips, cuts mitres, too.



Between-center turning. Tool rest and face plate furnished.

New **PET** Electric Saw with exclusive **TRU-GUIDE***!

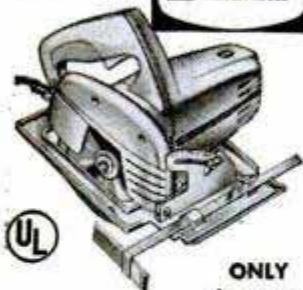

ONLY
\$32.00

*Guide and level index calibrated after each saw is assembled. TRU-GUIDE guarantees right-to-the-line cutting!

Light (only 6 lbs.); ideal for overhead work. Cuts plywood, sheathing, all interior trim. Cuts any angle 90° to 45°—and 1/8" to 1 1/4" deep. See it at your dealer's now.

64-Page Power Tool Guide!

\$1 Value... Yours for Only 15¢ With This Coupon!

PORTABLE ELECTRIC TOOLS, INC. PM-123
320 W. 83rd St., Chicago 20, Ill.

- Enclosed is 15¢ for 64-page book of helpful hints on use of portable power tools.
- Send free literature only on tools shown above.

Name.....
Street.....
City.....Zone.....State.....

Yet, with all the difficulties, the sturdy shoulders that will carry the power to Kitimat, will be ready for their burden by the time the first water plunges from the tailgates under the mountain at Kemano next year.

With that first flood of power, only one penstock will carry water through three big 150,000 horsepower turbines. The line of pots at the Kitimat smelter will produce 80,000 tons of ingots the first year. But if all goes as planned, another tunnel will start through the mountain at lake level. The underground powerhouse will expand to a total length of 1140 feet—big enough to engulf a 12-story office building sideways—and 16 massive turbines will wham up 2,240,000 horsepower to feed voltage across the mountains to the biggest aluminum smelter in the world. ★ ★ ★

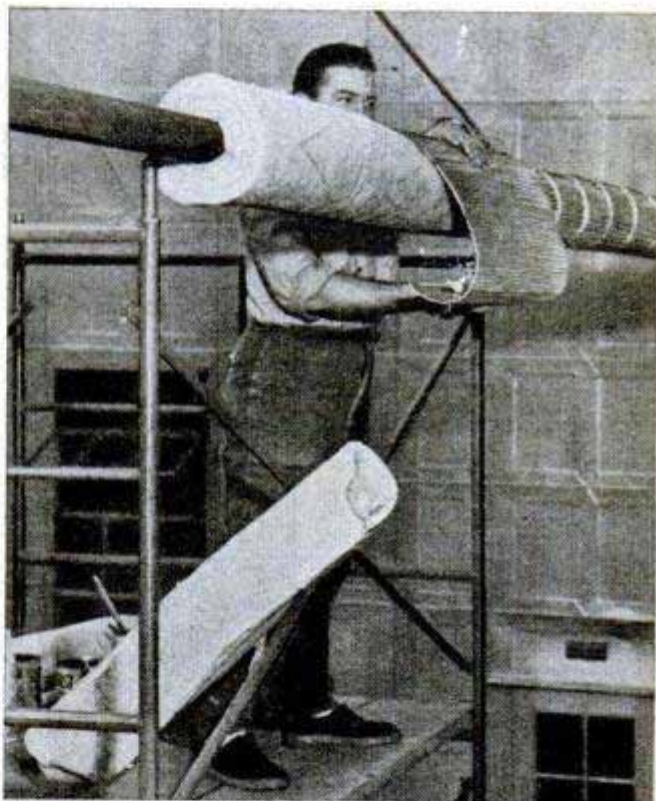

Wrap-Around Glass Fiber Blanket Insulates Any Size Pipe

Blankets made of glass fiber are wrapped around hot or cold pipes to insulate them. In the past, rigid materials have been used for this purpose, requiring a supply of many sizes to fit pipes of various diameters. The new blankets are available in 100-foot rolls 36 inches wide and 3/4 inch thick. Pieces from the same roll may be used on different sizes of pipe and fittings. Any number of layers can be used to build up to the desired thickness. The material, cut with shears, knife or paper cutter, is held in place with staples, adhesive or cord and covered with a jacket.

More Local Plants Needed to Make Cement Drain Tile

Hundreds of local plants are selling millions of dollars' worth of cement drain tile every year. But demand is getting bigger, and opportunities are open for hundreds more.

Farm drainage, reclamation projects, highway construction—these and other sources are creating a large market. It can be most economically supplied by compact, local plants.

Outstanding Manufacturing Opportunity

Champion drain tile machine is deliberately designed to supply compact, low-investment, tile-making equipment. Makes finest tile possible—dense, truly round, and shale proof. Better than clay tile, yet can sell for less because local production saves freight and distribution cost. But project possibilities are high. Business requires no previous experience—no skilled labor—no special building. Equipment available on easy terms. Full information on the cement tile business and equipment are given in the Drain Tile Book—free on request.



Concrete Equipment Company

E3 522 Ottawa Ave., Holland, Michigan



MAGNETS

GENUINE ALNICO—NEVER WEAKENS

225 lb. PULL

AMAZING, PERMANENT MAGNETS—WILL NOT WEAKEN! NON-ELECTRIC
Retrieve guns, tackle, tools and other steel items from lake, river, plating tanks, drains or other hard-to-reach spots. Recover drills, taps, etc. from sweeping. Clear alley of harmful tacks, nails. Many other uses. Pays for itself quickly. **GUARANTEED.** Try any magnet one week. Money refunded if you are not well pleased.
No. M-725 (Weights 54 oz.) Has pull of 225 lbs. on steel block. \$15.00
No. M-875 (Weights 49 oz.) Has pull of 175 lbs. on steel block. \$10.50
No. M-850 (Weights 41 oz.) Has pull of 150 lbs. on steel block. \$ 8.50
No. M-500 (Weights 15 oz.) Has pull of 50 lbs. on steel block. \$ 4.00
No. M-30 Hobbyist assortment of six small magnets. \$ 1.50
Send Money Order or Check. We pay postage. No C.O.D.'s.

MIAMI MAGNET COMPANY, 3240 N. W. 27th Ave., Miami 42, Fla.

ONE-MAN SAWMILL

LOW AS \$50⁰⁰ DOWN

Take BELSAW Portable Sawmill right to the trees—turn out valuable lumber for home and farm—sell to local yards—make up to \$50 a day custom sawing for neighbors. BELSAW lasts a lifetime. No crew needed. Power with tractor or auto engine. Beginners get excellent results. Send today for FREE BOOK, "HOW TO MAKE LUMBER".

BELSAW MACHINERY CO.
1118 Field Bldg. Kansas City 11, Missouri



Mortite

KEEPS COLD OUT SAVES FUEL

It's the perfect weatherstripping. Cordlike and pliable, Mortite goes on in a jiffy, without tools or tacks. Anyone—even Junior—can press it in place around windows, doors, transoms, baseboards. Comes off easily in spring. Hundreds of other plugger-upper uses the year around. 3 packages—29c contains enough for 1 window; 98c for 4, \$1.25 for 5 or 6 windows. Higher west of Rockies and Canada. Get Mortite at stores or write for circular. J. W. MORTELL CO., 522 Burch St., Kankakee, Ill.

Insure COLD-WEATHER Peace of Mind



with
Hot Spark!
Quick Start!

NIEHOFF

Warranted
IGNITION PARTS



End those Winter Worries NOW. Have your Certified Niehoff Dealer tune your car for Peace of Mind. Order needed parts replaced with hot-spark, quick-start NIEHOFF Ignition Parts—the kind master mechanics install in their own cars. Precision fit for all popular makes and models—cars, trucks, buses. See the Niehoff expert near you. 42,000 of them in the U. S.!

Ask About NIE-TRON Super Heavy-Duty Coil, at Right, Warranted 100,000 Miles!

Replaces any coil on any car produced in the past five years without changing condenser or mounting brackets. A hot spark high speed coil to meet top demands of today's improved engines.



See Your Niehoff Dealer Now

C. E. NIEHOFF & CO.
4925 LAWRENCE AVE.
CHICAGO 30, ILLINOIS

30th
ANNIVERSARY
YEAR



OWN YOUR BUSINESS

Start in Spare Time with a FOLEY SAW FILER

Here is a steady repeat CASH business you can start at home in your basement or garage, while you are working at your regular job. No experience is necessary to turn out perfect cutting saws—"the first saw I sharpened came out 100%. I think the Foley Saw Filer is a marvel of perfection," writes Clarence E. Parsons. Every saw you sharpen will bring you new customers. You will find you can make up to \$3 or \$4 an hour — \$20 to \$30 a week in your spare time as a starter.

With a Foley Saw Filer you can file all hand saws, also band and cross-cut circular saws. It is easy to operate—simple adjustments—no eye-strain. Patented jointing principle evens up all irregular teeth and makes an old saw cut just like new.

This Free Book Shows How to Start

"MONEY MAKING FACTS" shows you how to get plenty of saws to file without canvassing, and how you can develop into a general repair shop that will be your own business. This is a helpful, practical book that tells just what to do—send for your free copy today. No salesman will call.



Send for FREE BOOK

FOLEY MFG. CO., 1216-3 Foley Bldg.
Minneapolis 18, Minn.

Send me free book "MONEY MAKING FACTS."

Name _____

Address _____



The Most Practical and Fascinating small tool sets in the world. Regardless of your sport, hobby or trade, you'll find a Moody Kit that is perfectly suited for small precision work and does your job right. Perfect for:

Cameras, Guns, Fishing Reels, Model trains, Boats, Airplanes, Sewing machines, Eye glasses, Carburetors, Electric razors, Canvas, Rope and Sail sewing

Screwdriver Kit (3" high) shown contains five tiny blades sizes .100", .80", .70", .55", .40" and chuck type handle.

Write for free folder that completely describes all Moody Kits. You can buy them from your dealer or postpaid from:

Moody MACHINE PRODUCTS CO. INC.
32 Dudley Street, Providence 5, R. I.

PUMP WATER FAST!

DRAIN WASH TUBS, CELLARS, CISTERNS IRRIGATE—FILL TANKS—DRAW WELL WATER

Pumps 2800 GPH. 420 GPH at 75' High or 1600 GPH from 25' well. Sturdy, Rustproof Alloy Metal. Six Blade Impeller. Uses any 1/8 to 1/2 H.P. Motor. Will not leak or clog. Fits any garden hose. Immediate Money Back Guarantee. Send Check, M.O., or C.O.D. **\$95 IN U.S.**

MOORE MANUFACTURING CO.
SWEDESBORO 1 NEW JERSEY

Locate HIDDEN TREASURE . . . and METAL

with the *Model 100 Detector*

Weights 5 pounds, extremely sensitive. Factory assembled (\$79.90) or kit form (\$89.90). Free literature.

ELECTRONIC APPLICATIONS, Inc.
Dept. N, Box 4975, Washington 8, D. C.

BUMPER STRIPS THAT GLOW RED

PROTECT YOUR CAR FROM NITE ACCIDENTS

Reduce dangerous nite accidents, trim bumpers with these 1" reflective strips. Easily applied in 3 minutes. Glow fiery red when car lights touch them. Visible even in fog. 4 foot strip for one bumper, only \$1. Order now!

KENT ORIGINALS Dept. 16
250 BelAir Dr., N. E. Grand Rapids, Mich.

Now AUTOMATIC HEAT

from hand-fired furnaces

Install yourself—save \$20-\$40

Complete kit makes any furnace automatic: Thermostat, 110 v. motor, hi-limit control, pulley, chain, wire spring, screws, instructions. Order C.O.D. — or send Check or M.O. and we pay postage.

\$24.95

10-Day, Money-Back Guarantee

LINN PRODUCTS COMPANY

516 KARCHER ST.
MIAMISBURG, OHIO

- Cuts Fuel Bills—Pays for Itself
- Used in over 1,000,000 Homes
- Thermostat Responds to 1° Change
- Limit Control Prevents Overheating
- Controls Hot Air, Water, Steam

Millions Enjoy His Program Every Week on TELEVISION!
More Will Enjoy His New Popular Mechanics Book!

Make Boys and Girls Happy While They Learn

Mr. Wizard's Science Secrets

by TV's Famous Don Herbert



FREE!

Name Stamped on Cover
in Gold Letters

Give Mr. Wizard's Science
Secrets as a gift with re-
cipient's name stamped in
gold FREE.

give
them



150 Mystifying Experiments With Everyday Things
That Help in School and All Through Life!

Millions of children enjoy Don Herbert's science experiments on television. Now they can enjoy them more in his own brand-new book, *Mr. Wizard's Science Secrets*, with Mr. Wizard himself and his helpers, Willy and Betsy. Get this fascinating, entertaining and instructive book for your young people. Let them learn exciting scientific facts by doing Mr. Wizard's experiments themselves, using only simple materials, most of it in your kitchen and bathroom cabinets. Never before such a book. It entertains as it educates. It makes fun out of learning facts. Give your children—your friends' children—the educational advantages and joyous pastime which Mr. Wizard's book affords. See special gift offer—books will be personalized with recipients' names in gold FREE.



Above: Mr. Wizard in a demonstration of oxygen and combustion. Center: With helpers, Willy and Betsy, watching bottle fountain and action of carbon dioxide in bubbles. Willy and Betsy in a test that proves sound isn't so easy to locate. Hundreds of pictures like these in Mr. Wizard's book.

Some of 150 Projects and Experiments Explained and Pictured for Boys and Girls to Do at Home

- | | |
|--|---|
| Why salt melts ice. | How to make . . . |
| Experiments with vacuum. | Static electricity |
| What is air, oxygen, atmospheric pressure? | Water boil with an ice cube |
| What makes an airplane fly? | Your own telephone with tin cans |
| What is gravity? | Music boxes |
| Why does hot air rise? | Compasses |
| What is steam? | Your own telegraph set |
| Why does corn pop? | Water boil in a paper box |
| What are molecules? | Fire extinguishers |
| What is carbon dioxide? | How to carry sound in your finger tips. |
| How to write with invisible ink. | And more than a hundred others |

264 Fascinating Pages • 249 Illustrations — Made for This Book

Answers Hundreds of "How" and "Why" Questions

Mr. Wizard answers most of the questions children ask. They're all in his book. His answers and demonstrations are so fascinating that youngsters actually have fun learning the facts they should know and they never tire of learning. Parents and teachers will find the book a helpful treasure.

Science, Physics, Chemistry in Fascinating, Joyous Form

Mr. Wizard makes games out of science, physics and other subjects that keep young people occupied and interested for countless hours. He has special appeal to both boys and girls of all grammar school ages and imparts information that will be helpful to them now and throughout their lifetimes.

Order Today! Use Coupon to Get Mr. Wizard's Book. Include Name for FREE Gold Stamping.

Order this big, beautifully illustrated, printed and bound book now. It is the GIFT BOOK of the hour, with the added feature of the recipient's name in gold. Give it to all young people for birthdays, Christmas and other gift occasions—for merit awards—for good conduct—or just to help a boy or girl advance. Only \$3.00 postpaid. Order on the handy coupon.

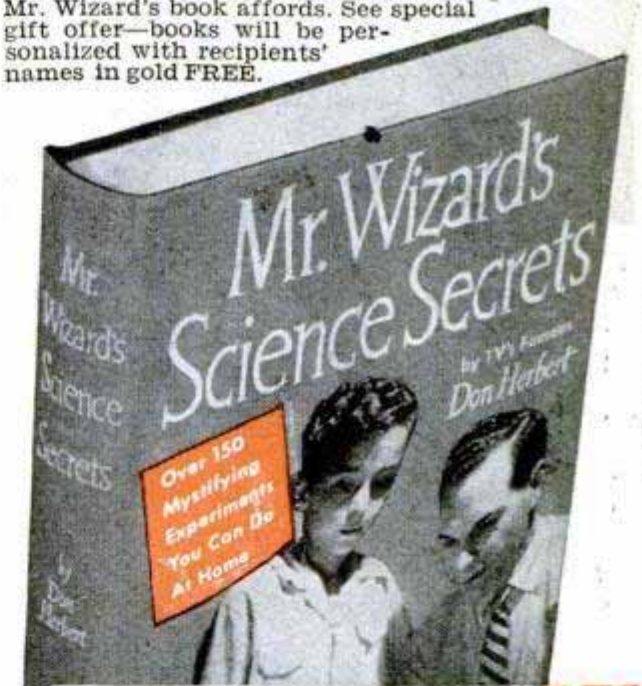

POPULAR MECHANICS PRESS

200 East Ontario St., Chicago 11, Ill.

Please send at once, delivery prepaid, _____ copies of *Mr. Wizard's Science Secrets* at \$3.00 each. Stamp names in gold without extra charge under your special FREE offer. Remittance enclosed \$ _____

Name _____

Address _____

City _____ State _____

Print name for gold stamping on this line. Use margin for extra names if required.

**Give Him
Extra Skill...
A PLUMB**

The perfect present
for any man or boy
is a Plumb hand tool.
Start a set—add a
new Plumb hand tool
every year.

*Holiday
Wrapped
for Gift
Giving*

For light Chopping—the Plumb
National Axe

Plumb Hammer
—makes hard
jobs easy

All-purpose tool
—the Plumb
Hatchet

PLUMB®

HAMMERS • HATCHETS • AXES • FILES

**you CAN
fix that
leaky
faucet..**



Snap-In Swivel Washers and Faucet Seats save you annually from \$75 to \$100 per hot water faucet. Stop leaks and last 10 to 20 times longer. Ordinary Washers wear out through rotation under pressure. It's a waste of time and money to replace the Washer and not the seat. Kit containing Seat, Washer, Insert Tool and Gauge available through your local hardware dealer.

SNAP PRODUCTS CORPORATION
3615 SO. JASPER PLACE CHICAGO 9, ILLINOIS

POWER HACKSAW \$55.75

LESS MOTOR
F.O.B. Benton Harbor

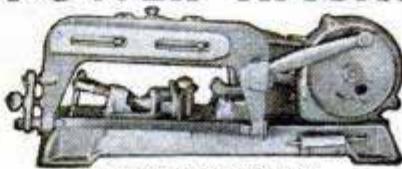

Send for full details and
name of nearest dealer.

• Rugged cast iron construction. Wt. 56 lbs. bronze bearings. Draw cut. Auto. return lift. Auto. shut-off. Vise swivels 45°. Cap. 4"x4".

EXCEL MACHINE TOOLS Dept. PM-123
BENTON HARBOR, MICHIGAN

**AMERICA'S
FINEST**



Preferred everywhere by men
who give precision tools the
care they deserve. Free Catalog.

GERSTNER TOOL CHESTS
453 Columbia St., Dayton 7, Ohio

SHOOT TELEVISION FILMS

FOR YOUR LOCAL TV STATION...make Extra
Profits with the "Cine-Voice" Sound-On-Film
16mm Camera. \$695.00 Write for free information.



BERNDT-BACH, Inc.
7333 Beverly Blvd., Los Angeles 36, Calif.

SOUND-ON-FILM SINCE 1931

**GRAVELY
Snowblower**

**BLOW YOUR
SNOW TROUBLES
AWAY!**

5 HP

Snow Blower attachment for powerful 5-Horsepower Gravelly Tractor moves deep, dangerous snow swiftly and easily. 20 other attachments for every lawn, garden, field job. All-gear drive, reverse. Postcard brings complete story of "Power vs. Drudgery."

FREE! Write Today! →

GRAVELY TRACTORS, INC.
BOX 1263 DUNBAR, WEST VA.

It's easy to finish walls smoothly with Gold Bond Tape Joint Kit!



Conceal wallboard joints for a better decorating job. Do it yourself!



1. Apply Cement. Smooth flowing channels formed by special tapered edged Gold Bond Gypsum Wallboard permit easy, uniform application.



2. Embed Tape. Gold Bond Perforated Tape combined with joint cement binds panels together... adds strength to finished wall.



3. Sand Smooth. Gold Bond Joint Cement dries quickly and evenly... needs only light pressure to level smoothly with wall.



4. Ready to Decorate. Seamless walls provide a "perfect" decorating job with either paint, wallpaper or textured finish.



Whether you're remodeling or building, the best way to get smooth, handsome new interior walls is to make the job 100% Gold Bond! Use sturdy, fire-proof panels of Gold Bond Gypsum Wallboard. Finish joints

and nailheads with the Gold Bond Tape Joint Kit... available in small, regular and large size packages at your local Gold Bond dealer.

NATIONAL GYPSUM COMPANY • BUFFALO 2, N. Y.

Fireproof Wallboards, Decorative Insulation Boards, Lath, Plaster, Lime, Sheathing, Roofing, Siding, Wall Paint, Textures, Rock Wool Insulation, Metal Lath and Sound Control Products.

MAIL THIS COUPON TODAY!

NATIONAL GYPSUM COMPANY, Dept. PM-123, Buffalo 2, N. Y.

Please send me a free copy of Gypsum Wallboard Application Instruction Folder.

Name.....

Address.....

City..... Zone..... State.....

Smitty DRIVER



for
**ALLEN
HEADS**

Everyone who works with socket heads or screws will really know there's a Santa Claus when they get this pocket tool of the year.

Fits all standard Allen type or socket-type bolts and screws. Equal to a whole set of socket head wrenches. 5 sizes of shafts, each swing out like a knife blade. Fits set screws #10 to 7/16" inclusive, cap screws #5 to 5/16" inclusive. Get yours today. ONLY \$1.50 POSTPAID

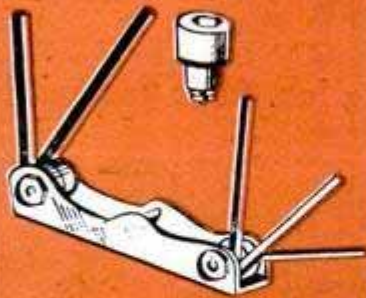

"Wouldn't sell mine for \$5.00 if I couldn't get another" — say thousands of daily users

Smitty Jr. Sizes .050 — 5/32" inclusive. \$1.44 ppd.

Dealer Inquiries Invited

Satisfaction or refund — Get Your Smitty Driver Today.

HUNTER TOOLS

Box 7395 Lugo Sta., Los Angeles 23, Calif.



Handle gives great leverage

IDEAL LAWNMOWER SHARPENER

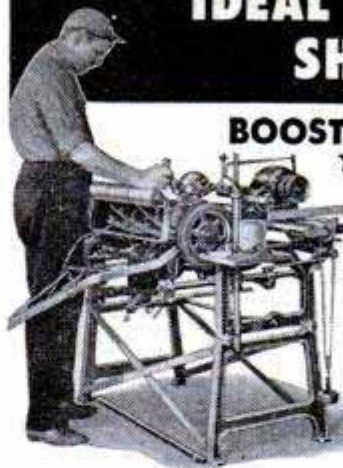

BOOST YOUR INCOME

You can earn extra cash with the Model 300 Ideal Lawnmower Sharpener. Used and recommended by leading manufacturers and service shops, the Ideal has everything you need, nothing else to buy. Grinds reel and bed knife, also reconditions. Get started now in this highly profitable business. Write for catalog today.

The Fate-Root-Heath Co.
Dept. PM-12, Plymouth, Ohio



ELECTRIC WELDER AC or DC 110 Volts

The "Little Marvel" all-metal welder. 5-year written guarantee. Welds 1/8" metal or money back. Repairs tanks, tools, fenders, machine parts, etc. Complete with everything—rods, unit, eye shield, directions.

\$8.45 plus 50c postage. Flame torch accessory for soldering, cutting, brazing \$3.95 complete with carbons, brass rods, flux. Sorry no C.O.D. Buy direct and save.

ESSAY MFG. CO., Dept. 51, Quincy 69, Mass.

\$6.45
Complete

"SNOOPER" GEIGER COUNTER



Super-sensitive! Only 1 1/4 lbs.! Fits pocket—uses flashlight battery. Find a fortune in uranium. Order Now! Send \$5.00, balance C.O.D. MONEY BACK GUARANTEE. FREE CATALOG—scintillator and larger uranium and metal detectors DEALERS WANTED.

2995
COMPLETE

PRECISION RADIATION INSTRUMENTS
2235 PM S. LA BREA, LOS ANGELES 16, CALIF.

Get what you want...and...save dollars, too...
SEND--TODAY--FOR THIS
Hunt's
BIG, NEW
WOODWORKERS
CATALOG NO. 20



144 pages of bargains. New, low, money-saving prices. Finest selection of domestic and imported hardwoods--all kinds, all properly kiln dried.

Like thousands of woodworkers all over the U.S.A.--you'll get what you want and save money, too--with this famous book. Filled with everything you need.

Shows 32 rare and fancy woods in color...275 scroll patterns...multicolor inlays, overlays, bandings...ornaments...moldings...hardware...tools...and...pages of information, tips, ideas. Send for your copy--right now. Only 15¢--refundable on first order.

QUICK DELIVERY

Maple, mahogany, red cedar, oak, cherry, poplar, walnut, and many others--all properly seasoned...and...kiln dried.

ONLY 15¢

MAIL TODAY

CRAFTSMAN WOOD SERVICE CO.

2729 S. Mary St., Dept. A12 Chicago 8, Ill.

Send me the big, new, money-saving Catalog No. 20. Enclosed is 15¢--refundable on my first order.

Name.....
Address.....
City..... Zone..... State.....

make your own **Gems** 29.50 F.O.B.
The Gem Maker comes complete with all necessary equipment, including a super-charged diamond blade for sawing, and all wheels for grinding, shaping and polishing; also complete instructions. The complete equipment as shown, less motor and belt, for only \$29.50, f.o.b., Burlington, Wisconsin. Write today for information and literature.
B&I MANUFACTURING CO.
Dept. S Burlington, Wis.



G E A R S

In Stock - Immediate Delivery
Gears, speed reducers, sprockets, thrust bearings, flexible couplings, pulleys, etc. A complete line is carried in our Chicago stock. Can also quote on special gears of any kind. Send in your blueprints and inquiries.

Send for Complete Catalog No. 10
CHICAGO GEAR WORKS
440-50 N. Oakley Blvd., CHICAGO 12, ILL.

KING MIDGET AUTO

Operate it for 75c per week. Amazing performance. Surprising comfort. All steel construction. Ready to run or assemble it yourself with our bolt together parts. Rider Agents wanted. Send 25c for detailed literature or \$1 (refunded first order) for actual assembly book and service manual filled with photos, drawings, specifications, etc.
MIDGET MOTORS MFG. CO., ATHENS, OHIO



WORLD'S LOWEST PRICED 2 PASSENGER AUTO

MANY ITEMS
JUST
RELEASED!

GOV'T. SURPLUS BARGAINS

SHOP BY MAIL
AND
SAVE

FREE WINTER EDITION

1953 CATALOG. 52 Pages, chock-full of unsurpassed War Surplus Equipment Bargains for farm, home, factory and workshop. Every item is unconditionally guaranteed. You save on everything! Write today.

D.C. GENERATORS

ITEM #91



Type R-1, rated 300 Amps.—30 Volts. Mfd. by Jack & Heintz. Gov't. Acq. Cost \$380.00.

Shpg. wt. 55 lbs. Dimensions 16" x 10" x 7". F.O.B. Chicago... **35.00**

ITEM #176—Type L-3. Rated 25 amps., 24 volts. Manufactured by Leece-Neville Co. Shpg. wt. 30 lbs. Dimensions 12" x 6 1/2" x 5 1/2". F. O. B. Chicago.



16.50

ITEM #90—Type P-1, rated 200 Amps.—28 Volts, 2500 RPM. Mfd. by General Electric, Ford, Delco-Remy and Westinghouse. Gov't. Acq. Cost \$300.00. Shpg. wt. 55 lbs. Dimensions 15"x9"x6". F.O.B. Chicago.... **22.50**

CENTRIFUGAL PUMP

Brand New GENERAL MOTORS — ALLISON

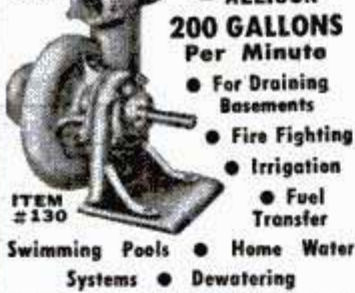

200 GALLONS Per Minute

- For Draining Basements
- Fire Fighting
- Irrigation
- Fuel Transfer
- Swimming Pools
- Home Water Systems
- Dewatering

For high volume commercial, home and industrial use. Standard 2 1/2" pipe thread inlet, twin 1 1/2" pipe thread outlets. Ball bearing supported 3/4" shaft. Easy priming. Rotation, counter-clockwise facing shaft. Gov't. acq. cost \$145.00. Complete with full instructions. Ship. wt. 35 lbs. F.O.B. Chicago.... **39.50**

Will deliver 200 gals. per min. against 65 ft. head using 5/2 H.P. at 3500 R.P.M.

Brand new—DOUBLE ACTION HYDRAULIC CYLINDER

ITEM #355—2 1/2" bore and 7 1/2" stroke, 1 1/2" stainless steel piston rod. Lift capacity 5000 lbs., using 1000 lbs. pump pressure. Manufactured by Delco-Remy Division of General Motors Corporation. Clevis mounting on base and piston rod for 7/16" bolt. Overall length closed 21". Distance between centers 19". Supplied with fittings to 3/4" pipe thread. Brand new — in original carton. F.O.B. Chicago. **16.00**

ITEM #355A—Same unit, but supplied with built in spring to provide cushion effect on power stroke and rapid return. F.O.B. CHICAGO... **17.00**

GENERATORS MANY SIZES FROM 350 WATTS TO 25 KVA



Item #183—3000 to 4000 Watt Generator Set —FEATURES—Power for your home or business. Simply connect to power panel or house circuit. • Constant voltage regardless of load. • Push button start or stop. • Easily made full automatic start or stop. SPECIFICATIONS—Sizes 19"x30"x48". Steel skids, weatherproof housing, requires no building. Wt. 725 lbs. • Hercules 4-cyl. 10 HP gasoline engine. Load governor. Oil filter. Quiet muffler. 6-volt starter, generator. • Hobart 115 volt, 60 cycle, 3000 to 4000-watt generator. Furnishes either single or three-phase power, 2 or 3 wire. • Panel contains oil gauge, voltmeter, ammeter, circuit breaker. voltage regulator start button. Today's cost over \$1200.00. SALE PRICE, F.O.B. Chicago... **465.00**

NOW... SAVE \$161.00 on this \$250.00 VALUE 350 WATT A.C. PORTABLE ELECTRIC LIGHT PLANT

Compact Electric Plant suited for small homes, cabins, campers, hunting and fishing camps, trailers and small electrical home appliances.

Operating costs: About 5c per hour. Runs exceedingly quiet. Sturdily constructed for dependable service.

Net weight only 88 lbs. Can be carried from place to place, or transported in trunk of car. 350 Watt—110 Volt—60 Cycle—A.C. Model — M.S. 35-3, made by Midco Mfg. Co. 1 Cylinder, 4 Cycle Engine complete with muffler, starting rope and oil bath air cleaner, direct coupled to a 350 Watt Generator with voltage control rheostat and twin outlets. Engine speed 1800 R.P.M. Shipping weight 116 lbs. COMMERCIAL LIST PRICE \$250.00. NOW ONLY... **89.00** F.O.B. Chicago

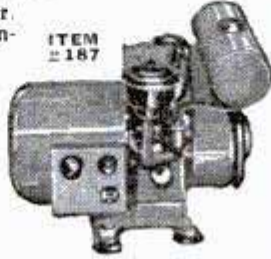

ITEM #187

GOV'T. SURPLUS! JUST RELEASED! 2-TON, 6-WHEEL HYDRAULIC LIFT TRAILERS

USE FOR: Conveyor ramp • Boat trailer • Lumber • Pipe • Pole trailer • Machinery trailer • Hydraulic dump for grain wagon • Coal truck • Lift truck • Variable height hydraulic work table • Removable rack permits use of hydraulic lift for other installations. Outstanding features of these Trailers are:—4000 lbs. pay load. 2 individual hydraulic lifts complete with hand pumps and valves, 6—18" x5.5 pneumatic tires included. Manual screw-down brakes. Ball-bearing axles, V-shape load rack—8' long. Towing tongue, 54" lift. Wheelbase 98". Ground clearance 4 1/2". Tread, width — 52". Overall width — 58". Overall length including drawbar — 167". Gov't. cost \$685.00. Ship. wt. 1400 lbs. F.O.B. Chicago... **169.50**

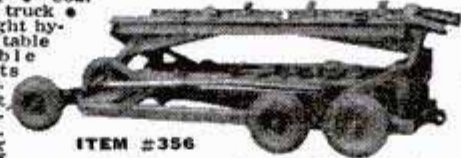

ITEM #356

HYDRAULIC SPEED REDUCER with FINGERTIP CONTROL

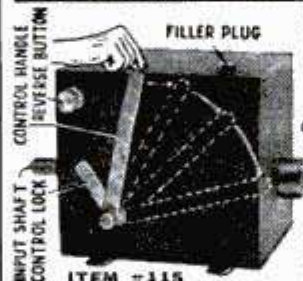

USE FOR: • Reamer Drives • Midget Cars • Feed Mills • Canning Machines • Conveyors • Lathes • Milling Machines • Motor Boats • Cream Separators • Garden Tractors • Pumps

Variable output speeds from 0 to input speed available by moving control handle. Locking handle maintains setting. Use input power of 1/4 to 1 1/2 H.P. This Westinghouse-Oil Gear Unit consists of a variable displacement hydraulic pump feeding a fixed displacement hydraulic motor. Adjustable relief valves set at factory for 100 inch pounds of torque may be reset up to 180 inch pounds. Independent reverse control allows full output power and speed selection in either direction of rotation. Shafts measure 5/8" diam. include keyway. Input rotation is counter-clockwise facing shaft. Recommended input speed not to exceed 750 R.P.M. Over-all dimensions, 7 1/2" x 7 1/2" x 11 1/2". Gov't. acquisition cost \$428.00. Shpg. wt. 31 lbs. Complete with 2 qts. of oil and full instructions. F.O.B. Chicago... **54.50**

TO PLACE PHONE ORDERS • CALL WEBSTER 9-3793

ROSS 4-WAY FOOT OPERATED AIR VALVE



BRAND NEW — For double-acting pneumatic devices. Fine for operating presses, air vises, air machinery of many types. Heavy duty cast construction. No neutral position. Maintains pressure against the piston when in the "Up" position. Threaded for 1/2" pipe. Dimensions of valve body: 7 3/4" long x 4 1/4" width x 7 1/2" high. Net weight 28 lbs. A \$64.00 value for only. **19.50** F.O.B. CHICAGO

ITEM #60

PURULATOR OIL FILTER

ITEM #70—A perfect permanent element oil filter to keep your motor oil or hydraulic fluid clean at all times. Protect your pump or engine with this unit. Just turn the handle and the element is clean. Standard 3/8" inlet and outlet ports accommodate 16 gallons per minute. Shipping weight 4 lbs. \$13.00 value. NOW ONLY... **5.95** Postpaid



ITEM #166—use on farm equipment, road machinery, vibrators, paper mills, wire reels, hydraulic brakes. Ball bearing construction, balanced cam design assures high efficiency performance. When used as a pump, delivers 11 G.P.M., 1000 P.S.I., 8 H.P. At 1800 R.P.M. as a HYDRAULIC MOTOR: Rated up to 12 H.P., up to 2400 R.P.M. Standard 3/4" pipe thread ports, 3/4" shaft with keyway. Dimensions: 14 1/2" x 8" x 7". Weight 63 lbs. Regular price today \$212.00. Our money saving price F.O.B. Chicago... **59.50**

BRAND NEW — BERRY — HEAVY DUTY HYDRAULIC PUMP OR MOTOR

ITEM #126—use on farm equipment, road machinery, vibrators, paper mills, wire reels, hydraulic brakes. Ball bearing construction, balanced cam design assures high efficiency performance. When used as a pump, delivers 11 G.P.M., 1000 P.S.I., 8 H.P. At 1800 R.P.M. as a HYDRAULIC MOTOR: Rated up to 12 H.P., up to 2400 R.P.M. Standard 3/4" pipe thread ports, 3/4" shaft with keyway. Dimensions: 14 1/2" x 8" x 7". Weight 63 lbs. Regular price today \$212.00. Our money saving price F.O.B. Chicago... **59.50**



FOUR-WAY, OPEN CENTER CONTROL VALVE

with built-in adjustable relief valve. Factory set at 1000 P.S.I., spring loaded, neutral position for use with one double acting cylinder. In neutral position cylinder is locked and pump unloaded. Fully balanced plunger type, smooth, positive, easy operation. Can be used as single unit or mounted in series of any combinations desired. Has 3/4" pipe thread inlet and outlet, 1/2" pipe thread cylinder ports. Newly manufactured to our specifications. Ship. wt. 8 1/4 lbs. An outstanding buy! F.O.B. Chicago... **21.50**



EXTRA HEAVY DUTY Double Action HYDRAULIC CYLINDER

ITEM #224. 3 1/4" bore, 24" stroke, will lift 8250 lbs. with 1000 P.S.I. line pressure. 1/2" pipe thread ports —1 3/8" stress-proof ground, polished & plated solid steel shaft. Overall length closed 36". 1/4" steel wall cylinder barrel clevis mounting at base and shaft. Features—Tie Rod construction. Honed barrel. Ship. wt. 50 lbs. F.O.B. Chicago... **39.60**

ITEM #16C—Double acting hydraulic cylinder, 1 1/2" bore, 26" stroke. Will lift 1760 lbs. with 1000 P.S.I. line pressure. Weight 8 lbs. A \$35.00 value. Now only... **16.95** Postpaid

ORDER DIRECT FROM AD — SEND PAYMENT OR PURCHASE ORDER TODAY — SATISFACTION GUARANTEED

GROBAN SUPPLY CO. 1139 SO. WABASH AVE., CHICAGO 5, ILL. DEPT PM12

The perfect, lasting gift for any motorist!



Deluxe Custom Model

STEWART-WARNER

MOTOR MINDER®

Swivel mounted on the windshield molding, this engine analyzer and driving gauge tells how to get more miles per gallon—top engine performance, as you drive! Motor Minder gives a constant, accurate check on valves, carburetor, spark plugs, piston rings, timing, etc. Installation is simple and quick! Dial is illuminated for night driving.

Get it at your dealer's. If he cannot supply you, send us his name and address with your check or money order for \$10.95. Motor Minder will be sent prepaid!

Pays for itself in a hurry! **Only \$10.95** In Gay Holiday Gift Wrap!

STEWART-WARNER

Instrument Div., Dept. N-123, 1840 Diversy Pky., Chicago 14, Ill.

BE YOUR OWN BOSS! Make UP TO **\$50.00** PER WEEK IN YOUR SPARE TIME

Mr. B. of California writes "The lawn mower grinding business, with my Universal Grinder, has been a gold mine these last two years." Mr. J.L.P. of Pennsylvania says "Thank you for getting me started in this wonderful business... I averaged \$100.00 per week for the month of May."

ONLY ON THE UNIVERSAL LAWN MOWER GRINDER

... can the inside face and edge of the stationary blade, as well as the reel blades, be ground to proper clearance

ALL IN ONE SET-UP

WITHOUT REMOVING ANY BLADE FROM THE MOWER

Users who have tried them all acclaim the UNIVERSAL far above any grinder on the market. Write today for full details of our Proved Success Plan. It's Free.

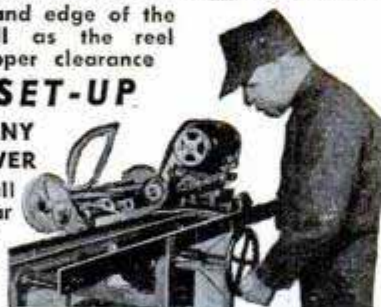

ROGERS MFG. CO., DEPT. M-123, LINDSEY, OHIO

SEND THIS COUPON NOW

ROGERS MFG. CO., Dept. M-123, Lindsey, Ohio
Please send me full details about the profit possibilities of Lawn Mower Sharpening.

NAME _____
ADDRESS _____
CITY _____ STATE _____



Here now for 1954

"Home Is Where You Take It" with America's leading all-steel insulated mobile home, the new HOWARD for 1954! Time-tested from Alaska to Florida, now better by far—for you and your car. For details write HOWARD Industries, Box 2188 . . . Dept. 21, Saginaw, Mich.

Howard MANSION COACH

HOWARD INDUSTRIES INC., SAGINAW, MICHIGAN

VARIABLE SPEED HYDRAULIC POWER TRANSMISSION



It has Infinite Speeds 0 to 550, Reverse, Automatic Overload Protection; Adjustable Torque up to 180 inch pounds. 5/8" input and Output Shafts. It will handle 1/2 to 1 1/2 H.P. Motor. Case measures 7 1/2" long, 7" high 6 1/2" wide. VALUE OVER \$300. Shipping Wt. 25#. On C.O.D. Orders we require a 10% only \$54.50 Deposit. Fob. Chicago

DIRZIUS MACHINE SHOP "I" 1423-25 So. 52nd Ave., Cicero 50, Ill.

TV TUBE TESTER
4" x 6" 7 ozs.
Tests electronic tubes. Fast, sure, self-contained. Be your own serviceman.
SMITHGUILD, INC.
360 W. 8th ST. ERIE, PA.

\$9.95 No C.O.D.
ORDER DIRECT FROM

LAWN ORNAMENT-NOVELTY PATTERNS
28 Lawn Ornament Patterns, 25c. Other Patterns; 15-20" high; Dutch Girl, Dutch Boy, Pirate, Bull Terrier, Mexican Girl, Mexican Boy, Dwarf, Penguin, Flower Girl, 15c each. 25 Novelty Patterns, 30c. All 62 Full Size Patterns, \$1.00. Strother Pattern Service, Dept. D0-8, Box 128, Belington, W. Va.

SET-UP - KNOCKDOWN SAWHORSE with Jiffy BRACKETS



No nails or bolts... use 2x4's for legs, 2x4 or wider for crossbar. Rugged, sturdy, easy to move, saves storage space. Sold by hardware and building material dealers, or order direct.

GRAND HAVEN STAMPED PRODUCTS CO., Grand Haven, Mich.

SAY YOU SAW IT IN POPULAR MECHANICS



Darra-James POWER TOOLS

More for Your Money

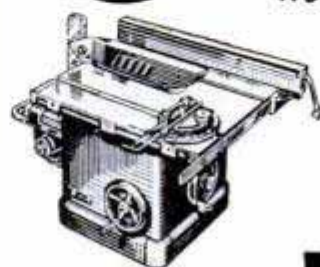

Better in every way... larger work tables... sturdier frames... newest mechanical improvements. Darra-James engineers are constantly working to give you more for your money. Get the facts today!

WRITE FOR CATALOGS

Professional Quality TILT ARBOR SAWS

TOOLKRAFT CORP.
SPRINGFIELD 1, MASS.

POWER HYDRAULICS for SNOW PLOWS

Use on



TRUCKS



JEEPS



TRACTORS

HY-LO-JACK
does the job
FASTER-EASIER

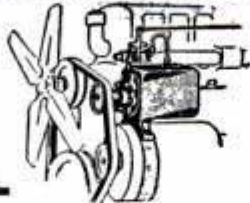

- Lifts average snow plow in 3 to 10 seconds.
- 1,000 lbs. per square in. pressure
- Quick, easy installation on new or existing equipment.
- Complete kit form, including the pump, tank, hose lines, etc.
- Electric unit also available for 6 or 12 volt systems.

* Write for Circular. See your Road Machinery, Jeep or Farm Equipment dealer.

MONARCH ROAD MACHINERY CO.
Quality Machinery since 1856
333 Front Ave., N. W., GRAND RAPIDS, MICH.



.01" ACCURACY with MAGNA DADO!

Geared hub. Sets in 5 seconds with Allen wrench. Cuts any groove 5/32"-7/8" wide. 2" max. depth. 12-gauge tempered steel blade; 8" dia. Available at SHOPSMITH dealers. Fits most saws. \$14.95.

MAGNETS OF ALL TYPES — 10c UP
AMAZINGLY POWERFUL!
6 ounce horseshoe magnet—\$1.50.
Our Leader, 1 lb. magnet lifts 25 lbs. \$2.95. New alloy—will not weaken!
Useful for lifting valuables from tanks, lakes, or rivers easily! 7 small magnets \$1.25 with list of many shop and home uses. Satisfaction guaranteed.
R. EYRICH, 1091 N. 48 STREET, MILWAUKEE-8, WISC.

DRAINS Cellars, Laundry Tubs; CIRCULATES Oil; IRRIGATES Gardens

Original "Type P" Pump has 2400 GPH capacity. 360 GPH 75' high, or 1500 GPH from 25' well. Use any 1/4 to 1/2 HP motor. DOES NOT CLOG. 1" intake; 3/4" outlet.

Postpaid if cash with order. (West of Miss. add 50c.) Motor coupling included.

MONEY BACK GUARANTEE
Also Gear Pumps in all sizes.

LABAWCO PUMPS, BELLE MEAD 7, N. J.

\$6.95



STOP THAT SQUEAKY FAN BELT for only 50c



* A few drops of Cling-Surface stops slipping, stops squeaks, makes belts last longer. Good for all belt driven power tools and appliances, too! Sold at service stations, auto parts and hardware stores. If your dealer can't supply you

Send 50¢ to:

CLING-SURFACE CO., INC.
1047 Niagara St. Buffalo, N. Y.
CANADIAN READERS SEND 75¢

THESE Starrett® TOOLS BELONG IN EVERY KIT

Starrett gives you perfect design and finish plus exclusive features you just don't find in other makes. Buy the best — buy Starrett.

AUTOMATIC CENTER PUNCH No. 18



An automatic, adjustable stroke punch — no hammer needed. 3 3/4, 5 or heavy duty 6" models.

STARRETT SCRIBERS



No. 70 Pocket type with reversible point, non-roll hex head.



No. 67 Straight, short bent and long bent points interchange in knurled stock.

No. 800 NAIL SETS
Easy to hold, easy to hit, won't roll. Five point sizes from 1/32 to 5/32".

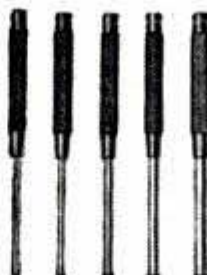
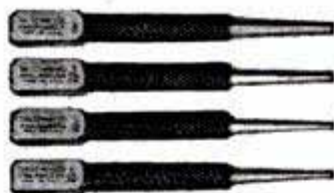

DRIVE PIN PUNCHES

No. 248 Extra long for deep holes. Five sizes from 1/8 to 3/8". Short types for heavy work.

SEND FOR IT — ONLY 10¢
Starrett "Tools and Rules" Book
50 page booklet shows the right tools for any precision measuring job. 100 pictures plus helpful reference tables. Send only one dime. Address Dept. AP.



THE L. S. STARRETT COMPANY · ATHOL, MASS., U.S.A.



MECHANICS' HAND MEASURING TOOLS AND PRECISION INSTRUMENTS
DIAL INDICATORS • STEEL TAPES • PRECISION GROUND FLAT STOCK
HACKSAWS, BAND SAWS and BAND KNIVES

DR. GRABOW

THE Pre-Smoked PIPE
GIVES YOU A COOLER,
SWEETER SMOKE!

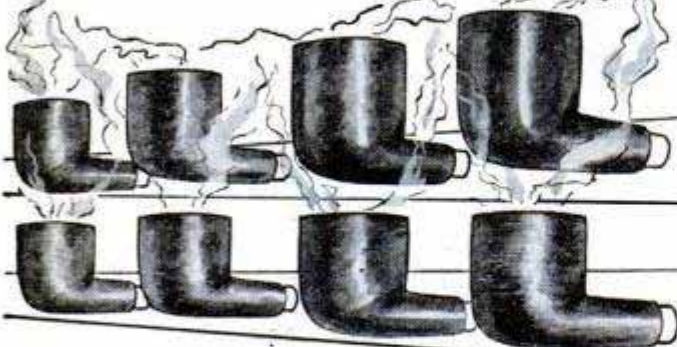

The first pipefuls determine the pleasure your pipe gives. Yes, the secret to a sweet smoking briar is to break it in properly . . . and Dr. Grabow does this for you.

Mechanical pre-smoking with Prince Albert tobacco breaks in each Dr. Grabow as it should be . . . never too hot, never too fast, never too slow . . . but just right for a cool, sweet smoke.

Buy a pre-smoked Dr. Grabow and taste the difference yourself.

\$1.50 and up

®

DR. GRABOW

THE Pre-Smoked PIPE

HENRY LEONARD & THOMAS • GREENSBORO, N. C.

BRIKCRETE



Local Manufacturers Have Broad Opportunities

Brikrete manufacturers operate compact, self-contained plants under franchise privileges in protected territories. Each is an independently owned unit in a country-wide chain, using local materials and local labor to supply the world's most modern masonry for local building needs.

Brikrete is rich in sales appeal because it is ahead in design, style, size, color, economy. Easily the preferred masonry. But because local production eliminates economic wastefulness,

Brikrete can be sold at a lower-than-lumber price. Yet still allow a generous profit margin.

Brikrete offers much to men looking for a community enterprise on a nominal investment. We supply complete equipment; easy terms when desired. Liberal cooperation. Write today for Brikrete Book No. 2—while territory is still open.

BRIKCRETE ASSOCIATES, INC.

4679 Division Avenue, S.
Grand Rapids 8, Mich. 82



HUB CAP LOCK



GUARD THOSE EXPENSIVE HUB CAPS & WIRE WHEEL DISCS AGAINST THEFT . . . ALSO PREVENTS PRANKSTERS DEFLATING TIRES . . . Simple to install; simply remove valve cap and screw on with key. Retail price,

\$2.49 per set of four with two keys. See your dealer first, if he cannot supply you, order COD or send check or money order.

KEY KAP CO.

36 VANCELEVE ST.

DAYTON 2, O.

WORLD'S BEST SMALL TRENCHERS



Portable DITCH-WITCH digs 2" to 6" clean, even ditches to 36" depth in all types of soil. Complete unit—self propelled—outdigs 8 men. Four rugged models.

Write for illustrated literature.
THE CHARLES MACHINE WORKS
620 B Street Perry, Oklahoma

SURPLUS SALE



\$39.50

Less Grinding Wheel

NEW TOOL POST GRINDERS
REGULAR PRICE \$125.00
1-6 H. P. MOTOR
TAKES WHEELS UP TO 1/2" x 4"
EXTRA QUILL EXTERNAL OR
INTERNAL \$19.50
MONEY BACK GUARANTEE

EDWARD J. NOLAN, PULASKI, NEW YORK



NEW SAW SHARPENER

Improved #64 Hand Gummer sharpens all types circular saws 4" to 20" diam. Ideal for saw shops. Self-centering adjustment for quick, easy set-ups. Complete with 1/4 HP motor, 1 grinding wheel & cord. \$79.50 FOB Portland. Wt. 7.0#. SEND FOR FREE LITERATURE.

P. T. HOBBS MACHINERY

8375 N. INTERSTATE AVE.
Dept. P.M.-61, PORTLAND 17, OREGON

SAY YOU SAW IT IN
POPULAR MECHANICS

TREASURE -- \$10,000

New locator detects metals, valuable minerals and buried treasure. Money-back guarantee of superiority.



Also geiger counters. Govt. reward of \$10,000 for uranium discovery. Write for FREE information.

THE GOLDAK COMPANY

1542 W. GLENOAKS BLVD., GLENDALE 1, CALIF.

MORE JOBS



EASIER—QUICKER

You'll like the smooth, powerful, gear-driven, easy operating action of the 4 1/2 or 6 H.P. WALKING MODEL with power turning clutch or the 8 1/2 H.P. RIDING MODEL with automotive

with
'RED-E'
GARDEN
TRACTORS

type differential. Our 2 and 3 H.P. Walking Models low as \$169. Attachments for plowing, sowing, cultivating, wood-sawing, snow-plowing, etc. Write for FREE Catalog New 1954 models on Easy Terms — special Factory-To-You discount.
RED-E TRACTOR CO., Richfield 435, Wis.

Fully Guaranteed
BUY DIRECT
from Manufacturer
and Save

POPULAR MECHANICS

Take The "PAIN" Out of PAINTING!



Basements . . . Fences . . . Furniture . . .

USE A BECKER CO₂ SPRAY GUN

Take It Anywhere! No Compressor . . . No Electric Cords Needed. Sprays: Paints, Oil, Varnishes, Insecticides, etc.

Men! Women! Here's the easy way to lick those tough, tedious, tiresome paint jobs. Becker Spray Gun is fun to use, requires no electricity or compressors—pressurized by low-cost CO₂ cartridges each sprays up to 21 oz. containerful. Used 5 years successfully in industry.

SEE YOUR DEALER! If he cannot supply, order direct for pspd. sht. Extra cartridges 10 for \$1.

SULLIVAN-BECKER CO.
Dept. 113-M Kenosha, Wis.



ONLY
\$19.95
with box of
10 cartridges

SHEET METAL BRAKES

Angles, flanges, Pittsburgh locks, 24 G. steel, heavier aluminum. Cam locking, mount on bench, truck or floor stand. Truss braced steel. Express collect, 30", 65 lbs., \$28.50, 30", 75 lbs., \$33.00, 48", 100 lbs., \$48.00. Portable stands, 32" hi., 35 lbs., \$7.00, 15", 40 lbs., capacity 16 gauge, \$21.50.

IRON BENDER forms hooks, angles, eyelets, etc. Capacity 1/4 x 2", 5/16 x 1 1/2". All steel. . . . \$9.50
30" CURVE FORMER. Forms straight and tapering pipes 2" to 2 ft. in diameter. 20 gauge, express collect \$9.50
(Immediate delivery. Order direct, cash or C.O.D., or send for folder)

VYKE BRAKE CO., P-2439 15th St., Denver 11, Colo.

Build your own JET ENGINE!



SEND NO MONEY

Order these plans today

1. JET PROPELLED BICYCLE. Assemble your own. Photo and instructions. \$1.00.
2. HOW TO MAKE EXPERIMENTAL JET ENGINES. Seven sheets drawings with information and instructions \$2.95.
3. BOTH OF ABOVE in one order \$3.75. SEND NO MONEY. Order both at once \$3.75 C.O.D. in USA plus c.o.d. postage. Send check or Money Order and we pay postage. Get other information too. Rush Order.

J. HOUSTON MAUPIN, Dept. 55, Tipp City, Ohio

LAND THAT FISH!

FISHSAVER, a compact landing device for all types of fishing. No net needed—gaff hook does the work. Two handy blades. Red handle.

D'FAPP, Ltd. Dept. P
610 16th St., Oakland, Calif.



695
postpaid
in U.S. or
Canada



OVERHAUL YOUR MOTOR in 10 minutes

STOP BURNING OIL. STOP PISTON SLAP

15,000 Mile Performance Guarantee!

1st Step—CLEANSE WITH "MOTOR PURGE"—In the FIRST step of the famous "Purge"—In the "Purge" formula cleans, quiets and frees rings, valves and pistons from efficiency and power robbing carbon, gums and varnish. Pour this miracle solvent into the cylinders, run your motor and watch the combustion residue billow out of your exhaust pipe.
2nd Step—RENEW WITH "COMPRESSION SEAL"—RE-STORE COMPRESSION—GET NEW POWER, SPEED AND ECONOMY with "Compression Seal"! As the SECOND step of the Renew treatment, squeeze this self expanding mineral compound into your cylinder where it can fill worn spots (which cause compression leaks) between cylinder walls and pistons. Thus it restores compression . . . cuts oil-gas waste and eliminates costly engine overhaul and ring jobs.

100% MONEY BACK GUARANTEE!

Free Auto Manual with each order. Kit treats all cars and trucks.

\$6.95 Postpaid (or send \$1 deposit, bal. C.O.D.)

Write "RENEW KIT," Dept. PMK-12
10407 W. Washington Blvd., Culver City, Calif.

Say "Merry Christmas" with POWER TOOLS



Wonderful to give...and wonderful to get. MALL tools make perfect Christmas gifts because they keep on giving enjoyment, useful service, and dependable performance year after year. Here are just a few of the many MALL gifts you can choose from.



1000 & 1 DRILL KIT

...the kit with a thousand and one uses. Features the famous MALL 149B drill with dozens of attachments for polishing, sanding, drilling... handling many, many jobs



around the house and workshop. \$31.95 complete.

Mall 7" CIRCULAR SAW

Cuts 2 x 4's at 45°. Automatic telescoping blade guard, built-in trigger switch, depth and bevel adjustments, and rip guide. Many other top quality features. Model 71—\$49.50

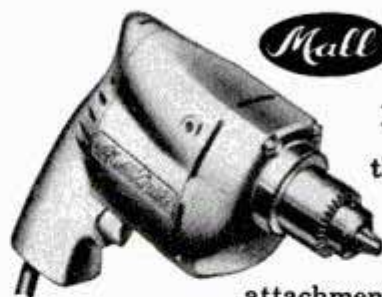
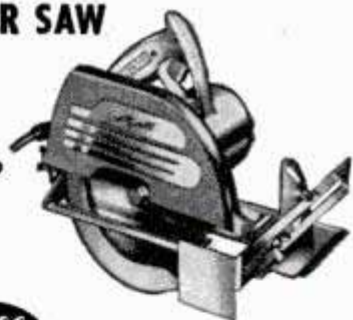

Mall

1/4" ELECTRIC DRILL

Drills 1/4" holes in steel, 1/2" in hardwood. Fits the palm snugly. Weighs only 3 1/2 lbs. 2000 rpm spindle speed. Geared chuck. Can operate dozens of work-saving attachments. Model 149B—\$20.50

SEND FOR MORE MALL GIFT SUGGESTIONS

40 Factory-Owned Service Warehouses, Coast-to-Coast, to Give Prompt, Economical Service.

MALL TOOL COMPANY

7805 S. Chicago Ave., Chicago 19, Illinois

Rush me more information about MALL gifts for Christmas.

Name _____

Address _____

HU-75

REMOVE RUST EASILY

from chrome and other metals



METAL TREAT is also an excellent rust preventative and metal pre-primer

Just rub on concentrated Metal Treat and unsightly, damaging rust comes right off automobile chrome, tools, outdoor furniture, machinery and other metal surfaces. And, before you paint any metal surface, prime it with diluted Metal Treat to prevent rust and make paint stick (12 oz. bottle makes full gallon). Metal Treat is sold by most paint and hardware stores.



METAL TREAT

Another quality product of

THE KLEAN-STRIP CO., INC.

2364 S. Lauderdale, Memphis 6, Tenn.

More work-savers:

GOOD SHORT-CUTS

from "Handy" SANDY



Handy tool you can make for removing rust and putting a fine touch on tools: glue a strip of Coarse ALOXITE® Metal Cloth to one side of a 12" flat stick, and a strip of Fine to the other. I recommend ALOXITE Metal Cloth by CARBORUNDUM because the tough, durable aluminum oxide grain cuts faster and lasts longer than any other abrasive. The backing is real flexible, too. Try it next time you're roughing or finishing hard metals.

Loosen stubborn light bulbs, bottle caps, etc.—quickly, safely. Get a firm grip on them with a small sheet of sandpaper or Emery Cloth, and twist. Saves tempers, avoids injuries. Top quality abrasives by CARBORUNDUM save work so many ways. Buy them from your favorite hardware or lumber dealer. Look for the brand name CARBORUNDUM® on the back.

Solder will flow faster if you hammer it flat before applying to the iron. Prevents overheating delicate work. Don't forget to clean the tip of your iron with CARBORUNDUM's Emery Cloth before fluxing.

Get your free copy of "HOW TO SAND", helpful folder by CARBORUNDUM® Write to me,

"Handy" SANDY
CARBORUNDUM

REGISTERED TRADE MARK

Niagara Falls, New York



German Flashlight Pencil Illuminates Writing Area

Writing in the dark is no problem with a mechanical German pencil which illuminates the writing area. A glass tip encloses the area around the lead. Just above the lead container is a flashlight bulb powered by two miniature batteries which fill most of the pencil case. A flick of the switch on top presses batteries and bulb together to turn on the light.



Skate Adapts to Ice or Concrete

Easily attached wheels allow a German ice skate to double as a roller skate. Designed by a watchmaker, it was exhibited at the German inventors' fair in Nuremberg.

Boys! Get **ERECTOR**[®]

and build hundreds of action models

Put together these gleaming STEEL precision parts and create hundreds of toys! Illustrated "How to Make 'Em" book in every set. But you can do your own inventing! Models whistle, "choo-choo," light up and puff smoke. Tell Dad you want ERECTOR and see displays at stores. For ERECTOR and Gilbert Toy Book (plus American Flyer trains) write Gilbert Hall of Science, Dept. K, Erector Square, New Haven 6, Conn. Enclose 10¢ for handling, postage.

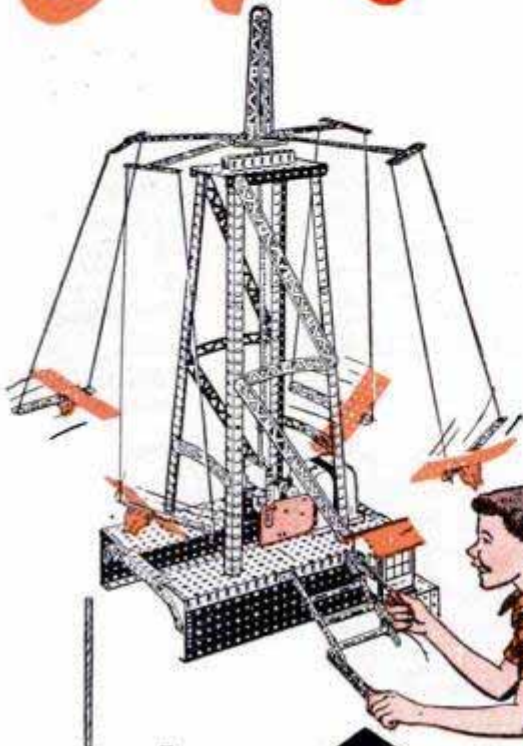

Make this high-swinging airplane ride with ERECTOR No. 6½.

No. 6½ has over 350 parts — sturdy girders, gears, wheels, etc. "Powerhouse" electric engine features many speeds (including reverse) to put *action* into your models. Builds pile driver, elevator, lift bridge, hundreds of other wonderful toys that work. \$12.95*

Square Girder Construction
Precision-matched parts easily lock together with nuts and bolts. Can't wobble or warp. Build bridges that hold more than 200 pounds. Parts have lasting gleam.



*ERECTOR prices slightly higher Denver and West

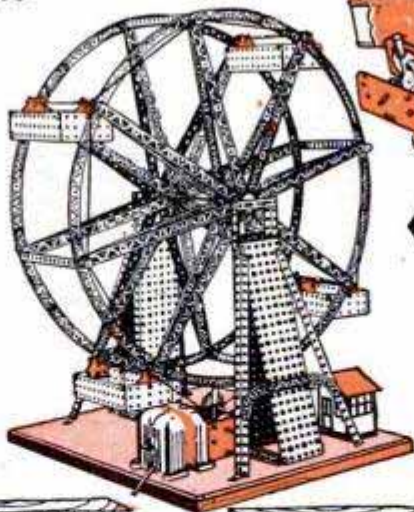

Huge ferris wheel turns fast or slow; reverses. Made with ERECTOR No. 8½.

The all-electric set (No. 8½) has nearly 16 lbs. of parts! Includes 4-speed forward and reverse electric engine, electric lights, electromagnet! Build a mighty crane, oil drilling rig, portable derrick, etc. Heavy gauge steel chest. \$23.50*

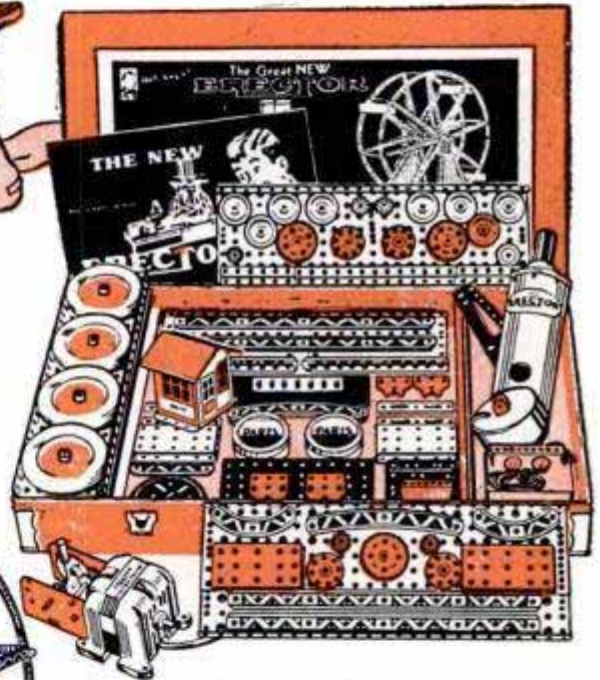

WORLD'S MOST FASCINATING CHRISTMAS GIFT

JR. ENGINEERS AT WORK WITH ERECTOR!

ERECTOR PRICES START AT \$2.00*

Oxwall TOOL KITS
MAKE
WONDERFUL GIFTS
FOR THE ENTIRE FAMILY



\$1.79

Oxwall DeLuxe

5-piece set includes Combination side-cutting plier; unbreakable shockproof, non-inflammable plastic handle with 3 interchangeable magnetized, tool-steel screw-driver blades in plastic kit.



\$2.98

Oxwall CHAMPION

7-piece set includes combination side-cutting plier; adjustable open-end wrench plus unbreakable plastic handle with 3 interchangeable magnetized tool-steel screw-driver blades & chisel in plastic kit.



\$2.49

Oxwall MY BUDDY

8-piece set includes unbreakable, plastic-handle with 5 interchangeable, magnetized, tool-steel screw-driver blades, steel tape rule, and combination side-cutting plier



\$1.00

Oxwall 6-PIECE SCREW DRIVER SET

includes unbreakable, shockproof, non-inflammable handle with 5 interchangeable magnetized tool-steel blades.

Look for these sets at your local hardware or chain store. Each set in an attractive gift box beautifully Christmas wrapped.

Insist on Oxwall — the handiest

tool kits in the world

Oxwall TOOL CO., Ltd.

928 Broadway • New York 10 • Factory: Oxford, N. J.

MODERN

LAWN MOWER SHARPENER

Service departments of leading Lawn Mower manufacturers use the Modern Lawn Mower Sharpener. One lever moves lawn mower into grinding position. Gasoline and oil remain in engine while sharpening, no dismantling of wheels, roller or handle. The Modern is a precision bed knife grinder—no extra grinder to buy. Imitated but never equaled—Compare before you buy. If it isn't a Modern it can't be Modern (Prices subject to change without notice)



WRITE FOR FREE BOOKLET 10P

\$263.00

with motor F.O.B. PASADENA

MODERN MFG. CO.
160 N. Fair Oaks • Pasadena 1, Calif.

DO MORE PLANING JOBS WITH LOW COST BELSAW

Exclusive MONEY-MAKING features:

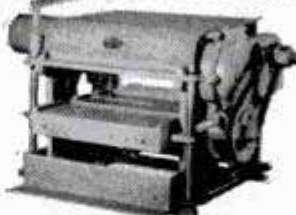

- Full 12 1/4 in. x 6 in. capacity
- Power feeds at 24 ft. a minute. (Easily adjusted for lower feed rate)
- Machined cast iron bed; adjustable rolls, total bed length 42 in.
- Provides for Grinding Knives in the Cutterhead.
- Attachments for Jointing, Rabbeting, Tongue, Groove, Matching.

Belsaw Multi-Duty Planer for cabinet shops, builders, lumber yards, woodworking plants and spare time work shops... Now you can convert low cost rough and random size lumber into high priced cabinet finished stock... Easy to make flooring and popular patterns. Belsaw quickly returns cost with savings on raw material... profits on finished stock.

Send Today for FREE literature on Belsaw, the LOW COST, high speed production planer.

BELSAW MACHINERY CO

1010 Field Bldg.

Kansas City 11, Missouri

LOW DOWN
PAYMENT
EASY
TERMS



Treasure - Minerals - COINS

Easily located with new Lightweight M-Scope Detector. Superior performance, lowest price, monthly payment plan.

FREE LITERATURE
FISHER RESEARCH LAB., INC.
PALO ALTO CALIF.

FREE CATALOG

ALL KINDS OF WAR SURPLUS
PRACTICAL ENGINEERING CO.
707 M NORTH SHERIDAN TULSA, OKLA.



PLANS! BEAUTIFY YOUR GARDEN

3 Distinctive Lawn Chair Plans for ONLY \$1.25
40" high Dutch Windmill Detailed Plan, ONLY 75c
Send 10c for Illustrated Catalog.

- DUTCH WINDMILLS
- LIGHTHOUSES
- LAWN CHAIRS
- BIRD HOUSES
- LAWN FIGURES

CRAFTSMAN'S MODEL CO. Dept. P-59 DELAFIELD, WIS.

Crosman for Christmas

WRITE FOR CATALOG

HIGH-POWERED .22 CAL. PNEUMATIC RIFLE

At dealers everywhere

Rifled barrel, military stock, adjustable sights, bolt action, wt. 4 lbs. 10 oz.

\$13.50

CROSMAN ARMS CO., Fairport, N. Y., Dept. 45

1954 CATALOG — Send 25c

41 models for '54! See World's finest line before you buy. Rated tops in design, styling, performance by te experts. '54 Catalog plus booklet "Boat Selection, Operation, Maintenance" \$1.00.

Custom-Craft
THE ORIGINAL "PACKAGED"
BOAT KITS

BOAT PLANS AND FULL-SIZE: PATTERNS

Over 100 Modern plans and full size patterns. Racing classes, cruisers, inboards, outboards, sail boats. By famous designers. 6' to 30'. DESIGN CATALOG only 35¢. For Design Catalog plus boat building handbook send \$1.00.

CUSTOM-CRAFT (DEPT. A) BUFFALO 7, N. Y.

Send for Your
FREE
Copy of the NEW 1954
MIDWEST
TELEVISION and
RADIO Catalog

MIDWEST *Presents*

For 1954 a Completely NEW LINE of
21" and 27" TELEVISION

CONSOLES
TABLE MODELS

and
COMPLETE CHASSIS

at
LOW FACTORY PRICES



YOUR CHOICE OF EITHER 12 CHANNEL
VHF or All-Channel VHF-UHF Models

Buy your Television or Radio Direct from the Midwest Factory . . . on 30 DAYS TRIAL . . . Easy Terms . . . and at LOW FACTORY PRICES. For 34 years Midwest, the world's largest and oldest exclusive Factory-To-You radio and television manufacturer, has served hundreds of thousands of satisfied customers all over the world.



EASY TERMS
30 DAYS TRIAL



FACTORY-TO-YOU

Also—Powerful New 1954 World-Ranging
MIDWEST Series 16 RADIOS
In Beautiful Consoles and Complete Chassis



Once again Midwest offers its famous series 16 five band AM-FM radio chassis and the magnificent new Symphony Grand Radio-Phonograph with 3-Speed Automatic Intermix Record Player. Also, a complete line of clock radios, table radios, and portables.



All models available in your choice of mahogany, walnut finish or blond lined oak.

WRITE IN NAME AND ADDRESS (PLEASE PRINT) ON COUPON OR 2c POSTCARD

MIDWEST RADIO & TELEVISION CORP.
Dept. E-25, 909 BROADWAY • CINCINNATI 2, OHIO
Please send me your new FREE 1954 Catalog.

NAME _____
ADDRESS _____
CITY _____ ZONE _____ STATE _____

MIDWEST RADIO & TELEVISION CORP.
DEPT. E-25, 909 BROADWAY, CINCINNATI 2, OHIO

PALMGREN

HOBB-E TOOLS

ROTARY INDEX MILLING TABLE

Turn drill press into vertical miller. Mill, Grind, Index, Rabbet, Mortise and Rout curved or straight. PALMGREN "Hobb-E" ROTARY TABLE is a precision machine, accurately graduated. Bolts to table. No. 83—8" Table, 4" Cross Feeds. **\$54.50** 360° Rotary Feed.

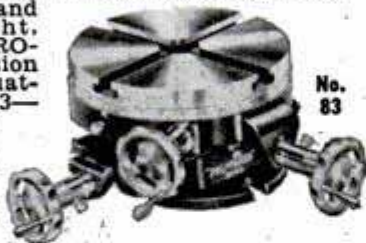

No. 82—Without Rotary Feed. **\$39.75**

ANGLE VISE

Set up hard angle jobs in 5 seconds. Drill, grind, mill, round, square or irregular pieces quickly and accurately. Save time, money and errors. PALMGREN ANGLE VISE has 2 1/2" Jaws. 1 Plain. 1 Grooved. Accurately machined and graduated.



\$11.75

No. 000 Angle Vise. Complete with Swivel Base

MILLING ATTACHMENTS

Mill it on YOUR LATHE! Now! You can make T-slots, Dovetails, Keyways—Recess. Grind. Square Shafts. Saw at Angles, etc. Fits any Lathe. Graduated for rotary and vertical feeds. Attaches to tool post in 10 seconds.

No. 150—1 1/2" Jaws. Fits 1" Post. **\$18.75**
 No. 250—2 1/2" Jaws. Fits 1 1/4" Post. **\$24.75**
 No. 400—4" Jaws. Fits 2" Post. **\$39.75**



ADJUSTABLE ANGLE PLATE

Every Hobbyist should have one for jobs difficult to hold in vise. No delay, less spoilage on complicated angles in drilling, milling, grinding or layout work. No. 256 B has 6"x6" surface plate, 8 bolt slots. Adjustable to full 90°. Accurate graduations. Mounted on Swivel Base.



\$14.35

No. 249B—9"x9 1/2" Plate Mounted on Swivel Base. **\$32.75**

BENCH DRILL PRESS VISE

A fine "Hobb-E" tool. Base bolts to work bench for general work. Vise is dovetailed and removable for use on drill press by loosening thumb screw. Unit rotates 360° horizontally. Adapter has steel jib which locks vise in position. No. 12 Removable Jaws 2 1/2" wide. 1 Plain 1 Grooved.

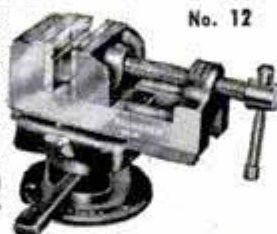

\$12.95

Only.....

Write for Circular No. 201 M.

ORDER NOW! SEND COUPON TODAY!

CHICAGO TOOL & ENGINEERING CO.,
 8366 South Chicago Ave., Chicago 17, Ill.

Enclosed find _____ for items checked below.
 PALMGREN "Hobb-E" ANGLE VISE. PALMGREN "Hobb-E" ANGLE PLATE PALMGREN "Hobb-E" ROTARY TABLE. PALMGREN MILLING ATTACHMENT.
 PALMGREN "Hobb-E" BENCH DRILL PRESS VISE.
 Send Circular No. 201M.

NAME _____
 ADDRESS _____
 TOWN _____ ZONE _____ STATE _____

DRILL SAW REAM CUT

INTERNATIONAL

HI SPEED COPE SAW DRILL BIT



IDEAL AS A CHRISTMAS GIFT

DRILL, SAW, REAM . . . metal, pipe, wood, plastic, Transite, etc. Use with any electric drill, slow drill press, lathe or milling machine. Drills own starting hole—upper part of bit is used to cut, saw or ream circles, ovals, squares or scrolls. Easy to operate. Ideal for carpenters, mechanics, electricians, plumbers, hobbyists, many others. Abrasive resistant, high speed steel. Flutes ground from solid. Will withstand severe continuous use without breaking. Resharpened at no charge. Takes place of up to \$50 in tools. 1/4" diameter, 2" cutting sections, total length 3 1/2". Available in three types—All Purpose, Wood, Heavy Metal. Specify type needed. Set of 3, \$11.50. Details on request. Shipped same day. Money-back guarantee. Dealer inquiries invited. ORDER NOW! SEND CASH, CHECK OR MONEY ORDER.

Manufactured and distributed by
INTERNATIONAL TWIST DRILL CORP.
 618 Wyandotte, Rm. 631, Kansas City 5, Mo.

only
\$3.95
 POST PAID

Magnetic-
 10 times the
 ordinary
 "pull"



4-in-1 Magna Tip Screwdriver—alnico magnet charges interchangeable hardened tool steel bits (stored in handle) with 10 times the pull. Holds slotted or Phillips head screws firmly for one-hand placing and driving in hard-to-reach places. Not sold in hardware stores. Send check or money order for \$3.95. Money back if not satisfied.

MAGNA DRIVER CORPORATION
 780 Washington St., Buffalo 3, N. Y.

ALPHABET PATTERNS

A MULTI-PURPOSE Alphabet Patterns—numerous craft uses. 14 distinctive alphabets-numerals-monograms. Over 500 individual patterns. 1/2" to 4" high. Only **\$1.00** Postpaid.

WALKER STUDIO Dept. AP, 4343 Lindell, St. Louis 8, Mo.

SUPER DRILL-GRINDER



Sharpens round shank drills from 3/32" to 1/2" in diameter, up to 6" long. Grinds old drills like new in 4 different point angles, using hand or power grinding wheels. Money-back guarantee. only **\$2.95**
 At Dealers or Postpaid

A. D. McBURNEY Dept. A-36
 5908 Hollywood Blvd. Hollywood 28, Calif.

YOU KNOW YOU CAN TRUST
A HULL AUTO COMPASS

● It's great to be completely confident of directions wherever, whenever you drive. Enjoy this absolute assurance with a HULL AUTO COMPASS . . . guaranteed more accurate because of special, patented features.

WRITE FOR LOCAL DEALER'S NAME, FREE LITERATURE



Beaconlite's \$6.95
 SIREMIENE \$4.95

HULL MFG. CO. P.O. Box 246, D-12
 WARREN, OHIO



The Magspark Ignition System derives its name from the magneto. It produces a magneto spark, long acclaimed by engineers as the best ignition . . . You can have this revolutionary ignition system on your own car and engine performance that will amaze you, by installing the Magspark Transformer and Distributor . . . The Magspark Transformer is not just another coil. It has a completely closed magnetic circuit which produces an alternating magnetic flux, the same as a magneto, generating a spark of very high voltage and of long duration . . . The Magspark System produces sparks per minute far above any speed your engine can reach. Many reports are received claiming more RPM's after installing the Magspark System . . . Your service station will purchase one for you and install it . . . Write today for free engineering data and catalog sheet.

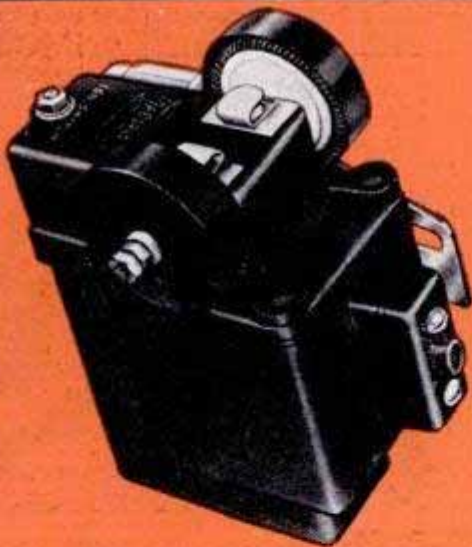

MAGSPARK TRANSFORMER

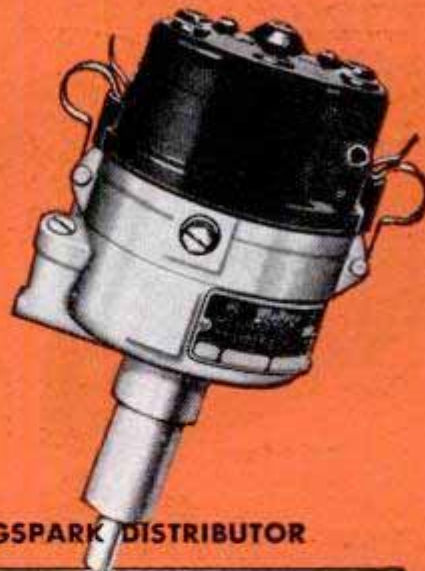

MAGSPARK DISTRIBUTOR

Mallory Electric Corporation has been operated by its founder, M. Mallory, and engaged in the manufacture of ignition systems for thirty years . . . It is of interest to note that approximately half of the automobiles produced in America today use Mallory principles in their ignition systems which were patented by M. Mallory.

MALLORY ELECTRIC CORPORATION
12416 CLOVERDALE AVE. • DETROIT 4, MICHIGAN



SANTA SAYS:

**"A WONDERFUL HOBBY
WORKSHOP GIFT!"**

CUT PERFECT GROOVES ON YOUR SAW WITH

Warren DADO SAWING WASHERS

Not One — Not 12 But 40 Different Cuts

Warren Washers — engineered to cut clean, accurate, parallel grooves with your present power saw. 40 micromatic adjustments — just dial the desired width. Strengthens blade, eliminates vibration — leave on saw for straight cuts. No burning or chewing. Over 250,000 satisfied users. Get genuine Warren Washers — they're **GUARANTEED!**

Arbor sizes $\frac{1}{2}$ ", $\frac{5}{8}$ ", $\frac{3}{4}$ ", 1". See your dealer or write direct.

Send for free booklet

ONLY **\$4.95**

WARREN WASHERS CO.

PER
SET

DEPT. 32 • BOX 98 • NORTH END STATION • DETROIT, MICH.



"I'll trade you some breast of guinea hen for some Vichysoisse!"

Aladdin

VACUUM BOTTLES
and LUNCH KITS



10 OUNCE
PINT
QUART

ALADDIN INDUSTRIES, INCORPORATED, Nashville, Tennessee



Human Hair Used in Control Of Home Dehumidifier

Human hair, extra sensitive to changing humidity, is the heart of an automatic control for home dehumidifiers. Resembling a thermostat and operated like one, it fastens to the wall and is plugged into a wall outlet. When the humidity exceeds the pre-set limit the dehumidifier is started automatically by a sensitive switch hooked to a one-eighth-horsepower motor.



Powerful Magnet Does Odd Jobs

Screwdrivers and other tools can be magnetized by pulling them along one pole of a powerful new magnet. The magnet also can be used to hide an extra key somewhere on a car and to hold papers to the instrument panel. Amateur geologists using the magnet can check rock formations for iron content.

give your hair that "JUST-COMBED" LOOK all day long

Because of Viratol—* a special compound found *only* in 'Vaseline' Cream Hair Tonic—hair stays in place, looks and feels natural all day long.

Try it *today*—and see if your friends don't notice the difference in your appearance. 'Vaseline' Cream Hair Tonic contains Triple-A Lanolin, too . . . and it's homogenized for easy flow.



Vaseline CREAM HAIR TONIC

TRADE MARK ©

VASELINE is the registered trade mark of the Chesebrough Mfg. Co., Cons'd

Say You Saw It in
POPULAR MECHANICS

RELIEVES
HEADACHE
NEURALGIA
NEURITIS PAIN

FAST



Here's Why . . .

Anacin® is like a doctor's prescription. That is, Anacin contains not one but a combination of medically proved active ingredients. Anacin is specially compounded to give FAST, LONG LASTING relief. Don't wait. Buy Anacin today.



The World's Most *USEFUL* Hand Tool!

What a budget-priced MAN'S gift — the handiest tool he can own! A squeeze of the hand locks jaws onto work with Ton-Grip! Won't slip. Bends, pulls, turns, twists, ratchets, HOLDS. A whole tool kit in one trim tool! 7" and 10", with or without cutter, only \$1.85 to \$2.60, at your hardware dealer.

FREE "HANDYMAN'S GUIDE"—Write for this handy, fully-illustrated guide to easier, faster fixin'.

PETERSEN MFG. CO., Dept. M-12, DeWitt, Nebr.

**DOUBLE-CIRCLE
GIFT
IDEAS**

Give him

**A SET OF DOUBLE-CIRCLE
POWER
AUGER BITS**

- Will bore hard and soft woods including plywood.
- Can be used in all electric drills with 1/4" or larger chuck.
- Contains one each 3/8", 1/2", 5/8", 3/4", 7/8" and 1" diameter bits.



Give him

**A HANDY SET OF
DOUBLE-CIRCLE DRILLS**

- Contain 1/4, 3/16, 3/8, 7/16, 1/2" diam.
- All drill have 1/4" diam. shanks
- Carbon Steel for wood or High Speed for metal
- Drills are contained in a handy plastic case



Ask your
Hardware Dealer
for the DOUBLE-CIRCLE



CHICAGO-LATROBE

411 W. ONTARIO ST. CHICAGO 10

DRILLS • REAMERS • COUNTERSINKS • COUNTERBORES • CARBIDE TOOLS • SPECIAL TOOLS



**Trade where
you see
this sign**

WELD

BRAZE, SOLDER,
and CUT →

ONLY
\$1475
F.O.B.
complete!



No experience needed. Follow simple instructions, weld on iron, steel, bronze, brass, aluminum, and other metals. Plugs into any properly wired 110 volt A.C. or D.C. line. Make or save time and money doing repair work for yourself and others. Repair men, farmers, tinsmiths, home and auto owners, hobbyists, etc., say **FOUR-WAY** pays for itself over and over. Order today or send for Free details. **MAKES AN IDEAL GIFT.** Larger Equipment Available on Request
FOUR-WAY WELDER COMPANY, Dept. F2-N
2326 S. Michigan Ave. • Chicago 16, Illinois

**ORDER
NOW
10 DAY
TRIAL**



...Wood Carvers!

"HERE'S THE
NEWEST
IN THE
CARVING FIELD!
\$9.95 PER SET!
OVERALL LENGTH OF
EACH TOOL 6 1/2".
PLASTIC HANDLES



6 PIECE CARVING SET

Most Complete Line of Chisels and Gouges

CATALOG
AVAILABLE!"

BUCK & BROS. INC.
RIVERLIN WORKS MILLBURY, MASS

**SAVE 30% ON ROTARY
TRACTORS**



WITH
REVERSE

MOWS LAWN
HAULS • MULCHES
AC POWER GENERATOR
PLOWES SNOW • SPRAYS
CUTS WOOD • SCYTHES
ROLLER • SULKY

Save 30% by buying direct factory-to-you. Tough, rugged 3 H.P. motor. Reverse & full differential for easy handling. Automatic clutch. Power take-off. Lowest priced tractor in the field. Words of praise from 48 states. Absolute factory guarantee. Act now. Write for information.

SEND FOR
FREE Booklet

CULTILLER Manufacturing Co.
Dept. 1 NEW BRUNSWICK, N. J.



BRONZE FOUNDRY

Schools and Home Workshops

Make your own castings of aluminum, copper, bronze, silver. Foundry sets are available in three sizes including 2400 Deg. F. blast Furnaces. \$22.50; \$29.50; and \$42.00. f.o.b. Kansas City. Free Circular.

KANSAS CITY SPECIALTIES CO. P. O. Box 6022, Dept. P-12
KANSAS CITY, MO.

Say You Saw It in Popular Mechanics

FREE! "HANDY TIPS FOR HANDY MEN"

BOOK OF HINTS to make home repairs and hobby projects easier. Write to: **THE BLACK & DECKER MFG. Co.**, Home Service Dept. H12M, Towson 4, Maryland.

9-in-1 Tackle Jack for Sportsmen



Nine tools—indispensable for camping and fishing—in a single compact, pocket-size unit! Includes file for sharpening hooks, clippers for lines and leaders, razor-edged knife, bottle opener, sturdy-end perforator, screw driver, tweezer for fly repairs, fish hook disgorger, key chain. Instruments are surgical steel.
Durable leather case..... \$2
ppd.



GODFREY IMPORT CORP.

277 Broadway, Dept. M12, New York 7, N.Y.

Midget Monitor S. W.

AMAZING PERFORMANCE!

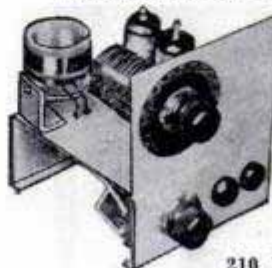

This short wave set receives "Ham," Aircraft, and Foreign broadcast. Uses only two tubes. Simple pictorial diagram. Kit with tubes and all parts less phone and batteries..... **ONLY \$7.99**
Foreign orders \$8.99. Batteries \$2.10. Phone \$2.00. Deposit \$1.00 on C.O.D. orders.

Dura-Mite Products Co.

210 Fifth Ave. New York 10, N. Y.

Wonderful Christmas gift for hobbyists, home craftsmen...

6-in-1 Saw

A \$13.95 VALUE!

Complete at only

\$4.95

POSTPAID

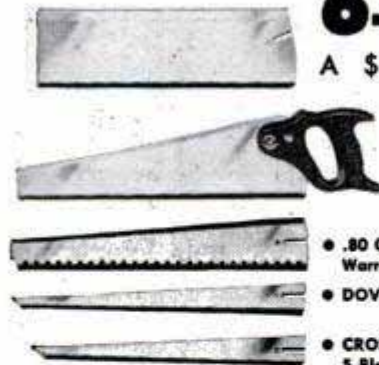

- .80 Carbon Spring Steel Warranted Fully Tempered
- DOVETAIL SAW • PANEL SAW • KEYHOLE SAWS
- CROSSCUT SAW and HACK SAW 5 Blades Interchangeable

Use it for home repairs, building extra storage, repairing toys, furniture, for cutting frozen meat, bones. You can build a house with it. Made by 50 year old concern. Order this sensational saw TODAY for self and gifts. Money-back guarantee.

B & M DISTRIBUTING CO.

2016 EAST ELEVENTH • TACOMA, WASH.



BUILD YOUR OWN MACHINE TOOLS CASTINGS - DRAWINGS

Catalog with complete construction drawings of this 7 inch bench lathe with plain slide rest, 25 cents postpaid, or send one dollar for drawings of three lathes, three milling machines and six inch crank shaper. Refund on castings order. POOTATUCK CORPORATION, 100 Sammis Pl., Stratford, Conn.

HASTINGS

STEEL-VENT PISTON RINGS
The best money you can spend on your car!

Biggest PRECISION TOOL Values

IMPORTER'S WHOLESALE PRICES

HI-SPEED DRILLS

- 1/4 60-1/4. 30 for \$2.95
- 1/4 1/2. 10 for \$3.00
- 1/4 Shank 5 for \$2.50
- 5/16-1/2 Wood-7-\$2.50

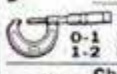

HELIOS MICROMETER

- 0-1 Lock Nut...\$10.50
- 1-2 Lock Nut...\$15.00

Check or M.O.
25% C.O.D. F.O.B. L.A.

METRO PRECISION TOOLS, 1507 S. LaCienega, Los Angeles, Dept. M

PRECISION CALIPERS
Helios w/case—
1/4 6 inch \$11.00
Precision 6 inch \$6.95

NEW DC GENERATORS

- P.I. Incl. Diagram \$21.00
- R.I. Incl. Diagram \$25.00

YOUR WORKSHOP ISN'T COMPLETE WITHOUT THE

Easy Plater

Here is a genuine tank electroplating process that makes chrome plating easy—even for inexperienced novices. "Easyplater" is not a dip, not a paint, not the inefficient brush plating, but a professional process. Here's all you do to make corroded, rusty hardware, tools, jewelry, plumbing fixtures shiny bright... like new.



BEFORE AFTER

Clean piece to be plated, clip to magic rack, immerse in solution of "EASYPLATER" chemicals previously dissolved in water. Remove 15 or 20 minutes later and it's fully replated—looks as new as the day it was made. And EASYPLATER requires no heat or electricity... is non-toxic and non-flammable. Each package makes a full gallon solution, comes complete with magic rack, plating chemicals, brighteners and instructions. Copper and Galvanize also available.

With the Easyplater you can plate for fun or for profit. It is the newest and most fascinating of all (do it yourself) tools and it costs less than a gallon of paint. Order one today and be the first to do your own plating.

COD's Accepted. Money Back Guarantee

only **\$3.98** post paid

EASYPLATER Box 293 D1 Red Lion, Pa.

Simpson Model 260

VOLT-OHM-MILLIAMMETER

\$38.95 Dealer's net.

USE IT FOR:

- TV SETS
- RADIOS
- TRANSMITTERS
- BROADCASTING EQUIPMENT
- HOME APPLIANCES
- TWO-WAY RADIO COMMUNICATIONS SYSTEMS
- PHONE LINES
- AIR CONDITIONING SYSTEMS
- STARTER CONTROLS
- AUTO IGNITIONS, GENERATORS, BATTERIES
- MOVIE EQUIPMENT
- PANEL INSTRUMENTS
- TV CAMERAS
- AUTO LIGHTING SYSTEMS
- GENERATORS
- VOLTAGE SOURCES
- "HAM" RADIO EQUIPMENT
- CABLES
- CONNECTORS
- AUDIO FREQUENCY SOUND CURRENTS

... and send 10c for your copy of "1001 Uses for the Simpson Model 260" 60 pages of uses.

BEST ALL-AROUND TESTER ON THE MARKET



BEST ALL-AROUND TESTER ON THE MARKET

RANGES:

- 20,000 OHMS PER VOLT DC
- 1,000 OHMS PER VOLT AC
- VOLTS, AC AND DC: 2.5, 10, 50, 250, 1,000, 5,000
- OUTPUT: 2.5, 10, 50, 250, 1,000
- MILLIAMPERES, DC: 10, 100, 500
- AMPERES, DC: 100
- DECIBELS, DC: 10
- OHMS (5 RANGES): -12 TO +55 DB
- OHMS: 0-2000 (12 OHMS CENTER), 0-200,000 (1,200 OHMS CENTER), 0-20 MEGOHMS (120,000 OHMS CENTER)

SIMPSON ELECTRIC COMPANY
6200 W. Kinzie St., Chicago 44 • ESTebrook 9-1121
In Canada: Bach-Simpson, Ltd., London, Ont.

NOW THE DrivingAid YOU HAVE ALWAYS WANTED for restful, economical motoring!

DIXON
steady-
drive

Weight of left foot on electric button holds accelerator at any setting, allowing the right leg to relax.



Users have proven these advantages

- Gas savings up to 19 per cent.
- Avoid leg and back strain—cramped muscles.
- Restful highway driving at any desired speed.
- Ideal protection through speed zones.
- Prevents excessive wheel spin on icy hills.
- No spurts of gas to carburetor on rough roads.
- Reduces motor stalling in warm-up period.
- One model fits all cars and trucks.
- Install without raising hood—no special tools required.

A Perfect Year'Round Gift Item!

See your dealer or send coupon today. We ship prepaid (in U.S.A.) same day order is received. Price \$7.95. Remit cash, check, or money order. No C.O.D.'s.

DIXON Automatic Tool, Inc.

2304-23rd Ave., Dept. PM12, Rockford, Ill.

I enclose _____ Send _____ STEADI-
DRIVE. Make of car _____ Year _____
Model _____. I understand this accessory
is fully guaranteed with a money back guar-
antee.

Name _____

Address _____

City _____ State _____

STOP CHANGING MOTOR OIL!

End this needless
expense forever with

RECLAIMO Today's most
advanced OIL RE-REFINING
filter FOR CARS, TRUCKS,
TRACTORS.

Continuously cleans and RE-
REFINES motor oil as you
drive by utilizing motor heat
— keeps oil in high grade
lubricating condition at all
times.

"RECLAIMO"

- REMOVES SOLIDS (by filtration)
- REMOVES WATER (by distillation)
- PREVENTS Excess fuel dilution
- PREVENTS Acid and Sludge Formation
- ADDS Thousands of Miles to Engine Life

MAINTAINS Stable Viscosity **ELIMINATES** All Oil Changes
FREE 32-page book "OIL FACTS" with
bonafide \$1,000.00 offer on page 30. Gives
you the complete "Reclaimo" story and
details of our extraordinary 90-DAY NO-
RISK TRIAL OFFER. Write for your copy
today!

RECLEAN FILTER CO.

5083 Elston Ave., Dept. M-12, Chicago 30, Ill.
Wm. Schwalge, U.S. Pats. 1757223, 1834654,
2068473.

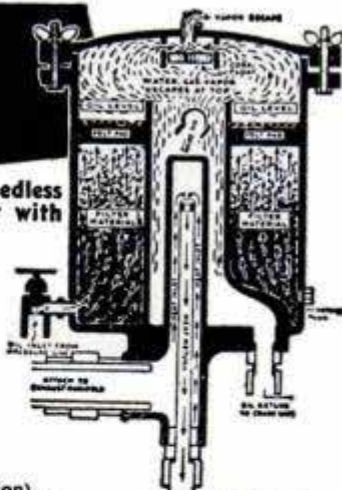

DEALERS
WANTED

U. S. BUREAU
OF STAND-
ARDS, Bul. 86
States, "Oil
does not wear
out mechani-
cally."



NO. 82
KNIFE SET
\$4.20

X-ACTO, INC.
48-41 Van Dam St.
Long Island City,
N. Y.

Send 20¢ for 28-page Catalog

FREE
CATALOG

BARGAINS GALORE

Welders, Welder-kits, Hydraulics, Hydraulic-kits, Gen-
erators, Motors, Pumps, Winches, Gauges, Magnet
Wire, Instruments, Toys, Work-shop Tools, Boats,
Boat-kits, Full-sized Swimming Pools, Appliances and
1500 other items including War Surplus.

DUNBAR MFG. CO., 10318-B3 Aurora Ave., Seattle 33, Washington



SAVE EXPENSIVE PLUMBING BILLS

...with a HANDE DRAIN CLEANER

Use a precision plumber's tool to free your clogged drains, lavatories,
disposal units, etc. Easy to operate, the Hande Drain Cleaner eliminates
expensive service calls—pays for itself first or second time it's used.
Cleans 1", 1 1/4", 1 1/2" lines. Has music wire cable, built-in clamping
device, tool that threads through crossbars of drain. Order today by
cable size: 1/4" x 15', \$8.55—1/4" x 25', \$10—3/8" x 15', \$9—3/8" x 25',
\$10.65. All prices postpaid.

THE OHIO TOOL & ENGINEERING CO., SPRINGFIELD, OHIO

PARTS FOR MILITARY TRUCKS

and **JEEPS** 4 & 6 WHEEL DRIVE. WRITE FOR
PARTS CATALOG STATING MAKES

JEEP TOPS and CURTAINS

All Brand New . . . Not Surplus

Made of Heavy Canvas Duck . . . Waterproof
MILITARY TYPE models, Top and
Curtains, complete.

\$59.50

TOP and CURTAINS, HALF CAB . . . MODELS CJ2A and
CJ3A, complete with hardware,

\$65.00

TOP and CURTAINS Complete, MODELS CJ2A and CJ3A,
with hardware for entire Jeep

\$88.80

When ordering please state exact model
All prices F.O.B. K.C. 25% dep. on COD's

American AUTO PARTS CO. INC.
1830 LOCUST—DEPT. PM-11
KANSAS CITY, MISSOURI



Worn, Damaged threads replaced quick, easy, same size

Drill out old threads.
Tap new threads with *Heli-Coil* tap.
Install *Heli-Coil* Screw Thread Insert in tapped hole with simple inserting tool.

*Reg. U.S. Pat. Off.

With *Heli-Coil** Screw Thread Inserts your old, worn or damaged threads are made better-than-new in seconds—they will hold better, wear forever. And you use original size screw!

Simple *Heli-Coil* tooling—usable forever—costs as little as \$15 each thread size. Inserts as low as 3¢ each. Available for all machine screw sizes—also spark plugs and pipe threads.

HELI-COIL CORPORATION

326 Shelter Rock Lane, Danbury, Conn.

Send literature on *Heli-Coil* Screw Thread Inserts.



Name _____

Company _____

Address _____

City _____ State _____



MAIL COUPON NOW!

Do It Yourself and **SAVE!**

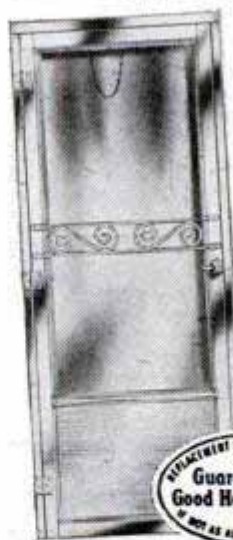

Duo-Dor

**ALL-ALUMINUM
COMBINATION
STORM-SCREEN**

DOOR \$39.95
Push Grille - \$1.50 extra



ANY SIZE
Slightly higher west of the Mississippi.
Reg. \$59.95 Value!

Complete, Including All Hardware! Comes with Pneumatic Door Check, Door Latch, 3 Stainless Steel Hinges, and Outside Aluminum Z-Bar!

Delivered Completely Assembled!

Easily Installed By Anyone!

Enclose check or money order or will ship C.O.D. Give door opening size when ordering!

- Over 1" Thick! • Aluminum Door Jamb!
- Glass & Screen Inserts Interchange Easily!
- Rugged All Aluminum Construction!
- Heavy Aluminum Kick-Plate!
- Adjustable for Perfect Fit!

THE WEATHER-PROOF CO.
1407 E. 40TH ST., DEPT. PM • CLEVELAND 3, O.



Free!

1954 CRAFTSMAN Power Tool Catalog!
Get yours NOW from the Hardware Department of your Sears Retail Store.
Sears, Roebuck and Co.

Say You Saw It in Popular Mechanics

MONEY for MEN ALL DATA FREE

THE PLASTEX Industry needs manufacturers on small scale and for big production of Lamp and Clock Stands, Art Goods and Novelties in Plastex and Marble imitation. Experience unnecessary. 1/2¢ material makes regular 10¢ store sellers. Rubber moulds furnished for speed production. Small investment brings good returns. We are now placing big Chain Store Orders with manufacturers. Ambitious men have chance for real prosperity. Our Free booklet will interest and benefit you.

PLASTEX INDUSTRIES, Dept. A
3400 Third Ave. New York 56, N. Y.

WHAT! NO LIGHTS!

You'll have AC Electricity anywhere . . . anytime with **KATO GENERATORS!**

KATO AC GENERATORS furnish the same kind of AC current as the high lines. Sizes range from 500 watts to 300 kilowatts. Protect yourself from a power failure with a KATO AC GENERATOR. Can be arranged for tractor drive. Also manufacturers of rotary converters, frequency changers, high frequency generators, AC and DC motors and motor generator sets. **WRITE TODAY!**

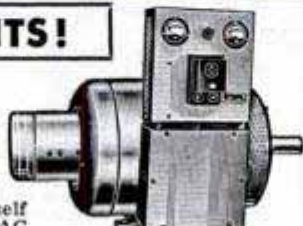

KATO Engineering Company

1402 FIRST AVENUE, MANKATO, MINNESOTA

DECEMBER 1953

This Is a Syncro Electric Jig Saw. It's a Complete Unit in Itself. You can carry it home under your arm, set it on a table or workbench, plug it in, and proceed to work on it.



Now this blade gives you 14,400 smooth strokes per minute, just about 5 times as fast as the ordinary jig saw blade. It is especially well suited to delicate fret saw work and it always cuts that smooth edge that requires no sanding. This last feature alone will save you many hours of time which you would ordinarily spend sanding such things as what-not shelves, magazine racks, fern stands and the many other things that you will like to make.



You will find that all the forests of the world are right at your elbow to provide you with rare and beautiful materials for your handicraft. But even with that, you are not limited to wood. Plastic materials are now appearing in a large variety of colors.

For instance, catalin, a molded plastic. It is comparatively easy to work on this jig saw and takes a beautiful polish. Not quite so easy to work, however, as bakelite. Bakelite, for a cast plastic, is hard and brittle and the ordinary saw cuts kind of a splintered or split edge on it. But the high speed and the fine teeth in these Syncro blades always insure a clean cut. You will find that these various plastic materials are particularly nice for working out such things as monogram pins, belt buckles, picture frames and wall lamps.



Now comes the best news of all. Parents especially are glad to know that here is a power jig saw that is safe also for boys and girls to use. Accidental injuries on this machine, even the slightest cuts, are very rare. Serious injuries are impossible. Now that may seem strange to you but the reason is very simple . . . the Syncro blade does not "pull" the "work" or finger towards it as belt-driven jig saw blades do.



If you happen to have seen a Boy Scout Troop doing handicraft metal work, you will always find a jig saw one of their main tools. Perhaps you have various ideas that you would like to work out in metal; a name plate out of aluminum, a shadow lamp out of copper, or book ends out of brass. You can do all these things on this same machine using the same one blade to cut all those different types

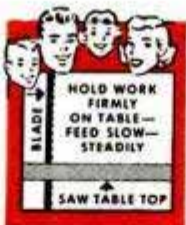

of metal, as well as wood, cardboard, etc. And remember that you can do all these things without a great deal of expensive equipment. Actually with only one machine — one jig saw and one blade — one saw you can carry home under your arm, plug it in and go to work on it. It comes complete with 6 blades and there is nothing else to buy. No belt, no pulley, no motor, or anything else. It is all complete (including built-in motor) in this one unit. The built-in power unit is also guaranteed against burn-out all during your ownership or is replaced free.



Syncro is a precision-built, UL-Approved, durable tool, and will last for years. Syncro electrical precision products have been made for 30 years. Your hardware dealer should have one on display.

However, if he is out of stock or no store is near you, send only \$24.95 direct to Syncro Corporation, Dept. D-123, Oxford, Michigan, and your Syncro Jig Saw No. 201 will be shipped to you postpaid. Use it 10 days, then if it does not please you 100%, return saw postpaid to Syncro and your money will be promptly refunded. Or send postcard for Free Circular of Syncro Saw and Syncro Sanders.



100%

MAGIC HAND CLEANER

7-11 LIQUID HAND SOAP INSTANTLY REMOVES
 • GREASE • TAR • PAINT
 • INK • CHEMICAL STAINS
FROM THE HANDS!



A heavy duty hand cleaner that cleans without abrasives! Shake ten drops or so of speedy acting "7-11" on the hands — work in — and rinse off. Grime, grease and stains—even paint, tar and ink — wash off like magic. No need of harsh abrasives that damage the skin and promote infection. Non-allergic, amazing "7-11" **HAND CLEANER** does not dry out the skin or injure it in any way. Indispensable to every workman, mechanic, painter, printer or hobbyist. At your dealers or send \$1.00 with name of your nearest dealer for full 12 oz. self-dispensing can, sent postpaid. Money-back guarantee. Send today!

DEALERS — DISTRIBUTORS

Write for full particulars and quantity prices!

KNOX SOAP COMPANY

3304 W. Cermak Rd., Chicago 23, Ill.

NEW, IMPROVED CALCULATOR FOR WOODWORKERS only 25c



Instantly gives information on lumber, nails, concrete mixes, painting materials, etc. Convenient, simple to read. Just set dial for nail specifications, to convert linear to board feet, find bit sizes for screws, compare characteristics of woods. 6" diameter heavily varnished cardboard. Send 25c, no stamps, please to Greenlee Tool Co., 2112 Columbia Avenue, Rockford, Illinois.

SILVER SOLDER TORCH & KIT \$7.95

JOINS ALL METALS PERMANENTLY
 Do your own repairing. KIT includes one tube silver solder paste and 10 5-in. lengths silver solder alloy. Hot-test ALCOHOL TORCH known. 2700° F. flame. Operates in any position, indoors or out. Pint of special fuel included. Complete outfit ready for use \$7.95 postpaid. TORCH alone with pint of special fuel \$6.85. KIT alone \$1.65. Instructions included. AMERICAN PRODUCTS CORP., 422 S. Dearborn, Dept. 3-L, Chicago

Our 673rd Advertisement REAL DIESEL ENGINE

\$3.95
 • for planes, boats, midget cars
 • 7500 RPM; 1/7 HP; ht. 3 1/2"; wt. 5 oz.
 • precision machined for smooth operation
 You just can't beat this price for a precision diesel engine! Streamlined, compact, easy to install. Thousands of satisfied users all over the world. Fast delivery if you ORDER TODAY! Send \$3.95 plus 25c postage.
 GOTHAM HOBBY CORP. Dept. P, 107 E. 126th St. New York 35, N. Y.

ELIMINATE VIBRATION WITH THE NEW

Dymondcut WHEEL DRESSER
only \$10.00
 Features genuine industrial diamond with micrometer adjustment.

Keep your grinding wheels in perfect condition with Dymondcut Dresser. Less vibration, minimum burning, greater grinding speed, longer life, finer accuracy, better finish. Dresser rests on and is guided by the tool rest of the grinder. Diamond can be adjusted to meet requirements. The perfect tool for home workshops, industry, auto mechanics and other trades. Priced at \$10.00 plus 30c postage. Send check or Money Order for yours today.
 H. B. Hazerodt Associates • 414 Ford Bldg., Detroit 26, Mich.

CUTTING GLASS is EASY

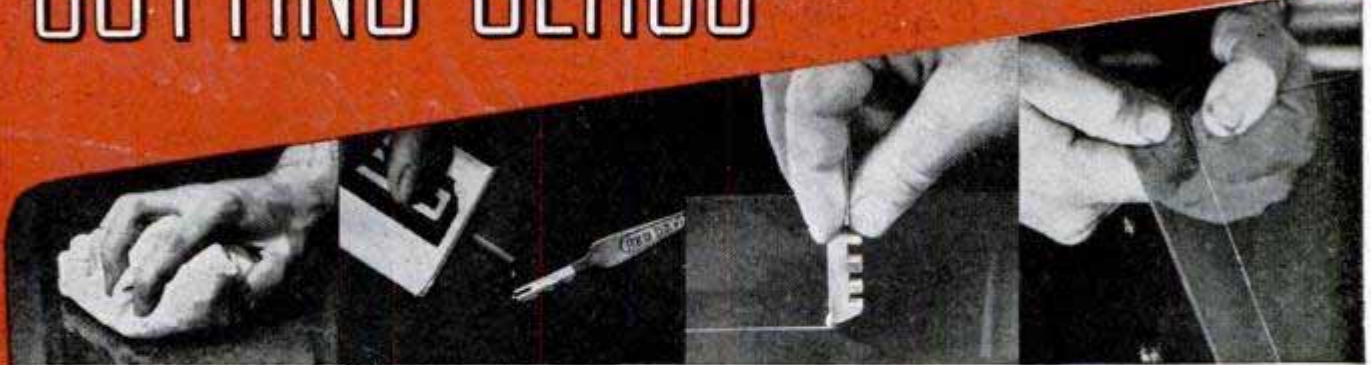

Wipe glass clean with clean rag. Get rid of all dirt or film which prevents the glass cutter from making a uniform cut.

Lubricate the wheel of your Red Devil glass cutter using any household oil. This supplies oil to cutter wheel and reduces friction between glass and edge of wheel.

Always make an even, continuous stroke across the whole surface and off the edge of the glass. Never cut twice. Practice cutting scrap glass, first.

To break glass, hold firmly on opposite sides of cut line. Give quick bending motion away from cut, keep fingers close to cut. Break right after cutting so cut does not get "cold."

EASY as this, if you have the right tools and know how to use 'em.

your ...

Red Devil

Hardware or Paint Dealer can take care of both those needs. Get full details by getting your free copy of Red Devil's booklet "How To Cut Glass" from your dealer or mail coupon today! Remember—you want Red Devil Tools—



the kind professionals use.

Red Devil Tools.

Dept. 802
Irvington 11, N. J.

Please send me "How To Cut Glass"

Name _____

Address _____

City _____ State _____ 3035

FREE 24-PAGE BOOKLET

Seal Heat IN, Seal Cold OUT



WITH
Bridgport
INNER-SEAL
WEATHER STRIPPING

Keep heat IN, seal drafts OUT — weather-strip with tough, flexible, waterproof INNER-SEAL! New booklet shows you how! INNER-SEAL's exclusive patented construction — spring steel molded in live sponge rubber — makes a pressure-tight seal that keeps air leaks out for good. Adjustable . . . fits perfectly even on warped frames. Easy to install — lasts for years.



Send for FREE copy of the new 24-page booklet "Why & How to Weather-Strip", and sample of INNER-SEAL.



WRITE DEPT. PM-12

BRIDGEPORT FABRICS, INC., BRIDGEPORT 1, CONN.

DECEMBER 1953

AT LAST! A PRECISION LEVELING INSTRUMENT FOR ONLY \$1295



Any leveling job is a cinch with LEVELALL. It's speedy . . . easy . . . accurate . . . economical.

For LEVELALL is a 75' transparent plastic tube with shut-off valves, mounting brackets and filled with a special anti-freeze liquid. And here's how it works: fasten tube brackets to forms, etc., snap open the valves and the liquid gives two accurately level points. The job is level . . . no doubt about it. It's as easy as hanging up your hat.

Now, all alone, you can quickly level points for footings, forms, piping, batter boards, sills, lintels, floors, ceilings, roads, driveways, lawns and all types of construction work without a transit.

Send today for your free copy of "On the Level," a booklet that tells and shows how to use the LEVELALL . . . better yet, order a Deluxe LEVELALL. Clip and mail the handy coupon now! Money-back satisfaction guaranteed. Dealer inquiries welcome.

LEVELALL

LEVELALL, 87-N Webster St., Rockland, Mass.

Please send free booklet. "On the Level." Mail me Deluxe LEVELALL @ \$12.95 Regular 50' model at \$9.95 Ship postpaid full price enclosed. Ship C.O.D.

Name _____

Street _____

City _____ Zone _____ State _____

[In Canada, prices slightly higher; write LEVELALL, INC., 5465 Decarie Blvd., Montreal, Que.]

GIFT SUPREME»

FOR THE
Home Handyman



you can **DO**
so much **MORE**
so much **BETTER**

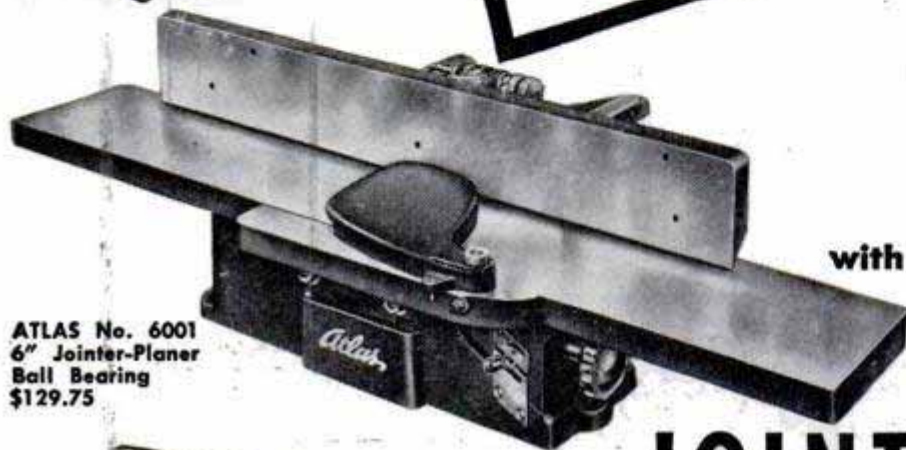

ATLAS No. 6001
6" Jointer-Planer
Ball Bearing
\$129.75



ATLAS WORKSHOP
No. 6050
4" Jointer-Planer
Ball Bearing
\$57.75

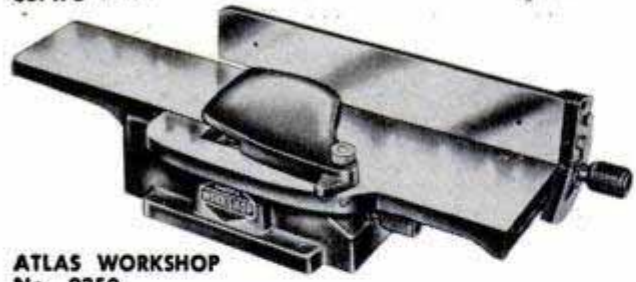

ATLAS WORKSHOP
No. 9350
4" Jointer-Planer
Bronze Bearing
\$31.50

with an *Atlas*
JOINTER-PLANER

If you want him to have America's finest 6" jointer-planer, get him an ATLAS 6001. Greater capacity and accuracy. Solid steel cutter-head-spindle (weighs 10 lbs.) Easily removable for resharpening blades without disturbing blade settings. Grey-iron tables, 42" overall, precision ground to .005 tolerance. Sealed-for-life ball bearings. Many exclusive superiorities. Also available in 4" ball bearing and 4" bronze bearing models. Use coupon for FREE literature and name of nearest franchised ATLAS dealer.

ATLAS makes machine tools for America's leading industries. This same precision goes into ATLAS woodworking power tools. Your assurance of plus-quality in circular, band and jig saws, drill presses, lathes, sanders, shapers is the ATLAS name. Write for illustrated catalog.

ATLAS PRESS COMPANY
1224 N. Pitcher St., Kalamazoo, Mich.

Please send selections I have checked:

Woodworking Power Tool Catalog. FREE

20-PLAN BOOK 50c 18-PLAN BOOK 50c (65c outside U.S.A.)

Name _____

Address _____

City and State _____

"DO-IT-YOURSELF"

WITH THESE LOW-COST, PRACTICAL

PLAN BOOKS

FREE CATALOG WRITE TODAY

1. **20-PLAN BOOK** — original furniture designs by noted authority. 50c
2. **18-PLAN BOOK** — outdoor equipment woodworking projects. 50c

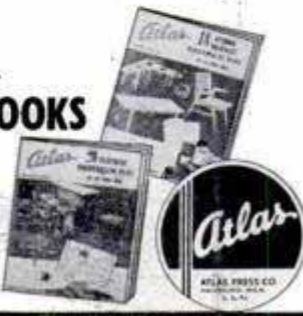

SOLD ONLY THROUGH FRANCHISED ATLAS DEALERS

She'll love this "YOURS and HERS" wardrobe

It's easy to make with
NOVOPLY®

Handsome . . . functional . . . yet all materials cost less than 1/2 price of ready-made Cabinet. This rich looking wardrobe made of California Redwood Novoply is the modern way to keep clothes neat. Has loads of hanger space behind sliding door, pull-out tie rack and 5 see-in drawers. Send for Easi-Bild* Pattern No. 139 (\$.60) which lists materials needed. Simplified step-by-step directions for cutting and assembling. Build It Yourself Patterns take the mystery out of building.

*T. M. REG. EASI-BILD PATTERN CO.



Novoply by

Weldwood®

UNITED STATES PLYWOOD CORPORATION

World's Largest Plywood Organization

Weldwood Building, 55 West 44th St., New York 36, N.Y.

U. S.-MENGEL PLYWOODS, INC.
Louisville, Ky.

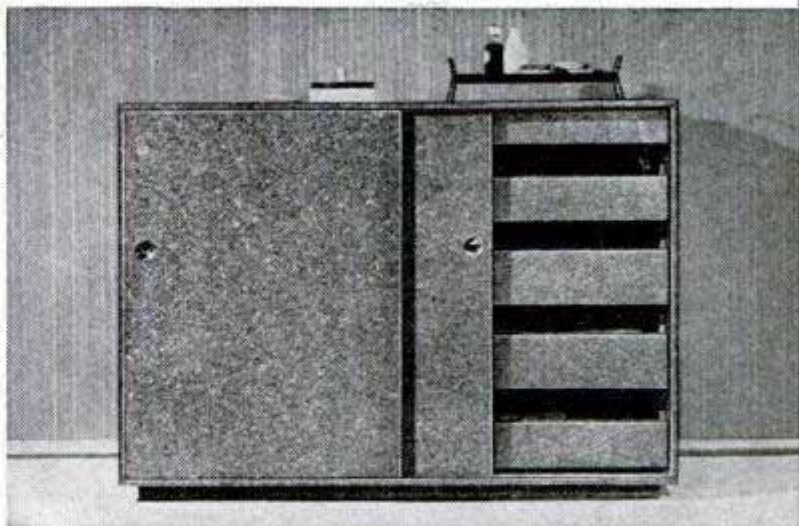

United States Plywood Corporation
Pattern Department, P.O. Box 215
Pleasantville, New York

PM-12-53

Enclosed please find 60¢ for pattern No. 139.

Enclosed please find 35¢ for 32-page pattern catalog illustrating over 200 different projects.

NAME

ADDRESS

CITY STATE

The QUICK-WAY to SHARPEN CIRCULAR SAWS



Now you can do it yourself—save time and money. The new QUICK-WAY Index Plate Circular Saw Sharpener makes your own power table a precision saw sharpener. Guarantees accurate grinding and spacing of every tooth. Complete unit only \$16.50 postpaid, including patented Index Plate block for mitre and \$3.00 grinding wheel . . . Nothing else to buy!

Send check, cash or money order. We pay postage.

Model 6-12P
\$16.50 Postpaid

QUICK-WAY Saw Company
11 Riverside Corning, N.Y.

Say You Saw It in
POPULAR MECHANICS

2 DRILLS in 1

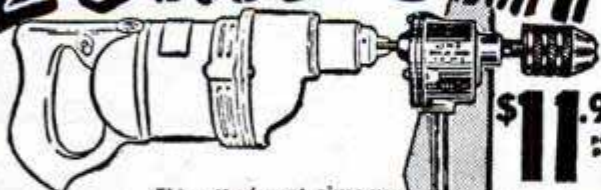

\$11.95
post paid

This attachment gives you two drills in one. It converts any 1/4 inch electric drill to 1/2 inch capacity. Reduction gears reduce the drill speed 5 to 1, the average speed of a 1/2 inch drill, and thereby increases the power. Absolutely indispensable for all shop work and home craftsmen.

Send check or Money Order
Satisfaction guaranteed
Order yours now

G. M. CO. MANUFACTURING, INC.
1308 43rd AVE.
LONG ISLAND CITY 1, NEW YORK

BUILD IT FIX IT with AMBROID



- Ready-to-use
- Fast drying
- High tensile strength
- Transparent
- Waterproof

IT STAYS STUCK

Dries entirely by evaporation of the solvent. Quick setting—no distortion. Ideal for assembling, repairing, home crafts, electrical work, factory, workshop or household use. Send postcard for free literature.

EIE Try Ambroid in your business, too. For over 40 years recognized as the leading industrial adhesive of its type.

Art galleries, museums, and leading industrial concerns, rely on AMBROID

TRY A TUBE TODAY—At most hardware stores and hobby shops. If your dealer cannot supply you, send 30c for big 2 oz. tube, postpaid. Money back guarantee.

AMBROID 303 FRANKLIN ST. BOSTON 10, MASS.



Babco Right Angle Drive for 1/4" Drills—Close coupled, fits on drill spindle. Remove chuck, attach to angle drive. Twice drill speed for sanding or half for polishing. Easy to drill in close spaces. \$4.95 ppd. Heavy-duty angle drive for 1/2" elec. drills \$19.95 ppd.

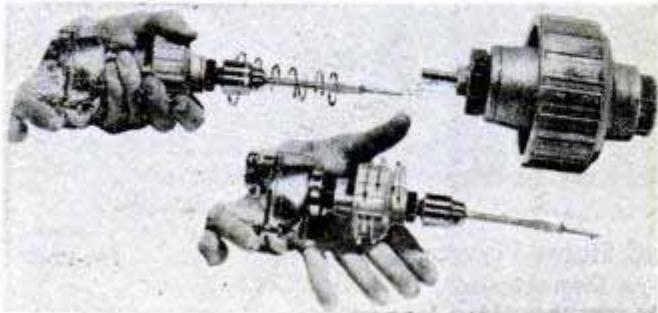

Babco 5-to-1 Speed Reducer Fits 1/4" Drills—Convert your 1/4" electric drill to electric screwdriver—drill holes to 1 1/4" in wood, 1/2" in masonry. Planetary gear system gives tremendous torque increase. Adapters furnished to use 1/4" or 1/2" chuck. Instant starting, stopping with hand clutch control. To operate tool, grip reducer, release to stop. \$9.95 ppd. At hdw. stores and tool dealers or from Babcock Mfg. Co., 6251 Claremont Ave., Oakland 18, California.



Make Your Own!
ASSEMBLE AMERICA'S
Most Beautiful
ALL-ALUMINUM
DOOR CANOPIES
AND WINDOW
AWNINGS



- THE ONLY TOOL YOU NEED IS A SCREWDRIVER
- These awnings are pre-treated, ready for paint. It's easy! Just do the top—the sides are assembled. Designed and engineered by Herbert's—with experience and machinery to sell you a better awning.
- AVAILABLE COMPLETELY ASSEMBLED WITH BAKED ENAMEL FINISH.

DIRECT FROM FACTORY

Save 50%

WRITE FOR FREE MEASURING CHART AND LITERATURE

8974 St. Charles Rd. **Herbert's** St. Louis 14, Mo.

NAME _____

ADDRESS _____

CITY _____ ZONE _____ STATE _____

PLYMOUTH OWNERS SAVE MONEY!



Learn How to Make Your Car Run Better . . . Last Longer . . . and Save Hundreds of Dollars!

Get this book, written especially for you, without one penny of risk and get more out of your car. Mail coupon for **MANUAL FOR PLYMOUTH OWNERS** today. When the book comes, skip through the pages and see how your investment in one of America's most popular automobiles can be even a better investment than you thought. If you don't agree, send the book back and you'll get your money back.

A Popular Mechanics Book Written Just for You

Not a re-hash of service manuals. A complete new Popular Mechanics book written for the Plymouth owner by an outstanding automotive authority with the full cooperation of Plymouth engineers and service directors. It will save you money on repairs and service; make your Plymouth last longer; give you safe, economical and trouble-free motoring. And this is true whether you take your Plymouth to a regular service station or service it at home.

Prevents Trouble. Cuts Down on Repair Bills

Nothing like this manual anywhere. It covers all phases of operation, service and maintenance. It has entire chapters on the individual parts of your Plymouth—battery, ignition, starter, generator, regulator, lighting, fuel system, engine, lubrication, gasoline qualities, cooling systems, transmission, differential, rear axle, brakes, wheel alignment, tire care, body maintenance, trouble shooting on the road, etc. It covers your Plymouth, new and older models, step by step—bumper to bumper—showing you how parts operate; what can go wrong; how repairs and adjustments should be made and how to avoid all types of troubles.

Money Back if Not Satisfied

Mail the coupon today. Send only \$3.50 or you can pay postman. Money back guarantee protects you.

Official, Authoritative, Practical Information

Written by C. E. Packer, formerly service school instructor and auto show lecturer for automobile manufacturers. Member Society of Automotive Engineers, Special Services Editor of Automobile Digest, contributor to leading magazines, author of some of the biggest selling books on Automotive subjects. Prepared with the full authority and active cooperation of the Plymouth Division of the Chrysler Corporation.

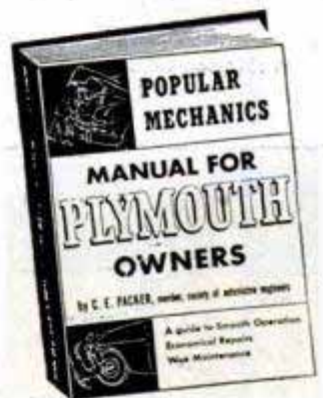

288 Pages. Hundreds of How-To-Do-It Illustrations and Diagrams

The entire book follows Popular Mechanics famous easy-to-read and easy-to-understand style. While primarily intended for the Plymouth owner, to help him get more out of his car at lower cost, it can be worth its weight in gold to the auto mechanic and service station operator who works, not only on Plymouths, but on all other makes as well, to which the information in the book can be easily applied.

Order on this Handy Coupon

POPULAR MECHANICS PRESS
200 E. Ontario St., Chicago 11, Ill.

Send Manual for Plymouth Owners at once. If not satisfactory I will return it within 5 days and you will refund full purchase price.

Remittance for \$3.50 enclosed. Send C.O.D.

Name _____

Address _____

City _____ State _____

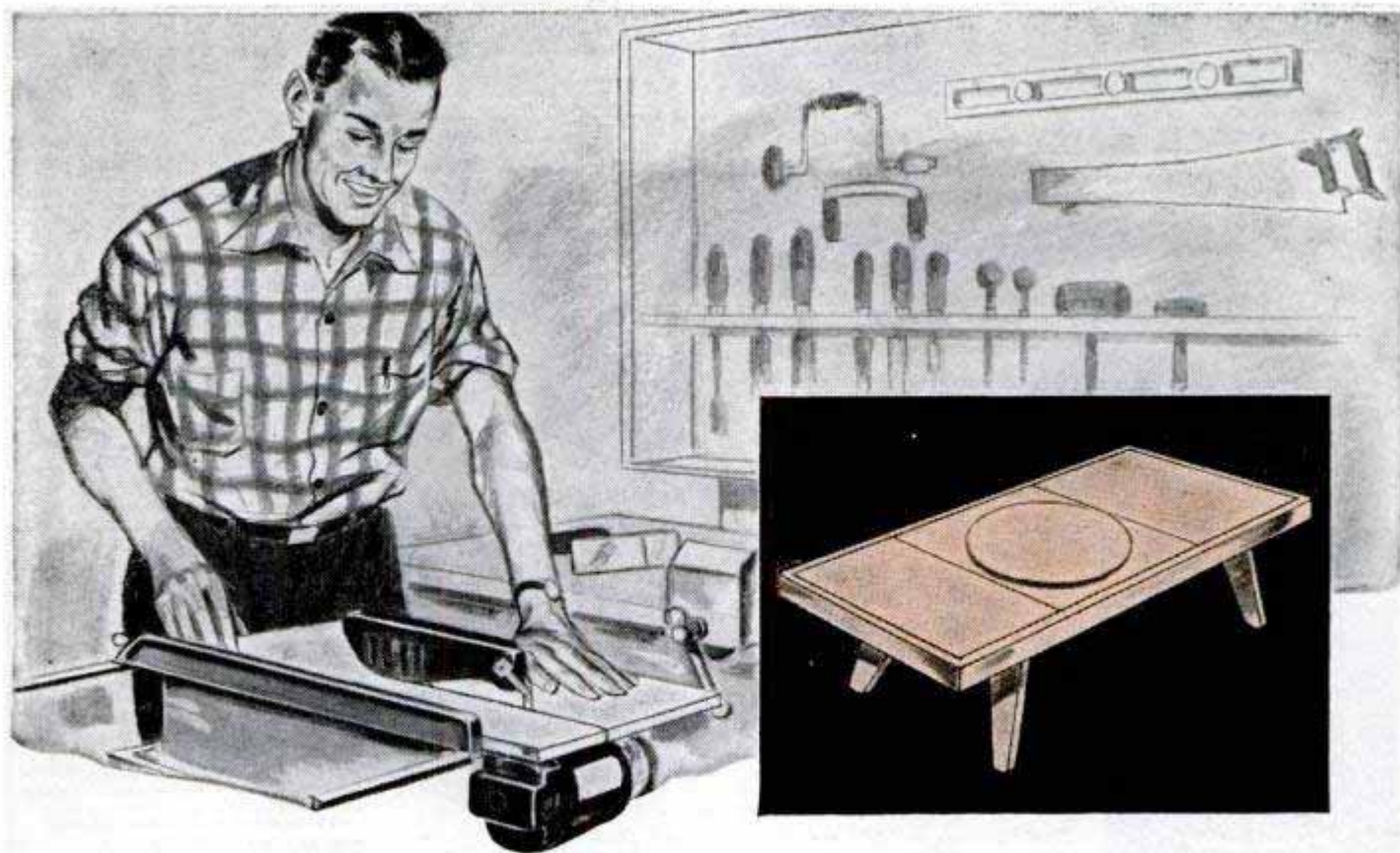

The *HANDY-CRAFT* Motor makes it fun to build this modern coffee table!

Be your own handy man . . . build fine furniture . . . save hundreds of "repair" dollars around your home. Start that home workshop now with a versatile Westinghouse Handy-Craft® Motor. Because it's small, light and easily portable, you can move it around your workshop and home to do 1001 jobs—quickly and easily. You can just mount it and plug it in. You'll like the quiet, maintenance-free operation of Handy-Craft Motor, too. And the name Westinghouse is your guarantee of a quality motor built to last.

J-03014

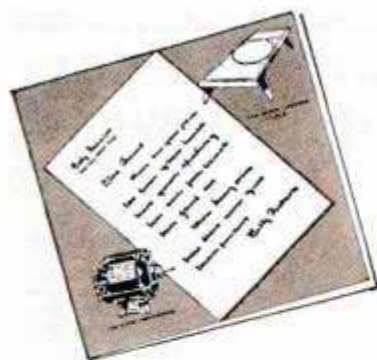

FREE PLANS!

Give complete drawings and instructions for constructing *Handy-Crafter* coffee table right in your own workshop. Offered by Betty Furness on Westinghouse "Studio One" TV. Now available free through your Handy-Craft Motor dealer. Mail in attached coupon for name of your nearest dealer. Do it today!

YOU CAN BE **SURE**...IF IT'S
Westinghouse



WESTINGHOUSE ELECTRIC CORPORATION
Handy-Craft Motors, P. O. Box 5151, Cleveland 1, Ohio

Please tell me where I can get my free woodworking plans for the *Handy-Crafter* coffee table.

Name _____

Address _____

City _____ Zone _____ State _____

PM-12-53

CHISEL AND PUNCH

QUICKLY AND EASILY

WITH **P & C** TOOLS



Buy your P & C TOOLS from this handy display

You go through the toughest metal with ease when you use a tough, rugged P&C Chisel or Punch. Made from special analysis alloy steel, hot forged, heat-treated and specially edged. Every P&C Tool is fully guaranteed and is always "the BEST tool money can buy".

Send 10c today for P&C's complete catalog. All info on over 300 tools.

P & C HAND FORGED TOOL COMPANY

Dept. H-1253, Box 5926
Portland 22, Oregon

REPLACE YOUR OLD WORN OUT CHUCK WITH A

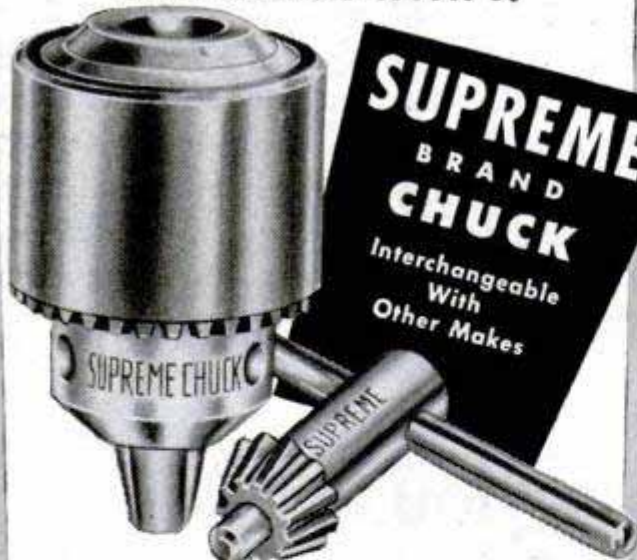

SUPREME BRAND CHUCK

Interchangeable With Other Makes

- ENTIRE CHUCK BODY HARDENED
- JAWS NICKEL CHROME MOLY ALLOY STEEL
- INDIVIDUALLY TESTED FOR ACCURACY
- STURDY ONE PIECE CONSTRUCTION

SOLD BY HARDWARE DEALERS



SUPREME PRODUCTS, INC., 2222 S. Columet Ave.
Chicago 16, Illinois
The chuck that lives up to its name... SUPREME

FILE SAWS THE RIGHT WAY

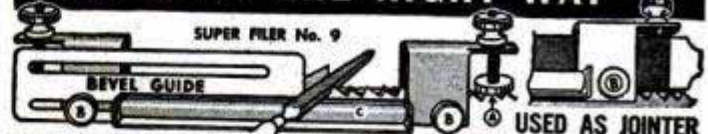

SO EASY with this new filing jig and jointer anyone can now sharpen any handsaw like new! When file hits hardened steel rollers teeth are finished and EXACTLY THE SAME HEIGHT. All teeth cut and saw runs true and smooth. Jig and instructions \$2.95 postpaid. FREE FOLDER.

SHARPEN YOUR CIRCULAR SAWS

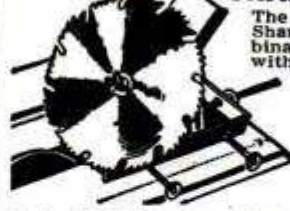

The RIGHT WAY on your own saw table. Sharpens rip, cutoff, hollow ground and combination blades—6" to 10". Saws stay round with correct bevel. Precision made, easy to use. GUARANTEED. Only \$8.95. Includes \$3.00 Grinding wheel.

"TRU-CIRCLE" saw set automatically sets teeth at 10° or more. \$2.95 AT DEALERS OR POSTPAID



A.D. McBURNEY, Dept. A-36
5908 Hollywood Blvd., Hollywood 28, Calif.

The SPEEDY STITCHER

Sews quick and strong, making new or repairing all sorts of leather and canvas articles — boots, shoes, coats, gloves, belts, saddles, golf bags, Ski, Football, Baseball, Skating, Hunting, Fishing, Camping togs, grain bags, burlap, etc.



Each stitcher comes ready to use with a reel of waxed thread and 3 needles, assorted sizes. Needles are carried in handle. A handy tool for home or on hunting, fishing or camping trips.

Price Postage prepaid \$1.00.

LYMAN BRADFORD CO.
Box No. 201 KINGSTON, MASS.

YOU CAN MAKE YOUR OWN SHOWER

easily and inexpensively with our cement stone base (rose colored) and highest quality chrome fixtures only \$19.75 F.O.B. NYC. Write for Free Circular

SAVE 2/3 COST

210 Fifth Avenue MONARCH SALES CO. New York 10, N.Y.



EASIER
QUICKER
BETTER

ROOF FRAMING

Rafter Length and Cuts Without Use of Square!

Lay out any type of roof more accurately and in only one-fifth of the time required by other methods. Get the POULSEN METHOD OF ROOF FRAMING. It will save your time and make money for you. Valuable tables—54 of them—starting with one-quarter inch rise per foot of run—simplify all roof framing problems. Tables give common, hip, valley and jack rafter length and necessary cuts in a jiffy without calculation. Learn also how to measure rafters from top and edge—definitely and accurately. No need to bother with centers and making adjustments for cuts.

Money Back Guarantee

Send your name and address and \$3.00 for your copy postpaid today, or order C.O.D. if you prefer. Money back if not fully satisfied.

For Amateur and Professional

Every handyman, repairman, amateur carpenter and professional builder needs this POULSEN METHOD book. It saves four-fifths of all roof layout time and labor. Everything is already worked out for you in simple, easy-to-use tables. Cloth bound. Book has 90 pages and many illustrations. Besides the tables it contains every other bit of roof information a carpenter, whether amateur or journeyman, should have.

POPULAR MECHANICS PRESS
DEPT. RF 200 E. ONTARIO ST. CHICAGO

New! SNOW SCOOP



WHY SHOVEL SNOW?

The new Reliable Snow Scoop ends back-breaking labor. Snow can be scooped away easily and quickly. There is no lifting the scoop — it glides along easily when full. **LESS EXERTION** — scooping is 3 times as fast as shoveling. It is easy to use, is well balanced and ruggedly built (welded steel body). 24" x 30", painted Reliable Red. Be ready for that first snowfall. Order yours today . . . only \$13.95 delivered.

RELIABLE SNOW SCOOP COMPANY
426 Lisbon Street Lewiston, Maine

MACMILLAN RING FREE Xtra Heavy Duty is the ONLY motor oil to GUARANTEE:

- to prevent Valves and Hydraulic Lifters from sticking
- to reduce Engine Ping... or Your Money Back!

For further information write: R. S. MACMILLAN, PRES.
530 West 6th St., Los Angeles, Calif.

PLANS 35c ARC-WELDER 85-110 AMPS. A.C. USES OLD GENERATOR COILS

WE SHOW YOU HOW simple it is to build this POWERFUL welder from old auto generator. Has 20 heats. Operates on 110 or 220 volts A.C. Thousands built and now in use. Save dollars. Do your own repairs. Make money welding for others. Complete plans—35c. Write for FREE War Surplus Catalog.



LEJAY MFG. CO. 3347 LeJay Bldg. Minneapolis, Minn.

MACHINE SHOP EQUIPMENT

The NEW edition of the famous Center Tool Co. Catalog is now ready! Every workshop owner should have a copy. 240 pages full of illustrations, descriptions, and prices of the latest tools made by best known manufacturers in U.S. You pay the cost of printing — \$1.00. We refund your \$1.00 with first order of \$25.00 or more. Prompt delivery on most tools. Send check or money order today!

CENTER TOOL CO.
153 Centre St., Dept. C, New York 13

Say You Saw It in Popular Mechanics

FORCED AIR

INSTALL IT YOURSELF AND SAVE UP TO \$200

CONVERT YOUR GRAVITY FURNACE TO MODERN QUICK FORCED AIR HEAT. INSTALL McLARTY FANS IN YOUR COLD AIR PIPES. NO SHEET METAL WORK REQUIRED. SIMPLE ELECTRIC CONNECTIONS. CALL YOUR HEATING DEALER OR WRITE US.

McLARTY SYSTEMS — 2607 DICKMAN RD. BATTLE CREEK, MICHIGAN

In Canada Write WINNIPEG SUPPLY & FUEL WINNIPEG, MANITOBA

FREE CIRCULAR

ceilings cracked? need more room?

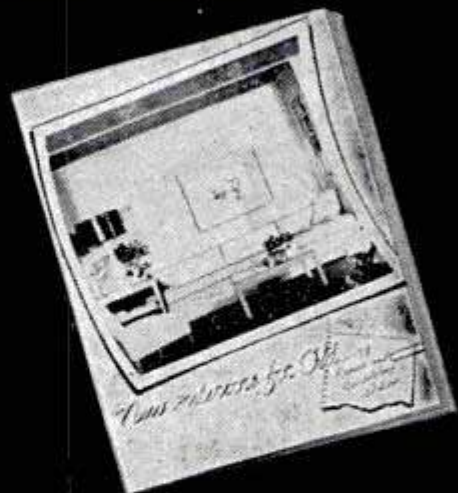

SEND 10c FOR ILLUSTRATED, FULL COLOR 32 PAGE IDEA BOOKLET

Tells how to do it yourself at low cost with Upson Panels.

Booklet packed with photos, step by step how to do it illustrations. Many pages in glorious full color. If you plan to repair or remodel, here's a booklet you must have.

Contains 79 repair and remodeling ideas. Plus 2-page color harmony guide worked out by experts, printed in rich full color.

Also, numerous sketches show ideas for extra storage space, closets, play corner for the kids, many more.

Discover how easy it is to do it yourself with Upson Panels. They're crack-proof, washable, paint beautifully.

FREE WITH BOOKLET. Yours, free of any extra cost, complete working drawing for building a storage wall. Also, on request, free booklet on new Upson All Weather Panels.

UPSON

Proven quality you can trust

Upson Strong-Bilt Panel, Upson Kuver-Krak Panel
new Upson All Weather Panel.

Mail coupon and 10c for your booklet today!

THE UPSON COMPANY

51112 Upson Point, Lockport, New York

I enclose 10c. Please rush me 32 page IDEA booklet. Plus FREE plans for storage wall.

Name _____

Address _____

City _____ State _____



BERNZ O-MATIC TORCH

Torch complete
ONLY \$6.95
at your hardware store. Replacement cylinder...\$1.95

Solders in a jiffy, burns paint, antiques furniture—lets you do hundreds of jobs yourself and saves you money.

Instant lighting, lightweight, compact. Disposable cylinder contains enough fuel for months of normal use.

FREE BOOKLET SHOWS YOU HOW TO USE TORCH FOR MANY JOBS

Send for booklet today. Write:

OTTO BERNZ COMPANY, Inc.
283 Lyell Avenue • Rochester 6, New York

BUILD YOUR OWN POWER TOOLS—TILT/ARBOR SAW

Exclusive GIL-BILT Build-It-Yourself Features

- No machining—build easily with hand tools only
- No blueprint reading—step-by-step pictorial plans, full scale patterns, actual photographs
- Sturdy wood, aluminum and steel construction
- Capacity and performance of commercial saws selling for \$60 and up
- Proved performance. Nationally advertised and sold for 6 years. Satisfied customers around the world.

**BANDSAW
BELT SANDER
SAVE \$50.
OR MORE**

GIL-BILT 10-INCH TILTING ARBOR SAW



- 27x28 in. table, 13 1/2 in. capacity in front of blade
- 10 in. blade cuts 3 1/4 in. deep, tilts full 45 degrees
- Floor model 34" high, table always stays level

- New Departure ball bearing arbor, 3/4" precision shaft turned down for 5/8" bore blades, alum. housing, shipped ready to run
- Jackscrew and 4 1/2 in. dia. handwheel lowers and raises blade
- Cast aluminum miter gauge and self-aligning rip fence guide

GIL-BILT Metal Parts Kit includes Plans, ball bearing arbor, miter gauge and bar, rip fence guide, dado insert, lock knobs, jackscrew mechanism and handwheel, and all other metal parts (less blade).....\$22.95
Same Kit with 10" Combination Blade \$25.90
Same Kit with 8" Combination Blade \$24.90

GIL-BILT 12-INCH BAND SAW

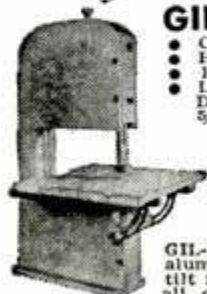

- Cuts to center of 24 inch circle
- Handles stock up to 6 inches thick
- 18x18 inch table tilts 45 degrees
- Lower wheel and drive pulley runs on sealed New Departure Ball Bearings. Upper wheel runs on two 5/8" bore Gilite Bronze bearings.
- Upper wheel tension and tilt mechanism of cast aluminum, completely assembled.
- Upper and lower blade guides. Each has ball thrust bearing, self-lub bronze jaws.
- Rigid cast aluminum wheels fully machined ready-to-install. Heavy rubber tires.
- Uses standard 78 inch blades up to 3/8 in. wide.
- Fully enclosed mechanism for utmost safety.

GIL-BILT Metal Parts Kit includes Plans, rubber tires, aluminum wheels, 1/4 in. blade, ball bearing spindle, tilt mechanism, blade guides, table tilt segments, and all other metal parts.....\$23.95

Return Kits in 10 days for refund if not satisfied.
For shipment up to 600 miles, add 5%; over 600 add 10%.
Amount in excess of actual postage will be refunded.

Also available—Plans and Parts Kit for 18" Band Saw, Belt Sander and 8" Tilt/Table Saw. Order Plans at \$1.00 each—Sent postpaid anywhere in the world or write for FREE descriptive catalog.

GILLIOM POWER TOOLS P. O. Box 1-PM, Lambert Field St. Louis 21, Missouri

SAVE MIDDLEMAN'S PROFITS ...buy DIRECT from C&H

LIGHT PLANTS



1000-1200 w AC, 115 v, 60 cyc. Powered by rugged 2 1/2 hp easy-starting Continental gas engine. No wiring. Just plug in, ready to go. Complete with 12 v starting winding. Easily connected for push-button battery starting. Fully guaranteed, easily worth \$325. Your Factory Price only \$194. Other bargain price models in stock, 300, 1500, 2500, 5000 w etc. SEND FOR FREE BOOKLET WITH VITAL FACTS ON HOW TO SELECT PROPER SIZE FOR YOUR JOB.

BOOSTER FANS



Fit any 8" to 12" furnace pipe. Mounting frame, 7" blade, 110v motor, 60 cyc. 1550 rpm with 6' cord. Silent operation. Easy to install. Warm those rooms with long runs. List \$11.95. Our price... \$6.95; two for \$11.95; three for \$14.95. Buy one for each room! REGISTER FAN for hot or cold air with bracket ready to mount; motor, 7" blade, 6' cord ONLY... \$7.50; two for \$12.95; three for \$16.95.

Here are only a few big \$\$\$ savings! More in our catalog!

Air Compressor	Electric Motors	Hand Truck	Rubber Cable
Air Tank	Electric Switches	Hydraulic	Rubber Wheels
Block & Tackle	Elevator	Cylinder	Saw Tables
Blowers	Drawing	Hydraulic	Shower Sprays
Bomb Trailer	Elevator Incline	Stacker	Starters
Buzz Saw	Fans, Exhaust	I Beam Trolley	Tools
Compressor	Fans, Heat	Lawn Mower	Transformers
Accessories	Booster	Sulky	Whiting Hoist
Clutches	Gas Engines	Magnetic Starter	Winch, Electric
Conveyors	Generators	Mail Chain Saw	Winch, Hand
Delta Tools	Grinders	Mail Grinder	Fire Extinguisher
Drop Cords	1/2 Ton Wagon	Pumps	4 Wheel Trailer
Electric Hoists	Hale Fire Pump	Reduction Gear	

Get this catalog! 72 pages packed with useful charts, information, more than 1100 tool and equipment items at money-saving, factory-to-you prices. Send 25cc (refund with first order) or write on company letterhead for free copy.

C&H ELECTRIC MACHINE Co. Inc.

434-A W. Juneau Ave., Milwaukee 3, Wisconsin

WONDER RAT GLUE BOARDS

A SURE WAY TO GET RID OF RATS and MICE

Catch Rats and Mice Like Flies on Fly Paper. No Springs — No Poisons.

\$9 PER DOZEN **SAMPLE BOARDS \$1 EACH**



STAR EXTERMINATING CO., 2958 Nostrand Ave., Brooklyn 29, N.Y.

HELPFUL BOOKS

Send post card asking for FREE catalog

Popular Mechanics Press, 200 E. Ontario, Dept. 601, Chicago 11

PAGE Tractors

Do The Job Faster—Easier—At Less Cost!

DOES TILLING, PLOWING, DISKING, Dozens of other jobs



Rugged 1954 riding, walking models 2 to 6 HP. All gear drive with reverse. Over 60 attachments! No belts, no chains. Fully Guaranteed!

Over 25 years' experience

Free Catalog—

PAGE 1904 S. 81st St. Milwaukee, Wis.

Do a Real Professional-Like Job Yourself and SAVE

HOW to PAINT With Brush and Spray

Covers All Painting Methods and Materials

You can do professional-like painting and finishing jobs yourself and save about two-thirds of the cost. Sam Brown, noted craft authority, makes it so easy for you in his book, HOW TO PAINT WITH BRUSH AND SPRAY. Order your copy now and enjoy this tremendous saving. It covers exterior painting, wall and interior decorating, furniture finishing, concrete painting — every type of painting with brush, spray gun, roller and other methods. Tells what finish is best; what materials to use, etc. No previous experience needed. Fully illustrated. Order by mail. Only \$2.50. Money back if not pleased.

POPULAR MECHANICS PRESS, Dept. PM18 200 E. ONTARIO ST., CHICAGO 11, ILL.





A
**Christmas
 Favorite
 for 42 years**

Northland SKIS

Beautifully hand crafted . . . a model for every skier. Giving or receiving, every winter sports enthusiast prefers to see internationally famous Northland skis under the Christmas tree.

 Look for the
Deer Head Trademark

Write for **FREE**
 booklet on how to ski

NORTHLAND SKI MANUFACTURING CO.
 95 Northland Park, North St. Paul 9, Minn.

WORLD'S LARGEST SKI MANUFACTURERS

MAKE BIG MONEY!



Be a floor surfacing contractor and sand both new and old floors. Sanders are easy to operate and better still, you're your own boss. Write for latest "tell-all" booklet entitled "Opportunities in Floor Surfacing", enclosing 25 cents in coin or stamps to cover handling.

AMERICAN

FLOOR SURFACING MACHINE CO.
 535 So. St. Clair Street • Toledo 3, Ohio

WHOLESALE ELECTRIC GUITARS—HEARING AIDS

Accordions, amplifiers, double-necks, triple-necks, pick-up mikes, mandolins, non-electric instruments, etc. 1954 MODELS WHOLESALE. FREE CATALOG FREE home study course with instruments. Specify catalog, musical instruments or hearing aids

CARVIN CO. Box 28 P.M. 12
 Baldwin Park, Calif.

STOP RADIO & TV NOISES INSTANTLY!

NEW ELECTRONIC DESIGN

Bell-Tronic line filter eliminates noisy interference caused by motor appliances, autos, oil burners, etc. Simply plug radio or TV cord into filter and filter into wall socket. Enjoy Bell Clear reception. Send \$1 ppd. No C.O.D. Try 5 days. Money back guarantee.

\$100
 PPD.



TUBE WHOLESALERS CO.
 Box 364, Dept. PM2, Rockville Centre, N. Y.

FILE SAWS FOR PROFIT!

BeMaCo Rapid Saw Filer

MAKES SAW FILING EASY.

Opens the door to extra profits. A power driven filer that takes the work out of saw filing. Anyone can operate it. Gives full control to the operator. Priced Right. Write for literature today!

BeMaCo Automatic Saw Set —

Uniformly sets 400 teeth per minute on hand or band saws. Perfect hammer and anvil action. Acclaimed by saw shops across the country.



**START
 EARNING
 TODAY!**

BEAVER MFG. CO.

Saw Machine Div. 7-C

800 S. ISIS AVE. • INGLEWOOD, CALIF.

CHANNEL LOCK pliers

The most versatile tools on your bench



insist on...

CHANNEL LOCK

TRADE MARK REG.

U. S. PATENT OFFICE



here's why

Look for the Channellock line when you're shopping for hand tools. Channellock pliers offer features that you can't get with other makes. And when you buy a Channellock plier, ask to see the full line — you'll find a style and model to do any job better.



CHANNEL LOCK

TRADE MARK REG. U. S. PATENT OFFICE

THE PLIER DESIGN THAT OBSOLETE ALL OTHERS

CHAMPION D^oARMENT TOOL CO. • MEADVILLE, PA.

**RIGHT AT THE TOP
ON MY LIST!**



NO. LP500

TURNER

LIQUEFIED **LP** PETROLEUM

TORCH

WITH
DISPOSABLE FUEL TANK

Lights Instantly!



Here is a really fine tool of exceptional quality . . . one that you'll find handy, clean, ready and easy to use for soldering, light brazing, hobbycraft work, dozens of do-it-yourself jobs around the house! Never requires filling . . . you just replace entire fuel tank (they're available at your dealer) as needed. Has *all-brass burner and fittings*, I.C.C. approved heavy-gauge large-diameter tank, pressure relief valve, wide-range positive-control flame adjustment. Tank measures 2-7/8" diameter x 9-9/16" high; fits conveniently in tool box or pocket. Tell your favorite Santa Claus — now — that you want this Turner LP Torch. Remember, too, it's a wonderful gift item for you to give a friend. Visit your dealer today . . .

LOOK... SPECIAL ACCESSORIES, TOO



Chisel Point Soldering Tip



Pointed Soldering Tip



Heavy Duty Burner



Flame Spreader

\$695

COMPLETE

Replacement Fuel Tank

\$195

SEE YOUR DEALER

THE TURNER BRASS WORKS

SYCAMORE ILLINOIS

Since 1871



Flashlight Bulb Throws Flood or Spot

Flipping a switch will make new flashlight bulbs developed by General Electric throw either a flood or a spot of light. Like automobile headlamps, they contain two filaments, either of which may be turned on independently. Flashlights now being designed for the new bulbs will have three push-button positions—off, spot and flood.

Plug-in Electric Muffs Warm Hands and Feet

You can warm chilled feet in a matter of minutes with a pair of plastic slippers that are heated by electrical coils. They'll work on AC or DC and build up to 125 degrees Fahrenheit—warm enough to coax circulation back into your feet, but not too hot for comfort. Similar heated envelopes come in the shape of mittens for hand beauty care. The lady smears hand cream on her hands, puts them in plastic envelopes to keep from soiling the mittens and then dons the outer mitts. Heat opens the pores and allows the cream to work its way into the skin. The maker claims that his mittens and slippers aid circulation and help soothe rheumatic pains.



YOU, TOO, CAN START A \$40 A DAY BUSINESS IN YOUR SPARE TIME!



Andy Phillips says:

"My BELSAW Sharp Smith gives me big profits at low expense—I can run 35 to 40 circular saws in an 8-hour day—that makes me \$40 cash—I also get BIG EXTRA PROFITS... grinding planer and jointer knives—always a demand for this kind of work."

You can start this REPEAT CASH business in your own home or garage while you are working at your regular job. Easy to operate, no experience needed. "My BELSAW paid for itself the first month."—H. J. Opie

For as little as \$15 down payment, you can get your BELSAW Sharp Smith rushed to you.

YOU can start making money the very day your BELSAW Sharp Smith arrives. Hundreds of jobs in your own neighborhood. No extra equipment needed, no canvassing.

FREE book tells how ▶

The new BELSAW Free Book "Lifetime Security In Your Own Business" tells how easily you can start a big REPEAT CASH business. Send Today for your FREE copy.

BELSAW MACHINERY CO

3705 Field Bldg. Kansas City 11, Mo.

BELSAW MACHINERY CO
3705 Field Bldg., Kansas City 11, Mo.
Send FREE Book, "Lifetime Security".

Name _____
Address _____
City _____ State _____

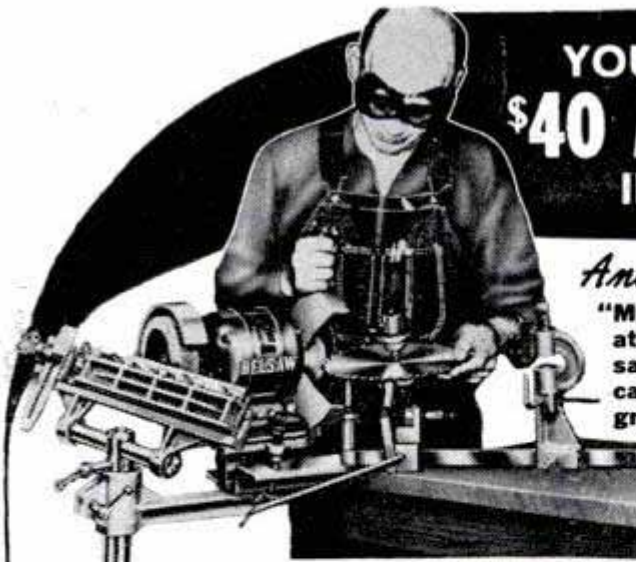

A COMPLETE LOW-COST REPAIR SHOP...

Your BELSAW quickly sharpens all popular circular saws.

Your BELSAW easily gives uniform set to all popular circular saws.

Your BELSAW puts keen edges on planer and jointer knives and plane irons.



World's Outstanding MICROSCOPE BARGAIN!

Lifetime Christmas Gift **\$9.95** postpaid complete



MODEL 300—100, 200, 300X, triple revolving turret microscope with cabinet, handbook-manual, prepared and blank slides—all inc. at 9.95 ppd. Years of adventure at a never-equalled price.

MODEL 600—150, 300, 600X, standard type \$29.95.

MODEL 800—75, 150, 300, 600X, prism type \$39.95.

HOBBY SUPPLY CATALOG

FREE! All materials to make your own slides, larger microscopes, 44 pages. Inc. with your order or mailed on request.

10-DAY MONEY-BACK GUARANTEE

Send check or M.O. for Christmas delivery. Calif. resid. add 3% state tax.



62 Akron Bldg., 4379 Sunset Blvd.
Los Angeles 27, Calif.

DECEMBER 1953

It's Fast! Powerful! Lightweight! AMAZING NEW GUARANTEED ELECTRIC SANDER

Now at Remarkably Low Price!

Buy direct from factory and save. SANDRITE is the finest orbital motion sander at any price. Does the big jobs fast, but lightweight and so perfectly balanced will not tire you. Change sanding or polishing surfaces quickly, easily. CARBORUNDUM process or adhesive—will not tear loose! Sturdy—precision made throughout for years of trouble free service. Sealed precision bearings—no greasing or oiling necessary. Use rough abrasive—will not stall—motor won't clog. SANDRITE a professional tool for every use—designed to reach hard to get places. You'll say this SANDRITE is the BEST BUY you ever made. SATISFACTION GUARANTEED!



Order Today
Now, postpaid, only
\$29.75

USE EVERYWHERE FOR SANDING, POLISHING

Perfect ease in handling on wood, metal, plastics, wallboard, plaster. Does rough sanding or fine polishing and finishing. Use it to simonize your car. An all purpose sanding and polishing tool!

SAVES TIME, MONEY, EFFORT

Here is the Electric Sander for every Home Workshop, Fix-It Shop; for building contractors, carpenters, cabinet makers, woodworking factories, boat yards. Large 7x3 7/8 inch surface. Outdoes hand sanding 10 to 1. Sands, Rubs, Smooths, Polishes.

FREE OF EXTRA COST! Order Now—get full size can of CARBORUNDUM Reactivator for adhesive pad at no extra charge. Keeps adhesive pad fresh—use it over and over indefinitely. (C.O.D.'s Accepted—send \$10.00 deposit)

Won't Stall
Sealed Precision
Bearings
Easy on Hand
Operation
Cast from Hi-
Strength Alumi-
num Alloy
Use press-on adhesive
paper with high
cutting capacity
Operate on AC or DC
Hand Control Switch
Extra Long Heavy
Duty Extension
Cord
Quiet in Operation

SKOLD ENGINEERING COMPANY, Dept. PM-12
1911 Irving Park, Chicago, Illinois

New Low Cost HOBART Air Cooled Arc Welder

"Husky Boy"
Welds Anywhere!
Repair
Construction
Production full 200 amp. cap'y.
Does those Big Pay Jobs!



AC Generator Only for building your own comb. welder-power plant.



Electric Drive DC Welder



Welding Lessons \$1.00

Complete operator's training course. 200 pages, fully illustrated.

For General Repair, Anywhere
You can do profitable general shop and outside repair work at a low investment with the "Husky Boy" 200 amp. arc welder. It's compact, lightweight, is easily portable and has an air-cooled gas engine drive. For inside use, easily attachable wheels and handles are available at a slight extra charge.

AC Welding and AC Power
"Build Your Own" combination arc welder and power unit using this AC-AC generator. Makes a big saving in first cost. Comes complete, ready to hook-up to your gasoline engine, tractor or truck.

Be Your Own Boss!
Cash in on the demand for dependable welders—start your own business with the Hobart 300 amp. electric drive welder. No other welder on the market can match it for completeness of equipment, economy of operation and welding range. It's a real all-purpose machine. Hobart Bros. Co., Box M-123, Troy, Ohio
"One of the world's largest builders of arc welders and equipment"

HOBART Trade School
Learn welding quickly, easily in this modern, non-profit school. Complete or partial courses. Best equipment, thorough training, experienced instructors. Ask for free booklet.

Enroll Now!
G.I. Bill approved



Hobart Brothers Co. Box M-123, Troy, Ohio

Send complete details on items checked.

Husky Boy Generator Only Electric Drive DC Welder Hobart Trade School Welding Lessons Book \$1.00

FREE!
 "Welders Vest Pocket Guide"

NAME _____

ADDRESS _____

CITY _____ STATE _____

War Surplus SAVE UP TO 85%



ALTIMETERS Pioneer sensitive altimeters . . . range 0-35,000 feet. Calibrated in 20 ft. increments. Barometric pressure setting adjustment. No hook-up required . . . ready for installation in auto or aircraft.
Used, Good, **\$12.95**



GENERATORS 115 VAC

FOR AUXILIARY LIGHT PLANTS
Here's the buy of the year . . . brand new Eclipse generators in the original box. These generators have an AC output of 115 volts, 9.4 amp, 1000 watts, single phase, 800 cycles, 2400-4200 rpm. DC output is 30 volts at 25 amp. The unit has a spline drive shaft and is self-excited. It will serve as a dependable 115V-AC auxiliary light plant when driven by a gasoline engine for farms, cottages, trailers, boats, flood lighting, or wherever power is not readily accessible. Shipping Wt. 50 lbs. Gov't cost more than ten times selling price.
BRAND NEW \$29.95
All Equipment F.O.B. Pasadena • Enclose Full Amount with Order

C & H SALES CO.

BOX 356-MM EAST PASADENA STA. • PASADENA 8, CALIF.

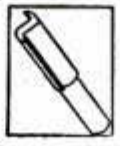

CARBIDE TIPPED ROUTER BITS

OUTLAST STEEL! 3/8" diameter 1/2" shank . . . \$6.75 ea. ppd.
1/2" diameter 1/2" shank . . . 6.75 ea. ppd.
5/8" diameter 1/2" shank . . . 7.25 ea. ppd.
Specials on quotation • Send check or money order.
Edward P. Johnson, 3412 Magnolia St., Oakland 8, Calif.

Guide for HOME ELECTRICIANS

Now You Can Install Fixtures, Make Most of Your Own Electrical Repairs and Save Hundreds of Dollars

Now you can do almost any electrical job that comes up around your home and pocket really worthwhile savings.

Read How — See How

No matter if you want to install fluorescent fixtures, test circuits, repair appliances, or do any one of the many electrical repair jobs that come up, Popular Mechanics' new **ELECTRIC FIX-IT BOOK** tells and shows you how, step-by-step.

7-Day Money Back Guarantee

Use this book in your home for 7 days and return it for a full refund if it isn't more than satisfactory.

Partial Contents
Rewire Your Home for Modern Lighting—Make a Shelf-Light—Service Electrical Home Equipment—Make Porch and Table Lamps—Install Fluorescent Fixtures—Repair a Vacuum Cleaner—Make Home Appliances Last Longer—Etc.



POPULAR MECHANICS PRESS, Dept. EF-1
200 E. Ontario St., Chicago 11, Ill.

Gentlemen:
Send postpaid my copy of **ELECTRIC FIX-IT BOOK**. Remittance for \$2.00 is enclosed. Unless it is entirely satisfactory I may return it within 7 days for a full refund.

NAME _____

ADDRESS _____

CITY _____ ZONE _____ STATE _____

Send C.O.D. (U.S.A. only). Postage extra.

Here's your

NEW ^{SIZE} 2U IMPACTOOL



**This MIGHTY MITE
is a real Multi-Purpose Tool**

SPEEDS

- automotive bench and body jobs
- metal fabrication jobs
- machine assembly and repair
- appliance assembly and repair
- electrical installation and maintenance

The new 2U Impactool will do all these jobs—and do them fast—

- run and remove nuts
- drill
- ream
- tap
- drive and remove screws
- drive and remove studs
- extract broken studs
- saw holes
- drill masonry
- bore wood
- run wire brushes

This newest and lightest Impactool has the time-proved Ingersoll-Rand impact mechanism that has an unmatched reputation for power and dependability in both air and electric Impactools. The "rotary" impacts do all the work. There's no kick or twist to the operator and the motor can't stall or burn out.

Ask for a demonstration of this new powerful little Impactool. Size 2U Impactool only \$97.50, also available in metal kit with multi-purpose attachments. You'll find it featured by leading automotive jobbers and industrial distributors from coast to coast. Ask for a demonstration or write for catalog.



SPECIFICATIONS OF NEW 2U IMPACTOOL

Capacity, bolt size	1/4"	Impacts per minute	2100
Weight, less cable	5 lbs.	Square socket driver	3/8"
Free speed	1750 rpm	Standard voltage	110 volts AC-DC

Ingersoll-Rand

11 Broadway, New York 4, N. Y. • Dept. M-12
Originators of Impactools—Air and Electric

**4
SIZES
OF I-R ELECTRIC
IMPACTOOLS TO
MEET YOUR
NEEDS**

2U
3/4" capacity



4U
3/8" capacity



8U
3/4" capacity



34U
1 1/2" capacity



Gifts he will use

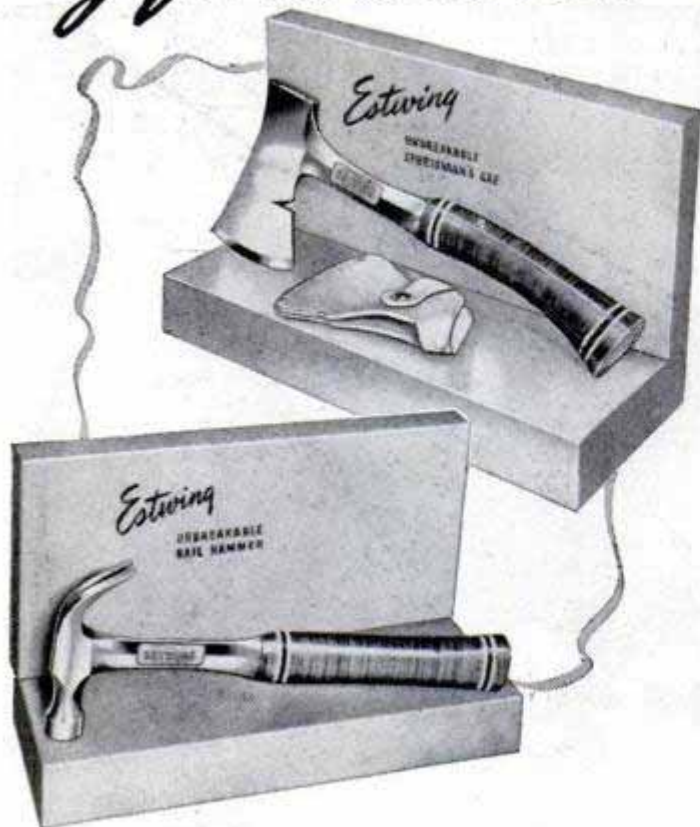

THE HEAD CAN'T FLY OFF. No more bother with loose or splintered handles. Estwing "Unbreakable" tools are forged in one-piece from tough tool steel. Grip is genuine leather, most comfortable and durable. Individually packed in colorful gift boxes. Axe \$4.50, hammer \$3.65. At all leading hardware stores. Write for FREE catalog.

ESTWING MFG. CO., Dept. P, Rockford, Illinois

Say You Saw It in Popular Mechanics



**THE ONLY
SPARK PLUG
WITH PATENTED
CORALOX
INSULATOR**

"Dial in the Dark"

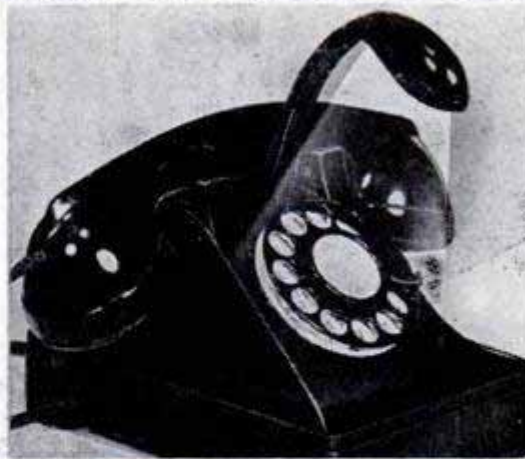

Amazing New Phone Light—\$1.95

Lift receiver — light's on! Replace receiver — light's off! Easy to install, just lift receiver and slide on. That's all — no wires, no plugging in, no screws or clamps. Fits any square base dial phone. Ideal for bedroom, hall or any other spot in home or office. Operates on 2 flashlight batteries. Gives off a brilliant light that lets you read even small print. Only \$1.95, batteries included.

SEND NO MONEY —Just mail order. Pay postman only \$1.95 plus few cents postage and C.O.D. charges. Or send payment with order and we pay postage. Money back if not delighted. Order now.
BARTON ROGERS 173 W. MADISON ST., DEPT. F-54, CHICAGO 2, ILLINOIS

HELPFUL BOOKS

Send post card asking for FREE catalog

Popular Mechanics Press, 200 E. Ontario, Dept. 601, Chicago 11

FURNITURE for YOUR BEDROOM

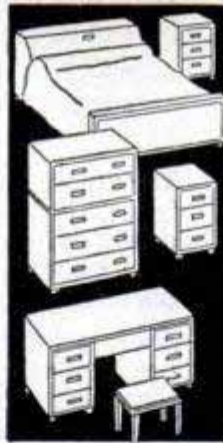

SAVE MONEY, be the envy of your neighbors by making this beautiful bedroom suite yourself! Only a power saw and jointer are needed to turn out this smart suite, featuring bed with storage space, three-piece vanity with cosmetic compartment and makeup mirror, Mr. and Mrs. dresser, and twin night stands with drawers. Letters demanding detailed plans poured in after this furniture was pictured in Popular Mechanics Magazine. Now the 4 plans are ready—easy-to-follow scale drawings—and they're yours for only \$2.00! Send for a complete set today.

POPULAR MECHANICS PRESS
200 EAST ONTARIO STREET, CHICAGO 11, ILL.

At Last! A PORTABLE Motor-Welder

9 TOOLS IN 1



Motor-Weld Model 1A
—Recommended for Hobby and Home work. Comes as illustrated above. Plugs into any 110 Volt AC or DC Line. Amperage Output is 50 to 70 Amps. Size: 11" deep, 6 1/2" high, 13" wide. Shipping Weight 45 lbs. Price F.O.B. Chicago, Ill. Less Accessories \$49.95. Complete with Accessories \$54.75. Fast Battery Charger Attachment \$5.00 Extra.

HAS SELF-CONTAINED MOTOR GENERATOR JUST LIKE BIG PLANT UNITS

MOTOR WELD is the only known motor-generator type unit that has its Large Amperage Output, is self-contained, yet has light-weight "Pickup" Portability and sold at transformer price levels. Low cost, economical operation. No special wiring—just plug into any 110 volt AC or DC line (any cycle) and it's ready to use! Its portable POWER UNIT can be used to operate saws, grinders, etc. Other models (150-225 amp.—Cart Models, etc.) available.

Send for FREE Literature
10-DAY FREE TRIAL
90-Day Warranty
On All Machines

Send remittance with order; will ship C.O.D. (\$15 deposit)

Porto-Weld Model 2A

—Amperage Output: 50 to 140 Amps. Input: 110-220V AC or DC. Line Draw: 24 Amps. on Each of Two 110V Circuits or 24 Amps. on a 220V Single or 3 Phase Line. Straight or Reverse Polarity. 5 Welding Heats. Size: 13 1/2" x 13 1/2" x 15". Shipping Weight 95 lbs. Price F.O.B. Chicago, Ill. Less Accessories... \$85.00. Complete with Accessories \$98.00*. Fast Battery Charger Attachment \$5.00 Extra. *Accessories include—300 Amp. Electrode Holder, Helmet, Ground Clamp, Sander, Buffer, Sample Electrodes, V-Pulley, 8' Welding & Ground Cables, and Instruction Booklet.



- ✓ WELDS
- ✓ BRAZES
- ✓ GRINDS
- ✓ SANDS
- ✓ POLISHES
- ✓ BUFFS
- ✓ BRUSHES
- ✓ POWER UNIT
- ✓ CHARGES BATTERIES



GENERATOR SALES CO. • 1627 N. Damen Ave. • Dept. K • Chicago 47, Ill.



Tell her you want MILLERS FALLS TOOLS for Christmas

Clean-cutting and beautifully balanced planes.
No. 9 Smooth Plane (9") \$8.25
No. 14 Jack Plane (14") \$9.00
No. 75 Block Plane \$3.00



Cuts most anything — most anywhere. Steel, wood, plastics, BX, etc. No. 725 "Nest of Saws". \$2.95



For doing work fast. Speedy way to drive screws, bore small holes. Complete with 2 screw driver bits, 3 drills. No. 29X Screw Driver. \$3.85



Sand and polish with any 1/4" electric drill. No. 2120 Buffing and Sanding Attachment with 5" rubber pad, 5" lamb's wool bonnet and two 5" sanding discs. \$8.45

No. 100 Automatic Drill for one-hand operation. Fast, accurate. 8 drills in indexed handle. \$4.40



New Right Angle Drive for 1/4" electric drills. Makes it easy to work in corners, between studs, in hard-to-get-at places. No. 2130. \$4.95

No. 106 Carving Tool Set. 6 razor-keen tools in most useful cutting shapes. \$4.80



Swivels and locks at any angle. Jaws open to 2 1/4". Clamps to benches up to 2" thick. No. 18 Swivel Vise. \$4.50

In gift-wrap boxes at your hardware dealer's



The Mark of Superiority

MILLERS FALLS COMPANY, Greenfield, Mass.

New "PULL-GEAR" SPEED-REDUCING PULLEY



Provides Correct Speed and Power to Drill Up to 1 3/8" with 1/2 H.P. Motor

Amazing new internally geared speed reducer doubles drill press capacity. Greater power, greater efficiency, greater productivity.

Provides the correct speed and power for larger drilling, reaming, tapping and boring on light presses. Easily installed in five minutes. Adaptable to all type machines. Spindle speed range approx. 45 to 3000 RPM. Made in 3 motor shaft sizes: 1/2"-5/8"-3/4". Write for literature.

WRITE FOR LITERATURE

THE PULL-GEAR CO.

4120 E. 8-Mile Rd.
Detroit 34, Mich.

1903 - GOLDEN ANNIVERSARY - 1953

SHAW "DU-ALL"

GARDEN AND SMALL FARM TRACTORS

Low Cost 1 1/2 to 5 H.P. Walking Models
Do All Garden and Yard Work
..Fast, Easy

5 H.P. Walking Model with 10-inch Plow



Plow with a 6-7-10 inch plow ... plant, cultivate ... mow, buldoze, saw wood ... do many other jobs with the Shaw Du-All. 1 1/2, 2 1/2, 3, 5

H.P. machines. Variable speeds, adjustable wheel widths, individual gang tool controls. Power take-off pulley and attachments. Power turn models available.

Powerful 2 1/2 to 12 H.P. Riding Tractors, Ideal for Larger Acreage

Famous Shaw design provides lowest cost power for small farms. Handle 10, 12, 14-inch plows. Work 4 to 8 acres daily. Handle all ground preparation and cultivation ... mow, rake, cut wood, spray trees, do many other jobs with power take-off. See the Shaw dealer. Write direct for

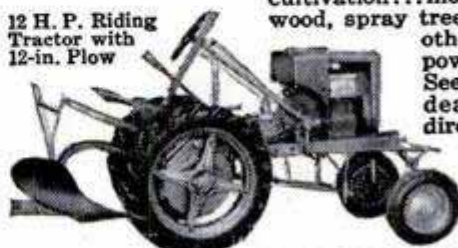

12 H.P. Riding Tractor with 12-in. Plow

FREE CATALOGS low prices complete Shaw line.

SHAW MANUFACTURING CO.
4512 Front St., Galesburg, Kansas
668-G N. 4th St., Columbus, Ohio

**I Made
\$15 PER HOUR..**

**with
my
SUPER-
SHOP**

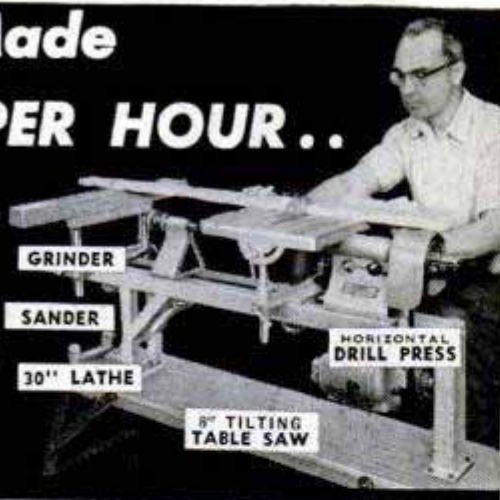

Every hour spent with SUPER-SHOP has been worth \$15 to me. Making it yourself is fun. SUPERSHOP is a complete, precision-built workshop. 100% ball bearing. Rugged tubular steel frame. Big capacity. 8 inch saw. Factory to you only \$79.95. Free trial. Easy pay plan. FREE catalog.

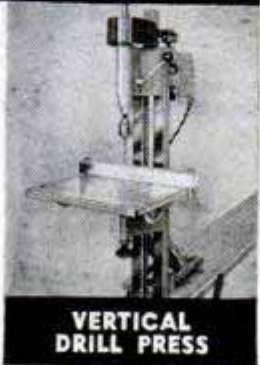

**Write for FREE Catalog
on Money Saving SUPERSHOP**

**POWER TOOLS INC. 154 Yates Ave.
BELOIT, WISCONSIN**

Give the Best...WISS!

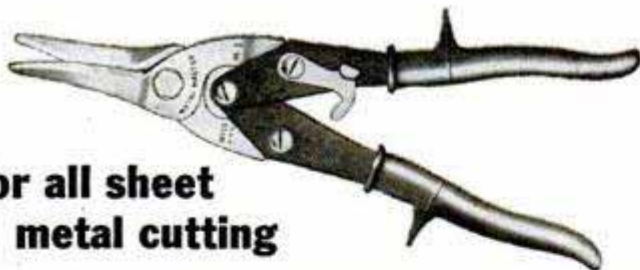

**for all sheet
metal cutting**

WISS Metal Master Compound Action Snips

#M-3 Easily cuts 18 gauge sheet metal. Cuts curves and circles as well as straight. Ideal for the home workshop. \$4.25. Rubber grips recommended, 60¢ extra.

WISS "Hy-Power" Pruners

#908 Pruning shears cut easily and cleanly. Non-pinching pistol grip handles. Soft anvil keeps knife blade sharp indefinitely. Choice of professionals. \$2.50

WISS Combination Snips

#V-13 Solid steel, with gray japanned handles. Cuts curves and irregular shapes with ease. Handy pocket size. 7" long. Accurately tempered jaws and strong bolts. \$1.85.

*Prices slightly higher
Denver and West*



Quality for more than a Century



J. WISS & SONS CO. • NEWARK 7, N.J.

**BUILD
THIS
HOUSE
Yourself**

**The Famous
Popular Mechanics
House**

The picture below is from an actual photograph of the Build-It-Yourself House with breezeway and garage, as built by Jack Brownson, 23-year-old veteran, in Aurora, Illinois.



**Mail Coupon
for New Book
and Plans!**

*Build It Yourself
or Have It Built
—Save Hundreds
of Dollars!*

Designed by Popular Mechanics and Famous Architects. Every Detail Simplified and Explained. No Previous Experience Needed!

Can you use everyday tools as well as the average Popular Mechanics reader? Then you, too, can easily build this modern house in any of its five designs, doing every part of the job yourself. The new Popular Mechanics Book, "Your Home—How to Build It Yourself" will show you how.

**Space for Living and
Family Growth**

This beautiful, modern house is 1½ stories, with basement, living room, kitchen, dining nook, two bedrooms, bath, plenty of closets and space for two additional bedrooms on second floor. The house itself is 35' 9"x28' 11"; breezeway 20' 10"x8'; garage 20' 10"x12'.

**The House That Has
Everything**

Designed for easy construction and the most living space for the least cost, the Build-It-Yourself House is also most attractive and suitable for any community and most income groups. The basic plan is adaptable to four other exterior designs.

**Get Book and Plans Now—
Build When You Can**

You may never have thought about actually building a house yourself, but now that building restrictions have been lifted, it is easier than you think. So order book and plans today. Even if you engage a contractor to build for you, you will need the plans. And you certainly will want the book which can easily save you hundreds of dollars, whether you build this or any other house.

**PLANS YOU CAN READ
AND FOLLOW**

Plans consist of ten working-size blueprints—floor plans, elevations, construction notes, framing, joints, lumber and mill list, specifications, plumbing and wiring diagrams. Every measurement is marked—every detail made clear as ABC. Book has 100 pages—three-fifths are photographs and drawings. Some sections in colors, showing just how your house will look when finished.

**BIG BOOK
8½x11 inches**



MAIL COUPON FOR BOOK AND PLANS

POPULAR MECHANICS PRESS, Dept. 16
200 E. Ontario St., Chicago 11

I enclose \$_____ Send me the items checked at once.

- Your Home and How to Build It Yourself.....\$ 3.00
 Complete set of plans for Popular Mechanics Home.. 12.50
 Book and plans at reduced price..... 14.00
 Duplicate sets of plans..... 5.00

Name_____

Address_____

City_____ Zone_____ State_____

**YOU CAN'T AFFORD TO BE WITHOUT
AN AMPCO UNIT ON YOUR CAR***
INSTALL AN IMPROVED . . .

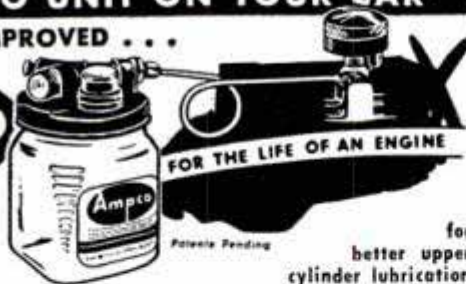

**INJECTION
LUBRICATOR**

Pays for itself in a few months in actual cash savings because you can: Increase your gas mileage from 2 to as high as 6 miles per gallon**—Increase your oil mileage some 600 additional miles**—Increase power up to 12 more brake Horse-Power**—Improve valve and hydraulic lifter action**. To you, as a car owner, this all means: (1) Elimination of sticky valves (2) Overcoming hydraulic lifter failure (3) Faster starting in any weather (4) Increased engine power (5) Reduction of carbon, gum, and acid deposits (6) Elimination of engine "ping" caused by deposits (7) Friction-free ring action. All this equals extended engine life—savings in gasoline and oil—cut in maintenance costs.

**Field test reports proving these results are available.
*AMPCO carries unconditional guarantee of improved engine performance.
AMPCO unit shipped complete with detailed instructions for simple installation on intake manifold.
Install an AMPCO yourself, or ask your friendly mechanic. When ordering, be sure to state year, make, and model of your car or truck. Order your AMPCO lubricator unit today. Makes an ideal Christmas gift, too. Gives your car new power—new smoothness—new efficiency—and, at the same time, saves gas and oil.

AMPCO VAPOR LUBRICATOR Model ST-100—\$12.00 plus Installation Kit
\$5.75* — Pontiac 6, Chrysler 6, De Soto 6, Dodge 6, Chevrolet, Ford 6, Plymouth, Nash, exc. Statesman
\$11.75* — Cadillac after '49, Buick 70 from '52, Hudson Hornet (duals), Packard '53, Olds Super 88 & 98 from '52, Lincoln from '53, Chrysler V-8
\$7.75* — All Others.

*Price includes one quart of Ampco-Approved Oil. Send check or money order, then complete unit shipped prepaid, or send \$2.00 deposit and complete unit shipped, balance C.O.D.

**ADVANCE MOTOR PRODUCTS CO. Dept. PM 12
WHITMAN, MASSACHUSETTS**

ELECTRIC MOTOR BARGAINS Brand New
WE GUARANTEE THESE BUYS CAN'T BE MATCHED!!
COMPARE PRICES—Then Order Fast
Limited Supply — SAVE OVER 1/2

	1 HP ^{3450 RPM} \$39.50	1 1/2 HP ^{3450 RPM} \$47.50
	2 HP ^{3450 RPM} \$65.00	3 HP ^{3450 RPM} \$90.00

100% GUARANTEE...YOU CAN'T LOSE
All prices F.O.B. Immediate Delivery
Heavy Duty, Repulsion Induction and Capacitor types. 110-220 Volts (except 2 and 3 HP which are straight 220). 60-cycle. Single phase. Famous makes (G.E., Wagner, Leland, Westinghouse, etc.) Brand new. Don't miss out. Rush order TODAY!
SEND FOR FREE CATALOG of other Motor Bargains
ROBERTS ELECTRIC CO., 849 W. Grand, Dept. 109, Chicago 2, Ill.

HELPFUL BOOKS
Send post card asking for **FREE catalog**
Popular Mechanics Press, 200 E. Ontario, Dept. 601, Chicago 11

BARRON Drill Press TOOLS
FOR WORKSHOP AND INDUSTRIAL USES . . .

● Over 40 precision built woodworking tools and accessories . . . Hi-Speed Router Bits—Rotary Surface Sanders & Drum Sanders—Safety Shaper Cutters—Dovetail Cutters—Large Auxiliary Metal Tables—All Metal Shaper Fences—Spindle Adapters—Handy Bench Vises. Many other items indispensable for accurate, useful, versatile workshop use. Every tool sold on complete satisfaction or your money back. See your Barron Dealer. Ask for special folder — "24 Extra Uses for Your Drill Press."

ROTARY PLANER
Planes • Rabbits
Tenons • Panels
Routs • Bevels

Only \$8.50 COMPLETE

BARRON TOOL CO. INC.
365 Architects Bldg., Detroit 1, Mich.

FREE Workshop Guide & Catalog

Personalize 

YOUR CAR

DAY or

NIGHT

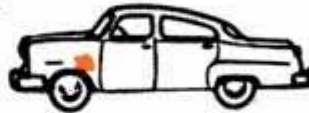

FENDER OR DOOR



(4/5 actual size)

(Pat. applied for)

MONO-LAMP

- EASILY INSTALLED IN MINUTES
- COMPLETE INSTRUCTIONS

This attractive chrome-nickel plated die-cast day and night insignia will add that touch to your car as identifying as your own finger print. In shining red and blue squares alternating with black as the background, your own initials in gold plate have that rich embossed look under the interchangeable molded plexiglass blocks. At night your initials illuminate whenever your car lights are on, as the Mono-Lamp becomes a part of your lighting system. All necessary parts including bulb, wiring, screws and instructions come with the Mono-Lamp and are guaranteed, except bulb, for one full year. Just \$3.98 each, prepaid. \$4.98 Gold Plated.

The Mono-Lamp makes a fine gift. Fill out order blank and mail today. Be sure to print initials desired in squares at bottom of coupon.

G. & S. MACHINE CO., MONO-LAMP DIV.

10725 Briggs Avenue • Cleveland 11, Ohio

Please send me Mono-Lamps at \$3.98 each
 I enclose _____
(check) (Money Order)

Send C.O.D. (Postage & handling charges extra.)

Name _____
Address _____
City _____ State _____

Initials desired:

Ohio residents add 9c per unit for Sales Tax

Extra-hardened at points of extreme wear. Last longer.



Are Your Pliers Worn Out?

Take a good look at your pliers and adjustable wrenches. Are they worn, nicked and burred?

If so, there's small satisfaction in using them. Jobs are harder and slower. Hobbies are less fun.

But fine, drop forged **UTICA** pliers and adjustable wrenches are a pleasure to use—because they make the job easier, quicker, better.

*Reg. U.S. Pat. Off.

It'll pay you to insist on **UTICA** pliers and adjustable wrenches. Your dealer has them or can get them for you.



The world's best tools are made in U.S.A.

HELPFUL BOOKS

Send post card asking for **FREE** catalog

Popular Mechanics Press, 200 E. Ontario, Dept. 601, Chicago 11

TRIPLE ELECTRODE

LUTHY AERO SPARK PLUGS

with ALUMINUM OXIDE INSULATORS

Just what your car needs—for extra "zip and go" and lasting power. **THREE TIMES LONGER LIFE.**

Give better performance and last longer because of these features:

- **3 POINT ELECTRODES.** Tapered points for hotter spark and 3 times longer life.
- **"LUM-OX" INSULATORS.** Used exclusively in the LUTHY AERO SPARK PLUG. First used in combat aircraft during World War II. Keep plugs cool by fast thermal conduction. Highly resistant to mechanical shock, too.
- **CHROME PLATED.** For resistance to rust.
- **NO GAP SETTING NECESSARY.** Every set perfectly engineered for your make and model at the factory.



LUTHY AERONAUTICAL SALES COMPANY
302-3 COOPER ST., JACKSON, MICH.
CANADIAN ADDRESS: BOX 394, HAMILTON, ONTARIO

Send me a set of _____ plugs. Enclosed is \$ _____
 Check here for C.O.D.
 Name _____
 Address _____
 Year of car _____ Make and Model _____

20 "SEE THRU" DRAWERS!

LOWEST COST — HANDIEST STORAGE

MODEL J-20\$7.95

Useful in every shop, lab., home, office, etc. For Radio, T.V. or ignition work. **KEEPS SMALL ITEMS HANDY.** No other cabinet can compare in price, construction strength. "SEE-THRU" durable plastic drawers can't spill accidentally. Strong welded steel cabinet. Drawers 5 1/2" L x 2 3/4" W x 1-7/16" D divide into 2 or 3 LENGTHWISE or CROSSWISE compartments. Sent complete, postpaid. Money back if not satisfied within 10 days. Free catalog on other sizes.

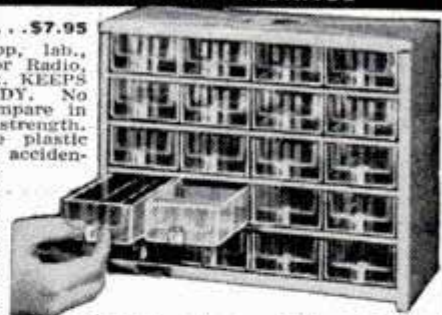

J-24, 24 drawers \$ 9.95
 J-32, 32 drawers 12.95
 J-64, 64 drawers 24.95

Contents always fully visible, clean, dustproof, organized and orderly indexed.

MFG. BY AKRO-MILS, INC., 818 E. MARKET, AKRON 5, O.

ATTENTION 1953 BUICK OWNERS!

LIGHT UP YOUR DYNAFLOW DIAL—ENJOY GREATER SAFETY AND CONVENIENCE. See what you are doing day and night. EASILY INSTALLED IN MINUTES. SIMPLE INSTRUCTIONS ENCLOSED. Proven Satisfactory—Thousands in use. Does not mar interior. No dangling wire, rattles or glare. Heavily chromed. ALSO SERVES AS A MAP-LIGHT. Available for all models of Fordomatic, Powerglide & older Buicks. Please state year, make & model of car. Never before offered **DIRECT TO YOU** at new low price. **JUST SEND MONEY ORDER FOR \$2.75** compl. Tax & Postage Incl. No COD. A swell gift for only \$2.75. **REX SALES CO., 3743 N. Halsted St., Chicago 13, Illinois**

SAY YOU SAW IT IN POPULAR MECHANICS



Make your **TV CONSOLE MOVABLE**
 —TV MOBILE UNIT FITS ALL SETS.
 NO INSTALLATION REQUIRED. **\$9.95**
 LIST PRICE

ANTHRO CO., 2235 Benderwirt, Rockford, Ill.

BE YOUR OWN BOSS

Make Hundreds of \$ Spare or Full Time Work

You can make simply and cheaply

NO EXPERIENCE NEEDED
 Here is the ideal business with no previous experience or large investment required and no high-priced equipment to buy. A business that will return dollars for the pennies you invest.

YOU CAN CAST ANYTHING

With *Flexible Mold Making and Ornamental Casting*, an amazing fact-packed book, you learn how you can cast practically any article in concrete, plaster, imitation marble or any other casting material using a marvelous new process. You can make ash trays, novelties, garden and lawn ornaments and hundreds of other highly profitable items that cost you but a few cents and sell for as much as \$5.00 and more. Why you can even make true-to-life full-sized busts of your neighbors and friends.

NO EXPENSIVE MOLDS TO BUY

Why buy high-priced molds from others? Learn how you can make your own molds quickly, easily and inexpensively with materials that can be used over and over. You get copyrighted formulas, complete instructions and detailed how-to-do-it photographs as well as complete sources of supply for the few inexpensive materials you need. This is the only book printed in America today that contains instructions for making profitable papier-mache casts.

MONEY BACK GUARANTEE

Start on your road to extra income and independence today. Send only \$3.00 for your copy of *Flexible Mold Making and Ornamental Casting*. Complete satisfaction guaranteed or your money refunded within seven days.



BUSTS



GARDEN URNS



NOVELTIES



TILE



STATUARY

POPULAR MECHANICS PRESS, Dept. 46
 200 E. ONTARIO ST., CHICAGO 11, ILL.

**GIGANTIC
SAVE-TO-70%**

MAIL SALE

**WAR SURPLUS
EXCESS INVENTORY
BANKRUPT STOCK**

POWER PLANTS & GENERATORS

Note: all AC plants are 115-v 60-c.

- Plants 25 KW A-C...\$1190
- Plants 5 KW A-C...\$531
- Plants 3 KW A-C...\$349
- Plants 2 KW A-C...\$289
- Plants 1 KW A-C...\$189
- Plants 3 KW 115-v D-C...\$169
- Plants 1.5 KW 32-v D-C...\$72
- Plants .6 KW 32-v D-C...\$64
- Gener. 3 KW 115-v A-C...\$149
- Gener. 2 KW 115-v A-C...\$139
- Gener. 1 KW 115-v A-C...\$104
- Gener. .6 KW 115-v A-C...\$79
- Gener. 3 KW 115-v D-C...\$49

Save to 70% — See our catalog.

WATER PUMPS & SYSTEMS

- Centrifugals 3/4" 1" 1 1/2" \$19.95 \$29.85 \$38.60
- Rotary. Bronze, rubber paddle. Self priming. Pressure to 30 lbs. 1/2" \$14.75; 3/4" \$19.50; 1" \$25.
- Rotary. Bronze-nylon roller. Self priming. Pressures to 100 lbs. 1/2" \$17; 3/4" \$24; 1" \$32.
- Auto Water System. Lifts to 22 ft. 110-v 300 gals. per hr. 40 lb. pres. Compact. Easy to install...\$70

SUPER CLOSEOUT BARGAINS

- Winch, 1500-lb. cap. 1-4 ratio...\$19.95
- Mechanics Tool Chest, deluxe...\$19.75
- Gas Chain Saws, leading make...\$199.00
- Foot Lockers, Army type...\$12.65
- Rural Magneto Phones...\$9.95
- Weed Spray Outfits, 7-row (\$200 cost)...\$130.00
- Tarpaulins, finest Army 10 oz. 8x10' \$8.80
- Tarpaulins, all sizes 10 oz. 11' sq. ft.
- Engineers Boots, Reg. \$14...\$8.76
- Electric Drill, 1/2" 110-v...\$26.95
- Electric Drill, 1/4" 110-v...\$16.89
- Emergency Air Unit, tank, hose, etc. \$14.95
- Hi-Spd. Hand Grinders, 19-pc. 110-v \$14.50
- Revolver, 9-shot HOR 6" \$28.95

Hundreds items, many less than mfg. cost.

BURDEN PAYS ALL SHIPPING CHARGES

Watches—Optical—Precision Units

- Fully guaranteed tax-paid top-quality leading makes—Save to 50%!
- Binoculars, 8x50 coated with case...\$42.95
 - Binoculars, 8x25 coated with case...\$29.75
 - Microscope, 3-turret 100-200-300X...\$9.95
 - Engineers Hand Level with case...\$5.84
 - Surveyors Tripod Level & Rod...\$37.95
 - Weather Unit, barometer, hygrometer, thermometer...\$12.50
 - Car Altimeter, 0-10,000' (Taylor)...\$9.00
 - Wrist Watch, 17-jew. "Executive" Enacor...\$18.15
 - Engr. Stop Watch, precision 1/10 sec...\$12.95
 - Inspection Magnifier, 2"x4" lens...\$2.89
 - DeLuxe Auto Compass, illum. type...\$5.49
 - Hand Tally Register, records 9999...\$4.95
 - Drawing Sets, finest 13-pc. in case...\$7.78

HYDRAULIC EQUIPMENT

- Savings to 80%. Build loaders, diggers, presses, etc. Marvelous values.
- Pump, 1000 lb. 12 gal. 500 RPM...\$45.50
 - Cylinders, 1-way 3"x8" \$11.95; 2-way 2"x10" \$22.85; 2-way 3"x24" \$39.90.
 - Valves, hand control, 1 or 2-way...\$18.00
 - Gauges, 1000 lb., 1500 lb. or 2000-lb. Many other items—see our catalog.

AIR COMPRESSOR UNITS

- Paint, clean, for tires, control termites, etc. Build your own or ready built units.
- DeLuxe Kit. Tank, comprsr., gauge, valves, paint gun, regulator, fittings, etc. "How To Build" instructions. \$70 value...\$45
 - Economy Kit, same, smaller tank, no regitr, paint gun...\$32
 - Components, Com pressors, \$20. Tanks \$5.79. Auto. Press. Switch \$4.95. Gauges (160 lb.) \$1.89. Pop-Off Valve \$1.95. Paint Gun \$9.95. Dust Gun \$1.29.

Many air items, see catalog.

SPECIAL FOR THE MONTH! ELECTRICAL PHYSICS LAB. KIT

● Ten-piece experimental kit. Conduct hundreds of fascinating instructive experiments in home laboratory. Keep abreast of our atomic age.

● Consists of hi-voltage alternating current hand generator, electro-magnetic super-strength unit, burglar-fire alarm, magnetic control, multi-contact relay, capacitor, resistors, experimental instructions and plans for home laboratory. Orig. cost over \$35.00. Prepaid in U.S.A. Only



\$6.99

EXTRAORDINARY SURPLUS BUYS!

Quantities are limited so order promptly!

ARMY PARTS CLEANER

● Amazing air-solvent cleaner. Makes dirty greasy parts shiny bright in secs. For garages, factories, farm, etc. 105 lbs.

● Heavy galv. tank 25x20x20". Air jet valve, hose, hyd. lid. Cost over \$1000. Ppd. \$29.95.



GENERATOR—3000W—115V

● Dir. Current ball brg. comp-pound-wound Delco unit. 1" shaft drive 2800 RPM. Ideal for portable tools, lights, boats, etc. Guar. List over \$100. Prepaid \$49.50

AIR CORPS SEARCH LIGHT

● Famous Grimes hi-intensity light, 4 signal filters. Mile beam. 6-v DC or AC. Widely used by police, boats, farmers. In case with ext. cord. Cost over \$30. Prepaid, \$4.39



OUR 30-YEAR POLICY • EVERYTHING GUARANTEED TO SATISFY • WE PAY ALL SHIPPING CHARGES IN U. S.

BURDEN SALES COMPANY
814 "O" ST., LINCOLN, NEBRASKA

NEW! Every Electric Drill A Powerful PORTABLE JIG SAW

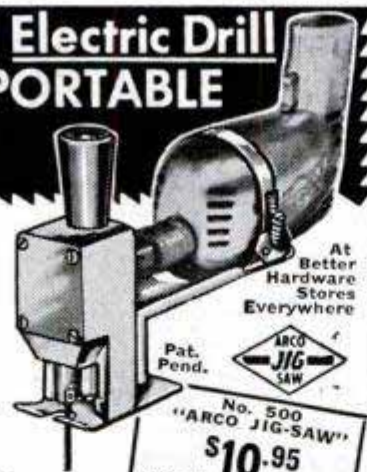

"ARCO JIG-SAW"

HAS SAME CAPACITY, CUTS AS FAST AS SAWS COSTING \$50 & UP!

DOES THE WORK OF ALL THESE SAWS: JIG, KEYHOLE, COPING, RIP, CROSSCUT, BAND, HACKSAW.

HAS EXCLUSIVE, BUILT-IN AUTOMATIC AIR BLOWER.

Here for the first time anywhere is a Portable Jig Saw that attaches in ONE MINUTE to any 1/4" electric drill. "ARCO JIG-SAW" will handle any project from the smallest to the largest. In minutes it cuts intricate patterns, circles, etc. in plywood, wallboard, plastics, metals—even cuts lumber up to 2x4's! It cuts openings for plumbing, switchboxes, etc. without boring a starting hole. Built-in AUTOMATIC BLOWER keeps cutting line free of sawdust.

"ARCO JIG-SAW" is a powerful, versatile tool that is light in weight and easy to handle because of its Right Angle Drive. Strong Safety-Yoke & Worm Drive Clamp make it a vibration-free unit. Extra large Shoe-Plate assures accurate and square cuts. Blades are changed in seconds with screwdriver.

No. 401 "ARCO STAND"—converts "ARCO JIG-SAW" into a stationary table model...\$2.75

No. 505 REPLACEMENT BLADES—8 assorted blades for hard & soft woods, plastics, metals; etc....\$1.95

90-DAY FACTORY GUARANTEE

BUY THE BEST—see your hardware dealer now! If not available, try "ARCO JIG-SAW" on our 10-DAY MONEY BACK GUARANTEE. Send us check or M.O. (Postpaid). C.O.D.'s—postage extra.

DEALERS—write for nearest jobber.

ARROW METAL PRODUCTS CO.

Dept. PM-12, 140 WEST BROADWAY, NEW YORK 13, N. Y.

send for FREE CATALOG

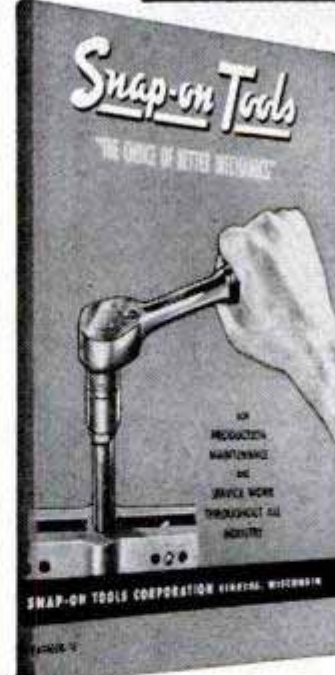

America's Foremost money-making MECHANICS' TOOLS

It's easy to own the same "pay-off" tools used and endorsed by America's top-earning mechanics throughout the automotive, aviation and industrial fields! Snap-on tools help you handle every repair job faster, easier, better. And they LAST... pay for themselves over and over again! Start building your own tool set now with basic Snap-on units—add others any time. Genuine Snap-on tools are never sold in stores—direct to users only. Mail coupon for free catalog.



Snap-on Tools Corporation
8062-L 28th Ave., Kenosha, Wis.

Send me free catalog. Occupation _____

Name _____

Address _____

City _____ Zone _____ State _____

ORDER BY MAIL AND SAVE \$\$\$\$

PORTABLE COMPRESSOR UNIT WITH 22 GALLON TANK

1/8 h.p. hvy. duty capacitor motor, 110V
A. C. Compressor 2" bore, 1 3/4" stroke, piston type, splash feed oiling, 14" x 32" tank, auto. pressure switch. CFM 2.8 at 100 pressure. Check, safety valve, air regulator with gauge, filter, 20 ft. air hose, air chuck for inflating tires. V belt drive. Ball bearing wheels with hvy. rubber tires. Ship. wt. 150 lbs. F.O.B. Chicago.



With 1/8 h.p. motor Reg. price \$175
Assemble Unit Yourself and Save \$5 \$72.95
Regulator, gauge, and filter, sold separately. Price for the 3 items... \$8.95

WELLWORTH COMPRESSOR SPECIALS

1 Year Guarantee

FEATURES:
2 compression and one oil ring, aluminum alloy connecting rod. Stainless steel valves with brass seats and retainers. Cool-flo cylinder head, spray mist lubrication to every moving part. 10 1/4" V groove fly wheel for 5/8" B section belt.

MODEL W3
2-1/2" x 2". 2.55 to 4.80 cfm up to 150 lbs. pressure. Operates with 1/3-1/2-3/4 HP motor. Ship. wt. 24 lbs. FOB Chicago. **\$29.95**
Special Price...

MODEL W7
2 cylinder 2-1/2"x2". 5.10 to 8.50 cfm up to 150 lbs. pressure. Operates with 1/2-3/4-1-1/2 HP motor. Ship. wt. 45 lbs. FOB Chicago. **\$59.95**
Special Price...

"WELLWORTH" BLOWER BARGAIN
BRAND NEW

Quiet operating. Double wheel inlet, double width blower. For heating, ventilating, cooling, air washing, exhausting and forced draft. DIMENSIONS: 10" wheel, outlet 13 1/4" by 11 3/8", inlet 8 3/4", Height 19", Width 18", Depth 16 1/2". CFM., 1/4" S.P. 1600; outlet vel. 1575. Wt. 45 lbs. **\$29.95**
BLOWER WITH DRIVE-LESS MOTOR Same blower complete with 1/4 h.p. motor... **\$45.00**

**SEND FOR FREE CATALOG OF 100 SPECIALS
ORDER FROM THIS AD AND SAVE**

WELLWORTH TRADING CO. DEPT. D1253
1832 S. WABASH AVE. CHICAGO 16, ILL.

HAVE A BIGGER — MORE EFFICIENT HOME WORKSHOP

Popular Mechanics **PLANNING YOUR HOME WORKSHOP** shows you how to make use of every inch of space in your workshop; detailed floor plans, wiring layouts and power tool hookups plus actual photographs of famous home workshops you can use as models. Save money by building your own shop furniture. Special Where-to-Buy-It Guide, 450 Illustrations, Cloth Bound, Working Diagrams. Order your **\$2.50** copy today from
POPULAR MECHANICS PRESS
200 E. Ontario Street Chicago 11

OWN A... PLYMOUTH?

FIX IT YOURSELF!

Popular Mechanics Magazine has just published a new Owners Manual covering all 1941 to 1952 models of Plymouth cars. So accurate mechanics use it... so simple a woman can understand it.



Save money on your Plymouth repairs. Prevent trouble. Enjoy care-free driving. Increase trade-in value. Avoid major repairs by fixing minor troubles before they get serious. Get sparkling performance at all times. Has 272 pages, more than 350 photos, diagrams, tables, charts, breakdown drawings, plus clear, non-technical directions that make all repairs simple as ABC. Written by Ed Packer with assistance of Chrysler Corporation. Shows you how to diagnose Plymouth troubles by feel, sound, sight, smell and performance. Simple trouble shooting. Permanent repairs. Emergency repairs. Plus, "How to get value from garages."

MONEY BACK IF IT DOESN'T SAVE MORE THAN IT COSTS!

One minor repair will save the cost ten times over. Read it. Then you decide. If you don't see that you'll save more than the cost, send it back for refund. **SEND NO MONEY.** Send postcard. Ask for PLYMOUTH Manual. Postman will deliver C.O.D. for \$3.50 plus postage. Or, save postage by sending \$3.50 with order. Send today. Save its cost on your next repair.

POPULAR MECHANICS PRESS
200 E. ONTARIO DEPT. 18 CHICAGO 11, ILLINOIS

Enjoy the Fascinating Story of the Horseless Carriage in

Popular Mechanics AUTO ALBUM

The most intriguing book about the automobile ever printed. It's thrilling, fascinating and informative. From the very first gasoline-propelled buggy to the cars of today and the atomic auto of the future. The first cars — the men who made them — the scrambled start and the development of the fabulous auto industry—the story of auto racing—the growth of the Nation's highways. 166 thrilling action pictures—old-time cars—racing cars—early auto advertising—automotive oddities. Roll call of names of more than 2000 autos made in the U.S. included. Ideal gift book. Cloth bound, only \$3.00 by mail. Money back if not pleased. Paper covered edition \$1.00 at newsstands.

POPULAR MECHANICS PRESS, Dept. PM14
200 East Ontario Street Chicago 11, Illinois

Say You Saw It in Popular Mechanics

CUT-TO-FIT HOMES CUT BUILDING COSTS

ORDER NOW

SAVE UP TO 1/3

CHOICE OF 57 DESIGNS

Build your own home and save the builders' profit—plus savings in lumber and labor with Sterling Ready-Cut-Homes. Anyone can assemble with simple, easy to follow plans furnished. Every house complete with all lumber, roofing, nails, glass, hardware, paint, doors and windows marked ready to erect. Freight paid. Complete building plans ready for filing at low cost. Sold separately if desired. Write today!

PRICED FROM \$2150 up
Five Easy Payment Plans
Send 25c for NEW COLOR CATALOG

INTERNATIONAL MILL AND TIMBER CO. DEPT. P.M. 123 BAY CITY, MICHIGAN

WAR SURPLUS AND OTHER **BARGAINS** SAVE UP TO 90%

NEW IMPROVED MODEL MAUSER-TYPE PRECISION 1/1000" VERNIER CALIPERS

Quick, handy, accurate. 6" Vernier Calipers. Glass hardened, lapped measuring surfaces. Fine engraved scales—1/1000" and 1/10 mm for inside, outside & depth measurements. Friction thumb release. Larger capacity. Two gib adjustments. Reg. \$25. Anniversary Special only \$6.95. Leather case \$1 extra.

MICROMETERS Chrome plated, precision engineered, carefully tooled to give long life. All new 0-1" cap. \$2.25 ea., 1-2" cap. \$3.50.

LOW VOLTAGE CIRCUIT TESTER

Made for U.S. Ordinance to rigid specification. Portable steel carrying unit, self-contained trouble shooting device makes complete & rapid check of generator battery circuit incl. any circuit & voltage regulators. Battery voltage, regulators, cut-out settings & generator performance easily determined. Any 6 or 12 volt system. Great for garages, mechanics, truck fleet owners, boat & marine mechanics. Every set checked out in our lab & in perfect condition. Shpg. Wt. 20 lbs. Approx. GOVT COST \$175. NEW. Complete with instruction book.



Anniversary Special ----\$29.75... WHILE THEY LAST!

D. C. GENERATORS—\$14.95

The generators listed below will weld up to 3/8" plate steel or better. They all can be used as a combination welder and light plant. Generators (Used) Pl. Perfect condition. 200 Amps. 28 Volts. 2500 to 4500 RPM. Wt. 53 lbs. Approx Govt Cost \$350.—\$14.95. Electric Auto-Lite. 140 AMPs. 24 Volt. 2500 RPM. Makes a dandy arc welder. Wt. 53 lbs. Approx Govt Cost \$450 NEW \$20. R1 Jack & Heintz. Rated 300 Amps, 30 Volts. Wt. 60 lbs. Approx Govt Cost \$450. Guaranteed perfect. \$25.

MAKE YOUR OWN ARC WELDER Complete make-up package consisting of one NEW Auto-Lite 140 AMP Generator (can be revved up to over 200 AMP), one giant toggle switch, one voltage regulator and a wiring diagram chart showing conversion of Aircraft Generator to Arc Welder. Special — **WHILE THEY LAST—\$30.**

SENSITIVE ALTIMETER IN 10 FT. INCREMENTS 0 to 35,000 ft. (inches of Mercury). Tested and inspected in our own instrument lab. Guaranteed perfect. Ready to install. \$15.95 pcd.



Send 25¢ for big 1953 catalog. Bargains for everyone. Check, Money Order or Cash. 25% deposit on C.O.D. orders. Prices F.O.B. Culver City, Calif., Unless otherwise stated.

AIRBORNE SALES CO., INC., Dept. PM1253, 8501 Stellar Dr., Culver City, Cal.

TV Purchase, Repair and Service

ALL ABOUT TELEVISION You can actually save \$50 to \$100 when you buy a TV set. You can save that much more every year on service with Popular Mechanics ALL ABOUT TELEVISION to guide you. Do 9 out of 10 service jobs yourself. Complete simplified instruction and 220 pictures show you how. No previous experience or knowledge of electronics required. Cloth bound edition only \$3.00 postpaid. Money back if not pleased. Paper covers 75 cents at newsstands.

POPULAR MECHANICS PRESS, Dept. PM11, 200 E. Ontario St., Chicago 11

SURPLUS BARGAINS! SATISFACTION GUARANTEED!

NEW CONTINUOUS DUTY 1/20 HP MOTOR

110-V. 60 Cy. 1750 RPM. Bronze bush bearings, 1/4" shaft. For fans, other long-running uses. Shipped postpaid.....Only... \$4.95



HIGH SPEED 1/2 SHANK DRILL SETS

5 pc. Set \$14.50 10 pc. set \$17.50
No. 32 No. 33

Both sets include sizes from 1/2" to 1-3/16". Highest tungsten content, sharp and ready to go. Reconditioned—all have at least 70% of original flute length. Fit any 1/2" drill, drill press or chuck. Shipped postpaid.

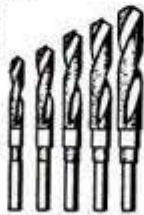

WRITE FOR OUR FREE CATALOG

T&T TOOL CO. Dept. - 124, 7667 GRAND RIVER, DETROIT 4, MICH.

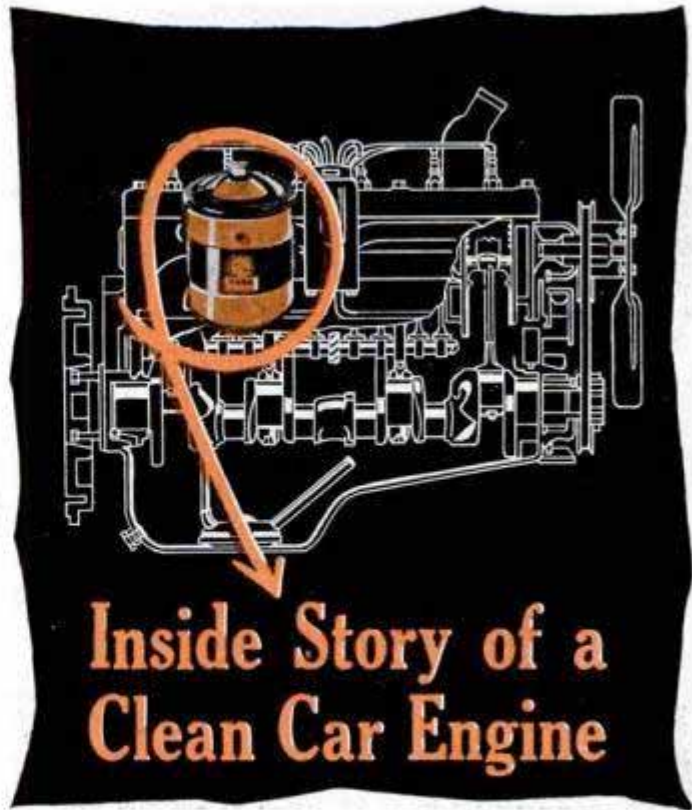

Inside Story of a Clean Car Engine

Your engine is built with close tolerances . . . mirror-finished to overcome the friction of high-speed operation. Clean oil keeps it this way to give you maximum pep, power and long life. In modern, high-compression engines, sludge and dirt increase friction . . . sapping engine power and causing excessive wear.

FRAM Cleans the Oil that Cleans the Motor

That's why 20,000,000 engines today are equipped with Fram Oil Filters. Fram-clean engines keep their power longer. Make it a practice with your car to replace the oil filter cartridge regularly. And replace it with a genuine Fram. There's a reason. Fram Cartridges trap more dirt. They even remove invisible dirt. They're engineered to your car manufacturer's specifications. And only Fram Cartridges are guaranteed best you ever bought or your money back.

FRAM FILTERS...

Best Life Insurance Your Car Ever Had



Call Western Union (by number) Operator 25 for name of nearest Fram Dealer.



FRAM
OIL • AIR • FUEL • WATER
FILTERS

FRAM CORPORATION
Providence 16, R. I.
In Canada: Fram Canada Ltd.
Stratford, Ontario

NATIONALLY FAMOUS PATHFINDER
AUTO LIGHTING ACCESSORIES

PERFECT TO GIVE OR GET
 ... XMAS TIME
 ... ANY TIME!



"JET-LITE"



**FULLY
 AUTOMATIC
 TRIPLE
 WARNING SIGNAL**

for **SUPER-SAFE** Driving!
 A real "traffic light" in miniature for your car! 3-way warning instantly signals following cars when you **STOP . . . GO . . . SLOW DOWN**—helps prevent collisions. Easily installed on trunk of car—no holes to drill! Beautifies any car with its handsome streamlined, chrome plated body and colorful lights. Theft-proof, weather-proof. Complete with all parts and instructions for easy installation.

- Automatically shows **RED** when you step on Brake
- Automatically shows **AMBER** when you release accelerator
- Automatically shows **GREEN** when you step on the Gas

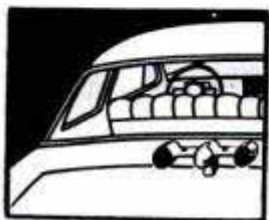

No. JL 600
\$595
 POSTPAID

"HANDEE-LITE"

PORTABLE SPOTLIGHT of 1001 USES!
 De luxe chrome plated spotlight for every night-driving emergency! No installation—just plug into Cigar Lighter socket. GE "Sealed-Beam" bulb throws brilliant light 500 feet. Modern streamlined design with built-in switch and adjustable stand. Complete with 10-foot cord and special lighter socket plug.



No. HL 600
\$595
 POSTPAID

"PORTA-LITE"

PUTS THE "SEE" in "EMERGENCY"!
 Compact, rugged model for instant, powerful light whenever and wherever you need it! Special plug fits into lighter socket—no installation needed. Baked blue enamel finish, powerful sealed-beam bulb. E-Z-grip handle acts as adjustable stand—leaves both hands free. Ready to use, including 10-foot cord and plug.



No. PL 400
\$395
 POSTPAID

ORDER TODAY ON MONEY-BACK GUARANTEE!

VISIONITE PRODUCTS CO.
 3544 W. Roosevelt Road • Chicago 24, Ill.
 SEND POSTPAID No. JL 600 JET-LITE
 HL 600 HANDEE-LITE PL 400 PORTA-LITE
 Enclosed is Check Money Order (Amt.) \$_____

Name _____
 Address _____
 City _____ Zone _____ State _____

**PERFECT FOR YOUR
 HOBBY SHOP
 BENCH SAW**



**MOLDING
 CUTTER
 HEAD**

1/2" 5/8" 3/4"
 SPECIFY SIZE

Molding Head and choice of one Shape..\$6.95
 Any Shape Cutter; set of three.....\$2.45

1. Balanced for greater safety
2. Scientifically heat treated and tempered
3. Positive locking device holds bits firmly
4. Fits bench saws with 1/2, 5/8, 3/4 in. arbors

The Molding Cutter Head lets you do all these jobs easily . . . picture frames, drawers, table top edges, moldings . . . and many more. Comes in plastic box with spaces to hold 4 sets of cutter bits. Wrench, spacer washer, bushing included.

Cutter Bit sets for use in Molding Head Cutter are made of specially heat-treated tool steel 1 in. wide. Vertical slot on back of blade assures alignment. Each set contains 3 bits.

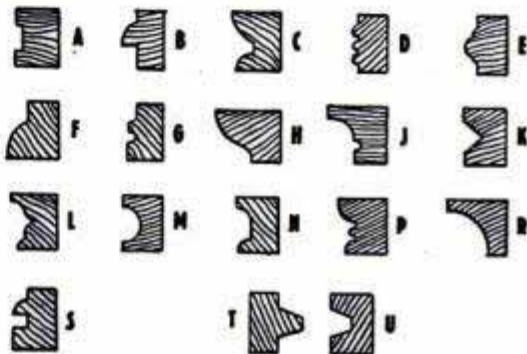

With proper bits you can plane, joint, cut interior and exterior trim, tongue-and-groove flooring . . . plus dozens of other jobs which save you money.

Order sets by LETTER (A, B, C, etc.)

Price:\$2.45 per set
 Complete operating instructions included.
 Perfect Christmas Gifts for him.

DADO SETS

For dadoing, grooving, rabbeting. Finest quality tempered steel outside saws — Precision ground — Perfectly matched chippers.



5 1/2 in. set includes: two 3/32 in. thick outside saws; 6-1/16 in. thick chippers . . . Will cut groove up to 9/16" wide.

Either 1/2 or 5/8 in. center hole.....\$4.95
 6" sets also available.....\$8.75

A Superior quality professional model . . . Will cut grooves up to 13/16"
DO THE JOB YOURSELF—SAVE MONEY
ORDER NOW—ALL SHIPMENTS PREPAID!
 No C.O.D. Send check or money order to:

SPECIALTIES, INC.

715 E. GRAY ST. LOUISVILLE 2, KY.

BUILD YOUR OWN ARC WELDER OR LIGHT PLANT

Save \$250 to \$500

D-C GENERATOR

\$15.50 used, good cond. Instruct. incl. for Comb. welder & light plant. 200 amps. 28 Volts. 2500 to 4500 R.P.M. or Brand New.....Price **\$21.50**

PRICE F.O.B. K. C. MO.

CONVERTS TO ARC WELDER 200-250 AMP. OR LIGHT PLANT CAP. LOAD 5000 WATTS

RHEOSTAT #R-27 heavy duty recommended for regulating the voltage on the converted electric welder. **\$6.95**

Carbon Pile GENERATOR VOLTAGE REGULATOR For use with 24 or 32 Volt D.C. Generators. Also recommended for the P-1 and R-1 type generators in "build your own" Light Plant. Only..... **\$6.95**

New Amplidyne MOTOR GENERATOR. Use as 24/32 D.C. motor, pulls 1/2 HP. Applicable for 110 V. A.C. by simple change in connection. Applicable to independent and rural lighting. Instructions incl. Wt. 30 lbs. Cost over **\$140.00**..... **\$7.50**

D. C. GENERATOR. Brand new. Navy Type for Farm-Home-Ranch. Delivers 430 Volts D.C. at 3450 R.P.M. Ball bearing supported. Fan cooled armature. Self lubricating bearing. #211220-A. Wt. **\$7.50** 21-lbs. Now only.....

ROMEC WOBBLE PUMP. Hand lever operated. Ideal for Camp, Farm, Ranch, for fuel transfer to boats, etc. Self priming, including built in relief valve. Capacity over 160 G.P.H. **\$8.95** \$60.00 value.....

WEAVER HYDRAULIC HAND PUMP New With Built in Check & relief valve. For oil or Hydraulic Fluid. Rated 2000 P.S.I. **\$9.95** data incl. \$75.00 Value.....

HEAVY DUTY ANGLE GEAR UNIT Equipped with ball bearings on all three shaft connections. The Angle shafts are 60 degree to right & left. Gear is 1-1 ratio. Rated 0 H.P. Ideal for driving fan attachments and machinery. Stock #73. Wt. 9 lbs. Tremendous bargain..... **\$7.95**

VALUABLE GEARS BARGAIN SPEED REDUCER. 5-1 or 10-1 ratio 90 degree angle 1/2" splined shaft with 3 mount- ing holes rated 2 H.P. **\$5.95** Postage

SOLENOID #804 Equipped with lever arm which gives a 1/2" or 1 1/4" travel. Compact, powerful as actuator & to operate locks, switches, toy applications, etc. For 24V D.C. & applicable to 110V. A.C. Per Instructions included. Ea. **\$2.95** Pair..... **\$4.95** paid

Hydraulic Solenoid Control Valve
BENDIX No. 81560. For remote control operation and to operate one single action or double action hydraulic cylinders with 24 V. D.C. 800 to 1500 P.S.I. connections are 550"-18th. Applicable for 115 V. A.C. Instructions & Data included. **\$3.95** ea. **\$7.50** pair \$35.00 value.....

ELECTRIC ACTUATOR Has a 1/2 H.P. 24V D.C. 7500 R.P.M. reversible motor with integral push pull actuator. Motor drives actuator in a 10" travel through a high reduction gear box. Ideal for remote control, two way action, for use in opening or closing, lifting or lowering. Unit is complete with adjustable micro switches. The stationary load rating is 2800 lbs. Overall length 19". Stock #AA-LM..... **\$12.95**

PESCO LARGE VOLUME UTILITY PUMP For Water, Oil, Insecticides, etc. Including built in relief and pass valve. Capacity 400 G.P.H. 1/2" drive spline shaft. 3/4" pipe inlet and outlets. Engineering data incl. **\$7.95** Stock #6001 only.....

G. E. SOLENOID #8240 incl. 1/2 RPM torque motor. Movement is 1/4 rev. 3/16" Dia. shaft. Operating lever 1 1/4". For operating latches, shutters, dampers, etc. For 24 V. D.C. and applicable for 110 V. A.C. Instructions New..... **\$4.95** paid

RIGHT ANGLE DRIVE with 1 to 1 ratio through 90 degree bevel gears. Drive and take off shaft are 3/8" dia. Self lubricating. Size 3 1/2" x 2 1/2" x 1 1/4". Rated 1/2 H.P. at 1750 R.P.M. Ideal for use with power tools, etc. Has three 3/16" mntg. holes on 1/2" post- 1-5/16" center. Price **\$3.50** paid

CUNO OIL FILTER—Brand New Aircraft type. Filters oil without cartridge replacements. Just turn handle and cartridge is clean. Standard 3/8" inlet and outlet ports to accommodate 14 gallons per minute. STOP CHANGING OIL. Instructions incl. **\$4.95** post- paid

Send CHECK OR M. ORDER. PRICES F.O.B. KCMO EXCEPT when marked POSTPAID U.S.A.

ELECTRIC MOTORS
GEAR HEAD MOTOR Heavy duty 1/2 H.P. 3400 R.P.M. Series wound, Reversible, including built in reduction gear with 14:1 ratio Gear shafts runs 600 R.P.M. For 24VDC & applicable for 110VAC. Ideal for rotating antenna, window display & other low speed drives. #921. Instruct. incl. **\$5.95** Stock No. 2832 is 1/4 H.P. 28V. D.C. 4000 R.P.M. with simple instructions to convert to 28-32V. A.C. Gov't. cost **\$4.95** #82.84. New.....

Stock No. 4949 is 1/2 H.P. 24 V. D.C. 2000 R.P.M. Mfg. by PESCO, applicable for 115 V. A.C. Instructions incl. Base mounted **\$3.95**

DELCO MOTOR 6 Volt DC. Shaft is 3/8" in dia., 1 1/4" long. Size 5"x3" two mount. Post- ing studs. 1200-2000 RPM. Price. **\$3.50** paid

AIRCRAFT STARTING MOTOR. Operates on 12 to 32 volts. Gives high torque, slow speed and tremendous power. Applicable for pulling or moving heavy loads. Makes ideal winch or heavy duty hoist. For belt or direct drive. Mfg. by Jack & Heintz. O. cost over \$300.00. Ship, wt. 55 lbs. **\$9.95** f.o.b. Stock #J10..... **\$9.95** KCMO.

ALUMINUM AIR FILTERS Brand New, 2" thick metallic mesh filters, ideal for warm air furnaces, air conditioning units, etc. Removes dirt, dust, lint, etc. with efficiency & economy. Fire- proof and odorless. Size 19"x33"x2". Built to give many years of service. Wt. 7 lbs. #F933. **\$35.00** value..... **\$2.95**

ECLIPSE MOTOR & GEAR UNIT. Brand New including 24V. D.C. Motor. Gear ratio 4:1, can be adapted for 2:1, 40:1 & 20:1. Ideal GARAGE DOOR OPENER, HOIST, PUMP JACK, HAY- LIFT, LAWN MOWER DRIVE, DRIVE FOR POST DRILL, etc. Gear unit applicable for 110 A.C. Diagrams & instructions incl. Gov't cost \$221.00. Wt. 23 lbs. **\$9.95** f.o.b. only..... **\$9.95** KCMO.

BEAM ROTATOR MOTOR New Powerful. Reversible, geared motor for TV aerials, Ham, FM, etc. Light weight, rugged. Shaft Speed is 9 R.P.M. Built in mounting bracket. (Applicable for 24V. D.C. and 110V. A.C.) Instructions **\$7.95** incl. Stock #AJ31. \$50.00 value.....

PESCO Centrifugal HEAVY DUTY PUMP Including built in motor. 1/4 H.P. Applicable for 24V. D.C./A.C. or 110V. A.C. The motor is explosion proof constructed for gasoline fuel, oils, water, fuel booster, etc. 3/4" hose connection. Rated capacity, 400 G.P.H. Instructions incl. Gov't cost **\$9.95** \$172.00 Stock #659.....

Adel Self-Priming ELECTRIC PUMP For pumping light oils, oil burners, fluid metering, fuel pump, tool post grinder, coolant, pressure lubricating pump, etc. 1/30 H.P. rated 1200 R.P.M. Applicable for 24 V. D.C./A.C. or use on 110 Volt A.C. Size 6 3/4" x 3 1/2" x 3 1/4", rated 3 G.P.H. Diagram and instr. **\$8.95** incl. \$50.00 value.....

ROTARY PUMP for pumping WATER FROM POOLS, OR BASE- MENTS, SUMPS, pumping lubri- cants. For Garden & lawn spray- ers. For use with hydraulic cylinders, vacuum, in dental lab, etc. Capacity 180 G.P.H., 200 lb. pressure, 29 in. vacuum. 500 to 3000 R.P.M.. Steel shaft Std. 1/2 in. Stock #101. Instr. incl. **\$7.50**

BENDIX VACUUM AIR GENERAL PURPOSE PUMP for water, oil, insecticides, Air, fluid pressure or vacuum or as auto drain case pump. 150 G.P.H. Instructions incl. **\$8.95** 3/4" pipe ports. Stock #75

PESCO OIL HYDRAULIC PUMP. Gear Type, High Pressure, heavy duty pump Rated 227 Cu. In. Rev. 198 G.P.H. 1500 P.S.I. Rotation either direction. 3/4" inlet and outlet ports. Shaft equipped with male spline 1 1/8" diameter. O. Gov't. cost over \$150.00. Data in- cluded. Stock #700 **\$9.95**

BENDIX HYDRAULIC PUMP and MOTOR POWER UNIT. Motor is 1 1/2 H.P. 24V. D.C. and operates on 12 and 32 Volt power. Rated 200 G.P.H. Pressure adjustable up to 1500 P.S.I. Ideal for Hyd. lift trucks, portable loaders, etc. Gov't. cost over \$300.00. New..... **\$12.95**

HYDRAULIC HOSE 2000 P.S.I. Pressure For Oil Fuel & Air. Highest Quality

Length	Fittings	Tube size	Price
27"	F & F	3/4"	\$1.10
27"	F & F	3/8"	1.15
40"	F & F	3/8"	1.35
28"	F & F	1/2"	1.45
17"	F & F	5/16"	.75

Add 20% for postage. Free Hose listing on request.

VICKERS CONSTANT DISPLACEMENT HY- DRAULIC PUMP Brand New No. PF-713-20. 375 G.P.H. 3750 R.P.M. 1000 P.S.I. to **\$17.50** #410 cu. in. rev.

115 V. A. C. GENERATOR IDEAL LIGHT PLANT & BATTERY CHARGER

\$25.50 used, good cond. Instr. incl. for combi- nation 115V. A.C. light plant & D.C. Battery Charger Stock #511 **\$35.50** PRICE New....

F. O. B. K. C. MO. **\$250 to \$500**

A-C D-C GENERATOR A. C. OUTPUT 1250 WATTS. 115 V 10.9 AMP. D. C. OUTPUT 200 AMPS, 30 VOLTS

Mfg. by G.E. The generator has a splined shaft and is self-excited. Will serve as a dependable, 115V. A.C. Light plant when driven by a gasoline engine. For farms, cottages, trailers, boats, flood lighting. Use D.C. output for battery charging, welding and marine use. Gov't. cost over \$300.00. Wt. 50 lbs.

Stratopower Constant Displacement HEAVY DUTY PUMP For operating Hydraulic cylinders, hydraulic motors on tractors, Bulldozers, Construction machinery. Lift trucks. For fuel or oil transfer. Industrial applications, etc. Delivers up to 400 G.P.H. at 3750 R.P.M. Rated 1250 to 1400 P.S.I. 3750 to 4500 R.P.M. HAS BUILT IN RELIEF AT HEAD. Rotation either direction without adjustment. \$100.00 value. Engineering data and instr. **\$17.50** incl. Stock #37. Wt. 8 lbs..

AIR OR OIL HYDRAULIC CYLINDERS Stock No. 17 Double action 1 1/2" Bore, 9 3/4" Stroke, 3/8" dia. shaft..... **\$9.95**

Stock #11—Double action 1 1/2" Bore, 6" Stroke, 3/8" Dia. shaft. Clevis mounting base and shaft end. Capacity 1160 lbs. with 1000 P.S.I. **\$8.95** post- input. \$50.00 value.....

Stock #303—Double Action 2" Bore, Stroke 1 1/4", 1 1/2" Dia. shaft. Overall length shaft retracted 23". 2000 lbs. capacity with 1000 PSI gives 2800 lbs. with our strato- **\$14.50** f.o.b. power. Wt. 14 lbs.. **\$14.50** K.C. Mo.

Stock No. 512. Double action 2 1/2" Bore, 4" Stroke, 3/4" Dia. shaft including built in Hy- draulic control valve which may be operated with rod or lever. Clevis mounting. \$75.00 value. **\$9.95** f.o.b. Wt. 9 lbs. **\$9.95** K.C. Mo.

Stock No. 12 Hydraulic Cylinder Double Action output 12560 lbs. with 1000 P.S.I. input. Gives 17584 lbs. with our STRATOPOWER PUMP 1400 P.S.I. or will produce 34168 lbs. with 3000 line pressure. Can also be operated on low pressure system. 4" Bore, 10 3/4" Stroke 1-5/16" Dia. Shaft, clevis mounting. O. Gov't. cost **\$25.50** f.o.b. \$300.00..... **\$25.50** K.C. Mo.

FOUR WAY HYDRAULIC CONTROL VALVE #329 For controlling 2 single action or 1 double action cylinder. Puts pressure on 1 cylinder & opens exhaust or returns to neutral position, and locks cylinders. Has dual handle control. 3/8" AC tube size **\$8.95** post- ports. Brand New.....

LARGE VOLUME HYDRAULIC Pressure relief valve 3/4" ports spring loaded 1250 P.S.I. adjustable up to 3000 P.S.I. **\$4.95** post- Brand New.....

FOUR WAY HYDRAULIC CONTROL VALVE for use with two hydraulic double action cylinders. Each cylinder may be operated independently of the other or in conjunction with the other. Oil may be locked in any of the cylinders to hold the piston at any required position. Brand New. \$60.00. **\$12.95** Post- value. Stock No. 620. Only.....

FOUR WAY HYDRAULIC CONTROL VALVE Poppet type Valve shuts off on neutral position. Has 3/4" A.C. Tube ports -9/16- 20 thread, capacity 1500 P.S.I. Brand **\$5.95** post- new. Stock #1032.....

FOUR WAY SOLENOID VALVE. OPERATES ON 24V. D.C. & applicable for 115V. A.C. Including manual override for operating 2 single or 1 double action hydraulic cyl., for remote control operations, etc. 3/4"-18thd size ports. Instructions incl. Brand New \$50.00 value. Stock #1213. **\$9.95**

BENDIX HYDRAULIC FLOW PROPORTIONER & PRESSURE BALANCER VALVE Guarantees equal flow & equal pressure for 2 cylinders or two systems. Cap. 350 G.P.H. 1500 P.S.I. data incl. \$50.00 **\$14.50** post- value. #404999.....

HYDRAULIC OIL Medium f.o.b. Red. 6 Gal. drum..... **\$5.95** K.C. Mo.

HYDRAULIC PRESSURE GAUGE For high pressure hyd. systems. Range 0 to 2000 P.S.I. **\$3.95** Post- value. Uses 1/4" fittings. New.....

Hydraulic Accumulators — Bendix Ball Type Dia. 5 1/2". Built to stand 2000 P.S.I. Stock #A-65. Wt. 4 lbs. only. **\$5.95**

BENDIX ACCUMULATOR Ball Type. Dia. 10 1/2" Built to stand 2000 P.S.I. Wt. 15 lbs. Stock #A-85. Only... **\$15.50**

Schupack's Amazing Tool Bargains! All Brand New! Save up to 100%!

112 PIECE ASSORTMENT \$3.95
FOR ELECTRIC GRINDER
\$10.00 VALUE - ONLY
Post-paid
Here's what you get! Mounted Stones on 1/2" mandrel, Drum Sander, Sanding Sleeves for sander, Rotary Cutters, Wire Scratch Brush, Bristle Brushes, Circular Saw, Buffing Wheel, Grinding Wheel, Rubber Polishing Wheel, Cut-off Wheels, Rubber Cylinders, Mandrels to fit above tool, Ass't'd Sanding Discs, Sharpening Stone, etc.

18 ROTARY CUTTERS \$5.85
\$13.50 Value
Post-paid
Illustrated in actual size
Assorted sizes cutter on 1/4" or 3/32" shank. Will fit all hand grinders. Ideal for cutting wood, metal, or plastic. Brand new.

2 DRUM SANDERS \$1.50
Post-paid
With 12 Bands in Assorted Grits. 1 1/2" dia. x 1" long on 1/4" arbor with 12 bands
ONE DRUM, 1" DIA. X 1" LONG ON 1/4" ARBOR WITH 6 EXTRA SLEEVES \$1.00
Post-paid

7 High Speed Twist Drills \$1.00 P.P.
15 DRILLS \$2.00 P.P.
7 Popular sizes—up to 1/4". Brand new. Set #16.
5 Drills from 1/4" to 1/2" Dia. \$1.95

Woodworkers' Drills \$2.00 P.P. U.S.A.
4 drills, from 5/16" to 1/2" with 1/4" shanks. Brand new, popular sizes. Set #14.

5 Woodworkers' Drills \$3.50
From 1/4" to 3/4". Set #15 Only... Ppd.

10 Twist Drills \$10.95
Brand New. From 1/4" to 1-1/4". High speed, and carbon steel. Set #18 Only... Ppd.
NEW ILLUSTRATED CATALOG 10c

FLEXIBLE SHAFT - ONLY \$4.95
Post-Paid
Fits all electric drills & hand power tools. 35 3/4" long. Oilite bearings. Core of specially wound, high carbon steel wire in flexible steel casing. Will accommodate tool shafts up to 1/4" dia. For lathes, electric drills, etc.

12 MINIATURE CUTTERS \$1.00
FOR CUTTING PLASTIC or METAL. Actual size. Ass't. shapes on 3/32" shank. For die makers, home workers, etc.
36 SHORT SHANK MINIATURE CUTTERS \$1.00

12 MOUNTED WHEELS \$2.95
Post-Paid
For grinding on plastic, wood, soft and hard metals. Regular List Value \$8.40.
12 MTD. WHEELS ON 3/32" SHANK \$3.60
18 MOUNTED POINTS ON 3/32" SHANK \$2.50

SCHUPACK SUPPLY CO., 7331 COTTAGE GROVE AVE., DEPT. M-49 CHICAGO 19, ILL. SEND CHECKS OR M. O. NO COD'S PLEASE

Drive Screws, Nuts, Bolts 10 TIMES FASTER with DRIL-O-DRIVER



Picture shows greatest little invention ever designed to save time and work for carpenters, cabinet makers, home craftsmen, hobbyists, electricians, plumbers, farmers — everybody who uses tools. The new DRIL-O-DRIVER is an Electric Drill Attachment that can be used with any quarter inch electric drill. It drives slotted and Phillips screws, nuts and bolts. Operator controls speed and force of drive. Designed to give durable, useful long years of service. Small enough to fit any kit. Unconditionally guaranteed. If your dealer does not stock Dril-O-Driver, send \$9.95 today for your DRIL-O-DRIVER, Screw Driver Bit and Drilo "Magic Connector" an adapter enabling you to use 54 standard tools available to electric drill owners. We pay postage.

NOW ONLY \$9.95 P. P.

THE DRILO CORPORATION
204 E. Carson St. Pittsburgh 19, Pa.

SAVE 50%—SURPLUS BENCH GRINDERS — NEW



Rugged, precision constructed for continuous heavy duty or light work. Adjustable babbitt bearings. Tool rests. Arbor 1 3/8" x 3/4" at ends. Takes up to 10" x 1 1/2" wheels. 2 combination grinder pulleys for flat or V-belt drive. Grinder weight 25#. Send check or money order. No C.O.D. orders. Price \$11.95 f.o.b. Plymouth, Ind.

CLIZBE BROS. MFG. CO., DEPT. B, PLYMOUTH, IND.

FREE CRAFT CATALOG



120 PAGES... Craft Supplies, Tools, Designs, Instruction Books from America's Largest, Most Complete Handcraft Stock.

Send for your free copy NOW!

GRIFFIN CRAFT SUPPLIES
5626-A Telegraph Ave • Oakland 9, Calif.

NEW SAF-PIC TOOL

A TOOL OF A THOUSAND USES
COLORFUL, DURABLE, ALL STYRON PLASTIC WITH HARDENED STEEL SHARP TEMPERED POINT.

FOR THE MECHANIC—A do all tool, scribing, punching, marking, etc.
FOR THE OUTDOOR MAN—Indispensable for fishing, camping, picnics, etc.
FOR THE HOUSEWIFE—For house, car, and safe for the children.

EUGENE SALAN
P.O. BOX 343 • CULVER CITY 2, CALIFORNIA

SO SAFE AND EASY TO USE

Illustration Showing Three Parts Pat. Pend.

\$1.00 MONEY-BACK GUARANTEE

Saf-Pic Ready for Use
Pick Concealed for Safety

WORLD'S LOWEST PRICED ADDING MACHINE

VEST POCKET SIZE FREE TRIAL \$2.95

IDEAL FOR BUSINESS AND PERSONAL USE — GUARANTEED ACCURATE

Not a toy. Operates with only a finger flick. Adds, subtracts, multiplies, divides. Counts up to one billion. Pays for itself over and over. Ideal Gift — for TOTAL COST Business, Income Tax and School use. **SEND NO MONEY** MONEY BACK GUARANTEE. Send name and address. Pay postman only \$2.95 plus postage. (Send full cash if outside U.S.) Beautiful rich-looking Leatherette Case included at no extra cost. Money back in 10 days if not delighted. AGENTS WANTED.

CALCULATOR MACHINE CO., (Mfrs.)
Dept. PM-312 Glenview, Illinois

BUY DIRECT MANUFACTURER TO YOU!

AUTOMATIC AIR COMPRESSOR

1/2 H.P. Heavy Duty Motor, 115-V, 60 cy., 1 ph., 1725 RPM, \$24.50; Quincy X2 — 3 CFM — 100-150 lbs. Compressor — 2 in. x 1 3/4 bore & stroke, \$20.50; Furnas Automatic Adjustable Pressure Switch, \$6.50; Tank 8" x 26", Rubber Tired Wheels and Handle, \$17.00; Speedy External Atomizing Quart Spray Gun, \$11.75; Pressure Regulator, \$4.25; Filter, \$3.25; Gauge, \$1.75; Hose & Tire Chuck, \$2.50; Check Valve, \$2.75; Safety Valve, \$1.50; V-Belt Drive, \$2.75.

PARTS CAN BE BOUGHT SEPARATE AT ABOVE PRICES. COMPLETE BALANCED UNIT AS ABOVE, ASSEMBLED, READY TO USE.

=S-55... fob Chi. \$99.00
SAVE \$20.00... 1/2 H.P. Outfit, knocked down, you assemble, =SK-55... Fob Chicago... Only \$79.00

=SK-100—1 H.P. Motor 15"x30" Tank Twin Cylinder 9 CFM Compressor. All Accessories. You Assemble \$169.50 Fob.

C. MARSHALL SALES
3546 W. Fullerton Ave. Dept. P-12 Chicago 47

ELECTRIC MOTOR BARGAINS FOR HOME, FARM AND INDUSTRY

1/4 HP Westinghouse, 1725 RPM, Ind. type... \$10.50
1/3 HP Westinghouse, 1725 RPM, Ind. type... \$12.50
1/2 HP West., 1725 RPM, double shaft... \$22.50
1/2 HP West., 3450 RPM, double shaft... \$23.50
1/2 HP G.E., 1725 RPM, bal. brg. \$26.50
3/4 HP West., 1725 RPM, Capacitor... \$32.50
3/4 HP West., 3450 RPM, Capacitor... \$33.50
1 HP Dayton, 1750 RPM, Capacitor... \$45.00
1 HP Dayton, 3450 RPM, R. I. and Cap. \$45.00
1 1/2 HP Dayton, 1750 RPM, Capacitor... \$52.00
1 1/2 HP Dayton, 3450 RPM, Rep. Ind. \$52.00

Above are 110 V. or 110/220 V. 60 cy. 1 ph. A.C. Motors. All Motor Prices are F.O.B.

All motors guaranteed 100%. We have large stock direct current and 3 Ph. motors, all sizes. Write for price on the motor or you need.

Write for CIRCULAR: Listing Motors; ALL SIZES: Fans and Air Compressors — ALL SIZES.

16 TO 1 SPEED REDUCERS
For Display Table — Barbecue Spits — Toy Auto Gear Box — Experimental Uses, Etc. Gears Enclosed in Aluminum Housing. Bronze Gear. Hardened Worm, Input Shaft 1/4 in. Output Shaft 3/8 in. Speed Reducer #R 161... \$5.95 Post Paid

**100-200-300 POWER
'HYPOWER' MICROSCOPE**



A VALUE UNSURPASSED ANYWHERE! Triple objective revolving lenses allow selection of 100, 200 or 300 power magnifications. Has built-in micro adjustment. Adjustable sub-stage mirror. Body is made to incline through 90°. Complete in dovetailed hardwood case. Ideal for student, lab, study of insects, etc.

SPECIAL 9.95

BARGAIN HOBBY MOTOR



Here's a real value for the hobbyist or home mechanic. This powerful little motor turns 2500 to 3600 RPM.

Has a double-end shaft fitted with an arbor for mounting small stones, wheels, buffers, etc. and a hand chuck for 3/32" and 1/8" shanks.

MOTOR complete with arbor & chuck --- 3.99

FLEXIBLE DRIVE-SHAFT for HOBBY MOTOR
36 inches long and complete with necessary adapters to take, grinding, buffing, polishing, wheel, etc. Shaft is 7/32" dia. Makes this motor a very versatile bench tool. **2.99**



**ARMY SURPLUS
TOOL BOX**

Made of finest Chest Steel. Reinforced corners. Welded piano hinge. Roomy lift-out tray. Leather handle. Size: 16" x 7" x 7". A \$6.95 VALUE! **ONLY 2.75**

FAMOUS SURPLUS MIXES



Another Palley Bargain Mix. 24 assorted hose clamps of various sizes & types. Ideal for use on autos, trucks, tractors, boats, planes, pumps, etc. All are finest aircraft quality. Be Prepared. **2.89**

GADGET MIX - Another SURPLUS BARGAIN!
This amazing mix includes a 'TREASURE' of small parts such as: Gags, Worm Gears, Wheel Bearings, Rivets, Spacers, Bolts, Screws, Springs and Clamps. 5 pounds for **ONLY 1.19**

ARMY D-12 MAGNETIC COMPASS



A real WAR SURPLUS BARGAIN! Was standard navigational equipment on all Army Aircraft. Has a rotating verge range ring, calibrated in 1 degree increments from 0 to 360°. Two parallel grid wires for N-S alignment. Ideal for airplane, boat, etc. **NEW 17.50**

Surplus JEEP CANS

FOR RESERVE GAS SUPPLY. Holds 5 Gallons. Has screw top and will take standard flexible nozzle. **1.39**

FLEXIBLE NOZZLE 49c

MARCHING COMPASS

Lensatic type. An all-purpose precision instrument for surveyors, hunters, sportsmen, boy scouts, hikers, etc. Can be used for map orientation, taking azimuth reading or as a guide in unfamiliar terrain.

The bezel ring is marked in 3° notches for computation and rotates through 360 degrees. Has a special "peep" sight and hair-line guide in lid for taking a bearing on a distant landmark or object. **3.95**

NEW RADIO SPEAKER

A very popular model for all types of radio, TV, public address systems, lab work, etc. Has a full tone range and true quality. Rim is 10 inch dia with standard hole mounting. Dynamic type with transformer. **2.95**

4 INCH ALNICO - Permanent magnet type speaker 2.49

Palley SURPLUS & NEW MERCHANDISE GIFT BARGAINS



**9 PIECE
DRAWING SET**

Suitable for the architect, student, draftsman, artist, etc. Contains 9 separate pieces including: one 5 1/2" divider; one each: - 3 1/4" bow divider, bow pencil & bow pen with wheel adjustment & reversible needle point; one 4 1/2" ruling pen with extra handle; capsule of extra leads. All in a 2 flap, velvet lined pocket book case. **ONLY 5.98**

**AIR CORPS SURPLUS
PLASTIC PARALLEL RULER**

Heavy durable plastic with guide knobs on top and rubber pads on bottom to prevent slipping. Has beveled edges for pen & pencil use. **98¢**

NEW BERNZ-O-MATIC TORCH

Makes the old "blowtorch" obsolete. Here is a self-contained fuel & burner unit that does a job where intense heat from a concentrated flame is needed. Absolutely SAVE! (ICC approved). High quality steel - lightweight - replaceable fuel cyl.

PENCIL FLAME TYPE - with 10 hour cylinder & burner unit - ONLY 6.95

EXTRA FUEL CYLINDERS - 1.95

NEW 7 to 1 HAND HOIST

Strongest hoist for its weight on the market. Will LIFT 1000 lbs. but weighs only 1 lb. Handy at home, on farm, in shop, etc. Consists of 2 pulley blocks, 100 feet of Nylon Cord, 2 Nylon slings and canvas bag. Easy to pack and carry. Ideal as hunters game hoist. **12.50**

**NEW POCKET
HAND WARMER**

Maintains a temperature up to 120° by radiation. Heats from 16 to 24 hours without re-filling. Uses cigarette lighter fluid or white gasoline. Absolutely Safe! Metal case. Extra Heating Elements for above - 2 for 75¢

SURPLUS TANK SCOPE

A very popular, inexpensive telescope. Easily sighted with formed face piece. All brass construction. FULL 20 POWER. **8.95**

HUNTING KNIFE

GENUINE G.I. EQUIPMENT
Has a 6-inch, polished Vanadium Blade with handle made of leather and fiber discs. Comes with a tanned leather sheath. **Only 1.98 5.00 VALUE**

AVIATORS (AN-6530) WINDPROOF GOGGLES

Genuine ARMY AVIATORS TYPE. Have interchangeable, precision ground lenses. Your choice of three lens colors - Clear, Amber or Green. Metal frames are rubber covered with a soft, chamois lining and have built-in, non-fogging breathers. Also has adjustable nose bar. **2.95**

EXTRA LENSES - Choice of three above colors. Per PAIR ONLY 1.35

**NEW B-9 TYPE
AIR CORPS PARKA**

32" Long Only 22.95



Same as original B-9 Parka. Length 32". Body of 9 oz., Gov't Sateen, Mountain Cloth. Body and sleeves fully lined with 16 ozs of quilted & covered wool. Has heavy duty, zippered front with button-down storm tab. Full cut Mouton fur lined hood with button around storm cuff, draw strings & gaggle strap. Coat has elastic inset across back for snug fit. Two, deep, roomy slash breast pockets and large side pockets - all with storm flaps. Button down shoulder tabs. Sleeves have adjustable cuff straps and inside knit storm cuffs. Color: Olive Drab. **Medium Sizes - 34-46 - \$22.95**
Large Sizes - 48-50 - \$26.25

Air Corps Type CAP

Special! For the Hunter, Camper, Farmer, etc. All Leather with soft suede lining & sheepskin lined. **2.59**

MITTENS

Sheepskin lined with leather outer cover. Ideal for all types of winter work. Sizes small, medium & large. **ONLY 2.69 PAIR**

NEW GENUINE U.S. NAVY SHEEPLINED FLIGHT BOOTS

Only 10.88 PR.

Can be worn with or without shoes. Has genuine leather uppers and rubber lowers. Laces up the back for snug fit. Has double zipper front closure to put on & take off easily. Leak-proof, weather-proof. Soles of heavy NON-SKID tread. The ideal rough weather boot. Sizes: Small, Medium, Large, Ext. Large.

WATERPROOF NON-SKID SHOE PAC

Has 10-inch, sturdy leather uppers and a genuine, all rubber shoe with a felt inner sole. Designed to wear over ordinary shoes. Gives complete protection from water, snow. **4.95 PR.**

ARMY SURPLUS SKI POLES

Laminated Steel, leather laced. Wrist strap. Also has leather laced snow ring. Metal tip. Length 4 ft. These poles are WORTH 3 TIMES OUR PRICE! **3.95 PR.**

1954 Edition WORLD'S MOST AMAZING BARGAIN CATALOG

320 PAGES - FULLY ILLUSTRATED
Larger than ever before. Packed with SENSATIONAL VALUES in **WAR SURPLUS, FACTORY CLOSE-OUTS** and **GENERAL MERCHANDISE!** Included are thousands of items in Hand & Power Tools; Hydraulic Cylinders, Pumps, Motors, etc.; Hardware; Industrial Tools; Cameras and Photo Supplies; Outdoor and Sporting Equipment; Microscopes, Binoculars, Telescopes, etc. Foam Rubber, Aircraft Parts, Electrical Motors, Blowers, etc.



Only 50¢ Order Your Copy Today! We refund your 50¢ on your first order of \$1.00 or more.

PALLEY SUPPLY CO 2263 E. VERNON AVE., DEPT. PM-12 LOS ANGELES 58, CALIF

Order From This Ad. Pay by M.O. or check. P.O.'s accptd. from D&B firms. 1/2 deposit with C.O.D.'s. All Prices FOB Los Angeles.

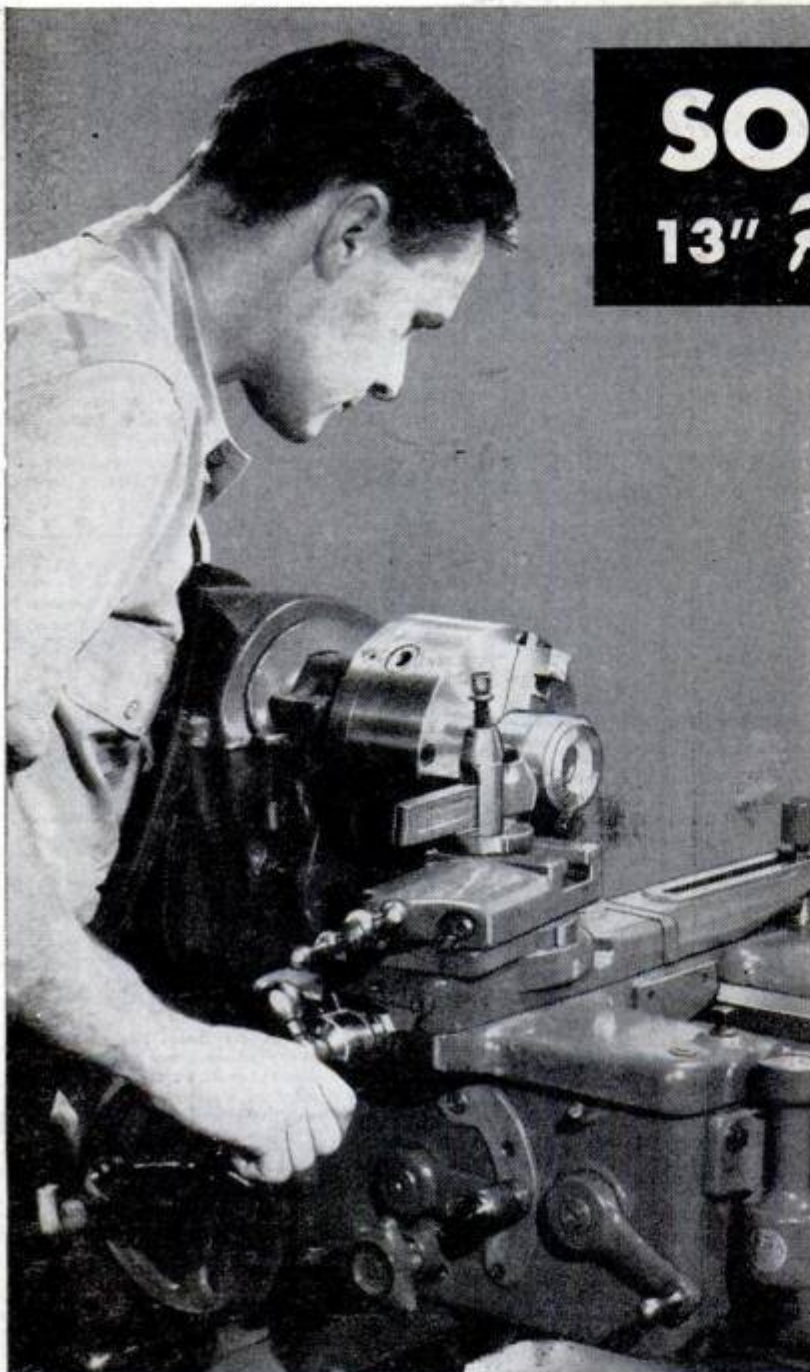

SOUTH BEND

13" Precision Lathes

**for accurate,
low-cost machining**

These lathes are popular in the toolroom, production shop, or wherever varieties of precision parts are machined. Users prefer them for their simplicity and practically effortless handling. Job set-ups and tooling changes are made so quickly and easily that down-time is held to a minimum. A very complete line of attachments simplifies tooling. Send coupon for complete information.

SPECIFICATIONS

Swing — 13 $\frac{1}{8}$ " over bed and saddle wings, 8" over cross slide.

Distances Between Centers — 28 $\frac{1}{4}$ ", 40 $\frac{1}{4}$ ", 52 $\frac{1}{4}$ " maximum.

Collet Capacity — 1" maximum (Collets interchangeable with South Bend 10"-1" Collet, 14 $\frac{1}{2}$ ", 16" and 16-24" lathes).

Spindle Bore — 1 $\frac{3}{8}$ ".

Spindle Speeds — Eight, 40 to 940 r.p.m., approximate.

Power Longitudinal Feeds — 48 R.H. or L.H., .0015" to .0841".

Power Cross Feeds — 48, .0006" to .0315".

Thread Cutting — 48 R.H. or L.H. pitches, 4 to 224 per inch.

Send For This Book!

Every machinist needs "How to Run a Lathe." This helpful handbook contains 128 pages and over 365 illustrations and diagrams on all phases of lathe operation and care. Price postpaid 50 cents.



Can I get it? When? How?

Yes—you can get most any South Bend product immediately from our distributor's stocks in principal cities. Items not stocked, shipped promptly from factory.

Three ways to order:

1. See or telephone nearest distributor.
2. Order by mail from your distributor.
3. If no distributor is nearby, order direct from factory.

South Bend machine tools with accessories may be purchased on convenient terms up to 12 months.

SEND INFORMATION CHECKED:



9" and 10" BENCH LATHES

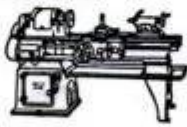

10" to 16-24" FLOOR LATHES



DRILL PRESSES

TOOL GRINDERS



$\frac{1}{2}$ " & 1" Collet TURRET LATHES



7" BENCH SHAPERS

Name _____ Company _____

Street _____ City & State _____

Building Better Tools Since 1906 • SOUTH BEND LATHE • South Bend 22, Indiana



**WHY you should buy
a new**

DAISY
TRAINING B-B RIFLE

**for your children
this Christmas, Pardner!**

—Red Ryder



No. 102 DAISY
350-Shot
REPEATER
\$3.98

No. 155
DAISY
1000-Shot
REPEATER
\$4.98

No. 142
DAISY
DEFENDER
REPEATER
\$6.98

No. 25
DAISY
PUMP GUN
\$7.98

No. 111
DAISY 1000-Shot
*RED RYDER
CARBINE
\$5.95

Prices subject to
change without
notice and higher
Rockies, West
Coast, Canada.
Do not order
direct—
**BUY FROM
YOUR
DEALER!**

**BOY SCOUTS OF AMERICA and
NATIONAL RIFLE ASSOCIATION
Offer New 15-Foot Junior
BB RIFLE TRAINING PROGRAMS**

DAD—wonderful news! Now your youngster can learn how to properly handle and shoot that "Christmas Daisy" three different ways: (1) by joining the Boy Scouts of America and earning the Marksmanship Merit Badge; (2) by joining the National Rifle Association; (3) by joining a local junior BB rifle club sponsored by an adult or organization. Write for details.

Safest Gun of Its Kind!

DAD! Daisys are often confused with other air rifles. *Here are the facts!* The Daisy is a spring-type, low "factory-limited" power, short range gun. It is NOT a high-powered compressed air or "pump-up-power" pneumatic gun. It has been America's safest training gun of its kind for sixty seven years. So—buy them a Daisy for Christmas! **BE SURE** you teach them proper gun handling OR have your proud Daisy owners join the BSA, NRA, or a junior BB rifle club! Give this wonderful opportunity to learn safety through skill—with a Daisy—safest training gun of its kind!

BUY A DAISY NOW AT—



HOW TO
ORGANIZE
AND CONDUCT
A JUNIOR
BB RIFLE
CLUB



Free BOOKS!

Write or send postal for 2 Free Daisy Booklets—facts on BB rifle marksmanship programs of the NRA, BSA, junior clubs—and how any adult or responsible group can start one. Daisy Catalog is included.



DAISY MANUFACTURING COMPANY
DEPT. 1893, PLYMOUTH, MICHIGAN, U. S. A.

*Licensed by
Stephen Slesinger, N. Y.

ONE SHOT



LASTS ALL WINTER!

You're SET...
You're SAFE...
You're SURE!



NEW!
"PRIME"
GAS LINE
ANTI-FREEZE
Ask your
"Prestone"
anti-freeze
dealer about
it! 65¢ per can.

\$3.75 per gallon • \$1.00 per quart, in quart cans

PRESTONE ANTI-FREEZE

BRAND

The terms "Prestone", "Prime" and "Eveready" are trade-marks of Union Carbide and Carbon Corporation
NATIONAL CARBON COMPANY • A Division of Union Carbide and Carbon Corporation • 30 East 42nd St., New York 17, N.Y.