

# POPULAR MECHANICS

## MAGAZINE

WRITTEN SO YOU CAN UNDERSTAND IT

**HELICOPTER TUG—**  
page 110



*In This Issue*  
**FORTUNES FROM IDEAS**

What the Owners Say  
About the **NASH**

*For the Craftsman*  
**Christmas Toys You Can Make**

# Your Ford won't feel the winter

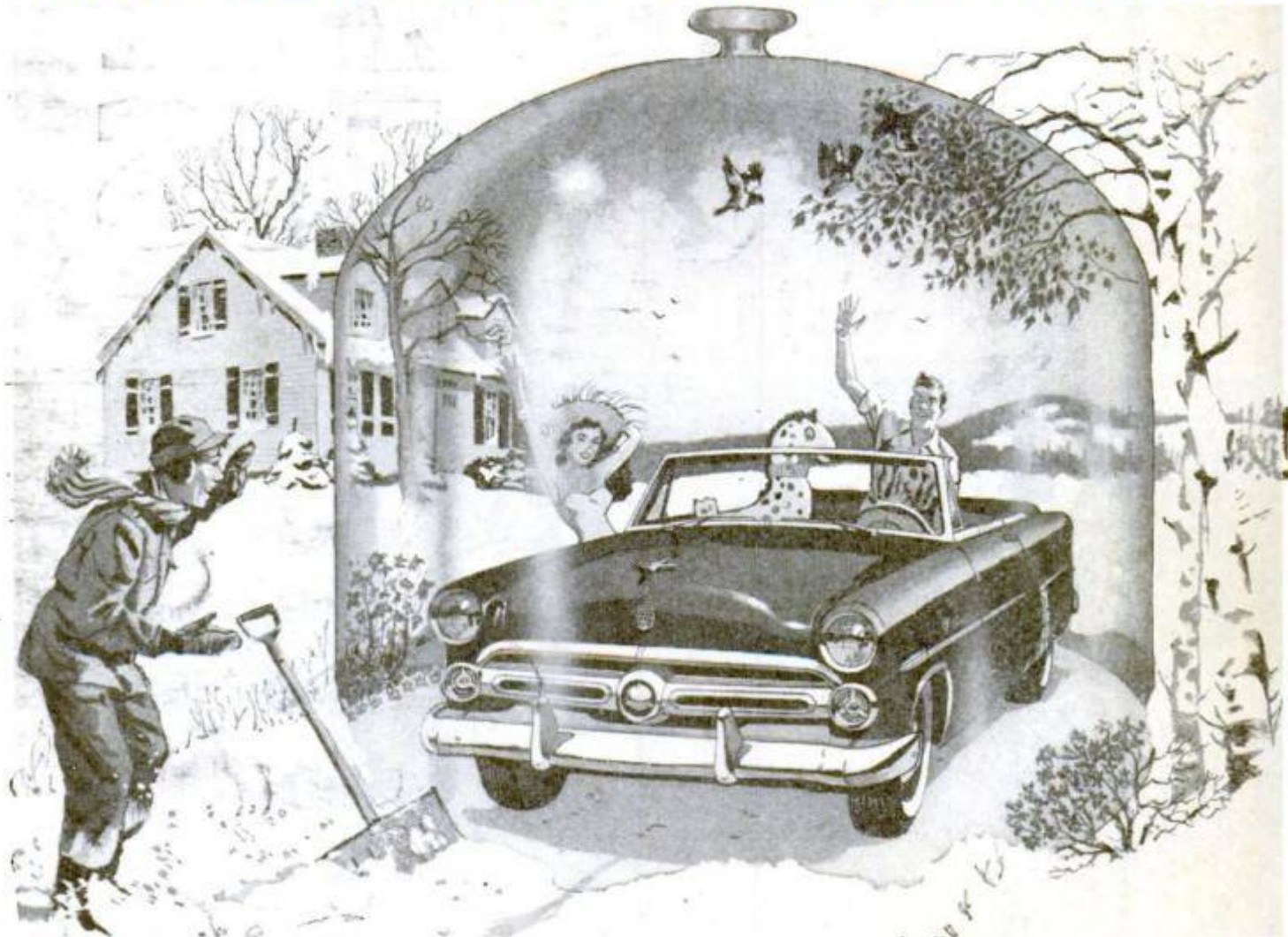

*...if you use parts that are made right for Fords*



When you get your Ford ready for winter . . . if replacements will add to its zip . . . insist on Genuine Ford Parts like the three at the left. Here's why they make a big difference:

**Ford Batteries** are tested to go at 20 below . . . shake-tested, impact-tested for durability and cycled from charge to discharge hundreds of times for long life. Testing batteries *before* approval for manufacture is assurance that your Ford is always ready to go!

**Ford Oil Filter Cartridges** are Track Tested for thousands of miles. Both full-flow and by-pass filters remove contaminants dependably, efficiently *without* removing useful oil additives!

**Ford Spark Plugs** are made to exact Ford specifications. They're balanced to your Ford's ignition system to give smooth engine performance and high gasoline mileage!

Available at all Ford Dealers and the selected independent garages where you see this Genuine Ford Parts sign.



**KEEP YOUR FORD ALL FORD**



**Never  
needs  
waxing!**

So I Says: **"O.K., MABEL—YOU DO IT!"**

I'm putting down a new floor of Goodyear VINYL-TILE in my kid's room when my wife, Mabel, says: "That looks easy!"

Well now I'd always prided myself on being sort of handy around the house—so this makes me burn. After all, I'd never tried to tell her how to cook.

So I calls her bluff and says: "O.K., Mabel—you do it!"

And bless Pat if she didn't! Together, we finished the room quick as a wink.

But I found out later that she still thinks I'm pretty smart. You see, it's the only flooring she's ever had that *never needs waxing* (that's because it's specially pre-polished at the factory to a natural, lifetime luster).

It's so easy to keep clean and sparkling—saves her so much time—that she's giving me all the credit when she shows off our new VINYL-TILE floor to her friends!

P. S. That's right! Goodyear VINYL-TILE is so easy to install, you can do a professional looking job in your own home—and it comes in 18 beautiful colors, by the tile or roll. SEND FOR THE FREE VINYL-TILE "SELF INSTALLATION" BOOKLET—address a postcard to: Goodyear, Flooring Dept. K-8318, Akron 16, Ohio.



**FLOR-MASTER INSTALLATION KIT**

provides the simple tools required to do a professional job in jig time. Available at all better dealers'—where Goodyear VINYL-TILE is sure to be a featured item.

**GOOD YEAR Vinyl-Tile**

By the Tile • By the Roll • FOR FLOORS • WALLS • COUNTER TOPS

Flor-Master—T. M. The Goodyear Tire & Rubber Company, Akron, Ohio

This One



NOVEMBER 1953

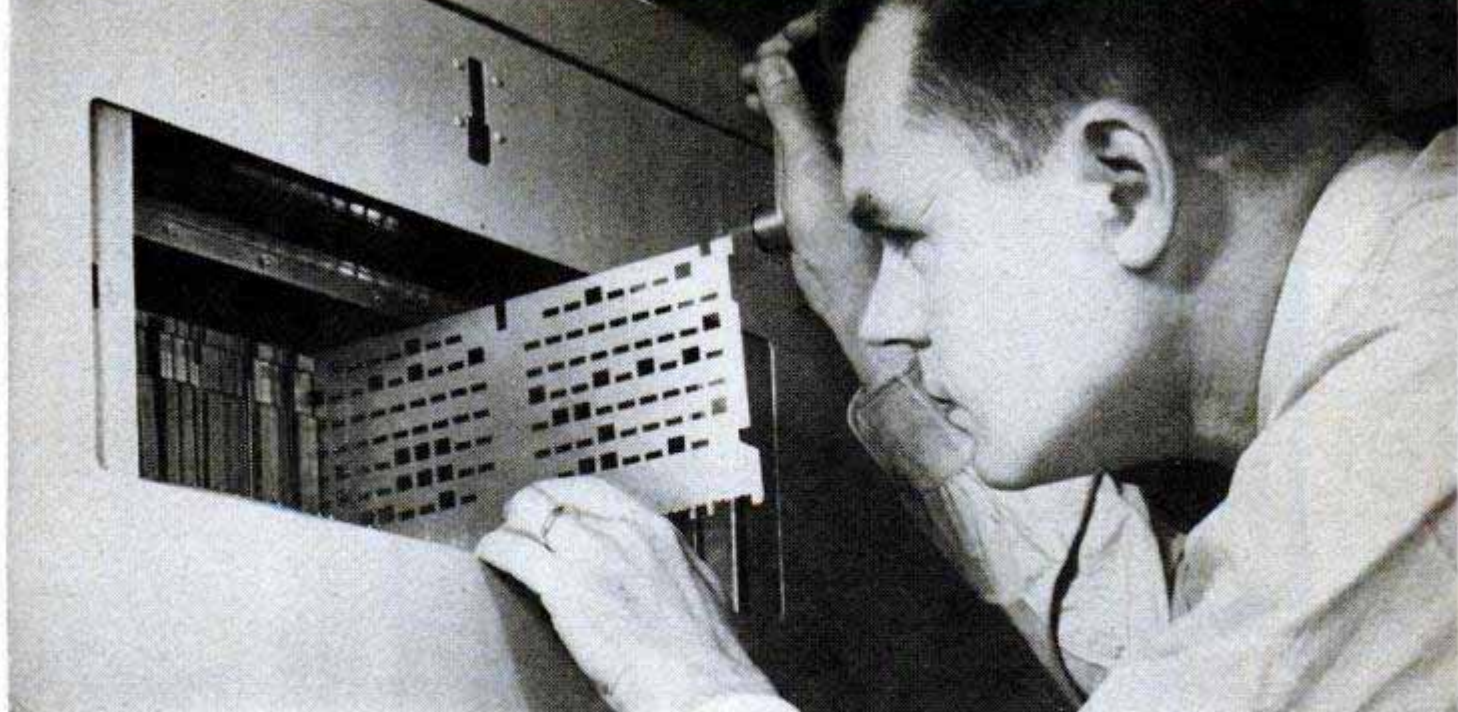

Checking perforated metal card in Bell's new "card file." If the first voice-way is in use, a "detour" is swiftly found.

## CARDS FOR CONVERSATION

To find out how to route Long Distance calls a dial system needs lots of information—fast. To provide it Bell Laboratories engineers developed a new kind of card file—one that dial systems can read.

Punched holes on metal cards tell how calls should be handled. When a call arrives the appropriate instruction card is displaced so that its pattern of holes is projected by light beams on a bank of Phototransistors, which signal switches to set up the best connection.

The "card file" will have its widest use in speeding Long Distance calls that are now dialed by a telephone operator and may one day be dialed by you personally. It is another example of how Bell Telephone Laboratories helps telephony to grow, as costs are kept down.

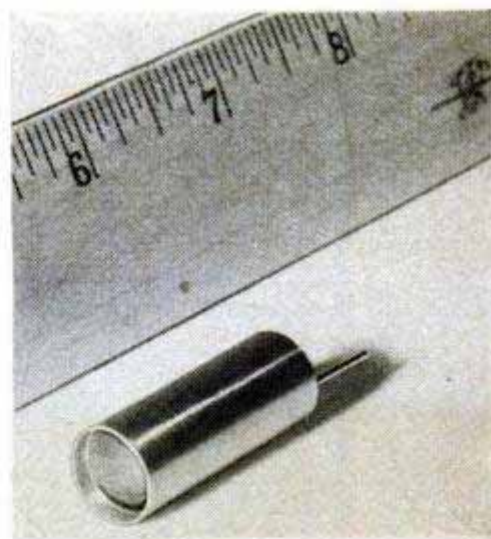

New Phototransistor unit. Light entering cylinder is focused by lens on germanium that responds by generating current. Like the Transistor, the Phototransistor was invented in Bell Telephone Laboratories.



### BELL TELEPHONE LABORATORIES

IMPROVING TELEPHONE SERVICE FOR AMERICA PROVIDES CAREERS FOR CREATIVE MEN IN SCIENTIFIC AND TECHNICAL FIELDS

# Popular Mechanics Magazine

Registered in U. S. Patent Office and Canada

H. H. WINDSOR, Founder

H. H. WINDSOR, JR., Editor and Publisher



## this month's cover

REMEMBER the old days—and not so many days ago, either—when a helicopter seemed downright ridiculous and everybody laughed at the weird craft as it shuddered laboriously into the air? The whirlybirds have come a long way since then, as a good many soldiers wounded in Korea will gladly attest. Now who can predict the future of these versatile windmills that outperform the birds themselves in flight? One of the leading helicopter experts, Dr. J. A. J. Bennett of Hiller Helicopters, now suggests it's entirely possible that powerful eggbeaters of the future may serve as tugs for big airliners. Airports could be moved to downtown locations, where a copter tug would lift a transport vertically, then detach itself when the big liner attained flying speed. Similarly the tug could fasten itself to an incoming plane and lower it to the ground. Turn to page 110 for details of this authoritative proposal

Published monthly by Popular Mechanics Company, 200 E. Ontario St., Chicago 11, Ill. H. H. Windsor, Jr., president; Wm. Harrison Petridge, exec. vice-pres.; D. P. Windsor, vice-president and secretary-treasurer; H. H. Windsor III, vice-president; Clover L. Perkins, advertising manager; Alan M. Devoy, circulation manager. Single copy in the United States and Canada, 35 cents; subscription rates in the United States and possessions, Canada, Philippines and countries of the Pan-American Postal Union, 1 year \$3.50; 2 years, \$6.00; 3 years \$8.00. To all other countries add \$1.00 a year over United States prices for overseas postage. If you plan to move, notify us at least 30 days in advance so you will not miss an issue. Give both your old and new addresses. Entered as Second Class Matter, September 15, 1903, at the Post Office at Chicago, Illinois, under Act of March 3, 1879. Entered as Second Class Matter at Post Office Dept., Canada, Registered as Second Class Matter at the Post Office at Mexico, D. F., Mexico, June 20, 1950. Copyright 1953 by Popular Mechanics Company. Copyright under International Copyright Union. Copyright in France. All rights reserved under Pan-American Copyright Union. Printed in the United States of America.

Volume 100

NOVEMBER 1953

Number 5

Address all communications to:  
200 East Ontario Street, Chicago 11, Illinois

Managing Editor.....	Roderick M. Grant
Assistant Managing Editor.....	Wayne Whittaker
Shop Notes and Crafts Editor.....	James R. Ward
Radio-Television, Electronics Editor.....	Frank L. Brittin
Associate Editor, Aviation.....	Aubrey O. Cookman, Jr.
Associate Editor.....	Clifford B. Hicks
Associate Editor, Automotive.....	Arthur R. Railton
Associate Editor, Shop Notes and Crafts.....	Wayne C. Leckey
Assistant Editor, Shop Notes.....	W. Clyde Lammy
Assistant Editor, Crafts.....	Frank N. Stephany
Assistant Editor, Makeup.....	John C. Dalen
Automotive Correspondent.....	Leo Donovan
Art Director.....	Frank Beatty
Assistant Editors	
Leonard F. Hiltz	Elsie L. Domin      Elliott H. McCleary Jay W. Hedden
Eastern Editor.....	Richard F. Dempewolff Empire State Bldg., Room 2906, New York City 1
Western Editor.....	Thomas E. Stimson, Jr.
London Manager.....	Douglas W. Wedderspoon Eagle House, Jermyn St., London S. W. 1, England
Director, Bureau of Information.....	Allan Carpenter 200 E. Ontario St., Chicago 11

## IN THIS ISSUE

Who Says Animals Are Dumb? - - - -	81
Fortunes in Toy Ideas - - - - -	88
Star Hunting by Radio - - - - -	98
The Owners Report on the Nash - - - -	102
Helicopter Tug to Launch Planes - - - -	110
Prospectors in Parkas Chart Canada's Oil -	113
Rice by the Square Mile - - - - -	122
Bullets Strictly for Bull's-Eyes - - - -	128
Smoke-Eaters With Sea Legs - - - - -	136
Moosehide Canoe - - - - -	150
Logging Booms in the Guianas - - - - -	156
Radio, TV and Electronics - - - - -	161

## For the Craftsman

Period Tables Feature "Plastic Inlay" Tops -	165
The Job's Half Done With Steel Legs - - -	178
New Life for Old Books - - - - -	182
Christmas Toys - - - - -	191
Make Wooden Threads on Your Drill Press -	201
Novelties in Bent Metal - - - - -	205
Holding Work With Clamps and Wedges - -	209
Heavy Duty Drill Press From Auto Parts - -	214
Clinic for Homemakers - - - - -	222

Other items, and manufacturers of available products described, are listed on pages 14, 16 and 18



# Don't put in a drop of anti-freeze...

UNTIL YOU'VE CLEANED OUT RUST WITH

## DU PONT *Cooling System* CLEANSER



**HOW RUST AND ACID CORROSION WASTE  
ANTI-FREEZE ... CAUSE TROUBLE AND EXPENSE**



Accumulated rust, scale and corrosion plug radiator passages. This slows down circulation, may cause leaks. Anti-freeze may leak out ... or "boil out" as motor overheats.



Acid corrosion and rust take place in engine block, too. Circulation slows down, proper cooling becomes impossible. Motor overheats and causes "boiling out" or creeping of anti-freeze.



Water-pump impeller blade is often attacked and eaten away by rust and corrosion. This causes failure of circulation in cooling system and dangerous overheating.

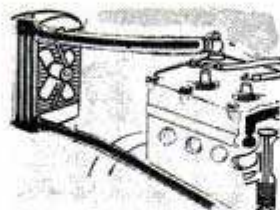

The heater is also part of your car's cooling system. Rust, scale and acid corrosion can impair its operation by clogging passages or destroying vital parts such as tubes.



Before you put in anti-freeze, your car's cooling system needs a careful check-up.

Clean out rust and scale—safely, easily, thoroughly—with Du Pont Cooling System Cleanser.

Simply pour Du Pont cleanser in the radiator and run the motor. It works even while you're driving ... dissolves rust so it can be drained out. No reverse flushing necessary. Neutralizer is included in each can to complete the job. Insist on the original and genuine Du Pont Cleanser, marketed only by Du Pont in a package bearing the red Du Pont oval trade mark.

Ask about the complete Du Pont pre-anti-freeze service at your service station today and assure trouble-free driving this winter. Or get a can of Du Pont Cooling System Cleanser at your auto supply store ... \$1.25 at most dealers.

Insure against leaks that waste anti-freeze with DU PONT Cooling System SEALER

Even though your cooling system seems watertight, many permanent anti-freezes will "creep" through tiny pinholes. You can stop this seepage immediately with Du Pont Cooling System Sealer. Simply pour it into your radiator. It can't clog or harm hose or metal parts.



BETTER THINGS FOR BETTER LIVING  
... THROUGH CHEMISTRY

Don't forget fuel line anti-freeze—Du Pont Gas Guard.

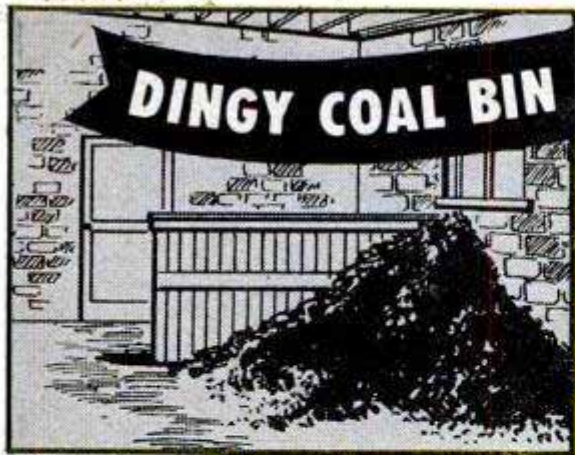

becomes **BRIGHT GAMEROOM**

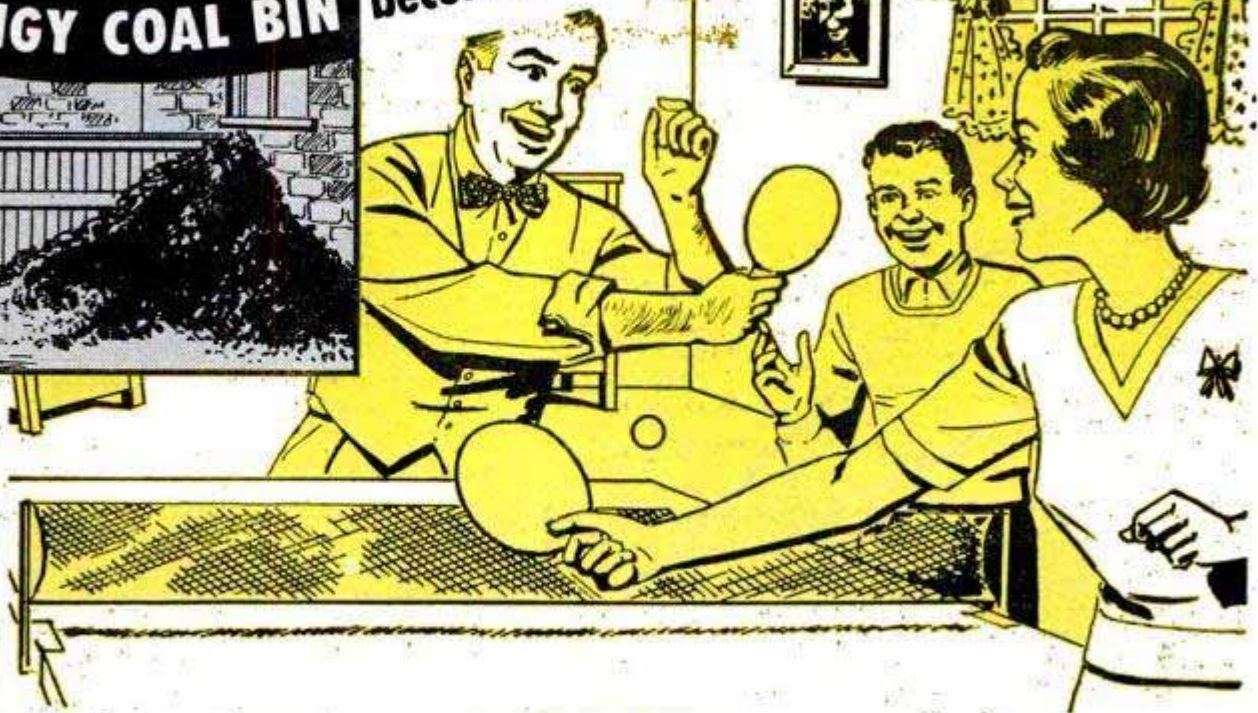

**TORIDHEET has direct heating action**

Flames actually contact the wall of the combustion chamber, concentrating intense heat directly on the surfaces which heat the water or air. This direct action insures speedy heating with top fuel efficiency.

**WITH TORIDHEET  
AUTOMATIC HEATING**

The instant you install modern, trouble-free TORIDHEET gas or oil heating in your home, your coal bin becomes a "has been". And you add enough extra space to build that children's playroom, family recreation room, or workshop you've always dreamed of.

Economical TORIDHEET pays for itself, slashing fuel bills up to 50%. No more ashes, clinkers or coal to haul ... just clean, even, healthful heat at the flick of a finger.

Don't spend this winter babying a fuel-hogging furnace. Install convenient TORIDHEET and relax in comfortable, work-free warmth.

**Complete Furnaces or Conversion Burners—oil or gas**

**ENJOY FUEL SAVINGS OF UP TO 50% — MAIL THIS COUPON TODAY!**



**TORIDHEET DIVISION  
CLEVELAND STEEL PRODUCTS CORP.  
7312 Madison Avenue, Cleveland 2, Ohio**

Please rush me complete facts on the TORIDHEET Wall Flame Burner with direct heating action.

Name \_\_\_\_\_

Address \_\_\_\_\_

City \_\_\_\_\_ Zone \_\_\_\_\_ State \_\_\_\_\_

# Gasoline Age...New Era for **FIRE PUMPING**



With the invention of the "gas buggy," dreams of a truly practical self-propelled fire engine became a reality. By 1910 several manufacturers were producing gasoline-propelled fire engines that far outclassed the horse-drawn pumps still in common use. Shown here is one type of gasoline-propelled pumper used nearly half a century ago.

## AC FUEL PUMPS

### ... America's First and Finest

Just as the gasoline engine brought a new era to fire fighting, AC Fuel Pumps brought a new era to automobile performance—supplying exactly the right amount of gasoline to the car's carburetor under all operating conditions.

That's why more than 115,000,000 AC pumps have been built—and more than 40,000,000 are now in daily use.

That's also why so many motorists—in order to maintain efficient performance and trouble-free service—replace their mileage-weary fuel pumps with new ACs—first choice of both car makers and car owners for 26 years.

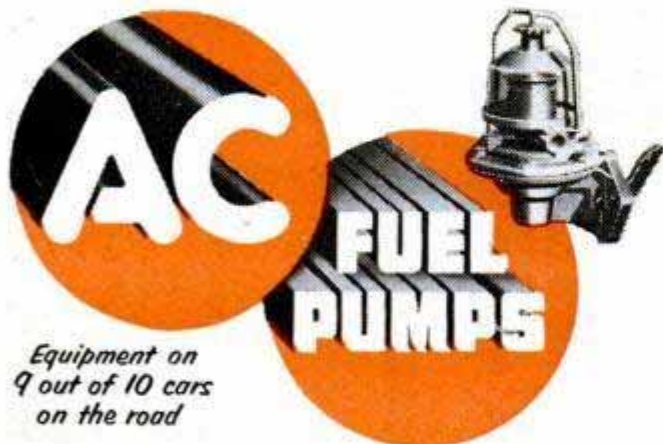

Equipment on  
9 out of 10 cars  
on the road

AC SPARK PLUG DIVISION



GENERAL MOTORS CORPORATION

in this corner.....

## THE EDITORS



### No Dumb Clucks Here!

Herewith we present two friends of Associate Editor Cliff Hicks. They live on a small farm near Hot Springs, Ark., the remarkable laboratory of psychologists Keller and Marian Breland.

The dog—"Putty" by name—can be molded into any out-of-this-world position and will remain motionless without a flick



of an eyelid until he is given a releasing command.

And the chicken? Keller Breland caught the bird in an untrained flock and gave it to our startled editor. "Train it to do anything you want," he said. Using Breland's training methods, Hicks taught the chicken within a half hour to leaf through a copy

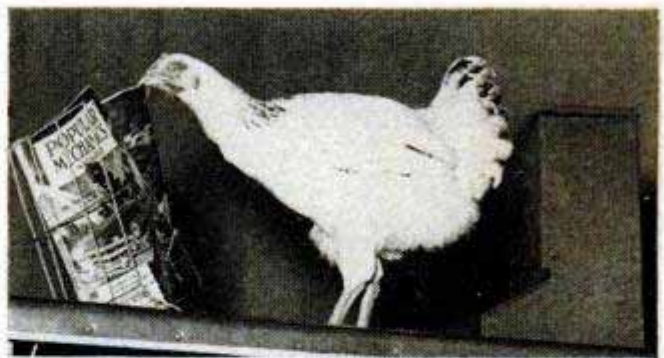

of *Popular Mechanics*, a page at a time. Now he swears he could have taught it to read the table of contents if he'd had another day or two with the Brelands! Keller, on the other hand, wasn't much impressed.

Starting on page 81, you'll meet a whole zoo of remarkable animals trained by the two Brelands. It's the first section of a two-part story. Of interest to pet owners is the fact that the psychologists make no secret of their simple training methods and say

(Continued to page 8)





To the man who wants to enjoy  
**an ACCOUNTANT'S CAREER**

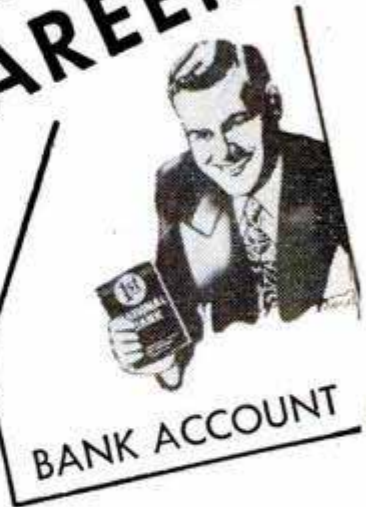
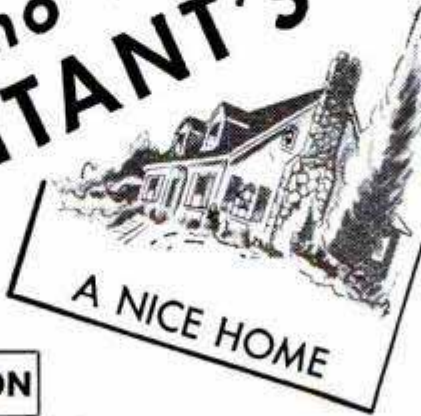

**FREE SAMPLE LESSON**

**IF** you're that man, here's something that will interest you.

Not a magic formula—not a get-rich-quick scheme—but something more substantial, more practical.

Of course, you need something more than just the desire to be an accountant. You've got to pay the price—be willing to study earnestly, thoroughly.

Still, wouldn't it be worth your while to sacrifice some of your leisure in favor of interesting home study—over a comparatively brief period? Always provided that the rewards were good—a salary of \$4,000 to \$10,000?

An accountant's duties are interesting, varied and of real worth to his employers. He has *standing!*

Do you feel that such things aren't for you? Well, don't be too sure. Very possibly they *can* be!

Why not, like so many before you, investigate LaSalle's modern Problem Method of training for an accountancy position?

Just suppose you were permitted to work in a large accounting house under the personal supervision of an expert accountant. Suppose, with his aid, you studied accounting principles and solved problems day by day—easy ones at first—then more difficult ones. If you could do this—and could turn to him for advice as the problems became complex—soon you'd master them all.

That's the training you follow in principle under the LaSalle Problem Method.

**Over 4,000 Certified Public Accountants among LaSalle alumni**

You cover accountancy from the basic Principles right up through Accountancy Systems and Income Tax Procedure. Then you add C. P. A. Training and prepare for the C. P. A. examinations.

As you go along, you absorb the principles of Auditing, Cost Accounting, Business Law, Statistical Control, Organization, Management and Finance.

Your progress is as speedy as you care to make it—depending on your own eagerness to learn and the time you spend in study.

Will recognition come? The only answer, as you know, is that success *does* come to the man who is really *trained*. It's possible your employers will notice your improvement in a very few weeks or months. Indeed, many LaSalle graduates have paid for their training—with increased earnings—before they have completed it! For accountants, who are trained in organization and management, are the executives of the future.

**Get Free Sample Lesson—Also "Accountancy, The Profession That Pays"**

For your own good get all the facts. Write for Free Sample Lesson—also 48-page book "Accountancy, The Profession That Pays." They will prove that Accountancy offers brilliant futures to those who aren't afraid of serious home study, and will show the wide range of opportunities that exist today. No cost or obligation. If you want a position of higher income, greater prestige and professional standing... **MAIL THE COUPON NOW!**

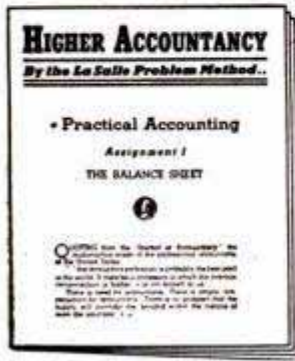

**LASALLE EXTENSION UNIVERSITY**  
**A CORRESPONDENCE INSTITUTION**

417 S. Dearborn St. Dept. 1164 H Chicago 5, Ill.

I want to be an accountant. Send me without obligation, Free Sample Lesson—also "Accountancy, The Profession that Pays."

Name.....Age.....  
 Address.....  
 City, Zone & State.....



**How YOU**  
can  
**SAW**  
**DRILL**  
**GRIND**  
**TURN**  
**SAND**

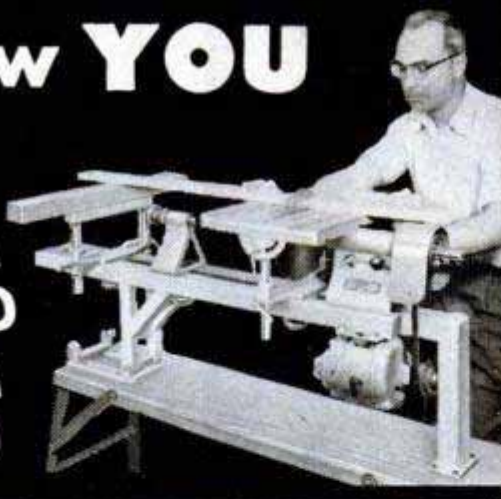

**with SUPERSHOP**

**5 BIG POWER TOOLS IN 1**

When you DO-IT-YOUR-SELF with SUPERSHOP you save money and you have fun. You can build a house or a garage — handle BIG jobs. The 8 inch saw cuts 2½ inches deep. Heavy tubular steel frame. 100% Ball Bearing. Lifetime accuracy. Save \$65.05—buy direct from factory. Take advantage of our FREE trial plan. You can buy on EASY TERMS. Write for FREE How-To-DO-It Catalog.



**DRILL PRESS**

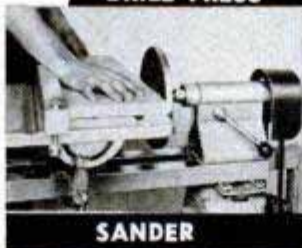

**SANDER**



**LATHE**

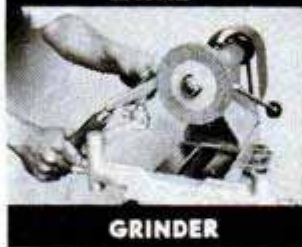

**GRINDER**

Write for **FREE** How-To-Do-It Catalog.

WRITE FOR  
YOUR COPY  
SEND POSTCARD

FACTORY  
TO YOU

**\$79<sup>95</sup>**

EASY PAY PLAN

**POWER TOOLS INC.** 153A Yates Ave.  
Beloit, Wis.

(Continued from page 6)

anyone can train a cat, dog, pig, chicken or even a bull to do spectacular tricks.

Two or three days after training his chicken, Hicks walked into the Brelands' home for his last lunch with the two psychologists. On the table was a delicious meal of cold chicken and deviled eggs. At that point our editor suddenly realized he had to run to catch his plane, and somehow he didn't find time to eat a bite that day.

Don't miss the Christmas gift section coming in the December issue—gifts for the man of the house, for the home and the woman who runs it, and for the youngsters.

**To the Editor:**

Since you ran the article on my bentho-scope dive to 4500 feet off Santa Cruz Basin in August 1949, I have visited another



Ready to go aloft in tree-climbing cage in jungle

new world. I enclose photos of a tree climber which I tried out in primeval tropical forests of Gabon and Oubangui-Chari, French Equatorial Africa. This represents civilized man's first attempt to explore the tropical treetop world. Here live colobus monkeys, guenon monkeys, mandrills, snakes, pangolins, pottos, galagos, hyraxes, etc. Only Pygmies have explored this world.

Otis Barton.

EDITOR'S NOTE: Our account of Doctor Barton's deep-sea adventure in the bentho-scope was published in PM, October 1949. He is now in Africa again. The treetop

(Continued to page 10)



# How to compete with college men for the best jobs



You can break through the education barrier that bars you from top-salary jobs. You can climb as fast and as far as any college man. Whether your field of interest is engineering, business management or industrial supervision, you can hurdle your education handicaps. How? Listen . . .

**AVOID THIS COMMON ERROR** Why do men spend four years at college? To get a good job when they get out. And many of them stop right there. They get their good job and relax. A college education is a fine thing. But it's not a free ticket to automatic prosperity.

The non-college man with average intelligence and above-average ambition can beat the free-rider every time. All it takes is a little concentrated training.

**TRAINING WHEN IT COUNTS** You learn best when you can apply what you learn *on the spot*. I. C. S. training is closely related to your job. You master a problem one day and put it into practice the next.

No lectures to attend. No notes to take. Your professor is your specially edited text. Your laboratory is your shop or office.

What's more, by learning on-the-job, you are bound to move up. Your study is reflected in your work. Your employer gets regular reports of your progress. You demonstrate your willingness and ability to make good. No free-rider, you. You earn every promotion and you're a better man for it.

**FREE EXPERT GUIDANCE** In this competitive world, you need help. No other training institution has had more experience guiding men and women to success than the International Correspondence Schools. None offers a wider selection of success-proved courses.

Mark and mail the coupon below. You will get the famous 36-page guidebook, "How to Succeed," plus the 1953-54 catalog on the subject that interests you. Here's free expert guidance! Here's the way to start cracking the education barrier!

## INTERNATIONAL CORRESPONDENCE SCHOOLS



BOX 5600-L, SCRANTON 9, PENNA.

Without cost or obligation, send me "HOW to SUCCEED" and the booklet about the course BEFORE which I have marked X:

- |   |   |   |   |  |
|---|---|---|---|--|
| <p><b>ART</b></p> <ul style="list-style-type: none"> <li><input type="checkbox"/> Commercial Art</li> <li><input type="checkbox"/> Magazine and Book Illustrating</li> <li><input type="checkbox"/> Cartooning</li> <li><input type="checkbox"/> Show Card and Sign Lettering</li> <li><input type="checkbox"/> Fashion Illustrating</li> <li><b>AUTOMOTIVE</b></li> <li><input type="checkbox"/> Automobile, Mechanic</li> <li><input type="checkbox"/> Auto-Elec. Technician</li> <li><input type="checkbox"/> Auto Body Rebuilding and Refinishing</li> <li><input type="checkbox"/> Diesel—Gas Engines</li> <li><b>AVIATION</b></li> <li><input type="checkbox"/> Aeronautical Engineering Jr.</li> <li><input type="checkbox"/> Aircraft Engine Mechanic</li> <li><input type="checkbox"/> Airplane Drafting</li> <li><b>BUILDING</b></li> <li><input type="checkbox"/> Architecture</li> <li><input type="checkbox"/> Arch. Drafting</li> <li><input type="checkbox"/> Building Contractor</li> <li><input type="checkbox"/> Estimating</li> <li><input type="checkbox"/> Carpenter and Mill Work</li> <li><input type="checkbox"/> Carpenter Foreman</li> <li><input type="checkbox"/> Reading Blueprints</li> <li><input type="checkbox"/> House Planning</li> <li><input type="checkbox"/> Plumbing</li> </ul> | <ul style="list-style-type: none"> <li><input type="checkbox"/> Heating</li> <li><input type="checkbox"/> Steam Fitting</li> <li><input type="checkbox"/> Air Conditioning</li> <li><input type="checkbox"/> Electrician</li> <li><b>BUSINESS</b></li> <li><input type="checkbox"/> Business Administration</li> <li><input type="checkbox"/> Certified Public Accountant</li> <li><input type="checkbox"/> Accounting</li> <li><input type="checkbox"/> Bookkeeping</li> <li><input type="checkbox"/> Stenography and Typing</li> <li><input type="checkbox"/> Secretarial</li> <li><input type="checkbox"/> Federal Tax</li> <li><input type="checkbox"/> Business Correspondence</li> <li><input type="checkbox"/> Personnel and Labor Relations</li> <li><input type="checkbox"/> Advertising</li> <li><input type="checkbox"/> Retail Business Management</li> <li><input type="checkbox"/> Managing Small Business</li> <li><input type="checkbox"/> Sales Management</li> <li><input type="checkbox"/> Salesmanship</li> <li><input type="checkbox"/> Traffic Management</li> <li><b>CHEMISTRY</b></li> <li><input type="checkbox"/> Chemical Engineering</li> <li><input type="checkbox"/> Chemistry</li> <li><input type="checkbox"/> Analytical Chemistry</li> <li><input type="checkbox"/> Petroleum—Nat'l Gas</li> <li><input type="checkbox"/> Pulp and Paper Making</li> <li><input type="checkbox"/> Plastics</li> </ul> | <p><b>CIVIL, STRUCTURAL ENGINEERING</b></p> <ul style="list-style-type: none"> <li><input type="checkbox"/> Civil Engineering</li> <li><input type="checkbox"/> Structural Engineering</li> <li><input type="checkbox"/> Surveying and Mapping</li> <li><input type="checkbox"/> Structural Drafting</li> <li><input type="checkbox"/> Highway Engineering</li> <li><input type="checkbox"/> Reading Blueprints</li> <li><input type="checkbox"/> Concrete Construction</li> <li><input type="checkbox"/> Sanitary Engineering</li> <li><b>DRAFTING</b></li> <li><input type="checkbox"/> Aircraft Drafting</li> <li><input type="checkbox"/> Architectural Drafting</li> <li><input type="checkbox"/> Electrical Drafting</li> <li><input type="checkbox"/> Mechanical Drafting</li> <li><input type="checkbox"/> Structural Drafting</li> <li><input type="checkbox"/> Sheet Metal Drafting</li> <li><input type="checkbox"/> Mine Surveying and Drafting</li> <li><b>ELECTRICAL</b></li> <li><input type="checkbox"/> Electrical Engineering</li> <li><input type="checkbox"/> Electrician</li> <li><input type="checkbox"/> Electrical Maintenance</li> <li><input type="checkbox"/> Electrical Drafting</li> <li><input type="checkbox"/> Electric Power and Light</li> <li><input type="checkbox"/> Lineman</li> <li><b>HIGH SCHOOL</b></li> <li><input type="checkbox"/> High School Subjects</li> </ul> | <ul style="list-style-type: none"> <li><input type="checkbox"/> College Preparatory</li> <li><input type="checkbox"/> Mathematics</li> <li><input type="checkbox"/> Commercial</li> <li><input type="checkbox"/> Good English</li> <li><b>MECHANICAL AND SHOP</b></li> <li><input type="checkbox"/> Mechanical Engineering</li> <li><input type="checkbox"/> Industrial Engineering</li> <li><input type="checkbox"/> Industrial Supervision</li> <li><input type="checkbox"/> Foremanship</li> <li><input type="checkbox"/> Mechanical Drafting</li> <li><input type="checkbox"/> Machine Design-Drafting</li> <li><input type="checkbox"/> Machine Shop Practice</li> <li><input type="checkbox"/> Tool Design</li> <li><input type="checkbox"/> Industrial Instrumentation</li> <li><input type="checkbox"/> Machine Shop Inspection</li> <li><input type="checkbox"/> Reading Blueprints</li> <li><input type="checkbox"/> Toolmaking</li> <li><input type="checkbox"/> Gas—Electric Welding</li> <li><input type="checkbox"/> Heat Treatment—Metallurgy</li> <li><input type="checkbox"/> Sheet Metal Work</li> <li><input type="checkbox"/> Sheet Metal Pattern Drafting</li> <li><input type="checkbox"/> Refrigeration</li> <li><b>POWER</b></li> <li><input type="checkbox"/> Combustion Engineering</li> <li><input type="checkbox"/> Diesel—Electric</li> <li><input type="checkbox"/> Electric Light and Power</li> </ul> | <ul style="list-style-type: none"> <li><input type="checkbox"/> Stationary Steam Engineering</li> <li><input type="checkbox"/> Stationary Fireman</li> <li><b>RADIO, TELEVISION, COMMUNICATIONS</b></li> <li><input type="checkbox"/> General Radio</li> <li><input type="checkbox"/> Radio Operation</li> <li><input type="checkbox"/> Radio Servicing—FM</li> <li><input type="checkbox"/> Television</li> <li><input type="checkbox"/> Electronics</li> <li><input type="checkbox"/> Telephone Work</li> <li><b>RAILROAD</b></li> <li><input type="checkbox"/> Locomotive Engineer</li> <li><input type="checkbox"/> Diesel Locomotive</li> <li><input type="checkbox"/> Air Brakes</li> <li><input type="checkbox"/> Car Inspector</li> <li><input type="checkbox"/> Railroad Administration</li> <li><b>TEXTILE</b></li> <li><input type="checkbox"/> Textile Engineering</li> <li><input type="checkbox"/> Cotton Manufacture</li> <li><input type="checkbox"/> Rayon Manufacture</li> <li><input type="checkbox"/> Woolen Manufacture</li> <li><input type="checkbox"/> Loom Fixing</li> <li><input type="checkbox"/> Finishing and Dyeing</li> <li><input type="checkbox"/> Textile Designing</li> </ul> |
|---|---|---|---|--|

**YEAR OF THE SIX  
MILLIONTH STUDENT**

Name \_\_\_\_\_ Age \_\_\_\_\_ Home Address \_\_\_\_\_  
 City \_\_\_\_\_ Zone \_\_\_\_\_ State \_\_\_\_\_ Working Hours \_\_\_\_\_ A.M. to \_\_\_\_\_ P.M.  
 Occupation \_\_\_\_\_

Special tuition rates to members of the U. S. Armed Forces. Canadian residents send coupon to International Correspondence Schools Canadian, Ltd., Montreal, Canada.

# IMAGINE THEIR JOY

when they found they could play this easy-as-ABC way!



**Learned Quickly at Home**  
"I didn't dream I could actually learn to play without a teacher. Now, when I play for people they hardly believe that I learned to play so well in so short a time."  
\*H.C.S., Calif.



**Plays at Dances**  
"Your lessons have been most satisfactory. I can play all of the popular songs. I have earned money playing at dances."  
\*E.N.J., New York

## What Instrument Would You Like to Play?

JUST name your instrument and we'll show you how you can learn to play it—quickly, easily, in spare time at home. Never mind if you don't know one note of music from another—don't worry about "special talent." And forget all you've ever heard about music being hard to learn.

The truth of the matter is that thousands now play who never thought they could! Yes, men and women everywhere have discovered this amazingly easy way to learn music at home. Now they are enjoying the thrilling satisfaction of playing the piano, violin, guitar, saxophone or other favorite instruments. Some of them are playing in orchestras and over the radio; others are teaching music, making money in spare or full time. And thousands are having the time of their lives playing for their own enjoyment and the entertainment of their friends.

No tedious study and practice, no tiresome exercises. You learn to play by playing—start right in with the melody of a simple tune! It takes only a few minutes a day; the cost is trifling. Does it sound too good to be true? Mail the coupon and get the FREE PROOF!



**Plays on Radio**  
"I can't keep from telling you that I have a good position playing from KTHS, Hot Springs, Ark., every morning."  
J.S., Okla.



Cage slides on cable with Pygmies for passengers



Closeup of treetop inhabitant was made from cage

world he is exploring starts, he says, about 100 feet above the forest floor and some trees are 300 feet high. Barton's tree climber is a cage of aluminum and wood equipped with two winches attached to the floor, each with a hand-lever ratchet. Each reel contains several hundred feet of 1/4-inch steel cable. The cage climbs to 150 feet above the ground in 20 minutes; landing safely on a high limb is a ticklish venture, Barton writes, and it is necessary to put a line over the limb above.

## Sorry, Our Mistake

A photograph on page 69 of our September issue bore a misleading caption indicating customs officers were hunting contraband in bales of wool. Actually their purpose was to sample wool shipments for tests to determine the required duty.

### Easy as A-B-C



### SEND FOR FREE PROOF

Fascinating illustrated booklet answers all your questions; free Lesson-Sample shows how method works. If interested, just mail coupon to U. S. SCHOOL OF MUSIC, Studio C3011, Port Washington, N. Y. (900,000 Students—Our 55th Successful Year.)  
\*Actual pupils' names on request. Pictures by professional models.

### FREE! Print and Picture Sample

U. S. SCHOOL OF MUSIC, Studio C3011, Port Washington, N. Y.

Send me Free Book and free Lesson-Sample. No salesman is to call upon me. I'm interested in playing (name instrument).....

I do  I do NOT—have instrument now.

Name.....  
(please print)

Address.....

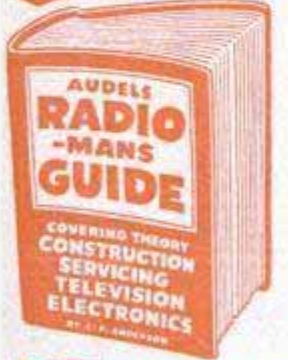

# AUDELS TV-RADIO SERVICE LIBRARY

**2 VOLS. \$6 COMPLETE. \$1 A MO. PAY ONLY 1 MO.**

**HERE IS LATE INFORMATION IN A HANDY FORM FOR RADIO & TELEVISION REPAIRMEN, SERVICEMEN AND STUDENTS IT PAYS TO KNOW!**

AUDELS T.V.-RADIO SERVICE LIBRARY presents the important subjects of Modern Radio, Television, Industrial Electronics, F.M. Public Address Systems, Auto, Marine & Aircraft Radio, Phonograph Pick-Ups, etc. Covers Basic Principles—Construction—Installation—Operation—Repairs—Trouble Shooting. Shows How to get Sharp, Clear T.V. Pictures, Install Aerials—How to Test, Explains Color Systems & Methods of Conversion. 1001 Facts—Over 1200 Pages—625 Illustrations of Parts & Diagrams—Valuable for Quick Ready Reference & Home Study. Tells How to Solve T.V. & Radio Troubles—Answers T.V. & Radio Questions.

**Get this information for Yourself. 7 DAY TEST—ASK TO SEE IT!**

## MAIL ORDER

**AUDEL, Publishers, 49 W. 23rd St., New York 10, N.Y.**  
Mail AUDEL'S T.V. RADIO SERVICE LIBRARY 2 Vols. \$6 on 7 days free trial. If O.K. I will remit \$1 in 7 days and \$1 monthly until \$6 is paid. Otherwise I will return them.

Name \_\_\_\_\_  
Address \_\_\_\_\_  
Occupation \_\_\_\_\_  
Employed by \_\_\_\_\_ P11

# AUDELS Carpenters and Builders Guides 4 vols. \$6



**Inside Trade Information** for Carpenters, Builders, Joiners, Building Mechanics and all Woodworkers. These Guides give you the short-cut instructions that you want—including new methods, ideas, solutions, plans, systems and money saving suggestions. An easy progressive course for the apprentice and student. A practical daily helper and Quick Reference for the master worker. Carpenters everywhere are using these Guides as a Helping Hand to Easier Work, Better Work and Better Pay. To get this assistance for yourself, simply fill in and mail FREE COUPON below.

### Inside Trade Information On:

How to use the steel square—How to file and set saws—How to build furniture—How to use a mitre box—How to use the chalk line—How to use rules and scales—How to make joints—Carpenters arithmetic—Solving mensuration problems—Estimating strength of timbers—How to set girders and sills—How to frame houses and roofs—How to estimate costs—How to build houses, barns, garages, bungalows, etc.—How to read and draw plans—Drawing up specifications—How to excavate—How to use settings 12, 13 and 17 on the steel square—How to build hoists and scaffolds—skylights—How to build stairs—How to put on interior trim—How to hang doors—How to lath—lay floors—How to paint.



**AUDEL, Publishers, 49 W. 23rd St., New York 10, N.Y.**  
Mail Audels Carpenters and Builders Guides, 4 vols., on 7 days' free trial. If O.K. I will remit \$1 in 7 days and \$1 monthly until \$6 is paid. —Otherwise I will return them. No obligation unless I am satisfied.

Name \_\_\_\_\_  
Address \_\_\_\_\_  
Occupation \_\_\_\_\_  
Employed by \_\_\_\_\_ P11

# WHAT ALL AUTO MECHANICS WANT TO KNOW

**1800 PAGES**

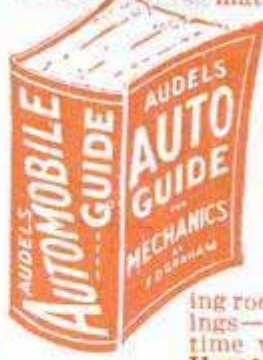

This Big Practical Book gives full information with working diagrams covering the principles, construction, ignition, service and repair of modern cars, trucks and buses.

## Diesel Engines, Hydramatic & Fluid Drives Fully Explained.

A complete Guide of 1800 pages, with over 1500 illustrations showing inside views of working parts, with instructions for service jobs.

### IT PAYS TO KNOW

How to fit pistons—How to locate engine knocks, How to fit connecting rod bearings—How to service main bearings—How to recondition valves—How to time valves—How to adjust fan belts—How to adjust carburetors and chokes, How to rebuild a clutch—How to service automatic transmissions—How to service brakes—How to adjust steering gear—How to cope with ignition troubles—How to service distributors—How to time ignition—How to "tune up" an engine.



**\$4 COMPLETE • PAY \$1 A MO. TO GET THIS ASSISTANCE FOR YOURSELF SIMPLY FILL IN AND MAIL COUPON TODAY.**

Step up your own skill with the facts and figures of your trade. Audels Mechanics Guides contain Practical Inside Trade Information in a Handy Form. Fully illustrated and Easy to Understand. Highly Endorsed. Check the book you want for 7 DAYS FREE EXAMINATION. Send No Money. Nothing to pay postman.

## MAIL ORDER

**AUDEL, Publishers, 49 W. 23 St., NEW YORK 10, N. Y.**

Please send me postpaid for FREE EXAMINATION books marked (x) below, if I decide to keep them I agree to mail \$1 in 7 Days on each book or set ordered and further mail \$1 monthly on each book or set until I have paid price, otherwise I will return them.

- AUTOMOBILE MECHANICS GUIDE, 1800 Pages \$ 4
- TRUCK & TRACTOR GUIDE, 1299 Pages . . . . . 4
- DIESEL ENGINE MANUAL, 575 Pages . . . . . 2
- MACHINISTS HANDY BOOK, 1650 Pages . . . . . 4
- WELDERS GUIDE, 400 Pages . . . . . 1
- BLUE PRINT READING, 416 Pages . . . . . 2
- MATHEMATICS & CALCULATIONS, 700 Pages. . . . . 2
- SHEET METAL PATTERN LAYOUTS, 1100 Pages 4
- SHEET METAL WORKERS HANDY BOOK, 388 Pgs. 1
- MECHANICAL DRAWING GUIDE, 160 Pages . . . . . 1
- MECHANICAL DRAWING & DESIGN, 480 Pages 2
- AIRCRAFT WORKER, 240 Pages . . . . . 1
- TELEVISION SERVICE MANUAL, 384 Pages . . . . . 2
- RADIOMANS GUIDE, 914 Pages . . . . . 4
- ELECTRONIC DEVICES, 216 Pages . . . . . 2
- ELECTRIC MOTOR GUIDE, 1000 Pages . . . . . 4
- ELECTRIC WIRING DIAGRAMS, 272 Pages . . . . . 1
- ELECTRICIANS EXAMINATIONS, 250 Pages. . . . . 1
- ELECTRIC POWER CALCULATIONS, 425 Pages. 2
- HANDY BOOK OF ELECTRICITY, 1440 Pages. . . . . 4
- ELECTRIC DICTIONARY, 9000 Terms . . . . . 2
- ELECTRIC LIBRARY, 7000 Pages (12 Book Set) 18
- MARINE ENGINEERS HANDY BOOK, 1258 Pgs. 4
- SHIPFITTERS HANDY BOOK, 250 Pages . . . . . 1
- REFRIGERATION & Air Conditioning, 1280 Pgs. 4
- MILLWRIGHTS & MECHANICS GUIDE, 1200 Pgs. 4
- POWER PLANT ENGINEERS GUIDE, 1500 Pages 4
- ENGINEERS & FIREMANS EXAMS, 525 Pages . . . . . 1
- PUMPS, Hydraulics & Air Compressors, 1658 Pgs. 4
- ENGINEERS LIBRARY (3 Book Set) . . . . . 9
- MECHANICAL DICTIONARY, 950 Pages . . . . . 4
- GARDENERS & GROWERS GUIDES (4 Book Set) 6
- CARPENTERS & BUILDERS GUIDES (4 Book Set) 6
- PLUMBERS & Steamfitters Guides (4 Book Set) 6
- MASONS AND BUILDERS GUIDES (4 Book Set) 6
- PAINTERS & DECORATORS MANUAL, 450 Pgs. 2
- HOUSE HEATING GUIDE, 1000 Pages . . . . . 4
- OIL BURNER GUIDE, 384 Pages . . . . . 1

## Check NOW!

*You Can Look Over Any Guide In Your Own Home — Start the Easy Payments If Satisfied*

## MAIL THIS TODAY

Name \_\_\_\_\_  
Address \_\_\_\_\_  
Occupation \_\_\_\_\_  
Employed by \_\_\_\_\_ P11

## Our 40th Year

NRI training is thorough, practical, up-to-date. When you enroll with NRI you benefit from our 40 years of successful experience training men at home.

*J. E. Smith*

President  
National Radio Institute  
Washington, D. C.



# I'll Train You RADIO-

## You Practice Broadcasting with Parts I Send

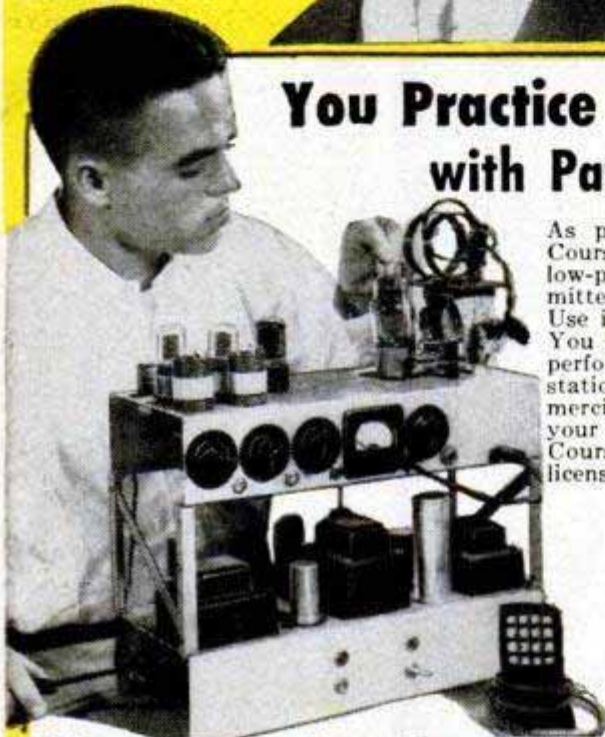

As part of my Communications Course I send you parts to build low-power Broadcasting Transmitter at left, and other equipment. Use it to get practical experience. You put this station "on the air," perform procedures demanded of station operators. An FCC Commercial Operator's License can be your ticket to a bright future. My Course trains you to get your license. Mail Coupon now!



## Television Is Today's Good Job Maker

Television now reaches from coast-to-coast. More than 25 million Television sets are already in use and require servicing; thousands more sets are being sold every week. About 200 TV stations are now on the air with hundreds more being built. This means new jobs, more jobs, better pay for trained men. The time to act is NOW! Start learning Radio-Television servicing or communications.

## You Practice Servicing with Parts I Send

Nothing takes the place of PRACTICAL EXPERIENCE. NRI training is based on LEARNING BY DOING. You use parts I send to build many circuits common to Radio and TV. You build the modern radio at right. Use Multi-tester you build to make money fixing sets. Many students make \$10, \$15 a week extra fixing neighbors' sets in spare time, starting soon after enrolling. All equipment I send is yours to keep.

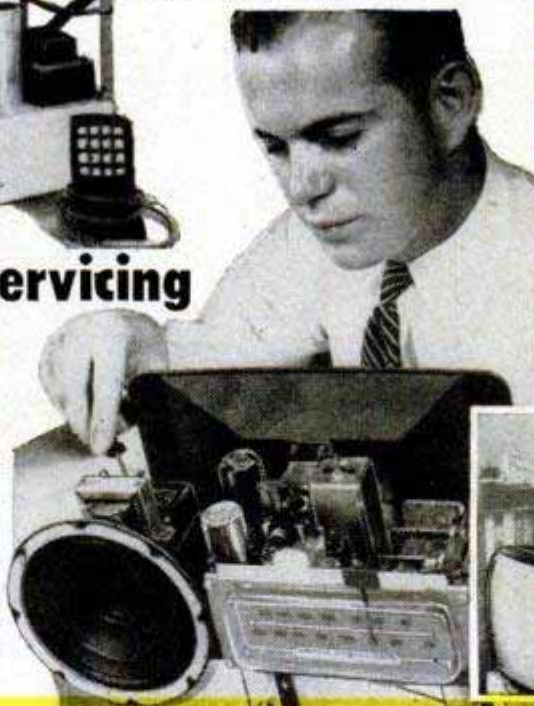

## Make Extra Money in Spare Time While Learning

Keep your job while training. Many NRI students make \$10, \$15 and more a week extra fixing neighbors' Radios in spare time. The day you enroll I start sending you special booklets that show you how to service sets. Multi-tester you build helps discover and correct Radio troubles, gives PRACTICAL EXPERIENCE on circuits common to radio and TV. Mail coupon today.



## I Trained these Men at Home



Laborer  
Finds  
Success in  
Radio-TV

"I was a laborer with no future. Now I have a position that pays well. My spare time servicing pays good money, too. Thanks to NRI."—Robert Ford, Johnstown, Pa.



Switched  
to TV  
Servicing

"I recently switched from studio work and am now holding a position as TV service technician. Enjoy my work more and more."—Norman Ward, Ridgefield Park, N. J.



Paid for  
Course, Car  
in Spare  
Time

"By the time I graduated I had paid for my course, a car and testing equipment. I can handle any job in Radio-TV."—E. J. Streitenberger, New Boston, Ohio.



\$10 to \$15  
Week  
Spare Time

"Four months after enrolling, was able to service Radios . . . averaged \$10 to \$15 a week spare time. Now have full time business."—W. Weyde, Brooklyn, N. Y.



Employed as  
Transmitter  
Operator

"A former employer recommended NRI training to me. Now employed as transmitter operator in Harrisburg."—Albert Herr, New Cumberland, Penna.

# AT HOME for Good Jobs in TELEVISION

## There is Success-Good Pay-Security for You in America's Fast Growing Industry



### NRI Training Leads to These Jobs in RADIO-TELEVISION

**BROADCASTING**  
Chief Technician  
Chief Operator  
Power Monitor  
Recording Operator

**SERVICING**  
Home and Auto Radios  
Television Receivers  
P.A. Systems

**MANUFACTURING**  
Design Technician  
Service Manager  
Tester  
Research Assistant

**SHIP AND HARBOR RADIO**  
Chief Operator  
Radiotelephone Operator  
Assistant Operator

**GOVERNMENT RADIO**  
Operator in Army, Navy, Marine Corps  
Airways Operator  
Forestry Dispatcher

**AVIATION RADIO**  
Transmitter Technician  
Airport Transmitter Operator

**TELEVISION**  
Pick-up Operator  
Television Technician  
Remote Control Operator  
Service and Maintenance Technician

**POLICE RADIO**  
Transmitter Operator  
Receiver Serviceman

DO YOU want good pay, a job with a bright future, security? Would you like to have a profitable business of your own? If so, find out how you can realize your ambition in the fast-growing RADIO-TELEVISION industry. Even without Television, the industry is bigger than ever before. Just think, over 115 million home and auto Radios, 3000 Radio Broadcasting Stations, plus 25 million Television sets and about 200 Television Broadcasting Stations. Expanding use of Aviation and Police Radio, Micro-wave Relay, Two-way Radio for busses, taxis etc., are making opportunities for Servicing and Communications technicians and FCC Licensed Operators.

### My Training Includes Television

You get practical experience by working on circuits common to both Radio and Television. My graduates are filling jobs, making good money in both Radio and Television. Many NRI trained men start their own Radio and Television servicing business with capital earned in spare time. Let me show you how you can be your own boss; earn \$10 to \$15 a week extra even while still learning. Now is the time to get ready for success in Radio-Television. Coupon below brings you Actual Lesson and 64-page book.

### Find Out What Radio-Television Offers You

What will YOU be doing one year from today? Decide now that you are going to know more and earn more. ACT NOW. Send the coupon below NOW for my FREE DOUBLE OFFER. You get Actual Servicing Lesson. Also my 64-page Book, "How to Be a Success in Radio-Television." Read what my graduates are doing, earning, see equipment you practice with at home. Mail coupon now, Send in envelope or paste on postal. J. E. SMITH, President, Dept. 3MA, National Radio Institute, Washington 9, D. C. Our 40th Year.

## Actual Lesson and 64-page Book BOTH FREE

The ABC's of SERVICING

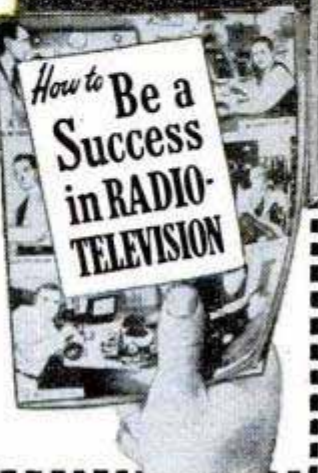

Control Operator, Station WEAN  
"Received my License and worked on ships. Now with Station WEAN. NRI Course is as complete as any radio course can be."  
—Raymond E. Arnold, Rumford, L. I.

Available to VETERANS under G. I. Bills

## MAIL THIS NOW!

MR. J. E. SMITH, President, Dept. 3MA  
National Radio Institute, Washington 9, D. C.

Mail me Sample Lesson and 64-page Book, FREE. (No salesman will call. Please write plainly.)

Name..... Age.....

Address.....

City..... Zone..... State.....

**VETS** write in date of discharge.....

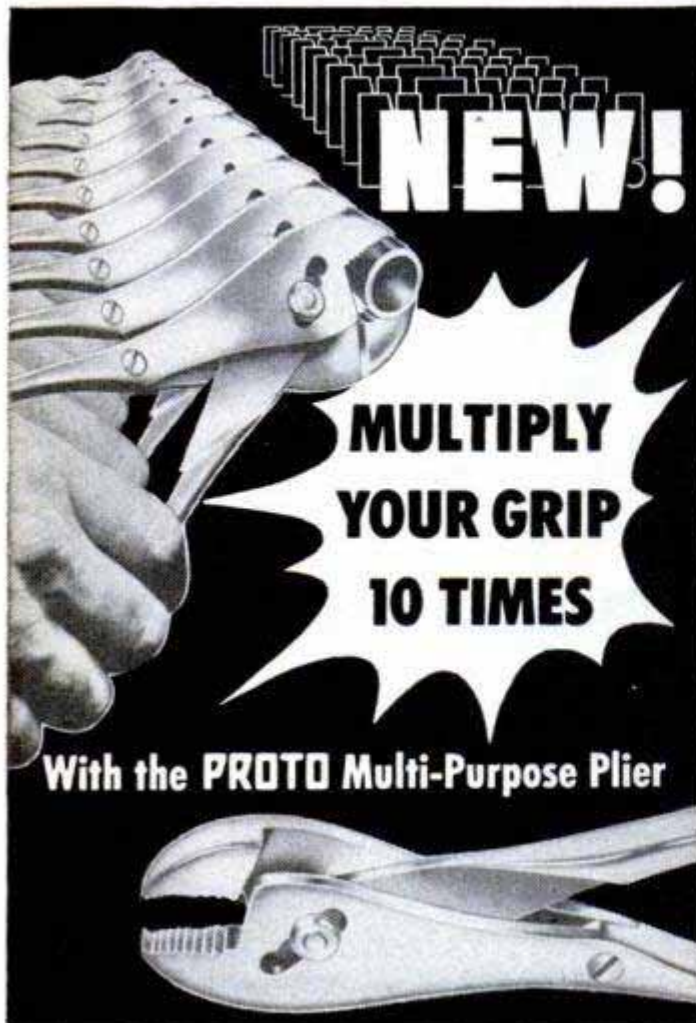

Try the sensational PROTO No. 234 Multi-Purpose Plier and you will want one for sure! Using a patented three-piece compound leverage design, pressure applied to the handles is increased *ten times* at the jaws! This plier is actually "a chest of tools in one." It securely holds square, round and even tapered objects. To make your work easier, buy one today!

**Choose PROTO for Your Other Plier Needs**  
In the extensive PROTO line, you will find the right size and style of plier for almost every job. And remember that every one has true *professional quality*. Send 10¢ for complete 68-page catalog to

**PLOMB TOOL COMPANY**

2255A Santa Fe Ave.,  
Los Angeles 54, Calif.

New—the No. 243 Multiple-Groove Joint Plier, which Handles Hundreds of Jobs. Five-Position, Tongue-and-Groove Joint Prevents Slippage.



Eastern Factory: Jamestown, N.Y.  
Canadian Factory: London, Ont.

## WHERE-TO-BUY-IT INDEX

Source of supply appears after items commercially available

### AUTOMOTIVE

Altered Studebaker coupe becomes fast sport car.....	86
The '54 car parade begins.....	94
Detroit Listening Post.....	96
Hudson and Packard present their "cars of the future".....	97
Hot rod for three-year old.....	127
Nested water bottles fill battery automatically (Embree Mfg. Co., 10 W. Mravlag Place, Elizabeth 4, N. J.).....	144
Portable service stations maintain company fleet.....	148
Self-adjusting tappets (Skinner-Moser Sales, Dunedin, Fla.).....	149
Spark-plug tester (Champion Spark Plug Co., 900 Upton, Toledo, Ohio).....	149
Auto-bumper plows clear wheel paths.....	153
Students drive model car over miniature test route (Allgaier Shops, 4004 5th Road, North Arlington, Va.).....	154
Kurtis offers chassis for build-a-car enthusiasts (Kurtis Sports Car Corp., 4619 Alger St., Los Angeles, Calif.).....	268

### AVIATION

Airlines offer mobile and drive-in ticket offices.....	86
Fighter packs 104-rocket "Sunday punch" in wing-tip pods (Northrop Aircraft, Inc., Hawthorne, Calif.).....	93
B-36's fly combat planes to and from "work".....	100
Fire-sensitive cable developed for airplane protection (Edison Laboratory, West Orange, N. J.).....	120
Landing-speed indicator (Flight Instruments Corp., White Plains, N. Y.).....	126
Rocket-powered guided missile exceeds 2600 miles per hour.....	134
Transport "swallows" fighter shorn only of its wings.....	155

### CHEMISTRY

Chemical stops mold (James R. Kearney Corp., 4236 Clayton Ave., St. Louis 10, Mo.).....	131
Gamma rays used for food preservation also destroy vitamins.....	149
Radioactive magnesium aids chlorophyll study.....	234
Antitrust fluid in oil tank stops leaks for three years (Shell Oil Co., 50 West 50th St., New York City 19).....	264

### CONSTRUCTION

Buckle-on stilts aid home construction workers.....	108
Metal sheets "buttoned" together without rivets or bolts (Crockatt Engineering Co., Phelan Bldg., San Francisco, Calif.).....	120
Pipe lines laid to depth of 243 feet under Straits of Mackinac.....	131
"Hot gun" porcelainizes surfaces of bridges and buildings (Seaporcel Metals Inc., 28-20 Borden Ave., Long Island City 1, N. Y.).....	148
200-pound falling weight drives posts into ground (Danuser Machine Co., Fulton, Mo.).....	155

### FARMING

Meter tells farmers when to irrigate crops (T. W. Prosser, Loring Bldg., Riverside, Calif.).....	87
Table-model "brain" solves barn problem (Minneapolis-Honeywell Regulator Co., 2954—4th Ave., S., Minneapolis 8, Minn.).....	107
Tractor shuts itself off if operator falls (Fleischer-Schmid Corp., Columbus, Neb.).....	131
Portable grain conveyor simply shoves into bin (Tri-County Mfg. Co., Box 405, Taylorville, Ill.).....	135
Chicken sex determiner.....	148

### HOUSE AND HOME

Electric drainboard dries dishes rapidly.....	108
Individual ventilator replaces glass block (Air Rectifiers Inc., 3734 N. Southport Ave., Chicago 13).....	126
Silicone-water mixture seals masonry walls (Rohloff & Co., 918 N. Western Ave., Los Angeles 29, Calif.).....	144
Island sink (American Radiator & Standard Sanitary Corp., Box 1226, Pittsburgh 30, Pa.).....	146
Folding wardrobe rack (Sherness Co., 3700 Nicollet Ave., Minneapolis 8, Minn.).....	146
"Cold light" (General Electric Co., Schenectady 5, N. Y.).....	146
Hot-roll cutter (Kesco Plastics, 5614 Blackstone Ave., Chicago 37).....	146
Midrange griddle (RCA Estate Appliance Corp., Hamilton, Ohio).....	147
Combination ladder (Speicher Ladder Co., Indianola, Iowa).....	147
Wall cabinet (Furniture Guild of California, 1601 East 15th St., Los Angeles 21, Calif.).....	147
Wheeled snow shovel (John H. Lee Co., Merchandise Mart, Chicago).....	153
Automatic baffle lessens heat loss (Fuel Econ-O-Mizer Co., 1 Washington Ave., Providence 5, R. I.).....	238

### MEDICINE

"Daylight" machine makes X-ray prints available in minute (Picker-X-Ray, 23 S. Broadway, White Plains, N. Y.).....	121
Refrigeration blanket cools surgical patient to 80 degrees.....	149
Color TV brings cancer lessons to doctors in five cities.....	238

### MILITARY AND NAVAL

Britain demonstrates "sombbrero" flame thrower.....	87
Heartbeats relayed from jet to ground.....	132
"Jammer" sends messages while interfering with enemy reception.....	143
Britain's Sarah uses television to rescue downed airmen.....	145

### NOVELTIES

Folks around the office.....	109
Robot song master stimulates Sunday-school singing.....	121
High-riding cyclist runs perilous course.....	134
Tiny carnival operates inside a five-gallon jug.....	160

(Continued to page 16)



# INVENTORS

**L**earn how to protect your invention. The U. S. Patent Laws provide that any new and useful art, machine, article of manufacture, or composition of matter, or any new and useful improvement thereof, may be patented if the act of invention is involved. Therefore, every inventor with a valuable invention should take advantage of the Patent Laws and proceed for patent protection in order to safeguard his rights.

A patent gives the inventor the exclusive right to prevent others from making, using, or selling the invention claimed in the patent for a period of seventeen years.

The Patent Laws were enacted for the benefit of the inventor to give him protection for the features of his invention which are patentable. These features must be properly and concisely set forth and claimed in a formal application for patent, in order to comply with the requirements of the Patent Laws. For that reason, unless the inventor is familiar with patent matters, he should engage a competent registered patent attorney or agent to represent him. We are registered to practice before the U. S. Patent Office and are prepared to serve you in the handling of your patent matters.

A specially prepared booklet entitled "Patent Guide for the Inventor", containing detailed information with respect to patent protection and procedure, together with a "Record of Invention" form will be promptly forwarded to you without obligation upon request.

---

**CLARENCE A. O'BRIEN & HARVEY JACOBSON**

*Registered Patent Attorneys*

**31-L DISTRICT NATIONAL BUILDING**

**WASHINGTON 5, D. C.**

OFFICE, SHOP AND STORE

Pen prints gold on materials (Osborn Brothers Supply Co., 223 W. Jackson Blvd., Chicago 6)	87
Vertical drafting machine is counterbalanced for ease of operation (V. & E. Mfg. Co., Box 950-M, Pasadena 20, Calif.)	100
Pocket-size phonograph designed for displays (Noma Electric Co., 55 West 13th St., New York City)	108
Two-ribbon typewriter emphasizes selected portions (Remington Rand Inc., 315-4th Ave., New York City 10)	126
Pocket-size cutter (Kenworth Mfg. Co., 3455 N. Holton St., Milwaukee 12, Wis.)	132
Vapor can soften paintbrushes (Wisconsin Laboratories, Inc., 2138 N. 3rd St., Milwaukee 12, Wis.)	134
Teletypewriter reels off 100 words per minute	135
Paint-can holder (Colonial Sales Corp., 377 Kenbrook Drive, Worthington Ohio)	260
Ceiling fan	260

SCIENCE

Iceberg detector	86
Piccard bathysphere mounts huge tank	135
Robot controls reactor (Minneapolis-Honeywell Regulator Co., 4494 Wayne Ave., Philadelphia 44, Pa.)	153
Induction coil slashes time required for heating aluminum	153

MISCELLANEOUS

Antibiotic ice	18
Electric socks keep feet warm (Benjamin Electric Mfg. Co., Des Plaines, Ill.)	86
Spring core for wire rope (Jones & Laughlin Steel Corp., 401 Liberty Ave., Pittsburgh 30, Pa.)	87
Streamlined motorcycle hits 170 miles per hour on Salt Flats	93
"Window shade" holder for road maps (MapMaster Mfg. Co., 205 W. 19th St., New York 11)	93
Three color cameras insure shooting ease (Eastman Kodak Co., Rochester 14, N. Y.)	101
Portable electric shaver runs on flashlight batteries (North American Philips Co., Inc., 100 East 42nd St., New York City)	107
Fish netting strung over pipes traps deer without injury	107
Overside lift for ships carries six men or 1000 pounds	126
Inflatable mattress slips into sleeping bag (U. S. Fiber & Plastics Corp., Stirling, N. J.)	127
Camera records "eye interest" of reader for items on page (Dr. Herman F. Brandt, Institute of Visual Research, 424 N. Homan Ave., Chicago 24)	131
Miniature air raid alarm	132
Piped-in sand forms new beach	143
Portable manuscript holder shifts pages for speaker (Roll-a-Talk Co., 11302 E. Jefferson Ave., Detroit 14, Mich.)	144
Plastic shell equips phone for two-way listening (Roger A. B. Heap, Hamburg Cove, Lyme, Conn.)	154
Sedative calms fish	258

Craftsman and Shop Notes Index

AUTOMOTIVE

Scraper cleans snow from car	170
Worn spot on auto armrest renewed with flock	185
Emergency repair for rusted door hinges of old automobiles	185
Stand supports wheel wrench to speed truck-tire change	203
Curtain keeps splashing water inside car-wash stall	203

CONCRETE WORK

Pipes used as leveling stakes when building footing forms	188
Striker board is self-aligning on concrete sidewalk forms	190
Level scrapes cement forms	203

FARMING

Guard on poultry feeder formed from stiff wire	203
Shield protects bottom of pail	203
Altered corn-planter plates give varying hill drop	208
Nesting boxes held on wall by screw eye "turn buttons"	213
Plowshare held for repairs in adjustable pipe rack	220
Harrow-disk storage tray swings under bench top	220
Lip on feed trough reduces waste	220

HOBBIES AND NOVELTIES

Table-top golf course	171
Deckle-edged greeting cards	172
Novel paperweight resembles spear	172
Magnifying small parts	176

HOUSE AND HOME

Lock for outdoor water faucet	170
Repairing open joints in doors	172
Solving Home Problems	174
Inner tubes protect furniture when packing trailer	188
Bath spray in holder makes shower for tub	188
Fur garments may be damaged when stored in home freezer	190
Pouring spout for milk carton	190
Deck cleats give nautical touch to den or recreation room	190
Installing aluminum downspouts on galvanized eaves trough	196
Metallic paints cut radiator heat	220

(Continued to page 18)

IMPORTANT NOTICE—It is the intention of this magazine to provide its readers with information regarding the latest developments in the mechanical arts. We take no responsibility as to whether the disclosures contained in our articles are covered by patents and advise readers to investigate this subject before making, using, or selling any of the products, machines, or processes described in order to avoid possible liability for patent infringements.

**"Cake"—not wood  
mellows  
your smoke**

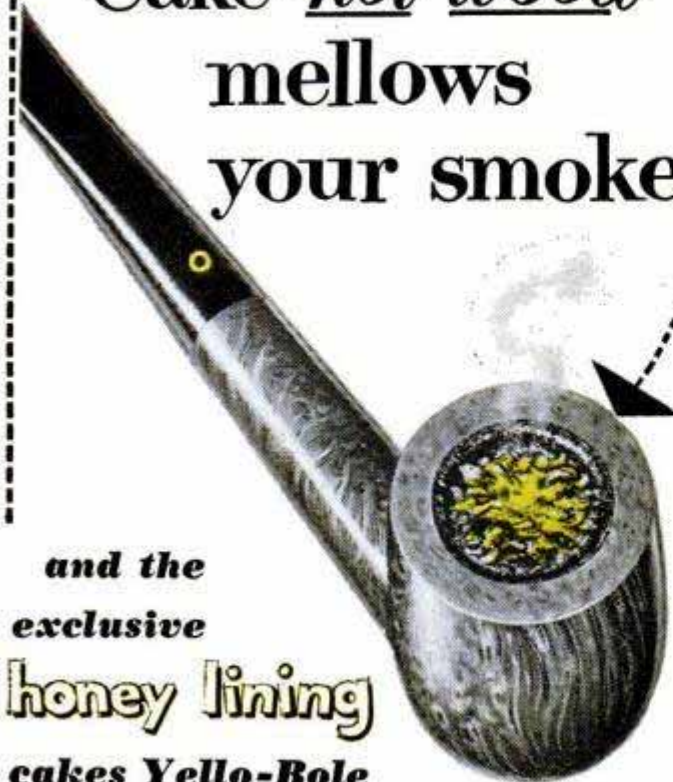

**and the  
exclusive  
honey lining  
cakes Yello-Bole**

**imported briar far faster  
than any pipe at any price!**



The yellow in Yello-Bole is real honey—and honey cakes faster! This great Yello-Bole exclusive builds up "cake" from the first puff . . . holds the cake fast to fine imported briar. One pipeful—and you're smoking cool and sweet. No break-in. No tongue sting! It's the pipe that takes the cake!

**PROOF?**  
Yello-Bole is the world's  
largest selling pipe . . . BY FAR!

**YELLO-BOLE**

**\$1.00  
TO  
\$2.50**



# BOOST YOUR EARNING POWER DURING THE HOURS THAT COUNT



"Every hour I spent on my I. C. S. Course has been worth \$95.00 to me! My position, my \$7,000 a year income, my home, my family's happiness - I owe it to spare-time training with I. C. S."

EVERY MAIL brings letters like this from men and women who studied I. C. S. courses in their spare time.

What are you doing with the hours after supper? Can you afford to let them slip by unimproved when you can easily make them mean so much?

No matter where you live, I. C. S. will come to you. No matter what your handicaps or achievements, whether you make \$2,000 or \$20,000 a year, I. C. S. has a plan to fit your needs exactly. No matter how limited your previous education, the simply written, fully illustrated I. C. S. textbooks make it easy to learn. No matter what career you may choose, some one of the 391 I. C. S. courses can be your springboard to success.

An hour or two a day spent with I. C. S. will prepare you for the position you want in the work you like best. Doubt it? Then put it up to us to prove it! Mark and mail this coupon -now! We'll send you full information plus free book, "How to Succeed."

## INTERNATIONAL CORRESPONDENCE SCHOOLS



BOX 5602-L, SCRANTON 9, PENNA.

Without cost or obligation, send me "HOW to SUCCEED" and the booklet about the course BEFORE which I have marked X:

- |  |   |  |   |  |
|--|---|--|---|--|
| <p><b>ART</b></p> <ul style="list-style-type: none"> <li><input type="checkbox"/> Commercial Art</li> <li><input type="checkbox"/> Magazine and Book Illustrating</li> <li><input type="checkbox"/> Cartooning</li> <li><input type="checkbox"/> Show Card and Sign Lettering</li> <li><input type="checkbox"/> Fashion Illustrating</li> </ul> <p><b>AUTOMOTIVE</b></p> <ul style="list-style-type: none"> <li><input type="checkbox"/> Automobile, Mechanic</li> <li><input type="checkbox"/> Auto-Elec. Technician</li> <li><input type="checkbox"/> Auto Body Rebuilding and Refinishing</li> <li><input type="checkbox"/> Diesel-Gas Engines</li> </ul> <p><b>AVIATION</b></p> <ul style="list-style-type: none"> <li><input type="checkbox"/> Aeronautical Engineering Jr.</li> <li><input type="checkbox"/> Aircraft Engine Mechanic</li> <li><input type="checkbox"/> Airplane Drafting</li> </ul> <p><b>BUILDING</b></p> <ul style="list-style-type: none"> <li><input type="checkbox"/> Architecture</li> <li><input type="checkbox"/> Arch. Drafting</li> <li><input type="checkbox"/> Building Contractor</li> <li><input type="checkbox"/> Estimating</li> <li><input type="checkbox"/> Carpenter and Mill Work</li> <li><input type="checkbox"/> Carpenter Foreman</li> <li><input type="checkbox"/> Reading Blueprints</li> <li><input type="checkbox"/> House Planning</li> <li><input type="checkbox"/> Plumbing</li> </ul> | <ul style="list-style-type: none"> <li><input type="checkbox"/> Heating</li> <li><input type="checkbox"/> Steam Fitting</li> <li><input type="checkbox"/> Air Conditioning</li> <li><input type="checkbox"/> Electrician</li> </ul> <p><b>BUSINESS</b></p> <ul style="list-style-type: none"> <li><input type="checkbox"/> Business Administration</li> <li><input type="checkbox"/> Certified Public Accountant</li> <li><input type="checkbox"/> Accounting</li> <li><input type="checkbox"/> Bookkeeping</li> <li><input type="checkbox"/> Stenography and Typing</li> <li><input type="checkbox"/> Secretarial</li> <li><input type="checkbox"/> Federal Tax</li> <li><input type="checkbox"/> Business Correspondence</li> <li><input type="checkbox"/> Personnel and Labor Relations</li> <li><input type="checkbox"/> Advertising</li> <li><input type="checkbox"/> Retail Business Management</li> <li><input type="checkbox"/> Managing Small Business</li> <li><input type="checkbox"/> Sales Management</li> <li><input type="checkbox"/> Salesmanship</li> <li><input type="checkbox"/> Traffic Management</li> </ul> <p><b>CHEMISTRY</b></p> <ul style="list-style-type: none"> <li><input type="checkbox"/> Chemical Engineering</li> <li><input type="checkbox"/> Chemistry</li> <li><input type="checkbox"/> Analytical Chemistry</li> <li><input type="checkbox"/> Petroleum-Nat'l Gas</li> <li><input type="checkbox"/> Pulp and Paper Making</li> <li><input type="checkbox"/> Plastics</li> </ul> | <p><b>CIVIL, STRUCTURAL ENGINEERING</b></p> <ul style="list-style-type: none"> <li><input type="checkbox"/> Civil Engineering</li> <li><input type="checkbox"/> Structural Engineering</li> <li><input type="checkbox"/> Surveying and Mapping</li> <li><input type="checkbox"/> Structural Drafting</li> <li><input type="checkbox"/> Highway Engineering</li> <li><input type="checkbox"/> Reading Blueprints</li> <li><input type="checkbox"/> Concrete Construction</li> <li><input type="checkbox"/> Sanitary Engineering</li> </ul> <p><b>DRAFTING</b></p> <ul style="list-style-type: none"> <li><input type="checkbox"/> Aircraft Drafting</li> <li><input type="checkbox"/> Architectural Drafting</li> <li><input type="checkbox"/> Electrical Drafting</li> <li><input type="checkbox"/> Mechanical Drafting</li> <li><input type="checkbox"/> Structural Drafting</li> <li><input type="checkbox"/> Sheet Metal Drafting</li> <li><input type="checkbox"/> Mine Surveying and Drafting</li> </ul> <p><b>ELECTRICAL</b></p> <ul style="list-style-type: none"> <li><input type="checkbox"/> Electrical Engineering</li> <li><input type="checkbox"/> Electrician</li> <li><input type="checkbox"/> Electrical Maintenance</li> <li><input type="checkbox"/> Electrical Drafting</li> <li><input type="checkbox"/> Electric Power and Light</li> <li><input type="checkbox"/> Lineman</li> </ul> <p><b>HIGH SCHOOL</b></p> <ul style="list-style-type: none"> <li><input type="checkbox"/> High School Subjects</li> </ul> | <ul style="list-style-type: none"> <li><input type="checkbox"/> College Preparatory</li> <li><input type="checkbox"/> Mathematics</li> <li><input type="checkbox"/> Commercial</li> <li><input type="checkbox"/> Good English</li> </ul> <p><b>MECHANICAL AND SHOP</b></p> <ul style="list-style-type: none"> <li><input type="checkbox"/> Mechanical Engineering</li> <li><input type="checkbox"/> Industrial Engineering</li> <li><input type="checkbox"/> Industrial Supervision</li> <li><input type="checkbox"/> Foremanship</li> <li><input type="checkbox"/> Mechanical Drafting</li> <li><input type="checkbox"/> Machine Design-Drafting</li> <li><input type="checkbox"/> Machine Shop Practice</li> <li><input type="checkbox"/> Tool Design</li> <li><input type="checkbox"/> Industrial Instrumentation</li> <li><input type="checkbox"/> Machine Shop Inspection</li> <li><input type="checkbox"/> Reading Blueprints</li> <li><input type="checkbox"/> Toolmaking</li> <li><input type="checkbox"/> Gas-Electric Welding</li> <li><input type="checkbox"/> Heat Treatment-Metallurgy</li> <li><input type="checkbox"/> Sheet Metal Work</li> <li><input type="checkbox"/> Sheet Metal Pattern Drafting</li> <li><input type="checkbox"/> Refrigeration</li> </ul> <p><b>POWER</b></p> <ul style="list-style-type: none"> <li><input type="checkbox"/> Combustion Engineering</li> <li><input type="checkbox"/> Diesel-Electric</li> <li><input type="checkbox"/> Electric Light and Power</li> </ul> | <ul style="list-style-type: none"> <li><input type="checkbox"/> Stationary Steam Engineering</li> <li><input type="checkbox"/> Stationary Fireman</li> </ul> <p><b>RADIO, TELEVISION, COMMUNICATIONS</b></p> <ul style="list-style-type: none"> <li><input type="checkbox"/> General Radio</li> <li><input type="checkbox"/> Radio Operation</li> <li><input type="checkbox"/> Radio Servicing-FM</li> <li><input type="checkbox"/> Television</li> <li><input type="checkbox"/> Electronics</li> <li><input type="checkbox"/> Telephone Work</li> </ul> <p><b>RAILROAD</b></p> <ul style="list-style-type: none"> <li><input type="checkbox"/> Locomotive Engineer</li> <li><input type="checkbox"/> Diesel Locomotive</li> <li><input type="checkbox"/> Air Brakes <input type="checkbox"/> Car Inspector</li> <li><input type="checkbox"/> Railroad Administration</li> </ul> <p><b>TEXTILE</b></p> <ul style="list-style-type: none"> <li><input type="checkbox"/> Textile Engineering</li> <li><input type="checkbox"/> Cotton Manufacture</li> <li><input type="checkbox"/> Rayon Manufacture</li> <li><input type="checkbox"/> Woolen Manufacture</li> <li><input type="checkbox"/> Loom Fixing</li> <li><input type="checkbox"/> Finishing and Dyeing</li> <li><input type="checkbox"/> Textile Designing</li> </ul> |
|--|---|--|---|--|

**YEAR OF THE SIX  
MILLIONTH STUDENT**

Name \_\_\_\_\_ Age \_\_\_\_\_ Home Address \_\_\_\_\_  
 City \_\_\_\_\_ Zone \_\_\_\_\_ State \_\_\_\_\_ Working Hours \_\_\_\_\_ A.M. to \_\_\_\_\_ P.M.  
 Occupation \_\_\_\_\_

Special tuition rates to members of the U. S. Armed Forces. Canadian residents send coupon to International Correspondence Schools Canadian, Ltd., Montreal, Canada.

# BECOME A Mechanical Engineer



## B. S. Degree in 36 months



50% of the nation's industrial leaders started their careers with engineering training. Today, young men like you are being urged to prepare for careers in these rapidly expanding fields. Nine separate programs give you a wide range of career opportunities.

### Choose From These Courses

**ENGINEERING 36 months,**  
Bachelor of Science Degree  
... optional year  
'round study.

- Mechanical Engineering with a major in Design, Metal Fabrication or Plant Engineering.
- Electrical Engineering with a major in Electronics or Power.

**TECHNICIAN 12 to 18 months**

- Radio and Television
- Electronics
- Electrical Power
- Mechanical
- Air Conditioning
- Welding

General preparatory course  
— 3 months

**SERVICE 6 to 12 months**

- Radio
- Welding
- Refrigeration
- Heating
- Electricity
- Television

## Terms open January, March, June, October

Faculty of specialists. 50,000 former students. Annual enrollment from 48 states and 23 overseas countries. Approved for Veterans. Your Military, Practical or Academic training evaluated for *advanced credit*. Send coupon for complete information. Residence courses only.

## MILWAUKEE SCHOOL OF ENGINEERING

50TH YEAR • NON-PROFIT

MILWAUKEE SCHOOL OF ENGINEERING  
Dept. PM-1153, 1025 N. Milwaukee  
Milwaukee 1, Wisconsin

Send pictorial  
"Your Career" booklet

I am also interested in \_\_\_\_\_

Name \_\_\_\_\_ name of course \_\_\_\_\_  
Age \_\_\_\_\_

Address \_\_\_\_\_

City \_\_\_\_\_ Zone \_\_\_\_\_ State \_\_\_\_\_

If veteran, indicate date of discharge \_\_\_\_\_



(Continued from page 16)  
OFFICE, SHOP AND STORE

Reducing putty drying time.....	170
Sealing loose inkwell cover.....	170
Memo pad for use with telephone improvised from film pack.....	172
Cornstarch-and-paint mixture used to patch cracks.....	188
Nails hold tubes at shelf edge.....	190
Handy rolling tool "tree" rotates for selection.....	196
Broken electric-light bulb removed with corncob.....	204
Surplus vibration dampeners used as machine mounts.....	208

### PHOTOGRAPHY

Shutter release takes nature close-ups.....	197
Two lenses used in tandem for close-up photographs.....	197
Enlarger should sit level.....	198
Dispenser measures solution.....	198
Sponge used to wipe film stored in glass jar.....	198
Stirring rod for darkroom use.....	198
Paint swatches aid exposure.....	198
Negatives numbered at the time of exposure.....	199
Brushes for cleaning negatives should be cleaned often.....	199
Sponge and electric mixer used as film agitator.....	200
Protect filters from lint.....	200
Drip catcher for chemical bottle.....	200

### TOOLS

Mercury plumb bob.....	204
Sound detector (Marsh Instrument Co., Skokie, Ill.).....	218
Pressure-lubricated centers (Tool Service, Box 10265-C, Tampa, Fla.).....	218
Toggle C-clamp (Peterson Mfg. Co., DeWitt, Neb.).....	218
Air-operated tacker (Heller Co., 2141-M Superior Ave., Cleveland 14, Ohio).....	218
Magnetic probes (Snap-On Tools Corp., Kenosha, Wis.).....	218
Hole gauge (Brown & Sharpe Mfg. Co., Providence 1, R. I.).....	219
Chamfer micrometer (Acme Industrial Co., 200 N. Laflin St., Chicago 7).....	219
Angle grinding-wheel dresser (Royal Oak Tool & Machine Co., 29800 Stephenson Highway, Royal Oak, Mich.).....	219
Replaceable-blade milling cutter (Millit, Inc., 55 Flint St., Rochester 8, N. Y.).....	219
Resistance gauges (Steel City Test Machines, Inc., 8817 Lyndon, Detroit 21, Mich.).....	219

### WOODWORKING

Cutlery cabinet.....	173
Dispenser for poker chips.....	177
Hanging bookshelf.....	181
Dispenser for cigarette pack keeps supply visible.....	181
Steps held child learn to use clothes closet.....	185
Plan of the month—shadow boxes.....	186
Two-level table.....	189

### WORKSHOP HINTS

Tennis ball in polishing bonnet provides hand rest.....	170
Table saw used as wood shaper.....	176
Square prevents handsaw binding.....	176
Emergency toggle bolt.....	188
Beveled file is cutting blade on bench utility shear.....	208
Slotted nut having offset pin "locks" when tightened.....	208
Gear keyed to shaft with pins.....	213
Hand-filed keyway in pulley aligned by drilling hole.....	213
Small end mill improvised from combination drill.....	213
File used first on soft metal will give longer service.....	217
Tap hand-started accurately.....	220

### MISCELLANEOUS

Brackets hold crutches within easy reach.....	172
Extra mittens for children dried over warm-air vent.....	176
Cold aids in replacing crystal.....	176
Rubber band "locks" drawers during heavy seas.....	196
Crate raised to insert rollers with bent spring leaf.....	217

## Radio-Television, Electronics

Miniature wireless microphone (Stephens Mfg. Co., 8538 Warner Drive, Culver City, Calif.).....	161
Amateur transmitter includes important TVI-suppression features: transmitter kit (E. F. Johnson Co., Waseca, Minn.).....	162
Tractor radio (Automatic Radio Mfg. Co., 122 Brookline Ave., Boston 15, Mass.).....	164
Grid-dip meter (Heath Co., Benton Harbor, Mich.).....	164
Long-life radio batteries (Radio Corporation of America, RCA Victor Div., Tube Dept., Harrison, N. J.).....	164

## Antibiotic Ice

Fish packed in flake ice containing one part of aureomycin to a million parts of ice stay fresh longer, a report shows. The effect was noticeable from freezing temperature to room temperature. In another effective method of preservation the fish were dipped in a solution of the antibiotic and packed in ordinary ice.

# INVENTORS

If you believe that you have an invention, you should find out how to protect it. The first step is to have a search made of the prior pertinent U. S. patents. If a report on this search indicates that the invention appears patentable you can apply for a patent, and the specifications and claims should be prepared.

The firm of McMorrow, Berman & Davidson, with offices in Washington, D. C., is qualified to take the necessary steps for you. We can make a preliminary search on your invention, advise you whether we think it can be patented, and prepare your application for

patent.

Unless you are fully familiar with the U. S. Patent Laws, we recommend that you engage the services of a Registered Patent Attorney to protect your interests. The patent laws are *your* laws. A patent gives you the right to prevent others from making, using or selling the invention claimed in your patent for a period of 17 years.

Use these patent laws for your protection. Investigate whether your invention can be patented. If you have what you believe to be an invention, we suggest that you have this firm make a search for you.

*Send for a copy of our Patent Booklet entitled "How To Protect Your Invention," containing information about patent protection and patent procedure. Along with this we will also send you an "Invention Record" form, for your use in writing down and sketching details of your invention. We will mail them promptly. No obligation. They are yours for the asking.*

## McMORROW, BERMAN & DAVIDSON

*Registered Patent Attorneys*

**PATENTS • COPYRIGHTS • PATENTS**

135-V VICTOR BUILDING, WASHINGTON 1, D. C.

# WHAT SECRET POWER DID THIS MAN POSSESS?

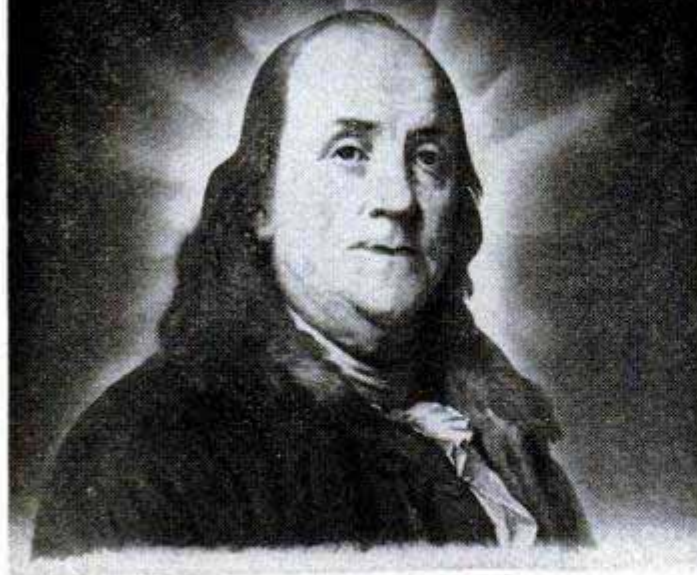

**BENJAMIN FRANKLIN**  
(A Rosicrucian)

**WHY** was this man great? How does anyone—man or woman—achieve greatness? Is it not by mastery of the powers within ourselves?

Know the mysterious world within you! Attune yourself to the wisdom of the ages! Grasp the inner power of your mind! Learn the secrets of a full and peaceful life!

Benjamin Franklin—like many other learned and great men and women—was a Rosicrucian. The Rosicrucians (NOT a religious organization) first came to America in 1694. Today, headquarters of the Rosicrucians send over seven million pieces of mail annually to all parts of the world. Write for YOUR FREE COPY of "The Mastery of Life"—TODAY. No obligation. No salesmen. A non-profit organization. Address: Scribe B.A.B.

**THIS BOOK FREE!**

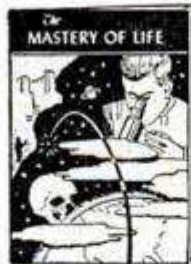

## The ROSICRUCIANS

SAN JOSE • (AMORC) • CALIFORNIA

SEND THIS COUPON

Scribe B.A.B.  
The ROSICRUCIANS (AMORC)  
San Jose, California  
Please send me the free book, *The Mastery of Life*, which explains how I may learn to use my faculties and powers of mind.

Name \_\_\_\_\_  
Address \_\_\_\_\_  
City \_\_\_\_\_

# SUCCESS • BIG PAY

*in Aviation*

## MASTER A & E MECHANICS

*urgently needed*

Maximum training in minimum time! Thorough, practical instruction backed by more than 25 years of aviation technical experience. Training authorized under G.I. Bill.

Write today!  
Illustrated Catalog  
Registrar, Dept. 99,  
Miami 30, Florida



**TRAIN IN MIAMI -- AIR CAPITAL OF THE WORLD**

## HOMECRAFTSMEN

QUALITY PRODUCTS BY HOME  
Member of  
**HOME INDUSTRIES**  
Association Inc.

**Make Money at Home**

Join non-profit national organization which promotes home-craft products and services. Group benefits at cost—HOW-TO-DO-IT PUBLICATIONS • MONEY-MAKING IDEAS • MARKET RESEARCH • ADVERTISING & MAIL ORDER SERVICES • SALES REPRESENTATION • GROUP INSURANCE • ACCOUNTING & TAX SERVICES. Send \$1.00 today for year's membership, descriptive booklet and credentials.

**HOME INDUSTRIES ASSOCIATION Inc.**  
1727 K STREET N. W. WASHINGTON 6, D. C.

### "How to Make Money with Simple Cartoons"

A book everyone who likes to draw should have. It is free; no obligation. Simply address **FREE BOOK**

**CARTOONISTS' EXCHANGE**  
Dept. 911A Pleasant Hill, Ohio

## Learn ACCOUNTING

### Business Administration

Bookkeeping, secretarial and allied subjects at home in your spare time or attend nationally approved resident school. Write for FREE Success Book giving complete details on courses, plans, rates and employment opportunities. G.I. approved.

**Hills BUSINESS UNIVERSITY AND EXTENSION SCHOOL**  
629 W. MAIN ST. OKLAHOMA CITY 2, OKLAHOMA

## PLASTICS

LEARN AT HOME

There are RICH OPPORTUNITIES for MEN and WOMEN with "know-how" in Plastics. Interstate's new Plastics course tells and shows how to make hundreds of fast selling items out of Plastics. Gives complete training in fabrication, casting, lamination, molding, internal carving, etc., in simple, easy, step-by-step language and pictures. Plastics and Fabricating Kits for 23 valuable Plastic items come with training at no extra cost. **START A PLASTICS BUSINESS OF YOUR OWN.** No other industry holds such promise for the future. You can make big money manufacturing novelties, toys, signs, etc., in your own home in spare or full time. Don't wait! Learn NOW how Interstate's Plastics Training qualifies you for success in the Plastics field.

PLASTICS AND SUPPLIES FURNISHED FOR 23 VALUABLE PROJECTS

**INTERSTATE TRAINING SERVICE**  
Dept. C3M Portland 13, Oregon

LEARN HOW TO MAKE fast-selling PLASTIC NOVELTIES FURNITURE JEWELRY SIGNS TOYS LAMPS

WRITE TODAY!

**Train QUICK  
in Big Coyne  
Shops**

# GREAT OPPORTUNITY FIELDS!

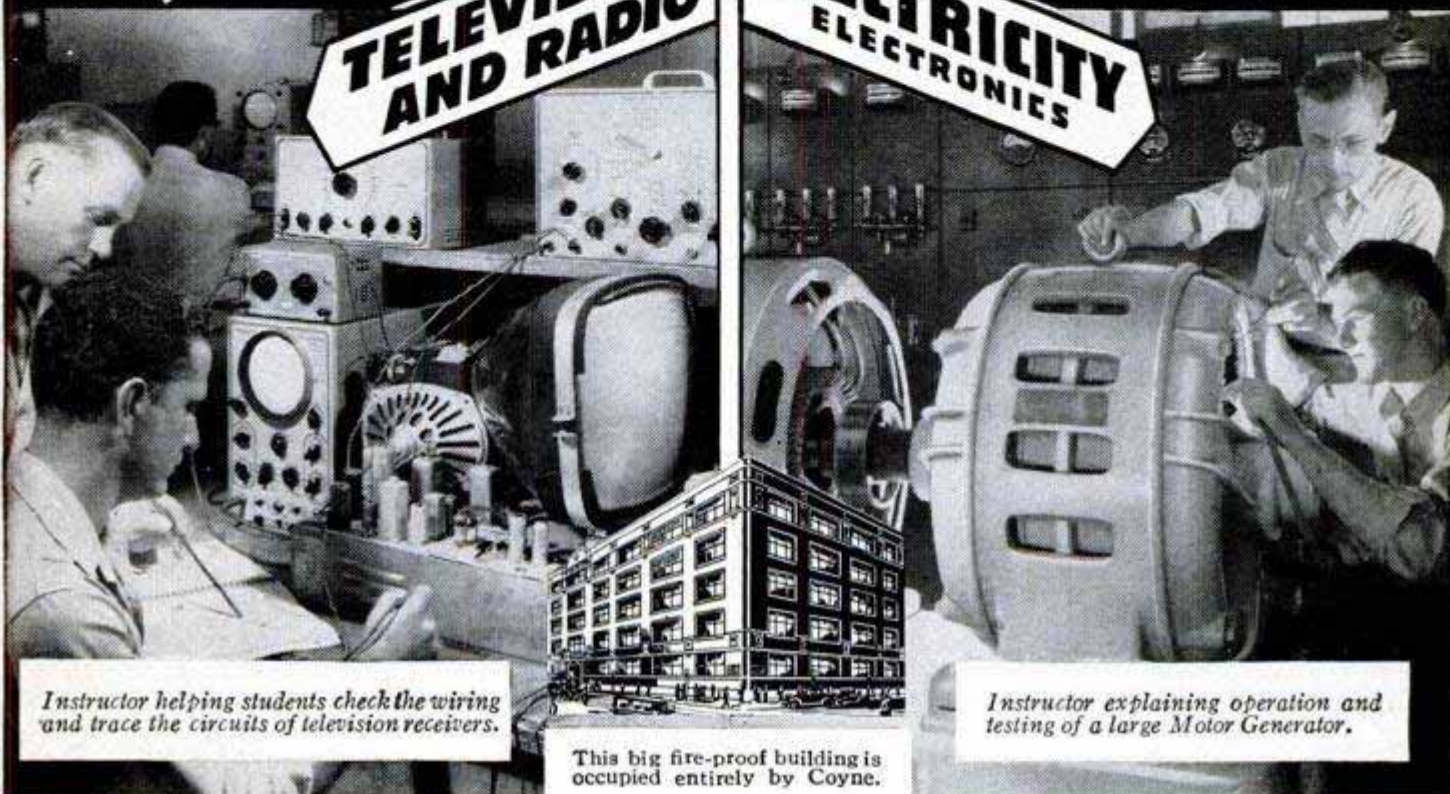

*Instructor helping students check the wiring and trace the circuits of television receivers.*

*Instructor explaining operation and testing of a large Motor Generator.*

This big fire-proof building is occupied entirely by Coyne.

## TRAINED YOUNG AND OLDER MEN— URGENTLY NEEDED IN VITAL FIELDS!

ELECTRICITY—RADIO—TELEVISION—ELECTRONICS—VITAL in defense program. Trained men whether 16 or up to 50 needed. TRAIN QUICKLY for better rating if drafted—Vital job in industry if not.

## TELEVISION-RADIO ELECTRICITY

Here at COYNE you're retrained for Television, Testing, Trouble-Shooting on Radio, Public Address, F. M. Sound Units, etc. Many Coyne trained men in good jobs or own well paying Television-Radio businesses of their own.

Big future in Power Plant Work, Motors, Industrial Electronics, Armature Winding, Home and Factory Wiring, Appliances, Refrigeration, Maintenance, Illumination, etc. Lifetime job service to Coyne graduates.

## WE TRAIN YOU IN CHICAGO

Our famous Practical-Technical method gives you practical experience on a massive outlay of equipment. Actual shop work plus necessary technical training. You are trained right here in the great Coyne shops. Send for BIG FREE BOOK.

**APPROVED  
FOR  
VETERANS**

### START NOW—PAY LATER

Enroll now, pay most of tuition after graduation. Special plan for men of draft age. We'll help you get part-time work, if you need it to help pay living costs while at Coyne.

B. W. COOKE, President

**COYNE**  
[SCHOOL]

A TECHNICAL TRADE INSTITUTE  
CHARTERED NOT FOR PROFIT  
Established 1899  
500 S. Paulina Dept. 83-72H  
Chicago 12, Illinois

ELECTRICITY ★ TELEVISION ★ RADIO ★ REFRIGERATION ★ ELECTRONICS

## LARGEST, OLDEST, BEST EQUIPPED SCHOOL OF ITS KIND IN THE U.S.

### Mail Coupon for Big FREE Book!



Whether you prefer Television-Radio or Electricity, train on actual equipment at Coyne. We will send you a Big, fully Illustrated Book. Indicate below which course interests you most. No salesman will call. Mail coupon TODAY.

B. W. Cooke, President  
COYNE SCHOOL, 500 S. Paulina St.  
Dept. 83-72H, Chicago 12, Ill.

Send me your Big Free book. I am interested in field checked below. This does not obligate me.

TELEVISION-RADIO  ELECTRICITY

NAME.....

ADDRESS.....

CITY.....STATE.....

# Inventors

The following are the usual preliminary steps to take toward patent protection.

You are advised first, to make a disclosure of your invention. Date, sign and have this document witnessed by two or more persons who are capable of understanding your invention. The "Evidence of Invention" form mentioned below, we offer as a convenience in making your disclosure and in starting action leading toward patent protection.

Mail your disclosure to the registered patent attorney or agent whom you select to assist you, together with a letter authorizing him to conduct a

preliminary search among previously granted U. S. patents for similar types of invention. He then prepares for you a report on the probable patentability of your invention and, if the report is favorable, recommends the further course you should take.

**This firm is registered to practice before the U. S. Patent Office and is available to assist you in the preparation and prosecution of patent applications. We shall be glad to send you without obligation, the "Evidence of Invention" disclosure form mentioned above and our instructive booklet, "Patent Protection for Inventors".**

**VICTOR J. EVANS & Co.** *Merlin M. Evans*  
REGISTERED PATENT ATTORNEY  
830 - M MERLIN BUILDING, WASHINGTON 6, D. C.

**EXPANDING AMERICA Needs DRAFTSMEN Now!**



**LEARN AT HOME AND GET ON THE SURE ROAD TO BIG MONEY**

Today more than ever Draftsmen are needed. America must produce better war and peace time equipment if America's well-being and prosperity is to continue. Draftsmen command big part or full time wages . . . own tremendous money earning businesses.

**VALUABLE EQUIPMENT SENT TO YOU**

Everything you need to train at home supplied. Professional set of drafting instruments, all drafting equipment needed and portable drafting table all furnished on **PAY AS YOU LEARN PLAN**. RUSH name today for **FREE Book**.

**CHRISTY TRADES SCHOOL, 4432 N. Kedzie, Dept. DB-2103, Chicago**

**Secrets of VENTRILOQUISM Now Revealed!**



Easy to learn in 60 to 90 days with our Home Study Course. **RESULTS GUARANTEED.** Make Money! Be Popular! Have Fun! Big Opportunity! Radio, Television, Stage Appearances! For **FREE** information regarding price and terms, **WRITE**. You must state your age. Dummy Catalog 25c.  
**FRED MAHER SCHOOL OF VENTRILOQUISM**  
Box 36, Studio 1 Kensington Station  
Detroit 24, Michigan

**EARN WHILE YOU LEARN AT HOME**

**How to Make Money in PHOTOGRAPHY**

If you are **OVER 17**—good pay, fascinating work await you in photography! Start making money quickly in sparetime—step into your own studio or exciting job. **LEARN-BY-DOING** method trains you at home! Write **TODAY** for **FREE** catalog. Also Resident Training. 44th Year! GI Approved.  
**NEW YORK INSTITUTE OF PHOTOGRAPHY**  
Dept. 49, 10 W. 33 St., New York 1, N.Y.

Send for **FREE BOOK**

**SAY YOU SAW IT IN POPULAR MECHANICS**

## Don't Neglect Slipping FALSE TEETH

Do false teeth drop, slip or wobble when you talk, eat, laugh or sneeze? Don't be annoyed and embarrassed by such handicaps. **FASTEETH**, an alkaline (non-acid) powder to sprinkle on your plates, keeps false teeth more firmly set. Gives confident feeling of security and added comfort. No gummy, gooey, pasty taste or feeling. Get **FAS-TEETH** today at any drug store.



# START YOUR FUTURE TODAY!

Get the facts on NATIONAL SCHOOLS' famous Shop-Method Home Training!

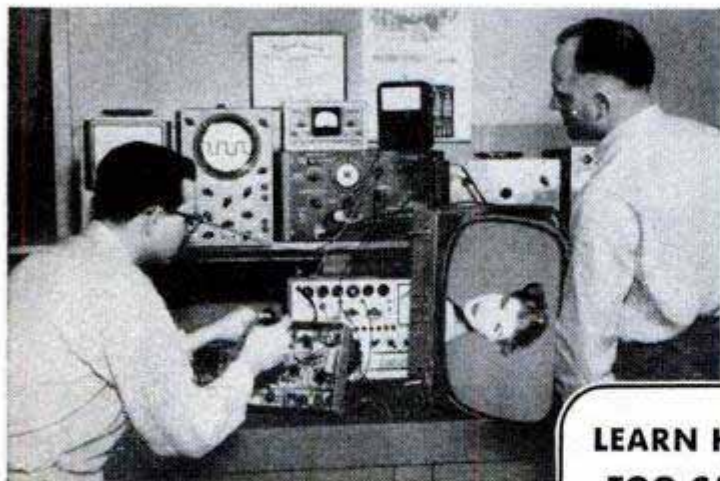

## RADIO-TELEVISION & ELECTRONICS

A BRIGHT FUTURE awaits you in booming Radio-TV industry. More than 100 million radio sets, 20 million TV sets, now in use! Backed by National Schools' famous Shop-Method Training from America's Radio-TV Capital you can command good wages in the opportunity-career of your choice — engineer, service-repair, inspector, designer — in radar, electronics — or your own profitable business! Make that bright future come true... start now!

**WE GIVE YOU COMPLETE PARTS, INCLUDING HIGH-MU TUBES!**

Yours to keep. You learn by doing, actually build generators, R-F oscillators, and this big Super-Het receiver!



**WE GIVE YOU THIS STANDARD PROFESSIONAL MULTITESTER!**

Locates trouble, adjusts delicate circuits—a valuable profit-earner

for you when you become a qualified Radio-TV technician!



**FREE! RADIO-TV BOOK & LESSON!**

**FREE! AUTO-DIESEL BOOK & LESSON!**

**MAIL COUPON NOW START YOUR HIGH-PAYING FUTURE TODAY!**



## AUTOMOTIVE-DIESEL & ALLIED MECHANICS

EXPANDING AUTO-DIESEL INDUSTRY needs more and more trained men! 55 million vehicles now operating, 6 million more this year—plus 150,000 new Diesel units! Garages, car dealers, transit lines, defense plants, manufacturers, are desperate for

the kind of *trained specialists* produced by National Schools' "Shop-Method Home Training." Start now on the road to lifetime security. Mail the coupon today!

**WE GIVE YOU THE TOOLS OF YOUR TRADE!** This fully-equipped, all-metal Tool Kit is yours to keep. We also give you a complete set of precision drawing instruments, and Slide Rule. These professional tools help you learn, then *earn!*



## NATIONAL SCHOOLS

Technical Trade Training Since 1905  
 LOS ANGELES 37, CALIFORNIA  
 In Canada: 193 East Hastings Street  
 Vancouver 4, B. C.  
 Both Home Study and Resident Courses Offered

**LEARN HOW YOU TOO CAN EARN TOP MONEY IN THESE BOOMING INDUSTRIES!**



LET NATIONAL SCHOOLS of Los Angeles, California, a Resident Technical Trade School for nearly half a century, train you at home for a high-paying future in these big-future industries.

### Earn While You Learn!

Make extra money repairing friends' and neighbors' cars, trucks, radios, TV sets, appliances. Every step fully explained and illustrated in National Schools' famous "Shop-Tested" lessons. Latest equipment and techniques covered. You master all phases—start part-time earnings after a few weeks!

**YOU RECEIVE FRIENDLY GUIDANCE**, both as a student and graduate. Our special Welfare Department is always at your service, to help you with technical and personal problems. You receive full benefit of our wide industry contacts and experience.

**DRAFT AGE?** National Schools training helps you get the service branch, and higher pay grade you want.



**APPROVED FOR G. I. TRAINING**

THESE COURSES ALSO OFFERED IN SPANISH AND PORTUGUESE

**GET FACTS FASTEST! MAIL TO OFFICE NEAREST YOU!**

(mail in envelope or paste on postal card)  
**NATIONAL SCHOOLS, Dept. B-113**

4000 S. Figueroa Street Los Angeles 37, Calif. or 323 West Polk Street Chicago 7, Ill.

Please rush *Free Book & Sample Lesson* checked below. No obligation, no salesman will call.

- "My Future in Radio-Television & Electronics"
- "My Future in Automotive-Diesel & Allied Mechanics"

NAME \_\_\_\_\_ BIRTHDAY \_\_\_\_\_ 19 \_\_\_\_\_

ADDRESS \_\_\_\_\_

CITY \_\_\_\_\_ ZONE \_\_\_\_\_ STATE \_\_\_\_\_

Check here if interested in Resident School Training at Los Angeles.  
 VETERANS: Give Date of Discharge \_\_\_\_\_

Note: You will find our ad below particularly interesting. Read about this new and profitable hobby.

Northwestern School of Taxidermy  
2511 Elwood Bldg., Omaha, Neb.

## World's Greatest Hobby For Men and Boys!

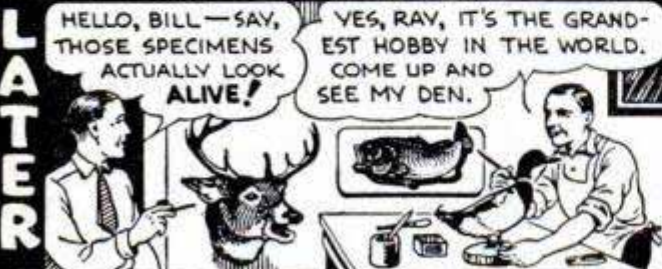

## WE CAN TEACH YOU TO MOUNT BIRDS

**Great Fun and Profit.** Send **Coupon** for marvelous **Free Book**. It tells **All** about taxidermy—how you can **Make Money** and have great **fun** and fascination mounting **Birds and Animals**. Save your wild-game trophies—mount for others. Also **Mount** common specimens, pigeons, squirrels, rabbits, even frogs, into humorous and useful groups—highly interesting and sell at sight. Wild-game **Not necessary**. Men, Women, Boys learn quickly by **Mail**. **Marvelous business, send coupon TODAY.**

**BIG PROFITS!** Turn your spare time to **Cash**. Besides Taxidermy learn also to **Tan Leather, Tan Fine Furs** and make them into scarfs, etc. We teach you **Genuine Chrome** method—never before revealed. 400,000 students endorse this old reliable school. We offer **You** our marvelous **Free Book**. Send for **Your** copy **Today**. In a few weeks we can teach you a **New Trade** that earns **Cash** in depression and good times, too. Then Taxidermy brings fun, fascination. **Investigate!** Get **Free Book**. Sign your name, state **AGE**, and the **FREE BOOK** is yours. Send coupon **Today**. Or a postal card will do.

## FREE BOOK

Northwestern School of Taxidermy,  
2511 Elwood Bldg., Omaha, Neb.

Gentlemen:—Please send me your free 48 page booklet explaining Taxidermy. Please print plainly, and please state your **AGE**.

Name \_\_\_\_\_ Age \_\_\_\_\_

Address \_\_\_\_\_  
Print plainly. Use margin, if necessary, or send postal.



## OWN Your Own Business



charges. Easy to learn . . . quickly established.

**DURACLEAN** cleans by absorption! No scrubbing, soaking or shrinkage. Dirt and grease vanish . . . matted pile rises . . . colors revive. Furnishings used again same day.

**DURAPROOF** resists moths and carpet beetles. Your service backed by an International Money Back 4 Year Warranty.

We furnish enough material to return your total investment in War-proof Business. **EASY TERMS.** Send for **FREE** booklet **TODAY.**

**DURACLEAN CO., 3-16N DURACLEAN BLDG. DEERFIELD, ILL.**

## AVIATION Pays You More With a Schooling at PARKS

**NOW! A&E MECHANIC LICENSE COURSE**

45-week course, all phases aircraft & engines.

**FLIGHT COURSES**—Private, Commercial, Instrument, Instructor, Multi-Engine.

**DEGREE COURSES**—B.S. degree in 3 yrs. from Saint Louis University — Aero. Engineering, Maint. Engineering, Aero. Administration.

All Parks Schooling Approved for Veterans Write Today.

**PARKS COLLEGE** ARNOLD HALL EAST ST. LOUIS, ILL.

## CASTING SECRETS REVEALED

Big money! Cast 1000's of plaques, figurines, etc. with X.L. rubber molds. No exper., little capital req. X.L. rubber pts. \$2.50, qts. \$4 (postage extra). Models, rubber for 3 molds, \$1.50 ppd. Send 25c (refundable) for 40 pp fact catalog.

**HUGE PROFITS! MORE MONEY!**

**PLASTIC ARTS STUDIO, Dept. 3, 3403 S. Madison St., Muncie, Ind.**

## RUPTURE



**RELIEF...OR YOUR MONEY BACK** Original, patented Web, copied but never matched. Users say it's best ever. Relief or no cost to you. Write:

**WEB TRUSS CO., Dept. M-11, Hagerstown, Md.**

Say You Saw It in Popular Mechanics

## BE A HIGH-PAID MAN IN YOUR COMMUNITY WITH THIS LONG NEEDED INVENTION

Earn up to \$10,000 or more per year! Nothing to invest! Be your own boss!

U.S. Pat. D 153853- D 153854

A worldwide product needed by every home, business and farm . . . priced to sell quickly at long profit! Automatic Red Comet goes into action as soon as fire starts . . . smotherers fire without human aid. It's a sales 'natural'!

### FREE SALES KIT

Demonstrator units, sales literature, etc., furnished you **FREE**. Handsome leather-type kit. Tried and proved, it will make you an independent businessman. **ACT NOW!** Someone in your community will be appointed soon. Write for details, today!

**RED COMET, INC.**

Dept. 346-G, R.C. Bldg., Littleton, Colo.

# HOW TO FIX ANY PART OF ANY CAR

USED BY U. S. ARMED FORCES

QUICKLY-- EASILY-- RIGHT!

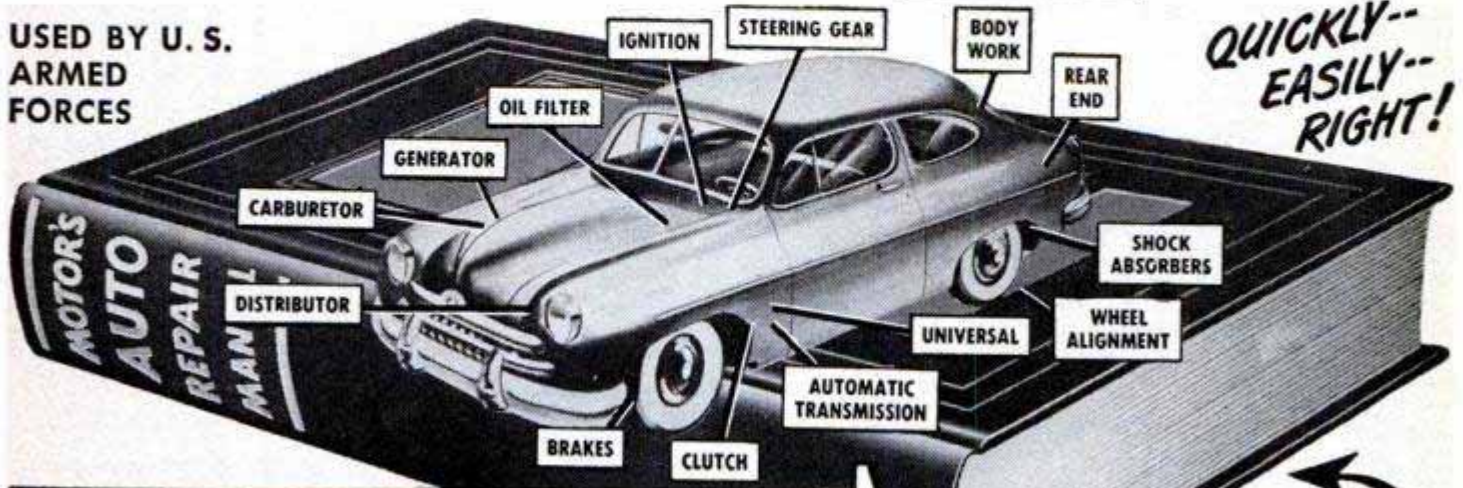

**NOW—Whether You're a Beginner or an Expert-Mechanic —You Can "Breeze Through" ANY AUTO REPAIR JOB! MOTOR'S BRAND-NEW 1953 AUTO REPAIR MANUAL Shows You HOW—With 2500 PICTURES AND SIMPLE STEP-BY-STEP INSTRUCTIONS.**

**Free 7-DAY TRIAL**  
Return and Pay Nothing If Not Satisfied!

## COVERS EVERY JOB ON EVERY CAR BUILT FROM 1935 THRU 1953

**Y**ES, it's easy as A-B-C to do any "fix-it" job on any car whether it's a simple carburetor adjustment or a complete overhaul. Just look up the job in the index of **MOTOR'S New AUTO REPAIR MANUAL**. Turn to pages covering job. Follow the clear, illustrated step-by-step instructions. Presto—the job is done!

No guesswork! **MOTOR'S Manual** takes nothing for granted. Tells you where to start. What tools to use. Then it leads you easily and quickly through the entire operation!

### Same FREE Offer On MOTOR'S Truck and Tractor Manual

Covers EVERY job on EVERY popular make gasoline truck, tractor made from 1939 thru 1953. FREE 7-Day Trial. Check proper box in coupon.

short-cuts that will amaze you. No wonder this guide is used by the U. S. Army and Navy! No wonder hundreds of thousands of men call it the "Auto Repair Man's Bible"!

### Meat of Over 189 Official Shop Manuals

Engineers from every automobile plant in America worked out these time-saving procedures for their own motor car line. Now the editors of **MOTOR** have gathered together this wealth of "Know-How" from over 189 Official Shop Manuals, "boiled it down" into crystal-clear terms in one handy indexed book!

### Covers 907 Models—All These Makes

- |           |           |              |
|-----------|-----------|--------------|
| Buick     | Henry J   | Nash Rambler |
| Cadillac  | Hudson    | Oldsmobile   |
| Chevrolet | Kaiser    | Packard      |
| Chrysler  | Lafayette | Plymouth     |
| Crosley   | La Salle  | Pontiac      |
| De Soto   | Lincoln   | Studebaker   |
| Dodge     | Mercury   | Terraplane   |
| Ford      | Nash      | Willlys      |
| Frazer    |           |              |



**Many Letters of Praise from Users**  
"MOTOR'S Manual paid for itself on the first 2 jobs, and saved me valuable time by eliminating guesswork."  
—W. SCHROP, Ohio.

**He Does Job in 30 Min.—Fixed motor another mechanic had worked on half a day. With your Manual I did it in 30 minutes.**  
—C. AUBERRY, Tenn.



**Over 2,500 Pictures! So Complete, So Simple, You CAN'T Go Wrong!**

**Try Book FREE 7 Days**

**SEND NO MONEY!** Just mail coupon! When the postman brings book, pay him nothing. First, make it show you what it's got! Unless you agree this is the greatest time-saver and work-saver you've ever seen—return book in 7 days and pay nothing. Mail coupon today! Address: **MOTOR Book Dept., Desk 111, 250 West 55th St., New York 19, N. Y.**

## MAIL COUPON NOW FOR 7-DAY FREE TRIAL

**MOTOR BOOK DEPT.**  
Desk 111, 250 W. 55th St., New York 19, N. Y.

Rush to me at once (check box opposite book you want):

**MOTOR'S New AUTO REPAIR MANUAL.** If O.K., I will remit \$1 in 7 days, \$2 monthly for 2 months and a final payment of 95c (plus 35c delivery charges) one month after that. Otherwise I will return the book postpaid in 7 days. (Foreign price, remit \$8 cash with order.)

**MOTOR'S New TRUCK & TRACTOR REPAIR MANUAL.** If O. K., I will remit \$2 in 7 days, and \$2 monthly for 3 months, plus 35c delivery charges with final payment. Otherwise I will return book postpaid in 7 days. (Foreign price, remit \$10 cash with order.)

Print Name.....Age.....

Address.....

City.....State.....

Check box and save 35c shipping charge by enclosing WITH coupon entire payment of \$5.95 for Auto Repair Manual (or \$8 for Truck and Tractor Repair Manual.) Same 7-day return-refund privilege applies.

# The **NEW** way to enjoy **SPORTS** **Movies, Plays, Nature,** **Television!**



Save \$8.00  
**NOW!**

**\$1.98**  
 F.T.I.

**NOW!**  
**GET CLOSE-UP**  
**VIEWS ALL DAY**  
**WITHOUT**  
**FATIGUE!**

IMPORTED FROM  
**GERMANY**

## The **IDEAL GIFT FOR THIS CHRISTMAS!**

Here for the first time—Germany's famous **SPEKTOSCOPES** — a revolutionary concept in optics. Wear them like ordinary eye glasses — hour after hour — without fatigue. Feather weight — only 1 oz. You'll hardly **FEEL** them! Yet here is a new, truly powerful optical design that gives you greater range than many expensive opera or field glasses and a far greater field of view than some selling for many times more! Has **INDIVIDUAL** eye focusing for clear, sharp viewing, whether you're looking at a play in the first row or a seashore scene miles away! **SPEKTOSCOPES** are ideal for indoors, outdoors or distant scenes or close-by viewing. Special low price — **\$1.98** a saving of 8.00 or more!

### **TRY AT OUR RISK—NO OBLIGATION!**

Enjoy at our risk for 5 days. You must be delighted! Otherwise your 1.98 will be refunded with no questions asked! Limited supply forces us to place a limit of 2 per customer. Send check or m.o. for prompt, free delivery. COD's sent plus COD fees. Use convenient coupon below!

## **5 DAY FREE TRIAL!**

International Binocular Co., Dept. 6-M-90  
 53 to 59 East 25th Street  
 New York 10, N. Y.

**RUSH** \_\_\_\_\_ **SPEKTOSCOPES** at 1.98 each (LIMIT—2)  
 on 5 day home trial. You are to refund my 1.98 if I am not  
 fully delighted.

Payment enclosed. Send post free.  Send COD plus post.

Name \_\_\_\_\_

Address \_\_\_\_\_

Town \_\_\_\_\_ State \_\_\_\_\_

**International Binocular Co.** Dept. 6-M-90  
 53 to 59 East 25th Street, New York 10, N. Y.

## **FAVORABLE EXCHANGE RATE** **MAKES THIS VALUE POSSIBLE!**

This is the first time that this type of optical instrument has ever sold for less than \$10.00. The favorable rate of exchange and Germany's need for dollars makes it possible. We have been chosen as the exclusive distributor for **SPEKTOSCOPES** to the American public. Get yours now at our low, low introductory price of **1.98** tax & post paid!

Now IN YOUR OWN HOME Learn

# TELEVISION RADIO ELECTRONICS

*the Amazingly Effective*  
**D. T. I. WAY**

—with the aid of BOTH  
HOME EQUIPMENT  
and HOME MOVIES

What will mailing the coupon below do for YOU? Just this! You'll find out about one of today's most remarkable . . . practical ways to prepare to get into America's amazing billion dollar opportunity field of TELEVISION-RADIO-ELECTRONICS. You'll see how to get into fascinating work that pays well . . . that offers one of America's most promising futures . . . that enables you to start your own business almost "on a shoe string," if you prefer this to a job opportunity.

And above all, you'll get some GOOD NEWS especially welcomed by men anxious to earn REAL MONEY in this thrilling field. For you'll see that NOW you can get the kind of practical, laboratory-type training so desirable for making real progress in Television-Radio-Electronics AND WITHOUT LEAVING HOME.

You'll see that DeForest's Training, Inc. sends everything needed to set up your own HOME LABORATORY.

You get and keep the same type of basic electronic equipment used in our modern Chicago Training Laboratories. You get home training that includes the knowledge and experience gained from training thousands of students first hand in Chicago.

And to top it all, you use DTI's amazingly effective and exclusive home training aid—**INSTRUCTIVE MOVIES**. But why not get the complete story? Mail coupon today for information-packed literature.

#### MODERN LABORATORIES

If you prefer, get all your preparation in our new Chicago Training Laboratories—one of the finest of its kind. Ample instructors, modern equipment. Write for details!

#### MILITARY SERVICE!

If you're subject to military service, the information we have for you should prove very helpful. Mail coupon today.

**FREE!**

*Mail Coupon Today*

NO PREVIOUS EXPERIENCE NEEDED  
NOW . . . get  
**EVERYTHING  
YOU NEED**

for real Laboratory-type training  
**AT HOME**

Above:  
Work over  
**300**  
fascinating  
experiments  
with this  
equipment

1. Build over 300 fascinating experiments from 16 BIG SHIPMENTS of Electronic-Radio parts which you KEEP.

2. Build valuable commercial-type test equipment—as shown to the left—which you KEEP. This includes a quality 5 INCH oscilloscope and jewel bearing Multi-Meter—both highly useful for Television work.

3. Build and keep a big 21 INCH TV Set. (D.T.I. offers another home training in Television-Radio-Electronics, but without the TV set.)

4. Use a 16 mm. movie projector and new series of highly instructive movies—a wonderful aid to help you grasp important fundamentals faster . . . easier . . . better.

5. Enjoy well-illustrated, easy-to-read lessons with handy FOLD-OUT diagrams.

6. Get an honest-to-goodness EMPLOYMENT SERVICE to help you get a good job after graduating—or assistance in starting your OWN SALES AND SERVICE BUSINESS. Mail coupon today for the complete details.

Get this  
information-packed publication

**89 WAYS  
TO  
EARN  
MONEY**  
IN TELEVISION  
RADIO-ELECTRONICS



"ONE OF AMERICA'S FOREMOST  
TELEVISION TRAINING CENTERS"  
— Established 1931 —

**DEFOREST'S TRAINING, INC.**  
AFFILIATED WITH  
**DEVRY Technical INSTITUTE**  
CHICAGO 14, ILLINOIS

DEFOREST'S TRAINING, INC. Dept. PM-11-J  
2533 N. Ashland Avenue, Chicago 14, Ill.

I would like your valuable information-packed publication showing how I can get started toward a good job or my own business in Television-Radio-Electronics.

Name..... Age.....  
Street..... Apt.....  
City..... Zone..... State.....

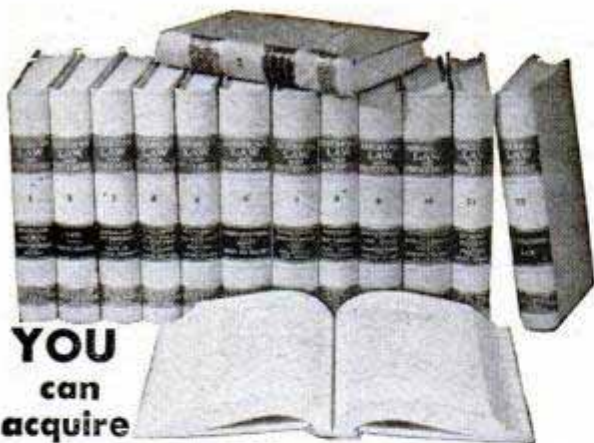

**YOU  
can  
acquire**

## LAW NIGHTS AT HOME! L. B. DEGREE

LaSalle's famous Law Library—used as reference in many Law libraries and Law offices—has enabled thousands to master Law surprisingly fast, in spare hours at home, for business and professional advancement.

These 14 remarkable volumes, compiled by leading professors and lawyers, cover the whole basic field of Law in condensed, orderly, simplified manner.

You advance rapidly with this great library, plus special lectures furnished. We guide you step-by-step with personalized Problem Method of instruction . . . you learn by doing—handling legal problems—not by memorizing rules.

Send for two FREE 48-page booklets, "Law Training for Leadership," and "Evidence," answering questions about Law and its value to you, and telling how LaSalle Law graduates are winning rapid advancement in business and public life. Mail coupon below. No obligation.

### LA SALLE EXTENSION UNIVERSITY A Correspondence Institution

417 S. Dearborn St. Dept. 1164L Chicago 5, Ill.

Send me your two FREE booklets described above, without obligation.

Name.....Age.....

Street.....

City, Zone & State.....



## SWISS MUSICAL CHURCH

Beautiful all Wood 11 inches high. Many lovely features. Regular Retailer \$7.50. Genuine Swiss Unit. COMPLETE KIT \$3.95 POSTPAID.

PILTZECKER SWISS IMPORTS, Wood-Ridge, N. J.

Say You Saw It in Popular Mechanics

## MAKE \$100 A WEEK—SPARE TIME!

### Assemble & Install Buckeye Screen & Glass Combination STORM WINDOWS

- Shipped Knocked-Down. Glass & Screen
- Thousands Sold. Panels Interchangeable
- Redwood or Aluminum. Winter Summer or
- Finest Quality. Winter



You Pay Only

**\$6.65**

For Redwood Storm Window to fit 28 1/2" x 66 1/2" window (screen & glass not included)

Make up to \$10.00 an hour SPARE TIME, assembling Buckeye Storm Windows. Sell year 'round—no slack period. Quick, easy to assemble. A sound, legitimate business. You risk nothing; no tools to buy; no big stock needed. We're 20 year-old company, A-1 financially.

Some Attractive

Dealer Territories

Still Open—Write!

**FHA FINANCING THROUGH YOUR BANK**  
Buckeye Storm Windows can be financed on FHA Plan. Add them to any home for as little as \$5.00 a month. No down payment. See your bank.

**BUCKEYE SCREEN & WEATHERSTRIP CO.**  
1380 S. 22nd Street, Columbus, Ohio

## Famous 15 and 17 Jewel BULOVA WATCHES \$16.95 PLUS TAX

PRACTICALLY WHOLESALE TO YOU

### UNLIMITED SERVICE GUARANTEE

WHY PAY \$59.50?  
SAVE \$42.55

Also Choice of • BENSUR  
• GRUEN • WALTHAM  
or • ELGIN WATCHES



You get these unredeemed SERVICE guaranteed Bulova and other movements in latest style Yellow Gold Cases at this sensationally low price because we bought out huge surplus STOCKS of leading New York and Md. Jewelers. Order now while they last. Specify make preferred and whether men's or ladies'. Only \$16.95 plus \$1.70 tax. Order right now.

**FREE TRIAL OFFER! WEAR AT OUR RISK!**  
Money back guarantee in 10 days if not delighted.

SEND ONLY \$1 with order. Pay balance C.O.D., plus postage. Or enclose \$16.95 plus \$1.70 tax, we pay postage.

Handsome Expansion Band with orders at no extra cost.

**AIRMAIL XMAS DELIVERY GUARANTEED**  
**MARYLAND DISTRIBUTORS, Dept. 560**

501 E. Baltimore St. Baltimore 2, Md.  
Write For Free Watch and Diamond Ring Catalog — Practically Wholesale Prices.

**UNLIMITED Service Guaranteed**  
**17 Jewel Swiss WRIST WATCH**

Worn by Army, Navy & Marines.

WHY PAY \$50?

Here Only **\$14.95** Plus \$1.50 tax.

New Incablock, Shock-Protected Water & Dust Tight

## FALSE TEETH KLUTCH holds them tighter

KLUTCH forms a comfort cushion; holds dental plates so much firmer and snugger that one can eat and talk with greater comfort and security; in many cases almost as well as with natural teeth. Klutch lessens the constant fear of a dropping, rocking, chafing plate. 25c and 50c at druggists . . . If your druggist hasn't it, don't waste money on substitutes, but send us 10c and we will mail you a generous trial box.

KLUTCH CO. Box 5393-K ELMIRA, N. Y.

**GET UP TO 40% OFF!** **BUY IT WHOLESALE!**  
**START A BUYING SERVICE** at home, spare time. Get big-name merchandise for clients (and yourself) at up to 40% and more below the regular list price. Make fat commissions. Folks eagerly buy through you to get sizeable discounts. Send postcard for details.  
**AMERICAN BUYERS' SERVICE, 631-R Linden Ave., Buffalo 16, N. Y.**

## THE KEY TO POWER

Life is law and never luck!

Create the future you desire by learning to control your subconscious mind. Free booklet. Write to

**KEY TO POWER**

Dept. PM, 7321 Beverly Blvd. Los Angeles 36, Calif.

## INSURED TIRE SERVICE POPULAR BRANDS

**FREE** INSURANCE POLICY given with each used tire sold. We guarantee the amount of service you pay for.  
Tube Given Free with Each Used Passenger Tire Upon Request

**SPECIAL!** Deduct 10% on orders for Two or More used tires

**YOU CAN'T LOSE!!**

Super Quality	Rugged Performance	15 Months Insured Service
600x16 \$4.55	670x15 \$5.25	700x16 10.45
650x15 4.95	670x16 5.35	760x16 8.35
650x16 5.45	700x15 5.40	820x15 6.45
		820x17 4.75

Supreme Quality	Nothing Finer	30 Months Insured Service
450x20 5.95	450x21 6.25	700x15 (6) 10.45
600x16 5.65	650x15 5.75	600x20 10.95
650x16 5.85	670x15 5.95	900x20 19.95
700x16 7.75	700x15 6.75	1000x20 20.45
750x16 12.50	710x15 6.50	1100x20 26.75
550x17 5.75	760x15 6.95	32x6 (8) 11.95
525x18 5.45	820x15 7.50	750x16 (8) 12.75
640x15 5.75	475x19 5.75	750x20 14.50
		1200x20 23.50
		1100x24 22.75

**MIDLAND TIRE SALES**

Speedy shipments on Mail Orders. F.O.B. Chicago. Insurance policy sent with each order. Deduct 10% on orders for 2 or more used tires. Send CHECK or MONEY ORDER.—No COD's.  
449 W. 37th St., Dept. PM-16, Chicago 9, Ill.



**TURN RIGHT**

# Get on the Road to a Better Job-Brighter Future with **RIGHT** Training —then You Can Really GO!

**AMERICAN SCHOOL, Dept. G845, Drexel at 58th, Chicago 37, Ill.**

Without obligation, please send FREE and postpaid, full particulars about the subject checked below.

- |  |   |   |
|--|---|---|
| <input type="checkbox"/> Accounting              | <input type="checkbox"/> Drafting—Building Trades | <input type="checkbox"/> Plastics Engineering |
| <input type="checkbox"/> Air Conditioning        | <input type="checkbox"/> Drafting—Machine Trades  | <input type="checkbox"/> Plumbing—Practical   |
| <input type="checkbox"/> Architecture & Building | <input type="checkbox"/> Electrical Engineering   | <input type="checkbox"/> Private Secretary    |
| <input type="checkbox"/> Automotive Technician   | <input type="checkbox"/> Electricity—Practical    | <input type="checkbox"/> Refrigeration        |
| <input type="checkbox"/> Better Foremanship      | <input type="checkbox"/> Electronics—Industrial   | <input type="checkbox"/> Retail Merchandising |
| <input type="checkbox"/> Bookkeeping             | <input type="checkbox"/> High School Courses      | <input type="checkbox"/> Salesmanship—Outside |
| <input type="checkbox"/> Business Management     | <input type="checkbox"/> Machine Shop Operations  | <input type="checkbox"/> Sheet Metal Work     |
| <input type="checkbox"/> Contracting             | <input type="checkbox"/> Mathematics & Slide Rule | <input type="checkbox"/> Tool Making          |
| <input type="checkbox"/> Diesel Technician       | <input type="checkbox"/> Mechanical Engineering   |   |

NAME \_\_\_\_\_ OCCUPATION \_\_\_\_\_  
HOME ADDRESS \_\_\_\_\_ AGE \_\_\_\_\_  
CITY \_\_\_\_\_ STATE \_\_\_\_\_

**START NOW by checking, filling in and mailing this coupon.  
You'll get full information — No cost, No obligation!**

• *Today*, make the **BIG** decision of your life. Choose the career you want and take the first easy step toward your goal. Learn how you can get the training that can put you in the bigger pay class and give you security in the years ahead. Find out how, in spare time at home, you can qualify for work you prefer, and higher pay. Or if you are already in the work you like, find out how you can win quicker promotion and a larger income.

### **Backed by 56 Years of Training Know-How**

Since 1897 American School has helped many thousands of ambitious people toward success by providing specialized training for

commercial and technical advancement. Its study program for *you* has been prepared by experts in the subject you select and the school will give you guidance every step of the way. In time you might otherwise waste and at a cost you can afford you can prepare at home and really GO on the *right* road.

### **Don't Delay YOUR Start**

Give serious thought to the list of training courses listed above. Pick the opportunity that interests you, check it and add your name and address. (Check more than one if you are undecided which appeals most.) Then clip and mail the coupon. Full information will be supplied without cost or obligation.

**PRACTICAL, EFFECTIVE HOME STUDY TRAINING SINCE 1897**

**AMERICAN SCHOOL, Dept. G845, Drexel at 58th, Chicago 37, Ill.**

**THE SOONER YOU START, THE SOONER YOUR GOAL CAN BE REACHED**

# C. T. C. TRAINING IN DRAFTING

PREPARES FOR  
PROMOTION  
MORE MONEY  
SUCCESS

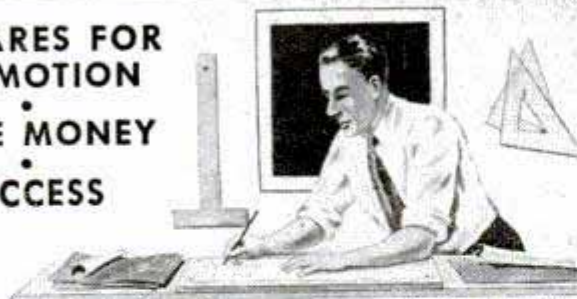

"Here I am at work making good money as a draftsman. I'm glad I sent the coupon to Chicago Tech for that Free Trial Lesson and found out how easy it is to learn Drafting in spare time at home. Today, I feel secure in my job. What's more, I feel I'm slated for promotion and more pay."

## LEARN IN SPARE TIME—AT HOME! (or at the College in Chicago)

A few hours of pleasant home study every week—that's all. All the tools you need; drawing outfit included. This tested method—developed over 49 years of C.T.C. progress—prepares men quickly for good positions in industry.



### FREE INFORMATION—SEND COUPON

To prove to you how easy it is to learn Drafting at home, we will send you this FREE TRIAL LESSON. Mail coupon or send post card today.

## CHICAGO TECHNICAL COLLEGE

P-251 Tech Bldg., 2000 So. Michigan Ave.  
Chicago 16, Illinois

Mail me FREE Lesson with information about big opportunities in DRAFTING.

Name \_\_\_\_\_ Age \_\_\_\_\_

Address \_\_\_\_\_

City \_\_\_\_\_ Zone \_\_\_\_\_ State \_\_\_\_\_

# UNLIMITED OPPORTUNITIES IN ENGINEERING

DEGREE  
IN 27 MONTHS

Study Engineering in this world-famed school. Established 1884. Demand for our graduates exceeds supply. Approved for Korean Vets.

Bachelor of Science Degree in Mechanical, Civil, Electrical, Chemical, Aeronautical, Radio (Television) Engineering; Business Administration and Accounting. Also 36-weeks certificate courses in Surveying and Drafting.

Personalized Instruction. Accelerated courses. Non-essentials eliminated. For ambitious, earnest students. Earn your degree in the shortest possible time. Preparatory courses. Placement service.

Extensive Campus. Well equipped, new and modernized buildings; up-to-date labs. Low cost. New terms start quarterly. Enter January, March, June, September.

Mail Coupon Today

## TRI-STATE COLLEGE

4113 College Avenue, Angola, Indiana

Please send me free catalog and special information. I am particularly interested in courses as checked:

Mechanical  Civil  Electrical  Chemical  Aeronautical  
 Radio (Television)  Business Administration  Accounting  
 Short Diploma Courses

Name \_\_\_\_\_

Address \_\_\_\_\_



# ITALIAN ACCORDIONS AT LOWEST WHOLESALE PRICES

5-DAY  
FREE  
TRIAL

"PAY AS  
YOU PLAY"

Small Down Payment  
As Little As  
**\$10** per  
month

DIRECT from  
Importer to You!

SATISFACTION GUARANTEED, or your money back! NOW you can save up to 50% by direct purchase from America's leading distributor of famous genuine ITALIAN ACCORDIONS. TRADE-INS ACCEPTED

Send for FREE Illustrated Catalog!

## ACCORDION MANUFACTURERS & WHOLESALE OUTLET

2003 West Chicago Ave. Dept. R-113, Chicago 22, Ill.



beautifully  
written, plus  
special pen-  
point for  
shaded  
writing.  
Only 10¢

## A "GOOD HAND" HELPS YOU SUCCEED! LEARN TO WRITE WELL

Handwriting quickly improves with our easy-to-understand picture lessons! Put your spare time to good use; send today for  FREE BOOKLET. "How to Become a Good Penman," or check volumes wanted below at \$1 each:  Business Writing  Artistic Writing  Card Writing  Bird & Design Flourishing  Engraving Alphabets. COMPLETE SET \$4.50. Ask for price list of penman's supplies.

OUR  
53rd  
YEAR

TAMBLYN SCHOOL of PENMANSHIP  
S.A. Ziller, Pres., 442 Ridge Bldg., Kansas City, Mo., USA

# LEARN WATCH REPAIRING



AT HOME. By our modern and original system of instruction you can learn every part of the WATCH REPAIRING TRADE AT HOME. Prepare yourself for a well-paying position or start in business after completing our course of instruction. Good watch repairers are in demand and generally earn very good salaries. For particulars apply to the WISCONSIN SCHOOL OF WATCH REPAIRING 759 N. Milwaukee St., Milwaukee 2, Wis.

## Finish HIGH SCHOOL AT HOME

Complete 4 Yrs. in 12 Months

Learn More! Earn More! Enter professional or technical schools. Advance Socially. Live a Happier, Fuller Life. Individual Courses or complete schedule. WRITE FOR SCHOOL BULLETIN.

ACADEMY FOR ADULTS

30 W. Washington, Dept. PM-113, Chicago, Ill.

Say You Saw It in Popular Mechanics

# ELECTRIFY your SEWING MACHINE

NEW LOW PRICE! **\$9.95** 1 YEAR GUARANTEE

Buy direct from manufacturer and save! Kit comes fully wired, installed in a jiffy. Fits all machines! You get ALL-NEW PARTS

- Motor & Bracket
- AC-DC 115v 60c
- Multi-speed foot control
- Cord set & block
- Easy instructions
- Steel pulley & belt

FREE . . . reg. \$2.95 chrome SEWLITE given with every kit.

10 DAY FREE TRIAL—ORDER NOW!  
Send no money, pay COD or send money order and we'll pay postage. Please state whether wheel on your machine turns toward you or away from you. Shipping wt. 6 lbs.

SENIOR SEWING MACHINE CO.  
Dept. PM50 Brooklyn 6, N. Y.

Box 147



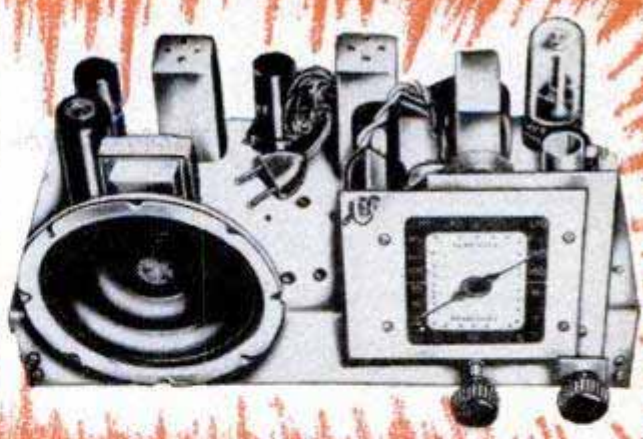

TRAIN **FASTER**—TRAIN **BETTER**—TRAIN **EASIER**  
 IN 10 MONTHS—OR LESS—FOR  
**RADIO-TELEVISION**

Our 21st Year Training Men for Greater Incomes and Security in Radio-Television

I SEND YOU  
**18 BIG KITS**

of Radio Television parts and equipment. Much of your training will be actual construction and experimentation . . . the kind of truly PRACTICAL instruction that prepares you for your Radio-Television career.



Frank L. Sprayberry  
 President  
 Sprayberry Academy  
 of Radio

**NEW! NO OBLIGATION PLAN**

You Have No Monthly Payment Contract to Sign  
 Pay For Your Training as You Earn and Learn

You can get into Radio-Television, today's fastest growing big money opportunity field, in *months* instead of years! My completely new "package unit" training plan prepares you in as little as 10 months or even less! *No monthly payment contract to sign—thus NO RISK to you!* This is America's finest, most complete, practical training—gets you ready to handle any practical job in the booming Radio-Television industry. Start your own profitable Radio-Television shop . . . or accept a good paying job. I have trained hundreds of successful Radio-Television technicians during the past 21 years—and stand ready to train you, even if you have no previous experience! Mail coupon and get all the facts—FREE!



**Valuable Equipment Included  
 With Training**

The new Sprayberry "package" plan includes many big kits of genuine, professional Radio-Television equipment. You perform over 300 demonstrations, experiments and construction projects. You build a powerful 6-tube 2-band radio set, multi-range test meter, signal generator, signal tracer, many other projects. All equipment and lessons are yours to keep . . . you have practically everything you need to set up your own profitable Radio-Television service shop.

**Earn Extra Money While You Learn!**

All your 10 months of training is IN YOUR HOME in spare hours. Keep on with your present job and income while learning. With each training "package" unit, you receive extra plans and "Business Builder" ideas for spare time Radio-Television jobs. New television stations everywhere, open vast new opportunities for trained Radio-Television Technicians—and those in training. If you expect to be in the armed forces later, there is no better preparation than practical Sprayberry Radio-Television training.

**YOU BUILD** the Television set and the powerful superhet radio receiver shown above IN ADDITION to the other test units shown here. (Many are not illustrated.)

Approved for Veterans under the G. I. Bill

**SPRAYBERRY ACADEMY OF RADIO 111 NORTH CANAL ST. Dept. 10-C, Chicago 6, Ill.**

**MAIL COUPON  
 TODAY!  
 NO OBLIGATION**

**SPRAYBERRY ACADEMY OF RADIO, Dept. 10-C  
 111 North Canal St., Chicago 6, Ill.**

Please rush to me all information on your 10-MONTH Radio-Television Training Plan. I understand this does not obligate me and that no salesman will call upon me. Be sure to include 3 books FREE.

Name..... Age.....

Address.....

City..... Zone..... State.....

I invite you to get all the facts —

**FREE TO YOU 3 BIG  
 RADIO-TELEVISION BOOKS**

Rush coupon for my three big Radio-Television books: "How to Make Money in Radio-Television." PLUS my new illustrated Television Bulletin PLUS an actual sample Sprayberry Lesson—ALL FREE. No obligation and no salesman will call. Mail coupon NOW!



# Give ME 15 MINUTES A DAY To Prove I Can make YOU a NEW MAN!

That's all I want — just 15 minutes a day to prove I can give you a powerful body of might and muscle — with my quick "Dynamic-Tension" method.

Mail coupon below — and I'll send you, absolutely free, my

**CHARLES ATLAS, Dept. 811,  
115 East 23rd Street, New York 10, N. Y.**

Send me your Free Book which proves how "Dynamic Tension" can make me a NEW MAN.

Name..... Age.....

Address.....

City..... State.....

new book, "Everlasting Health and Strength." Reveals secrets that changed me from a 97-pound weakling to winner of title, "World's Most Perfectly-Developed Man." Shows how I can build you a champion body the same easy way!

I've taken thousands of flabby men and given them powerful muscles, increased measurements, amazing strength, vitality, pep. My natural "Dynamic-Tension" method develops real men!

Send NOW for free copy of my book filled with pictures and body facts. Find out how I can make you the husky, big-muscled NEW MAN you can be! Mail coupon TODAY. **CHARLES ATLAS, Dept. 811, 115 East 23 St., N. Y. 10, N. Y.**

**CHARLES ATLAS, holder of title, "World's Most Perfectly-Developed Man."**



Mail Coupon Now For Free Book

## PORTABLE GARAGE

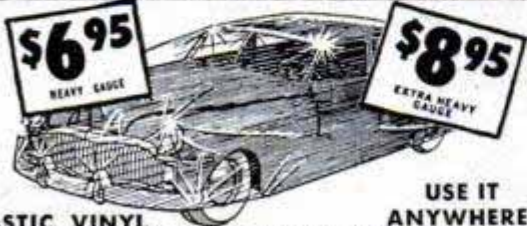

### PLASTIC VINYL

• Goes wherever your car goes • Folds compactly • Keeps rain, dust, salt air, sun away • Protects your car's finish • Durably constructed of vinyl plastic that is long wearing and tough • Nylon threads for extra security • Springtite elasticized bottom, holds securely in all kinds of weather • Fits all makes and models • Machinery, equipment, furniture, stock piles, etc. • Direct from manufacturer • Enclose check or money order for \$6.95 or \$8.95 • Add 35c for postage (or sent C.O.D.) 10-Day Money Back Guarantee

**MARDO SALES CORP.**

480 Lexington Ave., Dept. G-578, New York 17, N. Y.

## FREE 10 U.S. STAMPS



COLORFUL set of 10 famous historic U. S. stamps—all different—sent FREE to secure names for our mailing list. Each stamp worth real money. We'll also send other interesting offers for your inspection, plus FREE copy of our helpful "How to Collect Stamps." Supply limited. Rush name, address and 10c to help cover actual postage and handling to:  
**LITTLETON STAMP CO., Dept. 11-PM, Littleton, N. H.**



## LEARN LOCKSMITHING

Learn this fascinating, profitable trade from experts in your spare time at home! Age or physical handicap no disadvantage. Year around, steady income. Full or part time. Practical, illustrated lessons. You can make money even while learning! All materials and special tools supplied without extra charge.

**INSTITUTE OF LOCKSMITHING, Dept. P-48  
15 PARK AVENUE RUTHERFORD, N. J.  
Lic. by N.J. State Board of Educ.  
Approved for Vets**

## GREER SHOP TRAINING

2230 So. Michigan Blvd.  
Chicago 16, Illinois

### Leader in Practical Training for 50 Years

Gain success by learning a trade offering security and high pay—go into business for yourself.

### Get the "Know-how" at Greer

You learn in our new, large, modern shops by working with latest tools and equipment of the trade — tear down, inspect, repair and rebuild... under supervision of experts. Greer founded 1902. Over 51,000 successful grads. Part time, full time, day and evening. E-Z terms. Mail coupon today.

CLIP COUPON... MAIL TODAY  
Greer Shop Training—2230 South Michigan  
Chicago 16, Illinois Desk 213

Please send information about trade checked:

- In our Chicago Shops:  Auto Mechanics  
 Body, fender Repair  Diesel Mechanics  
 Welding—Arc, gas  Tool & Die  
 Refrigeration & Air-conditioning  
 Machinist  Piano tuning

APPROVED FOR CIVILIANS and G.I.'s  
ATTENTION: HIGH SCHOOL GRADUATES.  
Write for information on 2 year DIESEL-AUTOMOTIVE ENGINEERING COURSES.

Name.....

Address.....

City.....

State..... Age.....



## SHORTHAND IN

Famous Speedwriting Shorthand. 120 words per minute. No symbols; no machines; uses ABC's. Easiest to learn, write and transcribe. Low cost. 200,000 taught by mail. For business and Civil Service. Typing available. 31st Year. Write for FREE booklet to:

**Speedwriting**  
Dept. 1511-3  
55 W. 42 St., N.Y. 36, N.Y.

**6 WEEKS**

LOW OVERHEAD-LARGE VOLUME SALES & SMALL PROFITS  
BRING YOU THESE "LOWEST PRICES."

WHAT GOOD IS A TIRE WITHOUT A TUBE?  
TUBE GIVEN WITH EVERY TIRE AT NO EXTRA COST

WHY PAY MORE!  
20 YEARS AT THIS ADDRESS  
AN ESTABLISHED POLICY OF CAREFUL SELECTION ASSURES YOU, MANY HAPPY MILES. BE WISE—TRY ONE—YOU'LL BUY MORE! WE WELCOME COMPETITION. NO ONE CAN TOUCH OUR QUALITY & PRICE!

YOU GET WHAT WE ADVERTISE  
GOOD USED TIRES — NOT RECAPS — NOT RETREADS

FALL SPECIALS — SEND THIS AD  
EVERYBODY MAY TAKE 10% off ON EVERY TIRE  
20 MONTHS WRITTEN GUARANTEE

600-16	\$4.12	820-15	\$5.32	600-20	\$7.02	32x6(8)	\$8.52
650-16	5.52	700-15	4.52	650-20	7.82	32x6(10)	9.82
700-16	5.02	670-15	4.42	700-20	8.42	900-20	13.12
650-15	4.32	710-15	4.62	750-20	8.52	1000-20	13.72
760-15	4.92	550-17	4.42	825-20	14.62	1100-20	13.82

EXTRA SPECIAL—30 MONTH WRITTEN GUARANTEE—FREE TUBE					
600-16	\$5.32	475-19	\$4.82	700-15(6)	\$8.92
600-16(6)	6.42	640-15	5.02	750-16(8)	10.72
650-16	5.82	670-15	5.52	700-17	9.92
650-16(6)	7.32	710-15	5.72	750-17	11.72
700-16	6.42	760-15	6.02	750-15	13.92
750-16	9.22	800-15	6.52	825-15	12.92
525-18	4.72	820-15	6.62	600-20	8.72
550-17	4.72	670-16	6.32	650-20	10.22
650-15	5.32	760-16	7.12	32x6(8)	11.12
700-15	5.42	700-16(6)	7.62	32x6(10)	11.72
All White Walls	\$1.50 extra	Military treads	750-20	16.12	

Thousands of tires shipped all over U.S.A. All tires shipped F.O.B. Phila. Send Check or M.O. with this ad. Dept. 2.  
**STANDARD 834 N. Broad St., Philadelphia 30, Pa.**

Chief manual editor "Andy" Gray



... and 8 editors and consultants not shown

# Let these 19 Chilton experts make it E-A-S-Y FOR YOU TO REPAIR CARS!

The Chilton plant... largest automotive publishers in the world... home of Chilton Manuals, MOTOR AGE and AUTOMOTIVE INDUSTRIES magazines, the Flat Rate Book, etc.



## FIX FORDS!

All models 1940 to mid-1953, 144 pages, over 440 photos, diagrams and charts. Price only \$2.75.

## FIX PLYMOUTHS

DODGES & DE SOTOS!  
All models 1940 to mid-1953, 132 pages, over 360 photos, diagrams and charts. Price only \$2.75.

## FIX CHEVROLETS!

All models 1940 to mid-1953, 132 pages, over 500 photos, diagrams and charts. Price only \$2.75.

## FIX ALL Cars!

This complete "ALL CARS" Chilton Service Manual contains clear instructions for fast, easy handling of practically ANY job on ANY part of ANY car made from 1940 through June 1953.

Covers ALL models of the following makes: BUICK, CADILLAC, CHEVROLET, CHRYSLER, DeSOTO, DODGE, FORD, FRAZER, HENRY J., HUDSON, KAISER, LINCOLN, MERCURY, NASH, OLDSMOBILE, PACKARD, PLYMOUTH, PONTIAC, STUDEBAKER, WILLYS.

752 pages, 1800 photos, over 200 diagrams, easy-to-follow charts, data tables, etc. Price only \$5.95.

# Now! NO AUTO REPAIR JOB WILL "STUMP" YOU!...Tops for Beginners

Handle practically any job on any car easier and faster than you may have dreamed!

**FIRST**, look up the car make, model and part you want to fix in the giant Chilton Manual of your choice.

**SECOND**, follow the step-by-step instructions that show you just what to do—exactly how to do it. *The job is done in a jiffy—and it's done right!*

Everything is made crystal clear. Complicated jobs are explained both in text and by special photos and sketches. Trouble Analysis Charts guide you right to the trouble—help you fix it in half the usual time.

Over 800,000 Chilton Manuals are in use throughout the world in shops, garages,

automotive schools and in military depots and arsenals—by beginners and experienced mechanics alike.

The "ALL CARS" Manual includes more than 38,000 specifications on 19 makes of cars—over 1100 models in all. Over 220 official car manuals have been boiled down and simplified. Hundreds of service procedures developed by Chilton experts are fully described. 350 Quick Check Data Tables help you work faster and better. Over 1,800 illustrations explain operations almost at a glance. Manual includes latest data on everything from a "tune up" to automatic transmissions, power steering, the newest carburetors, chokes, fuel pumps, complete engine overhauls, etc.

You get *specific* data on *specific* jobs—not a lot of general information that may leave you wondering!

## PRACTICE 10 DAYS FREE!

If you repair all cars, then the big 752-page "ALL CARS" Manual at \$5.95 is the one for you! If you repair only Chevrolets, Fords or Plymouths (including Dodges and DeSotos), then save money by ordering any of these individual car make manuals listed above at only \$2.75 each.

Send no money! If not more than satisfied, return your manual postpaid and owe us nothing! Rush coupon to: Chilton Co., 56th & Chestnut Sts., Philadelphia 39, Pa.

## MAIL NOW for 10-DAY FREE TRIAL!

THE CHILTON CO., Dept. PM-113, 56th & Chestnut Sts., Philadelphia 39, Pa.

Please send the following manuals (check the ones you want):

### "ALL CARS" MANUAL

Send the big CHILTON "ALL CARS" REPAIR MANUAL (Price \$5.95) for 10-DAY FREE EXAMINATION. If O.K., I will promptly remit \$1.95 (plus 35c for postage and packing); then send you \$2 monthly for 2 months. Otherwise, I will return manual postpaid in 10 days and owe you nothing.

**OUTSIDE U. S. A.**—Cash only. "ALL CARS" Manual \$6.95. Individual Manuals \$3.00 each. Same 10-day return privilege with money refunded.

### INDIVIDUAL CAR MAKE MANUALS

- Chilton "CHEVROLET" Manual, price \$2.75
- Chilton "FORD" Manual, price \$2.75
- Chilton "PLYMOUTH-DODGE-DE SOTO" Manual, price \$2.75

**NOTE:** Individual car make manuals sold for  cash with order (we pay postal charges); or  we ship C.O.D. and you pay postman manual price plus post office charges. Specify which method desired. Any manual may be returned postpaid in 10 days and we guarantee to refund your \$2.75.

Name.....  
Address.....  
City, Zone, State.....



## Remember!

Using a Chilton Official Manual is like having 19 of the automotive trade's acknowledged experts standing beside you guiding every step of your work—even to the point of telling you what tools to use! It makes the tough jobs easy... makes the easy jobs a "cinch!"

# Turn Spare Hours

## into

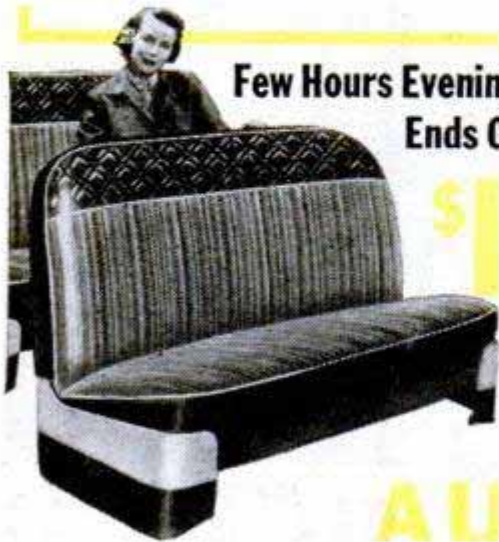

Few Hours Evenings and Week  
Ends Can Pay up to

**\$1**  
a day  
and more!  
Every Car  
Owner Wants  
Sensational  
"Wipe-to-Clean"  
Plastic

### EXTRA! Get Your Own Seat Covers FREE!

If you want extra money . . . plenty of it . . . day after day, this is the opportunity you've been waiting for! Just write your name and address on the coupon below, clip and mail TODAY for sensational new FREE Sample Outfit that will start you right off taking orders from car owners everywhere for exciting new Key Products expertly tailored auto seat covers. EXCLUSIVE NEW MATERIALS and PATTERNS to fit every make and model car right up to date. One order a day can pay up to \$16.50 for a few minutes pleasant work.

NO ONE can compete with you . . . in wide choice of exclusive materials . . . in superior quality . . . in skilled, perfect-pattern tailoring that makes every Key auto seat cover fit like a glove. Then you clinch the sale by quoting Key's sensationally low prices that are just a fraction of what your customer expects to pay. You shove those profit dollars into your pockets plenty fast from the first moment you begin showing the FREE Key Sales Outfit . . . so handy and convenient it fits into your side pocket; yet packed with generous swatches of all our exciting materials. Take this outfit with you wherever you go! And wait till you see that BONUS SEAT COVER OFFER . . . that puts Key seat covers in your car as our gift!

No experience needed. Every car owner your prospect. No investment to make. Rush coupon for FREE Sales Outfit with actual samples. Count on Key for fast action and big profits!

KEY PRODUCTS CORP., Dept. 311  
800 N. Clark St., Chicago 10, Ill.  
Rush Free Sample Outfit at once.

Name .....

Address .....

City ..... Zone ..... State .....

You don't need a car to make money—but if you own a car, include the following information:

Make ..... Year ..... Model .....

# SEND FOR Free Record

START SPEAKING  
**FRENCH**  
OR  
**SPANISH** ALMOST OVERNIGHT!



HERE'S the easiest way to learn FRENCH, SPANISH, Russian, German, Italian, Japanese or Brazilian. Listen to FREE 2-sided non-breakable record. Let your eyes follow words in FREE sample lesson. Almost at once you'll be chatting in a new language with a perfect accent! Offer may end soon. Rush 25¢ to help cover cost of special packaging, shipping of free record, lesson. State language you want. We'll also send free information on full Cortina course. CORTINA ACADEMY, Dept. 6411, 105 W. 40th St., New York 18.

## STUDY AT HOME WITH AN EDUCATIONAL INSTITUTION

Courses in ARTS AND SCIENCES: Philosophy; Education; Letters; Public Health; Medical Jurisprudence; Psychology; Sociology; Physics; Chemistry; Geology; Pol. Science; Theology; Law; Business and Commerce; Accounting; Mathematics; Statistics; Agriculture. ENGINEERING: Electrical, Civil, Mechanical, Drafting, Architectural, Steam, Diesel, Aeronautical, Radio, Structural, Mining, Industrial. Petroleum, Refrigeration, Chemical. Send for free catalog. McKinley-Roosevelt Incorporated, 4610-K32, Sheridan Rd., Chicago 40, Illinois

### NOW LEARN TV-RADIO Servicing AT HOME!

EARN WHILE YOU LEARN! No previous training needed. New, simplified lessons with complete parts kits. Build your own TV set! A leading school, approved for Korean vets. Also Residential Course (day & eve. classes). Send for FREE sample lessons and full details on a PROFITABLE, thrilling career. Write Dept. B11

#### CRESCENT SCHOOL

500 PACIFIC ST. • BROOKLYN 17, N. Y.

## Become a MENTAL SUPERMAN

OVERNIGHT! Floor everybody! Revolutionary "MEMO-PROP" does all your thinking! It's uncanny! Unprecedented! FREE LITERATURE! BIJOU STUDIO, BOX 1727MC, HOLLYWOOD 28, CAL.

### 60 POWER TELESCOPE \$3.98 VARIABLE EYEPIECE 20x-40x-60x — BRASS BOUND

NEW! Three telescopes in one. 3 different magnifications. 20 power for ultra-bright images with 40 and 60 power for extra long range. Guaranteed to bring distant objects, people, sports events, ships, moon, stars, etc. 60 times as close. Most powerful for anywhere near the moon. Contains 4 ground and polished lenses. Also used as a powerful compound microscope. Directions included. Mass production enables us to offer this instrument at amazing price of \$3.98 complete. Money back guarantee. We pay postage. Get yours now. Criterion Co., 331 Church St., Hartford, Conn., Dept. PMB 18

SAY YOU SAW IT IN  
POPULAR MECHANICS

## 2 OR 4 WHEEL DRIVE FOR JEEPS IN SECONDS



### AMAZING NEW WARN HUB

gives your 4-wheel drive Willys 2-wheel pep, power, speed, extra mileage, passenger car performance—as well as 4-wheel power and traction! Change from 2-wheel to 4-wheel or back in seconds by turning fingertip control on hubs. Warn hubs reduce wear on front axle assembly and front tires, eliminate shimmy, increase gas mileage up to 6 miles per gal. Unconditional Money Back guarantee. \$65.00 pair prepaid. ALSO AVAILABLE: Warn Standard Hub for Willys \$20.00 pr., Dodge \$23.00 pr. and Warn Automatic Hub for Willys \$120.00 pr. At Dealers or direct.

WARN MFG. CO., RIVERTON Box 6064-A2, Seattle 88, Wash.

**AMAZING  
OFFER**

# FREE!

**100 FOREIGN STAMPS**  
from all corners of the world  
**GUARANTEED WORTH \$1.00**  
AT STANDARD CATALOG PRICES

and Souvenir of World's Rarest Stamp

RUSH coupon at once. We'll send you by return mail this gigantic offer — 100 stamps from Europe, Asia, Africa, South America, Near East and Far East. **GUARANTEED WORTH \$1.00** at Standard Catalog prices. No telling what you'll find. **NO COST TO YOU!**

**VALUABLE SURPRISES**

These valuable stamps are all genuine — unpicked and unsorted. We just scoop them out of sacks we receive from foreign missionaries, banks, etc., and rush them into packets for you.

There are beautiful big pictorials, commemoratives — stamps from great empires and tiny republics. You'll find wild animals, far-off places and famous people on these wonderful stamps — even some from "iron-curtain" countries. Since no one has examined them, you may even find real *hidden treasures*, worth **REAL MONEY**.

**MAIL COUPON NOW**

Yes, we'll rush this wonderful offer that gives you 100 stamps from **EVERYWHERE**, plus a beautiful, souvenir of World's Rarest Stamp in color, **PLUS** our illustrated booklet "Stamp Collector's Guide" — **FREE**, if you act **AT ONCE!** Other valuable offers also included for your **FREE** inspection! If coupon is clipped, send 10¢ for postage and handling to: **GARCELON STAMP CO., Dept. PM11, Calais, Maine.**

**ALSO FREE!**

Valuable illustrated **STAMP COLLECTOR'S GUIDE** — tells how to start a collection, where to find rare stamps, tips on collecting, how to buy and sell stamps, and other helpful hints, will also be sent **FREE**, if you act **NOW!**



**PLUS**  
**BEAUTIFUL SOUVENIR OF  
THE WORLD'S RAREST STAMP  
IN COLOR**

Here is a treat indeed — and exclusive with us! Only here can you get this handsome, new folder with the fascinating story and reproduction of the World's Rarest Stamp. You'll be the envy of all who see it. Ideal for display in your album, or for framing to brighten up your room.

Here you will read about how an English schoolboy, in 1873, discovered this rarest of all stamps in covered its value, sold it for only a few dollars, and finally how it came to be valued at \$50,000 today! Yet this beautiful reproduction and the fascinating story is all yours **FREE** with this historic offer! This Limited Edition offer may have to be withdrawn soon, so don't miss this chance. **MAIL COUPON TODAY.**

**ACT NOW!**  
WHILE SUPPLY LASTS

**GET ALL 3 FREE**

**GARCELON STAMP CO., Dept. PM11, Calais, Maine**

Rush me **FREE** 100 FOREIGN Stamps, Rarest Stamp Souvenir and **STAMP COLLECTOR'S GUIDE**.

Enclosed is 10¢ for postage and handling.

NAME.....  
ADDRESS.....  
CITY..... ZONE..... STATE.....

FOR YOUR

# TECHNICAL AND VOCATIONAL TRAINING

Come to the  
**UNIVERSITY OF HOUSTON**

One of America's large and most modern universities. Select from these fascinating fields:  aeronautics  air conditioning & refrigeration  auto body and paint  auto mechanics  auto upholstery & trim  diesel  drafting  electricity  electronics  machine shop  photography  radio  stationary engineering  television  welding  woodworking  furniture upholstery. **PREPARE FOR YOUR FUTURE NOW . . .** with very latest methods and equipment, at modern U. of Houston College of Technology. Entrance: high school diploma, or over 18 and ability to profit from instruction. Beautiful campus—250 wooded acres in Houston, Texas—city of tomorrow. Full college activities, sports, social life. Day or night, short or longer courses. Co-op work-study programs . . . earn part of tuition and expenses with part-time job in your own career field, while you learn. Personal vocational counselling. Diploma on completion and all credits apply towards Bachelor of Applied Science Degree. Job placement assistance. Feb., June, Sept. semesters. Mail ad now for Free fully-illustrated brochure. No obligation. Mark X before choice of subject. **Do it today!**



ADMINISTRATION BUILDING

**University of Houston, College of Technology**  
Dept. 1B3 — HOUSTON 4, TEXAS

## INVENTORS

IF YOU WISH TO PROTECT YOUR INVENTION, You should take steps to protect it by a U. S. Patent. Write me for "INVENTION RECORD" form

**CARL MILLER**  
REGISTERED PATENT ATTORNEY

WOOLWORTH BLDG., 35th FLOOR, 113A  
NEW YORK CITY

STATEMENT OF THE OWNERSHIP, MANAGEMENT, AND CIRCULATION REQUIRED BY THE ACT OF CONGRESS OF AUGUST 24, 1912, AS AMENDED BY THE ACTS OF MARCH 3, 1933, AND JULY 2, 1946 (Title 39, United States Code, Section 233) of Popular Mechanics Magazine published monthly at Chicago, Ill., for September 1, 1953. 1. The names and addresses of the publisher, editor, managing editor, and business managers are: Publisher, Popular Mechanics Company, 200 E. Ontario St., Chicago 11, Ill.; Editor, H. H. Windsor, Jr., 200 E. Ontario St., Chicago 11, Ill.; Managing editor, R. M. Grant, 200 E. Ontario St., Chicago 11, Ill.; Business manager, W. H. Fetridge, 200 E. Ontario St., Chicago 11, Ill. 2. The owner is: (If owned by a corporation, its name and address must be stated and also immediately thereunder the names and addresses of stockholders owning or holding 1 percent or more of total amount of stock. If not owned by a corporation, the names and addresses of the individual owners must be given. If owned by a partnership or other unincorporated firm, its name and address, as well as that of each individual member, must be given.) Popular Mechanics Company, 200 E. Ontario St., Chicago 11, Ill.; H. H. Windsor, Jr., 200 E. Ontario St., Chicago 11, Ill.; H. H. Windsor, Jr., Trustee for H. H. Windsor III and Wm. T. Windsor, 200 E. Ontario St., Chicago 11, Ill. 3. The known bondholders, mortgagees, and other security holders owning or holding 1 percent or more of total amount of bonds, mortgages, or other securities are: (If there are none, so state.) None. 4. Paragraphs 2 and 3 include, in cases where the stockholder or security holder appears upon the books of the company as trustee or in any other fiduciary relation, the name of the person or corporation for whom such trustee is acting; also the statements in the two paragraphs show the affiant's full knowledge and belief as to the circumstances and conditions under which stockholders and security holders who do not appear upon the books of the company as trustees, hold stock and securities in a capacity other than that of a bona fide owner. 5. The average number of copies of each issue of this publication sold or distributed, through the mails or otherwise, to paid subscribers during the 12 months preceding the date shown above was: (This information is required from daily, weekly, semiweekly, and triweekly newspapers only.) Not daily publication. H. H. Windsor, Jr., Editor, publisher. Sworn to and subscribed before me this 3rd day of September, 1953. Vera L. Frechill, Notary Public. (My commission expires July 17, 1954.)

## INVENTORS

I shall be pleased to furnish you, upon request, with full information relative to patent procedure—without any obligation on your part.

**PATRICK D. BEAVERS**

Registered Patent Attorney

934 Columbian Building Washington 1, D. C.

# PATENTS

## C. A. SNOW & CO.

REGISTERED PATENT ATTORNEYS  
WRITE FOR INFORMATION TO  
428 SNOW BUILDING, WASHINGTON 1, D. C.

## INVENTORS

Whether an invention is patentable can be substantially determined by a search of the U. S. Patent records. Without obligation, write for information explaining the steps you should take to secure a patent.

**JOHN N. RANDOLPH**

Registered Patent Attorney

201 Columbian Building, Washington 1, D. C.

## INVENTORS

Send for PATENT INFORMATION Book and INVENTOR'S RECORD without obligation  
**GUSTAVE MILLER**  
113-PM WARNER BUILDING WASHINGTON 4, D.C.

REGISTERED PATENT ATTORNEY  
Patent Attorney & Advisor  
U. S. NAVY DEPT. 1930-1947  
ASSOCIATE EXAMINER  
U.S. PAT. OFF. 1922-1929  
PATENT LAWYER

## MECHANICAL DENTISTRY

A profession offering unlimited opportunities. Most modern and complete course embracing every branch from Plate to Porcelain Work, which prepares you to work for Dentists or start your own business. Individual instruction—practical training in day or night school. No books—no classes. Catalog upon request.  
McCARRIE SCHOOL OF MECHANICAL DENTISTRY  
207 N. Broad Street Dept. 23 Philadelphia 7, Penna.

## 2-BEDROOM HOME \$890

BUILD YOUR OWN

Living room 12x14. Master bedroom 10x12. Nursery-den 10x11. Kitchen 7x10. Bath 5x8. Concrete block built. Blue prints, material lists, exact instructions for 3 designs. Complete \$1 ppd.

SUNNY-CAL HOMES, Box 309-D-11 Hollywood 28, Calif.

## REAL ESTATE BE A BROKER

PAYS BIG! SEND FOR FREE, BIG, ILLUSTRATED CATALOG NOW! Graduates report making substantial incomes. Start and run your own business quickly. Men, women of all ages learn easily. Course covers Sales, Property Management, Appraising, Loans, Mortgages, and related subjects. **STUDY AT HOME** or in classrooms in leading cities. Diploma awarded. Write TODAY for free book! No obligation. Approved for World War II and Korean Veterans  
**WEAVER SCHOOL OF REAL ESTATE** (Est. 1936)  
Suite 300 Law Bldg. Dept. PM Kansas City, Mo.



# New Shipment of Famous Roth-Klaroptar Binoculars Has Arrived from Germany

## ALL NEW 1954 MODEL!

Not \$10  
\$ **3** Tax Paid!

**WATERPROOF  
CASE GIVEN!**

### ENJOY ONE AT OUR RISK!

**COMPARE IT UP TO  
18 MILES!**

Here at last — the all **NEW**, improved Roth binoculars with the famous 3X, 40 Klaroptar lenses—now better than ever before! They're more refined, sharper, clearer, 3 ways better than the sensational 1953 model! When we announced the '53 model we were swamped with over 50,000 orders! We were sold out and forced to hold up thousands of orders. Unfortunately, we disappointed lots of nice folks! This time we're taking no chances! We're strictly limiting orders to **ONE** 1954 model per family and will sell **NONE** to dealers!

#### KLAROPTAR LENSES ARE PRECISION MADE!

The secret of **ROTHLAR'S** great public acceptance is the precision made 3X, 40 lenses. Unlike other glasses, they are not moulded or stamped out on plastic presses. These new 1954 genuine Klaroptar lenses are ground out **ONE BY ONE** by proud German optical workers! This takes much more time and limits production. **BUT WHAT A DIFFERENCE!** This latest model gives you sharper, clearer, magic-like viewing. No annoying distortions! No chromatic fringe to cause eye-strain! **ALL** Klaroptar lenses are turned out under the supervision of **WALTER ROTH** in his small factory in Hartmannshof, Western Germany. He has the Old World family pride. Herr Roth simply won't let an inferior product bear his name. Naturally this means you get a really superior binocular if you are one of the lucky people to order this optical instrument!

#### BIG SIZE! BIG POWER! BIG VALUE!

Don't confuse **ROTH-KLAROPTAR BINOCULARS** with cheap, crudely made Japanese binoculars selling from \$2 to \$4. This is **NOT** a toy! Quality made throughout. Smooth synchronized **CENTER** focusing construction is rugged—yet they're **LIGHT**—easy to carry in their weather-protected case! The lenses are made with the same care as in \$10 binoculars! **NOW**—get a pair **DIRECT FROM THE IMPORTER** at the unbelievable low price of 3.00—while they last!

#### TRY WITHOUT OBLIGATION!

We'll send you the **ALL-NEW 1954 ROTH BINOCULARS** on **5-DAY TRIAL**. Enjoy without any obligation whatsoever! Use for nature study, boxing matches, races, basketball, football. Carry along a pair when motoring, sailing, flying, hunting and fishing, too! Use it for celestial observation, watching children and neighbors, television, movies, seashore scenes, etc. **COMPARE AT ANY DISTANCE FROM 18 FEET TO 18 MILES!** You must be delighted or your \$3 comes back—no questions asked! Please rush your order today. This shipment won't last long! First come, first served! Orders received too late will be returned promptly.

**THORESEN'S, Dept. 6-M-134**

352 FOURTH AVE.

NEW YORK 10, N. Y.

**THORESEN'S, Dept. 6-M-134**

**352 Fourth Avenue, New York 10, N. Y.**

**RUSH ONE 1954 ROTH-KLAROPTAR Binocular with case on 5-DAY TRIAL — money back guarantee.**

- Enclosed \$3 — send tax and postpaid.
- Send C.O.D. plus all postal fees.

Name \_\_\_\_\_

Address \_\_\_\_\_

Town \_\_\_\_\_ Zone \_\_\_\_\_ State \_\_\_\_\_

- Check here if you want **DELUXE MODEL** instead, with built-in compass. Only \$1 more—total \$4.

**NOTE: Only ONE model sent to a family address. No combinations sold at present.**

"I Have Earned an Average of  
**\$15.20 AN HOUR**"

with Science's New Midget Miracle,  
the PRESTO Fire Extinguisher

Says William F. Wydallis, Ohio.  
Many Others "Cleaning Up"  
—So Can YOU!



W. F. Wydallis

A MAZING new kind of fire extinguisher. Tiny "Presto" (about size of a flashlight!) does job of bulky extinguishers that cost 4 times as much, are 8 times as heavy. Ends fires fast as 2 seconds. Fits in palm of hand. Never corrodes. Guaranteed for 20 years! Sells for only \$3.98! Almost two million sold!



Science's New Midget Miracle—**"PRESTO"**

(If you want a regular Presto to use as a demonstrator, send \$2.50. Money back if you wish.)

Show it to civil defense workers, owners of homes, cars, boats, farms, etc. and to stores for re-sale.—make good income. H. J. Kerr reports \$20 a day. C. Kama, \$1,000 a month. Write for FREE Sales Kit. No obligation.

**MERLITE INDUSTRIES, Inc., Dept. 511**  
201 East 16th St., New York 3, N. Y.

IN CANADA: Mopa Co., Ltd., 371 Dowd St., Montreal 1, P. Q.



**MEN! TRAIN NOW FOR  
A BIG PAY FUTURE IN  
DIESEL  
& SCIENTIFIC MOTOR TUNE-UP**

- Diesel Construction
- Diesel Engine Repairman
- Diesel Operator
- Industrial Maintenance
- Auto Engine Rebuilding
- Bus & Truck Maintenance



### Be a Trained Diesel Man

Go places with DIESEL! Farms, factories and power plants, trains, ships, trucks, busses all use DIESEL POWER... all need DIESEL-trained men! You can start your DIESEL training at home, in spare time, with tested, proved U E I training. Course includes practical work on Diesel engines under skilled instructors. You learn the operation, maintenance, servicing of all types of Diesel engines, PLUS Scientific Motor Tune-up.

**ACT NOW!** If you have mechanical ability, you'll like Diesel! High School diploma not necessary. Write now for FREE book, "EARNING POWER IN DIESEL." Act Today!

**MAIL NOW FOR FREE BOOK!**

UTILITIES ENGINEERING INSTITUTE, Dept. DC-34,  
2521 Sheffield Ave., Chicago 14, Ill. (Founded 1927)  
O. K.! Rush, without obligation, FREE Book on DIESEL.

NAME \_\_\_\_\_

ADDRESS \_\_\_\_\_

CITY \_\_\_\_\_ ZONE \_\_\_\_\_ STATE \_\_\_\_\_

Check here for information if under 17.

*America's Great Diamond Values*

**GENUINE DIAMONDS**

VALUES FROM \$10 TO \$10,000

MONEY-BACK GUARANTEE    ALL DIAMONDS RESET IN BRAND NEW MODERN MOUNTINGS

Our Reference: Your own bank or any mercantile agency.

**Berman's Diamond Loan Bank**  
Dept. P —BERMAN BLDG., BALTO. 1, MD.

## RUPTURED?

### Get Relief This Proven Way

Why try to worry along with trusses that gouge your flesh—press heavily on hips and spine—enlarge opening—fall to hold rupture? You need the Cluthe. No leg-straps or cutting belts. Automatic adjustable pad holds at real opening—follows every body movement with instant increased support in case of strain. Cannot slip whether at work or play. Light. Waterproof. Can be worn in bath. Send for amazing FREE book, "Advice To Ruptured" and details of liberal truthful 60-day trial offer. Also endorsements from grateful users in your neighborhood. Write:

**CLUTHE SONS, Dept. 31, Bloomfield, New Jersey.**

**RADIO** Engineering. All phases radio & electronics theory & practice; television; FM; broadcasting; servicing; aviation, marine & police radio. Prepare for high pay; 18-month course. Graduates in demand by major companies. Enter Jan., March, June, Sept. Regular campus life. Write for catalog.

**VALPARAISO TECHNICAL INSTITUTE, Dept. D, Valparaiso, Ind.**

**LEARN TO THROW THE BOOMERANG**

A Fascinating Sport and Unique Gift

SEND FOR YOURS TODAY

Flight Tested—Guaranteed to Return  
Golden Red, Jade Green or Natural  
with Story and Instructions \$2.00 ea.

**CARVED by Postpaid**  
**COL. JOHN M. GERRISH**

4409-M S.W. Parkview Lane, Portland 1, Ore.

SAY YOU SAW IT IN POPULAR MECHANICS

**IT'S FREE!**

**New, exciting 16 page book on CHEMCRAFT and MICROSCOPES!**

Chemcraft brings the fun and adventure of a real chemical laboratory into your own home. You amaze friends with mysterious tricks of chemical magic. You do hundreds of regular chemical experiments just like a chemist. Send for your FREE booklet today...gives many home experiments. The Porter Chemical Co. 42 Prospect Ave., Hagerstown, Maryland.

**Chemcraft Senior Lab.**

**Ask for CHEMCRAFT**



**MILLIONS OF APPLIANCES NEED REPAIR!**

# EARN BIG MONEY.. WORK PART OR FULL TIME IN ELECTRIC APPLIANCE REPAIRING!

- ELECTRIC REFRIGERATORS
- WASHING MACHINES
- VACUUM CLEANERS
- ELECTRIC RANGES
- MOTORS
- SEWING MACHINES
- TOASTERS
- WAFFLE IRONS
- MANGLES
- HEATING PADS
- FREEZERS
- ELECTRIC FANS
- ELECTRIC IRONS
- LAMPS
- ETC., ETC.



**ELECTRONIC KIT TROUBLE DETECTOR**  
(Checks shorts, wattage, continuity, etc.)  
is sent to all students

**MAIL COUPON FOR FREE BOOK**

Learn this fascinating big money paying profession at home in your spare time. Learn by doing, by working with your hands building, testing, repairing electrical appliances of all kinds. Electrical appliance repairmen are needed everywhere — wherever electricity is used. You need no special previous training or experience. Age is no handicap. CHRISTY has trained over 33,000 men in all parts of the world. Men who today command big wages or own profitable businesses of their own.

**PAY LATER FROM EARNINGS WHILE LEARNING**  
CHRISTY shows you how to make money while still learning, what to charge, how to set up your own shop, how to build power tools from spare parts, etc. It will pay you to write today.

CHRISTY TRADES SCHOOL, Dept. D-2403  
4432 N. Kedzie Ave., Chicago 25, Ill.

Send me your FREE book on Electrical Appliance Repairing and special form for "paying later from earnings made while learning."

NAME \_\_\_\_\_ AGE \_\_\_\_\_  
ADDRESS \_\_\_\_\_  
CITY \_\_\_\_\_ STATE \_\_\_\_\_

## BRAND NEW NYLON COVERS

for outdoor storage of cars, boats, machinery, equipment, etc.

Strongest, lightest cover ever made. New DuPont Nylon with 1 side rubberized and the other of soft nylon, cannot scratch car surface. Will not harden, crack or mildew. Secured with heavy elastic and brass grommets. Protection against wind, rain, sun, snow, frost, etc. 15-day money-back guarantee. Material very many times stronger than regular plastics. Olive green color.



Give Car Model

Larger Size for Caddy, Inc., etc. \$2.95 extra

Nylon tarps to order, heavier weight, double coated, 8 oz., brass grommets. 10c sq. ft. Standard Size \$17.95 plus 90c postage

DEFENDER TEXTILE CORP., 425 B'way, Dept. PM-3, N. Y. 13, N. Y.

## Own, Operate, Route - "Wishing Wells"

Place these New \$8.50 Skill Games on counters in Cafes, Clubs, Luncheonettes, etc. — collect coins weekly. Details Free. Write LEGALSHARE PM-11 Box 929 Long Beach 1, Calif.

SAY YOU SAW IT IN POPULAR MECHANICS



## Start As High As \$3,795.00 A YEAR

### MEN—WOMEN

- Postoffice Clerks-Carriers
- Railway Postal Clerks
- Stenographers
- Accountants
- Immigrant Inspectors
- Typists
- Customs Inspectors
- Many Other Early Jobs

Veterans Get Preference

**MAIL COUPON TODAY SURE**

**FRANKLIN INSTITUTE**  
(Not Government Controlled)

Dept. F-83

Rochester 4, N. Y.

Gentlemen: Rush to me, FREE of charge, list of U. S. Government big pay jobs. Send FREE 36-page book describing salaries, vacations, hours, work, etc. Tell me how to qualify for one of these jobs.

COUPON

Name \_\_\_\_\_

Street \_\_\_\_\_

City \_\_\_\_\_ Age? \_\_\_\_\_

Fascinating hobby!  
Fabulous profit!

## GROW ORCHIDS at HOME



Imagine, beautiful Cattleyas, Exquisite Cymbidiums, and other colorful varieties...growing, blooming, right in your own living room! A single Orchid plant on a card table or window sill, can multiply into a fortune! NO EXPENSIVE EQUIPMENT NEEDED! GROWS IN ANY CLIMATE! Learn the amazing secrets, with easy-to-follow instructions. WRITE TODAY FOR FREE ILLUSTRATIONS and details on obtaining already potted ORCHID PLANTS FREE!

ORCHID-LAND

DEPT. 3E, BOX 27801, LOS ANGELES 27, CALIFORNIA

# This year...be sure you get the famous MILE-O-METER!

Let your family know that you want the famous Mile-O-Meter this Christmas! Thousands of men did just that last year... and were "surprised" with the valuable and useful gift they wanted most! You'll join them in saving money every mile you drive... it's what you need to get more miles per gallon, avoid highway breakdowns, and insure top engine performance. Simple to install on the dash of any car—no holes to drill—all directions and fittings included. The chrome and black Mile-O-Meter actually pays for itself over and over again... tell your family today!



MILE O-METER SHOWS

MILES PER GALLON

ENGINE CONDITION

ENGINE TROUBLES

Beautifully gift packaged. Mailed anywhere within 24 hours. Add 35c for Special Delivery. Money-back guarantee!

SEND  DELUXE  STANDARD MILE-O-METERS AT \$

**\$14.95** Deluxe Illuminated

**\$9.95** Standard

We pay postage!

NAME \_\_\_\_\_

ADDRESS \_\_\_\_\_

CITY \_\_\_\_\_ ZONE ( ) STATE \_\_\_\_\_

Check Enclosed  Money Order Enclosed  Send C.O.D.

**GALE HALL ENGINEERING, INC. DEPT. 387**  
NORTH HAMPTON, NEW HAMPSHIRE

## GIVE THE GIFT OF LANGUAGE

IT'S FUN TO LEARN

# by LINGUAPHONE

World's Standard Conversational Method

**FRENCH SPANISH GERMAN RUSSIAN**  
**JAPANESE ITALIAN NORWEGIAN**

Any of 29 languages available

A Linguaphone Language Set is a lasting gift—an invaluable asset in business, travel, school, armed services and social life. With LINGUAPHONE you LISTEN and LEARN another language the same easy, natural way you learned your own—AT HOME you hear native men and women make everyday conversation—you Understand—YOU SPEAK! It's like living in another country. Over a million home-study students of all ages. There's nothing like "The Gift of Language." Write TODAY for FREE Book, "Passport to a New World of Opportunity." Linguaphone Institute, 143-11 Mezz., Rockefeller Plaza, New York 20.

LINGUAPHONE INSTITUTE, 143-11 Mezz., Rockefeller Plaza, New York 20, N. Y.

Send me your FREE Book.

LANGUAGE INTERESTED.....

NAME.....

ADDRESS.....

CITY..... ZONE..... STATE.....

# Deodorant Special!

MONTH'S SUPPLY } 15¢



Special bargain way to try this great man's deodorant! Send 15¢ in coin for regular 29¢ bottle (month's supply)! Limited offer.

**MENNEN**  
BOX 1231  
NEWARK, N. J.

Is Your Life Crowned With Success?

## LEXIPOWER



WE THINK IN WORDS. THOUGHT IS POWER. Let this New Science show you how to WIN WITH WORDS—financially, socially, culturally. Develop a MASTERFUL VOCABULARY. Influence others, improve your personality, manifest your latent ability. You are judged and rated by every sentence you utter. Start using the POWER of LEXIPOWER after the first Lesson. Write NOW for FREE details about LEXIPOWER. Dime-a-Day LESSON CLUB.

### LEXIPOWER LESSON CLUB

517-K W. Deming Place Chicago 14, Illinois

## 'How to MAKE MONEY with Simple CARTOONS'



A book everyone who likes to draw should have. It is free; no obligation. Simply address

FREE BOOK

**CARTOONISTS' EXCHANGE**  
Dept. 911D Pleasant Hill, Ohio

## IMPROVE YOUR PENMANSHIP

Write Like This

Complete OUTLINE FREE!

YOUR penmanship can be improved in 3 hours or corrected to your satisfaction in 10 hours' practice with my DEFINITE HAND CONTROLS. New way!

WRITE OZMENT BOX 665 34-N, ST. LOUIS, MISSOURI

## Bar Bells



Buy Direct From Factory \$8.95 up

Write for free booklet and price list.

**INDEPENDENT IRON WORKS**  
2416 East 23rd Street, Dept. B-11  
Los Angeles 58, Calif.

## Develop Hidden Earning Power

# STUDY LAW

at home! LL.B. Degree

Qualify yourself in spare time for advancement, greater earnings, business success. Now, more than ever, legal ability is in demand! Easy-to-understand step-by-step lessons and text material furnished -- invaluable for permanent reference. Over 40 years expert instruction. 114,000 students enrolled. Easy payments. Find out now, at no cost, how study of law can help you. Write today for FREE Book "Law and Executive Guidance."

**AMERICAN EXTENSION SCHOOL OF LAW**  
Dept. PM-68, 664 N. Michigan Ave., Chicago, Ill.

WANT MORE PAY? MORE SECURITY? A JOB WITH FUTURE UNLIMITED?

VETERANS! CIVILIANS! NO EXPERIENCE NECESSARY!

# Go Into TELEVISION

I'll train you at home... in your spare time

for better-pay jobs in TV

L. C. Lane, B.S., M.A.

President: Radio-Television Training Association  
Executive Director: Pierce School of Radio & Television

## LEARN MORE

I give you ALL the practical training you need to qualify for the highest-paid technician jobs in TV.

### RADIO-FM-TV TECHNICIAN TRAINING

No experience necessary! You learn by practicing with equipment I send you. It's easy! I give you the same successful guidance that has helped hundreds of men towards a TV career. Many started with only grammar school training.

### FM-TV TECHNICIAN TRAINING

Saves you months if you have previous Armed Forces or civilian radio experience! Train at home. I give you kits, plus equipment to build BIG SCREEN TV RECEIVER, and FREE FCC COACHING COURSE! Everything AT NO EXTRA COST!

### OPTIONAL: TWO WEEKS TRAINING IN NEW YORK CITY AT NO EXTRA COST!

You get two weeks, 50 hours, of intensive Laboratory work on modern electronic equipment at our associated school in New York City—Pierce School of Radio and Television. And I give you all this AT NO EXTRA COST whatsoever, after you finish your home study training in the Radio-FM-TV Technician course and FM-TV Technician Course.

### FREE FCC COACHING COURSE!

Important for BETTER PAY JOBS requiring FCC License. You get this training AT HOME and AT NO EXTRA COST! Top TV jobs go to FCC licensed technicians.

### NEW! PRACTICAL TV CAMERAMAN & STUDIO COURSE!

(For men with previous radio and TV training)

I train you at home for an exciting high pay job as the man behind the TV camera. Work with TV stars in TV studios or "on location" at remote pick-ups! A special one-week course of practical work on TV studio equipment at Pierce School of Radio & TV, our associate resident school in New York City, is offered upon your graduation.

## VETERANS!

MY SCHOOLS FULLY APPROVED TO TRAIN VETERANS UNDER NEW G.I. BILL! If discharged after June 27, 1950 — CHECK COUPON! Also approved for RESIDENT TRAINING in New York City at Pierce School of Radio and Television... qualifies you for full subsistence allowance up to \$160 per month. Write for details.

### RADIO-TELEVISION TRAINING ASSOCIATION

52 EAST 19th STREET, NEW YORK 3, N. Y.

Licensed by the State of New York • Approved by the VA

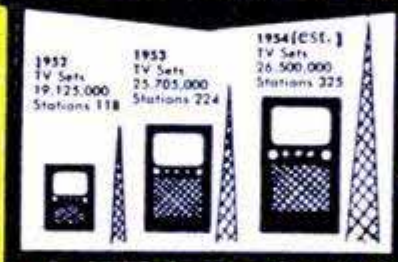

## PROOF!

### TV NEEDS THOUSANDS OF TECHNICIANS!

TV is coming into practically every community. More than 2,000 new TV stations authorized in this country alone! Thousands of new studios being planned and built. All kinds of new equipment coming on the market. Millions of new TV-set owners will need servicing. It's the rich field of the future with money-making opportunities NOW... if you get in on the ground floor. There just won't be enough TV Technicians to go around. It's your chance of a lifetime for GOOD EARNINGS in a TOP JOB or YOUR OWN BUSINESS!

Public Address System



C-W Telephone Transmitter



Combination Voltmeter-Ammeter-Ohmmeter



Super-Het Radio Receiver



RF Signal Generator

## EARN MORE

MORE MONEY AND A CAREER ARE WAITING FOR YOU HERE!

Earn while you learn by repairing TV sets for friends and neighbors. Many of my students make up to \$25 a week in spare time... pay for their entire training this way... start their own money-making service business. When they complete training and go into TV full time, their earnings zoom into big figures! My graduates are now working at RCA, NBC-TV, CBS-TV, DUMONT TV and numerous other TV studios and plants.

yours to build and keep!

## GET MORE

Enough equipment to start your own home Laboratory! You learn by doing. I give you ALL the equipment. You build and keep a professional GIANT SCREEN TV RECEIVER complete with mammoth picture tube (takes any size up to 21 inch) ... also a Super-Het Radio Receiver, RF Signal Generator, Combination Voltmeter-Ammeter-Ohmmeter, C-W Telephone Transmitter, Public Address System, AC-DC Power Supply, and more! 15 full Kits! All tubes supplied, too!



size up to 21 inch) ... also a Super-Het Radio Receiver, RF Signal Generator, Combination Voltmeter-Ammeter-Ohmmeter, C-W Telephone Transmitter, Public Address System, AC-DC Power Supply, and more! 15 full Kits! All tubes supplied, too!

## YOU GET ALL 4 FREE!

Just by mailing coupon. Try the Sample Lesson. Read how and where you can make big money in TV... easily!



MAIL THIS COUPON NOW! No Salesman Will Call!

Mr. Leonard C. Lane, President  
RADIO-TELEVISION TRAINING ASSOCIATION  
52 East 19th Street, New York 3, N.Y., Dept. M-11A

Dear Mr. Lane: Mail me your NEW FREE BOOK, FREE SAMPLE LESSON, and FREE aids that will show me how I can make BIG MONEY IN TELEVISION. I understand I am under no obligation and no salesman will call.

(PLEASE PRINT PLAINLY)

NAME \_\_\_\_\_ AGE \_\_\_\_\_  
ADDRESS \_\_\_\_\_  
CITY \_\_\_\_\_ ZONE \_\_\_\_\_ STATE \_\_\_\_\_

I AM INTERESTED IN:  
 Radio-FM-TV Technician Course  
 FM-TV Technician Course  
 TV Cameraman & Studio Course

VETERANS!  
Check here for Training under NEW G.I. Bill

**FIND OUT  
FREE!**

**HAVE YOU  
GOT WHAT  
IT TAKES?**

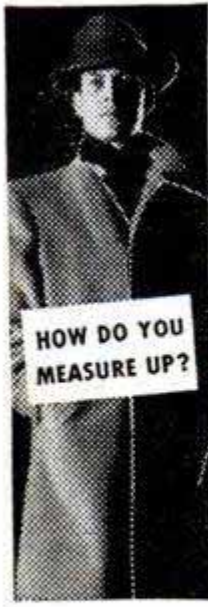

SUCCESS  
HOME STUDY  
WILL TO WIN  
CHARACTER  
HEALTH

...to become a  
**CRIMINAL INVESTIGATOR  
FINGER PRINT EXPERT?**

**FREE BOOKLET OFFER**

Everything to gain...nothing to lose. The famous, fascinating **BLUE BOOK OF CRIME** will give you examples of "what it takes" to track down outlaws and thieves. Read this exciting story of the triumph and battle of law and order against crime. THEN, decide for yourself if YOU have what it takes for exciting, steady, "good pay" work. **OUR GRADUATES ARE KEY MEN** in more than 800 Identification Bureaus. Institute of Applied Science has been teaching finger print and firearms identification, police photography and criminal investigation for more than 30 years. No obligation. No salesman will call.

**GET THE FACTS... FREE! Mail Coupon Today!**

**INSTITUTE OF APPLIED SCIENCE, Dept. 1358**  
1920 Sunnyside Ave., Chicago 40, Ill.  
(A Correspondence School Since 1916)

Gentlemen: Without obligation or expense to me, send me the famous "Blue Book of Crime" absolutely free.

Name \_\_\_\_\_

Address \_\_\_\_\_ RFD or Zone \_\_\_\_\_

City \_\_\_\_\_ State \_\_\_\_\_ Age \_\_\_\_\_

You must state your age.

**No other book  
makes so many  
jobs so *Easy***



**INCLUDING ELECTRICAL WORK**—silencing floor squeaks—chimney repairs—plumbing—carpentry. . . In fact, *Better Homes & Gardens HANDYMAN'S BOOK* shows you how to do 1600 jobs around your home. **INSTRUCTIONS ARE SO EASY** that a beginner can follow them. And they're clarified even more by simple diagrams and photographs. Good results are assured!

**GUARANTEED TO SAVE \$ \$ \$**

In plumbing bills! In carpenters' bills! In electricians' bills! We **GUARANTEE** the **HANDYMAN'S BOOK** will pay for itself within 6 months. Owners tell us we're too modest! On sale where books are sold, or order by mail. Only \$3.95. (Canada \$4.50.) Send coupon today.

**BETTER HOMES & GARDENS,**  
403 Meredith Bldg., Des Moines 3, Iowa

Please send me the **HANDYMAN'S BOOK**. I enclose check   
OR  money order for \$3.95. (Canada \$4.50.) If not entirely satisfied, I may return book in 10 days and my money will be refunded.

Name \_\_\_\_\_

Address \_\_\_\_\_

City \_\_\_\_\_ State \_\_\_\_\_

**Hand-Made in  
GUATEMALA**

NATURAL COLOR ADJUSTABLE STRAPS  
**IMPORTED COWHIDE SHOULDER BAGS**

SIZE 8"x10" \$9.65 PLUS \$1.93 FED. TAX  
SIZE 5 1/2"x7" \$4.75 PLUS .95c FED. TAX

**WRITE FOR FREE GIFT CATALOG**

Sold By Mail Only - Order Today!  
\$2.00 DEPOSIT ON C. O. D.'S

**BROPAR** Box 999, Dept. 1149  
San Antonio 6, Tex.

**250 POWER....**

**Complete Telescope Lens Kit** only \$3.49 postpaid

Conquer Space, Explore the Universe, Planets, Moon Craters, New Stars, etc. Complete Lens Kit consists of 80 inch focal length ground and polished objective lens, eyepiece lenses for 50 POWER, 100 POWER, 150 POWER, 200 POWER, 250 POWER, and all necessary lens fittings. Easy to make from simple step by step instructions. (Tripod and mount not included.) Money back guarantee.

**BUSSE SALES CO., Hartford, Conn., Dept. PM 17**

**TASOPE PHOTO-ENGRAVING PLANTS**

Establish your own profitable **PHOTO-ENGRAVING** business. Make cuts for newspapers, printers, and advertisers. Make etched name plates, plaques etc. Instructions furnished, no experience necessary. Sold direct from factory since 1931. First five hundred cuts sold locally or by mail will pay for plant and pay you well for your time. Write for **FREE** catalog.

**TASOPE DEPT. PM11, AURORA, MO.**

Material Cost Of This Cut 3.46  
Selling Price \$1.00 And Up

**TOOTHACHE?** TOOTH GUM TOOTH DROPS POULTICE

Ask your Druggist for **DENT'S**

**New Way to Improve YOUR ENGLISH**

A command of effective English gives you added advantages and better opportunities. Poor English handicaps you more than you will ever realize. You can improve your English through Sherwin Cody's 100% self-correcting invention. If you are embarrassed by mistakes in grammar, spelling, punctuation, or pronunciation, this free book "How You Can Master Good English in 15 Minutes a Day" will prove a revelation to you. Send for it now. It is free. No obligation. No agent will call. Address **SHERWIN CODY COURSE IN ENGLISH, 5811 Central Drive, Port Washington, N. Y.**

**New Low Cost Electric Water Heater Gives You HOT WATER AUTOMATICALLY From Your Present Tank!**

- No dirt, grime, soot, flame!
- **SAFE!** Every part UL approved!
- Install in 10 Minutes, or less!
- No new tanks or plumbing!
- Works automatically, saves fuel.

New, UL approved **LECTROMATIC** changes gas, coal or oil-burning water heater into modern **ALL-ELECTRIC** unit! Turns on automatically when needed, shuts off automatically when water is heated. To install, simply shut off water. Remove plug from water tank. Screw **Complete—Ready to \$19.95 Plug In — Only**

**LECTROMATIC** into opening (as shown), then **PLUG IN** 110 volt outlet. Uses 1250 watts. Plenty of hot water all day long. Uses only 1/4-1/2¢ electricity per gal. of hot water. Temp. adjustable from 100 to 180 degrees. Only \$19.95 C.O.D. plus shipping or send check or money order for \$19.95 now and we pay shipping. (Also 220 V., 2000 W. model \$21.95). Money back in ten days if not delighted. Full one year guarantee! **ORDER NOW!**

**COLLOID EQUIPMENT CO., INC.** Dept. PM-11, 19 MURRAY STREET  
NEW YORK 7, N. Y.

# DRAW THIS CAR!

Free \$295<sup>00</sup> Art Course!

COMPLETE \$295.00 ART COURSE INCLUDING ARTIST'S DRAWING SET!

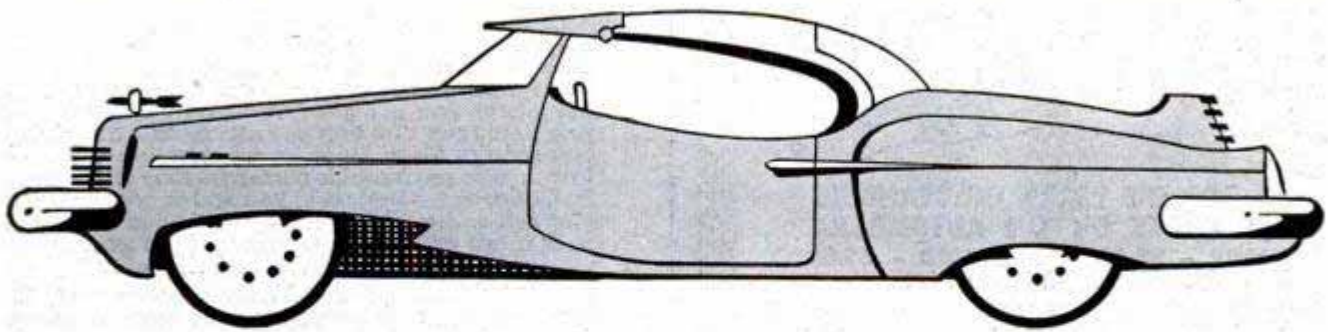

Here's your big chance, if you want to become a commercial artist, designer, or illustrator! An easy way to win FREE art training!

If your drawing shows promise we give you professional comments on it free! Trained illustrators, artists, and cartoonists are making big money. Find out now if YOU have profitable art talent. You've nothing to lose—everything to gain. Mail your drawing today.

**AMATEURS ONLY!** Our students not eligible. Make copy of car 8 ins. long. Pencil or pen only. Omit the lettering. All drawings must be received by Dec. 31, 1953. None returned. Winners notified.

## ART INSTRUCTION, INC., Dept. 11133

500 S. 4th St., Minneapolis 15, Minn.

Please enter my attached drawing in your December Draw a Car contest. (PLEASE PRINT)

Name \_\_\_\_\_ Age \_\_\_\_\_  
 Address \_\_\_\_\_ Apt. \_\_\_\_\_  
 City \_\_\_\_\_ Zone \_\_\_\_\_  
 County \_\_\_\_\_ State \_\_\_\_\_  
 Phone \_\_\_\_\_ Occupation \_\_\_\_\_



## GIANT BALLOONS

Surplus U. S. Gov't. (new—average) NEOPRENE weather, target balloons. For FUN or PROFIT. Great sport in the backyard; or for parties, picnics, dances, fairs. MONEY-MAKERS. Use these balloons to attract crowds to civic events, conventions, exhibitions, trade shows. TERRIFIC for high school and college PROMS. All sizes are approx. inflated size. Postage prepaid on prepaid orders. 3 ft. dia. 49c—6 ft. dia. 99c—13 ft. dia. \$1.59

20 ft. dia. \$1.95

• Calif. residents please add sales tax.

## WAR ASSETS DIV. VOLUME SALES CO.

Dept. M-11-53 3930 Sunset Blvd. Los Angeles 29, Calif.

Say You Saw It in Popular Mechanics

## WRIST CIGARETTE LIGHTER

Fits wrist like a fine watch



for GIFT Giving

America's most unique and practical double feature lighter arrangement. Beautiful high quality, imported, gleaming chrome finish wrist cigarette lighter, mounted on matching full wrist or 2-pc. expansion band. Just attach lighter on one side and your watch on the other side. Men and women owners marvel its perfect performance. Just press once and lid opens; press again and . . . it lights—never fails! Strikingly different and popular! Also unique for GIFT-giving! And, ONLY \$4.95 ppd., plus FREE miniature table lighter (shown). No C.O.D.'s. Money-back guarantee. Indicate choice of band in order!



OCIP Imports

224 S. Los Angeles St. Los Angeles 13, Calif.

NOVEMBER 1953

## ENGINEERING DEGREE IN 27 MONTHS

### INDIANA TECHNICAL COLLEGE

B. S. DEGREE, Aeronautical, Chemical, Civil, Electrical, Mechanical and Radio Engineering (inc. TV and Electronics). Drafting, 1-yr. G.I. Gov't approved. Low rate. Earn board. Large industrial center. Students from 48 states, 21 countries. Demand for graduates. Enter December, March, June, September. Write for catalog, 16113 E. Washington Boulevard, Fort Wayne 2, Indiana.

## FREE!

GET ALL THESE 5 PICTURE-PACKED COURSES If you mail coupon NOW! Millions have been sold at \$1.



In 10 Minutes of FUN a day I changed myself from this Bloodless, Pitiful SKINNY SHRIMP



to this NEW MUSCULAR RED-BLOODED HEAD-TO-TOE HE-MAN!

I just GAINED 35 NEW LBS. OF SHAPELY POWER-PACKED MUSCLES!

You can do the same as I and THOUSANDS have. You can add 10 inches to your CHEST 6 inches to each ARM and the rest in proportion as I did. NOT friend you don't have to be SKINNY, WEAK or FLABBY any more just mail NOW the FREE coupon below as I did.

### LAST CHANCE COUPON — 5 COURSES FREE!

HOW YOU CAN WIN A BIG 15" TALL SILVER CUP as I just did and how to WIN \$100

JOWETT INSTITUTE, Dept. PM311  
 225 Fifth Avenue, New York 1, N.Y.  
 Dear George: Please mail to the prepaid FREE Jowett's Photo Book of Strong Men, a Muscle Meter, plus all 5 Muscle Building Courses, "How to Become a Mighty He-Man." ENCLOSED FIND 50c for postage and handling (no C.O.D.).

NAME \_\_\_\_\_ AGE \_\_\_\_\_  
 (Please print plainly, include Zone Number)  
 ADDRESS \_\_\_\_\_  
 CITY \_\_\_\_\_ ZONE & STATE \_\_\_\_\_

# The Gift every man wants



**4 OF THE YEAR'S OUTSTANDING BOOKS ON THE AUTOMOBILE**  
**VALUE — \$8.00 POSTPAID — \$5.00**  
**GIFT WRAPPED. IMMEDIATE SHIPMENT.**

Carbon Monoxide, Your Car and You.....	\$2.00
The Truth About American Cars.....	2.00
The Big 3 and 1 More Make 4.....	2.00
Behind the Scenes in Scientific Car Testing.....	2.00
	<b>8.00</b>

**GIFT PACKAGE ONLY \$5.00 PREPAID**

Profusely illustrated books by A. J. White, director of the world's largest independent testing laboratory. If he's interested in cars, this is the outstanding gift for him this Xmas. Money back guarantee.

**Motor Vehicle Research, Inc.**  
**236 Huntington Avenue, Boston 15, Mass., Dept. B-16**  
 Please rush to me \_\_\_\_\_ Gift packages of 4 outstanding books by A. J. White at \$5.00 per package.

Name \_\_\_\_\_  
 Address \_\_\_\_\_  
 City \_\_\_\_\_ Zone \_\_\_\_\_ State \_\_\_\_\_

Enclosed is  Check  Money Order

**MOTOR VEHICLE RESEARCH, INC.**  
**236 Huntington Avenue, Boston, Mass.**



**SEND NO MONEY**  
**MORE THAN 4000 PAGES**  
**2750 PICTURES**

**9 BIG COMPLETE BOOKS**  
**BUILDING, ESTIMATING, CONTRACTING**

Examine this Up-to-Date Edition for 10 days. See how these nine books supply easily understood training that will help you to get a better job and make more money, or start a profitable business for yourself. Think what a BIG help it will be to have them handy for use in solving all sorts of building problems.

Learn to draw plans, estimate, do all-new construction and modern remodeling to meet fast growing demand. More than 4000 pages of practical, pay-raising information with 2750 helpful illustrations, on such subjects as blueprint reading, concrete forms, masonry, carpentry, steel square, electrical wiring, plumbing, heating, painting, and hundreds more.

In our more than 50 years we have never offered more complete building information. Send the coupon TODAY.

(A year's consulting privileges with our engineers now given with these books without extra cost.)

**AMERICAN TECHNICAL SOCIETY—Publishers Since 1898**  
**Dept. G819, Drexel Ave. at 58th St., Chicago 37, Ill.**

I would like to examine your 9-Volume Set of Building, Estimating, Contracting Books. I will pay the delivery charges only, but if I choose I may return them express collect. If after 10 days' use I prefer to keep them, I will send you \$3 plus postage and pay the balance at the rate of only \$4 a month until \$34.80 has been paid.

Name \_\_\_\_\_  
 Address \_\_\_\_\_  
 City \_\_\_\_\_ State \_\_\_\_\_

Please attach letter giving employer's name and address (if self-employed give business man reference). Men in service please give home address.

# EAT ANYTHING WITH FALSE TEETH

If you have trouble with plates that slip, rock and cause sore gums—try Brimms Plasti-Liner. One application makes plates fit snugly without powder or paste, because Brimms Plasti-Liner hardens permanently to your plate. It relines and refits loose plates in a way no powder or paste can do. Even on old rubber plates you get good results six months to a year or longer. **YOU CAN EAT ANYTHING!** Simply lay soft strip of Plasti-Liner on troublesome upper or lower. Bite and it molds perfectly. Easy to use, tasteless, odorless, harmless to you and your plates. Removable as directed. Plate cleaner included. Money back if not completely satisfied. If not available at your drug store, send \$1.25 for reliner for 1 plate.



**PLASTI-LINER INC., Buffalo 11, New York — Dept. 43-U**

## BRIMMS PLASTI-LINER

THE PERMANENT DENTURE RELINER

## MUSICAL Toilet Tissue Holder



Perfect for your own home!  
 Charming as a gift to others!

**\$7.80**  
 Only postpaid

Pull the paper and enjoy the Mustel Plays "Happy Days"

Are Here Again!

Guaranteed Swiss Music Movement.

Send check, or money order and we pay postage; C.O.D. you pay postage.

**Siesta Novelty** P.O. Box 1204  
 Miami Beach, Fla.

**DAN LURIE**  
 "America's Most Muscular Man"  
 —on television's "Big Top."



## FAMOUS DAN LURIE

# BARBELLS

with 4 courses—low factory prices  
 50 lb. set...\$ 8.48 | 150 lb. set...\$20.48  
 100 lb. set... 13.98 | 200 lb. set... 25.98

Write for Order by Mail: 50% with order, bal. C.O.D.  
 Free Catalog Extra wts. 13c per lb., F.O.B. plant

**DAN LURIE BARBELL CO.**  
 1701-M-11 Pitkin Ave., Dept. 359-L, Brooklyn, N. Y.

SILVER JET

MELLOW TONE



## TAIL PIPE EXTENSION

Protect your bumper from discoloration and rust. Install this heavy duty chrome-plated extension on your exhaust. Will fit all cars. \$1.50 ppd.

**JET PRODUCTS** P.O. Box 2005 Inglewood 4, Calif.

**Say You Saw It in Popular Mechanics**

## YOU MAKE IT!



## TWIN PISTOL SCABBARDS

Hand tool or "brand" your own Western Gun scabbards. Strong, genuine 8 oz. cowhide. Ready cut, holes punched with rivets. Twin Scabbards, kit complete, only \$1.00 pair.

Add 60c for Western Leather Belt.

**FREE** 44-PAGE INSTRUCTION BOOK AND LEATHERCRAFT CATALOG  
 NATIONWIDE — A TANDY STORE NEAR YOU  
**TANDY LEATHER COMPANY**

EST. 1919 P.O. Box 791-GJ, Fort Worth, Texas

RIGHT FROM DETROIT COMES THIS

# MOTORCADE BARGAIN

**8 FEET OF CARS**

**50 CARS FOR \$1**

Yes! These cars, trucks and planes put end-to-end reach almost 8 feet. You get **FIFTY** true three-dimensional colorful plastic scale models of streamline trolleys, highway vans, trucks, service cars, U. S. Army planes. Perfect collection to swap trade, exhibit! Order now!

**YOUNG PRODUCTS, Dept. 5058**  
2605 ELMHURST, DETROIT 6, MICH.



## TELEPHONES

Desk Stand style

Slightly used and in excellent condition.

**Many Valuable Uses—**

- Inter-house phones
- Loud Speakers
- Microphones
- Educational purposes
- Toys, etc.

**\$1.95**

Postpaid

Come complete, ready to use in U.S.A. Wiring Diagrams Furnished. Please add 75c shipping and handling cost.

**MICROPHONE Dept. X-802**  
1760 W. Lunt Ave., Chicago 26, Ill.

## LEARN CARTOONING

at home in spare time

Simplified Landon Picture Chart Method makes progress quick, exciting, easy. Former Landon students include creators of "Steve Canyon," "Freckles," "Out Our Way," "Winnie Winkle," "Regular Fellers," "The Neighbors," "Strange as it Seems" and many others. Earn while learning. Rush 10c for Picture Chart (to test your ability) and full details. Please state age.



Landon School of Cartooning, 5311 CT5 Bldg., Cleveland, O.

## Mr. Fisherman!

**YOU need "Goin' Fishin'!"**



• You haven't LIVED until you have read the hottest fishing book ever published for fishermen by 20 top-name authors . . . all the game fish spectacularly reproduced in full color . . . a riot of tall-tale fish cartoons in color . . . THE FISHING HALL OF FAME . . . Maps of Fish Hot Spots . . . 1,000 Better Places To Fish . . . Florida . . . Alaska . . . Pacific Coast . . . Atlantic . . . Great Lakes Region . . . Rockies . . . Texas, etc. All the best fishing gear on parade. ALL THIS FOR A DOLLAR. FREE! New secret method to catch more game fish. If tackle dealer cannot supply, write direct.

Joe Godfrey • Dept. III • Goin' Fishin' Everywhere  
422 South Dearborn St. • Chicago 5, Ill.

## SPORTSMEN! Get this

### AUTHENTIC BIG FISH MAP IN EIGHT COLORS



• Just the map for your home, office, club, cabin or yacht. Shows weights of fish and where caught. All world record fish listed. Price \$5.00 rolled in tube—shipped prepaid. Also Dog Map—Both Maps (Value \$10) and "Angler's Almanac" for only \$5.00. Almanac tells HOW and WHERE to Catch More Fish.

**SPORTSMAN'S MAP CO.**  
422 So. Dearborn Street Chicago 5, Ill.  
182 SPECIES SHOWN IN 8 NATURAL COLORS

## Print Your Own

Cards, stationery, circulars, tags, labels, photo and movie titles, advertising, etc. Save money. **Print for Others, Good Profit!** easy rules sent. Raised Printing like Engraving, too. Sold direct from factory only. Write for free catalog of outfits and all details. **KELSEY PRESSES, M-37, Meriden, Conn.**

# LEARN MEAT CUTTING AT NATIONAL

Pay After Graduation



The steady dependable trade of Meat Cutting taught easily in 8 short weeks. **YOU LEARN BY DOING** under actual meat market conditions in big modern school at Toledo.

For beginners or men with experience. Get a profitable store of your own. Remember, **PEOPLE MUST EAT!** Big pay jobs. Free employment help. Thousands of successful graduates.

Buying, cutting, percentage, pricing, advertising, selling, etc. A complete retail meat education. National School established over 25 years. Get National training NOW. Pay your tuition in easy weekly payments

after you graduate. Send coupon for FREE 52 page school catalog — TODAY. G.I. approved.

**National School of Meat Cutting, Inc., Dept. 50-X, Toledo 4, Ohio**

Send me your FREE school catalog on National Training at Toledo in Meat Cutting, Meat Merchandising and Self Service Meats. No obligation. No salesman will call.

Name \_\_\_\_\_ Age \_\_\_\_\_

Address \_\_\_\_\_

City \_\_\_\_\_ State \_\_\_\_\_

Approved for training Korean Veterans

GOOD FOR FREE SEEDS & PLAN

**NATIONAL NURSERY GARDENS Dept. M11**  
8463 So. Van Ness Ave., Inglewood 4, California  
Please rush me **FREE SEEDS** and illustrated Plan. I understand I am under no obligation. This is a Free offer from you.

Name \_\_\_\_\_  
Address \_\_\_\_\_ Zone \_\_\_\_\_  
City \_\_\_\_\_ State \_\_\_\_\_



FREE! GENUINE SEEDS

MAIL THIS **Certificate TODAY!**

and I'll send you **FREE!** genuine seeds & illustrated plan

HOW TO LEARN GROWING SECRETS



Earn **BIG Money** GROW **LIVING MING TREES**

NEW SHORT-CUT METHOD High Speed low maintenance Sprouting Time. Give you real living trees almost immediately.

"ORIENTAL SECRETS" CAN BE YOURS! It's New! Essencing. Get beautiful real live dwarf trees (only 17 inches high), Elm, Orange, Oak, Cypress—any kind! All bloom and even bear real fruit in perfect miniature. New fascinating hobby and quick profit business. **\$1000 WORTH OF SPACE ON YOUR WINDOW SILL**, in your living room, gar- age—anywhere. Fill your home with these beautiful wonders of nature. Start with pennies, and grow trees worth "tens of dollars." **SPARE-TIME OPPORTUNITY** — IT'S A HUNDRED TIMES MORE FASCINATING than any other kind of gardening or hobby, yet may be extremely profitable because miniature specimens are new and rare. **GROW HUNDREDS AT ONE TIME** — It's easy. Think of the profits of large crops when trees may sell for \$25 each. New short-cut method lets you see results immediately. **TAKES ONLY MINUTES PER DAY!** It's easier than you think — once you know the secrets. **GROW IN ANY CLIMATE**—From Maine to California. **SOME RARE TYPES SOLD FOR AS HIGH AS \$2,000 EACH**—but \$25, \$50, or \$100 per tree is common. You pocket the profits. **WE SUPPLY EVERYTHING**—at our risk! Yes, everything you need to start growing beautiful perfect Miniature Trees—and you don't risk one penny. New special plan offers amazing opportunity. **RUSH CERTIFICATE TODAY. HELP SUPPLY HUGE DEMAND** from homes, flower shops, interior decorators, clubs, hotels, churches, schools—everywhere!

**NATIONAL NURSERY GARDENS, 8463 SO. VAN NESS AVENUE, INGLEWOOD 4, CA. JHHA**

## EARN EXTRA CASH WITH ARC WELDING

Turn your spare time into cash at home or on the farm. **Repair** farm and garden tools, workshop tools, damaged car frames. **Build** metal furniture, all kinds of farm machinery. **Hardsurface** tools for longer life. **Solder** electrical wire, damaged car bodies. **Charge Batteries** for neighbors. Become the repairman in the neighborhood with your new Lincoln arc welder.

**WELDS • CUTS • SOLDERS BRAZES • CHARGES BATTERIES**



### "LINCWELDER 180"

- Current range 20 to 180 amps handles 1/16" to 5/32" electrodes.
  - Operates from 230 volt single phase current.
  - Approved by Underwriters' Laboratories.
- Also "Lincwelder 60" operates on 115 volt 60 cycle grounded circuit. (No. 12 wire fused for 20 amps.)

The Lincoln Electric Co., Dept. 2906, Cleveland 17, Ohio.

- Ship me the "Lincwelder" AC 180K \$201.  
 Ship me the "Lincwelder 60" \$48. Add State and Local sales tax. (Prices are for U. S. A. and include accessories.) Are Torch and Battery Charging Attachment extra.  
 Send me free bulletins on the "Linewelders".
- Name \_\_\_\_\_  
Address \_\_\_\_\_  
City \_\_\_\_\_ State \_\_\_\_\_

ORDER YOUR WELDER NOW! Fill out and mail TODAY!



## OVERHAUL YOUR MOTOR in 10 minutes

STOP BURNING OIL, STOP PISTON SLAP

15,000 Mile Performance Guarantee!

**1st Step — CLEANSE WITH "MOTOR PURGE"**—In the FIRST step of the famous Motor Renew Kit treatment, the "Purge" formula cleans, quiets and frees rings, valves and pistons from efficiency and power robbing carbon, gums and varnish. Pour this miracle solvent into the cylinders, run your motor and watch the combustion residue billow out of your exhaust pipe.

**2nd Step—RENEW WITH "COMPRESSION SEAL"—RESTORE COMPRESSION... GET NEW POWER, SPEED AND ECONOMY** with "Compression Seal"! As the SECOND step of the Renew treatment, squeeze this self expanding mineral compound into your cylinder where it can fill worn spots (which cause compression leaks) between cylinder walls and pistons. Thus it restores compression... cuts oil-gas waste and eliminates costly engine overhaul and ring jobs.

**100% MONEY BACK GUARANTEE!**  
Free Auto Manual with each order. Kit treats all cars and trucks. \$6.95 Postpaid (or send \$1 deposit, bal. C.O.D.)  
Write "RENEW KIT," Dept. PMK-11  
10407 W. Washington Blvd., Culver City, Calif.

## You Can Refinish Your Furniture!

It's easy when you know the tricks of the trade that the professionals use. And George Grotz tells them all in his best-selling, laugh-filled book called "FROM GUNK TO GLOW, or, the Gentle Art of Refinishing Furniture." The first practical guide written for the amateur: simple directions, easy-to-find materials. Only \$1 ppd.

**FREE:** Picture guide to American Furniture Periods with each copy. PLUS complete catalogue of refinishing supplies, brasses, hardware, upholstery and caning supplies, knock-down reproductions, etc. Send only \$1 for all three. Money back if you're not downright delighted.

**THE FURNITURE DOCTOR, Dept. PM1, Clinton, Conn.**

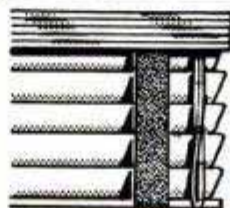

## VENETIAN BLINDS

CUSTOM MADE TO ORDER AT FAR BELOW WHOLESALE

**Ready to Assemble**  
Modernize your home with the finest, latest-style blinds — at a fraction of store price! Custom made to fit your windows. Get free measuring chart.

Write For Full Information  
**WRIGHT, Dept. P, 32 South Clark, Chicago 1, Illinois**

## MODERN ELECTRICAL SERVICING—

Learn at Home—Revolutionary New Audio Method of Training teaches you quickly and easily. \$3.50 and UP PER HOUR often earned while learning. Write today for **BIG, FREE Book and Illustrated Literature.**

**ADVANCE TRAINING INSTITUTE, Dept. 1401 CHICAGO 31, ILL. 5944 N. NEWARK AVE.**

## STOPS FOGGY WINDSHIELDS NEW Chemical Mitt



**Amazing Discovery!** Autoists wild over new FOG-STOP Windshield Cleaner. Simply glide over windshield chemically-treated Mitt—at once glass sparkles crystal clear. Blurry mist, frost, sleet, snow disappear like magic. Stops fogging. *Sells like wild!*

**SAMPLES FOR AGENTS** Sample offer sent immediately to all who send name at once. Hurry. Postcard will do. **SEND NO MONEY—just your name.** **KRISTEE CO., Dept. 672, AKRON 8, OHIO**



## REVERSIBLE AUTO SEAT COVERS

Made of **FLEXTON** plastic. Choice of: **SNAKE-ZEBRA DESIGN** or **LEOPARD-COWHIDE DESIGN**

Each Only **\$2.98**

**ORDER FROM MFR. AND SAVE** Colorful SNAKE AND ZEBRA DESIGN And LEOPARD-COWHIDE DESIGN. Can Be Used On Either Side. Water And Stainproof. Tailored With Side Grip Panels For Tight Fit. Sewn With NYLON Thread For Long Wear. Simple To Install. Dress Up Your Car With These Colorful Expensive Looking Covers!

### 10 DAY MONEY BACK GUARANTEE

Choice Of **SPLIT** Or **SOLID** Front Seat Only \$2.98. Complete Set For Both Front & REAR ONLY \$5.00. Specify Design Wanted, Make Of Car And Seat Style. Enclose Payment And Save Postage Or Sent COD.  
**MARDO SALES CORP., Dept. DS-745 480 Lexington Ave., New York 17, N. Y.**



# EVERY SANDING JOB IS EASY

WITH THIS NEW AMAZINGLY LOW-PRICED  
**BURGESS ALL-PURPOSE ELECTRIC  
 BELT SANDER**

\$ only  
**24<sup>95</sup>**  
 complete



PORTABLE—USE  
 IT ANYWHERE!

COMPLETE  
 WITH  
 BUILT-IN  
 MOTOR

**LOOK AT THESE  
 TOP QUALITY  
 FEATURES!**

- Sturdy Cast Aluminum Construction
- Built-in Motor has Self-lubricating Bearings!
- Smooth, Quiet, Positive Chain Drive!
- Automatic Blower Keeps Motor Cool!
- Belt is Flush with Left Side of Sander—Makes it Easy to sand into Corners!
- Uses Coarse, Medium, or Fine Belts—Change Belts in Less than 10 Seconds!

**10 TIMES  
 FASTER THAN  
 HAND-SANDING!**

NOW — for the sensationally low price of only \$24.95 complete, you can own the fine electric belt sander you've always wanted. Just plug in, press the switch, and sand tables, chairs, woodwork, floors, desks, cabinets, doors, workshop projects—any kind of surface large or small, horizontal or vertical, curved or flat! 10 times faster than hand sanding! Use the Burgess Belt Sander to remove paint and varnish, too!

**QUALITY FEATURES COMPARE WITH BELT SANDERS  
 SELLING AT TWICE THE PRICE —**

Made of cast aluminum for extra strength without extra weight — use on vertical surfaces without fatigue. Tempered coil spring keeps belt always at proper tension—no fussing with adjustments. Fool-proof, trouble-free—even a woman or a boy can handle it—turns hard work into play!

Just plug Burgess Belt Sander into any 110-125 volt, 50-60 cycle outlet, and let it do the work, from the roughest sanding with coarse belts to the finest smooth-as-glass finish! Comes complete with coarse and medium belts. Order today! We guarantee you'll be completely satisfied—or your money back! MAIL COUPON NOW!

**DOUBLE GUARANTEE**

Order your Burgess Belt Sander by mail today, under the John H. Fair Co. guarantee of absolute satisfaction or your money back if the Sander is returned within 10 days. In addition, you are protected by the Burgess guarantee on parts and workmanship, packed with every sander. You take no risk!

**JOHN H. FAIR CO., Dept. PM-11  
 Grayslake, Illinois**

I enclose \$24.95. Rush my Burgess BELT SANDER to me at once, postpaid. If not satisfied, I may return Belt Sander within 10 days for full refund.

Name .....

Address .....

City..... Zone..... State.....

Send the Burgess BELT SANDER C.O.D. On arrival I'll pay postman \$24.95 plus shipping charges. Same 10-day money back guarantee.

**JOHN H. FAIR CO.**

Dept. PM-11

GRAYSLAKE, ILLINOIS

# Start a profitable manufacturing business in spare time

with your own home as your headquarters

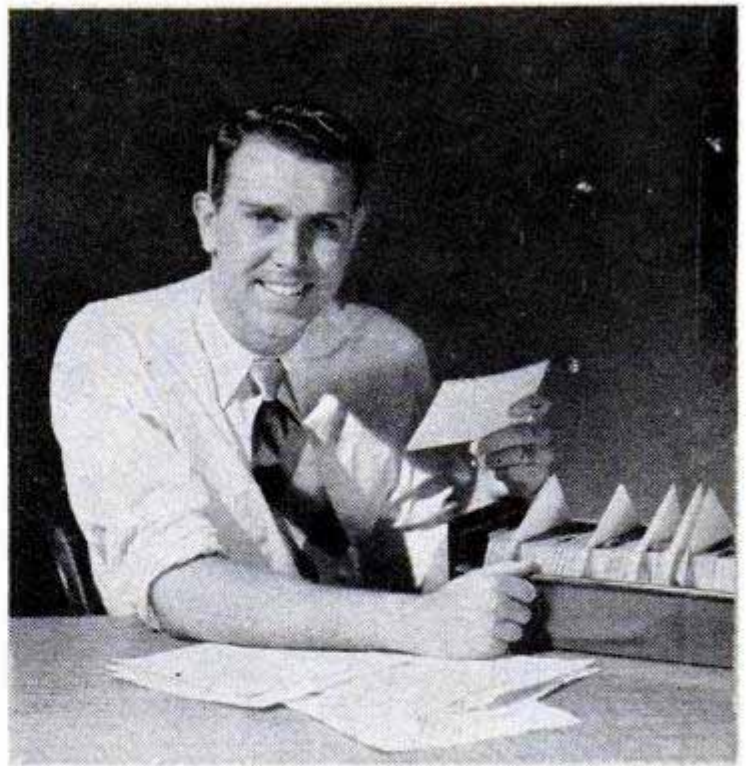

**R**IGHT at this moment there is a tremendous demand for new business enterprises in a branch of the plastics industry. Fortunately, this is a type of manufacturing business that does not require heavy or expensive machinery, rented space for storage, production or sales. A portable hand machine does the work wherever electric current is available, and the working area can be in almost any part of your home.

The opportunity that is open to you today, is to meet this growing demand in a new industry by establishing yourself as the manufacturing agent in your own trading area. Several hundred of our machines are already in use in both large and small communities. Some are even being operated successfully by women whose family duties make it necessary for them to be at home during the day, but whose family income is not enough to meet rising expenses. Most are being operated by men. Many started in spare time just to pick up an extra five or ten dollars for an evening's work. They found the work so profitable that some have now given up former jobs to devote full time to a business of their own.

One of our manufacturers gets all of his business by mail. Orders and money come to him in envelopes and he sends his products out the same way. Another delivers his entire output to stores in the vicinity. An-

other does a wholesale business supplying other manufacturers who do the selling. Still another works with advertisers in the manufacture of plastic advertising novelties and specialties.

The operation of the machine is simple and easy for anyone to learn. It does not require any knowledge of chemistry, mechanics, or electricity. And what some say is best of all, a manufacturing business like this enables a person to make good money without any house to house canvassing. The machine turns out from \$5.00 to \$15.00 worth of work per hour and it can be operated for as short or long a time as you wish.

We have prepared a simple step by step instruction manual that not only tells how to operate the machine, but also tells how to get the business coming in at a profitable clip right from the start. We will lend a copy of this book to any serious minded man or woman with the

understanding that a copy will be given them free if and when they purchase a machine—or the copy we lend can be returned if you decide not to go into the business. Reading it will not cost you anything.

If you are interested in a nice little home business that can bring in an extra \$60 or more for ten or twelve hours work in spare time, send your name. All information on the book and machine will be sent free, postage prepaid and no salesman will call to bother you. You read about it in the privacy of your own home without outside pressure and then decide whether you'd like to take the next step. Address your envelope to me in person. Send me the coupon below. Or, if you prefer send your name on a post card and ask for "Free information on starting a manufacturing business at home." Either way, send your name today and find out about this wonderful new fast growing money-making business.

RAYMOND E. BRANDELL

1512 Jarvis Ave., Dept. L-1011, Chicago 26, Ill.

Raymond E. Brandell, 1512 Jarvis Ave., Dept. L-1011, Chicago 26, Ill.

Dear Mr. Brandell: Please send information showing how I can start a profitable manufacturing business in my home in spare time. All the information you send will be mailed to me free of charge and no salesman is to call on me. I am not under any obligation to go ahead with the business and there is no charge for this information now or any other time.

Name \_\_\_\_\_

Address \_\_\_\_\_

City \_\_\_\_\_ Zone \_\_\_\_\_ State \_\_\_\_\_

POPULAR MECHANICS

**WORLD'S  
BEST  
WANT AD  
MEDIUM**

# CLASSIFIED Advertisements



Advertisements in this section 85 cents per word, each insertion, minimum 10 words, payable in advance. To be inserted under proper classification, copy must be in our office the 20th of the second month preceding date of issue  
F. W. Johnson, Manager, Classified Advertising  
Popular Mechanics Magazine, 200 East Ontario Street, Chicago 11, Illinois

## YOU'LL PROFIT

By reading and answering the classified ads in this section. Hundreds of opportunities for you to make and save money

### AUTOMOBILES. MIDGET CARS

**HI-Mileage-speed** equipment from the world's largest supplier. Dual manifolds, finned heads, electric doors, lowering sets, chrome panels, thousands of items for all cars. 1953 catalog 25c (illustrated literature free). Wholesale to garages. Newhouse Automotive Industries, Los Angeles 22.

**FIBERGLAS** Automobile bodies. Build your own. Gem-O'-Lite's own "how" book \$2.50. Information, materials catalog 10c. Airmailed 35c. Gem-O'-Lite, Box 6867A, North Hollywood, California.

**PHOTOGRAPHS**, World's finest automobiles. List, sample, 25c. Box 1028, Minneapolis, Minnesota.

**FREE** Motor magazines; automobile literature, old, new and foreign; glossy photos, dealer books; shop manuals—offered with non-profit organization; write today; get on free mailing list. Auto Maniacs, Stockbridge, Mich.

**PUNCTURE-Proof** your present tubes. Squeeze amazing new liquid rubber compound through air valve. Presto, flat tires are completely eliminated! Works on same principle as tubes costing ten times the price! Takes one minute each, lasts for life of tube. Now used in over half-million tubes. 100% money back guarantee if you ever get a flat. Cannot damage tube, tire or alignment. Only \$7.92 for enough for 4 tubes. We pay postage. Master Sales, 276 Fulton Ave., Hempstead, N. Y.

**KUSTOMIZE**, Dechrome, French headlights, make convertible into hardtop. No leading, welding, soldering. \$4.95 brings kit for dechroming and filling rust spots. Kustomize, 3337 Lincoln, Franklin Park, Illinois.

### AUTO SUPPLIES AND EQUIPMENT

**PROFESSIONAL** Automotive gauges—Surplus stock of famous Gale Hall instruments, brand new, original cartons! Compression gauges, originally \$10.75, only \$2.98 plus 40c postage! Precision engine analysis vacuum gauges, originally \$12.50, now only \$4.58 plus 40c postage! Catalog of other bargains sent free with first order! N. E. Surplus Sales, Dept. PMA-11, 67 High Street, Newburyport, Mass.

**BARGAIN Offer!** Surplus stock of Gale Hall's original gasoline economy and motor condition gauges, designed for permanent dashboard mounting. Brand new, original cartons! Directions and connections included. Original price \$7.50, now only \$3.98 plus 40c postage! Deluxe all-chrome model, originally \$12.95, now only \$5.98 plus 40c postage! Order now! N. E. Surplus Sales, Dept. PM-11, 67 High Street, Newburyport, Mass.

**SAVE 6c To 7c** gallon gasoline. Buy wholesale. Pump your own. Literature free. Kalmead Company, Box 145, Woodland, Calif.

**MOTORIST** Save gasoline by Vacu-mating overrich mixtures. Fits on cars. For free particulars write Vacumatic, Dept. 2044, Wauwatosa, Wis.

**CARBURETOR** Gum removed in 3 minutes. Applicator \$1.15. Pendleton Products, Box 164, Whittier, California.

**STOP** Burning oil, increase compression. Best compression seal only \$2.95. Dick, 134 Allen St., New York 2, N. Y.

**SPECIAL** Upper cylinder lubricator, simple installation, better mileage, cooler motor, reduces wear. For auto, truck, tractor. State year, make, model. Complete \$8.95. Lucey, Box 2075-P Station A, Worcester, Mass.

**GENUINE** Motor treatment, Lachapelle's (patented). For only \$3.00 delivered. Restores older motors. Restores compression, power. Saves gas, oil, repair bills. New motors will last longer. Money back guarantee. You can't lose. Free circular. Write Joe Dillon, Authorized Warehouse and Agents Distributor, Box 323-O, Bridgeport, Ohio. Exclusive distributorships, agencies open.

**AUTO** And body parts for passenger, truck, and midget cars. Used or new available. Any year, make, or model. Specify needs, Kenny Motor Sales, 429 South Wetherly Drive, Beverly Hills, Calif.

**SNO-GO's**. To get out of a rut in snow, ice, or mud without messing with chains! Light mats of rough steel mesh Sno-Go's wedge easily under a spinning tire, conform to ruts and bite in because they're flexible. Only \$2.25 pr. 3 pr. \$5.50, postpaid. Stop-Spin, 808 N. 3rd St., Milwaukee, Wis.

**MODEL T** Ford parts, engine and chassis. Parts for other make old models too. Special parts made to order. We also buy surplus items. B. S. Wisneski, Inc., Milwaukee 7, Wis.

**BUY** Wholesale nationally advertised auto supplies, thousands other products at big discount. Free wholesale plan. American Buyers', 629-D Linden, Buffalo 16, New York.

**PROTECT** Your children. Safety rear door auto locks, open from outside only. Install in five minutes. \$2.00 pair. Money back guarantee. King Distributors, Box 981, Hallandale, Florida.

**LACHAPELLE'S** Treatment. (Patented.) Puts babbitt bearings in the motor for the pistons to slide on. At your dealer \$3.00 or postpaid. Ferns Products, 8120-B Walnut Dr., Los Angeles 1, Calif. In Canada, Master, Box 3, Station C, Hamilton, Ontario. Data on request.

**REFLECTING** Bumper tape, prevents accidents. Red and silver. 5 ft. package \$1 postpaid. Reflecto, Box 232, Ravenna, Ohio.

**SELECTED** Products. Ideal Xmas gifts. Descriptive circulars free. M-R Company, D-19, Baxter Station, Louisville 4, Ky.

**INCREASE**—Gasoline mileage three to five more miles per gallon. Guaranteed gasoline vaporizer, also increases power; easier starting. \$3.50. Turb-O-Vane, Stockton, Calif.

**GM71** Discarded injector parts wanted. Bares, 7120 Carnegie, Cleveland, Ohio.

**HUBGLO** Reflects brilliant round red beams of light from hub-caps. Protects cars at night from side approach. Easily applied. 98c ppd. Hubglo, Station A, Box 134, Dayton, Ohio.

**CHEVROLET** Owners: Stop tappet noise with Kaye Tappet Silencers. Quality product. Easy to install. Complete set \$5.95. Kaye Products, 2067 B S. Layton Blvd., Milwaukee, Wis.

**NEW** And used guaranteed parts for civilian and army cars and trucks. Largest stock in America. Mail orders. Pioneer Auto and Truck Parts Co., 734 W. 13th Ave., Denver, Colorado.

**CORD** Parts, literature. Sell, swap. Greenlee, Box 1036-P, Anderson, Indiana.

**CRANKSHAFT** Grinder, hand operated. Makes bearings fit without taking engine apart. \$3.75. Literature. L. D. McGee, 719 Cascade St., Wenatchee, Wash.

**SAVE**—California custom accessories headquarters. Buy direct from original designers. Electric push button door-trunk conversions, bull noses, custom grilles, speed dress-up equipment. 40 page catalog, hundreds of photos. Send 25c to Eastern Auto, 3319A South Grand, Los Angeles 7, Calif.

**"WATER** Injection." Free descriptive, illustrated, information. Neher Industries, LaVerne, California.

**ELECTROPLATE** Auto parts, novelties, mirrors. Easy, inexpensive home processes. Free booklet. Tyco Metals, Box 13231-BG, Houston 19, Texas.

**BRUSH** Plating outfits connect to a battery. No tanks or shop required. Free particulars. Gunmetal Co., Ave. J., Decatur, Ill.

**1953 EDITION**. It's new! It's different! Get world's largest auto accessory and parts catalog and save money. 132 pages. Over 50,000 items, including Hollywood accessories. Hi-speed equipment. Rebuilt engines, all parts and accessories for all cars and trucks. We have that hard-to-get part! Jam packed with bargains. Completely illustrated. Send 25c (refundable). J. C. Whitney, 1919-KC Archer, Chicago 16.

**CAR** Burning oil? Losing compression? Try Clifford's Compression Seal. \$2 postpaid. Clifford's Engineering, 1329 Seventh, Aurora, Illinois.

### AUTO TRAILERS

**PLANS**, Builders kits and completed folding camp trailers. Free literature. Booher Equipment Co., N. C. 52, Warren, Ohio.

**EXCEPTIONAL** Expanding eight foot trailer. Accommodates family of five. Build yourself. Literature 10c. Fra-Mar Company, Jones Avenue, Wilmington, Mass.

**BUILD-It-yourself**. Trailer blueprints. Pickup coach. Boat kits. Catalog 10c. Comstock Trailers, 585 Parsons, Kansas.

**TRAILER** Building, illustrated, 20c. Craftsmann Books, Box 1153, Milwaukee 1, Wis.

**ALUMINUM** Camp trailer kit. Campers, hunters, fisherman. Sleeps four. Compact, folding. 560 lbs. Literature free. Master Camper, West Sayville, N. Y.

**BUILD** Your own trailer! Plans for all kinds. Illustrated catalog 10c. Jim Dandy, 125-M, Wausau, Wisconsin.

### MOTORCYCLES, BICYCLES, MOTORSCOOTERS AND SUPPLIES

**"BUZZZZ"**—The motorcycle magazine. International coverage. Thoroughly illustrated. Yearly \$2.00. Sample 20c. 5424-A Sawyer, Chicago 25.

**MOTORCYCLES** And parts, new and used, early and late models. Harley Davidson, 813 Ohio, Wichita Falls, Texas.

**RECONDITIONED** Motorcycles and motors. Chromium accessories. Complete stock Indian parts. Expert rebuilding. Fast service. Indian Motorcycle Sales, Kansas City 27, Mo.

**HARLEY-Davidsons**—America's best used buys! We pay shipping on motorcycles. Genuine new, used, parts, accessories for current and obsolete models. Send 25c for bulletin, catalog. Knuth's (Harley-Davidson factory dealer) 1753 Muskego, Milwaukee, Wis.

**CZEK** Motorcycle \$25; midget motorcycle \$20; Doodlebug motorscooter \$30; Whizzer bike motor \$10; two cylinder Maytag engine \$4. Four airplane tires \$3. Mailorder only. Send 25c for catalogue Number 56, just out, listing these and hundreds of other bargains in new and used midget cars, motorscooters, home-builders parts, plans, etc. (35c by first class mail). Midget Motors Directory, Athens, Ohio.

**NEW** Surplus motorcycle saddle bags. Genuine, top grain, natural finish steerhide. (14"x16"x6") \$16.50 pair delivered. Cash with order. Rio Mercantile Co., Station D, Atlanta, Ga.

**REPAIR** All makes easier. Comprehensive 214 page repairman's manual, 171 illustrations. Money back guarantee. Prepaid \$2.25, no c.o.d. Harley Davidson Factory Dealer, 813 Ohio Street, Wichita Falls, Texas.

**REBUILT** Gasoline engines \$17.00 to \$37.00. Cauffiel Motor Industries, Temperance, Michigan.

**LEATHER** Jackets repaired, free circular. Zip-Jack, 708 East Tremont Avenue, Bronx, New York.

### AVIATION

**PROPELLERS**, Plans, supplies—For snow sleighs, air boats. Immediate delivery. Catalog 25c. Banks-Maxwell, Box 3301E, Ft. Worth, Texas.

**LIGHTPLANE** Circular, illustrated, 20c. Craftsman Books, Box 1153, Milwaukee 1, Wisconsin.

**PROPELLERS**, Plans for snow sleighs, air boats. Lowest prices, fastest service. Literature. Gano Propeller, Box 3284A, Ft. Worth, Texas.

**HOME-Built** airplanes. Free details. William Bentley, Dept. 16, Box 2056, Pensacola, Florida.

**PRIMARY** Glider plans \$1.00. Literature 15c. McFarland Aircraft, Greenville, Ohio.

### BATTERIES, GENERATORS

**EDISON** Nickel odorless storage batteries. 12 to 600 ampere hour. Any voltage. Long guarantee. Literature. Hawley Smith Co., Croton Falls 1, N. Y.

### ELECTRICAL SUPPLIES

**MOTOR** Rewinding supplies. Magnet wire. Insulation. Morton Electrical Service, Round Lake, Ill.

**LAMPS**—25c Brings bargain catalog showing all parts for repairing, building. Contains instructions for electrifying vases, oil lamps, etc. Gyro Lamps, 5402P Clark, Chicago 40.

**ELECTRIC** Pencil: Engraves all metals \$1.50. Beyer Mfg., 10511-H Springfield, Chicago 43.

**A.C.** Watthour meters, \$5.00. Miller, 1011 W. 16th, Davenport, Iowa.

**INSTALL** Your own fixtures, make most of your own electrical repairs and, save hundreds of dollars with Popular Mechanics' Electric Fix-It Book, \$2.00. No matter if you want to install fluorescent fixtures, test circuits, repair appliances or do any one of many electrical repairs, this new book tells and shows you how, step-by-step. Popular Mechanics Press, Dept. EF-2, 200 E. Ontario, Chicago 11, Ill.

**FREE** Surplus catalog. You need it, we have it. Everything in hydraulics, pumps, winches, welders and supplies. Mechanical bins. Prices you can afford. LeJay, 47, Minneapolis, Minn.

**FREE** Catalog. Surplus and other merchandise. Hydraulics, generators, welders, motors, boat kits, winches, tools, pumps, 1500 items. Dunbar Mfg., 10318-B Aurora, Seattle, Washington.

**BURGLAR** And fire alarms. Pamphlet on installation and maintenance of all types \$1.00 postpaid. Price list free. Ideal Alarm Co., Danville, Ill.

**LAMP** Supplies—Wholesale. Any amounts. All parts for repairing and building lamps. Catalogue 15c. Brown Lamp Co., Box 501, Wellston Sta., St. Louis 12.

### WELDING, SOLDERING, PLATING

**ELECTRO-Plating** equipment—New and used. Complete assemblies. All sizes for all types of plating. Baby shoe metallizing sets. Mounts, supplies, instructions. Free catalog. Send description. Hollywood Bronze Supply, Dept. 2A, 1624 E. First Street, Los Angeles 33, Calif.

**ACETYLENE** Welding outfits new \$49; used \$29; arcwelders \$49.50. Eagle Welding, Dept. PM, 5085 Broadway, Chicago 40, Ill.

**WELDERS**—Electric, various models, \$28.50 to \$235.00, direct from manufacturer. Free literature. Champion Welder Mfg., 193MP Centre St., New York 13, N. Y.

**SELF-Training** system radiator, repairing, cleaning, recoring. How to equip small shop at low cost. Supply sources, trade secrets, instructions \$3.50 postpaid. Radiator Service, McBain, Mich.

**A.C. Welders**, 4 sizes. Lowest prices. Free literature. Holgeron's Service, Canton 1, Kans.

**"BUILD-Ur-Own"** a.c. welder and a.c. power plant with a good used engine and low cost Hobart generator. Welds anywhere and supplies 5KW stand-by power for any emergency. Write Hobartweld, Box M-1133, Troy, Ohio.

### MACHINERY, TOOLS, SUPPLIES

**ALLEN** One ton power bench type punch press. \$125. Circular. Allen, Dept. PMB, Clinton, Missouri.

**SCREW** Gage checks threads per inch and 38 screw sizes. Free details. Faas Laboratory, 13 Dogwood Road, West Orange, New Jersey.

**POWER** Tools, equipment wholesale prices. Free bulletin. Homecrafters Cooperative, Grand Rapids 6, Michigan.

**ATTENTION!** Foley Saw Filer users—If troubled with uneven teeth, carrier play, etc., send for particulars on our floating rollers. Use instead of clips. Precision work. Stadick Manufacturing Co., Searles, Minnesota. Canadian Distributor: B. G. Livingston, 609 Simpson St., Fort William, Ontario, Canada.

**NEW** Mall electric drills — 1/4", \$15.00; 1/2", \$25.00. Jacobs chucks. Wilt Surplus, 7829 S. Racine, Chicago 20, Ill.

**SHEBEL** Saw Filer. Files all saws. Circular. A. P. Shebel, 730 S. 2nd St., Milwaukee 4, Wis.

**CONCRETE** Block machines. Standard sizes. Free catalog. Concrete Machine Company, 5129 South Compton, St. Louis 11, Missouri.

**BUILD** Your own machine tools. Milling machine castings only \$49.50. 10" shaper \$97.50. Twenty others at low prices. Catalogue 10c. Lewis Machine Tool Co., Los Nietos, Calif.

**2000 TOOLS**, Supplies, novelties, (domestic-imported). Catalogue free. All-tools, Box 268-Me, New York 5.

### ENGINES, MOTORS, DYNAMOS

**MARINE**, Industrial engines, equipment, parts. J. W. Helwege Co., 741 S. Ocean, Freeport, N. Y.

**MOTORS**, Repulsion induction, 1 horse \$37.50. 2, \$67.50. 3, \$87.50. A.C. generators, 750 watt \$38.50. 5000, \$185. 2 cylinder compressors \$22.50. Butler, 1885 Milwaukee, Chicago 47.

**REBUILT** Gasoline engines \$17.00 to \$37.00. Cauffiel Motor Industries, Temperance, Michigan.

**INVALUABLE** Motor winders handbook. Simplifies complicated reconnecting. \$4.98. Jednak, Clinton, Penna.

**WINDING** Data, listing 225 motors, single and three phase, \$1.00. Motor Data Co., Box 7631, Kansas City 28, Mo.

### BOATS, OUTBOARD MOTORS

**FIBERGLAS** Permanent boat coating. Gem-O-Lite's own "how" book \$2.50. Complete catalog 10c. Airmailed 35c. Gem-O-Lite, Box 6867B, North Hollywood, California.

**MARINE** Conversions for Ford and Jeep engines. Catalog 10c. Lehman Manufacturing Company, 972D Broadway, Newark 2, New Jersey.

**KRAFT** Kote—An engineered product to give your boat lifetime protection. No seasonal maintenance. Easy to apply. Fiberglass and MP-19. For free data and wholesale prices write to Multiplastics, Marine Div., 35 S. Dearborn, Chicago 3, Ill.

**CONVERT** Fords and Jeeps to 100% marine engines with Osco's world famous Convo-Kits. Deluxe catalogue 25c (coin). Oscomotors, 3627B Lawrence, Philadelphia 40, Penna.

**NEW**, Used, rebuilt marine motors. Marine conversions, fittings. Free catalog. Stokes Marine Supply, Dept. 24, Coldwater, Michigan.

**OUTBOARD** Motor parts—New, used for all makes. Send stamp for price quotation, listing parts needed. Outboard Motor Mart, Inc., 229A State Street, Boston, Mass.

**PLANS:** Inboard-outboard runabouts, cruisers, sail, Wood, plywood, welded steel. Advise requirements. John B. Clark, N.A., 329 Kenmore, Bay Village, Ohio.

**BUILD** Marine engines with Federal conversion kits. Federal Marine Motors, 9011 Cottage Grove Ave., Chicago 19, Illinois.

**JOHNSON** Outboard specialists. Used parts for all models at substantial savings. Prompt quotations. Specify model serial. Crandall-Hicks, 910 Commonwealth, Boston, Mass.

**FULL** Size, cut-to-shape boat patterns, blueprints, 7 1/2-38 feet. New 1954 illustrated "Build a Boat" catalog of 50 naval architect-designed cruisers, runabouts, sloops, skiffs, outboard boats, sailing, racing, houseboats, 25c. Marine hardware catalog, \$1.00. "How to Build Boats" book, \$1.75. PolyWog Houseboat Plans, \$12. Cleveland Boat Blueprint Co., Dept. A-66, 9400 Steinway, Cleveland 4, Ohio.

**BUY** Wholesale nationally advertised outboards, thousands other products at big discount. Free wholesale plan. American Buyers', 628-D Linden, Buffalo 16, N. Y.

**MOST** Complete line of marine conversion parts on market. For all engines (Willys to Cadillac). Free conversion hints and catalog. Barr Marine, 2706B Castor Avenue, Philadelphia 34, Penna.

**SMALL** Boat hardware. Catalog free. Sewell Machine Works, Versailles, Ky.

**PLYWOOD** Boat plans, 21 for \$1.00. Catalog boat building plans and copy boating magazine special price for both 50c. The Rudder, 15 Murray Street, New York 7.

**BOAT** Kits, plans and patterns for America's fastest and finest outboard racers and runabouts, fishing boats, hunting skiffs, dinghies, canoes. Illustrated literature 25c. Schneider Boat Co., Dept. PM, 1913 W. Vliet, Milwaukee 5, Wis.

**BELLY** Tanks, \$9.95. Free picture. Buck's Auto Wrecking, Merced, California.

**BUILD** Beautiful fiberglass-plastic boats without using molds. New patented method. Write Speedcraft, 2450 Emerson, off Square Lake Road, Pontiac, Michigan.

**GET** Our big 224 page marine hardware, boat, equipment catalog. Send \$1.00 for handling costs, refunded with first order. Garland Frasher Marine Sales, 540-J 31st Street, Huntington, W. Va.

### ATHLETIC EQUIPMENT, BODY BUILDING COURSES

**BARBELLS**. Exercise equipment. Courses. Free booklet. Good Barbell Co., Reading, Penna.

**BEAUTY**. Poise, health, power. Both sexes. Learn scientific breathing, \$5.00. Ray, Box 873, Columbus 4, Ohio.

**WEIGHT-Gaining** secrets revealed! Rush dime. Cambria, Box 26-M, Cambria Heights 11, New York.

### SPORTING GOODS, GUNS, FISHING TACKLE, ARCHERY, TRAPPING

**PLENTY** Cash paid. Modern, antique guns, gold coins. Describe completely. Charlie Dutz, Box 284, Lincoln 5, Ill.

**MOLDS** For fisherman's sinkers, jigs, squids, casting and spinning lures. Sweet's Molds, Tonawanda 1, N. Y.

**5000 BARGAINS**, Firearms, binoculars, war relics. Catalog 50c. Smith Firearms, Runnemed, N. J.

**SHOTGUNS**, Rifles, Revolvers, 500 modern, obsolete. Also cartridges. Each list 10c coin. Ed Howe, 52 Main, Coopers Mills, Maine.

**120 PROFUSELY** illustrated pages antique pistols, swords, daggers, armor, etc. 50c. Robert Abels, M860 Lexington Ave., New York 21.

**CAST Iron molds**—For casting fishermen's sinkers. Free illustrated booklet. Reading Instrument Co., Box 78, Reading, Penna.

**CAMPING Equipment**, sleeping bags, tents. Low prices. Free 80 page catalogue. Mor-San Sales, 10-21R 50th Avenue, Long Island City 1, New York.

**GUN And ammunition prices slashed.** Many calibers below wholesale. Free list. Central Sports, Delphos, Ohio.

**JAP Rifle altering American shells \$6.00.** Catalog 5c. TP Shop, West Branch 11, Mich.

**FREE Catalog:** flies, lures, mustad hooks, fly tying, lure, spinner, rod making materials, nylon coils. Supreme Mfg. Company, Amarillo, Texas.

**SAVE 50% On finest bows, arrows, complete bowhunting outfits, etc.** Free catalog and "How To Select Archery Equipment" booklet. Malibu Archery, 3156—RN Eighth St., Los Angeles 5, California.

**IMPORTED Stiletos, daggers, pocket knives, etc.** Free catalog. D. J. Clinton, Mt. Clemens, Mich.

**BUY Wholesale nationally advertised sporting goods, thousands other products at big discount.** Free wholesale plan. American Buyers', 627-D Linden, Buffalo 16, N. Y.

**WINCHESTER Lever rifles.** List 25c. Refunded first order. Thompson, Box 2023P, Chicago 9.

**GOLFERS.** New combination golf cart and 14 club bag. \$39.50. Write for details. Pribil, 626 Gem, Tulare, California.

**GUNS! Guns! Guns! Mausers, Lugers, Kentuckies.** New-used hunting bargains. Antique arms. Illustrated catalog 50c. Ed Agramonte, Yonkers 2F, N. Y.

**FOREIGN Ammunition**—American ammunition. Save 50%. Buy direct. Catalog 200 calibers 10c. Write Firearms, 1517 Gardner, Hollywood 46, Calif.

**MAIL 3c For your sample of Fur-Fish-Game.** Contains true, vivid, stories on hunting, trapping, fishing. America's largest trapper's monthly magazine. Clip advertisement, send at once with name, address, three cents to Fur-Fish-Game, 173 East Long Street, Columbus 15, Ohio.

### TAXIDERMY

**MODERN Taxidermist Magazine,** Greenfield Center 2, N. Y. Devoted entirely to taxidermy, photos, articles, methods. Trial year's subscription, \$1.00.

### BINOCULARS, TELESCOPES, MICROSCOPES, MAGNIFIERS

**POWERFUL Astronomical telescopes** easily made. Perfect lenses and instructions for making erector 45X, 100X, 200X and 400X telescope—\$4.00. Suffolk Science Service, Riverhead 3, N. Y.

**AMAZING Prices, binoculars, telescopes, microscopes.** Free trial. Folder, "Binocular Selecting," optical catalog free. Prentiss Importers, Mercury Bldg., West Los Angeles 25, Calif.

**REFLECTING Telescopes, 60X,** completely assembled \$29.75. Guaranteed observatory clearness. Free information. Skyscope, 475 Fifth Avenue, New York 17.

**MAKE Your 6" telescope reflector.** Glass, abrasives, instructions—\$9.50. F. Cameron, Box 65, Inwood 96, N. Y.

**BINOCULARS.** Lowest prices. 8x30, \$32.00 guaranteed telescopes, microscopes. Free catalog: All sizes. Joe's Binocular Sales, 4827 Second Blvd., Detroit 1, Mich.

**SAVE Money**—Get interesting facts! Free 52 page three color catalog. 80 different models. United Binoculars, 9043 S. Western, A-5608, Chicago 20.

**GIANT Astronomical telescope complete** with 6 ft. tripod. 45X, 75X, 100X eyepieces. Sun projector lens. \$15.00. Money back guarantee. Suffolk Science Service, Riverhead 3, N. Y.

**BINOCULARS Specialists, all makes repaired.** Authorized Zeiss, Hensoldt dealer. Tele-Optics, 5514 Lawrence, Chicago 30, Illinois.

**BINOCULARS, Telescopes, microscopes.** Terrific values \$3.98 up. Request free money saving catalog. Criterion, Hartford, Conn. Dept. P17.

**WAR Surplus bargains, binoculars, telescopes, sextants, millions of lenses, prisms, reticles, eyepiece, objectives, etc.** Mail 10c for big catalog CH. Send \$1.00 for stock CH-10-piece lens kit and big instruction booklet. Edmund Scientific Corp., Barrington, N. J.

**REFLECTOR Telescope kits from \$6.25.** All parts designed and built at our Hoboken factory. Mirror cells, diagonals, focusing mounts, tripods, tubing, oculars. Fully guaranteed. Send for free illustrated catalog. Our only sales showroom, Esco Products, 134 West 32 St., Rm. 204-A, New York 1.

**GIANT 100 Diameters magnification,** clear vision, completely assembled telescope. Hardwood tripod. \$7.95 f.o.b. factory. Carl Jamer, Manorville, N. Y.

**SPECIALISTS.** Used, new microscopes. Prepared slides. Supplies. Telescopes. Free illustrated catalog. Nassau Optical, 9 W. Greenwich, Roosevelt, N. Y.

**GIANT 400X Telescope easily made.** Brass focusing tube, erector, 5 lenses, instructions. \$3.95 postpaid. Carl Jamer, Manorville, N. Y.

### PETS—DOGS, BIRDS, RABBITS, HAMSTERS, ETC.

**YOUNG Parrots—Make fine talkers.** Herb Miller, 1911-N, Lubbock, Texas.

**HAMSTERS—Delightful small pets.** Free illustrated details. Anderson's Hamstery, 35 Oneida, Pontiac, Michigan.

**DOLLAR-Maker rabbits!** Cash markets. Write today! Ramshead Ranch, Gibbsboro 3, New Jersey.

**FOR Sale:** A few outstanding Coonhounds, Beagle, and Rabbithounds. Prices from \$15.00 to \$40.00. Free literature. Trial. Dures Thomas, Box 268, Albertville, Alabama.

**HAMSTERS, Golden and Panda.** Literature free. Charles E. Bowser, Smokerun, Penna., Dept. H.

**HAMSTERS—Cages and equipment.** Free illustrated details. Lakeview Hamster Colony, Newfield, New Jersey.

**EARTHWORM Raising** pays worthwhile profits! Illustrated booklet explains raising, feeding, packing, marketing. 25c. Ozark Worm Farm—J. Willow Springs, Mo.

**STANDARD Rabbit Journal, B-241-M,** Milton, Penna. Year \$1.00, sample dime, beginner's manual 25c.

**MAKE Big money!** Raise Chinchilla rabbits. Cash markets supplied. Write today! Rockhill Ranch, Sellersville 15, Penna.

**MINK Raising information free.** Complete. Lake Superior Mink Farm, Superior, EE1, Wisconsin.

**CHINCHILLAS (No rabbit.)** Easily raised anywhere. Profitable. Big future. Terms. Hibner Chinchillas, Ithaca, Mich.

**SPORTSMEN:** 200 Pointers, setters, straight cooners, combination hunters, rabbit and fox hounds. Reasonable. List free. Ramsey Creek Kennels, Ramsey, Ill.

**RAISE Mink:** Free booklet, pen plans, inside secrets, feed, care. Mink are money makers. Investigate today. Lawrence Mould, Brigham City 12, Utah.

**CHINCHILLAS—Pedigreed South American.** Use spare room or cellar. No odors. Profitable. Stewart Chinchilla Ranch, Washingtonville, N. Y.

**RAISE Highly-profitable Angora and New Zealand rabbits.** Particulars free. White's Rabbitry, Jackson, Michigan.

**HAMSTERS—Golden; young, \$3.00 pair;** fully developed, \$4.00 pair. Send for prices on rare albinos. Adirondack Hamstery, Prospect 2, New York.

**RAISE Rabbits.** Extra money. Literature free. Tayco Rabbitry, Hapeville, Ga.

**RAISE Canaries.** Profitable! Fascinating book. Plus unusual gift. 50c. Corlin, 4741 N. Bernard, Chicago 25, Ill.

**NATURALIST'S Catalog 10c.** Turtle 85c. 35 jumping beans \$1.00. 200 mealworms \$1.20. Chameleon 75c. Quivira Specialties, Topeka 51, Kansas.

**"MONKEYS, Their Training, Care, and Feeding,"** new booklet describing 30 most popular varieties. 25c postpaid includes importers price list. Tropical Hobbyland, 1531 N. W. 27th Ave., Miami, Fla.

**ANGORAS, Chinchillas, White Giants!** World's most profitable rabbits! Catalog free. Grinstead's, Edwardsville, Illinois.

**NO Puppies.** Keeps male dogs away from females in season. Send \$1.00 postpaid. No. c.o.d.'s. Money-back guarantee. Flo-white Products M11, P.O. Box 9011, Knoxville 20, Tenn.

**GUINEA Pigs.** More money. Booklet free. Taylors, B426A, Hapeville, Georgia.

**BEAUTIFUL Pure white pedigreed police puppies.** Ansonia Kennels, Mose, N. Dak.

**CHINCHILLAS Rented.** We pay \$300.00 each for raising. Write: R. Rau, Route 2, Jeannette 9, Pennsylvania.

### PLANTS, SEEDS, NURSERY AND GARDEN SUPPLIES

**OPERATE Lucrative garden.** Everything furnished. Experience unnecessary. Yusko Products, R #3, Streator 12, Illinois.

**WE Sell on the installment plan.** Best varieties peach and apple trees, low as 12c; grapevines 5c; shrubs 13c; evergreens 15c. Berries and plants. Catalog free. Benton County Nursery, Box 542, Rogers, Arkansas.

**FRUIT Trees!** Stark Bro's sensational new "Dwarfs." Also standard size, exclusive patented, trade-marked varieties produce abundant, larger, better apples, peaches, pears. All fruit faster growing, quicker bearing. Also beautiful ornamental trees and shrubs. Get giant new colorphoto catalog free. Stark Bro's, Dept. 30054, Louisiana, Missouri.

**GROW Christmas trees.** Ornamental landscape evergreens. Profitable. Quality planting stock at wholesale on quantity. Free list. Planting guide. Suncrest Evergreen Nurseries, Dept. PM, Johnstown, Penna.

### FARMS, FARM LANDS, REAL ESTATE

**FLORIDA—New development adjoining Ocala National Forest in Lake County.** Best fishing, hunting. Nice homesites \$245 at \$10 monthly. Folder free. Howard Vernor, DeLand, Florida.

**FLORIDA—Homesites, business sites and acreage in Potterfield's Garden Acres.** High dry land about 40 miles from Tampa and St. Petersburg, close to wonderful hunting and fishing. Tracts as low as \$595.00 for three acres, only \$10.00 down, \$10.00 month. Information, write G. B. Potterfield, Owner, Dept. V, Charleston, West Virginia.

**FREE List farms, auto courts, homes.** Missouri Ozarks. Johnson Realty-PM, Marshfield, Mo.

**STROUT'S Farm catalog.** Farms, homes, businesses, 33 states, coast-to-coast, 3298 bargains described. Mailed free. World's largest; 53 years service. Strout Realty, 7-M So. Dearborn St., Chicago 3, Ill.

**\$5.00 MONTHLY Buys—5 acres;** excellent fishing and hunting; good land. Price \$120.00. Free list. Box 425-P, Carthage, Mo.

**TAX Lands, \$1 to \$5 per acre in California.** Write for legal description list. L. D. Taylor, Dunsmuir, Calif.

**FLORIDA—Beautiful retirement homesites near gulf coast.** Excellent hunting, fishing in 9 fresh and salt water rivers, 11 bays and gulf. \$250 at \$10 monthly. Free literature. A. M. Mathews, Box 1406, Asheville, N. C.

**HOMESITES \$400—Convenient payments.** California's finest garden section. On Morro Bay's scenic shores. Wonderful fishing, boating, bathing. Fertile soil, softest water, temperate climate, congenial community. Free literature. Richard Otto, Department M, San Luis Obispo, Calif.

**\$5.00 PER Acre, Missouri land.** Warranty deed. Free list. John Calvert, Plant City, Florida.

**FARM-Ranch opportunities.** Favorable conditions. Washington, Minnesota, Montana, Idaho, Oregon, North Dakota. Literature, farm descriptions. Specify which state. J. W. Haw, 119 Northern Pacific Ry., St. Paul 1, Minn.

**CALIFORNIA Ranch lands.** 50c to \$5 acre minimum bid. Farm-ranch-hunt-fish-retire. 10c brings illustrated land catalog, outline maps. Tax Land Sales, Box 2350 BW, Hollywood 28, Calif.

**FLORIDA Choice lakefront lots available.** Best fishing, hunting. Terms. Grace Parker, Paisley, Florida.

**FARM And business catalog free!** Big edition. Hundreds of bargains from \$1000 up. Maine to Florida. West's, M-11, Pittsburgh 17, Penna.

**FLORIDA, Central, Tavares, lake-front subdivision.** Lots 10% down, \$25.00 month. John Rapalje, Box 792B, Tavares, Fla.

**OZARK Farm \$800, \$25 monthly.** Listings. Write today. Mr. Armstrong, Shook, 34, Missouri.

**FLORIDA? Try my advisory service on all questions.** Ross, Wakeman, Ohio.

COME To Houston now and share in her marvelous growth. Big, booming Houston is America's miracle city today—a world metropolis tomorrow. You should profit from her amazing growth. Buy choice homesites in popular suburb for only \$345—payable \$15 monthly. Write today! Preston Wood, Box 413, Houston, Texas.

### POULTRY, FARM SUPPLIES

KNOW How to raise poultry for profit. Read Poultry Industry. Every issue packed with helpful hints and practical suggestions. Latest articles on breeding, feeding and management. Subscribe now, 1 year 50c, 3 years \$1.00. U. S. funds or checks payable at a New York or Boston bank. Poultry Industry, Dept. PM, 376 Boylston St., Boston 16, Mass.

POULTRY Farmers, broiler growers, turkey raisers read the new American Poultry Journal for latest ideas and greater profits. 12 months, 50c. Special offer, 4 years, \$1.00. American Poultry Journal, 182 North Wabash, Chicago.

### PROFITABLE OCCUPATIONS

RAISE Pheasants on \$100 week plan. Little capital and space can make you independent. Free details. Great Central System, Columbus 1, Kansas.

HOW New Geometric mailorder operates: offer meant for certain prospect class distributed by mailing-agents pertaining to that class. Precision method—extensive coverage with economical overhead. Works fast. Sold \$250,000.00 for us from home guest-room-turned-office. Geometric information free. Specialty House, 910 E. Main, Danville, Illinois.

DOCTOR Ordered, "slow down." We scrambled two college degrees in business science with some little-known mailorder procedure. Result—something revolutionary: a mass-attack method that mailed our circular to hundreds of prospects daily without our lifting a finger! Method returning \$12,000.00 yearly last 24 years, explained for beginners. Details free. Bond, Okeene, Oklahoma.

ALASKAN Jobs! Over 150 new construction projects with names, addresses companies hiring. Thousands needed. Highest wages. Military, private construction, mining, fishing, lumbering, aviation, railroads, homesteading. Skilled, unskilled workers. Salary information. Government map included. \$1.00 complete. Alaskan Opportunities (PM), Box 362, Kenmore, Washington.

HOME Business opportunities. Free details. Uncle Herb, Box 185, King, N. C.

FOREIGN And Latin American employment. 1953 "Foreign Service Directory" gives up-to-minute facts on military and civilian construction, government jobs, major oil listings, aviation, transportation, steamship lines, mining, importers, exporters, how-when-where to apply, application forms, hot list firms hiring. \$1.00 postpaid. Global Reports, Box 883-P, Hollywood 28, Calif.

GROW Mushrooms. Cellar, shed, and outdoors. Spare, full time, year round. We pay \$3.50 lb. We paid Babbitt \$4,165 in few weeks. Free book. Washington Mushroom Ind., Dept. 99, 2954 Admiral Way, Seattle, Wash.

MAKE Flexible molds! Cast plaques, bookends, figurines! Free sample! H. Tooker, 630-M Chestnut, Hamilton, Ohio.

FREE Book "505 Odd, Successful Businesses." Work home. Expect something odd! Pacific, Oceanside, Calif.

ALASKA! Last American frontier. \$1.00 brings 1953 business directory and government map. Military and civilian construction; homestead and highway facts; mining, aviation, fur farming, grazing, timber, travel directions. List of firms hiring. How to apply. Alaska Opportunist, Box 92-P, Hollywood 28, Calif.

BE The Popular Mechanics representative in your neighborhood and earn big profits in your spare time. Write Popular Mechanics Magazine, Room 408M, 200 E. Ontario St., Chicago, Ill.

TYPISTS—Profitable home business. Complete copyrighted information. 50c. Gaunt, 827-W Irving Park, Chicago, Ill.

FREE! "301 Profitable Small Businesses!" Amazing shoestring plans! Work home! Start sparetime! Deumant Surveys, Kenmore 23-PM, N. Y.

TO \$35.00 Weekly. Upholstering spare time. Instructions \$1.00. Custom Upholstering, Oxford, Penna.

RANCHING Isn't our business on this ranch. It's mailorder! A special new kind anyone intelligent can duplicate, in city apartment or suburbs. Brings us \$1,000 monthly. We're showing folks how. We'll start you, suggest items that sell, guide you till you gain confidence. Write: The Palmers, Carrollton, Texas.

HOME Mail order beginners. 10,000 word instruction book, plus opportunity offers, 25c. Carnahan Bros., 5582 Nelson, Cypress, Calif.

WELDING Pays big money. Learn easily at best equipped school in country. Non-profit school with low cost training. G. I. approved. Write Hobart Trade School, Box M-1132, Troy, Ohio.

MUSHROOMS Grown boxes, barrels. Manureless process 50c. Spawn \$1.00. Gordons, 553 William, Winnipeg, Manitoba.

SELL Popular Mechanics and all other magazine subscriptions. Free catalog, supplies. Subscription Service Company, Dept. B, P.O. Box 2070, Birmingham, Ala.

BUY Wholesale thousands nationally advertised products at big discount. Free wholesale plan. American Buyers, 628-P Linden, Buffalo, N. Y.

SEND For big, new 1953 illustrated catalog that will show you how to turn your spare time into cash—making quick-selling, highly profitable lamps. Every home a prospect. Hundreds doing it, you can, too. No experience or special tools required. Catalog No. 7 contains 56 pages filled with shades, shade frames, figurines and bases, oil lamp converters, boring compound, and dozens of similar items. Also all kinds of sockets, cords, pipes, harps, finials, bases, and hundreds of other parts—everything you need. Special 8-page section shows 6 beautiful lamps in kit form, ready to assemble. You buy wholesale, sell at retail. Make big profits. Send 25c today for new 1953 catalog and wholesale price list, you'll be glad you did. The 25c will be refunded on your first order. Gearon Co., Dept. 500-B 11, 27 S. Desplaines, Chicago 6, Ill.

\$10,800 PROFITS! Your own mailorder business! No risk! Success plan free! Treasury, 709 Webster, New Rochelle L-17, N. Y.

"HOW To Make Money With Simple Cartoons"—A book everyone who likes to draw should have. It is free; no obligation. Simply address Cartoonists' Exchange, Dept. 911CP, Pleasant Hill, Ohio.

WANT A diesel job? New opportunities to increase income. Higher pay. More money. We can help you qualify. Tools. Shop method home training. Write today! Diesel, Tractor, Heavy Equipment Division, Interstate Training Service, Dept. B3M, Portland 13, Oregon.

MONEYMAKING Opportunities, home-work. Free literature. Wiese, 1516 Franklin, Waterloo, Iowa.

BUY Wholesale thousands nationally advertised products. Save money! Make money! Postcard brings details. Kemah Company, 5017-J Washington, Houston 7, Texas.

FOREIGN Employment construction work. If interested in foreign projects with high pay write Foreign Service Bureau, (Dept. P.M.), Metuchen, New Jersey.

OVERSEAS Jobs foreign employment. Men and women in demand now. New jobs breaking. Big pay, tax free. For latest information on jobs covering 50 foreign countries, write: American Digest, Dept. PM, 601 South Vermont Ave., Los Angeles 5, Calif.

HEATLESS Plastic laminating, gold-stamping. Complete outfit, instructions, sales plans one dollar. Allstater, 1808 Ludlow, Philadelphia 3.

\$1300.00 MONTHLY For truck drivers, \$1400.00 monthly for carpenters, electricians, plumbers, mechanics, \$1200.00 for clerks and laborers. Replacement hiring now being done. Full information and complete foreign listings, with current information on Spain job, \$1.00. Women's listing, \$1.00. 25,000 men and women needed for new stateside project! Complete information and other domestic listings, \$1.00. Dept. 3-K, Opportunities Unlimited, 1110 Commerce Bldg., St. Paul, Minn.

GLITTERBIRDS Make beautiful Christmas decorations. Literature free. Kit 25c. Miles Crafts, 3220P Fish Avenue, New York 69, New York.

GENUINE Leather wallets easily made. Experience, tools unnecessary. Kit \$1.00. Miles Crafts, 3220P Fish Avenue, New York 69, New York.

FOREIGN Jobs. Contracts underway and soon starting in Africa, South America, Canada, England, Europe, South Pacific, Middle East, Mexico and Alaska. Send \$1.00 for foreign job news, information, application forms, etc. DCS Foreign Job News, Dept. 268-SV, Bridgeport, Ill.

OVERSEAS Opportunities. New construction jobs. Clerks, truck drivers, companies hiring. Highest wages. Thousands needed. Salary information, how and where to apply. Send \$1.00. Overseas Reports, 706 Insurance Center, 330 S. Wells Street, Chicago, Illinois.

OVERSEAS Jobs. Big pay, transportation, expenses. Clerical, professional, mechanical workers. Most all trades. Latest listings airline, construction, manufacturing, oil, steamship companies, government agencies, many other opportunities. Up to date information on securing employment, contracts, income tax, application forms. \$1.00. Overseas Jobs, Box 335-A15, Baton Rouge, La.

SECRET Investigation. Experience unnecessary. Investigators particulars free. George Wagoner, 125M West 86th, New York 24.

EVERYBODY Likes candy. Learn to make professionally. Our 43rd year. Ragsdale Candies, D6, East Orange, New Jersey.

CONFIDENTIAL Reports. Highest paying jobs in 28 countries, including United States, Alaska, South America, Europe, Middle East. Many average \$1450.00 monthly. Skilled, unskilled, laborers, trades, supervisory, clerical wanted. Only \$2, including one year registration-advisory service. Complete satisfaction guaranteed. National Services, Box 2954PA, St. Louis 17, Missouri.

CONSTRUCTION Job list. Published monthly. \$1.00. Dempster's Construction Scout News, Dept. 268-SU, Bridgeport, Ill.

### BOOKS, PERIODICALS, PICTURES, POSTCARDS

BOOKS New and used at special prices. Save money. Write for list of fifty free catalogs on text and occupational subjects. Many rare and out-of-print titles. We also buy books. Established 1902. Long's College Book Co., Dept. PM, Columbus 1, Ohio.

HOW To live without money. Write: H. M. Bishop, 405 Second St., Neenah, Wisconsin.

SENSATIONAL Book bargains! Free catalogue! Write: Old Prof's Book Shop, 9 W. Lawrence St., Pontiac 15, Mich.

BOOKHUNTERS! Scarce, unusual, miscellaneous books supplied. Atlantic Book Service, Lawrence Avenue, Charlestown 29, Massachusetts.

FREE Catalogue. Special interesting books. Powers, 1324 Wilshire, Hollywood 17, California.

BIG Catalogue; 1500 bargains, send 10c. Books, 3100 Ocean Parkway, Brooklyn 35.

NATIONAL Geographic Magazines, 1888-1952. Periodical Service, Box 465-PM, Wilmington, Delaware.

BOOKHUNTERS! All subjects. Send wants! Jaher Book Service, 620-P East 178 Street, New York 57.

BOOKS Located. No charge for searching. Delta Book Service, 2856a Woodlawn Terrace, Memphis, Tenn.

DO You like to laugh? America's greatest laugh book only \$1.00 postpaid. Auburn Products Company, Box 69M, Auburn, Mass.

BOOKHUNTERS! All subjects. Speedy service. Plymouth, Box 365-E, Far Rockaway, N. Y.

GOOD Used books, 50c-\$1. Postal brings lists. Editions, Dept. PM, Hempstead, N. Y.

FREE Subscription: The Americana Eagle. No fees. No purchases required. Send your name today to receive newspaper "Americana Eagle." Contains book news, other valuable information. Mail Order Division, Americana Corporation, Dept. No. PM11, 333 North Michigan Ave., Chicago 1, Ill.

SHORT-Cut mathematics, slide-rule, magic hand-wash wicks, bookmark greeting cards. All for \$1.00. Figueroa, Box 222, Chicago 90.

STUDENTS Of Spanish! Back dated Spanish magazines. Five for \$1.00. All different. Revistas Espanolas, Apartado 3476, Habana, Cuba.

**POSITIVE Bargains!** Brand new pocket-books just 11c! All kinds. Rush 25c (refunded!) for unique illustrated catalogue. Breezy, easy reading and save! Keystone Book Bazaar, 6882 Forrest Avenue, Dept. 94, Philadelphia 38, Penna.

**READ About pirate gold, lost treasure.** Many books. Informative list \$2.00. Alexander Bryant, 1518 Godwin, Houston, Texas.

**PICTURE Hunters.** All subjects. Send wants. Brochure 10c. Box 822A, G.P.O. 1, New York.

**SPARETIME Profits** taking subscriptions, all magazines. Wholesale catalog free. Cassell Agency, Westfield 2, New Jersey.

### GAMES, TOYS, NOVELTIES

**SURPRISE Accident car.** Explodes on collision. Reassembled easily for another hilarious accident or regular spring-driven racing. Fascinating fun! \$1.25 ppd. Harvest House, 3509 1/2 Wellington, Los Angeles 16.

### MAGIC TRICKS, PUZZLES, JOKER NOVELTIES

**WE Supply every noted magician.** Large professional catalog \$1.25. Holden's, 120 Boylston Street, Boston, Mass.

**500 TRICKS,** Douglas famous 120-page catalog, only 10c. Fastest service to magicians for 30 years. Send 10c today. Douglas Magicland, Dept. 1, Dallas, Texas.

**2500 TRICK Catalogue** (512-pages), pocket, parlor, stage. World's finest magic. Catalogue \$2.00 (dollar trick included free). Kanter's, M-1311 Walnut, Philadelphia 7.

**GENUINE Ventriloquism.** Secret, one dollar. Lou Martin, Box 1821, Tulsa, Okla.

**VENTRILOQUISM** Selftaught. My quick, easy instructions, 25c. Ventriloquist, Calallen, Texas.

**SPECIAL Offer:** Your choice of \$1.00 cut and restored rope trick or \$1.00 spirit photography for only 50c. Free, our new \$1.00 magic novelty catalog complete with 14 famous magic tricks with first order. Chicago Magic Center, 19 W. Randolph St., Dept. PM-11, Chicago 2, Ill.

**224 CATALOG,** Magic, illusions, sensational escapes, spiritualism. Also big mystery book. Illustrated, prepaid. Send one dollar. Heaney Magical Co., Oshkosh, Wisconsin.

**VENTRILOQUIAL Dummies,** low price, any type, custom-made. Send 25c for pictures and information. C. R. Gough, 218 N. Jefferson, Hartford City, Ind.

**ESCAPE Tricks!** Mind reading acts! Also included over 80 assorted tricks. Plus unusual free gift. Only \$1.00. Corlin, 4741 N. Bernard, Chicago 25, Ill.

**SPECIAL Offer!** \$1.00 buys four hot joke items. Bug in ice cube; "lit" cigarette; life-like rubber m. use; snap chewing gum. Garden City Fun Shop, Box 246, Garden City, N. Y.

**EASY Professional magic** for beginners. Trick and illustrated catalogue 35c. Kaye Enterprises, PM-6, Box 8084, Newark, N. J.

**MAGIC - Jokes, puzzles, modelcrafts.** Send 10c today for catalog. Del's Tricks and Hobbies, 806 Paris Ave., Rockford, Illinois.

**90 PAGE Novelty-magic catalog** with novelty. 25c. Allen, Dept. PMT, Clinton, Missouri.

**MAGIC-Parlor, stage. Joker's supplies,** lower prices. Giant catalog 25c. (Refunded). Top Hat Magic, Evanston, Illinois.

**REAR View mirror attachment** for glasses. \$1.00 post paid. Starling Co., 2206 M Starling Ave., New York City 62.

**PROFESSIONAL Catalog,** 175 pages, 25c. Williams, 900 Plymouth, Ellwood City, Penna.

**ENTERTAIN With magic - Hobby or profession.** Write Marsh's, 237 W. 11th, Columbus, Ohio.

**32 PAGE Book "Side Show Tricks Explained,"** 10c. Bookmaster, 2281 Kenwood, San Jose, Calif.

**LEARN Ventriloquism.** 3c stamp brings particulars. Smith, 801 Bigelow, Peoria 5, Ill.

**BE A magician.** Large professional magic catalog of latest tricks, 35c. Ireland, C-109 North Dearborn, Chicago 2.

**JUMBO Catalogue!** Tricks! Puzzles! Funmakers! 10c. Rick's, 1100P Loyola, Chicago 26.

**WOODEN Nickel, catalog, trick, 25c.** Fun'n Magic, 423-P North St. Marys, San Antonio, Texas.

**FREE Catalog!** Magic tricks, jokes. Kardell, Box 2058-M, Santa Fe, New Mexico.

**BIG Fun kit!** Tricks, jokes, novelties, books. Real gay stuff. Howls galore. \$1.00. Johnson, 414 McRae, Wilmington, N. C.

### COINS, TOKENS, CURRENCY

**\$1,000.00 NOTE** Only \$1.00. 100 page illustrated catalogue 25c. Shultz, Salt Lake 10, Utah.

**FREE!** Foreign coin, banknote and coin collectors illustrated catalog to approval service applicants. Send 3c postage. Tatham Coinco, Springfield 30, Mass.

**COIN Collector's Magazine.** Largest independent, over 1000 pages per year. Sample copy 30c; \$3.00 per year. Hewitt, 7320-J Milwaukee Ave., Chicago 31.

**INDIAN Cent** with bargain lists 10c. Hutchinson, 3463 "I" Street, Philadelphia 34, Penna.

**SCARCE 1931-S cent** only \$1.25; ancient Roman coin \$1.00; Whitman coin albums, three for \$1.00 postpaid. Ben's Coin Shop, 31 North Clark, Chicago 2.

**GET Profit and pleasure** in collecting old coins. Send 10c for 56 page illustrated coin catalog. You'll be delighted with it. Send for it now. B. Max Mehl, 370 Mehl Bldg., Fort Worth, Texas. Largest rare coin establishment in U. S. Established 53 years.

**10 DIFFERENT Foreign bills,** 10c. Free list. Dwight Musser, Dunbar, W. Va.

**LARGE \$1.00 Bill \$2.50;** new \$3.75. New 1/2—Stone Mountain, Cleveland, Arkansas, Texas, Carver, each \$2.50. Giant bargain catalogue 35c. Beebe's, 4514 North 30th, Omaha 11, Nebraska.

**66 COINS** And bills \$1.00. Oddehon, Box 482, St. Louis, Mo.

**U.S. Large cents** before 1839, 3 different \$2. 15 different Indian cents, \$1. Delmaco, Box 1123, Wilmington, Del.

**FORTY Different Liberty head dimes,** \$9.50. U. S. price list 10c. Johnson, 644 E. Valerio, Santa Barbara 3, Calif.

**WORLD'S Greatest magazine** for coin collectors and wooden nickel 10c. Lawrence Brothers, Anamosa, Iowa.

**FIFTEEN Different Liberty nickels** \$2.00. Twenty different Indian cents \$1.00. Sayers, 1000 East Unaka, Johnson City, Tennessee.

**COIN Valuation handbook,** prices we pay, 127 pages. 380 illustrations, clothbound, \$1.25. Cook Coins, Jackson 5, Mississippi.

**35 DIFFERENT Foreign coins** \$1.00. 20 different large foreign bills \$1.00. Claud Denney, 3633 Colonial, Dallas 15, Texas.

**OLD Money** wanted. Do you know that coin collectors pay up to \$100.00 for certain U. S. cents? And high premiums for all rare coins? We buy all kinds. Send 4c for large coin folder. May mean much profit to you. Numismatic Co., Dept. 20, Fort Worth, Texas.

**WHAT Are your coins worth?** Amazing Fell's new 1953 United States coin book. Everything on every single coin minted—Worth, value, how to sell, speculating, investment; other valuable facts. Clothbound. 150 illustrations. Send no money. Pay postman only \$1.50 (plus postage) or \$1.50 postpaid (refundable). Order now! Fell Publishers, 386-M-18 4th Ave., New York City 16.

**TWO Whitman coin folders,** (any type). Indianhead cent, bargain list. All for 50 cents. Economy Sales, Dean St., Mansfield, Mass.

**WANTED—1894-S dime** pay \$500.00. Certain 1913 nickel \$1,000.00. 1901-S quarter \$20.00 to \$150.00. Hundreds of others. Know their true value. Complete illustrated catalogue 25c. Worthycoin Corporation, (D-325), Boston 8, Mass.

**\$10.00 FOR Certain Lincoln pennies,** Indianheads \$50.00. New booklet listing prices paid, 20c. Lincoln Coins, D-229, Glendale, Arizona.

**COINS Bought and sold.** New catalog 10c. Brunk, 3530-F Osceola, Chicago 34.

**GOLD \$5 Pieces.** One Liberty, one Indian type. Both \$25. Thompson, Box 2023P, Chicago 9.

**ANCIENT Roman coin** only 90c. Rhodeco, 105 Windsor, Reading, Penna.

### STAMP COLLECTING

**100 YEAR Old U. S. stamps!** Believe it or not, but ours is the only firm capable of sending "on approval" all U. S. stamps, even those over 100 years old, all foreigners too, including Roosevelts, coronations. Try it and see! Send 10c for our introductory bargain of 50 different U. S. and state whether approvals shall be U. S., foreign, or both. Globus Stamp Co., 268-4th Avenue, New York 10, N. Y., Dept. 213.

**CONGO, 3 Triangles, Ceylon, \$10.00** airmail, Philippines, Erie, Timor, Kiwi bird, midget sailor, Leipzig Fair, others. Only 3c to approval buyers. Seabrook Stamp Co., P.M.M.-1, Washington 10, D. C.

**SCOTT'S Sure-to-please special offer.** Triangle collection of 25 all different stamps. Includes birds, animals, airplanes, Pope Pius, Liberia, Mozambique, San Marino, Monaco, and many others. Only 50c to applicants for our high quality foreign approvals. Remember, these are all triangles, all different, all guaranteed by Scott, the best-known name in philately. Rush 50c today to Scott Stamp & Coin Co., Dept. W1, 114-118 Liberty Street, New York 6, New York.

**FREE \$8.00 International album** to regular approval customers. Hal Buck, 935 Waterloo Road, Stockton, California.

**SPECTACULAR Bicolored New Zealand health set** for just 3c postage. Approvals. Lou Allmendinger, Warner, N. H.

**100 DIFFERENT World 10c.** Free gift. Bellet, Mapledale, Hazel Park, Mich.

**DEALERS—Wholesale list.** Postage 3c. Frank, 5031 Queensberry, Baltimore 15, Maryland.

**UNBEATABLE!** Nauru, Brunei, Cayman, Nyasaland, Liberia, Sarawak, Borneo, over 100 different. Everything 10c with approvals. Albert Ftacek, Route 1-P, Ottawa, Illinois.

**FREE: Mint British Colonies** from Tonga, Seychelles, Brunei, Transjordan, Sarawak, Solomon Islands, Caymans, Gilbert Ellice—Free with approvals. Viking, 11-Z Northern Blvd., Great Neck, N. Y.

**50 DIFFERENT U. S. commemoratives** 25c. Durham, 1021 N. Granger St., Saginaw, Michigan.

**ROOSEVELT Giant triangle, flower triangle, 52 others, 5c.** Approvals. Marylandco, Arlington-R, Baltimore 15, Maryland.

**EGYPT Arab Chieftains set 20c.** Approvals. Herman Wolfel, 135 Glenwood, Manchester, New Hampshire.

**100 DIFFERENT United States - 50c.** Approvals. Utechts, 1143D North Keeler, Chicago 51.

**GREATEST Free offer—Croatia exile government air set;** gorgeous birds, natural colored triangles. Also albums, supplies. All to our approval buyers. Bell Stamp Service, Dept. S-5, Bell, California.

**312 MIXED U. S. only 10c** to "Gold Nugget" approval applicants! Nothing like them. Kessel's, Folsom, California.

**HANDSOME Album pages** can be filled from our 1,000 variety approval books. Get rid of those blank spaces, at 1c and 2c each! Ask to see a book today. References appreciated. Roseland Stamp Co., Dept. 10-C, Spring Lake, Mich.

**100 MEXICO, 50 Varieties,** no revenues, 25 cents. Approval applicants—Blocks, airs, commemoratives. R. Lehr, Somerton, Philadelphia 16, Penna.

**SCANDINAVIAN, 50 Different,** only 12c in stamps. Kimber, Box 278, Norrkoping, Sweden.

**PAYING High prices** for approvals? If your collection numbers under 15,000 try our 1c and 2c approvals. In books of 1,000. Special offer to customers. Clark Stamp Co., Dept. P-1, Muskegon Heights, Mich.

**PACKETS - Countries, airmails, topicals, etc.** Write for free catalog. Trans-World Stamps, 455 East 92 Street, Brooklyn 12, N. Y.

**APPROVALS - United States, British, foreign.** Premium. Advanced or beginners. E. Mange, Box 6, Hanover, Penna.

**1165 WORLDWIDE Different \$1.00** with approvals. Karl Klondike, Harrisburg, Illinois.

**EXCHANGE Your duplicate stamps.** Send 100-200 different foreign and dime. Receive all different. Patterson, 5622 Broadway, Lancaster 13, New York.

FREE! 5 Different Liberia for 3c postage, to new approval applicants. Mounblow, Box 278L, East Northport, N. Y.

APPROVALS? U. S. or foreign? Mint? Used? Hotchkiss Stamps, Montpelier, Vermont.

COLLECTIONS Wanted. Accumulations, covers. Murray Gold, 150 Nassau, New York 38, N. Y.

RARE Octagonal stamp. Giant triangle, gorgeous diamond, also mammoth and midget stamps given to foreign approval buyers. Gifts with purchases including Scott's International \$6.00 album, also latest Scott catalogues. Plymouth, Dept. A9, Bell, California.

ALBUM! Capacity over 1,000 stamps! Only 10c! Stampmart, Hartford 1, Conn.

88 FLAGS in color. All nations. 10c to approval buyers. Potomac Stamps, Washington 15, D. C.

CANADA—100 Different, 25c with approvals. Crown Stamps, Box 331, Toronto, Canada.

GOYA Nude (2) 5c. Approvals. Hanay's, 310 Quail, Albany 3, N. Y.

50 DIFFERENT Latin American airmails 25c. Approvals. Johnson, Box 367, Morgan Hill, Calif.

BIG New U. S. catalog—Only 10c! Published by world's largest stamp firm. Completely illustrated. Bargain lists and approvals included. Harrisco, 202 Transit Bldg., Boston 17, Mass.

MINT, Unused U. S. approvals. Patrick Agencies, 3650 Central, Indianapolis 5, Ind.

ALBUM, 100 Diff. stamps, 3 premiums, 20c. Smithco, Northeast, Box 6618, Kansas City 23, Mo.

WORLDWIDE Stamp mixture, 5 ounce package, \$1.25. Veteran Frank Stroskey, 223 Market St., Perth Amboy, New Jersey.

ZOUNDS! Exciting strange countries packet. Free with approvals! Saxon, Vista, California.

DIFFERENT 500, 35c; 1000, \$1.00; 2000, \$2.75; 5000, \$11.00, with approvals at wholesale to clear. K. S. Holmes, London, Canada.

1000 FINE Mixed U. S. stamps 25c. Wright, 723 Washington, Hagerstown, Md.

96 PAGE Illustrated U. S. price list. Send 10c, cost of mailing. DeLisle, 154 S. Second St., San Jose, Calif.

850 MIXED U. S. old, new, 25c. Lists. Weatherby, Medina, Ohio.

OLD U. S. mixture 25c. Bargain approvals. Rothberg, X123-PM, Braintree 84, Mass.

FISHERMAN'S Treasure set of lovely mint Mozambique stamps. Each with tropical fish in brilliant natural colors. Only 5c. Approvals. Hathaway, Box 145M, Garden City, N. Y.

AMAZING Offer! 200 United States stamps—including commemoratives, airmails, high denominations to \$1.00. Only 10c to approval applicants! Illustrated bargain lists free. Mystic Stamp Co., Dept. 80, Camden, New York.

FREE: Scott catalog and other premiums. Approval applicants write for details. Newton Schrodt, Box 92, Sullivan, Ill.

GERMANY Colonies, offices, states. Mostly 1/2-1/5 catalogue. Twelve page list 3c. Myers, VanZandt, Little Neck, N. Y.

BARGAINS Galore. Low priced approvals. Schur, Box 245, Buffalo 12, N. Y.

225 STAMPS For only 10c! This mammoth value includes airmails, pictorials; stamps from strange countries cataloguing up to 25c each! Also approvals. Mystic Stamp Company, Camden 80, New York.

1000 MIXED United States. Guarantee over 140 different stamps. \$1.10 insured. Quaintance, Box 178F, Upper Sandusky, Ohio.

MONACO Nudes complete—10c with approvals. Royal Stamp Company, Tamaqua, Pennsylvania.

SCARCE Burma set. \$1.25 value. Native girl, elephant, Mandalay tower. Only 10c with approvals. Welles, Box 1246-R, Church St. Station, New York City.

50 DIFFERENT Worldwide 3c! Approvals. Vinny Jo, Box 3062, Seattle 14, Wash.

50 DIFFERENT Argentine 10c. Approvals. Reuter, 611 W. 40th Pl., Los Angeles 37.

WANT Better stamps? Try our quality U. S. foreign approvals. North Andover Stamp, North Andover, Mass.

WOW! 263 All different Germany 15c. Zeppelins, semi-postals, airmails, high values. Big bargain lists and approvals included. Jamestown Stamp, Dept. 512, Jamestown, N. Y.

FREE To approval applicants—Israeli, British, French Colonies, Latin American, U. S. packet. Hobbies, 1463 Drexel, Miami Beach 39, Florida.

UNITED States approvals. Select copies. Used, mint. Kingsbury, So. Woodbury 2, Vermont.

100 DIFFERENT Spain 25c. Penny approvals included. Reed, Box 980, Chicago 90, Ill.

FREE! Powerful magnifying glass for 5c post. Bargain lists and approvals. Jamestown Stamp Co., Dept. 207, Jamestown, New York.

327 DIFFERENT Stamps 25c! Including early Canada, Newfoundland, British Colonies, Vatican, Red Russia, Hitler heads, Indian states, animals, airmails, French Colonies, rarities, unusuals. Every stamp different. Rare bargain only 25c with our bargain approvals. Money back guarantee. Niagara Stamp Co., Niagara-on-the-Lake 61, Canada.

200 DIFFERENT Including Roosevelt triangle, 5c to approval applicants. M. Avalon Stamp Company, Springfield, Mass.

STAMPS Wanted. Collections, duplicates, surplus stock, mint and used. Good grades only. Buy outright if bargain. What have you? Write us details. Vanroy Shirk, Lebanon, Penna.

WORLD'S Largest stamp (7 1/2 x 14 inches). A real curiosity! Retail for 50c, only 3c to approval applicants. Tatham Stamp Co., Springfield 30, Mass.

OLD Scarce U.S. seconds on approvals. Slight imperfections, lowest prices. Hernefield, Clintonhill Sta., Newark 8, N. J.

UNITED States—40 different 10c; 40 different commemoratives 25c. No approvals. Seidenberg, Appleton 944, Wis.

FREE. Scott's International Album, other premiums. Details with approvals. Raymax, 35-Z Maiden Lane, New York City.

FREE Sample—Interesting, informative, illustrated! National Stamp News, Anderson, South Carolina.

POLAR Bear triangle, giant George Washington, six colored Ecuador, Arctic triangle, first American commemorative, Corsica, Devils Island, others. Everything free with approvals. Capital Stamps, Little Rock 2, Ark.

WONDERFUL Offer — 7 complete mint sets only 10c with approvals. Reich (M26), 1033 Lawrence, Chicago 40.

FREE. Valuable mystery gift. Approvals. Raymax, 37-Z Maiden Lane, New York City.

UNITED States—58 different including 8 airmails, 15 commemoratives, 10c. Approvals. Sunset, Box 47, South Gate, Calif.

GIGANTIC Surprise packet, contains hundreds, catalog to 40c each, only 10c, bargainful approvals. Dresel, Box 270-G, New York 25, N. Y.

U. S. Mint 797 SPA sheet 10c to U. S. approval applicants. D. Kelly, 235M-86th St., Brooklyn 9, N. Y.

12,000 PENNY Approvals waiting for you. Many from exotic countries, pictorials, airmails, new issues. Tilbury, Box 862, Newark 1, N. J.

PENNY Approvals by country. M. H. Hoerning, 15, Farmington, Ark.

FLOWER Collection—Multicolored Congo, Ruanda, Andorra. Free. Approvals. Pleasure Stamps, 1865P 52nd, Brooklyn 4, N. Y.

27 HITLER Stamps from five Nazi-dominated countries. Historically valuable collection only 5c. Request approvals. Gulfstream, "PM" Hillsdale, N. J.

60,000 DIFFERENT — On approval! Books, world-wide. Cole, 43-A Rinewalt, Buffalo 21, N. Y.

OPPORTUNITY, Gorgeous lot with triangles, giants, midgets, flags, airmail and railroad stamps. Also Brunel, Mongolia, Sarawak, etc. Everything only 10c to approval applicants. Evden, Valley Stream 12, N. Y.

FREE — 35 Different Austria-Hungary stamps sent with mammoth packet list. Write today. Econostamps, Box 168, Riverside 9, Calif.

CIPEX Souvenir sheet plus 25 different U.S., 10c. Approvals accompany. Village Stamps, 90-39P 214 St., Queens Village 28, N. Y.

AUSTRALIA, 47 All different 10c. Anderson, Box 45, Seaside Heights, N. J.

55 DIFFERENT Including Korea 5c. Approvals. Broad Stamp Co., Box 866, Lexington, Kentucky.

TRADE Your extra stamps. Join our stamp club. \$1.00 for two years. Free information. Valley Stamps, Box 87, New Cuyama, Calif.

500 MIXED U.S., 10c. List. Blanchard, Box 307, Medina, Ohio.

STAMP Wallet and small Egypt collection, 5c with approvals. Ambergs, 537J 35th, Union City, N. J.

75 DIFFERENT U.S. commemoratives, \$1.00. Plymouth, Box 365-F, Far Rockaway, N. Y.

COLONIAL Collection free—Magnificent collection, British, French, American and other colonies. Flowers, animals, commemoratives, triangles, pictorials, high values all free plus Philatopic Magazine. Send 5c for postage. Empire Stamp Company, Dept. PM, Toronto, Canada.

FREE Complete set of famous Americans, flags, parks and presidentials to approval buyers. Send 3c for 15 of the above stamps plus full particulars. Triboro Stamp Company, 145 Nassau Street, Dept. 111, New York 38, N. Y.

100 DIFFERENT U.S. 25c. approvals. Buckeye, Box 53, Mansfield 2, Ohio.

COMMEMORATIVES—25 Different U.S. only 25c with approvals. Amster, 1714 East 7th Street, Brooklyn, N. Y.

FREE! Obsolete U.S. occupation set with most attractive approvals ever offered. Riedell, Greensburg, Penna.

COLORFUL Surprise 10c; special offers, U.S., foreign, approvals. Bristol Stamps, Collinsville, Conn.

22 ALL Different 10c to approval applicants. Jayne, Gravesend Sta., Brooklyn 23, New York.

30,000 DESIRABLE Stamps on approval, 1c-5c each. Why pay more? Academy, Box 1838, Miami, Florida.

ALASKAN Map on Russian stamps! Set showing map, ships, mountains. Historical curiosity. Worth \$1.20. Only 25c to approval applicants. Edgar Bowles, Box 5659, Washington 16, D. C.

500 MIXED Stamps and surprise packet for 10c with approvals. Fahsing, Dept. PM, Atascadero, California.

PACKETS. World different 2,000, \$3.00; 3,000, \$6.00; 5,000, \$15.00; 10,000, \$47.00; 20,000, \$200.00; 30,000, \$610.00; 40,000, \$1,220.00; 50,000, \$2,180.00; 60,000, \$4,220.00; 70,000, \$8,040.00; 80,000, \$12,360.00. Russell Smoky Mountain, Box 2011D, Natural Bridge Station, St. Louis 15, Mo.

LION Triangle, 28 others 3c. K & S, 303 Clinton Ave., Newark, N. J.

100 DIFFERENT France 10c with approvals. Sadler, 9013 Central, Kansas City 14, Mo.

327 DIFFERENT Stamps 25c! Including early Canada, Newfoundland, British Colonies, Vatican, Red Russia, Hitler heads, Indian states, animals, airmails, French Colonies, rarities, unusuals. Every stamp different. Rare bargain with approvals. Money back guarantee. Niagara Stamp Co., Niagara-on-the-Lake 61, Canada.

500 MIXED U.S. 20c; 1000, 35c. Sibley Stamps, Mendon, Mass.

500 MIXED U. S. 25c. Brookside Stamps, Box 133, Mendon, Mass.

SPECIAL! Nudes collection; approvals, 10c. Atlas, 2830-M Eisenhower, Racine, Wisconsin.

U.S.-Canada approvals. Povilauskas, 212 E. 3 St., New York 9, N. Y.

SHILLINGS, Lei, Rupees, dollars, etc. 25 different. High values only! Over \$5.00 catalogue, \$1.00 approvals. Brooks, 2352H East 23rd Street, Brooklyn 29, New York.

U. S. Mint specials! Flag set, complete, \$1.00; 5 different 3c commemorative plate blocks, \$1.00. Want lists filled. Brooks, 2352A East 23rd Street, Brooklyn 29, N. Y.

45 ALL Different U. S. stamps. Includes 50 year olds, commemoratives, airmails and \$5.00 stamp. Only 10c. Approvals. Willett Co., Box 511-L, Port Chester, New York.

WOW! 7972 Different worldwide stamps from 36 stamp companies, \$8.00. Names 1000 stamp collectors \$1.00. M. King, 32 Alexander Ave., Kamloops, B.C., Can.

NEW Flowers, birds, animals, butterflies. 4 sets 25c with approvals. S. Penniston, Norborne, Mo.



**TRIANGLES!** Five different; 3c with approvals. Thrifty Company, Silver Spring, Maryland.

**GIVEN Free—U. S. \$1.00 presidential plus German peace issues. Approvals. Write Bala Stamps, Bala Cynwyd, Penna.**

**SENSATIONAL U. S. Confederate states catalogue free. Stone, 45-P Bromfield, Boston 8, Mass.**

**25 DIFFERENT U.S. commemoratives 10c. Approvals. Eugene Caron, Greenville, Ohio.**

**SCOTT U.S. album (looseleaf) \$2.50! Money saving stamp catalog free! Stamps By Mail, 2133 Lunt, Chicago 45.**

**CLOSEOUT Packages only 50c. Kenda, 82 N. J. Ave., Brooklyn 7, N. Y.**

**FREE—200 Different! Half price approvals. Brunning, Donaldson Ave., Rutherford, N. J.**

**25 DIFFERENT British Colonies 10c. Completely illustrated folders. Many free sets for customers. Stoll Stamp Service, 2632 Burnett, Louisville 10, Ky.**

**COLOSSAL Stamp zoo 10c. Jungle beasts, wildlife, domestic animals—Fifteen different, including, rhinoceros, elephant, snake, tiger, zebu, kangaroo, koalabear, emu, kookabura, bull, horse. Extraordinary accompanying approvals. Niagara Stamp Company, Niagara-on-the-Lake 51, Can.**

**THOUSAND Different world, plus bonus, only \$1.00. Premier Stamps R.R.3, Hannon, Ont.**

**VALUE Packed stamp mixtures. Price list free. Leslie J. Wiggins, Box 72-A, Guild, N. H.**

**BIRDS, Butterflies, flowers. 25 different, 25c with approvals. Southwest Stamps, Box 117, Long Beach 1, Calif.**

**100 U. S. Commemoratives, 10c. request approvals. Lancaster Stamp Co., Lancaster, Penna.**

**NEW Zealand triangles. Queen Elizabeth. 10c with approvals. Seminole Stamps, Box 1138-P, Coral Gables 34, Florida.**

**FREE! Unique illustrated bargain catalog listing hundreds mixtures, packets, accessories. Values galore for any collector! Latest releases! Tower, 1714 South Ashland, Chicago 8.**

**500 STAMPS, All different, 50c. Edd, Stoka, 10511 South Peoria Street, Chicago 43, Illinois.**

**TREMENDOUS Value! Colorful new Monaco transportation triangles! Bahawalpur U.P.U.'s! Airmails! Pictorials! \$10.000 stamp! All 10c when requesting interesting bargain approvals. Nemasket Stamps, Wareham St., Middleborough, Mass.**

### ANTIQUES, RELICS, INDIAN GOODS, CURIOS

**4 PERFECT Arrowheads \$1.00. Flint knife 50c. Hide scraper 50c. Stone axe \$3.00. Perfect pipe \$3.00. Flint hoe \$1.00. List 10c. H. Daniel, Lamar, Arkansas.**

**4 SELECTED Arrowheads \$1.00. List 5c. H. Talburt, Calico Rock, Ark.**

**INDIAN Relics, fossils, minerals, fire-arms, curios. 9 mounted different Indian relics \$1.00. 150 mixed trade beads \$1.00. 10 nice selected arrowheads \$1.00. Fine stone tomahawk \$1.00. Spade 75c. Relic guide \$1.00. Genuine, no fakes. Postage 20c. Free relic with order. Catalogue with identification chart 25c. Museum Supplies, Burlington 3, Wisconsin.**

**WINCHESTER 73's. Other famous weapons of Old West. List 25c. Refunded first order. Thompson, Box 2023M, Chicago 9.**

**"QWITSCHUERBELLERAIKEN:" Selling several hundred historical firearms, 30,000 Indian relics, collectors cartridges, coins, antiques, 400 bayonets, swords. Revolutionary, Civil War: Flintlocks, muskets, blunderbusses, snaphaunces, revolvers, frontiers, Kentuckles, Winchesters, ramrods, powderhorns, blo-horns, steerhorns, mounted pheasants, deerheads, daguerrotypes, ambrotypes, violin wood, arrowheads, spearheads, bannerstones, discoidal, tomahawks, bo-wood, agates, minerals, fossils, Indianheads, gold dollars. Catalog, profusely illustrated 35c. Heike, Wenona 31, Ill.**

**BLACK Obsidian arrowheads from Oregon \$1.00. List. Moise Penning, Klamath 3, California.**

**6 EXTRA Fine bird arrowheads \$2.00. 4 fine Indian arrowheads \$1.00. Good grooved tomahawk \$2.00. List free. Lear's, Glenwood, Arkansas.**

### PRECIOUS STONES, MINERALS

**FIND Tungsten, mercury, uranium with Mineralight. Free brochure. Write Dept. PM8 Ultra-Violet Products, South Pasadena, California.**

**HELPS Identify. 9 mounted minerals including opal, jade, \$1.25. 10 mounted fossils, including trilobite, petrified dinosaur bone \$2.00. Free fossil with order. Catalogue 25c. Museum Supplies, Burlington, Wisconsin.**

**GEM Stones, cabochon quality, average 1/2", cleaned, identified; aquamarine, garnet, peridot, amethyst, tourmaline, apatite; one of each \$1.00 postpaid, guaranteed. Lost Mountain Gems, Box 5012, Phoenix, Ariz.**

**URANIUM Prospectors, see us first. Beginners enclose 25c for complete info on detection, mining, equipment needed. R. Zarra, Box 1185, Newburgh, N. Y.**

**COLLECTORS. Two dollars bring twelve beautiful genuine specimens from gemland Brazil. Five dollars bring perfectly cut ten carat Braziltopaze. Airmail bills or check. Jean Bach, 413 Praia Icarai, Niteroi, Brazil.**

**GEMS, Minerals, a wonderful hobby. National magazine covers cutting, collecting, silversmithing, field trips. Monthly, only \$3.00 year. Subscribe now or write for free brochure. Gembook Company, Palm-dale, Calif.**

**GEMS, Precious and semi-precious, genuine, from world-wide sources. Deal direct, no overhead, save money. Catalog 10c. Hill Co., 5450-G Portland Rd., Salem, Oregon.**

**GEMOLOGY Books! Catalog 10c. Atlantic Books, Lawrence Avenue, Charlestown 29, Massachusetts.**

**JADE, Agates, gems, gem cutting machines, supplies. Free list. North West Gems, 2819 North Warner, Tacoma 7, Washington.**

**SAPPHIRE, Topaz, tourmaline, garnet, peridot. 5 uncut gem specimens, \$1.00. O'Brien's, 1116M Wilcox, Hollywood 38, Calif.**

**GEMSTONES, Mineral specimens. Every variety. Lowest prices. Postcard brings free booklet. Plummer's, 4720 Point Loma Ave., San Diego 7, Calif.**

**TEN New Mexico minerals \$1.50, six fluorescents \$1.00, fool's gold 25c. Free literature. Minerals, Winston, New Mexico.**

### HOBBIES AND COLLECTIONS

**NAZI, Soviet, campaign ribbons. Big packet, lists, \$1.00. Medcrafts, 1923 34th St. S.W., Calgary 2, Canada.**

**UNUSED Matchbook covers—100 different \$1.00. 36-page catalog 25c. Charles Edelman, 1311C East 84, Cleveland 3, Ohio.**

**INVENTING Can be an interesting and profitable hobby. Write for complete particulars. Institute of American Inventors, Dept. 40-E 631-E St. N.W. Washington 4, D. C.**

**WANTED Cigarette, tobacco, cards. Write Charles Bray, East Bangor, Penna.**

**AUTOGRAPHS, Original reproductions. Presidents, explorers, inventors, adventurers. Washington, Champlain, LaSalle, Paul Revere, Paul Jones, Capt. John Smith, Myles Standish, etc. Name yours. Enclose stamped, addressed envelope. 10c—12 for \$1.00. Autographs, Box 642, Miami 4, Florida.**

**EXCITING Hobby; collect authentic military patches, insignias, campaign ribbons, navy rates, etc. 57 assorted \$1.00. Free gift. Pritt, Dept. M-11, 12 West 27th, New York City.**

**CIRCUS Wagons. Railroad cars. Stamp list. Box 181, Omaha 7, Nebr.**

**CONY Island sea shells 25c. John Aufiero, 446 Crown St., Brooklyn, New York.**

**CIGAR Store Indians. Reproductions made to order. Peter Meindl, Raymond, N. H.**

**LINCOLN'S Gettysburg address, original copy, suitable for framing, 25c. Box 642, Miami 4, Florida.**

**CLEARANCE Sale—Army patches 3c up; catalogue 10c; 32 different emblems \$1. Hobbyguild, 550-A Fifth Ave., New York City.**

**MATCHBOOK Mounting, the easy way. Free. Matchless Album Co., Box 121PM, Long Branch, New Jersey.**

**8 HOTEL Baggage labels 50c. Copleston, 1555 Odell, New York 62, N. Y.**

**BELLS Make unique Xmas gifts. India nautch bell, list, dime. Larry's Bell Club, Box 104, Hinsdale, Illinois.**

### CAMERAS, PHOTO SUPPLIES

**WHOLESALE Photographic supplies. Cameras, films, projectors, enlargers. Write for free catalog. Capitol Photo Supplies, 2428 Guadalupe, Austin, Texas.**

**BASS Says: Trading since 1910. Used but good as new buys: 8mm. B.&H. Sportster \$52.50; 16mm. Keystone A-7, F:2.5 lens \$37.50; Voigt. 35mm. Vito II, flash shutter, Skopar F:3.5, like new \$38.50; Kodak Reflex F:3.5 lens, like new \$88.50; Contax I, F:2 Sonnar \$87.50; 3 1/4x4 1/4 Speed Graphic, Skopar F:4.5 Ibsor shutter, \$52.50. Satisfaction guaranteed. Bass Camera Co., Dept. AG, 179 W. Madison St., Chicago 2.**

**BUY Wholesale nationally advertised cameras, photo supplies, thousands other products at big discount. Free wholesale plan. American Buyers', 629-PP Linden, Buffalo 16, N. Y.**

**PHOTOGRAPHY For pleasure or profit. Learn at home. Practical basic training. Long established school. Free booklet. American School of Photography, 835 Diversey Parkway, Dept. 345B, Chicago 14, Illinois.**

**WILD Life films. Exciting, dramatic action in the natural habitat of animals of forest and plain. 8mm. or 16mm. in beautiful color or B & W. Also 2" x 2" color slides. Write for free illustrated literature. Wild Life Films, 5151AL Strohm Ave., North Hollywood, California.**

**DISCOUNT To 40%—Cameras, projectors, tape recorders, lenses. Quotations given on your specific needs. Classified Camera, 2375-D E. 65th St., Brooklyn, N. Y.**

### PHOTO FINISHING

**PLASTIC Sealing, lifetime protection for photographs. Plain or plaques. Request information, sample. Plastiseal, Dept. M2, 45-05 30th Ave., Long Island City 3, N. Y.**

**OVERSIZE Prints no extra charge, 8-exposure roll, 30c. 12-exposure, 45c. 16-exposure, 55c. Reprints oversize 4c. Finest quality. Mail Order Photo Service, Box 297, Watertown, Wisconsin.**

**PHOTO Xmas cards 20 for \$1.10. Techni-Foto, Dept. Pm, Lorain, Ohio.**

**TWO Happy people, you and we—When you send us your films. You will be pleased with the beautiful results, and we will be happy to please you. Jumbo oversize finishing. Quality work, low prices, same as contact. 8-exp. roll superfine finish only 40c. 12-exp. 55c. 16-exp. 70c. 36-exp. \$1.50. Oversize reprints 5c each. Send us your order. Free mailers. Mailbag Film Service, Box 5440A, Chicago 80, Ill.**

**SENSATIONALLY Magnificent jumbo oversize finishing at contact prices. New, improved equipment produces finest work at low prices. 8-exp. roll, deluxe finish, only 40c. 12-exp. 55c. 16-exp. 70c. 36-exp. \$1.50. Oversize reprints 5c each. Free mailers. Send us your next order, you will be delighted. Century Photo Service, Box 5208, Chicago 80, Ill.**

**TWO Prints each good negative, 8 exp. 35c; 12 exp. 50c; 16 exp. 65c. Reprints 4c. Mayfair Photo Service, Box 617-K, Toledo, Ohio.**

**ENLARGEMENTS! Eight 5 x 7's or five 8 x 10's, \$1.00. Wilart Enlargers, Box 967, Little Rock, Ark.**

**CUSTOM Photo finishing guaranteed. 8 exposures 35c; 12, 50c. Bound in beautiful plastic ringed album. Special! 35mm., 36 exposure \$1.00. Free mailer. Flash Foto, Box 36M, Brooklyn 4, N. Y.**

**6 OR 8 Picture roll 35c, 12 or 16 picture roll 55c. Each roll printed and developed. Handy album pack. If you fail to get pictures on your film a new roll will be sent you without extra cost. Send coin with roll. No c.o.d.'s. Mailing containers sent free. DeLuxe Film Service, Box 1268-A, Shreveport, Louisiana.**

**TOP Quality. Fast service. 8 jumbos 35c in beautiful Super Pak Album. 16 contacts 40c. Reprints—Jumbos 4c; contacts 3c. Satisfaction guaranteed. Write for free mailers and circulars. Fast-X-Foto, Box A, Jersey City, N. J.**

**12 JUMBOS 35c, 8 Jumbos 25c, 16 jumbos 50c from roll or negatives with this ad. S. Skrudland, Lake Geneva, Wisc.**

**GUARANTEED** Quality. Fast service. Eight jumbos in beautiful super pak plastic ring binder albums only 35c. Send for free mailers and particulars of our complete photo finishing service. Grand Fotos, G.P.O. Box 1410, New York 1, N. Y.

**BEAUTIFUL** Enlargement in album from each good picture on roll. 8 exposure, 40c; 12 exposure, 50c; 16 exposure, 65c. Cut Rate Photos, Dept. B-4, Janesville, Wis.

**THE Photo Mill.** Immediate service. Eight exposure roll developed and one print each good negative 30c; two, 40c; one jumbo each 38c; two, 68c. Write for complete prices and mailers. The Photo Mill, Dept. K, 1511 Hennepin, Minneapolis, Minnesota.

**TWO** Beautiful prints from each picture on 8 exposure roll 35c. Many years of satisfied customers. Quick service. Lens Photos, Dept. J-4, Janesville, Wis.

**PHOTOS** Copied—20 wallet-size deluxe prints \$1.00. Original picture returned. Send any size photo or negative. Federal Wallet-Size Photo Co., Dept. PM, P.O. Box 2448, Kansas City 6, Mo. (No c.o.d.'s please.)

**FREE** Mailers—Attractive packaging. Contact prints 4c. Jumbos 5c. Western Photo, Dept. PM113, Box 298, San Francisco 1, Calif.

**GIANT** Size deckle album prints. 8 exposure roll, 35c, 12 exposure 50c. Send money. Free mailers. Dowl Photo Co., P.O. Box 2077, Ft. Worth, Texas.

**COLOR** Prints from Kodachrome, Ansco, Ektachrome. Wallet size, 4 for \$1; 8 x 10 \$2 each. Colorfax, Dept. B, Box 3521, Washington 7, D. C.

### MOTION PICTURES AND SOUND EQUIPMENT

**"ENTIRE** Life Story of Christ." 8mm., 16mm., sound and silent, purchase or rent, state projector. Hemenway Film, 31F Church St., Boston 16, Mass.

**5000** NEW-Used 8-16mm. silent-sound films. International-B, 2120 Strauss, Brooklyn 12.

**RENT** 16MM. sound films, 50c reel. Large selection; free catalog. Film Service, 128 Chestnut St., Roselle Park, N. J.

**8-16MM.** Silent-sound films. Complete rental library. All latest subjects. Free catalogue, sample film 10c. Garden Film, 317 West 50th, New York 19.

**MOVIE** Camera film: 8mm. roll \$1.50, 16mm. 100' \$3.00. Free processing. Better Films, 742 New Lots, Brooklyn, N. Y.

**TAPE** Recorders, tapes, accessories. Unusual values. Dressner, 624-M East 20th Street, New York City 9.

**GUARANTEED** Fresh 8mm. roll, magazine; 16mm. roll, magazine movie films. Color, b&w. Free catalog. ESO-R, 47th Holly, Kansas City 2, Missouri.

**MOVIE** Film, guaranteed, 24 hour processing, 8mm \$1.80; 16mm \$2.40. Evans Photographic, 4919 Louise Ave., Torrance 1, Calif.

**NEW** Movie bargains! 50' 8mm. Prevue film, 59c. 300' 16mm. silent film (value \$9.75), \$1.98—Our title choice. Blackhawk 8mm. films: Hunting, fishing, railroads, collector's items, children's films, 150', \$2.98; Bible stories, 300', \$7.98. New, used 16mm. sound, silent bargains, too! Six used 100' 16mm. reverse-image Panoram musicals, \$3.49. Good used 16mm. sound projectors. All leading makes. \$129.95, some \$99.95. Big catalog free. Blackhawk Films, 1227 Eastin Bldg., Davenport, Iowa.

**8MM., 16MM.** U. S. National parks in color. Free list. Ideal Service Supply, 4644 Geary Blvd., San Francisco 18, California.

**SAVE** 25% On home movie equipment. All popular brands. Send postcard describing wants. Free literature. Morgan & Brownell, Algonquin, Illinois.

**BELL & Howell** 16mm. sound projectors. Castle sound films, splicers, reels, other supplies. Free catalog. Ideal Service Supply, 4644 Geary Blvd., San Francisco 18, Calif.

**EARN** Up to \$15.00 daily with your movie projector! Details free. Metcalf, 10806 Glenroy, Chicago 43.

**3500** PERFECT Used subjects, all complete. 200' 8mm., \$2.75; 350' 16mm. silent, \$3.75; sound, \$8.00. Postpaid. Choose. Free lists. Dept. M, Abbe Films, 503 5th Ave., New York 17.

### MUSIC AND MUSICAL INSTRUMENTS

**ANYONE** Can play the Block-Flute! Entertaining and relaxing! "C" soprano Block-Flute—\$6.50 prepaid. (Professional discount.) Art. Hersch, P.O. Box 24, Lakewood, New Jersey. Inquiries invited. Any instrument.

**RECORDING** Of your song by Ascap pianist and singer on professional 78 r.p.m. disc: \$5. Your poem set to music and recorded: \$15. No other charges! Edward Miller, 45 W. 88, New York City 24.

**SONGS** And music printed. Large or small quantities. Write for prices. Skoumal Music Publications, 319 E. State, Rockford, Ill.

**POEMS** Wanted to set to music. Free recording and song publisher list. Send poems for expert advice. Prof. Riddell, Newport, Delaware.

**I** Get my songs published! Information. Williams, 342 28th North, Kansas City 16, Missouri.

**SONGWRITERS.** Free book, "The Do's and Don'ts of Songwriting." Tells how to write, promote, sell songs! Send large, stamped, addressed envelope. Hecht Enterprises, 1571½ Harvard, Los Angeles, California.

**ACCORDIONS** And concertinas, save 50% and up. New and used. All brands. Wholesale to every one. Please specify. Free accordion or concertina catalogue. Del Principe, 29 South Cicero, Chicago 44, Illinois.

**SWISS** Musical movements, finest make, assorted tunes \$1.70. Direct imports. Helax Co., 218 West 72nd Street, New York City.

**SONGWRITERS!** Let me help you. Stamp for booklet. Mark Rubens, 146-D West 79 St., New York 24, N. Y.

**POEMS** Wanted for musical setting. Send poems. Free examination. Five Star Music Masters, 630 Beacon Bldg., Boston, Massachusetts.

**FREE** Record of your song. Your words, my melody. Free information. Johnny Mack, 1094 West 39th Street, Dept. A, Los Angeles 37.

**COLLABORATION** Offer. Newark Publications. GPO Box 1226, Syracuse, N. Y.

**POEMS** Wanted for musical setting. Send poems. Free examination. Crown Music Company, 1476 Broadway, New York City 36.

**SONGWRITERS!** Protect your ideas! Hold all songs, poems! Write for safe correct procedure first! Song Service, Dept. P, 333 W. 56th St., New York 19, N. Y.

**POPULAR** Songs. How to write and sell them. Write for free booklet Successful Songwriting. Gateway Songs, Box 2470, Hollywood 28, Calif.

**SONGWRITERS!** Send poems, songs. Music Service, 243 West 72nd St., PM, New York 23.

**POEMS** Wanted to be set to music. Free examination. Send poems. McNeil, Master of Music, 510-PM S. Alexandria, Los Angeles, California.

**WANTED!** Poems for musical settings. Write Songwriters' Service, Clifton, N. J.

**WRITE** Songs. Big money and reputation. Write for information. J. Gordon Pub. Co., 4700 South California Avenue, Chicago.

**SONGPOEMS** Wanted. Mail to: Tin Pan Alley, Inc., 1650 Broadway, New York 19, N. Y.

**POEMS** Wanted for musical setting. Send poem for immediate consideration and free rhyming dictionary. Richard Brothers, 24 Woods Building, Chicago 1.

**NEW** Songwriters can sell their songs for cash! Get free facts. No obligation. Meadowlark Music School, 204 Sumner Road, Colorado Springs, Colo.

**HAVE** You any records worth \$150? Price Guide (Moses) values 7500 records. \$2.50 postpaid. American Record Collectors' Exchange, 825 Seventh Avenue, New York City.

**ELECTRIC** Guitars, accordions, amplifiers. Wholesale. Free catalog. Carvin, Baldwin Park, Calif.

**SELF** Taught courses: Piano, singing, songwriting and other instruments. Song collections. Music Teachers' Associates, 26 Potters Lane, Great Neck, N. Y.

**MOUTHORGANS.** Harmonica King. World's best. Made in Germany. 20 tones in metalbox, \$1.00, 40 tones chromatic, \$6.00, 48 tones chromatic, \$9.00 postpaid. Why pay more? Literature free. Weiss Harmonica, 5519PM, Kenwood, Chicago 37.

**1953 ACCORDIONS** Wholesale. Free catalog. American Accordion Center, 5329 Belmont, Chicago.

**ACCORDIONS.** World's finest at lowest prices anywhere to everybody! Free catalogues on all brands. Sell accordions from home or store! Write now for confidential dealers price list. Accordions, 10 Conway Rd., Shelburne Falls, Mass.

**MELODIES,** Arrangements, autographing, printing. Send for samples. Wickens, 1139 West Summer, Appleton, Wis.

**FREE** Melody songs arranged, sold. Al Music, 24 W. 51st, New York City.

**MUSIC** Arranged, songs printed. Frank Wildt, Music Publisher, Lancaster, Penna.

**WANTED:** Songpoems, lyrics. To be set to music. Work done by Hollywood professional artists. Recordings made. Quarterly magazine. Write for free sample. Inside Music, 5653½ Hollywood Blvd., Dept. K-6, Hollywood 28, Calif.

### RADIO AND TELEVISION

**SUBSCRIBE** To Amateur Radio Frontiers magazine. \$3.00 year. 1379 East 15, Brooklyn 30, N. Y.

**LIMITED** Quantity surplus double headphones. High quality, slightly used, \$7.95 value. Special now \$2.95 postpaid. Guaranteed. Allen, Dept. PMH, Clinton, Mo.

**FREE** 268 Page 1954 television-radio-electronic catalog. World's largest stocks, lowest prices. Complete supplies for builders, experimenters, amateurs, servicemen. Latest TV, Hi-Fi, radios, phonos, recorders, P.A. equipment. Thousands of parts, tubes, test instruments, books, diagrams. Top quality money-saving values. Get yours now! Allied Radio Corp., 100 N. Western Ave., Dept. 34-L-3, Chicago 80, Ill.

**NEW** TV catalog free. Loaded with bargains for TV servicemen, technicians, installers. Finest new TV antennas, motorless directronics, multi-channel yagis, UHF antennas, converters, motors, boosters, parts, instruments, hundreds of quality accessories at money-saving prices. Get your catalog now! National Electronics, 3011 Delco Bldg., Cleveland 3, Ohio.

**DIAGRAMS:** Radio \$1.00, television \$2.00. Give make and model. Diagram Service, Box 672-PM, Hartford, Conn.

**YOU** Can repair radios first day; will tell and show you how. Instructions \$1.00. Slate's Radio Service, Corsicana, Texas.

**MAKE** Stroboscope, color wheel, TV cooler, operate models. 110V motor, switch, cord. \$4.95 postpaid. Fan free. Five motor tricks 25c. TV Aids, Box 6034, Long Beach, California.

**AMAZING** Newly developed, permanently fixed crystal detector with warranty guarantee and complete plans for building crystal radios only \$1.00 postpaid. Allen, 427-PM10, Clinton, Missouri.

**CRYSTAL** Radio kit, guaranteed to work, \$1.50; phone \$1.75. Clearco Crystal Co., Dept. 9, 1229-25th, Des Moines 11, Iowa.

**CLEARCO** Crystal radio kit \$1.50; preassembled \$1.75. Free catalogue. Clearco Crystal Co., Box 1857, Milwaukee, Wis.

**MAKE** Simple, tubeless, batteryless distance-getting crystal radios. Crystal and illustrated instructions 25c postpaid. Allen, 427-P, Clinton, Missouri.

**CRYSTAL** Radio experimenters. Write Leslie Hulet, R4, Lakewood, New Jersey.

**EXPERIMENTER'S** Plans, diagrams, booklets. Free catalog. Dittofax, 5208-I Onacrest, Los Angeles 43.

**BUILD** 15 Radios—Only \$19.95 complete. Free radio tester, tools, soldering iron. No experience required. Money-back guarantee. Order direct or send for descriptive literature. Free, valuable radio and TV repair guide on request. Progressive Electronics, 497 Union Ave., Dept. PM11, Brooklyn 11, N. Y.

**SAVE** 25% On all popular brands of tape recorders. Send post card describing wants. Free literature. Morgan & Brownell, Algonquin, Illinois.

**SENSATIONAL** Television development! Instantly eliminates annoying commercials. 100% profit. Franklin, 2156-W, Los Angeles 54.

**SIMPLEST** Capacity relay yet! Uses no idling power. Ideal for trick locks, scare 'em gadgets, burglar alarms, operating window displays. Complete schematic, illustrated set-up instructions, 50c postpaid. Not mimeographed sheets. Technix Laboratories, 568RO Riley, Buffalo 8, N. Y.

**TALKIE** Crystalphone — Nearest thing to a real walkie talkie. Talk and receive radio programs. Instructions 50c. Talkie Crystalphone, Valley Road, Box 27, Clark-Rahway, N. J.

**ZENITH** Super symphony FM-AM \$63.00. Save 25% on packaged HI-FI, Webcor Musicales, Motorola Sonota. All models of Columbia "360" series. Hallicrafter and V-M. RCA stratoworld, 7-band a.c.-d.c., climatized portable, \$105.00. Webcor Holiday phonograph \$69.50. Send postcard describing wants. Free literature. Morgan & Brownell, Algonquin, Illinois.

**TWO** Way radio. No license to operate. Send \$1.00. Bullock's, 1910 Montgomery, St. Louis, Mo.

**TELEVISION** Interference eliminated with amazing, easily installed, guaranteed, antenna high-pass filter. Unbelievable! Only \$1.00 postpaid. BMB Co., Box 8, Hillside Manor Branch, New Hyde Park, N. Y.

**2-WAY** Intercomm. Uses no power. Pair \$4.95. plans \$1.00. Ray's, 6631 Ashbury, Afton, Missouri.

**COLOR** Television! Enjoy multi-color filter screen now. Easily attached. Send \$2 for your screen size. Satisfaction guaranteed. Dealers opportunity. Zingo Products, Johnstown 7, New York.

### BUSINESS OPPORTUNITIES

**MAKE** Money selling by mail; instructive booklet 25c. Manhattan House, P.O. Box 51-M, Saint Albans 12, N. Y.

**EARN** More money. 137 Elite plans. Free information. Jorine, Snyders Lake, Troy 4, N. Y.

**START** Small business. Stir your imagination with over 100 business plans. Free information. Shore Enterprises, Box 91-C, Little Ferry, N. J.

**MADE** \$24,500 Using money making plans from world's oldest mailorder publication. Schemer Magazine, Canfield 1, Ohio. Year \$1.00. Sample 20c.

**OWN** A garden golf business. Experience unnecessary. Brockway, Seaside, Oregon.

**WHERE** To buy at wholesale 100,000 articles. Free list. Also extra-income information. Maywoode, 1133 Broadway, New York.

**BE** First amazing mentalist. Exclusive territory. Profitably entertain. Mystic Hadley, Rehobeth Beach, Delaware.

**UNUSUAL** Homework opportunity, sparetime, men, women. Angora House, PM, Springfield, Illinois.

**MAKE** Rubber stamps, repair dolls; learn silk screen printing; invisible reweaving. Catalogue (60 ideas) free. Universal, Box 1076-A, Peoria, Ill.

**EARN** Money! Amazing plans! Easily mastered at home. Details free. Bruns, Room 612B, 216 West Jackson Boulevard, Chicago 6, Ill.

**OWN**, Operate, route Wishing Wells. Place these new \$8.50 skill games on counters in cafes, luncheonettes, clubs, etc. Collect coins weekly. Write, Legalsharr, Box 929, Long Beach 1, California.

**HOME** Business opportunity. Mail literature to auto owners. Everything furnished. Big earnings. Eastern, Box 142-F, Dorchester 24, Mass.

**WE** Love our mailman—He leaves over \$1,000.00 monthly in our rural mailbox. My college professor husband drafted a scientific home mailorder method. We bought a Texas ranch, live as we always wanted. Now we sell the Ranch Mailorder Method. Operates anywhere. Inquire: Eveningshade Ranch, Helotes, Texas.

**HAVE** New York address with mail service \$2 month. 516 Fifth Ave., Suite 1004, New York.

**OPERATE** Escalator mailorder system, selling our products or any products. Fastest, most revolutionary mailorder system known. Write: Selbyco, Decatur 161, Ill.

**YOU** Can be notary public. Information free. Magnolia Press, Box 1272-F, Burbank, Calif.

**MAKE** Money; sell by mail; Money Getter's, monthly magazine shows how! Sample 10c, 3 months 25c, year \$1.00. Hurry! Dispensa Co., 2020 Harbor Ave., Ashtabula, Ohio.

**\$25 WEEKLY** Working two hours daily at home. Lycke, Box 2471-A, Cleveland 12, Ohio.

**START** Your own profitable home mail-order business! We supply everything! Write today! Studio Products, Box 564-A, Glendale 5, Calif.

**WHOLESALE** Of sensational nationally advertised appliances, silverware, watches, cameras, etc. Start your own business. Full details. Send 50c for catalogue. International Sales Co., 175 Fifth Ave., New York 10, N. Y.

**HOW** And where to obtain capital? Free details. Star Service, Wapakoneta, Ohio.

**LIVING** Miniature ("Ming") trees only 10 to 20 inches tall. Grow at home. Big profits! Spare time opportunity. Fascinating! Amazing! Write for free seed and plan. National Nursery, Dept. FC, Inglewood 4, California.

**BUY** It wholesale! Manufacturers, distributors offer 850,000 items. Literature free. Olsen, 1231-A East Third St., Duluth 5, Minn.

**BREED** Rare tropical fish at home. Earn big money! Learn secrets! Help fill huge demand. Amazing opportunity! Free plan. Tropicals, 1008-F Los Angeles St., Los Angeles 15.

**INCOME** From local information. No selling. Write Neherco, La Verne, Calif.

**RESILVERING** Mirrors, formula 50c; two-way lookout mirrors, (No one sees you), 50c; coppered mirrors, 50c. All \$1.00. Nelko-Mir, Box 3462-J, Chicago 54.

**FIGURINE** Molds and many others, liquid rubber, statuary plasters, flock finishes, Glo-candle wax, etc. Illustrated catalog and "Plastercraft" manual free. Blue Rapids Supply, Blue Rapids, Kansas.

**START** Home manufacturing business. Make cleaners, soaps, polishes, cosmetics. Free literature. Kemix, Park Ridge, Ill.

**MAKE** Money spare or full time, casting metal toys and novelties. Big wholesale and chain store demand for autos, soldiers, ashtrays, banks, etc., keeps manufacturers busy. Production moulds furnished for up to 100 and more castings per hour. No experience or special place necessary. Write for information and illustrations of patterns needed. Metal Cast Products Co., Dept. A, 1696 Boston Road, New York 60, N. Y.

**NEW** Exceptionally profitable plans, ideas for home operated mail business. Rush name. Miller, 1772-P Carlyon Road, East Cleveland 12, Ohio.

**MAKE** Flexible molds! Cast plaques, bookends, figurines! Free sample! H. Tooker, 630-R Chestnut, Hamilton, Ohio.

**RECAST** Old batteries into new. Latest achievements. Battery Laboratories, Minneapolis.

**READ** "Advance"—The voice of mail order. Offers money-making opportunities, sources of supply, personal guidance, etc. Issued monthly. Sample copy 35c. Yearly subscription \$2.00. Advance Publishing Company, 313 East 21st Street, Suite 450, New York 10, N. Y.

**GOOD** Paying business silvering mirrors, plating autoparts, reflectors, bicycles, bathroom fixtures, etc., by late method. No tanks or shop required. Outfit furnished. Free booklet. Gunmetal Co., Ave. H, Decatur, Illinois.

**BUY** Wholesale. Thousands articles. Supply directory, 10c. Idealso, Park Ridge, Illinois.

**EARN** Extra money! "Homeworker Magazine" tells how. Sample 25c. Sizemore, Box 7, 4917 Kostner, Chicago 30.

**EXTRA** Money—No selling, operate vendors. Amazing profits, details free. Silver King, Suite 220, 622 Diversey, Chicago 14.

**OPERATE** Profitable mail order business. Write Walter Service, 4159-A East 112th, Cleveland 5, Ohio.

**DOLLARS** In personalized baby record books. Sell by mail. Use same literature we do. No-Co-Ro, Oakland 6, Calif.

**MINK** Raising information free. Complete. Lake Superior Mink Farm, Superior. EE1, Wisconsin.

**COPUBLISH** Leading m.o. paper, Lat-est copy. Mail Sale Advertiser, details, dime. Vanroy Shirk, Lebanon, Penna.

**COLORGLAZED** Concrete pottery made without molds. Patented method. Cemetery products, novelties, tiles. Basement leak-sealing. Money-making projects. Booklet, details free. Men only. National Potteries Company, Grand Rapids, Minnesota.

**FREE** Book "505 Odd, Successful Businesses." Work home. Expect something odd! Pacific, Oceanside, Calif.

**START** Venetian blind laundry. Profitable lifetime business. New machine. Free booklet. F. C. Co., 442 N. Seneca, Wichita 12, Kansas.

**137 PLANS** For starting home business. Details: Elite Co., 220 Grand St., New York 13.

**MAKE** Perfume. Sell on smell. Mail order or local. Wilson made \$7200.00 first year. Free sample, plan revealed. McCann, 4019-21 Rio Grande, Amarillo, Texas.

**LEARN** Metalizing baby shoes, gifts, etc. Bronze, gold, silver. Folio free. Kiktavi, 7217-PM South Broadway, Los Angeles 3.

**LIQUID** Rubber, make flexible molds. Free sample. Chaney, 1130 E. 16th St., Jacksonville 6, Fla.

**FIX** Typewriters. Free booklet describes our modern, inexpensive home-study course. Factory methods taught. Write Typewriter, Building 1, Tarentum, Penna.

**MONEY** In new greaseless doughnuts. Start in kitchen. No smoke. Sell stores. Free recipes. M. Ray Company, 3605 South 15th Ave., Minneapolis 7, Minn.

**POPCORN** And potato chip equipment. Long Eakins Company, 5360 High, Springfield 99, Ohio.

**START** A lettershop on a shoestring! Sales \$56,000. Started \$36.00. Information? Merritt, Box 13, Basking Ridge, N. J.

**MAKE** Money at home as renewal headquarters for all magazines. Big Christmas sales profits now. Liberal commissions. Supplies furnished. Write for free catalog. McGregor Magazine Agency, Dept. 500 B, Mount Morris, Ill.

**NATURAL** Molding latex. Tinsel, flock, supplies. Extra thick. Free sample. W. Wooley, 115-A Donald, Peoria, Ill.

**EARN** Big money by mail. Depression-proof income. Circular 10 cents. Complete starting deal \$3.00 postpaid. Reho, Box 21A, Whitsett, Penna.

**FREE** Electroplating information. Money making plans. Send postcard for your copy. Highly paid, interesting, uncrowded field. Plater M. Hyde, 327 West 120th Street, Los Angeles 61, California.

**FREE** Details! Home operated mailorder business. Successful beginner's plan. Everything supplied. Lynn, 10420-M National, Los Angeles 34, California.

**VENDING** Machines—No selling. Operate a route of coin machines and earn amazing profits. 32-page catalog free. Parkway Machine Corporation, Dept. 72, 715 Ensor St., Baltimore 2, Md.

**FLEXIBLE** Rubber moulds for plaster and Marbleite figurines. Sample and large illustrated catalog 25c, refunded on first order. K-C Novelties, Dept. 73, Easthampton, Mass.

**50 HOME** Mail business plans! Proven money-makers! Personal help assures success. Verdo, B-37A, Huntsville, Missouri.

**UNUSUAL** Opportunity. Sell by mail—Books, merchandise. Complete setups. Write Sherron, Box 343P, Bloomfield, N. J.

**BOOKKEEPERS**, Increase earnings operating sensational bookkeeping service. Kern, 4942 Vineland, No. Hollywood, Calif.

**LEFT** 8 Hour job to take 14 hour, and love it! Working for myself, at home, it's different. Special mailorder procedure we developed (spot-mailings from different points over United States) allows me much leisure, and double enough to live on. I'm showing others how. Write: Cirves, 2834 W. 65th, Chicago 29, Illinois.

**PEOPLE** Write us they'd like to live as we do, rural, tranquil, with our home business, and money coming daily in the mail, and would we show them how? Yes. If you have capital, at least for postage and mail-order circulars, we'll get you safely started. Inquire: Craig, Southern Pines, North Carolina.

**ESCAPE** Wage slavery. Easily. Operate your own profitable lifetime business. Free literature. Corley, H186 Ackerman, Clifton, New Jersey.

**HAVE** Home mail business—Get \$10 orders in every mail. Keep \$8.00. Everything furnished. Hutchinson, 401-A Adams, Dorchester 22, Mass.

**ASK** Your wife if you love your job. She knows. Then write me about the mailorder method I perfected in 1929, that's dropped \$1,000 into my mailbox every month since, that lets me stay home and enjoy life working for myself. I'll help you start. Rotoletter, 1160 Seward, Detroit 2, Mich.

**FREE** Vending machines; if used to sell our profitable nuts. Continental, Box 1361-A, Milwaukee 1, Wisconsin.

**BOOKKEEPERS**, Keep books, small firms spare time. Manual latest technique by C.P.A., \$3.00. Modern Business, Box 406, Youngstown 1, Ohio.

**FREE Booklet** — "How to Make Money by Raising Fishworms." Please include 25c for postage and handling. Flint River Worm Farm, Reynolds 5, Georgia.

**DON'T** Fail to read our advertisement under **Moneymaking Opportunities**. Procto Products Company, Box #543, Oak Park, Illinois.

**MAKE** More money! Operate a profitable spare time business from your home. Learn how you can buy at wholesale prices. Write today for free folder "F." The Giftery, P.O. Box 12, Cincinnati 13, Ohio.

**FACTORY** Distributors for Lubri-Loy. Amazing oil concentrated guaranteed to make any car run better. Sell to automotive service dealers for resale to car owners. Exclusive sales rights. Excellent repeat sales. Earnings over \$10,000.00 a year. Lubri-Loy Company, 6325 Wilson Ave., St. Louis 10, Missouri.

**BIG** Money—Amazing new home business. Pearl finish baby shoes. Free plan. Pearl Art, 7216 Bear, Bell 1, Calif.

**START** A buying service, buy wholesale thousands nationally advertised products. Make big profits selling at sizable discounts. Postcard brings details. American Buyers, 627-P Linden, Buffalo, N. Y.

**INDUSTRIALISTS** — Businessmen. Investigate Florida. Rapidly-growing Florida offers innumerable opportunities for business and large and small industries and a highly favorable tax situation. Write State of Florida, telling type of business you're seeking and specific requirements. You'll be put in touch with communities where opportunities exist and where you'll enjoy Florida's wonderful year-round climate. Free, complete information will be sent you. Write today: State of Florida, Industrial Development Division, 4314A Caldwell Building, Tallahassee, Florida.

**RAISE** Orchids—At home. Big profits. Fascinating. Year 'round any climate. No greenhouse. Instructions, including blooming-size orchid plant, sent for no-risk examination. Free details. Flowerland, 4622-DR, Wilshire, Los Angeles 5.

**EARN** Amazing profits by following our instructions; selling nationally advertised watches, etc. Enclose 25c, refundable; receive multi-colored salesman's catalog and confidential price list. Result Sales Co., 580 Fifth Ave., New York.

**BE** Your own boss! Huge assortment home-business plans. Free details. Green Enterprises, 179 Fillmore Street, Yonkers, N. Y.

**WANTED!** Men-women! Read how others have made big money in their own home plastics business. Spare or full time. There's still room for you. No experience or special education needed. (Also colorful liquid marble details and beautiful plastic tile sample.) Free catalog. Write today! Bing Products, PM-1053, Watertown 72, Mass.

**FREE!** "301 Profitable Small Businesses!" Amazing shoestring plans! Work home! Start sparetime! Deumant Surveys, Kenmore 23-PM, N. Y.

**HOW** To raise needed funds. Free details. Enterprise Bureau, Syracuse 2-P, N. Y.

**LEARN** Refrigeration mechanics. Complete illustrated course. Free booklet. Mechanics School, 7217-PM South Broadway, Los Angeles 3.

**BIG** Profits, manufacture night glowing varnish. Chemicals, formula, \$1.00. Ceramic Products, Box 6321, Birmingham 7, Ala.

**100 FINEST** Steel double edge razor blades \$1.00. Carl Bohman, 110 Union Street, Schenectady, New York.

**FREE** Folder "How to make \$2400 per year selling \$1 books by mail." Wieland, 7601 Main, Kansas City 14, Missouri.

**SELL** Popular Mechanics and all other magazine subscriptions. Free catalog, supplies. Subscription Service Company, Dept. A, P.O. Box 2070, Birmingham, Ala.

**BUY** Wholesale from nationally advertised manufacturers, distributors. Literature free. Carter Publications, Box 6011-F, Chicago 80.

**SPARE** Time business. No investment. Details free. Howell, 1320 St. Andrew, New Orleans 13, La.

**MAKE** Money at home. Easy; pleasant; profitable. Paton, Box 55-E, New York 23, N. Y.

**START** Home mail order business. Details. Gedgard, Box 798-X, New York 1, N. Y.

**SAVE** Postage. Register your name with us. Receive mail dealers best offers without writing them. Only 25c. Falcon House, Winnebago, Ill.

**WANT** Profitable hobby? Try weaving potholders. Card brings particulars. Morgan's Hobby Supplies, Dept. C, Indiana, Penna.

**BUY** 250,000 Articles wholesale. Directory 10c. Publishers, Box 1486-P11, Detroit 31.

**BRONZED** Baby shoe supplies, instructions, mountings. Metal bookends, \$1.50 pair. Free catalog. National Bronze Supply, Box 56, Los Angeles 32, Calif.

**LIQUID** Marble—Colorful, glossy! Molded, brushed, sprayed! Cast novelties, statuary, colored tiles. Flexible molds. Composition floors. Particulars free. Marbleizing Service, Edwardsville, Illinois.

**MAKE** Tough, durable plastic—1c pound. Makes attractive floors, walls, built-ins, roof. Build good home \$150.00 room. Bays Laboratory, Oklahoma City 9.

**IMPORTING**, Exporting! Profitable details free. Warner's, Box 6, Fort Scott, Kansas.

**PERFUMERS**; Cut costs, 500 fragrances, supplies. Box 3267, San Diego, Calif.

**PROFITABLE** Home mail business. Details free. Service Bureau, Box 596, Toronto, Canada.

**GROW** Plants, flowers. Details free. Shiffer, Box 129, Millersburg, Penna.

**FISHWORMS**. Breeders 100 — \$1.00. Manual \$1.00. Postpaid. Literature free. Dixdok, Kent, Ohio.

**QUICK** Money! Repairing car batteries. At home! Easy, too! Batteryman, Grand Junction, Colorado.

**WHOLESALE** Prices — Known brands television, appliances, jewelry, sporting goods, furniture, etc. Send \$1.00 large catalog. Hamilton Sales Company, York, Nebraska.

**\$50, \$100 WEEKLY** Possible. Get indisputable proof immediately. Exciting information 3c stamp. Harrison, 980 Empire, Benton Harbor, Mich.

**OPERATE** Profitable garden, experience unnecessary. Proven plans sent you. Yusko Products, R#3, Streator 18, Illinois.

**EARN** Money at home, making rhinestone jewelry. Free catalog. Ebert, Box P183, East Orange, New Jersey.

**TYPISTS** Become public stenographer. Shorthand unnecessary. Unique, profitable. Free with purchase "Typewriter Profits" \$1.00. Arnolds, Box 524d, Sacramento 6, California.

**MAGAZINE** Agents. Largest commissions. Bonus. Qualified Publications, 451 A Kingston, Brooklyn 25, N. Y.

**OPERATE** Profitable collection agency. Become co-partner! Interesting details. Write: Edmondson, Box 4865-P, Atlanta 2, Georgia.

**"HOW** To Build Your Own Mailorder Business." 25c. Guaranteed. E. Merrill, Coldbrook Road, Bangor, Maine.

**YOUR** Own 200% profit business. Imported real feather bird pictures. Sample 20 cents. With hand carved frame and glass, \$2.00 value, \$1.00 p.p. Free details. Specialty Products Co., 301 New Market Ave., So. Plainfield, N. J.

**MAKE** Money sharpening saws at home, spare or full time. \$100 starts you. No selling. Free booklet tells how. Victor Foley Company, Columbia Heights, Minnesota.

**LEARN** Sewing machine repair, electrify, rent, trade, sell. Make up to \$150 week spare time setup. Motor kits, zigzag machines, etc., wholesale. Free particulars. Taylor Service, Hamilton PM-11, Ohio.

**START** Your own business on credit. Your own boss. 1658 of our dealers sold \$5,000 to \$27,500 in 1952. We supply stocks, equipment on credit. 200 home necessities. Sales experience unnecessary. Pleasant profitable business backed by world-wide industry. Write Rawleigh's, Dept. K-U-PPM, Freeport, Ill.

**IMPORT-Export!** Opportunity, profitable, world-wide, mail-order business from home, without capital; or travel abroad. Established World Trader ships instructions for no-risk examination. Experience unnecessary. Free details. Mellinger 70B, Los Angeles 24.

**INVISIBLE** Reweaving in big demand! Cash in servicing laundries, cleaners, stores, homes. Make tears, holes, cuts disappear from fabrics. Earn up to \$10.00 in an hour. Details free. Fabricon, Dept. C-11, 8342 S. Prairie, Chicago 19, Illinois.

**MAKE** Perfume. Catalog free. International, 6347 Farnell-PM-11, Chicago 21, Illinois.

**PERMANIZE**, Ceramize, porcelainize, metalize baby-shoes, crochet items, hundreds of keepsakes. No baking, no firing. Fantastic profits. Details for 25c. No equipment to buy! Jay Sales, Dept. 2-M, 192 N. Clark, Chicago.

**NEWEST** Spare, full-time home business. \$5 to \$10 hour possible. Paint with suede—The finish with touch and eye-appeal. Beautify auto dashboards, signs, radios, toys, figurines, lamps—1001 others. Complete, step-by-step instructions sent for no-risk examination. Free details. Coast, 1004-HX So. Los Angeles St., Los Angeles 15.

**ADVERTISING** Book matches—Cash in on big demand; sell union label matches. Cuts for all businesses and political parties. Free powerhouse selling kit, low prices, protection guaranteed on repeat orders. Cash commissions. Superior Match Co., Dept. MX-1153, 7530 Greenwood, Chicago.

**PROFITABLE** Opportunities, magazines—Dime. Far Hills, Box 544-MC, Dayton 9, Ohio.

**EARN** \$50 Weekly in spare time. Lifetime vitamin business. Details free! Emm-Bee, Dept. PM, Box 992, New York 8, N. Y.

**MAKE** Products. Sell mailorder. Formula catalogue free. Imasco, 6347 Farnell-PM-11, Chicago 21, Illinois.

**COLOR** Concrete with chemicals. Marble-glaze cement benches, pottery, garden ornaments. Home — shop. 10c brings sample, pictures. Hollywood Cementcraft, 8527-R Wonderland, Hollywood 46, Calif.

**BUY** Wholesale thousands nationally advertised products. Save money! Make money! Postcard brings details. Kemah Company, 5017-P Washington, Houston 7, Texas.

**SUNNY** California land bargains as low as \$5.00 per acre. Low down payments—Low monthly payments. Write for free information. Land Department, Suite 105, 1540 N. Highland Ave., Hollywood 28, Calif.

**BARGAINS**. Big monthly tabloid paper lists hundreds bankrupt, closeout, wholesale bargains. Many bargains 15c-20c on detail dollar! Lists sources 100,000 items wholesale, 6 months, \$1.00; 1 year \$2.00, regular \$3.00. Tower, Box 591-SH, Lynn, Mass.

**WHAT'S** Your field of interest? Whatever it is, specialized magazines will help you to greater success. Look over current copies of those covering your field through our easy-to-get-acquainted service. Choose from 4,387 publications covering all fields—business, vocational, agricultural, sports, hobbies, etc. Write for current list. It's free. Commercial Engraving Publishing Company, 34C North Ritter, Indianapolis 19, Indiana.

**\$1000 MONTHLY!** Successful nationwide business. Puraclean, 17-B East 42nd, New York 17.

**\$10,800 PROFITS!** Your own mailorder business! No risk! "Success Plan" free! Treasury, 709 Webster, New Rochelle LB-1, New York.

**NEW** Warm kitchen without extra heater. Even Temp. Manufact., Thornburg, Ark.

**SENSATIONAL** Television development! Instantly eliminates annoying commercials. Free details. Franklin, 2156-B, Los Angeles 54.

**LET** Others sell for you. Earn steady from home. Full set-up service from idea to success. Free information. Hermes Company, 152-H West 42, New York.

**MAILORDER** Business book. Full information for the beginner. Write Brown's Agency, Box 491, Tacoma, Wash.

**EARN** Money with typewriter — Sewing machine! Details free. Edwards, 3915-PM, 12th, Des Moines 13, Iowa.

**LEARN** Mailorder. Moneymaking opportunity. Work home. Literature free. Addison, 1840-P Addison, Chicago 13.

**OPERATE** Profitable mail order business. Splendid opportunity. Details. Write Frank Hawkins, 2806 Wenzel, Kansas City 3, Mo.

**SUCCESSFUL** Money-making plans. Home or mail-order. Details free. Stowell's, Woodstock, N. Y.

**BE** Notary public. Rate higher. Details free. Stationers, Helotes, Texas.

**WANTED!** Men—women! Read how others have made big money in their own home plastics business. Spare or full time work. There's still room for you. No experience needed. Free catalog. Write today! Bing Products, PM-1153, Watertown 72, Mass.

**STERLING** Silver religious medals, chains, gift boxed. \$2.90 retailer, \$1.00 ppd. Imprints, drop shipments. Unique, 472-A Hendrix, Brooklyn 7, N. Y.

**WANTED!** Home producers, by manufacturers in our clearing house service. Become a subcontractor, casting plastic products for these companies. Thousands of easy-to-make items required for consumer and industrial use. Cash in at home, without previous experience. Write Plastic Service Associates, Dept. PM8, East Boston 28, Mass.

**FOOD** Mailorder business. Home operated. Everything supplied. Successful proven plan. Free details. Frazar Foods, Desert Springs 10, California.

**BUY** Nylons direct from mill. Good profits. Quick delivery. Write for jobbers prices. Joy Hosiery Mills, Delawanna 38, New Jersey.

**SELL** By mail. New 10,000 word booklet shows how. At home. Sparetime. Small capital. 25c. Satisfaction guaranteed. Vernon-Hall, Box 193M, Abington 11, Penna.

**EARN** Big money resilvering mirrors. Instructions and formula \$1.00. Ray Fuiks, Box 248, Buffalo, Texas.

**CATALOG** Of top mail order plans and folios, proven and tested. Stamp please. Lindholm Service, P.O.B. 2504, St. Ann Station, Minneapolis, Minn.

**CLEAN** Watches for profit. Solvent and directions \$3. General Chemicals, Box 827, Pittsfield, Mass.

**START** A telephone answering service in your home. Profitable life time business. Postcard brings details. Telephone Answering Service Consulting Co., Box 293-1, Lexington, Mass.

**WE** Pay \$5.00 for some names. Make steady income sending us names. We buy thousands. Pacific, Box 73136, Los Angeles 3.

**\$46 FROM** Square foot plywood; jigsaw necessary. Write: Woodarts, Bridgewater, Mass.

**FREE** Instructions—Metallizing baby shoes. Mountings. Fosters, 1520 Ardmore, Chicago 26.

**QUICK** Sign painting. Use letter patterns, avoid sloppy work, wasted time. Write for sample. John Rahn, A1330 Central, Chicago 51.

**COPUBLISH** The Advertiser. Free advertising. Sample paper and plan 10c. Eagle, 751-P Jackson, Bronx 56, N. Y.

**NEW** Gift item. Just out. Free details. Boyd's, Galena, Missouri.

**EARN** \$200 Weekly operating your own buying service. No investment needed. Postcard brings free details. Citizen Buyers, Box 4523, Oklahoma City, Okla.

**MAKE** Perfumes and cosmetics at home. Write, Carey Laboratories, 1914 Chouteau, PM-11, St. Louis 3, Missouri.

**LEARN** Piano tuning at home in five weeks. Big demand. Earn \$6 hour full or spare time. Write: Empire School, 602E University, Champaign, Illinois.

**CASH** In during coming income tax season. Establish profitable dignified tax return business. Experience unnecessary. Free prospectus. Union Institute, Lakewood 2-E, N. J.

**INTERESTING** Literature, novelties, magazines, catalogs, 25c. Ohio Sales, Box 116, Kent 4, Ohio.

**ELECTROPLATING.** Profitable home business. Auto parts, novelties, giftwares, mirrors. Easy, inexpensive home processes. Free booklet. Tyco Metals, Box 13231-MK, Houston 19, Texas.

**SUNNY** Florida, healthful, cheaper. Spend winter! Furnished apartments \$35.00 week. Reservations, near ocean. Information. Pal Parker, Flagler Beach.

**STOP** Money worries! Own profitable business. Easy at home mail order sales. No merchandise investment. Write Specialty Products, PM-3, Mt. Holly Springs, Penna.

**BUILD** Luggage and cases at home. We sell your products. No special tools or equipment needed. Free details. Casecraft, 805-AB Sunset Blvd., Los Angeles.

**PROFITABLE** Countrylife, security, happiness. 100 tested plans. Inquire, Hermes, 152-L West 42, New York.

**FREE** Mailing lists! Directory gives over 300 sources furnishing millions of mail order prospects without charge. Write for full information. Research House, 3810 Merrill, West Palm Beach, Florida.

**ORGANIZE!** Guaranteed steady profitable renting-repairing-selling service of tools, appliances, supplies, instruments, etc. Everyone needs them! Complete course; first lesson free. Alltools, Box 268, New York 5.

**NOTICE:** Get, use, sell Missionary Scheall's new \$5.00 guaranteed automatic fire extinguisher grenades. Buy one, get three. Write Scheall, 263XX, Duluth, Minnesota.

**EARN** \$2.00 Hour! I do, making sandals. Youngs, 1308-PM, South First, Arcadia, California.

**FREE** Catalog! 50 home money-making opportunities! Maxson, Box 488, Falls Church 25, Virginia.

**100 TESTED.** Money-making plans. Dime. Regal, Box 173, Royal Oak, Mich.

**FORECAST** Cost of advertising your product, invention, business. Advertising Computer reveals typical rates. Covers 50 magazines, newspapers, radio, television stations. Useful! \$1.00. Adagency, Box 418, Seattle 11, Washington.

### MONEYMAKING OPPORTUNITIES

**LEARN** Professional candy making, profitable home business. Details free. Pate, Kissimmee, Florida.

**MAKE** \$2600.00 A year spending 5 hours a week. Start at home. New machine. Small investment. Free booklet. A.X. Co., 442 N. Seneca, Wichita 12, Kansas.

**DON'T** Be Mr. Average Man. Operate your own business. New field, sensational sales potential, highly profitable. Very desirable, non-perishable, no chemicals or liquids. High-grade proposition for men not afraid of earning \$10,000 and up annually. Can you recognize real opportunity? Postcard will bring details. Protecto Products Company, Box #543, Oak Park, Illinois.

**FREE** Folder. Dozens of new, different ways to make money at home. Write, Pomona Publications, Box 357-B, Pomona, California.

**STOP** Shopping! See our complete catalog of spare time opportunities. Free. Rush postal. Lewis Enterprises, P.O. Box 2367, Portland 14, Oregon.

**HOW** To earn up to \$500 for each script writing for television. New, different. Particulars free! Wonderful Products, Box 2113, Santa Fe, N. M.

**SELL** Jewelry by mail. Big demand, every woman buys. Everything furnished. Eastern, Box 142-D, Dorchester 24, Mass.

**CHURCHES,** Women's clubs, receive \$100.00 to \$500.00 and 24-card tables. Unique plan. Pine Hill, New Jersey.

**101 WAYS** To make \$1,000 at home. Details free. Business Surveys, 365 S. Fairfax, Los Angeles 48, Calif.

**HAVE** Money-making home mail business. Complete idea. Mailbox service. Personal help assures success. NMD Agency, Box 88-A, Dorchester 22, Mass.

**START** Your own business manufacturing driftwood lamps. Kit \$7.50. Sam Patchett, 2187 N.W. 24th Court, Miami, Florida.

**WOULD** You see your boy in your job? Does the job satisfy? Inspire you? Bring \$1,000 paycheck? My modest home mail-order does. In 24 years I've learned to avoid mistakes, cut corners, conduct a profitable, satisfying operation. If desired, I'll help you start, guide you. Thomas Cummings, 3070 Felton, Salem, Oregon.

**BORROWED** \$45 For stamps and circulars. To date sold quarter million dollars—In small orders! All from home, by novel mailorder method where we supply circulars to mailers in certain key positions. Orders come automatically, average \$40 daily. Now we're showing others how. Details free. Hometrend, Marshall, Illinois.

**DIME** Brings our nationally advertised opportunity packet. Rinehart, 235 Baltimore, Hanover, Penna.

**SELL** Titania gems: \$9.75 carat wholesale. More brilliant than diamonds. Free catalogue. Diamonite, 1404-M Mitchell, Oakland 1, California.

**50,000 ARTICLES** Wholesale. Source directory, dime. Nelko, Box 3462-DR, Chicago 54.

**FOUR** Ways to increase your income at home. Free details. Dixie Mailers, King, N. C.

**SCHOOL** Seniors—Sell classmates America's most beautiful graduation name cards. Largest selection. Highest commission. Outsell all others. Free sample kit. Printcraft, Dept. M, 1509 Maple Street, Scranton 5, Penna.

**MONEY** Found. Be our agent in your community. Top quality watches, diamonds, jewelry, etc., at wholesale prices. Amazing profits. No age limit. Experience unnecessary. Send for free catalog. Zerah Brothers, 602 Mission Street, Dept. 81, San Francisco 5, Calif.

**READ** Progressive Mailtrade, the magazine that tells how to make money by mail. Dime brings sample and special offer. Progressive Mailtrade, Box 357, Sheboygan, Wisconsin.

**START** A profitable subscription business in spare time! We need men and women (young or old) as representatives for all leading national magazines. Liberal commissions paid for new and renewal subscriptions. Start earning money in this pleasant work at once! Clip this ad and send with your name and address to: International Circulation Distributors, Dept. PM, Hearst Magazines, 250 W. 55th St., New York 19, N. Y.

**FREE** Book "505 Odd, Successful Businesses." Work home. Expect something odd! Pacific, Oceanside, Calif.

**137 PLANS** To make money, local mail-order. Details: Elite Co., 220 Grand St., New York 13.

**PUBLISH** Your own magazine. Handsome 52 page format, well edited, illustrated. Cost low as \$1.00 month. Brings you prestige, profits. 25c brings sample, details. National, Ord, Nebr.

**PAUZE** Liquid styptic stops bleeding quickly. Fast profits. Sampler 25c. Pauze, 1545-F Echo Park Ave., Los Angeles 26.

**MAILORDER**—Operate profitable home business using free advertising method reaching millions. Revealing information free. H. F. Seidel, 7070 Hollywood Blvd., Hollywood 28, California.

**22 MILES** Out of city I live, yet walk to work daily, to my office, a renovated barn 50 feet away! I planned it that way. We organized a home mailorder, a rare kind, branch-style. United States Postal Service approved. Grosses \$1,000 monthly. Organization duplicatable using other products. Inquire: Kerr, Gering, Nebraska.

**MAKE** Money at home by mail. Fast, easy. Liebig Industries, Beaver Dam 4, Wisconsin.

**MAKE** Cosmetics in your kitchen for own use or to sell. Easy, profitable, not seasonal. Ingredients available at drug stores. Twenty one formulas and instructions \$1.00. Moffet, 429 N. Gilbert, Danville, Illinois.

**MAKE** To \$4.50 hour doing common pen lettering. National Artists, 801½-A North Marsalis, Dallas 3, Texas.

**EXTRA** Income! Become a notary public! Complete details, your state, 50c! Filmer, 910 Marion, Pharr 10, Texas.

**GET** Facts—\$4.00 merchandise, \$2.00 treatise 100 money makers, \$6.00 value \$2.00. Kohne, 506 West 45th, Chicago 9.

**SPARETIME** Profits taking subscriptions, all magazines. Wholesale catalog free. Cassell Agency, Westfield 2, New Jersey.

**ROSARIES**—Make your own! For gifts, fun, profit! See complete line of religious goods, gold-filled and sterling rosary parts. Medals, books, statues, novelties. Big group of make-it-yourself items. Send 10c for new wholesale illustrated catalogue just off the press, bigger than ever! Greylock Creations, Box 1048-PM, Pittsfield, Mass.

**FREE!** "301 Profitable Small Businesses!" Amazing shoestring plans! Work home! Start sparetime! Deumant Surveys, Kenmore 23-PM, N. Y.

**"DOLLAR** Maker Tips." Stamp brings details and free gift. Flatwoods, Leesburg, Fla.

**FREE** Samples, diagrams, instructions. Completely new, enormously profitable business. Send 25c coin for handling. Hobby, 243 S. Lexington, St. Paul 5, Minn.

**STRANGE** Dry window cleaner. Sells like wild. Replaces messy rags, liquids. Simply glide over glass. Samples sent on trial. Kristee, 180, Akron, Ohio.

**BUY** Printing and office supplies wholesale. 10,000 items. Details free. Royal, Box 368-A, Cleveland 27, Ohio.

**START A buying service, buy wholesale thousands nationally advertised products. Make big profits selling at sizable discounts. Postcard brings details. American Buyers, 630-P Linden, Buffalo, N. Y.**

**\$1,000, \$4,000, \$10,000 BEING Made spare time at home. Simple mail-order secrets shows you step by step. Details 25c. Port Books, P.O. Box 453, Port Chester, N. Y.**

**EARN Money evenings, copying and duplicating comic cartoons for advertisers. Adservice, Argyle 1, Wisconsin.**

**CASH In. Get into mail order business—68 page book reveals business secrets, effective advertising, what to sell, beginners advice. Numerous tested and original money-making plans. Over 40,000 words. We'll include other helpful literature. Send only 25c to: Par Products, 2185 Bolton St., New York 62, N. Y.**

**EXTRA Money. No selling. No investment. Details free. Progressive Ideas, 51-A Clover Hill, Mt. Holly, N. J.**

**FREE Folder! Make money at home. Samuel Tell, Guaynabo, Puerto Rico.**

**TYPEWRITER Owners. Make handsome profits. Get details today. Groves Company, 682, Hastings 8, Nebraska.**

**FOREIGN Employment construction work. If interested in foreign projects with high pay write Foreign Service Bureau, (Dept. P.M.), Metuchen, New Jersey.**

**GENERAL Contest Bulletin. Issued monthly. Sample, 10c. 1609½ East 5th, Duluth, Minn.**

**FREE! Complete mailorder business! Terrific profits! No investment. Write today. VitaMins, 2908-PM Beverly Boulevard, Los Angeles 57.**

**BE Appointed notary public, your state. Greatly reduced costs. Thrilling experiences. Additional income. Men, women. Young, old. Write Box 3025, Dallas 1, Texas.**

**101 WAYS To make \$1000 at home. Details free. Business Surveys, 365 So. Fairfax, Los Angeles 39, Calif.**

**MINIATURE Trees—Why pay \$2.00-\$5.00 for growing secrets? Free details. Bassett, Dept. B, 5038 N. Winthrop, Chicago 40.**

**500% PROFIT! Boxed jewelry. Catalogue free! Jewelry-of-Season, 703 Industrialtrust Building, Providence, R. I.**

**MAKE T.V. antennas. Huge profits. Kit for 3, \$4.95. Plans \$1.00. Ray's, 6631 Ashbury, Affton, Missouri.**

**BUY Wholesale—Thousands nationally advertised items. Save, make money! Free details, Durex Co., Box 672-G, Chicago 90, Ill.**

**ORNAMENTAL Iron railings. Highly profitable business. No special tools required. Complete instructions \$1.00. Befro, Box 45, Fond du Lac, Wisconsin.**

**MAKE Money rehandling crooked pictures in offices, homes, hotels, etc. New, patented picture hanger keeps pictures straight permanently. Thousands being sold. Profitable wholesale and mailorder opportunities. 25c gets demonstrator and full information. Select-A-Level, 1122 National City Bldg., Dallas, Texas.**

**EARN \$50 Weekly in home operated mail business. We show you how. Write Lewis Bartlett, Richland, Georgia.**

**\$10,800 PROFITS! Your own mailorder business! No risk! Success plan free! Treasury, 709 Webster, New Rochelle, PM-17, N. Y.**

**FREE Folder! How to make thousands yearly selling by mail the way that pays. Fullmer, 92-A, Greenwood, Pocatello, Ida.**

**"HOW To Make Money With Simple Cartoons"—A book everyone who likes to draw should have. It is free; no obligation. Simply address Cartoonists' Exchange, Dept. 911CM, Pleasant Hill, Ohio.**

**GROCERIES Without cost! Guaranteed! Free information! Jaydee, Box 664, Woodland 3, California.**

**400 RADIO Stations active. Free radio advertising. Pay commission only on orders received. Free information. Mishek, 2, Waseca, Minn.**

**BUY Wholesale! Nationally advertised products. Tremendous discounts. Particulars free. Econ-O-Mart, Box 535B, Morristown, New Jersey.**

**AFRICAN Exports—Wholesale leather goods. Send \$3.00 for sample and literature. Drown, B.P.O. Box 302, Tangier, Morocco.**

**BUY Wholesale thousands nationally advertised products. Save money! Make money! Postcard brings details. Kemah Company, 5017-L Washington, Houston 7, Texas.**

**MAKE Money at home, it's easy. I'll show you how and help you. Write: Allen, Box 4A, Houma, Louisiana.**

**CEYLON Curios, gems. American testimonials. Unique opportunity. John Rajapakse, Negombo, Ceylon.**

**BEAUTIFUL Feather pictures. 200% profit! Free sample. Apartado 9036, Mexico 1, D. F.**

**ATOMIC Energy Commission expanding rapidly. Types of commodities you can sell and who to contact. Start small, grow big. \$1.00. Sandy Sales and Services, 1016 N. 8th, Mt. Vernon, Ill.**

**HOUSEWIVES! Make Xmas money! Toy samples. Unique sales plan \$1.00! Hurry! Kringle Products, Box 575, Hollywood 28, California.**

**NEW Plastic engraving, carving machine, "Dupliscaler." Fun and profits carving plastics! Details, sample 25c. Desco Distributors, 6334-Y Sepulveda, Van Nuys, Calif.**

**BUILD Fireplaces—The very best, for yourself and others. Scientific principle, different. Heats wonderfully well, does not smoke, no metal shells or dampers, build of rock, brick, etc. Instructions with working model \$4.85. Master Fireplaces, 730 State St., Bellingham, Wash.**

**33 IDEAS For home workers. Free details. Sterling, Great Neck 57, N. Y.**

**WINNING Prize contests is fabulous, confidential, home opportunity! Send stamp! National Contest Bulletin, Box 2685-P, Miami 16, Florida.**

**THE Newest most practical, most fascinating carving knife ever made. Write Harold's Supply Company, Box 2644, South Bend, Indiana.**

**SCHUHMACHER Matmakers. Convert old tires into dollars. Devote full or spare time. S and S Patents, Inc., 1307 North Clark St., Chicago 10, Ill.**

### FORMULAS, PLANS, ETC.

**PERFUME Manufacturing formulas. Fragrance Research Foundation, 1513 Oxford Way, Oklahoma City, Oklahoma.**

**FORMULAS: Big demand, easily prepared, profitable. Free list. Wall, 304N 27th Street, Alabama City, Alabama.**

**REAL Manufacturing formulas. Lists free. Cummings, Chemist, Gordon Ave., Syracuse 4, N. Y.**

**ANY Formula \$3.00. Chemical Instruction Sheet—catalog 10c. J. Belfort, 216 W. Jackson, Chicago 6.**

**FREE Formula catalog. Anything analyzed \$35. Western Chemical, Salem, Ore.**

**LABORATORY Tested formulas. Catalog free. Pont Chemical Company, Terre Haute 2, Indiana.**

**MODERN Formulas for many new and unusual business-building products. Fifty years supplying the best. Literature free! Liscomb Miller, Chemist, Tampa, Florida.**

**500 MONEY Making formulas, 25c postpaid. Allen, Dept. PMC, Clinton, Missouri.**

**FORMULAS; All kinds. Latest, best. Literature free. Kemixal, Park Ridge, Ill.**

**GENUINE Manufacturing formulas. Latest. Literature free. Nelko, 3462-P Merchandise Mart, Chicago 54.**

**SALTED-In-the-shell peanuts. Learn this interesting and secret process direct from the man with over thirty years experience. A formula of inestimable value. Send \$1.00 for complete details of process and instructions to B. & W. Nut Co., 932 S. Wilder St., St. Paul 5, Minn.**

**YOUR Future in money making formulas. 200 of the best \$2.00. List 25c. Marbill Mail Trade, 6660-A Winch St., North Burnaby, B. C., Canada.**

**ANY Formula. Jack, Consulting Chemist, 5138 Gainor Road, Philadelphia 31, Penna.**

### PLASTICS

**FIBERGLAS, Polyester, Plexiglas, Acetate, Vinylite; casting, coating plastics: My own Fiberglass "how" book now ready, \$2.50. Fast service, best prices. Catalog 10c. Airmailed 35c. Gem-O-Lite, Box 6867P, North Hollywood, California.**

**PLASTIC, Sheets, rods, tubes, etc. Free list. Plastic Supply Co., 2901 N. Grand Blvd., St. Louis 7, Mo.**

**PLEXIGLAS Sheets—Cut to size. Clear. All thicknesses. Standard outdoor translucent colors. McClarin Plastics, P.O. Box 168, Hanover, Penna.**

**DIRECTORY Of manufacturers, for liquid plastics, liquid rubber, wholesale. Castleo, 2139P, Paterson, New Jersey.**

**PLASTICS, Cements, dyes, findings, carvings. Wholesale prices. 64 page catalog free "Trace and Carve" pattern book for carving and coloring fish, birds, animals, only 35c. Taylor & Art, Inc., 1710 East 12th Street, Oakland 6, California.**

**LEARN Plastics at home. Complete course—\$5.98 postpaid. Dime brings sample plastic, three experiments, full details. Plastic Projects, Box 5151, Detroit 35, Mich.**

**PLEXIGLAS, Lucite. Any size sheets. Square foot (12 x 12) cost, 1/16" \$1.18, 1/8" \$1.55; 3/16" \$1.90; 1/4" \$2.25. Add 15% for postage. Minimum order \$3.00. Almac Plastics, 600 Broadway, New York City.**

**PLASTICS Home-craft course for men and women. Tells and shows how to make hundreds of fast selling plastics products. All plastics and materials for 23 projects included in course. No special tools needed. Course pays for itself. Write for free booklet. Interstate Training Service, Dept. D3M, Portland 13, Oregon.**

**NEW Liquid casting plastic. Clear, colors. Embed flowers, insects, coins. Saw, drill, carve. Send 25c for Castolite Creations Manual and proved success plan showing how to make money at home. Castolite, Dept. M-101, Woodstock, Ill.**

**UNUSUAL Christmas decorative materials fill our complete catalogue. Van Horn Plastics, 1905 Ingersoll, Des Moines, Iowa.**

### CHEMISTRY

**CHEMICALS And apparatus for industrial, analytical, and private laboratories. Catalog 25c. Dept. M-50, Biological Supply Co., 1176 Mt. Hope Ave., Rochester 20, N. Y.**

**ILLUSTRATED Catalog: Chemistry, mineralogy, biology. 10c. Tracey Laboratories, Evanston, Illinois.**

**NEW Idea chemical and apparatus outfits for home experimenting. Photo-scales, microscopes, chemicals, biological and laboratory supplies in small quantities. Catalog 25c. Established 1931. John H. Winn, 124A West 23rd Street, New York, N. Y.**

**SPECTROSCOPE For quick chemical analysis \$3.00. Kutting Sons, Los Altos, Calif.**

**CHEMICALS, Supply catalog, 15c. Laboratory Sales, Box 161-A, Brighton, Mass.**

**IMPROVED Second printing, "Spectacular Chemical Experiments" manual. Not mimeographed sheets. Contains complete formulas, set-ups, data, on thermites, fulminates, explosive powders, etc. Still \$1.00 postpaid. Chemi-Technix Laboratories, 568CJ Riley, Buffalo 8, New York.**

**AMAZING New book of science. Experiments, formulas and catalogue of laboratory supplies. Only 25c. National Scientific Co., Dept. 16, 2204 W. North Ave., Chicago 47, Illinois.**

**CHEMISTRY Step by step: A painstakingly designed course for those denied formal schooling in this modern giant among the sciences. Not a plaything. Not a toy. Fascinating, absorbing, breath-taking experiments. A whole new world of exciting adventure. Cultural. Practical. First lesson free. Parkway Laboratory, 1004 Second Ave., Pittsburgh 19, Penna.**

### AGENTS WANTED

**YOU Can make a fortune if you join us now. Sell sensational new \$4.95 non-electrical burglar alarm. Tremendous sales. Federal Products, Evanston 2, Illinois.**

**NEW Plastic mending tape. Just press on! Repairs clothing instantly. Lightning seller. Samples sent on trial. Kristee 125, Akron, Ohio.**

**EASY Handwork makes fast-selling useful articles. Sample free. Sunmade Company, Brockton 64, Massachusetts.**

**AGENTS Wanted: Sell household appliances. Send for wholesale catalog. Nueblings, Sicklerville-P, N. J.**

**FOG-Stop windshield cloth. Instantly removes blurry mist, frost, sleet, snow. Stops windshield fogging. Samples sent on trial. Kristee 124, Akron, Ohio.**

**101 WAYS To make \$1,000 at home. Details free. Business Surveys, 365 S. Fairfax, Los Angeles 49, Calif.**

**SENSATIONAL** New plan! Large wholesaler of appliances, cameras, watches, etc. will start you in new type of business. No selling. Free details. Cam Company, 6806PM-20th Ave., Brooklyn 4, N. Y.

**SCHOOL Seniors**—Have fun and spending money! Be popular with your classmates. Send postal for details. Craftcards, Box 235-L, Pittsburgh 19, Penna.

**STRIKE** It rich with flannel backs. Scientific tablecover marvel not plastic, not linen, better than either. Outlasts 16 years scrubbing. Show free samples. Take orders. Pocket juicy profits. Styleco, Dept. 399, Cincinnati 10, Ohio.

**PRINTING**, Salesbooks, envelopes. Free illustrated catalog. Ersco, Dept. PM, Bronx 72, N. Y.

**GOLD**, Silver lacquered letters. Windows, doors, trucks. Standard sizes. Penny and up. Big profits. Samples. Atlas-D, 544 West 79th, Chicago 20.

**MAKE** Extra money. Sell front door name plates to friends, neighbors. Retail \$1.98; you make \$1.00! Free selling kit. Modern Engraving Co., P.O. Box 194, Boston 14, Mass.

**ABSOLUTELY Free**—Sales kit. Yours for the asking. Send postcard today requesting kit showing new line, belt buckles with your name or personal initials, cap badges, choice 3000 different emblems. Write Hook-Fast, Box 1425PM, Providence, R. I.

**YOUR Own business**—Used suits \$1.50, overcoats 65c, mackinaws 35c, shoes 12½c, ladies coats 30c, dresses 15c. Enormous profits. Catalog free. Moro, 558-AA Roosevelt, Chicago 7.

**CALIFORNIA** Sweet smelling beads. Sensational sellers. Free particulars. Mission, 2328PM West Pico, Los Angeles 6, Calif.

**AGENTS**: Stamping names on key protectors. Sample 25c. Stamping outfits, checks, social security and name plates. Hart Mfg. Co., 303 Degraw St., Brooklyn, N. Y.

**AGENTS**—300% Profit selling genuine gold window letters; stores and offices. Free samples. Metallic Sign Letter Co., 431-D North Clark, Chicago.

**\$50 WEEKLY** Selling finest razor blades, other items. Free details. Edisons, Box 274, Far Rockaway, N. Y.

**EXCELLENT** Sideline for printing and advertising salesmen. Decalcomania name plates in small quantities. Great demand. Also, make money with our line of automobile initials and sign letters. Free samples. "Ralco" XL-Roxbury, Boston 19, Mass.

**\$1.00 PROFIT** Selling \$2.95 photo enlargement deal. Allen Studio, Riegler Bldg., Little Rock, Ark.

**MAKE** Christmas money at home. Take renewals and subscriptions for all magazines. Big Christmas profits now. Liberal commissions. Everything furnished. Free catalog. Write McGregor Magazine Agency, Dept. 500 A, Mount Morris, Ill.

**SENSATIONAL** Bargains—Profits! Used suits \$1.75, pants 35c, dresses 20c, shoes 20c. Operate from store, home, car. Free catalog. Superior, 1250-A Jefferson, Chicago 7.

**BEST** Source for wholesale nylons. 25 years dependable service. Fields Hosiery, 99-G Chauncy, Boston, Mass.

**ATTENTION** Jobbers, wagon men, church groups, etc. Sell Silver Grill. Amazing new magnesium alloy silver. Large profit. Send 75c for sample. Information. Portland Specialty Sales, Portland, Michigan.

**MAKE** Money spare time plus new car as encouragement bonus. No house-to-house canvassing required. Amazing 60 cleaner cleans immediately, automatically, gauge nylons 3 pairs guaranteed 3 months or replaced free. Write Wilknit, 17311 Wash., Greenfield, Ohio.

**MAKE** Money introducing world's cutest children's dresses. Big selection adorable styles. Low prices. Complete display free. Rush name. Harford, Dept. K-5341, Cincinnati 25, Ohio.

**BUY** Wholesale thousands nationally advertised products at big discount. Free wholesale plan. American Buyers, 629-P Linden, Buffalo, N. Y.

**MAKE** Money selling name and address stickers for Christmas. \$1.00. Foster's, 1509 Atlantic Ave., Atlantic City, N. J.

**MEXICAN** Feather pictures. High profits! Fast sellers! Adelphi, Box 57-B, Belle-rose 26, N. Y.

**MONEY** Makers now. 20" wood-chain saw. Rotohoe. Terms. Prepaid. Farmco, 51, Excelsior Springs, Mo.

**TELE-Pep** (TV) unit \$2.95. Sensation. Radio advertised. Smith Agency-VPM, Excelsior Springs, Mo.

**NEW** And unusual merchandise. E. Eller, 1000 Sutter St., San Francisco 9, Calif.

**AGENTS**—Salesmen: Sell beautiful hand colored plastic enlargements and sensational new personalized photo compacts, rings, bracelets, lockets, etc. Experience unnecessary. 40% advance commissions. We deliver, collect. Wonderful sideline—Better full time. Free sample outfit. Novel Portrait Co., 3343 North Ave., Chicago, Ill.

**BUY** Wholesale. 25,000 items. Catalogue 25c. Matthews, 1472-B2 Broadway, New York City 36.

**AGENTS**—Show America's leading nationally advertised line—Novelties, gifts, utility items. 100% profits. Prospects everywhere. Steady repeats. Write today for sensational low prices, free literature. Charms & Cain, 407-PM-113 South Dearborn, Chicago, Ill.

**SELL** Simulated engraved business cards. Profitable! Gooch, 202PM, Hernando, Miss.

**LIFETIME** Vitamin business! Sell sensational food supplement! Regular \$3.00 size (month's supply) \$1.50 postpaid. Money back guarantee. National Health Products, Dept. PM, 150 Broadway, New York 38.

**BUY** Wholesale and save 50% on big name merchandise, Xmas gifts. Make big profits selling your friends or for your own use. Our 1953 catalog is ready. Rake, 607-PM Spring Garden, Philadelphia 23, Penna.

**BUY** Wholesale thousands nationally advertised products. Save money! Make money! Postcard brings details. Kemah Company, 5017-K Washington, Houston 7, Texas.

**PROFIT** Packed Christmas sales. Famous brand French perfume, eau de cologne. Combination perfume-manicure cutlery gift sets, wildfire sellers. Lowest factory prices. Giant profit and bonus plan. Free testers with sample order. Write for free catalog. Lido Products, 126 Bleecker St., Dept. P-2, New York.

**SENSATIONAL** Television development! Instantly eliminates annoying commercials. Sample \$2.95. Franklin, 2156-A, Los Angeles 54.

**EASY** Extra income—Sell new sensational scorch-resistant ironing-board cover. Good Housekeeping approved. Write for free complete selling kit. Menell Products, P.O. Box 431, Midtown Station, New York 18, N. Y.

**SPARE** Time profit. Catalog, information, \$1.00. Erle Strickland, 4540 Kelsey, North Kansas City 16, Mo.

**FREE** Hosiery! Introduce sensational hosiery by giving every man and woman free trial pair to prove how good they are! Amazing nylon stockings guaranteed against runs and snags. New miracle one-size nylon two-way stretch socks. Contain no elastic yet fit any size foot. Never sag. Comfortable like second skin. Actually guaranteed one full year. Earn to \$3 hour in spare time. Mail postcard for free sample stocking and money-making outfits. Absolutely no obligation. Kendex, Babylon 63, N. Y.

**ORIENTAL** Magic age calculator. Determines anyone's exact age in 1 minute. Guaranteed accurate. Amazing party game. 100% profit. Details, sample 25c. Heier, 455 E. 7th, Brooklyn 18, N. Y.

**MEN**—Women: 100% profit taking orders for Sweet Georgia Brown beauty products. Tremendous demand by colored clientele. Sample offer. Valmor, 2451-BE Michigan, Chicago 16.

**MEXICAN** Feather pictures. Sell on sight; 200% profit! Free details. Sample 20c stamps. No coins. Sylviap, Apartado 9036, Mexico City.

**EXTRA** Money. Jewelry—Each piece an original, will not be duplicated. Details free. Faas Laboratory, 13 Dogwood Road, West Orange, N. J.

**INVEST** \$1.00. Earn \$5.00. Write how. R. Heitman, Ph.G., Steeleville, Illinois.

**QUALITY** Ties—Your profit, 140%. Catalog free. Loren Specialties, 4351-A Flournoy, Chicago 24, Illinois.

**BIG** Profits selling ties, \$2.00 values, \$6.50 dozen. Free catalog. Empire Cravats, 611A Broadway, New York 12.

**BALL** Pens \$10.00 gross, d.e. s.e. blades \$4.20 m, novelty flashlights with batteries \$2.25 dozen, assorted plastic ruffled aprons \$1.40 dozen up, needlebooks with threader \$6.25 gross. Lutsker, 871-N East 170th, New York City 59.

## SALESMEN—DISTRIBUTORS

**DISTRIBUTORS**—Large profits. Terrific repeat orders. Unique Italian brooms. Details free. Write Peacock, 400 Montgomery Street, San Francisco, California.

**BUY** Standard brand watches, dinner-sets, jewelry and ladies' nylon hosiery at rock bottom wholesale prices. Send for catalog with confidential price list. Bargain Merchandise, Dept. P, P.O. Box 66, Bronx 59, New York.

**NEW** Jobs open in selling. Send name, address for five free issues of Opportunity Magazine's money-making guide, listing hundreds of companies who'll pay you well, full or part-time. No experience needed. Opportunity, 28 E. Jackson, Dept. 17, Chicago 14, Ill.

**PROVEN** Profits: Magica, back sponge. Patented. Seventeen inch polystyrene handle. Suds as it washes. Soap saver. Sensational sales. Magica Products, Wollaston 70, Mass.

**NEW** Process, every car owner buys. Lifetime repeats. Profits 100% up. Exclusive territory. Wonder Glaze, Bay Port 7, Mich.

**BE** A jobber without investment, without inventory. Discounts 50% and more—Even on small orders. Draw from \$250,000 stock. Sell stores, individuals. Profits up to 100%. Terrific line toys, giftwares, appliances, jewelry, over 200 items! Free catalog. Modern Merchandise, Dept. 52, 169 W. Madison, Chicago 2, Illinois.

**ANYONE** Can sell famous Hoover uniforms for beauty shops, waitresses, nurses, doctors, others. All popular miracle fabrics—nylon, dacron, orlon. Exclusive styles, top quality. Big cash income now, real future. Equipment free. Hoover, Dept. U-100, New York 11, N. Y.

**SELL** Miracle Orlon embroidered work uniforms! Looks, feels, tailors like wool; wears 3 times longer. Outwears cotton 5 to 1. Acid-proof grease-resistant. Washes perfectly pressed. Amazing profits! Outfit free. Topps, Dept. R-5311, Rochester, Indiana.

**ADVERTISING** Book matches—Cash in on big demand; sell union label matches. Cuts for all businesses and political parties. Free powerhouse selling kit, low prices, protection guaranteed on repeat orders. Cash commissions. Superior Match Co., Dept. M-1153, 7530 Greenwood, Chicago.

**BUY** Wholesale thousands nationally advertised products. Save money! Make money! Postcard brings details. Kemah Company, 5017-N Washington, Houston 7, Texas.

**SELL** Auto seat covers. Up to \$16.50 every order. Sensational new materials; amazing low prices. Full time or spare hours. Own seat covers as bonus. Experience unnecessary. Write for big free sales outfit and samples. Key Products, Dept. 24311, 800 N. Clark St., Chicago 10, Ill.

**MONEY** Making opportunity! Take big profit orders for world famous patented varieties fruit trees. Also flowering shrubs, roses, vines. Big sales outfit free. Stark Bro's, Desk 30154, Louisiana, Missouri.

**SENSATIONAL** Money-maker! New portable dishwashing machine sets on drainboard; washes, dries all dishes for average family in minutes, automatically! Ends dishwashing drudgery! Under \$100. Big profit. Easy payment plan. Write Bessen, Dept. 104, 22 W. Division, Chicago 10, Ill.

**FROM** Failure to over \$50,000 a year. Learn how ex-housepainter enjoys fabulous success in direct selling. Also receive amazing magazine showing you how to make big earnings, spare or full time. Both free. Specialty Salesman, Rm. 810-B, 307 N. Michigan, Chicago 1, Ill.

**NO** Competition. New invention. Automatic metal traps. 3 samples \$1.00. Automatic, 44 North Albany, Chicago.

**IS** \$210 A week worth a postcard to you? Then rush card with name and address for special free trial plan that sells amazing new automatic refrigerator defroster like hot cakes! Write to Mr. Lewis, D-Frost-O-Matic Corp., Dept. H-102, 173 W. Madison, Chicago 2, Illinois.

NEW "Tas" expense account report and income tax deduction record, sells on sight. Salesmen, stores, individuals, profit 100% and up. Salesmens, businessmen, auto owner's necessity, 30 second demonstration. Send name and address, demonstrator sent on approval. Dept. PM-102, Box 9013, Houston 11, Texas.

RUN Your own repeat-order shoe business! 3 sales a day brings up to \$63 or more a week extra with fast-selling Consolidated shoes! No experience or investment needed. Fit customers stores are unable to take care of. Special kinds of shoes for different occupations. Send postcard now for free selling outfit! Consolidated Shoe System, Dept. CC-33, Chippewa Falls, Wis.

\$50 DAILY! Amazing atomic powder polishes cars quickly! Details free! 3 car can \$1. Star Dust, 405-A Madison, Fort Wayne, Indiana.

SALESMEN—\$50.00 In a day definitely assured, selling brand new item going to every type of food and beverage store, factories, laboratories, hospitals, etc. Samples furnished. Utility Durawear, 53 West Jackson Blvd., Dept. PM-11, Chicago, Illinois.

AD Matches! Sell amazing designs—20, 30, 40 and 240-light book matches. Bigger spot cash commissions; every business a prospect. Low prices for high quality. Repeats. Start without experience; men, women; full, part time. Buy nothing! Sales kit furnished. Match Corp., Dept. PM-47, Chicago 22, Illinois.

BUY Wholesale thousands nationally advertised products at big discount. Free wholesale plan. American Buyers, 630-D Linden, Buffalo, N. Y.

BIG Money making opportunity. Exclusive line work uniforms. Jackets, pants, shirts, coveralls, advertising embroidered. Every business prospect. Outfit free. Master Div., Dept. 720, Ligonier, Ind.

CALENDARS, Advertising novelties, matches. All styles, including religious, varnished, 12 sheet, girls. Hundreds of advertising novelties, book matches, etc. Fleming Calendar Co., Sales Division, 6539 Cottage Grove, Chicago 37, Ill.

ADVERTISING. Calendar, novelty, printing salesmen; Free, postpaid beautiful 17x22" prospectus, three colors. Write Nationwide, Arlington, Texas.

WOULD You like to begin selling advertising specialties? Get the facts on steady and guaranteed income for life! Raff Company, Box 29, Berwyn, Illinois.

SELL Wrist watches. Free literature. Kelley, Box 207, Rapid City, South Dakota.

## EDUCATIONAL AND INSTRUCTION

HIGH School diploma at home. Licensed teachers. Approved materials. Southern States Academy, Box 144, MX Station E, Atlanta, Georgia.

A College B.A. and M.A. degree by home study. State chartered. Fremont College, 915 Grand View St., Los Angeles 6, Calif.

PREPARE For career in private investigation or public law enforcement work. Write for free booklet. National Detective Academy, 8038 North 30th Drive, Phoenix, Arizona.

WINDOW Display home course. Shortcut to an excellent job. Small investment, quick results. Free brochure. Pan-America Art School, 321 West 56th Street, New York 19.

MIDLAND Linotype School. Charles City, Iowa. Civilian and Veteran Courses. Free placement. Established 1909.

CORRESPONDENCE Courses, educational books, bought, sold, rented, exchanged. Lists free. Magnolia Press, Box 1272-P, Burbank, Calif.

BE A real estate broker. Study at home or in classrooms in leading cities. Write for free book today. G.I. approved. Weaver School of Real Estate, 304 Law Bldg., Kansas City, Missouri.

EARN While you learn. Auto and diesel mechanics master this top paying trade. Many graduates earn \$100 a week and up. Approved for Korean veterans. For free information write Dept. No. 256, Nashville Auto-Diesel College, Nashville 3, Tenn.

BOOKKEEPERS! Increase your earnings! Operate your own simplified "Dollar-A-Week" bookkeeping and tax service. Full or spare time. Details free. No obligation. Ellis, Box 200, Cedar Grove, North Carolina.

MEDICAL Laboratory technicians in great demand. We train you in your own home. Catalogue free. Imperial Technical Institute, Box 973-J, Austin, Texas.

SECRET Investigation. Experience unnecessary. Investigators particulars free. George Wagner, M125 West 86th, New York 24.

INVESTIGATOR Training. Phillips Secret Service System, 1917-B North Kenneth, Chicago 39.

USED Correspondence courses and books sold and rented. Money back guarantee. Catalog free. (Courses bought.) Lee Mountain, Pisgah, Alabama.

MAKE Motion pictures a fascinating career—A paying hobby! Learn at home. Television, Hollywood, free lance films. Interesting, 6 week, approved course. Free catalog. Motion Picture Institute, Birmingham 6, Michigan.

LEARN Drafting. Fastest method. Low cost pay-as-you-learn plan. Drafting equipment furnished. Top grade industrial instructors. Free catalog. Cesco Industrial Training Services, 1704-A Frederick, Fort Worth 7, Texas.

STUDY For Degree of Doctor of Psychology (Ps.D.), Doctor of Metaphysics (Ms.D.), or Doctor of Divinity (D.D.). Write College of Divine Metaphysics, Dept. PM, 2811 North Illinois Street, Indianapolis, Indiana.

PRACTICAL Nursing—Learn easily at home, spare time. Big demand, good earnings. High school not necessary. Write for free facts. Wayne School, Dept. FG-20, 2525 Sheffield, Chicago 14, Ill.

HIGH School—No classes. Study at home. Spare time. Diploma awarded. Write for free catalog HF-38, Wayne School, 2527 N. Sheffield, Chicago 14, Ill.

IT'S Fun learning a language by Linguaphone. At home, in leisure time, quickly, easily master French, Spanish German, Japanese—29 languages by Linguaphone Conversational Method. Save time, money. Send for free book. Linguaphone Institute, 8311 Mezz., Rockefeller Plaza, New York 20.

A Profitable business of your own. Better job opportunities and big sparetime earnings available in billion dollar field of custom upholstery. Earn while learning at home through N. Y. State-approved UTS course. Course includes—4 big outfits of tools, frames, materials to make beautiful furniture you keep or sell. You learn furniture upholstery, reupholstery, finishing, slip cover, cushion, window cornice, drapery making! Free book tells about this booming business, how you earn as you train at home. Write today. Upholstery Trades School, Dept. BS-1402, 721 Broadway, New York.

LEARN Shorthand at home. Successfully taught system for 24 years. Easily understood. No long tedious studying. Write Maude E. Frank Secretarial School, Ridge Building, Kansas City, Missouri.

PHOTOGRAPHY For pleasure or profit. Learn at home. Practical basic training. Long established school. Free booklet. American School of Photography, 835 Diversey Parkway, Dept. 3436, Chicago 14, Illinois.

START A buying service, buy wholesale thousands nationally advertised products. Make big profits selling at sizable discounts. Postcard brings details. American Buyers, 633-D Linden, Buffalo, N. Y.

FOR An extremely profitable lifetime business, operate a collection agency. Quickly learned. Write Cole Associates, Syracuse 2, N. Y.

NEW Tool strips insulation from all wires, cable. \$2.95. E. V. Barber Company, Box 4525, Ecorse 29, Michigan.

BECOME A doctor of psychology or metaphysics. Learn secret of contentment, happiness. Win degree of Ps.D. or Ms.D. Solve mental worries. Free book. College of Universal Truth, 5038-C Broadway, Chicago.

WELDING Training pays at Hobart Welding School, Box M-1131, Troy, Ohio. VA contract. Best equipment. Catalog free.

OIL Coloring photographs. A fascinating hobby or profitable sideline for those with artistic talent. Learn at home. Easy simplified method. Free booklet. National Photo Coloring School, 835 Diversey Parkway, Dept. 3447, Chicago 14.

STUDY Technical, commercial, high school subjects. George Ward, Dublin, Texas.

YOUR Voice made loud, clear and powerful with my diaphragm exerciser. Inexpensive. Write, Inventor Oz, 34V, Box 665, St. Louis, Mo.

GOVERNMENT Position! Home training for examination, \$9.95. Refunded if don't pass. Write, Ozment Instructions, 34-CS, St. Louis, Mo.

LEARN Priceless secrets of technical metaphysics. Easy to learn. Only school of its kind. Write: Premier College of Technical Metaphysics, 2532 McKenzie St., Vancouver, B. C., Canada.

U. S. Civil Service jobs! Start high as \$316.00 month. Men—women, 18-55. Qualify now! 30,000 jobs open. Experience often unnecessary. Get free 36-page book showing jobs, salaries, sample tests. Write: Franklin Institute, Dept. G-24, Rochester, N. Y.

STRUCTURAL Drafting course. Drawing outfit furnished. Roth Technical Institute, Dept. M11, Box 2283, Youngstown Ohio.

GET New start in life in profitable collection business. Free booklet. Franklin Credit, Roanoke 7, Virginia.

COMPLETE Your high school at home in spare time with 55-year-old school. Texts furnished. No classes. Diploma. Information booklet free. American School, Dept. X845, Drexel at 58th, Chicago 37, Ill.

WANT A diesel job? New opportunities to increase income. Higher pay. More money. We can help you qualify. Tools. Shop method home training. Write today! Diesel, Tractor, Heavy Equipment Division, Interstate Training Service, Dept. B3 M, Portland 13, Oregon.

MAKE Movies a career, paying hobby, learn 3-D, TV films at home. Free catalogue. Motion Picture Institute, Birmingham 6, Mich.

USED Correspondence courses and educational books bought, sold, rented. Catalog free. Educational Exchange, Summerville, Ga.

PLAY Piano instantly. Novel approach guarantees satisfaction. Send \$2.00 to Path-A-Tune, 602 Fifth-Wood Bldg., Pittsburgh 22, Penna.

SIMPLIFIED Analytics teach algebra instantly; \$1.00, guaranteed. Ziembeck, 6123 Orchard, Dearborn, Mich.

TAX Preparation pays. Learn quickly by mail. Operate lucrative, dignified business from your home. Experience unnecessary. Reasonable. Information free. Taxteller Inc., 2708-10 North Grand, St. Louis 6, Missouri.

RADIO-TV broadcast job? F.C.C. license quickly. Residence. Correspondence. Dept.-6, Grantham School, 6064 Hollywood Blvd., Hollywood 28, California.

SUCCESS In journalism. Details \$1. Newsmen, Room 907, 400 Madison Ave., New York City.

MASSAGE Course, also principles of osteopathy, naturopathy, chiropractic, etc. \$2.00. Healthway, Box 5610, St. Ann 14, Missouri.

MINISTER'S, Laymen's religious courses. Free bulletin! Midwest Bible School, 517 Merchants Bank Building, Indianapolis, Indiana.

BECOME Tax expert. Earn big fees during income tax season and all year 'round. Free details. Union Institute, Lakewood 2-C, N. J.

MECHANICAL Engineering. Unusual home study opportunity. Registered professional engineers instructing. Midwest Engineering School, 10923 Hillcrest, Hickman Mills, Missouri.

WORRY Replaced with confidence or no cost. Free lecture and details. Personal Psychology, Box 1924-E, Louisville 1, Ky.

INCREDIBLE! Become mental superman overnight! Free booklet! Bijou, Box 1272-MB, Hollywood 28, California.

UNIVERSITY Degrees by residence and correspondence. Golden State University, Hollywood, Calif.

## PLAYS, STORIES, MANUSCRIPTS

BEGINNING Writers: Get \$1 to \$20 checks daily writing simple children's stories, articles, poetry in your sparetime. Experience unnecessary. Our instructions reveal how. Details free. W. Herman, 7016 Euclid, Cleveland 3, Ohio.

NO Luck finding a book publisher? Write for free Booklet PM. Vantage Press, 120 W. 31, New York.

I Want new writers. Experience unnecessary. Earn at home, spare time. Details free. Saunders Cummings Institute, P.O. Box 17006, Studio R11, Los Angeles 17, Calif.



## SPECIAL SERVICES

**TYPING.** Reasonable. Confidential. Reports, wills, manuscripts. Margason, 22 Elm, Shelbyville, Ind.

**KING of Siam** palace photograph enclosed free! Letters reairmailed from Siam. Really exciting! More fun! Only 1.00. Surianton, Box 696, Bangkok, Siam.

**LETTERS** Remailed from Canada 25c. Elliott's, 252 Gainsboro, Toronto, Canada.

**IDIOMA Club.** Letters remailed 50c. Monthly \$2.00 U.S. 1001 opportunities in South America. Joseph Smith, Paseo Colon 321, Lima, Peru.

**INFORMATION** On any matter. Ferguson Research, 116-14 141 St., South Ozone Park 36, N. Y.

**ELECTRICAL** Layouts and specifications. Drafting, residential, commercial, industrial. Miller, 1011 W. 16th, Davenport, Iowa.

**PROMPT** Research information to your questions on matters of fact. History, business; other subjects. \$2.00 per question. Gordon's Research, Box 1427, Chicago 90.

**SAMPLE** America's famous meat tenderizer. Send 25c. Tendex, Salem, Mass.

## CARTOONING, COMMERCIAL ART, SHOWCARD WRITING, SIGN PAINTING

**14 ALPHABET** Patterns. Monograms, numerals, 1/2"-4" high. Walker Studio All-PM, 4343 Lindell, St. Louis 8, Mo.

**"HOW To Make Money** With Simple Cartoons"—A book everyone who likes to draw should have. It is free; no obligation. Simply address Cartoonists' Exchange, Dept. 911C, Pleasant Hill, Ohio.

**YOU** Can learn to draw the body beautiful from pictures. Take as many lessons as you wish. Stop whenever you like. Your drawings corrected. First two lessons with drawing material \$1.00. Clapham Art Institute, 8214A Frankford Avenue, Philadelphia 36, Penna.

**FREE** Trial cartooning lesson to test your talent. Write Leo Janhonen, Spencer, N. Y.

**CARTOONING** Made easy. Nine lessons, 400 comics 25c coin. Randall, 312 First, Peoria, Ill.

**CHALK** Talks. Laugh producing program, \$1.00. Catalog 10c. Balda The Cartoonist, Oshkosh, Wisconsin.

**PAINT** Signs for profit. Biggest complete course with 324 illustrations. 18 in colors. Only \$5 postpaid. Descriptive circulars free. E. C. Matthews, 2325 Cass, St. Louis 6, Mo.

**FREE** Sample cartooning lesson. No obligation. Box 10074M, Knoxville 16, Tenn.

## ADVERTISING AGENCIES, LETTER WRITERS, FOR ADVERTISERS

**IDEAS.** Advertising plans. Free consultation. Artists, copywriters. Advertising Unlimited, Burlington, Wisconsin.

**GET** Thousands of dollars worth of national advertising for your new product, for only a few dollars. Williams Agency, 1117-C-1 Investment Bldg., Pittsburgh 22, Penna.

**USE** Sales letters that click! Lettermaster, 9B Clifton, Natick, Mass.

**RADIO** Stations seek mail order items to sell on commission basis. Stirling Associates, 210-B Fifth Ave., New York 10.

**ADVERTISE:** 24 Words, 100 Canadian newspapers \$5.50. Lists free. Advertising Bureau, 10511-C Springfield, Chicago 43.

**ADS** Placed in out of town newspapers and magazines. Low rates. Catalogue free. Ideas that pay. Baker Advertising Agency, Successors Ankrum Agency, 189 W. Madison, Chicago 2.

**MAILING** Lists, most any kind you need, 1000 \$5.00 up. Free prospectus. Dixie Mailers, King, N. C.

**FREE** Copy, layout service. Mailorder ad, 1,700,000 nationwide circulation, \$27.30 inch. 24-word classified, 20 big Sunday newspapers, \$30.00. Advertising ratebook free. Chicago Advertising Agency (established 1900), Chicago 4.

**ADVERTISERS!** Reach nearly 18,000,000 readers. 25 Sunday national key newspapers, 18 words, \$59.00. "Terrific pullers." 20 popular newspapers, \$11.50. Free booklet. Special—One inch display 2,-\$21,198 circulation. \$51.10. Newmark's Advertising Agency, (Established 1893), 217-7th Ave., New York 11.

**FREE!** 1953 Advertisers Rate and Data Directory, 592 pages! E. H. Brown Advertising Agency, 20 N. Wacker, Chicago 6.

## RUBBER STAMPS AND OFFICE SUPPLIES

**FREE** Stamp and printing catalog. 3 line pocket stamp \$1.00, 4 line rubber stamp \$1.00, 1000 6 3/4 envelopes printed \$6.10, 2000 2x1 1/2 gummed stickers \$3.23, all postpaid. Esco, 113 Print, 8 Holt, Dayton 7, Ohio.

**ENGRAVED** Plastic name plates. Save 1/2. Wise, 3527 1/2 Slauson, Maywood, Calif.

**RUBBER** Stamps. Send for catalog. Excello, Box 500, Shreveport, Louisiana.

**3 LINES,** \$1.00. Fast service! Catalogue. Johnson Press, Box 6-A, New York City 26.

**LINE** 25c; 2-45c; 3-65c. Stamp Works, Auburn, Nebraska.

## TYPEWRITERS, DUPLICATORS, OFFICE DEVICES

**RECONDITIONED** Typewriters, duplicating, printing devices, \$25.00 up. Supplies. Appliances, DixieGraph, King, N. C.

## PRINTING, MULTIGRAPHING, MIMEOGRAPHING GUMMED LABELS

**BEAUTIFUL** Two color raised print business cards. Dignified, appealing. Send for samples, prices. J. Hampton, 601 1/2 N. Main, Wichita, Kans.

**ATTRACTIVE** Printing, labels, stickers. Inexpensive. Samples, Fame, 291 Ellis, San Francisco 2, Calif.

**BUSINESS** Statements 500 for \$5, business forms a specialty. Samples. Stillwater Printers, Covington, Ohio.

**150** LETTERHEADS \$1.00. Envelopes same. Beautiful. Postpaid. Loudon's, Florida, Indiana.

**BUSINESS** Printing. Samples free. Homestead Press, 2718 East 58th Street, Huntington Park, California.

**ADDRESSING,** Mailing, mimeographing. Reasonable. Barsketis, 7404-58 Pl., Summit, Illinois.

**MIMEOGRAPHING** — Anything! 200, 8 1/2 x 11, \$2.00; 500, \$4.00; 1000, \$6.00. Guaranteed. Free samples. Quinn Sales, P.O. Box 967, Little Rock, Ark.

**100** ENVELOPES Or letterheads \$1.00. Two colors \$1.50. Salesbooks \$3 doz. Broadbrook, Botsford, Conn.

**FREE** Business cards. Particulars 3c. Lipke, 1127 Hoffman, Long Beach, Calif.

**QUALITY** Envelopes, letterheads, statements, \$1.50 per hundred; 500 for \$5.00, postpaid. Keelings, Valley City, N. Dak.

**1000** BUSINESS Cards \$2.50. Taylor, 5103 Forty-Third Avenue, Hyattsville, Md.

**100** LETTERHEADS Or envelopes \$1.00. Printing, 21 Barclay Ave., Portsmouth, Virginia.

**BUSINESS** Cards, 150 \$1.00. 125 letterheads 8 1/2 x 11, 125 envelopes \$2.50. Fender Press, Carson, Iowa.

**100** ENVELOPES. Printed 2-colors \$1.25. Box 523, Rochester 2, N. Y.

**1000** BUSINESS Cards \$2.45 postpaid. Other printing. Dornfeld, Iron Ridge 3, Wis.

**100** LETTERHEADS Or envelopes \$1.00 postpaid. Quality guaranteed. William Jones, Dept. P. Mineola, New York.

**FAST,** Guaranteed, complete service! Price list 3c stamp. Drobney Press, 8818 Forestview, Skokie, Ill.

**500** GUMMED Labels neatly printed with your name, business, address 40c. Other printing. Samples free. Ernest Cramer, 1010 East Morgan, Martinsville, Indiana.

**FREE** Catalog, samples. Dealers wanted. We fill orders at wholesale prices. Sutton Printing, Box 853-M, Waycross, Georgia.

**100** 8 1/2 x 11 LETTERHEADS. Carefully printed. \$1.00 postpaid. Envelopes same. Race Printers, Hudson, New York.

**TWO** Color 8 1/2 x 11 letterheads. 500, \$3.50. Samples. D'Yarmett Printing, Newark, Ohio.

**GIVE** Personalized stationery for Christmas—3c stamp brings samples. Franson, Box 3763, Kirkwood 22, Missouri.

**PRINTING** That pleases. Send copy for estimate. Samples, prices. Mercury Press, Box 69M, Marengo, Iowa.

**MIMEOGRAPHING**—Pricelists, letters, instructions. Free samples, prices. Loyal Brush, 3712 Walnut, Kansas City 11, Mo.

**EMBOSSED** Stationery adds prestige. Like engraving. Salem Print, 3131 Salem, Dayton 6, Ohio.

**MIMEOGRAPHING**—Letters, pricelists, formulas, instructions. Lowest prices. Lem's Letter Shop, 5710 Stanton, Detroit 8.

**500** 3/4 x 2 1/4 FOUR Line gummed stickers 50c. Red border \$1.00. Moritz Printery, Saginaw, Mich.

**100** 8 1/2 x 11 LETTERHEADS, 100 6 3/4 Envelopes, \$2.00, 250 each, \$3.75. 500 business cards \$1.95, 1,000, \$2.50. Postpaid. Allen, Dept. PMP, Clinton, Missouri.

**BUSINESS,** Personal stationery. Catalogs free. Howprint, 723-M Eunice, Webster Groves 19, Missouri.

## PRINTING OUTFITS AND SUPPLIES

**MAKE** Your own self-molding rubber printing cuts. Plexirubber, Argyle 1, Wis.

**PRESSES,** Type, cabinets, supplies. List for stamp. Lincoln Press Company, 220-Y Hartwell, Fall River, Mass.

**MAKE** Your own cuts. New, simple process. Low cost. Literature free. Walp, P.O. Box 4308, Mobile, Ala.

**PRESSES,** Supplies, paper. Catalog 10c. Custom, Box 211-P, Springfield, Missouri.

**HAND** Presses, small paper cutters, type cases, etc. Visit our store. Van Dillen Inc., 74 Beekman St., New York City.

**DO** Your own printing. Save money. Simple rules. We supply everything. Print for others; good profit. Raised printing like engraving too. Have home shop. Details free. Kelsey Presses, V-11, Meriden, Connecticut.

**PRINTING** Presses, type, supplies. Lists 3c. Turnbaugh Service, Loysville, Penna.

## PATENT ATTORNEYS

**INVENTORS:** Learn how to protect your invention. Unless the inventor is familiar with patent matters, he should engage a competent registered patent attorney or agent to represent him. We are registered to practice before the U. S. Patent Office and prepared to serve you in handling your patent matters. "Patent Guide for the Inventor" containing detailed information concerning patent protection and procedure with "Record of Invention" form will be forwarded to you upon request—without obligation. Clarence A. O'Brien & Harvey Jacobson, Registered Patent Attorneys, 31B-K District National Building, Washington, D. C.

**INVENTORS:** When you are satisfied that you have invented something of value write me, without obligation, for information as to what steps you should take to secure a patent. Write Patrick D. Beavers, Registered Patent Atty., 935 Columbian Bldg., Washington 1, D. C.

**PATENTS** — Irving L. McCathran, 315 McLachlen Bldg., Washington 1, D. C. Registered Patent Attorney.

**PATENTS.** "Proof of Invention" free. E. E. Vrooman, Registered Patent Attorney, 507 McKim Building, Washington 5, D. C.

**INVENTORS:** Without obligation, write for information explaining the steps you should take to secure a patent. John N. Randolph, Registered Patent Attorney, 203 Columbian Bldg., Washington 1, D. C.

**C. A. Snow & Co.**—M427, Snow Building, Washington 1, D. C. Registered Patent Attorneys. Write for information.

**"INVENTOR'S Guide"** free. Frank P. Ledermann, Registered Patent Attorney, 154 Nassau Street, New York.

**REGISTERED** Patent attorney offers services. Sanders, 6430 Evans, Chicago 37, Ill.

**CANADA**—Ramsay Company Registered, 273 Bank Street, Ottawa, Canada.

**INVENTORS**—If you consider your invention to be something of importance, take steps to protect it with a United States Patent which gives you the right to exclude others from making, using and selling your invention as claimed. "Patent Protection for Inventors" outlines steps to take to secure patent protection. Mailed promptly without obligation. Victor J. Evans & Co., Merlin M. Evans, Registered Patent Attorney, 831-M Merlin Building, Washington 6, D. C.

**INVENTORS**—If you believe you have an invention, you should find out how to protect it. The firm of McMorrow, Berman & Davidson with offices in Washington, D. C., is qualified to take the necessary steps for you. Send for copy of our patent booklet "How to Protect Your Invention." We will also send you an "Invention Record" form. No obligation. They are yours for the asking. McMorrow, Berman & Davidson, Registered Patent Attorneys, 134-Y Victor Building, Washington 1, D. C.

**INVENTORS**—For "Invention Record" form, contact Carl Miller, Registered Patent Attorney, Woolworth Building, New York.

#### FOR INVENTORS

**INVENTORS**—This firm is registered to practice before the United States Patent Office and is available to assist you in the preparation and prosecution of your patent application. "Patent Protection for Inventors" booklet containing detailed information and steps to take toward patent protection will be sent upon request. No obligation. Victor J. Evans & Co., 832-M Merlin Building, Washington 6, D. C.

**INVENTORS!** For "Copyright, Design and Patent Guide" contact Henry Metzler, 11 West 42nd, New York 18.

**MAXIMUM** Inventioneering possibilities! How? Free literature. Write: Inventor, Doniphan, Missouri.

**INVENTIONS**, Sold, leased, complete services. M. Joyce Humphries, 1425 Land-tile, Philadelphia 10.

**INVENTORS**—If you believe you have an invention, you should find out how to protect it. The firm of McMorrow, Berman & Davidson with offices in Washington, D. C., is qualified to take the necessary steps for you. Send for copy of our patent booklet "How to Protect Your Invention." We will also send you an "Invention Record" form. No obligation. They are yours for the asking. McMorrow, Berman & Davidson, Registered Patent Attorneys, 134-X Victor Building, Washington 1, D. C.

**FREE** Information—Tested way to prepare, protect and sell your inventions. O. W. Wood, 100 Church St., Liberty Corner, N. J.

**GOT** My patent the hard way. Knew nothing. Learned plenty, paid plenty. My Gamecraft product now sold nationally. "Story of a Patent" details my experiences, itemizes every cost. Chart calculates your total patent cost within \$50! Don't gamble. Know ahead. Save about \$200.00. Patent story information free. Gamecraft, Red Lion, Penna.

**FROM** One inventor to another: Is your invention ready for market? Have licensed over 60 of my own inventions to industry. Why not let me help you? Complete service. Patent searches. Commercial evaluations. Industry contacts. Free information. Jacquelin Harvey, Jr., Research Engineer, Realty Bldg., Washington 5, D. C.

**INVENTORS**: Learn how to protect your invention. Unless the inventor is familiar with patent matters, he should engage a competent registered patent attorney or agent to represent him. We are registered to practice before the U. S. Patent Office and prepared to serve you in handling your patent matters. "Patent Guide for the Inventor" containing detailed information concerning patent protection and procedure with "Record of Invention" form will be forwarded to you upon request—without obligation. Clarence A. O'Brien & Harvey Jacobson, Registered Patent Attorneys, 31A-K District National Building, Washington, D. C.

**PATENT** Searches, \$5.00, including patent copies. Same reliable search as conducted for patent attorneys. Free protection forms, 48 hour service. Patent Service Institute, 945-A Pennsylvania Avenue, Washington 4, D. C.

**PATENT** Searches \$5.00. 48-hour service. Inventions marketed and promoted. Free record of invention. Write Raymond L. Smith, Patent Searcher, 622 Sheraton Building, Washington 5, D. C.

**CASH** For your idea, 280 manufacturers need inventions, patented or unpatented. List free. Invention Bureau, 208M Clinton, Oak Park, Ill.

**INVENTORS**—For "Invention Record" form, contact Carl Miller, Registered Patent Attorney, Woolworth Building, New York.

**MAKE** Money from your ideas, gadgets, patents. Get "Inventors Guide." Helpful book tells you how. Send \$1.00, includes list of needed inventions. We have buyers. Inventors Creative Service, 354 South Spring, Los Angeles 13, Calif.

**PATENT** Searches \$5.00. Reports airmailed within 48 hours. Inventions marketed. Free protection forms. Write Miss Ann Hastings, P.O. Box 176, Washington 4, D. C.

**SEARCHES**—Put your patent searches in the hands of a registered patent attorney or agent, as he qualifies to give a worthwhile patentability report. Record of invention form upon request and information on patent protection. Patrick D. Beavers, Registered Patent Attorney, 936 Columbian Bldg., Washington 1, D. C.

**INVENTORS**: If you have an invention for sale, patented or unpatented, write Institute of American Inventors, Dept. 40A, 631-E St. N.W., Washington 4, D. C.

**INVENTORS**: Information on patent procedure furnished on request, without obligation. John Randolph, Registered Patent Attorney, 202 Columbian Building, Washington 1, D. C.

**I** Sell patents. Established 1900. Charles A. Scott, 773PM Garson Avenue, Rochester 9, N. Y.

**PATENT** Searches \$5.00. 48-hour airmail service. Invention protection forms free. Patent drawings prepared. Write Patent Engineering Service, 711 14th Street N.W., Washington 5, D. C.

**INVENTORS**—Send for free patent information book and inventor's record. Registered Patent Attorney, Associate Examiner, Patent Office 1922-29; Patent Attorney & Advisor, Navy Department 1930-47. Gustave Miller, 93A Warner Building, Washington 4, D. C.

#### INVENTIONS WANTED

**PROGRESSIVE**, reputable company wants inventions now in production or ideas fully worked out. Prefer wrenches, tools or attachments for electric drills. Will purchase or lease on royalty basis. Send pictures with full data. The Drilo Corporation, 200 East Carson Street, Pittsburgh 19, Penna.

**INVENTORS**: If your invention is adaptable to our business we will contract on cash or royalty basis. If not, we will try to place. Write today. Kessler Sales Company, Dept. 510, Fremont, Ohio.

**INVENTORS** don't sell your invention, patented or unpatented, until you receive our offer. Write Cowgill, Box 298, Marion, Ohio.

**INVENTIONS** Wanted. Industrial Engineering Research Institute, 132 Nassau, New York City.

**INVENTIONS** Wanted. Patented, pending only. Inventors Patent Exchange, Hartford 1, Conn.

**INVENTIONS** Wanted. Patented; unpatented. Tremendous manufacturers lists. Global Marketing Service, 1404 Mitchell, Oakland 1, California.

**MARKETING** Aid—Nation wide. Patented, patent pending. Booklet free. Market Contacts, 719-A2 Magnolia, Tupelo, Miss.

**INVENTORS**: Hundreds of manufacturers have requested our assistance in locating marketable new products. Complete information free. Institute of American Inventors, Dept. 40-D, 631-E St. N.W., Washington 4, D. C.

**INVENTIONS** Promoted. Patented or unpatented. Established 1911. Write Adam Fisher Company, 61 Enright, St. Louis, Mo.

**CASH** Buyers for ideas and inventions. Write National Inventors Institute, 4097 East 131st St., Cleveland 5, Ohio.

**INVENTIONS**, Ideas, advertising specialties wanted. Submit complete details. Pyramid Company, Antioch, California.

**INVENTIONS** Wanted. Patented or patent pending. 23 years experience promoting inventions. National Service Bureau, 3120 Meramec, St. Louis 18, Mo.

#### PATENTS FOR SALE

**LAWN** Edger Patent 2,594,508. Practical, inexpensive. Cash, royalty. Elbert Sitton, 1211 Nashua, Houston 8, Texas.

**INVENTORS**: Test the commercial value of your patented or unpatented inventions, quickly and inexpensively. Write for free information. Institute of American Inventors, Dept. 40-B, 631-E St. N.W., Washington 4, D. C.

**FISHING** Lure, Pat. 2,585,494. Guaranteed, salmon, salmon, salmon, salmon. Aade Pelto, R. 1, Box 26, Aurora, Minn.

#### MANUFACTURING

**MODELS**—Small lot manufacturing Metals, plastics, etc. Milburn, Burlington, Kentucky.

**MODEL** Making, experimental and machine work in metal, wood and plastic. Free estimate. Futuraire Engineering, Box 8, Parkville Sta., Brooklyn, N. Y.

#### MODELS, MODEL SUPPLIES

**NEW** Completely revised giant 88-page 1954 "O" gauge catalog for model rail roaders. Scale and tinplate. Fully illustrated. Hundreds of car kits all types steam locomotives, diesels, specialty items and parts galore. Catalog cost of 75c refunded with first \$5.00 order. All-Nation Hobby Shop, 182 N. La Salle St., Chicago 1, Ill.

**MODEL** Railroaders. Free literature of spikers, Hypo-rollers, railroad neckties, etc. Gaunt, 827-R Irving Park, Chicago 13, Ill.

**THE** Kelmar engine, blueprints, instructions. Henry Kelley, Greenville Jet, Maine.

**MODEL**, Hobby supplies, prepaid price list stamp. Western, Box 578, Laramie, Wyoming.

**1953** CAR Models, 1/25 scale, all metal chrome trim. Send for catalog. Ajax Toy Co., Dept. PM-12, 2637 W. Division St., Chicago 22.

**STEAM** Locomotives, 1 1/2", 1", 3/4", 1/2", 1/4" scales. Castings, rail, steam fittings. Thorough drawings with instructions. Catalog 50c. Little Engines, Wilmington, California.

**LIVE** Steam engine, 10 1/2" high, ready to-run \$5.95 postpaid. Catalog 35c. Merle, 50-18 94th Street, Elmhurst 73, N. Y.

**BUILD** Historic ships, vehicles. 50c to \$9.00 kits. Illustrated catalog 10c. Ideal Models, 21 West 18th Street, New York 11.

**NEW** Tiny power catalog—manual. Steam engines, boilers, tractors, locos, fittings, castings, prints, plus many pages helpful suggestions, building, operation. \$1.00. New book, "Miniature Steam Boilers—How To Build Them," complete step-by-step instructions building three types copper boilers, flanging, brazing, etc. \$2.50. Chas. Arnold, Box 218, Corvallis, Oregon.

**SHIP** And other scale models. Most complete line in New England. Kits, fittings, plans, books, tools, engines, motors. Illustrated catalog 25c. James Bliss & Co., Inc., Dept. SM, 342 Atlantic Ave., Boston 10, Mass.

**SHIP** And yacht model fittings; blueprints. Send 25c for illustrated catalog No. 28—listing hundreds of items. A. J. Fisher, 1002-1 Etowah Ave., Royal Oak, Mich.

**ILLUSTRATED** Lionel catalog, 10c. American Flyer, 10c; H. O. gauge, 10c. Ben's PM Dept., 134 North Dearborn, Chicago 2.

**BALSA** Wood, Grade AAA. Free sample, price list. Sig Mfg. Co., Montezuma, Iowa.

**BIG** Train accessory catalog free. Shannon's, 503 Franklin, Nutley 10, N. J.

#### HOME CRAFTSMEN

**MAKE** Attractive lamps and novelties. Silver glass jugs and bottles inside. Material inexpensive. Obtainable at drug stores. Formula and instructions \$1.00. Chas. Fane, Box 6202 Cimarron Station, Oklahoma City, Oklahoma.

**BRASS** Rods. List free. Miller, 388 East 34 St., Brooklyn 3, New York.

**52** PATTERNS And plans for Christmas novelties, toys, interior and exterior decorations \$1.00. C & E Specialties, Chippewa Falls, Wisconsin.

**LEATHERCRAFT**—New stylecraft folder free. New kits illustrated. Filigree belts, billfolds, purses, etc. Send 25c new catalog. Refunded first order. Apache Leather Co., 2804 East Washington St., Phoenix, Arizona.

**LEATHER**, Tools, lacings, supplies. Free catalog. National Handicraft, 199 William St., New York 7.

**PINE** Root for beautiful driftwood lamp \$1.00 plus postage c.o.d. Instructions included. Gover's Sales, Sheridan, Michigan.

**HOW** To refinish your own furniture \$1. Krafters, Box 86, Hubbard, Ohio.

**LEATHERCRAFTERS:** Illustrated catalog shows everything you need 10c. Art Leather, 411 Joseph Ave., Rochester 5, N. Y.

**"TOPS"** In everything for leathercraft. Lowest prices. Genuine "Craftool" stamps. Catalog 10c. Crown Leather Company, 22 Spruce Street, New York 38.

**KNOCKDOWN** Cedar chests and lumber. Free price list. Bedford Lumber Company, Shelbyville, Tennessee.

**MINIATURE** Furniture kits. Colonial reproductions. Solid cherry. Catalog 20c. Culver Miniatures, 194 61st St., Dept. A. Niagara Falls, N. Y.

**30 LAWN** Ornament patterns. Ready cut. Full size. Color indicated. \$1.00 postpaid. Lincoln Craft Studio, Columbia, Conn.

**FREE** Information. How to make money with jig saw. Write Jigsawers, 117-M Worth, New York 13.

**LEATHERCRAFT,** Metal tooling, textile painting, beadercraft, shellcraft. Many other crafts. Send for free, big, illustrated catalog today! Kit Kraft, Hollywood 46, Calif.

**BIG Savings** leather—Now, for first time, you can buy full sides of top grain cowhide at our special, amazingly low "tannery-to-you" prices. For details, write Dept. 1. W. D. Byron & Sons, Williamsport, Md. Fine cowhide tanners since 1832.

**VIOLINMAKERS,** Amateurs, professionals, fine tone European wood. Materials, instructions, tools, patterns. Illustrated catalogue. 10c refundable. Premier Violin Supplies, Dept. VZ, 430 South Broadway, Los Angeles 13, California.

**200 ONE-Evening** Projects that you can start and finish in one evening! Popular Mechanics editors have assembled 200 projects to be made with only simple hand tools, in a few hours time. Each project costs only 1c. Order your copy today. \$2.00. Popular Mechanics Press, Dept. EP-2, 200 E. Ontario, Chicago 11, Ill.

**WHY** Be puzzled by holiday gifts. Start now to make practical and unique Christmas gifts in leather. We can supply complete materials, tools, patterns and simple step-by-step instruction books. Send 25c for new large illustrated catalog of leathercraft supplies. Nicewarner Leather Co., Dept. No. 8, 14-16 E. Chestnut St., Columbus 15, Ohio.

**FREE** Artcraft catalog. Designs imprinted brass, copper, aluminum for metal pictures; burnt wood etchings; glorified glass, mirrors; pre-sketched paintings. Profitable art hobbies. Dept. PM, Thayer & Chandler, 910 W. VanBuren, Chicago 7, Illinois.

**101 FULL** Size patterns. Smart, new, gifts, novelties, lawn figures, shelves, action windmills, alphabets. Plus "Make Money Jig Sawing." Only \$1.00. Mastercraft 115M, 7041 Olcott, Chicago 31, Ill.

**WORKSHOP** Tips, by the hundred, in the new ten thousand word woodworking workshop manual, cover many details for starting, improving, and operating. Act fast. Also get five "How to Do It" books, or patterns, direct from manufacturers. All for \$3.00. U. S. funds accepted. Make It Yourself Club, 189 Church Street, Toronto, Canada.

**CRAFTSMEN!** Cypress lamp kits! Single \$3.95, double \$6.50. Instructions. Cypresscraft, RR#2, Box 557, Homestead, Florida.

**90 ALL** New, full size lawn ornament and novelty patterns, up to 20" high. Only \$1.00. Mastercraft 112M, 7041 Olcott, Chicago 31, Illinois.

**300 PROJECTS** You can make—In Popular Mechanics 32-page Blueprint catalog. Send 3c stamp for copy. Popular Mechanics Press, Dept. 106, 200 East Ontario St., Chicago 11, Ill.

**FREE** Catalog showing ready to assemble kits, ideal for Christmas gifts. Vest, moccasins, plastic beaded belts, billfolds, baby moccasins, and handbags. Tandy Leather, Box 397-M, Tulsa, Okla.

**SHOCK** Mount your power tools. Reduce noise, vibration. 8 mounts \$1.00 postpaid. Jamieson Industries, 1148 Lake Grove, S.E., Grand Rapids, Michigan.

**BIG** Full size patterns of Santa, sleigh and reindeer for roof or lawn. Complete directions for making, painting and lighting. \$1.00. Mastercraft, 116M, 7041 Olcott, Chicago 31, Illinois.

**FIXIT** Design kit. Four precision tools make ideal gift. Compass, dividers, inside, outside calipers, plastic case, \$2.49. Blake Company, 30 Shrewsbury, Worcester, Mass.

**THIRD** Dimension jeweled Xmas tree lapel pin kit. Partly finished. Make for gifts or to sell. \$4.00. Littlejack, 647 Cragmont Ave., Berkeley 8, California.

**RESEAT** Your chairs. Illustrated instructions. All necessary materials sent for one cane, rush, or porch chair, \$2.50 postpaid. Richmond Willow Works, Richmond 20, Virginia.

**LEATHERCRAFT** Spring punch makes oval lacing holes 3/32", 1/8". Free information. A. Mullin, 972 Harliss Ave., San Jose, Calif.

**PLANS**—Children's davenport and chair \$1.00; platform rocker 50c. Pennebakers, Creston, Iowa.

**93 ORIGINAL** Idea jig saw patterns \$1.00. Professional drawing, quality printing. Full size shelves, toys, lawn ornaments, novelties. Walker Studio, PM-V11, 4343 Lindell, St. Louis 8, Mo.

**SKILSAWS,** Table saws — jointed, gummed, filed and set up to 10 in. Mail \$1.00 and saw to Art Ganger, New Paris, Ind.

**LAMP** Size cypress knee \$1.00. Cy Products, Dept. I, Lafayette, La.

**BUY** Wholesale nationally advertised power, hand tools, thousands other products at big discounts. Free wholesale plan. American Buyers', 628-PP Linden, Buffalo 16, N. Y.

**89 FULL** Size jig saw patterns of beautiful shelves, ornaments, toys, novelties. Plus "How, Where to Sell." Only \$1.00. Mastercraft 114M, 7041 Olcott, Chicago 31, Illinois.

**LEATHERCRAFT** Supplies. Pre-cut kits, tools, etc., large stock. Catalog 10c, refunded first order. Whitman Saddle Mfg. Co., 1725 Powers St., C-11, Cincinnati 23, Ohio.

**MAKE** Your own models with kits from Del's Tricks and Hobbies. 806 Paris Avenue, Rockford, Illinois. Airplanes, automobiles, dolls, ships and trains. Send 10c for illustrated catalog.

**LEATHERCRAFT.** Everything needed by beginners, advanced hobbyists and professional leatherworkers. Largest stock of supplies in U. S. Moderate-priced tooling leathers, top quality calfskins, tools, supplies, kits. Send 10c for big catalog. J. C. Larson Co., 820 S. Tripp, Dept. 3650, Chicago 24.

**LEATHERCRAFT.** Tremendous stock of leather, tools, supplies, and kits. In leather business over forty years. Send 10c for big catalog. Sax Bros., 1111 No. 3rd, Dept. PM11, Milwaukee 3, Wisconsin.

**PLASTICS** Home-craft course for men and women. Tells and shows how to make hundreds of fast selling plastics products. All plastics and materials for 23 projects included in course. No special tools needed. Course pays for itself. Write for free booklet. Interstate Training Service, Dept. D3M, Portland 13, Oregon.

**100 FULL** Size jig saw patterns up to 20" high, only \$1.00. Pattern Service, Medway 9, Mass.

**50 TOYS.** Full size patterns, easily built. All age groups. \$1.00. Associated, 103 McGraw, Ithaca 2, N. Y.

**100 FULL** Size jig saw patterns up to 20" high, only \$1.00. Pattern Service, Medway 9, Mass.

**BLEACH** Furniture blond. Kit \$1. Complete with instructions. Send for free booklet. National Chemicals, Dept. 111, 3601 Bainbridge Ave., New York 67, N. Y.

**SPECIAL** Offer. 102 full size jig saw patterns only \$1.00. Lynds, 71 Park, Natick, Mass.

**LEATHERCRAFT.** Free list. Francis Byrd, 3406 Montrose Ave., Richmond, Virginia.

**PROFITABLE** Jigsaw patterns! Folder. Pauls Plans, 2233A North 35th, Milwaukee 8, Wis.

**25 LAMPS,** 10 Knickknacks, 20 novelties. Full patterns. Easily built. \$1.00. Associated, 103 McGraw, Ithaca 2, N. Y.

**SOMETHING** New. Four scenic model kits for framing or shadow box. Carve and paint yourself. Photos and description 10c. Richard Orr, Ship Studio, North Easton, Mass.

**\$46 FROM** Square foot plywood; jigsaw necessary. Write: Woodarts, Bridgewater, Mass.

**\$500.00 FROM** \$75.00 Worth pine boards. Hammer and saw only. Enclose \$1.00 for plans, plus how to sell. Thanks. Cooke, Stoddard, Wisconsin.

**ONLY** New money maker in years—Secrets of luggage making revealed. We sell your products. Casecraft, 805-H Sunset Blvd., Los Angeles.

**HELP** Yourself with proven easy way to remove rust from tools and parts by soaking. Get material reasonably from your grocer. Only 50c coin to Mr. Bello, Box 426, Butler, Wisconsin, brings directions.

## MAKE IT YOURSELF

**BUILD** Streamlined plywood kitchen cabinets. Plans, photos, instructions, 50c. Playnecabinets, 4617 Johnson, Western Springs, Ill.

**BUILD** A treasure and metal detector. Lightweight, sensitive, inexpensive. Complete kits, free literature. Dept. 1, Electronic Applications, Box 4975, Washington 8, D. C.

**BUILD** Your own tractor. Free information. Eltraco, D-I, Camptonville, California.

**MELT** Iron for castings. Free literature. Ursutz Burner, Box 92, Globe, Ariz.

**SEND** 25c Today for new large catalogue of supplies for 21 popular crafts. Dept. D-11, Dearborn Leather Company, 8625 Linwood Avenue, Detroit 6, Michigan.

**"CONCRETE** Block Homes." 32-page booklet, on how to build. \$1.00. H. C. Lightfoot, Civil Engineer, Richboro 1, Penna.

**BUILD** 3 Bedroom rancher. Large rooms. Fireplace. Only \$1200. Plans \$1.00. Minkoff, Box 52, Flushing, N. Y.

**\$800 BUILDS** Home, four rooms and bath. Concrete block construction. Plans, materials lists, instructions, \$1.00. U-Build-It Enterprises, Box 230, Springdale, Ark.

**MAKE** Your own stone veneer. Economical. Easily made. Quickly applied. Looks like genuine stone. Formulas, illustrations, patterns. Send \$1.00. Alburg, Box 17, Carrollton, Michigan.

**MAKE** Your own sliding door units. All hardware, instructions, drawings supplied. Prices start at \$7.00. Knockdown wooden parts, doors and catches available. Send for list. Greenlee Products, Hollywood, Fla.

**BUY** Beautiful undressed dolls from us. Box 262, Jefferson City, Missouri.

**BUILD** A table model power hack-saw. Cuts patterns in wood, metal, plastic. Make with hand tools. Plan \$1.00. Harvey, Thornwood, N. Y.

**COMPLETE** Brush plater 50c. Tank plater \$1.00. Positively everything included. Free literature. Larger models. Easy Plater. Box 293, PM4, Red Lion, Penna.

**BUILD** Luggage and cases at home. We sell your products. No special tools or equipment needed. Free details. Casecraft, 805-AB Sunset Blvd., Los Angeles.

**ADMIRAL** New refrigerator cabinet \$27.50. Guaranteed. Metro, 44 North Albany, Chicago.

**BUILD** Income duplex \$1300. Concrete block, copyrighted design. Blueprint, instructions, material cost list \$1.00. Melvin Bailey, Building Contractor, 915 Pyramid Life Building, Little Rock, Arkansas.

**JEWELRY** You can make! Illustrated workbook for hobby craftsman. \$2.50 ppd. Howard A. Boblet, 11017-PM South Vermont, Los Angeles 44, California.

## WATCHES, OLD GOLD, JEWELRY

**5000 JEWELRY** Styles you can easily make yourself. Rhinestones, pins, earrings, etc. Lowest prices guaranteed. Instructions and catalog 10c. Barry's, 165 Ardsley Court, Newark, N. J.

**WATCHMAKERS'** — Jewelers' complete informative catalogue 20c. Bengale Company, Culver City, California.

**JEWELRY** Making can be a profitable hobby—Send 20c for our latest illustrated catalog. Milady-Fair Co., G.P.O. Box 1328, New York City.

**CASH** For old gold, broken jewelry, gold teeth, watches, platinum, diamonds. Popular Refinery Co., C. C. Hurley, Mgr., 216 East Ontario St., Chicago 11, Ill.

**UNREDEEMED** Diamond, 1-carat, \$295. 30-day refund. Free catalog. Broff's Diamond Loan Association, 411 Smithfield, Pittsburgh, Penna.

**10 HIGH-Grade** Swiss ladies' and gents' wristwatches needing minor repairs. \$18.00. Write for prices. B. Lowe, Holland Bldg., St. Louis 1, Mo.

**HIGHEST** Prices paid for old gold, silver, platinum, diamonds, watches, gold teeth, spectacles. Cash immediately. Goods returned if offer unsatisfactory. United Smelting Works. (The Old Reliable), 39-B South State, Chicago 3.

**RHINESTONES.** Jewelry settings, cameos, sequins, beads. Send 10c for illustrated catalog. J & M Novelties, Dept. CM-3, Griffith, Ind.

**KLONDIKE**—Jewelry findings swept from manufacturers tables. Finished and unfinished parts for earrings, bracelets, necklaces, pins, etc. Sample pound \$2, 5 pounds \$7.50. Stones for rings, jewelry 1000—\$5. Sample 1000—\$1.50. Lustre pearls assorted sizes \$2.50 pound. 5 pounds \$10. Beads imported assortment \$1.50 sample pound. 5 pounds \$6. No c.o.d.'s. Satisfaction guaranteed. Merchandise Distributing Co., 19 E. 16th St., New York, Dept. E-51.

**FIX** Watches for pay or pastime. Free sample lesson. Chicago School, Dept. PM-11, 2330 Milwaukee Ave., Chicago 47, Illinois.

**WATCH** And clock repairing books for hobbyists. Free information. North American, Dept. 13-L, 2320 N. Milwaukee, Chicago 47, Illinois.

**CUCKOO** Clocks repaired. Beach's Clinic, 4055 S.E. Taylor, Portland 15, Ore.

**WATCHMAKERS:** Buy Swiss watch materials direct from importer. Phillip Vicinanza, 460 E. 137th St., New York 54, N. Y. Request price list.

**PRODUCE** Rhinestone jewelry—Simple manufacturing instructions. Illustrated catalogue, valuable stone—Size chart, samples. 25c. Refunded first order. Elzee A29, 102 W. 38th, New York City.

**TWO** New books show how to make jewelry at home and how to sell what you make. Send 25c for "How to Make Costume Jewelry" and "A Success Plan For You." Castolite, Dept. MJ-101, Woodstock, Ill.

**WATCHMAKERS'** Tools, materials, supplies, watches. Catalog. Gales, Box 1000, Chicago 90, Ill.

**FINE** Seventeen jewel Swiss Incabloc watch, water and dust resistant, shock-proof, antimagnetic radium dial, hands. Guaranteed. \$9.75 plus 98c tax. Money back in 10 days if not satisfied. Capital Distributing Company, 213 Atlantic Bldg., Washington 4, D.C.

**HIGHEST** Cash paid for old gold, broken jewelry, gold teeth, watches, diamonds, silverware, spectacles, platinum. Free information. Satisfaction guaranteed. Rose Smelting Company, 29-A East Madison, Chicago.

### RAZORS, BLADES, SHARPENING

**100** BLADES \$1. 3 Neckties \$1.50. Box 970J, Milwaukee, Wis.

**AT** Least six times as many keen shaves per double edge blade using top quality Dual Hone. Sharpens pocket knives. Send \$1.00 postpaid. De Naysen Corporation, Box 931, Philadelphia 5, Penna.

**SAVE** 25% On Remington, Schick, Norelco shavers, etc. Postpaid. Free literature. Morgan & Brownell, Algonquin, Ill.

**DOUBLE-Edge** 1000—\$6.00. Joe's Products, Southwick Street, Fitchburg, Mass.

**XMAS** Special ball pen. 100 double edge razor blades; guaranteed \$1.00. Payne, 5426 5th Ave., Los Angeles 43, Calif.

### FOR THE HOME

**CHAIRS,** Stools, cedar wardrobes, chests, juvenile furniture, cherry tables. Factory to you. Illustrated price list free. Southern Craftmasters, Department M-1, Columbia, Tennessee.

**IMPORTED** Black Forest cuckoo clock. Calls and gongs the full and half hour. Wills Brothers, 237 S. Ellwood Ave., Baltimore 24, Md.

**HEAT** Homes efficiently. Prints marked. Bill of material listed. Details free. Garver Company, Vermilion, Ohio.

**FOAM** Rubber utility pad, app. 20"x22"x 1". Suitable for car, boat, or home use. Factory seconds special \$2.00. Edwin Bowditch, Bloomfield, Conn.

**SAVE** 25% On your favorite brand home freezer. Send postcard describing wants. Free literature. Morgan & Brownell, Algonquin, Illinois.

**PRESERVE** Your rubber goods with Rubber Guard. Free details. Jeanes, 1409 Partridge, Mobile, Ala.

**MAGNETIC** Latch for cabinet size doors. Last forever. Doors open without snap. Hold firmly. Easily installed. 75c each. \$6.00 per doz. E. & A. Post Mart, Box 655, Trenton, Mich.

**KIRSCH** Extension drapery traverse rods. Finest quality. Easily installed. Completely assembled. 28"-48" \$2.60; 48"-86" \$3.70; 66"-120" \$5.40; 86"-150" \$7.10. Prepaid. Free instructions. Traverse Mart, 27-10 200 St., Bayside 60, N. Y.

**FOAM** Rubber furniture cushions. Factory seconds. 50% discount. Prices free. Perma-Foam, 140-C Main Street, East Orange, New Jersey.

### OF INTEREST TO WOMEN

**NYLONS** 8c Pair, anklets 12c pair, socks 9c, print 17c, panties 12c, dresses \$1.95, slips 47c, undershirts 17c, rugs 70c, robes \$1.65, spreads \$2.65, \$70.00 watches—\$18.95, jewelry sets \$1.25, pens 8c, combs 1c, aspirin \$1.00-1,000 brushes 9c, razor blades 5-2c, electric razors \$2.00. Complete stock list, picture catalogue, 25c if sent immediately. Sibert's, Chattanooga 4, Tenn.

**GOOD** Money in weaving. Weave rugs at home for neighbors on \$69.50 Union Loom. Thousands doing it. Booklet free. Union Looms, 153 Post St., Boonville, N. Y.

**WOMEN** Make money at home, spare time. Sew ready-cut Rap-a-Round. Easy, profitable. Hollywood Mfg. Co., Dept. BA, Hollywood 46, Calif.

**DOLLS,** Buy direct from manufacturer. Save half. Information free. Pickaninny for collectors 35c. Peggy's Doll House, Jefferson City, Missouri.

**SAMPLE** America's famous meat tenderizer. Send 25c. Tendex, Salem, Mass.

**FRAGRANT** Cloth remnants. A many purpose item. Wonderful in satchet bags, dresser drawers, chair cushions, pin cushions, sofa pillows and dolls. Homeworkers, gift designers, hobbyists for sample write Delight M Company, 4042 Kimball, Chicago 18.

**GIFTS** And gadgets galore. Free catalog. The Gift Fair, 2641 W. Walton St., Chicago 22.

**PROFITABLE** Home business. Make fast-seller chenille monkey trees, dolls, flowers. Terrific holiday demand. Information free. Velva, Bohemia 16, N. Y.

**DRESSES,** 24c; Shoes, 39c; men's suits, \$4.95; trousers, \$1.20. Better used clothing. Free cat. Transworld, 164-D Christopher, Brooklyn 12, N. Y.

### FOR SALE—MISCELLANEOUS

**TURBINE** Superchargers for B24 bombers. Many uses. \$100.00 each. 1721 Scott Rd., Burbank, Calif.

**HEARING** Aid batteries, wholesale. Free list. Habs, Box 51, York, Penna.

**SAVE** Money on army, navy and factory surplus. Write today for new 60-page illustrated catalog. Tennusa Sales Co., Dept. C, 1451 Market, Chattanooga, Tenn.

### WANTED—MISCELLANEOUS

**GRINDER** And saw filer. Box 574, Pearl River, N. Y.

**QUICKSILVER**—Highest prices paid. Free containers. Wholesale Terminal, Norwood, Massachusetts.

**SCRAP** Mercury (quicksilver) containers supplied—Tantalum, bismuth, tungsten. Metallurgical Products Company. Established 1909. 35th and Moore Sts., Philadelphia 45, Penna.

### PERSONAL

**REMAINS** From Louisiana's capital, 25c each; 6, \$1.00. Picou's, Box 2134, Baton Rouge, Louisiana.

**MIAMI,** Miami Beach: Letter remained 25c; local classified pages airmailed \$1.00. Confidential, Box 306, Miami 2, Fla.

**HAMMERLINED** finished personal file. Easy to carry. 12 1/2"x5 1/2"x10". Snap on lock, alphabet index. Colors, grey, blue, walnut, \$3.98. Jeanes Enterprises, 1409 Partridge, Mobile, Ala.

**DALLAS** Remails 25c. Other services. Hagler, 2838 Sharon, Dallas 8, Texas.

**FRESNO** Remail 25c. L.A., S.F., Fresno classified \$1.00. Roy, 3415 Mayfair Dr., No. Fresno, Calif.

**FREE** Sample! World's finest, French-type perfumes. Wholesale only! Elliott-Stuart Limited, 4616-A Hollywood Boulevard, Hollywood 27, California.

**LETTERS** Remailed 25c. Personal address service available. Write for rates. McLaughlin, 800 Stewart, Columbus 6, O.

**LAS** Vegas, Nevada. Letters remailed 25c. Miniature slot machine \$2.00. Master Mailers, Box 1725, Las Vegas, Nev.

**MIAMI** Remail and forwarding 25c. H. Boughner, 552 N.W. 45 St., Miami, Fla.

**PARTNERSHIPS.** How to start a business partnership, and how to withdraw, without losing your shirt. Includes practical partnership information. Helps settle partnership arguments. Booklet form. Copyrighted. Price \$2.00, money order or currency. If not satisfied, return in five days for refund. Fox Business Publications, Box 1265-A, Peoria, Ill.

**LET** Us airmail 3 of your friends beautifully colored Dutch mill or old-master postcards. Send \$1.00. Rotina, Postbox 4005, Rotterdam, Holland.

**SAN** Antonio re-mail 25c. Local information \$1.00. Re-Mail, Box 1918, San Antonio, Texas.

**LETTERS** Remailed San Francisco postmark 25c. Private receiving-forwarding address available. Shanks, Box 3110, San Francisco 19, California.

**AROUND** The world remailing, Chicago 25c. Business and personal address. Letters relay from other cities 75c. Full details 10c. C. Macks Mailorder, 5656 N. Hermitage, Chicago 26, Ill.

**NEW** Orleans remails 25c, private receiving address, scenic postcards. Rapp, 1527 Pace, New Orleans 14, La.

**LETTERS** Remailed 25c. Private receiving-forwarding address available. Hicks Service, 5216 Just Street, N.E. 303, Washington 19, D. C.

**"HOW** Can I find out?" You can! Information confidentially developed. Any matter, person, problem. Worldwide. Officially licensed. Established 1922. William Herman, 170 Broadway, New York City.

**UNITED** Nations—New York remailed 25c. U.N. stamps. French, 25 Cornelia St., Brooklyn 21, N. Y.

**CHICAGO** Mailing address, centrally located, lowest rates. International Mail-trade, 125 South Market Street, Chicago, Illinois.

### MISCELLANEOUS

**BUY** Wholesale thousands of nationally advertised appliances, giftware, watches, cameras, dolls, etc. Catalog 50c, refundable with order. Dart Sales, 3812 Atlantic Ave., Brooklyn 24, N. Y.

**MAGNETS**—Permanent Alnico. Never loses magnetism. Excellent for map and bulletin board work. Many uses. 12 for \$1.00. Pritt Co., Dept. MM-11, 12 West 27th, New York City.

**ARTIFICIAL** Human eyes—Assortment mailed you from world's largest, finest selection imported glass and all-plastic unbreakable eyes. Write for free booklet and color chart. Established 1906. Denver Optic Company, 1101 University Bldg., Denver 2, Colorado.

**CATCH** Mice my easy way. Effective, simple. They can't resist! Non-poisonous. \$1 brings complete information. Money refunded if not satisfied. Alma Wootan, Willcox, Arizona.

**EXCHANGE** 3 New neckties or 10 pocket novels 50c. Buy best 3 Mate nylons \$1.25 or 3 beautiful new neckties \$1.50. Perpetual big mail 2c. 1000 names 25c in four Barr's Mail Buyer's Directories, Box 861M, Milwaukee, Wisconsin.

**GERMANY** Export-Import-Industrial directory, 65,000 addresses. English index \$8 postpaid. Burke Associates, Manchester 1, Mass.

**DAY** And nite mailbox sign, all reflecting, same both sides, 18 letters lifetime aluminum. \$1.75 postpaid. Reflecto, Box 232, Ravenna, Ohio.

**NATURAL** Dates, figs, nuts. Gift packs, bulk. Free folder. Tontz, Dept. PM, Elsinore, Calif.

**BUY** Wholesale thousands nationally advertised products at big discount. Free wholesale plan. American Buyers, 631-D Linden, Buffalo, N. Y.

**X-RAY** Mind. Analyze and influence people at sight. Inquire. Send dime. Krishnar Institute, 1912 Lincoln Park West, 241-SZ, Chicago 14.

**FIRE** Alarm detectors for homes and buildings. Complete engineered system: Three detectors, 100 feet wire, bell, switches, instructions \$18.95. Additional detectors \$4.50 each. Gar Company, Cranston, R. I.

**DRIVEWAY Marker**, lifetime aluminum, reflects same as roadside billboards. 24 in. long. \$1.25 postpaid. Reflecto, Box 232, Ravenna, Ohio.

**LEATHERCRAFT** For pleasure or profit. Make easy-to-assemble purses, belts, gloves, wooskin toys, 100 other items for gifts or to sell. Send 10c today for big catalog. Largest leathercraft stock in U.S. J. C. Larson Co., 820 S. Tripp, Dept. 3351, Chicago 24.

**HAIRCUT** As you like it. Booklet explains. 25c. Mastrolia, 32-20BV 89th Street, Jackson Heights 69, New York.

**CHOPSTICKS**, Imported, 2 pairs, instructions, \$1.00. Kendall, 501 E. Norman, Arcadia, California.

**SURGEON'S Knife** with 6 removable blades. Supersharpened. Handy for workshop. 1/2 price closeout. Send \$1.00. Hal Schmitthorst, 7375 Cayuga, Cincinnati 27, Ohio.

**LEARN** To juggle. Details free. Write. Bates & Company, Riverton, Kentucky.

**MARBELCRETE**—Stops all dusting and wearing away of cement floors. Permanent treatment. Information free. Becker Paint & Varnish Co., Bay City, Michigan.

**AMAZING E-Z-Go** hand cleaner instantly removes printing, lithographic, spirit, off-set inks; Mimeograph, Hectograph, Multilith, carbon paper, typewriter ribbon stains. Send one dollar for pound can. Postpaid anywhere U.S.A. Aids chapped rough hands. Amaza Laboratories, Inc., Dept. D, Macedonia, Ohio.

**WHY** Pay retail prices? Get catalog showing nationally advertised merchandise at discounts. 25c. Budd Supply Co., Dept. 28, 918 St. Paul St., Baltimore, Md.

**GLASS** Frosting. Brushes on. Obscures vision but lets light through. Beautiful, lasting. Send \$2 for 40 sq. ft. supply. Kennedy Supply, Encinitas, Calif.

**EASILY** Home-made windmill gives plenty power. Guaranteed instructions, \$1. Ziembak, 6123 Orchard, Dearborn, Mich.

**B & B Photo** Christmas cards are the finest. Satisfied, repeat customers in 40 states. 25 large cards and envelopes \$1.69 postpaid. Send for order blanks and samples today or send negative with check. B & B Studios, Box P945, Wilmington 99, Delaware.

**WHOLESALE** Aluminum Venetian blinds. Prices on request. Delta Distributors, Moreauville, La.

**FINE** Delft-blue hand-painted pottery Dutch mill (H 3 1/2 inch) or Dutch clog (L 5 inch) \$1.00, airmail 50c extra. Rotina, Postbox 4005, Rotterdam, Holland.

**BUILDERS**, Contractors, home owners. Buy that safe now. Wall and floor safes. Write for information. Ernie Scott, 7905 Birchdale, Chicago 35, Illinois.

**HOSTS** Apron. A wonderful gift for someone who has everything. Covered with witty expressions and humorous cartoons. Rush \$2.00. Host, Box 1918, San Antonio, Texas.

**300 BIG** Mails guaranteed. Samples, plans, offers, propositions, 12 months listing, \$1.00 refundable. Wright Publications, 2270 Hubbard, Memphis 8, Tenn.

**SPEND** Your winters in Florida, starting with or without capital. Folio tells how, \$1.00. Particulars 10c. Koerner's, 1026 Asbury, Ocean City, New Jersey.

**WORRY** Replaced with confidence or no cost. Free lecture and details. Reverend Balliard, Box 1924-M, Louisville 1, Ky.

**INCREDIBLE!** Become mental superman overnight! Free booklet! Bijou, Box 1727-MB, Hollywood 28, California.

**RECEIVE** Mail, samples, magazines, catalogs, 10c. American Directory, CalAllen, Texas.

**PENMANSHIP** Courses. Improve your writing quickly. Learn shaded writing. Greeting cards, name cards, elegantly written. Free descriptive literature. Write: Tevis, A-25, Chillicothe, Mo.

**LEVEL** Land for irrigation. Advisory service. Loren Williams, P.O. Box 91, Willows, Calif.

**WRITE** Your name in raised gold, silver, copper. Complete kit \$1.00 postpaid. Nu-Man-Co, Denver, N. Y.

**UNIQUE** Playing cards. Life-like. All different. Brochure free. Beaumart's, Box 608B, Morristown, N. J.

**COTTON** Bolls from Texas. Large fluffy bolls of fleecy staple, \$2.00 per dozen postpaid. Cole Family, Box 992, Greenville, Texas.

**LOCATE** Hidden treasure, distinguish minerals from metals with the Model 100 Detector. Weighs 5 pounds, extremely sensitive. Factory assembled \$79.90 or kit form \$39.90. Free literature. Dept. P. Electronic Applications, Box 4975, Washington 8, D. C.

**HELP** Poor circulation, nervous tension. Free folder. Gyro-Belt, Upper Darby 7, Pennsylvania.

**RECEIVE** Magazines, samples, catalogs. Mails from everywhere. Offers hundreds, larger listing 35c. Rorick, Box 86, Cincinnati 26, Ohio.

**BE** The Popular Mechanics representative in your neighborhood and earn big profits in your spare time. Write Popular Mechanics Magazine, Room 408M, 200 E. Ontario St., Chicago, Ill.

**CIGARETTES**—Roll 200 mild, tasty, guaranteed to please for 75c. Details free. Pete Moberly, Box 857, Owensboro, Ky.

**SELECTIVE** Metal and mineral detector. Revolutionary design. Distinguishes metals from black magnetic sands. Readily detects metals under salt water. Also Geiger counters. Free literature. Gardiner Electronics Company, 2018 N. Dayton, Phoenix, Arizona.

**TREASURE** Finders for gold, silver and minerals. Money back guarantee, best available. Also Geiger counters for uranium prospectors, free information. Write Goldak Company, 1541 West Glenoaks, Glendale 1, Calif.

**STUDY** For game warden, park, fish, forestry, lookout, guide, wildlife conservation, immigration and highway patrol service. Details free. Write Delmar Institute, C5, Whittier, Calif.

**PASCINATING**, Practical book for the hunter and trapper. Guide to Good Hunting and Trapping lists all popular game animals, tells how to hunt and trap them. Many articles written by famous guides and well-known sportsmen. Author Joe Godfrey is famous sportsman, founder of Sportsman's Club of America. 160 pages, \$3.00. Popular Mechanics Press, Dept. 90, 200 E. Ontario, Chicago 11, Ill.

**TREASURE—M-Scope** Geiger counters, mineral locators. Why buy something inferior when you can buy the best at a lower price? Backed by years of experience. Fully guaranteed by factory. Detects minerals, metals, gold, silver, coins. Payment plan available. Proven superior performance. Free 16 page illustrated booklet. Fisher Research Lab., Inc., Palo Alto, California.

**CLOGGED** Drains opened by new powerful chemical called Sursolvent. Removes grease, soap, tree roots, etc., without expensive digging and electric rodding machines. Simple to use. Mix with water and pour down sink. Postal brings free details. Electric Sewer Cleaning Co., Allston 34, Mass.

**GOLD**, Silver, metal detectors. Geiger counters for uranium. Mineralights. Sensational new fully guaranteed models. None finer. Information free. Detectron Co., 5420 Vineland Ave., North Hollywood, California.

**70 BIBLE** Lessons, 25c. Bulletin, Box 87, Cathedral Station, N. Y.

**YOUR** Leather jacket renovated expertly. Free circular. Berlew Mfg. Co., Dept. 8, Freeport, N. Y.

**HOMES** You can build for \$4500 to \$7046. Books that take you through every step. Popular Mechanics Famous Concrete Block House, \$2.00. Your Home and How to Build It Yourself, \$3.00. Ranch Type House You Can Build, \$3.50. Also full-sized builder's plans for each home at nominal price. Popular Mechanics Press, Dept. 102, 200 E. Ontario, Chicago 11, Ill.

**SPORTS AND PROFESSIONAL**

# DIVING

**EQUIPMENT**

"IF IT'S FOR DIVING  
DESCO MAKES IT!"

\* World's largest manufacturers of Diving Equipment

CATALOG ON REQUEST 234 N. BROADWAY  
**DIVING EQUIPMENT & SUPPLY CO.**  
MILWAUKEE 2, WIS.

## POCKET COMPARATOR

**Check, Measure  
Inspect Small  
Parts and  
Dimensions  
with 6 POWER  
MAGNIFICATION**

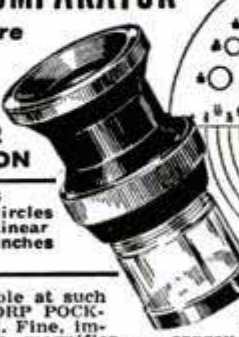

**MEASURES**  
• Angles • Circles  
• Radii • Linear  
in both decimal inches  
and millimeters

First time available at such low price! EDSCORP POCKET COMPARATOR. Fine, imported measuring magnifier—approx. size 1 1/2" x 2"—for fast, accurate inspection of intricate parts. Used to check layouts, machining on tools, dies, gauges—to check threads, chamfers, small holes. For scientists—in determining width of spectrograph lines. In photography—measuring and focusing at ground glass. Instrument comes in protective leather case. Money back guarantee.

**HANDY! FAST! ACCURATE!**

Stock No. 30,061-H. \$22.50 Postpaid  
Order by Stock No. Send check or M.O.  
GET FREE CATALOG "H"—Dozens of Amazing Optical Bargains!

**EDMUND SCIENTIFIC CORP., Barrington, N. J.**

# ENGINEERING DEGREE IN 27 MONTHS

## Big Demand for Graduates

**Aeronautical, Chemical, Civil, Electrical, Mechanical  
and Radio Engineering (inc. TV and Electronics)**

Hundreds of young men are earning B. S. ENGINEERING DEGREES annually in this recognized institution — year around operation. New terms start quarterly. Many students earn a major part of their college expenses in this large industrial center.

Low tuition. Competent instruction. Thorough, intense, practical program. Modern, well-equipped laboratories including new physics laboratory and modern wind tunnel. Individualized instruction emphasized.

Government approved for G.I.'s. Engineering preparatory courses. Students from 48 states and 21 foreign countries. Enter December, March, June, September. Send coupon for free catalog and full information. Enroll now.

**SEND COUPON TODAY**

## INDIANA TECHNICAL COLLEGE

5113 E. Washington Boulevard  
Fort Wayne 2, Indiana

Please send me free information on B.S. Engineering Degree in 27 months as checked.

Aeronautical,  Chemical,  Civil,  Electrical,  
 Mechanical,  Radio-Television

Name \_\_\_\_\_

Address \_\_\_\_\_

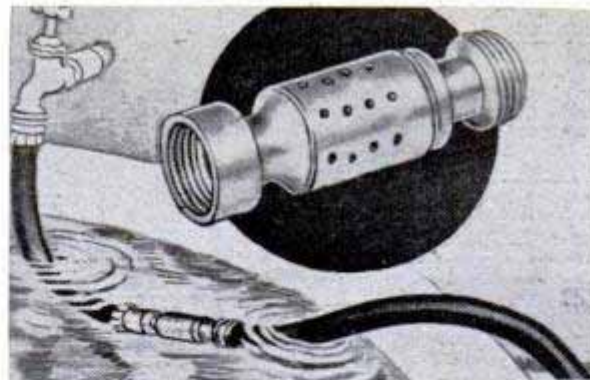

**3<sup>95</sup>**  
Postpaid

Without electricity or moving parts this suction drainer pumps 300 gallons of water per hour from flooded cellars, pools, trenches, etc. Just attach with a garden hose to any screw-type faucet, attach another section of hose to the discharge end, turn on the water and it goes to work. Solid brass, non-rusting. Send for Free Catalog. **NOVELTY MART, 59 E. 8th St., New York, N. Y., Dept. 205A**



**Free! 40 "Iron Curtain" Stamps**

**SENT TO MAKE NEW FRIENDS**

Get these valuable, all-different stamps from countries behind the Iron Curtain while supplies last! Many of these scarce stamps were smuggled into free Europe from Russia, Hungary, Poland, Czechoslovakia, Bulgaria, Rumania, East Germany and Siberia—lands cut off from the Western World by the ruthless "Iron Curtain" of Russian Communism and are becoming hard-to-get. Guaranteed worth at least \$1.00 in Standard Stamp Catalog! We may not be able to continue this offer for long—so RUSH coupon enclosing 10c for actual postage and handling charges. (We'll also include other exceptional values for inspection.)

**ALSO FREE—"The Stamp Collector's Manual"**—a practical illustrated guide to stamp collecting. Contains valuable information and stories about the world's most fascinating hobby.



**KENMORE STAMP CO., Dept. PM-1153**  
Milford, New Hampshire

Rush me **FREE 40 Iron Curtain Stamps** and "The Stamp Collector's Manual." I enclose 10c to help pay postage and handling.

Name \_\_\_\_\_  
Street \_\_\_\_\_  
City \_\_\_\_\_ State \_\_\_\_\_

**MONEY in DONUTS**

Make new greaseless donuts. Start in kitchen. No smoke. Sell stores. Cash daily. No experience necessary. *Free recipes.* No obligation. Write! **MARTIN RAY CO., 3605 SO. 15th AVENUE, MINNEAPOLIS 7, MINN.**

**SAY YOU SAW IT IN POPULAR MECHANICS**



**HANDS TIED?**

—because you lack a **HIGH SCHOOL DIPLOMA**

• You can qualify for an American School Diploma *in spare time at home!* If you have left school, write or mail coupon for **FREE** booklet that tells how. No obligation of any kind.

**OUR 56TH YEAR**

**AMERICAN SCHOOL, Dept. V845**  
Drexel at 58th, Chicago 37, Illinois  
*Please send FREE High School booklet.*

NAME \_\_\_\_\_  
ADDRESS \_\_\_\_\_  
CITY & STATE \_\_\_\_\_

**BOYS BUILD YOUR OWN CRYSTAL RADIO**

It's easy and lots of fun to build your own crystal radio set. You need no batteries or tubes when you use a "Melomite" Crystal and detector. Wonderful performance. "Melomite" crystal and detector with instructions and plans for building your own Crystal radio set—All for only 50c postpaid. Rush your order today, immediate delivery. **ALVA ALLEN RADIO, Dept. PM-511, Clinton, Mo.**

**100 BEST Woodworking Projects**

**SELECTED FOR YOU BY POPULAR MECHANICS EDITORS**  
Enjoy the fun—the pride—of making things. Get **100 BEST WOODWORKING PROJECTS**, complete with simplified instruction, plans, diagrams and more than 400 how-to-do-it pictures. Make all kinds of furniture, baby carriages, clocks, lamps, book shelves, fireplaces and other useful articles at little or no cost. Send only \$2.00 with name and address. Money back if not pleased.

**POPULAR MECHANICS PRESS, Dept. PM6, 200 E. Ontario St., Chicago 11**

**Direct from Importer at Big Saving! ENGLISH BICYCLES**

**Lightweight • Full Size**  
A thrilling gift for cyclists of every age! Latest model famous English bike (men's or ladies') direct from importer to you at Money-Saving low wholesale price. Features — 26" wheels, Chromium rims, 3-Speed gears, Front-Rear Hand Brakes, Chain guard, Brooks spring saddle, Reflector. Shipped anywhere Railway Express, Collect. Deposit \$5.00, balance C.O.D. 5 day Money-Back Guarantee. Order Today! **CLARION METAL PRODUCTS (Dept. M)**  
559 McDonald Ave., Brooklyn 18, N. Y.

**\$750 BUILDS 4 ROOMS & BATH!**

**WHY PAY RENT?** For Seven Hundred Fifty Dollars and 30 days of your spare time, you can build yourself this Beautiful Home. Living Room 11x15, Front bedroom 9x11, Back bedroom 10x12, Kitchen 9x11, Bath 5x8, Hall 3x4. Wind out steel casement windows. Concrete block, stuccoed. Step-by-step illustrated instructions, blueprint and material list \$1.00 ppd. No COD. Moneyback guarantee. **Economy Home, Dept. C**  
Box 645 Columbus 16, Ohio

**Wheels Wheels**

**Wheels Wheels**

7" Disc Wheel 3/4" Tire 3/8" sleeve	45c ea.
8" Disc Wheel 1 1/8" Tire 1/2" sleeve	70c ea.
7" Disc Wheel 1" Tire 1/2" ball bearing	80c ea.
8" Disc Wheel 1 1/8" Tire 1/2" ball bearing	\$1.00 ea.
6" Disc Wheel 1.50 semi-pneum. Tire 1/2" B.B.	\$1.35 ea.
8" Disc Wheel 2" semi-pneum. T. 1/2" B.B.	\$1.50 ea.
10" Disc Wheel 1.75 semi-pneum. T. 1/2" B.B.	\$1.50 ea.
10" Disc Wheel 2.75 semi-pneum. Tire 5/8" B.B.	\$3.50 ea.
12" Disc Wheel 3.75 semi-pneum. T. 1/2" B.B.	\$1.85 ea.

Above wheel prices includes hub cap. Plus Postage. C.O.D.'s accepted. AXLES—Sizes 5/16 in., 3/8 in., 1/2 in.—Cut to size—End holes drilled.

**UNITED WHEEL STAMPING CO.**  
12131 S. PEORIA STREET PM-11 CHICAGO 43, ILLINOIS

# 6X-10X POCKET

ALL 3 ARE Top Quality Precision PRISM Binoculars. Superb Craftsmanship. Superior in every detail.



## 10x They Are New! \$24.95

WEIGHS 7 1/2 OZ.! Palm sized. Full 10 Power. Color corrected. Achromatic lens. Perfect balance. Another UNITED first in revolutionary binocular developments.

## 6x DUO-TONE \$14.95

Illustrated. Weighs only 4 1/2 oz.! Provide an excellent field of view.

## 7x ALL CHROME \$19.95

Sturdy. Precision made. Sharp, clear vision! Sale priced.



## 16x50—\$69.50 Weighs only 27 ounces!

The ultimate in high powered binoculars. Easy to hold—Easy to focus. 2" wide objective lens assures brighter, sharper, clearer images. Water-Dust Resistant. Height only 7 inches. Not illustrated.

- |                                  |         |
|----------------------------------|---------|
| 6x30 15 oz. Economy.....         | \$34.50 |
| 7x35 5"x6 1/2" All purpose.....  | 45.50   |
| 7x35 CENTER FOCUS.....           | 49.50   |
| 7x35 German 16 oz. CEN. FOC..... | 69.50   |
| 7x40 CENTER FOCUS.....           | 52.50   |
| 7x50 31 oz! Bargain!.....        | \$36.00 |
| 7x50 CENTER FOCUS.....           | 39.50   |
| 8x30 German 11 oz!.....          | 39.50   |
| 8x30 18 oz! Favorite.....        | 39.50   |
| 8x40 More Power.....             | 54.50   |
| 8x40 CENTER FOCUS.....           | 52.50   |
| 8x40 CENTER FOCUS.....           | \$59.50 |
| 10x30 Compact Power.....         | 45.00   |
| 10x50 CENTER FOCUS. 27 oz!       | 59.50   |
| 12x50 CENTER FOCUS. 27 oz!       | 67.50   |
| 20x56 German 27 oz. CEN. FOC.    | 99.50   |

Same day AIRMAIL SERVICE. Add to price Pocket Binocular \$1.00; 6 or 8 power or telescope \$2.00; 10x, 12x, 16x or 20x \$3.00.

FROM 3 CONTINENTS come UNITED'S "Best-By-Test" binoculars. Made in Japan, unless stated otherwise, by skilled optical craftsmen of precision quality materials. Bear UNITED "Seal of Quality."

## SIX TELESCOPES

IN ONE! COATED

15 to 40 POWER American made Wollensak telescope. Instant focusing at tube to click — no guesswork. Telescope measures 9" closed, 27" when extended. Weighs only 18 oz.! Has rust proof chrome tubes, large 40mm objective lens. All 12 optic surfaces are COATED. See .22 bullet holes clearly at 300 feet. Use for astronomical observation. \$33.50 price includes fine leather case. No Fed. tax!

30 DAY NO-RISK TRIAL. If not satisfied return for full refund. Cash orders postpaid. C.O.D.'s require \$2.00 deposit. Add Federal tax. Leather case, straps included with all binoculars. UNITED BINOCULAR CO., United Bldg., 9043 S. Western Ave., Dept. ARF-6908, Chicago 20. DISPLAY SALES ROOMS OPEN 9-3:30 MON. THRU FRI. DEALERS WANTED

# BECOME AN EXPERT IN TRAFFIC

Traffic men earn \$4,000 to \$10,000 and up. Thousands of firms need experts on rates, tariffs, regulations. We train you thoroughly in spare time at home for executive traffic jobs. Personal training under traffic authorities. Placement counsel and help. Write for free 48-page book "Traffic Management—the Fast Growing Profession."

LASALLE Extension University, 417 So. Dearborn St. A Correspondence Institution Dept. 1164T Chicago 5, Ill.

# LOCKSMITHING & Key Making

PRACTICAL UP-TO-DATE COURSE—ONLY \$4.95

Easy-to-learn modern information for self-instruction. How to work on locks, de-code, make master-keys, repair, install, service, etc. For every handyman, home owner, carpenter, mechanic, service station operator, fix-it shop, hardware dealer, gunsmith. 53 plain illustrated lessons. FULL PRICE ONLY \$4.95. SEND NO MONEY.

Just pay postman plus C.O.D. postage. Or send \$4.95 with order, we'll ship postpaid. Satisfaction guaranteed or refund. NELSON-HALL CO., 210 S. Clinton Ct., Dept. LX-2, Chicago 5, Ill.

## Say You Saw It in Popular Mechanics

### IT COST ME MONEY TO FORGET !!@\*!!



The "AUTOMATIC MEMORY" Won't Let You Forget

**MEMINDEX** — the famous memory method and personal systematizer, is credited by thousands of successful persons with speeding their rise to the top. Memindex keeps all data on handy, cleverly indexed and dated cards—today's always visible. Handsome POCKET CASE organizes your daily memos—Sturdy DESK TRAY keeps permanent records for you. No transcribing. Worth 1000 times its small cost to salesmen, business and professional men, hobbyists and social leaders.

Style PK Lexide Pocket Case with heavy cardboard desk unit including year's supply of Dated Cards and otherwise indexed Cards, \$7.75. BONUS Dated Cards for remainder of '53 with all orders for '54. Other styles available with Genuine Leather Pocket Cases. Postpaid when cash accompanies order.

Satisfaction guaranteed.

FREE Brochure completely describing Memindex. FREE WRITE: Dept. PP-3, Wilson Memindex Co., 149 Carter St., Rochester, N. Y.



# IMPORT PAYS BIG!



B. L. MELLINGER  
Exporter-Importer

**NEW WORLD TRADE BOOM OFFERS BIG PROFIT OPPORTUNITY** to ambitious Men and Women everywhere. I'll show you how you may Import Thousands of desirable products at low foreign prices for buyers in your locality at high U.S. Prices —how you can operate a world-wide mail-order Import-Export business from home whether you live in a big city, or small town.

*B. L. Mellinger*



## HERE'S PROOF!

As startling first-hand proof I will send you an actual import from overseas, **AT MY COST** — something to see and use. Just mail me 25¢ in coin and I will rush you this Imported Melson Automatic cigarette lighter — made to retail in the U.S. at \$2. This magnificent Import will convince you of the tremendous profits being made in World Trade.

**START AT ONCE WITHOUT CAPITAL** or previous experience. Fantastic profits are possible. My training also includes shipment to you of many sample imports from 'round the world.

## GRASP THIS OPPORTUNITY TODAY!

Send for your Melson Automatic cigarette lighter now and I will include full details that show you how to learn my Big Profit secrets of World Trade—complete instructions that will put you on the road to a Profitable business of your own. Opportunity to travel abroad for profit and pleasure. I'll also show you how you can save many dollars on your own purchases of Clothes, Tools, Gems, Antiques, Watches, Cameras, China, Silks, Toys, etc. You can have the complete details FREE without ordering the lighter if you wish, but I would like to send you the Melson lighter as an actual demonstration of Import Values. Either way, mail coupon Now. Airmail reaches me overnight.

The Mellinger Co., Dept. 25B 1717 Westwood, Los Angeles, 24, Calif.

HERE'S MORE PROOF!

"We operate a profitable World Trade Business from our home... Thanks to MELLINGER."

Mr. and Mrs. Beke, N.Y.

MAIL COUPON NOW!



The Mellinger Co., Dept. 25B 1717 Westwood, Los Angeles 24, Calif.

Mr. Mellinger: Show me the big profits to be made through World Trade. I enclose 25¢ in coin. Send me one Melson Cigarette Lighter and your plan that shows me how to learn the secrets of World Trade.  Just send your FREE World Trade Plan.

Name \_\_\_\_\_  
Street \_\_\_\_\_  
Town \_\_\_\_\_ Zone \_\_\_\_\_ State \_\_\_\_\_

**NOW! BECOME EXPERT AT**

# RADIO-TELEVISION

## IN 4 EASY STEPS

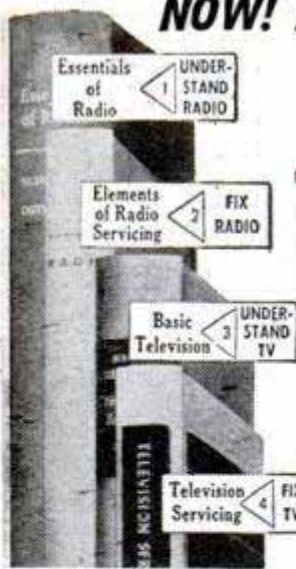

The McGraw-Hill Radio and TV Servicing Library gives you all you need to know for FM and TV in FCC's 1st-Class license exam.

Complete self-training library in RADIO and TELEVISION prepared by famous experts. Takes you by simple, practical steps from basic theory to advanced problems of repair, installation, color TV, etc. Do any repair job like an expert. Step into a good-paying job—or start your own business. Train AT HOME . . . in SPARE TIME.

**2296 pages — 1541 illustrations**

Every detail clearly explained with step-by-step instructions, "how-to-do-it" illustrations, cross-section diagrams, etc. Review, questions and answers "nail down" everything you learn. At-a-glance "trouble-shooting" charts show how to diagnose instantly any radio or TV breakdown . . . and how to repair it expertly and quickly.

**10 DAYS' FREE TRIAL**

McGraw-Hill Book Co., Inc., Dept. PM-11  
327 W. 41st St., N. Y. C. 36

Send me McGraw-Hill's Radio and TV Servicing Library, 4 volumes, for 10 day's examination on approval. If the books prove satisfactory, I will remit \$1.95 in 10 days, and \$4.00 monthly until \$21.95 is paid. Otherwise I will return books postpaid.

PRINT Name \_\_\_\_\_  
Address \_\_\_\_\_  
City \_\_\_\_\_ Zone \_\_\_\_\_ State \_\_\_\_\_  
Company \_\_\_\_\_  
Position \_\_\_\_\_ PM-11

## New Valuable Catalog for STAMP COLLECTORS!



**A "Must" for Veterans and Beginners!**

**'COLLECT STAMPS — and enjoy the world's most popular hobby!** In this catalog you will find "Everything for the Stamp Collector" — beautifully illustrated, clearly described, and priced to save you money! Catalog includes profusely illustrated Listing of United States Stamps; some Amazing Special Offers for advanced collectors; Complete Outfits for Beginners; and information on "How to Collect Stamps" Several interesting Special Offers will also be enclosed for your consideration. Send Coupon today enclosing only 10c to cover mailing costs.

**H. E. HARRIS & CO., Dept. PM-311, BOSTON 15, MASS.**  
THE WORLD'S LARGEST STAMP FIRM

H. E. HARRIS & CO., Dept. PM-311, Boston 17, Mass.  
I enclose 10¢ for a copy of your valuable new Catalog.

Name \_\_\_\_\_  
Address \_\_\_\_\_  
City & Zone \_\_\_\_\_ State \_\_\_\_\_

# MEN WANTED!



**Make \$15-\$20 in Few Hours Spare Time—up to \$210<sup>00</sup> a Week FULL TIME—with Amazing D-FROST-O-MATIC!**

Millions of housewives want this sensational new Automatic Refrigerator Defroster! No more messy hand defrosting! Just plug in D-FROST-O-MATIC and refrigerator is defrosted automatically every night! Sales easy, sure when you leave D-FROST-O-MATIC on FREE TRIAL—housewives won't let you take it out! Saves money, food, time, work! **Big profits for you—up to \$210.00 a week full time—\$15 to \$20 in just a few spare hours!** Start spare time and build big, prosperous business . . . quickly, easily!

**SELLY of California**

started in his spare time and now sells 1500 D-Frost-O-Matics a month!

**Rush Name Today for Profit Details and FREE TRIAL PLAN!**

More than **29,000,000** prospects waiting! Rush your name and address today. We'll airmail exciting facts, proof and sure-profit Free Trial plan. No obligation. Write today.

**D-FROST-O-MATIC, Dept. H-6**

**173 W. Madison Street, Chicago 2, Ill.**

In Canada—Write Silvex Co., 371 Dowd St., Montreal 1, Que.

## RAISE GIANT FROGS BIG DEMAND

Nuford Giants



**MILLIONS USED YEARLY!**  
Good prices year round! Breeder lays up to 20,000 eggs yearly. Nation-wide markets waiting for all you can ship. Get ready now for next spawn. New book tells how! Small pond starts you. Men and Women send for my illustrated FREE folder today. Do it now!

**ALBERT BROEL-7**

P.O. Box 506, New Orleans, La.

## Catalog of 3000 Novelties 10c



Send 10c for amazing catalog of novelties, live animals, scientific supplies, hobbies, funmakers, planes & boats, looms, magic tricks, joke articles, unusual seeds, gadget timesavers, cameras, optical goods, projectors, movies, lucky jewelry, religious novelties, disguises, musical instruments, stamps, coins, puzzles, fortune tellers, radios, auto & bike accessories, telescopes, magnifiers, compasses, banks, smokers' gadgets, artists' supplies, printing sets, engines, motors, shockers, knives, billfolds, guns, rifles, sports, books, games, plants, etc. Send name, address & 10c to:

**JOHNSON SMITH & CO., Dept. 693, Detroit 7, Michigan**

## AMAZING NEW POCKET SIZE RADIO

Really Works—Small as a Pack of Cigarettes!



FITS IN ANY POCKET OR PURSE—GETS LOCAL RADIO STATIONS WITH CLEAR BELL-LIKE TONE—NO STATIC OR INTERFERENCE! NEEDS NO TUBES, BATTERIES OR COMPLICATED HOOKUPS! NO AC PLUG INS! Nothing to wear out. Thousands of users—many report years of service. Uses new crystal diode and HI-Q coil. SELF-CONTAINED SPEAKER PHONE. Just the tiny radio to take with you ANYWHERE YOU GO—ON TRIPS, VISITING, ETC.—for real fun and enjoyment—ANY TIME. **SEND ONLY \$1.00**

(bill, ck., mo.) and pay postman \$3.99 C.O.D. postage or send \$4.99 for p.p. delivery. COMPLETE READY TO LISTEN. MIDWAY CO., Dept. PPM-11, Kearney, Nebr.

Say You Saw It in Popular Mechanics

# 60 BALLOONS \$2

THAT MAKE GIANT CIRCUS ANIMALS

Some from 3 ft. to 4 ft. Easy to make GIANT CIRCUS ANIMALS—instructions included. 3½ ft. Giraffe, a yard full of 12" kittens. Make a big SANTA CLAUS, a set of REINDEER, Seal, Kangaroo. FREE with \$4.00 order a balloon squawker. FREE with \$6.00 order 50 plastic toys. "A Complete Rodeo." Add 10c for postage.

**52 PARTY BALLOONS \$100**  
In assorted colors & sizes.

**50 PLASTIC TOYS \$100**  
A complete Rodeo.

CIRCUS BALLOONS, Dept. PM-11, Searsdale, N. Y.

POPULAR MECHANICS



# EARN \$20 AN HOUR

Become independent — earn big money! Hotels, restaurants, clubs are big-volume prospects for **KNIFE SERRATING**. They need their serrated knives sharpened... and until now... no one has had a machine that professionally and economically does the trick.

**SHARPEN  
SERRATED  
EDGES ON →  
KNIVES**

*Quickly — easily*

Entirely new... **SAW-KEEN Electric Knife Serrator** gives you a deal without competition. One call completes sale — no return trip for delivery or collection. Each sale will repeat in 6-months.

Proprietors of eating places love it... they can now get knives serrated without disrupting service — and at big savings. Machine will pay for itself the first few hours it is used.



## SAW-KEEN ELECTRIC KNIFE SERRATOR

Light in weight... sturdy, precision built. Plugs into any 110 volt light socket. Sharpens all kinds of knives as well as serrated types.

Write for complete details, without obligation, to:

**CUTTER-CRAFT MFG. CO.** 1000 E. GREEN ST. PASADENA, CALIF.

## BRASS NAME PLATES or KEY TAGS

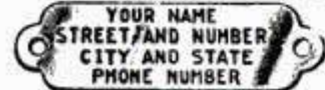

**40c each**

Half actual size  
QUANTITY PRICE — SAME STAMPING  
8 for \$2 — 15 for \$3 — 25 for \$4 — 50 for \$6  
LARGER QUANTITIES ON REQUEST

**TAGCO, P. O. BOX 203 X, PLEASANT VALLEY, N. Y.**

## Broken or Loose FALSE PLATE?

Fix it Yourself **EASILY** in a Few Minutes

Your plates may become broken or loose just when you need them most. With **FIX-IT-KIT** you can repair your own broken plates. Also tightens loose fitting plates, easily. Get permanent comfort with professional material. Complete instructions. Satisfaction guaranteed or your money refunded. **Order Now** at a new low price only **\$2.98** postpaid — or sent C.O.D.



Make Plates Like New

**DENT-FIX DENTAL PRODUCTS, Dept. PM-11**  
P.O. Box 674 Kansas City 8, Missouri

## Play GUITAR in 7 DAYS

**OR GET YOUR MONEY BACK!** Let Ed Sale teach you to play with his famous 66 page diagram photo system. Contains 52 photos, 87 diagrams, showing exactly how to place your fingers. Over 100 Hillbilly, Popular, and Western songs, words and music — along with complete, easy to learn instructions. Imagine your joy when you find after 7 days you are playing beautiful music! Amaze your friends! Be the life of the party! **SEND NO MONEY.** Pay Postman \$1.98 Plus Postage or send \$2 and I pay postage. (Same guarantee.) **ED SALE, Studio 1907, Bradley Beach, N.J.**

## Become an Expert Body and Fender Repair Man

The new 1953 edition of "The Key to Metal Bumping" is now out. 120 pages with 73 illustrations, show the Fairmount method of body and fender repair. Read this Manual written by Frank T. Sargent, the well-known authority on metal bumping, and you can become an expert in this high paying art. Order your copy today and be on your way to success. Mailed, prepaid, for \$1.00.



**FAIRMOUNT TOOL & FORGING, INC.**  
10609 Quincy Avenue, Cleveland 6, Ohio

# The WONDERS of LIQUID PLASTICS

**MANUFACTURE WITHOUT TOOLS OR MACHINERY!  
WE PAY YOU \$5.00 AN HOUR!**

No previous experience or special ability required! **NO TOOLS OR MACHINERY** required... the entire process is about as easy as pouring water out of a glass! The **WONDERS OF LIQUID PLASTICS** make all this possible! Many of the products made with our liquid plastics are so beautiful and attractive that we have created an unusual demand for this type of merchandise! That's why we will pay you \$5.00 an hour (materials extra) to make the items shown here and in our catalog for us!

### UNLIMITED POSSIBILITIES

Work with **LIQUID IVORY, LIQUID GLASS, LIQUID MARBLE, LIQUID EBONY, LIQUID PORCELAIN, LIQUID WOOD, LIQUID GEMSTONE** and many other **LIQUID PLASTICS** and in a matter of minutes turn them into an endless and valuable procession of beautiful imbedded jewelry, novelties, ornaments, statuettes, bookends, lamps, pensets, lighters, ashtrays, keychains, figurines, curios, **SOUVENIRS, art and gift products, fishing lures, BOATS, GADGETS** galore, exquisite **GEMS!** Make gears, tools, dies, forms, handles, dials, knobs, **MACHINE PARTS**, models of inventions, pistol grips... the list is endless! The only **LIMITATION** is your **IMAGINATION!** Liquid Plastics are the blessing of every creative and ambitious person... with these materials **ANYONE** can create and manufacture by the **THOUSANDS** and at a tiny fraction of what it would cost by any other method! Just send 25c and we will send you our book, "HOW TO MANUFACTURE WITHOUT TOOLS OR MACHINERY," included with our big 64 page catalog describing all the materials mentioned above; also details of our \$5.00-an-hour offer! Do it today... we want you to share in these wonderful opportunities as soon as possible!

**PLASTICAST CO., (Dept. C)**

P.O. Box 6737 (Write to P.O. Box 987  
Chicago 80, Ill. either address) Palo Alto, Calif.



## PLASTIC LAMINATING

This remarkable Plastic Laminating Machine will earn \$18.00 an hour right in your kitchen! Big profits laminating Business, Social Security, Identification, Credit CARDS of all kinds, photos, passes, clippings, etc. Price complete (illustrated) \$35.00 plus postage. Others higher. Literature free.

**PLASTICAST CO.**  
(Address in ad above)

**26" OPERATING SCALE MODEL SUBMARINE**  
Heavy duty spring motor drives twin propellers, thru sealed gears, running in oil. Water ballast chamber with air valve control for diving or operating submerged. **ALUMINUM HULL. BRASS DECK TRIM.**

**CONSTRUCTION KITS AND ASSEMBLED MODELS**  
Price Range \$4.95 to \$16.50. Send 3c stamp for detail literature.

**WESTLAKE MODEL CO. Dept. PM-N53 ERIE, PA.**

# WATCHMAKING FREE Sample Lesson

Watch repairing's fun... profitable too! An exciting hobby or fascinating career. Chicago School of Watchmaking offers complete home study training in professional watch repairing at amazing low cost. All equipment included at no extra charge. Or, if you prefer, attend school in person. No experience needed. Write today. No obligation.

## CHICAGO SCHOOL OF WATCHMAKING

2330 Milwaukee Ave., Dept. 1113, Chicago 47, Ill.  Veteran  
Send free sample lesson.  Home study  Resident school

Name \_\_\_\_\_  
Address \_\_\_\_\_  
City \_\_\_\_\_ Zone \_\_\_\_\_ State \_\_\_\_\_

# Can you improve your thinking by improving your English?

"Yes, you can improve your thinking by improving your English," says Don Bolander, director of English at Career Institute, Chicago.

"Men and women enroll for our home course in English to acquire the techniques of fluent conversation, to improve their writing, to increase their vocabularies, to speed up their reading, to stop making embarrassing mistakes in English. But the study of practical English pays off in unexpected ways," says Bolander, "because language is a tool of thought as well as a tool of expression.

"You use words with which to think. The more you learn about words and how to arrange them to express your ideas, the

better your thinking becomes. The improvement of your English—including your thinking—can lead to amazing personal achievements."

Write today for free 32-page booklet, **YOUR ENGLISH AND YOUR CAREER**. It explains the importance of your English in your personal, social, business life. In addition, it shows how the **CAREER INSTITUTE COURSE IN PRACTICAL ENGLISH** can help you achieve your special goals quickly in your spare time at home. Address a card or letter to Don Bolander, Dept. 111-A, Career Institute, 25 East Jackson Blvd., Chicago 4, Illinois. No salesman will call. The booklet will be mailed to you promptly.

## Mystery Lot BARGAIN

**POSTAGE STAMP CLEARANCE JOB LOT \$1.00**

Every two years we accumulate a load of discontinued sets and singles, mostly high & medium priced stamps with many cataloging more than \$1.00 each. We've broken this into a number of \$1.00 Bargain lots. **ANYTHING & EVERYTHING** can be found in this lot. But, because sorting is impractical for us, this material **SIMPLY**

**MUST GO . . .** And we guarantee that the **BETTER STAMPS ALONE WILL CATALOG WELL OVER \$10.00**. So, if you don't mind a little work, but want a lot of bargain, **SEND YOUR \$1.00 TODAY**. These lots are limited—so only one to a customer. Immediate refund if not pleased. **BARGAIN APPROVALS** accompany each order.

**BONUS: 40 PAGE STAMP DICTIONARY & GUIDE**  
**STAMPEX CO., 116-YM NASSAU ST., NEW YORK 38, N. Y.**

## TOOLS WHOLESALE

**MAKE EXTRA MONEY**

Start Your Own Business. Sell tools to your friends, neighbors, Part Time—Full Time.  
**A MILLION DOLLAR INVENTORY AT YOUR FINGERTIPS.**  
 Send \$1.00 for Dealer's Card and Wholesale Catalog  
**SILVO HARDWARE CO., Dept. M, 108 Market St., Phila. 6, Pa.**

Stanley, Millers Falls, Plumb, Disston, Wiss, and others at 30% to 50% off.

## UP TO 6 MILES MORE PER GALLON

Reported by Hundreds Using **MIRACLE ACTION TUR-B-LIZER**

Carburetor specialists say Tur-B-lizer is best patented improvement they have seen. Tested in millions of miles of driving in cars, trucks and tractors. Easily installed. Send \$3.00 for six cylinder type, \$4.50 for eight cylinder type. Try Tur-B-lizer for 30 days, if you are not enthusiastically satisfied as claimed by hundreds of users, your money will be promptly refunded.

Mechanics-Salesmen: Make big money selling and installing. Write for full facts.

**UNIVERSAL TUR-B-LIZER CO.**  
 621 E. STATE ST. MILWAUKEE 2, WISC.

## LEARN MODERN WATCH AND CLOCK REPAIRING

**Complete Course—Only \$5.95**

At home, spare time. Good field now . . . security and contentment in future. Start part-time business and **EARN** while you learn. Technology is precision instrument work . . . a great and growing field, sensational opportunities. Easy self-instruction course. Full price, only \$5.95. **SEND NO MONEY.** Just pay postman, plus C.O.D. postage. Or send \$5.95 with order, we'll ship postpaid. Satisfaction guaranteed or refund.

**NELSON-HALL CO., 210 S. Clinton St., Dept. 3LX-2, Chicago 6, Ill.**

## Wild Life Films

Exciting, dramatic action in the natural habitat of animals of forest and plains. 8 mm or 16 mm in beautiful color or B & W. Also 2" x 2" color slides. Write for free illustrated literature.

**WILD LIFE FILMS**  
 5151 Strohm Ave., Rm. 2L, No. Hollywood, Calif.

## GERMANY'S DIAMOND-LIKE BLUE-WHITE BRILLIANT

West Germany proudly sends us *The Gem of the Synthetics* **MAGA-LU-X & MAGA-LU-X-4**, wonderfully **BRILLIANT, BLUE-WHITE & HARD Synthetic** (±8 plus on Mohs Scale). "Toughness" factor similar **DIA.** No deterioration or lustre loss. **FREE REPLACEMENT** Guaranteed if Scratches, Chips or Breaks. Jewelers easily set **MAGA-LU-X.** Adv'd in Phila. Inq., N.Y. News, Pop. Sci., Pop. Mech., etc. "Beautiful . . . Excel. Prod. . . Add My Name Your List of Boosters." K.B., Chicago. Numerous others. **MAGA-LU-X's** not Titania or Zircon. Comes 1 to 12 Carats, \$15.00 **KT.**, 20% fed. tax. 35¢ shipping. Marquise, Square, 58 **FACET BRILLIANT**, Emerald & Triangle cuts. If no jeweler handy **MAN'S 14 KT solid gold GYPSY \$22.50. WOMAN'S TIFFANY ENGAGEMENT \$10.00.** \$2.50 setting charge. For the discriminating **MAGA-LU-X-4**, (Exp. series ±4) more expensive but worth it. Limited quantity \$20.00 the **KT.** All **MAGA-LU-X's** Exchangeable for Larger Ones Full Price Within 2 Years. **FREE INSPECTION.** Money back if not satisfied. Check or M.O. or C.O.D.'s 20% Dep. **SUPERB X'MAS GIFT. SEE OUR BEAUTIFUL DISPLAY.** **MAGA-LU-X** not sold elsewhere. Every Genuine **MX** registered your name. **STARFIRE CORP., Dept. M., 225 W. 34 St., N.Y.C. 1, N.Y.**

## Learn BAKING At Home

Baking is one of America's high industries in wages. Nearly depression-proof. Thorough basic home course lays sound foundation. If you have aptitude, write for **FREE BOOKLET**, "Opportunities in Commercial Baking."

**NATIONAL BAKING SCHOOL**  
 835 Diversey Parkway Dept. 1358 Chicago 14, Ill.



**I HELPED T.E.H. MAKE \$14 A DAY WHILE STILL LEARNING!**

T. E. H.—West Virginia. "By the time I finished half your course, I was making \$14.00 per day. I have made enough on the side to more than pay for the course."

**H. T. ARMSTRONG**

# Learn ELECTRIC APPLIANCE REPAIR & SERVICE

**WE TEACH:**  
 How to Repair  
 Washing Machines  
 Vacuum Cleaners  
 Electric Ranges  
 Lamps, Motors,  
 Irons, etc.,  
**REFRIGERATION and House Wiring At Home In Your Spare Time!**

For a man handy with tools, and happiest when working with his hands, **OPPORTUNITY** is Wide Open Today in this great and growing field. Everyone is a customer for the man trained to service electric appliances.

**Open Your Own Shop**

Our practical **HOME COURSE** teaches you this business from A to Z—preparing you to take a well paid job or open your own shop. You can actually start in your basement or garage with the tools we send you . . . before finishing.

We include An **ELECTRICAL APPLIANCE TESTER**  
 A Big Kit of Tools at **NO EXTRA COST**

**MAIL THIS COUPON for FREE BOOK**

**H. T. ARMSTRONG**  
**PACIFIC TRAINING SCHOOLS**  
 7217 S. Broadway, Dept. P-5311, Los Angeles 3, Calif.

Dear Sirs: Please send me, without obligation, your free booklet and complete details.

Name \_\_\_\_\_  
 Address \_\_\_\_\_  
 City \_\_\_\_\_ Zone \_\_\_\_\_ State \_\_\_\_\_

MONTH AFTER MONTH, YEAR AFTER YEAR, YOU SEE OUR AD.  
**CHECK AND DOUBLECHECK BEFORE YOU BUY ANYWHERE!**  
 1 Are These Tires "Family-Safe?" Our Families Use Them.  
 2 ARE THEY RECAPS? NO. (EXCEPT THE RETREAD SNO-TIRES)  
 3 Will I Get Goodyear & Other Famous Brands? From Us — Yes.  
 4 Is The Guarantee "Unconditional"? See Our Fine Offers Below.  
**"SPECIAL. TAKE 10% DISCOUNT OFF EVERY TIRE."**

**GOOD YEAR Firestone**

GOODRICH, U. S., ARMSTRONG & OTHERS. BEST USED TIRES  
 DOUBLE WARRANTY & FREE TIRE INSURANCE. YOU CAN'T LOSE.  
 We Select Your Tires As if Our Future Depended On It.

**FREE TUBE WITH EVERY GOOD & FINEST GRADE TIRE** | **BE WISE—BE CONVINCED**  
**SAVE TIME, SAVE \$**

GOOD SUPER GRADE, 20 MOS. GUARANTEE BOND		600-20		750-20	
600-16	\$3.64	670-15	\$4.04	600-20	\$6.74
650-16	4.14	710-15	4.24	650-20	7.24
700-16	4.54	760-15	4.54	700-20	8.04
650-15	3.94	800-15	4.94	32x6(8)	8.24
700-15	4.04	820-15	5.04	32x6(10)	9.24
				1100-20	13.44

**FINEST PREMIUM GRADE, 30 MOS. GOLDEN RULE GUAR. BOND**  
 THESE MADE THE BLATT NAME "WORLD FAMOUS"

600-16		640-15		30 MONTH GUAR. TRUCK TIRES	
600-16(6)	6.88	650-15	5.33	XTRA VALUE	XTRA MILEAGE
650-16	5.88	670-15	5.44	700-15(6)	\$8.88
650-16(6)	7.33	710-15	5.66	750-15	11.14
700-16	6.44	760-15	6.04	750-16(8)	11.50
700-16(6)	7.55	800-15	6.55	600-20	8.66
750-16(6)	8.84	820-15	6.55	650-20	10.22
550-17	4.88	700-15	5.44	700-20	13.00
BEST Whitewalls	\$2 ea.	Extra	750-20	14.44	1100-20
				1000-22	18.44

**YOU GET WHAT WE ADVERTISE**

MILITARY MUD-GRIP TREAD		Std. Guar. 20 Mos.		Rugged Guar. 32 Mos.	
750-16Rg	\$17.64	750-20Std	\$10.44	750-20Rg	\$16.14
1100-20Rg	22.04	600-16Std	11.94	300-16Rg	15.94
		600-16Std	6.44	300-16Rg	8.99

**FACTORY RETREAD SNOW-TIRES, 30-MONTH GUARANTEE "New Tire Traction"**  
 GOODYEAR, FIRESTONE & OTHERS

670-15	600-16	710-15	650-15	650-16
\$8.88	\$8.88	760-15	700-15	800-15
				\$11

**BLATT** Order From Your Nearest Store For FASTER Service. Send Ck. or Money Order With This Ad  
 Blatt Bldg., Phila., Pa. (11th St., & Spring Garden St.) Dept. PM  
 Blatt Bldg., Miami, Fla. (2827 N.W. 7th Ave.) Dept. PM

**ELECTROPLATE**  
 ANY OBJECT IN HOME, SHOP, GARAGE OR START YOUR OWN WELL PAYING ELECTROPLATING BUSINESS.

NO TANKS USED  
 NEW SIMPLIFIED METHOD  
 SUCCESS IN THE ELECTROPLATING BUSINESS

TOOLS: SILVERWARE, HOUSEHOLD ARTICLES, JEWELRY, BABY SHOES, AUTO PARTS & 1001 ARTICLES

Now, using NEW plating kit. It's easy to electroplate any object. Complete kit and instructions on plating metal and non-metal objects, with nickel, copper, chrome, gold, etc., plus full data on obtaining all the business you desire and make **BIG MONEY** full or spare time. **ONLY \$5.95. SEND NO MONEY**—everything sent C.O.D. plus postage—OR send \$5.95 now and receive it postpaid. Money back in 7 days if not satisfied.  
**M. Z. NATIONAL SALES CO., 113-R West 42 St., N. Y. 36, N. Y.**

**Cartoon the EASY way!**

**ORDER THIS KIT TODAY!**  
 Make your own cartoons for fun and profit. No skill needed. Plastic template with cut-out spaces and holes lets you make over 200 different cartoons. Kit also includes illustrated instructions, helpful hints book and information on selling. Only \$1.95 COD in USA plus c.o.d. postage. Send check or M.O. and we pay postage. Order today—or rush dime for circulars.  
**J. HOUSTON MAUPIN, Dept. 50, Tipp City, Ohio**

SEND NO MONEY

## Shrinks Hemorrhoids Without Surgery

Science Finds Healing Substance That Relieves Pain—Shrinks Hemorrhoids

Science has found a healing substance that shrinks hemorrhoids, stops pain promptly, ends bleeding — without surgery. Doctors report actual shrinking of hemorrhoids. Sufferers say, "Hemorrhoids have ceased to be a problem." The secret is **Bio-Dyne®** — already widely used for healing injured tissue. This substance is now available in a hemorrhoid ointment called **Preparation H\***. Ask your druggist for Preparation H. Money back guarantee. \*Trade Mark

**FREE**

SEND FOR THE **1954 ALLIED TV & RADIO CATALOG**

268 value-packed pages

WORLD'S MOST COMPLETE  
 Save on everything in TV and RADIO

Everything for Experimenters, Builders, Amateurs, Servicemen, Engineers and Soundmen

Send for ALLIED's big 268-page value-packed buying guide to everything in TV and Radio! Largest selections of custom TV chassis, TV accessories, FM and AM radios, High-Fidelity Sound, Amateur supplies, P.A. Systems, recorders, test instruments, builders' kits, industrial electronic supplies — plus the world's largest stocks of electronic parts, tubes, tools and books. Get everything — get more for your money — send today for your **FREE 1954 ALLIED Catalog**.

NEW HOME OF ALLIED RADIO

ultra modern facilities TO SERVE YOU BEST

**WORLD'S LARGEST STOCKS**

**SEND FOR FREE CATALOG**

**ALLIED RADIO**

ALLIED RADIO CORP., Dept. 5-L-3  
 100 N. Western Ave., Chicago 80, Illinois

Rush FREE 1954 ALLIED 268-Page Catalog

Name \_\_\_\_\_

Address \_\_\_\_\_

City \_\_\_\_\_ Zone \_\_\_\_\_ State \_\_\_\_\_

**"TOOK IN \$217  
FIRST 10 DAYS"**

Some make more, some less...

**We help you to start Your  
Own All-Year Business**

**Make Big Money!** With our easily operated, highly efficient wall washer, Charles Stelle took in \$217 gross in first ten days. E. L. Goss took in more than \$10,000 in one year. E. C. Taber wrote, "I made \$400 gross in two weeks."

And no wonder... this machine washes walls 6 times faster and better than by hand.

**Your Money-making Opportunity.** We want more men to go into this profitable business for themselves and enjoy independence—freedom from bosses, layoffs. Customers everywhere—homes, offices, schools, churches, hotels, etc. How much you earn depends largely on you. What you take in is mostly profit. No need to rent shop or office; operate business from home. Can start spare time until your full time is available.

Lose no time. Get all facts without obligation

**FREE BOOK! MAIL COUPON TODAY!**

**VON SCHRADER MFG. CO.**  
2150 "W" Pl., Racine, Wisconsin

Send at once (no obligation) your **FREE** booklet containing information about your **WALL WASHING MACHINE** and how I can start my own permanent, profitable business.

Name \_\_\_\_\_  
Address \_\_\_\_\_  
City \_\_\_\_\_ Zone \_\_\_\_\_ State \_\_\_\_\_



**CUSSIN'**

**WON'T START  
YOUR COLD OR  
WET MOTOR...**

**KAR-START WILL!**

Amazing device helps start cold or wet car engines instantly! 5 times more spark from plugs for sure-fire starts. Will not damage points. Simply installed—3 quick connections. Long lasting. If your dealer can't supply, order direct. Only \$5.95 postpaid. Buy Kar-Start today. Money back if not delighted. Write for free bulletin.



Get Kar-Start and GO!  
**SCHAUER MANUFACTURING CORP., 4532 ALPINE AVE.  
CINCINNATI 36, OHIO**

**TURK Cloak DAGGER**  
Crafted for **THROWING \$2.95**

Over a foot long—This type knife is used for combat and self defense. In ancient times it was carried by ASSASSINS. Balanced for throwing.

**ACCURATE  
SILENT**

**EASY  
TO THROW**



Beginners can stick this balanced knife consistently with our instructions. A beautiful heavy duty 12½" dagger, truly different. Tempered steel blade - Hand finished in polished chromium. A useful collectors piece. Not sold in stores. Your money back if not satisfied. Send \$2.95 to **WHOLESALE IMPORT CO., Box 2038 Alhambra, Calif.**

**Only NEW MONEY MAKER In Years!**

**Make Up To \$10,000 Yearly—Full or Part Time**

At last! Secrets of luggage and case making revealed. **BIG PROFITS**—huge market for special cases: traveling, photographers, salesmen, musicians, tools, electronics, jewelry, guns, portables, etc. Learn repairing. Fast, easy profits. No special tools or experience. Wholesale catalog. **FREE DETAILS and SAMPLE INSTRUCTIONS.**

**A B A R S I C A S E C R A F T**  
805-H4 West Sunset Blvd. • Los Angeles 12, Calif.

**Watch Repairing Pays  
Big Money Learn at home**



Watch repairers in great demand. Train step-by-step in 10 easy lessons. We furnish all tools and 15 jewel watch and practice movement. Turn spare time into cash. A licensed school. Low cost. Send for **FREE** book today.

**ILLINOIS SCHOOL OF WATCH REPAIRING**  
2870 Elston Ave., Dept. PM 113, Chicago 18, Ill.

**Say You Saw It in Popular Mechanics**

**Ball-Bearing SPEED WHEELS**



JUVENILE WHEELS (No bearing, solid tires)	
5" .....	.45¢ 6" .....
7" .....	.75¢
(Semi-pneumatic tire, ball bearing)	
8x1.25 .....	\$1.85 10x1.25 .....
8x1.75 .....	1.95 10x1.75 .....
8x2 .....	2.20 10x2.00 .....
	12x1.75 .....
	3.45
INDUSTRIAL WHEELS	
Lug Base, Semi-Pneumatic tire	
6x2 5W .....	\$3.45 10x2.00 .....
6x2.00 .....	4.00 10x2.75 .....
8x2.00 .....	5.20 12x2.00 .....
8x2.50 .....	5.40 12x3.00 .....
	9.20
	16x4.00 .....
	15.15
Smooth Base, Pneumatic tire and tube	
8x3.00 .....	\$11.00 12x4.00 .....
10x2.75 .....	6.80 4.00x8 .....
10x3.50 .....	10.55 14x4.50 .....
	13.40

Available Now — **CASTERS**  
Write for circulars on all wheels. Prices F.O.B. our plant.  
**JIM BROWN TOY COMPANY**  
1095 HOME AVENUE PM-853 AKRON 10, OHIO

POPULAR MECHANICS

**"NEW PAINT PEN"**

**PAINT STRIPING TOOL**  
*Works like a Fountain Pen*  
**Stripes with Paint instead of Ink!**

This amazing new "PAINT PEN" is a Paint Striping Tool that makes it easy to do expert striping on furniture, bikes, model planes, autos, signs, toys, linoleum, wall board, etc. Makes plain, painted walls look like tile. Paint straight, curved, circular or evenly spaced parallel lines the same way a professional painter does. Simply fill Tubular Glass Paint Fountain with any color paint and wheel tip feeds paint evenly. Tips interchangeable—jaws split apart for easy cleaning. Tool complete with tip for 1-16 inch stripe only \$1.00 postpaid. Other complete tools with 1-64, 1-32, 3-64, 5-64, 3-32, 1-8 in. tips, \$1.50 ea. Extra tips, 75c ea. Complete KIT with 7 tips, \$5.00. Also 1-4 in. tip only, \$1.00. COD's postage collect. Here's the handiest tool in your whole painter's kit. Get yours today.



**Home Craftsmen**  
Just the tool you've been waiting for! New Paint Striping Tool gives "professional" results every time, yet simple and easy to use as a fountain pen. Adjustable guide keeps lines straight as an arrow. Just as easy to make curves or free hand designs. Adds new beauty and finished look to everything you paint. Send \$1 now!

**WENDELL MFG. CO., Dept. 311**  
4234 LINCOLN AVENUE, CHICAGO 18, ILL.

**DEALERS**  
PAINT STRIPING TOOL packed in display cartons of 1 doz. Fast, profitable seller. Write for illustrated circular, discounts

Only \$1.00

# \$100,000 NEW WATCHES HAVE ARRIVED FROM SWITZERLAND!

**IMPORTER'S CUT PRICE DIRECT TO YOU!**

**Pay LESS than SWISS retail price!**

**WRITTEN GUARANTEE WITH EACH WATCH!**

**4 MODELS  
your choice:**

**5<sup>44</sup>  
PLUS  
TAX**



## SHOCK RESISTOR Drop it . . . Bang it!

The Staff Shock Absorber built into this remarkable watch is one of the greatest inventions since the creation of timepieces. Saves time, worry, expense. Ideal for active men, school boys. No need to remove from wrist when playing baseball, football, bowling! Drop it! Bang it! Actually defies breakage. Yours on 5 day trial—your money back if you **BREAK** it! Has Nite-Glo numerals, sweep-second hand, unbreakable crystal. Number **260**. Tax paid price—**5.98** a real bargain. . . . .

## ARISTOCRAT Newest 1954 Style!

Latest word for smart styling for men. Smart imitation rubies & diamonds around dial. Accurate, dependable movement. White **GOLD** color effect case & matching band. Makes a terrific impression everywhere . . . looks like a \$100.00 timepiece & it's accurate too! Compare with watches selling for much more — see if you can tell the difference! Don't let our low price confuse you. It has real quality! Order by No. **203**. Price, including federal tax, only. . . . . **5.98**

## DAINTY SPORTEX For Active Women!

Ideal watch for active women, typists, nurses, housewives, or just school girls. Sturdy, accurate & feminine looking. Sweep-second hand, luminous numbers & hands for easy night reading. Eye appealing color of sterling silver. Dainty yet durable nylon cord with metal loops. You'll wear this watch with pride year after year. Looks and actually works like much more expensive timepieces. Come see it if in town! You'll fall in love with it. Mail orders filled promptly. Order by No. **218**. Tax included price only. . . . . **5.98**

## "MAGIC BRAIN" Sports Watch

Amazing, uncanny watch with "mechanical brain" answers questions on distance & speed of fast cars, planes, horses. Measures distance and times sports, photos, lightning, pulse beats, etc. Handsome! Precision made! Wins admiration everywhere. Has features not found in more expensive watches. **2 PUSH BUTTONS** start & stop movement; telemeter & tachymeter dials; split-second calibrations. Numbers & hands glow at night; unbreakable crystal; centre sweep second. Instructions and metal-flex band included. No. **236**. Add **54c** tax. Total. . . . . **5.98**



**TAKE YOUR PICK—TRY AT OUR RISK!**

**Unlimited Guarantee**  
EXCLUSIVE OF PARTS

Repairs on watches, if ever needed, absolutely **FREE**. Never a charge for labor, handling, adjusting, etc. for the **LIFETIME** of this firm! You can rely on **THORESEN**—because we make lifetime friends!

Any watch sent on 5-DAY FREE TRIAL—you must be delighted or your money back without questions asked!

**NOW — LESS THAN SWISS RETAIL PRICE! DIRECT FROM IMPORTER TO YOU!**

None sold to dealers! No agents! No jobbers! You actually pay **LESS** than if you went to Switzerland itself for these quality watches! Written **GUARANTEE CERTIFICATE** as shown at left given with every watch. Also included a fine stretch band and gift box! You have everything to gain . . . nothing to lose! Send **COUPON** today. Order several for back-to-school and Christmas gifts.

**THORESEN'S**  
352 Fourth Ave. Dept. 6-M-200  
New York 10, N. Y.

## MAIL AT ONCE!

**THORESEN'S, Dept. 6-M-200**  
**352 Fourth Ave. (Near 25th) New York 10, N.Y.**

RUSH watch(es) checked below on 5 day trial, with money back **GUARANTEE** if I am not fully satisfied.

- Payment enclosed. Send prepaid.  Send COD plus postage.
- No. 260—Shock Resistor  No. 203—Aristocrat
- No. 218—Ladies' Sportex  No. 236—"Magic Brain"

NAME \_\_\_\_\_

ADDRESS \_\_\_\_\_

TOWN \_\_\_\_\_ ZONE \_\_\_\_\_ STATE \_\_\_\_\_

IT'S

**45 to 1**

That's the earning power you have—RIGHT FROM THE VERY START—in this profitable, new servicing business that you can operate right in your own basement or garage! Yes, it's true—with our new portable machine you can launder venetian blinds so cheaply that you'll make \$45 for every dollar of operating cost . . . and that \$45 goes into your own pocket because you are in business for YOURSELF! Look around your neighborhood and just count the hundreds of blinds in homes, stores, schools, and public buildings—and every one of them needs cleaning regularly! Others earning \$50 a week just spending an hour each weekday evening! Full time pays up to \$1,000 a month—and more! Requires no experience, and there's no age limit. Small investment for machine starts you in your own lifetime business.

**FREE** booklet tells all about machine, easy time-pay plan, how to get business. Get names of successful owners near you. No salesman will call—no obligation. Write today to Venetian Blind Laundry Equipment Co., Inc., 442 N. Seneca, Dept. 10-S, Wichita, Kansas.

**321 DIFFERENT STAMPS**

FROM ALL OVER THE WORLD

for only **25¢**

plus **FREE** Booklet on Stamp Collecting

Big valuable imported collection of 321 different stamps from dozens of hard-to-get countries! Regular \$3.50 value — yet all yours for only 25¢ to introduce our Bargain Approvals. Included, **FREE**, helpful booklet on Stamp Collecting—shows you how to identify stamps. Money back if not delighted. Send 25¢ today. Ask for Lot F0-10.

**MONACO** — Pope Pius triangles  
**SO. MOLUCCAS** — General MacArthur set.  
**UNITED NATIONS** — first 3 issues — historic set!

**ZENITH CO., 81 WILLOUGHBY ST., BROOKLYN 1, N. Y.**

**STUDY LAW FREE AT HOME .BOOK!**

**Prepare for the Bar!**

Write today for a copy of our **FREE** book, "The Law-Trained Man," which gives the bar rules in your state and tells how ambitious men and women since 1890 have been preparing at home in spare time for the practice of law by studying the famous Blackstone bar-training course. All needed instruction material is furnished including big 16-volume law library. Law diploma awarded. Moderate tuition; easy monthly terms. Write for **FREE** book today!

**BLACKSTONE SCHOOL OF LAW**

225 N. Michigan Ave., Dept. 58, Chicago 1, Illinois

**Grow ORCHIDS AT HOME**

"WE MAKE BIG PROFITS at home with ORCHIDS" — Louis & Gladys Schirmer



World's most thrilling hobby — profitable home business. Single Orchid plant may multiply into many — each as valuable as the first. Successful home grower shows you how! Raise gorgeous Cattleyas, Cymbidiums, Epidendrums, on living-room table. Big-profit orders come from friends, neighbors, florists, etc. — also Mail Orders. Illustrated secrets of the experts in simple "show-how" language AND blooming-size Orchid plant sent at **NO RISK**. Includes plan for starting your own home business. **FREE** — full details — **SEND NO MONEY**. Write today. **TROPICAL FLOWERLAND, Dept. 31B, 4622 Wilshire Blvd., Los Angeles 5, California**

**BE DANGEROUS! JIU JITSU (JUDO)**

SCIENTIFIC JAPANESE WRESTLING

**100 HOLDS AND THROWS!**

FEAR NO MAN! WITH JIU JITSU, "THE BIGGER THEY ARE, THE HARDER THEY FALL!"

**QUICK EASY FULLY EXPLAINED**

The feeling of confidence in any situation is wonderful and a bully will think twice before picking on YOU! Order now and become a "Master of Men!" Only \$1.00.

**ACE SUPPLY HOUSE** D12, P.O. Box 617 Muncie, Indiana

**MAKE \$5 PER HOUR WITHOUT A PRINTING PRESS**

**PRINTING** REVOLUTIONARY NEW SCREEN METHOD

**FREE** complete "BIG MONEY" Plan and SAMPLE!

**EARN AT HOME** SPARE or FULL TIME

PRINT colorful signs, posters, banners, fabrics, wall paper, show cards—ANYTHING! Print on any surface. NO printing press or special equipment is needed with this amazing "approved" new printing secret. 300% profit on nearly every job. Easy to learn — NO EXPERIENCE or art ability necessary. Exceptional opportunity. Complete illustrated detailed plan and colorful sample **FREE**—Write.

**SCREEN-PRINT COMPANY, Dept. 211**  
1010 So. Los Angeles St., Los Angeles 15, Calif

**.22 RIFLE BARGAIN**

**CARBINE STYLE (BRAND NEW!)**

34 inches long  
4 lbs., 3 oz.

**\$14.95**

Exclusive with UNITED! From Germany, home of some of the world's finest hunting and military guns, come these superb rifles. Factory was founded in 1865 in Thuringia, Germany's great arsenal and home of the famous Mauser Gun Works. Today, the plant has been moved to the American Zone and these rifles are made to rigid UNITED requirements. Bears the famous UNITED "Seal of Quality" BECAUSE this featherweight model is rugged in every detail. One screw take down assembly. Shoots Longs, Shorts and Long Rifles (regular and high powered). Has automatic ejector with self adjusting sporting rear sight and blade front sight. Sturdy Beech stock, barrel has SIX lands. Blued throat. CHROME plated smooth working bolt action. Amazing accuracy at 100 yard range. Ammunition is available anywhere and replacement parts can easily be had if ever needed. Low cost skilled labor makes possible our sensational bargain price. Supply is limited as yet, so quick action is urged. **10 DAY NO RISK TRIAL**. Use for 10 days. If not fully satisfied return for full refund! Remit \$14.95. Rifle shipped express. Transportation collect. C.O.D.'s require \$2.00 deposit. **UNITED ARMS CO., United Building, 9043 S. Western Ave., Dept. HOB-265, Chicago 20, Mail Orders Only. None sold to minors. STATE AGE!**

**I'll Send You This Handsome SAMPLE CASE - FREE**



and Show You How to Make Up to \$15.00 in a Day

Mail coupon for this Free Tailoring Sample Case packed with 150 beautiful, big-value suit and overcoat fabrics. Take orders from friends, fellow-workers, others, for fine quality, made-to-measure clothes. Pocket big cash profits in advance. Because wearing our suits and overcoats brings more orders, we make it easy for you to get your own clothes without 1¢ cost. No experience is needed. **SATISFACTION GUARANTEED. SEND NO MONEY.** Just fill out and mail coupon—today!

**STONE-FIELD CORP., 532 South Throop Street DEPT. C-816 CHICAGO 7, ILLINOIS**

**STONE-FIELD CORP., Dept. C-816**  
532 S. Throop St., Chicago 7, Ill.

Dear Sir: I WANT A MADE-TO-MEASURE SUIT TO WEAR AND SHOW, without paying 1¢ for it. Rush details and Sample Kit of actual fabrics, **ABSOLUTELY FREE.**

NAME \_\_\_\_\_ AGE \_\_\_\_\_

ADDRESS \_\_\_\_\_

CITY \_\_\_\_\_ STATE \_\_\_\_\_

# WILL YOU SMOKE MY NEW KIND OF PIPE 30 DAYS AT MY RISK?



All I want is your name—so I can tell you why I'll send you my pipe without a cent of risk on your part

I say "Smoking is convincing" and I want to send you one Carey pipe to smoke 30 days at my risk. At the end of that time, if you're willing to give up your Carey Pipe, simply break it to bits—and return it to me—the trial has cost you nothing.

Please send me your name today. Just a postal card will do. I'll send you absolutely free my complete trial offer so you can decide for yourself whether or not my friends are right when they say the Carey Pipe is the greatest smoking invention ever patented. Send your name today. As one pipe smoker to another, I'll guarantee you the surprise of your life, free. Write today! **E. A. Carey, 1920 Sunnyside Ave., Dept. 1011, Chicago 40, Illinois.**

**LOOK!** **A MILLION THRILLS!**

**High Power BINOCULARS**

**30 DAY FREE TRIAL**  
Finest Precision Optics  
Money Back Guarantee  
Easy Pay Plan

33 Models  
**\$9.95 UP**

**BUSHNELL Binoculars**

Free! Catalog & Book "How to Select Binoculars"  
Dept. M71 43 E. Green Pasadena, Calif.

## Say You Saw It in POPULAR MECHANICS



### HE-MAN VOICE!

**STRENGTHEN** your voice this tested scientific way. Yes—you may now be able to improve the **POWER** of your speaking and singing voice . . . in the privacy of your own room! Self-training lessons, mostly silent. No music required.

**FREE BOOK** Write TODAY for Eugene Feuchtinger's great booklet "How to Develop a Successful Voice." It's absolutely FREE! You must state your age. Booklet mailed postpaid in plain wrapper. No salesman will call. Send your name and age **RIGHT NOW!** Perfect Voice Institute, 210 S. Clinton St., Studio LX-2, Chicago 6, Ill.

**WHAM-O SPORTSMAN** \* **\$1.50** 35-LB. PULL!

HITS LIKE A RIFLE—KILLS RABBITS, SQUIRRELS. Powerful, silent, accurate. For hunting, target, routing pests. Sportsman's choice sold world over!

**HUNTING SLINGSHOT**

Heavy duty 7" ash stock. 40 steel balls, extra rubber, target. **GUARANTEED.** At dealers, or send \$1.50 to Wham-O Mfg. Co. Box 87, South Pasadena, Calif. \* Professional model of Nat'l Slingshot Assn.

# STOP BURNING OIL!



**LOSING POWER WASTING \$\$\$**

When your car "eats-up" oil, loses that get-up-and-go power, has poor gas mileage, it's a sure sign that you have worn rings, pistons, and cylinder walls in your engine. This is robbing you of driving pleasure and valuable \$\$\$ to the tune of \$250 every 10,000 miles in oil, gas, and repair bills.

### WHAT CAN YOU DO ABOUT IT?

You can either have an expensive overhaul job done or offset this wear with a

### RING-RE-NU MOTOR RECONDITIONER KIT

It's the inexpensive, proven answer to a worn engine. This terrific 1-2 combination restores power and zip to your car without expensive repair work, reduces oil burning, slashes gas consumption, brings back that "new car" performance to your car.

#### HERE'S HOW THIS DOUBLE VALUE KIT PERFORMS!

- 1. PVR COMPOUND**—is a hard hitting engine reconditioner that removes sludge, tars, sticky greases from a tired, worn engine. Pour in carburetor, idle engine. Leaves rings, valves, pistons whistle clean, ready for . . .
- 2. RING-RE-NU**—the amazing compound which when squeezed by tube on your pistons forms a tough, pliable, self-expanding seal on rings and pistons to compensate for wear.

**RESULT!**—You get power-packed, economical driving pleasure. Good for 10,000 plus miles. Adds years to the life of your car. Guaranteed not to harm the finest engine. Takes only 30 minutes to install.

#### Read ACTUAL PROOF From One of 100,000 Satisfied Users!

Cadillac Owner, E. L. G., Lawrence, Mass. writes — "My Cadillac was burning 2 qts. of oil every 100 miles. I have now travelled 400 miles since installing the kit. Haven't used one drop of oil. Further my gas consumption has been cut in half. I'm more than pleased with results — best investment I ever made."

#### NOTE! DON'T BUY HALF A TREATMENT!

Ring-Re-Nu is more than just a seal—it's a complete 1-2 combination. PVR to clean your engine, RING-RE-NU to seal in that "new car" power.

1 tube kit \$4.95 ppd. treats all cars except large 8 cyl. autos which require special 2 tube kit at \$8.95 ppd. sold with money back guarantee. (C.O.D.'s accepted. \$1 deposit required, bal. and postage on arrival.) For economical, power-packed, new car performance — rush order to:



Only **\$4.95**

(free folder available on request)

### RICHIE DISTRIBUTING, INC.

11916 MADISON AVENUE • DEPT. A11 • CLEVELAND 7, OHIO

RING-RE-NU . . . GOOD FOR YOUR CAR — GOOD FOR YOUR POCKETBOOK

Gives You A Business of Your Own

**OVERHAUL SEWING MACHINES**

Experience is absolutely unnecessary! Now our copyrighted, illustrated "Sewing Machine Repair Manual" will allow you to enter this profitable repair field. Special tools are not needed. Inexpensive mimeo printing makes possible the low price of 3.95. **GUARANTEED!**

**FIELDING SEWING MACHINES**  
BOX 133, OAKLAND 21, CALIF.

Now only **\$3.95**

# GET FASCINATING NEW FREE PROFIT PLAN

Tired of monotonous, low-pay jobs — of working for the other fellow? Tap rich profits in huge NEW field. Have your own lifetime business — earn REAL money — say goodbye forever to time clocks bosses! Become part of tremendous expanding industry — yet work right at home!

**LEARN IN A FEW DAYS THROUGH PROVED, TESTED METHODS** to start earning more money with this amazing **MIRACLE** finish—gives a velvety, luxurious surface to radios, lamps, toys, signs, store displays, figurines, auto dashboards—hundreds of items. **FREE PROFIT PLAN** offers everything you need to start at once. Fill out coupon, mail today.

**INVESTIGATE TODAY!**

**PROFIT UP TO \$500 PER HOUR**

**SEND NO MONEY. I WANT YOU TO EXAMINE EVERYTHING WITHOUT RISKING A CENT.**

**BIG DEMAND FOR NEW MIRACLE FINISH.** We show you every step. Filling huge year-round demand... easy to understand instructions tell you how. Earn up to \$5 an hour spare—full time. A few cents' worth of materials brings you dollars!

**GRASP THIS OPPORTUNITY TODAY.** It's too good to miss... Fill out coupon, mail today. Get **FREE** sample, **FREE** plan, big **IDEA** booklet. No salesman will call! Do it **NOW**... be first in your community to cash in on this huge new market!

**COAST INDUSTRIES Dept. 2B, 1004 S. Los Angeles Street Los Angeles 15, California.**

MR. NELS IRWIN

AUTO DASHBOARD  
SHOES  
PHONOGRAPH TURNTABLES  
AUTOTRUNK INTERIORS  
RADIO'S  
TOYS  
LAMPS  
JEWELRY BOXES  
COVERS ANY SURFACE

**FLOK KRAFT**

**COAST INDUSTRIES Dept. 2B**  
1004 S. Los Angeles St., Los Angeles 15, Calif.  
Gentlemen: Please rush me all details **FREE**

NAME \_\_\_\_\_  
STREET \_\_\_\_\_  
CITY \_\_\_\_\_ STATE \_\_\_\_\_

# THIS . . . . **GUIDE** 120 PAGE FOR AMBITIOUS MEN **FREE!**



Have you had your copy?

120 pages of guidance to best-paid positions. Up-to-the-minute information for men who want to climb to the top. Tells how to get promotion, security and better pay through home study courses. This handbook "Engineering Opportunities" is free and entirely without obligation. Send the coupon. Make this your big year! Describes over ninety courses including:

Mechanical  
Aeronautical  
Television  
Building

Electrical  
Radio  
Automobile  
A.M.I.Mech.E.

A.F.R.Ae.S.  
A.M.I.C.E.  
B.S. (Pure  
Science)

--- SEND COUPON TODAY ---

Canadian Institute of Science & Technology Limited, 569 Century Building, 412, 5th Street, N.W., Washington, D.C.

Please forward free of cost or obligation your handbook, "ENGINEERING OPPORTUNITIES".

Name .....

Address .....

Course interested in ..... Age .....

Canadian Address: Canadian Institute of Science Garden Building, 263 Adelaide St. W., Toronto, Ont.

**SAVE \$65 ON THIS LUXURIOUS \$100 CONTOUR CHAIR 34.95 FOR**

Everything Needed Complete To Put It Together In One Evening

Scientifically correct design for restful, healthful, relaxing. Adjusts for perfect sitting or reclining comfort. Proved beneficial to heart, nerves . . . most popular chair in the home. Firestone foam rubber and washable, pilable genuine Duran upholstery. Would cost \$100 or more in any store. Shipped all ready to put together in less than one evening by anyone who can use a screwdriver. No cutting, no drilling, no skill needed. A woman can do it. Order now! Everything needed for only \$34.95, f.o.b. Balto. State color wanted: forest green, sapphire, blue, lipstick red, walnut brown. Enclose \$5 deposit, pay balance on arrival. Money back guarantee. If not satisfied, return in 10 days. Make Money Selling and Assembling Contour Chairs for Friends.

**Bestcraft, Dept. 49, Mathieson Bldg., Baltimore 2, Md.**

Genuine FOAM RUBBER

## LEARN DIESEL NOW BIG PAY-GOOD FUTURE

Whether you are to serve in the Armed Forces . . . whether you want to work in a large city, small town, or in the country . . . whether you want to be a mechanic, salesman, or own your own business—the rapidly growing field of Diesel offers you outstanding opportunities NOW AND AFTER THE WAR.

Mail coupon now for FREE BOOKLET explaining the opportunities in Diesel.

**THE BAILEY DIESEL SCHOOL**

1651 S. Grand Ave. St. Louis (4), Mo.  
NATIONALLY RECOGNIZED

Name .....

Address .....

City ..... State .....

### FIELD TRANSMITTER SET

Complete; includes transmitter with pair of head phones, sending telegraph key, buzzer, double throw switch. Original cost of this instrument to English government well over \$100.00. Ship. wt. 20 lbs. each. Allow sufficient postage or will be shipped express charges collect. Two 4 1/2 volt C batteries needed in each set. Batteries 45c each extra. Wire needed to connect for operation. No. 438. Complete set. . . . **\$7.95**  
Two sets for. . . . . **\$15.00**



## WAR SURPLUS BARGAINS

**\$500,000.00 INVENTORY for QUICK LIQUIDATION**

Surplus items—hundreds of them for home, shop, factory, farm and outdoor use. New items, used items, reconditioned items—all at tremendous savings—all priced for quick sale.

**Page After Page of Values**

This big catalog shows page after page of amazing money saving values. Write for your copy today. Send 10c to cover postage, mailing, etc. Write today!

**SEND TODAY FOR YOUR COPY**

# STARK'S

10c

509 So. State St.  
Dept. PM-1153  
CHICAGO 5, ILL.

## STAMP COLLECTORS 25¢

327 GENUINE STAMPS ONLY

#1. Valuable foreign stamps showing Famous Americans. New Uruguay Roosevelt, Washington, Lincoln & MacArthur on Indonesian and Moluccas issues. Even from "Behind the Iron Curtain" stamps show Americans. ALSO fantastic Monte Carlo triangle shows giant ship "United States"!

#2. EXOTIC collection Yemen U.P.U., Pope Pius triangle, African natives, Israel, San Marino, Allied Military set and many other fine stamps.

YOU GET "Americana" collection (alone worth more than price of entire lot). Exotic packet, and special imported collection. 327 different stamps in all! Just 25c to introduce our approval service to you.

FREE (with order): Magnify glass, hinges and perforation gauge!

**NATIONAL STAMP SALES, 832 8th Av., Dept. 300, New York 19, N.Y.**

## Malayan THROWING DAGGER

BALANCED TO STICK! **\$1.98** post-pd

MALAYAN HUNTING KNIFE used for killing game. Exciting Target Sport, Easy to learn! Fun, indoors or outdoors!

**EASY TO THROW!**

**MONEY BACK GUARANTEE**

Fun, Thrills, Excitement!  
Indoors - outdoors!  
Learn this Sport! Easy to throw accurately with our clear instructions. Beautiful, heavy-duty 10" knife. Tempered steel. Tough, rawhide-bound handle. Rare souvenir, unusual bargain. Limited quantity. At dealers or send \$1.98

**WHOLESALE IMPORT CO. Dept. K, 604 Marengo, Alhambra, Calif.**

## GET "New Car" POWER!

- Stop Burning Oil!
- Restore Compression!

**\$3.95** post-paid

A small amount of Fisher's Compression SEAL in each cylinder bore gives you the economies of smooth, powerful "new car" performance and reduced oil consumption. Old, tired engines may not need expensive overhauling. Only takes minutes to apply—yet gives you 10,000 more miles of low-cost driving pleasure.

**SATISFACTION GUARANTEED!**  
Full purchase price refunded immediately, if not completely satisfied. No solvent baths necessary. Order today! Information. Dealers inquire.

**FISHER'S** 4756 S. Central, Dept. PM-11  
Los Angeles 11, Calif.



**Now YOU can PICK your JOB and BIG PAY Future in Allied's Nation-Wide Industrial Co-op Plan**

**INDUSTRY CRITICALLY NEEDS ALLIED TRAINED MEN TO FILL IMPORTANT JOBS**

- . TOOL ENGINEER**
- . TOOL & DIE DESIGNER**
- . MACHINE DESIGNER**
- . INDUSTRIAL ENGINEER**
- . DRAFTSMAN**
- . MASTER MACHINIST**
- . TOOL & DIE MAKER**

Shortages of Draftsmen, Designers, Tool Engineers, Machinists, Tool and Die Makers are so widespread that you can pick a key job and look forward to rapid promotions, better pay, job security, success and achievement. Industry is expanding so rapidly that there are more good paying jobs than there are trained men to fill them.

Industrial Co-op program is integrated so that you can either study at home or at the Allied Institute's fully equipped shops and laboratories. You may enroll in short courses or study progressively for a Degree of Bachelor of Tool Engineering.

Allied is approved by Industry, the American Society of Tool Engineers, Department of Registration and Education, Department of Public Instruction, State of Illinois, Department of Justice for foreign Students, and the Veterans Administration. Accredited by Central Schools Assoc.

**ALLIED SCHOOL of MECHANICAL TRADES**  
Allied Institute of Technology

1338-42 S. Michigan Ave. Dept. PM-11, Chicago 5, Illinois

Gentlemen:

I want to get into important Industrial Trades and Professions. Send me without obligation your **FREE BOOKS** explaining Allied's Courses of Instruction and information on Nation-Wide Industrial Co-op Plan.

I am interested in Resident Training  Home Study   
I am eligible for the G. I. Bill  I am not eligible

Name \_\_\_\_\_  
Address \_\_\_\_\_  
City \_\_\_\_\_ State \_\_\_\_\_

send for **FREE BOOKS**

**ALLIED SCHOOL of Mechanical Trades**  
1338-42 South Michigan Ave  
Chicago 5, Illinois

**Prints Postal Cards!**

**FREE** Use on 30 Day Trial! Send name today for facts and **FREE** Illustrated Book of unique advertising plans and money-making ideas for your business. Learn how others are boosting sales with post card ads... easy with Cardmaster.



Cardmaster Co., 1920 Sunnyside, Dept. 1311, Chicago 40, Ill.

**MASTER MIND!**

**Learn Short-Cut Mathematics**

Juggle figures, do baffling number tricks. Make people gasp at your marvelous lightning-quick mind. Multiply 4 figures by 4 figures without using old-fashioned multiplication! Big cloth-bound volume; fully illustrated course.

**Sharpen up Your Brain Power**

Includes worked out problems, answers, etc. Sensational bargain, only \$2.95, postpaid or COD plus postage. Satisfaction guaranteed or refund. Order this amazing "Short-Cut Mathematics" today!

**NELSON-HALL CO., 210 S. Clinton St. DEPT. 2LX-2 CHICAGO 6, ILL. \$2.95 Complete**

**Build the MONOGRAM SUPERKIT F-51 Mustang**



16 to 26 Plastic Parts in Each Kit

ONLY **89c**

**17 Other Thrilling Models - Flying and Solid • Jet Power Racers • Ships**

Here's thrilling fun for all kids 8 to 80 years old. Genuine SUPERKIT scale model airplanes including the famous F-51 Mustang shown above. Easiest of all to build yet most detailed models ever produced. Kits contain completed wings with double airfoil, smooth carved bodies, precision-cut balsa parts, plastic 3 and 4 bladed props, pilots, canopies, cannon, rockets, bombs, display stand and other plastic parts. Complete catalog of 18 planes, including jets, 5 jet power race cars and 5 U.S. fighting ships FREE in every kit. Be sure you get Monogram Models.

If no dealer near you send 89 cents for Mustang Kit, plus 25 cents for postage and packing to address below. Delivery guaranteed.

MONOGRAM MODELS, Dept. 18, 3421 W. 48th Place, Chicago 32

NOVEMBER 1953

**Say You Saw It in Popular Mechanics**

**"HOW I DOUBLED MY INCOME In Less Than A Year, As A CUSTOM UPHOLSTERER"**



Alvin Lederkramer, Former Low Salaried Auto Mechanic - Now Earning Big Pay

"When I enrolled for UTS training I was an auto mechanic earning a hand-to-mouth salary. While learning I earned good spare-time money. After graduation, I got a job in upholstery with better pay than ever before. Now, less than one year later, I've doubled my income. Soon, I'll get into my own business. The future looks bright thanks to UTS."

**WHAT DO YOU WANT? A Better Job—Your Own Business—Substantial Sparetime Earnings—A Better Future? They're all waiting for You in the Big-Opportunity Field of Custom Furniture Upholstery.**

AT HOME in spare time, you can do what Alvin Lederkramer and hundreds of UTS graduates have done—easily, quickly! Trained upholsterers are scarce. You can earn as you learn to make good money all year 'round at home, in your own shop, or in a well-paid job. The famed N.Y. State-approved UTS course teaches you custom furniture upholstery, reupholstery, slip covers, furniture finishing, repairs, PLUS 3 BIG EXTRAS—window cornice, cushion and drapery making.

You get—**FREE** of extra charge—4 **BIG** **OUT-FITS** of tools, complete frames and all materials to make beautiful upholstered furniture and slip covers that are yours to keep or sell! Our **FREE** book, "Your New Way to A Successful Career" tells you how you prepare at home for this fascinating, big pay, big opportunity trade. Write **TODAY!** Resident Training also available. Upholstery Trades School, Dept. BS 305, 721 Broadway, N. Y. 3, N. Y.

**YOU MAKE**

- SLIPPER CHAIR**
- CLUB CHAIR**
- OTTOMAN**
- PLUS SLIP COVERS**

**Yours to keep or sell**

**SEND FOR BIG FREE BOOK**

**UPHOLSTERY TRADES SCHOOL**  
Dept. BS 305, 721 Broadway, New York 3, N. Y.

Send me **FREE** book on:  
 Home Study  Resident Training  
Name \_\_\_\_\_  
Address \_\_\_\_\_  
City \_\_\_\_\_ Zone \_\_\_\_\_ State \_\_\_\_\_

# Chrome

is where  
the  
heart  
is!

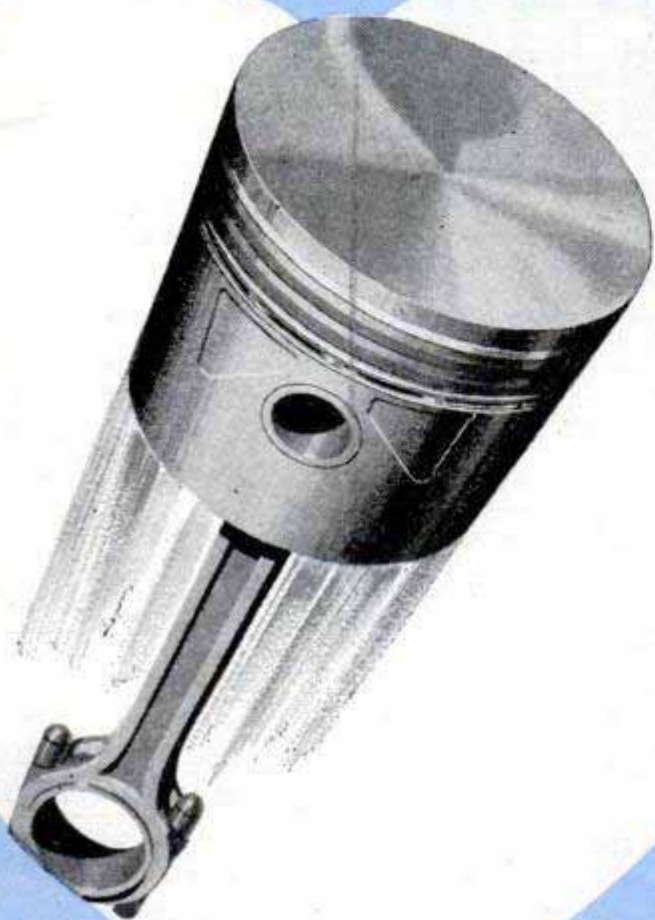

**No chrome** piston ring set can really give *complete* wear protection in the "heart of the engine" unless it provides a chrome-plated TOP ring, as well as a chrome-plated oil ring. For the top ring operates where heat is highest, pressure is greatest, and lubrication is poorest!

**That's why** Perfect Circle's 2-in-1 chrome piston ring set has established new standards of ring performance . . . why it seals compression and controls oil for *over twice as long as old style sets!* And only 2-in-1 furnishes an alternate HiPressure spring with each oil ring, for positive control even in badly worn engines!

Perfect Circle Corporation, Hagerstown, Indiana;  
The Perfect Circle Co., Ltd., Toronto, Ontario.

# Perfect Circle

PISTON RINGS • The Standard of Comparison

Yes, the heart of any engine is the piston and rod assembly . . . and Perfect Circle's 2-in-1 chrome piston ring set gives complete protection against wear where the power is produced!

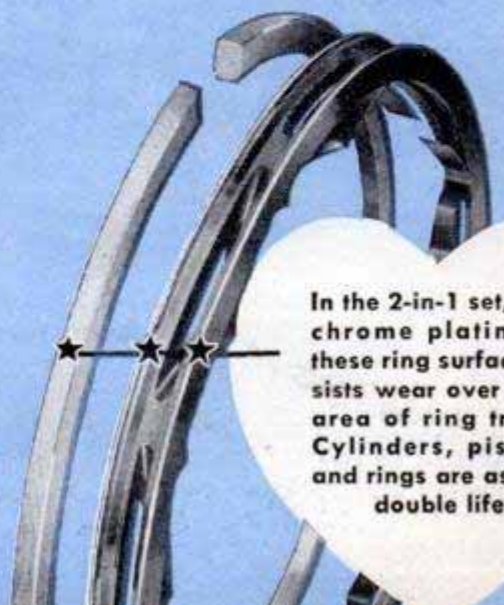

In the 2-in-1 set, solid chrome plating on these ring surfaces resists wear over entire area of ring travel. Cylinders, pistons, and rings are assured double life.

# POPULAR MECHANICS

NOVEMBER  
1953

WRITTEN SO YOU CAN UNDERSTAND IT  
VOL. 100 NO. 5

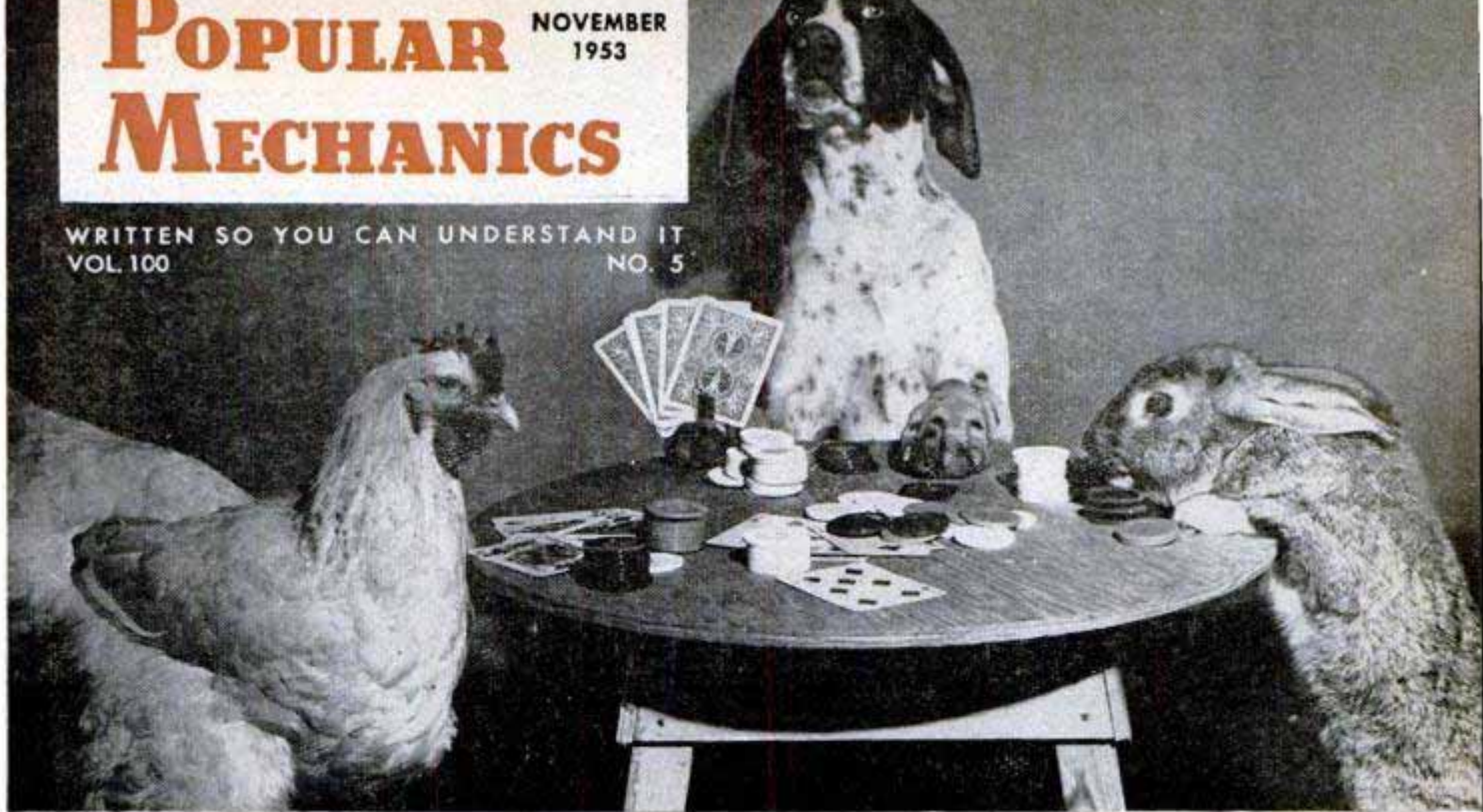

A quiet poker game in the firehouse. Animals learn to take their positions, then remain absolutely motionless

## WHO SAYS ANIMALS ARE DUMB?

*You can teach any animal—hen or cat, pig or rat. Take a lesson from the Brelands, who teach hens to play baseball and pigs to vacuum the floors. Their educated animals are wowing audiences from coast to coast*

By Clifford B. Hicks—Part I

**A**T A LITTLE FARM near Hot Springs, Ark., I saw a chicken do arithmetic problems and a rooster knock out a tune on a piano. I played a pinball game against a turkey, and invariably lost. I watched a hamster imitate Tarzan on a trapeze, a rabbit play basketball and a dozen chickens swing baseball bats.

After spending a few days in the society

of these incredible creatures, I came away completely convinced that anyone can train an animal or bird, and that most animals can be taught spectacular tricks. You just have to be smarter than the animal.

The Arkansas farm is the research laboratory of Mr. and Mrs. Keller Breland, a pair of graduate psychologists who train animals and birds as a means of studying behavior patterns. By teaching a 10-day-old chick to run up a ramp and ring a bell, a turkey to operate an electric train and a

In 25 minutes, using Brelands' methods, author taught chicken to turn the pages of *Popular Mechanics*. Fowl is rewarded with grain from "reinforcer" at right

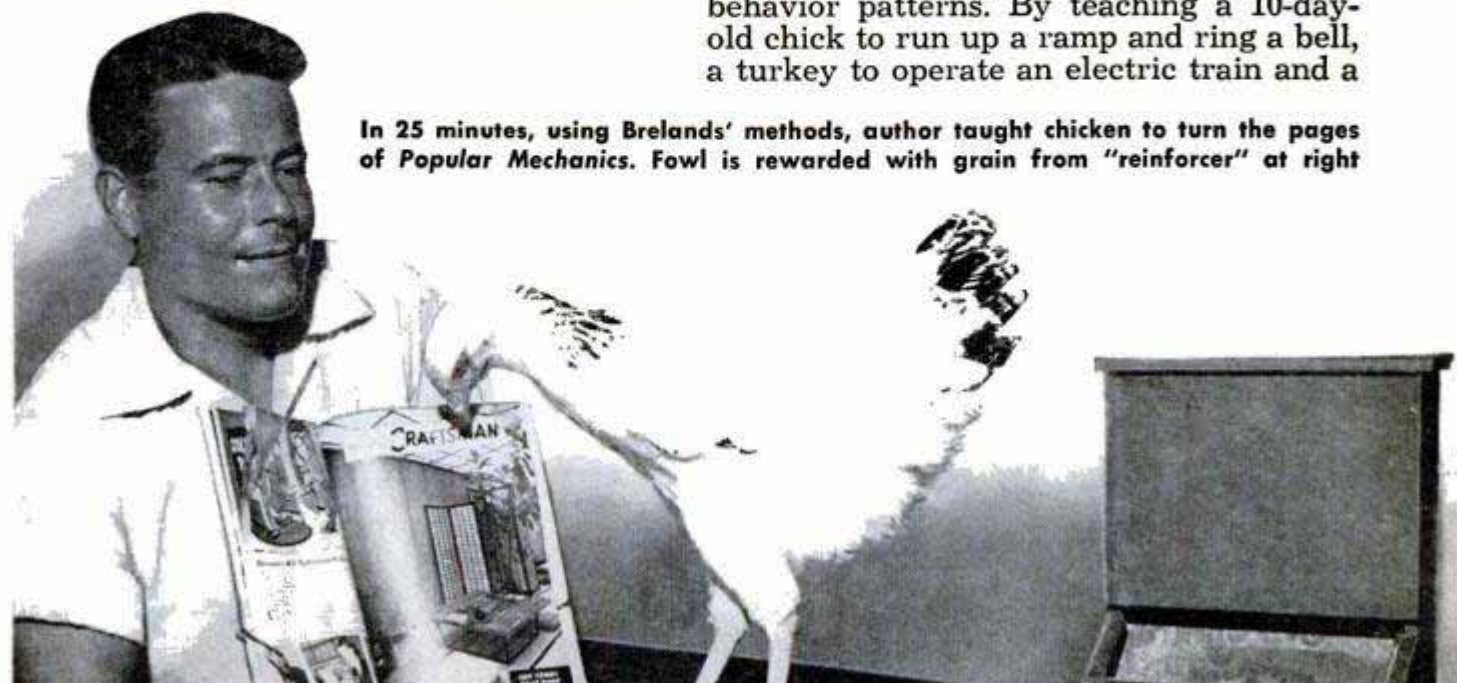



Even rabbits can learn the value of thrift. This one takes coins from Breland's lips and saves them until he has enough to "buy" a reward



Money-wise bunny deposits his coins one by one in a piggy bank. Having earned his reward, he's paid off in pellets of rabbit food. Below, this isn't the usual scene at the Breland dinner table, but it isn't unusual either. Rabbit and hen will hold their positions anywhere

rabbit to careen down a slide, these two psychologists are uncovering new and positive means of controlling behavior. Almost as a sideline to their research, the Brelands have developed some infallible new animal-training techniques.

Infallible? Take a look at my own experience.

Soon after I arrived at the Brelands' fascinating laboratory, Keller invaded a chicken coop and brought back an ordinary, untrained young hen.

"Here," he said, handing me the chicken. "You yourself can prove our training methods. What do you want to teach that bird to do?"

After a moment's hesitation, I asked doubtfully whether the hen could be trained to turn the pages of a magazine.

"That shouldn't take more than 30 minutes," Keller said.

I thought he was kidding. Twenty-five minutes later I had my chicken trained to leaf through *Popular Mechanics*, page by page, as often as desired.

Over a period of 12 years Keller and Marian Breland have amassed a good deal of significant information in the field of behaviorism—information on "reinforcement by variable ratios" and "patterns of response." Technical language aside, what they have done is to convert animal training into a science.

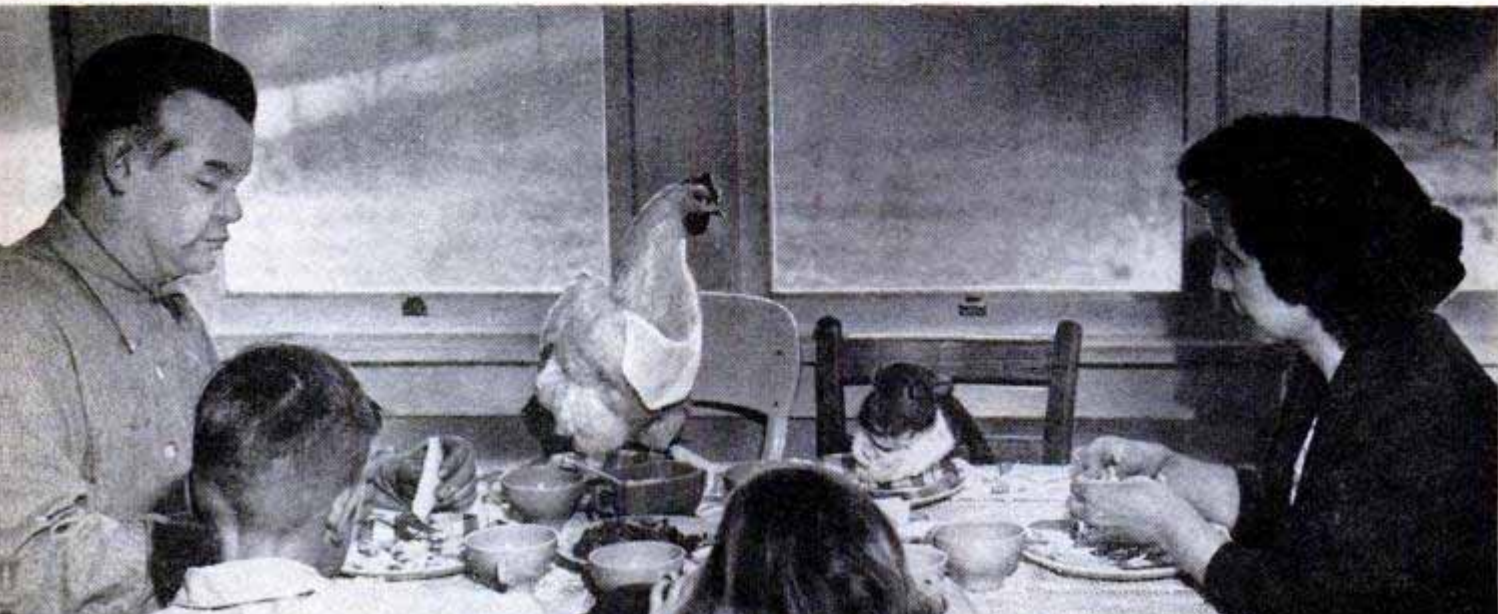

Furthermore, they say that anyone with a basic knowledge of their methods can train a chicken, rabbit, hamster, dog, cat or even a bull to perform tricks on signal.

The modest young Brelands have always been more interested in behavior patterns than in animal training, but some six years ago it occurred to them that their educated chickens might lay them a somewhat golden egg. They suggested to General Mills, Inc., makers of farm feeds, that a tap-dancing hen would be a great crowd-puller at feed stores. They were almost scoffed out of the building until a few of the executives watched a hen do a tap dance while a rooster played the piano. Since that time the Brelands have been working under contract to the company. Some 60 or 70 of their animals and birds are currently touring the country in the hands of feed salesmen, who put them on display at fairs, rodeos and feed stores. Altogether, the Brelands have trained some 4000 animals and birds which have been seen by about 1,000,000 entranced people.

The commercial contract under which they operate is unique because the Brelands absolutely guarantee to control animal behavior. At this moment some 125 Casey-at-the-Bat chickens, scattered across the country, are belting home runs. The Brelands have no idea where they are or who is handling them. They do know that day after day the hens are happily banging baseballs with precise regularity.

The Brelands are unprecedented as animal trainers because they can impart this regularity to any number of animals selected at random. Take Priscilla the Fastidious Pig. Actually there are nine Priscillas, all ordinary porkers without pedigrees, all trained to perform identical and complicated routines without any help from their handlers.

When the act starts, Priscilla is in bed and is awakened by an alarm clock. Clad in a neat house dress, the pig climbs out of bed and ambles over to a radio, which she turns on with her snout. With a soap opera blaring, she daintily seats herself on a chair at the dining table and eats her breakfast

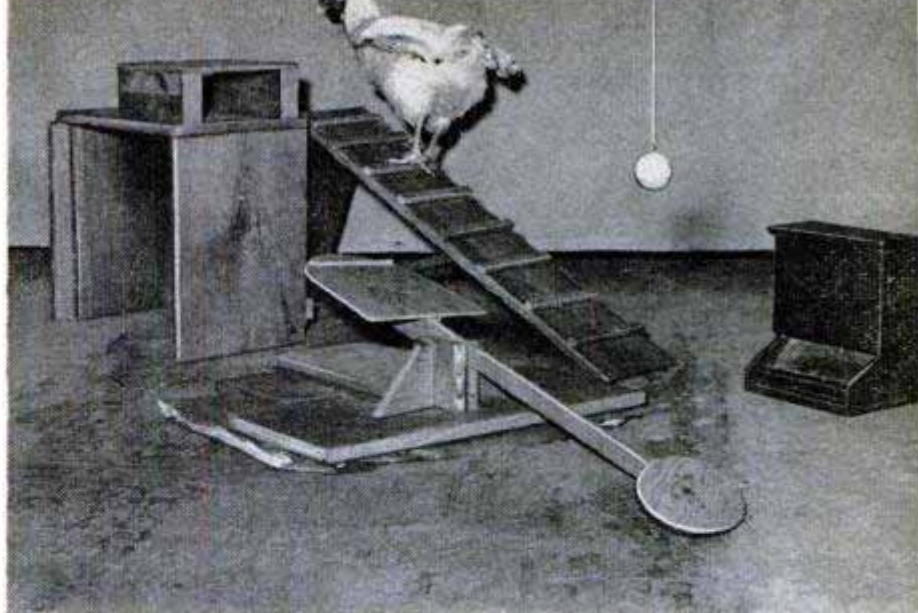

After solving the riddle of this experimental setup, hen will walk through it time after time with no one around. First she climbs up the cleated ramp and jumps over to the platform

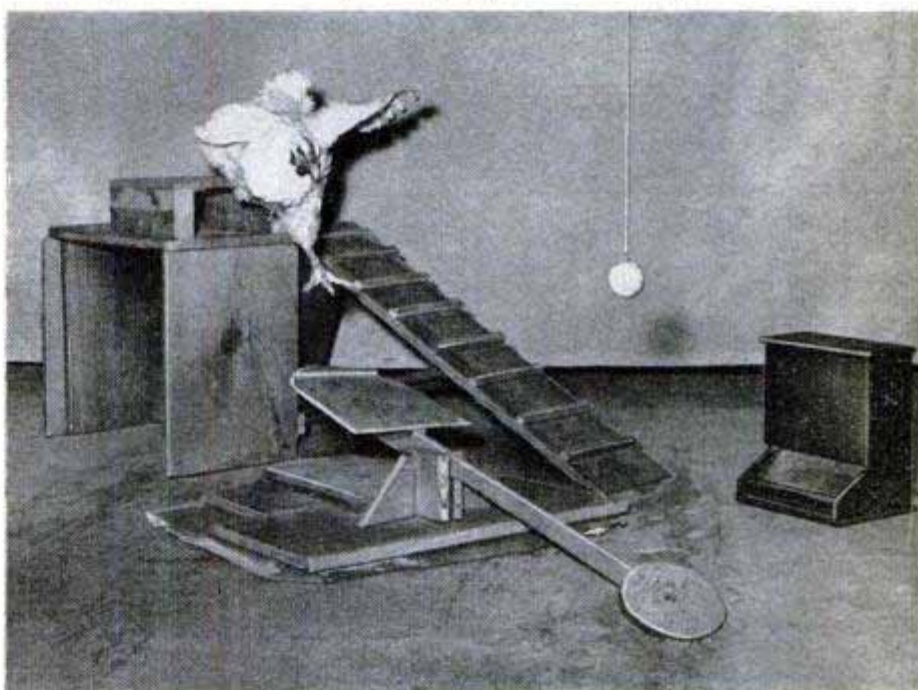

Biddy leaps to teeter board. If she flutters down, nothing happens, but if she lands solidly, the other end of the board strikes the ball, which soars to ceiling and trips reinforcer at right. Hen gobbles her reward and starts up the ramp again

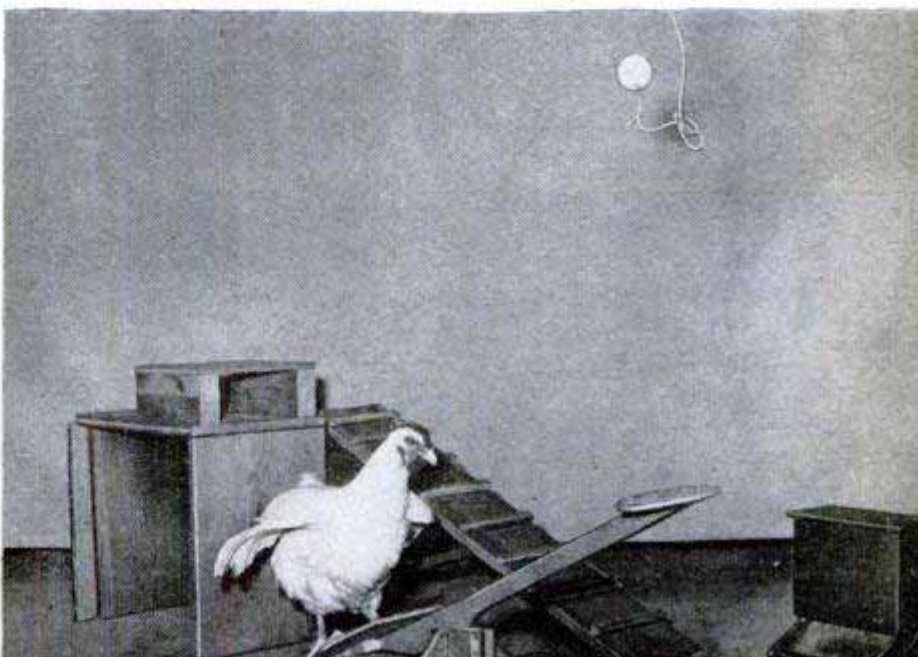

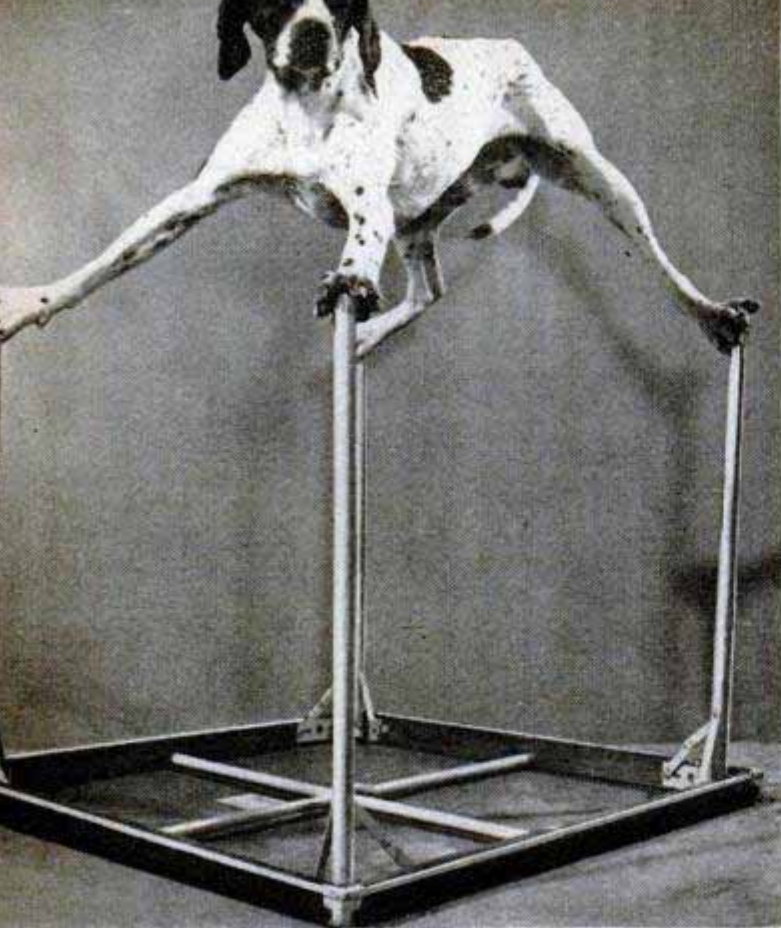

General Mills photo

**"Putty," the Brelands' farm dog, can be molded in any position, so it's easy to balance him on table legs**



**Proud hen wears tapdancing "shoes." When music is played, she clucks and clacks about room, her feet beating out staccato rhythm. Below, "Priscilla the Pig" turns on and tunes radio before doing housework**

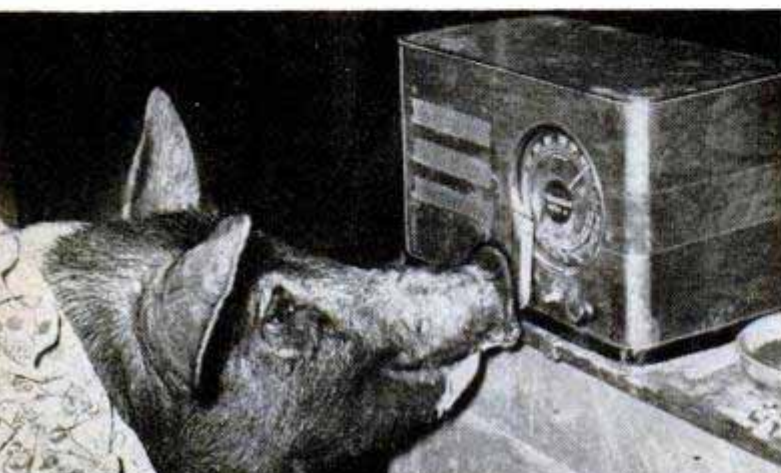

from a plate. But alas, a housewife's work is never done, so after breakfast she tidies up the room. Scattered about the floor are several items of clothing which she picks up one at a time and drops into a hamper. The pig then trots over to a vacuum cleaner in the corner, flips on the switch with her snout and roots the cleaner back and forth to the hilarious shouts of the audience.

Priscilla's actions are so human that she sends a tickle up your spine, especially when you recall that there are nine of her. All nine are in the hands of amateurs—feed salesmen with no more than two days' training as Priscilla-handlers. The salesman nonchalantly walks down the main street of a country town with Priscilla trotting at "heel" beside him, and within 15 minutes the news has flashed around the village, "There's a pig over in the feed store that thinks it's a housewife!" In one town with a population of 4000, more than 7000 people watched Priscilla.

What are the Brelands' training secrets? No secrets at all, for Keller Breland will explain all the techniques and urge you to try them yourself. Basically they use a "reinforcing stimulus," their scientific term for rewarding an animal or bird instantly when it makes even a random hint of doing what you wish. Although feed is the usual reward, the animals get as much feed as they want; it's just spread over the training period. No animal ever goes hungry, rations are always ample and the Brelands never use punishment in any form.

A bird or animal soon learns to go through an unbelievable number of steps to earn its "reinforcement." Quite by accident I opened one door at the laboratory and saw a lonely hen hard at work on some experimental equipment. With no one around to watch, Bidy would climb up a ramp, then jump across to a platform. There she'd survey the situation for a moment. Below her was the high end of a teeter board. Suddenly she'd leap out into space and land on the board. If she fluttered through the air, using her wings, she'd strike the teeter lightly and settle slowly to the ground. But if she plummeted down without using her wings, landing sharply and solidly on the board, the other end of the teeter would snap into the air, striking a rubber ball suspended on a string from the ceiling. The ball would shoot high in the air, a buzzer would sound and Bidy would cackle happily over to a feed trough and gobble down her reinforcement. Then off she'd go to climb the ramp again.

Keller has developed an electric feeder or "reinforcer" which is the heart of the training. His model is a superbly efficient one, but anyone could work out a similar, if cruder, mechanism. The reinforcer for

chickens is a small box with a feed trough at the bottom. Inside the box are three things: A buzzer, a hopper filled with feed and an electrical mechanism which drops about a dozen grains of feed into the trough when a button is pushed. The button is an ordinary doorbell button on a long wire.

How is an animal actually trained? At the start of my chicken-training session, Breland placed the reinforcer along one side of a card table, handed me the electric button and told me to put the chicken on the table.

"Push the button," he ordered. I pushed it, the buzzer sounded and a few grains of feed dropped into the trough. The chicken whirled around, spotted the grain and ate it. When she walked away, Keller told me to press the button again.

Within two minutes the chicken had learned that the sound of the buzzer meant feed in the trough. Keller then placed a wire rack on the table opposite the reinforcer and leaned an open magazine against it, with the pages slightly "dog-eared."

"Now don't reinforce her until she looks or walks at random toward the magazine," he ordered. "Then give it to her quick."

My hen wandered around for a few seconds, then accidentally drifted toward the magazine. I reinforced her pronto. After a dozen such reinforcements she had a definite pattern of behavior. Cluck cluck, straight to the magazine. Bzzzt. Whirl

around and peck at the feed. Cluck cluck, straight to the magazine. Bzzzt. Don't let anyone tell you a chicken is stupid.

"Now localize her," said Keller. "Don't reinforce her until she looks at the folded corners."

She cackled back over to the magazine and I waited for her to spot the turned-down corners. When she did, I gave her a tremendous buzz. This isolation of a point is the most difficult step, and Bidy required at least a dozen shots of reinforcement before she got the idea.

Finally, I disappointed her. She expected reinforcement when she gazed at the corner, but didn't get any. Made her so mad she pecked viciously at the turned-down page, and immediately she was rewarded.

One minute later she was so eager to please me that she would race over to the magazine, grab a page or two in her beak and pull. Each time she pulled, a page would turn over. Presto—she was turning the pages.

I looked at my watch. The training process had taken only 25 minutes. She kept browsing through the magazine for another 10 minutes until she was full.

We put her away temporarily, but a few hours later when we returned her to the table she immediately began to peck through the pages. A marvelous bird; I think Keller could teach her to read.

(Continued next month)

Another hen pecks out real—though simple—tune on toy piano. She gets "reinforced" from feeder at right

General Mills photo

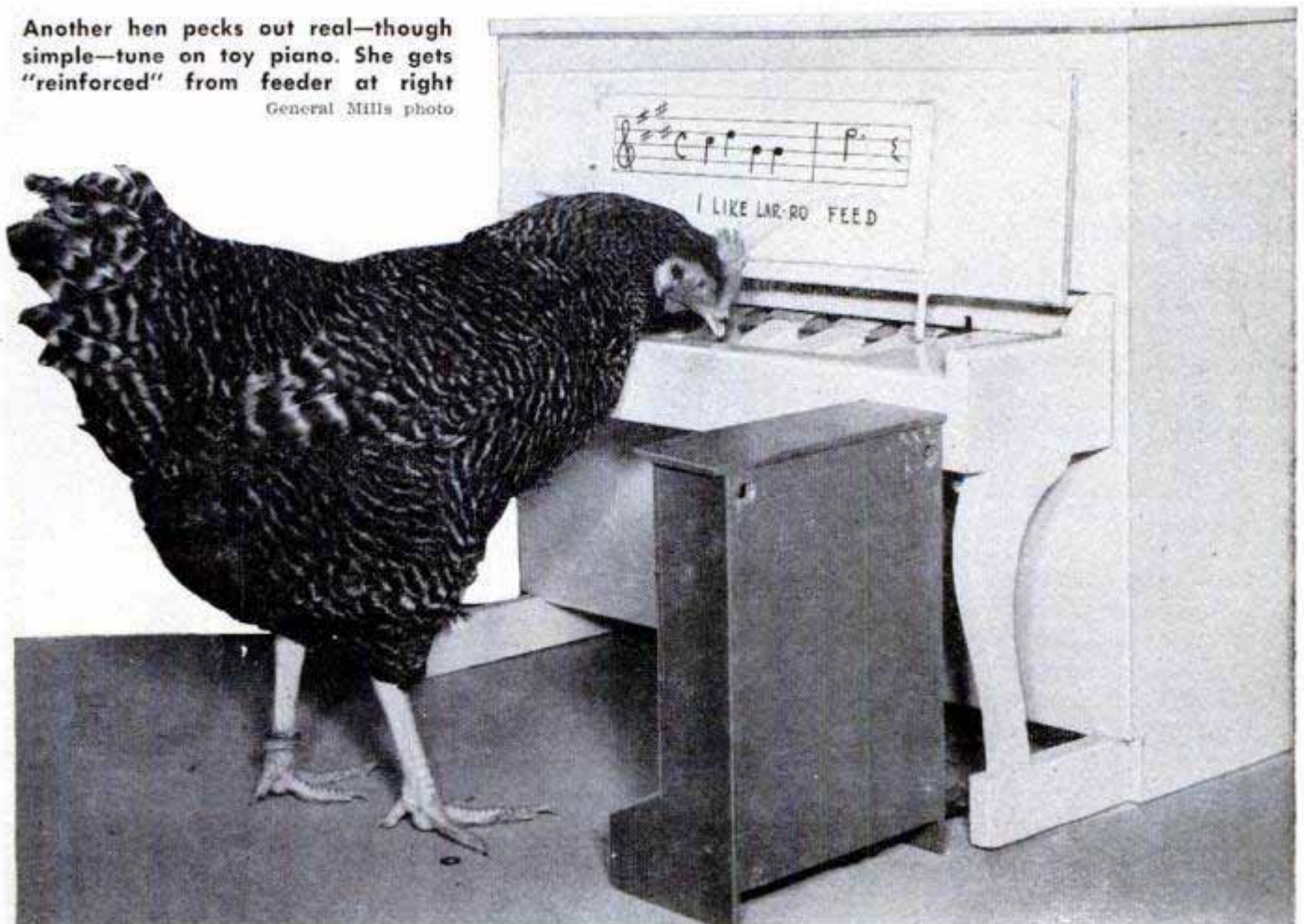

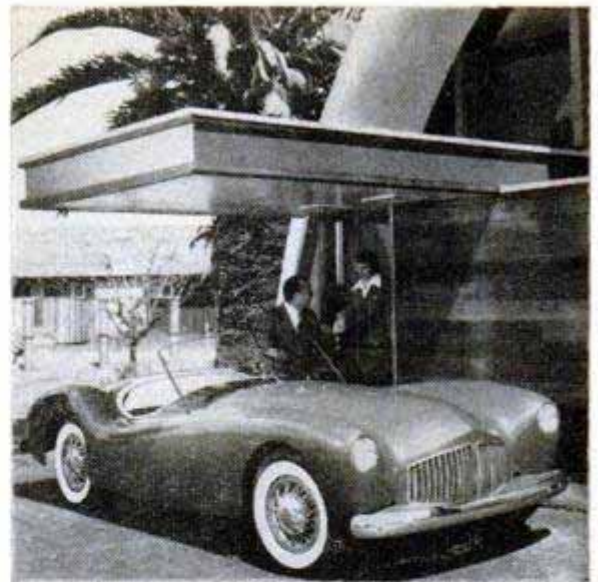

## Airlines Offer Mobile and Drive-In Ticket Offices

Airline tickets now come to the customer—or are purchasable at drive-in ticket offices. In Los Angeles and San Francisco, Trans World Airlines now has roving ticket offices, mounted on truck chassis, traveling over fixed routes. The body has a side-

panel opening for quick conversion to an outside ticket counter. United Airlines has opened a drive-in ticket office for suburbanites living south of San Francisco. A canopied parking area is provided for those desiring information on itineraries.

## Iceberg Detector

Icebergs can be detected from the air by a radiation thermometer even though the surface of the ocean is hidden beneath a cloud or fog formations. The airborne thermometer, capable of measuring the sea surface temperature from an airplane, was developed at the Woods Hole Oceanographic Institution. It has been used to track the inshore edge of the Gulf Stream.

## Electric Socks Keep Feet Warm

Cold feet are as old-fashioned as heavy blankets now that you can wear electric socks that operate like an electric blanket. Power for the socks is furnished by a six-volt battery worn on the belt. Wires run beneath the clothing to carry the current to warming wires woven into the toes of the socks, which are designed for hunters, ice fishermen and other winter-sports fans.

## Altered Studebaker Coupe Becomes Fast Sport Car

Although he's a Studebaker dealer, Charlie Stuart of Indianapolis got his roadster the hard way—by cutting off the top of a new five-passenger coupe. After removing all the glass, a cut was made below the bead on the tops of the doors and down to the back of the seats in the rear. Door tops were covered with 12-gauge sheet metal, being leaded in for contour, and the windshield was lowered about four inches. Then the frame was boxed with  $\frac{3}{8}$ -inch channel steel for added rigidity. The interior was covered with red leather upholstery and the body painted an oyster white. The V8 engine was ported and relieved with the heads being milled .090 of an inch. Dual manifold and exhausts make this combination give 160 horsepower. Speed of 120 miles per hour was achieved in a clocked road test.



## What About Trailer Living?

Why have 2,000,000 Americans become trailerites? What kind of a life do trailer-dwellers lead? Is it comfortable? Expensive? Fun? Aren't trailer dwellers cramped for space? Are those 40-foot trailers hard to handle on the highway? You'll find the answers to these questions, along with some surprising information on America's trailerites, in "Trailers Are Stay-at-Homes Now" coming up with many other features in the December issue



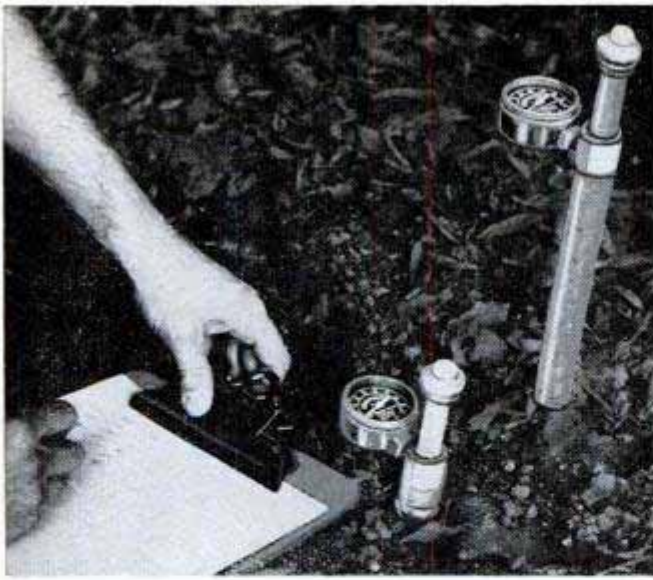

### Meter Tells Farmers When to Irrigate Crops

Irrigation farmers need not guess when their crops need water if they use a new moisture meter. The instrument is a plastic tube with a porous tip. With the tip buried in the ground, a dial indicates the moisture content of the soil. Usually a long tube is used to measure the moisture in the subsoil, while a shorter one indicates the water content near the surface.

### Pen Prints Gold on Materials

Gold monograms, drawings and signatures are imprinted on virtually any material by a new electric pen set. The item to be decorated is placed on a slanting stand and a strip of gold paper placed over the area to be imprinted. After the pen has been warmed up a few seconds it is moved across the paper to imprint the monogram, signature or design on the item. A 600-inch roll of gold paper is included with the pen and stand, and additional rolls are available. The pen will imprint leather, cloth, paper, plastic, felt, wood, crockery and painted or varnished surfaces.

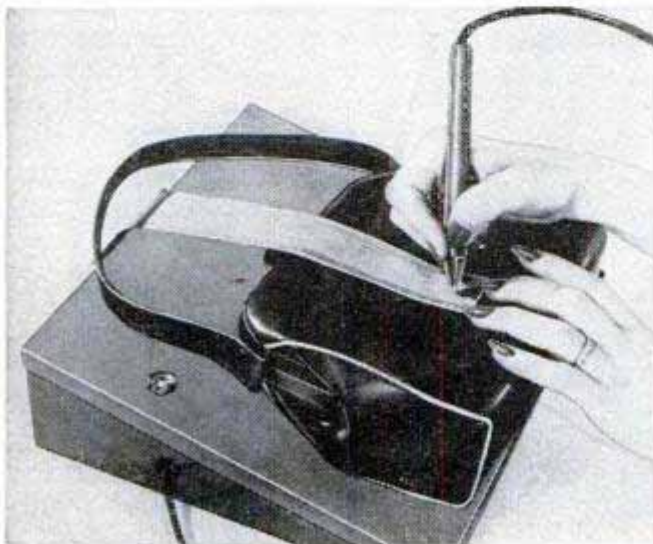

### Britain Demonstrates "Sombrero" Flame Thrower

Dubbed the "ack-pack," Britain's new flame thrower has an odd-shaped fuel tank that looks like a Mexican sombrero strapped to the soldier's back. The weapon is shorter than most flame throwers of previous design. A length of flexible hose connects the fuel tank with the gun.

### Spring Core for Wire Rope

Development of wire rope with a coiled steel-spring center is expected to solve a 50-year-old problem in deep oil and gas-well drilling. Wire rope has always been distorted and crushed by being wound layer upon layer around the huge drums of rotary rigs, under tensile loads of 50 tons or more. Some derricks use as much as 2800 feet of the rope which also has to be flexible enough to fasten around pulleys and blocks. The spring core principle developed by the Jones & Laughlin Steel Corporation resists crushing and gives firm internal support for the outer strands. Because of its hollow center, the new rope will hold more lubrication than previous types, reducing rust and friction wear.

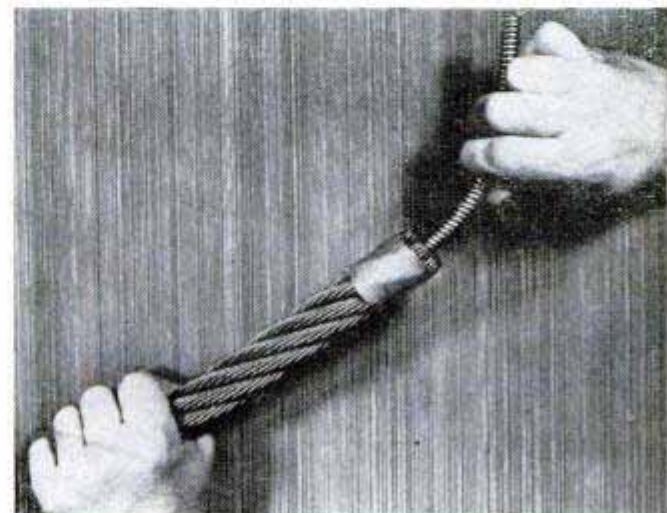

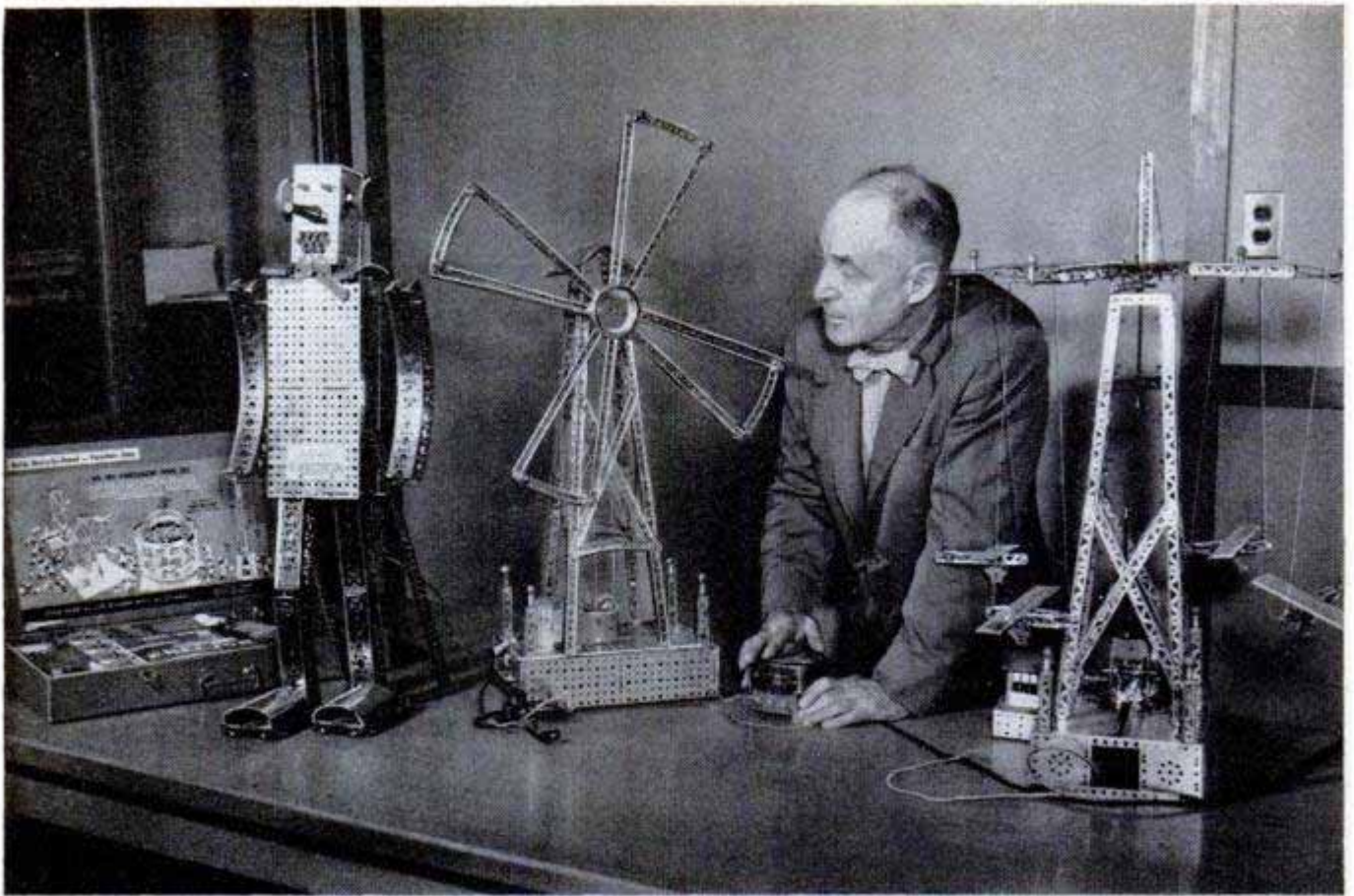

A. C. Gilbert became a millionaire by scaling construction girders down to a size that children could handle

# F O R T U N E S in Toy Ideas

By Melvin H. Williams



Sometimes two men hit on the same idea almost simultaneously. These plastic blocks fit together with snaps. Another firm makes a similar set from wood

WHERE DO TOY IDEAS come from?" Believe it or not, children usually invent the toy and parents perfect it. Housewives, office workers, teachers, hospital technicians, carpenters or businessmen are the toy designers of today. Some have made fortunes by developing good ideas they have found watching children "at work."

Almost anyone can come up with a new toy, as you'll see from the following examples. Each was successful in bringing fame and fortune to some person. Toys come and go like Christmas snows. Only one in a thousand becomes a best seller. But perhaps somewhere in these examples you can find the inspiration for a million-dollar idea of your own.

Some people spend a lifetime dreaming up new stunts to delight America's 45,000,000 children. In spite of this, there is a re-

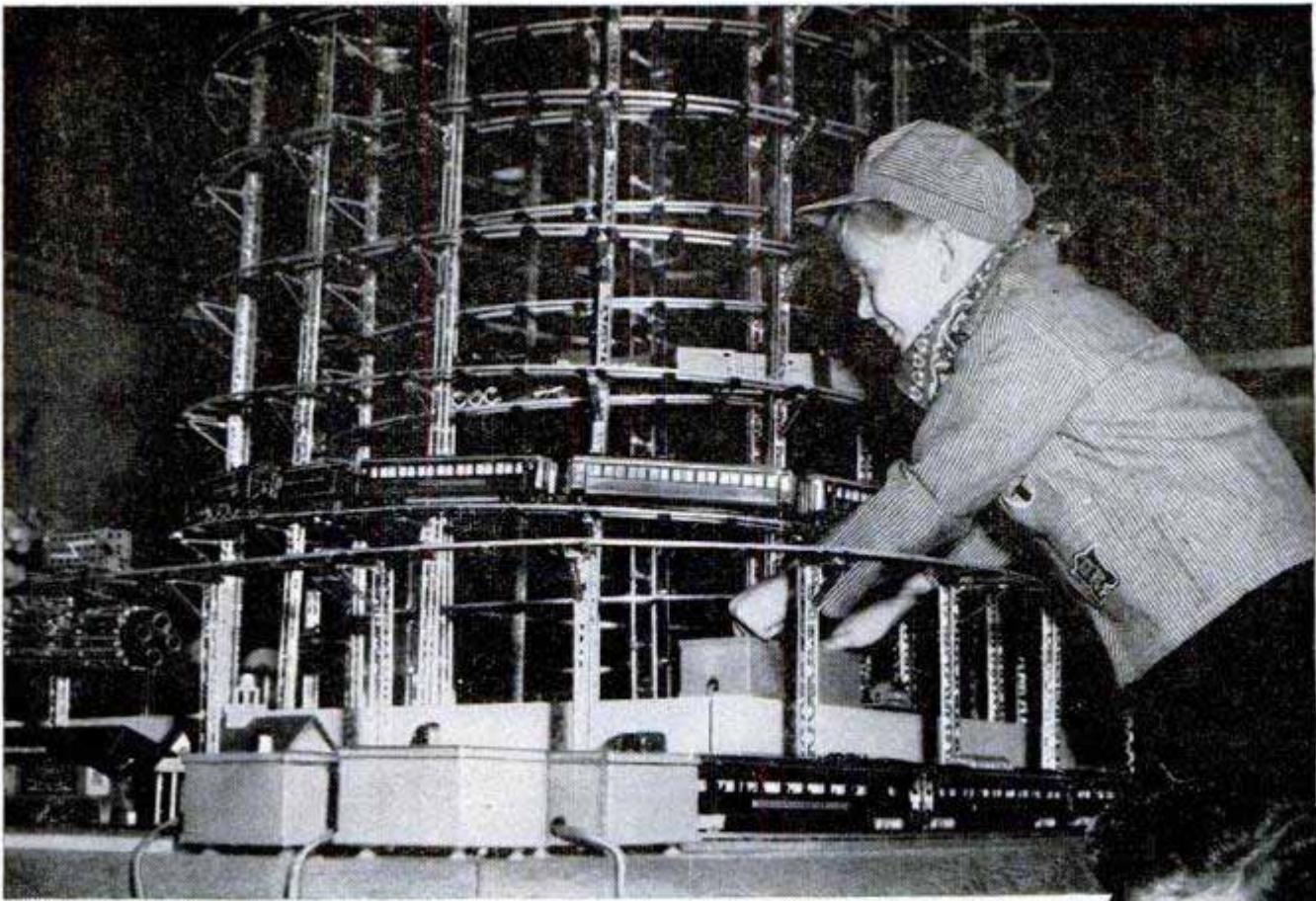

Corkscrew turnpike built of Erector parts handles four separate trains at the same time

markable shortage of new toy ideas. The billion-dollar toy industry eats up good toys faster than professionals can turn them out.

Each inventor has his own system. Some work from the old toy catalogs or samples in museums. Old ideas are frequently good. When one generation of children grows up, another is ready for the same type of toy. Some toy inventors do not wait for new generations, but simply adapt yesterday's hits to today's demands.

Sometimes two or three inventors working independently on a similar idea find that, by collaborating, their parts fit together into a solid toy hit.

In 1949 Albert Weinstein, a professional inventor from Alexandria, Va., got an idea for a remote-controlled toy car. He steered it with an air-pressure bulb, but had no idea how to power it. So he contacted a friend, Louis Van Order of Verona, N. J., executive of a firm that made a tiny electric motor powered by flashlight batteries. Between them they designed Weinstein's auto so that it could be electrically operated by the flashlight-powered motor, controlled by a switch on the end of a wire. At that time the Aluminum Model Toy Company of Birmingham, Mich., was planning to make a plastic scale model of a new car. Frank McGinnis, an executive of the car manufacturer, brought the three parties together and the original remote-controlled car was born. The auto, which can back up, go forward, race in circles and be ma-



Father's doodles of future car inspired this new toy

neuvered into the most intricate spaces by an operator 10 feet away, was an immediate sensation.

Designers often start something that just doesn't work out. If they're quick-thinking, they can turn their impractical "dream" into a profitable sale.

Elliot Handler, one of the country's most famous designers of children's music boxes, used to sketch ideas for "dream cars," just for fun. They were always far ahead of their time.

One day his 10-year-old son, Kenneth, found one of the drawings and asked his father to build him a streamlined car just like that. Flattered by his son's approval, Handler went ahead and built a toy car embodying his designs. The car was an instant hit with Kenneth and every other kid on



Eight years ago the Doepke brothers were repairing an old toy fire engine as a Christmas gift. Why not make better ones of steel? Today 270,000 trucks and machines roll out of their factory annually. Below, sturdy vehicles are exact copies

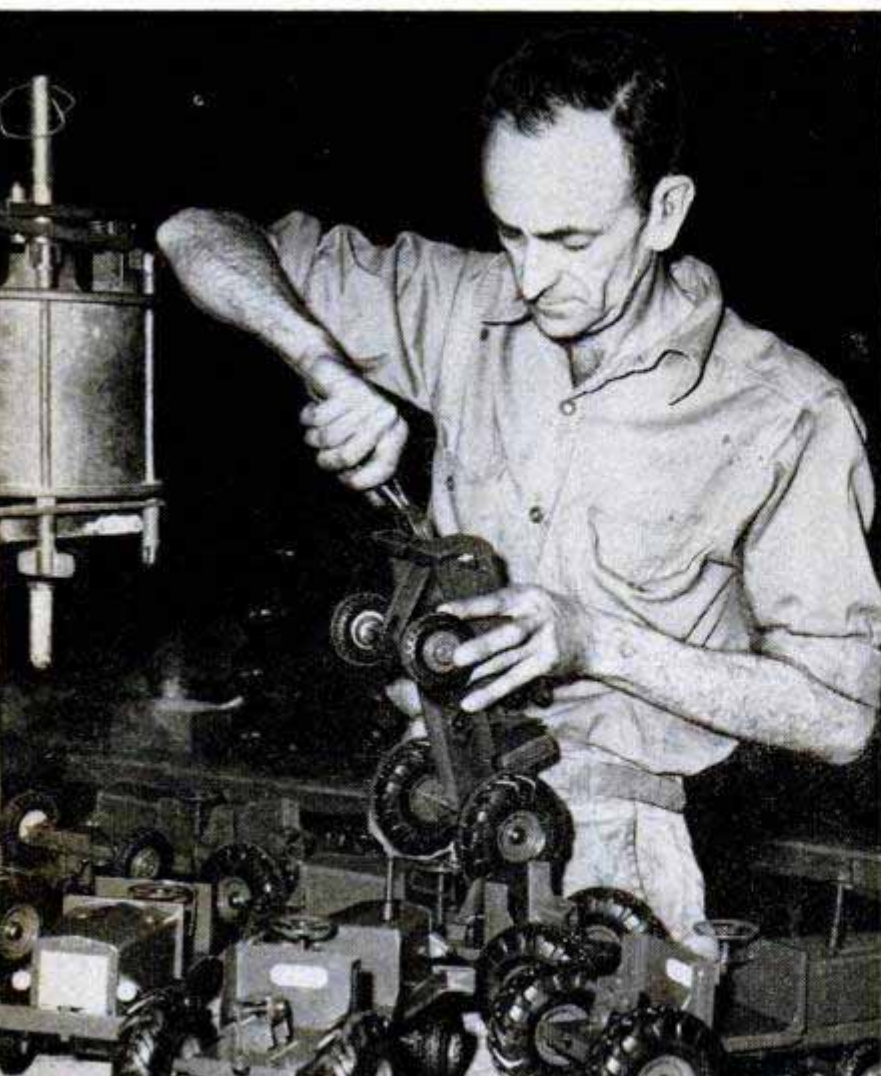

the block. So Handler, who was associated with Mattel, Inc., a Los Angeles toy firm, turned over his designs and model to the company. The firm is now producing 60,000 friction motor cars a day.

Most people in the toy business know they'll get good ideas if they study the simple things that children themselves invent to mimic adults.

For example, in late 1950 a toy manufacturer named Herman Kesler of the American Metal Specialties Corporation of Hatboro, Pa., was sitting in his kitchen lamenting the fact that another year would soon be upon him and he couldn't envision a single idea for a new toy. He watched idly as his children helped the maid with the dishwashing, using foaming suds, scouring pads, dish rack and a dish towel. Suddenly an idea clicked. From time immemorial, little girls have had tea dishes to play with and yet no one had ever given them their own dishwashing equipment. And what little girl doesn't like to play with sudsy water?

Thus was born one of the most popular girl's toys—the Doll-E-Do Dish, so obvious it defies inventiveness. It is simply a toy dishpan, dish-rack, sink strainer, apron and dish-mop, with real samples of brand name cleaning aids. Today, only a few years later, Kesler's firm has grossed over \$10,000,000 from just such simple ideas as this dishwashing kit.

A parent may invent a toy to meet the therapeutic needs of a sick child. It's strange but true that Vernon G. Eisel was literally forced to invent the Cradle Gym, one of the world's best-known infant toys.

In June, 1940, one of Eisel's twin infant daughters became paralyzed in her neck. Doctors agreed that manipulation of her neck muscles was necessary in order to strengthen them. To do it by hand was futile. The exercise had to be constant, which meant the infant would have to do it voluntarily.

Eisel had an idea. He threaded a lightweight steel chain through a rubber tube to which he attached two brightly colored handles and a cluster of tinkling bells. Then he strung the contraption across his daughter's crib. While he watched anxiously, she seized one of the colored handles. This caused the bells

to jingle and slowly her head turned toward the sound. The infant reached for another colored handle. Again a tinkle. Within 15 minutes she was straining her neck muscles actively in order to survey the whole gadget, and in less than two months the muscle damage had been repaired and the infant could turn her head normally. Eisel sold his device to a leading toy concern and just a few months ago received a check for his 100,000th royalty dollar. His Cradle Gym has now been used by more than 5,000,000 babies.

People who can't afford the real thing often design a new less expensive toy simply by improvising on the original. In March, 1952, John L. Joseph, a refrigerator-parts salesman, was watching his two preschool daughters fighting over some hollow wooden building blocks that had been given to them. There weren't enough to build their mutual houses, trains or boats. Joseph tried to buy more, but was astound-

ed to find they cost up to \$5 per block. He tried building suitable giant blocks out of wood. That was too expensive. He tried plastic. The cost of the dies ruled plastic out. For months he tinkered with the idea. All he wanted was a plain hollow block, no bigger than the cardboard carton his refrigerator parts came in. He jumped at the thought. Cardboard blocks. He took a heavy grade of corrugated kraft stock and finished it with a colored waxed surface. Then he reinforced the interior of each block with an egg-crate-type partition. This made the block so strong it would stand up under 500 pounds of dead weight. He could manufacture this block for a fraction of the cost of a wooden block, so he decided to become a toy manufacturer. His simple improvisation is a growing success and his firm is just completing its first year in the toy field with a handsome profit for its industrious founder.

Many successful toys are invented by utilizing some current news event or tying in a toy with a popular celebrity. Mickey Mouse, Howdy Doody and Hop-along Cassidy have made small fortunes for manufacturers of toys. But it is only the keen-eyed toy designer who catches the popularity on its upswing or gets

Back in 1902 a cartoon showing President Teddy Roosevelt and a bear cub inspired a toymaker to bring out a stuffed bear. Here's the first Teddy bear ever made, still popular with Roosevelt's great grandchildren





"Slinky" coil actually walked into someone's life. When an engineer was working with long springs, one of them was jarred loose and strutted down a pile of books. Buyers thought the idea crazy. Kids didn't

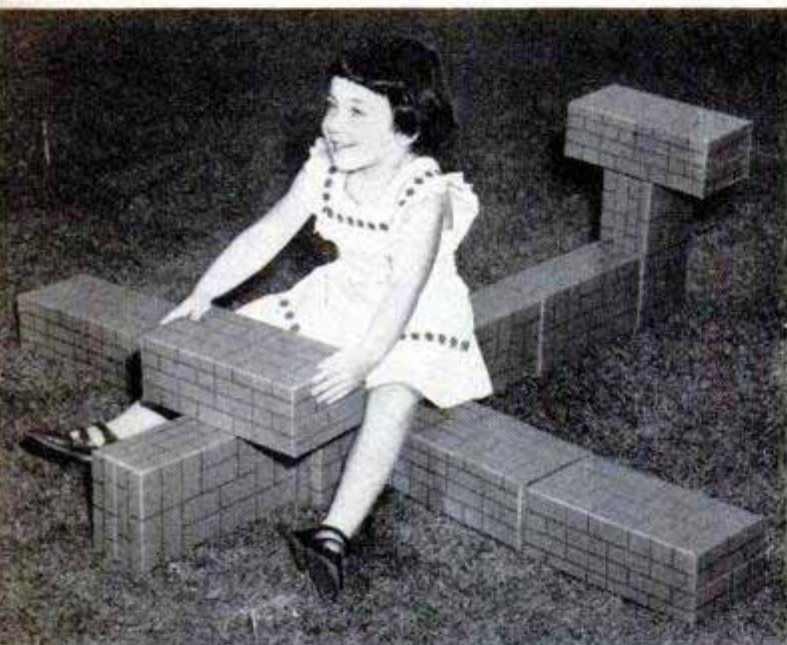

Some toys are less expensive adaptations of older toys. Big building blocks made of corrugated paperboard, reinforced with inner "egg crate," will hold 500 pounds. Below, "Why didn't I think of that?" Successful new toy is dishwashing equipment, sample size



the complete benefit of a celebrity tie-in.

On November 16, 1902, a newspaper cartoon appeared in *The Washington Post* showing President Theodore Roosevelt standing belligerently over a scrawny cub bear that had been dragged into his hunting camp by his guides. The cartoon became an immediate sensation. In Congress, in newspapers and in the street, people were discussing the incident of "Teddy's bear." To children, the term Teddy bear had a certain charm and they began asking for their own Teddy bear. To an enterprising New Yorker named Morris Michtom, this was the opportunity of a lifetime. He wrote to Roosevelt and asked the President for permission to use the name of "Teddy" on a line of toy stuffed bears. Roosevelt replied that he didn't know how much benefit his name would be in the toy business, but Michtom was welcome to use it.

In 1903, Michtom's first Teddy bear made its appearance and nearly 150 million of them have been made in the 50 years since then. By all estimates, it is the most popular toy in the world.

Plumbers, mechanics, carpenters and electricians may invent surprisingly successful toy tools just so their youngsters stay out of their own dangerous but intriguing tool kits.

Tom Grimes was in the basement workshop of his Chicago home in 1949 doing some needed repair work. His two-year-old son was also in the basement constantly reaching for a hammer, saw or screwdriver. As fast as Grimes retrieved one of the dangerous tools the boy would grab another. In desperation, Grimes made a small hammer out of a sanded piece of waste wood, drilled a hole in a board and let Junior bang round pieces of wood into the hole from one side and then from the other. The success of his idea delighted him as well as his son. The next day he made more tools out of wood. By week's end he had a whole workbench, accurate in scale, but complete with safe blunt wooden tools such as a hammer, screwdriver, wrench, vise and an assortment of wooden screws, nuts and bolts. Grimes took his idea to Playskool Manufacturing Company, educational toy firm, which tested his "workbench" in its clinics. The workbench, with a number of technical improvements, proved a big success in every test. Playskool has sold several hundred thousand of them in the past three years.

Every year, men looking for a profitable business to go into get ideas for toys and plunge in. When Fred Doepke came back from Army Air Corps service after World War II, he and his brother, Charles, an engineer, wanted a manufacturing busi-

(Continued to page 270)



Northrop Aircraft Co. photo

## Fighter Packs 104-Rocket "Sunday Punch" in Wing-Tip Pods

Wing-tip pod arsenals, packing a total of 104 lethal air-to-air rockets, now make the Scorpion F-89D the heaviest armed fighter. A hit with any one of the high-explosive missiles will destroy the biggest bomber. Radar in the 600-mile-per-hour-plus Scorpion guides it into attack position, where

an electronic brain takes over range calculations and the firing. With the rockets in the wing-tip pods, a little more than 50 feet apart, the F-89D lays down a barrage of rockets in twin patterns that saturate an area as large as a football field. The rockets can be fired in a single volley or in groups.

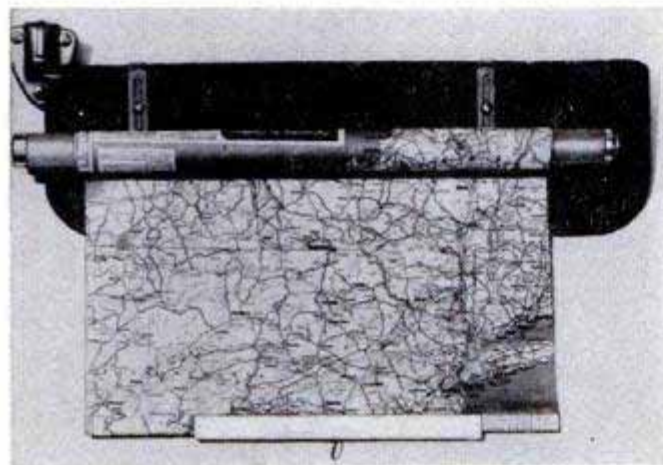

## "Window Shade" Holder For Road Maps

Motorists now can pull down their road maps like window shades for easy reference. Standard maps are rolled into a new holder which is fastened to the car's sun visor. When the motorist wants to make a quick check of the map he unrolls it by pulling down on a metal plate. When he is finished, he gives the plate another tug and it rolls up neatly into the holder. The unit pivots to show reverse side. Metal clips grip the sun visor to hold the roller.

## Streamlined Motorcycle Hits 170 Miles Per Hour on Salt Flats

Streamlined until it looks more like a porpoise than a racing machine, a competition motorcycle set a new United States record of 170.14 miles per hour on the Bonneville Salt Flats. Driven by Bobby Kelton, the cycle seemed to have plenty of reserve power, but it began to wobble and become airborne at that speed so he had to back off the throttle. The new mark is below the world's record of 180 miles per hour, set by a German. It is expected that an attempt to go 200 miles per hour will be made next year, using a redesigned shell and a battery-driven gyroscope.

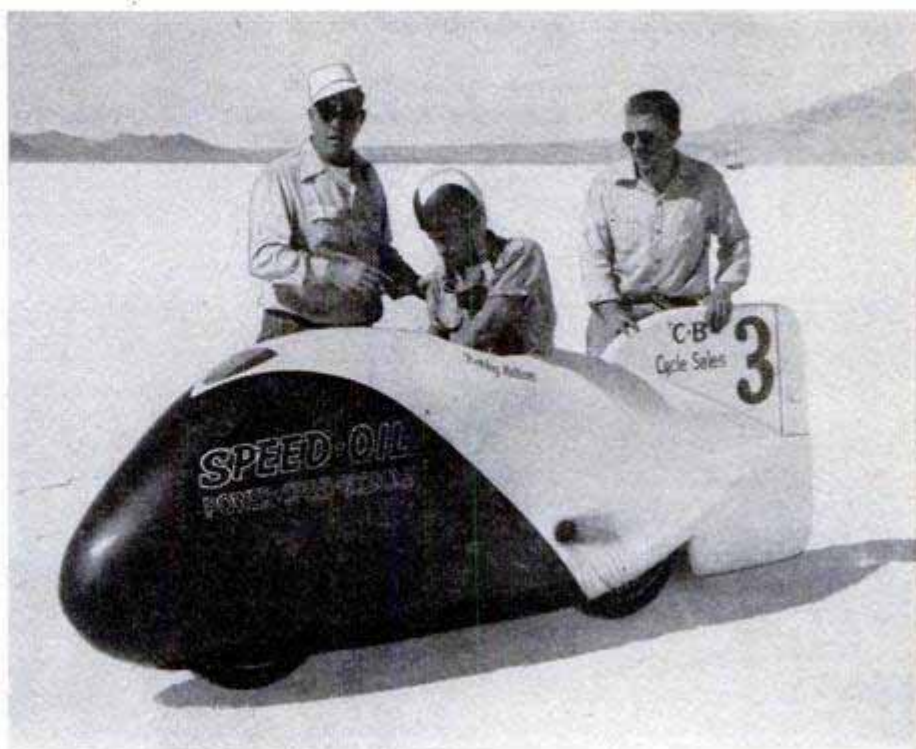



Dodge offers a luxury line, the Royal V8, of which the hardtop coupe is shown above. It has increased horsepower, a 7.5:1 compression ratio. All 1954 Dodge cars have newly designed trim, color-harmonized interiors



Slight trim changes distinguish the 1954 Jet from 1953 models. Inside are two extra inches of legroom in the rear. A two-door sedan (new this year) has a removable rear seat for conversion into a utility vehicle

Below, the 1954 Hudson has new fenders to make it look longer. The broader hood has a functional air scoop. Front grille styling is new also. Redesigned combustion chambers on all models give increased power

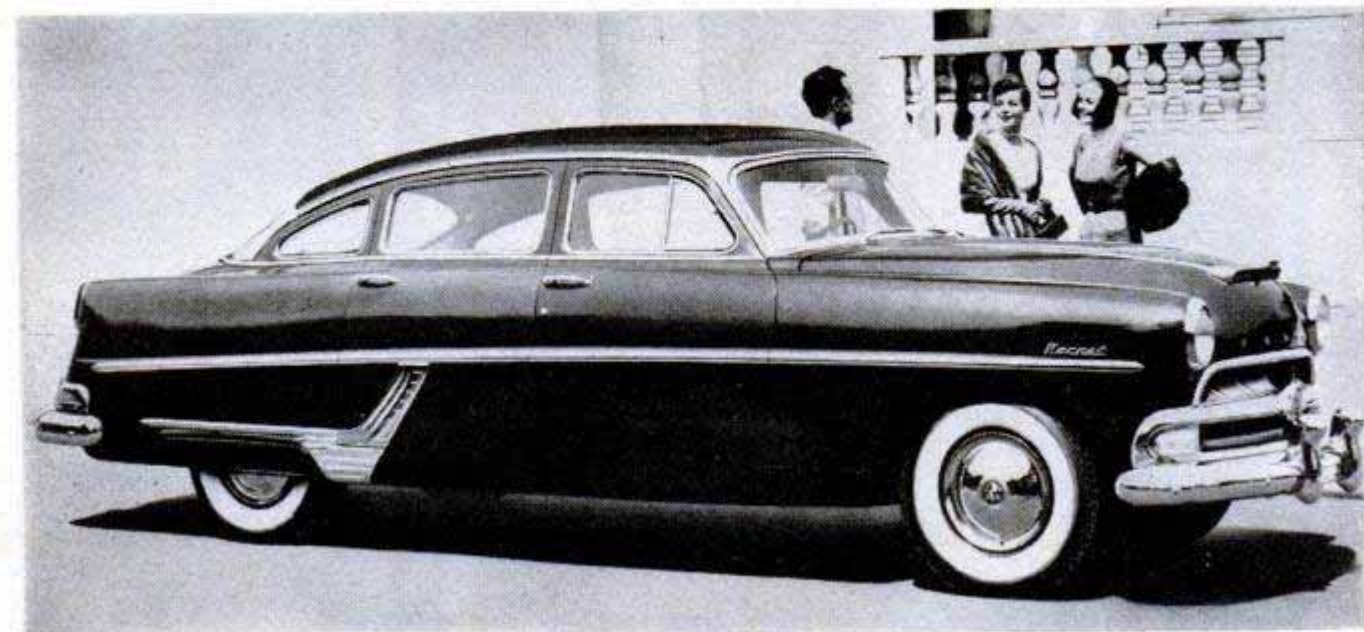



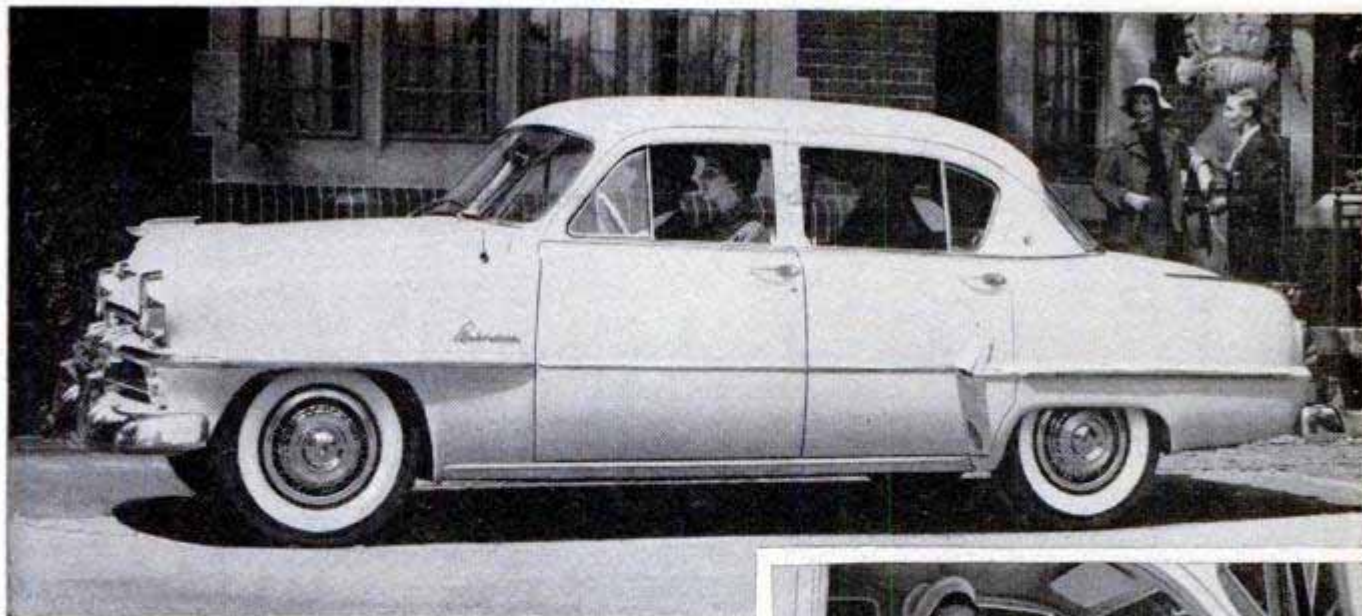

## The '54 Car Parade Begins

**L**EADING the 1954 new-car parade are Plymouth, Dodge, Chrysler and Hudson.

Plymouth moved bumpers outward to increase over-all length. Chrome headlight rims and rear-fender trim emphasize the longer look. Added is the Belvedere line, a luxury series with two-tone exteriors.

Dodge offers the Red Ram V8 with 150 horsepower (up 10 from 1953), PowerFlite automatic transmission and power steering. Length is increased five inches. Grille and trim are new.

Chrysler leads the power race with its 235-horsepower V8 engine, upped from 180 by a four-barrel carburetor, new intake and exhaust systems. PowerFlite is standard on all V8 models, optional on the Windsor 6.

Hudson has a "squarer" look with longer rear fenders. All models have one-piece windshields. Horsepower is 160 on the Hornet (170 optional). Rear-seat legroom in the Jet is greater and a two-door sedan has been added.

Below, Chrysler New Yorker with most powerful engine in the industry. Right, new grille and headlight treatment



Top, Plymouth is several inches longer in '54. Shown here is the four-door Belvedere. Above, interiors are more colorful and luxurious. No-glare instrument panel is new safety feature

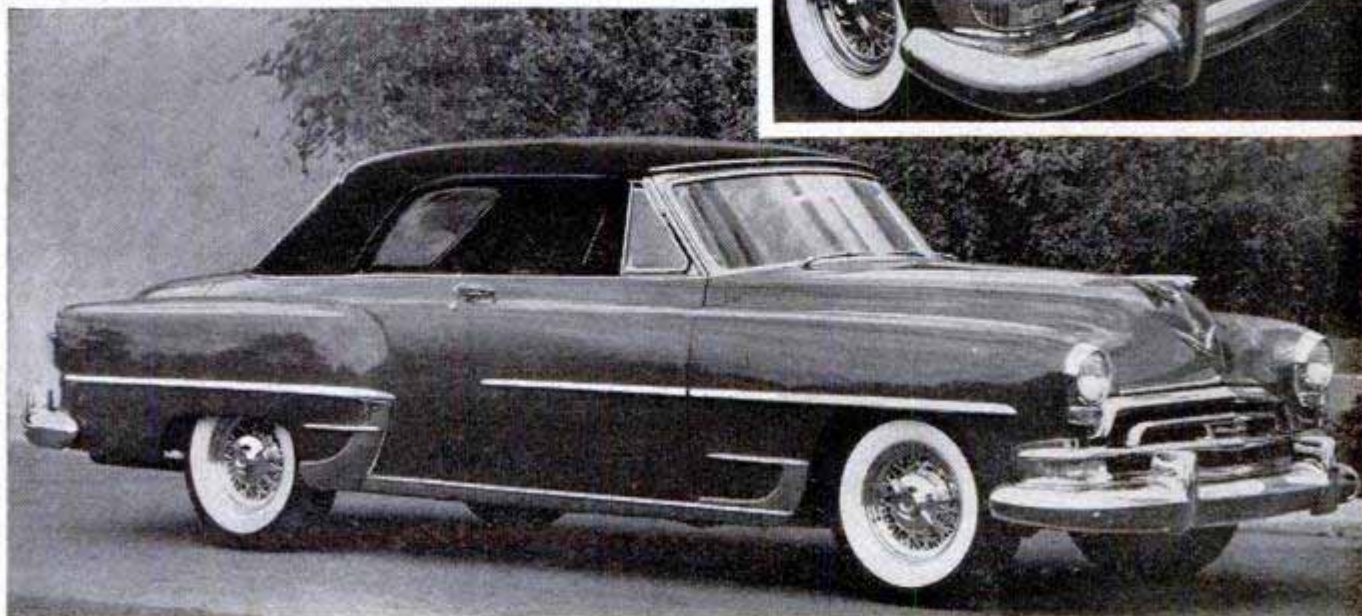

# Detroit Listening Post



By Leo Donovan

THERE ARE economists who say the automobile industry can produce a lot more cars than it can sell—and they are talking about the immediate future. Automobile makers don't share their pessimism. They are confident they can sell what they build in 1954 and they don't plan production cutbacks. Nor do they plan any movement toward a basic, economy or stripped automobile.

**Hudson**, for instance, led the 1954 model introductions with a line of higher-powered cars, changed externally to resemble more closely the speedy **Jet** it had so much trouble getting into volume production last year. Its new, experimental car of Italian styling joins the trend toward special-run "sports" cars or "cars of the future." Graceful and with little ornamentation in the Italian manner, the car, named the **Italia**, bears little resemblance to current production models.

With a whopping 235-horsepower engine, the big **Chrysler** is aimed at a prosperity market. That's the \$7500-a-year-and-up income group which has doubled in size since the war.

This year, **Plymouth** has joined the movement toward a super-de luxe series in the low-price field. Last year, **Chevrolet** started it by announcing a complete **Bel Air** series—a lush line-up of body styles at premium prices. For 1954, **Plymouth** brought out the **Belvedere** series, which includes a hardtop coupe, a four-door sedan, convertible and station wagon. Advance stories from Dearborn indicate that **Ford** will do the same when it comes out.

Along the same line, the trend seems to be to the two-tone paint jobs. And, while the more conservative blues, greens and blacks still lead, the public is taking to brighter hues like ivory, cream and gold.

**Dodge** retains the wheelbases it had in 1953 and hopes to improve its position in the market with extensive "brightwork" changes and new, brilliant interiors. It also offers more horsepower and higher compression. With these changes **Dodge** hopes

to climb back into the 6th position in sales. Currently, it is 7th, behind the Big Three and **Buick**, **Pontiac** and **Oldsmobile**.

The 1954 **Ford**, top seller in its field in convertible, station wagon and hardtop lines, will have a host of mechanical improvements, featuring its long-awaited overhead-valve V8 engine. The present **Ford** V8 has served its maker well, having been in production since 1932. Of course, there have been refinements and modifications, but the basic engine is the same. The new model, however, is completely new. As the engineers say, "we started with a blank sheet of paper." Improved brakes and suspension are also rumored among the mechanical changes. There is also expected to be an addition to the hardtop line that will, **Ford** hopes, be the talk of the auto shows next spring. Still under wraps, it is a bold, new idea in body styling.

**Mercury** will go to the new overhead-valve V8 when **Ford** does. The new engine will mean more power and a more sprightly performance. **Lincoln** is expected to rest on its laurels, having won the first four places in the 1952 Mexican Road Race with its 205-horsepower engine.

The disastrous fire that destroyed General Motors' \$40,000,000 Hydra-Matic plant has caused widespread dislocation in the industry. **Cadillac**, **Oldsmobile** and **Pontiac** production was cut back until changes could be made.

**Cadillac**, in short supply all year, made a quick switch to Dynaflow, the **Buick** automatic transmission. Only 27 days after the fire, the first Dynaflow-equipped **Cadillac** came off the assembly line. Automatic transmissions are a must with **Cadillac**; it uses them on 100 percent of its production.

**Oldsmobile** (with Hydra-Matic on 98.5 percent of its production) also turned to Dynaflow. Production plans call for 43 percent Dynaflow and 57 percent conventional hand-shift transmissions through the 1953 model year.

**Pontiac** (85 percent Hydra-Matic) is equipping its cars with Powerglide, borrowed from **Chevrolet**.

Independent **Hudson** (which installs Hydra-Matic on more than 50 percent of its cars) was hard hit because it is already in the midst of its 1954-model production. **Lincoln** installs Hydra-Matic on all its cars and is, at this writing, studying a switch to a transmission adapted from Merc-O-Matic.

Other independents, like **Nash** and **Kaiser**, that use Hydra-Matic apparently had enough in stock to keep them going.

General Motors claims that the fire will not delay the introduction of its new models. At this writing, it expects to be back in Hydra-Matic production at about the time this appears (late in October). The GM



Ten inches lower than a standard Hudson, the Italia has a wrap-around windshield to give full forward vision

## Hudson and Packard Present Their "Cars of the Future"

Showing "cars of the future" is popular with car manufacturers today as they sound out public tastes. This year, Hudson and Packard brought out their versions.

The Hudson Italia was built on a Jet chassis in Italy. The Packard Balboa, an American product, features a canopied rear window. Neither is planned for mass production.

Under the rear canopy, the Packard Balboa's rear window opens for ventilation and remains clear in a storm

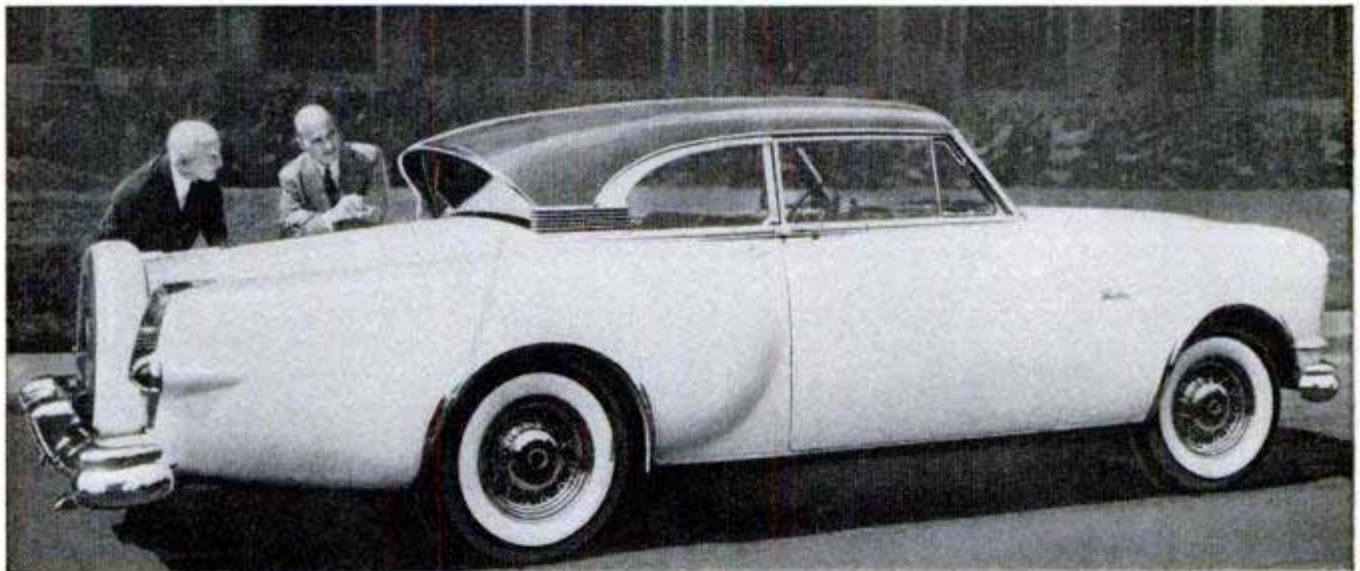

line will come out beginning in December.

The smaller GM cars are not expected to have major changes, although the rumor persists that **Chevrolet** may switch to a V8 engine in midseason next year. The same rumor crops up frequently about **Plymouth** (as does the story about a V6), but until sales become much slower than at present it is unlikely to occur in midseason.

Major body changes are expected to be made in the **Cadillac**, big **Buick** and **Oldsmobile** lines—rumor says the most extensive in the whole industry for 1954. The wrap-around windshield, scheduled for these cars, is expected to become standard design in most makes within a few years. Also expected are extended rear fenders.

**Packard** is going to take top honors in compression ratios, if stories now circulating are true. Engineering circles are speculating that the new **Packard** engine for 1954

will have a compression ratio of 9.0:1.

**Studebaker**, with its 1953 line being the most radical in history, is not expected to make major changes in 1954. There is some evidence that it will, for the first time, bring out a station-wagon body.

Evidence of the effective means auto makers have of checking on their competition was noted at the **Ford** proving ground early in September. At that time there were only a handful of **Chevrolet Corvettes** (the plastic roadster) off the assembly line and all were supposedly in the hands of GM big shots and friends. The press showing of the **Corvette** production models was scheduled for September 28th—then still two weeks away. Visitors at **Ford** spotted a shiny **Corvette** speeding around the test track trailing a fifth wheel and loaded down with test instruments as **Ford** engineers gave the sleek car the once-over. ★ ★ ★

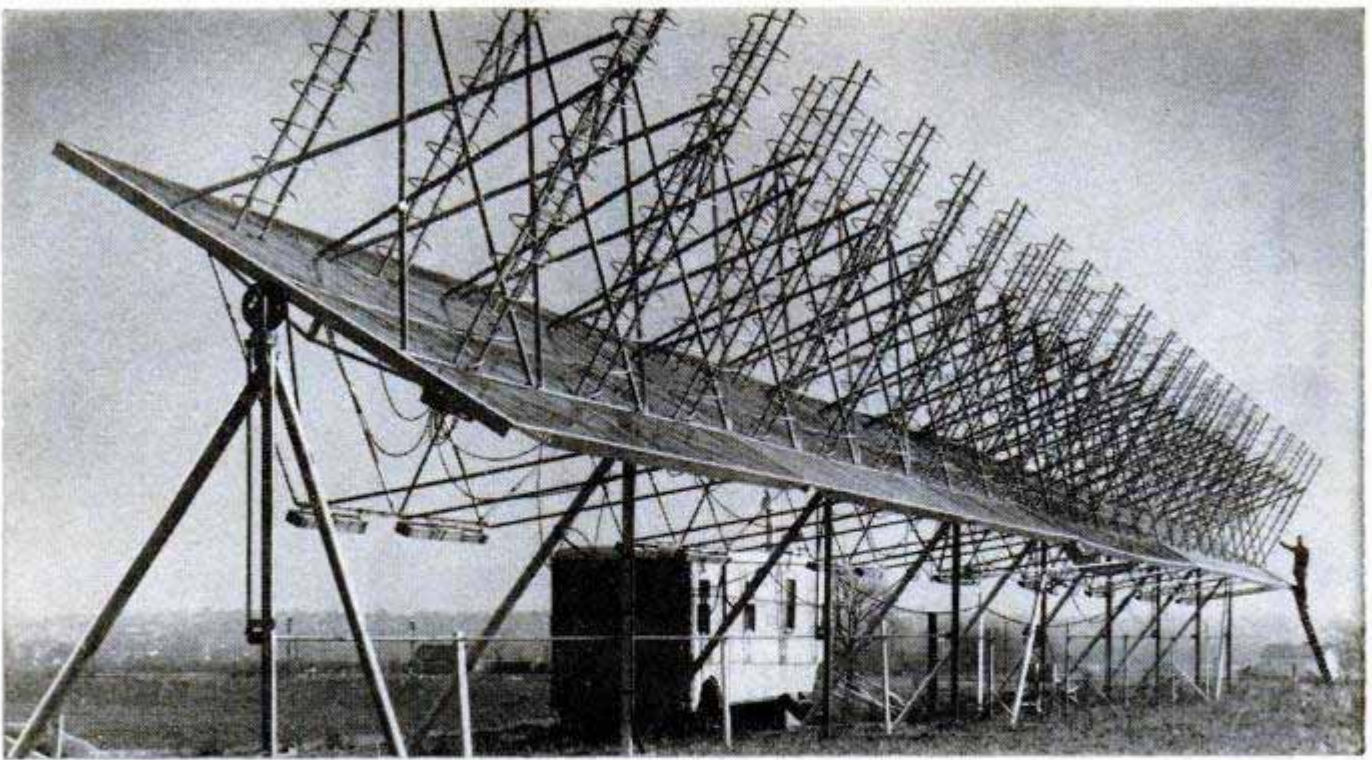

Corkscrew antennas mounted on pivoting frame trap radio waves from outer space. Trailer houses receiver

# *Star Hunting by Radio*

By William F. Rounds, Jr.

**T**HERE'S AN EASIER LIFE ahead for some astronomers, thanks to a new "push button" approach to stargazing.

In radio astronomy, the infant but rapidly growing branch of the ancient science, there need be no freezing nights in an unheated observatory, no waiting for skies to clear, no tedious hours spent in photographing infinitesimal pin points of light. Automatic installations, like Ohio State University's Radio Observatory, permit star hunting on "bankers' hours."

From a cornfield on the university farms, the nation's largest radio telescope systematically scans the heavens on a 24-hour schedule. Unattended for all but a few minutes a day, the giant antenna array is seeking sources of radio waves in outer space, trapping energy emitted by stars or nebulae thousands and millions of years ago.

Each day the telescope sweeps a small segment of the sky. The hissing, staticlike signals from the radio stars it encounters are put on paper by an automatic recorder.

Once a day a worker visits the observatory site to pick up a six-foot strip of paper tape. This contains, in a jagged, continuous line, the tangible results of the previous day's observations. Back in a campus laboratory, the peaks and valleys of the record are studied and interpreted. When a peak signal occurs from an apparently unoccupied portion of space, the radio astronomers note the location. If the signal is confirmed

by three succeeding days' observation they can write into the record a new heavenly body, perhaps a vast, invisible nebula millions of light years away.

By this method the scientists have doubled the number of recorded radio stars in a sky survey that began last February. Before, there were some 200 known stellar sources of radio waves.

Mass-production star finding takes a highly specialized and complex instrument. The observatory's equipment, valued at \$100,000, took a year and a half to build. The telescope has a 160-foot framework which supports 48 helical antennas. Their corkscrew design was originated by Dr. John D. Kraus, who supervised the construction and now directs operation. The unique array, one of the world's largest, serves as a telescope because it picks up radio emissions from space just as an optical instrument collects light. The telescope's framework pivots so that the angle of its beam above the horizon can be varied. The beam, less than a degree wide, is swept across the sky by the turning of the earth.

Engineers estimate that Ohio State's equipment is about a million times more sensitive than the average TV receiver. Some of the signals it picks up, Dr. Kraus reports, have the strength of a millionth of a millionth of a millionth of a watt per square yard of antenna surface. A large antenna and a delicate

receiver are necessary to catch such minute amounts of power.

From the antenna, the star signals are fed by coaxial cables into a four-stage radio-frequency preamplifier, then to an ultra-high-frequency superheterodyne receiver with five intermediate frequency-amplifier stages. At this point, the signal is converted to direct current and sent through five more amplifier stages before it finally activates the recording pen.

Tuning the receiver, incidentally, is a five-hour job. Receiver and recorder are housed in a trailer at the observatory site. Here also is a separate receiver which superimposes time signals on the star emissions. Precise timing is an important factor in locating the source of the waves.

University astronomers say the telescope's size, design and sensitivity give it the ability to ferret out stars never before recorded in the 21 years since Karl G. Jansky first discovered radio waves coming from space. Completed in the summer of 1952, the telescope first ran a trial sky survey.

Many of the celestial wave emitters found in the present survey are what Dr. Kraus calls "extended sources." While the sun covers about one half a degree in space, these sources, at much greater distances, reach across several degrees and must be fantastically large. Some of the newly found sources have been identified as galaxies, or island universes, at distances of millions of light years from the earth. Others are known to be great clusters of such galaxies.

But perplexing questions remain. Why does one nebula emit intense waves, while another does not? Why do the strongest radio stars often give the least light? Is radio energy created by actual stars, or by the interaction of swirling, tenuous gases? The push-button telescope may provide a basis for answers. ★ ★ ★



Declination of the telescope can be varied manually as shown here, or by motor controlled from trailer

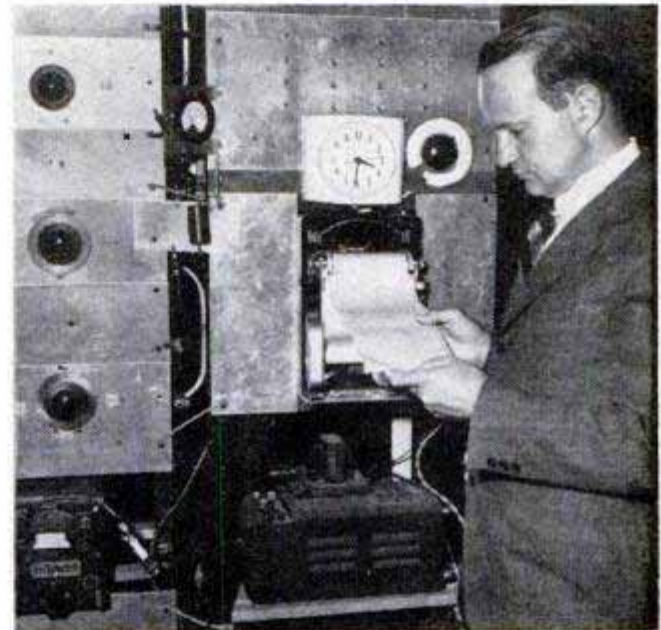

Observatory director Kraus studies star signals as they unroll from automatic recorder. At left is receiver panel. Below, graph recording of star signals. Jagged line shows waves emitted by a weak radio star and by strongest radio star yet found

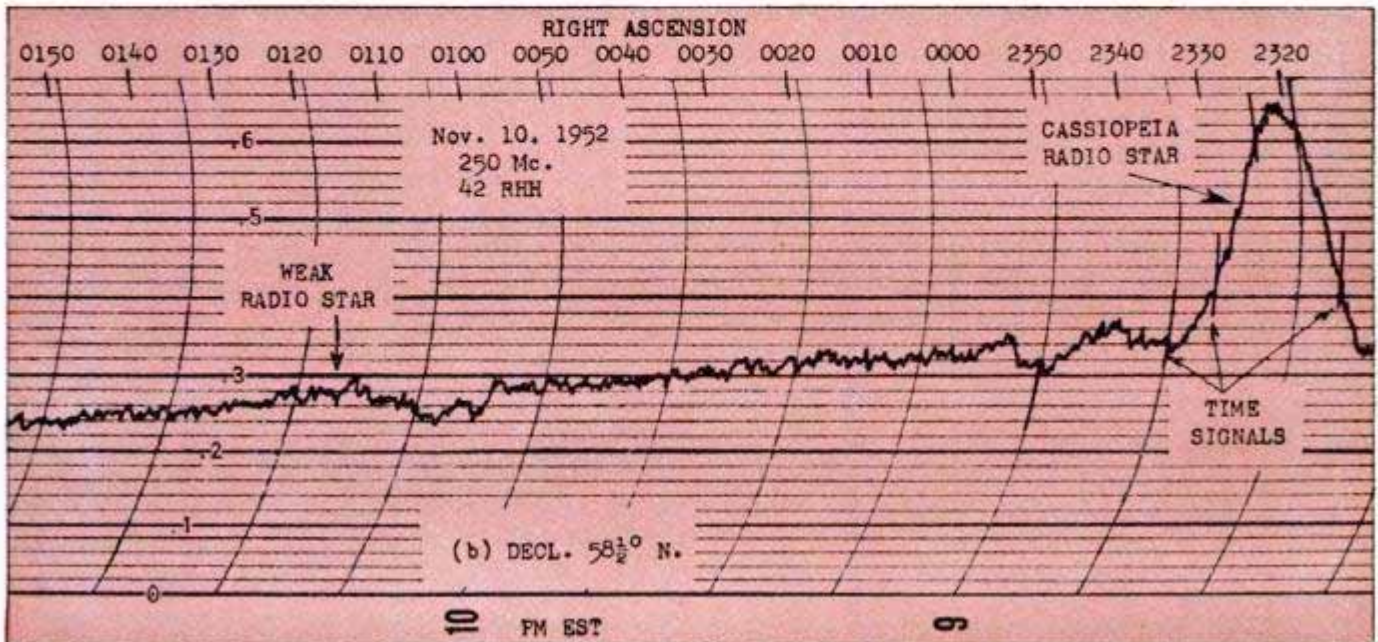

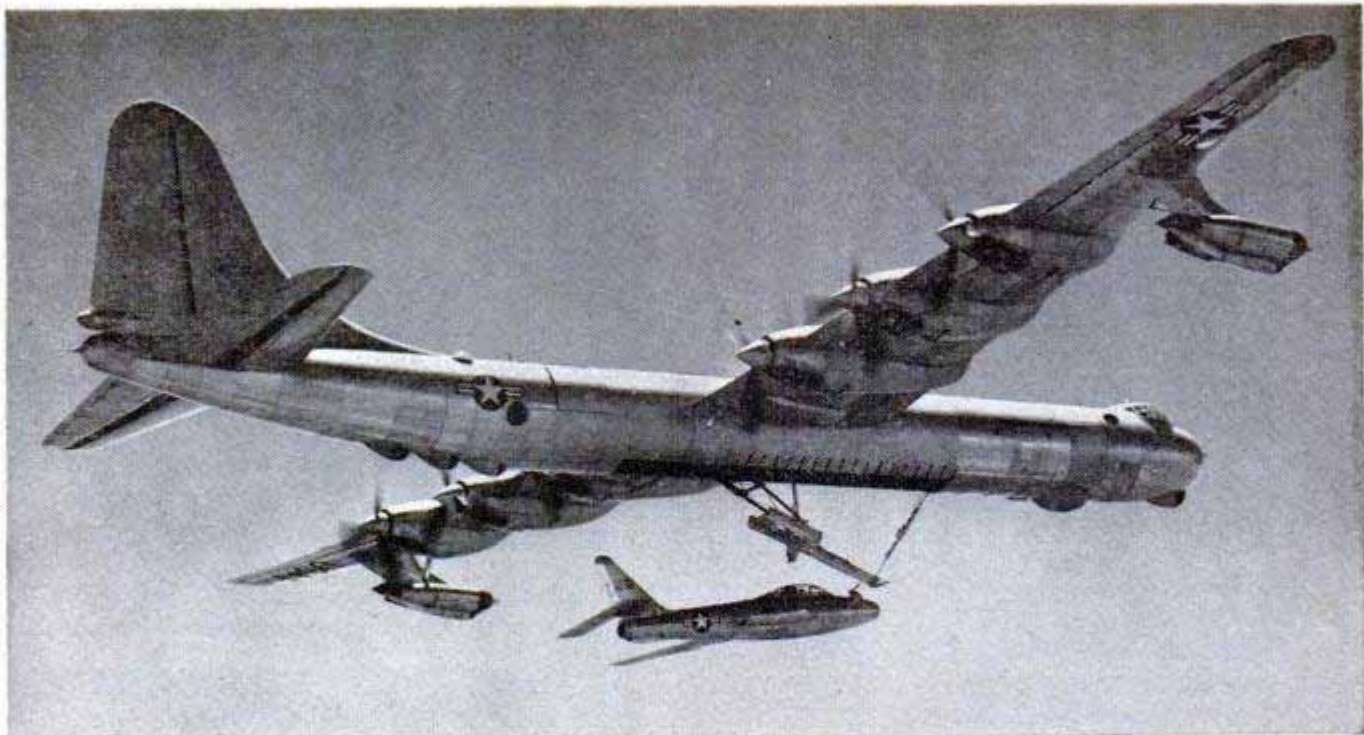

Air Research and Development Command photos

Swept-wing F-84 "parasite" shown just prior to making contact with retrieving mechanism beneath a B-36

## B-36's Fly Combat Planes to and From "Work"

Very little of the fighter protrudes from giant bomber's belly

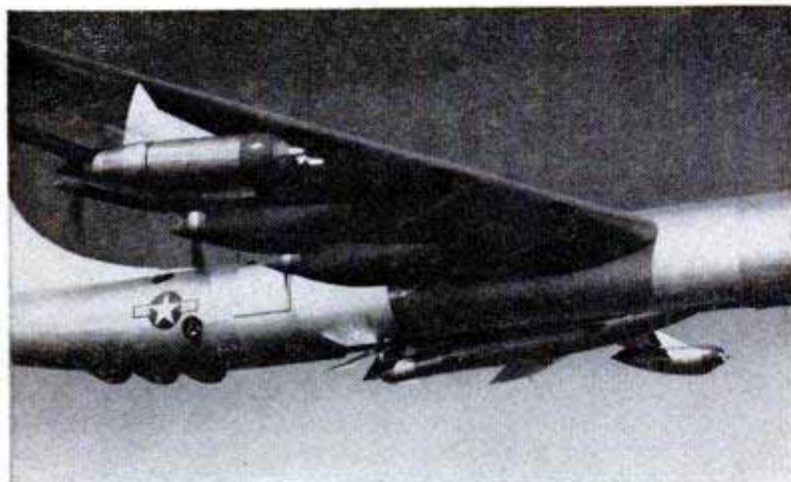

For the first time the U. S. Air Force is flying full-size combat airplanes from "mother" B-36s. A new retrieving mechanism permits Republic F-84s used in the tests to make in-flight landings as well as to be released in the air. This lift gives the carried aircraft the capability for long-range, high-speed reconnaissance. Research aircraft such as the Bell X-1 have been launched from B-29s but are unable to return. A small experimental "parasite" aircraft, was used during tests that led up to carrying the F-84.

## Vertical Drafting Machine Is Counterbalanced for Ease of Operation

Less tiresome to use because it lessens stretching, a vertical drafting machine has a brake to steady it in any position. In addition, the vertical mounting permits work on larger drawings and takes up less space than conventional equipment. It can be used with 12-inch vertical and 18-inch horizontal scales. The heads are counterbalanced to compensate for the weight of the scales.

Information not listed on articles in the index often is listed in the WHERE-TO-FIND-IT LIST, available at no cost from the Bureau of Information, *Popular Mechanics*, 200 E. Ontario, Chicago 11

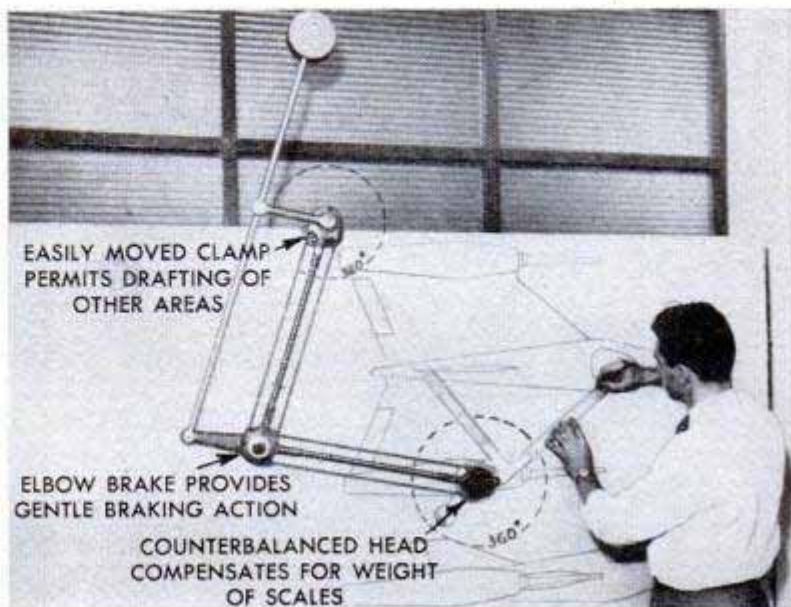

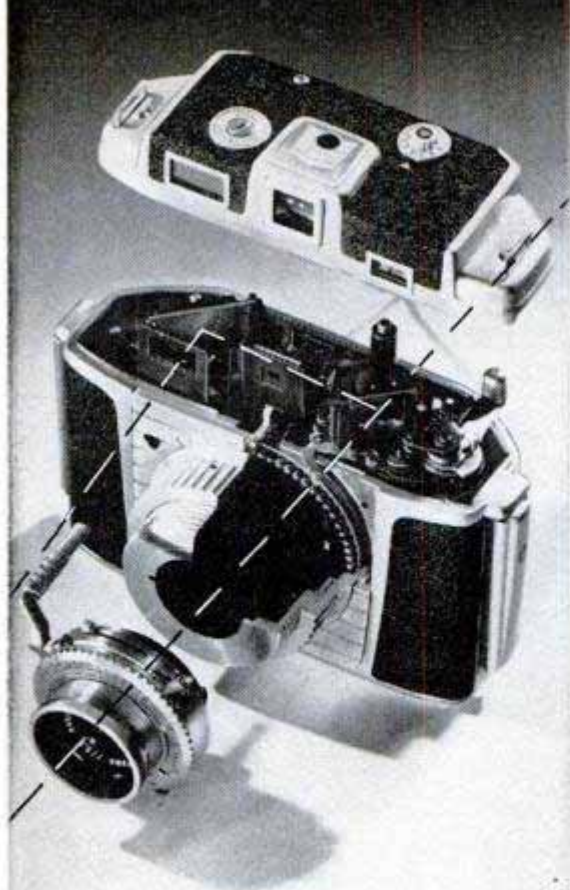

Kodak Chevron, above and top left, features precision split-beam range finder and a thumb lever that permits turning film to next frame without lowering camera. Twelve 2¼-inch-square exposures are taken on each roll of 620 film. Fast, accurate shutter operates at 10 speeds from 1 to 1/800 second

## ***Three Color Cameras Insure Shooting Ease***

Like other two models, Brownie Holiday camera, left, is especially designed for taking color pictures. Made for the casual snapshooter, camera has loading instructions on case



Lens-coupled range finder of Kodak Bantam RF camera, right, is similar to that of more-expensive Chevron. Equipment includes leather field case and flash holder. Shutter operates from 1/25 to 1/300 second, is synchronized for flash lamps at all speeds except 1/300 of a second. Camera has an automatic film stop and double-exposure prevention, with a release for intentional double exposure. Settings for bright, hazy and average conditions for black-and-white and color film are marked on camera as a guide for the amateur snapshooter



# The OWNERS

1. I own a 1953 Nash: Rambler  Statesman
2. It has conventional transmission  Overdrive
3. Speedometer reading now is 4768 miles.
4. I use regular  or premium (high-test)  gasoline.
5. My average gasoline mileage in city: 22 m.p.g.; in country: 27 m.p.g.
6. I add No quarts of oil in 1000 miles. I change oil every 1000 miles approximately.
7. Here is what I like best about my Nash: It is economical, drives good, handles good, and looks good!

PARIS, TEX., OIL REFINERY BOSS & STATESMAN OWNER

8. Here are my specific complaints: Turning radius is only thing I don't particularly like although for most operating conditions that is also satisfactory

## BIGGEST COMPLAINT OF NASH OWNERS

9. I rate its roadability\*: Excellent  Good  Unsatisfactory
10. I rate its handling\*: Excellent  Good  Unsatisfactory
11. I rate its structural rigidity\*: Excellent  Good  Unsatisfactory

\*For an explanation of these terms see reverse side of this sheet.

12. Acceleration from a standstill: Excellent  Good  Unsatisfactory
- Acceleration from 50 miles per hour: Excellent  Good  Unsatisfactory

13. I have tried Nash power steering and find it worth the extra cost
- Not worth the extra cost  Explain \_\_\_\_\_

14. I would  or would not  like power braking in this car. Explain Brakes could be improved

15. I would  or would not  prefer a V8 engine in this car. Explain Would like at least 20 more H.P.

16. My ratings of these specific features:

Visibility, forward	Like <input checked="" type="checkbox"/>	Acceptable <input type="checkbox"/>	Dislike <input type="checkbox"/>
Visibility, rear	Like <input checked="" type="checkbox"/>	Acceptable <input type="checkbox"/>	Dislike <input type="checkbox"/>
Riding comfort	Like <input checked="" type="checkbox"/>	Acceptable <input type="checkbox"/>	Dislike <input type="checkbox"/>
Horsepower output	Like <input type="checkbox"/>	Acceptable <input type="checkbox"/>	<u>Dislike</u> <input checked="" type="checkbox"/>
Exterior body styling	Like <input checked="" type="checkbox"/>	Acceptable <input type="checkbox"/>	Dislike <input type="checkbox"/>
Interior body styling	Like <input checked="" type="checkbox"/>	Acceptable <input type="checkbox"/>	Dislike <input checked="" type="checkbox"/>
Reclining front seat	Like <input checked="" type="checkbox"/>	Acceptable <input type="checkbox"/>	Dislike <input type="checkbox"/>
Bed-in-a-car feature	Like <input checked="" type="checkbox"/>	Acceptable <input type="checkbox"/>	Dislike <input type="checkbox"/>

Not enough for Ambassador

Too scratchy

SOME OWNERS WANT BETTER BRAKES

OAK RIDGE, TENN., RESTAURATEUR & AMBASSADOR OWNER

## TWO POPULAR REASONS FOR BUYING A RAMBLER

17. My Nash is too big  Too small  just right  Comment Working man's car.
18. I have  or have not  owned a Nash before. (How many? two)
19. I bought this Nash because newer styling - overdrive for economy
20. I would buy another Nash  would not  might
21. Over-all, I rate my Nash: Excellent  Good  Average  Poor

CINCINNATI, OHIO, AUTO MECHANIC & RAMBLER OWNER

Only complaint is small turning radius. Car will not turn in a satisfactory circle - very confusing when parking - especially in a lot.





# REPORT on the NASH

By Floyd Clymer

The true test of a car begins when the owner takes the wheel. *Popular Mechanics* sent questionnaires to 1000 Nash owners. Here's what they say about their cars

NASH OWNERS form a diversified group. Some drive big cars, some drive small cars and some drive medium-size cars.

There's the Ambassador—a 209-inch-long car, almost as roomy as a bus. Or the Rambler—185 inches of compact automobile on a 100-inch wheelbase. Between these two is the 202-inch-long Statesman.

Nash has variety in engines, too, offering 85, 90, 100, 120 and 140 horsepower. Car weights in the Nash line range from 2570 pounds for a Rambler to 3550 pounds for an Ambassador.

There is agreement on one point—all Nash owners seem to agree that their cars are economical to operate. Sixty-six percent of the Rambler owners responding listed economy as the feature they like best. Of the Statesman owners, 44 percent gave economy, and 41 percent of the owners of the Ambassador agreed that economy was a most-liked feature.

Here are the figures on gasoline economy as taken from the Owners Poll:

Rambler owners average 22.0 miles per gallon in the city, 26.1 in the country; Statesman owners average 17.6 in the city, 21.3 in the country; Ambassador owners average 16.1 in the city, 19.7 in the country. Oil consumption was almost zero, according to the owners.

Nash drivers also agreed on a common complaint—the large turn-circle diameter. Owners of all three models gave it as the least-liked characteristic.



Clymer's favorite test hill presented no problem to the Rambler. It topped the crest at 26 miles per hour, faster than many larger and more powerful cars have done it. Below, Nash offers buyers a range of sizes. Here are the biggest and smallest in the family

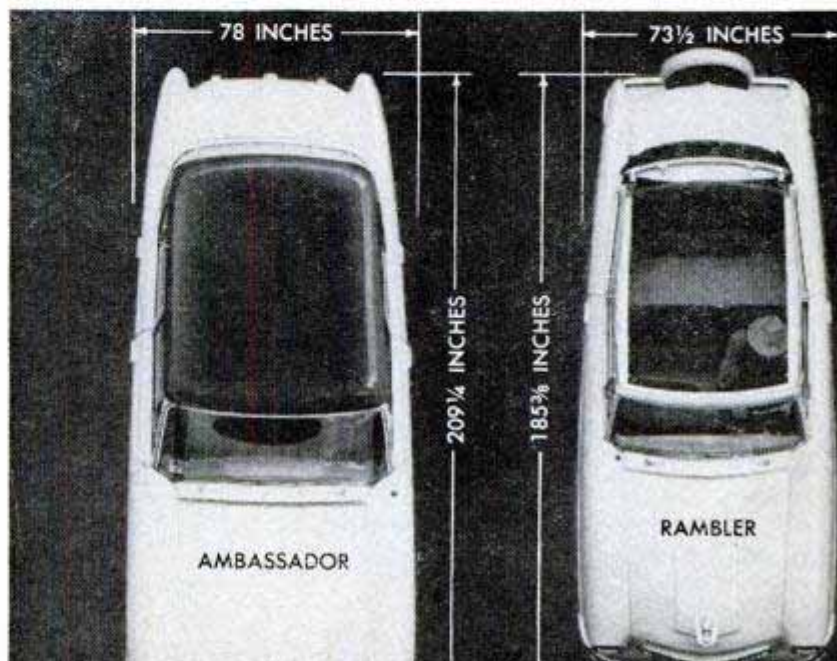

After a total of over 1,500,000 test miles, owners in 20 states tell how they like Nash

## Percentages from PM Poll of Nash Owners



### ALL NASH OWNERS REPORTING

Use regular gasoline.....	63%
premium gasoline.....	37%
Previous Nash owners.....	69%
Owners of five or more Nash cars previously.....	13%

### Ratings on particular features

	Like	Acceptable	Dislike
Visibility, forward.....	98%	1%	1%
Riding comfort.....	97%	2%	1%
Visibility, rear.....	97%	2%	1%
Reclining front seat.....	93%	5%	2%
Interior body styling.....	88%	12%	0%
Exterior body styling.....	87%	11%	2%
Bed-in-a-car feature.....	87%	11%	2%
Horsepower output.....	60%	35%	5%

### Chief purchase reasons

(in order of frequency)

1. Previous satisfactory Nash ownership
2. Styling features
3. Economy of operation
4. Trade-in allowance
5. Driving and handling qualities
6. Engine and performance

### NASH OWNERS BY MODELS

Average miles per gallon	Rambler	Statesman	Ambassador
city .....	22.0	17.6	16.1
country .....	26.1	21.3	19.7
<b>Roadability</b>			
excellent .....	54%	64%	78%
good .....	42%	35%	20%
unsatisfactory ...	4%	1%	2%
<b>Handling</b>			
excellent .....	71%	65%	66%
good .....	29%	33%	32%
unsatisfactory ...	0%	2%	2%
<b>Structural rigidity</b>			
excellent .....	75%	74%	64%
good .....	25%	22%	32%
unsatisfactory ...	0%	4%	4%

Acceleration from standstill	Rambler	Statesman	Ambassador
excellent .....	42%	30%	49%
good .....	48%	67%	48%
unsatisfactory ...	0%	3%	3%
<b>Acceleration from 50 m.p.h.</b>			
excellent .....	50%	34%	52%
good .....	50%	61%	42%
unsatisfactory ...	0%	5%	6%
<b>Would buy another Nash?</b>			
yes .....	78%	77%	78%
might .....	22%	21%	20%
no .....	0%	2%	2%

### Over-all rating of Nash

excellent .....	67%	62%	63%
good .....	33%	30%	32%
average .....	0%	7%	3%
poor .....	0%	1%	2%

### Best-liked features of Rambler

Economy .....	66%
Ease of handling, parking, etc.....	25%
Exterior styling.....	17%
Comfortable ride.....	17%
Reclining seats.....	13%

### Best-liked features of Statesman

Economy .....	44%
Ease of handling.....	36%
Exterior styling.....	32%
Comfortable ride.....	30%
Roominess .....	30%

### Best-liked features of Ambassador

Comfortable ride.....	45%
Economy .....	41%
Ease of handling.....	28%
Roominess .....	22%
Visibility .....	22%

### Most frequent complaints of Rambler owners

Large turning radius.....	38%
Visibility to rear.....	13%
Brakes fade.....	10%

### Most-frequent complaints of Statesman owners

Large turning radius.....	25%
Water and dust leaks in body.....	10%
Lack of power.....	10%
Poor chrome.....	7%
Poor dealer service.....	7%

### Most frequent complaints of Ambassador owners

Large turning radius.....	19%
Water and dust leaks.....	17%
Doors hard to operate, noisy.....	9%
Poor paint and chrome.....	9%
Poor dealer service.....	7%

### Nash owners with no complaints at all

Rambler owners.....	29%
Statesman owners.....	22%
Ambassador owners.....	26%

The skirted front wheels are responsible for this weakness which means U-turns are almost impossible on average streets and maneuvering into parking spaces and garages is difficult.

While only a few actually complained about it, not many were enthusiastic about Nash acceleration, especially among Statesman owners.

### Rambler Comments

These are some of the comments from Rambler owners:

"I read electric meters in the country and make about 250 stops a day. With this

type of driving I get 19 miles per gallon."—Menomonee Falls, Wis., meter reader.

"My gas mileage is 25-26 miles in town. On my 2600-mile trip through the South I bought 90 gallons of gas, averaging just short of 30 miles per gallon."—Miamisburg, Ohio, plant superintendent.

The smallness of the Rambler was another favorite point with the owners, 25 percent listing the ease of parking and handling as features they liked best.

"My wife finds our Rambler station wagon very easy to drive and park. It is also fine for family pleasure driving (I have

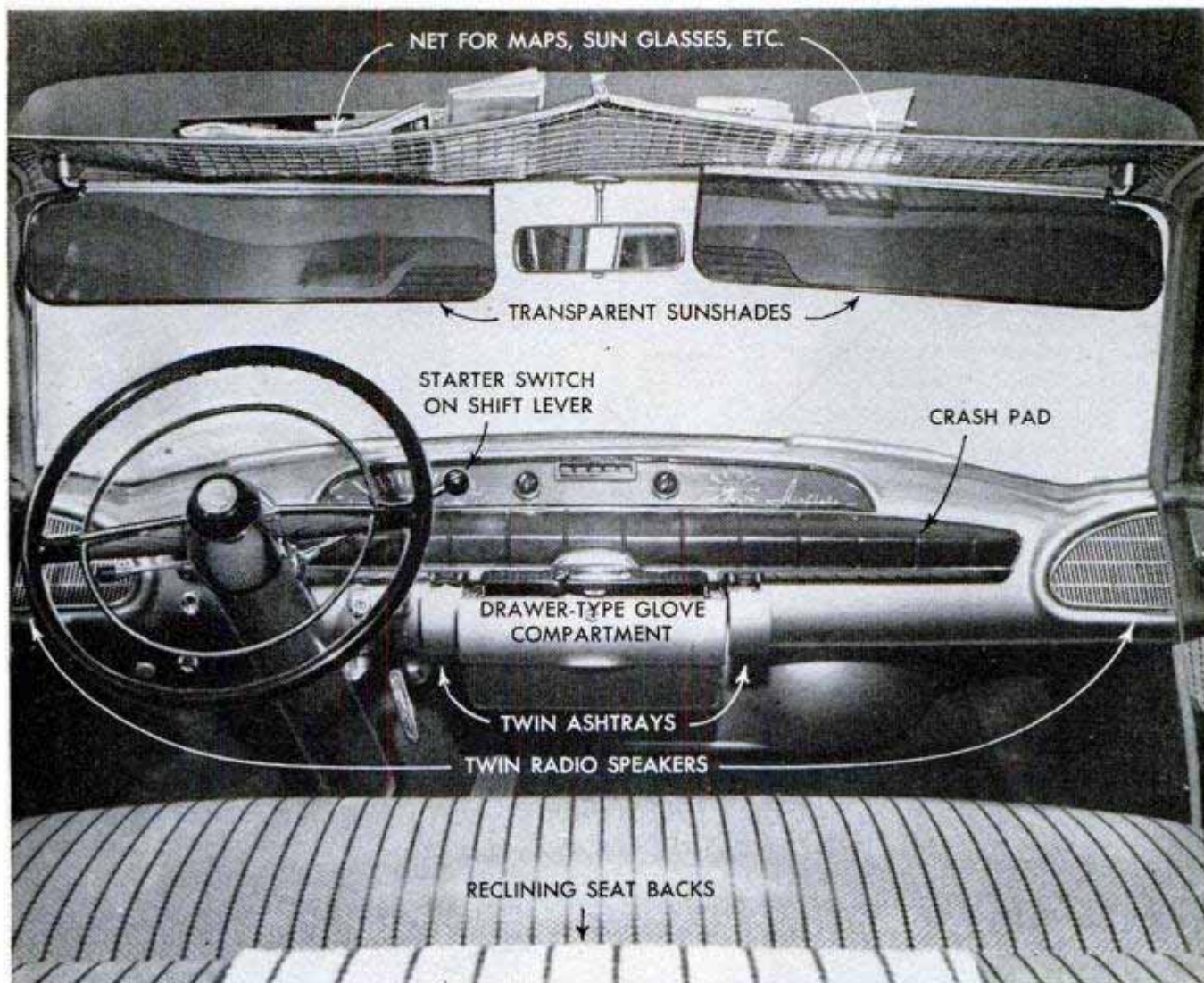

Ambassador interiors have features not found in other cars. Reclining seats are a favorite with the owners

three small children)." — E. Weymouth, Mass., electrician.

"Very easy to handle, especially parking." — Sandusky, Ohio, telephone operator.

Farina's new Rambler styling was mentioned by 17 percent of the owners.

"We are very proud and satisfied with our Rambler station wagon, which is beautiful." — Delaware, Ohio, housewife.

"I liked the improved visibility accomplished by lowering the hood and raising the fenders so that both are visible to driver at all times." — Oak Park, Ill., clerk.

"This is my first Nash. It is the first Rambler designed to attract people like myself. I never liked the looks of older models (too much hood)." — Woodstock, Ill., railroad worker.

The Rambler's comfortable ride and the luxury of reclining front seats were also favorites with owners in the poll.

But the body styling has disadvantages, say the owners.

"I like the body lines, but if the car could be turned at sharper angles when U-turning or parking I believe this would be an improvement." — Ripon, Wis., student, referring to the front-wheel skirts that give the Rambler a large turn-circle diameter.

"The 42-foot turn circle of my Rambler makes it harder to park than most larger cars." — Arlington Heights, Ill., housewife.

Of the Rambler owners reporting, 38 percent listed this inability to turn sharply as a complaint.

"Rear window is hard to see out of using the rear-view mirror." — Marion, Ohio, printer. Thirteen percent complained of poor vision to the rear.

"Poor brakes. Not enough braking surface. My complaint with all eight of my Nash cars is brakes." — Newark, Ohio, technician—10 percent agreed with him.

"I purchased a Rambler station wagon and found that with my family of four children this is an ideal car for going on trips and outings. Space in rear can be used as a bed. Easy to clean and rearrange as a pleasure car." — Akron, Ohio, foreman.

"Unit-weld body and frame [means] no rattles." — Willoughby, Ohio, technician.

There was a scattering of complaints by Rambler owners on the lack of legroom in the rear seat, water leaks in body, awkward position of the gear-shift lever and poor location of dimmer switch. However, 29 percent of the Rambler owners wrote "None" when asked to list complaints.

## ACCELERATION TEST

1953 NASH RAMBLER  
Hardtop Convertible with Overdrive

¼ mile from zero		21.1 sec.
½ mile from zero		33.9 sec.
0 to 30 m.p.h.		5.3 sec.
0 to 60 m.p.h.		18.9 sec.

Top speed by speedometer.....91-93 m.p.h.  
Actual top speed about 7% less (speedometer variation)

## ECONOMY TEST

MILES PER GALLON  
Constant-Speed Mileage

	Overdrive	Conventional
At constant 30 m.p.h.	30.1	29.6
At constant 50 m.p.h.	27.2	24.5
At constant 60 m.p.h.	22.1	20.4
At constant 75 m.p.h.	20.2	17.9

### Cross-Country Mileage

Los Angeles to Fresno, Calif.	22.4 m.p.g.
Fresno to Boise, Idaho (some mountains)	21.2 m.p.g.
Boise to Reno, Nev. (via Sun Valley)	22.9 m.p.g.
Reno to Los Angeles	23.1 m.p.g.

Regular gasoline was used over entire 2181 miles

Only four percent of the Rambler owners described the car as too small. None rated acceleration as unsatisfactory and 67 percent rated their Ramblers as excellent over-all.

### Statesman Comments

Like Rambler owners, the owners of Nash Statesman models rated economy tops.

"It is a poor man's car with a rich man's luxury."—Rochester, N. Y., foreman.

"I kept track of every drop of gas I bought and am getting 19.6 miles per gallon on all my driving. On trips I get over 24 miles per gallon."—Algoma, Wis., welder.

Of course, there are those who disagree.

"I think Nash should forget about economy in the Statesman and Ambassador and build a faster, more powerful car."—Lancaster, Tex., office worker.

Handling ease was second most popular with Statesman owners.

"Ease of handling on curves and in wind. Perfect balance under all conditions plus comfort unsurpassed by any car."—San Bernardino, Calif., retired owner.

About a third of the Statesman owners were most pleased with the Farina styling, as was an Ohio highway patrolman who wrote, "Has most modern design."

Two other oft-mentioned features are comfort and roominess.

"Comfortable sitting—spacious, adjustable seats. Economy of fuel and beauty of body lines."—Eugene, Ore., photographer.

"Have four children and there is plenty of room with all of us in the car. Trunk space is wonderful. Takes a baby carriage with trunk closed and has room to spare."—Rahway, N. J., salesman.

"Adequate room for family with six children. Comfortable ride. It is an ideal family auto."—Bemidji, Minn., examiner.

Nash is the only American car that features reclining seats and beds. Nash owners like these and many give them as the reason for buying Nash.

"You have a home wherever you are when traveling."—El Monte, Calif., high-lift operator.

"I have a summer camp and was thinking about adding another bedroom. I also wanted a new car. Could not afford both. Killed two birds with one stone and got a Nash. Extra guests sleep in car and very comfortably."—Syracuse, N. Y., salesman.

"Reclining seat is comfortable on long trips, as I like to snooze while my wife drives."—Fresno, Calif., fruit grower.

"I recently moved and by dropping the reclining seats I could fit almost as much stuff in as in a station wagon."—Cliffside Park, N. J., salesman.

Equally popular is Nash visibility.

"Body design allows you to see both front fenders."—Elberon, N. J., heat treater.

As in the entire Nash line, the most frequent complaint among Statesman owners was the large turn circle.

"Skirted front fenders look good, but not worth loss of short turning radius."—Midland, Tex., salesman.

Other complaints include:

"The car would flood up every time it rained. To this day it still leaks."—Long Island, N. Y., salesman.

"Too large. Will not fit in older garages."—Long Island City, N. Y., owner.

"Does not have enough pickup for passing cars."—Elgin, Ill., retailer.

"Expected much more of the added 15 horsepower between the 1951 and 1953 models."—St. Maries, Idaho, businessman.

"Poor visibility at right front due to large corner post."—Longview, Tex., salesman.

"Gas pedal too uncomfortable and too far to one side."—Everett, Mass., fireman.

"Very hard to park."—San Bernardino, Calif., telegrapher.

"At high speeds with car loaded, brakes seem inadequate."—Shawano, Wis., priest.

"Cooling system too small. Car heats in traffic."—Bridgeport, Ohio, mechanic.

"Big depreciation when ready to trade."—E. Paterson, N. J., office manager.

(Continued to page 250)

## Fish Netting Strung Over Pipes Traps Deer Without Injury

Wildlife researchers have found a trap that captures deer easily and without injury. The trap, devised by Melvin R. Clover of California's Department of Fish and Game, consists of fish netting strung on an iron-pipe frame. Gates at either end are held up by a pair of wire hooks. When a deer reaches for sliced-apple bait in the trap, its front feet hit a thread about six inches from the ground. This sets off a rattrap that jerks a cord leading to the hooks at both gates, causing the gates to drop and enclose the animal. The rope netting cannot injure a struggling deer, as did the wire netting formerly used on traps, and side ropes tied to trees keep the trap from tipping over. Deer are removed from the trap through a catch net placed at one end, hobbled and tagged with



a colored-plastic disk attached to its ear. Conservationists later obtain important herd-management data by recapturing deer or observing the disks, which are of various colors and sizes, with binoculars.

## Table-Model "Brain" Solves Barn Problems

Helping farmers solve the temperature and humidity problems of their barns, a miniature electronic "brain" absorbs a mass of information and comes up with a quick answer. You twist a certain knob to indicate the number of animals in the barn and another to register the heat and moisture each produces. Other dials are set at the various temperature and humidity marks of different areas of the building. The machine then calculates whether the barn needs a temperature or humidity-control system, or a furnace, and tells what size ventilating system is necessary. The portable brain is believed to be the first such device designed for agricultural use.



## Portable Electric Shaver Runs on Flashlight Batteries

Ordinary flashlight batteries or a six-volt automobile battery will power a new portable electric shaver. Equipped with an adaptor for an automobile lighter socket, it uses less than  $\frac{1}{10}$  as much current as a car radio. The shaver's two rotary action heads are operated by a brush-type motor which requires no lubrication. Twelve self-sharpening cutters in the two heads are designed to speed shaving by exposing maximum beard area to the cutters. A mirror is attached to the steel battery container.



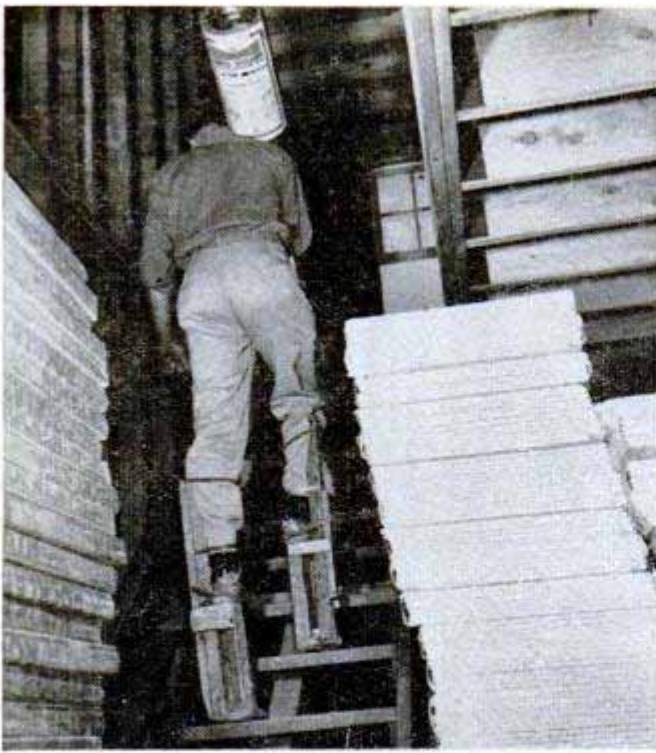

## Buckle-on Stilts Aid Home Construction Workers

Stilts have replaced scaffolds for a construction crew in Detroit, Mich. "Tall" men roam through partially finished homes applying insulation between the ceiling joists. The stilts are the inspiration of Hugh R. Dodge, an insulation contractor. The idea occurred to him as he watched his men

work from a sawhorse scaffold, then climb down, dismantle it and set it up again. Dodge built some crude stilts that could be buckled to the legs. The 12 men of his crew took to the idea immediately. Now the whole crew works on stilts, long ones for the short men, short ones for the long men.

## Electric Drainboard Dries Dishes Rapidly

Wiping the dishes is one chore English housewife Sally Hodges won't ever have to perform. She's invented an electrically heated drainboard which dries dishes as soon as they come out of the dishpan. The board can also be used to keep meals warm.

## Pocket-Size Phonograph Designed for Displays

Heralded as "the world's smallest phonograph," a tiny record player spins a 3½-inch disc. Powered by two flashlight batteries, it is designed for displays and training aids. Placed inside the product on exhibit, it delivers a 50-second message.



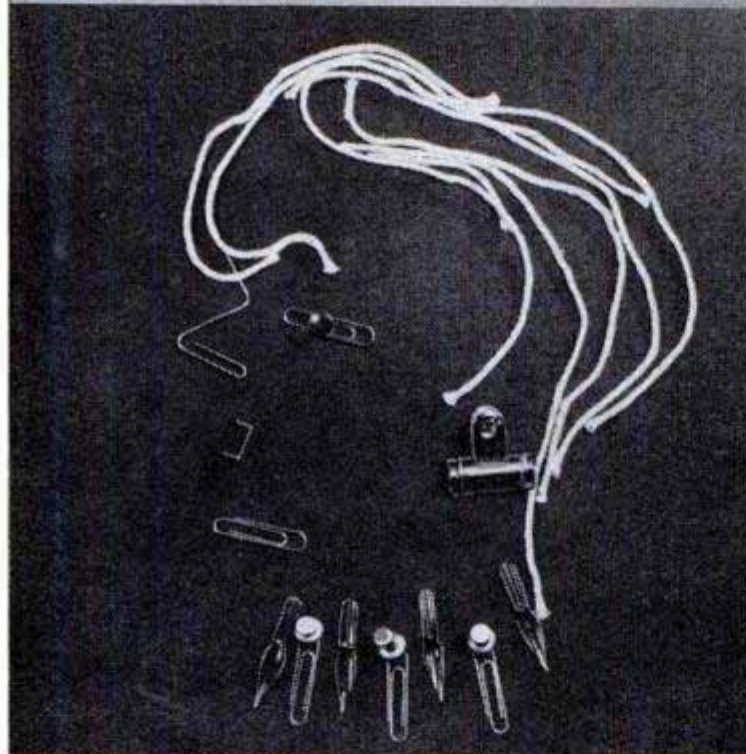
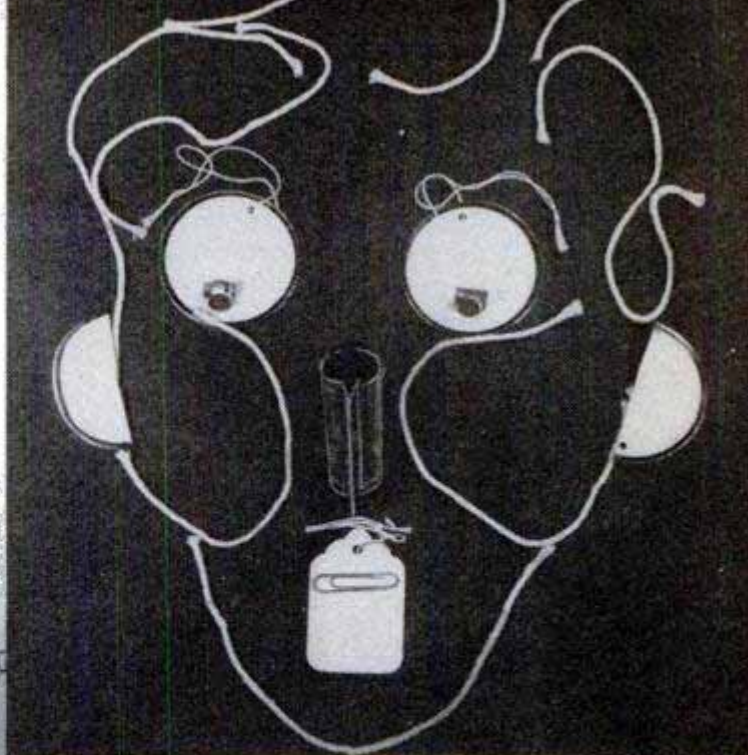

## ***Folks Around the Office***

ONCE UPON A TIME an office worker, sleepily reporting for his day's work, found a box of paper clips spilled across his desk. What struck his attention was that they seemed to outline a man's head. The worker idly began some experiments of his own with paper clips, erasers, rubber bands and tags. On this page you see his results, and anyone who has ever worked in a large office will recognize the spinster, the popeyed new employee, the dumb blonde, the project manager and the private secretary, all "drawn" with ordinary office materials. Try it yourself sometime!

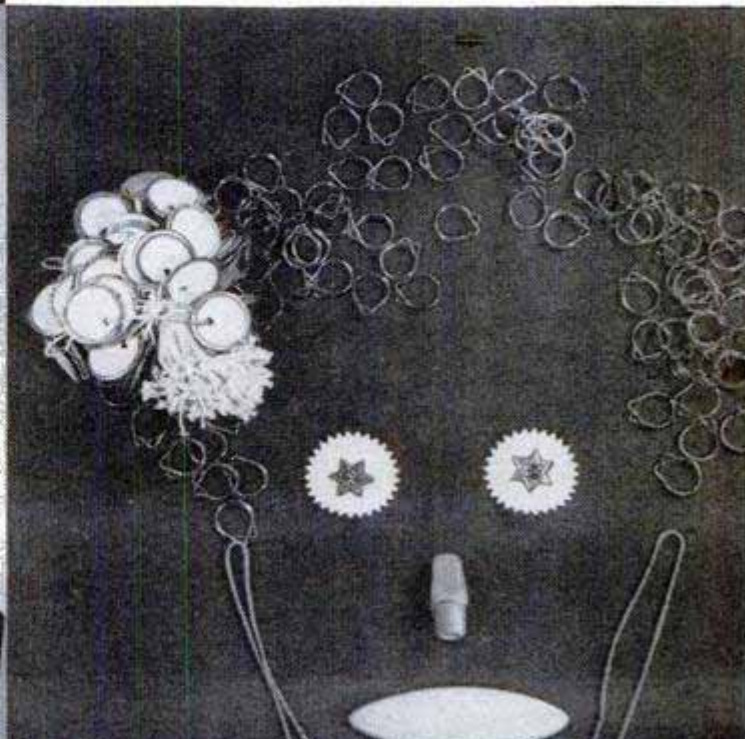
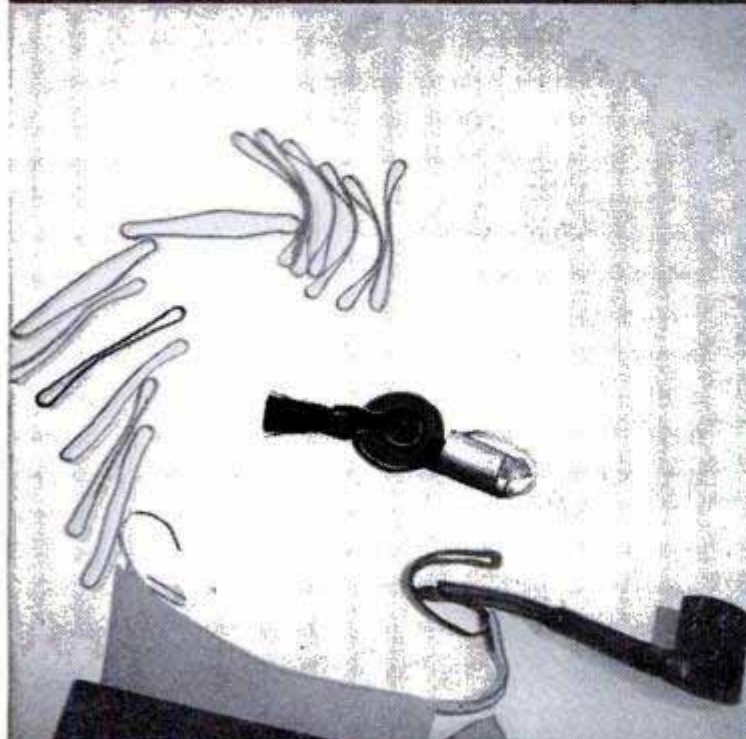

# HELICOPTER TUG

*West Coast designer foresees rotary-wing craft lowering and lifting tomorrow's transports and fighters in and out of small landing sites*

**J**ET TRANSPORTS of the future may be lifted from downtown locations by high-powered helicopter tugs that would detach themselves after the transports attain flying speed. That's the expectation of Dr. J. A. J. Bennett of Hiller Helicopters, who

has applied for patents covering several features of the idea.

The same helicopter tugs could fasten themselves to incoming transports and lower them safely and almost vertically.

This new method of assisting fast aircraft in and out of small landing sites would eliminate the need for long runways and the present necessity of locating airports at considerable distances from city centers.

Other benefits are that transports no longer would require the heavy landing gear they now carry, and they could operate at higher wing loadings.

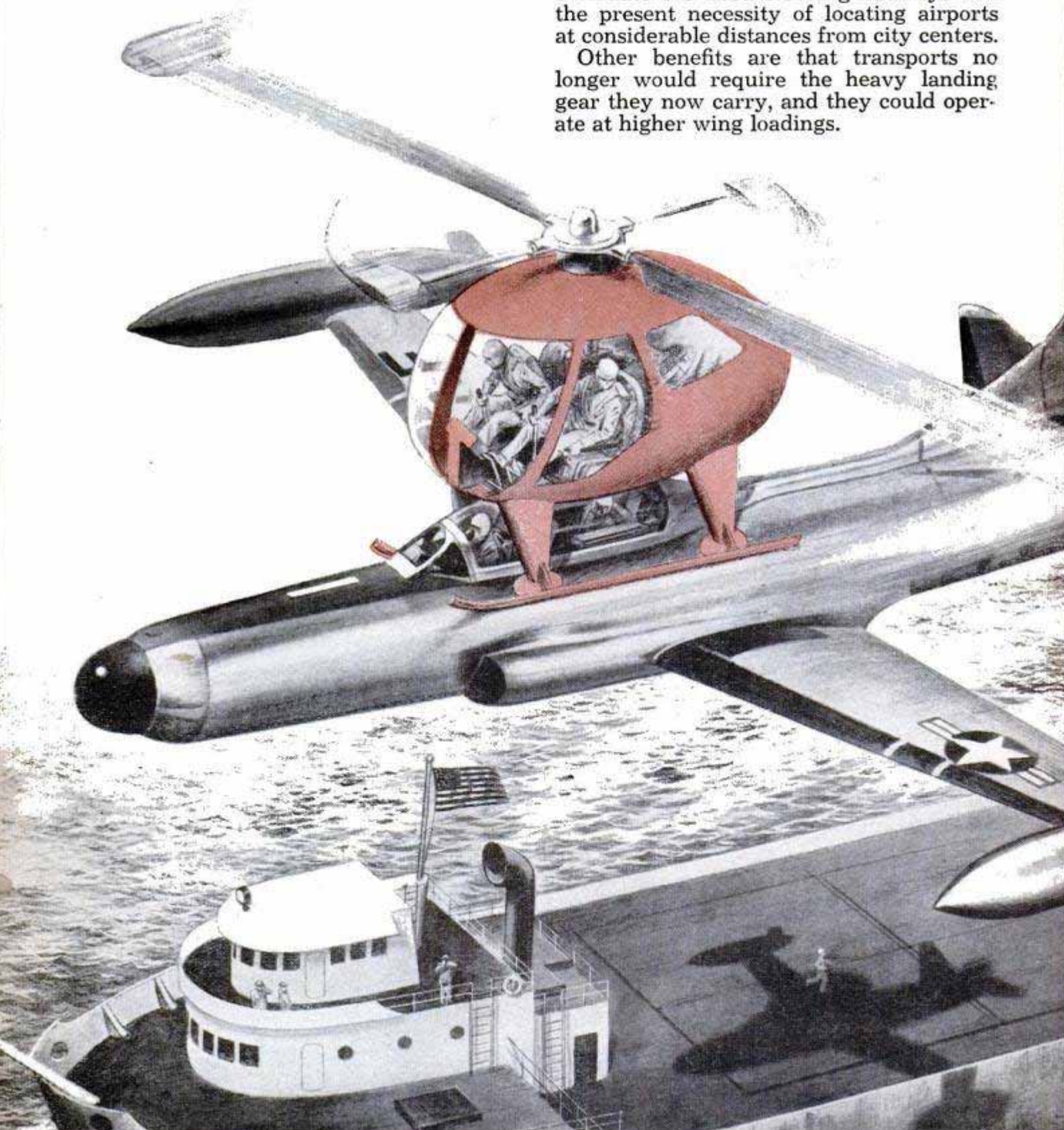



# TO LAUNCH PLANES

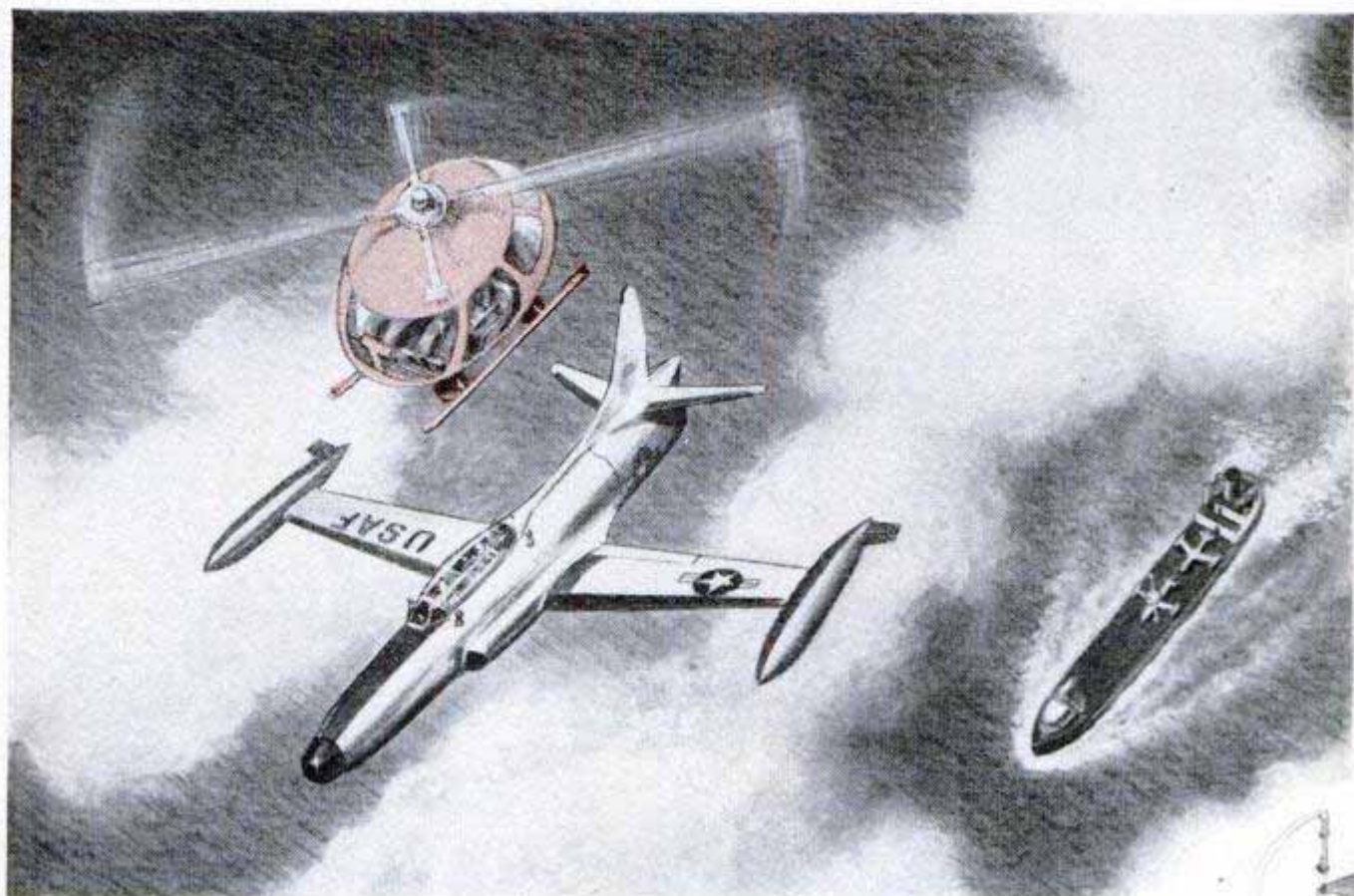

Jet fighters could be carried from cramped decks to sufficient altitude for release

Doctor Bennett points out that the problems associated with release and re-attachment in flight are somewhat comparable to those already solved in the refueling of aircraft by tanker planes. Methods of attachment by a helicopter tug riding piggy back on top of a transport are covered in his patent

Mockup of experimental ramjet engine, below, designed to produce more than 4000 horsepower for a future Hiller helicopter

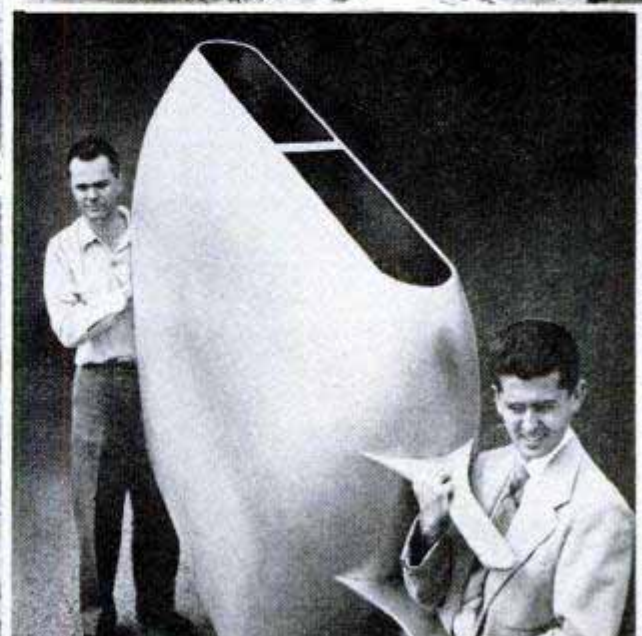
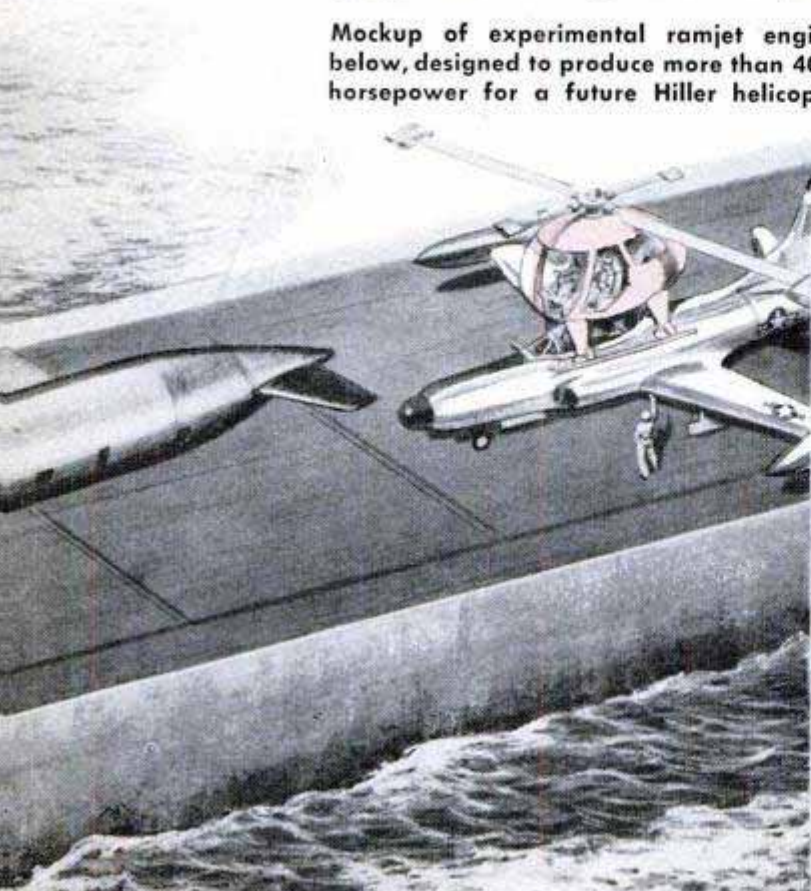

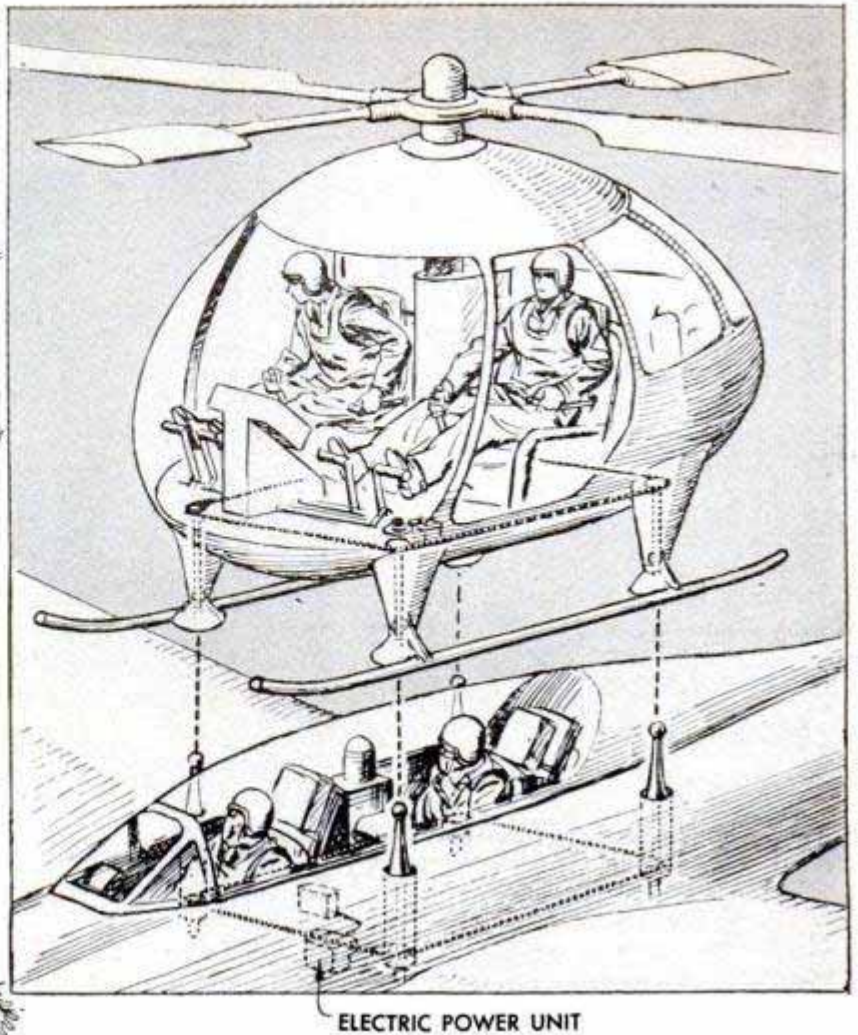
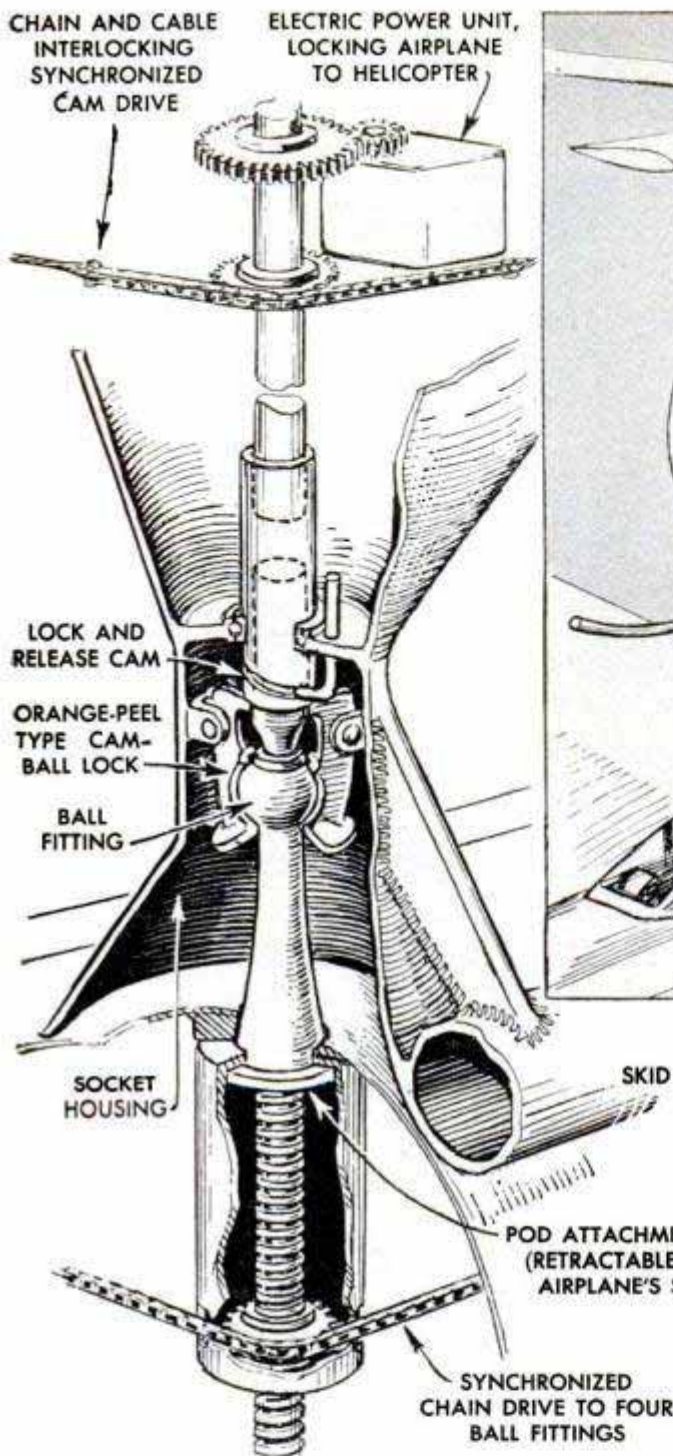

Sketch of Doctor Bennett's quick-release mechanism, left, for locking airplane to helicopter. Carrying craft would straddle the cockpit canopy of fighter below

from the deck of a ship. Doctor Bennett estimates that a helicopter tug having a rotor diameter of 75 feet and powered with ramjet engines at the rotor tips could lift a 15,000-pound fighter into the air without difficulty, then lower it again to shipboard after re-attachment.

This helicopter "elevator service" would permit full utilization of all available deck space for parked aircraft.

Large helicopter tugs will require ramjet engines of tremendous horsepower. One experimental design prepared by the Hiller propulsion section develops an estimated 4200 horsepower, providing a total of 8400 horsepower at the rotor tips.

Probably the helicopter tugs will dispense with the usual tail or antitorque rotor because of another Bennett development. Ramjet-powered helicopters require a small auxiliary engine to sweep the rotor blades around and thus start the engines. Doctor Bennett proposes that the auxiliary engine continue to apply power to the rotor shaft during the entire flight. This would balance the usual friction from hub bearings and accessories and allow the pilot to rotate the fuselage in either direction. ★ ★ ★

applications, together with quick-release methods. There appear to be no particular problems concerned with transitional speeds, and helicopters now being designed would be capable of attaining speeds fast enough to more than match the approach speeds of transports.

"The tug pilot would perform a function similar to that of a pilot at a port for ocean ships," Doctor Bennett explains. "He knows all the local hazards and is skilled in port navigation. This local knowledge would be especially valuable during a final let-down through cloud conditions. The tug and transport pilots would communicate by telephone meanwhile, similar to the intercommunication between the bridge and engine room of a ship."

Helicopter tugs also would be valuable for launching fighter or search aircraft



In bitter cold, crew drills hole for dynamite charge that will set off shock wave to map earth's subsurface

## Prospectors in Parkas Chart Canada's Oil

*Temperatures sink to 70 degrees below zero, diesel fuel turns to slush and it may take 24 hours to start a truck engine with a blowtorch, but still the search for oil goes on*

By John P. Tolbert

Photos by Harry Rowed

ONE OF THE HOTTEST oil areas in North America today is also the coldest. In terms of competition, western Canada—including northern Alberta, the Northwest Territories and British Columbia—is hot indeed, with most of the major oil companies involved. In terms of temperature, this search for oil goes on at 70 degrees below zero in the winter, with few trees to break the wind that knifes through to your marrow.

It's doubtful that oil men ever operated in such an uncomfortable climate, not even excluding Saudi Arabia's 125-degree summers. Certainly they never operated in a more remote area nor with any greater

dependence on airplanes and the radio.

Despite the discomfort that often amounts to physical pain, winter is still the best season for oil explorations in this part of Canada. The solid freeze makes good highways out of rivers and lakes, and bulldozers can cut roads through deep snows better than they can snake across the soft muskeg. Living in this country in the winter, you have to develop a whole new set of reflexes, learn to understand the weather with all its whims and deceptions and adapt yourself to it. Men—and this is strictly a man's country—have frozen to death standing up without ever realizing they were cold.

With the right sort of clothing and care, though, you can stay out in the open for hours. The men in this vast freezer wear heavy underclothing, extra trousers, sweaters, parkas, mukluks, mitts and sometimes flight suits and flight boots. The critical factor is not the temperature alone but also the wind velocity—what the U. S. Army calls the “wind chill” factor. A high-calorie diet helps, but whiskey and other forms of alcohol are forbidden because they can lull you into a deceptive sense of warmth.

In those vast frozen wastes that stretch to the North Pole—“down north to the Arctic” they say up there—you take care of your equipment the way a foot soldier nurses his feet. In dead winter, you keep your equipment running 24 hours a day—bulldozers, jeeps, weasels (tracked vehicles that move on land or water), bombardiers (a sort of cousin to the Army’s half-track) and motor-driven toboggans. If an engine

stops for long it may take you 24 hours to restart it, even with a blowtorch. If it stops when you’re alone any distance from camp, you may not live long enough to get it started again.

Every nut, bolt, cigarette, magazine and bite of food has to be brought in from “civilization,” which may be several hundred miles away. Ski-equipped bush planes, flown by some of the greatest pilots in the world, carry most of the load. Bulldozers ferry in long trains of ski-mounted carriers and bring up the trailers used for housing and offices. The oilmen eat well—a high-calorie diet is essential—but they don’t waste even a morsel of bread. They’re the perfect conservationists; they safeguard every nail, every tool, every drop of fuel.

Fuel, incidentally, is an interesting problem itself. Diesel fuel for bulldozers can freeze into a sluggish white mass too thick

**In some areas, every nut, bolt, cigarette and cracker must be flown part way, then transferred to dog sled**

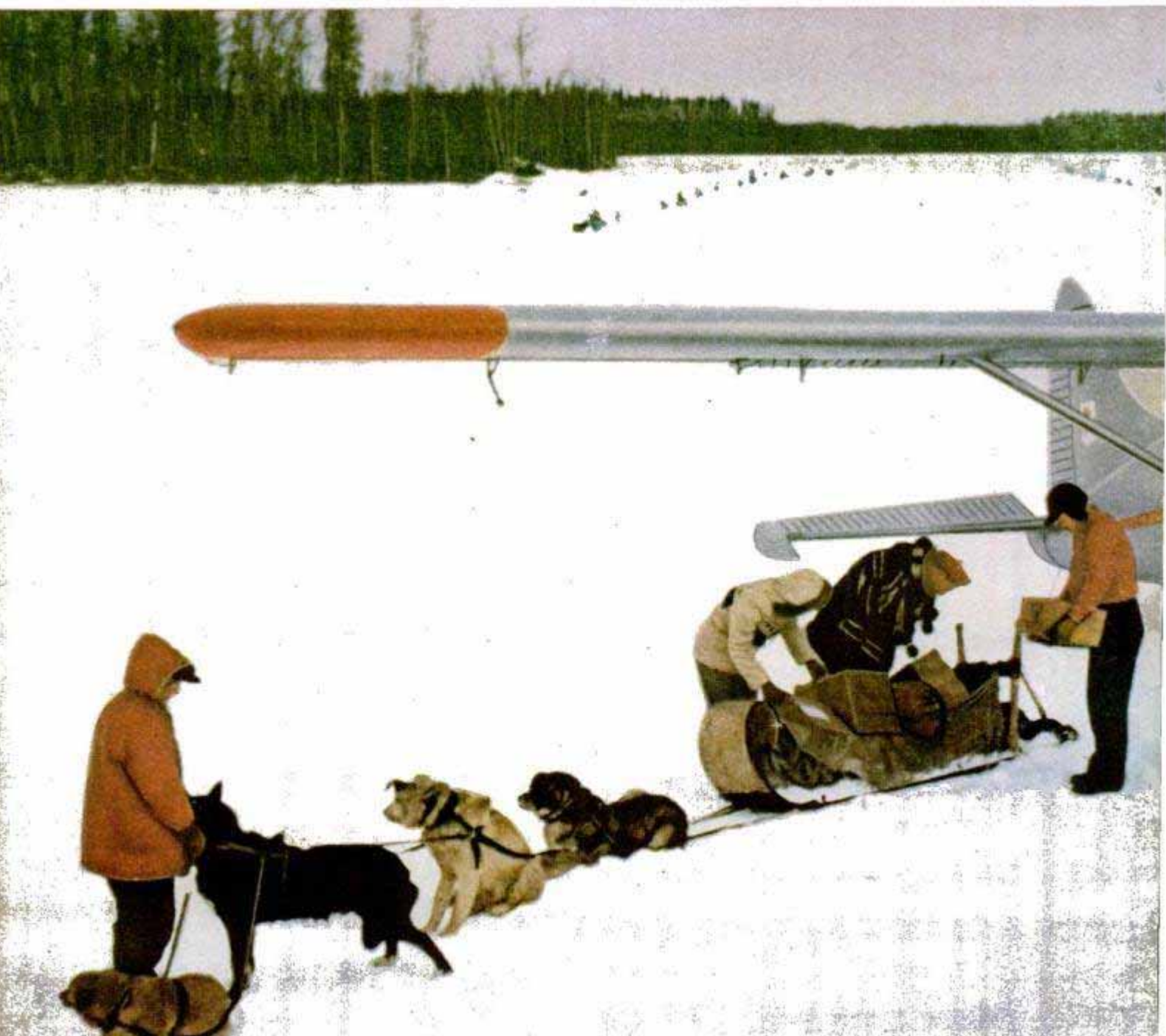

to pour. This fuel is diluted with kerosene to help move it through the fuel line. Very lightweight lubricants are used, and special arctic gear oils.

Airplanes, being such a high-priority item, get special handling. Whenever the motor is cut for a stop of any duration, a tent is lashed tight over the engine and propeller. A small stove placed inside the tent for 30 or 45 minutes helps warm up the engine when the pilot is ready to start it again. The engine oil is diluted with gasoline, which burns off quickly after the engine starts. The planes have to be anchored securely with guy wires, as the high winds can wreck a plane in a matter of minutes.

In the warmer part of winter, when the mercury jumps up to around 30 below, oilmen sometimes resort to a time-tested means of crossing a frozen stream when they aren't sure how thick the ice is. They melt huge quantities of snow in boilers,



Home freezer, arctic style. After each snow the men must shovel their way to the crude food-storage shack



Here's the goal—a producing oil well. This one was drilled in Alberta. Flare in background burns off gas as safety measure. Below, "jug hustler" plants a Geophone which is connected by cable to recording truck. Geophones pick up shock waves after explosion



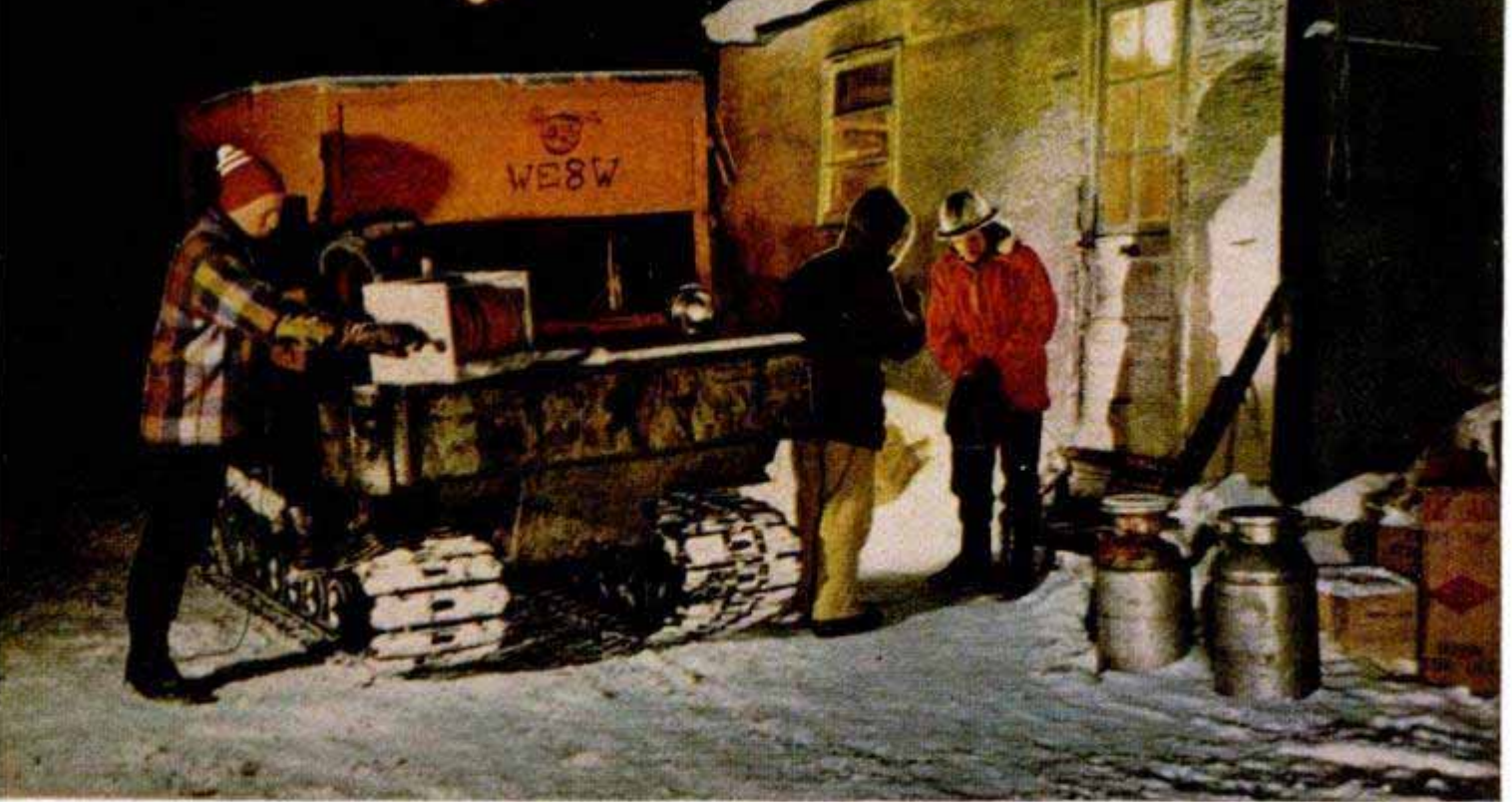

Seismic crew leaves trailer home for day's shooting. In midwinter, daylight only lasts four or five hours

pour the water thus obtained on the snow-covered stream and let it freeze. This way they know how much ice they have. A bulldozer needs 24 inches of ice for a comfortable safety factor. If they lose a bulldozer through the ice at a critical time, and some companies have, they may have to disassemble a bulldozer hundreds of miles to the south, fly in the components, reassemble the machine and then spend a day or so starting its engine.

Where only small, fairly light loads are involved, oilmen sometimes bypass this sort of "road building" by using dog teams. Sled dogs, used in unloading planes in many places, can go almost anywhere with

**Torch melts ice in tank so men can mix drilling mud. Water supply is continual problem—it's always ice**



any sort of decent footing. They have enormous appetites, which can be satisfied largely by fish caught through the ice, and unpredictable dispositions, which are better left to the care of old dog-handlers who understand their personalities.

All of this costly, time-consuming, uncomfortable operation is designed to support what looks like a simple business of shooting off dynamite in the ground. Because there aren't enough surface outcrops of rock in the region to be of much help to geologists, seismic shooting is the best way to map the earth thousands of feet below the surface. This mapping locates the types of structures that can trap oil if there's oil to be trapped. Only the drilling bits, backed by hundreds of thousands of dollars, can finally determine the presence or absence of oil, but there's no point in drilling until you know you're on a favorable structure.

The dynamite is placed in holes anywhere from 30 to 200 feet deep. Geophones, connected by wire to a recording truck, are strung out over a wide area to detect shock waves that bounce back to the surface whenever the waves set off by the blast encounter a different type of rock. The Geophones translate the shocks into electrical impulses, which are amplified and recorded on moving strips of photographic paper. Part of the wave keeps going down until it hits a new stratum of rock. Then, again, some of the wave bounces back to the surface and some of it keeps going until it finally hits "basement rock," the last reflecting horizon. This is igneous rock, once molten, in which oil has never been found. Oil is found only in the sedimentary



Main street in exploration area is road plowed by bulldozer. Oilmen have cut thousands of miles of such roads

rocks laid down slowly over millions of years. Seismic interpreters can read the squiggles that show up on the records and map the earth's subsurface with astonishing accuracy.

The surveyors and rodmen who plot locations for the shot holes often have to work hip-deep in snow, and there are no snack-bars where a man can put in for a

cup of coffee. The "jug hustlers," the men who position the Geophones, also slog through deep drifts. The "elite corps" is the drilling crew, with the men riding up on the truck-mounted, collapsible rigs. Bulldozers have to precede trucks every foot of the way. A good bulldozer operator—a "cat skinner"—can cut a straight road for long distances by dead reckoning.

White area on the map is the territory now being charted for oil. Note the two pipe lines from Edmonton

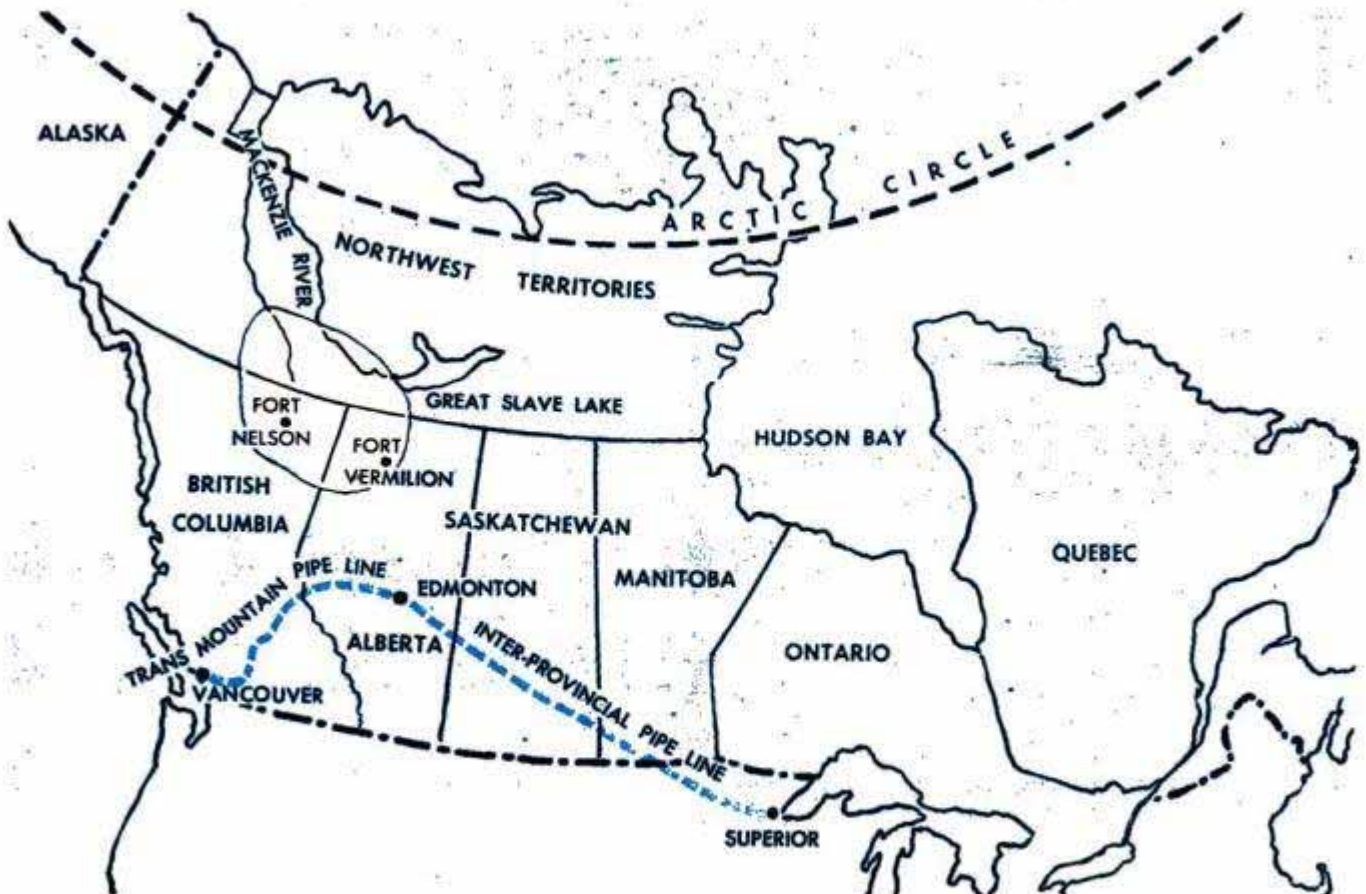



Men carefully tamp a charge of dynamite into a shot hole. Wire will link the detonator to shooting truck



"Fire in the hole!" is standard cry of blasters everywhere. When he presses the button—BOOM!



Seismic observer operates a complicated instrument panel inside truck. He determines placement of the dynamite, decides whether a re-shoot is necessary

Socony-Vacuum Oil Company, one of the largest operators in the western Canadian play, with exploration rights on millions of acres, estimates that its bulldozers have cut close to 2000 miles of road in that wilderness.

If and when oil on a commercial scale is found in this region, moving it to markets will present a problem, but oilmen think they can lick it. They've built pipe lines over 1000 miles long through the Arabian desert, the Venezuelan jungles, and across the Mississippi River. They're confident they can lay pipe lines even in the muskeg country of western Canada. The shortest route, in miles, would be to cut straight through to the Pacific Coast and to build a terminal and tanker docks from which the crude oil could be moved to the United States West Coast. But this would mean crossing the rugged Canadian

Finger points to broad wiggles that denote reflections of shock wave from rock structures beneath the surface

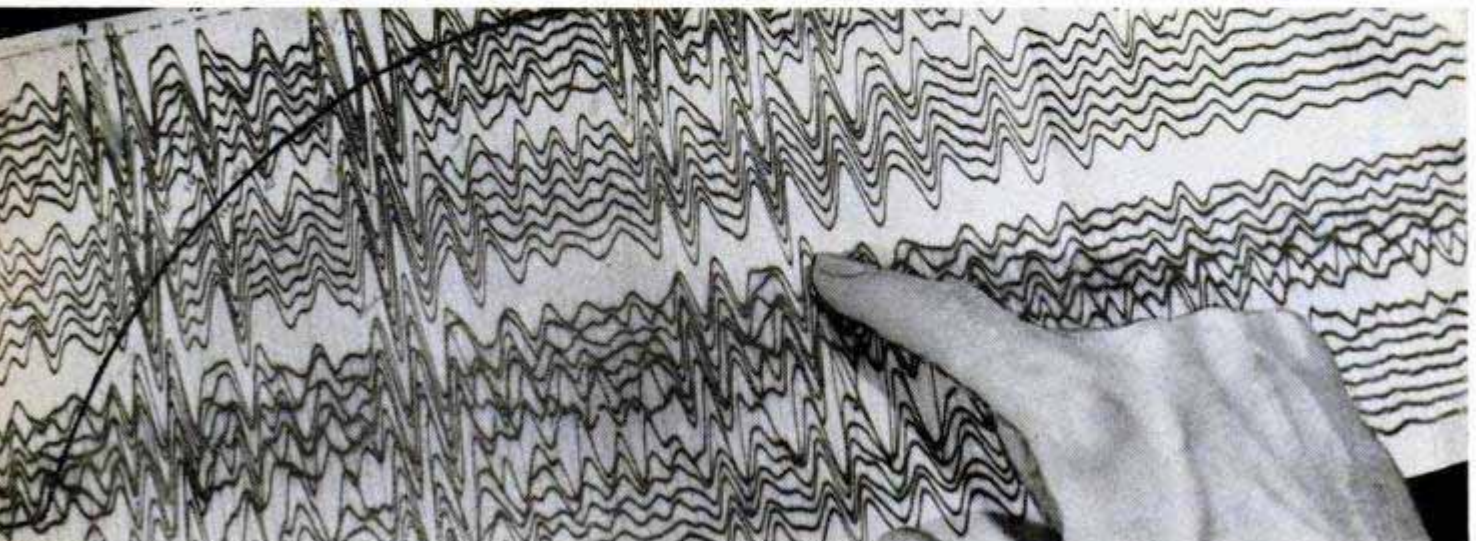



Rockies, so the probable solution will be a line possibly 400 to 700 miles long that would tap into one of two other pipe lines: Either the Inter-Provincial line from Edmonton, Alta., east to Superior, Wis.; or the Trans Mountain line now under construction from Edmonton to Vancouver, B. C.

Such a pipe line from the north country might have to run above ground part of the way, floating on the marshy muskeg. It would have to withstand contraction and expansion caused by temperature ranges from 70 below to 100 above, but pipe liners have mastered similar problems.

Until oil is actually found in commercial quantities, discussion of a pipe line to move it is just conjecture. But pipe liners have already done a lot of informed conjecturing about it. They say the three main factors that will determine the whole nature of the pipe line are the terrain, the quantities of crude oil to be moved and the characteristics of the crude oil.

The terrain is pretty well known already. The line could be buried four or five feet or more over much of the route. This would mean costly ditch-digging, but it would reduce somewhat the heating required to keep the oil flowing. The line would probably be buried eight feet or more under the beds of rivers and streams. Where the line had to be floated on top of the muskeg, more heating facilities would be required. In either case, the line would be insulated as heavily as possible. A protective

(Continued to page 262)



Surveyors who plot the shot holes and Geophone locations have to wade through knee-deep, sometimes hip-deep snow. Below, when it's time to move camp, trucks or bulldozers haul the skid-mounted trailer houses to a new area



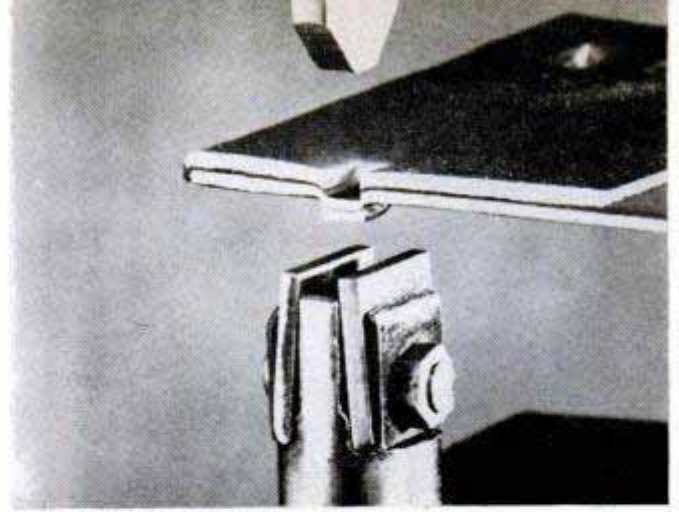
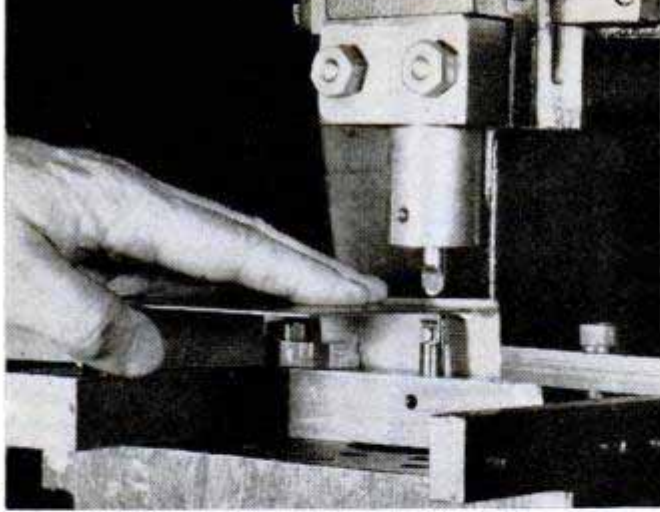

Descending action of punch makes a parallel double notch in metal sheets, "buttoning" them together

## Metal Sheets "Buttoned" Together Without Rivets or Bolts

Top and bottom views of sheet steel after punching

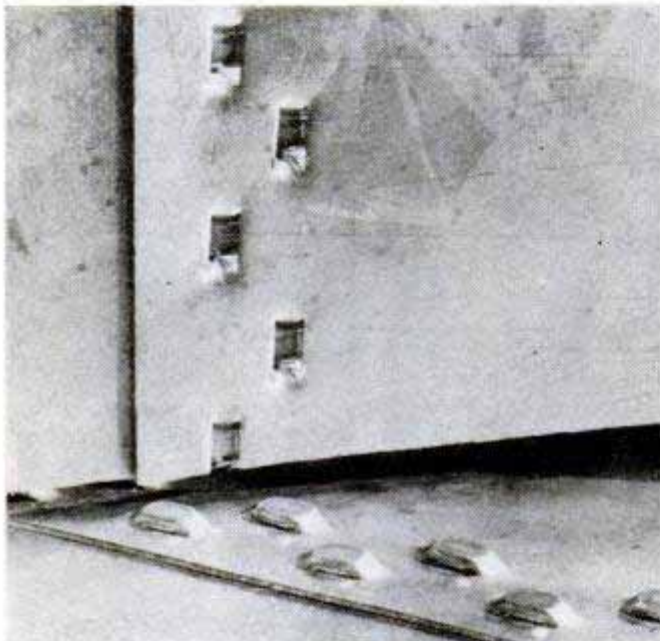

"Buttoning" metal sheets together, a new method of fastening, does away with rivets, bolts, solder or welding. From 25 to 50 per cent faster than usual methods, the process employs a punch and die which can be used in any punch press or incorporated in a special fastening machine. In a one-step operation, the device shears through the metal with parallel cuts in both sheets. After the incision the metal is rammed downward by the punch against the movable jaws of the die underneath where the impact depresses the metal sideways. This produces a buttoning effect that compares favorably with riveting. In tests, the fastening held while the metal actually broke under stress. The new method can be used to fasten sheets of metal up to  $\frac{1}{4}$ -inch thick. It works equally well on sheets of dissimilar metals such as steel and aluminum.

## Fire-Sensitive Cable Developed for Airplane Protection

Sensitive along its entire length to any touch of flame, a cable developed at Edison Laboratory for use in aircraft produces an electrical current that activates a fire alarm. In a recent demonstration, the cable was wrapped around a gasoline-soaked wooden box, then extended to an instrument panel connected to an alarm and a fire extinguisher. The box was ignited and the fire was extinguished automatically. The cable will be used to supplement other warning systems, particularly around the airplane engine.

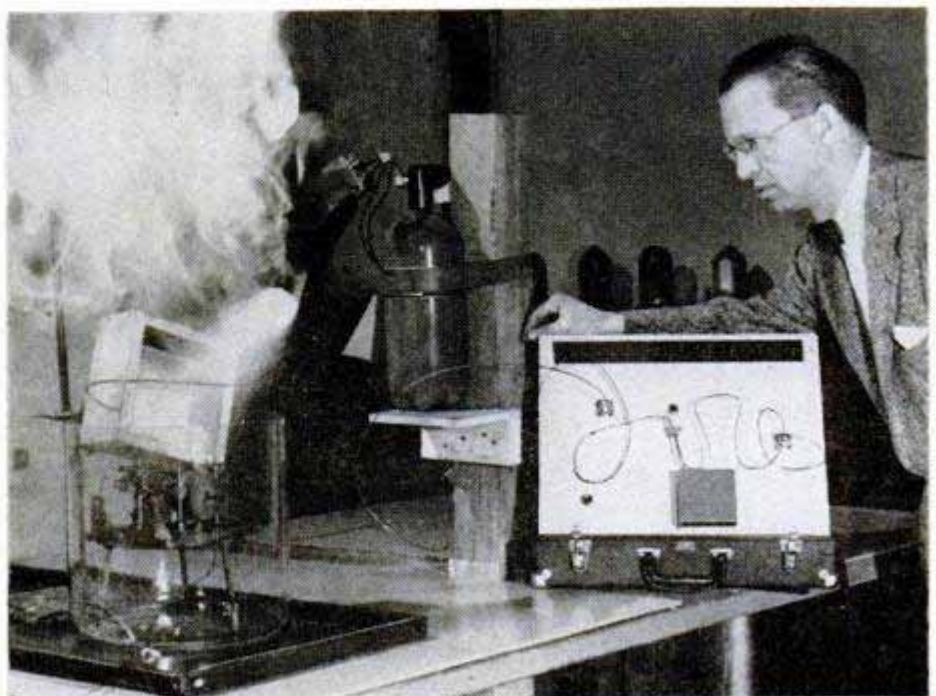

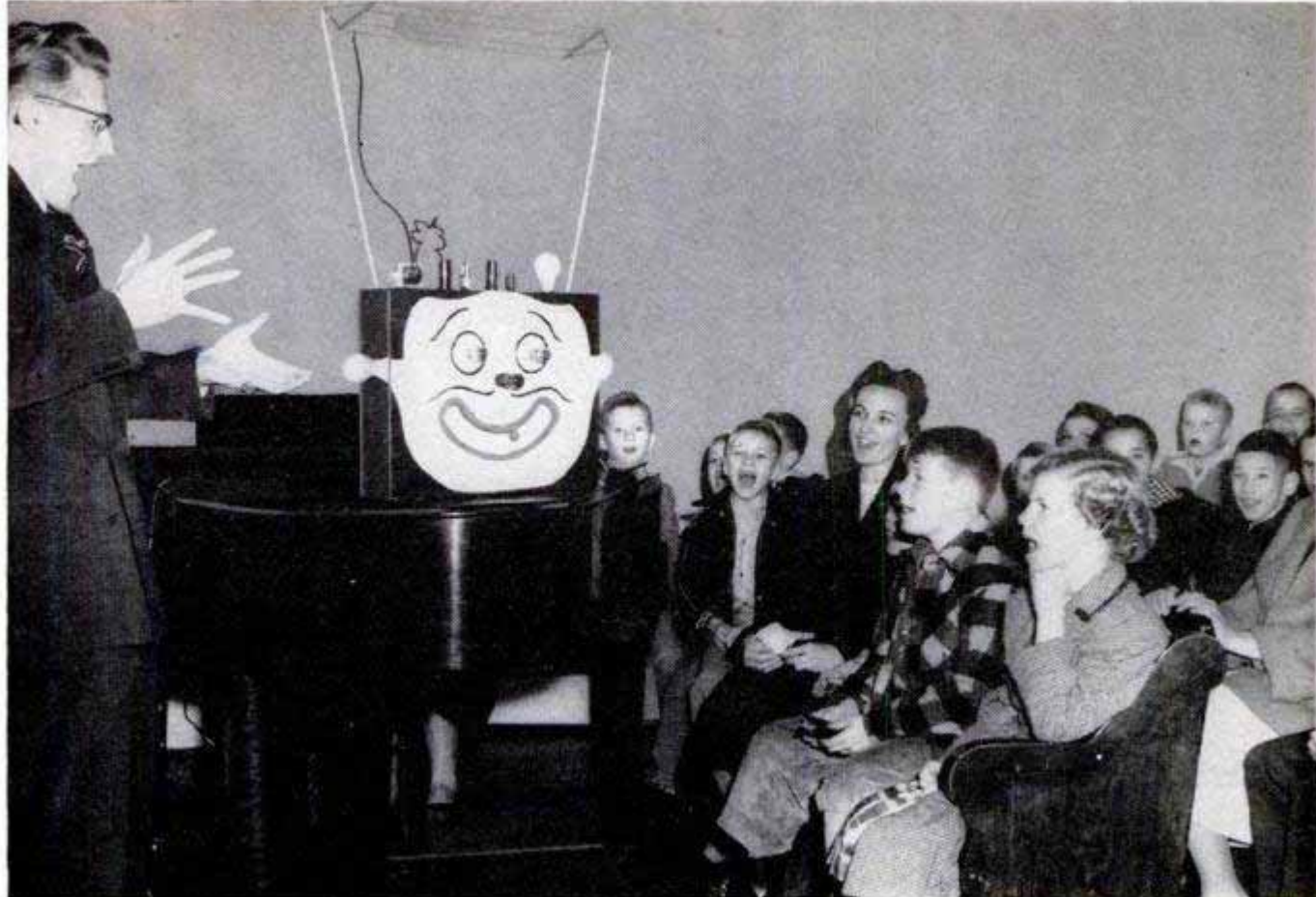

## Robot Song Master Stimulates Sunday-School Singing

Youngsters sing their lungs out to please a robot who draws big crowds to a Seattle Sunday-school class. "Sam" has eyes of radio tubes and light-bulb ears, a big square face and a grinning mouth. As the volume

of singing increases, bulbs light up and Sam's long red tongue wags back and forth. Besides functioning like an applause meter, Sam tells short Bible stories by means of a hidden tape recorder.

## "Daylight" Machine Makes X-Ray Prints Available in Minute

With a new type of laboratory equipment, X-ray prints are available within one minute after the picture is taken. The system is similar to that used in the Polaroid Land camera. No darkroom or wet chemicals are needed. The chemicals required to make the print are packaged with the sheet of film.

☐ Oceanographers have found that the greatest ocean waves, which reach a height of 300 feet, occur deep in the sea at the boundary of two unmixed bodies of water—such as water layers of different temperatures—one layer welling high up into the other one.



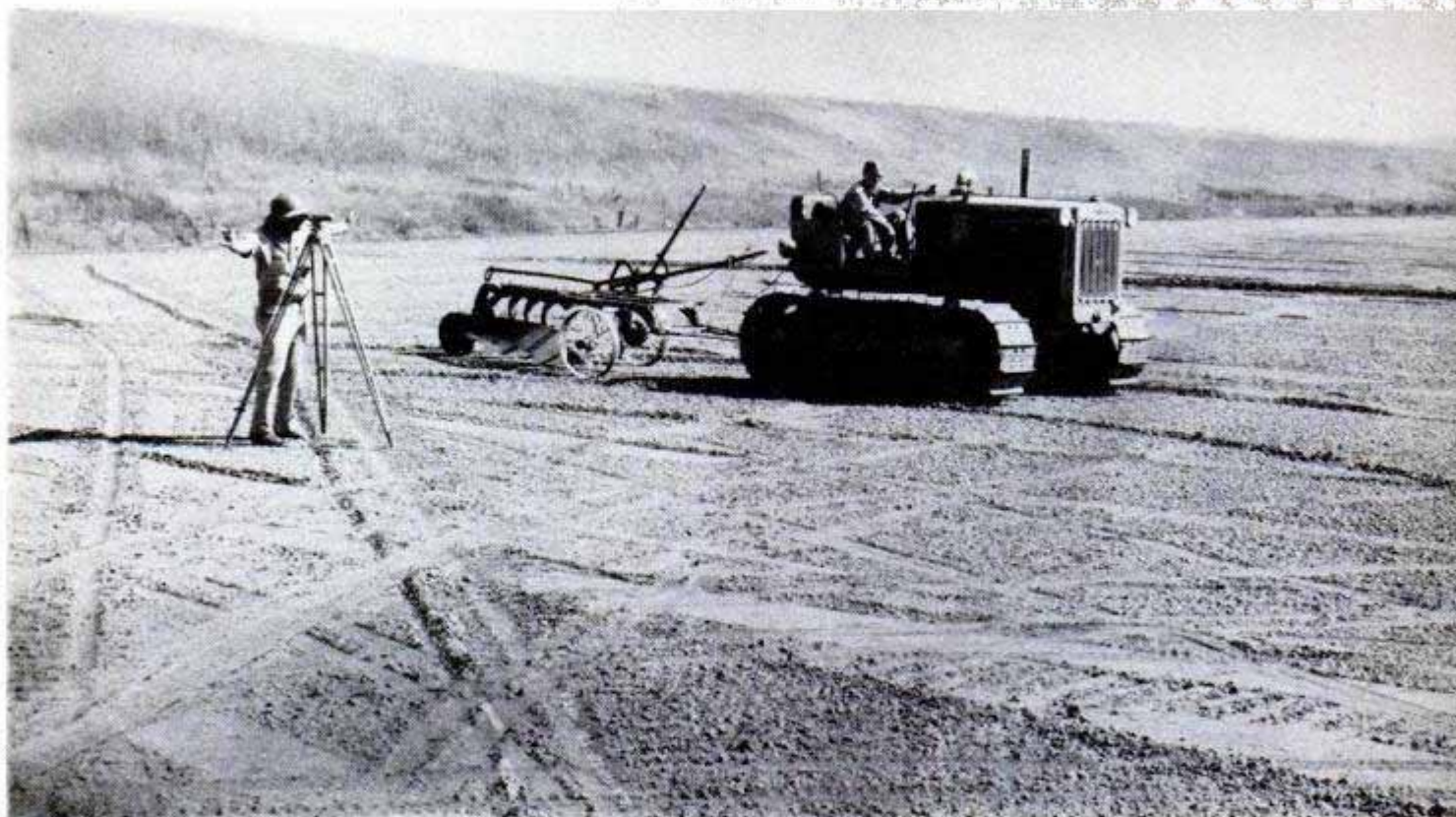

Surveyor followed by tractor and plow lays out paddies of different elevations in big California rice field



**T**HEY ARE SAYING that Paul Bunyan caught the sniffles in the cold north woods and so he and Blue Ox moved to the huge Sacramento Valley of California where they now act like coolies and soak up vitamin D in warm rice fields just their size. You would think so, too! The five-by-five rice paddy and barefooted coolie are completely unknown in the vast ricelands of California. If anyone were to wander into those enormous paddies with an ordinary shovel or hoe, he immediately would be measured as a hump by precision surveyors, leveled off by gigantic scrapers and either dived at by a guarding airplane or sprayed by helicopter as a new type of bug. The standard movie-type coolie would feel more at home paddling an iceberg.

Rice, no longer a staple food in just the Orient, is big business in Louisiana, Texas, Arkansas and California. The United States produces over 2,000,000,000 pounds of rice yearly, second only to China, and exports more than half of it back to Asia. Why? Because there the coolie farmer must labor so hard with primitive methods that he barely produces enough rice to keep himself alive. The Orient's city-dwellers are left short. In California and in our other rice-growing states, modern mechanical farming is completely reversing the picture—truly Paul Bunyan farming that pro-

Plane flying 20 to 40 feet high seeds the flooded fields. Splashes in foreground are made by seeds

**Movie-type coolies splashing through rice paddies have been replaced by giant machines in California where they grow**



# Rice by the Square Mile

**By Tom Riley**

duces huge surpluses of rice in paddies untouched by any form of hand labor.

Growing rice is a specialty. For centuries, it has been grown in the typical tiny paddy where it could be meticulously cultivated and cared for by hand. In the California paddies, rice is grown by the new continuous-submergence method, discovered at Biggs, Calif., 25 years ago. Instead of keeping the ground moist with many floodings and drainings, it is kept completely submerged under six to eight inches of water

throughout the growing season. The rice does well in the submerged land, which thus drowns out wild grasses and other weeds which, if present, would have to be removed by hand from the soggy ground. With the problem of weeding eliminated, technicians and machinery are able to take over completely the work of the coolie.

Surveyors are as important in the big fields as farmers. Each season, skilled surveyors lay out the huge rice paddies and draw highly accurate contour maps on the

**Cutaway of rice harvester below shows intricate mechanism of huge machine that cuts and threshes the grain**

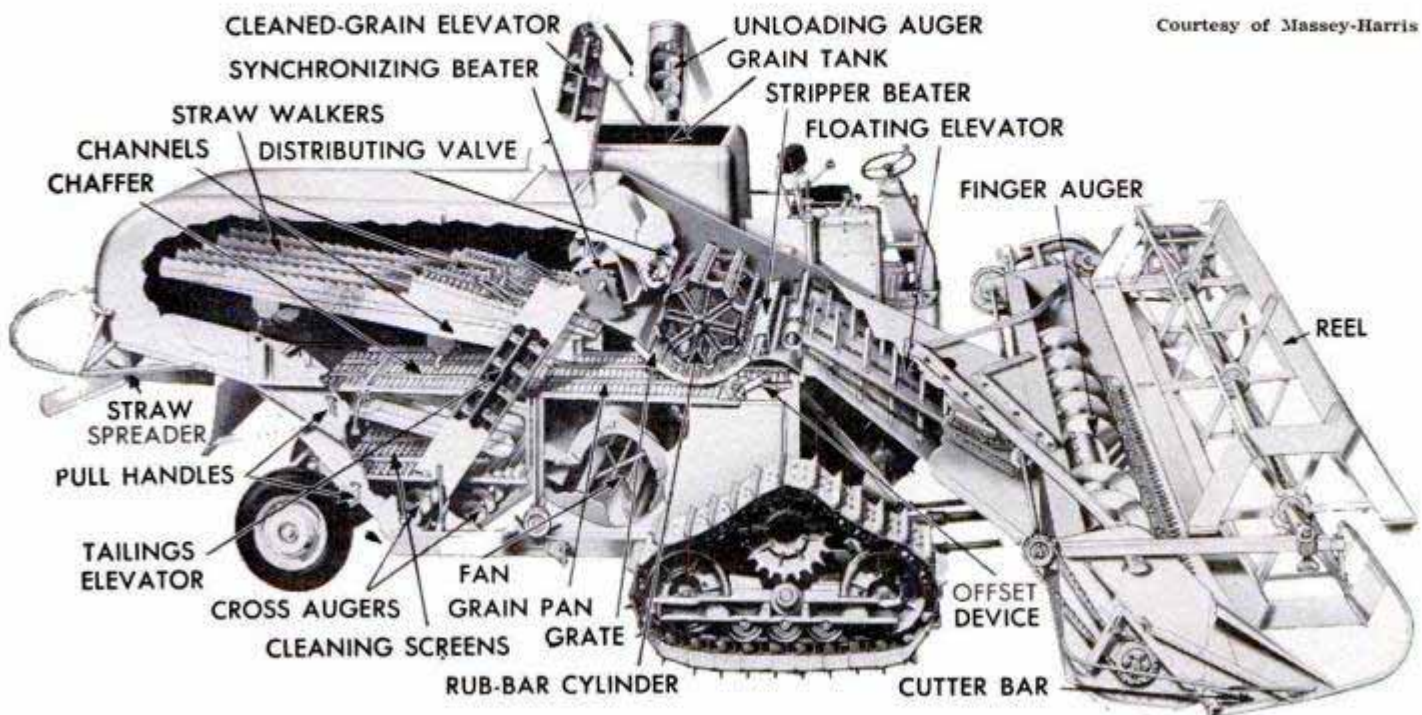



**This rice field has been leveled, contoured and flooded and will be seeded after aerial-photo checking**

ground itself. The large paddies must be absolutely level for the continuous-submergence farming; otherwise the yield will be spotty and weeds will appear through the water. The fields also need to be level in order to drain evenly and quickly in the fall when the rice is ripe. Heavy harvesting machinery must move in fast before fall rains can spoil the crop.

The surveyors level these fields with the most precise coincidence-reading engineers' levels available, and they level them by subdividing the fields with meandering contour lines. Contours are the wiggly lines you see on accurate maps, each line indicating a certain elevation around a hill or across a seemingly level field. For instance, the edge of a lake is a contour line. By accurately locating contours across the huge fields, each contour two or three inches higher or lower than the next, the surveyor establishes level grade lines and also locates the land for each paddy. The

paddies are formed of the land between contour lines that can economically be graded flat. As the surveyor traces the contour lines with his instruments, a tractor drawing a gang plow closely follows him and thus plows in or marks the contours on the ground.

The land between the contour lines is usually leveled flat with huge land planes, special 80-foot planes made for the rice fields. However, if the land is already fairly level, it is smoothed down by drags behind tractors. Checking machines, 16-foot snowplows in reverse, are drawn along the contour lines behind two large tractors to scoop up enough soil to form three to four-foot-high checks or dikes. Thus the fields, often two miles across, are subdivided into large paddies, each a two or three-inch step higher than the next. If all the land in an especially flat field is on one level, the checks are still put in—to prevent the wind from building up large waves on the shal-

**Land planes which are 80 feet long are dragged by tractor across the fields until they are perfectly flat**

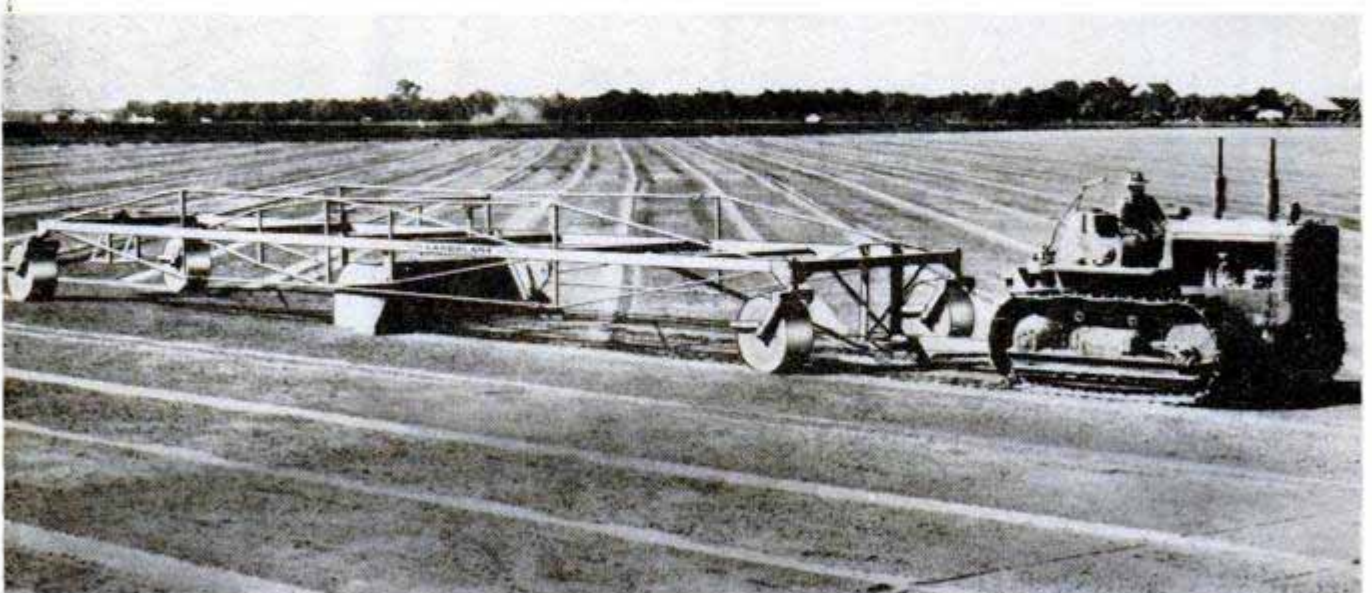

low lake, waves which could break the dikes.

Next, the fields are flooded from irrigation ditches through wooden gates built in the checks. So accurate must the leveling be that the fields are now flooded to a two-inch depth in each contour or paddy and are checked by taking aerial photos. The photos will show up in light and dark spots any shallow or deep areas that may need releveling. Seldom is releveling necessary, even in paddies that meander over miles. All this work is redone each year, because the old dikes are leveled out to remove accumulated weeds and to allow plowing the entire field.

When the fields are photo-checked, the surveyor relinquishes his job as farmer to the airplane pilot. Around the last of April, planes seed the inundated fields, spreading seed rice over the water in long, low sweeps. Aerial seeding of the flooded fields is inexpensive, fast and surprisingly requires less seed than hand methods. As the rice grows up through and above the water, spray equipment is attached to the busy airplanes. The pilots spray any weed-infested paddy with 2,4-D, the same as you would do to your lawn. Helicopters are also brought in for the spraying, because they can best reach the corners of the fields where the most weeds grow.

As the rice matures, the pilot farmers of the Sacramento Valley are kept busy at another job, herding wild ducks from the rice which is their favorite food. Whenever a flock of ducks settles in a paddy, a patrolling airplane zooms past—low—to frighten the flock into the air. As the ducks rise, quacking in complaint, the airplane slides in underneath them at slow speed and herds them away toward the Sacramento River and the federal bird refuges there.

The last—and rather anticlimactic part of this Paul Bunyan rice farming—is the harvesting. In October when the rice is ready, the check gates are simply opened to drain the fields. Then combines and bin-type wagons, similar to wheat-harvesting equipment but with everything on wide-cleated tracks, move in across the soft ground to thresh and hustle the bumper crop to the mills. ★ ★ ★



This checking machine scoops up dirt to form a levee along a contour line. It operates like a 16-foot snowplow in reverse

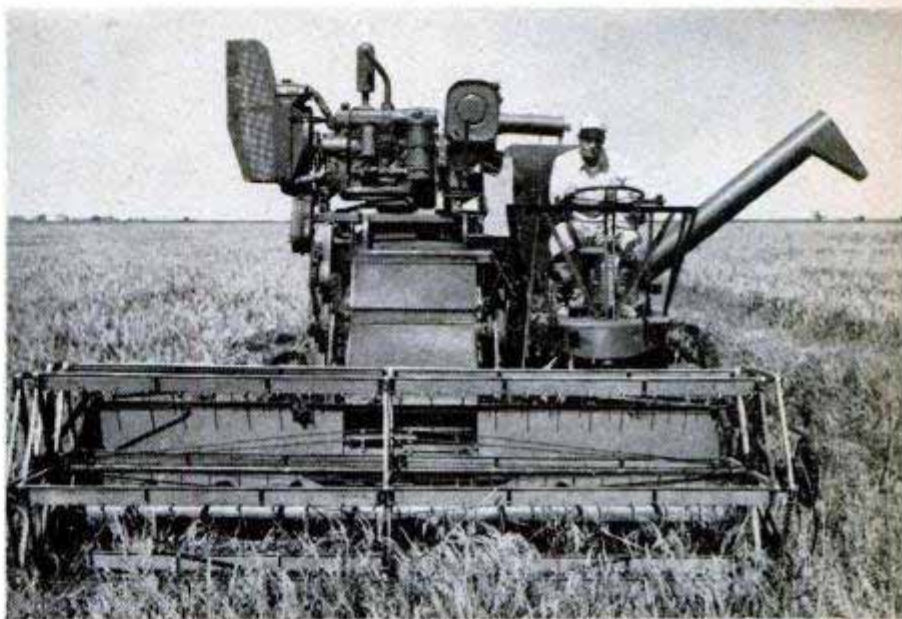

International Harvester Co. photo

Self-propelled rice harvester can do the work of more than 100 coolies in a single day. Operator's seat gives good view

Helicopters are used for spraying weeds in the hard-to-get-at corners of the rice paddies; airplanes are used for main job



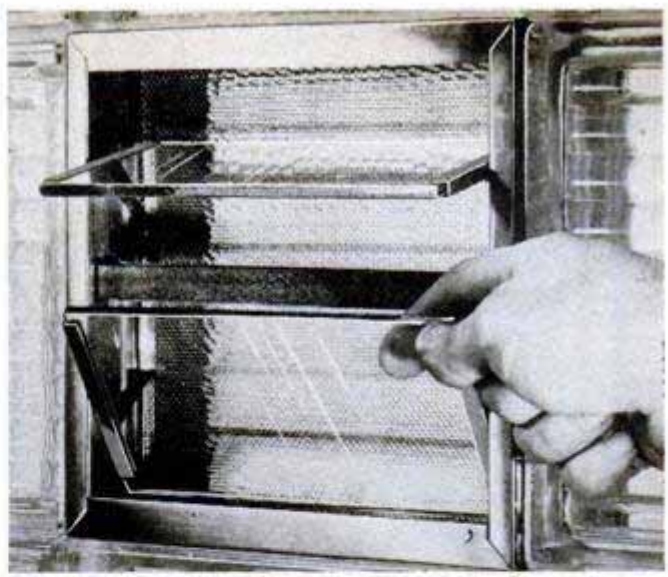
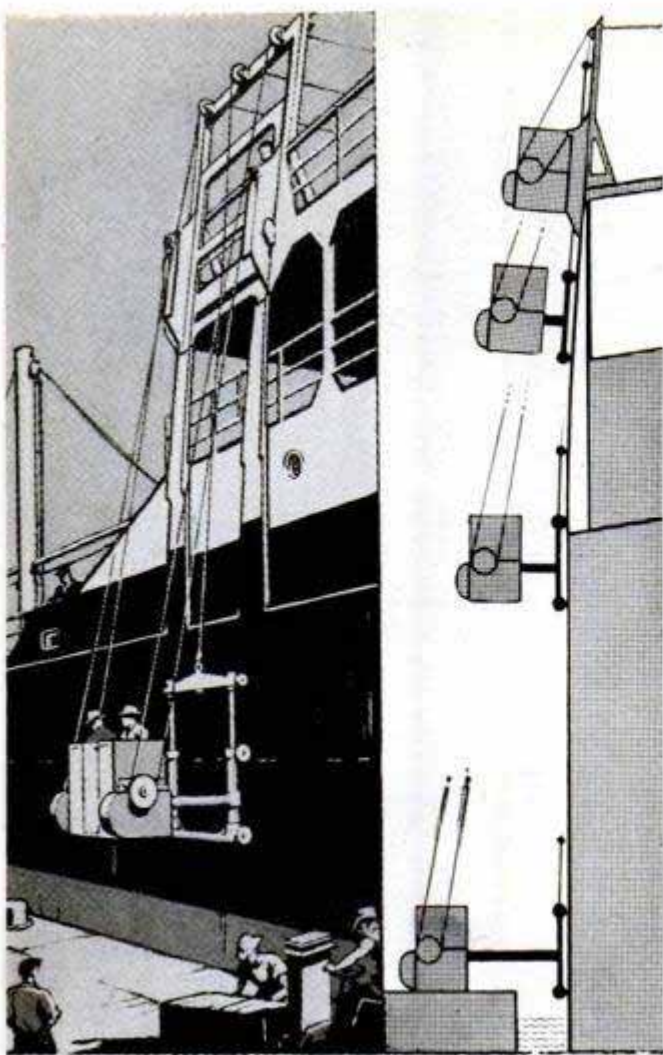

### Individual Ventilator Replaces Glass Block

Translucent glass louvers form the outside face of a ventilator which replaces a glass block in new or old walls. Rain or snow can't enter because of the downward slant of the louvers. Insects and dirt are barred by a wire screen in the middle of the unit. Two pivoting glass plates on the inside face regulate and direct the flow of fresh air or shut it off entirely. It is encased in a reinforced stainless-steel body.

### Overside Lift for Ships Carries Six Men or 1000 Pounds

Built to carry six men or 1000 pounds of stores as it rolls up the side of a new oil tanker, an overside lift is not affected by the list or trim of the vessel and is not dependent upon guide rails. Two metal arms extend from the wheeled framework to support the cargo box, which rolls in closer to the ship as it rises, until it is flush at the top of the lift. Electric motors drive the rope-and-pulley hoisting system. The lift eases the difficulty of getting on and off a tanker, which is so high out of the water when its cargo is discharged that the gangway is steeply tilted.

### Landing Speed Indicator

Use of a new aircraft instrument, the landing-speed indicator, makes it unnecessary for pilots to calculate airplane weight, flap position, wind and other factors during approaches. This is done automatically by a sensing unit mounted below the wing's leading edge. The unit is connected to an instrument-panel dial with a pointer moving through an arc of 75 degrees, marked by segments colored red, white and green. The pointer remains centered when the airplane is landing at the proper speed.

### Two-Ribbon Typewriter Emphasizes Selected Portions

When the typist operating a new electric typewriter wishes to emphasize certain words or phrases, she simply flicks a lever and the printing becomes twice as dark and bold. Reason for the difference is a second ribbon made of nylon fabric which rises in front of the regular ribbon when the button is pushed. This padding of the type results in a much thicker impression.

regular print or **this Bold**  
typescript at the flick  
of a switch.





## Hot Rod for Three-Year-Old

Washing-machine engine in rear powers racer. Battery supplies Austin self-starter. Plastic body will cover frame

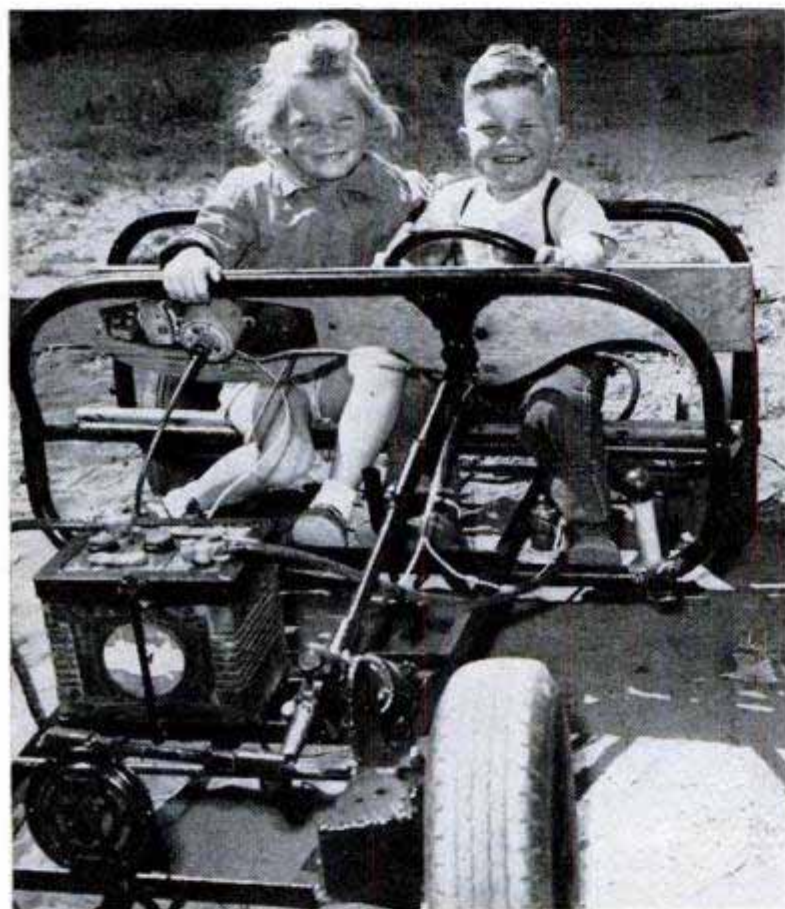

Curtis Smith is a California hot rodder and, being only three years old, is probably the world's youngest. His father is a Navy electrician who built a tiny car with tubing from war-surplus Navy cots and powered it with an old washing-machine engine. The wheels are from junked motor scooters and the transmission is a hydraulic unit once used in an aircraft gun turret. The tiny car even has a self-starter, borrowed from a British Austin. At present the car has no body, but Curt's dad is building a sleek plastic shell to dress up the vehicle. Actual top speed of the car is 20 miles per hour, but when Curt drives it the throttle is set for a top of 10 miles per hour. Most of Curt's driving has been on a 200-foot by 400-foot tract in an empty lot near his home, but he has also demonstrated his skill at the Paradise Mesa drag strip near San Diego. He's a veteran driver with several months' experience.

## Inflatable Mattress Slips Into Sleeping Bag

Sportsmen who like to "rough it" in comfort will take to a tufted air mattress that fits most sleeping bags. The tufted structure helps the mattress retain shape under varying body pressures. Made of plastic, it remains flexible at low temperatures and folds into a small package for carrying. Inflated by lung pressure, it measures 24 by 72 inches when ready for use.

Annual consumption of paper and paperboard in the United States is now about 31,000,000 tons, or approximately 14 times as much as was used in 1900.



# BULLETS STRICTLY FOR BULL'S-EYES



By Claude M. Kreider

**PIN-POINT ACCURACY** in rifle shooting has been sought by military authorities, hunters and target shooters since the days of the Kentucky "squirrel" rifles, 150 years ago. And, like all rifle "fans," Lorne Harbour and Frank Snow, of Whittier, Calif., were for many years dissatisfied with the accuracy obtained with even the finest equipment. So they did something about it.

Many factors enter into the problem of securing accuracy with the rifle. The first is human error. This may be almost eliminated by the use of a rifle whose special

heavy, "target" barrel is rested upon a firm pad while the shooter sits braced in a modern bench rest. Telescope sights provide clear definition of the target and reduce optical error to the minimum.

The rifle must be accurately bored and the cartridge case must fit its chamber with precision. Each powder charge must be weighed to the tiniest fraction of a grain to secure uniform results and the primer must be capable of instantly igniting it.

There is much more to the intricate science of ballistics, but these are the major necessities for accuracy except—perfect

Partners examine group fired at 328 yards. It's only .656 inch from bullet center to center at widest part



bullets, identical in every respect.

Bullets for superaccurate target work must be precisely formed, shaped to buck the wind and be exactly uniform in weight and dimensions. One thousandth of an inch variation in the bullet's diameter—one fourth the thickness of a human hair—can mean poor accuracy for that one shot.

Harbour and Snow, both expert machinists and tool designers, were joined by a third rifleman, James Spivey, in an effort to improve existing commercial bullets, both in design and machining methods. Their aim was to give the rifle world what it had always wanted—the perfect bullet.

They found that many jacketed bullets used for high-velocity target and game shooting varied as much as three or four grains in weight in bullets weighing 150 grains. This meant low shots on the target for the heavier bullet, higher shots with the lighter ones. Such "loose" grouping could lose a target match. Inaccurate bullets could miss a big-game animal at long range, despite the best of rifle holding, and might even endanger a hunter's life when pursuing dangerous game.

Pooling their engineering ability and ballistic know-how, these men have adapted a high-speed punch press for making jacketed bullets. They start with a jacket material of copper, to which is added five percent of zinc. This metal is capable of easy and accurate drawing to shape and has been found to cause little erosion in rifle barrels.

Inside each copper jacket is a core of lead, the only metal capable of providing the necessary weight for a given length and bullet diameter. It must be pressed firmly in place. And for big-game shooting, only a lead core with an exposed or expanding bullet point will give the necessary mushrooming effect for instantly killing large game.

Nearly all high-velocity bullets are of "spitzer" point design, tapering from the bore diameter in a constant curve to the sharp bullet point. A variation here of a fraction of a thousandth of an inch means an inaccurate bullet.

For months, this little three-man firm worked at the lathes and grinding machines, making and



Superaccurate, .30-caliber bullets must be uniform in weight. A bullet which varies more than a fifth of a grain is rejected



More than 300,000 cups in the large barrel will go through successive drawing operations to shape them to the exact jacket size of those in bucket. Below, precision tools are a necessity. Here a superaccurate die is ground automatically

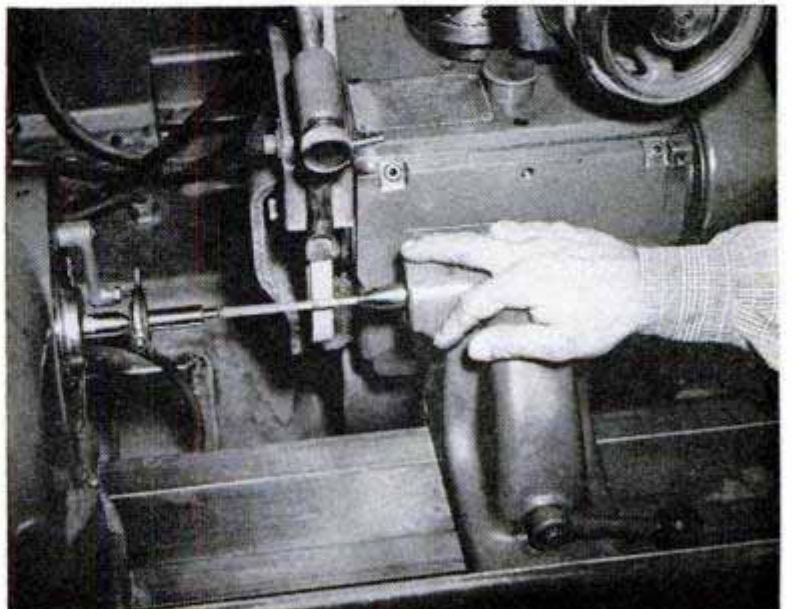

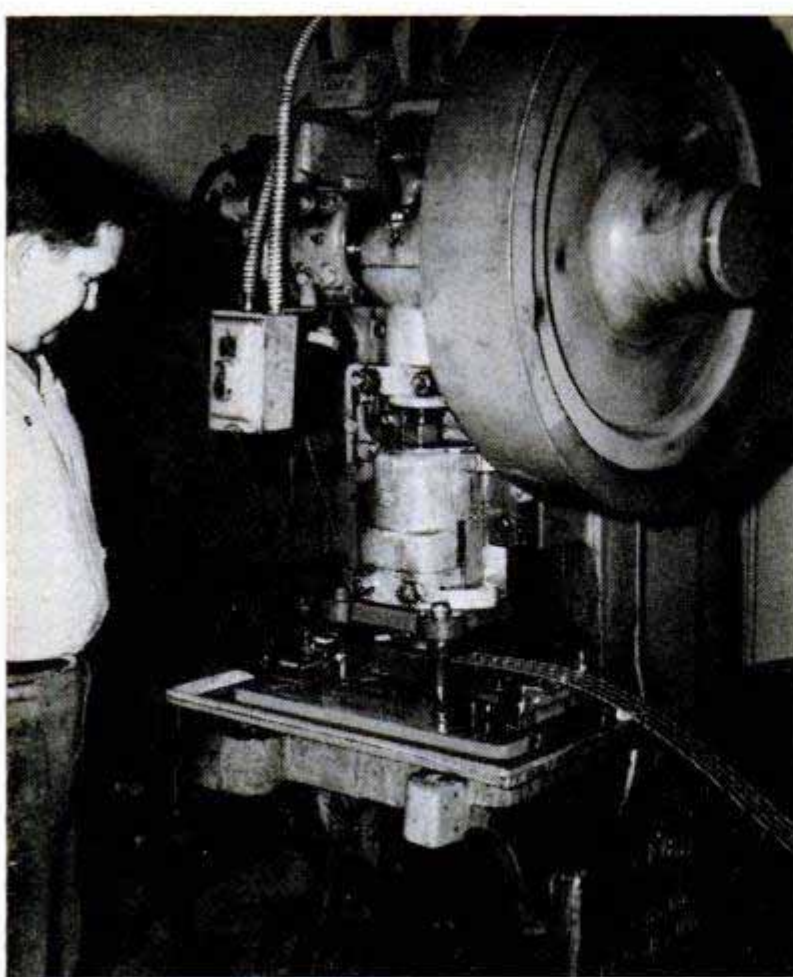

In first bullet-making operation, ribbon of copper alloy moves through press which stamps out and forms 20,000 cups, per hour

testing dies, and finally putting into action a superaccurate and automatic die press for bullet shaping. They made bullets, changed design, made more and tried them on the target range in the finest of rifle barrels. Thus were born the famous Sierra bullets, which now hold many world records for accuracy. These bullets will shoot a group at 200 yards which can be covered with a penny! And today more than a million of these superaccurate pellets, in calibers from .22 to .30, are shipped to rifle shooters and loading firms each month.

Strangely, it is the little .22-caliber bullet, fired in a heavy-barrel, which has established many of the existing records at

ranges of 100 and 200 yards. With the 55-grain, .22-caliber bullet Frank Cooper, in August, 1952, shot a new world-record group at 200 yards measuring only .6378 inch for 10 shots. The 10 bullet holes could almost be covered with a dime!

Proving that such accuracy is not an accident, in the same matches 78 shooters fired 200-yard, 10-shot groups averaging only .829 inch. Mrs. Oliver Walker fired off a 10-shot group of Sierra bullets at 100 yards which measured a bare .3268 inch—practically 10 bullets in one hole!

For many years the most accurate bullets for long range shooting were of the full-jacketed type. The soft-nosed (exposed-lead point) game bullet was not believed capable of real pin-point target group shooting. But the Sierra partners, working to close tolerances in weight and calibrations, produced such a bullet.

Their bullets are rejected if they vary more than .0002 inch in diameter or more than a fifth of a grain in weight!

Superaccurate target and big-game bullets must be fired at extremely high velocity. High speed means a low trajectory curve, a "flat" bullet flight, which lessens the necessity of guessing distance and changing the rifle's sighting adjustment for different ranges. A high-speed bullet is little affected by the wind which can deflect a low-speed bullet. And in game shooting, high velocity insures hard impact upon large animals and the necessary mushrooming of the bullet to insure instant killing.

Roy Weatherby, of South Gate, Calif., with custom rifles and Sierra bullets, has had notable results in big-game hunting.

(Continued to page 230)

How a bullet is made: Left to right, copper jacket is stamped out as a cup; three stages of jacket being drawn to shape; trimmed jacket; lead core; completed bullet; two mushroomed bullets which killed big game

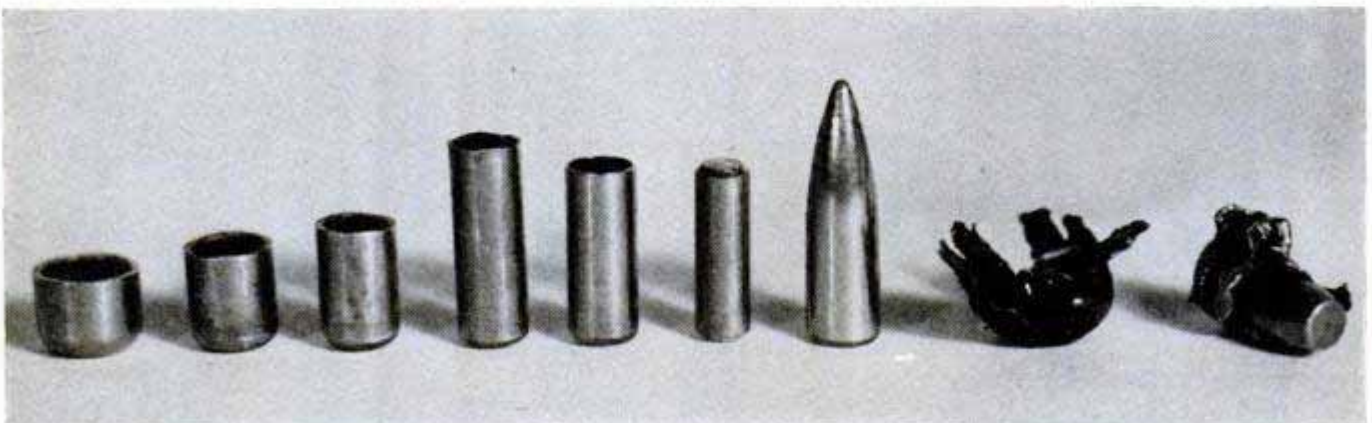

## Camera Records "Eye Interest" of Reader for Items on Page

Researchers using an improved tool virtually look through the eyes of a reader to determine what interests him in advertising, art and reading material. Blinders or glasses cause him to move his head as he glances at different sections of a page. A small spotlight affixed to his head focuses a beam of light on a reproduction of the page just above the reading rack, in the identical area observed by the subject. A camera behind the subject, snapping at a constant speed of two frames per second, records the exact location, duration and sequence of every glance. The film is then read and analyzed. It shows time for each pause.



## Tractor Shuts Itself Off If Operator Falls

Fatal accidents are prevented by a device that stops a tractor should its operator fall. It consists of a dashboard unit that is connected to the ignition wires, and a metal plug inserted in the unit to complete the circuit. The plug is attached to the driver's belt by a cord. If he falls, the plug is jerked out of the ignition circuit and the engine stops.

## Pipe Lines Laid to Depth of 243 Feet Under Straits of Mackinac

Oil will be piped over four miles across the Straits of Mackinac in two newly laid lines which will rest on a bottom that dips to 243 feet below the water's surface. A barge mounting a huge winch was used to pull the pipe, supported by buoys, across the water. Both pipes will be linked to the 30-inch line being laid between Superior, Wis., and Sarnia, Ontario. This line will connect to the present one from Edmonton, Alberta, to Superior for a total distance of 1756 miles.

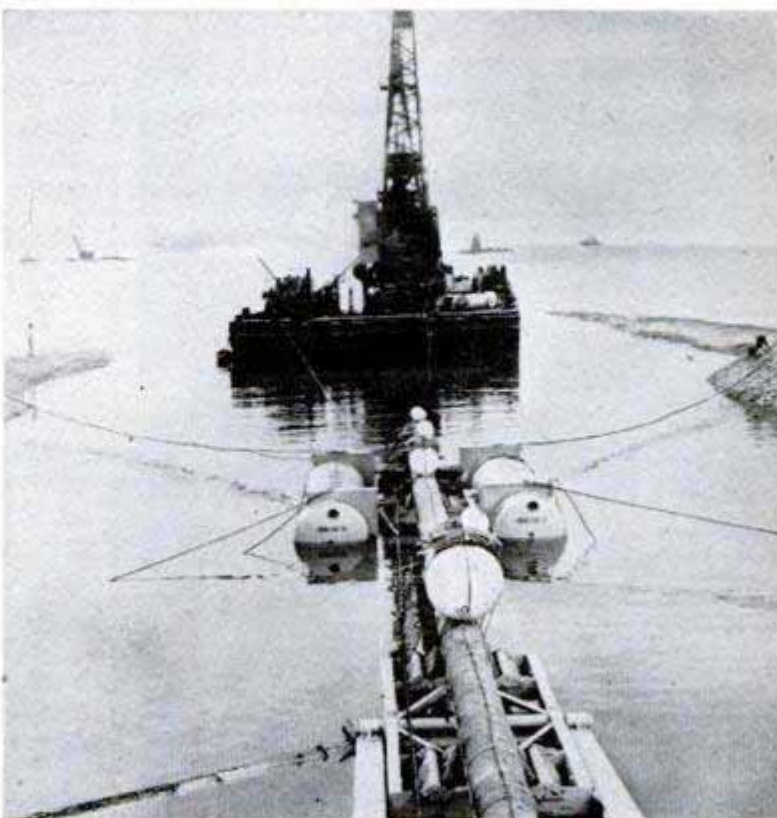

## Chemical Stops Mold

Sorbic acid has been found effective in checking the growth of mold on foods. The fatty acid is colorless, tasteless and digestible. First application of the preservative will be to protect packaged cheese. For this purpose, the wrapper will be treated.



### Miniature Air Raid Alarm

Plugged into any electric light socket, a midget air-raid and flood-warning alarm sounds a strident signal upon the lowering of the current cycle. During emergencies, power companies can alert homes and factories simply by decreasing the frequency of the current by three cycles a minute or more. Over 200 of the larger factory alarms have already been installed at the Los Alamos, N. M., atomic-bomb plant.

### Pocket-Size Cutter

Suitable for opening cartons, ripping seams, trimming photographs and clipping newspaper items, a handy cutter with a single-edge razor blade can be safely carried in the pocket. The replaceable blade slides into a holder which covers edge.



# Heartbeats Relayed From Jet to Ground

**H**IS PLANE out of control, a Navy test pilot stares half-consciously at the instrument panel as his supersonic craft dives through the purplish darkness of the upper stratosphere.

A shout in his earphones rouses him: "Wake up, you're passing out! Switch to a fresh oxygen tank!"

Fumbling, the pilot manages to turn on an emergency oxygen supply. His brain clearing, he pulls the needlelike ramjet-research plane out of its steep plunge. Both he and the valuable plane are saved by the ability of scientists on the ground to keep close tab of his physical and mental state.

In effect, the system lets the flight surgeon ride with the pilot in his one-man cockpit, continually checking on the man's rate and volume of breathing, his heartbeat, skin and body temperature and brain waves which tell when he is nearing an unconscious condition.

Small electrodes called transducers are taped to the pilot's forehead, neck, arms, chest and legs. When the man thinks or moves, his brain or muscles emit tiny electrical currents which are picked up by the electrodes and relayed to a small box behind the pilot's head. There they are multiplied 60,000 times and radioed to the earth by means of powerful high-frequency waves. Inked rolls of paper and oscilloscopes resembling TV picture tubes tell how the "guinea pig" is functioning.

Two years under development at the Naval Medical Research Institute at Bethesda, Md., the system has proved successful with pilots 60 miles away from the ground recording station. The higher a pilot goes, the farther the beams will reach, as the range of the wave is limited by the curvature of the earth. A pilot flying at 100,000 feet could be "watched" from 400 miles away.

Navy flight surgeons know that a pilot fails nine times as often as an engine or an airplane in flight. If they can avert such failures and learn why they occur, months of patient research, millions of dollars, and pilots' lives will be saved. ★ ★ ★

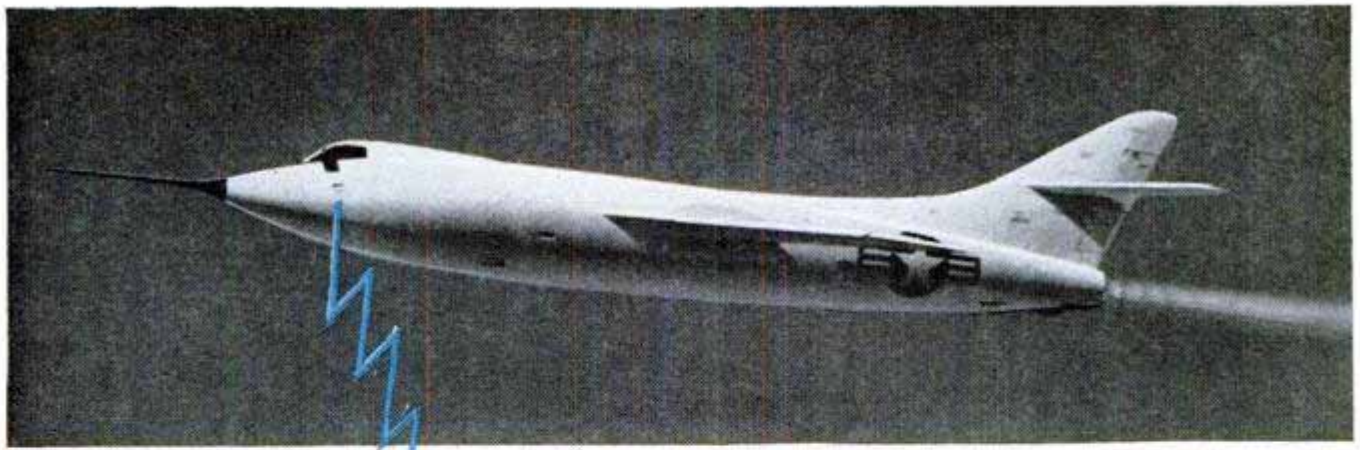

Telemeter in plane cockpit relays pilot's condition to ground. Plane above is the Skyrocket, world's fastest



Before a bank of receiving instruments, a technician examines inked graph of pilot's reactions. Beside him is an oscilloscope. At right, doctors tape electrodes to pilot's body. In pilot's lap is relay box. Below, human centrifuge previously used to test reactions of pilot under conditions similar to those of actual flight

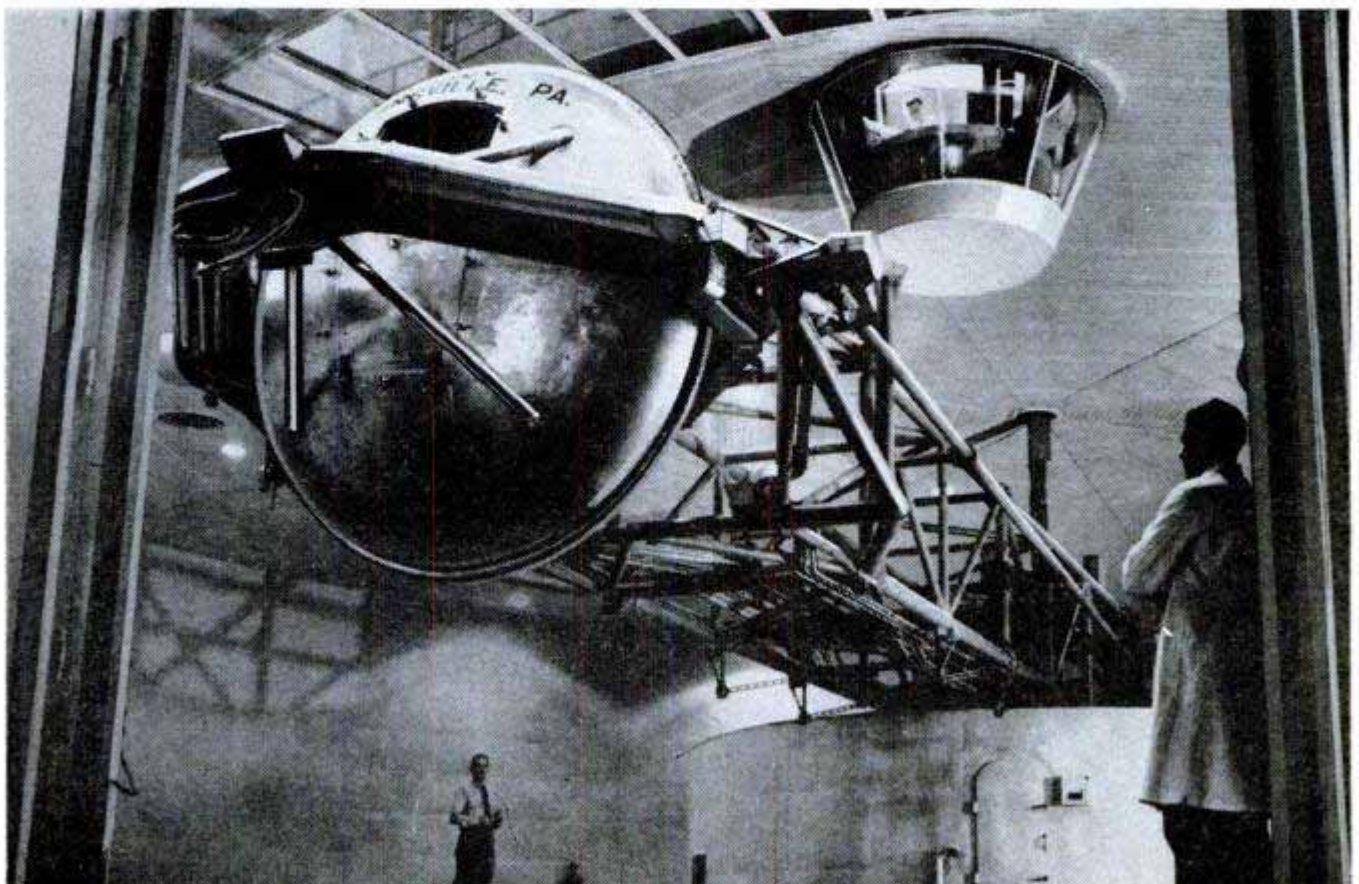

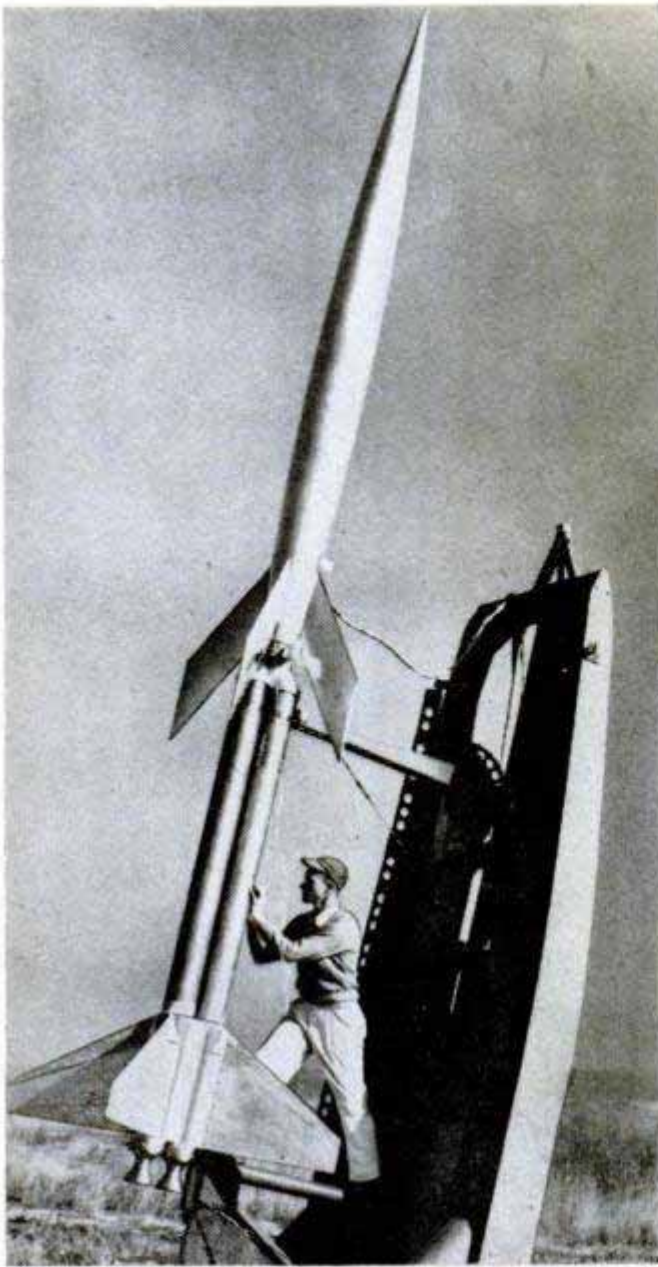

## Rocket-Powered Guided Missile Exceeds 2600 Miles Per Hour

Three rockets combine forces to give a new research missile a top speed exceeding 2600 miles per hour. Two rockets boost it to supersonic speed before a third, inside the missile, is ignited to increase the speed to four times that of sound. Tests of the 14-foot magnesium model are being made at the Pilotless Aircraft Research Station on Wallops Island, Va.

## High-Riding Cyclist Runs Perilous Course

Looping the loop 140 times per minute, half of a French acrobatic team revolves on his motorcycle in a cage high above the theater stage. Meanwhile, his partner strains to support and balance the swaying load. Motorcycle, cage, pole and rider weigh 529 pounds. "The Minivers" recently appeared at the Apollo Theater in Düsseldorf, Germany, where eager news photographers lay supine on the stage to shoot good action pictures.

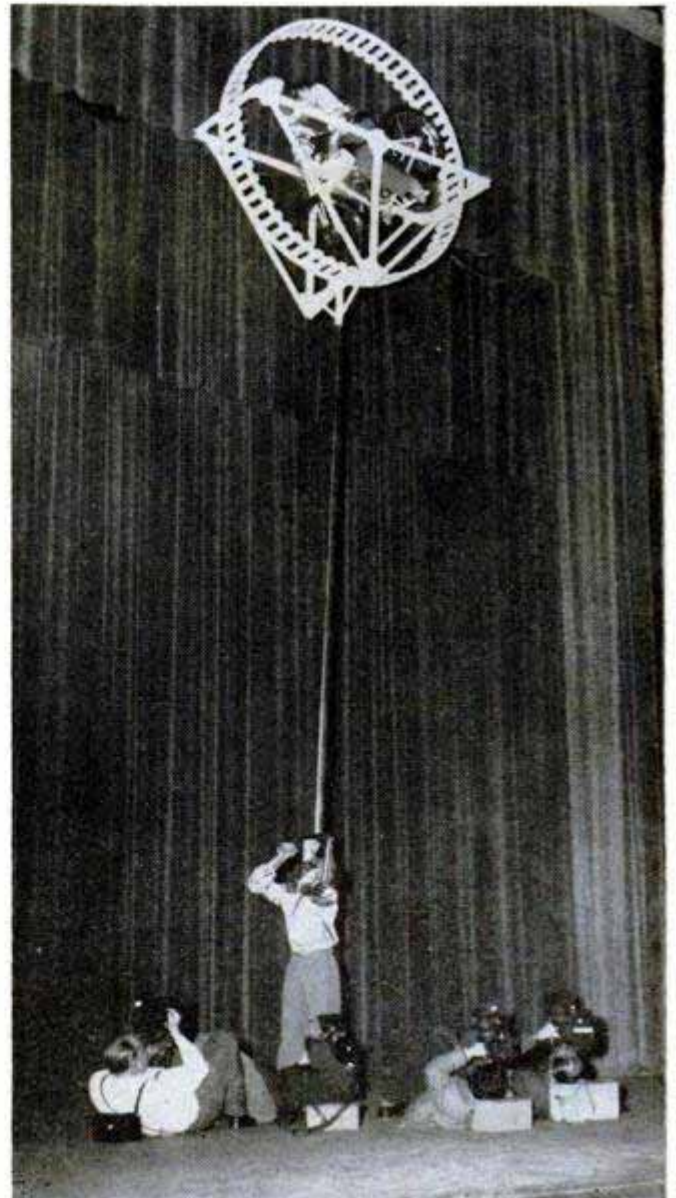

## Vapor Can Softens Paintbrushes



Paintbrushes are kept soft and flexible in a new airtight fiber storage container. The felt liner is first soaked in a liquid solvent which evaporates in the can and dissolves the paint on stiff brushes. Up to six brushes may be hung inside the container.

Eighteen times as many Americans hold civil pilot's licenses today—a total of 580,000—as were held before the start of World War II.





### Portable Grain Conveyor Simply Shoves Into Bin

Only four inches in diameter and 11 feet long, a 24-pound grain conveyor moves 400 bushels per hour. The projecting shaft at the upper end holds a 1/2-inch electric drill which powers the auger as it pushes grain through the pipe. Designed for small jobs where a scoop shovel would otherwise be used, it is useful in moving grain from wagon box to bin, or from storage bin to wagon. Plans are to manufacture the conveyor after more on-the-farm tests are made.

### Teletypewriter Reels Off 100 Words Per Minute

Clicking out 100 words per minute instead of 60, an improved teletypewriter will go into civilian service as soon as vital military orders are filled. The machine is quieter in operation and requires less maintenance than current machines. Type face is quickly changed and the ribbon lasts twice as long.

### Piccard Bathysphere Mounts Huge Tank

Launched with the aid of a 500-ton naval crane at a shipyard near Naples, Italy, a bathysphere built for Swiss scientist August Piccard is designed to probe unexplored ocean depths. Mounted on the bathysphere is a huge, cigar-shaped section composed of water-tight compartments where a quantity of special gasoline is stored to give the craft proper buoyancy. The bathysphere itself is equipped to house the professor and his son during their observations. The unit was built especially for a descent to 13,000 feet in waters off the Italian coast. A trial descent to 3608 feet required 20 minutes.

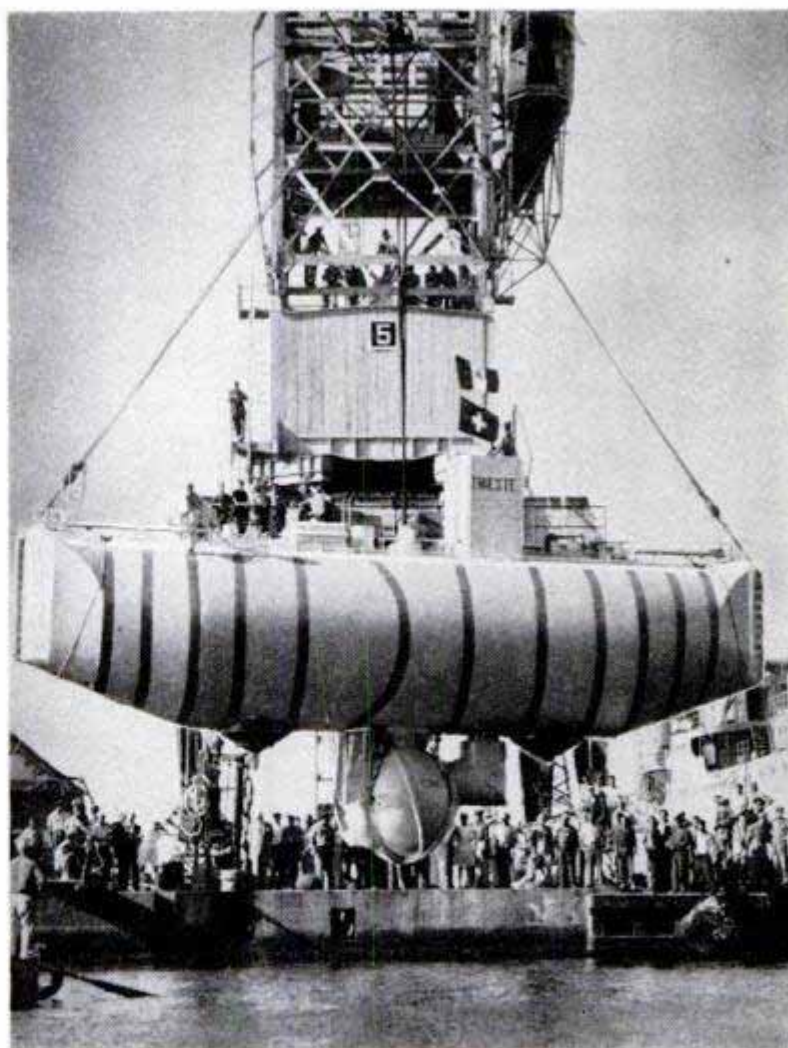

Sources of supply for available products described in this issue are listed in the index starting on page 14. Sources of further information on other articles in the magazine are listed in the WHERE-TO-FIND-IT LIST, which is available without charge from Bureau of Information, *Popular Mechanics*, 200 East Ontario Street, Chicago 11, Illinois

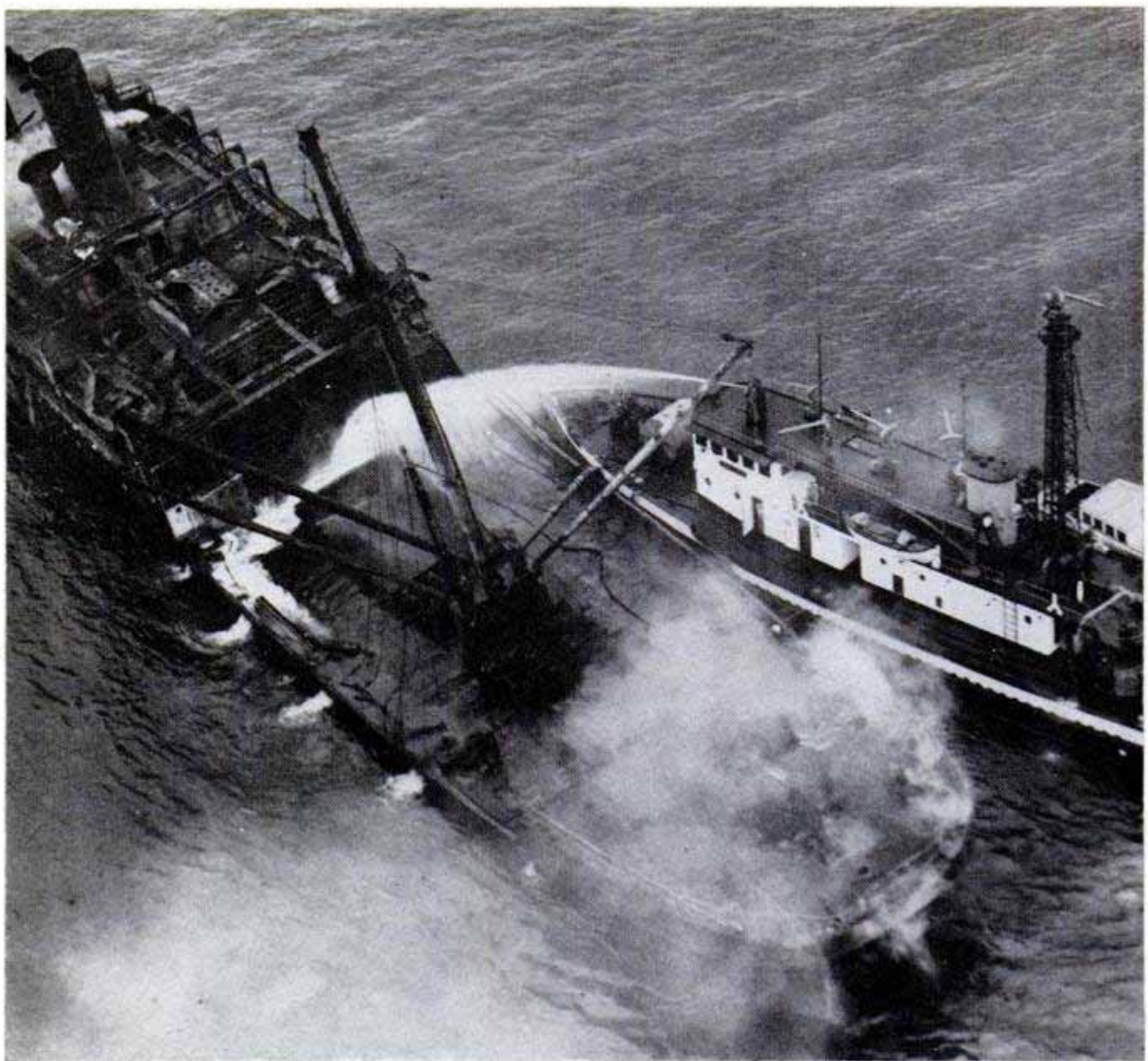

New York Daily News photo

Monitor on fireboat pours a river of water aboard the SS Panuco, her hold an inferno of blazing sisal

## SMOKE-EATERS WITH SEA LEGS

By Richard F. Dempewolff

**T**HE STACCATO CLANG of a bell taps out a signal code in the offices of Engine Company 57. The fireman at the desk snaps alert and riffles quickly through a card index that tells him the exact "box" from which the alarm signal is coming. "We go!" he yells as the last tap sounds. "Box 1395, Brooklyn."

Firemen, snatching on hats and rubber coats as they run, converge on a stairway. There is a brass pole in this firehouse, but no gleaming red trucks or pumpers. This is a pier jutting into the Hudson River at the foot of Manhattan. Alongside, the "engine" sways on the swell. She looks like an over-size tugboat except for the nine big monitors mounted on her superstructure like

antiaircraft guns, and the spiring water-tower. As the men scramble aboard, lines already are being cast off. Seconds later the mighty *Fire Fighter*, claimed to be the most powerful fireboat afloat today, noses into the river on another mission.

No one ever knows what kind of job will be waiting. It may be a vast waterfront blaze, like the Staten Island ferry terminal blaze a few years ago that consumed acres of buildings; a supercatastrophe, like the Black Tom explosion; a blazing oil tanker drifting toward a pier laden with explosives; or perhaps a helicopter pilot has dunked in the river, a boat is adrift, or someone has fallen off a ferryboat. It's all in a day's work for the men of the Marine

Division, New York City Fire Department. "It may not sound so tough," Marine Division Chief John Holian will tell you, "until you know that the port of New York consists of eight bays, four rivers, four straits and 578 miles of shoreline—most of it highly combustible. There are some 720 piers for major ships, constantly heaped with explosives, gasoline, ammunition and flammable sisal for making rope. The shores are lined with petroleum farms, refineries and warehouses. That doesn't count the Jersey coast, which we help protect."

More than 10,000 big ships came and left the harbor last year, bringing in about \$6,500,000,000 worth of cargoes. So the security maintained by the city's Marine Division affects the entire world.

To protect this potential pyre from the carelessness of its own makers takes the combined efforts of 10 marine companies under Chiefs Holian, Martin Carrig and George Carlen. Between them and nine big fireboats, they can muster the fighting power of 150 land companies, plus numerous hook-and-ladder and rescue units. And soon they'll be doing better.

Right now, on the ways of the John H. Mathis shipyards in Camden, N. J., a sleek 129-foot hull of welded steel is taking shape. Designed by naval architect John H. Wells, under the close supervision of New

*Fire Fighter has launch to carry hose between boat and fiery pier*

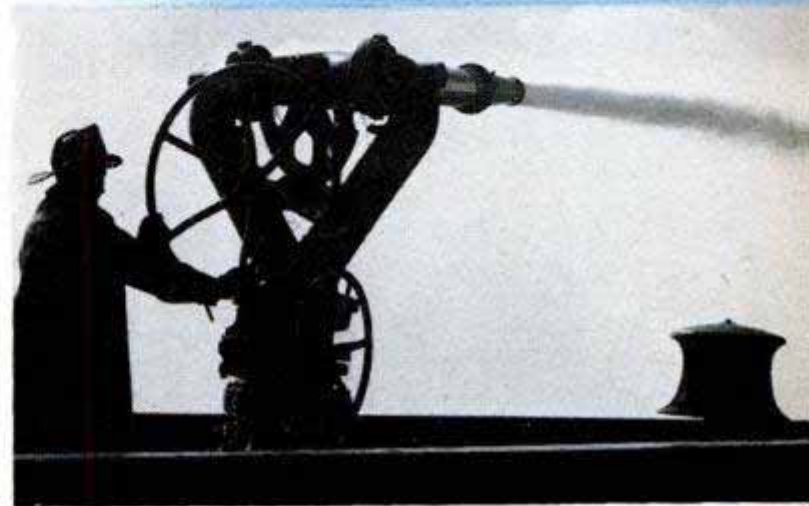

**Bow pipe is an artillery piece that shoots water**

**20,000 gallons of water per minute shoot from monitors and rail pipes as Fire Fighter greets incoming vessel**

*N. Y. Fire Department photos by Hellriegel and Heffernan*

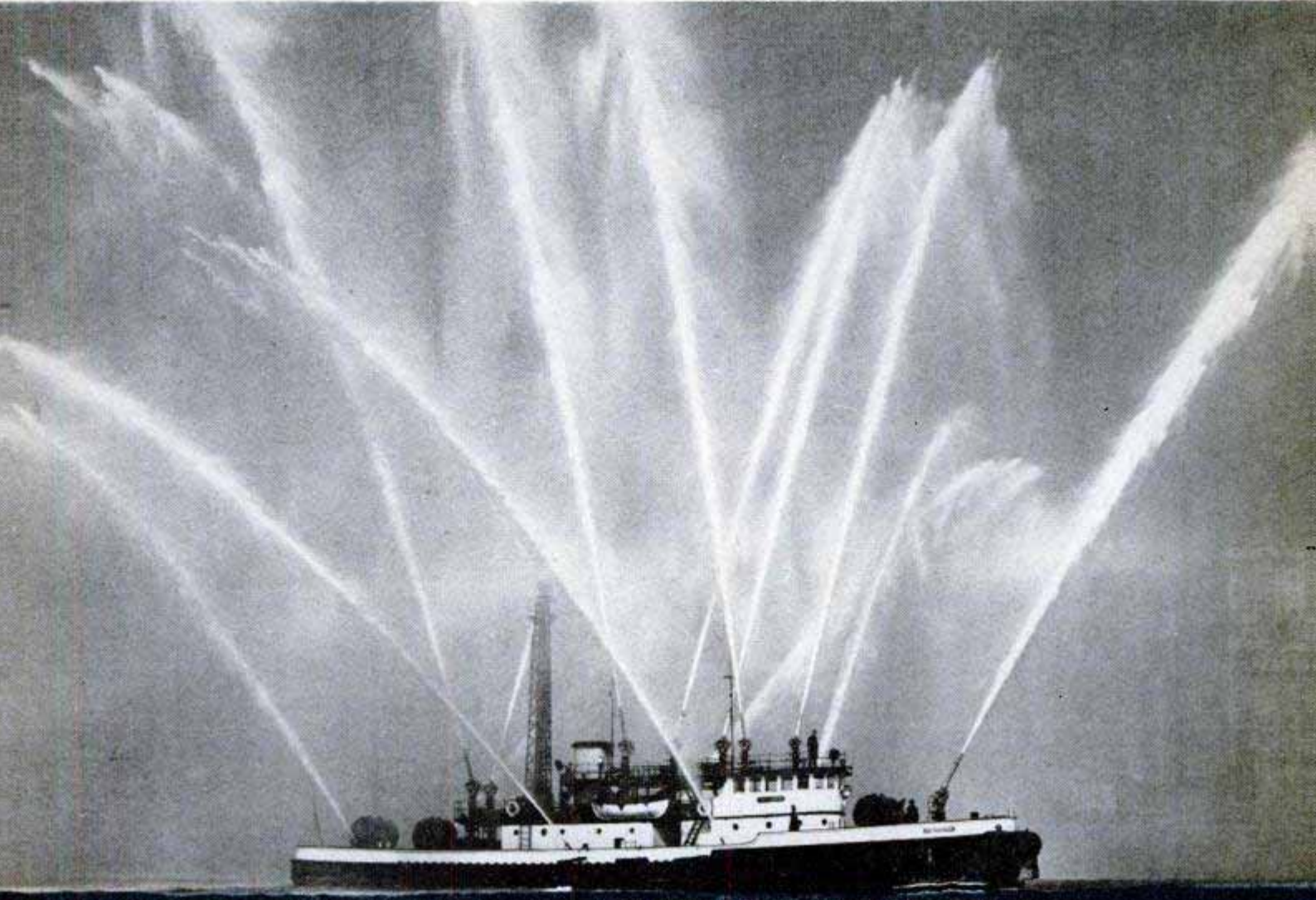

York fire commissioner Jacob Grumet, fire chief Peter Loftus and public works commissioner F. H. Zurmuhlen, the tough new \$1,426,053 fireboat will contain every device and improvement that modern marine fire-fighting techniques and shipbuilding science can put in her.

Four separate diesel power plants, whipping up a total of 4000 horsepower, will propel her and drive her pumps simultaneously. This means that while her four massive centrifugal pumps are shoving a Niagara of 14,000 to 18,000 gallons of water per minute, at 150 pounds pressure, through her six deck monitors and 16 hose connections, the other set can spin the twin screws that send her along at a 16-mile-per-hour clip. "Anything faster," the men explain, "would create a wash capable of doing as much damage to some waterfront structures as a fire."

The new fireboat's twin screws will be raised up inside a unique tunnel in her stern, above the craft's nine-foot shoal draft. Hence she will coast easily around the city's shallow bay waters without danger of banging up the propellers on submerged rocks or debris. What's more, if she should go aground she'll still have power to pull herself free.

Besides her six big monitors, the new vessel's topside armament will include a 53-foot tower strategically located forward instead of aft of the stack. Radar will guide her in bad weather. Her blunt seagoing hull will enable her to go out to ships afire

on the ocean and to nudge ships away from burning piers. And down in her hold there will be tiers of special beds for fire victims.

The team that this superseagoing fire engine will join is a smooth, grimly efficient little navy. In the gloomy recesses of Pier One where Chiefs Holian, Carrig and Carlen direct their tactical wars against fire, you can see how it works. Each fireboat has its own berth—strategically spotted at some distant pier on the vast waterfront. Each guards a separate section of harbor, responding to alarms pulled in that territory. The 132-foot *Fire Fighter*, 14-year-old queen of the fleet, is berthed at Pier One, for instance. Her territory includes all of lower New York, near-by New Jersey, Staten Island and parts of Brooklyn. Each crew shift, manning her around the clock, includes six firemen, one officer, three engineers (all of them trained firemen) and a pilot.

"We don't always wait for alarms," Chief Holian explains. "When an oil storage plant in Hoboken blew up recently, we saw the explosion and took off. The alarm came through when we were half way across the river. Frequently we see river boats in trouble and go to their rescue."

But most often it's the tapping bell that sends the men running. Last year the *Fire Fighter* made 200 runs, of which 72 were false alarms—nine of them listed in the log as malicious.

When that bell taps out a *Fire Fighter* box number, Pier One explodes with ac-

**New fireboat will have six big monitors, a 53-foot tower and radar for navigation during foul weather**

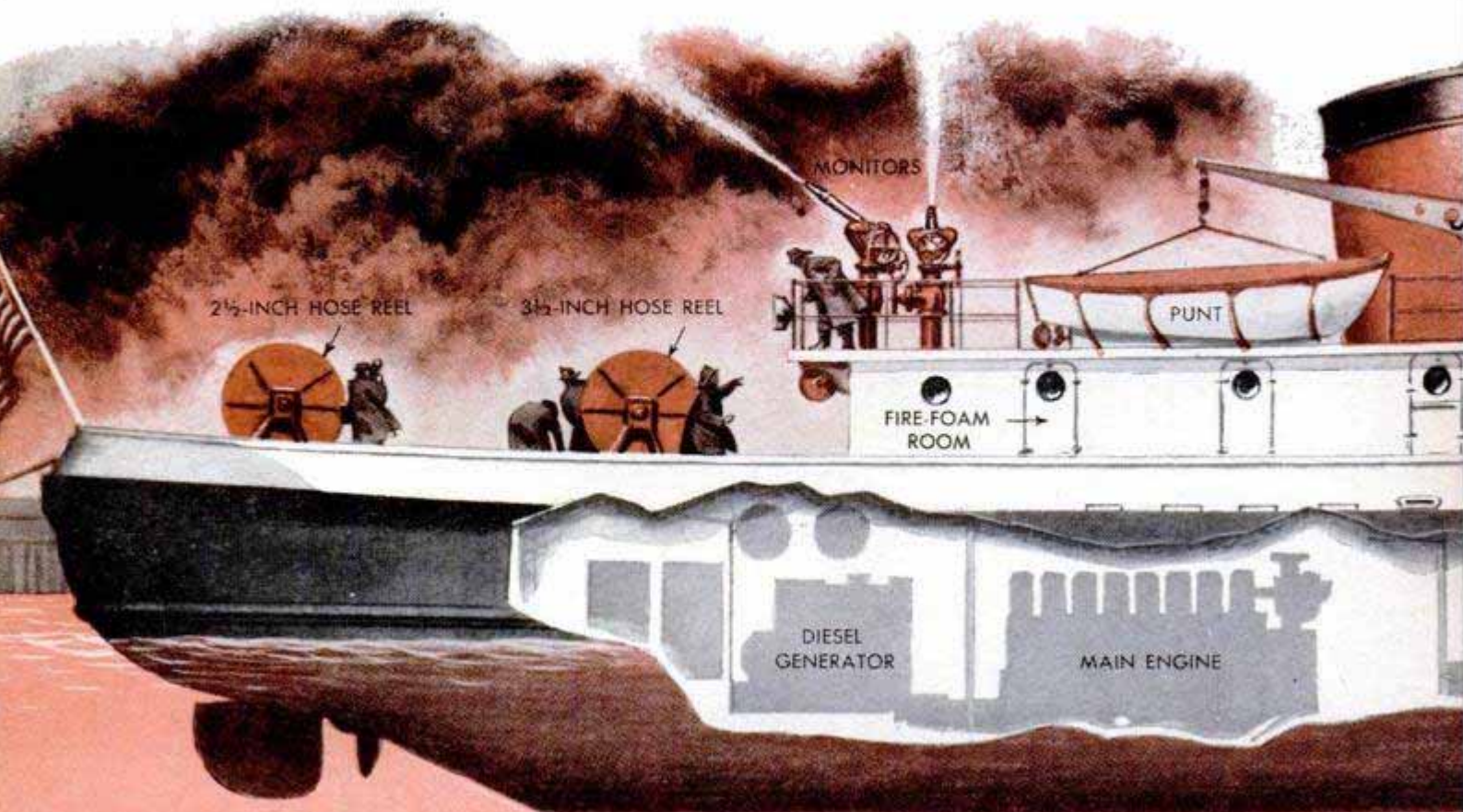

tivity. Within minutes (180 seconds is her best get-away time) lines are cast off and the big boat is moving. Down on the stern deck, rubber-coated men break out hose in 50-foot lengths. Ends are hitched to an array of 24 hydrants that project from two manifold hubs jutting up through rear-deck plates. Down in her engine room, powerful pumping engines are being warmed, ready to roar up the power that will send 20,000 gallons of water per minute at 150 pounds pressure gushing from her monitors.

Up in the pilothouse, the lieutenant is making contact with headquarters on the short-wave radio system. Over this radio net, strategies are worked out while fire fighting is in actual progress. "Suppose," says Lieutenant Albertella, "we have a pier fire that's too big for us. A call to headquarters will bring more boats on the run. With his radio, the lieutenant can maintain constant contact with his division chief—whether the chief is back at headquarters, or circling near by in the Marine Division's big tender—the *Smoke*."

Like any Marine fire company, the men at Engine 57 have tremendous pride in their "engine." They brag about the high-pres-

sure output of her monitors. It's something to brag about.

Shooting 8000 gallons per minute at full 300-pound pressure, the big five-inch bow pipe alone recently punched a huge hole through the 14-inch poured-concrete wall of a pier. It can send a pier roof flying. Last year, the fireboats fought a stupendous blaze in the Brooklyn coal docks. In three hours, one pier was nothing but a charred pile of steel beams, massive timbers, twisted steel sheets and crumpled heaps of smoking debris. Wrecking companies estimated two weeks to clear the mess from the concrete base of the pier. The *Fire Fighter* moved alongside and opened her bow pipe full blast. "Twelve by twelve timbers flew through the air like matchsticks," the men recall. "Steel beams and sheets flipped end over end into the water." In three hours, the pier base was clean as a whistle.

Piers laden with everything from chemicals to TNT, have provided New York's fireboat crews with some of the most spectacular jobs on record. Sitting down in the crew's quarters of the *Fire Fighter* between jobs, Fireman Jim McKenna and his mates spin tale after vivid tale. The roughest one the men recall was back in 1943 when, despite all efforts, Pier 4 in Hoboken burned to water level. The *Fire Fighter* arrived to find great stores of camphor, sisal and coal sizzling under a pall of smoke. This was one time when the big monitor appeared

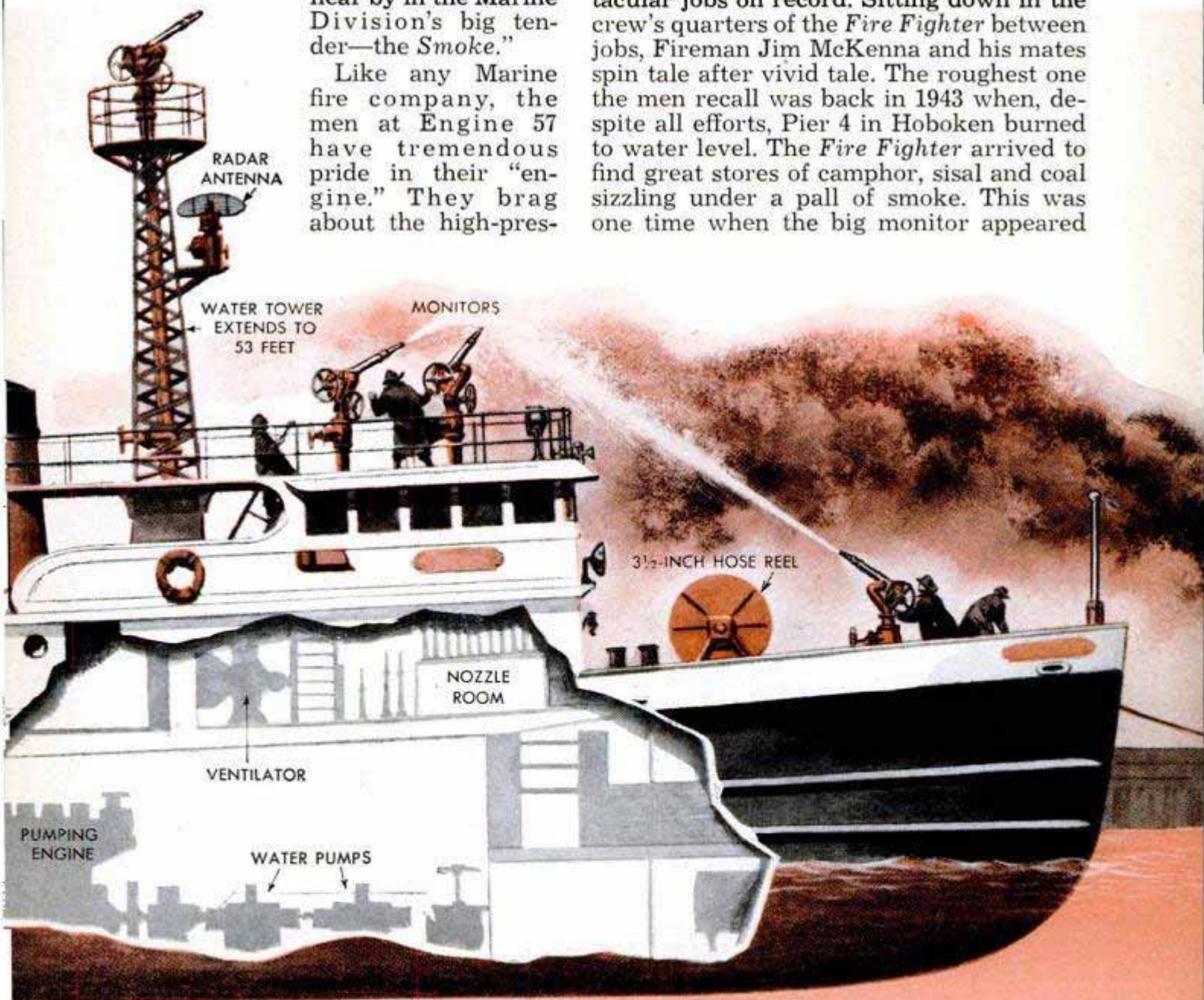



N. Y. Fire Department photo

**Fireboats and tugs work side by side to keep a burning ship in position while they pour water aboard**

to do too good a job. One blast and the pier wall ripped wide open. Out poured billows of smoke, blinding everyone on board. Crew after crew went down. One gang would be carried away while another took its place at the monitors. "Every man in Engine 57 wound up with conjunctivitis from that feed," McKenna recalls.

Pier fires, like the Grace Line blaze that

made headlines a couple of years ago, have a nasty habit of creeping along through the creosote and oil-soaked piling under the concrete floor and bursting out in new places. To get at these "creepers," the men use special equipment and techniques. Wearing their masks and air bottles, two or three firemen invade the burning structure. Hose is stretched in by one man ahead

of the others—to clear the way. Another carries one of the fireboat's pneumatic chisels. With it he will chew a series of holes through the concrete floor. From the boat's "gold room" up under the pilothouse, which contains a glittering array of polished brass nozzles, a "distributor" nozzle is selected for the job. This gadget, which comes in several huge sizes and types—including one designed by Chief Holian—works like an overgrown lawn sprinkler. Attached to the end of the hose, it is poked through the hole nearest the underpier blaze and set swirling, scattering thousands of gallons of water.

When this doesn't work—as it didn't at Grace Line's pier—the men break out their punts. Each fireboat has one of these heavy wooden bathtub-shaped boats lashed to her deck. The craft are jet propelled. A porta-

**Hydrant outlets—24 of them—jut from two huge manifolds aboard the Fire Fighter. Men connect 2½-inch hose to fight pier fire**



ble pump is loaded aboard. The water it sucks from the river is spewed out at 100 gallons per minute through two nozzles held by the fireman. By directing one stream over the stern, he can force the punt ahead and steer it through the smoke between the pilings until things get hot. Once there, he can hold position and turn his other portable stream on the blaze. These baby fireboats are also used for "stretching" hose across open water between the fireboat and a burning pier. But they're not too popular with the men. "It's rough duty," one of them points out, "when you've got five inches of ice water in the bottom on a freezing night and the back pressure is shoving you around like a crazy waterbug beneath a burning pier. If that's not enough, there's always the chance that pilings are so far gone a whole section may collapse on you."

Heroes come by the gross in this business, and the *Fire Fighter* has had her share. At this same Grace Line pier fire, she was tied up to a stringpiece to hold her close, against the back pressure of her roaring monitors. Suddenly the entire 1000-foot stringpiece burned loose and swayed toward the boat. In the face of being crushed to death, Fireman Peter McNulty leaped to the cracking timbers and raced to loosen the lines that held the boat fast in the fatal trap. He had just heaved

the last rope free and watched the *Fire Fighter* back off to safety when the massive stringpiece crashed over—taking him with it. Two buddies, Joe Evans and George Wissing, fished him out from under the broken timbers.

It wasn't the *Fire Fighter's* first threat of being squashed into the harbor bottom. The great *Normandie* almost sat on her, too. "We poured so much water in that ship to douse the fire in her," McKenna recalls, "that she developed a list. Then the tide went out. Pressure from the monitors on our boats had shoved her tight against the pier. She came down on the undredged edge of her berth and slowly tipped over on the *Fire Fighter*. We knew she was coming and we were ready, but for a minute we were snagged, while our crews whipped up full power and all hoses were cut. Then, suddenly, part of our snagged bow snapped off, and we popped out from under the burning liner just as she rolled over."

You can see the need for the rugged tug-boat-type construction of these boats as the men tell tales of the pounding they take. In 1902, the *William L. Strong*—an old coal-burning fireboat that the new one will replace—was fighting a catwalk fire on the towering Williamsburg Bridge when the whole walk cascaded into the water, missing her by inches and flipping her up on

Land engines and a fireboat form an efficient team to fight a smoky naphthalene fire on a pier in Brooklyn  
N. Y. Fire Department photo



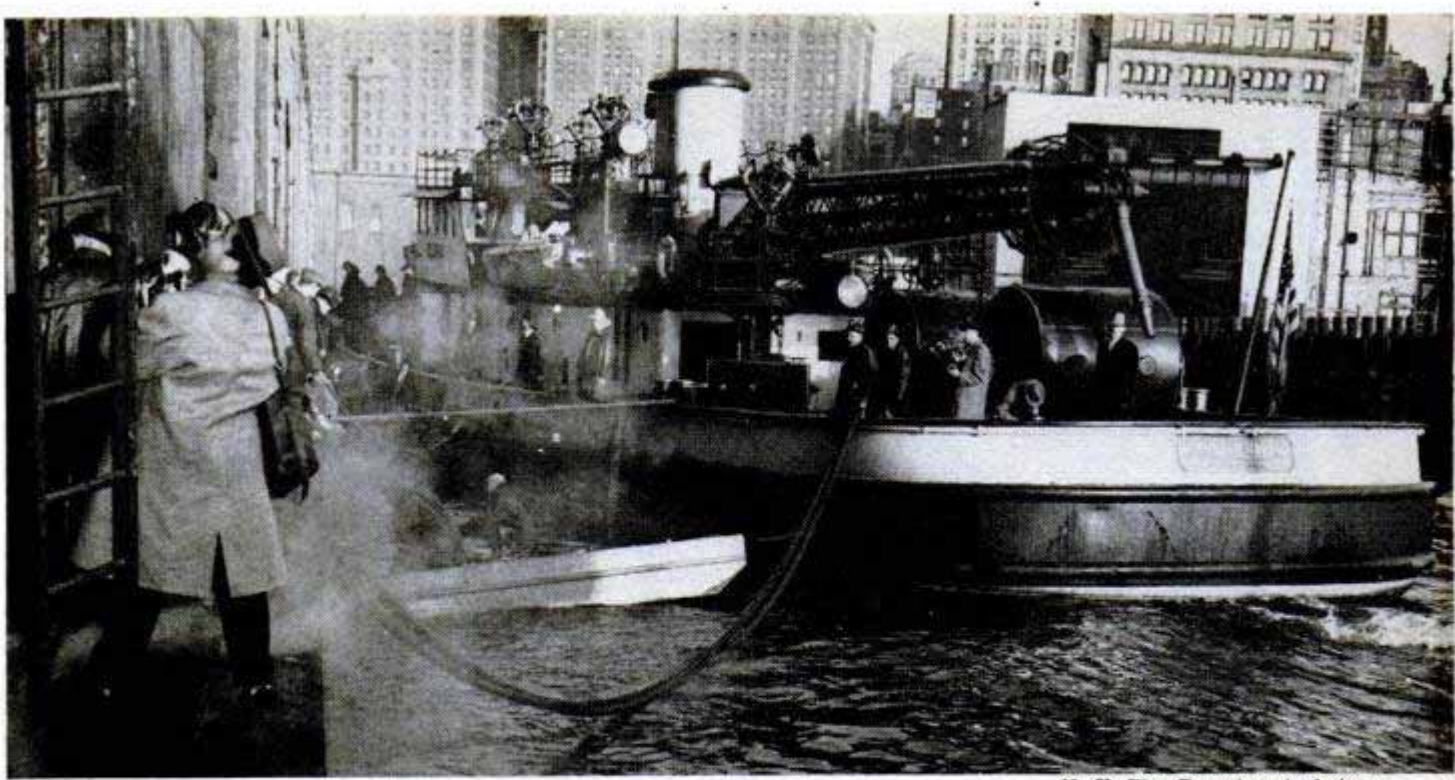

N. Y. Fire Department photos

Man in punt has already stretched line from boat to blazing pier. Now he heads underneath to check pilings

her beam end. The same boat shuddered under the explosion of a heavy-caliber shell that went through her stack when she was fighting the Black Tom explosion fire in 1928. Another fireboat, the *Thomas Willett*, narrowly escaped a watery end while attempting to drown a fire on a freighter, discharging nitrate and canaries at a pier. "Suddenly the nitrate let go with a wham that tore the ship apart," the boys recall.

Fighting a fire in a forest of blazing pilings is close, dangerous work. Men sometimes power and guide the boat with stream from a hose

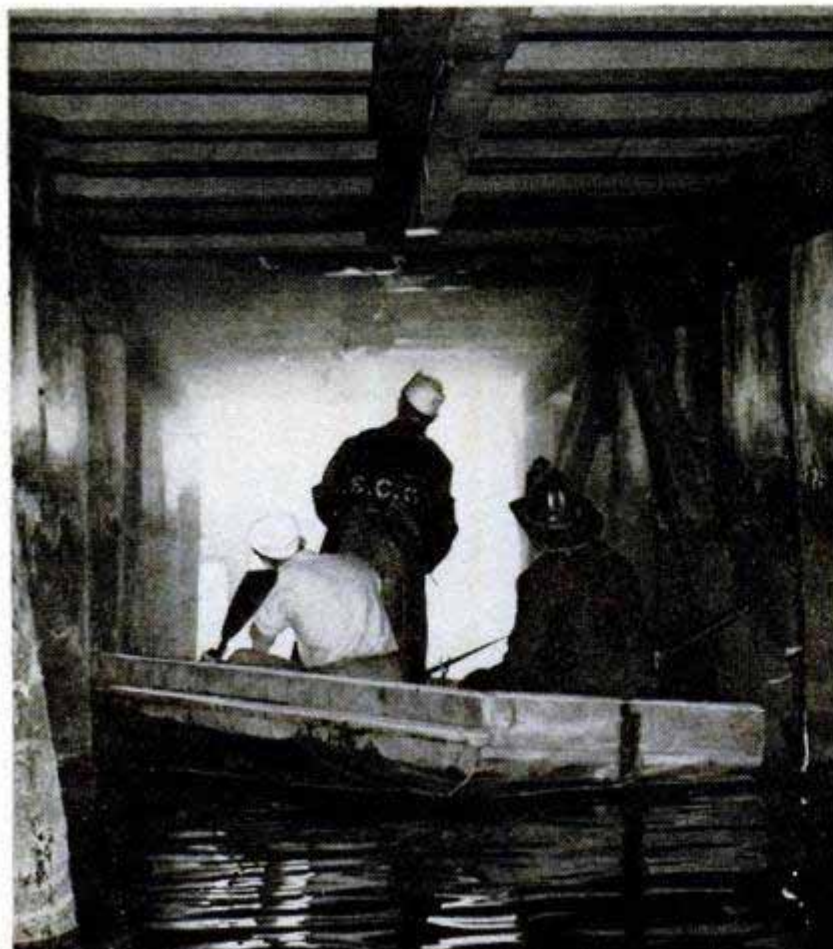

"A half-ton hatch cover soared through the air, whacked into the *Willett's* pilot-house, carried it away with one swipe and killed Pilot John J. Harvey. Two men were blown overboard. The explosion blew a hole in the water right under the *Willett*. She dropped 10 feet. Water closed over her, but she surfaced like a tough old whale, spilling water from every cranny."

There are plenty of times when fireboats must perform actual tug duty. For instance, when the SS *Panuco* was unloading sisal at barge-crowded Pier 26 in Brooklyn recently, someone dropped a lighted match in the excelsiorlike material. Whoom! Within seconds fire raced through the sisal from pier to ship, zipping down into the hold. A minute later it had jumped from barge to barge and two adjoining piers were ablaze. Flames traveled so fast that 45 able and lively men working on the sisal couldn't get out of the way in time. When the *Fire Fighter* moved into this mess, three piers were burning, the *Panuco* was a holocaust and 20 burning barges were drifting loose, carrying the fire all over the harbor. The big fireboat had to tie on to the burning *Panuco*, haul her white-hot hulk to open water and pull out her anchor from the side. Then the fireboat rounded up the blazing barges,

(Continued to page 266)



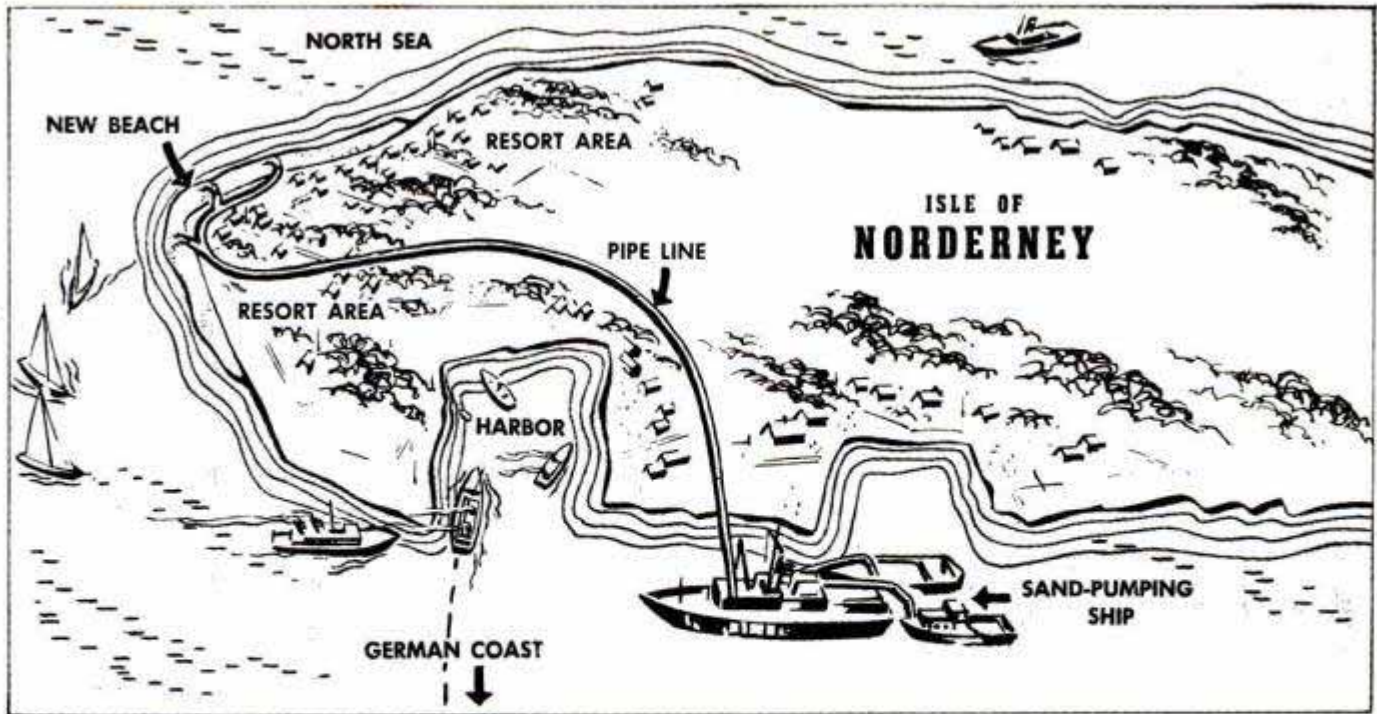

Underwater sand is pumped into barge beside ship, mixed with water, and piped across island to new beach

## Piped-In Sand Forms New Beach

After a tidal wave swept away the sand from a resort beach on the northwest coast of Norderney Isle early this year, sand from the opposite side of the island was pumped across land to re-cover the beach. Pure sand underlies the shallow strait separating the island from the German coast. So shallow is the strait that the ebb tide has been known to leave the sand flats exposed at certain times creating a dry footpath to the mainland. Pumps mounted on a steamer in the strait sucked up sand which was deposited in a barge alongside the ship. There the sand was mixed with water and the resulting mixture was forced through a pipe line that stretched the width of the island. The pipe line ended in several "mouths" which poured the slurry along the shore.

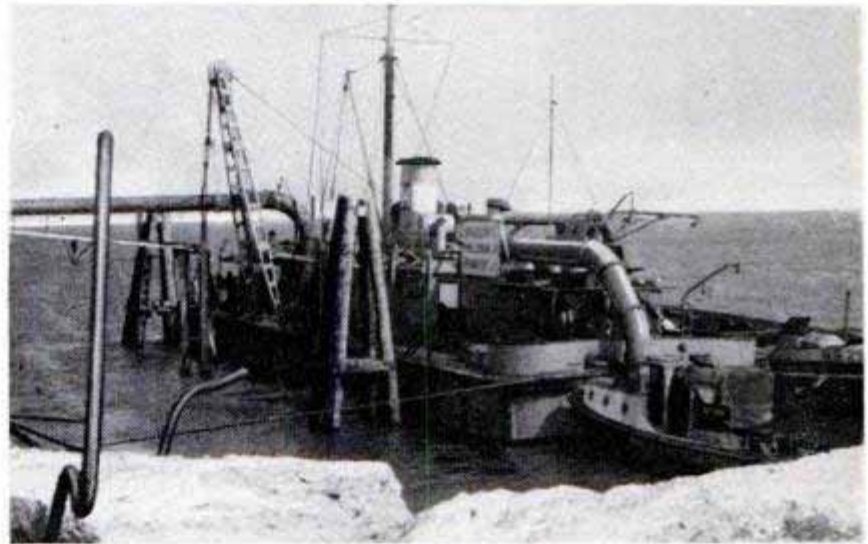

Above, sand-pumping ship. Pipe at left carries sand to shore. Barge is behind ship. Below, sand pouring from pipe line onto rebuilt beach

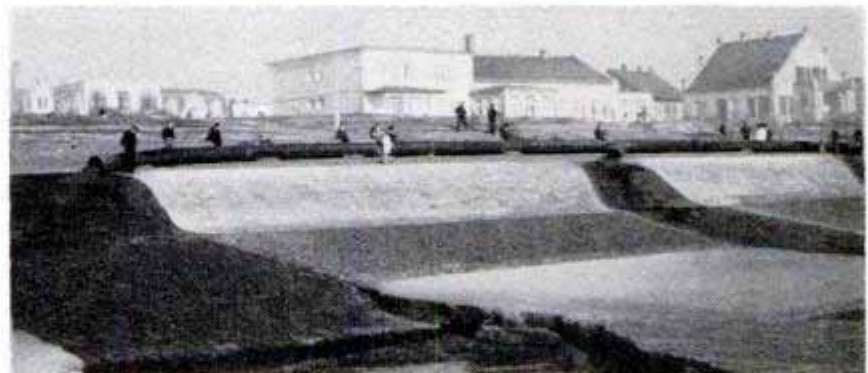

## "Jammer" Sends Messages While Interfering With Enemy Reception

During World War II, radio messages were sent by a secret method that eliminated enemy interception. The method was revealed recently when the inventor was granted a patent. The system fooled the enemy by making him believe the transmission was for the purpose of jamming his

own radio signals. Two transmitters and two receivers are used. One transmitter sends out a jamming pulse at regular intervals, and the other sends part of a message between the pulses. One receiver hears the jamming pulse and utilizes it to trigger the other receiver into operation.



### Silicone-Water Mixture Seals Masonry Walls

Walls made of stucco, concrete or brick will repel water when treated with a new silicone solution. The silicone is available in concentrated form which is mixed with seven parts of water. When this is applied to the wall with spray or brush, it reacts chemically with the water-soluble compounds in the masonry to make the wall water-repellent. It thereby protects against staining, rust streaks, dirt and efflorescence (the white "salts" that appear on many masonry walls). The silicone-treated surface can be painted with oil or water-based stucco paints if desired.

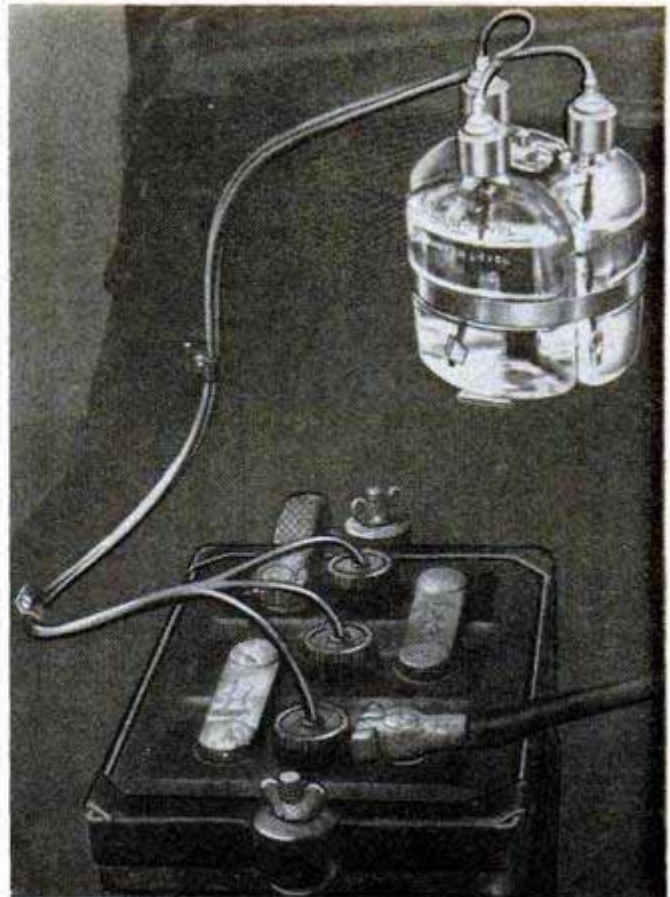

### Nested Water Bottles Fill Battery Automatically

Three nesting bottles mounted under the hood keep automobile batteries supplied with water automatically. The water is carried to the battery cells through three plastic hoses, one for each cell. The bottles can be mounted anywhere in the engine compartment, either above or below battery level. Heat from the engine expands the air in the bottles, forcing water into the cells and keeping it at the proper level. A slight transfer of battery water back into the bottles results when the engine cools. This acid prevents the water from freezing, according to the manufacturer.

### Portable Manuscript Holder Shifts Pages for Speaker

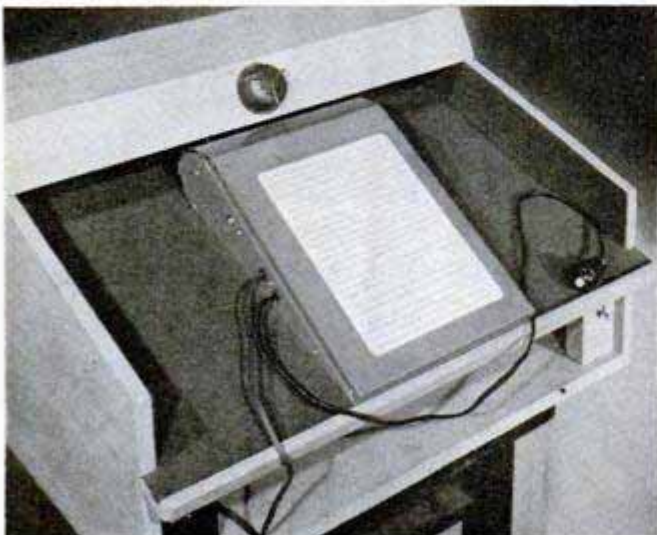

There's no shuffling of the script when your prepared speech is held by a portable electric device. A continuous sheet of paper feeds from a roller at the bottom to one at the top. A control button on the end of a two-foot cord regulates advance of the script. When you near the bottom of a page, you press the button and a new section appears along with the last few lines of the preceding page.

Ground-up nut shells and fruit pits serve as anti-skid agents in car tires, "fillers" in fine plastics, litters for poultry-house floors and blasting grits for cleaning airplane-engine parts.

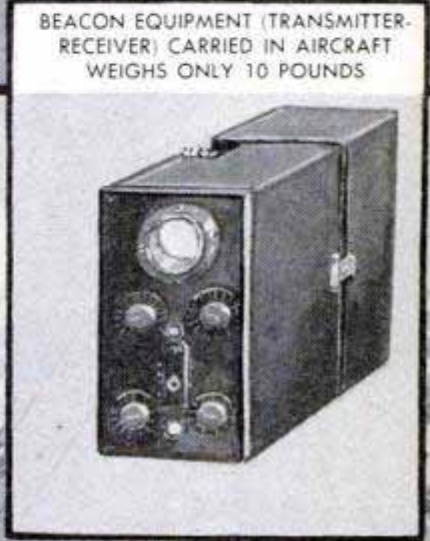
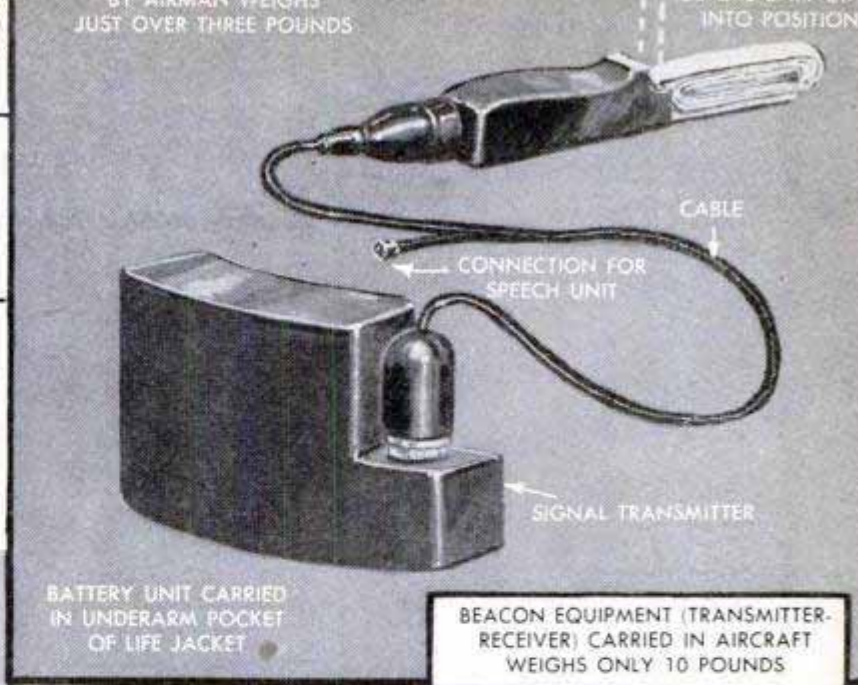
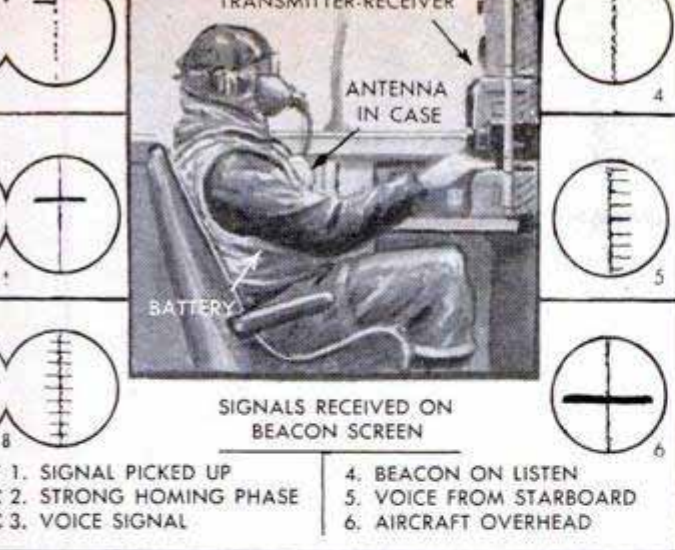

# BRITAIN'S SARAH USES TELEVISION TO RESCUE DOWNED AIRMEN

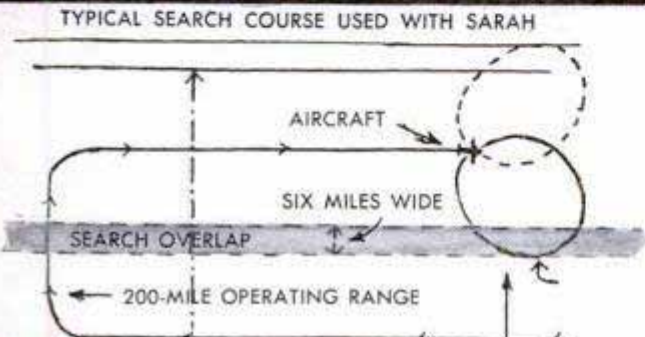
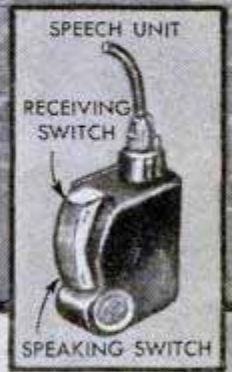
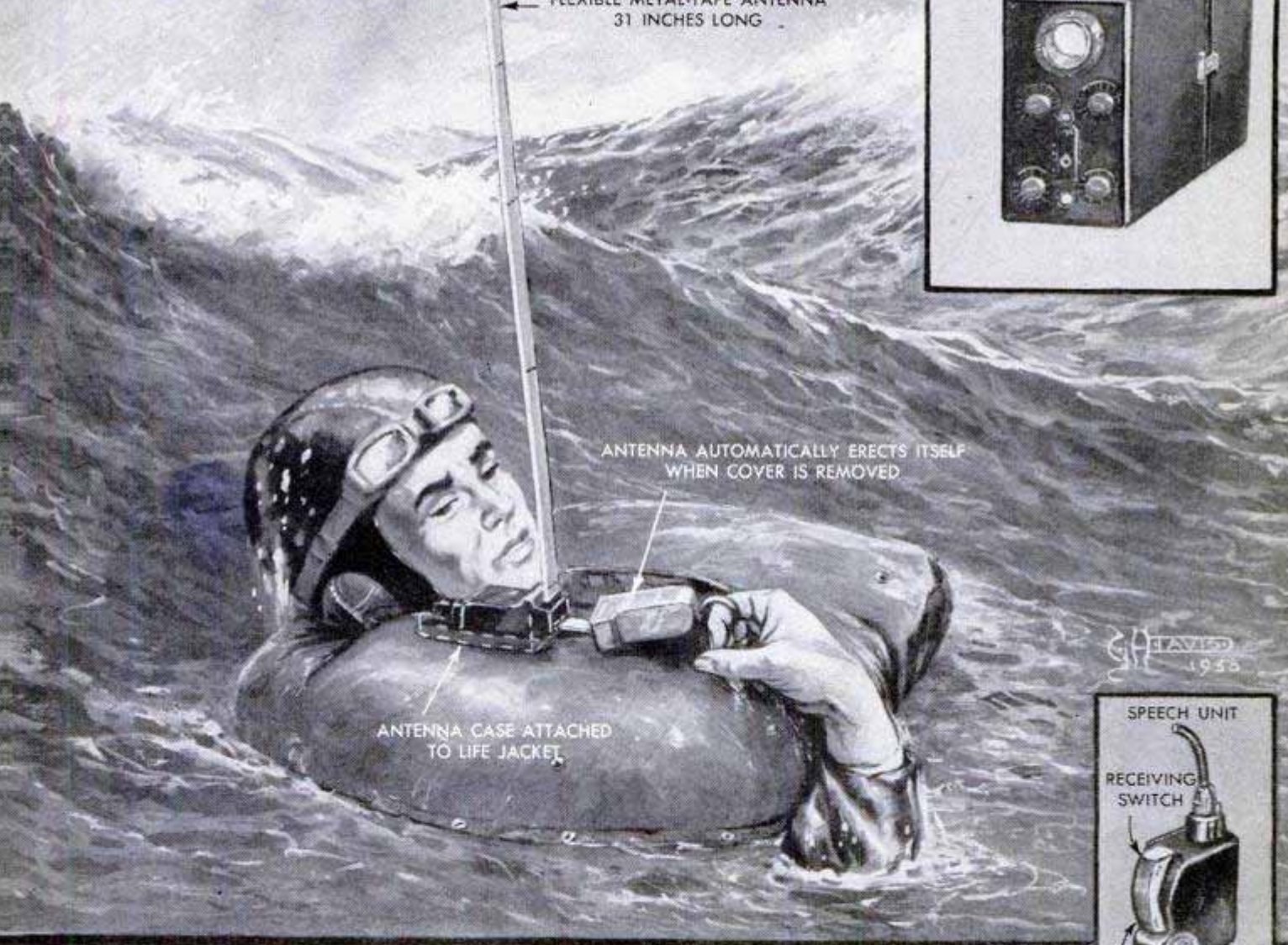

WHAT'S NEW FOR

# Your Home



**ISLAND SINK** for large kitchens is only a few steps away from wall cabinets, refrigerator and dinette. Drainboard running the full length of sink provides abundant working space. Below are roomy cabinets. Built-in outlets permit use of appliances



**FOLDING WARDROBE RACK** holds two or three hats and six coats. When not in use, it folds into a wall fixture only 3¾ inches thick. Neat and compact, the rack leaves floor open for easy cleaning, is suited to entrance halls, bedrooms and waiting rooms

**"COLD LIGHT,"** lower left, illumines clockface evenly, at cost of half cent a year. Clock at right is unevenly lighted by one-watt bulb at 50 times that cost. Cold light results when electric current is applied to phosphor painted on conducting glass

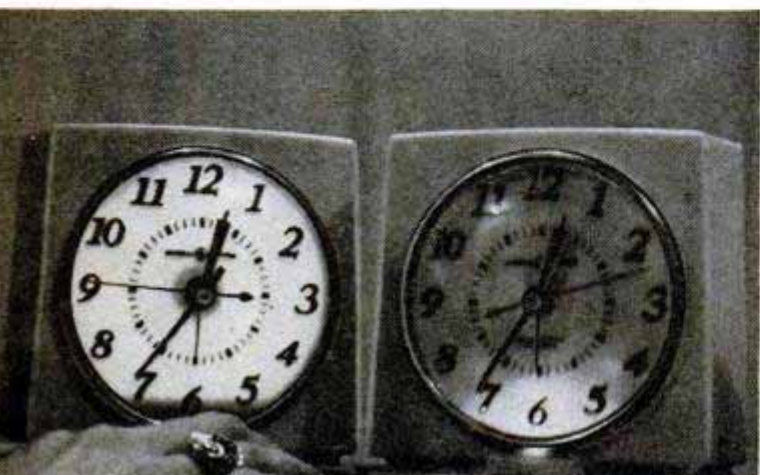

**HOT-ROLL CUTTER,** below, ends shaping of spiral and multileaf rolls by hand. Spiral blade for making pinwheel rolls is on one side and four blades to make four and eight-leaf rolls on other. Cutter is dipped in melted butter before it is used to separate dough





**WALL CABINET** expands into a full-size dining table by means of drop-leaf panels supported by leg frames which swing out from cabinet. Half of one leaf can be used alone as a card table or writing desk. Cabinet has drawers and shelves for storage



**COMBINATION LADDER**, right, can be used as a stepladder, a flat-step extension ladder, a stairway ladder for various-pitch stairways, or as separate straight ladders. Shipped unassembled, ladder is quickly put together in any of various combinations

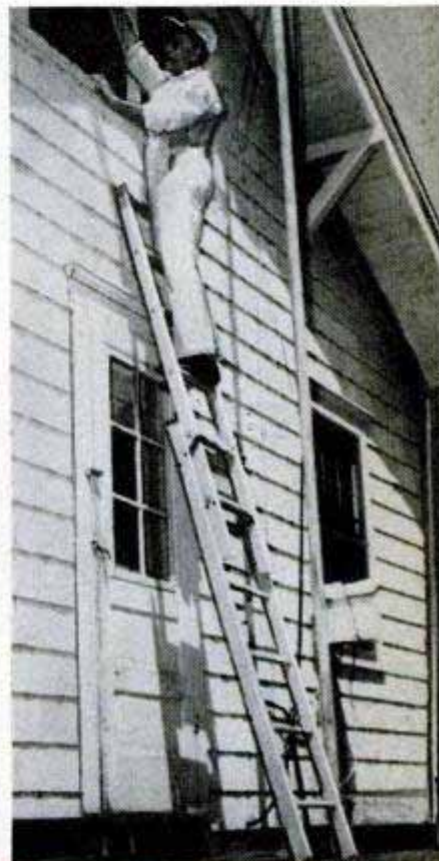

**MIDRANGE GRIDDLE** in both gas and electric models serves as grill or warming plate, or can be removed to expose a giant seven-heat cooking unit for kettles up to 25 quarts. Cover folds down flush with work top, when upright serves as a splasher back



## "Hot Gun" Porcelainizes Surfaces of Bridges and Buildings

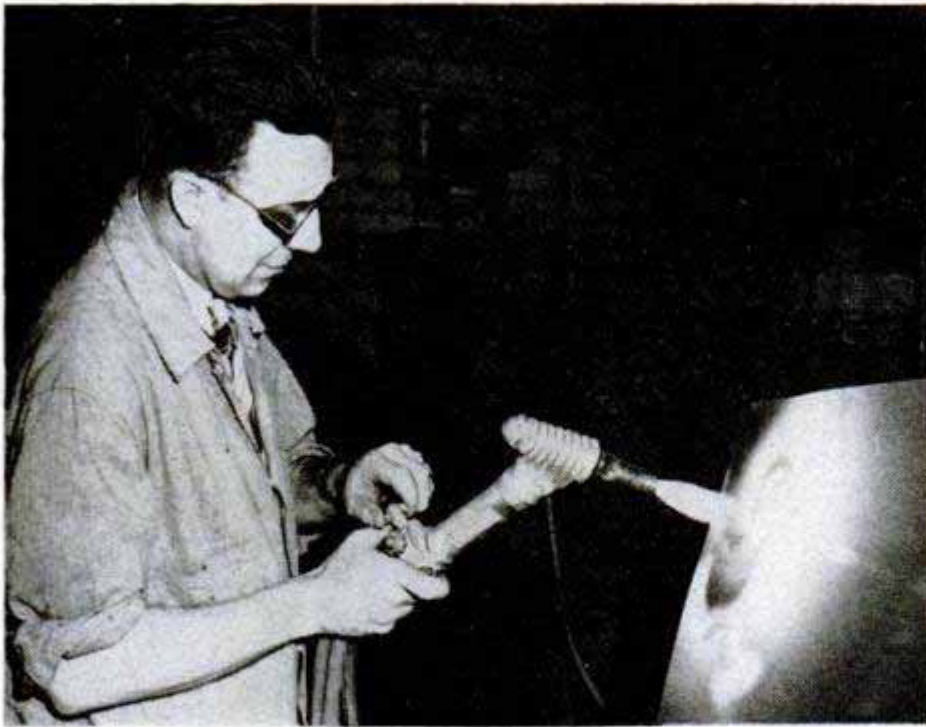

Bridges, buildings and even ocean vessels will be coated with porcelain after they're built if a new spray gun comes into wide use. The gun shoots porcelain material through an acetylene torch and fuses it to steel. The torch preheats the steel surface and then shoots the porcelain material from tiny holes around the nozzle through the 1600-degree flame to melt it. The glasslike surface of the porcelain coating prevents corrosion, simplifies maintenance and is designed to provide long-lasting protection.

## Portable Service Stations Maintain Company Fleet

Cars, trucks and buses numbering in the hundreds are serviced in parking lots at Douglas Aircraft plants by traveling service stations. Each motor-driven unit carries 200 gallons of gasoline, 50 quarts of oil, a large tank of water and an air compressor. One man now services an entire fleet.

Wheeled unit provides water for radiators, right, and air for tires, below, plus gas and oil



## Chicken Sex Determiner

With a new electrical instrument developed in Japan, the sex of as many as 150 chickens can be determined within an hour. Chicken-sex determination has long been a monopoly of the Japanese, but the machine's results are said to be more accurate than those of human experts. More than 500 of the mechanical units have already been exported to the United States.

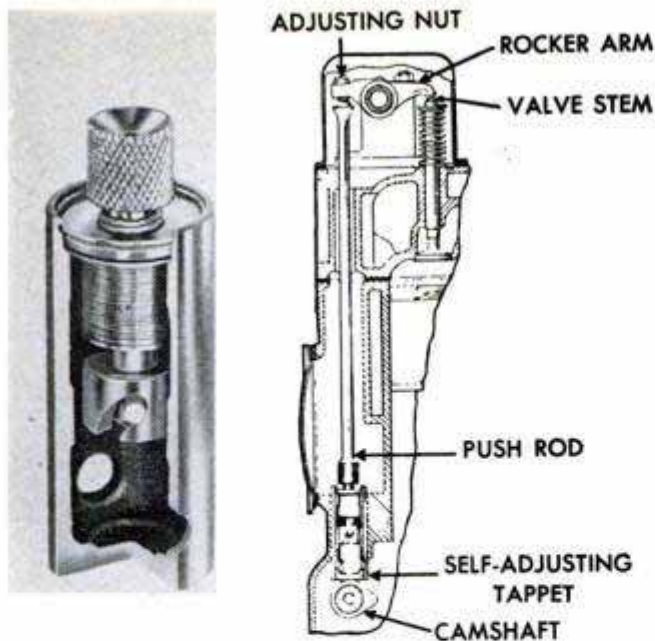

### Self-Adjusting Tappets

Proper valve timing is maintained over thousands of miles of hard driving by self-adjusting tappets that react to temperature changes as well as wear. An internal-tension control automatically adjusts at every piston stroke to variations in the length of the valve-mechanism system. The tappets compensate for expansion and lengthening of the system at high engine heat and for contraction and shortening when the engine is cold.

### Spark-Plug Tester

Spark plugs covered by protective rubber boots are quickly checked with an improved indicator that has a needle probe to perforate the insulation. The probe is withdrawn inside a metal sheath when not in use. The neon tube of the indicator responds to the high voltage and its brightness indicates the condition of the ignition system.

### Gamma Rays Used for Food Preservation Also Destroy Vitamins

Atomic rays used for food sterilization not only kill harmful bacteria but also destroy necessary vitamins, three Columbia University researchers report in the *Journal of Agricultural and Food Chemistry*. It has been proposed that gamma rays be

used to kill bacteria that cause food spoilage, making it possible to keep food indefinitely without canning it. Research on milk indicates that 70 percent of the vitamin A in raw whole milk is destroyed by a six-hour exposure to gamma radiation.

### Refrigeration Blanket Cools Surgical Patient to 80 Degrees

Another milestone in medicine was marked by a recent heart operation in which body temperature of the patient was lowered to 80 degrees. A refrigeration blanket cooled the patient while an electric recording thermometer kept careful track of temperature. Although normally it is impossible to stop the flow of blood through the heart for more than two or three minutes, in the 80-degree state it may be excluded from the circulatory system much longer.

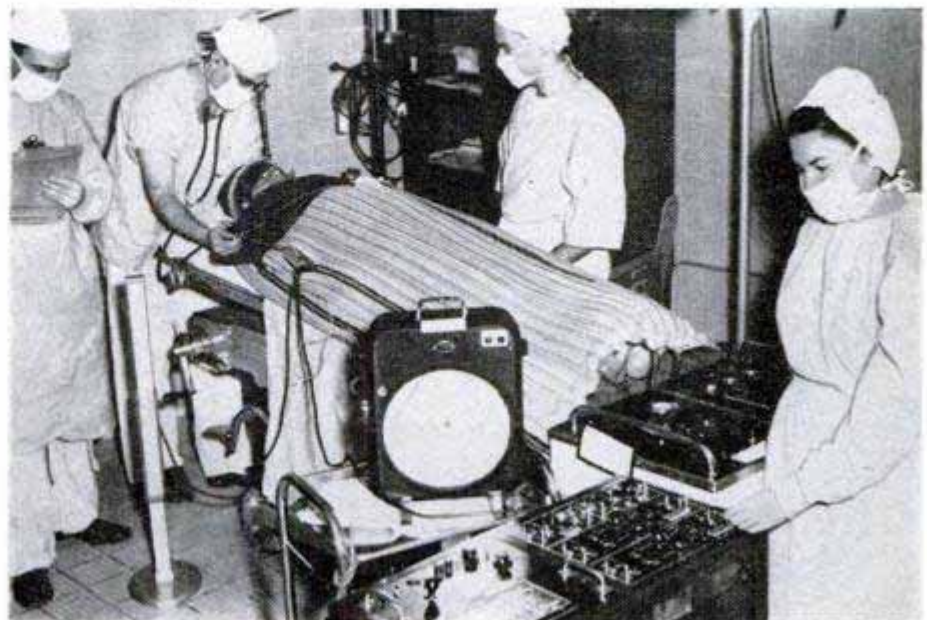

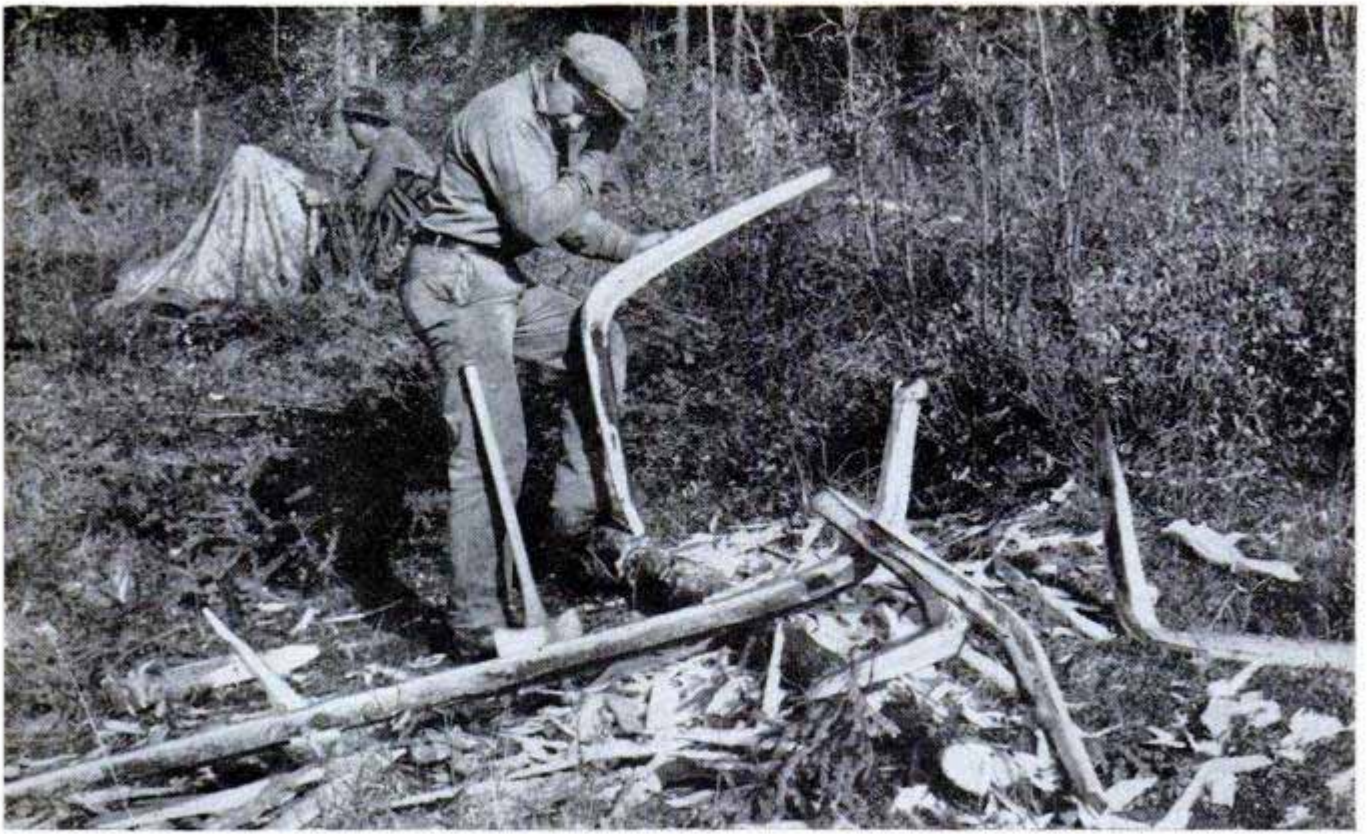

While Louis Brown dresses a mooseskin, Norman Mervyn wields an axe to shape the canoe's skeleton



*In a race against an early freeze-up as an arctic winter approached, these hunters took what nature offered and built their own escape boat—a*

# MOOSEHIDE CANOE

*By F. Wallace Taber*

Spruce roots cannot penetrate the frozen earth deeply, so they lateral out, forming perfect canoe ribs

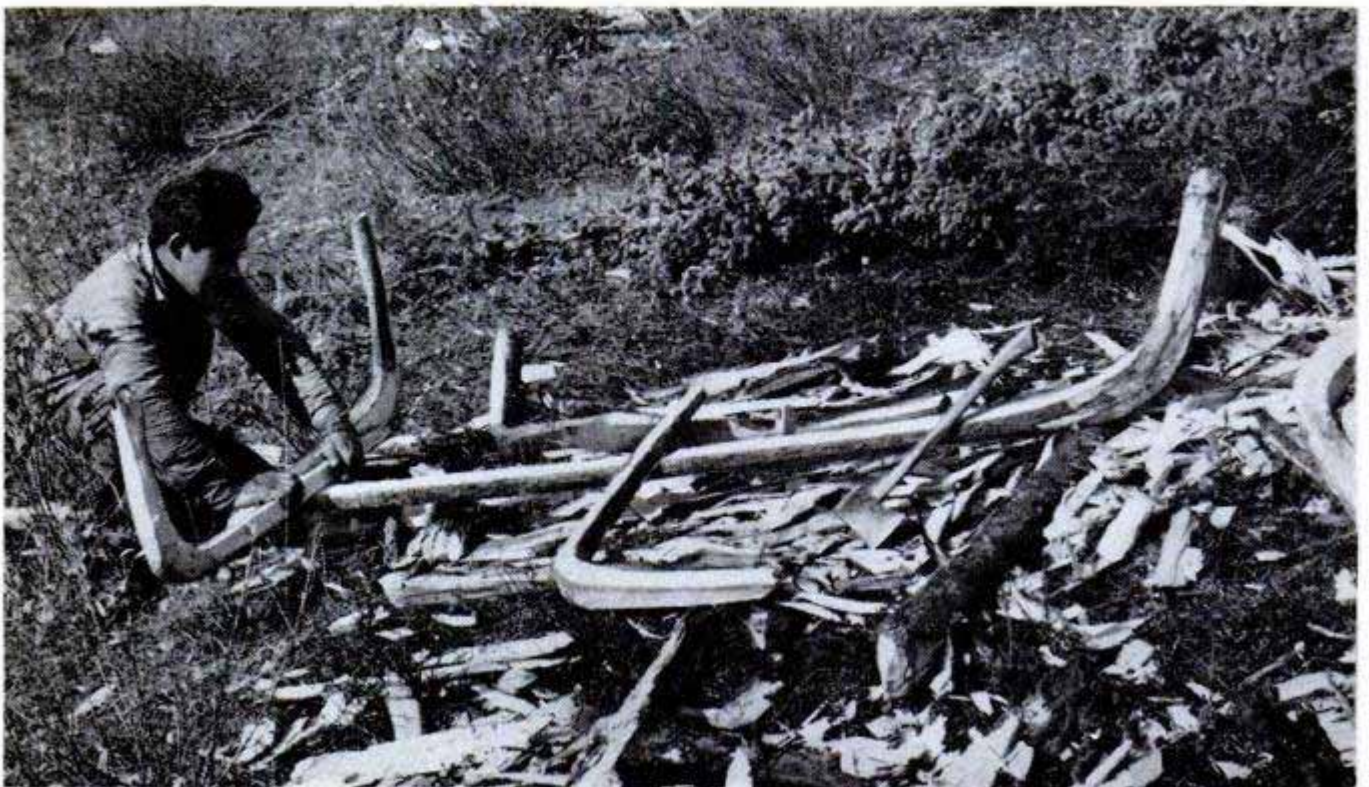



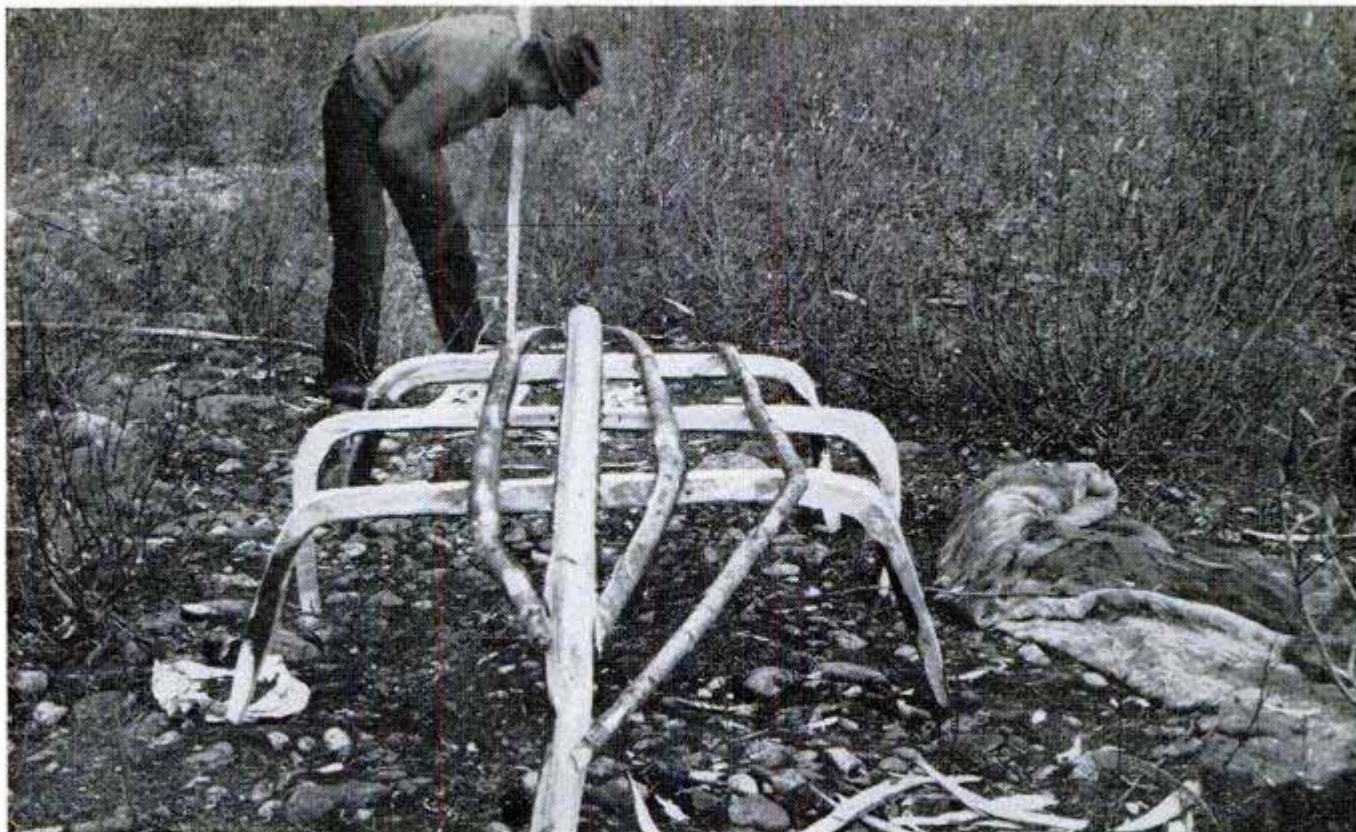

With the ribs notched, wedged and pinned into place, they are next tied with strips of moosehide and further secured in position with the handful of nails that were available. Both guides were experienced in the lore of the wilderness country

With the ribs spaced to utilize the full width of the available mooseskin, the precious nails were distributed sparingly to provide a rigid bond between the canoe's ribs and keel

**I**MAGINE YOURSELF 500 miles from your jumping-off spot. You're in the very heart of the uncharted wilderness that is the northern Yukon territory of Canada. Shore ice is forming fast. It will soon meet in the middle of the river and seal your last retreat route back to civilization.

The bogs and muskegs, too, are freezing each night, thick enough that, loaded down, your pack horses break through and cut their legs on the jagged ice. Unloaded, they can remain on top, make good time, and probably beat winter back to civilization.

You're faced with the plight of leaving much of your supplies and all of the near-record trophies you've labored for nearly 90 days to amass. Neither you nor your Indian guides had reckoned on such an unseasonably early winter. One day it was fall. The next, bleak winter. You must get out fast. But how?

This is the plight that faced big-game hunter Jim Bond who, when not hunting, operates a pair of grocery stores in the state of Washington.

After the full realization of their plight had registered, Bond and guides Norman Mervyn and Louis Brown lost no time reverting to the lore that makes the vast Yukon wilderness a year-round home to



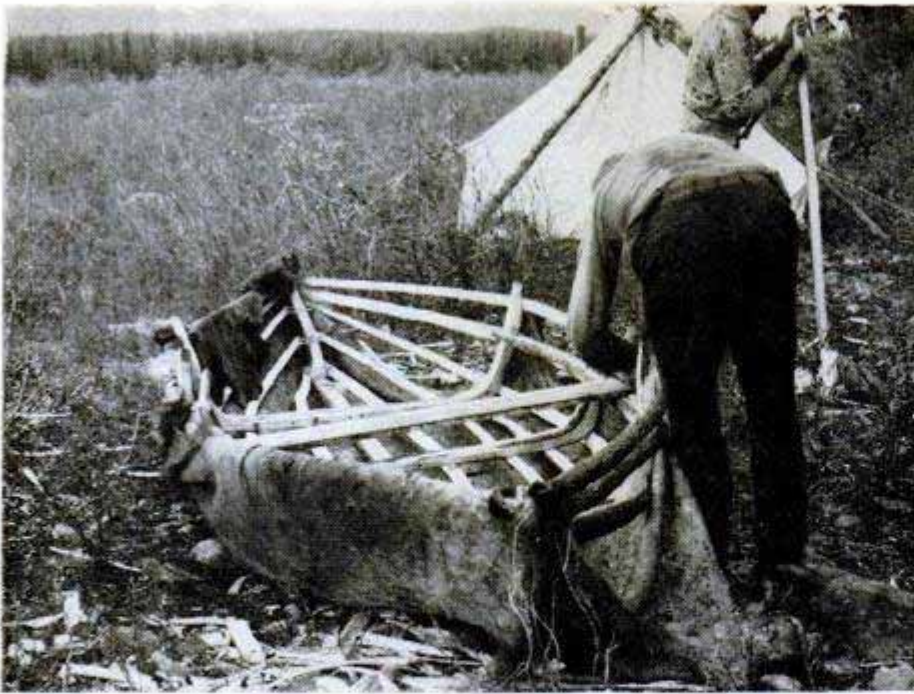

the Indian. They built a moosehide canoe, using only the materials nature provided, plus a scant handful of nails they were fortunate enough to find in the duffel. They loaded the canoe with the bag and trophies and began drifting. First, Mervyn and Bond went down the Beaver, a tributary, and then down the Stewart.

Meanwhile, relieved of their loads, the horses struck back overland 500 miles to Mayo under Brown's guidance.

Ten days later, with provisions two days gone, Mervyn and Bond floated into the docks at Mayo, their wilderness-made canoe still afloat with her prized cargo. The next day, Brown arrived with the string of horses, cut and bruised, but alive. The following day, the Stewart was frozen tight. The escape route was shut off. But the hardy trio had made it with one night to spare. ★ ★ ★



Framework completed, upper left, the green moose skin is pulled and stretched into place. Whittling a paddle from dried spruce, left, is the last labor. Below, with the cargo lashed down, the canoe is ready for flight before winter freezes the rivers





### Wheeled Snow Shovel

Shoveling snow isn't such a task with a new shovel that is never lifted off the ground. Two wheels tilt the device at a good scraping angle as it is pushed along the sidewalk. The operator tosses the snow to either side by depressing one of two hand-operated levers.

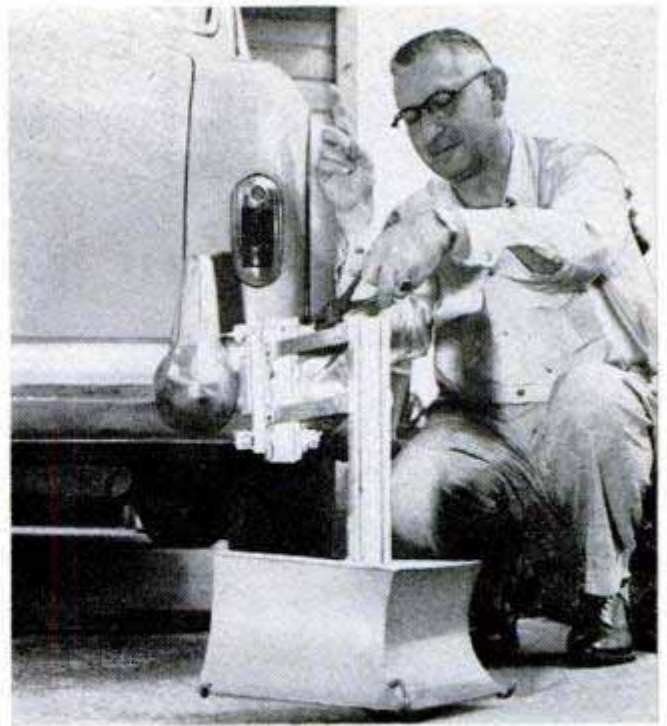

### Auto-Bumper Plows Clear Wheel Paths

Tired of shoveling driveways, two Cleveland men invented miniature snowplows that let cars clear their own way. Two of the plows are mounted on either the front or rear bumper. The automobile then can be driven along wheel paths cleared for free passage. The plows also work in sand.

### Induction Coil Slashes Time Required for Heating Aluminum

Ordinary household electric power is used to heat a 7700-pound aluminum ingot to working temperature in 50 minutes instead of the 12 hours needed by a conventional furnace. In a method developed by Alcoa, the unheated ingot (far right) is placed within a huge electrical coil (right). Sixty-cycle current flowing through the coil induces a heavy current in the ingot itself, causing the temperature rise in the metal.

### Robot Controls Reactor

Atomic piles are prevented from blowing their tops by a robot safety system. Electronic instruments and motors of the system regulate the generation of power inside a reactor at any predetermined level. The system is said to be the first developed as a "package." The robot mechanisms keep moving rods of boron steel into and out of the pile to control the activity of the neutrons.

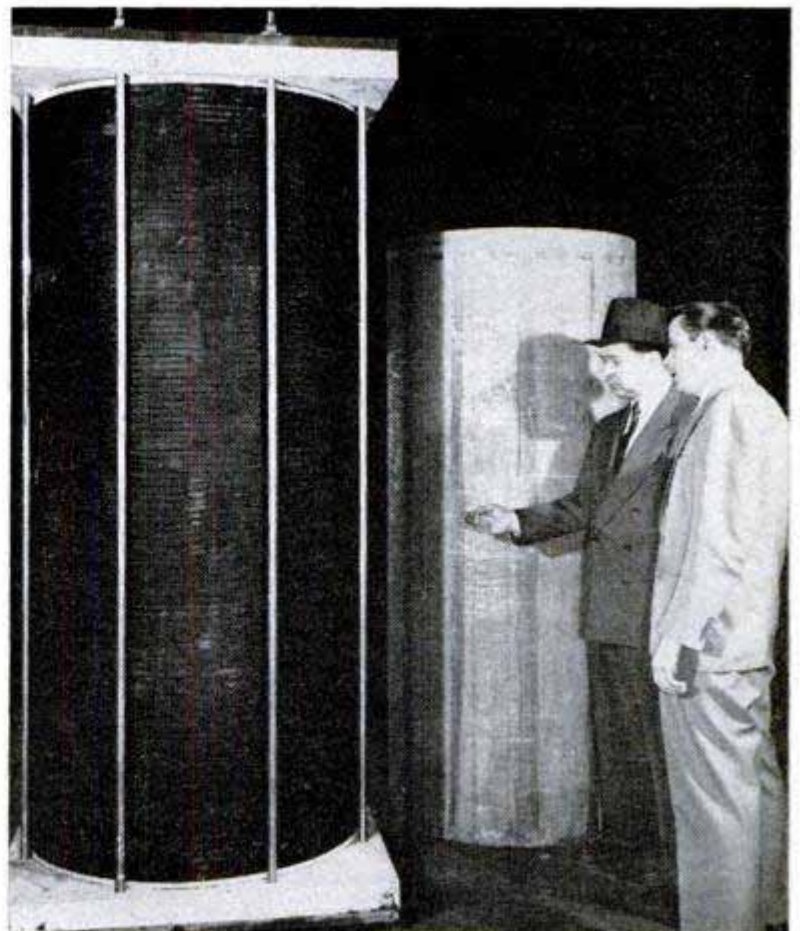

## Students Drive Model Car Over Miniature Test Route



When the driver shifts gears, the car increases its speed realistically. Turning the steering wheel keeps the car on the moving highway. With the reverse gear, the driver learns to back into small parking spaces

Better drivers result from a training machine that tells you exactly what is wrong with your driving. The machine consists of regulation steering wheel, brake and clutch pedals, accelerator and instrument panel. The roadway, white lines painted on a green canvas, moves beneath the car at speeds regulated by the accelerator. The model responds as a standard car would. Various signals are included so the driver can test his reaction time and judgment of speed and distance. The machine shows each time a driver unnecessarily touches the clutch, brake or shifts gears.

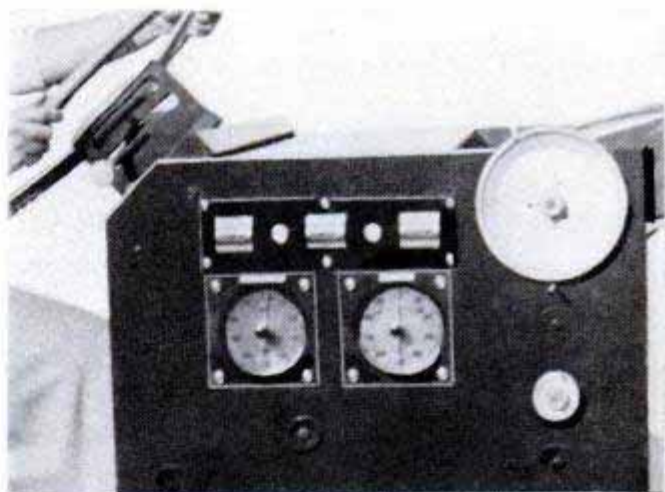
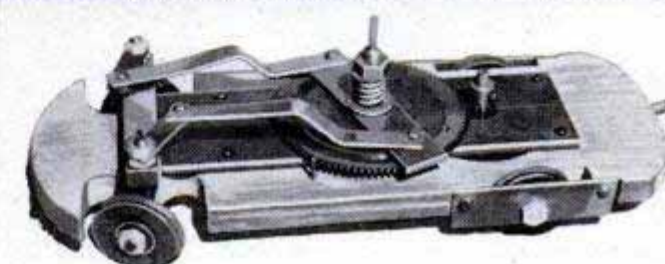

Top, chassis of the car. Large gear steers the front wheels. Above, on one side of the machine are two counters that record the mistakes made by the driver



## Plastic Shell Equips Phone For Two-Way Listening

Two persons can share the same telephone with a device patented by Roger Heap of Lyme, Conn. Simple in design, it consists of a T-shape plastic shell which cups over the receiving end of the phone. The hollow arms transmit the message to listeners at both sides. Heap fashioned the device so that he and Mrs. Heap could join in three-way conversations with their son in Detroit.



British Information Services photo

## Transport "Swallows" Fighter Shorn Only of Its Wings

Through its broad front doors, a Bristol Freighter can "swallow" a jet fighter fuselage and carry it away for overhaul or repair. Only the wings, easily detached, have

to be removed. The rest of the fighter fits in easily. The Royal Canadian Air Force previously had to ship damaged planes by truck and rail to repair depots.

## 200-Pound Falling Weight Drives Posts Into Ground

Steel or wood posts up to four inches in diameter are pounded into the ground by an implement that is mounted on a tractor or pulled by a truck. Operated by power take-off or gasoline engine, the post driver has a free-falling 200-pound weight that delivers 25 blows a minute. It operates at 53 to 100 inches above the ground. Requiring only one operator, the device drives posts about twice as fast as other methods, and can even drive steel posts into frozen ground. The driving head can be tilted when driving posts into hill-sides or into uneven ground. If desired, the head may be inverted and used to break pavement or tamp soft ground.

¶ Prof. Alex D. Krieger of the University of Texas estimates that man has inhabited America for well over 15,000 years.

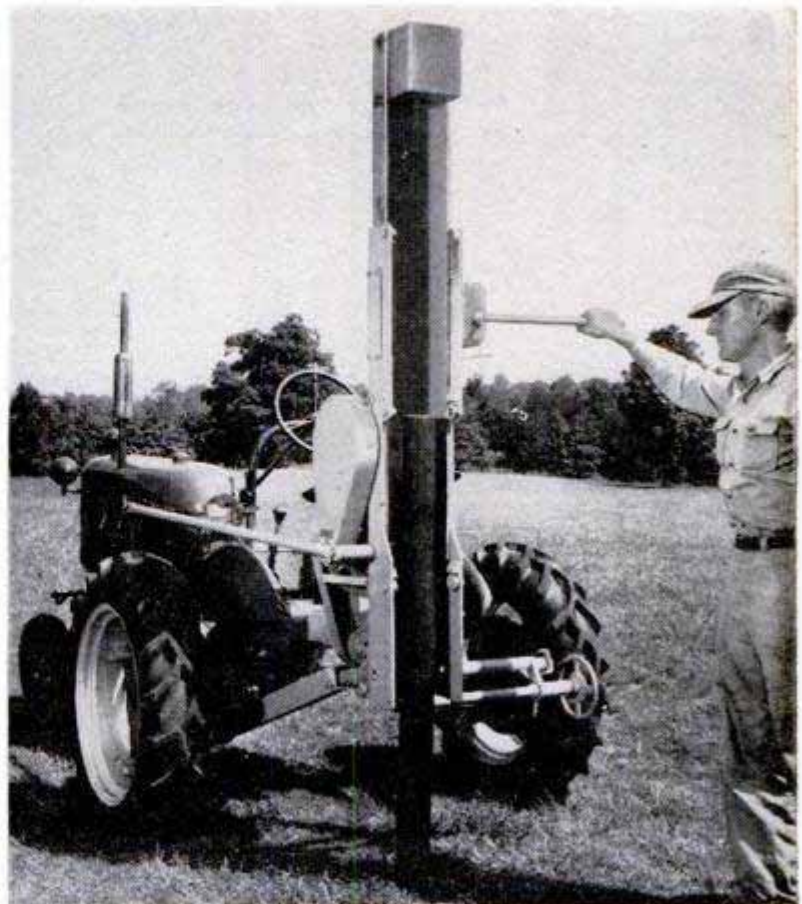



Logs float down the river into a canal and are carried by jack ladder to the saws

# Logging Booms in the Guianas

*By Lyn Harrington*

*Photos by Richard Harrington*

So heavy are some woods, such as greenheart, that the logs won't float and must be lashed between lightweight balsa logs

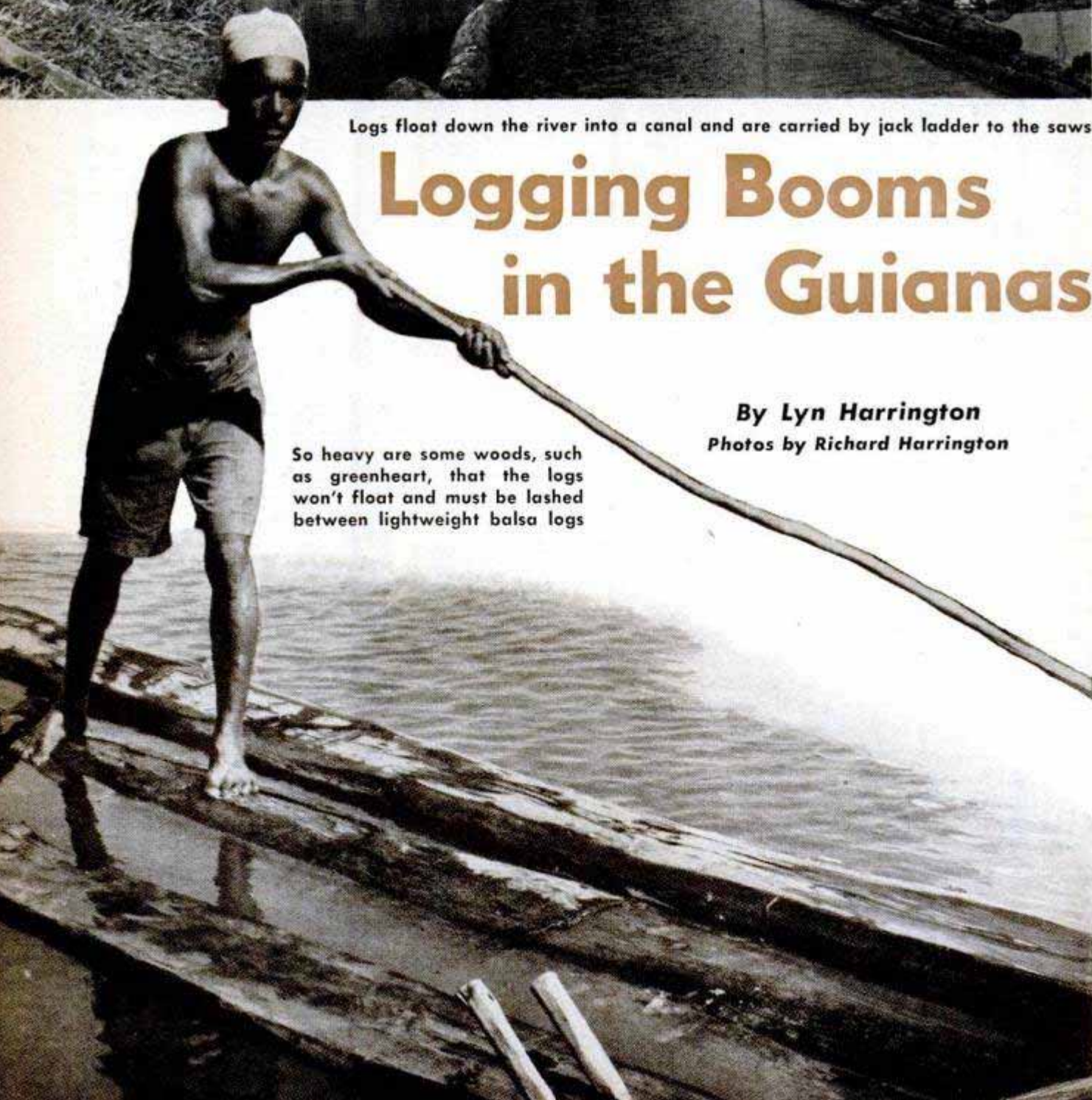

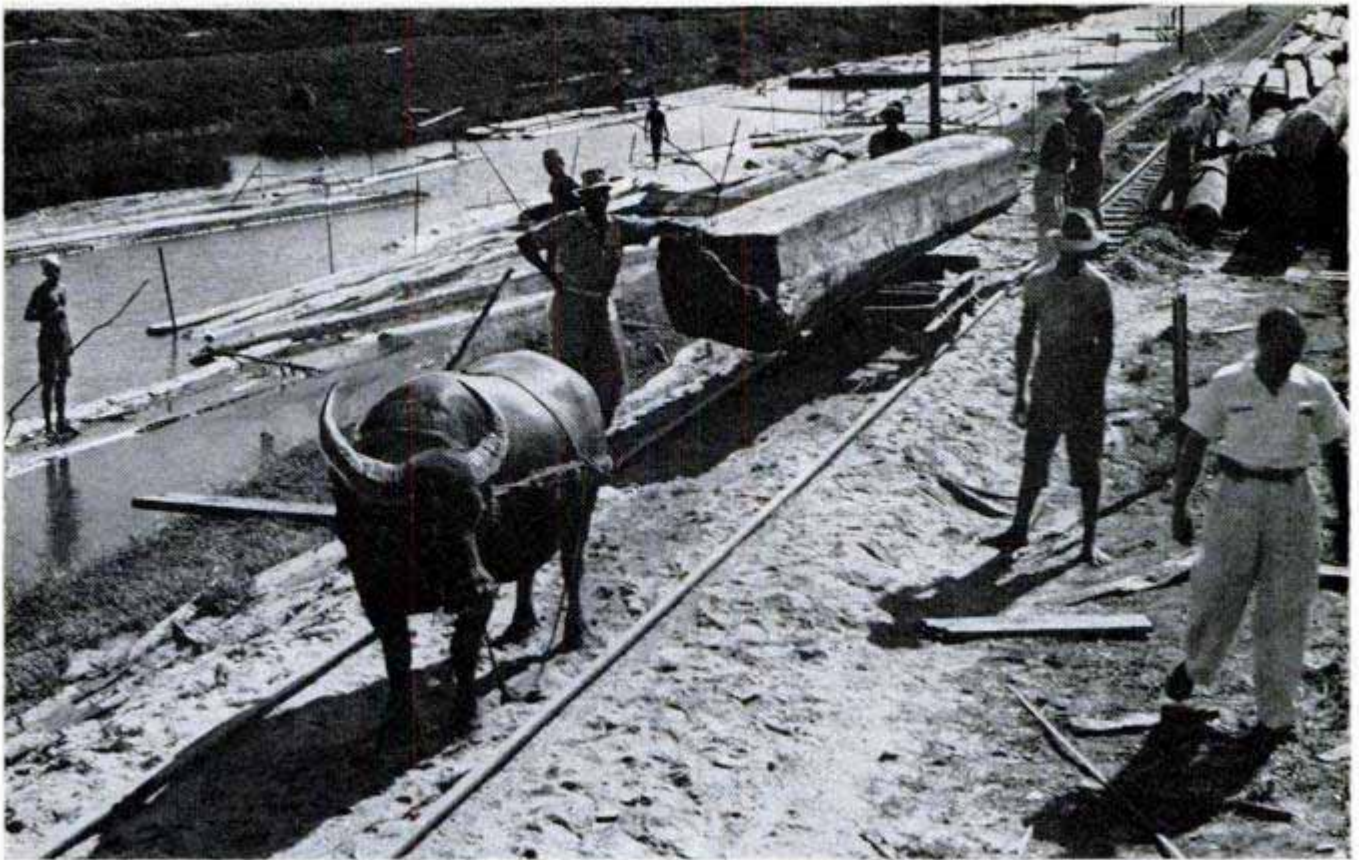

Along the canal stretches a narrow-gauge railway on which logs are hauled to the mill by water buffalo

**I**N THE VAST, steaming jungles of Surinam and neighboring South American countries, large-scale logging is at last penetrating huge tracts of untouched timber.

Near Paramaribo, capital city of Surinam (Dutch Guiana), stands the country's first plywood factory, built in 1947. Each morning, trucks crammed with barefoot loggers roll into the forest over shell-paved roads. At the cutting site the workers select their trees and chop a bite in each tree at a point about eight feet from the ground. Into the crevices go poles on which to stand while cutting proceeds with two-man saws. As soon as a giant topples, other men set about removing the limbs and cutting the trunk into standard lengths.

Logs may be lashed into rafts and floated down the Surinam River, dragged out by shiny tractors and transferred to modern trucks for shipment to the mill, or finish the last leg of their trip behind the water buffalo which takes the place of a locomotive on the tract's narrow-gauge railway.

At the mill, squared logs from the forest are cut into timbers for construction purposes and round logs that are smooth and fairly even go under the veneer knife. The veneer emerges as long, thin peelings, about six feet wide and up to  $\frac{3}{4}$  inch thick. Treated for termites, the sheets are next glued, pressed together into laminate and trimmed to proper size.

Six hundred men are employed at the factory, a modern plant similar to mills in other parts of the world except that it has

Pajama-clad worker chops a tree trunk into standard lengths. Tractors snake logs out of cutting area



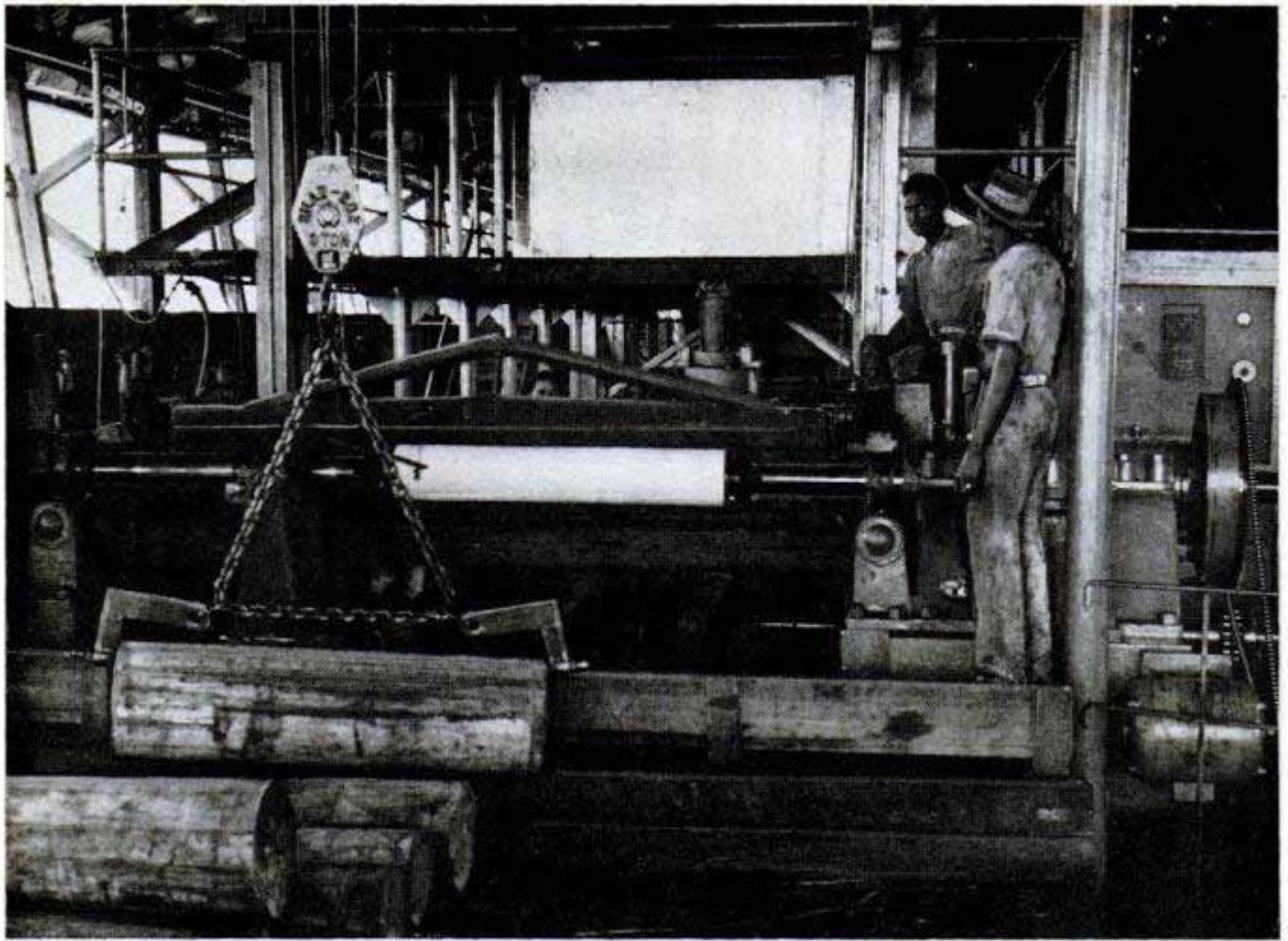

Sections of log await their turn under the peeling knife. Cores are used as fuel by the mill's steam plant  
Rude platform is used to saw tree at proper height



no walls; none are needed in this equatorial region. Power machinery (including power saws to fell the dense hardwood trees of the jungle), tractors and trucks combine to lower the cost of turning trees into lumber.

Only a few years ago the timber of the British and Dutch Guianas was considered almost worthless because of the high cost of removal. There was demand for a few types of valuable lumber, like mahogany, but the individual trees were scattered so sparsely about the jungle that removal cost was great. Besides, they were costly to cut and heavy to handle. Dutch Guiana exported almost no lumber; sole export of British Guiana was greenheart.

With the world lumber shortage came a demand for other kinds of South American lumber. Today, heavy woods like purpleheart, brownheart, ironheart and greenheart are being exported. "Kankantry" (a type of cottonwood), crabwood (a type of mahogany), "basra locus," "crappo," cedar, "pisie," "wana," banak and "copie" are being shipped abroad.

Greenheart has long been popular in dock construction and in shipyards. A very tough hardwood, it resists marine borers and has outlasted steel in underwater construction. Greenheart is so heavy it will not float. In order to raft one of the logs, it must be lashed between two lightweight



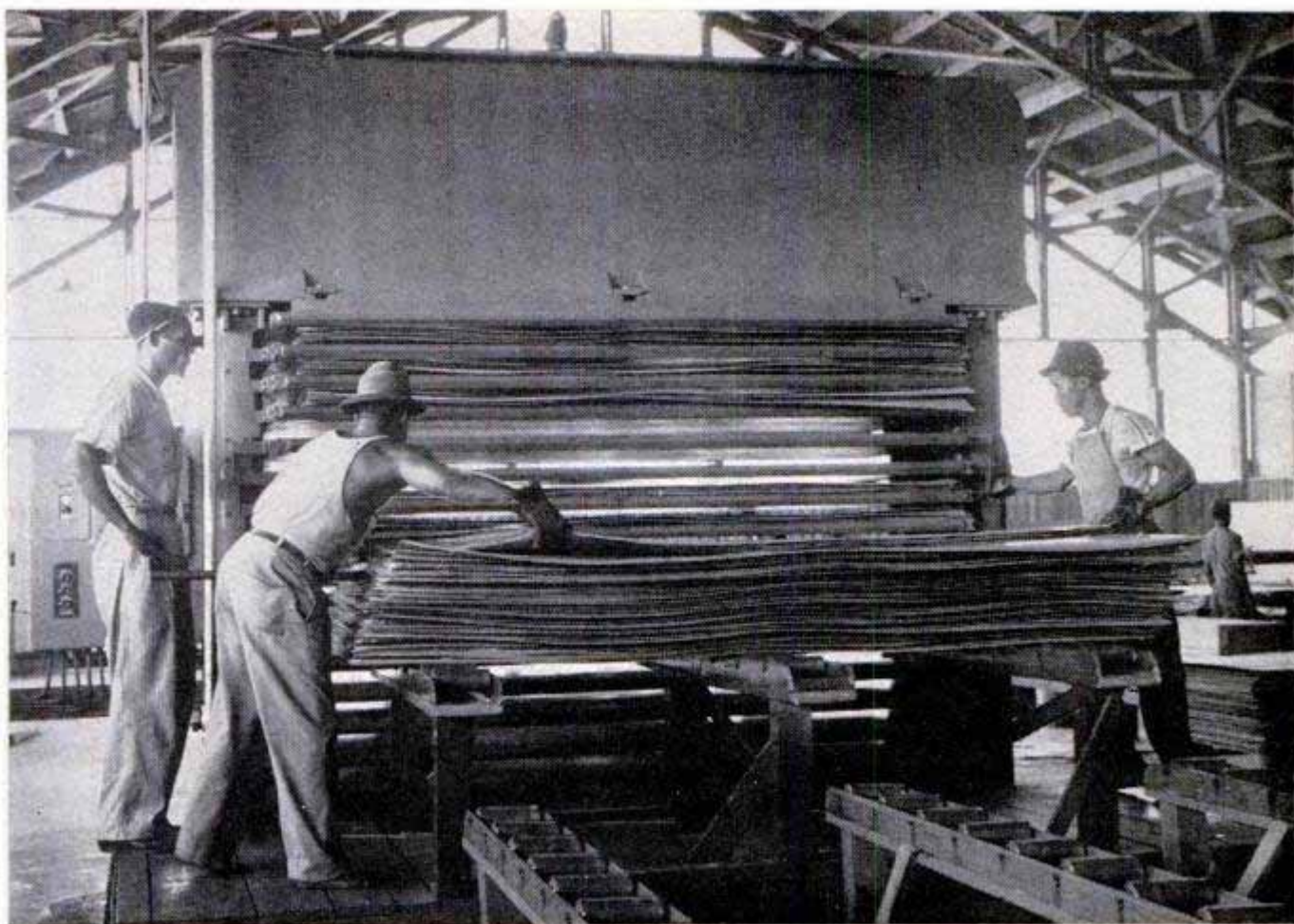

Adhesive and sheets of veneer are shoved into press where they will be stamped into plywood for use abroad

logs, such as balsa, to keep it from sinking.

Balsa came into general use along with the model-airplane fad, and even went into real airplanes. It is still a valued export of tropical South America.

Another forest product of the Guianas is balata—raw rubber from the milky sap of the bullet tree. The trees are tapped to produce a gallon per day per tree—about five pounds of balata. The sap is poured into a big wooden tray, where it gradually thickens into a tough layer that is peeled off and folded like oxhide for shipment. Balata is used in the manufacture of golf balls and machine belting, though synthetic rubber is cutting into its market.

But as the demand for rubber slows, the need for lumber increases as the other nations of the world consume their timber resources. Valuable timber covers much of the Guianas; Surinam, a country about the size of Wisconsin, is forested from the savannas which border the coastal plain south to the mountains of Brazil.

Holland buys a large part of the lumber output of its colony and the United States is another good customer, particularly for veneers. Spurred by the demands of the world's builders, the Guianas are importing northern machinery and expanding operations to answer the call for more lumber. Here in the rainy tropics may be the great timberlands of tomorrow. ★ ★ ★

Sheets of crude balata rubber are loaded into plane





Braided strings looped around the phonograph turntable operate the carnival rides within the five-gallon jug

## Tiny Carnival Operates Inside a Five-Gallon Jug



Beggs has a delicate touch. He uses only two forceps, one long and one short, and a long wire to assemble his intricate models



**KENNETH BEGGS** of Minneapolis not only builds models inside of bottles—he makes them run with a phonograph motor!

Beggs recently completed an elaborate miniature carnival inside a five-gallon jug, a creation that took about 10,000 hours of nerve-racking work. Then he deftly hooked strings to the tiny merry-go-round, Ferris wheel and airplane swing and connected them to the turntable of an old phonograph. When the turntable revolves, the carnival under glass springs into life, with the Ferris wheel, carrousel and airplane ride all working in perfect unison.

Most of Beggs' models are log cabins set against a backdrop of tiny trees. To provide a base, the modelmaker fills a gallon jug a third full of sand. Then a layer of hot paraffin is poured over the soil and left to cool. This provides a solid "floor" to work upon. Then the delicate task begins. Beggs gently inserts a template of cardboard into the bottle to serve as one side of his cabin. Next come the "logs," cut from wood matches, dipped in glue and tediously placed side by side on the cardboard. Beggs soon has all four walls inside the bottle and ready to be glued together. He values his miniature carnival at \$10,000.

# Radio Television Electronics

## MINIATURE WIRELESS MICROPHONE

BROADCASTING performers can rove at will when using a wireless microphone no larger than a pack of cigarettes. There are no cables to trip over; in fact, it is a miniature FM-transmitting system designed for high-fidelity sound pickup in stage, radio, television, motion-picture and industrial applications. The wireless microphone shown in photo A, together with its companion battery pack, are small enough to be held in one hand. The tiny battery pack is concealed easily in the operator's pocket as illustrated in the sketch.

The receiving equipment (backstage) is shown in photo B. It consists of two small leatherette-covered portable cases, one of which houses a specially designed, highly sensitive receiver, the other, the power supply which also contains speaker-and-headphone monitoring facilities. The audio output of the receiver may be fed into standard mike inputs, as this miniature Tru-Sonic wireless-microphone system is interchangeable with sound equipment presently in use.

This system also makes possible amphitheater lecturing by surgeons in hospitals, recording the operation or the doctor's own comments for closed-circuit television. In industry, a technician may move about his work giving directions or descriptions with his hands free and no connecting cables to limit him. The tiny wireless-microphone FM transmitter employs two CK5672 sub-miniature tubes and it weighs only about four ounces.



# AMATEUR TRANSMITTER INCLUDES

By Frank L. Brittin W9DCX

TELEVISION INTERFERENCE (TVI) presented a greater problem to the radio amateur than broadcast interference (BCI) ever did. This was partly due to the fact that TV receivers operate at higher frequencies more susceptible to interference from amateur transmitters than are standard radios operating on the lower frequencies. Interference in television receivers also is caused by many other electrically operated devices, FM stations and even other television receivers operating in the immediate vicinity. Practically all of these interfering factors can be eliminated by proper shielding and filtering. Television set manufacturers soon recognized this fact and incorporated necessary shielding in their receivers. Manufacturers of many electrical appliances keep this type of interference in mind when designing their new products.

During the past three years much technical information has been made available to radio amateurs to aid them in TVI proofing their transmitters. Such articles have appeared frequently in *QST*, *CQ* and other magazines devoted exclusively to ham radio activities. That these instructions have been followed is evidenced by the comparatively few complaints now made by TV set owners, and the fact that there are over 104,000 licensed amateur radio operators in the United States. Recommended measures include complete shielding and filtering, or bypassing, of all power supply or

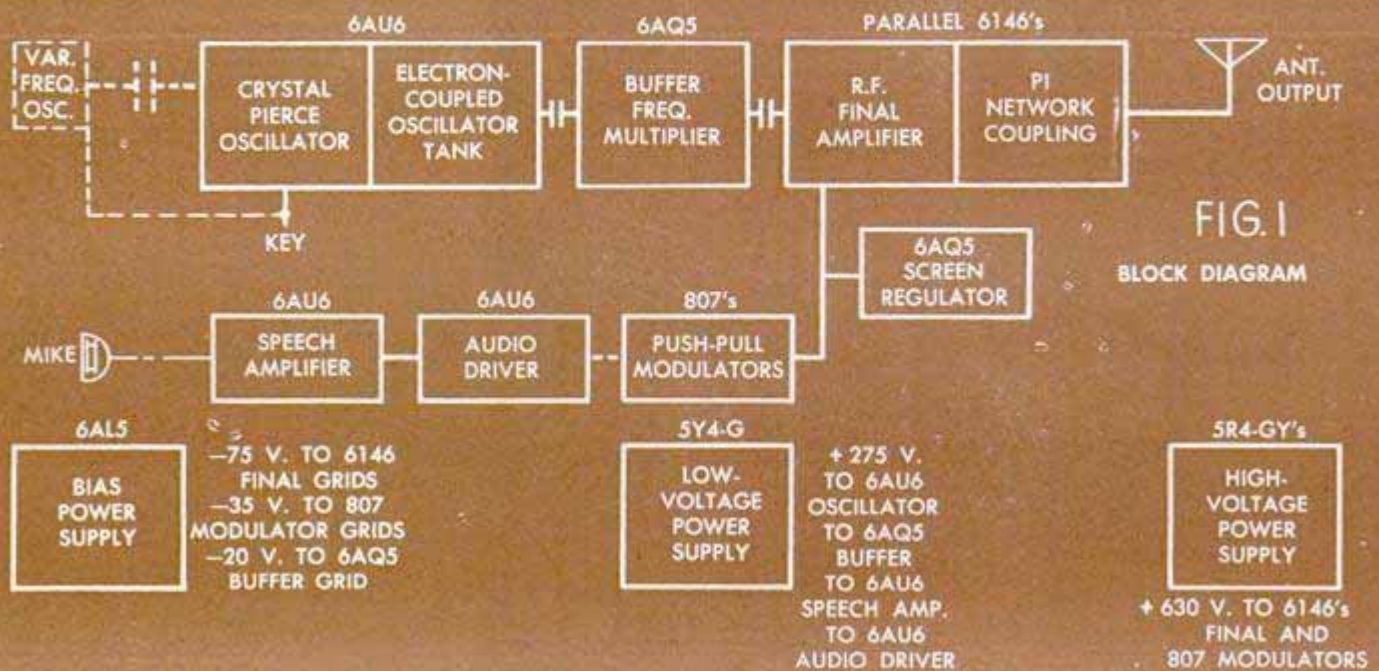
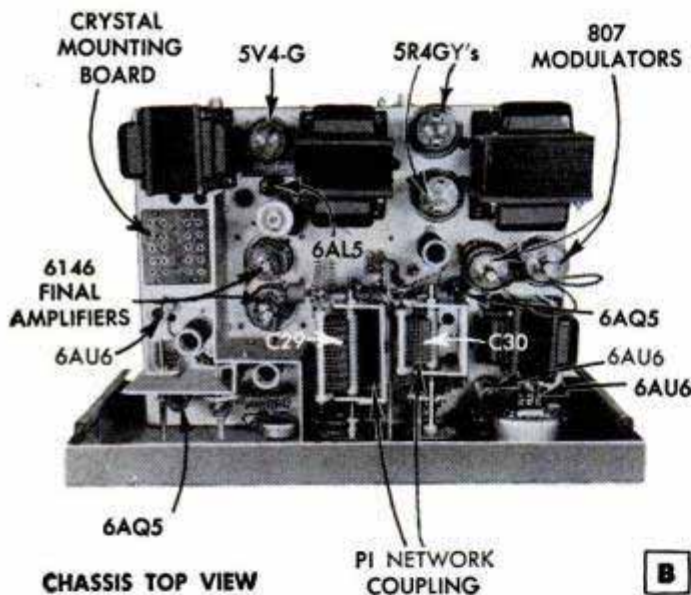
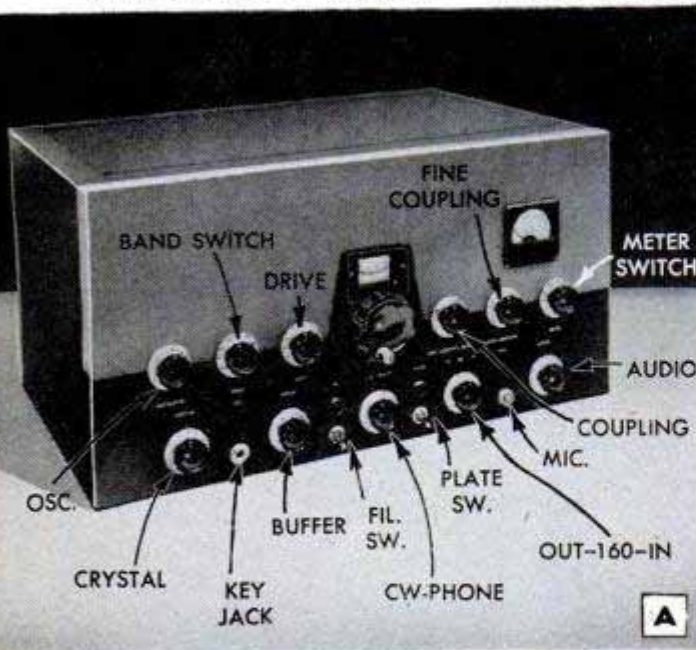

# IMPORTANT TVI-SUPPRESSION FEATURES

control leads to and from the transmitter.

Both manufacturers, and the hams themselves, many of whom are well-known radio engineers such as A. M. Pichitino WØEDX, photo C, whose original low-pass filter for TVI suppression appeared in the January 1950 issue of *QST*, have cooperated in designing many of the necessary filters and other devices. Pichitino also won top phone honors in a recent American Radio Relay League contest. Several manufacturers make complete TVI-suppressed amateur transmitters, but some of these are out of the pocketbook range of the average amateur. However, a complete kit for building a TVI-suppressed transmitter at moderate cost is now available from radio-parts houses. This is the E. F. Johnson Viking II kit which includes all the necessary parts, hardware, tubes, wiring harness, special cabinet and complete assembly instructions.

Photo A shows the completed transmitter, and a top view of the chassis base appears in photo B. The main TVI-suppression features are illustrated in photos D, E and F. These include the heavily copper-plated steel cabinet with perforated top and bottom to provide ventilation. The lid is easily removed as shown in photo F; it is bonded with silver-plated, phosphor bronze contact fingers, and this same bonding strip is used in the locations indicated in photo D. Special shields for meter, dial window and VFO (variable-frequency oscillator) power receptacle, maintain effective TV shielding. Filters consisting of

(Continued to page 240)

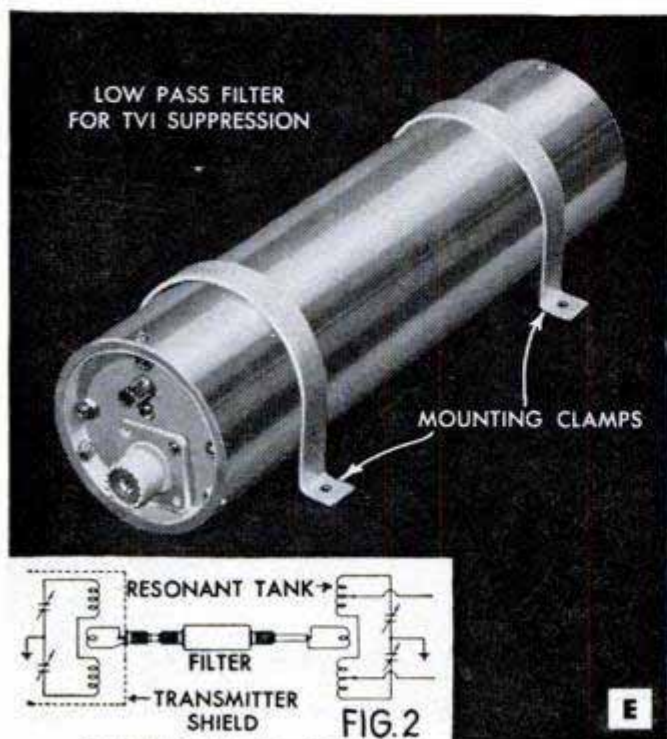
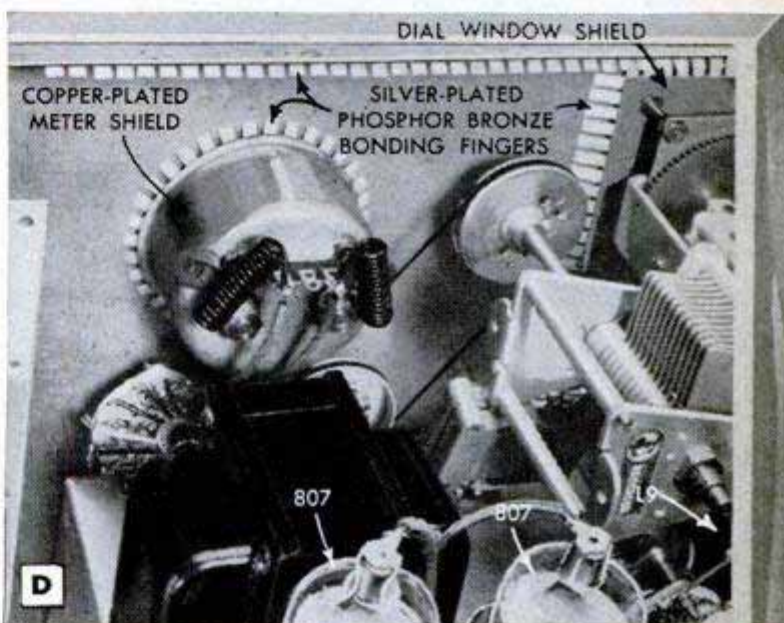

## Radio and Electronics Today

HOMEMAKERS and decorators faced with the problem of having varied activities going on in the same room with radio, television and record-playing equipment will welcome this idea of a room-divider unit illustrated in photo A. This experimental model recently suggested by Motorola engineers as a "designer piece" of the future, is 5½ ft. in length and 5 ft. high.

Perhaps one of the most interesting developments in personal-type portable radio receivers is the long-life alkaline "B" battery, recently introduced by the tube department of RCA Victor. These "crown type" cells, shown in photo B, resemble bottle caps which are placed close together to form the necessary 67½-volt B battery in the set illustrated. The "A" battery is a new design claimed to have long life.

The grid-dip meter shown in photo C was assembled from a Heathkit. This type of test meter has many useful applications for radio amateurs, servicemen and experimenters. Grid-dip meter operation is based on a sensitive meter measurement of grid current in a variable oscillator circuit. When coupled to a resonant circuit, a pronounced dip of the meter pointer occurs as the oscillator is tuned through that frequency under test—hence the name grid dip. It is useful in tuning and neutralizing transmitters, also in TV and radio repairs.

Now you can listen to radio programs while you are plowing the fields for spring planting. The rugged, automatic type TR-12, shockproof mounted and weather-proofed radio shown on the tractor in photo D, is an 8-tube receiver that operates on a 6-volt storage battery. It is claimed to have sufficient volume to bring in your favorite music, weather forecasts, news and crop reports loud enough to overcome motor noise.

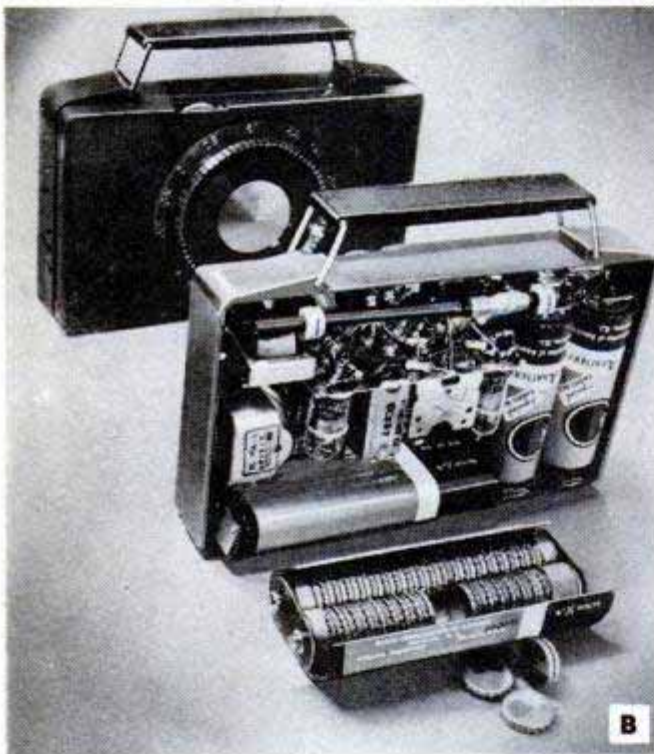

the

POPULAR  
MECHANICS

# CRAFTSMAN



18th Century  
Step Table

## PERIOD TABLES

feature "plastic inlay" tops

By John Bergen

THE FURNITURE-STORE price tag on tables like these would probably make your eyes pop—but you can reproduce them for a surprisingly few dollars. Outside of legs, posts and molding where solid mahogany is used, gum, poplar or birch-faced plywood is transformed into beautiful "mahogany" by the use of easy-to-apply plastic veneer—described in the Feb. 1952 issue of *Popular Mechanics*. Even the rich-looking leather and gold-inlay work on the table shelves is of this inexpensive decal-type finish. And it takes close scrutiny to tell it from the real thing. So, make sure the saw blade's sharp, dust the cobwebs from your lathe and turn out some of the most distinctive furniture ever to come from your shop.

W T M '55  
18th Century Tier Table



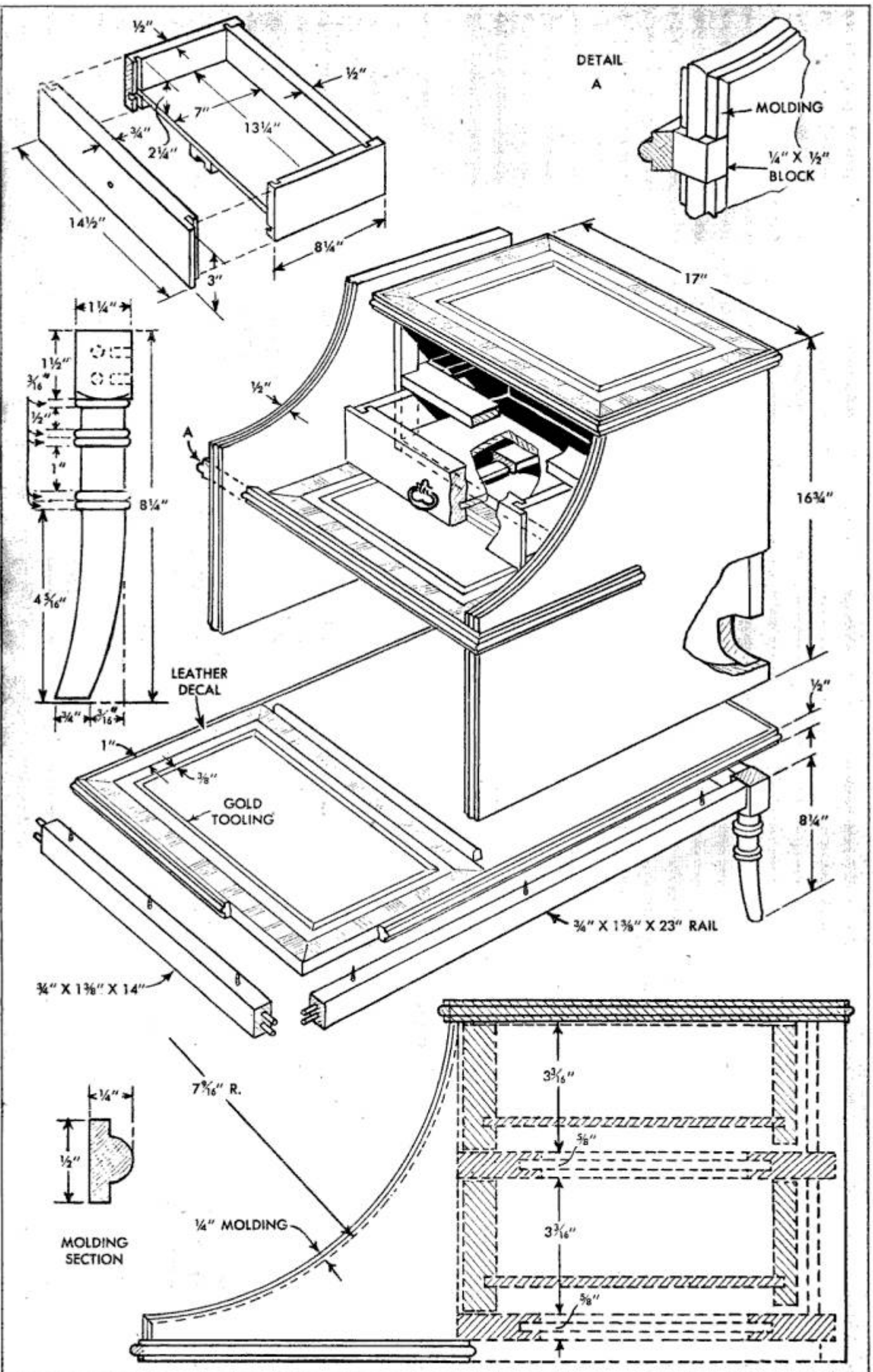



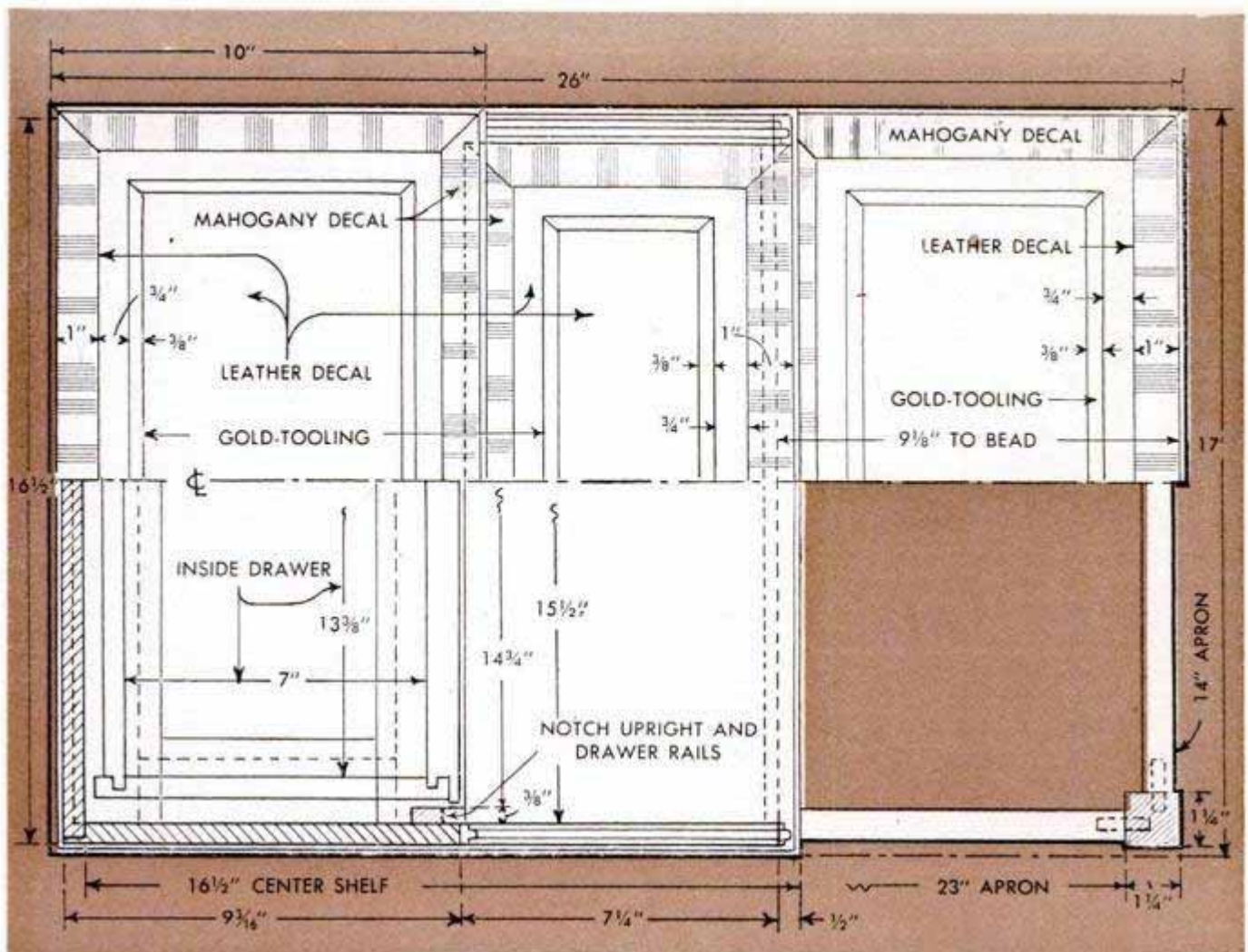

Note from plan view of step table that center section of each shelf is covered with leather decal surrounded with a 1-in.-wide band of mahogany wood-grain decal. Gold-tooling decal is applied over "leather"

**18th Century Step Table:** The base frame and legs of this table are of solid mahogany, the frame rails being  $\frac{3}{4} \times 1\frac{3}{8}$ -in. stock doweled to the four legs. The upper portion of each leg is  $1\frac{1}{4}$ -in. square and the section directly below is a straight beaded turning. The lower  $4\frac{7}{16}$  in. of the leg is splayed. Each leg is made from a block  $1\frac{5}{8}$ -in. sq. and  $8\frac{1}{4}$  in. long. The center portion is turned and the splayed portion is worked to shape by hand. The diameter of the beads on the turned section of the leg is  $1\frac{3}{16}$  in., while the basic diameter of the turning is  $\frac{15}{16}$  in. The splayed portion tapers from a  $\frac{15}{16}$ -in. dia. at the top to a  $\frac{3}{4}$ -in. dia. at the bottom.

The frame rails are fastened to the  $\frac{1}{2}$ -in.-plywood bottom shelf with glue and countersunk flat-headed screws. A  $\frac{1}{4} \times \frac{1}{4}$ -in. groove for a stop bead is cut across the top surface of the bottom shelf,  $9\frac{1}{8}$  in. from the front edge of the panel, as indicated by the dotted lines in the detail above. This can be done with a router or by running a dado all the way across the panel. The beaded edge molding and the vertical side panels will conceal the ends of the groove. The stop bead which is glued in this groove is a strip of  $\frac{1}{4} \times \frac{1}{2}$ -in. mahogany. The exposed edge of the stop bead is rounded, thus providing a neat-looking separator be-

tween the front and rear section of the bottom shelf.

The side panels are grooved  $\frac{1}{4}$  in. deep to take the edges of the center shelf and rabbeted for the back panel. The top shelf is rabbeted  $\frac{1}{4} \times \frac{1}{2}$  in. for the upper edges of the side panels and back panel.

Drawer frames are built of  $\frac{5}{8}$ -in. stock, mahogany being used for the exposed portions, if desired. Front and back members are grooved to take tenons cut on the ends of the side members. The back panel is grooved  $\frac{1}{4}$  in. deep for the rear edges of the two drawer frames. The latter are simply butted and glued to the side panels and the front frame members are notched to form half-lapped joints with an upright at each side of the drawer-frame assembly. The drawers themselves are made as in the upper left-hand detail on the opposite page,  $\frac{1}{4}$ -in. plywood or hardboard being used for the drawer bottoms.

Exposed edges of the shelves and side panels are covered with  $\frac{1}{4} \times \frac{1}{2}$ -in. beaded molding which also should be of mahogany. All corner joints of the molding are mitered and the ends of the molding that extend around the side panels from the front of the center shelf are coped to form an end bead. The points where the center-shelf

molding and the side-panel molding cross must be fitted with  $\frac{1}{4}$  x  $\frac{1}{2}$ -in. blocks as in detail A on page 166.

The detail on page 167 gives the layout for applying the leather, gold-tooling and striped-mahogany plastic veneer to the table shelves. The gold-tooling decal is applied directly over the leather. Mahogany-crotch plastic veneer is applied to the side panels and drawer fronts, while the rear section of the lower shelf can be covered with plastic veneer or simply painted with a toner to blend with the mahogany finish. Solid-mahogany parts of the table are finished natural.

**18th Century Tier Table:** The mahogany turning for the center post is made in three parts, following the over-all dimensions given in the half pattern on the opposite page. A  $\frac{3}{4}$ -in. cleat, 8 in. sq. and beveled all around, is screwed and glued to the top end of the lower turning to provide support for the lower shelf. The center of the cleat is bored to take the end of a  $2\frac{3}{4}$ -in. length of 1-in. dowel. Both the lower shelf and the lower end of the center-post section are bored to take the remaining length of the dowel, and the shelf is screwed and glued to the bottom of the center section. Then the post-and-shelf assembly is glued over the dowel and to the 8-in.-sq. cleat. The center and top shelves and the upper-post section are joined similarly.

The shelves, which are covered with plastic veneer, can be of gum, poplar or birch plywood. The four edges of each shelf are covered with  $\frac{3}{8}$  x  $\frac{5}{8}$ -in. mahogany molding, mitered at the corners.

Curved legs, tapering from a  $1\frac{5}{8}$  in. width at the top to  $\frac{7}{8}$  in. at the bottom, are bandsawed from hardwood. As the legs also are covered with plastic veneer, any close-grained hardwood can be used. The inside flat on the upper portion of the leg is drilled for two  $\frac{1}{4}$ -in. dowels and then filed or drum-sanded concave to match the radius of the center post. The lower end of each leg is similarly drilled and shaped to match the radius of the 1-in.-dia. foot.

Each foot is  $2\frac{1}{4}$  in. long and the upper  $1\frac{1}{4}$ -in. length is turned to a 1 in. dia. Then a  $\frac{3}{16}$ -in. bead is turned to an over-all diameter of  $1\frac{1}{4}$  in. and the lower portion of the foot is tapered from 1 in. dia. to  $\frac{5}{8}$  in. dia. This is shown in the squared pattern on the opposite page. A  $1\frac{1}{4}$ -in.-dia. rosette is glued to the top of the foot. This rosette, as well as the large,  $2\frac{1}{4}$ -in. rosettes used to decorate the upper sides of the legs, may be purchased, or turned from mahogany as in the detail above the table drawing.

Plastic veneer, preferably in fiddle-back mahogany, should be applied to the surfaces of the legs before mounting the large rosettes. This will save the task of trimming

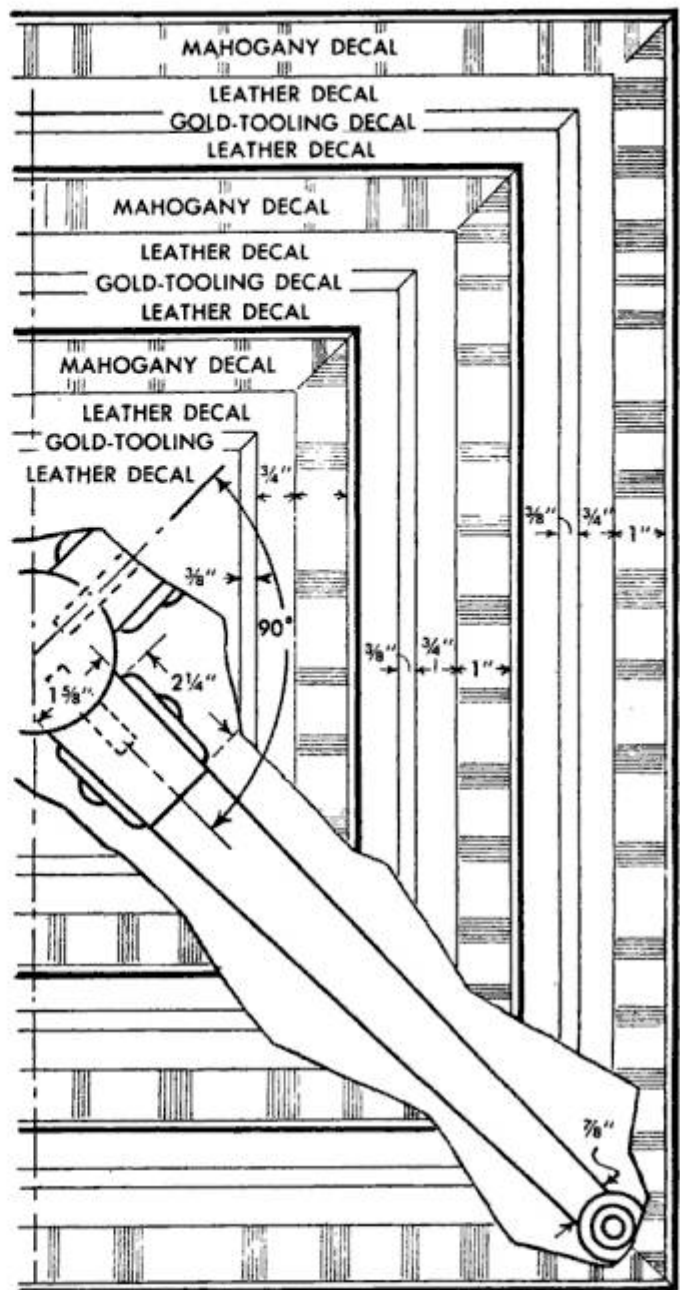

Plastic-veneer treatment of shelves on three-tier table matches step table. Stop the veneer at edge molding

the veneer around the rosettes and result in a neater job in the long run. When applying the veneer, cut away most of the veneer which would be under the rosettes.

Plastic veneer is applied to the three shelves as in the detail above. Carefully miter the corners by overlapping adjacent strips of veneer, cutting the mitered joint and then pulling out the excess scrap before finally smoothing the veneer in place with a squeegee. Trim the veneer neatly along the joint of the shelf and molding.

Apply the plastic veneer to the shelves and finish the mahogany center post before assembly. Spray the veneered portions of the shelves with clear, satin-finish lacquer or varnish. Any joints or edges of the plastic veneer which do not fit as neatly as you would like, can be concealed by rubbing the spots with a dry stain, commonly sold in solid form for removing scratches. This is done before finishing. ★ ★ ★

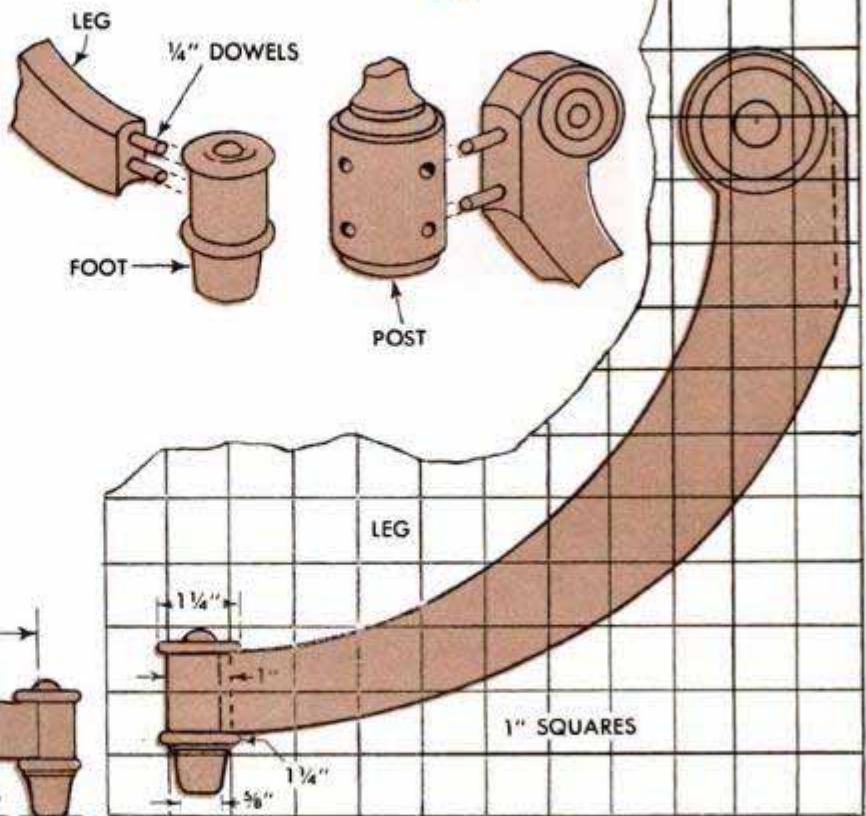
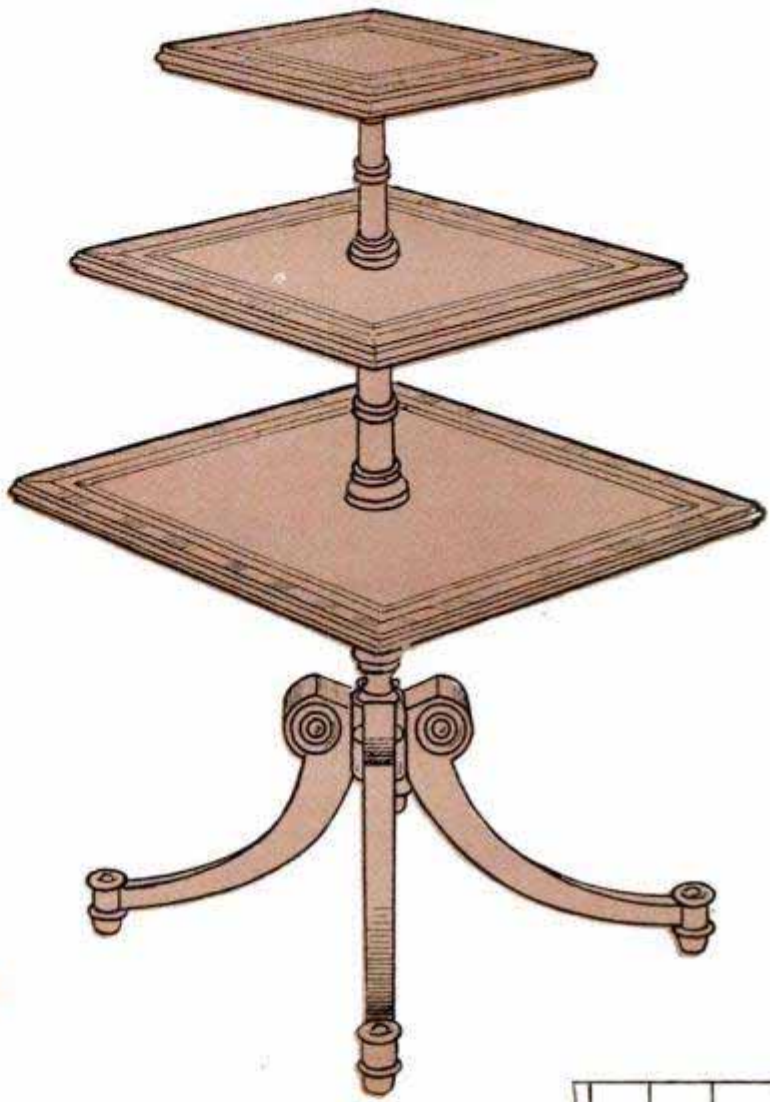
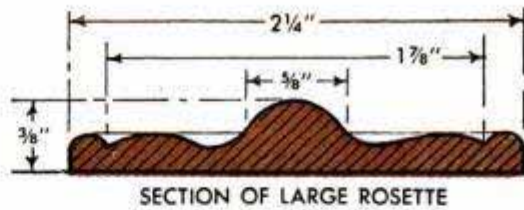
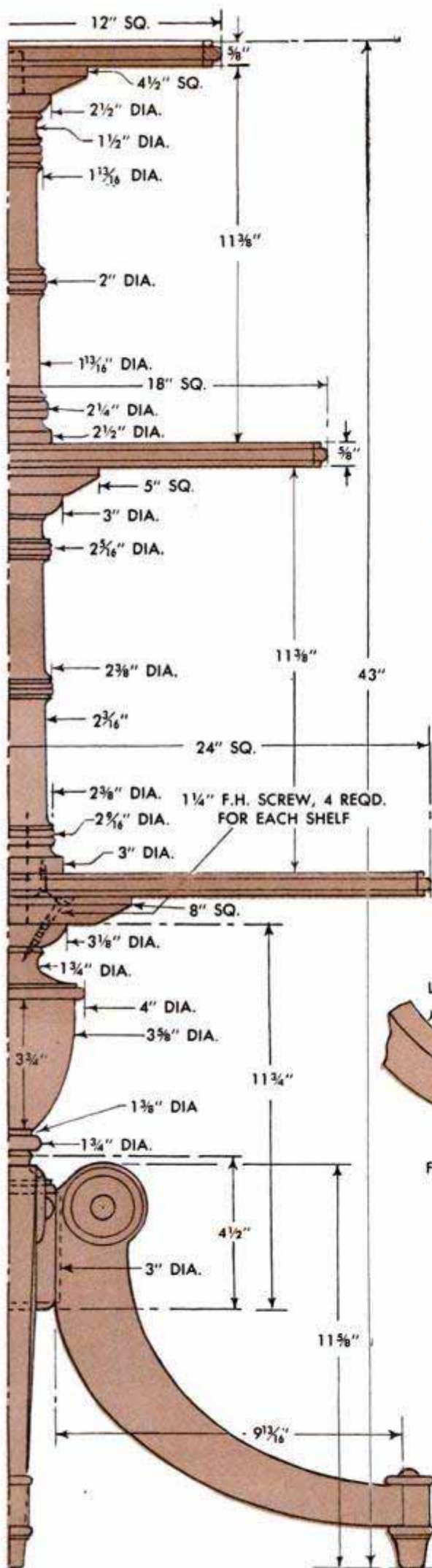

## Scraper Cleans Snow From Car

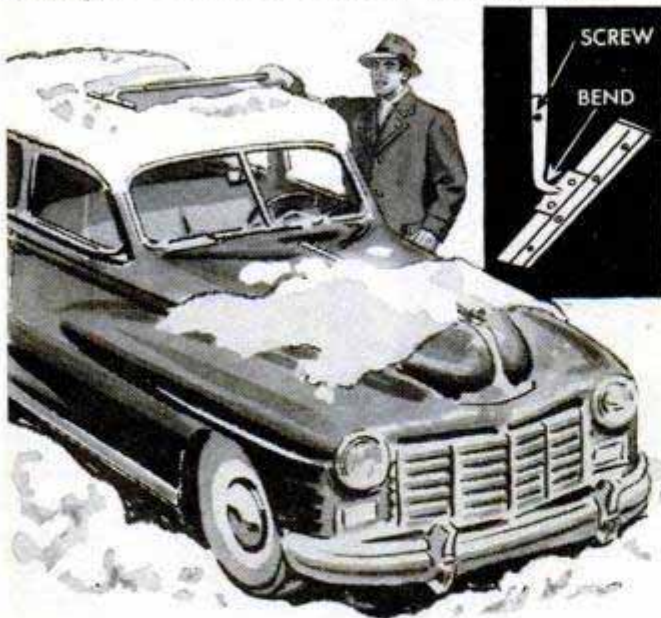

Using an ordinary window squeegee, you can make a handy scraper for cleaning snow from your parked car without getting the snow on your clothes. Fit the squeegee to a 2 or 3-ft. length of broomstick and bend the blade of the squeegee at right angles to the broom handle. The scraper can easily be stored in the trunk.

Walter L. White, Chicago.

## Tennis Ball in Polishing Bonnet Provides Hand Rest

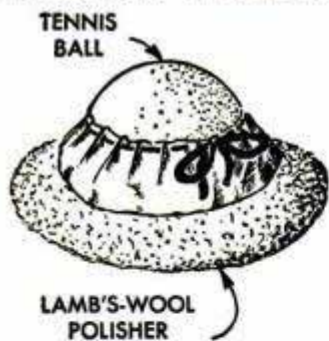

A standard 4-in. lamb's-wool polishing bonnet, such as is used with a portable electric drill, can be converted for use as a hand polisher and buffer if a tennis ball is inserted in it as a hand rest. Simply insert the tennis ball in place, draw the strings of the bonnet tight and tie. This makes a polishing head that is comfortable to the hand for use in polishing furniture or a car.—Glen F. Stillwell, Manhattan Beach, Calif.

## Sealing Loose Inkwell Cover

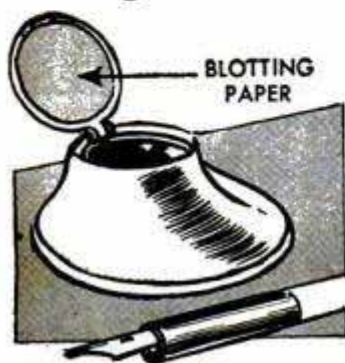

If a loose-fitting cover on an inkwell of the type shown in the illustration allows the ink to evaporate rapidly, blotting paper can be used to provide a seal. Cut a piece to press-fit under the

rim of the cover. A seal of this type will slow down evaporation considerably and can be replaced easily when ink-soaked.

R. M. Woodbury, Natick, Mass.

## Lock for Outdoor Water Faucet

To prevent children from opening an outdoor water faucet, one homeowner devised the method shown in the illustration for locking the faucet. He attached a hasp to the wall above the faucet with bolts and expansion sleeves, and placed it so as to allow the hasp slot to line up with one of the openings in the handle of the faucet. Then he passed a padlock of the appropriate size through both the hasp and the faucet handle. If the faucet handle happens to be of the metal disk type, the same idea can be used by drilling a  $\frac{1}{4}$  or  $\frac{3}{8}$ -in. hole in the handle to take the shackle of the padlock.

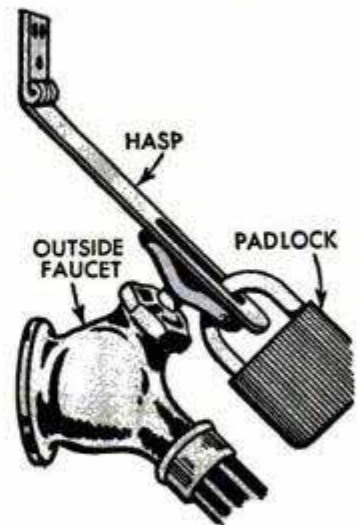

Arthur Trauffer, Council Bluffs, Iowa.

## Reducing Putty Drying Time

The one hour of drying time usually needed when powdered putty is used to make repairs, can be cut substantially if some of the dry powder is sprinkled over the spot which has been repaired. The dry powder, acting as a blotter, draws some of the water from the putty in the repair, and then is brushed off. To get better contact, press the powder into the repaired spot with a putty knife. When the spot takes on a lighter color, the putty is becoming dry.

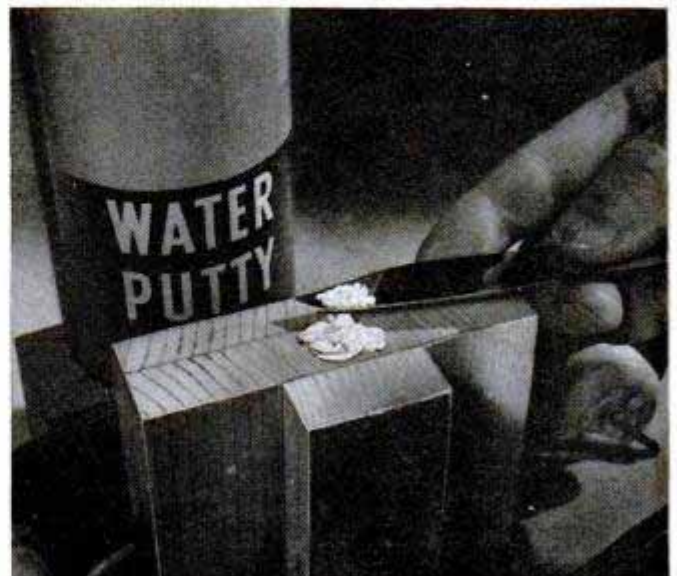



# TABLE-TOP GOLF COURSE

MANY EVENINGS of fun for the entire family is the outstanding feature of this table-top golf course. Easily built of plaster of paris, balsa and cheesecloth on a 3 x 6-ft. base, the course is played with  $\frac{1}{4}$ -in. ball bearings and small wooden clubs. The base may be a panel of plywood, hardboard, fi-

berboard or cardboard. Thin balsa strips provide railings and obstacles, and hills are built up of plaster of paris. Cheesecloth is used to cover fairways and greens, as it forms a slightly rough surface to permit better control of the ball bearings.

Lyle M. Christ, Alliance, Ohio.

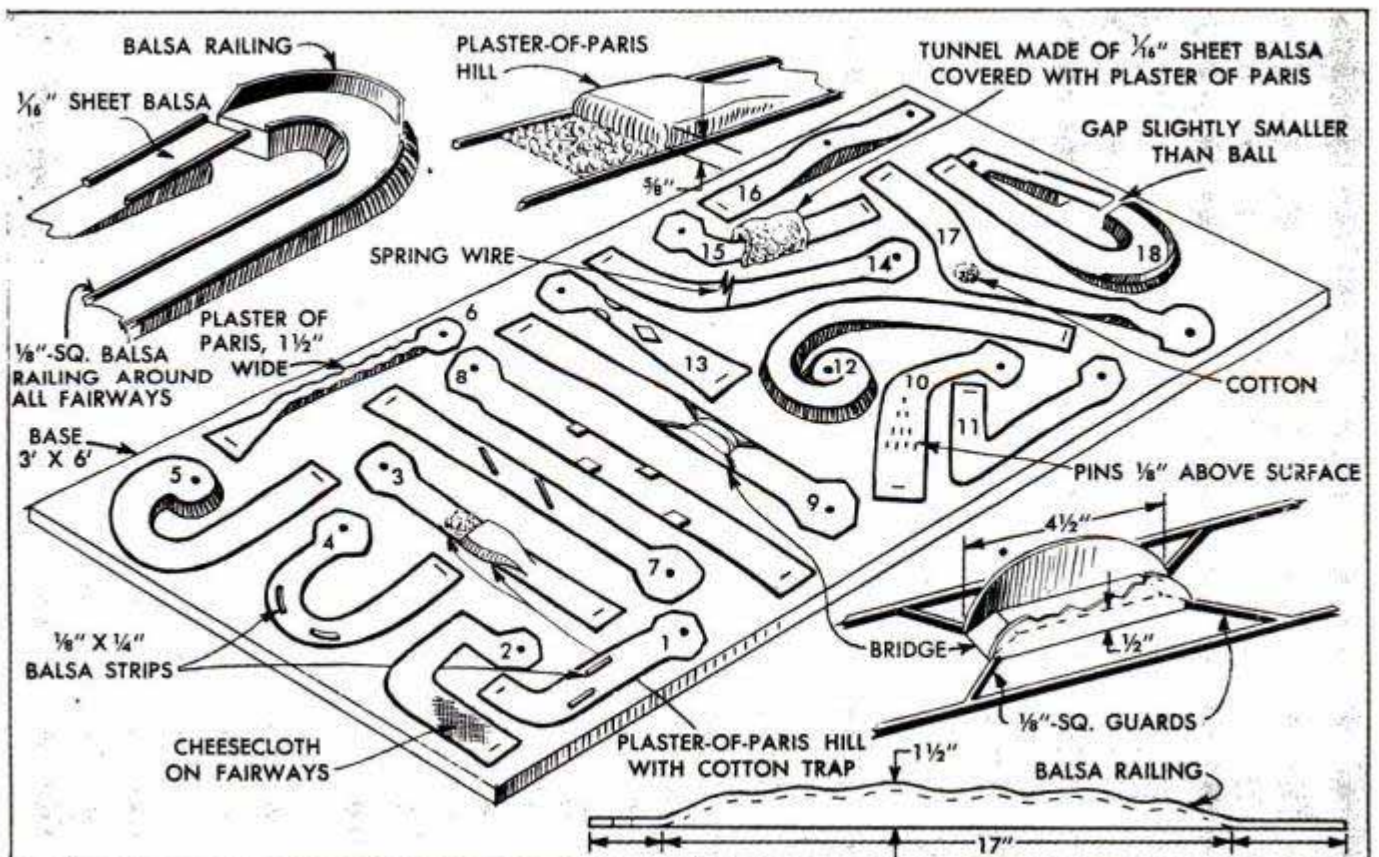



### Brackets Hold Crutches Within Easy Reach

One amputee veteran of World War II has found a very satisfactory and inexpensive way of keeping his crutches within easy reach of his bed and at the same time out of the way. He attached a pair of plastic drapery tiebacks to the wall near the head of his bed, as shown, and another pair to the wall near his desk. They are placed at a height to permit the crutches to clear the floor. Available in several colors, the tiebacks can be selected to harmonize with the wall.—Ross D. Meyer, Detroit, Mich.

### Deckle-Edged Greeting Cards



When making your own Christmas cards, you can produce a deckle-edged effect on the edges by using a bread knife of the type shown. Tear the edge against the blade to get the desired effect. The torn edges may

then be tinted with water colors for a pleasing holiday effect. Photographers can use this kink to decorate the edges of prints.

### Repairing Open Joints in Doors

For a simple but permanent repair when an old door has opened at the joints, place a bar clamp across the door and draw up the joints tight. Then while the door is still clamped, drive two or three screws

through the stiles and into the housed tenons, locating the screws about  $\frac{1}{2}$  in. from the joint. The heads of the screws should be countersunk and filled with wood putty.

J. Howard Cooper, Philadelphia, Pa.

### Novel Paperweight Resembles Spear

This unusual paperweight gives the illusion that the papers are pierced by the blade of the weight. Actually only a dummy envelope has been penetrated. The blade may be cut from a toy dagger or shaped from a piece of

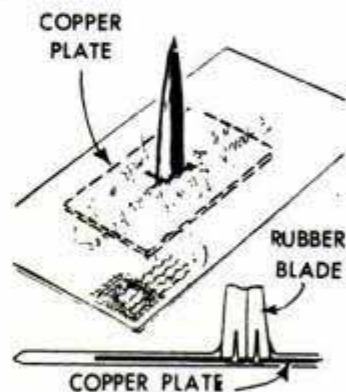

brass. The weight is provided by a sheet of copper small enough to fit inside of an envelope. Two nails are pushed through holes drilled for them in the copper, and then the copper is inserted in an envelope. The blade is forced through the envelope and then down on the two nails.

Frank Shore, New York City.

### Memo Pad for Use With Telephone Improvised From Film Pack

Needing a memo pad for use with telephone calls, I found that a discarded film pack containing sheets of paper cut to the proper size filled the bill very satisfactorily. The overlapping top side of the pack holds the sheets firmly in place, while the weight of the pack makes it possible to write without having to steady the pad. A moistened finger or a pencil eraser may be used to free one end of the top sheet for quick removal.—David Findlay, Brooklyn, N. Y.



# CUTLERY CABINET

By Dick Hutchinson

Here's a chance to put your craftsmanship on display by building this interesting cutlery cabinet. The cabinet features novel interlocking construction and, whether made of plywood, hardwood or knotty pine, it makes an attractive addition to a kitchen or dining room



TO BUILD THIS cutlery cabinet, use 1/4-in. plywood for the back panel and 3/8-in. plywood for the remaining parts. Birch plywood was used for the cabinet pictured. First, jigsaw the back panel, following the squared pattern for the top and bottom scrolled designs. Then cut the two side panels, slotting them to receive the tabs on the back panel and top and bottom pieces. The latter are cut identically and a section of half-round molding is glued to the inside surface of the bottom piece to provide a stop for the cabinet doors. The doors, which are 4 by 14 1/2-in. panels, are hinged as in the lower left-hand detail, round-headed wood screws being driven through oversize holes in the top and bottom pieces to form pivots. The knife rack is cut and shaped from 1 3/8-in. hardwood and slotted to take the knife blades. The narrow edge of the rack is glued and screwed to the back panel. Finish all parts separately before assembly, and then lock the parts together by driving tapered hardwood pegs through the projecting tabs.

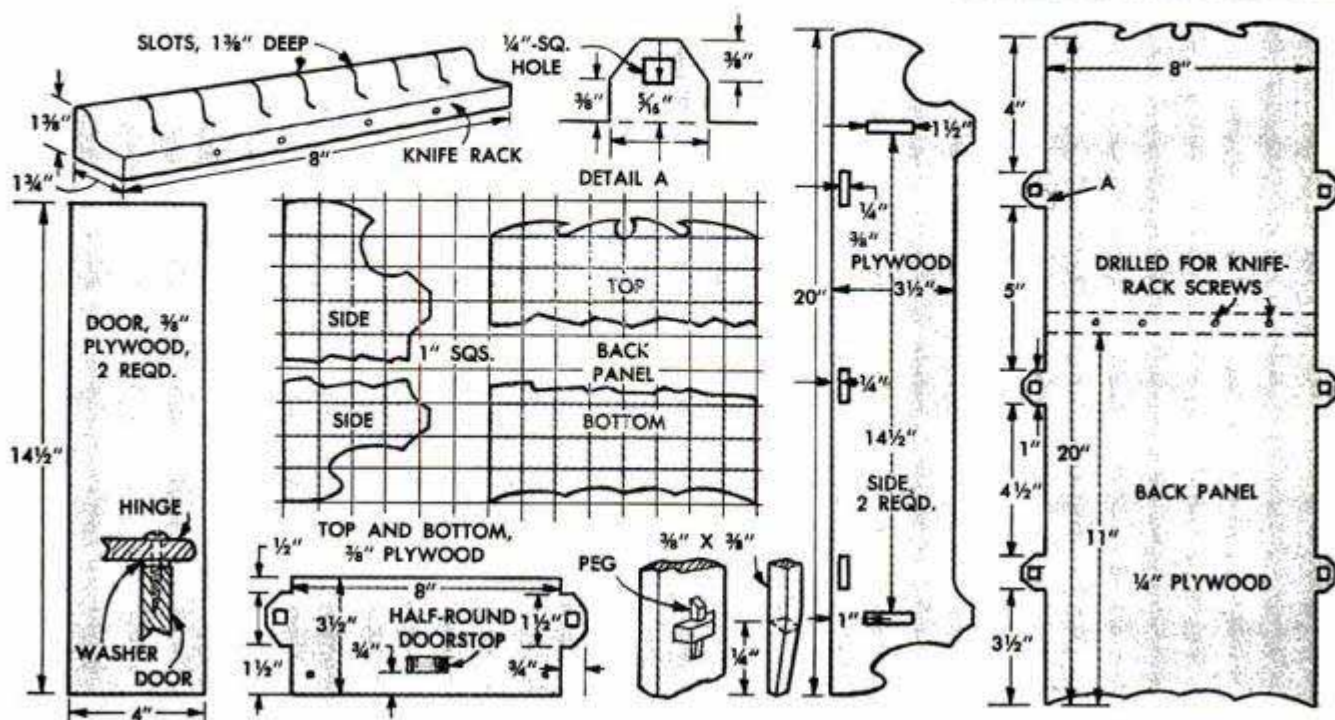

# Solving

# PROBLEMS

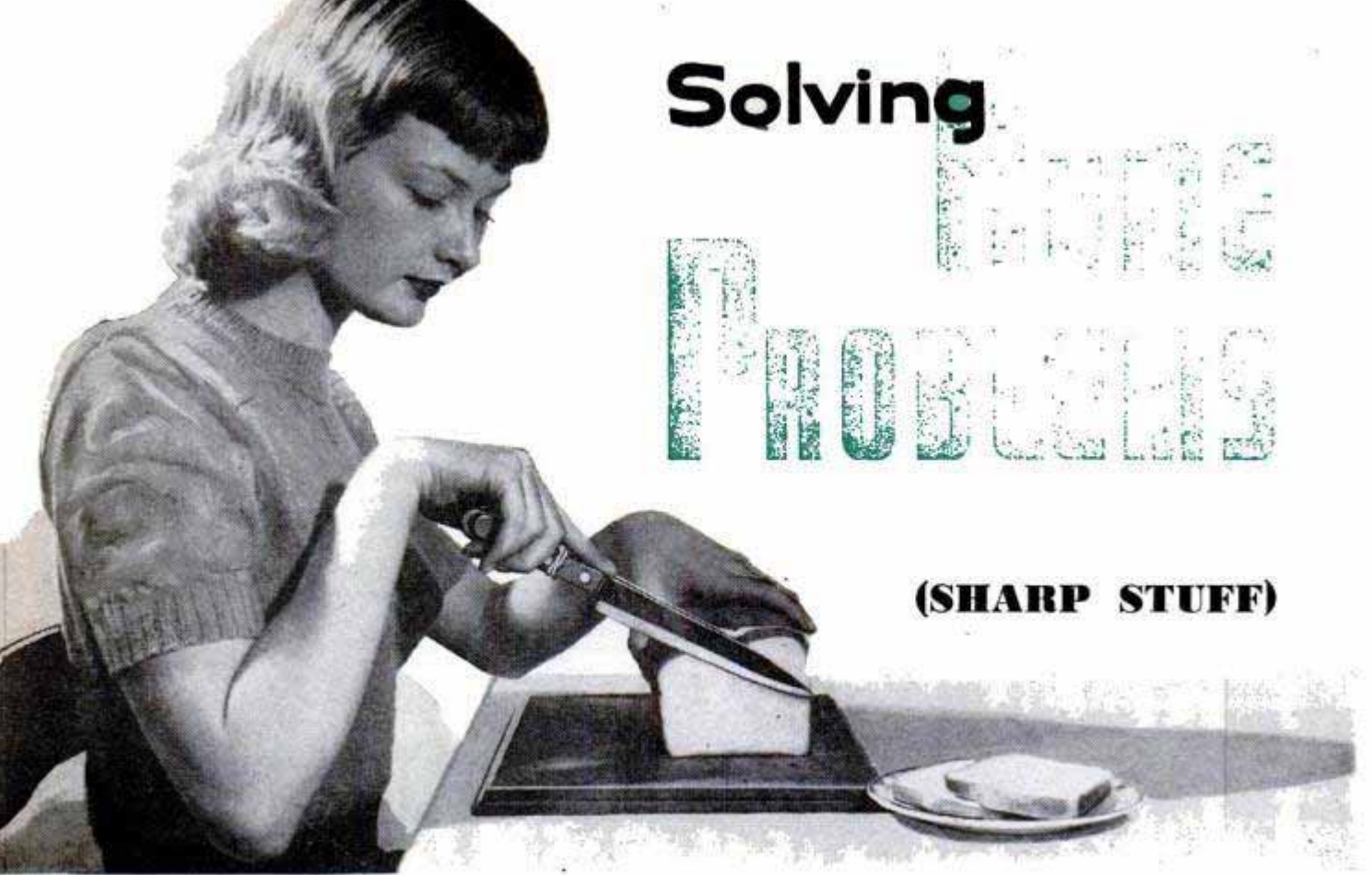

**(SHARP STUFF)**

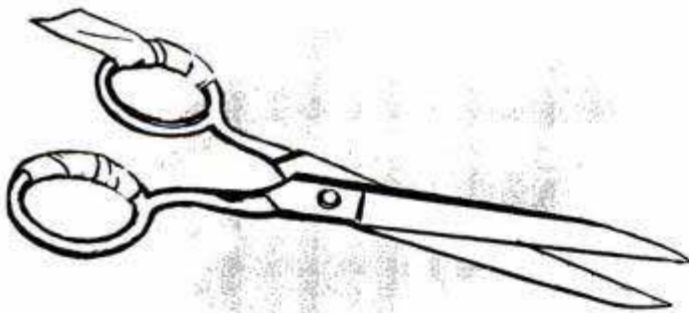

**CUTTING BREAD** into uniform slices is done easily by using two knives bound together with rubber band wrapped around handles. Inner blade does cutting while outer blade serves as guide

**TO PREVENT SORE FINGERS** when using scissors for prolonged periods of time, pad handles with moleskin adhesive tape, left. Apply the soft tape to the handles where fingers rub against metal

**TWO ADHESIVE BANDAGES** applied to medicine-cabinet door, below, form holder for fingernail scissors

**FASTENED TO A WALL** or cabinet door, back of ring binder provides excellent hanger for large scissors, below. Upper ring engages handle of scissors while lower ring holds blades in place

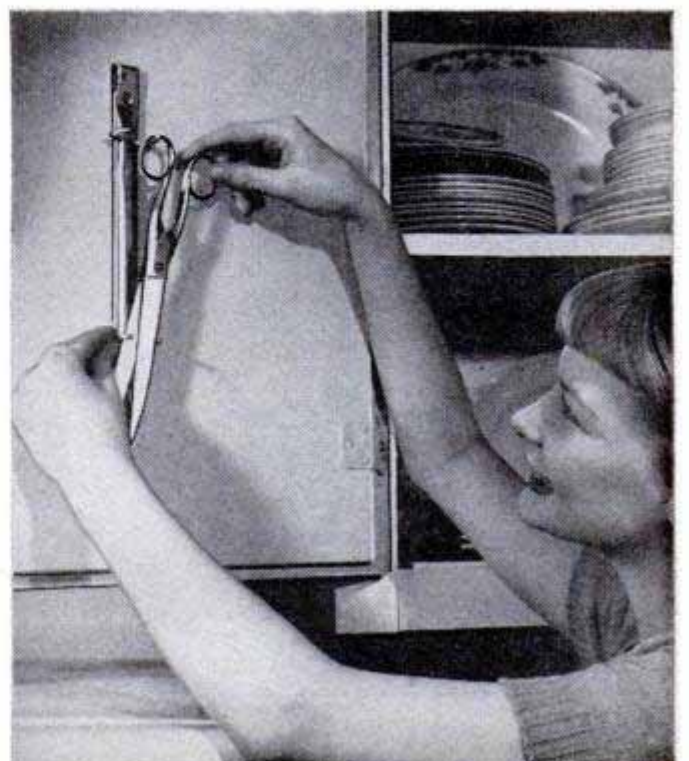
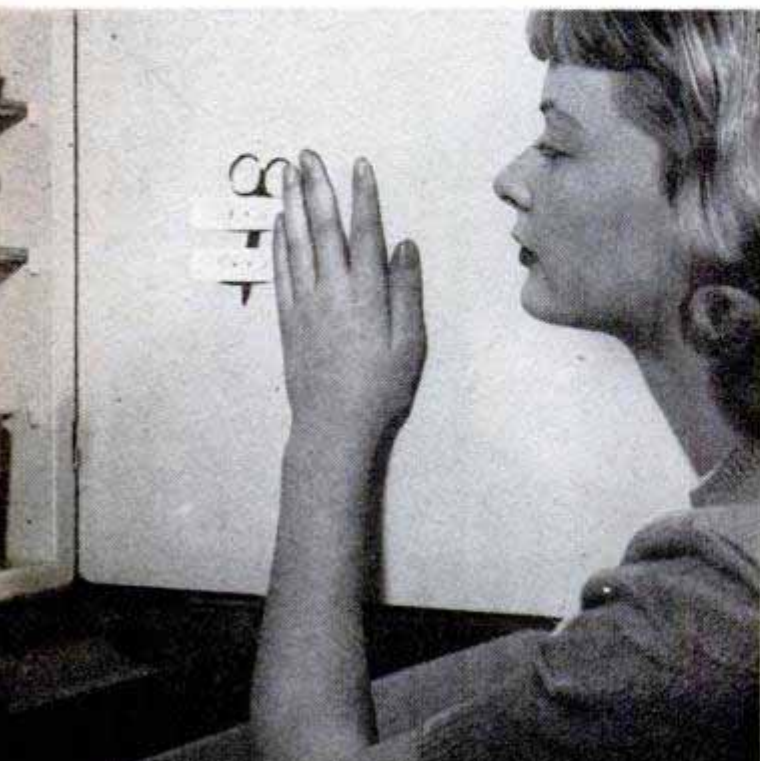





**KNIVES** may be honed on dowel wrapped with piece of 2/0 emery cloth



**SLOTTED** hardwood dowel fitted in knife drawer keeps knives separated to preserve sharpness of the blades



**PAINTING THE TOP OF KNIFE HANDLE** tells you at glance which edge of blade is the cutting edge. This is especially helpful from a safety standpoint when edges of the blade are curved similarly

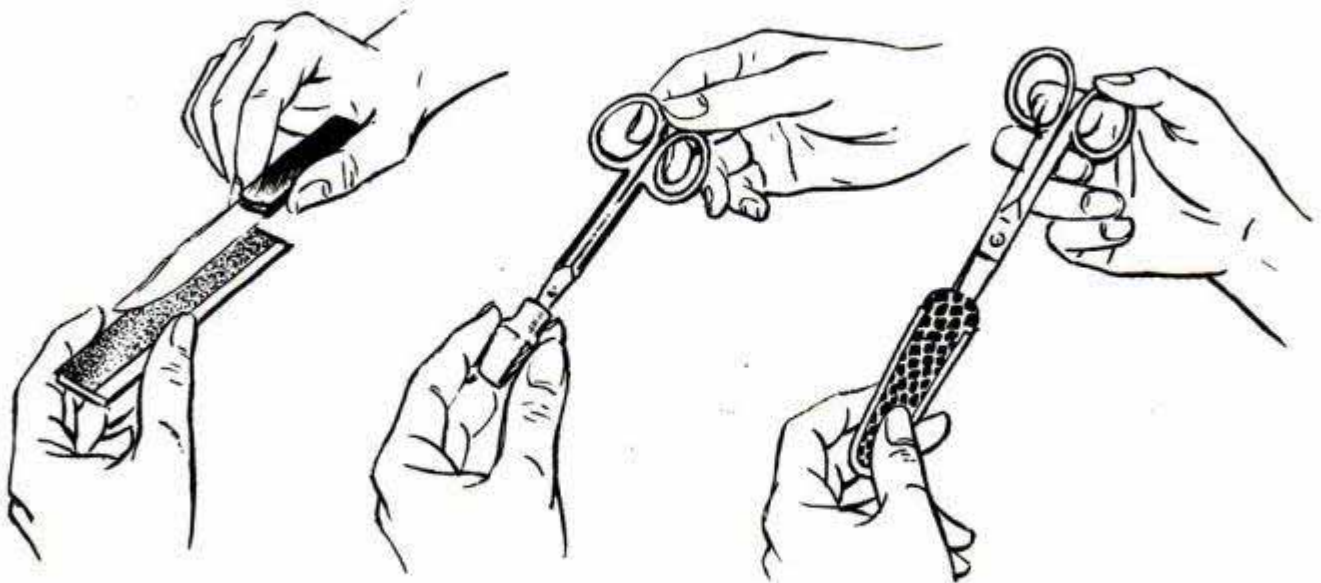

**HANDY "WHETSTONE"** for small kitchen knives is made by wrapping a piece of wood or heavy cardboard with emery cloth. Tack or glue cloth to backing

**SHEATH** for fingernail scissors can be improvised from an ordinary slip-on pencil eraser. Sheath protects your fingers as well as blades of the scissors

**SHARP-POINTED** scissors may be carried in pocket or handbag without danger if points are shielded by slipping a fingernail-file case over blade ends

## Table Saw Used as Wood Shaper

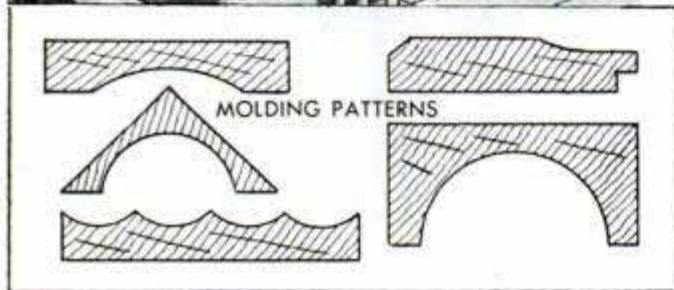

Picture framing, ceiling cove and other decorative wood-strip moldings can be shaped on a table saw. Clamp a straight piece of wood diagonally across the saw table with two C-clamps, as shown, to serve as a fence. The greater the angle between the saw blade and fence, the wider will be the groove cut in the stock as it passes over the saw. Raising the saw blade will increase both the width and depth of the cut. When making deep cuts, start with the blade only about  $\frac{1}{16}$  in. above the table. Make several passes, raising the saw no more than  $\frac{1}{16}$  to  $\frac{1}{8}$  in. after each pass until the desired depth has been reached. It is best to practice on scrap pieces of lumber to get the correct pattern, before running a good piece of stock through the saw.

Melvin Ham, Choteau, Mont.

## Extra Mittens for Children Dried Over Warm-Air Vent

To keep her children supplied with warm, dry mittens during the winter months, one homemaker hangs extra pairs on a clothesline near a warm-air vent. The mittens are secured to the line by means of spring-type clothespins suspended 4 or 5 in. apart along the line. The line, which is threaded through the spring coil of each clothespin and knotted to separate them,

is kept within reach of the smallest child to encourage the children to hang up their wet mittens and change to dry ones.

Rosena Wark, Kensall Park, Ont., Can.

## Magnifying Small Parts

If you lack a magnifying glass for examining or adjusting small parts, a magnifying mirror of the type sometimes used as a shaving mirror not only will provide an effective substitute but will also leave both hands free to work. To use, simply adjust the mirror as shown, moving the

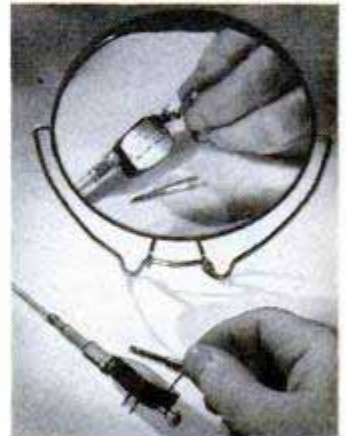

article away from it to increase magnification, or closer to decrease it.

## Cold Aids in Replacing Crystal

When a watch crystal which has dropped out of its frame is difficult to replace, put it into the refrigerator for a short time. The cold will contract it sufficiently so that it will fit in place easily. And on warming up to room temperature again, it will expand to fit tightly into its frame.

Ray Baldwin, Laurel, Miss.

## Square Prevents Handsaw Binding

When ripping a board with a handsaw, binding can be prevented if a try square or combination square is slipped into the kerf. The flat blade of the square will keep the saw cut spread and yet when loose will not fall from the slot.

Joel Miles, Denver, Colo.

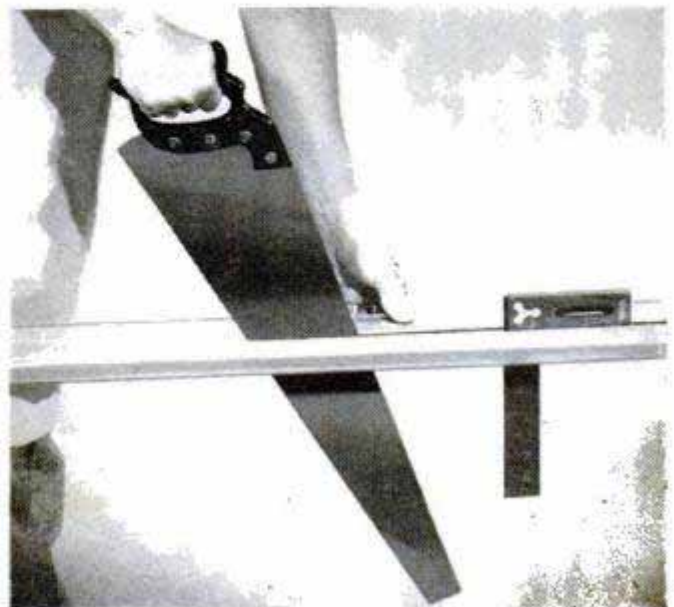

# DISPENSER FOR POKER CHIPS

By W. G. Waggoner

ADDING UNIQUE pull-out trays to the bottom of this hardwood poker-chip rack transforms it into a time-saving dispenser that counts out chips five at a time. The dispensing mechanism consists of a dozen wedge-shaped segments, each of which is bored for the chips. A screw eye is driven in the inner end of each dispenser and threaded on a length of curtain spring. The dispensers are held in position by means of a hardboard disk and thin wooden separators. Furniture nails driven through slots in the disk permit pulling out the spring-loaded dispensers with the finger tip.

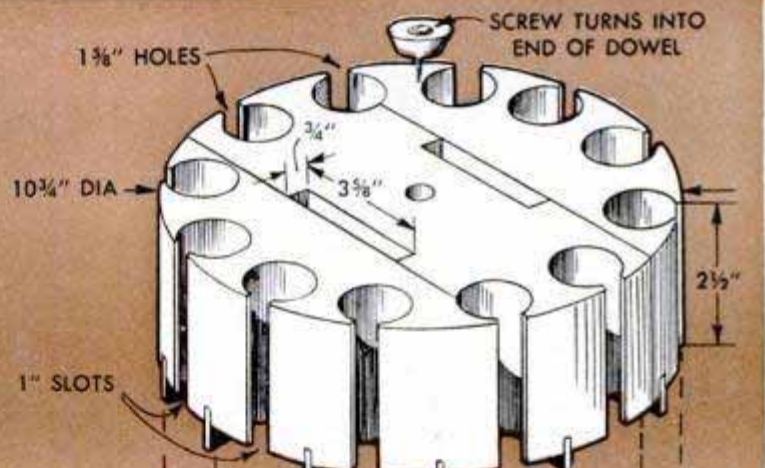
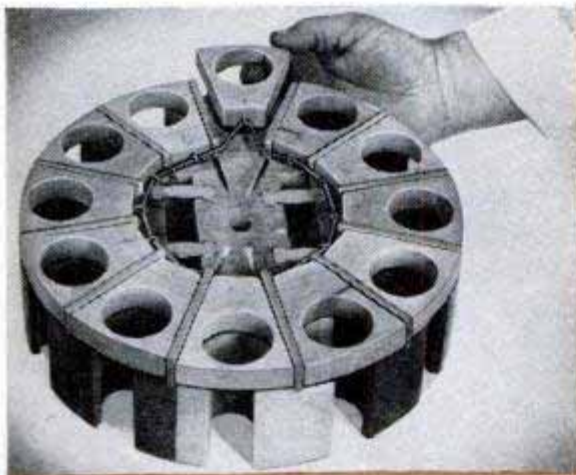
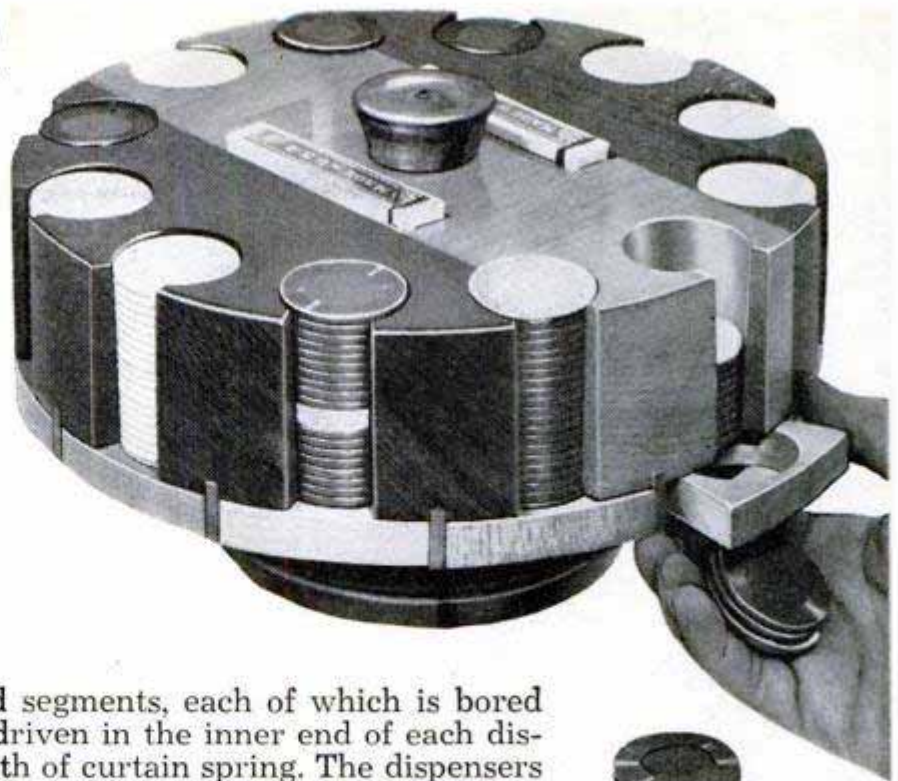

COMPARTMENT  
FOR CARD DECKS

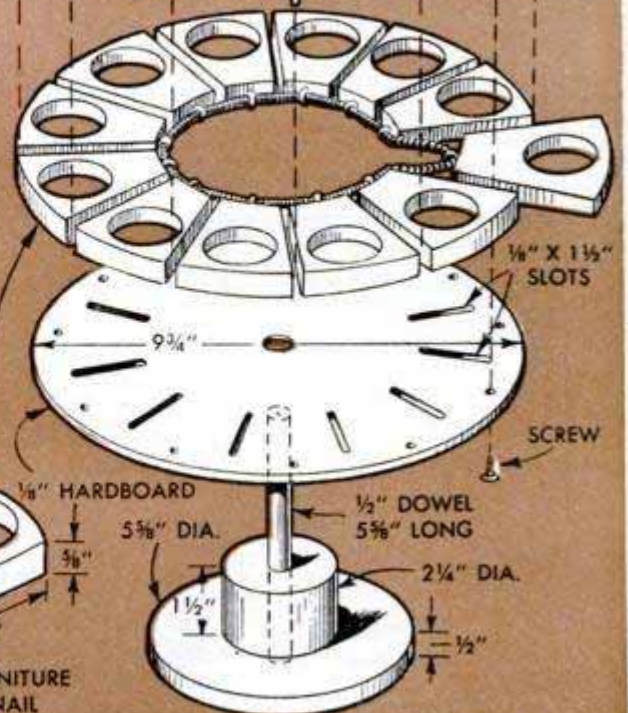
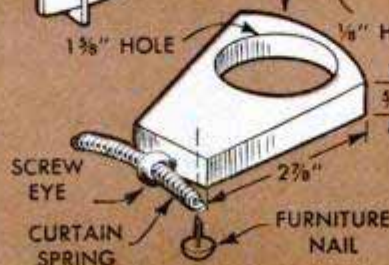
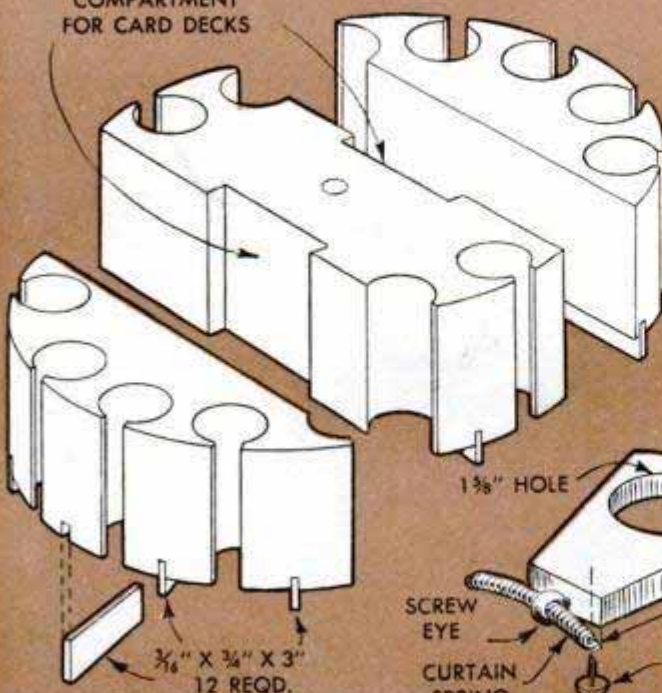

# THE JOB'S HALF READY-MADE



By Wayne C. Leckey

**W**ANT TO BUILD a table with a screwdriver? You can do just that with ready-made steel legs—a new idea that equips the home furniture builder with prefabricated units, complete with screws, ready for attaching. For example, with a set of these modern steel legs, anyone can build a sturdy, smart-looking dinette table in little more than the time it takes to screw them to a flush-type door. By attaching them directly to a table-model TV set, Fig. 1, a smart wrought-iron stand is had that is right at home with modern furnishings. These are but two of any number of simple applications to which these practical legs can be put. Bookcases, chests, hollywood beds, desks and chairs are other uses.

The legs come in various lengths, shapes

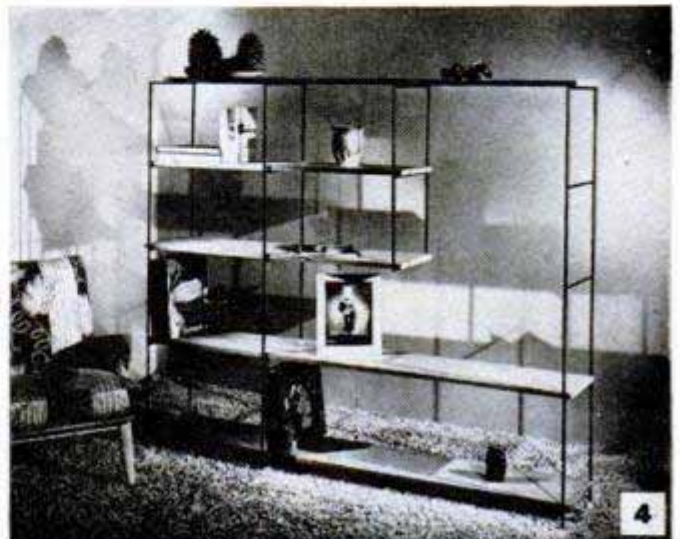
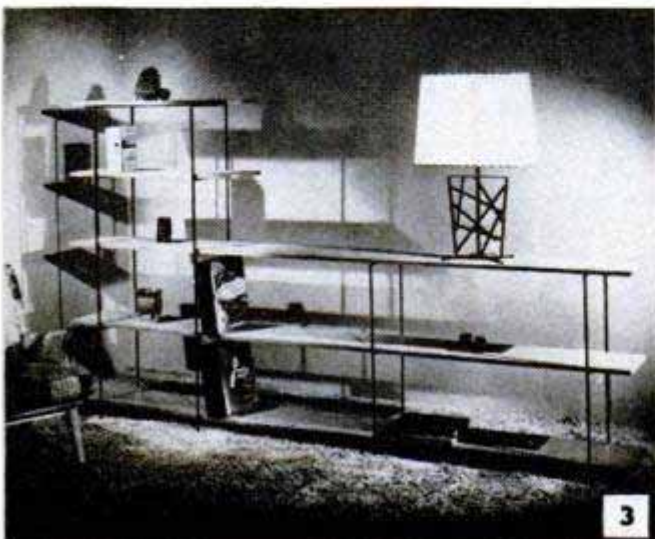
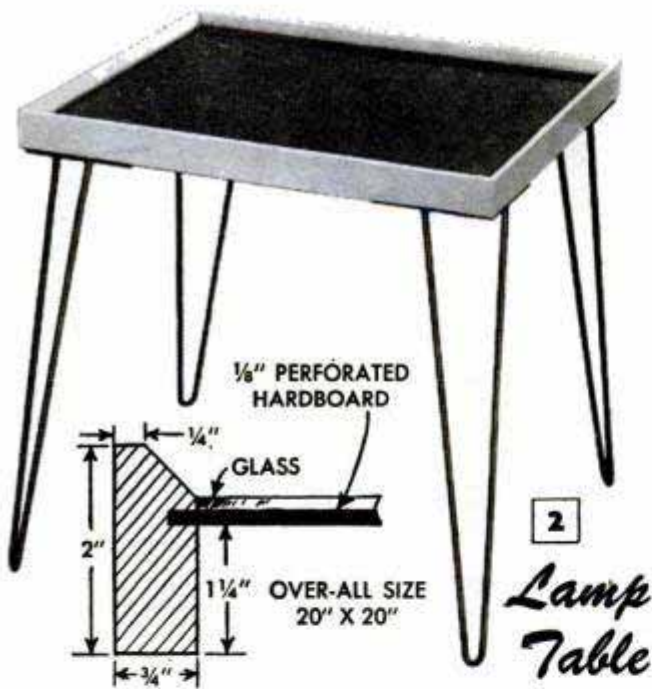

# DONE WITH STEEL LEGS

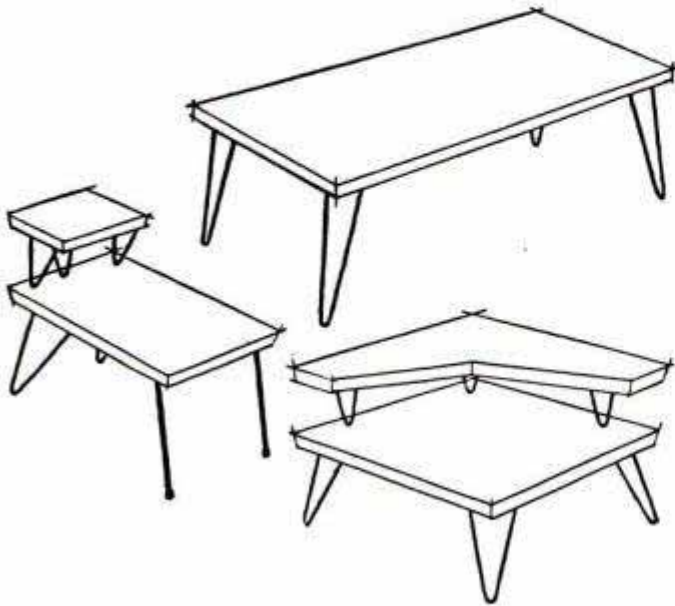

and finishes, Fig. 9. In addition to black-finish hairpin legs, there are tubular ones in brushed chrome and plain, standard wrought-iron ones tipped with rubber. Still others in the form of welded frames are available for making room dividers, Figs. 3 and 4. Room dividers are the latest trend in flexible room arrangements and, as in the case of the legs, the welded frames are simply screwed to wooden shelves and the job is done. Similar frame units are available for making end tables and wall shelves as pictured in Figs. 10 and 11.

The popular hairpin-design leg can be

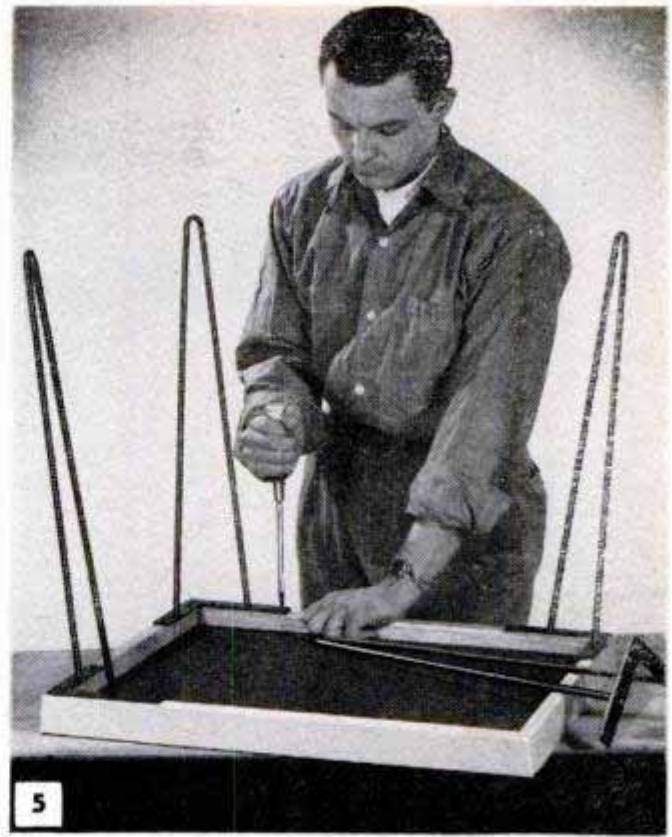

*Coffee Table*

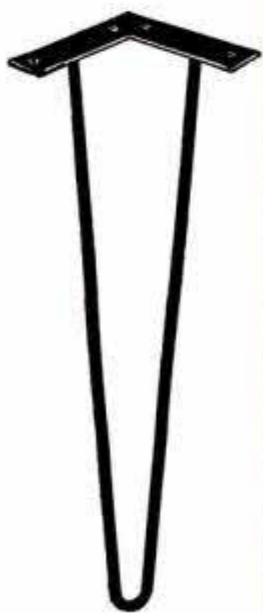
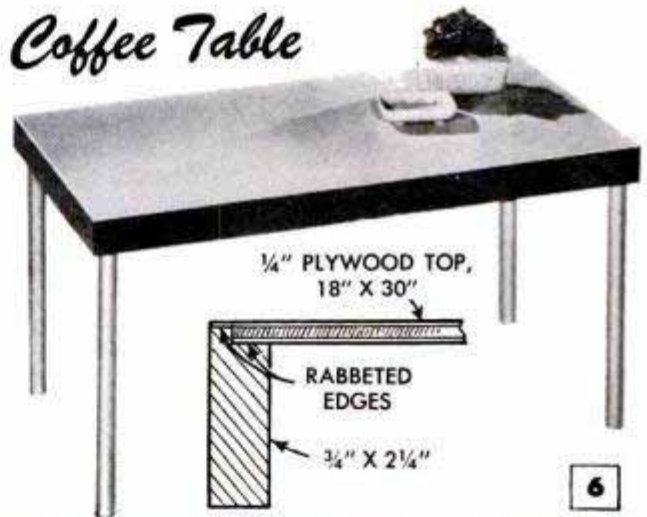

HAIRPIN LEG

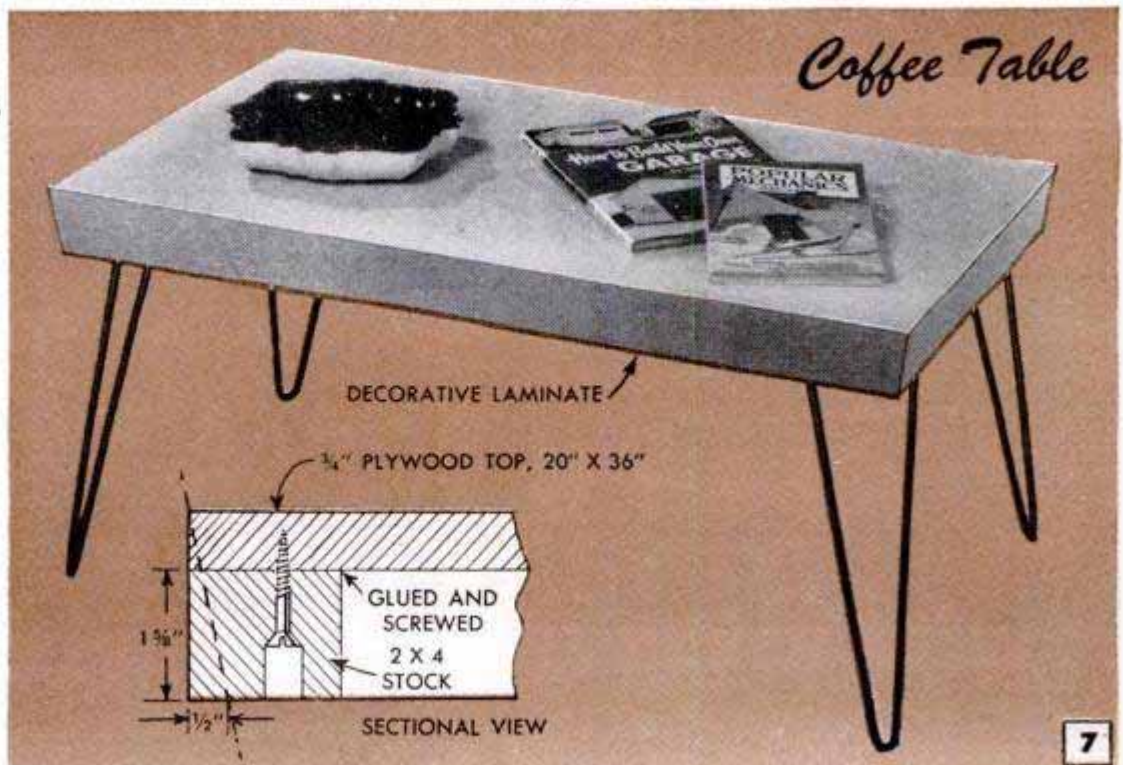

# Cocktail Table

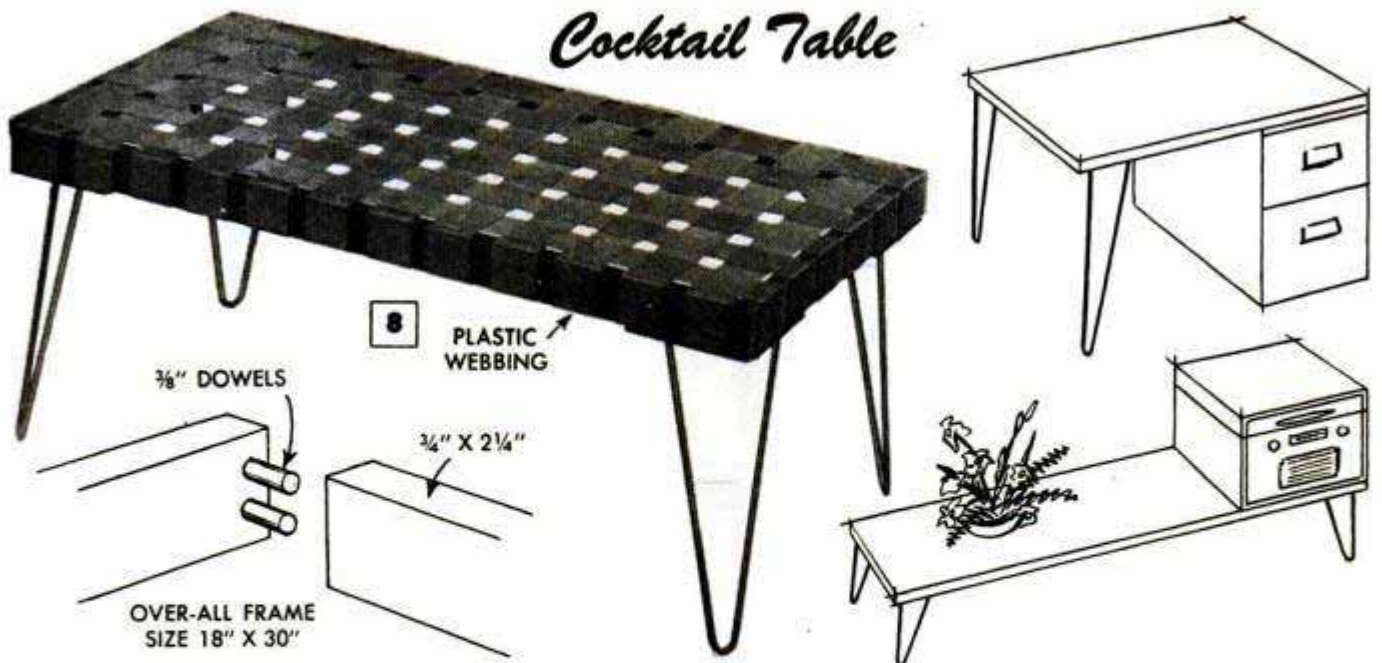

## Additional Legs Available

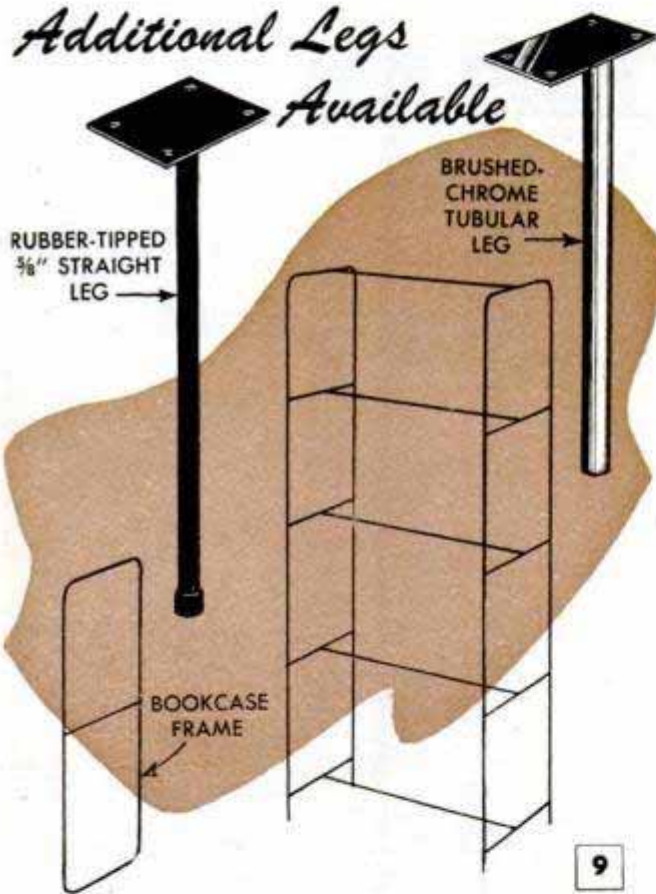

had in some seven different lengths, 6, 9, 12, 14, 16, 22 and 28 in. The 12-in. size, suitable for a coffee table, averages about \$7.00 per set of four legs. Other sizes are proportionately priced. Aside from their ease of application, the particular design of the hairpin leg helps to strengthen any framework table top to which they might be attached, Fig. 5, and while the longer sizes might appear to be somewhat frail looking, the outward flare of the legs actually tends to add exceptional rigidity.

The tables pictured in Figs. 2, 6, 7 and 8 detail several attractive table tops which the home craftsman can build for hairpin legs. The table shown in Fig. 2 is nothing more than a mitered "picture frame" assembly fitted with a panel of leather-textured hardboard. In Fig. 7, the wooden top has been covered with gray-linen decorative laminate. An article in the October 1952 issue of *Popular Mechanics* describes how this material is applied. The cocktail table, Fig. 8, consists of a simple rectangular frame of hardwood, painted flat black and woven with Chinese-red plastic webbing, laced and tacked to the frame. ★ ★ ★

Information and certain photos courtesy E. F. Lawrence Iron Works

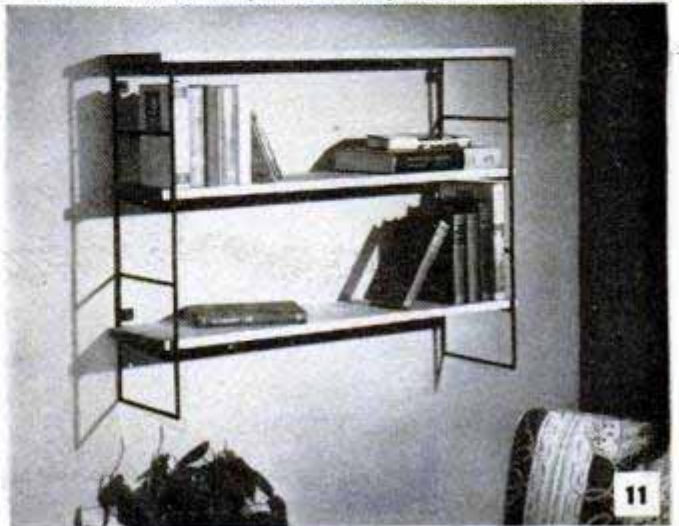

# HANGING BOOKSHELF

Useful for books as well as knickknacks, this hanging wall shelf fills the bill perfectly where floor space is limited. Keyhole slots in metal L-brackets permit the shelf to be hung securely from round-headed screws driven in the wall. The 2-in. posts separating the three shelves are turned and cut to the lengths indicated in the sectional drawing. The two 11-in. sections of the posts are drilled to receive 1/4-in. rods which tie the assembly together. Note that the sections rest in counterbored holes.—Richard N. Nierenberg, Dayton, Ohio

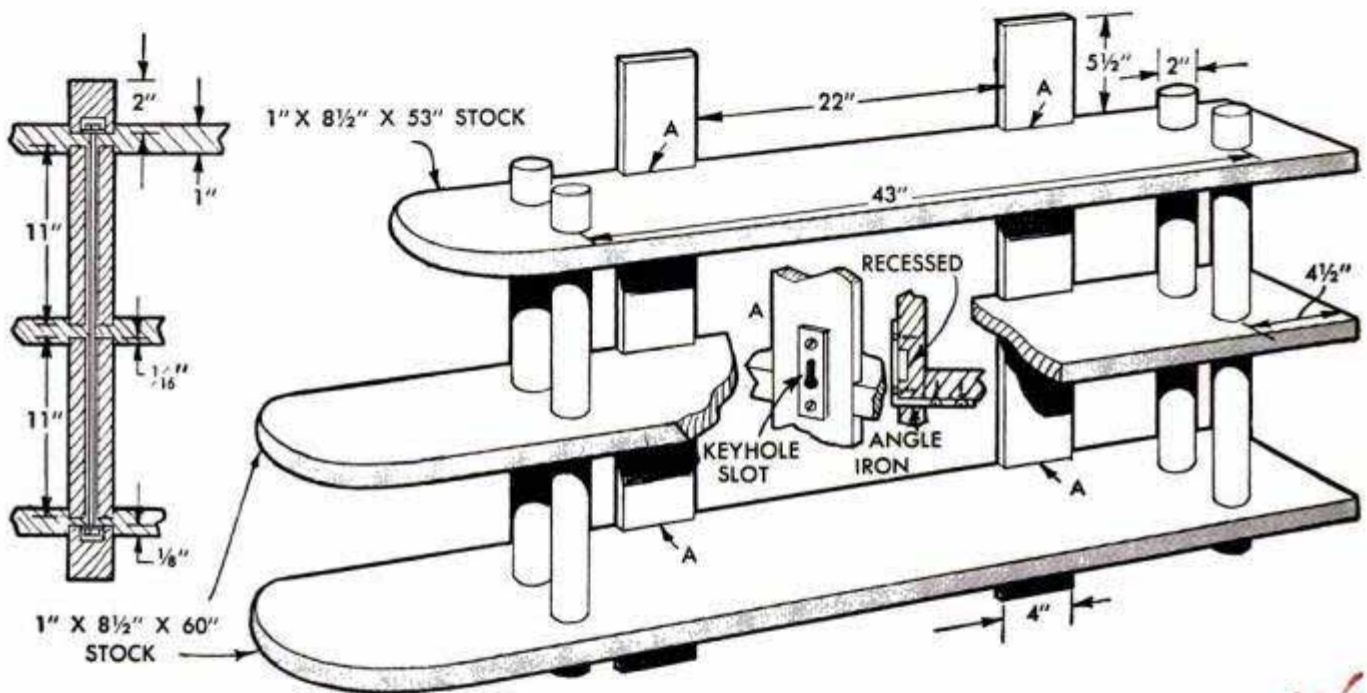
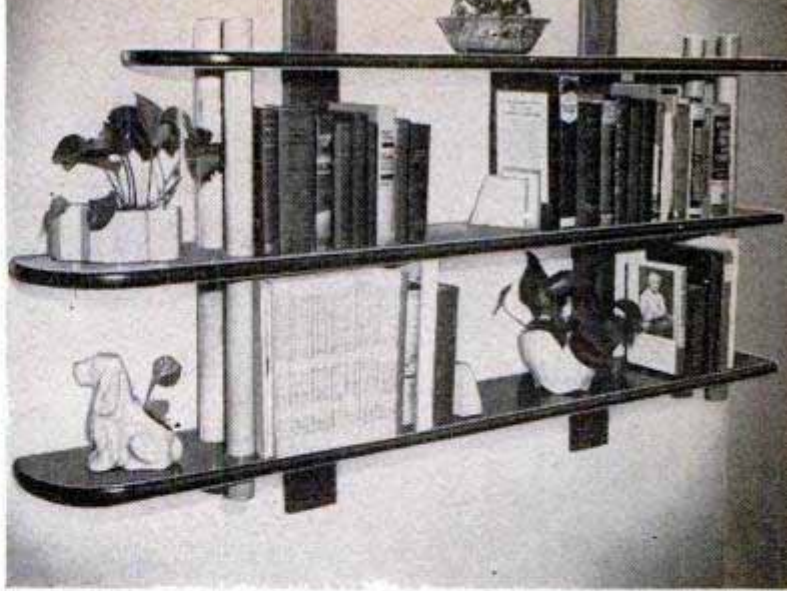

## Dispenser for Cigarette Packs Keeps Supply Visible

WIM '55

Hang this cigarette-pack dispenser on your kitchen wall and you'll know at a glance when the supply is getting low. The back, sides and bottom of the dispenser are made from 1/4-in. stock, cut as shown in the detail. The two sidepieces are grooved to receive the plastic sheet which forms the front of the dispenser. The plastic front should be cut a little oversize, so that the sidepieces have to be bent slightly outward to accommodate it. If fitted tightly in this fashion, the plastic will stay in place without further support. Since the dispenser is to be mounted on a wall, it should be finished in a decorative manner. It can be lacquered to match the other colors used in the room, or it can be stained to simulate one of the hardwoods. Decals can be used on the plastic front or on the sides.

Bertram Brownold, Cedarhurst, N. Y.

Aluminum foil wrapped around a tree trunk protects it from rabbits.

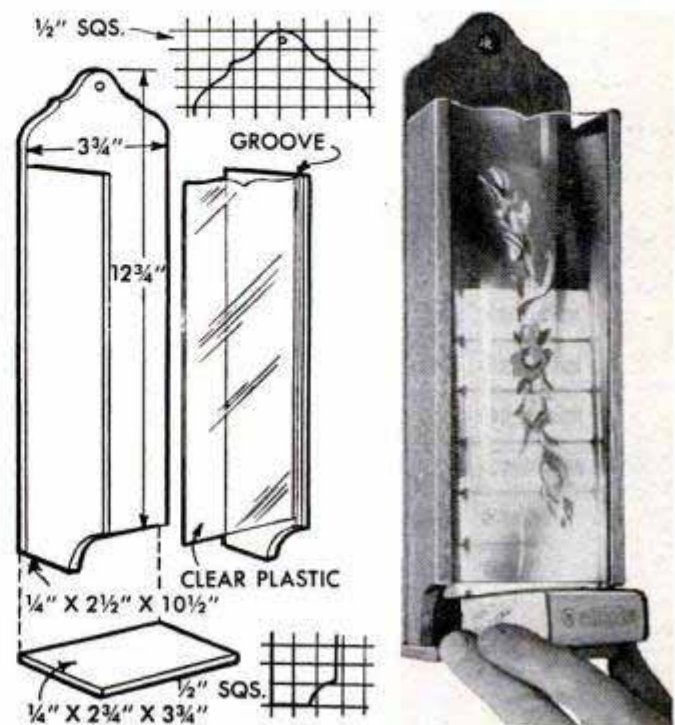

# NEW LIFE FOR OLD BOOKS

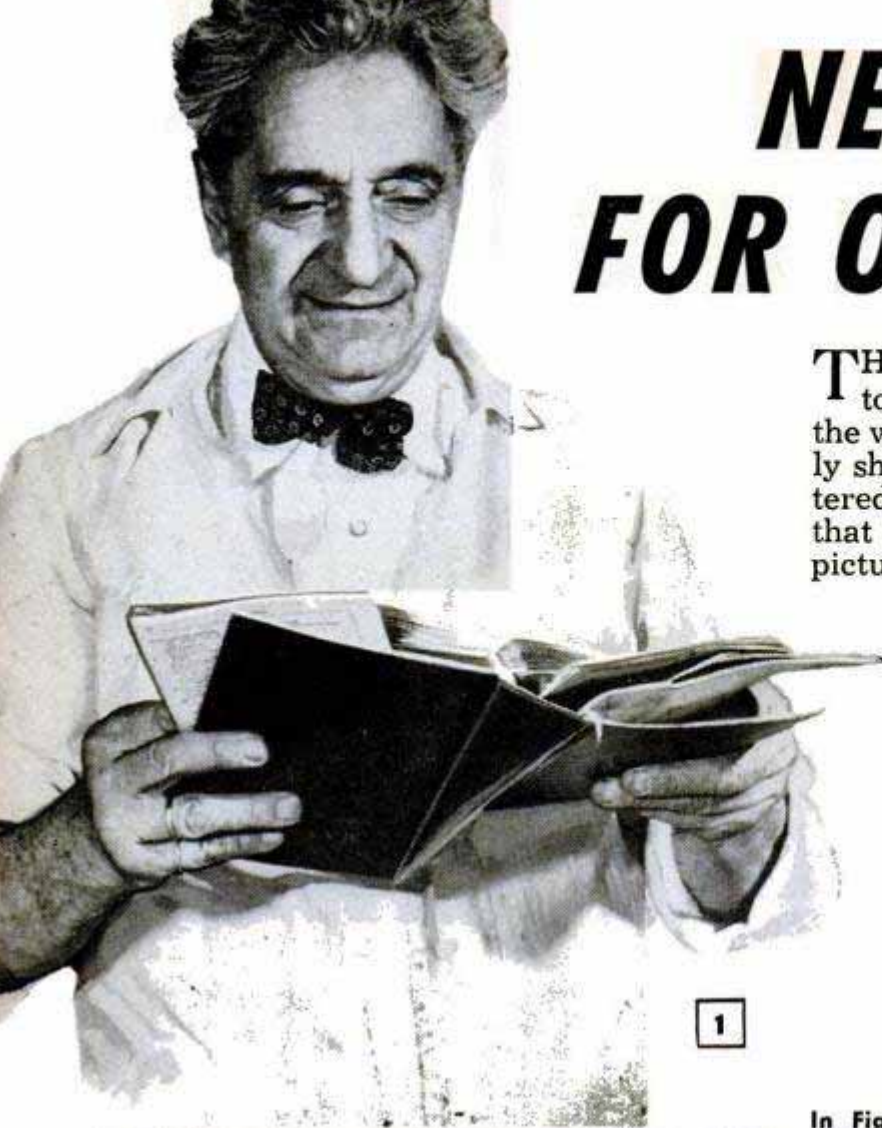

THE POWER of the printed word is said to be eternal, but the bindings in which the words are preserved have comparatively short lives. If you have broken and battered books on your shelves, you will find that by following the simple steps in these pictures you can give them new life and restore their appearance. Eric Hollander, a New York City bookbinder, shows you how it's done. The materials required are inexpensive and easy to obtain. The most unusual item is a book press, but a vise will do just as well. Other than that, all you need is a paste pot, a pair of scissors, some bookman's (or No. 25 linen) thread and a paper cutter, if one is available. Stiff paper and poster board complete the list. The most ticklish part of the job is taking the book apart without further damaging it. The rest is easy. ★ ★ ★

In Fig. 1, the bookbinder holds a volume that is falling apart and badly in need of rebinding. The book must now be taken apart without doing any further damage to the pages. Cover is removed first

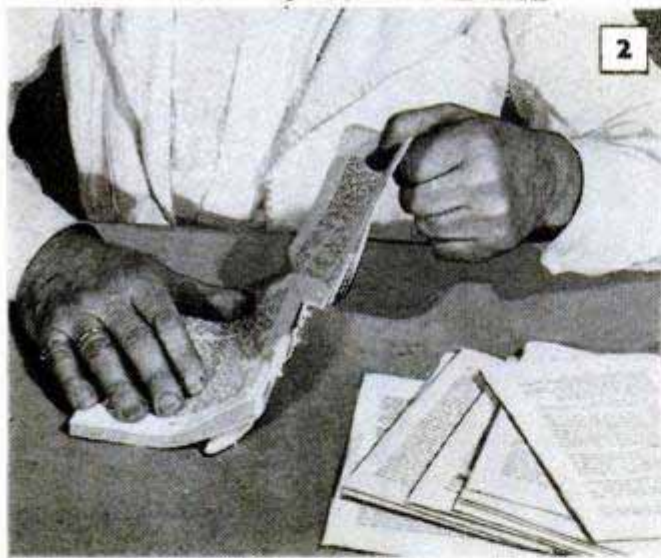

Below, in Fig. 3, the individual sections are cleaned with a knife, leaving them smooth and free for re-binding. Then any damaged pages are repaired with transparent tape, as the book-binder is doing in Fig. 4

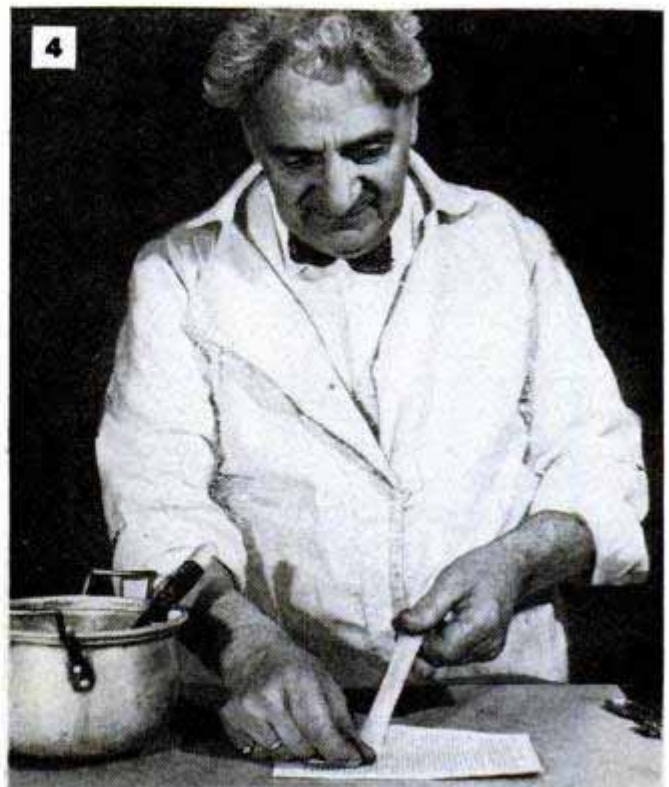





A sheet of stiff paper is doubled and then cut to the exact page size, Fig. 5, to make a cover plate. The creased edge, placed along the back of the book, is not cut. Two cover plates like this are required

Now sew sections of book together. Two strips of crinoline wrapped around back are sewn to book as in Fig. 6. Stitches are put through crease of each section, then run to next section in continuous stitch

The cover plates, which previously have been cut to size, are now placed on the front and back of the book, Fig. 8, and crinoline tabs glued on top of them, binding them to the pages. Apply the glue carefully

A strip of kraft paper, wide enough to cover both the back of the book and the crinoline tabs on both sides, is now glued in place. It should be shorter than the book back. Book is then clamped in press to dry, Fig. 7

Fig. 9 shows the cloth for the cover being cut. One piece is used, measuring  $1\frac{1}{2}$  in. longer and wider than the final dimensions of the cover itself to allow for wrapping around the edges of the cover boards

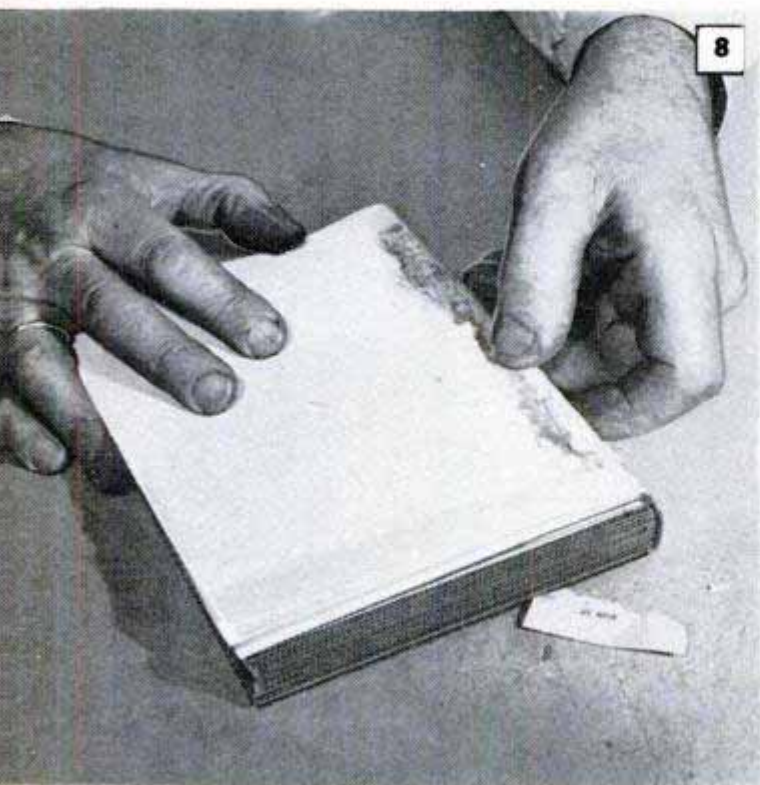
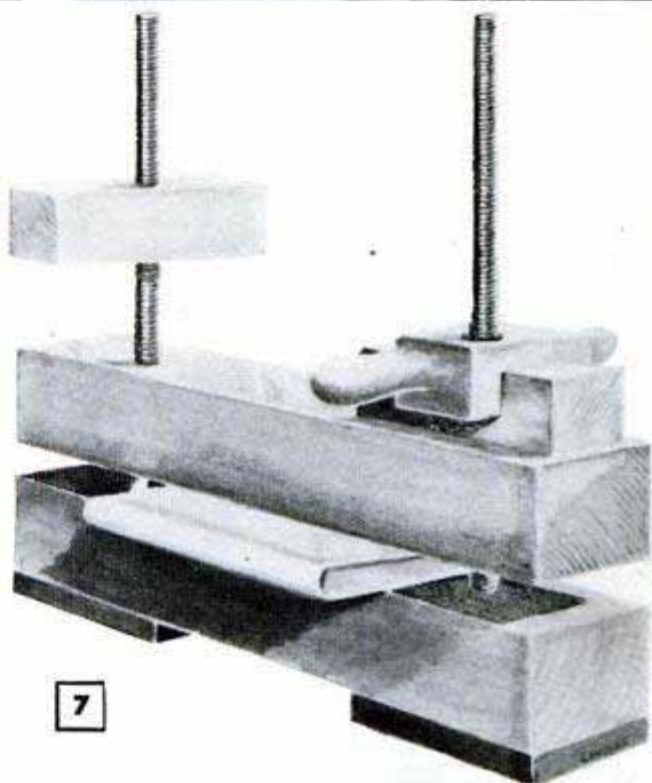

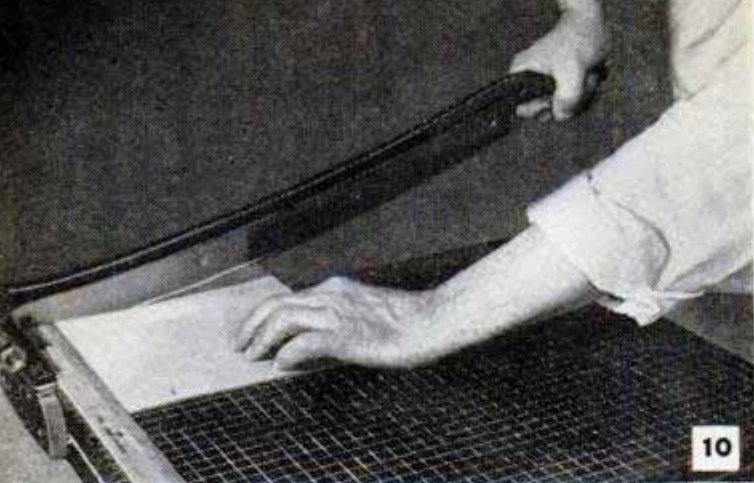

10

The front and back cover boards are now cut from heavy cardboard stock, Fig. 10. These should measure  $\frac{1}{8}$  in. longer than the page length, but should be exactly the same width. A backing strip, the same length as the cover boards and slightly wider than the book back, should be cut from the same material



11

The cover cloth is laid out flat, as indicated in Fig. 11, and the cover boards and backing strip are placed on it. Space must be allowed on both sides of the backing strip for bending the cover. When lined up, the cover boards and backing strip are glued to the cloth. Edges are wrapped and glued

Glue is carefully applied to one cover plate with a brush, Fig. 12. Then the book is pressed on the already prepared cover. Next, glue is spread on the second cover plate and the cover is wrapped around the book and pressed in place. Carelessness at this point of the work will smear glue, causing a messy job

To finish the rebinding job, place the book in a press under heavy pressure overnight, Fig. 13. By morning the glue will have dried thoroughly, and you will have a new-looking book for your library shelves. Instead of cloth, the cover can be leather, leatherette or plastic, if a more luxurious look is wanted

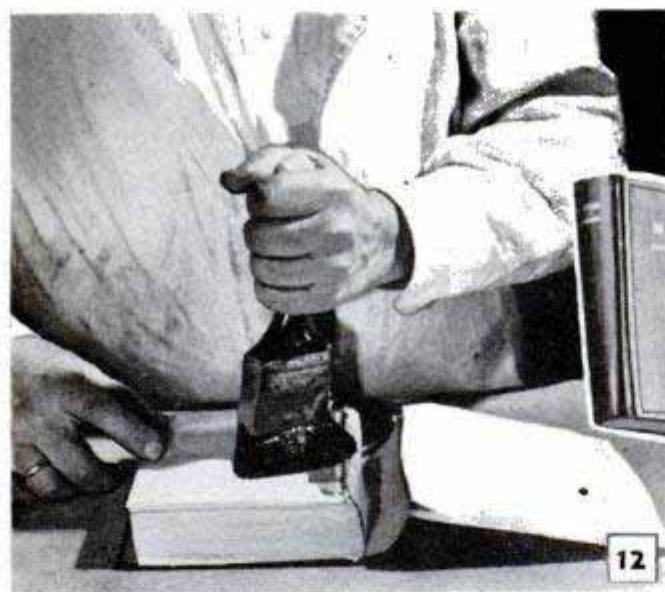

12

Eric Hollander views the rebound volume in Fig. 14. The title of the book can be hand-lettered on the new cover in gold or a bright color. Or, as is frequently done, it may be lettered or printed on small rectangles of heavy-weight paper, which then are glued to the front cover and to the back strip

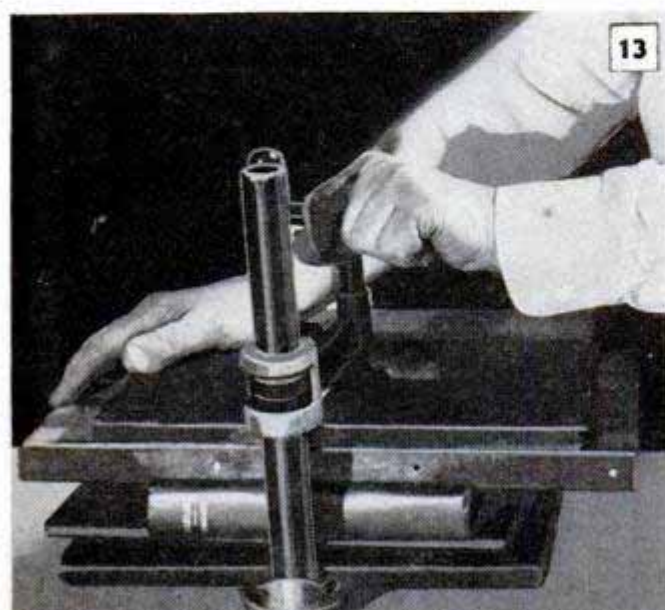

13



14

# Steps Help Child Learn to Use Clothes Closet

Children can't be trained to hang their clothes in a closet until they are tall enough to reach the clothes pole, unless you provide them with a means of getting up in the closet. A pair of steps which can be their very own property will do the trick and go far toward training them to be neat about their clothes. These steps are easily moved around his room by the child, and while they are high enough so he may reach his clothes, they are not so high as to be dangerous. Constructed of  $\frac{3}{4}$ -in. lumber and fastened

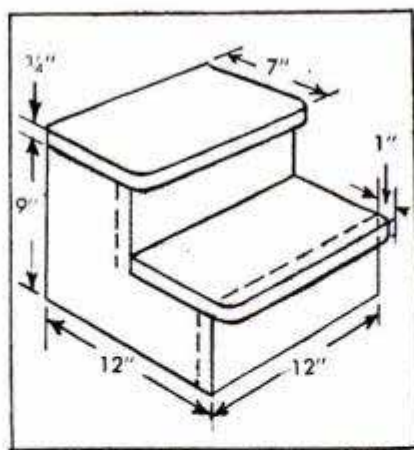

together with wood screws, the steps are an easy one-evening project for the home craftsman. All the necessary dimensions

are given in the detail. When completed, the steps can be finished to match the other furniture in the room.—I. M. Fenn, Chicago.

## Emergency Repair for Rusted Door Hinges of Old Automobiles

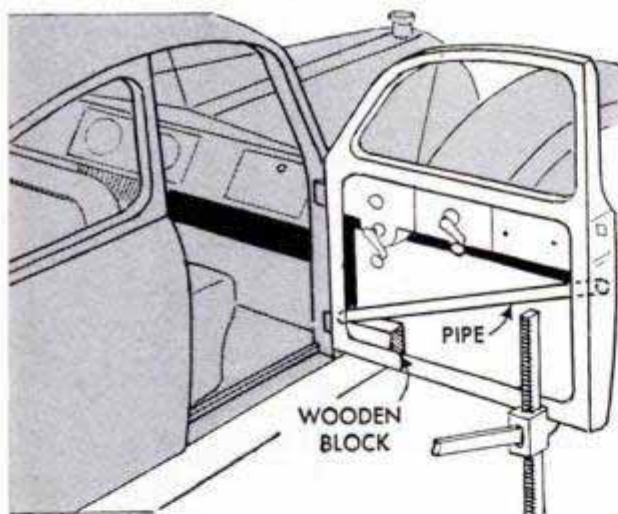

When the lower hinge on the door of an older automobile rusts out, it often can be repaired even though excessive rust prevents welding. First remove the upholstery from the inside of the door, and then, with the door wide open, jack up the outside corner until the broken hinge is in its original position. Measure the distance between the two lower corners of the door on the inside of the frame and cut a length of  $\frac{1}{2}$ -in. pipe, making it  $\frac{1}{4}$  in. longer than this measurement. Wedge this pipe inside the door, as shown, with one end against the center of the broken hinge and the other against the opposite side. To prevent the pipe from slipping, insert a block of wood under it.

Robert E. Damm, Englewood, Colo.

## Worn Spot on Auto Armrest Renewed With Flock

When the upholstery on the armrest of your car becomes worn, it can be repaired by spraying it with flock of the same color as the upholstery. Remove the armrest from the door, trim off the worn edges of the material, and glue down any loose edges. Spray or lightly brush a thin layer of flock undercoating on the exposed area and, when it is tacky, apply the flock, either with a flock gun or by sifting through a fine sieve. The result will wear well.

Ken Murray, Colon, Mich.



☐ Your name printed on a strip of adhesive tape can be wrapped around the shaft of an umbrella to serve as identification.

# PLAN of the MONTH...

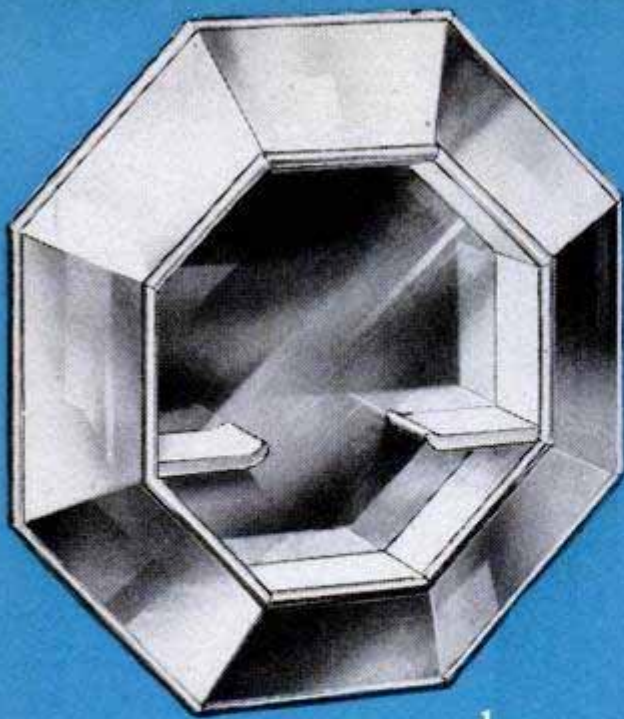

1

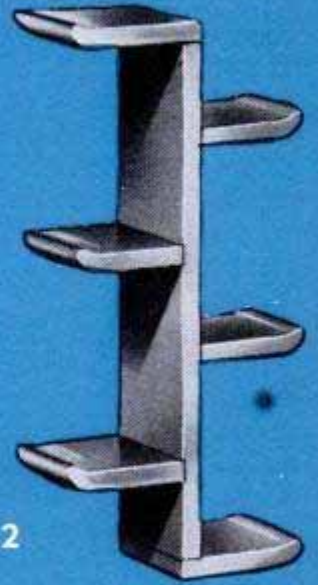
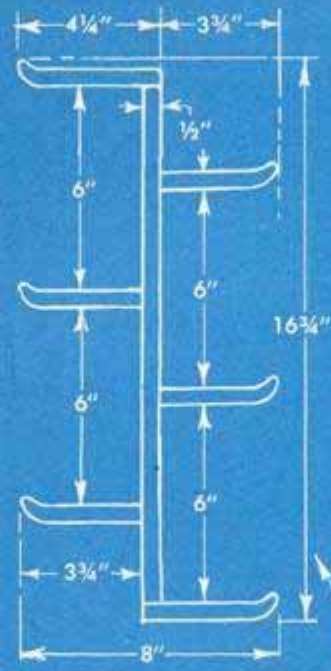

2

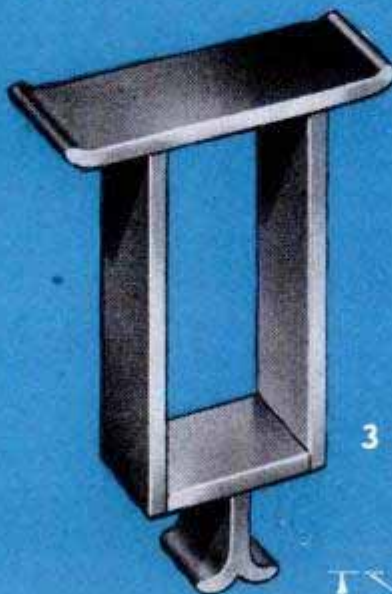
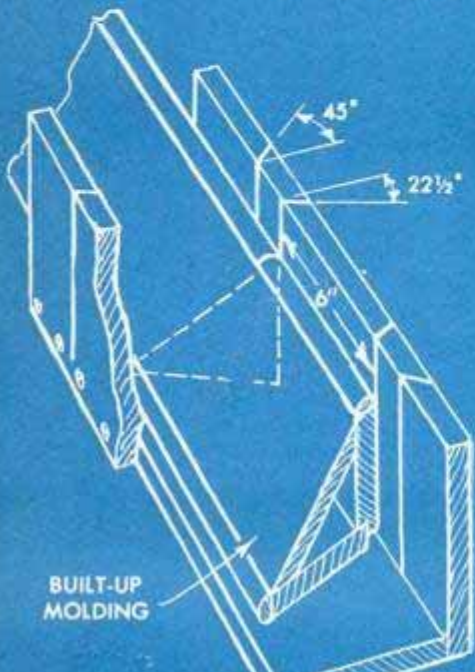
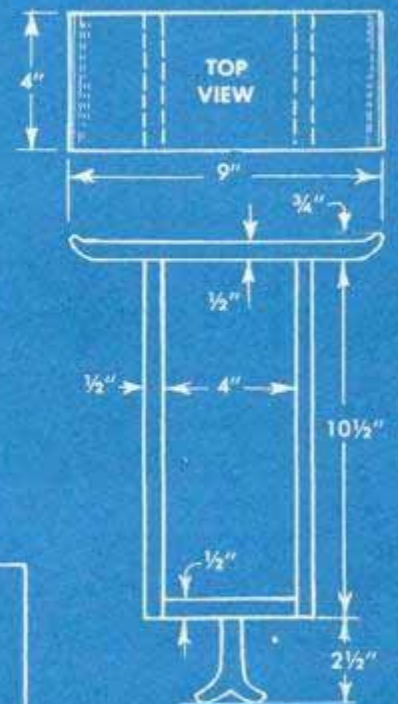
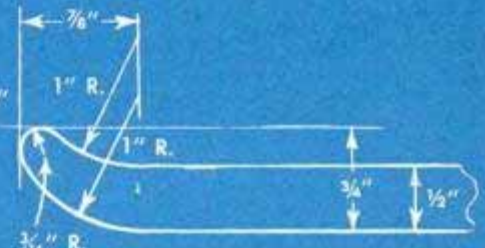
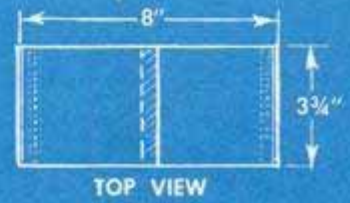
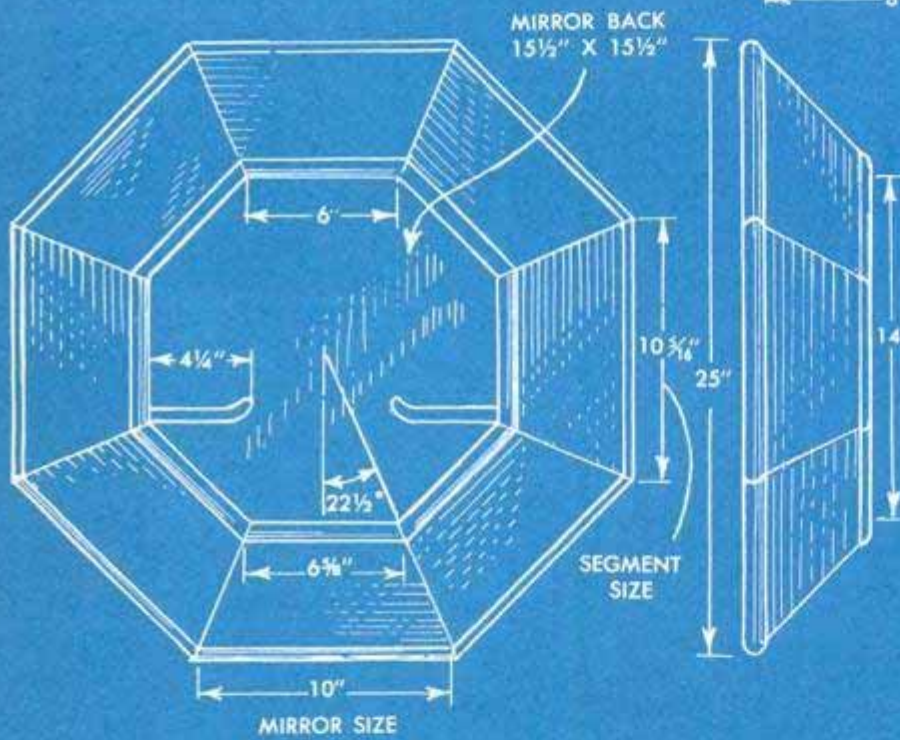

3



HOMEMADE

# Shadow Boxes

Modern Furniture

## Box No. 1

### Plywood

- 1 pc.— $\frac{1}{4}$ " x  $15\frac{1}{2}$ " x  $15\frac{1}{2}$ "—Back
- 8 pcs.— $\frac{1}{2}$ " x  $5\frac{21}{32}$ " x  $10$ "—Sides

### Lumber

- 8 pcs.— $\frac{3}{4}$ " x  $4\frac{1}{2}$ " x  $6\frac{5}{8}$ "—Inside sides
- 8 pcs.— $\frac{3}{4}$ " x  $4\frac{3}{8}$ " x  $10$ "—Frame backs
- 8 pcs.— $\frac{3}{8}$ " x  $\frac{3}{4}$ " x  $6\frac{5}{8}$ "—Half rounds (face)
- 8 pcs.— $\frac{3}{8}$ " x  $\frac{3}{4}$ " x  $10\frac{5}{16}$ "—Half rounds (sides)
- 2 pcs.— $\frac{3}{4}$ " x  $4\frac{1}{2}$ " x  $4\frac{1}{4}$ "—Shelves

### Mirrors, Single Strength

- 8 pcs.— $5\frac{21}{32}$ " x  $10$ "—Sides
- 1 pc.— $15\frac{1}{2}$ " x  $15\frac{1}{2}$ "—Back

## Box No. 2

### Lumber

- 1 pc.— $\frac{1}{2}$ " x  $3\frac{1}{2}$ " x  $15\frac{1}{2}$ "—Center
- 2 pcs.— $\frac{3}{4}$ " x  $3\frac{1}{2}$ " x  $4\frac{1}{2}$ "—Shelves
- 4 pcs.— $\frac{3}{4}$ " x  $3\frac{1}{2}$ " x  $3\frac{3}{4}$ "—Shelves

## Box No. 3

### Lumber

- 1 pc.— $\frac{3}{4}$ " x  $4$ " x  $9$ "—Top
- 2 pcs.— $\frac{1}{2}$ " x  $4$ " x  $10\frac{1}{2}$ "—Sides
- 1 pc.— $\frac{1}{2}$ " x  $4$ " x  $4$ "—Bottom
- 1 pc.— $1\frac{3}{4}$ " x  $2\frac{1}{2}$ " x  $4$ "—Ornament

## Box No. 4

### Plywood

- 1 pc.— $\frac{1}{4}$ " x  $18\frac{1}{2}$ " x  $26\frac{1}{2}$ "—Back
- 2 pcs.— $\frac{1}{2}$ " x  $5\frac{21}{32}$ " x  $27\frac{1}{4}$ "—Sides
- 2 pcs.— $\frac{1}{2}$ " x  $5\frac{21}{32}$ " x  $35\frac{1}{4}$ "—Sides

### Lumber

- 2 pcs.— $\frac{3}{4}$ " x  $4\frac{3}{8}$ " x  $27\frac{1}{4}$ "—Side back frame
- 2 pcs.— $\frac{3}{4}$ " x  $4\frac{3}{8}$ " x  $35\frac{1}{4}$ "—Top and bottom back frame
- 2 pcs.— $\frac{3}{4}$ " x  $4\frac{1}{2}$ " x  $19$ "—Sides
- 2 pcs.— $\frac{3}{4}$ " x  $4\frac{1}{2}$ " x  $27$ "—Sides
- 2 pcs.— $\frac{3}{8}$ " x  $\frac{3}{4}$ " x  $19$ "—Half rounds (face)
- 2 pcs.— $\frac{3}{8}$ " x  $\frac{3}{4}$ " x  $27$ "—Half rounds (side)
- 2 pcs.— $\frac{3}{8}$ " x  $\frac{3}{4}$ " x  $28$ "—Half rounds (side)
- 2 pcs.— $\frac{1}{2}$ " x  $4\frac{1}{2}$ " x  $19\frac{1}{2}$ "—Shelves
- 2 pcs.— $\frac{1}{2}$ " x  $4\frac{1}{2}$ " x  $12$ "—Partitions

### Mirrors, Single Strength

- 2 pcs.— $5\frac{21}{32}$ " x  $27\frac{1}{4}$ "—Sides
- 2 pcs.— $5\frac{21}{32}$ " x  $35\frac{1}{4}$ "—Sides
- 1 pc.— $18\frac{1}{2}$ " x  $26\frac{1}{2}$ "—Back

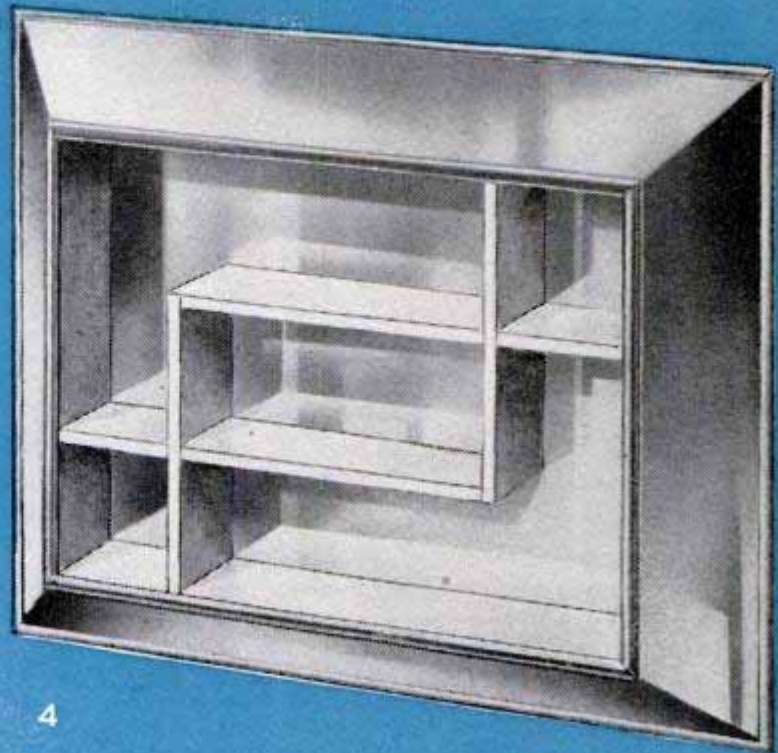

4

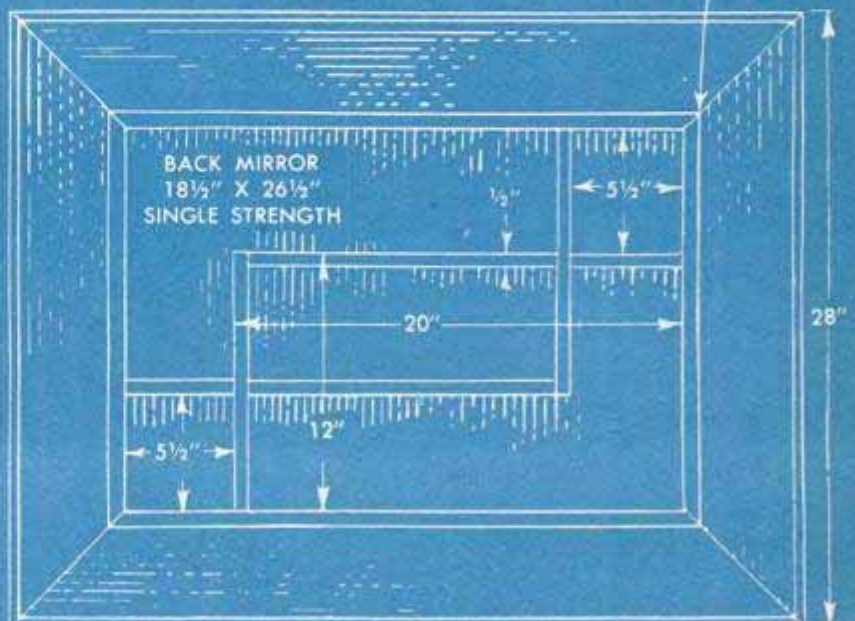
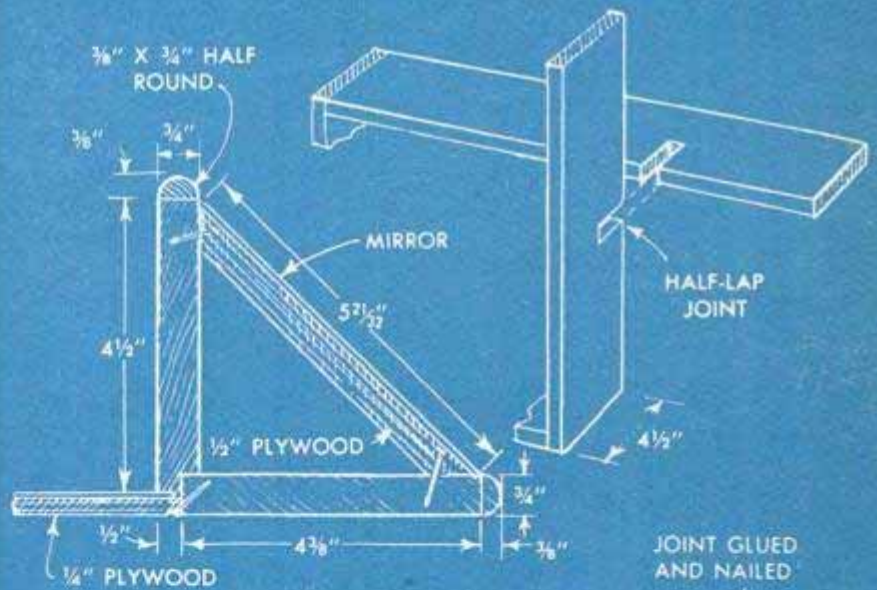

## Inner Tubes Protect Furniture When Packing Trailer

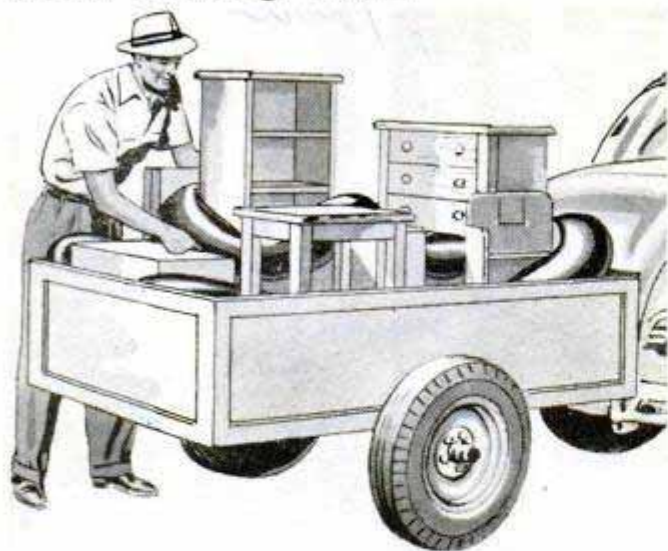

Inflated inner tubes make excellent cushions for protecting easily scratched and damaged furniture when packed in a trailer or truck for moving. For ease of packing, stretch the tubes around the furniture while uninflated. When the furniture is in place, inflate the tubes until they expand sufficiently to fill the space between the articles, thus holding them safely apart. The flexibility of the tubes allows them to be used around irregular shapes, and for a large piece of furniture, several can be tied together to make a buffer.

Emil T. Settlage, Los Angeles, Calif.

## Emergency Toggle Bolt

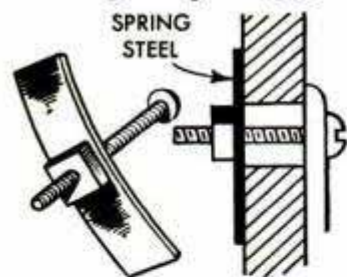

An emergency toggle bolt that will support light objects can be made simply by cutting a strip of light-steel banding of the type used to band packing crates and drilling a hole in the strip to take a stove bolt. When inserting the bolt in the hole in the wall, the ends of the spring steel are held together. When inside the wall, the banding straightens out and expands in back of the hole, thus allowing the bolt to be tightened.

## Cornstarch-and-Paint Mixture Used to Patch Cracks

A small amount of the paint intended for use on a wall can be mixed with cornstarch to make a putty for filling cracks before painting. Cornstarch is added to the paint until the mixture is stiff enough to spread with a putty knife. Ordinarily it is not necessary to wait until the patched spots dry

before painting over them. But if the cracks or holes are large, they should be filled and allowed to dry so they can be sanded smooth before the paint is applied.

Harry J. Miller, Sarasota, Fla.

## Bath Spray in Holder Makes Shower for Tub

You can install a shower in your bathtub without the expense of installing plumbing fixtures, simply by supporting a bath spray in the holder shown. The holder is made by bending heavy wire to shape and



then inserting the ends in two large rubber vacuum cups. In attaching the vacuum cups to the wall, note that they will hold better if the inside of the cup is rubbed with soap before being pressed to the wall.

Carl S. Bates, Chicago.

## Pipes Used as Leveling Stakes When Building Footing Forms

Grade-leveling stakes for footings that are not easily knocked out of line can be made from 2-ft. lengths of pipe. The pipe stakes are driven into the ground along the center line of the proposed footings, at about 12-ft. intervals. They are driven in until their tops will just come flush with the point where the tops of the forms will be. They then can be used as a guide for a spirit level when setting up the forms, as shown in the photo. If a transit cannot be borrowed from an engineer or surveyor friend, it will pay the amateur builder to hire a professional to set the stakes level. This will assure greater accuracy in leveling the footing, foundation and house.

Peter G. Gordon, Ontario, Can.

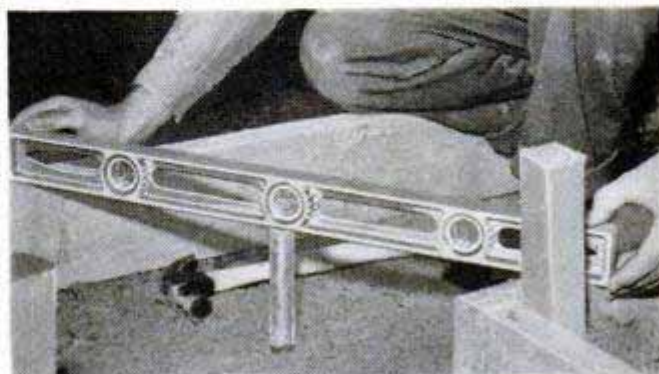

☐ Air bubbles appearing in the glass bowl of the fuel pump indicate there is a leak in the gas line between the tank and the pump.

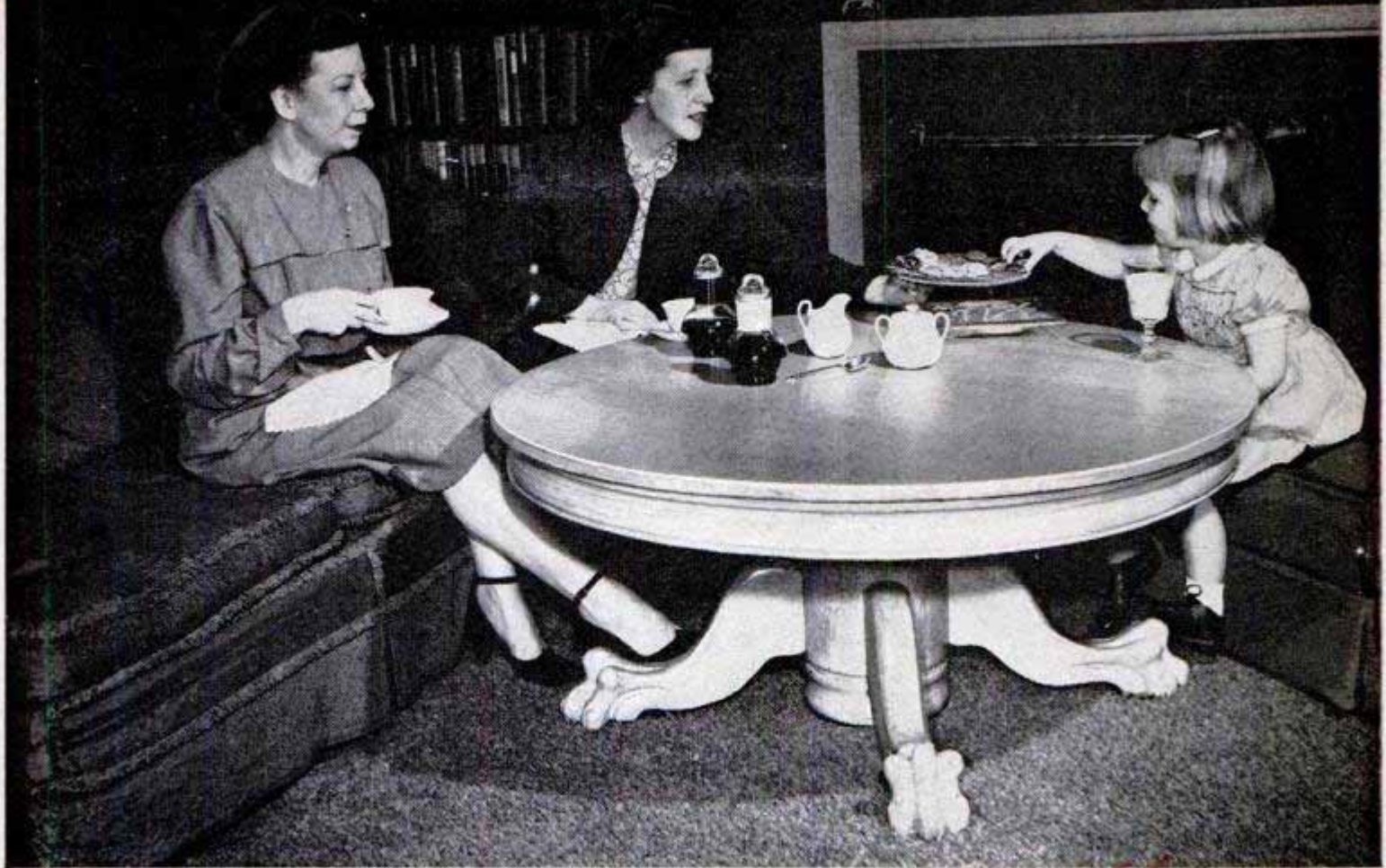

W T M ' 55

# TWO-LEVEL TABLE

By Charles E. Duval

LIKE THE OLD-TIME piano stool that was rotated to raise or lower, this revamped round, oak dining table is made to serve as a low cocktail table or a convenient card table by merely twirling the top. Many of these popular old tables, now an eyesore with modern furnishings, can be brought back from the attic and transformed into smart, good-looking pieces of highly functional furniture. Essentially, the conversion

job consists of cutting off a portion of the hollow pedestal and embedding a threaded bushing in the top. A large "washer" is used to hold the bushing in place in the manner indicated in the drawing. The screw is machined and threaded from 1 1/4-in. steel which is welded to a steel plate for fastening to the table top. Note that the travel of the screw is limited by an extension and crosspin.

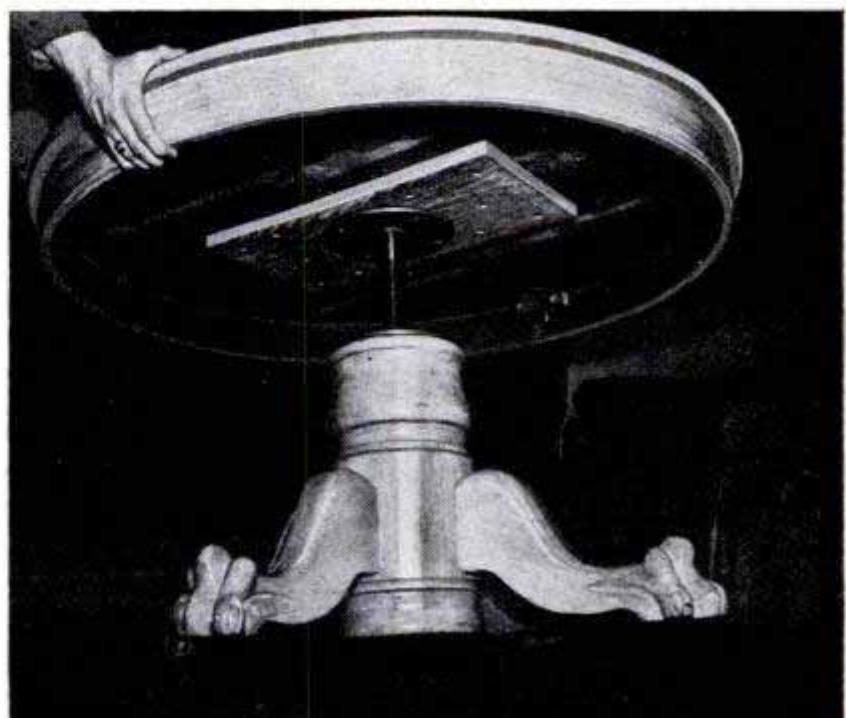
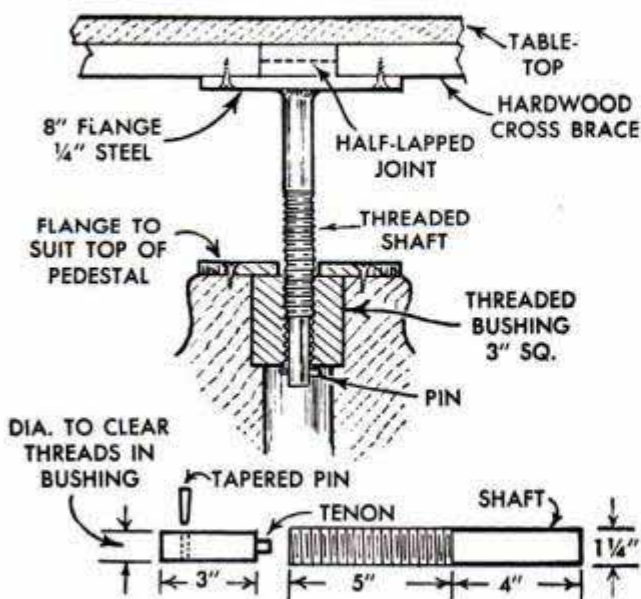

Note diameter of extension, which is a press-fit in end of screw, is smaller than screw to permit passage of extension through bushing

## Striker Board Is Self-Aligning On Concrete Sidewalk Forms



This self-aligning striker board was made by one contractor to overcome the difficulty of holding the regular straight-edge vertical when striking off the finish coat of concrete on sidewalk jobs. Two straight edge boards are fastened together in the center and held apart at both ends by large spacers which serve as convenient handles when using the striker. The spread of the boards at the end, resting on the forms, keeps the striker standing on edge. The curve of the bow also keeps the concrete running to the middle instead of spilling over the edges of the forms.

## Nails Hold Tubes at Shelf Edge

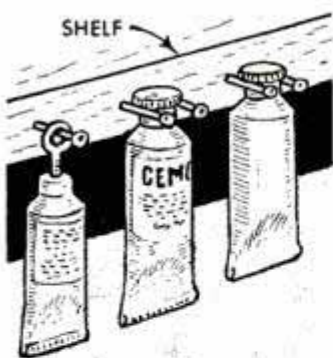

To prevent tubes of glue and household cement from being misplaced, store them between finishing nails driven in the edge of a shelf. Tubes having key-type stoppers can be hung from a single nail.

## Fur Garments May Be Damaged When Stored in Home Freezer

Fur garments that have been stored in a home freezer usually are found to be creased and crushed upon removal, in which case glazing or other treatments will be necessary to raise and straighten the fur. If a pelt has been frozen stiff, it very likely will be cracked at the folds, especially if any weight such as packaged foods has been placed on or against it. There also

is the possibility of damage due to dampness, either in the freezer or when the fur is in the process of thawing. Dampness may cause aging, fading, loss of lustre or mildewing. On the other hand, fur garments preserved in commercial cold-storage warehouses have the advantage of being hung loosely to permit air to circulate freely around them, while temperatures and humidity are carefully regulated and kept under constant check.

## Pouring Spout for Milk Carton

A pouring spout for cardboard milk cartons of the type shown that will eliminate dripping and spilling, and allow the carton to be drained completely, can be made by slitting the ridge of the carton and pulling out the fold under the ridge. To re-seal the carton, simply push the flap back to its original position. On most cartons, this can be done without removing the staple, but a few have a long staple, which interferes if not removed.

CUT ON DOTTED LINE AND FOLD BACK

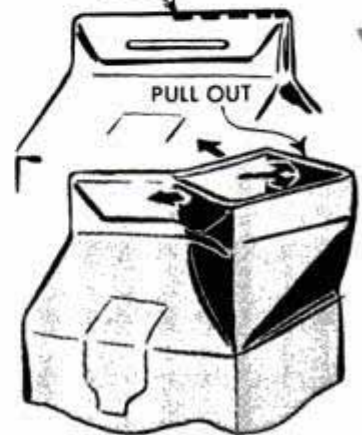

## Deck Cleats Give Nautical Touch To Den or Recreation Room

If you are planning a nautical theme in the decoration of your den or recreation room, use deck cleats for door handles, drawer pulls and window lifts to help carry out the idea. These are available in various sizes and can be purchased in any marine-supply house. The cast-brass type are the most colorful for this use. They can be buffed to a high polish and coated with clear shellac to prevent discoloration.

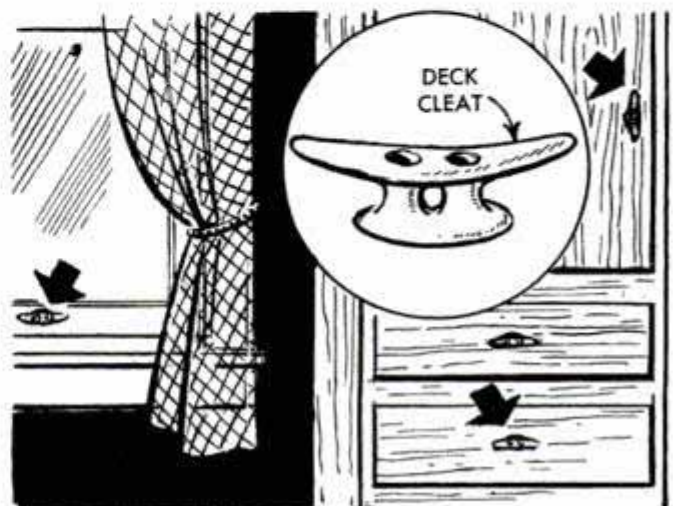



# Christmas Toys

By  
Hi Sibley

**S**URPRISINGLY SIMPLE to build, the wooden toys shown on these pages add up to something really special under the tree on Christmas morning. And they'll save you money, too—an especially pleasant prospect with Christmas approaching—as the few dollars worth of wood and paint involved in their construction amounts to a bare fraction of what toys of similar quality would cost in a store.

The sled detailed on the following page is modeled after the sturdy pungs used in maple-sugar camps. The runner assemblies are of hardwood or pine, while the box is of  $\frac{1}{2}$ -in. exterior plywood or  $\frac{3}{4}$ -in. pine lumber. The runners consist of top and bottom rails mortised to receive tenons cut on the ends of 1-in.-sq. vertical separators. The curved front section of each runner is bandsawed to shape and fastened to the end of the lower rail with a scarfed joint, using waterproof glue and countersunk screws as in the lower left-hand detail. Note how the top rail and the upper section of the curved front are notched to provide a half-lapped joint. The separator tenons are glued and pinned into the rail mortises. The underside of each runner is covered with  $\frac{1}{16}$  x 1-in. flat steel, which is drilled and countersunk for flat-headed wood screws.

Three 1-in. cleats are fastened across the bottom of the box

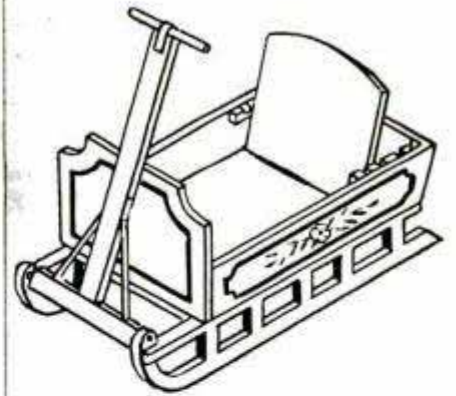

Sled



Doll Bath

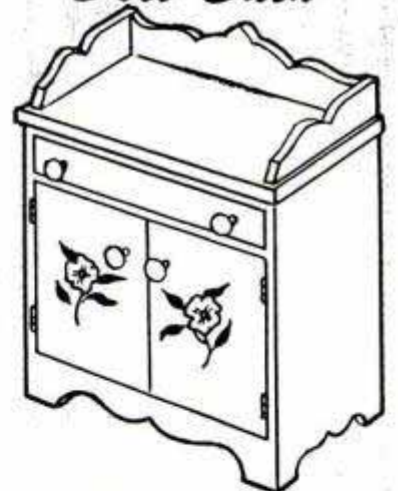

Sideboard



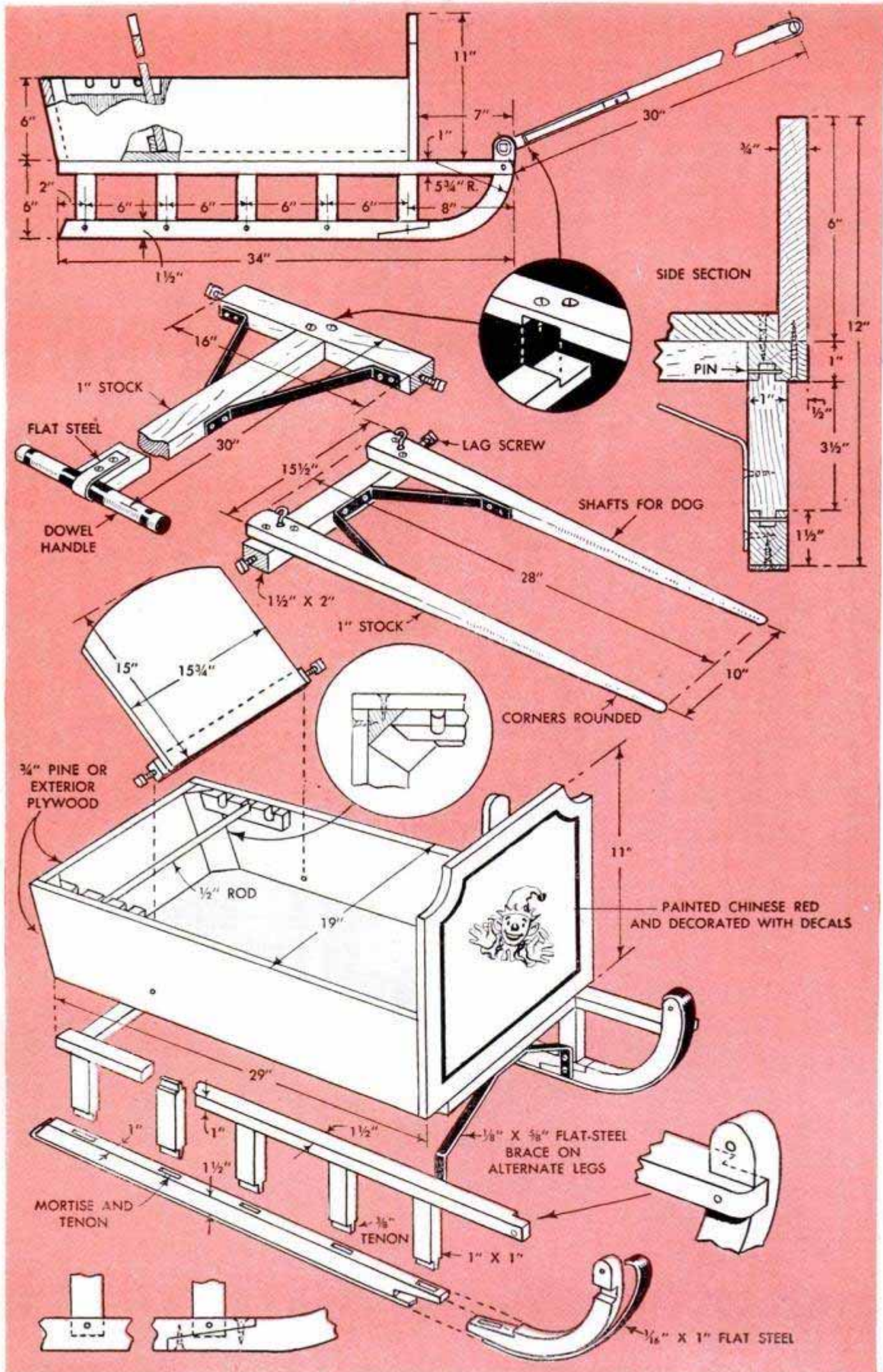

to align with the center and end rail separators. Then a flat-steel brace is screwed to each cleat and to the corresponding runner separators and lower rails. The finished sled can be equipped with a convenient handle or with shafts for harnessing a dog.

The neat little doll bath shown below is easy to make from 1/2-in. stock, plywood and rubberized sheeting. The X-frame legs are pivoted at the center to permit folding and the rear tray

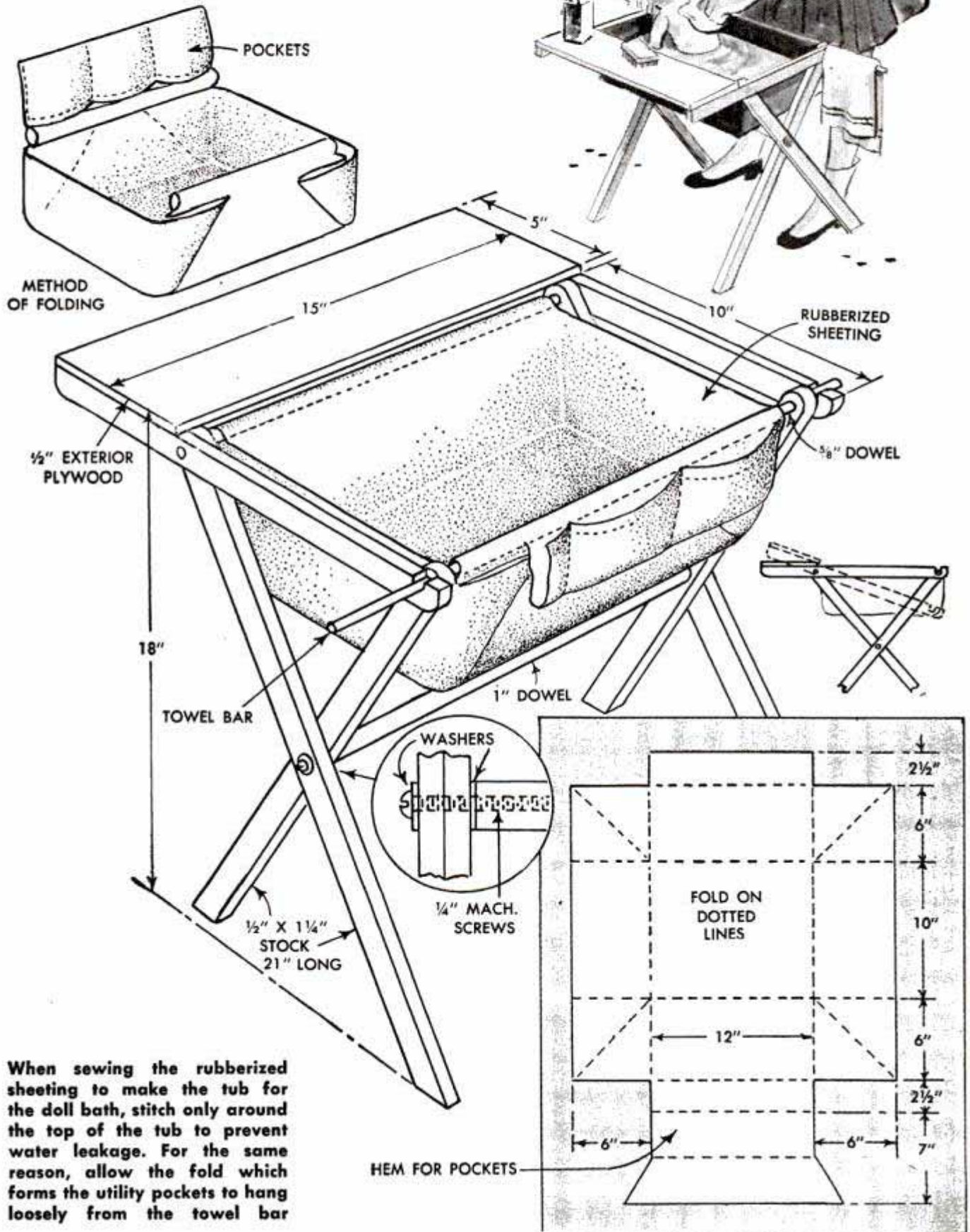

When sewing the rubberized sheeting to make the tub for the doll bath, stitch only around the top of the tub to prevent water leakage. For the same reason, allow the fold which forms the utility pockets to hang loosely from the towel bar

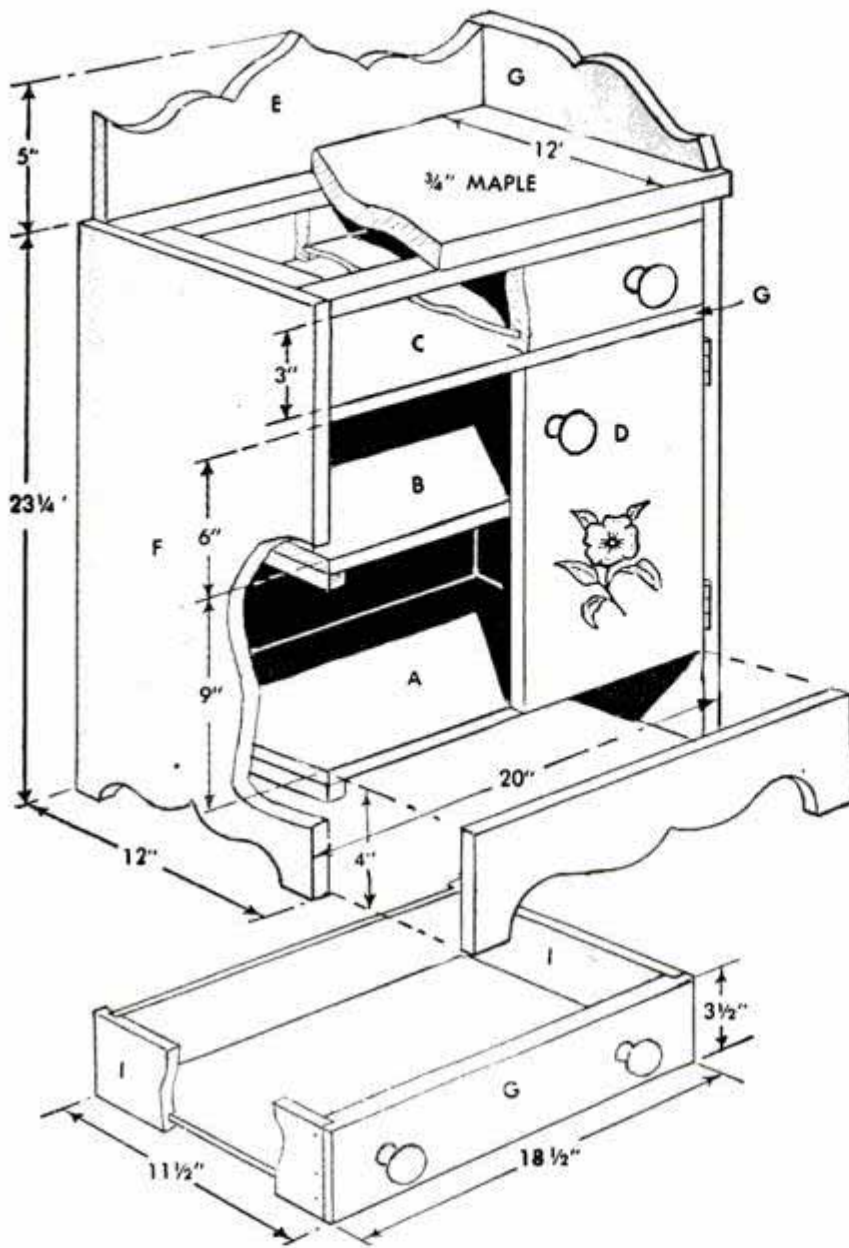

pivots on a length of dowel which extends through both leg frames. The front end of each tray arm is notched to engage the ends of the towel bar. After the tub pattern is cut from rubberized sheeting, all edges are taped. Then the sheeting is folded, as indicated by the dotted lines, stitched along the taped edges and hemmed to slip over the rear dowel and the towel bar. The wooden framework and shelf should be painted, preferably pink or blue, before assembly.

The sideboard and the table-and-chair set are made from 1/2-in. plywood as detailed on this and the opposite page. All plywood pieces for the sideboard can be cut from a 4-ft.-sq. sheet. The parts on the layout are keyed with the assembly drawing. A simple frame for the top of the sideboard, cleats for the shelves, wooden drawer pulls, hinges for the doors and a 1/4-in. plywood or hardboard drawer bottom complete the assembly.

Plywood pieces for the table-and-chair set are cut from a 4 x 6-ft. sheet of 1/2-in. plywood. After the table legs and side aprons have been jigsawed to the patterns shown, they are screwed and glued to a frame of 1 x 2-in. stock. The ends of the frame are beveled and the aprons mounted to splay the legs as in the upper right-hand detail. The 20 x 32-in. table top is fastened to the frame with countersunk screws driven from the top or with screws driven up from the underside of the frame. If the former method is used, the countersunk holes should be filled with wood putty before finishing the table.

Assembly of the chairs is done by adding cleats to the front-and-back pieces and then installing the cross braces, D. The seats are fastened to the cleats in the same way as the table top. Both the table-and-chair set and the sideboard can be finished natural, covered with wood-grain plastic veneer or enameled, with decorative decals added if desired. ★ ★ ★

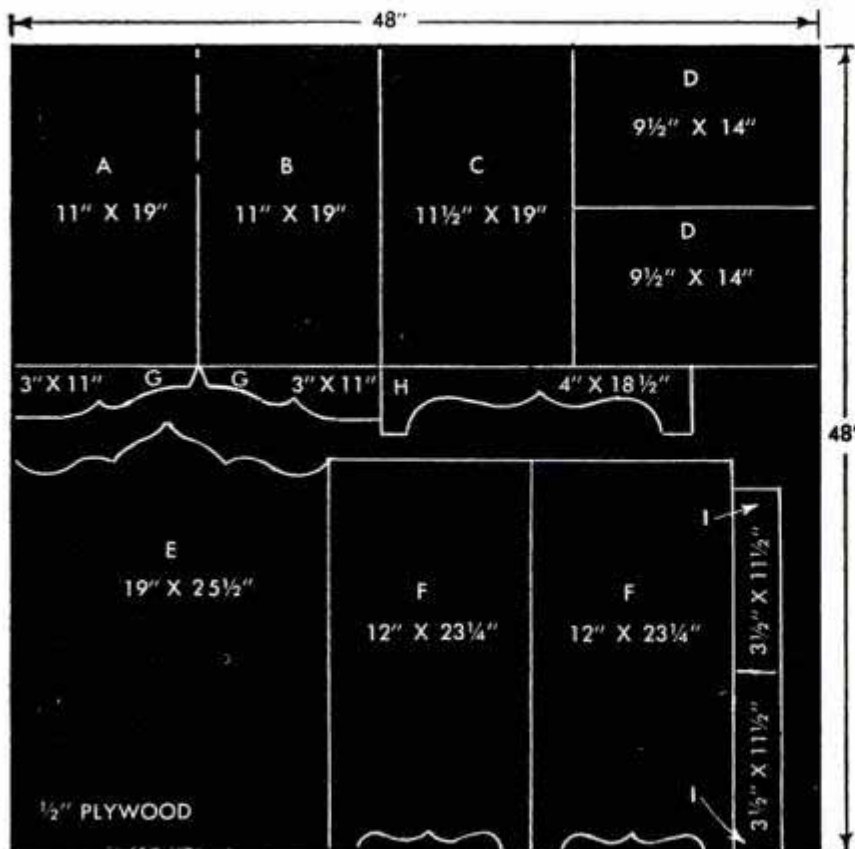

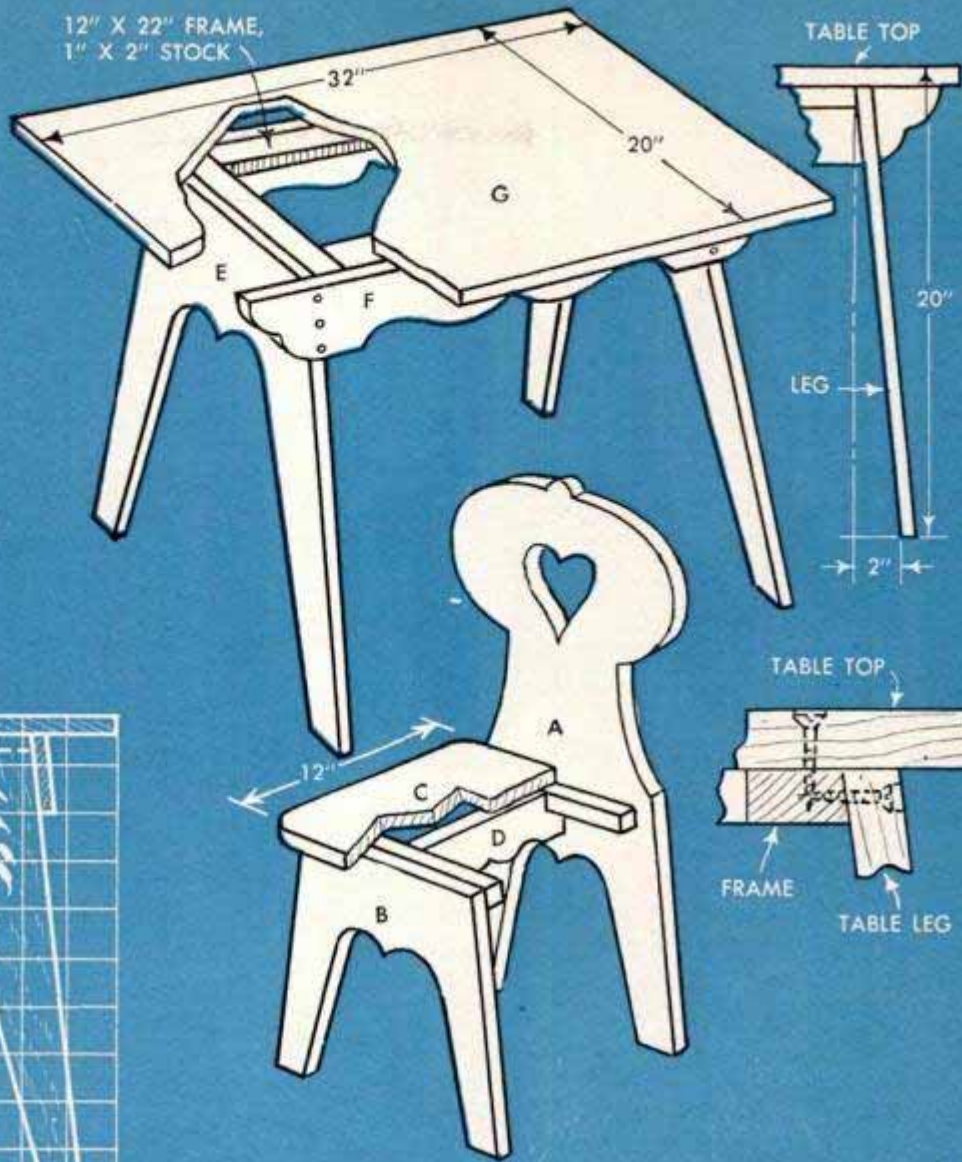
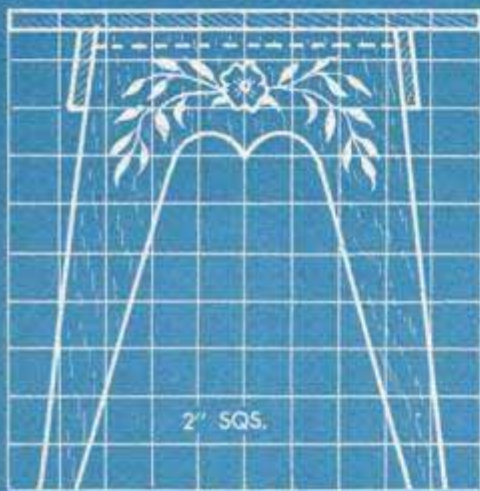

1/2" X 48" X 72" PLYWOOD

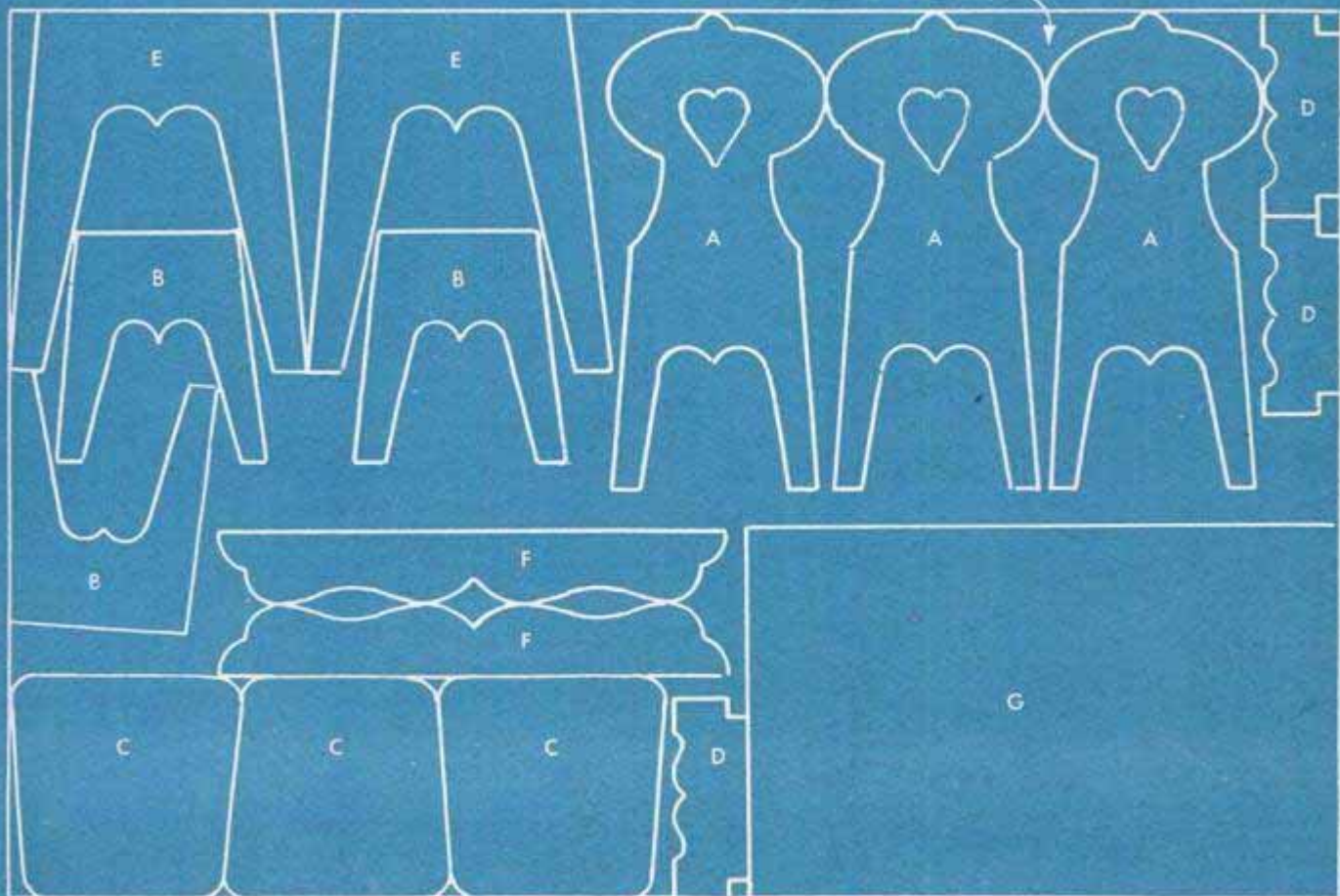

## Handy Rolling Tool "Tree" Rotates for Selection



Especially useful to the auto mechanic in that it can be rolled from one repair job to the next, this novel tool tree keeps tools close at hand and rotates for quick selection. The pedestal supporting the tool holder is a 2 ft. length of 1-in. pipe which is fitted at one end with a floor flange for attaching it to a caster-fitted base. The upper end of the pipe is also fitted with a flange and screwed to a 12-in. plywood turntable. The holder itself is pivoted to the turntable with a single bolt after placing a large wooden washer between the two parts for free turning. One side of the pyramid-shaped holder is left open and is fitted with two or more shelves and the outer surfaces of the holder are fitted with hooks for hanging countless small hand tools. If you wish, the holder can be made to lift off the pipe standard.

## Installing Aluminum Downspouts on Galvanized Eaves Trough

One homeowner, who decided to replace the rusted downspouts of his galvanized gutters with aluminum downspouts, discovered that contact with the galvanized eaves trough set up an electrolytic action which caused deterioration of the aluminum. To avoid this, he installed each of the downspouts as shown in the detail. Using a square, tapered wooden block, he squared the end of the downspout, and then made a hanger from heavy sheet aluminum. The hanger, which fitted into the bottom of the eaves trough, was cut so that four tabs were formed, and the downspout was screwed to these. A heavy coating of roofing cement was applied between the hanger and eaves trough to prevent contact.—J. Howard Cooper, Philadelphia, Pa.

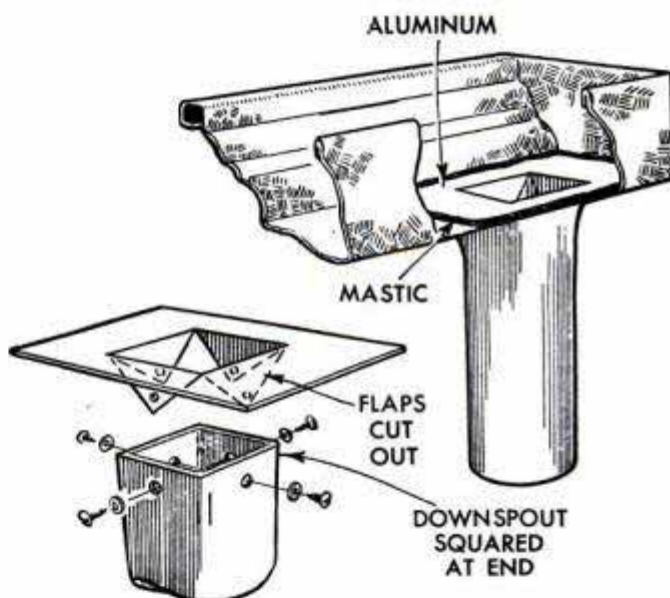

## Rubber Band "Locks" Drawers During Heavy Seas

To prevent the drawers in the galley of a small boat from sliding out in heavy weather, one boatman used a rubber band fastened between two aluminum clips, as shown. The upper clip was made to slip over the counter rail and the lower one was fastened to the cabinet with screws. He cut a strip of inner tube,  $\frac{1}{2}$  in. wide, tied it into a loop, and used it over the clips in rough seas. The top clip and rubber band are stored in a corner of the top drawer, ready to be slipped on at a moment's notice.—George Brook Taylor, Daytona Beach, Fla.

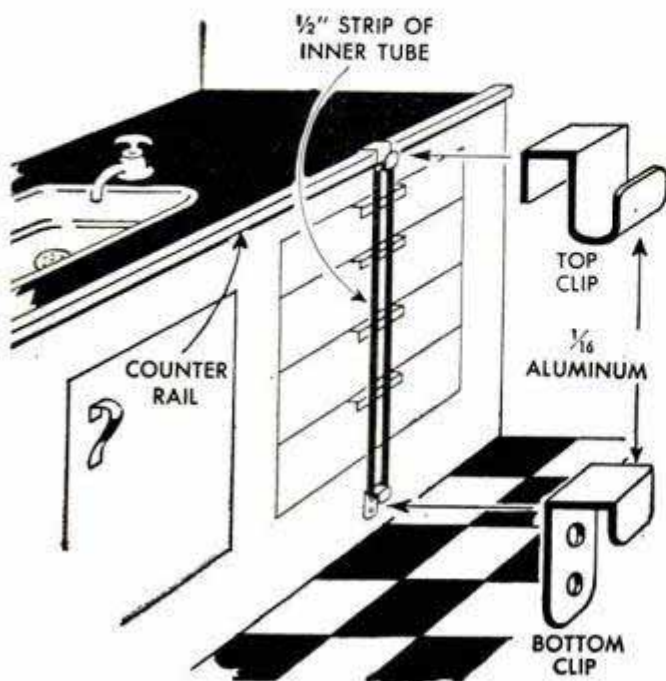

☐ To keep garden tools from rusting, drain the old crankcase oil from your car into a box of sand and stick tools into it.



## SHUTTER RELEASE *takes nature close-ups*

By George T. Hillman

Designed for 35-mm. cameras having a plunger-type shutter release on the frame, this quickly improvised arrangement provides a reliable remote control for taking candid close-ups of live subjects, such as wild animals and birds. An ordinary safety pin supplies the necessary spring and striker. The clasp of the pin is bent at right angles as shown, and the pointed arm is soldered to a sheet-metal bracket which slips over the body of the camera. The bent clasp forms the striker. It is released by a "trigger" consisting of a wire ring and arm, the ring being slipped over both the clasp and the point of the safety pin when the release is "set." An eye at the end of the trigger arm takes a hook bent at one end of a length of wire. The opposite end of the wire is bent and twisted to form an eye for attachment of the trip cord, or thread. A pull on the thread from a place of concealment draws the trigger ring forward, releasing the safety-pin clasp which snaps downward, striking the plunger and releasing the shutter.

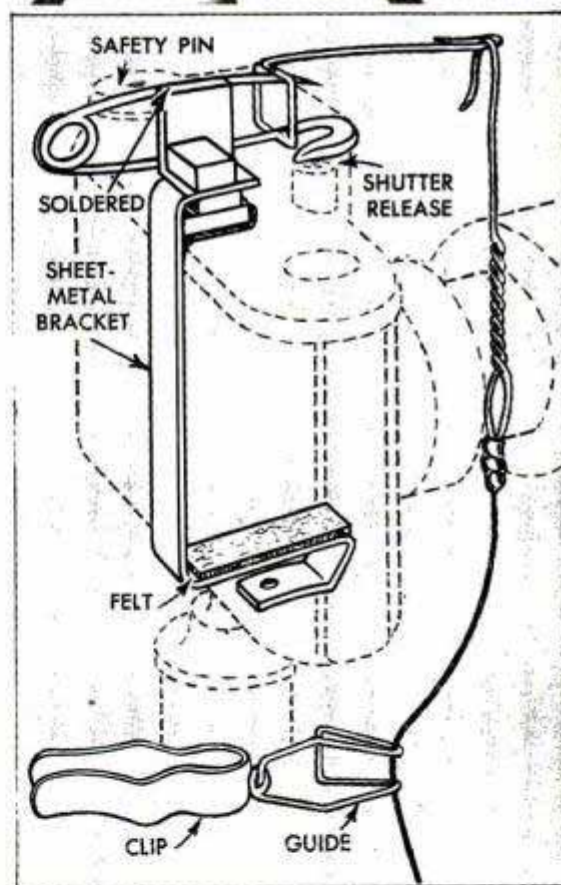

## Two Lenses Used in Tandem for Close-Up Photographs

For extremely close-up photography, when a copy attachment is not available, a second camera lens can be placed in front of the regular one for excellent results. A short cardboard adapter in the form of a ring that fits over the barrel of the camera lens and the rear-element mount of the extra lens is used to couple the lenses. The two lenses are mounted as close together as possible without the glass touching. Focusing with this setup is best done on a

ground-glass. When the camera has no such direct-focusing facilities, set its focusing scale at infinity and place the object to be photographed so that the distance from it to the second lens is the same as the equivalent focal length of the auxiliary lens. Stop down the camera lens for the exposure, and increase exposure to three or four times the amount normally required. The result can be as good as if a copy attachment were used.



### Enlarger Should Sit Level

In addition to resting firmly on a sturdy table, a photographic enlarger also should sit perfectly level. A slightly lopsided or tilted bellows, as well as a tendency of the enlarger head to stick when raised or lowered, are indications that the enlarger base is not level. Metal strips cut from film-pack containers are ideal for shimming the enlarger base to bring it level.—Robert Hertzberg, Jackson Heights, N. Y.

### Dispenser Measures Solution



Small amounts of wetting agent can be added conveniently to a photographic solution if a hand-lotion dispenser is inserted in the bottle. The dispenser helps to avoid mixing too strong a solution, by squirting out just the right amount for small quantities,

and eliminating the difficulty of measuring the agent from large bottles. The dispenser is available wherever cosmetics are sold.

## Your Versatile Shaper

There's more to be had from a shaper than merely running an edge on a table top. In fact, one of its main uses is molding and coping panel doors. Get the most from your shaper by reading, "How to Make Panel Doors" in the December issue. Profusely illustrated, this picture story shows you how to turn out millwork of professional quality

### Sponge Used to Wipe Film Stored in Glass Jar

A viscous (cellulose-type) sponge is excellent for wiping excess moisture from photo films before they are hung up to dry, but it is important that the sponge be kept free of grit. One way of keeping the sponge clean is to store it in a wide-mouthed glass jar. The type in which peanut butter and other foods are packed is ideal for this purpose.



Virginia Hanson, Venice, Calif.

### Stirring Rod for Darkroom Use

Obtainable at most ten-cent stores, a glass rod of the type used on inexpensive towel racks will provide an ideal noncontaminating rod for mixing and crunching photo chemicals in gallon bottles. When the rod is not in use, a holder can be provided for it by mounting one of the towel-rack brackets on the darkroom wall.

Andy Holmberg, Elsinore, Calif.

### Paint Swatches Aid Exposure

In color photography, it is often desirable to accent one color more than the others, as for example, when photographing a cloth in which there are several colors. The exposure meter held against the cloth will not give a true reading. But if a packet of paint swatches, such as are supplied by many paint manufacturers and contain several hundred colors and shades, is at hand, the job is an easy one. Hold a paint swatch that closely matches the color to be accented under the same light in which the picture will be taken, and take an exposure meter reading up close. The setting indicated will bring out the best reproduction of the desired color.





# Negatives Numbered at the Time of Exposure

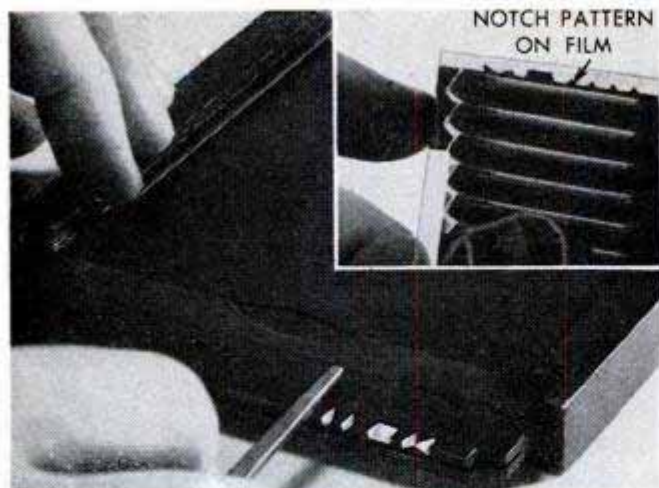

Above, notch patterns filed in edge of holder flap expose film, reproducing pattern as in the inset. Below, numbered holders aid in recording data



This numbering system enables the photographer to set up any convenient negative file with each number symbol registered on the negative at the time of exposure. The number symbols can be keyed in such a way as to record exposure data, place, time, season or any other desired information. To record the numbers of the film, notches are filed in the opened film-holder flap as in the upper left-hand photo. Although the notches can be in any convenient pattern or shape, the pattern pictured works out very well with a recorded system of values attached. As an example, a single V-notch can indicate 1, a square notch 5, and two V-notches with the Vees filed to a point might be given a value of 20. By using these, or similar combinations,



all holders and negatives can be numbered. The number symbols on the negative are outside the picture area as in the inset in the upper left-hand photo.

As an added convenience, the holders may also be numbered on the outside with small decal numerals as in the lower left-hand photo, the numbers corresponding with those represented by the notches in the flap. After applying to the frame of the holder, the decal numerals are shellacked.

To record data at the time the exposure is made for copying later into a record file, adhesive tabs applied to the holders as in the right-hand photo provide a quick means of jotting down a record which can be correlated later for a permanent reference.

Donald W. Honick, Chicago.

## Brushes for Cleaning Negatives Should Be Cleaned Often

Because a camel-hair brush used for cleaning negatives soon becomes contaminated and eventually deposits more than it picks up, it should be washed regularly with a soap shampoo. A coconut-oil or emulsifier-type of shampoo is best for this job, because it leaves a slight film of oil on

the camel hair, preserving its softness and preventing it from drying out. Detergents and dry-cleaning fluids should not be used, since they dissolve the natural oils of camel hair. Cleaning fluids also have a tendency to destroy the rubber base that anchors the bristles of the brush.

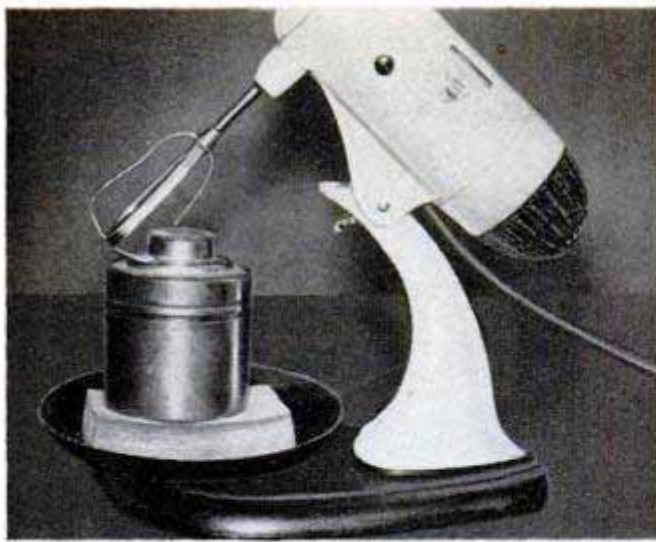

### Sponge and Electric Mixer Used as Film Agitator

When developing film, one photographer provides himself with an economical agitator for a film developing tank by using a small sponge and an electric food mixer as indicated. The tank is set upon the sponge so it will tilt easily in any direction, and then moved within reach of each of the mixing blades. With the mixer operating at slow speed, this arrangement allows the rotating blades to hit against the tank lightly, thus creating the desired rocking movement.—J. M. Bridger, Bladenboro, N. C.

### Drip Catcher for Chemical Bottle

A hollow rubber ball can be adapted easily for the purpose of helping to prevent photographic chemicals and other corrosive liquids from dripping down the side of the bottle while being poured. After cutting the ball in half, cut a small hole in one of the halves that will permit it to be forced over the neck of the bottle to form a collar. When finished, simply replace the bottle cap and rinse out the collar by holding it beneath a water faucet.

### Protect Filters From Lint

By replacing the cellulose-fiber padding found in filter cases with pads cut from sheet foam rubber, photographers will find that their filters are free from lint when removed from the case. Using rubber cement, one pad should be cemented in place in the bottom of the case and another in the top to adequately protect the filter.



Robert C. Florian, Cicero, Ill.

## Popular Mechanics Bookshop



### Gadgets Galore

DORSEY CONNORS, famous television star, tells you how to make hundreds of useful household items from materials you ordinarily would throw in a wastebasket. With wire coat hangers, old shirts, thumbtacks and scraps of wood she fashions countless ornamental and useful objects. Here's a book that will keep the woman of the house fascinated for hours on end, and one that would make a fine gift for anybody. Price is just \$2.95



### Album of Aviation

REMEMBER the balloon rides at the county fair? The old-time daredevils that provided chills and thrills at the early air shows? The headlines when Lindbergh landed in France? You'll find them all in the *Album of Aviation*. Between the covers of this book are hundreds of pictures, a sparkling text, and a good deal of nostalgia. It's an entertaining history of man's humorous, foolhardy and brave efforts to fly. Price, \$3.00

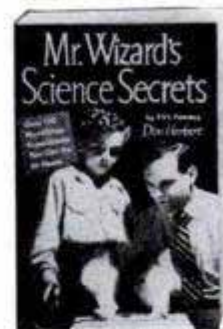

### Mr. Wizard

THIS SPACE is reserved for junior wizards: Sometimes older folks have trouble answering questions, especially those involving science. Mr. Wizard, the TV star, can answer most any such questions, which he does in this book. Actually, he helps you find the answers yourself in 150 exciting experiments. He tells you how to boil water with ice, how to make a telegraph set, and demonstrates the magic of electromagnetism. Price, \$3.00

All books available from Popular Mechanics Book Department, 208 E. Ontario St., Chicago 11

## MAKE WOODEN THREADS

*on your Drill Press*

By T. L. Stalker

CLEAN, SHARP THREADS can be cut in hardwoods by utilizing the high speed of the drill press and the free-cutting properties of special router bits. Hardwood screws for clamps, or hand screws, handles and hand presses of various kinds are easily made in less time than it would take to thread metal rods for the same applications. A simple two-piece jig or guide clamped to the drill-press table gives the thread the correct pitch. This consists of the parts A and B in the detail at the right. Part B is bored as indicated, the size of the body hole being slightly larger than the diameter of the turned portion of the work on which the threads are to be cut. Part A is bored with a tap hole, the diameter of the hole being slightly greater than the root diameter of the thread. The hole is then tapped, using a special tap for wood threads of the type pictured in the upper right-hand photo on the following page. These special taps are easily made on a metal-turning lathe or can be purchased ready-made in limited-size variations. After tapping, part A is sawed on the dotted lines and the remaining portion of the block is then bolted to part B, with the bottom of the thread lining up with the side of the body hole. This assembly forms the combination guide and lead screw which is clamped to the drill-press table as in the photo above. Locate the guide on the drill-press table so that it centers under the chuck at a point about  $\frac{1}{8}$  in. from the edge of part B, and directly over the center of the body hole. Then insert a  $\frac{3}{8}$ -in. bit in the chuck and drill the clearance hole for the router bit.

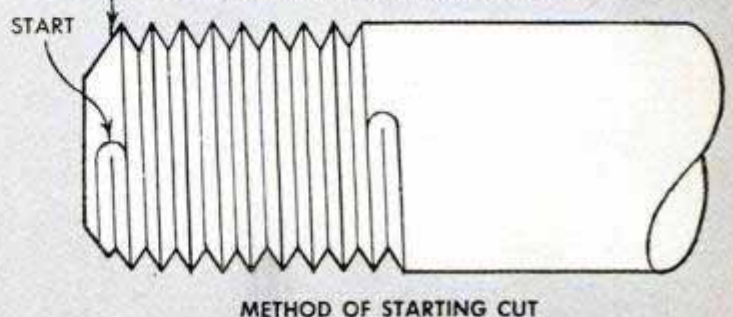
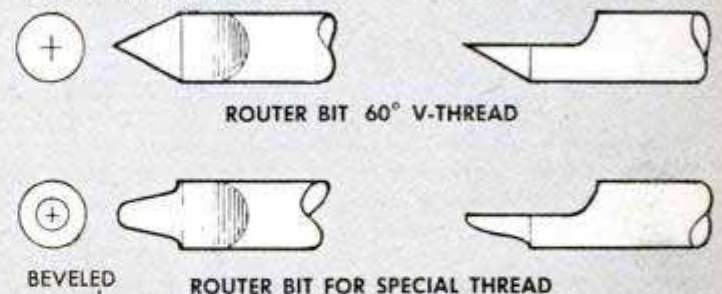
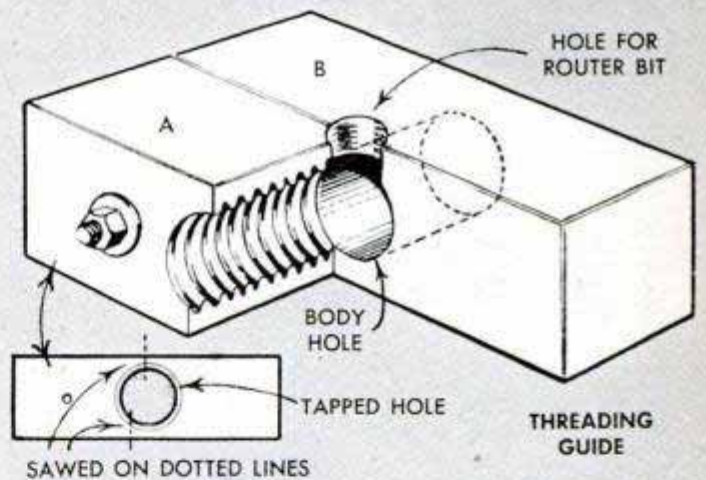
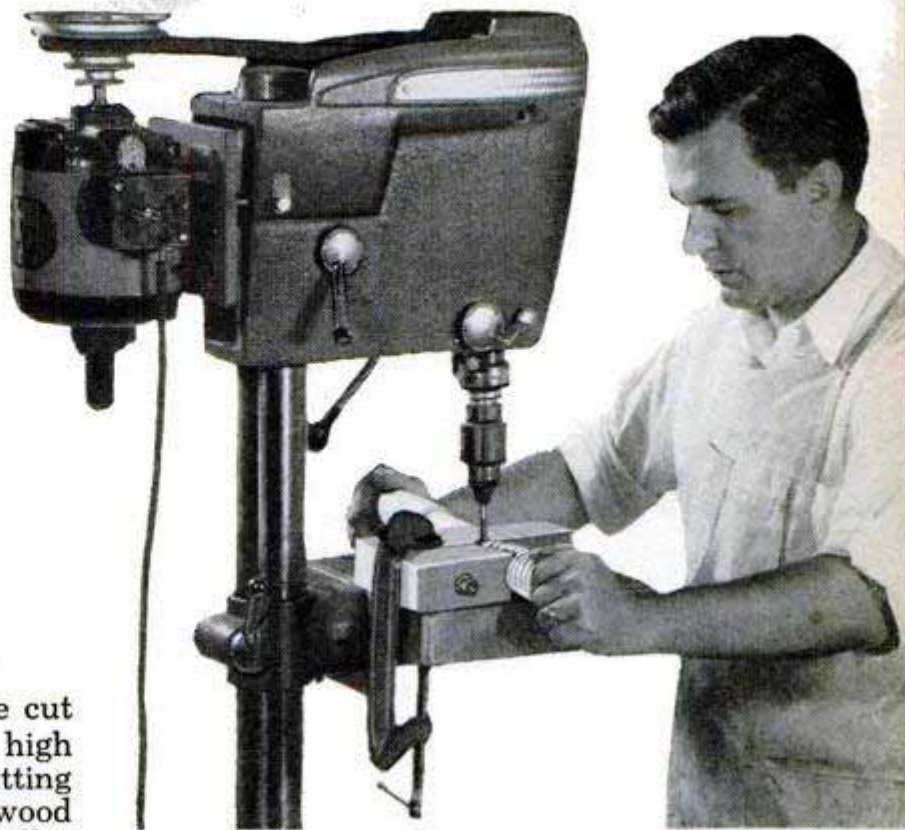

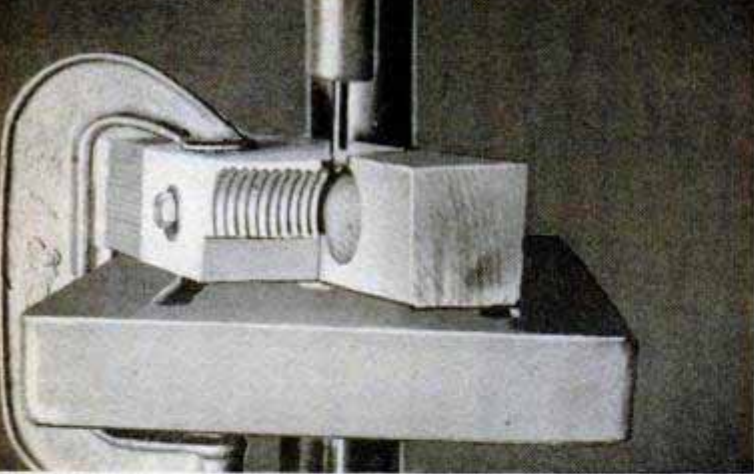

Jig, or guide, is clamped to drill-press table with router bit lowered to position in clearance hole

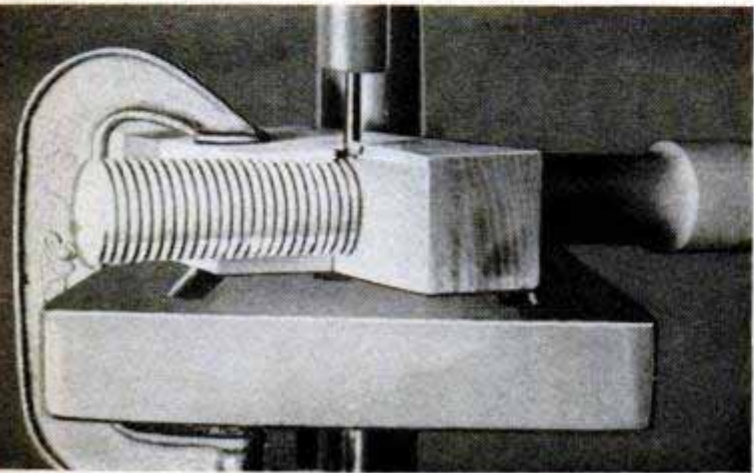

A 60-deg. thread partially cut. Lead screw on tapped section of jig gives newly cut thread correct pitch

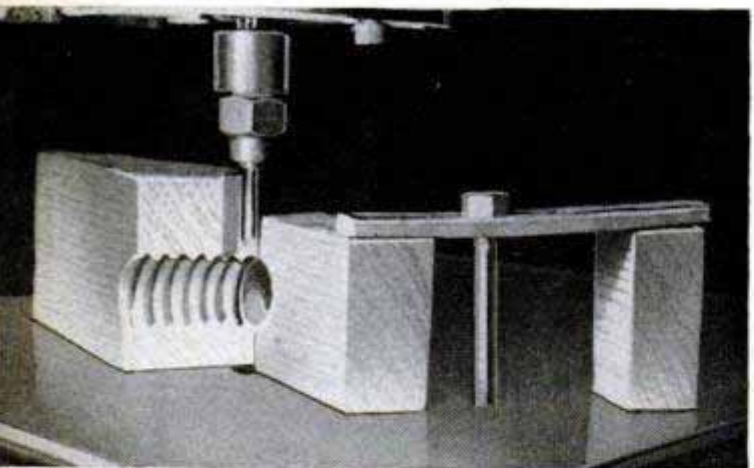

Photos above and below show jig set up on over-arm router for cutting a round-bottom thread. Here a table clamp rather than a C-clamp is used to hold jig in position. Note coarser pitch of thread

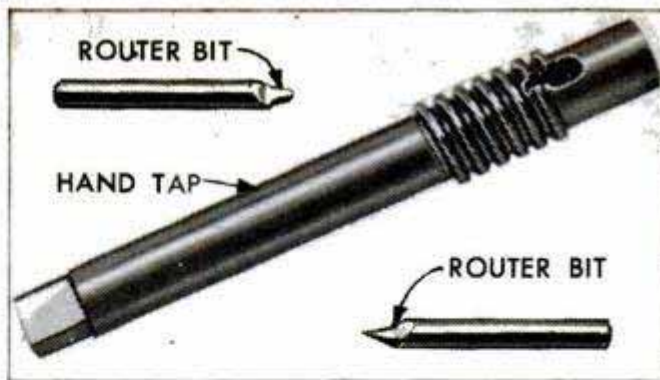
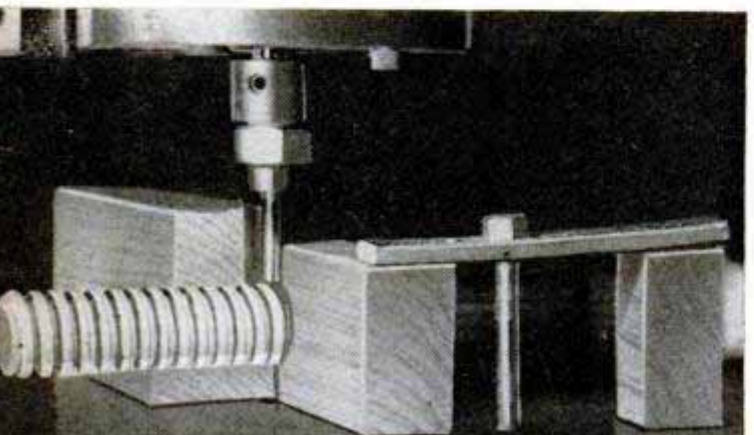

Suitable router bits can be made from  $\frac{1}{4}$ -in. drill rod by grinding a flat to the center line and then grinding a 60-deg. point on the end to form a sharp V-thread, or a rounded point to form a round-bottom special thread as in the center details on the preceding page. The two upper photos at the left show a 60-deg. thread being cut, while the lower photos show a round-bottom thread partially cut. The 60-deg. thread usually is preferred in hardwoods such as maple and beech.

The portion of the work on which the threads are to be cut should be turned to a diameter about  $\frac{1}{32}$  in. less than that of the body hole in the guide. This allowance permits the work to turn freely yet holds it sufficiently true to the axial line to assure threads of a uniform depth. Note in the lower detail on the preceding page, that the end of the blank to be threaded is beveled. This bevel takes the form of a spiral having approximately the same lead as the thread to be cut. Wrap a strip of paper around the end of the blank and then shift it until the edge forms the required spiral. Hold in place with tape and file the bevel to the edge of the paper.

Now insert the router bit in the chuck and lower it to cut to the correct depth, as in the upper left-hand photo. Arrange the belt on the V-pulleys to give the highest spindle speed. Then insert the blank in the body hole in the guide and bring it up until the bit touches the side of the beveled end. Start the drill press, steady the work with both hands and turn it slowly to the right. As soon as the newly cut thread engages the lead screw it will advance automatically the correct amount for each turn. Any slight irregularity in starting the thread can be corrected easily with a three-cornered file after the work is removed from the guide. In some woods the threads cannot be cut successfully to a sharp crest without some chipping. In this case, set the router bit a trifle higher so a narrow flat is left at the crests. If the thread cut in this way fits too tightly in the tapped hole, it can be cut deeper with a file. Softer woods often thread best when the blank is soaked overnight in linseed oil. ★ ★ ★

## Shield Protects Bottom of Pail

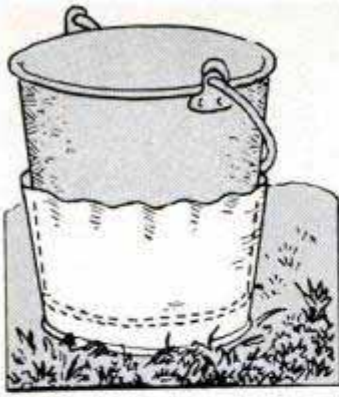

To guard against denting or puncturing the bottoms of feed and milk pails, especially the latter, one farmer makes an effective shield by cutting off the lower half of a discarded pail and fitting this over the bottom of the good

one as shown in the illustration. The cut edge of the shield is crimped lightly so that it will grip the sides of the pail and stay in position. The shield is easily removed when cleaning the pail.

## Level Scrapes Cement Forms

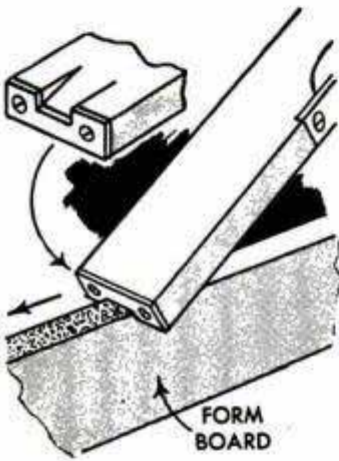

Form boards used in sidewalk construction and later re-used for other work are often so coated with dried cement that it is difficult to use a level on them. To scrape the edges of these boards quickly, one contractor filed a deep notch in the metal end

plate of his level. This permits rapid cleaning of the boards without using an extra tool and does not affect the usability of the level for its original purpose.

## Guard on Poultry Feeder Formed From Stiff Wire

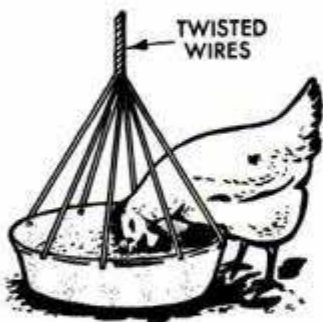

Improved from an old dishpan or wash basin, this inexpensive poultry feeder is provided with a wire guard to keep chickens from climbing into the pan and upsetting it. First, holes are

punched around the edge of the pan 3 or 4 in. apart to take the ends of short lengths of stiff wire, which then are twisted and secured around the rim. The upper end of the wires are joined by twisting to form the guard. The top of this guard can be a handle for lifting the feeder.

Albert P. Zanelli, Tampa, Fla.



## Stand Supports Wheel Wrench To Speed Truck-Tire Change

Supporting one end of a wheel wrench as shown, this sturdy stand enables a farmer to apply extra leverage when loosening and tightening nuts or cap screws on a truck wheel with less chance of the wrench slipping off. The stand is assembled from lengths of pipe and scrap steel welded together, along with cleats welded to one leg that permit supporting the wrench at whatever height may be required.

Grover Brinkman, Okawville, Ill.

## Curtain Keeps Splashing Water Inside Car-Wash Stall

In one garage, a clear-plastic shower curtain installed across the opening to the car-wash stall not only keeps the splashing water confined to the stall but also permits the customer to watch without getting wet. This arrangement is especially useful in a garage or service station having a small stall located in the midst of other activities.



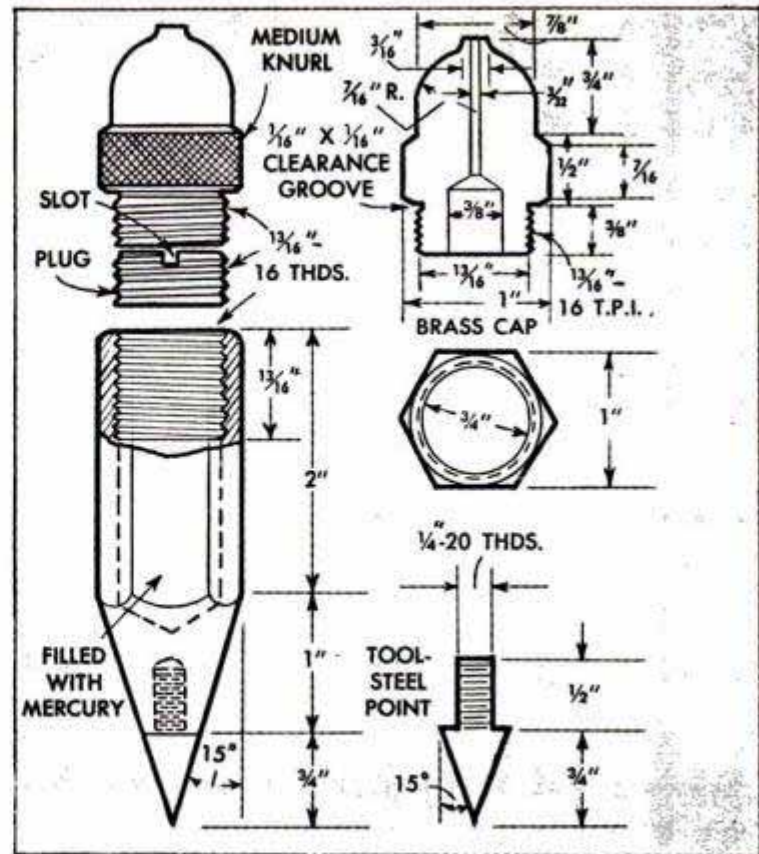

# MERCURY PLUMB BOB

By C. W. Woodson

FOR PRECISE WORK, such as setting up a transit, a plumb bob must be of the correct proportions and weight so that it steadies quickly and remains in position. A mercury bob, being considerably heavier than the normal solid type of equivalent size, has less tendency to swing in a breeze and thus takes less time to come to rest.

The body of the bob is turned from 1-in. hexagon brass rod. When chucking the work for the first operation sequence, be sure that it runs dead true. Turn the taper on the end, face-off and then drill and tap 1/4-20 for the tool-steel point. Reverse the work and recenter it as before. Bore to a depth of 2 in. with a tap drill for a 13/16-16 thread. Run the thread into the bore to a depth of 13/16 in., then face-off the end.

Next, the tool-steel point is machined to the same taper as the body of the bob. Then it is threaded, hardened and the temper drawn to a purple color. Both the plug and the end cap must be machined from stock long enough to be held securely in the chuck. Turn and thread the plug and slot the end before cutting off in the lathe. Note that the end cap is turned to the acorn shape, counterbored for the cord and that the flange is knurled. Run a squaring cut on the lower end of the flange so that it

seats tightly on the top of the body. Then cut a 1/16 x 1/16-in. clearance groove and run the threads back on the shouldered projection to the groove.

Fill the body of the bob with mercury and turn in the plug slowly to allow any entrapped air to escape. Then tie a knot in the end of the cord, pass the cord through the counterbore and screw the cap in place finger-tight. *Caution:* Use extreme care in handling mercury. Dispose of all unused portions safely.

## Broken Electric-Light Bulb Removed With Corncob

To remove a broken bulb from an electric-light socket without the risk of cutting himself, one farmer inserted the end of a corncob in the bulb for loosening it. When pressed tightly against the socket and remaining fragments of the bulb itself, the corncob in most cases will grip the bulb sufficiently for unscrewing it. Care should be taken, however, to make sure the current is off and, as an added precaution, that the corncob used is neither wet nor damp. A large bottle cork also may be used for this purpose.

G. E. Hendrickson, Argyle, Wis.



# NOVELTIES in bent metal

**S**IMPLE PROJECTS in bent sheet-metal have a certain decorative individuality not matched by other hand-crafted pieces. Bends in the attractive projects pictured are made quickly with a small bending brake, but they can be just as easily formed by hammering over hardwood blocks. Very little curved work is involved and the stretchouts are easily developed as in the cross-hatched patterns detailed on the following two pages. Use 20-ga. materials for the projects, as this thickness in either copper or aluminum works readily, takes sharp bends and holds its shape after forming. Such projects as the ash tray, coal-hod planter and the flower-pot holder are typical one-evening jobs, but the umbrella planters and the lamp will require a little more time. The toolholder is a job for the bending brake. Use 22-ga. metal and hem the edges before making the reverse bends. The hanging umbrella planters can be made either half or full umbrella shape and with plain or scalloped edges. For artificial flowers the assembly is made with sheet-metal screws or rivets. For growing plants the joints must be made watertight by soldering. The lamp shade is made from the umbrella pattern, but the base is developed as in the lower left-hand detail on page 207. Be careful to cut the inner radius accurately, as the metal must fit tightly around the lamp socket. Both the lamp shade and the full-umbrella planter have a turned brass insert at the tip of the cone. In the planter this is drilled for the hanger hook, but the shade is tapped from both sides for top ornament and bulb clip. To make the joint watertight fill the openings with solder or waterproof cement, such as household cement. ★★

By Sam Brown

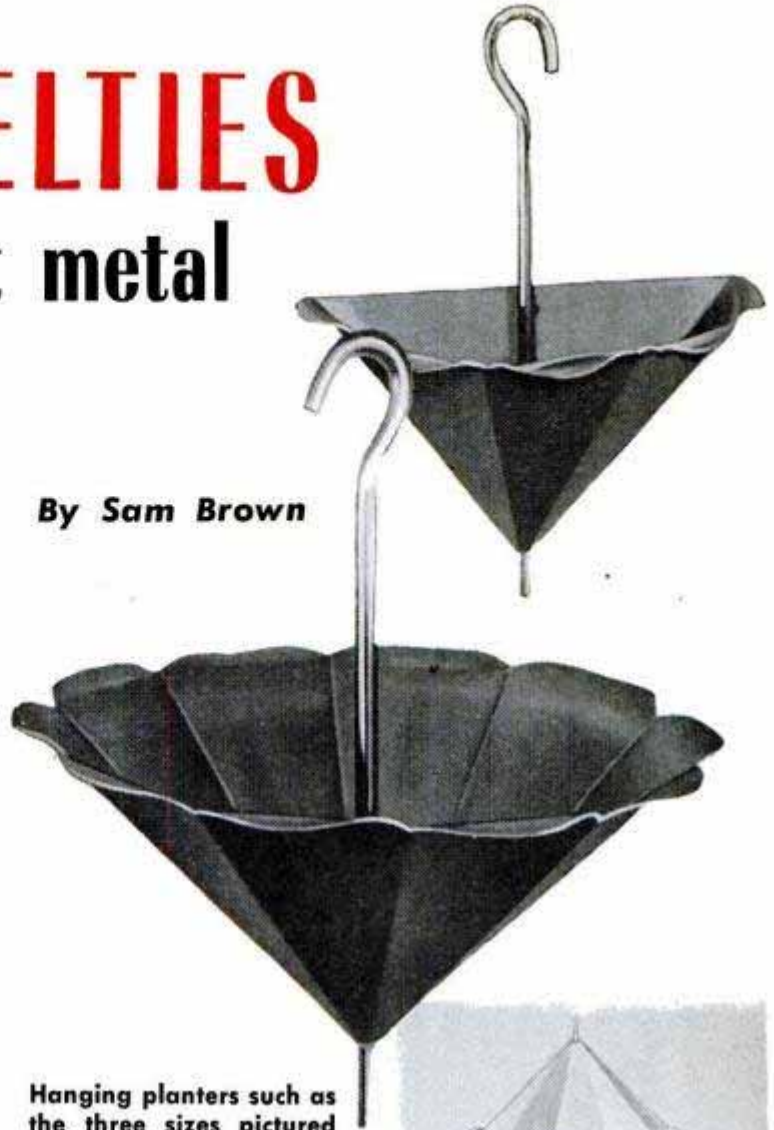

Hanging planters such as the three sizes pictured above, can be made either half or full umbrella shape, with scalloped or plain edges. Lamp shade at right is same as full umbrella



Ash tray, coal-hod planter and pot holder are especially attractive when made of copper and highly polished. Ash tray itself is separate and can be hammered, spun or purchased in size required. Scotty pattern is part of holder and cut on jigsaw



COLLAR  
34-GA. STAINLESS STEEL

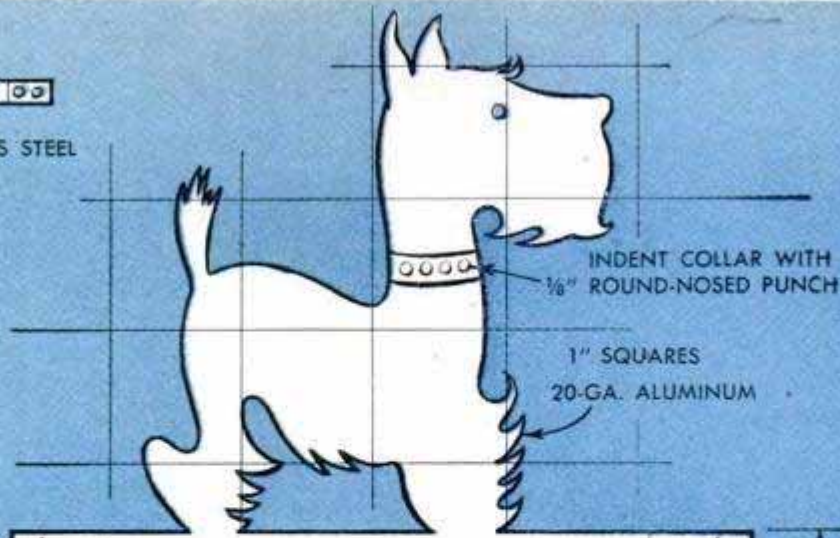

INDENT COLLAR WITH  
 $\frac{1}{8}$ " ROUND-NOSED PUNCH

1" SQUARES  
20-GA. ALUMINUM

*Ash  
Tray*

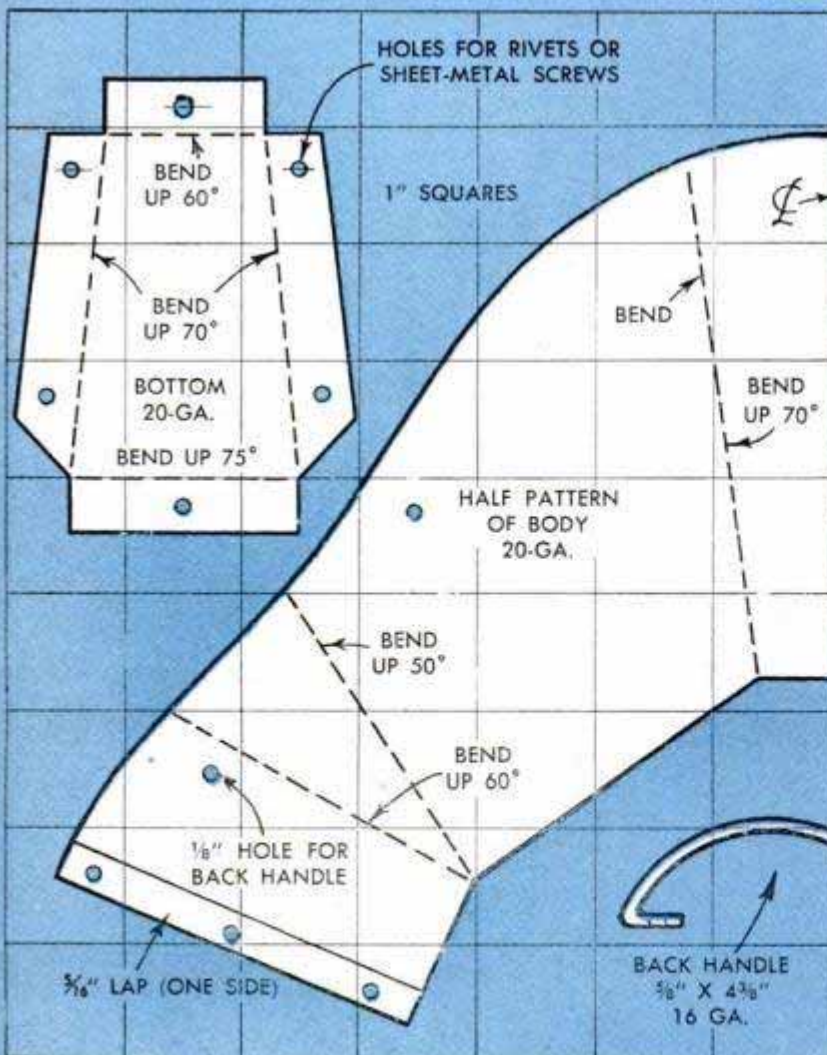
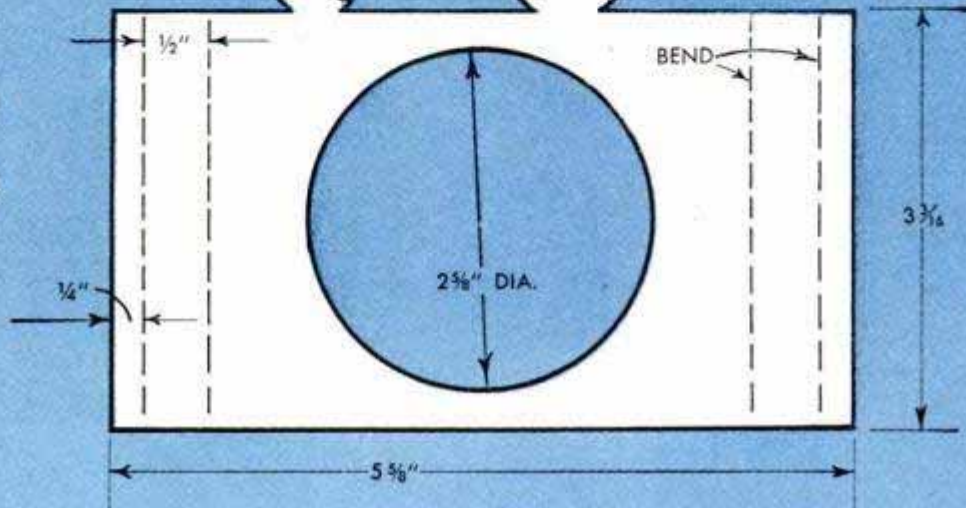

*Flower Pot  
Holder*

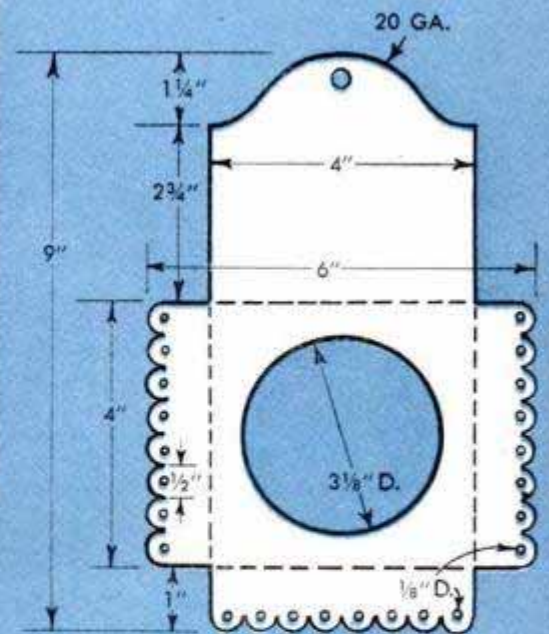

*Coal-Hod  
Planter*



FULL UMBRELLA SHAPE IS DOUBLE THIS HALF SHAPE

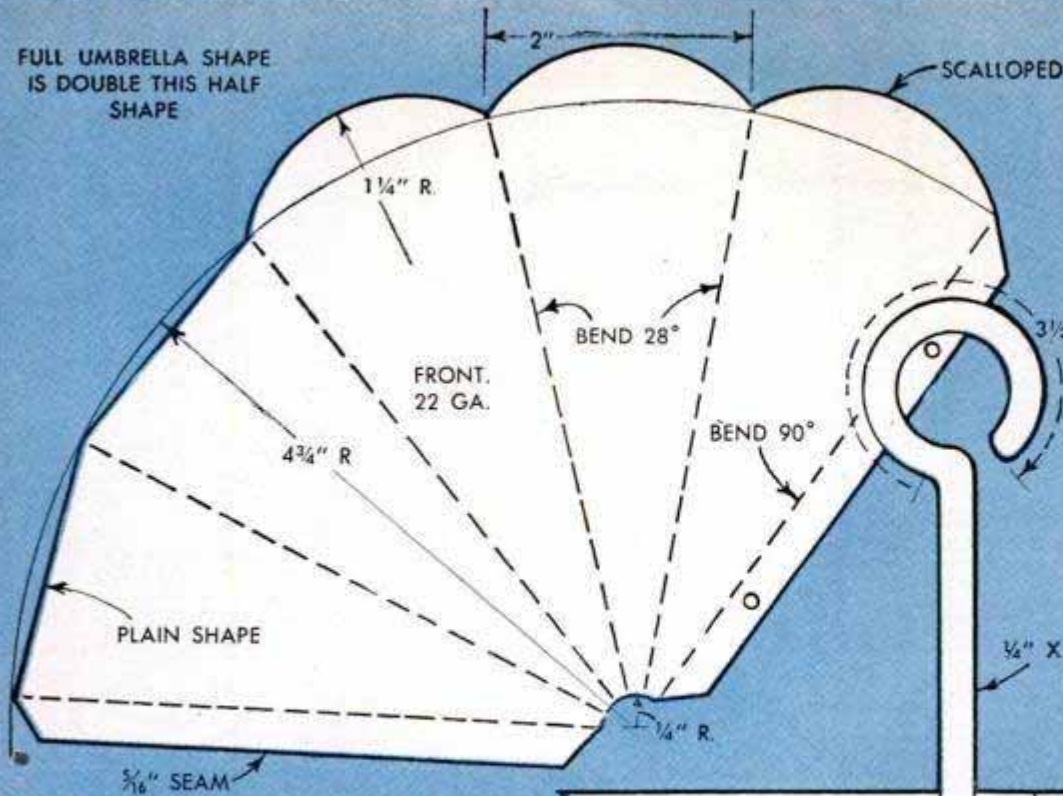

### Umbrella Planter

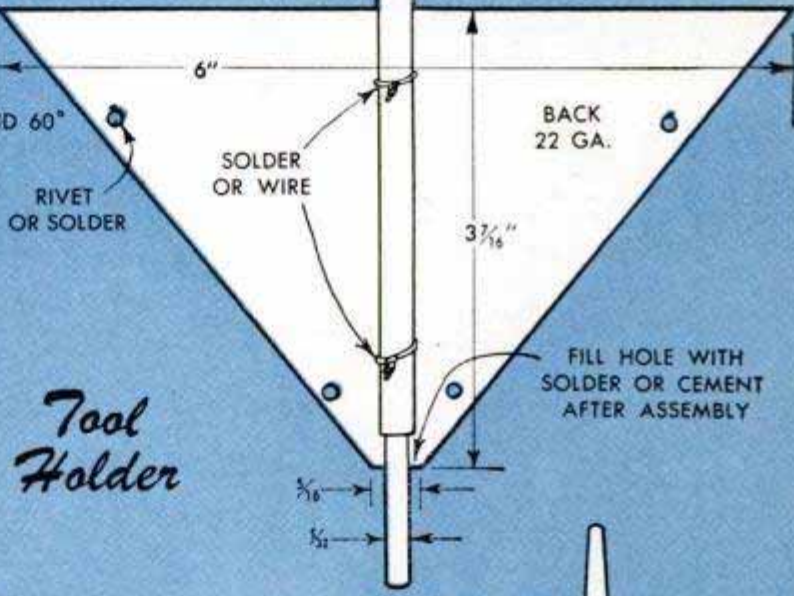
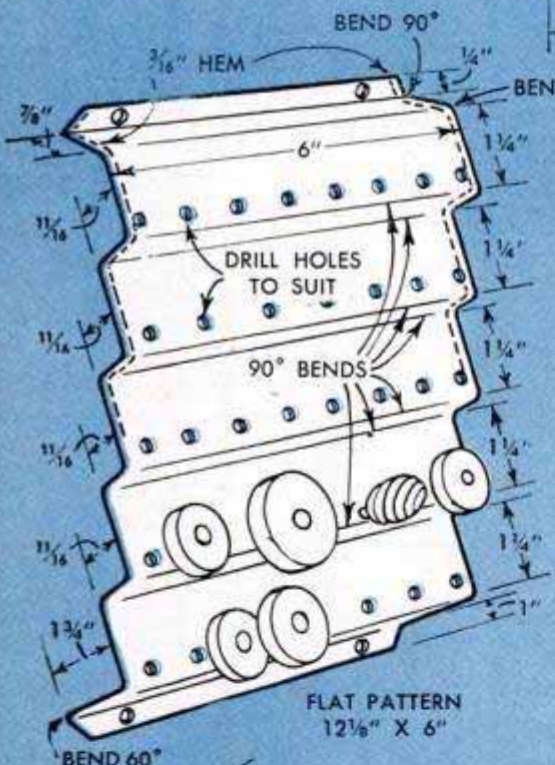

### Tool Holder

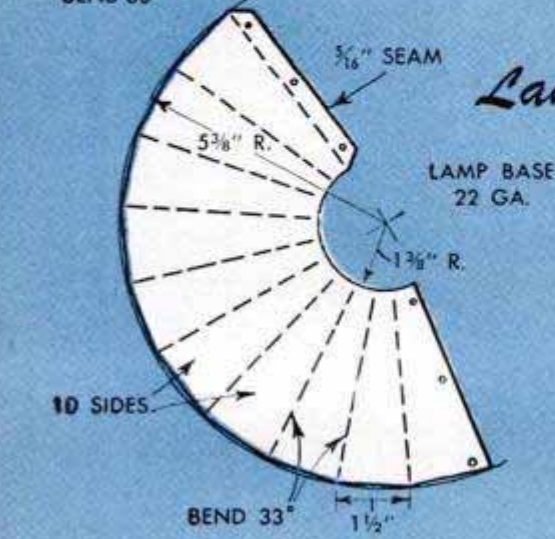

### Lamp

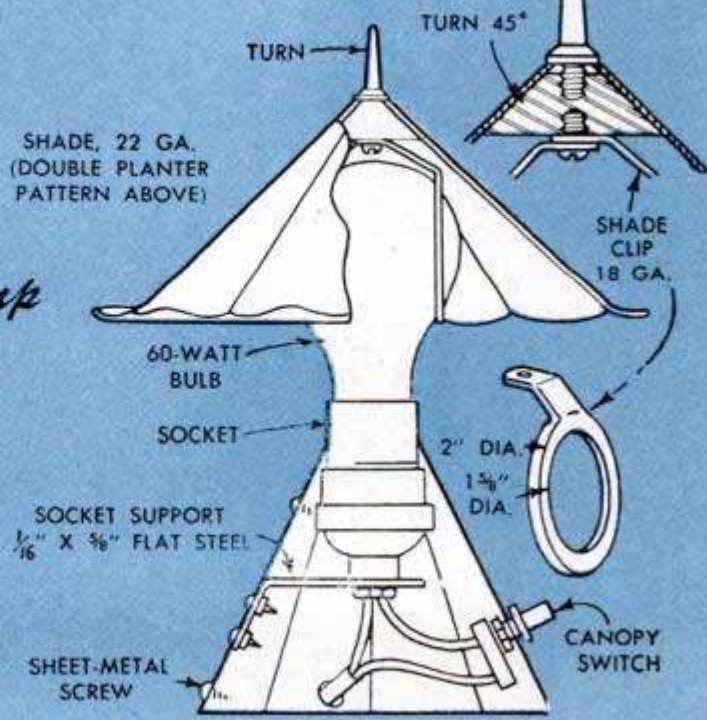

## Beveled File is Cutting Blade On Bench Utility Shear



Made from a large file and a short length of heavy steel angle, this bench shear will perform many cutting jobs around the shop or farm. One web of the angle is flame-cut to a semicircular shape with slots of various sizes cut in one half of the curved edge. Holes of different diameters are drilled in the other half in which bolts, heavy wire, etc., may be held for cutting. The other web of the angle is clamped in a bench vise. The file is ground to a bevel along one edge and either riveted or bolted to pivot on the horizontal web as shown. The bevel should be no more than 5 deg.—10 deg. at most—to lessen the possibility of the edge chipping off under too much strain. A handle completes the unit.

## Altered Corn-Planter Plates Give Varying Hill Drop



On average land farmers can increase corn yields in good years by altering planters to alternately drop three and four kernels per hill. To accomplish this change in the rate of drop, opposite openings on planter plates of the edge-drop type are closed by running metal from a bronze welding rod into each

opening as indicated by the arrows. The weld metal is then ground down to the exact contour of the plate. As will be seen from the photo, this procedure reduces the openings in the plate from 16 to 14, or 4 and 3 on each side of the plate. When these altered plates are used the planter will drop alternately three and four kernels per hill.

## Surplus Vibration Dampeners Used as Machine Mounts

Excellent sound and shock-absorbing pads for light machinery can be improvised from shear-type vibration dampeners. First designed for use as instrument mountings in planes and tanks, the rubber-cushioned dampeners are well suited to any number of uses where vibration is a problem. Available as war surplus, the dampeners are ready-drilled for attaching to both machine and surface.



opening as indicated by the arrows. The weld metal is then ground down to the exact contour of the plate. As will be seen from the photo, this procedure reduces the openings in the plate from 16 to 14, or 4 and 3 on each side of the plate. When these altered plates are used the planter will drop alternately three and four kernels per hill.

## Slotted Nut Having Offset Pin "Locks" When Tightened

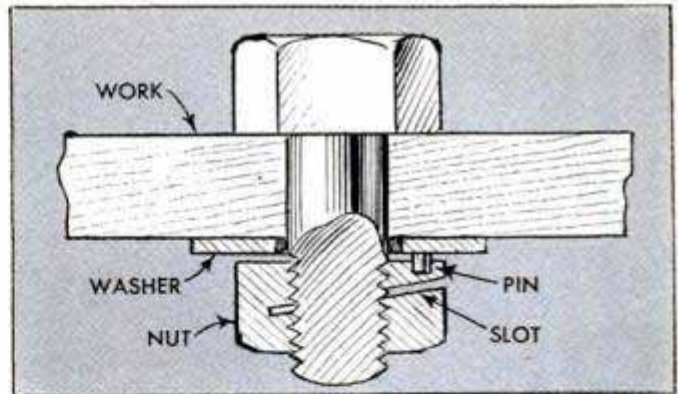

An ordinary nut can be made into a lock-nut by slotting it at an angle approximately three-quarters of the way through, and drilling a blind hole near one edge to take a tiny pin as shown. As the nut is tightened, the sides of the slot are forced together due to the offset pin, causing the threads of the nut and bolt to bind and thus "lock" together.—Max Schuelke, Milwaukee, Wis.

## Sorry . . .

An article entitled "Floor Fan Doubles as End Table," published in the May issue of *Popular Mechanics*, is a patented item of commerce made by the Diehl Manufacturing Co., and may be purchased at appliance stores under the trademark "Diehl"

Glued work requires that pressure be applied by clamps to close the joints tightly and hold them in position

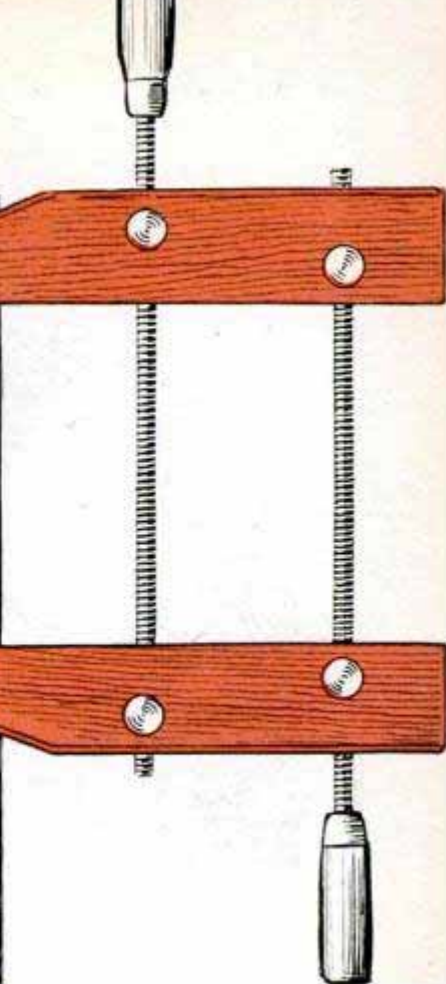
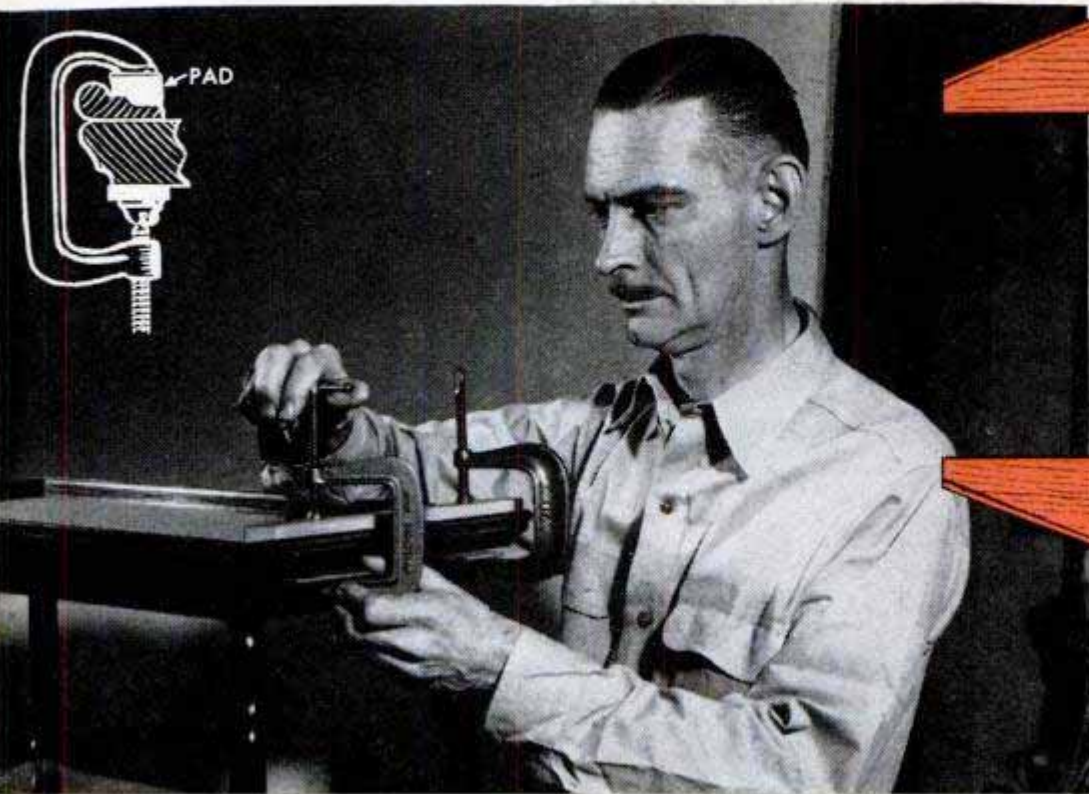

# Holding Work with CLAMPS and WEDGES

By E. R. Haan

**S**MALL PARTS that are to be joined by gluing often can be clamped in the bench vise, but larger and longer pieces joined edge-to-edge or face to face require the use of clamps suited to the size and nature of the work. Clamps of the various common types also are used for holding parts securely in position when assembling with other types of fasteners such as nails, screws and bolts.

**C-clamps:** The C-clamp, detail A, Fig. 1, probably is used more frequently than any other clamp. Six of these in sizes that open from 2 to 8 in. generally are sufficient for the small shop. The smallest C-clamps have

knurled finger grips; larger ones have either fixed wings or sliding T-handles. For holding small assemblies that must be manipulated in various positions, a hand vise, detail B, is often most convenient. The jaws separate by spring action as the screw is released. A spring-type clamp for small work is shown in detail C. Sizes having jaw openings from 1 to 3 in. are available. On C-clamps only the swiveling pad at the end of the screw and the fixed pad on the frame contact the work. In some cases it's best to place small blocks of wood or hardboard between the pads and the surface of the work, detail D, Fig. 1, to prevent

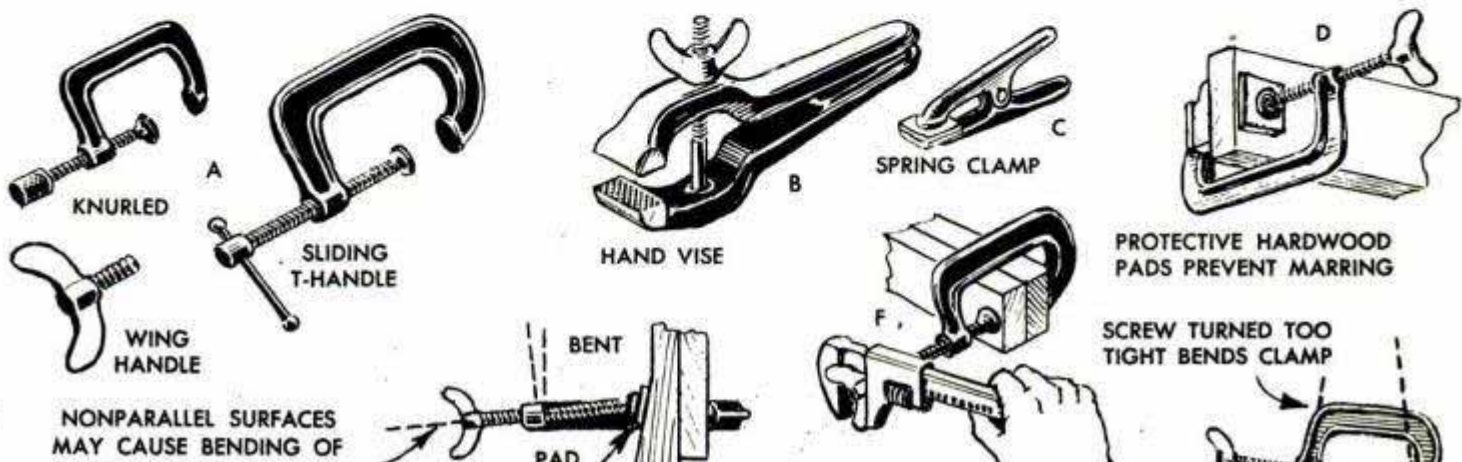



HAND SCREWS GIVE  
MAXIMUM SURFACE  
CONTACT

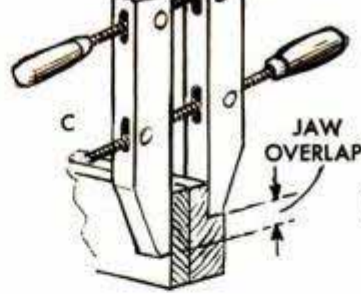
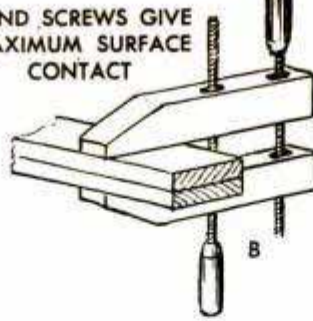

JAWS SET AT ANGLE  
CLAMP BEVELED WORK

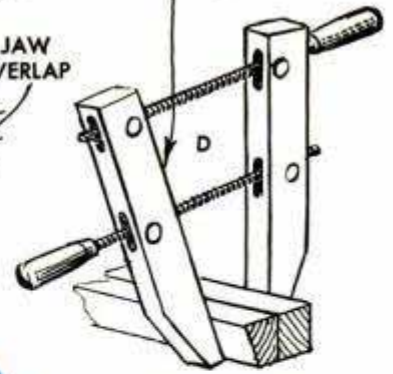

SCREWS PIVOT IN  
METAL INSERTS

TO OPEN

TO CLOSE

2

HANDSCREWS

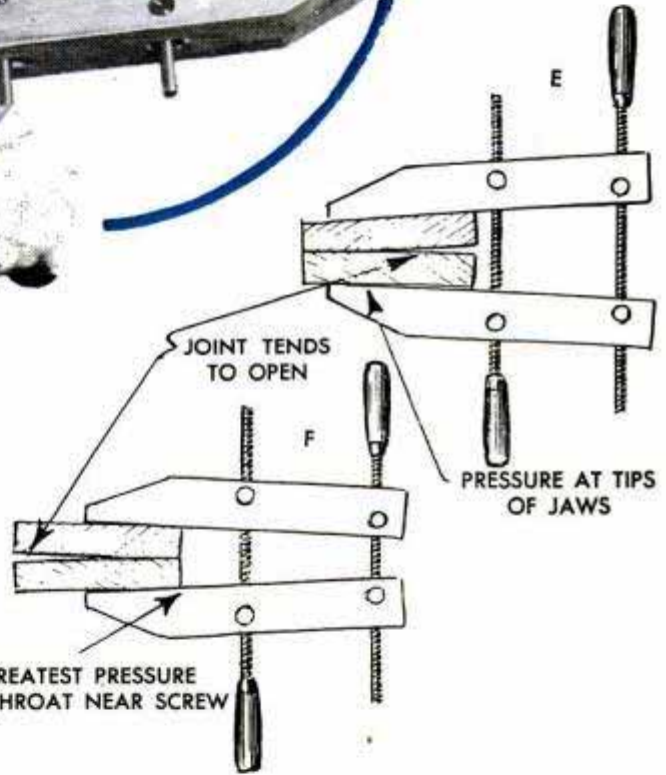

PIPE-BAR  
CLAMP

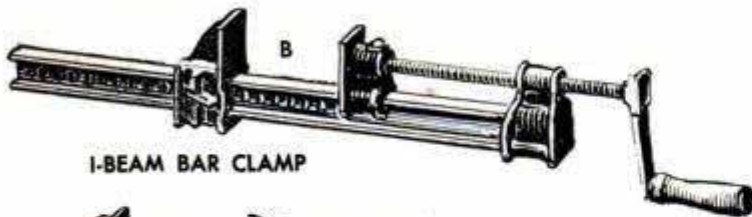

I-BEAM BAR CLAMP

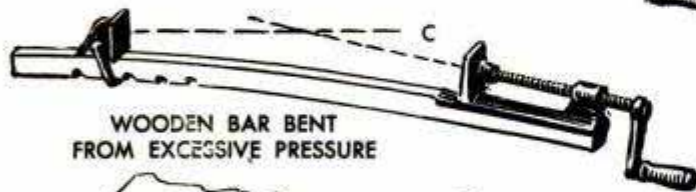

WOODEN BAR BENT  
FROM EXCESSIVE PRESSURE

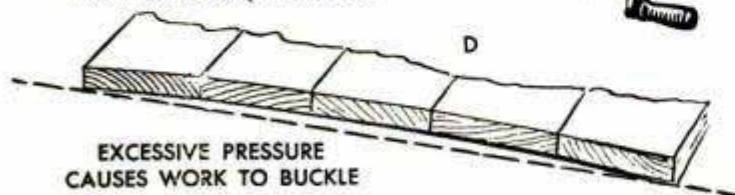

EXCESSIVE PRESSURE  
CAUSES WORK TO BUCKLE

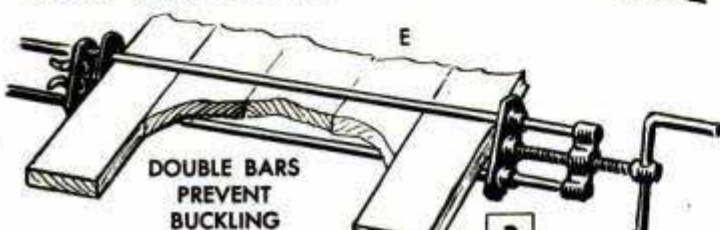

DOUBLE BARS  
PREVENT  
BUCKLING

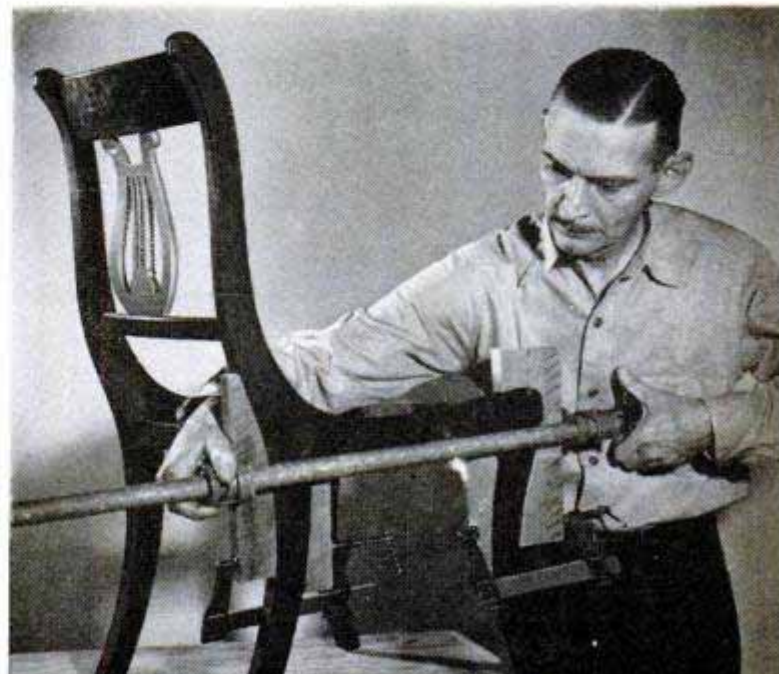

marring or denting. C-clamps should be applied only to parallel work surfaces. If these are at an angle as in detail E, the clamp pad may slip as indicated by the arrow. This can bend the screw and frame out of alignment when considerable pressure is applied. Too much pressure on C-clamps may bend them as in detail F.

**Hand screws:** Hard-maple hand screws often are preferred to C-clamps on woodwork. To open or close the jaws of a hand screw quickly for approximate spacing to suit the work, grasp both screw handles and turn them simultaneously by swinging the jaws around as shown in detail A, Fig. 2. After placing the jaws over the work, adjust them as required. Hand screws grip the work over a much larger contact area than C-clamps, as shown in detail B.

There are two types of hand screws; the nonadjustable type in which the screws are always at right angles to the jaws, and the adjustable type in which the screws thread through metal inserts that pivot in the jaws. The adjustable hand screw can be set with one jaw advanced farther than the other one as in detail C. Also, they can be clamped on surfaces that are not parallel, detail D. Nonadjustable hand screws must be used only on work having parallel surfaces. Incorrectly clamped work is shown in details E and F.

**Bar clamps:** For wide work beyond the range of a vise, C-clamps or hand screws, use bar clamps as in Figs. 3 and 4. As the metal jaws are likely to mar the work, protective pads should be used. Fig. 3 shows three types of bar clamps. The one shown in detail A consists of a length of  $\frac{3}{4}$ -in. pipe turned into the crank-screw fixture which has a movable jaw. A sliding jaw fitted with a camming lock can be set at any point along the pipe bar. Detail B shows a bar clamp on which the sliding

jaw locks by means of a pawl in any one of a number of notches formed in the web of the I-beam bar. These clamps come in lengths from 2 to 6 ft. Clamps having wooden bars will bend if too much pressure is applied, detail C. This causes the work to buckle as in detail D. Buckling of work also may result when using bar clamps in perfect condition, if the edges of the workpieces are not jointed at right angles to the sides. A type of bar clamp that assures a straight assembly of glued-up stock, such as that intended for a table or bench top, is shown in detail E. The jaws of this clamp slide on two parallel rods that bear against both sides of the work and thus prevent it from buckling.

**Clamping irregular work:** The surfaces on which bar or C-clamps are applied must be straight, parallel to each other and at right angles to the line of thrust, as shown in Fig. 5. To prevent a clamp from slipping on surfaces not parallel to each other, especially curved surfaces, use wooden blocks sawed to a matching contour. Their outer surfaces must be parallel and they must be arranged so that they will not slip.

Detail A shows the arm of a chair clamped to its vertical support. Two blocks, sawed to fit the curvature on both sides of the arm are held on a piece of plywood. The lower one extends downward to serve as a stop to keep the upper one from sliding out of position. A C-clamp holds the blocks on the arm, after which a bar clamp is applied to exert pressure on the glued joint.

Detail B shows how C-clamps are used to hold a split block around the end of cracked scrollwork. Another application of clamps is shown in detail C where curved legs of a chair are held tightly against the side rail after regluing the doweled joints. In this case the plywood

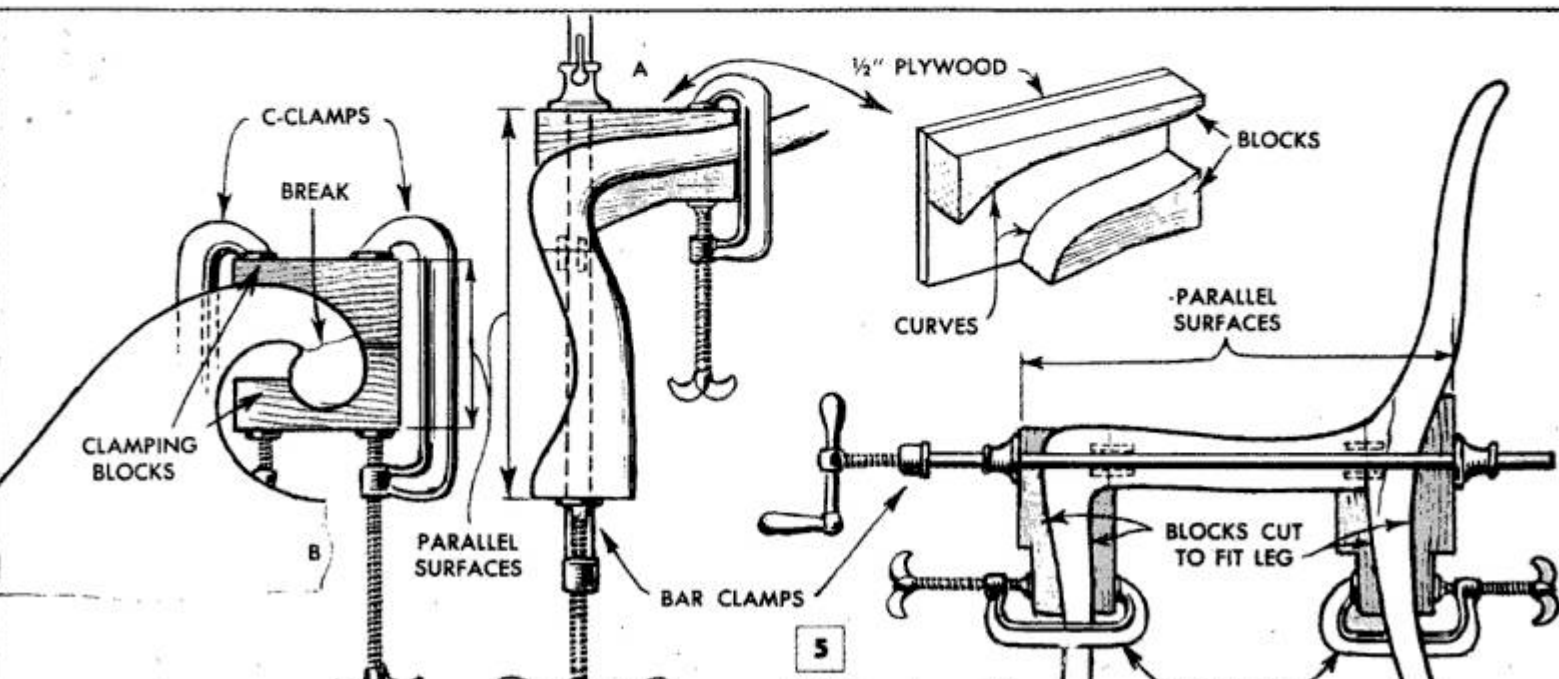

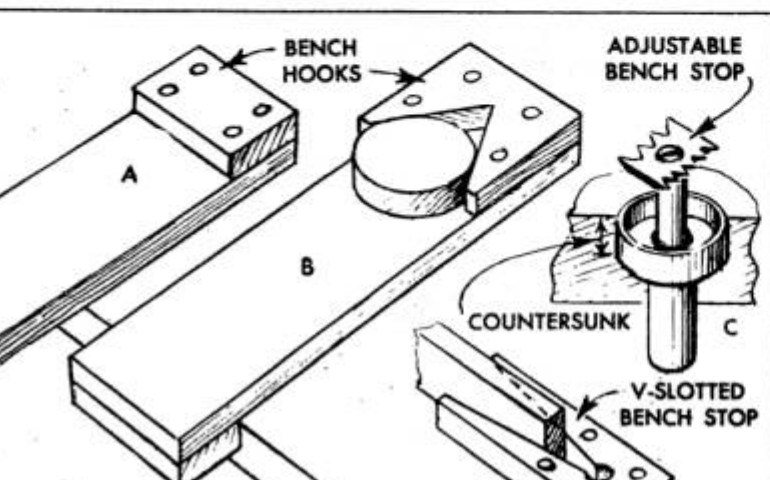
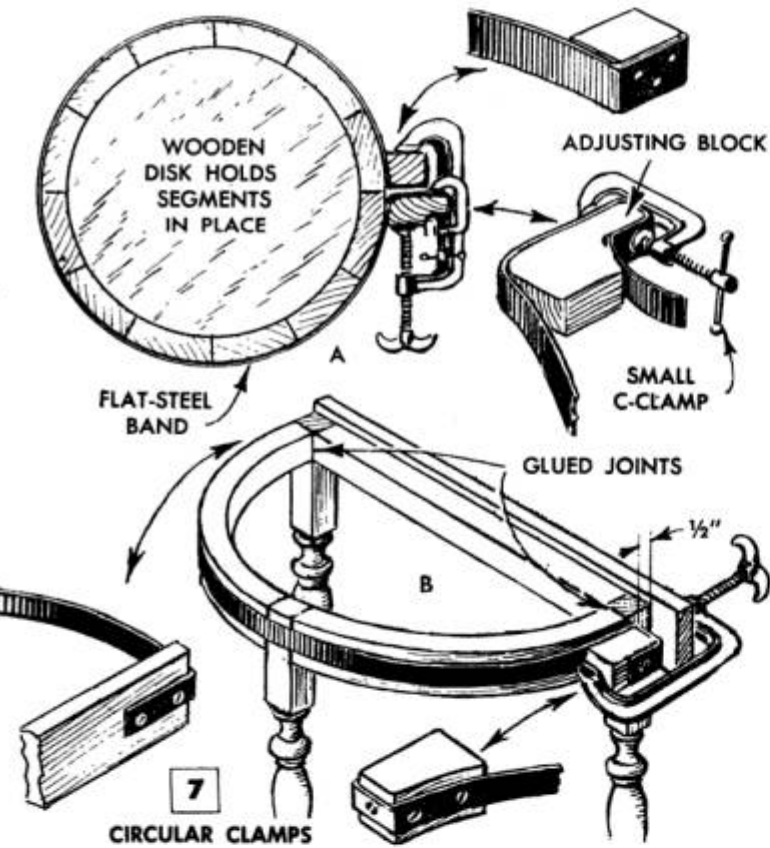
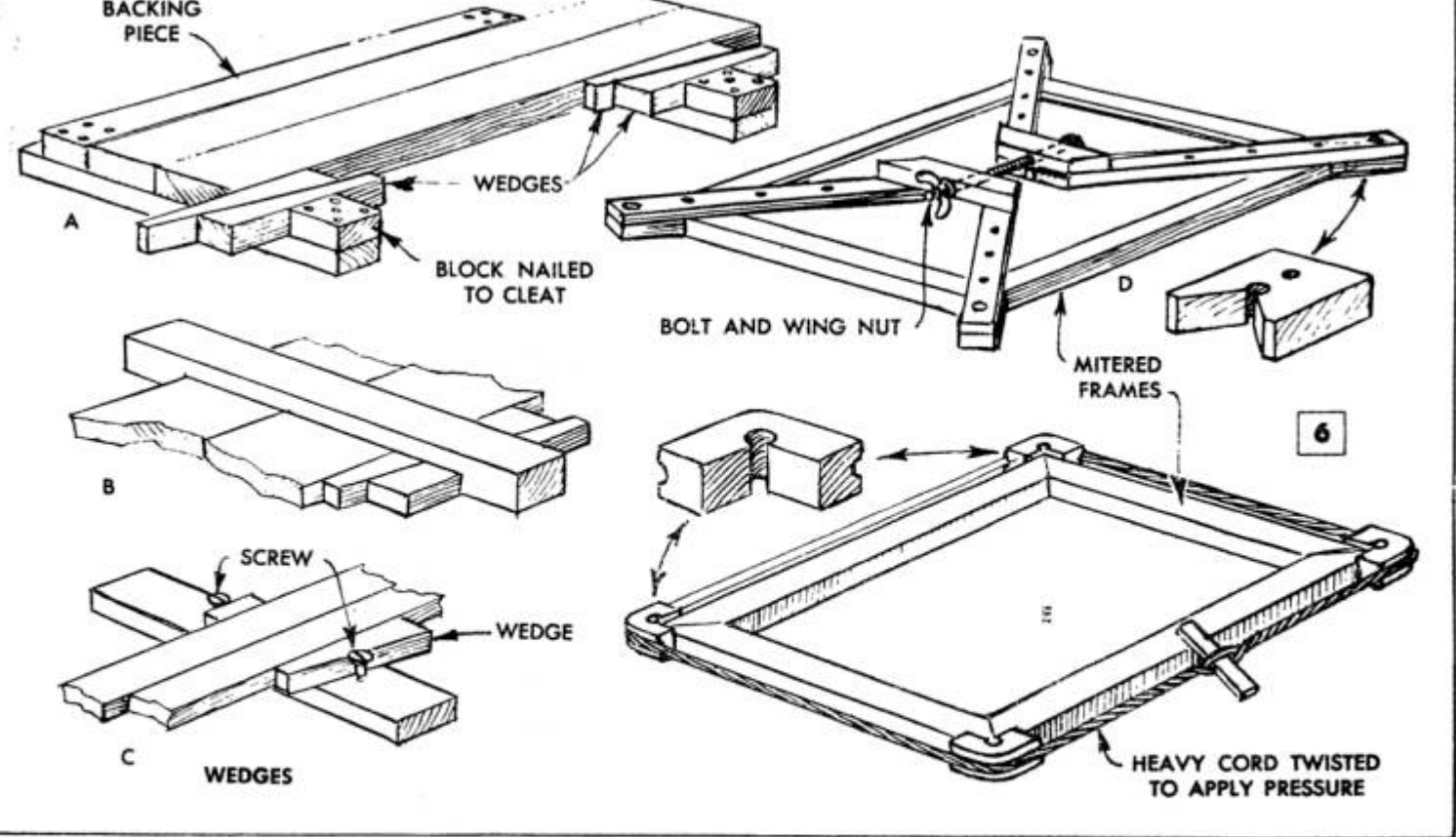

tie pieces are omitted since the outside blocks are not likely to slip. Note that the outer block on the rear leg nests in a long reverse curve, which prevents movement.

**Improved clamping methods:** When clamps are not available or cannot be used, you can improvise wedge clamps to hold the work as in details A, B and C, Fig. 6. Square or rectangular frames having mitered corners may be put under firm pressure by means of the clamping methods shown in details D and E. A number of wooden segments built up to form a ring or cylinder may be held together tightly with one or more thin steel bands of the kind commonly used for packaging large cartons, detail A, Fig. 7. One end of the band is nailed to a hardwood block and a second curved block is held at the other end by a small C-clamp which permits adjustment. A semicircular piece of work may be clamped to a straight piece in much the same manner, detail B.

**Bench hooks and stops:** A bench hook, details A and B, Fig. 8, prevents work from sliding when the thrust of a tool is applied, as when sawing, planing, chiseling and sanding. Detail B shows a bench hook having a V-shaped cutout in the cleat to support round work.

Where a long board must be held lengthwise for planing, chiseling or other operations, and it cannot be held in a vise, a bench stop is convenient. The disappearing type, detail C, Fig. 8, is preferred. Where wide boards must be held on edge securely, use a block having a narrow, tapered V-slot as in detail D. This may be fastened to the bench top with screws or bolts with wing nuts. ★ ★ ★

## Nesting Boxes Held on Wall By Screw Eye "Turn Buttons"

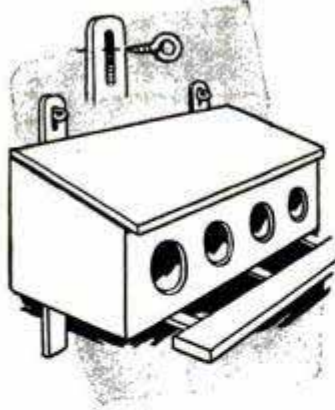

When mounted on slotted cleats that fit over large screw eyes which have been driven into a wall or partition, the nesting boxes in a chicken house can be removed easily for cleaning and disinfecting. Simply turn the heads of

the screw eyes to a vertical position for removal. To secure the boxes once again when cleaning is completed, the screw eyes are turned horizontally.

## Hand-Filed Keyway in Pulley Aligned by Drilling Hole

In an emergency requiring the hand-filing of a keyway in a gear or pulley, one way to get accurate alignment is to first drill a hole slightly smaller than the width of the finished keyway, as shown. To keep the drill from running into the shaft hole in the pulley, force a snug-fitting rod into the hole. This rod should be of the same hardness of metal as the gear or pulley to keep the drill from drifting. A slight flat filed on the rod beforehand will allow the drill to cut an open groove which can then be quickly filed square for the keyway. Clamp the pulley when drilling so that neither the pulley or rod move.—Morris Scott Dollens, Los Angeles, Calif.



## Small End Mill Improvised From Combination Drill

Less expensive and ordinarily available in smaller sizes than the smallest end mills, a combination countersink and center drill can be adapted for use as a small-diameter end mill to cut slots, grooves, etc. This is done by grinding the point flat, and then grinding a clearance angle on each cutting edge. The improvised cutter will work best at high speeds, using a shallow cut and fine feed. When working in steel, a good cutting oil should be flowed over the tool.

F. Shelford, Los Angeles, Calif.

## Gear Keyed to Shaft With Pins

Lacking a keyway cutter for slotting the end of a shaft, I drilled two adjacent holes in the center of the shaft to take steel pins that serve the same purpose as a

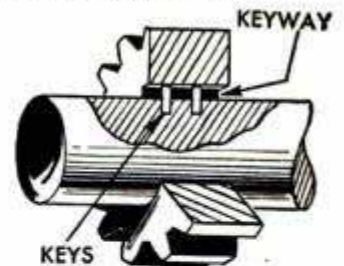

"key." To assure locating the holes on the exact center line of the shaft, the latter was mounted in a lathe and scored horizontally with the point of a turning tool by moving the carriage back and forth. Following this, two punch marks were made  $\frac{1}{2}$  in. apart on the line and a  $\frac{1}{4}$ -in. hole,  $\frac{3}{8}$  in. deep, drilled at each mark. The pins, each of which are  $\frac{5}{8}$  in. long, were cut from  $\frac{1}{4}$ -in. drill rod and driven into the holes. It's a good idea to use collars on both sides of the gear to prevent creeping.

Fred Alkire, Santa Barbara, Calif.

# HEAVY-DUTY DRILL PRESS *from auto parts*

By L. H. Houck

THIS FLOOR-TYPE drill press was designed and built by William Martin of Eldon, Mo., for heavy work in his own service shop on both metal and wood. The unit stands 74 in. high, has a spindle range of 5 in. and drills to the center of a 22-in. circle. Auto and tractor parts and stock sizes of angle, flat and round steel were used in the construction. As originally built, the spindle is bored to a No. 2 Morse taper to take Morse-taper drills and adapters. By turning a taper on the spindle nose, various types of chucks can be mounted.

Usually it's best to begin the construction by building up the base and column first. The base consists of a rectangular angle-steel frame welded at the corners. This is covered with a 1/4-in. steel plate welded to the frame. A 12-in. length of the bell housing from the rear axle of a Fordson tractor forms the lower end of the 70-in. column. The bell end of the housing is welded to the base. A 58-in. length of 4-in. pipe (4-in. o.d. steel tubing is better, if available) welded to the upper end of the bell housing completes the column. Care must be taken to weld these members together in line.

The spindle drive utilizes a portion of the drive shaft and the bell housing of a Ford Model-A rear axle. This unit must include the drive shaft and the differential. The wheel spindle is not required as the drill spindle is substituted in the assembly. The drive-shaft housing is cut to 21 in. long and the bell housing to 13 in. as indicated. A portion of the drive shaft must project beyond the housing so that a driving pulley can be mounted. Before assembling on the column, the Model-A rear axle is disassembled, the differential pinions removed and the second gear from a Model-A transmission is annealed and turned down so that it can be forced into the hub of the differential gear as in detail A. This forms the splined hub which rotates the splined drill spindle and at the same time permits it to be raised and lowered. The spindle is built up as in detail D, using two shafts from Model-A transmissions and also a length of wheel spindle from a '38 Chevrolet

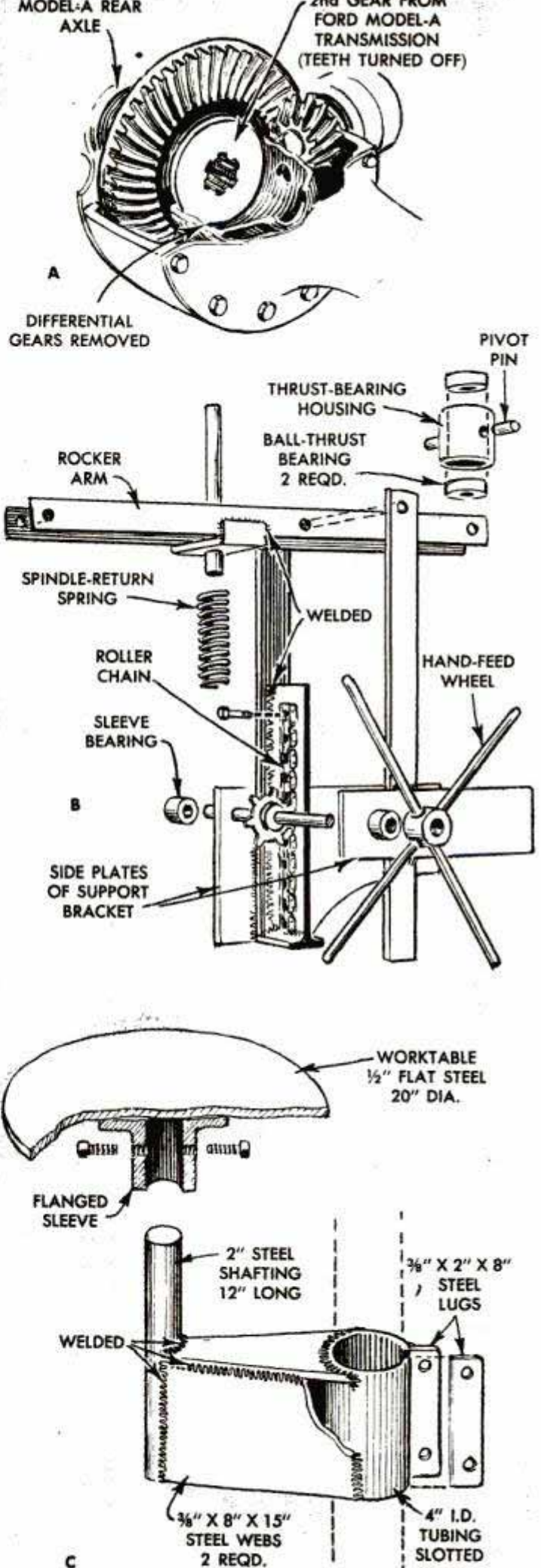



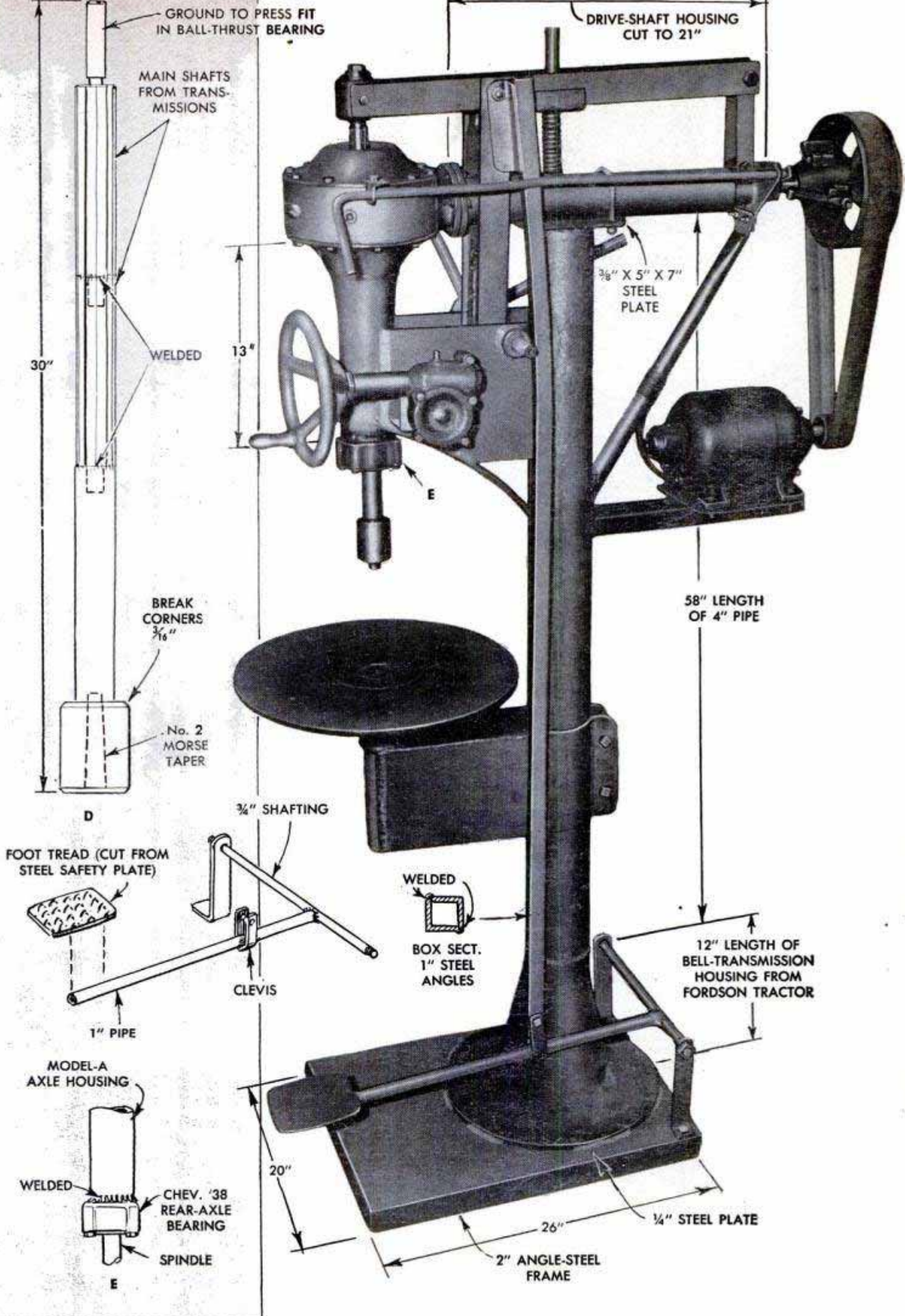

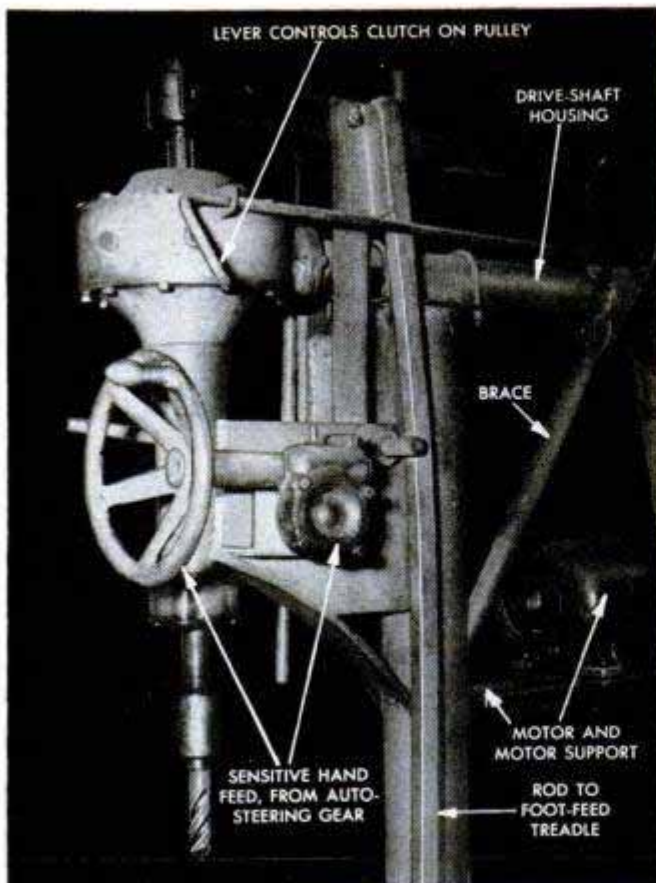

Photos courtesy Lincoln Electric Co.

This view shows the sensitive hand feed. Turning hand wheel moves the steering arm which contacts the spindle lowering rack as in the photo below. Gives sensitive feed for small drills but is not essential in average work. Can be omitted if desired

Rear brace from column to drive-shaft housing carries one end of lever controlling pulley clutch. When using plain V-pulley, bracket is omitted and brace welded directly to drive-shaft housing. Note position of shelf which provides handy storage space

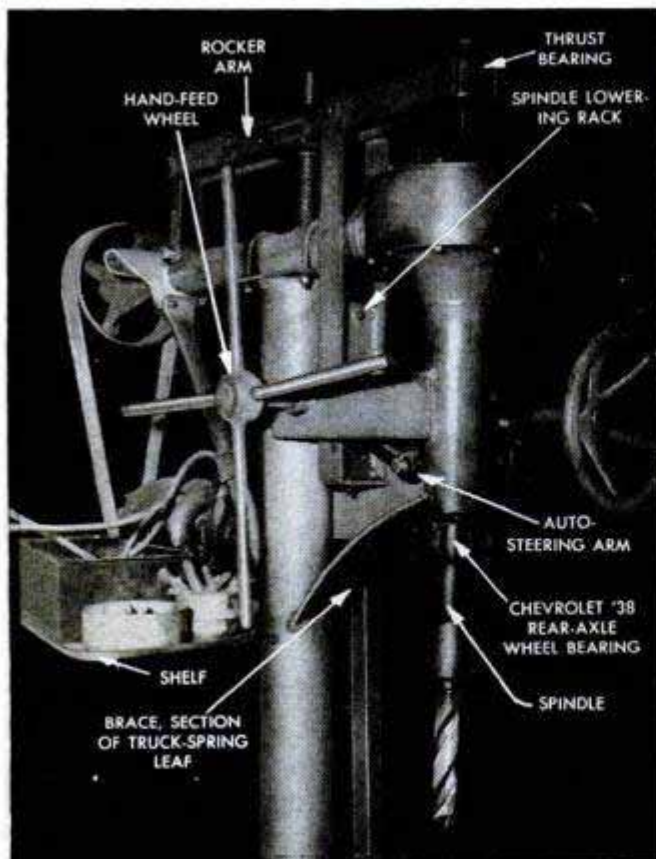

rear-axle assembly. These three sections are welded together. A fourth section, 2 in. in diameter and about 3 in. long, is added to give an over-all length of 30 in. Note that the top end of the assembled spindle is shouldered and the projection ground to a press fit in the thrust ball bearings which fit into a housing as in detail B. An alternate construction is to assemble the two splined sections as in detail D and substitute a length of 2-in. dia. steel shafting for the lower section. This is shouldered down to a diameter that will fit a '38 Chevrolet rear-axle bearing. The latter, together with the housing, or seat, is welded to the lower end of the Model-A axle housing as in detail E. The opposite end of the spindle is cut off square and a front-wheel spindle with bearings is welded to it to form the thrust bearing. In most cases the wheel hub can be utilized as a housing with very little alteration, except that pivot pins must be inserted in holes drilled in the housing to take the drilled ends of the rocker arms, detail B. In either case taper-bore the lower end of the spindle as in detail D, and break the corners of the enlarged section  $\frac{3}{16}$  in. as indicated. When fitting the spindle be sure that it slides freely in the splined differential hub and in the lower spindle bearing.

A  $\frac{3}{8} \times 5 \times 7$ -in. steel plate welded to the top end of the column serves as a mounting pad for the spindle-drive assembly. Drill  $\frac{3}{8}$ -in. holes near the four corners of the pad for  $\frac{3}{8}$ -in. U-bolts. Then locate the assembly so that the spindle centers approximately  $11\frac{1}{4}$  in. from the side of the column. Tighten the U-bolts temporarily. Now measure for size and cut the side plates of the support bracket, detail B. Dimensions of these are not given as the size must be determined after assembling parts to this stage. Weld to the housing and column as in the photo on the preceding page. Weld short steel or bronze sleeves to the side plates and drill through the plates to form bearings for the sprocket shaft, detail B. Note that the sprocket, detail B, engages a length of roller chain bolted to the web of the built-up slide. When fabricated and assembled, this unit forms a raising and lowering rack for control of the spindle by means of the hand-feed wheel. Note its position in the lower photo at the left. In the assembly a flat-steel cross member (not shown) is welded between the side plates to serve as a guide and to prevent the slide from swinging forward.

The hand-feed wheel is made by welding four  $\frac{1}{2}$ -in. steel rods of equal length to a steel sleeve which forms the hub. The wheel is locked to the sprocket shaft with a setscrew. The spindle-return spring is

placed over a length of shafting welded to the top of the drive-shaft housing. A short length of steel channel welded to the rocker arms serves both as a spacer for the arms and as a pad for the upper end of the spring. The pad is center-drilled and the hole elongated for a loose fit over the shaft. The rear ends of the rocker arms are bolted to links, the lower ends of which pivot on a bolt passing through a short length of  $\frac{1}{2}$ -in. pipe welded to the drive-shaft housing. This arrangement equalizes the necessary lateral movement of the rocker arms when the spindle is lowered.

The forward ends of the rocker arms are drilled to fit  $\frac{3}{8}$ -in. steel pins which are a drive-fit in holes drilled in opposite sides of the thrust-bearing housing. Also the upper extensions of the lowering rack are bolted to the rocker arms as in the photos on the opposite page. Note in the upper photo, page 216, that the rod to the foot-feed treadle is welded to an angle-steel bracket attached to the rocker arm by the same bolt that holds the lowering-rack extension.

With the assembly complete to this stage, braces to the rear end of the drive-shaft housing from the column, and from the bell housing to the column are welded in place. The latter is a section of truck-spring leaf and is welded only to the right-hand side plate as pictured. The remainder of the assembly will be quite clear from the photos and details. The table and its sliding bracket, detail C, are built up from stock materials in the manner indicated. It will be noted that the size of the sliding clamp is given as 4-in.-i.d. tubing. This will slide easily over 4-in.-o.d. tubing, but if pipe is used for the column it will be necessary to make up a special clamp from flat steel. The sensitive hand feed, upper photo on page 216, consists of an auto-steering gear and a salvaged handwheel. Turning the latter brings the steering arm to bear on the lower end of the spindle-lowering rack as in the lower photo, opposite page. This arrangement gives an extremely sensitive feed, but is not essential in ordinary work. For this reason it can be eliminated if desired. The photos also show a flat-belt drive from the motor to a clutch pulley on the drive shaft. A V-belt drive is equally satisfactory. A clutch-type pulley is not essential for average work. The  $\frac{1}{2}$ -hp. motor pictured is bolted to a mounting plate which is in turn bolted to a channel-steel bracket welded to the column, and the lower photo at the left shows a shelf which is welded to the motor bracket. This provides convenient storage space for drill bits and other accessories. As a final step, assemble the treadle and bolt to the base.

★ ★ ★

## Crate Raised to Insert Rollers With Bent Spring Leaf

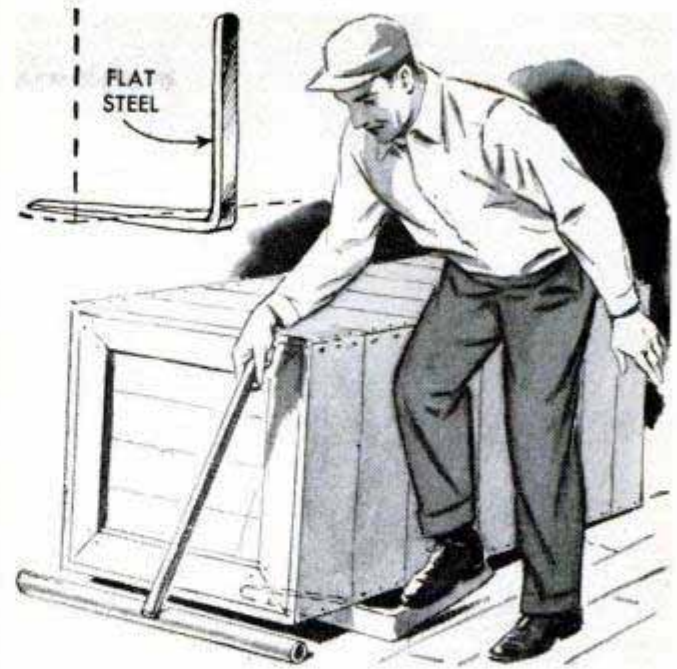

Much of the difficulty of raising a heavy crate for moving on rollers can be overcome by using part of an old automobile-spring leaf bent at a right angle as shown. In use, the tapered end of the spring leaf is forced under one end of the crate while the other end is pushed to the floor with the feet, thus leaving the hands free to manipulate a roller into position. After the roller is positioned properly, foot pressure on the tool is released gradually until the crate rests on the roller. The tool then is removed and applied to the opposite end of the crate.

## File Used First on Soft Metal Will Give Longer Service

A new file will give longer service if used at first only on soft metals such as brass and copper, after which it still will be sharp enough for filing iron and steel. Should immediate filing of one of the harder metals be found necessary, the file may be used on one side only, while the other side is marked to reserve it for soft metals until it, too, becomes worn. An easy way of marking it is to daub it lightly with red fingernail polish.

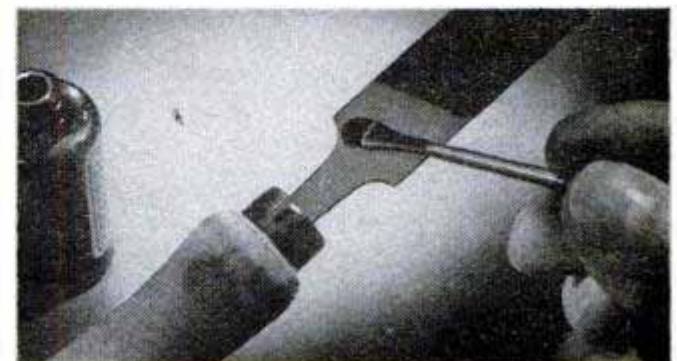

# SHOPPING FOR TOOLS



**1. SOUND DETECTOR** is especially sensitive to sounds which cannot be distinguished by the human ear. These can be picked up and amplified to the point where they are easily identified. Sound is transmitted directly to earphones by a sensitive probe which can reach any point accessible to an ordinary pencil. Picks up the sound of leaking valves, wrist pin and bearing knocks, grinding gears and other mechanical defects

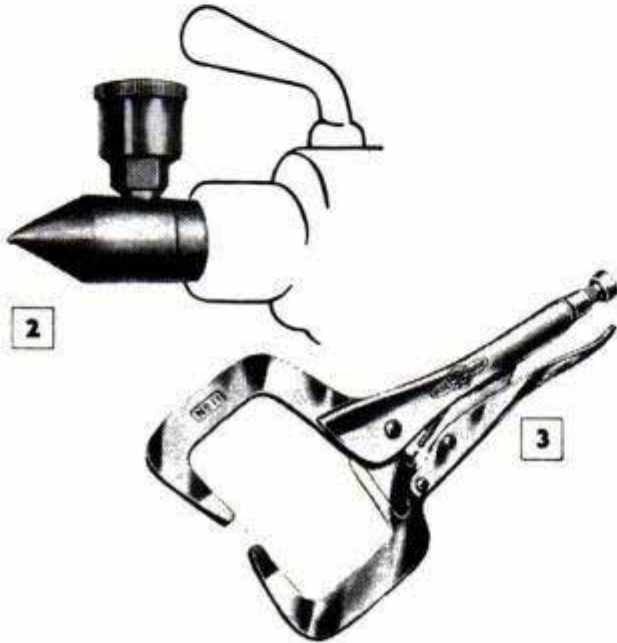

**2. PRESSURE-LUBRICATED CENTERS** for lathes and grinding machines prevent damage to precision work caused by heating. Centers are tipped with a special alloy for long wear and resistance to scoring. Lubricant is supplied from a pressure cup through a pin-sized jet in the center point. This method of pressure lubrication prevents metal chips and abrasive dust from collecting on the surfaces in contact

**3. TOGGLE C-CLAMP** is operated in a manner similar to pliers and has an adjustment which permits pre-setting the jaw opening to suit the work. After pre-setting the jaws, the operator can manipulate the clamp with one hand. By utilizing this feature it is possible to hold an assembly for welding, brazing or soldering without having to clamp it to a table or in a special fixture. Locks securely in any position

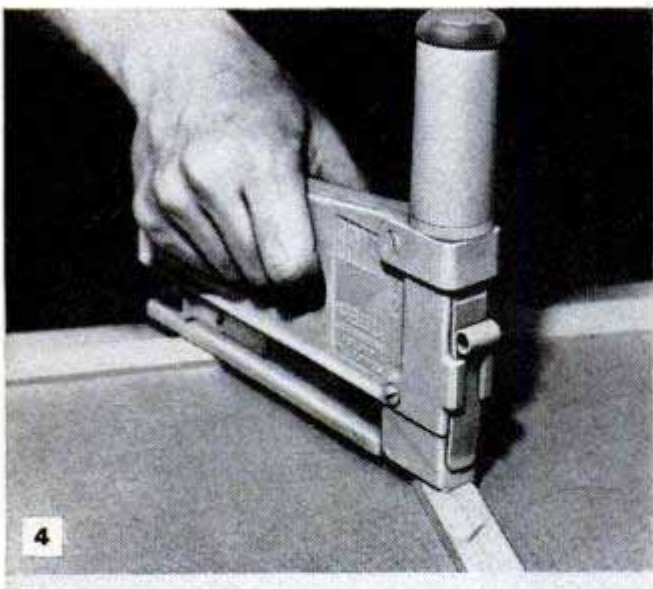

**4. AIR-OPERATED TACKER** works on 40 to 80-lb. air pressures and can drive more than 200 staples per minute where the nature of the work will permit this speed. Has a simplified direct drive, loads from the front and takes staples in a variety of metals and finishes from 5/32 to 13/16 in. long. Light weight combined with specially shaped handle permits one-hand operation at top speed without undue fatigue

**5. MAGNETIC PROBES** retrieve metal chips, tools, bolts and other objects dropped into inaccessible places. Handy for machine assemblers, auto mechanics, electricians and others who assemble parts. Probes come in several sizes, the long probe pictured having a flexible shaft, or body, which enables the operator to lower it into curved pipes or tubes. Powerful permanent magnets pick up heavy bolts and nuts easily

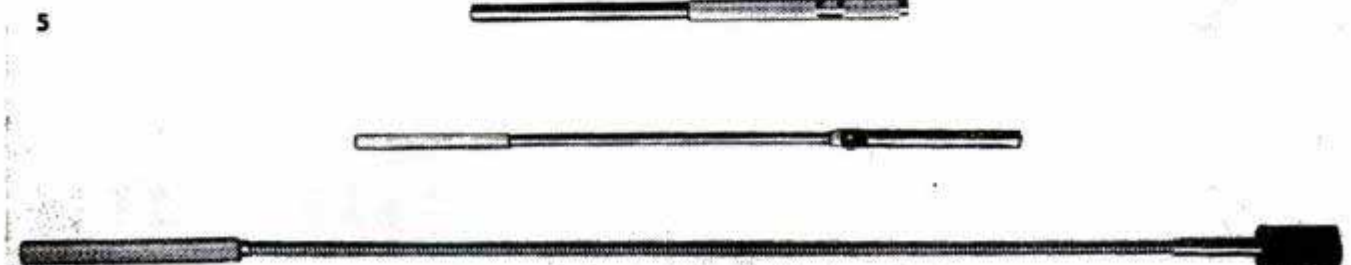

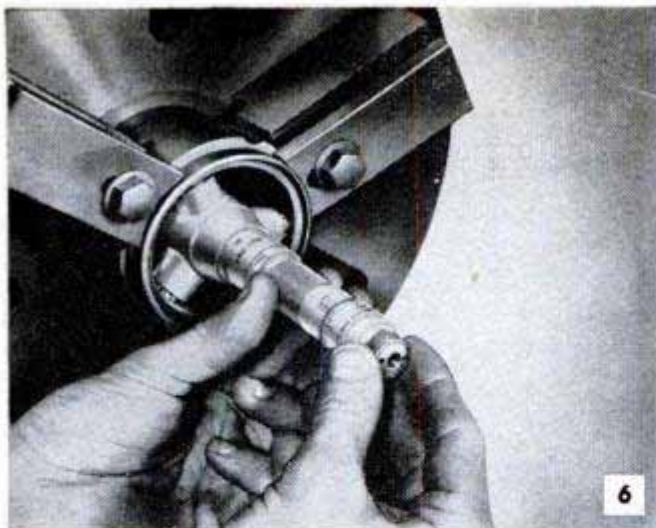

**6. HOLE GAUGE** reads to .0001, is self-centering in any internal work within its adjustment range. Available in two sizes, the smaller having a measuring range from .275 to .500 to a depth of 2 in. or 6 in. with extension. A larger size has measuring range from .500 to 4 in. to depth of 9 in. with extension

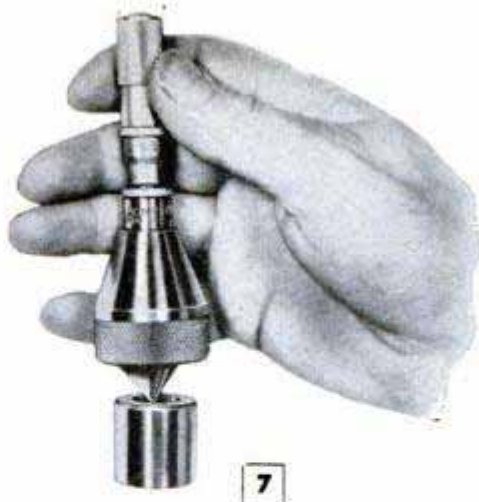

**7. CHAMFER MICROMETER** measures end diameters of chamfers up to 1 in. and from 0° to 90°. Depth of chamfer is easily computed from readings. A master check bar with known end diameter and chamfer is included with each unit for checking calibrations. Instrument offers machinists substantial saving in time

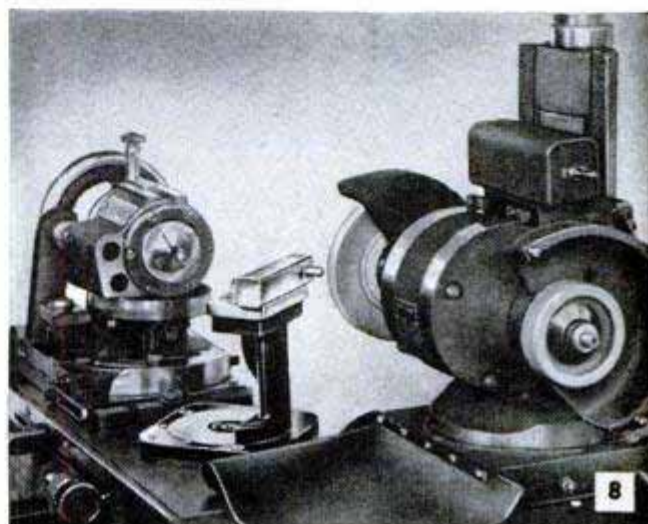

**8. ANGLE GRINDING-WHEEL DRESSER** is especially designed for use on radial relief grinders, but can also be used on cutter grinders of various types. Has a graduated base and 5-minute vernier for precision setup. Inverted milled T-slide permits dressing wheel on either side to any desired face angle

**9. REPLACEABLE-BLADE MILLING CUTTER** is available with choice of blades in carbide, high-speed steel or cast alloy. Rigidity of solid cutter is obtained by seating replaceable blades against abutments milled on the periphery of the new-type head. A dowel accurately locates the tail of each blade in the head

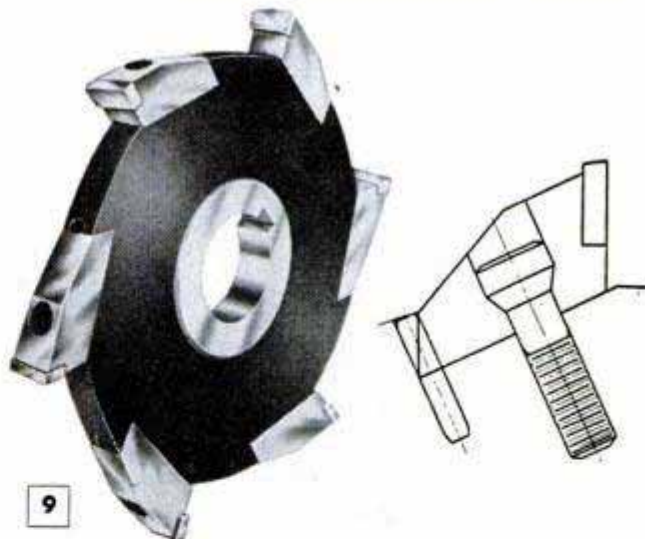

**10. RESISTANCE GAUGES** determine comparative drawing quality and stretcher-strain characteristics of sheet metal without damaging the piece being tested. Material is flexed at corner and gauge shows resistance to bending. A test with the second gauge shows the curvature of the bend and stretcher strain





### Plowshare Held for Repairs In Adjustable Pipe Rack

This adjustable rack, which holds plowshares conveniently for welding, repointing and hard facing, was made from the window-cranking assembly of an old car as well as other scrap parts. The cranking assembly was welded to a short length of pipe that pivots in the upper end of a pipe stand. The plowshare is held in the rack by means of a simple clamp. The crank tilts the plowshare to the angle most satisfactory for the job involved, and simplifies angular adjustments during work.

### Harrow-Disk Storage Tray Swings Under Bench Top

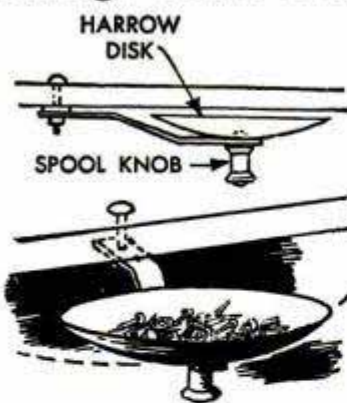

A discarded harrow disk bolted to a flat-steel bracket pivoted to the bench top makes a handy swinging tray for the farm-shop bench. The shape and size of the disk make it especially useful for storage of small parts of

various sizes, also screws, nails, bolts and nuts. Use  $\frac{3}{8}$  or  $\frac{1}{2}$ -in. flat steel for the bracket and bend an offset in the piece which is approximately equal to the concavity of the disk. Then bolt the bracket to the bench top, placing a large washer between the top and the bracket to permit free movement. Nick the bolt threads with a cold chisel so the nut does not loosen. A large spool attached to the bottom of the disk as shown, makes a good handle.

### Metallic Paints Cut Radiator Heat

Metallic paints, such as aluminum and bronze, may reduce the heating efficiency of a radiator as much as 20 percent, according to heating experts. Paints of this type have heat reflecting qualities and thus tend to reduce passage of heat from the outer surface of the radiator. For more efficient heat radiation, the experts recommend painting the radiators with a regular oil-base paint.—A. E. Fenn, Chicago.

### Lip on Feed Trough Reduces Waste

To cut down excessive waste from ground spillage in feed troughs, one farmer formed a lip on each side of the trough as illustrated. He cut pieces of  $\frac{1}{2}$  x 2-in. stock to fit the length of the trough sides and nailed them to

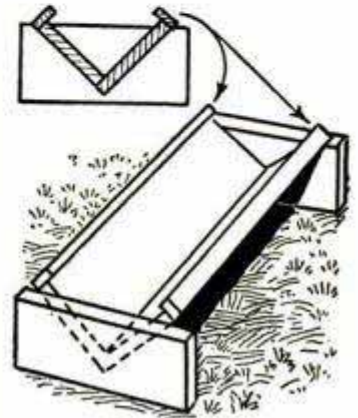

overhang the edges. The lips thus formed do not in any way interfere with feeding, and yet effectively cut down on spillage.

Norm Jacky, Fond du Lac, Wis.

### Tap Hand-Started Accurately

To eliminate the difficulty of starting a tap accurately by hand, I made this jig which is drilled in graduated sizes for guiding taps in holes that are at right angles to the surface of the work. Each hole in the jig, which is made from a 2 x 3-in. block of  $\frac{1}{2}$ -in. cold-rolled steel, is reamed slightly larger than the diameter of the corresponding tap. After the jig has been drilled, it is hardened to prevent the taps from wearing and enlarging the holes. In use, the jig is placed on the work so the proper guide hole is centered over the hole to be tapped. When possible, the jig should be clamped to the work.

Henry Sevcik, Los Angeles, Calif.

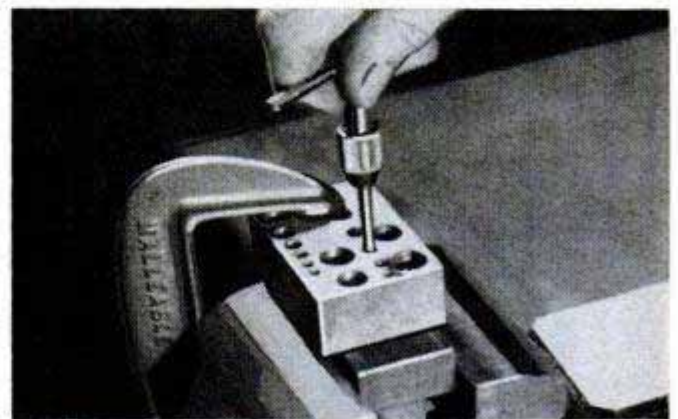



### Movies indoors or out

For indoor movies just attach Kodak's Photo-Light Bar (only \$8.75; lamps, \$2.70 for two) . . . set and shoot. That's all there is to it!

### Color movies, too

30-to-40-scene Kodachrome Film costs but \$3.95 a roll (8mm.) — including processing! (Only \$3.25 for black-and-white.)



### Exposure guide "delivers the goods"

Built-in exposure guide takes out all the figuring, leaves only the fun . . . makes sure exposure's right every time!

# Most exciting family gift of all

# ... a Kodak Movie Camera

## CINE-KODAK RELIANT CAMERA

Moderately priced, but it has lots of advanced features . . . makes slow-motion movies, accepts telephoto lens. Uses economical 8mm. roll film for movies with snapshot ease, at snapshot cost. With f/2.7 lens, \$89.50. With f/1.9 lens, \$110. See the "Reliant" at your Kodak dealer's.



"It's Kodak's budget special"



### Brownie Movie Camera

Most economical way to crisp, clear movies in full color or black-and-white. Uses 8mm. roll film. Features easy, no-thread loading, built-in exposure guide. With fine, fast f/2.7 lens, \$39.75. With super-speed f/1.9 lens, \$49.50.

"Men sure go for this one!"

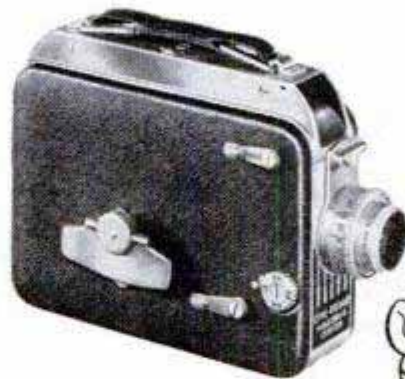

"Here's versatility plus"



### Cine-Kodak Magazine 8 Camera

Loads in 3 seconds with magazines of 8mm. film. Accepts telephoto lenses; has many luxury features. With f/1.9 lens, \$160. For really BIG movies, ask to see the "Royal," Kodak's finest personal 16mm. movie camera. With superb "Ektar" f/1.9 Lens, \$176.25.

Prices include Federal Tax where applicable and are subject to change without notice.

# Kodak



# Care and Feeding of Engines

BY S. P. CORP

## COOLING SYSTEM CARE

All that water you put in your radiator during warm weather contained lime and minerals. These, combined with engine heat, form scale such as you see in the bottom of a teakettle, as well as rust. Scale and rust in the engine block will form hot spots in the water passages. Carried over into the radiator, they clog tubes.

Reverse-flushing of the cooling system should be a seasonal maintenance operation. Do this by removing upper and lower radiator hoses to reverse flush water through radiator. With radiator cap removed, this flow will clear tubes and allow clogged material to drain out at top of radiator. Or you can leave cap on and carry flush stream away through hose attached to upper opening. *Do not apply pressure until water begins to flow through, then use only normal pressure.* If radiator is clogged, use a pulsating flow. The commercial method uses a flushing gun which supplies air agitation to loosen rust and scale.

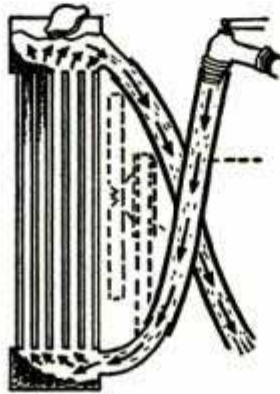

When radiator is clear, connect radiator hose and add a good cooling system cleaner. Run engine until temperature is from 160° to 200°, then stop engine and drain system again, being sure to open drain cocks on side of engine block. Again flush system until clear water comes out of drain cocks.

In extreme cases, remove water distributor tube and thermostat before reverse-flushing cylinder block. On old cars you may need to remove core hole plugs from block.

After thorough cleaning, add rust-inhibitor to the cooling water. Good anti-freeze solutions already contain rust-inhibitors. Avoid salt-base or petroleum-base anti-freeze solutions, as they cause corrosion and deterioration of radiator hose.

## FREE BOOKLET ON CAR CARE

Write for free illustrated booklet on car care, "MORE POWER, Less Gas, Less Oil," which contains many valuable suggestions. When you re-ring, insist on

Sealed Power KromeX Full-Flow Ring Sets to fight heat, friction, corrosion, and abrasion. These sets contain the famous MD-50 Steel Oil Ring, the only ring with the Full-Flow Spring, best for oil control even in badly tapered and out-of-round bores, for easier starting and thousands of extra miles. Sealed Power Corp., Dept. G-11, Muskegon, Michigan.



# Clinic for Homemakers

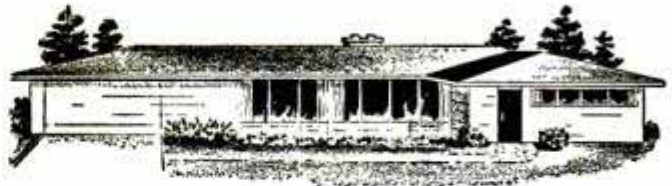

As a service to our readers in solving the hundreds of problems pertaining to a home—inside or out—the editors of *Popular Mechanics* invite you to present your problems to The Clinic Editor for help and advice. Address your questions to The Clinic Editor, *Popular Mechanics Magazine*, 200 East Ontario Street, Chicago 11, Ill.

## Sagging Ceiling

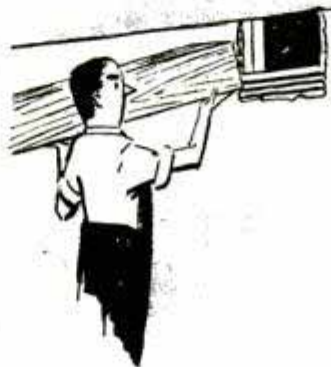

**Q**—Recently I purchased an older-type home and now I'm wondering what to do about the ceiling in the living room which has sagged about 2 in. near the center, cracking the plaster badly. Apparently the room was enlarged at some time and no support was installed where the partition was taken out. Plaster also is cracking upstairs in two rooms.

*Of course, something must be done, but what? I don't want to partition the living room if it is avoidable.—P.R., R.I.*

**A**—Why not consider the installation of ceiling beams? These can be solid, rough-hewn from the log or timber, or they can be built up by boxing a 4 x 6 or 4 x 8-in. timber with stock which matches the window and door trim. You did not give the room area or ceiling height, but as a rule beams that must support weight should be spaced not less than 60 in. center-to-center, and the ends must be adequately supported on ribbands mortised into the studs. Another method, often advantageous in supporting the ends of a heavy beam, is to cut the studs and install headers, thus forming a pocket for the ends of the beam. Another arrangement which is generally attractive in a rectangular room considerably longer than it is wide, is to install a heavy center beam and then locate smaller beams, equally spaced across the ceiling in both directions from the center. This placement of the beams has the effect of dividing the ceiling. In your case we would suggest that you consider the latter method, as the center beam must be relied on to support the ceiling as a substitute for the bearing wall which has been removed. Of course, the ceiling must be raised on jacks before installing the beam.

## Musty Odor in Upstairs Rooms

**Q**—We recently moved into an old house and ever since have been troubled by a persistent musty odor in the upstairs rooms, particularly in the clothes closets. Nothing seems to eliminate it. Ventilation, deodorants of various types apparently have little or no effect. Clothes closets are unpainted but the rooms are papered. There is no sign of dampness. Can you suggest any remedy?

*M.S., Minn.*

**A**—We'd guess right away that the trouble is due to aging plaster. It also could be caused by a slow decomposition of the paste used in applying the wallpaper. Homemade paste and wall size sometimes cause this trouble. However, the fact that

(Continued to page 224)





**OLD TIMERS KNOW** the value of a reliable, smooth-running, long-lasting motor. They get all this and much more in the all-new G-E Utility Motor for shop, farm and home!

# Why take less... make sure you get the all-new G-E motor!

Now available through your local dealer —the completely new G-E Utility Motor gives you more for your motor dollar! Packed with more power per pound, it's smaller, lighter, easier to handle, mount and wire! You can use it with shaft up,

down or at any angle — it will maintain the right lubrication and *no* oil leakage! Designed for home workshops by the world's biggest motor manufacturer, why take less? Ask your dealer about the all-new G-E Utility Motor today!

*You can put your confidence in—*

**GENERAL  ELECTRIC**



**FREE**

Section 674-167, General Electric Co., Schenectady 5, N. Y.  
Send me the new 16-page booklet that gives general tips on motor selection and tells about the all-new G-E Motor.

Name \_\_\_\_\_

Street and address \_\_\_\_\_

City \_\_\_\_\_ Zone \_\_\_\_\_ State \_\_\_\_\_

# Hobbyist's Delight



## Nicholson X.F. Swiss Pattern Needle Files

Greatest little tools for making things fit—work—look the part of expert craftsmanship! Whether it's a mechanical toy, metal decorative piece, clock repair, or model of your inventive brain-child, these ingenious hand instruments are just the thing for taking "bugs" out and putting neatness or operating smoothness in.

Nicholson X.F. (meaning Extra Fine) Swiss Pattern Needle Files come in 12 assorted shapes for performing most any delicate filing operation. They're as accurately made as many of the fine instruments themselves that professionals turn out.

Have you thought about an unusual Christmas gift—for Junior, say, or for yourself? Ask your hardware or industrial supply store for this neat orange-and-black plastic-cased kit.

For very helpful 48-page FREE BOOK, "File Philosophy," write to us.

### NICHOLSON FILE CO.

22 Acorn St., Providence 1, R. I.

(In Canada: Nicholson File Company of Canada Ltd., Port Hope, Ontario)



**NICHOLSON**  
**FILES** FOR EVERY PURPOSE

(Continued from page 222)

the odor is most apparent in the clothes closets suggests that it is the plaster that is at fault, rather than the paper adhesive. Unfortunately, the remedy is not so simple, especially if the plaster in the closets is very old and rather porous. The step that would seem most likely to prove successful is to sand the walls and ceilings of the closets lightly to smooth the surfaces and then apply an undercoater of the type used under oil-base wall paints. Two coats may be necessary to seal the surface effectively. Then follow with two coats of oil-base wall paint. An alternative is to cover the walls with red-cedar closet lining. Remove the paper from the room walls and ceilings, wash thoroughly to eliminate all traces of paste. Then apply undercoater and paint.



### Paint Failure

**Q**—The paint on the north side of my house is very finely checked. It had been painted only a few months before I moved in and is now three years old. Only the north side appears to be affected all over, but several spots on the east end of the building also are checked. What is the cause? Should I remove the old paint before repainting?

P.B., Del.

**A**—If we understand your description correctly, the cause is a wet undercoat, that is, the first coat over the primer was not thoroughly dry when the second, or finish coat, was applied. Without a thorough examination of the surface at firsthand, it is difficult to say just what to do. We hesitate to suggest that you remove the paint back to the bare wood, as in most cases the defective paint film still is bonded firmly to the siding. When faced with this problem many homeowners have rented a portable belt sander from a local paint dealer and sanded the paint smooth before repainting. This usually proves a satisfactory procedure, although it is a rather tedious job. If you try sanding in the manner suggested, we would caution you to wear a respirator of the type designed to prevent inhalation of fine dust.



### Leak at Flashing

**Q**—My home has a large inside chimney. Lately we've noticed during heavy rains, that water apparently seeps through the chimney and dampens the plaster in two upstairs rooms. So far I have been unable to determine just where the water is coming from. Is it possible that the flashing is defective?—F.N., Wis.

**A**—We think you have the answer when you mention a defective flashing, although it is possible there is a leak in the chimney itself. However, this is less likely, especially if the flue is tile-lined. Frequently a leak in the chimney flashing is difficult to locate. You did not say whether your chimney comes through the roof at the ridge or below it on either side. If the chimney is below the ridge, then the first place to search for a leak is on the upper side. In some cases you may be able to locate the leak by examining the chimney from the attic. If there is an opening, even though it is very small, it will show clearly against the light from above. Insert a length of wire in the hole so you can locate it from above. How the repair is made depends on the type of flashing that has been used. If a galvanized-metal flashing has been used and rust has eaten through the metal, then the parts affected must be replaced. However, a small opening can be sealed with roofing cement and the rest of the flashing painted.

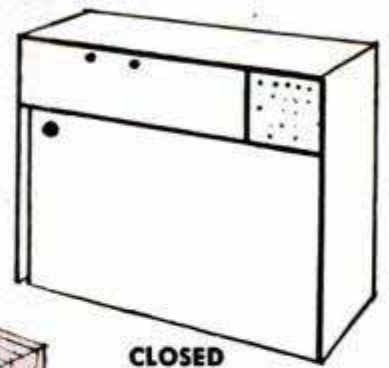
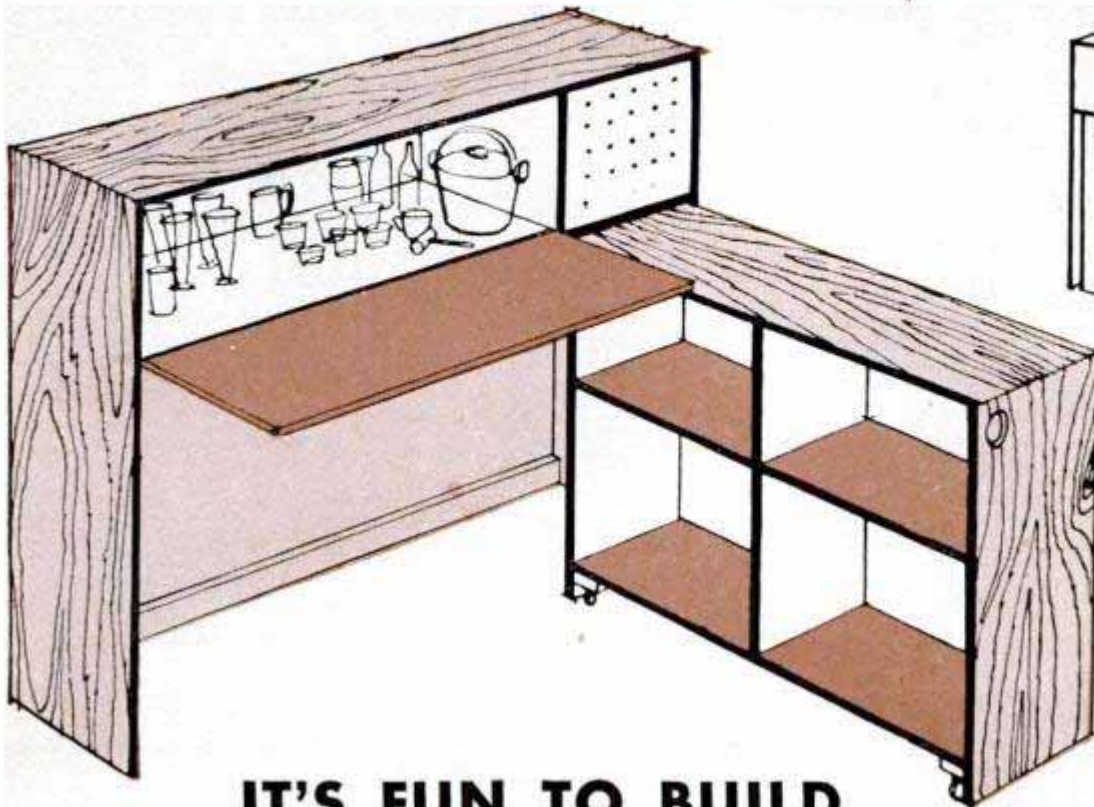

CLOSED

IN USE

## IT'S FUN TO BUILD THIS CABINET BAR! —COLOR-TONED WITH

*Rez*<sup>LAUX</sup>

Closed, it's a smart cabinet... open, it's a versatile bar or utility unit. Perfect for your rathskeller, porch, patio... anywhere in your home. Fun to make... costs little. Send for detailed plans today.

Use Rez in finishing the unit. Rez—which primes, seals and gives you the natural wood finish decorators recommend.

Rez Color Tones, such as the Cedar Rez shown here, bring you ultramodern natural colors: *Redwood, Cedar, Sage, Driftwood, and Mahogany.* White Rez provides a 1-coat blond finish. Just put it on and wipe with a cloth. Clear Rez beautifies grain in the original wood color.

You can paint like a professional with Rez. Brushes, sprays or wipes on like water... can't leave streaks or brush marks.

Rez protects wood, too. It seals out moisture, checks warping and swelling. Ends the nuisance of "sticking" drawers, doors and windows.

So many places to use Rez! Paneling, siding, flush doors, fencing, furniture... wherever you want a modern natural wood finish. See the beauty of Rez Color Tones soon.

Ask your dealer for color samples!

*Laux Rez: Reg. U. S. Pat. Off.*



SERVING INDUSTRY... WHICH SERVES MANKIND

### MAIL COUPON AND 25¢ CASH FOR PLANS

MONSANTO CHEMICAL COMPANY  
Merchandising Division  
1700 South Second Street  
St. Louis 4, Missouri

Enclosed find 25 cents (25¢) for which please send plans and specifications for Cabinet Bar (Monsanto Rez Moderns, Plan No. 9).

Name.....

Street.....

City..... Zone..... State.....



**LOOK FOR THIS DELTA WINDOW IN YOUR TOWN**

## 1 DELTA SHOP

Four most basic Delta Homecraft Tools in a compact one-motor unit:

- big capacity 8" circular saw with tilting blade; husky 4" jointer; standard 11" drill press; versatile disc sander

Does 95% of all home-shop operations. Keep it anywhere, use it anywhere. All tools ready—no adjustment nuisance. Get it all at once or one tool at a time. Price, complete with stand—less motor . . . \$229.50—a low price for Delta quality.

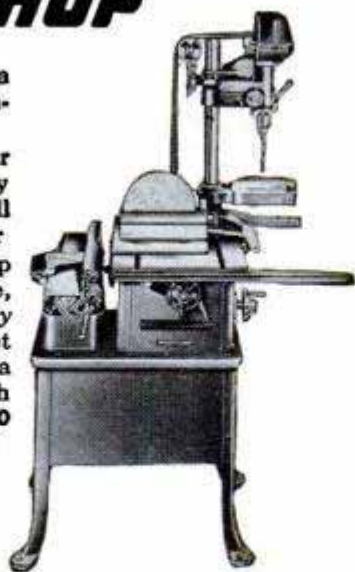

## 2 BAND SAW

Ideal for curve cuts, inside and out; and for straight cutting of heavy stock. A natural No. 5 tool for the well equipped shop. Price . . . \$54.50—a low price for Delta quality.

## 3 SCROLL SAW

For cutting intricate patterns, fret-work; both inside and outside cuts. Youngsters love the scroll saw—safety features make it an ideal "learning tool." Price . . . \$43.50—a low price for Delta quality.

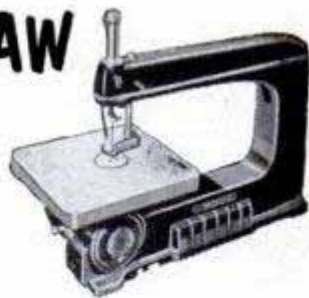

## 4 DE LUXE JOINTER

Husky precision jointer noted for safety. Puts on a perfect "finish" edge with one easy pass. Planes surfaces up to 4" width; also does many extra jobs. Price . . . \$59.50—a low price for Delta quality.



## 5 ECONOMY SAW

Circular saw with tilting table instead of tilting blade. Accurate saw for basic cutting at minimum cost. Price . . . \$44.50—a low price for Delta quality.

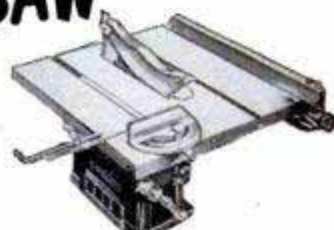

# Pick Your Year-Around Gift from the **DELTA** POWER TOOL WINDOW

A whole lifetime of enjoyment is wrapped in every one of these famous Delta Homecraft Tools—and how well you know it! Any one of them is a welcome gift—as fine tools as money can buy, yet priced for any budget. If you're a veteran shopman, here are tools to complete your equipment, a scroll saw, drill press, jointer, lathe, grinder or shaper. Or if you've just started, there's the DELTASHOP—a one-motor combination of the four basic, most-used Delta Homecraft Tools. All have this in common—they quickly pay for themselves by cutting home maintenance and repair bills and giving you the satisfaction of "doing a job like a professional."

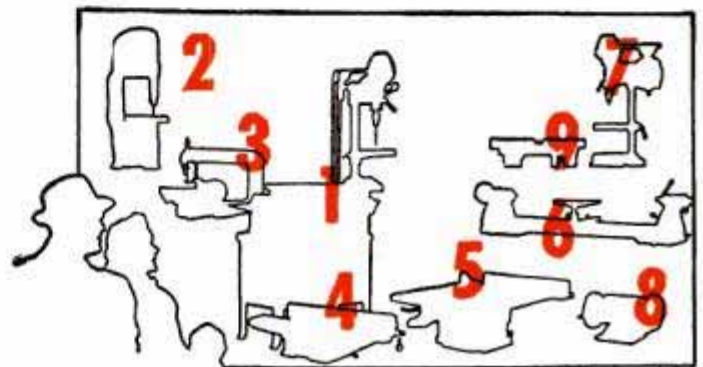

Most probably this very window will be shown by one or more of your local stores. It will pay you well to find it. Pick out the tools you'd like to own—then be sure to bring the family and give them your "Christmas hint" early.

## 6 LATHE

For veterans who love to make their own designs, then turn them. No finer tool than this Delta Homecraft 11" Lathe. Price . . . \$64.50—a low price for Delta quality.

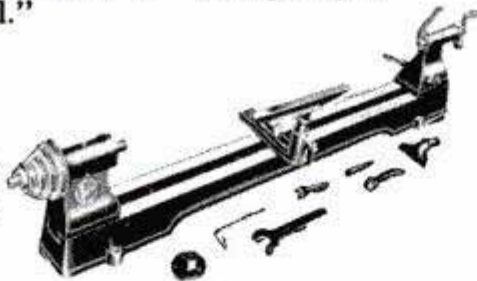

## 9 SHAPER

Make cope and reverse mouldings—sash, door and brick mouldings, base moulds, ornamental edges; a wanted tool for post-grad shopmen. Price . . . \$69.50—a low price for Delta quality.



## 7 DRILL PRESS

Rugged, accurate "must" for every shop; the most-used tool—can be used to drill, route mortise, carve, many more. With Delta accessories, its usefulness is almost unlimited. Price . . . \$54.50—a low price for Delta quality.



Delta dealers are listed under "Tools" or "Machinery" in the yellow pages of your phone book. You can also buy Delta Homecraft tools from leading department stores and IRHA hardware stores in your city. Delta Power Tool Division, Rockwell Manufacturing Company, 502L N. Lexington Avenue, Pittsburgh 8, Pa.

Prices slightly higher west of the Rockies

## 8 GRINDER

This carefully engineered bench grinder keeps cutting tools sharp and bright. Can also be used to clean and buff. A real time and money saver in the workshop. Price . . . \$39.95—a low price for Delta

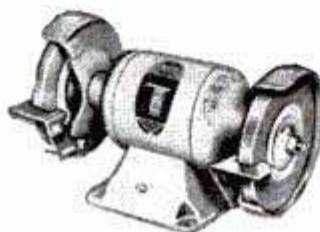

**DELTA** QUALITY POWER TOOLS  
Another Product of **Rockwell**



THE WORLD'S FIRST REALLY

# QUIET

OUTBOARD MOTOR



*"Quiet as a Cloud"*

Entirely New!

Entirely Different!

5½ Horsepower! No Vibration!

Revolutionary Quiet!

Full Gear Shift! FORWARD-NEUTRAL  
REVERSE

Mile-Master Fuel System!

Up-and-Off Motor Hood!

Twist-Grip Speed Control!

A Beauty to Look at...

And a Dream to Drive!



THE NEW JOHNSON  
SEA-HORSE 5½

*This*—you've got to try yourself—the new Sea-Horse 5½! There has never been anything like it!

It's quiet! So quiet that conversation now becomes a part of outboard boating. So quiet that it means the eventual revolution of all outboard manufacture. Motors that deafen are doomed!

And such silk-hat quality! Vibration is gone. No more transom chatter. No more plank-sting. Even the steering handle rests in your hand as still as a tiller.

Best of all, it's miraculously trained down to the size that most outboard users prefer. Same popular handling ease as its famous predecessor, the Sea-Horse 5—but even sweeter power—and more of it!

See your Johnson Dealer. Look for his name under "Outboard Motors" in your classified phone book.

**FREE!** Write for the new Sea-Horse literature that describes the greatest line of motors Johnson has ever built.

**JOHNSON MOTORS**  
400 Pershing Rd., Waukegan, Ill.  
In Canada: Mfd. by Johnson Motors,  
Peterborough

**THE NEW 1954 SEA-HORSES**  
**SEA-HORSE 5½**—5½ hp. Johnson's new Suspension Drive Sensation. Only.... \$210.00\*  
**SEA-HORSE 10**—10 hp. New. Improved. More brilliant than ever..... \$297.50\*  
**SEA-HORSE 25**—25 hp. Only 99 lbs. Over 30 mph. It trolls! Everything deluxe... \$410.00\*  
**SEA-HORSE 3**—3 hp. 32 lb. twin. Rugged. With amazing Angle-matic Drive... \$145.00\*  
**SHIP-MASTER REMOTE CONTROL**—Shift-and-throttle. Corrosion-proof. Instant hook-up on Sea-Horse 10 and Sea-Horse 25.... \$29.50\*



\*Prices f.o.b. factory, subject to change.  
OBC certified brake hp at 4000 rpm.  
Weights are approximate.

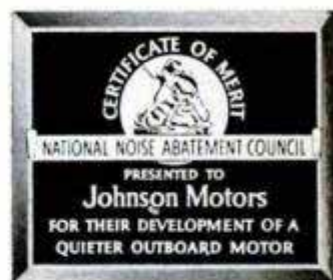

Johnson's revolutionary new outboard construction that isolates your boat from engine vibration. No jitter, chatter, throb, or noise.

**Johnson Sea-Horses** FOR **DEPENDABILITY**



pick up

# BURGESS *flashlight* BATTERIES



**Chrome Protected for longer life**

ASK FOR THEM  
AT YOUR  
FAVORITE STORE

BURGESS BATTERY COMPANY • FREEPORT, ILL. • NIAGARA FALLS, CANADA

A QUALITY DRY  
BATTERY FOR  
EVERY PURPOSE

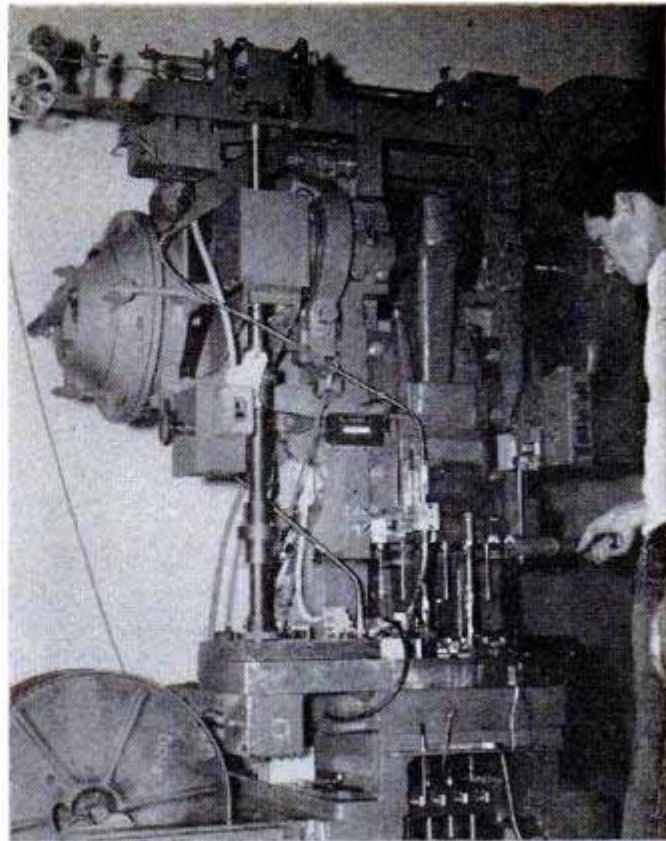

Lead wire, unrolling from spool at left, is cut to length and pressed firmly into the finished jackets

## Bullets Strictly for Bull's-Eyes

*(Continued from page 130)*

Using a 180-grain, .30-caliber bullet, he killed a rhinoceros with one shot in the head. This bullet, fired at a velocity of 3400 feet a second, had an explosive effect upon the two-ton beast. Formerly such dangerous game was hunted with extremely heavy, double-barrel rifles firing bullets weighing up to 500 grains at relatively low velocities.

Mr. Weatherby, testing this bullet on an eight-inch limb of a tree, literally cut it in two with one shot. The muzzle velocity of this bullet, if maintained for one mile, would carry it that distance in less than two seconds. And its muzzle energy (striking power) is 4400 foot pounds.

In the Sierra plant, a dozen experts supervise the automatic punch and die presses which turn out these little bullets at dazzling speed.

The first operation is that of the blanking and cupping press. Rolls of copper alloy from 2 to 2<sup>11</sup>/<sub>16</sub> inches in width and from .02 to .04 inch thick (depending upon bullet size desired) are fed into the machine, which punches out disks and forms these into cups at the rate of three per stroke. Its capacity is 20,000 cups per hour.

The cups then go through the next die press, which makes a series of four or five "draws" (the number depending upon the

*(Continued to page 234)*



Don't be satisfied with an ordinary radio...

get a **hallicrafters**



**Model S-53A.** The finest small communications receiver built and ideal where maximum performance is required in small space. Covers Broadcast Band 540-1630 kc plus four short-wave bands covering 2.5-31 and 48-54.5 Mc.

Electrical bandspread for easy tuning. Two i-f stage. Switches for automatic noise limiter, code reception and high-low tone. Phono jack for records. Headphones tip jacks on rear and built-in PM speaker. Temp. compensated to reduce fading due to frequency shift.

Satin black steel cabinet with brushed chrome trim. 12 $\frac{7}{8}$ " x 7" x 7 $\frac{3}{4}$ " deep. Ship. wt. 19 lbs. Piano hinge top. Seven tubes plus rectifier. For 105/125 V. 50/60 cycle AC..... **\$99<sup>95</sup>**



**Model S-76.** Double conversion receiver. Value packed communications receiver with Broadcast Band 538-1580 kc plus three short-wave bands covering 1720 kc-34 Mc.

Electrical bandspread tuning control with calibrated dial to separate stations on crowded bands. Double superhet with 50 kc second i-f and giant 4-inch "S" meter. Five position selectivity, one r-f, two conversion, two i-f stages, temperature compensated. Phono input jack. 3.2 or 500 ohm outputs. Socket for external power or remote control.

Satin black steel cabinet with chrome plastic trim rings. 18 $\frac{1}{2}$ " x 8 $\frac{7}{8}$ " x 9 $\frac{1}{2}$ " deep. Ship. wt. 41 lbs. Piano hinge top. Nine tubes plus voltage regulator and rectifier. For 105/125 V. 50/60 cycle AC..... **\$199<sup>95</sup>**  
Use R-46 speaker.



**and Hear it All!**

Now, at prices no higher than you'd expect to pay for ordinary radio, you can have all the thrills of short-wave reception, plus tops in regular broadcasts, too. You hear London, Paris, Rio, Moscow—hear ships at sea and planes in the air—police and military broadcasts—and you hear them *direct* with a Hallicrafters.

Hear amateur broadcasts from all over the world, and get in on the fun of the world's greatest hobby. And you'll hear them on the sets that these critical experts choose for themselves . . . Hallicrafters. For many years Hallicrafters has been first choice with amateurs, just as governments all over the world, including our own, have chosen Hallicrafters for critical communications.

**Hallicrafters prices start at \$59.95**

**Write today for full information.**

**hallicrafters**

4401 West Fifth Avenue, Chicago 24, Illinois  
Hallicrafters Ltd., 51 Camden Street, Toronto, Canada

World's Leading Exclusive Manufacturer  
of High Fidelity and Communications Equipment,  
Radio and Television

# Now! A "Double-Lifetime" Used Car

that can save you hundreds of dollars!

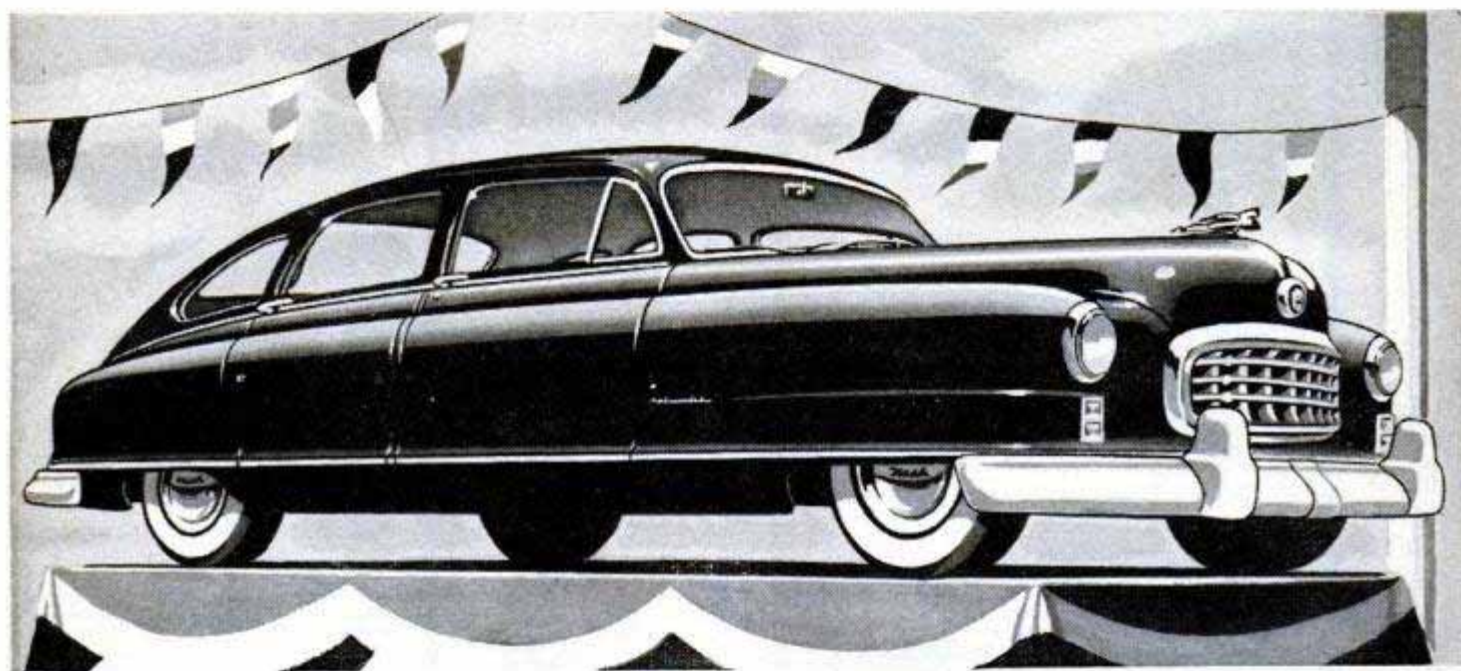

Yes, today there's a new used-car value—a car built with a "Double-Lifetime" to last years longer so it's like new even as a used car . . . costs you less to own and drive. That car is Nash!



When you buy a used Nash you get a car that is more economical—more fun to drive, *newer-looking, newer-feeling*—a *newer* car for your money.

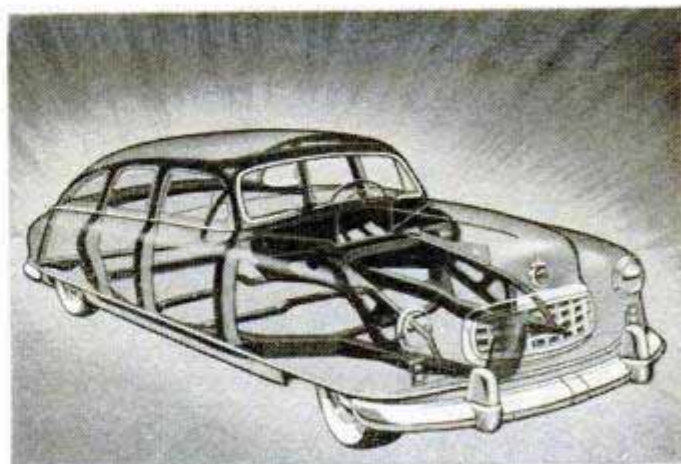

Nash is America's safest car with body and frame welded into a single, rock-solid unit that can never loosen, rattle or squeak. Huge steel girders surround the passenger compartment, protecting you and yours.



Smoothest ride on the road with coil springs and stronger, rattle-free Air-flyte Construction. Ample road clearance, too, for those spots in the woods. Drive a postwar Nash for more fun at less cost.

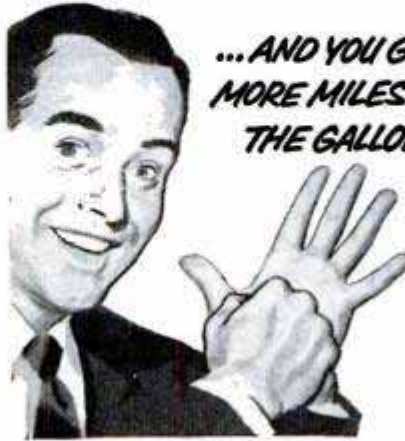

**...AND YOU GET MORE MILES TO THE GALLON**

Nash Owners report more miles a gallon than owners of other make cars. Amazing gasoline savings are only one of the many economies you enjoy in Nash. Save on body up-keep and repair bills!

Nash beauty lasts' (1) Metal is Bond-erized (2) for rustproofing, two coats of (3) primer sealer are baked 90 minutes. Two coats of (4) enamel are baked on to sparkle "like new" years longer.

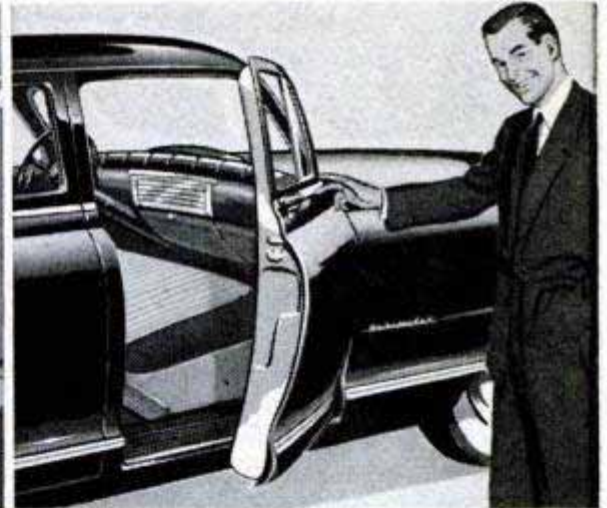

For real driving pleasure there's nothing like a Nash, with features that double the family fun—like famous Twin Beds that make up in seconds. With one bed made up, children can nap on trips.

Proof of a used car's condition is the way the doors fit. Because Nash is twice as rigid, doors fit without sagging—proof it's safer, stronger and longer-lasting—the car with a "double-lifetime."



Airliner Reclining Seat—only in Nash—adjusts to comfortable, relaxing positions. And only Nash offers you Weather Eye—world's finest heating and ventilating system.

# Nash

The Car with the Double Lifetime  
... Built to Stay New Longer

Nash Motors, Division Nash-Kelvinator Corp., Detroit Mich.



See a Nash Dealer

For the Best Used Car Buy in Town

**Brighten  
Your Home**



**with Werner  
Chromtrim**

So quick and easy to install...so inexpensive...yet looks just like a professional job.

Here's a project that everybody is sure to spot and praise. Dress

up your kitchen, rumpus room, bathroom with Chromtrim metal mouldings. Aluminum or stainless steel — many bright new styles for the edges of your kitchen sink, cabinets, walls or stairs. Trim average table or counter for only \$3.20.

**Chromtrim makes any home look smarter!**

Be sure you get Werner Chromtrim in the red striped wrap. Ask for it at your dealer. Also look for Werner Alumiladders (effort-saving aluminum ladders and step stools) and Alumidryers (rust-proof, light-weight clothes dryers).

It's easy to turn out a smart, professional-looking job with Chromtrim!



No special tools required. Saws easily.



Forms with light hand pressure.



Chromtrim nails give professional look.

FREE—Send for your free copy of "Trim It Yourself" booklet (also project plans). Shows how to pick the right Chromtrim for your needs and how to apply it.



**Werner**

R. D. WERNER CO., INC.  
295 5th Ave., N. Y. 16, N. Y.  
Dept. C17

CHROMTRIM

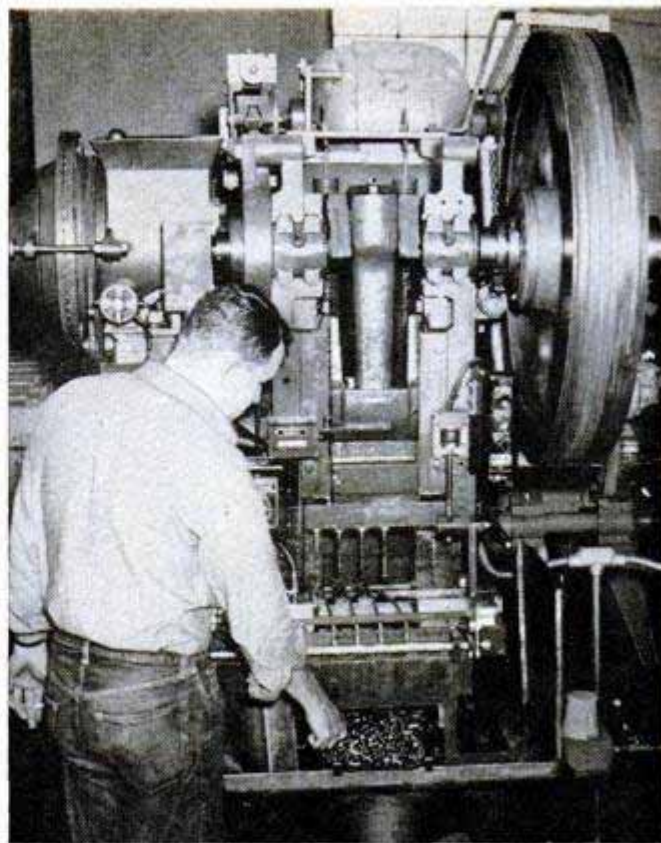

Copper cups are fed into die press which makes four or five precise "draws" to form the bullet jackets

bullet size), to bring the jacket to the desired caliber and length. This press forms 6000 jackets per hour.

Another automatic machine trims the open end of the jackets to a tolerance of .001 inch. Following this operation the jackets are given a special bath to remove all traces of lubricating fluid and any other foreign film.

Next a robot machine takes over. This multiple-purpose die press actually seems to think for itself. While an expert operator watches, six dies work at high speed to perform their magic. Through a long tube the jackets are fed into the first die. Down another tube slide the lead cores, cut to exact length from a large coil of lead wire.

Down comes a plunger and the lead core is inserted. Successive dies in the row take over. The long, gracefully curved bullet nose is formed, the tiny lead point extruded and shaped precisely.

Finally, every bullet is microscopically examined for the tiniest imperfection.

Bullet design has always intrigued ballistic engineers. An innovation in design was the "boat tail" type, which tapers sharply from the portion which bears on the barrel.

This streamlining, it is believed, increases velocity by reducing the vacuum behind the bullet. And a bullet of this design possesses better balance.

With the higher speed thus obtained, the

(Continued to page 236)

**NOW**  
a power tool that's

*Really New!*



**JUST TURN TO RIP**  
No need to disassemble and reassemble when changing from cross-cutting to ripping. Just turn head 90° ... you're all set to rip!

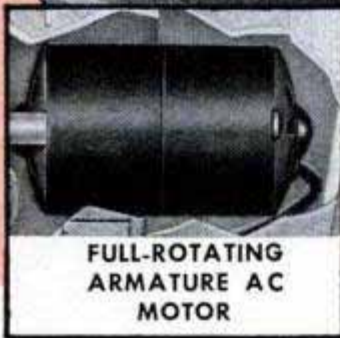

FULL-ROTATING  
ARMATURE AC  
MOTOR

**SHOPMASTER'S**

*Sensational* **20" JIG SAW**  
with **Self-Contained Motor**

Think of it—this rugged 20-inch jig saw has its own built-in motor! Not a solenoid or a vibrator, but a full-rotating armature, powerful AC motor.

A rugged, professional power tool that cuts up to 2½" stock with ease, this newest of all power tools makes precision woodworking actually easy. Shopmaster's EXCLUSIVE COMBINATION MITRE GAUGE AND RIP FENCE accessory sees to that!

Want to rip? Just turn saw head 90°. It's that simple. Truly the most outstanding QUALITY power tool value on the market today!



**Just plug  
it in**

(Exclusive combination mitre gauge and rip fence available at slight extra cost.)

**\$39<sup>95</sup>** Motor included

Slightly higher in zone 2

**OTHER FAMOUS  
SHOPMASTER  
TOOLS**



FAMOUS UNIVERSAL  
COMBINATION TOOL

**WRITE FOR FREE CATALOG**

There's a Shopmaster power tool for every need. Write today for catalog of complete line.

**SHOPMASTER, INC.** Room 10E  
1214 South 3rd St. • Minneapolis, Minn.



# Starrett<sup>®</sup> Satin Chrome INSIDE MICROMETERS

No. 124 — with solid rods

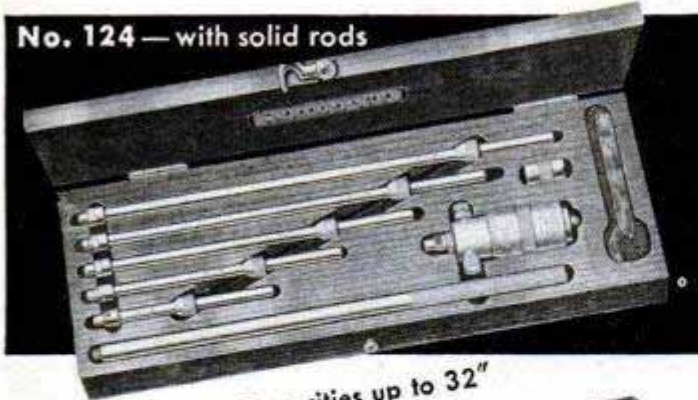

Capacities up to 32"

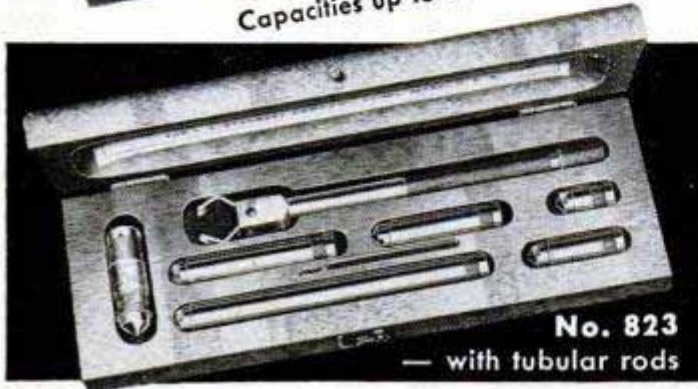

No. 823

— with tubular rods

Choose your favorite from these two excellent inside micrometers. No. 124 has small diameter solid rods while No. 823 has light yet rigid  $\frac{3}{8}$ " diameter tubular rods. Both have Satin Chrome Finish on micrometer heads to eliminate glare, retard corrosion, increase reading speed and accuracy... also, hardened and ground contact surfaces plus compensation for wear. See them today — at your Starrett Tool distributor's.

SEND FOR IT — ONLY 10¢

Starrett "Tools and Rules" Book

shows the right tools for any measuring job. 50 pages, 100 pictures, helpful reference tables. Address Dept. AP



THE L. S. STARRETT COMPANY • ATHOL, MASS., U.S.A.



MECHANICS' HAND MEASURING TOOLS AND PRECISION INSTRUMENTS  
DIAL INDICATORS • STEEL TAPES • PRECISION GROUND FLAT STOCK  
HACKSAWS, BAND SAWS and BAND KNIVES

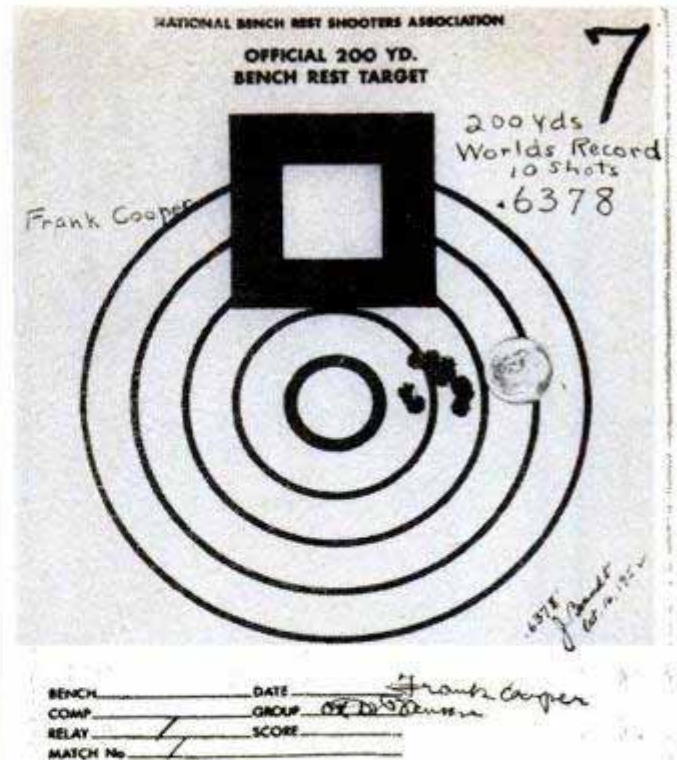

World-record .22-caliber group, fired at 200 yards, has 10 holes that can almost be covered with a dime

force of gravity, creating trajectory curve, is minimized. A bullet which flies almost "flat" is the result. The 150-grain Sierra boat-tail bullet, in .270 caliber, rises only five inches above the line of sight when fired at 300 yards, producing a trajectory which is remarkably flat.

It has always been the goal of riflemen to drive bullet after bullet into the same hole. The Sierra designers are constantly striving to produce bullets that will help the rifleman to achieve his goal. ★ ★ ★

## Radioactive Magnesium Aids Chlorophyll Study

Probing the secrets of photosynthesis, Dr. Raymond K. Sheline of Florida State University is using a new radioactive isotope of magnesium to discover how magnesium gets into the chlorophyll molecule. Photosynthesis, the process by which sugars and starches are formed from carbon dioxide and water under the influence of light, takes place in the chlorophyll tissues of plants—and chlorophyll has magnesium in its molecule. How the magnesium enters the molecule, since this takes place only in the plant tissues, is a puzzle Sheline hopes to solve through tracer studies with magnesium 28. The isotope, which has a half-life of 21.3 hours, is over 100 times as long-lived as previous magnesium isotopes. Formed in the atomic laboratories of the University of California and the University of Chicago, it is rushed to Doctor Sheline by plane.



## Owner goes 'round the world in 40 seconds!

With this new multi-wave portable you can circle the globe in the time it takes to twist a dial.

That's because the RCA Victor Strato-World radio is blessed with Electronic Band Spread Tuning.

Instead of being squeezed together on one-band segment, short-wave stations are in spread formation across the dial of your 7-band Strato-World. You can tune London, Rome, Moscow, Tokyo just as you do the local stations.

See this globe-trotting, pace-setting portable at your RCA Victor dealer's.



**RADIO CORPORATION OF AMERICA**

*World leader in radio—first in television*

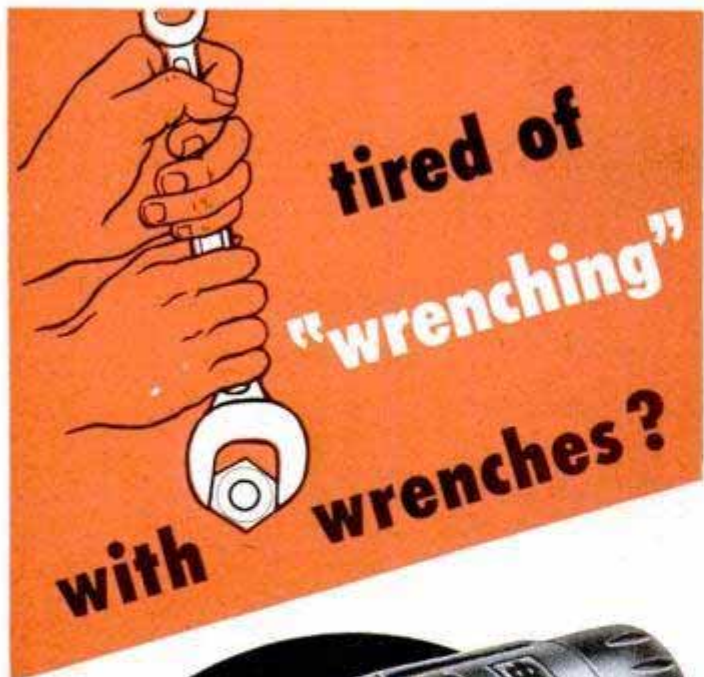

Use  
Ingersoll-Rand  
ROTARY ELECTRIC  
**IMPACTTOOLS**

**3**  
SIZES FIT  
EVERY NEED!

**RUN AND REMOVE  
NUTS EASIER . . .  
9 TIMES FASTER!**

Handles tough nut running jobs easily and fast—even frozen nuts no wrench could budge—in one-tenth the time! Also Drills • Reams • Taps • Drives Screws • Drives and Removes Studs • Wire Brushes • Saws Holes • Drills Masonry • Drives Wood Augers. Standard Attachments handle all operations. 1900 rotary impacts per minute—forward or reverse—do all the work. Motor never stalls . . . can't burn out.



**3 SIZES** fit every need . . . 4U, 8U and 34U (extra heavy duty). Size 4U Impactool only \$120.00, also available in metal kit with multi-purpose attachments. Sold by all leading automotive jobbers and industrial distributors. Ask for a demonstration or write for catalog.

895-18

**IR Ingersoll-Rand**  
Dept. M-11, 11 Broadway, New York 4, N. Y.

ORIGINATORS OF IMPACTTOOLS—AIR AND ELECTRIC

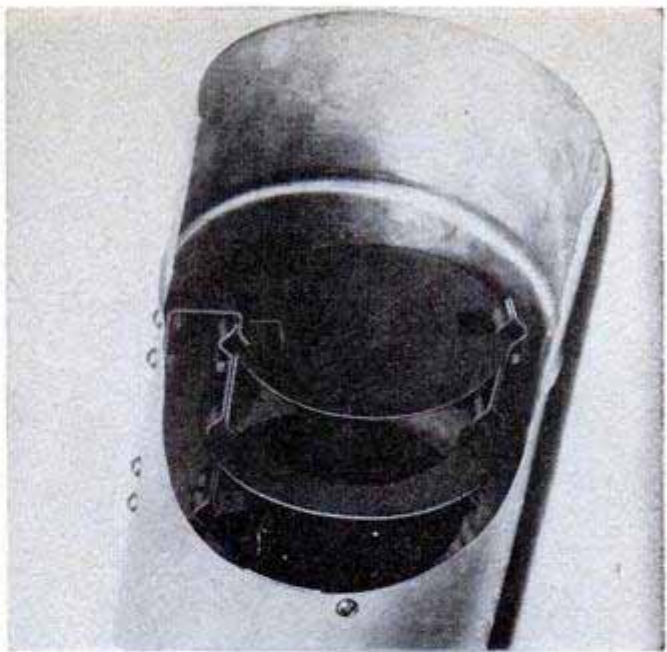

**Automatic Baffle  
Lessens Heat Loss**

Installed in the flue pipe of an oil furnace, an automatic baffle acts as a valve to reduce the amount of heat which goes up the chimney. Suspended from a bracket inside the pipe, it opens wide or closes as pressure and conditions change. The baffle is one of three features of a fuel-saving system for oil furnaces. A second feature is a simplified antipulsating combustion head which will fit the majority of gun-type burners. It produces a turbulating action which increases atomization of the fuel oil for better combustion. A third feature is a powder which is spread on the floor of the combustion chamber. The substance crystallizes from the heat to produce a reflecting surface which is self-cleaning and which reflects heat upward, increasing flame temperature. It glows after the burner shuts off to maintain a warm combustion chamber at all times. Fuel savings of 15 to 40 percent are reported for the system.

**Color TV Brings Cancer Lessons  
To Doctors in Five Cities**

Watching four-by-six-foot color-television screens, doctors in five cities are getting one-hour lessons weekly in the detection, diagnosis and treatment of cancer. Arranged by the American Cancer Society, the program is beamed over a closed circuit from New York to medical centers in Boston, Philadelphia, Pittsburgh, Detroit and Toledo. Each of the large screens will accommodate approximately 500 viewers. The weekly series will continue until May.

Lightweight, rustproof aluminum chain is being manufactured for use aboard ships.



Spark Plugs That Perform **LIKE THIS** —

Will Make **YOUR CAR** Perform Better!



Official U. S. Air Force Photo

REFUELING IN FLIGHT, where plane speeds must be synchronized, presents a problem in engine operation that calls for flawless spark plug performance. Spark plugs engineered and manufactured by Champion—a prime supplier to the United States Air Forces—meet this exacting demand.

The Champions you purchase for your car are better spark plugs because of such challenges to Champion research, engineering and manufacturing facilities, all of which are devoted exclusively to the production of spark plugs.

So, try Champions in your car—you'll never again be satisfied with ordinary spark plugs.

CHAMPION SPARK PLUG COMPANY, TOLEDO 1, OHIO



*Better by Far for **EVERY CAR** Regardless of Make or Year*

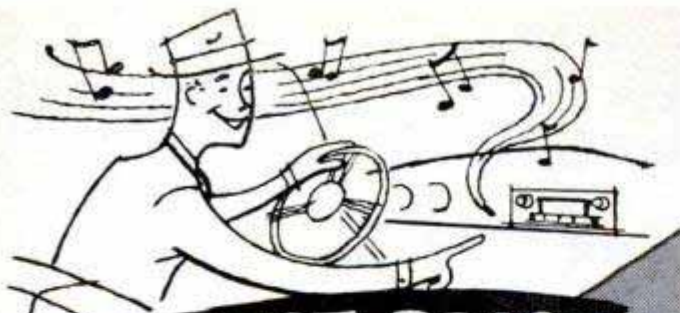

**LOWEST PRICE  
EVER!**



Model 403

# Motorola Car Radio

ONLY \$ **39<sup>95</sup>**

Imagine a powerful, magnificently toned radio like this at such an unbelievably low price! High fidelity, superior tone, extra range and power. Patented motor noise filter, automatic volume control, big speaker and control head adaptable to instrument panel. So easy to install, it can be put in your car while you wait.

Look for this  
Sign



**Motorola**  
*Authorized Dealer*  
**Car Radio**

Better See **Motorola** *Golden Voice of Radio*



## Amateur Transmitter Includes Important TVI-Suppression Features

(Continued from page 163)

low-inductance chokes and ceramic-disk capacitors are located at the power line, keying jack, microphone connector and VFO power socket. The antenna relay connector, energized by the "plate" switch is likewise filtered. Coaxial output and VFO-input connectors keep shielding intact. The kit can be assembled by a novice as well as the experienced amateur.

Thoroughly tested on the air by the writer, who is located in a metropolitan area, this kit transmitter was operated in the same room with a table-model television receiver (which employs an indoor antenna) without a trace of interference in the picture or test patterns.

It is an excellent performer on every band from 10 to 160 meters. Output ratings of 100 watts phone and 130 watts CW have

(Continued to page 244)

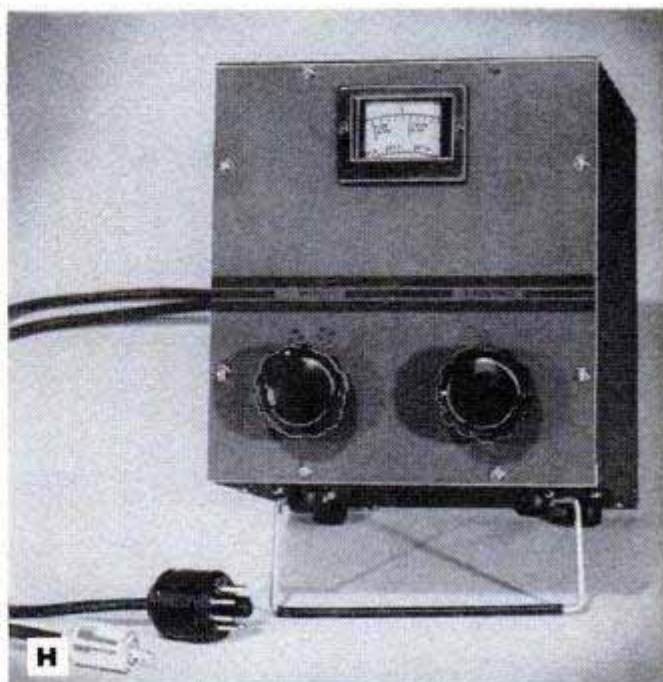

# "PINE PANEL" YOUR WALLS

*with Gold Bond Gypsum Wall Planks...the newest in Gypsum Wallboard!*

It's an easy, one-man job to put these new lightweight planks right over dull, drab walls. Prefinished Gold Bond *Knotty Pine* and *Bleached Walnut* give you the beauty of fine wood paneling at a fraction of the cost. *Standard* Wall Plank can be painted, textured or wallpapered. See your Gold Bond lumber and building material dealer today!



(2) A special Gold Bond Laminating Adhesive is all that's needed to apply these wall planks. Just mix the adhesive with water, spread on the back of the panels and press into place. No joints to conceal, no nailheads to treat.

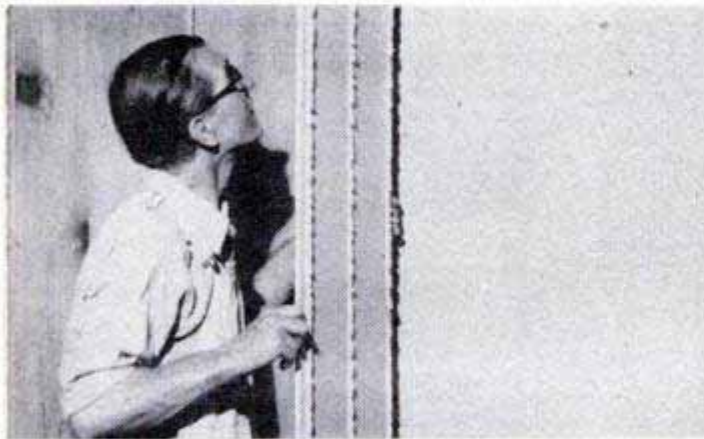

(4) Apply first plank at a corner. Press plank firmly against the wall to insure even adhesion, and use a carpenter's level to plumb. Install three planks and re-plumb. Then continue across the wall.

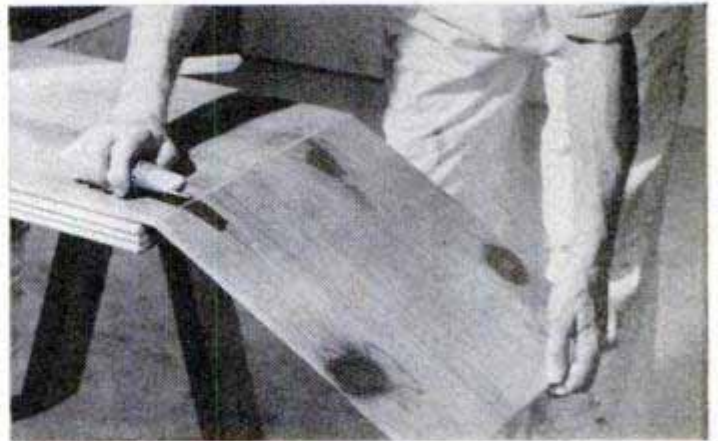

(1) Gold Bond Gypsum Wall Planks are only 16" wide, weigh only 16 lbs. in the 8' lengths. They are simpler to cut than wood—just score and snap (above), or saw if you wish. Unlike wood, they are **FIREPROOF!**

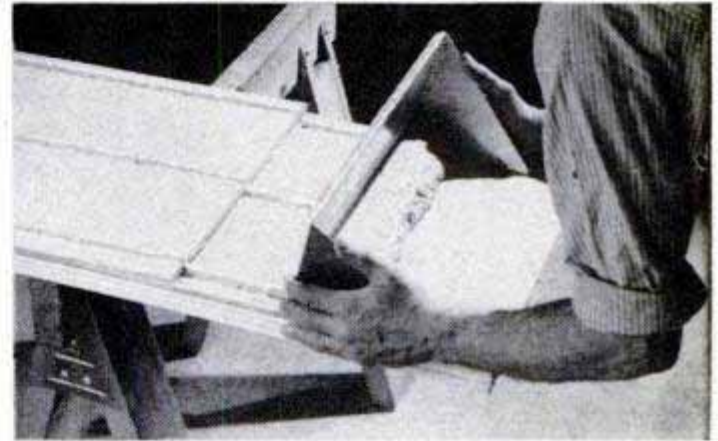

(3) Here's how you spread the adhesive on the plank. Your Gold Bond lumber and building material dealer will supply this 3-notch spreader which simply slides along the plank leaving three straight ridges of cement.

## NATIONAL GYPSUM COMPANY • BUFFALO 2, N.Y.

*Fireproof Wallboards, Decorative Insulation Boards, Lath, Plaster, Lime, Sheathing, Roofing, Sidings, Wall Paint, Textures, Rock Wool Insulation, Metal Lath and Sound Control Products.*

### MAIL COUPON TODAY!

**NATIONAL GYPSUM COMPANY**  
Dept. PM-113, Buffalo 2, N. Y.

You'll build or  
remodel better with  
**Gold Bond**

Please send me a complete description of this new remodeling system, and complete instructions for applying Gold Bond Gypsum Wall Planks.

Name .....

Address .....

City ..... Zone ..... State .....

# Why Pay More

**CRAFTSMAN**  
REG. U. S. PAT. OFF.

## Carbide Tipped Saws

NOW! Save up to \$2.00 during November and December. All sizes reduced until December 31, 1953.

**\$7.50**  
8-inch

### ONE OF THESE SAWS

—a 10-inch blade in actual service—sawed more than 27 miles of 1/2-in. laminated Masonite without resharp-ening, until damaged by a steel object!

=CRAFTSMAN=



Superior blade design provides greater safety. It has only 8 teeth, each projecting .020-in. above non-cutting edge—practically eliminates kickbacks.

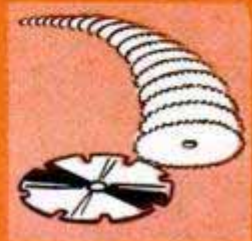

Amazingly long life! We have testimony proving these blades last more than 20 times longer than ordinary circular saws in actual service.

### Compare these NEW LOW Sale Prices

Sears introduced this special-design saw less than 2 years ago. Since then it has been so enthusiastically received by circular saw users that our increased production has enabled us to decrease our costs. We want you to share this NEW LOW PRICE!

Tungsten carbide tipped—hardest metal known! Special steel saw blade is heat treated. Teeth are ground with diamond wheels to exacting tolerances to give faster, smoother, more efficient cutting; less vibration; less noise. Needs less resharp-ening. Rips, cross-cuts, miters. Cuts all woods, plastic, Formica, aluminum, plywood, abrasive building material, wallboard, etc. Not for masonry, steel or other ferrous metals.

Prices reduced at your nearest Sears Retail Store!

Diam.	Arbor Hole	Fits These Saws	Price
5 7/8 in.	13/16 in. diamond	6-in. Skil-saw elec. hand saw...	\$ 6.50
6 in.	1/2 in. square	Mall; DUNLAP elec. hand saw...	6.50
6 in.	5/8 to 1/2 in. round bushed arbor	Porter-Cable electric hand saw; bench saws	6.50
6 1/8 in.	1 1/8 in. round	6-in. Black and Decker	6.50
6 1/2 in.	1/2 in. round	CRAFTSMAN 6 1/2-in. electric hand saw; bench saws	6.50
7 in.	5/8 to 1/2 in. round bushed arbor	Bench saws	7.25
7 in.	13/16 in. diamond	Skil-saw and Sears former 02186 electric hand saw	7.25
7 in.	1/2 in. square	Mall electric hand saw	7.25
8 in.	5/8 to 1/2 in. round bushed arbor	CRAFTSMAN 8-in. electric hand saw; bench saws	7.50
8 in.	13/16 in. square	Mall electric hand saw	7.50
8 in.	13/16 in. diamond	Skil-saw electric hand saw	7.50
8 in.	1 3/8 in. round	Black & Decker elec. hand saw	7.50
10 in.	1 to 3/4-5/8 in. round bushed	Bench, builders', radial, and swing saws	8.95
12 in.	1 to 3/4 in. round bushed arbor	Radial saws, swing saws, and bench saws	15.50



1/2 or 13/16 in. square    1, 1 1/4, 1 3/8 in. round    1 1/2, 3/4, 3/4 in. round    13/16 in. diamond

# For Top Quality?

**CRAFTSMAN**  
REG. U.S. PAT. OFF.

## Molding Cutter Set

**SEARS**  
ROEBUCK AND CO.

Separate price \$17.45.  
You SAVE during  
November and De-  
cember. Set reduced  
until Dec. 31, 1953

**\$9.95**



NEW Plastic Storage Box in-  
cluded with each set. Has six  
compartments for cutter bits  
... compartment for molding  
head and accessories



Seventeen different  
cutter bit sets avail-  
able at Sears Stores

### Convert your Bench Saw to a Jointer-Planer and Shaper

- NEW positive-grip safety lock aligns bits accurately, securely; makes it easy to replace bits quickly
- Fits most bench saws with  $\frac{1}{2}$ ,  $\frac{5}{8}$ , or  $\frac{3}{4}$ -in. arbors (arbor bushings included with set). Fits most dado inserts
- Made of special analysis steel, balanced for greater safety; scientifically heat treated and tempered

We were selling this outstanding set at the lowest price we've ever heard of. NOW, through a special arrangement with our manufacturer we are able to offer this amazing Molding Cutter Set at a NEW LOW SALE PRICE, during the months of November and December. We know of NO comparable set selling at anywhere near this new low price. Sale priced until December 31, 1953. The most versatile attachment we've seen. Saves lumber costs; saves time. Make your own molding, building trim, picture frames, table edges, many other designs.

**NUMBER OF DESIGNS ARE UNLIMITED!** You are actually limited only by your imagination! Cuts can be planned to overlap, to just meet, to be separated by uncut wood, or to be repeated a number of times. Cutters available at Sears Retail Stores to make tongue and groove flooring, and to cut many other designs.

Cutter bits are made from special heat-treated tool steel; 1-inch wide. Vertical slot in back of blade assures alignment in molding head. Five different cutter bits included (each cutter set has 3 bits) as shown at right. (A) 1-inch planer and jointer . . . use for close tolerance work, drawer parts. (B) Cabinet Door Cutter Bits . . . use for decorative trim on cabinets, tables, etc. (C) Decorative Molding Cutter Bits . . . use to make picture frames, decorative trim. (D) Bead Cutter Bits . . . use for furniture trim, cabinet making, etc. (E) Base Molding Cutter Bits . . . use for building trim, shoe molding, etc.

Set includes cutter head, five sets cutter bits, wrench, space washer, bushings and instructions. In plastic box with slots for six sets of bits. At your nearest Sears Retail Store, at this price until December 31, 1953.



**CRAFTSMAN** Hand and Power Tools by **SEARS, ROEBUCK and CO.**  
Famous for fine quality . . . precision performance . . . low price!

been established on the 10 meter band. Full excitation to the final amplifier is provided on all frequencies. The block diagram of the transmitter appears in Fig. 1. The line-power consumption is approximately 375 watts when delivering full phone output. It is designed for operation on 115-volt 50/60 cycle a.c. supply only.

The low-pass filter Fig. 2, photo E, is used with this transmitter when extra harmonic attenuation measures are required in TV fringe areas where the TV signals are at an extremely low level. It is installed as close as possible to the transmitter output and the usual antenna-coupler system. Some of the TVI-suppression features such as the low-pass filter, cabinet-bonding fingers (in 3 ft. strips) and similar units are available separately from parts houses for use by amateurs for making TVI-suppression improvements in any ham transmitter.

Another assembled and tested device designed as a companion unit is the completely self-contained and fully shielded, antenna-coupling system shown in photo G. This Matchbox performs all transmission line matching and switching functions, and can be used with any 250-watt transmitter. A built-in change-over relay switches the antenna from the receiver to the transmitter and mutes the receiver

during transmission. A kit-type variable-frequency-oscillator (VFO) companion unit is illustrated in photo H. The VFO is a crystal substitute for those who do not wish to use crystal control; this has excellent stability and is easy to assemble. A useful standing-wave-ratio (SWR) bridge, shown in photo I and Fig. 3, provides accurate measurements and insures the most effective use of the low-pass filter and the antenna coupler for the ultimate in TVI suppression. ★ ★ ★

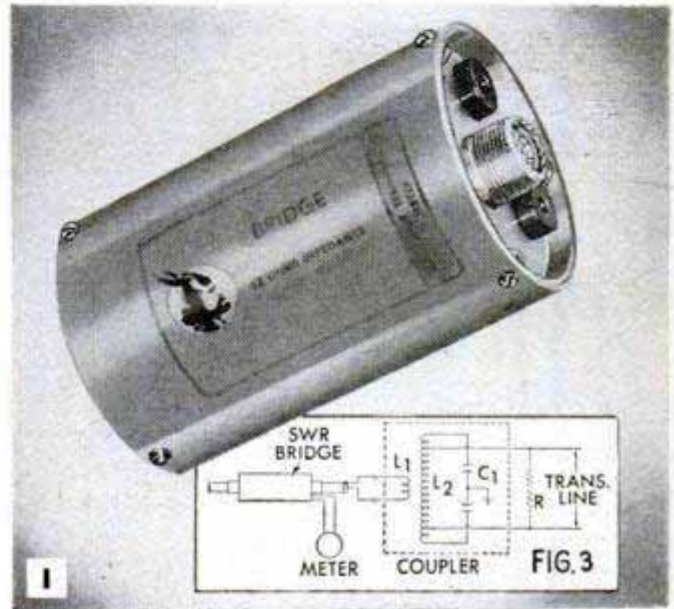

# Scrap pile got you down?



Write today for complete facts and illustrated instructions.

\*Reg. U. S. Pat. Off.

**HELI-COIL CORPORATION**  
 391 Shelter Rock Lane, Danbury, Conn.  
 Please send full information on Heli-Coil inserts.

Name \_\_\_\_\_  
 Address \_\_\_\_\_  
 City \_\_\_\_\_ State \_\_\_\_\_

2142

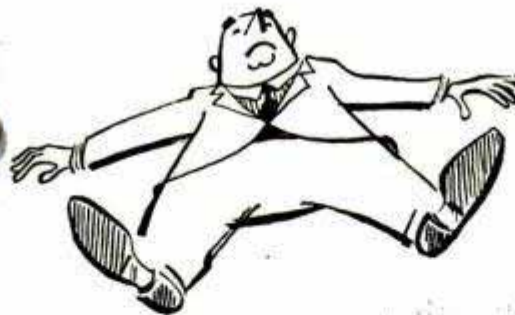

Stripped, damaged or poorly tapped threads—previously considered beyond hope—are now made better-than-new in seconds on the production line with Heli-Coil\* Screw Thread Inserts. These new threads take original size screw, are stronger than before, and last forever in metals, wood, plastics. Fine, too, for quick, economical field repairs.

Needed Heli-Coil tooling practically never wears out, costs as little as \$15 per thread size. Inserts as low as 3c each. Available for all thread sizes including spark-plug and pipe threads.

Never before - a **heating guarantee** like this!

**\$1,000.00 Bond** backs Coleman Blend-Air!



**Complete heating comfort guaranteed with each Blend-Air system installed**

What makes this valuable insurance service possible? It's Coleman's exclusive Magic Blenders that give a new, more efficient air blending and circulating process. (See below how the Blenders work.) They mean *no* stale hot air. *No* heat packed at the ceiling with floors freezing cold. Instead, you get continuous, gentle movement of fresh warm air; warm floors; uniform temperature from floor to ceiling.

A completely automatic system with overall temperature control and *independent* control in each room.

Before installing any system, have your Coleman dealer describe the many new health and comfort features now guaranteed with Blend-Air. Look him up in the Yellow Pages of your telephone book or write us for free literature. The Coleman Company, Inc., Wichita, Kansas.

BLENDED AIR



**The Magic Blender does it**

*In winter, it blends room air with freshly heated furnace air to maintain comfort. In summer, it blends with cool dehumidified air.*

- 1** You're More Comfortable with Blend-Air circulation
- 2** You Save on Installation with easy-to-fit 3½" tubes
- 3** You Save Space with compact furnace
- 4** You're Cool in Summer Add unit any time

**Coleman**®

**Blend-Air**®  
CENTRAL HEATING AND AIR CONDITIONING SYSTEM

OIL  
GAS  
LP-GAS

The Coleman Company, Inc.  
Dept. 702-PM, Wichita 1, Kansas  
Please send me free literature on the revolutionary Coleman Comfort Bond.

Name \_\_\_\_\_  
Address \_\_\_\_\_  
City \_\_\_\_\_ State \_\_\_\_\_

ROOM AIR ENTERS Heaters • Floor Furnaces • Wall Heaters • Water Heaters



1

Replace thermostat every year for maximum heater efficiency and better cooling system performance. Quality built original equipment replacement. Rust proof. Easy to install. Either Alcohol type or Permanent Anti-freeze type for all popular cars from..... **\$1.47 to \$2.10**



2

Enjoy cozy "living-room" warmth. Supreme EA Double-Flow Heater with 7½" dual fan delivers 250 cu. ft. of air per minute. Heavy-duty motor. Illuminated variable speed switch. Original equipment styling. (Defroster kit available.) (Z1134) **\$32.95**  
Deluxe EA Hot Wave (Z1132) **\$21.95**

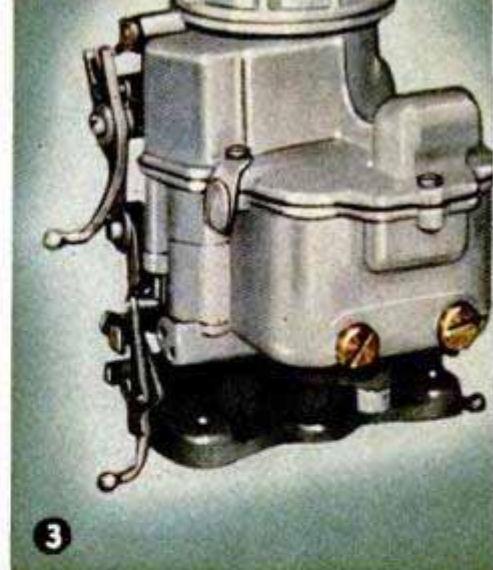

3

Get better gas mileage, smoother idling, greater power with a fully guaranteed remanufactured carburetor. All parts brand new or fully remanufactured like new. Pressure and flow-meter tested, assuring correct gas and air ratio for top performance. For all popular cars. (Exch.) **\$4.75 to \$7.95**



## New Power... New Beauty...

Over 40 Years... Headquarters



7

**Drednaut Hydraulic Jack** takes work and danger out of tire changing. Easy wrist-action lifts any car. Twist—it's down, safely and smoothly. Precision built to meet most severe passenger service requirements. Raises from 7" high to 14¼". Pumping handle included. (A6188) . . . . **\$11.15**

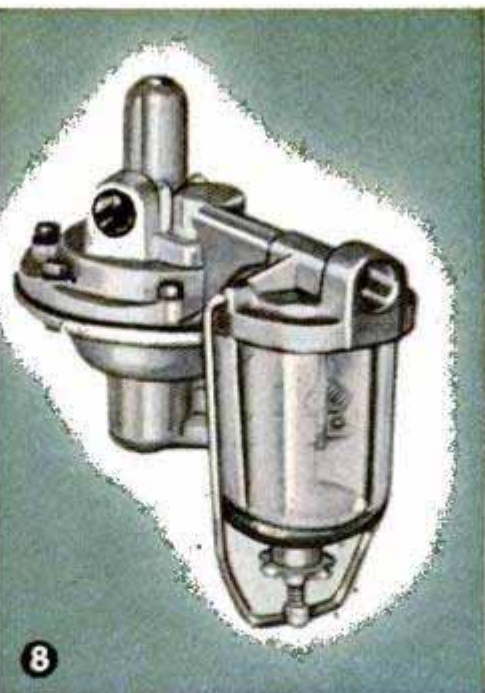

8

**Wizard fuel pumps**, guaranteed for long, dependable service. Original equipment replacement. Diecast body; precision machined surfaces and parts; fully tested for correct pressure. Diaphragm of extra high quality for longer life, top performance. For all popular cars..... **\$2.49 to \$7.95**

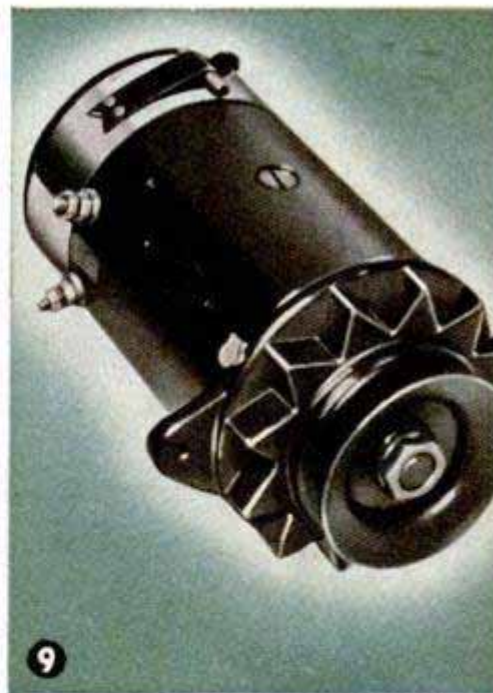

9

**Wizard generators** are fully remanufactured to original equipment tolerances and unconditionally guaranteed to equal original equipment performance. New carbon brushes. All parts brand new or fully remanufactured like new. Factory test-run. For all popular cars. From **\$7.95(exch.)**





Don't be stranded by a worn-out fan belt. Replace now with a Western Auto extra-quality fan belt. Inner core of endless cable cords. Tough rubber cushion reduces heat, assures long life, cooler-running performance. Can't warp, slip, or stretch. Guaranteed fit **65c to \$1.95**

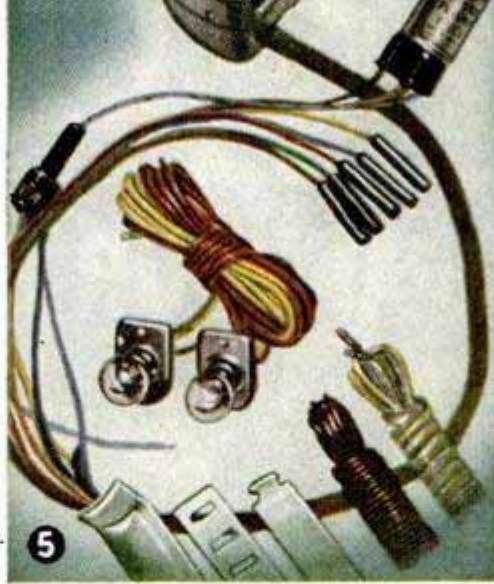

Reduce driving hazards with this turn signal set. Automatically returns to neutral position when turn is completed. Blends with dash and steering wheel. Flashing red indicator light on switch. (2LR6176) . . . . . **\$6.45**  
**Wiring kit**, with all installation material. (2LR6177) . . . . . **\$2.98**

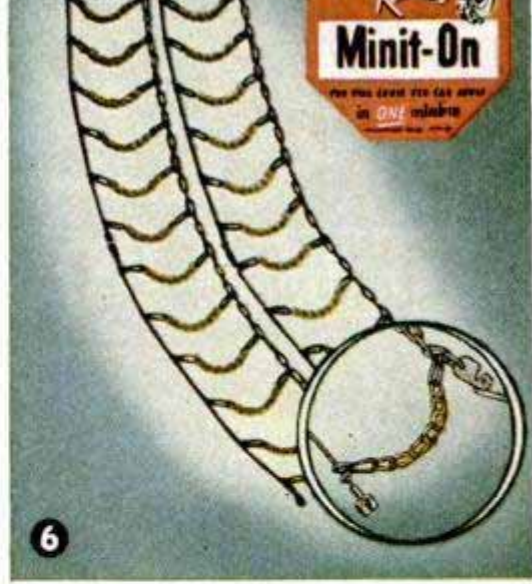

"Minit-On" Tire Chains — so revolutionary you can put them on in just *one* minute. Install anyplace—in snow, on ice, or on a hill. Not "snap-ons", but complete, patented chains with adjusters. Tough, wear-resisting links. Plastic coat sleeve protectors included. Pr. from **\$13.95**

# New Safety For Your Car At Western Auto

STORES AND ASSOCIATE STORES

For Top Quality Auto Supplies.

NOTE: Western Auto Associate Dealers own their stores and set their own prices, terms and conditions. Prices may vary due to difference in local conditions. (PM113)



Guaranteed to fire in oil. Aldor spark plugs have bi-metallic thermostat control that keeps spark plug always at peak efficiency for smoother running, easier starting. Adjusts to any heat range requirement automatically. Special non-burning electrodes. Each, in sets . **95c**



Add new beauty and style to your car's interior, and protect your floor mat from excessive wear with these handy rubber utility mats. Also has many uses around the house. Easy to clean. Black, blue, red, or green.  
 17" x 17" (2N1105-8) . . . . . Ea **89c**  
 17" x 20" (2N1110-13) . . . . . Ea **\$1.19**

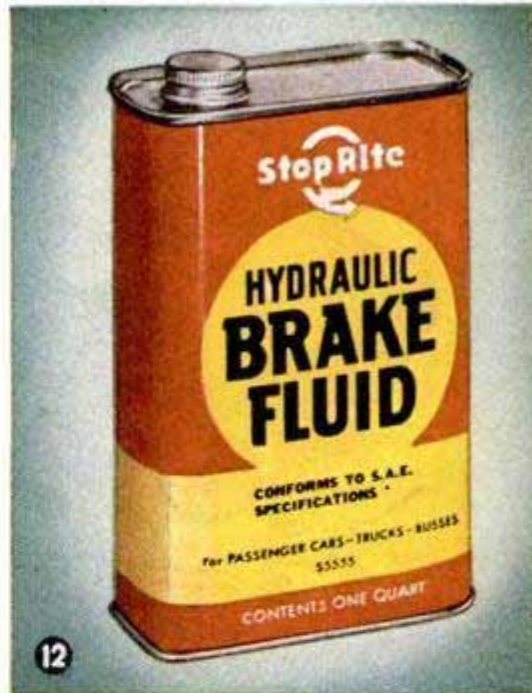

Top quality brake fluid meets S.A.E. standards. Permanent-type, for all cars and trucks. Mixes with any fluid. Perfect all-weather performance—no loss at extremely hot temperatures or freezing at cold temperatures.  
 Quart (S5555) . . . . . **\$1.09**  
 4 OZS. (S5553) . . . . . **25c**

# GET THESE BIG NEW

POPULAR  
MECHANICS

## BOOKS AT YOUR NEWSSTAND

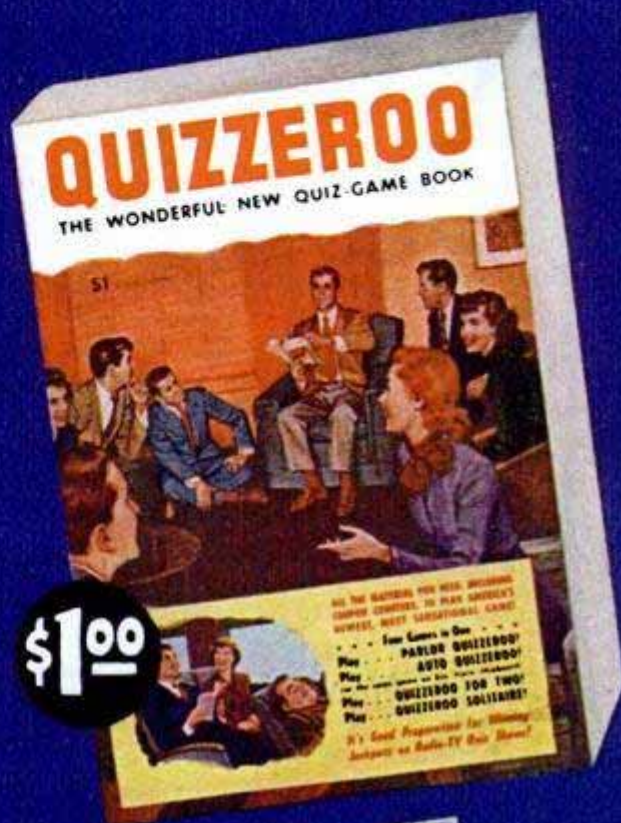

### WRITTEN IN THE FAMOUS POPULAR MECHANICS STYLE!

**WHAT TO MAKE 1954** offers hundreds of fascinating projects for the home workshop craftsman. There are more than 500 things to make—for pleasure and profit—including a number of exclusive projects such as glassware art objects, a baby bi-plane, toys made from shipping cartons and occasional furniture. **\$1.00**

**POPULAR MECHANICS BOOK OF TOYS YOU CAN MAKE** is composed entirely of toy projects, all proven favorites

**QUIZZEROO** is the wonderful new quiz-game book that everyone is talking about. Now everyone can join in the fun and play America's newest, most sensational question and answer game! Good preparation for winning radio and TV jackpots, too. All the material needed, including coupon counters, is contained in the book. **\$1.00**

**100 BEAUTIFUL PIECES OF FURNITURE** is the perfect guide for building furniture for every room of your home.

you can DO }  
 so much MORE }  
 so much BETTER }  
 with an *Atlas*  
 15" DRILL PRESS

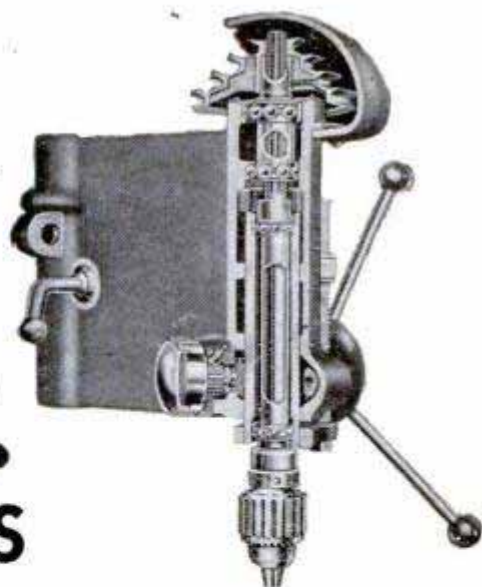

**AMERICA'S FINEST**  
 Cross section of the massive drill head shows exclusive ATLAS floating drive, sealed-for-life ball bearings and precision ground spindle and quill.

If all drill presses in the price range of the ATLAS Model 1060 were lined up for your inspection, your choice would be easy. On a comparative basis the 15" ATLAS is a standout value. The head is almost twice as heavy, and this, with the balanced overall design, assures maximum accuracy and rigidity. And if you compared performance, the ATLAS would earn your overwhelming preference. Built to strictest industrial standards for actual production use, the 15" ATLAS costs no more than ordinary drill presses. Send coupon or postcard for full information.

**DON'T BE IN A HURRY...**

**Investigate Before You Invest! Be Sure Your Drill Press Has These Important Features!**

1. Biggest, heaviest head with the widest spaced column bearings for maximum accuracy and rigidity. Remember, the head is the heart of the drill press.
2. Table, column, and base are of heavy-duty industrial weight for more accurate work and really s-m-o-o-t-h performance. Balanced design throughout.
3. Exclusive floating drive with six splined spindle and drive sleeve for maximum accuracy.
4. Four widely spaced sealed-for-life ball bearings . . . two on drive sleeve, two on spindle . . . provide greater accuracy, smoother, quieter operation, longer service life.
5. Exclusive neoprene quill stop bumper assures shock-proof return . . . lengthens tool life.
6. Machine ground table may be tilted to any angle, right or left.
7. 41" work capacity over table, 46" over base. Handles bigger jobs.
8. Quick-positioning, direct-reading Vernier depth control stop . . . saves setup time.
9. Built-in switch, coordinate clamp locks, column collar, adjustable feed tension, 3-spoke feed wheel (all furnished) . . . combine to give better control.



15" Floor-Type  
 (Also available in 15" and 12 3/4" bench models)

THIS YEAR —  
 GIVE HIM AN  
 ATLAS  
 GIFT  
 CERTIFICATE



**"DO-IT-YOURSELF"**

with these low cost, practical  
**PLAN BOOKS**

1. 20 PLAN BOOK—Original furniture designs by noted authority.
2. 18 OUTDOOR EQUIPMENT Woodworking Plans. 50c each, 65c outside U.S.A.

**FREE  
 CATALOG  
 WRITE  
 TODAY**

**ATLAS PRESS COMPANY**

1124 N. Pitcher St., Kalamazoo, Mich.

- Please send free Drill Press Catalog  
 Enclosed is \_\_\_\_\_ for  20 PLAN BOOK 50c  
 18 PLAN BOOK 50c

NAME \_\_\_\_\_

ADDRESS \_\_\_\_\_

CITY, STATE \_\_\_\_\_

**SOLD ONLY THROUGH FRANCHISED ATLAS DEALERS**



**...When you use these WIZARDS with WOOD!**

When you join two pieces of wood with Weldwood Glue, brother—they stay joined! When you use Firzite and Satinlac for finishing, brother—they look great! Mail coupon below for free leaflets.

**The Wood Glue you can rely on**

To make things or fix things, use Weldwood Glue for all wood-to-wood bonds. Makes joints stronger than the wood itself. Mixes easily with water. Stain-free, rot-proof... highly water-resistant!

**WELDWOOD®**  
PLASTIC RESIN GLUE

**For blond or pickled effects—**

White Firzite produces those magical "woody" effects—on hard wood or soft, plywood or solid lumber. For light pastel tones, tint White Firzite with Colors-in-Oil. (On fir plywood stain jobs, tame that wild grain with Clear Firzite.)

**White FIRZITE®**

**Gets that Natural-Wood Finish**

On furniture, panelling or woodwork, there's nothing like Satinlac. Brings out natural grain and color beauty of any plywood or solid wood. Avoids that "built-up" look; will not turn yellow or darken with age. "Water-clear," easy to brush or spray, dries ready for next coat in 2 or 3 hours.

Pints, Quarts, Gallons **SATINLAC®**

**United States Plywood Corporation**  
Dept. 272, 55 West 44th St., New York 18, N. Y.

Send me free leaflets on Weldwood Glue, Firzite and Satinlac.

NAME \_\_\_\_\_  
ADDRESS \_\_\_\_\_

**The Owners Report on the Nash**

(Continued from page 106)

"Wheels are very easy to get out of line."  
—Oklahoma City, Okla., postal worker.

"Foot brake too close to steering post."  
—Athol, Mass., clerk.

"Trunk should have entirely flat floor with tire on the side or else completely set in."  
—Fennimore, Wis., bartender.

**1953 NASH RAMBLER SPECIFICATIONS**

ENGINE		WITH HYDRA-MATIC
STANDARD		
Type	6-cyl., in-line, L-head	
Bore and stroke	3 1/8 x 4 in.	3 1/8 x 4 1/4 in.
Piston displacement	184 cu. in.	195.6 cu. in.
Compression ratio	7.25:1 (7.5 optional)	7.3:1 (7.5 optional)
Brake horsepower	85 at 3800 r.p.m.	90 at 3800 r.p.m.
CAPACITIES		
Oil	4 qt.	
Water (with heater)	12 qt.	
Gasoline	20 gal.	
GENERAL		
Steering ratio, over-all	19.5:1	
Steering wheel, lock to lock	3.5 turns	
Turning diameter (curb to curb)	42 ft. 4 in.	
Brakes	conventional hydraulic with riveted linings	
Tire size	6.40 x 15	
Shipping weight	2475 lb.	
Wheelbase	100 in.	
Tread, front	53 3/8 in.	
Tread, rear	53 in.	
Length, over-all	185 3/8 in.	
Width, over-all	71 1/2 in.	
Height, over-all	59 in.	
Road clearance	7 3/4 in.	
INTERIOR DIMENSIONS		
Front-seat width	58 in.	
Rear-seat width	45 1/4 in.	
Headroom, front	36 1/2 in.	
Headroom, rear	35 1/2 in.	
Legroom, front	41 in.	
Legroom, rear	37 1/2 in.	

(All Rambler dimensions for two-door sedans; others for four-door sedans)

**1953 NASH MODELS STATESMAN AND AMBASSADOR SPECIFICATIONS**

ENGINE		AMBASSADOR
STATESMAN		
Type	6-cyl., in-line, L-head	6-cyl., in-line, O.H.V.
Bore and stroke	3 1/8 x 4 1/4 in.	3 1/2 in. x 4 3/8 in.
Piston displacement	195.6 cu. in.	252.6 cu. in.
Compression ratio	7.45:1	7.3:1 (8.0:1 optional)
Brake horsepower	100 at 3800 r.p.m.	120 at 3700 r.p.m. 140 at 4000 r.p.m. (optional)
Transmission	Conventional 3-speed drive or Dual-Range extra.	unit standard. Over-Hydra-Matic optional
CAPACITIES		
Oil	4 qt.	6 qt.
Water	15 qt.	18 qt.
Gasoline	20 gal.	20 gal.
GENERAL		
Steering ratio, over-all	24:1	25.5:1
Steering wheel, lock to lock	3.5 turns	3.5 turns
Turning diameter (curb to curb)	42 ft. 6 in.	44 ft. 8 in.
Brakes	conventional hydraulic	with riveted linings
Tire size	6.70 x 15	7.10 x 15
Shipping weight	3070 lb.	3480 lb.
Wheelbase	114 1/4 in.	121 1/4 in.
Tread, front	55 1/2 in.	55 3/8 in.
Tread, rear	59-11/16 in.	60 1/2 in.
Length, over-all	202 1/4 in.	209 1/4 in.
Width, over-all	78 in.	78 in.
Height, over-all	61 3/4 in.	62 1/4 in.
Road clearance	7 1/2 in.	8 in.
INTERIOR DIMENSIONS		
Front-seat width	65 in.	65 in.
Rear-seat width	64 1/2 in.	64 1/2 in.
Headroom, front	37 1/2 in.	37 1/2 in.
Headroom, rear	36 in.	36 in.
Legroom, front	41 1/2 in.	41 1/2 in.
Legroom, rear	37 3/8 in.	37 3/8 in.

"Chrome strip below dash reflects into windshield. I painted mine to offset the glare."  
—Beardstown, Ill., iron worker.

"Driver's seat should be moved back two or three inches for more legroom."  
—Henderson, Tex., oil-field pumper.

**Ambassador Comments**

Comfort and riding qualities nosed out economy for top honors with Ambassador owners. Almost half of the owners (45

(Continued to page 252)

# BOYS! Get **ERECTOR**<sup>®</sup>

## and build hundreds of action models

Put together these gleaming STEEL precision parts and create hundreds of toys! Illustrated "How to Make 'Em" book in every set. But you can do your own inventing! Models whistle, "choo-choo," light up and puff smoke. Tell Dad you want ERECTOR and see displays at stores. For ERECTOR and Gilbert Toy Book (plus American Flyer trains) write Gilbert Hall of Science, Dept. J, Erector Square, New Haven 5, Conn. Enclose 10¢ for handling, postage.

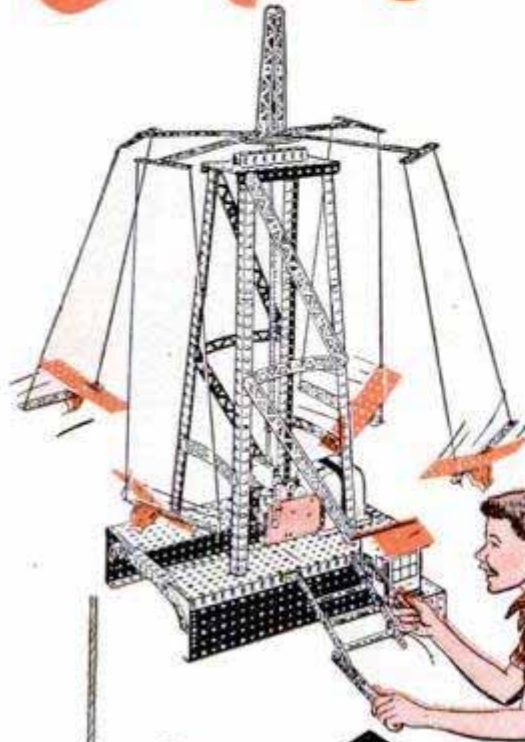

Make this high-swinging airplane ride with ERECTOR No. 6½.

No. 6½ has over 350 parts — sturdy girders, gears, wheels, etc. "Powerhouse" electric engine features many speeds (including reverse) to put *action* into your models. Builds pile driver, elevator, lift bridge, hundreds of other wonderful toys that work. \$12.95\*



### Square Girder Construction

Precision-matched parts easily lock together with nuts and bolts. Can't wobble or warp. Build bridges that hold more than 200 pounds. Parts have lasting gleam.

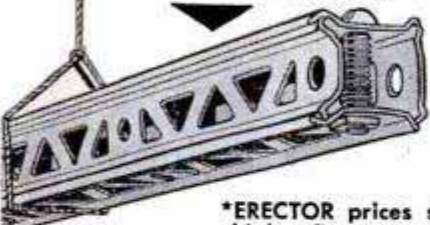

\*ERECTOR prices slightly higher Denver and West

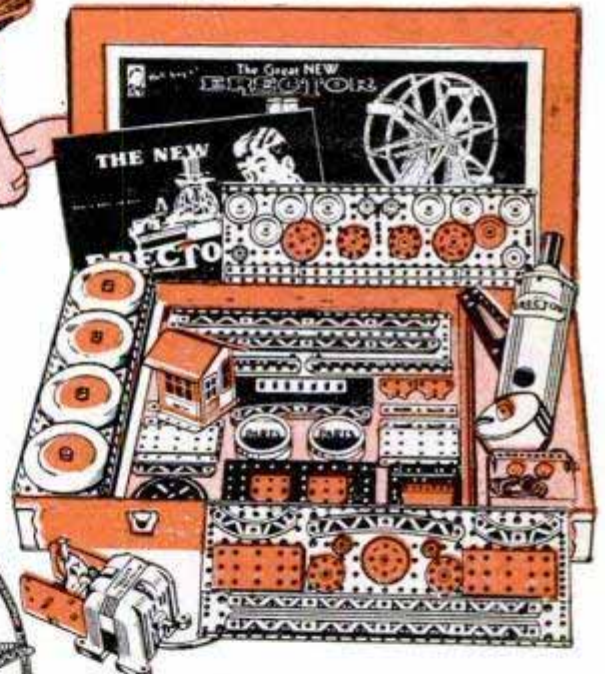

Huge ferris wheel turns fast or slow; reverses. Made with ERECTOR No. 8½.

The all-electric set (No. 8½) has nearly 16 lbs. of parts! Includes 4-speed forward and reverse electric engine, electric lights, electromagnet! Build a mighty crane, oil drilling rig, portable derrick, etc. Heavy gauge steel chest. \$23.50\*

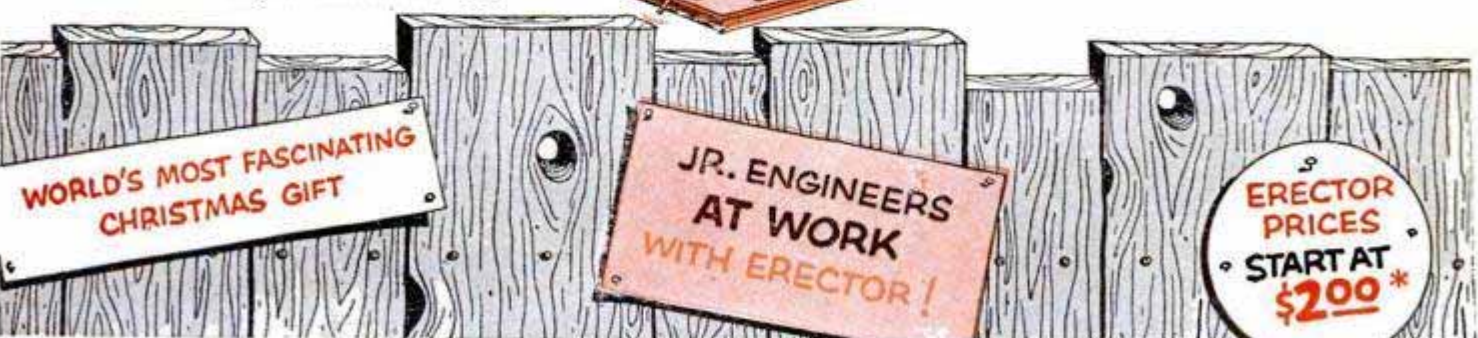

WORLD'S MOST FASCINATING CHRISTMAS GIFT

JR. ENGINEERS AT WORK WITH ERECTOR!

ERECTOR PRICES START AT \$2.00\*

percent) gave comfort and ride as the qualities liked most.

"Doesn't tire you out on long drives; rides very comfortably."—Freeport, Ill., welder.

"Soft but firm ride; flat ride on curves."—Buffalo, N. Y., lathe operator.

But even the big Ambassador is stingy with fuel, owners say. Forty-one percent listed economy as one of the best characteristics of their cars.

"On a 3339-mile trip I used 149 gallons of gas, traveling 60 to 70 miles per hour."—Hartford, Conn., credit manager.

Handling ease was next in the favor of Ambassador owners (28 percent listing it).

"It is the easiest car to handle on the road that I have ever driven. (I have owned 27 cars of all makes in the past 20 years.)"—Oakland, Calif., clergyman.

"I like best the balance on highway at high speed."—Skokie, Ill., sales manager.

Roominess, visibility and exterior styling were popular with about 22 percent of the Ambassador owners.

"The car has a large passenger compartment and room for a lot of luggage."—Hazel Park, Mich., owner.

"At first the car seemed so wide it made it awkward to park. The longer I drive it the less I notice this wideness."—Decatur, Ill., evangelist.

The Nash bed-in-a-car is popular.

"We love the bed feature. In 1949 we drove our 1948 Nash through 18 states (9450 miles) . . . on the road 52 days . . . slept in the car 45 nights . . . saved \$500."—Battle Creek, Mich., railroad engineer.

As with Statesman owners, the large turn circle was the biggest complaint.

"Cannot turn very short . . . hard to park."—Minneapolis, Minn., carpenter.

Body leaks were complained of by 19 percent of the Ambassador owners.

"Glass gaskets no good—water leaks in."—Birmingham, Mich., engineer.

Another cause of complaint (for 9 percent of the owners) was the doors.

"Door and trunk locks poor. They work hard."—Appleton, Wis., businessman.

"Doors rattle."—Worcester, Mass., school teacher.

**And now for my own test:** I drove the Farina-styled Nash Rambler hardtop convertible from Los Angeles to Boise, Idaho, via Reno, Nev., and returned through Sun Valley, Idaho, Tonapah, Nev., and across the desert to Los Angeles. Total mileage was 2181 miles.

The Rambler is a short car, but it does have an amazing amount of room for its length. Incidentally, the short 100-inch wheelbase becomes less noticeable the

(Continued to page 256)

**NEW!**

## DO-IT-YOURSELF CARBURETOR CLEANING KIT

Everything\* you need to clean your own carburetor right on the engine without taking it apart

\*Includes pint of GUMOUT and easy-to-use applicator.



Get better engine performance—smoother idling, faster pick-up, greater gasoline economy. Eliminate engine stalling, bucking, and fuel waste caused by a dirty gummed-up carburetor.

Keep your carburetor clean all the time. *Do it yourself* with GUMOUT and KIT—sold by leading auto supply stores, service stations, car dealers. GUMOUT refills always available from your dealer.

If your local dealer can't supply you, order direct. \$3.95 postpaid.

GUMOUT DIVISION  
PENNSYLVANIA REFINING COMPANY  
2683 LISBON ROAD, CLEVELAND 4, OHIO

**AUTO-LITE "Sta-ful"**  
needs water only  
3 times a year\*.  
lasts longer, too  
Here's why —

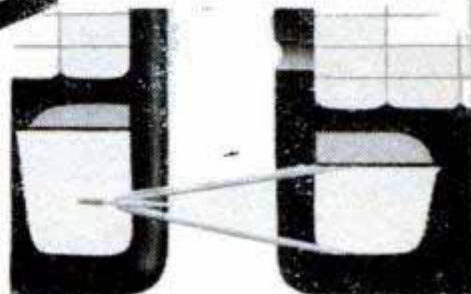
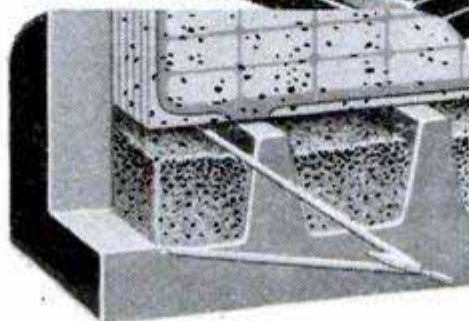
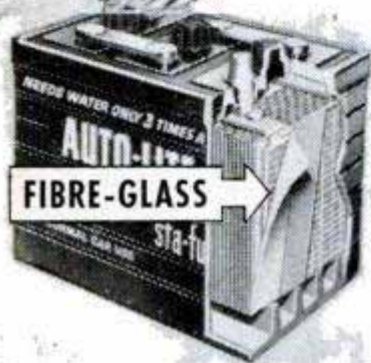

ORDINARY

STA-FUL

1. Auto-Lite "Sta-ful" has Fibre-glass retaining mats that help keep power-producing material in place to reduce plate shedding and flaking.

2. Because this flaking in ordinary batteries can short circuit plates and, cause failures, a deep sediment well is necessary in ordinary batteries to catch flaking waste.

3. Fibre-glass mats, therefore, permit Auto-Lite engineers to lessen sediment-well depth in "Sta-ful," adding extra space above battery plates.

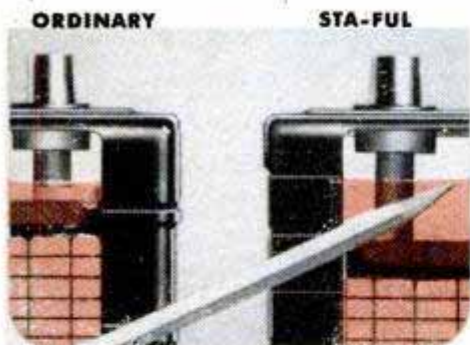

4. This additional reserve over plates gives "Sta-ful" more than 3 times the liquid reserve of ordinary batteries, helps keep plates fully covered and active longer . . .

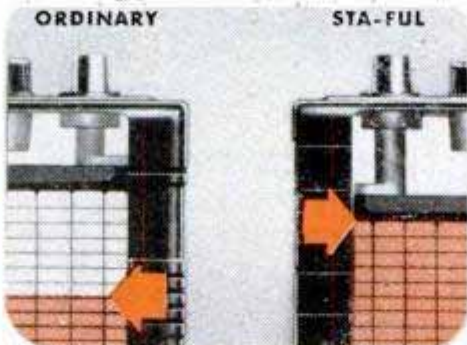

5. . . . as shown by an equal water evaporation test, proving "Sta-ful" gives you greater protection against liquid loss. Make your next battery an Auto-Lite "Sta-ful," the battery that needs water only 3 times a year.\*

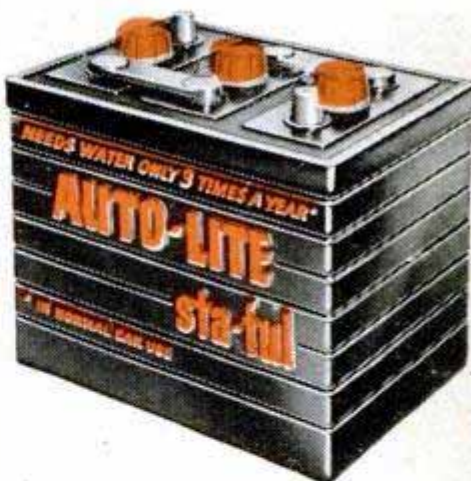

**AUTO-LITE BATTERY CORPORATION**

Toledo 1, Ohio

Toronto, Ontario

**AUTO-LITE** sta-ful

Tune in "SUSPENSE!" . . . CBS Radio Mondays . . . CBS Television Tuesdays

...needs water only 3 times a year \* IN NORMAL CAR USE

# PROVE TO YOURSELF

# WHICH POWER TOOL

How can you do it? Easy—get a demonstration\*. Not only of SHOPSMITH, but of other leading makes, too. It's the only

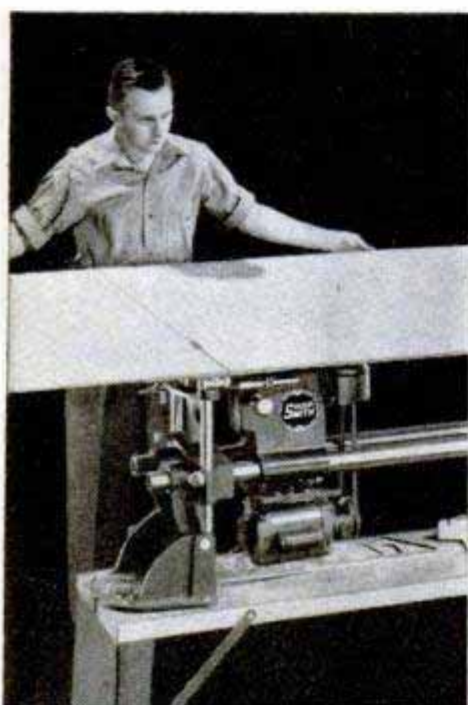

**COMPARE CAPACITY** Notice that SHOPSMITH's 8" Circular Saw can rip 8' panels into two identical 4' sections. What other saw can do this? And what other drill press can drill to the center of a 15" circle? What other lathe has a 15" swing? What sander has unlimited capacity?

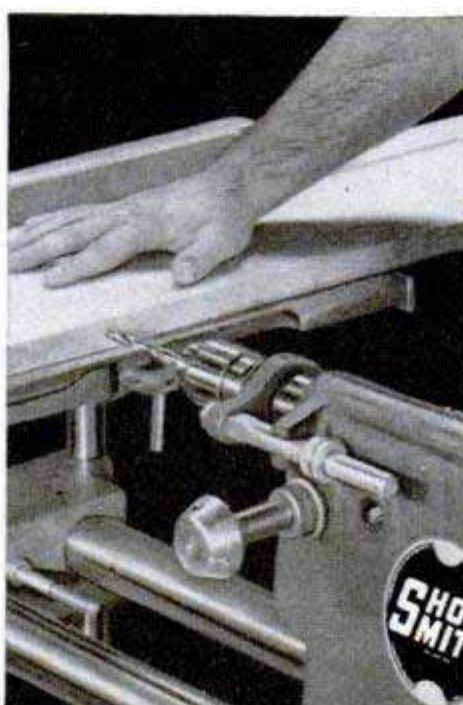

**COMPARE ACCURACY** Precision is built into every part of every SHOPSMITH. But don't take our word for it—see how the Horizontal Drill Press, for example, dowels large flat pieces *with absolute accuracy*. Notice, too, SHOPSMITH's method for setting the saw blade right to a hairline.

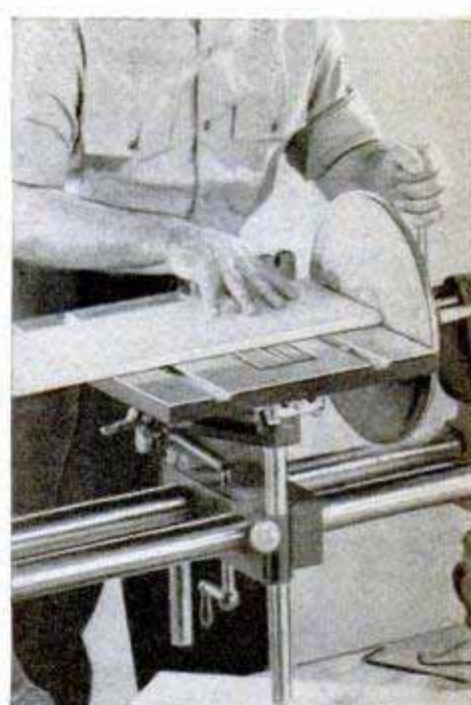

**COMPARE VERSATILITY** SHOPSMITH is the five most-used big tools in one compact unit—an 8" Circular Saw, a 12" Disc Sander, a 33" Lathe, a Vertical and a Horizontal Drill Press. When you get SHOPSMITH, you get exactly the tool you need for every job you want to do. No special jiggling.

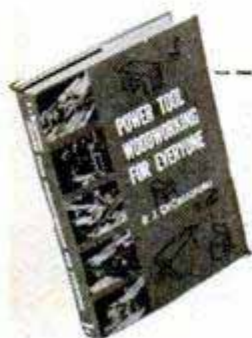

**HAVE YOU READ THE NEW MCGRAW-HILL WOODWORKING BOOK?** It's the most complete power woodworking book ever published! *Power Tool Woodworking for Everyone* has 283 pages of valuable information and 560 photographs and drawings. Only \$4.95 at book stores and where SHOPSMITH is sold.



# IS BEST FOR YOU

fair, convincing way to pick a power tool. Here are a few points to keep in mind when you get your demonstration:

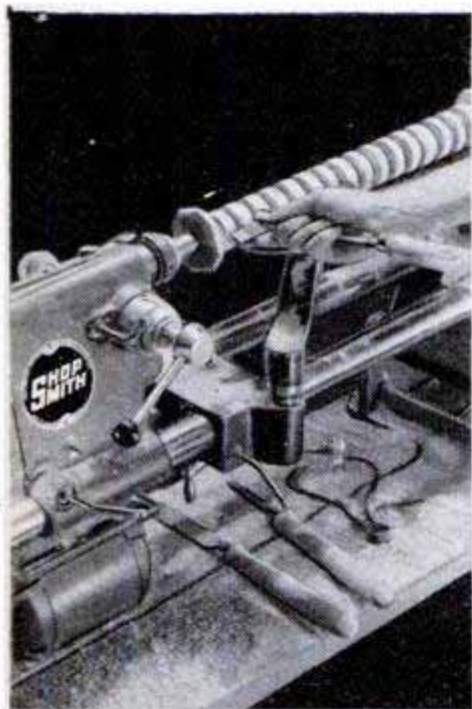

**COMPARE EASE OF OPERATION** Lathe's sliding headstock puts work within easy reach, allows you to *face* work. Swiveling tool rest slides parallel to piece being turned, eliminates need to reset constantly. Single belt and pulley facilitate speed and tool changes. Makes hard jobs easy.

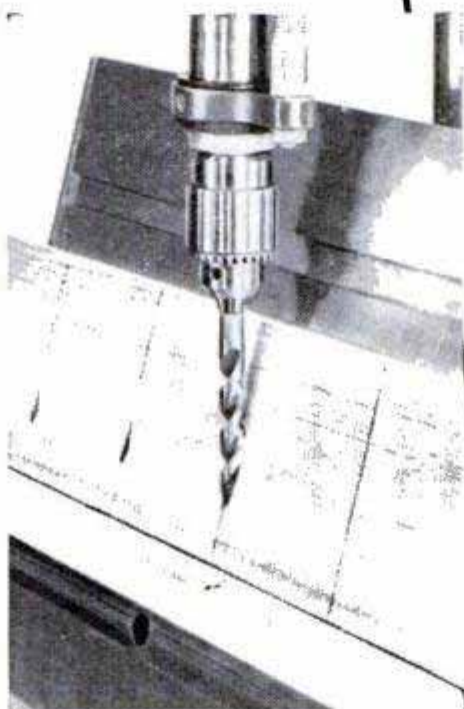

**COMPARE CHANGE-OVER TIME** And don't take claims for facts — not even ours. For example, see for yourself how you can change SHOPSMITH from a Saw, Horizontal Drill, Disc Sander or Lathe, into a Vertical Drill Press in less than 60 seconds! Note quick accessory attachments, too.



**New Shopsmith 4" Precision Jointer:**  
Extra-long 28" table. Attaches quickly, easily. Can be operated simultaneously with saw as conventional saw-jointer combination. Three-knife cutter head runs on grease-sealed ball bearings. Unique Allen-wrench knife adjustment is easiest method ever devised for jointer knife adjustment. Fence tilts 45°-45°; automatic stops. Width of cut 4"; depth of rabbet,  $\frac{3}{8}$ ". Only \$44.95 (mounting kit, \$9.95).

## COMPLETE 5-TOOL UNIT

ONLY **\$199.50**

Motor\*\* and bench ends extra

Chrome rust-proofing now standard on all SHOPSMITHS.

\*\*Special heavy-duty SHOPSMITH ball-bearing motors:  $\frac{1}{2}$  h.p., \$34.50;  $\frac{3}{4}$  h.p., \$44.50

\*See America's fastest-selling power tool at leading hardware and department stores, or at Montgomery Ward. Stop in for an on-the-job demonstration. **Prove to yourself SHOPSMITH is the best power tool for you.**



MAGNA ENGINEERING CORPORATION, Dept. 255-B at factory nearest you: 12819 Coit Rd., Cleveland 8, Ohio, or Menlo Park, California.

Please send me a free copy of the latest SHOPSMITH 16-page booklet.

Name \_\_\_\_\_

Address \_\_\_\_\_

City \_\_\_\_\_ State \_\_\_\_\_

longer you drive. I'm long legged and I was cramped on only one stretch when we covered 500 miles in less than nine hours. Cushions and back-seat springing are above average. The ride was surprisingly satisfactory. Suspension is especially good, and the car, due to its short wheelbase, handles far above average on short turns or mountain curves. You can "scat" in and out of corners unbelievably fast.

Acceleration, power on the hills and top speed were excellent. On long open stretches in overdrive the speedometer hit from 91 to 93 miles per hour. It will cruise at 80 to 85 miles per hour. The car handled well at high speeds even in strong winds, which we had most of the time returning through Idaho and Nevada. The "Flying Scot" 184 cubic-inch, 85 horsepower engine of L-head design has a bore and stroke of 3 1/8 by 4 inches and a 7.25:1 compression ratio. (Rambler Hydra-Matic models have 195.6 cubic inch displacement, 90 horsepower and 7.3:1 compression ratio—7.5:1 head is optional—and the stroke is increased to 4 1/4 inches. See specification table. I found regular gas satisfactory, as did 63 percent of the owners answering our poll. Nash has a large (20 gallon) gas tank. This is an excellent feature, especially with the Rambler, as unbelievable distances can be covered between refuelings.

All Nash cars have an unusual suspension. The coil springs are extra long and the "sea leg" shock absorbers aid in increasing front-end stability on curves and riding comfort. The coil springs bear directly against the kingpins and the lighter control arms permit less unsprung weight, which is good. The conventional heavy front cross member is eliminated in Nash design. The large armrest interferes somewhat with the window-crank movement. The armrests are the same as used in the larger Nash models. They appear large in the Rambler and would be more comfortable if mounted lower on the door. The wide doors open easily by pinch-type locks. They could close easier and fit better.

All instruments are neatly housed in one shrouded glass, directly in front of the driver. I'm happy to say that the unnecessary upper half of the horn ring does not interfere with speedometer or instrument vision. Lights for oil and ammeter warnings are used. I like indicating needles better.

The glove compartment has considerable room and is a pull-out drawer. Improvements should be made in the operation of the drawer. Twice it fell off the rails when pulled out too far.

The Rambler hood has a slot in front which admits fresh air to the engine—a

(Continued to page 258)

## Save money... step into a Fortune!

STYLE 6016



*Glen-Castle*

GRAINS

sturdy styles in  
grain leathers  
for rugged wear

- You get America's top styling at the popular price you like to pay in Fortune's "Glen Castle" grains. Made of sturdy grain leathers, these handsome shoes are built to give you rugged wear, comfort, and good looks. Your Fortune dealer has styles for every occasion. Save money... step into a Fortune.

**\$8.95 to \$12.95**  
most styles

*Fortune*  
SHOES FOR MEN



RICHLAND-DAVIDSON SHOE COMPANY • A DIVISION OF  GENERAL SHOE CORP. • NASHVILLE, TENNESSEE

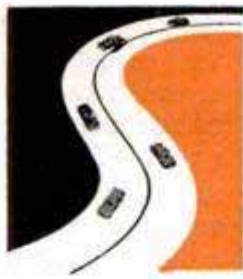

Number Two of a Series

# What every Automobile man should know about **Power Steering**

**P**OWER STEERING is attracting more attention in the automotive field, and winning more rapid public acceptance, than anything since automatic transmission. Saginaw Power Steering is now available on all General Motors cars and three other well-known makes. Already over *half a million* new-car owners are enjoying it—yet, as with any new product, there are still some misconceptions due to incomplete or faulty information. That's why we, as the world's largest producer of power and manual steering gears, are publishing this series of messages to help answer some of the questions most frequently asked about Power Steering.

#### 4. WHY IS "FEEL OF THE ROAD" SO IMPORTANT TO POWER STEERING SAFETY?

Without

this familiar "feel" in the steering wheel, many drivers have a sense of insecurity and a tendency to oversteer. In other words, *when power is applied continuously, steering is frequently too easy for safety.* So we have deliberately designed Saginaw Power Steering to go to work *only when you need it.* Whenever mere "fingertip" effort is needed to steer (as at high speeds on a smooth, straight highway) your car remains under conventional manual control. But, the moment *more than "fingertip" effort is called for,* Saginaw Power Steering instantly supplies the additional "muscle"—with just enough effort left to the driver to assure the normal "feel of the road"—as graphically shown in the chart. With Saginaw Power Steering there is never any sensation of "driving on ice." *It never interferes with safe control of your car.*

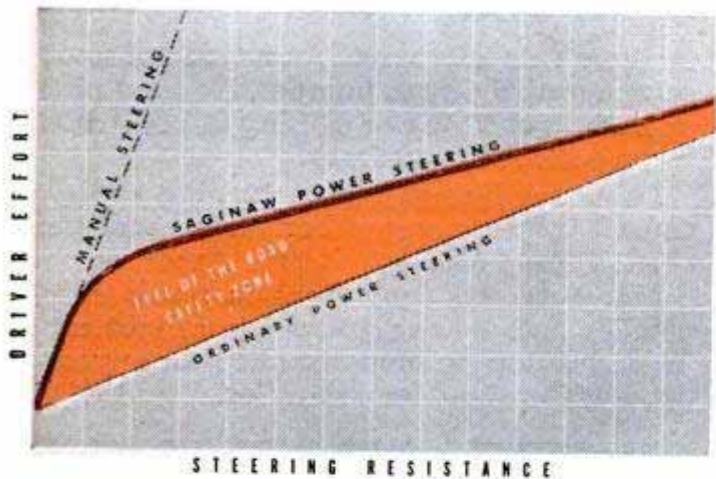

This simplified graph shows the basic difference between Saginaw Power Steering and ordinary types. The latter apply power at the slightest touch of the wheel, tending to cause overcontrol. Saginaw Power Steering goes into action only when more than "fingertip" pull is needed. This SAFETY ZONE is purposely provided to assure normal "feel of the road" and prevent oversteering.

#### 5. MUST DRIVERS BECOME ACCUSTOMED TO POWER STEERING?

Not Saginaw Power Steering! There's nothing new to learn because your wheel still has that reassuring "feel of the road" at all times. *You cannot feel Saginaw Power Steering "cut in" or "cut out."* The only difference you notice is the effortless ease of turning . . . the wonderful freedom from "wheel fight." After a turn, your car straightens out exactly as with manual steering.

The simple, ingenious Saginaw design which accomplishes all this so dependably will be the subject of our next message.

**MEANWHILE**—if you'd like to learn more, we'll be delighted to send you "THE FACTS ABOUT POWER STEERING"—an interesting booklet we've prepared to help give you a better understanding of this important new development. It's yours for the asking—just use the handy coupon.

# Saginaw

**POWER STEERING**

Saginaw Steering Gear Division  
General Motors Corporation  
Saginaw, Michigan (Dept. M)

Please send a free copy of "The Facts About Power Steering."

NAME \_\_\_\_\_

ADDRESS \_\_\_\_\_

CITY \_\_\_\_\_ ZONE \_\_\_\_\_ STATE \_\_\_\_\_



# FOR SMOO-OO-THER WINTER DRIVING

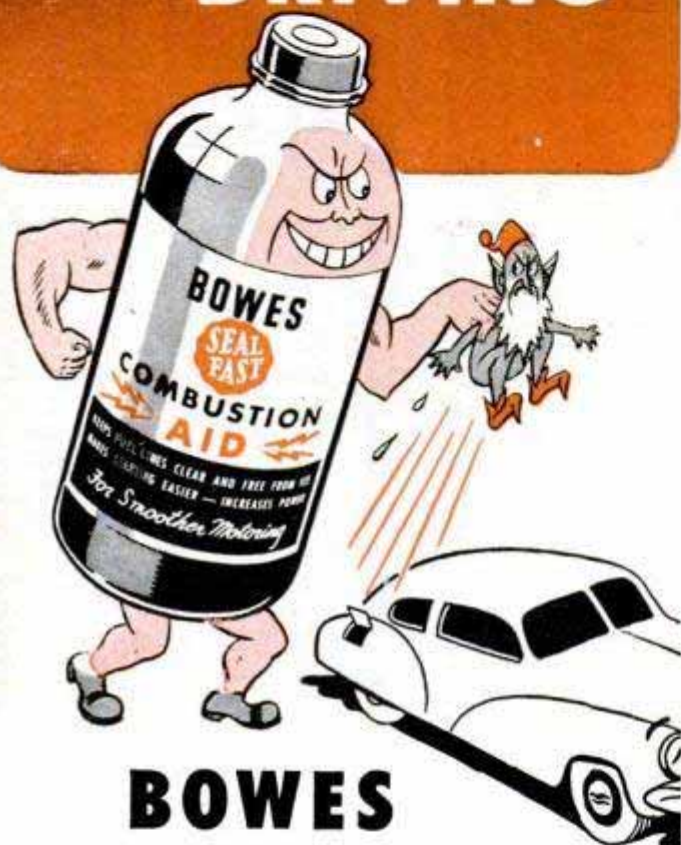

## BOWES COMBUSTION AID

**KEEPS JACK FROST  
OUT OF YOUR GAS TANK,  
MAKES STARTING EASIER,  
INCREASES POWER**

Be *sure* of quick, easy starting this winter! BOWES Combustion Aid absorbs the water in your fuel lines, keeps them free of gums and rust, softens and removes carbon. Easy to use . . . just put it in your gas tank . . . and have dependable, inexpensive cold weather protection! Your Bowes "Seal Fast" dealer can supply you.

**DRIVE IN  
WHERE YOU  
SEE THIS EMBLEM**



BOWES "SEAL FAST" CORP., INDIANAPOLIS 7, INDIANA

good idea. Due to the sloping front hood, vision directly in front of the wheels is excellent. The Rambler is a safe car because of the protection furnished by the unique Nash construction—body and chassis are welded together and are not two separate units as in conventional cars. This construction undoubtedly helps to decrease rattles and squeaks and adds to safety in event of an accident. During the long hard test I made in the Rambler there was slight seepage of water during a moderate rain because of one poor-fitting door.

The brakes operate with slight pedal pressure and for normal driving are entirely satisfactory but there was some fading at high speeds and on winding roads. The Rambler brakes (and also the Statesman) are of the simple but dependable two-shoe design. Hydra-Matic Ramblers have a larger front brake drum to compensate for additional weight. In the larger and heavier Ambassador models the Duo-Servo system is used (where the two brake shoes are hooked together), thereby multiplying the braking effort by the brake pedal.

The spare tire is mounted outside the trunk, giving the car a somewhat sporty appearance. Through a lever arrangement, the tire quickly tilts backward on a hinge mount so it does not interfere with trunklid operation. In this hardtop model there is considerable space in the trunk for a 100-inch wheelbase car. Due to the tire location, the rear bumper extends a few inches farther. This overhang I found caused some scraping of the rear bumper, exhaust pipe or both in entering or coming out of driveways with sharp inclines.

I did not like the large turning radius, caused by the narrow front tread and the skirted front wheels.

Many drivers feel there is much road wander and bouncing about in a light car. This idea will be soon dispelled for anyone driving the Rambler 200 miles. ★ ★ ★

### Sedative Calms Fish

Sodium amytal, a sedative and hypnotic used to quiet patients before surgery, is soothing fish en route from state hatcheries to lakes and streams in California. Because the calmed fish use less oxygen, 500 instead of 200 fingerlings can be transported in a gallon of water to which has been added a half-grain of the barbiturate. As soon as the fish are dropped into fresh water they throw off the drug and swim away unharmed, in better condition than if the drug had not been used. Fewer trips by tank trucks and airplanes result in savings to the hatcheries.

# NEW

# DREMEL

# STRAIGHT-LINE ACTION

# SANDER

**JUST IN TIME FOR CHRISTMAS GIVING!**

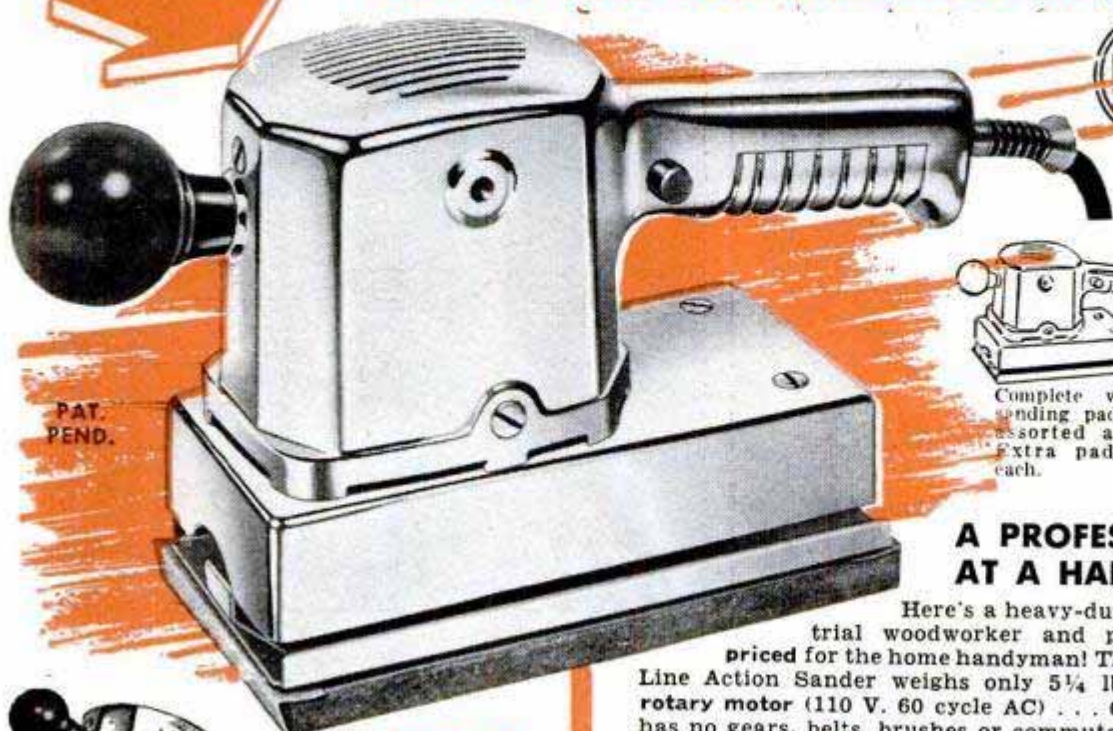

**HAS A POWERFUL ROTARY MOTOR!**



Complete with: two sanding pads, and 6 assorted abrasives. Extra pads \$2.75 each.

**\$34.85**

**A PROFESSIONAL SANDER AT A HANDYMAN'S PRICE**

Here's a heavy-duty sander built for the industrial woodworker and professional craftsman, and priced for the home handyman! The new Dremel "53" Straight-Line Action Sander weighs only 5 1/4 lbs., is driven by a powerful rotary motor (110 V. 60 cycle AC) . . . 6,900 strokes per minute . . . has no gears, belts, brushes or commutator to wear out and replace. Dremel Straight-Line Action guarantees satin-smooth finishes you'll be proud to show. Detachable paper holder speeds up paper changes. Use it for WET or DRY, coarse, medium or fine sanding . . . the Dremel "53" is positively the most versatile . . . the greatest sander value in today's market.

PAT. PEND.

**LIFETIME SEALED BALL BEARINGS**



**EASY ON! EASY OFF!**

Unique paper holder is detachable. Grits can be switched quickly without bothersome paper change.

25 sq. in. (3 5/8" x 7") sanding surface!

**Here's Why Craftsmen Approve... Use... Only Straight-Line Action Sanding!**

Wood fibers lie with-the-grain . . . are directional. Sanding cross-grain is much like brushing a suede jacket against the nap. It leaves marks or "scratches." Sanding with-the-grain is like brushing the suede with the nap . . . leaving a velvet-smooth surface, entirely scratch-free. Shown below are four common types of sanding actions. Only Dremel "Straight-Line Action" sands 100% with the grain . . . Only Dremel can guarantee 100% scratch-free finishes.

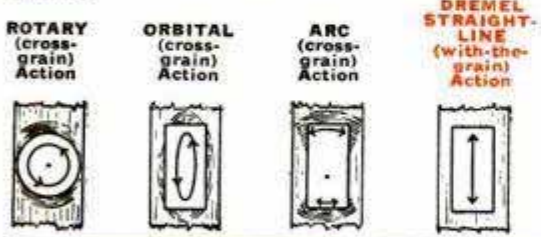

**SEE YOUR FAVORITE DEALER:** Dremel Tools are sold at better dealers everywhere. If your dealer can't supply, order direct on a five-day trial, money-back guarantee. Remit in full, and we will ship postpaid. Or, send only \$2.00 now, pay postman balance plus postage and C.O.D. fee.

**THERE'S A DREMEL SANDER FOR EVERY USE**



**DREMEL MODEL "2000" SANDER-POLISHER**

Perfect for small shop use, home repair, and workshop projects. Choice of craftsmen for fine finishing operations. Features Dremel "Straight-Line Action": 14,400 strokes per min.; 5 lb. wt.; 21 sq. in. (3 1/8" x 7") sanding surface.

Model "2000" Sander-Polisher, 25 ass't'd. abrasives, 1 polish pad in sturdy steel carrying case.. **\$24.50**

**DREMEL MODEL "A" SANDER-POLISHER-MASSAGER**

Lighter capacity model, a favorite for general home maintenance, hobbycraft, furniture polishing, etc. Effective body massager. Features Dremel "Straight-Line Action." Wt. 2 1/2 lbs.; 12 sq. in. (2 3/8" x 5 3/8") sanding surface.

Model "A" Sander-Polisher-Massager, 6 abrasives, 1 polish pad, 1 massage pad..... **\$14.85**

**DREMEL MANUFACTURING COMPANY, Dept. 113-L, Racine, Wisconsin**



## make your *HANDS* *MORE CREATIVE* with **x-acto Knives and Tools**

Creative hands can be your greatest asset... X-acto knives and tools help the intelligent coordination of active minds and agile fingers... they can develop skill and dexterity in any art or handicraft you select.



Whether it's boat whittling, model airplanes, wood-carving, leathercraft, model railroads or any other handicraft, you can make your hands more creative with "designed-for-the-job" precision-engineered X-acto knives, tools and handicraft kits.



X-acto offers the complete line of handicraft knives, interchangeable blades, tools and attractive kits



From 25¢ to \$30.—at dealers everywhere.



No. 82  
X-ACTO KNIFE CHEST  
\$4.20



Send 20¢ to cover postage  
for our new illustrated  
28-page Catalog.



**X-acto Crescent Products Co., Inc.**  
440 Fourth Avenue, New York 16, New York

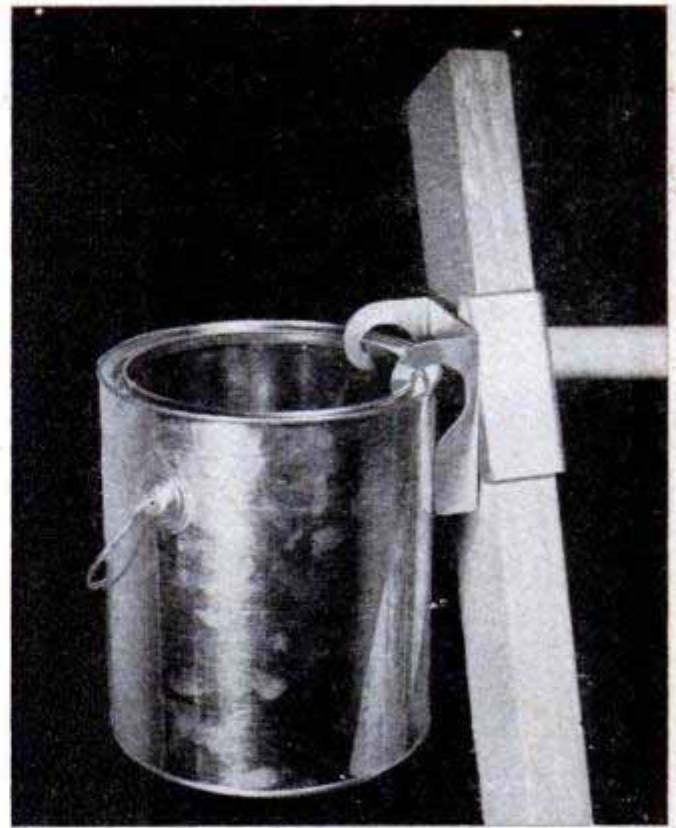

### Paint-Can Holder

Painting from a ladder is simplified by a fixture which holds a gallon paint can against the side of the ladder. The device rests on the frame, supported by an interior fastener which hooks to the rung. Two hooks on the outside grip the can firmly by the rim. The device may be used on either side of the ladder.

### Ceiling Fan

Good air circulation is claimed for a device of novel design. Three tiny fans suspended from the arms of a ceiling fixture rotate the hanger as they ventilate the room. The appliance, manufactured in Germany, is silent and is said to provide comfortable cooling.

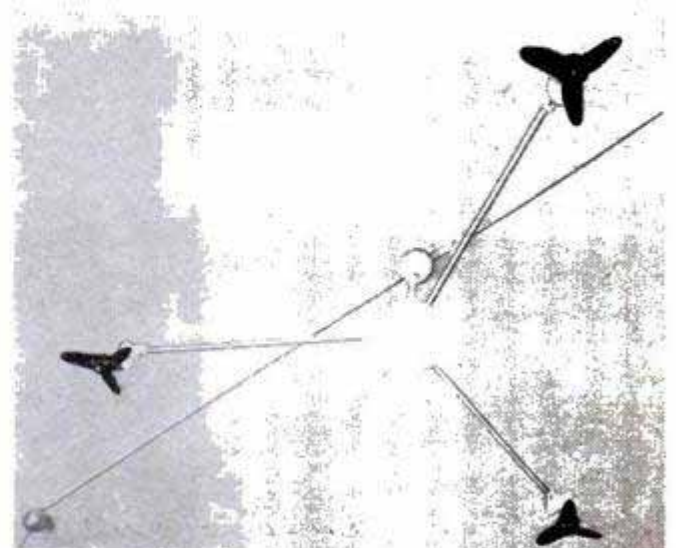

Send for Your  
**FREE**  
Copy of the NEW 1954  
**MIDWEST**  
**TELEVISION and**  
**RADIO Catalog**

# MIDWEST *Presents*

For 1954 a Completely NEW LINE of  
**21" and 27" TELEVISION**

CONSOLES  
TABLE MODELS

and  
**COMPLETE  
CHASSIS**

at  
**LOW FACTORY  
PRICES**



YOUR CHOICE OF EITHER 12 CHANNEL  
VHF or All-Channel VHF-UHF Models

Buy your Television or Radio Direct from the Midwest Factory . . . on 30 DAYS TRIAL . . . Easy Terms . . . and at LOW FACTORY PRICES. For 54 years Midwest, the world's largest and oldest exclusive Factory-To-You radio and television manufacturer, has served hundreds of thousands of satisfied customers all over the world.



**EASY TERMS**  
— — —  
**30 DAYS  
TRIAL**



## FACTORY-TO-YOU

Also—Powerful New 1954 World-Ranging  
**MIDWEST Series 16 RADIOS**  
In Beautiful Consoles and Complete Chassis

All models available in your choice of mahogany, walnut finish or blond lined oak.

Once again Midwest offers its famous series 16 five band AM-FM radio chassis and the magnificent new Symphony Grand Radio-Phonograph with 3-Speed Automatic Inter-mix Record Player. Also, a complete line of clock radios, table radios, and portables.

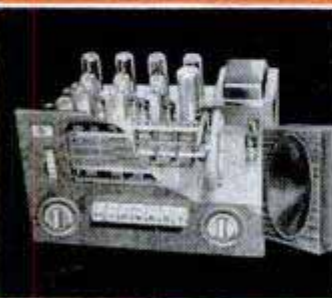

• WRITE IN NAME AND ADDRESS (PLEASE PRINT) ON COUPON OR 2c POSTCARD •

MIDWEST RADIO & TELEVISION CORP.  
Dept. D-25, 909 BROADWAY • CINCINNATI 2, OHIO

Please send me your new FREE 1954 Catalog.

NAME \_\_\_\_\_  
ADDRESS \_\_\_\_\_  
CITY \_\_\_\_\_ ZONE \_\_\_\_\_ STATE \_\_\_\_\_

**MIDWEST RADIO & TELEVISION CORP.**

DEPT. D-25, 909 BROADWAY, CINCINNATI 2, OHIO

## Prospectors in Parkas Chart Canada's Oil

(Continued from page 119)

priming coat would be followed by a coat of coal-tar enamel applied at a temperature of around 475 degrees F. Then would come a layer of glass-fiber matting and, on top of that, asbestos felt. In rock cuts, an extra layer of the felt, known as rock shield, could be applied.

It's unlikely that any company would want to lay such a costly line without an assured supply of at least 10,000 barrels a day, which would mean proved reserves of about 100,000,000 barrels. It would probably want assurance of well over 10,000 barrels a day even to start, and might want to plan on an ultimate movement of as much as 200,000 barrels daily. The quantity would determine the diameter of the line—probably between 18 and 24 inches—as well as the pumping capacity.

Now the \$64 question: the characteristics of the oil. Crude with a low viscosity and a low pour point is what oilmen hope to find there, since this kind is the easiest to move. The higher the viscosity and the pour point, the more heat will be required to keep the oil liquid enough to flow. The proportion of sulphur, asphalt and wax is also important. A high proportion of these would also increase heating requirements and would, at the same time, reduce the crude's usefulness at the pump stations. If the crude is relatively free of these, and if it has other good characteristics, the pump stations can be self-fueling. They can simply tap off their own fuel from the oil flowing through the line. They could thus be unattended—what oilmen call "satellite stations."

Once oilmen find just how much oil, with what characteristics, they have to move, they can plan a pipe line. In their words, "Nothing is impossible in this business. It's just a question of how much you're willing and able to spend, of how much something is worth to you." They say that if necessary they can build generator stations all along the line and heat the oil by electricity. Heat could be applied not only at pump stations, but also at separate installations between pump stations. More powerful pump stations, closer together, can be used to cross mountains. As for the geographical distance between stations, pipe liners fall back on their constant refrain: "It all depends on the situation. How much oil, what kind of oil, over what terrain? Maybe a station every 10 miles, maybe every 100 miles."

(Continued to page 264)



## Quit driving an oil-burner— get new piston rings!

Oil pumping is just the start of expense and trouble—the first danger signal from worn-out piston rings. The longer you let those old rings stay in, the more oil you'll use, the more power you'll lose, and the bigger your repair bill will be!

As your engine gets older, it runs hotter because of accumulations in the cooling system. The cylinders wear tapered and out-of-round—need more oil on the walls.

It requires a special type of piston rings—replacement rings—to deliver this extra oil, under full control, without waste.

Hastings makes replacement rings exclusively, devotes all its research on the highways and in the laboratory, to the particular replacement problems of each make and type of engine.

That's why Hastings Rings *stop* oil-pumping, *check* cylinder wear, *restore* engine performance—in re-ring, re-bore and re-sleeve installations.

So go to your motor specialist at the first sign of oil-pumping or performance drop-off. If rings are the trouble, ask him to install a Hastings Steel-Vent replacement set. Truly the best money you can spend on your car! Hastings Manufacturing Company, Hastings, Michigan; Hastings Ltd., Toronto; Piston Rings, Spark Plugs, Oil Filters, Casite, Drout.

## HASTINGS STEEL-VENT PISTON RINGS

*Regular or Chrome*

Tough on Oil-Pumping  
Gentle on Cylinder walls





# EXTRA QUALITY...especially for you

If you own a Plymouth, Dodge, De Soto,  
Chrysler, Dodge "Job-Rated" Truck



**MOPAR**

means genuine Chrysler Corporation  
parts and accessories

Chrysler Corporation believes in "taking care of its own". It provides the best possible parts for owners of its cars and trucks. These are MoPAR parts—your assurance of the *extra quality* that comes from the very finest of materials, the most skillful design, the most careful manufacture and inspection.

So let the MoPAR sign be your guide to thorough satisfaction—with parts that fit right and work right. Look for this sign, displayed by thousands of Plymouth, Dodge, De Soto and Chrysler dealers and many general service and repair shops.

Chrysler Corporation  
Parts Division  
Detroit 31, Michigan

## How to get more mileage out of your motoring dollar

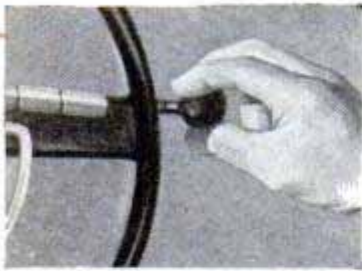

SHIFT WITH CARE

**Use low and second gears carefully** when starting. It's the mark of a good driver to shift at low speeds —

thus avoiding excessive engine wear and gas consumption. Experts agree the most economical shifting speeds are: low to 2nd—about 5 mph; 2nd to 3rd—between 10 and 15 mph

**Wash with a mild detergent** or auto soap. Strong cleansers quickly wash away protective wax coatings . . . may wear paint. After a good wax job, water alone should get the car clean. Later, a little mild soap or detergent may help. Frequent washing keeps gritty dirt from working into and damaging the finish.



NEVER USE STRONG SOAP

**Keep a clean oil filter on the job.** Your oil filter traps engine-wrecking abrasives and sludge out of engine oil. In time, however, any filter loads up—gets so clogged it can't filter anymore. Before that happens, put in a new Purolator Micronic\* Refill. Accordion-pleated,



FINEST OIL FILTER

plastic-impregnated element has up to 10 times more capacity than ordinary filters . . . stops dirt you can't even see. There's a Purolator\* engineered for every make of car and truck. Refills cost as little as \$1.60. Takes just a few minutes to install.

\*Reg. U. S. Pat. Off.

Check your oil filter every time you change your oil

**PurOlator**  
World's finest OIL FILTER



The experience of the Trans Mountain pipe line, now under construction from Edmonton to Vancouver, offers some clues to what might be required farther north. This line is in relatively "easy" terrain, but construction is so tough that it's already being called the "Inch-by-Inch" and the "Robert Ripley" line. This line expects to get by with only five pump and booster stations along its 711-mile length, but the total cost of the line will crowd \$100,000,000, and about \$5,000,000 worth of crude will be required just to fill it. This 24-inch line is being built for an ultimate movement of 200,000 barrels of crude a day.

On the exploration job, there's nowhere to go and nothing much to do except work, so the men put in long hours, seven days a week, for long stretches. They also save money, since there's no place to spend it. When, as they say, they're "bushed," they're flown into civilization—which may be anywhere from New Orleans to Montreal—where they relax and kick up their heels until they're ready to go back into the bush for another hitch. Since recreations are few, reading, playing cards and listening to records constitute the main amusements. All seismic camps are equipped with two-way radio systems, but these have to be kept free for urgent communications.

It's a hard, lonely life but it may mean fuel in the gas tank of your automobile a few years hence. ★ ★ ★

## Antirust Fluid in Oil Tank Stops Leaks for Three Years

Leaks caused by corrosion in fuel-oil tanks are prevented by a new crystalline substance developed by the Shell Oil Company. Experiments indicate the corrosion results from water created by moisture condensing within tanks from the humid air breathed in through the vents. Being heavier than oil, the water sinks to the bottom and lies in small droplets. A tiny electric current is set up through the water, eating away the steel and converting it to rust. It deepens into a pit, then eats through to cause a leak. The new substance, called Sonitor, sinks to the bottom and mixes with the water. It stops the electric current that attacks the metal, as well as reacting with the metal to form a protective coating on it. The contents of one small can are sufficient for three years of protection.

☐ In 1952, according to the U. S. Department of Agriculture, there were 4,170,000 tractors on American farms, compared with 1,545,000 in 1940.

MANY ITEMS JUST RELEASED

# GOV'T. SURPLUS and other BARGAINS

SHOP BY MAIL SAVE

ORDER DIRECT FROM AD \* ALL ITEMS UNCONDITIONALLY GUARANTEED

## FREE FALL EDITION

1953 CATALOG, 52 Pages, chock-full of unsurpassed War Surplus Equipment Bargains for farm, home, factory and workshop. Every item is unconditionally guaranteed. You save on everything! Write today.

### D.C. GENERATORS

**ITEM #91** Type R-1, rated 300 Amps.—30 Volts. Mfd. by Jack & Heintz, Acq. Cost \$380.00. Shpg. wt. 55 lbs. Dimensions 16" x 10" x 7". F.O.B. Chicago. . . . . **35.00**

**Item #176**—Type L-3, Rated 25 amps., 24 volts. Manufactured by Leece-Neville Co. Shpg. wt. 30 lbs. Dimensions 12" x 6 1/2" x 5 1/2". F.O.B. Chicago. . . . . **16.50**

**Item #90**—Type P-1, rated 200 Amps.—28 Volts, 2500 RPM. Mfd. by General Electric, Ford, Delco-Remy and Westinghouse. Gov't. Acq. Cost \$300.00. Shpg. wt. 55 lbs. Dimensions 15" x 9" x 6". F.O.B. Chicago. . . . . **22.50**

### GENERATORS

**MANY SIZES FROM 350 WATTS TO 25 KVA**  
**ITEM #183-3000 to 4000 Watt Generator Set**  
**FEATURES**—Power for your home or business. Simply connect to power panel or house circuit. • Constant voltage regardless of load. • Push button start or stop. • Easily made full automatic start or stop. **SPECIFICATIONS**—Size 19"x30"x48". Steel skids, weatherproof housing, requires no building. Wt. 725 lbs. • Hercules 4-cyl. 10 HP gasoline engine. Load governor. Oil filter. Quiet muffler. 6-volt starter generator. • Hobart 115 volt, 60 cycle, 3000 to 4000-watt generator. Furnishes either single or three-phase power, 2 or 3 wire. • Panel contains oil gauge, voltmeter, ammeter, circuit breaker, voltage regulator, start button. Today's cost over \$1200.00. **SALE PRICE, F.O.B. Chicago. . . . . 465.00**

### GOV'T. SURPLUS! JUST RELEASED!

**2-TON, 6-WHEEL HYDRAULIC LIFT TRAILERS**  
**USE FOR:** Conveyor ramp • Boat trailer • Lumber • Pipe • Pole trailer • Machinery trailer • Hydraulic dump for grain wagon • Coal truck • Lift truck • Variable height hydraulic work table • Removable rack permits use of hydraulic lift for other installations. Outstanding features of these Trailers are:—4000 lbs. payload. 2 individual hydraulic lifts complete with hand pumps and valves. 6-18" x 5.5 pneumatic tires. Manual screw-down brakes. Ball-bearing axles. V-shape load rack—8' long. Towing tongue. 54" lift. Wheelbase 98". Ground clearance 4 1/2". Tread width—52". Overall width—58". Overall length including drawbar—167". Gov't. cost \$685.00. Ship. wt. 1400 lbs. F.O.B. Chicago. . . . . **169.50**

Use the adjustable height load rack for boats, lumber, poles or pipe. By adding a plate, you have a ramp adjustable to freight car or truck body height. Add a grain wagon body to the frame for a perfect self-contained hydraulic dump wagon. Mount work-in-process on trailers, permitting adjustment of work height for maximum efficiency. Easy launching and recovery of boats from sloping beaches is done by hydraulically raising and lowering either end of load rack.

### ELECTRIC GENERATOR SET—MODEL 2510

2500 watts, 115 volts, 60 cycles, single phase, A.C. electric generating plant, powered by dependable 6.5 H. P. Wisconsin engine—Two pole ball bearing belt driven high efficiency generator with heavy duty windings for high torque motor starting loads. Rated 3000 watts for intermittent service. Light weight portable rugged unit, easily transported to job site. Consumes 3 quarts of gas per hour at rated load. Dimensions: 24"x20"x24", ship. wt. 220 lbs. Complete with fused outlet box and voltmeter. F.O.B. CHICAGO. . . . . **329.00**

**Item #178**—350 Watt—110 Volt—60 Cycle A.C. Model MS-35-3, made by Midco Mfg. Co. 1 cylinder, 4 cycle engine complete with muffler, starting rope and oil bath air cleaner, direct coupled to a 350 watt generator with voltage control rheostat and twin outlets. Engine speed 1800 R.P.M. Shipping weight 116 lbs. F.O.B. Chicago. . . . . **89.00**

### BRAND NEW — BERRY — HEAVY DUTY HYDRAULIC PUMP OR MOTOR

**ITEM #166** — use on farm equipment, road machinery, vibrators, paper mills, wire reels, hydraulic brakes. Ball bearing construction, balanced cam design assures high efficiency performance. When used as a pump: delivers 11 G.P.M. at 1000 P.S.I. At 1800 R.P.M. as a HYDRAULIC MOTOR: Rated up to 12 H.P., up to 2400 R.P.M. Standard 3/4" pipe thread ports. 3/4" shaft with keyway. Dimensions: 14 1/2" x 8" x 7". Weight 63 lbs. Regular price today \$212.00. Our money saving price F.O.B. Chicago. . . . . **110.00**

**Item #150**—Double acting hydraulic cylinder, 2 3/4" bore, 12" stroke. Use either foot or clevis mounting. Will lift 4400 lbs. using 1000 P.S.I. Overall length 19 1/2". Shpg. wt. 18.00 lbs. Postpaid. . . . . **18.00**

**QUICK DISCONNECT HYDRAULIC HOSE COUPLER** — **Item #309** — Self sealing, for uncoupling oil lines under pressure. Made by the Brunning Company. Each end threaded for 1/2" pipe connection. Rugged three piece precision steel construction. 4" long, 1 1/2" dia. Ship. Wt. 2 lbs. Regular price \$12.50. Special price . . . . . **5.75**

### CENTRIFUGAL PUMP

**General Motors — Allison**  
**200 GALLONS PER MINUTE**  
**For Draining Basements • Fire Fighting**  
**Irrigation • Fuel Transfer**  
**Swimming Pools • Home Water Systems • Dewatering**

For high volume commercial, home and industrial use. Standard 2 1/2" pipe thread inlet, twin 1 1/4" pipe thread outlets. Ball bearing supported 3/4" shaft. Easy priming. Rotation, counter-clockwise facing shaft. Gov't. acq. cost \$145.00. Complete with full instructions. Ship. wt. 35 lbs. F.O.B. Chicago. . . . . **39.50**

Will deliver 200 gals. per min. against 65 foot head using 5.2 H.P. at 3500 R.P.M.

### HEAVY DUTY HYDRAULIC and AIR EQUIPMENT

Large supply of new labor-saving, economical hydraulic equipment in many types and sizes. Use these positive, highly efficient smooth pressure hydraulics on presses, arbors, lifts, loaders, power control, positioning, brakes, plastic dies, auto frame alignment, etc. **ALL ITEMS BRAND NEW.**

### HYDRAULIC SPEED REDUCER

**WITH FINGERTIP CONTROL**  
**USE FOR:** • Reamer Drives • Midget Cars • Feed Mills • Canning Machines • Conveyors • Lathes • Milling Machines • Motor Boats • Cream Separators • Garden Tractors • Pumps

Variable output speeds from 0 to input speed available by moving control handle. Locking handle maintains setting. Use input power of 1/4 to 1 1/2 H.P. This Westinghouse-Oil Gear Unit consists of a variable displacement hydraulic pump feeding a fixed displacement hydraulic motor. Adjustable relief valves set at factory for 100 inch pounds of torque may be reset up to 180 inch pounds. Independent reverse control allows full output power and speed selection in either direction of rotation. Shafts measure 5/8" diam., include keyway. Input rotation is counter-clockwise facing shaft. Recommended input speed not to exceed 750 R.P.M. Over-all dimensions, 7 1/2" x 7 1/2" x 11 1/2". Gov't acquisition cost \$428.00. Shpg. wt. 31 lbs. Complete with 2 qts. of oil and full instructions. F.O.B. Chicago. . . . . **54.50**

### EXTRA HEAVY DUTY Double Action HYDRAULIC CYLINDER

**Item #224**, 3 1/4" bore, 24" stroke, will lift 8250 lbs. with 1000 P.S.I. line pressure. 1 1/2" pipe thread ports—13/8" stress-proof ground, polished & plated solid steel shaft. Overall length closed 36". 1/4" steel wall cylinder barrel clevis mounting at base and shaft. Features — Tie Rod construction. Honed barrel. Ship. wt. 50 lbs. F.O.B. Chicago. . . . . **39.60**

**TO PLACE PHONE ORDERS CALL WEBSTER 9-3793**

### Item #126—Four-way, open center control valve with built-in adjustable relief valve. Factory set at 1000 P.S.I., spring loaded neutral position, for use with one double acting cylinder. In neutral position cylinder is locked and pump unloaded. Fully balanced plunger type smooth, positive, easy operation. Can be used as single unit or mounted in series of any combinations desired. Has 3/4" pipe thread inlet and outlet. 1 1/2" pipe thread cylinder ports. Newly manufactured to our specifications. Ship. wt. 8 1/4 lbs. An outstanding buy! F.O.B. Chicago. . . . . **21.50**

**Item #1036**—Double acting hydraulic cylinder, 3" bore, 36" stroke, 1 1/2" pipe thread ports, 1 1/4" solid steel shaft. Overall length closed 49". Clevis mounting at base and shaft. **FEATURES** • Cup & Chevron Packing • All Welded Construction • Precision Ground and Honed Construction • Will lift 7000 lbs. using 1000 P.S.I. line pressure. Wt. (net) 57 1/2 lbs. F.O.B. Chicago. . . . . **50.00**

**Item #16C**—Double acting hydraulic cylinder, 1 1/2" bore, 26" stroke. Will lift 1760 lbs. with 1000 P.S.I. line pressure. Weight 8 lbs. A \$55.00 value. Now only Postpaid . . . . . **16.95**

### ROSS 4-WAY FOOT OPERATED AIR VALVE

**BRAND NEW—Item #60**—For double-acting pneumatic devices. Fine for operating presses, air vises, air machinery of many types. Heavy duty cast construction. No neutral position. Maintains pressure against the piston when the foot control is in the "Up" position. Threaded for 1/2" pipe. Dimensions of valve body: 7 3/4" long x 4 1/4" width x 7 1/2" high. Net weight 28 lbs. A \$84.00 value for only **19.50** F.O.B. CHICAGO

### NEW AIR FORCE SURPLUS — SHATTERPROOF AIR TANK

**Item #303**  
**ITEM #303**—Use for air compressors, surge tanks, CO-2 tanks, liquid containers, floats, buoys. 24" long —4" diameter—1 1/2" pipe thread port. Ship. Wt. 10 lbs. F.O.B. Chicago. . . . . **2.50**

ORDER DIRECT FROM AD — SEND PAYMENT OR PURCHASE ORDER TODAY — SATISFACTION GUARANTEED

**GROBAN SUPPLY CO., 1139 SO. WABASH AVE., CHICAGO 5, ILL. DEPT PM-11**



## A tip for the 'Missus' who wants Christmas kisses

**GRIP-SNIP**



... the  
**Hercules  
Plane**



Both these SARGENT tools will gladden the man in her life!

If she doesn't know what to give you . . . if she throws out hints about neckties and such . . . prop this page open where she will be sure to see it.

You know you need SARGENT GRIP-SNIPS\*. You've seen them displayed at your hardware dealer's. You've admired their pleasant 'heft' in the hand, the narrow, parallel jaws, their powerful vise-like grip, their decisive wire-cutting action.

You also know how handy a SARGENT "Hercules" plane would be. Sturdy. Made the Sargent way, with Vanadium tool steel "Golden Cutter" blade, and strong, true iron frame and reinforced bed.

Ask your hardware dealer to show you SARGENT GRIP-SNIPS and a Hercules "Golden Cutter" Plane. Or write direct to Dept. 20L.

\*TRADEMARK



**SARGENT &  
COMPANY**

New York • NEW HAVEN, CONN. • Chicago

Builders Hardware and Fine Tools since 1864

## Smoke-Eaters With Sea Legs

(Continued from page 142)

returned to the piers and doused them. Ship fires pose tough problems for the fireboats. When all the monitors are spewing tons of water over the same side at once, the back pressure will send even the heavy *Fire Fighter* scooting sideways, away from the blaze she's trying to subdue. If you ever see a fireboat spraying water away from a fire, chances are she's holding her ground against back pressure.

One of the worst ship fires, the men think, was the *Black Gull*. "We met her off Montauk," says McKenna. "In some spots her hull plates were white hot. We had to use some monitors to hold position while we sprayed her for 2½ hours so she'd be cool enough to get lines aboard. Then we threw up hook ladders and climbed in. Naphthalene on her deck flared like explosives. We found four bodies aboard. Three were near the rear rail. They'd been racing to get over the side but never made it."

For sheer heroics, few wild tales can match the job the men did on the freighter *El Estero* during the war. Every available fireboat in the fleet was in on that fire. *El Estero* was loading ammunition at the Caven Point pier, close by the biggest ammunition dump on the East Coast, when fire broke out in her engine-room bilge. Flames raced up through hatches to the cargo hold and lapped against the ammunition storage bulkheads. When the boats

(Continued to page 268)

With pneumatic drills, firemen chip holes through concrete pier floors to get at blazing piling beneath  
N. Y. Fire Department photo





# Give yourself years of easier, faster painting pleasure with a DeVilbiss Home Spray Outfit



P-NCD OUTFIT

## \$85<sup>95</sup>

F.O.B. Toledo, Ohio

### Complete outfit includes all this:

- heavy-duty 1/3-hp. electric motor with switch, electric cord and plug, and sturdy, long-lived diaphragm compressor
- precision-built fully adjustable spray gun
- full one-quart aluminum paint cup
- 12-ft. air hose with connections

Save hundreds of dollars in just a few years with an easy-to-operate DeVilbiss Home Spray Outfit. Do your home and shop painting in 1/4 the time. Get better finishes *whatever the material used*. Top results with paints, lacquer, enamel, varnish, synthetics. Other "bonus" uses: mothproof clothes, spray home and garden insecticides, apply car or floor wax, inflate tires. Sold by automotive jobbers, paint, hardware and department stores and other paint outlets. Available in Canada.

### THE DEVILBISS COMPANY, Toledo, Ohio

Windsor, Ontario • London, England • Santa Clara, Calif.



## "Spray Painting Made Easy"

Ask your local dealer for 34-page booklet "Spray Painting Made Easy"—a complete spraying guide for home owners and craftsmen—or mail coupon and 35c in coin.

**The DeVilbiss Company**  
 Department PM-11, Toledo 1, Ohio

- 35c in coin enclosed. Send me spray painting booklet.
- Tell me where I can see a DeVilbiss Outfit.

Name \_\_\_\_\_  
 Address \_\_\_\_\_  
 City \_\_\_\_\_ Zone \_\_\_\_\_ State \_\_\_\_\_

# WEEK-END DECORATORS!

## Peel off old paint FOR A BETTER JOB



Why try to paint over a cracked, checked or broken finish . . . when it's so easy to "peel it off" with Klean-Strip? This modern remover leaves the surface clean, smooth and dry — ready for a

better, longer-lasting paint job. Non-inflammable Klean-Strip works fast on all type finishes. Needs no afterwash or neutralizing . . . saves labor and materials. Buy it when and where you buy paint.

**Made by The Klean-Strip Co., Inc.**

2340 S. Lauderdale, Memphis 6, Tenn.

**KLEAN-STRIP TAKES OFF ANY FINISH**

Clip and save these  
**GOOD SHORT-CUTS**  
from "Handy" SANDY



**Quick fix for doors that stick on the bottom:** Insert a sheet of Medium CARBORUNDUM Brand Flint Paper between door and saddle—grain side up. Close and open the door until it's free. (If the paper won't "sit still", fasten it to the floor with FLEXBAC Masking Tape—Peels off quickly, leaves no trace.)

**It's easy to true small miter joints this way:** Glue two strips of CARBORUNDUM Brand Flint Paper—one Medium, one Extra Fine—to the top of your work-bench. Rub the joint back and forth, applying pressure on point or heel as needed.

**Pays to have an assortment of CARBORUNDUM Brand Flint Papers in your tool kit or workshop.** Five useful grades: Extra Fine, Fine, Medium, Coarse, Extra Coarse. Get my inexpensive "Handy Sandy" Assortment, and some full sheets, from your favorite hardware store or lumber dealer—today! And pick up a roll or two of FLEXBAC Masking Tape—another top-quality work-saver by CARBORUNDUM.

**Free! "How to Sand"**—new pamphlet by CARBORUNDUM. Ask for it—send a postcard to me.

**"Handy" SANDY**  
**CARBORUNDUM**  
Niagara Falls, New York

"CARBORUNDUM" AND "FLEXBAC" ARE REGISTERED TRADEMARKS OF THE CARBORUNDUM COMPANY, NIAGARA FALLS, NEW YORK

90-329

arrived, it was obvious that at any moment the ship would blow skyhigh—and with it would go everything in sight, including Caven Point.

In the face of this threat, fireboats started to tow her away from the pier. As she inched slowly from the stringpiece, gasoline drums on her deck began to explode. Gushing monitors were brought into play and sent the drums spinning across the deck and into the water, spreading liquid fire across the surface. It was a life-and-death race, for the monitors couldn't reach the fire that was warming up the big shells deep in the hold. "Every man aboard the *Fire Fighter*," says Jim McKenna, "figured it was his last day—and I guess the other crews felt the same. The suspense was terrific. She didn't go. They got her out into the river, aimed all monitors at her open hatches and with painful slowness she settled to the bottom of the river, sizzling and bubbling. But if it hadn't been for the Marine Division's grim determination, an epoch-making disaster would have been written in the history books that day. ★★ ★

## Kurtis Offers Chassis For Build-a-Car Enthusiasts

Enthusiasts who prefer to assemble their own competition cars can now buy a 300-pound chassis patterned after the 1953 Indianapolis winner driven by Bill Vukovich. The chassis has a 100-inch wheelbase and is available with various assemblies including torsion-bar suspension, rear axle, steering gear, radiator and brakes. The 300-pound weight includes all these items plus running gear. The frame is of seamless steel tubing with an X-channel stiffening cross member. Adaptable to either a metal or plastic body, the chassis can be used for both competition and highway driving.

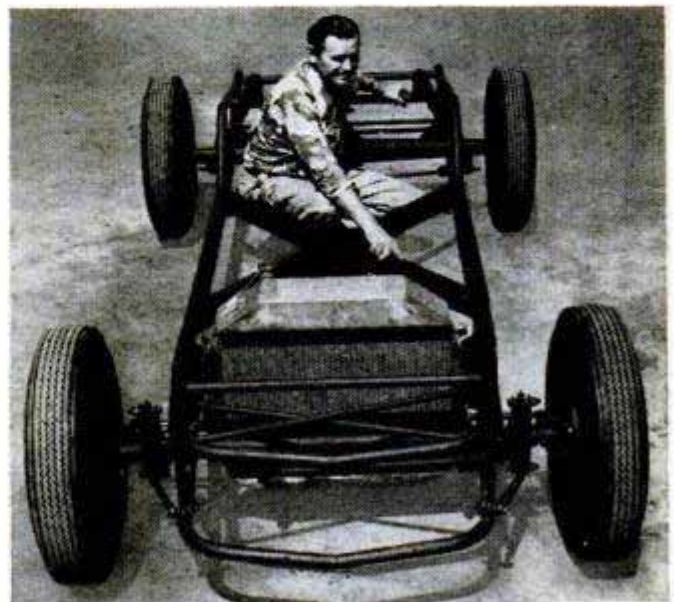

POPULAR MECHANICS



# to help you better organize your tools IN WORKSHOP AND GARAGE

## PANELS AND FIXTURES

Imagine... all your tools neatly arranged and easy to reach... paint cans on shelves... your bottles of nails in handy racks... and all on a set-up you can install or change to a different arrangement in *minutes*. "PEG-BOARD" perforated hardboard with hanging fixtures has dozens of uses throughout your home—in closets, bedrooms, kitchens, etc.

Special fixtures lock into place in seconds... are easily removed.



**WRITE TODAY** for illustrated descriptive booklet, "Home Decorating Ideas with 'PEG-BOARD' WORKING WALLS".

"PEG-BOARD" is the Reg. T.M. of the B. B. Butler Mfg. Co., Inc. used to identify its products.

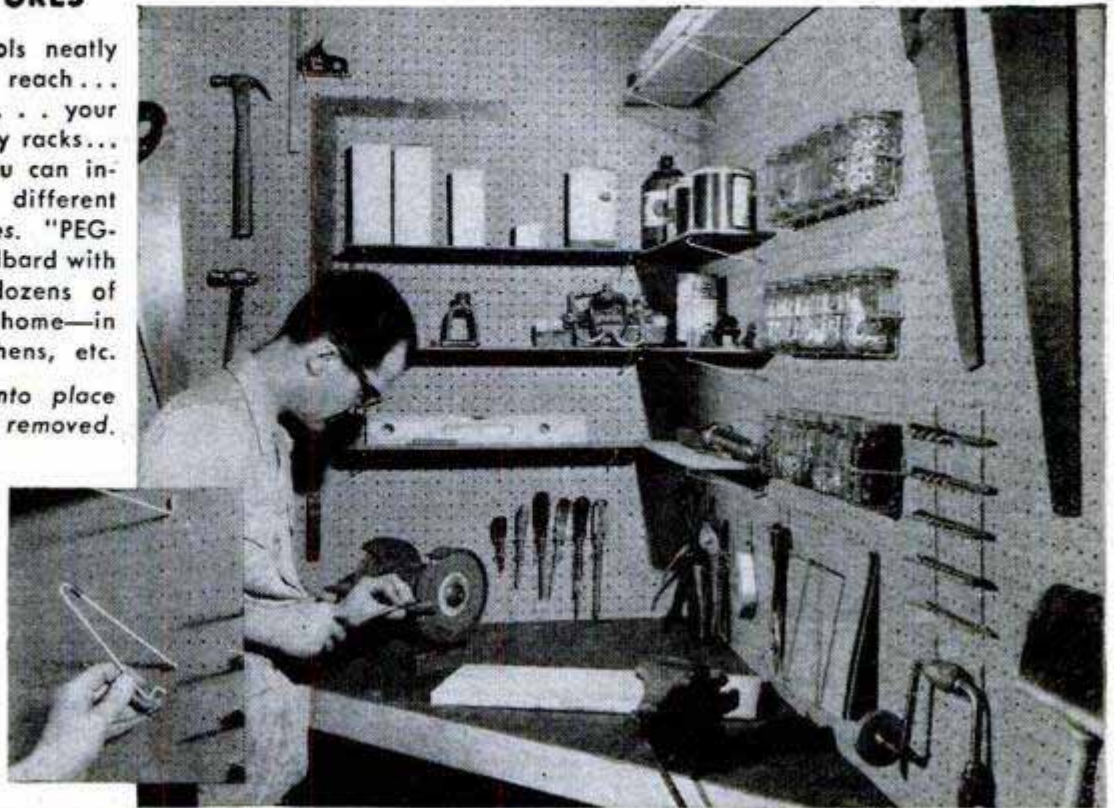

Copyright 1953 by **B. B. BUTLER MFG. CO., INC.**, 3155 Randolph Street, Bellwood, Illinois

## A PROFESSIONAL PRECISION TOOL!

# 8" TILT ARBOR SAW

CUTS 2 x 6's  
IN 2 1/2 SECONDS

ALL METAL

SAVE \$20 to \$40!

**\$19.95**

Blade  
\$2.95  
Extra

West of the  
Mississippi \$21.95

\*Patent Number 2590035



**ONLY REAL IMPROVEMENT  
IN TILT ARBOR SAW IN 75 YEARS!**

**PLANA CENTRIC SUSPENSION**

*"Tilt the Blade — not the Table"*

This revolutionary invention slashes costs yet gives you rugged, accurate, lifelong service. No expensive worm gears or winding wheels... saw blade, arbor and tilting-raising-lowering mechanism mounted on one simple unit — adjusts instantly for height and tilt, locks rigidly.

### DOES WORK OF '60 SAWS!

**RIPS** any length, any type wood, plywood, composition panels, any thickness up to 2 1/2".

**MITRES** — smooth, accurate cuts from perfect right angle to 45° either way, compound angles, too.

**BEVELS** — blade tilts, table stays level — safer, no binding because wood doesn't fall on blade.

**DADOS** — Removable throat insert lets you use dado or molding cutters, grinding wheels, sanding discs, etc.

**PATENTED** motor mount — 1/4 or 1/2 h.p. motor rides on ball-bearing rollers, keeps belt tight, transmits full power to blade.

### YOLANDS PRECISION TOOL CO., Dept. PM11-3

20 Boylston St., Boston 16, Mass.

Rush me your new ALL-METAL 8-INCH TILT ARBOR POWER SAW. I enclose  check  money order for \$19.95 (\$21.95 West of the Mississippi) plus \$1.00 for postage.

**Budget if you choose: send \$5.00 with coupon, \$5.00 per month thereafter.** (Your money back if not satisfied in 10 days.)

Name.....

Address.....

City.....Zone.....State.....

If 8" combination Rip and Cross Cut Blade is desired enclose \$2.95 extra and check here

## Fortunes in Toy Ideas

(Continued from page 92)

ness. They had a small machine shop in a suburb of Cincinnati. For months they pored through trade journals in search of possible products—something that could be stamped, pressed and embossed in metal. These were the only operations their machines could perform.

One bleak morning in early December, 1945, Charles was sitting disconsolately in his office. Christmas was just around the corner, but he couldn't get in the spirit of the season. Then Fred walked into the office with a wooden toy truck under his arm. It was an old fire truck he'd received when he was six years old.

"Thought I'd fix it up and give it to the kids at Christmas," he said to Charley. The two of them started to repair the toy, replacing a missing wheel, straightening the axle and brightening it up with a new coat of paint. Fred remarked that he could probably make even better fire trucks out of metal. The spark of his idea blazed the two brothers into action.

"Why not?" said Charley. "We could make model toys that wouldn't fall apart under the most savage treatment." They decided to manufacture scale models of real construction and fire-engine equip-

ment. Despite the fact that they were making toys at a new high in selling price, from \$12 to \$20, their accurate, durable trucks and road-building equipment became a whooping success. Today 270,000 Doepke toy trucks and machines annually roll off the assembly line in their new manufacturing plant at Rossmoyne, Ohio. Manufacturers of real construction equipment are begging Doepke to make scale-model duplicates of their own brand-name trucks and machinery for two very good reasons: To promote good will among thousands of "tomorrow's" customers, and to be used as samples by their salesmen.

A few toys are invented by accident. One called "Slinky" actually walked right into someone's life. A 29-year-old engineer, Dick James, was employed by a Philadelphia shipyard in 1943. He was trying to mount delicate marine torsion meters so they would be both free of the savage roll of a ship in heavy seas and protected from the recoil of heavy gunfire. One idea was to suspend them on springs.

He tried hundreds of springs of different sizes and tensions, piled them on his desk when they didn't work. One day something jarred one coil loose and it commenced to strut down a pile of books like an animated accordion. As the top of the spring would

(Continued to page 272)

## UNCLE WALTER

**IT SMELLS GRAND**



AROMA PROMISING SWEET RELEASE

**IT PACKS RIGHT**



CUT TO PACK  
SO JOYS INCREASE

**IT SMOKES SWEET**



MAKES EVERY PIPE  
A PIPE OF PEACE!

**IT CAN'T BITE!**

SIR WALTER RALEIGH'S BLEND OF CHOICE KENTUCKY BURLEYS IS EXTRA-AGED TO GUARD AGAINST TONGUE BITE. STAYS LIT TO THE LAST PUFF. AND NEVER LEAVES A SOGGY HEEL IN YOUR PIPE.



*It costs  
no more  
to get  
the best!*



**RELIEVES  
HEADACHE  
NEURALGIA  
NEURITIS PAIN**

**FAST**



**Here's Why...**

Anacin® is like a doctor's prescription. That is, Anacin contains not one but a combination of medically proved active ingredients. Anacin is specially compounded to give **FAST, LONG LASTING** relief. Don't wait. Buy Anacin today.

**Crosman for Christmas**

WRITE FOR CATALOG

HIGH-POWERED .22 CAL. PNEUMATIC RIFLE

At dealers everywhere

Rifled barrel, military stock, adjustable sights, bolt action, wt. 4 lbs. 10 oz.

**\$13.50**

CROSMAN ARMS CO., Fairport, N. Y., Dept. 45

**LAWN ORNAMENT-NOVELTY PATTERNS**

28 Lawn Ornament Patterns, 25c. Other Patterns: 15-20" high: Dutch Girl, Dutch Boy, Pirate, Bull Terrier, Mexican Girl, Mexican Boy, Dwarf, Penguin, Flower Girl, 15c each. 25 Novelty Patterns, 30c. All 62 Full Size Patterns, \$1.00. Strother Pattern Service, Dept. DN-8, Box 128, Belington, W. Va.

WITH **Mortite** YOU CAN WEATHERPROOF A WINDOW FOR 29¢

This is *modern* weatherstripping... quick, thorough, economical. You just press it into place around windows, transoms, baseboards. No tools, no tacks, and practically no time. Amazing MORTITE stays on indefinitely, yet can be stripped off in seconds. Try it! Keep out chilly drafts, soot, etc. Hundreds of other plugger-upper uses the year around. 29c, 98c, and \$1.25 at stores. Higher West of Rockies and Canada. Write for circular.

J. W. Mortell Co., 522 Burch St., Kankakee, Ill.



**MEN!** Here's how to get the Black & Decker tool you want this Christmas —

**CUT OUT—PUT WHERE YOUR FAMILY WILL SEE**



**NEW!**  
**1/4" Deluxe DRILL KIT**  
only **\$46.95**



Makes home repairs, projects easy! Includes 1/4" Utility Drill, horizontal stand, wire wheel brush, grinding wheel, arbor, 13 drill bits, paint mixer, sanding pad and discs, in steel case.

**DO 1001 JOBS!**

Home chores actually become fun when a B&D Drill replaces hand labor! Remove paint & rust, sharpen cutlery, put up shelves faster, easier and neater!



**NEW!**

**1/4" All-Purpose DRILL KIT**  
only **\$52.50**



Includes: 1/4" All-Purpose Drill, 7 drill bits, 3 wood bits, countersink, sanding pad and discs, polishing bonnet, electric wax, and paint mixer, in fitted steel box that can be mounted easily on your workshop wall and quickly removed for carrying to the job. The perfect Christmas gift!

**No. 44 SANDER** Fast-cutting, powerful orbital sander gives satin-smooth finish on wood or metal; eliminates hand sanding. Powered by B&D-built motor. Only **\$46.95**



For free booklet, "Handy Tips for Handy Men," full of hints for home repairs and projects, write: Bob Davis, Dept. H11M, THE BLACK & DECKER MFG. CO., Towson 4, Maryland.

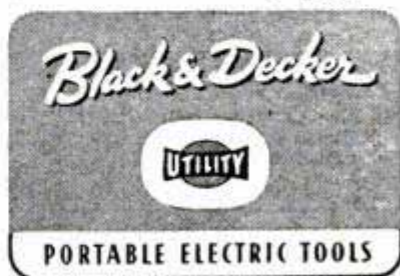

# Science Speeds Shaving With "Canned Lather"!

That's right! They've invented a gadget that makes your shaving mug obsolete! Now you can get rich, creamy lather right out of a can. No brush, no greasy cream. Just push valve—out comes lather! New AERO SHAVE contains 3 beard softeners, wilts toughest whiskers in hard or soft water. And built-in Lano-Lotion soothes your skin. Handy metal container has turret top; won't leak when you travel. Get an AERO SHAVE Lather Bomb. Only 59¢.



## WAKE UP

### to a Warm House — with the



ONLY \$12.95

## PARAGON Nightrol

Here's how the Nightrol works for you!

**Every Morning.** Automatically turns up heat before you awake. Lets you dress in warm comfort.

**Every Night.** Automatically turns heat down 6° to 10°. Keeps home cooler for greater comfort while you sleep. Saves up to \$40 on fuel each year.



\*According to Government Surveys. Install it yourself! It's easy! Timer plugs directly into convenient electric outlet. Set back unit attaches directly into thermostat. Then set it and forget it . . . that's all there is to it. Approved by U.L. as a safe appliance for the home.

ENJOY ECONOMICAL AUTOMATIC HEAT CONTROL . . . MAIL COUPON TODAY —

PARAGON ELECTRIC CO., Dept. PM101, Two Rivers, Wis.  
 Please send me complete information on Paragon Nightrol.  
 Please send me a Paragon Nightrol. Enclosed is check or money order for \$12.95.

Name.....

Address.....

City.....Zone.....State.....

© 1953

reach a lower level, the bottom part would snap over its head like a tumbling acrobat and go down to the third level. James took the wire coil home for his children. The accidental plaything became a neighborhood craze. James began thinking seriously of marketing his toy but manufacturers told him he was crazy. "It's only an unpainted spring. You can't sell that as a toy." But James was too fascinated to give up. In the summer of 1945 he found a machine shop that would make the 2½-inch stack of 98 coils. He ordered all he could pay for. Then he went through four weeks of arguing with store buyers to give him counter space. Finally one relented, and with James demonstrating his slinky traveler, the store sold 450 within one hour and a record-breaking 20,000 before Christmas.

On James' desk in Clifton Heights, Pa., there's an annual pile of orders for more than 100,000 of these metal shavings. They come from all over the United States and from 20 foreign countries. After 10 years "Slinky" is still literally walking around the world.

Adult activities fascinate children, and more than one successful toy came from someone with an eye for simplifying something and putting it in a kit.

In 1912, A. C. Gilbert of New Haven, Conn., was an Olympic pole-vaulting champion three years out of Yale. One afternoon on his way to New York he watched workmen erecting steel towers and frames to support new power lines. He admired the way the girders could be used for so many different purposes. That night he designed some miniature girders out of cardboard and started building his own railroad, electric towers and bridges. But the cardboard wasn't durable enough, so Gilbert decided to make them out of steel. He got a local New Haven toolmaker to help. For some time he kept his hobby set to himself. When his company, the Mysto Manufacturing Company, needed another product besides magic sets to bolster lagging sales, Gilbert decided to give his steel girder construction set a fling as a toy. His toy is the world famous Erector set and three years after its birth it had netted Gilbert \$300,000. Today he is a millionaire.

In practically all the above examples of toy inventing, there is one underlying theme. The toys were imitations of something in adult life. There are thousands of dollars of unwanted "space" toys and nuclear-fission chemistry sets lying under counters today because some inventors were more "out of this world" than the toys. Fission to a child is something that should be done with a rod and reel. So, keep your idea simple, and good luck. ★ ★ ★

## EXTENSION CORD

(Item 16) Heavy duty, made of Buna rubber insulated #14-2 cond. 7 strand wire encased in a treated braided jacket. So tough that you can drive over it. Use indoors or out. Resists oil, grease or water. Extends electricity up to 400 ft. without voltage drop. Complete with heavy rubber plug and outlet. (Item 16) 40 ft. (wt. 2 1/2 lbs.) Usually \$4.50

**\$1.99**

Special. Combination 2-40 ft. & 1-20 ft. (total 100 ft.) (Item 16c) \$4.95 100 ft. length (1 piece) (Item 16p) \$4.85  
**NEOPRENE EXTENSION CORD** #16, 2 conductor stranded wire, extremely flexible, ideal for hedge trimmers, lawn mowers, power tools, etc. Tough and rugged, withstands any abuse. Complete with rubber plug and outlet. 40 ft. (Item 17a) Wt. 2 1/2 lb. Regularly \$4.95 SPECIAL \$2.49  
 Combination 2-40 ft. & 1-20 ft. (total 100 ft.) (Item 17n) \$5.95 100 ft. length (1 piece) (Item 17e) \$5.85  
 Wire only. No fittings. 100 ft. (Item 17f) \$5.00  
**NEOPRENE CABLE** #14-2 (Item 18) Heavy duty, very flexible, 20 year quality. Wt. 9 lbs. 100 ft. Complete with rubber plug and outlet. A terrific buy at only \$8.95  
**NO. 12-2 POWER CABLE.** Very flexible rubber covered, special outside shield for grounding power tools, etc. 50 ft. (Item 199) Wt. 8 lbs. \$5.95  
 100 ft. (Item 200) \$12.95

## 37 Pc. SOCKET SET



Highest quality, guaranteed non-breakable sockets made by Husky. Beautifully matched chrome alloy. Absolutely the best. Complete range of 17 sockets from 1/4" thru 1 1/8" (1/2" drive) and 7/16" thru 1-1/16" (3/4" drive), 1 extension, reversible 1/2" ratchet, adapter bit, sliding "T" handle, "L" handle, 1/2" speeder, 5 pc. alloy combination wrench set, 8 pc. Allen wrench set, and a big doghouse tool box. We challenge anyone to match this value. Easily worth \$41.95. Wt. 14 lb. (Item 59) **\$16.95**

## 44 Pc. SOCKET SET

(Item 596) Same unconditionally guaranteed, non-breakable sockets as above—but with added sizes. Complete range of 21 sockets from 1/4" thru 7/16" (1/2" drive) & 7/16" thru 1-1/16" (3/4" drive). Two extensions, reversible 1/2" ratchet, 3 drift punches, sliding "T" head, all angle coupling, 1/2" speeder, 1/4" breaker, 5 pc. high chrome alloy combination wrench set and 8 pc. offset wrench set in big doghouse tool with ample room for other tools. Reg. \$49.50 **\$21.95**

## 52 Pc. SOCKET SET

(Item 205) Contains a complete set of sockets in 1/2" drive, 3/8" drive and 1/4" drive, plus all necessary extensions, handles, speeders, reversible ratchets, etc.: all uncond. guaranteed against breakage. Beautifully matched chromed thin wall alloy sockets in a sturdy hand-some steel box. Wt. 17 lbs. List price \$62.90 **\$27.95**

## JET FLOW BLOWER

Tremendous air movement (1700 CFM) and quiet operation make this double inlet 1/2" turbine blower unbeatable for heating, cooling, drying and air conditioning. Ideal for attic or barn ventilation, converting gravity heating to forced air; spray booth exhausts, etc. Operates with any 1/4, 1/3 or 1/2 HP motor. Oversized, long life bearings. Includes variable speed motor pulley and belt. Dimensions 19" h. x 8 1/2" d. Outlet opening 13" x 11 1/2" Wt. 45 lbs. (Item 245) Reg. \$54.50 **\$27.50**  
**HEAVY DUTY 1/4 HP motor** for above. \$16.95

## GET YOUR OWN ELECTRIC POWER AT DIRECT FACTORY PRICES

### PORTABLE LIGHT PLANTS



(Item 24) 700-800 Watt Plant (Item 44) same as Item 24 but larger engine. **\$169.95**  
 1500-1700 Watt Plant (Item 20) Similar to Item 24, but has three times more capacity. Wt. 173 lbs. Factory price. **\$279.50**

**PUSH BUTTON START A.C. LIGHT PLANT 600-700 watts—115 v.—60 cyc. A.C.** Powered by a rugged 2 hp. easy-starting Briggs gas engine. No wiring necessary, just plug in and operate. Plenty of current for any oil burner, freezer, brooder, emergency lights, etc. which require up to 700 watts. Ideal for Civil Defense, Fire Depts., trailers and camps. Complete with Voltmeter and built-in winding to charge 6 v. auto batteries. Item 24. Wt. 75 lbs. Be prepared if war or storm knocks out power lines. Reg. \$275 value. **\$143.50**  
**1000-2000 Watt Plant (Item 45) same as Item 24 but larger generator & engine. \$199.50**  
**350 Watt Plant (Item 273) 115 v. D.C. 1 1/2 hp. Briggs Engine.** Perfect for lights, radios, small power tools. Wt. 85 lbs. Factory price. **\$99.75**

### GIANT 2000-2500 WATT PLANT

110-120 V. 60 cyc. A.C. Absolutely the best made—exclusive dynamically balanced armature; heavy windings develop up to 5000 watt overload for motor starting. Skid-mounted—portable. Powered by easy starting Briggs or 6 hp. Wisconsin engine—complete with all accessories; engine easily disconnected for other uses. Big outlet box, voltmeter, no wiring necessary. Ample current for all purposes. Factory warranty and complete instructions included. (Item 31) Wt. 210 lbs. Reg. price \$585.00. Special at **\$299.50**  
 Generator Only and control box. \$169.50  
**3000-3500 WATT PLANT (Item 198) 110-220 v. 60 cyc. A.C. Belt drive Wis. Engine.** Push button start. Wt. 370 lbs. Heavy duty \$399.50  
 Generator only for belt drive. Wt. 115 lbs. (Item 198A) \$239.50  
**MASTER-LITE 2500 Watt Plant 110/120 v. 60 cyc. A.C.** A powerful plant, ruggedly constructed and yet designed for easy portability. Can be started by rope or built-in 1 1/2 electric push button starter. Built-in winding to charge battery. Powered by a big 5-10 HP Briggs engine, complete with all accessories. Includes control box, voltmeter, and handy plug-in power receptacle. An ideal plant for permanent or stand-by service. Wt. 225 lb. Regular price \$645.00. Factory price **\$329.50**  
**3500 Watt Plant (Item 23) 115 v. 60 cyc. A.C. Push Button Start. Direct Drive. Wt. 270 lbs. Factory Price. \$379.50**



(Item 31)

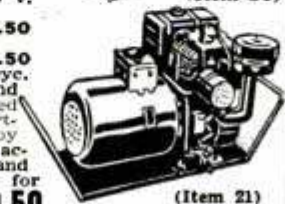

(Item 21)

### HI-LINE 6000 WATT PLANT

Push Button Start, 115-230 v. 60 cycle A.C. A brute of a power plant with a rugged 14 hp. Wisconsin engine. Plenty of electricity for ranges, water heaters, freezers, pumps, machinery, etc. Affords both 110 and 220 volts. Ideal where heavy current is needed. Wt. 540 lbs. Easily worth \$995.00. With self starter. Factory price **\$645.00**  
 Same plant but with Crank Start. (Item 166) **\$585.00**  
 Generator and control box only, belt driven. Use your own engine or tractor. Wt. 240 lbs. (Item 163) Factory price **\$345.00**

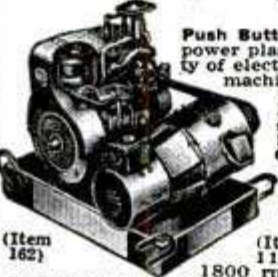

(Item 162)

### DIESEL LIGHT PLANT

(Item 1660) Diesel Master 11-12 kw. 115/230 v. AC. Single or 3 phase. 1800 rpm. direct connected. Electric Self-starting. Engineered for permanent power where continuous low cost, heavy duty service is important. Wt. 1350 lbs. Reg. list \$3650.00. **\$1895.00**  
**10-11 kw. GAS DRIVEN PLANT. 115-230 v. 60 cyc. A.C. Single or 3 phase, powered by 4 cylinder Wisconsin air cooled engine. Belt driven. Constructed similarly to Hi-Line 6 KW shown above but much larger. (Item 217) (with crank start) Wt. 900 lb. Factory price \$1075.00**  
 Same plant with elec. self-starter. **\$1145.00**  
 We make fully automatic controls to operate any of the above light plants. Write for details. We make all sizes up to 25,000 Watts.

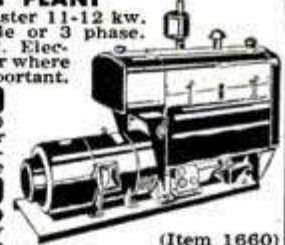

(Item 1660)

### HEATING & VENTILATING FAN

(Item 10) Easily installed in furnace pipes. Forces even heat to all rooms. Over range removes kitchen smoke and odors. Powerful, continuous duty motor, 110-120v. AC. Mount in wall or ceiling to ventilate any area. Quiet, super efficient fan moves huge volume of air. (400 to 600 CFM)  
 8" Fan, wt. 5 lb. \$6.85  
 9" Fan, wt. 6 lb. \$7.85  
 10" Fan, wt. 7 lb. \$8.85  
 12" Fan, wt. 8 lb. \$9.85  
**HEAVY DUTY FAN.** Semi-enclosed motor, suitable for spray booths, restaurant exhausts, poultry houses, etc. 10" Fan, wt. 8 lbs. (Item 10E) \$11.95  
 12" Fan, wt. 10 lbs. (Item 10D) \$12.95



### MASTER AIR COMPRESSOR

(Item 209) High pressure type for large volume of air for heavy duty service. For paint spraying, inflating truck & auto tires, greasing & the hundreds of other jobs done by compressed air. Piston type. 2" bore compressor with built-in air filter. Master built with high strength alloys and precision bearings. Stainless steel tank, 12"x24", 2100 cu. in. cap. Heavy duty automatic switch starts and stops motor to maintain desired pressure (up to 150 lb.). Has check valve, safety valve, gauge, shut-off valve. 20 ft. air hose and tire chuck. Beautifully balanced on ball bearing wheels and rubber tires. Low factory prices. **\$109.50**



Tank Tested up to 500 lbs. per sq. in.

### FLEXIBLE SHAFT

A precision built, heavy duty tool with amazing flexibility. Replaces a dozen individual tools—drills, buffs, grinds, sands, saws—handles jobs in impossible places. Fits any 3/8" motor shaft or use with drill press, grinder, lathe, gas engine, etc. Heavy duty 3/8" piano wire core encased in tough rubber housing. Handle and arbor have rugged industrial type precision ball bearings for years of service. Arbor takes all 1/2" bore wire wheels, grindstones, etc. 1 1/2"-20 standard threads. Use with any 1/4, 1/3 or 1/2 hp motor. Wt. 10 lbs. Reg. \$29.95. **\$15.95**

(Item 240) With 1/2 hp. motor, 110v. AC motor. Reg. \$175. (Item 209p) **\$109.50**  
 With 1/2 hp. motor, Reg. \$190.50 (Item 209Ap) **\$129.50**  
 2 hp. Briggs Gas Engine. Reg. \$199.50. (Item 209Bp) **\$119.50**

## MASTER GARDENER

**SELF-PROPELLED** It's a snow-blower It's a power sickle It's a cultivator  
**NO PUSHING** It's a rotary tiller It's a plow It's a rotary mower  
 Tractor shown with Snow Blow Attachment (Item 206)



Where can you get a power tool that does so many jobs? Works for you the year 'round. Does terrific job of cleaning snow from walks, drives, etc. without backbreaking work. Also prepares deep mellow seed beds, cuts weeds, lawns, etc. The Master Gardener performs better—does more than tractors costing twice as much. Converts in minutes to Tiller. Power Sickle, etc. Basic, self-propelled 2 hp. tractor. Briggs engine or Clinton engine. **\$119.50**  
 Snow Blow. \$39.50  
 Cultivator. \$8.75  
 Rotary Tiller. \$42.50  
 Disc Harrow. \$15.75  
 Furrowing Tool. \$8.75  
 Plow. \$15.00  
 Rotary Lawn Mower. \$42.50  
 Sickle Bar Mower. \$42.50  
 Lawn Mower Hitch. \$4.50  
 Freight prepaid to most areas. Easy payment plan available.

### HEAVY DUTY D-C ARC WELDER

Use as portable or shop welder. Up to 300 amps. Senior model. Made for years of trouble-free, continuous service. Will handle light or heavy jobs. Easily welds up to 3/4" plate using 1/4" rods. Built-in air cooling system. Arc is easy to strike and hold, because of specially designed arc stabilizer. Hi-lo switch and dial control gives wide range of welding heats. Run welder at 2600 rpm. with tractor, jeep or 14 hp gas engine or 7 hp elec. motor. Complete with instructions, guar. and double V belt or flat pulley. You can pay more, but you can't buy a better welder. (Item 38) Wt. 110 lbs. \$400 value at. **\$99.75**  
**DUAL CONTROL MODEL** same as above but with built-in dual rheostat for low heat soldering, brazing, welding. Special. **\$119.50**  
**WELDING KIT.** Two 10 ft. leads, welding helmet, electrode holder, ground clamp. Sold only with welder at. **\$10.50**  
 Write for prices on A.C. Arc Welders.

**Power Master Arc Welder**  
 Now! a portable, rugged, self-powered industrial type welder with terrific performance, yet at a price hundreds of dollars less than you'd expect. High capacity DC welding unit enables you to tackle any job with confidence—easily handles anything up to 2" plate using from 1/16" to 1/4" rods. Built-in stabilizer and dual control simplifies any welding job from 30 to 250 amps. Welder is powered by 14 HP 2 cylinder air cooled Wisconsin industrial engine with triple V-belt drive. Mounted on a welded steel chassis—easily transported on trailer or pickup truck. Ideal for shop, factory or farm welding. Complete with instructions and guarantee. Wt. 480 lbs. Compares with welder costing \$1200. (Item 280) **\$499.50**

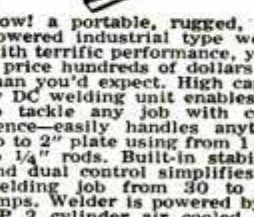

(Item 280)

Send check or M.O. Prices f.o.b. Factory. 10 day Money back guarantee. Send 10c for BIG Catalog.

**MASTER MECHANIC MFG. CO., DEPT. 61D Burlington, Wis.**

**MADE IN SWEDEN  
OF famous  
SWEDISH STEEL**



**MORA  
HUNTING KNIVES**

Seven Models of these famous Swedish Knives. They're hand forged, and honed to a razor edge. Polished curly birch handle with metal guard and fittings.

All styles have leather sheaths. All reinforced with rivets, some with metal guards.

**SWEDISH  
WOOD CHISELS**

Finest Swedish steel makes these chisels the pride of every craftsman. Machined Tenite handles. 11 sizes from 1/4" to 2".

Each size marked in top of handle. Chisels come with protective plastic film over blade.

Write for Literature  
Stocked by Leading Retail Stores

**GENSCO TOOL DIVISION**

1832 N. Kostner Ave., Chicago 39, Ill.

**NEW!**  
Save  
your  
Battery!



- Eliminates Corrosive Action
- Water Lasts 7 Times Longer

**\$3.25**  
per set of 3  
prepaid

**Hydrocaps . . .**

Scientifically developed in the Laboratories of the University of Miami, Hydrocaps definitely prolong the life of your battery and save you many times their original cost. Save money and trouble.

Tex-Max Inc., 1408 N. Cong., Austin, Tex.		MAKE OF BATTERY	CHECK
NAME _____			
ADDRESS _____		MAKE OF CAR	C. O. D.
CITY _____	STATE _____		
FULL MONEY-BACK GUARANTEE			

**\$40 A DAY BUSINESS  
IN YOUR SPARE TIME**



**ANDY PHILLIPS SAYS:**

"My Belsaw Sharp Smith gives me big profits at low expense - I can run 35 to 40 Circular Saws in an 8-hour day - that makes me \$40 cash."

"I also get BIG EXTRA PROFITS... up to \$4 an hour... by grinding planer and jointer knives - there's always a demand for this kind of work."

You can start this REPEAT CASH business in your own home or garage while you are working at your regular job. Easy to operate, no experience needed. "My BELSAW paid for itself the first month." - H. J. Opie

For as little as \$15 down payment, you can get your BELSAW SHARP SMITH rushed to you.

**FREE book tells how**

YOU can start making money the very day your BELSAW SHARP SMITH arrives. Hundreds of jobs in your own neighborhood. Send for Free book "Life-Time Security."

**BELSAW MACHINERY CO**

3705 Field Building Kansas City 11, Mo.



**MAGNETS**

GENUINE ALNICO - NEVER WEAKENS

**225 lb.  
PULL**

**AMAZING, PERMANENT MAGNETS—WILL NOT WEAKEN! NON-ELECTRIC**

Retrieve guns, tackle, tools and other steel items from lake, river, plating tanks, drains or other hard-to-reach spots. Recover drills, taps, etc. from sweeping. Clear alley of harmful tacks, nails. Many other uses. Pays for itself quickly. GUARANTEED. Try any magnet one week. Money refunded if you are not well pleased.

- No. M-725 (Weights 54 oz.) Has pull of 225 lbs. on steel block. \$15.00
- No. M-675 (Weights 49 oz.) Has pull of 175 lbs. on steel block. \$10.50
- No. M-650 (Weights 41 oz.) Has pull of 150 lbs. on steel block. \$ 8.50
- No. M-500 (Weights 15 oz.) Has pull of 50 lbs. on steel block. \$ 4.00
- No. M-30 Hobbyist assortment of six small magnets. . . . . \$ 1.50

Send Money Order or Check. We pay postage. No C.O.D.'s.  
MIAMI MAGNET COMPANY, 3240 N. W. 27th Ave., Miami 42, Fla.

**TOOL  
PROTECTION**



Only Gerstner Chests assure proper care of precision tools. Write for Free Catalog.

**GERSTNER TOOL CHESTS**  
453 Columbia St., Dayton 7, Ohio

**Send FOR this Giant AUTOMOTIVE Catalog**

& Save to 50% on All Parts & Accessories

**1953 EDITION JUST OUT**

World's largest Auto Accessory & Parts Catalog. Over 50,000 items:—Hollywood Accessories, Hi-Speed Equipment, Rebuilt Engines. Everything for all cars & trucks. We have that Hard-To-Get part: Jam packed with bargains. Completely illustrated (134 pages). Send 25c (refundable).

**J. C. WHITNEY & CO.** 1917xp Archer, Chicago 16



**107 TOOL SILHOUETTES**

**PUT YOUR SHOP IN ORDER!  
STOP HUNTING FOR TOOLS!**

**MAKE A TOOL BOARD** that shows everyone where to replace tools. Simply cut out and apply with ordinary electric iron. New adhesive plastic is not affected by moisture. Your 107 "Tracers" include full size silhouettes of 2 saws, complete set of chisels, box end wrenches, open end wrenches, bits, clamps, pliers, cutters, etc. Face of "Tracers" is ready varnished for long life.

Mail Check, M.O. or C.O.D. to

**TRACERS** 1970 MARSHALL RD., KIRKWOOD (22) MO.



MAIL ORDER ONLY  
**\$2.49**

# the 10 Feature shoe that's DOUBLE CUSHIONED

*extra Comfort for*

- MECHANICS
- CARPENTERS
- FILLING STATION OPERATORS
- TRUCKERS
- RANCHERS

Here is real comfort for the man that works on his feet all day. Both oxford and high shoe have extra thick oil-resistant Neoprene Crepe cushion soles and cushion insoles.

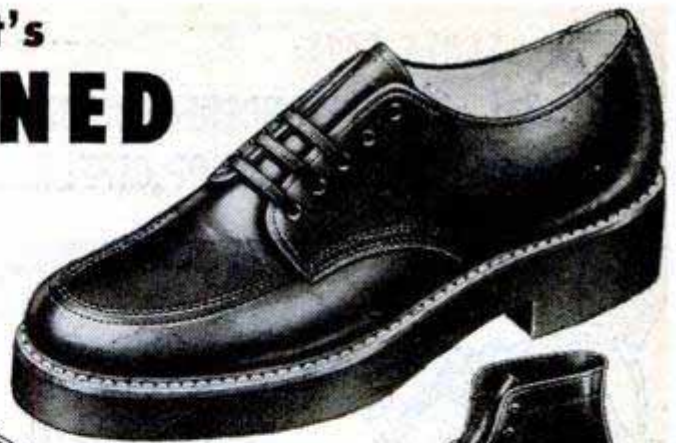

Stock No. 4093  
to retail at  
about \$12.95



Stock No. 4063  
to retail at  
about \$13.95

## 10 FEATURE VALUE FACTORS

- 1 CUSHION INSOLE... soft as a pillow
- 2 QUALITY LEATHER CONSTRUCTION in Hidden Parts
- 3 COOKIE ARCH... for proper foot balance
- 4 STEEL SHANK... will not break... firmly secured
- 5 NEOPRENE CUSHION CREPE HEELS AND SOLES... oil-resistant, non-slip

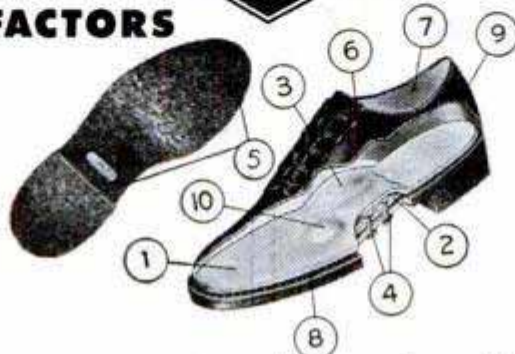

- 6 ELK FINISHED UPPER LEATHER... takes a good polish
- 7 FIRST QUALITY DRILL LININGS
- 8 STITCHED with 4 ROWS LINEN THREAD... will not rip apart
- 9 SNUG HEEL FITTING... combination fitting
- 10 METATARSAL PAD... extra comfort... balances foot.

For name of nearest dealer write to

Dept. PM-11, Peters Shoe Company • Division: International Shoe Company • St. Louis

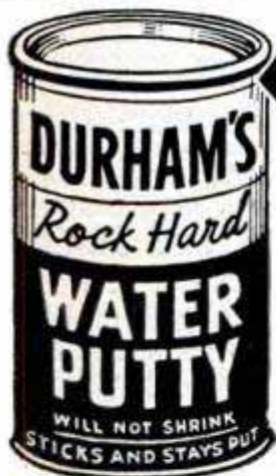

The Modern PLASTIC  
for lasting Home Repairs

PERMANENTLY mends cracks or holes in wood, tile, stone or plaster. Sticks and stays put—Does not chip, shrink or fall out. Easy to use. Economical. Mold it, chisel it, polish or paint it. If unobtainable from your lumber, paint or hardware dealer, the big 4-lb. can will be sent you post-paid (in U.S.) for only \$1.25. Full money-back guarantee, order now.

DONALD DURHAM CO.  
203 School St., Des Moines, Iowa

SAY YOU SAW IT IN POPULAR MECHANICS

## TOOLMAKERS FLAT



8" x 12" x 2"

Made of hardest  
**BLACK GRANITE**  
at bargain price  
Now for first time, you can obtain genuine Black Granite Surface Plate at unbelievable low price.

Precision-ground to over-all accuracy of .0002". Non-glare. Diamond-like hardness. Warp-free. No rust. Wt. 15 lb. Only \$22.95 delivered. Money-back guarantee. 10-day approval. COLLINS MICROFLAT CO., 2326 E. 8th St., Los Angeles 21, Cal.

Want a smoother  
running engine?

ask for  
**WOLF'S  
HEAD**  
Motor Oil

100% Pure  
Pennsylvania

45c a quart

WOLF'S HEAD—100% Pure Pennsylvania, Specially Refined, Scientifically Fortified, *cleans as it lubricates*... provides maximum protection against wear, sludge, corrosive acids in all cars and all types of service. Reduces oil consumption. Write for FREE "Guide to the Weather" Folder.

WOLF'S HEAD OIL REFINING CO., INC.  
Oil City, Pa. • New York 10, N. Y.



SANTA SAYS:

"A WONDERFUL HOBBY  
WORKSHOP GIFT!"

CUT PERFECT GROOVES ON YOUR SAW WITH

## Warren DADO SAWING WASHERS

Not One — Not 12 But 40 Different Cuts

Warren Washers — engineered to cut clean, accurate, parallel grooves with your present power saw. 40 micromatic adjustments — just dial the desired width. Strengthens blade, eliminates vibration — leave on saw for straight cuts. No burning or chewing. Over 250,000 satisfied users. Get genuine Warren Washers — they're GUARANTEED!

Arbor sizes 1/2", 3/8", 3/4", 1". See your dealer or write direct.

Send for free booklet

WARREN WASHERS CO.

DEPT. 31 • BOX 98 • NORTH END STATION • DETROIT, MICH.

ONLY \$4.95  
PER SET

## SAVE \$18.00 29 PIECE A. S. DRILL SET

(Drills from 1/16" to 1/2" by 64ths)

29.95 VALUE  
only \$11.95

Alloy steel, made in Denmark. The Danish equivalent of American High Speed Drills. Free stand as pictured with each purchase.

Money Back Guarantee

13 pc. Drill Sets — 1/16" to 1/4" by 64ths. Same Quality. \$6.00 value only \$2.35 plus 15c postage. Cash, check or M.O. (no COD's).

B & W WHOLESALE SUPPLY CO., INC.

1413 Washington Av. S. Dept. PM-10 Minneapolis 15, Minn.

# MAGIC HAND CLEANER

7-11 LIQUID HAND SOAP  
INSTANTLY REMOVES

- GREASE • TAR • PAINT
  - INK • CHEMICAL STAINS
- FROM THE HANDS!

A heavy duty hand cleaner that cleans without abrasives! Shake ten drops or so of speedy acting "7-11" on the hands — work in — and rinse off. Grime, grease and stains—even paint, tar and ink — wash off like magic. No need of harsh abrasives that damage the skin and promote infection. Non-allergic, amazing "7-11" HAND CLEANER does not dry out the skin or injure it in any way. Indispensable to every workman, mechanic, painter, printer or hobbyist. At your dealers or send \$1.00 with name of your nearest dealer for full 12 oz. self-dispensing can, sent postpaid. Money-back guarantee. Send today!

KNOX SOAP COMPANY

3302 W. Cermak Rd., Chicago 23, Ill.



DEALERS —  
DISTRIBUTORS

Write for full particulars and quantity prices!

## DINSMORE AUTO COMPASS



The PERFECT GIFT Compact, attractive — it fits all cars. Shows you the right way—the short cuts. Lots of folks say they save a tank of gas a month. Enjoy the confident ease of driving with America's first and finest auto compass. Fully jeweled with patented micromatic compensator. Send for FREE folder "Pants, Knives, Compasses" and name of nearest dealer.

Dinsmore Instrument Co.  
1802-41 Kelso St. Flint, Michigan Illuminated

Only \$5.49

Say You Saw It in Popular Mechanics



CUT BUILDING COSTS 2/3!  
Make Your Own Concrete  
BLOCKS and BRICKS  
To Use or Sell

New superior moulds make absolutely square; true, easy-to-lay blocks which will pass any building code. Production is fast . . . easy. One durable \$30 machine will make four 5"x8"x12" blocks per minute—1,000 a day. Pays for itself in one day! Sell blocks for big profit . . . or save 2/3 building cost for yourself. POST CARD BRINGS FREE FOLDER.

ECONOMY MFG. CO.

DEPT. P STONE MOUNTAIN, GA.

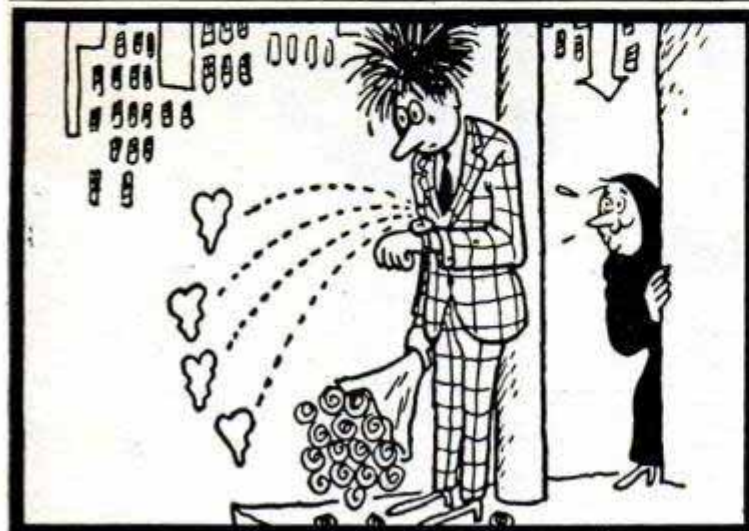

GET WILDROOT  
CREAM OIL  
CHARLIE



# Be the Perfect Host with this Easy-to-Build Bar

Picture this attractive, roomy, movable cabinet-bar of beautiful Weldwood birch in your home. Makes hosting a pleasure. And you can build it yourself very simply from Easi-Bild Pattern No. 189.

Plans show every step, every detail of construction. All you do is order the list of materials specified on the envelope, follow the simple directions and assemble. Easi-Bild patterns and beautiful Weldwood paneling are both available at your lumber dealer.

If you prefer, send 35¢ in cash or money-order for Easi-Bild\* Pattern No. 189. Send 35¢ additional for 36-page pattern catalogue illustrating over 180 other pattern projects.

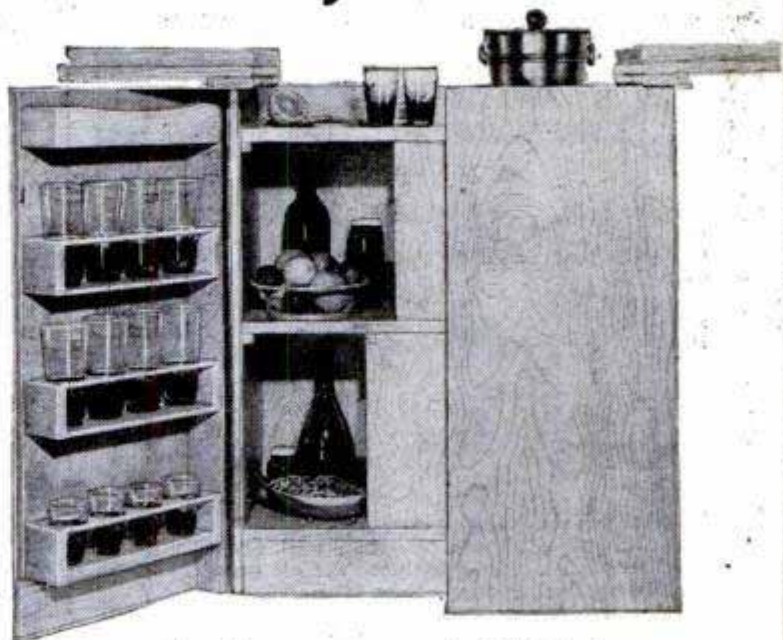

Any weekend carpenter can build this bar at a fraction of what it would cost ready-made

## UNITED STATES PLYWOOD CORPORATION

World's Largest Plywood Organization

Pattern Department, P.O. Box 215, Pleasantville, N. Y.

\*T.M. Reg.

## MODEL MAKERS! GADGETEERS! SAVE MONEY!

**MINIATURE ELECTRIC MOTORS.** Run on 1½ to 6 volt battery. Weight only 2 oz.; speed 2000 to 10,000 RPM. Bronze bearings. 3/32" shaft. BRAND NEW, with instructions. POSTPAID \$1.75 ea.

**6 VOLT MINIATURE WET BATTERIES.** The famous NT-6 2.4AH 6 volt battery. A standard for model control, etc. Plastic case; only 35/8" long, 1-13/16" wide, 2 3/4" high. Uses standard electrolyte. Ship. wt. 2 lbs. . . . . **NEW \$2.45, or 4 for \$8.75**

**TELEPHONE DIALS.** Standard 10-holers, complete mechanism. For radio controls, etc. Ship. wt. 1 lb. EXC. USED. . . . . **\$3.75 ea.**

**800:1 OIL SEALED GEAR MOVEMENTS.** 3 1/2" dia., 3 1/2" high, complete with frame. Easy to mount. Use flea power to generate powerful torque. Ship. wt. 1 lb. . . . . **NEW \$1.45 ea.**

**2 RPM TIMER MOTORS.** Oil sealed movement, 1/8" shaft. Run on 12 V 60 cy AC, 1/2 amp. Has very powerful torque. Only 2 1/4" x 2 1/4" x 2 1/4". Ship. wt. 1 lb. . . . . **NEW 89¢ ea.**

**SUPER SPECIAL:** Six of these motors plus 110 V 60 cy AC transformer to run all six at once. Ship. wt. 9 lbs. . . . . **\$5.95**

**THROAT MIKES.** Each contains 2 carbon buttons. Use for intercoms, vibration pick-up, etc. . . . . POSTPAID 29¢ or 4 for \$1.00

Order direct from this ad. All FOB except POSTPAID items. No C.O.D.'s, please! Calif. Buyers include 3% sales tax.

### G.L. ELECTRONICS, Dept. ME-9

905 South Vermont Ave. Los Angeles 6, Calif.

## MODERN LAWN MOWER SHARPENER

Service departments of leading Lawn Mower manufacturers use the Modern Lawn Mower Sharpener. One lever moves lawn mower into grinding position. Gasoline and oil remain in engine while sharpening, no dismantling of wheels, roller or handle. The Modern is a precision bed knife grinder—no extra grinder to buy. Imitated but never equaled—Compare before you buy. If it isn't a Modern it can't be Modern

(Prices subject to change without notice)

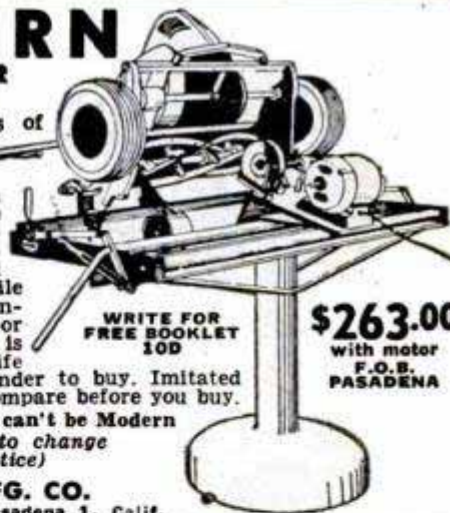

**MODERN MFG. CO.**  
160 N. Fair Oaks - Pasadena 1, Calif.

DON'T GET LEFT—GET WILDROOT CREAM-OIL. KEEPS HAIR GROOMED NATURALLY ALL DAY, WITHOUT GREASINESS. NO DRYING ALCOHOL. NO HARSH SYNTHETICS. CONTAINS MAGIC LANOLIN, SO MUCH LIKE NATURAL OILS OF HAIR AND SCALP. TRY A BOTTLE OR HANDY TUBE TODAY.

29¢ and 59¢

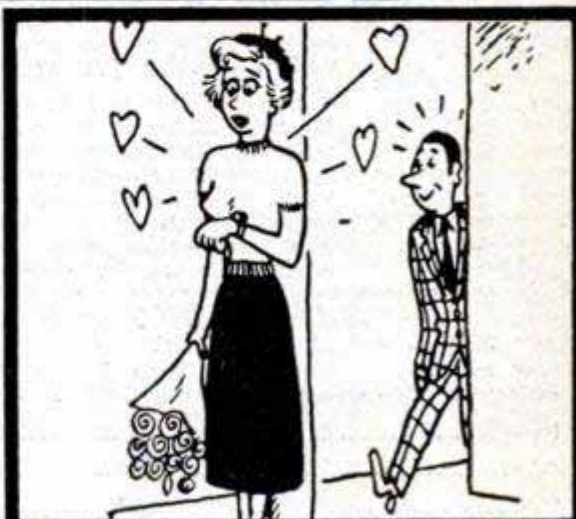



## The Electric Shaver for "HE-MAN" BEARDS!

WHISK AWAY EVEN A 7 DAY BEARD  
WITH THE WHISKER ELECTRIC SHAYER

Precision-built,  
with .002"  
thin blade that  
shaves all  
beards  
smoothly,  
closely.



Whether you shave once a day,  
or once a week you'll like WhiskER Electric Shaver.  
Its clipper-like blade is designed for all beards,  
is definitely less irritating. 110v AC model; no TV  
or radio interference. See your barber or dealer.  
If he cannot supply you, send \$15.95—we pay  
postage; or send \$2, you pay balance plus postage  
and COD. 10-day money-back guarantee.

### CADET ELECTRIC HAIR CLIPPER

The same fine quality clipper  
used and sold in many beauty  
shops. See your shop, or dealer.  
If you prefer, send \$10.95—we  
pay postage; or \$2, you pay post-  
man balance, postage and C.O.D.



ELECTRO TOOL CORP., Dept. W523-L Racine, Wis.

## DO MORE PLANING JOBS WITH LOW COST BELSAW

Exclusive MONEY-MAKING features:

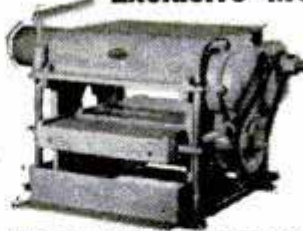

- Full 12 1/4 in. x 6 in. capacity
- Power feeds at 24 ft. a minute.  
(Easily adjusted for lower feed  
rate)
- Machined cast iron bed; adjust-  
able rolls, total bed length 42 in.
- Provides for Grinding Knives in  
the Cutterhead.
- Attachments for Jointing, Rabbet-  
ing, Tongue, Groove, Matching.

Belsaw Multi-Duty Planer for cabinet shops, builders, lumber  
yards, woodworking plants and spare time work  
shops... Now you can convert low cost rough and  
random size lumber into high priced cabinet  
finished stock... Easy to make flooring and popular  
patterns. Belsaw quickly returns cost with savings  
on raw material... profits on finished stock.

Send Today for FREE literature on Belsaw,  
the LOW COST, high speed production planer.

**BELSAW MACHINERY CO**

1010 Field Bldg.

• Kansas City 11, Missouri

LOW DOWN  
PAYMENT  
EASY  
TERMS

## NEW, IMPROVED CALCULATOR FOR WOODWORKERS only 25c



Instantly gives information on lumber,  
nails, concrete mixes, painting materials,  
etc. Convenient, simple to read. Just  
set dial for nail specifications, to convert  
linear to board feet, find bit sizes for screws,  
compare characteristics of woods. 6" dia-  
meter heavily varnished cardboard. Send  
25c, no stamps, please to Greenlee Tool Co.,  
2111 Columbia Avenue, Rockford, Illinois.

Our 663rd Advertisement

## REAL DIESEL ENGINE

\$3.95

- for planes, boats, midget cars
- 7500 RPM; 1 1/7 HP; ht. 3 1/2";  
wt. 5 oz.
- precision machined for smooth  
operation

You just can't beat this price for a precision diesel  
engine! Streamlined, compact, easy to install.  
Thousands of satisfied users all over the world.  
Fast delivery if you ORDER TODAY! Send \$3.95  
plus 25c postage.

GOATHAM HOBBY CORP. Dept. P, 107 E. 126th St.  
New York 35, N. Y.

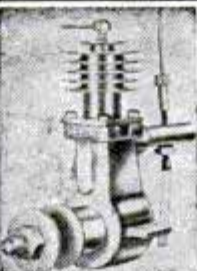

**Kar-Lite**  
lights your way  
when you  
park in the dark!

Time Switch turns head-  
lights off automatically  
after you leave your car.  
Easy to install. At auto-  
motive supply stores, or  
write for near-  
est dealer.

\$595

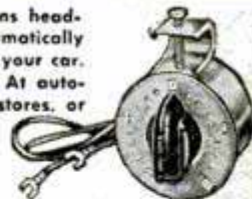

**M. H. RHODES, INC.**  
HARTFORD 6, CONNECTICUT

SAY YOU SAW IT IN  
POPULAR MECHANICS

Regular Price of a  
Slide Rule \$4 and up

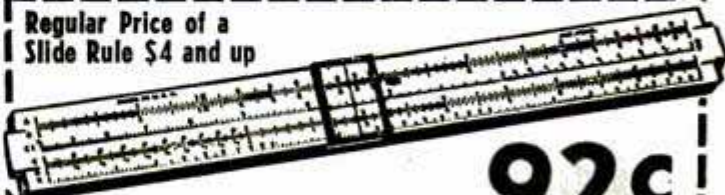

**Slide Rule**

**92c**  
and this coupon  
Add 8c Postage

If you can use a pencil you can use a slide rule  
For bookkeepers, accountants, salesmen (figuring commissions,  
cost, etc.), farmers, housewives, etc. For Armed Forces highly  
important. Men's most useful tool. Easy to calculate instantly.  
Multiplying, proportions, division, roots, etc. "High Vision"  
Clear View Slide. Full 10" Rule. A, B, C, D, C1 and K scales.  
**FREE** 28-page instruction book on how to get correct  
answers instantly without pencil or paper.

Gene Loewy, 545 5th Ave., Dept. 43 G, N.Y. 17  
Limit three rules to each coupon

Get what you want...and...save dollars, too...  
SEND--TODAY--FOR THIS  
**Hunt's**  
**BIG, NEW**  
**WOODWORKERS**  
**CATALOG NO. 20**



144 pages of bargains. New,  
low, money-saving prices.  
Finest selection of domestic  
and imported hardwoods--all  
kinds, all properly kiln dried.

QUICK  
DELIVERY

ONLY  
**15c**

Maple, mahog-  
any, red cedar,  
oak, cherry,  
poplar, walnut,  
and many others  
--all properly  
seasoned...and  
...kiln dried.

Like thousands of woodworkers  
all over the U.S.A.--you'll get  
what you want and save money,  
too--with this famous book. Filled  
with everything you need.

Shows 32 rare and fancy woods  
in color...275 scroll patterns...  
multicolor inlays, overlays, band-  
ings...ornaments...moldings...hard-  
ware...tools...and...pages of in-  
formation, tips, ideas. Send for  
your copy--right now. Only 15¢  
--refundable on first order.

MAIL  
TODAY

**CRAFTSMAN WOOD SERVICE CO.**

2729 S. Mary St., Dept. A11 Chicago 8, Ill.

Send me the big, new, money-saving Catalog No. 20.  
Enclosed is 15¢--refundable on my first order.

Name.....

Address.....

City..... Zone..... State.....



# CAREFREE LIVING?

sure is—in our

# New Moon

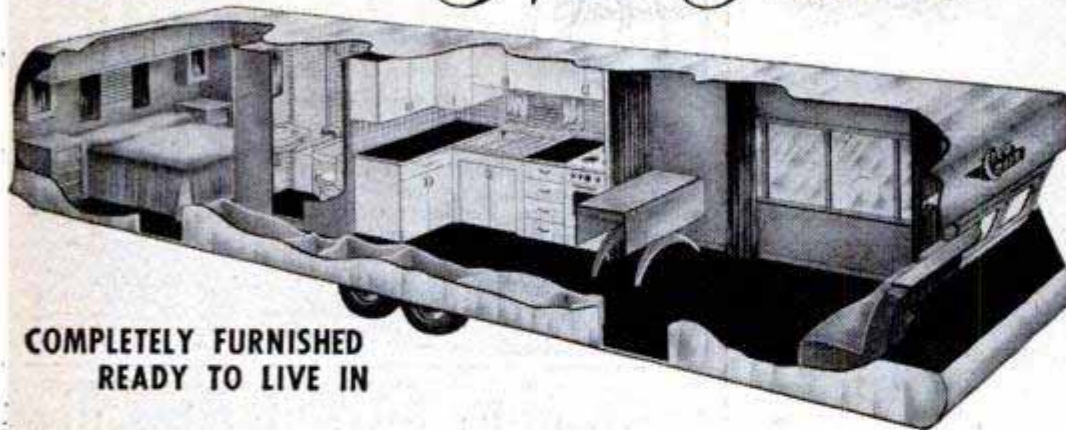

**COMPLETELY FURNISHED  
READY TO LIVE IN**

From its plane stress chassis to its weathertight roof, a New Moon home is tops in built-in comfort. Its thick blanket of insulation, the piano hinges on its doors, the triple trapped enclosed plumbing, its custom cabinet work with mortise and tenoned joining—these are but a few of the many features that make living in a New Moon "carefree." Write for your copy of "Adventures In Living" and learn other advantages.

## New Moon Homes, Inc.

FORMERLY REDMAN TRAILER CO. ALMA 40, MICHIGAN



**SELECTED AS AMERICA'S OUTSTANDING MOBILE APARTMENT HOME**

to be featured in

*Starring*

**LUCILLE BALL AND DESI ARNAZ  
in "THE LONG, LONG TRAILER"**

**M-G-M's**

**New Technicolor Hit  
(TO BE RELEASED SOON)**

Stars of Philip Morris Hit  
TV Show "I LOVE LUCY"

**AT ALL HARDWARE STORES**

**FULLER'S famous  
"FOUR-IN-ONE" Screwdriver**

All these blades included:

- No. 2 Recessed for cross head screws;
- 1/8" Diameter for fine work;
- 3/16" for electrical work;
- 1/4" Diameter for regular work;
- heavy aluminum chuck.

**UNBREAKABLE HANDLE  
HI-CARBON STEEL!**

**ONLY \$1 set**

**FULLER TOOL CO., Inc. 3522 Webster Ave., N. Y. 67**  
Export Sales Dept., John H. Graham Co., 105 Duane St. • New York, U. S. A.

## Buy the Best...WISS!

**for all sheet  
metal cutting**

**WISS Metal Master Compound Action Snips**  
#M-3. Easily cuts 18 gauge sheet metal. Cuts curves and circles as well as straight. Ideal for the home workshop. \$4.25. Rubber grips recommended, 60¢ extra.

**WISS Straight Cut Snips**  
#9. Crucible steel inlaid blades. The basic snips for straight metal cutting. Gun metal handles. Overall length 12 1/2". \$5.25.

**WISS Combination Snips**  
#V-13. Solid steel, with gray japanned handles. Cuts curves and irregular shapes with ease. Handy pocket size. 7" long. Accurately tempered jaws and strong bolts. \$1.85.

## Take The "PAIN" Out of PAINTING!

Basements . . . Fences . . . Furniture . . .

### USE A BECKER CO<sub>2</sub> SPRAY GUN

Take It Anywhere! No Compressor . . .  
No Electric Cords Needed. Sprays:  
Paints, Oil, Varnishes, Insecticides, etc.

Men! Women! Here's the easy way to lick those tough, tedious, tiresome paint jobs. Becker Spray Gun is fun to use, requires no electricity or compressors—pressurized by low-cost CO-2 cartridges each sprays up to 21 oz. containerful. Used 5 years successfully in industry.

SEE YOUR DEALER! If he cannot supply, order direct for pspdp. shpt. Extra cartridges 10 for \$1.

**SULLIVAN-BECKER CO.**  
Dept. 113-L Kenosha, Wis.

**ONLY \$19.95**  
with box of 10 cartridges

Prices slightly higher  
Denver and West

**Quality for more than a Century**

**J. WISS & SONS CO. • NEWARK 7, N. J.**

*Gifts he will use*



**THE HEAD CAN'T FLY OFF.** No more bother with loose or splintered handles. Estwing "Unbreakable" tools are forged in one-piece from tough tool steel. Grip is genuine leather, most comfortable and durable. Individually packed in colorful gift boxes. Axe \$4.50, hammer \$3.65. At all leading hardware stores. Write for FREE catalog.

ESTWING MFG. CO., Dept. P, Rockford, Illinois

## BUILD MODERN FURNITURE

Build this handsome, modern cabinet *yourself* with an Easi-Bild full-size pattern . . . and finish with amazing Plastic Wood! Handles like putty, hardens into wood! Can be molded, sanded . . . takes *any* finish!



EASI-BILD®  
Pat. No. 129-50c



CELLULOSE FIBRE FILLER

IN CANS OR TUBES

Get Pattern #129 at any hardware counter. Or send 50¢ to: Plastic Wood, Box 215, Pleasantville, N.Y.

*P.S.* Pulleys, hinges, locks and latches work better with **3-IN-ONE Oil**

# 2 DRILLS in 1

**\$11.95** post paid

Send check or Money Order  
Satisfaction guaranteed  
Order yours now

This attachment gives you two drills in one. It converts any 1/4 inch electric drill to 1/2 inch capacity. Reduction gears reduce the drill speed 5 to 1, the average speed of a 1/2 inch drill, and thereby increases the power. Absolutely indispensable for all shop work and home craftsmen.

**G. M. CO. MANUFACTURING, INC.**  
1308 43rd AVE.  
LONG ISLAND CITY 1, NEW YORK

## ONE-MAN SAWMILL LOW \$50.00 DOWN AS...

Take BELSAW Portable Sawmill right to the trees—turn out valuable lumber for home and farm—sell to local yards—make up to \$50 a day custom sawing for neighbors. BELSAW lasts a lifetime. No crew needed. Power with tractor or auto engine. Beginners get excellent results. Send today for FREE BOOK, "HOW TO MAKE LUMBER".

**BELSAW MACHINERY CO**  
8118 Field Bldg., Kansas City 11, Missouri



## GEARS

**In Stock - Immediate Delivery**  
Gears, speed reducers, sprockets, thrust bearings, flexible couplings, pulleys, etc. A complete line is carried in our Chicago stock. Can also quote on special gears of any kind. Send in your blueprints and inquiries.

Send for Complete Catalog No. 10  
**CHICAGO GEAR WORKS**  
440-50 N. Oakley Blvd., CHICAGO 12, ILL.

**AUTOMOBILE BEVERAGE CONTAINER HOLDERS** of sturdy metal for the car. Will hold bottles, cans, glasses, paper cups, baby's milk bottles. Simply fit over the window frame—inside the car. Order for each member of your family and for gifts. 2 for \$1 ppd. Free gift folder.  
**B. C. MOSES, Box 8052, Houston 4, Texas**

## WORLD'S BEST SMALL TRENCHERS



Portable DITCH-WITCH digs 2" to 6" clean, even ditches to 36" depth in all types of soil. Complete unit—self propelled—outdigs 8 men. Four rugged models.

Write for illustrated literature.  
**THE CHARLES MACHINE WORKS**  
620 B Street Perry, Oklahoma

## FILE SAWS THE RIGHT WAY



SO EASY with this new filing jig and jointer anyone can now sharpen any hand saw like new! When file hits hardened steel rollers teeth are finished and EXACTLY THE SAME HEIGHT. All teeth cut and saw runs true and smooth. Jig and instructions \$2.95 postpaid. FREE FOLDER.

## SHARPEN YOUR CIRCULAR SAWS

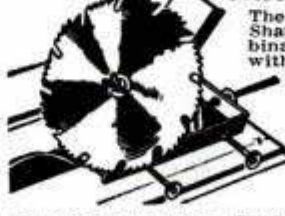

The RIGHT WAY on your own saw table. Sharpens rip, cutoff, hollow ground and combination blades—6" to 10". Saws stay round with correct bevel. Precision made, easy to use. GUARANTEED. Only \$8.95. Includes \$3.00 Grinding wheel.

"TRU-CIRCLE" saw set automatically sets teeth at 10° or more.  
\$2.95  
AT DEALERS OR POSTPAID

**A.D. McBURNEY, Dept. A-35, 5908 Hollywood Blvd., Hollywood 28, Calif.**

# PLEASANT SURPRISE!

for all home craftsmen:

**MANY GIFTS IN ONE**

Extra features at no extra cost—

Steel channel slide enclosed screw

Swivel base

hardened steel jaw inserts

pounding anvil

cut-off tool

4 sizes for all needs

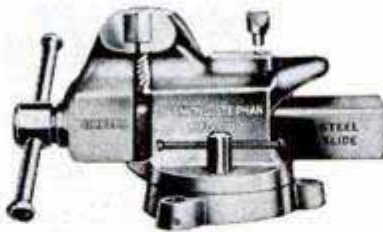

Give your favorite home craftsman this truly fine basic tool he'll enjoy for years. Ask your **HARDWARE DEALER** for the Desmond "Vise Application" folder, or write to the **DESMOND-STEPHAN MFG. CO., URBANA, OHIO.**

## DESMOND-SIMPLEX VISES

make all shop tools more useful

### LAND THAT FISH!

**FISHSAVER**, a compact landing device for all types of fishing. No net needed—gaff hook does the work. Two handy blades. Red handle.

**D'FAPP, Ltd. Dept. P**  
610 16th St., Oakland, Calif.



695

postpaid in U.S. or Canada

## MAGNETS OF ALL TYPES — 10c UP

AMAZINGLY POWERFUL!!  
6 ounce horseshoe magnet—\$1.50.  
Our Leader, 1 lb. magnet lifts 25 lbs. \$2.95. New alloy—will not weaken! Useful for lifting valves from tanks, jakes, or rivers easily! 7 small magnets \$1.25 with list of many shop and home uses. Satisfaction guaranteed.  
**R. EYRICH, 1091 N. 48 STREET, MILWAUKEE-8, WISC.**

## Build your own JET ENGINE!



SEND NO MONEY

Order these plans today

1. JET PROPELLED BICYCLE. Assemble your own. Photo and instructions, \$1.00.
2. HOW TO MAKE EXPERIMENTAL JET ENGINES. Seven sheets drawings with information and instructions \$2.95.
3. BOTH OF ABOVE in one order \$3.75. SEND NO MONEY. Order both at once \$3.75 C.O.D. in USA plus c.o.d. postage. Send check or Money Order and we pay postage. Get other information too. Rush Order.

**J. HOUSTON MAUPIN, Dept. 55, Tipp City, Ohio**

## Save UP TO 20% ON QUALITY BALL-BEARING WHEELS



TOP QUALITY AT ROCK-BOTTOM PRICES!

Stamped steel wheels at savings up to 20%—rust-resistant and built for rugged service. Semi-pneumatic tires, heavy red enameled finish; ball bearings for 1/2" axle diam. (O.E.M. inquiries invited.)

SIZE	MAXIMUM LOAD	ONLY
6x1.50	50 lbs.	\$1.50
8x1.75	80 lbs.	1.95
10x1.75	100 lbs.	2.30
10x2.00	140 lbs.	2.65

Order Now—Send cash, check or M. O., pay shipping charges on delivery.

**ROTARY WHEEL CO.**

Dept. M-11, 710 E. 12th St., Kansas City, Mo.

10-DAY RETURN PRIVILEGE. We guarantee no better wheels are made regardless of price!

**FREE** GET THE WORLD'S LEADING TV & RADIO CATALOG

## ALLIED'S 1954 ELECTRONICS BUYING GUIDE

268 VALUE-PACKED PAGES



SAVE ON EVERYTHING IN TV AND RADIO

Everything for Experimenters, Builders, Amateurs, Servicemen, Engineers and Soundmen...

Get ALLIED's big 268-page Catalog featuring the world's largest selections of latest top-quality electronic equipment at lowest, money-saving prices. See the newest in custom TV chassis, TV accessories, FM and AM radios, High-Fidelity sound, Amateur equipment, P.A. systems, recorders, test instruments, builders' kits, industrial electronic supplies—plus thousands of parts, tubes, tools and books. Get more for your money—send today for your FREE 1954 ALLIED Catalog!



NEW HOME OF ALLIED RADIO

ultra-modern facilities TO SERVE YOU BEST

**ALLIED RADIO**

SEND FOR FREE CATALOG

- ALLIED RADIO CORP., Dept. 5-11-3
- 100 N. Western Ave., Chicago 80, Illinois
- Rush FREE 1954 ALLIED 268-Page Catalog

Name \_\_\_\_\_

Address \_\_\_\_\_

City \_\_\_\_\_ Zone \_\_\_\_\_ State \_\_\_\_\_



Hack Saws                      Back Saws  
 Mitre Saws                    Coping Saws  
 Compass Saws                Keyhole Saws  
 Pruning Saws                Nests of Saws  
 Mechanic-Kut Circular Saws

# No More Wrist Strain!

● Only Atkins handsaws have the famous *Perfection Handle*—a basic design change to permit faster, easier cutting with no wrist strain!

Atkins *Perfection Handle* applies cutting pressure on a straight line from the elbow, through the wrist, to the middle of the cutting edge. There's no wrist action... less fatigue... the cut runs perfectly true!

**WHEN YOU BUY A SAW, BUY A GOOD ONE—ATKINS!**

# ATKINS

ATKINS SAW DIVISION

Borg-Warner Corporation • Indianapolis 9, Indiana

Do It Yourself and **SAVE!**

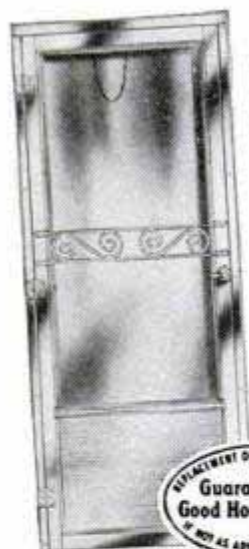

## Duo-Door

**ALL-ALUMINUM  
 COMBINATION  
 STORM-SCREEN  
 DOOR**

**\$39.95** Push Grille - \$1.50 extra

ATTACHMENT OR REFUND OF MONEY  
 Guaranteed by  
 Good Housekeeping  
 IF NOT AS ADVERTISED THEREIN

**ANY SIZE**  
 Slightly higher west of the Mississippi.  
**Reg. \$59.95 Value!**

Complete, Including All Hardware! Comes with Pneumatic Door Check, Door Latch, 3 Stainless Steel Hinges, and Outside Aluminum Z-Bar!

- Over 1" Thick! ● Aluminum Door Jamb!
- Glass & Screen Inserts Interchange Easily!
- Rugged All Aluminum Construction!
- Heavy Aluminum Kick-Plate!
- Adjustable for Perfect Fit!

**Delivered Completely Assembled!**  
**Easily Installed By Anyone!**

Enclose check or money order or will ship C. O. D. Give door opening size when ordering!

**THE WEATHER-PROOF co.**  
 1407 E. 40TH ST., DEPT. PM • CLEVELAND 3, O.

**AUTO DEALERS  
 TOY STORES  
 WRITE US  
 FOR  
 DEALER  
 PRICES  
 ON YOUR  
 LETTER-  
 HEAD**

**70 MILES PER GAL. GAS  
 CHILD'S AUTO WITH MOTOR**

Sturdy, Safe for kids 5 to 15 Years. Also pulls Mowers, Carts and Power Takeoff drives Pumps, Saws, etc. Write for literature. **ESHELMAN**, Dept. CM-102, 119 Light St., Balto. 2, Md. 7070 Hollywood Blvd., Los Angeles 28, Cal.



**SUPER POCKET-PAL RADIO  
 AMAZING NEW PORTABLE!**

Tiny package of "ELECTRONIC MAGIC" only 2 inches wide and 5 inches tall and **GUARANTEED TO OUT-PERFORM** any other "so called pocket radio" available. Enjoy while walking about anywhere... tiny hearing-aid earset insures privacy. Built in unique antenna system and **TWO POWERFUL LOW DRAIN ELECTRON TUBES** give "REAL KICK." Sensitive circuit receives all standard broadcast stations with perfect selectivity. Complete **PRE-FAB** set that anyone can assemble in an evening includes attractive metal case, tubes and special miniature parts... Only \$9.95. Midget batteries \$1.75 per set. Hearing-aid earset shown in photo supplied at wholesale cost of \$6.75 or use any regular size headphone. If not delighted with the fine quality of this little radio return the kit for prompt full refund.



**ONLY \$9.95**  
 (less batteries and earset)

**RUSH ORDER TO-DAY — NOW!**  
**ELECTRONIC MINIATURES  
 BEAVERDAM, VIRGINIA**

# The only trains in all the World with Magne-Traction

# LIONEL TRAINS

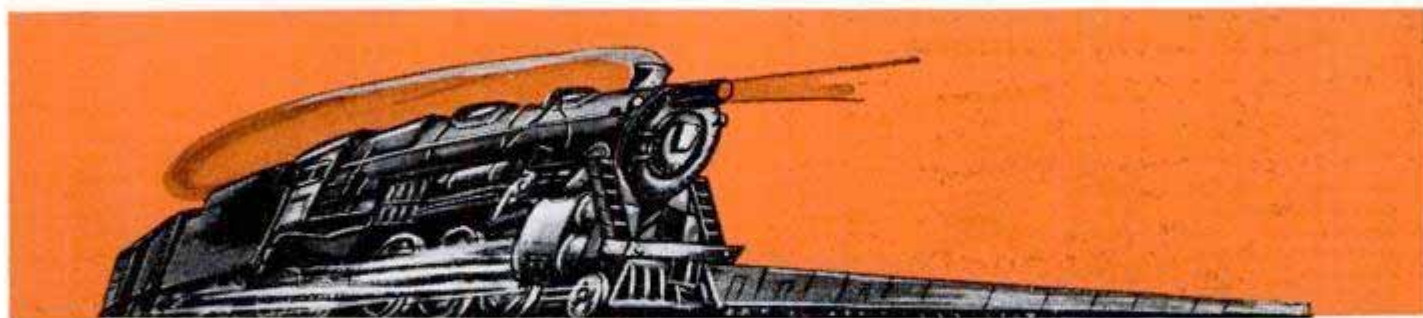

**That's Why They Have More Speed...More Pull...More Climb...More Control...Than Any Other Trains In The World!**



**ACTION!**



**Remote Control Operating Milk Car and Platform.** Press button. Doors open and milkman delivers milk can on platform.

**ACTION!**

**Lionel Rotary Beacon.** Tall! Red and green lens. Rotated by warm air from lamp!



**ACTION!**

**Operating Freight Station.** Baggage men run electric cars in and out of station.



**Only Lionel Trains** feature the greatest advance in model railroading . . . "Magne-Traction" . . . the permanent track-gripping power that's built-in, can't wear out. That's why they're unmatched for action . . . they take steeper grades and sharper curves, pull more cars faster, start and stop on a dime! And they're unequalled for realism, the Lionel trademark for over 50 years . . . smoke-puffing steam locos with built-in, two-tone whistle . . . horn blaring Diesels. They're built for lifetime action . . . solid steel wheels, heavy-duty trucks. And *all* Lionel Trains have real R.R. remote-control knuckle couplers! See them and the most exciting accessories and operating cars in the world at your local Lionel dealer's and bring Dad along!



**SPECIAL BIG-3 OFFER! ALL FOR ONLY 50¢ postpaid**  
**NEW TRACK LAYOUT PRINTING KIT PLUS SET OF EIGHT FULL-COLOR BILLBOARDS WITH THE NEW 1953 LIONEL CATALOG . . . 40 PAGES IN FULL COLOR!**

**LIONEL TRAINS, P. O. Box 9, Dept. W, New York 46, N. Y.**

I enclose 50¢ for Big-3 Coupon offer above.

10¢ for Catalog only.

Name \_\_\_\_\_

Address \_\_\_\_\_

City \_\_\_\_\_ Zone \_\_\_\_\_ State \_\_\_\_\_

# "DO IT YOURSELF" FANS!

There's a  
**CORBIN CABINET LOCK**  
for every purpose

Put easy-to-install Corbin Cabinet Locks on ALL your desks, sliding doors, closets, drawers, chests, wardrobes, tool boxes. They make your work easier... make it look better. And they keep valuables secure... keep children away from medicines, guns, etc.

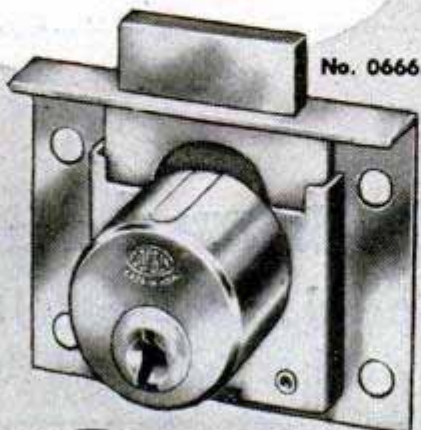

No. 0666

Be sure... with



at leading hardware stores everywhere

**CORBIN CABINET LOCK** Division

The American Hardware Corporation  
New Britain, Connecticut

U. S. Patents  
No. 2,351,906  
No. 2,461,872

# Save Fingers

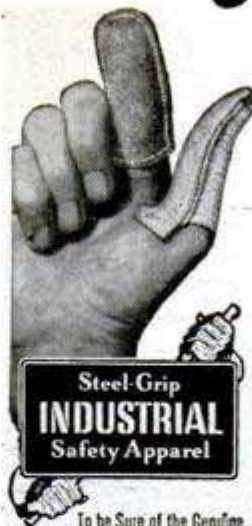

Steel-Grip  
**INDUSTRIAL**  
Safety Apparel

To be Sure of the Genuine  
Demand This Trade Mark

**Steel-Grip Finger Guards**  
Lower Your Hand Protection Cost

Hundreds of factories save time and injuries by protecting workers with Steel-Grip Open End Finger Guards. For handling rough, sharp articles, buffing, grinding, sanding, punch press work, and hundreds of other jobs. Protect fingers or thumbs, front or back, from cuts, abrasions or blisters. Various designs in leathers and other materials; elastic web back for snug, cool, comfortable fit. Sizes for men and women. Send 10¢ for sample. *Catalog of Safety Apparel Free.*

**INDUSTRIAL GLOVES COMPANY**  
A Corporation

1400 Garfield St., Danville, Ill.  
(In Canada, Safety Supply Co., Toronto)

FAMOUS INDUSTRIAL SAFEGUARDS SINCE 1910



TRANSFORMER WELDER \$18.95 FOB QUINCY

Complete with everything. Ready to plug in. 110 volts AC. 15-30 amps. 3 heats. Welds metal from 1/16" to 1/4" using 1/16" to 3/32" standard rods. Guaranteed unconditionally. 10-day trial. No C.O.D. Does everything welders costing up to \$75.00 do. Buy direct and save.

ESSAY MFG. CO., INC., Dept. 51, Quincy 69, Mass.

**make your own Gems** 29.50 F.O.B.

The Gem Maker comes complete with all necessary equipment, including a super-charged diamond blade for sawing, and all wheels for grinding, shaping and polishing; also complete instructions. The complete equipment as shown, less motor and belt, for only \$29.50, f.o.b., Burlington, Wisconsin. Write today for information and literature.

**B&I MANUFACTURING CO.**  
Dept. S Burlington, Wis.

**PLANS! BEAUTIFY YOUR GARDEN**

3 Distinctive Lawn Chair Plans for ONLY \$1.25  
40" high Dutch Windmill Detailed Plan, ONLY \$0.75c  
Send 10c for illustrated Catalog.

- DUTCH WINDMILLS
- LIGHTHOUSES
- LAWN CHAIRS
- BIRD HOUSES
- LAWN FIGURES

**CRAFTSMAN'S MODEL CO.** Dept. P-58 DELAFIELD, WIS.

**36 1/2" HIGH 30 DRAWER ALL-PURPOSE STEEL SMALL PARTS STORAGE CABINET**

WONDERFUL GIFT FOR CHRISTMAS

Solves all storage problems. Ideal for office, home, factory, toolroom, den, workshop! 1001 uses. Sturdy welded construction. Fire-resistant. Protects, organizes small articles, papers, machine parts, tools, etc! 36 1/2" high, 29 3/8" wide, 12" deep. Grey or green. Send check or M.O. No C.O.D.'s, FOB, NYC. **\$35.95**  
Money-back if not satisfied.

**NEW YORK STEEL CO.**  
Dept. PM-11, 35 Maiden Lane, N.Y. 38, N.Y.

**WHY MOST MOTORISTS INSIST ON HULL AUTO COMPASSES**

• Because of patented features... and because of construction superiority resulting from Hull's greater manufacturing experience... THE HULL AUTO COMPASS IS THE MOST ACCURATE, MOST RUGGED OBTAINABLE. Prove it to yourself. Write for local dealer's name, free literature.

MORE HULLS IN USE THAN ALL OTHERS COMBINED

**HULL MFG. CO.** P.O. Box 246-D-11 WARREN, OHIO

Beaconlite \$6.95  
Illuminated  
STREAMLINE \$4.95  
non-illuminated

Enjoy New Driving  
Comfort with  
the Sensational



**PNEUMATIC  
SPRING BOOSTER**



Front AIR LIFTS are specifically designed to give you new driving comfort. They dampen the suspensions, cushion the bumps and eliminate costly repairs.

You'll appreciate the ease with which you can drive the roughest roads and the severest turns with AIR LIFTS to steady your car.

For comfort, stability and safety install AIR LIFTS in your FRONT coil springs. To assist your rear springs... if you are carrying overloads... use REAR AIR LIFTS. Installation is simple... nothing to dismantle... economical and guaranteed.



See Your Dealer Today or Write to:

**AIR LIFT CO.**  
2330 W. Main Street  
LANSING, MICHIGAN



## COLORCRETE

Lifetime beauty comes out of a gun! Colorcrete is a cementitious plastic, applied by pneumatic pressure to new or old concrete, stucco, etc. Tough, tenacious, enduring. Can be washed or scrubbed. Dirty, drab surfaces become sparkling white or tinted from a range of 30 colors.

### "Building-Beautifying" - Your Big Opportunity

Colorcreting is a fascinating and profitable opportunity for men who want to build a substantial, long-term business. Colorcreting is exclusive. Rich in sales appeal to building owners. Income potentials are high; investment is low. We supply complete equipment, full instructions and liberal cooperation. Requires no previous experience or special ability. Write or wire for the Opportunity Book today. Be the first in your community.

**COLORCRETE INDUSTRIES, INC.**  
570 Ottawa Ave., Holland, Mich.



### Treasure - Minerals - COINS

Easily located with new Light-weight M-Scope Detector. Superior performance, lowest price, monthly payment plan.

FREE LITERATURE  
**FISHER RESEARCH LAB., INC.**  
PALO ALTO CALIF.



**SILVER SOLDER TORCH & KIT \$7.95**  
JOINS ALL METALS PERMANENTLY  
Do your own repairing. KIT includes one tube silver solder paste and 10 5-in. lengths silver solder alloy. Hottest ALCOHOL TORCH known. 2700° F. flame. Operates in any position, indoors or out. Pint of special fuel included. Complete outfit ready for use \$7.95 postpaid. TORCH alone with pint of special fuel \$6.85. KIT alone \$1.65. Instructions included.  
**AMERICAN PRODUCTS CORP., 422 S. Dearborn, Dept. 3-K, Chicago**



### 6 GREAT SHAW DU-ALL

Plow  
Plant  
Cultivate  
Mow  
Rake  
Cut  
Trees  
Saw Wood



**Walking or Riding Tractors**  
1 1/2, 3, 5 H.P. walking models. 1 1/2 to 12 H.P. riding tractors. Get just the power you need in Shaw extra strength superior traction machines. All wanted tools, attachments. Dependable for nearly 50 years. See a Shaw dealer. Write for FREE literature, low prices—today.

**SHAW Mfg. Co.** 4511 Front St., Galesburg, Ks.  
668-G N. 4th St., Columbus, O.



## Darra-James POWER TOOLS

*More for Your Money*

Better in every way... larger work tables... sturdier frames... newest mechanical improvements. Darra-James engineers are constantly working to give you more for your money. Get the facts today!

WRITE FOR CATALOGS

**TOOLKRAFT CORP.**  
SPRINGFIELD 1, MASS.

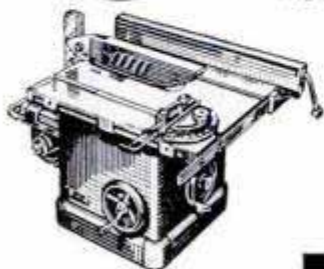

Professional Quality  
TILT ARBOR SAWS



## FRAM FILTERS

save pep and power,  
cut repair bills

Whether you're heading for southern sun, a hunting trip, or just driving around home, you're better off with a Fram-clean engine.

With a genuine Fram Cartridge in your oil filter your engine stays cleaner, peppier, more powerful. It spends its time going places... not fighting sticky, gummy, power-stealing sludge.

That's because Fram Filter Cartridges do a better job of keeping your oil and engine clean. They trap more dirt and sludge... and in tough winter driving that's important.

So why not see your Fram Dealer right away to find out, "How's your Oil Filter?" If it's time to replace the cartridge, insist on a genuine Fram.

*Best life insurance your car ever had.*

For the name of your nearest Fram Dealer, call Western Union (by number) Operator 25



**FRAM**  
OIL • AIR • FUEL • WATER  
**FILTERS**

FRAM CORP.,  
Providence 16,  
R.I. In Canada:  
Fram Canada  
Ltd., Stratford,  
Ontario

# DR. GRABOW

THE *Pre-Smoked* PIPE  
GIVES YOU A COOLER,  
SWEETER SMOKE!

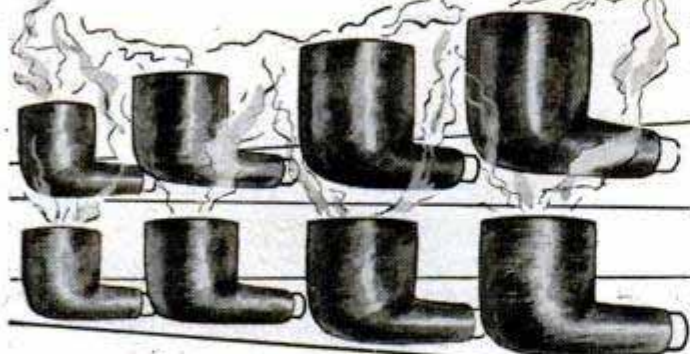

The first pipefuls determine the pleasure your pipe gives. Yes, the secret to a sweet smoking briar is to break it in properly . . . and Dr. Grabow does this for you.

Mechanical pre-smoking with Prince Albert tobacco breaks in each Dr. Grabow as it should be . . . never too hot, never too fast, never too slow . . . but just right for a cool, sweet smoke.

Buy a pre-smoked Dr. Grabow and taste the difference yourself.

**\$1.50 and up**



HENRY LEONARD & THOMAS • GREENSBORO, N. C.

SEND 10c TODAY FOR THE BOOKLET

"1001 Uses for the Simpson Model 260" in your home-garage-shop or hobby

Find out how you can check and trouble shoot faulty circuits in • TV sets • radios

• transmitters • broad-casting

equipment • home ap- p l i

ances • two-way radio c o m

munication systems • phone

lines • air conditioning systems •

starter controls • auto ignitions,

generators, batteries • movie

equipment • panel instru-

ments • TV cameras • auto

lighting sys- tems • generators

• voltage sources • "ham" radio

equipment • cables • connectors • audio

frequency sound currents

USE THIS AD AS YOUR COUPON.

**Simpson** Print your name and address in the margin. Mail to  
**ELECTRIC COMPANY**

5200 W. KINZIE ST., CHICAGO 44 • ESTEBROOK 9-1121  
IN CANADA: BACH-SIMPSON, LTD., LONDON, ONT.

Simpson "260" Volt-Ohm-Milliammeter reads voltage, current and resistance only \$38.95

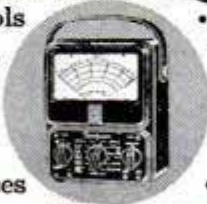

No. 10-W \$2.60

SEE THE MUSCLES IN A VISE-GRIP WRENCH!

Cut-Away View (Partly Open)

A. Adjusting Screw  
B. Toggle Arm Gives Double-Lever Action  
C. Coil Spring for Pliers Action

**Double-Lever Action Locks Jaws with TON-GRIP**  
Look INSIDE the most useful tool in the world! Only Double-Lever action could provide Ton-Grip. See how a squeeze of the hand locks jaws to work! Won't slip. Can hold, twist, bend, pull, ratchet, cut! How you'll USE it! 7" and 10" only \$1.85 to \$2.60. At your hardware dealer.  
Manufactured Only By  
**PETERSEN MFG. CO., Dept. M-11, DeWitt, Nebr.**

**3 CU. FT. MIXER 3975**  
DIRECT FROM MFR.

Fills long felt need for small mixer for concrete, feed, fertilizer, seed and many other materials. Saves \* cost of ready mixed concrete. Pays for itself on first job. Combination belt pulley and crank for hand operation. Also power mixers. Write for circular.

3 Cu. Ft. Drum—Mixes 2 Cu. Ft. Concrete ..... \$39.75  
5 Cu. Ft. Drum—Mixes 3 Cu. Ft. Concrete ..... \$9.50

FOB Pulaski, N. Y. Cash, Check or M. O. Money back guarantee

**UNITED STATES FORGE AND FOUNDRY CO.**  
CONSTRUCTION EQUIPMENT DIV. PULASKI, NEW YORK

**POWER HACKSAW \$55.75**  
LESS MOTOR  
F.O.B. Benton Harbor

• Rugged cast iron construction. Wt. 56 lbs. bronze bearings. Draw cut. Auto. return lift. Auto. shut-off. Vise swivels 45°. Cap. 4"x4".

Send for full details and name of nearest dealer.

**EXCEL MACHINE TOOLS** Dept. PM-113  
BENTON HARBOR, MICHIGAN

**TANK PERISCOPES - Look Over Fences**

Brand New Tank Periscopes for the first time at a fraction of original cost. High Precision Optical Viewing Instrument. Ideal Gift. 11" long, 6 1/2" wide, 1 3/4" deep. Only 200 available. Can be revamped to various lengths with little effort. Can also be sealed for underwater use. Postage paid in U. S. and Canada. \$12.95

**MAXIMOFF RESEARCH COMPANY**  
5916 Sepulveda Blvd., Van Nuys, Calif.

**Midget Monitor S. W.**  
**AMAZING PERFORMANCE!**

This short wave set receives "Ham," Aircraft, and Foreign broadcast. Uses only two tubes. Simple pictorial diagram. Kit with tubes and all parts less phone and batteries.....ONLY **\$7.99**

Foreign orders \$8.99. Batteries \$2.10. Phone \$2.00. Deposit \$1.00 on C.O.D. orders.

**Dura-Mite Products Co.**  
210 Fifth Ave. New York 10, N. Y.



# DO IT YOURSELF!



## CALK WITH *Nu-Calk* SPEED LOAD

It's easy to calk those cracks around window and door frames. Just slip a Speed Load into the gun and you're ready! It's the fastest, most economical way to apply Nu-Calk — the world's finest calking compound.

## REPAIR ROOFS WITH *Nu-Phalt* PLASTIC ASPHALTIC CEMENT

Don't put up with leaky roofs or flapping shingles. Use Nu-Phalt—the ready-to-use asphalt base cement—on chimney flashing, gutters and general roof repairs. Has outstanding adhesive qualities on wet or dry surfaces. Can be applied with a calking gun, or with a putty knife.



On Sale at all Leading Hardware, Lumber and Building Supply Dealers

AVAILABLE WITH OR WITHOUT PLASTIC NOZZLE



## MACKLANBURG DUNCAN CO. OKLAHOMA CITY, OKLA.

AVAILABLE WITH OR WITHOUT PLASTIC NOZZLE

## SHEET METAL BRAKES

Angles, flanges, Pittsburgh locks, 24 G. steel, heavier aluminum. Cam locking, mount on bench, truck or floor stand. Truss braced steel. Express collect. 30", 65 lbs., \$28.50. 36", 75 lbs., \$33.00. 48", 100 lbs., \$48.00. Portable stands, 32" hi., 35 lbs., \$7.00. 15", 40 lbs., capacity 16 gauge, \$21.50. IRON BENDER forms hooks, angles, eyelets, etc. Capacity 1/4 x 2", 5/16 x 1 1/2". All steel.....\$9.50 30" CURVE FORMER. Forms straight and tapering pipes 2" to 2 ft. in diameter, 20 gauge, express collect \$9.50 (Immediate delivery. Order direct, cash or C.O.D., or send for folder) VYKE BRAKE CO., P-2439 15th St., Denver 11, Colo.



Say You Saw It in Popular Mechanics

## GRAVELY Snowblower

BLOW YOUR SNOW TROUBLES AWAY!

5 HP

Snow Blower attachment for powerful 5-Horsepower Gravelly Tractor moves deep, dangerous snow swiftly and easily. 20 other attachments for every lawn, garden, field job. All-gear drive, reverse. Postcard brings complete story of "Power vs. Drudgery."



FREE! Write Today!

GRAVELLY TRACTORS, INC. BOX 1163 DUNBAR, WEST VA.

## BUILD YOUR OWN GARAGE DOOR...

## SAVE MONEY!

WORK FROM A PAPER PATTERN — STEP-BY-STEP DIRECTIONS

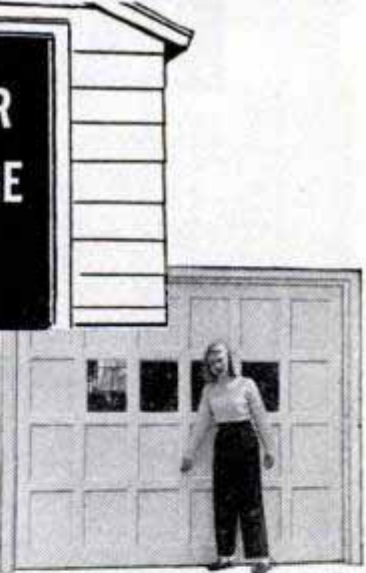

With Easi-Bild® Build It Yourself Pattern No. 86 you can have a garage door with Stanley Swing-Up Hardware — for less than 1/2 present cost! Pattern tells what materials to buy, where and when each is used. No special tools or skill required. Install the Stanley Garage Door Set with hand tools.

You'll be amazed at how easily and economically you can build a professional looking door by following the step-by-step procedure outlined in this pattern. Ask your dealer for Simplified Directions for installing Stanley Garage Door Hardware, and Easi-Bild Pattern — or send coupon below.

\*Trade Mark Reg. U. S. Pat. Off — Easi-Bild Pattern Co.

EASI-BILD PATTERN CO., Dept. 5-4, Pleasantville, N. Y.

Enclosed is 50c in Coin, Money Order, Check for Single and Double Garage Door Pattern No. 86.

Please send Simplified Directions for installing  Single  Double Garage Door Hardware

Name.....  
Address.....  
City..... State.....

best  
white tape  
made

ONLY  
**98¢**\*



The new Evans "White-Tape" has everything you'll find in tapes costing over \$1.50—plus.

- snow-white blade with bold, legible, jet-black numerals and graduations. Graduated in 32nds for first 6 inches.
- sturdy die-cast case heavily chrome-plated, calibrated for quick reading inside and outside measurements.
- blade 1/2" wide made of finest high carbon steel—tempered—Bonderized—enamelled—baked.
- blade replaceable in seconds—without tools—without even opening case. And Evans replacements cost far less.
- every Evans "White-Tape" is unconditionally guaranteed.
- exclusive Evans automatic brake gives smoother push-pull action with absolutely no "creeping" of tape into case.
- underside is white, too. Mark with ordinary pencil, remove mark with flick of thumb.
- unheard-of low price\*: 10-ft. \$1.49; 8-ft. \$1.19; 6-ft. 98c. Prices higher in far west and Canada.

**Evans**

Sold only through retailers.  
& CO. • Elizabeth, N.J. • Montreal, Que. © 1959

Makers of Evans 6-ft. Folding Rule and "Folding Yardstick"

send for **FREE CATALOG**

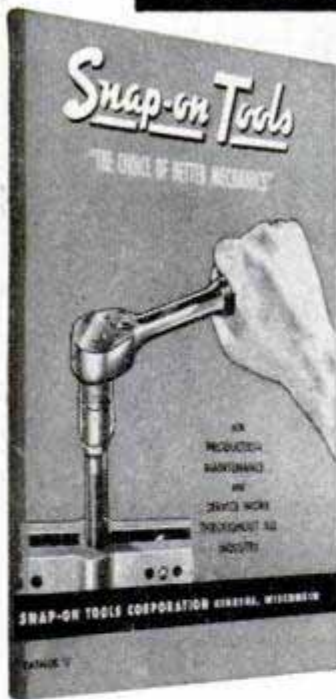

America's Foremost  
*money-making*  
**MECHANICS'**  
**TOOLS**

It's easy to own the same "pay-off" tools used and endorsed by America's top-earning mechanics throughout the automotive, aviation and industrial fields! Snap-on tools help you handle every repair job faster, easier, better. And they LAST... pay for themselves over and over again! Start building your own tool set now with basic Snap-on units—add others any time. Genuine Snap-on tools are never sold in stores—direct to users only. Mail coupon for free catalog.

**Snap-on Tools**  
THE CHOICE OF BETTER MECHANICS

Snap-on Tools Corporation  
8062-K 28th Ave., Kenosha, Wis.

Send me free catalog. Occupation \_\_\_\_\_

Name \_\_\_\_\_

Address \_\_\_\_\_

City \_\_\_\_\_ Zone \_\_\_\_\_ State \_\_\_\_\_

**THOUGHTFUL GIFTS FOR HOBBYISTS**



Model 3100-A — "Tiny Atom" Motor — speeds up to 6000 R.P.M. Double extended shaft. Permanent Alnico magnet field — wound rotor. For hobby and experiment. Runs all rotating small toys and models. 1 1/2-3 volt — \$2.00. Higher voltages, \$2.50.

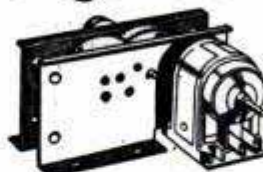

Model 3000 — "Tiny Atom" Motor and variable speed gear train. Ten useful powerful working speeds from 30 R.P.M. to 400 R.P.M. Complete kit with educational handbook, \$4.00.

**CHOICE OF 3 USEFUL KITS**

Vial containing all parts for applying power to toys and models by belt, direct connection, spur gear or worm drive. Kit K-1300 ..... \$1.00

"Tiny Atom" Motor and all components for every type of drive, either direct or radio controlled. Kit K-4000... \$5.00. Similar Kit without motor. Kit 3700..... \$3.00

For quick delivery see your local dealer — or order direct



Remit to Dept. M with order and we pay postage in U.S.A. No C.O.D. shipments.

**WILSON'S OF CLEVELAND**

425 Lakeside Ave., N.W. • Cleveland 13, Ohio



**NEW SAW SHARPENER**

Improved #64 Hand Gummer sharpens all types circular saws 4" to 20" diam. Ideal for saw shops. Self-centering adjustment for quick, easy set-ups. Complete with 1/4 HP motor, 1 grinding wheel & cord. \$79.50 FOB Portland, Wt. 70#. SEND FOR FREE LITERATURE.

**P. T. HOBBS MACHINERY**  
8375 N. INTERSTATE AVE.  
Dept. P.M.-61, PORTLAND 17, OREGON



Find **HIDDEN TREASURES**

**GEIGER COUNTERS** (as shown) for Uranium Detection. **TREASURE DETECTORS** for gold, silver, etc. Lightweight, ultra sensitive. Best at any price. Also mineralights. • INFORMATION FREE •

*Detectron* co.  
5420 Vineland, North Hollywood, Calif

**TV TUBE TESTER**  
4" x 6" 7 ozs.  
\$9.95 No C.O.D.  
Tests electronic tubes. Fast, sure, self-contained. Be your own serviceman.  
**SMITHGUILD, INC.**  
360 W. 8th ST. ERIE, PA.

**KING MIDGET AUTO**

Operate it for 75c per week. Amazing performance. Surprising comfort. All steel construction. Ready to run or assemble it yourself with our bolt together parts. Rider Agents wanted. Send 25c for detailed literature or \$1 (refunded first order) for actual assembly book and service manual filled with photos, drawings, specifications, etc.  
**MIDGET MOTORS MFG. CO., ATHENS, OHIO**

WORLD'S  
LOWEST PRICED  
2 PASSENGER AUTO



# RENEW WOOD FLOORS

QUICKLY • EASILY



Remove old finish, wax and dirt with a Red Devil Sanding Machine. You can rent one very inexpensively from your local dealer.

Then brush on either floor seal, varnish or shellac to provide a hard, smooth base for the wax and to bring out the beauty of the wood grain.



Then the Red Devil FP-33 Floor Conditioner is put to work. With the waxing brushes a smooth, even coat of paste wax is applied to the floor.

With the buffing pads in place the Red Devil FP-33 easily completes the job by polishing the floor to a glistening, satiny finish.

Easy as this, if you have the right tools and know how to use them.

your...

## Red Devil

Hardware or Paint Dealer can take care of both these needs. Get full details by getting your FREE copy of Red Devil's "How To Maintain Wood Floors" from your dealer or mail the coupon today.

Remember — you want Red Devil Tools — the kind professionals use.



### Red Devil Tools.

Box 702

Irvington 11, N. J.

Please send me "How To Maintain Wood Floors"

Name \_\_\_\_\_

Address \_\_\_\_\_

City \_\_\_\_\_ State \_\_\_\_\_ 3036



## BOAT SUPPLIES

MARINE HARDWARE  
SAVE BY MAIL!

Save on marine paint, fittings and hardware from the nation's most complete marine supply store. Everything for your boat.

FREE  
44 PAGE  
CATALOG

**SOUTH COAST COMPANY** Since 1908  
2212 Newport Blvd., Newport Beach, California

FREE MONOGRAM WITH UNIFORM. Matched uniform of pants and shirt, 8 oz. Sanforized herringbone twill. Six months guarantee or money refunded. Choice of color: medium blue or marine tan. Send waist size, leg length of pants, shirt size, and name for monogram. Send check, or money order \$6.50

Reference: National State Bank of Orange  
**UNITED UNIFORM COMPANY**  
28 Buckingham Road West Orange, New Jersey



## BUILD your own SMITH AIR COMPRESSOR

Operates spray guns, rock drills, tampers, paving breakers, sandblasting . . . Uses only 1 gallon of gas an hour! Famous the world over! Capacity 60 cu. ft.; pressure up to 100 lbs. per sq. inch. Just order the Smith Compressor Head and Accessories with complete instructions for assembling. All you need is a Ford Motor and shop facilities. Head equipped with high speed compressor valves; automatic unloading and idling.

Write for complete information!

**GORDON SMITH & COMPANY, Inc.**  
410 College Street • Bowling Green, Ky.

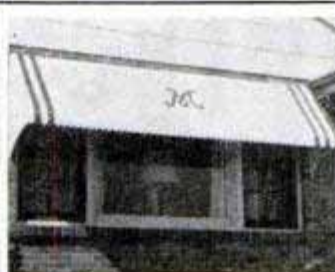

## Make Your Own!

ASSEMBLE AMERICA'S

Most Beautiful  
ALL-ALUMINUM  
DOOR CANOPIES  
AND WINDOW  
AWNINGS

● THE ONLY TOOL YOU NEED IS A SCREWDRIVER

● These awnings are pre-treated, ready for paint. It's easy! Just do the top — the sides are assembled. Designed and engineered by Herbert's — with experience and machinery to sell you a better awning.

● AVAILABLE COMPLETELY ASSEMBLED WITH BAKED ENAMEL FINISH.



DIRECT FROM FACTORY

WRITE FOR FREE MEASURING CHART AND LITERATURE

## Save 50%

8974 St. Charles Rd. **Herbert's** St. Louis 14, Mo.  
ALUMINUM AWNINGS

NAME \_\_\_\_\_

ADDRESS \_\_\_\_\_

CITY \_\_\_\_\_ ZONE \_\_\_\_\_ STATE \_\_\_\_\_



**Keeping a gouge sharp  
is easy...**

with a  
**NORTON INDIA® Gouge Slip**

The gouge has a curved edge and requires a stone formed to fit the curve. Rotate the gouge from side to side as illustrated. Then turn the stone over and using the narrow end give the inside of the gouge a few deburring strokes, keeping the inside face flat on the stone. Get FS-76 at your hardware store or direct, \$2.25.

Are the rest of your tools sharp? If not, send 10¢ for the "How to Sharpen" Book to Behr-Manning Corp., Troy, N. Y., Dept. PM-11. C-6



**BEHR-MANNING**  
CORPORATION  
division of NORTON Company

▲ COATED ABRASIVES ▲ SHARPENING STONES ▲ PRESSURE-SENSITIVE TAPES

# WOODS

## Get This BIG Manual And Bargain Book

Loaded with how-to-do it articles on wood-finishing, veneering, making inlay pictures and cabinets. Contains 83 distinct inlay designs and borders, plus a wood identification panel of 60 different varieties. All shown in full natural color suitable for framing.



### A MULTITUDE OF MATERIALS

- Lowest Prices On**
- Veneers
  - Inlays
  - Lumber
  - Plywood
  - Plans
  - Supplies
  - Plastics
  - Period Furniture Hardware
  - Modern Picture Frame Molding
  - Upholstery
  - Hand and Electric Tools
  - Finishing Materials
  - Decorative Metals
  - Leather

Albert Constantine & Son, Inc.  
Dept. PM-18, 797 E. 135th St., N.Y. 54

● VISIT US at our N.Y. Plant. Demonstrations every Saturday on making inlay pictures, wood finishing and other crafts. Everyone invited.

## SEND THIS COUPON!

Albert Constantine & Son, Inc., Dept. PM-18  
797 E. 135th St., New York 54, N.Y.

Enclosed find 25c (refunded on 1st order) for your copy of "Manual For Craftsmen" No. 52.

Name \_\_\_\_\_  
Address \_\_\_\_\_  
City \_\_\_\_\_ State \_\_\_\_\_

## PARTS FOR MILITARY TRUCKS

and **JEEPS** 4 & 6 WHEEL DRIVE. WRITE FOR PARTS CATALOG STATING MAKES

### JEEP TOPS and CURTAINS

All Brand New . . . Not Surplus  
Made of Heavy Canvas Duck . . . Waterproof  
MILITARY TYPE models, Top and Curtains, complete. **\$59.50**  
less bows . . . . .  
TOP and CURTAINS, HALF CAB . . . MODELS CJ2A and CJ3A, complete with hardware. **\$65.00**  
less bows . . . . .  
TOP and CURTAINS Complete, MODELS CJ2A and CJ3A, with hardware for entire Jeep **\$88.80**  
less bows . . . . .

When ordering please state exact model  
All prices F.O.B. K.C. 25% dep. on COD's

**American AUTO PARTS CO. INC.**  
1830 LOCUST - DEPT. PM-10  
KANSAS CITY, MISSOURI

## ?? DOES YOUR CAR ??

**SMOKE - DRINK - LOAF - STUMBLE**

### Because of A Weak, Low-volt Electrical System SELECT - A - CHARGE WATTAGE REGULATOR



With EZ Adjustable Voltage Booster Switch  
A SURE-CURE for most chronic generator, regulator and battery troubles . . .

**Salesmen Wanted!! Big Profits**

Write for Free Details - How you can get a Select A Charge Regulator on your car for introducing. **SCIENTIFIC ELECTRIC CO.** P. O. BOX 2162-C CLEVELAND 8, OHIO.

**CRESCENT TOOLS**  
*Give Wings to Work*

ASK YOUR  
HARDWARE  
DEALER

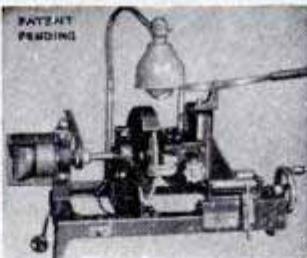

## Start a NEW BUSINESS!

or Add to your present  
Repair Business

### SHARPEN DULL PIPE WRENCHES

PIPE TAPS & DIES  
"GUM" CIRCULAR SAWS  
Write for Information

**J. C. MOORE INDUSTRIES**  
BOX M 276 FREDONIA, PA.

**SURPLUS SALE**

**\$39.50** NEW TOOL POST GRINDERS  
REGULAR PRICE \$125.00  
1-6 H. P. MOTOR  
TAKES WHEELS UP TO 1/2" x 4"  
EXTRA QUILL EXTERNAL OR  
INTERNAL \$19.50  
MONEY BACK GUARANTEE

Less Grinding Wheel  
**EDWARD J. NOLAN, PULASKI, NEW YORK**

Say You Saw It in Popular Mechanics

## CARBIDE LATHE CHISEL

Two of these chisels do work of regular set of turning tools. Cut metal, wood, plastics free hand on your wood turning lathe. Plated shank. Long cutting life. Easy grip handle of hard maple. Sharpens on regular grinding wheels. Send Money Order or-Check today!

**\$4.00 each Sent Postpaid**

- \*No. 18 - 1/8" Sq. Nose
- \*No. 28 - 1/8" Rd. Nose
- \*No. 14 - 1/4" Sq. Nose
- \*No. 24 - 1/4" Rd. Nose

Complete set of 4 . . . . . **\$15.00**

**MILHAUPT CO.** 407 E. Michigan Milw. 2, Wis.

# FINE TOOLS NEED FINE OIL!



• Lubricates



• Prevents Rust

• Cleans • Polishes

SOLD EVERYWHERE

## 3-IN-ONE Oil

# SAVE 30% ON ROTARY TRACTORS



Save 30% by buying direct factory-to-you. Tough, rugged 3 H.P. motor. Reverse & full differential for easy handling. Automatic clutch. Power take-off. Lowest priced tractor in the field. Words of praise from 48 states. Absolute factory guarantee. Act now. Write for information.

SEND FOR FREE Booklet

**CULTILLER Manufacturing Co.**  
Dept. 1 NEW BRUNSWICK, N. J.

# BATTERIES! — START

—a factory at home and re-cast junk batteries into new; latest achievement. We supply complete instructions and everything needed. Large daily profits!

BATTERY LABORATORIES, Dept. PM, Minneapolis 4, Minn.



# DRAINS Cellars, Laundry Tubs; CIRCULATES Oil; IRRIGATES Gardens

Original "Type P" Pump has 2400 GPH capacity. 360 GPH 75' high, or 1500 GPH from 25' well. Use any 1/8 to 1/2 HP motor. DOES NOT CLOG. 1" intake; 3/4" outlet.

Postpaid if cash with order. (West of Miss. add 50c.) Motor coupling included. MONEY BACK GUARANTEE. Also Gear Pumps in all sizes.

**\$6.95**



LABAWCO PUMPS, BELLE MEAD 7, N. J.

SAY YOU SAW IT IN  
POPULAR MECHANICS

# Holds the Screw! Drives it too!



Unconditionally  
Guaranteed

Quick-Wedge  
SCREW-HOLDING  
SCREWDRIVER

Ask for it at your Dealer

Kedman Co., 233 S. 5 W., Salt Lake City, Utah

# SELF-CONTROL STARTS HERE

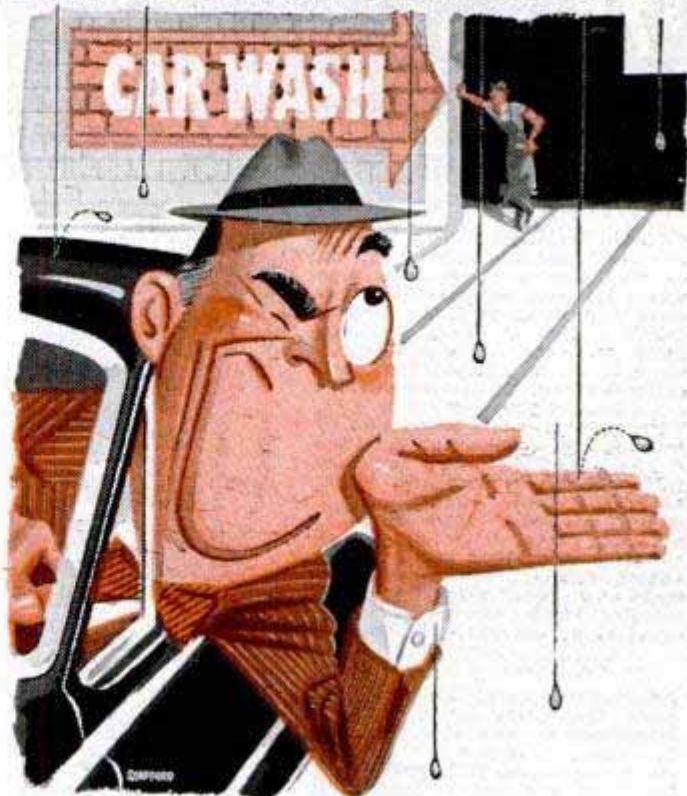

AND TO RESTORE  
CAR PERFORMANCE

# OIL-CONTROL STARTS HERE

To stop oil-pumping, replace worn engine  
connecting rod bearings

The pleasure of car driving can be thoroughly dampened when worn engine bearings cause oil pumping. Worn engine bearings let excess oil reach combustion chambers, burn to performance-stealing carbon on spark plugs, valves, pistons and piston rings. Performance goes up in smoke!

Don't blame the piston rings for oil pumping caused by worn engine bearings. Give the rings a chance—check for worn engine bearings on every overhaul. Replace with genuine Federal-Mogul bearings, engineered for the job of oil control. They'll restore power and performance — ask your mechanic!



FEDERAL-MOGUL SERVICE  
(Division of Federal-Mogul Corporation)  
DETROIT 13, MICHIGAN

CONTROL OIL-PUMPING  
WHERE IT STARTS—REPLACE WITH

# FEDERAL-MOGUL

OIL CONTROL BEARINGS



own your own business! earn up to  
**\$75 A DAY CLEAR PROFIT**  
 in your back yard or basement!

**MAKE CONCRETE BLOCKS With Amazing New  
 LOW PRICED GENERAL BLOCK MACHINE**

**NOW! Big Building Boom**

**Profits Within Your Reach**  
 You don't need much cash to cash in on the building boom! New high speed, low cost General Block Machine produces up to 1,000 concrete blocks a day for homes, factories, buildings, garages. Your profit mark-up is 100% to 150%! Fool-proof, easily operated, sturdy steel machine can make any size from 4" to 12". These superior 3-core blocks meet all building code requirements for foundation, chimney, corner, sash and many other types of blocks. Works indoors or out. Sand, cement and water available anywhere! Simple operating instructions and mixing formulae for cement and cinder blocks supplied FREE. Get full details, no obligation!



R.L.T. of New York City Reports: "My General Block Machine PAID FOR ITSELF IN FIRST 2 WEEKS!"  
 Thousands now in use the world over!  
 Write for FREE details TODAY

**EXTRA!**

Amazing illustrated book gives floor plans for 6 sensational concrete block bungalows. Tells how to lay blocks, lay out building lines, mix concrete, build steps, porch and concrete floors all at great savings. Written by experts. Can save many times the cost of the machine! Get it now! No strings attached.

HOW TO BUILD YOUR OWN CONCRETE BLOCK HOME Only 1 Prepaid

SEND \$1 — Refunded if you buy machine!

**GENERAL ENGINES COMPANY**

Dept. M-113, 307 HUNTER STREET, GLOUCESTER, N. J.

**TAKES BUTT END MEASUREMENTS AT 2, 4, & 6 INCH INTERVALS**

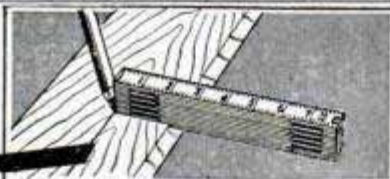

**CAN BE USED AS A MARKING GAGE**

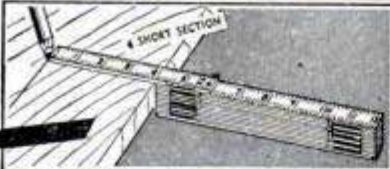

**New LUFKIN No. 466**

**BUTT SPACING RULE**

Unique 4 inch first end section permits taking measurements or using as a marking gage at any even numbered interval. Ideal for 12", 16", 24" centers. Has all the famous Lufkin RED END features.

BUY **LUFKIN** TAPES • RULES • PRECISION TOOLS AT YOUR HARDWARE OR TOOL STORE

272



**THE AMAZING STORY OF MEASUREMENT**

LUFKIN RULE CO., Dept. PM, Saginaw, Mich. Please send me this fascinating booklet. Enclosed is 10c (no stamps) to cover handling and Mailing.

NAME \_\_\_\_\_  
 ADDRESS \_\_\_\_\_  
 CITY \_\_\_\_\_ STATE \_\_\_\_\_

**STOP CHANGING MOTOR OIL!**

End this needless expense forever with

**RECLAIMO** Today's most advanced OIL RE-REFINING filter FOR CARS, TRUCKS, TRACTORS.

Continuously cleans and RE-REFINES motor oil as you drive by utilizing motor heat — keeps oil in high grade lubricating condition at all times.

**"RECLAIMO"**

- REMOVES SOLIDS (by filtration)
- REMOVES WATER (by distillation)
- PREVENTS Excess fuel dilution
- PREVENTS Acid and Sludge Formation
- ADDS Thousands of Miles to Engine Life

**MAINTAINS** Stable Viscosity **ELIMINATES** All Oil Changes  
 FREE 32-page book "OIL FACTS" with bonafide \$1,000.00 offer on page 30. Gives you the complete "Reclaimo" story and details of our extraordinary 90-DAY NO-RISK TRIAL OFFER. Write for your copy today!

**RECLAIMO MFG. CO., INC.**

5083 Elston Ave., Dept. M-11, Chicago 30, Ill.  
 Wm. Schwalge, U.S. Pats. 1757223, 1834654, 2068473.

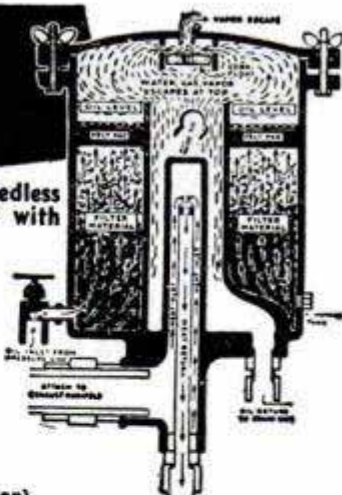

**DEALERS WANTED**

U. S. BUREAU OF STANDARDS, Bul. 86 States, "Oil does not wear out mechanically."

**WOOD LASTS LONGER WHEN WOODLIFE TREATED**



WOODLIFE protects wood against swelling, shrinking, warping, checking, decay and termites. Clean—odorless when dry. Improves paintability. Contains Pentachlorophenol. Buy WOODLIFE-treated lumber or apply it yourself. See your lumber dealer.

PROTECTION PRODUCTS MFG. CO.  
 Kalamazoo 5-2, Michigan

SEND FOR FREE LITERATURE

**NOW! FILE YOUR OWN SAWS**



Do expert saw filing at home. Precision filing easy without experience. Two simple adjustments. Keeps any hand saw extra sharp and true-cutting. Complete with file. Money back guarantee. Cash with order, pre-paid. (COD postage extra.) Order today.

Another Speedcor Tool  
**THE SPEED CORP., PM-11**  
 3420 S.W. Macadam Ave.  
 Portland 1, Oregon

\$2.95 EACH

**SUPER DRILL GRINDER**

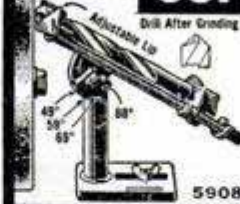

Sharpens round shank drills from 3/32" to 1/2" in diameter, up to 6" long. Grinds old drills like new in 4 different point angles, using hand or power grinding wheels. Money-back guarantee... only \$2.95 At Dealers or Postpaid

**A. D. McBURNEY** Dept. A-35  
 5908 Hollywood Blvd. Hollywood 28, Calif.

Enjoy the Fascinating Story of the Horseless Carriage in



Popular Mechanics

**AUTO ALBUM**

166 Illustrations

The most intriguing book about the automobile ever printed. It's thrilling, fascinating and informative. From the very first gasoline-propelled buggy to the cars of today and the atomic auto of the future. The first cars — the men who made them — the scrambled start and the development of the fabulous auto industry—the story of auto racing—the growth of the Nation's highways. 166 thrilling action pictures—old-time cars—racing cars—early auto advertising—automotive oddities. Roll call of names of more than 2000 autos made in the U.S. included. Ideal gift book. Cloth bound, only \$3.00 by mail. Money back if not pleased. Paper covered edition \$1.00 at newsstands.



**POPULAR MECHANICS PRESS, Dept. PM14**  
 200 East Ontario Street Chicago 11, Illinois

# BETTER SIGHTS for BETTER SHOTS



For faster, more accurate sighting, equip with a combination of

## MARBLE'S SIGHTS

Flat Top Sporting Leaf \$2.25

Flat Top Rear, \$2.25

Semi-Buckhorn Rear \$2.25

Sheard "Gold" Front Sight \$2.00

Standard Front Sight \$1.25

Marble's Flexible Rear Sight, with automatic spring joint. Can be locked down. With 2 discs. \$6.00

(A-262)

At your dealer, or write for Catalog

Marble Arms & Mfg. Co., 578 Delta Ave., Gladstone, Mich.

## STOP JERKY STARTS! with an AUTOMATIC CLUTCH

**END BELT SLIPPAGE**—Get smooth pickup for your power mower, scooter or garden tractor with only throttle control.

**PREVENT STALLING** engine, cut belt wear, gain no-load idling. Quickly and easily installed on 1/2", 5/8", 3/4", 1" shafts. Every clutch factory tested.

**V-PLEX CLUTCH DIVISION** • Hagerstown, Indiana

## BAKE YOUR OWN FINISHES IN YOUR SHOP

Real industrial baked finishes now possible for small consumers and home workshops. Quality paints at factory prices. Send 10c for color charts, information and prices. M & S INDUSTRIAL PAINT CO., 3338 Maple Avenue, Berwyn, Illinois. Write today!

## NEW SAF-PIC TOOL

A TOOL OF A THOUSAND USES. COLORFUL DURABLE. ALL STYRON PLASTIC WITH HARDENED STEEL SHARP TEMPERED POINT.

FOR THE MECHANIC—A do all tool, scribing, punching, marking, etc.

FOR THE OUTDOOR MAN—Indispensable for fishing, camping, picnics, etc.

FOR THE HOUSEWIFE—For house, car, and safe for the children.

EUGENE SALAN

P.O. BOX 343 • CULVER CITY 1, CALIFORNIA



SO SAFE AND EASY TO USE

Illustration Showing Three Parts Pat. Pend.

Saf-Pic Ready for Use

Pick Concealed for Safety

\$1.00 MONEY-BACK GUARANTEE

## GET THIS STRAIGHT you can't beat an EMPIRE LEVEL



For improved accuracy, better visibility, less breakage, use the new Empire 9" aluminum Torpedo pocket level with machined bottom groove and protected, easy-reading vials. See your dealer today for all-purpose Empire Levels.

## EMPIRE

LEVEL MFG. CO. | 10930 W. Potter Rd., Dept. PM Milwaukee 13, Wisconsin



# CUTS ALL with SAME BLADE!

## WORLD'S MOST Versatile JIG SAW

This truly amazing, versatile Syncro Magnetic Jig Saw actually cuts all the different materials pictured here with the same blade so smoothly sanding is not needed—no "splintering!" NOW—work with any type wood—the vast variety of plastics—thin metals like copper, brass, aluminum—even copper tubing, cardboard, tile, linoleum—cut them ALL "satin" smooth without "splintering" with this really remarkable saw. SYNCRO is also so QUIET it can be used in apartments—so PORTABLE you use on a table, a chair—anywhere—so POWERFUL it's ideal for Dad's workshop. SAFE FOR CHILDREN—blade does not pull finger toward it! Stroke is adjustable. Arm swings to take any length cut! Thousands used in schools, homes, hospitals, Cub Dens, Scout Troops. Just plug in this sturdy, precision-made "wonder" tool to any 110-220 Volt A.C. wall outlet—saw for fun or profit! Remember—it never needs oiling, has no gears or belts! Its new Reciprocating Electric Motor is BUILT-IN and GUARANTEED against burn-out during your ownership or replaced FREE.

See Syncro at hardwares! If store has none or no store near, send only \$24.95, we'll ship yours postpaid on 10 Days Money Back Trial! Or mail coupon for Free SYNCRO SAW and SANDER Catalog!



## SYNCRO ELECTRIC JIG SAW

and Electric Sanders

THE BASIC SHOP TOOL

THE MOST POWERFUL SAW OF ITS KIND

BLADE WON'T PULL FINGER TOWARD IT!



Syncro Electric Precision Products Made for 30 Years MAIL COUPON!

SYNCRO CORPORATION Dept. D-113—Oxford, Michigan, U.S.A.

ORDER. I enclose \$24.95. Send No. 201 Saw postpaid on 10 Day Money Back Trial. Built-In Motor, cord, plug, blade INCLUDED in price.

FREE SAW & SANDER CIRCULARS. Send new SYNCRO CIRCULAR showing new electric JIG SAWS, SANDERS!

No. 504 SYNCRO Electric Sander

Name: \_\_\_\_\_  
St. & No. \_\_\_\_\_  
City \_\_\_\_\_ Zone \_\_\_\_\_ State \_\_\_\_\_



### Babco Right Angle Drive for 1/4" Drills

Close coupled, fits on drill spindle. Remove chuck, attach to angle drive. Twice drill speed for sanding or half for polishing. Easy to drill in close spaces. \$4.95 ppd. Heavy-duty angle drive for 1/2" elec. drills \$19.95 ppd.

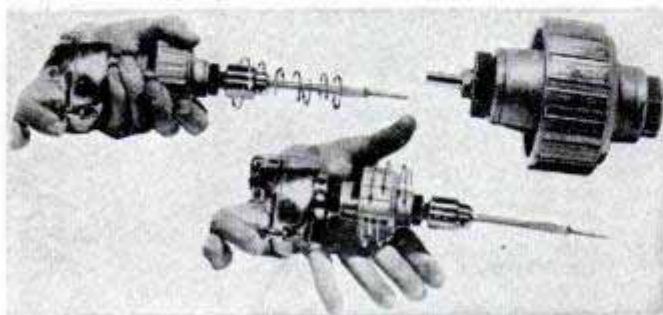

### Babco 5-to-1 Speed Reducer Fits 1/4" Drills

Convert your 1/4" electric drill to electric screwdriver—drill holes to 1 1/4" in wood, 1/2" in masonry. Planetary gear system gives tremendous torque increase. Adapters furnished to use 1/4" or 1/2" chuck. Instant starting, stopping with hand clutch control. To operate tool, grip reducer, release to stop. \$9.95 ppd. At hdw. stores and tool dealers or from Babcock Mfg. Co., 6251 Claremont Ave., Oakland 18, California.

**YIPPEE-EE**  
A SAWHORSE  
IN A JIFFY

NO NAILS  
NO BOLTS  
NO SCREWS



## WITH **Jiffy** SAWHORSE BRACKETS

**ALL WELDED** construction. Use any 2x4's for legs and cross bar.

**SET UP OR** knocked down instantly. Easy to move from job to job, and easy to store.

**FOR SALE BY** most hardware and lumber stores. If your dealer cannot supply you, write us direct.



At Work



At Home

**GRAND HAVEN STAMPED PRODUCTS CO.**  
GRAND HAVEN, MICH.



## ...Wood Carvers!

"HERE'S THE  
NEWEST  
IN THE  
CARVING FIELD!  
\$9.95 PER SET!  
OVERALL LENGTH OF  
EACH TOOL 6 1/2".

PLASTIC HANDLES



6 PIECE CARVING SET

Most Complete Line of Chisels and Gouges

CATALOG  
AVAILABLE!"

**BUCK BROS. INC.**  
RIVERLIN WORKS MILLBURY, MASS.

### TRAILER AXLE

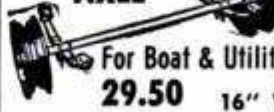

For Boat & Utility Trailers

29.50 16" Wheels

### ALL PURPOSE WINCH



For a Million Uses  
9.25

**NORJACK CO.**

612 S. 108th St. Milwaukee 14, Wis.

## "SHOOOPER" GEIGER COUNTER



2995  
COMPLETE

Super-sensitive! Only 1 1/4 lbs.! Fits pocket—uses flashlight battery. Find a fortune in uranium. Order Now! Send \$5.00, balance C.O.D. MONEY BACK GUARANTEE. FREE CATALOG—scintillator and larger uranium and metal detectors DEALERS WANTED.

**PRECISION RADIATION INSTRUMENTS**  
2235 PM S. LA BREA, LOS ANGELES 16, CALIF.

## VARIABLE SPEED HYDRAULIC POWER TRANSMISSION



It has Infinite Speeds 0 to 550. Reverse, Automatic Overload Protection; Adjustable Torque up to 180 inch pounds. 5/8" Input and Output Shafts. It will handle 1/4 to 1 1/2 H.P. Motor. Case measures 7 1/2" long, 7" high 6 1/2" wide. VALUE OVER \$300. Shipping Wt. 25#. On C.O.D. Orders \$54.50 we require a 10% only Deposit. Feb. Chicago

DIRZIUS MACHINE SHOP "H" 1423-25 So. 52nd Ave., Cicero 50, Ill.



**FINE BOWS and ARROWS**  
SELECTED RAW MATERIALS

**Catalog 5c** Send for it  
**HAND BOOK**—Illustrated Instructions on Making and Shooting Archery Tackle—75c  
**L. E. STEMLER CO.**  
Manorville (Box 3) L. I. N. Y.

## MAKE UP TO \$5 AN HOUR WITH

## EASISHARP



Big profits in your spare time sharpening scissors. We show you how to start making money immediately. This is your chance now to have your own business with Easisharp. Sharpen a pair of scissors in less than two minutes! A child can operate it. Weighs only 10 lbs. Every home, barber, tailor, dressmaker — everybody uses scissors and all need sharpening two to four times a year. Don't let some one else get ahead of you. Write immediately to

MONEY MAKING SALES PLAN FREE

**SERR-EDGE MACHINE CO., 9731 Lorain Ave., Cleveland, Ohio**



# Woodworking is Easy

with these plans and

## ROGERS GLUE

Yes Sir! Rogers Project Plans are easy to follow . . . show you step-by-step how to build attractive furniture for your home—how to make useful gifts for your friends. They even tell you how to set up a simple workshop. Rogers Glue is easier to work . . . is stronger than wood itself. Send only 15c for a full-sized jar of famous Rogers Glue and set of Project Sheets. Mail today to Rogers Isinglass & Glue Co., Gloucester, Mass. Ask for Rogers Glue at your local hardware store.



## ROGERS

the best LIQUID FISH GLUE  
GLOUCESTER, MASS.



"A Ton of Strength in Every Drop"

## PUMP WATER FAST!

DRAIN WASH TUBS, CELLARS, CISTERNS  
IRRIGATE—FILL TANKS—DRAW WELL WATER

Pumps 2800 GPH. 420 GPH at 75' High or 1600 GPH from 25' well. Sturdy. Rustproof Alloy Metal. Six Blade Impeller. Uses any 1/8 to 1/2 H.P. Motor. Will not leak or clog. Fits any garden hose. Immediate Money Back Guarantee. Send Check, M.O., or C.O.D.

895  
IN  
U.S.

MOORE MANUFACTURING CO.  
SWEDSBORO | NEW JERSEY



## Want a HOME?



Before you choose, be sure to GET THE FACTS about Schult mobile homes. Write or wire Dept. 3211 SCHULT CORP., ELKHART, IND.

SCHULT  
TRAILERS

## Oxwall TOOL KITS are Wonderful Gifts

Handy Tool Kits for use in every home, car and workshop. High quality tools in plastic kits. Priced from 98c up. Sold at your local hardware and chain store.



# 600

\$298  
retail

Oxwall TOOL CO., LTD.  
928 Broadway New York 10, N. Y.

Protect your home against power interruptions with an...

## ONAN Emergency ELECTRIC PLANT

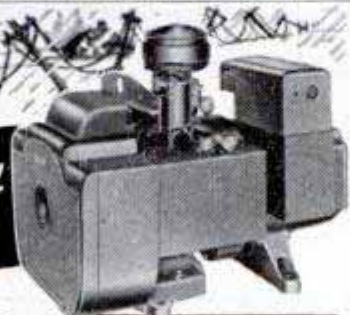

Provides dependable stand-by electricity for heating system, pumps, freezer, lights, appliances. Keeps home safe, livable. Automatic start and stop. Find out how little it costs!

### A SIZE FOR EVERY NEED

1,000 to 50,000 watts. Compact, quiet-running, easy to install. Gasoline engine powered.

Write for Folder!

D. W. ONAN & SONS, INC.  
8571 University Ave. S. E. • Minneapolis 14, Minnesota

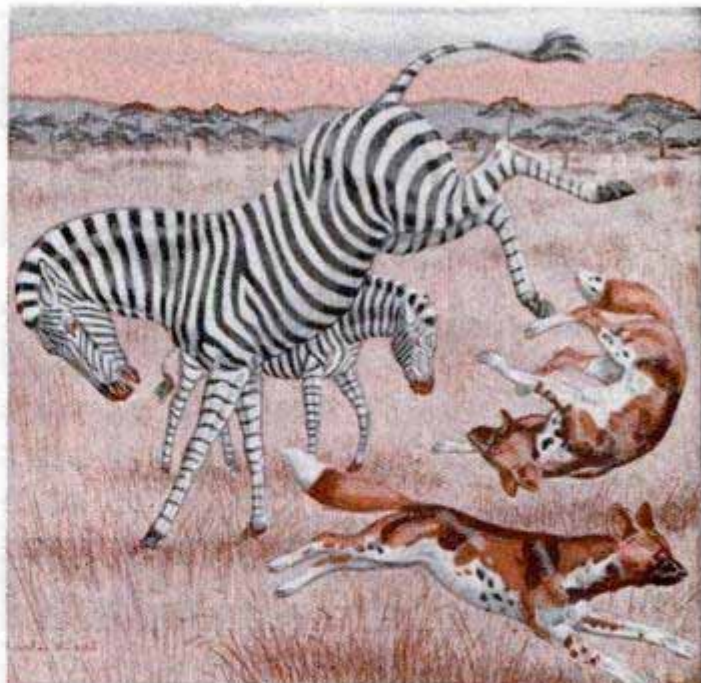

Zebras are formidable opponents when protecting themselves against their natural enemies in the wilds of Central Africa. Here a zebra stallion is shown fighting off vicious spotted hyenas.

## Outstanding Protection

Your engine has natural enemies, too—the sludge and grit that accumulate in lubricating oil, attacking vital precision parts. Your best protection is an AC Aluvac Element in your oil filter, to trap all harmful substances. Aluvac cleans oil better for four reasons:

- **Microscopic filtration**—AC Aluvac removes sludge and dirt particles as small as 1/100,000 of an inch.
- **Maximum filtering area per cubic inch**—AC Aluvac has 10 times the area of ordinary elements.
- **No harmful chemicals**—AC Aluvac won't remove detergents from heavy-duty motor oil.
- **Acidproof**—secret process renders AC Aluvac material resistant to acid, gasoline and water.

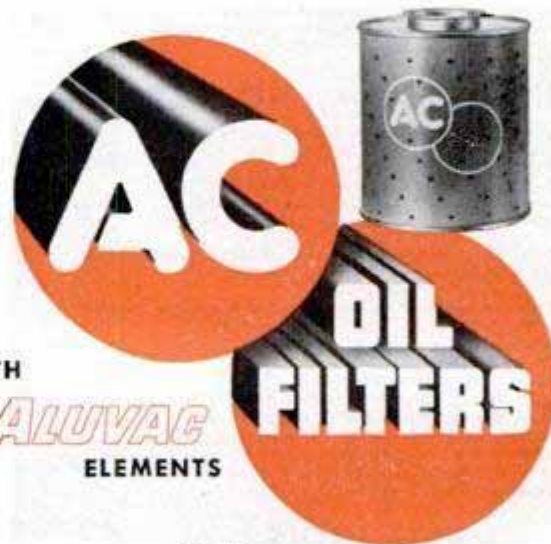

WITH

ALUVAC  
ELEMENTS

OIL  
FILTERS



AC SPARK PLUG DIVISION

GENERAL MOTORS CORPORATION



**NOW! SAW 2x4's  
IN ONE EASY CUT  
WITH NEW LARGER  
'ARCO-SAWS'**

AT  
BETTER  
HARDWARE  
STORES  
EVERY-  
WHERE

**ARCO  
SAW**

No. 455  
"ARCO-SAW"  
For Depth &  
Bevel Cuts.  
**\$12.50**  
with ALL GAGES & 5"  
"ARCO SAFECUT" Blade.

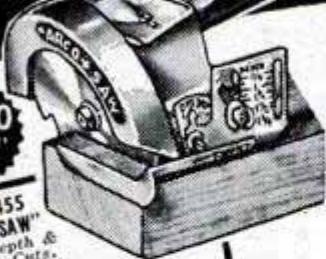

Amazing New Safecut  
Blade Allows Any 1/4"  
Drill To Whiz Thru  
Heavy Lumber, Wall-  
board, Plywood, etc.

At last, here are the  
first—the only—gear  
driven saw attachments  
to whiz thru 2x4's in  
one cut! Imagine, now  
you can build anything from  
bookcases to a bungalow with  
these sensational new saws.

A moderately priced drill will do the job  
because of new "ARCO SAFECUT" Blade.

**ONLY "ARCO" GIVES YOU THESE FEATURES:**

5-inch Safecut Blade—cuts faster—uses 30% less power. Gradu-  
ated Depth & Bevel Gages for cuts to 13/4"—bevels from 0 to  
45°. Adjustable Rip Gage & Visual Guide. Sturdiest and Easily  
Adjusted Safety-Yoke keeps drill steady. Worm Drive Clamp  
releases drill in seconds. Precision Gear Box with Steel Gears.

**90-DAY FACTORY GUARANTEE**

REPLACEMENT BLADES: Specify 5" Safecut,  
or Combination, or Rip, or Crosscut Style. . . . . **\$1.75**

**UNCONDITIONAL 10-DAY MONEY-BACK GUARANTEE**

BUY THE BEST—see your hardware dealer now!  
Don't accept inferior substitutes—if not available  
send us check or M.O. (Postpaid). C.O.D.'s—  
postage extra.

DEALERS  
Write for  
nearest jobber.

**ARROW METAL PRODUCTS CO.**

Dept. PM-11, 140 WEST BROADWAY, NEW YORK 13, N. Y.

**MONEY FOR MEN ALL FREE**  
DATA

THE PLASTEX Industry needs manufacturers on small  
scale and for big production of Lamp and Clock  
Stands, Art Goods and Novelties in Plastex and Marble  
imitation. Experience unnecessary. 1/2c material makes  
regular 10c store sellers. Rubber moulds furnished for  
speed production. Small investment brings good re-  
turns. We are now placing big Chain Store Orders with  
manufacturers. Ambitious men have chance for real  
prosperity. Our Free booklet will interest and benefit you.

**PLASTEX INDUSTRIES, Dept. A**  
3400 Third Ave. New York 56, N. Y.

**STOP RADIO & TV NOISES  
INSTANTLY!**

**NEW ELECTRONIC  
DESIGN**

Bell-Tronic line filter eliminates noisy interference  
caused by motor appliances, autos, oil burners, etc.  
Simply plug radio or TV cord into filter  
and filter into wall socket. Enjoy Bell  
Clear reception. Send \$1 ppd. No C.O.D.  
Try 5 days. Money back guarantee.

**\$1.00  
PPD.**



**TUBE WHOLESALERS CO.**  
Box 364, Dept. PM1, Rockville Centre, N. Y.

**WATERLOO  
METAL  
BOXES  
AND  
CHESTS**

**BUY THE FINEST  
Metal Boxes  
FOR EVERY  
SHOP USE**

• Designed to meet exacting require-  
ments of tool experts in every phase of  
automotive, radio, electrical, and indus-  
trial work. Unmatched for lightness,  
strength, beauty, durability. See them  
at your hardware dealer now or write  
for free catalog.

**WATERLOO VALVE SPRING  
COMPRESSOR CO., WATERLOO, IOWA**



FOR  
ROUND-THE-CLOCK  
**COLOR**  
AT MINIMUM COST!



Get the amazing

**GRAFLEX®**

**CIRO 35**

**COLOR OUTFIT**



only **\$69<sup>95</sup>**

including Flash  
and ever-ready case.  
(Price subject to change.)

• You needn't spend a penny more  
to equip yourself *completely* for color!  
Night or day, rain or shine . . . you'll make  
gorgeous slides for little more than the cost  
of ordinary snaps. Range-finder focusing  
makes fuzzy shots practically impossible—  
and your Cirol 35's coated, color-corrected  
Graflex f/3.5 lens assures all-over picture  
sharpness. Count its other features too,  
including no-tear film wind. You'll be  
amazed by the *all-metal* Cirol 35's terrific  
value!



See your Graflex dealer today  
or write Graflex, Inc., Dept. 86B,  
Rochester 8, N. Y.—for FkC  
literature.

**GRAFLEX®**

*Prize-Winning Cameras*

Enjoy that  
**"FEEL BETTER"**  
 Feeling



**Alka-Seltzer**  
 BRAND Reg. U.S. Pat. Off.

for  
**ACID INDIGESTION**

Be wise. Alkalize with ALKA-SELTZER. Instant alkalizing action soothes and settles your stomach. Feel better FAST with ALKA-SELTZER.



and it's also **FIRST AID** for  
**HEADACHE**  
**COLD DISCOMFORTS**  
**MUSCULAR ACHES**



ON DISPLAY AT  
 ALL DRUG STORES

MILES LABORATORIES, INC., ELKHART, IND.



**BRONZE FOUNDRY**

Schools and Home Workshops  
 Make your own castings of aluminum, copper, bronze, silver. Foundry sets are available in three sizes including 2400 Deg. F. blast Furnaces. \$22.50; \$29.50; and \$42.00. f.o.b. Kansas City. Free Circular.

KANSAS CITY SPECIALTIES CO. P. O. Box 6022, Dept. P-11  
 KANSAS CITY, MO.

**POWER HYDRAULICS**  
 for SNOW PLOWS

Use on



TRUCKS



JEEPS



TRACTORS

**HY-LO-JACK**

does the job

**FASTER-EASIER**



- Lifts average snow plow in 3 to 10 seconds.
- 1,000 lbs. per square in. pressure
- Quick, easy installation on new or existing equipment.
- Complete kit form, including the pump, tank, hose lines, etc.
- Electric unit also available for 6 or 12 volt systems.

\* Write for Circular. See your Road Machinery, Jeep or Farm Equipment dealer.

**MONARCH ROAD MACHINERY CO.**  
 Quality Machinery since 1858  
 333 Front Ave., N.W., GRAND RAPIDS, MICH.



**MAKE YOUR OWN FOUNTAINS, LAKES, RIVERS, WINDOW DISPLAYS**

With New Miniature Water Pump

Here's real action for window displays, Xmas tree layouts, or the home lab. Pump only 4 3/4" high—1 1/4" wide. Threaded for pipe, or uses 3/8" rubber tubing. Operates in 1" of water, 110 A.C. 60 Cycle. Furnished complete—ready to work—your satisfaction absolutely guaranteed.

\$9.95

or your money back, and...  
**MOORE MANUFACTURING COMPANY**  
 Swedesboro 2, N. J.



**TREASURE HUNTERS**

New type metals detector. Distinguishes metals from black magnetic sands. Ideal for locating gold nuggets, placer deposits. Detects metals under salt water. Locates coins, jewelry on beaches. Free from false detections. Free literature. Gardiner Electronics Company, Dept. P-3, 2018 N. Dayton, Phoenix, Arizona.

**FREE CRAFT CATALOG**



120 PAGES... Craft Supplies, Tools, Designs, Instruction Books from America's Largest, Most Complete Handcraft Stock.

Send for your free copy NOW!

**GRIFFIN CRAFT SUPPLIES**

5626-A Telegraph Ave • Oakland 9, Calif.

Say You Saw It in Popular Mechanics

**The QUICK-WAY to SHARPEN CIRCULAR SAWS**



Now you can do it yourself—save time and money. The new QUICK-WAY Index Plate Circular Saw Sharpener makes your own power table a precision saw sharpener. Guarantees accurate grinding and spacing of every tooth. Complete unit only \$16.50 postpaid, including patented Index Plate block for mitre and \$3.00 grinding wheel... Nothing else to buy!

Send check, cash or money order. We pay postage.

Model 6-12P  
 \$16.50 Postpaid

**QUICK-WAY Saw Company**  
 11 Riverside Corning, N.Y.

# Light and Comfortable! Yet this Amazing NEW Work Glove WEARS UP TO 5 TIMES LONGER!

## Extra Wear **GUARANTEED!**



Available in all popular styles.

Users report 2 to 5 times more wear from these amazing new work gloves! Permanently imbedded tiny plastic dots provide lots more wear, yet give you a glove that is soft, flexible, comfortable.

**Make Big Savings!** Now you can buy the same "Plastic-Dot" work glove that has set spectacular records for wear and economy in leading industrial plants from coast to coast!

Independent testing organization made exhaustive wear tests showing "Plastic-Dot" fabric withstood over 15 times more wear cycles than 10-ounce fabric used in heavy canvas gloves.

**Real Working Comfort . . . Safer, Surer Grip!** They're as comfortable as the

glove you wear now, but they'll last more than twice as long, save you money! And what's more, they offer a safer, surer grip!

"Plastic-Dot" gloves have already proven their value for homeowners and hobbyists, service and repairmen, painters, farmers, housewives, gardeners, oil workers, lumbermen, masons, truck drivers, carpenters, cotton pickers, canners, steel workers, and many more.

Now On Sale in Hardware, Automotive, Drug and Department Stores, Groceries, Supermarkets, Variety Stores, Army-Navy Stores and wherever work gloves are sold. If your dealer hasn't got them yet, send coupon for trial pair.

## Riegel "PLASTIC-DOT" WORK GLOVE

Trade-Mark

**Guaranteed to Outwear 2 or More Pairs of Heavy Canvas Gloves!**



### TRIAL OFFER!

See for yourself how wonderful this new glove is!

SEND **50¢** FOR SAMPLE PAIR

LIMIT 2 PAIRS, \$1

Save money on work gloves, get full protection and real working comfort with Riegel "Plastic-Dot"

RIEDEL TEXTILE CORP., BOX 250, NEW YORK 16

Send me AMAZING NEW Riegel "Plastic-Dot" work gloves. No C.O.D.'s.

1 pr. 50¢  2 prs. \$1. (LIMIT 2 PAIRS)

NAME \_\_\_\_\_

STREET \_\_\_\_\_

CITY \_\_\_\_\_ STATE \_\_\_\_\_

## SHOPMASTER'S SENSATIONAL

# universal POWER TOOL

## with RADIAL ARM



Here's a complete workshop for the hobbyist or woodworking craftsman—all in one tool. Easy to convert . . . simple to operate, it's precision-built to finest professional quality. All moving parts glide on ball bearings. Tools lock in any position. The most versatile and useful all-purpose woodworking power tool ever developed!

it's a circle saw, drill press, sander, router, shaper, lathe

(slightly higher in zone 2) **\$269<sup>95</sup>** LESS MOTOR

*All in one*



**Circle Saw.** Mitres, compound mitres, cross-cuts, dados, rips, cups, grooves.

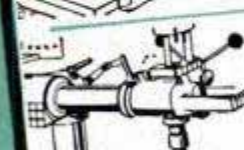

**Drill Press.** Drill, rout or mortise at any angle within any radius, in 36" circle.



**Sander.** Locks in vertical or horizontal position or at any angle.



**EASILY MOVED**  
All-steel stand tilts back on casters for easy moving.

SHOPMASTER, INC., Room 10E a  
1214 3rd St. So., Minneapolis, Minn.  
Send information on new Shopmaster Universal Power Tool TODAY!

Name \_\_\_\_\_  
Address \_\_\_\_\_  
City \_\_\_\_\_ State \_\_\_\_\_

**MAKE  
Big Money  
SANDING  
FLOORS!**



**BE YOUR OWN BOSS**

It's easy to turn your own labor into money—**BIG MONEY**—in floor surfacing work. You keep *all the profits* from your labor! Thousands of prospects—sand floors in maintenance or remodeling of old homes... also new homes! Earn \$50 a day and more... pleasant indoor work... and *you are boss!* Send for "tell-all" booklet entitled "Opportunities in Floor Surfacing" enclosing 25 cents in coin or stamps to cover handling. The American Floor Surfacing Machine Co., 535 So. St. Clair St., Toledo 3, Ohio.

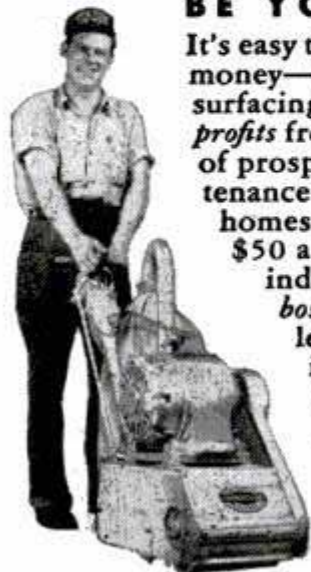

**AMERICAN**

FLOOR MACHINES • PORTABLE TOOLS

**For work-free masonry drilling**



Use new **CARBOLOY**  
"LIVE-SPIRAL"  
Masonry Drill

**Even drills concrete like wood!**

Now... rotary drill any masonry in your home with ease! New Carboloy "Live-Spiral" Masonry Drills bite cleanly through brick, slate, tile, concrete or cast stone. Won't stick, stall, bind.

Super-hard carbide tip gives extra-long use. Lets you drill holes at any angle... to bolt down washer, dryer, tubs... fasten hooks, screens, awnings, trellises... attach bath, kitchen fixtures, partitions, furring strips, etc.

Get "Handy-Man" Kit today. Contains 3 "Live-Spiral" Drills; 1/4", 3/8", 1/2". Fit 1/4" chucks. \$6.65 per kit. Send coupon, or see your hardware dealer.

"Carboloy" and "Live-Spiral" are registered trademarks of the Carboloy Department of General Electric Company



**MAIL THIS COUPON TODAY**

**CARBOLOY**

DEPARTMENT OF GENERAL ELECTRIC COMPANY

11185 E. 8 Mile Road, Detroit 32, Michigan

Send me Handy-Man Kits at \$6.65 per kit, postpaid.  Enclosed is check or money order for \_\_\_\_\_.  Send C.O.D.  Send me free folder.

Name \_\_\_\_\_  
Address \_\_\_\_\_  
City \_\_\_\_\_ Zone \_\_\_\_\_ State \_\_\_\_\_

**EXECUTIVE INTERCOM SYSTEM**



**New!**  
**\$19.95**  
POSTPAID

Normally sold for \$49.95. Two ultramodern French phones with desk cradles! Completely self contained. Handsome contemporary design. Lifetime construction. Built-in double buzzer system. Operated anywhere by ordinary 1 1/2 volt flashlight batteries (2 in each cradle) completely concealed. Excellent fidelity, range, clarity. Interoffice, on ranches, between buildings, anywhere. Black satin finish. Quality never approached at 4 times price. Two phones, two cradles (4 batteries inc.) postpaid \$19.95. Double wire, postpaid 3c per ft. Calif. resid. add 3% tax. 10-day money back guar. Send check or M.O.

**THE AKRON** 56 AKRON BLDG., 4379 SUNSET BLVD. LOS ANGELES 27, CALIF.



**KEEPS NEEDLE-POINT SHARPNESS!**  
Revolutionary new STAINLESS STEEL hand saw! Tough "ARMCO @ 17-7-PH" hardened blade... rust WILL NOT destroy edge! Contour ground, perfect temper and balance, readily filed. Laminated, lacquered handle.  
**6.95** Postpaid  
**MONEY-BACK GUARANTEE!** Specify 8 or 10 point, send check or money-order to HAYWOOD SALES, Dept. P, Box 5063 Tri-Village Sta., Columbus 12, Ohio.  
(Ohio residents add 3% sales tax)

**TREASURE -- \$10,000**

New locator detects metals, valuable minerals and buried treasure. Money-back guarantee of superiority.  
Also geiger counters. Govt. reward of \$10,000 for uranium discovery. Write for FREE information.



**THE GOLDAK COMPANY**  
1542 W. GLENOAKS BLVD., GLENDALE 1, CALIF.

**Handy Mail Order List**

**Little Library of Useful INFORMATION**

**5 for \$1.00**  
**12 for \$2.00**  
**25¢ Each**

Here at amazingly low cost is the practical help and information you have always wanted. Articles in previous issues of Popular Mechanics have been classified according to subject and are now available in these handy reprint booklets.

- How to Use Measuring Tools—Micrometers, Calipers, etc.—106.
- Power Driven Saws—74.
- Drill Presses, Grinders, Etc.—79.
- Wood, Metal Turning—Lathes—81.
- Filing Machine, Hacksaw, Cutoff Wheel, Shaper—82.
- Lathe Tools You Can Make—101.
- Workbenches—Tool Cabinets—47.
- Spray Painting—91.
- From Pattern to Casting—91.
- Tool and Saw Sharpening—92.
- Sharpening Drills, Wood Bits—90.
- Successful Wood Turning—32.
- How to Read Blueprint—71.
- Metal Turning Lathe Kinks—99.
- Operating a Metal Lathe—100.
- Heat Treating, Hardening—102.
- Working With Glass—103.
- Servicing Elec. Motors—75.
- Electromagnets & Solenoids—44.
- Transformer Construction—41.
- The Boy Electrician—43.
- Soldering and Brazing—17.
- Arc and Spot Welders—5.
- Electroplating With Nickel, Chromium, Cadmium, Etc.—86.
- Plating Leather, Wood, etc.—87.
- Lower Your Fuel Costs—31.
- Curing Leaky Basements—45.
- Fitting Home Game Room—55.
- Indoor & Outdoor Fireplaces—88.
- Backyard Gardening—39.
- Lawn and Garden Novelties—72.
- Trellises, Pergolas, Fences—76.
- Lawn and Garden Furniture—77.
- Playground Equipment—73.
- How to Use Your Drill Press—125.
- Making Serving Trays—53.
- Knots and Ropework—105.
- Sanders—80.
- House Wiring—89.
- Hanging Wallpaper—38.
- Built-in Fixtures—78.
- Bird Houses—7.
- Magazine Racks—49.
- Clock Cases—50.
- Book Ends—52.
- Small Tables—54.
- Smoking Stands—56.
- Desks—58.
- Book Cases—59.
- Action Toys—66.
- High Flying Kites—67.
- Telescopes—20.
- Metal Craft—28.
- Small Looms—37.
- Gem Cutting—42.
- Photo Enlargers—1.
- Photo Kinks—98.
- Cleaning Formulas—11.
- Taxidermy—9.
- Photo Lighting—119.
- Training Dogs—35.
- Small Furnaces—36.
- Working With Plastics—61.
- Simple Home Improvements—104.
- Ridding Home of Insect Pests—107.
- Children's Room Furniture—51.
- Jigsawed Novelties—57.
- Doll House & Doll Furniture—60.
- 25 Shelves You Can Make—64.
- Novelties Turned on Lathe—62.
- Inlay Pictures—Veneering—63.
- Wood, Soap Carving—65.
- Windmills & Weathervanes—68.
- Lamps from Wood, Metal—69.
- Rustic Furniture—18.
- Wood Finishing—40.
- How to Fix Electrical Appliances—111.
- Painting Your House—117.
- Build Your Own Relays—123.
- Rowboats, Small Dinghy—83.
- Small Sail Boats—84.
- Two Outboard Runabouts—85.
- Build Own Canoe, Kayak—30.
- Build Class-E Ice Yacht—22.
- Auto Kinks. Shortcuts—10.
- Lawn and Garden Equipment—124.
- Motor-Driven Midget Cars—34.
- Stop Auto Elect. Troubles—95.
- Photo Printers and Dryers—25.
- Photo Darkroom Equipment—96.
- Trick and Table Top Photos—97.
- Home Movie Equipment—118.
- Poultry Houses—108.
- Guns and Decoys—109.
- Re-Silvering Mirrors—70.
- Chemical Experiments—93.
- Log Cabins, Tourist Houses—14.
- Using Basic Tools—120.
- Farm and Garden Tractors—8.
- Building Extra Attic Rooms—23.
- Attractive Basement Rooms—24.

Check Titles Wanted, Clip, Mail with Remittance to  
**POPULAR MECHANICS PRESS, Dept. 23, 200 E. Ontario, Chicago 11**

# STOP DRAFTS



A sure, easy way to save fuel! Just drop a Handi-calk cartridge into the gun, press the trigger... add comfort to your home. Write for leaflet.

## Handi-calk

2370 Woodhill Rd.

Cleveland 6, Ohio



AT HARDWARE, PAINT AND LUMBER DEALERS

Make Money  
**SELLING**  
Eshelman  
Tractors  
and doing  
GARDEN  
WORK

**ESHELMAN** FOR BETTER **LAWNS AND GARDENS**

RAKES  
PLOWS  
CULTIVATES  
HARROWS  
HAULS  
SPRAYS  
SAWS  
DOZER  
MOWS  
CUTS  
ROLLS  
SNOW PLOW

Low As \$69 Plus Tools

Also Power Reverse. Women can operate it. Free Catalog. Write: **ESHELMAN**, Dept. 511, 119 Light St., Balto., Md. 333 N. Michigan Ave., Chicago 1, Ill. 7070 Hollywood Blvd., Los Angeles 28, Cal.

1 1/2 3.6 H.P.

## MARVEL Mystery Oil

- Frees Sticky Valves
- Stops Hydraulic Valve Clatter

Buy it at your favorite gas station



### TRIAD TAPPER FOR YOUR DRILL PRESS

Positive alignment of tap. No tap breakage. Interchangeable on chucks of 1/4" or 5/16" key holes. Drill press accuracy. Rugged—Indispensable—simple. \$3.50 P.P.

**GENIE DEVICES — Box 236**  
Oakland 12, Calif.

## SWISS pattern... NEEDLE FILES

For Fine PRECISION Work

HUNDREDS OF USES FOR HOBBYISTS, JEWELERS, WATCH-MAKERS, TOOL, DIE AND PATTERNMAKERS



Imported Set of 12 all different shapes 7" long

only \$2.95 Postpaid

**LIND SALES CO.** Send check or money order  
1521 S. La Cienega Blvd. PM1153 Los Angeles 35, Calif.

## NEW for Your Workshop!

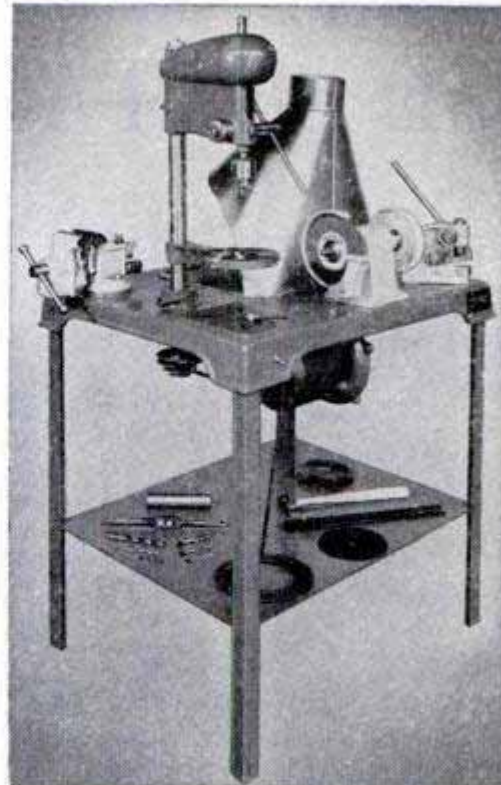

Original  
•  
Complete  
•  
Ready to Use!  
•  
Only  
**\$269.50**

F.O.B.  
Lancaster, Pa.  
Ship. Wt. 240 lbs.

## The Champion FORGE SHOP

Works Iron, Sheet Metal,  
Aluminum, Brass for  
Homeshop, Farm, Factory  
Estates, Repair Shops, etc.

Includes: 1/3 h.p. Motor; 15" x 20" Forge with air blast regulator; electric blower; 3 1/2" machinists vise; 14" two speed radial bench drill press; Grinder & Polisher with emery, cut-off, polishing and wire wheels; 3" lever operated Shear; Hammer; Fire Tong; Tap Wrench; Set of 1/4", 3/8", 1/2" taps and drill bits to match; 1/2" steel burr; complete assembly & instruction book.

Make your own furniture, signs, railings, trellises, repairs, etc.

See the FORGE SHOP today at your hardware store or Hobby Shop—OR write for Free Catalog to Champion Blower & Forge Co., Dept. P, Lancaster, Penna.

Name \_\_\_\_\_

Street \_\_\_\_\_

City \_\_\_\_\_ State \_\_\_\_\_

# THESE PENTA-TREATED STEPS WILL LAST YEARS LONGER!



*PENTA, the clean wood preservative, makes the wood you use last years longer . . . protects against both termites and decay*

**SEND FOR THIS FREE BOOKLET**

The Dow Chemical Company  
Dept. PE 3-6B2  
Midland, Michigan



Please send me without cost:

— "Handyman's Guide to Home Wood Preservation."

— Location of my nearest PENTA dealer.

Name \_\_\_\_\_

Address \_\_\_\_\_

City \_\_\_\_\_ State \_\_\_\_\_

You can make wood last years longer by protecting it against termites and decay with a wood preservative containing PENTA\*. Simply flood it on the wood with a broad brush. Water-repellent solutions containing PENTA also improve dimensional stability and reduce checking caused by moisture and hot sun. The wood you treat with this type of PENTA solution is clean and paintable, too.

Write for Dow's new booklet, *Handyman's Guide to Home Wood Preservation*. It tells how to apply PENTA solutions to porches, storm windows, fencing, picnic tables and other projects you plan for your home.

Your lumber dealer or paint store stocks name brand wood preservatives in both paintable grades and those to be left natural. Look for the name \*PENTACHLOROPHENOL on the label. THE DOW CHEMICAL COMPANY, Midland, Michigan.

*you can depend on* **DOW CHEMICALS**

**DOW**



**PAY ONLY \$1 A WEEK OR \$4 A MONTH!**  
**JUST RELEASED — NEW JET MODEL**  
**All-Metal Electric SPRAY GUN**

**Save Hundreds of Dollars  
 On Your Painting & Spraying**

The new, non-corrosive jet piston action, efficient spray-control dial and eye-level nozzle mean this: just plug in, press trigger and you're painting! Hundreds of tough tasks are made easy. No compressor needed. **ALL METAL**, including 25-oz. polished aluminum container. Compares with spray guns selling up to \$49.95. Clog-proof, fool-proof, trouble-free, this Jet Model is available only from us. Sprays all paints—including rubber-base paints—lacquers, enamels, varnishes, chemicals, oils, insecticides, deodorants, shellacs; for waxing, rust-proofing, waterproofing, etc. Built for heavy duty. AC current. Entire unit, every part, fully UL Approved, including 8-ft. S.J. Neoprene Cord & Plug Set. Included: 5 extra nozzle discs; 232 pg. "Home Fixit Guide." Send \$19.95, we pay postage. Or pay \$5 down and \$1 a week (or \$4 a month). 15-Day Money-Back Guarantee, either way.



**No Carrying Charges or Interest Added!**  
**Entire Sprayer UL Approved!**  
**25-oz. Polished Aluminum Container** Complete—Nothing Else to Buy!  
**\$19.95**  
**WALDORF SALES CO., Dept. PG-2411**  
**363 Central Pk. Ave., Yonkers, N. Y.**



**Here now for 1954**

"Home Is Where You Take It" with America's leading all-steel insulated mobile home, the new HOWARD for 1954! Time-tested from Alaska to Florida, now **better by far—for you and your car.** For details write HOWARD Industries, Box 2188 . . . Dept. 21, Saginaw, Mich.

**Howard MANSION COACH**  
 HOWARD INDUSTRIES INC., SAGINAW, MICHIGAN

**PLANS 35c ARC-WELDER 85-110 AMPS. A.C. USES OLD GENERATOR COILS**  
**BUILD YOUR OWN**

WE SHOW YOU HOW simple it is to build this POWERFUL welder from old auto generator. Has 20 heats. Operates on 110 or 220 volts A.C. Thousands built and now in use. Save dollars. Do your own repairs. Make money welding for others. Complete plans—35c. Write for FREE War Surplus Catalog.



**LEJAY MFG. CO.** 3347 LeJay Bldg. Minneapolis, Minn.

**NEW, EXCLUSIVE LOK-BLOK® LOCKS BLADE IN HANDLE**

**Now TWIST & IMPACT PROOF!**

Plus many other great features and unsurpassed quality... yet cost no more than ordinary drivers!

At All Leading Dealers  
 UPSON BROS., INC., Rochester 14, N. Y.



**HOLD-E-ZEE**  
 The Original Automatic Grip SCREWDRIVERS

**Made \$900 IN SPARE TIME**

*Trade Mark Reg. U.S. Pat. Off.*

**with FOLEY\* automatic SAW FILER**

"I did very well last year with my Foley equipment, sharpening about 950 saws in my spare time. About \$900 for me."  
 Leo H. Mix

"I have done 4 or 5 thousand saws in my spare time in the 4½ years since I got the outfit, and they are all coming back."  
 Len Crego

**Make up to \$3 or \$4 an hour in Spare Time**  
 With the high prices of food, clothing and everything else, just think what you could do with extra money every week! With a Foley Automatic Saw Filer you can file hand, band and circular saws better than the most expert hand filer. "The first saw I sharpened with my Foley Filer came out 100%" — writes Clarence E. Parsons. Cash business, no canvassing. No eyestrain, no experience needed.

**FREE BOOK Shows How to Start "MONEY MAKING FACTS"** Tells just what to do to start your own spare time business in your basement or garage. Just think — with a small investment, no overhead, no stock of goods to carry, you can get right into a cash business. Send coupon today — no salesman will call.



**Send for FREE BOOK**

**FOLEY MFG. CO.,**  
 1116-3 Foley Bldg., Minneapolis 18, Minn.  
 Send FREE BOOK — "Money Making Facts"

Name \_\_\_\_\_  
 Address \_\_\_\_\_

The **NEW Model 60**

# AUTOMOTIVE TESTER FOR REPAIRING ALL ELECTRICAL CIRCUITS and PARTS IN AUTOMOBILES-TRUCKS



- Includes 2 Voltage ranges for both 6 Volt and 12 Volt systems.
- Measures exact current consumption at any point. Reads direct in amperes.
- Incorporates direct-reading resistance range which will accurately measure all resistances commonly used in the electrical circuits of all battery-powered automotive equipment.
- Sensitive leakage indicator for tracing and locating cause of trouble in the ignition coil and firing circuits.
- Will test storage batteries under load, generators, distributor, lamps, directional signals, horn, condensers, fuses, cigarette lighter, clock, cut-outs, solenoids used in over-drive systems, magnetos, ignition coils, electric heating systems, spark and glow plugs, etc.

temperature, oil and gasoline gauges; relays, regulators, field coils, armatures, brushes, circuit breakers, vibrators, condensers, fuses, cigarette lighter, clock, cut-outs, solenoids used in over-drive systems, magnetos, ignition coils, electric heating systems, spark and glow plugs, etc.

Handsome round cornered molded bakelite case 3 1/8" x 5 7/8" x 2 1/4". Complete with all test leads and instructions.

**\$13<sup>90</sup>**

**SOLD ON EASY PAYMENTS AT THE NET CASH PRICE**

**MOSS ELECTRONIC DISTRIBUTING CO., INC.**  
Dept. B-85, 38 Murray Street, New York 7, N. Y.  
Please rush 1 Model 60 AUTOMOTIVE TESTER. I am enclosing \$1.00 as down payment, and agree to pay balance at the rate of \$4.00 per month.  
(No interest or carrying charges added.)

Name \_\_\_\_\_  
Address \_\_\_\_\_  
City \_\_\_\_\_ Zone \_\_\_\_\_ State \_\_\_\_\_



## ELECTRIC EYE

Self generating photo cell—Dia. 1-3/16 inch. This cell turns light directly into electricity—no outside power needed. Make your own Exposure meter—Foot candle light meter, use with a 200 micro-ampere meter. Output as much as 5 ma. in sunlight. Will operate meter type relays directly.

Shipped postpaid with instruction sheet, ONLY \$1.00.  
**ELECTRONIC PRODUCTS CO., Dept. C, St. Charles, Ill.**

**THIS WIRE HAS NOT BEEN OVERSEAS**  
This high quality two conductor communication wire offered in No. 18 and No. 22 gauge is ideal for intercoms, lead-ins, telephones, indoor and outdoor speaker extensions, doorbells, signal and burglar alarm systems, shot firing, etc., etc. **SAMPLES ON REQUEST.**

## U.S. GOV'T CLOSEOUT

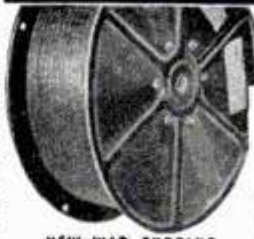

*Wire*

**U. S. Signal Corps Communication Wire**  
TWISTED TWO CONDUCTOR \$5.00  
No. 18 STRANDED per 1000 ft.  
**\$7.50** per 1300 ft. TWISTED TWO CONDUCTOR No. 22 STRANDED

**Won't Last Very Long at These Prices**  
**Stock Up Now — Subject to Prior Sale — Order Today**  
**W-110-B — TWO CONDUCTOR #18 STRANDED** (four steel and three copper strands) rubber covered plus weatherproof cotton braid and twisted, 5,280 feet per steel reel. Only \$3.50 per thousand feet on 5,280 foot reels or \$18.25 per reel.  
**W-130 — TWO CONDUCTOR #22 STRANDED** and twisted (one copper and six steel strands) in your choice of rubber or plastic insulation, 10,000 feet per steel reel. Only \$3.50 per thousand feet on 10,000 foot steel reel or \$35.00 per reel.  
(Note: Steel strands are incorporated for extra tensile strength and are tinned and treated for efficient conductivity.)  
Wt. per 100 ft. #18 wire, 23 lbs. Wt. per 1300 ft. #22 wire, 11 lbs. All these way below market prices, our stock will not last long. Take advantage of this exceptional closeout and **STOCK UP NOW!**  
Prices F.O.B. Chicago. Include approx. postage on orders paid for in advance. C.O.D. orders enclose 25%, balance sent C.O.D.

**U. A. S. Corp.** Dept. PM11, 5637 W. 63rd Pl. Chicago 38, Illinois



## \$ Free Course! Big Profits! \$ Flocks & Sandblasts

**Dual Purpose Spray Gun!** Uses only 25 lbs. Air Pressure  
• Thousands of uses in Home, Shop, Industry. Makes Auto Interiors Clean & New, Lines drawers, Marproofs lamp bases, Refinishes any object. All in colorful Flock. Etch & Frost windows, glassware, etc. Removes Paint & Rust from Autos, Tools. Guaranteed! Send \$29.75 or write for free information. Flocking supplies!  
**BLASTO SPRAY GUN MFG.**  
Dept. PM-11, 7007 Haas Avenue, Los Angeles 47, Calif.

## FUN TO DO . . . PROFITABLE TOO! LEATHERCRAFT

Textile Painting • Shellcraft  
Beadcraft • Metal Tooling  
Lamp Shade Making  
Other Crafts Complete supplies, everything you need

**KIT KRAFT, Dept. 24, 7373 Melrose Ave., Hollywood 46, Calif.**

## Say You Saw It in Popular Mechanics

**\$2.95 EACH OR 2 FOR \$5.00!**



Genuine Telephone Company Upright telephone complete with cord in Tested and Guaranteed condition. For inter-communication or extension. Complete line of telephones and parts, inter-communication systems, switchboards, handsets, magneto and dial telephones, etc. Write for free list. C.O.D. orders accepted. All shipments F.O.B.

**TELEPHONE ENGINEERING CO.**

Dept. B-1 Simpson, Pa.

# IDEAL CHRISTMAS GIFT for yourself.. and friends

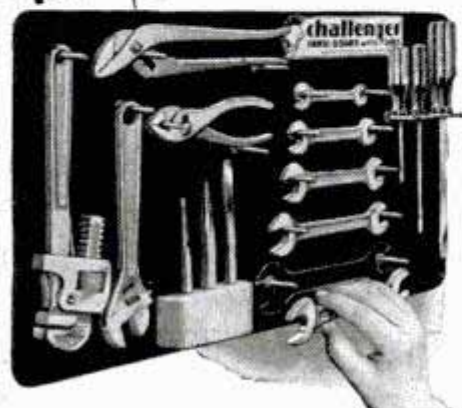

## Challenger "Handi-Board" Tools

FOR 1001 "DO-IT-YOURSELF" JOBS... TOOLS ALWAYS READY FOR INSTANT USE! Every household needs this super-compact "Tool Center"... to handle countless mechanical, electrical, plumbing and general fixing jobs. For turning all kinds of nuts, bolts, screws... also bending, chiseling, punching, cutting wire, etc. Tools lift off instantly from pegs on Handi-Board... and you can't miss putting tools back in proper places because positions are outlined on board. Makes a handsome permanent fixture on wall. Comes with 15 Fine Quality Challenger Tools plus Handi-Board in rich maroon. Only \$12.95 complete... at your local hardware or tool dealer—or write address below. Also ask for **FREE Brochure** on Challenger's complete line of over 2,000 Top-Quality Low-Cost Tools.

**PENENS CORPORATION, Dept. P.M., Schiller Park, Ill.**

FOR HANGING ON ANY WALL





### B-T HACKSAW

Powerful, portable, pocket size! Saws wood, plastic, steel and sheet metal, pipe, plaster board, Celotex. Ideal for scroll work. Full  $\frac{1}{2}$ " chip clearance. Weighs only 11 oz., folds up into pocket or tool box with blade protected. A "must" for home craftsmen, electricians, carpenters, plumbers, etc. Only

**495**

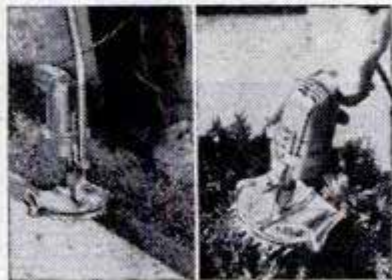

### "EDGER-N-HEDGER"

Now you can use your  $\frac{1}{4}$ " electric drill to trim grass, shrubs, bushes, weeds — quickly, electrically! New Edger-n-Hedger reaches everywhere, keeps you off your hands and knees. Use it with handle as a miniature power mower to edge walls and walks; remove handle and trim shrubs. Won't clog or stall—even in knee-high grass! Safe, easy one-hand operation. Fits any  $\frac{1}{4}$ " electric drill. Complete with removable handle, only.....

**995**



### ROTO MORTISING KIT

When you need to drill "square holes" here's the powerful mortising tool that really makes the chips fly. The quick way to recess hinges and hardware; ideal for making furniture joints. Kit includes Roto Mortising Adapter cut from solid aluminum with double-shield ball bearings and  $\frac{1}{4}$ ",  $\frac{3}{8}$ " and  $\frac{1}{2}$ " chisels with corresponding bits. Fits any  $\frac{1}{4}$ " electric drill or drill press. Complete, ready to chuck in your drill..

**2390**

### ROTO UTILITY KIT

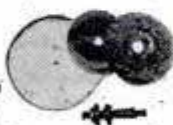

Includes  $2\frac{1}{2}$ " grindstone, 3" wire brush, 4" cloth buffing wheel and "drive shaft" that chucks into your drill. Use it on metals, to polish, buff, grind, scrape, sharpen, remove rust, paint, scale, etc. Complete, only..

**295**

### 4-IN-1 HOLE SAW



Cuts 1",  $1\frac{1}{2}$ ", 2",  $2\frac{1}{2}$ " holes through any  $\frac{3}{4}$ " stock. Used by craftsmen and tradesmen everywhere to cut holes for plumbing, conduits, pipe, outlets, drains, toys, etc. A real help when making modern furniture and fixtures in your shop. Comes complete with 4 blades, yet costs less than you would expect to pay for one — only .....

**495**

Your **ELECTRIC DRILL** becomes a **PORTABLE POWERHOUSE** with these time-tested, time-saving **ROTEX tools!**

An electric drill is just a drill—until you team it up with these Rotex attachments. Then your drill becomes a portable powerhouse that quickly does scores of jobs that are difficult or impossible to do by hand. So start making the most of your drill; see and order these Rotex tools today—for Christmas gifts . . . for your own workshop!

See your dealer. If he doesn't yet stock, send cash, check or M.O. for prepaid shipment.

**ROTEX COMPANY**  
835 W. Davis St. Dallas, Texas

### ROTO SABRE SAW



A heavy duty hacksaw for any  $\frac{1}{4}$ " electric drill that out-performs saws selling for \$25.00 up. Goes through wood, plastic, steel and sheet metal, pipe, plaster board, Celotex like hot butter! All parts of specially designed alloy steel machined to exacting standards, hardened and ground to close tolerance. Because the blade makes only one stroke for two revolutions of your  $\frac{1}{4}$ " drill, it is easy to operate, won't burn saw blades. Comes complete with 3 blades (one for heavy wood, one for scroll work, one for metal). Only .....

**1195**



### "RIDGE RUNNER"

It's a 1", 2" and 3" portable drum sander all in one! Removes old paint and varnish in a wink . . . sands flat or contour surfaces . . . chamfers and shapes wood . . . ideal for pattern making, wood sculpturing. Telescoping diameters easy to change. Comes complete with sandpaper sleeve for each diameter. Only .....

**695**

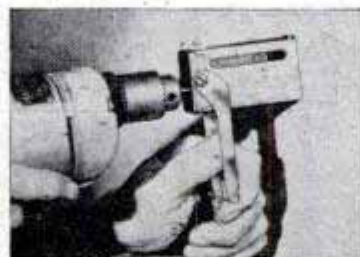
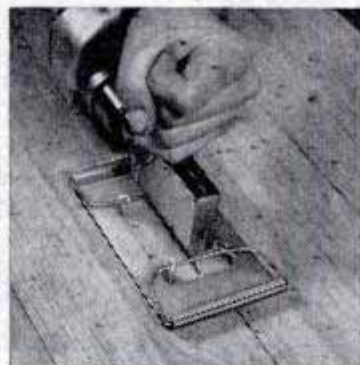

### HACKSAW-SANDER KIT

Kit includes reciprocating sander with 3"x6" surface for rough or fine finishing with grain . . . plus famous B-T Hacksaw attachment for wood or metal. Sander takes full  $\frac{1}{2}$ " stroke. Perfect for polishing and rubbing out finishes with oil and pumice. Sanding sheets easy to change. Comes complete with 6 sandpaper sheets, 2 hacksaw blades and polishing kit, all for only.....

**895**



### HEDGE TRIMMER

Just chuck the Roto Hedge Trimmer in your  $\frac{1}{4}$ " electric drill, and you've got a "power mower" that does all the work for you! The shuttle action of the 9" hardened high carbon steel blade clips any hedge cleanly . . . quickly . . . more evenly than you can do by hand. Also ideal for trimming grass around walls, house, trees, shrubs, etc. Blade can be turned to any angle. Light, easy to carry. No vibration. Complete, ready to chuck in your drill .....

**1295**

### HORIZONTAL DRILL STAND



At last! a drill stand that won't shake or shimmy! It's the Roto Drill Stand — a rugged, sturdy cast stand that holds your drill firmly while you polish, buff, grind, scrape, sharpen, remove paint, scale, rust, etc.....

**395**

If you do not own a grindstone, wire brush, cloth buffer, and arbor, order Roto Utility Kit (shown on this page) for only \$2.95 extra.

# Make Your Home Draft-Proof

WITH

*Bridgeport*

## INNER-SEAL

WEATHER STRIPPING

over 600 million feet sold!

Home owners from coast to coast keep their fuel bills low with INNER-SEAL, the flexible, tight-sealing weather stripping! INNER-SEAL's exclusive patented construction — spring steel molded in live sponge rubber — makes a pressure-tight seal that keeps heat IN . . . keeps cold OUT! Tough neoprene coat makes INNER-SEAL waterproof, abrasive-resistant, durable. INNER-SEAL is adjustable, fits perfectly even on warped frames. Easy to install, lasts for years . . . has dozens of handyman uses.

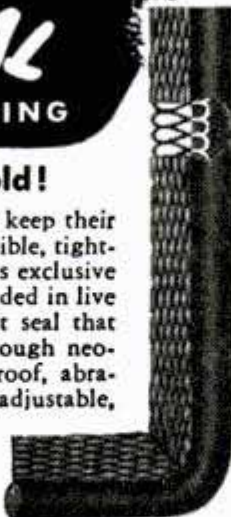

For your overhead garage doors — heavy-duty INNER-SEAL Weather Strip Cushion . . . seals out moisture, cold, dirt . . . prevents doors from splintering or freezing.

Get your FREE copy of the new 24-page booklet "Why & How To Weather-Strip". Available where you buy your hardware or building supplies.



OR, WRITE DIRECT TO DEPT. PM-11 . . . . .  
BRIDGEPORT FABRICS, INC., BRIDGEPORT 1, CONN.

# BE YOUR OWN BOSS!

Make UP TO \$50.00 PER WEEK IN YOUR SPARE TIME

Mr. B. of California writes "The lawn mower grinding business, with my Universal Grinder, has been a gold mine these last two years." Mr. J.L.P. of Pennsylvania says "Thank you for getting me started in this wonderful business . . . I averaged \$100.00 per week for the month of May."

## ONLY ON THE UNIVERSAL LAWN MOWER GRINDER

. . . can the inside face and edge of the stationary blade, as well as the reel blades, be ground to proper clearance

### ALL IN ONE SET-UP

WITHOUT REMOVING ANY BLADE FROM THE MOWER

Users who have tried them all acclaim the UNIVERSAL far above any grinder on the market. Write today for full details of our Proved Success Plan. It's Free.

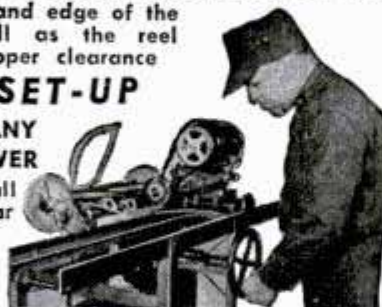

ROGERS MFG. CO., DEPT M-113, LINDSEY, OHIO

### SEND THIS COUPON NOW

ROGERS MFG. CO., Dept. M-113, Lindsey, Ohio  
Please send me full details about the profit possibilities of Lawn Mower Sharpening.

NAME \_\_\_\_\_  
ADDRESS \_\_\_\_\_  
CITY \_\_\_\_\_ STATE \_\_\_\_\_

## PICTURED PERFECTION— BULLDOG TRAILER PARKING JACKS!



MODEL 50-P makes hitching or parking trailers an easy, one-man job. Rides flush. Easily installed. \$15.37 complete, postpaid (when paid in advance).

Manufacturers of a complete line of Safety-Engineered trailer parts. Write for Brochure 13-K

HAMMER BLOW TOOL COMPANY  
"As old as the Industry"  
WAUSAU, WISCONSIN

## TOOLS AT WHOLESALE

PROFESSIONAL MECHANICS HAND TOOLS

Farm, Household and Special Tools

TOP QUALITY, FACTORY GUARANTEED

MECHANICS TOOLS CO.

Write Today for  
FREE CATALOG

Dept. X Oakland 8, Calif.



## HAVE A BIGGER — MORE EFFICIENT HOME WORKSHOP

Popular Mechanics PLANNING YOUR HOME WORKSHOP shows you how to . . . use of every inch of space in your workshop; detailed floor plans, wiring layouts and power tool hookups plus actual photographs of famous home workshops you can use as models. Save money by building your own shop furniture. Special Where-to-Buy-It Guide. 450 Illustrations, Cloth Bound, Working Diagrams. Order your copy today from

\$2.50  
POPULAR MECHANICS PRESS  
200 E. Ontario Street Chicago 11

## MACMILLAN RING FREE Xtra Heavy Duty is the ONLY motor oil to GUARANTEE:

- to prevent Valves and Hydraulic Lifters from sticking
- to reduce Engine Ping . . . or Your Money Back!

For further information write: R. S. MACMILLAN, PRES.

M 530 West 6th St., Los Angeles, Calif. M

## ARMSTRONG Drop Forged "C"—CLAMPS

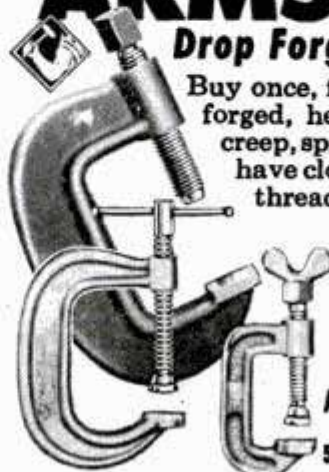

Buy once, for life. These famous drop-forged, heat treated clamps will not creep, spring, spread or break. Screws have close fitting smooth operating threads. Available in heavy duty, medium service, extra deep throat and welding types. Recognized throughout industry as the very finest.

Write for catalog.

ARMSTRONG BROS. TOOL CO.  
"The Tool Holder People"  
5268 W. Armstrong Ave., Chicago 30, U.S.A.

# NEW! Every Electric Drill A Powerful PORTABLE JIG SAW

## "ARCO JIG-SAW"

HAS SAME CAPACITY,  
CUTS AS FAST AS SAWS  
COSTING \$50 & UP!

DOES THE WORK OF  
ALL THESE SAWS: JIG,  
KEYHOLE, COPING, RIP,  
CROSSCUT, BAND,  
HACKSAW.

Attaches in ONE MINUTE  
to Any 1/4" Electric Drill.

Attention Homecraftsmen, Cab-  
inetmakers, Electricians,  
Plumbers! Here for the first

time anywhere is a Portable JIG SAW Attachment to fit  
any electric drill. No need to put in hard-working hours  
to make fancy cuts by hand. "ARCO JIG-SAW" will handle any  
project from the smallest to the largest. In minutes you can cut  
intricate patterns, circles, etc. Make furniture, toys, do all  
home repairs. Cut openings for plumbing, switchboxes without  
boring a starting hole! Whiz thru plywood, wallboard, plastics,  
metals — even lumber up to 2x4's! All you do is guide  
"ARCO JIG-SAW" over your cutting line while air stream  
blows sawdust away from blade. Can be used with one hand!

Yes, here is a powerful, versatile tool that is light in weight  
and easy to handle because of its Right Angle Drive. Strong  
Safety-Yoke & Worm Drive Clamp give you a vibration-free unit.  
Blades are easily changed in seconds with ordinary screwdriver.

### 90-DAY FACTORY GUARANTEE

BUY THE BEST—see your hardware dealer now! If not available,

**DEALERS—**  
write for  
nearest jobber.

try "ARCO JIG-SAW" on our 10-DAY MONEY  
BACK GUARANTEE. Send us check or M.O.  
(Postpaid). C.O.D.'s—postage extra.

## ARROW METAL PRODUCTS CO.

Dept. PM-11, 140 WEST BROADWAY, NEW YORK 13, N. Y.

# BIG SAVINGS BRAND NEW RELEASE Genuine GOV'T SURPLUS

## PORTABLE AUTOMATIC COMPRESSOR ASSEMBLY **79<sup>00</sup>**

Complete  
All for

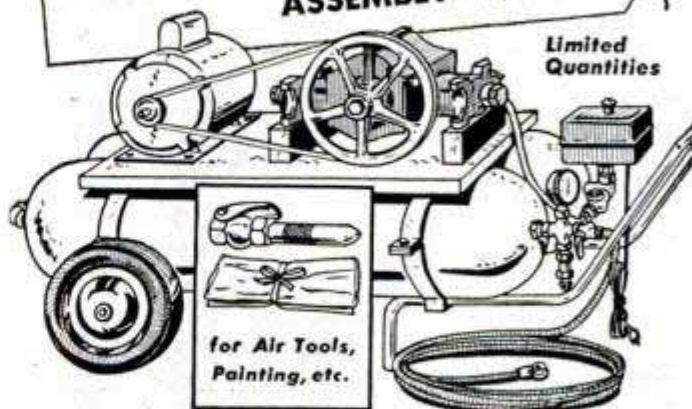

Limited  
Quantities

## YOU GET THIS COMPLETE ASSEMBLY AT A FRACTION OF NORMAL COSTS

### WESTINGHOUSE AIR BRAKE Model T-1 COMPRESSOR

2-cylinder piston type, huge volume 6.54 cfm at 1200-RPM  
high-pressure 75-100 lbs, 2" bore, 1 1/2" stroke, built-in air  
filter, delivers OIL-FREE AIR, precision made to rigid US  
Army Ordnance specs of drop forged steel and cast iron.

### JACK & HEINTZ 1/2 HP CAPACITOR MOTOR 1725 RPM

115/230 volts, 60-cycle single phase —overload protected.

**PLUS**—Two 6"x45" tanks (400# test, 10-gal. capacity), check  
valve, safety relief valve, gauge, shut-off valve, hose, coup-  
plings, tire chuck, industrial-type Schrader blow gun and 2-way  
air valve, tubular steel handle, precision pneumatic 10 x 1.75  
tires, Cutler-Hammer Automatic Pressure Switch. Shipped K.D.

**PLUS SPECIAL REPAIR KIT** including wrench and all neces-  
sary spare parts for overhauling compressor. You get every-  
thing for a complete compact assembly—wonderfully bargain-  
priced. Can be sold less motor, or compressor only.

Send Check or Money Order, or if C.O.D. send 25% Deposit.  
Prompt delivery guaranteed. Shipping weight 100#. Order from:

**NATIONAL EQUIPMENT CO. WILMERDING, PA.**

Say You Saw It in  
**POPULAR MECHANICS**

## WELD BRAZE, SOLDER, and CUT →

ONLY  
**\$1475**  
F.O.B.  
complete!



No experience needed. Follow  
simple instructions, weld on iron,  
steel, bronze, brass, aluminum,  
and other metals. Plugs into any  
properly wired 110 volt A.C. or  
D.C. line. Make or save time  
and money doing repair work for yourself and  
others. Repair men, farmers, tinsmiths, home and  
auto owners, hobbyists, etc., say FOUR-WAY  
pays for itself over and over. Order today or send  
for Free details. **MAKES AN IDEAL GIFT.**  
Larger Equipment Available on Request  
**FOUR-WAY WELDER COMPANY, Dept. F2-M**  
2326 S. Michigan Ave. • Chicago 16, Illinois

**ORDER  
NOW  
10 DAY  
TRIAL**

# BOAT KITS BY U-MAK-IT

18 FT.—21 FT.—23 FT. OUTBOARD and  
INBOARD CABIN CRUISERS



**30 Models**  
8 TO 23 FEET

**INBOARDS**  
16 to 23 Ft.

**ROWBOATS**  
8 to 14 Ft.  
**OUTBOARDS** 12 to 21 Ft.



**U-MAK-IT PRODUCTS** 703P-WHITTIER ST. BRONX 59, N. Y. CITY

**BIG  
ILLUS.  
CATALOG**  
44 PAGES, shows construction  
details. Incl everything to build  
your own—hardware, engines,  
conversions, paint & color chart.  
Also Fibreglas covering for all  
Kit Boats, Cabin Roofs and Decks  
**SEND 35¢ COIN TODAY**



## Perform near-miracles with this really new TOOL

Reaches around the tubing or pipe  
and down on the fitting . . .

### SLASHES WORKING TIME!

Now you can own a TAC Open End ratchet Wrench set, complete with your most needed sizes of TAC snap-in open end sockets. Slips over and around pipe, tubing, cable, conduit, spark plugs, long studs, etc. —then down on the fitting. Fast ratcheting action saves up to 85% of your time. Especially good in tight working areas: will ratchet with as little as 7° handle swing. Tremendous torque strength. A favorite in Army-Navy-Air Force, and Industry. Now available to you. Write for catalog, prices and name of nearest dealer.



## TAC OPEN-END ratchet wrench

TAC  
TUBING  
APPLIANCE  
COMPANY  
Dept. 96  
10321 Anza Ave.  
Los Angeles 45,  
California



## FOR TOP GRINDING WHEEL PERFORMANCE Dymondcut WHEEL DRESSER



**NEW!**  
GENUINE INDUSTRIAL DIAMOND

Keep your grinding wheels true with the Dymondcut Wheel Dresser. Features genuine industrial diamond. Gives freedom from vibration, greater grinding speed, less burning, longer life, finer accuracy and better finish. Diamond is mounted in holder which is advanced or retarded by micrometer adjustment. Holder is mounted on cast iron base. Dresser is guided by tool rest for maximum precision. Ideal for home workshops, industry, auto mechanics and all trades. Only \$10 plus 30c postage.

only \$10.00

Mail to:  
**H. B. HAZERODT ASSOCIATES,**  
414 Ford Bldg., Detroit 26, Michigan

Mail me \_\_\_\_\_ Dymondcut Wheel Dressers. If not satisfied, Dresser may be returned within 10 days and money will be refunded. My check or Money Order is enclosed.

Name \_\_\_\_\_  
Address \_\_\_\_\_ Zone \_\_\_\_\_ State \_\_\_\_\_  
City \_\_\_\_\_

## DRILL SAW REAM CUT INTERNATIONAL HI-SPEED COPE SAW DRILL BIT



### IDEAL AS A CHRISTMAS GIFT

DRILL, SAW, REAM . . . metal, pipe, wood, plastic, Transite, etc. Use with any electric drill, slow drill press, lathe or milling machine. Drills own starting hole—upper part of bit is used to cut, saw or ream circles, ovals, squares or scrolls. Easy to operate. Ideal for carpenters, mechanics, electricians, plumbers, hobbyists, many others. Abrasive resistant, high speed steel. Flutes ground from solid. Will withstand severe continuous use without breaking. Resharp-ened at no charge. Takes place of up to \$50 in tools. 1/4" diameter, 2" cutting sections, total length 3 1/2". Available in three types—All Purpose, Wood, Heavy Metal. Specify type needed. Set of 3, \$11.50. Details on request. Shipped same day. Money-back guarantee. Dealer inquiries invited. **ORDER NOW! SEND CASH, CHECK OR MONEY ORDER.**

Manufactured and distributed by  
**INTERNATIONAL TWIST DRILL CORP.**  
618 Wyandotte, Rm. 630, Kansas City 5, Mo.

only  
**\$3.95**  
POST PAID

## BUILD OR BUY ARC WELDER

DUNBAR'S Build-Or-Own PLANS show you how to build a 300 amp. DC Welder the easy way using Aircraft Generator. Our FREE Big Catalog listing 1500 items also lists 3-low-priced DC Welder Kits you can assemble in few minutes. Send 25c today for Complete PLANS. Catalog included. Or, send for the FREE Catalog.



DUNBAR MFG. CO., 10318-82 Aurora Ave. Seattle 33, Washington

## Save Hundreds of Dollars On Home Repairs . . .

Add to Your Home's Beauty and Comfort  
. . . Increase Its Selling Price

Here is the last word in dependable, money-saving help for the home-owner. *Guide to Home Repairs*, written by the editors of Popular Mechanics, gives you the know-how you need to repair and maintain plumbing; install and repair wiring; paint and decorate; install insulation, etc.

192 Pages  
646 Illustrations  
**\$2.50**

### Step-by-Step Instructions Tell How — Pictures Show How

First you read how to do it in the famous Popular Mechanics "Written So You Can Understand It" style and then hundreds of photos, drawings and diagrams show you how it is done. Nothing is left to the imagination. Now you can lay floor tile and linoleum, repair doors and windows, tuckpoint, repair and install gutters, etc. Order your copy today. If it isn't entirely satisfactory you may return it in seven days for a full refund.



**POPULAR MECHANICS PRESS, Dept. HR-1**  
200 E. Ontario St., Chicago 11, Ill.

Send at once my copy of *Guide to Home Repairs*. My remittance for \$2.50 is enclosed. If it isn't satisfactory I may return it in 7 days for a full refund.

NAME \_\_\_\_\_

ADDRESS \_\_\_\_\_

CITY \_\_\_\_\_ ZONE \_\_\_\_\_ STATE \_\_\_\_\_

Check here for C.O.D. shipment. (U.S.A. only). Postage extra.

**YOU CAN'T AFFORD TO BE WITHOUT AN AMPCO UNIT ON YOUR CAR\***

INSTALL AN IMPROVED . . .

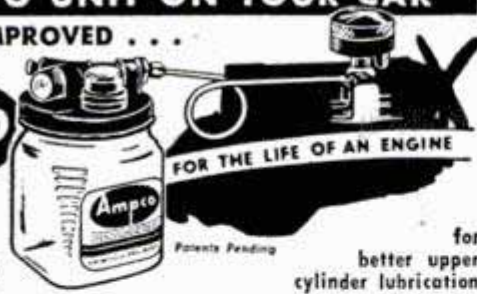

**INJECTION LUBRICATOR**

Pays for itself in a few months in actual cash savings because you can: Increase your gas mileage from 2 to as high as 6 miles per gallon\*\*—Increase your oil mileage some 600 additional miles\*\*—Increase power up to 12 more brake Horse-Power\*\*—Improve valve and hydraulic lifter action\*\*. To you, as a car owner, this all means: (1) Elimination of sticky valves (2) Overcoming hydraulic lifter failure (3) Faster starting in any weather (4) Increased engine power (5) Reduction of carbon, gum, and acid deposits (6) Elimination of engine "ping" caused by deposits (7) Friction-free ring action. All this equals extended engine life—savings in gasoline and oil—cut in maintenance costs.

\*\*Field test reports proving these results are available. \*AMPCO carries unconditional guarantee of improved engine performance.

AMPCO unit shipped complete with detailed instructions for simple installation on intake manifold. Install an AMPCO yourself, or ask your friendly mechanic. When ordering, be sure to state year, make, and model of your car or truck. Order your AMPCO lubricator unit today. Makes an ideal Christmas gift, too. Gives your car new power—new smoothness—new efficiency—and, at the same time, saves gas and oil.

AMPCO VAPOR LUBRICATOR Model ST-100—\$12.00 plus Installation Kit

- SPECIFY YEAR, MAKE AND MODEL WITH ORDER**
- \$5.75\* — Pontiac 6, Chrysler 6, De Soto 6, Dodge 6, Chevrolet, Ford 6, Plymouth, Nash, exc. Statesman
  - \$11.75\* — Cadillac after '49, Buick 70 from '52, Hudson Hornet (duals), Packard '53, Olds Super 88 & 98 from '52, Lincoln from '53, Chrysler V-8
  - \$7.75\* — All Others.

\*Price includes one quart of Ampco-Approved Oil. Send check or money order, then complete unit shipped prepaid, or send \$2.00 deposit and complete unit shipped, balance C.O.D.

**ADVANCE MOTOR PRODUCTS CO. Dept. PM 11**  
WHITMAN, MASSACHUSETTS

**Say You Saw It in POPULAR MECHANICS**

**WHAT! NO LIGHTS!**

You'll have AC Electricity anywhere . . . anytime with **KATO GENERATORS!**

KATO AC GENERATORS furnish the same kind of AC current as the high lines. Sizes range from 500 watts to 300 kilowatts. Protect yourself from a power failure with a KATO AC GENERATOR. Can be arranged for tractor drive. Also manufacturers of rotary converters, frequency changers, high frequency generators, AC and DC motors and motor generator sets. **WRITE TODAY!**

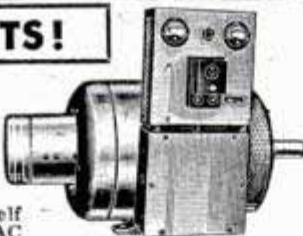

**KATO Engineering Company**  
1402 FIRST AVENUE, MANKATO, MINNESOTA

**AMAZING NEW "SQUIRT" ASHTRAY**



Automatically extinguishes forgotten cigarettes. A cigarette left burning on rest is easily and safely extinguished by an ingenious device

which releases a jet of water directly on it. Refills with plain water and douses many cigarettes with each refilling. Metal figure finished in bronze, mounted on sturdy Bakelite tray with gold trim. 5" x 5" . . . . . **\$2.50** postpaid

Elephant "Squirt" Illustrated. Also available with Fireman "Squirt" or Soda Siphon "Squirt." Please specify style desired.

**MONEY BACK GUARANTEE**

Please send check or money order to **HomeCrafts Dept. S-9, 799 Broadway, N.Y., N.Y.**

**PALMGREN HOBB-E TOOLS**

**ROTARY INDEX MILLING TABLE**

Turn drill press into vertical miller. Mill, Grind, Index, Rabbet, Mortise and Rout curved or straight. PALMGREN "Hobb-E" ROTARY TABLE is a precision machine, accurately graduated. Bolts to table. No. 83—8" Table, 4" Cross Feeds, 360° Rotary Feed. . . . . **\$54.50**



No. 82—Without Rotary Feed. . . . . **\$39.75**

**ANGLE VISE**

Set up hard angle jobs in 5 seconds. Drill, grind, mill, round, square or irregular pieces quickly and accurately. Save time, money and errors. PALMGREN ANGLE VISE has 2 1/2" Jaws. 1 Plain. 1 Grooved. Accurately machined and graduated. **\$11.75**



No. 000 Angle Vise. Complete with Swivel Base

**MILLING ATTACHMENTS**

Mill it on YOUR LATHE! Now! You can make T-slots, Dovetails, Keyways—Recess, Grind, Square Shafts, Saw at Angles, etc. Fits any Lathe. Graduated for rotary and vertical feeds. Attaches to tool post in 10 seconds.

- No. 150—1 1/2" Jaws. Fits 1" Post. . . . . **\$18.75**
- No. 250—2 1/2" Jaws. Fits 1 1/4" Post. . . . . **\$24.75**
- No. 400—4" Jaws. Fits 2" Post. . . . . **\$39.75**



**ADJUSTABLE ANGLE PLATE**

Every Hobbyist should have one for jobs difficult to hold in vise. No delay, less spoilage on complicated angles in drilling, milling, grinding or layout work. No. 256 B has 6"x6" surface plate, 8 bolt slots. Adjustable to full 90°. Accurate graduations. Mounted on Swivel Base. . . . . **\$14.35**



No. 249B—9"x9 1/2" Plate Mounted on Swivel Base. . . . . **\$32.75**

**BENCH DRILL PRESS VISE**

A fine "Hobb-E" tool. Base bolts to work bench for general work. Vise is dovetailed and removable for use on drill press by loosening thumb screw. Unit rotates 360° horizontally. Adapter has steel jib which locks vise in position. No. 12 Removable Jaws 2 1/2" wide. 1 Plain. 1 Grooved. **\$12.95**

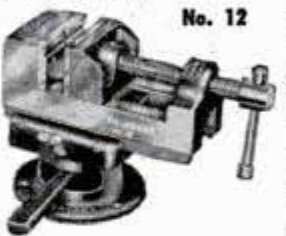

Only . . . . . **\$12.95**

**ORDER NOW! SEND COUPON TODAY!**

**CHICAGO TOOL & ENGINEERING CO.,**  
8365 South Chicago Ave., Chicago 17, Ill.

Enclosed find \_\_\_\_\_ for items checked below.  
 PALMGREN "Hobb-E" ANGLE VISE.  PALMGREN "Hobb-E" ANGLE PLATE  PALMGREN "Hobb-E" ROTARY TABLE.  PALMGREN MILLING ATTACHMENT.  
 PALMGREN "Hobb-E" BENCH DRILL PRESS VISE.  
 Send Circular No. 201M.

NAME \_\_\_\_\_  
 ADDRESS \_\_\_\_\_  
 TOWN \_\_\_\_\_ ZONE \_\_\_\_\_ STATE \_\_\_\_\_

# HOBART "Simplified" Arc Welding

**Pays BIG Profits**



250 amp. Gas Drive DC Welder. Has 1KW DC auxiliary power outlet.

## Welds Anywhere!

Would you like to OWN YOUR OWN BUSINESS—one that pays big from the start—has an unlimited future—yet requires no special talent or big investment? If so, WELDING IS FOR YOU!

Just one low cost Hobart Welder puts you in business. It goes anywhere, handles any job. Gives you better welds—dependable, low cost service. Has exclusive remote control and 1000 combinations of heat on all standard models to make learning and operation easy. Check coupon!

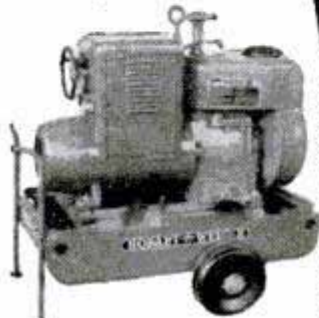

200 amp. portable Gas Drive Welder with air-cooled engine.

## "Build Your Own"



AC Generator Only for building your own comb. welder-power plant.

For even greater profits, you can "build your own" combination welder-power plant and save hundreds of dollars over cost of complete factory-built model. All you need do is hook low cost Hobart Generator to a used auto engine.

Model illustrated gives you a 300 amp. AC welder—plus plenty of AC power for operating lights, tools, etc. Check coupon today!

**Hobart Electrodes** give smooth, tough welds, easy and fast ...try them!



## HOBART Trains You —

...for a big pay welding career in this modern, non-profit school. Complete or partial courses. Best equipment and instructors.

**Hobart Brothers Co., Box M-113 Troy, Ohio**  
"One of the world's largest builders of arc welders"

**Free!**

"Welder's Vest Pocket Guide"

HOBART BROTHERS CO., BOX M-113, TROY, OHIO  
Send complete details on items checked.

Gas Drive Welders  Electric Drive Welders  
 Generator Only  Air Cooled Gas Drive  
 Welding School  Electrodes  Accessories

NAME \_\_\_\_\_

ADDRESS \_\_\_\_\_

CITY \_\_\_\_\_ STATE \_\_\_\_\_

## SAVE MIDDLEMAN'S PROFITS ...buy DIRECT from CGH

### LIGHT PLANTS



1000-2000 w AC, 115 v, 60 cyc. Powered by rugged 2 1/2 hp easy-starting Continental gas engine. No wiring. Just plug in, ready to go. Complete with 12 v starting winding. Easily connected for push-button battery starting. Fully guaranteed, easily worth \$325. Your Factory Price only \$194. Other bargain price models in stock, 300, 1500, 2500, 5000 w etc. SEND FOR FREE BOOKLET WITH VITAL FACTS ON HOW TO SELECT PROPER SIZE FOR YOUR JOB.

### BOOSTER FANS



Fit any 8" to 12" furnace pipe. Mounting frame, 7" blade, 110v motor, 60 cyc. 1550 rpm with 6' cord. Silent operation. Easy to install. Warm those rooms with long runs. List \$11.95. Our price . . . \$6.95; two for \$11.95; three for \$14.95. Buy one for each room! REGISTER FAN for hot or cold air with bracket ready to mount; motor, 7" blade, 6' cord ONLY . . . \$7.50; two for \$12.95; three for \$16.95.

More than 1100 big \$\$\$ saving buys. These are only a few of the many items at sensationally low prices! Send for FREE 68 page catalog!

- |                |                   |                  |                 |
|----------------|-------------------|------------------|-----------------|
| Air Compressor | Delta Tools       | Gas Engines      | Mail Grinder    |
| Air Tank       | Drop Cords        | Generators       | Pumps           |
| Block & Tackle | Electric Hoists   | Grinders         | Reduction Gear  |
| Blowers        | Electric Motors   | 1/2 Ton Wagon    | Rubber Cable    |
| Bomb Trailer   | Electric Switches | Hale Fire Pump   | Rubber Wheels   |
| Buzz Saw       | Elevator          | Hand Truck       | Saw Tables      |
| Compressor     | Drawing           | Hydraulic        | Shower Sprays   |
| Accessories    | Elevator Incline  | Cylinder         | Starters        |
| Clutches       | Fans, Exhaust     | Hydraulic        | Tools           |
| Conveyors      | Fans, Heat        | Stacker          | Transformers    |
|                | Booster           | I Beam Trolley   | Whiting Hoist   |
|                |                   | Lawn Mower       | Wilton Vise     |
|                |                   | Sulky            | Winch, Electric |
|                |                   | Magnetic Starter | Winch, Hand     |
|                |                   | Mail Chain Saw   |                 |

Fire Extinguisher 4 Wheel Trailer

SEND TODAY FOR FREE CATALOG

**C&H ELECTRIC MACHINE Co. Inc.**

4342 W. Juneau Ave., Milwaukee 3, Wisconsin

## HELPFUL BOOKS

Send post card asking for FREE catalog

Popular Mechanics Press, 200 E. Ontario, Dept. 601, Chicago 11

## Save on all PLUMBING JOBS

When You Build · When Making Improvements · Repairs · Maintenance

Get POPULAR MECHANICS Home Plumbing Guide



How to plan plumbing installations, select materials and fixtures.

How to save money on all plumbing jobs using approved methods.

Easy to Do Professional-Like Jobs and Save Over One-Half

Get the Popular Mechanics HOME PLUMBING GUIDE. It shows how you can do every kind of plumbing job yourself and save from a few to hundreds of dollars. Covers plans, layouts, installation, maintenance and repair. Shows what materials to get and use, where to get them and how to do a proper job with approved methods. Few, other than the simplest tools are required and some of these can be rented. Don't pay high prices for work you can do yourself. Get the HOME PLUMBING GUIDE for only \$3.50. You will be amazed how jobs you thought difficult are simplified.

Clip This Ad and Mail. Money Back if Not Pleas

Invest only \$3.50. Use the book for 7 days. Then if you are not satisfied return it for full refund of your money. Sent C.O.D. (U.S.A. only) if you prefer.

- 15 Ways to Save Money  
All about modern home plumbing  
How to use plumbing tools  
Getting acquainted with pipe  
Planning home plumbing systems  
Installing and maintaining home drainage systems  
Private sewage disposal systems  
Causes and cures of drainage troubles  
Installing home waterlines  
Private water supply systems  
Water Heaters  
Water Conditioning  
Water system troubles and cures  
Installing and caring for fixtures  
What to do with valves and faucets

Over 500 How-to-do-it Pictures Guide You

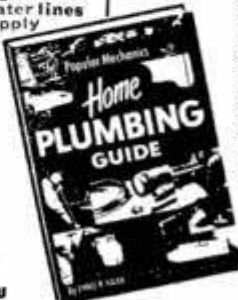

POPULAR MECHANICS PRESS, Dept. HPG-10, 200 E. Ontario St., Chicago 11





# Be a "Do-it-Yourself" Santa with easy-to-use FIR PLYWOOD

THIS YEAR, do your Christmas shopping at home—in your own workshop. Save money by making your own gifts and decorations with inexpensive fir plywood. You'll have a lot of fun and satisfaction in the process. Whether it's a doll house for your daughter . . . new kitchen cabinets for the wife . . . or life-size Christmas cut-outs—you'll do a better job, faster . . . with light, strong, good-looking fir plywood.

**ASK FOR DFPA-INSPECTED FIR PLYWOOD**

get all 10 plans for only 10¢

... see your lumber dealer or send 10c to Douglas Fir Plywood Assn., Dept. C, Tacoma, Washington. (Offer good in U. S. A. only)

Child's drawing desk is one of 10 projects shown below

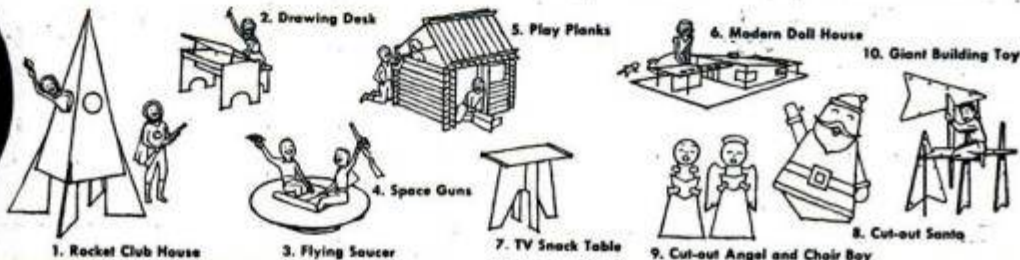

1. Rocket Club House

3. Flying Saucer

7. TV Snack Table

9. Cut-out Angel and Choir Boy

## How to Build Your Own GARAGE



Save as Much as 50% of Usual Construction Costs

Get Popular Mechanics' brand new book *How to Build Your Own Garage* by Wayne Leckey, Assistant Shop Notes Editor, and find out how you can build your own garage at savings of 50% of usual cost. Leckey tells in famous step-by-step instructions and shows in big, clear photos, drawings and diagrams how to perform every building operation from laying the concrete to installing the final trim. There are 25 designs. Brick, frame, and concrete block fully covered. Send \$3.50 for your copy. 7-day money back guarantee.

POPULAR MECHANICS PRESS, 200 E. Ontario, Chicago 11, Ill.

## HARD ALUMINUM



**STRAIGHT EDGE-RULES**

LIGHT STRONG NO RUST NO EYE-STRAIN SHARP BLACK NUMBERS

**12" to 144"**  
GRADUATED T-SQUARES  
**ALL PRECISION MADE**  
See Your Dealer

THE **FAIRGATE** RULE COMPANY  
BOX 278, COLD SPRING-ON-HUDSON, N. Y.

WRITE FOR CATALOG



**400 DELUXE DRILL KIT THE BUY OF THE YEAR**

do hundreds of jobs  
**EASIER  
FASTER  
BETTER**



**YOU GET ALL THIS**

Model 149B, 1/4" capacity, electric drill with precision geared chuck, key, and holder. Set of three wood bits, seven steel bits. 6" dia. sheep's wool polishing bonnet. Plastic bag for polishing bonnet. 5" dia. rubber backing pad. Five assorted abrasive discs. 4" dia. rag buffing wheel. 4" dia. wire wheel. 4" dia. grinding wheel. Paint stirrer attachment. Stick of polishing rouge. Drill pedestal. Adequate assembling accessories. Heavy gauge steel carrying case.



ONE \$39.95  
LOW PRICE

40 MALL branch offices, coast to coast, serve our customers and thousands of dealers.

MAIL THIS COUPON NOW

**MALL TOOL COMPANY**  
7805 S. Chicago Ave., Chicago 19, Illinois  
Send me more information about the MALL 400 DeLuxe Drill Kit.  
Name \_\_\_\_\_  
Address \_\_\_\_\_

HU-71

**115 V. A. C. GENERATOR IDEAL LIGHT PLANT & BATTERY CHARGER**

**\$29.50**

Used, good condition. Instructions incl. for Combination, 115V. A.C. Light Plant & DC Battery Charger. Stock #311.



**A.C. - D.C.**

PRICE F.O.B.

K.C. MO. ~~\$250~~ **\$500**

A.C. OUTPUT 1250 WATTS. 115 V. 10.9 AMPS. 480 CYCLES. D.C. OUTPUT 200 AMPS. 20 VOLTS

Stock #500 A.C.-D.C. Generator Mfg. by G.E. When driven by 3 H.P. gasoline engine makes a dependable light plant for homes, farms, house trailers, boats, etc. Use D.C. output for battery charging, welding, marine use, etc. Govt. cost over \$300.00. Wt. 50 lbs. New **\$39.50**

**VICKERS CONSTANT DISPLACEMENT HYDRAULIC PUMPS.** Brand New Stock No. PF-713-20. For any type liquid pumping job.



375 gal. per hr. at 3750 R.P.M. 1000 P.S.I. 410 cu. in. per rev. Govt. cost over \$150.00. Data and inst. incl. **\$17.50** paid

**BUILD YOUR OWN ARC WELDER OR LIGHT PLANT**

**D-C GENERATOR**

**\$15.50**

used, good cond. Instruct. incl. for Comb. welder & light plant. 200 amps. 28 Volts. 2500 to 4500 R.P.M. Or Brand New.....Price \$21.50 PRICE F.O.B. K.C., MO.

CONVERTS TO ARC WELDER 200-250 AMP. OR LIGHT PLANT CAP. LOAD 5000 WATTS

Stock No. 711 D. C. Generator R-1 Jack & Heintz, rated 300 Amp. 30 Volts. Gov't. cost \$300.00. Instruction for converting to welder or light plant incl. **\$27.50**



**CUNO OIL FILTER—BRAND NEW**

Aircraft type. Filters oil without cartridge replacements. Just turn handle and cartridge is clean. Std. 3/8" inlet & outlet ports. **\$4.95** paid

Instructions incl. **\$4.95** paid

Send check or M. Order. Prices f.o.b. KCMo Except when marked postpaid U.S.A.

GENERAL SALVAGE CO., Dept. 713, 2922 E. 27 St., Kansas City, Mo.

**Hydraulic Solenoid Control Valve**

**BENDIX. No. 81560.** For remote control operation and to operate one single action or double action hydraulic cylinder with 24 V. D.C. 800 to 1500 P.S.I. connections are .550" 18thd. Applicable for 115 V. A.C. Instructions & Data included. \$35.00 value. **\$3.95** ea. **\$7.50** per pair

**PESCO LARGE VOLUME UTILITY PUMP**

For Water, Oil, Insecticides, etc. Including built-in relief and by pass valve. Capacity 400 G. P. H. 1 1/2" drive spline shaft. 3/4" pipe inlet and outlets. Data incl. **\$7.95**

**BEAM ROTATOR MOTOR**

New. Applicable for 110V. A.C. or 24V. D.C. Powerful geared motor for TV aerials, Ham FM antennas etc. Approx. 9 R. P. M. free swing Instructions incl. Stock #AJ31 **\$7.50** \$50.00 value

**RHEOSTAT #R-21**

heavy duty recommended for regulating the voltage on the converted electric welder. **\$6.95** (for P-1 or R-1) postpaid

**VOLTAGE REGULATOR for P-1 or R-1**

**\$6.95**

"BUILD YOUR OWN DIVING LUNG" AN-6004-1 Demand OXYGEN REGULATOR Brand New... **\$9.95** post paid

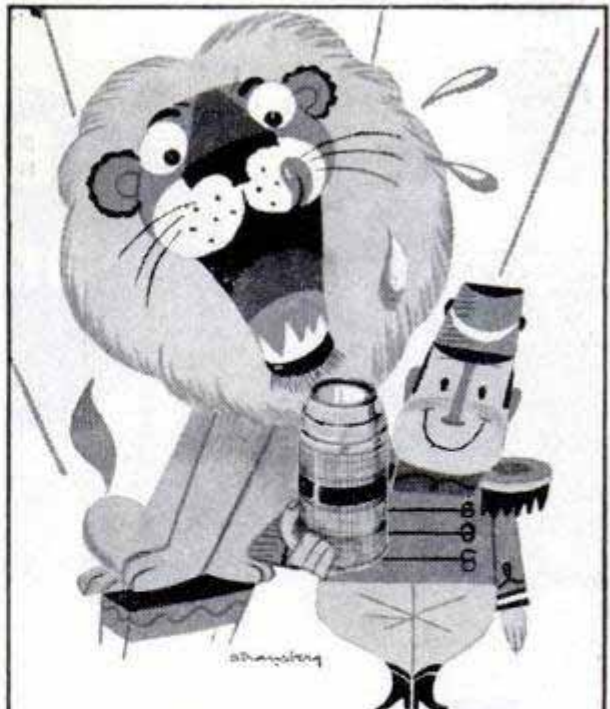

"He refuses to eat unless we keep his food fresh in an Aladdin WIDE MOUTH!"

*Aladdin*



10 OUNCE  
PINT  
QUART

VACUUM BOTTLES and LUNCH KITS

ALADDIN INDUSTRIES, INCORPORATED, Nashville, Tennessee.

**DRILL-RITE—The All-Purpose Drill**

For Home - Work Shop - Hobbyists - Garages Home Craftsmen, etc.

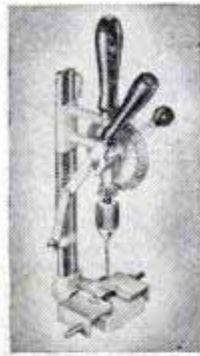

● A combination Tool of 100 and 1 uses . . . easily changes from a hand drill to a drill press or back again in seconds.

DRILL-Rite is a sturdily constructed quality tool, indispensable for home use or light industry . . . attached to bench or shelf, DRILL-RITE will become the favorite of your shop. Nothing like it on the market. Postpaid with check or M.O. each **\$9.75**

25% deposit with C.O.D.'s. Money back guarantee. Ideal Christmas Gift. Order Now.

**DRILL-RITE MFG. CO., Dept. PM**  
7028 Stony Island Ave., Chicago 49, Ill.

**PLYWOOD BOAT KITS**

(Freight Included) **\$97<sup>00</sup>**



Build this 12-foot sport runabout from ready-cut parts. Kits include all hardware, etc., to complete the boat shown. Send for free folders of all models as low as \$32.00 freight included.

**TAFT MARINE WOODCRAFT**

Dept. PM, 636 39th Ave., N-E, Minneapolis 21, Minn.

Say You Saw It in  
**POPULAR MECHANICS**

**Skymaster Palm-size Radio**

Selective 250-mile day-time reception. 1100 miles received at night

Owners report this amazing VACUUM TUBE miniature pulls loud, clear reception up to 1100 miles at night. Covers standard broadcast band, 550 to 1600 KC. Hearing aid battery powered. Powerful low-drain ELECTRONIC tube outperforms sub-miniature types or transistors. FULLY ASSEMBLED . . . NOT A "KIT". Enjoy Skymaster at home, in bed, in office or camp. Make it your PERSONAL RADIO. Batteries including EXTRA "A" battery supplied at \$1.50 per set. 1500-ohm earphone with ALNICO PERMANENT MAGNETS as described in Sat. Eve. Post only \$1.45 with set. C.O.D. orders accepted with \$1 deposit within U. S. and possessions.

**\$8<sup>95</sup>**

Postpaid incl. fed. tax



SAVE \$2.20—YOU ASSEMBLE

Assemble your own Skymaster Radio and save \$2.20. Kit includes picture diagram with instructions for radio beginners. Batteries, earphone as above. Ideal for schools. ALL PARTS GUARANTEED. Only

**\$6.75** postpaid

PRECISION ELECTRONICS, DEPT. 7 . . . PLACERVILLE, CALIFORNIA



**WINTER OR SUMMER  
DO EVERY OUTDOOR JOB  
FASTER—EASIER—BETTER**

WITH A **GEORGE** GARDEN TRACTOR

**\$119.50**

F.O.B. Sullivan, Ill.

Illustrated:  
2 wheel, 2 HP GEORGE Garden Tractor, Briggs or Clinton Engine

Your George garden tractor is a multi-purpose, year-round work saver. In price, it compares with a power mower. In use, the George garden tractor is incomparable. Complete range of attachments for tilling gardens... mowing lawns... cutting weeds... removing snow. A George tractor is ideal for every purse and purpose.

**SEND TODAY**

Write for free copy of illustrated George garden tool folder. See how a George garden tractor can do every outdoor chore.  
George Garden Tool Div.  
PM-11  
Sullivan, Illinois

**GEORGE GARDEN TOOL**

Div. of Community Industries Ass'n

**YES! SEND**



directly  
to my door  
every month

I am enclosing

- \$3.50 for 1 year  
 \$8.00 for 3 years

name \_\_\_\_\_

address \_\_\_\_\_

city \_\_\_\_\_ zone \_\_\_\_\_ state \_\_\_\_\_  
A-113

Hand this order to your newsdealer or send it to

**POPULAR MECHANICS**  
200 East Ontario St. Chicago 11, Ill.

**SANDS FASTER  
Than 10 Pairs  
of Hands!**



**PORTER-CABLE  
BELT  
SANDER**  
only

**\$62.50**

Weights  
Only 9 lbs.  
2" Belt



**Speeds Paint Removal . . .** Used to be tough and messy to remove paint and varnish — not any more! It's easy with this powerful motor and high belt speed working for you.



**Plane-Sands Faster . . .** Another job made easy. The Porter-Cable Belt Sander is perfect for taking off stock to close dimensions.



**A Whiz at Preparing for a Finish . . .** Always a uniformly fine, velvet-smooth surface. No waves or swirls — levels perfectly — cleans blemishes! And that's not all!

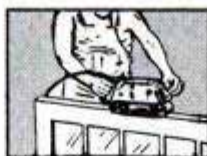

**Speeds Screen, Sash and Door Fitting . . .** And does a workmanlike job that will amaze you.

• This Porter-Cable Sander does that job *fast* without hand-sanding drudgery! No bearing down — the powerful motor insures effortless, efficient cutting. So light, so perfectly balanced, it handles easily in *any* position. High speed abrasive belts have a variety of grits for work on wood, composition, plastic, metal, glass. Handy bench (extra) converts the Porter-Cable Sander to a tool grinder — and to a machine for truing and smoothing butt and mitre joints.



Bench Stand

See your dealer for free demonstration.  
It'll open your eyes. Send in coupon today.

Send me literature on the Porter-Cable A-2 Sander and Bench Stand. Also name of my nearest dealer.

Name .....

Address .....

City ..... State .....

**PORTER-CABLE MACHINE CO.**

1451 N. Salina St., Syracuse 8, N. Y.

NEW! HI-SPEED! MORE EFFICIENT!

# DU-FAST\* ORBITAL MOTION Universal Model UN-12 SANDER & POLISHER

*Fits  
ANY make  
1/4 Electric  
Drill!*



\* PAT. NO.  
2614269  
OTHER PATS.  
PEND.

**OPERATES AT DOUBLE RPM DRILL SPEED!**

Yes!—DU-FAST now comes to fit ANY MAKE 1/4" ELECTRIC DRILL

**BETTER THAN EVER!** The DU-FAST Attachment is light weight—produces smooth, effortless work without tiring—tackles the toughest Sanding and Polishing job with ease!

**ORBITAL MOTION**—big 3 3/8" x 7" working surface—uses standard cut 3 3/8" sandpaper!

**OVER 200,000 SATISFIED USERS**

DU-FAST  
MODEL UN-12  
**\$15.95**  
Attachment  
Only

Made by **DU-FAST, INC.** 32 East 4th St. New York 3

## FREE BOOKLET

### Your Guide to Speedy Accurate LEVELLING

Send for your free copy of "ON THE LEVEL," a booklet that tells you how to handle every type of leveling job speedily, easily, accurately and economically with the new, amazing LEVELALL.

Learn how LEVELALL operates on the principle that "water seeks its own level." . . . how you can level points all alone . . . how easy it is to handle and use the transparent plastic tube, shut-off valves and mounting brackets . . . why LEVELALL is better and quicker than a transit . . . how LEVELALL pays for itself quickly by saving time and costs . . . and how satisfied customers praise this precision instrument.

Send for the booklet and get the facts . . . then you'll want a Deluxe LEVELALL . . . only \$12.95. Better yet, take advantage of our money-back guarantee and order your LEVELALL now. Dealer inquiries welcome.

## LEVELALL

LEVELALL, 87M Webster St., Rockland, Mass.

Please send free booklet, "On the Level."  Mail me Deluxe LEVELALL @ \$12.95  Regular 50' model at \$9.95  Ship postpaid full price enclosed.  Ship C.O.D.

Name \_\_\_\_\_

Street \_\_\_\_\_

City \_\_\_\_\_ Zone \_\_\_\_\_ State \_\_\_\_\_

[In Canada, prices slightly higher; write LEVELALL, INC., 5465 Decarie Blvd., Montreal, Que.]



How to save money on all plumbing jobs — using approved methods.

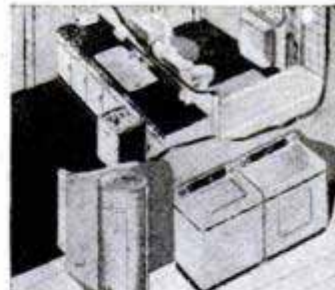

How to select materials and fixtures.

## Save on Plumbing Costs

When You Build · When  
Making Improvements  
Repairs · Maintenance

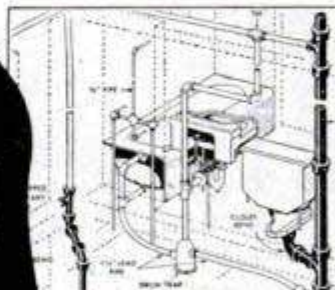

How to plan and lay out plumbing installations.

### Do All Kinds of Jobs Yourself With Home Plumbing Guide

Got a leaky faucet; a clogged drain; a noisy hammering water pipe? Want to add a bathroom to your home, install a new kitchen, or even build a home? Then you need Popular Mechanics' HOME PLUMBING GUIDE. It shows how you can do every kind of plumbing job yourself and can easily save you hundreds of dollars. Savings on even a small job will pay for this practical book many times over. It covers plans and layouts, installation, maintenance and repair of all home plumbing systems; tells you what materials to get and use and how to do a proper job with approved methods.

Over 500 Pictures and Diagrams and  
Hundreds of Money-Making Tips

Simple everyday jobs, bigger remodeling and improvement jobs and complete installations are made clear and simple and easy to follow. Few, other than the simplest tools are required and some of these can be rented. Pipe, materials and fixtures are available from mail order houses, hardware dealers and supply houses. Don't pay high prices for work you can do yourself. Get the HOME PLUMBING GUIDE. You will be amazed how the practical text and hundreds of how-to-do-it pictures simplify jobs you thought might be difficult.

Mail Coupon. Money Back if  
You Want It

Get the HOME PLUMBING GUIDE today. Only \$3.50. Read it. Study it. Put the vital information it contains into practice. Then if you are not satisfied return the book for a complete refund of your money. Order today.



15 Ways to Save Money in Your Own Home

All about modern home plumbing

How to use plumbing tools in your home

Getting acquainted with pipe

Pointers on planning home plumbing systems

Installing and maintaining the home drainage system

Your own private sewage disposal system

The causes of drainage troubles and how to cure them

Home water lines and how to install them

Valves and faucets and what to do with them for best and most economical service

Your own private water supply system

All about water heaters and automatic supply

Methods and advantages of water conditioning

Water system troubles and how to prevent and cure them

How to install plumbing fixtures and take care of them for longer life

### Mail Coupon Today for Money Back Home Trial

POPULAR MECHANICS PRESS, Dept. HPG-1  
200 East Ontario Street, Chicago 11, Ill.

Send Popular Mechanics HOME PLUMBING GUIDE in cloth binding at once. I understand I may return the book in 7 days for full refund of my money.

Remittance for \$3.50 enclosed. Send postpaid.

Send C.O.D. (U.S.A. only) I will pay postman plus charges.

Name \_\_\_\_\_

Address \_\_\_\_\_

City \_\_\_\_\_ Zone \_\_\_\_\_ State \_\_\_\_\_

# BUILD YOUR OWN POWER TOOLS - TILT/ARBOR SAW

## Exclusive GIL-BILT Build-It-Yourself Features

- No machining—build easily with hand tools only
- No blueprint reading—step-by-step pictorial plans, full scale patterns, actual photographs
- Sturdy wood, aluminum and steel construction
- Capacity and performance of commercial saws selling for \$60 and up
- Proved performance. Nationally advertised and sold for 6 years. Satisfied customers around the world.

**BANDSAW**

**BELT SANDER**

**SAVE \$50. OR MORE**

## GIL-BILT 10-INCH TILTING ARBOR SAW



- 27x28 in. table, 13 1/2 in. capacity in front of blade
- 10 in. blade cuts 3/4 in. deep, tilts full 45 degrees
- Floor model 34" high, table always stays level

- New Departure ball bearing arbor, 3/4" precision shaft turned down for 5/8" bore blades, alum. housing, shipped ready to run
- Jackscrew and 4 1/2 in. dia. handwheel lowers and raises blade
- Cast aluminum miter gauge and self-aligning rip fence guide

GIL-BILT Metal Parts Kit includes Plans, ball bearing arbor, miter gauge and bar, rip fence guide, dado insert, lock knobs, jackscrew mechanism and handwheel, and all other metal parts (less blade).....\$22.95  
Same Kit with 10" Combination Blade \$25.90  
Same Kit with 8" Combination Blade \$24.90

## GIL-BILT 12-INCH BAND SAW



- Cuts to center of 24 inch circle
- Handles stock up to 8 inches thick
- 18x18 inch table tilts 45 degrees
- Lower wheel and drive pulley runs on sealed New Departure Ball Bearings. Upper wheel runs on two 3/8" bore Ollite Bronze bearings.

• Upper wheel tension and tilt mechanism of cast aluminum, completely assembled.  
• Upper and lower blade guides. Each has ball thrust bearing, self-lub bronze jaws.  
• Rigid cast aluminum wheels fully machined ready-to-install. Heavy rubber tires.  
• Uses standard 78 inch blades up to 3/4 in. wide.  
• Fully enclosed mechanism for utmost safety.  
GIL-BILT Metal Parts Kit includes Plans, rubber tires, aluminum wheels, 1/4 in. blade, ball bearing spindle, tilt mechanism, blade guides, table tilt segments, and all other metal parts.....\$23.95

Return Kits in 10 days for refund if not satisfied.  
For shipment up to 600 miles, add 5%; over 600 add 10%. Amount in excess of actual postage will be refunded.

Also available—Plans and Parts Kit for 18" Band Saw, Belt Sander and 8" Tilt/Table Saw. Order Plans at \$1.00 each—Sent postpaid anywhere in the world or write for FREE descriptive catalog.

**GILLIOM POWER TOOLS** P. O. Box 1-PL, Lambert Field St. Louis 21, Missouri

# HOW TO BUILD Your Own GARAGE

Save Up to 50% of Usual Cost!

Get Popular Mechanics' brand new book *How to Build Your Own Garage* by Wayne Leckey, Assistant Shop Notes Editor, and find out how you can build your own garage at savings of 50% of usual cost. Leckey tells in clear step-by-step instructions and shows in big, clear photos, drawings and diagrams how to perform every building operation from laying the concrete to installing the final trim. There are 25 designs. Brick, frame, and concrete block fully covered. Send \$3.50 for your copy. 7-day money back guarantee.

POPULAR MECHANICS PRESS, 200 E. Ontario, Chicago 11, Ill.

boost your income with the

## IDEAL LAWNMOWER SHARPENER

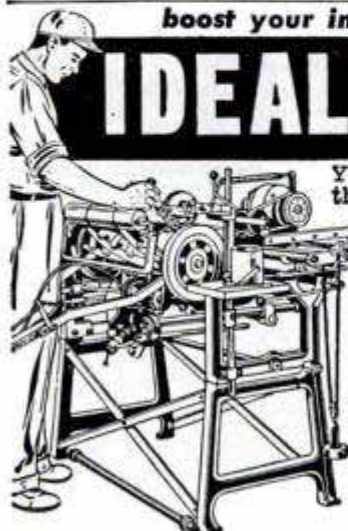

You can earn extra cash with the Model 300 Ideal Lawnmower Sharpener. Used and recommended by leading manufacturers and service shops, the Ideal has everything you need, nothing else to buy. Grinds reel and bed knife, also reconditions. Get started now in this highly profitable business. Write for catalog today.

The Fate-Root-Heath Co.  
Dept. PM-11, Plymouth, Ohio

from  
basement  
to attic



## General Controls

General Controls add safety, comfort and convenience to modern living. Your **FURNACE**, equipped with General Controls' famous BX-69 temperature control system, operates safely and silently. **AIR CONDITIONED COMFORT** winter and summer is yours when General Controls' handsome T-70H room thermostat is in control. **CLOTHES DRIERS** equipped with General Controls' K-4 combination safety and magnetic gas valves are efficient, economical and failure-free. Your **KITCHEN RANGE**



is probably safeguarded by one of General Controls' MR Series Valves. Your **WATER HEATER** gives hot water at the temperature you dictate with complete safety when equipped with General's G-2G Gas control. Even in your attic, unseen and unattended, the **VENTILATING FAN** serves you faithfully, controlled by General Controls' 5T interval on-off switch. Write today for your free copy of "How to convert your home to automatic heat."

and in industry, too

General Controls valves, such as the Hydramotor, right, provide remote control of steam, gas or oil lines in chemical plants, refineries and power installations.



## GENERAL CONTROLS

Glendale, California • Skokie, Illinois

Manufacturers of Automatic Pressure, Temperature, Level and Flow Controls for Heating, Home Appliances, Refrigeration, Industrial and Aircraft Applications.

FACTORY BRANCHES IN 35 PRINCIPAL CITIES  
See your classified telephone directory.

# BUY DIRECT MANUFACTURER TO YOU!

# New MOTOR BARGAINS for Home, Farm & Industry

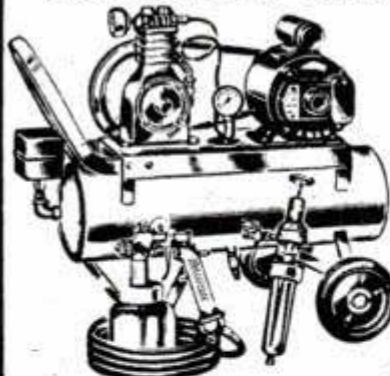

## AUTOMATIC AIR COMPRESSOR

1/2 H.P. Heavy Duty Motor, 115-V, 60 cy., 1 ph., 1725 RPM, \$24.50; Quincy X2 — 3 CFM — 100-150 lbs. Compressor — 2 in. x 1 3/4 bore & stroke, \$20.50; Furnas Automatic Adjustable Pressure Switch, \$6.50; Tank 8" x 26"; Rubber Tired Wheels and Handle, \$17.00; Speedy External Atomizing Quart Spray Gun, \$11.75; Pressure Regulator, \$4.25; Filter, \$3.25; Gauge, \$1.75; Hose & Tire Chuck, \$2.50; Check Valve, \$2.75; Safety Valve, \$1.50; V-Belt Drive, \$2.75. PARTS CAN BE BOUGHT SEPARATE AT ABOVE PRICES. COMPLETE BALANCED UNIT AS ABOVE, ASSEMBLED, READY TO USE.

#S-55 . . . fob Chi. . . . . \$99.00  
SAVE \$20.00 . . . 1/2 H.P. Outfit, knocked down, you assemble, #SK-55 . . . Fob Chicago . . . . . Only \$79.00

#SK-100—1 H.P. Motor 15"x30" Tank Twin Cylinder 9 CFM Compressor. All Accessories. You Assemble \$169.50 Fob.

**C. MARSHALL SALES**  
Dept. P-11

3546 W. Fullerton Ave.

Chicago 47

**KNOCK DOWN LARGER PORTABLE UNIT**



Above are 110 V. or 110/220 V. 60 cy. 1 ph. A.C. Motors. All Motor Prices are F.O.B.



1/2 H.P. { Dayton, 3450 RPM IND type . . . \$18.50  
Westinghouse, DBL shafts, 1725 RPM. \$22.50  
Westinghouse, dbl. shafts, 3450 RPM. \$23.50

3/4 H.P. { Eicor, capacitor type ball brg., 1725 RPM . \$32.50  
General Electric, cap. ball brg. dbl. shafts, 1725 RPM . . . \$34.50  
General Electric, cap. type, 3450 RPM . \$34.50

**SPECIAL BARGAIN OFFER . . .**  
Brand New! 2 H.P. Repulsion Induction Single Phase Late Style—Name Brand—220 V 60 Cy 3450 Rpm 3/4 Shaft . . . Only \$65.00. Weight approx. 100 lbs.

Write for CIRCULAR: Listing Motors: ALL SIZES: Fans and Air Compressors — ALL SIZES.

## 16 TO 1 SPEED REDUCERS

For Display Table — Barbecue Spits — Toy Auto Gear Box — Experimental Uses, Etc. Gears Enclosed in Aluminum Housing. Bronze Gear, Hardened Worm. Input Shaft 1/4 in. Output Shaft 3/8 in. Speed Reducer  
#R 161 . . . . . \$5.95 Post Paid

## Say You Saw It in Popular Mechanics

## New "SHOPLITE" Fluorescent Kit



### 24 Inch Assemble-Yourself Fixture

Save Money! Assemble your own fluorescent fixture for shop, laundry, playroom, etc. with complete kit of parts

and tubes. Ready to put together in minutes with screwdriver and pliers. No soldering. All metal parts and wire pre-cut and pre-formed. 2-20 watt tubes, U L approved components. Send only \$8.95 for each kit . . . we pay postage. Money back guarantee. Order today. VEGA CO., Dept. P M, P. O. BOX 5907, Chicago, Ill.

**\$8.95** complete—postpaid



## YOU CAN BUILD A VIOLIN FOR PLEASURE OR PROFIT

Now you can build a rich toned mellow violin modeled after a famous "Strad." YOU CAN MAKE A STRADIVARIUS VIOLIN contains 8 full scale plans plus complete instructions. You work directly from the plans with no confusing scale of dimensions to translate. Detailed instructions for each step including varnishing and stringing—even shows how to build your own tools. Cloth bound. Order today from

**POPULAR MECHANICS PRESS . . . \$3.50**  
200 EAST ONTARIO STREET, CHICAGO 11, ILLINOIS

## WAR SURPLUS AND OTHER BARGAINS SAVE UP TO 90%



### D. C. GENERATORS—\$14.95

The generators listed below will weld up to 3/8" plate steel or better. They all can be used as a combination welder and light plant.

Generators (Used) Pl. Perfect condition. 200 Amps. 28 Volts. 2500 to 4500 RPM. Electric Auto-Lite. 140 AMPS. 24 Volt. 2500 RPM. Makes a dandy arc welder. Wt. 53 lbs. Approx Govt Cost \$450 **NEW \$20.**  
R1 Jack & Heintz. Rated 300 Amps. 30 Volts. Wt. 60 lbs. Approx Govt Cost \$450. Guaranteed perfect. **\$25.**

**MAKE YOUR OWN ARC WELDER** Complete make-up package consisting of one NEW Auto-Lite 140 AMP Generator (can be revved up to over 200 AMP), one giant toggle switch, one voltage regulator and a wiring diagram chart showing conversion of Aircraft Generator to Arc Welder. Special — **WHILE THEY LAST—\$30.**

### AERO JET BUBBLE GOGGLES

Affords protection over eye glasses or can be worn as plain goggles. Improves vision. Scientifically blended for eye protection and comfort. Gives panoramic view for skiing, farming, driving, boating, shop, fishing, cycling, flying, golfing. Colors: clear—amber—green. **STYRENE. \$2.75 ppd.**



### LOW VOLTAGE CIRCUIT TESTER

Made for U.S. Ordinance to rigid specification. Portable steel carrying unit, self-contained trouble shooting device makes complete & rapid check of generator battery circuit incl. any circuit & voltage regulators. Battery voltage, regulators, cut-out settings & generator performance easily determined. Any 6 or 12 volt system. Great for garages, mechanics, truck fleet owners, boat & marine mechanics. Every set checked out in our lab & in perfect condition. Shpg. Wt. 20 lbs. Approx. GOVT COST \$175. **NEW. Complete with instruction book—\$36**



### SENSITIVE ALTIMETER IN 10 FT. INCREMENTS

0 to 35,060 ft. (inches of Mercury). Tested and inspected in our own instrument lab. Guaranteed perfect. Ready to install. **\$15.95 ppd.**



**MICROMETERS** Chrome plated, precision engineered, carefully tooled to give long life. All new 0-1" cap. \$2.25 ea., 1-2" cap. \$3.50.

Send 25¢ for big 1953 catalog. Bargains for everyone. Check, Money Order or Cash. 25% deposit on C.O.D. orders. Prices F.O.B. Culver City, Calif., Unless otherwise stated.

**AIRBORNE SALES CO., INC., Dept. PM1153**  
8501 Stellar Dr., Culver City, Cal.

## Guide for HOME ELECTRICIANS

Now You Can Install Fixtures, Make Most of Your Own Electrical Repairs and Save Hundreds of Dollars

Now you can do almost any electrical job that comes up around your home and pocket really worthwhile savings.

### Read How — See How

No matter if you want to install fluorescent fixtures, test circuits, repair appliances, or do any one of the many electrical repair jobs that come up, Popular Mechanics' new **ELECTRIC FIX-IT BOOK** tells and shows you how, step-by-step.

### 7-Day Money Back Guarantee

Use this book in your home for 7 days and return it for a full refund if it isn't more than satisfactory.

**Partial Contents**  
Rewire Your Home for Modern Lighting—Make a Shelf-Light—Service Electrical Home Equipment—Make Porch and Table Lamps — Install Fluorescent Fixtures — Repair a Vacuum Cleaner — Make Home Appliances Last Longer — Etc.



**POPULAR MECHANICS PRESS, Dept. EF-1**  
200 E. Ontario St., Chicago 11, Ill.

Gentlemen:  
Send postpaid my copy of **ELECTRIC FIX-IT BOOK**. Remittance for \$2.00 is enclosed. Unless it is entirely satisfactory I may return it within 7 days for a full refund.

NAME \_\_\_\_\_

ADDRESS \_\_\_\_\_

CITY \_\_\_\_\_ ZONE \_\_\_\_\_ STATE \_\_\_\_\_

Send C.O.D. (U.S.A. only). Postage extra.

# TOOL TIPS

MAKE YOUR SHOP MORE COMPLETE

with a set of

## DOUBLE CIRCLE POWER AUGER BITS

- Will bore hard and soft woods including plywood
- Can be used in all electric drills having 1/4" or larger chuck
- Set contains one each 3/8", 1/2", 5/8", 3/4", 7/8" and 1" diameter bits.

Ask for **DOUBLE CIRCLE** Power Auger Bits at your Hardware Dealers

WRITE FOR FOLDER No. 187



### CHICAGO-LATROBE

411 W. ONTARIO ST. CHICAGO 10

DRILLS • REAMERS • COUNTERSINKS • COUNTERBORES • CARBIDE TOOLS • SPECIAL TOOLS

SAY YOU SAW IT IN POPULAR MECHANICS

WRITTEN ALL TIME SERVICE GUARANTEE

## 17 JEWEL SHOCK RESIST NEW WATCH

DROP IT WET IT BANG IT

WAS \$50.00 under O.P.A. OUR PRICE ONLY **\$14.95** Plus \$1.50 tax

YOU SAVE **\$35.00**



WEAR AT OUR RISK

Guaranteed Inca-Bloc, Shock-Protected Damp-resist, Dust Resist construction. Anti-magnetic. Proved in Army, Air, and Navy service. Has sweep second hand, radium dial, genuine imported 17-jewel Swiss lever movement. You save sensationally on new de-luxe watches sold with WRITTEN ALL TIME SERVICE GUARANTEE, because we buy out distress and surplus stocks. Order now. Wear 10 days. Money back if not delighted. Order men's style—\$14.95, plus \$1.50 tax. Or ladies' style, \$15.95 plus \$1.60 tax. Send only \$1 down payment with order, pay balance on arrival. Or enclose full payment plus tax, and we pay postage. Handsome expansion band included free if you order now.

MEADE CO. DEPT. 44, 175 FIFTH AVENUE NEW YORK—10, NEW YORK

## PERFECT FOR YOUR HOBBY SHOP BENCH SAW

### MOLDING CUTTER HEAD

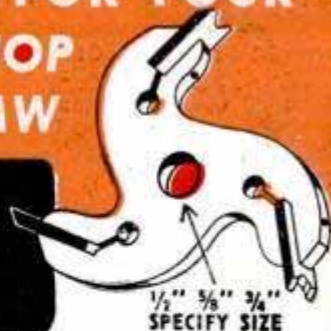

Molding Head and choice of one Shape..\$6.95  
Any Shape Cutter; set of three.....\$2.45

- Balanced for greater safety
- Scientifically heat treated and tempered
- Positive locking device holds bits firmly
- Fits bench saws with 1/2, 5/8, 3/4 in. arbors

The Molding Cutter Head lets you do all these jobs easily . . . picture frames, drawers, table top edges, moldings . . . and many more. Comes in plastic box with spaces to hold 4 sets of cutter bits. Wrench, spacer washer, bushing included.

Cutter Bit sets for use in Molding Head Cutter are made of specially heat-treated tool steel 1 in. wide. Vertical slot on back of blade assures alignment. Each set contains 3 bits.

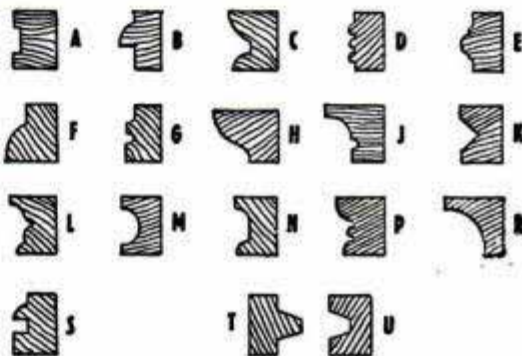

With proper bits you can plane, joint, cut interior and exterior trim, tongue-and-groove flooring . . . plus dozens of other jobs which save you money.

Order sets by LETTER (A, B, C, etc.)

Price: .....\$2.45 per set  
Complete operating instructions included.  
Perfect Christmas Gifts for him.

### DADO SETS

For dadoing, grooving, rabbeting. Finest quality tempered steel outside saws — Precision ground — Perfectly matched chippers.

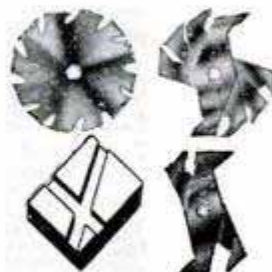

5 1/2 in. set includes: two 3/32 in. thick outside saws; 6-1/16 in. thick chippers . . . Will cut groove up to 9/16" wide.

Either 1/2 or 5/8 in. center hole.....\$4.95  
6" sets also available.....\$8.75

A Superior quality professional model . . . Will cut grooves up to 13/16" . . .  
**DO THE JOB YOURSELF—SAVE MONEY**  
**ORDER NOW—ALL SHIPMENTS PREPAID!**  
No C.O.D. Send check or money order to:

## SPECIALTIES, INC.

715 E. GRAY ST. LOUISVILLE 2, KY.

# GIGANTIC MAIL SALE

WAR SURPLUS  
EXCESS INVENTORY  
BANKRUPT STOCK

## POWER PLANTS & GENERATORS



- LeRoi Plant 25 KW, 115-v, 60-c, 4-cyl., push button start. Cost \$4000. \$1190 FOB.
- Onan Plant, 5 KW, 115-v, 60-c, 4-cyl. (\$1400) \$595.50
- Burdex Plant, 2-KW, 115-v, 60-c, \$289.50
- Generator, 3000 Watt 115-v, DC \$49.50
- Generator, 115-v, 60-c, ball bearing 1 KW, \$104.50; 2 KW, \$139.50; 3 KW (115-230-v) \$194.50.

Many others—write for catalog

## WATER PUMPS & SYSTEMS



- Centrifugal stainless steel shaft, bronze impeller, ball bearing, 3/4", \$19.95; 1", \$29.85; 1 1/2" \$38.60.
- Rotary Rubber Paddle, self-priming, 30 psi, 1/2", \$14.75; 3/4", \$19.50; 1", \$25.50.
- Rotary Nylon Roller, self priming, 150 psi, 1/2", \$16.75; 3/4", \$24; 1", \$32.25.
- Automatic Shallow Well System, 110-v, 60c, 300 gph, 40 lbs., \$69.50.

Hose, gauges, foot valves & pump accessories. Pumps for every use, free advice and catalog.

## HYDRAULIC EQUIPMENT

Savings to 80%. Build your own loaders, diggers, presses, etc.

- Pump 1000 psi 12 gal 400 rpm \$45.50
- Cylinders 1-way, 3"x8", \$11.95; 2-way, 2"x10", \$22.85; 2-way, 3"x24", \$39.90
- Control Valves, 1 or 2-way, \$18.00
- Break-Away quick couplers, \$5.95
- Gauges, 1000-1500 or 3000 psi, \$3.49

Many other values. Send for catalog.

## AIR COMPRESSOR UNITS



Assemble your own or buy ready-built.

- DeLuxe Air Kit. Everything but motor. 1 cyl. comp. 12"x24" tank, spray gun, gauge, hose, etc. \$45.49
- 1-Cyl. Comp., 2.8 cfm, 150 psi. \$20.50
- Adj. Pressure Switch, 50-80 psi. \$4.95
- Adj. Pressure Regulator, 0-250 psi. \$2.95
- Pop-Off Valve, \$1.95
- 160 Lb. Gauge, \$1.89. Air Tank (400 lb.) 10" x18". \$5.79.
- Spray Gun, \$9.95.
- Blow Gun, \$1.29.

Complete stock air equipment catalog



## SUPER CLOSEOUT BARGAINS

- Electric Drill, 1/2" (\$39.95) \$26.95
- Electric Portable 1/4" Saw (\$11.50) \$9.95
- Surveyor's, Contr's Tripod & Level \$37.95
- Stainless Steel 7-row weed spray, \$129.50
- Finest Gas Chain Saw, \$254.20
- Binoculars, Top quality, 7x50, \$42.95
- Army Parts Washer (\$115) \$29.95
- Engineer's Hand Level, \$5.84
- Guy-Turnbuckles 12' cable, 10 for \$3.89
- Battery Charger, 110 v, 6 amp., \$12.95
- Precision Stop Watch, \$12.95
- Tarpaulin 8'x10', finest army duck \$8.80
- Hi Intensity Spot Light, 6 volt, \$4.39
- Rural Magneto Phones, \$9.95
- Relays, sensitive 2 m.a., \$89

FREE CATALOG

# SPECIAL FOR THE MONTH

## WESTERN ELECTRIC CITY TELEPHONES



● Genuine W.E. wall or desk phones, same as used on city telephone systems. Useful for inter-communication, private system, extension ringer, etc. Specify "wall" or "desk". Original cost over \$20.00. Prepaid Sale, \$4.99 each. Two for \$9.69.

## WINCHES - HOISTS - BLOCKS



- Boat, Farm, utility hand winch, 1-4 gear ratio, 1500 lb. \$19.95
- Farm-Truck-Contractor heavy duty hand winch, 1-3, 1-9 ratio, 2000 lbs., \$31.90
- Chain Hoist (lever type) 3000 lb. \$19.50
- 4" 3000 lb. Snatch Block \$5.49

● Flexible Cable 1/4", 14c; 3/8", 18c; 1/2", 23c per foot.

# FREE Catalog!

1000s of items! Motors, sporting goods, hand and electric tools, clothing, watches, binoculars, tarps, search lights, etc., etc. Rush postcard or letter for your copy of free catalog today.

## BURDEN SALES COMPANY

813 "O" ST.

LINCOLN, NEBRASKA

## AMAZING NEW MIRACLE ALL PURPOSE

### METAL POLISH

QUICK - EASY - WIPE ON, WIPE OFF - EVERYTHING GLEAMS!



Wipe away rust, bring back original luster of automobile chrome, faucets, doorknobs and all hardware, tools, metal trim. Use in home, shop, institutions, everywhere you want metal to gleam. Cleans, polishes, preserves. Use it on chrome, nickel, copper, brass, bronze, porcelain, clay tile, stainless steel. New formula discovered for use in big plating plant—contains wonder-working Carnauba Wax made from Brazilian palm

leaves. Save time, money, restore newness of everything from brass candlesticks to chrome fittings. Money back guarantee. C.O.D.'s Accepted, or send cash with order and save postage. Big 8 oz. jar, only \$2.00. GRUNWALD INDUSTRIES, 2559 W. 21st Street, Dept. PM-11, Chicago, Ill.



## Guide to HOME REPAIRS

## Pays for Itself 100 Times Over

Beat the high cost of home upkeep. Save hundreds of dollars every year on carpentry, electrical, painting, plumbing and other jobs around the house with Popular Mechanics GUIDE TO HOME REPAIRS. Simplified how-to-do-it instruction and 646 pictures make all jobs, inside and out, easy. Covers construction, remodeling, modernizing, repairing that you can do yourself at small cost. 192 page cloth bound book only \$2.50 postpaid. Order today under our money back guarantee.

POPULAR MECHANICS PRESS, Dept. PM16  
200 EAST ONTARIO STREET CHICAGO 11, ILLINOIS



## ALL ABOUT TELEVISION

## Save Money on TV Purchase, Repair and Service

You can actually save \$50 to \$100 when you buy a TV set. You can save that much more every year on service with Popular Mechanics ALL ABOUT TELEVISION to guide you. Do 9 out of 10 service jobs yourself. Complete simplified instruction and 220 pictures show you how. No previous experience or knowledge of electronics required. Cloth bound edition only \$3.00 postpaid. Money back if not pleased. Paper covers 75 cents at newsstands.

POPULAR MECHANICS PRESS, Dept. PM11, 200 E. Ontario St., Chicago 11

## Say You Saw It in POPULAR MECHANICS

# SURPLUS TO SAVE YOU UP TO 85% SAVE BY MAIL ORDER TODAY

## NEW SLITTING SAWS WITH MANDREL



SET Ass't. of 18 unpolished Slitting and Slotting Saws, plus universal mandrel for 1/4" and 1/2" chucks. Diam. 1 1/4" to 2 3/4". Thickness from .015 to .102. Limited Quantities. Special Price this month only \$4.49

SET Complete set of 10, from 1/4" to 1/2" by sixteenths. Both N.C. and N.F. \$11.00 value for only \$2.98

A-1 MERCHANDISE—SATISFACTION GUARANTEED OR MONEY REFUNDED

## HIGH SPEED STRAIGHT SHANK DRILLS



SET 30 selected H. S. Straight Shank Drills J1A up to 1/4". Lengths up to 4", only \$2.49

SET 12 Different Size H.S. Straight Shank Drills J2A 1/4" to 1/2". Lengths up to 5", only \$3.49

SET 10 Different Size H. S. Morse Taper Shank Drills. Up to 1", only \$8.95

ALL ITEMS PREPAID FREE WAR SURPLUS CATALOG

## HIGH SPEED DRILLS WITH 1/2" SHANKS

SET 5 Different Size H.S. Drills 1/2" to 1". These H.S. Precision Drills with 1/2" Shanks can be used in a 1/2" Electric Drill or a 1/2" capacity lathe or Drill Press, only \$7.95

SET 10 Different Size H.S. Drills, 1/2" Shanks. J13A Same as above, only \$14.50

High Speed Straight Shank Chucking Reamers SET 20 Different size H.S. Straight Shank Chucking Reamers up to J10A 9/16", only \$6.95

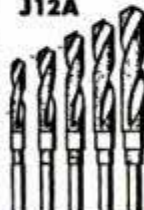

## Practical Engineering Co. 707 N. Sheridan Tulsa, Okla.



REG. TRADEMARK

## Dustite GASKET

SEALS METAL CASEMENT WINDOWS



Get year 'round comfort with this flexible sealing lip . . . Keep your home free of Dust, Drafts, Rain and Bugs. Seals and insulates metal contact between frame and window. Controls Condensation where storm windows are used. Ideal for air-conditioned homes. Easily installed!

### SAVES FUEL!

See your neighborhood hardware store or write for free sample to



**DUSTITE PRODUCTS COMPANY**

DEPT. 2 • 6 CANTERBURY DRIVE • DAYTON 9, OHIO

INVENTED IN 1948

## DIRECT CURRENT WELDERS

at AC Transformer Welder Prices

**\$350.00 VALUES for Only \$85**

Belt driven models and self-contained motor welders at amazing low prices. New, exclusive machines with FULL YEAR GUARANTEES. Sent on

### 10-DAY FREE TRIAL OFFER

**BIG MONEY MAKERS**

Cash in on today's fastest growing trade. Save money doing your own welding . . . for home, shop, plant, garage, and farm! Make money . . . start earning hundreds of extra dollars. These welders enable you to do better, faster, lower cost work!

### WRITE FOR FULL DETAILS

and FREE CATALOG OF MOTOR BUYS plus other Electrical Bargains

**ROBERTS ELECTRIC CO., Dept. 105, 849 W. Grand, Chicago 22**



Say You Saw It in Popular Mechanics

**PLEASE SEND ME**



for the  
time checked.  
I am enclosing . . .

1 year \$3.50  
2 years \$6.00

name \_\_\_\_\_

address \_\_\_\_\_

city \_\_\_\_\_ zone \_\_\_\_\_ state \_\_\_\_\_ C-113

Hand this order to your newsdealer or send it to

**POPULAR MECHANICS**  
200 East Ontario St. Chicago 11, Ill.

# ONLY the **STANLEY** X226 Extension Rule gives you . . .

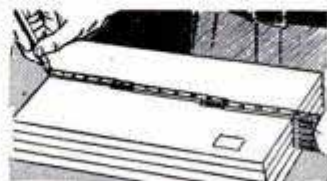

Easy marking gauge in even lengths. Square ends guide rule.

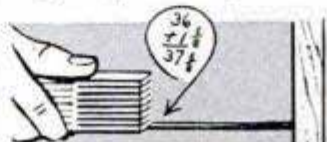

Conventional and centered inside measurement reading . . . using brass slide.

Opening in even 1/2 foot sticks . . . end to end in most-used lengths, 12", 18", 24"

Green end features — 4-times tougher plastic finish, nickel silver positive-lock joints, easy-reading big black numbers, extra-thick rock maple sticks.

## "YANKEE" TOOLS

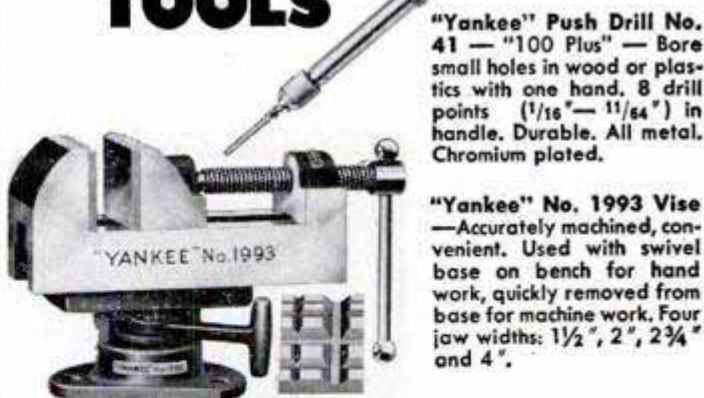

"Yankee" Push Drill No. 41 — "100 Plus" — Bore small holes in wood or plastics with one hand. 8 drill points (1/16" — 11/64") in handle. Durable. All metal. Chromium plated.

"Yankee" No. 1993 Vise — Accurately machined, convenient. Used with swivel base on bench for hand work, quickly removed from base for machine work. Four jaw widths: 1 1/2", 2", 2 3/4" and 4".

**STANLEY TOOLS**  
New Britain, Connecticut  
THE TOOL BOX OF THE WORLD



Indispensable for hobbyist, handyman, home owner — "How To Work With Tools and Wood". 192 pages, more than 150 illustrations and facts. Cross-indexed. Only \$2.00 ppd.



**STANLEY TOOLS, 3113 Elm St., New Britain, Conn.**  
(In Canada: Send to Stanley Tool Co. of Canada, Ltd., 3113 Stanley St., Roxton Pond, Quebec.)

Please send me:  
 "How to Work with Tools and Wood" (T-135).1 enclose \$2.00.  
 FREE Stanley Rule Folder No. T-142  
 FREE "Yankee" Tool Book No. Y-14

Name \_\_\_\_\_

Address \_\_\_\_\_

HARDWARE • TOOLS • ELECTRIC TOOLS • STEEL STRAPPING • STEEL

# FORD Owners SAVE MONEY



**Learn How to Make Your Ford Run Better . . . Last Longer . . . and Save Hundreds of Dollars!**

Get this book, written especially for you, without one penny of risk and get more out of your car. Mail coupon for MANUAL FOR FORD OWNERS today. When the book comes, skip through the pages and see how your investment in one of America's most popular automobiles can be even a better investment than you thought. If you don't agree, send the book back and you'll get your money back.

## A Popular Mechanics Book Written Just for You

Not a re-hash of service manuals. A complete new Popular Mechanics book written for the Ford owner by an outstanding automotive authority with the full cooperation of Ford engineers and service directors. It will save you money on repairs and service; make your Ford last longer; give you safe, economical and trouble-free motoring. And this is true whether you take your Ford to a regular service station or service it at home.

## Prevents Trouble. Cuts Down on Repair Bills

Nothing like this manual anywhere. It covers all phases of operation, service and maintenance. It has entire chapters on the individual parts of your Ford—battery, ignition, starter, generator, regulator, lighting, fuel system, engine, lubrication, gasoline qualities, cooling systems, transmission, differential, rear axle, brakes, wheel alignment, tire care, body maintenance, trouble shooting on the road, etc. It covers your Ford, new and older models, step by step—bumper to bumper—showing you how parts operate; what can go wrong; how repairs and adjustments should be made and how to avoid all types of trouble.

## Money Back if Not Satisfied

Mail the coupon today. Send only \$3.50 or you can pay postman. Money back guarantee protects you.

## Official, Authoritative, Practical Information

Written by C. E. Packer, formerly service school instructor and auto show lecturer for automobile manufacturers, Member Society of Automotive Engineers, Special Services Editor of Automobile Digest, contributor to leading magazines, author of some of the biggest selling books on Automotive subjects.

## Entire Chapters on Fordomatic and Overdrive

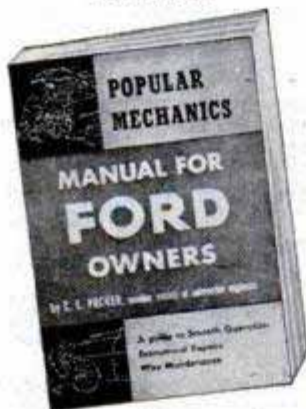

## 304 Pages. Hundreds of How-To-Do-It Illustrations and Diagrams

The entire book follows Popular Mechanics famous easy-to-read and easy-to-understand style. While primarily intended for the Ford owner, to help him get more out of his car at lower cost, it can be worth its weight in gold to the auto mechanic and service station operator who works, not only on Fords, but on all other makes as well, to which the information in the book can be easily applied.

## Order on this Coupon

**POPULAR MECHANICS PRESS**  
200 E. Ontario St., Chicago 11, Ill.

Send Manual for Ford Owners at once. If not satisfactory I will return it within 7 days and you will refund full purchase price.

Remittance for \$3.50 enclosed.  Send C.O.D.

Name \_\_\_\_\_

Address \_\_\_\_\_

City \_\_\_\_\_ State \_\_\_\_\_



# BUILD Your Own GARAGE

**Save Up to 50% of Usual Cost!**

Build your own garage and save! Wayne Leckey, Popular Mechanics Assistant Shop Notes Editor, tells and shows how in his new book *How to Build Your Own Garage*.

## No Previous Building Experience Required

If you can use a hammer and a saw you can build your own garage. Leckey tells how in simple step-by-step instructions and shows how in big, clear photos, drawings and diagrams. Everything is covered from the laying of the foundation right up to and including applying the final trim.

## 25 Designs—Brick, Frame and Concrete Block

### Construction. Complete Building Data

There are 25 different designs from which you may choose. Brick, frame and concrete block construction is fully covered. Leckey tells and shows how to pour the foundation, erect the framework, erect the roof, apply insulation and shingles, lay the driveway, install trim, flower boxes, etc. It's all there for you to read and see.

## 7-Day Money Back Guarantee

Get your copy of this valuable book today. Read and use it for seven days and if it isn't entirely satisfactory return it for a full refund. Send only \$3.50 for your copy to

Dept. 90  
**POPULAR MECHANICS PRESS**  
200 E. Ontario, Chicago 11, Ill.

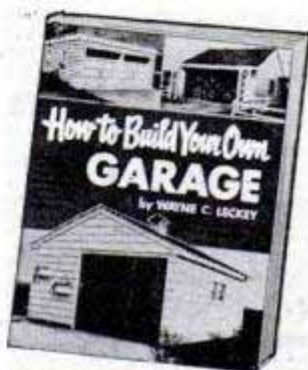

## SEND ME



every month so I am sure to see each new issue. Here's

- \$3.50 for 1 year  
 \$8.00 for 3 years

name \_\_\_\_\_

address \_\_\_\_\_

city \_\_\_\_\_ zone \_\_\_\_\_ state \_\_\_\_\_

B-113

Hand this order to your newsdealer or send it to

**POPULAR MECHANICS**  
200 East Ontario St. Chicago 11, Ill.

25¢ PACKAGE SENT  
**FREE**

JUST SEND POSTCARD

Original  
**RUM and  
MAPLE**

PIPE MIXTURE

GOOD . . . By Itself . . . GOOD As a Mixer with other tobaccos



Send Postcard to RUM and MAPLE TOBACCO CORP.  
Dept. T-4 26 West 23rd Street, New York City 10

French STYLE **DUELING SWORDS** SET OF TWO \$3.98

Once used in deadly combat—now an exciting sport! Learn right at home. Fun—safe—educational. These swords are made of fine blue spring steel, polished metal



guards, turned handles, rubber safety tips. Fencing teaches quick thinking, develops coordination, posture. Since the Middle Ages, Europeans have enjoyed the sport of dueling. "Now advocated by U.S. colleges. Set includes two swords and the booklet, "The Art of Fencing". Special mail order price. **YOUR MONEY REFUNDED IF NOT COMPLETELY SATISFIED** Send \$3.98 to

TECHRITE CORP., Box 12 A, South Pasadena, Calif



**TALK—SING—PLAY OVER YOUR RADIO**

with the real Radio Mike! Attaches in a jiffy—full instructions given! Swell for "parties"—"cut in" on or "kid" regular network programs or put on your own broadcasts! Amaze your friends—real fun. Beautiful Metallic Plastic 6 in. high! 12 RADIO BROADCAST LESSONS GIVEN with each mike

**SEND NO MONEY** Just pay postman \$3.99 COD plus postage or send \$5.99 and we pay postage! Radio Mike is available only from us by mail—guaranteed. Midway Co., Dept. MPM-11, Kearney, Nebr.

**HELPFUL BOOKS**

Send post card asking for **FREE** catalog

Popular Mechanics Press, 200 E. Ontario, Dept. 601, Chicago 11

**TROPICAL FISH BREED FOR PROFIT**

EARN \$\$\$\$\$ at HOME DURING SPARE TIME. Wonderful new Home-Business opportunity! HELP US FILL HUGE DEMAND from 20 million hobbyists. Some Rare beautiful multi-colored species sold for \$75 PR. AND MORE. It's easy! It's fun! WE SUPPLY EVERYTHING YOU NEED. Write for **FREE** plan, reprint, folder and all the details. Please state your age. TROPICAL FISH BREEDERS OF AMERICA, Dept. D11, Los Angeles 15, Calif.

1954 CATALOG — Send 25c

41 models for '54! See World's finest line before you buy. Rated tops in design, styling, performance by te experts. '54 Catalog plus booklet "Boat Selection, Operation, Maintenance" \$1.00.

**Custom-Craft**  
THE ORIGINAL "PACKAGED"  
**BOAT KITS**

**BOAT PLANS AND FULL-SIZE: PATTERNS**

Over 100 Modern plans and full size patterns. Racing classes, cruisers, inboards, outboards, sail boats. By famous designers. 6' to 30'. DESIGN CATALOG only 35¢. For Design Catalog plus boat building handbook send \$1.00.

CUSTOM-CRAFT (DEPT. A) BUFFALO 7, N. Y.

I Made  
**\$15 PER HOUR..**

with  
my  
**SUPER-SHOP**

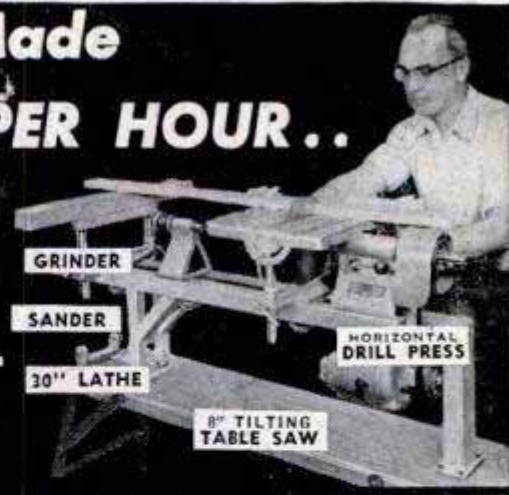

Every hour spent with **SUPER-SHOP** has been worth \$15 to me. Making it yourself is fun. **SUPERSHOP** is a complete, precision-built workshop. 100% ball bearing. Rugged tubular steel frame. Big capacity. 8 inch saw. Factory to you only \$79.95. Free trial. Easy pay plan. **FREE** catalog.



**VERTICAL DRILL PRESS**

Write for **FREE** Catalog on Money Saving **SUPERSHOP**

**POWER TOOLS INC.** 153 Yates Ave. BELOIT, WISCONSIN

**FREE** **1954 CATALOG**

**WORLD RADIO LABORATORIES**

"The World's Largest Distributor of Amateur Radio Transmitting Equipment."

Jam packed with bargains—everything in Radio, TV, and Hi-Fi— for Handyman, Ham, Experimenter or Serviceman!

- Pay Only 10% Down
- Easy Terms
- Liberal Trade-Ins
- Save Over 50% on Used Equipment
- Over 600 reconditioned items, with new factory guarantee.



**WORLD RADIO LABORATORIES**  
3415 W. Broadway — Council Bluffs, Iowa

Leo I. Meyerson

**MAIL HANDY COUPON**

**WORLD RADIO LABORATORIES** Dept. PM  
3415 W. Broadway — Council Bluffs, Iowa

Free 1954 Catalog  Used Equipment List

NAME \_\_\_\_\_

ADDRESS \_\_\_\_\_

CITY \_\_\_\_\_ STATE \_\_\_\_\_

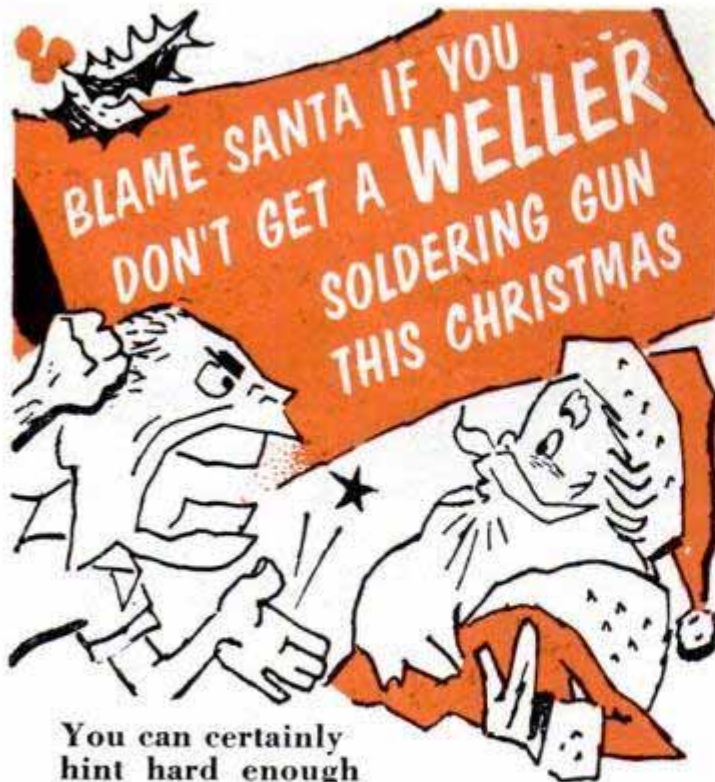

You can certainly hint hard enough telling everybody a Weller Soldering Gun tops your "want" list because it makes all kinds of homecraft and hobby jobs easier, faster and better. So if you don't get one, it's because the old guy kept it for sled repairs and his toy factory. Even at the North Pole, there are endless uses for the new Weller Soldering Guns!

While you're thinking about it... they're gift wrapped for Christmas and a sure-fire idea for giving, too!

**INSTANT HEAT**—saves time and current  
**2 SPOTLIGHTS**—eliminate shadows  
**SPECIAL TIPS**—for cutting, smoothing and soldering



Cuts plastic tile



Seals freezer packages

Removes hard putty

Solders and repairs

**Weller** SOLDERING GUNS  
 816 Packer Street, Easton, Pa.  
 AT BETTER HARDWARE STORES EVERYWHERE

**SAVE 50% DESIGN AND BUILD YOUR OWN MODERN FURNITURE**



**TWO STYLES OF METAL LEGS**

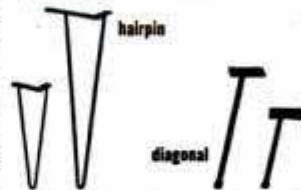

**HANDSOME WROUGHT IRON LEGS**

Simply attach with a screwdriver to flush door, plywood, etc. Make tables, couches, benches, modernize old and unpainted furniture. RUST-RESISTANT, matte black finish. All screws included. Postpaid.

PRICES ARE FOR SET OF 4 LEGS

Height Leg	HAIRPIN Specify 3/4" or 1/2" Rd.	DIAGONAL 3/4" Rd.
6"	\$ 5.55	\$5.25
9"	5.75	5.45
12"	5.95	5.65
14"	6.65	5.85
16"	6.95	5.95
19"	7.95	6.75
22"	8.95	
28"	13.45	12.00

**FEATURED BY POPULAR MECHANICS**

**ROOM DIVIDERS**

The latest decorating idea. Make any shape room divider, bookcase, album rack, etc., using combinations of four units and 1" x 12" boards. #501—59" high, \$18.95; #502—27" high, \$4.25; #503—59" high, \$7.95; #504—32 1/2" high, \$4.95 Express charges collect.

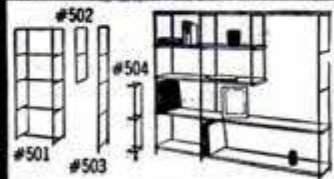

**BUILD BOOKCASES ANY LENGTH**

Smart sturdy wrought iron frames. Painted and rust-resistant. Make your own bookcases to stand or hang on the wall by adding 1" x 10" boards from your local lumber yard. All screws and braces included. Single frames \$4.50 each \$8.95 per pair postpaid.

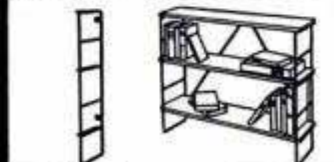

**FREE BOOKLET "Design and Build Your Own Modern Furniture"**

Buy Direct From The Factory And Save  
**E. F. LAWRENCE IRON WORKS** Dept 11  
 2911-33 Whittier Blvd., Los Angeles 23, California

**ATTENTION ALL SCREWDRIVER OWNERS**

**SENSATIONAL! NEW!**



**SCREW STARTING AWL ATTACHMENT**

Carpenters—Electricians—Home Craftsmen. Here is the handiest tool ever. Fastens on any 5/16" screwdriver shank. Starts wood screws in any position, even overhead, with one hand! No more looking for hammer and nails or punch. Safe, easy to use, locks out of way when not in use. Made of fine steel—lasts forever. ORDER TODAY! . . . ppd. **\$1.00**  
**CRANDALL MFG. CO., Dept. M-11**  
 7008 S. Western Ave. Los Angeles 47, Calif.

**MAKE MONEY PLOWING SNOW FROM ROADS & DRIVEWAYS**



**CAR SNOW PLOW**  
 CLEARS ROADS & DRIVEWAYS

Fits any car, jeep, truck. Attached in 2 minutes. Clears snow 24" deep and full width of car. Lightweight, sturdy. Free literature. Write Esheleman, Dept. SP 24, 119 Light St., Balto. 2, Md.; 333 N. Michigan Ave., Chicago 1, Ill.; 7070 Hollywood Blvd. Los Angeles 28, Cal.

**HELPFUL BOOKS**

Send post card asking for **FREE** catalog  
 Popular Mechanics Press, 200 E. Ontario, Dept. 601, Chicago 11

**Enjoy the Fascinating Story of the Horseless Carriage in**

It's thrilling, fascinating, informative. From the very first gasoline-propelled buggy to the cars of today and the atomic auto of the future. The first cars—the men who made them—the scrambled start and development of the fabulous auto industry—the story of auto racing. 166 thrilling action pictures—old-time cars—racing cars—early auto advertising—automotive oddities. Listing of 2000 U. S. autos included. Ideal gift book. Cloth bound, only \$3.00 by mail. Money back if not pleased. Paper covered edition \$1.00 at newsstands.



POPULAR MECHANICS PRESS, Dept. PM15, 200 E. Ontario St., Chicago 11

**SAVE  
over  
\$50.00**

ON A *Genuine...*  
**\*WESTINGHOUSE  
1 H. P. ELECTRIC MOTOR**

Thousands sold at \$77.86 to U. S. Govt. If you have 220-volt, 3-phase current, you will want this \*SURPLUS MOTOR. Heavy-duty, totally enclosed, moisture-proof, 60-cycle, 1145 RPM, shaft 2" long.

**Your Cost... \$25.**

Motors are unused and perfect. Shipped F.O.B. Washington. Crated free! Wt. approx. 70 lbs. Send order with remittance now — or write for descriptive folder. No C.O.D.'s. Quantities limited.

**RUSS J. MOURE**

6521 Kerby Hill Rd., Washington 22, D. C.

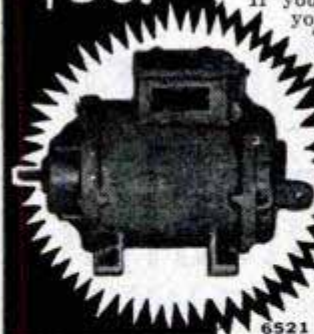

**MALAYAN KRIS**

**\$3.95**  
postpaid

Beautifully hand finished. Coined blade - 12½" long. High tempered steel... deep blued gun finish. Genuine mahogany handle. A knife never before offered. Not sold in stores. Your money back if not completely satisfied. Send \$3.95 to

WHOLESALE IMPORT COMPANY, Box P-911, Alhambra, Calif

**strange oriental dagger** This type knife was used by natives for ceremonies, ancient rites and sacrifices. A truly different knife. Genuine collector's piece... for den, desk, or knife throwing.



**RICH CARBURETOR  
ROBS MOTORIST**



Car owners who are wasting money, getting poor mileage due to over-rich mixtures, will be pleased to learn how to save gasoline by **VACU-MATING OVER-RICH MIXTURES**. Vacu-Matic fits all cars, trucks and tractors. Automatic and operates on the supercharge principle. Easily installed in a few minutes.

**SALESMEN WANTED! Big Profits**

For FREE particulars, how you can install one on your own car for introducing, just send your name and address on a postcard to **VACU-MATIC, 7617-14 W. State St., WAUWATOSA, WIS.**



**FREE 156 PAGE  
1954 B-A CATALOG**

Complete guide to Everything in Radio, TV and Electronics for Dealers, Servicemen, Schools, Amateurs, Broadcasters, Public Utilities, Engineers, Experimenters, Factories and Laboratories.

**BURSTEIN-APPLEBEE CO., 1012 McGEE ST., KANSAS CITY, MO.**

**JUST LIKE NEW WITH**

**RAMCOTE LEATHER  
FINISH**

You read the story of RamCote in the February issue of *Popular Mechanics* (page 185)—how this amazing flexible paint makes shabby and worn leather, leatherette and plastic articles look and wear just like new. Thousands of readers have re-colored and restored scuffed luggage and brief cases, worn leather furniture, faded sports-car upholstery, shoes, handbags, sports equipment, and at a fraction of their original cost. And it's so easy! You brush RamCote on like lacquer, dries quickly, washable, fade-proof and will not chip or peel. Preserves original leather grain with thin, tough film. Pint \$2.60, quart \$4.60 ppd. Available at leading paint, hardware, and dept. stores or by mail from **WAYNE PRODUCTS CO., 2757 Hawthorne St., Dept. 108, Franklin Park, Ill.**

**COLORS —**

Brown, tan, yellow, red, ivory, gray, green, light blue, dark blue, white, black and clear.

*A "whole Machine Shop" of tools for less than \$50.00*

**SpeedWay**

**No. 200-JTD  
SpeedDrill  
KIT**



Here are tools to build with. Power tools to install, repair and maintain the modern home and its equipment. Built around the famous extra power, 2400 RPM, No. 200-J SpeedDrill, this kit provides: a portable drill or a drill press; a portable power saw or a rotary table saw, as well as a portable or bench type—grinder, buffer, polisher, scratch brush or disc sander. It does all these operations, drills holes up to ¼" diameter in steel or ½" in wood—even stirs paint by power.

With this kit you can do dozens of tedious hand jobs, the modern way—easily, quickly and better—with power. It's creative, enjoyable, healthy and profitable to be your own builder, installer and repair man. It's the new American way. Join the hundreds of thousands of satisfied users of SpeedWay Power Tools. Ask your local dealer to demonstrate this special SpeedWay Kit or

**\$49.95**

Write for Bulletin showing over 40 SpeedWay Home and Industrial Power Tools



**SpeedWay MANUFACTURING CO.**

1863 So. 52nd Ave., Cicero 50, Ill.

# SAVE BIG MONEY ON TOOLS

With TandT's SURPLUS BARGAINS!

## BARGAIN TOOL AND SHOP MIXES — PPD.



H. S.  
DRILL  
MIX  
\$2.98

Used high speed drill bits up to 1/4". Some have to be sharpened. Ideal for pin punches, drift pins, etc. 2 1/2 lbs. — approx. 300 pieces!

• **SPRING MIX**  
Approx. 300 springs — compression, tension and torsion types. Up to 6" lengths.  
**\$1.79**

• **ABRASIVE DISC MIX**  
36 assorted 11" discs in grits 50, 60 and 100. For sanding cars, wood, metal and plastics.  
**\$3.75**

• **SURPRISE MIX for DRILL**  
Over 50 pieces for 1/4" electric drill. Rotary files, drills, reamers, grinding wheels, arbor, etc. Many pleasant surprises—satisfaction guaranteed.  
**\$2.98**

• **100 MOUNTED POINTS**  
SET 21. 1/8" and 3/32" shanks. Assorted wheels and points, various shapes and sizes.  
**\$9.98**

**HIGH SPEED MORSE TAPER SHANK DRILLS**  
Set of 20  
**\$12.95**

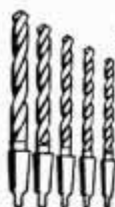

Highest tungsten content, sharp and ready to go. Used drills have at least 70% of original flute length. 20 sizes, 1/4" to 1". \$70 value.



1/2 SHANK

## DRILL SETS

• **No. 32—5 PIECE SET**  
High speed steel. Sizes 1/2" to 1-3/16".  
**\$9.55**

• **No. 33—10 PIECE SET**  
High speed steel. Sizes 1/2" to 1-3/16".  
**\$17.40**

These drills will fit any 1/2" drill, drill press or chuck. Reconditioned — all have at least 70% of original flute length. Highest tungsten content, sharp and ready to go. We also take special orders for drills from 1" up with any size straight shank. Write us for your needs.

### MONEY BACK GUARANTEE

All orders shipped prepaid, saving you up to 25% on total delivered costs. Orders from outside U.S.A. add 10%. Mich. residents please add 3% sales tax.

### WRITE FOR OUR BIG NEW FREE CATALOG

Thousands of bargains in cutting tools, power tools, and surplus equipment of all kinds, both new and used.

**T&T TOOL CO.** Dept. - 120  
7667 GRAND RIVER  
DETROIT 4, MICH.

## LUTHY AERO TYPE SPARK PLUGS

### Aluminum Oxide Insulators

Material developed during World War II for high speed combat aircraft. Aluminum Oxide insulator cools very rapidly, is stronger, has greater resistance to moisture and reduces breakage to a minimum. Correct Gap setting and proper heat range for your automobile, truck, tractor, hot-rod and stock car.

### Packed In Engineered Sets

PACKED IN SETS OF 4 OR 6 - CORRECTLY GAPPED FOR THE MODEL AND YEAR OF ALL CARS

## ORDER YOUR SETS NOW

8 cyl. set  
**7.12**

6 cyl. set  
**5.34**



More R.P.M.

More Miles Per Gal.

Pat. App. For

Satisfaction Guaranteed

Longer Life More Economy  
High Speed Performance

Luthy Aeronautical Sales Company

JACKSON, MICHIGAN (Canadian address, Box 394, Hamilton, Ontario)

Send me a set of \_\_\_ plugs. Enclosed is \$\_\_\_ Check here if you want us to ship COD.

Name..... Address.....

Year of Car..... Make and Model.....

3 point e lect r o d e d

## TRICKLING... NOISY?

TOILET

GET A

# WATER MASTER

AMERICA'S LARGEST SELLING TOILET TANK BALL



Noisy running toilets can waste over 500 gallons of water a day. Stop this annoying noise, waste and expense. The amazing new patented Water-Master Tank Ball instantly stops the flow of water after each flushing — stops the flow everytime, not just some of the time.

75c AT HARDWARE STORES EVERYWHERE



## WORLD'S LOWEST PRICED ADDING MACHINE

IDEAL FOR BUSINESS AND PERSONAL USE — GUARANTEED ACCURATE. Not a toy. Operates with only a finger flick. Adds, subtracts, multiplies, divides. Counts up to one billion. Pays for itself over and over. Ideal Gift — for Business, Income Tax and School use. MONEY BACK GUARANTEE. Send name and address. Pay postman only \$2.95 plus postage. (Send full cash if outside U.S.) Beautiful rich-looking Leatherette Case included at no extra cost. Money back in 10 days if not delighted. AGENTS WANTED.

CALCULATOR MACHINE Co., (Mfrs.)  
Dept. PM-311 Glenview, Illinois

## ELECTRICIANS JUST WHAT YOU'VE BEEN LOOKING FOR!

Latest National Electrical Code tables in pocket-size booklet. Provides quick, easy reference for wire capacities, motor currents, etc. Carry this vital information with you on the job... fits into your shirt pocket. Send \$1.00 today for your copy. Money back guarantee. THE KEYSTONE CO., Dept. 101, PO Box 2817, Dallas, Texas.

## 96 PAGE CATALOG OF UNUSUAL PERSONALIZED ITEMS

SELECTED FOR GOOD TASTE AND GOOD VALUE

Send 25c for amazing catalog of novelties and practical gifts, personalized rubber doormats, personalized office, home, lawn, chimney, auto, and nameplate signs, personalized bookplates, birthday and Christmas greeting phonograph records—office, home, wardrobe and costume furniture—unpainted furniture, bookcases, "dog lover" and telephone gadgets, binoculars, microscopes, magnifiers—folding tables, chairs and legs—"how to" books, wall murals, magnesium ladders, radios, radiators, rainwear, clocks, globes, plus hundreds of other unique items. Send name, address, 25c to TYCO, DOBBS FERRY, N. Y.

## SAVE MONEY! SAVE SERVICE CALLS! CHECK ALL TV, RADIO & PICTURE TUBES

with this VISULITE TV TUBE CHECKER



NO TECHNICAL KNOWLEDGE REQUIRED  
Simple Instructions Furnished  
SAFE — QUICK — FOOLPROOF

Most Radio set failures are due to burned out tubes. Just plug tube into socket provided and Neon Lamp indicates this condition instantly. Operates on 110 Volt AC or DC.

### PERFORMS 1001 ELECTRICAL CHECKS!

Checks continuity of resistors, appliances, motors or any Electrical device. Sturdily built for long life of trouble shooting. Test Leads included—Nothing else to buy. **SOLD ON 10 DAY MONEY BACK GUARANTEE.** See it at your distributor today. If he can't supply, order direct from factory. \$3.95 Postpaid anywhere in the U.S.

VISULITE CO., Dept. PM-11 423 Broome St., New York 13, N.Y.

# ASSEMBLE IT YOURSELF — SAVE MONEY!

## Automatic COMPRESSOR UNIT With 22 Gallon Tank

Unusual value compressor, assemble it yourself and save \$25.55. Heavy duty compressor with outstanding features: 1/2 hp. heavy duty capacitor motor, 110 volt, A.C. 2" bore, 1 3/4" stroke, 125 lbs. pressure capacity, 2.8 cu. ft. Stainless steel valves, 3 piston rings, aluminum piston, brass valve retainers. Comes complete with rubber tired wheels, 10 ft. cord and plug, 20 ft. non-corrosive air hose, tire chuck, air intake filter, dustproof crankcase. Positive lubrication, balanced crankshaft, fan-cooled pulley, automatic pressure switch, safety valve and check valve. Simple instructions included for assembling. Assemble it yourself and save. Ship. weight 150 lbs. NOTHING EXTRA TO BUY.

Regular  
\$175 value

Shipped  
Unassembled  
**\$72<sup>95</sup>**  
Shipped  
Assembled  
**\$98.50**



BRAND NEW



## Regular \$135 value PORTABLE SPRAY OUTFIT WITH 1/3 H.P. HEAVY DUTY MOTOR

Outstanding value. Professional type paint sprayer mounted on 7 1/2 in. by 25 in. tank, 1/3 h.p. 110V AC motor, 10 foot cord with plug, V belt drive. Heavy duty piston type compressor with 2 compression rings, 1 oil ring, 2 in. bore, 1 3/4" stroke. Displacement 2.86 c.f.m. at 60 lbs. pressure. Complete with safety valve, internal atomizing gun with fan, round and angle spray nozzles, quart cup, 35 to 40 lb. working pressure automatically maintained. Oil and water extractor, 20 ft. non-corrode hose, leakproof fittings, carrying handle. Assemble it yourself and save \$20. Instructions for easy assembling included. Wt. 90 lbs. NOTHING EXTRA TO BUY.

Shipped  
Unassembled  
**\$47<sup>95</sup>**  
Shipped  
Assembled  
**\$67.50**

### FREE CATALOG

Send for free catalog of compressors, paint sprayers, light plants, motors and many other money saving items. Tanks of all sizes, stainless and carbon steel.

Prices F.O.B. Chicago. Order from this ad. On Money Back Guarantee. Send check or money order.

## WELLWORTH TRADING CO.

1832 S. Wabash Avenue, Dept. D-1153, Chicago 16, Ill.

## BARRON Drill Press TOOLS

FOR WORKSHOP AND INDUSTRIAL USES...



### ROTARY PLANER

Planes • Rabbits  
Tenons • Panels  
Routs • Bevels

Only **\$8.50**  
COMPLETE

Over 40 precision built woodwork tools and accessories... Hi-Speed Router Bits—Rotary Surface Sanders & Drum Sanders—Safety Shaper Cutters—Dove-tail Cutters—Large Auxiliary Metal Tables—All Metal Shaper Fences—Spindle Adapters—Handy Bench Vises. Many other items indispensable for accurate, useful, versatile workshop use. Every tool sold on complete satisfaction or your money back. See your Barron Dealer. Ask for special folder — "24 Extra Uses for Your Drill Press."

FREE  
Workshop  
Guide &  
Catalog

BARRON TOOL CO. INC.  
365 Architects Bldg., Detroit 1, Mich.

## TEST THIS Amazing AUTOMATIC MECHANIC FREE ON YOUR OWN CAR!



Purges carbon—Lubes upper cyl. area—Stops valve sticking—Keeps rings free—AUTOMATICALLY! Precision injector meters correct charge of tune-up fluid every 100 miles while you drive. Keeps engine running free, clean and cool, for only 1/20 cent per mile!

Send No Money—Try before you buy! Use for 10 days Free then, if you like it, remit \$14.95 (full price), or just return it, and you owe us nothing—no questions asked!

Write today for Automatic Tune-Up Injector (Includes line, fittings, fluid, etc. and instructions).

NEWHOUSE AUTOMOTIVE INDUSTRIES  
5805 E. Beverly Blvd., Dept. 99, Los Angeles 22, Calif.

## this ONE GOVERNOR

fits ALL popular farm & industrial gasoline engines



## PIERCE LONG RANGE Universal Governor

ONLY

**\$39<sup>50</sup>**

Instant variable speed selection and accurate engine control at any speed setting within 1200 to 2600 RPM. Higher and lower ranges obtainable by simple change of pulley. Also "constant speed" operation.

Accurate, dependable speed control for engines operating corn shellers, drag lines, hoists, arc welders, trucks and tractors with power take-offs, etc.

Pulley extra  
Send Check or Money Order. State Make, Model of engine.

Write for Complete Information

DEALERSHIPS AVAILABLE

"World's Most Experienced Governor Manufacturer"

THE PIERCE GOVERNOR CO., Inc.  
1652 Ohio Avenue, Box 1000  
Anderson, Indiana, U. S. A.

# Schupack's Amazing Tool Bargains! All Brand New! Save up to 100%!

## FLEXIBLE SHAFT — ONLY \$4.95

Fits all electric drills & hand power tools. 35 3/4" long. Oilite bearings. Core of specially wound, high carbon steel wire in flexible casing. Will accommodate tool shafts up to 1/4" dia. For lathes, electric drills, etc.



## SURPRISE VALUE 100 PIECES \$1.00

FOR ELECTRIC GRINDERS  
Grinding Wheels, Cut-off Wheels, Sanding Discs, Mounted Stones, Sharpening and Honing Stones, Rotary Cutting Burs, Abrasive Cartridges, Mandrels, and many other items.

## 75 Pieces \$4.50

For work on Wood, Plastic or Metal. Reg. \$9.00 Value. 20 mounted wheels and points on 3/32" mandrel; 24 miniature cutters on 3/32" mandrel, 25 short shank min. cutters. Will fit all electric drills and hand grinders.



## 2 CIRCULAR SAWS \$1.50

ON 2 MANDRELS — ALL AT ONE LOW PRICE  
1" diameter saws on 1/4" Mandrels. For cutting wood, plastic, or soft metals. Order at once! Send Check or Money Order.

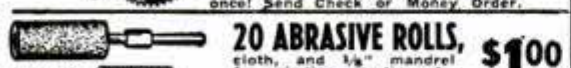

## 20 ABRASIVE ROLLS, \$1.00

cloth, and 1/4" mandrel for grinding, sanding, deburring metal, plastic, wood or rubber. ONLY

## 2 DRUM SANDERS \$1.50

With 12 Bands in Assorted Grits. 1 1/2" dia. x 1" long on 1/4" arbor with 12 bands  
ONE DRUM, 1" DIA. x 1" LONG ON 1/4" ARBOR WITH 6 EXTRA SLEEVES \$1.00



## Woodworkers' Drills \$2.00 P.P. U.S.A.

4 drills, from 5/16" to 1/2" with 1/4" shanks. Brand new, popular sizes. Set #14.

## 5 Woodworkers' Drills \$3.50

From 1/4" to 3/4". Set #15 Only Ppd.

## 7 High Speed Twist Drills \$1.00

15 DRILLS \$2.00! Popular sizes—up to 1/4", Brand new, Set #16.

## 5 Drills from 1/4" to 1/2" Dia. \$1.95

From 1/16" to 1/2" high speed, and carbon. Set #17 Only Ppd.

## 10 Twist Drills \$10.95

Brand New. From 1/4" to 1-1/4". High speed, and carbon steel. Set #18 Only Ppd.

## 5 All New Drills \$7.50

From 1/2" to 1-1/4". High speed, and carbon. Set #19 Only Ppd.

## 30 Assorted Drills \$2.75

All new. Mixed high speed, and carbon. Up to 1/4" dia. Set #20. Ppd.

## 12 Assorted Drills \$3.60

High speed & carbon steel, from 1/8" to 1/2". Set #21 Ppd.

## 8 Assorted Drills \$9.50

High speed & carbon steel, from 1/4" to 1-9/16". Set #22. Ppd.

NEW ILLUSTRATED CATALOG 10c

## 12 MOUNTED WHEELS and points on 1/4" Shank. \$2.95

For grinding on plastic, wood, soft and hard metals. Regular List Value \$8.40.

## 18 MOUNTED POINTS ON 3/32" SHANK. \$3.60

12 MTD. WHEELS ON 1/4" SHANK... \$3.60

## ADAPTER CHUCK \$1.50

With 2 interchangeable collets, opening from 3/32" to 0, on 1/4" mandrel. Price each only

## 4 HIGH SPEED SLITTING SAWS \$2.95

From 1 1/2" to 3" dia. 3/4" to 1" arbor hole. For cutting hard and soft metals, wood, or plastic. Ass'd. thicknesses. A regular \$8.00 value.

## 112 PIECE ASSORTMENT FOR ELECTRIC GRINDER \$3.95

\$10.00 VALUE — ONLY Here's what you get! Mounted Stones on 1/2" mandrel, Drum Sander, Sanding Sleeves for sander, Rotary Cutters, Wire Scratch Brush, Bristle Brushes, Circular Saw, Buffing Wheel, Grinding Wheel, Rubber Polishing Wheel, Cut-off Wheels, Rubber Cylinder, Mandrels to fit above tool, Ass'd Sanding Discs, Sharpening Stone, etc.

## 18 ROTARY CUTTERS \$5.85

Assorted sizes cutter on 1/4" or 3/32" shank. will fit all hand grinders. Ideal for cutting wood, metal, or plastic. Brand new.

## 12 MINIATURE CUTTERS \$1.00

FOR CUTTING WOOD, PLASTIC, or METAL. Actual size, Ass'd. shanks on 3/32" shank. For die makers, home workshop, etc.

SCHUPACK SUPPLY CO., 7331 COTTAGE GROVE AVE., DEPT. M-48 CHICAGO 19, ILL. SEND CHECKS OR M. O. NO COD'S PLEASE

## 20 "SEE THRU" DRAWERS! LOWEST COST — HANDIEST STORAGE

MODEL J-20 ..... \$7.95  
Useful in every shop, lab., home, office, etc. For Radio, T.V., or ignition work. KEEPS SMALL ITEMS HANDY. No other cabinet can compare in price, construction strength. "SEE-THRU" durable plastic drawers can't spill accidentally. Strong welded steel cabinet. Drawers 5 3/8" L x 2 3/4" W x 1-7/16" D divide into 2 or 3 LENGTHWISE or CROSSWISE compartments. Sent complete, postpaid. Money back, if not satisfied within 10 days. Free catalog on other sizes.

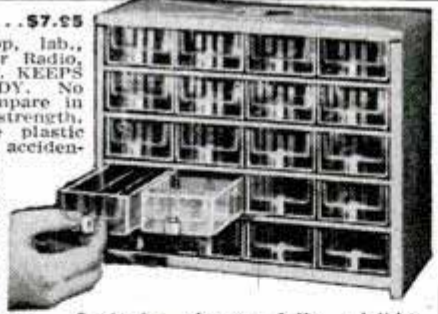

J-24, 24 drawers \$ 9.95  
J-32, 32 drawers 12.95  
J-64, 64 drawers 24.95

Contents always fully visible, clean, dustproof, organized and orderly indexed.

MFG. BY AKRO-MILS, INC., 818 E. MARKET, AKRON 5, O.

No Leak Lamp

Test 110-600 Volts

\$2.75  
\$1.50 add'l for 2 ft. leads. At dealers . . . or order direct from us. Mailed POSTPAID

TEST Circuits, Fuses, Outlets easily, quickly, safely. Shockproof. Pull fuses, 10 to 100 Amp.

**STAR TEST-PLIERS**

STAR FUSE CO., 233 Canal St., New York 13, N. Y.

**New Portable RADIO**  
Complete Kit Only \$9.95 Money Back Guarantee

Plays anywhere. Needs no batteries or electric current. Excellent performance guaranteed. Germanium crystal diode can get stations over 500 miles away. Head phones, aerial kit included. Nothing else to buy. Assembled in minutes. Popular 5"x4 1/2"x6 3/4" personal size. Send \$2.00 deposit now, we'll mail C.O.D. plus postage. Satisfaction guaranteed.

**JAEGER & CO.**  
P.O. BOX F246 SKOKIE, ILL.

## The Chief's WORK BENCH

Built to Last a Lifetime!

With Bottom Shelf and 18" Sq. Drawer. 2"x6", Solid Plank, Grooved and Dovetailed Top and 1"x8" Back Rail, Shellacked to a Smooth, Satiny Finish.

MOHAWK LUMBER CO. Dept. 33  
14525 W. Chicago Blvd. Detroit 27, Mich.  
Enclosed  Check  Money Order for \$.....  
Ship..... CHIEF WORK BENCHES at  
Quantity  
\$19.95 each, F.O.B. Detroit, Mich.  
 Send C.O.D., \$5 Deposit Enclosed.

NAME.....  
ADDRESS.....  
CITY..... STATE.....

Prompt Delivery  
**MOHAWK LUMBER CO.**  
14525 W. Chicago Boulevard  
DETROIT 27, MICHIGAN

\$19.95  
F.O.B. DETROIT

Send Check or Money Order, or Will Ship C. O. D. (\$5 Deposit)



# FOAM RUBBER



Relax in comfort after a rough day outdoors. Sleep on Foam Rubber. Ideal for sleeping bag pads, mattresses, chair or auto seat cushions.

### SLAB STOCK

Thick	Per sq. ft.	Thick	Per sq. ft.
1/8"	\$ .15	1/2"	\$ .50
1/4"	.25	3/4"	.75
3/8"	.38	1"	1.00

### CORED STOCK

1"	\$1.00	3"	2.60
1-1/2"	1.50	4"	3.00
2"	1.90		
2-1/2"	2.30		

### FOAM RUBBER, BUNK BED MATTRESS - Top Quality.

Soft and very restful. Size: 30" wide, 76" long and 4 1/2" thick. **34<sup>95</sup>**

### NAVY Sealed Beam LAMP

U.S. Navy Portable search-spot light. Has pistol grip & aiming sight. Makes an ideal Search, Spot or Emergency light for Auto, Boat or Camp.

12 Volt light - 4" lens .... \$4.29  
12 Volt light - 5" lens .... \$4.29  
24 Volt light - 5" lens .... \$4.79  
Set of 3 filters: red, green, amber for 5" size ONLY ..... **99c**

### GOOSENECK LAMP

A Real Surplus Buy! For the Home or Workshop. An ideal lamp for student or craftsman. Has flexible shaft, socket, cord & switch. 110V. AC. **125**

### GOOSENECK INSPECTION LAMP

Has black bakelite case with a 13 inch tubular metal extension. 7" of the extension is flexible allowing a 180° bend. Ideal for reaching into remote places with plenty of light for inspection, etc. Takes 2 ordinary flashlight batteries & comes with 1 extra bulb. Has magnifying lens at tip. **195**

### 4-WAY SWIVEL LAMP

A handy lamp for desk, work bench, chart table, engine room, etc. May be used on 6 - 12 - 24 or 110 volt current by simply changing the bulb. Has 3 foot shaft with four movable joints to adjust light. **395**

### AIRCRAFT CABLE

Rust resistant, alloyed steel. Extra flexible. Pre-formed, 7 x 19 strand. On reels.

1/16" - 4 1/2 ft. (7x7)	7/32" - 11 1/2 ft.
5/64" - 5 ft. (7x7)	1/4" - 12 1/2 ft.
3/32" - 5 1/2 ft. (7x19)	9/32" - 15 ft.
1/8" - 7 1/2 ft.	5/16" - 16 1/2 ft.
5/32" - 8 1/2 ft.	3/8" - 18 ft.
3/16" - 10 1/2 ft.	1/2" - 20 ft.

Stainless Steel Cable  
1/16" . . . 7 ft. 5/32" . . . 20 ft.  
1/8" . . . 18 ft.

### FIRE EXTINGUISHER

Kiddie Lux - CO<sub>2</sub> Type. Built to Gov't specifications. Has heavy, shatter-proof case. Recent hydrostatic test. Reconditioned and fully charged. LIKE NEW! All are READY FOR INSTANT USE!

3 1/2 lb. size with Swing Nozzle . . . \$14.95  
7 1/2 lb. size with Horn . . . . . 21.75  
10 lb. size with new Squeeze Grip Handle & 3/8" flex hose with Horn 27.75  
15 lb. size with Wheel Central . . . 35.75  
15 lb. size with Squeeze Grip Handle, 4 ft. flex hose, Plastic Horn . . 39.95

# PALLEY SUPPLY CO.

# SAVE UP TO 85% ON WAR SURPLUS

FROM WORLD FAMOUS 'GADGETEER'S' HEAVEN

### SWISS PATTERNED NEEDLE FILES

For you riflemen who make or repair your own guns - here is a set of files that will do that precise job. Made of the finest quality file steel, specially hardened and accurately machined for precision work. **295**

NOW set of 12 assorted shapes **295**

### GERMAN PRECISION MICROMETER

1 inch Reads from 0 to 1 inch in .001. Has ratchet stop and lock nut. Decimal chart on frame. One of the finest quality, imparted, precision tools on the market. Case & wrench included at this low price. **12.50 VALUE NOW 975**

# SAVE ON HYDRAULICS AT PALLEY'S

Here at Palley's we carry the WORLD'S LARGEST supply of special Hydraulic Equipment. Our huge stocks of Hydraulic Cylinders alone feature over 20,000 units in 61 sizes and types. We also stock thousands of accessories such as Hydraulic Pumps, Transmissions, Valves, Tanks, Fittings, Hose, etc.

### HYDRAULIC CYLINDERS

No. 3 - Double Action Cylinder. Bore is 1", Shaft 1/2", Stroke adjusts from 2-1/2" to 4" with internal sleeve stops. Length overall 8-1/2". Will take 1500 lbs. continuous - 3000 lbs. intermittent. Will lift or push 1100 lbs. . . **575**

No. 66 - Double Action Cylinder. Bore 2-1/4", Shaft 1", Stroke 4-1/2", Length 13-1/4". Lifts 6000 lbs. with 1500 lbs. pressure. **1150**

No. 53 - Double Action Cylinder. Bore is 2-3/8", shaft 1 1/2", stroke 1 1/2", length 26". Gives 6645 lbs. lift with 1500 lbs. line pressure. . . . **2050**

NO. 29 - Double Action Cylinder Special Gives 20,000 lbs. lift with 1500 PSI line pressure, or will give 40,000 lbs. thrust on intermittent 3000 lb. line pressure. Has 4" bore, 1-1/2" dia. piston shaft, 18" stroke, 30-1/2" length. Ideal for presses, road, farm and shop equipment. Cost Gov't \$390. **2995**

### HYD. HAND PUMP

Has operating pressure of 2000 PSI. Capacity of 1.5 cu. inches per complete cycle. Our special price ONLY. **1275**

### HYDRAULIC ACCUMULATOR

Designed for pressures up to 2000 PSI. Has a 3" diameter by 18" long. **ONLY 1075**

### RIGHT ANGLE DRIVE

Has direct 1 to 1 ratio through 90° bevel gears. Drive & take-off shafts are 3/8" diameter. Gears are self-lubricating, hi-speed steel. Ideal for use on power tools, flex drives, etc. Size: 3 1/2" x 2 1/2" x 1 1/4". **225**

### P-1A PESCO GEAR PUMP

Capacity, 1 1/4 GPM at 1500 RPM at 1500 PSI. Pressure limit is 1500 PSI continuous, with intermittent maximum of 1875 PSI for 15 seconds. Normal operating speed is 3750 RPM with an intermittent maximum speed of 4500 RPM. Rotates right-hand only. **NOW 895**

### BENDIX 4-WAY VALVE

Poppet type. Off at neutral. Has pressure inlet, and return & 2 pressure outlets for operating two cylinders independently. Position of handle selects either cylinder. Can also be used with hydraulic motors. Has 1/4" internal ports with 7/16-20 thread. Overall size is 3" in diameter & 1" thickness. **675**

### VICKERS HYDRAULIC TRANSMISSION

Self-contained, constant torque at all speeds with variable volume, reversible piston pump supplies piston hydraulic motor. Power output RPM -0 to 1/3 input RPM in both directions. Input RPM, 1800 continuous. **2 H.P. 4250**

### PROP PITCH MOTOR

Tremendous, torque-power output. Develops 1/2 HP on 20-32 volts DC. 7000 to 1 ratio. **1095**

### AUTO PULSE ELECT PUMP

A self-contained, electrically operated pump for use with gas, alcohol, fuels, light liquids, etc. Ideal for boats, trucks, etc. having a 24 volt system. Can be changed to 6 or 12 volt by rewinding solenoid. **495**

# WORLD'S MOST AMAZING BARGAIN CATALOG

Packed with SENSATIONAL VALUES in WAR SURPLUS, FACTORY CLOSE-OUTS and GENERAL MERCHANDISE! Fully Illustrated. Thousands of items in Hand & Power Tools, Outdoor & Sporting Equipment, Hardware, Photo Supplies, Foam Rubber, Industrial Tools, Aircraft Parts, Metals, Plastics, Gadgets, Hydraulic Supplies & many, many more.

Only 50¢ We'll refund it on your first order of \$1.00 or more.



Order From This Ad. Pay by M.O. or check. P.O.'s acptd. from D&B firms. 1/2 deposit with C.O.D.'s. All Prices FOB Los Angeles.

# SURPLUS ELECTRONICS & RADIO MIX

A Jumbo Surprise Package containing controls, coils, switches, wire and a variety of other valuable radio and electronic devices. A BARGAIN BUY! **225**

### NEW - TURNING GOUGE

A heavy duty, wood turning tool. Made of tempered steel to hold a sharp cutting edge. Especially suited to furniture work and for making first cuts in hard wood. Overall length with handle, 19". Blade length 8 1/2", width 2 inches. Comes with handle. **495**

### CHEMISTRY SET

Made for Chemical Warfare Division for testing water, etc. A handy addition to the chemistry lab or an exciting experiment for the amateur. Set includes test tubes & complete instructions. 15 different items. Packed in attractive Lucite box with cover and dividers. . . . **189**

### ARMY PORTABLE SHOVEL

Carry in the car for emergency snow shovel. Has 20" wood handle. Blade folds to make a shovel or pick axe. Ideal for motorist, camper, farmer, gardener, etc. **149**

### USAF THROAT MICROPHONE

Genuine USAF type T-30-0. Gives distinct voice reproduction for aircraft or amateur radio broadcasting. Consists of two microphones, mounted on rubber neckpiece elastic neck band. Operates between 100 & 300 ohms . . . **139**

### SIGNAL CORPS TEL. KEY

The new model J5A with ball type, flame-proof, metal key. perfectly balanced to permit positive contact with minimum effort. An ideal instrument for "ham" or professional use. A BUY at . . . **NEW 189**

### RADIO ANTENNA REEL

For tuning beam antenna. Powered by 1/8 HP, 24V, GE motor, engaged to gear reduction only when electrical contact is made. Operated in either direction. Ideal for auxiliary power take-off. 150 RPM at take-off. Used for opening & closing doors etc. A tremendous value. **875**

### UNIVERSAL JOINT

Rotates with full flexibility from 90 to 180 degree angle. Body is solid bronze. Drive shaft is 1" dia. steel. Joint is Ball and Socket type. Ideal for use on boats and heavy machinery. **595**

### TIME DELAY RELAY SWITCH

A 24 volt solenoid is held from a fraction of a sec. to 5 seconds by a Time Delay mechanism. When coil is energized it operates a double pole, single throw Relay Switch. Use on electric locks, alarm signs, etc. Can be adjusted by set screw. A \$15.00 value. **225**

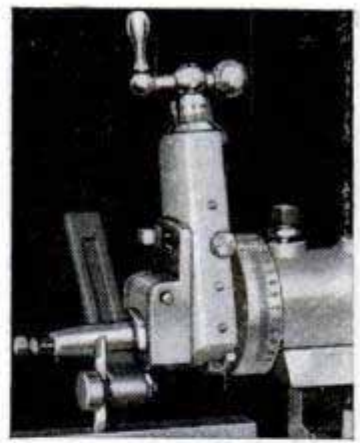
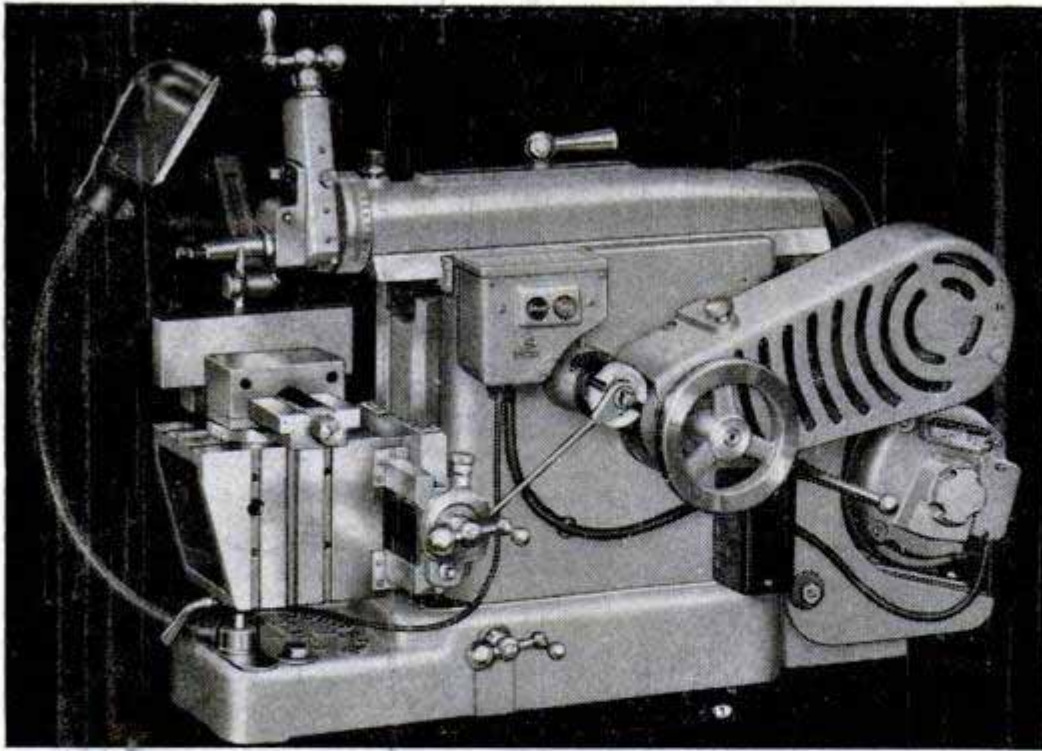

Tool head locks in any position. Rugged clapper box is adjustable.

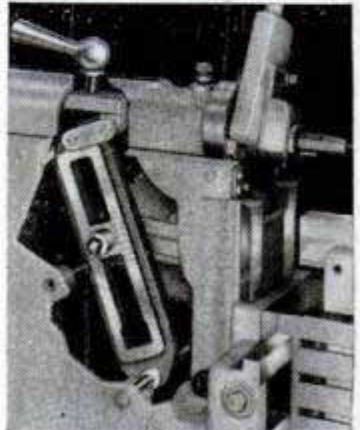

Rocker and crank with graduated eccentric adjustment for stroke.

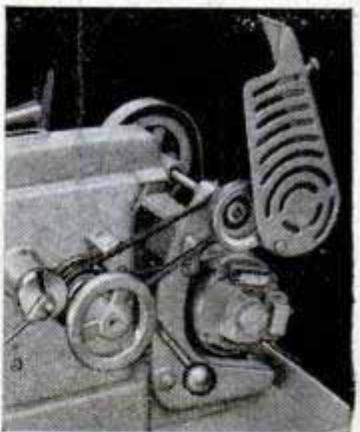

Guards on all pulleys and belts. Quick-acting belt tension release.

# SOUTH BEND 7" PRECISION SHAPER

Precision engineered and sturdily constructed, this compact bench shaper has the built-in accuracy and rigidity for rapid machining on small parts. The stroke rate per minute is higher than for larger shapers, permitting greater production on work within its capacity. The ease of setting up work in the bench shaper, its high operating speeds, and low power consumption keep costs at a minimum. A number of practical attachments can be supplied to increase its versatility on toolroom, production, or maintenance work. Check coupon for literature.

**SPECIFICATIONS: RAM**—Stroke length—0 to 7". Strokes per minute (4)—42 to 195. Cutting speeds—3 to 114 feet per minute.

**TOOL HEAD**—Vertical feed—3". Swivels—360°. Tool post opening—13/32" x 7/8".

**TABLE**—Horizontal travel—9 1/2". Vertical travel—5". Power cross feeds (6)—.002 to .012". Ram clearance—1/2 to 5-1/2". Table size—5-3/8 x 5 x 6-5/16".

**WISE**—Jaw width—4". Jaw depth—1". Maximum opening—4". Swivel base.



Can I get it?  
When? How?

Yes—you can get most any South Bend product immediately from our distributor's stocks in principal cities. Items not stocked, shipped promptly from factory.

Three ways to order:

1. See or telephone nearest distributor.
2. Order by mail from your distributor.
3. If no distributor is nearby, order direct from factory.

South Bend machine tools with accessories may be purchased on convenient terms up to 12 months.

SEND INFORMATION CHECKED:



9" and 10" BENCH LATHES



10" to 16-24" FLOOR LATHES



DRILL PRESSES

TOOL GRINDERS



1/2" & 1" Collet TURRET LATHES



7" BENCH SHAPERS

Name \_\_\_\_\_ Company \_\_\_\_\_

Street \_\_\_\_\_ City & State \_\_\_\_\_

Building Better Tools Since 1906 • SOUTH BEND LATHES • South Bend 22, Indiana

PRINTED IN U.S.A.

# New!

## Willard Weathermaster the first and only battery with Climate Control

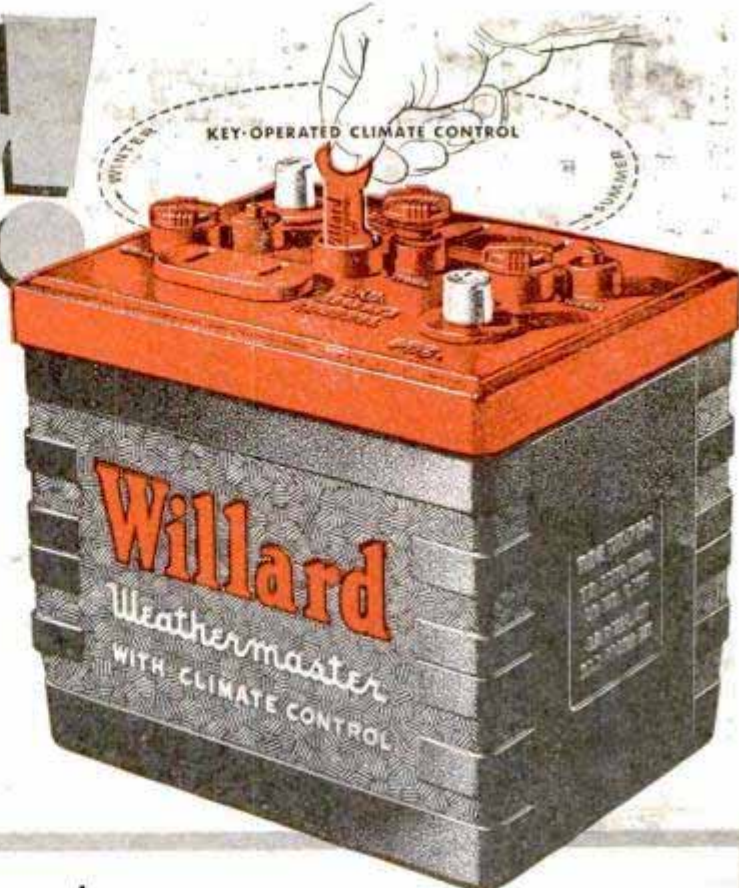

*Just turn this Key...*

### CLIMATE CONTROL INCREASES BATTERY LIFE IN ANY CLIMATE

**Saves power in hot weather  
Gives extra power in cold weather**

Wherever you live—you'll want the revolutionary new Willard Weathermaster with Climate Control. Best for hot weather driving ... best for cold weather starting ... it's the first and only battery that automatically adjusts its power-output to meet *your* climate—at the turn of a key. Buy it from your nearby Willard Dealer.

Call Western Union by number. Ask for Operator 25 ... she will give you the name of your nearest Willard Dealer. Or, look under "Batteries" in the Yellow Pages of your telephone directory.

### HOW WILLARD CLIMATE CONTROL WORKS:

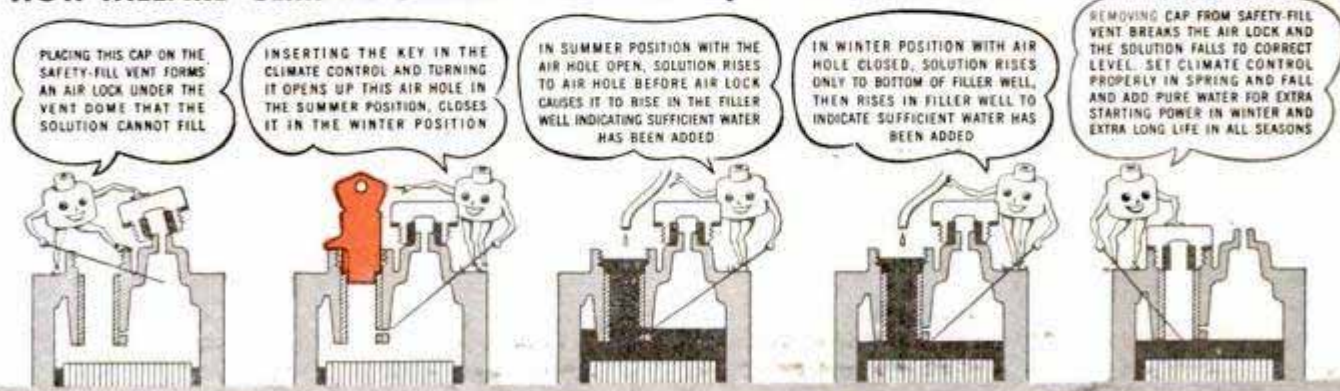

and these features  
guarantee extra performance  
**IN ANY WEATHER**

New one-piece top    New stronger case  
New mechanical    New stepped-up power  
separators        New Metallex grids  
Genuine Willard Safety-Fill

Every Willard Battery is backed by a written guarantee. Willard prices start at **\$16.65** less a liberal trade-in allowance for your old battery.

# Willard

## Weathermaster

**WITH CLIMATE CONTROL**  
**WILLARD STORAGE BATTERY COMPANY,**  
Factories in: Cleveland • Los Angeles • Dallas  
Memphis • Portland • Allentown • Toronto.

# NO OTHER ANTI-FREEZE GIVES YOUR CAR THE SAME COMPLETE PROTECTION!

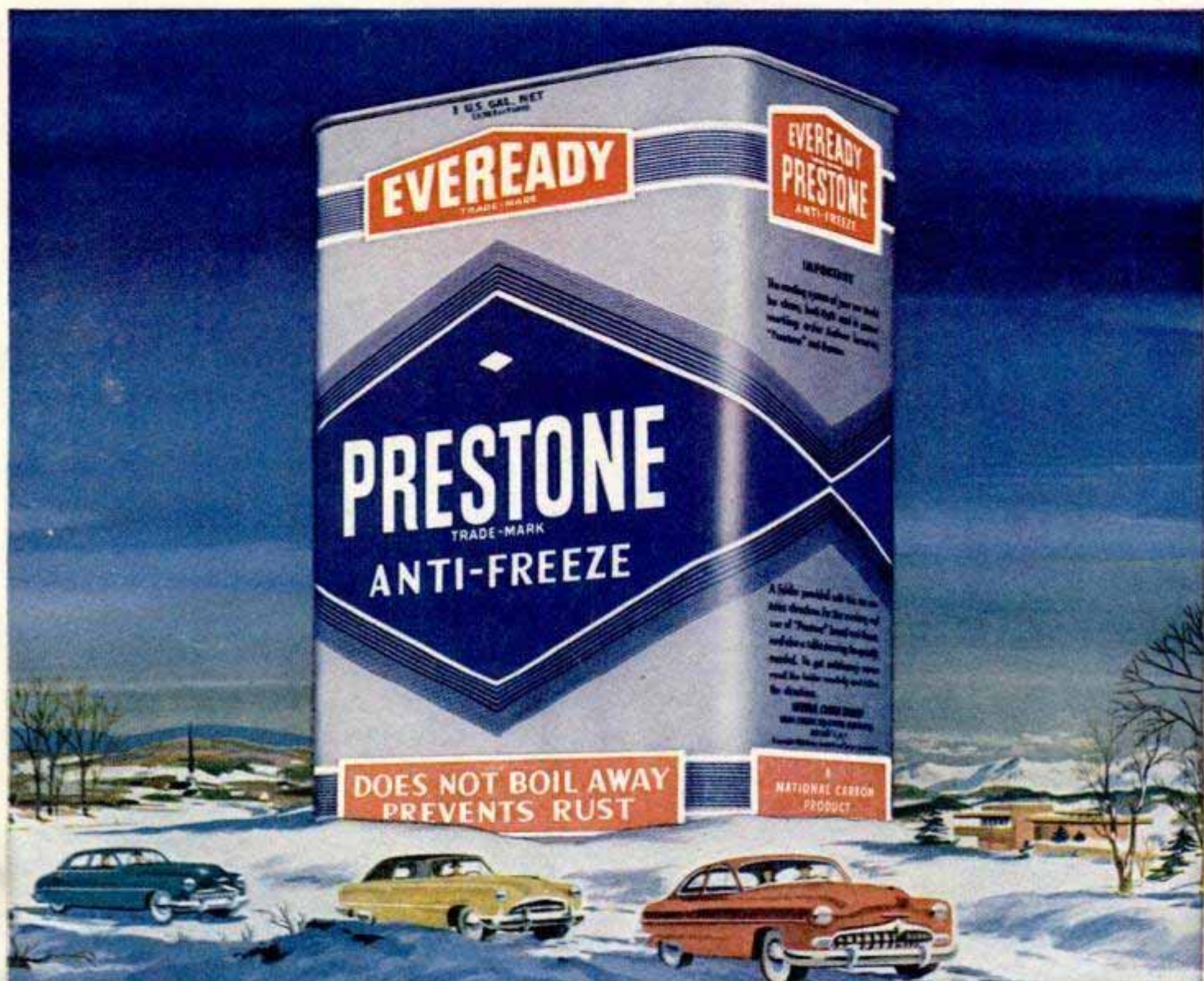

## You're SET...

One shot lasts all winter. Just put "Prestone" anti-freeze in and forget it till spring! No boil-away... no repair bills — its special inhibitors give the best protection against rust, clogging and foaming.

## You're SAFE...

High compression engines and efficient car-heaters make non-evaporating anti-freeze more important now than ever. There's not one drop of boil-away alcohol or methanol in "Prestone" anti-freeze.

## You're SURE...

With "Prestone" brand anti-freeze in your car, you're sure you've bought the best. It's America's No. 1 brand. No other anti-freeze gives your car the same complete protection. It's guaranteed!

\$3.75 per gallon • \$1.00 per quart, in quart cans

# PRESTONE ANTI-FREEZE BRAND

NATIONAL CARBON COMPANY • A Division of Union Carbide and Carbon Corporation  
30 East 42nd Street, New York 17, N. Y.

The terms "Prestone", "Prime" and "Eveready" are trade-marks of Union Carbide and Carbon Corporation



**NEW!**  
**"PRIME"**  
GAS LINE  
ANTI-FREEZE  
Ask your  
"Prestone"  
anti-freeze  
dealer about  
it... 65¢  
per can.