

# POPULAR MECHANICS

## MAGAZINE

WRITTEN SO YOU CAN UNDERSTAND

REG'D TRADE MARK GREAT BRITAIN No. 41022

### Special! Giant Home Section

48 Pages All About Houses . . . Model Homes . . . Prefabs . . . Mass Housing . . . Ways to Save When Building or Remodeling . . . Financing Your Home . . . plus hundreds of tips



# Amazing New Hair-Grooming Discovery!



## It's Here!

**NEW MIRACLE GROOMING AGENT—GROOMIX  
—IN LUCKY TIGER 3-PURPOSE HAIR TONIC!**

**Natural-looking, longer-lasting hair grooming  
OR Your Money Back!**

*Not a grease, not a cream . . .* Contains amazing new Groomix, with lanolin. Groomix is an utterly new kind of grooming agent—not an oil, grease or cream. Keeps hair in place all day—yet never looking greasy, oily or “slicked-down.”

**New Lucky Tiger 3-Purpose Hair Tonic**—with Groomix—will groom your hair evenly, completely, give it that *natural* lustrous look that every woman admires. No old-style cream or oil tonic can groom your hair so attractively—for so long!

**Helps Control Scalp Bacteria . . .** Tests at a leading university show Lucky Tiger controls scalp bacteria 150% as effectively as any leading cream or oil tonic. Kills on contact the P.O.\* dandruff germ.

**Conditions your scalp . . .** relieves dryness, itching.

\*Pityrosporum ovale, a common cause of infectious dandruff.

**Ask Your Barber  
—he knows!**



**Test Lucky Tiger 7 Days—See For Yourself!**

Use Lucky Tiger 3-Purpose Hair Tonic *daily for one week*. Unless you agree it grooms your hair better—longer—mail what's left to Lucky Tiger for full refund.

*Look at your hair... She will!*

When You Wash Your Hair Use  
**LUCKY TIGER MAGIC DANDRUFF REMOVER SHAMPOO**

# You can't have a high time on a low battery



Don't get thrown for a loss by a worn-out battery. First chance you have, make an end run to your Goodyear dealer's. He'll check your battery free with the portable, accurate Goodyear All-Purpose Tester. That's the sure way to catch battery troubles before they start. While you're there don't forget to ask about the Goodyear Dry Proof Double Eagle Batteries, too.

Goodyear, Battery Dept., Akron 16, Ohio

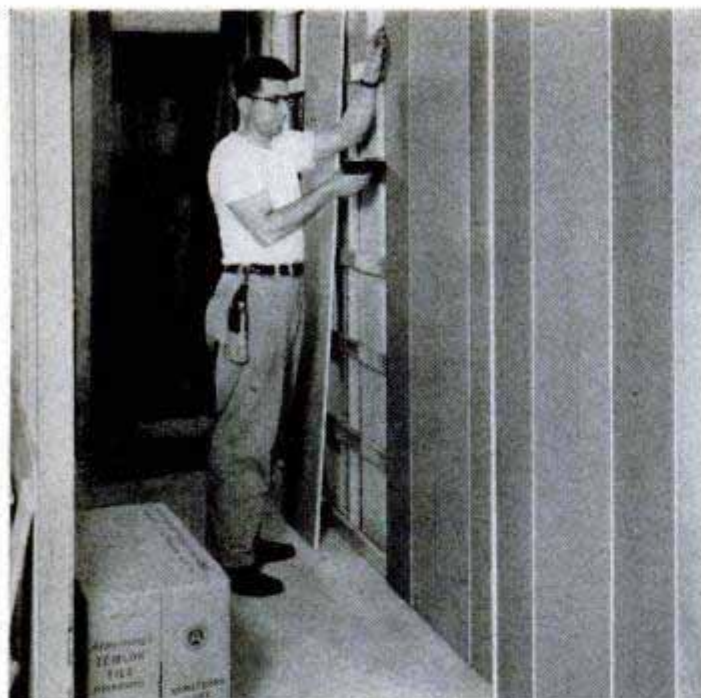


Double Eagle—T. M. The Goodyear Tire & Rubber Company, Akron, Ohio

# GOODYEAR

**DRY PROOF • DOUBLE EAGLE BATTERIES**

We think you'll like "THE GREATEST STORY EVER TOLD"—every Sunday—ABC Radio Network—  
THE GOODYEAR TELEVISION PLAYHOUSE—every other Sunday—NBC TV Network



Handsome walls of Temlok Plank go up quickly, easily




"Lok-Bevel" joint on Temlok Tile speeds application

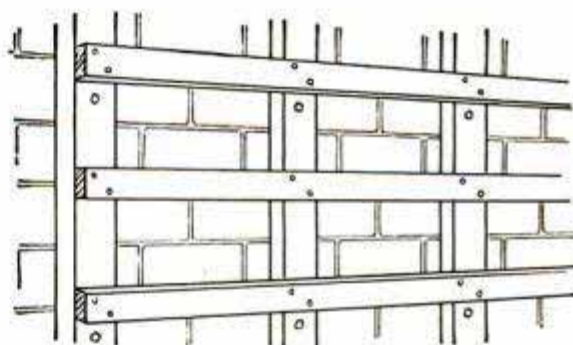
## IT'S EASY TO FINISH YOUR BASEMENT WITH TEMLOK

Here's a practical way to convert your basement into an attractive room for work or play. You can do the job yourself quickly, economically, with Armstrong's Temlok Plank and Tile. Both materials are made with the "Lok-Bevel" joint which makes nailing or stapling extra easy. This special tongue-and-groove conceals the nails or staples, insures a neat, professional looking joint. You'll be proud of the results.

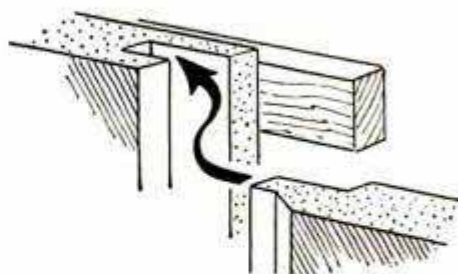
What's more, you don't have to paint Temlok. It comes already finished with two coats of good-looking, durable paint. Temlok is a wood fiber insulation board. It will help keep your basement comfortable.

Temlok Plank for walls is made in a handsome "Suntan Blend", in 8", 12", and 16" widths, and up to 12' lengths. Ceiling tiles come in White or Light Ivory, either plain or perforated. Sizes are 12"x12", 16"x16", and 16"x32".

Ask your local lumber or building supply dealer to show you samples of Temlok and help you with your plans. For free booklet, "New Ways to Remodel Your Home," write Armstrong Cork Company, 3710 Watch Avenue, Lancaster, Penna. 



Anchor wide flat side of 2"x4" studs against the foundation, two feet apart. Nail 1"x3" furring strips 12" apart over studs and finish with Temlok Plank. Cross-furring behind Temlok provides air circulation. Small vents at top and bottom carry off basement moisture.



This special joint on Armstrong's Temlok Tile and Plank provides a wide nailing flange and speeds installation. Nailheads and staples are concealed by the adjoining piece of material.

# ARMSTRONG'S BUILDING MATERIALS

Temlok® • M-67 Monowall® • Cushiontone® • Insulating Wool • Hardboards

# Popular Mechanics Magazine

Registered in U. S. Patent Office and Canada

H. H. WINDSOR, Founder

H. H. WINDSOR, JR., Editor and Publisher



## this month's cover

DON AND JANE Engelhard, newlyweds now living in Oak Park, Ill., are house-hunting in typical husband-and-wife fashion on our cover. The workshop of a model home has caught Don's eye but Jane is determined he'll see the well-planned kitchen first. Just before the Engelhards were graduated from Beloit College, Beloit, Wis., they wrote the editors of this magazine a letter requesting information that would help them in planning a home. On page 144 you'll find their letter, along with our reply in the 48-page housing section that follows. This special section, which features the work of leading United States architects, designers and builders, will answer a good many questions of all the Dons and Janes who are house-planning or house-hunting. You will meet Don and Jane in various places in the housing section as they look over some of the best-planned, most attractive houses of today

Published monthly by Popular Mechanics Company, 200 E. Ontario St., Chicago 11, Ill. H. H. Windsor, Jr., president; Wm. Harrison Petridge, exec. vice-pres.; D. F. Windsor, vice-president and secretary-treasurer; H. H. Windsor III, vice-president; Clover L. Perkins, advertising manager; Alan M. Doyoe, circulation manager. Single copy in the United States and Canada, 35 cents; subscription rates in the United States and possessions, Canada, Philippines and countries of the Pan-American Postal Union, 1 year \$3.50; 2 years, \$6.00; 3 years \$8.00. To all other countries add \$1.00 a year over United States prices for overseas postage. If you plan to move, notify us at least 30 days in advance so you will not miss an issue. Give both your old and new addresses. Entered as Second Class Matter, September 15, 1903, at the Post Office at Chicago, Illinois, under Act of March 3, 1879. Entered as Second Class Matter at Post Office Dept., Canada. Registered as Second Class Matter at the Post Office at Mexico, D. F., Mexico, June 20, 1950. Copyright 1953 by Popular Mechanics Company. Copyright under International Copyright Union. Copyright in France. All rights reserved under Pan-American Copyright Union. Printed in the United States of America.

Volume 100

OCTOBER 1953

Number 4

Address all communications to:  
200 East Ontario Street, Chicago 11, Illinois

Managing Editor.....Roderick M. Grant  
Assistant Managing Editor.....Wayne Whittaker  
Shop Notes and Crafts Editor.....James R. Ward  
Radio-Television, Electronics Editor.....Frank L. Brittin  
Associate Editor, Aviation.....Aubrey O. Cookman, Jr.  
Associate Editor.....Clifford B. Hicks  
Associate Editor, Automotive.....Arthur R. Railton  
Associate Editor, Shop Notes and Crafts.....Wayne C. Leckey  
Assistant Editor, Shop Notes.....W. Clyde Lamme  
Assistant Editor, Crafts.....Frank N. Stephany  
Assistant Editor, Makeup.....John C. Dalen  
Automotive Correspondent.....Leo Donovan  
Art Director.....Frank Beatty

### Assistant Editors

Leonard F. Hilt Eastern Editor.....Richard F. Dempewolff  
Empire State Bldg., Room 2906, New York City 1  
Elsie L. Domin Western Editor.....Thomas E. Stimson, Jr.  
Eagle House, Jermyn St., London S. W. 1, England  
Elliott H. McCleary London Manager.....Douglas W. Wedderspoon  
Director, Bureau of Information.....Allan Carpenter  
200 E. Ontario St., Chicago 11

## IN THIS ISSUE

|                                     |           |     |
|-------------------------------------|-----------|-----|
| On Patrol With a Killer Sub         | - - - - - | 97  |
| Swing Like a Pendulum               | - - - - - | 108 |
| The Owners Report on the Hudson Jet | - - - - - | 118 |
| Hot Rod, Junior                     | - - - - - | 130 |
| We Drive a Foreign Car              | - - - - - | 139 |

### Special Housing Section—

|                                      |           |     |
|--------------------------------------|-----------|-----|
| Tomorrow's Trend in Homes            | - - - - - | 145 |
| When You Plan That House             | - - - - - | 149 |
| More House for Less Money            | - - - - - | 157 |
| Mr. House Expert, We Have a Question | - - - - - | 164 |
| Let's Look at the Prefabs            | - - - - - | 169 |
| 20 Ways to Improve Your Home         | - - - - - | 177 |
| What's New in Wall Coverings         | - - - - - | 181 |
| Keep Your Basement Dry               | - - - - - | 189 |

## For the Craftsman

|                              |           |     |
|------------------------------|-----------|-----|
| Furniture for Modern Living  | - - - - - | 197 |
| Bring Yourself Back Alive    | - - - - - | 209 |
| Working With Plastic Metal   | - - - - - | 214 |
| Shooting Night-Fire Pictures | - - - - - | 218 |
| Know-How With Pliers         | - - - - - | 227 |
| How to Saw Segments          | - - - - - | 234 |
| Radio, TV and Electronics    | - - - - - | 245 |
| Clinic for Homemakers        | - - - - - | 254 |

Other items, and manufacturers of available products described, are listed on pages 16, 18 and 20

**Man with  
stapler beats  
man with  
glue 10 to 1**



**...and cuts fastening costs 70%!**

This carton-sealing race took place in a rubber products plant—the man at left using glue, his companion sealing 10 times faster with a Bostitch Autoclench Stapler.

Gone are the gluepots, dripping brushes, spattered aprons. No more “glue-cake” on floor or hand truck. No “weighting” of sticky carton flaps. Cartons go off faster, cleaner, and can be re-used. And because the men are paid on piecework, take-home pay is bigger.

The Autoclench is just one of 800 kinds of Bostitch staplers that trim time and costs on

thousands of different fastening jobs in factory and office. To fit the right stapler to the job, Bostitch has a staff of 300 Economy Men working out of 123 U. S. and Canadian cities.

If you are responsible for buying equipment, call the Economy Man nearest you. If not, tear out this page and take it or route it to the man who is. Every day's delay may mean more money down the drain.

The Bostitch Economy Man will tell you honestly whether stapling can save you time and money. Look for “Bostitch” in your phone directory, or write us.

*Fasten it better and faster with*



**BOSTITCH, 550 Mechanic St., Westerly, R. I.**

- Would like an Economy Man to analyze our fastening problems.
- Would like to have FREE BULLETIN telling how stapling can cut costs on fastening jobs checked below.

I want to fasten:

- |                                  |                                       |                                 |                                  |
|----------------------------------|---------------------------------------|---------------------------------|----------------------------------|
| <input type="checkbox"/> cartons | <input type="checkbox"/> plastics     | <input type="checkbox"/> wood   | <input type="checkbox"/> leather |
| <input type="checkbox"/> rubber  | <input type="checkbox"/> light metals | <input type="checkbox"/> fabric | <input type="checkbox"/> roofing |

Name \_\_\_\_\_

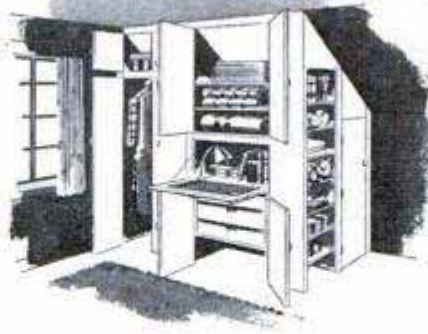
Company address \_\_\_\_\_

City \_\_\_\_\_ Zone \_\_\_\_\_ State \_\_\_\_\_



1. **Flexible Storage Wall**, Simplicity of construction, adaptability mark this striking plywood built-in. Sections can be added or subtracted to fit your wall space. Cost of fir plywood needed to build unit shown.....\$105\*

2. **Under-Eave Storage** makes good use of usually wasted space. Unit can be made to fit any ceiling slope, has ample space for clothes, bedding, bulk storage. Cost of fir plywood only.....\$95\*



3. **Shelf-Door Wardrobe** saves space by combining features of roomy closet, chest of drawers and dresser. Paint it in bright accent colors or stain to feature natural plywood grain. Cost of fir plywood only.....\$55\*

# 8 WAYS to get MORE ROOM in your home with low-cost fir plywood built-ins

## PLANS AVAILABLE

HERE are eight new ideas for modern, space-saving built-ins that will pay you big dividends in comfort, convenience and livability. Each of these built-ins gives you neat, compact storage... crisp, modern beauty... far more usable floor space. And they're such an inexpensive luxury. See how little you pay\* for the fir plywood you'll need to enjoy these space-thrifty built-ins in your home.

Fir plywood is light, strong and very easy to use—even for "week-end" carpenters. When you plan your built-ins with these large, light real wood panels, you have complete choice of

size, design, finish and color. No other material is so adaptable to your own ideas and requirements. You can have any one of these eight built-ins in your home in a very short time. Get fir plywood and easy-to-follow plans from your lumber dealer. Or order plans by number from Douglas Fir Plywood Association, Dept. BI, Tacoma 2, Washington. Please enclose 10c for each plan. (Offer good in U.S.A. only).



PlyPanel® grade fir plywood is most useful for dozens of indoor building and remodeling jobs. Use quality-tested PlyPanel where only one side of panel is seen. Other fir plywood grades available for uses where both sides of panel will be seen.

**ASK FOR DFPA-INSPECTED FIR PLYWOOD**



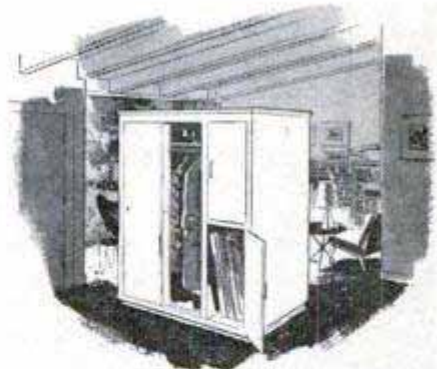
4. **Sectional Storage Units** can be combined to form shoulder-high storage wall for living room or den. Build it with fir plywood for only...\$90\*

5. **Child's Storage Wall** has ample room for toys, clothes, bedding. Clothes pole, desk can be raised as child grows. Tough fir plywood doors and drawers can't be hurt by children at play. Fir plywood for this practical built-in only.....\$80\*



7. **Odds and Ends Cabinet** can be built in a few hours with easy-to-use plywood. Use it in bathroom to reclaim wasted space above water closet...in kitchen or utility room for extra storage space. Fir plywood for this handy cabinet costs.....\$8\*

8. **Demountable Music Wall** is made by stacking simple interchangeable plywood boxes on low plywood table. Note clean, simple lines. Boxes hold radio, record player, television and record albums, can be arranged to fit any room. Fir plywood you'll need to build it costs.....\$60\*



6. **Island Entry Wall** defines entry and living areas without confining either. Entry closet and space for bulk storage is on one side, cabinets and shelves on the other. Cost of fir plywood you'll need to build it.....\$100\*

\*Based on latest available Chicago retail sales for fir plywood compiled by leading trade magazine, prices may vary throughout nation depending upon location and source of supply.

# Genuine Macmillan RING-FREE Motor Oil is Sold ONLY at

- ✓ SERVICE STATIONS
- ✓ GARAGES
- ✓ CAR DEALERS

Look for The  
BIG RED M



The big red M sign is your guide to your nearest dealer where *genuine* Macmillan RING-FREE Motor Oil is sold.

When many people are asked about Macmillan RING-FREE Motor Oils, they think of them as oils to clean carbon out of sluggish engines—to reduce ping.

But that's just another popular misconception.

Actually the regular use of Macmillan RING-FREE Xtra Heavy Duty Oil prevents *hydraulic valves from sticking* and more than pays for itself in the gasoline it saves!

### LOOK AT THESE FIGURES:

Average oil drain . . . . . 1500 miles  
At 15 miles per gallon, gas consumed . . . 100 gallons  
8% saving on 100 gallons gasoline . . . . 8 gallons  
Gasoline average cost\* . . . . . 28.63 cents per gallon  
Savings (8 x 28.63¢) . . . . . \$2.29

\*Includes premium and regular grade.

This \$2.29 more than pays for your oil  
drain of 5 quarts at 45¢<sup>†</sup> per quart.  
<sup>†</sup>Slightly higher in some areas.

Compared to other brands—under the same load, speed and road conditions—Macmillan RING-FREE Xtra Heavy Duty Motor Oil in hundreds of tests in cars of many makes showed an average reduction in gasoline consumption of 8% over all other brands of oil tested.

Start using Macmillan RING-FREE Xtra Heavy Duty Oil because it does such a wonderful job of cleaning. But keep on using it—month in and month out—because it reduces friction inside your engine, *prevents hydraulic valves from sticking*, saves wear and tear and repair bills, makes your car stay newer longer *and more than pays for itself in the gas it saves!*

*R. S. Macmillan* President

MACMILLAN PETROLEUM CORPORATION  
530 W. 6TH STREET, LOS ANGELES  
624 S. MICHIGAN, CHICAGO 50 W. 50TH, NEW YORK

—CLIP OUT AND MAIL TODAY!—

R. S. Macmillan, President, Dept. P-8  
Macmillan Petroleum Corporation  
530 West Sixth St., Los Angeles 14, California  
Please send me your folder—"The Oil that Pays  
for Itself in the Gas It Saves."  
Also tell me my nearest Macmillan Oil dealer.

Name \_\_\_\_\_

Address \_\_\_\_\_

in this corner.....

## THE EDITORS



### Meet the Skipper

When we send him up in one of these newfangled airplanes, our western editor, Thomas E. Stimson, Jr., of Los Angeles, is often very shy. There is some uncertainty



in his mind about the future of aviation. But he had no qualms about crossing the Pacific under water when we dispatched him to Pearl Harbor for a submarine ride. He tells of his trip on the *Segundo* in his story, "On Patrol With a Killer Sub," on page 97.

### To the Editor:

Guaranteed to call and gather cattle, an electric auto horn which simulates the deep tones of a bellowing bull is among the mechanical timesavers available to today's



cattlemen. The horn was originally designed as a truck fog horn and warning signal, complete with variable pitch and

(Continued to page 10)



# 5 reasons why ACCOUNTANCY



**offers you MORE MONEY . . . and SUCCESS!**

**REASON #1.** If you were an expert accountant right now, chances are you would find yourself among the highest-paid of all professional men and women. Even back in "depression years," surveys showed that accountants earned more on the average than men in other major professions.

**REASON #2.** The demand for accountants is great—everywhere. All businesses must have trained accountants to cope with ever-growing requirements. It's a profession offering wide opportunity—always—to the man who knows.

**REASON #3.** You can fit into any business, anywhere in the country—because accounting principles are universal. Think what this means in terms of security and independence!

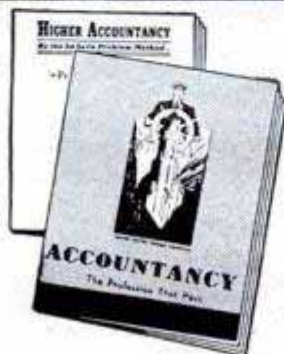
**REASON #4.** Accountancy is open to all. Any man or woman of good intelligence, who enjoys figure work and is willing to follow LaSalle's systematic "problem method" plan, can rapidly qualify for a highly profitable, enjoyable lifetime career . . . and he doesn't have to finish his training before beginning to "cash in."

**REASON #5.** Without losing a day from your present work, you can prepare in spare hours at home, at low cost, under LaSalle's step-by-step "Problem Method" of "learning by doing." This famous plan accounts for LaSalle's remarkable record of having trained nearly 10 per cent of all Certified Public Accountants in the U. S. . . . and of having put many thousands of others into high-paying careers.

Send today for Free Sample Lesson and "Accountancy, the Profession That Pays." Learn about the five great fields of opportunity . . . and LaSalle's time-tested plan for helping men and women to rapid advancement, higher income, greater prestige and professional standing. The coupon below will bring this information to you—without cost or obligation.

**MAIL THE COUPON—NOW**

**GET FREE SAMPLE LESSON**



**LASALLE**  
417 S. Dearborn St.,  
CHICAGO 5, ILL.

OCTOBER 1953

**LaSalle Extension University**  
— A Correspondence Institution —

Dept. 1064-H, 417 S. Dearborn St., Chicago 5, Ill.

Please send me, free of all cost or obligation, a sample lesson in Accounting . . . also, your 48-page illustrated book, "Accountancy, the Profession That Pays."

Name . . . **This One** ..

Address . . . ..

City, Zoi . . . ..



UYER-8BA-GCJ6

# OPPORTUNITY OUTLOOK FOR

## AUTOMOTIVE

**AUTOMOBILE MECHANIC.** Many openings for beginners. High turnover. Average straight-time earnings from \$1.31 to \$2.15. 2 years high school desirable. Excellent training available through I.C.S. Free catalog.

**DIESEL MECHANIC.** Prospects for experienced men highly favorable. Limited openings for helpers and apprentices. I.C.S. training helping many qualify. Also helps supplement experience. Big future.

## AVIATION

**AERONAUTICAL ENGINEERING.** Employment still high. Best insurance against layoff is good training. Guided missiles open new field. High starting salaries for qualified newcomers. I.C.S. offers basic courses.

**AIRCRAFT ENGINE MECHANIC.** Unlimited opportunities. Best jobs going to trained men. Draft eligible men can train now for good Air Force ratings. I.C.S. training leads to CAA certification. Course includes electrical hydraulic systems.

**AIRCRAFT DRAFTING.** Still a critical occupation. Trained men command high pay. Drafting department is springboard for big money planning and designing jobs. I.C.S. course rates high.

### What I.C.S. Can Do For You

1. Help you qualify quicker for better job, bigger pay.
2. Give you new self-confidence.
3. Save you time and expense. No out-of-date or unnecessary material to study.
4. Keep your employer informed of your progress (if you wish).

## BUILDING

**ARCHITECTURE.** High pay. Professional status. I.C.S. training plus experience recognized by most States. I.C.S. graduates among leaders in the field.

**ARCHITECTURAL DRAFTING.** Excellent way to enter field. Start as draftsman. Advance as ability becomes recognized. I.C.S. offers two approved courses.

**BUILDING CONTRACTOR.** Current and long-range outlook good. Chance for tradesman to start business of his own. Knowledge of estimating and superintendence essential. I.C.S. course complete, up-to-date, low in cost.

**READING BLUEPRINTS.** Men who can read blueprints usually promoted first. Six I.C.S. courses. Architect's, Electrical, Structural (including steel, concrete). Free catalog describes each.

**ELECTRICIAN.** Long-range outlook good. Hourly wages from \$2-\$3. Unions, States set job qualifications. Both approve I.C.S. training.

## BUSINESS

**BUSINESS ADMINISTRATION.** Growing need for engineers, technicians with business training. Management openings. Top salaries. I.C.S. executive training meets requirements of hundreds of up-and-coming men. Special refresher courses. Many companies are using I.C.S. courses to train foremen, salesmen, young executives. Write for free catalog. Check coupon.

**CERTIFIED PUBLIC ACCOUNTANT.** Heavy competition. Big demand for C.P.A.'s. Employment gains expected in 1954. C.P.A.'s average \$10 more per week than other accountants. I.C.S. Course helps meet qualifications of most State boards. Includes Federal Tax, Business and Commercial Law.

### Why I.C.S. Is Best For You

1. I.C.S. offers 277 success-tested courses, 1,438 different texts.
2. I.C.S. texts are used by U. S. Armed Forces Institute, Marine Corps Institute, Coast Guard Institute, as well as by colleges and universities.
3. I.C.S. courses are used by 4,330 businesses and industries to train employees.
4. I.C.S. has spent five million dollars keeping texts up to date.

**ACCOUNTING.** Bachelor's degree or diploma from recognized school required for best jobs. Experience in accounting offers excellent background for top business positions. I.C.S. offers comprehensive course for beginners and bookkeepers requiring further training. Catalog brings you complete information. Mark and mail coupon.

**BOOKKEEPING.** Many more openings in 1954-55. High school required by most employers. Weekly earnings average \$53-\$70 for hand operators, \$45-\$62 for machine operators. Opportunities for advancement. Study at home, in your spare time, with I.C.S. Wide selection of courses, combining bookkeeping with other subjects. Short course for managers of small businesses.

**STENOGRAPHY AND TYPING.** Excellent prospects through 1955. High school preferred. Additional training desirable. High demand has improved starting rates in most areas. Home study available through I.C.S.

**SECRETARIAL.** Long-run trend upward. Shortage of secretaries puts extra premium on training, allows newcomers to pick field of interest. Many openings in government service. Excellent home study course offered by world famous I.C.S.

**RETAIL BUSINESS MANAGEMENT.** Competition great for top jobs. Men with sound training given priority. Knowledge of merchandising, advertising, sales management essential. High salaries plus bonuses. For complete information send for I.C.S. catalog. See coupon.

**CREATIVE SALESMANSHIP.** General tightening of business will put new emphasis on creative salesmanship. Forward looking men already enrolling for refresher courses and new I.C.S. course in Creative Salesmanship. Texts prepared by experts, have full endorsement of leaders.

## CHEMISTRY

**CHEMICAL ENGINEERING.** Employment prospects for new graduates reach new high, particularly in Eastern States, Midwest, Texas and California. Monthly salaries of \$800 to \$1000 not uncommon. Best opportunities for men with approved schooling. I.C.S. course used by many companies to train new chemical engineers. Free catalog. Complete information. Send coupon.

### Advantages of I.C.S. Method

1. You earn while you learn. No time lost "going to school."
2. Study in your spare time, at work, at home or in between.
3. Set your own pace—never hurried or held back by others.
4. Study when convenient—no missed classes due to illness, business or social engagements.
5. Individual, personalized instruction. You correspond directly and privately with your instructor.

## CIVIL, STRUCTURAL ENGINEERING

**CIVIL ENGINEERING.** 15,000 new openings expected by 1960. Salaries for beginners, \$3000. For managers, over \$10,000. Many of nation's leading civil engineers were I.C.S. trained. Courses recommended by public agencies, private companies.

**STRUCTURAL ENGINEERING.** Outlook depends on building activity—good through mid-fifties. Need greatest in steel industry, railroad, and public utilities. I.C.S. texts used by many engineering schools. No finer home study course. Send coupon for details.

**SURVEYING & MAPPING.** Excellent foundation for student engineers. No experience needed. I.C.S. course qualifies you for surveying corps or topographic draftsman's job.

**HIGHWAY ENGINEERING.** Limited opportunities. Training essential to qualify for State highway jobs. I.C.S. course is standard in majority of States. Course includes airport layout and runway construction.

## DRAFTING

**DRAFTSMEN.** Aircraft, Architectural, Electrical, Mechanical, Structural, Sheet Metal, Mine. Favorable prospects. Top jobs going to trained men. Train at home. I.C.S. success-tested courses. Drawing equipment. Diploma awarded. Low cost. Rapid progress. Free catalog and sample lesson showing famous instruction service. Check coupon.

## ELECTRICAL

**ELECTRICAL ENGINEERING.** Excellent outlook for those now starting training. Earnings high—from \$235 a month for beginners to \$1000 a month for chief engineers. Complete or special I.C.S. courses—only training of its kind for both college and non-college employees. Coupon brings free book.

**ELECTRICAL MAINTENANCE.** Industrial electricians in short supply. Excellent opportunities for men with broad general knowledge of electric circuits, apparatus. High pay. Future security. Fifty lesson I.C.S. course gives necessary background training.

**ELECTRO POWER & LIGHT.** Huge industry-wide expansion still underway. New managers, superintendents being drawn from ranks. Need for technical plus commercial training. I.C.S. offers ten different courses including steam, hydro-electric, overhead power lines. Send coupon for free catalog and full details.

### There's a Difference!

One important value is that I.C.S. gives you the bedrock facts and theory, plus practical application. No skimping. Instead of just becoming good, you become expert with an expert's knowledge of fundamentals.

That is the big difference between I.C.S. and other teaching methods.

## HIGH SCHOOL

**I.C.S. COURSES.** Twenty-two different courses on high school and college subjects. Also special, made-to-order courses for those requiring fewer subjects. Lessons prepare you for State equivalency examinations. Certificates awarded. Rapid progress. Cost surprisingly low. Credit for subjects already completed. Full particulars on request. Send coupon.

# 1954



Here's a list of opportunities now open to YOU. International Correspondence Schools can help you forge ahead in any one of these fields. Check the course in which you are interested on the coupon printed below. Clip the coupon and mail for "How to Succeed" book and full information. No obligation whatever. But don't delay — mail it TODAY.

## 5 Reasons Why You Should Mail Coupon TODAY

1. It brings you two free books by return mail.
2. It puts you in touch with the world's largest training school.
3. It proves to everyone (including yourself) that you are determined to make good.
4. It starts the pattern that has led thousands to richer, fuller lives.
5. It costs you absolutely nothing. Nor are you obligated in any way.

### MECHANICAL AND SHOP

**MECHANICAL ENGINEERING.** Largest branch of engineering and still growing. Good job opportunities. 2,000 needed annually for replacement alone. Interesting, rewarding work. I.C.S. courses written by top men. No previous education required. You teach yourself from special textbooks.

**INDUSTRIAL SUPERVISOR.** Key positions in industry today. Most companies now have training programs for industrial supervisors. Many use I.C.S. texts. Smartest men do not wait for company. They enroll themselves.

**FOREMANSHIP.** Growing importance of foremen reflected in higher pay scale, more responsibility. I.C.S. course recognized as standard for industry. Easily adapted to needs of individual or group. You learn while you earn.

**MACHINE SHOP.** Many opportunities for new workers. Quick advancement for skilled men and women. Additional training can mean promotion to tool or die maker. I.C.S. offers excellent course in Machine Shop Practice.

**TOOL DESIGN.** Limited field. Highly competitive. Very high earnings. Top working conditions. Men planning to enter this field must devote much time to training in tool designing, drafting, mathematics. I.C.S. graduates have advanced to broader, more responsible jobs in tool engineering.

**INDUSTRIAL INSTRUMENTS.** Small, fast-growing field. Good opportunities for trained newcomers. High school desirable. I.C.S. combines all needed training into new course in Industrial Instrumentation. Free catalog with complete details.

**TOOLMAKING.** Highest paid machine-shop occupation. Stepping-stone for supervisor jobs. Long-run prospects good for employment. Requires rounded experience plus special training. Hundreds find I.C.S. course best in field.

### RADIO, TV, COMMUNICATIONS

**PRACTICAL RADIO-TELEVISION ENGINEERING.** Opportunity trend upward due to TV electronics. Also new opportunities in industry. I.C.S. course prepared by leading technicians. Excellent foundation course for men entering Armed Forces.

**TELEVISION TECHNICIAN.** High-level technical positions await men with training. One of few schools with complete, up-to-date course. I.C.S. offers work in camera, studio, transmitter techniques. Also manufacture, sale and installation of TV equipment.

**RADIO OPERATION.** Rising volume of government openings. Airlines and military demands high. Typical earnings: \$180-\$300 a month. I.C.S. courses prepare for Civil Service examinations.

**ELECTRONICS.** Rapid growth in both government and industry. Excellent opportunities for qualified technicians. Manufacturing. Research. Defense. Unparalleled chance to learn and serve at same time. Investigate I.C.S.

**RADIO-TV SERVICING.** Critical shortage of trained specialists. Opportunity for you to start your own profitable business. Especially bright future. Not too late to learn. No previous training required. I.C.S. method has proved successful in over 1000 cases of recent graduates. Send for full particulars.

### RAILROAD

**DIESEL LOCOMOTIVE.** Marked trend toward Diesel equipment on all major railroads. Technical knowledge speeds advancement, though promotions based on seniority for the most part. Good pay. Security. I.C.S. courses adopted by over 300 leading railroads.

### POWER

**DIESEL.** Large, growing employment. Best prospects for trained specialists. Excellent home training available through I.C.S. Four courses. Railroad. Marine. Trucks. Free, illustrated catalog. Just mark and mail the coupon.

### TEXTILE

**TEXTILE MANUFACTURING.** Great shortage of college trained technical and supervisory personnel. Many overseers I.C.S. trained in carding, spinning, weaving, warping, throwing, finishing, dyeing, cotton, synthetics, wool.

### ART

**COMMERCIAL ART.** Good demand for top-notch commercial artists. Payments up to \$1200 per illustration. Best opportunities in metropolitan areas. Brisk demand everywhere for lettering artists and sign painters. Send for beautiful, new art catalog.

## 2 FREE BOOKS

The coupon below will bring you Free Book about course in which you are interested. Also "How to Succeed," a 36-page gold mine of advice telling Why People Fail... How to Pick Your Goal... How to Develop Hidden Talent, etc. No cost — no obligation. Take advantage of today's new job opportunities. Mail this coupon TODAY.



# INTERNATIONAL CORRESPONDENCE SCHOOLS



BOX 5597-L, SCRANTON 9, PENNA.

Without cost or obligation, send me "HOW TO SUCCEED" and the booklet about the course BEFORE which I have marked X:

- |  |   |   |   |  |
|--|---|---|---|--|
| <p><b>ART</b></p> <ul style="list-style-type: none"> <li><input type="checkbox"/> Commercial Art</li> <li><input type="checkbox"/> Magazine and Book Illustrating</li> <li><input type="checkbox"/> Cartooning</li> <li><input type="checkbox"/> Show Card and Sign Lettering</li> <li><input type="checkbox"/> Fashion Illustrating</li> <li><b>AUTOMOTIVE</b></li> <li><input type="checkbox"/> Automobile, Mechanic</li> <li><input type="checkbox"/> Auto-Elec. Technician</li> <li><input type="checkbox"/> Auto Body Rebuilding and Refinishing</li> <li><input type="checkbox"/> Diesel—Gas Engines</li> <li><b>AVIATION</b></li> <li><input type="checkbox"/> Aeronautical Engineering 'yr.</li> <li><input type="checkbox"/> Aircraft Engine Mechanic</li> <li><input type="checkbox"/> Airplane Drafting</li> <li><b>BUILDING</b></li> <li><input type="checkbox"/> Architecture</li> <li><input type="checkbox"/> Arch. Drafting</li> <li><input type="checkbox"/> Building Contractor</li> <li><input type="checkbox"/> Estimating</li> <li><input type="checkbox"/> Carpenter and Mill Work</li> <li><input type="checkbox"/> Carpenter Foreman</li> <li><input type="checkbox"/> Reading Blueprints</li> <li><input type="checkbox"/> House Planning</li> <li><input type="checkbox"/> Plumbing</li> </ul> | <ul style="list-style-type: none"> <li><input type="checkbox"/> Heating</li> <li><input type="checkbox"/> Steam Fitting</li> <li><input type="checkbox"/> Air Conditioning</li> <li><input type="checkbox"/> Electrician</li> <li><b>BUSINESS</b></li> <li><input type="checkbox"/> Business Administration</li> <li><input type="checkbox"/> Certified Public Accountant</li> <li><input type="checkbox"/> Accounting</li> <li><input type="checkbox"/> Bookkeeping</li> <li><input type="checkbox"/> Stenography and Typing</li> <li><input type="checkbox"/> Secretarial</li> <li><input type="checkbox"/> Federal Tax</li> <li><input type="checkbox"/> Business Correspondence</li> <li><input type="checkbox"/> Personnel and Labor Relations</li> <li><input type="checkbox"/> Advertising</li> <li><input type="checkbox"/> Retail Business Management</li> <li><input type="checkbox"/> Managing Small Business</li> <li><input type="checkbox"/> Sales Management</li> <li><input type="checkbox"/> Salesmanship</li> <li><input type="checkbox"/> Traffic Management</li> <li><b>CHEMISTRY</b></li> <li><input type="checkbox"/> Chemical Engineering</li> <li><input type="checkbox"/> Chemistry</li> <li><input type="checkbox"/> Analytical Chemistry</li> <li><input type="checkbox"/> Petroleum—Nat'l Gas</li> <li><input type="checkbox"/> Pulp and Paper Making</li> <li><input type="checkbox"/> Plastics</li> </ul> | <p><b>CIVIL, STRUCTURAL ENGINEERING</b></p> <ul style="list-style-type: none"> <li><input type="checkbox"/> Civil Engineering</li> <li><input type="checkbox"/> Structural Engineering</li> <li><input type="checkbox"/> Surveying and Mapping</li> <li><input type="checkbox"/> Structural Drafting</li> <li><input type="checkbox"/> Highway Engineering</li> <li><input type="checkbox"/> Reading Blueprints</li> <li><input type="checkbox"/> Concrete Construction</li> <li><input type="checkbox"/> Sanitary Engineering</li> <li><b>DRAFTING</b></li> <li><input type="checkbox"/> Aircraft Drafting</li> <li><input type="checkbox"/> Architectural Drafting</li> <li><input type="checkbox"/> Electrical Drafting</li> <li><input type="checkbox"/> Mechanical Drafting</li> <li><input type="checkbox"/> Structural Drafting</li> <li><input type="checkbox"/> Sheet Metal Drafting</li> <li><input type="checkbox"/> Mine Surveying and Drafting</li> <li><b>ELECTRICAL</b></li> <li><input type="checkbox"/> Electrical Engineering</li> <li><input type="checkbox"/> Electrician</li> <li><input type="checkbox"/> Electrical Maintenance</li> <li><input type="checkbox"/> Electrical Drafting</li> <li><input type="checkbox"/> Electric Power and Light</li> <li><input type="checkbox"/> Lineman</li> <li><b>HIGH SCHOOL</b></li> <li><input type="checkbox"/> High School Subjects</li> </ul> | <ul style="list-style-type: none"> <li><input type="checkbox"/> College Preparatory</li> <li><input type="checkbox"/> Mathematics</li> <li><input type="checkbox"/> Commercial</li> <li><input type="checkbox"/> Good English</li> <li><b>MECHANICAL AND SHOP</b></li> <li><input type="checkbox"/> Mechanical Engineering</li> <li><input type="checkbox"/> Industrial Engineering</li> <li><input type="checkbox"/> Industrial Supervision</li> <li><input type="checkbox"/> Foremanship</li> <li><input type="checkbox"/> Mechanical Drafting</li> <li><input type="checkbox"/> Machine Design-Drafting</li> <li><input type="checkbox"/> Machine Shop Practice</li> <li><input type="checkbox"/> Tool Design</li> <li><input type="checkbox"/> Industrial Instrumentation</li> <li><input type="checkbox"/> Machine Shop Inspection</li> <li><input type="checkbox"/> Reading Blueprints</li> <li><input type="checkbox"/> Toolmaking</li> <li><input type="checkbox"/> Gas—Electric Welding</li> <li><input type="checkbox"/> Heat Treatment—Metallurgy</li> <li><input type="checkbox"/> Sheet Metal Work</li> <li><input type="checkbox"/> Sheet Metal Pattern Drafting</li> <li><input type="checkbox"/> Refrigeration</li> <li><b>POWER</b></li> <li><input type="checkbox"/> Combustion Engineering</li> <li><input type="checkbox"/> Diesel—Electric</li> <li><input type="checkbox"/> Electric Light and Power</li> </ul> | <ul style="list-style-type: none"> <li><input type="checkbox"/> Stationary Steam Engineering</li> <li><input type="checkbox"/> Stationary Fireman</li> <li><b>RADIO, TELEVISION, COMMUNICATIONS</b></li> <li><input type="checkbox"/> General Radio</li> <li><input type="checkbox"/> Radio Operation</li> <li><input type="checkbox"/> Radio Servicing—FM</li> <li><input type="checkbox"/> Television</li> <li><input type="checkbox"/> Electronics</li> <li><input type="checkbox"/> Telephone Work</li> <li><b>RAILROAD</b></li> <li><input type="checkbox"/> Locomotive Engineer</li> <li><input type="checkbox"/> Diesel Locomotive</li> <li><input type="checkbox"/> Air Brakes</li> <li><input type="checkbox"/> Car Inspector</li> <li><input type="checkbox"/> Railroad Administration</li> <li><b>TEXTILE</b></li> <li><input type="checkbox"/> Textile Engineering</li> <li><input type="checkbox"/> Cotton Manufacture</li> <li><input type="checkbox"/> Rayon Manufacture</li> <li><input type="checkbox"/> Woolen Manufacture</li> <li><input type="checkbox"/> Loom Fixing</li> <li><input type="checkbox"/> Finishing and Dyeing</li> <li><input type="checkbox"/> Textile Designing</li> </ul> |
|--|---|---|---|--|

Name \_\_\_\_\_ Age \_\_\_\_\_ Home Address \_\_\_\_\_  
 City \_\_\_\_\_ Zone \_\_\_\_\_ State \_\_\_\_\_ Working Hours \_\_\_\_\_ A.M. to \_\_\_\_\_ P.M.  
 Occupation \_\_\_\_\_

Special tuition rates to members of the U. S. Armed Forces. Canadian residents send coupon to International Correspondence Schools Canadian, Ltd., Montreal, Canada.

# NEWS FROM SCIENCE ABOUT YOUR HAIR



## V-7

— new  
grooming discovery  
outdates messy oils

Not an animal, vegetable or mineral oil, V-7 in new Vitalis Hair Tonic is a completely new greaseless grooming agent.

### PROOF

you don't need  
grease to  
correct dryness



New research on human hair shows that even very dry hair regains its normal moisture content faster with new Vitalis than with any leading cream or oil hair tonic.

## KEEPS YOUR HAIR NEAT ALL DAY —GREASELESSLY

Even hard-to-manage hair stays neatly in place with Vitalis. No gummy film or "oil-slick" look.



New, finer  
**VITALIS**<sup>®</sup>  
Hair Tonic with V-7  
Product of Bristol-Myers

(Continued from page 6)

volume control. Then a cattle buyer of South St. Joseph, Mo., V. F. Wright, discovered that the horn renders an impressive imitation of a bull's bellow and will call cattle, who quickly respond to the roar and gather around the vehicle.

Caroline V. Allen,  
Burbank, Calif.

### To the Editor:

I wondered if some of your readers might be interested in seeing an 18-inch model of the SS *United States* [built from plans in *Popular Mechanics*, December 1952]. We decided upon a smaller version because of the space available for a model ship.

Construction was started January first and the enclosed photo shows the model near completion in March after approximately 150 hours.



Doyle compares his 18-inch model with the original *Popular Mechanics* model of SS *United States*

The hull contains some 600 portholes made from  $\frac{1}{16}$ " o.d. tube cut to length and pressed in place. Practically all of the superstructure was made of .012-inch-brass sheet with portholes, passageways and windows punched out with tool steel.

Lifeboats were individually carved and suspended from davits fabricated from  $\frac{1}{32}$ -inch-o.d. copper tube. Hooks and eyes to fasten the boats were made from .010-inch-diameter wire.

I believe this was the best and most complete series your magazine has made available thus far and sincerely hope that similar projects are in the offing.

Richard H. Doyle III,  
Des Plaines, Ill.

(Continued to page 14)

# WHAT Every MECHANIC Wants to Know

## AUDELS AUTO MECHANICS GUIDE. \$4

A practical quick ready reference book for auto mechanics, service men, operators & owners. Explains theory, construction & servicing of modern motor cars, trucks, buses & auto type Diesel engines. 1800 pages, fully illustrated. 73 chapters. Indexed. A standard book for mechanics. New Hydraulic & Fluid drive covered.

## AUDELS TRUCK & TRACTOR GUIDE. \$4

A Shop Companion—1299 Pages—78 Chapters Fully Illus. Covers Gas & Diesel Motors—Construction—Operation—Maintenance—Repair—Service Operations. Trouble Shooting—Engine Tune-up—Carburetor Adjusting—Ignition Timing—Brakes—Complete Service of all Parts. Includes Farm Tractors, Fire Trucks and Buses.

## AUDELS MACHINIST & TOOLMAKERS HANDY BOOK. \$4

Covers modern machine shop practice in all its branches. Tells how to set up & operate lathes, screw and milling machines, shapers, drill presses & all other machine & hand tools. 1600 pages, fully illustrated. Indexed. 5 sections. 1—Modern Machine Shop Practice. 2—Blue Print Reading & How to Draw. 3—Calculations & Mathematics for Machinists. 4—Shop Physics. 5—How to Use the Slide Rule. 60 chapters. Easy to read and understand. A shop companion that answers your questions.

## AUDELS WELDERS GUIDE. \$1

A concise, practical text on operation & maintenance of all welding machines for all mechanics. Over 400 pages; illustrated. Covers all methods of electric and acetylene welding including airplane work.

## AUDELS BLUE PRINT READING. \$2

For Mechanics & Builders. Covers all types of blue print reading including ship & airplane. 416 pages, fully illustrated.

## AUDELS MATHEMATICS & CALCULATIONS FOR MECHANICS. \$2

Mathematics for home study or reference. 700 pages, 550 illus. Practical mathematics from beginning. How to figure correctly. Easy, correct methods covering complete review. Illus. & Indexed.

## AUDELS SHEETMETAL HANDY BOOK \$1

Practical inside information. Fundamentals of Sheet Metal Work. 388 pages. Illustrated. 11 sections. Clearly written. Essential & important facts, figures, pointers in everyday language. Ref. Index.

## AUDELS SHEETMETAL PATTERN LAYOUTS. \$4

Developed by Experts for Sheet Metal Workers, Layout Men & Mechanics. A Practical Encyclopedia in 10 Sections, size 7 x 10 x 2—1100 Pages—350 Layouts—1600 Illustrations. 1001 Key Facts. Fully indexed for ready reference in answering your layout problems. Covers all phases of sheet metal work including Pattern Cutting, Pattern Development & Shop Procedure.

## AUDELS PLUMBERS & STEAMFITTERS GUIDES—(4 Book Set) \$6

A Practical Trade Assistant & Ready Reference. Explains in plain language & by clear illustrations, diagrams, charts, graphs, pictures principles of modern plumbing practice including Pipe Fitting and Air Conditioning. 4 Vols.—1670 Pages—3642 Diagrams & Illustrations. Each Vol. Sold Separately, \$1.50 a Vol.

## AUDELS OIL BURNER GUIDE. \$1

384 Pages Covering Installation, Servicing & Repairs All Types Domestic & Industrial Burners. Illustrated. Highly Endorsed.

## AUDELS CARPENTERS & BUILDERS GUIDES—(4 Book Set) \$6

A practical illustrated trade assistant on modern construction for carpenters, joiners, builders, mechanics and all woodworkers. 4 vols., 1600 pages, 3700 Illustrations. Fully indexed. Each volume Sold Separately, \$1.50 a vol.

## AUDELS ELECTRIC MOTOR GUIDE. \$4

Practical Information Covering Construction, Control, Maintenance & Wiring Hookups of All Types Electric Motors also Armature Winding. 1000 Pages Fully Illustrated & Indexed.

## AUDELS PRACTICAL ELECTRICITY. \$4

A key to a practical understanding of Electricity. For maintenance engineers, electricians & all electrical workers. 1440 Pages, 2600 Illus. Covers important electrical information in handy form—including wiring for Light & Power. Indexed.

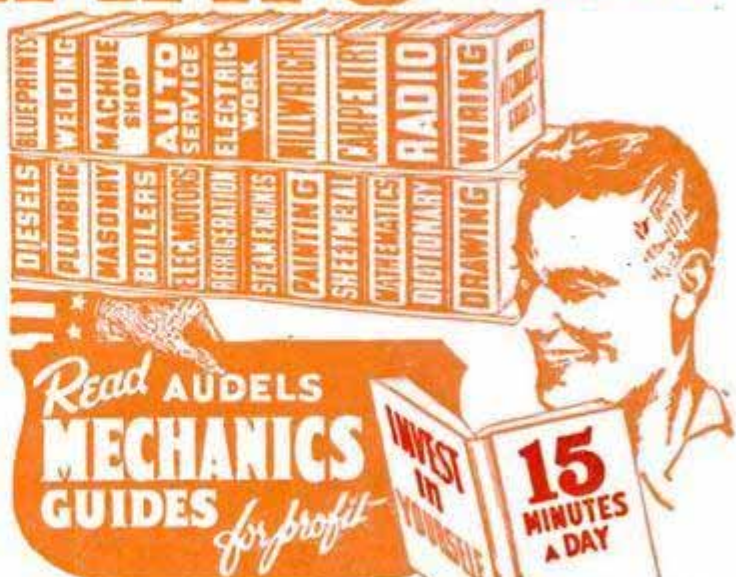
## AUDELS RADIOMANS GUIDE. \$4

A key to the practical understanding of radio including Frequency Modulation, Television, etc. Aircraft & Marine Radio. For radio engineers, servicemen, amateurs. 914 Pages, 633 Illustrations & Diagrams. Photos. Review Questions & Answers. Reference Index.

## AUDELS TELEVISION SERVICE MANUAL. \$2

Tells How to Solve T.V. Troubles. 384 Pages on Installing, Trouble Shooting & Repairing. Shows Good Receiver Adjustment—How to Install Aerials—Explains Color Systems. 225 Illus. & Diagrams covers Operating Principles of Modern T.V. Receivers.

AUDEL, Publishers, 49 W. 23 St., N. Y. 10, N. Y.



**AN AUDEL GUIDE IS A GOOD FRIEND!**  
Step Up Your Own Skill with the Practical Facts and Figures of Your Trade. Save time and money with right methods, short cuts, labor saving ideas. CHECK NOW! You can look over any Au-del Guide in your home. Start the Easy Payments if satisfied.

## CUT HERE MAIL ORDER

AUDEL, Publishers, 49 W. 23 St., NEW YORK 10, N. Y.  
Please send me postpaid for FREE EXAMINATION books marked (x) below. If I decide to keep them I agree to mail \$1 in 7 Days on each book or set ordered and further mail \$1 monthly on each book or set until I have paid price, otherwise I will return them.

- MACHINISTS HANDY BOOK, 1650 Pages . . . \$4
- WELDERS GUIDE, 400 Pages . . . 1
- BLUE PRINT READING, 416 Pages . . . 2
- MATHEMATICS & CALCULATIONS, 700 Pages . . . 2
- SHEET METAL PATTERN LAYOUTS, 1100 Pages . . . 4
- SHEET METAL WORKERS HANDY BOOK, 388 Pgs. . . 1
- MECHANICAL DRAWING GUIDE, 160 Pages . . . 1
- MECHANICAL DRAWING & DESIGN, 480 Pages . . . 2
- AUTOMOBILE MECHANICS GUIDE, 1800 Pages . . . 4
- TRUCK & TRACTOR GUIDE, 1299 Pages . . . 4
- DIESEL ENGINE MANUAL, 575 Pages . . . 2
- AIRCRAFT WORKER, 240 Pages . . . 1
- TELEVISION SERVICE MANUAL, 384 Pages . . . 2
- RADIOMANS GUIDE, 914 Pages . . . 4
- ELECTRONIC DEVICES, 216 Pages . . . 2
- ELECTRIC MOTOR GUIDE, 1000 Pages . . . 4
- ELECTRIC WIRING DIAGRAMS, 272 Pages . . . 1
- ELECTRICIANS EXAMINATIONS, 250 Pages . . . 1
- ELECTRIC POWER CALCULATIONS, 425 Pages . . . 2
- HANDY BOOK OF ELECTRICITY, 1440 Pages . . . 4
- ELECTRIC DICTIONARY, 9000 Terms . . . 2
- ELECTRIC LIBRARY, 7000 Pages (12 Book Set) . . . 18
- MARINE ENGINEERS HANDY BOOK, 1258 Pgs. . . 4
- SHIPFITTERS HANDY BOOK, 250 Pages . . . 1
- REFRIGERATION & Air Conditioning, 1280 Pgs. . . 4
- MILLWRIGHTS & MECHANICS GUIDE, 1200 Pgs. . . 4
- POWER PLANT ENGINEERS GUIDE, 1500 Pages . . . 4
- ENGINEERS & FIREMANS EXAMS, 525 Pages . . . 1
- PUMPS, Hydraulics & Air Compressors, 1658 Pgs . . . 4
- ENGINEERS LIBRARY (3 Book Set) . . . 9
- MECHANICAL DICTIONARY, 950 Pages . . . 4
- GARDENERS & GROWERS GUIDES (4 Book Set) . . . 6
- CARPENTERS & BUILDERS GUIDES (4 Book Set) . . . 6
- PLUMBERS & Steamfitters Guides (4 Book Set) . . . 6
- MASONS AND BUILDERS GUIDES (4 Book Set) . . . 6
- PAINTERS & DECORATORS MANUAL, 450 Pgs. . . 2
- HOUSE HEATING GUIDE, 1000 Pages . . . 4
- OIL BURNER GUIDE, 384 Pages . . . 1

**Check NOW!**

*Audels List Of Time Tested Practical Handy Books For Mechanics That Will Answer Your Questions — Highly Endorsed*

**MAIL THIS TODAY**

YOUR OPPORTUNITY

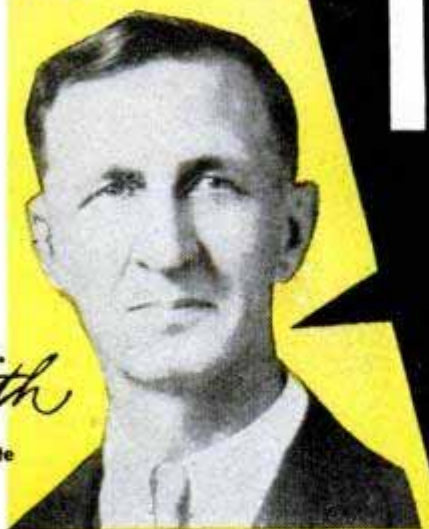
Name \_\_\_\_\_  
Address \_\_\_\_\_  
Occupation \_\_\_\_\_  
Employed by \_\_\_\_\_ P-10

## Our 40th Year

NRI training is thorough, practical, up-to-date. When you enroll with NRI you benefit from our 40 years of successful experience training men at home.

*J. E. Smith*

President  
National Radio Institute  
Washington, D. C.



# I'll Train You RADIO-

## You Practice Broadcasting with Parts I Send

As part of my Communications Course I send you parts to build low-power Broadcasting Transmitter at left, and other equipment. Use it to get practical experience. You put this station "on the air," perform procedures demanded of station operators. An FCC Commercial Operator's License can be your ticket to a bright future. My Course trains you to get your license. Mail Coupon now!



## Television Is Today's Good Job Maker

Television now reaches from coast-to-coast. More than 25 million Television sets are already in use and require servicing; thousands more sets are being sold every week. About 200 TV stations are now on the air with hundreds more being built. This means new jobs, more jobs, better pay for trained men. The time to act is NOW! Start learning Radio-Television servicing or communications.

## You Practice Servicing with Parts I Send

Nothing takes the place of PRACTICAL EXPERIENCE. NRI training is based on LEARNING BY DOING. You use parts I send to build many circuits common to Radio and TV. You build the modern radio at right. Use Multi-tester you build to make money fixing sets. Many students make \$10, \$15 a week extra fixing neighbors' sets in spare time, starting soon after enrolling. All equipment I send is yours to keep.



## Make Extra Money in Spare Time While Learning

Keep your job while training. Many NRI students make \$10, \$15 and more a week extra fixing neighbors' Radios in spare time. The day you enroll I start sending you special booklets that show you how to service sets. Multi-tester you build helps discover and correct Radio troubles, gives PRACTICAL EXPERIENCE on circuits common to radio and TV. Mail coupon today.



## I Trained these Men at Home



**Laborer Finds Success in Radio-TV**

"I was a laborer with no future. Now I have a position that pays well. My spare time servicing pays good money, too. Thanks to NRI."—Robert Ford, Johnstown, Pa.



**Switched to TV Servicing**

"I recently switched from studio work and am now holding a position as TV service technician. Enjoy my work more and more."—Norman Ward, Ridgefield Park, N. J.



**Paid for Course, Car in Spare Time**

"By the time I graduated I had paid for my course, a car and testing equipment. I can handle any job in Radio-TV."—E. J. Streitenberger, New Boston, Ohio.



**\$10 to \$15 Week Spare Time**

"Four months after enrolling, was able to service Radios . . . averaged \$10 to \$15 a week spare time. Now have full time business."—W. Weyde, Brooklyn, N. Y.



**Employed as Transmitter Operator**

"A former employer recommended NRI training to me. Now employed as transmitter operator in Harrisburg."—Albert Herr, New Cumberland, Penna.

# AT HOME for Good Jobs in TELEVISION

## There is Success-Good Pay-Security for You in America's Fast Growing Industry



### NRI Training Leads to These Jobs in RADIO-TELEVISION

**BROADCASTING**  
Chief Technician  
Chief Operator  
Power Monitor  
Recording Operator

**SERVICING**  
Home and Auto Radios  
Television Receivers  
P.A. Systems

**MANUFACTURING**  
Design Technician  
Service Manager  
Tester  
Research Assistant

**SHIP AND HARBOR RADIO**  
Chief Operator  
Radiotelephone Operator  
Assistant Operator

**GOVERNMENT RADIO**  
Operator in Army, Navy, Marine Corps  
Airways Operator  
Forestry Dispatcher

**AVIATION RADIO**  
Transmitter Technician  
Airport Transmitter Operator

**TELEVISION**  
Pick-up Operator  
Television Technician  
Remote Control Operator  
Service and Maintenance Technician

**POLICE RADIO**  
Transmitter Operator  
Receiver Serviceman

DO YOU want good pay, a job with a bright future, security? Would you like to have a profitable business of your own? If so, find out how you can realize your ambition in the fast-growing RADIO-TELEVISION industry. Even without Television, the industry is bigger than ever before. Just think, over 115 million home and auto Radios, 3000 Radio Broadcasting Stations, plus 25 million Television sets and about 200 Television Broadcasting Stations. Expanding use of Aviation and Police Radio, Micro-wave Relay, Two-way Radio for busses, taxis etc., are making opportunities for Servicing and Communications technicians and FCC Licensed Operators.

### My Training Includes Television

You get practical experience by working on circuits common to both Radio and Television. My graduates are filling jobs, making good money in both Radio and Television. Many NRI trained men start their own Radio and Television servicing business with capital earned in spare time. Let me show you how you can be your own boss; earn \$10 to \$15 a week extra even while still learning. Now is the time to get ready for success in Radio-Television. Coupon below brings you Actual Lesson and 64-page book.

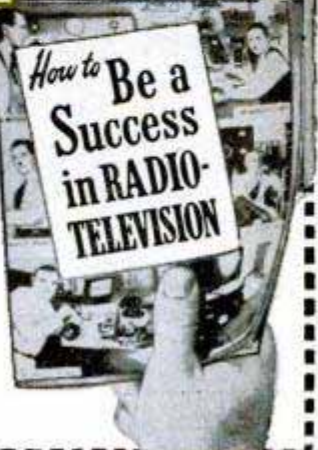
### Find Out What Radio-Television Offers You

What will YOU be doing one year from today? Decide now that you are going to know more and earn more. ACT NOW. Send the coupon below NOW for my FREE DOUBLE OFFER. You get Actual Servicing Lesson. Also my 64-page Book, "How to Be a Success in Radio-Television." Read what my graduates are doing, earning, see equipment you practice with at home. Mail coupon now. Send in envelope or paste on postal. J. E. SMITH, President, Dept. 3KA, National Radio Institute, Washington 9, D. C. Our 40th Year.

### Actual Lesson and 64-page Book

**BOTH FREE**

The ABC's of SERVICING



### MAIL THIS NOW!

MR. J. E. SMITH, President, Dept. 3KA  
National Radio Institute, Washington 9, D. C.

Mail me Sample Lesson and 64-page Book, FREE. (No salesman will call. Please write plainly.)

Name ..... Age .....

Address .....

City..... Zone..... State.....

**VETS** write in date of discharge .....



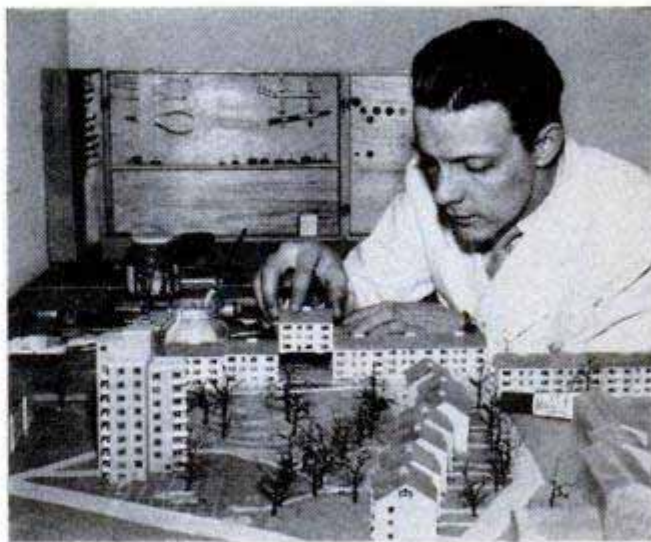
Control Operator, Station WEAN

"Received my License and worked on ships. Now with Station WEAN. NRI Course is as complete as any radio course can be."  
—Raymond E. Arnold, Rumford, E. I.

Available to **VETERANS** under G. I. Bills

**To the Editor:**

With reference to the June 1949 issue of your magazine and the article concerning models of the projected new bridge from



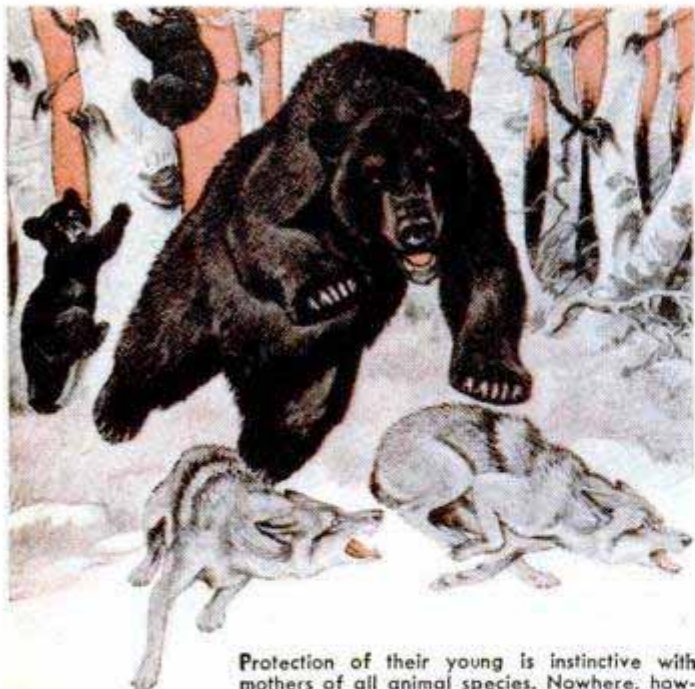
San Francisco to Oakland, I am a builder of models and would very much appreciate coming into contact with colleagues abroad. . . . I am young and wish to learn, would like to cross the Atlantic to study in your wonderful and progressive country.

Owe Victorsson,  
Sodertalje, Sweden

**To the Editor:**

This smoking stand is made from a tree which grew in Whitman, Mass. There are ten right angles in it; it is 21 inches tall. I cannot find out what kind of a tree it was. The wood is yellow and medium hard.

Fred Hunter,  
287 Pine St.,  
Whitman, Mass.



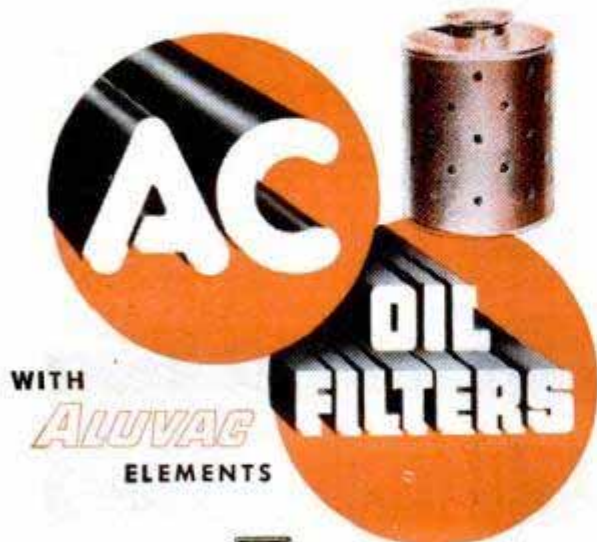
Protection of their young is instinctive with mothers of all animal species. Nowhere, however, is this mother protection more dramatically demonstrated than when the Grizzly Bear drives off a pair of treacherous coyotes about to attack her cubs.

# Protection At Its Best

No wonder so many motorists prefer the engine protection offered by AC Aluvac Oil Filter Elements. Just look at these features!

- **Microscopic filtration**—AC Aluvac removes dirt particles as small as 1/100,000 of an inch.
- **Maximum filtering area per cubic inch**—AC Aluvac has 10 times the area of ordinary elements.
- **No harmful chemicals**—AC Aluvac won't remove detergents from heavy-duty motor oil.
- **Acidproof**—secret process renders AC Aluvac material resistant to acid, gasoline and water.

Standard or optional factory equipment on Oldsmobile, Buick, Cadillac and Chevrolet cars—Chevrolet and GMC Trucks



AC SPARK PLUG DIVISION

GENERAL MOTORS CORPORATION





# INVENTORS

Learn how to protect your invention. The U. S. Patent Laws provide that any new and useful art, machine, article of manufacture, or composition of matter, or any new and useful improvement thereof, may be patented if the act of invention is involved. Therefore, every inventor with a valuable invention should take advantage of the Patent Laws and proceed for patent protection in order to safeguard his rights.

A patent gives the inventor the exclusive right to prevent others from making, using, or selling the invention claimed in the patent for a period of seventeen years.

The Patent Laws were enacted for the benefit of the inventor to give him protection for the features of his invention which are patentable. These features must be properly and concisely set forth and claimed in a formal application for patent, in order to comply with the requirements of the Patent Laws. For that reason, unless the inventor is familiar with patent matters, he should engage a competent registered patent attorney or agent to represent him. We are registered to practice before the U. S. Patent Office and are prepared to serve you in the handling of your patent matters.

A specially prepared booklet entitled "Patent Guide for the Inventor", containing detailed information with respect to patent protection and procedure, together with a "Record of Invention" form will be promptly forwarded to you without obligation upon request.

**CLARENCE A. O'BRIEN & HARVEY JACOBSON**

*Registered Patent Attorneys*

**31-K DISTRICT NATIONAL BUILDING**

**WASHINGTON 5, D. C.**

# Keeps hair in place -leaves no trace!



GROOMS  
HAIR,  
NEVER  
GREASES IT!

**MENNEN**  
*Cream  
Hair Oil*  
**FOR MEN**

**KEEPS YOUR HAIR  
NEATLY IN PLACE**

**53¢**  
20% more  
for your  
money

CONTAINS LANOLIN  
NON-TECHNOLOGIC NET 3 FL. OZ.  
THE MENNEN COMPANY  
MADE IN U.S.A. REGISTERED U.S.P. PAT.



NO GREASE  
ON HANDS



NO OIL  
ON HATS



NO SPOTS  
ON  
FURNITURE



NO SMUDGE  
ON PILLOWS

**AT LAST**, a hair groom that keeps your hair neat, well-groomed, good-looking, and yet never leaves a tell-tale trace! Change today to Mennen Cream Hair Oil. It's lightly blended to groom hair, but never grease it. Contains lanolin. Helps remove dandruff scales and relieve dry scalp. Economical, too. Get a bottle today!

**MENNEN** CREAM HAIR OIL  
FOR MEN

## WHERE-TO-BUY-IT INDEX

Source of supply appears after items commercially available

### AUTOMOTIVE

- Glass "ambulance" replaces car windows at scene of crash...116
- Detroit Listening Post.....123
- Students learn to drive in safety of classroom.....133
- We drive a foreign car (Herndon Hudson, 407 Elmwood Place, Athens, Ohio).....139
- Valise-size motor scooter parks in home or office.....143

### AUTOMOTIVE ACCESSORIES

- Power-brake attachment for older cars (Bendix Products Div., Bendix Aviation Corp., South Bend, Ind.).....107
- Drip-mold latch locks rear door (Spencer Specialties, 356 S. Broadway, Los Angeles 13, Calif.).....114
- Vacuum-bottle rack (Poyer Products, 9450 Collins Ave., Miami Beach 41, Fla.).....114
- Magnets hold visor (Magnetic Visor Co., 1814 N. Leavitt St., Chicago 47).....114
- Mirror says "dim your lights".....114
- Push-button ignition lock (Victor Devices, Inc., 840 Van Houten Ave., Clifton, N. J.).....115
- In-the-car coffeemaker (Cuno Sievers, 101 Cedar St., New York City 6).....115
- Periscope aids driver in traffic (Fulton Company, 1913 South 82nd St., West Allis, Wis.).....115
- Hook-on heating hoses warm cars at drive-in.....116
- Spot and trouble light housed in phone handset (Carr-Lite Co., Box 228, Kalamazoo, Mich.).....116

### AVIATION

- Fast British research plane has movable tail.....107
- Avro Atlantic.....126
- Fuel-saving jet engines for trans-Atlantic transport.....318

### HOUSE AND HOME

- Plastic friction catch holds cupboard door (Washington Steel Products, Inc., Tacoma 2, Wash.).....134
- Humming detector unit spots hidden conduits (Detectron Co., 5631 Cahuenga Blvd., North Hollywood, Calif.).....134
- Deodorizer (Peters Company, 101 Francis St., Stevens Point, Wis.).....136
- Mixer (Federal Tool Corp., 3606 W. Pratt Blvd., Chicago 45).....136
- Table-top tray (Mrs. Dorothy Damar, Damar Bldg., Treat Place, Newark 2, N. J.).....136
- Cabinet lavatory.....137
- Bathroom scale (Standard Building Products Co., 621 McDonald Ave., Brooklyn 18, N. Y.).....137
- Recessed hamper (Standard Building Products Co., 621 McDonald Ave., Brooklyn 18, N. Y.).....137
- Plastic shelf unit (Lyon Metal Products, Inc., Aurora, Ill.).....137
- Windows to dress up your home (1) Wasco Flashing Co., 87 Fawcett St., Cambridge 38, Mass. (2) Wisco Aluminum Co., 3945 A St., Detroit 16, Mich. (3) Curtiss Co., Service Bureau, Clinton, Iowa. (4) Sun-Sash Co., 38 Park Row, New York City 38. (5) Ernest Pierson Co., 4100 Broadway, Eureka, Calif. ....167
- Lawn-mower sprayer attachment (Blitz-Fog Co., 310 N. Water St., Milwaukee 2, Wis.).....308

### HOUSE CONSTRUCTION

- Buoyant stone replaces wood.....117
- Home built in a day with precast brick panels.....125
- "Terraced" apartment in Denmark has foam-rubber floor.....125
- Machine forms roofing at homesite (Rolliton of America, 714 E. Van Buren, Phoenix, Ariz.).....128
- Flexible coating turns wood floors into "concrete" (Surface Coatings, Inc., 110 Pear St., S.E., Atlanta, Ga.).....133
- How to read a blueprint.....154
- Tips on good construction practices.....155
- Here's your "dictionary" of building terms.....156
- Light your home by remote control (General Electric Co., Bridgeport 2, Conn.).....168
- Air conditioning—the year 'round.....174
- How to finance your home.....175

### INDUSTRY

- Magnet on lift truck spots freight-car runways.....124
- "Pumping up" a city with rainwater.....125
- Lumber carrier hauls concrete.....135
- Truck-mounted suction cleaner scours streetcar tracks.....138
- Automatic plant turns wood scraps into hardboard (Anacortes Veneer, Inc., Anacortes, Wash.).....142

### MILITARY AND NAVAL

- Army "robot psychologist" finds right men for the right job...113
- Marine reconnaissance boat has multiple cells (Playtex Corp., Dover, Del.).....129
- Moisture-sensing element sealed in container (American Instrument Co., Silver Spring, Md.).....134

### OFFICE, SHOP AND STORE

- Calculator with Braille symbols aids blind (Marchant Calculators, Inc., Oakland, Calif.).....135
- Mechanical wall washer scrubs with soap and running water (Ernest Flores, 909 SW 34th St., San Antonio, Tex.).....138
- Plastic clamp-on outlet taps electric cord (Academy Electrical Products Corp., 3842 9th Ave., New York City 34).....260
- Trimming board (Zeus Rolcut Co., Box 177, Sausalito, Calif.).....272

(Continued to page 18)

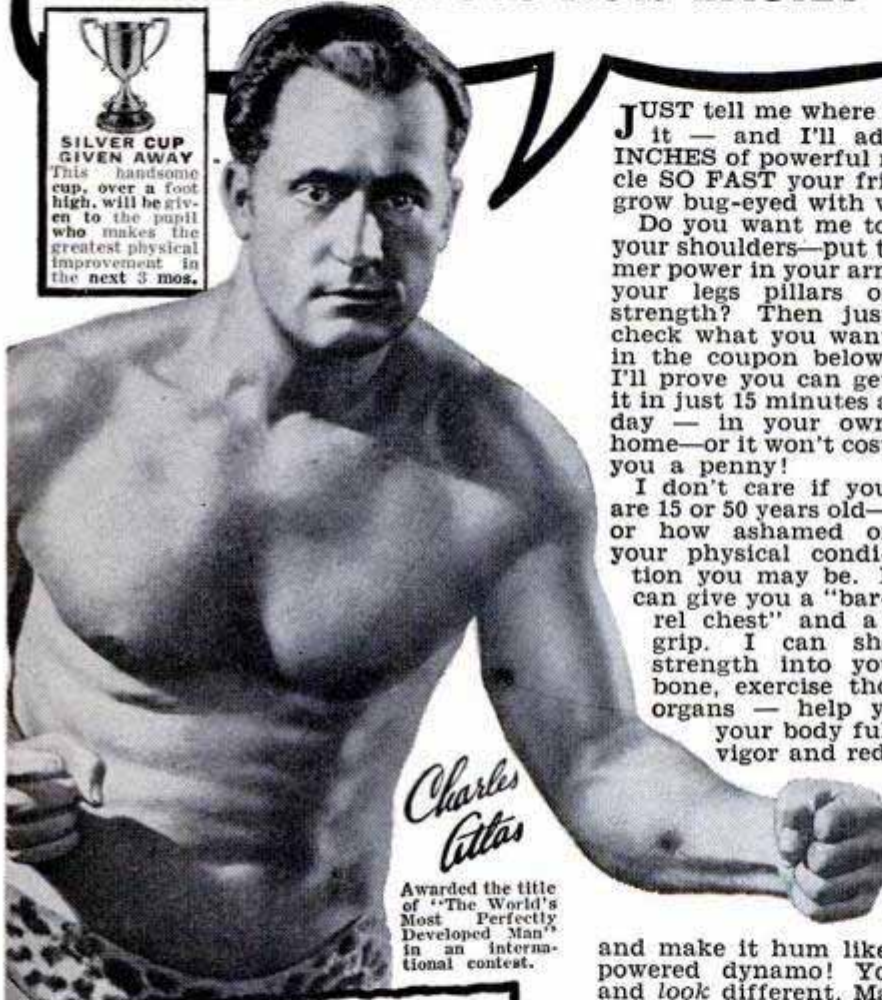
# Check the Kind of Body YOU Want!

**RIGHT IN THE COUPON BELOW**

**...and I'll Prove How EASILY You Can Have It!**



**SILVER CUP GIVEN AWAY**  
This handsome cup, over a foot high, will be given to the pupil who makes the greatest physical improvement in the next 3 mos.



*Charles Atlas*

Awarded the title of "The World's Most Perfectly Developed Man" in an international contest.

**JUST** tell me where you want it — and I'll add **SOLID INCHES** of powerful new muscle **SO FAST** your friends will grow bug-eyed with wonder!

Do you want me to broaden your shoulders—put trip-hammer power in your arms—make your legs pillars of strength? Then just check what you want in the coupon below. I'll prove you can get it in just 15 minutes a day — in your own home—or it won't cost you a penny!

I don't care if you are 15 or 50 years old—or how ashamed of your physical condition you may be. I can give you a "barrel chest" and a vise-like grip. I can shoot new strength into your backbone, exercise those inner organs — help you cram your body full of pep, vigor and red-blooded

vitality! I'll wake up that sleeping energy of yours and make it hum like a high-powered dynamo! You'll feel and look different. Man, you'll begin to LIVE!

ling I was at 17 to my present superman physique! Thousands of fellows are becoming marvelous physical specimens — my way. I give you no gadgets or contraptions to fool with. When you develop your strength through "Dynamic Tension"

## ARE YOU

Skinny, Weak and run down?  
Always tired?  
Nervous?  
Lacking in confidence?  
Constipated?  
Suffering from bad breath?  
Fat and flabby?  
Do you want to lose or gain weight?  
**WHAT TO DO ABOUT IT is told in my FREE BOOK**

you can laugh at artificial muscle-makers. You simply utilize the dormant muscle-power in your own God-given body—watch it increase and multiply double-quick into real solid **LIVE MUSCLE**.

My method — "Dynamic Tension" is so easy! Spend only 15 minutes a day in your own home. From the very start you'll be using my method of "Dynamic Tension" almost unconsciously every minute of the day—walking, bending over, etc.—to **BUILD THE MUSCLE and VITALITY** you want. And you'll be using the method which many great athletes use for keeping in condition — prize fighters, wrestlers, baseball and football players, etc.

**FREE** Illustrated 32-Page Book. Just Mail the Coupon.

SEND NOW for my famous book, "Everlasting Health and Strength." (Over 3½ MILLION fellows have sent for it already.) 32 pages, packed with photographs and valuable advice. Shows what "Dynamic Tension" has done for others, answers many vital questions. This book is a real prize for any fellow who wants a better build. Yet I'll send you a copy absolutely FREE. Rush coupon to me personally: Charles Atlas, Dept. 810, 115 East 23rd St., New York 10, N. Y.



### Here's The Kind of Results I Give:

"I gained 11 lbs. and 4½ inches on my chest, 3 inches on my arms. I am never constipated."  
—Henry Neven, Canada

"I gained 34 lbs. and increased my chest 6 inches."  
—Stanley Lynn, Calif.

"What a difference! Have put 3½ inches on my chest (normal) and 2½ inches expanded."  
—F. S., New York

"Gained 29 pounds. When I started your

course I weighed only 141. Now I weigh 170."  
—T. K., New York

"The benefits are wonderful. The first week my arm increased one inch, my chest two inches."  
—E. M., Conn.

"You changed me from a weakling to a real he-man. My chest has gone up 6 inches. I am a solid mass of muscle. Friends and doctors have noticed a great change in me."  
—J. W., Montana

### WHAT'S MY SECRET?

"DYNAMIC TENSION"! That's the ticket! The identical natural method that I myself developed to change my body from the scrawny skinny chested weak-

**CHARLES ATLAS, DEPT. 810**  
115 East 23rd St., New York 10, N. Y.

*Dear Charles Atlas: Here's the kind of Body I Want:*

(Check as many as you like)

- More Weight—Solid—In The Right Places
- Broader Chest and Shoulders
- More Powerful Arms and Grip
- Slimmer Waist and Hips
- Better Regularity, Digestion, Clearer Skin
- More Powerful Leg Muscles
- Better Sleep, More Energy

Send me absolutely FREE a copy of your famous book "Everlasting Health and Strength"—32 pages, crammed with photographs, answers to vital health questions and valuable advice. I understand this book is mine to keep and sending for it does not obligate me in any way.

NAME.....AGE.....  
(please print or write plainly)

ADDRESS.....

CITY.....STATE.....

**RUSH COUPON FOR FREE BOOK**

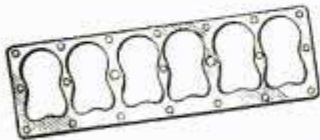


# Sealing Savvy

YOU CAN SEAL ABOUT EVERYTHING WITH

## PERMATEX FORM-A-GASKET®

Leakproof against water, oil, gasoline, most chemicals, heat and cold.



### REPAIR HEAD GASKETS

Coat new head gaskets on both sides with Form-A-Gasket No. 3. If no replacement is available, repair old gasket with Form-A-Gasket No. 1.



### STOP RADIO RATTLES

Vibration works speaker screws loose and causes noise. Cement cone with Form-A-Gasket No. 1.



### SEAL PAINT CANS

Save your half-filled cans of paint by brushing Aviation Form-A-Gasket No. 3 on sealing ring of can.



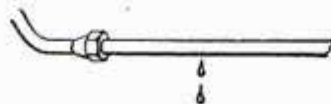
### PLUG GAS TANKS

Use a sheet metal screw larger than the hole. Push screw through a piece of gasket material. Apply Form-A-Gasket No. 1 and insert screw in hole.



### MOUNT LAMPS

Coat the back of truck clearance lamps with Form-A-Gasket No. 2 to prevent water seepage. Lamps can easily be removed for replacement.



### REPAIR GAS LINES

Disconnect leaking gas lines and cover with a light coat of Form-A-Gasket No. 1. Allow to dry, tape, then apply another light coating of No. 1.

## 3 TYPES

- No. 1** Sets quickly, dries hard
  - No. 2** Sets slowly, remains pliable
  - No. 3 (Aviation)** Brushable liquid, sets to a paste; remains tacky.
- All three belong in your shop!



**PERMATEX COMPANY, INC., Brooklyn 35, N.Y.**  
Over 50 Chemical Products for Better Automotive Maintenance

(Continued from page 16)

### MISCELLANEOUS

|  |     |
|--|-----|
| Egg Roaster .....  | 20  |
| On-the-job inventions save U. S. half-million dollars.....   | 103 |
| Farm-built ski tow.....  | 104 |
| Caterpillar skis.....  | 106 |
| Motor-driven massage table helps busy executives relax at office (Buffalow Mfg. Co., 618 South Old Ranch Rd., Arcadia, Calif.) ..... | 107 |
| Squeezeless German accordion powered by electricity.....   | 113 |
| Machine makes ribbon bows for Christmas wrapping.....  | 113 |
| Librarian's helper checks out books by photographing cards (Remington Rand, 315 4th Ave., New York City 10).....                     | 124 |
| Electrical music mentor buzzes when pupil hits sour note.....  | 124 |
| Quickly mounted corn picker has twin elevators (J. I. Case Co., Racine, Wis.).....   | 138 |
| Mechanical hospital bed serves patient at touch of button (Dr. Marvel Beem, 11702 Mississippi Ave., Los Angeles 25, Calif.) .....    | 143 |
| Rocket camera snaps sun from 50-mile altitude.....   | 286 |
| Safety appliance cord (Noma Lites, Inc., 55 W. 13th St., New York City 11).....  | 308 |
| Meter shows photographer how to take portraits (Kanco Photo Corp., 30 West 31st St., New York City 1).....                           | 318 |

## Craftsman and Shop Notes Index

### AUTOMOTIVE

|   |     |
|---|-----|
| Milk cartons burned as flares.....                              | 196 |
| Wax kept in glove compartment permits polishing of trim.....    | 206 |
| Plug valve drainage holes.....                                  | 213 |
| Improvised carbon contact stops intermittent firing.....        | 226 |
| Tiny iron particles in auto fuel removed with small magnet..... | 226 |
| Center lines on front tires aid measuring wheel toe-in.....     | 231 |
| Grooved distributor shaft prevents oil seepage.....             | 240 |

### ELECTRICAL REPAIRS

|  |     |
|--|-----|
| Fraying of pull cord prevented.....                          | 202 |
| Buzzing in electric clocks caused by oil leak.....           | 212 |
| Notches filed in electric plugs identify cords by touch..... | 216 |

### FARMING

|   |     |
|---|-----|
| Cattle cannot remove barn door if top hinge is inverted.....    | 226 |
| Sturdy rack holds long pipe for safe hauling.....               | 226 |
| Portable brush burner.....                                      | 226 |
| Improvised shoe scraper.....                                    | 232 |
| Ear corn in overhead bin fed directly into grinder.....         | 232 |
| Hydraulic cylinder on wagon speeds dumping of load.....         | 240 |
| Wall-supported pipe rails aid cleaning farrowing pen.....       | 241 |
| Ventilator provides circulation for low-roofed cattle shed..... | 244 |
| Mechanical hoe weeds raspberry field faster and cheaper.....    | 244 |

### HOBBIES, NOVELTIES AND TOYS

|   |     |
|---|-----|
| Jig aids in tying ratlines for model sailing vessel.....    | 196 |
| Tumbling toy from capsule.....                              | 202 |
| Photograph mounted on plastic decorates novel doorstep..... | 208 |
| Decorative kitchen wall light made from spoon and bowl..... | 212 |
| Hinge leaves provide bearings for axles of toy wagon.....   | 212 |
| Strictly for the birds.....                                 | 217 |

### HOUSE AND HOME

|  |     |
|--|-----|
| Avoid mixed-wood flooring.....                                 | 188 |
| Warped plywood closet doors straightened by turnbuckle.....    | 188 |
| Removable ventilating fan installed in kitchen window.....     | 188 |
| Dolly moves scrub pail and brush easily as you wash floor..... | 188 |
| Framed opening in partition wall forms telephone shelf.....    | 193 |
| Solving Home Problems.....                                     | 194 |
| Loose hinges on old doors fixed by boring new holes.....       | 202 |
| Scale measures floor plans.....                                | 203 |
| House-plant watering can.....                                  | 212 |
| It's no trick to install a full-length door mirror.....        | 213 |
| Sliding rack in deep closets provide more storage space.....   | 213 |
| Picture hanger without nails.....                              | 216 |
| Removing stains from old china.....                            | 216 |

### METALWORKING

|  |     |
|--|-----|
| Cans assembled with bolts make small-parts tray..... | 196 |
| Eaves-trough hanger eye crushed to hold nail.....    | 196 |
| "Lazy Susan" rack for metal-lathe accessories.....   | 233 |

### OFFICE, SHOP AND STORE

|  |     |
|--|-----|
| Chisel for removing sash putty.....                          | 193 |
| Wood-and-felt glue applicator is improvement over brush..... | 203 |
| Hang keys on handy hook.....                                 | 206 |
| Can holds tape on toolbox.....                               | 233 |
| Alcohol simplifies cutting of auto safety glass.....         | 244 |

### PAINT AND PAINTING

|   |     |
|---|-----|
| Concrete should be left unpainted if test shows dampness..... | 193 |
| Stop stains from "bleeding".....                              | 193 |
| Pouring spout for paint can soldered to lid.....              | 216 |

(Continued to page 20)

**IMPORTANT NOTICE**—It is the intention of this magazine to provide its readers with information regarding the latest developments in the mechanical arts. We take no responsibility as to whether the disclosures contained in our articles are covered by patents and advise readers to investigate this subject before making, using, or selling any of the products, machines, or processes described in order to avoid possible liability for patent infringements.

# INVENTORS

If you believe that you have an invention, you should find out how to protect it. The first step is to have a search made of the prior pertinent U. S. patents. If a report on this search indicates that the invention appears patentable you can apply for a patent, and the specifications and claims should be prepared.

The firm of McMorrow, Berman & Davidson, with offices in Washington, D. C., is qualified to take the necessary steps for you. We can make a preliminary search on your invention, advise you whether we think it can be patented, and prepare your application for

patent.

Unless you are fully familiar with the U. S. Patent Laws, we recommend that you engage the services of a Registered Patent Attorney to protect your interests. The patent laws are *your* laws. A patent gives you the right to prevent others from making, using or selling the invention claimed in your patent for a period of 17 years.

Use these patent laws for your protection. Investigate whether your invention can be patented. If you have what you believe to be an invention, we suggest that you have this firm make a search for you.

*Send for a copy of our Patent Booklet entitled "How To Protect Your Invention," containing information about patent protection and patent procedure. Along with this we will also send you an "Invention Record" form, for your use in writing down and sketching details of your invention. We will mail them promptly. No obligation. They are yours for the asking.*

## McMORROW, BERMAN & DAVIDSON

Registered Patent Attorneys

PATENTS • COPYRIGHTS • PATENTS

135-T VICTOR BUILDING, WASHINGTON 1, D. C.



shake it on  
every morning  
then...



every step  
of the day

# QUINSANA FIGHTS ATHLETES FOOT INFECTION

QUINSANA works full-time—and fast! 9 out of 10 report amazing results. 91% of foot specialists interviewed used it on their patients. For burning, itching feet—cracking, peeling skin... get QUINSANA quick!

*Soothes, cools  
tired feet!*



**49¢**  
TAX FREE

(Continued from page 18)

## PHOTOGRAPHY

|  |     |
|--|-----|
| Rack aids photo blotter drying.....                              | 222 |
| Link adapts auto-focus enlarger to use of longer-focal lens..... | 222 |
| Lamp fixture held in hand or mounted on stand.....               | 222 |
| Adjustable-column tripod.....                                    | 223 |
| Glycerin makes ground-glass viewer more translucent.....         | 224 |
| Photo enlarger substituted for contact printer.....              | 224 |

## TOOLS

|   |     |
|---|-----|
| Touch-up container for spray guns.....  | 225 |
| Portable jigsaw (Black & Decker Co., Towson, Md.).....  | 242 |
| Carbide-tipped penetrating end mills (Super Tool Co., 21650 Hoover Rd., Detroit 13, Mich.)..... | 242 |
| Vibration measuring instrument (Martin Engineering Co., Kewanee, Ill.).....                     | 242 |
| Detachable pouring lip (Pormix Corp., Greenwich, Conn.).....                                    | 242 |
| Small-diameter sanding spindles (Spingrit Co., 16565 Greenfield Rd., Detroit 35, Mich.).....    | 243 |
| Combination grinder-hone (Atlas Press Co., 2343 N. Pitcher St., Kalamazoo, Mich.).....          | 243 |
| Universal handle (Size Control Co., 2500 W. Washington Blvd., Chicago 12).....                  | 243 |
| Ladder caddy (The Felices, 545 5th Ave., New York City).....                                    | 243 |
| Nail holder (Pollock Engineering Co., Dept. H, 10342 S. Church St., Chicago 43).....            | 243 |

## WOODWORKING

|  |     |
|--|-----|
| Underside of basement stairs used as out-of-way tool storage rack..... | 193 |
| Large block for sanding panels.....                                    | 202 |
| Plan of the month—Ice-fishing shelter.....                             | 204 |
| Jig to sand edges square.....  | 206 |
| Grooved block holds plywood for easier sawing.....                     | 206 |
| 3-tiered snack tray.....   | 207 |

## WORKSHOP HINTS

|  |     |
|--|-----|
| Chisel rack from fence pickets.....                                    | 196 |
| Emergency socket-head wrench from three-cornered file.....             | 206 |
| Cutting small rods squarely.....                                       | 208 |
| Setscrew holds handle of tap wrench.....                               | 208 |
| Orlocks inserted in sawhorse hold pipe for cutting.....                | 208 |
| Use scrap lumber under board when making small cuts.....               | 216 |
| Improvised "jig" for drill press aids drilling cabinet end-pieces..... | 232 |
| Saw-blade tool removes key.....  | 240 |
| Oversized chuck improvised from pipe and hex nut.....                  | 240 |
| Stub shafts on wooden roller improvised from lag screws.....           | 244 |

## MISCELLANEOUS

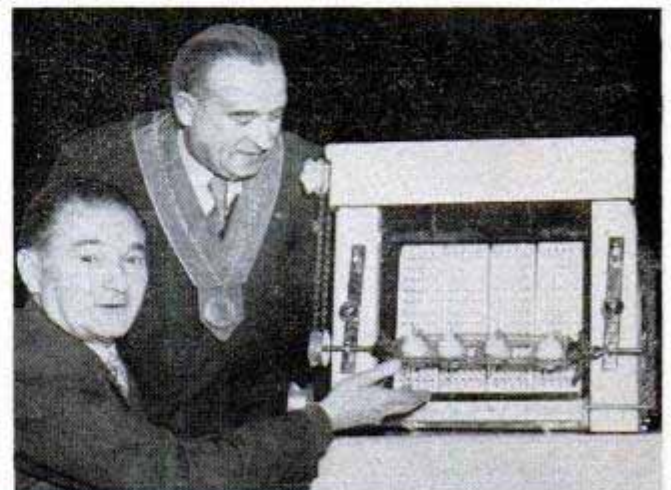
|  |     |
|--|-----|
| Lathe helps in adding new line to deep-sea fishing reel..... | 202 |
| Micrometer carrying case from revolver holster.....          | 232 |
| Gravel speeds lowland drainage.....                          | 240 |
| Floating tractor saw cuts stumps underwater.....             | 241 |

## Radio-Television, Electronics

|  |     |
|--|-----|
| TV-subscriber system (Skiatron Electronics and Television Corp., 30 East 10th St., New York City 3)..... | 245 |
| How to build experimental transistor receivers.....  | 246 |

## Egg Roaster

From Paris, where gastronomes are numerous as well as imaginative, comes word of an electric grill that roasts eggs in the shell. The eggs, held in wire cups, are rotated on a roasting spit, turned by a chain.



# LEARN ELECTRICITY AND ELECTRONICS

ON REAL EQUIPMENT  
IN THE GREAT SHOPS  
OF **COYNE**

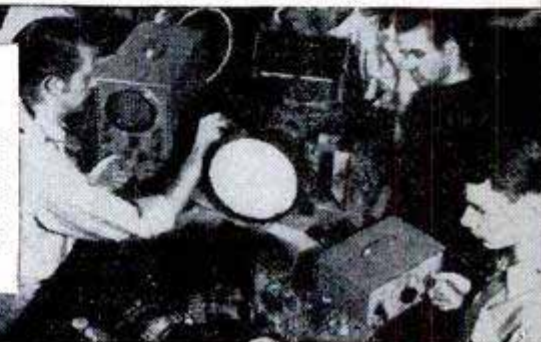


## RADIO-TELEVISION

A GREAT BOOMING INDUSTRY

### Largest, Oldest Best Equipped School of its Kind!

Thousands of successful men have been trained at Coyne over past 54 years. There is no substitute for Coyne's wealth of experience.



The tremendous growth of this new field is almost unbelievable. TV has been given the "go-ahead" in 1227 new communities, with 1845 new stations to be built. Unusual opportunity to get in on ground floor. RADIO-TELEVISION and ELECTRONICS are vital to our Defense Program. And they offer a world of opportunities for a real future when the emergency is over. Train quickly on actual equipment at Coyne by practical-technical methods. Get big Free Book today.

## ELECTRICITY-

### The Power Behind Our Industrial Program

A great opportunity field and vital to Defense. Thousands of trained Electrical and Electronics men needed in good jobs and a real future. Why be satisfied with a "no future" job? Get Free Book that tells how thousands have prepared quickly for Electricity and Electronics at Coyne.

### TRAIN QUICKLY AT COYNE FOR VITAL FIELDS

ELECTRICITY-RADIO-TELEVISION-ELECTRONICS-VITAL in Industry and Armed Forces. TRAIN QUICKLY for better rating, if drafted—vital job in Industry, if not. Trained men whether 17 or up to 45 needed. Prepare now for steady, well paid, essential jobs in A FIELD THAT ALSO OFFERS A REAL FUTURE WHEN THE EMERGENCY IS OVER.

### START NOW—PAY LATER

Enroll now, pay most of tuition later. Monthly payment plan especially designed for K-Vets. If you need part-time work to help out with living expenses while at Coyne, we'll help you get it. Special tuition plan for men of Draft Age.



B. W. COOKE

### APPROVED FOR VETERANS



**1** You are TOLD the how and why of each job.



**2** You're shown how to do typical jobs by trained instructors.



**3** You DO practical job YOURSELF on equipment.

### Mail Coupon for Big Free Book

Whether you prefer Electricity or Television-Radio, train on actual equipment, at Coyne. Fill in and mail coupon TODAY. Paste it on a postcard if you wish. A big fully illustrated booklet and complete details will come by return mail. No salesman will call.

B. W. COOKE, President



## COYNE SCHOOL

A TECHNICAL TRADE INSTITUTE  
CHARTERED NOT FOR PROFIT  
Established 1899  
500 S. Paulina Dept. 73-72H  
Chicago 12, Illinois

ELECTRICITY ★ TELEVISION ★ RADIO ★ REFRIGERATION ★ ELECTRONICS

B. W. COOKE, President  
COYNE SCHOOL  
500 S. Paulina St., Chicago 12, Ill.  
Dept. 73-72H

Send your BIG FREE BOOK and details of your training offer. This does not obligate me and no salesman will call. I am interested in:

ELECTRICITY  TELEVISION-RADIO

NAME.....

ADDRESS.....

CITY.....STATE.....

# Inventors

The following are the usual preliminary steps to take toward patent protection.

You are advised first, to make a disclosure of your invention. Date, sign and have this document witnessed by two or more persons who are capable of understanding your invention. The "Evidence of Invention" form mentioned below, we offer as a convenience in making your disclosure and in starting action leading toward patent protection.

Mail your disclosure to the registered patent attorney or agent whom you select to assist you, together with a letter authorizing him to conduct a

preliminary search among previously granted U. S. patents for similar types of invention. He then prepares for you a report on the probable patentability of your invention and, if the report is favorable, recommends the further course you should take.

This firm is registered to practice before the U. S. Patent Office and is available to assist you in the preparation and prosecution of patent applications. We shall be glad to send you without obligation, the "Evidence of Invention" disclosure form mentioned above and our instructive booklet, "Patent Protection for Inventors".

VICTOR J.  
**EVANS & Co.** *Merlin M. Evans*  
REGISTERED PATENT ATTORNEY  
830 - L MERLIN BUILDING, WASHINGTON 6, D. C.

Say You Saw It in Popular Mechanics



## Electrical Appliance Repairs MADE EASY

New Repair Manual Covers EVERY Repair on ALL Home Appliances

NO repair job is too tough with the help of this big new Guide. TELLS and SHOWS how to service ALL home appliances. SAVE MONEY keeping your own appliances like new—or MAKE MONEY with a home repair shop of your own . . . full or spare time.

OVER 850 "how-to-do-it" pages, packed with pictures, drawings, diagrams. Sectional charts locate "trouble spots" in a jiffy . . . make it easy to dismantle and reassemble appliances correctly. A-B-C directions tell "why" as well as "how" Book covers fundamentals of electricity for beginners. Over 150 manufacturers supplied the servicing and repair data.

FREE 10-DAY EXAMINATION—Coupon will bring you "Electrical Appliance Servicing" to examine FREE—without obligation. Mail it NOW!



Covers ANY Service or Repair on:  
Irons • Toasters • Heaters • Vacuum Cleaners • Sewing and Washing Machines • Refrigerators • Air-Conditioners • Fans • and much more.

McGRAW-HILL BOOK CO., Inc., Dept. PM-10  
327 West 41st St., New York 36, N. Y.

Send Crouse's Electrical Appliance Servicing for 10-DAY FREE EXAMINATION. If not satisfied I will return it—pay nothing. Otherwise, I will keep it—send only \$3 (plus small delivery charge) then—and \$3.00 a month for 2 months to complete payment.

Name \_\_\_\_\_  
Address \_\_\_\_\_ PM-10  
Employed by \_\_\_\_\_  
City \_\_\_\_\_ Zone No. \_\_\_\_\_ State \_\_\_\_\_  
(if any)

WE'LL PAY DELIVERY if you remit (check or M.O.) WITH coupon. Same Refund Privilege. (Offer applies to U. S. only).

MEN AND WOMEN TRAINED AT HOME  
FOR PROSPEROUS BUSINESS IN  
**UPHOLSTERING**

Tools, Supplies, everything necessary to get started sent. Illustrated training shows how — progress rapidly. No previous experience necessary. Make over old furniture, sell for many times cost to you. Establish full or part time money making business. Free booklet explains plan. Send name, address to

COMMERCIAL TRADES INSTITUTE  
1400 GREENLEAF, DEPT. U2-10, CHICAGO 26, ILL.

**REAL ESTATE**  
**BE A BROKER**

PAYS BIG! SEND FOR FREE, BIG, ILLUSTRATED CATALOG NOW! Graduates report making substantial incomes. Start and run your own business quickly. Men, women of all ages, learn easily. Course covers Sales, Property Management, Appraising, Loans, Mortgages, and related subjects. STUDY AT HOME or in classrooms in leading cities. Diploma awarded. Write TODAY for free book! No obligation.

Approved for World War II and Korean Veterans  
WEAVER SCHOOL OF REAL ESTATE (Est. 1936)  
Suite 300 Law Bldg. Dept. PM Kansas City, Mo.

**LEFAX** POCKET SIZE **\$1**  
**TECHNICAL DATA BOOKS** each

Printed on loose leaf, six hole, 6 3/4"x3 3/4" bond paper, each book contains about 140 pages of technical data, presenting condensed, accurate and essential data for the student, engineer, technical worker and business man.

- |                        |                     |                    |
|------------------------|---------------------|--------------------|
| Architecture           | Phys. & Thermodyn.  | Transformers.      |
| Home Heating           | Data                | Relays, Meters     |
| Illumination           | Phys. & Org.        | Hydraulics         |
| Electrician's Data     | Chemistry           | Surveying          |
| Builder's Data         | Metals              | Mechanical Drawing |
| Lumber Data            | General             | Machine Design     |
| Air Conditioning       | Chemistry           | Machinists' Data   |
| General Math.          | Reinforced Concrete | Piping Data        |
| Math. Tables           | Building Constr.    | Surveying Tables   |
| Physics                | Radio               | Trig-Log Tables    |
| Chemical Tables        | Television & FM     | Metallurgy         |
| Mechanics of Materials | Electricity, AC     | Analytic           |
| Power Trans. Mach'y.   | Electricity, DC     | Chemistry          |
| Thermodynamic          | AC Motors and       | Highway            |
| Tables & Charts        | Generators          | Engineering        |

Write for FREE catalogs (over 2000 listings). See for yourself how helpful LEFAX can be to you. Send \$1 for each book (or \$5 for any six books listed above), to

LEFAX DEPT. PM-16 PHILADELPHIA 7, PA.  
POPULAR MECHANICS



Now IN YOUR OWN HOME Learn

# TELEVISION RADIO ELECTRONICS

*the Amazingly Effective*

## D. T. I. WAY

—with the aid of BOTH  
HOME EQUIPMENT  
and HOME MOVIES

NO PREVIOUS EXPERIENCE NEEDED

NOW... get  
**EVERYTHING  
YOU NEED**

for real Laboratory-  
type training  
**AT HOME**

Above:  
Work over  
**300**  
fascinating  
experiments  
with this  
equipment

1. Build over 300 fascinating experiments from 16 BIG SHIPMENTS of Electronic-Radio parts which you KEEP.

2. Build valuable commercial-type test equipment—as shown to the left—which you KEEP. This includes a quality 5 INCH oscilloscope and jewel bearing Multi-Meter—both highly useful for Television work.

3. Build and keep a big 21 INCH TV Set. (D.T.I. offers another home training in Television-Radio-Electronics, but without the TV set.)

4. Use a 16 mm. movie projector and new series of highly instructive movies—a wonderful aid to help you grasp important fundamentals faster... easier... better.

5. Enjoy well-illustrated, easy-to-read lessons with handy FOLD-OUT diagrams.

6. Get an honest-to-goodness EMPLOYMENT SERVICE to help you get a good job after graduating—or assistance in starting your OWN SALES AND SERVICE BUSINESS. Mail coupon today for the complete details.

What will mailing the coupon below do for YOU? Just this! You'll find out about one of today's most remarkable... practical ways to prepare to get into America's amazing billion dollar opportunity field of TELEVISION-RADIO-ELECTRONICS. You'll see how to get into fascinating work that pays well... that offers one of America's most promising futures... that enables you to start your own business almost "on a shoe string," if you prefer this to a job opportunity.

And above all, you'll get some GOOD NEWS especially welcomed by men anxious to earn REAL MONEY in this thrilling field. For you'll see that NOW you can get the kind of practical, laboratory-type training so desirable for making real progress in Television-Radio-Electronics AND WITHOUT LEAVING HOME.

You'll see that DeForest's Training, Inc. sends everything needed to set up your own HOME LABORATORY.

You get and keep the same type of basic electronic equipment used in our modern Chicago Training Laboratories. You get home training that includes the knowledge and experience gained from training thousands of students first hand in Chicago.

And to top it all, you use DTI's amazingly effective and exclusive home training aid—INSTRUCTIVE MOVIES. But why not get the complete story? Mail coupon today for information-packed literature.

### MODERN LABORATORIES

If you prefer, get all your preparation in our new Chicago Training Laboratories—one of the finest of its kind. Ample instructors, modern equipment. Write for details!

### MILITARY SERVICE!

If you're subject to military service, the information we have for you should prove very helpful. Mail coupon today.

Get this  
information-packed publication

**89 WAYS  
TO  
EARN  
MONEY  
IN TELEVISION  
RADIO-ELECTRONICS**

**FREE!**

*Mail Coupon Today*

DEFOREST'S TRAINING, INC. Dept. PM-10-J  
2533 N. Ashland Avenue, Chicago 14, Ill.

I would like your valuable information-packed publication showing how I can get started toward a good job or my own business in Television-Radio-Electronics.

Name..... Age.....  
Street..... Apt.....  
City..... Zone..... State.....

5 INCH  
"SCOPE"

Oscilloscope

Multi-Meter

21 INCH

Build and keep this BIG DTI  
engineered TV set—easily  
converted to U.H.F.

"ONE OF AMERICA'S FOREMOST  
TELEVISION TRAINING CENTERS"  
— Established 1931 —

DEFOREST'S TRAINING, INC.

AFFILIATED WITH

DEVRY Technical INSTITUTE

CHICAGO 14, ILLINOIS

**CONCERT HALL SOCIETY  
INVITES YOU TO ACCEPT THIS**

*Special  
Introductory  
Offer*



L.P.  
33-1/3  
RPM

**ANY ONE OF THESE LONG-PLAYING RECORDS**

**Only \$1.00**  
(WORTH \$4.67 RETAIL)

**MOZART**

Piano Concerto in D, K. 537  
("Coronation Concerto")

**OR SCHUBERT**

Symphony No. 8 ("The Unfinished")

**OR BEETHOVEN**

Sonata in C Minor, op. 13 ("Pathétique") and  
Piano Sonata in A-Flat, op. 110

**H**ERE is an extraordinary opportunity for music lovers! We will send you your choice of one of these delightful recordings—the Mozart concerto brilliantly performed by the celebrated pianist Frank Pelleg; the Schubert Symphony by the Zurich Tonhalle Orchestra, and the Beethoven sonatas by the noted Beethoven interpreter, Grant Johannesson. These recordings represent the ultimate result of the latest high-fidelity recording techniques—yet you may have any one of them for only one dollar!

We make this special offer to demonstrate the remarkable quality of Concert Hall high-fidelity recordings. We also send our free brochure telling how you can obtain our new series of recordings available nowhere else at any price!

**Membership Limited to 3000**

Only 3,000 members can own these limited-edition recordings; and right now only 275 subscriptions are still available. The whole interesting story is told in our free brochure, which we will send with the LONG-PLAYING record described above. Simply enclose one dollar with the coupon. If not delighted with the record, return it in five days and your dollar will be cheerfully refunded.

**Concert Hall Society, Inc. 5710  
507 W. 56th St., New York 19, N. Y.**

I enclose \$1. Please send me the high fidelity LONG-PLAYING record checked below. If not delighted, I may return it in 5 days for refund of my dollar. Also send, free, your brochure describing the new 1953-54 series of Limited Edition recordings.

**MOZART**     **SCHUBERT**     **BEETHOVEN**  
(This special offer good only in U. S. A. and Canada)

Name .....  
(Please Print Plainly)

Address .....

City.....Zone.....State.....

**SAVE 75%  
ON**



**WORK CLOTHES!**

**SURPLUS STOCK FROM  
MIDWEST SUPPLY FIRM!**  
Terrific values you've got to see to believe!

**SHIRTS 79c**

Made to sell for 2.99! Now Only 4 for \$2.99

What a buy! 4 for the price of one! These shirts, though used, are washed, sterilized and ready for long, tough wear. In blue or tan. Send name, address, neck size.

**PANTS to match**

Sold for 3.95 now only ..... **99c**  
Unbelievable Bargains! Send waist measure and inside leg length. 4 for \$3.75

**COVERALLS** ... wear 'em used and save plenty! Originally 5.95. Now only 3 for \$5.45  
Send chest measurement.

**SATISFACTION GUARANTEED!** Money back if you're not convinced these are bargains you can't beat! You can't lose so order TODAY for immediate delivery! Pay postman or send money with your order and save postage.

**GALCO SALES CO., Dept. 1310**  
4064 East 71st Street • Cleveland 5, Ohio

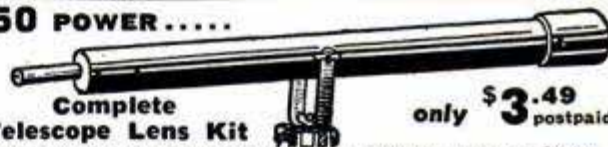


**Bar Bells**

Buy Direct From Factory **\$8.95** up  
Write for free booklet and price list.

**INDEPENDENT IRON WORKS**  
2416 East 23rd Street, Dept. B-10  
Los Angeles 58, Calif.

**250 POWER.....**



Complete Telescope Lens Kit **only \$3.49** postpaid

Conquer Space, Explore the Universe, Planets, Moon Craters, New Stars, etc. Complete Lens Kit consists of 80 inch focal length ground and polished objective lens, eyepiece lenses for 50 POWER, 100 POWER, 150 POWER, 200 POWER, 250 POWER, and all necessary lens fittings. Easy to make from simple step by step instructions. (Tripod and mount not included.) Money back guarantee.

**BUSSE SALES CO., Hartford, Conn., Dept. PM 16**

**ENGINEERING DEGREE IN 27 MONTHS**

**INDIANA TECHNICAL COLLEGE**

**B. S. DEGREE**, Aeronautical, Chemical, Civil, Electrical, Mechanical and Radio Engineering (inc. TV and Electronics). Drafting, 1-yr. G.I. Gov't approved. Low rate. Earn board. Large industrial center. Students from 48 states, 21 countries. Demand for graduates. Enter December, March, June, September. Write for catalog, 16103 E. Washington Boulevard, Fort Wayne 2, Indiana.



**REVERSIBLE AUTO SEAT COVERS**

Made of **FLEXTON** plastic.  
Choice of: **SNAKE-ZEBRA DESIGN**  
or **LEOPARD-COWHIDE DESIGN**

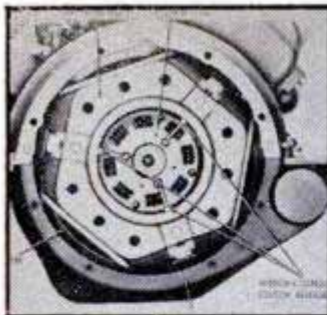
Each Only **\$2.98**

**ORDER FROM MFR. AND SAVE**  
Colorful **SNAKE AND ZEBRA DESIGN** And **LEOPARD-COWHIDE DESIGN**. Can Be Used On Either Side. Water And Stainproof. Tailored With Side Grip Panels For Tight Fit. Sewn With **NYLON** Thread For Long Wear. Simple To Install. Dress Up Your Car With These Colorful Expensive Looking Covers!

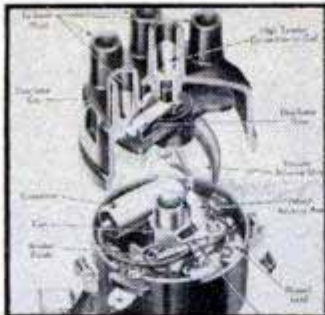
**10 DAY MONEY BACK GUARANTEE**

Choice Of **SPLIT** Or **SOLID** Front Seat Only \$2.98. Complete Set For Both Front & REAR ONLY \$5.00. Specify Design Wanted. Make Of Car And Seat Style. Enclose Payment And Save Postage Or Sent COD.

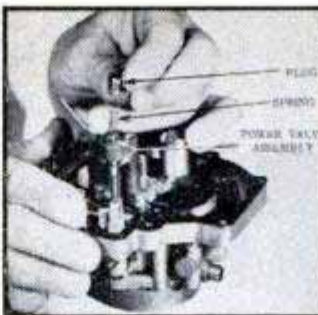
**MARDO SALES CORP., Dept. DS-734**  
480 Lexington Ave., New York 17, N. Y.



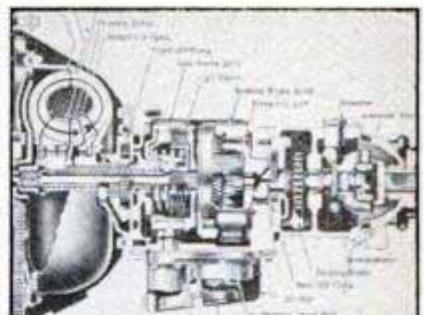
Cut-away diagrams make every operation easy. Above — Ford clutch.



Diagrams, tables and text take the "mystery" out of all ignition systems.



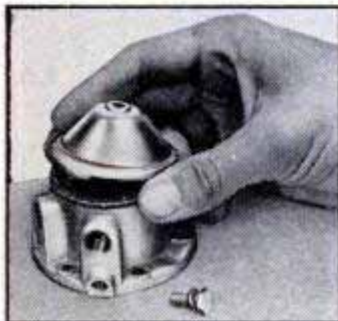
You get illustrated repair procedures for all types of carburetors.



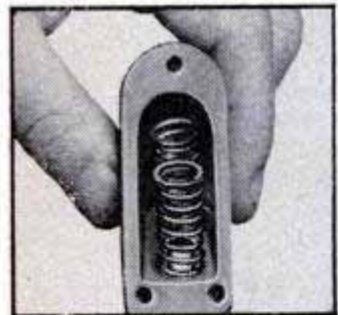
Buick Dynaflo. Book crammed with 2500 diagrams, photos, cutaway pictures (of which these are mere miniatures) that show every part in detail. ALL automatic transmissions are fully covered.

## Here's the EASY Step-by-Step Way to

# FIX ANY CAR IN A JIFFY!



Fuel pumps can cause trouble. Pictures show exactly how to take them apart, fix them.



No guesswork. Clear pictures show how to fix water pump, generator, brakes, chokes, etc.

**Just 2 of the Many Letters of Praise**  
Does Every Job. "My MOTOR Manual is a wonderful help. It has a position to do every job." — S. L. Sharpless, Los Angeles, Calif.

**Amazed Self and Friends.** "I amazed myself and my friends, too. Now do jobs that stumped me before." — Michael Baliczky, Newark, N. J.

**Now—Whether You're a Beginner or Expert Mechanic—You Can "Lick" Any Auto Repair Job On Any Car Built Since 1935**

**N**OW you can tackle any repair job, and do it quickly, easily, right—the first time! MOTOR'S BRAND-NEW AUTO REPAIR MANUAL shows you how—with crystal-clear pictures and step-by-step directions you can easily follow.

No guesswork. This giant guide tells you where to start; what tools to use. Leads you easily and quickly through the entire operation. Covers everything from a simple carburetor adjustment to a complete overhaul.

### Everything You Need to Know

**BIG, NEW REVISED Edition has MORE REPAIR INFORMATION THAN EVER!** Over 850 giant pages, 2,500 "This-Is-How" pictures — clear drawings, diagrams, cut-away photos — make every step EASY. Over 200 "Quick Check" charts — more than 37,000 essential repair specifications. Over 227,000 service and repair facts. Instructions and pictures so COMPLETE, so CLEAR — you CAN'T go wrong!

Even a green beginner can do a good job. If you're a top mechanic, you'll be amazed at the time-saving procedures.

### The "Meat" of Over 189 Official Shop Manuals

The editors have put together the "Know-How" from over 189 Official Shop Manuals; "boiled it down" into one handy indexed book.

Includes ALL Automatic Transmissions (including Dual Range Hydra-Matic). Covers the newest Carburetors, Engines (including new Buick & Dodge V-8s) ... Chokes ... Fuel Pumps ... Oil Filters ... Starting Motors ... Generators ... Distributors ... Clutches ...

Universals ... Axles ... Brakes ... Power Steering ... Shock Absorbers, etc.

Factory Specifications and Adjustment Tables. Tune-up Charts. Tables of Measurements and Clearances. Overhauling and Replacement Facts—AND MUCH MORE.

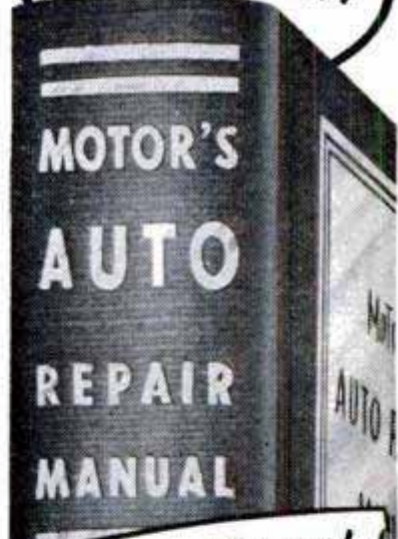
Used by Armed Forces, hundreds of thousands of auto service men! YOU'LL want to try it, too—on the following UNCONDITIONAL GUARANTEE:

### Try Book for a Week FREE

SEND NO MONEY. Pay nothing to postman. Test book in your own garage or shop. It's GUARANTEED to pay for itself in 7 days. If it doesn't just return the book, and owe nothing. Rush coupon for your free-trial copy of this great money-saving Manual. MOTOR Book Dept., Desk 110, 250 West 55th St., New York 19, N. Y.

USED BY  
U.S. ARMY  
NAVY  
MARINES

**BRAND-NEW EDITION!**



**SEND NO MONEY! TRY BOOK FOR A WEEK FREE!**

### MAIL COUPON NOW FOR 7-DAY FREE TRIAL

MOTOR Book Dept., Desk 110, 250 West 55th Street, New York 19, N. Y.

Rush to me at once: (Check box opposite book you want.)  
 MOTOR'S New AUTO REPAIR MANUAL. If okay, I'll remit just \$1.00 in seven days, then \$2.00 monthly for two months and a final payment of 95c (plus 35c delivery charges) one month after that. Otherwise, I'll return the book postpaid in seven days. (Foreign price: Remit \$8.00 cash with order.)  
 MOTOR'S New TRUCK AND TRACTOR REPAIR MANUAL. (Described at left.) If okay I will remit \$2.00 in seven days, and \$2.00 monthly for three months, plus 35c delivery charge with final payment. Otherwise, I will return book promptly. (Foreign price: Remit \$10.00 cash with order.)

Print Name.....Age.....  
 Print Address.....  
 City & Zone No.....State.....  
 SAVE 35c delivery charge by enclosing WITH COUPON check or money order for full payment of \$5.95 for Auto Repair Manual (or \$8.00 for Truck and Tractor Manual). Same 7-day return-for-refund privilege applies.

**Same FREE 7-Day Offer on MOTOR'S TRUCK and TRACTOR REPAIR MANUAL**

Covers EVERY job on EVERY gasoline-powered truck and farm tractor made from 1939 thru 1953. 2200 pictures, 904 big 8 1/2 x 11 inch pages, 300,000 facts. Check proper box in coupon for free trial.

**COVERS 907 MODELS— ALL THESE MAKES**

|           |           |            |
|-----------|-----------|------------|
| Buick     | Henry J   | Nash       |
| Cadillac  | Hudson    | Rambler    |
| Chevrolet | Kaiser    | Oldsmobile |
| Chrysler  | Lafayette | Packard    |
| Crosley   | La Salle  | Plymouth   |
| De Soto   | Lincoln   | Pontiac    |
| Dodge     | Mercury   | Studebaker |
| Ford      | Nash      | Terraplane |
| Frazer    |           | Willis     |

These great minds were Rosicrucians . . .



Francis Bacon Benjamin Franklin Isaac Newton

## WHAT SECRET POWER DID THEY POSSESS?

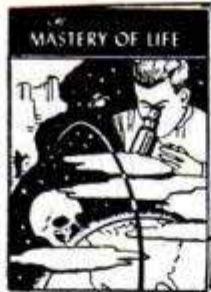
### Why were these men great?

How does anyone—man or woman—achieve greatness? Is it not by mastery of the powers within ourselves?

Know the mysterious world within you! At-tune yourself to the wisdom of the ages! Grasp the inner power of your mind! Learn the secrets of a full and peaceful life!

Benjamin Franklin, statesman and inventor . . . Isaac Newton, discoverer of the Law of Gravitation . . . Francis Bacon, philosopher and scientist . . . like many other learned and great men and women . . . were Rosicru-cians. The Rosicrucians (NOT a religious organization) have been in existence for centuries. Today, headquarters of the Rosicrucians send over seven million pieces of mail annually to all parts of the world. Ad-dress: Scribe A.K.T.

**THIS BOOK FREE**



## The ROSICRUCIANS

San Jose (AMORC) California, U.S.A.

—SEND THIS COUPON—

Scribe A.K.T.  
The ROSICRUCIANS  
(AMORC)  
San Jose, California, U.S.A.

Please send me the free book, *The Mastery of Life*, which explains how I may learn to use my faculties and powers of mind.

Name \_\_\_\_\_

Address \_\_\_\_\_

City \_\_\_\_\_

State \_\_\_\_\_

**SAVE UP TO 50% & MORE!**

from New York's leading  
**PAWNBROKER**

**GENUINE DIAMONDS**

Buy diamonds and diamond jewelry half-priced from Kaskel's, America's foremost Pawnbroker. Every diamond is re-set in a luxurious new mounting . . . graded according to nationally accepted standard . . . and bonded to this effect. For over 70 years we've served over 1,000,000 satisfied customers from all 48 States.

**10 DAY UNCONDITIONAL MONEY-BACK GUARANTEE.**

References:  
Your bank,  
or any  
Rating  
Agency.

SEND FOR BIG

**FREE ILLUSTRATED CATALOG**



**KASKEL'S** 9 Columbus Avenue, Dept. 307K  
New York 23, N. Y.

**A "GOOD HAND" HELPS YOU SUCCEED!**

**LEARN TO WRITE WELL**

*Your Name*

beautifully written, plus special pen-point for shaded writing.

Only 10¢

OUR 53rd YEAR

Handwriting quickly improves with our easy-to-understand picture lessons! Put your spare time to good use; send today for  FREE BOOKLET, "How to Become a Good Penman," or check volumes wanted below at \$1 each:  Business Writing  Artistic Writing  Card Writing  Bird & Design Flourishing  Engraving Alphabets. COMPLETE SET \$4.50. Ask for price list of penman's supplies.

**TAMBLYN SCHOOL of PENMANSHIP**  
S.A. Ziller, Pres., 442 Ridge Bldg., Kansas City, Mo., USA



**MAGNETS** **225 lb. PULL**  
GENUINE ALNICO—NEVER WEAKENS

**AMAZING, PERMANENT MAGNETS—WILL NOT WEAKEN! NON-ELECTRIC**  
Retrieve guns, tackle, tools and other steel items from lake, river, plating tanks, drains or other hard-to-reach spots. Recover drills, taps, etc. from sweeping. Clear alley of harmful tacks, nails. Many other uses. Pays for itself quickly. **GUARANTEED.** Try any magnet one week. Money refunded if you are not well pleased.  
No. M-725 (Weights 54 oz.) Has pull of 225 lbs. on steel block. \$15.00  
No. M-675 (Weights 49 oz.) Has pull of 175 lbs. on steel block. \$10.50  
No. M-650 (Weights 41 oz.) Has pull of 150 lbs. on steel block. \$ 8.50  
No. M-500 (Weights 15 oz.) Has pull of 50 lbs. on steel block. \$ 4.00  
No. M-30 Hobbyist assortment of six small magnets. . . . \$ 1.50  
Send Money Order or Check. We pay postage. No C.O.D.'s.  
**MIAMI MAGNET COMPANY, 3240 N. W. 27th Ave., Miami 42, Fla.**



**ITALIAN ACCORDIONS**  
**AT LOWEST WHOLESALE PRICES**

**5-DAY FREE TRIAL**

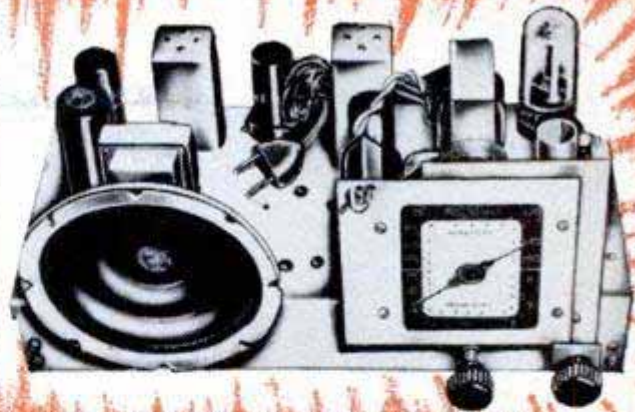
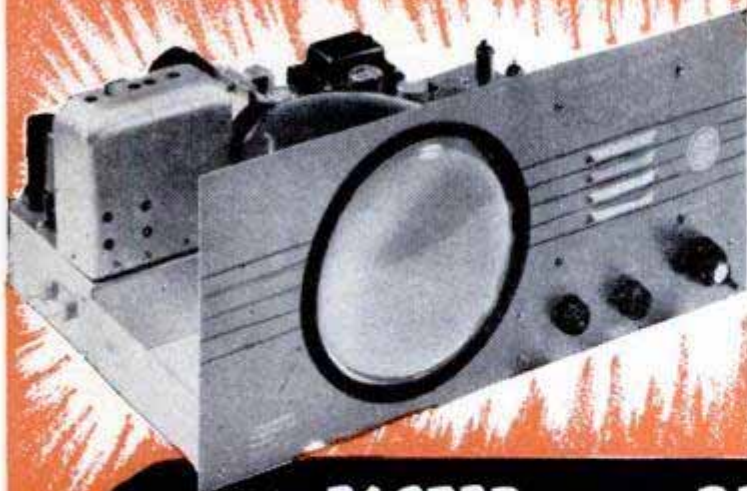
**"PAY AS YOU PLAY"**  
Small Down Payment  
As Little As  
**\$10** per month

**DIRECT from Importer to You!**

**SATISFACTION GUARANTEED**, or your money back! NOW you can save up to 50% by direct purchase from America's leading distributor of famous genuine **ITALIAN ACCORDIONS**. TRADE-INS ACCEPTED

Send for **FREE Illustrated Catalog!**

**ACCORDION MANUFACTURERS & WHOLESALE OUTLET**  
2003 West Chicago Ave. Dept. R103, Chicago 22, Ill.

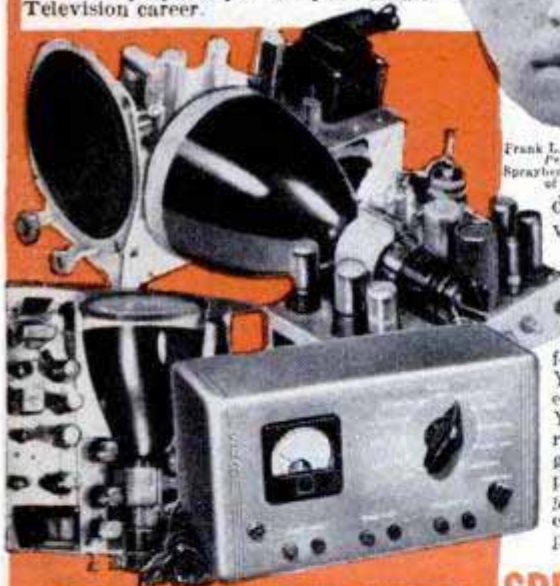


TRAIN **FASTER**—TRAIN **BETTER**—TRAIN **EASIER**  
 IN 10 MONTHS—OR LESS—FOR  
**RADIO-TELEVISION**

Our 21st Year Training Men for Greater Incomes and Security in Radio-Television

I SEND YOU  
**18 BIG KITS**

of Radio Television parts and equipment. Much of your training will be actual construction and experimentation . . . the kind of truly PRACTICAL instruction that prepares you for your Radio-Television career.



Frank L. Sprayberry  
 President  
 Sprayberry Academy  
 of Radio

**NEW! NO OBLIGATION PLAN**

You Have No Monthly Payment Contract to Sign  
 Pay For Your Training as You Earn and Learn

You can get into Radio-Television, today's fastest growing big money opportunity field, in *months* instead of years! My completely new "package unit" training plan prepares you in as little as 10 months or even less! *No monthly payment contract to sign—thus NO RISK to you!*

This is America's finest, most complete, practical training—gets you ready to handle any practical job in the booming Radio-Television industry. Start your own profitable Radio-Television shop . . . or accept a good paying job. I have trained hundreds of successful Radio-Television technicians during the past 21 years—and stand ready to train you, even if you have no previous experience! Mail coupon and get all the facts—FREE!

**Valuable Equipment Included  
 With Training**

The new Sprayberry "package" plan includes many big kits of genuine, professional Radio-Television equipment. You perform over 300 demonstrations, experiments and construction projects. You build a powerful 6-tube 2-band radio set, multi-range test meter, signal generator, signal tracer, many other projects. All equipment and lessons are *yours to keep* . . . you have practically everything you need to set up your own profitable Radio-Television service shop.

**Earn Extra Money While You Learn!**

All your 10 months of training is IN YOUR HOME in spare hours. Keep on with your present job and income while learning. With each training "package" unit, you receive extra plans and "Business Builder" ideas for spare time Radio-Television jobs. New television stations everywhere, open vast new opportunities for trained Radio-Television Technicians—and those in training. If you expect to be in the armed forces later, there is no better preparation than practical Sprayberry Radio-Television training.

**YOU BUILD** the Television set and the powerful superhet radio receiver shown above IN ADDITION to the other test units shown here. (Many are not illustrated.)

Approved for Veterans under the G. I. Bill

**SPRAYBERRY ACADEMY OF RADIO** 111 NORTH CANAL ST.  
 Dept. 10-B, Chicago 6, Ill.

**MAIL COUPON  
 TODAY!  
 NO OBLIGATION**

I invite you to get all the facts —

**FREE TO YOU 3 BIG  
 RADIO-TELEVISION BOOKS**

Rush coupon for my three big Radio-Television books: "How to Make Money in Radio-Television," PLUS my new illustrated Television Bulletin PLUS an actual sample Sprayberry Lesson—ALL FREE. No obligation and no salesman will call. Mail coupon NOW!

**SPRAYBERRY ACADEMY OF RADIO, Dept. 10-B**

111 North Canal St., Chicago 6, Ill.

Please rush to me all information on your 10-MONTH Radio-Television Training Plan. I understand this does not obligate me and that no salesman will call upon me. Be sure to include 3 books FREE.

Name..... Age.....

Address.....

City..... Zone..... State.....



# EARN MORE IN DRAFTING



More Opportunities for Employment and Promotion

"Here I am at work making good money as a draftsman. I'm glad I sent the coupon to Chicago Tech for that Free Trial Lesson and found out how easy it is to learn Drafting in spare time at home. Today I feel secure in my job because the draftsman's work comes first on any new project. And, in addition, draftsmen can't be replaced with machines. What's more, I feel I'm slated for promotion and more pay, because I see so many draftsmen advancing to high-pay jobs."

## LEARN IN SPARE TIME - AT HOME!

(or at the College in Chicago)

A few hours of pleasant home study every week—that's all. No interference with your present job. All the tools you need; drawing outfit included. With Chicago Tech's help, you train yourself step by step. This tested method—developed over 48 years of C.T.C. progress—prepares men quickly for good positions in industry.



### FREE INFORMATION—SEND COUPON

To prove to you how easy it is to learn Drafting at home by the Chicago Tech method, we will send you this FREE TRIAL LESSON. No charge for this lesson, now or later. Fill out and mail coupon, or send post card today.

## CHICAGO TECHNICAL COLLEGE

N-251 Tech Bldg., 2000 So. Michigan Ave., Chicago 16, Illinois

Mail me FREE Lesson with information about big opportunities in DRAFTING.

Name \_\_\_\_\_ Age \_\_\_\_\_

Address \_\_\_\_\_

City \_\_\_\_\_ Zone \_\_\_\_\_ State \_\_\_\_\_

# UNLIMITED OPPORTUNITIES IN ENGINEERING

DEGREE IN 27 MONTHS

Study Engineering in this world-famed school. Established 1884. Demand for our graduates exceeds supply. Approved for Korean Vets.

Bachelor of Science Degree in Mechanical, Civil, Electrical, Chemical, Aeronautical, Radio (Television) Engineering; Business Administration and Accounting. Also 36-weeks certificate courses in Surveying and Drafting.

Personalized Instruction. Accelerated courses. Non-essentials eliminated. For ambitious, earnest students. Earn your degree in the shortest possible time. Preparatory courses. Placement service.

Extensive Campus. Well equipped, new and modernized buildings; up-to-date labs. Low cost. New terms start quarterly. Enter January, March, June, September.

Mail Coupon Today

## TRI-STATE COLLEGE

4103 College Avenue, Angola, Indiana

Please send me free catalog and special information. I am particularly interested in courses as checked:

- Mechanical  Civil  Electrical  Chemical  Aeronautical  
 Radio (Television)  Business Administration  Accounting  
 Short Diploma Courses

Name \_\_\_\_\_

Address \_\_\_\_\_



I'LL PAY YOU to Introduce Amazing Nylons (guaranteed against runs) BY GIVING AWAY FREE SAMPLE PAIRS!

How would you like to give every woman a pair of beautiful nylons as a gift (regardless whether or not final purchase is made) just to prove how good they are? Man or woman, young or old, you can earn up to \$3 an hour introducing amazing nylons guaranteed against runs and snags. You buy nothing. Deliver nothing. Advance cash plus huge 40% cash bonus. Mail postcard NOW for free sample stocking and money-making outfits prepaid. Nothing to pay now or later. No obligation.



KENDEX CORPORATION, BABYLON 246 N. Y.

## NOW LEARN TV-RADIO Servicing AT HOME!

EARN WHILE YOU LEARN! No previous training needed. New, simplified lessons with complete parts kits. Build your own TV set! A leading school, approved for Korean vets. Also Residential Course (day & eve. classes). Send for FREE sample lessons and full details on a PROFITABLE, thrilling career. Write Dept. B10

## CRESCENT SCHOOL

500 PACIFIC ST.

BROOKLYN 17, N. Y.

## BRAND NEW NYLON COVERS

for outdoor storage of cars, boats, machinery, equipment, etc.

Strongest, lightest cover ever made. New DuPont Nylon with 1 side rubberized and the other of soft nylon, cannot scratch car surface. Will not harden, crack or mildew. Secured with heavy elastic and brass grommets. Protection against wind, rain, sun, snow, frost, etc. 15-day money-back guarantee. Material very many times stronger than regular plastics. Olive green color.



Give Car Model

Larger Size for Caddy, Linc., etc. \$2.95 extra

Nylon tarps to order, heavier weight, double coated, 8 oz., brass grommets, 10c sq. ft. Size Standard \$17.95 plus 90c postage

DEFENDER TEXTILE CORP., 425 B'way, Dept. PM-2, N. Y. 13, N. Y.



Send for FREE BOOKLET

## LEARN LOCKSMITHING

Learn this fascinating, profitable trade from experts in your spare time at home! Age or physical handicap no disadvantage. Year around, steady income. Full or part time. Practical, illustrated lessons. You can make money even while learning! All materials and special tools supplied without extra charge.

INSTITUTE OF LOCKSMITHING, Dept. P-47  
 15 PARK AVENUE RUTHERFORD, N. J.  
 Lic. by N.J. State Board of Educ.  
 Approved for Vets

## MOST TERRIFIC LIGHTER VALUE EVER OFFERED!

You've seen similar LIGHTERS selling up to \$10.00

Fully automatic. Push-up windshield chrome finish. Size 2 1/4" x 1 3/4" Machine-turned. You would expect to pay several times as much! Bargain priced to win 10,000 new customers. You must agree it's the best value you've ever seen or money promptly refunded. Sent postpaid when you remit with order.



SEND FOR FREE WAR SURPLUS CATALOG

only \$1.88 POST PAID

SIoux FALLS SURPLUS STORE, SIoux FALLS, S. D.

# THOUSANDS NOW PLAY

## who never thought they could!



**"Opened Door to Popularity"**

"I was able to play many pieces in a short time. Family and friends certainly surprised. Course opened door to popularity, wider circle of friends. Recently I entered amateur contest—won First Prize."—Peter H. Kozyra, Manitoba, Canada.



**Course Inspires Music Circle**

Shown above is Miss Mildred Cade, of Houston, Texas. She and a number of her friends are so enthusiastic about the U. S. School of Music's quick easy way of learning that they've ALL taken it up.



**Plays Banjo in a Short Time**

"Enjoy your lessons for the Tenor Banjo; am progressing rapidly. Lessons are so simple, anyone can understand; yet so thorough I have learned to play by note in little more than a month!" — Andrew Schneider, Hanna, Wyoming.



**"Can't Thank Your School Enough"**

"Never studied music before. Your method is easy; being your own teacher is best. After 4 lessons, I could play a few pieces. Now play any piece I like. Can't thank you enough." — Rose Boyer, Blackwell, Mo



**Learns Faster Without Teacher**

"I have no special talent — but thanks to you I play my guitar better than many who have taken lessons from teachers longer, and naturally at higher cost." — Myrella-Muquette Saint Andre, Montreal, Canada.



**Now a Famous Orchestra Leader**

"I got my start in music with a U. S. School Course. How easy it is to learn to read notes, play an instrument, this 'teach-yourself' way! I've enrolled my two daughters." — Lawrence Welk.

## You, too, can play any instrument— By this EASY A-B-C Method

You think it's difficult to learn music? That's what thousands of others have thought! Just like you, they long to play some instrument — the piano, accordion, violin, guitar, saxophone or some other favorite. But they denied themselves the pleasure — because they *thought* it took months and years of tedious study to learn!

### Learn in Spare Time at Home

And then they made an amazing discovery! They learned about a wonderful way to learn music at home — without a private teacher — without tedious study — and in a surprisingly short time. They wrote to the U. S. School of Music for the facts about this remarkable short-cut method. And the facts opened their eyes! They were amazed to find how easy it was to learn!

### 900,000 Students!

The result? Over 900,000 men and women have taken up music at home this simple, A-B-C way. Now, all over the world, enthusiastic music-lovers are enjoying the thrilling satisfaction of creating their own music. They have found the key to good times, and popularity.

### CHOOSE YOUR FAVORITE INSTRUMENT

Piano, Guitar, Piano Accordion, Violin, Haw. Guitar, Mandolin, Trumpet, Cornet, Saxophone, Tenor Banjo, Organ, Ukulele, Clarinet, Trombone, Flute, P.c-colo. Write your choice in coupon.

### Costs Only Few Cents a Lesson

And that's what you can do, right now. NO TEDIOUS PRACTICING OF BORING SCALES AND EXERCISES! Even if you don't know a single note now, you'll "start right in on pieces." This builds up your skill and confidence so rapidly that soon you'll be able to play ALL your favorite songs and compositions *by note*. It's all so clearly explained—so EASY to understand—that even children "catch on" at once.

Get the proof that you, too, can learn to play your favorite instrument — quickly, easily, in spare time at home for only a few cents a lesson!

## FREE BOOK AND FREE LESSON-SAMPLE

Never mind if you have no musical knowledge, training or talent. Just read the fascinating FREE BOOK and Lesson-Sample that fully explain all about the famous U. S. School method. (Instruments supplied when needed, cash or credit.) If interested tear out the coupon now, before you turn the page. U. S. SCHOOL OF MUSIC, Studio C3010, Port Washington, N.Y. (55th Successful Year.)



### U. S. SCHOOL OF MUSIC, Studio C3010, Port Washington, N. Y.

Send me FREE BOOK and FREE Lesson-Sample. No obligation —and no salesman is to call upon me. I'm interested in play-

ing (name instrument) \_\_\_\_\_  
 I do  I do NOT — have instrument now.

Name \_\_\_\_\_ (please print)

Address \_\_\_\_\_

# DRAFTING *pays* BIG MONEY



Draftsmen earn more, enjoy pleasanter working conditions. Get into DRAFTING and Blue-Printing, the starting point of all production. Trained Draftsmen are needed everywhere. Machines can never replace the draftsman.

## LEARN AT HOME IN SPARE TIME

Revolutionary new method teaches you quickly the hows and whys of Mechanical, Structural, Machine, Architectural, etc. Drafting. You are sent professional drafting instruments, drafting equipment, portable drafting table, etc., at no extra cost. You learn by making actual drawings.

**BIG MONEY... ADVANCEMENT OPPORTUNITIES** offered trained draftsmen. Drafting is light, pleasant work paying big salaries. Is a stepping stone to top managerial jobs. The draftsman plans the World of Tomorrow. That is why drafting is such interesting work.

## OWN YOUR OWN DRAFTING FIRM

The investment requirement is small, the earning possibilities great. Many draftsmen eventually branch out into manufacturing the products they created. Learn of the opportunities in Drafting.

## MAIL THIS COUPON TODAY!

CHRISTY TRADES SCHOOL, Dept. DB-2003  
4432 N. Kedzie Ave., Chicago 25

Mail at once your big FREE book on Drafting and Blue-Printing. Tell me how your Home Training and Professional Drafting Instruments, Portable Drafting Table, Drafting Equipment, etc. can be had on a PAY AS YOU LEARN plan.

NAME \_\_\_\_\_ Age \_\_\_\_\_  
ADDRESS \_\_\_\_\_ CITY \_\_\_\_\_ STATE \_\_\_\_\_

## LEARN WATCH REPAIRING



**AT HOME.** By our modern and original system of instruction you can learn every part of the **WATCH REPAIRING TRADE AT HOME.** Prepare yourself for a well-paying position or start in business after completing our course of instruction. Good watch repairers are in demand and generally earn very good salaries. For particulars apply to the **WISCONSIN SCHOOL OF WATCH REPAIRING** 759 N. Milwaukee St., Milwaukee 2, Wis.

## Say You Saw It in Popular Mechanics

LOW OVERHEAD-LARGE VOLUME SALES & SMALL PROFITS  
BRING YOU THESE "LOWEST PRICES."

WHAT GOOD IS A TIRE WITHOUT A TUBE?

**TUBE GIVEN WITH EVERY TIRE AT NO EXTRA COST**

**WHY PAY MORE!**

20 YEARS AT THIS ADDRESS AN ESTABLISHED POLICY OF CAREFUL SELECTION ASSURES YOU, MANY HAPPY MILES. BE WISE—TRY ONE—YOU'LL BUY MORE! WE WELCOME COMPETITION. NO ONE CAN TOUCH OUR QUALITY & PRICE!

**YOU GET WHAT WE ADVERTISE**

GOOD USED TIRES — NOT RECAPS — NOT RETREADS

**FALL SPECIALS — SEND THIS AD EVERYBODY MAY TAKE 10% off ON EVERY TIRE 20 MONTHS WRITTEN GUARANTEE**



|   |        |           |        |           |        |            |         |
|---|--------|-----------|--------|-----------|--------|------------|---------|
| 600-16  | \$4.12 | 820-15    | \$5.32 | 600-20    | \$7.02 | 32x6(8)    | \$8.52  |
| 650-16  | 5.52   | 700-15    | 4.52   | 650-20    | 7.82   | 32x6(10)   | 9.82    |
| 700-16  | 5.02   | 1670-15   | 4.42   | 700-20    | 8.42   | 900-20     | 13.12   |
| 650-15  | 4.32   | 1710-15   | 4.62   | 750-20    | 8.52   | 1000-20    | 13.72   |
| 760-15  | 4.92   | 850-17    | 4.42   | 825-20    | 14.62  | 1100-20    | 13.82   |
| <b>EXTRA SPECIAL—30 MONTH WRITTEN GUARANTEE—FREE TUBE</b> |        |           |        |           |        |            |         |
| 600-16  | \$5.32 | 475-19    | \$4.82 | 700-15(6) | \$8.92 | 700-20     | \$11.02 |
| 600-16(6)   | 6.42   | 640-15    | 5.02   | 750-16(8) | 10.72  | 750-20(10) | 15.42   |
| 650-16  | 5.82   | 670-15    | 5.52   | 700-17    | 9.92   | 750-20(8)  | 15.02   |
| 650-16(6)   | 7.32   | 710-15    | 5.72   | 750-17    | 11.72  | 125-20     | 18.32   |
| 700-16  | 6.42   | 780-15    | 6.02   | 750-15    | 13.92  | 900-20     | 17.22   |
| 750-16  | 9.22   | 800-15    | 6.52   | 925-15    | 12.92  | 1000-20    | 17.72   |
| 825-18  | 4.72   | 820-15    | 6.62   | 600-20    | 8.72   | 1100-20    | 19.52   |
| 550-17  | 4.72   | 670-16    | 6.32   | 650-20    | 10.22  | 1000-22    | 19.42   |
| 650-15  | 5.32   | 760-16    | 7.12   | 32x6(8)   | 11.12  | 1100-22    | 20.42   |
| 700-15  | 5.42   | 700-16(6) | 7.62   | 32x6(10)  | 11.72  | 1100-22    | 20.42   |
| All White Walls \$1.50 extra Military treads 750-20 16.12 |        |           |        |           |        |            |         |

Thousands of tires shipped all over U.S.A. All tires shipped F.O.B. Phila. Send Check or M.O. with this ad. Dept. 2.

**STANDARD 834 N. Broad St., Philadelphia 30, Pa.**

## PORTABLE GARAGE



### PLASTIC VINYL

● Goes wherever your car goes ● Folds compactly ● Keeps rain, dust, salt air, sun away ● Protects your car's finish ● Durably constructed of vinyl plastic that is long wearing and tough ● Nylon threads for extra security ● Springtite elasticized bottom, holds securely in all kinds of weather ● Fits all makes and models ● Machinery, equipment, furniture, stock piles, etc. ● Direct from manufacturer ● Enclose check or money order for \$6.95 or \$8.95, or sent C.O.D. Add 35c postage. 10-Day Money Back Guarantee

**MARDO SALES CORP.**

480 Lexington Ave., Dept. G-555, New York 17, N. Y.



## SEND FOR THIS FREE!

Make money. Know how to break and train horses. Write today for this book **FREE**, together with special offer of a course in Animal Breeding. If you are interested in Galting and Riding the saddle horse, check here ( ) Do it today—now.

**BEERY SCHOOL OF HORSEMANSHIP**  
Dept. 11010 Pleasant Hill, Ohio



## Wild Life Films

Exciting, dramatic action in the natural habitat of animals of forest and plains. 8 mm or 16 mm in beautiful color or B & W. Also 2" x 2" color slides. Write for free illustrated literature.

**WILD LIFE FILMS**

5151 Strohm Ave., Rm. 2K, No. Hollywood, Calif.

## Save Hundreds of Dollars On Home Repairs . . . .

**Add to Your Home's Beauty and Comfort . . . Increase Its Selling Price**

Here is the last word in dependable, money-saving help for the homeowner. *Guide to Home Repairs*, written by the editors of *Popular Mechanics*, gives you the know-how you need to repair and maintain plumbing; install and repair wiring; paint and decorate; install insulation; etc.

192 Pages  
646 Illustrations  
**\$2.50**

### Step-by-Step Instructions Tell How — Pictures Show How

First you read how to do it in the famous *Popular Mechanics* "Written So You Can Understand It" style and then hundreds of photos, drawings and diagrams show you how it is done. Nothing is left to the imagination. Now you can lay floor tile and linoleum, repair doors and windows, tuckpoint, repair and install gutters, etc. Order your copy today. If it isn't entirely satisfactory you may return it in seven days for a full refund.



**POPULAR MECHANICS PRESS, Dept. HR-10**  
200 E. Ontario St., Chicago 11, Ill.

Send at once my copy of *Guide to Home Repairs*. My remittance for \$2.50 is enclosed. If it isn't satisfactory I may return it in 7 days for a full refund.

NAME \_\_\_\_\_  
ADDRESS \_\_\_\_\_  
CITY \_\_\_\_\_ ZONE \_\_\_\_\_ STATE \_\_\_\_\_  
 Check here for C.O.D. shipment. (U.S.A. only). Postage extra.



*America's Great Diamond Values*

OUT OF PAWN...



# GENUINE DIAMONDS

VALUES FROM \$10 TO \$10,000

TOP QUALITY

Send for Brand New 36 PAGE FREE ILLUSTRATED CATALOG

Over 100,000 satisfied customers have bought their diamonds from Berman's

MONEY-BACK GUARANTEE      ALL DIAMONDS RESET IN BRAND NEW MODERN MOUNTINGS

Our Reference Your own bank or any mercantile agency.

**Berman's Diamond Loan Bank**  
 Dept. P —BERMAN BLDG., BALTO. 1, MD.



## GIANT BALLOONS

Surplus U. S. Gov't. (new—overage) NEOPRENE weather, target balloons. For FUN or PROFIT. Great sport in the backyard; or for parties, picnics, dances, fairs, MONEY-MAKERS. Use these balloons to attract crowds to civic events, conventions, exhibitions, trade shows, TERRIFIC for high school and college PROMS. All sizes are approx. inflated size. Postage prepaid on prepaid orders.

3 ft. dia. 49c—6 ft. dia. 99c—13 ft. dia. \$1.59  
 20 ft. dia. \$1.95

• Calif. residents please add sales tax.

**WAR ASSETS DIV. VOLUME SALES CO.**  
 Dept. M-10-53 3930 Sunset Blvd. Los Angeles 29, Calif.

## CASTING SECRETS REVEALED

Big money! Cast 1000's of plaques, figurines, etc. with X.L. rubber molds. No exper., little capital req. X.L. rubber pts. \$2.50, qts. \$4 (postage extra). Models, rubber for 3 molds, \$1.50 ppd. Send 25c (refundable) for 40 pp fact catalog.

**HUGE PROFITS! MORE MONEY!**



**PLASTIC ARTS STUDIO, Dept. 3,**  
 3403 S. Madison St., Muncie, Ind.

## Secrets of VENTRILOQUISM Now Revealed!



Easy to learn in 60 to 90 days with our Home Study Course. **RESULTS GUARANTEED.** Make Money! Be Popular! Have Fun! Big Opportunity! Radio, Television, Stage Appearances! For FREE information regarding price and terms, WRITE. You must state your age. Dummy Catalog 25c.

**FRED MAHER SCHOOL OF VENTRILOQUISM**  
 Box 36, Studio J Kensington Station  
 Detroit 24, Michigan

## Develop Hidden Earning Power

# STUDY LAW

### at home! LL.B. Degree

Qualify yourself in spare time for advancement, greater earnings, business success. Now, more than ever, legal ability is in demand! Easy-to-understand step-by-step lessons and text material furnished -- invaluable for permanent reference. Over 40 years expert instruction. 114,000 students enrolled. Easy payments. Find out now, at no cost, how study of law can help you. Write today for FREE Book "Law and Executive Guidance."

**AMERICAN EXTENSION SCHOOL OF LAW**  
 Dept. PM-67, 664 N. Michigan Ave., Chicago, Ill.

# FIX CARS!

## All Makes — All Models

Fix cars easier than you may have thought possible! Train to be a well-paid expert in a field that is clamoring for good men!

Just look up in the giant 752-page Chilton "ALL CARS" Manual the make, model and part of the car you want to repair. It shows what to do... exactly how to do it. Covers step-by-step details on specific jobs... not a lot of meaningless theory. Widely used in garages, schools and for Army-Navy training. Ideal for teaching beginners. A gold mine of time-saving data for experienced mechanics. Helps you work faster—and better!




## MAKES TOUGH JOBS EASY... MAKES EASY JOBS A CINCH!

Contains easy-to-understand service details on every model made from 1940 through June 1953: BUICK, CADILLAC, CHEVROLET, CHRYSLER, DESOTO, DODGE, FORD, FRAZER, HENRY J., HUDSON, KAISER, LINCOLN, MERCURY, NASH, OLDSMOBILE, PACKARD, PLYMOUTH, PONTIAC, STUDEBAKER, WILLYS—over 1100 models. 350 Quick Check Data Tables and more than 2,000 illustrations explain service operations almost at a glance. Order Chilton "ALL CARS" Manual in coupon. Practice 10 days free!

**New Edition**  
 Tops for training beginners!... helps experienced mechanics do jobs in minutes instead of hours!  
 Published by Chilton... world's largest automotive publishers.  
**Only \$5.95**

## FIX CHEVROLETS!



Backed with this 132-page Manual, you'll find it twice as easy to be an expert on Chevrolet repairs! Covers service details on EVERY Chevrolet car made from 1940 through June 1953. Complete—accurate—authentic. Dozens of clear illustrations plus 55 page section "General Service and Trouble Shooting." Order Chevrolet Manual in coupon. Money-back guarantee!

**Only \$2.75**

## FIX FORDS!



Handle practically any Ford repair job easier than you may have dreamed! Gives easy step-by-step service instructions on EVERY model between 1940 and June 1953 plus 55-page section on "General Service and Trouble Shooting." 144 pages; over 440 illus.; 36 Quick Check Data Tables, etc. Specify Chilton Ford Manual in coupon. Money-back guarantee!

**Only \$2.75**

## FIX PLYMOUTHS! DODGES and DESOTOS!

Here is your master guide to fast, easy service on EVERY Plymouth, Dodge and DeSoto passenger model made between 1940 and June 1953. Just look up the job you want to do! 132 pages; over 365 illus.; 53 Quick Check Data Tables plus 55-page section on "General Service and Trouble Shooting." Order Chilton Plymouth Manual in coupon. Money-back guarantee!

**Only \$2.75**

## PRACTICE 10 DAYS FREE!

The Chilton Co., Dept. PM-103  
 56th & Chestnut Sts., Philadelphia 39, Pa.

Send the big CHILTON "ALL CARS" MANUAL (price \$5.95) for 10-day FREE EXAMINATION. If O.K., I will promptly remit \$1.95 (plus 35c postage); then send \$2 monthly for 2 months. Otherwise, I will return manual postpaid in 10 days and owe you nothing.

Check here to order individual car make manuals

- Chilton "CHEVROLET" Manual. Price \$2.75
- Chilton "FORD" Manual. Price \$2.75
- Chilton "PLYMOUTH-DODGE-DESOTO" Manual. Price \$2.75

NOTE: Individual car make manuals sold for  cash with order (we pay postage.) Or,  we ship C.O.D. and you pay postman manual price plus post office charges. Specify which method desired. Any manual returnable in 10 days if not satisfactory and we guarantee to refund your \$2.75.

(OUTSIDE U.S.A.—Cash only. Prices: "ALL CARS" Manual, \$6.95; individual manuals \$3.00 each. Same 10-day return privilege with money refunded.)

Name.....  
 Address.....  
 City, Zone, State.....

# BECOME AN Electrical Engineer



- Major in Power or Electronics
- Earn B. S. Degree in 36 months

Over 50% of the nation's industrial leaders began their careers with engineering training. Today, the demand for young, trained Electrical Engineers and Technicians is constantly expanding. Eight separate programs give you a wide range of career opportunities.

## Plan Your Career From these Courses in Electrical Technology

### ENGINEERING COURSES

**Electrical Engineering** — Bachelor of Science Degree  
Save a valuable year through optional year 'round study.  
**Electronics major** ..... 36 months  
**Power major** ..... 36 months

### TECHNICIAN COURSES

**Electro Technician** ..... 12 months  
**Electronics Technician** ..... 12 months  
**Radio Technician** ..... 12 months  
**Radio and Television Technician** ..... 18 months

### SERVICE COURSES

**Electrical Service** ..... 6 months  
**Radio and Television Service** ..... 12 months

**MECHANICAL TECHNOLOGY COURSES** — Also available, Service Technician courses 6 to 18 months — Heating, Refrigeration, Welding, Air Conditioning and Mechanical — Mechanical Engineering with a major in Design, Metal Fabrication or Plant Engineering.

Also, general 3-month preparatory course.

Terms open July, October, January, April

Approved for veterans. Prior Military, Practical or Academic training evaluated for advanced credit. Faculty of specialists. 50,000 former students. Annual enrollment from 48 states and 23 overseas countries. 50th year. Non-profit. Residence Courses only. Send coupon for facts.



## MILWAUKEE SCHOOL OF ENGINEERING

MILWAUKEE SCHOOL OF ENGINEERING  
Dept. PM-1053, 1025 N. Milwaukee  
Milwaukee 1, Wisconsin

Send:  Free 160-Page Catalog  
 "Your Career" Booklet

I, am interested in ..... name of course

Name ..... Age .....

Address .....

City ..... Zone ..... State .....

If veteran, indicate date of discharge .....

## Try This Shaving Magic AERO SHAVE "Push-Button" LATHER



JUST PUSH VALVE  
...OUT COMES  
LATHER!



### Best Shave News In 50 Years!

- Richer, Creamier Lather
- No Brush Needed
- No Greasy Cream
- 3 Beard Softeners
- Built-in Lano-Lotion

69 SHAVES  
59c push button lather

## AERO SHAVE Lather Bomb

### OWN WORLD'S FINEST CRYSTAL RADIO

Complete Kit Only **\$8.95** Money Back Guarantee



Plays anywhere. Needs no batteries or electric current. Excellent performance guaranteed. Germanium crystal diode can get stations over 500 miles away. Head phones, aerial kit included. Nothing else to buy. Assembled in minutes. Popular 5"x4 1/2"x6 5/8" personal size. Send \$2.00 deposit now, we'll mail C.O.D. plus postage. Satisfaction guaranteed.

**JAEGER & CO.**  
P.O. BOX E246 SKOKIE, ILL.

## Broken or Loose FALSE PLATE?



### Fix it Yourself EASILY in a Few Minutes

Your plates may become broken or loose just when you need them most. With **FIX-IT-KIT** you can repair your own broken plates. Also tightens loose fitting plates, easily. Get permanent comfort with professional material. Complete instructions. Satisfaction guaranteed or your money refunded. **Order Now** at a new low price only **\$2.98** postpaid — or sent C.O.D.

**Make Plates Like New**  
**DENT-FIX DENTAL PRODUCTS, Dept. PM-10**  
P.O. Box 674 Kansas City 8, Missouri



## Print Your Own

Cards, Stationery, Advertising, labels, circulars, photo and movie titles, church work, tags, etc. **Save money.** Sold direct from factory only. Raised printing like engraving, too. **Print for Others, Good Profit.** Have a home print shop. Easy rules supplied. Pays for itself in a short time. Write for free catalog of outfits and all details.

**KELSEY PRESSES, N-37 MERIDEN, CONN.**

## KING MIDGET AUTO

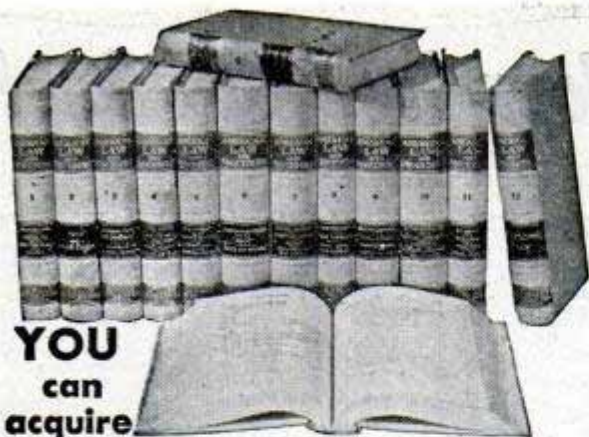
Operate it for 75c per week. Amazing performance. Surprising comfort. All steel construction. Ready to run or assemble it yourself with our bolt together parts. Rider Agents wanted. Send 25c for detailed literature or \$1 (refunded first order) for actual assembly book and service manual filled with photos, drawings, specifications, etc.

**MIDGET MOTORS MFG. CO., ATHENS, OHIO**

WORLD'S  
LOWEST PRICED  
2-PASSENGER AUTO







**YOU  
can  
acquire**

## **LAW NIGHTS AT HOME! L. L. B. DEGREE**

LaSalle's famous Law Library—used as reference in many Law libraries and Law offices—has enabled thousands to master Law surprisingly fast, in spare hours at home, for business and professional advancement.

These 14 remarkable volumes, compiled by leading professors and lawyers, cover the whole basic field of Law in condensed, orderly, simplified manner.

You advance rapidly with this great library, plus special lectures furnished. We guide you step-by-step with personalized Problem Method of instruction . . . you learn by doing—handling legal problems—not by memorizing rules.

Send for two FREE 48-page booklets, "Law Training for Leadership," and "Evidence," answering questions about Law and its value to you, and telling how LaSalle Law graduates are winning rapid advancement in business and public life. Mail coupon below. No obligation.

### **LA SALLE EXTENSION UNIVERSITY A Correspondence Institution**

417 S. Dearborn St. Dept. 1064L Chicago 5, Ill.

Send me your two FREE booklets described above, without obligation.

Name.....Age.....

Street.....

City, Zone & State.....

## **ENGINEERING DEGREE IN 27 MONTHS**

### **Big Demand for Graduates**

**Aeronautical, Chemical, Civil, Electrical, Mechanical and Radio Engineering (inc. TV and Electronics)**

Hundreds of young men are earning B. S. ENGINEERING DEGREES annually in this recognized institution — year around operation. New terms start quarterly. Many students earn a major part of their college expenses in this large industrial center.

Low tuition. Competent instruction. Thorough, intense, practical program. Modern, well-equipped laboratories including new physics laboratory and modern wind tunnel. Individualized instruction emphasized.

Government approved for G.I.'s. Engineering preparatory courses. Students from 48 states and 21 foreign countries. Enter December, March, June, September. Send coupon for free catalog and full information. Enroll now.

SEND COUPON TODAY

### **INDIANA TECHNICAL COLLEGE**

5103 E. Washington Boulevard  
Fort Wayne 2, Indiana

Please send me free information on B.S. Engineering Degree in 27 months as checked.

Aeronautical,  Chemical,  Civil,  Electrical,  
 Mechanical,  Radio-Television

Name.....

Address.....

## **SUCCESS • BIG PAY in Aviation**

### **MASTER A & E MECHANICS urgently needed**

Maximum training in minimum time! Thorough, practical instruction backed by more than 25 years of aviation technical experience. Training authorized under G. I. Bill.

Write today!  
Illustrated Catalog  
Registrar, Dept. 99,  
Miami 30, Florida



### **TRAIN IN MIAMI -- AIR CAPITAL OF THE WORLD**

**DAN LURIE**  
"America's Most  
Muscular Man"  
—on television's  
"Big Top."

**FAMOUS DAN LURIE**



## **BARBELLS**

with 4 courses—low factory prices  
50 lb. set...\$ 8.48 | 150 lb. set...\$20.48  
100 lb. set... 13.98 | 200 lb. set... 25.98

Write for Free Catalog Order by Mail; 50% with order, bal. C.O.D. Extra wts. 13c per lb., F.O.B. plant

**DAN LURIE BARBELL CO.**

1701-M-10 Pitkin Ave., Dept. 359-K, Brooklyn, N. Y.

**Want a  
HOME?**



Before you choose, be sure to GET THE FACTS about Schult mobile homes. Write or wire Dept. 3210 SCHULT CORP., ELKHART, IND.

**SCHULT  
TRAILERS**

### **MAKE BIG MONEY at HOME!**

## **INVISIBLE REWEAVING**

Pays up to \$10 an Hour!  
Make moth holes, cigarette burns, tears, rips DISAPPEAR from all fabrics. Little-known craft pays big spare-time profits at home. Write today for exciting details FREE!

FABRICON, Dept. 3210, 8342 S. Prairie, Chicago 19, Ill.



## **You can play the GUITAR!**

...in a few happy hours with my new, amazingly simple home method. Knowledge of music not necessary. Thrill to The Steel Guitar Rag; Sweet Hour of Prayer; Red River Valley, etc. Arranged for singing, solos, duets. Play at school, Church, parties. \$2 post paid. Order today!  
**PIERCE GUITAR METHODS • 5812 Market St. • San Diego 14, Calif.**

## **WELD YOUR WAY AHEAD!**

### **Learn Arc and Gas Welding In Spare Time**

Your opportunities are greater when you learn to use this great tool of modern industry. Training in welding opens the door to many key industries. Now you can train at home with UET's practical course. Includes techniques, metallurgy, blueprints, shop practices, other important phases.



Write For FREE Facts! You can follow home-study training with actual shop practice. High school diploma not necessary. Write NOW!

### **UTILITIES ENGINEERING INSTITUTE**

2523 Sheffield Ave., Dept. WC-4, Chicago 14, Ill.

**I have a good proposition for men or women who would like to make an extra \$125.00 a month for spare time**



**By Frank W. Strong**

**I won't make any fancy promises of \$50.00 a day. And I'm not after any of your money. What I can do is show you a simple plan by which you can pick up enough extra money every week to help make up for the money you're losing in higher taxes and higher costs of living. And I supply your working outfit free—no charge and no deposit. Just your name is all I need. Read my proposition. It is honest and down to earth. And it won't cost you anything to try it.**



These 15 Utensils and covers are all interchangeable. They fit into each other so as to make up 23 different cooking combinations for "Waterless Cooking." The four egg cups make a 19-piece set that covers 99% of all cooking needs.

TODAY almost everyone needs extra money. Increased taxes and increased living costs are making your dollar worth less and less, so you have to have more and more dollars just to keep even. There are lots of good ways to make extra money. I don't say my way is the best. I do say it's one of the easiest and most pleasant. It even leads to making new friends. It doesn't call for house-to-house canvassing, either. Let me explain:

I am Sales Manager for a very big manufacturing company. We make Stainless Steel Cooking Utensils. We do an enormous business with hotels, restaurants, hospitals, and institutions. We also make utensils for the Army, Navy and Air Force.

As a result, we have very low manufacturing costs. We can sell a set of Stainless Steel Cookware for home use for about what it costs some companies to make it! In fact, for years we did sell to one Sales Organization who resold our cookware house to house under their own name. They got \$120.00 for the same set that our people sell for approximately half of that.

You've probably heard of salesmen who give dinner parties in homes and then take orders from the ladies who attend. These salesmen have to get a high price because it costs money to give parties—he has to make his share—and his supervisor has to make his. The sales organization adds a profit and the manufacturer has to make his. So there are about four or five profits added to the actual manufacturing cost.

About two years ago I got to figuring. There are five good reasons why Stainless Steel is the kind of cookware that should be in every home. 1. It washes as easy as a drinking glass. No scouring, scraping or scrubbing. 2. It doesn't rust or corrode—and it doesn't stain. 3. It doesn't affect the taste of food. 4. Carlton Ware enables you to prepare food by the method called "waterless cooking" which keeps more of the natural minerals and vitamins in your food and makes the food taste better. 5. Buy it once and you're all through buying for life. You can't wear it out.

You see, Stainless Steel is not a coated or plated metal, like chromium plate on the bumper of your car. That chromium plate can chip or wear off and exposes the raw steel underneath. Then the steel rusts. But our kind of Stainless Steel is stainless all the way through. It can't chip, crack, peel, or wear off. You could use a set the rest of your lifetime and then give it to your children and it would still be good for their children.

Well, I figured that if the price was low enough every family could afford Stainless Steel Carlton Ware. So I worked out this plan! We would sell a complete set of 15 pieces at a figure that would include our profit. Then you add your profit and re-sell this set to your friends and neighbors for just about half of the usual price charged on the "party plan." They are glad to get such a bargain and they feel that you've done them a real favor.

The plan becomes like an endless chain. When a woman gets her first piece of Carlton Ware she gets so thrilled with its better cooking and easy cleaning that she talks and talks. She can't wait to demonstrate it to her friends and tell them all about it. She's so proud of its silvery sheen that she just "bubbles over." So just by letting your own friends in on a good thing, before you know it their friends call you up and ask

if you can get the same low prices for them. Then their friends call you and their friends' friends. It goes on and on!

To make an extra \$125.00 a month, you only have to deliver seven sets and that's easy. Mrs. Montell in Pennsylvania took orders for \$1400.00 worth in her first month. And Mrs. William Hanchow wrote, "Got my set Saturday—I already have 17 customers."

Now, I'll let you in on another part of my plan. If you take only ten set orders a month for six months my company pays your expenses for a winter vacation in Florida. We maintain a beautiful resort in the Florida Keys just so our sales representatives can enjoy a Florida vacation at company expense.

Get all the information right now. I'll not only be glad to send Free Information, I'll also send you a complete demonstrating outfit that you can show to your friends and neighbors. And I'll give you exact instructions by which you can write up orders without ever trying to "sell" and without making any house-to-house calls.

Everything I send you is free. When you qualify, I'll even furnish you with a complete 15-piece set of Carlton Ware to use in your own kitchen and show to your friends. It's an extra bonus I give to encourage good earnings on your part.

Send your name today in confidence. You'll be glad you wrote. This ad may not appear in this magazine again, so don't take any chances on losing out. Send the coupon or just send your name on a postcard. I won't send any salesmen to call on you and you won't be under the slightest obligation.

**Frank W. Strong**

*Carlton of Carrollton, 3310 High St., Carrollton, Ohio*

**Frank W. Strong, Carlton of Carrollton  
3310 High St., Carrollton, Ohio**

Dear Mr. Strong: Please send me free and without any obligation a complete selling and demonstrating outfit with exact instructions for making an extra \$125 a month. I don't want to do any house-to-house selling, but I will show our products to my friends and give them the advantage of the low prices.

Name .....

Address .....

City..... Zone....State.....

I am already selling Cookware and am interested in getting a line that can be sold at a lower price. Please send me your Distributor's proposition.

# SHORTHAND IN 6 WEEKS AT HOME

WRITE 120  
WORDS PER  
MINUTE

## Age No Obstacle

Famous Speedwriting Shorthand. No symbols, no machines. Uses ABC's. Easiest to learn and use. Qualify at home in spare time or through classroom instruction. Fast preparation for a better position and a sound, substantial future. Nationally used in leading offices and Civil Service; also by executives, students, etc. 120 words per minute—50% FASTER than Civil Service requirements. Over 200,000 graduates. Also typing.

The very low cost will surprise you

31st YEAR

Schools in over 360 cities in U. S., Canada, Cuba and Hawaii.

Write for FREE Booklet to:



MASTERS  
SPEEDWRITING  
IN A FEW  
WEEKS OF  
STUDY

"Tired of the routine of my clerical job, I decided that Speedwriting would help me obtain the better position I wanted. Within a few weeks of study, I mastered the ABC principles of Speedwriting, and now have been promoted to a fine position." — W. E. Pearson, New Kensington, Pa.

# Speedwriting

Dept. 1510-3, 55 West 42 St., N.Y. 36

## Shows You The Easy Way To Do 1600 Jobs

HOW TO DO your own home maintenance—expertly. How to improve your home, do building and decorating—at less cost in time and money.

CLEAR, SIMPLE instructions and step-by-step pictures make even difficult jobs easy. Owners report: "the best book in the field."

*We guarantee!*

that the 510-page *Better Homes and Gardens Handyman's Book* will save you more than its cost within the first 6 months. Get it wherever books are sold, or use handy coupon to order by mail.



### BETTER HOMES & GARDENS

402 Meredith Bldg., Des Moines 3, Iowa

Please send me the HANDYMAN'S BOOK. I enclose  check OR  money order for \$3.95. (Canada, \$4.50.) If not entirely satisfied, I may return book in 10 days and my money will be refunded.

Name \_\_\_\_\_

Address \_\_\_\_\_

City \_\_\_\_\_

State \_\_\_\_\_

# INVENTORS

IF YOU WISH TO PROTECT YOUR INVENTION, You should take steps to protect it by a U. S. Patent. Write me for "INVENTION RECORD" form

**CARL MILLER**

REGISTERED PATENT ATTORNEY

WOOLWORTH BLDG., 35th FLOOR, 103A  
NEW YORK CITY

## PATENTS

### C. A. SNOW & CO.

REGISTERED PATENT ATTORNEYS  
WRITE FOR INFORMATION TO  
428 SNOW BUILDING, WASHINGTON 1, D. C.

# INVENTORS

Whether an invention is patentable can be substantially determined by a search of the U. S. Patent records. Without obligation, write for information explaining the steps you should take to secure a patent.

**JOHN N. RANDOLPH**

Registered Patent Attorney

201 Columbian Building, Washington 1, D. C.

# INVENTORS

Send for  
PATENT INFORMATION

Book and

INVENTOR'S RECORD

without obligation

**GUSTAVE MILLER**

103-PM WARNER BUILDING  
WASHINGTON 4, D. C.

REGISTERED PATENT  
ATTORNEY

Patent Attorney & Advisor  
U. S. NAVY DEPT. 1930-1947

ASSOCIATE EXAMINER  
U.S. PAT. OFF. 1922-1929

PATENT LAWYER

# HELPFUL BOOKS

Send post card asking for FREE catalog

Popular Mechanics Press, 200 E. Ontario, Dept. 601, Chicago 11

# INVENTIONS WANTED

If you want to market, or sell, your invention for cash or royalties. Write for our Free Booklet. Send no drawings. We also welcome hearing from firms, or private capital, wishing to review inventions in any field. We will be glad to send notice of our clients' inventions.

**GLOBAL MARKETING SERVICE**

1404 Mitchell Street

Dept. PD

Oakland 1, Calif.

# INVENTORS

I shall be pleased to furnish you, upon request, with full information relative to patent procedure—without any obligation on your part.

**PATRICK D. BEAVERS**

Registered Patent Attorney

934 Columbian Building Washington 1, D. C.



# NO EXPERIENCE NECESSARY!

# LEARN TELEVISION AT HOME

# IN YOUR SPARE TIME!

L. C. Lane, B.S., M.A.  
President: Radio-Television Training Association  
Executive Director: Pierce School of Radio & Television

Super-Het Radio Receiver



Public Address System



C-W Telephone Transmitter



AC-DC Power Supply



Giant Screen TV Receiver



RF Signal Generator

You build all this equipment and more! Everything yours to keep.

Combination Voltmeter-Ammeter-Ohmmeter



## VETERANS! CIVILIANS!

## PREPARE FOR A BRIGHTER FUTURE AS A TRAINED TV TECHNICIAN!

Thousands of new jobs in TV are opening up in every state as new stations go on the air. You too can take your place in America's booming TELEVISION and Electronics Industries... enjoy the success and happiness you always wanted. Keep your present job while I prepare you at home for a life-time career as a trained TV Technician. You "learn-by-doing" with the actual parts and equipment I send you... the same successful methods that have helped hundreds of men - many with no more than grammar school training - master television!

### ENOUGH EQUIPMENT TO SET UP YOUR HOME LABORATORY!

As part of your training, I give you ALL the equipment you need to prepare for a BETTER PAY TV job. You build and keep a professional GIANT SCREEN TV RECEIVER complete with big picture tube (designed and engineered to take any size up to 21-inch)... also a Super-Het Radio Receiver, RF Signal Generator, Combination Voltmeter-Ammeter-Ohmmeter, C-W Telephone Transmitter, Public Address System, AC-DC Power Supply. Everything supplied including all tubes.

### GOOD SPARE TIME EARNINGS!

Almost from the very start you can earn extra money while learning, repairing Radio-TV sets for friends and neighbors. Many of my students earn up to \$25 a week... pay their entire training from spare time earnings... start their own profitable service business. Act now! Mail coupon and find out for yourself what a TV career can do for you!

## VETERANS!

MY SCHOOLS FULLY APPROVED TO TRAIN VETERANS UNDER NEW G.I. BILL! If discharged after June 27, 1950 - CHECK COUPON! Also approved for RESIDENT TRAINING in New York City... qualifies you for full subsistence allowance up to \$160 per month.

### ADVANCED FM-TV TECHNICIAN TRAINING!

My FM-TV Technician Course can save you months of training if you have previous Armed Forces or civilian radio experience! Train at home with kits of parts, plus equipment to build BIG SCREEN TV RECEIVER, and FREE FCC Coaching Course! ALL FURNISHED AT NO EXTRA COST!

### NEW! PRACTICAL TV CAMERAMAN & STUDIO COURSE!

(For men with previous radio & TV training)

I train you at home for an exciting high pay job as the man behind the TV camera. Work for TV stars in TV studios or "on location" at remote pick-ups! Course includes one week of actual work with TV CAMERAS and STUDIO EQUIPMENT at our associate resident school in New York City AT NO EXTRA COST!

### FREE FCC COACHING COURSE!

QUALIFIES YOU FOR HIGHER PAY! Given to all my students AT NO EXTRA COST after TV Theory and Practice is completed. Helps you qualify for the TOP JOBS in Radio-TV that demand an FCC License! Full training and preparation at home for your FCC License.

### At No Extra Cost! You Get A ROUND TRIP TO NEW YORK CITY Only RTTA Makes This Amazing Offer!

Yes... FROM ANYWHERE IN THE U.S. OR CANADA - I pay your way to New York and return, PLUS 2 FREE WEEKS of advanced instruction and shop training at the PIERCE SCHOOL OF RADIO & TELEVISION! Available at NO EXTRA COST to all students enrolled for complete Radio-TV Technician Course after home study training is completed.

**RADIO-TELEVISION TRAINING ASSOCIATION**  
1629 Broadway, Radio City Station, New York City 19, N. Y.  
LICENSED BY THE STATE OF NEW YORK

### MAIL COUPON TODAY!

MY 4 FREE AIDS SHOW YOU HOW AND WHERE TO GET A BETTER PAY JOB IN TELEVISION! See for yourself how my simple, practical methods make success easy.



### NO SALESMAN WILL CALL!

Mr. Leonard C. Lane, President  
RADIO-TELEVISION TRAINING ASSOCIATION  
1629 Broadway, New York 19, N. Y. Dept. M-10A

Dear Mr. Lane: Mail me your NEW FREE BOOK, FREE SAMPLE LESSON, and FREE aids that will show me how I can make BIG MONEY IN TELEVISION. I understand I am under no obligation and no salesman will call.  
(PLEASE PRINT PLAINLY)

NAME \_\_\_\_\_ AGE \_\_\_\_\_

ADDRESS \_\_\_\_\_

CITY \_\_\_\_\_ ZONE \_\_\_\_\_ STATE \_\_\_\_\_

#### I AM INTERESTED IN:

- Radio-TV Technician Course      **VETERANS! Check here**  
 FM-TV Course      for Training under NEW  
 TV Cameraman & Studio Course      G.I. Bill .....

# Learn **ELECTRIC** APPLIANCE REPAIR IN YOUR Spare Time at Home



## START YOUR OWN BUSINESS

WITH A POTENTIAL MARKET OF 50,000,000 CUSTOMERS  
New shop-method, home training system gives you electrical know-how that used to take years to learn. Learn at home by building valuable testing kits, repairing your own and neighbor's appliances. It is not unusual for appliance repairmen to charge on the basis of \$3.00-\$6.00 an hour.  
**FREE ILLUSTRATED BOOK** Shows you how you learn every phase of electrical appliance. How to make money while you learn. Write today for your **FREE COPY**.

**CHRISTY TRADES SCHOOL, Dept. D-2303**

4432 North Kedzie Ave. Chicago 25

SAY YOU SAW IT IN POPULAR MECHANICS

**CORTINA**  
makes it FUN to



# SPEAK FRENCH-SPANISH

**RUSSIAN-GERMAN  
ITALIAN-BRAZILIAN-JAPANESE**  
"Learn by Listening" to CORTINA RECORDS, at home, the NATURAL way — quickly, easily, cheaply.

## Only 15 Minutes a Day!

The CORTINA method, famous for 71 years, teaches you to speak like a native. THOUSANDS have found it the most fascinating, most effective way to learn languages for Pleasure, Business, Travel, Culture. INVESTIGATE!

## Send For FREE BOOK!

Big, illustrated 32-page book, "The Cortina Short-Cut" sent FREE. No obligation. Tells just what you want to know. Interesting. Get it!

**ALL NEW RECORDINGS ON  
UNBREAKABLE RECORDS** WRITE TODAY

**CORTINA ACADEMY (Est. 1882)**  
Suite 6410, 105 W. 40 St., N. Y. 18, N. Y.  
Please send me — without obligation — your free book. I am interested in (check)  
 French  Spanish  German  Italian  Brazilian  
 Russian  Japanese

Name.....

Address.....

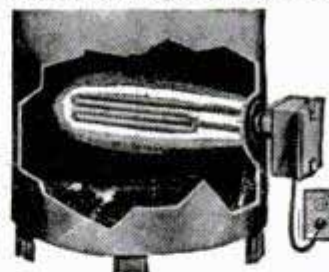
City.....State.....

**VETS!** Check if discharged after June, 1950.

## New Low Cost Electric Water Heater Gives You

# HOT WATER AUTOMATICALLY

From Your Present Tank!



Complete—Ready to **\$19.95**  
Plug In — Only

LECTROMATIC into opening (as shown), then PLUG IN 110 volt outlet. Uses 1250 watts. Plenty of hot water all day long. Uses only 1/4-1/2¢ electricity per gal. of hot water. Temp. adjustable from 100 to 180 degrees. Only \$19.95 C.O.D. plus shipping or send check or money order for \$19.95 now and we pay shipping. (Also 220 V., 2000 W. model \$21.95). Money back in ten days if not delighted. Full one year guarantee! **ORDER NOW!**

**COLLOID EQUIPMENT CO., INC.** Dept. PM-10, 19 MURRAY STREET  
NEW YORK 7, N. Y.



## Play GUITAR in 7 DAYS

**OR GET YOUR MONEY BACK!** Let Ed Sale teach you to play with his famous 66 page diagram photo system. Contains 52 photos, 87 diagrams, showing exactly how to place your fingers. Over 100 Hillbilly, Popular, and Western songs, words and music—along with complete, easy to learn instructions. Imagine your joy when you find after 7 days you are playing beautiful music! Amaze your friends! Be the life of the party! **SEND NO MONEY.** Pay Postman \$1.98 Plus Postage or send \$2 and I pay postage. (Same guarantee.) **ED SALE, Studio 1906, Bradley Beach, N.J.**

## BECOME AN EXPERT IN

# TRAFFIC

Traffic men earn \$4,000 to \$10,000 and up. Thousands of firms need experts on rates, tariffs, regulations. We train you thoroughly in spare time at home for executive traffic jobs. Personal training under traffic authorities. Placement counsel and help. Write for free 48-page book "Traffic Management—the Fast Growing Profession."

**LASALLE Extension University, 417 So. Dearborn St.**  
A Correspondence Institution Dept. 1064T Chicago 5, Ill.



## SWISS MUSICAL CHURCH

Beautiful all Wood 11 inches high. Many lovely features. Regular Retailer \$7.50. Genuine Swiss Unit. **COMPLETE KIT \$3.95 POSTPAID.**

**PILTZECKER SWISS IMPORTS, Wood-Ridge, N. J.**

## THE KEY TO POWER

*Life is law and never luck!*

Create the future you desire by learning to control your subconscious mind. Free booklet. Write to

**KEY TO POWER**  
Dept. PM, 7321 Beverly Blvd. Los Angeles 36, Calif.

## Ball-Bearing **SPEED WHEELS**



**JUVENILE WHEELS** (No bearing, solid tires)  
5" ..... 45¢ 6" ..... 65¢  
7" ..... 75¢  
(Semi-pneumatic tire, ball bearing)  
8x1.25 ... \$1.85 10x1.25 .. \$2.20  
8x1.75 ... 1.95 10x1.75 .. 2.30  
8x2 ..... 2.20 10x2.00 .. 2.65  
12x1.75 .... 3.45

### INDUSTRIAL WHEELS

Lug Base, Semi-Pneumatic tire  
6x2 SW ... \$3.45 10x2.00 ... \$6.10  
6x2.00 ... 4.00 10x2.75 .. 5.15  
8x2.00 ... 5.20 12x2.00 .. 6.90  
8x2.50 ... 5.40 12x3.00 .. 9.20  
16x4.00 ... 15.15  
Smooth Base, Pneumatic tire and tube  
8x3.00 ... \$11.00 12x4.00 ... \$12.10  
10x2.75 ... 6.80 4.00x8 ... 13.10  
10x3.50 ... 10.55 14x4.50 ... 13.40

Available Now — **CASTERS**  
Write for circulars on all wheels.  
Prices F.O.B. our plant.

No c.o.d. orders. **JIM BROWN TOY COMPANY**  
1095 HOME AVENUE PM-853 AKRON 10, OHIO



# Famous 15 and 17 Jewel BULOVA WATCHES \$16.95 PLUS TAX

PRACTICALLY WHOLESALE TO YOU



**UNLIMITED SERVICE GUARANTEE**  
**WHY PAY \$59.50? SAVE \$42.55** Also Choice of • BENSUS • GRUEN • WALTHAM or • ELGIN WATCHES

You get these unredeemed SERVICE guaranteed Bulova and other movements in latest style Yellow Gold Cases at this sensationally low price because we bought out huge surplus STOCKS of leading New York and Md. jewelers. Order now while they last. Specify make preferred and whether men's or ladies'. Only \$16.95 plus \$1.70 tax. Order right now.

**FREE TRIAL OFFER! WEAR AT OUR RISK!** Money back guarantee in 10 days if not delighted.

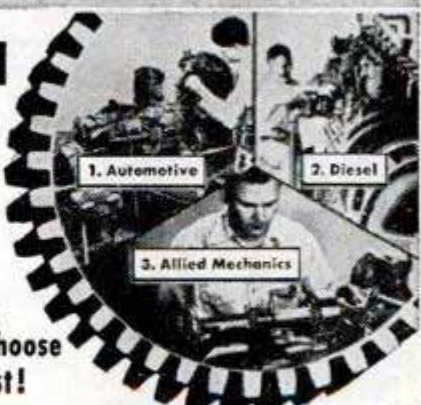
SEND ONLY \$1 with order. Pay balance C.O.D., plus postage. Or enclose \$16.95 plus \$1.70 tax, we pay postage.

Handsome Expansion Band with orders at no extra cost.  
**MARYLAND DISTRIBUTORS, Dept. 559**  
 501 E. Baltimore St. Baltimore 2, Md.  
 Write For Free Watch and Diamond Ring Catalog - Practically Wholesale Prices.

**UNLIMITED Service Guaranteed**  
**17 Jewel Swiss WRIST WATCH**  
 Worn by Army, Navy & Marines.  
**WHY PAY \$50?** Plus Here Only **\$14.95** \$1.50 tax.  
 New Incablock, Shock-Protected Water & Dust Tight

# GET INTO AUTOMOTIVE DIESEL AND ALLIED MECHANICS

## Shop-Method Home Training



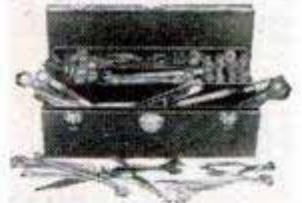
Jobs Like These Are Open To You as a Trained Mechanic...Choose The Field You Like Best!

Diesel Fuel Injection • Automotive Motor Tune-up • General Garage Mechanics • Diesel Engine Maintenance • Auto Engine Rebuilding • Auto Elec. Service • Public Utilities • Parts Dealers • Bus & Truck Lines • Contracting & Excavating • Business of Your Own • And MANY other similar openings.  
**MASTER ALL PHASES!** Get Master Shop-Method Home Training from an Established Resident Technical Trade School with its own Training Shops and Laboratories—almost 50 years of Successful Experience in Training Men.

**WE BRING NATIONAL SCHOOLS TO YOU!** National Schools trains you for all opportunities in the dynamic, fast-growing Automotive-Diesel and Allied Industries. Pay is good, the future excellent!  
**EARN WHILE YOU LEARN!** Spare Time Work Lessons show you how to earn while you learn...for extra money and experience. You learn by DOING!

**YOU RECEIVE AND KEEP ALL THIS MATERIAL:** Basic Lesson Texts • Diesel Installation, Operation, Maintenance • Diesel Chart Manual • Spare Time Lessons • Thermodynamics • Engine Service Manuals • Engine Repair • Drive Systems.

**WE GIVE YOU TOOLS OF YOUR TRADE!** Including Drawing Set, Slide Rule, and this all-metal, fully-equipped Tool Kit—all free!



This course also offered in Spanish & Portuguese

**FREE BOOK & SAMPLE LESSON SHOW YOU HOW**

**APPROVED FOR G. I. TRAINING**

## NATIONAL SCHOOLS

Technical Trade Training Since 1905  
 LOS ANGELES 37, CALIFORNIA  
 IN CANADA: 193 EAST HASTINGS STREET, VANCOUVER 4, B. C.  
 BOTH HOME STUDY AND RESIDENT COURSES OFFERED

**FIND OUT NOW—MAIL COUPON TODAY!**

**NATIONAL SCHOOLS, Dept. DB-103**  
 4000 South Figueroa Street  
 Los Angeles 37, California

Mail in envelope or paste on postal card

Mail me FREE the book "My Future in Automotive-Diesel and Allied Mechanics," together with FREE Sample Lesson. I understand there is no obligation, and no salesman will call.

NAME \_\_\_\_\_ AGE \_\_\_\_\_  
 ADDRESS \_\_\_\_\_  
 CITY \_\_\_\_\_ ZONE \_\_\_\_\_ STATE \_\_\_\_\_

Check here if released from service less than 4 years ago.  
 Check here if interested in Resident Training at Los Angeles.

# AVIATION NOW! A&E MECHANIC LICENSE COURSE

45-week course, all phases aircraft & engines.  
**FLIGHT COURSES**—Private, Commercial, Instrument, Instructor, Multi-Engine.  
**DEGREE COURSES**—B.S. degree in 3 yrs. from Saint Louis University — Aero. Engineering, Maint. Engineering, Aero. Administration.

Pays You More With a Schooling at PARKS  
 All Parks Schooling Approved for Veterans Write Today.  
**ARNOLD HALL EAST ST. LOUIS, ILL.**

## CARTOONING

HAVE FUN! MAKE MONEY! Cash in on your sense of humor AT HOME—BY MAIL! No experience needed to start. Write today FOR FREE TRIAL LESSON and full particulars.  
 Moon Gag Cartoon School, Dept. P, Fall Creek, Wis.

## 60 POWER TELESCOPE \$3.98

VARIABLE EYEPIECE 20 x 40 x 60 — BRASS BOUND

NEW! Three telescopes in one. 3 different magnifications. 20 power for ultra-bright images with 40 and 60 power for extra long range. Guaranteed to bring distant objects, people, sports events, ships, moon, stars, etc. 60 times as close.

Most powerful for anywhere near the moon. Contains 4 ground and polished lenses. Also used as a powerful compound microscope. Directions included. Mass production enables us to offer this instrument at amazing price of \$3.98 complete. Money back guarantee. We pay postage. Get yours now.

Criterion Co., 331 Church St., Hartford, Conn., Dept. PMB 17

## MAKE \$100 A WEEK—SPARE TIME!

**Assemble & Install Buckeye Screen & Glass Combination STORM WINDOWS**

- Shipped Knocked-Down. Glass & Screen Thousands Sold.
- Redwood or Aluminum. Panels Interchangeable Summer or Winter.
- Finest Quality.

Make up to \$10.00 an hour SPARE TIME, assembling Buckeye Storm Windows. Sell year 'round—no slack period. Quick, easy to assemble. A sound, legitimate business. You risk nothing; no tools to buy; no big stock needed. We're 20 year-old company, A-1 financially.

Some Attractive Dealer Territories Still Open—Write!



You Pay Only **\$6.65**  
 For Redwood Storm Window to fit 28 1/2" x 56 1/2" window (screen & glass not included)

**FHA FINANCING THROUGH YOUR BANK**  
 Buckeye Storm Windows can be financed on FHA Plan. Add them to any home for as little as \$5.00 a month. No down payment. See your bank.

**BUCKEYE SCREEN & WEATHERSTRIP CO.**  
 1380 S. 22nd Street, Columbus, Ohio

**For FUN and PROFIT learn to MOUNT BIRDS**




**AND ALL KINDS OF ANIMALS**  
**SPORTSMEN, SAVE YOUR TROPHIES!** Learn at home in spare time to mount all kinds of birds and animals. Decorate your den with trophies of field and stream. We teach you this **FASCINATING SPORTSMEN'S HOBBY**. Quickly, easily learned. Wild game is growing **scarcer**. Trophies now more valuable than ever! Shoot **FEWER** and **MOUNT** them true to life. **IT'S PROFITABLE!** Many report earning \$25 to \$75 a month mounting specimens for hunters. Why not **YOU?** Learn to make **USEFUL** articles from mounted specimens such as book ends, lamps, etc., etc. (See squirrel lighter to left.)  
**WILD GAME NOT NEEDED.** If you don't hunt you can mount **COMMON** specimens: Owls, crows, pigeons, hawks, rabbits, even frogs. **Real FUN.**  
**LEARN TANNING** We also teach you to tan furs soft and pliable and new method to **TAN GENUINE LEATHER** from all kinds of hides. **Great spare time money maker.**  
**FREE BOOK** Send right now for beautiful free 48-page booklet, illustrated, telling how easily **YOU** can learn to be a Taxidermy Artist. Contains many fine pictures. Intensely interesting. **Get YOUR copy today.** No cost or obligation. **Send now!** State **AGE.**  
**N. W. SCHOOL of TAXIDERMY, 2510 Elwood Bldg., Omaha, Neb.**

**AUTO BODY AND FENDER REPAIR**



**Men!**  
 Reading This Message Could Be the Most Important 40 Seconds In Your Life

From every indication Auto Body and Fender Repair work will continue to be one of America's Big Income fields. Here at U.E.I. we're training men for it—a **proven** plan that combines spare-time, home study and actual shop practice. Men from coast to coast have successfully completed the U.E.I. course in Auto Body and Fender Repair—many earned money while learning—many now have their own shops. What about you? Isn't this the time for you to see what this big-pay field offers you? Do this: Mail the coupon below and we'll send you our big, descriptive book, "Opportunities." It's Free—Mail the Coupon.

**UTILITIES ENGINEERING INSTITUTE, Chicago 14, Illinois**  
 Founded 1927

**UTILITIES ENGINEERING INSTITUTE,**  
 2523 Sheffield Ave., Dept. XC-24, Chicago 14, Illinois  
 Please send, Free, Your Book "Opportunities".  
 NAME (print) ..... AGE.....  
 ADDRESS .....  
 CITY..... (Zone).... STATE.....  
 Check here for information if you are under 17.

**OWN a Business**  
**\$5 HOURLY Profit . . . .**  
**Even if NOW Employed**



Alert dealers can average \$5 hourly gross profit on services they render and \$3 on EACH of their servicemen at National Price Guide charges. You can profitably operate part time while building a full time business with servicemen.

**Clean & Mothproof, Rugs & Upholstery**  
 Duraclean cleans by absorption! No scrubbing, soaking or shrinkage. Dirt and grease vanish as if by magic . . . matted pile rises . . . colors revive. Furnishings ready for use the same day. Duraproof protects against moths and carpet-beetles. Makes materials resistant to both. Backed by an International Money-Back 4-Year Warranty.  
 No experience needed. Easy to learn. Quickly established. Nationally Advertised Services rendered "In the home." No Shop Needed. We furnish enough materials to return your TOTAL investment. Territories limited. Write today for FREE booklet explaining details and Easy Terms. . . . Don't delay!  
**DURACLEAN CO., 3-160 Duraclean Bldg., Deerfield, Ill.**

**STOPS FOGGY WINDSHIELDS**  
**NEW Chemical Mitt**



**Amazing Discovery!** Autoists will ever new FOG-STOP Windshield Cleanser. Simply glide over windshield chemically-treated Mitt—at once glass sparkles crystal clear. Blurry mist, frost, sleet, snow disappear like magic. Stops fogging. *Sells like wild!*  
**SAMPLES FOR AGENTS** Sample offer sent immediately to all who send name at once. Hurry. Postcard will do. **SEND NO MONEY—just your name.**  
**KRISTEE CO., Dept. 672, AKRON 8, OHIO**

**TASOPE PHOTO-ENGRAVING PLANTS**



Establish your own profitable **PHOTO-ENGRAVING** business. Make cuts for newspapers, printers, and advertisers. Make etched name plates, plaques etc. Instructions furnished, no experience necessary. Sold direct from factory since 1931. First five hundred cuts sold locally or by mail will pay for plant and pay you well for your time. Write for FREE catalog.  
**TASOPE DEPT. PM10, AURORA, MO.**

**Make BIG MONEY!**  
**RAISE CHINCHILLA RABBITS!**



Cash Markets Supplied for Your Production  
**FREE - Illustrated Booklet - WRITE TODAY!**  
**ROCK HILL RANCH, SELLERSVILLE 36, PA.**  
 World's Largest Breeder of Chinchilla Rabbits

**BRASS NAME PLATES**  
 or KEY TAGS  
**40c each**



YOUR NAME  
 STREET/AND NUMBER  
 CITY AND STATE  
 PHONE NUMBER  
 Half a-tual size QUANTITY PRICE - SAME STAMPING  
 3 for \$1.00  
 8 for \$2 - 15 for \$3 - 25 for \$4 - 50 for \$6  
 LARGER QUANTITIES ON REQUEST  
**TAGCO, P. O. BOX 203 X, PLEASANT VALLEY, N. Y.**

**MAKE EXTRA MONEY** **PLASTICS** **LEARN AT HOME**



**LEARN HOW TO MAKE fast-selling PLASTIC NOVELTIES FURNITURE JEWELRY SIGNS TOYS LAMPS**  
 There are **RICH OPPORTUNITIES** for MEN and WOMEN with "know-how" in Plastics. Interstate's new Plastics course tells and shows how to make hundreds of fast selling items out of Plastics. Gives complete training in fabrication, casting, lamination, molding, internal carving, etc., in simple, easy, step-by-step language and pictures. Plastics and Fabricating Kits for 23 valuable Plastic items come with training at no extra cost. **START A PLASTICS BUSINESS OF YOUR OWN.** No other industry holds such promise for the future. You can make big money manufacturing novelties, toys, signs, etc., in your own home in spare or full time. Don't wait! Learn **NOW** how Interstate's Plastics Training qualifies you for success in the Plastics field.  
**PLASTICS AND SUPPLIES FURNISHED FOR 23 VALUABLE PROJECTS**  
**INTERSTATE TRAINING SERVICE**  
 Dept. C3K Portland 13, Oregon

# WHEN IS WOOD GLUE REALLY WATERPROOF?

ANSWER: when it meets Military Specifications for marine use.

Elmer's Waterproof Glue (formerly Cascophen) is the only cold-setting glue that passes these specs and comes in small packages!

Use it for permanent wood-to-wood bonds. Write for free folders. The Borden Co., Chemical Div., Dept. PM 103 350 Madison Avenue, N. Y. 17, N. Y. B.3.10



IF IT'S *Borden's* IT'S GOT TO BE GOOD!



**30 DAY FREE TRIAL**

**High Power BINOCULARS**

Finest Precision Optics  
Featherlight  
Money Back Guarantee  
Easy Pay Plan

Leather Case Incl'd.  
**Free!** Catalog & Book  
"How to Select Binoculars"  
Dealer Inquiries Invited  
Bushnell Bldg., Dept. M70  
Pasadena 1, Calif.

33 MODELS  
**\$14.95**  
up

**BUSHNELL Binoculars**



## MECHANICAL DENTISTRY

To make Crowns, Plates, Bridgework, etc., for Dentists. Easy practical way to learn mechanical dentistry at home in spare time. FULL EQUIPMENT OF TOOLS AND MATERIALS INCLUDED WITH COURSE. Low tuition. Easy terms. Write for FREE BOOK about this money making profession that is not affected by machine age.

McCARRIE SCHOOL OF MECHANICAL DENTISTRY  
207 N. Broad St., Dept. 22, Philadelphia 7, Pa.

## 2-BEDROOM HOME \$890

BUILD YOUR OWN



Living room 12x14. Master bedroom 10x12. Nursery-den 10x11. Kitchen 7x10. Bath 5x8. Concrete block built. Blue prints, material lists, exact instructions for 3 designs.

Complete **\$1** ppd.

SUNNY-CAL HOMES, Box 309-D-10 Hollywood 28, Calif.



## FULLY GUARANTEED TIRES COST LESS!

Nationally famous FIRESTONE, GOODRICH, U. S. ROYAL, GOODYEAR, and other makes. Every tire selected and inspected for your safety.

FREE TUBE ON REQUEST WITH PASSENGER TIRES (WHITE WALLS \$1 EXTRA)

HIGH GRADE TIRES GUARANTEED 12 MONTHS

|        |      |           |      |            |       |         |       |
|--------|------|-----------|------|------------|-------|---------|-------|
| 600x16 | 4.14 | 700x16    | 5.14 | 32x6(8)    | 8.84  | 825x20  | 14.24 |
| 650x16 | 4.54 | 670x15    | 4.74 | 32x6(10)   | 10.84 | 900x20  | 13.34 |
| 650x15 | 4.34 | 650x20    | 7.84 | 750x20(8)  | 8.54  | 1000x20 | 14.14 |
| 700x15 | 4.64 | 700x20(8) | 8.94 | 750x20(10) | 9.94  | 1100x20 | 16.14 |

AAA PREMIUM GRADE GUARANTEED 18 MONTHS

|           |      |           |      |           |       |            |       |
|-----------|------|-----------|------|-----------|-------|------------|-------|
| 550x15    | 5.48 | 700x15    | 5.98 | 760x15    | 5.58  | 750x20(10) | 14.98 |
| 600x16    | 5.28 | 700x16    | 6.78 | 550x17    | 5.48  | 825x20     | 18.68 |
| 600x16(6) | 6.58 | 700x16(6) | 7.98 | 600x20    | 9.78  | 900x20     | 18.98 |
| 640x15    | 5.68 | 750x16(6) | 8.98 | 650x20    | 10.88 | 1000x20    | 19.98 |
| 650x16    | 5.78 | 800x15    | 6.88 | 700x20    | 12.88 | 1000x22    | 21.98 |
| 650x16(6) | 6.98 | 820x15    | 7.48 | 32x6(8)   | 10.48 | 1100x20    | 20.98 |
| 650x15    | 5.98 | 710x15    | 6.09 | 32x6(10)  | 12.48 | 1100x22    | 21.98 |
| 670x16    | 6.18 | 550x18    | 5.98 | 750x20(8) | 12.98 | 1100x24    | 23.98 |

|                          |                          |                         |       |           |       |
|--------------------------|--------------------------|-------------------------|-------|-----------|-------|
| MILITARY SPECIAL         | AA Guaranteed 12 Months— | NEW TREAD GUAR. 24 MOS. |       |           |       |
| 900x16                   | 10.69                    | 1000x20                 | 19.98 | 600x16    | 8.98  |
| 750x20                   | 10.98                    | 1100x20                 | 21.98 | 600x16(6) | 9.98  |
| AAA GUARANTEED 18 MONTHS |                          | 700x15(6)               | 15.95 |           |       |
| 900x16                   | 14.98                    | 750x20                  | 16.48 | 750x20(8) | 24.98 |

Largest stock of used tires in the East. Thousands of satisfied customers. Write for Free Catalogue. MONEY ORDER OR CHECK WITH ORDER. NO C.O.D.'s

**PYRAMID TIRE CO.**  
1333-35 North 5th St. Dept. M., Phila. 22, Pa.

# FREE

SEND FOR THE

# 1954

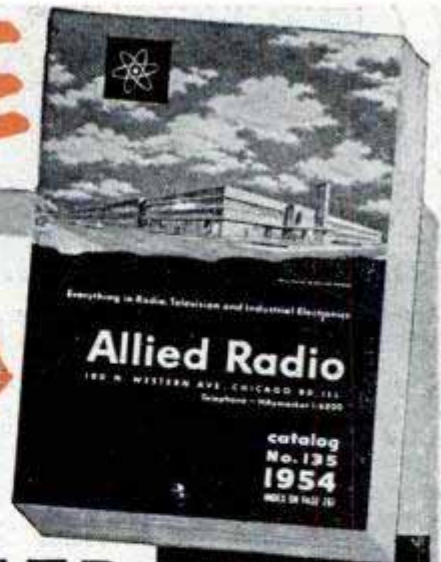
# ALLIED

268 value-packed pages

# TV & RADIO CATALOG

WORLD'S MOST COMPLETE

Save on everything in TV and RADIO



Everything for Experimenters, Builders, Amateurs, Servicemen, Engineers and Soundmen

Send for ALLIED's big 268-page value-packed buying guide to everything in TV and Radio! Largest selections of custom TV chassis, TV accessories, FM and AM radios, High-Fidelity Sound, Amateur supplies, P.A. Systems, recorders, test instruments, builders' kits, industrial electronic supplies—plus the world's largest stocks of electronic parts, tubes, tools and books. Get everything—get more for your money—send today for your FREE 1954 ALLIED Catalog.



NEW HOME OF ALLIED RADIO



ultra modern facilities TO SERVE YOU BEST

SEND FOR FREE CATALOG

# ALLIED RADIO

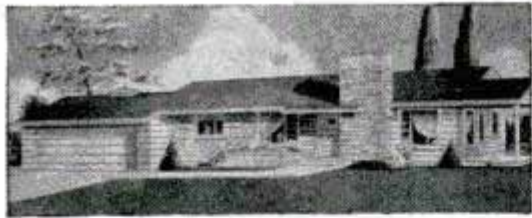
ALLIED RADIO CORP., Dept. 5-K-3  
100 N. Western Ave., Chicago 80, Illinois

Rush FREE 1954 ALLIED 268-Page Catalog

Name \_\_\_\_\_

Address \_\_\_\_\_

City \_\_\_\_\_ Zone \_\_\_\_\_ State \_\_\_\_\_



## Garlinghouse HOME PLANS

America's Pioneer Home Plan Service **for Better Living**

### 5 LATEST PLAN BOOKS—1 TO 4 BEDROOM SIZES

- **"RANCH AND SUBURBAN"**  
128 ranch plans most practical for town and country.....50c
- **"DELUXE SMALL HOMES"**  
Our largest selection—155 modern, time-tested designs...\$1.00
- **"HOMES IN BRICK"**  
Many of these 115 tested designs of medium and large homes are in color.....\$1.00
- **"YOUR NEW HOME PLANS"**  
2nd Edition. 64 pages (16 in color) of excellent plans for modern families .....50c
- **"BLUE RIBBON HOMES"**  
2nd Edition. 63 pages of homes proved popular by actual sales. Many in color.....50c

Select your new home from the hundreds of photographs and colored drawings in these five books. All sizes and styles are shown along with accurate description and floor plan of each. Complete working plans, specifications, lumber and mill lists are available for every design at low cost which is listed with each design. The moderate price of these plan sets is your best investment when building, since you know in advance what you are getting, thus avoiding misunderstandings. Complete plan sets when ordered will be sent by return mail on a money-back guarantee if unused plans are returned in five days.

All 5 above books for \$3.00, Postpaid—  
Our Complete Home Plan Library — 18 books and over  
1,250 Home Designs — Only \$8.00, a \$2.50 Saving.

**ORDER YOUR BOOKS TODAY**

All Books POSTPAID. No C.O.D.'s Please

L. F. GARLINGHOUSE CO., INC., Box **BO** **PM-19** **TOPEKA, KANSAS**

FOR YOUR

# TECHNICAL AND VOCATIONAL TRAINING

Come to the **UNIVERSITY OF HOUSTON**

One of America's large and most modern universities. Select from these fascinating fields:  aeronautics  air conditioning & refrigeration  auto body and paint  auto mechanics  auto upholstery & trim  diesel  drafting  electricity  electronics  machine shop  photography  radio  stationary engineering  television  welding  woodworking  furniture upholstery. **PREPARE FOR YOUR FUTURE NOW** . . . with very latest methods and equipment, at modern U. of Houston College of Technology. Entrance: high school diploma, or over 18 and ability to profit from instruction. Beautiful campus—250 wooded acres in Houston, Texas—city of tomorrow. Full college activities, sports, social life. Day or night, short or longer courses. Co-op work-study programs . . . earn part of tuition and expenses with part-time job in your own career field, while you learn. Personal vocational counselling. Diploma on completion and all credits apply towards Bachelor of Applied Science Degree. Job placement assistance. Feb., June, Sept. semesters. Mail ad now for Free fully-illustrated brochure. No obligation. Mark X before choice of subject. **Do it today!**



ADMINISTRATION BUILDING

**University of Houston, College of Technology**  
Dept. 1A3 — HOUSTON 4, TEXAS

## "YOU ARE UNDER ARREST!"



There's a Thrill in Bringing a Crook to Justice Through Scientific

### CRIME DETECTION!

We have taught thousands this exciting, profitable, pleasant profession. Let us teach you, too, in your own home. Learn Finger Printing, Firearms Identification, Police Photography and Criminal Investigation thoroughly, quickly and at small cost.

Over 800 of All U. S. Bureaus

of Identification employ students or graduates of I. A. S. You, too, can fit yourself to fill a responsible crime detection job with good pay and steady employment. But don't delay—get the details now. Let us show you how easily and completely I can prepare you for this fascinating work, during spare time, in your own home. You may pay as you learn. Write today, stating age. No salesman will call.

(A Correspondence School Since 1916)

**INSTITUTE OF APPLIED SCIENCE**  
1920 Sunnyside Ave., Dept. 1357 Chicago 40, Ill.

Be A **FINGER PRINT Expert**

**FREE!!!**  
Send for Thrilling "BLUE BOOK OF CRIME"

## TOOLS WHOLESALE

**MAKE EXTRA MONEY**

Start Your Own Business. Sell tools to your friends, neighbors, Part Time-Full Time. **A MILLION DOLLAR INVENTORY AT YOUR FINGERTIPS.**

Send \$1.00 for Dealer's Card and Wholesale Catalog

**SILVO HARDWARE CO., Dept. M, 108 Market St., Phila. 6, Pa.**

Stanley, Millers Falls, Plumb, Disston, Wiss, and others at 30% to 50% off.

## SHOOT TELEVISION FILMS

FOR YOUR LOCAL TV STATION...make Extra Profits with the "Cine-Voice" Sound-On-Film 16mm Camera. \$695<sup>00</sup> Write for free information.

**BERNDT-BACH, Inc.**  
7333 Beverly Blvd., Los Angeles 36, Calif.  
SOUND-ON-FILM SINCE 1931



## Become a MENTAL SUPERMAN

OVERNIGHT! Floor everybody! Revolutionary "MEMO-PROP" does all your thinking! It's uncanny! Unprecedented! FREE LITERATURE!

BIJOU STUDIO, BOX 1727MB, HOLLYWOOD 28, CAL.

## Catalog of 3000 Novelties 10c

Send 10c for amazing catalog of novelties, live animals, scientific supplies, hobbies, funmakers, planes & boats, looms, magic tricks, joke articles, unusual seeds, gadget timesavers, cameras, optical goods, projectors, movies, lucky jewelry, religious novelties, disguises, musical instruments, stamps, coins, puzzles, fortune tellers, radios, auto & bike accessories, telescopes, magnifiers, compasses, banks, smokers' gadgets, artists' supplies, printing sets, engines, motors, shockers, knives, billfolds, fireworks, guns, rifles, sports, books, games, plants, etc. Send name, address & 10c to:

**JOHNSON SMITH & CO., Dept. 674, Detroit 7, Michigan**

## LEATHERCRAFT

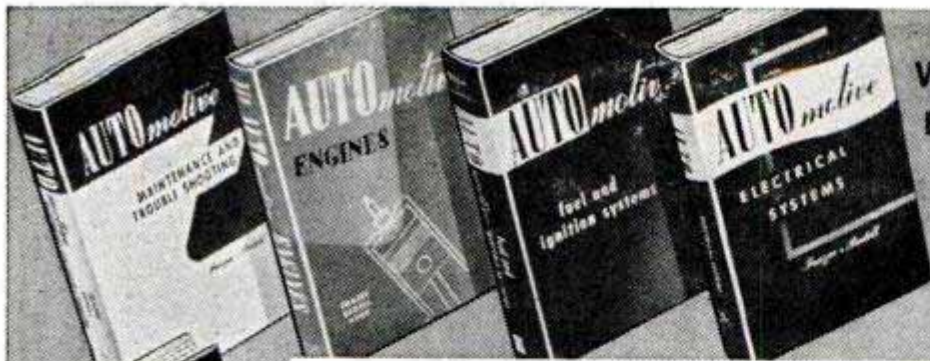
THE "HE-MAN" HOBBY

**Make Leather Items for Gifts, to Sell, or for Your Own Use**

Get started now. LARSON Beginners' Kits of ready-cut projects require no tools or experience. Free instructions included. Make belts, gloves, moccasins, billfolds, woolskin animals and mittens, other attractive leather items. Also America's most complete stock for advanced hobbyists and professional craftsmen. **SEND 10c TODAY for big illustrated catalog.**

**J. C. LARSON CO., 820 So. Tripp Ave. Dept. 3027, CHICAGO 24, ILLINOIS**





WANT A BETTER JOB OR A BUSINESS OF YOUR OWN?

# BE AN AUTO PRO!

6 New Books of How-to-Do-It Facts for Home Study or On-the-Job Use  
**MORE THAN 2350 PAGES, 1750 PICTURES**

● Do you sometimes wonder about men who are in high-pay jobs or who are successful in their own businesses? Do you ask yourself, "What did they have that I haven't got?" Actually it's not likely that many were above average in ability but they were ambitious and did something about it. They acquired specialized knowledge and they learned how to apply it in their work.

Has it occurred to you that YOU may follow the same plan and reach the goal you seek? If you are willing to invest some of your spare time in earnest self-training for success you should be able to do what thousands of others have done in the field of expert auto servicing.

The 6, big NEW volumes pictured here are full of the exact information that will help you to win the success you want. They will enable you to do important work better and faster and qualify for promotions. The set was prepared by automotive engineers with many years of prac-

tical experience. Every page was written in easy-to-understand language and all books are profusely illustrated to make them equally valuable to both beginners and advanced mechanics.

To have these great books at hand for study and reference is like having a group of qualified experts at your side, ready to answer questions. To make these training books available to ambitious men, more than \$250,000 was invested in producing them—the most complete and thorough set in our long experience. You can have the six-volume set on 10 days' approval! Simply fill in and mail the coupon at once. Send no money until you have examined each book.

ON APPROVAL  
 SEND NO MONEY

**AMERICAN TECHNICAL SOCIETY—Publishers Since 1898**  
 Dept. A719, Drexel Ave. at 58th St., Chicago 37, Ill.

I would like to examine your Six Big Auto Books. I will pay the delivery charges only, but if I choose I may return them express collect. If after 10 days' use I prefer to keep them, I will send you \$3 plus postage and pay the balance at the rate of only \$4 a month until \$29.20 has been paid.

Name \_\_\_\_\_  
 Address \_\_\_\_\_  
 City \_\_\_\_\_ State \_\_\_\_\_  
 Please attach letter giving employer's name and address (if self-employed give business man reference). Men in service please give home address.

## Grow ORCHIDS

**"WE MAKE AT HOME BIG PROFITS at home with ORCHIDS"**—Louis & Gladys Schirmer

World's most thrilling hobby—profitable home business. Single Orchid plant may multiply into many—each as valuable as the first. Successful home grower shows you how! Raise gorgeous Cattleyas, Cymbidiums, Epidendrums, on living-room table. Big-profit orders come from friends, neighbors, florists, etc.—also Mail Orders. Illustrated secrets of the experts in simple "show-how" language AND blooming-size Orchid plant sent at **NO RISK**. Includes plan for starting your own home business. **FREE**—full details—**SEND NO MONEY**. Write today. **TROPICAL FLOWERLAND**, Dept. 31A, 4622 Wilshire Blvd., Los Angeles 5, California

YEAR 'ROUND ANY CLIMATE No Green House Spare-Full Time

## Own, Operate, Route - "Wishing Wells"

Place these New \$8.50 Skill Games on counters in Cafes, Clubs, Luncheonettes, etc. — collect coins weekly. Details Free. Write **LEGALSHARE, PM-10** Box 929 Long Beach 1, Calif.

## WANTED: NEW PRODUCTS OR

will acquire a business that needs financial, production, or merchandising assistance. Royalty basis or outright purchase of the product or business will be considered. Prefer items that could be sold through hardware, automotive, plumbing jobbers, department stores or chain organizations.

Turner — P.O. Box 1003 — Sycamore, Illinois

not everyone does as well, but E. O. Lockin, who started a business of his own, reports...

for 12 months I've averaged  
**\$800 PER MONTH INCOME** —  
 most of it clear profit for me!

● Many men have discovered how to be independent, to be free of bosses and layoffs. L. A. Eagles grossed more than \$200 his first week. Others report gross up to \$12,000 per year. How much you make depends largely on you. You need no special skill, no large investment.

**No shop necessary.** Our **ELECTRIC RUG WASHER** cleans rugs, carpets right on floor... helps to show their natural color, beauty. So efficient and safe, used by largest hotels and railroads.

You take no risk. Machines fully guaranteed. Write for full information including how to make big profits in **YOUR OWN BUSINESS.**

**MAIL COUPON TODAY FOR FREE BOOK**

● **VON SCHRADER MFG. CO., 2050 "R" Pl., Racine, Wis.**

● Without obligation, send your **FREE** booklet containing information about your **ELECTRIC RUG WASHER** and how I can start my own permanent, profitable business.

● Name \_\_\_\_\_

● Address \_\_\_\_\_

● City \_\_\_\_\_ Zone \_\_\_\_\_ State \_\_\_\_\_

# GREER SHOP TRAINING

2230 So. Michigan Blvd.  
Chicago 16, Illinois



## Leader in Practical Training for 50 Years

Gain success by learning a trade offering security and high pay—go into business for yourself.

## Get the "Know-how" at Greer

You learn in our new, large, modern shops by working with latest tools and equipment of the trade — tear down, inspect, repair and rebuild... under supervision of experts. Greer founded 1902. Over 51,000 successful grads. Part time, full time, day and evening. E-Z terms. Mail coupon today.

CLIP COUPON... MAIL TODAY  
Greer Shop Training—2230 South Michigan  
Chicago 16, Illinois Desk 213

Please send information about trade checked:  
In our Chicago Shops:  Auto Mechanics  
 Body, fender Repair  Diesel Mechanics  
 Welding—Arc, gas  Tool & Die  
 Refrigeration & Air-conditioning  
 Machinist  Piano tuning

APPROVED FOR CIVILIANS and G.I.'s  
ATTENTION: HIGH SCHOOL GRADUATES.  
Write for information on 2 year DIESEL-AUTOMOTIVE ENGINEERING COURSES.

Name \_\_\_\_\_  
Address \_\_\_\_\_  
City \_\_\_\_\_  
State \_\_\_\_\_ Age \_\_\_\_\_



SAY YOU SAW IT IN  
POPULAR MECHANICS

## INSURED TIRE SERVICE POPULAR BRANDS

**FREE** INSURANCE POLICY given with each used tire sold. We guarantee the amount of service you pay for.  
Tube Given Free with Each Used Passenger Tire Upon Request

**SPECIAL!**  
Deduct 10% on orders for two or more used tires  
**YOU CAN'T LOSE!!**

| Super Quality | Rugged Performance | 15 Months Insured Service |
|---------------|--------------------|---------------------------|
| 600x16 \$4.55 | 670x15 \$5.25      | 700x16 \$5.55             |
| 650x15 4.95   | 670x16 5.35        | 710x15 5.45               |
| 650x16 5.45   | 700x15 5.40        | 760x15 5.95               |

| Supreme Quality | Nothing Finer | 30 Months Insured Service |
|-----------------|---------------|---------------------------|
| 450x20 5.95     | 450x21 6.25   | 700x15 (9) 10.45          |
| 600x16 5.65     | 650x15 5.75   | 600x20 10.95              |
| 650x16 5.85     | 670x15 5.95   | 650x20 11.75              |
| 700x16 7.75     | 700x15 5.75   | 700x20 12.50              |
| 750x16 12.50    | 710x15 6.50   | 32x6(8) 11.95             |
| 550x17 5.75     | 760x15 6.95   | 32x6(10) 12.75            |
| 525x18 5.45     | 820x15 7.50   | 750x20 14.50              |
| 640x15 5.75     | 475x19 5.75   | 825x20 21.50              |

**MIDLAND TIRE SALES**  
Speedy shipments on Mail Orders. F.O.B. Chicago. Insurance policy sent with each order. Deduct 10% on orders for 2 or more used tires. Send CHECK or MONEY ORDER.—No COD's.  
449 W. 37th St., Dept. PM-15, Chicago 9, Ill.

## Learn ACCOUNTING Business Administration

Bookkeeping, secretarial and allied subjects at home in your spare time or attend nationally approved resident school. Write for FREE Success Book giving complete information about courses, plans, rates and employment opportunities.



**Hills BUSINESS UNIVERSITY AND EXTENSION SCHOOL**  
629 W. MAIN ST. OKLAHOMA CITY 2, OKLAHOMA

## WHAT'S YOUR FIELD OF INTEREST?

Specialized magazines will help you get ahead. See current copies of those in your field through our easy-to-get acquainted service. Hundreds of business, trade, professional, educational, craft, hobby, sport and others covering all fields. Send today for List of more than 1,200 publications. It's free.  
Commercial Engraving Publ. Co., 34AB North Ritter, Indianapolis 19, Ind.

## MONEY in DONUTS

Make new greaseless donuts. Start in kitchen. No smoke. Sell stores. Cash daily. No experience necessary. Free recipes. No obligation. Write! MARTIN RAY CO., 3605 SO. 15th AVENUE, MINNEAPOLIS 7, MINN.

## GET UP TO 40% OFF! BUY IT WHOLESALE!

**START A BUYING SERVICE** at home, spare time. Get big-name merchandise for clients (and yourself) at up to 40% and more below the regular list price. Make fat commissions. Folks eagerly buy through you to get sizeable discounts. Send postcard for details.

AMERICAN BUYERS' SERVICE, 631-R Linden Ave., Buffalo 16, N. Y.

## New Way to Improve YOUR ENGLISH

A command of effective English gives you added advantages and better opportunities. Poor English handicaps you more than you will ever realize. You can improve your English through Sherwin Cody's 100% self-correcting invention. If you are embarrassed by mistakes in grammar, spelling, punctuation, or pronunciation, this free book "How You Can Master Good English in 15 Minutes a Day" will prove a revelation to you. Send for it now. It is free. No obligation. No agent will call. Address SHERWIN CODY COURSE IN ENGLISH, 5810 Central Drive, Port Washington, N. Y.

## STUDY LAW FREE AT HOME LAW BOOK!

**Prepare for the Bar!**  
Write today for a copy of our FREE book, "The Law-Trained Man," which gives the bar rules in your state and tells how ambitious men and women since 1890 have been preparing at home in spare time for the practice of law by studying the famous Blackstone bar-training course. All needed instruction material is furnished including big 16-volume law library. Law diploma awarded. Moderate tuition; easy monthly terms. Write for FREE book today!  
**BLACKSTONE SCHOOL OF LAW**  
225 N. Michigan Ave., Dept. 57, Chicago 1, Illinois



### 10 POWER POCKET BINOCULAR

**UNITED**  
SEAL OF QUALITY  
Etched into your United Binocular—Insist On It!

**\$24.95!**

"TITAN MIDGET" 1 3/4"x3 1/4"  
Weights 6 1/2 oz. Yet, a FULL 10 POWER with color corrected Achromatic lens. Interior surfaces of VITAL front and rear Achromatics are COATED to assure brighter, sharper, clearer images! Made by skilled optical craftsmen of precision, quality materials to rigid UNITED requirements. It explains why Price is LOW, Quality is HIGH. With genuine leather case, straps, \$24.95. OTHER POCKET MODELS. 6x Duo-Tone (5 1/2 oz.)—\$17.95, 7x All Chrome—\$19.95.

**16x50—\$69.50** Weighs only 27 ounces!  
The ultimate in high powered binoculars. Easy to hold—Easy to focus. 2" wide objective lens assures brighter, sharper, clearer images. Water-Dust Resistant. Height only 7 inches. Not illustrated.  
6x30 15 oz. Economy.....\$34.50  
7x35 5"x6 1/2" All purpose.....45.50  
7x35 CENTER FOCUS.....49.50  
7x35 German 16 oz. CEN. FOC.....69.50  
7x40 CENTER FOCUS.....52.50  
7x50 31 oz! Bargain!...\$36.00  
7x50 CENTER FOCUS...39.50  
8x30 German 11 oz!....39.50  
8x30 18 oz! Favorite....39.50  
8x40 More Power.....54.50

**SIX TELESCOPES IN ONE!**  
15 to 40 POWER  
American made Wollensak telescope. Instant focusing at 15x, 20x, 30 and 40x, etc. Turn power tube to click — no guesswork. Telescope measures 9" closed, 27" when extended. Weighs only 18 oz.! Has rust proof chrome tubes, large 40mm objective lens. All 12 optic surfaces are COATED. See .22 bullet holes clearly at 300 feet. Use for astronomical observation. \$33.50 price includes fine leather case. No Fed. tax!  
**30 DAY NO-RISK TRIAL.** If not satisfied return for full refund. Cash orders postpaid. C.O.D.'s require \$2.00 deposit. Add Federal tax. Leather case, straps included with all binoculars. **UNITED BINOCULAR CO.,** United Bldg., 9043 S. Western Ave., Dept. ARF-6808, Chicago 20. DISPLAY SALES ROOMS OPEN 9-3:30 MON. THRU FRI. DEALERS WANTED

## BUY A NEW CAR EVERY YEAR ...OUT OF SPARE-TIME EARNINGS

EARN \$2600.00 A YEAR  
LAUNDERING VENETIAN BLINDS

Start in basement, garage, or utility room. In one hour new portable machine washes 10 blinds, at \$1.00 each. Spend an hour a day for 5 days, earn \$50 weekly, or \$2600 a year—in SPARE TIME! (Even if you spend only one hour a week, you've increased your income \$40 per month!) Venetians are in every city—small or large. Small investment for machine. No experience needed—no age limit. FREE booklet tells how to start. Get names of successful operators in your state. No salesman will call—no obligation. WRITE TODAY!



VENETIAN BLIND LAUNDRY EQUIPMENT CO., INC.  
442 NORTH SENECA, Dept. 10-R WICHITA 12, KANSAS

## HERE'S A PROFITABLE BUSINESS FREE!

**MONEY MAKING OPPORTUNITY  
FOR YOU WITHOUT INVESTMENT!**

No experience needed to act as our Local Dealer for MASTER Work Uniform garments. Every business concern a prospect. Advertising embroidered on garments is a big sales feature. Stores can't compete. You can easily earn up to many thousands of dollars yearly. We supply all Sales Equipment FREE. Write GEO. MASTER GARMENT DIV. 601 WATER STREET, LIGONIER, INDIANA



## EASY TO LEARN CODE

Learn to increase speed with an Instructograph—the Radio-Telegraph Code Teacher that takes the place of an operator-instructor and enables anyone to master code without further assistance. Available tapes from beginners alphabet to typical messages on all subjects. Speed range 5 to 40 WPM. Always ready—no QRM. Thousands have "acquired the code" with the Instructograph System. Write today for convenient rental and purchase plans.



INSTRUCTOGRAPH COMPANY  
4701-V Sheridan Road, Chicago 40, Illinois

## 'How to Make Money with Simple Cartoons'



A book everyone who likes to draw should have. It is free; no obligation. Simply address

FREE  
BOOK

CARTOONISTS' EXCHANGE  
Dept. 910A Pleasant Hill, Ohio

Say You Saw It in Popular Mechanics

## Jet Racers

Build and Have Fun With  
Monogram Models



MONO-JET

They Get Power With Jet Cartridge

For the thrill of your life build the Midjet (Midjet type) and Monojet (Indianapolis type) jet power race cars. Power with inexpensive CO2 cartridge for sale everywhere. Speeds up to 50-60 mph. Kits include shaped and bored balsa bodies, rubber wheels, metal axles, plastic shields, instructions and other parts. Easy to build in one evening.

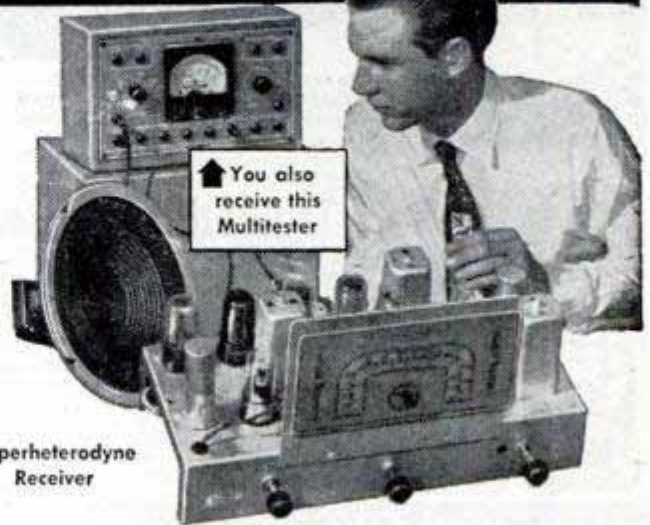
MONOGRAM MODELS, Dept. 17, 3421 W. 48th Place, Chicago 32

Complete Kit of  
Parts—Each Only 85¢

Send 3c Stamp for Big  
Catalog of Planes-Ships-Racers

If no hobby shop near you order from address below. Either racer sent postpaid for \$1.10 — two racers for \$1.95. Delivery guaranteed. If you want catalog in colors showing airplanes, ships and race cars send 3 cent stamp.

## Get into RADIO-TELEVISION ELECTRONICS by Shop-Method Home Training



Superheterodyne  
Receiver

**GOOD JOBS AWAIT THE TRAINED RADIO-TV TECHNICIAN!**  
Business of Your Own • Broadcasting • Radio Manufacturing, Sales, Service • Telecasting • Television Manufacturing, Sales, Service • Laboratories: Installation, Maintenance of Electronic Equipment • Electrolysis, Call Systems • Theatre Sound Systems, Police Radio • Garages: Auto Radio Sales, Service • Sound Systems, Telephone Companies, Engineering Firms, etc. WE BRING NATIONAL SCHOOLS TO YOU! There is a place for you in the great Radio-Television-Electronics industry when you are trained as National Schools will train you at home! OUR METHOD IS PROVED BY THE SUCCESS OF OUR GRADUATES SINCE 1905.

YOU RECEIVE AND KEEP Signal Generator, T.R.F. Receiver, Audio Oscillator and Superheterodyne Receiver, plus professional Multitester shown above. No extra charges. EARN WHILE YOU LEARN—we show you how!

This course also offered in Spanish & Portuguese

APPROVED FOR G. I. TRAINING



FREE  
RADIO-TV  
BOOK &  
SAMPLE  
LESSON!

**MASTER ALL PHASES!** Get Master Shop-Method Home Training from an Established Resident Technical Trade School with its own Training Shops, Laboratories, Studios—almost 50 Years of Successful Experience in Training Ambitious Men.

## NATIONAL SCHOOLS

Technical Trade Training Since 1905

LOS ANGELES 37, CALIFORNIA

In Canada: 193 East Hastings Street, Vancouver 4, B. C.

BOTH HOME STUDY AND RESIDENT COURSES OFFERED

### FIND OUT NOW—MAIL COUPON TODAY!

NATIONAL SCHOOLS, Dept. RB-103  
4000 South Figueroa Street  
Los Angeles 37, California

Mail in envelope  
or paste on  
postal card

Mail me FREE the book "My Future In Radio-Television & Electronics," together with FREE Sample Lesson. I understand there is no obligation and no salesman will call.

NAME \_\_\_\_\_ AGE \_\_\_\_\_

ADDRESS \_\_\_\_\_

CITY \_\_\_\_\_ ZONE \_\_\_\_\_ STATE \_\_\_\_\_

Check here if released from service less than 4 years ago.

Check here if interested in Resident Training at Los Angeles.



**MEN! TRAIN NOW FOR  
A BIG PAY FUTURE IN  
DIESEL  
& SCIENTIFIC MOTOR TUNE-UP**



- Diesel Construction
- Diesel Engine Repairman
- Diesel Operator
- Industrial Maintenance
- Auto Engine Rebuilding
- Bus & Truck Maintenance



**Be a Trained Diesel Man**

Go places with DIESEL! Farms, factories and power plants, trains, ships, trucks, busses all use DIESEL POWER... all need DIESEL-trained men! You can start your DIESEL training at home, in spare time, with tested, proved U E I training. Course includes practical work on Diesel engines under skilled instructors. You learn the operation, maintenance, servicing of all types of Diesel engines, PLUS Scientific Motor Tune-up.

**ACT NOW!** If you have mechanical ability, you'll like Diesel! High School diploma not necessary. Write now for FREE book, "EARNING POWER IN DIESEL." Act Today!



**MAIL NOW FOR FREE BOOK!**

UTILITIES ENGINEERING INSTITUTE, Dept. DC-33,  
2521 Sheffield Ave., Chicago 14, Ill. (Founded 1937)  
O.K.! Rush, without obligation, FREE Book on DIESEL.

NAME \_\_\_\_\_  
ADDRESS \_\_\_\_\_  
CITY \_\_\_\_\_ ZONE \_\_\_\_\_ STATE \_\_\_\_\_  
 Check here for information if under 17.

**RADIO** Engineering. All phases radio & electronics theory & practice; television; FM; broadcasting; servicing; aviation, marine & police radio. Prepare for high pay; 18-month course. Graduates in demand by major companies. Enter Jan., March, June, Sept. Regular campus life. Write for catalog. VALPARAISO TECHNICAL INSTITUTE, Dept. D, Valparaiso, Ind.



**GIVE BLOOD  
NOW** Give it Again  
and Again!

**Free Information Tells How  
You Can Have More,  
Do More, Be Happier**

You need not be held back by disturbing emotions, mental handicaps, lack of influence over others, too little energy.

**Use Your Sleeping Powers**

NEO-SCIENCE reveals the physical, mental and emotional conditions for successful, happy living. It teaches you to develop and control your body, mind, emotions and behavior; finds and uses hidden powers; energizes body and mind; builds success habits. NEO-SCIENCE requires no tiresome exercises, no irksome restrictions of activities, and no absurd beliefs.

NEO-SCIENCE differs in every way from all other plans. It is a complete, scientific, sensible, practical and joyous way of living. And it will work for you.

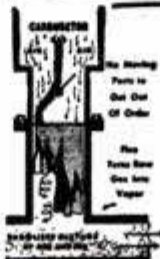
**Send Your Name For Free Lecture**

You can begin your advancement towards a fuller, happier life by sending your name and address to Dr. Denton A. Higbe, 4955 Wolfram St., Chicago 41, Ill. Do it now.



**FINE BOWS and ARROWS**  
SELECTED RAW MATERIALS

**Catalog 5c** Send for it  
**HAND BOOK—Illustrated**  
Instructions on Making and  
Shooting Archery Tackle—75c  
**L. E. STEMLER CO.**  
Manorville (Box 3) L. I. N. Y.



**UP TO 6 MILES MORE PER GALLON**  
Reported by Hundreds Using  
**MIRACLE ACTION TUR-B-LIZER**

Carburetor specialists say Tur-B-lizer is best patented improvement they have seen. Tested in millions of miles of driving in cars, trucks and tractors. Easily installed. Send \$3.00 for six cylinder type, \$4.50 for eight cylinder type. Try Tur-B-lizer for 30 days, if you are not enthusiastically satisfied as claimed by hundreds of users, your money will be promptly refunded.

**UNIVERSAL TUR-B-LIZER CO.**  
621 E. STATE ST. MILWAUKEE 2, WISC.

**Only NEW MONEY MAKER In Years!**

**Make Up To \$10,000 Yearly—Full or Part Time**  
At last! Secrets of luggage and case making revealed. BIG PROFITS—huge market for special cases: traveling, photographers, salesmen, musicians, tools, electronics, jewelry, guns, portables, etc. Learn repairing. Fast, easy profits. No special tools or experience. Wholesale catalog. FREE DETAILS and SAMPLE INSTRUCTIONS.

**A B ARSI CASECRAFT**  
805-H3 West Sunset Blvd. • Los Angeles 12, Calif.

**\$750 BUILDS 4 ROOMS & BATH!**

**WHY PAY RENT?** For Seven Hundred Fifty Dollars and 30 days of your spare time, you can build yourself this Beautiful Home. Living Room 11x15, Front bedroom 9x11, Back bedroom 10x12, Kitchen 9x11, Bath 5x8, Hall 3x4. Wind out steel casement windows, Concrete block, stuccoed. Step-by-step illustrated instructions, blueprint and material list \$1.00 ppd. No COD. Moneyback guarantee.  
**Economy Home, Dept. C**  
Box 645 Columbus 16, Ohio



**HOMECRAFTSMEN**  
Make Money at Home

QUALITY PRODUCTS BY HOME  
Member of  
**HOME INDUSTRIES**  
Association

Join non-profit national organization which promotes home-craft products and services. Group benefits at cost—HOW-TO-DO-IT PUBLICATIONS • MONEY-MAKING IDEAS • MARKET RESEARCH • ADVERTISING & MAIL ORDER SERVICES • SALES REPRESENTATION • GROUP INSURANCE • ACCOUNTING & TAX SERVICES. Send \$1.00 today for year's membership, descriptive booklet and credentials.

**HOME INDUSTRIES ASSOCIATION Inc.**  
1727 K STREET N. W. WASHINGTON 6, D. C.



# SKYMASTER POCKET RADIO

POWERFUL! PERSONAL! PORTABLE!

- Palm Size REAL RADIO (not a toy) covers 550 to 1600 KC
- Selective 250 mile Day-time reception. 1000 mile received at night
- All parts fit within case
- Tiny Acorn tube outperforms sub-miniature types or transistors
- Loud clear tone
- Hearing aid battery powered
- Long life
- Ideal for schools
- Picture diagram with instructions for radio beginners



A POWERFUL VACUUM TUBE MINIATURE KIT designed for your personal enjoyment. Take it on camping trips, to your office or to bed, use it without disturbing others. ALL PARTS FULLY GUARANTEED. Hearing aid batteries INCLUDING EXTRA "A" BATTERY supplied at \$1.50 per set. ALNICO MAGNET POWERED 1500 ohm EARPHONE only \$1.45 when purchased with kit. COD ORDERS ACCEPTABLE WITH \$1.00 deposit within U.S. and possessions.

**\$6.75** postpaid

**PRECISION ELECTRONICS, Dept. M**  
PLACERVILLE, CALIF.

## ORLON Work Uniforms

**Coining Money for Salesmen!**

The billion-dollar work uniform business is up for grabs! Miracle ORLON UNIFORMS make wool and cotton obsolete! Outwears wool 3-to-1; outwears cotton 5-to-1. What's more, ORLON is acid-proof, water-repellent, grease-resistant. Looks like wool, tailors like wool—but washes clean in soap and water. Dries out with original factory press! Everybody buys—service stations, garages, factories, etc. Huge demand and huge profits! Custom embroidery clinches sales. Write for Free selling outfit, actual samples.



**TOPPS**  
Dept. L-6110, Rochester, Indiana

# RUPTURED?

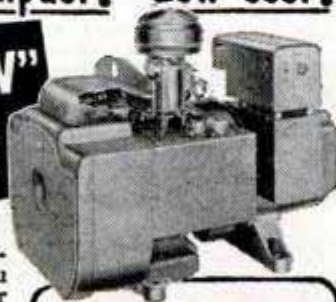
**Get Relief This Proven Way**

Why try to worry along with trusses that gouge your flesh—press heavily on hips and spine—enlarge opening—fail to hold rupture? You need the Cluthe. No leg-straps or cutting belts. Automatic adjustable pad holds at real opening—follows every body movement with instant increased support in case of strain. Cannot slip whether at work or play. Light. Waterproof. Can be worn in bath. Send for amazing FREE book, "Advice To Ruptured" and details of liberal truthful 60-day trial offer. Also endorsements from grateful users in your neighborhood. Write:

CLUTHE SONS, Dept. 31, Bloomfield, New Jersey.

**High output! Compact! Low cost!**

**NEW ONAN "CW"**  
**ELECTRIC PLANTS**  
5,000 or 10,000 watts A.C.



YEARS AHEAD in design, performance, value! Give you regular 110-volt current for trailers, homes, farms, cabins, resorts. Air-cooled, heavy-duty engine. Costs less than any other complete electric plant.

WRITE FOR FOLDER.

**D. W. ONAN & SONS INC.**  
8570 Univ. S.E. • Minneapolis 14, Minn.

- Quiet-running • Fits in small space • Vacuum air-cooled engine and generator • Lightweight
- Completely equipped

# NEW way to enjoy SPORTS movies, television

MADE IN GERMANY

CLIP THIS AD

SAVE \$8.00



NOW ONLY \$1.98

Now...

## GET CLOSE-UP VIEWS ALL DAY...WITHOUT FATIGUE!

Here for the first time—Germany's famed SPEKTOSCOPIES — a revolutionary concept in binoculars. Wear them like ordinary eye-glasses — hour after hour — without fatigue. Featherweight — only 1 oz. You'll hardly FEEL them! Yet here is a new, truly powerful optical design that gives you greater range than many expensive opera or field glasses and a far greater field of view than some selling for many times more! Has INDIVIDUAL eye focusing for clear, sharp viewing, whether you're looking at a play in the first row or a seashore scene miles away! SPEKTOSCOPIES are ideal for indoors, outdoors or distant scenes or close-up viewing. Special low price — \$1.98, a saving of \$8.00 or more!

**Try at Our Risk — No Obligation!**

Enjoy at our risk for 5 days. You must be delighted! Otherwise, your \$1.98 will be refunded with no questions asked! Limited supply forces us to place a limit of 2 per customer. Send check or m.o. for prompt, free delivery. COD's sent plus postage. Use convenient coupon below!

## ● NOTICE!

FAVORABLE EXCHANGE RATE MAKES THIS VALUE POSSIBLE! This is the first time this type of optical instrument has ever sold for less than \$10.00. The favorable rate of exchange and Germany's need for dollars make it possible. We're the exclusive distributors of SPEKTOSCOPIES in the U.S.A. Order today!

## INTERNATIONAL BINOCULAR CO.

Dept. 6-L-90, 53 to 59 E. 25th St., New York 10, N.Y.

Your Name \_\_\_\_\_  
Address \_\_\_\_\_  
Town \_\_\_\_\_ Zone \_\_\_\_\_ State \_\_\_\_\_



## We're Especially Proud . . .

of our latest achievement. Somehow you get an added thrill out of doing something for youngsters. So we were extra-pleased to receive a certificate putting us in the Hobby Hall of Fame for an outstanding hobby achievement in publishing our new edition of *The Boy Mechanic*. This is a not-lightly-made award of the Hobby Guild of America, in conjunction with the National Hobby Museum. Our humble thanks go to Albert O. Basuk, president of the Hobby Guild of America.

### ABOUT THE BOY MECHANIC . . .

Various editions of *The Boy Mechanic* have been appearing since 1913. But the big, new sixth edition we've published recently is a honey—containing more than 500 projects for the young home craftsman. Here are instructions, written so any boy can understand them, and fully illustrated with photos, drawings and diagrams, for making many things dear to a boy's heart. Just some of the models he can build: planes, a racing yacht, a cargo steamer, a naval cannon, an iceboat, a tractor. He can learn to build his own soap-box derby racer, sidewalk tank, four-place sidewalk coaster, bobsled, archery set, sea sled and his choice of several small boats.

Rainy days will be happy days for the boy who teaches himself some of the basic crafts from *The Boy Mechanic*. This craftwork includes woodworking, carving, molding, metalworking, etching, leathercraft, bicycle repairing, block printing, stenciling, book binding, plaster casting, plastic craft, paper crafts and puppetry.

### THE BOY SCIENTIST . . .

has a whole section of the book to himself in *The Boy Mechanic*. There are some simple but exciting experiments in electricity, chemistry and basic physics and engineering which require very little equipment. Your boy also is taught to mount fish and birds, establish a home weather bureau, make a play telephone, toy motors, steam engines, a sun dial, 100-power microscope, electromagnets, etc.

### AS THE TWIG IS BENT . . .

Things like this will keep a boy busy and happy, and, what is more, turn out a man who can use his hands as well as his head and heart. Yet the more than 500 things to make and do provided in *The Boy Mechanic* come to you for the low price of \$2.95. A slightly smaller collection of projects is contained in *The Young Craftsman* for \$2. A good companion volume for boys is *Mr. Wizard's Science Secrets* (\$3), written especially for youngsters by Don Herbert of TV fame. All of these famous books make treasured gifts. They can be obtained at your bookstore. Or you can write



**POPULAR MECHANICS PRESS**  
200 East Ontario Street Chicago 11, Illinois

# RELINE and REPAIR! Your FALSE TEETH

- 1. ENJOY PERFECT PLATE COMFORT!** Reline your plate at home! You'll be amazed at the soft, mild, comfortable cushion Poly-liner forms between your plate and gums, and besides it refits and holds your plate firmly in a way no powder or paste can do. So don't tolerate sore gums caused by loose, wobbly plates, send for Poly-liner, enjoy eating in comfort.
  - 2. REPAIR PLASTIC!** Easy to repair your own plate, quick too. Saves you expensive repair bills, delay, Natural color, self hardens in minutes. Only a few minutes work and your plate is ready again.
  - 3. POLY-POLISH!** A great favorite with plate users. Cleans, polishes, removes stubborn stains in a jiffy.
- ALL THREE FOR ONLY  
**\$2.95**  
POSTPAID  
**POLY-LINER PLASTIC PROD.**  
115 West 7th Street • Los Angeles 14, California



Price \$6.95 Delivered to You  
Par'd. Order from R. V. LEHNER, NESS CITY, KANSAS



Protect your bumper from discoloration and rust. Install this heavy duty chrome-plated extension on your exhaust. Will fit all cars. \$1.50 ppd.

**JET PRODUCTS P.O. Box 2005 Inglewood 4, Calif.**

## Become a Doctor of PSYCHOLOGY

Win the degree of Ps.D. Learn the secret of contentment, happiness. Solve mental worries. Experience the revelation of truth. Chartered college. Individual help. Write for FREE book. **COLLEGE OF UNIVERSAL TRUTH, 5038-B Broadway, Chicago.**

## RECORD SHATTERING PROFITS FOR YOU!!!

Selling quality Pennsylvania Saw Sets full or part time. Earn \$30.00 a day with these 5 different saws on one handle that everyone wants and needs. Send 10¢ for complete selling outfit on our line. Build your own Hardware Business. No Obligation.

**JAMES R. BARNET COMPANY**  
DEPT. PM10, BOX 188, WELLESLEY HILLS 82, MASS.

Build WESTERN MODELS 50c to \$2.25 SEE YOUR HOBBY DEALER

**START YOUR COLLECTION Today**  
12 DIFFERENT EARLY WESTERN VEHICLE KITS COMPLETE WITH PLANS, PREFABRICATED PARTS  
OR SEND 10¢ FOR CATALOG & LITERATURE

**FRONTIER Mfg. CO.**  
DEPT. F, 221 SAN FERNANDO RD. LOS ANGELES 31, CALIFORNIA

## 2 OR 4 WHEEL DRIVE FOR JEEPS IN SECONDS



**AMAZING NEW WARN HUB**  
gives your 4-wheel drive Willys 2-wheel pep, power, speed, extra mileage, passenger car performance—as well as 4-wheel power and traction! Change from 2-wheel to 4-wheel or back in seconds by turning fingertip control on hubs. Warn hubs reduce wear on front axle assembly and front tires, eliminate shimmy, increase gas mileage up to 6 miles per gal. Unconditional Money Back guarantee. \$65.00 pair prepaid. ALSO AVAILABLE: Warn Standard Hub for Willys \$20.00 pr., Dodge \$23.00 pr. and Warn Automatic Hub for Willys \$120.00 pr. At Dealers or direct.

**WARN MFG. CO., RIVERTON Box 6064-A2, Seattle 88, Wash.**

# McNess WANTS MEN

TO RUN McNESS FARM HOME STORES

## Wonderful Work for Man with Car

Use your car as McNess Farm Home Store. Call on same homes month after month. Every farm family becomes your friend. Farmers depend on McNess Farm Home Stores for countless necessities—save orders for you—buy everything they can because McNess quality is tops, values are best, and every sale is guaranteed. Premiums, special offers, new products help you make good money from start.



**Use Your CAR to Raise Your PAY**

### WE SUPPLY CAPITAL

You supply car. We'll supply capital and sales know-how. You start making money first day. There's no finer, more enjoyable work anywhere. Pays well, permanent, no boss, no age limit. No sales experience necessary. This can easily be the biggest paying job you've ever had. Write today for free McNess Dealer Book. No obligation. (16)

**THE McNESS CO., 85 Clark St., Freeport, Ill.**

## Now! You Can Do This Magician's Trick

### MAGIC FLOWER

Flowers Appear From Your Fingertips!! Show your empty hand and then produce a beautiful flower at your fingertips... like out of the air. Repeat as many times as you like... real magic in the Houdini tradition. Amaze the ladies... fun at parties, work, club, home... No skill required... Send only **\$1 FREE**—Book of Magic Tricks with each order.



**The MAGIC CENTER**  
"world's largest magic store"  
Dept. PM-1, 741 8th Ave., New York 19, N.Y.

## LEARN CARTOONING at home in spare time

Simplified Landon Picture Chart Method makes progress quick, exciting, easy. Former Landon students include creators of "Steve Canyon," "Freckles," "Out Our Way," "Winnie Winkle," "Regular Fellers," "The Neighbors," "Strange as it Seems," and many others. Earn while learning. Rush 10c for Picture Chart (to test your ability) and full details. Please state age.



Landon School of Cartooning, 5310 CTS Bldg., Cleveland, O.

## "PLASTICS FABRICATING MANUAL"

New book shows you how to work in Plastics for fun and profit! Jam packed with "How to do it" illustrations. Learn latest methods of carving, sawing, cementing, polishing, casting, drilling every type of plastic including Lucite, Acetate Plexiglas, Catalin, Bakelite, etc. A real gold mine for advanced workers or beginners. Shows how to make hundreds of useful and decorative items from plastic sheets, rods, tubes and casting resins. Manual also contains complete illustrated catalog of our line of plastic hobby supplies including plastic stock sheets—rods—tubes—casting resins—cements—dyes—tools and project plans. Send 25c for this valuable manual. Edition limited—act fast!

**ONLY 25c**

HOUSE OF PLASTICS, 8648 Linwood, Dept. PM-10, Detroit 6, Mich.

## Super Powerful All Channel TV RECEPTION IN ALL DIRECTIONS



**Rocket DIRECTRONIC MOTORLESS TV ANTENNA**  
360° Electronically Switched Beam

- No Motors
- No Ghosts
- No Roof
- Flick of Switch Clears Picture Instantly
- Orientation
- No Electric Power

In the city or in an ultra-fringe area, the Directronic will outperform ordinary antennas. Only the Motorless 360° Directronic TV Antenna offers "around the compass" reception WITHOUT Rotors. Clarity of picture will amaze, it's so bright, so sharply defined. AX-599 "Service-man's Array" contains Hi-Pac molded insulator of extremely high tensile strength, 18 hi-tensile aluminum alloy elements, 1 set of connecting stubs (3), Universal U-Clamps for masts to 1 1/2", Directronic Beam Selector, 75 feet of Tri-X Cable.

**AX-599 Directronic \$16.95**  
You pay postage

Do not remit more than complete purchase price. 25% deposit on C.O.D. orders, please. Money-back guarantee.  
**NATIONAL ELECTRONICS OF CLEVELAND**  
310 DELCO BLDG. CLEVELAND 3, OHIO

# IMPORT PAYS BIG!



B. L. MELLINGER  
Exporter-Importer

**HERE'S PROOF!**  
New World Trade Boom Offers Big Profit Opportunity to ambitious Men and Women everywhere. I'll show you how you may Import Thousands of desirable products at low foreign prices for buyers in your locality at high U. S. Prices—how you can operate a world-wide mail-order Import-Export business from your own home whether you live in a big city, small town, or on a farm.

*B. L. Mellinger*



**SEE FOR YOURSELF.** Would you like to see what tremendous values you can get from overseas? As startling first-hand proof I will send you an actual import **AT MY COST**—something to see and use. Just mail me 25¢ in coin and I will rush you this Imported Melson Automatic cigarette lighter—made to retail in the U.S. at \$2. This magnificent Import will convince you of the tremendous profits being made in World Trade. **START AT ONCE WITHOUT CAPITAL** or previous experience. Fantastic profits are possible. My training also includes shipment to you of many sample imports from 'round the world. **GRASP THIS OPPORTUNITY TODAY.** Send for your Melson Automatic cigarette lighter now and I will include full details that show you how to learn my Big Profit secrets of World Trade—complete instructions that will put you on the road to a Profitable business of your own and future security. Opportunity to travel abroad for profit and pleasure. I'll also show you how you can save many dollars on your own purchases of Clothes, Tools, Gems, Antiques, Watches, Cameras, China, Silks, Toys, etc. You can have the complete details **FREE** without ordering the lighter if you wish, but I would like to send you the Melson lighter as an actual demonstration of Import Values. Either way, mail coupon now. Airmail reaches me overnight.

The Mellinger Co., Dept. 25A 1717 Westwood, Los Angeles, 24, Calif.

**HERE'S MORE PROOF!**  
"We operate a profitable World Trade Business from our home... Thanks to MELLINGER."  
Mr. and Mrs. Beke, N.Y.

**MAIL COUPON NOW!**

The Mellinger Co., Dept. 25A  
1717 Westwood, Los Angeles 24, Calif.

Mr. Mellinger: Show me the big profits to be made through World Trade. I enclose 25¢ in coin. Send me one Melson Cigarette Lighter and your plan that shows me how to learn the secrets of World Trade.  Just send your FREE World Trade Plan.

Name \_\_\_\_\_  
Street \_\_\_\_\_  
Town \_\_\_\_\_ Zone \_\_\_\_\_ State \_\_\_\_\_

# "How to become a Mail Order Millionaire"

**Yours — for the asking — free of charge!**

Read how Gilbert built a "peanut" investment into \$240 a day — how a Chicago clerk jumped from \$75 a week to \$22,000 a year — how a G.I. made a fortune selling war surplus by mail.

Send just your name—no money—for free copy of this inspiring reprint from *Mechanix Illustrated*. With it, I'll send details on the **L. W. Survey**. No tiresome study. An easy guide to mail order success. Shows **how** to start on small capital; **how** to pick the right product; **how** to get big money in the mail. Gives actual examples of money-making ads and letters. Tells how to start; how to operate.



### Many of the Biggest Give Me Credit for Their Success

My 36 years' experience with hundreds of mail order projects brings even the biggest to my office for consultation. Many of today's giants credit me with their success. The same methods I use for them can now be yours through personal coaching that accompanies my Survey. —L. W.

## SEND NAME FOR FREE COPY!

No salesman will call. Read the facts. Then decide whether you want to start a "little gold mine" in spare time, using this remarkable course as your daily guide. The **L. W. Survey** shows how to use your home as headquarters; how to follow in steps of hundreds of men who have won fortunes in this fascinating business. Ganes retired after five years selling a pants-presser by mail. Duggan, former truck driver, six years after starting says: "I don't know how much I'm worth. After the first million you quit counting." Jorgenson went from failure to sales of over half a million his first year. Their methods are revealed in the Survey—your guide to a rich and happy future. **Rush your name now.**

**L. W. SURVEY** 805 Larrabee St., Dept. 110  
Los Angeles 46, California

## Become a TAX EXPERT

Earn big fees during the income tax season and all year 'round. Cash in on the unprecedented boom. New, simple home-study course prepares you in a few weeks, shows you how to start your own tax practice immediately. Full or spare time. Experience unnecessary. Write TODAY for free details, no obligation. **UNION INSTITUTE**, Lakewood 9, N. J.

## AGENTS: Here's Your Chance to Sell the Steady, Profitable ARTMOORE Line

Backed by 20 Years of Square Dealing

YOU sell—  
WE deliver

No fancy deals; just steady cash for you daily. Users say it's perfect for scrubbing, dusting and waxing floors and washing painted walls. Write for details and generous sample offer.



**ARTMOORE COMPANY**

Dept. PM-103

1319 No. 3rd St.

Milwaukee 12, Wis.

## IT'S FREE!

New, exciting booklet . . .  
**"THE INVISIBLE WORLD and THE WONDERS OF CHEMISTRY"**



Big, precision built Sciencecraft microscopes are equipped with velvet touch focusing adjustment, 90 degree inclination joints, fully adjustable mirrors, and spring stage clips. Accurately ground and polished optical glass lenses are carefully synchronized to insure perfect resolving power and definition.

Now available! New, improved triple objective turret microscope. Exclusive index gives complete coverage of large subjects. Magnification 50-150 and 300 diameters. Priced as low as \$8.95 . . . Explore the exciting world of science. Send for your free booklet today.

The Porter Chemical Company  
41 Prospect Avenue, Hagerstown, Maryland



SAY YOU SAW IT IN  
POPULAR MECHANICS

## WANT TO Write Stories

FREE LESSON Articles & Mysteries?

shows how you learn at home



The demand for writers is creating great new opportunities and it's not as hard to succeed as you may imagine. At home, you may learn fiction writing, best basis for all fields; short stories, radio & TV, articles, business items. Palmer training is endorsed by famous authors, scores of successful graduates. Complete instruction, professional coaching. FREE book and lesson show how you may enjoy an ideal part-time or full-time career. Write TODAY (no salesman will call). Approved for veterans; advise if eligible.

**PALMER INSTITUTE OF AUTHORSHIP**, Since 1917  
1680 N. Sycamore, Hollywood 28, Calif., Desk T-10-3

PLEASE  
SEND ME



for the  
time checked.  
I am enclosing . . .

1 year \$3.50

2 years \$6.00

name

address

city

zone

state

C-103

Hand this order to your newsdealer or send it to

**POPULAR MECHANICS**

200 East Ontario St.

Chicago 11, Ill.

# LEARN MEAT CUTTING AT NATIONAL

Pay After Graduation



The steady dependable trade of Meat Cutting taught easily in 8 short weeks. YOU LEARN BY DOING under actual meat market conditions in big modern school at Toledo.

For beginners or men with experience. Get a profitable store of your own. Remember, PEOPLE MUST EAT! Big pay jobs. Free employment help. Thousands of successful graduates.

Buying, cutting, percentage, pricing, advertising, selling, etc. A complete retail meat education. National School established over 25 years. Get National training NOW. Pay your tuition in easy weekly payments

after you graduate. Send coupon for FREE 52 page school catalog — TODAY. G.I. approved.

**National School of Meat Cutting, Inc., Dept. 50-W, Toledo 4, Ohio**

Send me your FREE school catalog on National Training at Toledo in Meat Cutting, Meat Merchandising and Self Service Meats. No obligation. No salesman will call.

Name \_\_\_\_\_ Age \_\_\_\_\_  
 Address \_\_\_\_\_  
 City \_\_\_\_\_ State \_\_\_\_\_  
 Approved for training Korean Veterans

## Say You Saw It in POPULAR MECHANICS

### MEN! WE FIT W-I-D-E FEET!

E to EEEE Only  
 Sizes 5 to 13

Real comfort at last for w-i-d-e feet! We specialize in wide sizes and offer you styles you like to wear but can't find in the width you need. Fine dress shoes, work shoes, casuals, smart hand-sewn genuine moccasins. Top quality. Popular prices.

**Money Back Guarantee**  
 Not sold in stores. Write for FREE catalog today. No obligation!  
**HITCHCOCK SHOES, Hingham 28, Mass.**



FREE CATALOG  
 Write Today

### Watch Repairing Pays Big Money Learn at home



Watch repairers in great demand. Train step-by-step in 10 easy lessons. We furnish all tools and 15 jewel watch and practice movement. Turn spare time into cash. A licensed school. Low cost. Send for FREE book today.

**ILLINOIS SCHOOL OF WATCH REPAIRING**  
 2870 Elston Ave., Dept. PM-103, Chicago 18, Ill.

### INCREASE POWER—SAVE GAS with Sensational DYNA-CARBURETOR



#### STOP WASTING DOLLARS!

You've never seen anything like this. Mixes air and gas with violent force, lowering fuel-air temperature 50° to 60°. Atomizes the fuel, steps up horsepower and gives up to 2-5 MPG increase.

Fits all standard cars. Easy to install. Pays for itself in savings alone!

**FREE SALESMEN WANTED**  
**DETAILS!** A single demonstration sells it! Send for details today.

**JOSEPH CONRAD & ASSOC.**  
 1645 E. SLAUSON, LOS ANGELES, CALIF.

### GO PLACES LEARN ANOTHER LANGUAGE

EASILY — QUICKLY IN 20 MINUTES A DAY  
 by **LINGUAPHONE**

World's-Standard CONVERSATIONAL METHOD

**FRENCH  
 SPANISH  
 GERMAN  
 RUSSIAN  
 JAPANESE  
 NORWEGIAN**  
 —any of  
 29 Lan-  
 guages.

Are interesting job, travel, armed services', cultural opportunities passing you by because you speak only one tongue? Learn AT HOME the same natural easy way you learned English long before you went to school. YOU LISTEN—you hear native men and women speak—you understand—YOU SPEAK. World-wide educational, business endorsement; over a million home-study students of all ages. FREE BOOK gives fascinating facts. WRITE TODAY! LINGUAPHONE INSTITUTE, 143-10 Mezz., Rock. Plaza, N. Y. 20.

LINGUAPHONE INSTITUTE, 143-10 Mezz., Rock. Plaza, N. Y. 20, N. Y.  
 Send me your FREE book. I want to learn \_\_\_\_\_ language.  
 Name \_\_\_\_\_  
 Address \_\_\_\_\_  
 City \_\_\_\_\_ Zone \_\_\_\_\_ State \_\_\_\_\_

### WORK FOR THE



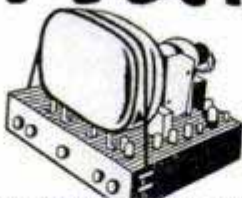
### GOVERNMENT

START AS HIGH AS \$3,795.00 YEAR  
 Many Appointments To Be Made. Experience Often Not Required. MEN—WOMEN. Mail Coupon Today—Sure.

**FRANKLIN INSTITUTE, Dept. E-83, Rochester 4, N. Y.**  
 (Not Government Controlled) Sirs: Rush without charge, (1) 36-page book with list of U. S. Government Jobs. (2) Tell me how to get one of these jobs.  
 Name \_\_\_\_\_  
 Address \_\_\_\_\_ Age? \_\_\_\_\_

# BUILD <sup>your own</sup> TV Set

YES, actually build a valuable TV Set right at home. At the same time learn all about installing, repairing, servicing—and get ready for a Big-Pay Job in America's fastest-growing, most exciting industry. The CTI TV Train-at-Home Plan is preparing hundreds for bigger pay TODAY—and a brighter Future TOMORROW. No experience needed. We supply easy-to-understand instructions—made clear with hundreds of charts, diagrams, photos—plus TWENTY KITS of Parts, Professional Equipment and Tools. Get a TV Set to ENJOY. Get set to ENJOY a TV Future. Make money in spare time while taking Course. THOUSANDS SUCCEEDING! So can You. Send today for big FREE Book, "You Can Succeed in Television."



## COMMERCIAL TRADES INSTITUTE

Dept. T2-10, 1400 Greenleaf Ave., Chicago 26, Ill.

### TO LOCATE THE WOOD STUDS IN YOUR WALL



## USE A DOWSER\*

When hanging mirrors, pictures, shelves. Also when repairing or altering. Does not depend on magnetism for its operation.

**\$2.00 Ppd. Money-back guarantee.**

The Roll of the Ball Finds the Stud in the Wall You May Need One Tomorrow!

\*PATENTED  
FORD PRODUCTS, Dept. P-3, Port Chester, N. Y.

Say You Saw It in Popular Mechanics



SEND NO MONEY  
• MORE THAN 4000 PAGES  
• 2750 PICTURES

## 9 BIG COMPLETE BOOKS BUILDING, ESTIMATING, CONTRACTING

Examine this Up-to-Date Edition for 10 days. See how these nine books supply easily understood training that will help you to get a better job and make more money, or start a profitable business for yourself. Think what a BIG help it will be to have them handy for use in solving all sorts of building problems.

Learn to draw plans, estimate, do all-new construction and modern remodeling to meet fast growing demand. More than 4000 pages of practical, pay-raising information with 2750 helpful illustrations, on such subjects as blueprint reading, concrete forms, masonry, carpentry, steel square, electrical wiring, plumbing, heating, painting, and hundreds more.

In our more than 50 years we have never offered more complete building information. Send the coupon TODAY.

(A year's consulting privileges with our engineers now given with these books without extra cost.)

AMERICAN TECHNICAL SOCIETY—Publishers Since 1898  
Dept. G719, Drexel Ave. at 58th St., Chicago 37, Ill.

I would like to examine your 9-Volume Set of Building, Estimating, Contracting Books. I will pay the delivery charges only, but if I choose I may return them express collect. If after 10 days' use I prefer to keep them, I will send you \$3 plus postage and pay the balance at the rate of only \$4 a month until \$34.80 has been paid.

Name \_\_\_\_\_

Address \_\_\_\_\_

City \_\_\_\_\_ State \_\_\_\_\_

Please attach letter giving employer's name and address (if self-employed give business man reference). Men in service please give home address.

# Make Your Own POWER TOOLS

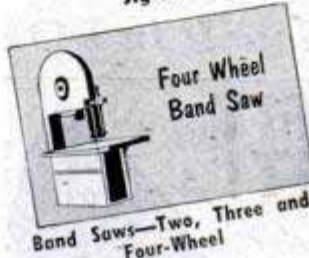
Enjoy Fun and Profit With a Low Cost Motorized Shop!



3 Different Drill Presses You Can Make



All Types of Saws—Circular, Jig and Others



Band Saws—Two, Three and Four-Wheel

## New Popular Mechanics Book Shows How to Make 60 Tools from Scrap, Discarded Parts!

Get SIXTY POWER TOOLS AND HOW TO BUILD THEM, the sensational new book in the Popular Mechanics Craftsman Series. Build your own lathe, drill press, sander, circular and band saw and other power tools at a cost of only a few dollars each. Use old auto parts, pipe, wood and odds and ends that cost little or nothing. Every detail of construction is given in plain language you can understand and follow in this timely how-to-do-it book.

## 200,000 Copies of Earlier Edition Now in Use

More than 200,000 copies of the earlier book "Forty Power Tools You Can Make" have been sold. This is a brand new book with new material and new machines—SIXTY POWER TOOLS AND HOW TO BUILD THEM. Hundreds of pictures and plans show every step to follow in making the power tools you want. Actual photos of finished machines included. Note partial list of power tools you can make below.

## Examine for 7 Days • Your Money Back if Not Pleased

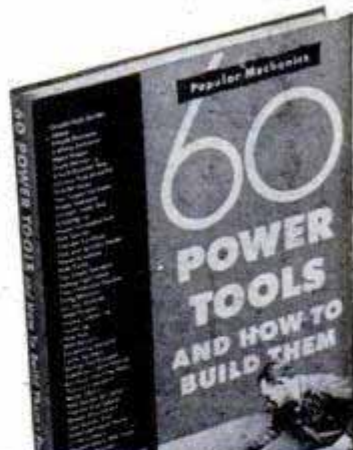
Mail the coupon today with only \$2.50 or we will send book C.O.D. Your money back if you return the book. You'll be amazed with the practical tools you can make and how little they cost. With this book you can have a complete motorized workshop and save hundreds of dollars. Mail coupon today.

## Save Hundreds of Dollars on an Up-to-Date Shop Make All of These

- Jig Saw from Old Sewing Machine
- Two, Three and Four-Wheel Band Saws
- Drill Presses from Old Auto Parts and Pipe
- Precision Drill Press for Model Makers
- Swing Saw
- Power Hacksaw
- 10-inch Table Saw With Tilting Arbor
- Disk and Spindle Sander
- Power Scroll Saw
- Thickness Planer—10 Inch
- Wood Shaper from Pipe and Plywood
- Disk Sander, 12 In., With Tilting Table
- Motorized Hand Plane
- One-Motor Workshop
- Electric Filing Machine
- Heavy Duty Grinder
- Flexible Belt Sander
- and others—60 Power Tools in All.



Over 250 Photos, Diagrams and Working Drawings



## Use This Coupon • Mail it Today!

POPULAR MECHANICS PRESS, Dept. PT-4, 200 E. Ontario St., Chicago 11

Send me SIXTY POWER TOOLS AND HOW TO BUILD THEM.

Remittance for \$2.50 enclosed. Send postpaid.

Send C.O.D. (U.S.A. only). I will pay postman.

I understand I may return book within 7 days if not satisfactory and you will refund full purchase price.

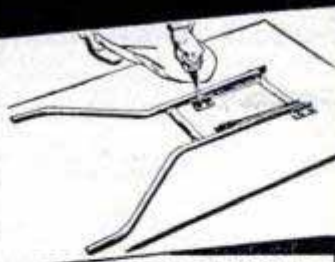
Name \_\_\_\_\_

Address \_\_\_\_\_

City \_\_\_\_\_ Zone \_\_\_\_\_ State \_\_\_\_\_

# MAKE YOUR OWN FOLDING TABLES IN MINUTES

WITH  
TABLECRAFTERS'  
TUBULAR STEEL  
FOLDING  
TABLE LEGS



Screw leg assemblies to your table top. Guide holes assure accurate assembling. Sturdy, rustproof legs have safety lock... won't collapse... fold easily for storage. For hobby, work, banquet, buffet, game tables.

**\$995** COMPLETE KIT FOR ONE TABLE

If you send check or money order, we pay postage. Special discounts to institutions.

Dep't G-10

● **TABLECRAFTERS** 1114 York Rd., Abington, Pa. ●

**29¢ SIZE, ONLY 15¢**

INTRODUCTORY SPECIAL

Bargain way to try this great made-for-men deodorant! Send 15c in coin for regular 29c size — month's supply!

MENNEN, BOX 1197, NEWARK, N.J.



*Hand Guide!*

OZMENT (INVENTOR), 34-P, ST. LOUIS, MO. (BX665)

**POSITIVELY** controls movement of hand until one's Penmanship is quickly corrected. Inexpensive. Write.

## What to Make with CONCRETE

Even little concrete jobs cost big money — mostly for labor. Get Popular Mechanics **WHAT TO MAKE WITH CONCRETE** and save all the labor cost while making your home or farm ship-shape. Book shows all — tells all — how to make the right mixture, plan, apply and gives 50 professional short cuts. Hundreds of pictures. Only \$2.00 postpaid. Order today. Money back if not pleased.

POPULAR MECHANICS PRESS, Dept. PM9, 200 E. Ontario St., Chicago 11



Build Your Own Fireplace, Driveways, Walks, Etc.

**PROOF! Toilet Tissue Makes Ideal Oil Filter Refill... Costs Only**

**10¢**

Install Retlif Adapter Plates in your car oil filter and you can use ordinary toilet paper roll for the filter element! Laboratory tests, thousands of motorists, proved conclusively that toilet paper cleans dirty motor oil faster and better than popular makes of filter elements! And costs only 10¢! Now get these advantages with Retlif Adapter Plates. Easily installed. Write today for facts, proof, descriptive literature.

**RETLIF CORPORATION, Dept. 123**  
915 N. Highland Ave., Los Angeles 38, Calif.



Filters Oil the full length of the Pack

10,000 Sq. In. of Filtering Surface

Plates Last Indefinitely

# The WONDERS of LIQUID PLASTICS

**MANUFACTURE WITHOUT TOOLS OR MACHINERY! WE PAY YOU \$5.00 AN HOUR!**

No previous experience or special ability required! **NO TOOLS OR MACHINERY** required... the entire process is about as easy as pouring water out of a glass! The **WONDERS OF LIQUID PLASTICS** make all this possible! Many of the products made with our liquid plastics are so beautiful and attractive that we have created an unusual demand for this type of merchandise! That's why we will pay you \$5.00 an hour (materials extra) to make the items shown here and in our catalog for us!

## UNLIMITED POSSIBILITIES

Work with **LIQUID IVORY, LIQUID GLASS, LIQUID MARBLE, LIQUID EBONY, LIQUID PORCELAIN, LIQUID WOOD, LIQUID GEMSTONE** and many other **LIQUID PLASTICS** and in a matter of minutes turn them into an endless and valuable procession of beautiful imbedded jewelry, novelties, ornamentals, statues, bookends, lamps, pensets, lighters, ashtrays, keychains, figurines, curios, **SOUVENIRS**, art and gift products, fishing lures, **BOATS, GADGETS** galore, exquisite **GEMS!** Make gears, tools, dies, forms, handles, dials, knobs, **MACHINE PARTS**, models of inventions, pistol grips... the list is endless! The only **LIMITATION** is your **IMAGINATION!** Liquid Plastics are the blessing of every creative and ambitious person... with these materials **ANYONE** can create and manufacture by the **THOUSANDS** and at a tiny fraction of what it would cost by any other method! Just send 25c and we will send you our book, "**HOW TO MANUFACTURE WITHOUT TOOLS OR MACHINERY**," included with our big 64 page catalog describing all the materials mentioned above; also details of our \$5.00-an-hour offer! Do it today... we want you to share in these wonderful opportunities as soon as possible!

**PLASTICAST CO., (Dept. C)**

P.O. Box 6737 (Write to) P.O. Box 987  
Chicago 80, Ill. either address) Palo Alto, Calif.



## PLASTIC LAMINATING



This remarkable Plastic Laminating Machine will earn \$18.00 an hour right in your kitchen! Big profits laminating Business, Social Security, Identification, Credit CARDS of all kinds, photos, passes, clippings, etc. Price complete (illustrated) \$35.00 plus postage. Others higher. Literature free.

**PLASTICAST CO.**  
(Address in ad above)

Say You Saw It in  
**POPULAR MECHANICS**



**HANDS TIED?**

—because you lack a  
**HIGH SCHOOL DIPLOMA**

● You can qualify for an American School Diploma *in spare time at home!* If you have left school, write or mail coupon for **FREE** booklet that tells how. No obligation of any kind.

OUR 56TH YEAR

**AMERICAN SCHOOL, Dept. V745**  
Drexel at 58th, Chicago 37, Illinois

Please send **FREE** High School booklet.

NAME.....

ADDRESS.....

CITY & STATE.....

# MEN WANTED!



**Make \$15-\$20 in Few Hours Spare Time—up to \$210.00 a Week FULL TIME—with Amazing D-FROST-O-MATIC!**

Millions of housewives want this sensational new Automatic Refrigerator Defroster! No more messy hand defrosting! Just plug in D-FROST-O-MATIC and refrigerator is defrosted automatically every night! Sales easy, sure when you leave D-FROST-O-MATIC on FREE TRIAL—housewives won't let you take it out! Saves money, food, time, work! **Big profits for you—up to \$210.00 a week full time—\$15 to \$20 in just a few spare hours!** Start spare time and build big, prosperous business . . . quickly, easily!

**SELLY of California** started in his spare time and now sells 1500 D-Frost-O-Matics a month!

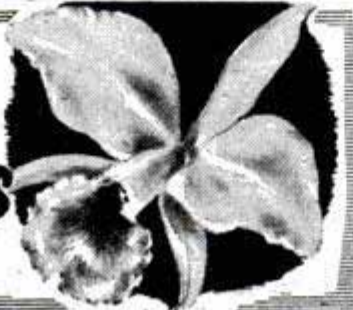
**Rush Name Today for Profit Details and FREE TRIAL PLAN!**

More than 29,000,000 prospects waiting! Rush your name and address today. We'll airmail exciting facts, proof and sure-profit Free Trial plan. No obligation. Write today.

**D-FROST-O-MATIC, Dept. G-6**  
173 W. Madison Street, Chicago 2, Ill.  
In Canada—Write Silvex Co., 371 Dowd St., Montreal 1, Que.

Fascinating hobby!  
Fabulous profit!

**GROW ORCHIDS at HOME**



Imagine, beautiful Cattleyas, Exquisite Cymbidiums, and other colorful varieties...growing, blooming, right in your own living room! A single Orchid plant on a card table or window sill, can multiply into a fortune! **NO EXPENSIVE EQUIPMENT NEEDED! GROWS IN ANY CLIMATE!** Learn the amazing secrets, with easy-to-follow instructions. **WRITE TODAY for FREE ILLUSTRATIONS and details on obtaining already potted ORCHID PLANTS FREE!**  
**ORCHID-LAND**  
DEPT. 2E, BOX 27801, LOS ANGELES 27, CALIFORNIA

## YOU'LL CATCH BIGGER FISH

and have more fun catching them after you read Popular Mechanics HOW TO TEMPT A FISH! Here is the experience of veteran guides and fishermen brought to you for hours of enjoyable reading. Many pages of brilliant full color Kodachrome plates. Covers every phase and style of fishing—even tells where to find the big ones and what baits to use. Hundreds of kinks and tips to make every trip more enjoyable. Endorsed by leading sportsmen throughout the country. 128 pages. 325 illus.



**POPULAR MECHANICS PRESS \$2.00**  
200 E. Ontario Street, Chicago 11

Say You Saw It in Popular Mechanics

## WATCHMAKING FREE Sample Lesson

Watch repairing's fun . . . profitable too! An exciting hobby or fascinating career. Chicago School of Watchmaking offers complete home study training in professional watch repairing at amazing low cost. All equipment included at no extra charge. Or, if you prefer, attend school in person. No experience needed. Write today. No obligation.

### CHICAGO SCHOOL OF WATCHMAKING

2330 Milwaukee Ave., Dept. 1103, Chicago 47, Ill.  Veteran  
Send free sample lesson.  Home study  Resident school

Name \_\_\_\_\_

Address \_\_\_\_\_

City \_\_\_\_\_ Zone \_\_\_\_\_ State \_\_\_\_\_

## Handy Mail Order List

Little Library of Useful INFORMATION

5 for \$1.00  
12 for \$2.00  
25¢ Each

Here at amazingly low cost is the practical help and information you have always wanted. Articles in previous issues of Popular Mechanics have been classified according to subject and are now available in these handy reprint booklets.

- How to Use Measuring Tools—Micrometers, Calipers, etc.—106.
- Power Driven Saws—74.
- Drill Presses, Grinders, Etc.—79.
- Wood, Metal Turning—Lathes—81.
- Filing Machine, Hack Saw, Cutoff Wheel, Shaper—82.
- Lathe Tools You Can Make—101.
- Workbenches—Tool Cabinets—47.
- Spray Painting—94.
- From Pattern to Casting—91.
- Tool and Saw Sharpening—92.
- Sharpening Drills, Wood Bits—90.
- Successful Wood Turning—32.
- How to Read Blueprint—71.
- Metal Turning Lathe Kinks—99.
- Operating a Metal Lathe—100.
- Heat Treating, Hardening—102.
- Working With Glass—103.
- Servicing Elec. Motors—75.
- Electromagnets & Solenoids—44.
- Transformer Construction—41.
- The Boy Electrician—43.
- Soldering and Brazing—17.
- Arc and Spot Welders—5.
- Electroplating With Nickel, Chromium, Cadmium, Etc.—86.
- Plating Leather, Wood, etc.—87.
- Lower Your Fuel Costs—31.
- Curing Leaky Basements—45.
- Fitting Home Game Room—55.
- Indoor & Outdoor Fireplaces—88.
- Backyard Gardening—39.
- Lawn and Garden Novelties—72.
- Trellises, Pergolas, Fences—76.
- Lawn and Garden Furniture—77.
- Playground Equipment—73.
- How to Use Your Drill Press—125.
- Making Serving Trays—53.
- Knots and Ropework—105.
- Sanders—80.
- House Wiring—89.
- Hanging Wallpaper—38.
- Built-in Fixtures—78.
- Bird Houses—7.
- Magazine Racks—49.
- Clock Cases—50.
- Book Ends—52.
- Small Tables—54.
- Smoking Stands—56.
- Desks—58.
- Book Cases—59.
- Action Toys—66.
- High Flying Kites—67.
- Telescopes—20.
- Metal Craft—28.
- Small Looms—37.
- Gen Cutting—42.
- Photo Enlargers—1.
- Photo Kinks—98.
- Cleaning Formulas—11.
- Taxidermy—9.
- Photo Lighting—119.
- Training Dogs—35.
- Small Furnaces—36.
- Working With Plastics—61.
- Simple Home Improvements—104.
- Ridding Home of Insect Pests—107.
- Children's Room Furniture—51.
- Jigsawed Novelties—57.
- Doll House & Doll Furniture—60.
- 25 Shelves You Can Make—84.
- Novelties Turned on Lathe—62.
- Inlay Pictures—Veneering—63.
- Wood, Soap Carving—65.
- Windmills & Weathervanes—68.
- Lamps from Wood, Metal—69.
- Rustic Furniture—18.
- Wood Finishing—40.
- How to Fix Electrical Appliances—111.
- Painting Your House—117.
- Build Your Own Relays—123.
- Rowboats, Small Dinghy—83.
- Small Sail Boats—84.
- Two Outboard Runabouts—85.
- Build Own Canoe, Kayak—30.
- Build Class-E Ice Yacht—22.
- Auto Kinks, Shortcuts—10.
- Lawn and Garden Equipment—124.
- Motor-Driven Midget Cars—34.
- Stop Auto Elect. Troubles—95.
- Photo Printers and Dryers—25.
- Photo Darkroom Equipment—96.
- Trick and Table Top Photos—97.
- Home Movie Equipment—118.
- Poultry Houses—108.
- Guns and Decoys—109.
- Re-Silvering Mirrors—70.
- Chemical Experiments—93.
- Log Cabins, Tourist Houses—14.
- Using Basic Tools—120.
- Farm and Garden Tractors—8.
- Building Extra Attic Rooms—23.
- Attractive Basement Rooms—24.

Check Titles Wanted. Clip, Mail with Remittance to

POPULAR MECHANICS PRESS, Dept. 23, 200 E. Ontario, Chicago 11

## SEND ME



every month so I am sure to see each new issue. Here's

- \$3.50 for 1 year
- \$8.00 for 3 years

name \_\_\_\_\_

address \_\_\_\_\_

city \_\_\_\_\_

zone \_\_\_\_\_

state \_\_\_\_\_

B-103

Hand this order to your newsdealer or send it to

**POPULAR MECHANICS**  
200 East Ontario St. Chicago 11, Ill.



MONTH AFTER MONTH, YEAR AFTER YEAR, YOU SEE OUR AD.

**CHECK AND DOUBLECHECK BEFORE YOU BUY ANYWHERE!**  
 1 Are These Tires "Family-Safe?" Our Families Use Them.  
 2 Are They Recaps, (Or "New Treads" Recaps)? Ours Are Not.  
 3 Will I Get Goodyear & Other Famous Brands? From Us — Yes.  
 4 Is The Guarantee "Unconditional"? See Our Fine Offers Below.  
 "SPECIAL TAKE 10% DISCOUNT OFF EVERY TIRE."

**GOOD YEAR Firestone**

GOODRICH, U. S., ARMSTRONG & OTHERS. BEST USED TIRES  
 DOUBLE WARRANTY & FREE TIRE INSURANCE. YOU CAN'T LOSE.

We Select Your Tires As If Our Future Depended On It.

**FREE TUBE WITH EVERY GOOD & FINEST GRADE TIRE** | **BE WISE—BE CONVINCED**  
**SAVE TIME, SAVE \$**

| GOOD SUPER GRADE, 20 MOS. GUARANTEE BOND |               | FINEST PREMIUM GRADE, 30 MOS. GOLDEN RULE GUAR. BOND |               |
|--|---------------|--|---------------|
| 600-16 \$3.64                            | 670-15 \$4.04 | 600-20 \$6.74  | 750-20 \$8.14 |
| 650-16 4.14                              | 710-15 4.24   | 650-20 7.24  | 825-20 13.14  |
| 700-16 4.54                              | 760-15 4.54   | 700-20 8.04  | 900-20 13.44  |
| 650-15 3.94                              | 800-15 4.94   | 32x6(8) 8.24   | 1000-20 13.44 |
| 700-15 4.04                              | 820-15 5.04   | 32x6(10) 9.24  | 1100-20 13.44 |

THESE MADE THE BLATT NAME "WORLD FAMOUS"

| FINEST PREMIUM GRADE, 30 MOS. GOLDEN RULE GUAR. BOND |               | 30 MONTH GUAR. TRUCK TIRES |                 |
|--|---------------|----------------------------|-----------------|
| 600-16 \$5.33  | 640-15 \$5.04 | 700-15(6) \$ 8.88          | 32x6(8) \$11.11 |
| 650-16 5.88  | 680-15 5.33   | 750-15 11.14               | 32x6(10) 11.74  |
| 700-16 6.44  | 710-15 5.66   | 750-16 10.77               | 825-20 18.22    |
| 700-16(6) 7.33                                       | 760-15 6.04   | 600-20 8.56                | 900-20 17.22    |
| 750-16 7.55  | 800-15 6.55   | 650-20 10.22               | 1000-20 17.22   |
| 750-16 8.84  | 800-15 6.55   | 700-20 10.99               | 1100-20 18.44   |
| 650-19 9.94  | 820-15 6.55   | 750-20 14.44               | 1000-22 18.44   |
| 550-17 4.88  | 700-15 5.44   |                            |                 |

Whitewalls \$2 ea. Extra

**YOU GET WHAT WE ADVERTISE** | **MILITARY MUD-GRIP TREAD**

| Size      | Std. Guar. 20 Mos. | Rugged Guar. 32 Mos. |
|-----------|--------------------|----------------------|
| 750-16Rg  | \$17.64            | \$10.44              |
| 900-16Rg  | \$22.04            | \$16.14              |
| 1100-20Rg | \$22.04            | \$16.14              |
| 600-16Rg  | \$6.44             | \$8.99               |

**BLATT** Order From Your Nearest Store For FASTER Service. Send Ck. or Money Order With This Ad  
 Blatt Bldg., Phila., Pa. (11th St. & Spring Garden St.) Dept. PM  
 Blatt Bldg., Miami, Fla. (2827 N.W. 7th Ave.) Dept. PM

**Cartoon the EASY way!**

**ORDER THIS KIT TODAY!**

Make your own cartoons for fun and profit. No skill needed. Plastic template with cut-out spaces and holes lets you make over 200 different cartoons. Kit also includes illustrated instructions, helpful hints book and information on selling. Only \$1.95 COD in USA plus c.o.d. postage. Send check or M.O. and we pay postage. Order today—or rush dime for circulars.

J. HOUSTON MAUPIN, Dept. 50, Tipp City, Ohio

**How to Build Your Own GARAGE**

Save as Much as 50% of Usual Construction Costs

Get Popular Mechanics' brand new book **How to Build Your Own Garage** by Wayne Leckey, Assistant Shop Notes Editor, and find out how you can build your own garage at savings of 50% of usual cost. Leckey tells in famous step-by-step instructions and shows in big, clear photos, drawings and diagrams how to perform every building operation from laying the concrete to installing the final trim. There are 25 designs. Brick, frame, and concrete block fully covered. Send \$3.50 for your copy. 7-day money back guarantee.

POPULAR MECHANICS PRESS, 200 E. Ontario, Chicago 11, Ill.

Learn the Secrets **BREED RARE tropical fish**



| KIND OF FISH | EGGS OR YOUNG PRODUCED AT ONE BIRTH | APPROX. RETAIL PRICE OF FULL-GROWN FISH |
|--------------|-------------------------------------|---|
| Swordtail    | 20 to 100                           | \$3.00 to \$4.00 Pr.                    |
| Red Betta    | 70 to 200                           | 3.00 to 4.00 Pr.                        |
|              | 150 to 180                          | 8.00 to 11.00 Pr.                       |

Proof of tremendous profits!

**... IN YOUR HOME... SPARE ROOM, BASEMENT, GARAGE... ANYWHERE!**  
**EARN BIG MONEY—SPARE TIME**

New "Chance of Lifetime" opportunity! Start your own spare or full time business once you know the revealing breeding secrets. It's fascinating! It's Fun! Breed EXOTIC and graceful "Angel Fish", BEAUTIFUL "Gourami" that are 12 DIFFERENT COLORS, "Fighting Fish" THAT FIGHT UNTIL DEATH; "Danio" that are STRIPED LIKE A ZEBRA; TRANSPARENT FISH—hundreds of expensive varieties. Some fish lay 300 to 600 eggs at one time. (Some very rare fish have sold for over \$75 a pair.) Get into PARTNERSHIP WITH NATURE and let nature multiply your profits for you. NO EXPENSIVE EQUIPMENT—NO EXPERIENCE NECESSARY. WE SUPPLY EVERYTHING YOU NEED. HELP FILL HUGE DEMAND from stores, offices, theaters, hotels, etc. New plan lets YOUR MAILMAN BRING YOU ORDERS. Investigate TODAY.

**FREE!** Colorful "How To Do It" success BOOK-LET, REPRINTS, breeding BROCHURE and ALL DETAILS. Rush coupon today!

**RUSH this Coupon TODAY!**

Tropical Fish Breeders of America, Dept. D 10  
 1010 S. Los Angeles St., Los Angeles 15, California

Dear Sir:

Please rush me all Free Details.

Name \_\_\_\_\_

Address \_\_\_\_\_

City \_\_\_\_\_

State \_\_\_\_\_

Your Age \_\_\_\_\_

**STOP BURNING OIL!**  
 LOSING POWER WASTING \$\$\$

When your car "eats-up" oil, loses that get-up-and-go power, has poor gas mileage, it's a sure sign that you have worn rings, pistons, and cylinder walls in your engine. This is robbing you of driving pleasure and valuable \$\$\$ to the tune of \$250 every 10,000 miles in oil, gas, and repair bills.

**WHAT CAN YOU DO ABOUT IT?**

You can either have an expensive overhaul job done or offset this wear with a

**RING-RE-NU MOTOR RECONDITIONER KIT**

It's the inexpensive, proven answer to a worn engine. This terrific 1-2 combination restores power and zip to your car without expensive repair work, reduces oil burning, slashes gas consumption, brings back that "new car" performance to your car.

**HERE'S HOW THIS DOUBLE VALUE KIT PERFORMS!**

- 1. PVR COMPOUND**—is a hard hitting engine reconditioner that removes sludge, tars, sticky greases from a tired, worn engine. Pour in carburetor, idle engine. Leaves rings, valves, pistons whistle clean, ready for . . .
- 2. RING-RE-NU**—the amazing compound which when squeezed by tube on your pistons forms a tough, pliable, self-expanding seal on rings and pistons to compensate for wear.

**RESULT!**—You get power-packed, economical driving pleasure. Good for 10,000 plus miles. Adds years to the life of your car. Guaranteed not to harm the finest engine. Takes only 30 minutes to install.

Read **ACTUAL PROOF** From One of 100,000 Satisfied Users!

Cadillac Owner, E. L. G., Lawrence, Mass. writes — "My Cadillac was burning 2 qts. of oil every 100 miles. I have now travelled 400 miles since installing the kit. Haven't used one drop of oil. Further my gas consumption has been cut in half. I'm more than pleased with results — best investment I ever made."

**NOTE! DON'T BUY HALF A TREATMENT!**

Ring-Re-Nu is more than just a seal—it's a complete 1-2 combination. PVR to clean your engine, RING-RE-NU to seal in that "new car" power.

1 tube kit \$4.95 ppd. treats all cars except large 8 cyl. autos which require special 2 tube kit at \$8.95 ppd. sold with money back guarantee. (C.O.D.'s accepted. \$1 deposit required. bal. and postage on arrival.) For economical, power-packed, new car performance—rush order to:



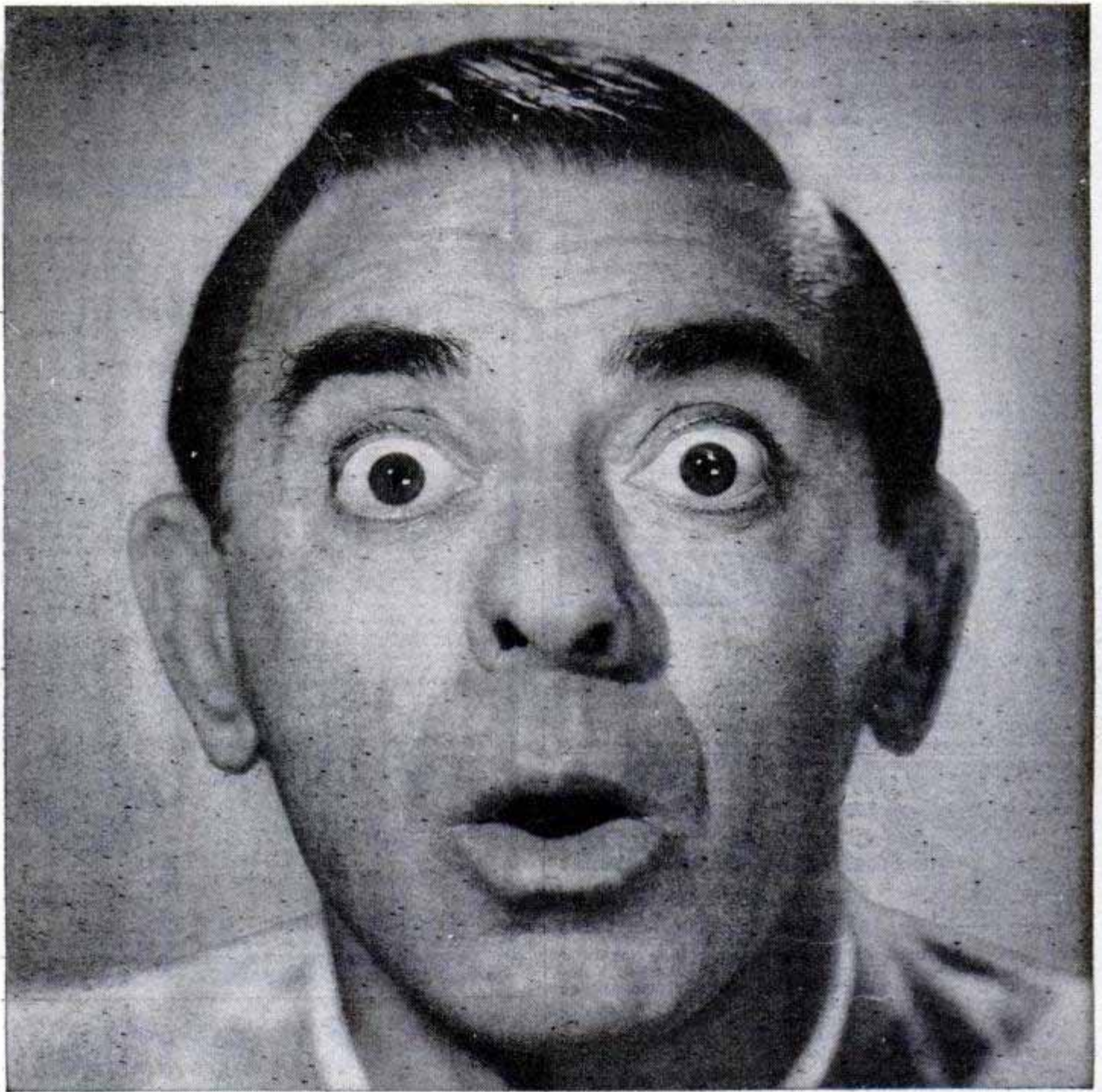
**RICHELIE DISTRIBUTING, INC.**  
 11916 MADISON AVENUE • DEPT. A10 • CLEVELAND 7, OHIO

RING-RE-NU... GOOD FOR YOUR CAR—GOOD FOR YOUR POCKETBOOK

**STOP TV JITTERS!!**

Amazing new IG ANTENNA Filter (not a line filter) rejects interference from airplane, auto ignition, oil burner, electric shaver, small motors. Easily installed. Send \$2.98 to

**TELE-TRENDS CO.** DEPT. 6M, P. O. BOX 21  
 FOREST HILLS, N. Y.



## “My eyes are my trademark!”

When you see Eddie Cantor's famous banjo eyes, you look for comedy, humor, a touch of pathos — a real virtuoso performance.

And when you see a familiar brand name as you shop, you expect an equally outstanding performance — or you don't buy the product again.

That's one big advantage about living in a land where you enjoy free choice among many fine products, each identified by its own brand name.

Leading manufacturers, seeking to win your favor for their brands, take infinite pains and

a great deal of pride in bringing you wonderful products, continuously improved, representing unusual value for your money.

As you leaf through the pages of this magazine, note how many of the products advertised here already have satisfied you. And always *remember* that when you name your brand, you better your brand of living!

### **BRAND NAMES FOUNDATION**

INCORPORATED

A Non-Profit Educational Foundation  
37 West 57th Street, New York 19, New York

## FIELD TRANSMITTER SET

Complete; includes transmitter with pair of head phones, sending telegraph key, buzzer, double throw switch. Original cost of this instrument to English government well over \$100.00. Ship. wt. 20 lbs. each. Allow sufficient postage or will be shipped express charges collect. Two 4½ volt C batteries needed in each set. Batteries 45c each extra. Wire needed to connect for operation. No. 438. Complete set... **\$7.95**  
Two sets for.....\$15.00



**WAR SURPLUS BARGAINS**

# WAR SURPLUS BARGAINS

**\$500,000.00 INVENTORY for QUICK LIQUIDATION**

Surplus items—hundreds of them for home, shop, factory, farm and outdoor use. New items, used items, reconditioned items—all at tremendous savings—all priced for quick sale.

**Page After Page of Values**  
This big catalog shows page after page of amazing money saving values. Write for your copy today. Send 10c to cover postage, mailing, etc. Write today!

**SEND TODAY FOR YOUR COPY**

## STARK'S

**10c**

509 So. State St.  
Dept. PM-1053  
CHICAGO 5, ILL.

$5 \times 5 = 25$   
 $5 \div 5 = 1$   
 $10 \div 9 = 1.111$

## MASTER MIND!

**Learn Short-Cut Mathematics**

Juggle figures, do baffling number tricks. Make people gasp at your marvelous lightning-quick mind. Multiply 4 figures by 4 figures without using old-fashioned multiplication! Big cloth-bound volume; fully illustrated course.

**Sharpen up Your Brain Power**

Includes worked out problems, answers, etc. Sensational bargain, only \$2.95, postpaid or COD plus postage. Satisfaction guaranteed or refund. Order this amazing "Short-Cut Mathematics" today!

**NELSON-HALL CO., 210 S. Clinton St., CHICAGO 6, ILL. \$2.95 Complete**

### Enjoy the Fascinating Story of the Horseless Carriage in

It's thrilling, fascinating, informative. From the very first gasoline-propelled buggy to the cars of today and the atomic auto of the future. The first cars—the men who made them—the scrambled start and development of the fabulous auto industry—the story of auto racing. 166 thrilling action pictures—old-time cars—racing cars—early auto advertising—automotive oddities. Listing of 2000 U. S. autos included. Ideal gift book. Cloth bound, only \$3.00 by mail. Money back if not pleased. Paper covered edition \$1.00 at newsstands.

**POPULAR MECHANICS PRESS, Dept. PM15, 200 E. Ontario St., Chicago 11**

Popular Mechanics

## AUTO ALBUM

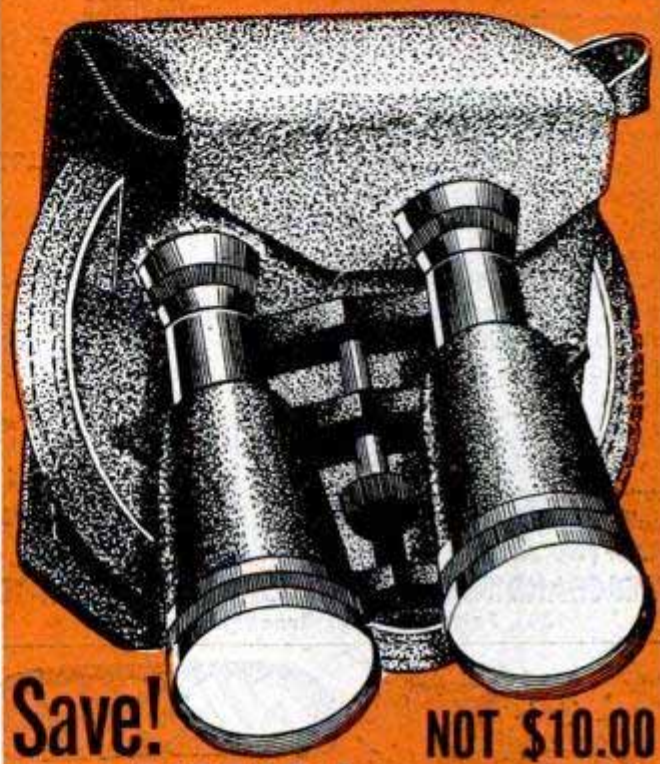
## FURNITURE for YOUR BEDROOM

**SAVE MONEY**, be the envy of your neighbors by making this beautiful bedroom suite yourself! Only a power saw and jointer are needed to turn out this smart suite, featuring bed with storage space, three-piece vanity with cosmetic compartment and makeup mirror, Mr. and Mrs. dresser, and twin night stands with drawers. Letters demanding detailed plans poured in after this furniture was pictured in Popular Mechanics Magazine. Now the 4 plans are ready—easy-to-follow scale drawings—and they're yours for only \$2.00! Send for a complete set today.

**POPULAR MECHANICS PRESS**  
200 EAST ONTARIO STREET, CHICAGO 11, ILL.

# Special Announcement

## NEW SHIPMENT OF FAMOUS ROTH-KLAROPTAR BINOCULARS HAS ARRIVED FROM GERMANY



Save!

Buy DIRECT from IMPORTER!

\$3

COMPARE UP TO 18 MILES!

Tax Paid CASE GIVEN

We're happy indeed to announce that a shipment of several thousand of these famous 3 X, 40 Binoculars has arrived from Germany. Some time ago we got a shipment and were flooded with orders. We were sold out in practically no time! We were forced to hold up thousands of orders and disappointed a lot of nice folks. This time we're taking no chances! We are strictly limiting orders to ONE per family and will sell NONE to dealers.

**Rothlar Lenses Are Precision Made**

The secret of ROTHLAR'S great public acceptance is the precision-made lenses. Unlike other glasses, they are not moulded or stamped out on plastic presses! They are ground out ONE BY ONE by proud German optical workers. This takes much more time and limits production. But what a difference! Viewing is sharp, clear, magic-like! No annoying distortions! No chromatic fringe to cause eyestrain! ALL Rothlar glasses are turned out under the supervision of WALTER ROTH, in his small factory in Hartmannshof, Western Germany. He has the Old World family pride. Herr Roth simply won't let an inferior product bear his name. Naturally this means you get a really superior binocular if you are one of the lucky people to order this instrument.

**Enjoy One at Our Risk!**

We'll send you a ROTHLAR for 5 DAYS' TRIAL. Enjoy it without obligation. Use it for sports, boxing matches, races, basketball, football, it's ideal for nature study, motoring, sailing, airplane spotting, watching your neighbors, celestial observation and viewing distant scenery. Compare it at ANY distance from 18 feet to 18 miles. You must be delighted or your \$3 comes back—no questions asked! We suggest you rush your \$3 by return mail or come in person, if you can. These few thousands won't last long! First come, first served. Orders received too late will be returned promptly. To order: Clip out ad and write name in margin.

**THORESEN'S**  
352 FOURTH AVE., DEPT. 6-L-134, N. Y. 10, N. Y.



**SAVE** up to 40%! This money-saving, nationwide merchandise club saves you 10-20-30-40% or more from list price on nationally advertised, standard brand merchandise. You **ORDER BY MAIL**, giving complete description of goods you want. The Club gives you a **BIG DISCOUNT** made possible by central buying, and **YOU GET BRAND NEW MERCHANDISE** in factory-sealed cartons. Services of the Club are available to Members in the Continental United States only.

Send today for free information on this simple, convenient way to save hundreds, even thousands of dollars a year. **NO OBLIGATION TO SPEND A CENT. WRITE TODAY!**

**MERCHANDISE CLUB OF AMERICA, Dept. PM-103**  
381 Fulton Street, Brooklyn 1, N. Y.

**ON ADVERTISED BRANDS OF**

- WASHERS
- FREEZERS, ETC.
- FURNITURE
- TELEVISION
- RADIOS—JEWELRY
- WATCHES
- GIFTS
- LUGGAGE
- CUTLERY
- DISHES—TOOLS
- SPORTING GOODS
- CAMERAS
- SILVERWARE—and practically anything else you can think of.

**CUSSIN'**  
**WON'T START YOUR COLD OR WET MOTOR...**  
**KAR-START WILL!**

Amazing device helps start cold or wet car engines instantly! 5 times more spark from plugs for sure-fire starts. Will not damage points. Simply installed—3 quick connections. Long lasting. If your dealer can't supply, order direct. Only \$5.95 postpaid. Buy Kar-Start today. Money back if not delighted. Write for free bulletin.

**SCHAUER MANUFACTURING CORP., 4532 ALPINE AVE. CINCINNATI 36, OHIO**

Get Kar-Start and GO!

**Say You Saw It in Popular Mechanics**

**SAVE \$65 ON THIS LUXURIOUS \$100 CONTOUR CHAIR \$34.95**  
Genuine **FOAM RUBBER** For Everything needed complete to

**PUT IT TOGETHER IN ONE EVENING!**

Scientifically correct design for restful, healthful, relaxing. Adjusts for perfect sitting or reclining comfort. Proved beneficial to heart, nerves... most popular chair in every home. Firestone foam rubber and washable, pliable genuine Duran upholstery. Would cost \$100 or more in any store. Shipped all ready to put together in less than one evening by anyone who can use a screwdriver. No cutting, no drilling, no skill needed. A woman can do it. Order now! Everything needed for only \$34.95, f.o.b. Balto. State color wanted: forest green, sapphire blue, lipstick red, walnut brown. Enclose \$5 deposit, pay balance on arrival. Money back guarantee. If not satisfied, return in 10 days.

**Bestcraft, Dept. 43, Mathieson Bldg., Baltimore 2, Md.**

Make Money Selling and assembling contour chairs for friends

**BUILD Your Own GARAGE**

**Save Up to 50% of Usual Cost!**

Build your own garage and save! Wayne Leckey, Popular Mechanics Assistant Shop Notes Editor, tells and shows how in his new book *How to Build Your Own Garage*.

**No Previous Building Experience Required**

If you can use a hammer and a saw you can build your own garage. Leckey tells how in simple step-by-step instructions and shows how in big, clear photos, drawings and diagrams. Everything is covered from the laying of the foundation right up to and including applying the final trim.

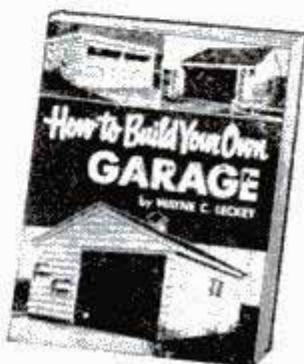
**25 Designs—Brick, Frame and Concrete Block Construction. Complete Building Data**

There are 25 different designs from which you may choose. Brick, frame and concrete block construction is fully covered. Leckey tells and shows how to pour the foundation, erect the framework, erect the roof, apply insulation and shingles, lay the driveway, install trim, flower boxes, etc. It's all there for you to read and see.

**7-Day Money Back Guarantee**

Get your copy of this valuable book today. Read and use it for seven days and if it isn't entirely satisfactory return it for a full refund. Send only \$3.50 for your copy to Dept. 90

**POPULAR MECHANICS PRESS**  
200 E. Ontario, Chicago 11, Ill.



**YES! SEND**



**directly to my door every month**

I am enclosing

- \$3.50 for 1 year
- \$8.00 for 3 years

name \_\_\_\_\_

address \_\_\_\_\_

city \_\_\_\_\_

zone \_\_\_\_\_

state \_\_\_\_\_

A-103

Hand this order to your newsdealer or send it to

**POPULAR MECHANICS**  
200 East Ontario St. Chicago 11, Ill.

# 313 HARD-TO-GET ALL-DIFFERENT STAMPS—25¢

SPECIAL IMPORTED COLLECTION  
incl. BEAUTIFUL GERMAN

## MONA LISA

Look at all you get for 25c! GERMAN — beautiful Mona Lisa; HUNGARY Diamond Shapes — 3 largest sport stamps ever issued; SAN MARINO — multi-colored triangles; AZERBAIJAN — 1922 Famine Imperfs cpl.; BOSNIA — 1917 Assassination set complete; plus hundreds of other unusual stamps and sets from all over the world — Andorra, Israel, etc. Total of 313 stamps — a \$2.50 value — all yours for only 25c to introduce our Bargain Approvals. Money back if not delighted. Send 25c today. ASK FOR LOT F0-9



**PLUS FREE**

"Midget Encyclopedia of Stamps"

—includes Stamp Identifier and Dictionary—plus terrific bargains!

**ZENITH CO.** 81 Willoughby St.  
Brooklyn 1, N. Y.

**"How to Make Money with Simple Cartoons"**

A book everyone who likes to draw should have. It is free; no obligation. Simply address **FREE BOOK**

**CARTOONISTS' EXCHANGE**  
Dept. 910D Pleasant Hill, Ohio

Learn Deep Professional Secrets of Engineering

### SCIENCE • INVENTION

HELP RELIEVE DANGEROUS SHORTAGE IN THESE FIELDS  
Formula in this document has achieved outstanding success for many. College degree not necessary.

Document written in non-technical language  
THIS DOCUMENT CAN AFFECT YOUR FUTURE

SEND NOW! \$2.75 POSTPAID — CASH, MO. COD  
Panoramic Research 4421 N.14th St. Phoenix Arizona

## RAISE GIANT FROGS BIG DEMAND



**MILLIONS USED YEARLY!**  
Good prices year round! Breeder lays up to 20,000 eggs yearly. Nation-wide markets waiting for all you can ship. Get ready now for next spawn. New book tells how! Small pond starts you. Men and Women send for my illustrated FREE folder today. Do it now!  
**ALBERT BROEL-7**  
P.O. Box 506, New Orleans, La.

## YOU CAN BUILD A VIOLIN FOR PLEASURE OR PROFIT



Now you can build a rich toned mellow violin modeled after a famous "Strad." YOU CAN MAKE A STRADIVARIUS VIOLIN contains 8 full scale plans plus complete instructions. You work directly from the plans with no confusing scale of dimensions to translate. Detailed instructions for each step including varnishing and stringing—even shows how to build your own tools. Cloth bound. Order today from

**POPULAR MECHANICS PRESS . . . \$3.50**  
200 EAST ONTARIO STREET, CHICAGO 11, ILLINOIS

## Learn BAKING At Home

Baking is one of America's high industries in wages. Nearly depression-proof. Thorough basic home course lays sound foundation. If you have aptitude, write for FREE BOOKLET, "Opportunities in Commercial Baking."  
**NATIONAL BAKING SCHOOL**  
835 Diversey Parkway Dept. 1357 Chicago 14



### Mutual Funds

#### Investors MUTUAL, INC.

An open-end management type mutual fund diversifying its investments among common stocks, preferred stocks and bonds.

#### Investors SELECTIVE FUND, INC.

An open-end management type mutual fund diversifying its investments among bonds, preferred stocks, and other senior securities.

#### Investors STOCK FUND, INC.

An open-end management type mutual fund diversifying its investments among common stocks and other equity securities.

### Face-Amount Certificate Company

#### Investors

#### SYNDICATE OF AMERICA, INC.

A face-amount certificate company issuing installment certificates of 6, 10, 15 and 20 year maturities and single payment face amount certificates.

This is not an offer to sell these securities. They are subject to the registration and prospectus requirements of the Federal Securities Act. Information about the issuer, the securities and the circumstances of the offering is contained in the prospectus which must be given to the buyer. Copies of the prospectus relating to the shares of capital stock or certificates of the above companies may be obtained from the national distributor and investment manager:

### Investors Diversified Services, Inc.

211 Roanoke Building Minneapolis 2, Minnesota

Send me the prospectus relating to the company I've checked:

- Investors Mutual, Inc.  Investors Selective Fund, Inc.  
 Investors Stock Fund, Inc.  Investors Syndicate of America, Inc.

NAME \_\_\_\_\_

ADDRESS \_\_\_\_\_

CITY \_\_\_\_\_

STATE \_\_\_\_\_

Say You Saw It in Popular Mechanics

## NEW "PAINT PEN"

**PAINT STRIPING TOOL**  
Works like a Fountain Pen  
Stripes with Paint instead of Ink!

This amazing new "PAINT PEN" is a Paint Striping Tool that makes it easy to do expert striping on furniture, bikes, model planes, autos, signs, toys, linoleum, wall board, etc. Makes plain, painted walls look like tile. Paint straight, curved, circular or evenly spaced parallel lines the same way a professional painter does. Simply fill Tubular Glass Paint Fountain with any color paint and wheel tip feeds paint evenly. Tips interchangeable—jaws split apart for easy cleaning. Tool complete with tip for 1-16 inch stripe only \$1.00 postpaid. Other complete tools with 1-64, 1-32, 3-64, 5-64, 3-32, 1-8 in. tips, \$1.50 ea. Extra tips, 75c ea. Complete KIT with 7 tips, \$5.00. Also 1-4 in. tip only, \$1.00. COD's postage collect. Here's the handiest tool in your whole painter's kit. Get yours today.



Paint STRAIGHT, CURVED OR PARALLEL LINES

### Home Craftsmen

Just the tool you've been waiting for! New Paint Striping Tool gives "professional" results every time, yet simple and easy to use as a fountain pen. Adjustable guide keeps lines straight as an arrow. Just as easy to make curves or free hand designs. Adds new beauty and finished look to everything you paint. Send \$1 now!

**DEALERS**  
PAINT STRIPING TOOL  
packed in display cartons of 1 doz. Fast, profitable seller. Write for illustrated circular, discounts

Only \$1.00

**WENDELL MFG. CO., Dept. 310**  
4234 LINCOLN AVENUE, CHICAGO 18, ILL.

# Make Big Money Quick IN SPARE TIME!

SHOW CAR OWNERS

**HOW TO PUNCTURE-PROOF TIRES...in ONE MINUTE**

Amazing Invention Acclaimed Year's BIGGEST MONEY MAKER! Agents "Clean Up" in Gigantic New, Untouched Market.

## NEW! DRAMATIC!

Drive a 2" nail into a tire... pull it out! NOT ONE POUND OF AIR LOST! It's like selling puncture-proof tires for only \$1.98 each Car owners usually buy 4 that's an easy \$7.92 you MAKE \$4.24 CLEAR PROFIT!

I'M NO SALESMAN, BUT...

**I MADE \$29.68 DURING MY LUNCH HOUR!**



Part and Full Time SAFE-T-GARD Agents Report Service Stations, Friends and Neighbors, Garages, Taxicab Companies, Truck Companies Order by the DOZENS!

### IT'S EASY! NO EXPERIENCE NECESSARY!

SAFE-T-GARD is squeezed into tube through tire air valve. The miracle liquid coats the inside of tube... ACTUALLY PUNCTURE-PROOFS THE TIRE. Each tube of SAFE-T-GARD is \$1.98, you make \$1.06 PROFIT! (And they usually buy 4 at a time.) All you do is demonstrate and write orders. Be your own boss

### EVERY CAR OWNER A POTENTIAL \$4.24 PROFIT TO YOU!

Gigantic advertising campaigns, nation-wide publicity pave way for SAFE-T-GARD agents! Laboratory tested and proved SAFE-T-GARD opens door to sensational new career. Get into amazing new million dollar industry. Earn big money.

### NO-RISK DEMONSTRATION SAMPLE... WRITE TODAY!

This is big! We want men who are sincere, ambitious and want to make money! Write for full information. If interested in making money right away, here's what you do. Send \$5.00 (cash, check or money order) You receive 4 tubes of SAFE-T-GARD (regular price \$7.92) PLUS COMPLETE SALES MATERIAL and everything you need to start writing orders. Use the demonstration sample on your car... then if everything we've said isn't 100% true, return for full refund. WRITE TODAY.

SAFE-T-GARD CO., Dept. 102, 10 E. 49 St., N. Y. 17, N. Y.

# NEW! CHEAP! OIL BURNER

AMAZING HEAT INVENTION  
 \$14.75 for Stoves  
 \$29.50 for Furnaces  
 FITS IN ANY COAL STOVE, RANGE, BOILER OR FURNACE. No more shoveling Coal or Ashes. This Universal Unit makes one of the quickest, hottest, cheapest fires known. Sold on a 60 day Money-Back Guarantee. Send No Money. You will receive Agents Prices and full details by sending your name to  
 NORTHWEST MFG. CO., 10-M Main, Mitchell, South Dakota

## LOCKSMITHING & Key Making

PRACTICAL UP-TO-DATE COURSE—ONLY \$4.95  
 Easy-to-learn modern information for self-instruction. How to work on locks, de-code, make master-keys, repair, install, service, etc. For every handyman, home owner, carpenter, mechanic, service station operator, fix-it shop, hardware dealer, gunsmith, 53 plain illustrated lessons. FULL PRICE ONLY \$4.95. SEND NO MONEY. Just pay postman plus C.O.D. postage. Or send \$4.95 with order, we'll ship postpaid. Satisfaction guaranteed or refund.  
 NELSON-HALL CO., 210 S. Clinton Ct., Dept. KX-2, Chicago 5, Ill.

## BARGAINS IN BOOKS

Save money on latest best-sellers of all publishers. Also old-time favorites. New 57th annual catalog lists 25,000 books on Fiction, Reference, Juvenile, History, Religion, Science, Child Guidance, etc. Send post card today for FREE copy of 1953 catalog, "Bargains in Books."  
**FREE 128-page CATALOG**  
 THE BOOK SUPPLY COMPANY, Dept. 22  
 564-566 West Monroe St., Chicago 6, Ill.

## GET 20 TO 30 SHAVES LIKE MAGIC! FROM ORDINARY BLADES

Save money. Save your face from scrapes, scratches, nicks. Widely-used Blade Master's rotary honing action keeps blades sharper than new. No stropping, just insert — use. Money back guarantee. Special offer... \$2.95.  
 ENRIGHT'S, Inc., 3074 Kensington Ave. Phila. 34, Pa., Dept. M-10

## FREE BOOK CATALOG

Everything—shop tools, hunting, fishing, making money at home, concrete work, welding, mail order, plastics, painting, carpentry, photography, boat building, gardening, auto repair, hobbies, home building—is listed in the new 40-page 1953 catalog of easy-to-understand Popular Mechanics books. Write for your free copy now! Dept. CT2,  
 Popular Mechanics Press, 200 E. Ontario, Chicago 11

## ELECTROPLATE

NO TANKS USED NEW SIMPLIFIED METHOD  
 ANY OBJECT IN HOME, SHOP, GARAGE OR START YOUR OWN WELL PAYING ELECTROPLATING BUSINESS  
 NOW, using NEW plating kit, It's easy to electroplate any object. Complete kit and instructions on plating metal and non-metal objects, with nickel, copper, chrome, gold, etc., plus full data on obtaining all the business you desire and make BIG MONEY full or spare time. ONLY \$5.95. SEND NO MONEY—everything sent C.O.D. plus postage—OR send \$5.95 now and receive it postpaid. Money back in 7 days if not satisfied.  
 M. Z. NATIONAL SALES CO., 113-M West 42 St., N. Y. 36, N. Y.

## Wheels Wheels

- 7" Disc Wheel 3/4" Tire 3/4" sleeve.....45c ea.
  - 8" Disc Wheel 1 1/8" Tire 1 1/2" sleeve.....70c ea.
  - 7" Disc Wheel 1" Tire 1 1/2" ball bearing.....80c ea.
  - 8" Disc Wheel 1 1/4" Tire 1 1/2" ball bearing.....\$1.00 ea.
  - 6" Disc Wheel 1.50 semi-pneum. Tire 1 1/2" B.B.....\$1.35 ea.
  - 8" Disc Wheel 2" semi-pneum. T. 1 1/2" B.B.....\$1.50 ea.
  - 10" Disc Wheel 1.75 semi-pneum. T. 1 1/2" B.B.....\$1.50 ea.
  - 10" Disc Wheel 2.75 semi-pneum. Tire 3/4" B.B.....\$3.50 ea.
  - 12" Disc Wheel 1.75 semi-pneum. T. 1 1/2" B.B.....\$1.85 ea.
- Above wheel prices includes hub cap. Plus Postage. C.O.D.'s accepted. AXLES—Sizes 5/16 in., 3/8 in., 1/2 in.—Cut to size—End holes drilled.  
 UNITED WHEEL STAMPING CO.  
 12131 S. PEORIA STREET PM-10 CHICAGO 43, ILLINOIS

POPULAR MECHANICS

## UP TO \$16.50 A DAY SPARE TIME WITH THIS FREE MONEY MAKING OUTFIT



Showing Car Owners Exciting New AUTO SEAT COVERS

Every car owner is your prospect! Show the sensational new Key Auto Seat Cover line... pocket big money every day with easy, quick orders you get for the asking! Show exclusive new long life plastic materials and fabrics... including the exciting new BAMBOO. Offer superb tailoring and perfect fit for every make, year, and model car. Quote Key's amazingly low prices and be sure of an order every time!

**EXTRA Get Own Seat Covers as Bonus**  
 Make money full time or in your spare hours. Every order pays up to \$16.50 spot cash for few moments' work. No experience needed. NO INVESTMENT. Everything you need to start making money at once is packed into big beautiful sales outfit we send you just for mailing coupon below. We'll tell you how to get BONUS SEAT COVERS for yourself without one penny cost. Get into the hottest big money opportunity open today. Fill out and rush coupon now. Mail today!

SEND NO MONEY — MAIL COUPON AT ONCE

KEY PRODUCTS CORP., Dept. 4310  
 800 N. Clark St., Chicago 10, Ill.  
 Rush FREE KEY Sample outfit at once. I'm ready to start!

Name \_\_\_\_\_  
 Address \_\_\_\_\_  
 Town \_\_\_\_\_ Zone \_\_\_\_\_ State \_\_\_\_\_

# NEW AUTOMATIC DEFROSTER

ONLY  
**\$7.95**

**YOU MAKE UP TO \$4  
ON EVERY FAST SALE!**



Millions of defroster attachments sold at \$12.50. Now — with new guaranteed HOLWIN at \$7.95, sales breaking all records! Men selling as many as 10 and 12 a day — right now. Your profits big — as high as \$4.00 cash on every sale. Converts any old style refrigerator into automatic defroster in 10 seconds. Just plug in. Terrific demonstrator. Women crazy for it at this price. Sell 4 out of 5 calls.

**NO CHARGE** for complete selling kit and offer of sample demonstrator. Rush name. If you've ever sold anything you'll clean up with HOLWIN. All mailed Free. Send name today for \$140-a-week opportunity and offer of demonstrator.

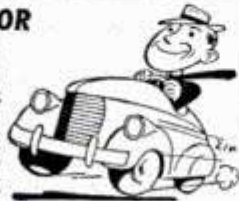
DEFROSTER SALES CO., 415 LaSalle St., Dept. H-810 Chicago 10, Ill.

## FREE SEND NAME

Rush name for free sales kit and offer of demonstrator sample. Sales skyrocketing. Send name. Get in on big money.

# NEW POWER FOR SLUGGISH AUTOS!

If your car wants to konk out on a hill . . . If it lacks power for emergencies or compression to pass on the highway . . . then you will want to try Fisher's Compression SEAL. Guaranteed to restore compression, reduce oil consumption and stop piston slap or your money back. Thousands of economy minded motorists who were faced with an expensive motor overhaul have been using it for years. Here's how it works—a small amount in each cylinder bore, expands up to 30 times, closing and sealing excessive clearance between the worn piston and cylinder bore . . . thus giving you 10,000 plus miles of "new" car economy. Takes only minutes to apply. Insured not to harm the finest engine.



Send cash, check or M.O. today. Only \$3.95 postpaid. (If COD, you pay postage!) Free literature. Dealers, inquire!

**FISHERS, Dept. PM-10**

4756 S. CENTRAL AVE., LOS ANGELES 11, CALIF.

## WHOLESALE

Professional Electric Guitars, accordions, amplifiers, double-necks, triple-necks, pick-up mikes, mandolins, non-electric instruments, etc.  
1954 MODELS WHOLESALE. FREE CATALOG  
FREE home study course with instruments.  
Box 28 P.M. 10  
**CARVIN CO.** Baldwin Park, Calif.



## \$10,800 Profits at Home!

Free Advertising Method builds your own Home Mailorder Business! Capital, experience unnecessary. Start spare time. No merchandise investment! No advertising risk! Exciting, practical. Copyrighted, notarized proven successful plan (worth \$2) FREE! Write today! Treasurer, 709 Webster Ave., New Rochelle DPM-1, N. Y.

## \$2.95 EACH OR 2 FOR \$5.00!



Upright Telephone complete with cord in Tested and Guaranteed condition. For Inter-communication or extension. Complete list of telephone parts, inter-communication sets, switchboards, handsets, magneto and dial telephones, etc. Write for list. F.O.B. Simpson, Pa. C.O.D. shipments accepted.

**TELEPHONE ENGINEERING CO.**

Dept. 99 Simpson, Pa.

**MAIL THIS COUPON TODAY! Free Facts  
On How You Can Make \$10,000 a Year!**

## RED COMET, INC.

325-G R. C. Bldg., Littleton, Colorado  
Send me at once complete information about Red Comet Automatics—the fire extinguisher that stops fire automatically—without human aid. Needed now by every home, farm, business. Tell me how I can make \$10,000—and more—a year, full time . . . \$75 to \$100 a week part time. I understand you will furnish me FREE professional Sales Kit with actual sample units, sales manual, other helpful literature to make me a Red Comet Dealer.

NAME \_\_\_\_\_ STATE \_\_\_\_\_  
ADDRESS \_\_\_\_\_ CITY \_\_\_\_\_

Advised  
Post, Collier's, Business Week

# WHAT DO YOU WANT?



- Your Own Business?
- A Better Job?
- Substantial Sparetime Earnings?
- A Brighter Future?

They're All Waiting for YOU in

## CUSTOM FURNITURE UPHOLSTERY

With upholstery booming you can do what Albert Clarke and hundreds of other UTS graduates have done. Well-paid jobs for expert upholsterers everywhere. Be your own boss, make good money working at home, or in your own shop. Best of all you can earn while you learn! Now the famed N. Y. State-approved UTS course is available to you at home. You learn custom furniture upholstery, reupholstery, furniture finishing, repairs—PLUS 4 BIG EXTRAS—slip cover, window cornice, cushion, and drapery making. Course includes FREE of extra charge 4 BIG OUTFITS of tools, complete frames and all materials to build beautiful furniture and slip covers that are yours to keep or sell! Many UTS students can earn enough in spare time to get STARTING CAPITAL for their own shops. What they have done, YOU CAN DO!



Albert Clarke, mechanic, earns extra \$20 weekly doing spare-time upholstery while getting UTS Training.

### Big FREE Book Gives Details

Our FREE book "A New Way to A Successful Career" tells how you can prepare at home for this fascinating, big pay, big profit trade. WRITE TODAY! Resident training also available. Upholstery Trades School, Dept. BR-304, 721 Broadway, New York 3, N.Y.



## SEND FOR BIG FREE BOOK

UPHOLSTERY TRADES SCHOOL, Dept. BR-304  
721 Broadway, New York 3, N. Y.

Send me FREE book on:

- Home Study  Resident Training

Name \_\_\_\_\_

Address \_\_\_\_\_

City \_\_\_\_\_ Zone \_\_\_\_\_ State \_\_\_\_\_

No salesman will call.

## PREPARE FOR BETTER JOB, BIGGER PAY IN SPARE TIME AT HOME

Today, choose the job you want—and prepare for it in time you might otherwise waste. Or if you are already in the work you like best, start training now for quicker promotion and increased pay. During more than 50 years AMERICAN SCHOOL has helped ambitious people to reach higher goals. Check subject that interests you and mail coupon for full information.

AMERICAN SCHOOL, Dept. G745, Drexel at 58th, Chicago 37, Ill.

Without obligation, please send FREE and postpaid, full particulars about the subject checked below.

- |  |   |   |
|--|---|---|
| <input type="checkbox"/> Accounting              | <input type="checkbox"/> Drafting—Building Trades | <input type="checkbox"/> Plastics Engineering |
| <input type="checkbox"/> Air Conditioning        | <input type="checkbox"/> Drafting—Machine Trades  | <input type="checkbox"/> Plumbing—Practical   |
| <input type="checkbox"/> Architecture & Building | <input type="checkbox"/> Electrical Engineering   | <input type="checkbox"/> Private Secretary    |
| <input type="checkbox"/> Automobile Technician   | <input type="checkbox"/> Electricity—Practical    | <input type="checkbox"/> Refrigeration        |
| <input type="checkbox"/> Better Foremanship      | <input type="checkbox"/> Electronics—Industrial   | <input type="checkbox"/> Retail Merchandising |
| <input type="checkbox"/> Bookkeeping             | <input type="checkbox"/> High School Courses      | <input type="checkbox"/> Salesmanship—Outside |
| <input type="checkbox"/> Business Management     | <input type="checkbox"/> Machine Shop Operations  | <input type="checkbox"/> Sheet Metal Work     |
| <input type="checkbox"/> Contracting             | <input type="checkbox"/> Mathematics & Slide Rule | <input type="checkbox"/> Tool Making          |
| <input type="checkbox"/> Diesel Technician       | <input type="checkbox"/> Mechanical Engineering   |   |

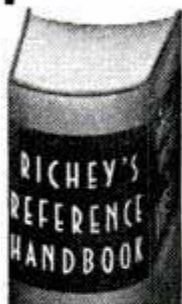
- |  |   |   |
|--|---|---|
| <input type="checkbox"/> Accounting              | <input type="checkbox"/> Drafting—Building Trades | <input type="checkbox"/> Plastics Engineering |
| <input type="checkbox"/> Air Conditioning        | <input type="checkbox"/> Drafting—Machine Trades  | <input type="checkbox"/> Plumbing—Practical   |
| <input type="checkbox"/> Architecture & Building | <input type="checkbox"/> Electrical Engineering   | <input type="checkbox"/> Private Secretary    |
| <input type="checkbox"/> Automobile Technician   | <input type="checkbox"/> Electricity—Practical    | <input type="checkbox"/> Refrigeration        |
| <input type="checkbox"/> Better Foremanship      | <input type="checkbox"/> Electronics—Industrial   | <input type="checkbox"/> Retail Merchandising |
| <input type="checkbox"/> Bookkeeping             | <input type="checkbox"/> High School Courses      | <input type="checkbox"/> Salesmanship—Outside |
| <input type="checkbox"/> Business Management     | <input type="checkbox"/> Machine Shop Operations  | <input type="checkbox"/> Sheet Metal Work     |
| <input type="checkbox"/> Contracting             | <input type="checkbox"/> Mathematics & Slide Rule | <input type="checkbox"/> Tool Making          |
| <input type="checkbox"/> Diesel Technician       | <input type="checkbox"/> Mechanical Engineering   |   |

NAME \_\_\_\_\_ OCCUPATION \_\_\_\_\_ AGE \_\_\_\_\_  
HOME ADDRESS \_\_\_\_\_ STATE \_\_\_\_\_  
CITY \_\_\_\_\_

MAIL COUPON NOW



Examine FREE . . . Greatest Handbook of  
**BUILDING FACTS and  
METHODS Ever Published!**



Save Time • Save Money  
Avoid Mistakes

**RICHEY'S  
REFERENCE HANDBOOK**

for Builders • Carpenters • Architects  
Engineers • Contractors • Etcetera

**1,640 Pages • 400 Tables  
544 Drawings • 500,000 Words!**

**H**ERE is the greatest collection of drawings, tables and practical building and construction data ever assembled! You have never seen a book like this before. It is a giant, 1,640 page volume packed with thousands upon thousands of facts, figures, statistics, procedures and illustrations covering EVERY STEP OF MODERN BUILDING PRACTICE.

**Packed with Up-to-date Building Know-How on:**

Carpentry—Woodworking  
Hardware—Wood Fastenings—Concrete Forms—Excavating—Foundation Walls—Waterproofing—Dampproofing—Stone Masonry—Structural Slate and Glass—Terrazzo—Tile Work—Composition Floors—Bricklaying—Fireproofing and Fire Prevention—Curbs and Copings—Cast Iron—Structural Iron and Steel—Tin and Sheet Metal Work—Painting—Plastering—Plumbing—Sewers and Drains—Heating and Ventilation—Strength and Weight of Materials—Laying out Rafters, Curves for Walks, Arches, Circles, etc.—Engineering Formulas—Electric Wiring—Conduit Systems—Elevator Installation—Glass and Glazing—Etc.

No matter what building question you may have, this great new book tells you WHAT to use and HOW to do it. It gives you, not building theory, but up-to-date building FACTS. On every kind of construction operation, RICHEY tells you in plain language the method or methods that years of experience have proved sound and efficient. RICHEY warns you of costly pitfalls you must be careful to avoid . . . guides you in safe, fast, economical building methods . . . helps you select the latest qualities, grades, types, sizes, etc., of building materials for best results.

Every page of RICHEY is packed with crystal-clear information . . . the book is crammed with thousands of clear detailed drawings and time-saving information tables and charts.

**FREE 10 DAY TRIAL** Send No Money Now! Simply fill in and mail the coupon below to get a copy of RICHEY'S REFERENCE HANDBOOK for free Examination. Use it for 10 days. If you don't agree it's the greatest construction handbook ever published, return it without cost or obligation.

**MAIL COUPON TODAY**

Simmons-Boardman Books, Dept. PM-1053  
30 Church Street, New York 7, N. Y.

Please send me a copy of RICHEY'S REFERENCE HANDBOOK for 10 days' FREE EXAMINATION. Within 10 days I will either remit \$9.95 plus postage, or return the book and owe nothing.

Name \_\_\_\_\_  
Address \_\_\_\_\_  
City \_\_\_\_\_ Zone \_\_\_\_\_ State \_\_\_\_\_

**YOURS ALMOST  
ASA GIFT!**

YES! SEND ONLY 25c FOR THESE

**126 STAMPS**

ALL VALUABLE—ALL DIFFERENT  
PLUS FAMOUS BERLIN BEAR STAMP

Get this entire collection of 126 fascinating stamps—ALL DIFFERENT. Plus the famous BERLIN BEAR STAMP (issued by Russians as propaganda to show Russian Bear rebuilding Berlin). Yours practically as a GIFT—only 25c for the entire set. We also include FREE information on how to collect, trade stamps plus other interesting offers for your inspection. We make this special offer to get names for our mailing list. But offer may end soon. Hurry. Rush your name and address plus 25c to:

**LITTLETON STAMP CO., Dept. 10-PM, Littleton, N. H.**



**FORD Owners  
SAVE  
MONEY**



Learn How to Make Your  
Ford Run Better . . . Last  
Longer . . . and Save Hundreds of Dollars!

Get this book, written especially for you, without one penny of risk and get more out of your car. Mail coupon for **MANUAL FOR FORD OWNERS** today. When the book comes, skip through the pages and see how your investment in one of America's most popular automobiles can be even a better investment than you thought. If you don't agree, send the book back and you'll get your money back.

**A Popular Mechanics  
Book Written Just for You**

Not a re-hash of service manuals. A complete new Popular Mechanics book written for the Ford owner by an outstanding automotive authority with the full cooperation of Ford engineers and service directors. It will save you money on repairs and service; make your Ford last longer; give you safe, economical and trouble-free motoring. And this is true whether you take your Ford to a regular service station or service it at home.

**Prevents Trouble. Cuts  
Down on Repair Bills**

Nothing like this manual anywhere. It covers all phases of operation, service and maintenance. It has entire chapters on the individual parts of your Ford—battery, ignition, starter, generator, regulator, lighting, fuel system, engine, lubrication, gasoline qualities, cooling systems, transmission, differential, rear axle, brakes, wheel alignment, tire care, body maintenance, trouble shooting on the road, etc. It covers your Ford, new and older models, step by step—bumper to bumper—showing you how parts operate; what can go wrong; how repairs and adjustments should be made and how to avoid all types of trouble.

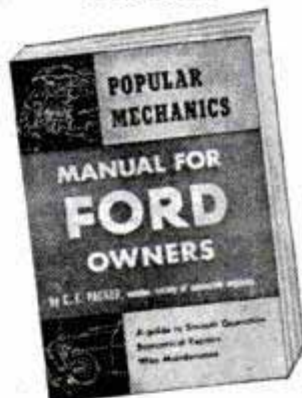
**Money Back  
if Not Satisfied**

Mail the coupon today. Send only \$3.50 or you can pay postman. Money back guarantee protects you.

**Official, Authoritative,  
Practical Information**

Written by C. E. Packer, formerly service school instructor and auto show lecturer for automobile manufacturers, Member Society of Automotive Engineers, Special Services Editor of Automobile Digest, contributor to leading magazines, author of some of the biggest selling books on Automotive subjects.

**Entire Chapters on  
Fordomatic and  
Overdrive**



**304 Pages. Hundreds of How-To-Do-It Illustrations and Diagrams**

The entire book follows Popular Mechanics famous easy-to-read and easy-to-understand style. While primarily intended for the Ford owner, to help him get more out of his car at lower cost, it can be worth its weight in gold to the auto mechanic and service station operator who works, not only on Fords, but on all other makes as well, to which the information in the book can be easily applied.

*Order on this Coupon*

**POPULAR MECHANICS PRESS**  
200 E. Ontario St., Chicago 11, Ill.

Send Manual for Ford Owners at once. If not satisfactory I will return it within 7 days and you will refund full purchase price.

Remittance for \$3.50 enclosed.  Send C.O.D.

Name \_\_\_\_\_

Address \_\_\_\_\_

City \_\_\_\_\_ State \_\_\_\_\_



**NEW - ELECTRIC REMOTE CONTROL**

**"Electra-JEEP" the new 1953 sensation!**

**\$3.98 complete**

*A terrific buy at this price!*

**RUSH ORDER TODAY!**

● GOES FORWARD . . . REVERSE . . . LEFT . . . RIGHT.  
● PUSH-BUTTON CONTROL . . . TORQUE STEERING . . . MOTOR  
● INDOORS ON RUGS . . . OUT DOORS ON PAVEMENT.  
● OVERALL SOLID METAL BASE

Here is the sensationally new scale model ELECTRA JEEP that captivates every child! Push the button and off she goes—forward, to the left, to the right, or reverse. Runs outdoors on pavement or indoors on rug. Over 1/2 foot long with overall solid metal base and solid rubber wheels, and motor torque steering. Loads of fun for children and grownups alike! Rush your order today! **SEND NO MONEY.** (C.O.D. you pay postage. Remit with order, we pay postage.)

SEND 10c FOR XMAS NOVELTY CATALOG  
NOVELTY MART, 59 E. 8th St., New York 3, N. Y., Dept. 205

### Prints Postal Cards!

**FREE** Use on 30 Day Trial! Send name today for facts and **FREE** Illustrated Book of unique advertising plans and money-making ideas for your business. Learn how others are boosting sales with post card ads . . . easy with Cardmaster.

Cardmaster Co., 1920 Sunnyside, Dept. 1318, Chicago 40, Ill.



### LEARN MODERN WATCH AND CLOCK REPAIRING

**Complete Course—Only \$5.95**  
At home, spare time. Good field now . . . security and contentment in future. Start part-time business and **EARN** while you learn. Horology is precision instrument work . . . a great and growing field, sensational opportunities. Easy self-instruction course. Full price, only \$5.95. **SEND NO MONEY.** Just pay postman, plus C.O.D. postage. Or send \$5.95 with order, we'll ship postpaid. Satisfaction guaranteed or refund. **NELSON-HALL CO., 210 S. Clinton St., Dept. 3KX-2, Chicago 6, Ill.**



## HELPFUL BOOKS

Send post card asking for **FREE** catalog  
Popular Mechanics Press, 200 E. Ontario, Dept. 601, Chicago 11

**New! 2 in 1 Combination!**  
**Pocket-Size**

**50 POWER MICROSCOPE**  
and **10 POWER TELESCOPE**  
Only **\$4.50** ppd.



Useful Telescope and Microscope combined in one amazing, precision instrument. Imported! No larger than a fountain pen. Telescope is 10 Power. Microscope magnifies 50 Times. Sharp focus at any range. Handy for sports, looking at rare objects, just plain sniping. Wonderful Xmas gift. Send check or M.O. Satisfaction Guaranteed! Order Stock #30,059-H. . . . . **\$4.50** ppd.

**GET FREE CATALOG #H—World's largest variety of Optical items. Bargains galore . . . War Surplus — Imported — Domestic! Microscopes, Telescopes, Hand Spectroscopes, Prisms, Lenses, Reticules, Mirrors and dozens of other hard-to-get Optical items. Ask for FREE CATALOG #H.**

**EDMUND SCIENTIFIC CORP., Barrington, N. J.**

**MEN - WOMEN!**

**BUILD A BIG PROFIT HOME BUSINESS...**



# Suede Paint!

the **NEW WONDER FINISH** that **COVERS EVERYTHING**

Make \$500 to \$1000 per Hour & More



... Plastic, Fabric, Metal, Plaster, Wood, Rubber.. any Surface!

**READ WHAT OTHERS SAY ABOUT FLOK-KRAFT SUEDE PAINT**

"Got \$52.50 for about 4 hrs. work."  
J. O., Mo.

"Getting orders faster than I will be able to handle in spare time!"  
W. R., Wyo.

"... pleased with your course and I'm being swamped with work."  
W. F., Pa.



**SECRETS OF NEW INDUSTRY NOW YOURS**  
At last, secrets of this amazing miracle finish can be yours! Huge profits waiting to be tapped in tremendous new field. Flok-Kraft gives a velvety, luxurious surface to radios, lamps, toys, signs, store displays, figurines, auto dash boards—a thousand and one items to be seen on every hand easily and quickly beautified, enriched, increased in value with Flok-Kraft. Make old objects beautiful—saleable, make new things worth much more with this soft, rich covering that can be applied to any surface, even if old or worn.

**BIG PROFITS RIGHT AWAY—LEARN IN FEW HOURS**  
Make to \$5.00—yes! even \$10.00 and more per hour. Fully detailed Flok-Kraft instructions—complete and easy to understand—every point explained—shows you how to start on the road to big money, full or spare time.

**WE FURNISH EVERYTHING YOU NEED TO START**  
You also get complete Flok-Kraft kit of materials and equipment that enables you to start at once. Add to your income from your regular job or begin to build a successful business of your own and do it all, right in a corner of your basement, garage, service porch, kitchen or living-room.

**GRASP THIS LIFETIME OPPORTUNITY TODAY**  
I'll arrange to send you the complete outfit—everything you need to start—for leisurely, no-risk examination right in your own home. You owe it to yourself to investigate. Fill out and mail the coupon below for **FREE** details, Sample, Plan, etc. Do it today! Everything I send you now is **FREE** of charge and postpaid. Airmail is faster.

**Coast Industries, Dept. 2A**  
1004 S. Los Angeles St., Los Angeles, Calif.

### YOURS TO EXAMINE WITHOUT RISK!

Examine in your own home—then decide. The complete instructions, the full starting kit of materials and equipment plus full details on how you may open your own business—spare or full time—**EVERYTHING** will be sent you to **EXAMINE AT OUR RISK**.

### FLOK-KRAFT AND DEFENSE

This amazing miracle finish is of inestimable value for use on hundreds of defense products. Flok-Kraft offers you a way to big, extra money, assisting manufacturers in many lines as well as filling a big demand on the home front.

### MAIL COUPON NOW!

**COAST INDUSTRIES, Dept. 2A**  
1004 S. Los Angeles St., Los Angeles 15, California  
Gentlemen:  
Please rush me **FREE** details, sample, etc. I understand that everything you send is free and that I'm be under no obligation now or ever.

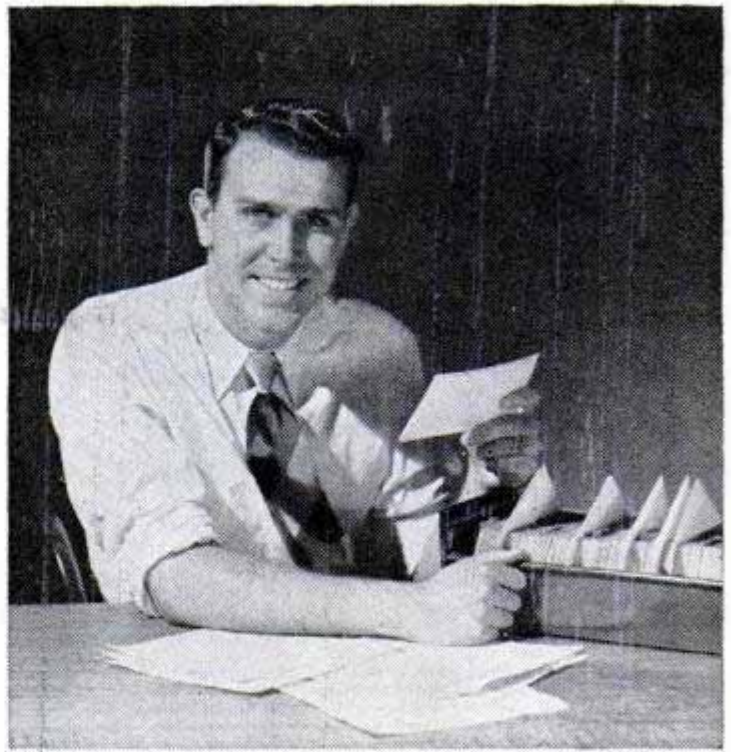


**FREE! Booklet, Sample, Plan!**

NAME \_\_\_\_\_  
STREET \_\_\_\_\_  
CITY \_\_\_\_\_ STATE \_\_\_\_\_

# Start a profitable manufacturing business in spare time

with your own home as your headquarters



**R**IGHT at this moment there is a tremendous demand for new business enterprises in a branch of the plastics industry. Fortunately, this is a type of manufacturing business that does not require heavy or expensive machinery, rented space for storage, production or sales. A portable hand machine does the work wherever electric current is available, and the working area can be in almost any part of your home.

The opportunity that is open to you today, is to meet this growing demand in a new industry by establishing yourself as the manufacturing agent in your own trading area. Several hundred of our machines are already in use in both large and small communities. Some are even being operated successfully by women whose family duties make it necessary for them to be at home during the day, but whose family income is not enough to meet rising expenses. Most are being operated by men. Many started in spare time just to pick up an extra five or ten dollars for an evening's work. They found the work so profitable that some have now given up former jobs to devote full time to a business of their own.

One of our manufacturers gets all of his business by mail. Orders and money come to him in envelopes and he sends his products out the same way. Another delivers his entire output to stores in the vicinity. An-

other does a wholesale business supplying other manufacturers who do the selling. Still another works with advertisers in the manufacture of plastic advertising novelties and specialties.

The operation of the machine is simple and easy for anyone to learn. It does not require any knowledge of chemistry, mechanics, or electricity. And what some say is best of all, a manufacturing business like this enables a person to make good money without any house to house canvassing. The machine turns out from \$5.00 to \$15.00 worth of work per hour and it can be operated for as short or long a time as you wish.

We have prepared a simple step by step instruction manual that not only tells how to operate the machine, but also tells how to get the business coming in at a profitable clip right from the start. We will lend a copy of this book to any serious minded man or woman with the

understanding that a copy will be given them free if and when they purchase a machine—or the copy we lend can be returned if you decide not to go into the business. Reading it will not cost you anything.

If you are interested in a nice little home business that can bring in an extra \$60 or more for ten or twelve hours work in spare time, send your name. All information on the book and machine will be sent free, postage prepaid and no salesman will call to bother you. You read about it in the privacy of your own home without outside pressure and then decide whether you'd like to take the next step. Address your envelope to me in person. Send me the coupon below. Or, if you prefer send your name on a post card and ask for "Free information on starting a manufacturing business at home." Either way, send your name today and find out about this wonderful new fast growing money-making business.

RAYMOND E. BRANDELL

1512 Jarvis Ave., Dept. L-1010, Chicago 26, Ill.

Raymond E. Brandell, 1512 Jarvis Ave., Dept. L-1010, Chicago 26, Ill.

Dear Mr. Brandell: Please send information showing how I can start a profitable manufacturing business in my home in spare time. All the information you send will be mailed to me free of charge and no salesman is to call on me. I am not under any obligation to go ahead with the business and there is no charge for this information now or any other time.

Name \_\_\_\_\_

Address \_\_\_\_\_

City \_\_\_\_\_ Zone \_\_\_\_\_ State \_\_\_\_\_

POPULAR MECHANICS

**WORLD'S  
BEST  
WANT AD  
MEDIUM**

# CLASSIFIED Advertisements



Advertisements in this section 85 cents per word, each insertion, minimum 10 words, payable in advance. To be inserted under proper classification, copy must be in our office the 20th of the second month preceding date of issue  
F. W. Johnson, Manager, Classified Advertising  
Popular Mechanics Magazine, 200 East Ontario Street, Chicago 11, Illinois

## YOU'LL PROFIT

By reading and answering the classified ads in this section. Hundreds of opportunities for you to make and save money

### AUTOMOBILES. MIDGET CARS

**CUSTOMIZE** Your car with a Kustomize kit. A fiberglass and plastic product, stronger than steel, easy to apply—dechrome the easy way. No leading, welding or warping. \$4.95 kit will dechrome more than hood and deck. Multiplastics, 35 S. Dearborn, Chicago 3, Illinois.

**INCREASE!** Gasoline mileage 3 to 5 more miles per gallon. Guaranteed gasoline vaporizer, also increases power. Easier starting. \$3.50. Turb-O-Vane, Stockton, California.

**PHOTOGRAPHS**, World's finest automobiles. List, sample, 25c. Box 1028, Minneapolis, Minnesota.

**REAR Bumper reflector** Scotchlite sign, "Please Dim Lights." Easily attached. \$1 postpaid. Bumper Sign, Box 164, Beaver Dam, Wis.

**NON-Profit organization** offers automobile literature. Old, new and foreign; glossy photographs; dealer books; service manuals; free motor magazines. Write today; get on free mailing list. Auto Maniacs, Stockbridge, Mich.

**ANTIQUA** Automobile color slides, 2x2, on approval. Universal, Box 779A, Beverly Hills, Calif.

**EUROPEAN** Automobile magazines, four samples \$1.00. Also catalogs, photographs, books, insignias, list free. Auto Europa, Sabotino 2, Milan, Italy.

**FREE** Sample copy. Franson's Motor News, Box 254, Eugene, Oregon.

**FIBERGLAS** Automobile bodies. Build your own. Gem-O-Lite's own "how" book \$2.50. Information, materials catalog 10c. Airmailed 35c. Gem-O-Lite, Box 6867A, North Hollywood, California.

**HI-Mileage-speed** equipment from the world's largest supplier. Dual manifolds, finned heads, electric doors, lowering sets, chrome panels, thousands of items for all cars. 1953 catalog 25c (illustrated literature free). Wholesale to garages. Newhouse Automotive Industries, Los Angeles 22.

1953 **SUPERIGNITIONER**; Starting, pep, mileage. \$4.50. EG Mfg., Elmsford, N. Y.

### AUTO SUPPLIES AND EQUIPMENT

**SPECIAL** Upper cylinder lubricator, simple installation. Better mileage, cooler motor, reduces wear. For auto, truck, tractor. State year, make, model. Complete \$8.95. Lucey, Box 2075-P, Station A, Worcester, Mass.

170 **MECHANICS** Special tools. Free catalog. Atmars, Mechanico, 3561 Lakeshore, Oakland 10, Calif.

**CHEVROLET** Owners: Stop tappet noise with Kaye Tappet Silencers. Quality product. Easy to install. Complete set \$5.95. Kaye Products, 2067 B S. Layton Blvd., Milwaukee, Wis.

**BUY** Wholesale nationally advertised auto supplies, thousands other products at big discount. Free wholesale plan. American Buyers', 629-DD Linden, Buffalo 16, New York.

**LACHAPPELLE'S** Treatment. (Patented.) Puts bearings on the cylinder walls for the pistons to slide on. Makes any gasoline motor better for only \$3.00. Write, Ferns Products, 8120-B Walnut Dr., Los Angeles 1, Calif., for free information.

**SAVE** Gas, oil, repair bills, restore compression, power to older motors. Keep new motors new with Lachapelle's Genuine Motor Treatment (patented) for only \$3.00 postpaid on money back guarantee. You can't lose. For free circular, write Joe Dillon, Authorized Warehouse and Agents Distributor, Box 323-M, Bridgeport, Ohio. Exclusive distributorships, agencies open.

**BATTERY** Weak? Long life guaranteed. Write Abcon, 6003 Center, Omaha.

**FREE** Accessory catalog. Fisher's, 4756 South Central, Los Angeles 11, Calif.

**BARGAIN** Offer! Surplus stock of Gale Hall's original gasoline economy and motor condition gauges, designed for permanent dashboard mounting. Brand new, original cartons! Directions and connections included. Original price \$7.50, now only \$3.98 plus 40c postage! Deluxe all-chrome model, originally \$12.95, now only \$5.98 plus 40c postage! Order now! N. E. Surplus Sales, Dept. PM-10, 67 High Street, Newburyport, Mass.

**BEST** Piston seal for only \$1.95 postpaid. Saves oil, gas, repairs and increases compression. Contains vermiculite and molybdenum disulfide. Guaranteed. Why pay more? Industrial Research, 15505 Crenshaw Station, Los Angeles 8, Calif.

**CARBURETOR** Gum removed in 3 minutes. Kit \$1.50. Free literature on power load meter and engine balance indicator. Pendleton Products, Box 164, Whittier, California.

**MOTORIST** Save gasoline by vacuumating overrich mixtures. Fits on cars. For free particulars write Vacuumatic, Dept. 2042, Wauwatosa, Wis.

**CORD** Parts, literature. Sell, swap. Greenlee, Box 1036-P, Anderson, Indiana.

**CRANKSHAFT** Grinder, hand operated. Makes bearings fit without taking engine apart. \$3.75. Literature. L. D. McGee, 719 Cascade St., Wenatchee, Wash.

**PROFESSIONAL** Automotive gauges—Surplus stock of famous Gale Hall instruments, brand new, original cartons! Compression gauges, originally \$10.75, only \$2.98 plus 40c postage! Precision engine analysis vacuum gauges, originally \$12.50, now only \$4.58 plus 40c postage! Catalog of other bargains sent free with first order! N. E. Surplus Sales, Dept. PMA-10, 67 High Street, Newburyport, Mass.

**OIL** Doesn't wear out. Clean it my method. Guaranteed save money. Cheap. Simple tools. Send dollar bill for photos and instructions. Hills Service, 425-N-59th Ave., W. Duluth 7, Minnesota.

**NEW** And used guaranteed parts for civilian and army cars and trucks. Largest stock in America. Mail orders. Pioneer Auto and Truck Parts Co., 734 W. 13th Ave., Denver, Colorado.

**SAVE**—California custom accessories headquarters. Buy direct from original designers. Electric push button door-trunk conversions, bull noses, custom grilles, speed dress-up equipment. 40 page catalog, hundreds of photos. Send 25c to Eastern Auto, 3319A South Grand, Los Angeles 7, Calif.

**"WATER** Injection." Free descriptive, illustrated, information. Neher Industries, LaVerne, California.

**ELECTROPLATE** Auto parts, novelties, mirrors. Easy, inexpensive home processes. Free booklet. Tyco Metals, Box 13231-BG, Houston 19, Texas.

**BRUSH** Plating outfits connect to a battery. No tanks or shop required. Free particulars. Gunmetal Co., Ave. J., Decatur, Ill.

**AUTOMOTIVE** Trouble shooting—500 questions and answers; \$1.00 postpaid. M. E. Figgott, 1112 Westerly Terrace, Los Angeles 26, Calif.

1953 **EDITION**. It's new! It's different! Get world's largest auto accessory and parts catalog and save money. 132 pages. Over 50,000 items, including Hollywood accessories. Hi-speed equipment. Rebuilt engines, all parts and accessories for all cars and trucks. We have that hard-to-get part! Jam packed with bargains. Completely illustrated. Send 25c (refundable). J. C. Whitney, 1919-KC Archer, Chicago 16.

**MUD** Flaps. Truck owners free sample. Buck's Truck Wrecking, Merced, Calif.

**CAR** Burning oil? Losing compression? Try Clifford's Compression Seal. \$2 postpaid. Clifford's Engineering, 1329 Seventh, Aurora, Illinois.

### AUTO TRAILERS

**EXCEPTIONAL** Expanding eight foot trailer. Accommodates family of five. Build yourself. Literature 10c. Fra-Mar Company, Jones Ave., Wilmington, Mass.

**TRAILER** Building, illustrated, 20c. Craftsman Books, Box 1153, Milwaukee 1, Wis.

**TRAILER** Blueprints. All kinds. Slip-on coach for pickups. Catalog 10c. Comstock Trailers, 585, Parsons, Kansas.

**ALUMINUM** Camp trailer kit. Campers, hunters, fisherman. Sleeps four. Compact, folding. 560 lbs. Literature free. Master Camper, West Sayville, N. Y.

**BUILD** Your own trailer! Plans for all kinds. Illustrated catalog 10c. Jim Dandy, 125-M, Wausau, Wisconsin.

### MOTORCYCLES, BICYCLES, MOTORSCOOTERS AND SUPPLIES

**ONE** Passenger car \$5. Servicycle \$5. Cushman Airborne \$20, less engines; engines \$4 up. Whizzer engine \$5. Four airplane tires \$3. Mailorder only. Send 25c for catalogue Number 55, just out listing the above and hundreds of other bargains in new and used motorscooters, midget cars, homebuilders parts, plans, etc. 35c by first class mail. Midget Motors Directory, Athens, Ohio.

2½ H.P. Whizzer \$18.50; midget car \$15.00; Doodlebug motorscooter \$37.50; homemade motorscooter \$6.00. Send 25c (35c first class mail) for catalog #24 jammed with sensational bargains in wheels, motors, motorscooters, midget cars, motorbikes, construction plans, etc. Gail, 538 Erie, Toledo, Ohio.

**RECONDITIONED** Motorcycles and motors. Chromium accessories. Complete stock Indian parts. Expert rebuilding. Fast service. Indian Motorcycle Sales, Kansas City 27, Mo.

**"BUZZZZ"**—The motorcycle magazine. International coverage. Thoroughly illustrated. Yearly \$2.00. Sample 20c. 5424-A Sawyer, Chicago 25.

**U. S. Govt. surplus "45" Harley Davidson** motors, complete with carburetor and generator, in running condition—\$69.50 f.o.b. Chicago. 25% deposit with order. Parts and accessory catalog 25c. Triangle, 2157 Harrison, Chicago.

**HARLEY-Davidsons**—America's best used buys! We pay shipping on motor-cycles. Genuine new, used, parts, accessories for current and obsolete models. Send 25c for bulletin, catalog. Knuth's (Harley-Davidson factory dealer) 1753 Muskego, Milwaukee, Wis.

**MOTORCYCLES** And parts, new and used, early and late models. Harley Davidson, 813 Ohio, Wichita Falls, Texas.

**ENGLISH Bicycles**, lightweight, brand new, direct from importer at money-saving low wholesale price, only \$37.86. Regular \$59.00 value. Full size, 3 speed gears, front-rear hand brakes, chromium rims, chain guard, reflector, Brooks saddle. Shipped anywhere Railway Express. Deposit \$5.00, balance c.o.d. 5 day money-back guarantee. Clarion Metal Products, 559-F McDonald Ave., Brooklyn 18, N. Y.

### AVIATION

**HOME-Built airplanes**. Free details. William Bentley, Dept. 10, Box 2056, Pensacola, Florida.

**BUILD** Your own airplane. Regulations and building guide, \$1.00. Aerodyne, 2004 So. 29th, Milwaukee 15, Wisconsin.

**PROPELLERS**, Plans, supplies—For snow sleighs, air boats. Immediate delivery. Catalog 25c. Banks-Maxwell, Box 3301E, Ft. Worth, Texas.

**LIGHTPLANE** Circular, illustrated, 20c. Craftsmann Books, Box 1153, Milwaukee 1, Wisconsin.

**PROPELLERS**, Plans for snow sleighs, air boats. Lowest prices, fastest service. Literature. Gano Propeller, Box 3284A, Ft. Worth, Texas.

### BATTERIES, GENERATORS

**GENUINE** Edison batteries. Long life. Five year guarantee. Illustrated literature. Kohler light plants. Emergency Lite, 300 Twelfth Avenue, Paterson, New Jersey.

**EDISON** Nickel odorless storage batteries. 12 to 600 ampere hour. Any voltage. Long guarantee. Literature. Hawley Smith Co., Croton Falls 1, N. Y.

### ELECTRICAL SUPPLIES

**MOTOR** Rewinding supplies. Magnet wire. Insulation. Morton Electrical Service, Round Lake, Ill.

**LAMP** Supplies—Wholesale. Any amounts. All parts for repairing and building lamps. Catalogue 15c. Brown Lamp Co., Box 501, Wellston Sta., St. Louis 12.

**LAMPS**—25c Brings bargain catalog showing all parts for repairing, building. Contains instructions for electrifying vases, oil lamps, etc. Gyro Lamps, 5402P Clark, Chicago 40.

**FREE** Surplus catalog. You need it, we have it. Everything in hydraulics, pumps, winches, welders and supplies. Mechanical books. Prices you can afford. LeJay 47, Minneapolis, Minn.

**ELECTRIC** Pencil: Engraves all metals \$1.50. Beyer Mfg., 10511-H Springfield, Chicago 43.

**A.C.** Watthour meters, \$5.00. Miller, 1011 W. 16th, Davenport, Iowa.

**INSTALL** Your own fixtures, make most of your own electrical repairs and, save hundreds of dollars with Popular Mechanics' Electric Fix-It Book, \$2.00. No matter if you want to install fluorescent fixtures, test circuits, repair appliances or do any one of many electrical repairs, this new book tells and shows you how, step-by-step. Popular Mechanics Press, Dept. EF-2, 200 E. Ontario, Chicago 11, Ill.

### WELDING, SOLDERING, PLATING

**"BUILD-UR-OWN"** a.c. welder and a.c. power plant with a good used engine and low cost Hobart generator. Welds anywhere and supplies 5KW stand-by power for any emergency. Write Hobartweld, Box M-1033, Troy, Ohio.

**VOLCANO** Gas torch, 2270 F°, operates without compressed air for light silver brazing, soldering and many other uses. \$3.95 guaranteed. Miller Metal Products, Box 4026, Dept. C, Roanoke 15, Virginia.

**WELDERS**—Electric, various models, \$28.50 to \$235.00, direct from manufacturer. Free literature. Champion Welder Mfg., 193MP Centre St., New York 13, N. Y.

**SELF-Training** system radiator, repairing, cleaning, recoring. How to equip small shop at low cost. Supply sources, trade secrets, instructions \$3.50 postpaid. Radiator Service, McBain, Mich.

**A.C. Welders**, 4 sizes. Lowest prices. Free literature. Holgerson's Service, Canton 1, Kans.

**ELECTRO-Plating** equipment—New and used. Complete assemblies. All sizes for all types of plating. Baby shoe metallizing sets. Mounts, supplies, instructions. Free catalog. Send description. Hollywood Bronze Supply, Dept. 2A, 1624 E. First Street, Los Angeles 33, Calif.

**ACETYLENE** Welding outfits new \$49; used \$29; arcwelders \$49.50. Eagle Welding, Dept. PM, 5085 Broadway, Chicago 40, Ill.

### MACHINERY, TOOLS, SUPPLIES

**KEEPS** Needle-point sharpness! Revolutionary stainless steel hand saw, rust won't destroy edge. Tough, perfect temper and balance. Contour-ground, readily filed. Only \$6.95 postpaid, check or money order, money-back guarantee. Dept. P, Hayward Sales, Box 5063 Tri-Village Station, Columbus 12, Ohio.

**ALLEN** One ton power bench type punch press, \$125. Circular, Allen, Dept. PMB, Clinton, Missouri.

**CONCRETE** Block machines. Standard sizes. Free catalog. Concrete Machine Company, 5129 South Compton, St. Louis 11, Missouri.

**5-IN-1** Saw. Blades interchangeable. \$3.95. Circular free. Malit, Box M-297, Pottstown, Penna.

**SCREW** Gage checks threads per inch and 38 screw sizes. Free details. Faas Laboratory, 13 Dogwood Road, West Orange, New Jersey.

**ONLY** \$3.95. Precision 2" universal lathe chuck, \$14 value. Har Mur, 2349 Devon, Chicago 45, Ill.

**TOOLCHESTS** Complete \$50. Foster, 244 West 106 St., New York 25.

**FREE!** Lufkin folding rule! Order amazing 7-in-1 combination ratchet tool (screw-driver, drill, brace, etc.). \$3.49 prepaid. If not delighted, return. Keep ruler! Money order to TV Specialties, Box 588, Hicksville, N. Y.

**SPECIAL** Tools for woodworking machines, also metal turning attachment for Shopsmith. Free lists. Dixieng, 7301-F N.W. 10th Ave., Miami 38, Florida.

**POWER** Tools, equipment wholesale prices. Free bulletin. Homecrafters Cooperative, Grand Rapids 6, Michigan.

**SCREWS**, Nuts, washers, rivets. Over 35 sizes. Large assortment. Satisfaction guaranteed. \$2.00 postpaid. Ace Screw, 2431 Highland, Berwyn, Illinois.

**ATTENTION!** Foley Saw Filer users—If troubled with uneven teeth, carrier play, etc., send for particulars on our floating rollers. Use instead of clips. Precision work. Stadick Manufacturing Co., Searles, Minnesota. Canadian Distributor: B. G. Livingston, 609 Simpson St., Fort William, Ontario, Canada.

**RUBBER** Standard saw guard—Protects and cushions teeth, impregnated with castor oil, preventing rust. \$1.00. Jeane's, 1409 Partridge, Mobile, Ala.

**GET** A set of 7 genuine Vanadium tool steel screw drivers, with square shanks and hardwood handles. Sizes 2" to 10" for only \$3.00 postpaid, or \$3.50 c.o.d. Name engraved free, on each tool. Makes a fine gift. Used by world's finest mechanics. Guaranteed satisfaction. Order today, immediate delivery. Mallory Products, 745-1 Troy St., Dayton 4, Ohio.

**NEW** Mall electric drills— $\frac{1}{4}$ ", \$15.00;  $\frac{1}{2}$ ", \$25.00. Jacobs chucks. Wilt Surplus, 7829 S. Racine, Chicago 20, Ill.

**SHEBEL** Saw Filer. Files all saws. Circular. A. P. Shebel, 730 S. 2nd St., Milwaukee 4, Wis.

### ENGINES, MOTORS, DYNAMOS

**MARINE**, Industrial engines, equipment, parts. J. W. Helwege Co., 741 S. Ocean, Freeport, N. Y.

**ALTERNATING** Current generators, 750 watt, \$38.50; 5000, \$185. Motors  $\frac{1}{2}$  horse \$15.  $\frac{3}{4}$ , \$22. 1, \$35. Butler, 1885 Milwaukee, Chicago 47.

**INVALUABLE** Motor winders handbook. Simplifies complicated reconnecting. \$4.98. Jednak, Clinton, Penna.

**WINDING** Data, listing 225 motors, single and three phase, \$1.00. Motor Data Co., Box 7631, Kansas City 28, Mo.

### BOATS, OUTBOARD MOTORS

**PLYWOOD** Boat plans, 21 for \$1.00. Catalog boat building plans 25c. The Rudder, 15 Murray Street, New York 7.

**FIBERGLAS** Permanent boat coating. Gem-O-Lite's own "how" book \$2.50. Complete catalog 10c. Airmailed 35c. Gem-O-Lite, Box 6867B, North Hollywood, California.

**BUY** Wholesale nationally advertised outboards, thousands other products at big discount. Free wholesale plan. American Buyers', 628-DD Linden, Buffalo 16, N. Y.

**MARINE** Conversions—Willys to Cadillac. Manifolds, pumps, transmissions converted, reverse gears, etc. Catalog and conversion hints free. Barr Marine Products Co., 2706 E. Castor Avenue, Philadelphia 34, Penna.

**KRAFT** Kote—An engineered product to give your boat lifetime protection. No seasonal maintenance. Easy to apply. Fiberglass and MP-19. For free data and wholesale prices write to Multiplastics, Marine Div., 35 S. Dearborn, Chicago 3, Ill.

**MARINE** Conversions for Ford and Jeep engines. Catalog 10c. Lehman Manufacturing Company, 972D Broad Street, Newark 2, New Jersey.

**BELLY** Tanks, \$9.95. Free picture. Buck's Auto Wrecking, Merced, California.

**CONVERT** Fords and Jeeps to 100% marine engines with Osco's world famous Convo-Kits. Deluxe catalogue 25c (coin). Oscomotors, 3627B Lawrence, Philadelphia 40, Penna.

**NEW**, Used, rebuilt marine motors. Marine conversions, fittings. Free catalog. Stokes Marine Supply, Dept. 24, Coldwater, Michigan.

**OUTBOARD** Motor parts—New, used for all makes. Send stamp for price quotation, listing parts needed. Outboard Motor Mart, Inc., 229A State Street, Boston, Mass.

**PLANS:** Inboard-outboard runabouts, cruisers, sail, Wood, plywood, welded steel. Advise requirements. John B. Clark, N.A., 329 Kenmore, Bay Village, Ohio.

**BUILD** Marine engines with Federal conversion kits. Federal Marine Motors, 9011 Cottage Grove Ave., Chicago 19, Illinois.

**JOHNSON** Outboard specialists. Used parts for all models at substantial savings. Prompt quotations. Specify model serial. Crandall-Hicks, 910 Commonwealth, Boston, Mass.

**FULL** Size, cut to shape boat patterns, blueprints, 7 $\frac{1}{2}$ -38 feet. Illustrated "Build a Boat" catalog, 25c (coin). "How to Build Boats" book, \$1.00. PolyWog houseboat plans \$10. Cleveland Boat Blueprint Co., 9400 Steinway Ave., Cleveland 4, Ohio.

**SAVE** Money, have fun—Build your own boat. Popular Mechanics "23 Boats You Can Build" tells and shows you how. 192 pages, 500 illus., detailed diagrams and material lists. Everything from 10 ft. dinghy to 25 ft. cabin cruiser. Only \$2.00. Order today from Popular Mechanics Press, Dept. 107, 200 E. Ontario, Chicago 11, Ill.

### ATHLETIC EQUIPMENT, BODY BUILDING COURSES

**BARBELLS**. Exercise equipment. Courses. Free booklet. Good Barbell Co., Reading, Penna.

**BEAUTY**, Poise, health, power. Both sexes. Learn scientific breathing. \$5.00. Ray, Box 873, Columbus 4, Ohio.

### SPORTING GOODS, GUNS, FISHING TACKLE, ARCHERY, TRAPPING

**SAVE** 50% On finest bows, arrows. Complete bowhunting outfits, etc. Free catalog and "How to Select Archery Equipment" booklet. Malibu Archery, 3156-RB Eighth, Los Angeles 5, California.

**2000 HUNTING** Guns. Mausers, Lugers, Colts, Kentuckles, Westerns. Gunsmithing. Illustrated bargain catalog 50c. Ed Agramonte, Yonkers 2G, N. Y.

**AMAZING** Vest pocket rod and reel! Fish anywhere, anytime! Excellent for ice fishing! Free details! Gadgets, 3031 Fullerton, Chicago 47, Illinois.

**SEND** 10c For lists either shotguns, rifles, handguns, ammunition, or send 25c for all lists. Frayseth's, Willmar, Minn.

**BUY Wholesale** nationally advertised sporting goods, thousands other products at big discount. Free wholesale plan. American Buyers', 627-DD Linden, Buffalo 16, N. Y.

**PLENTY** Cash paid. Modern, antique guns, gold coins. Describe completely. Charlie Dutz, Box 284, Lincoln 5, Ill.

**MOLDS** For fisherman's sinkers, jigs, squids, casting and spinning lures. Sweet's Molds, Tonawanda 1, N. Y.

**5000 BARGAINS**, Firearms, binoculars, war relics. Catalog 50c. Smith Firearms, Runnemedede, N. J.

**SHOTGUNS**, Rifles, Revolvers, 500 modern, obsolete. Also cartridges. Each list 10c coin. Ed Howe, 52 Main, Coopers Mills, Maine.

**120 PROFUSELY** illustrated pages antique pistols, swords, daggers, armor, etc. 50c. Robert Abels, M860 Lexington Ave., New York 21.

**CAST** iron molds—For casting fishermen's sinkers. Free illustrated booklet. Reading Instrument Co., Box 78, Reading, Penna.

**CAMPING** Equipment, sleeping bags, tents. Low prices. Free 80 page catalogue. Mor-San Sales, 10-21R 50th Avenue, Long Island City 1, New York.

**GUN** And ammunition prices slashed. Many calibers below wholesale. Free list. Central Sports, Delphos, Ohio.

**JAP** Rifle altering American shells \$6.00. Catalog 5c. TP Shop, West Branch 11, Mich.

### TAXIDERMISTRY

**MODERN** Taxidermist Magazine, Greenfield Center 2, N. Y. Devoted entirely to taxidermy, photos, articles, methods. Trial year's subscription, \$1.00.

### BINOCULARS, TELESCOPES, MICROSCOPES, MAGNIFIERS

**BINOCULARS**, Telescopes, microscopes. Terrific values \$3.98 up. Request free money saving catalog. Criterion, Hartford, Conn. Dept. P-16.

**FREE** Literature. Giant telescope \$12. 400X telescope makers lens kit, \$6. Telescope Company, Manorville, N. Y.

**SAVE!** Save! New binoculars! Free catalog. Free book, "How to Select Binoculars." Write today! Bushnell's, 43-M70 Green, Pasadena 1, Calif.

**WAR** Surplus bargains. Binoculars, telescopes, sextants, millions of lenses, prisms, reticles, eyepieces, objectives, etc. Mail 10c for big Catalog CH. Send \$1.00 for Stock CH—10-piece lens kit and big instruction booklet. Edmund Scientific Corp., Barrington, N. J.

**16-21 POWER** Telescope kit. 5 ground, polished lenses, tubing, etc., including illustrated instructions, \$2.95 postpaid! Hobbycraft, 7113-A Princeton, Chicago 21.

**SPECIALISTS** in microscopes and supplies. New catalog free. Nassau Optical, 9 W. Greenwich, Roosevelt, L. I.

**AMAZING** Prices, binoculars, telescopes, microscopes. Free trial. Folder, "Binocular Selecting," optical catalog free. Prentiss Importers, Mercury Bldg., West Los Angeles 25, Calif.

**REFLECTING** Telescopes, 60X, completely assembled \$29.75. Guaranteed observatory clearness. Free information. Skyscope, 475 Fifth Avenue, New York 17.

**MAKE** Your 6" telescope reflector. Glass, abrasives, instructions—\$9.50. F. Cameron, Box 65, Inwood 96, N. Y.

**BINOCULARS**. Lowest prices. 8x30, \$32.00 guaranteed telescopes, microscopes. Free catalog: All sizes. Joe's Binocular Sales, 4827 Second Blvd., Detroit 1, Mich.

**SAVE** Money—Get interesting facts! Free 52 page three color catalog. 80 different models. United Binoculars, 9043 S. Western, A-5608, Chicago 20.

**REFLECTOR** Telescope kits—Precision eyepieces, mirror cells, diagonal holders, saddles, tripods, equatorial mountings, tubing, other optical bargains. Free illustrated bulletins. Esco Products, 1426 Willow Ave., Hoboken, N. J.

**POWERFUL** Astronomical telescopes easily made. Perfect lenses and instructions for making erector 45X, 100X, 200X and 400X telescope—\$4.00. Suffolk Science Service, Riverhead 3, N. Y.

**GIANT** Astronomical telescope complete with 6 ft. tripod. 45X, 75X, 100X eyepieces. Sun projector lens. \$15.00. Money back guarantee. Suffolk Science Service, Riverhead 3, N. Y.

### PETS—DOGS, BIRDS, RABBITS, HAMSTERS, ETC.

**RABBITS**. Amazing home business. Request information. Tayco Rabbitry, Hapeville, Georgia.

**YOUNG** Parrots—Make fine talkers. Herb Miller, 1911-N, Lubbock, Texas.

**EXCELLENT** Production rabbits—Whites, reds. Write for free information and price list. Miracle Hill Rabbitry, Box 204M, Grapevine, Texas.

**NATURALIST'S** Catalog 10c. Turtle 85c. 200 mealworms \$1.20. Chameleon 75c. Quivira Specialties, Topeka 51, Kansas.

**EARN** Up to \$400 monthly raising Angora or New Zealand rabbits. Plenty markets. Particulars free. White's Rabbitry, 209-3rd Street, Jackson, Michigan.

**HAMSTERS**—Delightful small pets. Free illustrated details. Anderson's Hamstery, 35 Oneida, Pontiac, Michigan.

**BEAUTIFUL** Pure white pedigreed police puppies. Ansonia Kennels, Mose, N. Dak.

**GUINEA** Pigs—Home business. Request information. Taylors, B426A, Hapeville, Georgia.

**HAMSTERS**, Sideline, hobby, income. Virgin stock. Stafford Hamstery, Stafford, New Jersey.

**DOLLAR-MAKER** rabbits! Cash markets. Write today! Ramshead Ranch, Gibbsboro 3, New Jersey.

**BIG** Profit raising chinchilla. Good breeding registered stock now available. H. Sheppard, 124 Columbia Road, Ellicott City, Md.

**TROPICAL** Fish, weird and beautiful. Send \$1 for catalogue. 1214 North Old Manor, Wichita, Kansas.

**FOR** Sale: A few outstanding Coonhounds, Beagle, and Rabbithounds. Prices from \$15.00 to \$40.00. Free literature. Trial. Dures Thomas, Box 268, Albertville, Alabama.

**HAMSTERS**, Golden and Panda. Literature free. Charles E. Bowser, Smokerun, Penna., Dept. H.

**HAMSTERS**—Cages and equipment. Free illustrated details. Lakeview Hamster Colony, Newfield, New Jersey.

**EARTHWORM** Raising pays worthwhile profits! Illustrated booklet explains raising, feeding, packing, marketing. 25c. Ozark Worm Farm—J. Willow Springs, Mo.

**STANDARD** Rabbit Journal, B-241-M, Milton, Penna. Year \$1.00, sample dime, beginner's manual 25c.

**HAMSTERS**—Virgin stock; young, \$3.00 pair; fully developed, \$4.00 pair. Adirondack Hamstery, Prospect 2, New York.

**MAKE** Big money! Raise Chinchilla rabbits. Cash markets supplied. Write today! Rockhill Ranch, Sellersville 15, Penna.

**MINK** Raising information free. Complete. Lake Superior Mink Farm, Superior, EEl, Wisconsin.

**CHINCHILLAS** (No rabbit.) Easily raised anywhere. Profitable. Big future. Terms. Hibner Chinchillas, Ithaca, Mich.

**SPORTSMEN**: 200 Pointers, setters, straight cooners, combination hunters, rabbit and fox hounds. Reasonable. List free. Ramsey Creek Kennels, Ramsey, Ill.

**STEADY** Earnings with Angora rabbits. Free illustrated booklet tells how, lists markets, successful raisers. National Angoras, Fullerton 16, Calif.

**RAISE** Mink: Free booklet, pen plans, inside secrets, feed, care. Mink are money makers. Investigate today. Lawrence Mould, Brigham City 12, Utah.

### PLANTS, SEEDS, NURSERY AND GARDEN SUPPLIES

**FRUIT** Trees! Stark Bro's sensational new "Dwarfs." Also standard size, exclusive patented, trade-marked varieties produce abundant, larger, better apples, peaches, pears. All fruit faster growing, quicker bearing. Also beautiful ornamental trees and shrubs. Get giant new colorphoto catalog free. Stark Bro's, Dept. 30004, Louisiana, Missouri.

**PROFIT** From your soil now. Newly-invented pocket soil test kit shows how. 60 tests, directions, treatment data, \$1.00. Guaranteed. N. Crane Co., 144 Eighth, Passaic, N. J.

**ORNAMENTAL** Palm trees. Grow at home. Instructions, seed \$1.00. Free unusual seed, plant food with order. Irving Walker, Box 33, Bellerose 26, N. Y.

**FUN** Growing air plants. Grow quickly, reproduce themselves. Require practically no attention. Very ornamental. Packet 25c. Nagel Groves, Winterhaven, Fla.

**OPERATE** Lucrative garden. Everything furnished. Experience unnecessary. Yusko Products, R #3, Streator 12, Illinois.

**NEW** Elderberry stemmer, removes berries from stems. Price \$7.50. Fred Howe, Wellsboro, Penna.

### FARMS, FARM LANDS, REAL ESTATE

**FLORIDA**—Beautiful retirement homesites near gulf coast. Excellent hunting, fishing in 9 fresh and salt water rivers, 11 bays and gulf. \$250 at \$10 monthly. Free literature. A. M. Mathews, Box 1406, Asheville, N. C.

**HOMESITES** \$400—Convenient payments. California's finest garden section. On Morro Bay's scenic shores. Wonderful fishing, boating, bathing. Fertile soil, softest water, temperate climate, congenial community. Free literature. Richard Otto, Department M, San Luis Obispo, Calif.

**HOUSTON** Has everything! Year 'round summer climate, unexcelled educational facilities, unlimited opportunities in commerce, industry, medicine. Come live in fabulous Houston, "land of the big rich." Earn more than ever before! Magnificent homesites now available in choice suburban areas for only \$345. Payable \$15 month. Write now for sensational details. Preston Wood, Box 413, Houston, Texas.

**FLORIDA**—New development adjoining Ocala National Forest in Lake County. Best fishing, hunting. Nice homesites \$245 at \$10 monthly. Folder free. Howard Vernor, DeLand, Florida.

**SMALL** Home, 80 acres, bordering state park, \$1750. \$25 terms. Free giant listings mailed. Write Mr. Armstrong, Shook 34, Missouri.

**FARM** And business catalog free! Big edition. Hundreds of bargains from \$1000 up. Maine to Florida. West's, M-10, Pittsburgh 17, Penna.

**\$5.00 PER** Acre, Missouri land. Warranty deed. Free list. John Calvert, Plant City, Florida.

**FARM-Ranch** opportunities. Favorable conditions, Washington, Minnesota, Montana, Idaho, Oregon, North Dakota. Literature, farm descriptions. Specify which state. J. W. Haw, 119 Northern Pacific Ry., St. Paul 1, Minn.

**CALIFORNIA** Ranch lands. 50c to \$5 acre minimum bid. Farm-ranch-hunt-fish-retire. 10c brings illustrated land catalog, outline maps. Tax Land Sales, Box 2350 BW, Hollywood 28, Calif.

**FARMS**, homes, businesses, 33 states, coast-to-coast, over 3000 bargains described. Mailed free. World's largest; 53 years service. Strout Realty, 7-M So. Dearborn St., Chicago 3, Ill.

**FLORIDA** Choice lakefront lots available. Best fishing, hunting. Terms. Grace Parker, Paisley, Florida.

**\$5.00 MONTHLY** Buys—5 acres, excellent fishing and hunting; good land. Price \$100.00. Free list. Box 425-P, Carthage, Mo.

**FLORIDA**, Central, lake-front subdivision near Tavares. Lots 10% down, \$25.00 month. Write J. D. Rapalje, Box 792B, Tavares, Fla.

### POULTRY, FARM SUPPLIES

**KNOW** How to raise poultry for profit. Read Poultry Industry. Every issue packed with helpful hints and practical suggestions. Latest articles on breeding, feeding and management. Subscribe now, 1 year 50c, 3 years \$1.00. U. S. funds or checks payable at a New York or Boston bank. Poultry Industry, Dept. PM, 376 Boylston St., Boston 16, Mass.

### PROFITABLE OCCUPATIONS

**\$35.00 OR** More weekly. Upholstering spare time. Complete instructions \$1.00. Custom Upholstering, Oxford, Penna.

**WELDING** Pays big money. Learn easily at best equipped school in country. Non-profit school with low cost training. G.I. approved. Write Hobart Trade School, Box M-1032, Troy, Ohio.

**FREE!** "301 Profitable Small Businesses!" Amazing shoestring plans! Work home! Start sparetime! Deumant Surveys, Kenmore 23-R, N. Y.

**"HOW To Make Money With Simple Cartoons"**—A book everyone who likes to draw should have. It is free; no obligation. Simply address Cartoonists' Exchange, Dept. 910CP, Pleasant Hill, Ohio.

**BUY Wholesale** thousands nationally advertised products at big discount. Free wholesale plan. American Buyers, 628-R Linden, Buffalo, N. Y.

**\$500,000 BY Mail** from home. Free details. Publicity, Kalamazoo 26DC, Mich.

**RADIO Advertising.** No risk. 400 station list, 50c. Publicity, Kalamazoo 26DB, Mich.

**OVERSEAS Jobs.** Big pay, transportation, expenses. Clerical, professional, mechanical workers. Most all trades. Latest listings airline, construction, manufacturing, oil, steamship companies, government agencies, many other opportunities. Up to date information on securing employment, contracts, income tax, application forms. \$1.00. Overseas Jobs, Box 335-A14, Baton Rouge, La.

**CONSTRUCTION Job list.** Published monthly. \$1.00. Dempster's Construction Scout News, Dept. 268-SS, Bridgeport, Ill.

**FOREIGN Employment.** Top pay. U. S. companies need personnel for foreign assignments. Now! For immediate valuable information, how to apply, application forms etc., send \$1.00. Receive free with this offer "Opportunities in Booming Brazil." Worldwide Job News, Box 271, Temple City, California.

**SECRET Investigation.** Experience unnecessary. Investigators particulars free. George Wagner, M125 West 86th, New York 24.

**RAISE Pheasants** on \$100 week plan. Little capital and space can make you independent. Free details. Great Central System, Columbus 1, Kansas.

**\$10,800 PROFITS!** Your own mailorder business! No risk! Success plan free! Treasury, 709 Webster, New Rochelle L-16, N. Y.

**EVERYBODY Likes candy.** Learn to make professionally. Tools and supplies. Interesting work. (Our 43rd year.) Ragsdale Candies, D6, East Orange, New Jersey.

**SELL Popular Mechanics** and all other magazine subscriptions. Free catalog, supplies. Subscription Service Company, Dept. B, P. O. Box 2070, Birmingham, Alabama.

**MUSHROOMS** Grown boxes, barrels. Manureless process 50c. Spawn \$1.00. Gordons, 553 William, Winnipeg, Manitoba.

**BE A merchant seaman.** High pay. World travel. Details free. Maritime Information, Box 451, Lafayette, La.

**FOREIGN Jobs.** Contracts underway and soon starting in Africa, South America, Canada, England, Europe, South Pacific, Middle East, Mexico and Alaska. Send \$1.00 for foreign job news, information, application forms, etc. DCS Foreign Job News, Dept. 268-ST, Bridgeport, Ill.

**WANT A diesel job?** New opportunities to increase income. Higher pay. More money. We can help you qualify. Tools. Shop method home training. Write today! Diesel, Tractor, Heavy Equipment Division, Interstate Training Service, Dept. B3K, Portland 13, Oregon.

**SEND For big, new 1953 illustrated catalog** that will show you how to turn your spare time into cash—making quick-selling, highly profitable lamps. Every home a prospect. Hundreds doing it, you can, too. No experience or special tools required. Catalog No. 7 contains 56 pages filled with shades, shade frames, figurines and bases, oil lamp converters, boring compound, and dozens of similar items. Also all kinds of sockets, cords, pipes, harps, finials, bases, and hundreds of other parts—everything you need. Special 8-page section shows 6 beautiful lamps in kit form, ready to assemble. You buy wholesale, sell at retail. Make big profits. Send 25c today for new 1953 catalog and wholesale price list, you'll be glad you did. The 25c will be refunded on your first order. Gearon Co., Dept. 500-B-10, 27 S. Desplaines, Chicago 6, Ill.

**HATE Going to work?** I did, and quit job teaching business administration to develop a special self-operating, broad-coverage mailorder system that needs only supervising. Brings me \$250 weekly last twenty years. On request, method has been "blueprinted" for beginners. Literature free. Tom Dougherty, Box 88-J, Van Nuys, California.

**500 FOREIGN Jobs—Corporations, firms** in 33 countries. All fields. To \$12,000. Enclose \$1.00. Box 991, Washington, D. C.

**HOW New Geometric mailorder operates:** offer meant for certain prospect class distributed by mailing-agents pertaining to that class. Precision method—extensive coverage with economical overhead. Works fast. Sold \$250,000.00 for us from home guest-room-turned-office. Geometric information free. Specialty House, 910 E. Main, Danville, Illinois.

**UNLIMITED Income:** Mail-order or direct. Neaf, 5976 Cote Brillante, St. Louis, Missouri.

**DOCTOR Ordered, "slow down."** We scrambled two college degrees in business science with some little-known mailorder procedure. Result—something revolutionary: a mass-attack method that mailed our circular to hundreds of prospects daily without our lifting a finger! Method returning \$12,000.00 yearly last 24 years, explained for beginners. Details free. Bond, Okeene, Oklahoma.

**NORTHERN Airbase construction opportunities!** Transportation paid. Laborers earn \$255 weekly, skilled \$340. Complete information, wages, overtime, conditions, how to apply, etc. Plus, latest bulletin, "World Job News." Everything, \$1. Job-service N-16, Box 30, Billings, Montana.

**WOOD Fibre—You can learn to make** these flowers from the original teacher of wood flowers. For years I taught thousands with my illustrated lessons. You can't fail to learn. Write for free sample and information. Beatrice Makranzy, 11305-P Goss St., Sun Valley, Calif.

**ALASKAN Jobs!** Over 150 new construction projects with names, addresses companies hiring. Thousands needed. Highest wages. Military, private construction, mining, fishing, lumbering, aviation, railroads, homesteading. Skilled, unskilled workers. Salary information. Government map included. \$1.00 complete. Alaskan Opportunities (PM), Box 362, Kenmore, Washington.

**HOME Business opportunities.** Free details. Uncle Herb, Box 185, King, N. C.

**FOREIGN And Latin American employment.** 1953 "Foreign Service Directory" gives up-to-minute facts on military and civilian construction, government jobs, major oil listings, aviation, transportation, steamship lines, mining, importers, exporters, how-when-where to apply, application forms, hot list firms hiring. \$1.00 postpaid. Global Reports, Box 883-P, Hollywood 28, Calif.

**GROW Mushrooms.** Cellar, shed, and outdoors. Spare, full time, year round. We pay \$3.50 lb. We paid Babbitt \$4,165 in few weeks. Free book. Washington Mushroom Ind., Dept. 99, 2954 Admiral Way, Seattle, Wash.

**MAKE Flexible molds!** Cast plaques, bookends, figurines! Free sample! H. Tooker, 630-M Chestnut, Hamilton, Ohio.

**FREE Book "505 Odd, Successful Businesses."** Work home. Expect something odd! Pacific, Oceanside, Calif.

**ALASKA!** Last American frontier. \$1.00 brings 1953 business directory and government map. Military and civilian construction; homestead and highway facts; mining, aviation, fur farming, grazing, timber, travel directions. List of firms hiring. How to apply. Alaska Opportunist, Box 92-P, Hollywood 28, Calif.

**FOREIGN Employment construction work.** If interested in foreign projects with high pay, write Foreign Service Bureau, Dept. PM, Metuchen, New Jersey.

**BE The Popular Mechanics representative** in your neighborhood and earn big profits in your spare time. Write Popular Mechanics Magazine, Room 408M, 200 E. Ontario St., Chicago, Ill.

**HOME Mail order beginners.** Sources, methods, complete information. Free details. Carnahan Bros., 5582 Nelson, Cypress, Calif.

**EARN Money writing stories; expert guidance.** Pauline Bloom Workshop, 58 Willow-P, Brooklyn 2, N. Y.

**TYPISTS — Profitable home business.** Complete copyrighted information, 50c. Gaunt, 827-W Irving Park, Chicago, Ill.

**RANCHING Isn't our business on this ranch.** It's mailorder! A special new kind anyone intelligent can duplicate, in city apartment or suburbs. Brings us \$1,000 monthly. We're showing folks how. We'll start you, suggest items that sell, guide you till you gain confidence. Write: The Palmers, Carrollton, Texas.

**SOILLESS Gardening (Hydroponics).** Easy, profitable. Complete instructions 25c. Earl Riley, Red Bluff, Calif.

**MAKE Used nylon stockings** into beautiful flowers, corsages, etc. Fascinating, profitable. Kit and selling plan with free specimen 50c. White Specialty Sales, P.O. Box 5505, Cleveland, Ohio.

**CREDIT Correspondents wanted.** Work furnished. Small investment. Very profitable. Write National Correspondent Service, 1518 Randolph, St. Paul 5, Minn.

## BOOKS, PERIODICALS, PICTURES, POSTCARDS

**FREE Subscription:** The Americana Eagle. No fees. No purchases required. Send your name today to receive newspaper, "Americana Eagle." Contains book news, other valuable information. Mail Order Division, Americana Corporation, Dept. PM91, 333 N. Michigan Ave., Chicago 1, Ill.

**BACK Number magazine specialist.** Specific requests. Ellis Chalfin, 410 East 17th Street, Brooklyn, New York.

**CURRENT Issue mail order assembler** 5c. Summers Company, 917 E. 47th St., Chicago 15, Ill.

**BOOKS New and used** at special prices. Save money. Write for list of fifty free catalogs on text and occupational subjects. Many rare and out-of-print titles. We also buy books. Established 1902. Long's College Book Co., Dept. PM, Columbus 1, Ohio.

**CURRIER & Ives reprints.** Free list. Dinneny, 31-53 34th St., Astoria 3, N. Y.

**POSTCARDS.** 1000 From photograph or drawing \$10 postpaid. Samples. Tuttle Pub., Rutland, Vt.

**FREE—98 Issues of Life,** weekly news picture magazine if you subscribe for 3 years at only \$11.50. (Below publisher's rates.) Armi Maki, 8928 Portland, Detroit 17, Mich.

**3-D ITALIAN Postcards.** Viewing glasses attached. Italy postmark or in envelope. Seven for \$1.00. European magazines, every subject and hobby, send for free catalog and samples. Four Italian "3-dimension" magazines, \$1.00. Mondino, Sabotino 2, Milan, Italy.

**BOOKS. 50% To 80% off!** Free list. Panos, West Bridgewater, Massachusetts.

**HOW To live without money.** Write: H. M. Bishop, 405 Second St., Neenah, Wisconsin.

**OUT Of print books.** Send wants. Bookfinder, 6494 Aylesworth, Cleveland 29, Ohio.

**SHORT-Cut mathematics \$1.00 postpaid.** Slide-rule free. Mathmagic, Box 222, Chicago 90.

**SENSATIONAL Book bargains!** Free catalogue! Write: Old Prof's Book Shop, 9 W. Lawrence St., Pontiac 15, Mich.

**BOOKHUNTERS!** Scarce, unusual, miscellaneous books supplied. Atlantic Book Service, Lawrence Avenue, Charlestown 29, Massachusetts.

**FREE Catalogue.** Special interesting books. Powers, 1324 Wilshire, Hollywood 17, California.

**BIG Catalogue; 1500 bargains,** send 10c. Books, 3100 Ocean Parkway, Brooklyn 35.

**NATIONAL Geographic Magazines, 1888-1952.** Periodical Service, Box 465-PM, Wilmington, Delaware.

**BOOKHUNTERS!** All subjects. Send wants! Jaher Book Service, 620-P East 178 Street, New York 57.

**BOOKS Located.** No charge for searching. Delta Book Service, 2856a Woodlawn Terrace, Memphis, Tenn.

**BOOKS Found!** Any author, old or new. Rush titles wanted; no obligation. International Bookfinders, Box 3003-PM, Beverly Hills, California.

## GAMES, TOYS, NOVELTIES

**CHECKER Strategy** taught new way, without numbers. Have 91 strategic checker games, 2c each. Minimum order twenty games. Stanfield, Box 1071, Mountain Home, Tenn.

**SURPRISE Accident car.** Explodes on collision. Reassembled easily for another hilarious accident or regular spring-driven racing. Fascinating fun! \$1.25 ppd. Harvest House, 3509 1/2 Wellington, Los Angeles 16.

**TWENTY Adult party games.** Expect fun. Entertaining troubles over. Send dollar bill. Games, Box 582, Pocatello, Idaho.

## MAGIC TRICKS, PUZZLES, JOKER NOVELTIES

**MAGIC**—Jokes, puzzles. Modelcrafts. Send 10c today for catalog, Del's Tricks and Hobbies, Box 1689, Rockford, Illinois.

**MAGIC**—Parlor, stage. Joker's supplies. Lower prices. Giant catalog 25c. Refunded. Top Hat Magic, Evanston, Illinois.

**PROFESSIONAL**, Amateur tricks. 3c. Keller, Box 686, Jamaica, New York.

**REAR** View mirror attachment for glasses. \$1.00 postpaid. Starling Co., 2206 M Starling Ave., New York 62.

**NEW** Magic catalogue and magic circulars 10c. New joke lists 5c. Magic Factory, Minneapolis 2, Minn.

**WE** Supply every noted magician. Large professional catalog \$1.25. Holden's, 120 Boylston Street, Boston, Mass.

**PROFESSIONAL** Catalog, 150 pages, 25c. Williams, 900 Plymouth, Ellwood City, Penna.

**500 TRICKS**, Douglas famous 120-page catalog, only 10c. Fastest service to magicians for 30 years. Send 10c today. Douglas Magician, Dept. 1, Dallas, Texas.

**2500 TRICK** Catalogue (512-pages), pocket, parlor, stage. World's finest magic. Catalogue \$2.00 (dollar trick included free). Kanter's, M-1311 Walnut, Philadelphia 7.

**PROFESSIONAL** Catalog and free trick 35c. Terry's Magic Studio, 1921 66th Street, Brooklyn 4, New York.

**GENUINE** Ventriloquism. Secret, one dollar. Lou Martin, Box 1821, Tulsa, Okla.

**90 PAGE** Novelty-magic catalog with exciting trick, 25c. Allen, Dept. PMT, Clinton, Missouri.

**VENTRILQUISM** Selftaught. My quick, easy instructions, 25c. Ventriloquist, CalAllen, Texas.

**EASY** Professional magic for beginners. Illustrated catalogue and trick 35c. Kaye Enterprises, PM-5 Box 8084, Newark, N. J.

**SURPRISE** Book! "What Most Men Know About Women." Free gift. Only 25c. R. Ramey, Oakwood Ave., Waukegan, Ill.

## COINS, TOKENS, CURRENCY

**BEAUTIFUL** Siam porcelain coins, 2, \$1.00. Irish set 8 animal coins \$3.00. Elizabeth coronation dollar \$1.85. Giant bargain catalogue 35c. Bebee's, 4514 North 30th, Omaha 11, Nebraska.

**40 DIFFERENT** Coins, \$1.00. 100 different bills, \$1.00. Oddehon, Box 482, St. Louis, Mo.

**CANADIAN** Large cents. Five different fine to very fine for 50c. Price lists of U.S.A. and foreign coins free. No approvals sent. Bryson Stamp Co., 612 White, Toledo, Ohio.

**35 DIFFERENT** Foreign coins, \$1.00. 20 different foreign bills, \$1.00. Claud Denney, 3633 Colonial, Dallas 15, Texas.

**\$1,000.00 NOTE** Only \$1.00. 100 page illustrated catalogue 25c. Shultz, Salt Lake 10, Utah.

**COIN** Valuation handbook, prices we pay, 127 pages, 380 illustrations, cloth-bound, \$1.25. 50 Indian cents \$3.00. Cook Coins, Jackson 5, Mississippi.

**WHAT** Are your coins worth? Amazing Fell's new 1953 United States coin book. Everything on every single coin minted—Worth, value, how to sell, speculating, investment; other valuable facts. Cloth-bound. 150 illustrations. Send no money. Pay postman only \$1.50 (plus postage) or \$1.50 postpaid (refundable). Order now! Fell Publishers, 386-M-17 4th Ave., New York City 16.

**OLD** Money wanted. Will pay fifty dollars for nickel of 1913 with Liberty head (not buffalo). We pay cash premiums for all rare coins. Send 4c for large coin folder. May mean much profit to you. Numismatic Co., Dept. 20, Fort Worth, Texas.

**FOREIGN** Coins 10 different 25c. Foreign bills 10 different 15c. Lists. Oliver Arnold, Macon, Missouri.

**1867 SHIELD** Nickel and 3c nickel, \$1. Fine quality U. S. large cents, 3 different \$2. Delmaco, Box 1123, Wilmington, Del.

**FORTY** Different uncirculated silver dollars, \$72.50. U. S. price list 10c. Johnson's, 644 E. Valerio, Santa Barbara 3, California.

**\$10.00 FOR** Certain Lincoln pennies, Indianheads \$50.00. New booklet listing prices paid, 20c. Lincoln Coins, D-129, Glendale, Arizona.

**WORLD'S** Greatest magazine for coin collectors and wooden nickel 10c. Lawrence Brothers, Anamosa, Iowa.

**FREE!** Foreign coin, banknote and coin collectors illustrated catalog to approval service applicants. Send 3c postage. Tatham Coinco, Springfield 30, Mass.

**COIN** Collector's Magazine. Largest independent, over 1000 pages per year. Sample copy 30c; \$3.00 per year. Hewitt, 7320-J Milwaukee Ave., Chicago 31.

**INDIAN** Cent with bargain lists 10c. Hutchinson, 3463 "I" Street, Philadelphia 34, Penna.

**SCARCE** 1931-S cent only \$1.25; ancient Roman coin \$1.00; Whitman coin albums, three for \$1.00 postpaid. Ben's Coin Shop, 31 North Clark, Chicago 2.

**GET** Profit and pleasure in collecting old coins. Send 10c for 56 page illustrated coin catalog. You'll be delighted with it. Send for it now. B. Max Mehl, 370 Mehl Bldg., Fort Worth, Texas. Largest rare coin establishment in U. S. Established 53 years.

**ENGLISH** Coronation crown in plastic case—\$2.00; full coronation set \$4.50; 3 genuine Roman coins \$1.00; 25 different foreign coins or bills \$1.00. Catalog 10c. Royal Coin Co., Dept. PM, 47 W. 46 St., New York 36, N. Y.

## STAMP COLLECTING

**RARE** Octagonal stamp. Giant triangle, gorgeous diamond, also mammoth and midget stamps given to foreign approval buyers. Gifts with purchases including Scott's International \$6.00 album, also latest Scott catalogues. Plymouth, Dept. A9, Bell, California.

**25 DIFFERENT** French colonies 5c with approvals. Adlez, 367 Park Ave., Newark 7, N. J.

**ALBUM!** Capacity over 1,000 stamps! Only 10c! Stampmart, Hartford 1, Conn.

**BIG** Stamp zoo 10c. Jungle beasts, wildlife, domestic animals—Fifteen different, including rhinoceros, elephant, snake, tiger, zebu, kangaroo, koalabear, emu, kookabura, bull, horse. Extraordinary accompanying approvals. Niagara Stamp Company, Niagara-on-the-Lake 51, Ont., Canada.

**TIRED** Of messy, poorly mounted and unattractive approvals? Waiting for you are some of the world's most beautiful stamps neatly mounted in books of 1,000. Most of which we sell for 1 and 2c each. See what you have missed. Write today. Satisfaction guaranteed. Wolverine Stamp Service, Dept. C-2, Fruitport, Mich.

**FREE**, World's largest stamp! Three inches! Jim, 714 Chaplin St. S.E., Washington 19, D. C.

**THE** Work is done—Pleasure is yours. Be a satisfied customer and send for our beautiful, neatly mounted approvals. Scott's catalog number and price under each stamp. Terrific discounts. Modern Stamp Co., Dept. A-2, Ferrysburg, Mich.

**700 COLLECTIONS** By countries. Bargain list, 10c. Plymouth, Box 365-B, Far Rockaway, N. Y.

**88 FLAGS** In color. All nations, 10c to approval buyers. Potomac Stamps, Washington 15, D. C.

**ARMISTICE** In Korea. Set of 7 different Korea stamps for only 10c to approval applicants. Alpine Company, Box 536, New Rochelle, N. Y.

**CANADA**—100 Different, 25c with approvals. Crown Stamps, Box 331, Toronto, Canada.

**100 DIFFERENT** World 10c. Free gift. Bellet, Mapledale, Hazel Park, Mich.

**FREE** Catalog! William Bentley, Dept. 12, Box 2056, Pensacola, Florida.

**PAKISTAN** 25 Different 25c. Free packet list. Burtner, 709 Washington, Reading, Penna.

**JET** U. S. packets! All different; Bicentennials complete; 10 airmails; 22 presidentials; 15 revenues; 12 coils. 25c each. All 5, \$1.00. U. S. approvals 1c up. Escro, Route 1, Port Jervis, N. Y.

**GOYA** Nude (2) 5c. Approvals. Hanan's, 310 Quail, Albany 3, N. Y.

**GOOD** To fine U. S. used approvals. Glades Stamp Company, Box 2842, Miami 18, Florida.

**1155 WORLDWIDE** Different \$1.00 with approvals. Karl Klondike, Harrisburg, Ill.

**50 DIFFERENT** Latin American airmails 25c. Approvals. Johnson, Box 367, Morgan Hill, Calif.

**BIG** New U. S. catalog—Only 10c! Published by world's largest stamp firm. Completely illustrated. Bargain lists and approvals included. Harrisco, 202 Transit Bldg., Boston 17, Mass.

**MINT**, Unused U. S. approvals. Patrick Agencies, 3650 Central, Indianapolis 5, Ind.

**WHOLESALE** Job lots for dealers and exchangers. Particulars free. Progressive, 270 Burkhart, Cincinnati 15, Ohio.

**500 MIXED** U. S. 20c; 1000, 35c. Sibley Stamps, Mendon, Mass.

**FINE** Approvals. Fast, personal service. What countries do you prefer? I'll send their stamps. Skinner, 438 Locust, Long Beach 12, California.

**ALBUM**, 100 Diff. stamps, 3 premiums, 20c. Smithco, Northeast, Box 6618, Kansas City 23, Mo.

**100 DIFFERENT** France 10c with approvals. Sadler, 9013 Central, Kansas City 14, Mo.

**253 U. S.**, Foreign, 25c. Schmitt, 730 South Jackson, Green Bay, Wisconsin.

**HYGRADE** U. S. approvals priced to please. Wenigman, 1933 Patterson, Chicago 13.

**66 DIFFERENT** United States, 10c. Approvals. Utechts, 1143D North Keeler, Chicago 51.

**MINT** Five pound British Colony stamp, guaranteed genuine, face value \$25. Just 25c to introduce our famous approvals. Viking, 11-ZZ Northern Blvd., Great Neck, N. Y.

**222 ALL** Different, 10c to approval applicants. Jayne, Gravesend Sta., Brooklyn 23, New York.

**SERIOUS** Collectors! Custom-made approvals. State needs. Brooks, 2352M East 23rd Street, Brooklyn 29, New York.

**U. S. Army-Navy** cpl. mint 50c. Lancaster Stamp Co., Lancaster, Penna.

**WORLDWIDE** Stamp mixture, 5 ounce package, \$1.25. Veteran Frank Stroskey, 223 Market St., Perth Amboy, New Jersey.

**U. S. Mint** specials! Flag set, complete, \$1.00; 5 different 3c commemorative plate blocks, \$1.00. Want lists filled. Brooks, 2352A East 23rd Street, Brooklyn 29, N. Y.

**FREE!** Obsolete U. S. occupation set with most attractive approvals ever offered. Riedell, Greensburg, Penna.

**ZOUNDS!** Exciting strange countries packet. Free with approvals! Saxon, Vista, California.

**DIFFERENT** 500, 35c; 1000, \$1.00; 2000, \$2.75; 5000, \$11.00, with approvals at wholesale to clear. K. S. Holmes, London, Canada.

**FREE** Congo flower stamps. Request beautiful foreign approvals. Every stamp a gem. Pearl Stamp Co., Box 112, New Kensington, Penna.

**50 DIFF.** Belgium 10c with approvals. Scheerer, Box 301, Pottsville, Penna.

**FREE**—200 Different stamps! Approvals. Brunning, Donaldson Ave., Rutherford, N. J.

**1000 FINE** Mixed U. S. stamps 25c. Wright, 723 Washington, Hagerstown, Md.

**14,000 DIFFERENT** Yours on our streamlined systematic club plan for only 50c weekly. Big shipment every two weeks. Details free. Sjoquist, Box 217, Valley Stream 75, New York.

**96 PAGE** Illustrated U. S. price list. Send 10c. cost of mailing. DeLisle, 154 S. Second St., San Jose, Calif.

**WOW!** 7972 Worldwide stamps from 36 stamp companies with approvals, \$8.00. M. King, 32 Alexander Ave., Kamloops, B.C., Can.

**850 MIXED** U. S. old, new, 25c. Lists. Weatherby, Medina, Ohio.

**EXCHANGE** Your duplicate stamps. Send 100-200 different foreign and dime. Receive all different. Patterson, 5622 Broadway, Lancaster 10, New York.

**KOREA** Airmails #C1-2 (catalog \$1.00) free with approvals. Le Blanc, Box 111, Woodstock, Illinois.

**U. S. Approvals**, mint, used! Square Deal Teal, 663 Beach, Rochester 12, N. Y.

**FIFTY** Different United States; commemoratives, airmails, etc. All for 10c. Ed. Keller, Library 1, Penna.

**OLD** U. S. mixture 25c. Bargain approvals. Rothberg, X123-PM, Braintree 84, Mass.

117 DIFFERENT Worldwide 3c. Approvals. Bell, 2221-F Parkway, Winston-Salem, N. C.

FISHERMAN'S Treasure set of lovely mint Mozambique stamps. Each with tropical fish in brilliant natural colors. Only 5c. Approvals. Hathaway, Box 145M, Garden City, N. Y.

BARGAIN 10 Plateblocks 40 stamps U.S. 3c mint \$1.85, 25 plateblocks, 100 stamps, \$4.25. Cross Country Sales, 48 Wloughby Street, Brooklyn 1, N. Y.

FREE! Colorful Mozambique—Approvals. Pegram, Box 785, Huntington Park, Calif.

500 MIXED U. S., 10c. List. Blanchard, Box 307, Medina, Ohio.

67 DIFFERENT U. S. stamps 10c with approvals. Oehlman, Hebron, Indiana.

GRABBAGS 25c Each, 5 for \$1.00. Israel Company, Dept. 27, Washington 5, D. C.

PRESIDENTIAL Coils complete unused 60c. No approvals. U. S. lists. Standard, 10840E Woodview, Parma Hts. 29, Ohio.

STAMP Wallet plus small German collection, 5c with approvals. Amberg, 537H 35th, Union City, N. J.

UNITED States price list, 100 pages, over 400 illustrations, plus information on stamp identification 10c, deductible first order. Thom, 4808 15th Ave., Minneapolis 17, Minn.

500 MIXED U.S. and foreign 25c. Monjar, Cincinnati 14, Ohio.

CIPEX Souvenir sheet plus 25 different U. S., 10c. Approvals accompany. Village Stamps, 90-39P 214 St., Queens Village 28, N. Y.

SENSATIONAL Offer! 100 different stamps free. Approvals. Norge, Ho-Ho-Kus, N. J.

URUGUAY Roosevelt set 10c with approvals. Seminole Stamps, Box 1138-P, Coral Gables, Florida.

300 DIFFERENT Given free with approvals. Particulars. Windsor Stamps, 1435 East 67th Place, Chicago 37.

NAMES 1000 Stamp collectors \$1.00. M. King, 32 Alexander Ave., Kamloops, B.C., Canada.

STAMP Buyers. Minimum purchase \$20 until Christmas will have camera loaded with film for their gift patronizing. Sophus Jensen, Coupeville, Washington.

BETTER Grade U. S. or foreign approvals. Ocean Stamp Co., Box 64-M, Brooklyn 29, N. Y.

AMAZING Offer! 200 United States stamps—including commemoratives, airmails, high denominations to \$1.00. Only 10c to approval applicants! Illustrated bargain lists free. Mystic Stamp Co., Dept. 80, Camden, New York.

STEEL Tongs, magnifying glass 50c; 100 different stamps free. Dolin, 31 Park Row, New York City 38.

FREE! Scott catalog and other premiums. Approval applicants write for details. Newton Schrod, Box 92, Sullivan, Ill.

LOOK! 100 Different used large size U. S. commemoratives—Plus 1947 CipeX souvenir sheet \$1.00. Sutton's, 1219 Napa, Vallejo, Calif.

150 FACE Different United States \$1. No approvals. Collier, Box 4243, Atlanta 2, Georgia.

1/2c APPROVALS. Povilauskas, 212 E. 3 St., New York 9, N. Y.

GERMANY Colonies, offices, states. Mostly 1/2-1/5 catalogue. Twelve page list 3c. Myers, VanZandt, Little Neck, N. Y.

BARGAINS Galore. Low priced approvals. Schur, Box 245, Buffalo 12, N. Y.

FREE Complete set of famous Americans, flags, parks and presidentials to approval buyers. Send 3c for 15 of the above stamps plus full particulars. Triboro Stamp Company, 145 Nassau Street, Dept. 110, New York 38, N. Y.

225 STAMPS For only 10c! This mammoth value includes airmails, pictorials; stamps from strange countries cataloguing up to 25c each! Also approvals. Mystic Stamp Company, Camden 80, New York.

GIGANTIC Collection free. Includes triangles, early United States, animals, commemoratives, British Colonies, high value pictorials, etc. Complete collection plus big illustrated magazine all free. Send 5c for postage. Gray Stamp Company, Dept. PM, Toronto, Canada.

OUTSTANDING Bargain. 200 different China 25c with approvals. Ward, 241 South Winchester, Campbell, Calif.

DISCRIMINATING Collectors—For the first time, mailed direct to you from remote world capitals, two striking covers bearing exotic native stamps and postmarks, only \$1.00. Limited offer only! Valuable souvenirs now, gems later. International Stamp Sales Co., 84 State Street, Boston, Mass.

SENSATIONAL U. S. and Confederate states catalogue free. Stone, 45-P Bromfield, Boston 8, Mass.

1000 MIXED United States. Guarantee over 140 different stamps. \$1.10 insured. Quaintance, Box 178F, Upper Sandusky, Ohio.

START Your own stamp business. Send for free circular. Donald Shepard, Box 1147, Chicago.

ESTONIA Carrier pigeon set free to approval applicants. Canyon Stamps, Box 808, San Fernando, California.

500 STAMPS. All different, 50c. Edd. Stoka, 10511 South Peoria Street, Chicago 43, Illinois.

50 DIFFERENT Free to approval applicants. Buckeye Stamps, Urbana, Ohio.

COMPLETE Mint sets on approval. Free bonus. Robbins, 1780-M East 13 St., Brooklyn 29, N. Y.

BEST Offer. 400 U. S.; including commemoratives. 25c. Approvals. Cooper, Box 44, Quincy 69, Mass.

JAMAICA Jamboree, Australian zoologicals, 55 extras. Only 10c. Approvals. Yankee Doodle, Box 75-V, West Thornton, New Hampshire.

MONACO Nudes complete—10c with approvals. Royal Stamp Company, Tamaqua, Pennsylvania.

50 UNIVERSAL 3c With approvals. Aranjan, Box 467, Woodstock, Illinois.

FIVE Swedish sets \$1.00 with approvals. S. Penniston, Norborne, Missouri.

TRANSATLANTIC Air flight (1934) commemorated on four brilliant, bi-colored airport stamps; planes, map, death's angel. Fresh mint set cataloging 40c, only dime. Approvals. Edgar Bowles, Box 5659, Washington 16, D. C.

25 BRITISH Colonies 10c completely illustrated folders. Stoll Stamp Service, 2632 Burnett, Louisville 10, Ky.

PACKETS. World different 2,000, \$3.00; 3,000, \$6.00; 5,000, \$15.00; 10,000, \$47.00; 20,000, \$200.00; 30,000, \$610.00; 40,000, \$1,220.00; 50,000, \$2,180.00; 60,000, \$4,220.00; 70,000, \$8,040.00; 80,000, \$12,360.00. Russell Smoky Mountain, Box 2011D, Natural Bridge Station, St. Louis 15, Mo.

TRIANGLES, Airmails, bicolors, U.S.A. stamp centenary, Columbus, Trieste, Garibaldi, fortresses, large historical pictorials, 3c to approval buyers. Fortune Stamp Company, PMM-1, Washington 10, D. C.

SCARCE Burma set, \$1.25 value. Native girl, elephant, Mandalay tower. Only 10c with approvals. Welles, Box 1246-R, Church St. Station, New York City.

50 DIFFERENT Worldwide 3c! Approvals. Vinny Jo, Box 3062, Seattle 14, Wash.

GREAT Free offer—Weird mosquito stamp, thrilling bicycle race, gorgeous orchid, colorful native drummer, gigantic diamond airmail, stamp albums, all to our approval buyers. Bell Stamp Service, Dept. S-4, Bell, California.

50 DIFFERENT Argentine 10c. Approvals. Reuter, 611 W. 40th Pl., Los Angeles 37.

WANT Better stamps? Try our quality U. S. foreign approvals. North Andover Stamp, North Andover, Mass.

WOW! 203 All different Germany 15c. Zeppelins, semi-postals, airmails, high values. Big bargain lists and approvals included. Jamestown Stamp, Dept. 512, Jamestown, N. Y.

SENSATIONAL Guaranteed bargains! 1,000 different colorful, attractive mounted stamps, 1 and 2c each. Rushed immediately. Niagara Stamps, Niagara-on-the-Lake 71, Canada.

FREE To approval applicants—Israeli, British, French Colonies, Latin American. U. S. packet. Hobbies, 1463 Drexel, Miami Beach 39, Florida.

UNITED States approvals. Select copies. Used, mint. Kingsbury, So. Woodbury 2, Vermont.

100 DIFFERENT Spain 25c. Penny approvals included. Reed, Box 980, Chicago 90, Ill.

FREE! Powerful magnifying glass for 5c post. Bargain lists and approvals. Jamestown Stamp Co., Dept. 207, Jamestown, New York.

327 DIFFERENT Stamps 25c! Including early Canada, Newfoundland, British Colonies, Vatican, Red Russia, Hitler heads, Indian states, animals, airmails, French Colonies, rarities, unusuals. Every stamp different. Rare bargain only 25c with our bargain approvals. Money back guarantee. Niagara Stamp Co., Niagara-on-the-Lake 61, Canada.

200 DIFFERENT Including Roosevelt triangle, 5c to approval applicants. M. Avoian Stamp Company, Springfield, Mass.

STAMPS Wanted. Collections, duplicates, surplus stock, mint and used. Good grades only. Buy outright if bargain. What have you? Write us details. Vanroy Shirk, Lebanon, Penna.

WORLD'S Largest stamp (7 1/2 x 14 inches). A real curiosity! Retail for 50c, only 3c to approval applicants. Tatham Stamp Co., Springfield 30, Mass.

OLD Scarce U.S. seconds on approvals. Slight imperfections, lowest prices. Herfield, Clintonhill Sta., Newark 8, N. J.

UNITED States—40 different 10c; 40 different commemoratives 25c. No approvals. Seidenberg, Appleton 944, Wis.

FREE. Scott's International Album, other premiums. Details with approvals. Raymax, 35-Z Maiden Lane, New York City.

FREE Sample—Interesting, informative. Illustrated! National Stamp News, Anderson, South Carolina.

POLAR Bear triangle, giant George Washington, six colored Ecuador, Arctic triangle, first American commemorative, Corsica, Devils Island, others. Everything free with approvals. Capital Stamps, Little Rock 2, Ark.

WONDERFUL Offer — 7 complete mint sets only 10c with approvals. Reich (M26), 1033 Lawrence, Chicago 40.

FREE. Valuable mystery gift. Approvals. Raymax, 37-Z Maiden Lane, New York City.

UNITED States—58 different including 8 airmails, 15 commemoratives, 10c. Approvals. Sunset, Box 47, South Gate, Calif.

GIGANTIC Surprise packet, contains hundreds, catalog to 40c each, only 10c, bargainful approvals. Dresel, Box 270-G, New York 25, N. Y.

U. S. Mint 797 SPA sheet 10c to U. S. approval applicants. D. Kelly, 235M-86th St., Brooklyn 9, N. Y.

12,000 PENNY Approvals waiting for you. Many from exotic countries, pictorials, airmails, new issues. Tilbury, Box 862, Newark 1, N. J.

99 COUNTRIES, 99 Stamps \$1.00. Ray Worth, 321 S. Cicero, Chicago 44.

100 DIFFERENT Worldwide 10c with approvals. Herget Stamps, Buffalo 15, N. Y.

SPECIAL! Nudes collection; approvals —5c. Atlas, 2830-M Eisenhower, Racine, Wis.

PENNY Approvals by country. M. H. Hoerning, 15, Farmington, Ark.

FLOWER Collection—Multicolored Congo, Ruanda, Andorra. Free. Approvals. Pleasure Stamps, 1865P 52nd, Brooklyn 4, N. Y.

50 DIFF. Finland, 10c with approvals. Carroll's, W. 310-A Sprague, Spokane, Wash.

27 HITLER Stamps from five Nazi-dominated countries. Historically valuable collection only 5c. Request approvals. Gulfstream, "PM" Hillsdale, N. J.

10,000 DIFFERENT World, \$47.00; 5000, \$15.00; 3000, \$6.00; 2000, \$3.50. Gould's, Box 631, San Francisco 1, Calif.

SOMETHING New in approvals. Premiums. Exchanges. Paul Meglitsch, 3701 Cottage Grove, Des Moines, Iowa.

60,000 DIFFERENT — On approval! Books, world-wide. Cole, 43-A Rinewalt, Buffalo 21, N. Y.

50 DIFFERENT Netherlands free to approval applicants. Collier, Box 4243, Atlanta 2, Ga.

OPPORTUNITY, Gorgeous lot with triangles, giants, midgets, flags, airmail and railroad stamps. Also Brunei, Mongolia, Sarawak, etc. Everything only 10c to approval applicants. Evden, Valley Stream 12, N. Y.

BARGAINS. Albums, supplies. Free list. Buywise, Box 115B, Hollis 23, N. Y.



**FREE — 35 Different Austria-Hungary stamps sent with mammoth packet list.** Write today. Econostamps, Box 168, Riverside 9, Calif.

**45 ALL Different U. S. stamps.** Includes 50 year olds, commemoratives, airmails and \$5.00 stamp. Only 10c. Approvals. Willett Co., Box 511, Port Chester, New York.

**15x9 BOX Packed full U. S. hi-low values, commemoratives.** \$2.00 plus postage. Superior, Grafton, Ohio.

### OLD STAMPS WANTED

I Will pay \$100.00 each for 1924 1c green Franklin stamps, rotary perforated eleven (up to \$1,000 each unused). Send 10c for large illustrated folders showing amazing prices paid for old stamps, coins and collections. Vernon Baker, PM-310, Elyria, Ohio.

### ANTIQUES, RELICS, INDIAN GOODS, CURIOS

**SPECIAL:** 10 Indianhead pennies \$.78. 5 prehistoric arrowheads \$1.48. Scalper \$2.88. Hammerstone \$1.98. Pestle \$8.88. Civil War; bayonet \$1.98. Canteen \$1.95. Geode, Pyrite, Galena, Molybdenite, Rico-lite, Muscovite, Turquoise, Agate, Fossil, Gastropod, Brachiopod, 48c each. Heike, Wenona 30, Illinois.

**BEAUTIFUL Black Obsidian arrowheads from the Klamath country, \$1.00.** Moise Penning, Klamath, California.

**6 TINY Bird arrowheads \$2.00.** Grooved stone tomahawk \$2.00. 2 flint knives \$1.00. List free. Lear's, Glenwood, Ark.

**4 PERFECT Arrowheads \$1.00.** Flint knife 50c. Hide scraper 50c. Stone axe \$3.00. Perfect pipe \$3.00. Flint hoe \$1.00. List 10c. H. Daniel, Lamar, Arkansas.

**4 SELECTED Arrowheads \$1.00.** List 5c. H. Talburt, Calico Rock, Ark.

**QWUITSCHUERBELLERACKEN:** For sale: Several hundred historical firearms, 25,000 Indian relics, collectors cartridges, coins, antiques.—Revolutionary, Civil War, Indian wars, flintlocks, muskets, pistols, blunderbusses, Winchesters, buffalo guns, carbines, bullet molds, ramrods, pepper-boxes, powder flasks, Kentuckies, frontiers, 400 bayonets, swords. Mounted deer heads, pheasants, steer horns, elk antlers, buffalo horns, powder horns, bio-horns. Arrowheads, spearheads, tomahawks, discoids, banner stones, gorgets. Violin wood, gold dollars, daguerrotypes, gun locks, parts. Agates, minerals, fossils, marine shells, lapidary supplies. Catalog profusely illustrated 35c. Heike, Wenona 30, Illinois.

### PRECIOUS STONES, MINERALS

**GEMS, Minerals, a wonderful hobby.** National magazine covers cutting, collecting, silversmithing, field trips. Monthly, only \$3.00 year. Subscribe now or write for free brochure. Gembook Company, Palm-dale, Calif.

**GEMS, Precious and semi-precious, genuine, from world-wide sources.** Deal direct, no overhead, save money. Catalog 10c. Hill Co., 5450-G Portland Rd., Salem, Oregon.

**GEMOLOGY Books! Catalog 10c.** Atlantic Books, Lawrence Avenue, Charlestown 29, Massachusetts.

**12 RARE Minerals \$1.** Twenty specimens P.O. Box 98, Mareeba, N.Q., Australia.

**ALUMAG Gems!** The world's most beautiful synthetic gemstone. Bluewhite, 58 facets, hand cut and polished. Harder than Zircon or Rutile. \$12.00 carat. Satisfaction or full refund. Rogers Jewelers, 291 Grant, Buffalo, N. Y.

**URANIUM Ore samples now available.** Know what to look for. Get yours today. \$1.00 ppd. Westwinds, Box 1271, Gallup, New Mexico.

**GENUINE Red Arizona rubies (garnets).** Send quarter for packet. Bitner's, Box 1025B, Scottsdale, Arizona.

**WYOMING Jade or moss agate 25c.** Jade jewelry in GF mounts. Hays, 417 W. 17th, Casper, Wyoming.

**JADE, Agates, gems, gem cutting machines, supplies.** Free list. North West Gems, 2819 North Warner, Tacoma 7, Washington.

**AMERICA'S Most popular magazine on minerals.** Established 1926. Issued every two months. \$3.00 year, sample copy 60c. Rocks and Minerals, Dept. PM, Box 29, Peekskill, N. Y.

**SAPPHIRE, Topaz, tourmaline, garnet, peridot, 5 uncut gem specimens, \$1.00.** O'Brien's, 1116M Wilcox, Hollywood 38, Calif.

**GEMSTONES, Mineral specimens.** Every variety. Lowest prices. Postcard brings free booklet. Plummer's, 4720 Point Loma Ave., San Diego 7, Calif.

**TEN New Mexico minerals \$1.50, six fluoroscents \$1.00, fool's gold 25c.** Free literature. Minerals, Winston, New Mexico.

**ROCKS, Ores, minerals precisely analyzed \$5.** Absolute spectrographic detection of 45 elements including uranium. Free information. Keldon Research, Box 2555, Los Angeles 54, Calif.

### HOBBIES AND COLLECTIONS

**EXCITING Hobby; collect authentic military patches, insignias, campaign ribbons, navy rates, etc.** 57 assorted \$1.00. Free gift. Pritt, Dept. M-10, 12 West 27th, New York City.

**DIFFERENT New hobby publication.** Sample 10c. Beaver Specials, Maynard, Iowa.

**WORLD'S Smallest Bible 25c.** Five, \$1.00. Empire, Box 301, Amesbury, Mass.

**ALLIGATORS, Live baby, guaranteed delivery, airmail, \$3.00.** Sea shell collection, 15 pieces, includes, conch, cockle, cowry, coral, star, postpaid \$1.00. Tropical coconut in natural husk postpaid \$1.00. Direct Sales, Box 718M, Miami 35, Fla.

**400 NOVELTY Jewelry stones, assorted shapes, colors \$2.50 lot.** International Materials & Merchandise, G.P.O. Box 817, Brooklyn 1, N. Y.

**50 DIFFERENT Army embroidered patches \$1.** Other bargains. Insignia Mart, 703A Broadway, New York 3, N. Y.

**EXCLUSIVE—Beautiful colored railroad emblems showing insignia, slogans, etc.** Over 60 different roads. 3 emblems and list, twenty cents. Webber Co., Box 1112, Burbank, Calif.

**NAZI, Soviet, campaign ribbons.** Big packet, lists, \$1.00. Medcrafts, 1923 34th St. S.W., Calgary 2, Canada.

**UNUSED Matchbook covers—100 different \$1.00.** 36-page catalog 25c. Charles Edelman, 1311C East 84, Cleveland 3, Ohio.

**INVENTING Can be an interesting and profitable hobby.** Write for complete particulars. Institute of American Inventors, Dept. 40-E 631-E St. N.W. Washington 4, D. C.

**WANTED Cigarette, tobacco, cards.** Write Charles Bray, East Bangor, Penna.

### CAMERAS, PHOTO SUPPLIES

**PHOTOGRAPHY For pleasure or profit.** Learn at home. Practical basic training. Long established school. Free booklet. American School of Photography, 835 Diversey Parkway, Dept. 345B, Chicago 14.

**BUY Wholesale nationally advertised cameras, photo supplies, thousands other products at big discount.** Free wholesale plan. American Buyers', 629-RR Linden, Buffalo 16, N. Y.

**BEAUTIFUL Souvenir photo album \$7.95 postpaid.** Attractive cover. Inquiries invited. M. Tsuji, Tokyo, Japan, Yoyogi P.O. Box 21.

**NEW Argus C-3 \$51.75.** Rotobroil "Riviera" rotisserie \$44.90. Other terrific savings appliances, photographic equipment. Free catalog. Camera Shoppe, Box 601-M4, Mount Vernon, New York.

**WILD Life films.** Exciting, dramatic action in the natural habitat of animals of forest and plain. 8mm. or 16mm. in beautiful color or B & W. Also 2" x 2" color slides. Write for free illustrated literature. Wild Life Films, 5151AK Strohm Ave., North Hollywood, California.

**SHOOT Color! Make money.** Picture leads furnished. Coaching service offered. American Calendar Agency, 210 W. 8 St., Kansas City 6, Mo.

**WHOLESALE Photographic supplies.** Cameras, films, projectors, enlargers. Write for free catalog. Capitol Photo Supplies, 2428 Guadalupe, Austin, Texas.

**BASS Says: Trading since 1910.** Used but good as new buys: 8mm. B.&H. Sportster \$52.50; 16mm. Keystone A-7, F:2.5 lens \$37.50; Voigt. 35mm. Vito II, flash shutter, Skopar F:3.5, like new \$38.50; Kodak Reflex F:3.5 lens, like new \$88.50; Contax I, F:2.8 Sonnar \$87.50; 3 1/4 x 4 1/4 Speed Graphic, Skopar F:4.5 Ibsor shutter, \$52.50. Satisfaction guaranteed. Bass Camera Co., Dept. AG, 179 W. Madison St., Chicago 2.

### PHOTO FINISHING

**TWO Happy people, you and we—**When you send us your films. You will be pleased with the beautiful results, and we will be happy to please you. Jumbo oversize finishing. Quality work, low prices, same as contact. 8-exp. roll superfine finish only 40c. 12-exp. 55c. 16-exp. 70c. 36-exp. \$1.50. Oversize reprints 5c each. Send us your order. Free mailers. Mailbag Film Service, Box 5440A, Chicago 80, Ill.

**PROTECT Valued snapshots, cards.** Permanent plastic sealing. Wallet sized 3 for \$1.00. Larger sizes, extremely low prices. Plastiseal, Dept. M2, 45-05 30th Ave., Long Island City 3, N. Y.

**FREE Mailers—Attractive packaging.** Contact prints 4c, Jumbos 5c. Western Photo, Dept. PM103, Box 298, San Francisco 1, Calif.

**OVERSIZE Prints no extra charge, 8-exposure roll, 30c.** 12-exposure, 45c. 16-exposure, 55c. Reprints oversize 4c. Finest quality. Mail Order Photo Service, Box 297, Watertown, Wisconsin.

**SENSATIONALLY Magnificent jumbo oversize finishing at contact prices.** New, improved equipment produces finest work at low prices. 8-exp. roll, deluxe finish, only 40c. 12-exp. 55c. 16-exp. 70c. 36-exp. \$1.50. Oversize reprints 5c each. Free mailers. Send us your next order, you will be delighted. Century Photo Service, Box 5208, Chicago 80, Ill.

**PHOTO Christmas cards—Eighteen, \$1.00.** Brownell, Route #3, Siloam Springs, Arkansas.

**SATISFIED Customers in over 30 states.** 8 exposures 35c, 12 exposures 50c, jumbo prints in Kodak album. Reprints 4c. Fast service. Free mailers. B & B Studios, Box P-945, Wilmington 99, Del.

**TWO Prints each good negative, 8 exp. 35c; 12 exp. 50c; 16 exp. 65c.** Reprints 4c. Mayfair Photo Service, Box 617-K, Toledo, Ohio.

**SAME Day service.** Double-sized prints from 8 exposure roll, 40c. Satisfaction guaranteed. Enclose 4 dimes with each roll. Del's Service, Box 238, Jefferson City, Mo.

**ENLARGEMENTS! Eight 5 x 7's or five 8 x 10's, \$1.00.** Wilart Enlargers, Box 967, Little Rock, Ark.

**CUSTOM Photo finishing guaranteed.** 8 exposures 35c; 12, 50c. Bound in beautiful plastic ringed album. Special! 35mm., 36 exposure \$1.00. Free mailer. Flash Foto, Box 36M, Brooklyn 4, N. Y.

**6 OR 8 Picture roll 35c, 12 or 16 picture roll 55c.** Each roll printed and developed. Handy album pack. If you fail to get pictures on your film a new roll will be sent you without extra cost. Send coin with roll. No c.o.d.'s. Mailing containers sent free. DeLuxe Film Service, Box 1268-A, Shreveport, Louisiana.

**TOP Quality. Fast service.** 8 jumbos 35c in beautiful Super Pak Album. 16 contacts 40c. Reprints—Jumbos 4c; contacts 3c. Satisfaction guaranteed. Write for free mailers and circulars. Fast-X-Foto, Box A, Jersey City, N. J.

**GUARANTEED Quality. Fast service.** Eight jumbos in beautiful super pak plastic ring binder albums only 35c. Send for free mailers and particulars of our complete photo finishing service. Grand Fotos, G.P.O. Box 1410, New York 1, N. Y.

**12 JUMBOS 35c, 8 Jumbos 25c, 16 jumbos 50c** from roll or negatives with this ad. S. Skrudland, Lake Geneva, Wisc.

**BEAUTIFUL Enlargement in album from each good picture on roll.** 8 exposure, 40c; 12 exposure, 50c; 16 exposure, 65c. Cut Rate Photos, Dept. B-4, Janesville, Wis.

**THE Photo Mill. Immediate service.** Eight exposure roll developed and one print each good negative 30c; two, 40c; one jumbo each 38c; two, 68c. Write for complete prices and mailers. The Photo Mill, Dept. K, 1511 Hennepin, Minneapolis, Minnesota.

**TWO Beautiful prints from each picture on 8 exposure roll 35c.** Many years of satisfied customers. Quick service. Lens Photos, Dept. J-4, Janesville, Wis.

**PHOTOS Copied—20 wallet-size deluxe prints \$1.00.** Original picture returned. Send any size photo or negative. Federal Wallet-Size Photo Co., Dept. PM, P.O. Box 2448, Kansas City 6, Mo. (No c.o.d.'s please.)

## MOTION PICTURES AND SOUND EQUIPMENT

NEW Movie bargains! 50' 8mm. Prevue film, 59c. 300' 16mm. silent film, value \$9.75, \$1.98, our title choice. Blackhawk 8mm. films, hunting, fishing, railroads, collector's items, children's films, 150', \$2.98; Bible stories, 300', \$7.98. New, used 16mm. sound, silent bargains, too! Six used 100' 16mm. reverse-image Panoram musicals, \$3.49. Good used 16mm. sound projectors, all leading makes, \$129.95, some \$99.95. Big catalog free. Blackhawk Films, 1226 Eastin Bldg., Davenport, Iowa.

BARGAIN List of new and used films and equipment, 10c coin or stamps. Home Movies, 19th and Green, Allentown, Penna.

EARN Up to \$15.00 daily with your movie projector! Details free. Metcalf, 10806 Glenroy, Chicago 43.

WILL Buy 16 m.m. sound films. Also for sale and exchange. Bedner, 5300 S. Talman, Chicago.

EXCHANGE 16 MM films, sound or silent, \$1.00 per reel. Estes Exchange, Brunswick, Missouri.

"ENTIRE Life Story of Christ." 8mm., 16mm., sound and silent, purchase or rent, state projector. Hemenway Film, 31F Church St., Boston 16, Mass.

5000 NEW-Used 8-16mm. silent-sound films. International-B, 2120 Strauss, Brooklyn 12.

RENT 16MM. sound films, 50c reel. Large selection; free catalog. Film Service, 128 Chestnut St., Roselle Park, N. J.

8-16MM. Silent-sound films. Complete rental library. All latest subjects. Free catalogue, sample film 10c. Garden Film, 317 West 50th, New York 19.

MOVIE Camera film: 8mm. roll \$1.50, 16mm. 100' \$3.00. Free processing. Better Films, 742 New Lots, Brooklyn, N. Y.

TAPE Recorders, tapes, accessories. Unusual values. Dressner, 624-M East 20th Street, New York City 9.

8MM., 16 MM. home movies of beautiful national parks in kodachrome. Free list. Ideal Service, Box 8637, Oklahoma City 14, Okla.

GUARANTEED Fresh 8mm. roll, magazine; 16mm. roll, magazine movie films. Color, b&w. Free catalog. ESO-R, 47th Holly, Kansas City 2, Missouri.

## MUSIC AND MUSICAL INSTRUMENTS

ACCORDIONS And concertinas, save 50% and up. New and used. All brands. Wholesale to every one. Please specify. Free accordion or concertina catalogue. Del Principe, 29 South Cicero, Chicago 44, Illinois.

BEAUTIFUL Swiss music-boxes. Ask for price list. Ernst Schar, Allschwilerstr. 123, Basel, Switzerland.

SWISS Musical movements, finest make, assorted tunes \$1.70. Direct imports. Helax Co., 218 West 72nd Street, New York City.

SONGWRITERS! Let me help you. Stamp for booklet. Mark Rubens, 146-D West 79 St., New York 24, N. Y.

POEMS Wanted for musical setting. Send poems. Free examination. Five Star Music Masters, 630 Beacon Bldg., Boston, Massachusetts.

SWISS Musical movements. First quality, \$2.50. Spielman, 131 West 42nd, New York 36.

SONGWRITERS Learn to write songs that sell. Popular, hillbilly, novelty and others. Send \$2.00 for book. Toole House of Music, 6200 Cottage Grove Ave., Chicago 37, Ill.

ELECTRIC Guitars, amplifiers. Wholesale. Free catalog. Carvin, P.M., Baldwin Park, California.

MUSIC Arranged. Songs published. Frank Wildt, Music Publisher, Lancaster, Pennsylvania.

FREE Record of your song. Your words, my melody. Free information. Johnny Mack, 1094 West 39th Street, Dept. A, Los Angeles 37.

COLLABORATION Offer. Newark Publications, GPO Box 1226, Syracuse, N. Y.

STRICTLY Professional piano vocals \$6.00, booklet. Robert Vansickle, Bonifay, Florida.

NEW Songwriters can sell their songs for cash! Get free facts. No obligation. Meadowlark Music School, 203 Sumner Road, Colorado Springs, Colo.

UKULELE: Play by ear easily. Instructions \$1.00. Details free. Eby, Box 81, Perry, Okla.

POEMS Wanted for musical setting. Send poems. Free examination. Crown Music Company, 1476 Broadway, New York City 36.

SONGWRITERS! Protect your ideas! Hold all songs, poems! Write for safe correct procedure first! Song Service, Dept. P, 333 W. 56th St., New York 19, N. Y.

POPULAR Songs. How to write and sell them. Write for free booklet Successful Songwriting. Gateway Songs, Box 2470, Hollywood 28, Calif.

SONGWRITERS! Send poems, songs. Music Service, 243 West 72nd St., PM, New York 23.

POEMS Wanted to be set to music. Free examination. Send poems. McNeil, Master of Music, 510-PM S. Alexandria, Los Angeles, California.

WANTED! Poems for musical settings. Write Songwriters' Service, Clifton, N. J.

WRITE Songs. Big money and reputation. Write for information. J. Gordon Pub. Co., 4700 South California Avenue, Chicago.

SONGPOEMS Wanted. Mail to: Tin Pan Alley, Inc., 1650 Broadway, New York 19, N. Y.

POEMS Wanted for musical setting. Send poem for immediate consideration and free rhyming dictionary. Richard Brothers, 24 Woods Building, Chicago 1.

## RADIO AND TELEVISION

BUILD Your own top quality TV set. We supply complete equipment, tools, instructions as part of America's finest home-study TV course. Be a high-paid TV technician. Install, repair, service all makes of sets. Many excellent jobs now open. Or start your own business. Get full facts free. Write: Commercial Trades Institute, Dept. CT2-10, 1400 Greenleaf Ave., Chicago 26, Ill.

HALLICRAPPER World wide 8 band portable TW-1000. New. Guaranteed. \$115.00 net. \$10.00 deposit. Smith & Hawkins, 943 Forest, Deerfield, Illinois.

FREE 268 Page 1954 television-radio-electronic catalog. World's largest stocks, lowest prices. Complete supplies for builders, experimenters, amateurs, servicemen. Latest TV, Hi-Fi, radios, phonos, recorders, P.A. equipment. Thousands of parts, tubes, test instruments, books, diagrams. Top quality money-saving values. Get yours now! Allied Radio Corp., 100 N. Western Ave., Dept. 34-K-3, Chicago 80, Ill.

CRYSTAL Radio needs no antenna, ground. Receives while carrying. Ideal on bicycles. Plans 25c. Box 6008, Kansas City, Missouri.

EXPERIMENTER'S Illustrated plans, instructions, diagrams. All kinds. Free catalog. Dittofax, 5208-1 Onacrest, Los Angeles 43.

SIMPLEST Capacity relay yet! Uses no idling power. Ideal for trick locks, scare 'em gadgets, burglar alarms, operating window displays. Complete schematic, illustrated instructions, 50c postpaid. Not mimeographed sheets. Technix Laboratories, 568RN Riley, Buffalo 8, New York.

SUBSCRIBE To Amateur Radio Frontiers magazine. \$3.00 year. 1379 East 15, Brooklyn 30, N. Y.

INSTRUCTIONS How to repair radios \$1.00. Slates Radio Service, Corsicana, Texas.

LOUD Crystal, catwhisker, radio plans, catalogue: 25c. Amorose's, Route Four, Richmond, Virginia.

MINIATURE Voltmeter for radio, electrical servicing. 65-650 volts a.c. d.c. Guaranteed \$3.75 postpaid. Ramapo Engineering, Riverdale, New Jersey.

INSTRUCTION Booklet for new twin crystal set and crystal set with signal strength meter 50c. Potential Radio Company, 446 Crown Street, Brooklyn, N. Y.

BUILD 15 Radios—Only \$19.95 complete. Free radio tester, tools, soldering iron. No experience required. Money-back guarantee. Order direct or send for descriptive literature. Free, valuable radio and TV repair guide on request. Progressive Electronics, 497 Union Ave., Dept. PM10, Brooklyn 11, N. Y.

WEEBOR Tape recorders #2010. New. Guaranteed. \$150.00 net. \$10.00 deposit. Smith & Hawkins, 943 Forest, Deerfield, Illinois.

UHF Converter \$34.95. UHF strips \$9.50. Free lists. Ben's Radio, No. Tonawanda 2, New York.

BRAND New rhythm and blues, hot jazz, pop or modern music. 20 ten inch records, \$2.49; 40, \$4.75. Include sufficient postage with remittance. No c.o.d. Newark Surplus Materials Co., Box 1000-C, Newark, N. J.

ELECTRONIC Ear! Turns radios, etc., on automatically. Plans \$1.00. Electronics, 506 W. 3rd St., Bethlehem, Penna.

CHANGES Your TV into beautiful, breath-taking colors at low cost. National Telecolorvision, Box 708, Brownsville, Texas.

COLOR Television! Enjoy Zingo rainbow color filter screen now. Easily attached. Send \$1 screen 16" or under; \$1.25, 17"; \$1.50, 20"; \$2, 21". Satisfaction guaranteed. Dealers opportunity. Zingo Products, Johnstown 7, New York.

24 PAGE Plans. 18 long distance crystal sets 25c, including Radiobuilder, catalog. Laboratories, 328-C Fuller, Redwood City, California.

ZENITH Trans-oceanic portables H-500. New. Guaranteed. \$93.00 net. \$10.00 deposit. Smith & Hawkins, 943 Forest, Deerfield, Illinois.

MAKE Louder crystal radio. Plans, mounted crystal, catwhisker, 25c. Complete kit \$1.00. Mallory, Box 1031, Tacoma 1, Wash.

LIMITED Quantity surplus double headphones. High quality, slightly used. \$7.95 value. Special now \$2.95 postpaid. Guaranteed. Allen, Dept. PMH, Clinton, Mo.

MAKE Simple, tubeless, batteryless distance-getting crystal radios. Crystal and illustrated instructions 25c postpaid. Allen, 427-P, Clinton, Missouri.

CRYSTAL Radio experimenters. Write Leslie Hulet, R4, Lakewood, New Jersey.

SENSATIONALLY New! Closed circuit television. Build your own TV camera. Works with any TV receiver. Complete, detailed instructions. Information on all closed circuit cameras. Get into this new field now. Become an expert TV cameraman. Send 25c for brochure to TTLB, PO Box 1321, Indianapolis 6, Ind.

TELEVISION Picture tubes. Top quality. Unconditionally warranted one year. \$1.25 per inch. Any size. Safe shipment guaranteed. Commercial Tube, 840 Cherry St., Detroit 1, Mich.

## BUSINESS OPPORTUNITIES

EARN Amazing profits by following our instructions; selling nationally advertised watches, etc. Enclose 25c, refundable; receive multi-colored salesman's catalog and confidential price list. Result Sales C, 580 Fifth Ave., New York.

MAKE Money selling by mail; instructive booklet 25c. Manhattan House, P.O. Box 51-M, Saint Albans 12, N. Y.

TYPISTS Become public stenographer. Shorthand unnecessary. Unique, profitable. Free with purchase "Typewriter Profits," \$1.00. Arnolds, Box 524b, Sacramento 4, Calif.

START A buying service, buy wholesale thousands nationally advertised products. Make big profits selling at sizable discounts. Postcard brings details. American Buyers, 627-R Linden, Buffalo, N. Y.

START Spare-time fixit shop at home. Hardware dealers get saws and lawnmowers to sharpen on commission. Make extra \$100 monthly. Free booklet tells how. Victor P. Foley Company, Columbia Heights, Minnesota.

EARN More money. 137 Elite plans. Free information. Jorine, Snyders Lake, Troy 4, N. Y.

\$26,500 SALES in two weeks! Amazing radio-mail order method. Free details. Broadcast Service, 1412-B Great Northern Building, Chicago 4, Illinois.

NEWSPAPER Clippings bring extra dollars! Jay Cutler Publishing, Reading, Pennsylvania.

MAKE Perfumes at home, write Carey Laboratories, 1914 Chouteau PM-10, St. Louis 3, Missouri.

START Home mailorder business. Details. Gedgard, Box 798-T, New York 1, N. Y.

MAKE Money in mailorder! "Progressive Mailtrade" shows how. Sample, 25c. Jorine, Snyders Lake, Troy 4, N. Y.

ESTABLISH Profitable automatic shoe shine route. Proven. Write Jiffy Shine, 1630 S. 2nd St., Philadelphia, Penna.

**ONLY** New moneymaker in years. Free details. Cascraft, 805-F Sunset Blvd., Los Angeles, Calif.

**START** Small business. Stir your imagination with over 100 business plans. Free information. Shore Enterprises, Box 91-C, Little Ferry, N. J.

**MADE** \$24,500 Using money making plans from world's oldest mailorder publication. Schemer Magazine, Canfield 1, Ohio. Year \$1.00. Sample 20c.

**FREE!** "301 Profitable Small Businesses!" Amazing shoestring plans! Work home! Start sparetime! Deumant Surveys, Kenmore 23-R, N. Y.

**MAKE** Tough, durable plastic — 1c pound. Makes attractive floors, walls, built-ins, roof. Build good home \$150.00 room. Bays Laboratory, Oklahoma City 9.

**MAKE** \$6.73 Every time you sell one—and they're amazingly easy to sell! We have new adding machines in original factory cartons you can sell for only \$14.95 and you make 45%. They're executive model portables, precision built with automatic clearance, direct subtraction, fully guaranteed. Send for life size color photo with full details. Write today to Lightning Adding Machine Co., Inc., Dept. P-34, 1260 West Second Street, Los Angeles 26, California.

**SPECIALIZED** Magazines help you to greater success. Latest copies of business, trade, professional, educational, sport, hobby, brick, coal, detective, drugs, feed, florist, heating, investment, lecturing, marking products, paper, petroleum, radio, safety, taxation, watchmaking, writers and others covering all interests. List free. Commercial Engraving Publishing Company, 34C North Ritter, Indianapolis 19, Indiana.

**EARN** \$2.00 Hour! I do, making sandals. Youngs, 1308-PM, South First, Arcadia, California.

**OPERATE** Profitable collection agency. Become co-partner! Interesting details. Write: Edmondson, Box 4865-P, Atlanta 2, Georgia.

**CERAMICS** — Fastest growing hobby. Profitable pottery at home. Complete instructions \$1.00. Ceramics, Box 126F, Artesia, Calif.

**OWN** A garden golf business. Experience unnecessary. Brockway, Seaside, Oregon.

**WHERE** To buy at wholesale 100,000 articles. Free list. Also extra-income information. Maywoode, 1133 Broadway, New York.

**FISHWORMS.** Breeders 100 — \$1.00. Manual \$1.00. Postpaid. Literature free. Dixdok, Kent, Ohio.

**TUDOR** Publications: Books, folios, plans. Every phase mail order. Wholesale and retail. Box 8, Alden Manor, Elmont, New York.

**WHOLESALE!** Hundreds nationally known appliances, silverware, dolls, aluminumware. More 50% off. Picture catalog 10c. Refundable. Supply, 1402 North 21st, Birmingham 4, Alabama.

**UNUSUAL** Homework opportunity, sparetime, men, women. Angora House, PM, Springfield, Illinois.

**"HOW** To Build Your Own Mailorder Business." 25c. Guaranteed. E. Merrill, Colebrook Road, Bangor, Maine.

**MAKE** Money at home mailing literature offering fast selling books and merchandise. Everything supplied at low cost. Rush name. Thomas Jerdon, Hermansville, Maryland.

**BUY** 250,000 Articles wholesale. Directory 10c. Publishers, Box 1486-P10, Detroit 31.

**PERFUME.** Make at home. Write, Emly, Box 319, PM 10, North Hollywood, Calif.

**SPARE** Time business. No investment. Details free. Howell, 1320 St. Andrew, New Orleans 13, La.

**START** Profitable home business in spare time! Make good, extra money! Experience not essential. Literature free. L. A. Dwellie, 1888-A Sycamore, Des Plaines, Illinois.

**BUY** Wholesale thousands nationally advertised products. Save money! Make money! Postcard brings details. Kemah Company, 5017-P Washington, Houston, Texas.

**BE** First amazing mentalist. Exclusive territory. Profitingly entertain. Mystic Hadley, Rehoboth Beach, Delaware.

**TIN-Cans.** Turn them into cash. Nine methods. Instructions 50c. Charles Company, 12-DBK, Norwood, Ohio.

**MAKE** Rubber stamps, repair dolls; learn silk screen printing; invisible reweaving. Catalogue (60 ideas) free. Universal, Box 1076-A, Peoria, Ill.

**FREE** Catalog! 50 home money-making opportunities! Maxson, Box 488, Falls Church 25, Virginia.

**EARN** Money at home, making rhinestone jewelry. Free catalog. Ebert, Box p183, East Orange, New Jersey.

**EARN** Money! Amazing plans! Easily mastered at home. Details free. Bruns, Room 612B, 216 West Jackson Boulevard, Chicago 6, Ill.

**OWN** Your mail-order paper products business. Envelopes, tags, bags, boxes, wholesale. No investment. Omaha Envelope Service, Dept. 12, 4721 California, Omaha 3, Nebr.

**SELL** Popular Mechanics and all other magazine subscriptions. Free catalog, supplies. Subscription Service Company, Dept. A, P.O. Box 2070, Birmingham, Alabama.

**100 TESTED** Money-making mail order plans. Dime. Regal, Box 173, Royal Oak, Michigan.

**OWN,** Operate, route Wishing Wells. Place these new \$8.50 skill games on counters in cafes, luncheonettes, clubs, etc. Collect coins weekly. Write, Legalsharr, Box 929, Long Beach 1, California.

**MAKE** Products. Sell mailorder. Formula catalogue free. Imso, 6347 Parnell-PM-10, Chicago 21, Illinois.

**\$50; \$100 WEEKLY** Possible. Get indisputable proof immediately. Exciting information 3c stamp. Harrison, 980 Empire, Benton Harbor, Mich.

**HOME** Business opportunity. Mail literature to auto owners. Everything furnished. Big earnings. Eastern, Box 142-F, Dorchester 24, Mass.

**MAIL** Postcards at home. Get lots of orders. Keep all money. Orders filled free. Schipper, 121-A Wilkins, Rochester 21, New York.

**MAKE** Money selling merchandise through post cards. Fast sellers. Everything furnished. Literature 25c. Beglen, 49 Cove Lane, Levittown, New York.

**\$1,000 MONTHLY!** Renovating household furnishings. Puraclean, 17-A East 42nd, New York 17.

**RAISE** Orchids at home. Big profits—Fascinating. Year 'round any climate. No greenhouse. Instructions, including 3 orchid plants, sent for non-risk examination. Free details. Flowerland, 4622-DP Wilshire Blvd., Los Angeles 5.

**MAKE** Perfume. Catalog free. International, 6347 Parnell-PM-10, Chicago 21, Illinois.

**START** Your own business on credit. Your own boss. 1658 of our dealers sold \$5,000 to \$27,500 in 1952. We supply stocks, equipment on credit. 200 home necessities. Sales experience unnecessary. Pleasant profitable business backed by world-wide industry. Write Rawleigh's, Dept. J-U-PPM, Freeport, Ill.

**IMPORT-Export!** Opportunity, profitable, world-wide, mail-order business from home, without capital; or travel abroad. Established World Trader ships instructions for no-risk examination. Experience unnecessary. Free details. Mellinger 70A, Los Angeles 24.

**NEWEST** Spare, full-time home business. \$5 to \$10 hour possible. Paint with suede—The finish with touch and eye-appeal. Beautify auto dashboards, signs, radios, toys, figurines, lamps—1001 others. Complete, step-by-step instructions sent for no-risk examination. Free details. Coast, 1004-HW So. Los Angeles St., Los Angeles 15.

**INVISIBLE** Reweaving in big demand! Cash in servicing laundries, cleaners, stores, homes. Make tears, holes, cuts disappear from fabrics. Earn up to \$10.00 in an hour. Details free. Fabricon, Dept. C-10, 8342 S. Prairie, Chicago 19, Illinois.

**DISPLAY**—Store, window, exhibits. Big informational kit only \$4.00 until January. Guaranteed. Larry Vandeman, Box 104, Hinsdale, Illinois.

**WE** Two haven't worked for anyone in twenty years, thanks to a marvelous mail-order procedure lately becoming popular. This method achieves nationwide mailings through agents—Like reaching new mothers through maternity-ward nurses. Other uses yet untapped. Information free. Crowther Merchandise, Rt. 3, Box 386-A, Ogden, Utah.

**NOTARY** Public commands more money. Be one. Stationers, Helotes, Texas.

**BLESS** Our jolly postman! Every day he leaves a bunch of letters—And every day they have money! The cause is an extraordinary new multiplying mailorder method. United States postal service approved. Circular coverage redoubles automatically. One person handles volumes! Multiplication Mailorder literature free. Bowers Business Service, 16196 Linwood, Detroit 21, Michigan.

**FREE** Wholesale catalog—Lucite encased gold, silver, plated, religious medals, fraternal emblems, armed forces insignia. Caraday, Box 71, Ryder Station, Brooklyn 34, New York.

**WE** Love our mailman—He leaves over \$1,000.00 monthly in our rural mailbox. My college professor husband drafted a scientific home mailorder method. We bought a Texas ranch, live as we always wanted. Now we sell the Ranch Mailorder Method. Operates anywhere. Inquire: Eveningshade Ranch, Helotes, Texas.

**SUCCESS?** Profits? Mail Order Enterprises, 411 W. Fulton, Grand Rapids, Mich. For aspiring inventors, ambitious writers, mail order trade, everyone. Copy 25c. Limited offer: Send \$1.00 today for year's subscription, famous "Write Your Own Ads" booklet free.

**ADVERTISING** Book matches—Cash in on big demand; sell union label matches. Cuts for all businesses and political parties. Free powerhouse selling kit, low prices, protection guaranteed on repeat orders. Cash commissions. Superior Match Co., Dept. MX-1053, 7530 Greenwood, Chicago.

**PERMANIZE,** Ceramize, porcelainize, metalize baby-shoes, crochet items, hundreds of keepsakes. No baking, no firing. Fantastic profits. Details for 25c. No equipment to buy! Jay Sales, Dept. 1-M, 192 N. Clark, Chicago.

**HAVE** New York address with mail service \$2 month. 518 Fifth Ave., Suite 1004, New York.

**CASH** In on coming income tax boom. Earn \$50-\$100 daily preparing tax returns. Experience unnecessary. Details free. Union Institute, Lakewood 2-B, N. J.

**LEARN** Sewing machine repair, electrify, rent, trade, sell. Make up to \$150 week spare time setup. Motor kits, zigzag machines, etc., wholesale. Free particulars. Taylor Service, Hamilton PM-10, Ohio.

**START** Home bookkeeping service. Keep books for others. Pays well. Easily understood. Details free. Mixon, P.O. Box 2048, Los Angeles 53, Calif.

**HUGE** Collection of wholesale sources! Moneymaking opportunities! Free information. Paramount Sales, 244 Broad, Lynn, Mass.

**NOTICE:** Get, use, sell Missionary Scheall's new \$5.00 guaranteed automatic fire extinguisher grenades. Buy one, get three. Write Scheall, 263XX Duluth, Minnesota.

**OPERATE** Escalator mailorder system, selling our products or any products. Fastest, most revolutionary mailorder system known. Write: Selbyco, Decatur 161, Ill.

**QUICK** Money! Repairing car batteries. At home! Easy too! Batteryman, Grand Junction, Colorado.

**WHOLESALE**—Liquid rubber. Molds; models; casting; coloring; metal coating; pearl finishing; baby-shoe mountings, etc. Big illustrated catalog with samples, 25c, refunded. Artcraft, 938-42 Belmont, Chicago.

**YOU** Can be notary public. Information free. Magnolia Press, Box 1272-P, Burbank, Calif.

**MAGAZINE** Agents. Largest commissions. Bonus. Qualified publications. 451 Kingston, Brooklyn 25, N. Y.

**WHAT!** \$2400 Per year selling \$1 book by mail? Details free. Wieland, Box 8456, Kansas City 14, Missouri.

**BELGIUM.** Important firm looks for new lines, new ideas, new inventions, especially in cleaning products and home appliances. We buy large quantities. Send by air-mail: prices, samples, all details to Mr. A. Bousson, 18, Avenue des Ormeaux, Uccle-Brussels (Belgium).

**BOOKKEEPERS**—Complete manual. "Eleven Plans For Establishing Successful Bookkeeping and Tax Service." with licenses to operate. Only \$3.00. Commercial Business Service, 411 Fairfield Rd., High Point, N. C.

**VARIOUS** Very profitable endeavors. Free details. Krafft's, Box 855, Norwalk, Conn.

**MAKE Money; sell by mail; Money Getter's**, monthly magazine shows how! Sample 10c, 3 months 25c, year \$1.00. Hurry! Dispenza Co., 2020 Harbor Ave., Ashtabula, Ohio.

**\$25 WEEKLY** Working two hours daily at home. Lycke, Box 2471-A, Cleveland 12, Ohio.

**WHOLESALE** Of sensational nationally advertised appliances, silverware, watches, cameras, etc. Start your own business. Full details. Send 50c for catalogue. International Sales Co., 175 Fifth Ave., New York 10, N. Y.

**BRONZED** Baby shoe supplies, instructions, mountings. Metal bookends, \$1.50 pair. Free catalog. National Bronze Supply, Box 56, Los Angeles 32, Calif.

**HOW** And where to obtain capital? Free details. Star Service, Wapakoneta, Ohio.

**START** Your own profitable home mail-order business! We supply everything! Write today! Studio Products, Box 564-A, Glendale 5, Calif.

**LIVING** Miniature ("Ming") trees only 10 to 20 inches tall. Grow at home. Big profits! Spare time opportunity. Fascinating! Amazing! Write for free seed and plan. National Nursery, Dept. FC, Inglewood 4, California.

**BUY** It wholesale! Manufacturers, distributors offer 850,000 items. Literature free. Olsen, 1231-A East Third St., Duluth 5, Minn.

**BREED** Rare tropical fish at home. Earn big money! Learn secrets! Help fill huge demand. Amazing opportunity! Free plan. Tropicals, 1008-F Los Angeles St., Los Angeles 15.

**INCOME** From local information. No selling. Write Neherco, La Verne, Calif.

**\$46 FROM** Square foot plywood; jigsaw necessary. Write: Woodarts, X-154, Bridgewater, Mass.

**PROFITABLE** Home business, electroplating novelties, giftwares, auto parts, mirrors. Easy, inexpensive home processes. Free booklet, Tyco Metals, Box 13231-MJ, Houston 19, Texas.

**RESILVERING** Mirrors, formula 50c; two-way lookout mirrors, (No one sees you), 50c; coppered mirrors, 50c. All \$1.00. Neiko-Mir, Box 3462-J, Chicago 54.

**FIGURINE** Molds and many others, liquid rubber, statuary plasters, flock finishes, Glo-candle wax, etc. Illustrated catalog and "Plastercraft" manual free. Blue Rapids Supply, Blue Rapids, Kansas.

**START** Home manufacturing business. Make cleaners, soaps, polishes, cosmetics. Free literature. Kemix, Park Ridge, Ill.

**MAKE** Money spare or full time, casting metal toys and novelties. Big wholesale and chain store demand for autos, soldiers, ashtrays, banks, etc., keeps manufacturers busy. Production moulds furnished for up to 100 and more castings per hour. No experience or special place necessary. Write for information and illustrations of patterns needed. Metal Cast Products Co., Dept. A, 1696 Boston Road, New York 60, N. Y.

**NEW** Exceptionally profitable plans, ideas for home operated mail business. Rush name. Miller, 1772-P Carlyon Road, East Cleveland 12, Ohio.

**MAKE** Flexible molds! Cast plaques, bookends, figurines! Free sample! H. Tooker, 630-R Chestnut, Hamilton, Ohio.

**RECAST** Old batteries into new. Latest achievements. Battery Laboratories, Minneapolis.

**READ "Advance"**—The voice of mail order. Offers money-making opportunities, sources of supply, personal guidance, etc. Issued monthly. Sample copy 35c. Yearly subscription \$2.00. Advance Publishing Company, 313 East 21st Street, Suite 450, New York 10, N. Y.

**GOOD** Paying business silvering mirrors, plating autoparts, reflectors, bicycles, bathroom fixtures, etc., by late method. No tanks or shop required. Outfit furnished. Free booklet. Gunmetal Co., Ave. H, Decatur, Illinois.

**BUY** Wholesale. Thousands articles. Supply directory, 10c. Idealso, Park Ridge, Illinois.

**EARN** Extra money! "Homeworker Magazine" tells how. Sample 25c. Sizemore, Box 7, 4917 Kostner, Chicago 30.

**EXTRA** Money—No selling, operate vendors. Amazing profits, details free. Silver King, Suite 220, 622 Diversey, Chicago 14.

**OPERATE** Profitable mail order business. Write Walter Service, 4159-A East 112th, Cleveland 5, Ohio.

**DOLLARS** In personalized baby record books. Sell by mail. Use same literature we do. No-Co-Ro, Oakland 6, Calif.

**MINK** Raising information free. Complete. Lake Superior Mink Farm, Superior, EE1, Wisconsin.

**COPUBLISH** Leading m.o. paper, Latest copy. Mail Sale Advertiser, details, dime. Vanroy Shirk, Lebanon, Penna.

**COLORGLAZED** Concrete pottery made without molds. Patented method. Cemetery products, novelties, tiles. Basement leak-sealing. Money-making projects. Booklet, details free. Men only. National Potteries Company, Grand Rapids, Minnesota.

**FREE** Book "505 Odd, Successful Businesses." Work home. Expect something odd! Pacific, Oceanside, Calif.

**START** Venetian blind laundry. Profitable lifetime business. New machine. Free booklet, F. C. Co., 442 N. Seneca, Wichita 12, Kansas.

**SELL** Books by mail! Wholesale catalog, 25c. Monarch, Auburn, New York.

**MAKE** Money from newspaper clippings. Siegel, Box 183 PM, New York 2.

**137 PLANS** For starting home business. Details: Elite Co., 220 Grand St., New York 13.

**MAKE** Perfume. Sell on smell. Mail order or local. Wilson made \$7200.00 first year. Free sample, plan revealed. McCann, 4019-21 Rio Grande, Amarillo, Texas.

**LEARN** Metalizing baby shoes, gifts, etc. Bronze, gold, silver. Folio free. Kiktavi, 7217-PM South Broadway, Los Angeles 3.

**PEARL** Finishing. New amazing home, full-time business. Free success plan. Pearlite, Box 73136, Los Angeles 3.

**LIQUID** Rubber, make flexible molds. Free sample. Chaney, 1130 E. 16th St., Jacksonville 6, Fla.

**FIX** Typewriters. Free booklet describes our modern, inexpensive home-study course. Factory methods taught. Write Typewriter, Building 1, Tarentum, Penna.

**MONEY** In new greaseless doughnuts. Start in kitchen. No smoke. Sell stores. Free recipes. M. Ray Company, 3605 South 15th Ave., Minneapolis 7, Minn.

**POPCORN** And potato chip equipment. Long Eakins Company, 5360 High, Springfield 99, Ohio.

**START** A lettershop on a shoestring! Sales \$56,000. Started \$36.00. Information? Merritt, Box 13, Basking Ridge, N. J.

**SELL** Printing by mail! We fill orders. Free plans, samples. Sutton Printing, Box 853-G, Waycross, Georgia.

**MAKE** Money at home as renewal headquarters for all magazines. Big Christmas sales profits now. Liberal commissions. Supplies furnished. Write for free catalog. McGregor Magazine Agency, Dept. 500 B, Mount Morris, Ill.

**MONEYMAKING** Mailorder plan, 25c. George Lenhoff, Box 201-M, Lincoln 1, Nebraska.

**MAIL** Order business in your home. Details free. Easy Shopper, 1026 McKelvey, Cincinnati 15, Ohio.

**3 MINUTE** Auto waxing guaranteed. Can't wash-off. Electric Clintonizer and enough pure wax for 42 cars. \$23.45 delivered. Write Clinton Spray Wax Corp., 3651 Albion, Chicago 45, Illinois.

**NATURAL** Molding latex. Tinsel, flock, supplies. Extra thick. Free sample. W. Wooley, 115-A Donald, Peoria, Ill.

**FABULOUS** Bronzed baby shoe mountings, equipment. Posters, 1520 Ardmore, Chicago 26.

**URANIUM**, Metals, oil, map Western Canada. \$1. Yeo Agency, 627 Vancouver Block, Vancouver, B. C.

**EARN** Big money by mail. Depression-proof income. Circular 10 cents. Complete starting deal \$3.00 postpaid. Reho, Box 21A, Whitsett, Penna.

**FREE** Electroplating information. Money making plans. Send postcard for your copy. Highly paid, interesting, uncrowded field. Plater M. Hyde, 327 West 120th Street, Los Angeles 61, California.

**BIG** Profits and demand for home-made Christmas candies. Professionally in your kitchen. No special equipment. Fancy bitter-sweet chocolate drops, coconut bonbons, divinity, mint patties, etc. Full instructions \$1.00. Elco Products, P.O.B. 43, Dayton, Ohio.

**FREE** Details! Home operated mailorder business. Successful beginner's plan. Everything supplied. Lynn, 10420-M National, Los Angeles 34, California.

**VENDING** Machines—No selling. Operate a route of coin machines and earn amazing profits. 32-page catalog free. Parkway Machine Corporation, Dept. 72, 715 Ensor St., Baltimore 2, Md.

**FLEXIBLE** Rubber moulds for plaster and Marble figurines. Sample and large illustrated catalog 25c, refunded on first order. K-C Novelties, Dept. 73, Easthampton, Mass.

**50 HOME** Mail business plans! Proven money-makers! Personal help assures success. Verdo, B-37A, Huntsville, Missouri.

**UNUSUAL** Opportunity. Sell by mail—Books, merchandise. Complete setups. Write Sherron, Box 343F, Bloomfield, N. J.

**BOOKKEEPERS**, Increase earnings operating sensational bookkeeping service. Kern, 4942 Vineland, No. Hollywood, Calif.

**FLORIDA** Opportunities! Hundreds of jobs, businesses, farms, groves, homes. Free details! Florida Opportunity Bulletin, Box 456-N14, Coconut Grove, Miami 33, Florida.

**LEFT** 8 Hour job to take 14 hour, and love it! Working for myself, at home, it's different. Special mailorder procedure we developed (spot-mallings from different points over United States) allows me much leisure, and double enough to live on. I'm showing others how. Write: Cirves, 2834 W. 65th, Chicago 29, Illinois.

**MEN-Women!** Make money at home. Exciting new ideas, plans assure big earnings. Drake, 136-A Walmer Road, Toronto, Can.

**PEOPLE** Write us they'd like to live as we do, rural, tranquil, with our home business, and money coming daily in the mail, and would we show them how? Yes. If you have capital, at least for postage and mail-order circulars, we'll get you safely started. Inquire: Craig, Southern Pines, North Carolina.

**EARN** Money with typewriter—Sewing machine! Details free. Edwards, 3915-PM 12th, Des Moines 13, Iowa.

**ESCAPE** Wage slavery. Easily. Operate your own profitable lifetime business. Free literature. Corley, H186 Ackerman, Clifton, New Jersey.

**HAVE** Home mail business—Get \$10 orders in every mail. Keep \$8.00. Everything furnished. Hutchinson, 401-A Adams, Dorchester 22, Mass.

**OPERATE** Your own profitable mail-order business. Full or part time basis. Write Vernon-Hall, Box 193M, Abington, Penna.

**WANTED!** Home producers, by manufacturers in our clearing house service. Become a sub-contractor, casting plastic products for these companies. Thousands of easy-to-make items required for consumer and industrial use. Cash in at home, without previous experience. Write Plastic Service Associates, Dept. PM9, East Boston 28, Mass.

**MAKE** Money selling merchandise by mailing cards. Paton, Box 55-E, New York 23, N. Y.

**ASK** Your wife if you love your job. She knows. Then write me about the mailorder method I perfected in 1929, that's dropped \$1,000 into my mailbox every month since, that lets me stay home and enjoy life working for myself. I'll help you start. Rotoletter, 1160 Seward, Detroit 2, Mich.

**FREE** Vending machines; if used to sell our profitable nuts. Continental, Box 1361-A, Milwaukee 1, Wisconsin.

**BOOKKEEPERS**, Keep books, small firms spare time. Manual latest technique by C.P.A., \$3.00. Modern Business, Box 406, Youngstown 1, Ohio.

**FREE** Booklet—"How to Make Money by Raising Fishworms." Please include 25c for postage and handling. Flint River Worm Farm, Reynolds 5, Georgia.

**MINIATURE** Trees—Why pay \$2.00-\$5.00 for growing secrets? Free details. Bassett, Dept. B, 5038 N. Winthrop, Chicago 40.

**BUY** Wholesale—Thousands nationally advertised items. Save, make money! Free details. Durex Co., Box 672-B, Chicago 90, Ill.

**DON'T** Fail to read our advertisement under Money-making Opportunities. Procto Products Company, Box #543, Oak Park, Illinois.

## MONEYMAKING OPPORTUNITIES

**SHINE Shoes** without polish. New invention. Lightning seller. Shoes gleam like mirror. Samples sent on trial. Kristee, 179, Akron, Ohio.

**FREE!** "301 Profitable Small Businesses!" Amazing shoestring plans! Work home! Start sparetime! Deumant Surveys, Kenmore 23-R, N. Y.

**TYPEWRITER Owners**, make handsome profits. Write today, now. Groves Company, 682, Hastings 8, Nebraska.

**START A buying service**, buy wholesale thousands nationally advertised products. Make big profits selling at sizable discounts. Postcard brings details. American Buyers, 630-R Linden, Buffalo, N. Y.

**FREE Folder!** Make money—at home. Samuel Tell, Guaynabo, Puerto Rico.

**LEARN Professional candy making**, profitable home business. Details free. Pate, Kissimmee, Florida.

**ONLY New moneymaker in years**. Free details. Casecraft, 805-F Sunset Blvd., Los Angeles, Calif.

**SECRETS Of moneymaking**. Write Ahrens, Box 41, Roosevelt, N. Y.

**BUY Wholesale!** Nationally advertised products. Tremendous discounts. Particulars free. Econ-o-mart, Box 535B, Morris-town, New Jersey.

**FREE Samples**, diagrams, instructions. New enormously profitable business. Send 25c coin for handling. Hobby, 243 S. Lexington, St. Paul 5, Minn.

**"HOW To Make Money With Simple Cartoons"**—A book everyone who likes to draw should have. It is free; no obligation. Simply address Cartoonists' Exchange, Dept. 910CM, Pleasant Hill, Ohio.

**MAKE \$2600.00 A year** spending 5 hours a week. Start at home. New machine. Small investment. Free booklet. A.X. Co., 442 N. Seneca, Wichita 12, Kansas.

**EARN Money evenings**, copying and duplicating comic cartoons for advertisers. Adservice, Argyle 1, Wisconsin.

**DON'T Be Mr. Average Man**. Operate your own business. New field, sensational sales potential, highly profitable. Very desirable, non-perishable, no chemicals or liquids. High-grade proposition for men not afraid of earning \$10,000 and up annually. Can you recognize real opportunity? Postcard will bring details. Protecto Products Company, Box #543, Oak Park, Illinois.

**FREE! Complete mailorder business!** Terrific profits! No investment. Write today. VitaMins, 2908-PM Beverly Boulevard, Los Angeles 57.

**MONEYMAKING Deluxe opportunity packet**. Only 10c. Don Supkow, Blackwood, N. J.

**FREE Folder**. Dozens of new, different ways to make money at home. Write, Pomona Publications, Box 357-B, Pomona, California.

**FREE Folder!** Make money at home. Samuel Tell, Guaynabo, Puerto Rico.

**EXCEPTIONALLY Profitable home mail business opportunity**. Write Lewis Barlett, Richland, Georgia.

**MONEYMAKING Opportunities**, home-work. Free literature. Wiese, 1516 Franklin, Waterloo, Iowa.

**\$10,800 PROFITS!** Your own mailorder business! No risk! Success plan free! Treasury, 709 Webster, New Rochelle, PM-16, N. Y.

**STOP Shopping!** See our complete catalog of spare time opportunities. Free. Rush postal. Lewis Enterprises, P.O. Box 2367, Portland 14, Oregon.

**TYPEWRITER Owners**. Make handsome profits. Get details today. Groves Company, 682 Hastings 8, Nebraska.

**BEAUTIFUL Feather pictures**. 200% profit! Free sample. Apartado 9036, Mexico 1, D.F.

**WHOLESALE Services**. (Bonded.) One-year. \$1.00. Rhipco, Box 5387, Tucson, Arizona.

**"MONEYMAKING For the Millions"** can help you. Get free details. Merit Mail Order, Montrose 1, Mo.

**WHOLESALE Information**. Circular, interesting magazine, dime. Zen Publishers, Elkhart, Ind.

**HOW To earn up to \$500** for each script writing for television. New, different. Particulars free! Wonderful Products, Box 2113, Santa Fe, N. M.

**HOUSEHOLD**. Patented items for sale. Dr. Roberts, LakePark, Ga.

**SELL Jewelry** by mail. Big demand, every woman buys. Everything furnished. Eastern, Box 142-D, Dorchester 24, Mass.

**CHURCHES**, Women's clubs, receive \$100.00 to \$500.00 and 24-card tables. Unique plan. Pine Hill, New Jersey.

**101 WAYS To make \$1,000** at home. Details free. Business Surveys, 365 S. Fairfax, Los Angeles 48, Calif.

**IMPRINTS For homeworkers**. Samples free. No obligation. Fowico, Muncie, Ind.

**HAVE Money-making home mail business**. Complete idea. Mailbox service. Personal help assures success. NMD Agency, Box 88-A, Dorchester 22, Mass.

**FREE Folder!** How to make thousands yearly selling by mail the way that pays. Fuller, 92-A, Greenwood, Pocatello, Idaho.

**MONEY With any type camera**. City or country. Spare or full time. Complete details \$1. Lafferty, 2205 B, Brownwood, Texas.

**FUTURE Security!** Learn watch-clock repairing at home. Inquire. Modern Technical Supply, 55 PM West 42nd Street, New York 36.

**BE Independent**, be secure, have your own profitable business—Earn \$20.00 and more a day making beautiful, fast-selling lamps at home. No equipment needed. Illustrated course teaches you quickly. Course, parts catalog, wholesale price list—only \$2. Gearon Co., Dept. 200-B10, 27 S. Desplaines, Chicago 6, Ill.

**START Your own business manufacturing driftwood lamps**. Kit \$7.50. Sam Patchett, 2187 N.W. 24th Court, Miami, Florida.

**PLAIN Folks**, we married on nothing—12 years later own properties, houses, lands. All from scientific mailorder routine, the coming method: only definite prospects receive our circulars, mailed by others on commission. Sales astonishing on modest operation—\$144,000.00 in 12 years! Commission Mailorder details free. Caldwell, Box 293, San Diego 12, California.

**WOULD You see your boy in your job?** Does the job satisfy? Inspire you? Bring \$1,000 paycheck? My modest home mail-order does. In 24 years I've learned to avoid mistakes, cut corners, conduct a profitable, satisfying operation. If desired, I'll help you start, guide you. Thomas Cummings, 3070 Felton, Salem, Oregon.

**BORROWED \$45 For stamps and circulars**. To date sold quarter million dollars—In small orders! All from home, by novel mailorder method where we supply circulars to mailers in certain key positions. Orders come automatically, average \$40 daily. Now we're showing others how. Details free. Hometrend, Marshall, Illinois.

**PROFITS To \$5 hour!** Engraving plastics titleplates; sensational new engraving, carving machine, Dupliscaler. Details, sample 25c. Desco Distributors, 6334-O Sepulveda, Van Nuys, Calif.

**DIME Brings our nationally advertised opportunity packet**. Rinehart, 235 Baltimore, Hanover, Penna.

**BE Appointed notary public**, your state. Thrilling experiences. Increased income. Men, women, young, old. Write Box 3025, Dallas 1, Texas.

**SELL Titania gems**; \$9.75 carat wholesale. More brilliant than diamonds. Free catalogue. Diamonite, 1404-M Mitchell, Oakland 1, California.

**50,000 ARTICLES Wholesale**. Source directory, dime. Nelko, Box 3462-DR, Chicago 54.

**WIN Contest money**. General Contest Bulletin gives hundreds of tips. Lists current contests and rules. Sample 25c. General Contests, 1609½ East 5th, Duluth, Minnesota.

**FOUR Ways to increase your income** at home. Free details. Dixie Mailers, King, N. C.

**SCHOOL Seniors**—Sell classmates America's most beautiful graduation name cards. Largest selection. Highest commission. Outells all others. Free sample kit. Printcraft, Dept. M, 1509 Maple Street, Scranton 5, Penna.

**MONEY Found**. Be our agent in your community. Top quality watches, diamonds, jewelry, etc., at wholesale prices. Amazing profits. No age limit. Experience unnecessary. Send for free catalog. Zerah Brothers, 602 Mission Street, Dept. 81, San Francisco 5, Calif.

**READ Progressive Mailtrade**, the magazine that tells how to make money by mail. Dime brings sample and special offer. Progressive Mailtrade, Box 357, Sheboygan, Wisconsin.

**START A profitable subscription business** in spare time! We need men and women (young or old) as representatives for all leading national magazines. Liberal commissions paid for new and renewal subscriptions. Start earning money in this pleasant work at once! Clip this ad and send with your name and address to: International Circulation Distributors, Dept. PM, Hearst Magazines, 350 W. 55th St., New York 19, N. Y.

**FREE Book "505 Odd, Successful Businesses"**. Work home. Expect something odd! Pacific, Oceanside, Calif.

**137 PLANS To make money**, local mail-order. Details: Elite Co., 220 Grand St., New York 13.

**PUBLISH Your own magazine**. Handmade 52 page format, well edited, illustrated. Cost low as \$1.00 month. Brings you prestige, profits. 25c brings sample, details. National, Ord, Nebr.

**SCHUHMACHER Matmakers**. Convert old tires into dollars. Devote full or spare time. S and S Patents, Inc., 1307 North Clark St., Chicago 10, Ill.

**MONEY Needed?** Start home business. Grant Specialties, 721 28th, South Bend 15, Indiana.

**PAUZE Liquid styptic stops bleeding** quickly. Fast profits. Sampler 25c. Pauze, 1545-F Echo Park Ave., Los Angeles 26.

**MAILORDER**—Operate profitable home business using free advertising method reaching millions. Revealing information free. H. P. Seidel, 7070 Hollywood Blvd., Hollywood 28, California.

**22 MILES Out of city I live**, yet walk to work daily, to my office, a renovated barn 50 feet away! I planned it that way. We organized a home mailorder, a rare kind, branch-style. United States Postal Service approved. Grosses \$1,000 monthly. Organization duplicatable using other products. Inquire: Kerr, Gering, Nebraska.

**FREE Information reveals secrets of unusual profitable home businesses**. Rare opportunity. Home Business Surveys, 365 S. Fairfax, Los Angeles 39, Calif.

**MAKE Money at home by mail**. Fast, easy. Liebig Industries, Beaver Dam 4, Wisconsin.

**FOREIGN Employment construction work**. If interested in foreign projects with high pay, write Foreign Service Bureau, Dept. PM, Metuchen, New Jersey.

**MAKE Cosmetics in your kitchen** for own use or to sell. Easy, profitable, not seasonal. Ingredients available at drug stores. Twenty one formulas and instructions \$1.00. Moffet, 429 N. Gilbert, Danville, Illinois.

**MAKE To \$4.50 hour** doing common pen lettering. National Artists, 801½-A North Marsalis, Dallas 3, Texas.

**DOUBLE, Triple, quadruple your income**. Free information. Future Foundation, Pensacola 2, North Carolina.

**EXTRA Income!** Become a notary public! Complete details, your state, 50c! Filmer, 910 Marion, Pharr 10, Texas.

**GET Facts—\$4.00 merchandise**, \$2.00 treatise 100 money makers, \$6.00 value \$2.00. Kohne, 506 West 45th, Chicago 9.

## FORMULAS, PLANS, ETC.

**FORMULAS: Big demand**, easily prepared, profitable. Free list. Wall, 304N 27th Street, Alabama City, Alabama.

**EXCLUSIVE Formulas for manufacturing perfume compounds** that are sales-tested and profit-making. None better at any price. Formula for reproducing a world famous perfume and brochure "Perfume Compounding" containing information not available elsewhere \$10. Fragrance Research Foundation, 1513 Oxford Way, Oklahoma City, Oklahoma.

**PRODUCT Analysis**, manufacturing formulas, processes developed. Moderate fees. Plastics, Box 1574, Boston 4, Mass.

**FORMULA For protective hand cream** now being offered for sale. Not a cleanser. Apply directly to skin surfaces before undertaking work involving inks, greases, paints, etc. Needs only water to remove. Simple to make and sell. Market wide open. Send \$1.00. Ottawa Engineering and Sales Company, Box 835 Creston Station, Grand Rapids, Michigan.

**FORTUNES In profitable formulas**. Far Hills, Box 544-MB, Dayton 9, Ohio.

**FORMULAS: All kinds**. Latest, best. Literature free. Kemixal, Park Ridge, Ill.

**REAL Manufacturing formulas.** Lists free. Cummings, Chemist, Gordon Ave., Syracuse 4, N. Y.

**ANY Formula \$3.00.** Chemical Instruction Sheet—catalog 10c. J. Belfort, 216 W. Jackson, Chicago 6.

**FREE Formula catalog.** Anything analyzed \$35. Western Chemical, Salem, Ore.

**LABORATORY Tested formulas.** Catalog free. Pont Chemical Company, Terre Haute 2, Indiana.

**MODERN Formulas for many new and unusual business-building products.** Fifty years supplying the best. Literature free! Liscomb Miller, Chemist, Tampa, Florida.

**500 MONEY Making formulas.** 25c postpaid. Alien, Dept. FMC, Clinton, Missouri.

**ANY Formula.** Jack, Consulting Chemist, 5138 Gainer Road, Philadelphia 31, Penna.

**GENUINE Manufacturing formulas.** Lat-est. Literature free. Nelko, 3462-P Merchandise Mart, Chicago 54.

## PLASTICS

**PLEXIGLAS.** Lucite. Any size sheets, masked. Square foot (12 x 12) cost, 1/16", \$1.20; 1/8", \$1.40; 3/16", \$1.75; 1/4", \$2.08. Include 10% postage. Minimum order \$3.00. Almac Plastics, 600 Broadway, New York City.

**REPAIR False teeth yourself!** Special professional plastic. Guaranteed. Send only \$1.00. Grant Laboratory, 219 W. 7th, Los Angeles 14, Calif.

**FIBERGLAS, Polyester, Plexiglas, Acetate, Vinylite;** casting, coating plastics: My own Fiberglass "how" book now ready, \$2.50. Fast service, best prices. Catalog 10c. Airmailed 35c. Gem-O'-Lite, Box 6867P, North Hollywood, California.

**NEW Liquid casting plastic.** Clear, colors. Embed flowers, insects, coins. Saw, drill, carve. Send 25c for Castolite Creations Manual and proved success plan showing how to make money at home. Castolite, Dept. L-101, Woodstock, Ill.

**PLASTICS Home-craft course for men and women.** Tells and shows how to make hundreds of fast selling plastics products. All plastics and materials for 23 projects included in course. No special tools needed. Course pays for itself. Write for free booklet. Interstate Training Service, Dept. D3K, Portland 13, Oregon.

**SPECIAL Plastic for laminating photos, cards, etc.** Send for prices. Solomson, 46 Cornhill, Boston 8, Mass.

**"HANDBOOK Plastic Information"** designs, fabrication instructions, material catalog, complete 50c. Plastic's, Box 1812, Salt Lake City, Utah.

**UNUSUAL Christmas decorative materials** fill our complete catalogue. Van Horn Plastics, 1905 Ingersoll, Des Moines, Iowa.

**PLASTIC, Sheets, rods, tubes, etc.** Free list. Plastic Supply Co., 2901 N. Grand Blvd., St. Louis 7, Mo.

**PLEXIGLAS Sheets—Cut to size.** Clear. All thicknesses. Standard outdoor translucent colors. McClarin Plastics, P.O. Box 168, Hanover, Penna.

**DIRECTORY of manufacturers,** for liquid plastics, liquid rubber, wholesale. Castleco, 2139P, Paterson, New Jersey.

## CHEMISTRY

**IMPROVED Second printing, "Spectacular Chemical Fireworks Experiments"** manual. Not mimeographed sheets. Contains complete formulas, set-ups, data, on thermites, fulminates, explosive powders, etc. Still \$1.00 postpaid. Chemi-Technix Laboratories, 568CG Riley, Buffalo 8, N. Y.

**COMPLETE Catalog.** 15c. Surplus lists. Laboratory Sales, Box 161-A, Brighton, Mass.

**MERCURY.** One ounce 50c, two 75c, five \$1.50. We pay postage. Nucleus, 1558 Minford Place, New York City 60.

**CHEMICALS And apparatus for industrial, analytical, and private laboratories.** Catalog 25c. Dept. M-50, Biological Supply Co., 1176 Mt. Hope Ave., Rochester 20, N. Y.

**ILLUSTRATED Catalog:** Chemistry, mineralogy, biology. 10c. Tracey Laboratories, Evanston, Illinois.

**NEW Idea chemical and apparatus** outfits for home experimenting. Photo-scales, microscopes, chemicals, biological and laboratory supplies in small quantities. Catalog 25c. Established 1931. John H. Winn, 124A West 23rd Street, New York, N. Y.

**SPECTROSCOPE** For quick chemical analysis \$3.00. Kutting Sons, Los Altos, Calif.

**AMAZING New book of science.** Experiments, formulas and catalogue of laboratory supplies. Only 25c. National Scientific Co., Dept. 16, 2204 W. North Ave., Chicago 47, Illinois.

## AGENTS WANTED

**REAL Diamond rings.** Sell direct. Make big middleman's profit. No investment. Experience unnecessary. Free catalog, details. Sternberg, 111C No. Columbus, Mount Vernon, New York.

**EARN \$50 Weekly spare time.** Sell vitamins. Emm-Bee. Box 992, New York 8, New York.

**MIRACLE Profits in miracle plastics!** Dishware, fabric textured drapes, gift-wares, rainwear. Over 200 fast-selling household items assures big spare-time profits. Thrilling catalog free. Loraine, 846-H Adams, Chicago 7, Ill.

**SENSATIONAL High quality, low priced retractable ball pen, permanent ink.** Extra refills free. Fast, profitable seller. 60c for sample refundable on first dozen order. Lucar Trading Co., 225-A Lafayette St., New York, N. Y.

**ANY Gift shops can sell purses, belts and other handmade typical items from Guatemala.** Free catalog. Use airmail. Mapillon, Box 268, Guatemala, C.A.

**BE First to distribute our glamorous reversible spread and drape set.** More than 100% profit in every sale. Every home a prospect. Write for free details. National Home Distributors, Dept. P.M., 210 Fifth Ave., New York 10, N. Y.

**YOU Can make a fortune if you join us now.** Sell sensational new \$4.95 non-electrical burglar alarm. Tremendous sales. Federal Products, Evanston 2, Illinois.

**BUY Wholesale thousands nationally advertised products at big discount.** Free wholesale plan. American Buyers, 629-R Linden, Buffalo, N. Y.

**NEW Plastic mending tape.** Just press on! Repairs clothing instantly. Lightning seller. Samples sent on trial. Kristee 125, Akron, Ohio.

**SELL New automatic floor waxer.** Trigger on handle. Retail \$2.95. Your profit 125%. Write Smith, Inc., Greenfield 7, Massachusetts.

**FOG-Stop windshield cloth.** Instantly removes blurry mist, frost, sleet, snow. Stops windshield fogging. Samples sent on trial. Kristee 124, Akron, Ohio.

**START Greeting card, gift shop from home.** Display fascinating Christmas, all occasion cards. Big profits. New type bonus-premium reward. Write for feature samples on approval, free samples name imprinted Christmas cards, exclusive stationery, free color illustrated catalog, selling guide. New England Art Publishers, North Abington 1033-A, Mass.

**MEN, Women, make money spare time plus new car as bonus for encouragement.** Amazing hosiery guaranteed to wear without holes, snags, and runs, or replaced free. For example, lovely 60 gauge nylons guaranteed for as long as 1 1/2 years, or replaced free. Write Wilknit, 17310 Wash., Greenfield, Ohio.

**BALL Pens \$10 gross, d.e. s.e. blades \$4.20 M, novelty flashlights with batteries \$2.25 dozen, assorted ruffled plastic aprons \$1.40 dozen up. YoYo tops \$12 gross.** Lutzker, 871AJ East 170th, New York City 59.

**EASY Handwork makes fast-selling useful articles.** Sample free. Sunmade Company, Brockton 64, Massachusetts.

**QUALITY Ties—Your profit, 140%.** Catalog free. Loren Specialties, 4351-A Flournoy, Chicago 24, Illinois.

**BIGGEST Profits.** New all-purpose silver plating polish. Cloth rub-on. NuSilver, 508-PM10, Aurora, Illinois.

**300% PROFIT.** Millions prospects. Take orders for plastic sealing of cards, photos, papers. Sample, details free. Plastiseal Company, Dept. M1, 45-05 30th Ave., Long Island City 3, N. Y.

**EXPERIENCED Distributors, agents.** 150% new vitamin supplement. Write Pas-Cal Vitamin-Mineral Products, Box 203-P, Altadena, Calif.

**MEXICAN Feather pictures.** Sell on sight; 200% profit! Free details. Sample 20c stamps. (No coins.) Sylvia P. Apartado 9036, Mexico City.

**AGENTS Wanted:** Sell household appliances. Send for wholesale catalog. Nueblings, Sicklerville-P, N. J.

**PROFIT Packed Christmas sales.** Famous brand French perfume, eau de cologne. Combination perfume-manicure cutlery gift sets, wildfire sellers. Lowest factory prices. Giant profit and bonus plan. Free testers with sample order. Write for free catalog. Lido Products, 126 Bleeker St., Dept. P-1, New York.

**MEXICAN Feather pictures.** High profit! Fast sellers! Adelphi, Box 57-B, Bellerose 26, N. Y.

**A Dress-lingerie shop in your home.** No investment. Good commissions. Write for sample book. Modern Manner, 260PA Fifth Avenue, New York.

**BIG Money selling Walker's famous tooth powder.** James Walker, Jr., 663 S. Plymouth Court, Dept. 11, Chicago 5, Ill.

**PAY Way! Wood-chain saw, Rotohoe.** Also, TV unit. Earn yours! Farmco-51, Excelsior Springs, Mo.

**MAKE Money introducing world's cutest children's dresses.** Big selection adorable styles. Low prices. Complete display free. Rush name. Harford, Dept. K4341, Cincinnati 25, Ohio.

**AT Last! Something new and sensational in Christmas cards.** Make extra money fast! Show satins, velours, metallics. Gets easy orders. Pays up to 100% cash profit. 30 free samples. With name 50 for \$1.50. Big line. Amazing new Glo-in-the-Dark ornaments, personalized matches, stationery. Several \$1.00 boxes on approval. Pure Greetings, 2801 Locust, Dept. 340-M, St. Louis, Mo.

**AGENTS—Show America's leading nationally advertised line—Novelties, gifts, utility items.** 100% profits. Prospects everywhere. Steady repeats. Write today for sensational low prices, free literature. Charms & Cain, 407-PM-103 South Dearborn, Chicago, Ill.

**BIG Profits selling ties.** \$2.00 values, \$6.50 dozen. Free catalog. Empire Cravats, 611A Broadway, New York 12.

**SELL Quix Timesavers.** Self-addressing labels. Steady repeat income. Proven product. Good Xmas gift. 300 in plastic gift box \$1. (100 gold, 100 blue, 100 white.) 500 all white in Mason box \$1. Keep 40c, send us 60c. Satisfaction guaranteed. Start in business today! Ask for special agent offer with color display card and 50 order blanks free. Start to make money same day for yourself or organization. Write Loomis & Co., 201-W Devonshire St., Boston 10, Mass.

**SENSATIONAL New plan! Large wholesaler of appliances, cameras, watches, etc.** will start you in new type of business. No selling. Free details. Cam Company, 6806PM-20th Ave., Brooklyn 4, N. Y.

**A Postcard can put you in a fine business!** Complete line. Leather jackets, 151 shoe styles. Big commissions. No experience, no investment. Send postcard for free outfit. Consolidated Shoe, Dept. CC32, Chippewa Falls, Wis.

**\$10 TO \$50 Daily selling magic Carbonex.** Free details. Sycamore, Box 13-PM, Oak Park, Illinois.

**TERRIFIC Profit maker.** Sensational costume jewelry promotion! 144 pieces, all new, all different! Pins, earrings, bracelets, necks—Enamel stones, rhinestone, tailored. Only \$42.00 gross. Special factory prices! Also religious goods. Free price lists. Customcraft Jewelry Mfg. Co., 26 Customhouse Street, Providence, R. I.

**AMAZING Profits selling exclusive Sunshine Christmas cards:** Nature prints, scripture text, imprints, nationally famous. 21 for \$1.00 assortments all sell on sight! Many others! Also gift wraps, stationery, etc. Send for samples on approval. Sunshine Art Studios, Inc., Dept. PM-10, Springfield 1, Mass.; Pasadena 3, California. (Note: East of Rockies address Springfield office.)

**BUY Wholesale from nationally advertised manufacturers, distributors.** Literature free. Carter Publications, Box 6011-H, Chicago 80.

**100% PROFIT With new Red-E cover guard!** Keeps garbage lids secure against weather and animals. 10-second demonstration sells on sight! Prospects everywhere. Dollar brings sample; \$6 brings dozen. Red-E Supply Co., 1240 Rose Lane, Wantagh, New York.

**AGENTS! Demonstrators! Distributors!** Direct from manufacturer \$25 luxury gift set, sells on sight. All gold plated bankers style ball pen, mechanical pencil, tie clip and smart cuff links. All gold plated. Beautiful jewelry box. Sample \$5, guaranteed satisfaction. Union Pencil Company, 389 Broadway, New York City.

**DOUBLE Your money in spare time.** Fast selling automatic downspout extension brings 100% profit. Easy 2-minute demonstration. Every house a prospect. Householders won't let you take it off after demonstration. Just clamp "Rain-A-Way" to downspout, show how it lowers automatically during a rain, folds up when rain stops. No moving around a Rain-A-Way, eliminates falls, drains water away from house foundations. Trouble-free action, heavy gauge aluminum won't rust. Fully patented. Don't wait—Be the Rain-A-Way salesman in your own exclusive territory. Full or part-time. Write today for free literature. Crawford Co., 1524 4th Ave., Rock Island, Ill.

**MEN-Women; 100% profit taking orders for Sweet Georgia Brown beauty products.** Tremendous demand by colored clientele. Sample offer. Valmor, 2451-MK Michigan, Chicago 16.

**FREE Nylons!** Men and women wanted to introduce amazing nylon stockings (guaranteed against runs and snags) by giving away free trial pair to every woman regardless whether or not final purchase is made! Earn up to \$3 an hour spare time. Advance cash plus 40% bonus. Postcard brings you free sample stocking and moneymaking outfits. Nothing to pay now or later. No obligation. Kendex, Babylon 53, N. Y.

**BUY Wholesale and save 50% on big name merchandise, Xmas gifts.** Make big profits selling your friends or for your own use. Our 1953 catalog is ready. Rake, 607-PM Spring Garden, Philadelphia 23, Penna.

**101 WAYS To make \$1,000 at home.** Details free. Business Surveys, 365 S. Fairfax, Los Angeles 49, Calif.

**SCHOOL Seniors—Have fun and spending money!** Be popular with your classmates. Send postal for details. Craftcards, Box 235-L, Pittsburgh 19, Penna.

**STRIKE It rich with flannel backs.** Scientific tablecover marvel not plastic, not linen, better than either. Outlasts 16 years scrubbing. Show free samples. Take orders. Pocket juicy profits. Styleco, Dept. 399, Cincinnati 10, Ohio.

**BUY Wholesale.** 25,000 items. Catalogue 25c. Matthews, 1472-B1 Broadway, New York City 36.

**AMAZING New mop.** Whirlwind seller. Wonderful profits. Generous sample offer. See Artmoore ad, page 50.

**\$200 WEEKLY.** New invention. Amazing 4-second Presto emergency tire chains, fit all modern auto wheels. National advertising building big demand. 3 sales daily to oil stations, dealers, etc., make \$200 or more weekly. Territory going fast. Write Presto Chain Co., Dept. P-24, Des Moines 2, Iowa.

**WHOLESALE Catalog.** Nationally advertised appliances, watches, etc. Send today for free catalog. Carroll Distributors, 4421 Snyder Ave., Brooklyn 3, N. Y.

**PRINTING.** Salesbooks, envelopes. Free illustrated catalog. Erscoc, Dept. PM, Bronx 72, N. Y.

**GOLD.** Silver lacquered letters. Windows, doors, trucks. Standard sizes. Penny and up. Big profits. Samples. Atlas-D, 544 West 79th, Chicago 20.

**MAKE Extra money.** Sell front door name plates to friends, neighbors. Retail \$1.98; you make \$1.00! Free selling kit. Modern Engraving Co., P.O. Box 194, Boston 14, Mass.

**ABSOLUTELY Free—Sales kit.** Yours for the asking. Send postcard today requesting kit showing new line, belt buckles with your name or personal initials, cap badges, choice 3000 different emblems. Write Hook-Fast, Box 1425PM, Providence, R. I.

**YOUR Own business—Used suits \$1.50, overcoats 65c, mackinaws 35c, shoes 12½c, ladies coats 30c, dresses 15c.** Enormous profits. Catalog free. Moro, 558-AA Roosevelt, Chicago 7.

**CALIFORNIA Sweet smelling beads.** Sensational sellers. Free particulars. Mission, 2328PM West Pico, Los Angeles 6, Calif.

**AGENTS: Stamping names on key protectors.** Sample 25c. Stamping outfits, checks, social security and name plates. Hart Mfg. Co., 303 Degraw St., Brooklyn, N. Y.

**AGENTS — 300% Profit selling genuine gold window letters; stores and offices.** Free samples. Metallic Sign Letter Co., 431-D North Clark, Chicago.

**\$50 WEEKLY Selling finest razor blades, other items.** Free details. Edisans, Box 274, Far Rockaway, N. Y.

**EXCELLENT Sideline for printing and advertising salesmen.** Decalcomania name plates in small quantities. Great demand. Also, make money with our line of automobile initials and sign letters. Free samples. "Ralco" XL-Roxbury, Boston 19, Mass.

**150% PROFIT Demonstrating amazing new perfumed waterless hand cleaner.** Write, Hill Sales Co., Waynesburg 8, Penna.

**\$1.00 PROFIT Selling \$2.95 photo enlargement deal.** Allen Studio, Riegler Bldg., Little Rock, Ark.

**SCHOOL Seniors—Earn sensational profits selling classmates America's most beautiful graduation name cards.** Largest selection. Outsells all others. Free sample kit. Printercraft, Dept. M, 1509 Maple Street, Scranton 5, Penna.

**MAKE Christmas money at home.** Take renewals and subscriptions for all magazines. Big Christmas profits now. Liberal commissions. Everything furnished. Free catalog. Write McGregor Magazine Agency, Dept. 500 A, Mount Morris, Ill.

**SENSATIONAL Bargains—Profits!** Used suits \$1.75, pants 35c, dresses 20c, shoes 20c. Operate from store, home, car. Free catalog. Superior, 1250-A Jefferson, Chicago 7.

**'54 WHOLESALE Dealer kit on appliances, typewriters, recorders, cameras, giftware, lighting fixtures.** Free. Write Arrow Distributing, 154K, Nassau St., New York City.

**BEST Source for wholesale nylons.** 25 years dependable service. Fields Hosiery, 99-G Chauncy, Boston, Mass.

### SALESMEN—DISTRIBUTORS

**BIG Money making opportunity.** Exclusive line work uniforms. Jackets, pants, shirts, coveralls, advertising embroidered. Every business prospect. Outfit free. Master Div., Dept. 719, Ligonier, Ind.

**IMPORTED Chrome spaghetti tongs.** Excellent sideline. Wholesale 50c, earn 100%. D'Indri Imports, 5529 Quincy, Chicago 44.

**BE A jobber without investment, without inventory.** Discounts 50% and more—Even on small orders. Draw from \$250,000 stock. Sell stores, individuals. Profits up to 100%. Terrific line toys, giftwares, appliances, jewelry, over 200 items! Free catalog. Modern Merchandise, Dept. 51, 169 W. Madison, Chicago 2, Illinois.

**IS \$210 A week worth a postcard to you?** Then rush card with name and address for special free trial plan that sells amazing new automatic refrigerator defroster like hot cakes! Write to Mr. Lewis, D-Frost-O-Matic Corp., Dept. G-102, 173 W. Madison, Chicago 2, Illinois.

**AD Matches!** Sell amazing designs—20, 30, 40 and 240-light book matches. Bigger spot cash commissions; every business a prospect. Low prices for high quality. Repeats. Start without experience; men, women; full, part time. Buy nothing! Sales kit furnished. Match Corp., Dept. PM-46, Chicago 22, Illinois.

**WANTED—Man earn \$500 month full or part time.** Exclusive. \$11 sale earns \$6. Prospects everywhere. Details free. Write Superior Products, Inc., Dept. 153, 3410 Main St., Kansas City, Mo.

**ANYONE Can sell famous Hoover uniforms for beauty shops, waitresses, nurses, doctors, others.** All popular miracle fabrics—nylon, dacron, orlon. Exclusive styles, top quality. Big cash income now, real future. Equipment free. Hoover, Dept. T-100, New York 11, N. Y.

**DISTRIBUTORS—Large profits.** Terrific repeat orders. Unique Italian brooms. Details free. Write Peacock, 400 Montgomery Street, San Francisco, California.

**BUY Standard brand watches, dinner-sets, jewelry and ladies' nylon hosiery at rock bottom wholesale prices.** Send for catalog with confidential price list. Bargain Merchandise, Dept. P, P.O. Box 66, Bronx 59, New York.

**SELL Miracle Orlon embroidered work uniforms!** Looks, feels, tailors like wool; wears 3 times longer. Outwears cotton 5 to 1. Acid-proof grease-resistant. Washes perfectly pressed. Amazing profits! Outfit free. Topps, Dept. R-5310, Rochester, Indiana.

**SALESMEN Make up to \$50.00 in a day selling brand new item going to every type of food and beverage store, factories, laboratories, hospitals, etc.** Samples furnished. Utility Durawear, 53 West Jackson Blvd., Dept. PM-10, Chicago, Illinois.

**MEN! Money! Miracle Spray-A-Tint tints windshields, gives marvelous glare-protection, plus new 1954 look!** Sprays on in jiffy. Reduces glare from sun, snow, headlights, etc. Lasts for years. Auto, truck owners buy on sight! Profits 100% up! Spray-a-Tint, Dept. PM-10, Consumers Bldg., Chicago 4, Illinois.

**MASTICOTE Asbestos liquid roofing.** No heating, anyone can apply. Guaranteed ten years. Dept. PC-5310, The Madison Paint Company, Cleveland 2, Ohio.

**ADVERTISING Book matches—Cash in on big demand; sell union label matches.** Cuts for all businesses and political parties. Free powerhouse selling kit, low prices, protection guaranteed on repeat orders. Cash commissions. Superior Match Co., Dept. M-1053, 7530 Greenwood, Chicago.

**NEW "Tas" expense account report and income tax deduction record, sells on sight.** Salesmen, stores, individuals, profit 100% and up. Salesmen, businessmen, auto owner's necessity, 30 second demonstration. Send name and address, demonstrator sent on approval. Dept. PM101, Box 9013, Houston 11, Texas.

**SELL Foam rubber stuffed Terry Pup.** Wonderful toy. Equally popular with women and teen agers as a bed decoration. Liberal profit and bonus. May be sold to stores. Jesse Levy & Company, 126 N. 3rd Street, Philadelphia, Penna.

**BUY Wholesale thousands nationally advertised products at big discount.** Free wholesale plan. American Buyers, 630-DD Linden, Buffalo, N. Y.

**OPERATE Wholesale confectionery business.** Details, samples \$3.00. Sallydee Candies, Newport, R. I.

**NEW Jobs open in selling.** Send name, address for five free issues of Opportunity Magazine's money-making guide, listing hundreds of companies who'll pay you well, full or part-time. No experience needed. Opportunity, 28 E. Jackson, Dept. 17, Chicago 14, Ill.

**PROVEN Profits: Magica, back sponge.** Patented. Seventeen inch polystyrene handle. Suds as it washes. Soap saver. Sensational sales. Magica Products, Wollaston 70, Mass.

### EDUCATIONAL AND INSTRUCTION

**WELDING Training pays at Hobart Welding School, Box M-1031, Troy, Ohio.** VA contract. Best equipment. Catalog free.

**OIL Coloring photographs.** A fascinating hobby or profitable sideline for those with artistic talent. Learn at home. Easy simplified method. Free booklet. National Photo Coloring School, 835 Diversey Parkway, Dept. 3447, Chicago 14

**UPHOLSTERING — Train at home for prosperous business.** Tools, supplies sent. Illustrated training shows how—previous experience unnecessary. Establish full or part time business. Free booklet explains plan. Write Commercial Trades Institute, 1400 Greenleaf, Dept. U2A-10, Chicago 26.

**A Profitable business of your own, big sparetime earnings, better job opportunities available in billion dollar field of custom upholstery.** Earn while learning at home through N. Y. state-approved UTS Course. Course includes—4 big outfits of tools, frames, materials to make beautiful furniture and slip covers you keep or sell. You learn furniture upholstery, finishing, slip cover, cushion, window cornice, drapery making! Free book tells about this booming business, how you earn as you train at home. Write today. Upholstery Trades School, Dept. BR-1402, 721 Broadway, New York 3.

**HIGH School diploma at home.** Licensed teachers. Approved materials. Southern States Academy, Box 144, MX Station E, Atlanta, Georgia.

**LEARN Priceless secrets of technical metaphysics.** Easy to learn. Only school of its kind. Write: Premier College of Technical Metaphysics, 2532 McKenzie St., Vancouver, B.C., Canada.

**PHOTOGRAPHY For pleasure or profit.** Learn at home. Practical basic training. Long established school. Free booklet. American School of Photography, 835 Diversey Parkway, Dept. 3436, Chicago 14.

**A College B.A. and M.A. degree by home study.** State chartered. Fremont College, 915 Grand View St., Los Angeles 6, Calif.

**USED Correspondence courses and educational books bought, sold, rented.** Free catalog. Educational Exchange, Summer-ville, Ga.

**IT'S Fun** learning a language by Linguaphone. At home, in leisure time, quickly, easily you listen and learn to speak French, Spanish, German, Russian, Japanese — 29 languages by Linguaphone world's standard conversational method. Save time, money. Send for free book. Linguaphone Institute, 8310 Mezz., Rockefeller Plaza, New York 20.

**PRACTICAL Nursing** — Learn easily at home, spare time. Big demand, good earnings. High school not necessary. Write for free facts. Wayne School, Dept. FG-19, 2525 Sheffield, Chicago 14, Ill.

**MIT Graduate**, former MIT instructor, offers instruction by correspondence in drafting, blueprint reading, physics, and all levels of mathematics. Write for details. Technical Instruction by Correspondence, P.O. Box 69, Cambridge 39, Mass.

**PREPARE** For career in private investigation or public law enforcement work. Write for free booklet. National Detective Academy, 8038 North 30th Drive, Phoenix, Arizona.

**WINDOW Display** home course. Short-cut to an excellent job. Small investment, quick results. Free brochure. Pan-America Art School, 321 West 56th Street, New York 19.

**STRUCTURAL Drafting**. Drawing outfit furnished. Roth Technical Institute, Box 2283, Youngstown 4, Ohio.

**WANT A diesel job?** New opportunities to increase income. Higher pay. More money. We can help you qualify. Tools. Shop method home training. Write today! Diesel, Tractor, Heavy Equipment Division, Interstate Training Service, Dept. B3 K, Portland 13, Oregon.

**COMPLETE** Your high school at home in spare time with 55-year-old school. Texts furnished. No classes. Diploma. Information booklet free. American School, Dept. X745, Drexel at 58th, Chicago 37, Ill.

**HIGH School** — No classes. Study at home. Spare time. Diploma awarded. Write for free catalog HF-37, Wayne School, 2527 N. Sheffield, Chicago 14, Ill.

**WANT U. S. gov't. job?** Men-women, 18-55. Start high as \$316 month. Qualify now! 30,000 jobs open. Experience often unnecessary. Get free 36-page book showing jobs, salaries, requirements, sample tests. Write: Franklin Institute, Dept. F-24, Rochester, N. Y.

**INCREDIBLE!** Become mental superman overnight! Free booklet! Bijou, Box 1727-MA, Hollywood 28, California.

**SMASH** That old worry habit and become what you desire. Our amazing home-study plan benefits all or no cost. Exciting lecture sent free. No obligation. Write Personal Psychology, Inc., Box 1924-E, Louisville 1, Ky.

**TELEGRAPHY** Learned easily. New teaching machine. Moderately priced. Illustrated circular. Harris, 9534-P Lem-turner, Jacksonville 8, Fla.

**START A buying service**, buy wholesale thousands nationally advertised products. Make big profits selling at sizable discounts. Postcard brings details. American Buyers, 633-DD Linden, Buffalo, N. Y.

**SELF-Help** courses, folios, manuals composed. Ralph Underhill, Beebe, Arkansas.

**MIDLAND Linotype School**. Charles City, Iowa. Civilian and Veteran Courses. Free placement. Established 1909.

**CORRESPONDENCE** Courses, educational books, bought, sold, rented, exchanged. Lists free. Magnolia Press, Box 1272-P, Burbank, Calif.

**BE A real estate broker**. Study at home or in classrooms in leading cities. Write for free book today. G.I. approved. Weaver School of Real Estate, 304 Law Bldg., Kansas City, Missouri.

**EARN** While you learn. Auto and diesel mechanics master this top paying trade. Many graduates earn \$100 a week and up. Approved for Korean veterans. For free information write Dept. No. 256, Nashville Auto-Diesel College, Nashville 3, Tenn.

**HOME** Study course, drugless therapy. Free literature. Institute of Drugless Therapy, Tama, Iowa.

**MEDICAL** Laboratory technicians in great demand. We train you in your own home. Catalogue free. Imperial Technical Institute, Box 973-J, Austin, Texas.

**SECRET Investigation**. Experience unnecessary. Investigators particulars free. George Wagner, M125 West 86th, New York 24.

**INVESTIGATOR Training**. Phillips Secret Service System, 1917-B North Ken-neth, Chicago 39.

**BOOKKEEPERS!** Increase your earnings! Operate your own simplified "Dollar-A-Week" bookkeeping and tax service. Full or spare time. Details free. No obligation. Ellis, Box 200, Cedar Grove, North Carolina.

**USED** Correspondence courses and books sold and rented. Money back guarantee. Catalog free. (Courses bought.) Lee Mountain, Pisgah, Alabama.

**PLANNING** Your career? Which job? Which school? Aptitude, personality tests give scientific answers. Details free. Guidance Associates, 1714M Ocean Parkway, Brooklyn 23, N. Y. Established 1938.

**MAKE** Motion pictures a fascinating career—A paying hobby! Learn at home. Television, Hollywood, free lance films. Interesting, 6 week, approved course. Free catalog. Motion Picture Institute, Birmingham 6, Michigan.

**LEARN** Drafting. Fastest method. Low cost pay-as-you-learn plan. Drafting equipment furnished. Top grade industrial instructors. Free catalog. Cesco Industrial Training Services, 1704-A Frederick, Fort Worth 7, Texas.

**FOREMANSHIP**—Learn basic rules of human relations and worker instruction. Complete report \$2.00 postpaid. Satisfaction guaranteed. Write now. Hawthorne School, 27A Andrews St., New Britain, Conn.

**NEW TV stations** starting every day. Accepted scripts bring big money. Learn how to write them from "TV Script Manual" and "Writing Guide Manuscript," lists 100 cash-buying markets. Write for information National Writers, P.O. Box 1612, Oakland 4, California.

**SIMPLIFIED** Analytic method teaches algebra instantly; \$1—Guaranteed. Zlem-bek, 6123 Orchard, Dearborn, Mich.

**3800 LATEST** Used correspondence courses catalog \$1.00. 130-pound barbells, \$19.50. EG, Elmsford, N. Y.

#### PLAYS, STORIES, MANUSCRIPTS

**I Want new writers**. Experience unnecessary. Earn at home, spare time. Details free. Saunders Cummings Institute, P.O. Box 17006, Studio M11, Los Angeles 17, Calif.

**TYPING:** Expert and expeditious. Editing. Manuscript Service, 1533 East Boulevard, Cleveland 6, Ohio.

**POETS!** Send your lyrics to a published poet for honest, professional criticism. \$1 each. Miller, Apt. 8, 45 W. 88 St., New York City.

**BEGINNING** Writers: Get \$1 to \$20 checks daily writing simple children's stories, articles, poetry in your sparetime. Experience unnecessary. Our instructions reveal how. Details free. W. Herman, 7016 Euclid, Cleveland 3, Ohio.

**NO Luck** finding a book publisher? Write for free Booklet PM. Vantage Press, 120 W. 31, New York.

#### SPECIAL SERVICES

**INFORMATION** On any matter. Ferguson Research, 116-14 141 St., South Ozone Park 36, N. Y.

**LETTERS** Retailed from Boston 25c each. Clinton Libby, 239 Atherton, Milton 86, Mass.

**SMALL** Business simplified bookkeeping system by public accountant \$5.00. V. Snyder, 102 N. Vernon Ave., Newark, Ohio.

**INFORMATION** And other research service. Any kind. Fee \$2.00. H. Smith, 210 5th Ave., New York 10, N. Y.

**TRANSLATION**. Business or private. English and Spanish. Write Butler, 5327 Shattuck, Oakland, California.

**ELECTRICAL** Layouts and specifications. Drafting, residential, commercial, industrial. Miller, 1011 W. 16th, Davenport, Iowa.

**PRIZE** Contests feather the nests of thousands! Confidential, legitimate, prize-winning service! Send stamp. National Contest Bulletin, Box 2685-P, Miami 16, Fla.

#### CARTOONING, COMMERCIAL ART, SHOWCARD WRITING, SIGN PAINTING

**CHALK** Talks. Laugh producing program, \$1.00. Catalog 10c. Balda The Cartoonist, Oshkosh, Wisconsin.

**PAINT** Signs for profit. Biggest complete course with 324 illustrations. 18 in colors. Only \$5 postpaid. Descriptive circulars free. E. C. Matthews, 2325 Cass, St. Louis 6, Mo.

**FREE** Sample cartooning lesson. No obligation. Box 10074M, Knoxville 16, Tenn.

**9 ALPHABET**, 3 Numeral pattern sets and raised wood letter catalog, \$1.00. Sign Letter Distributors, P.O. Box 101, Mineola, N. Y.

**YOU** Can learn to draw the body beautiful from pictures. Take as many lessons as you wish. Stop whenever you like. Your drawings corrected. First two lessons with drawing material \$1.00. Clapham Art Institute, 8214 Frankford Avenue, Philadelphia 36, Penna.

**"HOW** To Make Money With Simple Cartoons"—A book everyone who likes to draw should have. It is free; no obligation. Simply address Cartoonists' Exchange, Dept. 910C, Pleasant Hill, Ohio.

#### ADVERTISING AGENCIES, LETTER WRITERS, FOR ADVERTISERS

**ADVERTISING** Consultants, artists, copywriters. Reasonable prices. Advertising Unlimited, Burlington, Wisconsin.

**500 CIRCULARS** Mailed first class mail with others \$1.00. Israel Company, Dept. 26, 6051, Washington 5, D. C.

**NEW** Mothers' names, 1000-\$3.00. Sample sheet 3c. Jim Prince, 924 North 7th, Paducah, Ky.

**ADVERTISE:** 24 Words, 100 Canadian newspapers \$5.50. Lists free. Advertising Bureau, 10511-C Springfield, Chicago 43.

**GET** Thousands of dollars worth of national advertising for your new product, for only a few dollars. Williams Agency, 1117-C Investment Bldg., Pittsburgh 22, Penna.

**ADS** Placed in out of town newspapers and magazines. Low rates. Catalogue free. Ideas that pay. Baker Advertising Agency, Successors Ankrum Agency, 189 W. Madison, Chicago 2.

**MAILING** Lists, most any kind you need, 1000 \$5.00 up. Free prospectus. Dixie Mailers, King, N. C.

**MAILING** Lists; many classifications. Literature free. Richard Dunlap, Box 1046, Colorado Springs, Colo.

**ADVERTISERS!** Reach nearly 18,000,000 readers. 25 Sunday national key newspapers, 18 words, \$59.00. "Terrific pullers." 20 popular newspapers, \$11.50. Free booklet. Special—One inch display 2,-821,198 circulation. \$51.10. Newmark's Advertising Agency, (Established 1893), 217-7th Ave., New York 11.

**FREE** Copy, layout service. Mailorder ad, 1,700,000 nationwide circulation, \$27.30 inch. 24-word classified, 20 big Sunday newspapers, \$30.00. Advertising ratebook free. Chicago Advertising Agency (established 1900), Chicago 4.

**FREE!** 1953 Advertisers Rate and Data Directory. 52 pages! E. H. Brown Advertising Agency, 20 N. Wacker, Chicago 6.

**DECALS!** Decals! To advertise or identify your product or service. Printed to your copy. Catchy designs, low price, folder free. Grand, 2506M-52nd, Kenosha, Wis.

#### RUBBER STAMPS AND OFFICE SUPPLIES

**RUBBER** Stamps. Send for catalog. Excello, Box 500, Shreveport, Louisiana.

**3 LINES**, \$1.00. Fast service! Catalogue. Johnson Press, Box 6-A, New York City 26.

**NOW!** Protectograph checkwriter. Free literature. \$21.95 postpaid. Write. Model Service, Box 777A, St. Louis 1, Missouri.

**3 LINE** Pocket stamp \$1.00. Made to order stamp and ink pad \$1.00, postpaid. Ball point pen free with order. Send for free catalog. Esco, 103 Print, Dayton 7, Ohio.

**LINE** 25c; 2-45c; 3-65c. Stamp Works, Auburn, Nebraska.

#### TYPEWRITERS, DUPLICATORS, OFFICE DEVICES

**GUARANTEED** Check protector—Inks, perforates. \$3.95. Denison Enterprises, 760-H Hippodrome, Cleveland 15, Ohio.

**RECONDITIONED** Typewriters, duplicating, printing devices. \$25.00 up. Supplies. Appliances. DixieGraph, King, N. C.



## PRINTING, MULTIGRAPHING, MIMEOGRAPHING GUMMED LABELS

GIVE Personalized stationery for Christmas—3c stamp brings samples. Franson, Box 3763, Kirkwood 22, Missouri.

FREE—New offset printing price list. Fidelity Company, Princeton 1, W. Va.

1000 BOND Letterheads, 5½ x 8½, \$6.00 postpaid. Free estimates. Mangum Pub. Co., Mangum, Okla.

MIMEOGRAPHING Circulars, letters, booklets. Free samples. Publicity, Kalamazoo 26DA, Mich.

BEAUTIFUL Two color raised print business cards. Dignified, appealing. Send for samples, prices. J. Hampton, 601½ N. Main, Wichita, Kans.

100 LETTERHEADS, Envelopes or business cards, carefully printed \$1.00. Postpaid. Race Printers, Hudson, New York.

500 ENVELOPES \$2.85 Postpaid. F. Doerr, 220 84th, Niagara Falls, New York.

MIMEOGRAPHING Any copy, colors. Eagle Publications, 849 Monmouth, Gloucester, N. J.

PRINTING That pleases. Send copy for estimate. Samples, prices. Mercury Press, Box 69M, Marengo, Iowa.

FREE Catalog, samples, letterheads, envelopes, 95c hundred. Weco, Box 8717, Fort Worth, Texas.

PRINTING. Booklet and publication specialists. Guaranteed. Merchants Press, Taylor, Texas.

100 PRINTED Envelopes or letterheads \$1.00. Two colors \$1.50. Salesbooks. Broadbrook, Botsford, Conn.

EMBOSSING Stationery adds prestige. Like engraving. Salem Print, 3131 Salem, Dayton 6, Ohio.

LETTERHEADS, 8½x11. 12 Designs, \$3.50 up. D'Yarmett Printing, Newark, Ohio.

MIMEOGRAPHING—Pricelists, letters, instructions. Free samples, prices. Loyal Brush, 3712 Walnut, Kansas City 11, Mo.

100 ENVELOPES Or letterheads \$1.00. Printing, 21 Barclay Ave., Portsmouth, Va.

YOU Need quality printing. Satisfaction guaranteed. Catalog 10c (refundable). Beaver Press, Box 268B, Maynard, Iowa.

1000 EMBOSSING Business cards \$3.00 postpaid. Free samples and printing prices. Write: Lites, 5352-PM South Princeton Avenue, Chicago 9, Illinois.

100 8½x11 HAMMERMILL Letterheads and 100 envelopes \$1.95 postpaid. H. Hudson, Centredale, R. I.

MIMEOGRAPHING—Letters, pricelists, formulas, instructions. Lowest prices. Lem's Letter Shop, 5710 Stanton, Detroit 8.

500 ¾x2¼ FOUR Line gummed stickers \$50c. Red border \$1.00. Moritz Printery, Saginaw, Mich.

100 8½x11 LETTERHEADS, 100 6¼ Envelopes, \$2.00. 250 each, \$3.75. 500 business cards \$1.95. 1,000, \$2.50. Postpaid. Allen, Dept. PMP, Clinton, Missouri.

100 LETTERHEADS (8½x11) Or envelopes \$1.00 postpaid. William A. Jones, Mineola, New York.

BUSINESS, Personal stationery. Catalogs free. Howprint, 723-M Eunice, Webster Groves 19, Missouri.

MIMEOGRAPHING—Anything! 200, 8½x11, \$2.00; 500, \$4.00; 1000, \$6.00. Guaranteed. Free samples. Quinn Sales, P.O. Box 967, Little Rock, Ark.

ATTRACTIVE Labels, stickers. Inexpensive. Samples. Fame, 291 Ellis, San Francisco 2, Calif.

## PRINTING OUTFITS AND SUPPLIES

PRESSES, Supplies, paper. Catalog 10c. Custom, Box 211-P, Springfield, Missouri.

MAKE Your own self-molding rubber printing cuts. Plexirubber, Argyle 1, Wis.

BEGINNERS Instructions, many illustrations, 25c. Malibu Press, Box 43, Malibu, Calif.

HAND Presses, small paper cutters, type cases, etc. Visit our store. Van Dillen Inc., 74 Beekman St., New York City.

DO Your own printing. Save money. Simple rules. We supply everything. Print for others; good profit. Raised printing like engraving too. Have home shop. De-tails free. Kelsey Presses, V-11, Meriden, Connecticut.

PRINTING Presses, type, supplies. Lists 3c. Turnbaugh Service, Loysville, Penna.

## PATENT ATTORNEYS

INVENTORS—If you believe you have an invention, you should find out how to protect it. The firm of McMorrow, Berman & Davidson with offices in Washington, D. C., is qualified to take the necessary steps for you. Send for copy of our patent booklet "How to Protect Your Invention." We will also send you an "Invention Record" form. No obligation. They are yours for the asking. McMorrow, Berman & Davidson, Registered Patent Attorneys, 134-W Victor Building, Washington 1, D. C.

INVENTORS—If you consider your invention to be something of importance, take steps to protect it with a United States Patent which gives you the right to exclude others from making, using and selling your invention as claimed. "Patent Protection for Inventors" outlines steps to take to secure patent protection. Mailed promptly without obligation. Victor J. Evans & Co., Merlin M. Evans, Registered Patent Attorney, 831-L Merilin Building, Washington 6, D. C.

INVENTORS: Learn how to protect your invention. Unless the inventor is familiar with patent matters, he should engage a competent registered patent attorney or agent to represent him. We are registered to practice before the U. S. Patent Office and prepared to serve you in handling your patent matters. "Patent Guide for the Inventor" containing detailed information concerning patent protection and procedure with "Record of Invention" form will be forwarded to you upon request—without obligation. Clarence A. O'Brien & Harvey Jacobson, Registered Patent Attorneys, 31B-K District National Building, Washington, D. C.

HERMAN Lewis Gordon, Registered Patent Attorney. Patent investigations and opinions. Invention record form furnished on request. Warner Building, Washington 4, D. C.

INVENTORS: When you are satisfied that you have invented something of value write me, without obligation, for information as to what steps you should take to secure a patent. Write Patrick D. Beavers, Registered Patent Atty., 935 Columbian Bldg., Washington 1, D. C.

PATENTS—Irving L. McCathran, 315 McLachlen Bldg., Washington 1, D. C. Registered Patent Attorney.

PATENTS. "Proof of Invention" free. E. E. Vrooman, Registered Patent Attorney, 507 McKim Building, Washington 5, D. C.

INVENTORS: Without obligation, write for information explaining the steps you should take to secure a patent. John N. Randolph, Registered Patent Attorney, 203 Columbian Bldg., Washington 1, D. C.

C. A. Snow & Co.—M427, Snow Building, Washington 1, D. C. Registered Patent Attorneys. Write for information.

"INVENTOR'S Guide" free. Frank P. Ledermann, Registered Patent Attorney, 154 Nassau Street, New York.

REGISTERED Patent attorney offers services. Sanders, 6430 Evans, Chicago 37, Ill.

INVENTORS—For "Invention Record" form, contact Carl Miller, Registered Patent Attorney, Woolworth Building, New York.

CANADA—Ramsay Company Registered, 273 Bank Street, Ottawa, Canada.

## FOR INVENTORS

PATENT Searches, no rush work, 10 day certified service by experts, \$8.00. No charge for patent sales contract, copy of U. S. patent laws, patent copies and protection forms, all forwarded free with report. Capitol Patent Service, 941 Maine Ave., S.W., Washington, D. C.

INVENTORS: Learn how to protect your invention. Unless the inventor is familiar with patent matters, he should engage a competent registered patent attorney or agent to represent him. We are registered to practice before the U. S. Patent Office and prepared to serve you in handling your patent matters. "Patent Guide for the Inventor" containing detailed information concerning patent protection and procedure with "Record of Invention" form will be forwarded to you upon request—without obligation. Clarence A. O'Brien & Harvey Jacobson, Registered Patent Attorneys, 31A-K District National Building, Washington, D. C.

INVENTORS—This firm is registered to practice before the United States Patent Office and is available to assist you in the preparation and prosecution of your patent application. "Patent Protection for Inventors" booklet containing detailed information and steps to take toward patent protection will be sent upon request. No obligation. Victor J. Evans & Co., 832-L Merilin Building, Washington 6, D. C.

PATENT Searches, \$5.00, including patent copies. Same reliable search as conducted for patent attorneys. Free protection forms, 48 hour service. Patent Service Institute, 945-A Pennsylvania Avenue, Washington 4, D. C.

INVENTORS—If you believe you have an invention, you should find out how to protect it. The firm of McMorrow, Berman & Davidson with offices in Washington, D. C., is qualified to take the necessary steps for you. Send for copy of our patent booklet "How to Protect Your Invention." We will also send you an "Invention Record" form. No obligation. They are yours for the asking. McMorrow, Berman & Davidson, Registered Patent Attorneys, 134-V Victor Building, Washington 1, D. C.

PATENT Searches \$5.00. 48-hour service. Inventions marketed and promoted. Free record of invention. Write Raymond L. Smith, Patent Searcher, 622 Sheraton Building, Washington 5, D. C.

GET The attention of manufacturers! Prepare your own pictorial graphic illustrations that show all advantages of your invention. Samples, information free. Graphics, 6217 Lodewyck, Detroit 24, Mich.

INVENTORS. Sell your invention. Write direct to manufacturers. Quickest way to sell your patent. 25 manufacturers' names and addresses. \$1.00. Million names to choose from. R. Coup, 1402 Craig Street, McKeesport, Penna.

PATENT Searches \$5.00. Reports airmailed within 48 hours. Inventions marketed. Free protection forms. Write Miss Ann Hastings, P.O. Box 176, Washington 4, D. C.

INVENTORS! For "Copyright, Design and Patent Guide" contact Mr. Metzler, 11 West 42nd, New York 18.

FROM One inventor to another: Is your invention ready for market? Complete service. Patent searches. Commercial evaluations. Industry contacts. Have licensed more than 60 of my own inventions to industry. Why not let me help you market yours? Free information on request. Jacquelin Harvey, Jr., Research Engineer, Realty Bldg., Washington 5, D. C.

STALLED! Ridiculous! Apply tested methods. Succeed! Write: Inventor, Doniphan, Missouri.

SAVE Money. Obtain patents yourself. Write for form G. Glen-Lea Company, Box 164, Valley Stream, N. Y.

PATENT Searches \$5.00. 48-hour airmail service. Invention protection forms free. Patent drawings prepared. Write Patent Engineering Service, 711 14th Street N.W., Washington 5, D. C.

MAKE Money from your ideas, gadgets, patents. Get "Inventors Guide." Helpful book tells you how. Send \$1.00, includes list of needed inventions. We have buyers. Inventors Creative Service, 554 South Spring, Los Angeles 13, Calif.

CASH For your idea, 280 manufacturers need inventions, patented or unpatented. List free. Invention Bureau, 208M Clinton, Oak Park, Ill.

INVENTORS—For "Invention Record" form, contact Carl Miller, Registered Patent Attorney, Woolworth Building, New York.

SEARCHES—Put your patent searches in the hands of a registered patent attorney or agent, as he qualifies to give a worthwhile patentability report. Record of invention form upon request and information on patent protection. Patrick D. Beavers, Registered Patent Attorney, 936 Columbian Bldg., Washington 1, D. C.

INVENTORS: If you have an invention for sale, patented or unpatented, write Institute of American Inventors, Dept. 40A, 631-E St. N.W., Washington 4, D. C.

INVENTORS: Information on patent procedure furnished on request, without obligation. John Randolph, Registered Patent Attorney, 202 Columbian Building, Washington 1, D. C.

I Sell patents. Established 1900. Charles A. Scott, 773PM Garson Avenue, Rochester 9, N. Y.

**INVENTORS**—Send for free patent information book and inventor's record. Registered Patent Attorney. Associate Examiner, Patent Office 1922-29; Patent Attorney & Advisor, Navy Department 1930-47. Gustave Miller, 93A Warner Building, Washington 4, D. C.

THE Air Force spends billions every year for its vast supplies; from boots to bombers, from rivets to radar. This equipment must be the best if our Air Force is to remain supreme. Your ideas may bring you handsome cash rewards if you follow a plan of action that will put your ideas to work. Our engineering staff is especially well qualified to advise you concerning the usefulness of your ideas to the Air Force. We have spent over fourteen years in close contact with the Air Force engineering and buying center at Wright Field. Let us send you, without obligation, our free plan for getting the biggest rewards for your ideas. Merely send your name and address on a postcard today to New Product Sales, 621 Hulman Building, Dayton 2, Ohio.

PATENT Office search including patentability report \$5.00. Protection forms free. Industrial Patent Reports, Box 6296, Washington 15, D. C.

### INVENTIONS WANTED

**CAPITALIZE** On your inventions. Use our manufacturing and marketing facilities. Careful confidential consideration given any inquiries at no cost. Kalamazoo Enterprise Company, 750 Whites Road, Kalamazoo, Michigan.

**INVENTIONS** Wanted. Patented, pending only. Inventors Patent Exchange, Hartford 1, Conn.

**INVENTIONS** Wanted. Patented; unpatented. Tremendous manufacturers lists. Global Marketing Service, 1404 Mitchell, Oakland 1, California.

**MARKETING** Aid—Nation wide. Patented, patent pending. Booklet free. Market Contacts, 719-A2 Magnolia, Tupelo, Miss.

**INVENTORS:** Hundreds of manufacturers have requested our assistance in locating marketable new products. Complete information free. Institute of American Inventors, Dept. 40-D, 631-E St. N.W., Washington 4, D. C.

**INVENTIONS** Promoted. Patented or unpatented. Established 1911. Write Adam Fisher Company, 61 Enright, St. Louis, Mo.

**CASH** Buyers for ideas and inventions. Write National Inventors Institute, 4097 East 131st St., Cleveland 5, Ohio.

**INVENTIONS,** Ideas, advertising specialties wanted. Submit complete details. Pyramid Company, Antioch, California.

**INVENTIONS** Wanted. Patented or patent pending. 23 years experience promoting inventions. National Service Bureau, 3120 Meramec, St. Louis 18, Mo.

**INVENTIONS** Bought or developed. Outright purchase or royalty. Complete manufacturing and sales facilities. Tri-Pak Machinery Service, Inc., P.O. Box 1228, Harlingen, Texas.

### PATENTS FOR SALE

**INVENTORS:** Test the commercial value of your patented or unpatented inventions, quickly and inexpensively. Write for free information. Institute of American Inventors, Dept. 40-B, 631-E St. N.W., Washington 4, D. C.

### MANUFACTURING

**WE** Design and build special machinery. Henry, Engineer, 2815 Blvd., Jersey City 6, N. J.

**INVENTORS,** Engineers, experimenters. Models built all types. Free estimate. Futuratre Engineering, Box 8, Parkville Sta., Brooklyn, N. Y.

**MANUFACTURING,** Model making, metal stamping, tools, dies, plastic molding, small or large quantities. Estimates cheerfully furnished. Allen, Dept. PMM, Clinton, Missouri.

**WILL** Manufacture wood or metal items to your specifications. Foundry, machine shop, welding, woodworking. Small or large quantities. Estimates furnished. Tri-Pak Machinery Service, Inc., P.O. Box 1228, Harlingen, Texas.

**MODELS**—Small lot manufacturing. Metals, plastics, etc. Milburn, Burlington, Kentucky.

### MODELS, MODEL SUPPLIES

**BUILD** Historic ships, vehicles. 50c to \$9.00 kits. Illustrated catalog 10c. Ideal Models, 21 West 18th Street, New York 11.

**LIVE** Steam engine, 10½" tall, ready-to-run, \$5.95 postpaid. Merlo, 50-18 94th Street, Elmhurst 73, New York.

**NEW** Tiny power catalog—manual. Steam engines, boilers, tractors, locos, fittings, castings, prints, plus many pages helps, suggestions, building, operation. \$1.00. New book, "Miniature Steam Boilers—How To Build Them," complete step-by-step instructions building three types copper boilers, flanging, brazing, etc. \$2.50. Chas. Arnold, Box 218, Corvallis, Oregon.

**POWER** Models. Unusual steam, gasoline and traction engines, fittings, metals. New catalog 50c. Chas. Cole, Ventura, Calif.

**MODEL** Steam engine or gasoline engine complete kit, castings, \$4.00 postpaid. Catalogue 10c. Lewis Machine Tool Company, Los Nietos, Calif.

1953 **CAR** Models. 1/25 scale, all metal, chrome trim. Send for catalog. Ajax Toy Co., Dept. PM-11, 2637 W. Division St., Chicago 22.

**SHIP** And other scale models. Most complete line in New England. Kits, fittings, plans, books, tools, engines, motors. Illustrated catalog 25c. James Bliss & Co., Inc., Dept. SM, 342 Atlantic Ave., Boston 10, Mass.

**SHIP** And yacht model fittings; blueprints. Send 25c for illustrated catalog No. 28—listing hundreds of items. A. J. Fisher, 1002-1 Etowah Ave., Royal Oak, Mich.

**ILLUSTRATED** Lionel catalog, 10c; American Flyer, 10c; H. O. gauge, 10c. Ben's PM Dept., 134 North Dearborn, Chicago 2.

**BALSA** Wood. Grade AAA. Free sample, price list. Sig Mfg. Co., Montezuma, Iowa.

**BIG** Train accessory catalog free. Shannon's, 503 Franklin, Nutley 10, N. J.

**AMERICAN** Military miniatures. Catalogue 25c. Bussler Miniatures, Dept. B, 59 Russell Park, Quincy 69, Mass.

10 **MICROMODELS** \$1.00. Jenid Imports, 558 Loring Station, Minneapolis 3, Minnesota.

### HOME CRAFTSMEN

101 **FULL** Size patterns. Smart new gifts, novelties, lawn figures, shelves, action windmills, alphabets. Plus "Make Money Jig Sawing." Only \$1.00. Mastercraft 105M, 7041 Olcott, Chicago 31, Illinois.

**MAKE** Attractive lamps and novelties. Silver glass jugs and bottles inside. Material inexpensive. Obtainable at drug stores. Formula and instructions \$1.00. Chas. Fane, Box 6202 Cimarron Station, Oklahoma City, Oklahoma.

**BUY** Wholesale nationally advertised power, hand tools, thousands other products at big discounts. Free wholesale plan. American Buyers', 628-RR Linden, Buffalo 16, N. Y.

**BIG** Full size patterns of Santa, sleigh and reindeer for roof or lawn. Complete directions for making, painting and lighting. \$1.00. Mastercraft 106M, 7041 Olcott, Chicago 31, Illinois.

**FIXIT** Design kit. Four precision tools make ideal gift. Compass, dividers, inside, outside calipers, plastic case, \$2.45. Blake, 210PM, 30 Shrewsbury, Worcester, Mass.

**BRASS** Rods. List free. Miller, 388 East 34 St., Brooklyn 3, New York.

52 **PATTERNS** And plans for Christmas novelties, toys, interior and exterior decorations \$1.00. C & E Specialties, Chippewa Falls, Wisconsin.

**LEATHERCRAFT**—New stylecraft folder free. New kits illustrated. Filigree belts, billfolds, purses, etc. Send 25c new catalog. Refunded first order. Apache Leather Co., 2804 East Washington St., Phoenix, Arizona.

**BLEACH** Furniture blond. Kit \$1. Complete with instructions. Send for free booklet. National Chemicals, Dept. 110, 3601 Bainbridge Ave., New York 67, N. Y.

"**VACATION** Daze" is an intriguing little wooden puzzle that will entertain and fascinate. Excellent gift for young and old. Easy to make. For full details and photograph send \$1.00 to Philip Jones, Shelton, Conn.

**IDEAL** Gift for the craftsman. Lawn furniture plans. 5, \$2.00. 10, \$3.50. 15, \$5.00. Complete instructions free. Decalcomania Summercraft Studio, Dept. C, Hampton, N. H.

93 "ORIGINAL Idea" jig saw patterns \$1.00. Professional drawing, quality printing. Full size shelves, toys, lawn ornaments, novelties. Walker Studio, PM-V10, 4343 Lindell, St. Louis 8, Mo.

**LEATHER,** Tools, lacings, supplies. Free catalog. National Handicraft, 199 William St., New York 7.

**SHOCK** Mount your power tools. Reduce noise, vibration. 8 mounts \$1.00 postpaid. Jamieson Industries, 2028 El Dorado Dr., Grand Rapids, Michigan.

**YOU** Cast anything with metal. Free literature. Castings, Box 124, Lynwood, California.

**PINE** Root for beautiful driftwood lamp. \$1.00 plus postage c.o.d. Instructions included. Gover's Sales, Sheridan, Michigan.

**PROFITABLE** Jigsaw patterns! Folder. Pauls, 2233A North 35th, Milwaukee 8, Wis.

89 **FULL** Size jig saw patterns of beautiful shelves, ornaments, toys, novelties. Plus "How, Where to Sell." Only \$1.00. Mastercraft 104M, 7041 Olcott, Chicago 31, Illinois.

**LEATHERCRAFT.** Tremendous stock of leather, tools, supplies, and kits. In leather business over forty years. Send 10c for big catalog. Sax Bros., 1111 No. 3rd, Dept. PM10, Milwaukee 3, Wisconsin.

**LAMP** Size cypress knee \$1.00. Cy Products, Dept. I, Lafayette, La.

**STERLING** Silver wire jewelry. Free illustrated directions for bracelets, pins, rings you can make yourself. Write Craft Service Department, Handy & Harman, 82 Fulton Street, New York 38, N. Y.

**LEATHERCRAFT** For pleasure or profit. Make easy-to-assemble purses, belts, gloves, woolskin toys, 100 other items for gifts or to sell. Send 10c today for big catalog. Largest leathercraft stock in U.S. J. C. Larson Co., 820 S. Tripp, Dept. 3550, Chicago 24.

90 **ALL** New, full size lawn ornament and novelty patterns, up to 20" high. Only \$1.00. Mastercraft 102M, 7041 Olcott, Chicago 31, Illinois.

**LEATHERCRAFT** Supplies. Pre-cut kits, tools, etc., large stock. Catalog 10c, refunded first order. Whitman Saddle Mfg. Co., 1725 Powers St., C-10, Cincinnati 23, Ohio.

\$46 **FROM** Square foot plywood; jigsaw necessary. Write: Woodarts, X-154, Bridgewater, Mass.

**LEATHERCRAFTERS:** Illustrated catalog shows everything you need 10c. Art Leather, 411 Joseph Ave., Rochester 5, N. Y.

**PLASTICS** Home-craft course for men and women. Tells and shows how to make hundreds of fast selling plastics products. All plastics and materials for 23 projects included in course. No special tools needed. Course pays for itself. Write for free booklet. Interstate Training Service, Dept. D3K, Portland 13, Oregon.

**HOW** To refinish your own furniture \$1. Krafters, Box 86, Hubbard, Ohio.

**GENUINE** Leather moccasin kit only \$1.75. The Tandy-Moc—Complete with pre-cut leather, lacing holes punched, lacing. Sizes 4 to 11. Colors: Turquoise, palomino, red, brown, and pearl. Send check or m.o. Free 48 page catalog on request. Tandy Leather, Box 397-M, Tulsa, Okla.

16 **NEW** Lawn chairs, 22 picnic tables, benches, trellises, etc. All 38 plans with necessary full size patterns. \$1.00. Mastercraft 103M, 7041 Olcott, Chicago 31, Ill.

"**TOPS**" In everything for leathercraft. Lowest prices. Genuine "Craftool" stamps. Catalog 10c. Crown Leather Company, 22 Spruce Street, New York 38.

**KNOCKDOWN** Cedar chests and lumber. Free price list. Bedford Lumber Company, Shelbyville, Tennessee.

**KNOCKDOWN** Cedar chests. Lumber and veneers. Free price list. Giles & Kendall Company, Huntsville, Ala.

**MINIATURE** Furniture kits. Colonial reproductions. Solid cherry. Catalog 20c. Culver Miniatures, 194 61st St., Dept. A, Niagara Falls, N. Y.

30 **LAWN** Ornament patterns. Ready cut. Full size. Color indicated. \$1.00 postpaid. Lincoln Craft Studio, Columbia, Conn.

**FREE Information.** How to make money with jig saw. Write Jigsaws, 117-M Worth, New York 13.

**LEATHERCRAFT.** Metal tooling, textile painting, beadcraft, shellcraft. Many other crafts. Send for free, big, illustrated catalog today! Kit Kraft, Hollywood 46, Calif.

**BIG Savings leather—Now,** for first time, you can buy full sides of top grain cowhide at our special, amazingly low "tannery-to-you" prices. For details, write Dept. 1. W. D. Byron & Sons, Williamsport, Md. Fine cowhide tanners since 1832.

**VIOLINMAKERS,** Amateurs, professionals, fine tone European wood. Materials, instructions, tools, patterns. Illustrated catalogue. 10c refundable. Premier Violin Supplies, Dept. VZ, 430 South Broadway, Los Angeles 13, California.

**200 ONE-Evening Projects** that you can start and finish in one evening! Popular Mechanics editors have assembled 200 projects to be made with only simple hand tools, in a few hours time. Each project costs only 1c. Order your copy today, \$2.00. Popular Mechanics Press, Dept. EP-2, 200 E. Ontario, Chicago 11, Ill.

**WHY Be puzzled by holiday gifts.** Start now to make practical and unique Christmas gifts in leather. We can supply complete materials, tools, patterns and simple step-by-step instruction books. Send 25c for new large illustrated catalog of leathercraft supplies. Nicewarner Leather Co., Dept. No. 8, 14-16 E. Chestnut St., Columbus 15, Ohio.

### MAKE IT YOURSELF

**BUILD A small compressor.** Use our precision made piston cylinder. Easily adapted for almost any use requiring air or liquid pressure. \$4.75 each. Colma, Inc., 70 Piedmont, Worcester, Mass.

**ELECTROPLATE** For pleasure or profit with new simplified process. Write Easyplater, Box 293-PM3, Red Lion, Penna.

**FLUORESCENT Workshop light.** Assemble yourself. Save dollars. Guarantee. Literature free. Vega Company, Box 5907, Chicago 80, Ill.

**ORNAMENTAL Iron porch railings.** Build your own. Complete plans. \$1.00. Befro, Box 45, Fond DuLac, Wis.

**H-BOMB Shelter,** build your own. Complete instructions for eight types. \$1.00. Seeley Products, 3038 Addison, Chicago 18, Illinois.

**BUILD Your own concrete block machine.** Easy. Inexpensive. Motor or hand. Also build mixer. Write C. Lee, Mountain View, Oklahoma.

**GRANDFATHER Clock** easily built. Big savings. See ad on page 314.

**BUILD A treasure and metal detector.** Lightweight, sensitive, inexpensive. Complete kits, free literature. Dept. 1, Electronic Applications, Box 4975, Washington 8, D. C.

**BUILD Your own tractor.** Free information. Eltraco, D-1, Camptonville, California.

**MELT Iron for castings.** Free literature. Ursutz Burner, Box 92, Globe, Ariz.

**SEND 25c Today** for new large catalogue of supplies for 21 popular crafts. Dept. D-11, Dearborn Leather Company, 8625 Linwood Avenue, Detroit 6, Michigan.

**BUILD 3 Bedroom rancher.** Large rooms. Fireplace. Only \$1200. Plans \$1.00. Mink-off, Box 52, Flushing, N. Y.

**"CONCRETE Block Homes."** 32-page booklet, on how to build. \$1.00. H. C. Lightfoot, Civil Engineer, Richboro 1, Penna.

### WATCHES, OLD GOLD, JEWELRY

**10 HIGH-Grade Swiss ladies' and gents' wristwatches** needing minor repairs. \$18.00. Write for prices. B. Lowe, Holland Bldg., St. Louis 1, Mo.

**5000 JEWELRY Styles** you can easily make yourself. Rhinestones, pins, earrings, etc. Lowest prices guaranteed. Instructions and catalog 10c. Barry's, 165 Ardsley Court, Newark, N. J.

**HIGHEST Cash paid** for old gold, jewelry, gold teeth, watches, diamonds, silverware, spectacles, platinum. Free information. Satisfaction guaranteed. Rose Smelting Company, 29-A East Madison, Chicago.

**WATCHMAKERS Journal** contains instructive articles for watchmakers and beginners. \$1.00 year. Sample copy 20c. Dean Co., Box 3218, Daytona Beach, Fla.

**KLONDIKE—Jewelry findings** swept from manufacturer's tables. Finished and unfinished parts for earrings, bracelets, necklaces, pins, etc. Sample pound \$2, 5 pounds \$7.50. Stones for rings, jewelry; 1000, \$5, sample 100, \$1.50. Lustre pearls, assorted sizes. \$2.50 lb., 5 lbs. \$10. Beads, imported assortment, \$1.50 sample pound, 5 pounds \$6.00. No c.o.d.'s. Satisfaction guaranteed. Merchandise Distributing Co., 19 E. 16 St., Dept. E-36, New York City 3.

**RHINESTONES.** Jewelry settings, cameo, sequins, beads. Send 10c for illustrated catalog. J & M Novelties, Dept. CL-3, Griffith, Ind.

**WATCH And clock repairing** books for hobbyists. Free information. North American, Dept. 13-K, 2320 N. Milwaukee, Chicago 47, Illinois.

**FIX Watches** for pay or pastime. Free sample lesson. Chicago School, Dept. PM-10, 2330 Milwaukee Ave., Chicago 47, Illinois.

**SET Imported rhinestones** in plated metal jewelry backs. Fascinating, profitable. Earn 100%. Manufacturer's catalog 20c. Bergen Arts, 128M Main St., Hackensack, N. J.

**FREE Wholesale list—Brass, gold, silver neck chain** and jewelry findings. Excellent values! Caraday, Box 71, Ryder Station, Brooklyn 34, New York.

**HIGHEST Prices** paid for old gold, silver, platinum, diamonds, watches, gold teeth, spectacles. Cash immediately. Goods returned if offer unsatisfactory. United Smelting Works (The Old Reliable), 39-B South State, Chicago 3.

**WATCHMAKERS'—Jewelers' complete** informative catalogue 20c. Bengale Company, Culver City, California.

**JEWELRY Making** can be a profitable hobby—Send 20c for our latest illustrated catalog. Milady-Fair Co., G.P.O. Box 1328, New York City.

**CASH For old gold, broken jewelry, gold teeth, watches, platinum, diamonds.** Popular Refinery Co., C. C. Hurley, Mgr., 216 East Ontario St., Chicago 11, Ill.

**UNREDEEMED Diamond, 1-carat, \$295.** 30-day refund. Free catalog. Broff's Diamond Loan Association, 411 Smithfield, Pittsburgh, Penna.

**CUCKOO Clocks** repaired. Beach's Clinic, 4055 S.E. Taylor, Portland 15, Ore.

### TOBACCO, SMOKERS' SUPPLIES

**PIPE Smokers! Cigar smokers!** Free illustrated catalog saves up to 50% on choice imported, domestic pipes, cigars, tobaccos, supplies. Write Wally Frank, Dept. 209, 150 Nassau St., New York 38, N. Y.

**HAND Made cigars.** Write for price list. Ideal Supply, 1903 Nebraska, Tampa M, Florida.

### RAZORS, BLADES, SHARPENING

**GUARANTEED Blades** 100, \$1.00; 300, \$2.50; 500, \$3.50. \$20 electric shavers, \$4.95. Paul Hollman, 6308 S. Throop, Chicago, Ill.

**XMAS Special ball pen.** 100 double edge razor blades; guaranteed \$1.00. Payne, 5426 5th Ave., Los Angeles 43, Calif.

### FOR THE HOME

**FOAM Rubber utility pad,** app. 20"x22"x 1". Suitable for car, boat, or home use. Factory seconds special \$2.00. Edwin Bowditch, Bloomfield, Conn.

**CHAIRS, Stools, cedar wardrobes, chests, juvenile furniture, cherry tables.** factory to you. Illustrated price list free. Southern Craftmasters, Columbia, Tennessee.

**TERMITES.** Treat them yourself, save hundreds of dollars. Send \$1.00 for booklet. Money back guarantee. J. R. Wynne & Co., 426 Transportation Bldg., Cincinnati 2, Ohio.

**FOAM Rubber furniture cushions.** Factory seconds. 50% discount. Prices free. Perma-Foam, 140-C Main Street, East Orange, New Jersey.

### OF INTEREST TO WOMEN

**NYLONS 8c Pair; anklets 12c pair; socks 9c; print 17c; panties 12c; dresses 1.95; slips 47c; undershirts 17c; rugs 70c; robes 1.65; spreads \$2.65; \$70.00 watches, \$18.95; jewelry sets \$1.25; pens 8c; combs 1c; aspirin \$1.00, 1,000; brushes 9c; razor blades 5-2c; electric razors \$2.00.** Complete stock list, picture catalogue, 25c if sent immediately. Sibert's, Chattanooga 4, Tenn.

**GIFTS And gadgets galore.** Free catalog. The Gift Fair, 2641 W. Walton St., Chicago 22.

**JAPANESE Doll,** hand made. Beautifully decorated. Sure to please. \$8.95 postpaid. Inquiries invited. M. Tsuji, Tokyo, Japan, YoYoGi, P.O. Box-21.

**TWO-Fold opportunity—1.** Restore, preserve original lustre and beauty of your furniture. Wonder-Wax, homogenized all purpose polish, cleans, waxes and polishes in one application. Special offer, regular \$3.00 value, 1/2 gallon for \$2.00 with this ad postpaid. Money back guarantee. 2. You can tell and sell your friends and neighbors this wonderful polish. Make 100% profit. Write for details. Wonder-Wax, Post Office Box 5508, Cleveland 13, Ohio.

**TWELVE Pair full fashioned nylons** \$2 prepaid. Nelson Hosiery Sales, Greenville 5, Alabama.

**DOLL Shoes,** genuine leather, send dollar-quarter outline foot, color preference. Baker, 305 Monroe, Jefferson City, Mo.

**FREE Sample! World's finest, French-type perfumes.** Wholesale only! Elliott-Stuart Limited, 4616-A Hollywood Boulevard, Hollywood 27, California.

**PROFITABLE Home business.** Make fast-seller chenille monkey trees, dolls, flowers. Terrific holiday demand. Information free. Velva, Bohemia 16, N. Y.

**DRESSES, 24c; Shoes, 39c; men's suits, \$4.95; trousers, \$1.20.** Better used clothing. Free cat. Transworld, 164-D Christopher, Brooklyn 12, N. Y.

**DOLLS,** Buy direct from manufacturer. Doll hospital. Save half. Information free. Peggy's Doll House, Jefferson City, Missouri.

### FOR SALE—MISCELLANEOUS

**SAVE Money** on army, navy and factory surplus. Write today for new 60-page illustrated catalog. Tennusa Sales Co., Dept. C, 1451 Market, Chattanooga, Tenn.

**GERMAN Pocket knife.** Two, top quality blades. Satisfaction guaranteed or money refunded. \$3.50 postpaid. Hepner, Box 1905, Huntington, W. Va.

### WANTED—MISCELLANEOUS

**WILL Buy** presidential campaign buttons. Levinsohn, 9952-66 Road, Forest Hills, N. Y.

**QUICKSILVER—Highest prices paid.** Free containers. Wholesale Terminal, Norwood, Massachusetts.

**SCRAP Mercury (quicksilver) containers** supplied—Tantalum, bismuth, tungsten. Metallurgical Products Company. Established 1909, 35th and Moore Sts., Philadelphia 45, Penna.

**WANTED Saw filer and grinder.** Box 574, Pearl River, N. Y.

### PERSONAL

**REMAIL, Airmail, P.O. Box 455,** Port of Spain, Trinidad, B.W.I. One dollar, two letters.

**AROUND The world remailing,** Chicago 25c. Business and personal address. Letters relay from other cities 75c. Full details 10c. C. Macks Mailorder, 5656 N. Hermitage, Chicago 26, Ill.

**LETTERS Remailed 25 cents.** DeWitte, 2694 17th St., Sarasota, Florida.

**LETTERS Remailed** from beautiful Tia Juana, Mexico or San Diego, California—\$1.00 each. Bob Tato, Box 13002, San Diego 13, Calif.

**MEXICO—Letters remailed 25c (stamps).** Vazquez, Apartado 25960, Mexico, 12, D.F.

**PARTNERSHIPS.** "How to start a business partnership and how to withdraw without losing your shirt." Includes practical partnership information. Helps settle partnership arguments. Booklet form. Copyrighted. Price \$2.00 (currency). Satisfaction guaranteed or money refunded in five days. Fox Business Publications, Box 1265-A, Peoria, Ill.

**SOUTH Africa.** Letters remailed. Air \$1 each. Sea 3 for \$1. Cash. Bengis, Box 2796, Cape Town, So. Africa.

**HONOLULU—Letters remailed 25c; 5 color viewcards \$1.00; want ads \$1.00; receiving address \$2.00 monthly.** Jones, 1244 Nakuina St., Honolulu 17, Hawaii.

**LETTERS Remailed** San Francisco, Stanford University or Palo Alto post marks, 25c. Walter A. Wood, Box 815, Los Altos, Calif.

**CLEVELAND 1**, Ohio remail, 25c. Classifieds airmailed, \$1.00. Ford Thompson, Box 6773.

**NEW Orleans** remails 25c, private receiving address, scenic postcards. Rapp, 1527 Pace, New Orleans 14, La.

**LETTERS Remailed** San Francisco postmark 25c. Private receiving-forwarding address available. Shanks, Box 3110, San Francisco 19, California.

**BIBLE** Reveals time of end. Free. Write: Harvest, Jefferson City, Missouri.

**ITALY** Postmark! Letter reairmailed from Rome, Naples, Florence, Venice or Milan, \$1.00. Five Italian photocolor postcards, \$1.00, remailed free. Mondino, Sabotino 2, Milan, Italy.

**MIAMI**, Hollywood, Fort Lauderdale. Letters remailed 25c, post cards 15c. Confidential receiving-forwarding address. Dorothy Comito, 4423 N.W. 23rd Court, Miami, Fla.

**JACKSONVILLE**, Florida, remails 25c. Harris, 9534-P Lemturner, Jacksonville 8, Fla.

**LETTERS Remailed** 25c. Private receiving-forwarding address available. Hicks Service, 5216 Just Street, N.E. 303, Washington 19, D. C.

**"HOW Can I find out?"** You can! Information confidentially developed. Any matter, person, problem. Worldwide. Officially licensed. Established 1922. William Herman, 170 Broadway, New York City.

**GET 40-50**. Or more, smooth shaves from one double-edge blade resharpened by the Blade Master! Unbelievably inexpensive. Send for literature. General Products Sales, Passaic, New Jersey.

**UNITED Nations**—New York remailed 25c. U.N. stamps, French, 25 Cornelia St., Brooklyn 21, N. Y.

**APPRAISE** Your old stock, bond certificates. You may be worth a million and not know it. Write: Tom Dougherty, Box 88J, Vannuys, Calif.

**CHICAGO** Mailing address, centrally located, lowest rates. International Mail-trade, 125 South Market Street, Chicago, Illinois.

**POWER!** Through psychology! Free outline. Box 8621-D, Hollywood 46, Calif.

**OLE Virginia**, letters remailed 25c, 5 scenic cards \$1. Enterprise MS, Box 875, Newport News, Va.

## MISCELLANEOUS

**LEATHERCRAFT**. Everything needed by beginners, advanced hobbyists and professional leatherworkers. Largest stock of supplies in U. S. Moderate-priced tooling leathers, top quality calfskins, tools, supplies, kits. Send 10c for big catalog. J. C. Larson Co., 820 S. Tripp, Dept. 3251, Chicago 24.

**RECEIVE** Mail, samples, magazines, catalogs, 10c. American Directory, Calallen, Texas.

**GERMANY!** A to Z export-import directory. 65,000 manufacturers addresses, 9,800 products. English index of commodities. \$8.00 pp. J. M. Burke, P.O. Box 248, Manchester, Mass.

**LABELS**. Small corrugated cartons. List 10c. Smith's, Box 6572, Los Angeles 55.

**STOKER** Owners attention. Save \$2.00 to \$4.00 per ton on fuel. I do. Details \$1.00. Woody, Box 420, LaCrosse, Wis.

**PORTRAIT** Painted from your photograph, 11"x14" \$3. Prompt service. Kates, P.O. Box 7903, Philadelphia 2, Penna.

**"X-RAY Mind."** Entire course. Adults. Inquire. Send dime. Krishnar Institute, 1912 Lincoln-Park-West, 240-SZ, Chicago 14.

**300 BIG** Mails guaranteed. Samples, plans, offers, propositions, 12 months listing, \$1.00 refundable. Wright Publications, 2270 Hubbard, Memphis 8, Tenn.

**ANGEL** Chimes-Swedish. Brass-coated aluminum. Four candle. \$2.25. Ten candles 75c. Brick House, 3411 Sheridan, Des Moines 10, Iowa.

**SEPTIC** Tanks, cesspools, toilets, cleaned, deodorized with Tru-Septic. No mixing, no bother. Guaranteed. 4 treatments costs only \$1.75 at your dealer, or order direct. Earl Young Co., Encino, California.

**PENMANSHIP** Courses. Improve your writing quickly. Learn shaded writing. Greeting cards, name cards, elegantly written. Free descriptive literature. Write: Tevis, A-25, Chillicothe, Mo.

**FREE** Catalog organic dates, figs, nuts, honey. Tontz, Elsinore, Calif.

**HEARING** Aid batteries, wholesale. Free list. Habs, Box 51, York, Penna.

**LEVEL** Land for irrigation. Advisory service. Loren Williams, P.O. Box 91, Wil-lows, Calif.

**WRITE** Your name in raised gold, silver, copper. Complete kit \$1.00 postpaid. Nu-Man-Co, Denver, N. Y.

**UNIQUE** Playing cards. Life-like. All different. Brochure free. Beaumart's, Box 608B, Morristown, N. J.

**BOYS**, Girls, adults who wear T shirts send 25c for 10 Van Tasy dry transfers, press them on with a hot iron. Size 2 square inches, color red. J. P. Lesley, Sunset, S. C.

**PICTURES**—Jesse James robbed the train in Missouri. 8x10 actual photograph \$1.00 postpaid. Box 124, Flat River, Mo.

**MAKE** Blueprints with sunlight—Low price machine for small shops, students etc.; electronic models available. Free folder. Griffin Special Machines, 5145 Martin Road, Muskegon, Michigan.

**BARGE**—All purpose cement. For wood, glass, rubber, steel, etc. Solid sticker or money back. Large tube 75c postpaid. Lynn Sales, P.O. Box 218, Newark, N. J.

**HOME** Owners and professional people. Do you have trouble getting the signs that you need? Write Rod Krieger Enterprises, Coloma 22, Michigan.

**DO** You think that people can safely follow the teachings of the Bible? Write for free literature. Mar-Sav, Box 5152 Industrial Station, St. Paul 4, Minn.

**HAIRCUT** As you like it. Booklet explains. 25c. Mastrolia, 32-20BT 89th Street, Jackson Heights 69, New York.

**COTTON** Bolls from Texas. Large fluffy bolls of fleecy staple, \$2.00 per dozen postpaid. Cole Family, Box 992, Greenville, Texas.

**6 NEW** Ties, \$5.00. Regular, \$2.00 each. Ed Bennington, 3L2, P.O. Box 1051, Tacoma, Washington.

**INCREDIBLE!** Become mental superman overnight! Free booklet! Bijou, Box 1727-MA, Hollywood 28, California.

**SMASH** That old worry habit and become what you desire. Our amazing home-study plan benefits all or no cost. Exciting lecture sent free. No obligation. Write Personal Psychology, Inc., Box 1924-M, Louisville 1, Ky.

**BUY** Wholesale thousands nationally advertised products at big discount. Free wholesale plan. American Buyers, 631-DD Linden, Buffalo, N. Y.

**LOCATE** Hidden treasure, distinguish minerals from metals with the Model 100 Detector. Weighs 5 pounds, extremely sensitive. Factory assembled \$79.90 or kit form \$39.90. Free literature. Dept. P. Electronic Applications, Box 4975, Washington 8, D. C.

**FUN**. Eat with chopsticks. Surprise your friends. Easy instructions, 2 prs. imported chopsticks, \$1.00. Oriental recipes free. Extra prs., 25c each. Satisfaction guaranteed. K. Kendall, 501 E. Norman, Arcadia, California.

**EXCHANGE** 3 New neckties or 10 pocket novels 50c. Buy best 3 Mate nylons \$1.25 or 3 beautiful new neckties \$1.00. 1000 names 25c in four. Barr's Mail Buyer's Directories, Box 861, Milwaukee, Wis.

**100** BLADES \$1. Big mail 10c. Box 970A, Milwaukee, Wis.

**BIG** Mails, magazines, samples, offers, propositions. Listing 25c. Provence Publications, 3708 W. Lexington St., Chicago 24, Ill.

**SELL** Mechanics' aprons; \$1.39 value, swing pocket plus 2 more. Choice blue denim, striped, unbleached 36 length. Save on grouping orders. Dozen \$10.00; six \$5.50; sample \$1.00. Postpaid. Rapid Service Garment Corp., Chicago, Ill.

**BE** A citizen of Texas. Honorary appointment. Passport included. Impress your friends, \$1. Tex, 1209 Calhoun, Houston 3, Texas.

**TARNISH**-Resistant replating, trays, pitchers, anything. Send name, size. Harris, Clayville, N. Y.

**GOLD** Prospecting catalogue—Listing maps, pans, mineral books, gold machine blueprints. Gold panning lesson free. Old Prospector, Box 729D9, Lodi, Calif.

**HELP** Poor circulation, nervous tension. Free folder. Gyro-Belt, Upper Darby 7, Pennsylvania.

**RECEIVE** Magazines, samples, catalogues. Mails from everywhere. Offers hundreds, larger listing 35c. Rorick, Box 86, Cincinnati 26, Ohio.

**SLIDE** Rule with free 28-page instruction book. Multiplying, proportion, division, roots, etc. A, B, C, D, C1, and K scales. Everyone can use. Full 10". Special 92c plus 8c postage. Gene P. Loewy, 545 Fifth Avenue, New York 17.

**BE** The Popular Mechanics representative in your neighborhood and earn big profits in your spare time. Write Popular Mechanics Magazine, Room 408M, 200 E. Ontario St., Chicago, Ill.

**WHY** Pay retail prices? Get catalog showing nationally advertised merchandise at discounts. 25c. Budd Supply Co., Dept. 28, 918 St. Paul St., Baltimore, Md.

**CIGARETTES**—Roll 200 mild, tasty, guaranteed to please for 75c. Details free. Pete Moberly, Box 857, Owensboro, Ky.

**SELECTIVE** Metal and mineral detector. Revolutionary design. Distinguishes metals from black magnetic sands. Readily detects metals under salt water. Also Geiger counters. Free literature. Gardiner Electronics Company, 2018 N. Dayton, Phoenix, Arizona.

**TREASURE** Finders for gold, silver and minerals. Money back guarantee, best available. Also Geiger counters for uranium prospectors, free information. Write Goldak Company, 1541 West Glenoaks, Glendale 1, Calif.

**STUDY** For game warden, park, fish, forestry, lookout, guide, wildlife conservation, immigration and highway patrol service. Details free. Write Delmar Institute, C5, Whittier, Calif.

**FASCINATING**. Practical book for the hunter and trapper. Guide to Good Hunting and Trapping lists all popular game animals, tells how to hunt and trap them. Many articles written by famous guides and well-known sportsmen. Author Joe Godfrey is famous sportsman, founder of Sportsman's Club of America. 160 pages, \$3.00. Popular Mechanics Press, Dept. 90, 200 E. Ontario, Chicago 11, Ill.

**TREASURE**—M-Scope Geiger counters, mineral locators. Why buy something inferior when you can buy the best at a lower price? Backed by years of experience. Fully guaranteed by factory. Detects minerals, metals, gold, silver, coins. Payment plan available. Proven superior performance. Free 16 page illustrated booklet. Fisher Research Lab., Inc., Palo Alto, California.

**CLOGGED** Drains opened by new powerful chemical called Sursolvent. Removes grease, soap, tree roots, etc., without expensive digging and electric rodding machines. Simple to use. Mix with water and pour down sink. Postal brings free details. Electric Sewer Cleaning Co., Allston 34, Mass.

**GOLD**, Silver, metal detectors. Geiger counters for uranium. Mineralights. Sensational new fully guaranteed models. None finer. Information free. Detectron Co., 5420 Vineland Ave., North Hollywood, California.

**70** BIBLE Lessons, 25c. Bulletin, Box 87, Cathedral Station, N. Y.

**YOUR** Leather jacket renovated expertly. Free circular. Berlew Mfg. Co., Dept. 8, Freeport, N. Y.

**DYEING** Rugs, drapes, slip covers and army uniforms. Write Dyrte Dyers, 8094 E. Forest Ave., Detroit 14, Michigan.

**SELF**-Oiler for electric motors. 3 for \$1.00. United States Petroleum Co., Dept. C, Clifton, N. J.

**HOMES** You can build for \$4500 to \$7046. Books that take you through every step. Popular Mechanics Famous Concrete Block House, \$2.00. Your Home and How to Build It Yourself, \$3.00. Ranch Type House You Can Build, \$3.50. Also full-sized builder's plans for each home at nominal price. Popular Mechanics Press, Dept. 102, 200 E. Ontario, Chicago 11, Ill.

**STOPS!** Stops! Stops! New amazing door-check stops banging doors, broken doorglass, lopsided doors, heat loss, etc. Free information. Write Harold's Supply Company, P.O. Box 2644, South Bend, Ind.

*Just  
Released!*

**LATEST 1954 MODEL**

*Recipro Register*

**17 JEWEL CHRONOGRAPH**

**World Famous Watch  
of Amazing Accuracy**

**SOLD DIRECT FROM IMPORTER TO YOU!**

Thoresen is first again with the latest! The all-new **RECIPRO-REGISTER CHRONOGRAPH** for 1954 is now available. 50 years of Schild know-how have gone into it. This veritable triumph of Swiss watch making is packed with superior features found in watches selling for \$100.00 or more. The **Recipro-Register** is a unique timepiece of incredible accuracy! It automatically computes speeds and distances down to 1/5th second tolerances! The Recipro-Register **FREEZES** the result indefinitely. It "remembers" for you while the movement keeps going. Compare it with other stop-chronographs and you will never be satisfied with anything less than this truly precision timepiece!

**OVER 25 FEATURES FOR 1954**

- 17 Full Jewels
- It "remembers"
- 1/5th Second Calibrations
- 30 minute Register
- Anti-magnetic
- 5 Dial Arrangement
- Beryllium Balance
- 2 Independent Movements
- Super-Thin Case
- Stainless Steel Back
- Sweep Second Hand
- Built-in Telemeter
- Nivarox Spring that lasts
- Dual clutch operation
- **INCABLOC SHOCK ABSORBER WITH 2 JEWELS**

The 5 multi-function dials are automatically coupled and synchronized for hours, minutes, seconds and 1/5th seconds! Contact clutch starts computation. Brake clutch erases back to zero. Genuine radium-active light-absorbing numerals and hands glow in the dark. The case is sturdy but unusually **THIN**—giving this 1954 model that new tomorrow look. The new **DUAL JEWEL Incabloc Shock absorber** gives it longer life, sparkling performance, greater protection! This Schild masterpiece has won acceptance in over 38 countries because of its precision engineering, meticulous workmanship and quality materials.

**DIRECT-FROM-SWITZERLAND LOW PRICE!**

Recipro-Registers are flown in direct from Switzerland to us. No dealers or jobbers profits added. You pay the **SAME** price as if you were in Switzerland itself! **NOW . . .** direct to you for only **29.95**, tax paid. Save postage by remitting check or money order for **QUICK** delivery. Or order COD plus postage. Instructions Brochure, Service Certificate and handsome gift box included. A handsome Flexible Metal Band given with each watch at no extra cost.

**Do you want to try one at our risk?**

We should like to have you examine a 1954 **Recipro-Register** for 5 days without obligation. You must be delighted with its rich, ultra-modern look. Check it for accuracy against U. S. Naval Observatory radio signals. Try its many timing and measuring functions. Then have it appraised by your trusted jeweler! If you find anything to compare with it under **\$100.00**—or if you are not thrilled with this **NEW**, fun way to tell time, return for a full refund! Rush order **NOW**—don't wait for Christmas rush. This ad will not be repeated this year. Better clip coupon and mail today.

**THORESEN'S**

352 FOURTH AVENUE

DEPT. 6-L-233

NEW YORK 10, N. Y.

(Visit us when in New York.)

**THORESEN'S, Dept. 6-L-233, 352 Fourth Avenue, New York 10, N.Y.**

Gentlemen: Yes! I want to test, compare, appraise your **Recipro-Register CHRONOGRAPH** for 5 days. You're to return my **\$29.95** if I am not fully satisfied.

Payment enclosed. Send prepaid.

Send Chromed & Steel Model—**29.95**, tax paid.

Send COD plus postage.

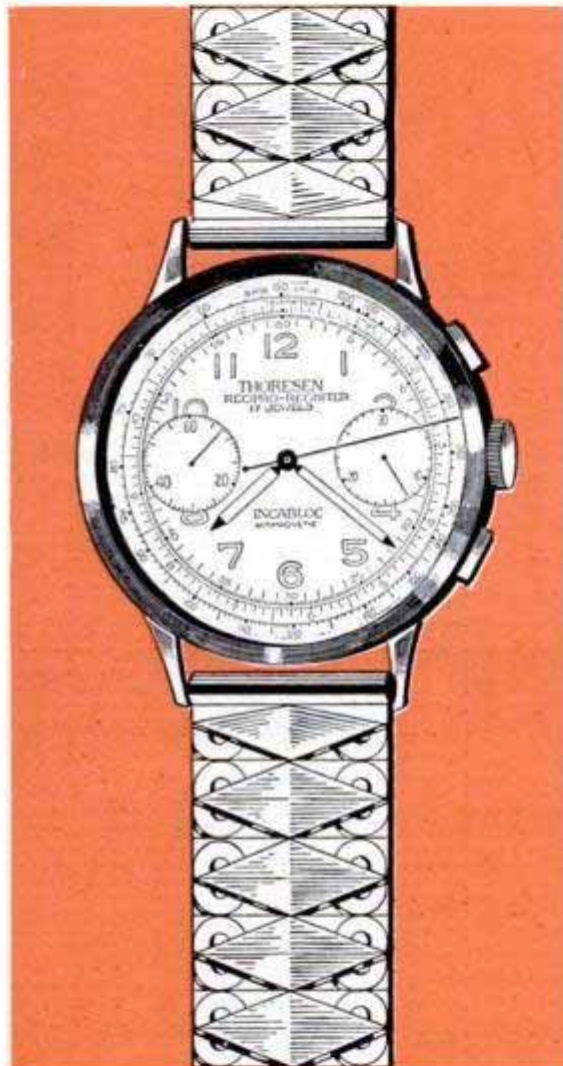
Send Rolled Gold Plate Model at **34.95**, tax paid.

NAME \_\_\_\_\_

ADDRESS \_\_\_\_\_

TOWN \_\_\_\_\_ ZONE \_\_\_\_\_ STATE \_\_\_\_\_

**CHECK** here if 2 chronographs are desired, special at **\$55**. Same \$5.00 saving available on purchase of 2 rolled gold plate models—total: **\$65.**



**2 Jewel Incabloc Shock Absorber  
protects, improves performance**



This unique and patented shock absorber has taken the watch industry by storm! Its **TWIN JEWEL** pivots and **SEALED OIL CHAMBER** give the greatest possible shock-protection for the heart of your chronograph, the delicate balance assembly. Works like a willow in a windstorm—**GIVES** under pressure, then **SNAPS BACK** instantly! It protects the life of your new 1954 **Recipro-Register**—insuring its accuracy!

# ALKA-SELTZER

BRAND

Reg. U.S. Pat. Off.



"SPEEDY"

TRADE MARK

## for "Speedy" HEADACHE RELIEF

Try this faster relief from a headache. Actual clinical tests prove the system absorbs *more* of the pain-reliever *faster* from ALKA-SELTZER. Gentle—soothes your stomach too!

**FIRST AID for**  
ACID INDIGESTION  
COLD DISCOMFORTS  
MUSCULAR ACHES



ON DISPLAY AT  
ALL DRUG STORES

Made by

MILES LABORATORIES, INC., ELKHART, IND.



### TALK-SING-PLAY OVER YOUR RADIO

with the real Radio Mike! Attaches in a jiffy—full instructions given! Swell for "parties"—"cut in" on or "kid" regular network programs or put on your own broadcasts! Amaze your friends—real fun. Beautiful Metallic Plastic 6 in. high!

12 RADIO BROADCAST LESSONS GIVEN with each mike

**SEND NO MONEY** Just pay postman \$3.99 COD plus postage or send \$3.99 and we pay postage! *Radio Mike* is available only from us by mail—*guaranteed*. Midway Co., Dept. MPM-10, Kearney, Nebr.



### European STYLE DUELING SWORDS

First used in deadly combat by the Men of South Europe—in the Middle Ages. Now a fascinating sport. Made of fine plated spring steel—rubber safety tip—hardwood formed handle—polished metal guard. Educational—advocated by U.S. Colleges—promotes quick

thinking—develops coordination—posture. Safe—exciting—fun. Learn at home. Set includes two swords and booklet, "Correct Fencing." Special Price—Money Back Guarantee. Sent Postpaid \$3.95; Single sword, \$2.25; Booklet 25c. Dealers Write

BLADE IS FULL 33"

SET OF TWO \$3.95 POST PAID

Westlake Distr. Co. Sports Div. M10  
7905 Santa Fe Overland Park, Kansas

### DEVELOP A STRONG HE-MAN VOICE

**STRENGTHEN** your voice this tested *scientific* way. Yes—you may now be able to improve the **POWER** of your speaking and singing voice—and in the privacy of your own room! Self-training lessons, mostly silent. No music required.

**WRITE TODAY FOR FREE BOOK**

Eugene Feuchtinger's great booklet "How to Develop a Successful Voice." It's absolutely FREE! You must state your age. Booklet mailed postpaid in plain wrapper. No salesman will call. Send your name, age now!

**PREFECT VOICE INSTITUTE**  
210 S. Clinton St., Studio KX-2 Chicago 6, Ill.

## HELPFUL BOOKS

Send post card asking for FREE catalog

Popular Mechanics Press, 200 E. Ontario, Dept. 601, Chicago 11

## EARN EXTRA CASH

**be your own welder on the farm... in the garage**



This Low Priced "Lincwelder" Makes Welding Simple Costs a few pennies a weld

- **MAKES REPAIRS . . .** on farm machinery, automobile bodies and frames, garden tools.
- **BUILDS YOUR OWN** farm tools, wagons, labor-saving machinery, garden furniture. **IDEAL** for soldering, brazing, hardsurfacing, all steel parts . . . and charging car batteries.

**SIMPLE TO OPERATE**

- Handles  $\frac{1}{16}$ " to  $\frac{3}{32}$ " electrodes with current range 20-180 amps.
- Approved by Underwriters' Laboratories.
- Operates from 230-volt single-phase line.

**FOR THE HOME "LINCWELDER 60" . . .**

handles  $\frac{1}{8}$ " and  $\frac{5}{64}$ " electrodes . . . operates on 115 volt grounded circuit fused for 20 amps.

**ORDER YOUR WELDER NOW!**

**Fill out and mail TODAY!**

The Lincoln Electric Co., Dept. 2905, Cleveland 17, Ohio.

Ship me the "Lincwelder" AC 180T \$165.  
 Ship me the "Lincwelder 60" \$48 (in the U.S.A.)

Add State and Local sales tax. (Prices include accessories.)

Arc torch and Battery Charging Attachment extra.  
Enclosed is  check  money order

Send me free bulletins on the "Lincwelders."

Name \_\_\_\_\_  
Address \_\_\_\_\_  
City \_\_\_\_\_ State \_\_\_\_\_

# How long since your last raise?



Sure, you've had a "cost of living increase." But what about the *big* pay boost?—the kind the boss asks you not to talk about and the kind that starts you thinking about a new car, a better home, luxuries for your family!

If you've had one of these in the past six months, stop reading right here. If not, it's time to start doing something about it.

**Look around you. The men who are advancing are the trained men. They've learned special skills that bring them higher pay. It's the men without training who get what's left.**

What are you going to do about it? Just wait and hope for the jackpot to pay off? If you really want the *big money*, you can start by getting the necessary training at home in your spare time.



## Why Home Study?

When you learn the I. C. S. way, your time is your own. Arrange your schedule to suit yourself. No tiresome traveling to and from school. No classes missed because of other engagements. Home study through I. C. S. has proved out for millions of ambitious men and women. You, too, can use it to get ahead!

International Correspondence Schools offer you a course in 391 success-proved subjects. You get the practical plus the bedrock facts and theory. You earn while you learn. Students often report their first *big* pay increases right after enrolling.

**Read carefully the list of subjects in the coupon below.** Pick out the field of study that interests you most—the one with the greatest future for you. Then mark and mail the coupon and *find out* what I. C. S. can do for you. All it costs is a stamp or a postcard. Why not do it right away—it may be the most important step you've ever taken!

## wide choice of courses

I. C. S. offers a total of 391 different courses—391 roads to advancement. Among them is the one you want. You'll find the lessons modern, simple, easy to understand. Each one you study takes you farther along the road to knowledge and success.

## machine operator to shop foreman

"When I enrolled for my I. C. S. course in Carpentry and Millwork, I was a machine operator. Today, eleven months later, I am a shop foreman. As a consequence my salary has been increased 73.3%."

# INTERNATIONAL CORRESPONDENCE SCHOOLS



BOX 5598-L, SCRANTON 9, PENNA.

Without cost or obligation, send me "HOW to SUCCEED" and the booklet about the course BEFORE which I have marked X:

- |   |   |   |   |  |
|---|---|---|---|--|
| <p><b>ART</b></p> <ul style="list-style-type: none"> <li><input type="checkbox"/> Commercial Art</li> <li><input type="checkbox"/> Magazine and Book Illustrating</li> <li><input type="checkbox"/> Cartooning</li> <li><input type="checkbox"/> Show Card and Sign Lettering</li> <li><input type="checkbox"/> Fashion Illustrating</li> <li><b>AUTOMOTIVE</b></li> <li><input type="checkbox"/> Automobile, Mechanic</li> <li><input type="checkbox"/> Auto-Elec. Technician</li> <li><input type="checkbox"/> Auto Body Rebuilding and Refinishing</li> <li><input type="checkbox"/> Diesel—Gas Engines</li> <li><b>AVIATION</b></li> <li><input type="checkbox"/> Aeronautical Engineering Jr.</li> <li><input type="checkbox"/> Aircraft Engine Mechanic</li> <li><input type="checkbox"/> Airplane Drafting</li> <li><b>BUILDING</b></li> <li><input type="checkbox"/> Architecture</li> <li><input type="checkbox"/> Arch. Drafting</li> <li><input type="checkbox"/> Building Contractor</li> <li><input type="checkbox"/> Estimating</li> <li><input type="checkbox"/> Carpenter and Mill Work</li> <li><input type="checkbox"/> Carpenter Foreman</li> <li><input type="checkbox"/> Reading Blueprints</li> <li><input type="checkbox"/> House Planning</li> <li><input type="checkbox"/> Plumbing</li> </ul> | <ul style="list-style-type: none"> <li><input type="checkbox"/> Heating</li> <li><input type="checkbox"/> Steam Fitting</li> <li><input type="checkbox"/> Air Conditioning</li> <li><input type="checkbox"/> Electrician</li> <li><b>BUSINESS</b></li> <li><input type="checkbox"/> Business Administration</li> <li><input type="checkbox"/> Certified Public Accountant</li> <li><input type="checkbox"/> Accounting</li> <li><input type="checkbox"/> Bookkeeping</li> <li><input type="checkbox"/> Stenography and Typing</li> <li><input type="checkbox"/> Secretarial</li> <li><input type="checkbox"/> Federal Tax</li> <li><input type="checkbox"/> Business Correspondence</li> <li><input type="checkbox"/> Personnel and Labor Relations</li> <li><input type="checkbox"/> Advertising</li> <li><input type="checkbox"/> Retail Business Management</li> <li><input type="checkbox"/> Managing Small Business</li> <li><input type="checkbox"/> Sales Management</li> <li><input type="checkbox"/> Salesmanship</li> <li><input type="checkbox"/> Traffic Management</li> <li><b>CHEMISTRY</b></li> <li><input type="checkbox"/> Chemical Engineering</li> <li><input type="checkbox"/> Chemistry</li> <li><input type="checkbox"/> Analytical Chemistry</li> <li><input type="checkbox"/> Petroleum—Nat'l Gas</li> <li><input type="checkbox"/> Pulp and Paper Making</li> <li><input type="checkbox"/> Plastics</li> </ul> | <p><b>CIVIL, STRUCTURAL ENGINEERING</b></p> <ul style="list-style-type: none"> <li><input type="checkbox"/> Civil Engineering</li> <li><input type="checkbox"/> Structural Engineering</li> <li><input type="checkbox"/> Surveying and Mapping</li> <li><input type="checkbox"/> Structural Drafting</li> <li><input type="checkbox"/> Highway Engineering</li> <li><input type="checkbox"/> Reading Blueprints</li> <li><input type="checkbox"/> Concrete Construction</li> <li><input type="checkbox"/> Sanitary Engineering</li> <li><b>DRAFTING</b></li> <li><input type="checkbox"/> Aircraft Drafting</li> <li><input type="checkbox"/> Architectural Drafting</li> <li><input type="checkbox"/> Electrical Drafting</li> <li><input type="checkbox"/> Mechanical Drafting</li> <li><input type="checkbox"/> Structural Drafting</li> <li><input type="checkbox"/> Sheet Metal Drafting</li> <li><input type="checkbox"/> Mine Surveying and Drafting</li> <li><b>ELECTRICAL</b></li> <li><input type="checkbox"/> Electrical Engineering</li> <li><input type="checkbox"/> Electrician</li> <li><input type="checkbox"/> Electrical Maintenance</li> <li><input type="checkbox"/> Electrical Drafting</li> <li><input type="checkbox"/> Electric Power and Light</li> <li><input type="checkbox"/> Lineman</li> <li><b>HIGH SCHOOL</b></li> <li><input type="checkbox"/> High School Subjects</li> </ul> | <ul style="list-style-type: none"> <li><input type="checkbox"/> College Preparatory</li> <li><input type="checkbox"/> Mathematics</li> <li><input type="checkbox"/> Commercial</li> <li><input type="checkbox"/> Good English</li> <li><b>MECHANICAL AND SHOP</b></li> <li><input type="checkbox"/> Mechanical Engineering</li> <li><input type="checkbox"/> Industrial Engineering</li> <li><input type="checkbox"/> Industrial Supervision</li> <li><input type="checkbox"/> Foremanship</li> <li><input type="checkbox"/> Mechanical Drafting</li> <li><input type="checkbox"/> Machine Design-Drafting</li> <li><input type="checkbox"/> Machine Shop Practice</li> <li><input type="checkbox"/> Tool Design</li> <li><input type="checkbox"/> Industrial Instrumentation</li> <li><input type="checkbox"/> Machine Shop Inspection</li> <li><input type="checkbox"/> Reading Blueprints</li> <li><input type="checkbox"/> Toolmaking</li> <li><input type="checkbox"/> Gas—Electric Welding</li> <li><input type="checkbox"/> Heat Treatment—Metallurgy</li> <li><input type="checkbox"/> Sheet Metal Work</li> <li><input type="checkbox"/> Sheet Metal Pattern Drafting</li> <li><input type="checkbox"/> Refrigeration</li> <li><b>POWER</b></li> <li><input type="checkbox"/> Combustion Engineering</li> <li><input type="checkbox"/> Diesel—Electric</li> <li><input type="checkbox"/> Electric Light and Power</li> </ul> | <ul style="list-style-type: none"> <li><input type="checkbox"/> Stationary Steam Engineering</li> <li><input type="checkbox"/> Stationary Fireman</li> <li><b>RADIO, TELEVISION, COMMUNICATIONS</b></li> <li><input type="checkbox"/> General Radio</li> <li><input type="checkbox"/> Radio Operation</li> <li><input type="checkbox"/> Radio Servicing—FM</li> <li><input type="checkbox"/> Television</li> <li><input type="checkbox"/> Electronics</li> <li><input type="checkbox"/> Telephone Work</li> <li><b>RAILROAD</b></li> <li><input type="checkbox"/> Locomotive Engineer</li> <li><input type="checkbox"/> Diesel Locomotive</li> <li><input type="checkbox"/> Air Brakes</li> <li><input type="checkbox"/> Car Inspector</li> <li><input type="checkbox"/> Railroad Administration</li> <li><b>TEXTILE</b></li> <li><input type="checkbox"/> Textile Engineering</li> <li><input type="checkbox"/> Cotton Manufacture</li> <li><input type="checkbox"/> Rayon Manufacture</li> <li><input type="checkbox"/> Woolen Manufacture</li> <li><input type="checkbox"/> Loom Fixing</li> <li><input type="checkbox"/> Finishing and Dyeing</li> <li><input type="checkbox"/> Textile Designing</li> </ul> |
|---|---|---|---|--|

**YEAR OF THE SIX MILLIONTH STUDENT**

Name \_\_\_\_\_ Age \_\_\_\_\_ Home Address \_\_\_\_\_  
 City \_\_\_\_\_ Zone \_\_\_\_\_ State \_\_\_\_\_ Working Hours \_\_\_\_\_ A.M. to \_\_\_\_\_ P.M.  
 Occupation \_\_\_\_\_

Special tuition rates to members of the U. S. Armed Forces. Canadian residents send coupon to International Correspondence Schools Canadian, Ltd., Montreal, Canada.

SPARE TIME!

# Sensational New HOME-BUSINESS!

**PRINT WITHOUT A PRINTING PRESS!**

OR ANY SPECIAL EQUIPMENT



**WHAT IS SCREEN PRINTING?**

It's a revolutionary new method of printing - WITHOUT an expensive printing press. This amazing new development lets you print 25, 50, 100, 500, or even 1,000 copies in many cases, FOR LESS THAN YOU CAN PRINT ON A \$5,000 PRINTING PRESS. Just put anything under a screen and take out beautiful products of printing—no expensive plates or "cuts" needed. No big overhead. Never has such an opportunity been offered the spare-time person who wants to make "Extra Income" in his home.

**PRINT IN COLORS—EVEN NEW FLUORESCENTS**  
It's easy to print in luminescent, "glowing" fluorescent colors, too. Screen-Print lets you print on paper, cardboard, leather, glass, wood, plaster, fabrics—anything!

**NO ART NECESSARY—EASY TO LEARN**  
Beautiful printing can be produced WITHOUT doing any art work.

**A BUSINESS OF YOUR OWN**  
Be your own boss. Operate from the corner of your kitchen or garage. Build a successful future with a few cents worth of materials. Screen-Printing is the opportunity to establish a spare-time business without sacrificing job or pay check.

**THERE'S \$\$\$ IN ADVERTISING!**  
Here's your chance to GET INTO ADVERTISING—one of the largest paying businesses in America. Most Screen-Printing is used for advertising purposes. Materials cost you 10%—you can earn 90%—few businesses offer this high profit.

**HUGE DEMAND! ENORMOUS PROFITS!**  
Millions of shops, stores, theaters, markets—almost any business needs Screen-Printing done for them. Make \$10 to \$20 profit on each dollar of cost on some jobs. Here's...

**YOUR "Chance of a Lifetime" OPPORTUNITY** to "cash-in" on this new printing method not generally known. We supply everything you need! A complete ready-made BUSINESS PLAN guides you every step of the way. This all can be yours—at our risk. Don't waste a minute—mail coupon NOW! TODAY!—and get all the FREE FACTS and ACTUAL SAMPLE

**AMAZING NEW PRINTING SECRETS CAN BE YOURS**

For Pleasure & Profit. Once you learn the classically guarded printing secrets of Screen-Print there's virtually no limit to how much "extra money" you can earn. SPARE-TIME WORK—FULL-TIME PROFITS.



PRINT ADVERTISING DISPLAYS FOR STORES, GAS STATIONS, THEATRES, MARKETS—EVERYWHERE!



PRINT SIGNS, BANNERS, POSTERS, LABELS, ETC. FOR EVERY BUSINESS, LARGE OR SMALL.



PRINT CLOTH, GLASS, WARE, NOVELTIES, LAMP, CALENDARS, DRAPERIES, PAPER, ETC.

**FREE**

MY BOOKLET AND ACTUAL SAMPLE OF SCREEN-PRINTING. TELLS ALL THE FACTS ABOUT MY HOME-BUSINESS OPPORTUNITY PLAN.

**FREE BOOKLET AND REAL SAMPLE MAIL TODAY!**



SCREEN-PRINT CO., Dept. 210

1010 So. Los Angeles Street Los Angeles 15, Calif.

Dear Mr. Nowak: Please rush me booklet, facts, sample and entire Home-Business Plan. All this is FREE. No salesman will call. I am under no obligation now or ever.

Name \_\_\_\_\_  
Address \_\_\_\_\_  
City \_\_\_\_\_ Zone \_\_\_\_\_ State \_\_\_\_\_

# Taking Vitamins?

Cut Your Costs up to 50%

A Postcard Will Bring You **FREE CATALOG**

that lists practically every known combination of vitamins and vitamins and minerals.

Also **FREE Vitamin Guide Book**

that shows you how to read a vitamin label and compare values.

No longer need you pay \$4, \$5, \$6, up to \$15. per 100 capsules for the same vitamins your Doctor advises. After 20 minutes' reading of this Guide Book you will understand vitamins as you never have before. You will not be fooled again by confusing, mysterious labels; you will be able to pick up any vitamin product and know if you are getting your money's worth. In this free catalog you are sure to find the combination of vitamins or vitamins and minerals you are now using. Compare the potencies and the prices and you'll be amazed at the savings of up to 50%. Stop buying vitamins blindly. Send postcard today for free guide book and catalog to VITAMIN-QUOTA, Dept. 252, 880 Bway, New York 3, N. Y., or Dept. 252, 1125 Crenshaw Blvd., Los Angeles 19, California.

## French STYLE DUELING SWORDS

SET OF TWO \$3.98

Once used in deadly combat—now an exciting sport! Learn right at home. Fun—safe\*—educational. These swords are made of fine blue spring steel, polished metal

guards, turned handles, rubber safety tips. Fencing teaches quick thinking, develops coordination, posture. Since the Middle Ages, Europeans have enjoyed the sport of dueling. Now advocated by U.S. colleges. Set includes two swords and the booklet, "The Art of Fencing". Special price. **MONEY BACK IF NOT COMPLETELY SATISFIED** At sporting goods dealers or send \$3.98 to **TECHRITE CORP.**, Box 12HT, South Pasadena, Calif



## War Surplus SAVE UP TO 85%

**ALTIMETERS** Pioneer sensitive altimeters . . . range 0-35,000 feet. Calibrated in 20 ft. increments. Barometric pressure setting adjustment. No hook-up required . . . ready for installation in auto or aircraft.



Used, Good, \$12.95

### GENERATORS 115 VAC

**FOR AUXILIARY LIGHT PLANTS**  
Here's the buy of the year . . . brand new Eclipse generators in the original box. These generators have an AC output of 115 volts, 9.4 amp, 1000 watts, single phase, 800 cycles, 2400-4200 rpm. DC output is 30 volts at 25 amp. The unit has a spline drive shaft and is self-excited. It will serve as a dependable 115V-AC auxiliary light plant when driven by a gasoline engine for farms, cottages, trailers, boats, flood lighting, or wherever power is not readily accessible. Shipping Wt. 50 lbs. Gov't cost more than ten times selling price.



**\$29.95**

BRAND NEW . . . . . \$29.95  
All Equipment F.O.B. Pasadena • Enclose Full Amount with Order

## C & H SALES CO.

BOX 356-MM EAST PASADENA STA. • PASADENA 8, CALIF.

## Learn PHOTOGRAPHY at Home

Splendid opportunities. Prepare in spare time. Practical basic training. Long-established school. Send for free book, "Opportunities in Photography." No obligation. **AMERICAN SCHOOL OF PHOTOGRAPHY**, 835 Diversoy Pkwy., Dept. 1357, Chicago 14, ILL.



**\$10.00** Down  
DELIVERS  
BRAND NEW  
**30-Piece**  
**ARGUS C-3 OUTFIT**  
Balance: \$10.30 Per Month\*

POPULAR Mechanics Readers  
**SAVE NOW ON THIS**  
**SPECIAL OFFER**

Nothing Else to Buy!  
From "Shooting to Showing"—  
Entire Outfit—Camera, Flashgun,  
Filters, Slide Projector, Screen, Film,  
Many Other Items.

Now YOU can enjoy the thrills of 35  
mm. photography... with this amaz-  
ing 30-Piece Argus C-3 outfit! Cost of  
individual items if bought separately  
would be more than the special pack-  
age price to you... but all you pay is  
\$99.50, in easy monthly payments.

**35mm Photography is Thrilling!**  
Everywhere you go, all your most inter-  
esting experiences, the people you meet  
can be your keepsakes forever in breath-  
takingly black and white or color 35  
mm. photography. Order your Argus  
C-3 outfit today and pay as you shoot,  
only **\$99.50**

Just look at all you get  
for only **\$10.00** Down.

- Argus C-3 with  
f/2.5 Cinlar Lens
- Argus C-3 Flash Gun
- Argus C-3  
Carrying Case
- 35 mm. Slide  
Projector
- 30 x 40" Beaded  
Screen
- 4 Filters
- Filter Case
- Filter Holder
- Sun Shade,
- 6 Rolls Ansco or  
Kodak Black and  
White Film (Reloads)
- 1 Roll Color Film
- 10 Flash Bulbs
- Book: "Argus  
Camera Guide"

**ORDER THIS EASY WAY**

—Mail your order and down  
payment, giving two references,  
your employer and your age.

Your Credit is Always Good With "THE GENERAL"

**10 DAY**  
Money Back Guarantee

**The General Camera Co.**, Mail Order Division,  
Dept. P11 Chicago 45, Ill.

# "BIGGEST SHOTGUN VALUE!"

**3-shot repeaters  
with C-LECT-CHOKE**

Any choke desired, instant-  
ly, by a twist of the fingers.  
Settings are positive and  
visual, like a micrometer.  
NOT an "extra". You  
buy gun and C-LECT-  
CHOKE installed  
at these amazing  
prices—and there  
is no finer varia-  
ble choke.

**YOUR MOSSBERG  
DEALER WANTS TO  
SHOW YOU THESE**

Drop in and have a look.  
You'll be delighted with  
the beauty, quality and  
fine balance of the #185K  
and #190.

**No. 185K**    **No. 190**  
**20 ga. \$29<sup>95</sup>**    **16 ga. \$31<sup>95</sup>**  
(\$30.95 W. of Rockies)    (\$32.95 W. of Rockies)  
Prices above are with C-LECT-  
CHOKE and ventilated barrel.

Send for  
**FREE**  
catalog  
No sales at  
factory

**HUNTER'S BEST FRIEND**

Best friend the hunter has is the  
property owner. Good hunters are  
careful and considerate of the  
property on which they hunt.

**Mossberg**  
EST. 1816

39710 St. John St., New Haven 5, Conn.

## HELPFUL BOOKS

Send post card asking for **FREE** catalog

Popular Mechanics Press, 200 E. Ontario, Dept. 601, Chicago 11



I MADE  
**\$14 PER DAY**  
While still learning!

T. E. H.—WEST VIRGINIA



I MADE  
**\$800 IN 3 MONTHS**  
While taking your course!

F. V.—NEW YORK

Get  
into the

## ELECTRIC APPLIANCE REPAIR & SERVICE BUSINESS

**OPEN YOUR  
OWN SHOP**

As soon as you  
enroll, I send  
you my New  
Book "How to  
Open Your Own

Business" at no extra cost. PTS train-  
ing is more than a home study course  
in electric appliance repair and service.  
It gives you the "know how" on the  
operation of your shop from a business  
standpoint: What to charge, how to get  
customers. Everything possible is done  
to start you on the road to success.

**WE TEACH YOU:**

Electric motors, house  
wiring, refrigerator,  
auto ignition, auto-  
matic washers, gar-  
bage disposals, flu-  
orescent lights, irons,  
cleaners, etc., at  
home.

FULL OR SPARE TIME

**SEND  
FOR  
THIS  
FREE  
BOOK**



**SPARE OR FULL TIME**

You can actually increase your income  
while still learning—spare or full time  
**ACT NOW**

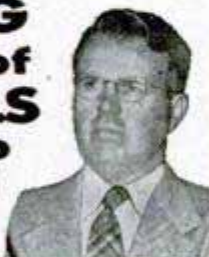
Want a good-paying business—a job in  
a fast-growing industry? Send now for  
your **BIG FREE BOOK**—"My Plan for  
your Success." Get started **NOW**

**EASY TO LEARN**

Men of all ages, yes, even the man of  
69 can get into this expanding field. A  
**REAL OPPORTUNITY** for the practical  
man who wants the **BETTER THINGS  
IN LIFE**. The easy PTS Home Study Plan  
prepares you for greater earnings **NOW!**

I SEND  
YOU A

**BIG  
KIT of  
TOOLS  
at No  
Extra  
Cost**



**MAIL THIS COUPON TODAY**

**PACIFIC TRAINING SCHOOL** H. T. ARMSTRONG  
7219 So. Broadway, Dept. P-5310 Los Angeles 3, Calif.  
Please send me, without obligation, your free booklet and details.

Name \_\_\_\_\_

Address \_\_\_\_\_

City \_\_\_\_\_ Zone \_\_\_\_\_ State \_\_\_\_\_



Like thousands this reader says, "I would not be without Lawn Care. It's rendered a great service to us. Incidentally, we have the finest lawn on the street."

**It's FREE!**



PEOPLE WITH THE FINEST LAWNS

READ *Lawn Care*

T. M. REG.

It's as simple as that! Lawn Care tells you how to get rid of ugly weeds and other turf pests—how and when to feed grass—in short, Lawn Care outlines the year 'round program for outstanding lawn beauty. It's easy to get Lawn Care—a card will start your free two-year subscription. Just write . . . **O M Scott & SONS CO**

70 Fourth St., Marysville, Ohio also Palo Alto, California

**FREE AMAZING NEW BOOK "HOW TO ANSWER ADS"**



Never before have you seen anything like this. Tells you in simple language the correct way to answer ads. Gets you quicker replies—better results, and greater satisfaction. Will save you time and money and it's **ABSOLUTELY FREE**. No obligation whatever. Every reader of advertising should have this booklet. Send a postcard for your copy **NOW**. Advertising Department, Popular Mechanics Magazine, Room 600, 204 East Ontario Street, Chicago 11, Ill.

**SAVE UP TO \$40\***  
on fuel each year—with the



the "MAGIC" BRAIN that lets you wake up to a warm house!

ONLY \$12.95

**PARAGON Nightrol**

Here's how the Nightrol works for you!

**Every Morning.** Automatically turns up heat before you awake. Lets you dress in warm comfort.

**Every Night.** Automatically turns heat down 6° to 10°. Keeps home cooler for greater comfort while you sleep. Saves up to \$40 on fuel each year.

\*According to Government Surveys. Install it yourself! It's easy! Timer plugs directly into convenient electric outlet. Set back unit attaches directly into thermostat. Then set it and forget it . . . that's all there is to it. Approved by U.L. as a safe appliance for the home.



ENJOY ECONOMICAL AUTOMATIC HEAT CONTROL . . . MAIL COUPON TODAY—

PARAGON ELECTRIC CO., Dept. PM102, Two Rivers, Wis.  
 Please send me complete information on Paragon Nightrol.  
 Please send me a Paragon Nightrol. Enclosed is check or money order for \$12.95.

Name \_\_\_\_\_

Address \_\_\_\_\_

City \_\_\_\_\_ Zone \_\_\_\_\_ State \_\_\_\_\_

© 1953

**GET INTO A PROFITABLE PROFESSIONAL FIELD**

Normal education, self confidence, average intelligence and invincible determination can put you on a rising star!

**Operate a Successful Correspondence Club**

We set you up in business, furnishing illustrated magazines with your own name and address imprinted on front and back covers. At a price less than linotyping cost of one page you can obtain your own magazine and get started in this uncrowded field of unlimited possibilities. Part time, just your evenings, can start you in this fascinating business. 25c brings sample copy and complete information.

**DESTINY SYNDICATE**

Aberdeen 51, Washington

**WHAM-O SPORTSMAN\***

\$1.50 POSTPAID 35-LB. PULL!

HITS LIKE A RIFLE—KILLS RABBITS, SQUIRRELS. Powerful, silent, accurate. For hunting, target, routing pests. Sportsman's choice sold world over!



**HUNTING SLINGSHOT**

Heavy duty 7" ash stock. 40 steel balls, extra rubber, target. GUARANTEED. \*Professional model of Nat'l Slingshot Assn. If your sporting goods dealer can't supply you, send \$1.50 to Wham-O Mfg. Co., Box 87M, South Pasadena, Calif.

**AMAZING NEW POCKET SIZE RADIO**

Really Works—Small as a Pack of Cigarettes!



FITS IN ANY POCKET OR PURSE—GETS LOCAL RADIO STATIONS WITH CLEAR BELL-LIKE TONE—NO STATIC OR INTERFERENCE! NEEDS NO TUBES, BATTERIES OR COMPLICATED HOOKUPS! NO AC PLUG INS! Nothing to wear out. Thousands of users—many report years of service. Uses new crystal diode and HI-Q coil. SELF-CONTAINED SPEAKER PHONE. Just the tiny radio to take with you ANYWHERE YOU GO—ON TRIPS, VISITING, ETC.—for real fun and enjoyment—ANYTIME. **SEND ONLY \$1.00** (bill, ck., mo.) and pay postman \$3.99 C.O.D. postage or send \$4.99 for u.p. delivery. COMPLETE READY TO LISTEN. MIDWAY CO., Dept. PPM-10, Kearney, Nebr.

**.22 RIFLE BARGAIN CARBINE STYLE (BRAND NEW!)**

34 inches long 4 lbs., 3 oz.

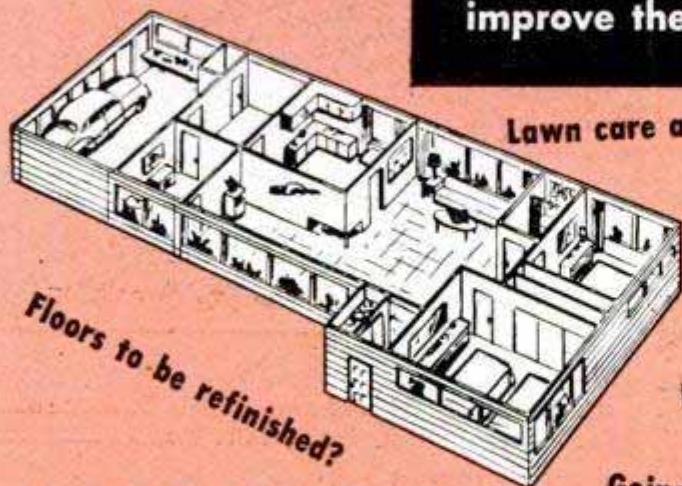
**\$14.95**

Exclusive with UNITED! From Germany, home of some of the world's finest hunting and military guns, come these superb rifles. Factory was founded in 1865 in Thuringia, Germany's great arsenal and home of the famous Mauser Gun Works. Today, the plant has been moved to the American Zone and these rifles are made to rigid UNITED requirements. Bears the famous UNITED "Seal of Quality" BECAUSE this featherweight model is rugged in every detail. One screw take down assembly. Shoots Longs, Shorts and Long Rifles (regular and high powered). Has automatic ejector with self adjusting sporting rear sight and blade front sight. Sturdy Beech stock, barrel has SIX lands. Blued thruout. CHROME plated smooth working bolt action. Amazing accuracy at 100 yard range. Ammunition is available anywhere and replacement parts can easily be had if ever needed. Low cost skilled labor makes possible our sensational bargain price. Supply is limited as yet, so quick action is urged. **10 DAY NO RISK TRIAL.** Use for 10 days. If not fully satisfied return for full refund! Remit \$14.95. Rifle shipped express. Transportation collect. C.O.D.'s require \$2.00 deposit. **UNITED ARMS CO., United Building, 9043 S. Western Ave., Dept. HOB-165, Chicago 20.** Mail Orders Only. None sold to minors. **STATE AGE!**



Bigger garden next year?  
Plan any painting?

**FREE Popular Mechanics service for readers of this issue who plan to build, remodel, and improve their homes.**



Floors to be refinished?

Need a better hot water heater?

Lawn care a problem?

Planning to build a new house?

Intend to add a new room to your house?

New garage doors needed?

New heating system necessary?

Going to redecorate?

Going to remodel your home?

The interesting catalogs offered FREE by the building material, home equipment, and building supply advertisers in this issue can give you a better picture of the best available today.

All such advertisers in this issue are listed on this and the following page. Each listing gives the page number of an ad.

Study the advertisements. Then, if you wish certain

catalogs,—either write directly to the advertisers— or, save bother, time and postage by using this

FREE *Popular Mechanics* service: mail your request for catalogs, directly to us. We'll get them for you. A coupon for your convenience appears at the bottom of the following page. On it, circle the numbers of the desired catalogs. P-R-I-N-T your name and address, and mail coupon to:

*Popular Mechanics*  
Reader Service, Room 305  
200 East Ontario Street  
Chicago 11, Illinois

Here is the classified list of the home products and services advertised in this issue. Read listings—to see advertisements themselves, turn to pages indicated by numbers following each listing.

**AWNINGS**

- 1. Herbert's Aluminum Awning.....326

**BUILDING MATERIALS**

- 2. Armstrong Cork Co., building materials..... 2
- 3. Bruce Co., E. L., hardwood floors.....256
- 4. Marsh Wall Products, Inc., Marlite prefinished wallpanels .....347
- 5. Masonite Corp., Presdwood products.....272
- 6. United States Plywood Corp., plywood.....266

**HEATING AND AIR CONDITIONING**

- 7. Cleveland Steel Products Corp., automatic heating .....255

- 8. Coleman Co., The, Blend-Air.....287
- 9. Midget Louver Co., The, ventilating units.....312
- 10. Paragon Electric Co., automatic heat control..... 88
- 11. Timken-Detroit Axle Co., The, automatic heating..267

**HOMES**

- 12. Aladdin Co., The, Readi-Cut homes.....351
- 13. Pease Woodwork Co., fabricated homes.....278

**HOUSEHOLD SUPPLIES**

- 14. Ambroid Co., Inc., liquid cement.....320
- 15. Boyle-Midway Inc., 3-In-One oil.....286

List continued on next page

**FREE Popular Mechanics service for readers of this issue who plan to build, remodel, and improve their homes**

*continued from preceding page: Classified list of home products and services advertised in this issue. Numbers following each listing refer to magazine page numbers.*

**INSULATING MATERIALS**

- 16. Bridgeport Fabrics, Inc., weather-stripping.....319
- 17. Macklanburg Duncan Co., weather-stripping.....352
- 18. National Gypsum Co., insulation.....285
- 19. Reynolds Metal Co., insulation.....347
- 20. Zonolite Co., insulation.....324

**LAWN AND GARDEN**

- 21. Gravely Tractors, Inc., tractors.....334
- 22. Parker Sweeper Co., lawn sweepers.....305
- 23. Scott & Sons Co., O. M., lawn care..... 88

**PAINTS, VARNISHES, ETC.**

- 24. Alumi-Gard Co., plastic coating.....356
- 25. Baker Brush Co., Inc., paint brushes.....342
- 26. Devoe & Reynolds Co., Inc., paints.....262
- 27. Klean-Strip Co., Inc., The, paint brush cleaner.....308
- 28. Monsanto Chemical Co., sealers & primers.....357
- 29. Savogran Co., finishing products.....280
- 30. Thomas Products Co., paint rollers.....293

**SLIDING DOORS**

- 31. American Welding & Mfg. Co., The, sliding door units.....326

**TILE**

- 32. Mastic Tile Corp. of America, tile flooring.....335
- 33. Wilson Plastics, Inc., plastic tile.....330

**WATER SYSTEMS**

- 34. Goulds Pumps, Inc., water systems.....363

**WINDOWS**

- 35. Curtis Companies, windows.....268
- 36. Sun-Sash Co., louvered windows.....348

**WOODWORK**

- 37. Precision Parts Corp., attic stairways.....342
- 38. Rolscreen Co., folding doors.....314

**MISCELLANEOUS**

- 39. Borg-Warner Corp., Atkins Saw Division, pruning saws.....302
- 40. Molly Corp., screw anchors.....323
- 41. Werner Co., R. D., Alumiladders.....274
- 42. Steel Protection & Chemical Co., Plastex waterproofing .....341

**Use this convenient coupon, fill out and mail TODAY.**

The numbers below correspond to the numbers of the lines in the listings above, and on the preceding page. If you want information on any subject listed, simply circle corresponding number below, then fill out card and mail to: *Popular Mechanics*, Reader Service, Room 305, 200 East Ontario Street, Chicago 11, Illinois.

|    |    |    |    |    |    |    |    |    |
|----|----|----|----|----|----|----|----|----|
| 1  | 2  | 3  | 4  | 5  | 6  | 7  | 8  | 9  |
| 10 | 11 | 12 | 13 | 14 | 15 | 16 | 17 | 18 |
| 19 | 20 | 21 | 22 | 23 | 24 | 25 | 26 | 27 |
| 28 | 29 | 30 | 31 | 32 | 33 | 34 | 35 | 36 |
| 37 | 38 | 39 | 40 | 41 | 42 |    |    |    |

NAME \_\_\_\_\_

STREET \_\_\_\_\_

CITY \_\_\_\_\_ ZONE \_\_\_\_\_ STATE \_\_\_\_\_

Mark and fill out this coupon TODAY. Mail to: *Popular Mechanics* Reader Service, Room 305, 200 East Ontario Street, Chicago 11, Illinois. No obligation.

# Light and Comfortable! Yet this Amazing NEW Work Glove WEARS UP TO 5 TIMES LONGER!

## Extra Wear **GUARANTEED!**



Available in all popular styles.

Users report 2 to 5 times more wear from these amazing new work gloves! Permanently imbedded tiny plastic dots provide lots more wear, yet give you a glove that is soft, flexible, comfortable.

**Make Big Savings!** Now you can buy the same "Plastic-Dot" work glove that has set spectacular records for wear and economy in leading industrial plants from coast to coast!

Independent testing organization made exhaustive wear tests showing "Plastic-Dot" fabric withstood over 15 times more wear cycles than 10-ounce fabric used in heavy canvas gloves.

**Real Working Comfort . . . Safer, Surer Grip!** They're as comfortable as the

glove you wear now, but they'll last more than twice as long, save you money! And what's more, they offer a safer, surer grip!

"Plastic-Dot" gloves have already proven their value for homeowners and hobbyists, service and repairmen, painters, farmers, housewives, gardeners, oil workers, lumbermen, masons, truck drivers, carpenters, cotton pickers, canners, steel workers, and many more.

Now On Sale in Hardware, Automotive, Drug and Department Stores, Groceries, Supermarkets, Variety Stores, Army-Navy Stores and wherever work gloves are sold. If your dealer hasn't got them yet, send coupon for trial pair.

## Riegel "PLASTIC-DOT" WORK GLOVE

Trade-Mark

**Guaranteed to Outwear 2 or More Pairs of Heavy Canvas Gloves!**

### TRIAL OFFER!

See for yourself how wonderful this new glove is!

SEND **50¢** FOR SAMPLE PAIR

LIMIT 2 PAIRS, \$1

Save money on work gloves, get full protection and real working comfort with Riegel "Plastic-Dot"

RIEDEL TEXTILE CORP., BOX 250, NEW YORK 16

Send me AMAZING NEW Riegel "Plastic-Dot" work gloves. No C.O.D.'s.

1 pr. 50¢  2 prs. \$1. (LIMIT 2 PAIRS)

NAME \_\_\_\_\_

STREET \_\_\_\_\_

CITY \_\_\_\_\_ STATE \_\_\_\_\_

## HELPFUL BOOKS

Send post card asking for FREE catalog

Popular Mechanics Press, 200 E. Ontario, Dept. 601, Chicago 11

start a big profit business with a small investment  
**EARN UP TO \$200 a DAY**

Manufacturing Exciting New

### RAINBOW ROCK

Concrete Slump Brick in your back yard

Earn big building boom profits with Rainbow Rock, the colorful new building brick that's taking the country by storm. Sell all you can make to contractors, builders, building supply houses. **RAINBOW ROCK CUTS LABOR COSTS BY 1/3!** Amazing low cost machine makes modern slump brick 24" long (3 times the length of ordinary brick) in a variety of widths and pastel colors . . . up to 1500 bricks a day! **NEEDS NO SPECIAL SKILL.** Operates indoors or out. Full instructions and valuable mixing formulae supplied. **YOU CAN START EARNING BIG MONEY NOW. PAY AS YOU PROFIT!** A limited number of machines available on easy payment terms. **NOW** is the time to start. Write today for free literature and full information.

**GENERAL ENGINES CO., INC.**  
Dept. MR-103—307 Hunter Street  
Gloucester, N.J. - Gloucester 6-1337



**STEEL PIER SENSATION**  
Luxurious RAINBOW ROCK fireplace wall in living room of the "Home of the Century" in Atlantic City, N. J.'s Steel Pier . . . acclaimed by over 500,000 Summer, 1953 visitors as the most beautiful they'd ever seen! Endorsed by the Pier's famous architect, William F. B. Koelle.



Makes beautiful, decorative fences, garden walls, garages, outside walls, room separators, etc.

## THOUSANDS OF \$\$\$\$

PAID FOR PICTURES IN

### POPULAR MECHANICS!



This single issue of *Popular Mechanics* contains thousands of dollars worth of photographs—some taken by staff photographers, others by free lancers, still others from studios all over the country. This is just a small fraction of the many more thousands paid out to photographers every week. It's easy to train AT HOME in spare time for your share of these tremendous money-making opportunities.

You can *earn while you learn*. NYI trains you for big income jobs, your own business, or sparetime money-making with your camera. Expert **PERSONAL** guidance from beginning to end.



### Send For BIG FREE Book

NYI's colorful FREE book gives you a thrilling behind-the-scenes picture of photography today and the many opportunities in it for you—when you are trained. Send for it TODAY. Also Resident Training. *Approved for Veterans.*

**NEW YORK INSTITUTE OF PHOTOGRAPHY**  
Dept. 49, 10 West 33 Street, New York 1, N. Y.

Please send me complete information regarding

Correspondence Course  Resident Training

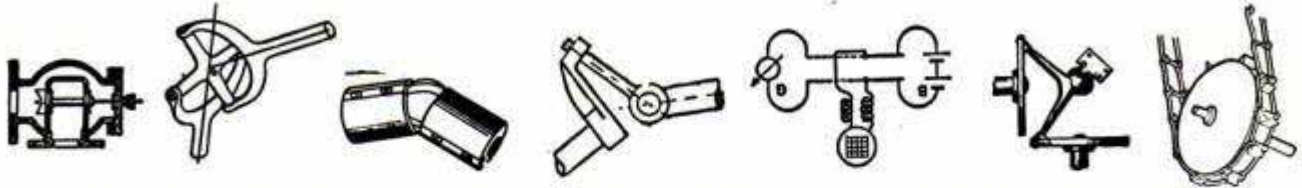
Name \_\_\_\_\_

Address \_\_\_\_\_

City \_\_\_\_\_ Zone \_\_\_\_\_ State \_\_\_\_\_

Check if eligible under new G.I. Bill

# A BOOK THAT SHOWS YOU 4000 ILLUSTRATIONS and DESIGNS OF MECHANICAL DEVICES, CONTRIVANCES, MOVEMENTS AND DETAILS



The newest, most comprehensive and most useful reference work of its kind ever put together. Every possible kind of machine device and mechanical function is briefly explained and illustrated in this one-volume mechanical encyclopedia. The book aims to provide, side by side, the various methods possible for accomplishing any particular movement or work.

Every engineer, mechanic or inventor finds the need of devising, simplifying or improving some mechanical process, method or detail. In doing this he has to rely on memory or experience. Here you will find countless suggestions, classified and arranged in such a way as to make it easy to find the answer to the problem.

**PARTIAL CONTENTS**—Accumulators, Actimeter, Alcometer, Anti-Friction, Ball and Socket, Barometers, Batteries, Bearings, Bells, Blowing, Brakes, Buoys, Baffles, Buzzers, Ball Joints, Blowers, Burners, Chimes, Cutters, Color Wheels, Cycle Gas Engines, Cams, Chain Gears, Chopping, Chucks Systems, Calorimeter, Compressors, Checks, Carburetors, Cells, Droppers, Dirt Pockets, Eccentrics, Engines, Expandors, Filtering, Gears, Governors, Grips, Grinding, Heating, Hinges, Hydraulics, Indicators, Levers, Links, Lowerings,

Lubrication, Measuring and Weighing, Mixing, Nozzles, Parallel Motions, Pipes, Pivots, Power Propulsion, Raising, Ratchets, Rotary Engines, Safety Appliances, Shafting, Signals, Slides, Sounds, Speed Spindles, Springs, Starting, Striking, Swivels, Tanks, Traps, Turbines, Valves, Water Wheels, Winding, Wipers, Whistles. Also—Sirens, Alarms, Sonar, Eophone, Stethoscope, Density, Sound Film, Pickups, Speakers, Turntables, Amplifiers, Switches, Gauges, Thermostats, Regulators, Radiators, Valves, Pumps, Gear Trains, Gear Motions, Feed Rolls, Meters, Separators, Spigots, Gates, Lifts, Shock Absorbers, Steering, Scales, Indicators, Turbo-Jet Engines, Chargers, Refrigeration Units, Welders, Incinerators, Furnace Fans, Air Conditioners, Freezing Injectors, Tools, Telephones, Lightning Arrestors, Fireplaces, Water Heating Units, Boilers, etc.

If you work with machinery of any kind, this new "ILLUSTRATED REFERENCE BOOK OF MECHANISMS AND DEVICES" by Simon Palearant, should prove extremely helpful on many occasions.

**BRAND NEW BOOK**  
1953 Publication  
256 Pages 6x9 Inches  
Cloth Bound \$3.95  
Only.....

Send only \$3.95 (or C.O.D. plus postage). It's really a remarkable value and sold on a money back guarantee.  
**Homecrafts • Dept. SK 587 • 799 Broadway, New York 3, N. Y.**

## HELPFUL BOOKS

Send post card asking for FREE catalog

Popular Mechanics Press, 200 E. Ontario, Dept. 601, Chicago 11

**FREE 50 BRITISH EMPIRE STAMPS**

### SENT TO MAKE NEW FRIENDS

Send for this valuable "Get-Acquainted" offer of exciting all-different stamps from the far corners of the British Empire: Pitcairn Islands (settled by mutineers), Falkland Islands (only post-office in Antarctic Circle), Tanganyika (land of pygmies and head-hunters), Ceylon, South Africa, many others! Price in Standard Stamp Catalog guaranteed at least \$1.00! Supply limited — so rush coupon today enclosing 10c to help pay postage and handling charges. (We'll also include other exceptional values for your inspection.)

#### Also FREE—

"The Stamp Collector's Manual" — a practical illustrated guide to stamp collecting. Contains valuable information and stories about the world's most fascinating hobby.



**KENMORE STAMP CO., Dept. PM-1053A**  
Milford, New Hampshire

Rush me FREE 50 British Empire Stamps and "The Stamp Collector's Manual." I enclose 10c to help pay postage and handling.

Name \_\_\_\_\_  
Street \_\_\_\_\_  
City \_\_\_\_\_ State \_\_\_\_\_

## Malayan THROWING DAGGER

BALANCED TO STICK! \$1.98

MALAYAN HUNTING KNIFE postpaid

used for killing game.  
Exciting Target Sport,  
Easy to learn! Fun  
indoors or out-

doors!  
EASY TO  
THROW!

Fun, Thrills, Excitement!  
Indoors—outdoors.  
Learn this Sport! Easy  
to throw accurately with our  
clear instructions. Beautiful, heavy-duty 10" knife. Tempered steel. Tough, rawhide-bound handle. Rare souvenir, unusual bargain. Limited quantity. At dealers or send \$1.98  
WHOLESALE IMPORT CO. Dept. K, 604 Marengo, Alhambra, Calif.



## LIFETIME POSITION



### LOCKSMITHS & TRAINEES WANTED

Guaranteed income, with commission and bonus! Paid vacations, group insurance! No investment or fees. Depts. open in major cities. If not experienced, we will train with salary. Write:

**NATIONAL KEY CO.**  
Dept. PM-10 • 4515 Superior • Cleveland, Ohio

Say You Saw It in Popular Mechanics

RIGHT FROM DETROIT COMES THIS

# MOTORCADE BARGAIN

**8 FEET OF CARS**

**50 CARS FOR \$1**

Yes! These cars, trucks and planes put end-to-end reach almost 8 feet. You get **FIFTY** true three-dimensional colorful plastic scale models of streamline trolleys, highway vans, trucks, service cars, U. S. Army planes. Perfect collection to swap trade, exhibit!

Order now!

**YOUNG PRODUCTS, Dept. 5047**  
2605 ELMHURST, DETROIT 6, MICH.

**GOOD FOR FREE SEEDS & PLAN**

**NATIONAL NURSERY GARDENS Dept.**  
8463 So. Van Ness Ave., Inglewood 4, California

Please rush me **FREE SEEDS** and Illustrated Plan. I understand I am under no obligation. This is a Free offer from you.

Name \_\_\_\_\_  
Address \_\_\_\_\_ Zone \_\_\_\_\_  
City \_\_\_\_\_ State \_\_\_\_\_

**FREE! GENUINE SEEDS**

**MAIL THIS Certificate TODAY!**

and I'll send you **FREE!** genuine seeds & illustrated plan



**NEW SHORT-CUT METHOD**  
High Speed Idea eliminates Sprouting Time. Gives you real living trees almost immediately.

**Earn BIG Money GROW LIVING MINING TREES**

"ORIENTAL SECRETS" CAN BE YOURS! It's New! Fascinating! Grow beautiful real live dwarf trees (only 12 inches high). Elm, Orange, Oak, Cypress—any kind! All bloom and even bear real fruit in perfect miniature. New fascinating hobby and quick profit business. **\$1000 WORTH OF SPACE ON YOUR WINDOW-SILL**, in your living room, garage—anywhere. Fill your home with these beautiful wonders of nature. Start with pennies, and grow trees worth **THOUSANDS OF DOLLARS**. **SPARE-TIME OPPORTUNITY** — IT'S A **HUNDRED TIMES MORE FASCINATING** than any other kind of gardening or hobby, yet may be extremely profitable because miniature specimens are new and rare. **GROW HUNDREDS AT ONE TIME** — It's easy. Think of the profits of large crops when trees may sell for \$25 each. New short-cut method lets you see results immediately. **TAKES ONLY MINUTES** per tree. **NATIONAL NURSERY GARDENS, 8463 SO. VAN NESS AVENUE, INGLEWOOD 4, CALIFORNIA**

**FREE-LANCE ADVERTISING ARTISTS! EARN TOP MONEY! LEARN PROFESSIONAL PHOTO RETOUCHING THIS EASY WAY — AT HOME!**

You're ready to earn extra money after only a few weeks practice under our expert guidance. Get \$10, \$50, and \$100 for retouching photos for ads, mfrs., photographers in your spare time . . . \$10,000 up per year as a professional! Free brochure shows how our unique mail instruction prepares you for this wide-open, top-pay field. Write: **PROFESSIONAL ART INSTITUTE, Dept. PM10, P.O. Box 567, San Francisco, California.**

*Say You Saw It in Popular Mechanics*

**I'll Send You This Handsome SAMPLE CASE—FREE**



**and Show You How to Make Up to \$15.00 in a Day**  
Mail coupon for this Free Tailoring Sample Case packed with 150 beautiful, big-value suits and overcoat fabrics. Take orders from friends, fellow-workers, others, for fine quality, made-to-measure clothes. Pocket big cash profits in advance. Because wearing our suits and overcoats brings more orders, we make it easy for you to get your own clothes without the cost. No experience is needed. **SATISFACTION GUARANTEED. SEND NO MONEY.** Just fill out and mail coupon — today!  
**PIONEER TAILORING CO., Congress & Throop Sts. DEPT. B-1116 CHICAGO 7, ILLINOIS**

**PIONEER TAILORING CO., Dept. B-1116 Congress & Throop Sts., Chicago 7, Ill.**  
Dear Sir: I WANT A MADE-TO-MEASURE SUIT TO WEAR AND SHOW, without paying 1c for it. Rush details and Sample Kit of actual fabrics, **ABSOLUTELY FREE.**

NAME \_\_\_\_\_ AGE \_\_\_\_\_  
ADDRESS \_\_\_\_\_  
CITY \_\_\_\_\_ STATE \_\_\_\_\_

**FREE**

to start you in a . . .



**FABULOUS BUSINESS of YOUR OWN Part or Full Time**

Thousands of men and women will attest to the money making power of this great catalog. It is specially designed for a highly profitable business of your own . . . without investing in stock . . . and is jam packed with amazing values.

Here you will find merchandise of the highest quality, styling and popular acceptance, with famous brand names in every category. Hundreds upon hundreds of items include Appliances, Binoculars, Cameras, Clocks, Costume Jewelry, Cutlery, Diamonds, Dolls, Fishing Tackle, Houseware, Luggage, Pearls, Pens and Pencils, Radios, Wallets, Watches and many more . . . all beautifully illustrated.

The new 68 page 1953-54 edition is just off the press. Write for your **FREE** copy today. You'll be astounded how simple it is to build a business the Temple way.

**Clip and Mail Today!**

**TEMPLE COMPANY, INC.**  
804 Sansom Street, Phila. 6, Pa. Dept. P.  
Please rush Temple's 1953-54 Catalog and Confidential Price Book. No obligation.

Name \_\_\_\_\_  
Address \_\_\_\_\_  
City \_\_\_\_\_ Zone \_\_\_\_\_ State \_\_\_\_\_

**FREE!**

GET ALL THESE **5 PICTURE-PACKED COURSES**

If you mail coupon NOW! Millions have been sold at \$1.

- 1** **MIGHTY CHEST** — How to make your chest muscles bigger and stronger.
- 2** **MIGHTY ARM** — How to make your arms bigger and stronger.
- 3** **MIGHTY BACK** — How to make your back muscles bigger and stronger.
- 4** **MIGHTY GRIP** — How to make your grip stronger.
- 5** **MIGHTY LEGS** — How to make your legs bigger and stronger.

In 10 Minutes of FUN a day I changed myself from this Bloodless, Pitiful **SKINNY SHRIMP**



to this **NEW MUSCULAR RED-BLOODED HEAD-TO-TOE HE-MAN!**

I just **GAINED 35 NEW LBS.** OF SHAPELY POWER-PACKED **MUSCLES!**

You can do the same as I and THOUSANDS have. You can add 10 inches to your CHEST & 6 inches to each ARM and the rest in proportion as I did. NO! friend you don't have to be SKINNY, WEAK or FLABBY any more just mail NOW the FREE coupon below as I did.

**LAST CHANCE COUPON — 5 COURSES FREE!**

**JEWETT INSTITUTE, Dept. PM-310 220 Fifth Avenue, New York 1, N. Y.**  
Dear George: Please mail to me prepaid FREE Jewett's Photo Book of Strong Men, a Muscle Meter, plus all 5 Muscle-Building Courses, "How to Become a Mighty He-Man." ENCLOSED FIND 10c for postage and handling (No C.O.D.'s).

NAME \_\_\_\_\_ AGE \_\_\_\_\_  
(Please print plainly, include Zone Number)  
ADDRESS \_\_\_\_\_  
CITY \_\_\_\_\_ ZONE & STATE \_\_\_\_\_



## Aircraft repairmen and mechanics

# Choose your job in Army Aviation

**DON'T DELAY!**  
See your local Army  
recruiter, or fill out  
this coupon today!

DEPT. 2C

**THE ADJUTANT GENERAL**  
Department of the Army, Washington 25, D.C.  
ATTN: AGSN-M

Please send me further information on the  
Army's Aviation Maintenance program:

Name \_\_\_\_\_ Age \_\_\_\_\_

Address \_\_\_\_\_

City \_\_\_\_\_ State \_\_\_\_\_

Specialty \_\_\_\_\_ Experience \_\_\_\_\_

(If student, fill out following:)

Subject \_\_\_\_\_ Date of graduation \_\_\_\_\_

School \_\_\_\_\_

**THE BOOM IS ON!** Now, for the *first* time, the United States Army invites you to enlist *directly* for top jobs in aircraft maintenance. If you are a certified aircraft repairman or mechanic—or if you are a student about to graduate from an accredited civilian aviation school, you can begin your Army service as a specialist, doing the work of your choice.

**Get in on the ground floor!** Due to current defense needs, the Army's aviation program has greatly expanded. Not only have its planes increased in number, but also in size and complexity. This means plenty of room for you at the top . . . and plenty of opportunity to practice and improve your present skills!

By acting now, you enter a "boom" program with every chance of growing with it! You get valuable "on the job" experience and fine opportunities for advancement . . . even to such grades as crew chief and pilot!

Choose your Army Aviation specialty from this list:

Airplane Repairman • Helicopter Repairman • Airplane Mechanic  
Helicopter Mechanic • Rotor and Propeller Repairman  
Airframe Repairman • Airplane and Powertrain Repairman  
Aircraft Instrument and Electrical Systems Repairman





# Now YOU Can Quickly Get Ready for a More SUCCESSFUL FUTURE In Industry With

## ALLIED'S Nation Wide Industrial Co-Op Plan

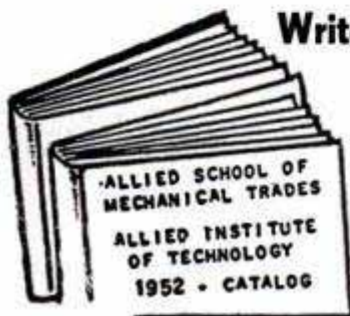
APPROVED FOR G.I. TRAINING ON HOME STUDY OR RESIDENT COURSES

Learn how you can partake in Allied's Nation Wide Industrial Co-Op Plan either through resident training in the great Allied Shops — or through home training. Program helps you prepare quickly for the better paying jobs—Co-Op plan makes possible rapid progress to higher paying jobs. Free employment service and housing assistance all through your training period and after your graduation. Can combine home study and resident training, also continue to degree of Bachelor of Tool Engineering.

### PICK A JOB WITH A BIG PAY FUTURE

**TOOL ENGINEER                      INDUSTRIAL**  
**TOOL & DIE DESIGNER          DRAFTSMAN**  
**MACHINE DESIGNER            MASTER MACHINIST**  
**INDUSTRIAL ENGINEER TOOL & DIE MAKER**

### Write for FREE Books



Write for ALLIED'S valuable free books, find out now about the Nation Wide Industrial Co-Op Plan. Allied is approved by Industry, the American Society of Tool Engineers, Department of Education and Registration, the Department of Public Instruction — State of Illinois. Accredited by the Central Schools Association.

**ALLIED SCHOOL OF MECHANICAL TRADES**  
**ALLIED INSTITUTE OF TECHNOLOGY**  
 1338-42 S. Michigan Avenue, Dept. PM-10, Chicago 5, Illinois

Gentlemen:  
 I want information at once about your Nation Wide Industrial Co-Op Plan. Send me without obligation your FREE BOOKS explaining ALLIED'S course of instruction.

I am interested in  Resident Training  
 I am interested in  Home Study Training  
 I am eligible  I am not eligible  for training under G.I. Bill.

Name \_\_\_\_\_ Age \_\_\_\_\_  
 Address \_\_\_\_\_  
 City \_\_\_\_\_ State \_\_\_\_\_

# NEW INVENTION REPLATES by ELECTROPLATING RESTORES HOME, AUTO METALS CHROME-SILVER-GOLD!

BRILLIANT NEW METAL LIFE—NEW BEAUTY WITH JUST 1 PLATING!  
**SILVER-CHROME-GOLD**



**REPLATED. Quickly, Easily**  
 Now—with an amazing new invention, APPL-I-COTER, you plate hundreds of items, using the mild, safe current of 2 flashlight batteries in its handle. ALL YOU DO is simply attach clamp to item—dip brush into solution—press button on APPL-I-COTER—then coat.

**RESTORES METALS LIKE NEW**  
 Replates Silver, Chrome, Nickel, Steel, Gold and Brass—all worn Spots, Stains, "Blisters," Silverware, Trays, Teapots, Rims of Holloware and other items can look like new again with this exclusive Electroplating process. Restore all your valuable Gold jewelry with amazing APPL-I-COTER. The plating you apply becomes an indestructible part of the metal itself!

**QUICKLY BUILDS-UP A THICK NEW PLATING WITH EACH APPLICATION.**



Complete Set:  
 MET-L-COTE & COP-R-COTE Solutions with Applicator to Cover All Metals..... \$3.95  
 SILV-R-COTE & SILVER POLISH with Applicator..... \$3.95  
 Combination Set of MET-L-COTE & SILV-R-COTE Solutions with Applicators..... \$5.95  
 GOLD-COTE with Applicator \$5.95



**BRILLIANT AUTO TRIM** — You'll be mighty proud of the Dazzling new finish on your car's bumpers and trim after replating with MET-L-COTE.... And remember, each time you electroplate with the APPL-I-COTER, you build up a lasting layer of coating that tremendously lengthens the life of original trim.

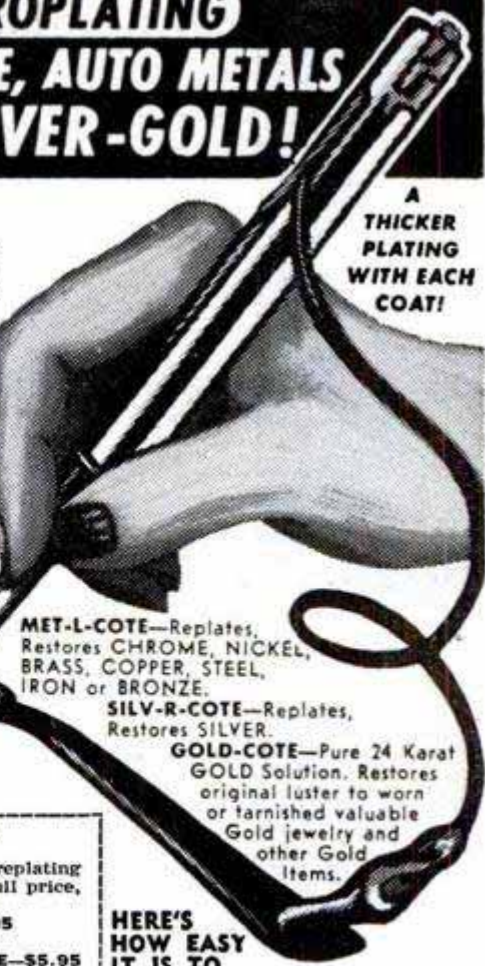
**MET-L-COTE** is constantly used in leading hospitals, and in doctors' and dentists' offices to Replate surgical instruments —Also in hotels and restaurants to RESTORE cutlery.

**CASH REFUND IF NOT COMPLETELY SATISFIED**

**EMPIRE MERCHANDISING CO., Dept. J-10**  
 28 East First St., Mt. Vernon, N. Y.  
 Please rush the New Pocket Applicator and replating solutions I have checked below. I enclose full price, send postpaid, or send C.O.D. plus postage.

MET-L-COTE & COP-R-COTE—\$3.95  
 SILV-R-COTE & POLISH—\$3.95  
 Combination MET-L-COTE & SILV-R-COTE—\$5.95  
 GOLD-COTE with Gold Applicator—\$5.95

NAME \_\_\_\_\_  
 ADDRESS \_\_\_\_\_  
 CITY \_\_\_\_\_ STATE \_\_\_\_\_



**A THICKER PLATING WITH EACH COAT!**




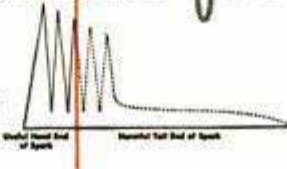





**MET-L-COTE**—Replates, Restores CHROME, NICKEL, BRASS, COPPER, STEEL, IRON or BRONZE.  
**SILV-R-COTE**—Replates, Restores SILVER.  
**GOLD-COTE**—Pure 24 Karat GOLD Solution. Restores original luster to worn or tarnished valuable Gold jewelry and other Gold Items.

**HERE'S HOW EASY IT IS TO REPLATE WITH THE APPL-I-COTER**

**RESTORE YOUR TREASURES.. MAKE THEM VALUABLE AGAIN**

# How a tiny Auto-Lite *Resistor* helps give you better car performance!



When you replace old  worn out spark plugs with new **AUTO-LITE Resistor**  Spark Plugs the tiny 10,000 ohm  resistor filters out harmful end of spark  permitting a wider gap  setting to deliver a  super spark for quick  starts smoother  performance and double  life

*You're always right with...*

**AUTO-LITE**  
*Resistor*  
**SPARK PLUGS**



## ON PATROL WITH A KILLER SUB

U. S. Navy photo

By Thomas E. Stimson, Jr.

I'VE JUST SPENT a week on a killer submarine—one that fights other subs below the surface.

The only warning an enemy would receive would be a sudden beelike buzz as one of our torpedoes raced toward him, followed by an instant of terrible commotion and then oblivion.

That's what would happen if we heard the intruder first. But if we were noisy it might be the enemy who delivered the first, lethal punch.

To rehearse this eerie kind of warfare we lay quietly in the depths of the Pacific with our ultrasensitive listening mechanisms probing the water in all directions.

During the war our undersea forces sank more than a score of enemy submarines that were traveling on the surface. Those experiences led to the concept of real underwater warfare, a grim blind battle between submerged fighting ships. Our new K-class submarines are designed to kill enemy subs that otherwise could wipe out our around-the-world shipping.

Before we had dived to listening depth on our practice cruise,

Lt. Comdr. R. G. Johns, Jr., captain of the *Segundo*, explained the job of the killer to me.

"It's an ultimate in mechanized warfare," he declared soberly, "for you never are personally aware that an enemy is within reach. We can't see a submerged target. We fight with dials and gauges, automatic calculating machines and push buttons.

Under guidance of sub's skipper, the author takes over the sonar panel to listen to fish chirp and possibly to detect a surface vessel





Stimson watches while officers transfer sonar information on a submerged target to the plotting board

"Only by instruments is a target detected. It's tracked by other instruments and is fired upon by means of instruments. And only by instruments can we tell if we have smashed and sunk the enemy.

"We rely mostly on sound waves to detect the enemy, and the enemy has ears, too. That's why we remain quiet."

It seemed quiet enough to me, standing in the control room, when the diesels were shut off on our first dive. Men had rushed to their stations when the diving horn blared, hatches were slammed shut. The deck tilted underfoot. There was a short blast of compressed air and then the boat became silent.

But it wasn't quiet enough for its role of stalking other submarines. The captain

picked up his microphone as soon as the boat leveled off.

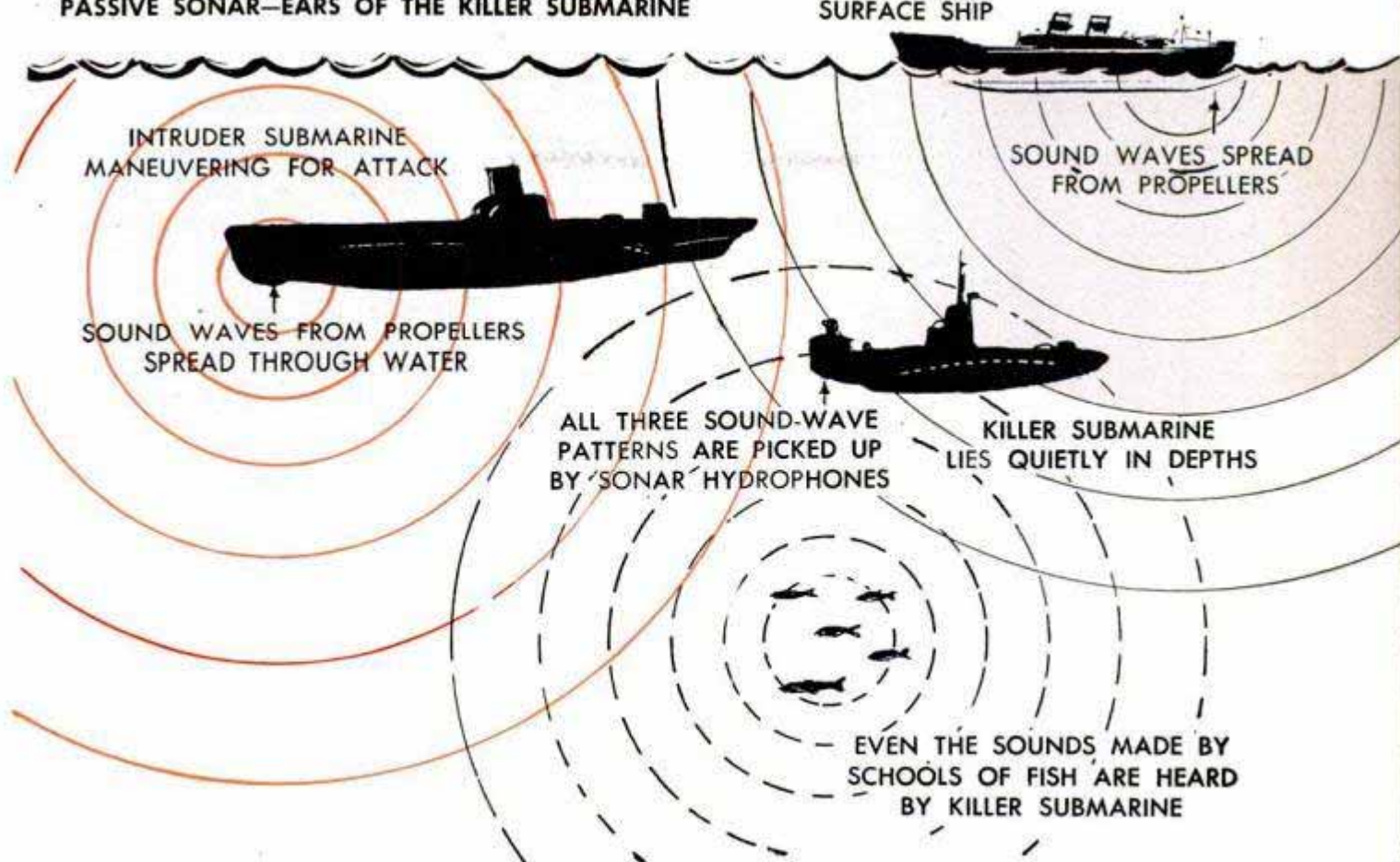
"Rig ship for ultraquiet!"

Men shut down every piece of machinery that could be spared. The air-conditioning system came to a stop and the switch was pulled on the intercom system. From now on communication would be by sound-powered phones.

In the main sound room and at other locations the sonar operators were adjusting their earphones and balancing their circuits to filter out the background noises. The rustle of water through our own superstructure, the slow turning of our propellers when we are moving and the staticlike crackle of waves all form part of the sound background.

Submarine is literally jammed with equipment. Here the air manifold operator prepares to blow ballast tanks





In the control room, a sailor pulled his phone leads from the self-noise panel, satisfied that we were emitting no sounds that would travel very far. This detector is something like a stethoscope with which you can listen to the beating of your own heart. It's attached to hydrophones on the outside of the hull and not only measures our own sound level but helps to identify any machinery that might be causing unnecessary noise.

Meanwhile, the main sonar operator has been sweeping all around the compass with his long-range listening device. His assistant passes notes to him instead of speaking.

An experienced sonar operator can identify sounds that most people would hardly notice. With training he can locate schools of fish and sometimes even identify their species by the chirps, hoots or squeaks they emit. He can locate reefs, identify various types of surface ships and hear the faint sounds of another submarine traveling submerged.

Lying dead in the water, the killer submarine is so delicately balanced that a man walking the length of the boat can change its trim. We have been sinking slowly for awhile, then the depth gauge shows that the downward motion has stopped. The chief of the watch explains that we have settled onto a layer of cold water that will support us for a long time.

It will be a long time until dark, the clock shows, and there's little to be done until

Using passive sonar, killer submarine lies silently in water, listening to every sound. The sonar operator can detect schools of fish, surface ships and an enemy sub maneuvering into position for an attack

Inside soundproof room, the sonar operator becomes ears of the sub. His "talker" in foreground relays information from conning tower, writing down messages to avoid talk that might interfere with listening





When sub surfaces, lookouts scramble up to their stations beside "sail." Snorkel subs seldom need to surface completely

then, aside from the ceaseless listening. After dark we'll go up to snorkel depth for a battery recharge. In the meantime most of the crew rests or reads. A movie in the forward torpedo room helps to pass the time. If the air becomes stale it will be freshened by releasing oxygen from a cylinder and by spreading on the decks a substance that absorbs carbon dioxide.

In actual warfare this routine could go on for three weeks or more, just on the chance of getting three minutes of action. This would begin when one of the sound men detected a suspicious noise. Within seconds he can localize its direction:

"High noise level bearing three four zero!"

It could be a surface ship in which we aren't interested; the crew is called to battle stations only if the object proves to be a submarine. A man in each compartment

quietly taps anyone who is asleep, sonar begins to feed information to "sound plot," and the computer starts grinding out the necessary firing data for the torpedoes.

There's no question in the captain's mind as to whether he will fire on the unseen intruder. No other friendly sub has been assigned to this area.

The captain's big hope is to get off a shot before the enemy suspects he is there. The first shot must count and to make sure that it will, the killer sub has a torpedo that needs to be fired only in the general direction of a target. Once on its way it steers itself directly to its goal. During training maneuvers, a torpedo of this kind, without a warhead, has smashed with a solid thump against the side of a target submarine that was trying to elude a killer.

The K subs use two kinds of sonar—active and passive. One of the sound men explained the difference.

"In passive sonar," he said, "you just listen to the sounds that our hydrophones pick up. But passive listening doesn't detect an object that creates no noise. We can track another submarine while it is moving but it just seems to vanish when its motors and propellers are stopped.

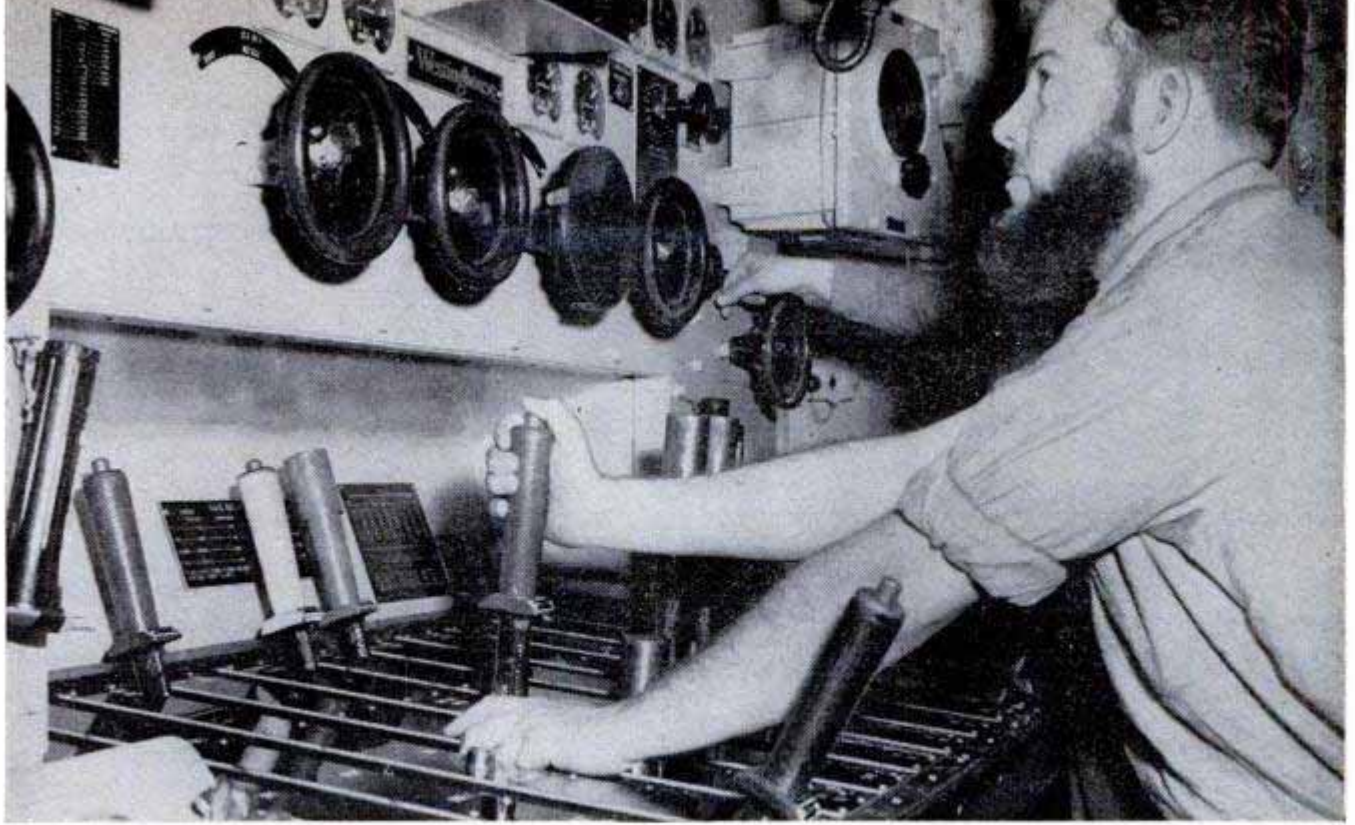
"Active sonar can still find it, however. This apparatus sends out pulses or pings of sound. We can hear any reflections that bounce back from objects. The principle is similar to radar and has the same objections. That is, the target submarine can hear our pings and become aware of us. Then each submarine stalks the other."

Rear Adm. C. B. Momsen compares this situation to a fight between two blind men in a small room, each armed with a hatchet. Both are likely to be killed.

"There are sonar countermeasures, to be sure," the sound man explained. "The Germans used sound-absorbent coatings on the hulls of submarines to prevent reflecting sonar pings. But a coating is good for only one wavelength, while we can ping at various wavelengths.

"Another countermeasure consists of noisemakers that are fired from the tubes. Noisemakers thrash around on different courses and tend to confuse anyone who is listening."

Even at its best, sound is not always reliable for pin-pointing a target, I learned. There are many reflective surfaces underwater that can bounce sound. Reflections or refractions occur at each thermocline or division between layers of water having different temperatures. Too, a layer of cold



In the maneuvering room, controller men change speeds of the powerful diesel engines by moving lever switches

water with warmer water above and below it may serve as a channel and conduct faint sounds for many miles. A sonar operator can't always be sure of the exact location of a target even if he does detect its actual presence.

A killer boat has no friends. Ships or aircraft on its own side might not pause to identify it, so a killer rarely climbs all the way to the surface. Instead, it goes up to snorkel depth and raises its breathing tube into the air. This furnishes enough air for operating one or more of the oxygen-consuming diesels that charge the batteries.

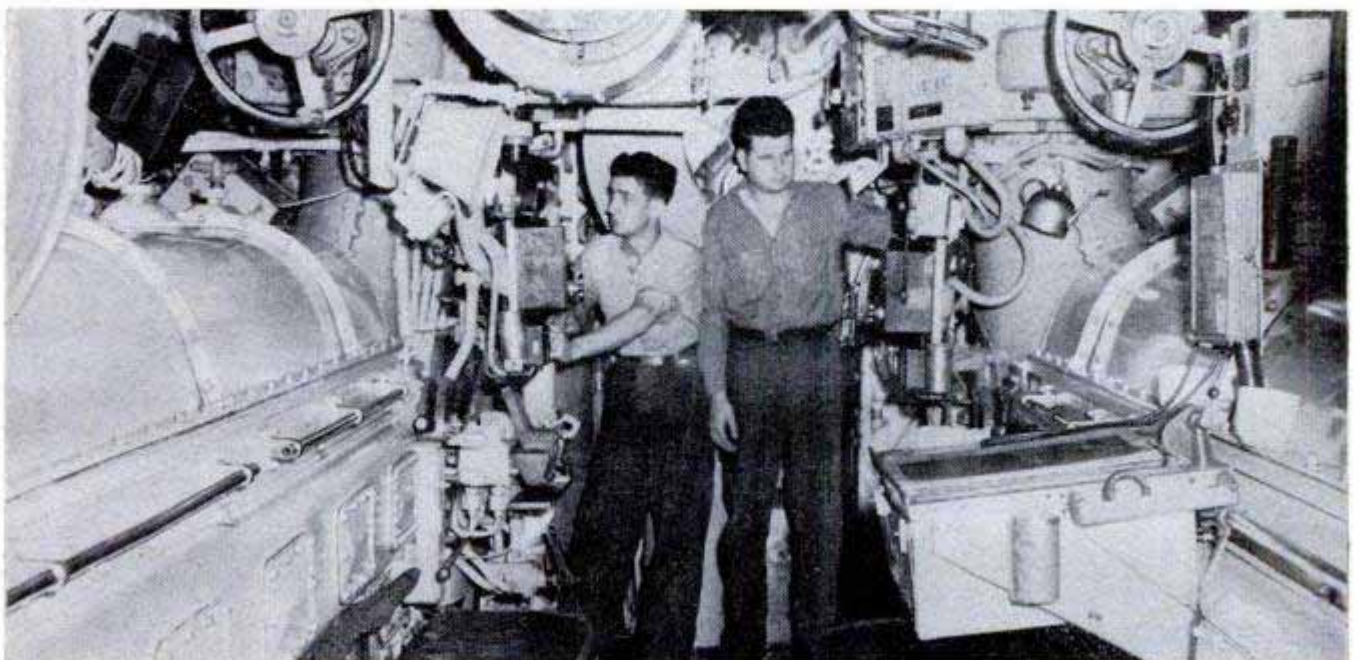
I'd been wondering why the *Segundo* carried an aircraft altimeter and I found

out the reason when we started up toward snorkel depth. All day we had been under an air pressure equal to 200 feet below sea level and, now that we were ascending, air was pumped from inside the hull to help blow the ballast tanks. This restored the atmospheric pressure to that of sea level.

But the pull on your eardrums suggested that the air pressure had changed again as soon as snorkeling began. A glance at the altimeter showed that we were now cruising at 2000 feet altitude, a perfectly silly reading for a submarine.

One of the engineer officers grinned when I asked him how come, and explained that the volume of air drawn down the snorkel

Throttleman and oiler check two of the four engines which propel the submarine and charge the batteries





Pleasant dreams! Quarters are so cramped that some members of crew of 80-odd men sleep beside or atop spare torpedoes. Below, operation of stern light is checked as sub leaves harbor



pipe didn't quite meet the demands of the two diesels. The engines had sucked some air from inside the boat itself. This demand was equalized when the pressure inside the hull corresponded to 2000 feet altitude.

Occasionally we'd "climb" another 500 feet when the snorkel valve automatically closed to prevent our being swamped by a wave. Then we'd return to the previous pressure when the valve opened. A snorkeling submarine can change air pressure more rapidly than a fighter plane.

If we'd lost depth control and had submerged for a longer period the engines would continue to consume the air inside the hull until the pressure dropped to the equivalent of 5800 feet altitude. Then a pressure switch would automatically shut off the diesels.

Actually the *Segundo* is not one of the new K-class boats that have been built especially for killer duties. The *Segundo* is a wartime sub that sank its share of Japanese ships and that has been modernized with new sonar gear and a snorkel pipe. Its crew, nevertheless, is being trained in killer tactics because any of our up-to-date attack-type submarines can play the role of a killer if necessary. Also, men of the submarine fleet must be trained in the special killer tactics so they can be transferred without difficulty to any of the new K-class submarines.

The new special killers are about half the size of the large attack submarines. The killers are 195 feet long, displace about 750 tons, and have a crew of five officers and about 42 men. They can be recognized on the surface by the special streamlined "house" above the bow that is packed with the latest long-range-sound gear.

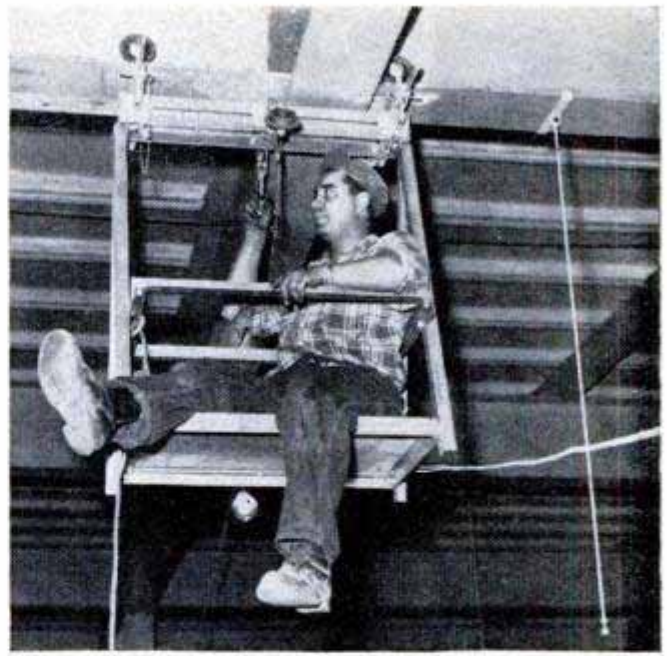
The wartime job of any of the killer subs is to lie in wait below the surface in areas where hostile submarines might be expected to attack our own surface ships. Once on station a killer lashes out automatically against any other submarine that approaches.

It is possible that killer submarines of the future may have nuclear power plants which would enable them to stay on patrol and submerged for long periods of time. ★ ★ ★





Rolling platform was devised to install fixtures overhead where the plant was without roof or floor



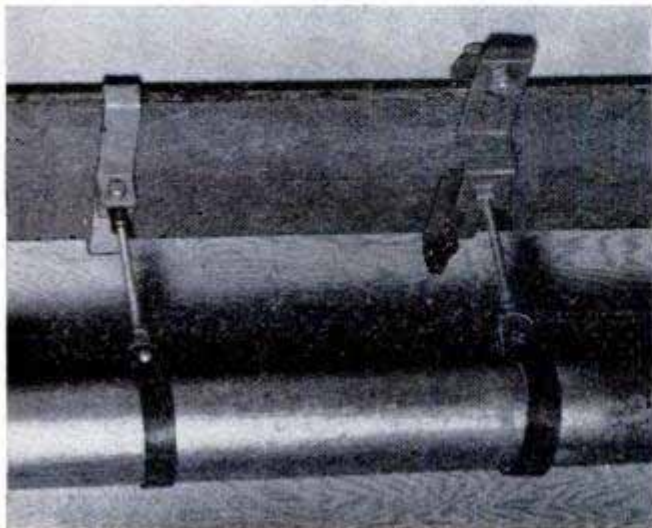
Ceiling work was done from an ingenious "trolley scaffold" in sections that had a roof but no floor

## *On-the-Job Inventions Save U. S. Half-Million Dollars*

THREE INVENTIONS developed by a contractor have saved the government more than \$500,000 in speeding construction of the Navy's new jet-engine plant in Detroit. Thousands of ceiling-light brackets, 15 miles of conduit and 40,000 hanging rods had to be installed quickly in a building only partially roofed and floored. To speed work in sections without roof or floor, C. Allen Harlan, president of the electrical contracting company, took the wheels from his son's soapbox-derby racer and fashioned a rolling platform with guides to keep it moving safely along upper rails of the steel girders with two workmen aboard. For work in the unfloored sections, a trolley scaffold was made of strong alu-

minum alloy. It moved along the lower rails of steel girders on three sets of wheels. When crossing beams, the man in the trolley unlocked a safety catch attached to the wheels and propelled himself past the junction. An electrically operated lift was rigged on a regular aluminum scaffolding to facilitate the raising of long, heavy pieces of conduit. A fourth timesaver was the use of a simplified hanger for conduit.

Time was saved by using a simple new strap, below, for hanging electrical conduit. Right, electric lift hoisted long, heavy pieces of conduit into place



# FARM-BUILT SKI TOW

By William Gilman

Below, rustic bridge supported by steel cable spans a little river to lead skiers into the miniature winter playground. In the homemade cabin, Greene sells refreshments and waxes to boost his farm income



**W**HEN WINTER SETTLES across Vermont and Albert Greene can no longer raise crops on his hillside farm near Middletown—he starts raising skiers. Greene operates a home-built ski tow to supplement his regular farm income.

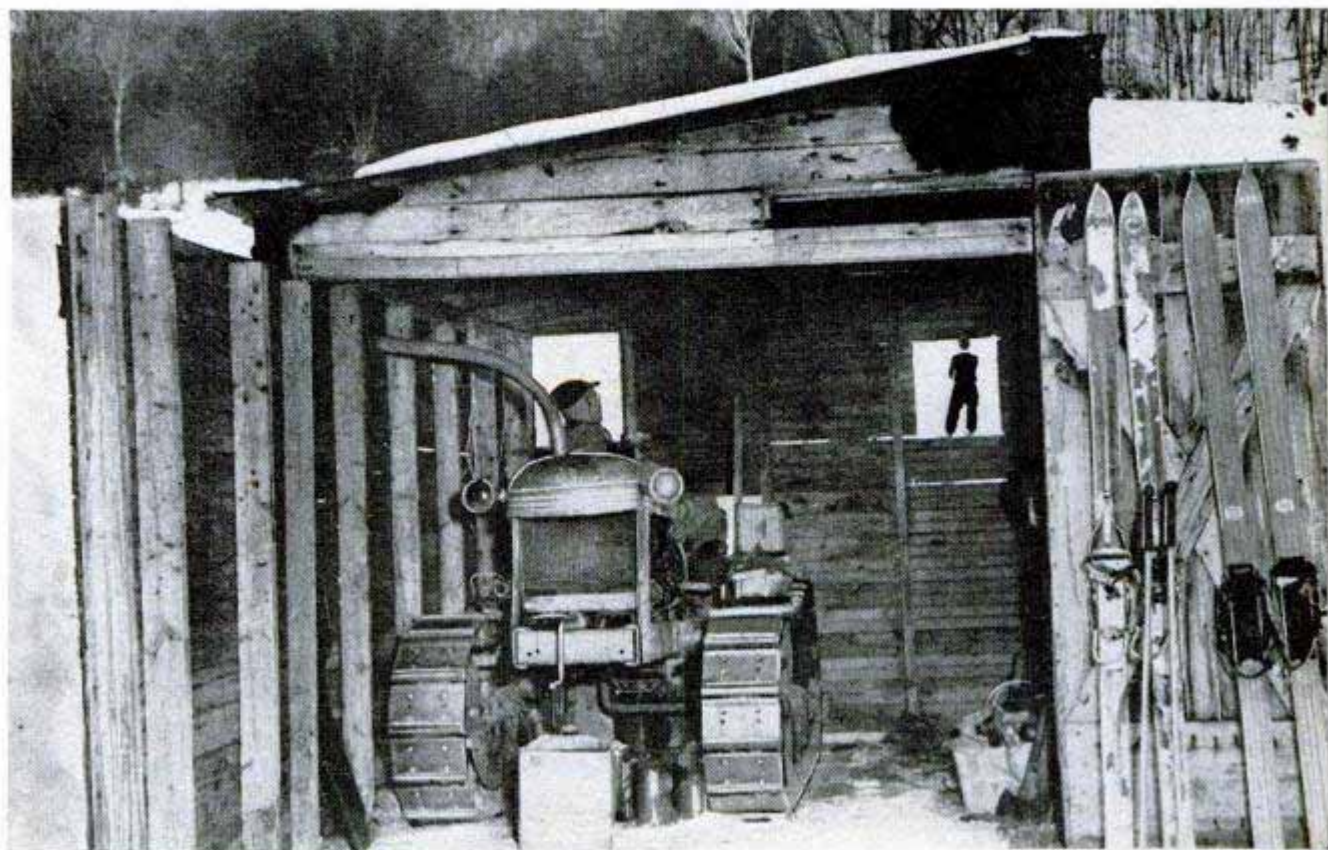
His first step in building the tow was to move an old chicken brooder house to the bottom of a steep pasture. Comes December, he drives his crawler tractor into the old building. The tractor serves as power plant for the tow and the pasture doubles as the ski slope.

The captive tractor operates an 1100-foot rope tow that whisks winter sports fans to the top of the hill in 1½ minutes. Greene uses one-inch rope for the ski tow, which runs off a pulley turned by the tractor's power take-off belt. The rope passes first through an idler pulley, adapted from an old automobile wheel. A similar idler is anchored to a tree at the top of the hill.

Near by, Greene built a rustic bridge and a hut where skiers can buy refreshments and ski waxes, and can warm up between runs down the steep slope. It adds up to a neat winter playground—and a profit for the farmer. ★ ★ ★



Enterprising farmer oils idler pulley while two skiers await a fast trip to the top of the ski slope. ↓ Operating captive tractor, Greene watches through window of old chicken house as skier traffic moves uphill



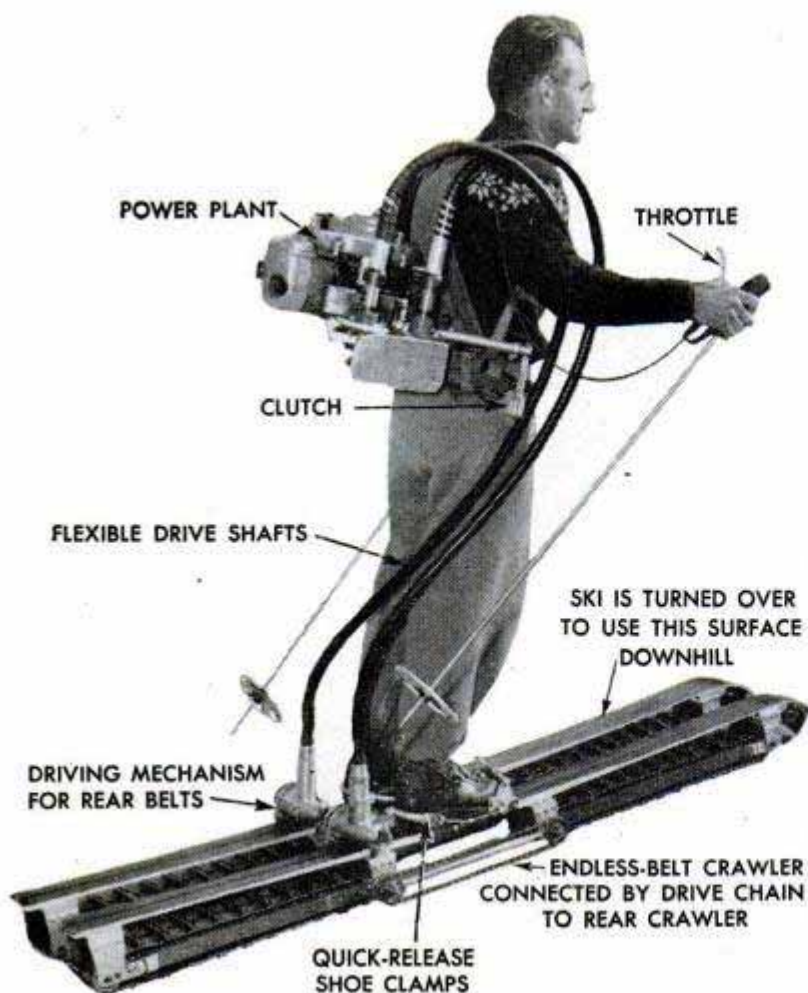
# CATERPILLAR SKIS

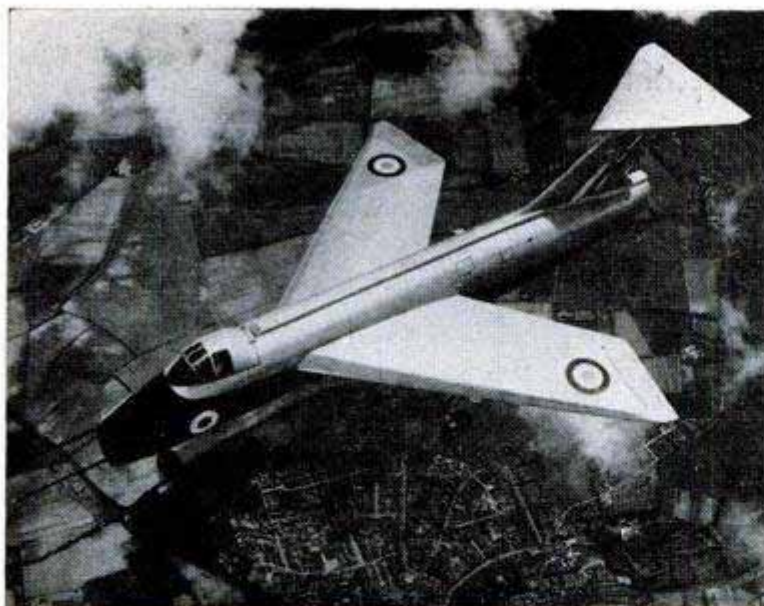


STAN VOORHEES of West Los Angeles doesn't hitch a ride on a ski lift when he goes out for winter sports. His motorized skis propel him uphill faster than a man can walk. Fitted with crawler-type cleats and powered by a  $3\frac{1}{2}$ -horsepower outboard-type gas engine that straps to his back, his skis carry him up a 20-degree slope at 4 miles per hour. At the top of the slope, Voorhees detaches the drive mechanisms and turns the skis over, then coasts downhill. Traversing and other maneuvers are easy. The endless belts are attached to standard seven-foot Army skis. At present, each ski weighs 30 pounds but, with re-designing, Voorhees expects to reduce the weight. Ultimately, a small motor in each ski may replace the present power plant now carried on his back.

Moving uphill at four miles per hour, users of powered skis find snow humps and other obstacles no problem. Below, power-plant pack weighs 47 pounds

Attaching power-plant shafts, below, to tractor drives on skis. Bottom, with the shafts removed and the skis turned over, the skier is ready for downhill travel



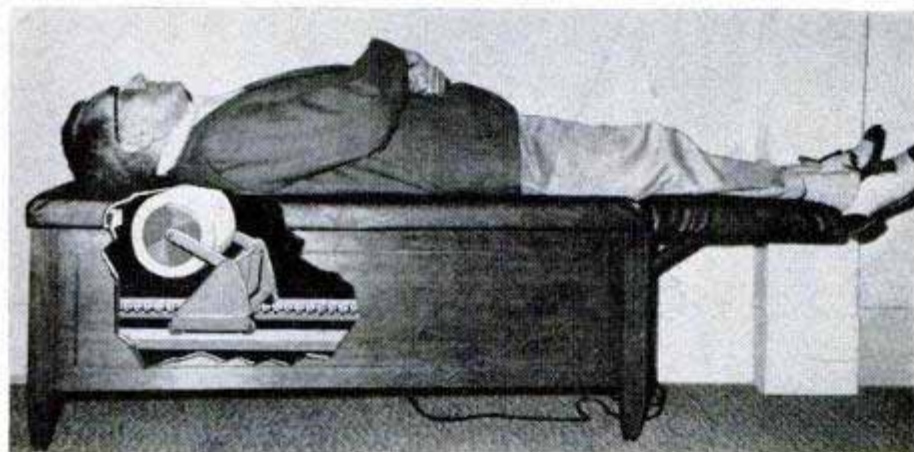


## Fast British Research Plane Has Movable Tail

Short, stubby swept-back wings and a movable, delta-shape tail distinguish the SB-5, new British research plane. The little

plane was built to study the problems of swept-back wing models. It's one of the fastest jets aloft.

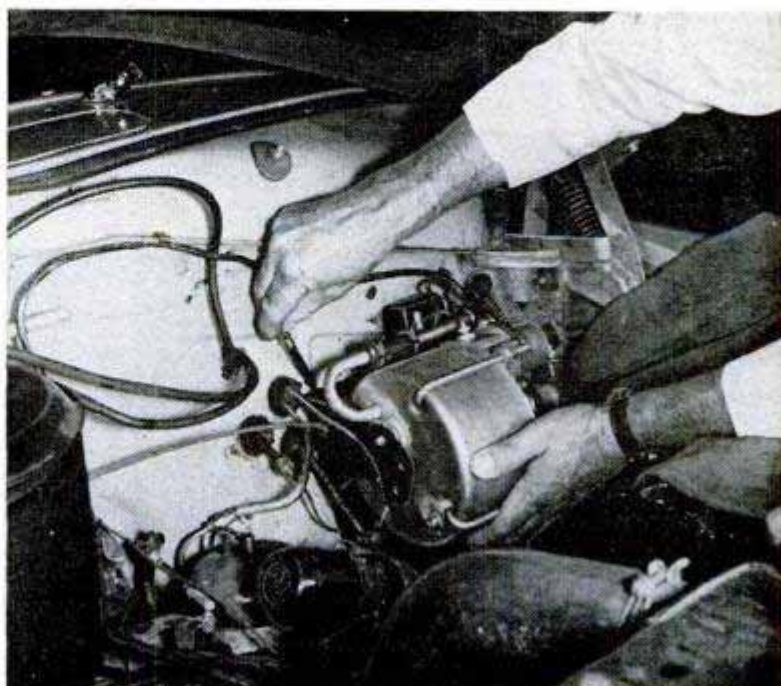
## Motor-Driven Massage Table Helps Busy Executives Relax at Office



Spinal massage to reduce muscle and nerve tension is provided by a mechanical relaxing bench, designed for busy executives who are under constant strain during their working hours. A motor-driven sponge-rubber cylinder moves back and forth along a nine-inch-wide slot in the bench top, gently massaging the spine.

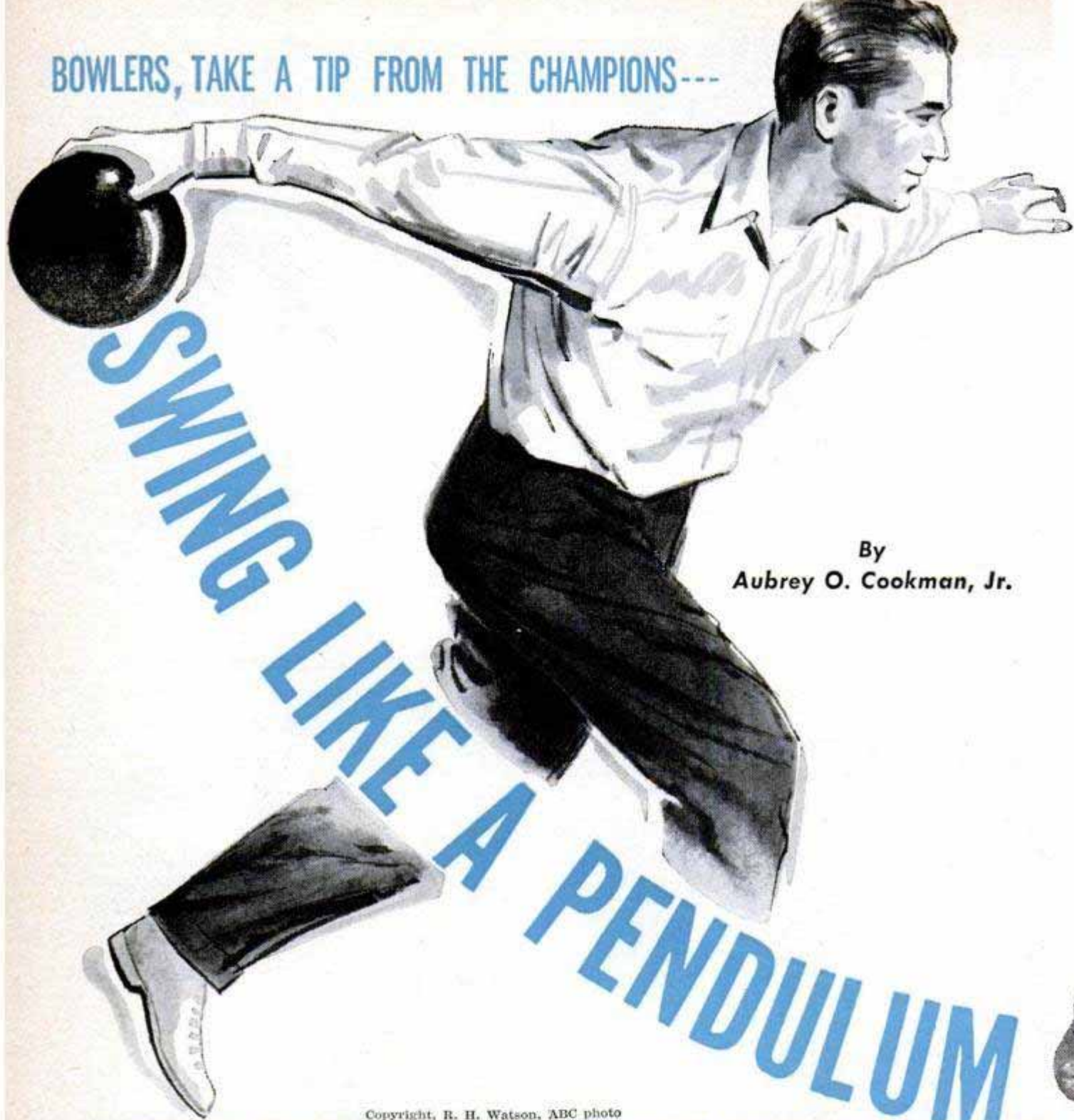
## Power-Brake Attachment For Older Cars

Power brakes now can be applied to cars as much as seven years old. A power-brake unit, manufactured by Bendix Aviation Corporation, can be installed on virtually any make of passenger car by a competent mechanic. The unit adds power braking to regular hydraulic brakes. It is complete with all fittings necessary for installation in engine compartment.



Information not listed on articles in the index frequently is listed in the WHERE-TO-FIND-IT LIST, which is available to readers without charge from Bureau of Information, *Popular Mechanics*, 200 East Ontario Street, Chicago 11

BOWLERS, TAKE A TIP FROM THE CHAMPIONS---



# SWING LIKE A PENDULUM

By  
Aubrey O. Cookman, Jr.

Copyright, R. H. Watson, ABC photo



**R**EMEMBER THE RHYTHMIC, measured swing of the pendulum on the old grandfather clock? Too bad those towering timepieces are a rarity now, because seeing that motion regularly would be a helpful influence on some 20 million enthusiasts bowling regularly in the United States.

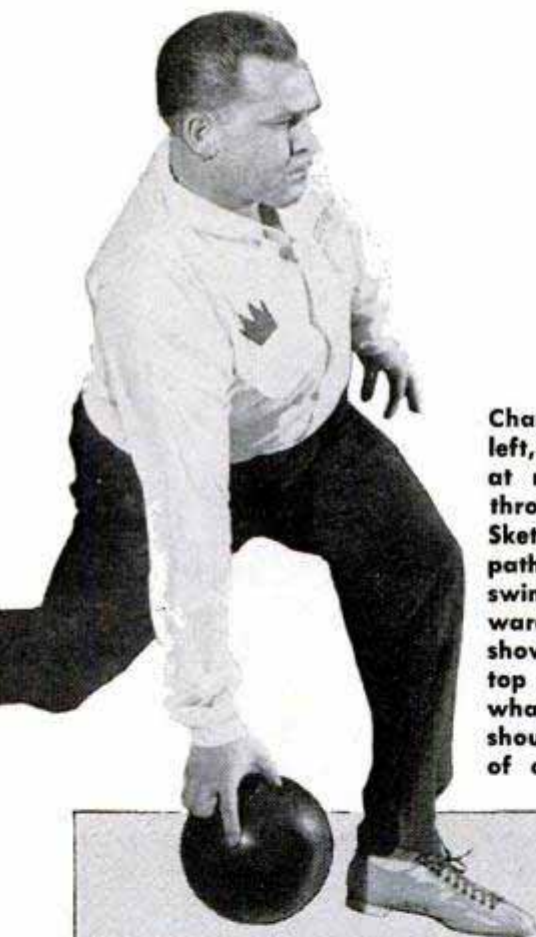
Swing your arm like a pendulum, the experts say, and you've cleared the toughest single hurdle on the way to developing a sound tenpin game. Failure to do it accounts for about 75 percent of bowling's "wild pitches."

Swing your arm on a straight line, all the way back and all the way forward, until the ball has left your hand. Sounds simple, doesn't it? Yet, most teaching professionals, though they differ on other how-to-do-it aspects of the game, agree that the pendulum swing is a fundamental. Mastery of it can spell the difference between a me-

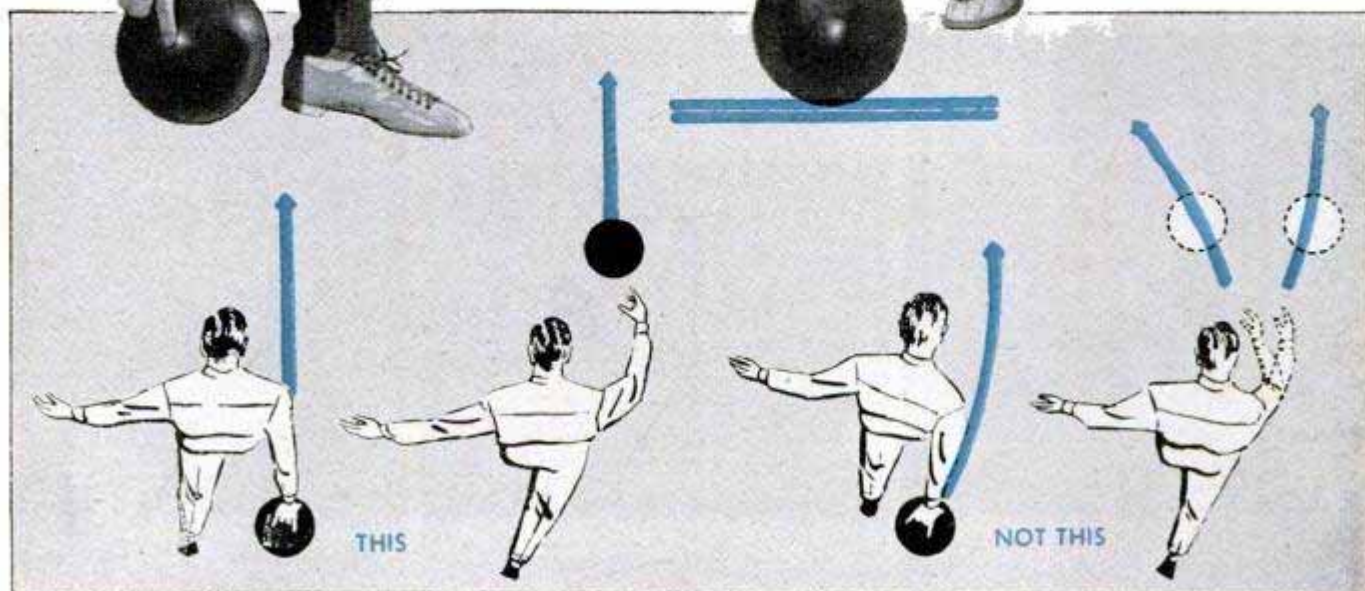
diocre, erratic bowler and one in the 175-plus average class.

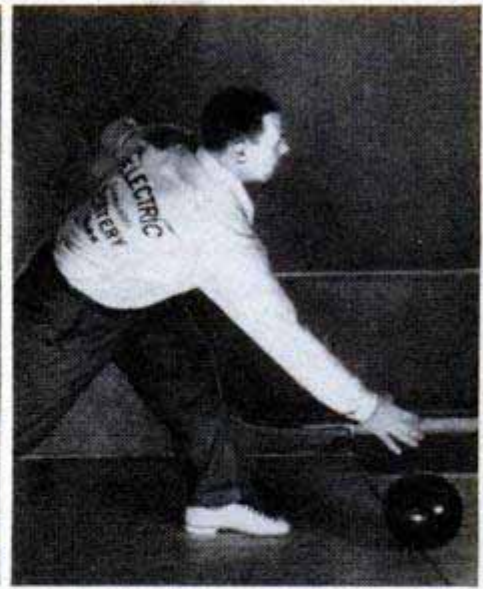
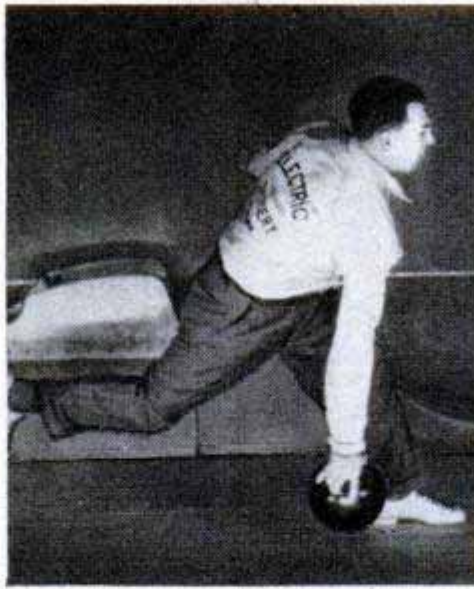
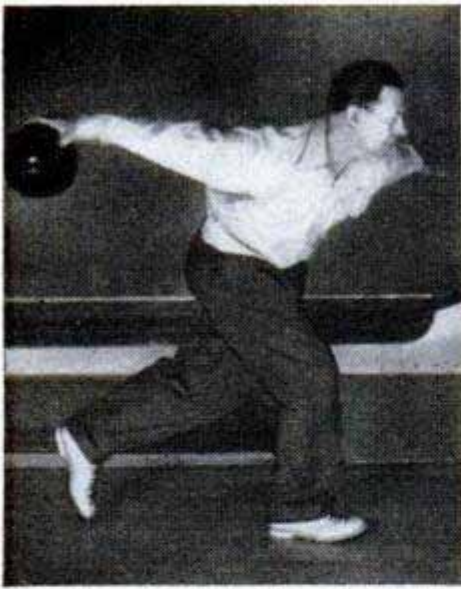
Remember last season, when your ball scooted wildly to the left of the strike slot? Nine out of 10 times that happened because your shoulder shifted forward near the end of your delivery, finishing ahead of your body. In contrast, those off-center pitches to the right side probably came when shoulder lagged behind body.

Those mistakes are often compounded or aggravated at the top of the backswing, where many bowlers crook their throwing arm behind them. Some flip the arm outward at this stage, many inches out of the pendulum groove. Once his arm is out of the groove, it is a rare kegler who can recover fast enough to straighten out his delivery during the fraction of a second of the downswing. It usually continues along the same swerving path.



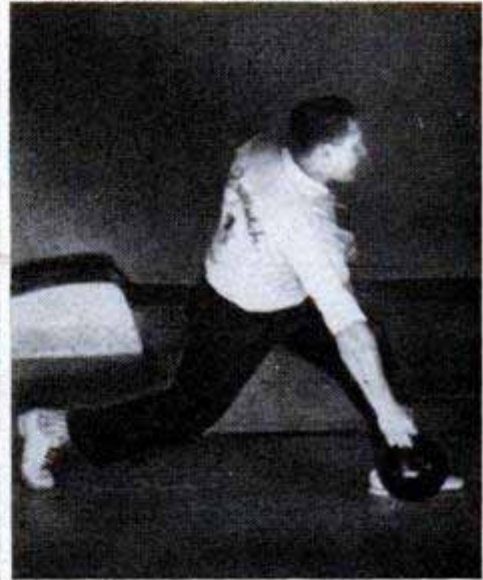
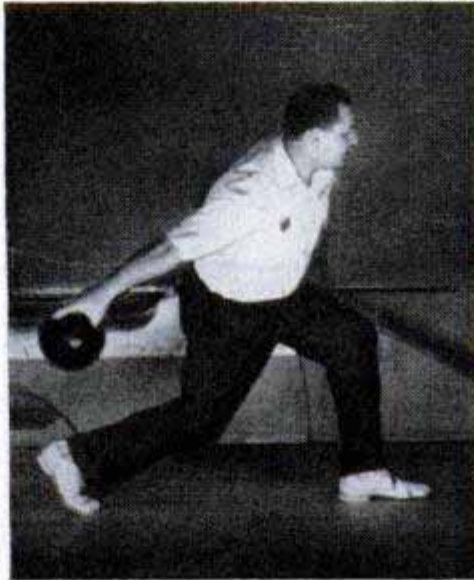
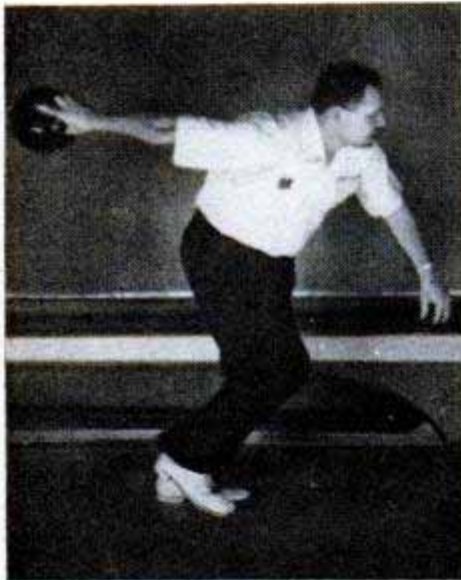
Champs like Steve Nagy, left, and Stan Slomenski at right swing straight through on deliveries. Sketches, left, indicate path arm follows as it swings back and forward. Drawings at right show shoulder off line at top of backswing and what happens when shoulder finishes ahead of or behind the body





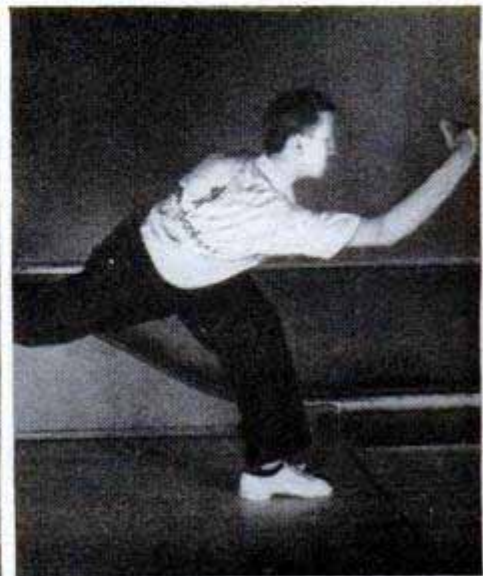
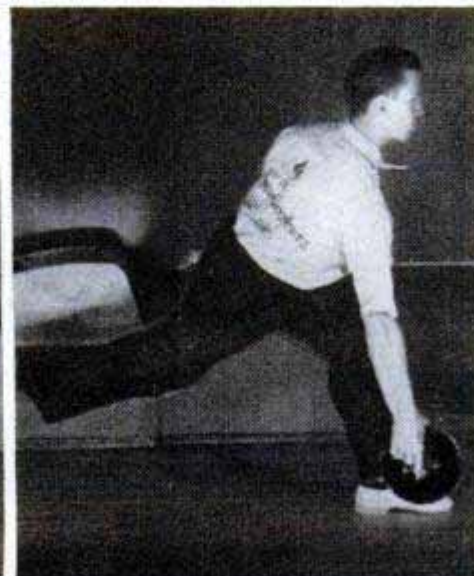
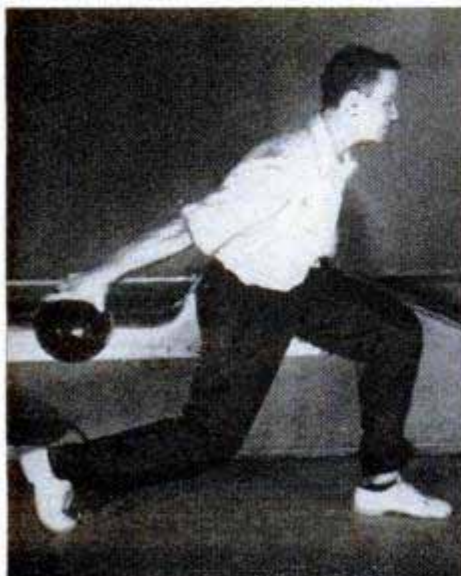
Here is Stan Slomenski, a former national champion, at the height of his backswing, just as the second step is completed. In the middle panel he has reached the halfway mark of his delivery, with his right foot swung behind his body for balance during the slide. Right, he has released the ball and his hand follows swing through

Photos on this page courtesy of Bowling Magazine



In contrast to Slomenski's three-step approach, Steve Nagy, another topnotcher, takes five steps. His backswing, left, is at its height between the third and fourth steps. Nagy's body is lowered, center, as he starts his final sliding step. Right, Steve's thumb is out of the ball and his fingers are giving it a final lifting motion

Bill Lillard's forte is a good hook ball. Left, a straight wrist enables him to stay under the ball with his fingers as it swings down during his fifth and final step. In the center panel his arm is swinging past the left foot, which is sliding. Note cupping motion of his hand, right, as he follows through after releasing the ball





You'll be surprised at the many bowlers whose effectiveness is mainly limited by a faulty arm swing. Sit behind some at your local alleys and watch the wobbly paths their arms follow back and forward. In your own case, a full-length mirror will be helpful in smoothing out the wrinkles as you try for a pendulum swing.

Dick Watson, a Hollywood film projectionist, has devised another way of seeing yourself in action and makes it available each year at the American Bowling Congress tournament. Watson, who is also a star bowler, groups a battery of speed lights around a stub alley, consisting only of the approach space and a few feet beyond the foul line, and has a photocell tripper that takes a photograph of the bowler at the instant the ball leaves his hand.

When the pendulum swing is mastered you are ready to arm yourself with the second ingredient needed for an expert game—a hook. Rarely does a bowler move into the championship class, or even get to be a topnotcher, without an effective hook. That's one sports axiom that has stood the test of time.

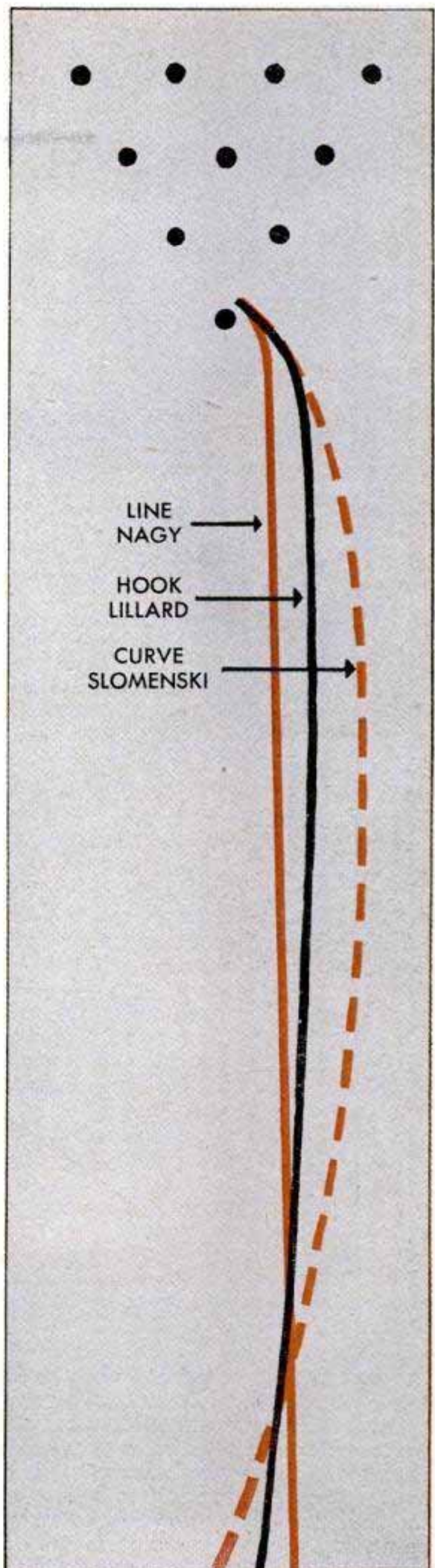
The hook and its variations are balls that swerve, curve or turn into the "pocket" between the 1-3 pins, for right-handers, or the 1-2 for left-handers. Nine out of 10 times, properly thrown, a hook will topple all 10 pins for a strike. If you're a sports novice, the strike in bowling is comparable to a home run in baseball, a touchdown in football or a 250-yard drive down the middle in golf.

From a mechanical standpoint, at least, the hook isn't overly difficult to throw. Once mastered, throwing it regularly is only a matter of practice and concentration.

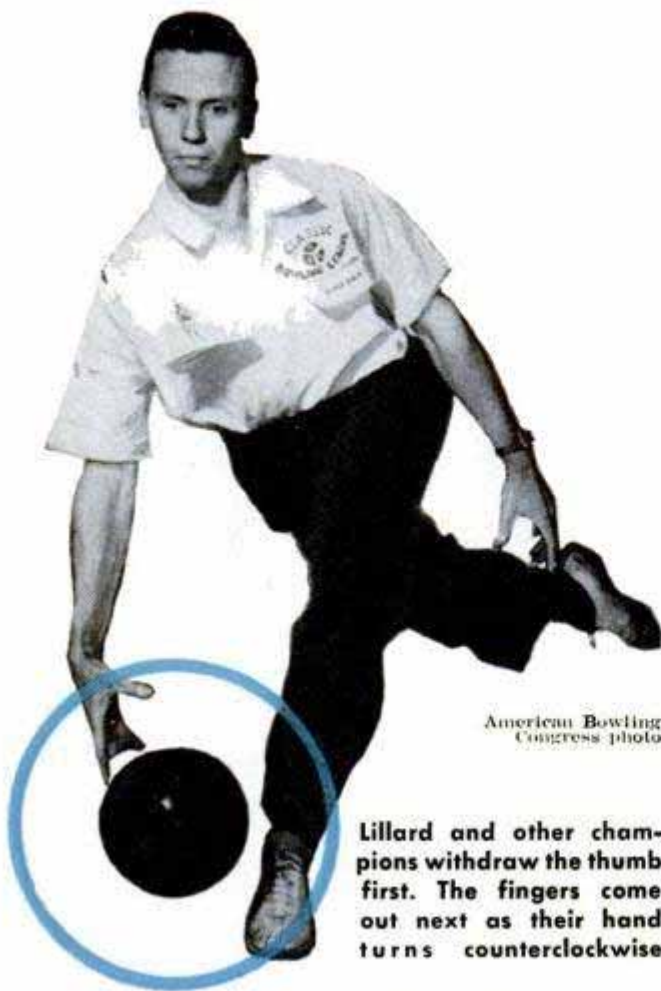
Let's run briefly through the fundamentals of the delivery of a hook or any other type ball. The distance you travel before reaching the foul line, where the ball is released, or how many steps you take to get there, varies with the individual. There is no inflexible rule for either. The length of your legs and the span of your usual stride will be the main determinants. Most players find four steps feel natural and comfortable, but among champs there've been many who took three and five, and a few who even shuffled through a modified two steps.

Much of bowling's mass popularity is because success in it isn't keyed to any particular kind of build, which likewise explains the leeway the game permits in styles. Fat, thin, tall and short men, as well as average individuals, are among the topnotchers. As evidence that power or strength isn't vital, Hank Marino of Milwaukee, voted the outstanding star over the first half of the century, is a slight, rather short man.

Start the ball waist high, centered in front of your shirt buttons. Drop it easily, not abruptly, into the pendulum groove. Keep your backswing low, so that gravity doesn't speed the ball too



Here are examples of the approximate paths of three types of "breaking" balls thrown by Nagy, Lillard and Slomenski



American Bowling Congress photo

Lillard and other champions withdraw the thumb first. The fingers come out next as their hand turns counterclockwise

much as it comes forward. Don't force or push the delivery. A ball descending too fast will drop down jerkily, cheating the bowler out of the lifting action he should get at the last moment of the upswing. This lift supplies the mixing action as the thumb, then the fingers, leave the ball. At this point the bowler's thumb and forefinger form a wishbone parallel to the foul line.

As the fingers come out of the ball, the hand is turning counterclockwise, causing the ball to spin to the left as it moves down the alley. That final lift gives the ball the spin that is the essence of an effective hook. This spinning motion of the ball throws the pins it strikes with more telling effect against the remainder of the pins. In comparison, a straight ball, with no "stuff," generally knocks over few more than the pins it actually hits or pushes over. It gets virtually no help from pins striking the other pins, particularly those in the corners, the 7 and 10.

For best results the hook is thrown so the ball first touches the alley a foot or more beyond the foul line. The spinning action reaches its peak effectiveness somewhere past the alley's halfway mark. Most champions throw the ball so that it passes over a preselected spot 10 to 20 feet beyond the foul line. They use this as an aiming point, knowing from experience the approximate path the ball will follow from

there. It is easier to hit this close-up aiming point, like the sight on a rifle, than to rely on the head pin, 60 feet away.

Broadly classified, there are three kinds of hook balls. They're similar in that all cause the ball to change course and head inward towards the pins. They differ in the paths they follow and the sharpness of that final inward turn.

Steve Nagy of Cleveland, for example, throws a "line" ball. Coholder of the all-time doubles scoring mark, Nagy has a delivery that sends the ball on a relatively straight line, then breaks it into the pocket at the very last moment. Until the last split second it resembles a straight ball, but the short turn at the final moment drives it in with a spinning punch to splatter the pins.

At the other extreme is Stan Slomenski of Newark, N. J., with a sweeping curve that baseball fans would call a "round-house." Stan releases the ball near the center of the alley, but it first heads toward the side before swerving widely back to the center pocket. This is the most difficult type of hook to control and isn't suggested for beginners. One noticeable thing about this pronounced-curve delivery is that its users, like Slomenski, generally release the ball low, with very little loft out onto the alley. With a curve delivery the ball generally contacts the alley only a few inches beyond the foul line.

Bill Lillard, a former Texan now bowling out of Chicago, is a new start with a strong-hook delivery. His ball begins to break sharply about 12 feet out from the head pin, as a rule, though this can be varied to suit alley conditions. Lillard throws the ball with a cupped motion of his hand and forearm, accentuating the spin.

Incidentally, though many bowlers are now inserting their thumb full length into the ball, Lillard puts his thumb in only to the first joint and the fingers in to the second knuckle.

Hook advocates, arguing against the curve-ball delivery, point out that the alley's boards, laid lengthwise, tend to slow up the ball. Traveling across more boards, from left to right and then back again (for righthanders), also tends to make the ball's behavior less predictable, since the wood varies in hardness and polish. While experienced professional bowlers can quickly compensate for these differences, they point out, the once-a-week or occasional bowler isn't skilled enough to make the adjustments.

All the pros and teachers are agreed, though, that a breaking ball—whether it is a hook, curve or line ball—is the most effective way of knocking down all the pins in one toss. Speed and accuracy, alone, isn't enough. ★ ★ ★

## Machine Makes Ribbon Bows for Christmas Wrapping

Fancy ribbon bows for gift wrapping are produced at the rate of 150 per hour by a small, hand-operated machine. Each hank of ribbon for a bow is formed by turning a handle which cranks the desired amount of ribbon around a pair of adjustable winding arms. The hank is then manually removed, cut, notched, and tied at the notch with a ready-to-use narrower strip of ribbon. Completed bows can be stored for later use—retailers are thus able to prepare for the Christmas rush in slack periods. An attachment permits production of multicolored bows.



## Army "Robot Psychologist" Finds Right Men for the Right Jobs



Input section at right receives and stores data. Operator's console has controls for receiving data from it, computing elements, viewing screen and camera for photographing screen

Army psychologists have a new, complex tool to aid them in finding the right man for the right job. It's a "robot psychologist" with an electronic brain, a memory and a cathode-ray viewer. Statistical results of paper-and-pencil tests given to people already in specific vocations are fed into the machine. A summary of test results appears on the viewing screen as a pattern of dots. A characteristic dot pattern for each job is thus determined, and used in mass testing and placement of recruits. Information not required in a particular problem is stored for future use. Similar problems are solved in days instead of years.

## Squeezeless German Accordion Powered by Electricity

German technicians have taken the squeeze out of the "squeeze box" with a new electric accordion. Plugged in and placed on a table, it's played by fingering two keyboards of 41 keys each. The bottom keyboard regulates the pressure of air against vibrating tongues; the top controls electrically produced sound. Switch buttons and dials allow selection from seven different timbres and permit a tremor effect, or allow the top keyboard to play with wind pressure. Two rods projecting downward are pressed by either knee to produce swells in volume.



¶ In seven years, 2800 commercial helicopters have been built in the United States.

# Your Car May Need One of

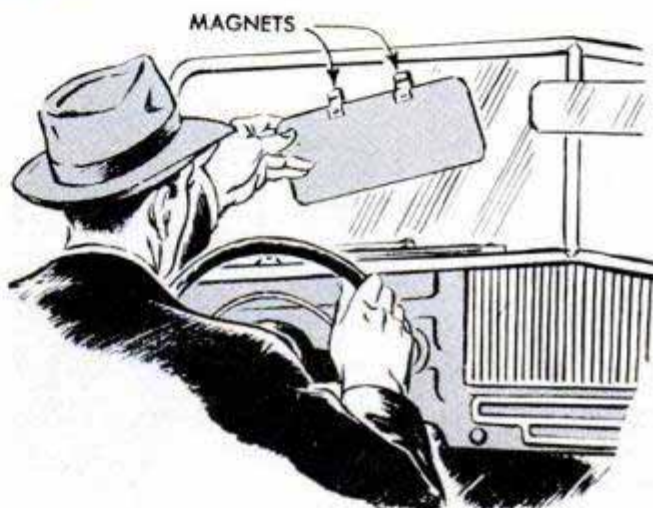


## Mirror Says "Dim Your Lights"

Motorists who insist on driving behind a car with their bright lights bothering the driver may find themselves victims of their own lights. Two Georgia men invented a mirror device that is mounted on the rear shelf so that it aims the light rays back into the eyes of the discourteous motorist

## Magnets Hold Visor

Held in position against the windshield metal trim by two permanent magnets, a tinted visor eliminates the driver's eyestrain under strong sunlight. The visor is transparent and does not obstruct view in any direction. It also can be used on a door window



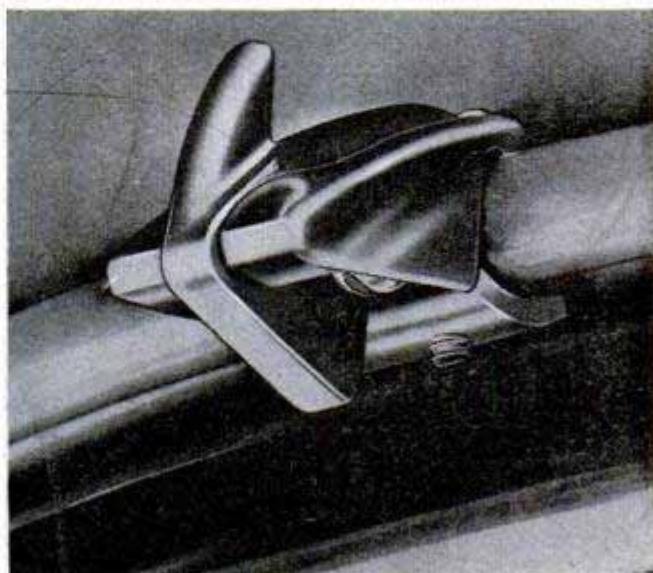
## Vacuum-Bottle Rack

Hot or cold drinks are close at hand on long trips when you have a rack that clamps to the bottom of the front seat and holds two vacuum bottles safely. Attached or removed quickly without tools, the rack keeps the bottles upright inside rubber-padded rings

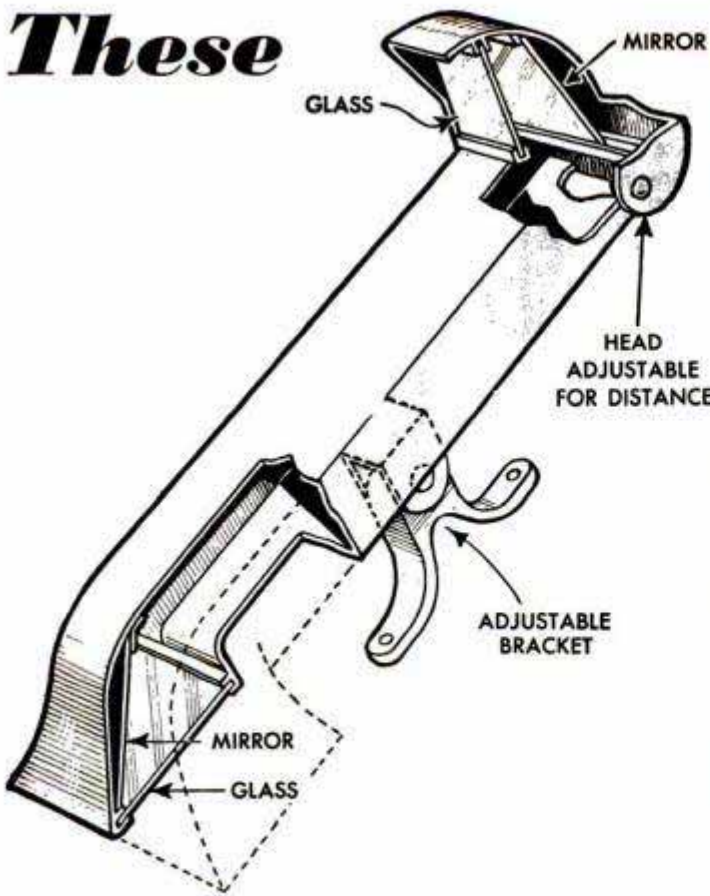


## Drip-Mold Latch Locks Rear Door

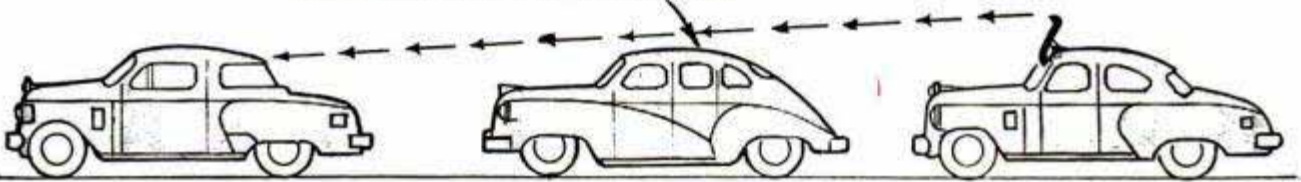
Clamped to the drip molding above the rear door of a sedan, a latch prevents accidental opening of the door while the car is moving. Even though the door handle (either inside or outside) is operated, the door won't open until a lug on the latch is lifted



# These



DRIVER CAN SEE OVER PRECEDING CAR



## Periscope Aids Driver in Traffic

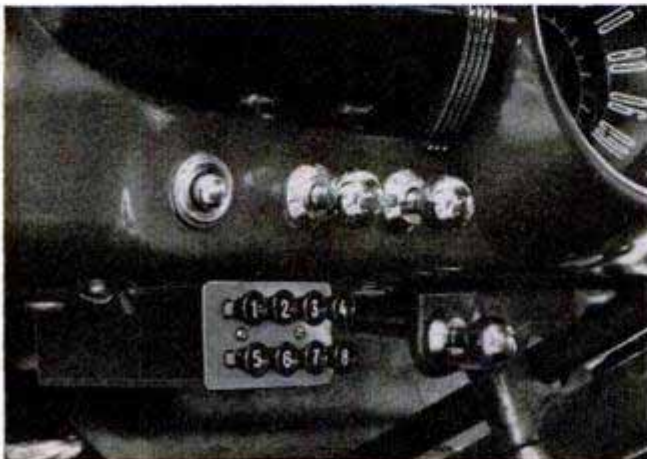
Lines of traffic don't block the driver's vision when he is using a periscope that mounts atop the windshield. With it, the driver is able to look over the top of the preceding automobile. It is expected to prove useful on ambulances, police cars and other emergency vehicles as well as on standard automobiles

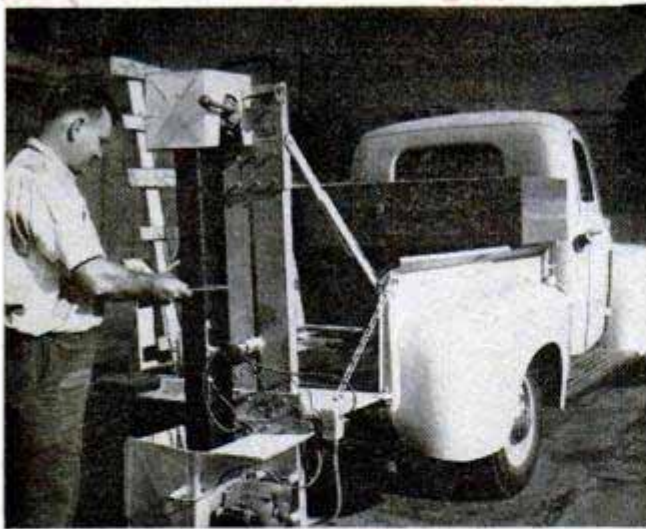
## In-the-Car Coffeemaker

Motorists make coffee on the way to work in a German coffeemaker that plugs into the dash. In 10 minutes, coffee is ready. Base of the maker becomes a cup

## Push-Button Ignition Lock

You won't lose the key to your car with a combination ignition lock. You punch out the combination on eight push buttons and the switch turns on. If anyone tries the wrong combination, your horn blasts out an alarm





## Glass "Ambulance" Replaces Car Windows at Scene of Crash

Broken windshields or windows are replaced at the scene of the accident by a mobile glass shop in a pickup truck. The truck carries an electric belt sander for grinding and polishing the glass. It is cooled by a tank of water on the running board. A large chest contains 6000 glass

patterns—enough for all American cars. These patterns are printed on large rolls. The top of the chest is the cutting table. Also included in the truck are racks for glass storage, a supply of window channels, a welding outfit and a hot wire for heating the plastic center of safety glass.

## Spot and Trouble Light Housed in Phone Handset

Spotlight and trouble light are combined in a device that looks like a telephone handset and clips to an automobile dashboard. Power from the car's electrical system is supplied through a rubber-covered coiled wire that lengthens to 10 feet for use anywhere about the car as a trouble light. A sealed lamp in the receiver end of the handset is bright enough to use in spotting house numbers or road markers at night. The switch is housed in the "mouthpiece." Installation is simple and quick.

## Hook-On Heating Hoses Warm Cars at Drive-In

Pull into a drive-in restaurant near Temple, Tex., on a cold winter day and you'll be supplied with heat as well as food. The car hop takes a big hose off a hook, inserts it in a back window and rolls the glass up tight against the metal outlet. The forced hot air comes from two gas furnaces which feed ducts running the length of two long carports. At each parking space is a length of airplane heating hose with an outlet nozzle. An air-conditioning system, using the same hoses in summer, is now planned.





## ***Buoyant Stone Replaces Wood***

ROCK so lightweight it floats, so workable that it can be sawed like wood, is booming business in a small Japanese fishing town.

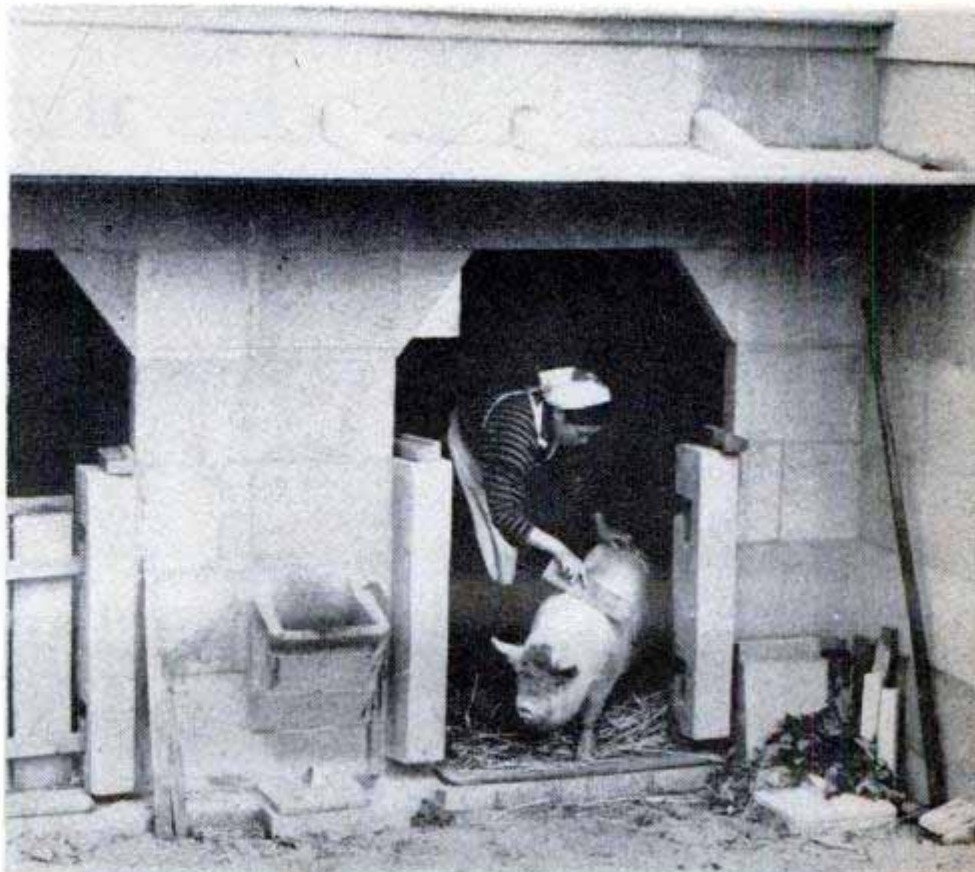
Easily quarried at a mountain near New Island Village, the porous stone is used in fireproofing large buildings. The volcanic rock is sawed into regular sizes and shapes and then smoothed with a plane. Villagers sell only the best stones, using the rest to construct homes and farm buildings. Lightweight-rock construction has definite advantages in case of an earthquake, as a collapsing house would be less likely to harm the occupants.

The stones have a ready market; a good stone one foot by six sells for the Japanese equivalent of one dollar. As a result, the local villagers are enjoying a period of unparalleled prosperity. They used to work three days in a rice paddy for the same sum they now receive for just one stone.

New Island youngsters, capitalizing on the stone's floating qualities, take a few of the buoyant rocks with them when they go swimming. The stones make good life preservers, they report.



Quarry workman, above left, saws a piece of the volcanic stone as if it were wood. Children, above, use the stones as life preservers. A well-groomed, well-fed hog enjoys attractive living quarters made of the lightweight stone found near Japanese fishing village.



**WHAT THEY LIKE:**

POPULAR MECHANICS CONDUCTED BY FLOYD CLYMER

Hornet

**The OWNERS**

- 1. I own a 1953 Hudson: Jet or Super Jet  V-8  Over
- 2. It has conventional transmission
- 3. Speedometer reading now is: 5280
- 4. I use regular  or premium (high test)
- 5. My average gasoline mileage in city: 19 1/2
- 6. I add 0 quarts of oil in 1000 miles. I change oil every 1000 miles.
- 7. Here is what I like best about my Hudson: It is small - easy to park, handles nice. Good looking. Has plenty of H.P. to suit my needs.

DENVER, COLO., TRUCK DRIVER

- 6. I add      quarts of oil in 1000 miles. I change oil every 1500 miles.
- 7. Here is what I like best about my Hudson: Snappy performance, ease of handling, roadability (at any speed) and comfort. Top speed is 95 m.p.h.

SAN DIEGO, CALIF., SAILOR

- 6. I add      quarts of oil in 1000 miles. I change oil every 1200 miles.
- 7. Here is what I like best about my Hudson: Small size, short turning radius, light weight yet big engine, giving very good power to weight ratio and hot performance.

SAN FRANCISCO AIRLINE WORKER

**WHAT THEY DISLIKE:**

- 8. Here are my specific complaints: GAS MILEAGE THEY CLAIM IS NOT WHAT I'M GETTING. POOR PAINT JOB. NOT ENOUGH LEG COMFORT IN REAR SEAT.

CHICAGO, MACHINIST

- 8. Here are my specific complaints: Doors rattle and noise near front seats. Rain seeps through doors and body. Doors do not open and close smoothly.
- 9. I rate its roadability\*: Excellent  Good  Unsatisfactory

BROOKLYN, N. Y., SALESMAN

- 8. Here are my specific complaints: Car is without trim on both sides which I think would make it more beautiful

- 9. I rate its roadability\*: Excellent  Good  Unsatisfactory

BUFFALO, N. Y., CONSTRUCTION WORKER





# REPORT on the HUDSON JET

The true test of a car begins when the owner takes the wheel. *Popular Mechanics* asked Jet owners from coast to coast about their cars. Here is what they have to say

By Floyd Clymer

**DO OWNERS MEAN IT** when they say that America needs more good small cars? Hudson aims to find out with the only new name among the 1953 models—the Hudson Jet.

To discover what kind of a car it is to own, drive and live with, *Popular Mechanics* questioned Jet owners from coast to coast.

A very large percentage of them agree on what they like best about their cars. It is the way the Jet handles—48 percent of the owners listed handling and maneuverability among the points they like best.

“Very easy to park . . . turns on narrow streets without reversing.”—Brooklyn, N. Y., retired owner.

“Easy riding and parking. Easy driving on mountain roads.”—San Francisco railroad worker.

“A short person can drive without banking himself with pillows, yet a tall person can also drive comfortably.” Detroit, Mich., teacher.

Close behind handling was performance in the list of favorites among owners. Forty-seven percent mentioned acceleration, top speed, or some other characteristic of good performance.

“Terrific performance. From a standstill to 60 in 10.5 seconds with no lag in power in any speed.”—Brooklyn, N. Y., telephone worker.

“Plenty of speed.”—Duluth, Minn., factory worker.

“I like its pickup ability and its climbing ability.”—Cleveland, Ohio, pipe fitter.

“Drove it up to 85 miles per hour and it handles very satisfactorily.”—Detroit, Mich., supervisor.

“Excellent acceleration even from 60 to 80 miles per hour.”—Detroit, Mich., truck driver.

“Will out-accelerate 9 out of 10 cars. I can do 98 miles per hour.”—St. Louis, Mo., carpenter.

“I have driven this car at 90 miles per hour and no car feels more solid.”—Chicago Pullman conductor.

Top complaints were body rattles and the lack of legroom in the rear seat. These were voiced by 13 and 11 percent of the owners respectively.

“Doors rattle and there’s a noise near the front posts.”—Brooklyn, N. Y., salesman.

“Lots of wind and road noise. Quite a few rattles.”—Havre, Mont., telephone worker.

“Rattles, rattles, rattles and very poor on rough roads.”—Salem, Mass., insurance broker.

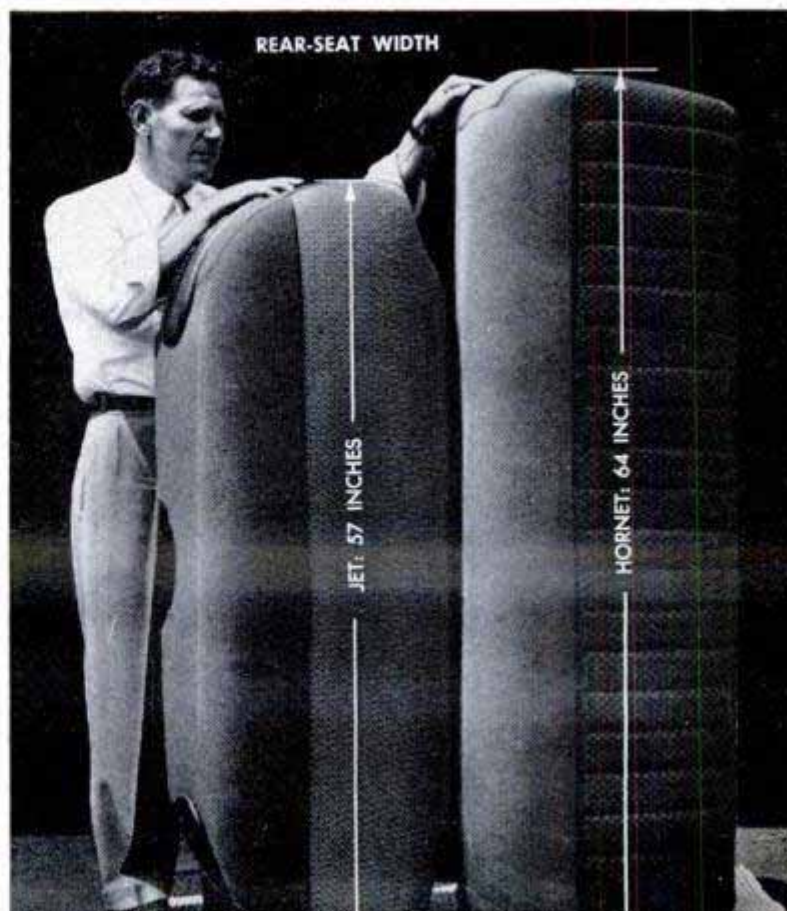
“Hardly any knee or foot space in back seat. Step-down feature makes sweeping floor difficult.”—Buffalo, N. Y., carpenter.

“Body is too small for traveling on fishing trips. Space in back seat is too small for anything but the feet of anyone riding there. Not enough room for baggage.”—Chicago, mechanic.

“My friends tell me there is no room in the back seat. I don’t ride back there so it makes no difference.”—Chicago salesman.

Water and dust leaks and poor dealer service were next most frequent complaints—nine percent of the Jet owners listing each of them.

Hiproom in Jet rear seat is 58 inches, enough to seat three easily. Cushion measures slightly less. Hornet cushion is one of the widest in the industry



## Percentages from PM Poll of Hudson Jet Owners

### GENERAL INFORMATION

|  |      |
|--|------|
| Average speedometer mileage.....               | 3514 |
| Owners using regular gasoline.....             | 60%  |
| premium gasoline.....                          | 40%  |
| Previous Hudson owners.....                    | 37%  |
| Owners of five or more Hudsons previously..... | 8%   |

### RATINGS ON PARTICULAR FEATURES

|                            | Like | Acceptable | Dislike |
|----------------------------|------|------------|---------|
| Visibility, forward.....   | 98%  | 2%         | 0%      |
| Interior styling.....      | 92%  | 8%         | 0%      |
| Visibility, rear.....      | 92%  | 5%         | 3%      |
| Horsepower.....            | 88%  | 12%        | 0%      |
| Riding comfort.....        | 84%  | 14%        | 2%      |
| Exterior body styling..... | 67%  | 30%        | 3%      |

### PERFORMANCE RATINGS

|                              |      |
|------------------------------|------|
| Average miles per gallon     |      |
| city.....                    | 19.3 |
| country.....                 | 22.0 |
| Roadability                  |      |
| excellent.....               | 78%  |
| good.....                    | 20%  |
| unsatisfactory.....          | 2%   |
| Handling                     |      |
| excellent.....               | 91%  |
| good.....                    | 8%   |
| unsatisfactory.....          | 1%   |
| Structural rigidity          |      |
| excellent.....               | 51%  |
| good.....                    | 45%  |
| unsatisfactory.....          | 4%   |
| Acceleration from standstill |      |
| excellent.....               | 82%  |
| good.....                    | 17%  |
| unsatisfactory.....          | 1%   |
| Acceleration from 50 m.p.h.  |      |
| excellent.....               | 73%  |
| good.....                    | 27%  |
| unsatisfactory.....          | 0%   |

### OVER-ALL RATING OF THE JET

|                |     |
|----------------|-----|
| Excellent..... | 68% |
| Good.....      | 23% |
| Average.....   | 7%  |
| Poor.....      | 2%  |

### BEST-LIKED FEATURES

|  |     |
|--|-----|
| Handling and maneuverability.....            | 48% |
| Performance (acceleration, speed, etc.)..... | 47% |
| Compact size.....                            | 34% |
| Economy.....                                 | 33% |
| Roadability.....                             | 21% |
| Riding comfort.....                          | 21% |

### MOST FREQUENT COMPLAINTS

|                              |     |
|------------------------------|-----|
| Body noises.....             | 13% |
| Lack of legroom in rear..... | 11% |
| Water and dust leaks.....    | 9%  |
| Poor dealer service.....     | 9%  |
| Poor paint and chrome.....   | 8%  |
| Body styling.....            | 6%  |

### MISCELLANEOUS

|                                       |     |
|---------------------------------------|-----|
| Owners with no complaints at all..... | 30% |
| Would buy another Hudson?             |     |
| yes.....                              | 76% |
| possibly.....                         | 21% |
| no.....                               | 3%  |
| How is dealer service?                |     |
| excellent.....                        | 31% |
| good.....                             | 29% |
| average.....                          | 21% |
| poor.....                             | 19% |
| How do you rate the Jet's size?       |     |
| just right.....                       | 87% |
| too small.....                        | 13% |
| too large.....                        | 0%  |

"Window vents have tendency to leak."  
—Buffalo, N. Y., aircraft worker.

"In hard rain, water comes in around doors."—Chicago guard.

"Dealer service has been poor. They certainly will lose out with the kind of service they have given me."—Baltimore, Md., business manager.

"In view of the rotten dealer service, I can't tell whether some of my complaints are warranted or not. I feel that if my complaints were attended to, I'd be much happier with my Super Jet."—Cleveland, Ohio, photographer.

Other complaints included the usual one of poor paint and chrome, about which eight percent of the owners wrote.

"Exterior finish, paint and chrome, are not to my satisfaction."—Los Angeles, aircraft mechanic.

"Paint job isn't too good."—from a Chicago supervisor.

The Jet's body styling did not appeal to six percent of the owners.

"Styling in front is not too good. Hood could be a little lower. Front grille looks like a guppy."—San Francisco clerk.

"Should be lower and wider."—San Bernardino, Calif., jet-engine inspector.

"Rear view exaggerates its narrow

width. It appears somewhat out of proportion—width to height."—Chicago engineer.

"Car is without trim on both sides which I think would make it more beautiful."—Buffalo, N. Y., laborer.

Despite these complaints, Jet owners seem to be a satisfied group. In fact, 30 percent of the owners did not list a single complaint on the questionnaire. Sixty-eight percent of the Jet owners rated their cars as excellent over-all. Only seven percent said the Jet is average and a mere two percent described it as poor.

Here are some additional reasons why Jet owners are so satisfied:

"The car has ample room for six persons, yet is not too big."—a Chicago machine operator claims.

"It is small, yet big enough for my family."—Cleveland, Ohio, welder.

"Will turn in a shorter radius than any car."—E. Jaffrey, N. H., lab worker.

Thirty-four percent of the owners put the compactness of the Jet among best-liked features. Economy is also a favorite reason why Jet owners are satisfied.

"Just came off my vacation trip of 953 miles. Bought 37 gallons of gas."—Chicago shipping clerk.

"Returned from 2804-mile trip to Okla-

homa. Used 101 gallons of gas.”—Detroit, Mich., owner.

Average mileage of all owners polled was 22 miles per gallon in the country and 19.3 in the city.

Roadability and riding comfort were also top favorites among the Jet owners.

“Holds road well. I rarely tire on long trips. Good visibility.”—Brooklyn, N. Y., salesman.

“I like the way it holds the road at a fast rate of speed.”—Buffalo, N. Y., salesman.

“Has good roadability despite the fact it is small.”—Detroit, Mich., trucker.

“Rides like a dream (wife’s comment) and I can relax completely.”—Cleveland, Ohio, painter.

“Has the riding comforts of a big car.”—Chicago tool and diemaker.

Here are some miscellaneous comments:

“Favorable weight-to-horsepower ratio, handling ease, cornering qualities and step-down design.”—Denver, Colo., plasterer.

“Like Hydra-Matic and the Jet is the only low-price car with it.”—Fort Wayne, Ind., farmer.

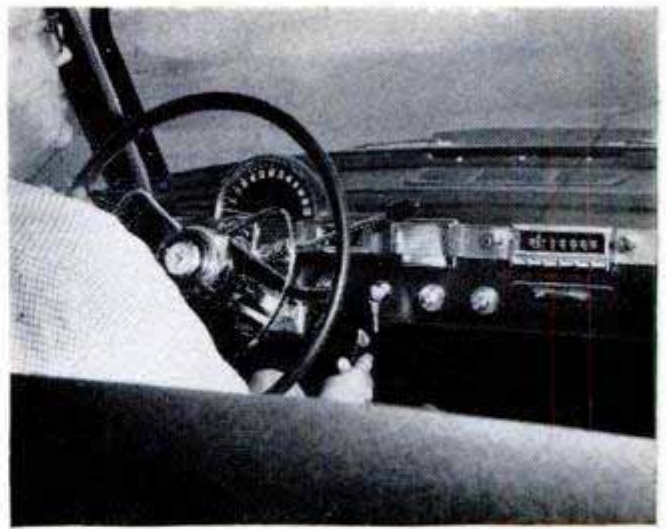
“Bumper and grille of very thin material. I gave a man a push and bent a bumper.”—Chicago factory owner.

“It’s a good car but costs too much.”—Duluth, Minn., sandblaster.

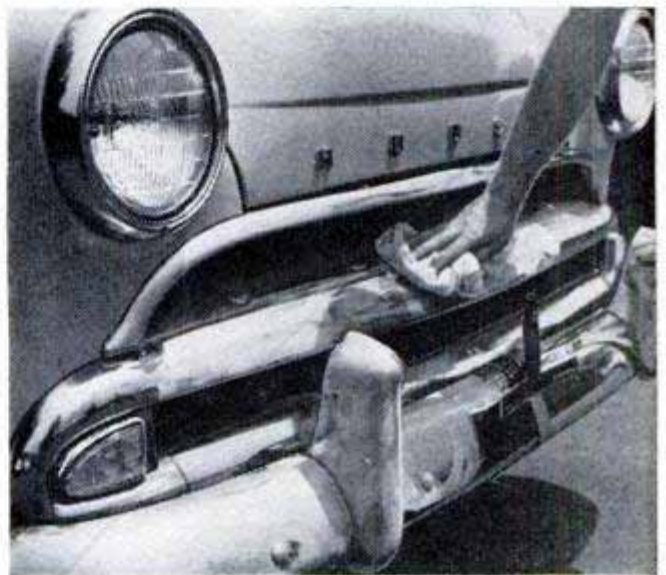
“The clutch is not as smooth as other Hudsons. I believe the wet clutch is more efficient.”—Bronx, N. Y., diemaker.

“Boxy body, engine slightly rough and too softly sprung, making sway on the corners, although less than other low-price cars. Don’t care much for fake air scoop on hood.”—San Francisco, airline employee.

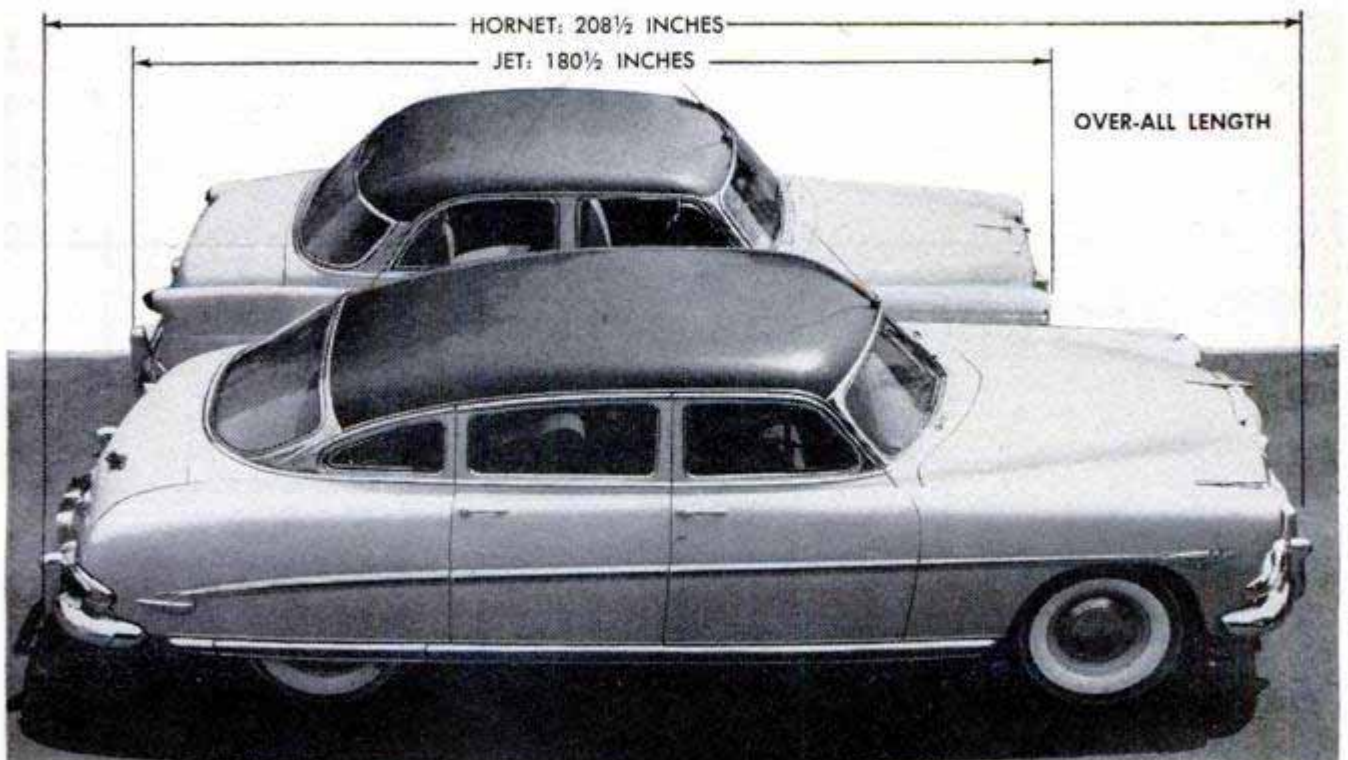
“Can see the road clearly from the driver’s seat.”—Detroit, Mich., repairman.



Clymer likes the absence of unnecessary top half on the horn ring. Speedometer is large, easy to read



Grille of the Jet is uncluttered, simple to clean and polish. However, one owner said it looked like a guppy’s mouth. Below, the Jet and its big brother



"Extreme agility in traffic."—Chicago college student.

"Windows roll up and down easily."—Chicago waitress.

"Should have safety mechanical brakes (under hydraulic system) like other Hudsons."—Cleveland machine-shop worker.

"Real answer to modern traffic, particularly the hills and traffic of San Francisco."—California bottler.

"Ought to have larger shock absorbers. Car also bottoms with 3 or more passengers."—Cleveland, Ohio, decorator.

The fact that most owners are well satisfied is borne out by answers to the question "Would you buy another Hudson?" Only three percent said no; 76 percent said definitely yes; the others answered the question with a possibly.

Thirteen percent of the owners said the Jet was too small, in response to the specific question. For these and other percentages see the table accompanying this article.

**And now for my own test:** When I took delivery of the Super Jet test car, it was well broken in with 3000 demonstrating miles on the speedometer. I drove the car from Indianapolis, Ind., to Los Angeles, a distance of 2536 miles, which included some off-road testing.

### ACCELERATION TEST

1953 HUDSON SUPER JET 4-DOOR SEDAN  
with Hydra-Matic and Twin-H Power

|                          |              |                |
|--------------------------|--------------|----------------|
| ¼ mile<br>from zero      | (Drive only) | 19.6 sec.      |
| ½ mile<br>from zero      | (Drive only) | 30.4 sec.      |
| 0 to 30<br>m.p.h.        | (Low only)   | 4.5 sec.       |
| 0 to 60<br>m.p.h.        | (Drive only) | 14.6 sec.      |
| Top speed by speedometer |              | 100-102 m.p.h. |
| Actual top speed         |              | 94-95 m.p.h.   |

### BRAKING TEST

Shortest Possible Stopping Distances



### ECONOMY TEST

MILES PER GALLON  
Constant-Speed Mileage

|  |             |
|--|-------------|
| At constant 30 m.p.h.  | 24.2 m.p.g. |
| At constant 50 m.p.h.  | 21.4 m.p.g. |
| At constant 60 m.p.h.  | 20.2 m.p.g. |
| At constant 75 m.p.h.  | 17.1 m.p.g. |
| Cross-Country Mileage  |             |
| Indianapolis, Ind., to St. Louis, Mo.<br>(considerable traffic)                      | 21.8 m.p.g. |
| St. Louis to Wichita, Kans.  | 21.1 m.p.g. |
| Wichita to Amarillo, Tex. (strong<br>side and head winds across Oklahoma)            | 19.6 m.p.g. |
| *Amarillo to Los Angeles (via Phoenix, Ariz.)<br>(Total cross-country mileage: 2536) | 22.4 m.p.g. |

\* Premium gasoline used on this portion of test only

The car was equipped with twin carburetors (which Hudson calls "Twin-H Power"). It develops 114 horsepower with 8.0:1 compression ratio, using an aluminum head. The Jet has a single carburetor and cast-iron head with 7.5:1 compression as standard equipment.

The car's terrific power and speed are due to the fact that the engine is a large one for the weight of the car (2700 pounds). It has the highest horsepower-to-weight ratio in its price range.

The 202-cubic-inch L-head 6-cylinder engine is of conventional design. Hudson sticks to a long stroke—4.75 inches with a bore of only 3 inches.

Any skeptic regarding the power, speed, handling and acceleration of this short (105-inch) wheelbase car will find the surprise of his life when he gets behind the wheel.

The car has amazing performance. It literally flies up the hills and getaway from traffic signals is incredible. It will cruise mile after mile at 90 miles per hour. Top speed was 100-102 miles per hour by the speedometer (fast by about 6 percent).

The engine is smooth with very little vibration and under no circumstances, even in the heat of the desert, did it overheat.

The handling characteristics are a little hard to describe. There is some road wander in crosswinds. The narrow tread (54 inches front and 52 inches rear) coupled with extremely soft front-end suspension tend to cause considerable up and down floating of the front end, especially at high speeds. There is considerable roll on sharp corners. Yet the car is easy to handle. There is a good feeling of safety and it is easily controlled at all times. The soft front springing does provide a comfortable ride, but it is much too soft for high-speed work or fast cornering. It should have heavier shock absorbers as well as stiffer springs in the front.

The splay-mounted rear springs (positioned at an angle) and the diagonally mounted rear shock absorbers give a comfortable rear-seat ride for a car of the Jet's size. It rides as well as some larger cars, but there is some rear-end hop on rough roads.

I found regular gasoline to be satisfactory, as did 60 percent of the Jet owners who answered our questionnaire. Gasoline economy was good and would have been even better with the single-carburetor or overdrive equipped Jet. Top speed and fast acceleration naturally increase gasoline consumption.

The servo-action hydraulic brakes are good, although at times there were some squeaks. There was little fading, even in

(Continued from page 304)

# Detroit Listening Post



By Leo Donovan

**B**EFORE THE OLD race is over, a new one begins!

With Chrysler Corporation bringing out its 1954 models in October, the competition completes the cycle as the year's fourth quarter begins. From now on, the merry-go-round will gain momentum until the last of the new models makes its appearance.

More power under the hood and easier control on the wheel appear to be the dominant theme in the 1954 models.

**Plymouth** is expected to unveil its own power steering as a feature of its new line. It will be of the linkage-booster type, designed by its own engineers. Gossip has it that the price will be lower than that of competitors. **Plymouth's** Hy-Drive, the no-shift transmission, will be continued.

The theory that motorists want improved performance in each new-model crop will be supported by the carmakers with the presentation of higher-horsepower engines in 1954. **Chrysler** probably will lead the pack with a 235-horsepower engine.

**Cadillac** has a 250-horsepower engine in its experimental Le Mans model, but it isn't expected to market such a powerhouse in a standard car this year. The plans of **General Motors** in the horsepower department are still in engineering laboratories.

**Packard** is a dark horse in the power race. For two generations, **Packard** engines have won acclaim for their superior qualities. Don't be surprised if **Packard** zooms into the lead with the largest engine and highest compression ratio of the season.

It is doubtful whether **Chevrolet** and **Pontiac** will bring out their awaited V8 engines in the 1954 models, although engineers were hopeful earlier that tool-and-die production could be rushed to accomplish the change-over.

The most popular V8 engine in the world, the **Ford V8**, is due for a change this year, according to Detroit gossip. It and its bigger brother, the **Mercury**, are expected to have overhead valves. **Mercury** is also believed to be planning a special model of the sports-car type. What it will be is still

a mystery, but it is expected to open some eyes among industry stylists.

Speaking of stylists, those at **Chrysler Corporation** have been given new design freedom, which will mean improvements over what the designers facetiously call "executive styling." In the parlance of the trade this describes the influence of top management over the drawing board. Because of this new freedom, we will await with interest the **Plymouth, Dodge, DeSoto** and **Chrysler** lines for 1955.

**Studebaker, Nash, Willys** and **Kaiser** are not expected to make much more than identification or face-lifting changes this year. Both **Studebaker** and **Nash** have styling that is comparatively fresh from the designer's board and will probably go along with minor changes for a while. **Nash** engineers are still working on the **NKI** (which started life as the **NXI**), the car that the corporation bets will make an impressive showing in the lowest-price field.

**Willys** and **Kaiser**, now brothers after their combination, are currently involved in straightening out the confusion that always accompanies such an amalgamation.

Edgar F. Kaiser, president of both companies, said they would introduce new models in 1954 and would depend upon the demand for five kinds of vehicles to build towards their goal of four percent of the market—meaning both the passenger and commercial-vehicle fields. Elaborate plans have been drawn for merchandising the **Jeep** and other four-wheel-drive vehicles, as well as the **Kaiser, Henry J** and **Willys** passenger cars.

When the new **Cadillac** makes its appearance with higher fenders, we're informed, it also will be one of the first to come out with the wrap-around windshield. Corner supports will be moved back and that will give the driver a lot more visibility and will eliminate the dangerous blind spot to his left. And engineers say they have solved the problem of excessive glare.

Remember how fast the hardtop styling caught on? Most industry observers are convinced that the wrap-around windshield will capture the public fancy just as fast.

Motorists who have been looking forward to a general decline in car prices need not expect such a step to be taken soon by the manufacturers. True, dealers began giving discounts on some hard-to-move models during the year and there were a few cases of price cutting. But, altogether, the rate of new-car sales found few carmakers worried about the market's ability to match production schedules. Some may make a few optional accessories standard equipment on the new models, but they aren't likely to begin cutting prices unless production suddenly and greatly outdistances sales.

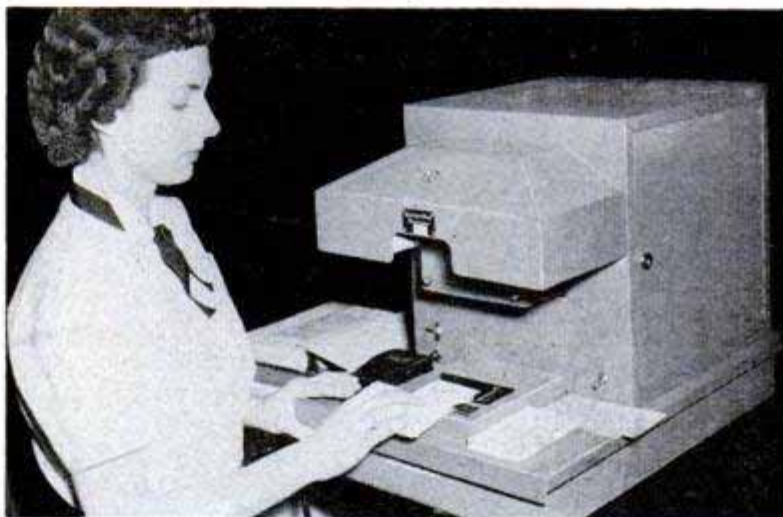
## Magnet on Lift Truck Spots Freight-Car Runways



Heavy steel runways, the flat metal sheets that serve as "gangplanks" between freight cars and loading docks, are put into position easily and effortlessly by a portable electromagnet that slips over the fork of a lift truck. Normally, it requires four men to move the 300-pound sheets into place. With the lift, two sheets are picked up at a time and lowered into position. The truck's storage battery provides the necessary power.

## Librarian's Helper Checks Out Books By Photographing Cards

Library books are charged out quickly and without chance of error by an automatic camera that photographs the data for filing purposes. Book card, due-date card and the borrower's library card are all placed on a shelf in the machine and photographed simultaneously when a foot lever is pressed. Should the book become overdue, the librarian can refer to the photographic record. The information is recorded on long rolls of sensitized paper which are automatically transferred to a light-tight box as they are used.

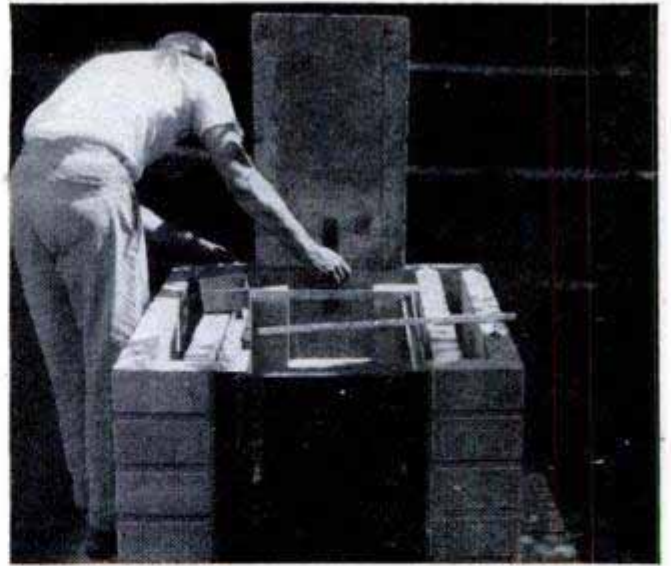
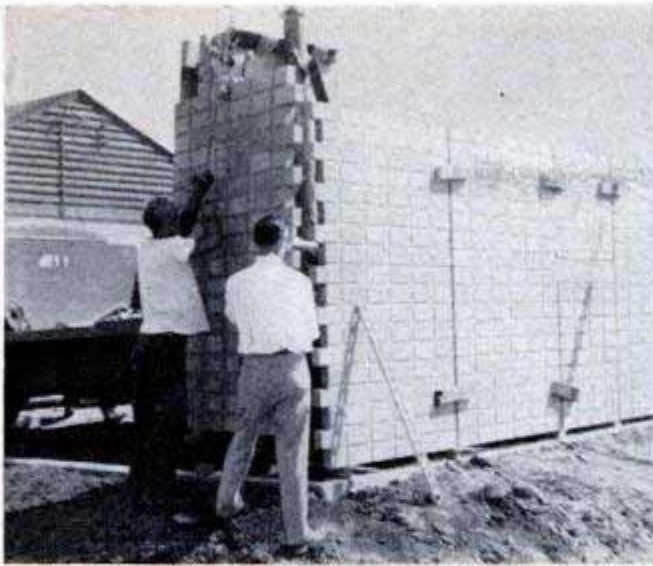


## Electrical Music Mentor Buzzes When Pupil Hits Sour Note



Piano pupils learn their scales with the aid of an electrical device that fits on any keyboard. When a student practices scales, he sets a dial for a certain music key. As he plays, a light flashes on the device before him to indicate the position of each correctly played note, but a buzzer sounds if he's wrong.

More than 422,000,000 miles were flown by company-owned aircraft in the United States last year, compared with 457,000,000 miles flown by the scheduled domestic airlines during the same period.



Workman, left, lowers a large brick-wall panel into place. Panel fireplace at right is assembled in an hour

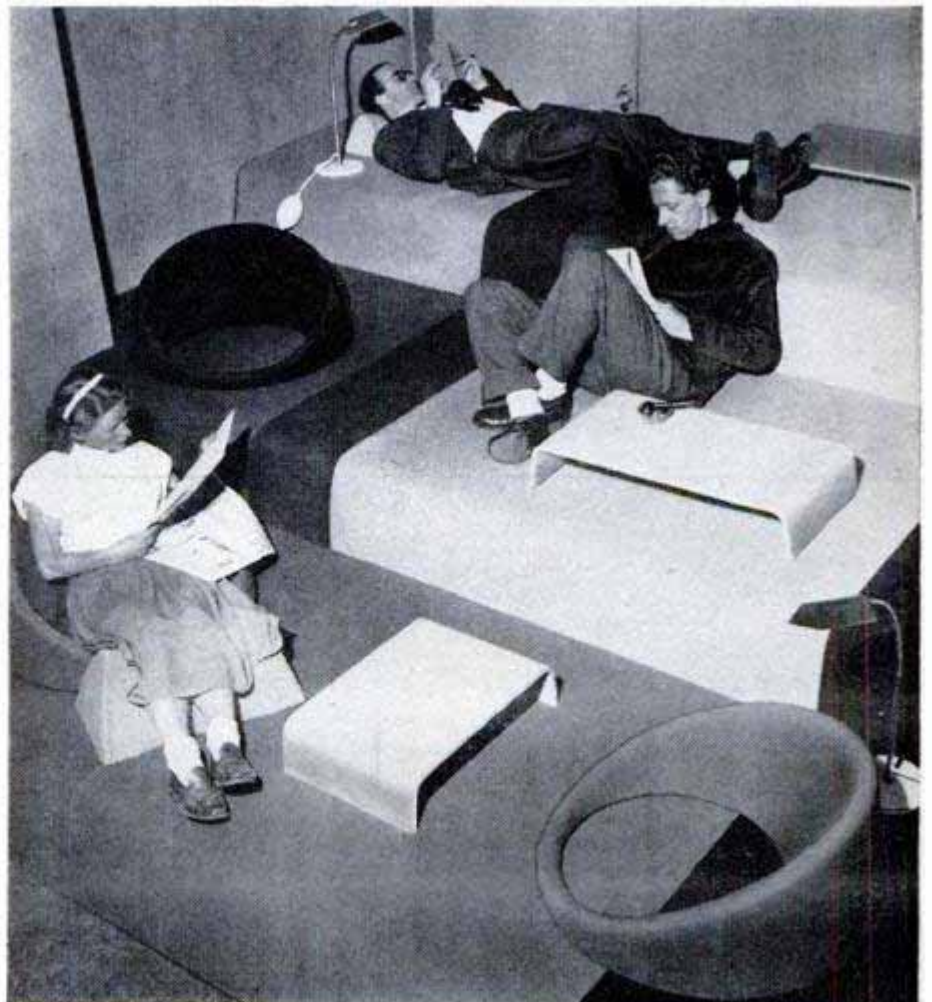
## Home Built in a Day With Precast Brick Panels

Precast brick panels in sizes up to eight by five feet enable a small crew to erect a home in a day. Reinforced vertically and horizontally with steel rods, the panels can withstand 50 tons of pressure though they are only 2½ inches thick. Labor cost in erecting a model home with a wall area of 700 square feet was 16 percent less than that required by a similar brick home. Be-

cause wall thickness was reduced, the home had six percent more living space than a brick house of equal dimensions. Wall construction took 39 man hours—19 hours for wall erection and 20 hours for grouting; the roof structure was put in place before joints were grouted. The panels may also be used for garages or for building an outdoor fireplace from a kit.

## "Terraced" Apartment in Denmark Has Foam-Rubber Floor

Three terraces covered with foam rubber occupy a living room-bedroom designed by a Danish architect. "Chairs" are rings of foam rubber, supplemented by knee rests. Compact and comfortable, the arrangement allows you to lounge almost anywhere in the room.



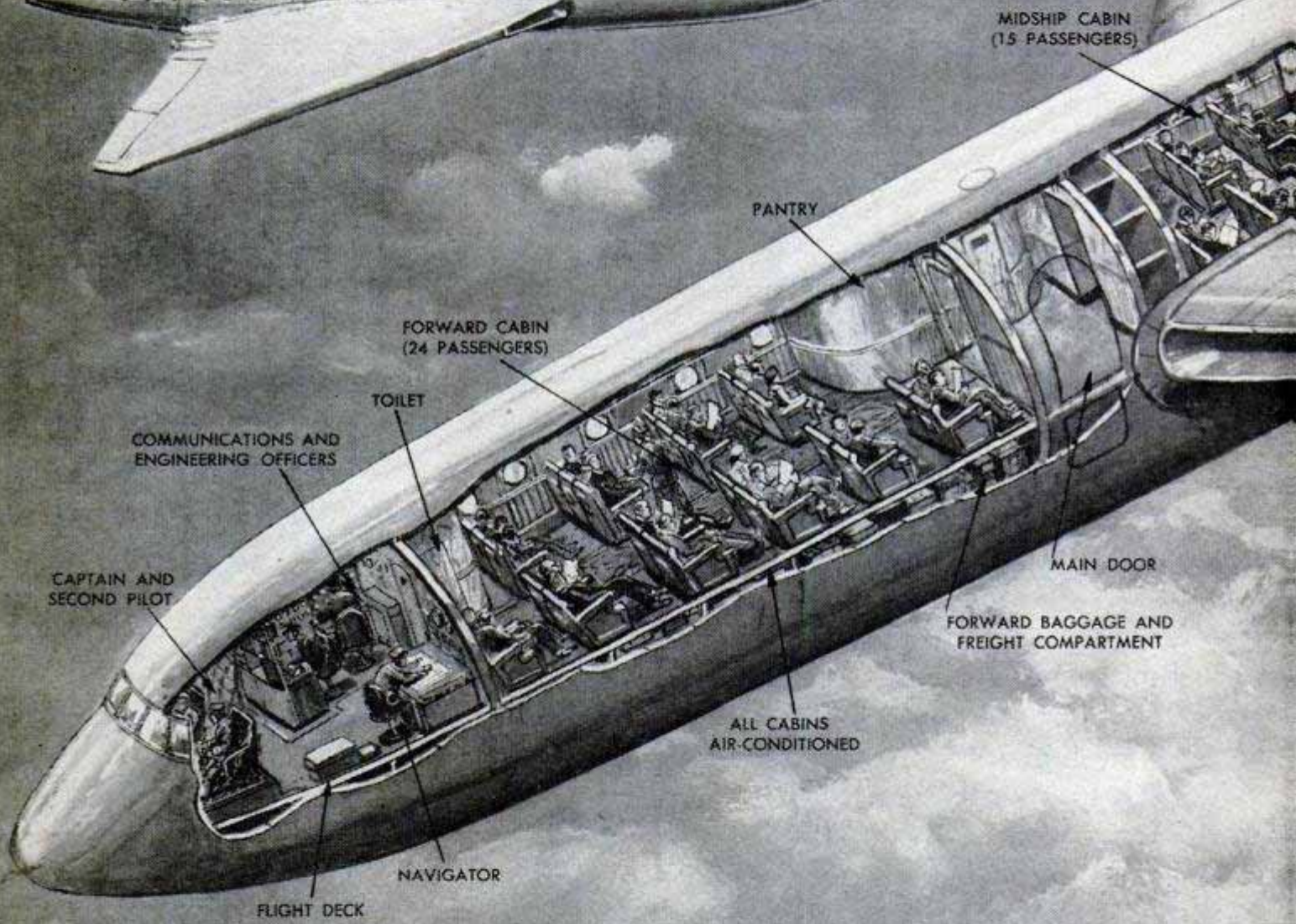
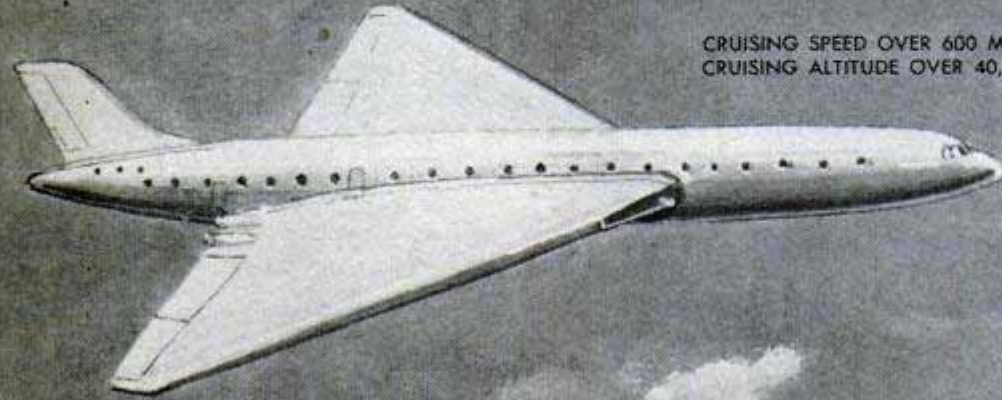
## "Pumping Up" a City With Rainwater

Hydraulic engineers are studying ways of "pumping up" Mexico City, which has been sinking at a rate of a foot a year since 1948. The soil structure under the city is 85 percent water, which is pumped out to supply the residents. The engineers plan to restore the soil's equilibrium through new rehydration wells that will pump the overflow rainwater back down into the subsoil.

# AVRO ATLANTIC



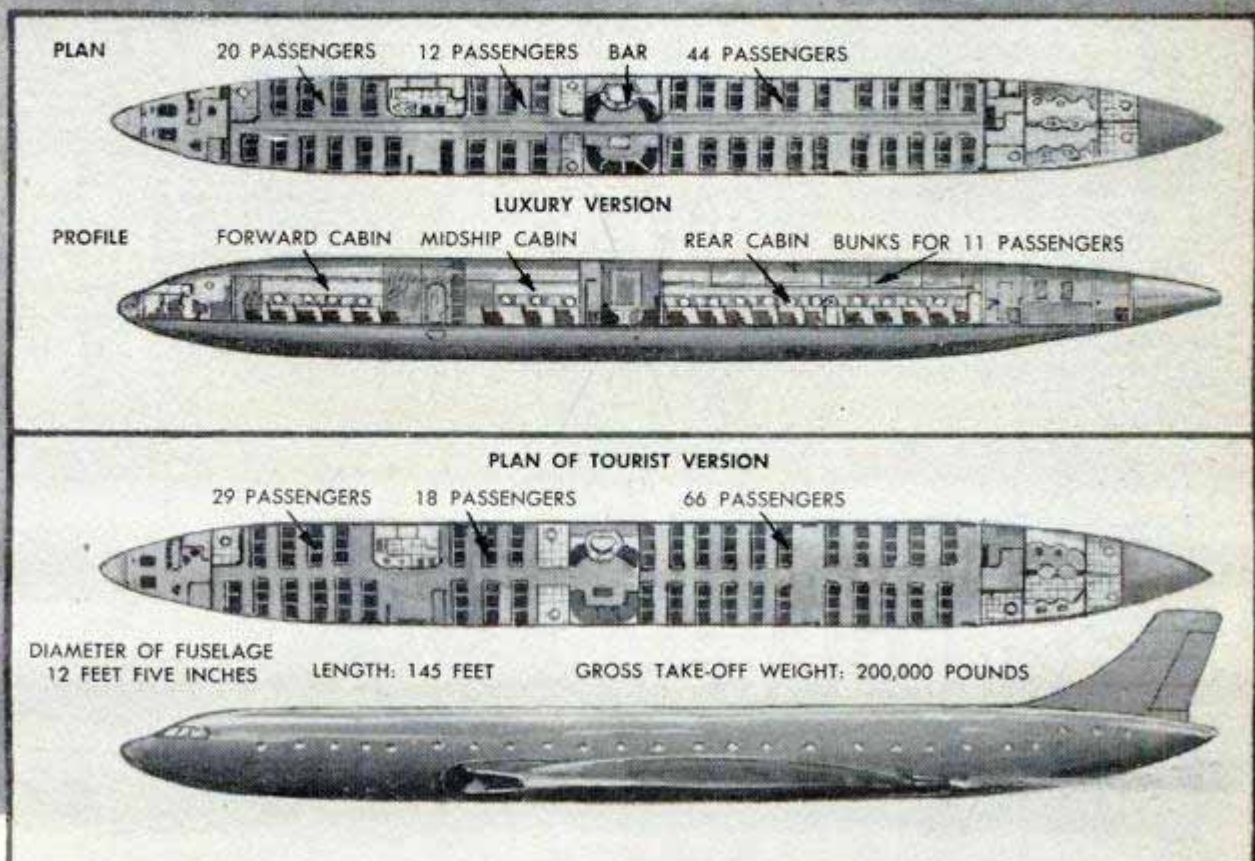
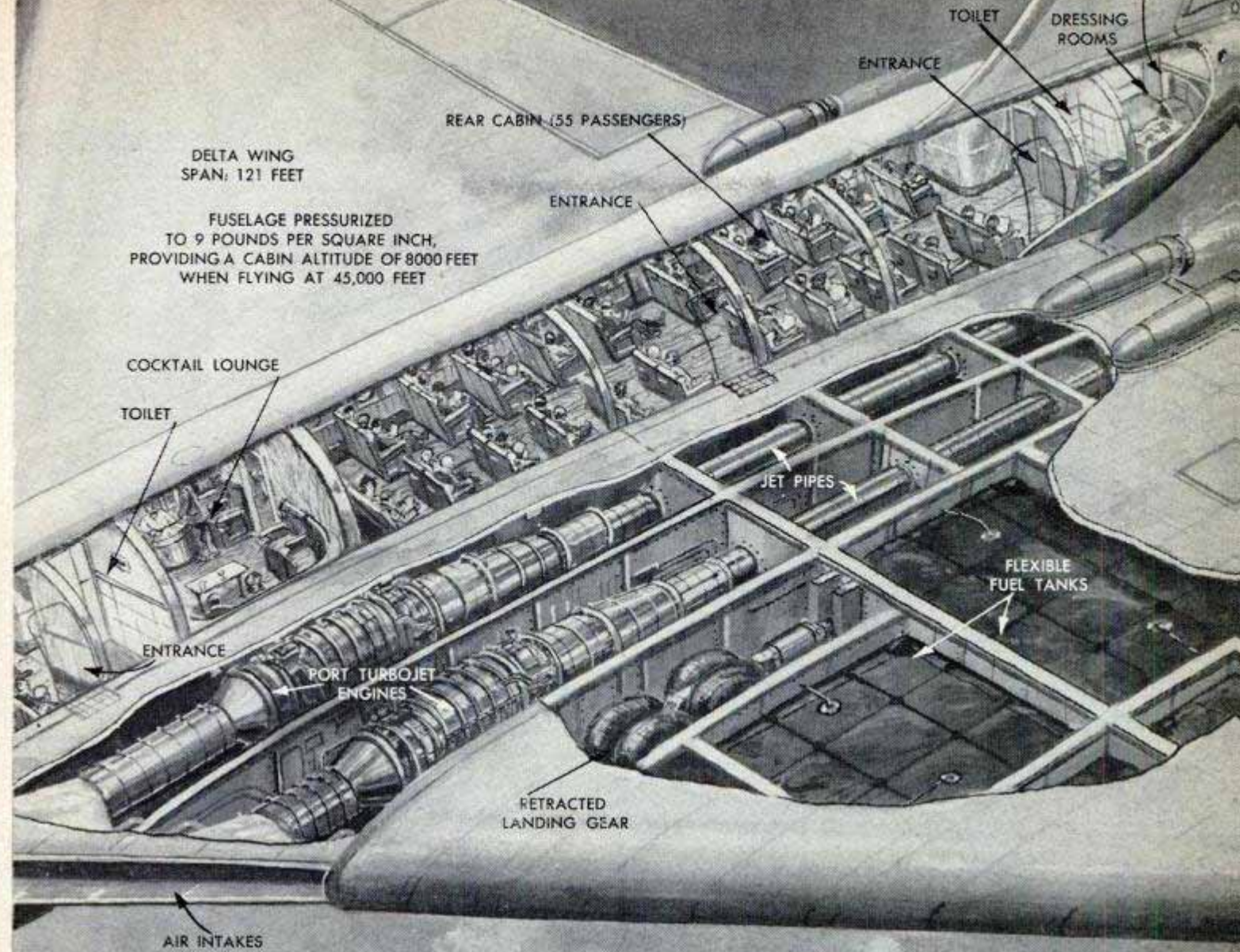
CRUISING SPEED OVER 600 MILES PER HOUR  
CRUISING ALTITUDE OVER 40,000 FEET



MORE THAN 100 PASSENGERS will be able to fly through the stratosphere between London and New York in five to seven hours in a jet liner to be built in England. It will cruise at more than 600 miles per hour. Called the Avro Atlantic and scheduled for completion in 1958, it is a development of the Avro Vulcan bomber now being built for the British Royal Air Force. Its delta-wing design will put the exhaust ends of the four turbojet engines, where the noise level is highest, well behind the rear passenger seats. All the passenger seats will face the rear, an arrangement recommended by many safety experts. With the entire fuselage pressurized to nine pounds per square inch, the cabin "altitude" will be only 8000 feet when the airliner is flying at 45,000 feet. A luxury version of the Atlantic, with all seating two abreast, will carry 76 passengers, while a tourist model of the huge plane will comfortably accommodate as many as 113

G. H. JAVIS







Continuous length of metal goes up over the top of the roof and down the other side



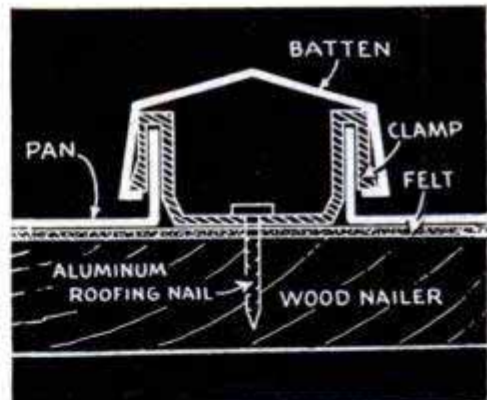
Rolls of sheet aluminum feed machine, which turns them into battens and roofing panels cut to desired size

## Machine Forms Roofing at Homesite

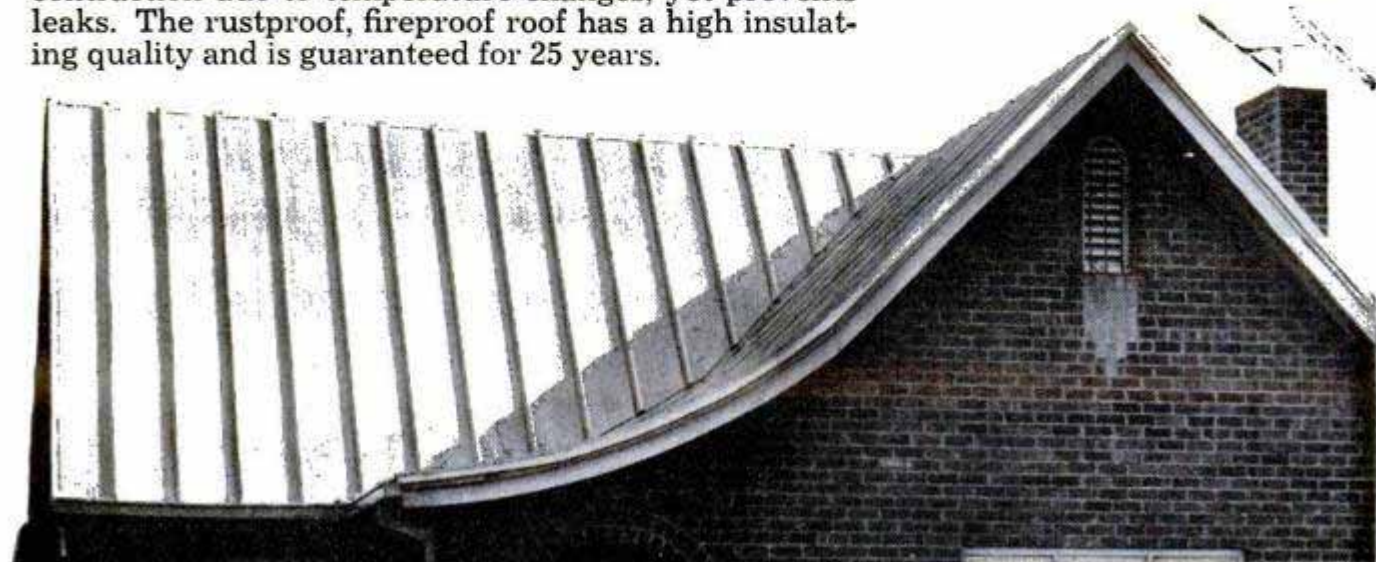
TWO MEN CAN INSTALL a permanent aluminum roof on the average house in one day, using a machine that forms the roof panels right on the job.

Coils of 16-inch aluminum sheet are fed into the machine, which turns up their edges and cuts them in lengths that fit the roof. A narrow strip of aluminum that goes into the machine at the same time comes out in the form of a continuous batten strip for covering the seam between adjoining panels. Clamps that are nailed into the subroof hold the panels and batten strips in place.

The system may be used for recovering old roofs, for new construction, or application of aluminum siding. The design of the battens permits expansion and contraction due to temperature changes, yet prevents leaks. The rustproof, fireproof roof has a high insulating quality and is guaranteed for 25 years.



Cross-section drawing shows how panels are joined by overlapping clamp that is topped by batten. Below, finished roof laid with the portable machine





Raiding team cuts 25-hp. motor and switches to oars when close to shore. Large 2450-pound model carries nine

## Marine Reconnaissance Boat Has Multiple Cells

MARINES ENGAGING in midnight patrols along enemy beaches will skim to shore in a boat made of inflated rubber tubes. A constantly taut nylon-fabric hull insures rigid-boat performance. Enemy fire must damage over 11 of the 22 tubes before the boat becomes inoperable; bladders can be replaced with the boat in motion.

A 4-man, 14-foot model carries 1100 pounds and weighs 95 pounds deflated. The 9-man, 18½-foot model carries 2450 pounds and weighs 142 pounds deflated. Plopped into the water from a helicopter or launched from boat, shore or submarine, the boat inflates in 30 seconds with gas cylinders.

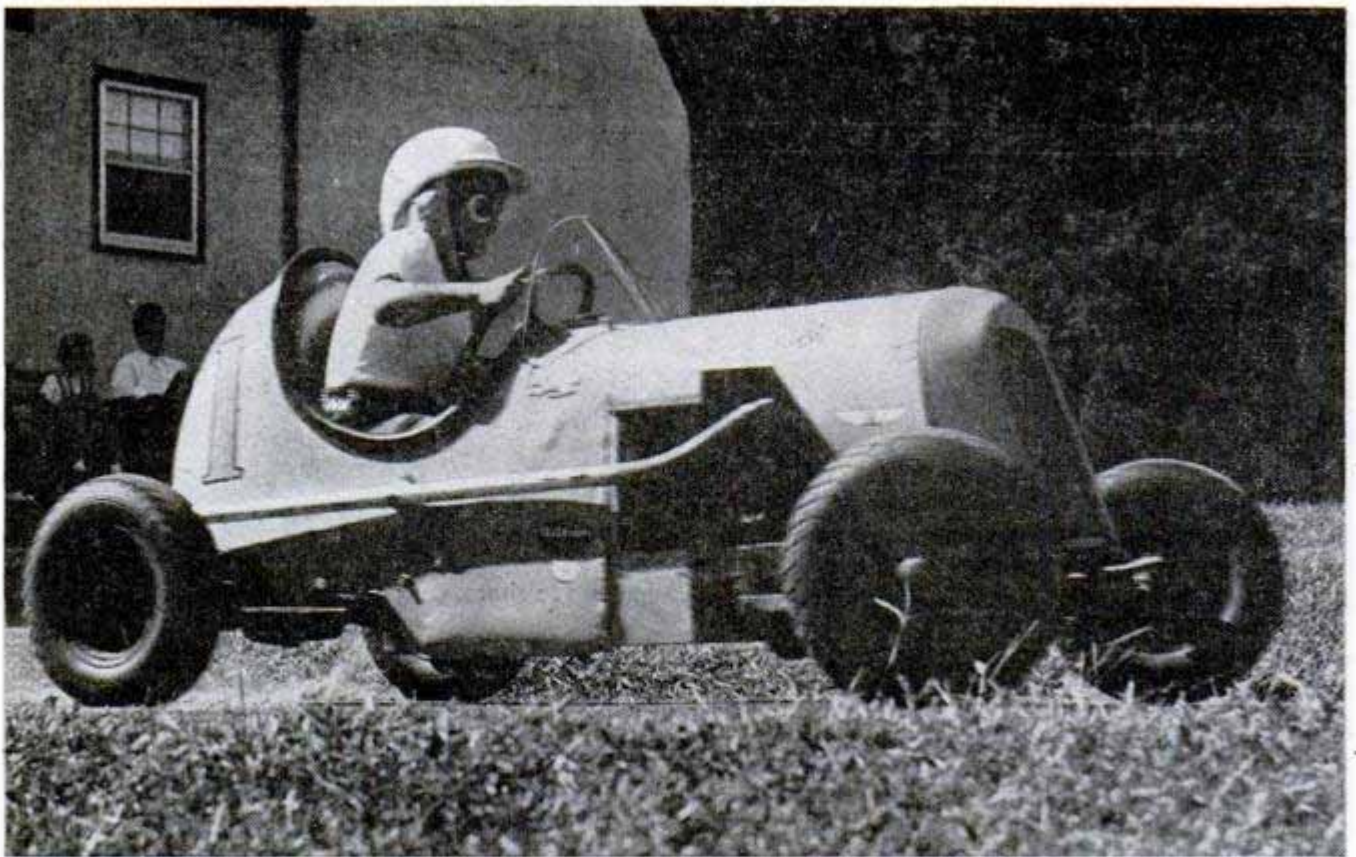
Paddles, a 10-horsepower outboard motor for the small boat or a 25-horsepower motor for the big boat propel the craft. Top speed is over 20 knots. Loaded speed is 12. Arms and equipment used in reconnaissance, rescue work and transportation are firmly secured even if the boat capsizes.



Carbon-dioxide cylinders inflate boat in 30 seconds

Four-man model churns water in test run. Rigid hull allows high speed, easy handling, excellent maneuverability





Six-year-old Paul Vilardi spins around a turn in a souped-up one-cylinder midget built by his racing father

## *Hot Rod, Junior*

**T**IRES SCREAMING, a pair of midget automobiles buzz around a sharp turn on a little track in suburban New York. Huddled low in the cockpits are five-year-old Billy Amado and six-year-old Paul Vilardi, junior hot rodders who learned to race before they could read.

While other kids in the block play with tricycles, Billy and Paul don crash helmets,

**By William H. Charnley**

climb into their own gasoline-powered racers and fasten safety belts. Then, at speeds approaching 20 miles per hour, they roar around a 90-by-50-foot track near Billy's home.

The fun began in 1951 when Paul, then 4½, showed signs of following in his father's footsteps. Dolph Vilardi is one of the leading amateur sports-car-competition drivers

Vilardi swings wide of corner as his five-year-old competitor takes lead. Cars' top speeds are 18 and 15 m.p.h.





Paul Vilardi's father, who started it all, winning 750 cc. sports car class in 1952 Grand Prix road race

in the country. Last year, driving a Crosley Special, he took first place and the Queen Catherine Cup in the 750 cc. sports-car class of the Fifth Annual International Grand Prix races at Watkins Glen, N. Y.

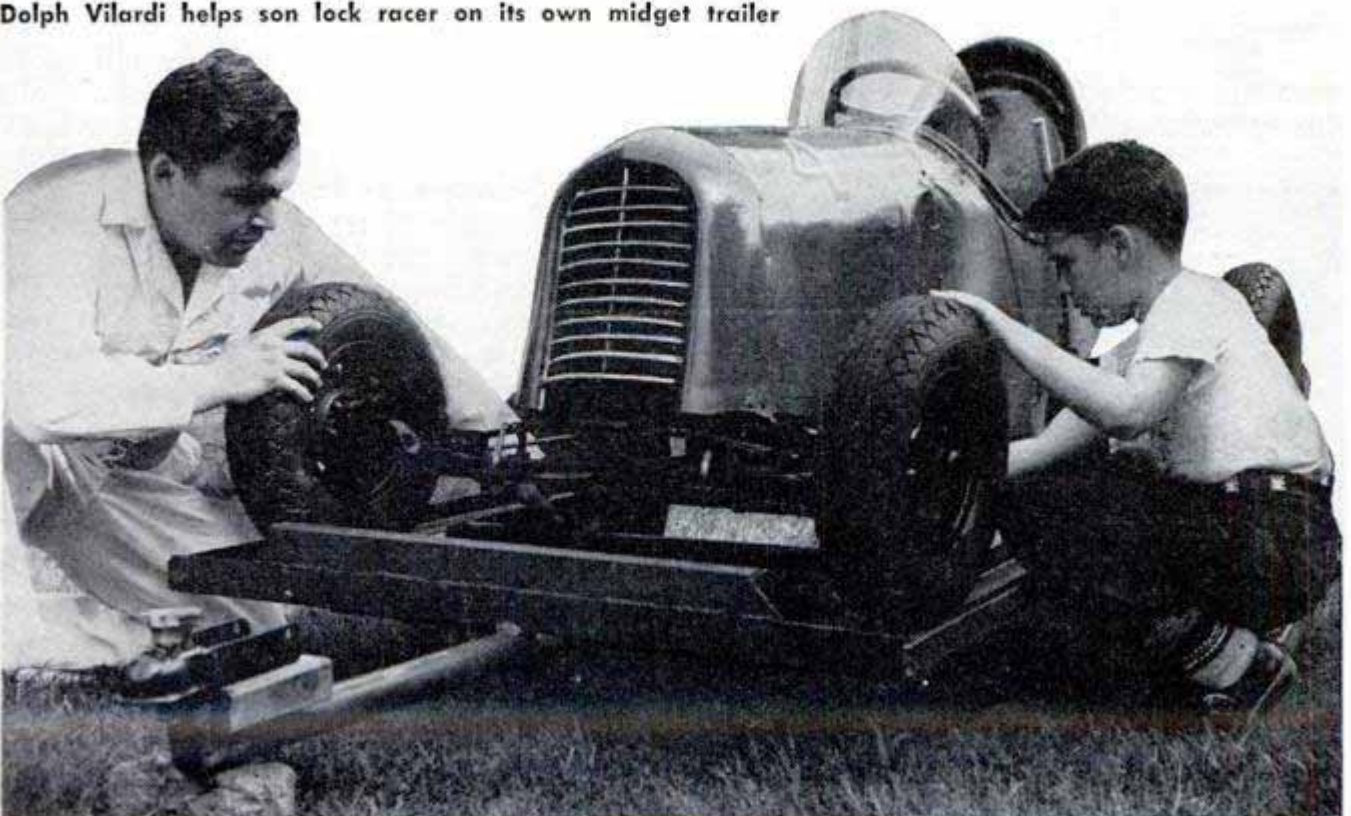
From the angle iron of an old bed Vilardi fashioned the frame of his son's racer. The drive shaft, steering mechanism, axles and body came from a 1936 Crosley.

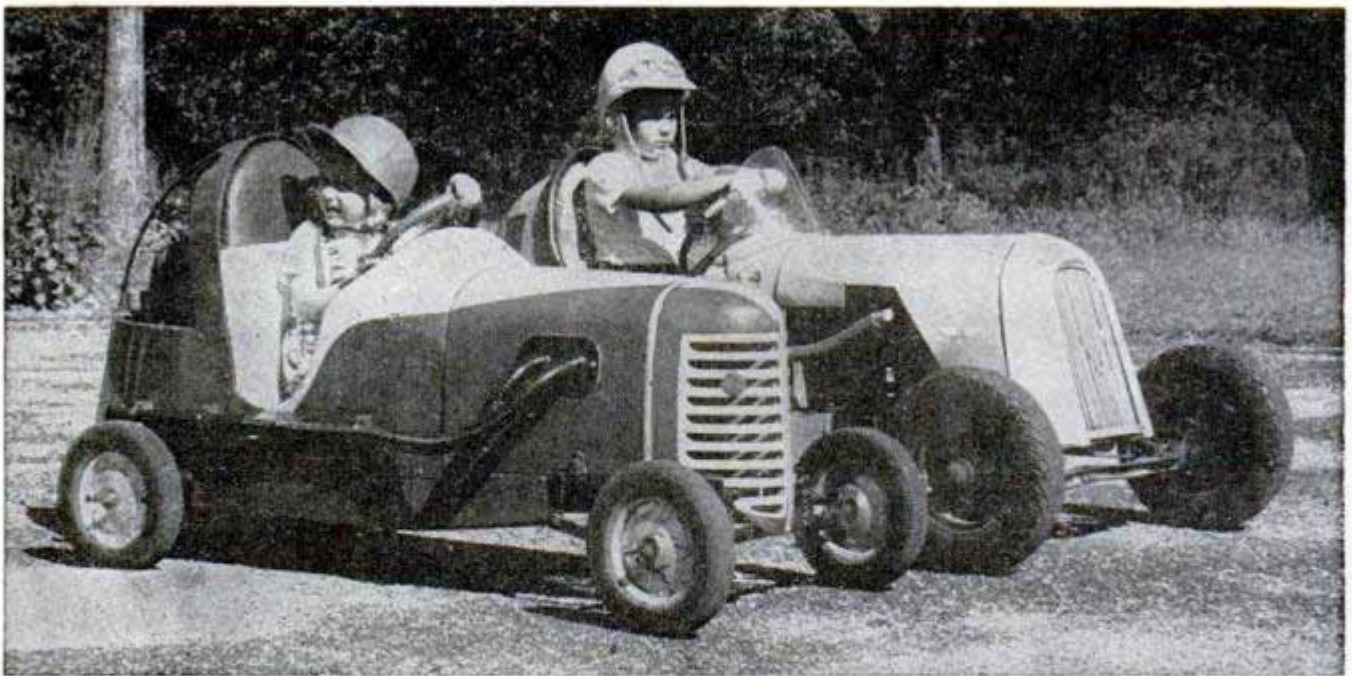
Five inches were cut from the center of

the front axle, 2½ inches from each side of the rear axle. The transverse front spring was adapted from Crosley front semielliptic leaves. The rear springs are quarter elliptic, made by halving a Crosley front spring.

A 1934 Dodge furnished the grille and pneumatic-tired wheelbarrows the wheels. A 1½-horsepower Briggs & Stratton gasoline engine like those on power mowers

Dolph Vilardi helps son lock racer on its own midget trailer





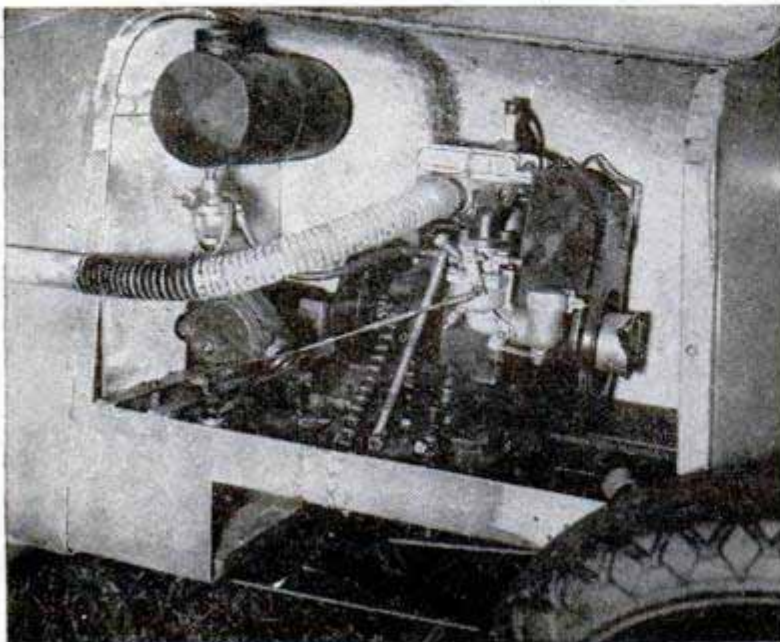
Billy's car, left, is rear-engine job with chain drive. Forward engine in Paul's car powers drive shaft

serves as the power plant. By enlarging and polishing the intake-manifold ports of the engine, Vilardi has increased its output to about two horsepower. The completed car is about five feet long and three feet wide across the wheels—about three quarters of the size of a regular midget racer.

Six months after he began work on the racer, Vilardi started the motor and climbed aboard the completed car, one foot on the tiny seat, the other on the gas pedal. The midget leaped forward as Vilardi struggled to retain his balance. "It was going about 30 miles per hour, and almost threw me off," he reports. Despite Paul's objections, the car was geared down to six miles per hour after that wild ride.

After six weeks, however, the speed was

**Hopped-up Briggs & Stratton in Paul's car has centrifugal clutch that drives through sprocket on end of modified Crosley torque tube. Crosley steering box has welded extension. Left, gas tank**



increased slightly. Gradual boosts have since brought it to 18 miles per hour.

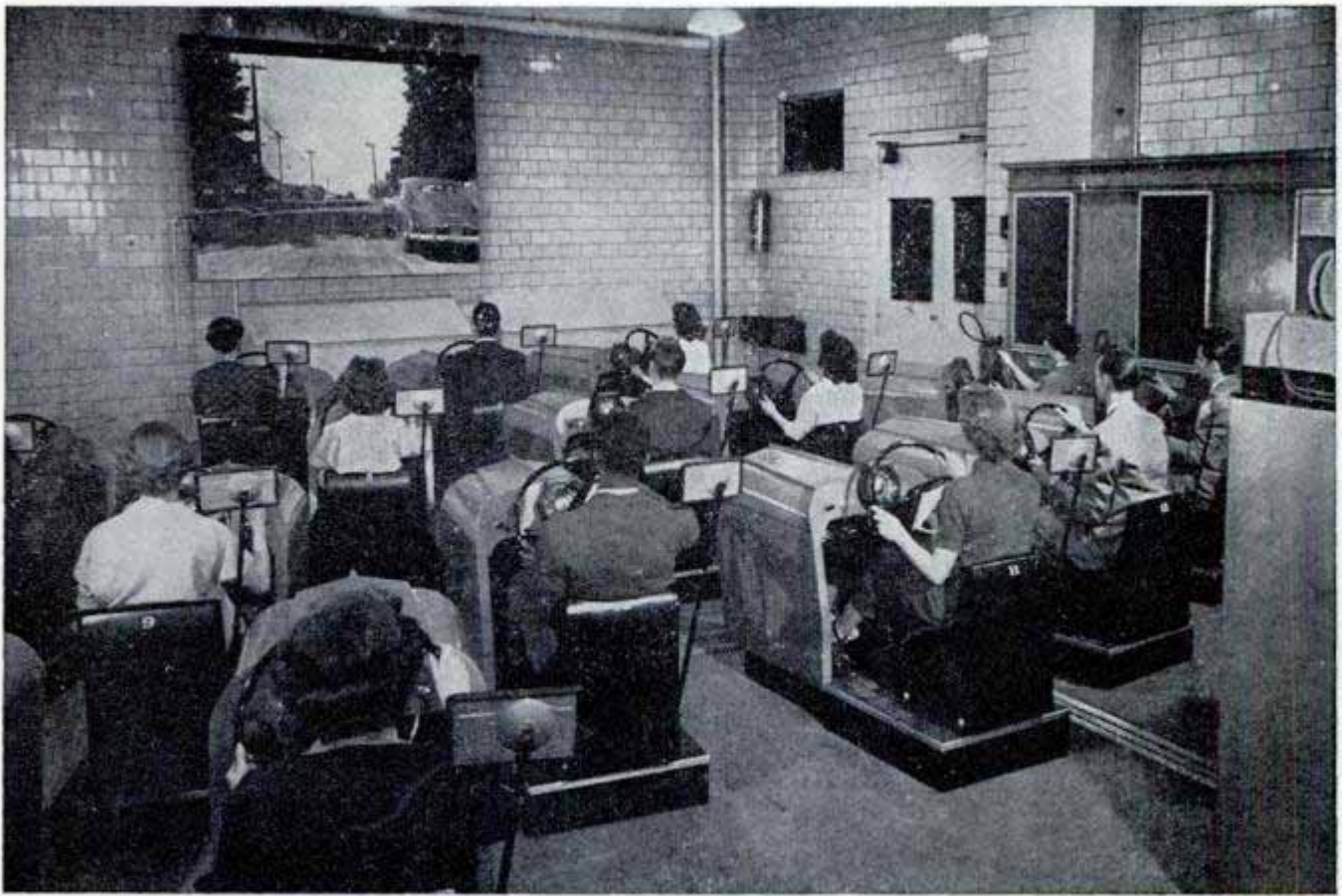
Among Paul's friends was another youngster who longed to become a track burner with a car of his own. Soon Ray Amado was at work on a rear-engine racer for his son Billy. Last summer Billy piloted his own car on its first test run around a .05-mile track built near the Amado home in Garnerville, N. Y.

Billy's racer is the same size and is powered by an engine identical with the one in Paul's car. However, the only auto parts used in its construction were a Crosley steering mechanism and a grille from an Austin Bantam. The rest of the car, including its chain drive to the rear wheels, Ray Amado built himself.

At present Billy's car will hit 15 miles per hour. As a result, Paul's car can zoom around the track six times in a minute, while Billy makes five revolutions.

But Paul's yellow racer isn't always the winner. Often Billy will cut his midget sharply inside Paul's on a turn, bear down on the throttle, adroitly pull out of the forced skid and into the lead, leaving Paul biting dust on the turn.

Both boys are excellent drivers and have never had an accident. The cars are tipproof; safety helmets and safety belts are always worn during races, which are supervised by their fathers. Speeds are not greater than they would reach on unprotected bicycles. But to envious young neighbors who flock to watch the races, the miniature track is Le Mans and Indianapolis rolled into one. ★ ★ ★



No fenders are wrinkled as students learn to drive on a "highway" projected on a movie screen. Right, backing is practiced by watching highway in a mirror

## Students Learn to Drive In Safety of Classroom

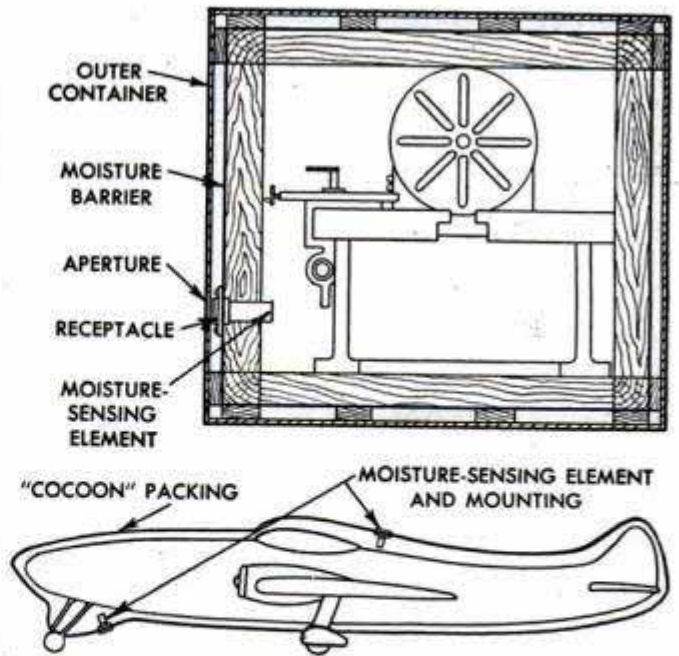
Although their "cars" never move, student drivers travel down a "highway" and meet all traffic conditions in a New York City schoolroom. Making this possible is the Drivotrainer, developed by the Aetna Casualty and Surety Company. Conventional controls are built into 15 cars arranged in rows in the classroom. The students watch a movie screen at the front of the room on which a moving highway scene is projected. An automatic-scoring system is built into the training aid. Attached to the seats, behind the right shoulder of the drivers, are mirrors into which the students look when driving backwards. The course covers everything from simple starting and stopping to driving in city traffic.



## Flexible Coating Turns Wood Floors Into "Concrete"

Coating materials that are mixed and applied like plaster or concrete but require no anchoring clips or expansion joints can be troweled over wood or masonry to provide a wear-resistant surface. Similar to concrete, the new materials use latex-water emulsion binders instead of water alone. Two types of the material have been developed. Both are tough and flexible and have outstanding adhesive qualities. In one

type, the waterproofing qualities are stressed, making it excellent for roofing purposes. The other is designed to provide a long-lived surface coating for floors, platforms, sidewalks and driveways. A quarter-inch coating, tests have shown, has the resilience of wood and better wear resistance than concrete. The coatings can be used over masonry, concrete, plaster, wood, glass or metal.



## Moisture-Sensing Element Sealed Into Container

Moisture which might rust stored equipment is detected by an element which is sealed into the side of the package. The sensing element consists of a tiny plastic cylinder with a dual winding of precious-metal wire, a coating of moisture-absorbing compound and plug-in contact pins. A portable unit powered by dry battery is plugged

into the sensing element, sends a charge through the element, and measures the electrical resistance on a meter. Since resistance is determined by the amount of moisture collected on the element, this tells the inspector the dryness of the packaged contents. The system was developed for use in Army Corps of Engineer warehouses.

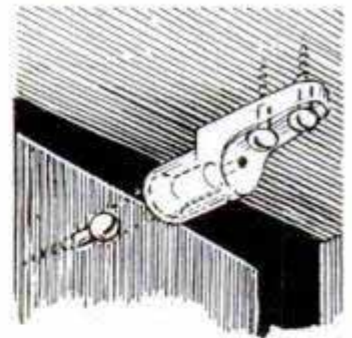
## Humming Detector Unit Spots Hidden Conduits

Plastered-over conduit and wall boxes are quickly located by an electronic detector. Holding the instrument an inch away from the wall, the operator quickly "sweeps" a large area. A loud hum signals the presence of a conduit or wall box. Weighing only 3¼ pounds, the detector uses low-cost tubes and dry-cell batteries.



## Plastic Friction Catch Holds Cupboard Door

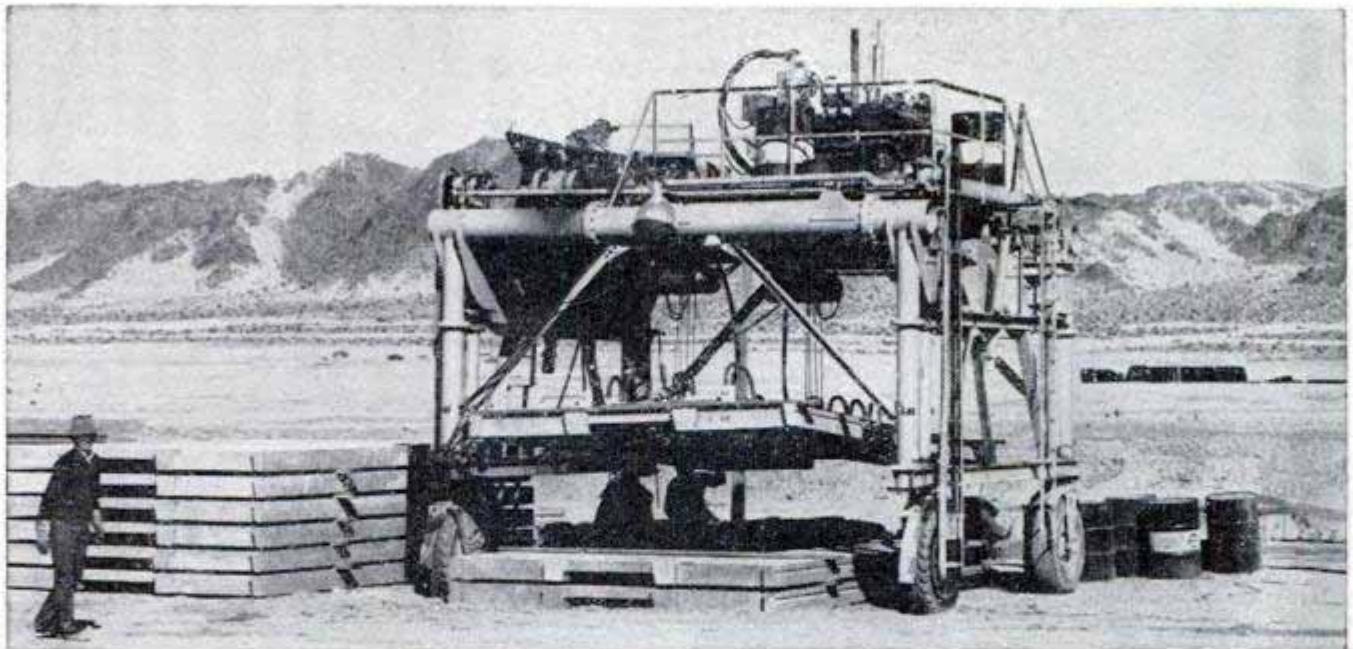
Simple to install and operate, a plastic friction catch holds a cupboard door closed tightly yet releases it smoothly when the door is pulled open. The catch is simply a tapering tube of flexible plastic attached to a shelf. A ball-headed screw is attached to the door. When the door is pushed shut, the ball-headed screw is forced into the tapered tube and held tight by friction. The plastic fixture will wear indefinitely and results in quieter closing of cabinet doors.



## Chickens Play Baseball,

pigs vacuum rugs and rabbits careen down slides at a little farm near Hot Springs, Ark. The farm is the laboratory of a pair of psychologists who have converted animal training into a precise science. What's more, they say anyone can teach a hen, dog, bull or hamster to do tricks. You'll learn their training techniques in "Who Says Animals Are Dumb?" coming up in the November issue



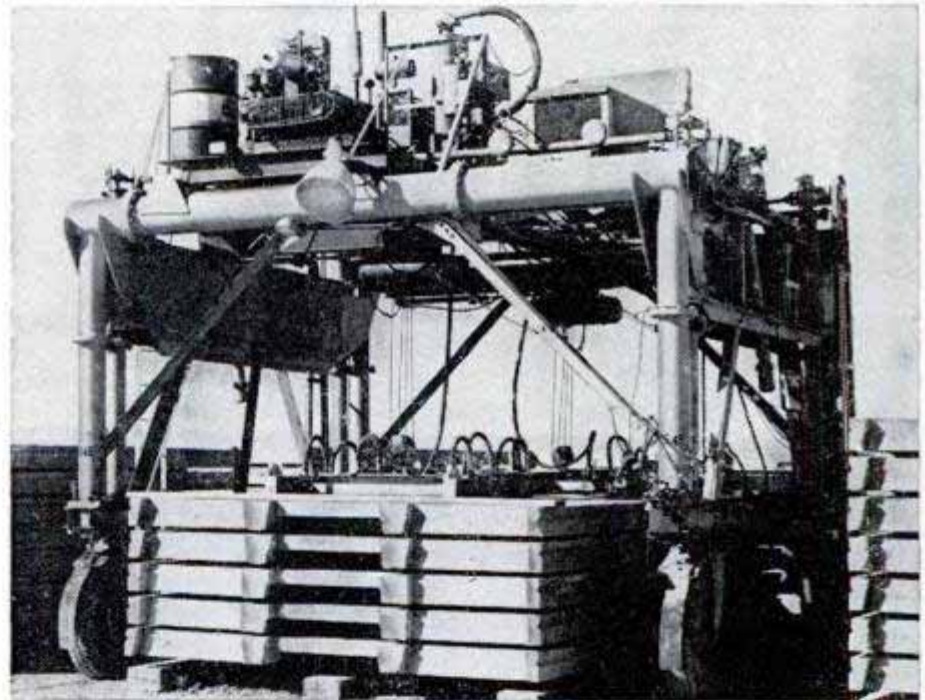


Converted lumber carrier gently lowers a partially cured concrete section into position on stock pile

## Lumber Carrier Hauls Concrete

Straddling a pile of massive concrete slabs, a converted lumber carrier at a California building project lowers two giant suction cups, gently raises a section and carries it away to the construction site. The machine, originally a standard lumber carrier, was broadened  $9\frac{1}{2}$  feet to make its width  $17\frac{1}{2}$  feet. Five feet were added to each of the four legs, raising the height to 20 feet. Drive chain and steering shafts were extended and the entire structure strengthened. Two three-ton hoists were installed, along with a hydraulic system to center the slab after it has been picked up. The vacuum lifting device consists of two mats ringed with sponge rubber and connected to a vacuum

Vacuum pump and equipment atop carrier connect by hose to suction hoists



pump atop the machine. The eight-inch concrete slabs weigh only 100 pounds per square foot, but the vacuum is great enough to lift 14 times that load.



## Calculator With Braille Symbols Aids Blind

Performing all the operations of a standard machine, a new calculator enables a blind operator to check figures as he enters them or to read the answers without help. Braille symbols on its three rows of numbered dials, exposed for finger-tip access, enable him to read results in any stage of the calculations. Totals may then be recorded on a Braille typewriter placed beside the calculator.

# WHAT'S NEW FOR Your Home



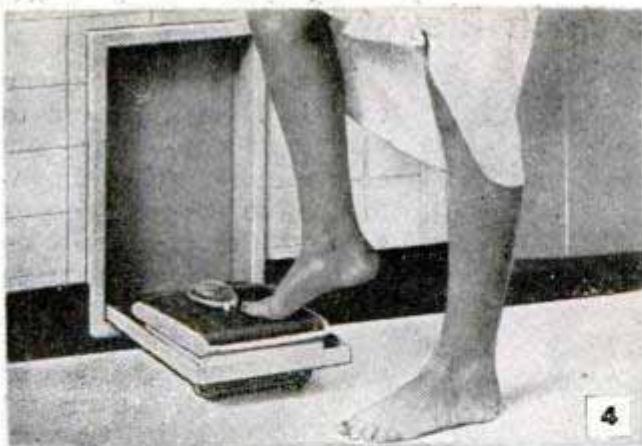
**1. TABLE-TOP TRAY** fits over a card table so that you can load it with food and setting—exactly as it will be used on the table—fold up the corners and carry the completely loaded unit by the cut-out handles. Of steel, it is finished with white enamel

**2. MIXER** for fruit-juice concentrates, powdered milk, beverages or batter also serves as a pitcher and a storage container, is easy to clean and does a quick job. Contents are agitated with a plunger. Made of plastic, it holds two quarts, is marked for measuring



**3. DEODORIZER** and insect killer plugs into any electric outlet, vaporizes insecticide pellets and deodorizing tablets. The nonstaining insecticide vapor settles in the room, leaving a residue said to be effective for 14 days. A bulb acts as a night light



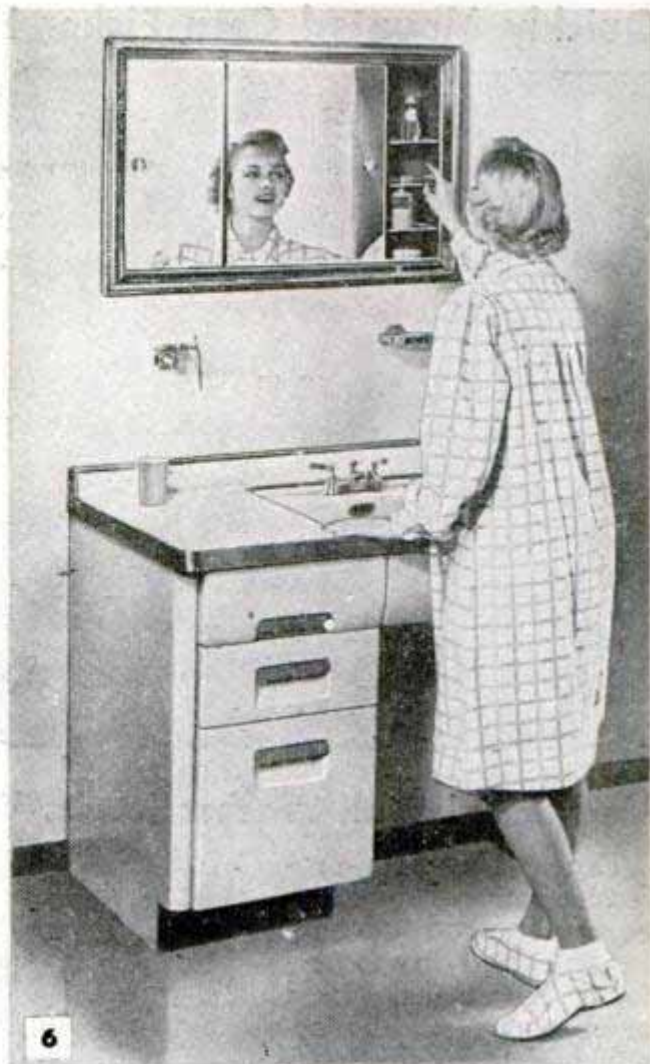


**4. BATHROOM SCALE** folds into wall when not in use. Crossbar handle opens the door on its bottom hinges, causing the scale to come to rest on the floor with the handle serving as a sturdy support. Scale bottom is enameled to blend with wall tile

**5. PLASTIC SHELF UNIT** held together with a chromium rod mounts on the side of a kitchen cabinet to hold knickknacks or needed articles. Shelves are made with rounded corners, will not splinter or chip. Unit is designed for standard 30-inch cabinet

**6. CABINET LAVATORY** has drawers for towels and a roomy top to hold toilet and shaving articles. Sliding door on medicine cabinet makes it possible for cabinet to be twice as wide as swinging-door type and eliminates danger of hitting head on door

**7. RECESSED HAMPER** for soiled clothes contains two doors: The upper or smaller one is a lift door through which clothes are dropped into the hamper, the lower or larger one is swung out whenever hamper is emptied. Baked enamel covers the steel container



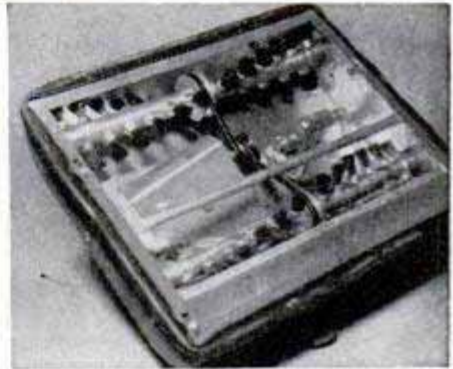
## Quickly Mounted Corn Picker Has Twin Elevators



Twin elevators carry ear corn from picker to wagon in a new two-row cornpicker. The elevators have several speeds so that the corn can be tossed to the front, middle or rear of the wagon. The tractor operator has complete control of the picker from his seat. To mount the picker on his tractor, he simply drives the tractor into the U-shaped framework and attaches the machine by use of hydraulic controls, without leaving his seat. Dismounting is equally simple, so that the farmer can move from job to job.

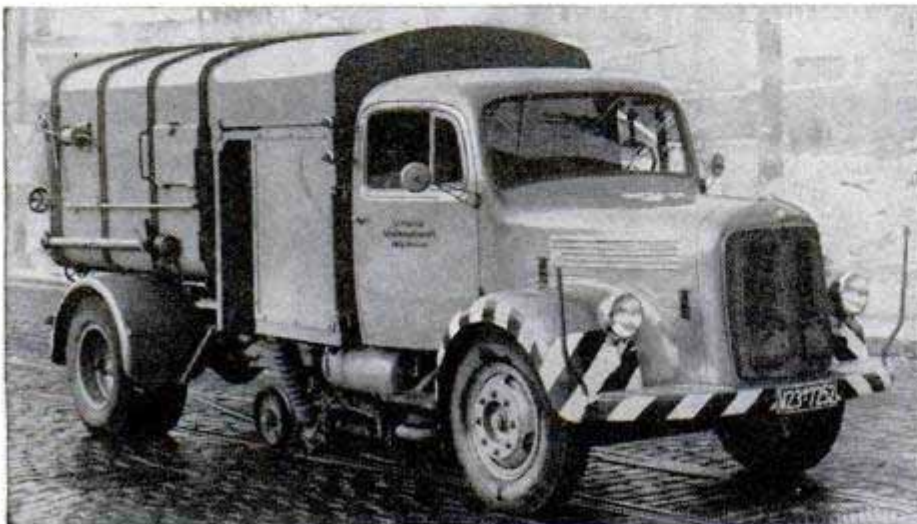
## Mechanical Wall Washer Scrubs With Soap and Running Water

Ernest Flores, a professional wall washer, never stopped wishing for an easier way to perform his tasks. He'd been watching housewives clean their floors with vacuum sweepers all his wife. Why not adapt the same principle to washing walls? He did, except that his device as yet employs no vacuum. The six-pound washer resembles a vacuum sweeper, even in size, but without the handle or dirt bag. It has two easy-to-grasp handles on top, one with a thumb lever to control the flow of water. On the side where the right middle finger can reach it is a button which activates a tiny pump for detergent



solution. Inside, two brushes rotate toward each other while water is sprayed from a punctured pipe between. A rubber bushing around the bottom of the machine prevents leakage of water down the wall. One hose connection admits water and another drains it away. An electric cable supplies power to the half-horsepower motor.

## Truck-Mounted Suction Cleaner Scours Streetcar Tracks



Streetcar tracks in Germany are cleaned regularly by a motor truck that uses water pressure and suction for the job. The cleaning unit is mounted beneath the truck body, which is the repository for the dirt and holds up to five tons. Signal lights in the cab show the driver when the cleaning unit is correctly positioned on the rails. Flanged wheels guide the cleaning unit.

# We Drive a Foreign Car

By Herndon Hudson

**I**T WAS A JULY morning in London, England, when we first took possession of our little red-upholstered black English sedan. Just over a year later, the car completed its first 10,000 miles. The place was Athens, Ohio, U.S.A.

We were ready to make an appraisal of our first year's experiences based on a careful accounting of expenses. This article is a report on a year with a foreign car—in our case a Hillman Minx.

We bought our Hillman by depositing a check for \$1645 in New York City. The car was



Photos courtesy Schmidt Motor Sales, Chicago

Although unmistakably foreign, the 1953 Hillman Minx is close enough to modern American styling so it doesn't look eccentric

Small cars are very maneuverable. Hillman's 33-foot turn-circle diameter enables it to swing around easily in this intersection



delivered to us in London and the price included subsequent shipment to the United States, clearance, customs and United States federal taxes. Actually, we got most of the customs charge of \$100 refunded later because we had not used all of our personal exemptions. British licensing, number plates and compulsory insurance (all for three months) cost a total of \$57. All these details were arranged by the company.

We selected the Minx because its styling corresponds most closely to that of current American models. Some of the other European cars are too narrow for their height, have "old fashioned" mountings for spare tires or unusual silhouettes. We didn't mind driving a smaller car, but we didn't want one that looked peculiar.

Since traffic keeps to the left in Britain, domestic cars have the steering wheel on the right. Export cars (and ours was one of these) have the wheel on the left. The dash arrangement was not shifted with the wheel so the speedometer is far to the right, the gasoline and temperature dials are in an awkward position and the bottom of the speedometer needle overlies the odometer at cruising speeds. That portion of the instrument panel nearest the driver contains a metal plaque illustrating how to shift gears. The car has four forward speeds and one reverse speed. The shift-lever movements are opposite to those in American cars. All this, however, is less complicated than it sounds and in a few hours shifting is done without thinking.

The front windows do not turn completely down and you can't rest your arm on the sill comfortably. One misses the armrest on the left front door. The electric windshield wipers have only one speed and the trunk lid only one support [1953 models have two supports—Ed.]. In heavy rain,

water drips into the glove compartment and onto the floor and the trunk is neither waterproof nor dustproof. The bumpers are light by American standards, but the slip-proof, built-in socket for the jack is convenient and safe.

The Minx presents difficulties for tall or stout persons, especially in the rear seat. The legroom is limited and the rear doors are narrow and do not open fully. We found that we could carry six persons on occasion, but the capacity is really four persons and, on the whole, the car is most suitable for two, using the rear seat for baggage.

Gasoline (or petrol) in Britain cost us 42.5 cents for the equivalent of a United States gallon. For the 4000 miles we traveled there, we averaged more than 26 miles per gallon (United States). For approximately 6000 miles in this country we averaged 23 $\frac{2}{3}$  miles per gallon. On long trips the Minx goes 31 miles to the gallon. On a 1074-mile trip in April, we used \$9.56 worth of gasoline (35 gallons). In July, a 1445-mile trip cost \$12.52 in fuel (46.5 gallons). As the tank holds 8.5 gallons, one must refill about every 250 miles. The mileage figure for driving around town is, quite naturally, not so good. In the winter when the car is being driven only between the home and office, the mileage falls below 20 miles per gallon. The fact that the engine has to be choked considerably in cold weather increases gas consumption.

On the curving roads of Britain the small size and low power of most British cars keep average speed well below that in the United States. Some of our friends predicted that we would be thrown all over the road at American speeds in such a small, light car. However, we find that the weight (2075 pounds) and the height (60 inches) combine to produce a firm, steady feeling that makes even long trips not at

**Small cars are easy to park. The Hillman has room to spare in a space that would be tight for a large car**





Safe and slipproof is the Minx jack. The arm on the jack slips into a socket welded just under the bumper



Getting in and out of the rear seat takes practice. The door opening is small and the wheel interferes

all tiring. Cruising speed is around 50 miles per hour, though one may approach 60 or more without strain. The small four-cylinder engine has a narrow power margin and requires frequent gear shifting. Its 42-horsepower engine cannot be expected to produce very fast acceleration. In passing and on hills, one has to avoid demanding too much of the fuel pump.

Of the four forward speeds, high is vir-

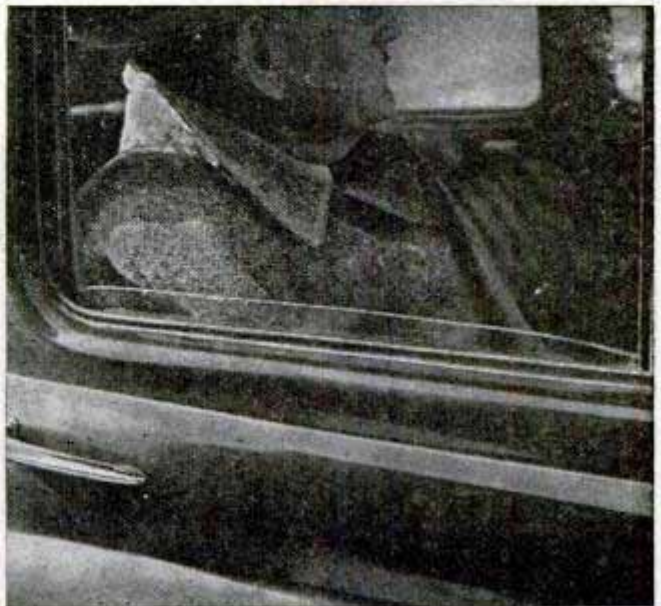
tually overdrive and is most satisfactory for level cruising. On a hill, one must shift promptly to third. This gear is also useful for braking on steep descents. Second gear corresponds to our low. First gear is an emergency low, used in difficult terrain or when starting on a sharp incline.

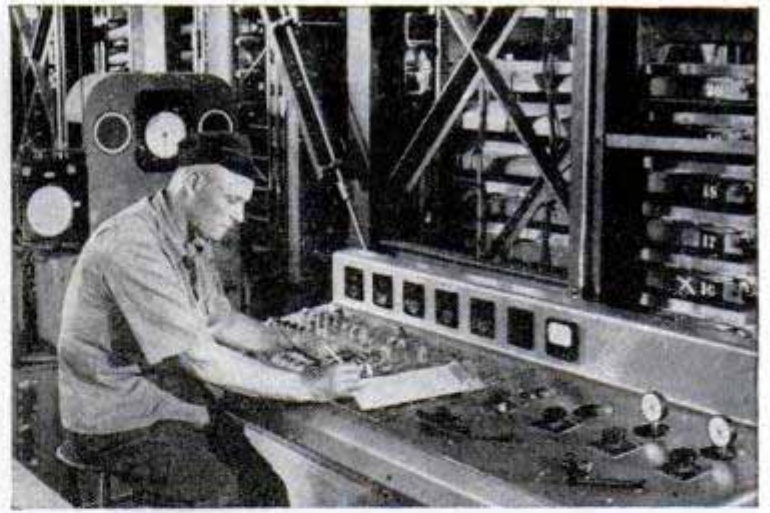
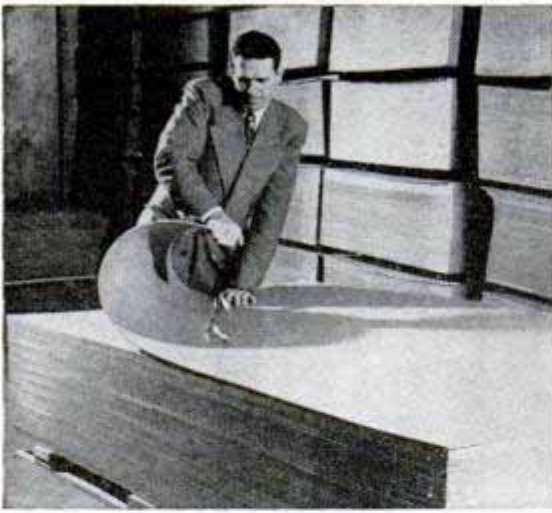
The easy steering (no power booster needed!), the quick, sure deceleration, the

(Continued to page 258)

Shifting is unlike the U.S. system. Lever here is in reverse. Note the speedometer location at far right

Window glass in front doors won't go all the way down and sill can't be used as a comfortable armrest





High strength and flexibility are features of hardboard. Right, one of two control boards on production line

## Automatic Plant Turns Wood Scraps Into Hardboard

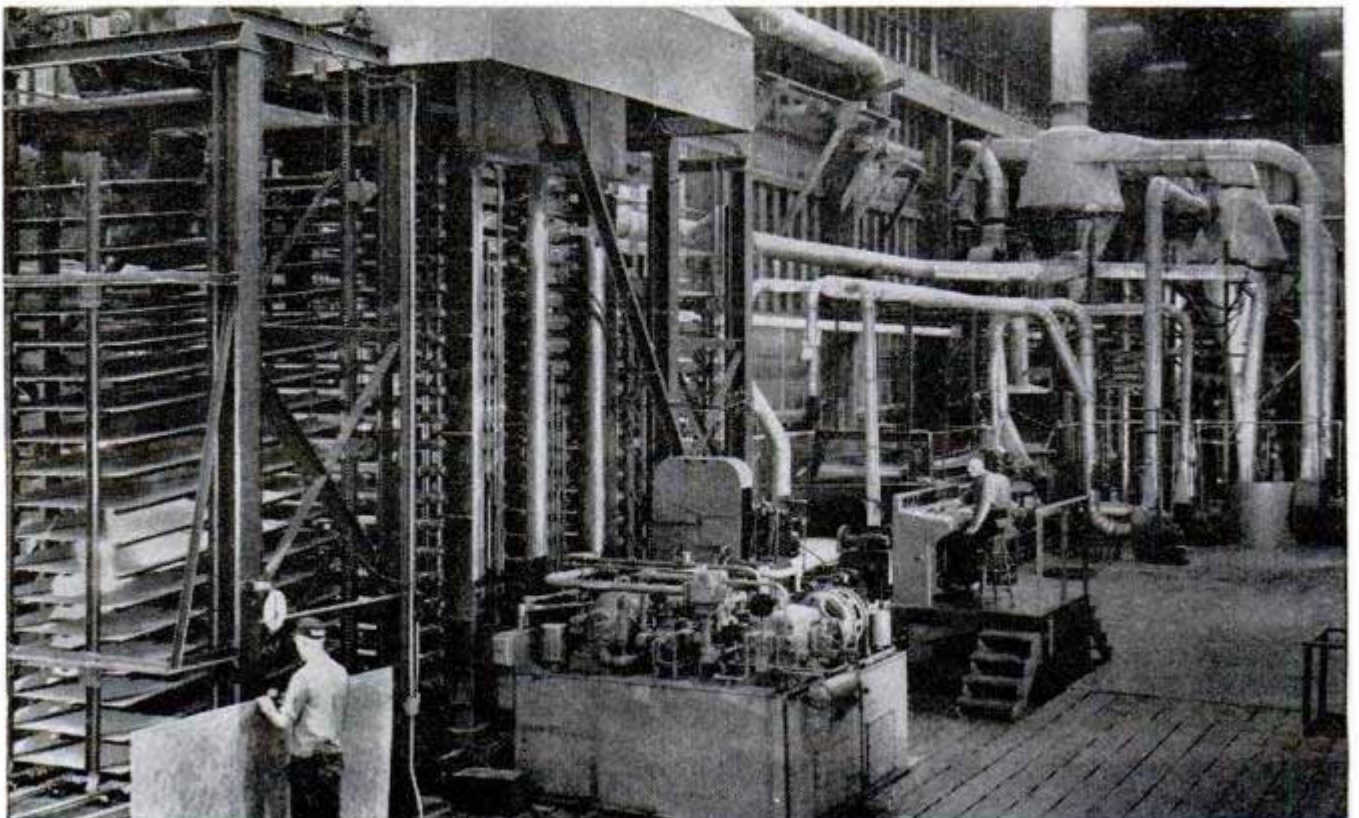
PUSH BUTTONS control operations at a million-dollar plant in Anacortes, Wash., which produces strong hardboard panels from plywood scrap. Only 30 men are required to turn out 2,500,000 square feet of board per month.

The waste material—log centers which remain after the veneer is peeled off, and solid old-growth Douglas fir—is first chopped into thumbnail size. These chips, softened by steam, are mechanically ground into tiny fiber bundles with brushed-out ends. Resins and other additives blend with the fibers as the material moves along a belt. The deep, spongy mass is hot pressed to form panels which are cut to desired size. About the only work done by

the operators—besides pushing buttons—is to feed the raw material into the machine, unload the trimmed pieces and grade the finished stock.

The resulting hardboard consists of thousands of microscopic, interlocking tresses that give the board elasticity and a high degree of shock resistance. In fact, the manufactured wood is so flexible that a strip of board  $\frac{1}{8}$ -inch thick can be bent into a circle the size of a hatband without cracking. The hardboard, available in  $\frac{1}{8}$ ,  $\frac{3}{16}$  and  $\frac{1}{4}$ -inch thicknesses, is light tan in color with a hard, satiny surface that takes paint well. The wood can be used for crates, display fixtures, underflooring, wall paneling and in cabinetwork.

Chips are softened in cooker section, right, before entering hot press, left. Few workers are needed in process







### Valise-Size Motor Scooter Parks in Home or Office

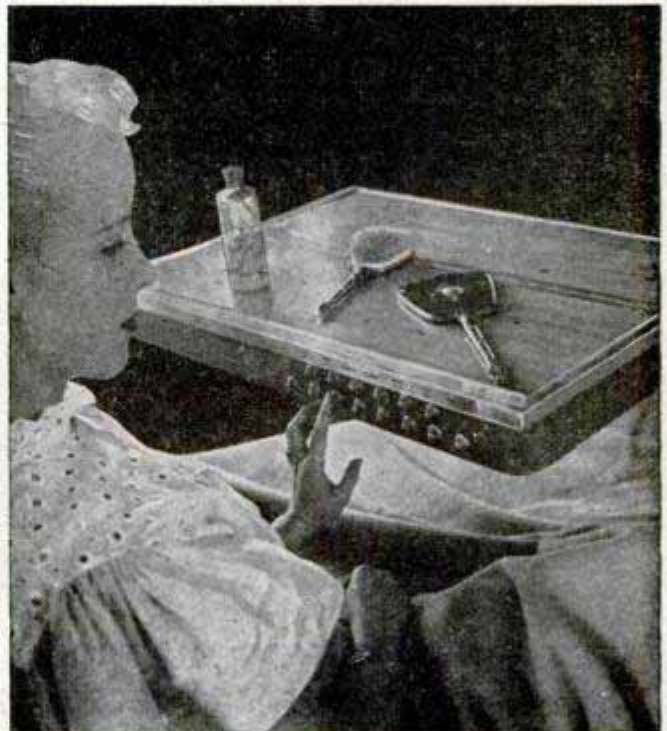
Parking is no problem when you own a collapsible French motor scooter that you can take into your kitchen or office. It's called a Valmobile because it's valise-size.

On the road, the vehicle looks like any other scooter. When you stop, you simply fold the steering wheel and front wheel inside the body and pull the scooter indoors.

### Mechanical Hospital Bed Serves Patient at Touch of Button

Built-in plumbing is a main feature of a mechanical hospital bed controlled from an instrument panel mounted on the bed tray. A touch of a button slides out a lavatory complete with hot and cold running water and drain. Another button brings a toilet beside the bed. Other buttons control head and knee lifts, a retractable trapeze with

reading light, elevation of the bed from 23 to 32 inches, tilting or vibration of the bed. The bed's movements are hydraulically actuated. A one-half-horsepower motor runs the hydraulic mechanism. The time required for care of the patient is reduced as much as 46 percent by the bed. Greater comfort and self-sufficiency result.



# Introducing—JANE and DON ENGELHARD



a typical newly married American couple who are looking into the future with dreams of a home of their own. *Popular Mechanics* editors invited them to Chicago for conferences on their housing problem after

## THEY WROTE US THIS LETTER:

*Beloit, Wis*

*The Editor  
Popular Mechanics Magazine  
200 East Ontario St  
Chicago 11, Ill.*

*Dear Sir:*

*We are a young married couple, and one of the biggest interests in our lives is getting a home of our own. But how do we go about it? Should we build a new home, buy one already built, or fix up an old one? Of course, the state of our finances when we get ready to acquire a home is going to dictate much of the decision.*

*But like every other young couple, I guess, we like to plan and look ahead into the future. Right now we would like to start learning the things we need to know about homes. If we build, what is the best way to go about it—go to an architect, contractor, or both? What should we know about construction—just to make sure that we are getting a good house whether we build or buy it? We don't even know how to read a blueprint.*

*We would appreciate all the help you might give us.*

*Donald and Jane Engelhard*

**THE ANSWERS TO THEIR QUESTIONS—AND WE HOPE THOSE OF THOUSANDS OF OTHER COUPLES—ARE PRESENTED ON THE FOLLOWING 48 PAGES...**

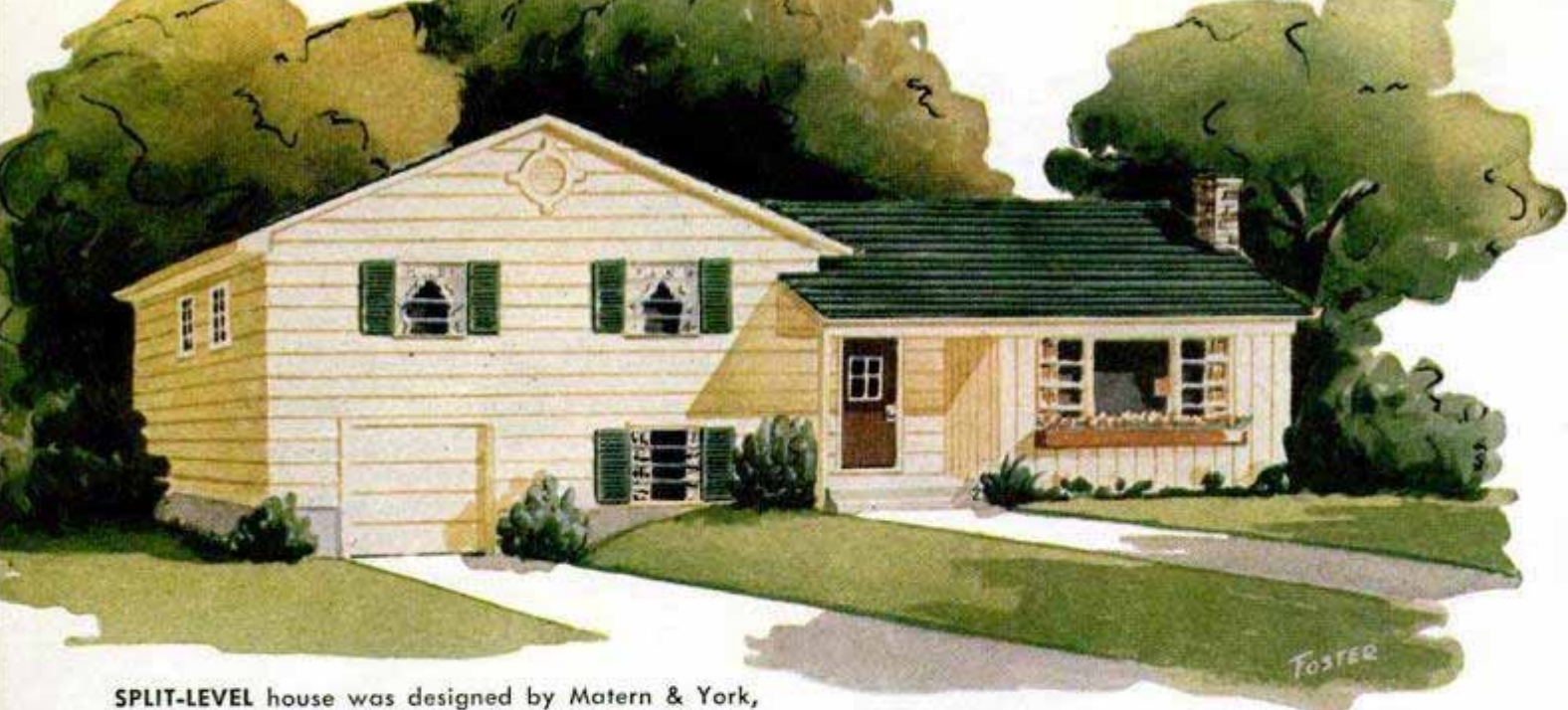


Jane and Don Engelhard ponder the problems of all prospective home builders: How much can we afford to pay? Two bedrooms or three? Basement or none? Carport or garage? And should it be traditional or modern type

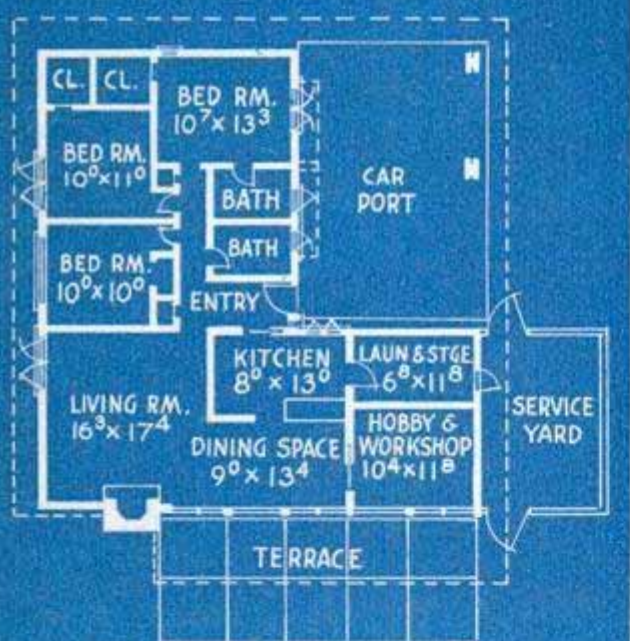
# Tomorrow's Trend in Homes

**P**ICTURED on this page and in more detail (including floor plans) on the following color pages are six modern homes of various types chosen from the million-odd new homes being built in the United States this year. Each was selected by the editors of *Popular Mechanics* for its outstanding livability, economy and general excellence in both interior and exterior planning. These houses range in price from \$7245 (including the lot) to \$19,800 (not in-

cluding lot). Building costs vary across the country and the prices listed represent the costs in the particular areas where the homes have been built. The exterior designs include the popular split-level, the contemporary flat-top, a modern adaptation of a Cape Cod house, an attractive California house with floor-to-ceiling glass walls, an inexpensive concrete-block house and modifications of the so-called ranch-type dwelling. ★ ★ ★



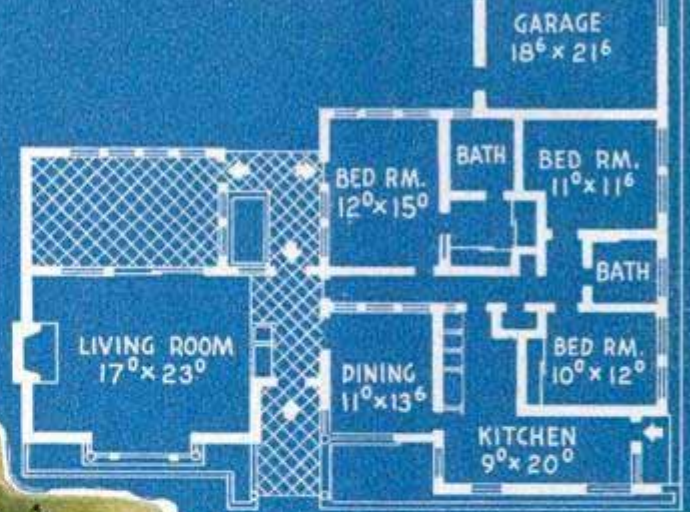
**SPLIT-LEVEL** house was designed by Matern & York, Jamaica, L. I., N. Y., and built by Viceroy Homes Inc., at Westbury, L. I., N. Y. Price, including landscaped lot 75 by 100 feet, is \$18,490. House has a full cellar with poured-concrete foundation. The exterior is wood siding. The floor area is 1234 square feet for the house and 243 for the recreation room



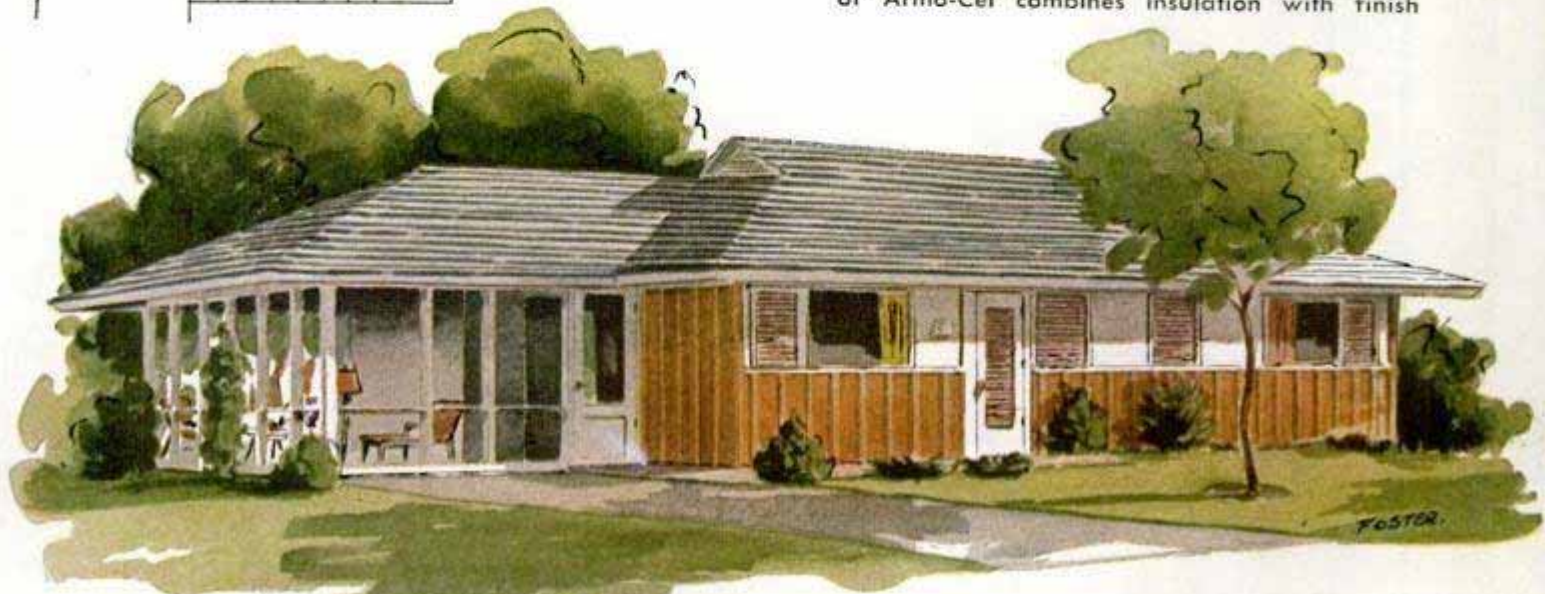
**CALIFORNIA** house planned for outdoor living, designed by Anshen & Allen, San Francisco, and built by Eichler Homes, Palo Alto, at Redwood City, Calif. The price, including lot, is \$17,750. Construction is standard stud wall with exterior sheathing of ship-lap redwood siding. Floors in living areas and hallways are cork; kitchen has stainless-steel sink (with garbage-disposal unit) and hardwood cabinets; price includes electric range; Philippine mahogany paneling throughout. The floor area is 1425 square feet



**TRADITIONAL** house with modern touches, especially the interior planning, was designed by James Ronald Fetridge and built by George D. Buccola (owner acting as his own contractor) both of South Pasadena, Calif. The cost was \$19,800, not including the lot. Exterior construction includes vertical redwood siding and brick. House has a shake roof, steel sash, hardwood floors in living area (tile in kitchen and baths and in smallest bedroom used as den), plaster walls. Tiled passage with doors at either end separates living room from rest of house. The terrace, or lanai, is partially enclosed with walls and is at rear. Total floor area is 2070 square feet

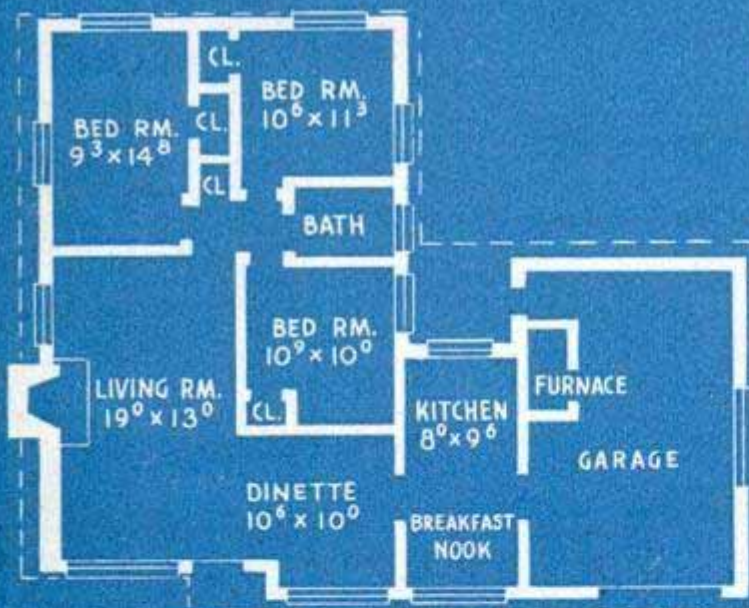


**ECONOMY** ranch-type house was designed and built by Martin L. Bartling, Jr., of Knoxville, Tenn. The price (\$11,740) includes a lot 100 by 150 feet landscaped and with black-top driveway. Floor area is 1000 square feet. House is frame with exterior plywood covered with batten strips. Roof construction is trussed and all interior partitions are storage walls. If third bedroom or den is not needed, wall can be shifted to enlarge living room. Screens at front of porch are a door which swings out to convert it into a carport. House is built on concrete slab foundation and is fully insulated. Heating is electric radiant Ceil Heat embedded between two layers of sheet rock in ceiling. Roofing of Armo-Cel combines insulation with finish





**FLAT-TOP MODERN** house has price tag of only \$7245, including the lot, and was designed and built by Earl W. Smith of El Cerrito, Calif. The floor area is 900 square feet; wall construction is standard frame; ceiling is two-inch plank and beam with ½-inch insulating board and covered with a built-up gravel roof. Steel sashes and copper plumbing are used throughout. Floors are finished with asphalt tile. Bedrooms have sliding floor-to-ceiling wardrobe doors. Storage closet at rear of carport measures 4 feet by 10 feet 6 inches. This is one of the most popular contemporary homes being built on West Coast



**CONCRETE BLOCK** house was built by Albert Balch, Seattle, and was designed for the Balch enterprises by Ken Burlingame. The price (without lot) is \$12,500. Square footage totals 1338 (including 321 for the garage). Concrete slab floor is poured over copper tubing for radiant heat. All windows are over-size with steel sash; roof is cedar shake and doors are of mahogany. Roman brick of fireplace wall extends from hearth to front wall of the house as can be seen in floor plan. Kitchen is equipped with fan, formica counter tops and birch cabinets. Additional space for workshop or extra storage could be added easily at rear of garage for a nominal cost



To Jane and Don and millions of other couples interested in buying or building a home—here are valuable tips from a noted architect on some of the 1001 things to bear in mind . . .



# When You Plan That House

By Rudard A. Jones, A.I.A.

Assistant Director, University of Illinois Small Homes Council

**I**T'S FUN to plan a house. Just take a look at your way of living—that's the starting point. Keep in the back of your mind, though, the thought that your new home will be one of your major investments—not only in money, but also in future living satisfaction.

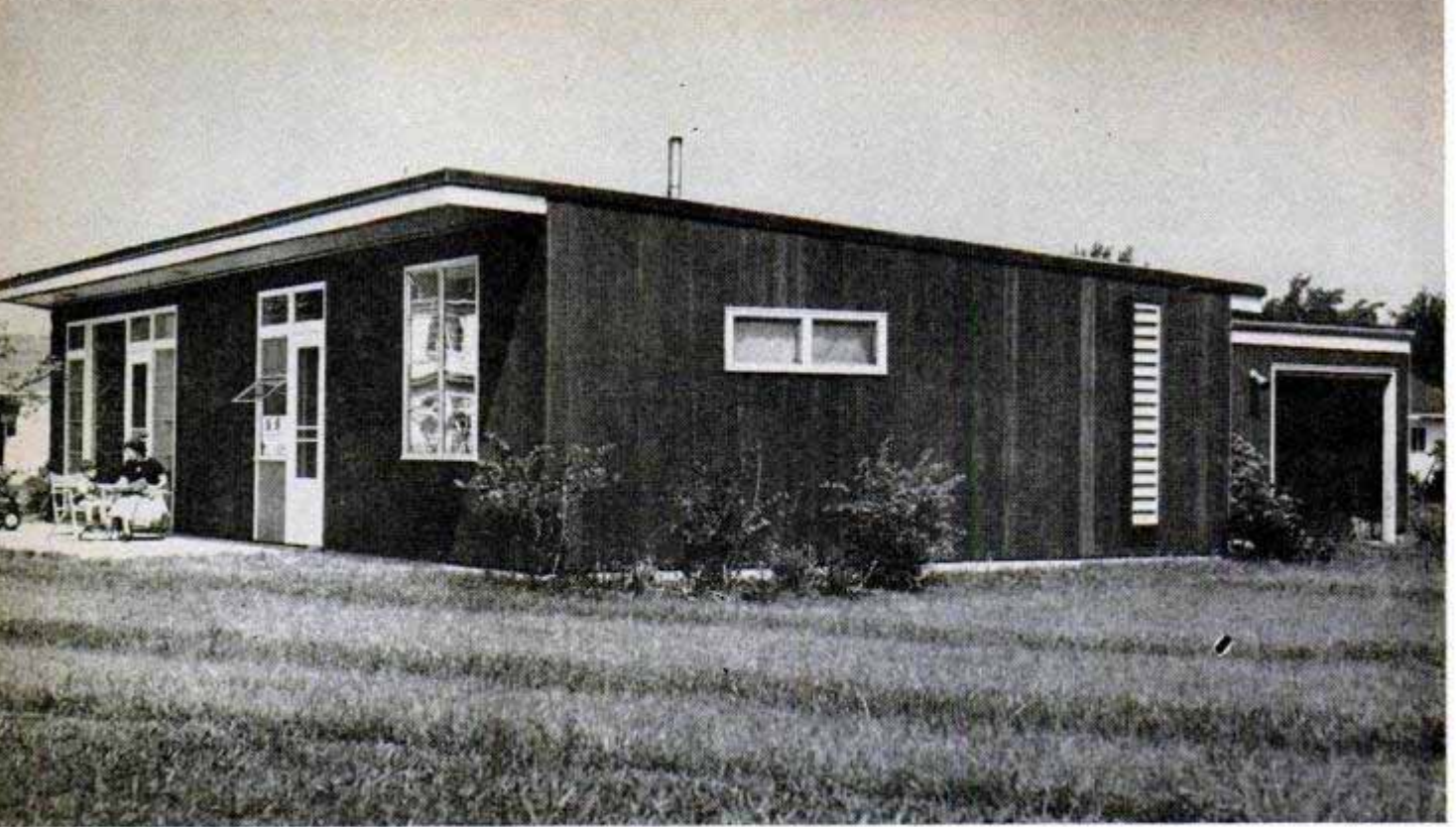
Informality keynotes our way of life today, with emphasis on comfort and convenience. Ostentatiousness is out. Our goal is to plan a house that we can run, rather than a house that runs us. Since we seldom have servants, we must give careful thought to planning features that will mean convenient use of the house. Every step saved

means time saved, time we can use to relax and enjoy our surroundings.

To get the most and best space for your money, study your requirements carefully. A thorough analysis of your needs can aid your architect immeasurably in planning a perfect home for you. This means deciding not only the number of bedrooms and other rooms you would like, but including in your study the influences of modern machines and materials. For instance, the constant use of the automobile means your "front door" will most likely be the entrance closest to the garage and to parking space for visitors. Your television set may

Split-level house designed by the author uses windows for indoor-outdoor effect





Architect Jones incorporated many of his ideas in this contemporary house. This photo was taken from the position of arrow No. 1 shown on floor plan on opposite page. Overhangs at front and rear help control sun

be the focal point in your living and dining areas. Remember that better heating makes rooms 100 percent usable with no wasted space. Air conditioning gives freedom in window placement, thus keeping windows strictly for light and view. New materials permit imaginative details you may like to include; for example, double glass makes large glass areas practical even in northern climates. You will want to study carefully the area for your laundry work so you can make the best use of modern laundry equipment.

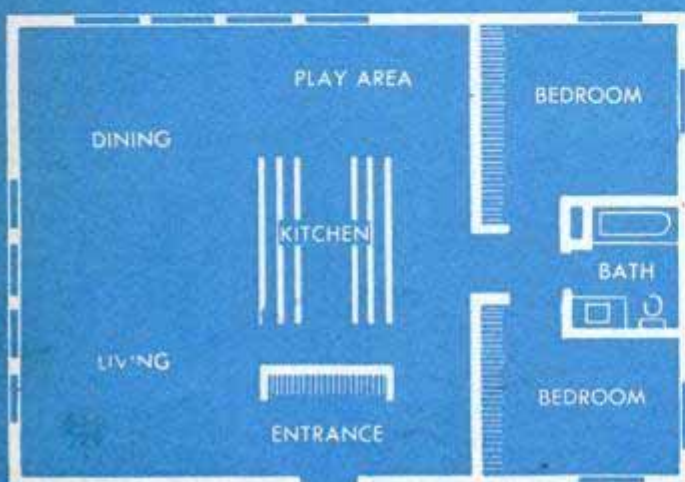
**Site.** Before you are ready to start thinking about your new house in detail, you must make several basic decisions. First is the selection of the building site. Check these facilities: Sewage disposal, water supply, electricity, gas, streets and side-

**Jones is a strong advocate of the open-type plan with only full height walls around bedrooms, bath**

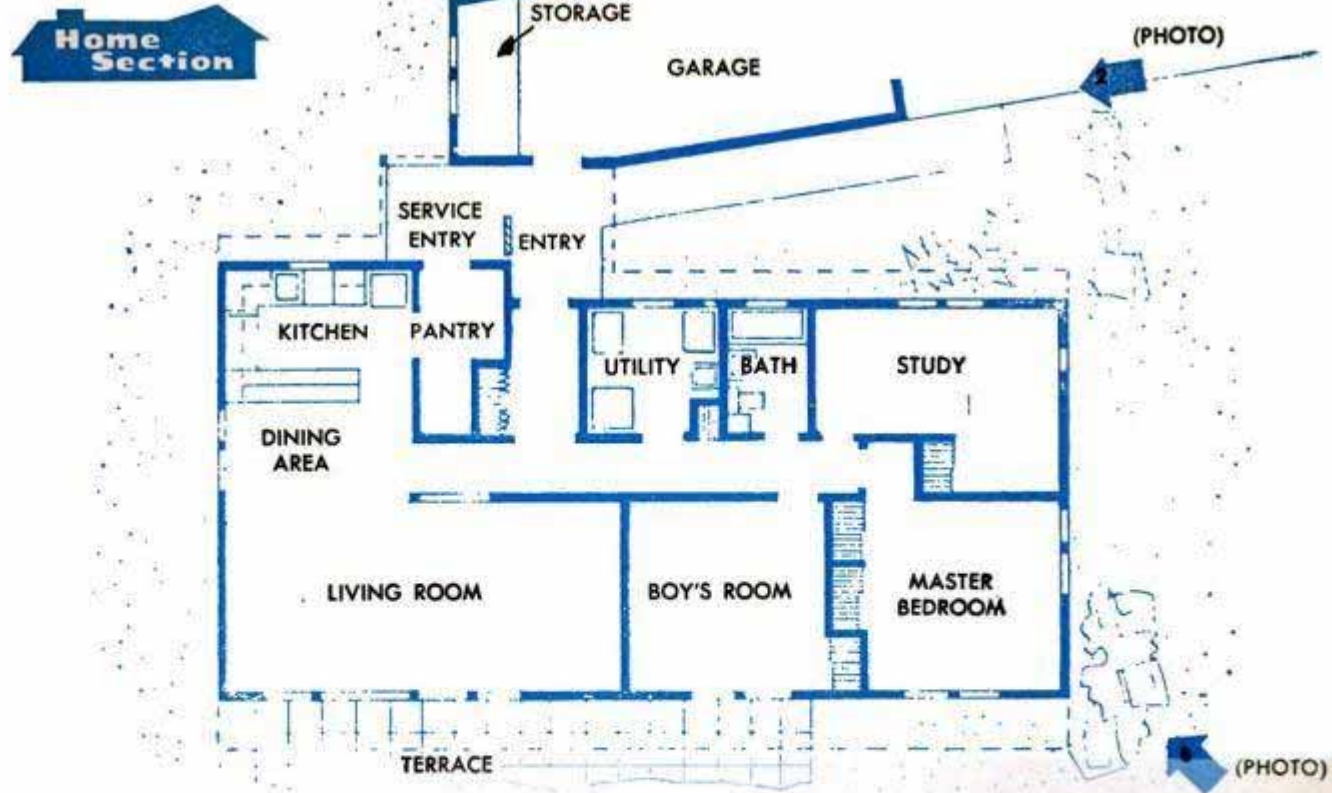
walks. Can the land be drained properly? Is there adequate fire and police protection? What about zoning? There may be special features—an exceptional view, a fine grove of trees, and so forth. A small site may require a multistory structure; a good view may change your plan entirely. The site directly influences the house.

**Basement or No Basement.** In the first stages of planning you will have to decide whether or not you are to have a basement. A light, dry basement provides an excellent spot for storage, heating system, laundry, workshop, hobby and recreation areas. In addition, basement space is much less costly than space on the first floor.

The disadvantages of the basement, however, may outweigh its advantages. On some sites it is difficult to prevent basement leakage economically. Condensation on walls or pipes may also be a problem in areas where summers are humid. Sometimes it is difficult to get satisfactory natural light in the basement. If the house is raised to expose the basement windows, the house appears awkward and too high. Grading may be done to improve the appearance of the house from the street but, in general, this will reduce the low-to-the-ground look that is considered desirable. In addition, there is often much stair climbing involved in using a basement. Finally, you may find that in spite of the low cost per square foot, the total cost of a full basement is too much considering the amount the basement is actually used. In these cases it may be possible to provide only a partial basement. The split-level







This home was designed for a family with one son. Study could be a third bedroom. Note service and main entry

house is one answer. If the basement is eliminated, additional space must be provided to compensate for it. [Editor's note: For further remarks on the subject of basements, see panel discussion, page 164.]

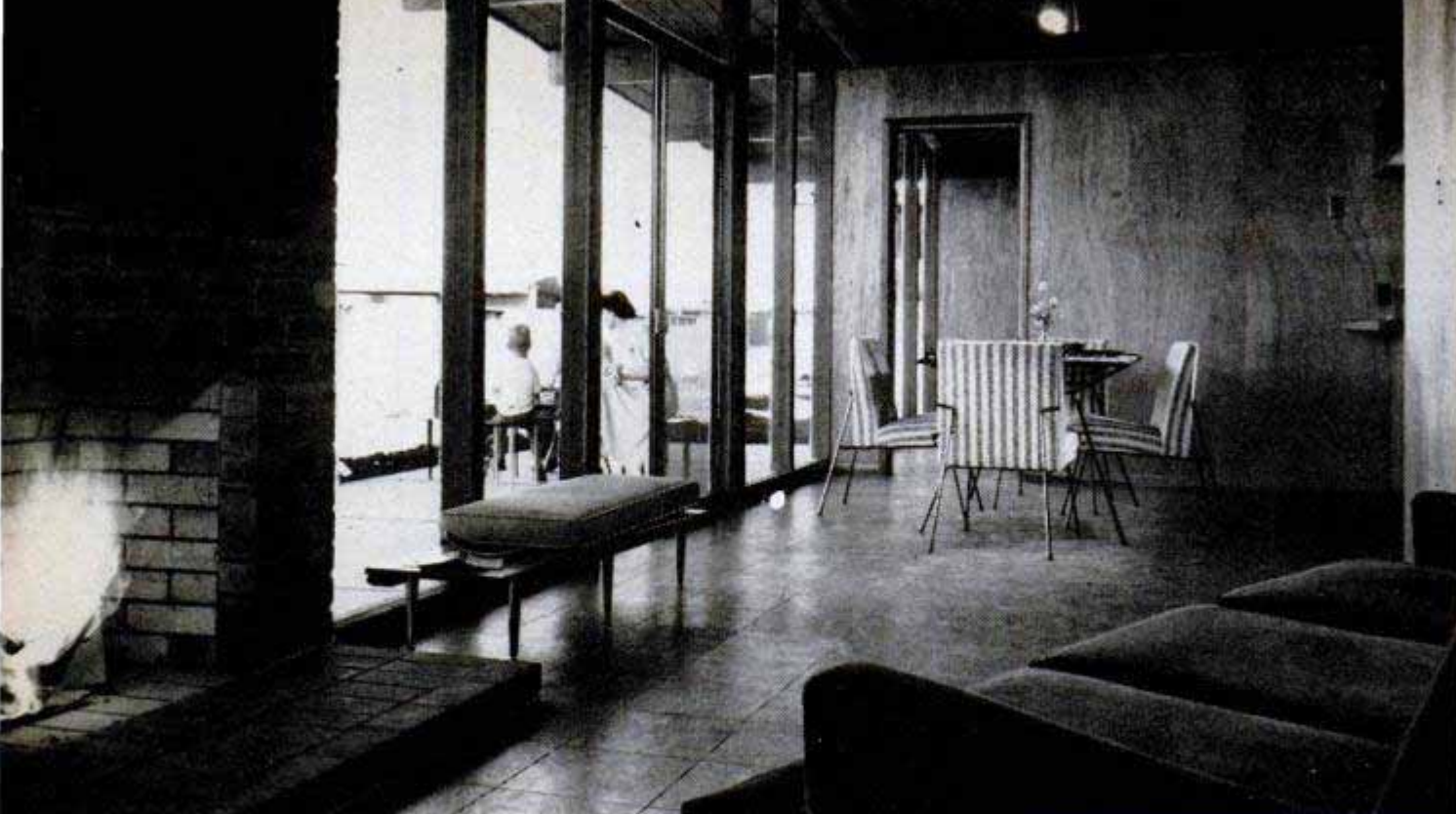
**Number of Stories.** Shall the house be a 1-story, a 1½-story, a 2-story, or shall it be a split-level house? You should examine the advantages and disadvantages of various types to see which suits best your way of living. Currently, the most popular house is the one-story. It is popular because there is no stair climbing, there is more freedom in arrangement of the plan and the house has the popular long, low look. This type often takes more hall space.

The 1½-story house is still popular in some areas especially in the north and east sections of the United States. It is compact and affords an opportunity for expansion. Dormers are required if cross ventilation is to be provided on the second floor; they are, however, expensive to build. The need for a bath on each floor often complicates the cost. It requires careful planning to arrange an expandable 1½-story house so that it is satisfactory both before and after the expansion.



Kitchen is separated by only partial partition from the dining area in keeping with open-type planning which makes any small house seem larger. Picture below was taken at position of arrow No. 2 on floor plan. Partition hides service entry to kitchen





Ronald Partridge photo for Eichler Homes

Contemporary home designed by Anshen & Allen uses glass walls in living room which opens onto rear terrace

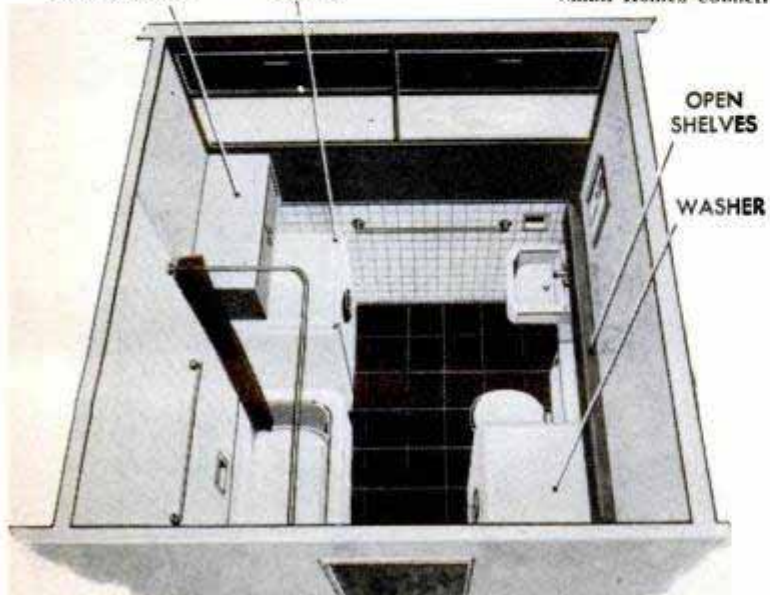
Stair climbing is a problem in the 1½-story house.

The two-story house is dwindling in popularity although it is almost mandatory on smaller lots. The house is compact, and it probably has lower costs per square foot of livable area than any other house because there is less roof and less foundation. Here again, though, there is the problem of stair climbing and it is usually desirable to have two bathrooms.

The split-level house or trilevel house often proves an excellent compromise between one-story and multistory houses. In one type of split-level house, the living room, dining room, kitchen and front entrance are on the ground level. One half flight of stairs above this level is the bed-

Laundry-bath contains conventional bathroom equipment plus an automatic washer and electric drier

LINEN CLOSET      DRIER      University of Illinois  
Small Homes Council



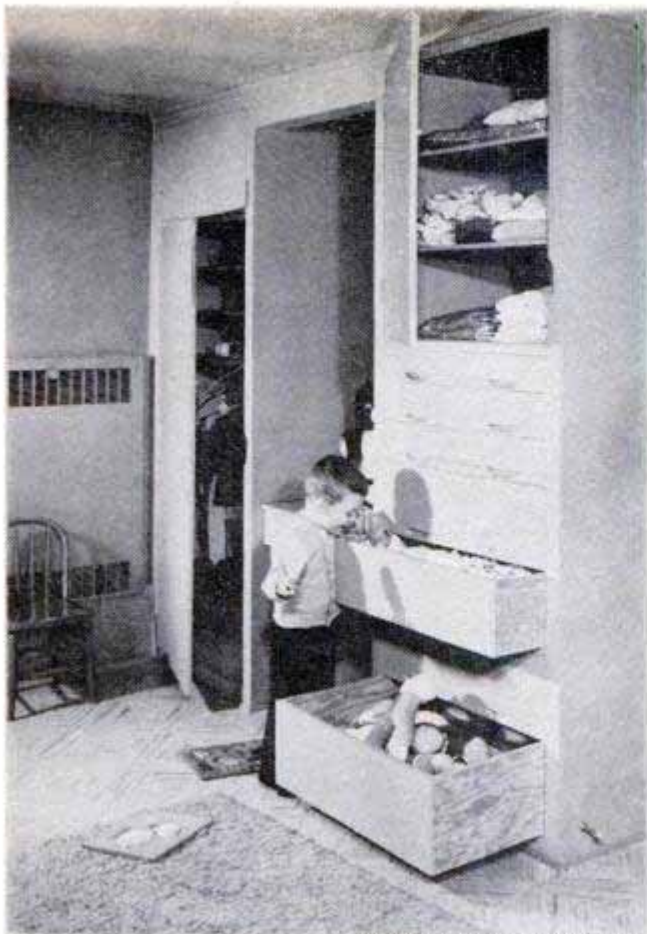
room-bathroom area. Below the bedroom area, and a half flight of steps lower than the ground floor, is the utility level. Here are the laundry facilities, the heating system, a workshop or playroom.

Advantages of the split-level scheme are several. The walls of the basement, or utility section, are actually about half out of the ground and, therefore, this level is well lighted and makes an excellent working area. Since this area is only about half of the house, the cost is not great. Stair climbing is not excessive as there are only six or seven steps between levels. Another advantage—the bedroom level is well isolated both from the street and the remainder of the house. Many believe the split-level house may be built only on sloping lots. This is not true, as the scheme is equally successful on flat ground.

**Selecting the Rooms.** Planning the house involves the pleasing arrangement of spaces to care conveniently for the various activities of the family. This involves the design and placement of rooms with consideration given to the activities to be carried on in these rooms. After you have made your basic decisions about the site and type of house you wish to build, you are ready to consider the rooms.

**Living Room.** A wide variety of activities, including daily living, reading, listening to the radio, watching television, child play, guest reception, entertainment and general recreation, takes place in the average living room. There is feeling on the part of many architects and homeowners that there

(Continued to page 262)



Monsanto Chemical Company

Storage walls in small homes save space by taking the place of furniture. These are fir plywood units



University of Illinois Small Homes Council

Closet wall with attractive glass screen for doors also saves space; sliding doors do the same thing

## FIRST STEP IN HOME PLANNING—CHECK LIST FOR FAMILY NEEDS



### HOUSEWORK

#### Food preparation

- Kitchen

#### Laundry

- Basement
- Utility room
- Kitchen-laundry combined

#### Sewing

- Utility room
- Kitchen-laundry combined
- Dining space
- Bedroom

#### Housecleaning

- Proper storage

#### Garden and yardwork

- Basement or utility workshop
- Garage or utility workshop

#### Maintenance (Tools, paints, etc.)

- Basement workshop
- Garage workshop

#### Domestic help

- Servant's room
- Lavatory or bath



### FAMILY GROUP LIFE

#### Dining

- Dining room
- Part of living room
- Part of kitchen

#### Family leisure

- Living room
- Bedrooms
- Study or "quiet area"

#### Outdoor living-dining

- Porch or terrace
- Lawn

#### Recreation and entertaining

- Living-dining areas
- Kitchen
- Basement game room
- Utility-game room
- Terrace, porch or yard

#### Small children's activities

- Utility-playroom
- Living room
- Play-bedroom combined
- Terrace, porch or yard



### FAMILY PRIVATE LIFE

#### Sleeping and dressing

- Bedroom or other area
- Clothes storage
- Bath

#### Hygiene

- Bath
- Lavatory

#### Individual work, hobbies

- Study or "quiet area"
- Bedrooms
- Basement workshop
- Utility room workshop
- Garage workshop

#### Isolation (infants or sick)

- Quiet bedroom

#### Guest accommodations

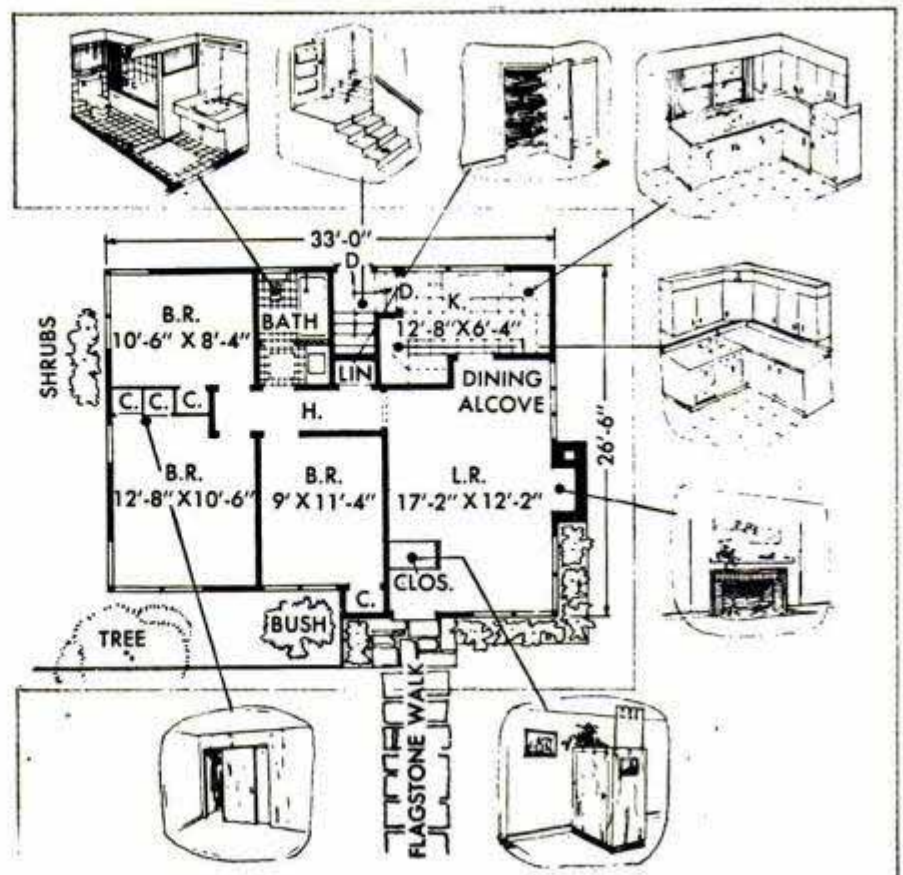
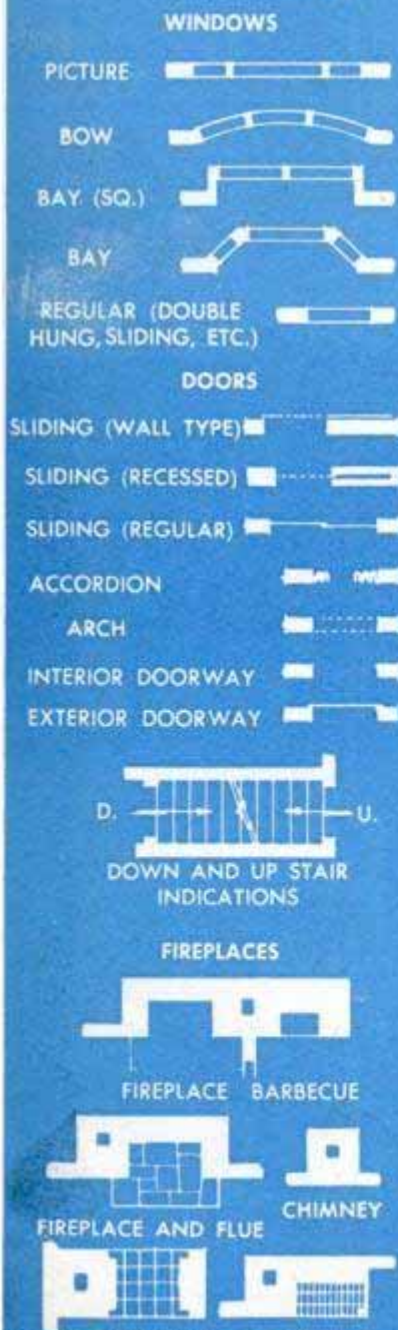
- Guest room, or
- Sleeping facilities in
  - Study
  - Living room
  - Utility room
- Convenient lavatory



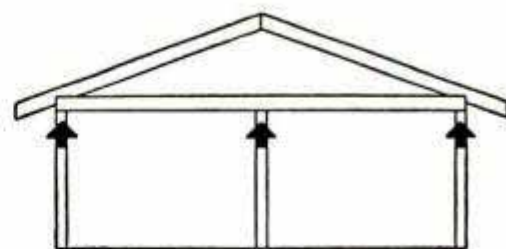
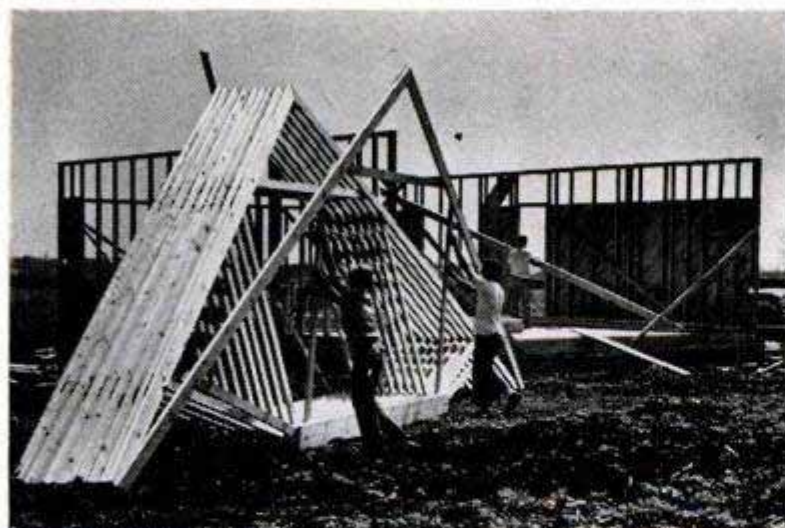
Don and Jane's troubles in reading a blueprint are no more, thanks to Rudolph A. Matern, noted architect, whose handiwork decorates this page. Learning basic symbols takes few minutes

# How to Read a Blueprint

THE SYMBOLS and abbreviations on blueprints are a language in themselves—the trouble is that too few persons understand them. Once you learn what they mean, it takes only a little imagination to visualize a complete home from the floor plan. Doorways, windows, fireplace, closets, stairs, built-ins, the arrangements of kitchen and bathrooms come to life. Once the symbols are learned, the house should be imagined in third dimension (see sketches around floor plan below) just as if it had been sawed through horizontally. Another great advantage of understanding a blueprint is that it makes it possible for a prospective builder to plan his home more accurately.

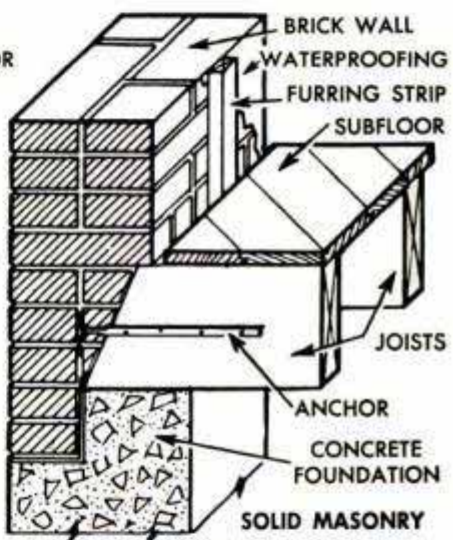
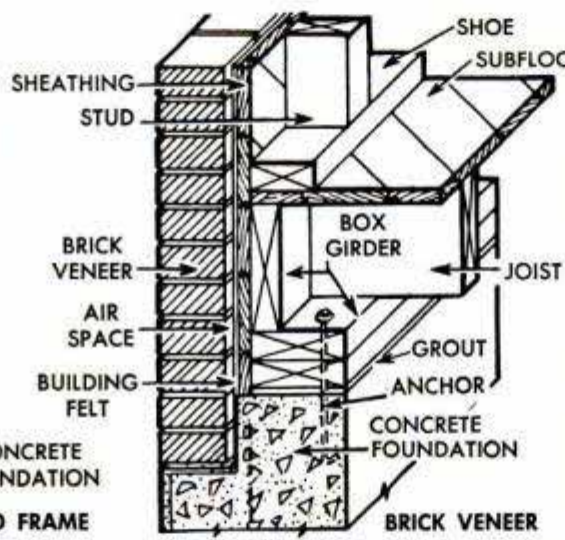
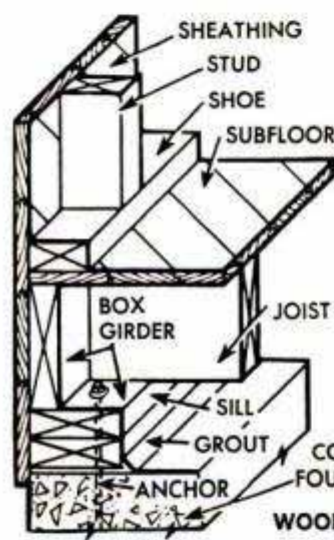


# Tips on Good Construction Practices



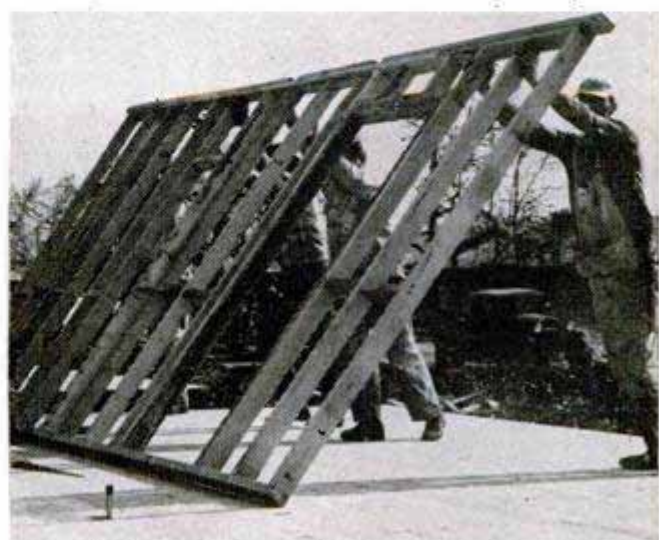
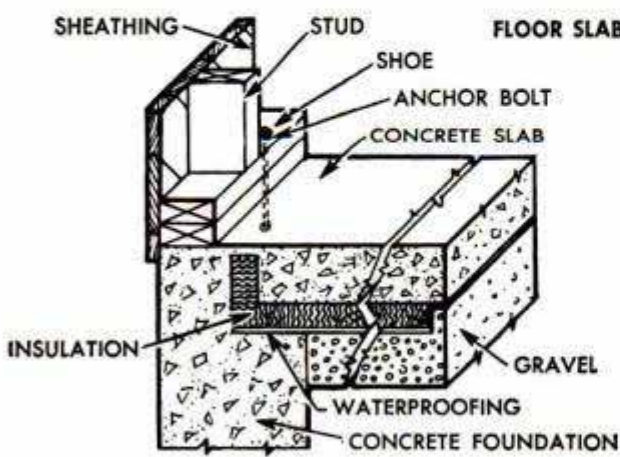
University of Illinois photo

Precutting roof trusses on site saves many man-hours. The W-truss in sketch above permits weight of roof to be supported by exterior walls. Top sketch shows conventional roof with interior support. First used on one-story houses, the W-truss (photo above) is being tested for 1½-story homes at University of Illinois



Approved practices for wood frame, solid masonry and brick veneer construction are shown left to right. These are the three basic types of construction used in home building and permit any desired architectural effect. The majority of U.S. homes are of frame construction consisting of vertical studs and sheathing

Right, tilt-up wall is tilted into position after it was assembled on floor where nailing is easier



Approved construction for concrete-floor slab uses waterproofing and insulation between slab and earth and also between the slab and the foundation wall. Slab foundation is used in the basementless house



With Levittown, Pa., in background, Don and Jane weigh advantages of mass-built home

*Any reliable architect or builder will tell you that if the mass-produced house meets your needs you can get*



# More House for Less Money

By Richard F. Dempewolff

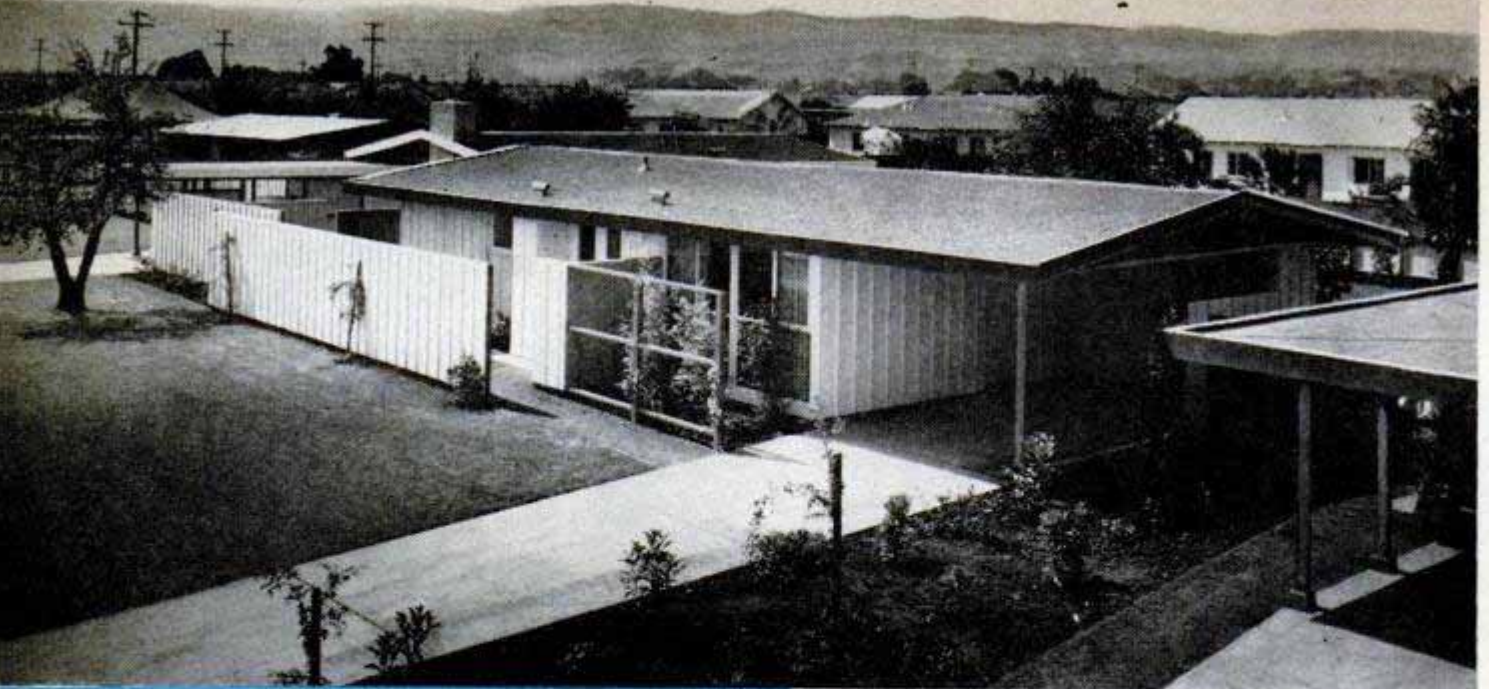
A PALL OF DUST hangs over southern Bucks County, Pa., these days. A roar of clanking machines resounds through the hills. Bulldozers are shoving the topography around to improve on nature's drainage over a 5½-square-mile chunk of countryside. Whirling shovels of mechanical ditch-diggers spin like Ferris wheels as trenches for an entire city's sewerage system snake out behind them. Convoys of trucks rumble by, each laden with precut lumber for whole houses. Here, a crew of men is pouring a network of concrete streets from the revolving drums of concrete-mixer trucks. Up the hill, a forest of framing for several hundred homes is taking shape. Beyond them, carpenters, ma-

sons, plumbers, electricians and painters are finishing another huge tract of houses.

"Once the groundwork is finished," says the man largely responsible for all this, "the houses go up boom, boom, boom."

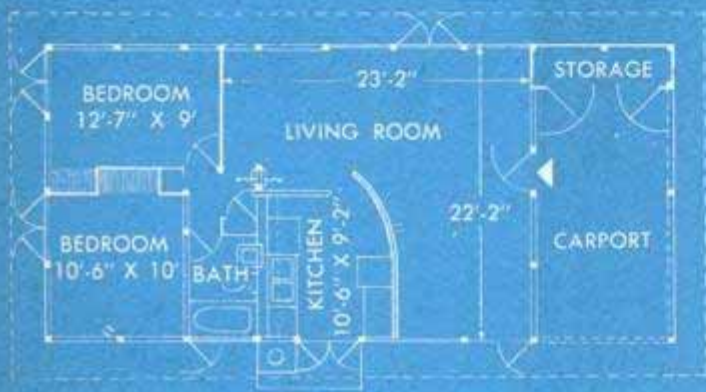
He's not fooling. William Levitt, the Henry Ford of the housing business, along with his architect brother, Alfred, and their landscaper-lawyer father, Abraham, is building another city on a dizzying timetable that sees a home completed every 12 minutes when things are going top-tilt.

Last year at this time, the site near U. S. Steel's new Fairless Works, a few miles south of Trenton, N. J., was sparsely settled rolling farmland. By next year, Levittown, Pa., will be a full blown city of 70,000



Valley Realty Company photo

Designed by Cliff May and Chris Choate this two-bedroom house (815 square feet) will sell for only \$7500



people living in 16,000 modern homes containing about every convenience today's housewife can desire. Nine thousand dollars buys the two-bedroom Rancher with expansion attic, \$10,990 the three-bedroom Levittowner and \$17,990 gets the handsome Country-Clubber. Unlike the 17,450-house Levittown on Long Island, which sprouted from the potato fields in more or less haphazard subdivisions, the new Levittown is a completely planned modern city, designed from scratch. That price tag on his house also buys each purchaser his share

Living room of May-Choate California house has floor-to-ceiling windows and doors that open onto terrace





of eight olympic-size swimming pools and recreation areas, a \$300,000 community house, a 25-acre lake, a \$20,000,000 shopping center with covered walkways, vast parking areas, curbed concrete streets feeding off four-lane main arteries lined with aluminum street lamps—not to mention some half million newly planted shade, fruit and evergreen trees that grace not only individual plots with seeded lawns, but also landscaped public areas. Eight public schools and a brand new railroad station will round out the community's facilities.

When Levitt & Sons first began to turn out houses like so many automobiles back in 1947, they were pioneers with a new housing technique. Today, mass builders, using similar cost-cutting techniques have been cropping up as bountifully as the homes they produce. Money saved by putting up 5000 instead of 5 houses at a time is passed along to the buyer who, for less money than he would have to pay a private contractor for the same floor plan, gets himself a building of top-grade materials, fully equipped with a glittering array of modern conveniences.

More than 1000 Levitt-type homes have sprouted outside Philadelphia in new subdivisions. In Portland, Ore., Franklin T. White has copied Levitt's ranch-type house and erected miniature Levittowns at somewhat higher prices than Levitt gets. On a slope in San Francisco,



Luxury tract house built by David Bohannon near San Francisco sells for about \$25,000 and would cost much more if custom built. Fifty homes of this type were built as a mass project. Called the Pace Setter, this model won prize

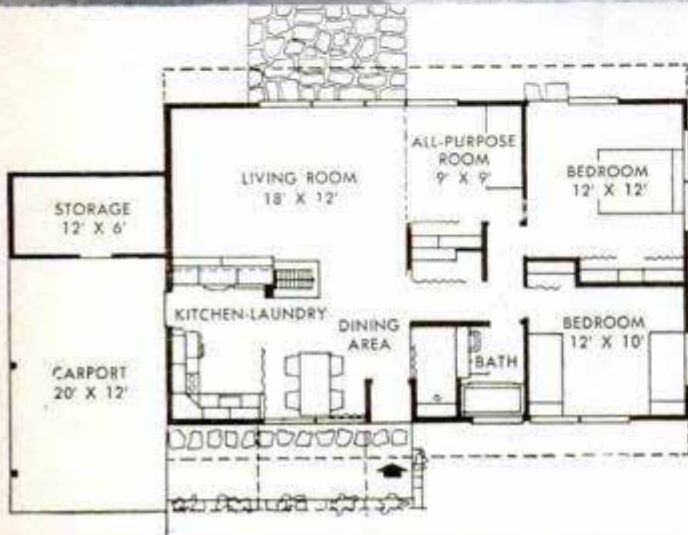


Dining area of tract house built by California builder Henry Cox has sliding glass doors that open to back yard patio. Snack bar, left, shuts off kitchen area. Below, Cox house with pleasing design and shake roof sells for \$16,000 but with optional extras such as radio-controlled garage doors goes to \$18,000





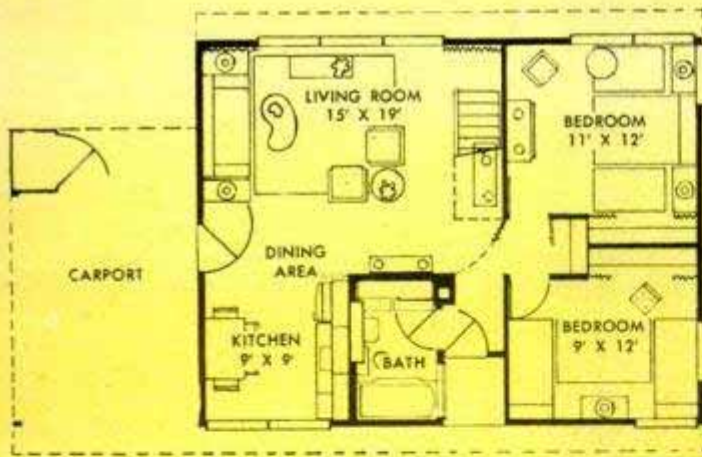
Most popular of Levitt's production homes is this three bedroom Levittowner which sells for \$10,990



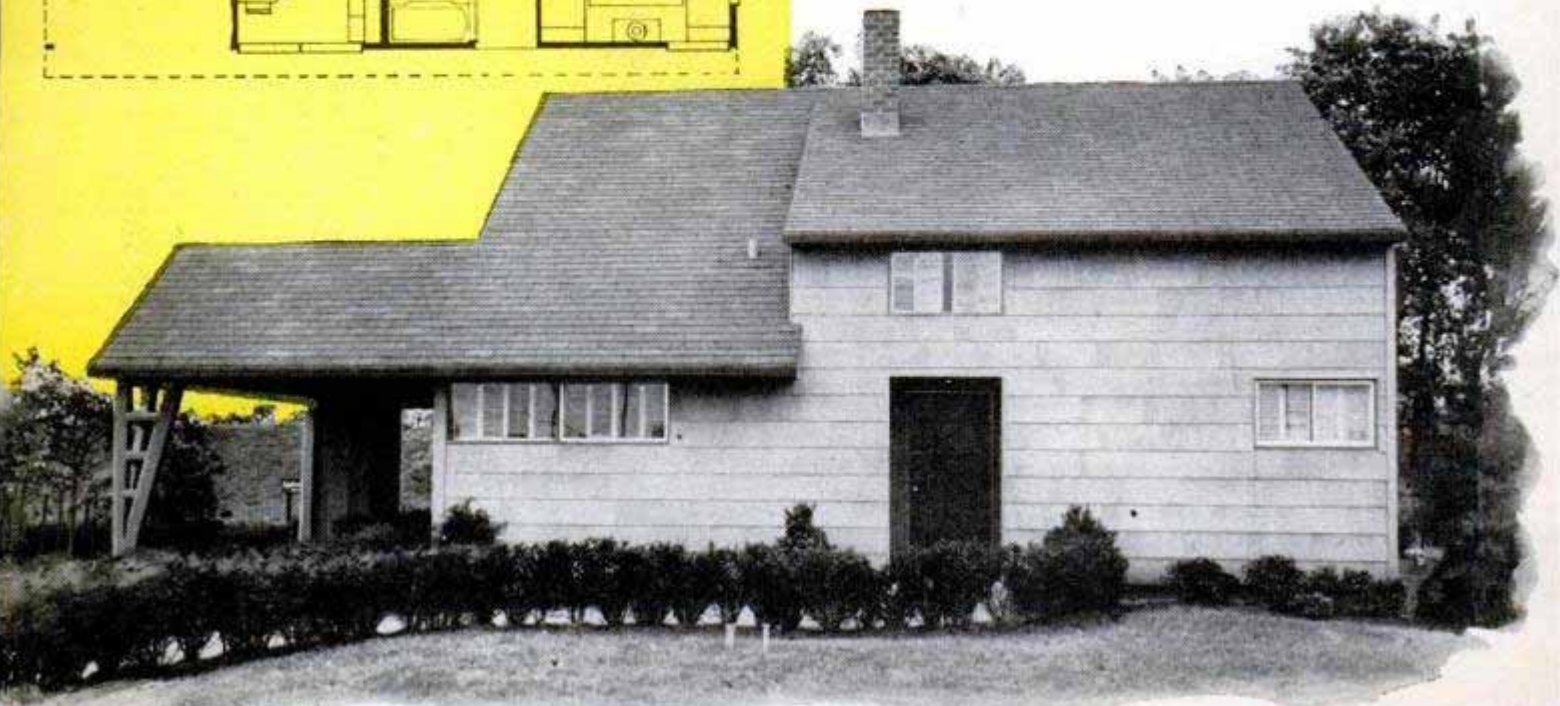
a project builder named Henry Doelger has put up so many rows of white two-story, five-room houses on 25-foot lots that quipsters call his development "the white cliffs of Doelger."

Many of the new, well-planned communities are a bonanza for the man with a middling pocketbook and an instinct for comfortable living. David Bohannon's 8000-house tracts near San Francisco give prospective owners a choice of 24 basic one-story designs on 60-foot-wide lots. The houses feature wood paneling, tile baths, U-shaped flow areas and laundries, for prices ranging between \$8850 (for two bedrooms) and \$12,650 (for a large three-bedroom cedar-shingled ranch house).

Bigger yet are the "grid" rows of California's largest "housing city" — Lakewood. Here, on a 10-square-mile area near Los



Newest model offered by the Levitts is two-bedroom Rancher. Attic can be finished off for extra rooms

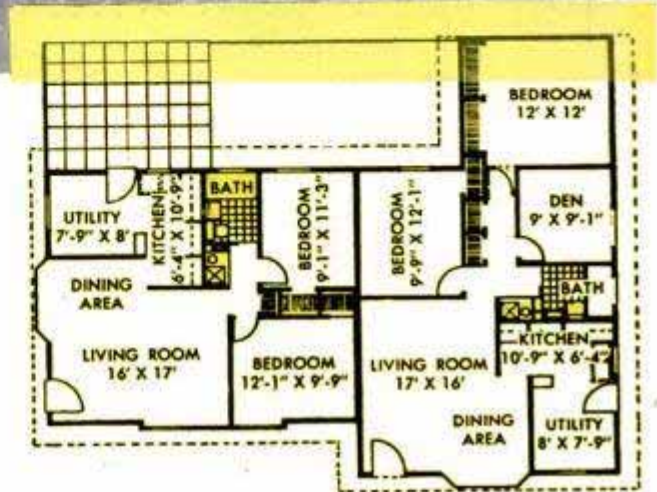




**Duplex homes in Hometown (bordering on Chicago) get away from monotony of small homes on small lots**

Angeles, sit 25,000 homes inhabited by some 106,000 people. Started in 1934 by Aetna Construction Company and Biltmore Homes, Lakewood is still growing. For \$7895 to \$10,000 today, you may have your choice of 26 basic floor plans and 76 exterior finishes. Focal point for the endless chains of homes is a spanking new \$100,000,000 Lakewood shopping center containing everything from a 30-lane bowling alley to a 250-bed hospital. Music is piped all along the canopied streets and its parking areas hold 11,000 cars at one time. A half-mile tunnel under the stores is the "service entrance" for delivery trucks that back up to underground loading docks, leaving streets clear for pedestrians and baby buggies.

What do you get in this kind of mass housing besides a big community and a cheaper price tag than you'd have to face if you built your home individually? It depends. Some builders put most of the sav-



ing in the price. Others go in for spectacular "solid comfort" and "eye appeal" features. Most combine the two. Among the most spectacular are Henry Cox's fancy dwellings in Orange County, Calif., where a phenomenal amount of house is wrung from every dollar. Cox subdivides orange groves, so that every lot gets two or three trees. His newest 1020 homes (he has built

(Continued to page 288)

**Three-bedroom home in Park Forest, Ill., has a 19-foot living room with picture window. It sells for \$14,500**

American Community Builders, Inc., photo



# The Lifetime Home

## That Expands and Contracts



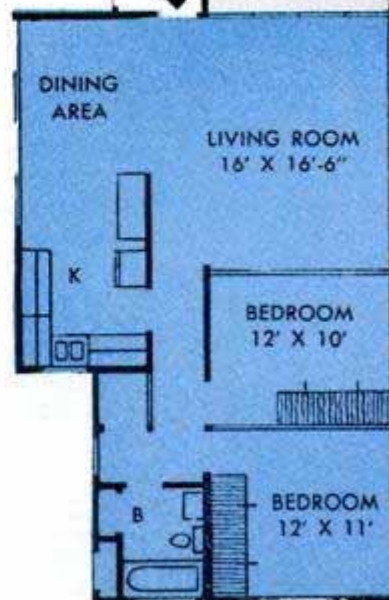
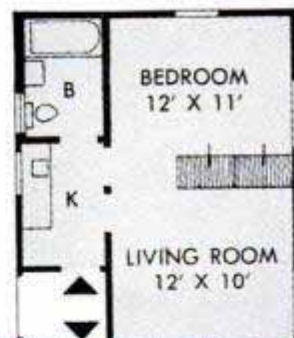
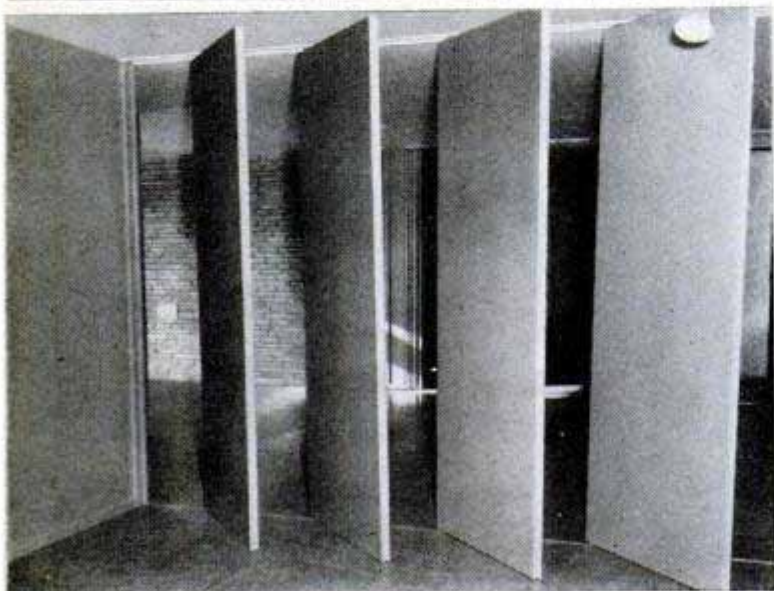
**THE ANSWER** to a long-felt need is the Flexabilt house built by Frank Robertson, Sr., of San Antonio, Tex., and designed by his son, Frank Robertson, Jr. It's a one-story, two-bathroom house with movable partitions for all rooms except bathrooms and kitchen. Facilities for a kitchenette concealed in one wall make it possible

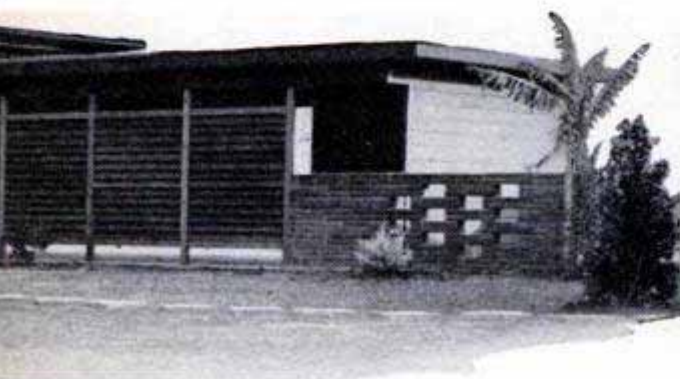
Low and modern, this convertible home looks like a single-family house. The Flexabilt floor plan above shows the two-bedroom arrangement



Left, bedroom walls are movable partitions which are easily shifted as in bottom left

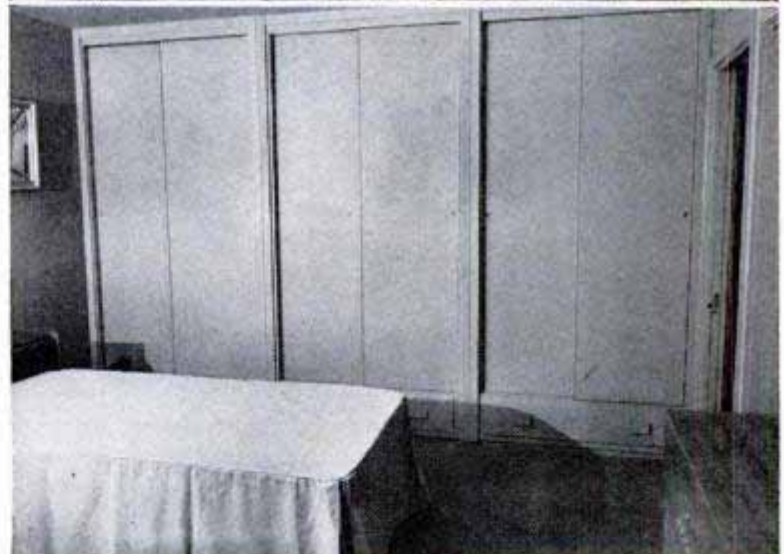
Below, duplex arrangement provides studio apartment and a complete two-bedroom unit





Top, floor plan shows how walls are shifted to create a four-bedroom, two-bath home from the duplex. The house has 72 variations

Top right, mobile wall section stripped of drawers and doors is being tipped into position. Right, closet units form bedroom wall



to convert the house into a duplex. By shifting partitions within the 1250 square feet of floor area, the Robertsons have worked out 72 possible combinations. A young couple can arrange the interior so they can occupy the kitchenette apartment and rent out the larger apartment when their family is small and mortgage payments high. As the family expands and income increases they can move to the two-bedroom apartment and finally convert the house to a single-family home with three or four bedrooms. In later years, as the children leave home, they can reverse the process. Specially-designed for the home are movable storage walls four feet

wide and two feet deep, three-foot-wide wall panels and bookcase-wall units. A plywood panel covers the installations for kitchenette equipment and when the panel is removed it is easy to install a four or five-foot efficiency kitchen unit. The Robertsons are building five demonstration Flexabit houses, all with carports but with varying exterior treatment, including vertical redwood rough siding, finished redwood horizontal siding, yellow pine and vertical fir siding. All have some stone or brick trim. Although the model homes cost between \$20,000 and \$22,500, the Robertsons expect to build them at a lower figure once they get into production. ★ ★ ★



## Mr. House Expert,

Don and Jane listen in as a panel of noted housing experts answer questions put to them by *Popular Mechanics* editors. The experts: Earl W. Smith, mass-project builder, El Cerrito, Calif.; L. Morgan Yost, Chicago, chairman of the Committee on Homebuilding Industry, American Institute of Architects; Leonard Haeger, director of Technical Services, National Association of Home Builders, Washington, D. C., and Martin L. Bartling, Jr., director of the NAHB, home builder, Knoxville, Tenn.

**QUESTION:** What are the first steps any couple, such as Don and Jane, should consider in building or buying a new house?

**SMITH:** The first step is very basic: They should evaluate realistically their ability to purchase a home. I think one of the major problems is to have to unsell a family on some preconceived ideas of a house they cannot afford. [Ed. note: Mr. Smith is the designer and builder of the house featured at the top of page 148.]

**Q:** What would you say is a safe yardstick for monthly payments on a home?

**SMITH:** Generally, somewhere between a quarter and a fifth of gross monthly in-

come. That is the rule of thumb applied by the bank, by the FHA or the VA.

**HAEGER:** I think we should make clear that the function of the VA and FHA is not to supply funds to the home buyer or builder, but merely to guarantee or insure loans made by lending institutions.

**SMITH:** Also, the total price of the house is important to consider in relation to the buyer's economic position, but it is not quite as important as the debt-paying ability. There are insured FHA loans and guaranteed veterans' loans which make it possible to buy a house with a low down-payment. Then the monthly payment becomes the most important consideration.



## We Have a Question

**HAEGER:** This is an area where there are no hard and fast rules. Another formula for the total cost of a home a man can afford is to multiply the annual income by  $2\frac{1}{4}$  or  $2\frac{1}{2}$ .

**BARTLING:** I think we have overlooked one thing in this one-fifth formula for monthly payments. I believe the banker and the FHA pay more attention to the personality, ability and background in terms of paying bills promptly. The credit information is extremely important. [Ed. note: Mr. Bartling is the designer and builder of the home featured at bottom of page 147.]

**SMITH:** There is a great assistance in terms of mortgage credit now. The man of very modest income can find himself a home.

**YOST:** The larger the nest egg the more house a man can afford.

**HAEGER:** There's furniture, too. Might run as high as \$4000.

**YOST:** That is one reason we are trying to get more appliances and furniture as part of the house itself, so they can finance it over 20 or 25 years. I mean storage walls,

kitchen appliances, laundry, all that sort of thing.

**Q:** Can you name some specific hidden costs against which people should be on guard?

**BARTLING:** They should consider the type of structure, whether it will require a lot of upkeep after two or three years. Some materials lend themselves to longer life—redwood versus pine siding, for instance. They should consider the quality of shingles on the roof. Also, is the house weatherstripped and insulated? If not, operating costs will get out of proportion to income.

**YOST:** The maintenance of a house can add effectively to the monthly payments.

**SMITH:** I think another piece of advice to the couple going out to build a custom-built home is to seek a good architect who will recommend a good builder. The average lay person is not going to learn very rapidly the difference between the quality



Smith: "We want our customers to own their homes; we do not want the homes to own the customers . . ."

of materials. They are going to have to take someone's word for it. If they are in the economic group which must needs go into the mass group, or subdivision type of thing, they want to find, again, a builder whose reputation is good.

**BARTLING:** The thing I was getting at is many

people, in all areas, buy a house for price.

**SMITH:** The price is all right, if they know the man is behind it with value.

**BARTLING:** If that is all they buy on, very often they are stung.

**SMITH:** They have to make sure the firm or individual they are buying from delivers an honest piece of goods.

**YOST:** The best way to find out about that is to ask people who live in houses that firm or individual has done, either the architect's house or builder's house, whether it is a custom-built house or a mass-produced tract house.

**Q: Which should a prospective builder go to—an architect or a contractor?**

**YOST:** They have to decide whether they can afford, or are best served by, a custom-built house, or whether they are going to go to a mass-produced house in which they buy what is produced in a group.



Yost: "The traditional house won't continue any longer than ultraconservative minds force it to"

**Q: Suppose they feel they cannot afford an architect. What is the best method of procedure?**

**YOST:** Do not say they cannot afford an architect; say they cannot afford a custom-built house. My contention is, they cannot afford to be without an architect if they decide on a custom-built house.

**SMITH:** In other words, it is a question of their pocketbook. It is like buying an automobile. They might buy a hand-built Italian car which will cost them a lot of money; but they will certainly, in their own minds, know they are able to pay for it. Again, most people, however, will have to buy a mass-produced car which is cheaper, yet much the same as all other cars on the road, and still a very good car.

**BARTLING:** I think, also, what Mr. Yost means is that a really good architect can design a house, regardless of the price strata, and can absorb his fee in better ways of putting it together. Actually, it is not a luxury, in many cases, to have an architect.

**Q: Will you give some advice about the architect's fees?**

**YOST:** There is no such thing as a standard fee. The fee depends on the architect's experience, ability and reputation. It also depends on the amount of service he is to perform and whether he takes care of letting of the contract and supervision as well as providing the design, working drawings and specifications. Some famous architects charge 15 percent while a younger man with small overhead and little experience might do the job for 6 percent.

**HAEGER:** I hope that anything which is said on this panel would not tend to exaggerate the notion that there is some conflict between builders and architects. I think the fact is that the really good houses for any family are designed by good architectural brains, whether they are built on the single-house or group-house basis.

**BARTLING:** If you build an \$8000 house, or a house costing less, it just automatically rules out hiring an architect.

**SMITH:** I would not say that. I would say—and I think Mr. Haeger would agree with me—in our postwar experience around the NAHB there has been a growing tendency, on the part of subdivision builders who build in the mass, to employ better and better design talent. Of course, you find such talent in the architectural group.

**Q: How can you get the most house for your money? Is it a custom-built, mass-produced, prefab or shell house?**

**SMITH:** It depends on what you want. Value varies in the minds of people. There are those who want certain amenities of



Bartling: "If you build an \$8000 house, or . . . less, it automatically rules out hiring your own architect"



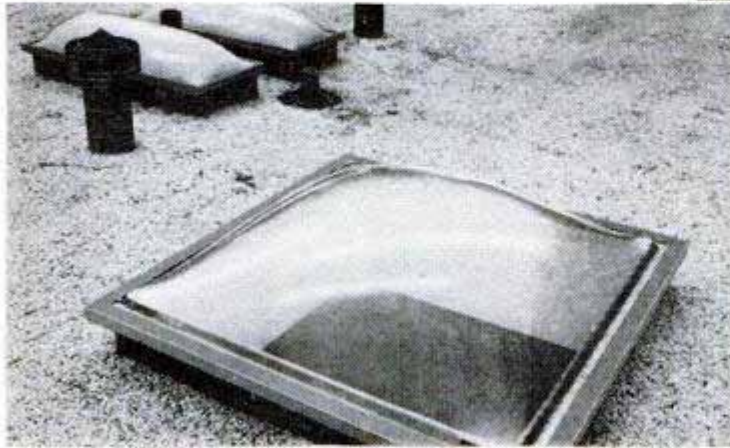
Haeger: "We should make clear . . . function of the VA and FHA is not to supply funds but to insure loans"

(Continued to page 276)



# Windows to Dress Up Your Home

Bulged skylights easily installed on flat or sloping roofs flood rooms with sunlight but stop fabric-fading solar rays. Dead-air space between ceiling layer and bulge gives maximum insulation. Rectangular, square and round windows, clear or frosted, are made

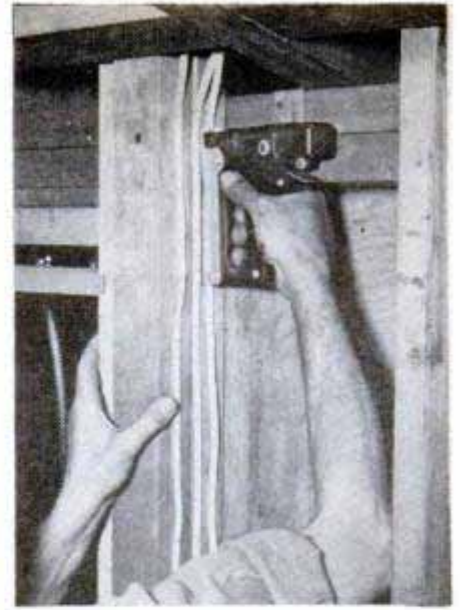


Aluminum window that is removed for washing slides in a rubber-lined groove which holds it in any position. Below, controlled ventilation is possible with tilt-open windows which are opened and closed with a crank



Louver window contains six-inch panes which open or close with movement of single lever, overlap slightly when shut. Below, sashless window consists of two pieces of crystal glass in weatherproof grooves





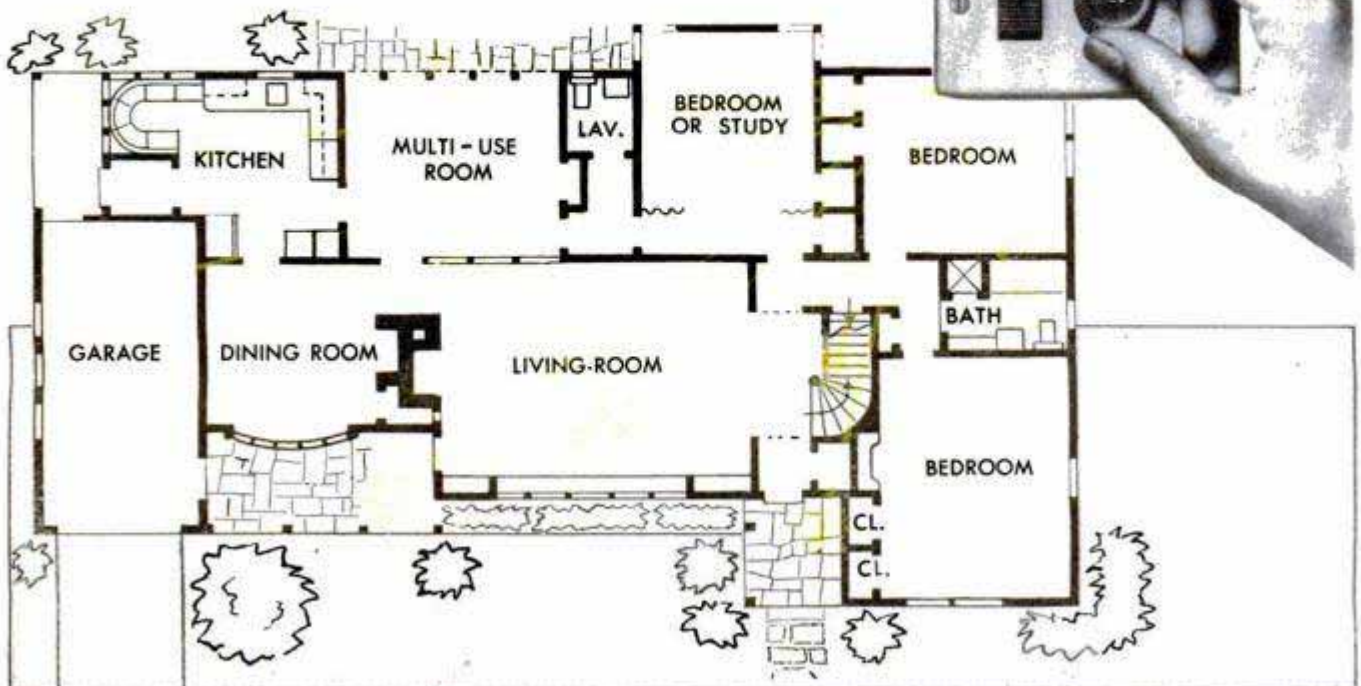
Forgotten lights are easily turned off with master switch in bedroom. Right, installing the flexible wire

# Light Your Home by Remote Control

WITH A REMOTE-CONTROL wiring system you can easily switch as many as nine lights on or off from a single master control. Also, you can install master controls in various parts of the house to suit your pleasure. This is possible with a low-voltage system utilizing a nine-circuit central switch plus push-button switches. The master control operates small motors and electrical appliances as well as the important lighting circuits in the home. You can turn outdoor lights on from the inside, or operate garage lights from indoors and vice versa. The system can be used to turn on the coffeemaker from the master bedroom,

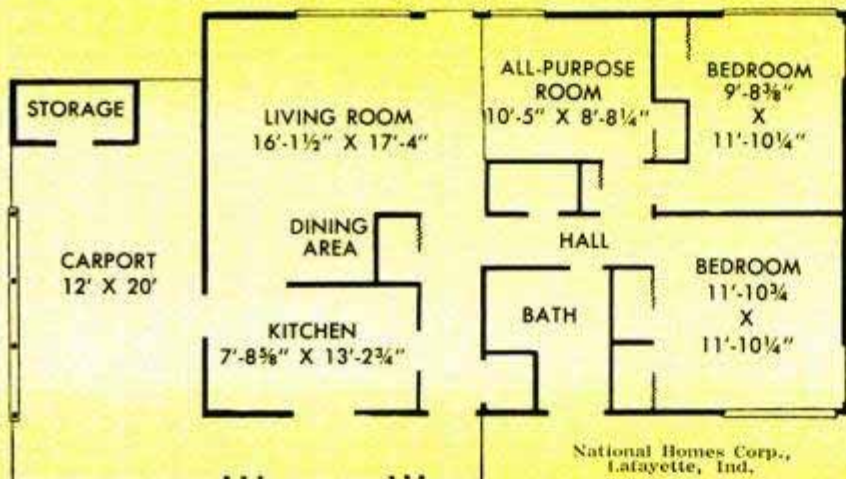
the heater in the bathroom, or to turn off forgotten lights or TV sets. Developed by General Electric, the system uses flat, flexible wires stepped down to 24 volts by a transformer. The heart of the operating system is a split-coil dual-action solenoid that controls 2770 watts of power—yet uses only a minute flow of independent electric current. When installed in a new house, remote-control wiring costs from \$50 to \$75 more than a conventional system. In addition to its use in private homes, remote control for lighting circuits and appliances has many possible adaptations for farms, hospitals, schools, factories and office buildings.

A remote-control master switch can turn off lights or operate electric appliances at nine locations in house, garage or even outdoors





## Let's Look at the Prefabs



National Homes Corp.,  
Lafayette, Ind.

**By Tom Riley**

Don and Jane look over prefab featuring many closets, carport with storage, an all-purpose room that can serve as third bedroom. Price, with washer, drier, dishwasher (but without lot) is \$11,650 in its production area

**I**N THESE TIMES of continued high costs, the prefabricated house—often dubbed the house of tomorrow—becomes more and more a good bet for the prospective homeowner today. Some 50 well-established prefab manufacturers, who have been and are pioneering a change in housebuilding methods, are investing millions in research, engineering and modern plants. Today they offer everything from cabins to 100-foot mansions in every type of prefab from packages of precut lumber to trailerlike "mobiles."

Page & Hill Homes, Inc., Shakopee, Minn.

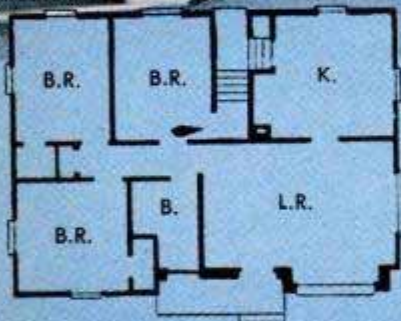
The general impression has been that prefabrication meant flimsy construction. This was definitely true with most war-emergency prefab housing, but is a complete misconception in 1953. Precuts, for instance, are built by standard construction methods and with standard materials. An expert can find no difference in the completed house. Other prefab methods are claimed to be even superior to standard construction. The major defect of a prefabricated house—a fixed plan not necessarily tailored to your individual desires—has

Prefabs no longer have corner-cutting look. Many big homes similar to this one are available





Aladdin Company, Bay City, Mich.



Example of a precut house is this three-bedroom home. The basic price is \$4510 for the "package" of precut materials. Homeowner buys his lot and either pays someone to erect the home or does the work himself. Also available are garages to match house

been virtually eliminated with the many plans and models now available.

You don't need a slide rule to realize that power machinery and assembly-line methods of prefabrication can save many man-hours and dollars in the construction of your new home. There are other advantages, too. The prefab manufacturers can and do employ the nation's leading architects—thus producing homes without "plan mistakes" and in full compliance with FHA and mortgage company requirements. Prefabs can also use the best materials, not just those locally available, through quantity buying. Quick erection at the site eliminates damage from lengthy exposure to rain or snow.

Actually, more than 250,000 prefabricated houses have been built in the United States

Factory-built home below can be erected in 55 man-hours, exclusive of asphalt shingles

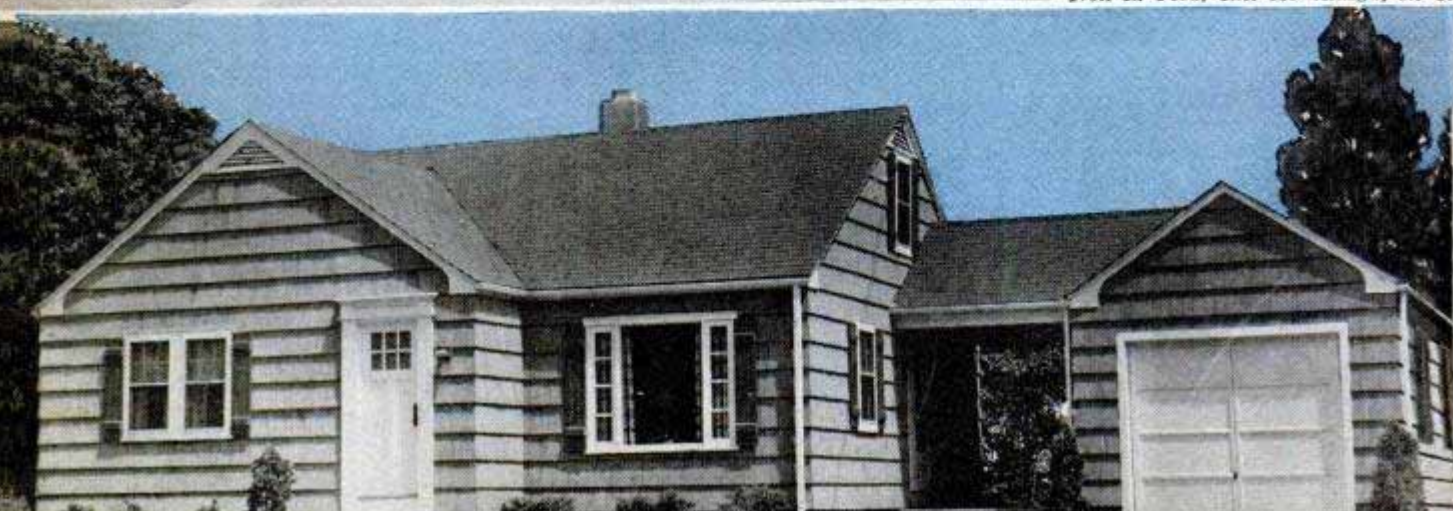
Ivon R. Ford, Inc. McDonough, N. Y.



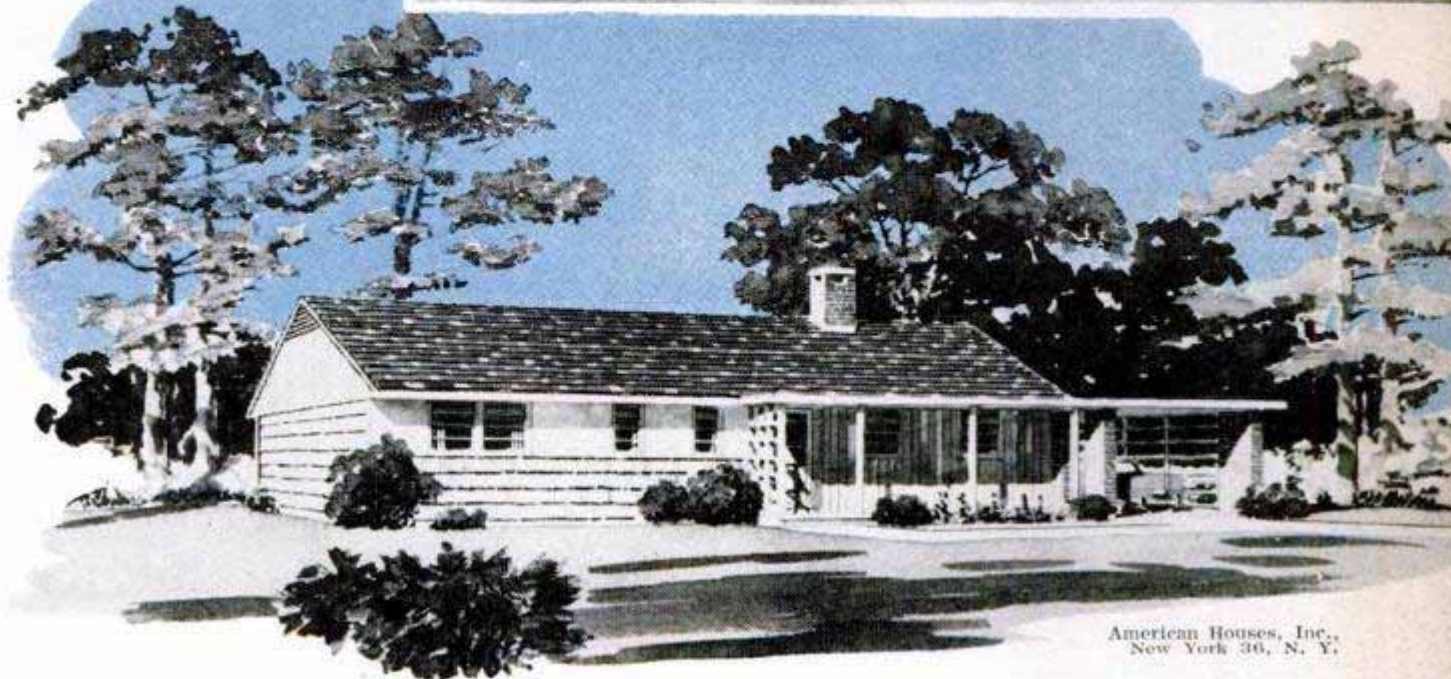
National Homes Corp., Lafayette, Ind.

Walls of four-bedroom home above are prefabricated in panels at factory. Panels then are joined on the site. Home below is available in two sizes, one featuring a 15 by 16-foot living room. The house has perimeter heating, with provision for air conditioning on optional basis

Gunnison Homes, Inc., New Albany, Ind.



Four-bedroom luxury prefab has huge windows, year-round air conditioning. Below, 1130-sq. ft. house, also with air conditioning, is less than \$20,000



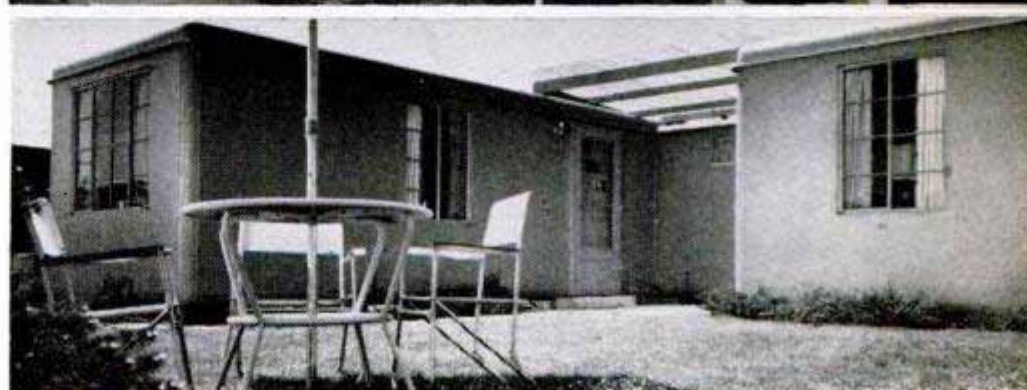
American Houses, Inc.,  
New York 30, N. Y.

since World War II. Probably 60,000 prefab houses will be built this year. Pricewise, the big majority of these will be two and three-bedroom homes selling from \$6000 to \$12,000, including erection labor. In this price range there is an excellent variety of both traditional and contemporary designs from which to choose. Some manufacturers will also provide, at extra cost, heating and air-conditioning units and complete kitchen and laundry appliances. Definite savings are claimed by this quantity buying of appliances. A surprising trend was started in 1952 when prefabs also entered the field of more expensive homes, some manufacturers adding a "Cadillac" model to their lines—houses, usually of modern design, offering features that few home buyers associate with prefabrication. Prices of these run \$20,000 to \$25,000.

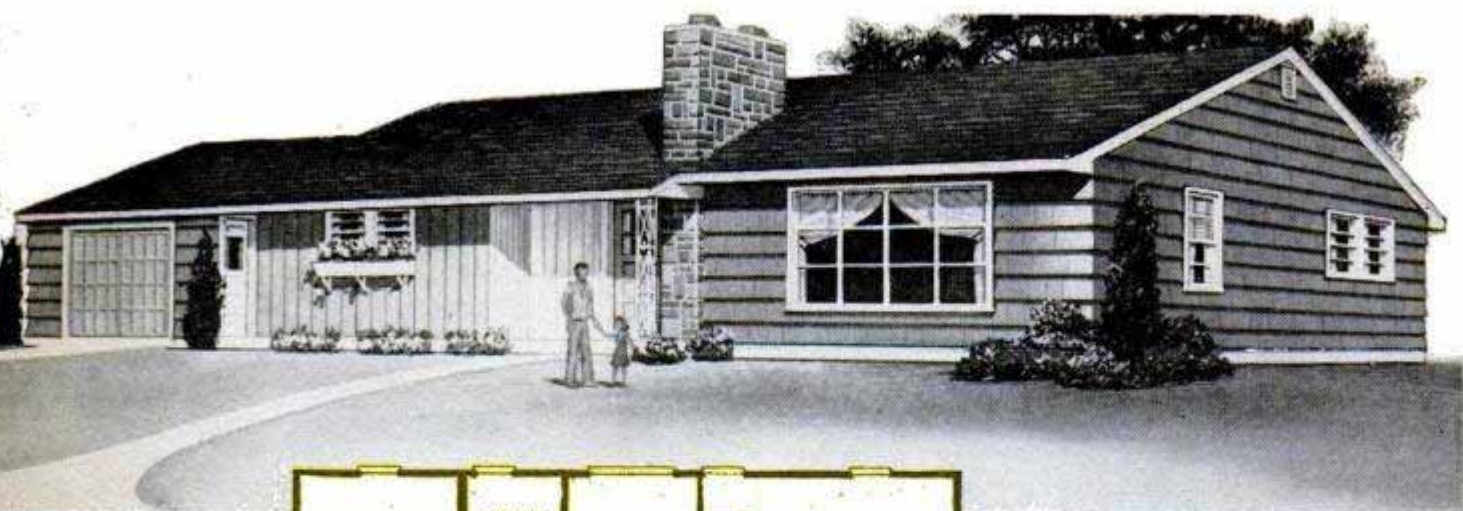
It is not as simple, however, to buy a "mail order" house as it is to order a bill of goods from a catalogue. Because of shipping costs, some prefab manu-

facturers confine orders to a 200 to 500-mile radius of their factories. Others ship their houses on a national scale with no limitations as to distance. Some municipal building codes, many of which are sadly in need of reform, are a problem, prohibiting the erection of any prefabricated house. In rare instances, local prejudice can prevent you from obtaining the financing for a factory-built home. If you are interested in prefabricated or partially prebuilt houses, you should understand the four

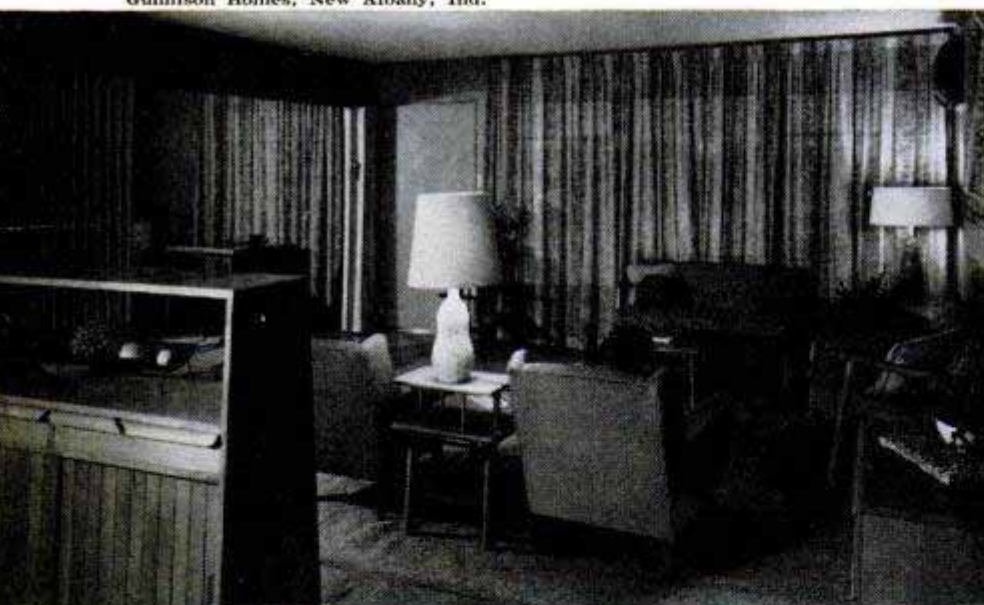
Pressed Steel Car Co., Chicago 33, Ill.



Mobile prefab is three trailerlike units fastened together. Above is the big living-dining area



Here's another attractive precut home, modern in design. Conventional building techniques are used throughout, but all parts are packaged and ready for erection. Note big living room and master bedroom. Price for parts is about \$6500. Below, interior and exterior views of prefab exclusively designed for the west. Cost: about \$10,750 with the lot Gunnison Homes, New Albany, Ind.



different types—the precut, the panel, the sectional and the mobile.

When you order a *precut* house, you will receive all the lumber cut to size, notched and numbered for the particular house plan you have chosen. The Aladdin Company of Bay City, Mich., which has been making pre-cut houses for 46 years, also includes in the package the windows, stairs, shingles, building paper, nails, hardware, paint and even shutters and flower boxes shown on the plan. Several others do the same. From the blueprints and diagrams furnished with the freight-car "package," you can build your own home by conventional construction. You may prefer to have local carpenters build it, and you will still save considerable money because of the factory's savings on the lumber and the fewer man-hours needed at the site. The cost of the pre-cut house packages runs lower than the figures already given, from \$2000 to \$8000, depending on the house size; but this, of course, does not include the erection labor costs.

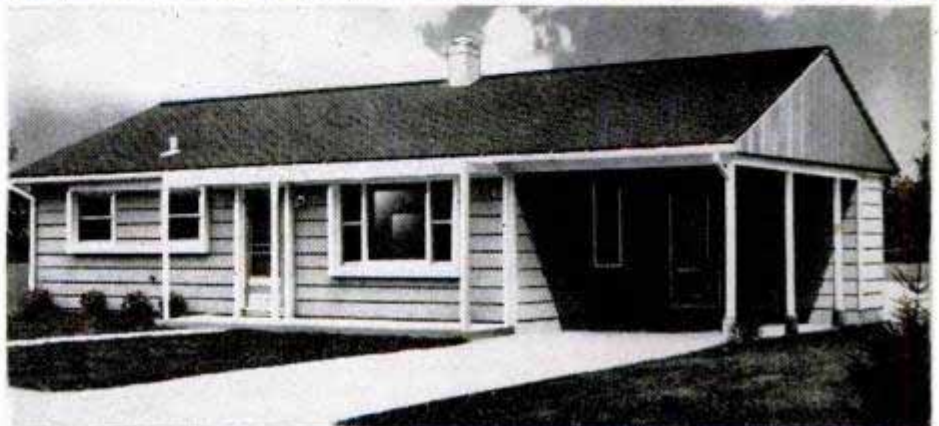
A *panel* prefab is quite different and is usually erected by specialists. It is a house formed of ready-built panels, which are often 4 by 8 feet in size and sheathed with plywood. The "Bench-Build Ranch House" in the August, 1951, issue of *Popular Mechanics*, is a good example. The panels can be just the

rough walls; they can also be complete to window glass, doors and interior and exterior finish. For the later type, all that is necessary after erecting the panels at the site is to cover the joints and give the panels a final coat of paint on the outside and paint or paper the inside. Some manufacturers turn out larger panels, in some cases the whole side of a room.

The *sectional* prefabs are an enlargement on the panel type, usually with more than one wall connected and usually complete to exterior and interior finish, with doors, windows, porch lights and other details factory-installed. In some of these, the sections are complete rooms that specialists fasten permanently together at the site; and at least one is a completely prebuilt house that is sliced into two sections for delivery.

The *mobile* prefabs are a new trend to answer the shifting housing needs of defense projects, as well as the needs of many families. Here the house is of two or more complete units, each similar to a house trailer, which bolt together to form a full house. The Pressed Steel Car Company's Unishelter is a well-known mobile and is available in models up

(Continued to page 274)



P & H Homes, Harnischfeger Corp., Port Washington, Wis.

Example of a sectional prefab is this house with attached carport and storage wall. Walls are prebuilt at factory, assembled into home upon delivery. A feature of house is pass-through from kitchen to dining area



Swift Homes, Inc., Clairton, Pa.

Another precut house with parts ready for assembly is this neat four-bedroom model. Homeowner or contractor provides the lot and foundation, then assembles the parts. Below, this three-bedroom home is erected from completely finished full-length wall sections. The house is sold only through contractors. Depending on size, homes of this type cost \$8500 to \$13,500

Page and Hill Homes, Inc., Shakopee, Minn.



# AIR CONDITIONING—THE YEAR 'ROUND

*The big news in housing is the dual-purpose heating and cooling units that provide comfortable and healthy living inside the home in winter or summer*



House planned for year-'round air conditioning should take advantage of trees which shade in summer, but not in the winter



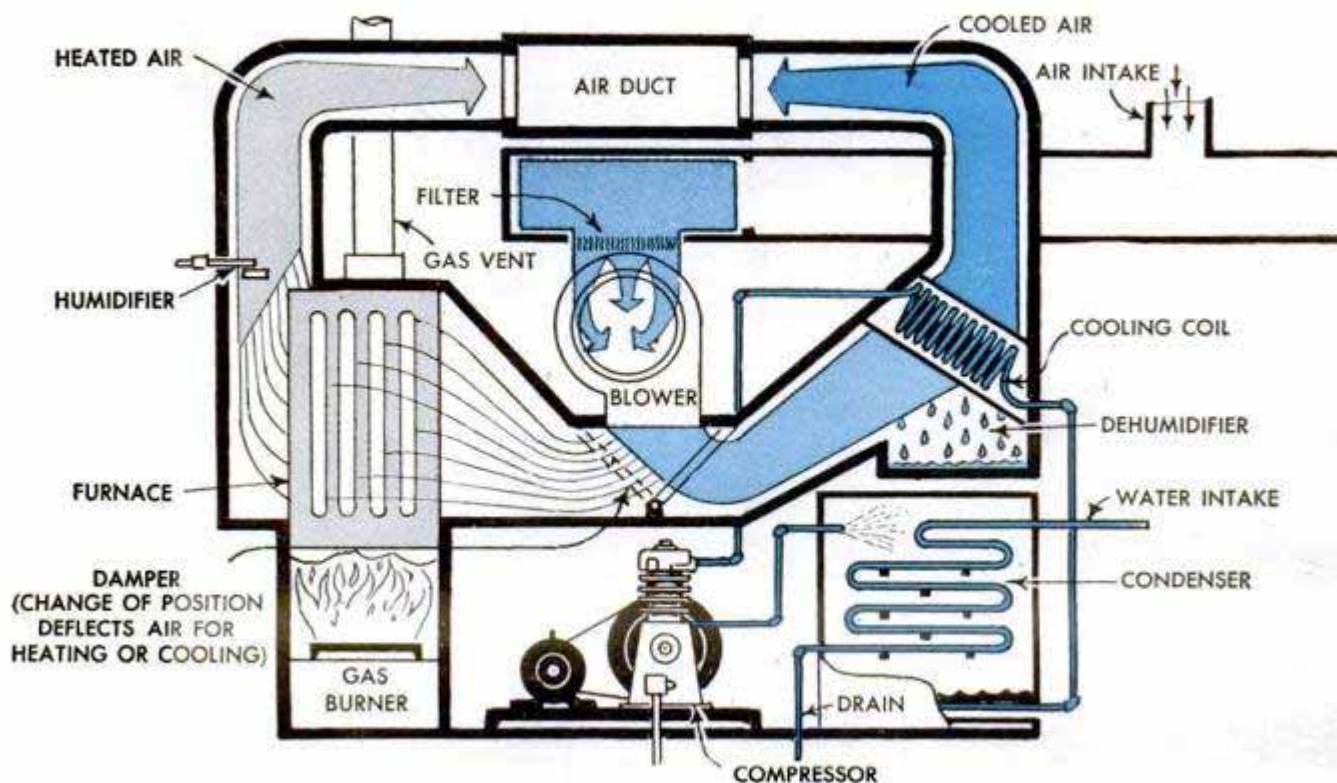
Where windows are exposed to the sun, some shading device must be provided as in sketch



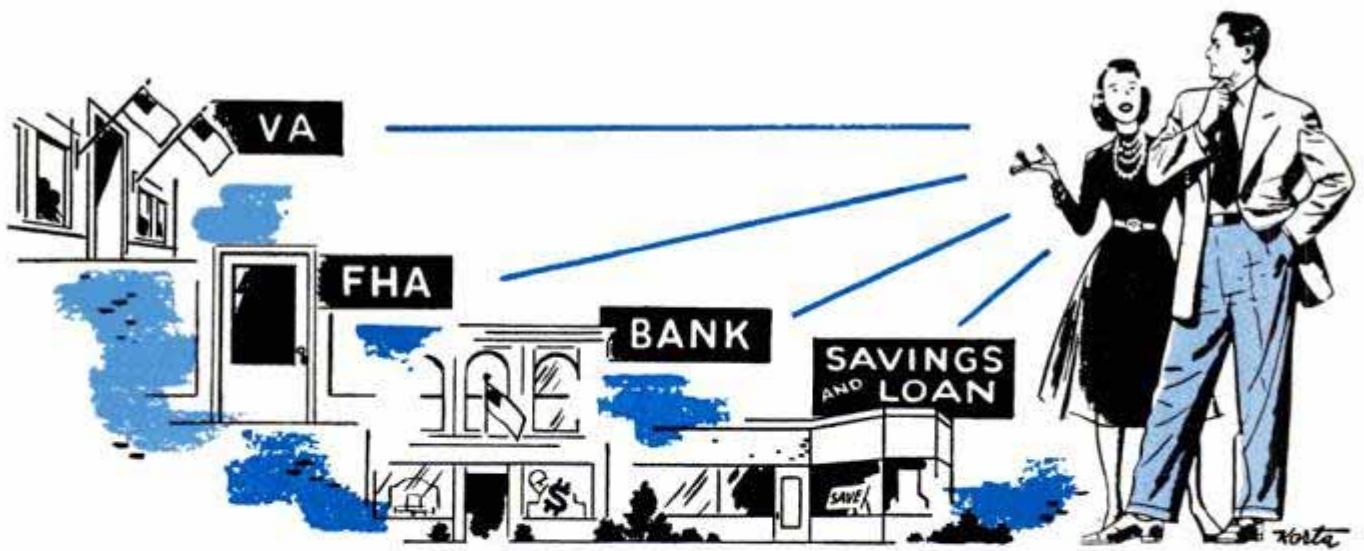
West walls of a well-planned home should offer protection from sun and winds. A garage on west side is one good idea

ONCE CONSIDERED a luxury item, air conditioning for both large and small homes is fast becoming a reality. One of the reasons for this is the economy effected by dual-purpose units that use the same air ducts for cooling in summer and heating in winter. Many new homes, particularly those being built in warm climates, are designed today to take the greatest advantage of these dual units. Such homes have reduced the cost of maintenance and operation. First of all, the house must be situated on its lot to work with the climate, both summer and winter. West windows, for example, are kept to a minimum or adequately shaded in summer. Trees which are correctly placed provide summer shade and permit the sun's warmth to penetrate during the winter. Overhangs, awnings and sun screens are other effective devices. Double-glazed windows also save money both winter and summer. Other aids found in the properly designed home include insulated walls, ceilings and floors, a properly vented attic and vapor barriers where needed. In addition to the advantages of health and comfort, air conditioning keeps dirt out of the house and saves on cleaning and decorating bills, also on screens and storm windows. Dual-purpose units range in cost from \$600 to \$1000 more than a furnace alone, depending on the amount of space to be cooled. One mass builder is planning a home with a cooling unit at an additional cost of only \$500. In existing homes with a warm-air system already installed, it costs more to add the cooling installation even though the same air ducts are used. Self-contained cooling units are frequently installed in homes having hot water or radiant heating. The installation of air ducts especially for cooling is expensive.

Dual-purpose heating and cooling unit saves hundreds of dollars by using the same air ducts year 'round







## How to Finance Your Home

**T**HERE ARE three general types of loans for building or buying a home:

1. Veterans Administration (VA) guaranteed loans.
2. Federal Housing Administration (FHA) insured loans.
3. Conventional loans, which include bank loans, life-insurance company loans and savings-and-loan or building-and-loan association loans.

There are also instances where a purchaser with good earnings or possibilities of good earnings arranges purchase of a home under what is termed a contract for warranty deed to be delivered by the owner after an agreed upon equity payment has been made to him, but these cases are in the minority. Another type is a farm-housing loan made by the Farmers Home Administration of the U. S. Department of Agriculture for the construction and repair of farmhouses and other farm buildings.

**VA Loans.** Home purchasers should bear in mind that in certain areas veterans loans may be made directly by the VA, but for the most part these loans must be obtained from a lending institution. Veterans are given every consideration both in amount and term of loan. The interest rate cannot be more than 4½ percent.

In certain places, lower-cost homes can be constructed and, in those areas, terms longer than the usual 20 years are granted. However, these matters should be discussed with the lending institutions. Plans, specifications, location and other details should accompany application for a loan.

Type of construction, the city or area in which the proposed home is to be located will, of course, be quite a factor to a lending institution in arriving at what loan it will make. But, supposing all of these factors are favorable and a \$12,000 purchase

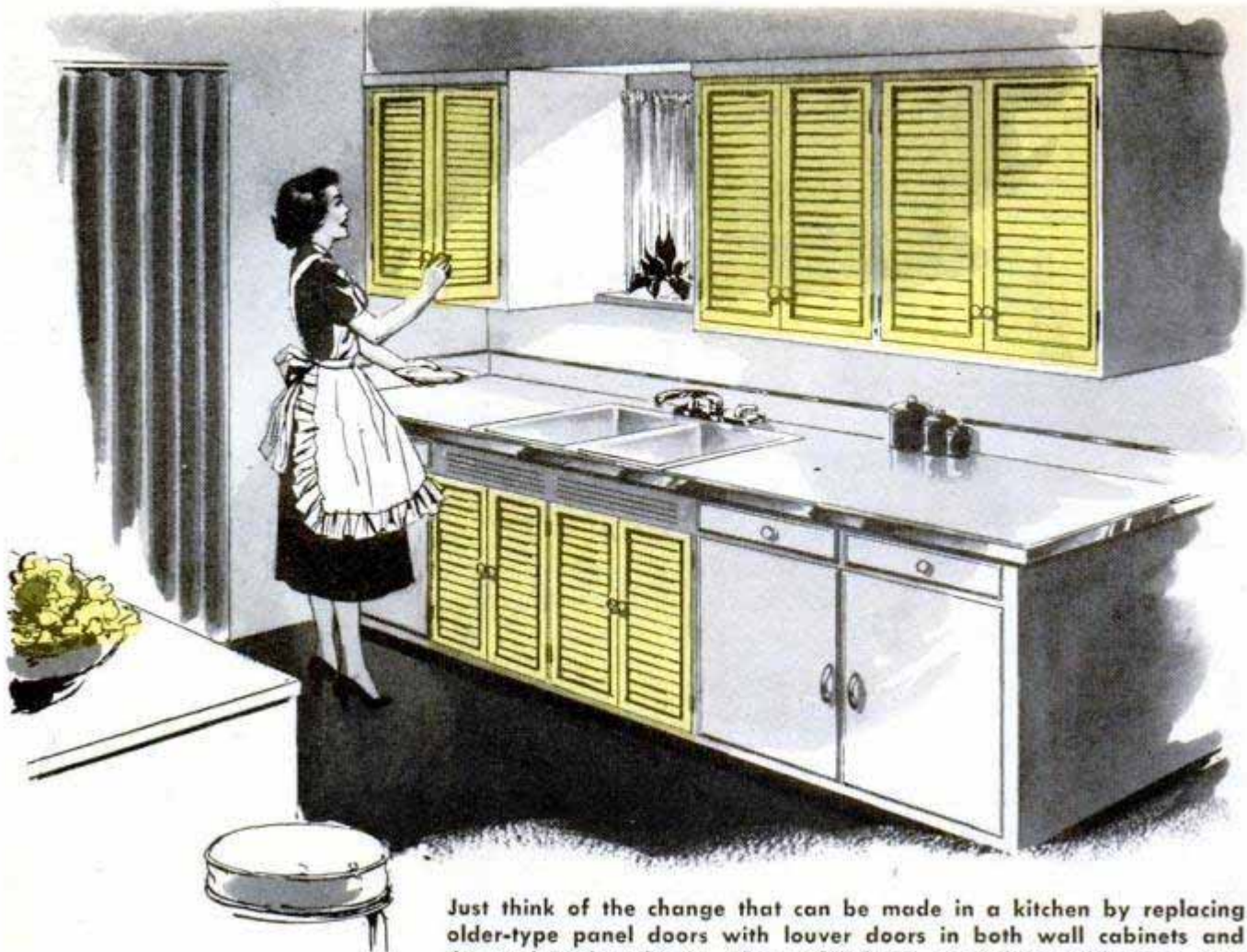
price is being considered, it is conceivable that some lending institutions will make a \$10,000 first-mortgage loan. The VA guaranteed percentage (60) of that loan will therefore be \$6000. The unguaranteed portion is \$4000. It is entirely up to the lending institutions whether or not they are willing to lend their money with that amount of risk. The VA can guarantee 60 percent of each loan up to a maximum of \$7500.

In the smaller-cost bracket of home, veterans' loans are easier to obtain in certain areas than in others because the exposed portion of the loan often is negligible. Under VA policies, if it is found that the veteran is paying a price for the home that is not in keeping with the VA's estimate of reasonable value, then no financing is available under this type of loan unless the seller reduces his price. These are matters that the lending officer of the institution considering the loan can usually detect before requesting approval of the loan from the Veterans Administration.

Periodic inspections during construction are made by the VA, similar to those made by FHA, which assures construction in accordance with the plans and specifications. These inspections, of course, protect the mortgage on the house.

It is recommended that in the purchase contract to be signed by the veteran there be stipulated a clause equivalent to: "In the event the purchaser cannot arrange a veterans loan in an amount not less than \$..... on or before a certain number of days, the contract is to be declared null and void and the earnest money deposited by the veteran is to be returned to him intact without any deduction therefrom whatsoever" Therefore, in order that the purchaser may avoid the loss of his deposit or other pitfalls,

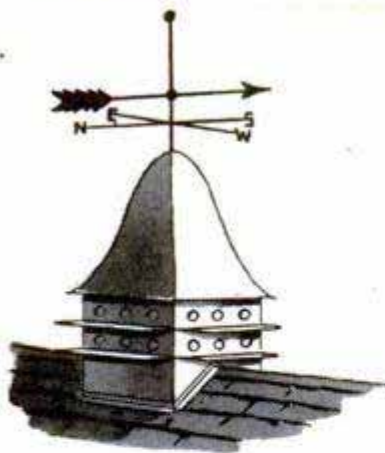
(Continued to page 298)



Just think of the change that can be made in a kitchen by replacing older-type panel doors with louver doors in both wall cabinets and the undersink cabinet. After refinishing, everything will seem new

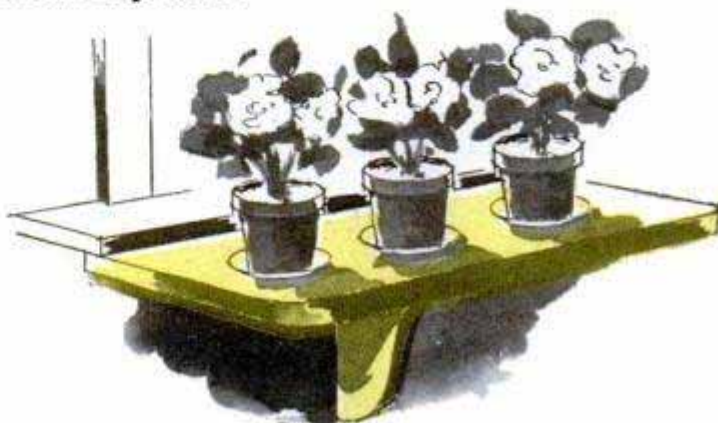
## 20 WAYS TO IMPROVE

By W. Clyde Lamme



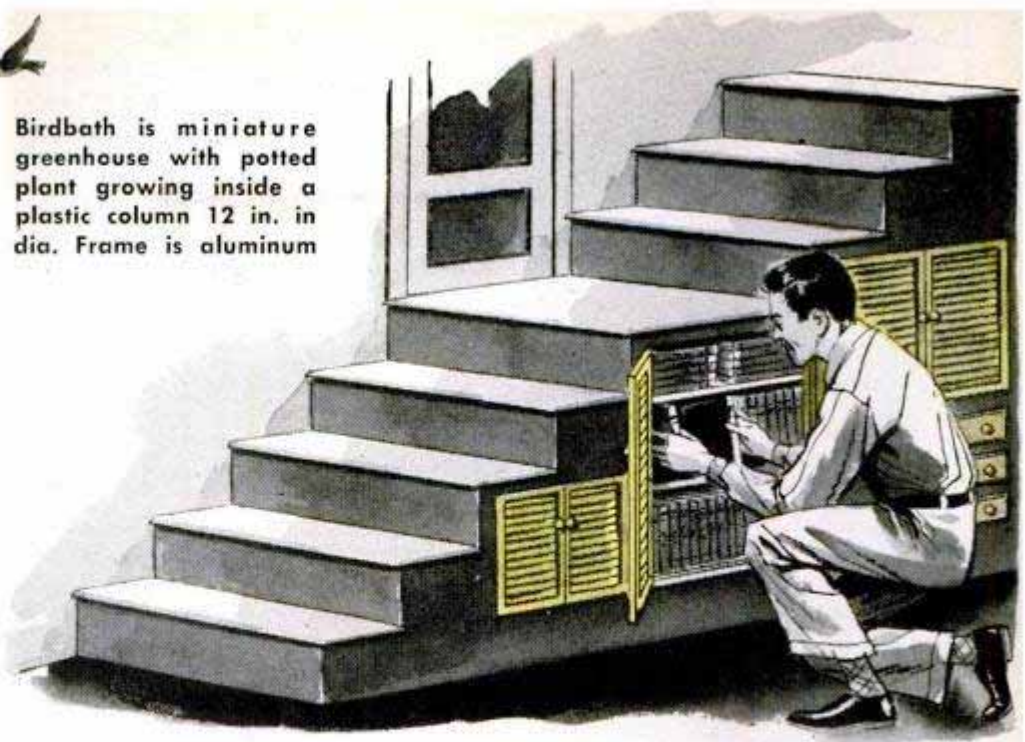
Above, a garage never looks just ordinary after you add a cupola or a weathervane. It's the one finishing architectural detail that does things for the appearance of the whole structure. Available ready-made in a range of styles

Right, potted plants will thrive the year 'round if you give them their place in the sun with this two-piece window shelf. Shelf is screwed to the underside of window stool and is supported by a butterfly bracket bearing against wall

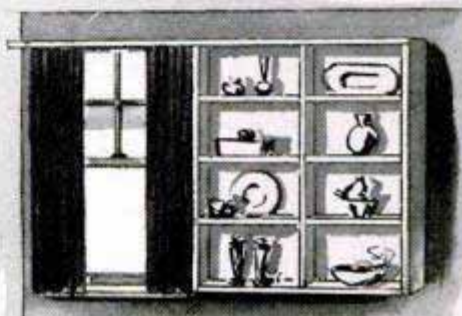




Birdbath is miniature greenhouse with potted plant growing inside a plastic column 12 in. in dia. Frame is aluminum



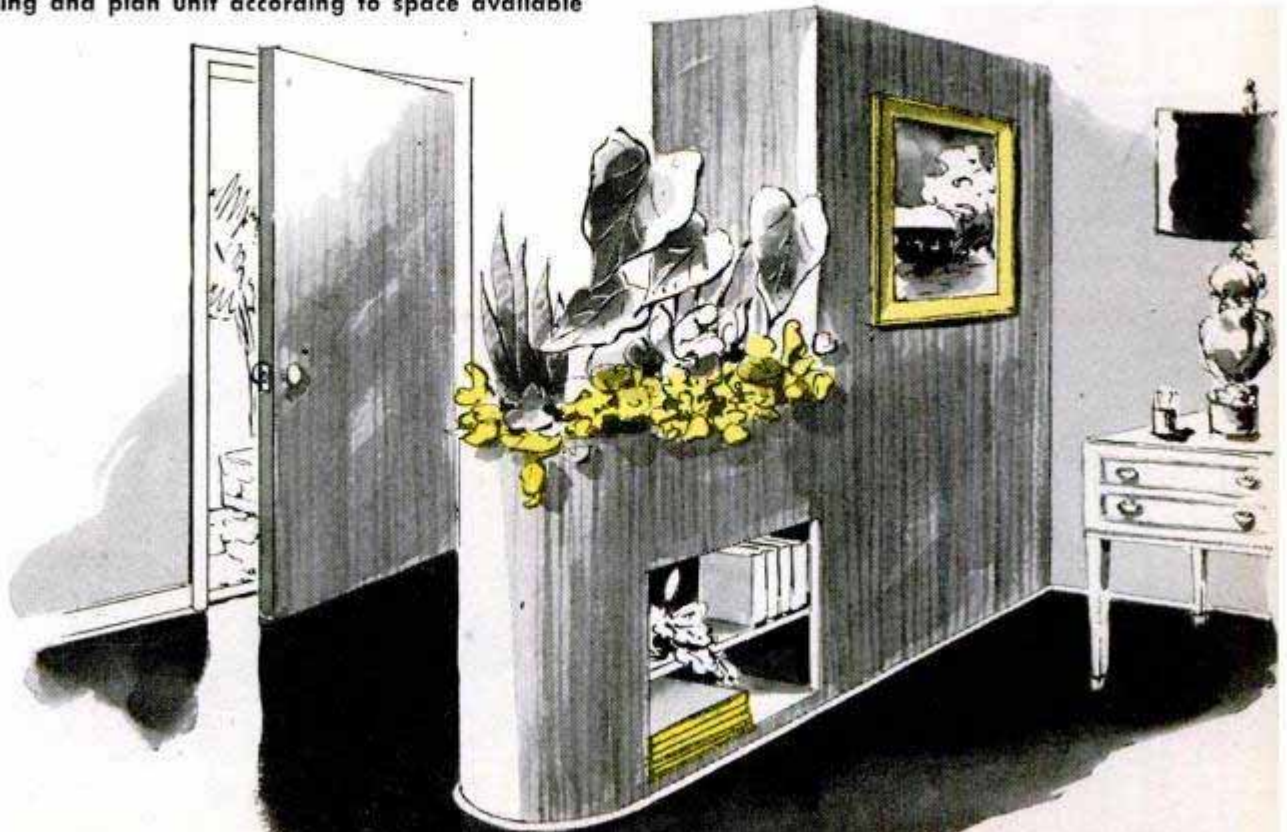
There's a lot of storage space going to waste under your basement stairs and in a small home that's an item worth accounting. Using plywood and louver doors—these are a must due to ventilation problem—you can build a storage space for canned foods, laundry accessories, tools, even books and magazines you want to keep in a safe place for reference

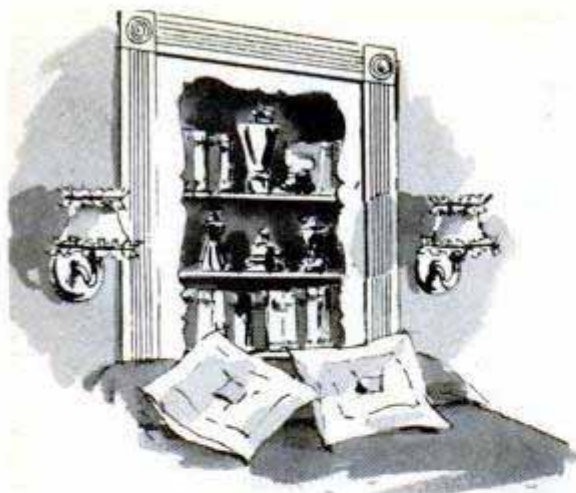


Decorating a window in the corner of a small room just isn't simple or easy until you utilize the widening effect of open shelves. Open cabinet can be any design—that shown is only a suggestion—but must be full length

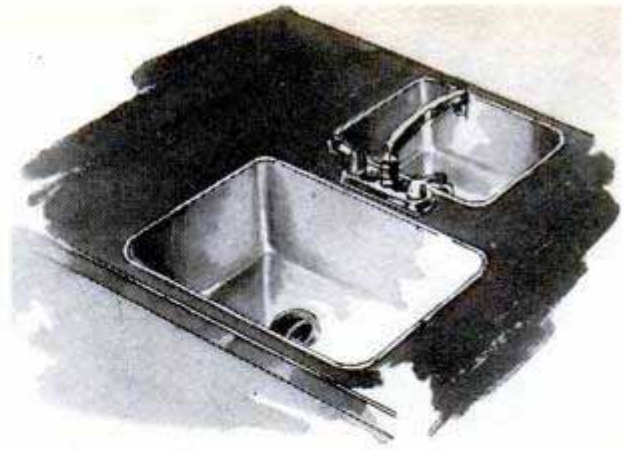
# YOUR HOME

A clothes closet, planter and bookcase are built into this "island" entryway. Use textured plywood as paneling and plan unit according to space available

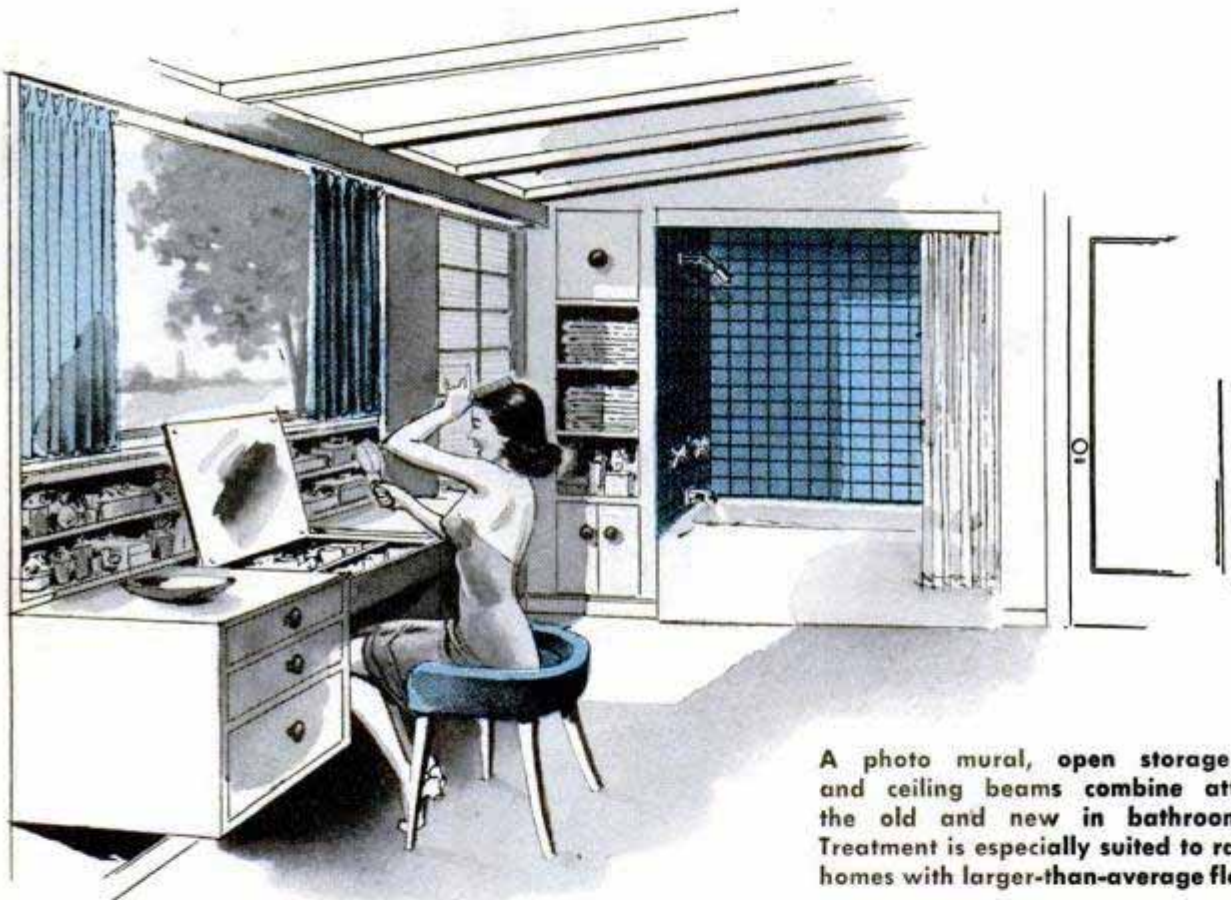




An unused doorway in an older home provides space for an attractive built-in. No need to remove the trim; just install shelves and frame opening as shown



When remodeling a kitchen take into account the possibilities of a peninsula or island sink of the type having two bowls which permit working from both sides of the unit. Saves steps and time



A photo mural, open storage shelves and ceiling beams combine attractively the old and new in bathroom decor. Treatment is especially suited to ranch-type homes with larger-than-average floor areas

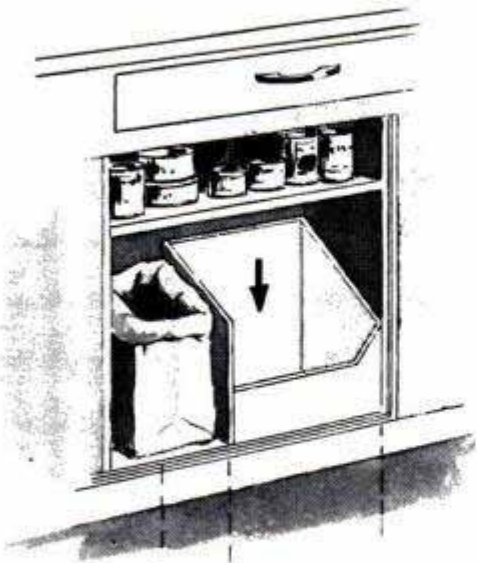
When a partition cuts off light—often a problem in older homes—defect can be corrected by installing a vertical jalousie unit that opens and closes



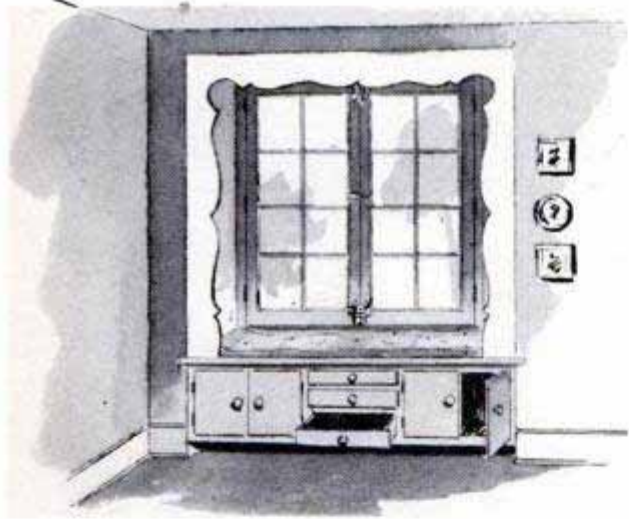
Unightly radiators under wide windows can be hidden effectively, without impairing efficiency, by means of a built-in having open grille and storage cabinets



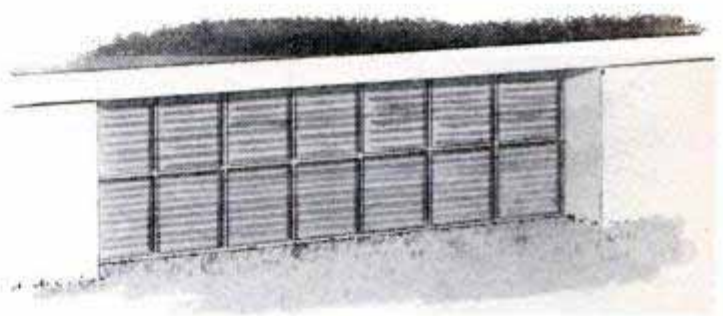
Bring outdoors into living or dining areas with this rock-walled planter. Makes an out-of-the-ordinary room divider. Works into nearly all new-home plans



When there's no other place for the laundry chute, locate it in a kitchen cabinet. It's out of sight and out of mind but still useful



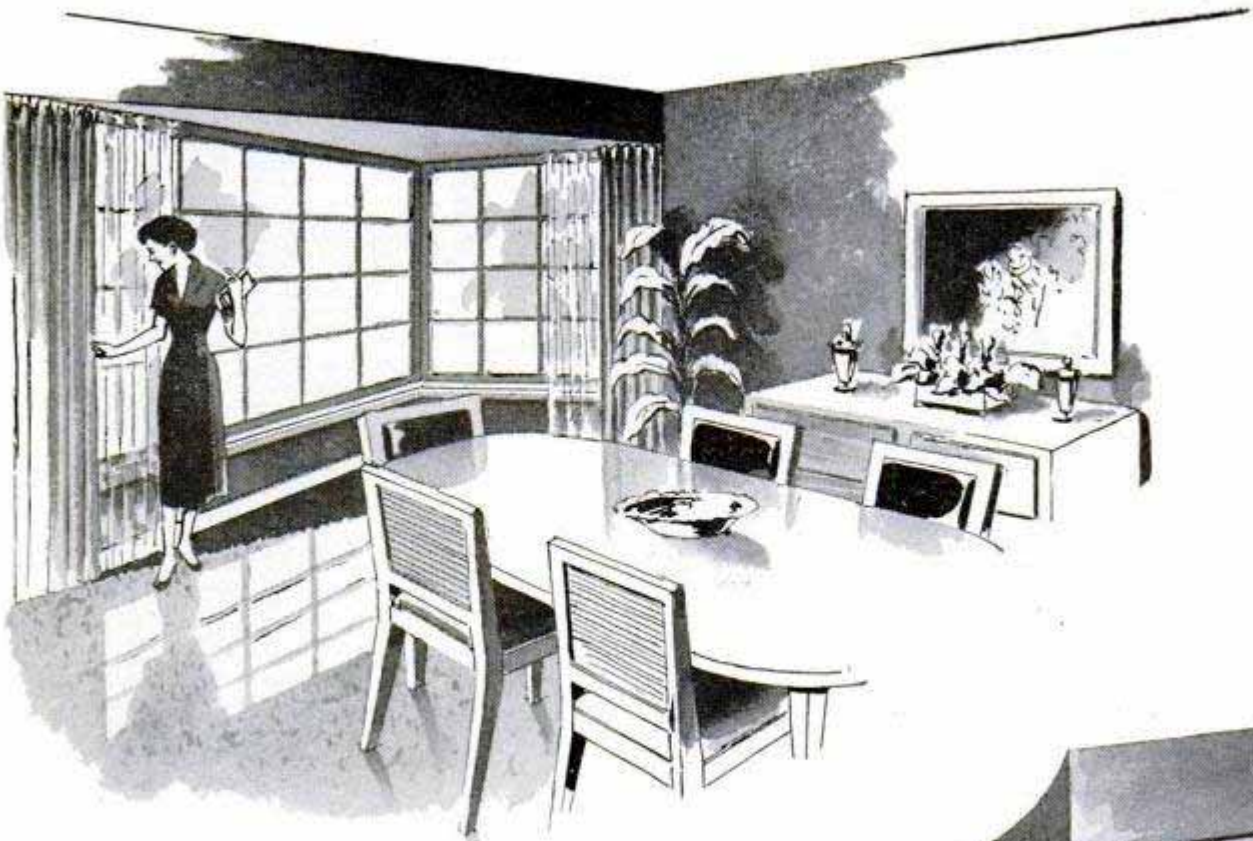
An old-style square bay is just the place to build in a window seat. Trim the opening with a scrolled frame and add storage cabinets and drawers below the seat. If there's a cold-air intake under the window, fit the storage cabinets with louver doors



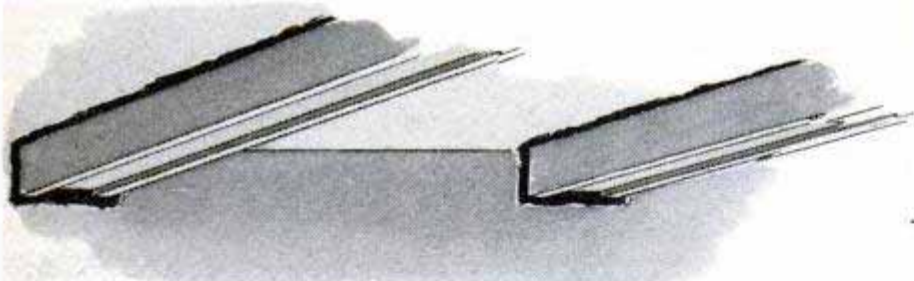
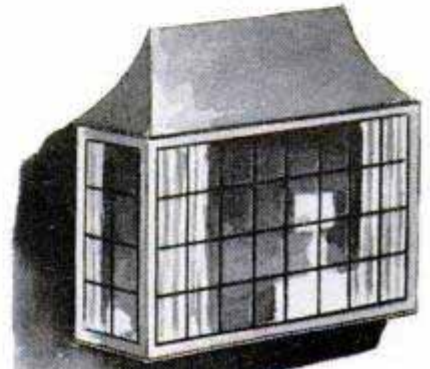
Replacing basement windows on the street side with glass blocks gives you light and privacy in the basement workshop or recreation room. Blocks are easily installed, there are no sash frames to rust or rot

Window shelves divide floor-to-ceiling panes attractively and provide greenhouse growing conditions for potted plants, seedlings and succulents. Of course, no collector will overlook the possibilities for a display of colored glass

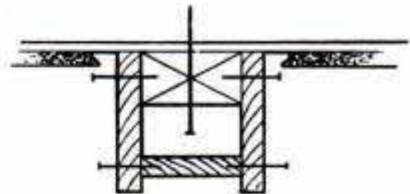




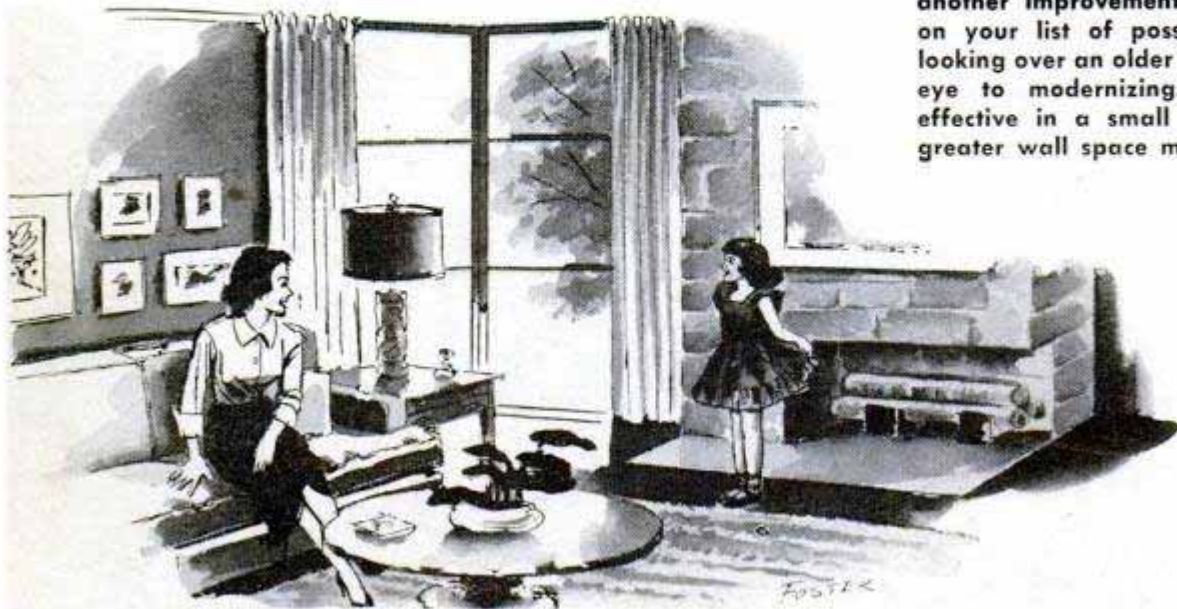
Angle bays, also the oriel, or hanging bay, right, fit into the design of almost any type of home, old or new. Usually, removal of an existing window provides at least a part of wall opening required. Bays offer a most inexpensive way of increasing size of small room



False ceiling beams are not only attractive in themselves but they are an inexpensive way of making a high ceiling appear lower. Sectional detail at right shows how beam is assembled



A floor-to-ceiling corner window is another improvement to jot down on your list of possibilities when looking over an older house with an eye to modernizing. It's usually effective in a small room due to greater wall space made available



If you are one of the many homeowners who turns week-end carpenter to beat high labor costs, you'll be interested in knowing about these new "do-it-yourself" building products now available



U. S. Gypsum Co. photo

# WHAT'S NEW IN WALL COVERINGS

By **Wayne C. Leckey**

**S**UCH OLD RELIABLES as common wall-board, plywood and plasterboard are gradually giving way to a host of new and beautiful wall coverings that are making the job of repairing, remodeling and dry-wall construction a homeowner's delight. Anyone thinking of converting attic space into living quarters, transforming the basement into a rumpus room or wondering how to hide the cracks in a plastered wall or ceiling will want to know what's new in wall coverings.

What are some of these new products? One is Panel Sheetrock, a fireproof gypsum wall-board 16 in. wide, that comes in panel form, predecorated in knotty pine and striated finishes to save you both the time and expense of





Placing ribbed texture of "bamboo" tile at right angles to each other produces pleasing basket-weave effect. Irregularities in tile joints are concealed with special colored filler

Courtesy Bolta Products Sales, Inc.

Above, bonded to the surface with a special adhesive which is applied with a trowel, this newest product in tile is actually fun to apply. Necessary tools, including joint roller, are available in kit form

Below, swirling grain of this "sculptured" plywood paneling provides dramatic driftwood effect in keeping with texture decorating. Two-tone color treatment is optional  
Georgia-Pacific Plywood Co., photo



Dramatic two-tone harmony of color and texture, as shown at left, is obtained by painting plywood with a base color, then wiping off second contrasting color







Contrasting wall of sturdy striated wallboard, finished green, gives "luxury look" at low cost. Lends contemporary feeling

**Home Section**

decorating. The striking effect, as pictured on page 181, closely simulates real wood-grain paneling at a fraction of the cost. It's manufactured from standard  $\frac{3}{8}$ -in. gypsum board in 8, 9 and 10-ft. lengths and is faced on one side with a wood-grain paper, lacquer-coated for easy cleaning. Differing from regular gypsum board where joints require taping, seam work is eliminated with this new covering, as the rounded edges of the material are a part of the over-all panel effect. In remodeling, the panels can be installed over existing walls of plaster, or wallboard. For new work, a base layer of  $\frac{3}{8}$ -in. gypsum is required. Each panel is individually cemented in place with regular tape-seam cement and the way it is done is told in pictures on page 187.

Where a small-panel effect is not desired, the homeowner now can buy regular 4 x 8-ft. sheets of gypsum wallboard pre-decorated in simulated wood grains which include knotty pine, bleached mahogany and straight-grain fir. The knotty-pine sheets have

Rich, subtle tones of cork wall tile add a distinguished air to any room as shown at right



square edges which, when butted together, form fine-line joints that look like a part of the wood pattern. The walnut and mahog-

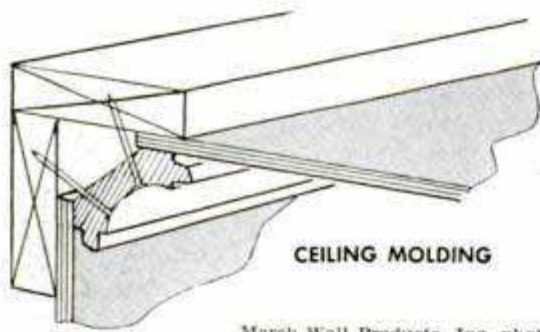
any panels are made with beveled edges to form V-joints. Nailhead treatment is taken care of with special enameled nails which match the particular wood-grain finish.

Perhaps newest in the tile field is an 8-in.-sq. vinyl-plastic tile, called Bolta Wall-Tile, which has the realistic look of genuine split bamboo. Claimed not to chip, crack, peel or become brittle with age due to its rubber-saturated paper backing, this semi-flexible material can be bent around corners, resists abrasion and staining, and can be wiped clean with a soapy cloth. It comes in several colors including natural and may be applied to a plaster, plasterboard, hardboard or plywood wall. The tiles are applied

Kentile, Inc. photo



The Upson Co. photo



CEILING MOLDING

Marsh Wall Products, Inc. photo



individually with a special water-soluble adhesive similar to linoleum cement, which is troweled on the surface. The ribbed surface of each tile is placed at right angles to the adjacent one to give a strikingly modern basket-weave effect. A special colored filler is provided to fill any irregularities in tile joints. The same material also is made in roll form 48 in. wide and in a rich, simulated leather-grain texture which offers the same ease-of-cleaning advantage. However, being produced only in large sheets, it is more difficult to handle than the tile squares and, therefore, is not recommended for application by the average homeowner.

A new texture-plywood paneling is WedgeWood, a 4 x 8-ft. lightweight board with a sculptured, swirling grain that lends itself to smart decorative two-tone color effects. The sheets can be nailed right over dilapidated plaster to modernize old rooms, or nailed to studs or furring to form finish walls in new construction. The material may be left in its natural-wood finish, or it may be painted or stained in one or two colors of light and dark shades. The panels are factory-treated with a slightly pigmented resin sealer so no priming coat is necessary before painting or staining.

New among the wallboard group are strong, laminated fiber panels by Upson. Made in sizes large enough to cover a single wall in one piece if desired (8 x 16 ft.), this economical covering comes in standard 4-ft. widths. You have a choice between an attractive pebbled surface or a smart

striated (textured) surface. The panels are pre-sized to provide a perfect painting surface. Whereas the other coverings so far described are primarily designed for wall application, laminated fiber panels are ideal for covering cracked plaster ceilings. The series of photos on page 186 show how this is done.

Long used primarily as a floor covering, the rich, subtle texture of cork tile makes an unusual wall covering for one-wall application. Kencork, one of several brands of cork tile on the market, comes in random natural tones, ranging from light oak to dark walnut, and in four standard sizes: 6 x 6, 6 x 12, 12 x 12 and 12 x 36 in. It may be obtained either factory-waxed or in a natural finish, with beveled or square edges.

Lustrous, plastic-finished panels, called Marlite, offer the homeowner a beautiful wall covering that comes prefinished in some 67 striking color and pattern combinations. Featuring a permanent baked-on finish that wipes clean like glass and never needs refinishing, the paneling faithfully reproduces the rich coloring and grain of actual, fully finished wood-grain and marble patterns. The "decal" veneers are bonded and sealed for life to panels of smooth hardboard. The panels are available in 4 x 6 and 4 x 8-ft. sizes. They are cemented in place and neatly trimmed with special metal molding.

A new and completely different wood paneling has made its debut under the trade name of Novoply. A predecorated board in its natural state, it forms a distinctive wall covering as well as a warp-free material for furniture, cabinets, sliding



*Novoply*



*Peg-Board*

*Plyweave*



United States Plywood Co. photo

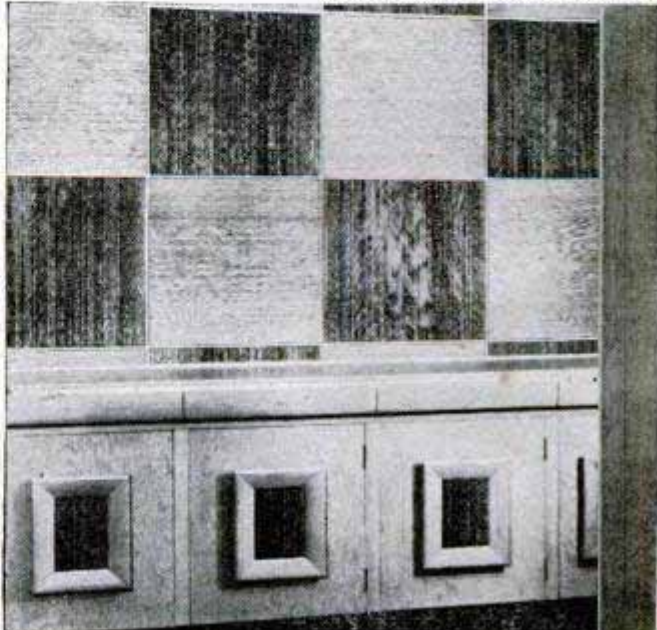
A predecorated board in its natural state, this warp-free plywood is ideal also for cabinets, furniture



B. B. Butler Mfg. Co., Inc. photo

Above, perforated board presents brand-new concept in wall paneling, provides smart modern pattern and is highly functional. Below, checkerboard pattern of texture plywood adds interesting, one-wall contrast

M and M Wood Working Co. photo



## Covering Cracked Ceiling With Laminated Wallboard



The Upson Co. photos

First step in re-covering a cracked plaster ceiling is to nail 1 x 3 furring strips, 16 in. apart, to old ceiling



Next, special metal clips, called floating fasteners, and which anchor the wallboard securely from the back, are nailed to the furring strips. Below, T-shaped prop of 2 x 4s is used to hold wallboard sheets in position against furring strips



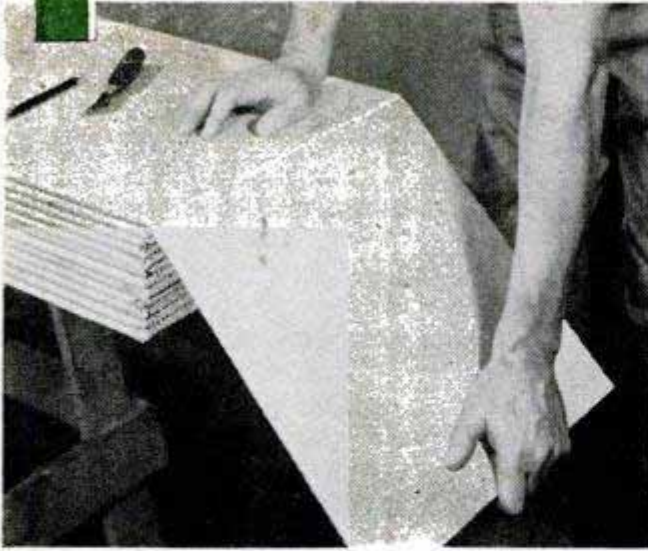
Padded block is used to force prongs of fastener securely into rear side of the wallboard

doors and built-ins of all kinds. Made of resin-coated wood flakes and chips bonded under pressure, this new version of plywood takes on an attractive variegated texture that requires no painting or staining. It comes in two thicknesses,  $\frac{3}{8}$  and  $\frac{3}{4}$  in., and is lower in price than common plywood due to the fact that it is manufactured from waste timber normally unusable.

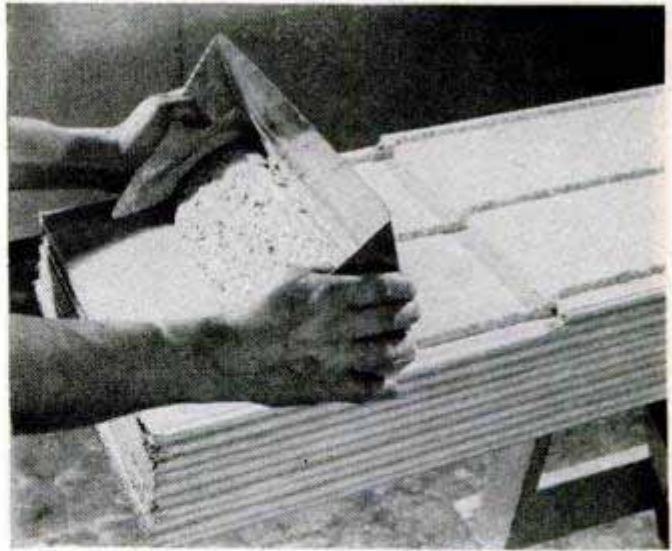
While Peg-Board, a comparatively new perforated hardboard, has found wide use as a display paneling, it also offers a functional, versatile, as well as decorative, wall covering for the home. Some 60 different hanging fixtures, all interchangeable without screws, match holes in the perforated board and provide countless picture

Finally, specially designed wooden moldings are applied over joints and at ceiling line





Panels are cut by cutting through paper covering on both faces, then snapping off to break gypsum core



U. S. Gypsum Co. photos

Surplus cement, which is applied with notched spreader, is transferred to next panel in manner shown above

and shelf-arrangement possibilities without damage to the wall. In addition to a smooth surface, the perforated board can be had in an attractive simulated-leather texture.

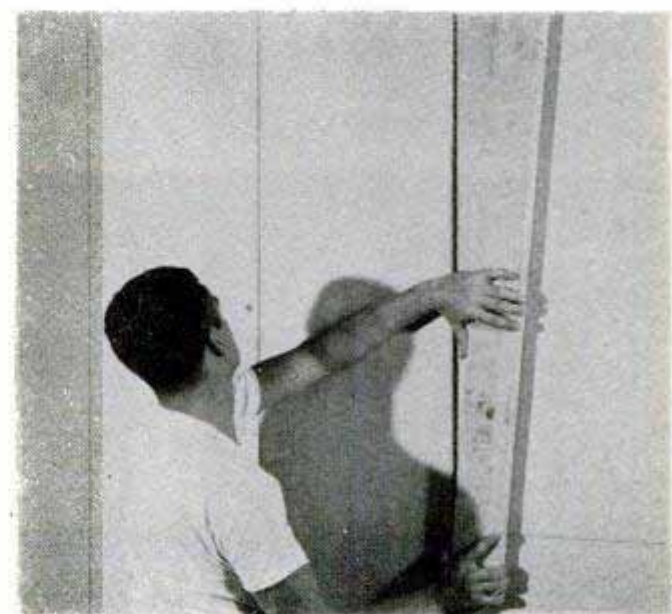
Popular among the textured boards recently introduced is Plyweave, a fir paneling which makes a most attractive wall covering. Because it is made under heat and pressure, it presents a hard surface not easily scarred and is simple to clean. Finished with a base coat of white paint, topped with a gray glaze, which is wiped off with a cloth, a pleasing three-dimensional effect is obtained.

Several of the coverings described are one-wall coverings. Many times the overall effect is monotonous when the same covering is used on all four walls. By combining the texture of two different boards, a pleasing contrast results. ★ ★ ★

Single nail driven through panel at ceiling keeps top edge tight against wall. Molding covers nail



Above, place the first panel at a corner and plumb it with a carpenter's level. Press board lightly against surface to assure even adhesion. Below, succeeding panels are kept snug by tapping with 2 x 4



## Dolly Moves Scrub Pail and Brush Easily as You Wash Floor

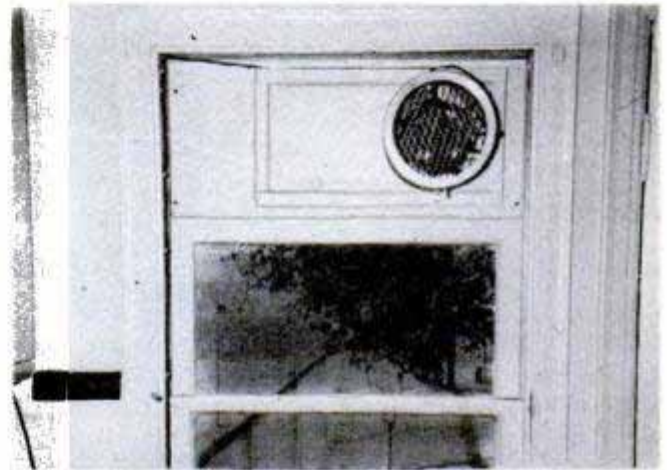


A dolly that holds a brush and pail and can be rolled with you as you work, will save much time and energy when scrubbing floors. To make such a dolly, use a piece of  $\frac{3}{4}$ -in. plywood,  $10\frac{1}{2}$  x  $14\frac{1}{2}$  in. as the base. The sides are made from 1 x 3 lumber,  $14\frac{1}{2}$  in. long, and the endpieces are of the same stock, 12 in. long. The divider is a  $10\frac{1}{2}$ -in. length of 1 x 2 lumber. After assembling the dolly with glue and screws, swivel casters are attached at each of the four corners. The divider is located  $10\frac{1}{2}$  in. from one end of the dolly, making a large compartment for the pail and a smaller one for the brush and soap. To finish the dolly, paint or varnish.

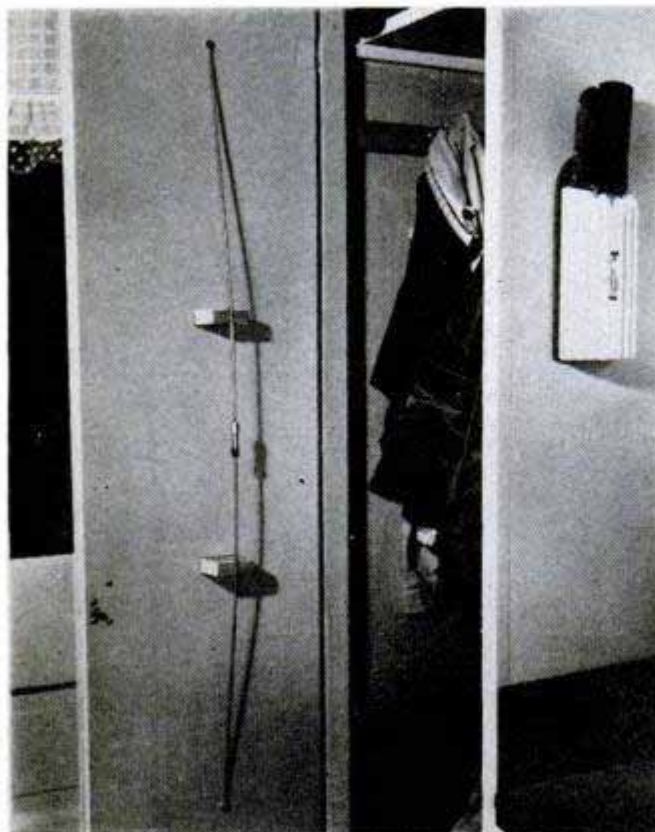
## Removable Ventilating Fan Installed in Kitchen Window

For apartment dwellers and others who need a kitchen ventilating fan but cannot install a permanent one, this removable fan is the answer. A 6-in. fan is mounted in a panel of  $\frac{1}{2}$ -in. plywood which has been cut to fit in the upper part of the kitchen window, as shown. Small aluminum fins are attached to the outside of the ventilator, pivoted to open when the fan is blowing, and close when the fan is inoperative. To lock the window with the fan installed, nail a crosspiece just over the top rail of the lower sash. The unit can be removed in a few minutes.

Robert M. Kinney, Detroit, Mich.



## Warped Plywood Closet Doors Straightened by Turnbuckle



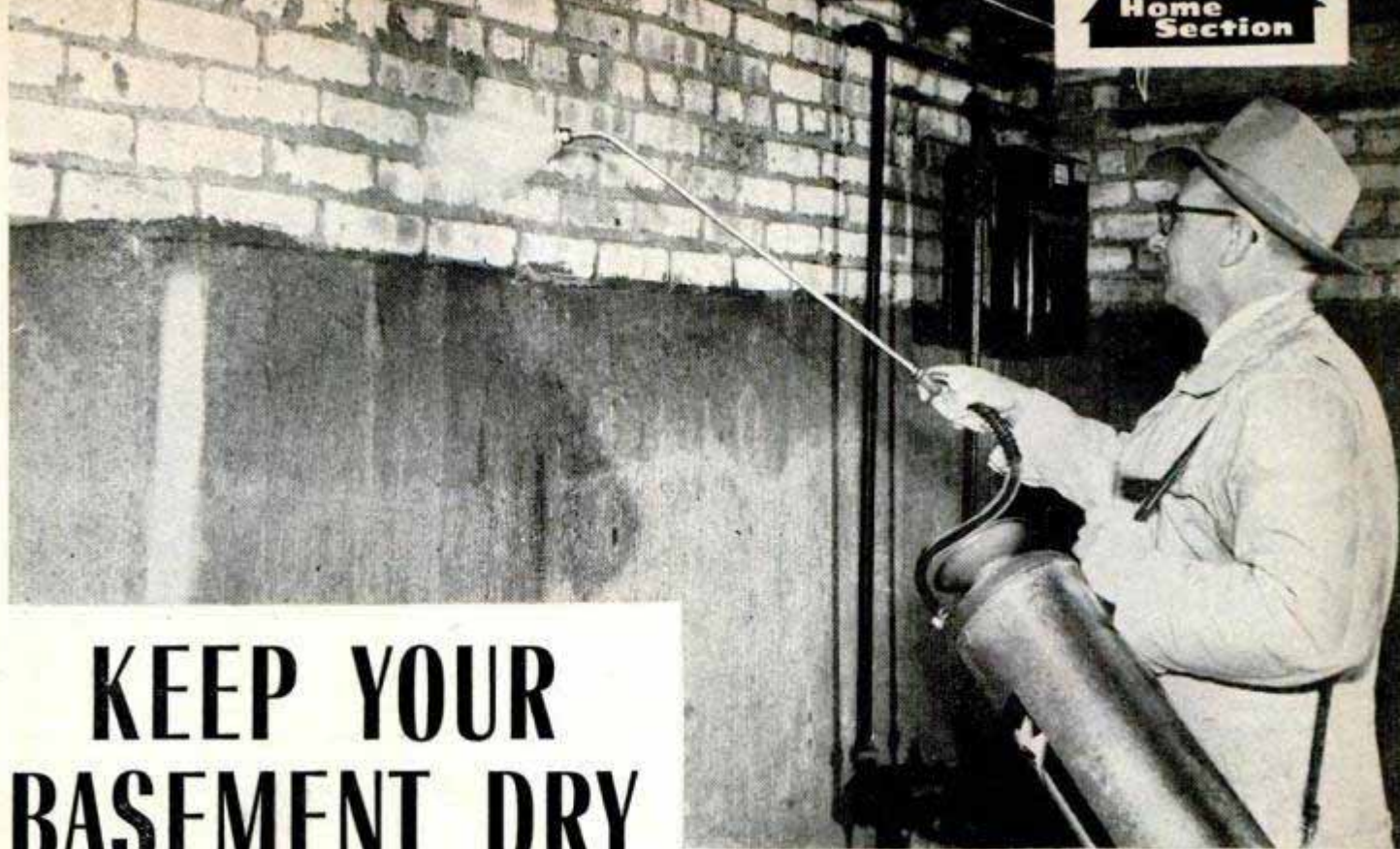
Long narrow doors consisting of plywood panels without framing, frequently used on closets and cabinets, may become warped and thus not close properly, giving an unsightly appearance. If this has happened to such a door in your home, you can remedy the situation by fastening an ordinary screen-door brace to the inside face of the door. Fasten the brace vertically on the door and place two wooden blocks under it. Then tighten the turnbuckle until the top and bottom of the door are pulled into line.

Kenneth R. Greene, Tescott, Kan.

## Avoid Mixed-Wood Flooring

Mixing different species of wood flooring is a practice that should be avoided. Northern hard maple, for instance, is the hardest of the floorings commonly used in present-day construction and should not be mixed with soft maple or other woods of inferior wearing qualities. If this is done, the floor does not wear uniformly and irregular surfaces eventually develop.

James DeLorme, Jackson, Mich.



# KEEP YOUR BASEMENT DRY

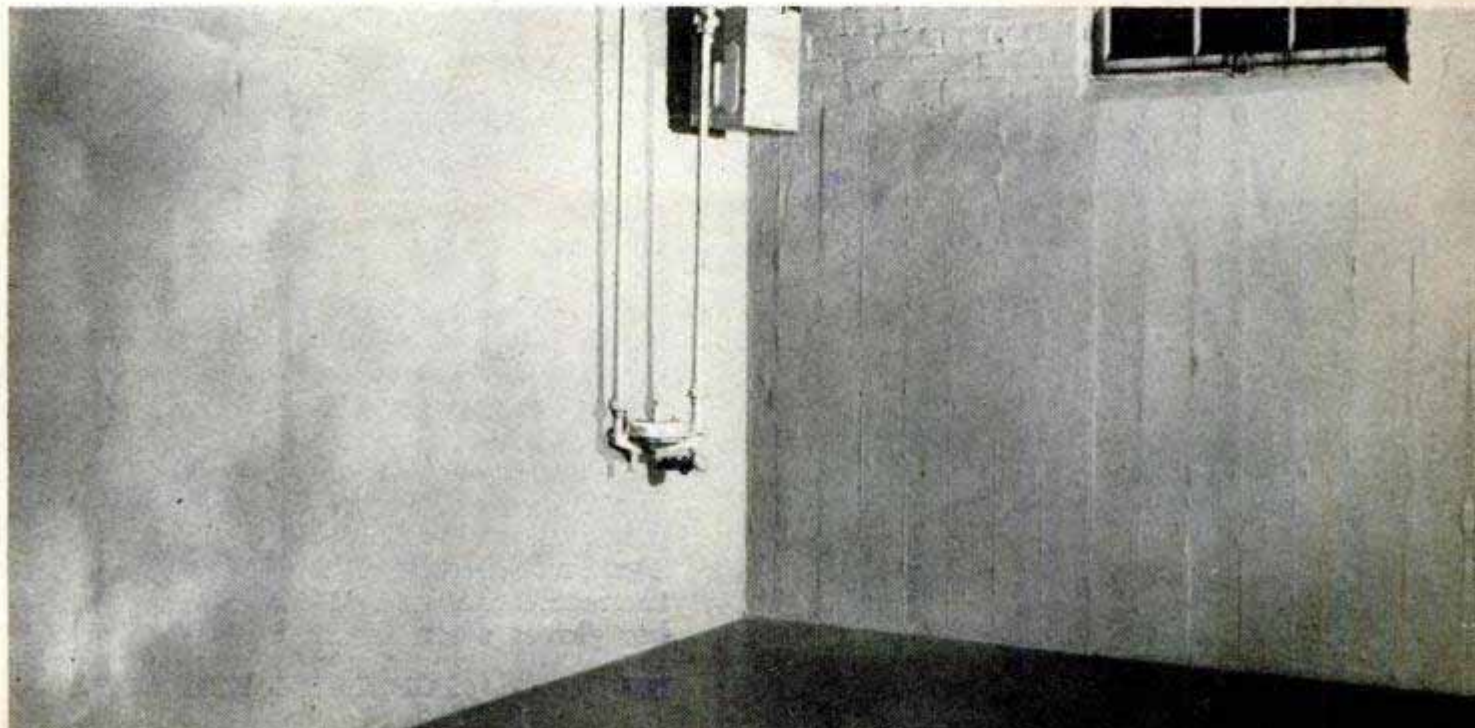
By James R. Ward

**T**HERE'S ONE PROBLEM that frequently keeps the basement from becoming one of the most useful areas in the home. That problem is moisture. Troublesome in varying degrees, from dampness penetrating the walls to severe water seepage, basement moisture not only rusts tools and causes mildew, but often makes it impossible to use the basement even for a home workshop, much less a rumpus room or living quarters.

If proper measures for preventing basement dampness were not taken when your home was built, you can eliminate the trouble and make your basement livable by

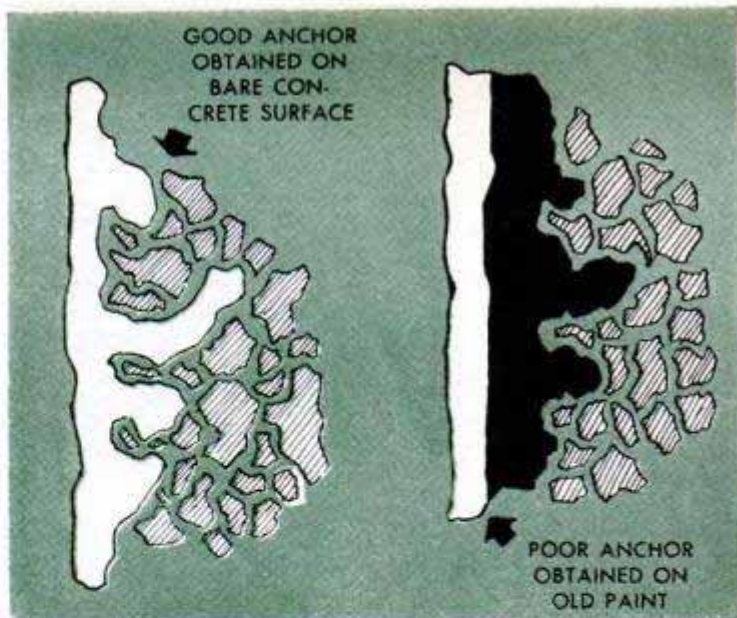


Photo above pictures "waterlogged" corner of basement. The corner is shown below, after waterproofing

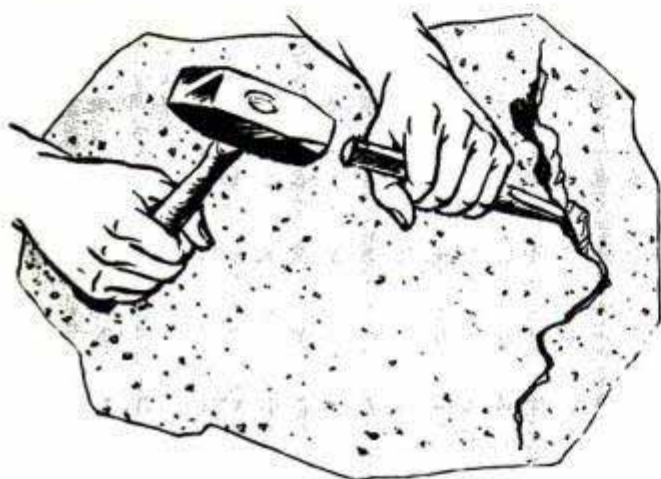




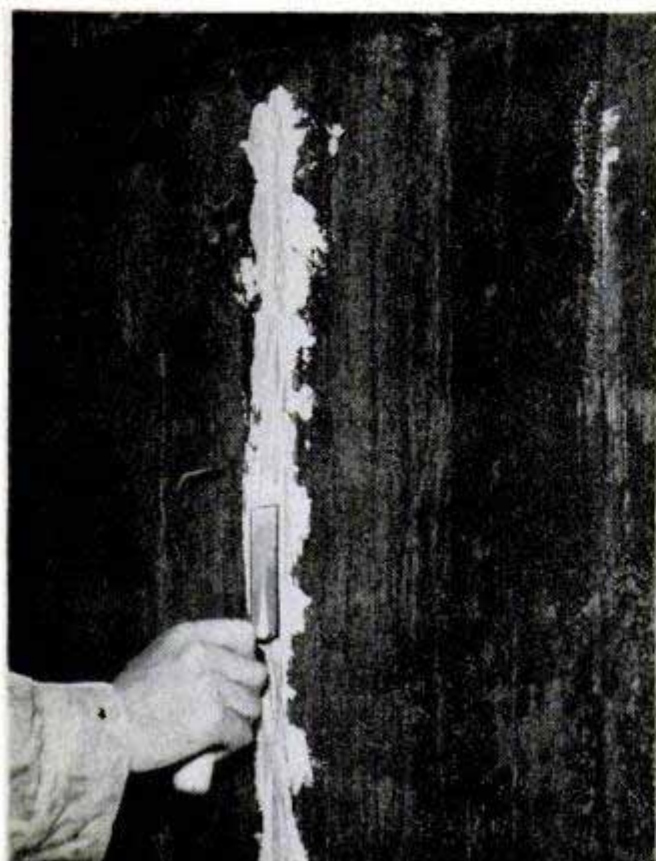
Unpainted wall is cleaned with scrubbing brush and washed down. Efflorescence should be removed by etching and rinsing. Allow walls to dry before painting



Drawings above illustrate how removal of old paint from masonry surface permits new coating of cement paint to obtain good anchor on the porous surface



To seal cracks in walls, undercut with cold chisel, above, and fill with cement-paint mortar, as below

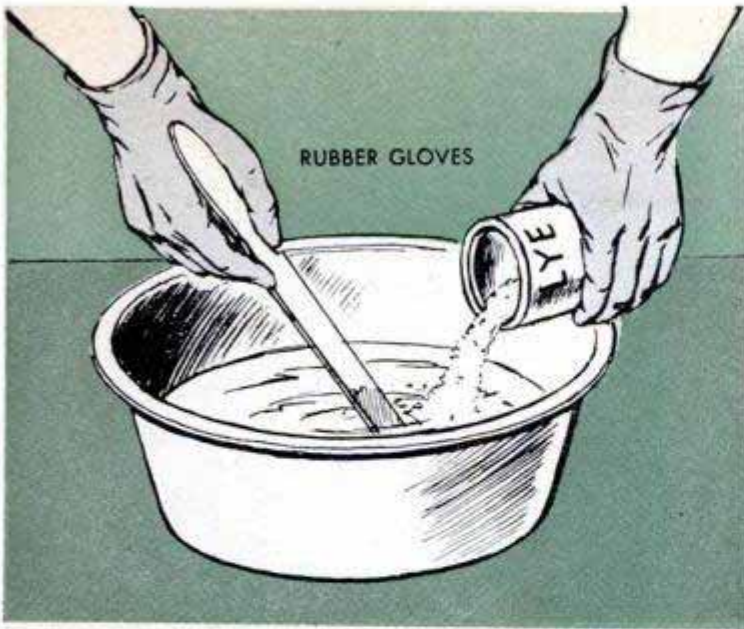


sealing the walls and floor with cement paint which actually becomes part of the masonry. In addition to waterproofing the masonry, the cement paint, which is available in white and pastel colors, will improve its appearance to a surprising extent. Even though the basement is reasonably dry at the present time, cement paint can be used to give it a final dampproofing for added comfort. Rox, one of several popular brands of this paint, was used to finish the basement pictured.

The first step in waterproofing your basement is to clean the surface of the masonry. If the surface has not been painted, a brisk "going-over" with a wire brush and a wash-down with water will usually prove satisfactory. Any efflorescence (salts in the masonry) should be removed with an etching acid, following the acid application with a thorough wire brushing. Then the acid is neutralized by rinsing with water. In both cases, allow the masonry to dry thoroughly before painting.

A better bond is had if the masonry has never been painted. The reason for this is illustrated by the drawings at the top of the page which show how a coat of old paint will keep the cement paint from anchoring solidly to the masonry. Whitewash or calcimine can be removed by scrubbing with hot water. For water-soluble, resin-based paints, use a 20-percent solution of muriatic acid, rinsing with water after applying the remover. In addition to removing most of the old paint, the acid will also etch the surface to provide a better bond for the cement paint. To remove oil-based paint, use a solution of lye, 1 lb., to water, 1 gal., working the solution thoroughly into the masonry surface. Be sure to wear rubber gloves when mixing and applying the





When mixing a lye solution for removing oil paint from walls, be sure to wear rubber gloves, as above

lye solution, as well as muriatic acid, and then rinse the wall carefully. An ordinary scrubbing brush is excellent for applying the paint remover.

Although the basement floor may not have been painted, etching the concrete with a 20-percent solution of muriatic acid is recommended before applying the cement paint. Wear rubber overshoes and gloves when working with the acid and wash the floor thoroughly with water after etching.

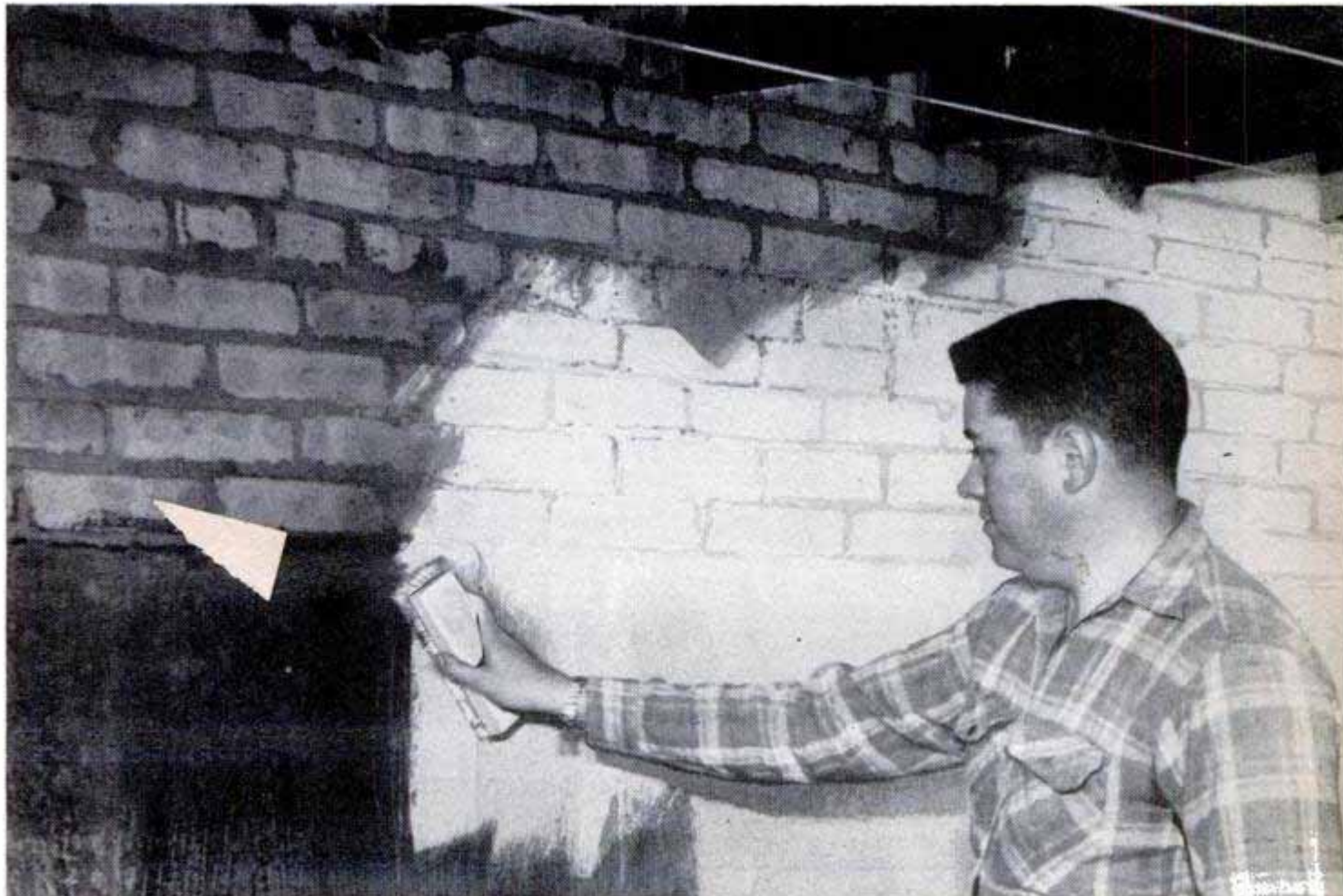
Cement paint is literally scrubbed onto masonry surface, using an ordinary fiber scrubbing brush. Care must be taken to fill all depressions and small cracks with the paint. Two coats are required to seal the wall

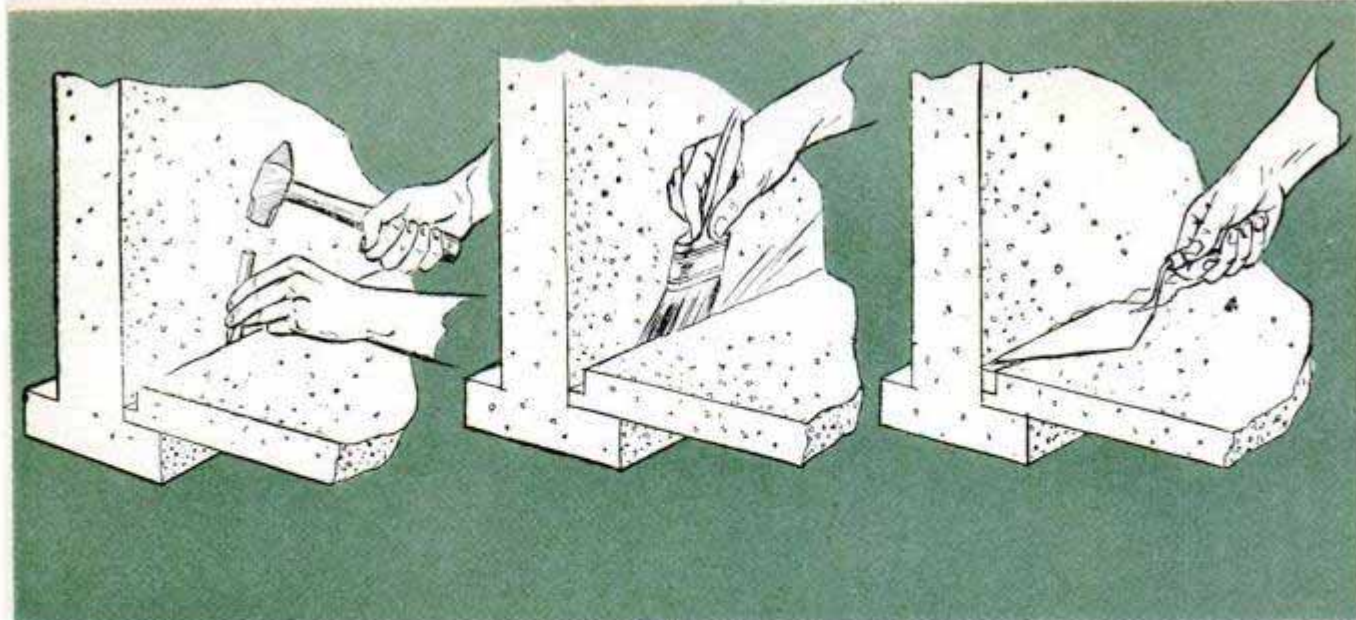
When the walls have been properly prepared, the next step is to mix the cement paint, following the manufacturer's directions carefully. In the case of the Rox paint, 10 lb. of powder was mixed with 2½ qt. of water for the first coat, and 10 lb. of powder with 3 qt. of water for the second coat. This should be done by measuring the powder into a clean pail, adding just the right amount of water and stirring until completely mixed. Use a paddle to mix the paint—do not mix with your bare hands—and don't mix more paint than can be applied in about 2 hr. Stir the paint frequently while using.

To apply the first coat, begin by dampening the wall. Use the finest possible spray from your garden hose or, better yet, dampen the wall with a portable garden sprayer, as in the photo on page 189. Spray sections of the wall just before you are ready to paint them so that the surface of the masonry is damp but not wet. Do not soak the masonry before painting.

Apply the cement paint to the dampened wall with a scrubbing brush, as in the photo below, being careful to fill all depressions and small cracks with the paint. When you reach the bottom of the wall, scrub the paint into the corner formed by the wall and floor, coating at least an inch of the floor along the wall.

After the first coat of cement paint has dried for 48 hr., the second coat may be





Leaking joints between basement walls and floor slab can be sealed with a mix of cement paint and sharp sand. Widen joints with chisel and brush out



Wall-floor joint is painted with scrubbing brush, as above, bringing paint at least an inch over floor

applied. In this case, do not dampen the wall before painting. Simply scrub the second coat of paint right over the first one, handling the paint in the same way. Note that the second coat is slightly thinner than the first coat, and also that you will get three to four times as much coverage. Allow the paint to dry overnight. Then, in the morning, dampen the painted walls with a fine water spray and repeat again in the evening. Paint the floor in the same way as the walls.

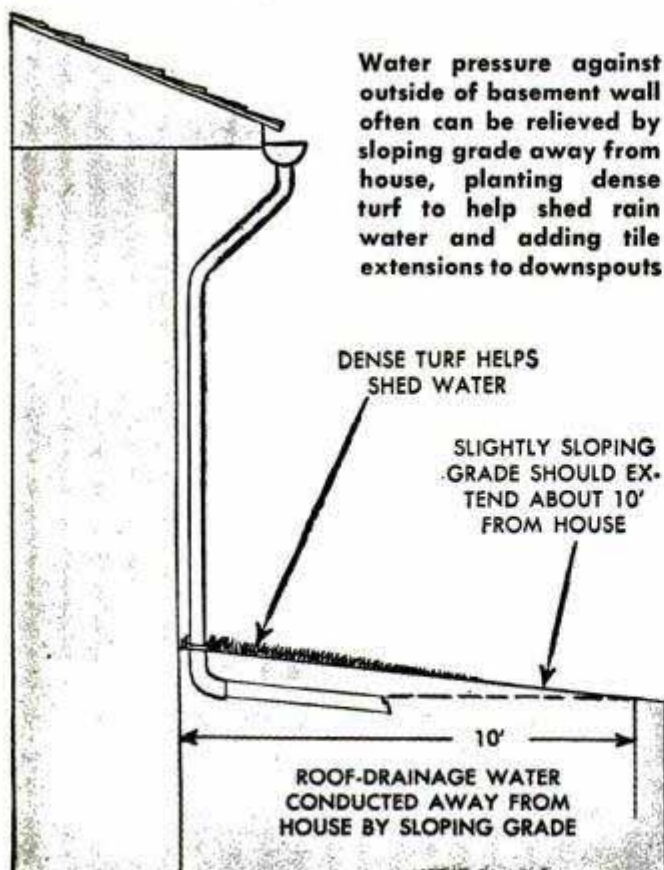
Filling cracks and holes with cement paint is shown on page 190. Undercut and, where necessary, widen the crack with a cold chisel. Then brush out the masonry particles. Make a fairly stiff paste, or mortar, by mixing cement paint, 1 part, and sharp sand, 2 parts, with just enough water to bring the mortar to a workable consistency. Then, dampen the crack—don't soak it—and trowel on the mortar.

Leaks at the joints where the concrete floor slab joins the walls can be stopped similarly, as detailed above. First the joints are widened with a cold chisel. Then they are brushed out thoroughly, and finally, the stiff mortar is troweled into them.

Pressure from rain water is one of the chief causes of leaking basement walls. This can be relieved by draining the water away from the house as in the detail at the left. Note how the grade is sloped away from the house and also that the end of the downspout is brought into several lengths of tile to conduct the water away from the foundation.

Cement paint can be used on masonry surfaces on the outside of the house as well as on the interior. It is not recommended, however, for use on lime brick or block.

★ ★ ★



## Chisel for Removing Sash Putty



A chisel made from a discarded doorknob and shaft will come in handy for removing hardened putty from a window sash. Grind the end of the shaft to a beveled point.—G. E. Hendrickson, Argyle, Wis.

## Stop Stains from "Bleeding"

When painting over woodwork which has been stained a mahogany or dark walnut, it is good practice to test it for "bleeding." Brush white paint on a small area and see what happens to it after a week or so. Sometimes the oil in the paint activates the old dye in a matter of hours, or it may take several days. If no discoloration takes place after a reasonable exposure, it may be assumed that the old stain will not bleed through the new paint. If the stain does bleed, and turns the test paint pink or brown, it must be removed before the new paint is applied. The stain may be soluble in oil, water or alcohol, and after you have determined which will dissolve it, the area to be painted should be washed with the solvent. Then give the area one or two coats of shellac to seal it before applying the new paint.

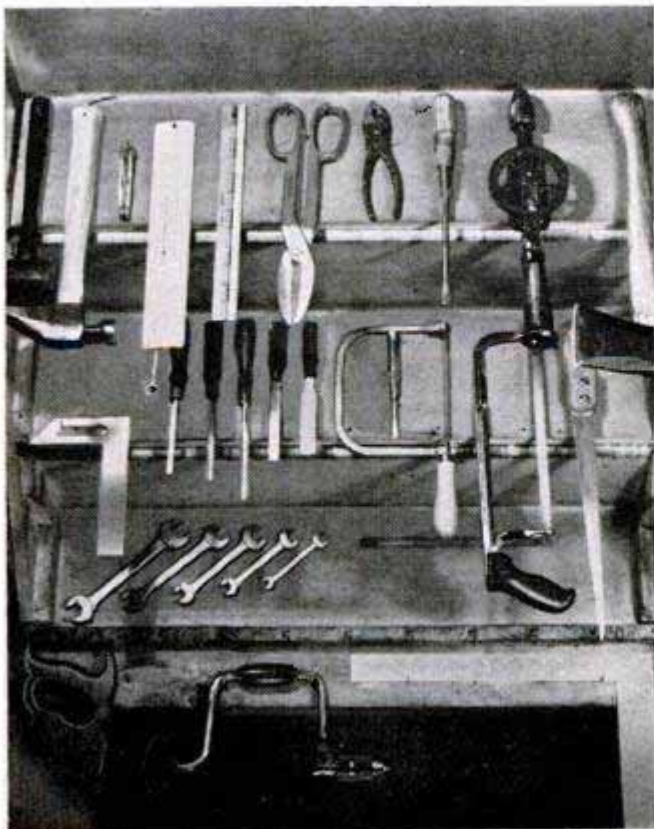


## Framed Opening in Partition Wall Forms Telephone Shelf

To save steps when answering the telephone, one homeowner has built this "window" between the kitchen and living room of his home by cutting through the partition wall between studs and framing the opening. The window trim matches the woodwork in the room in which it faces. To close the window and prevent cooking odors from entering the living room, a sliding panel could be installed if desired and a wide sill for a note pad can be included.

A. M. Wettach, Mt. Pleasant, Iowa.

## Underside of Basement Stairs Used as Out-of-Way Tool Storage Rack

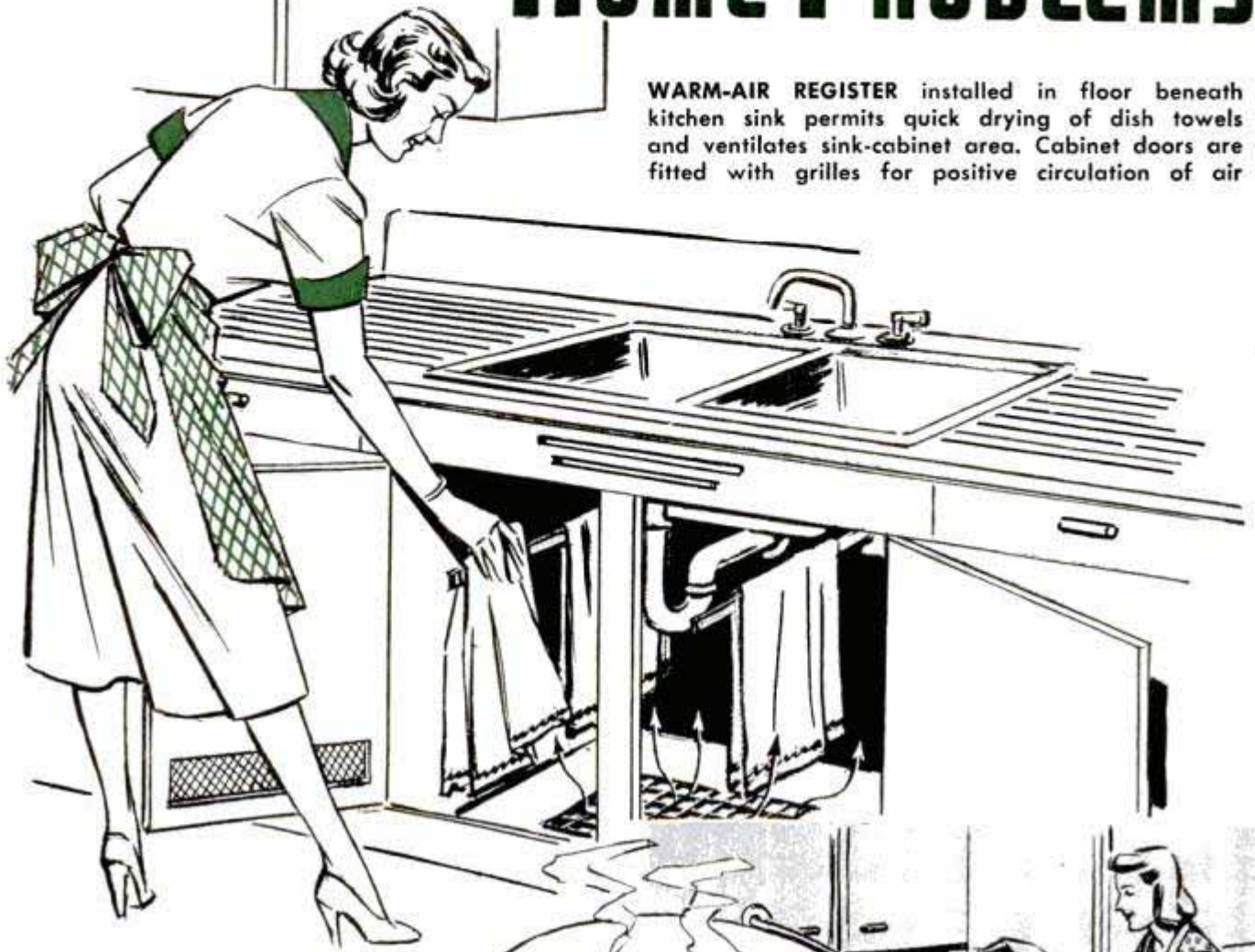


Confronted with a storage space problem, one home-workshop owner used the underside of his basement stairs as a ready-made tool rack. After a few minutes devoted to installing hooks, hangers and clips, he had a convenient tool board. Because of the step construction, he found that more tools could be stored in less space by using this method.—J. W. Schwartz, Ames, Iowa.

## Concrete Should be Left Unpainted If Test Shows Dampness

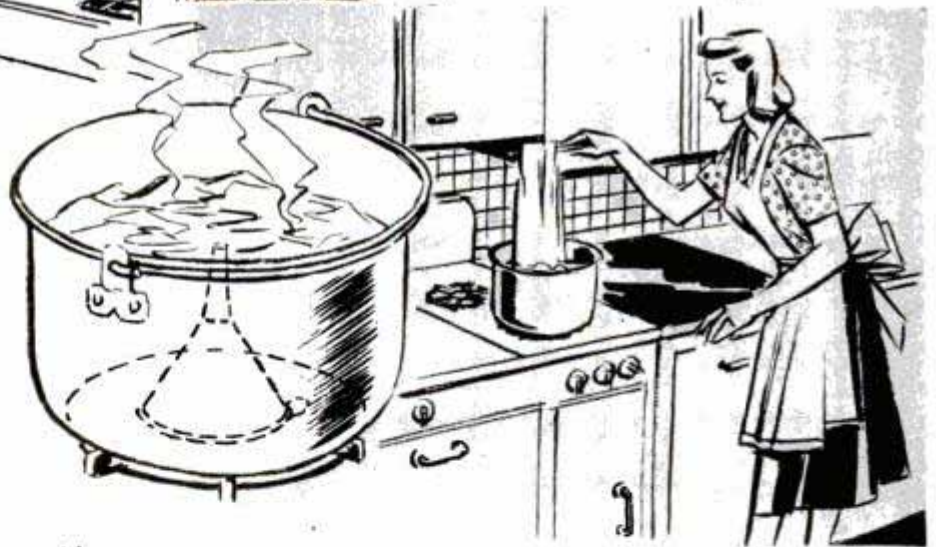
Concrete floors that are known to be damp should not be painted. Pressure from outside or underneath often forces moisture up through below-grade floors, bringing active alkali which mixes with the oil of the paint and produces a soap. To determine whether a floor is too damp, place a small section of linoleum on the floor for several days. If the area beneath it appears damp, paint failure will likely result. Alkali-resistant paints can be used where there is only a trace of dampness.

# Solving **HOME PROBLEMS**



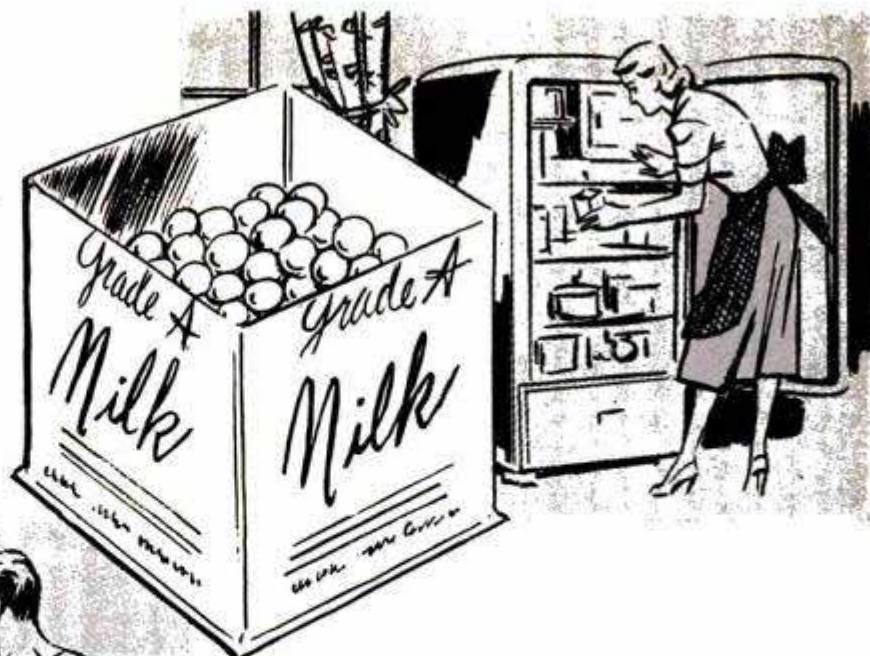
**WARM-AIR REGISTER** installed in floor beneath kitchen sink permits quick drying of dish towels and ventilates sink-cabinet area. Cabinet doors are fitted with grilles for positive circulation of air

**FUNNEL** set in center of dye kettle keeps fluid circulating to help eliminate dark streaks in fabric. Heated dye "percolates" through funnel spout, and boiling agitates funnel sufficiently to allow fluid to flow under rim. Continue to stir dye in the usual manner



**MARBLES** in bottom of double boiler give warning when water has almost boiled away. As water becomes dangerously low, marbles will bounce noisily on bottom of pot so you'll know it's time to add water

**CARDBOARD MILK CARTONS** are just the thing for storing leftover food in the refrigerator. Cut off bottom section of carton, leaving a couple of inches of the sides intact. After filling with food, cover with wax paper, if desired. Square cartons take up less refrigerator space



**CELLULOSE SPONGE** provides neat soap "dish" for bathroom lavatory, as it absorbs water from bar of soap and does not slip on the porcelain. Sponge also is convenient for wiping off basin



**SPLASHING** of wash water from discharge hose of washing-machine pump is avoided by clamping a cloth sleeve to end of hose. Sleeve is made from leg section cut from cotton sock



**TO PROTECT WALLS** from being marred by metal rim of wastebasket, apply  $\frac{3}{4}$ -in. adhesive tape or masking tape all around the rim. If you wish, use decorative tape of a color to match the room



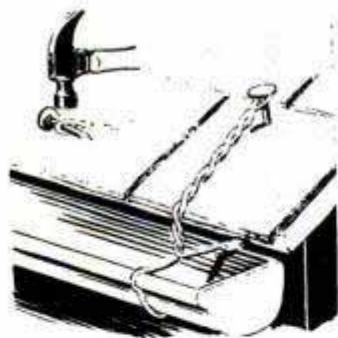
## Jig Aids in Tying Ratlines For Model Sailing Vessel



To simplify tying ratlines when rigging model sailing vessels, one modelmaker uses a jig made from two mousetraps and a plywood base. The traps are screwed or nailed vertically to the ends of the base, the latter being cut to suit the length of the shrouds. The edges of the trap are notched for proper spacing of the shrouds, and the trap jaws hold the shrouds taut while the ratlines are tied.

Louis Booker, Louisville, Ky.

## Eaves-Trough Hanger Eye Crushed to Hold Nail



By crushing the eyes of eaves-trough hangers over nails, a metalworker found that he could simplify the job of hanging eaves-trough sections. The crushed eye holds the nail so

that it may be driven with one hand while the other hand holds the trough in the proper position. Thus one man can hang an eaves trough with a minimum of juggling.

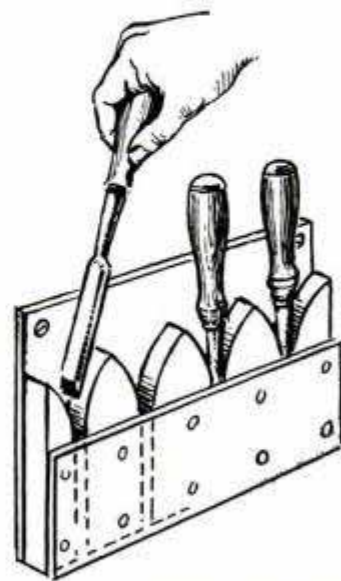
## Milk Cartons Burned as Flares

When a flat tire or engine failure forces you to pull off to the side of the highway at night, use a milk-carton signal flare to warn approaching motorists. Quart-size milk cartons provide economical, long-burning lights. Place one at the front of the car and another about 25 ft. in back of it. Then light the flap which covers the opening of each carton. Some roadside sand

or a few pebbles dropped in the bottom of the carton will hold it upright and keep it from blowing away. It is worth-while to carry half a dozen of these "flares" in your trunk for night-driving emergencies.

## Chisel Rack From Fence Pickets

A handy wall rack for chisels and screwdrivers can be made by fitting tapered blocks, which might be cut from discarded fence pickets, between two pieces of plywood, as illustrated. The blocks are spread far enough apart to accommodate the blades of the tools. Such a rack is especially handy when mounted on a wall over your wood-turning lathe, as it keeps all the turning chisels at hand, makes selection easy and allows the chisels to be put back in place.

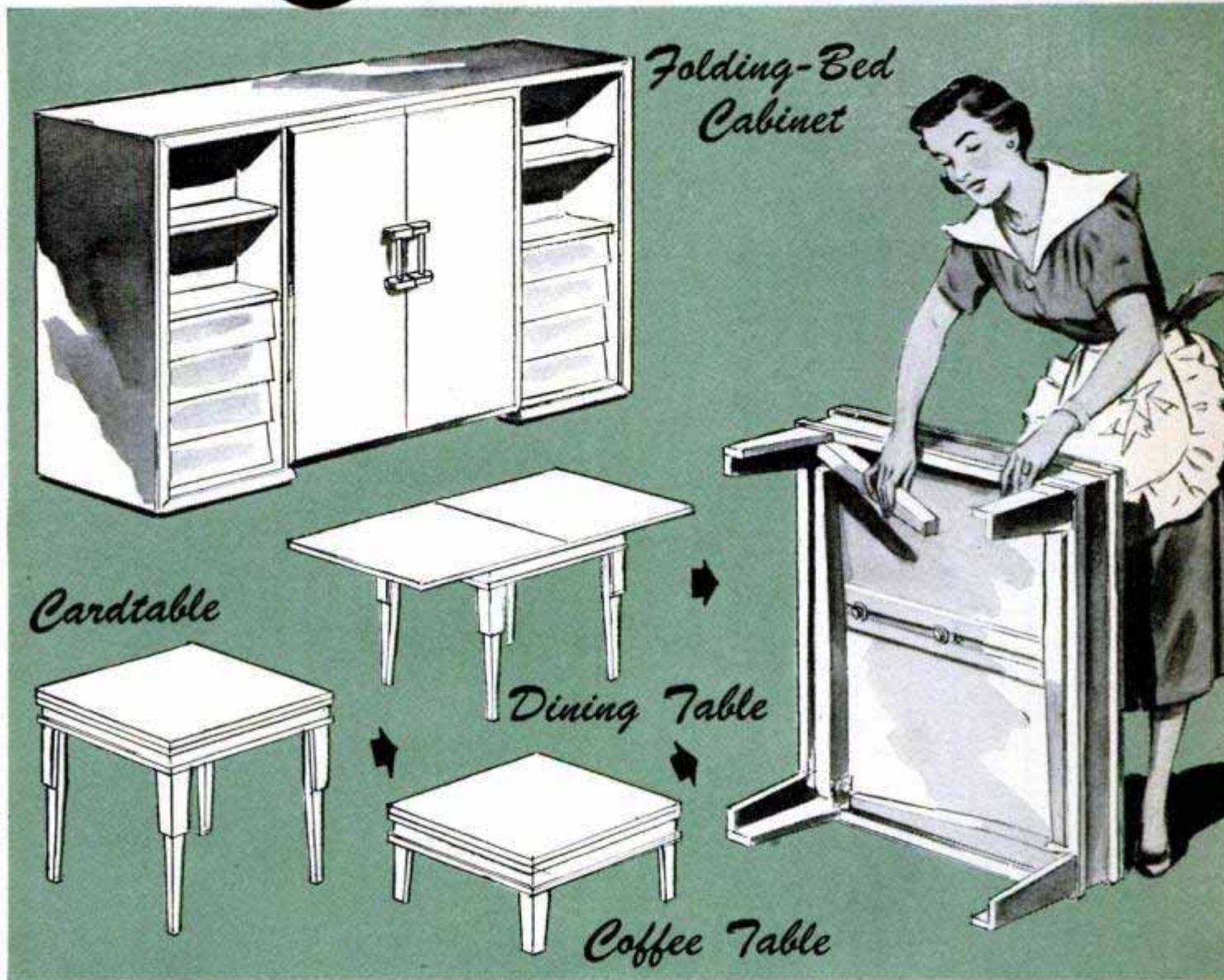


—Morris Scott Dollens, Los Angeles, Calif.

## Cans Assembled With Bolts Make Small-Parts Tray

Using four or more empty cans of a suitable size and shape, you can assemble a handy small-parts tray in a few moments. Punch holes through the sides of the cans near the top with an awl or ice pick, and then fasten the cans together with small nuts and bolts, as shown. A handle can be made by bending a length of  $\frac{1}{4}$ -in. brass rod, flattening the ends and drilling them to permit bolting them between the cans. If desired, the outside of the cans may be painted or covered with a decorative paper.





*Folding-Bed Cabinet*

*Cardtable*

*Dining Table*

*Coffee Table*

By John Bergen

## FURNITURE for MODERN LIVING

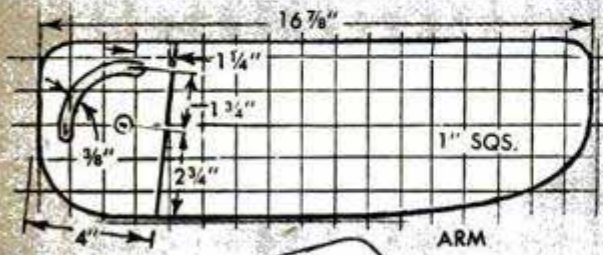
WTM '55



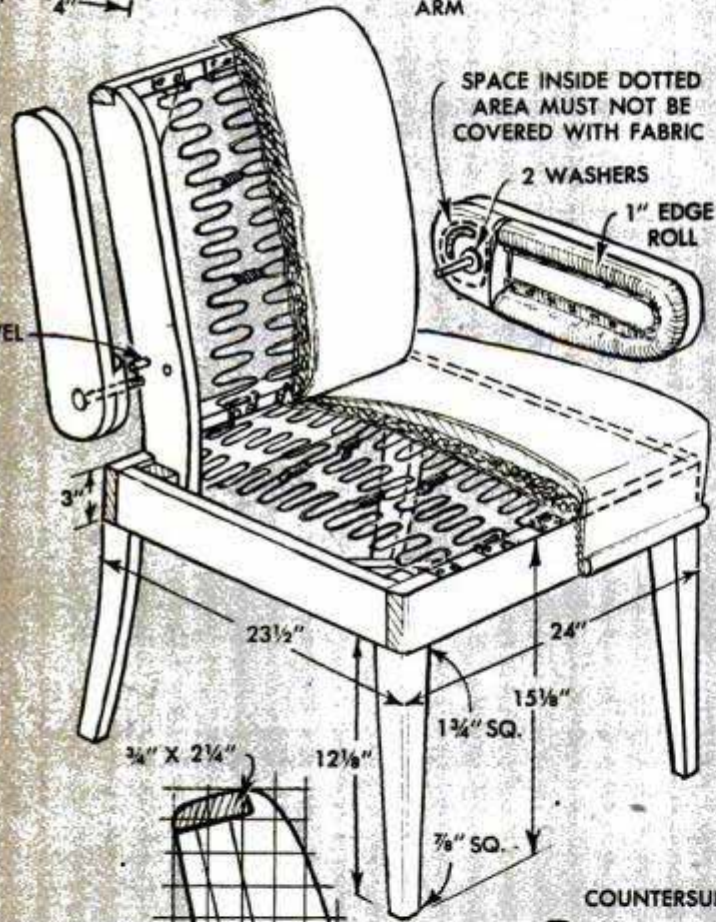
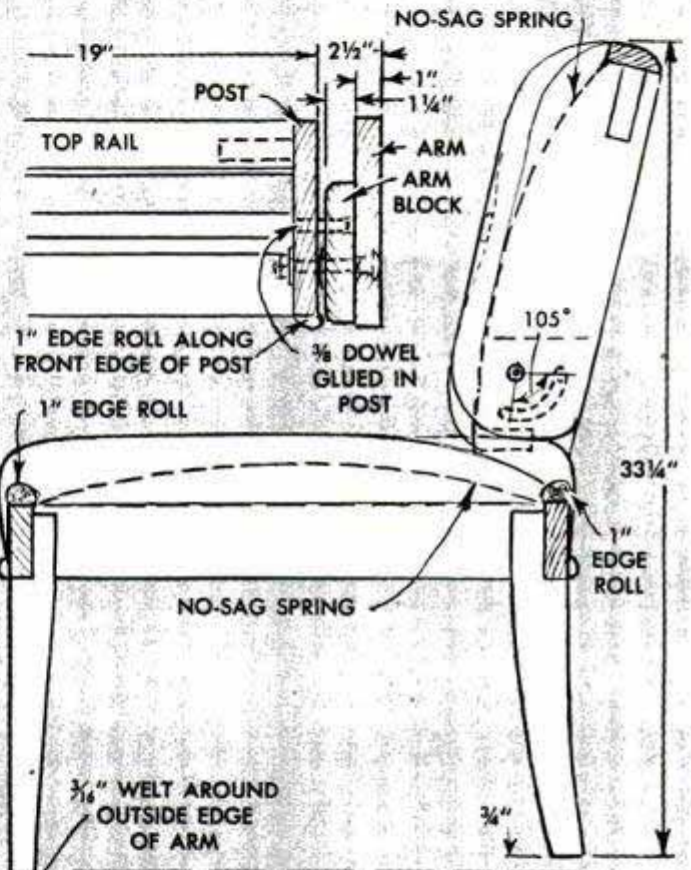
*Sectional Chair*

FURNITURE DESIGNED for modern living is keyed to simple beauty, utility and convenience. The three pieces of furniture shown on these pages achieve these aims to a high degree, and in the matter of utility, go far beyond them. For example, the sectional chair with its movable arms may be used in four ways—the left arm down, the right arm down, both arms down or both arms up—depending on how you wish to arrange your furniture. And two or three can be placed together to make a sectional piece if your room arrangement requires it.

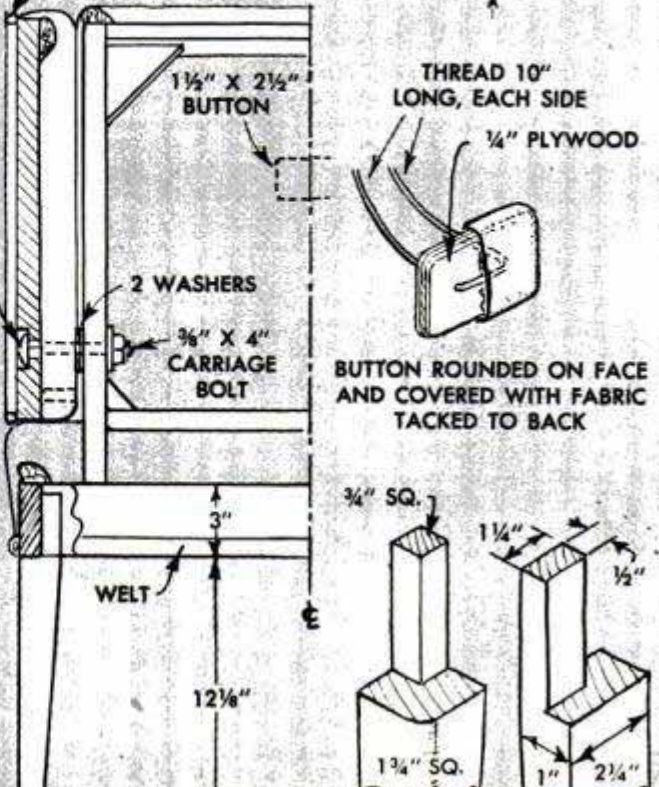
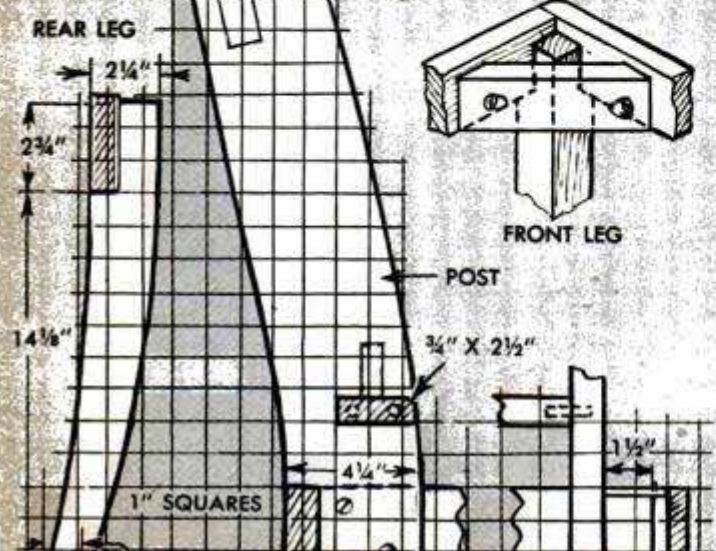
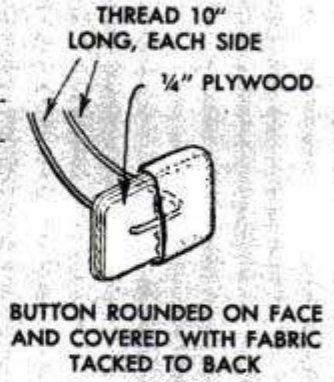
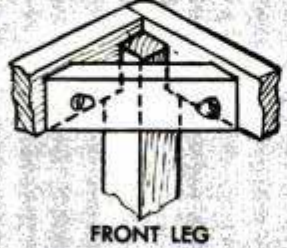
As a unit of multiple-use design, the



ARM



COUNTERSUNK







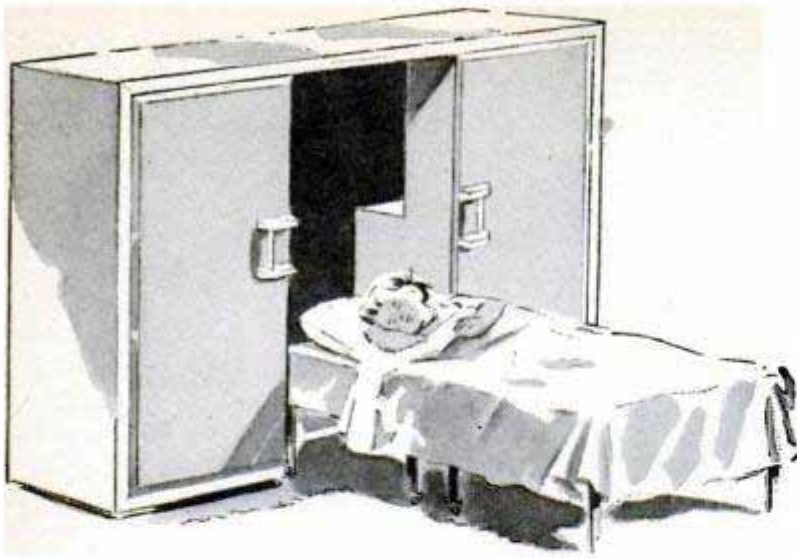
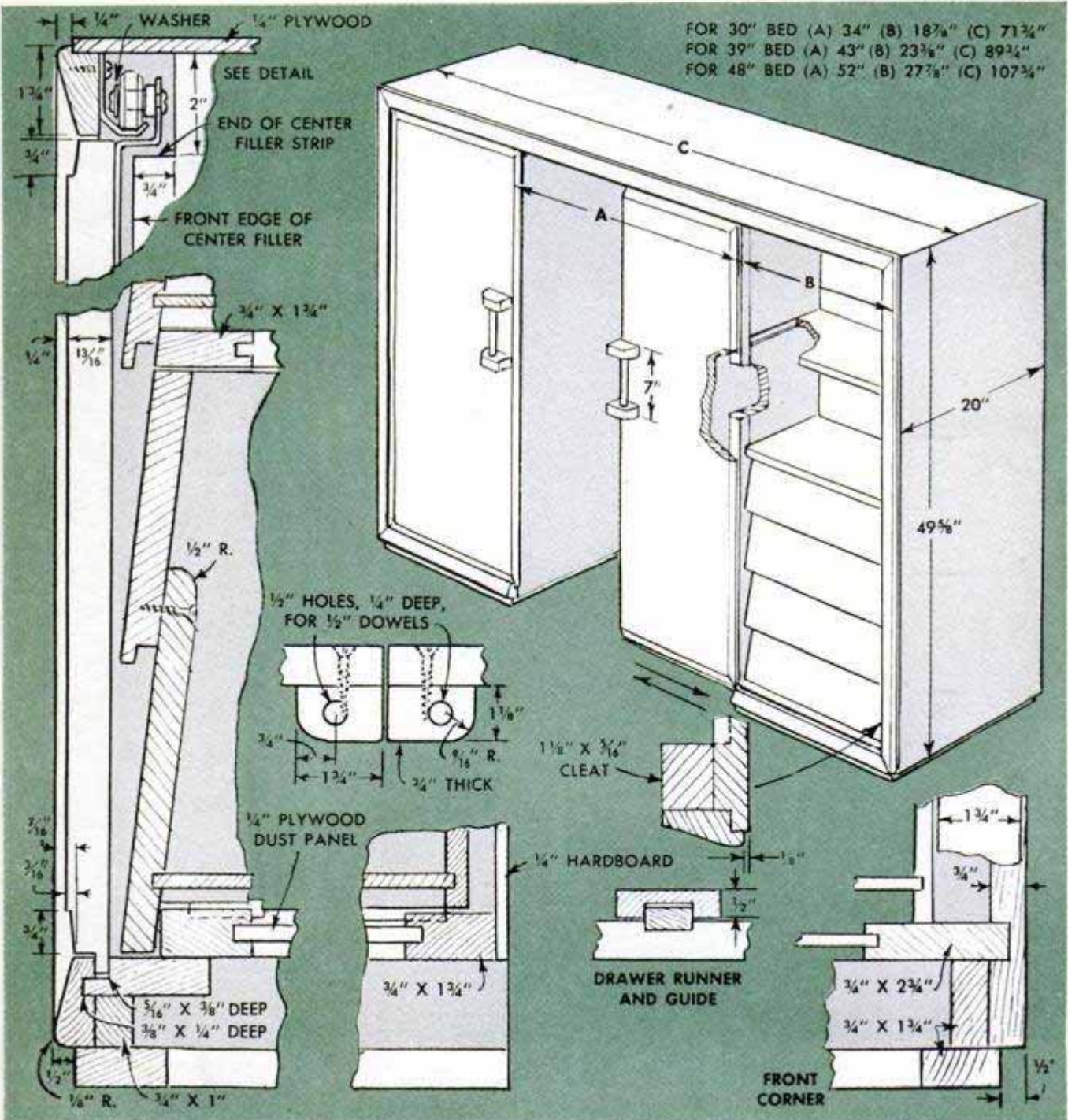


table is unsurpassed. With the legs folded, it is a low coffee table of smart appearance. When the legs are extended and one segment of the top is used, it becomes a fine utility or card table. And when the two segments of the top are spread out, it serves as a dining table. The outstanding feature of the table is the fact that through all these changes it maintains its lines of simple beauty, a rare thing in any convertible piece of furniture. The third item for modern living shown here is the folding-bed cabinet. In rooms where space is at a premium, the cabinet permits the use of a folding bed, and provides space in which to store the bed out of sight during the day. In addition, the cabinet features shelves and drawers to



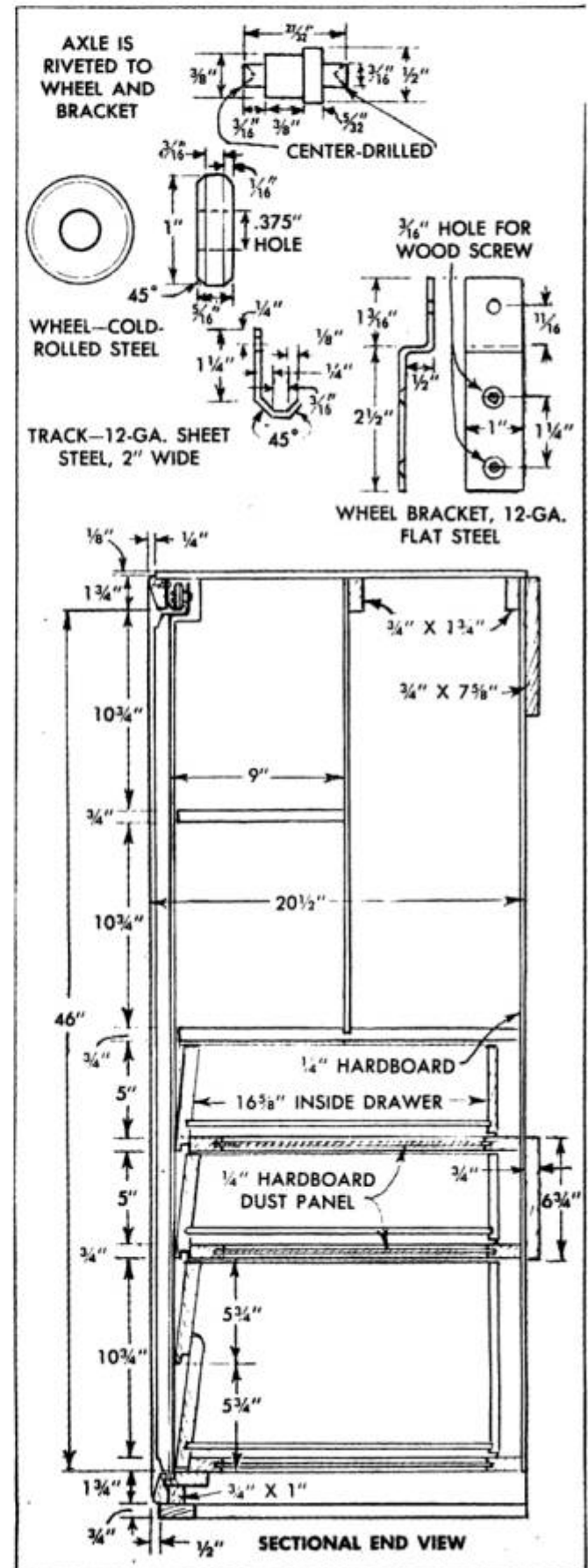
increase the available storage space in the room. All in all, it is an ideal unit for converting a small room into a much-needed bedroom.

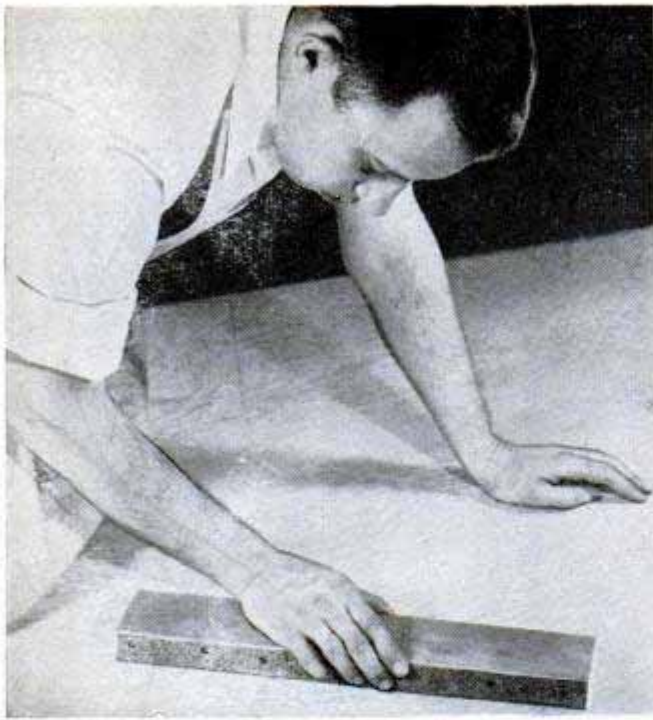
The construction of the chair is begun by assembling the frame of the seat. Then the legs are shaped as shown and attached with glue and screws. Corner braces, screwed to the inside of the seat rails, are used to give rigidity to the front legs, while the back legs are braced by the sides of the chair back. Note the 1½-in. filler block at each rear leg. After the frame is completely assembled, the arms are made, but not attached until after the chair is upholstered. Be sure to leave the fabric on the back loose until the arm is bolted in place. A dowel pin that rides in a semi-circular groove limits the movement of the arm. Now sagless-type springs are tacked in place on the frame and the upholstery work is started. The plans show those places where edge rolls are required and indicate the proper size to use. After they are in place, the springs are covered with burlap, and then a layer of curled hair is random-stitched to the burlap. A layer of cotton padding is placed over the hair, and finally the fabric which has been selected as a covering is put on. No padding is used in upholstering the side panels of the chair back, and you must be careful to see that nothing interferes with moving the arms.

Details for the construction of the table are shown on page 199. The table frame and the short legs are assembled first, then the extension legs are attached. These legs are rounded at the top and pivot on a lag screw driven through an L-shaped, strap-steel brace. To lock the extension leg in the vertical position, the spring catch mounted in it engages a hole in the short leg. To lock it in the horizontal or folded position, the spring catch engages a hole on the inside of the table rail. To permit the table to be used as a dining table, the top is fastened to a slide, as shown in the detail. The slide unit consists of two ¾ x 1¾-in. guides housed in opposite side rails with a mortise and tenon. Fitted between these is a ¾ x ¾-in. slide, 15 in. long. This slide is screwed to the bottom of the table top, large washers being used with the screws to lock the table top to the under-frame. The slide is attached to the table top on the side near the hinged edge, so that when it is shifted to the other side, the hinged portion will be in the center of the table. Thus, when the table segments are opened, no additional supports are needed.

The folding-bed cabinet is designed to accommodate a rollaway-type bed. Since these beds are generally manufactured in three sizes, the proper dimensions for a cabinet to take care of each size are given.

An unusual "siding" effect is used for the drawer fronts, to add to the attractiveness of the cabinet. The sliding doors are hung on overhead rollers, which you can make yourself from the detail, or which may be purchased. The handles for the doors are blocks with ½ x 6-in. dowels fitted between them. Cabinet plywood should be used for the exterior of the cabinet. ★ ★ ★



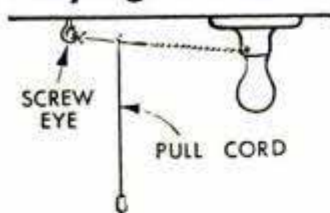


### Large Block for Sanding Panels

To simplify the sanding of large pieces of work, such as plywood panels, use a sanding block like the one shown. Cover a wooden block 4 in. wide and 18 in. long, with sheets of sandpaper, stretching the sheets firmly across the bottom surface and tacking them to the sides. Use the block with a circular motion and even pressure. To prevent uneven finishing of the surface, the block should be held at the center.

M. B. Birge, Hinsdale, Ill.

### Fraying of Pull Cord Prevented



as shown. When rigged in this fashion, the pull cord does not come in contact with any wearing surface. It also permits a direct sideward pull on the switch.

B. J. Wakeland, Davenport, Iowa.

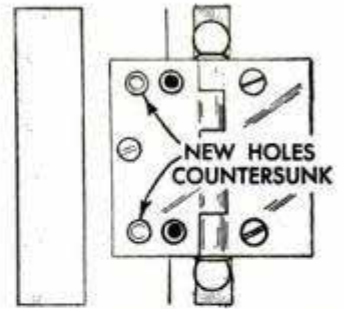
### Tumbling Toy From Capsule

A tumbling toy like those that fascinated children years ago can be made by inserting a steel ball bearing into a gelatin capsule. The capsules can be obtained from any drug store, and the ball bearing is of the type found in any roller-skate wheel. After placing the ball in the larger half of the capsule, moisten the smaller half and insert it into the larger half. The moisture softens the gelatin and causes the two halves of the capsule to stick together.

Andrew Vena, Philadelphia, Pa.

### Loose Hinges on Old Doors Fixed by Boring New Holes

Doors in an older house, where the trim is brought flush with the jamb, often have hinges fastened to the jamb so that two of the screws are located directly on the joint between the trim and the jamb. When these screws come loose, causing the hinge to wobble, a satisfactory repair can be made by drilling and countersinking two new holes through the hinge to one side of the original ones, so that these screws can be redriven into solid wood. The third screw, if it also is loose, can be replaced with a slightly larger one.



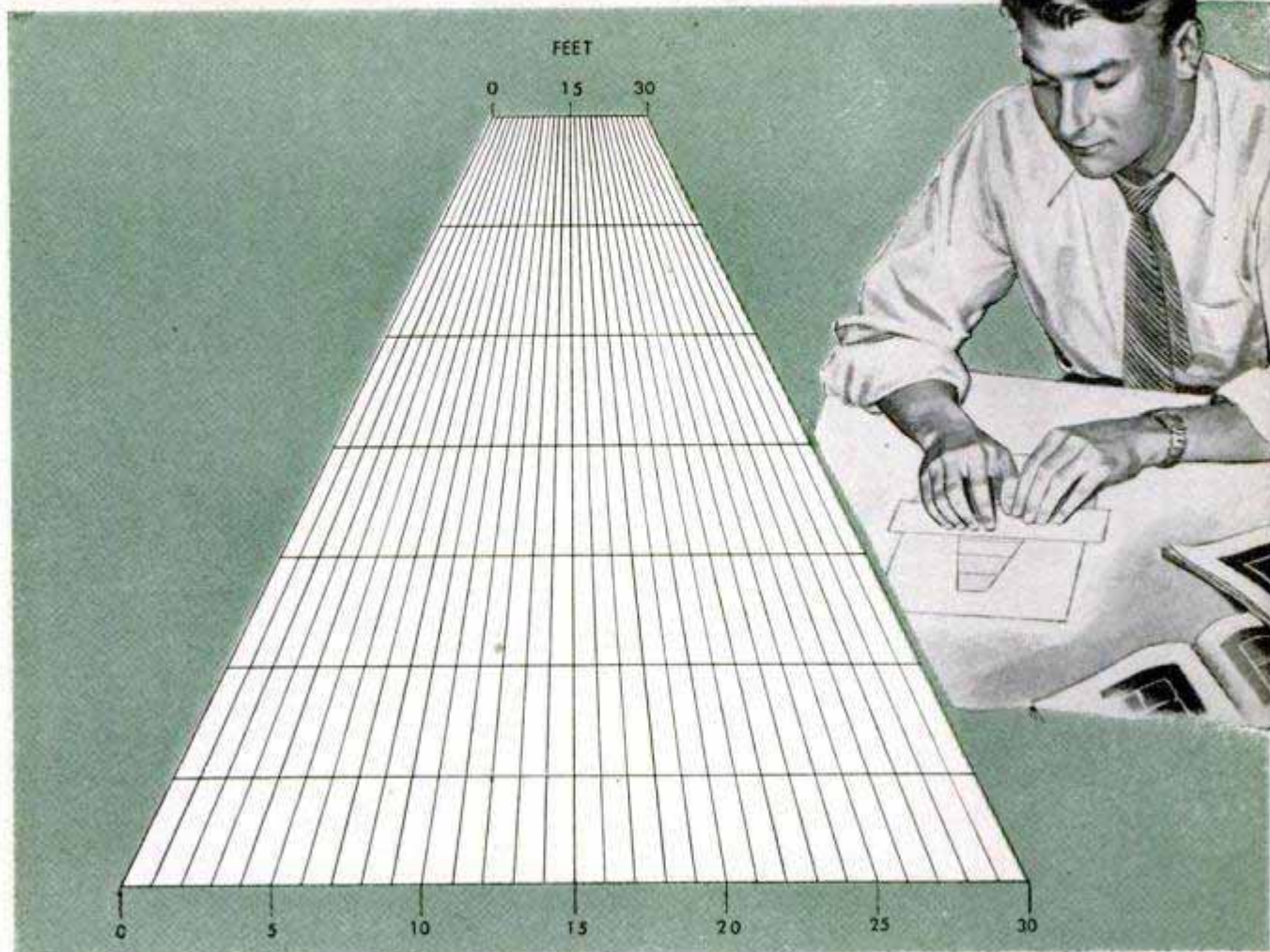
J. Howard Cooper, Philadelphia, Pa.



### Lathe Helps in Adding New Line To Deep-Sea Fishing Reel

When splicing line onto a deep-sea fishing reel, it is best to put the new line on first, after taking the old line completely off the reel. Removing the old line is easy if you use a lathe. First mount a 6 or 8-in. length of 1-in. dowel between centers and tie the end of the line to it. Set the reel for a slight drag. If a wood lathe is used, start it at its slowest speed. Hold the reel in one hand and place the other on the lathe switch, ready to cut off the power in the event of a snarl in the line. After the old line is unwound, attach the new line to it and wind it onto the dowel also. Finally, remove the dowel from the lathe and place it in a box or pail to prevent it from rolling around, and rewind the spliced line onto the reel.—Ed Widdis, La Crescenta, Calif.

# Scale Measures Floor Plans



**MOST FLOOR PLANS** that appear in magazines give the dimensions of the principal rooms, but often do not give those of halls, closets, patios and other features. With a "ruler" in the exact scale of the house, this information can be had simply by measuring directly on the magazine plan. To make such a ruler, select a given dimension on the plan, such as the length of one wall of the living room, and mark it off on a strip of paper. Let's say it is 20

ft. Locate the right-hand mark on the 20-ft. index at the bottom of the scale shown above, and then slide the strip of paper up the scale on the 20-ft. line until the left-hand mark coincides with the zero line. Now complete the ruler by making a mark on the strip where each line of the scale intersects it, each mark representing 1 ft. For measurements of less than a foot, you can interpolate on the scale.

Elmer L. Goodwin, Orlando, Fla.

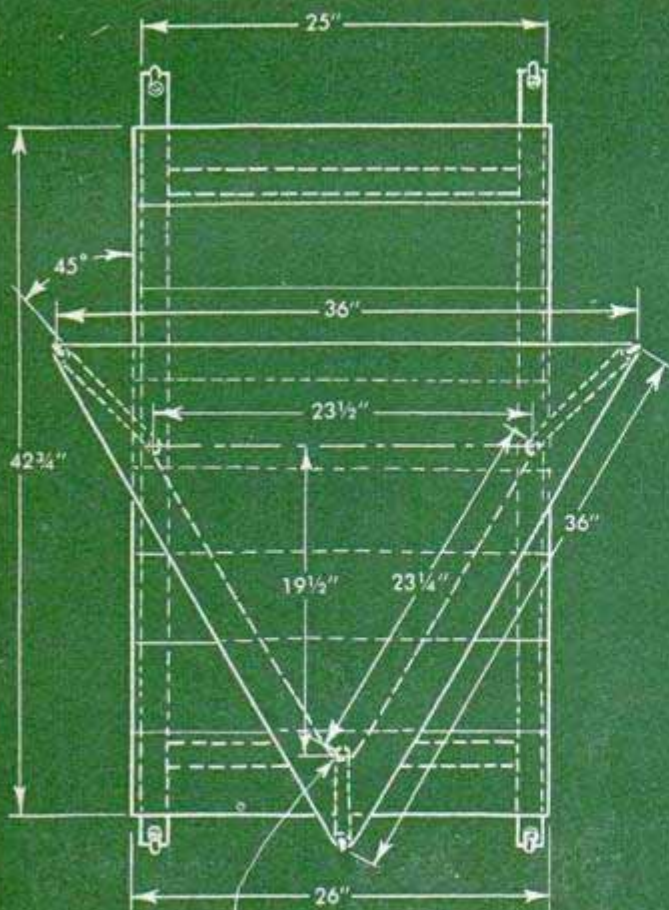
*1434 Hamlin Ave.*

## Wood-and-Felt Glue Applicator is Improvement Over Brush



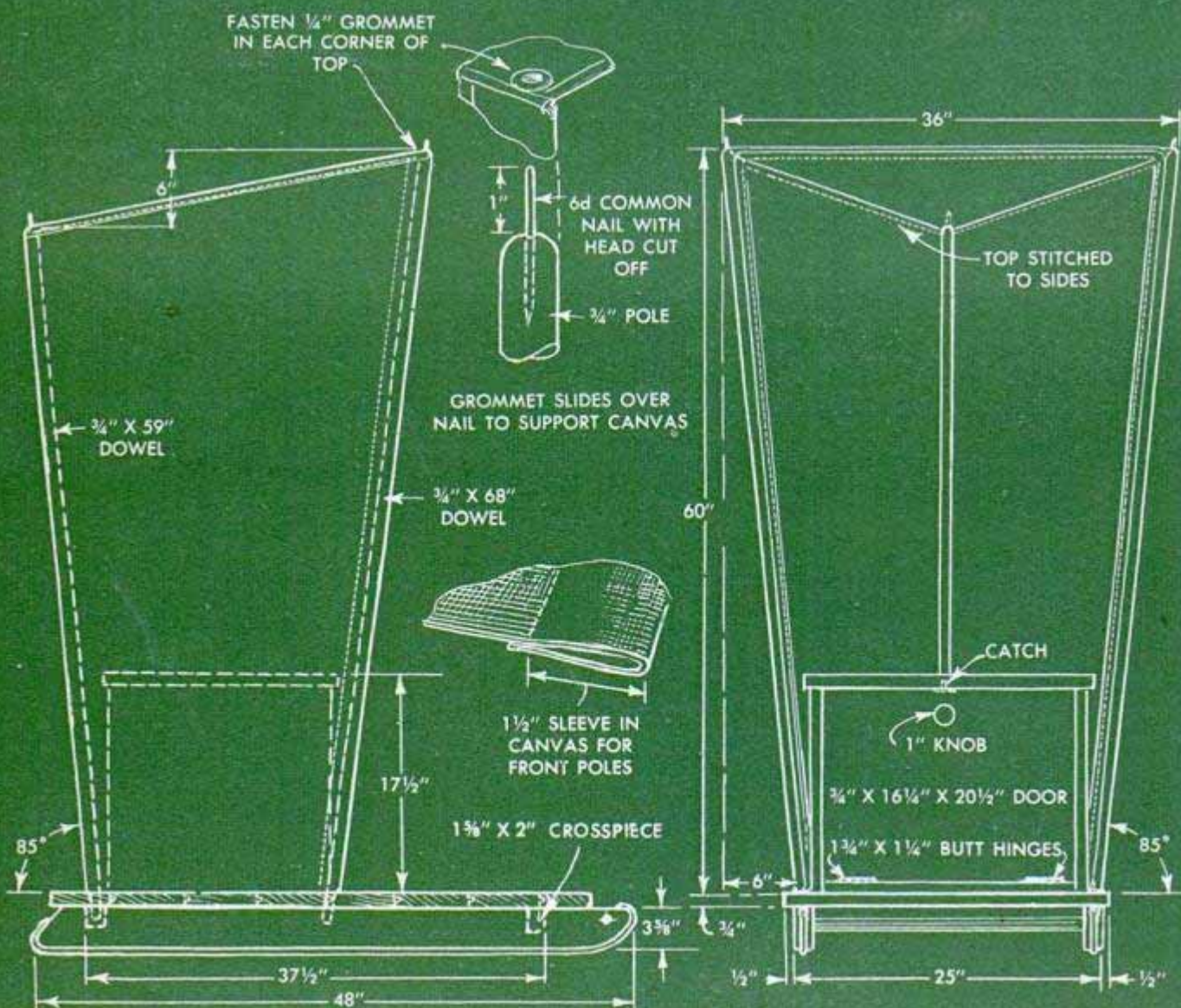
A liquid-glue applicator that deposits a thin, even film can be made by folding three or four strips of felt over the end of a thin piece of wood and binding them with a rubber band. An ordinary tongue depressor is ideal for this purpose, and strips of heavy flannel can be used if felt is not available. The applicator soaks up the glue and serves as a reservoir so that it need not be dipped frequently. Since the applicator costs so little to make, it can be discarded after use. However, if you want to save it, clean it by removing the felt and squeezing it out under running water.

# PLAN of the MONTH...



DRILL HOLES AT  
82° ANGLE, 2" DEEP

Ice-fishing enthusiasts will tell you that there is no sport in the world like it. That question may be argued, perhaps, but there is no doubt that ice fishing is a popular sport. If you're one of those who has tried it, you'll recognize the practical value of the shelter shown on these plans. And if you're a novice about to take up the sport, we would advise you to consider building this shelter. You'll appreciate the protection it affords on a wind-swept stretch of ice-bound lake. By facing the back of the hood into the wind, you can keep quite comfortable, and a gasoline lantern or small stove placed under the seat will provide some heat. The straps at the side of the sled will hold the folded canvas hood and also your fishing rods while you are traveling to and from the lake. If the winds are strong, the shelter should be anchored to a spike driven into the ice. Note that before using this shelter you should check your state conservation laws. While this design is legal in most states, you may have to alter it before using it in some areas. Some states permit no ice-fishing shelter at all.



# Ice-Fishing Shelter

## Material List

### Fir or Pine

- 2 pcs.—2" x 4" x 48"—Runners
- 1 pc.— $\frac{3}{4}$ " x  $1\frac{3}{4}$ " x 10"—Cleats
- 2 pcs.— $1\frac{5}{8}$ " x 2" x  $21\frac{1}{4}$ "—Spreaders

### Tongue-and-Groove Pine

- 1 pc.—1" x 6" x 20"—Flooring
- 1 pc.—1" x 6" x 14"—Seat sides
- 1 pc.—1" x 6" x 6"—Seat

### Hardwood

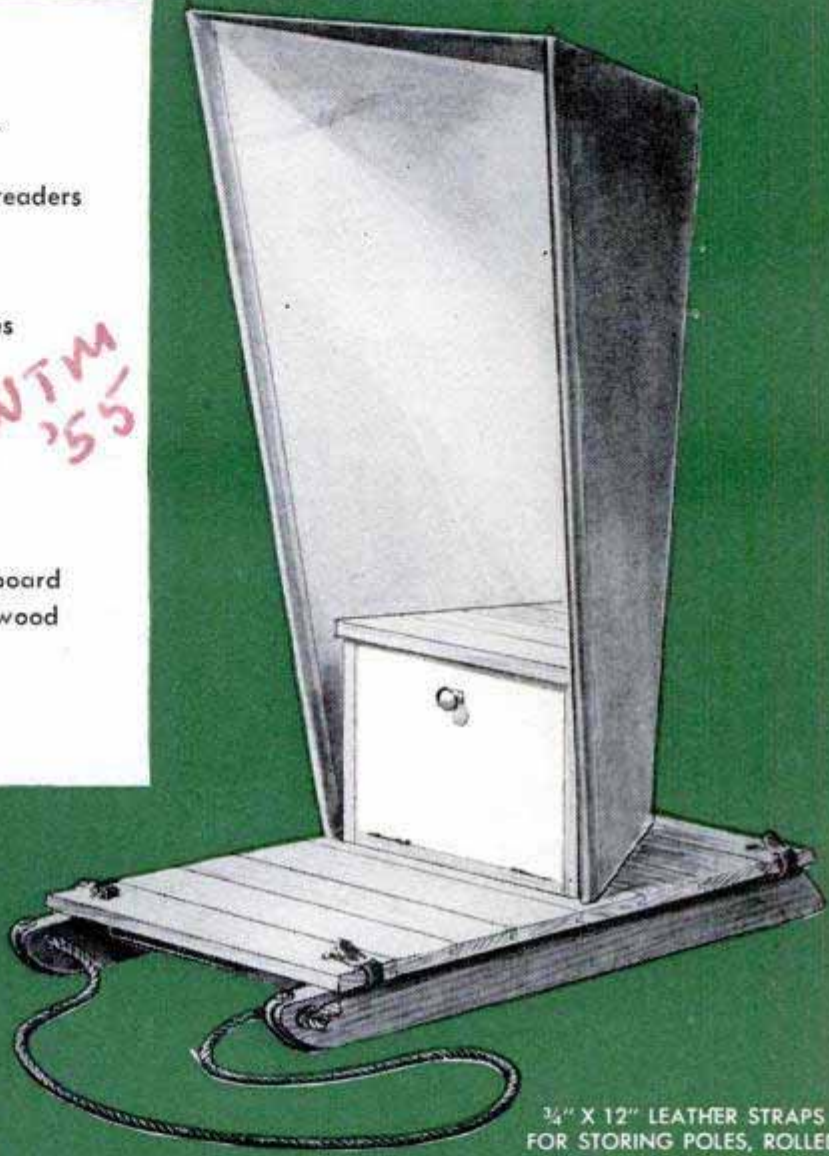
- 2 pcs.— $\frac{3}{4}$ " dia. x 68"—Poles
- 1 pc.— $\frac{3}{4}$ " dia. x 59"—Pole

### Miscellaneous

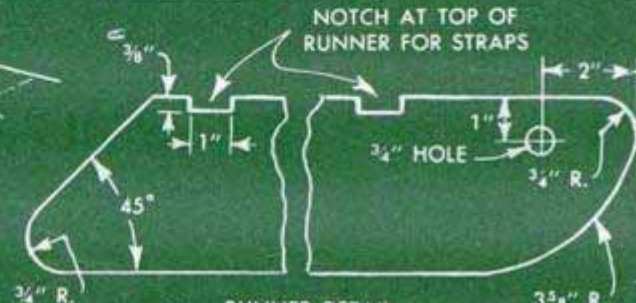
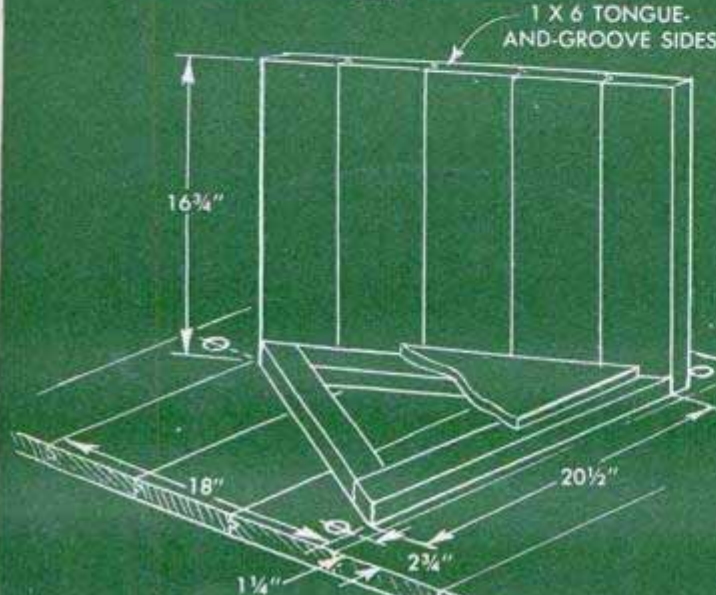
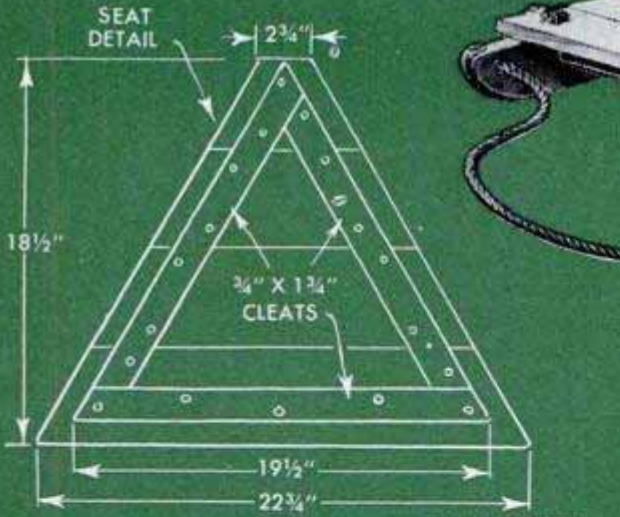
- 1 pc.— $\frac{1}{4}$ " x  $17\frac{1}{4}$ " x 20"—Hardboard
- 1 pc.— $\frac{3}{4}$ " x  $16\frac{1}{4}$ " x  $20\frac{1}{2}$ " Plywood
- 2— $\frac{1}{2}$ " dia. x 5' Steel runners
- 4— $\frac{3}{4}$ " x 12" Leather straps
- 6 yd.—27" wide canvas

WTM  
55

W  
T.  
M.  
55



$\frac{3}{4}$ " X 12" LEATHER STRAPS FOR STORING POLES, ROLLED HOOD AND FISHING RODS





### Grooved Block Holds Plywood For Easier Sawing

When cutting a sheet of plywood with a handsaw, you can prevent vibration and pinching of the saw by holding the plywood with a grooved block. After starting the saw cut, slip the block over the edge of the plywood, as pictured, so the groove engages the sections of the panel on both sides of the cut. To be most effective, the groove should be a snug fit over the plywood and at least  $\frac{1}{2}$  in. deep.

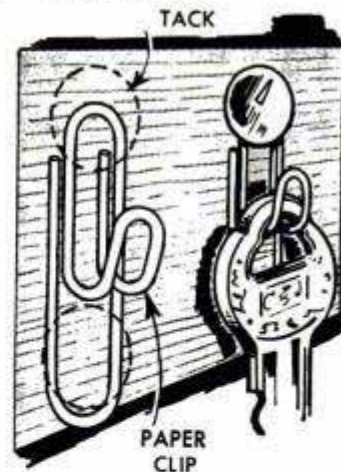
### Wax Kept in Glove Compartment Permits Polishing of Trim

While you're waiting in the parked car for your wife to return from shopping, polish the interior trim. This is a worth-while way to kill time while waiting, as keeping a coat of wax on the instrument panel, door handles and window trim will not only preserve the finish but make dusting the interior considerably easier. So you'll be able to polish the trim whenever the opportunity presents itself, keep a shoe-polish can filled with wax in the glove compartment. A small pad of cheesecloth is stored in the can as an applicator and a soft polishing cloth may be wrapped around the can.—W. H. McClay, Pasadena, Calif.



### Hang Keys on Handy Hook

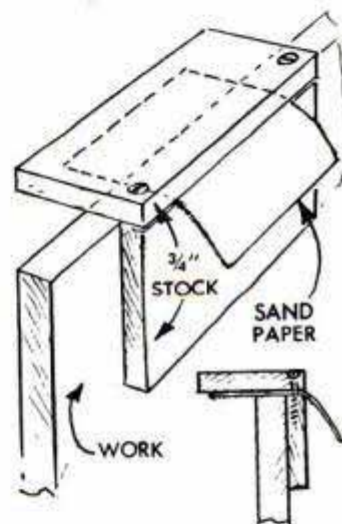
A light wall hook for keys and other small objects can be made by bending a paper clip as shown in the detail. The bend may be made easily if a needle-nosed pliers is used. The hook then is attached to the wall with two thumbtacks. An excellent key-storage board can be made by fastening a number of these hooks on a panel, which is then hung in a convenient place.



Frank Shore, New York City.

### Jig to Sand Edges Square

Sanding the edges of boards so they remain true and square is easy if you use this sanding jig. It consists of two boards screwed together at right angles, with a piece of sandpaper clamped in place at the joint. To change the sandpaper sheet, simply loosen the screws slightly,

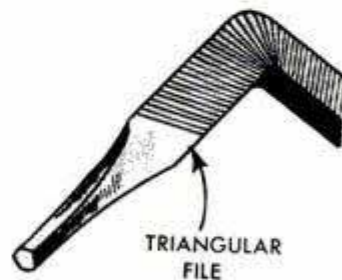


pull out the old paper and feed in a new sheet. In making the jig, care should be taken to see that the two boards used are exactly at right angles to each other.

Marvin Reid Hartley, San Diego, Calif.

### Emergency Socket-Head Wrench From Three-Cornered File

An emergency socket-head wrench can be made quickly from the tang of an old three-cornered file. As the hex-shaped tang tapers, it is first cut



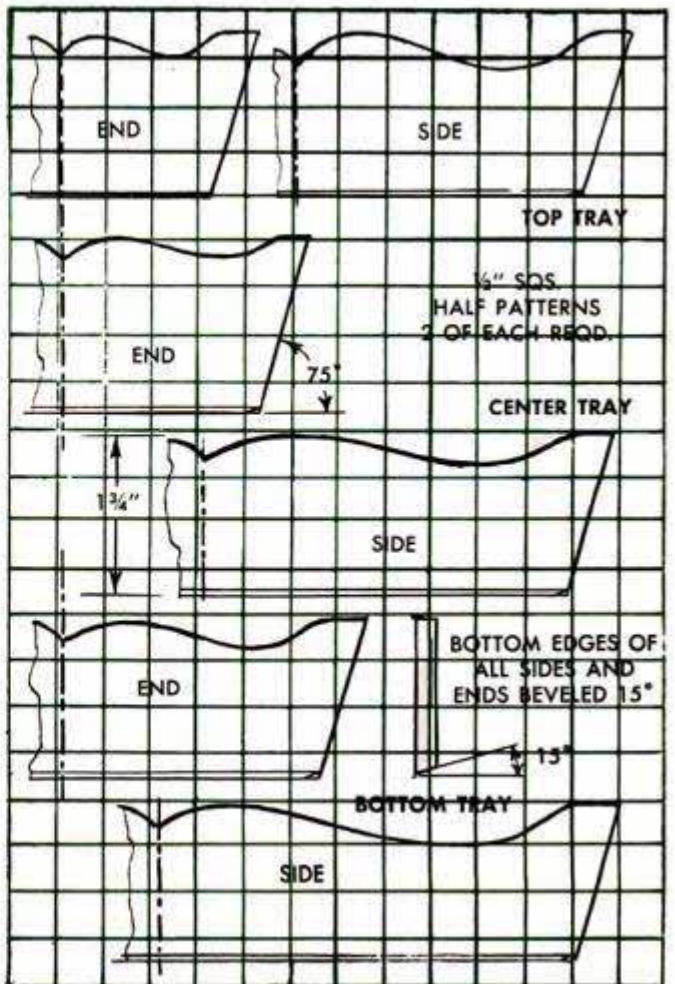
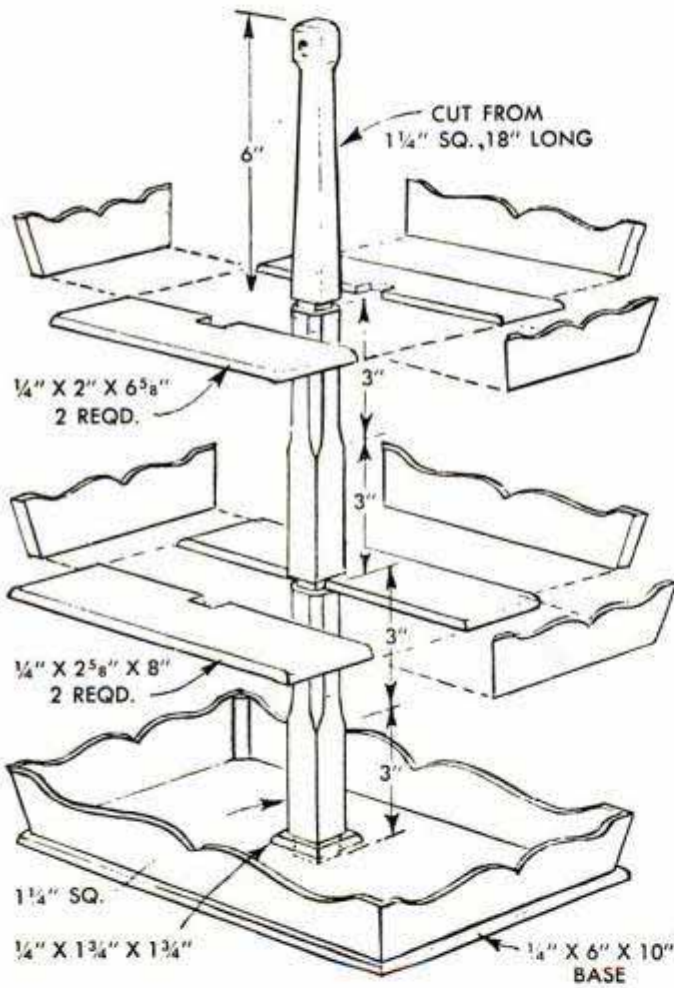
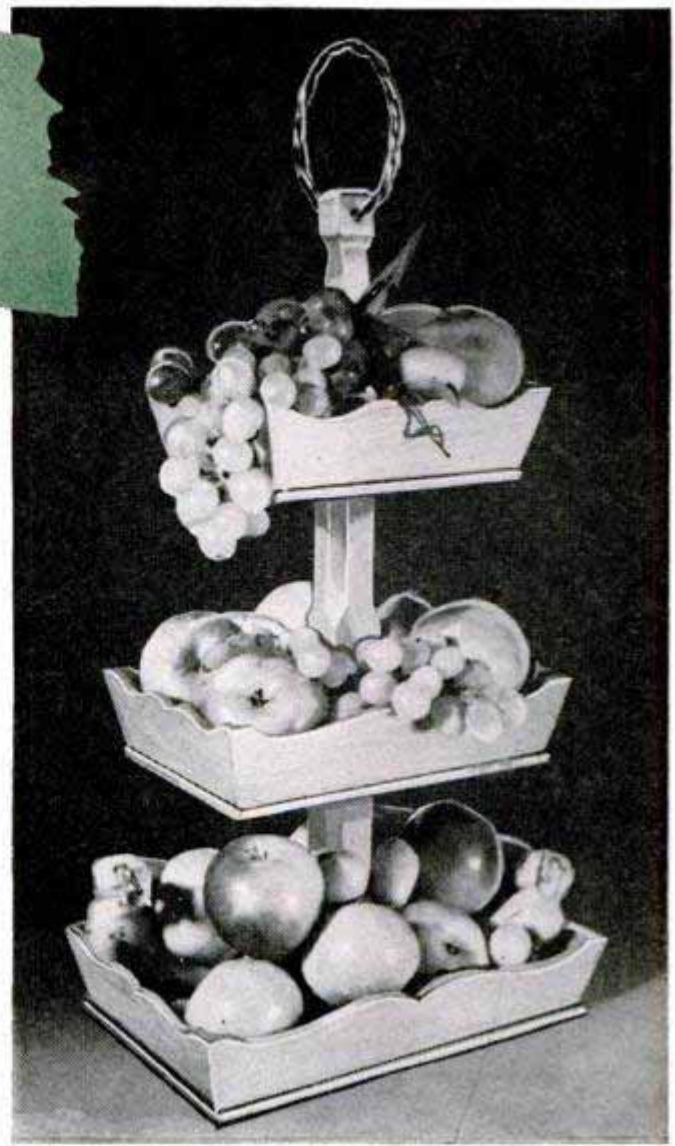
off at the point which will provide a wrench of the proper diameter. Then the file is heated red-hot and bent into an L-shaped handle, as shown. To restore the temper to the file, reheat to a cherry-red and then quench it in cold water.



# 3-TIERED SNACK TRAY

By Bertram Brownold

This attractive tray for fruit, candy, cookies or flowers stands 18 in. high and serves as an interesting table centerpiece. The standard is of 1¼-in.-sq. stock and each tray is of ¼-in. plywood or solid stock. Sides and ends are cut according to the squared pattern. Note that standard is tenoned at the lower end and grooved at 6-in. intervals to take notched tray bottoms. Tray side and end pieces are beveled along the lower edges and the corner joints are mitered. Ring handle is made of twisted wire

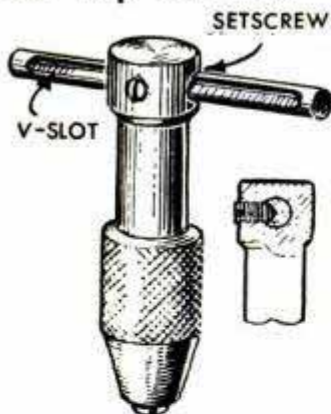


## Oarlocks Inserted in Sawhorse Hold Pipe for Cutting



Workmen who find it necessary to cut lengths of pipe, drapery poles and other similar round stock, will find that a pair of open oarlocks mounted on a sawhorse can be used as an effective cradle to hold the pieces for cutting. The oarlocks are inserted in holes drilled in the top of the sawhorse, and can be removed quickly when desired.

## Setscrew Holds Handle Of Tap Wrench



To prevent the handle of my tap wrench from sliding to one side while in use, I milled a slot in it, then drilled a hole in the side of the wrench and tapped the hole to receive a setscrew. Tightening the setscrew in the slot holds

the T-handle in any desired position and increases the efficiency of the wrench considerably.—R. M. Woodbury, Natick, Mass.

## Cutting Small Rods Squarely

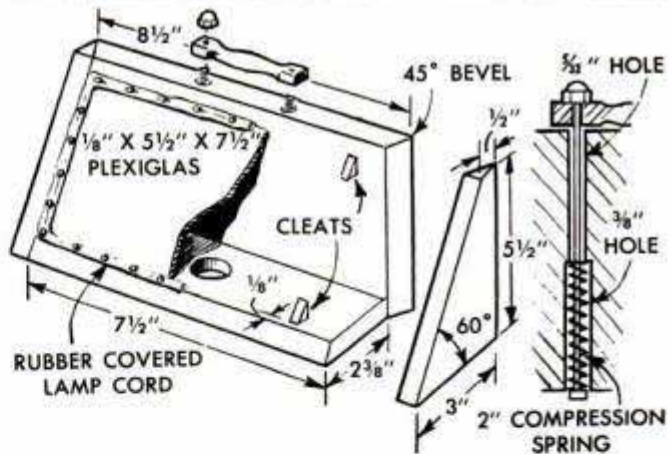
One craftsman finds that his drill press simplifies the job of cutting pipe and small rods squarely with a hacksaw. One end of the work is chucked in the drill press, with the other end extending down through the drill-press table. The drill press is then belted for low-speed operation and the hacksaw laid flat on the table. After start-

ing the drill press, the hacksaw is held against the rod or pipe with just enough pressure to keep the teeth cutting.

John A. Comstock, Wellsboro, Pa.

## Photograph Mounted on Plastic Decorates Novel Doorstop

Using sand for weight, this decorative doorstop is easy to handle. The detail gives all necessary dimensions for its construction. Either hardwood, such as walnut or mahogany, or softwood stained to simulate hardwood, can be used. The handle is spring-loaded, so that it is out of the way when not needed. The photograph mounted under the Plexiglas should be an enlargement on single-weight paper. First, it is soaked in water until limp, and then dipped in gelatin well dissolved in water and having the consistency of cream. It is then



placed face down on the Plexiglas and squeegeed until all the bubbles are out. Very heavy weights are placed on it until it is dry. Rubber-covered lamp cord, available in a number of colors, is used as a molding to hold the Plexiglas in place after it is mounted in the doorstop. After the doorstop is completely assembled, it is filled with sand through the hole in the bottom, which is then plugged and sealed.—Theodore K. Hastings, Los Angeles, Calif.

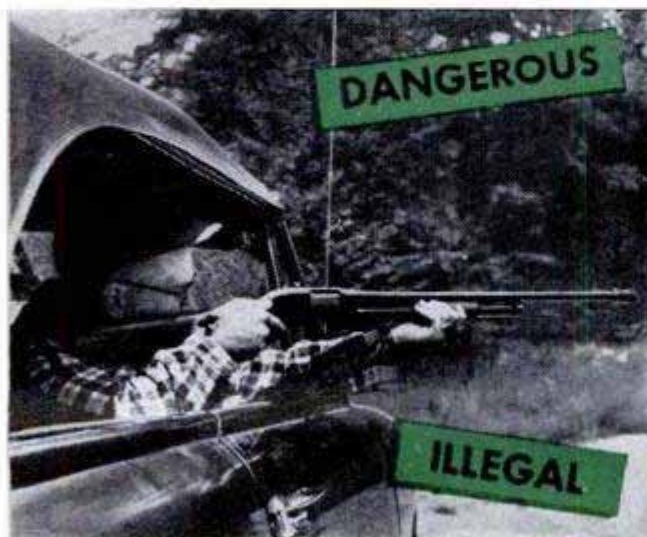
After some use, a setscrew threaded into hardwood will begin to loosen in its hole. One or two coats of shellac applied to the threads when this happens will give the screw a snug fit once again.

*Bring*  
**YOURSELF**  
*Back Alive*

**T**HIS FALL, the National Safety Council predicts, hundreds of hunters will "bite the dust" along with their furred and feathered friends. Many of these hunters will rise again with only minor wounds, but others will not be so fortunate. The photographs on these pages, prepared with the cooperation of the New York State Conservation Department, illustrate what to do and what not to do, depending on whether or not you want to return home. In addition to the "do's" and "don'ts" shown in the photos, here are a few important rules to keep in mind. Never look down the barrel of your gun. Don't go hunting in cowboy-type boots having high heels, as you are likely to trip. Don't stick a gun barrel in the snow—it might explode the next time you fire it—and don't move around in a boat while carrying a loaded gun. Playing with the hunting dogs while you're holding a loaded gun, also is dangerous. Never climb a tree with a loaded gun—chances of accidentally discharging the gun are excellent. Finally, remember that gunpowder and alcohol don't mix. ★ ★ ★

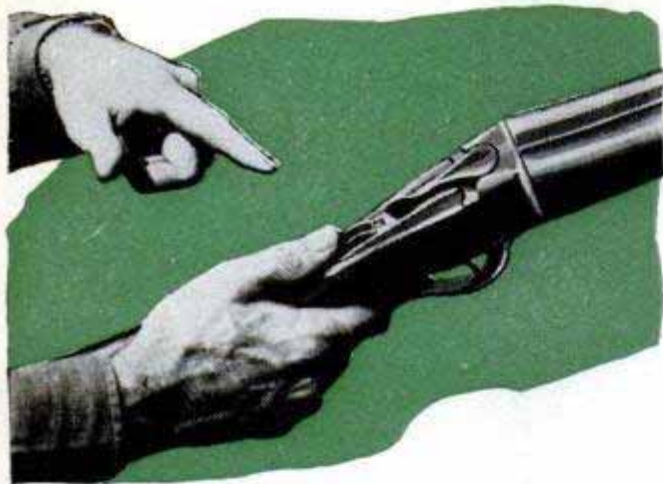
Guns make comfortable but unsafe leaning posts. The pose in the picture at the right will keep dust out of the barrel, but may put holes in the hunter

Shooting from a car is not only unlawful in most states, but also unsportsmanlike and very dangerous. Anyone walking near the road is in jeopardy





*You'll get home*



Left, the safety catch is put on a gun to prevent accidents. Use it. Upper left, when another hunter approaches, it is wise to break open gun as an extra safety factor. Above, game warden advises hunter to keep his finger off the trigger until he is ready to fire—and also tells him never to point the gun at any living thing unless he intends to shoot

Lower left, don't put a loaded gun into a car at any time. And even if you think the gun is unloaded, don't point it at yourself as this Nimrod is doing. The reason should be obvious. Below, this man is using his gun as a lever to pry up some logs. Used in this fashion, gun is excellent lever for lifting yourself into eternity. Best advice is, don't



*It's doubtful*





*like this*

Here is a wise hunter who intends to be around when the seasons open for years to come. Before getting into his car he breaks gun and unloads it. Then he can be sure that the jolting of the road won't cause the gun to fire unexpectedly—and he knows that if the trigger should catch on some of the equipment in the back seat, no one will get hurt

The question raised in the photo below seems to be, which of these two hunters will last the longest. Each has his gun pointed at the other. After examining the picture, we're betting that the man in the checkered shirt will be the first to go. His friend is doing some interesting calisthenics with his gun that are practically guaranteed to kill somebody



It has been said that more hunters are shot climbing fences than at any other time. The man above will be around to get his limit today because he knows how to climb a fence. First he breaks and unloads his gun, then pushes it under the fence. Then he climbs the fence. This method takes a little longer but saves wear and tear on the hunter

"Look, Ma, no hands." And the man at the left in this picture will soon be saying, "No head, either." Climbing shaky fences and stone piles with a loaded gun is an invitation to disaster. If you slip, you may clutch the trigger or drop the gun. Hunting deaths may be called accidental, but such fatal accidents don't happen if the hunter uses his head

*this way!*



## Decorative Kitchen Wall Light Made From Spoon and Bowl



A different and attractive wall light to decorate a bare wall or dark corner of a kitchen, can be made from a wooden salad bowl, a wooden salad spoon and an ordinary light socket. A  $\frac{1}{8}$ -in. pipe nipple is threaded into the light socket, and this assembly is inserted in a hole drilled through the side of the bowl, as shown. The nipple should be a tight fit in this hole. Place a 15 or 25-watt bulb in the socket, and then attach the spoon to the edge of the bowl with a screw, positioning it so the bowl shields the light bulb.

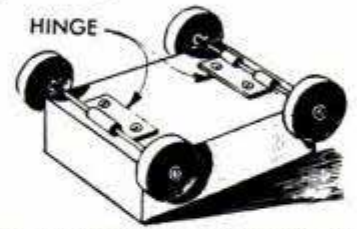
## Buzzing in Electric Clocks Caused by Oil Lack

When an old electric clock develops a buzzing or grinding sound, it usually indicates lack of oil. Repairmen customarily replace the motor when this happens, which is expensive. A less expensive way to restore the clock is to oil the motor. Remove the back of the clock and drill an oilhole in the motor case near the magnet pieces that surround the armature. The hole should be in the top half of the case to make a spill-proof reservoir, using a  $\frac{1}{8}$ -in. drill. Drill slowly to make sure you don't cut into the rotor. When the drill is about to break through the wall of the case, use an awl or ice pick to open the bottom of the hole. Pour mineral oil or fine gun oil into the hole. Pry the rotor back and forth with the pick to work in the oil. Plug in the clock and continue to work the oil into the hole, now using a toothpick to lessen the shock danger. The clock should be tipped to various positions to permit the oil to work into

the bearings. Finally, the hole is covered with waterproof adhesive or masking tape to keep out dust and to retard evaporation of the oil.—Dean Rossiter, Riverside, Calif.

## Hinge Leaves Provide Bearings For Axles of Toy Wagon

The next time you are looking for a simple way to attach the axles to a toy wagon, take a loose-pin hinge apart and use the leaves as shown here. Where it is desired to pivot the axle, blocks are added under both axles and a washer is placed between the front block and the body to permit the axle to pivot freely.



## House-Plant Watering Can

A watering can for house plants that enables you to control the amount of water applied to them and, at the same time, prevent spilling, is made by removing the bottom of a pressurized whipped-cream dispenser. In use, the dispenser is turned upside down and filled with water. A slight pressure on the nozzle of the can allows a small quantity of water to flow onto the plants.—George E. Bilhorn, Jr., Chicago.



During rainy weather a large desk blotter placed inside the front door provides an excellent mat for drying wet galoshes and rubbers.

# It's No Trick to Install a Full-Length Door Mirror

632 Duquesne Way  
Pittsburgh Pa.



Photos courtesy Pittsburgh Plate Glass Co.

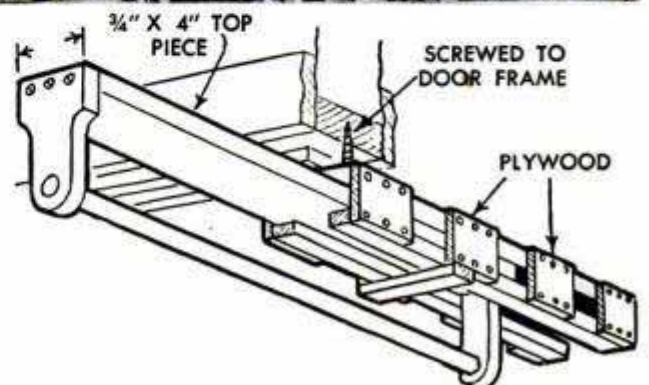
A full-length mirror in the bedroom or hall of any home is a real convenience. To many homeowners the job of mounting such a mirror on a door may seem a formidable one, yet it actually is a fairly simple undertaking. The easiest method is to attach the mirror to the door by means of special plastic clips. The door is taken

down and a mirror slightly larger than the panels of the door is positioned on it. Then the clips are placed; two at the top, two at the bottom and several along the sides. After the clips are in place, the door is rehung and the job is finished. To make it even easier for the homeowner, complete packaged units are now on the market.

## Sliding Rack in Deep Closets Provides More Storage Space

Utilizing all of the space in a deep closet, this sliding rack often will double available storage space. The "track" for the sliding section consists of a top piece of  $\frac{3}{4}$ -in. plywood, 4 in. wide, two slides, 1 in. wide and sidepieces of  $\frac{1}{4}$ -in. plywood. The sliding section is made of a board  $3\frac{7}{8}$  in. wide, two endpieces and a pipe or dowel clothes pole. The front endpiece is shaped as shown to clear the slides.

Clinton R. Hull, Costa Mesa, Calif.



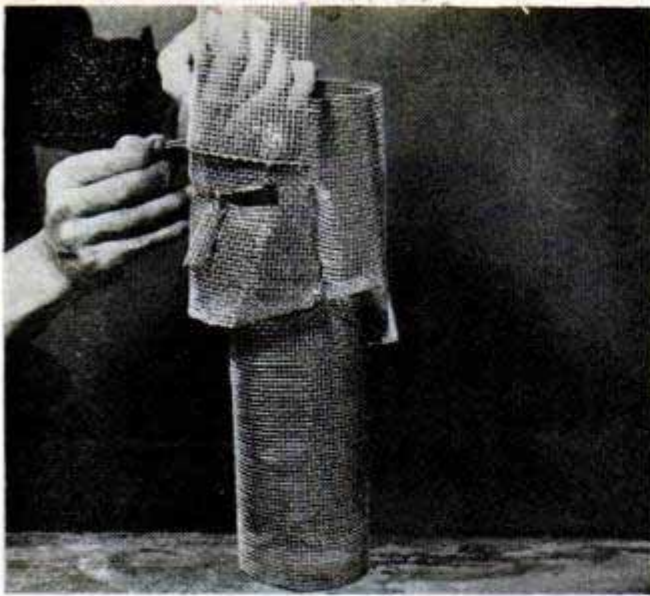
## Plug Valve Drainage Holes

One automobile mechanic saves time and trouble on valve grinding jobs by keeping an assortment of bottle corks at hand. Where the valve-chamber drainage openings are round holes, these corks are used to plug the holes before valve-spring washer locks are removed and replaced.

H. W. Swope, Danville, Pa.

# Working With PLASTIC METAL

By Theodosia Carpenter



Large sculptures can be made by applying the plastic metal over a hollow-core armature made of screen wire. Basic shape is formed by cutting the screen wire to shape and tying it together with fine wire



After the armature is completed, the joints are dabbed with the plastic metal. When this has dried, the entire form is given a coating of the metal,  $\frac{1}{8}$ -in. thick. This should then dry for several days



**A** PLASTIC METAL that can be thinned to a liquid, and yet hardens into real aluminum, is the latest product in the craft and hobby field. The uses of this metal are almost endless. When taken from the can, the material has the consistency of putty. It can be thinned for spraying or brushing, or it can be used as a putty for other types of work, such as sculpturing. Once it has hardened, the metal won't rust, can be sawed, carved or machined, and will not chip, crack, expand or shrink.

Sculpturing with this new product is done by applying the plastic metal to a hollow-cored armature (form) made of screen wire. Since you have a metal statue as soon as the last layer dries, the usual method of carving in clay, then casting in plaster and finally casting in metal is simplified. Another effective use of plastic metal is inlaying designs in wood. The desired design is traced on the wood, and then a groove is routed out along the traced lines. The groove is then filled with the plastic metal. The metal and wood are sanded at the same time when the metal has dried, and the result is a very attractive inlay.

Plaster statues can be made to look like metal castings by brushing on several

Features such as nose and mouth are built up in  $\frac{1}{8}$ -in. layers, each layer being allowed to harden. Smooth surfaces, such as the face, are sanded and the piece is burnished with steel wool for luster







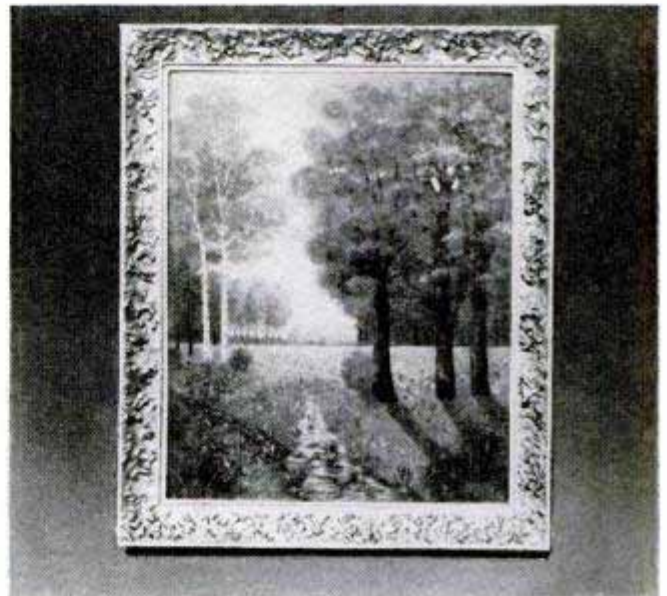
Metalizing baby shoes with the plastic metal is easy. The shoes are filled with plaster and allowed to dry. Then several layers of the plastic metal are brushed on. After drying, shoes are burnished

coats. It can be brushed or sprayed on materials such as canvas, cardboard, paper and leather to achieve a true metal finish. And it can be used to make metal trim for models of all kinds. Metalizing baby shoes and other mementoes of childhood with the plastic metal is easy. The surfaces of the baby shoes are cleaned, and then the shoes are filled with plaster. They should be allowed to dry for several days after the plaster has hardened. Then several layers of the metal are brushed on. When dried, the shoes are burnished and then mounted in book ends or used as desk ornaments. Plain wooden picture frames, with the metal applied at random with a putty knife, can be made to look like hand-tooled and burnished antique-silver frames. ★ ★ ★

To make this inlaid metal design, the pattern was first traced on the wood, and then routed out. The groove was filled with the plastic metal, and then the metal and wood were sanded to a smooth finish



Plaster statues, such as above, can be given several coats of the plastic metal for a beautiful finish. Below, a wooden picture frame with the metal applied at random looks like antique silver



Metal overlays are easy with the plastic metal. A mixture of metal, 1 part, and thinner, 1 part, is brushed over the lines of the design until they have been built up as high above surface as desired



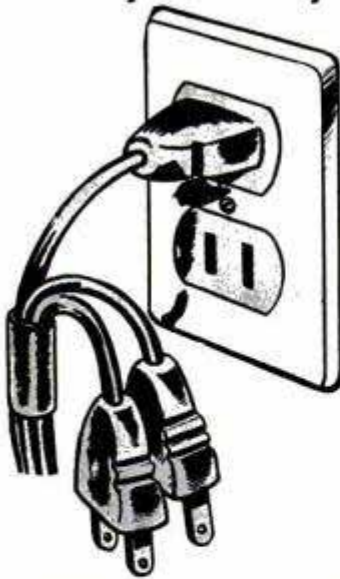
## Pouring Spout for Paint Can Soldered to Lid



If you find that pouring paint from a can is a messy job, use a lid fitted with a pouring spout. To prepare the lid, which may be switched from one can to another, simply cut off the tail end of a cheap funnel and solder it over a hole cut in the lid near one side. Punch a vent hole on the opposite side. When using the lid, be sure it is pressed tightly in place, and clean it after each use.

William B. Eagan, Louisville, Ky.

## Notches Filed in Electric Plugs Identify Cords by Touch



When several electrical plugs are grouped together for independent attachment to one wall outlet, the selection of the proper cord can be simplified by filing notches in the sides of the plugs. As each plug has a different number of notches, it is possible to identify the plugs by touch. This idea would be particularly

useful to a photographer, enabling him to select plugs easily in the darkroom without turning on a light.

## Removing Stains From Old China

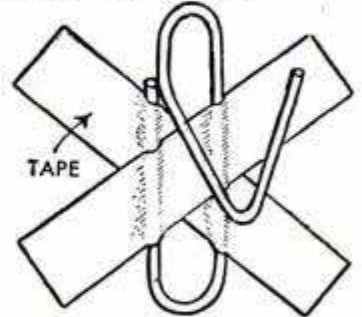
Old pieces of china very often are spoiled in appearance by the presence of coffee stains in the hairline cracks of the glaze. To

remove these blemishes, make a paste of baking soda and apply to the stained areas. After letting it stand for about an hour, wash the pieces with soap and warm water. In cases of severe discoloration, this treatment may have to be repeated two or three times.—John Devlin, Merrick, N. Y.

## Picture Hanger Without Nails

Taping a paper clip, bent as shown, to the wall provides a hanger strong enough to support most small pictures without the use of nails.

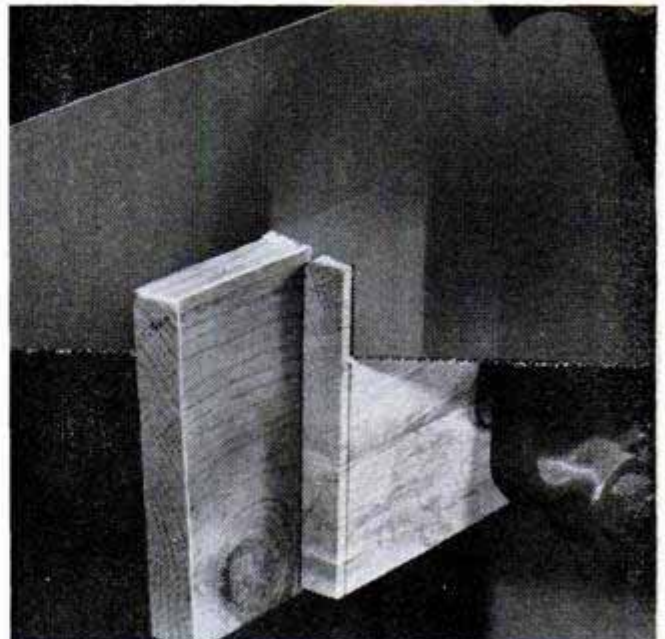
Use painter's masking tape and, to make sure it will stick to the wall, momentarily hold a match under the adhesive side before applying it. This will make the adhesive more tacky. Then, use a smooth hard object, such as the underside of a teaspoon, to smooth out the tape after it is in place.—Norm Jacky, Fond du Lac, Wis.



## Use Scrap Lumber Behind Board When Making Small Cuts

When it is necessary to trim  $\frac{1}{8}$  or  $\frac{1}{16}$  in. from the end of a board with a handsaw, an even cut can be made if a piece of scrap lumber is put behind the stock to be cut. Mark the line of the cut to be made, then clamp the two pieces in a vise to saw them. Smooth cuts that are otherwise almost impossible to make can be done this way.

Elmer Henning, Augusta, Ga.

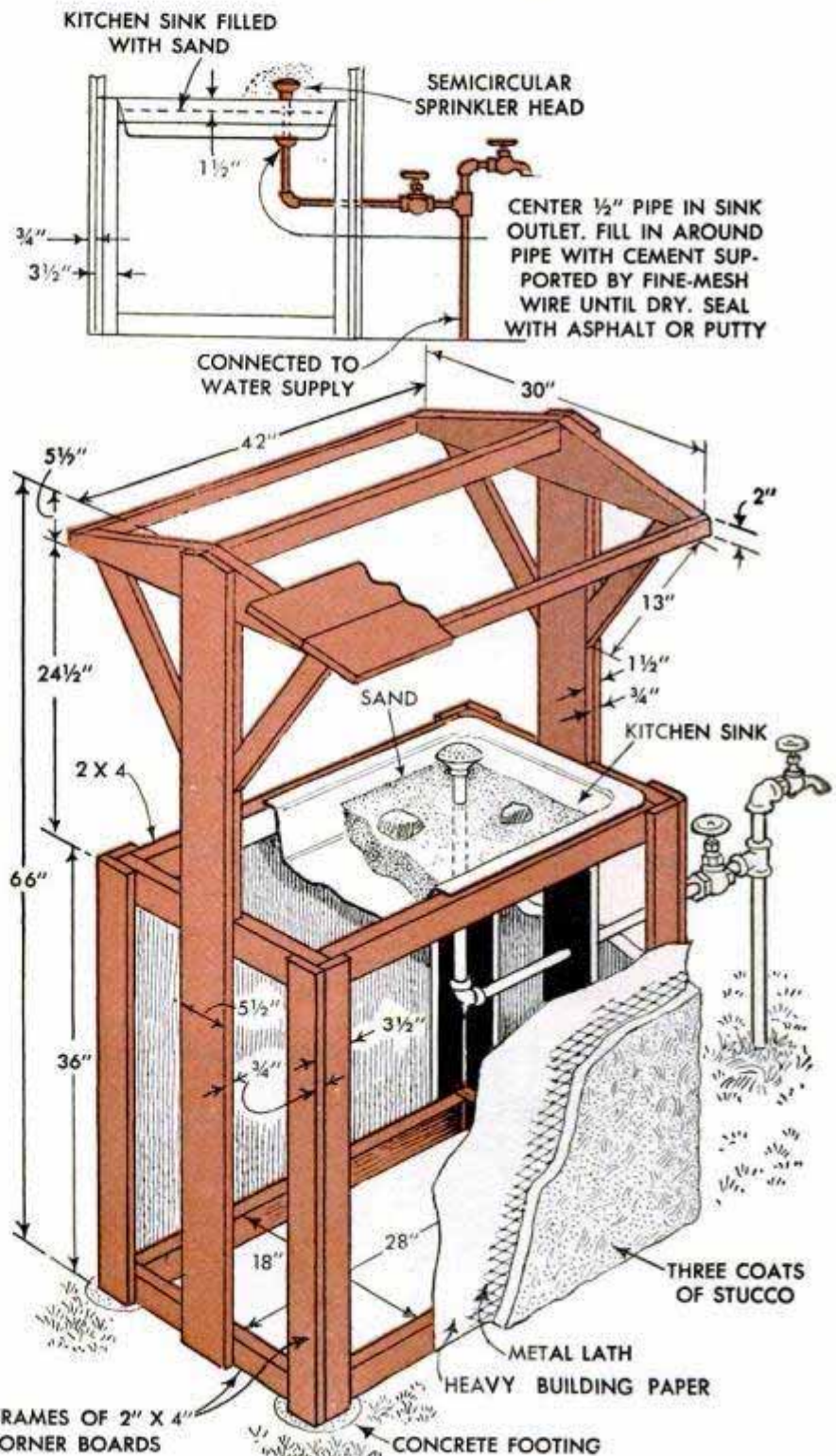
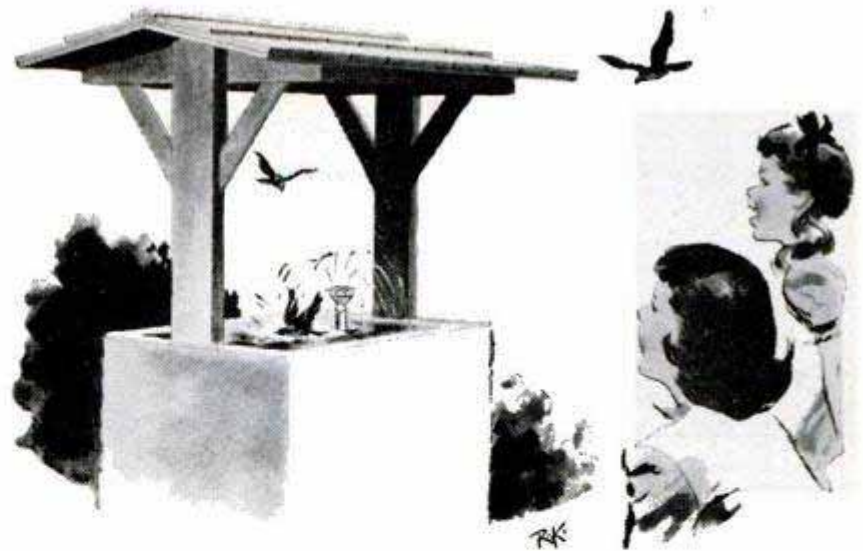


¶ To improve the appearance of an asbestos-board ceiling over a heating unit, trim the edges with metal molding.

# STRICTLY FOR THE BIRDS

By Dick Hutchinson

REPRESENTING a modern version of the old oaken bucket, this novel replica offers something different in the way of a sheltered bird-bath for your lawn. Besides featuring a canopy to offer a shaded oasis in the hot sun, it has a built-in shower which is used to replenish the water in the bath. Construction is simplified in being centered around an old kitchen sink which serves as the "bathtub." An 18 x 28-in. sink was used in the original. If you wish, the birdbath may be connected permanently to a lawn water tap or water can be "piped" to it by a garden hose. A foundation for the stucco which covers the base of the birdbath is formed by wrapping the framework with heavy building paper and metal lath. Three coats of stucco are applied, consisting of a mixture of sand, 3 parts and portland cement, 1 part. The pipe which comes up through the sink is sealed with concrete, followed with a coat of asphaltum varnish. Fill the sink with enough clean sand to bring it 1½ in. from the top, and place one or two large stones in the sand for the birds to alight on.





You don't need expensive equipment to shoot night-fire pictures. A box camera will do it, with careful handling. It's a good idea to have a flash unit handy for filling in foregrounds. If you forgot to bring a tripod along, a medium-sized box will serve

## Shooting

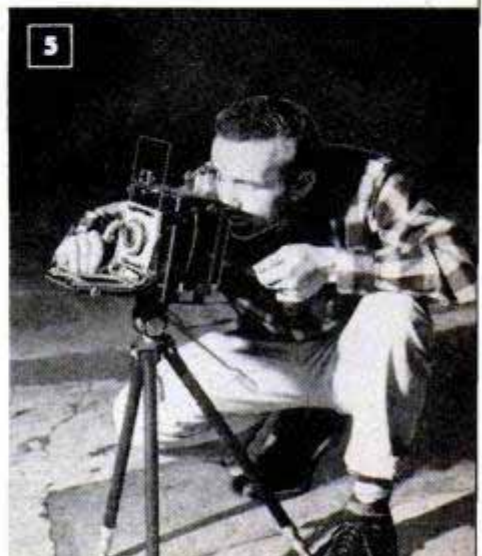
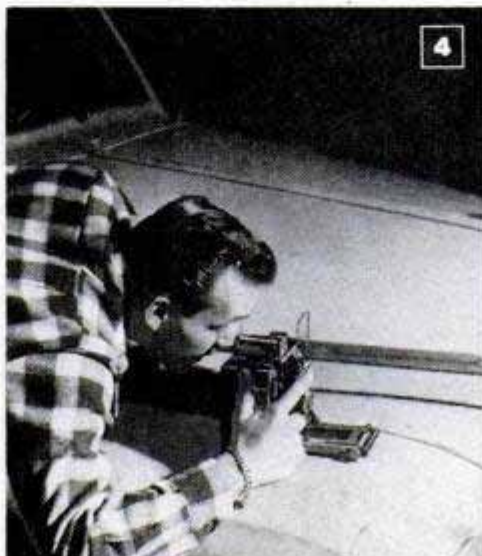
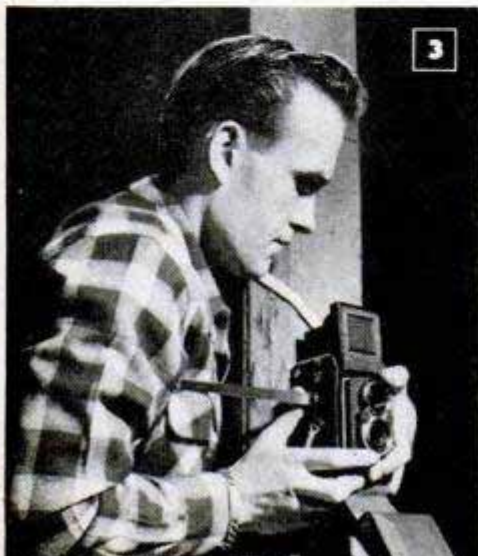
By Richard W. Emery

**S**HOOTING A BIG FIRE at night looks simple enough but roaring flames can be blinding even at a safe distance, and reflections may appear to light up the foreground and near-by objects in daylight detail. Because of this, inexperienced photographers can be fooled into making an ordinary daylight exposure. When the film is developed there probably will be only a flare or two on the negative, and perhaps a few points of flame where it was brightest when the shutter was tripped.

Try this simple test and you will see what happened: Place a lighted candle on a table with a clock or some other small object near by. Focus on the candle flame and set the lens for an average daytime exposure. After shooting the picture, take a second one, using an exposure 1000 times as great. The first shot will show only the flame, nothing more. But the second shot will get the scene in detail. That's the trick in shooting night-fire pictures.

Multiplying the exposure is simple enough with almost any camera. If the

The three photos below, and also Fig. 2 above, show ways of supporting the camera firmly for the long time exposures often required. A heavy-duty tripod is best, but a post, car fender or box will do in a pinch. Holding the camera firmly against a post, or light pole, as in Fig. 3 usually will get the picture





# NIGHT-FIRE PICTURES

Photos by Richard W. Emery and Charles Tally

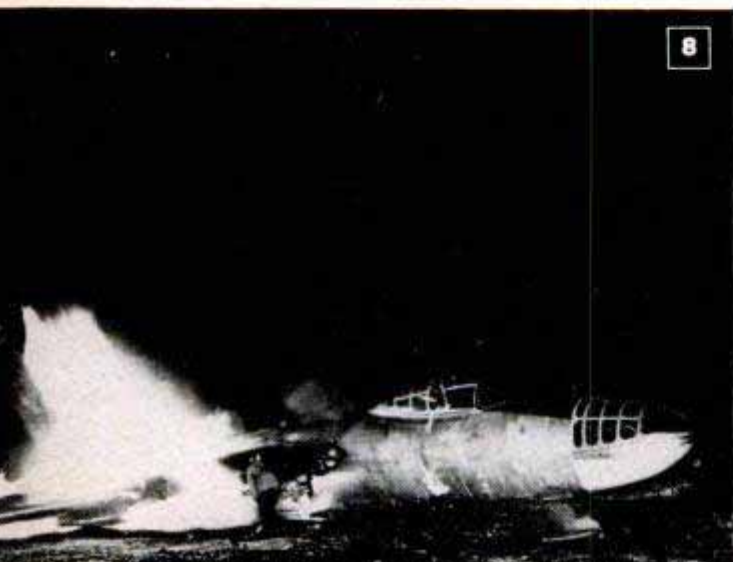
shutter speed for the average daytime shot works out well at 1/100th second, exposure will be increased 100 times by a one-second exposure. Opening the lens one stop doubles the intake of light. Two stops quadruple the amount of light admitted, giving 400 times the daylight exposure. Using an exposure of 1/100th second at f:16 as a unit, Table I on page 220 shows what happens as shutter speed is slowed and the diaphragm opened. Because shutter speed and diaphragm openings measure light by time and area, they multiply each other. By opening the diaphragm fully and setting the shutter on time exposure, the amount of light admitted to the film is increased enormously. Note, for example, how it adds up in Table II. However, even with greatly increased exposures, foreground objects still will appear on the negative as silhouettes, as shown in Figs. 1, 6, 7 and 9. By simply flashing a single bulb over the foreground you will fill in areas not illuminated by firelight. Good examples of the effectiveness of the bulb in bringing out the picture story are Figs. 8, 11, 12 and 14. However, there are instances where use

Without foreground lighting this picture would not have told the full story of the stricken plane. Note the detail picked up by flash-lighting the scene



Always be alert for opportunities to picture firemen at work. Here the figures are silhouetted against the blaze by a short exposure that stopped action

Here's a shot in which reflected light from the blaze lighted the foreground, making the flash unnecessary. Silhouettes of firemen give feeling of action





of the firelight alone heightens the dramatic effect. As an example of this, compare Figs. 14 and 15 and also refer to Figs. 10, 13, 16 and 17. Camera position should also be considered. For example, the big blaze in Fig. 1 was shot with the camera at ground level while that in Fig. 12 was shot from a ladder. The roaring oil-well fire pictured in Fig. 13 lighted up the area for a mile around. Everything appeared as "bright as day." But a daytime exposure got only the flame and a small portion of the wreckage in silhouette. In this case the spectacular flames justified the risk of the short exposure. Shooting upward from a comparatively low level accentuated the height of the flames.

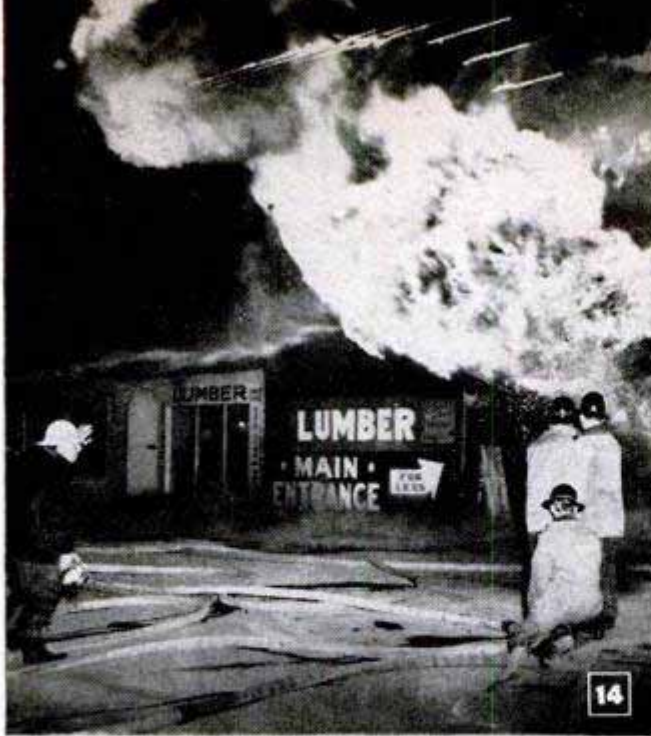
If, in the excitement, you forgot to bring along a heavy-duty tripod like that in Fig. 5, you can quickly improvise on the spot a suitable camera support for a time exposure as in Figs. 2, 3 and 4. Whatever is utilized for this purpose must be rigid. A

**Table I**

|  |
|--|
| 1/100th sec. at f:16—1 unit (daytime exposure) |
| 1 full sec. at f:16—100 units                  |
| 5 full sec. at f:16—500 units                  |
| 1/100th sec. at f:16—1 unit                    |
| 1/100th sec. at f:11—2 units                   |
| 1/100th sec. at f:8—4 units                    |
| 1/100th sec. at f:5.6—8 units                  |
| 1/100th sec. at f:4.5—16 units                 |

**Table II**

|  |
|--|
| 1/100th sec. at f:16—1 unit (daytime exposure) |
| 1 full sec. at f:16—100 units                  |
| 1 full sec. at f:4.5—1600 units                |
| 5 full sec. at f:4.5—8000 units                |



rectangular wooden box such as that shown in Fig. 2 is just the thing—if you can find it. The cleats across the ends will support the camera at the proper angle with a minimum of blocking or other adjustment, and you can position the camera at three levels simply by placing the box in different positions. The next best thing is to steady the camera against a post, Fig. 3, or on the front fender of your car as in Fig. 4. Of course, you will remember to stop the engine.

While you are about the business of preparing to take photos, watch for dramatic stopped action. Examples are Figs. 6, 7, 8, 14 and 15. Firemen often group themselves on a hose line and stand braced and motionless for seconds, giving you the opportunity for a sharp silhouette. Keep always in mind that the average exposure time will run from one to five seconds. Watch for the development of pictorial foregrounds and be ready to shoot the picture the instant the composition takes form. ★ ★ ★

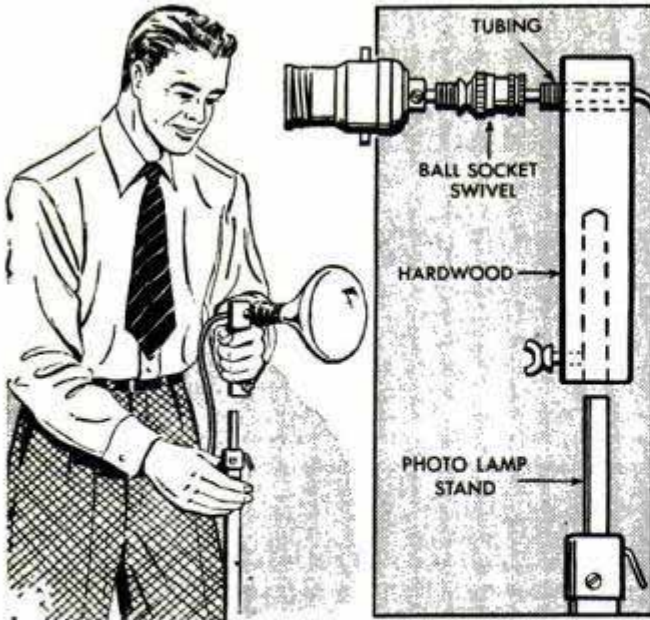


In the two photos above, the foreground flash in the one at the left showed the hose lines being laid. As the blaze became larger and more intense the photographer moved his camera farther back and still picked up hose lines and firemen by reflected light with a second shot. Two photos show rapid spread of flames. Note burning insulation on wires

In the left-hand photo, below, the photographer chose a position which would silhouette building, firemen and hose streams against the flames. Both photos emphasize the importance of including sufficient detail in fire shots to tell the story. One glance at the right-hand photo and you know a ship is burning because prow shows amid flames



## Lamp Fixture Held in Hand or Mounted on Stand



Attached to this easy-to-make fixture, your reflector-type photoflood or photo spot lamp may be held either in the hand or mounted on a photo lampstand. The fixture is a 1 x 1-in. hardwood block, 5 in. long, having rounded corners to make it easier to grip. A ball-socket swivel is used to make the lamp socket adjustable. The swivel is screwed onto a short length of standard threaded tubing that has been turned into an undersized hole near the upper end of the block. The lower end of the block is drilled  $2\frac{1}{2}$  in. deep to slip over the stand. If desired, a locking wing screw may be improvised by soldering half a washer in the slot of a machine screw, which then is threaded into an undersized hole in one side of the block.

Arthur Trauffer, McClelland, Iowa.

## Link Adapts Auto-Focus Enlarger to Use of Longer-Focal Lens

Limited to one specific lens in my auto-focus enlarger, I was never able to use a lens having a longer focal length. To save the cost of a regular extension tube made for this purpose, I adapted the enlarger to take more than one lens by fitting it with an adjustable link, or extension, to hold the lensboard farther out from the column. To do this, I sawed through the metal casting between the lensboard and the enlarger head and drilled and fastened a hardwood link to the two projecting stubs. By using wing nuts, I not only was able to adjust

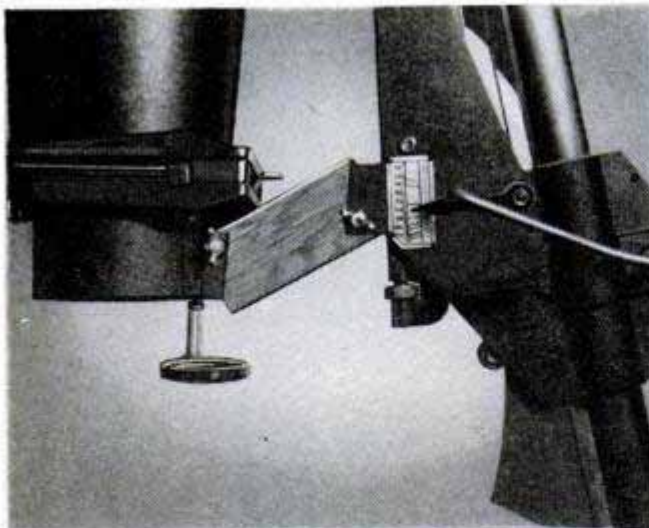
the link easily, but was able to tilt the lensboard when necessary to correct distortion in the print. Note the position of the wing nuts in the link, each being placed in opposite corners. Also, it should be noted that the corners of the link at which the wing nuts are located are rounded. Lock washers under the wing nuts will prevent slippage once the link is set.

Bert Lovett Forse, Washington, D. C.

## Rack Aids Photo Blotter Drying

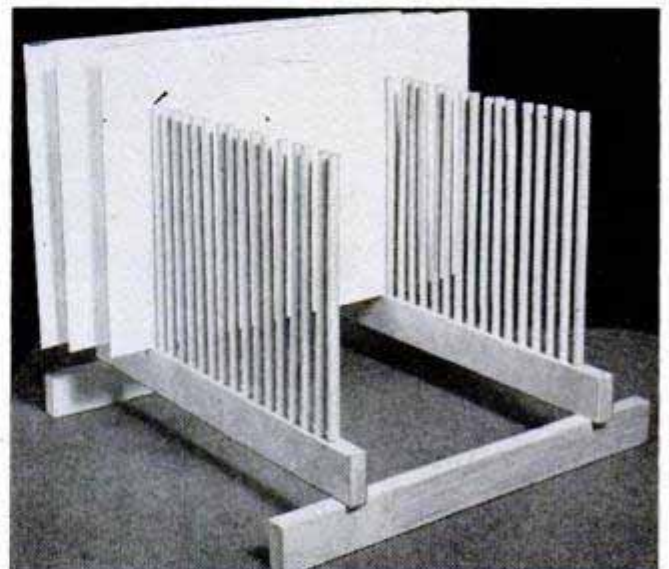
An efficient drying rack for blotters can be made by drilling cross members of a frame assembled from  $\frac{3}{4}$  x  $1\frac{1}{2}$ -in. stock to take the ends of  $\frac{3}{8}$ -in. dowels as shown. The holes are spaced  $\frac{3}{4}$  in. apart on centers. In permitting free circulation of air around each blotter, the rack makes quick work of drying large numbers of blotters when the weather is damp.

Hartwell J. Kennard, Gonzales, Tex.



### *A Helping Hand . . .*

Santa generally is a pretty busy fellow come December. Right now the poor guy is going full blast trying to meet the 25th deadline. A Christmas toy story in the November issue shows how you can lend a helping hand by starting your workshopping early and save money in the bargain





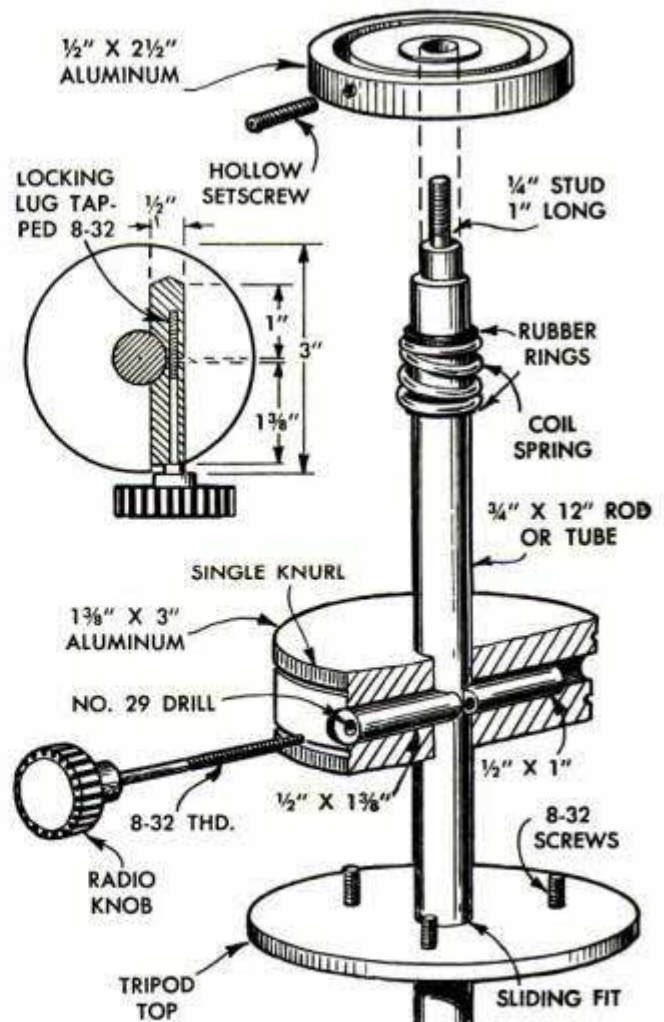
Left, camera can be raised, lowered or swiveled to any position without shifting the tripod legs. Right, pad supporting camera is press-fitted to top of column and locked with a setscrew

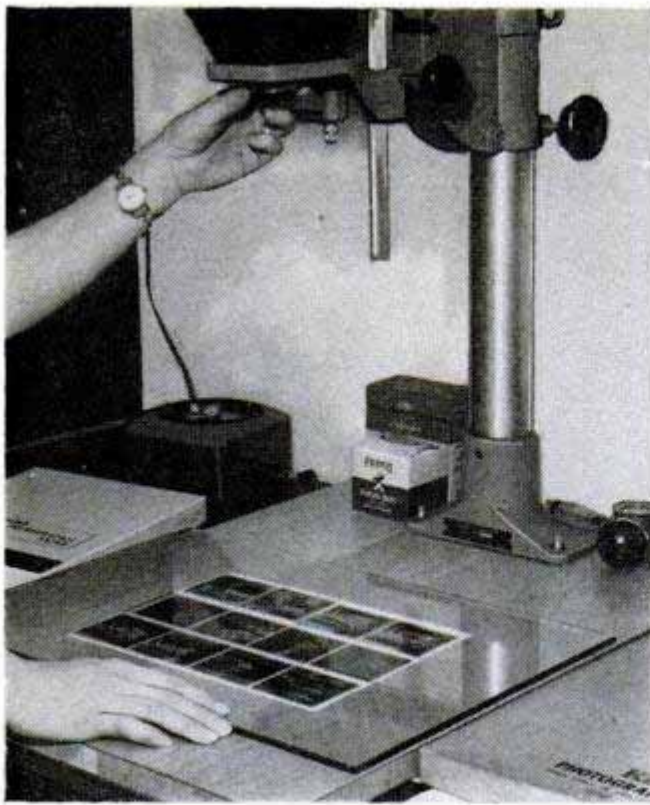


Below, camming pins which lock column are axially drilled off-center with clearance and tap holes for a locking screw. Concaves filed at ends of pins bind on the column

## ADJUSTABLE-COLUMN TRIPOD

DESIGNED FOR CAMERA tripods not having an adjustable column, this fitting provides quick adjustment of camera height without moving or telescoping the tripod legs. As shown in the detail and pictured above, the sliding column, which can be made 12, 18 or 24 in. long, is held at any desired height by an improvised cam lock fitted into a disk which is screwed to the tripod top. The disk and tripod top are center-drilled to take the column in an easy sliding fit. The disk also is drilled transversely off-center, the hole cutting into the center hole about one-third its diameter. The camming pins which slide in this hole are drilled off-center axially, the short pin with a tap hole, the long pin with a clearance hole for an 8-32 screw. The ends of the camming pins are milled or filed to a  $\frac{3}{8}$ -in. radius, each concavity clearing the axial hole by about  $\frac{1}{32}$  in. When the knob is tightened the concave ends of the pins are drawn tightly against the column, holding it securely in any position. Note that there is a cushion spring placed between the cam lock and pad supporting the camera. The spring is held in place with rubber rings, or washers, and prevents breakage should the cam lock be loosened inadvertently.





## Photo Enlarger Substituted For Contact Printer

If you use a contact printer only infrequently and not often enough to warrant the purchase of one, you can save the cost of one, as well as the price of contact paper, by letting your enlarger take over. All that's needed is a piece of clear plate glass approximately 14 x 16 in. Whether making one or several prints at a time, first place a sheet of enlarging paper on the easel emulsion side up, and then lay the negatives on the paper, emulsion side down. Use the glass to hold the negatives in position and to weight them in contact with the paper, being sure that the glass is clean on both sides. Check before making the actual exposure to see if the enlarger head is high enough to cover the entire area being printed. The exposure is made as you would in making an enlargement. The lens aperture is used to control the amount of light needed for the exposure.

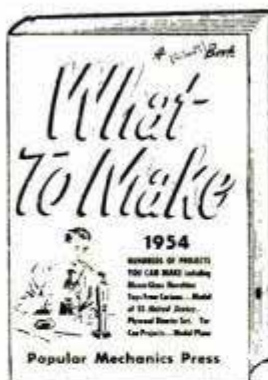
Robert C. Florian, Chicago.

## Glycerin Makes Ground-Glass Viewer More Translucent

For close-up pictures, some photographers prefer a fine focus on the ground-glass viewers of their cameras. To get this, a spot of glycerin the size of a half-dollar is placed on the matte side of the glass, which increases the translucence of the glass at that point. Then, to get an even finer focus,

a magnifying glass may be used. To make the viewer permanently translucent, the glass can be worked down by rubbing the matte side with a mixture of oil, 3 parts, and rottenstone, 1 part. The face of a large cork should be used to rub the mixture on the glass.

## Popular Mechanics Bookshop



### What to Make

The latest edition of an old-time favorite, this book contains 500 projects for the home workshop craftsman. Included are glassware art objects, a baby biplane, occasional furniture and toys from shipping cartons. Here are 240 pages that promise many evenings of fun. \$2.00



### Sporting Season

Fall is the outdoorsman's time of year. It's the season for game birds and a last big catch of fish before the winter closes in. Here's a book chock-full of ideas on guns, traps, outboard motors, fishing gear and boats, along with helpful tips on camping and outdoor life. Price, \$2.00



### In One Evening

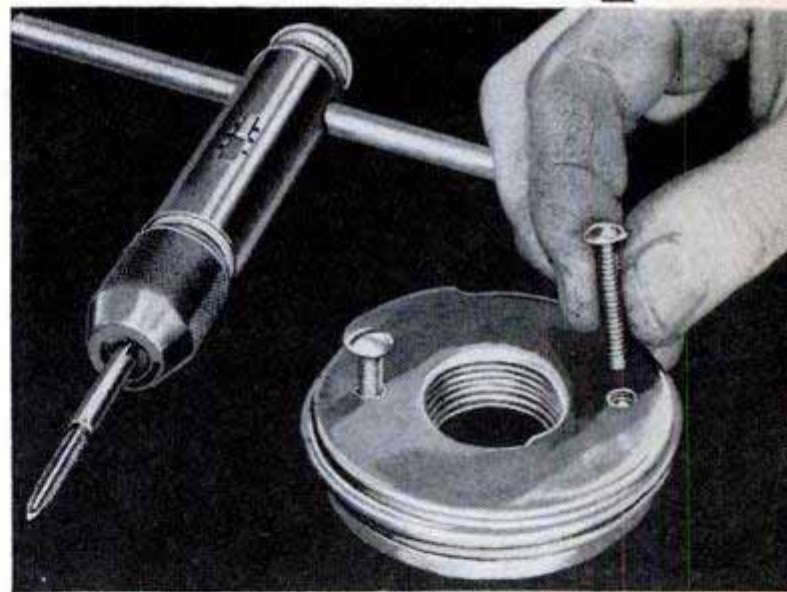
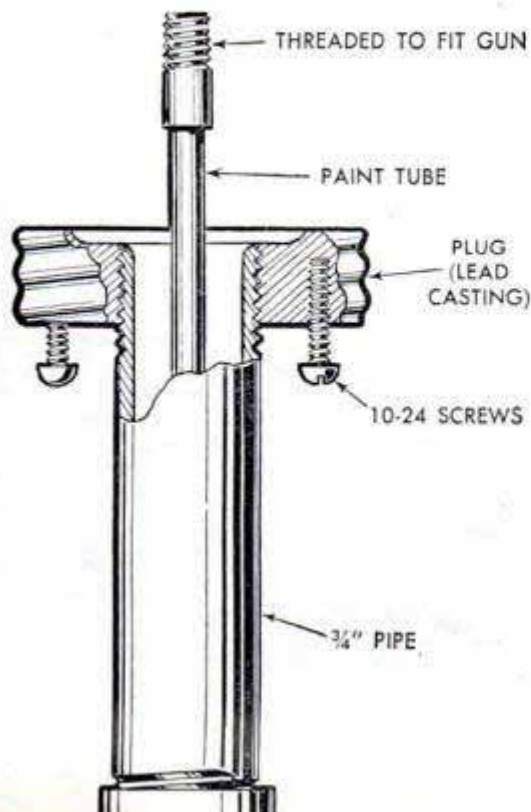
... you can finish any of the attractive and useful projects in this book. Here are plans, diagrams, photos and instructions for making modern tables, footstools, magazine racks, picnic iceboxes and a good many other exciting but quick-to-complete projects. Price, \$2.00

All books available from Popular Mechanics Book Department, 208 E. Ontario St., Chicago 11

## TOUCH-UP CONTAINER *for Spray Guns*

By Walter E. Burton

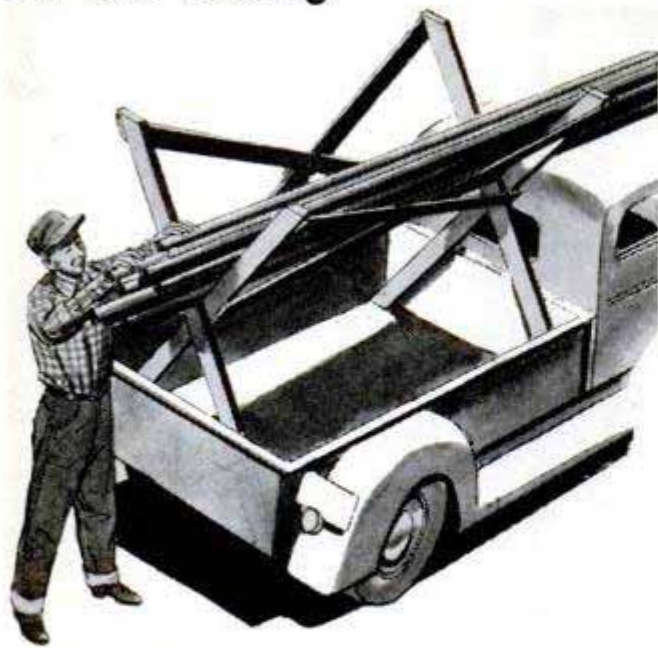
THIS ATTACHMENT is so easily made that it can be duplicated to provide separate containers for each touch-up color likely to be used. The detail below and the photos at the right show clearly the construction procedure. First, a lead or die-metal plug is cast, using a fruit-jar lid as a mold. This forms threads on the plug that fit the spray-gun cap. Before pouring the metal, place a hardwood dowel in the center of the mold, the diameter of the dowel being slightly less than the outside diameter of the 6-in. pipe nipple. The latter cuts its own threads when turned into the casting. Drill and tap two holes in the casting for 10-24 screws which serve as handles for removing the container from the spray-gun cap. Then make a paint tube, or suction tube, and thread to fit the gun.



Above, threads formed on edge of soft-metal plug fit those in spray-gun cap. Pipe container cuts its own threads when turned into plug casting. Below, duplicate containers fitted with pipe cap at each end provide a quick change from one color to another

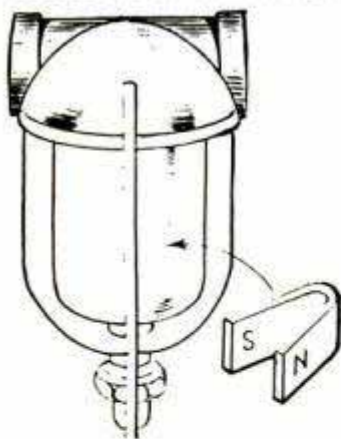


## Sturdy Rack Holds Long Pipe For Safe Hauling



Rather than risk damaging long sections of pipe by dragging them on the ground, one farmer erected a wooden rack on his pickup truck for hauling the pipe as shown. Consisting of X-shaped end sections of 2 x 4s and cross bracing cut from lighter stock, the rack holds the pipe high enough to clear the top of the truck cab, permitting the pipe to overhang several feet at each end of the rack.

## Tiny Iron Particles in Auto Fuel Removed With Small Magnet



A small magnet of the same type and size used in crankcase and transmission housings can be placed in the gasoline filter of your car to catch minute iron particles that sometimes get past the filter. Laid in the bottom of the filter's glass bowl, the magnet will prevent these particles from gathering on the needle valve, causing the carburetor to flood.

Ed Packer, Chicago.

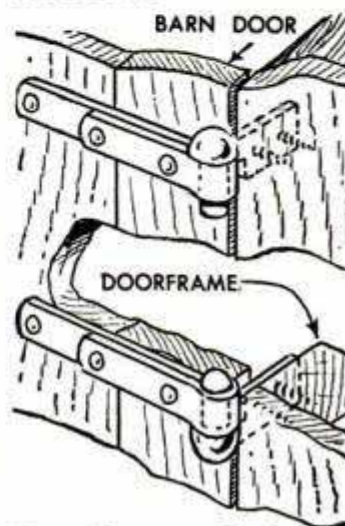
## Improvised Carbon Contact Stops Intermittent Firing

An automobile engine frequently will miss due to poor contact between the carbon and spring contacts on the distributor rotor arm. If the brush is worn flush with the metal band that holds it in place, the result will be poor contact that causes the

engine to fire intermittently at normal speeds. When a new distributor cap cannot be provided immediately, remove the carbon contact and replace it with one made from an old motor or generator brush, and install it so that it projects about  $\frac{1}{8}$  in. beyond the metal. Then scrape off any corrosion on the points with a sharp knife. Before installing the improvised carbon, examine the spring contact to make sure that it has not been damaged by arcing.

## Cattle Cannot Remove Barn Door If Top Hinge Is Inverted

When hinges of the type shown are used on barn doors, invert the top hinge so the pin points downward. This arrangement will prevent livestock from nosing the door off the hinges. Also, it will prevent unauthorized persons from entering a building by lifting off a door on which hinges of this type are used. It is best to bolt the hinges in position, securing them with nuts inside the building so they cannot be tampered with from the outside.



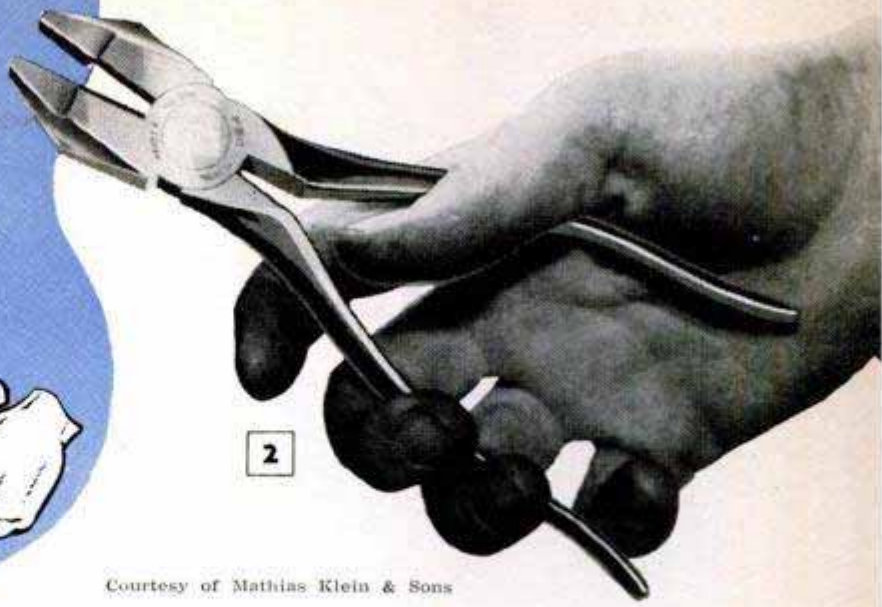
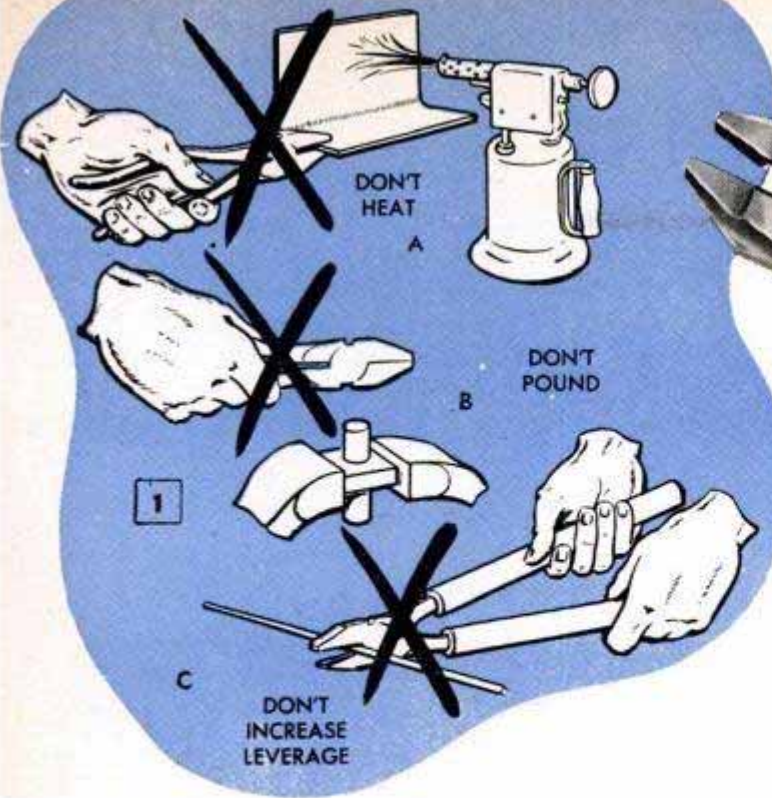
G. E. McVickar, Bethesda, Md.

## Portable Brush Burner

Easily towed by a truck or tractor, this all-metal trailer furnishes one orchardist with a safe, convenient means for collecting and burning brush and tree trimmings. The bed, which is taken from a pickup truck, is mounted on a chassis assembled from steel channel and steel wagon wheels. The front axle pivots on a fifth wheel welded to a U-shaped bolster that supports the forward end of the trailer bed. Ashes are emptied by dropping the tail gate and sweeping them out.

Charles L. Stratton, Hollis, N. H.





Courtesy of Mathias Klein & Sons

# KNOW-HOW with PLIERS

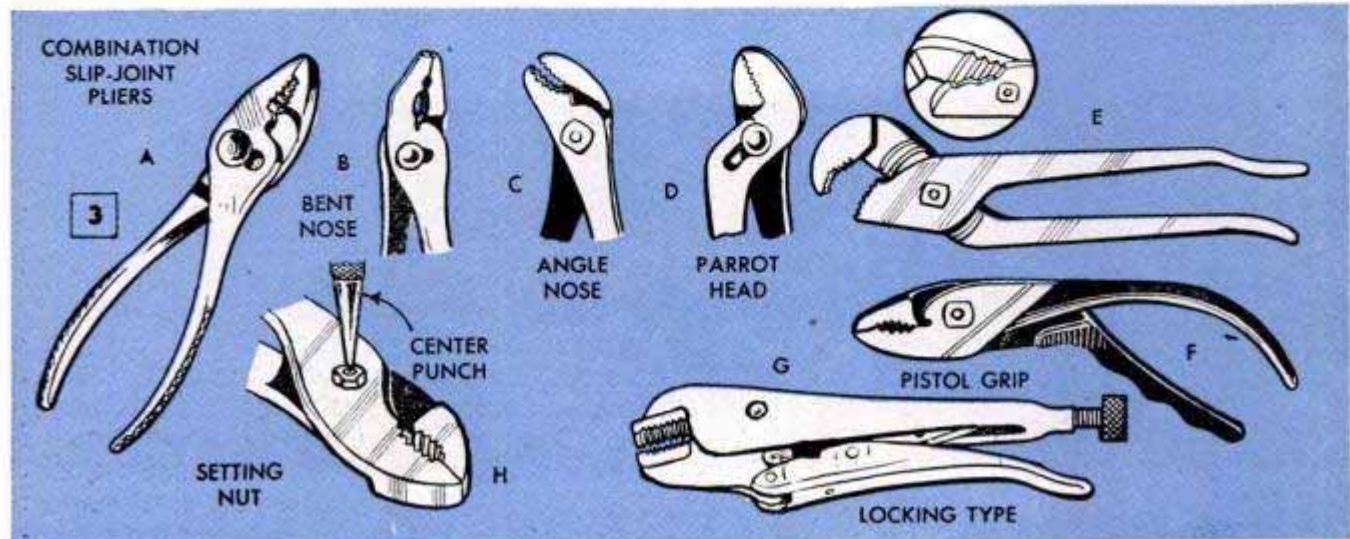
By E. R. Haan

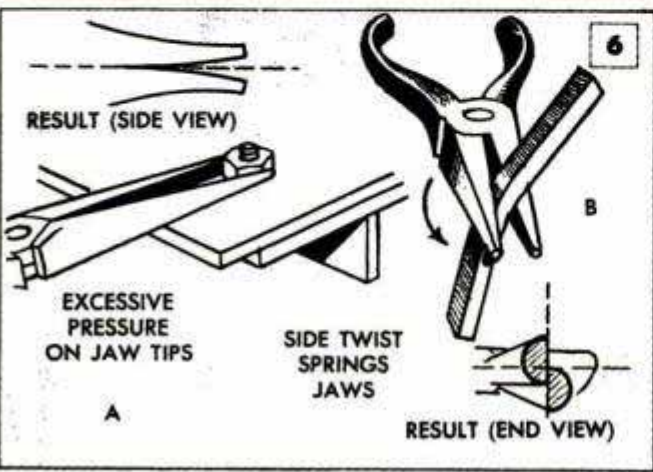
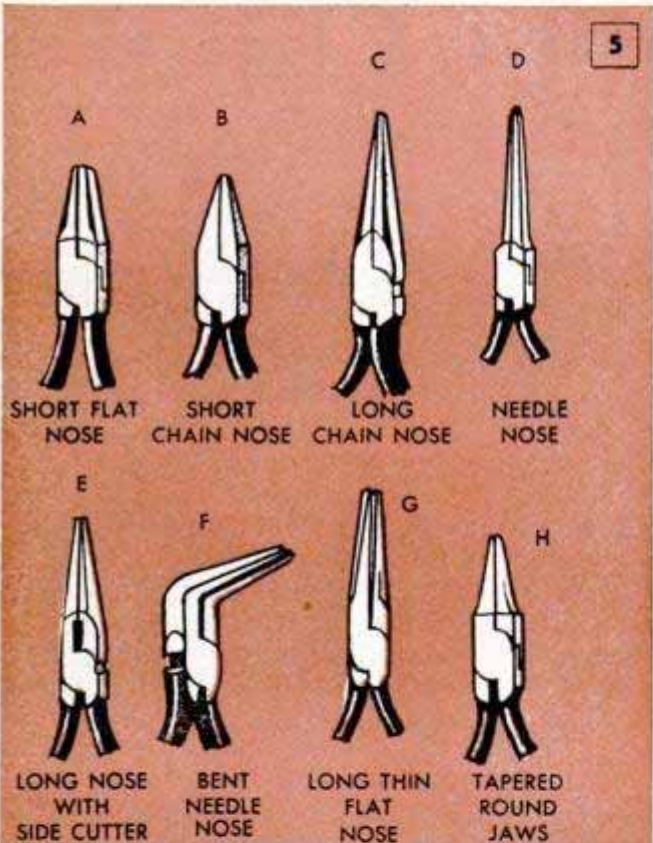
**ORDINARY PLIERS** perform several hand-tool operations, holding, twisting, turning and cutting being the most common. Other types have both handles and jaws of a design adapted to the special requirements of the job. Most pliers have jaws which are especially heat-treated to withstand any normal pressure that can be exerted on the handles by one hand, and the jaw faces are either single checked or cross-checked (knurled) to afford a secure grip on work of almost any shape.

**General usage and care:** Good pliers can be irreparably damaged by exposing them to extremes of heat, detail A, Fig. 1, or by using the flat side of the jaws as a hammer, detail B, or by increasing the leverage as

in detail C. To prevent rust on pliers not in daily use, wipe them with an oily rag. Clean the inner surfaces of the jaws with a wire brush or a file card, and coat with oil. A good rust preventive for cutting pliers is to dip them in thinned transparent lacquer. When the coating starts to wear off remove with lacquer thinner and recoat.

To assure easy operation and to prolong the life of pliers, apply a drop or two of light machine oil to the joint occasionally, letting it run in at the base of the jaws. To remove dirt and congealed oil, immerse pliers overnight in benzine or carbon tetrachloride (in a closed container), then coat with oil to prevent rust. Avoid dropping pliers on concrete floors, which may crack





hardened parts. An invisible crack may develop into a break under strain. When gripping hardened steel, protect the jaws from dulling and losing their grip by using cardboard, canvas or fiber pads. Pins and rods that must be held firmly for turning or pulling, can be wrapped with fine emery cloth to obtain a secure grip. Dulled checking or knurling on the jaws often can be restored by using a fine triangular file. Don't use pliers to turn nuts except in an emergency.

**Combination pliers:** Slip-joint combination pliers, detail A, Fig. 3, are general-purpose tools. They can be adjusted to two or more size ranges by means of a sliding pivot. The jaws have sharp, hardened cross teeth similar to those on the jaws of a pipe wrench. Often there is a short shearing edge next to the head, or in the head itself, for wire cutting. Besides the straight-nose type, bent-nose, angle-nose and parrot-head variations are available, details B, C and D. Similar pliers are used on water-pump and conduit locknuts, and also for ignition work. Note how the jaws of different types are notched (burner cut) or are straight to hold round or flat work. The slip-joint pliers shown in detail E have an extremely powerful gripping action. A series of closely spaced, self-cleaning milled joints take the strain and eliminate wear on the pivot bolt. Slip-joint pliers having pistol-grip handles, detail F, Fig. 3, are designed for greater holding power and easier handling. Locking pliers, detail G, have a built-in, compound leverage to exert great pressure. When the handles are locked in position, the tool serves as a small pipe wrench or vise. When the nut on the pivot bolt of the pliers loosens, it should be tightened to eliminate excess play. File the end of the bolt flush with the surface of the nut; then prick-punch as in detail H, Fig. 3, to lock the nut on the end of the bolt.

**Other holding and bending pliers:** On most pliers used for small work as in Figs. 4 and 5, the jaws are flat inside and finely cross-checked. The heavier ones are used for bending light wire and sheet metal, while the lighter ones are designed for picking up and holding small parts, as in assembly work. For ease in opening and closing pliers constantly, hold them as in Fig. 2, with the small finger on the inside of the handle. On repetitive work, pliers having spring-opened handles are faster and less tiring on the fingers. Long-nose pliers are handy to get into narrow, restricted places, Fig. 5, A to H inclusive. Some of these are equipped with side cutters. Too much pressure on the tips of long-nose pliers may bend or break them, detail A, Fig. 6. Usually you can restore tips that are bent open by inserting a  $\frac{1}{16}$ -

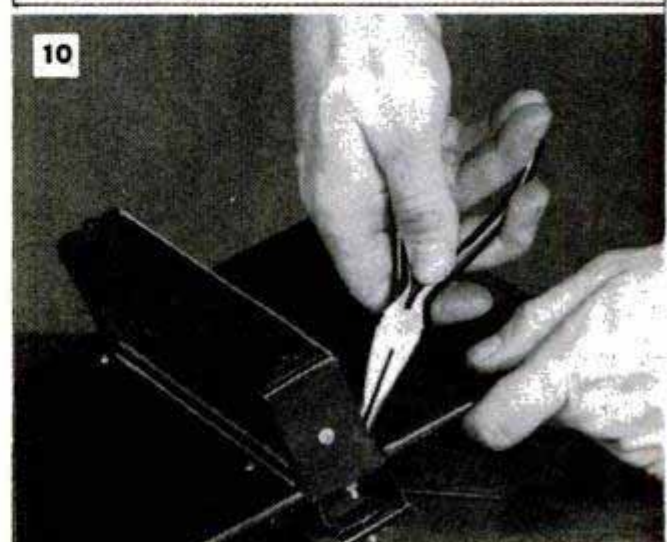
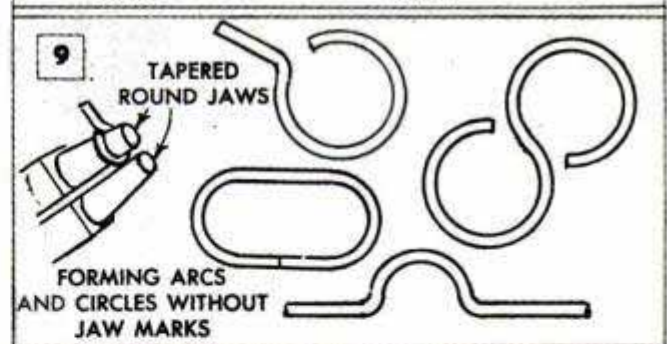
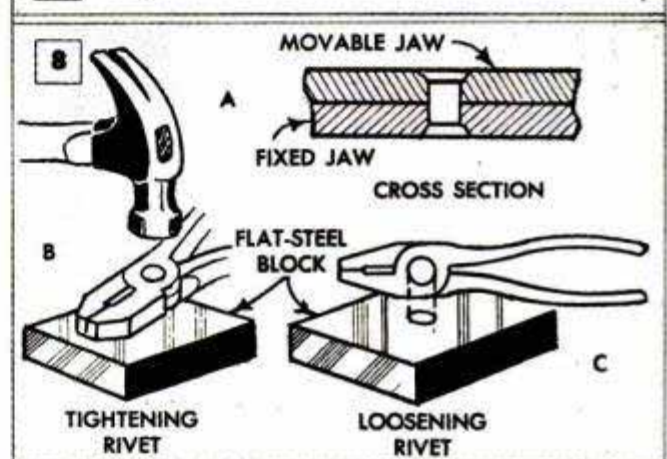
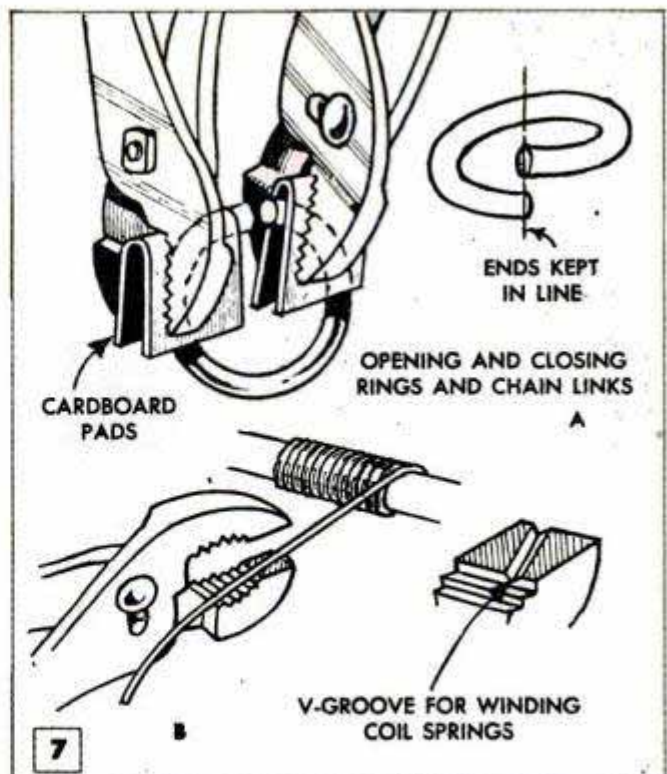
in. metal strip between the jaws and striking them carefully with a hammer about  $\frac{1}{2}$  in. from the tip. Frequently long-nose pliers are bent or broken by excessive side twist, detail B, especially those having side cutters.

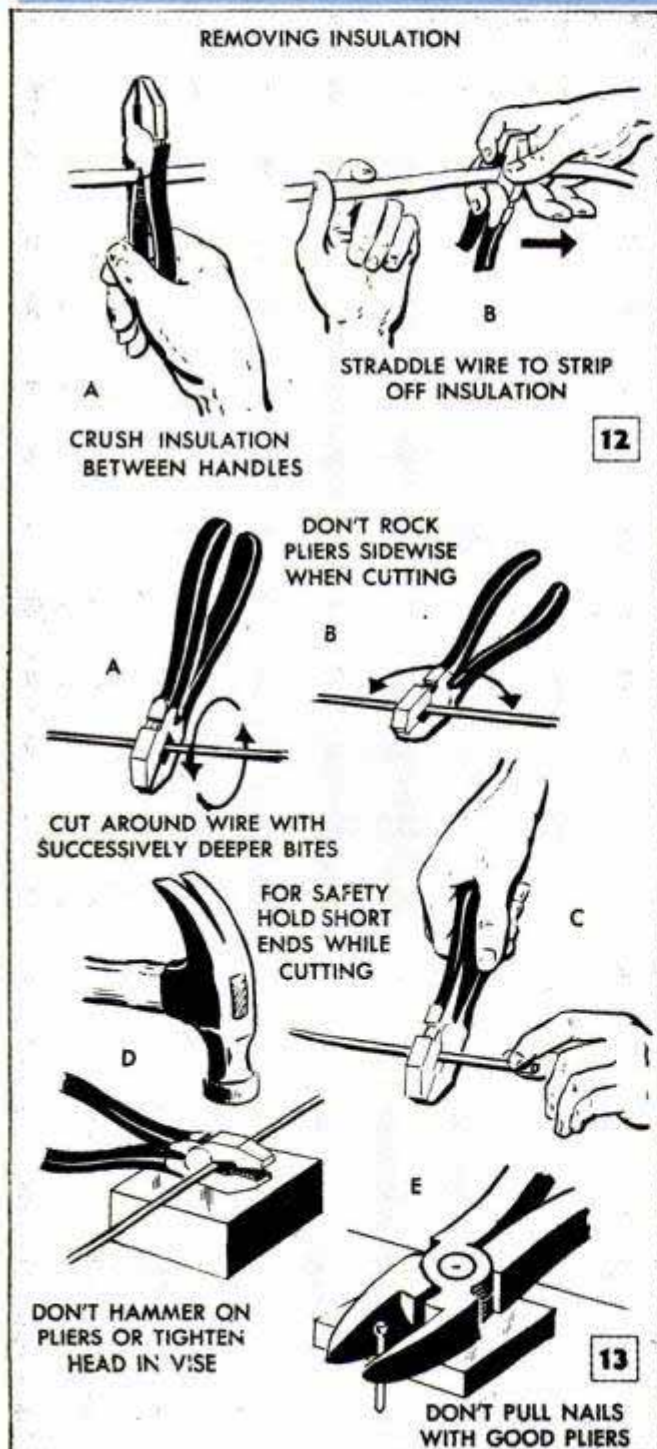
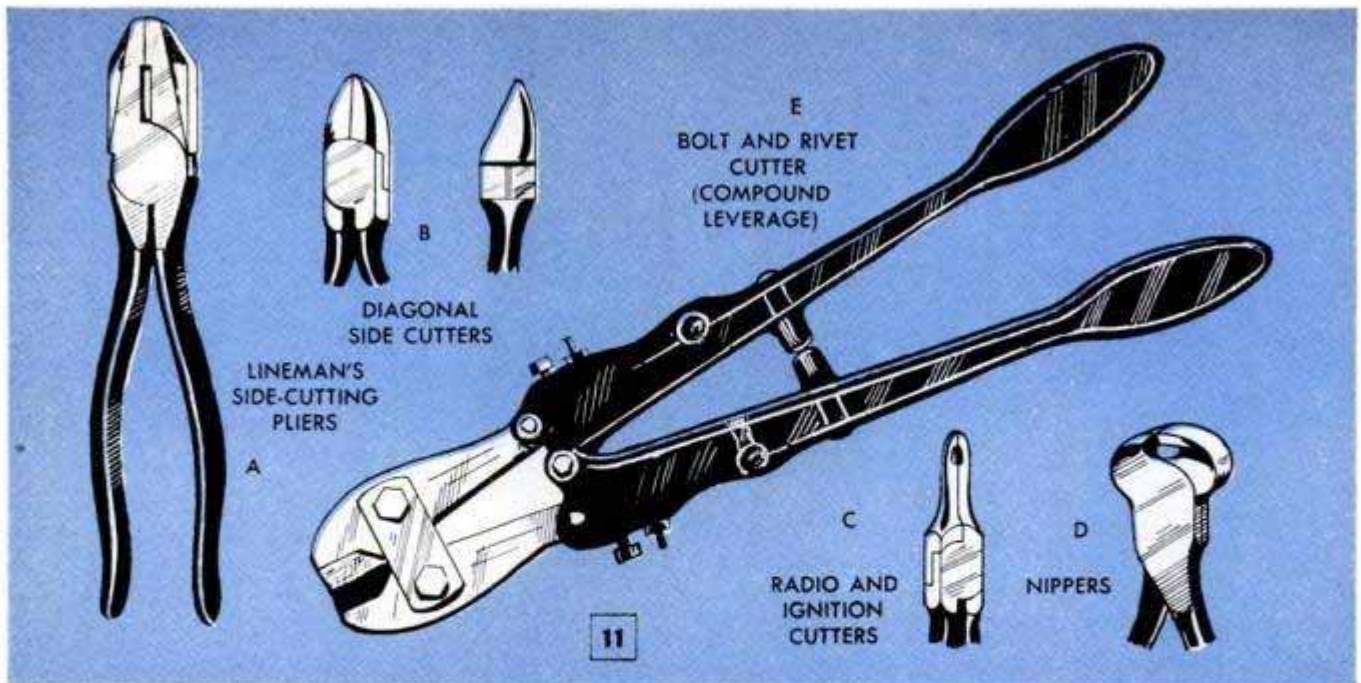
To avoid marring nickel and chromium-plated parts that must be gripped with pliers, use protecting pads. Or, you can stick a piece of adhesive tape over each jaw if it is flat and finely knurled. Clean the jaws later with a solvent. To open rings and chain links, spread them sideways, using two pliers as in detail A, Fig. 7. If the ends of the link are welded together, grip them in a vise and with a hacksaw first. Protect the finish with pads. When winding coil springs hold the wire with an old pair of pliers having a diagonal V-groove ground in one jaw, detail B. The depth of the groove should be such that the wire is gripped by the other jaw.

**Adjusting "box"-joint pliers:** Nearly all pliers except the combination type have a "box" (half-lap) joint, detail A, Fig. 8. When there's excessive side play due to a loose rivet, tightness can be restored as in detail B. The jaw that does not rotate but is fixed to the rivet is laid on a steel block or anvil. Then the exposed end of the rivet is struck with the flat face of a hammer to spread the metal. Don't use the peening end of a machinist's hammer or a punch for this. Check for tightness after each blow. To loosen a tight rivet hold the pliers in the same way over a hole in the block, detail C, so that the rivet is not supported.

**Bending arcs and circles:** Chain-nose pliers shown in details, B and C, in Fig. 5, are handy for bending angles, arcs and circles in light wire and metal, Fig. 10, where a straight portion of the work can be held between flat jaws. For bending eyes in wire without getting jaw marks on the work, use pliers having round jaws, or pliers having one round and one flat jaw for greater gripping power. The flat jaw contacts the outside of the curve. Round jaws may be of one diameter, stepped diameters, or they may be tapered. Diameters larger than those of the jaws are formed by a series of small bends spaced equidistantly, Fig. 9, or by wrapping the material around a rod or cylinder.

**Types of cutting pliers:** Lineman's and electrician's straight side cutters, detail A, Fig. 11, are designed primarily for cutting electric wire. Some have insulated handles, but plastic grips that slip over plier handles also are available. On diagonal side cutters, detail B, the cutting edges are at an angle, which makes the pliers easier to handle when nipping off projecting ends of wire, nails and pins close to the surface of the work. These pliers are available in



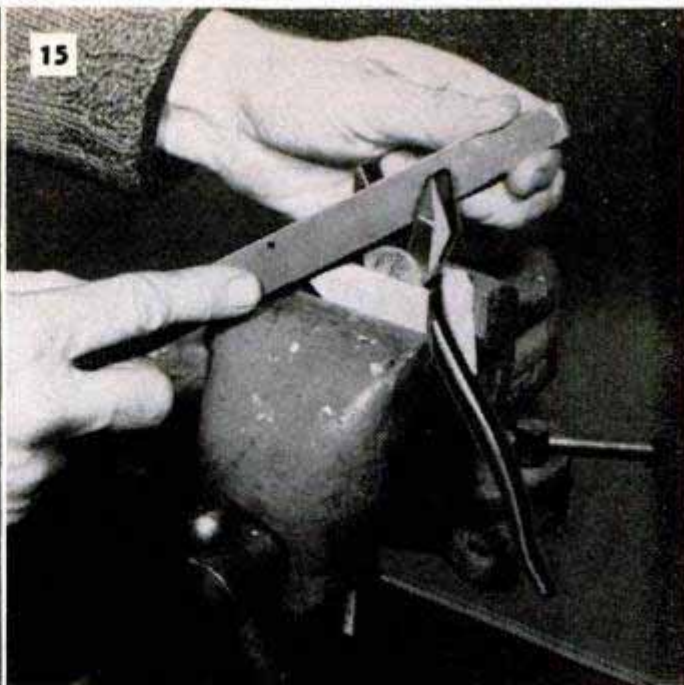
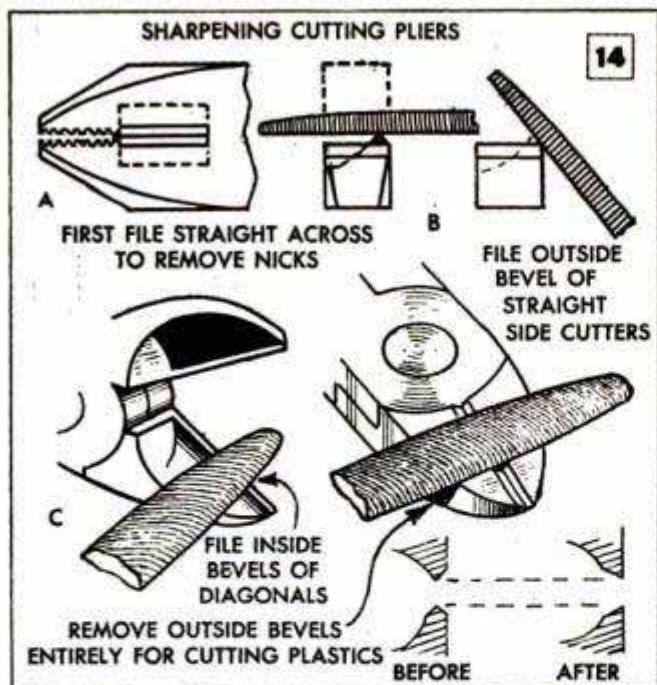


standard or high-leverage types—the latter having the pivot closer to the ends of the jaws. Side cutters are provided at the ends of pliers used for radio and ignition work, detail C. Nippers, detail D, cut at their ends, come in both standard and high-leverage types. They are used to cut off projecting wire, nails and pins close to the surface of the work. Bolt and rivet cutters, detail E, have powerful leverage and cut at the side, end or both.

**How to use cutting pliers:** To remove insulation from wire, first crush in the insulation between the handles of lineman's pliers as in detail A, Fig. 12. Then strip it off, holding the pliers as in detail B, so the cutters straddle the wire but do not cut it. Some side cutters have notches to slip over the wire for stripping. Be careful not to cut "live" wires. Besides the danger of shock, the arc caused by short-circuiting a double conductor that carries current may ruin the cutting edges.

Ordinary cutting pliers are intended for use on small wire and rods of soft metal such as brass, copper, aluminum and mild steel. Don't use them for cutting hardened pins and piano wire. To cut harder metals, use specially hardened cutting pliers such as are used by makers of coil springs. Cut large-diameter wire all around with a gradually increased bite, detail A, Fig. 13. Or, cut the wire part way, then grip it with the flat part of the jaws and bend it back and forth until it breaks. This procedure is of value also where sharp, exposed ends of wire can cause injury. Don't subject the cutters to side strain, detail B, which is likely to damage the edges. For safety to yourself and others near by, hold the ends of wire, nails or pins as in detail C, while cutting them. If you can't hold the wire, cup your hand over the head of the pliers





or turn them so that the piece will be stopped by the bench top or floor. Don't force the cutters through thick material by hammering on the head of the pliers, detail D, or applying pressure in a vise. As side pressure ruins cutting edges, don't use new diagonal pliers for pulling brads and finishing nails, detail E, or cotter pins from castle nuts. For these purposes use an old pair of pliers no longer serviceable for cutting. When pulling brads use a protective pad as a fulcrum to prevent marring the adjoining surface of the work.

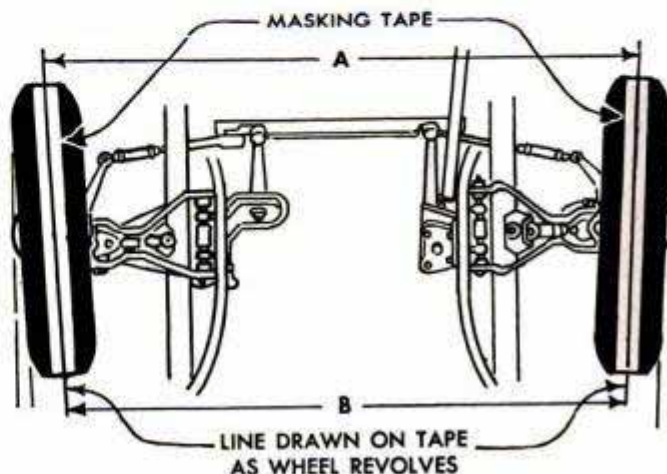
**Sharpening cutters:** Most side cutters and nippers can be resharpened when nicked or dulled. On side cutters the cutting edges to be resharpened must project above the level of the jaw faces. If ground below this level the cutting edges will not come together. Use a very fine file such as a No. 2 half-round diemaker's file, or a thin, fine-grit abrasive stone, holding the pliers between pads in a vise. The degree of hardness of cutting pliers is slightly less than that of files. First dress down the

edge to remove nicks, detail A, Fig. 14, also Fig. 15. On side cutters, you file the outside bevel, detail B, but on diagonals you file the inside bevel, detail C. Just touch-up the opposite side to produce a slightly rounded edge that still feels sharp to the touch. This is more resistant to nicking. Retain the original angles when filing. Also check constantly by closing the jaws and holding toward light. When the edges are restored they should close light-tight along the entire length.

To alter diagonals and nippers for cutting plastics, grind or file the head down as in detail C, Fig. 14, to remove the small outside bevels of the cutters. When grinding hold the edge to the wheel with very little pressure. Dip frequently in water to avoid drawing the temper. For cutting plastics a sharp edge is better than a rounded one, as the latter does not make a clean cut but tears the stock due to wedging action. Pliers having side cutters ground for plastics are no longer suitable for cutting metal. ★ ★ ★

## Center Lines on Front Tires Aid Measuring Wheel Toe-In

To measure the toe-in of car front wheels accurately, one shop man first applies strips of masking tape over the treads as nearly centered as possible. Then a soft pencil, held against a steady rest, is used to scribe a true line around the circumference of each tire. Following this, distance A at the back edges of the tires, is measured approximately 8 in. from the floor, after which distance B is measured in the same manner. The difference between the measurements, when B is shorter than A, indicates the amount of toe-in the wheels have. As a rule,  $\frac{1}{8}$ -in. toe-in is right for most cars, but the original specifications should be checked.



## Ear Corn in Overhead Bin Fed Directly Into Grinder



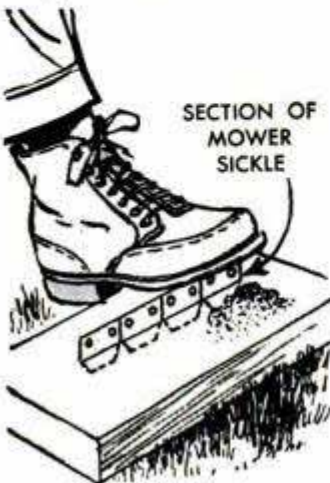
To save extra handling when grinding ear corn, one farmer locates his feed grinder directly under the chute of a hopper-type bin in his granary. The flow of corn is controlled by a sliding shutoff in the bottom of the chute.

George Laycock, Batavia, Ohio.

## Micrometer Carrying Case From Revolver Holster

To protect his micrometer from possible damage when stored in a tool kit or workbench drawer, one machinist uses an inexpensive flap-type revolver holster to provide a case for the instrument. The only alteration made was to sew the bottom closed to keep out dirt, trash, metal shavings, etc. Another advantage in favor of the holster-type case is that it can be worn on the user's trouser belt.

## Improved Shoe Scraper

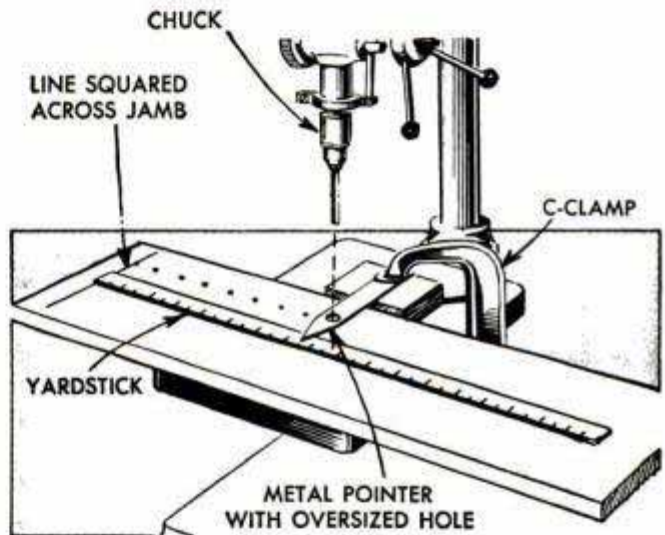


Needing foot scrapers at the dairy barn, milk house and also at the back door of the farm home, one farmer improvised them by cutting 12-in. lengths from an old mower sickle and simply driving each one into a length of 2 x 6-in. stock. The points of the sickle sec-

tions are readily driven into the wood and due to the triangular shape of each section they hold securely. The scrapers can be anchored at the edge of a path with stakes made from 1/2-in. rods. The square corners of the knife bars clean shoe soles effectively.

## Improved "Jig" for Drill Press Aids Drilling Cabinet Endpieces

Equally spaced holes for shelf-support brackets can be drilled quickly and accurately in the endpieces of a cabinet or bookcase by improvising a "jig" from a yardstick and metal pointer for use on a drill press. First, square a line across one end of an endpiece where the first two holes are to be drilled, and then place a yardstick on the work so the numerically low end is even with the line. Center the graduated edge of the yardstick lengthwise on the

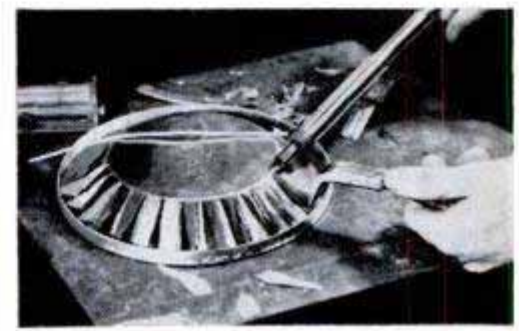
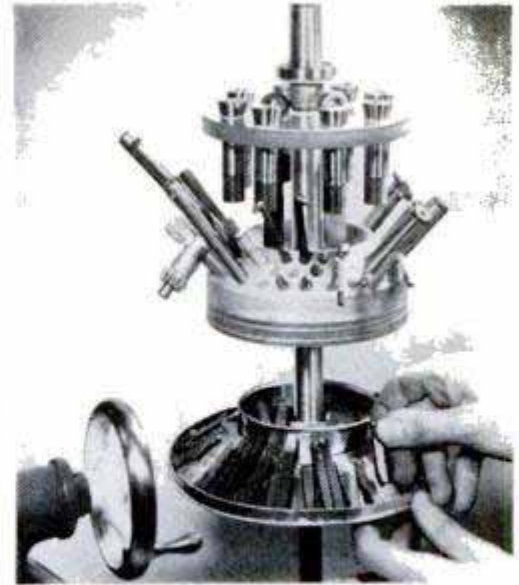
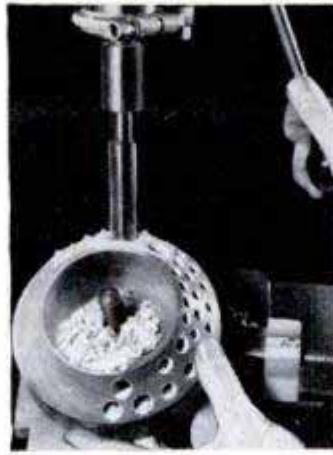
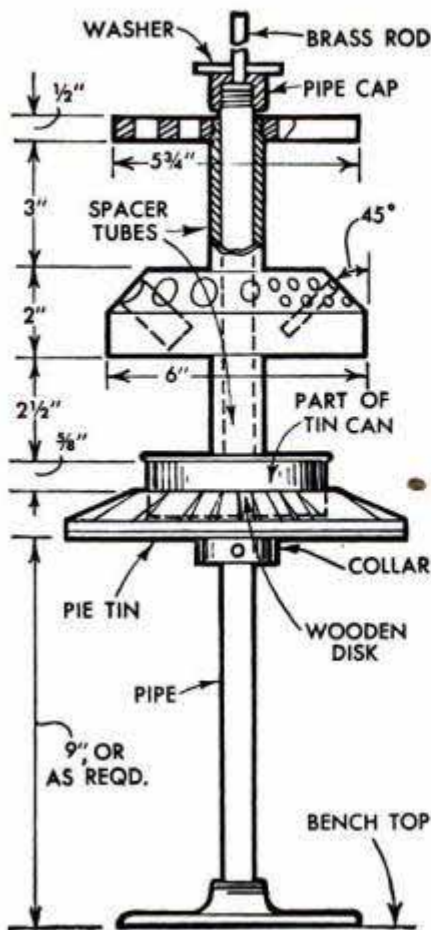


work and thumbtack in place. Following this, cut a pointer from sheet metal which is clamped together with a wooden raising block to the drill-press table. The pointer is cut and drilled so that, when clamped in place, the point is even with the graduated edge of the yardstick and an oversized hole in the pointer arm is aligned directly beneath the drill bit. The wooden block not only is used to elevate the pointer slightly above the surface of the work, but also serves as a guide for the work. Adjustment of the block will determine the distance the row of holes will be drilled from the edge of the work. In use, the work is moved over the drill-press table until the pointer registers on a predetermined measurement on the yardstick, at which point the drill bit is lowered through the hole in the pointer for drilling. In drilling the second row of holes, the work is reversed.

George B. Moses, Unionville, Conn.

☞ To prevent car doors from freezing, rub a little glycerin on the weather stripping.

# "Lazy Susan" Rack for Metal-Lathe Accessories



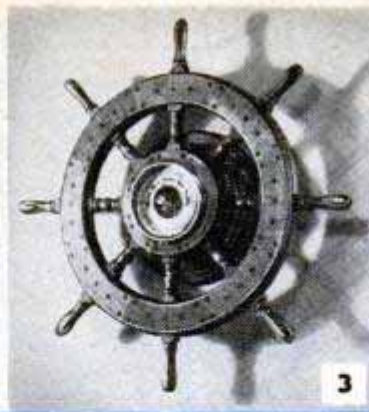
CONSISTING OF A TRAY and two disk holders that rotate on a pipe standard, this handy rack mounted on the end of a lathe bench brings all lathe accessories within easy reach. The standard is threaded at both ends, the lower end being turned into a pipe flange screwed to the bench top. The tray and holders are positioned on the standard by metal spacers and supported by a shaft collar located beneath the tray as shown in the detail. Designed for holding cutting bits, the tray is made from an 8-in. piepan inverted and nailed to a wooden-disk stiffener. A strip of thin sheet metal, or metal from tin cans, is soldered around the rim of the pan, and partitions of the same metal are soldered to the sloping surface to form small compartments as illustrated above in the photo at the lower right. A ring cut from a can is then soldered to the top of the tray to provide a receptacle for miscellaneous accessories. The stiffener disk is drilled in the center to fit against a shallow shoulder cut or filed on a short piece of the same tubing from which the spacers are made. This piece which projects below the stiffener and rotates on the collar in the manner of a hub or bearing, is reamed, as are the spacers, to slip over the  $\frac{3}{8}$ -in. standard, and rotate with a minimum of play. The center holder, which is made by gluing two wooden disks together, is mounted in a lathe for bevel-turning one

edge 45 deg. and, if desired, cutting the center of the top surface to form a concavity for holding small parts. Next, the beveled surface is drilled and reamed, as in the photo at the upper left, to provide holes of various sizes in which center drills, chuck keys, twist-drill bits, etc., can be stored. The holder then is drilled in the center to fit against a shoulder cut or filed on the upper end of one of the spacer tubes. The top holder was made from  $\frac{1}{2}$ -in. plastic cut in the shape of a disk and drilled, as shown in the photo at the lower left, to hold an assortment of lathe collets. Drilling should be done slowly to avoid fracturing the plastic. As in previous steps, the center of the disk is drilled to fit against a shoulder on the other spacer. The threaded upper end of the standard is fitted with a pipe cap that has been drilled and tapped to receive the threaded end of a brass rod. With a washer slipped over the rod to serve as a stop, this makes a handy place for storing a collet adapter.

Walter E. Burton, Akron, Ohio.

## Can Holds Tape on Toolbox

To store a roll of friction tape so it always will be handy, one electrical worker keeps it in a shoe-polish can nailed to the end of his toolbox. The press-fit cover is easily removed or replaced as necessary.



# HOW TO SAW SEGMENTS

By Sam Brown

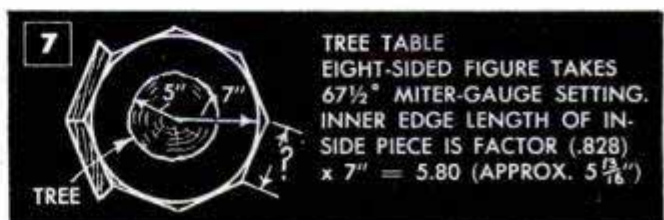


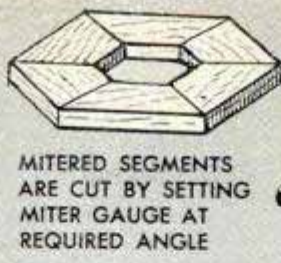
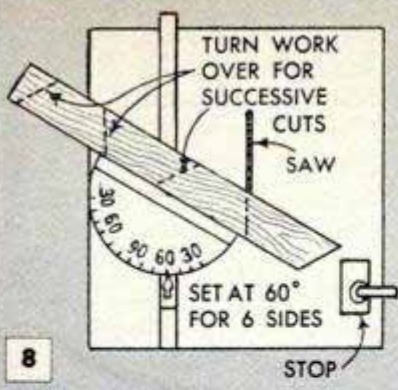
Above, setup for cutting curved segments in two thicknesses of stock. Be sure bandsaw blade is sharp and properly set. Below, an example of the polygonal form is six-sided table built with straight segments



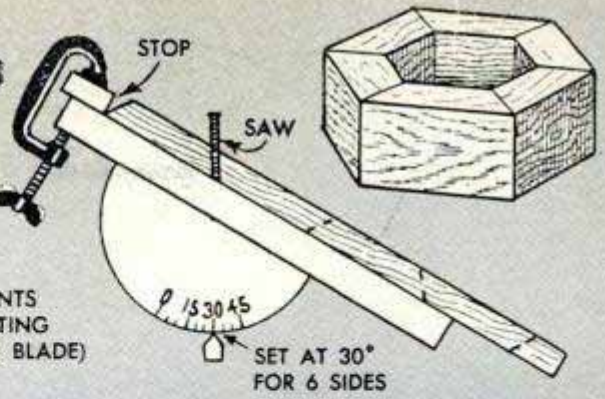
WHENEVER A RING of wood is required for any purpose, either in the circular or polygonal form, you generally can effect a marked saving in stock and achieve far greater structural strength by using segmental construction. The assembly can take a number of forms, typical applications being pictured in Figs. 1 to 4 inclusive, also Fig. 6. The circular, semicircular and polygonal forms find the most common use. Ordinary work of this type is first built up in the basic polygonal form, but only in certain types of construction is this the completed form. Usually circular cuts are necessary to bring the work to the desired size and shape.

**Polygons:** These are easy to cut to any size required with a circular saw or a miter box. Fig. 9 details 12 regular polygonal forms having 3 to 20 sides. The 4, 6, 8 and 12-sided figures are the ones most commonly used. The data included in Fig. 9 gives the center angle which is necessary when making a drawing of the figure. The miter and bevel settings are given for each figure, and also the multiplying factor to determine the side length of the figure. Fig. 8 shows how the work is done on the circular saw, the workpiece being turned over for the alternate miter cuts as indicated by the dotted lines. This effects a material



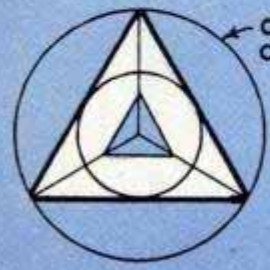


MITERED SEGMENTS ARE CUT BY SETTING MITER GAUGE AT REQUIRED ANGLE

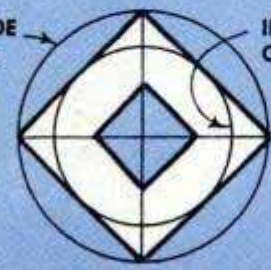


BEVELED SEGMENTS ARE CUT BY TILTING SAW TABLE (OR BLADE)

8



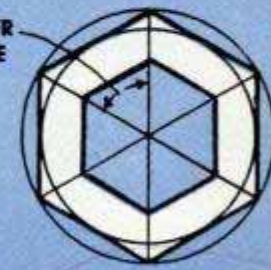
**3 SIDES — TRIANGLE**  
 CENTER ANGLE—120°  
 MITER—30°  
 BEVEL—30°  
 OUTSIDE CIRCLE—1.732  
 INSIDE CIRCLE—3.464



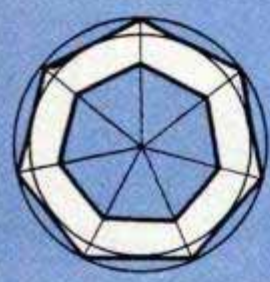
**4 SIDES — SQUARE**  
 CENTER ANGLE—90°  
 MITER—45°  
 BEVEL—45°  
 OUTSIDE CIRCLE—1.414  
 INSIDE CIRCLE—2.000



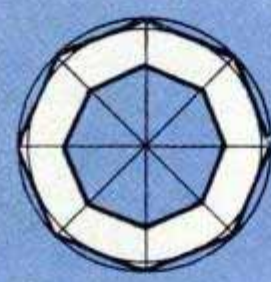
**5 SIDES — PENTAGON**  
 CENTER ANGLE—72°  
 MITER—54°  
 BEVEL—36°  
 OUTSIDE CIRCLE—1.176  
 INSIDE CIRCLE—1.454



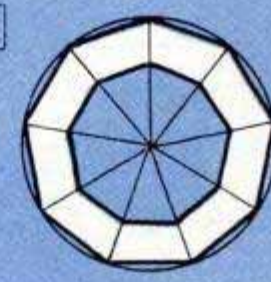
**6 SIDES — HEXAGON**  
 CENTER ANGLE—60°  
 MITER—60°  
 BEVEL—30°  
 OUTSIDE CIRCLE—1.000  
 INSIDE CIRCLE—1.155



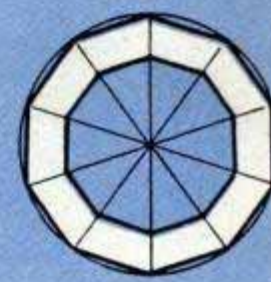
**7 SIDES — HEPTAGON**  
 CENTER ANGLE—51.43°  
 MITER—64.28°  
 BEVEL—25.71°  
 OUTSIDE CIRCLE—.868  
 INSIDE CIRCLE—.963



**8 SIDES — OCTAGON**  
 CENTER ANGLE—45°  
 MITER—67.5°  
 BEVEL—22.5°  
 OUTSIDE CIRCLE—.765  
 INSIDE CIRCLE—.828

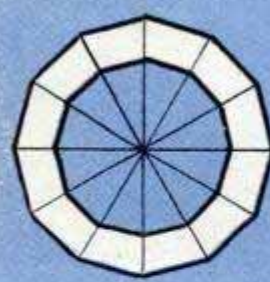


**9 SIDES — NONAGON**  
 CENTER ANGLE—40°  
 MITER—70°  
 BEVEL—20°  
 OUTSIDE CIRCLE—.684  
 INSIDE CIRCLE—.728

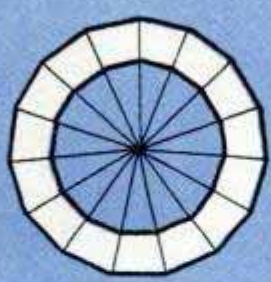


**10 SIDES — DECAGON**  
 CENTER ANGLE—36°  
 MITER—72°  
 BEVEL—18°  
 OUTSIDE CIRCLE—.618  
 INSIDE CIRCLE—.650

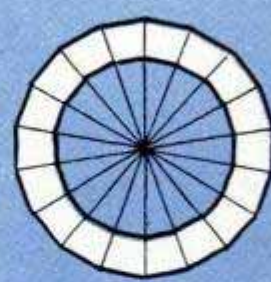
9



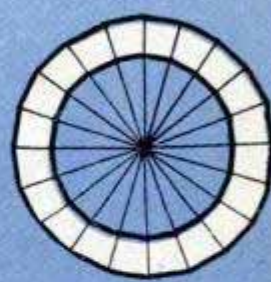
**12 SIDES**  
 CENTER ANGLE—30°  
 MITER—75°  
 BEVEL—15°  
 OUTSIDE CIRCLE—.518  
 INSIDE CIRCLE—.536



**15 SIDES**  
 CENTER ANGLE—24°  
 MITER—78°  
 BEVEL—12°  
 OUTSIDE CIRCLE—.416  
 INSIDE CIRCLE—.425

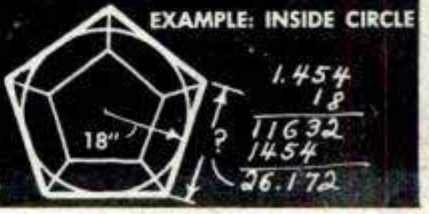
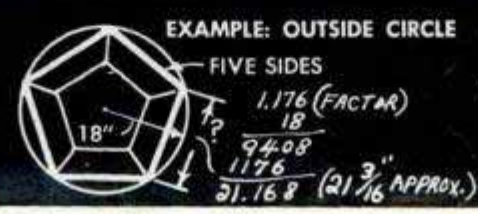


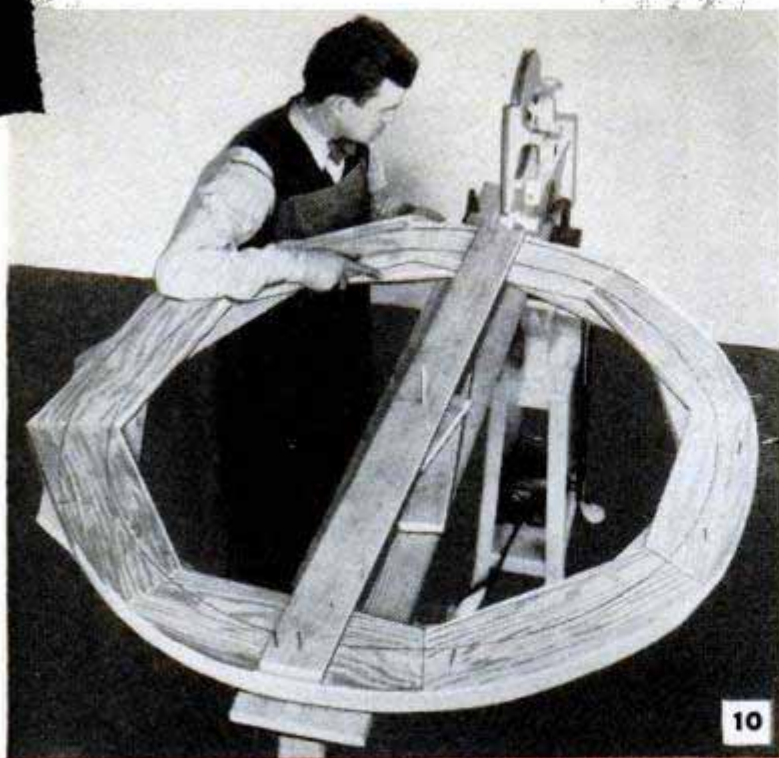
**18 SIDES**  
 CENTER ANGLE—20°  
 MITER—80°  
 BEVEL—10°  
 OUTSIDE CIRCLE—.347  
 INSIDE CIRCLE—.353



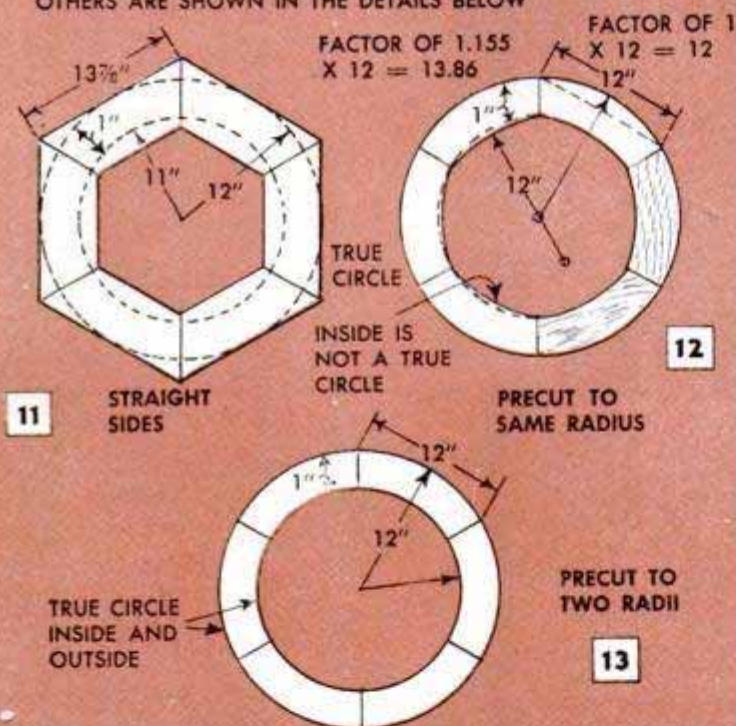
**20 SIDES**  
 CENTER ANGLE—18°  
 MITER—81°  
 BEVEL—9°  
 OUTSIDE CIRCLE—.313  
 INSIDE CIRCLE—.317

SIDE LENGTH OF FIGURE IS FOUND BY MULTIPLYING INNER OR OUTER-CIRCLE FACTOR BY THE RADIUS (SEE EXAMPLE AT RIGHT)

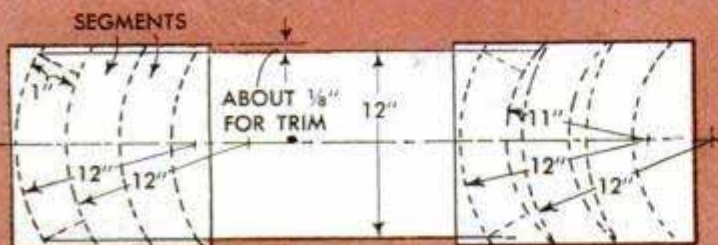




SAWING TO SHAPE AFTER ASSEMBLY IS ONE METHOD OF MAKING A SEGMENT RING. THIS METHOD AND TWO OTHERS ARE SHOWN IN THE DETAILS BELOW



ALL EXAMPLES 6-SIDED FIGURE TO FINISH 24" DIA. (ALLOW FOR TRIMMING IF REQUIRED)



saving in stock, as a number of pieces can be cut from one board without undue waste. The angle setting of the saw actually is the same for either miter or bevel, but the readings differ because the miter gauge ordinarily reads 90 deg. for a square cut, while the tilt scale reads zero when the blade is perpendicular with the table. Thus for direct settings, the miter angle is the complement of the tilt angle and the multiplying factor is the length of the side of the figure per inch of radius. The factor to use, inside or outside, depends on whether the figure being worked up is based on an inside or outside circle.

**The straight-sided figure:** This basic form is complete in itself for a job such as the tree table in Fig. 6. Here no secondary circular cuts are necessary to complete the parts ready for use. When making the tree-table top, the inside course of segments is used as a basis for determining the size of those succeeding, Fig. 7. Probably a more common form of the straight-sided figure, Fig. 11, is an assembly from which a circular ring can be cut on a bandsaw as in Fig. 10. Although the method is simple to do, even where several thicknesses must be stacked and glued, considerable stock is wasted. In some cases, the waste may be justified by the nature or requirements of the job, especially where the segments are wide and the flat grain is to be exposed in the finished work.

**Precut segments:** Precutting to the circular shape is a preferred method in nearly all production and pattern work involving segmental construction. In this procedure the segments are cut on crescent curves, the same radius being used for cutting the inside and outside edges of each segment, Fig. 12. This gives a perfect outer circle when the segments are assembled, but results in an imperfect inner circle. In some types of work this is of no importance, but when both sides of the assembly must be finished, the inside edge is easily jigsawed to form a true circle.

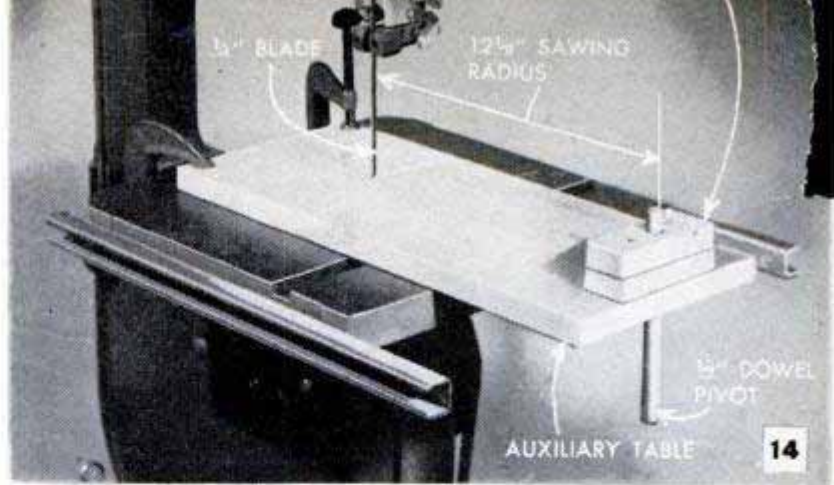
**Cutting same-radius segments:** The curved rail of the drum table, Fig. 1, is an example of this work. Here the job calls for a built-up

ring, 24 in. in diameter and 3 in. deep, which forms a core for veneering. The form is made up with six curved segments stacked, or laminated, to four thicknesses to obtain the required depth. Fig. 13 shows such a job dimensioned net, but note in the lower detail in Fig. 13 that about  $\frac{1}{8}$  in. is added for trim, thus the actual working radius would be approximately  $12\frac{1}{8}$  in.

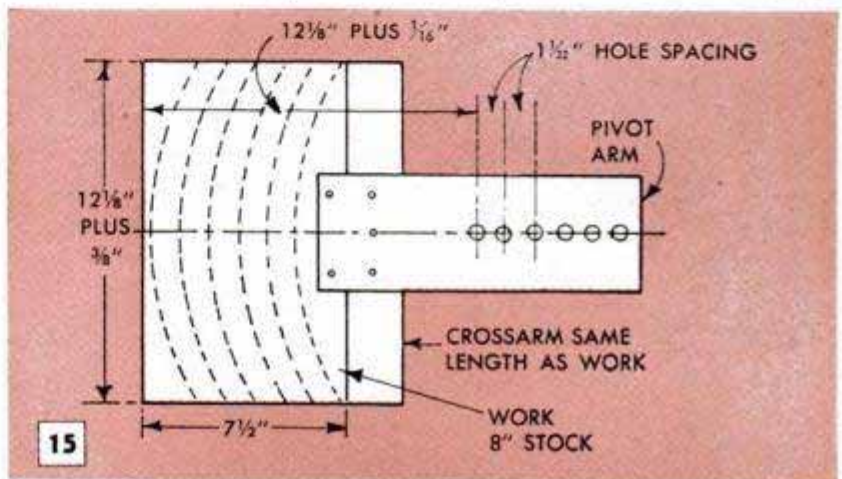
Using these dimensions as a working basis set up the band-saw as in Fig. 14, and then make the T-pivot as in Fig. 15. Note in this detail that the crossbar, or stop, is the same length as the work, and that stock of the width given will cut five segments. When it is necessary to speed up the job it is entirely practical to cut two thicknesses, as in Fig. 5. Note also in Fig. 15 that the sawing radius, plus  $\frac{1}{16}$  in. locates the first pivot hole. The  $\frac{1}{16}$ -in. allowance keeps the blade inside the line. Ordinarily the pivot-hole spacing should be a trifle more than the segment width.

**Trimming ends of segments:** When cutting the final segments of an assembly, skip the first pivot hole to make a guide piece as in Fig. 16. Attach a wooden strip to the circular-saw miter gauge, then toenail the curved guide to it as in Fig. 18. The guide should be located so as to permit trimming one end of each segment. Now, trim one end of all segments. Then tack a stop to the guide as in Fig. 19, to set the trim length for the opposite end of each segment. It is necessary to be exact in this setting, as for any specified radius you must have the same proportionate side length to obtain a perfect fit. Using a  $12\frac{1}{8}$ -in. radius, the side length should also be  $12\frac{1}{8}$  in., Fig. 17. The matching dimensions apply only to a six-sided figure. For other polygonal forms use the multiplying factor for an outside circle to get the segment length.

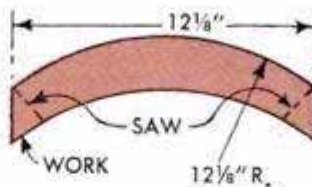
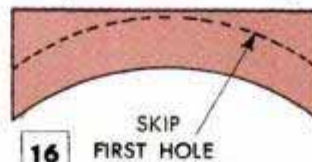
**Assembly of segments:** If the built-up form must be turned, it's a good idea to lay



In order to work circular segments on a small bandsaw, an auxiliary table carrying the pivot pin is clamped to the bandsaw table. Two raising blocks are required for two thicknesses

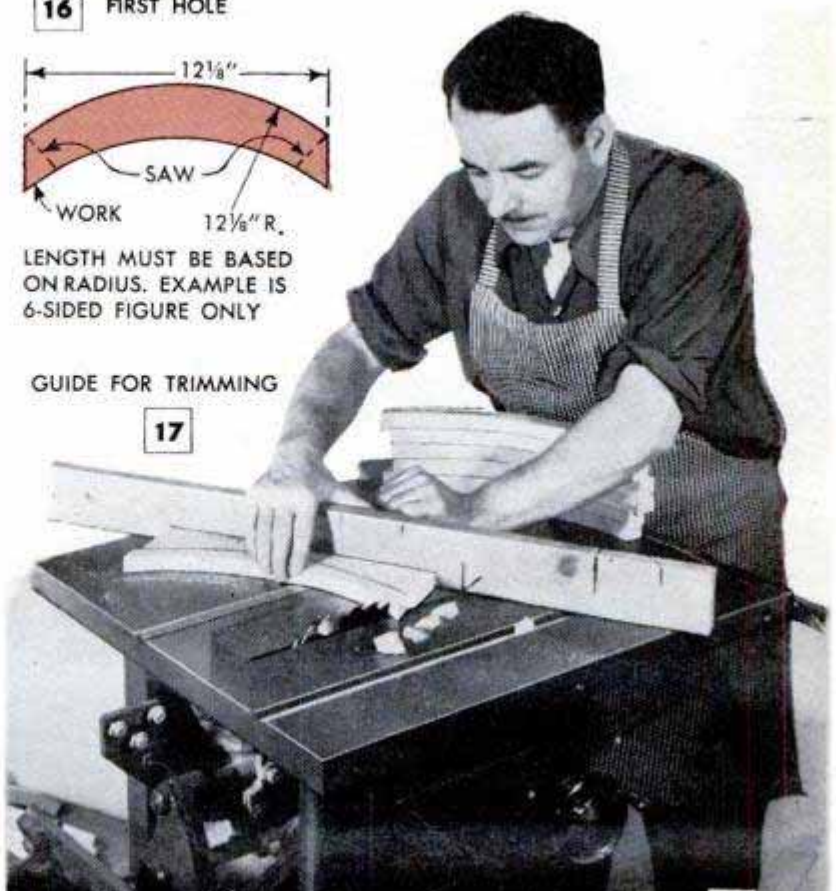


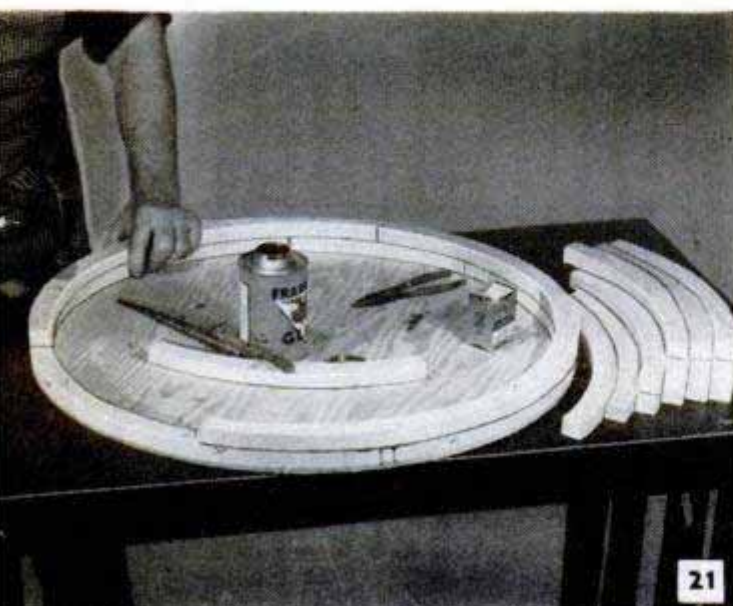
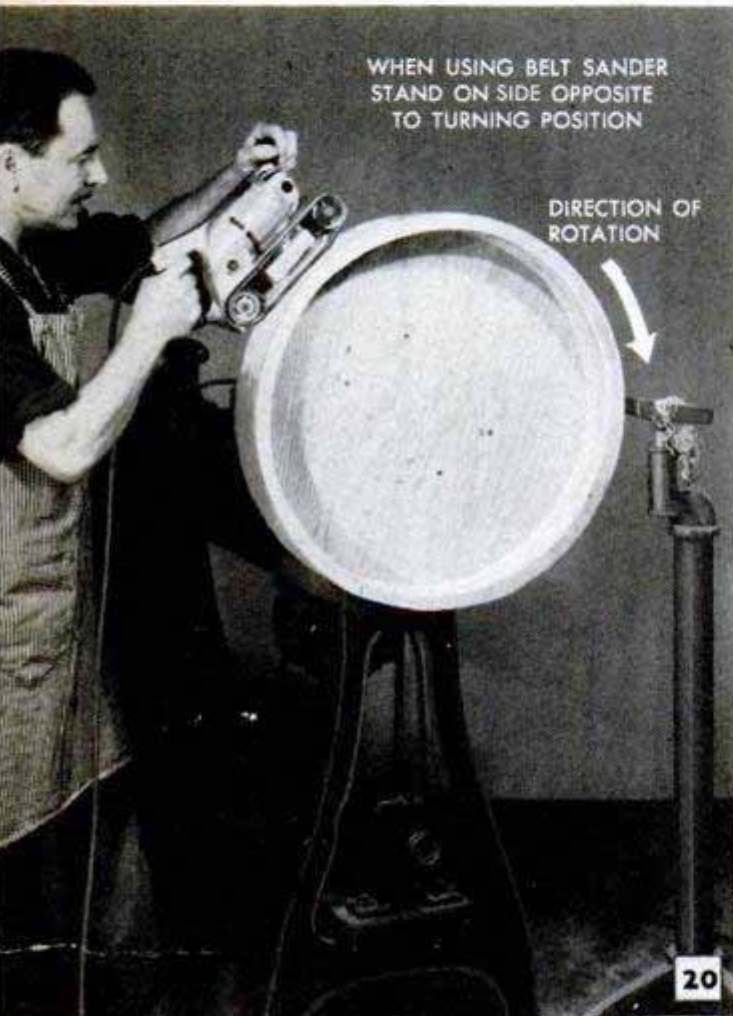
OUTSIDE PORTION OF WORK PIECE PROVIDES JIG FOR TRIMMING ENDS. IT IS NAILED TO MITER-GAUGE FACING. GAUGE IS SET AT 60° (FOR 6-SIDED FIGURE)



LENGTH MUST BE BASED ON RADIUS. EXAMPLE IS 6-SIDED FIGURE ONLY

GUIDE FOR TRIMMING



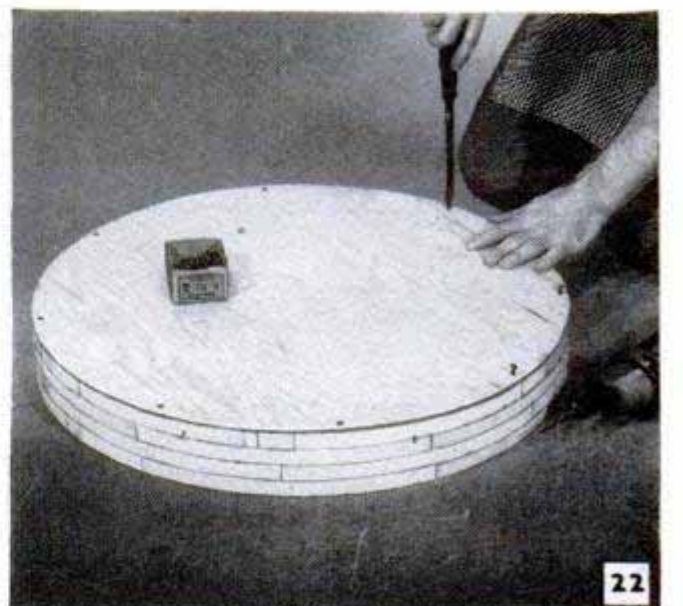


it up on a disk cut from  $\frac{3}{8}$ -in. plywood as in Figs. 21 and 22, the first course of segments being glued to the disk with a sheet of paper between. The paper "shim" permits easy removal of the work from the disk when the finishing operations are completed. After turning in the lathe at slow speed, the outer face of the ring can be sanded as in Fig. 20.

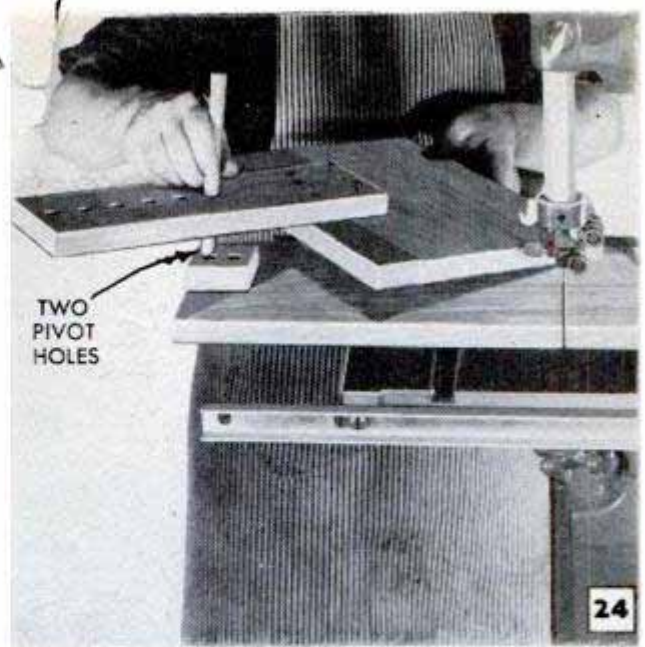
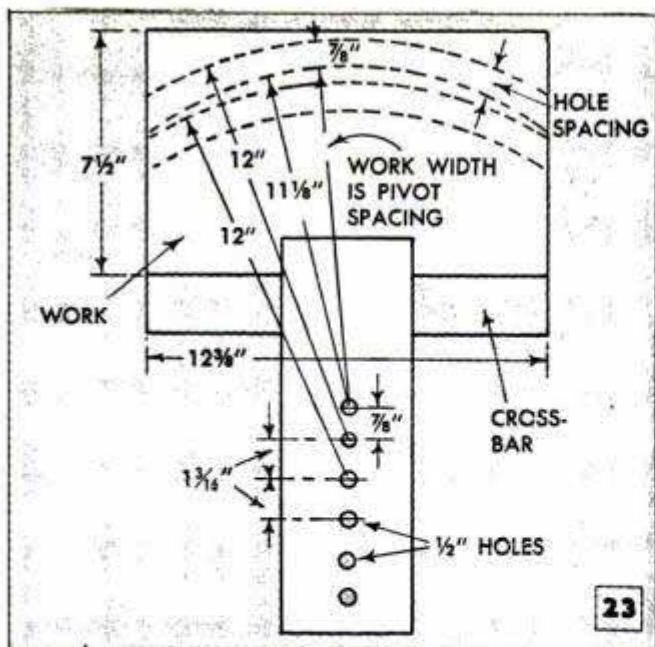
**Two-radii segments:** When the inner and outer edges of the segments must form a perfect circle, use the setup shown in Figs. 23 and 24, or, if you have the fittings pictured, you can set up the jig as in Figs. 25, 26 and 27. The auxiliary wooden table is clamped to the bandsaw table and the outer pivot hole is located at the required radius to cut the outer edge of the segment. The hole spacing on the pivot arm must be somewhat greater than the width of the work, and the best way to determine this accurately is to make a full-size layout, Fig. 23. The pivot pin is inserted from the top of the pivot arm, Fig. 24. In cutting the outer radius, the pin is inserted in the first hole (nearest the crossbar) and into the outer pivot hole. Then the pin is inserted in the inner pivot hole to cut the inner radius. Repeat for the second segment, using the second hole. Note that this procedure leaves a thin curved strip of waste between the segments. The alternate jig, Fig. 25, also Figs. 26 and 27, is somewhat faster in adjustment. It is built up from standard hold-down parts supplied as circular-saw accessories.

**Single-thickness work:** All the work so far described has been laminated, consisting of several thicknesses built up with the joints broken like those in a masonry wall. When a segment ring is to be made up in

Lower photos show method of building up a ring of circular segments laminated to three thicknesses. Lower row of segments is tacked to a plywood disk



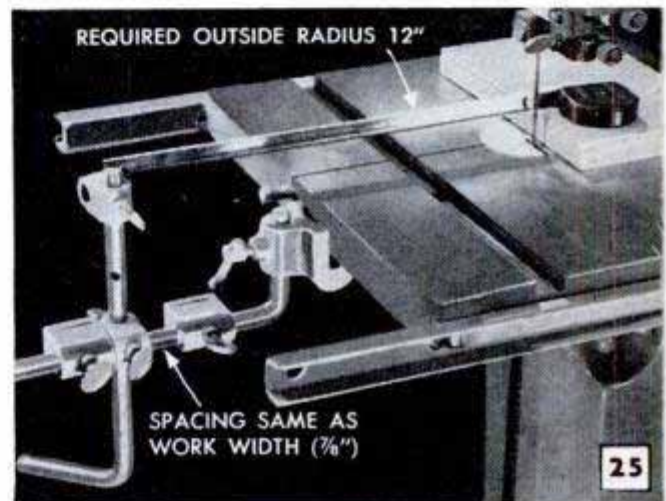




a single thickness of stock, the miter joints are strengthened with splines or dowels. In this work the miter angles are somewhat more critical. It's a good idea to first run a few test segments in waste wood to be sure of correct fit.

In all work of this type it is essential that both the bandsaw blade and the circular-saw blade be correctly set and filed with the teeth jointed to a uniform height. If the bandsaw blade runs out even slightly, you are likely to have trouble cutting same-radius segments, and if the circular-saw blade is dull or improperly sharpened this condition is likely to cause the stock to creep when making miter cuts. Also, it is necessary to make sure that the pivoted jigs are centered with the bandsaw blade to prevent binding of the blade when making the curved cuts, especially on short-radius segments. Be sure the setting is correct before starting the machine. ★ ★ ★

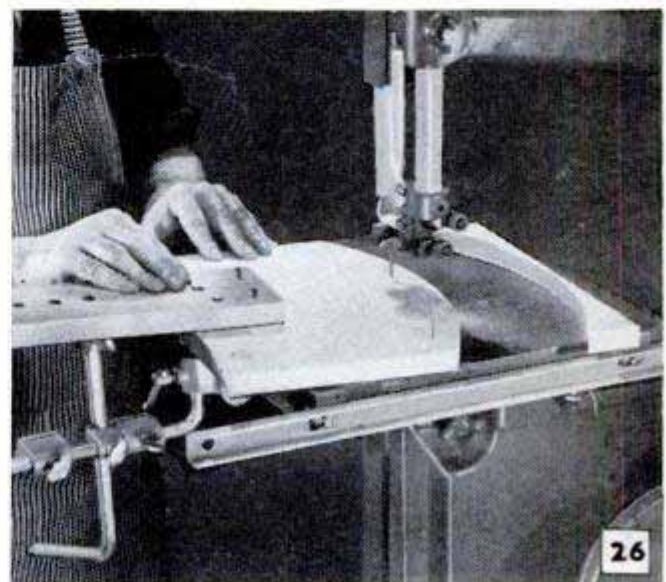
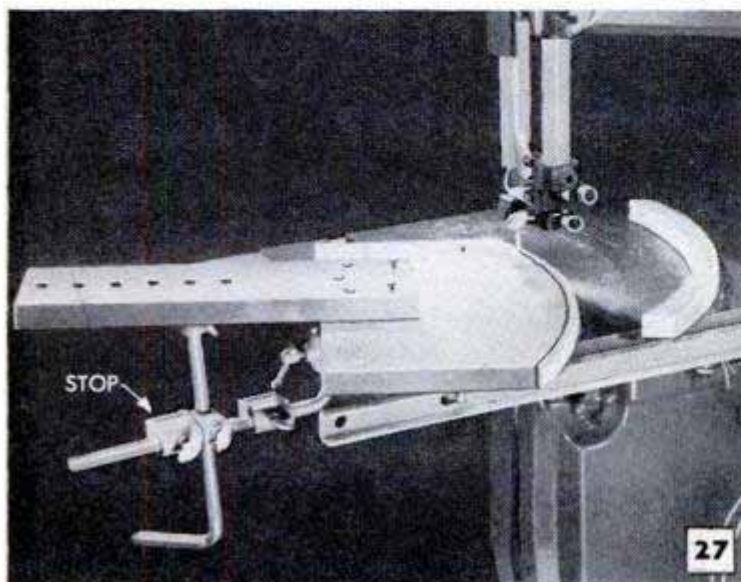
When two radii are used segments will laminate with the inner and outer edges forming perfect circles. Pivot pin is worked alternately in two pivot holes



Another setup for dual-radius sawing, using standard hold-down parts supplied as circular-saw accessories. Unit has adjustable stops for locating the pivot

Here the first cut has been made to remove the waste piece and the second cut to form the segment is in progress. Note the position of the sliding pivot

In this step one segment has been cut and now the waste piece is being removed by a third cut all the way through. Again note position of sliding pivot



## Hydraulic Cylinder on Wagon Speeds Dumping of Load

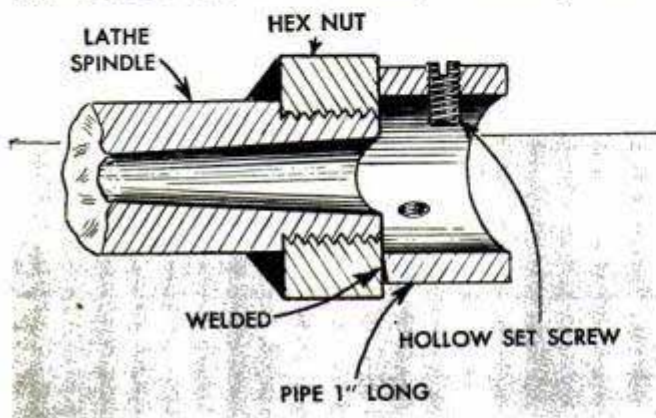


By mounting a hydraulic cylinder on the front end of a wagon, one farmer makes quick work of dumping loads of cut silage, small grain, ear corn, etc. Installed on the chassis frame, the cylinder is positioned so the piston will thrust against a cable secured to the upper end of the cylinder and also to the end of the wagon-bed frame. The cylinder is operated by attaching it to the hydraulic system of a tractor.

John Krill, North Lima, Ohio.

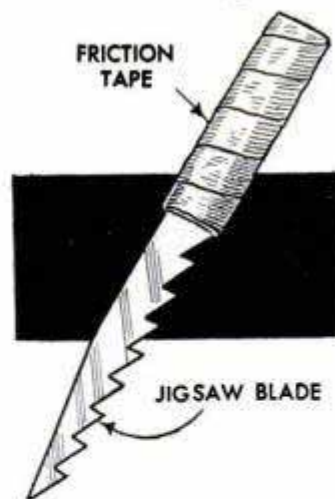
## Oversized Chuck Improvised From Pipe and Hex Nut

Lacking a hand-type chuck large enough to hold short lengths of dowel for turning on my lathe, I improvised one from a piece of 1-in. pipe and a large hex nut that fitted the lathe spindle. The pipe was drilled and tapped to take three equally spaced setscrews for gripping the dowel, after which it was welded to a standard 3/4-in. hex nut. In use, the hex nut is threaded on the spindle, and the dowel is held in the pipe by the setscrews.—H. Cowan, Clinton, Iowa.



## Saw-Blade Tool Removes Key

The tip of a key broken off inside a car-door lock, or other tumbler-type lock, may be removed easily by using a tool improvised from a jig or coping-saw blade. The tool is made by grinding the end of the blade as shown, and then wrapping tape around the opposite end to provide



a handle. In use, the tool is inserted in the lock so the beveled upper edge of the blade raises the first tumbler sufficiently to allow teeth on the lower edge of the point to be hooked into the broken piece for withdrawal.—J. R. Paquin, Worcester, Mass.

## Gravel Speeds Lowland Drainage

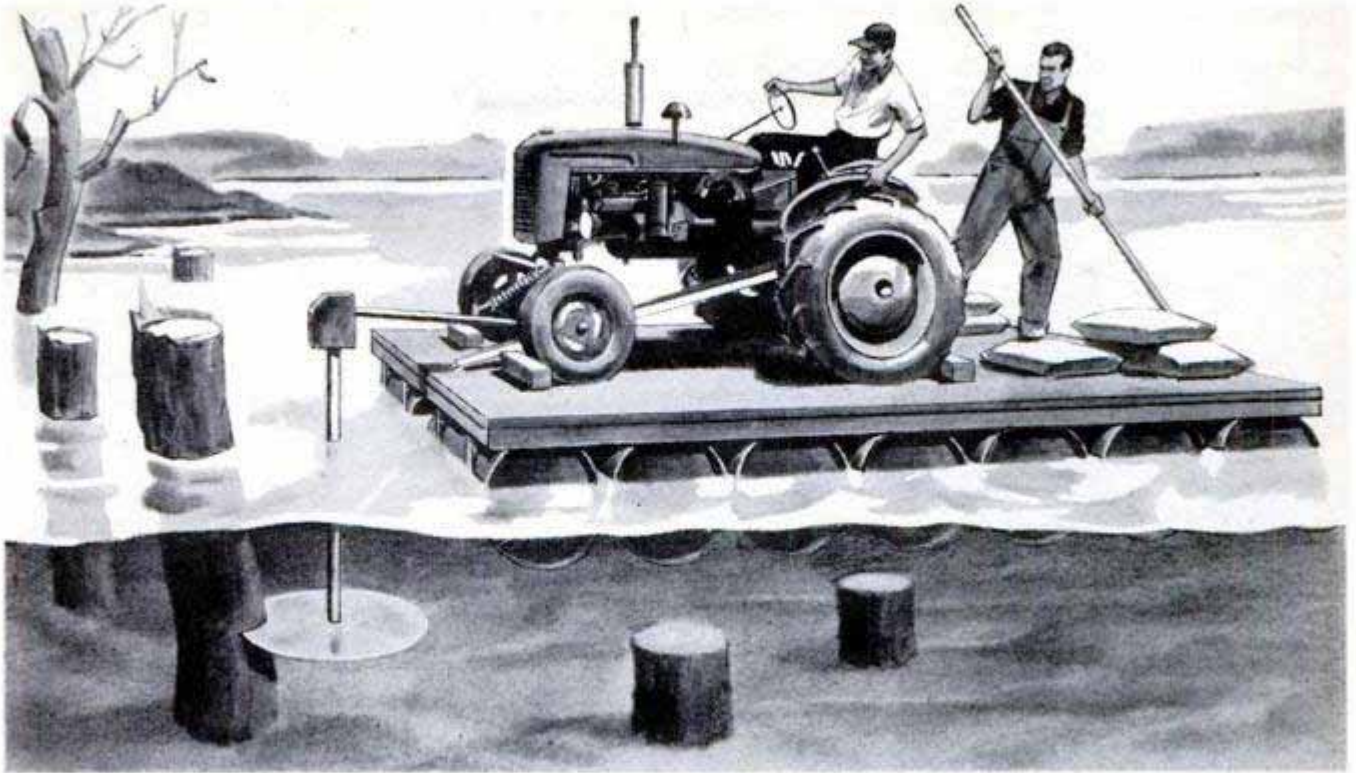
Discovering that a certain section of bottom land still remained wet after drain tile had been installed, one farmer dug down to the tile at intervals of 10 to 15 ft. and placed a shovelful of gravel over each of the tile joints exposed, after which the soil was replaced. The gravel prevents the wet soil from becoming packed around the joints, thus increasing the efficiency of the system sufficiently to drain the area and allow it to dry.

## Grooved Distributor Shaft Prevents Oil Seepage

On certain makes of older cars, oil from the crankcase has a tendency to work up into the distributor, usually as a result of wear in the distributor shaft. One way to remedy this until permanent repairs or replacements are made, is to grind or file a groove around the shaft so that it will spiral downward as the shaft rotates. Thus, the groove will carry excess oil back into the crankcase. At the point where the shaft fits inside of the bushings, the groove should encircle the shaft twice.



# Floating Tractor Saw Cuts Stumps Underwater

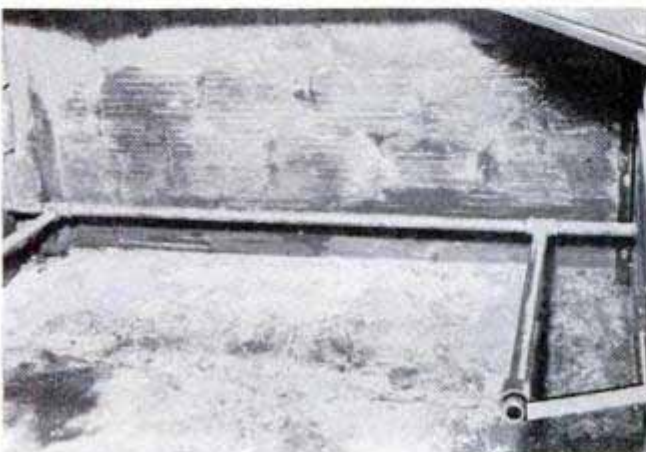


To clear a shallow lake of tall stumps which remained as a hazard to boating when the water was impounded by damming cutover swamp land, the owner floated a tractor and saw on a barge consisting of a heavy platform lashed to oil drums. To support a small tractor of the type pictured, fourteen 55-gal. drums placed under the platform in two rows of seven drums each were found sufficient. A larger tractor, two-plow size, would require a minimum of 20 drums, with 24 drums giving a more ample safety margin. When selecting the drums be sure that each is airtight and watertight. The platform should be constructed of heavy stock and braced so that it will support the tractor without springing or buckling under the weight. Have several bags of sand handy to "trim" the barge so that it will float level with the tractor blocked in working position near

one end. The saw used is of the universal tractor-mounted type having a swiveling joint at the bevel-gear housing, which permits the blade to be operated in either the vertical or horizontal position. In order to locate the saw at the depth required, it is necessary to extend the swiveling section of the arbor by means of a special housing. A new arbor and arbor bearing must be fitted into the substitute housing. In use, the tractor is securely blocked in position on the barge with the wheel brakes locked. Then the barge is trimmed with the sandbags so that it floats level. One man operates the tractor and saw, while another controls movement of the barge by poling as pictured. In some cases two men with poles will be required to ease the barge into position and feed the underwater saw uniformly into the cut.

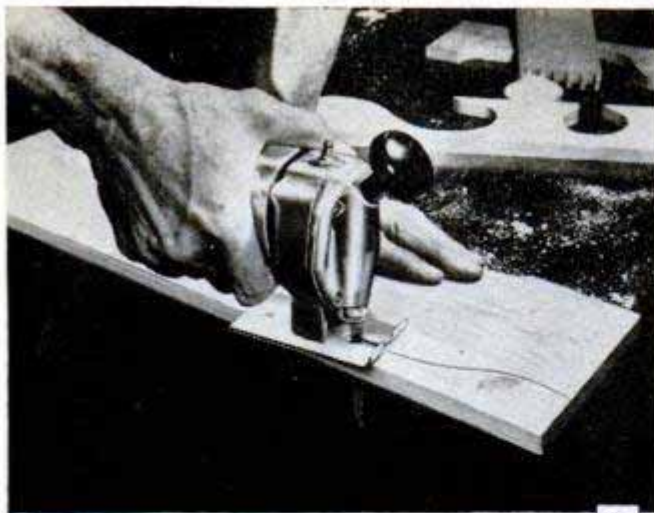
Perry S. Graffam, Chicago.

## Wall-Supported Pipe Rails Aid Cleaning Farrowing Pen



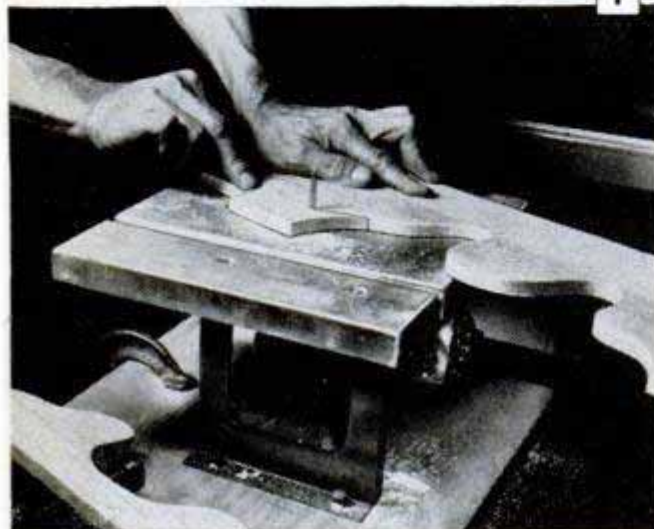
Assembled from lengths of pipe and pipe tees, the rails in this farrowing pen not only prevent a sow from crushing her young, but also improve sanitation by providing an unobstructed floor area that is easily cleaned and aired. The side rails are supported at the front of the pen by brackets formed from automobile-spring leaves that are bolted to side partitions. The opposite ends of the side rails are turned into pipe tees that connect to other lengths of pipe to form the back rail. Ends of this rail are inserted in holes in the side partitions for added support.

# SHOPPING FOR TOOLS

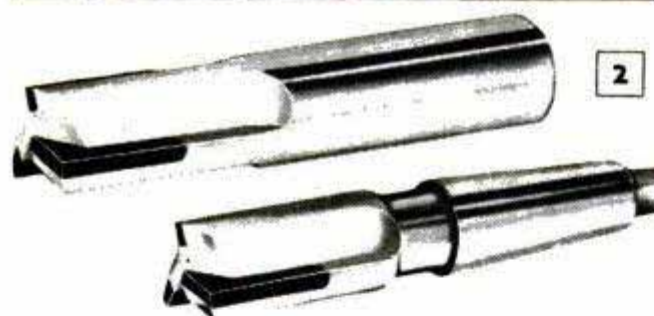


1

**1. PORTABLE JIGSAW** does work of several machines. The hand-held unit makes curved cuts in hard and soft woods, nonferrous metals and plastics. Works in places inaccessible even to a keyhole saw. Makes pocket cuts in 1-in. stock without a starting hole. The motor housing is made to serve as a handle and the wide shoe steadies the units so that cuts square with surface are made easily. High speed of the blade results in extremely smooth work, requiring very little sanding. When mounted in an accessory table as in the lower photo, unit does accurate crosscutting, ripping and angle sawing with the guides supplied



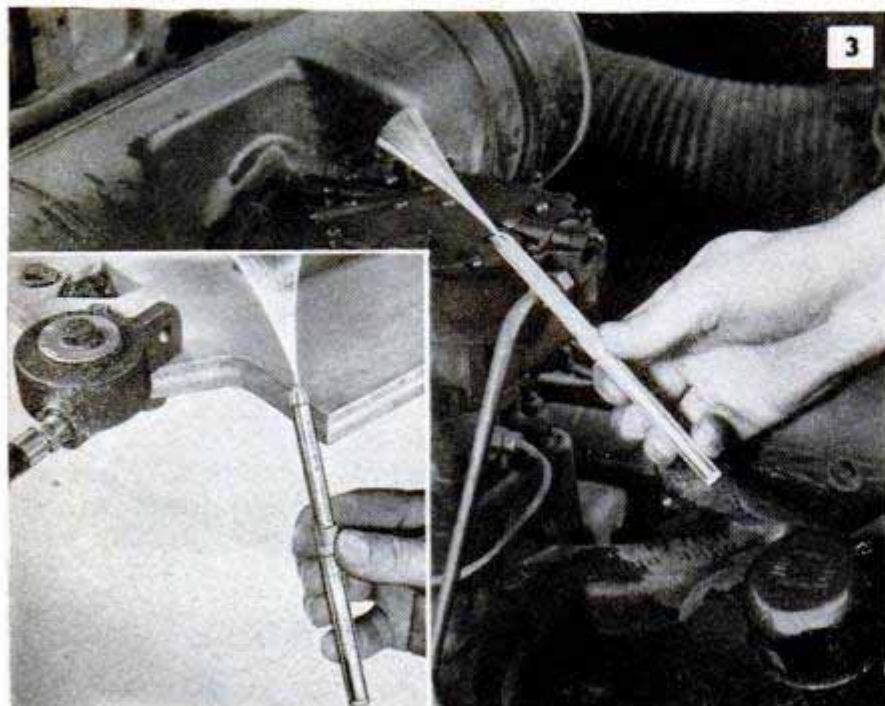
**2. CARBIDE-TIPPED PENETRATING END MILLS** are designed to penetrate and cut laterally in such operations as routing and also face and slab milling in nonferrous metals and nonmetallic materials. Furnished in three-flute types for soft metals and in two and six-flute types for machining steel and harder metals



2

**3. VIBRATION MEASURING INSTRUMENT** locates the source of unwanted vibrations and then measures amplitude and rate by means of a "tuning" slide and vibrating reed. Movement of tuning slide to give maximum throw of reed results in a direct scale reading which is multiplied by 1000 to give cycles per minute

**4. DETACHABLE POURING LIP** fits 1-gal. paint containers having friction-type lids. To use, just remove the can cover and press the pouring lip in place. Permits pouring paint from one container to another without spilling. Paint in container can be stirred with paddle without splashing. Made of plastic. Easy to clean

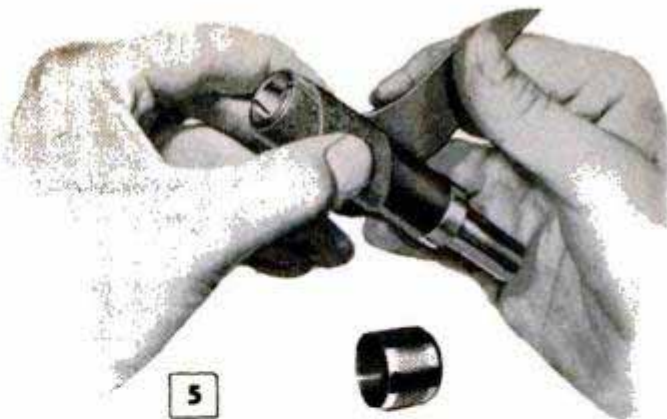


3

4



**5. SMALL-DIAMETER SANDING SPINDLES** come in sizes from  $\frac{1}{4}$  in. to 1 in. and are designed for chucking in drill press, flexible shaft, lathe or portable drill. Spindle is fitted with specially made locking device that makes it possible to use strips cut from ordinary sandpaper of any grade desired. Strips are spirally wrapped around the spindle and securely locked at both ends. Smallest size will work in any intricate jigsawed scrollwork having radii as short as  $\frac{5}{16}$  in.



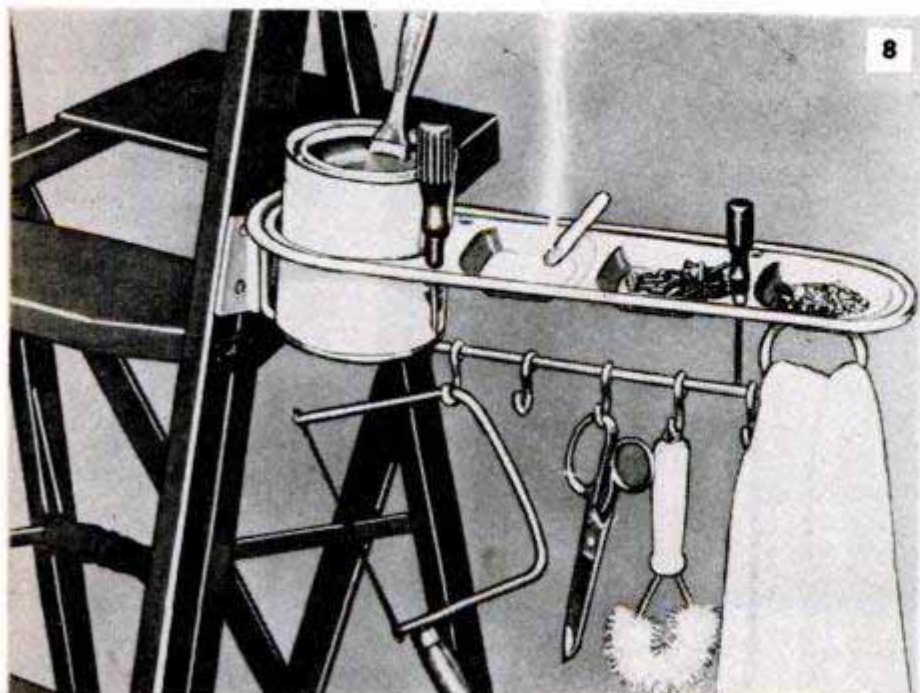
**6. COMBINATION GRINDER-HONE** provides small shops with complete grinding equipment for all types of edge tools. When belted to a small motor the abrasive wheel is driven at a speed of 3000 r.p.m. while the circular hone, which is geared to the wheel spindle, rotates at 110 r.p.m. Hone is sandwich type, providing grit No. 120 for whetting and No. 320 for honing. Hone is driven in a friction cup and is reversed simply by lifting it out of the holder and turning over



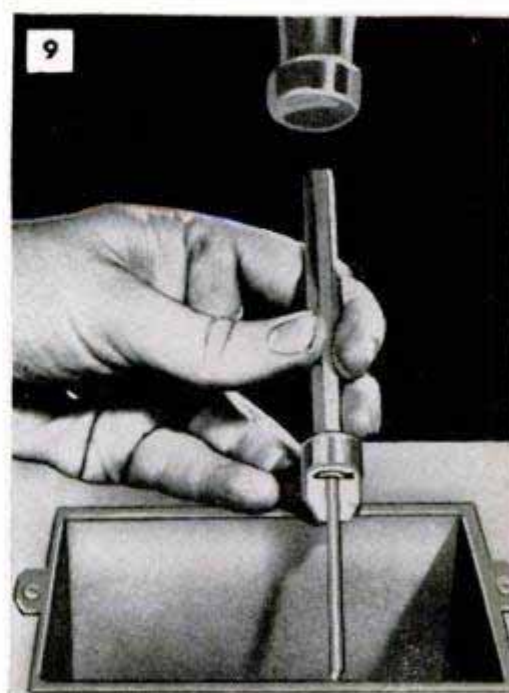
**7. UNIVERSAL HANDLE** for go and no-go gauges permits the user to make up multiple combinations for fast, accurate checks at the inspection bench or at the machine. Eight handles in a set will accommodate a range of plug gauges from .010 to .750. Handle is hexagonal in shape to prevent it from rolling off the bench and damaging the gauges. It is made of anodized aluminum and is fitted with "chucks," or collets, at each end which permit adjustment of gauges



**8. LADDER CADDY** attaches to stepladder by means of a metal bracket. Has a tray for small tools, screws, nails, brushes. An opening in the tray holds a can of paint and a rod swinging below the tray carries a number of sliding hooks for large tools. There's also a ring for the dustcloth. Anyone who works from a stepladder will quickly appreciate the saving in time and steps effected by having all the necessary tools within easy reach from the working position



**9. NAIL HOLDER** saves time and eliminates finger bruises when starting nails in places ordinarily difficult to reach. Electricians find it handy for starting nails in outlet boxes, carpenters and finishers use it both as a holder and driver when working in close quarters. Holds almost any type of nail, even roofing nails, in position for starting, and is used as a driver in places inaccessible to the hammer. Head of nail is held securely in a milled slot



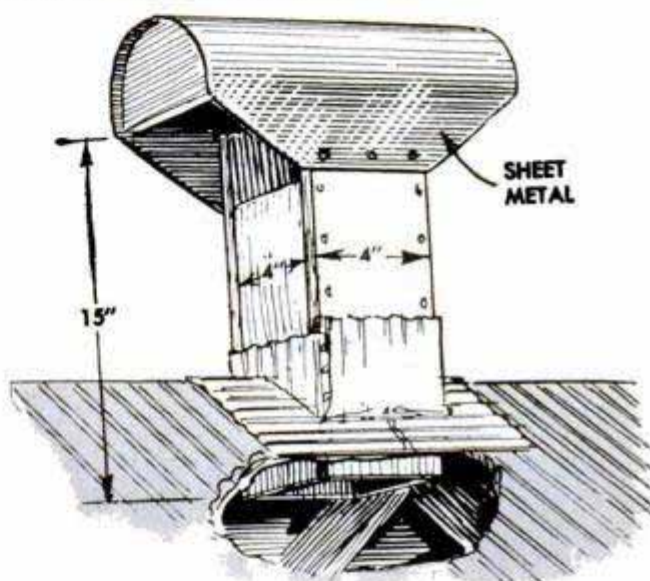
## Mechanical Hoe Weeds Raspberry Field Faster and Cheaper



One berry grower has designed a mechanical hoe to cut the cost of weeding and hoeing his raspberry fields. The operation now requires only two men and a few days time, where before as a hand operation, the work of ten men for four weeks was needed to finish the job. The hoe itself is a disk with six steel teeth extending downward from it. The power is supplied by a 3½ hp. gasoline engine, which drives the hoe through a right-angle drive unit improvised from a small automobile differential. The assembly is carried on a frame mounted on the tractor drawbar. One man drives the tractor and the second guides the hoe.—Bill Dugovich, Tacoma, Wash.

## Ventilator Provides Circulation for Low-Roofed Cattle Shed

This improvised ventilator is one farmer's answer to the problem of providing adequate ventilation in a low-roofed stock shed. The vent is an open-ended box made of 1 x 12 lumber, two sides being 3 in. longer than the others. The top end of the box is covered with sheet metal. The ends are reinforced with rounded pieces of 1 x 4 lumber. To install, a hole is cut in the roof next to a rafter to which the ventilator is nailed. It is cross braced on the opposite side and flashing is then nailed around the base of the ventilator.



## Stub Shafts on Wooden Roller Improved From Lag Screws



Drilling a hole for a shaft through the entire length of a wooden roller to be used as a sander drum or conveyor roller is unnecessary, if the ends are drilled to take stub shafts improvised from lag screws. This is done by sawing off the head of each screw after it has been inserted, and then rounding the end with a file. The screws should be centered accurately in order to minimize any tendency of the roller to wobble when rotated. If a metal-turning lathe is available, wobbling may be eliminated by first rough-turning the roller, inserting the shafts and then mounting it in the lathe

again, this time supported by the shafts for finishing. Or, if a roller has been rough-turned on a wood lathe for use as a sander drum, the shafts can be inserted and the roller mounted in the sander-drum bearings for truing with a turning tool.

Dick Hutchinson, San Gabriel, Calif.

## Alcohol Simplifies Cutting Of Auto Safety Glass

The difficult job of cutting safety glass in the small shop can be made easier if alcohol is used to dissolve the "plastic" between the glass sheets. First scribe the desired pattern on both sides of the glass and then carefully break the glass, one side at a time. When the two sides have been broken along the scribed lines, pour a small amount of alcohol into the crack from one side only. The alcohol softens the plastic after a few moments, making it easy to remove the surplus glass by applying pressure to the unwanted sections.

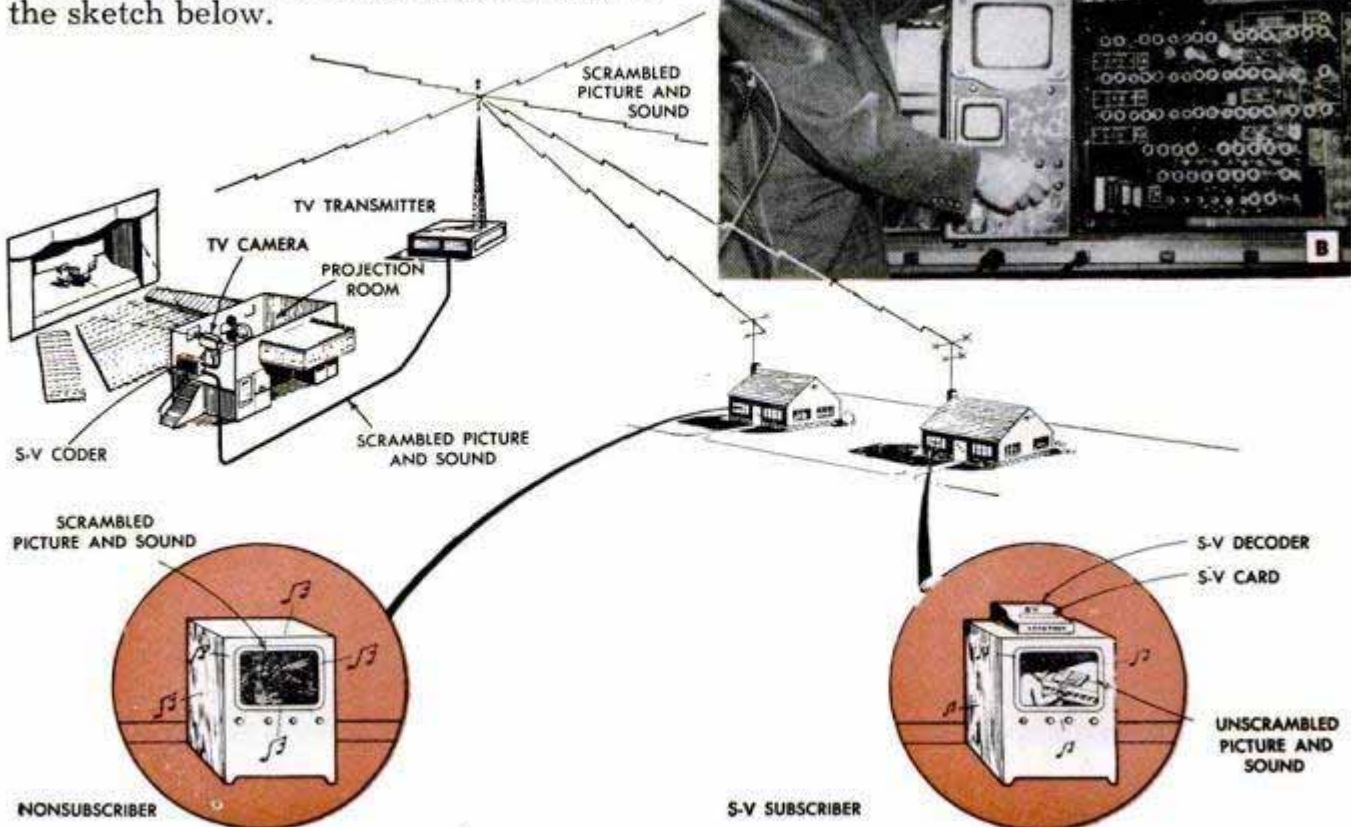
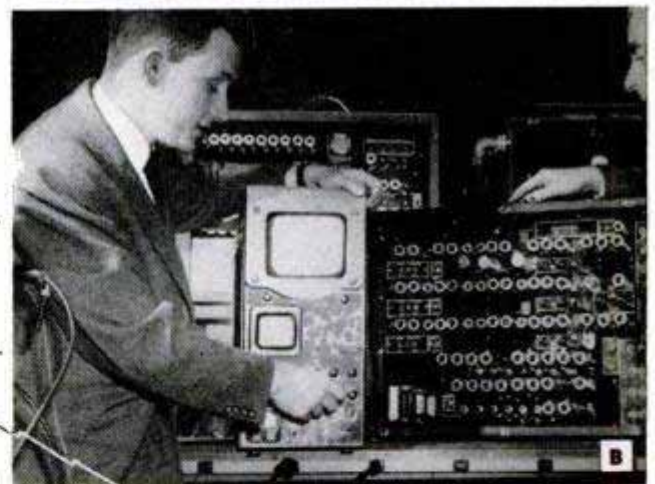
John Devlin, Merrick, N. Y.

# RADIO *Television* ELECTRONICS

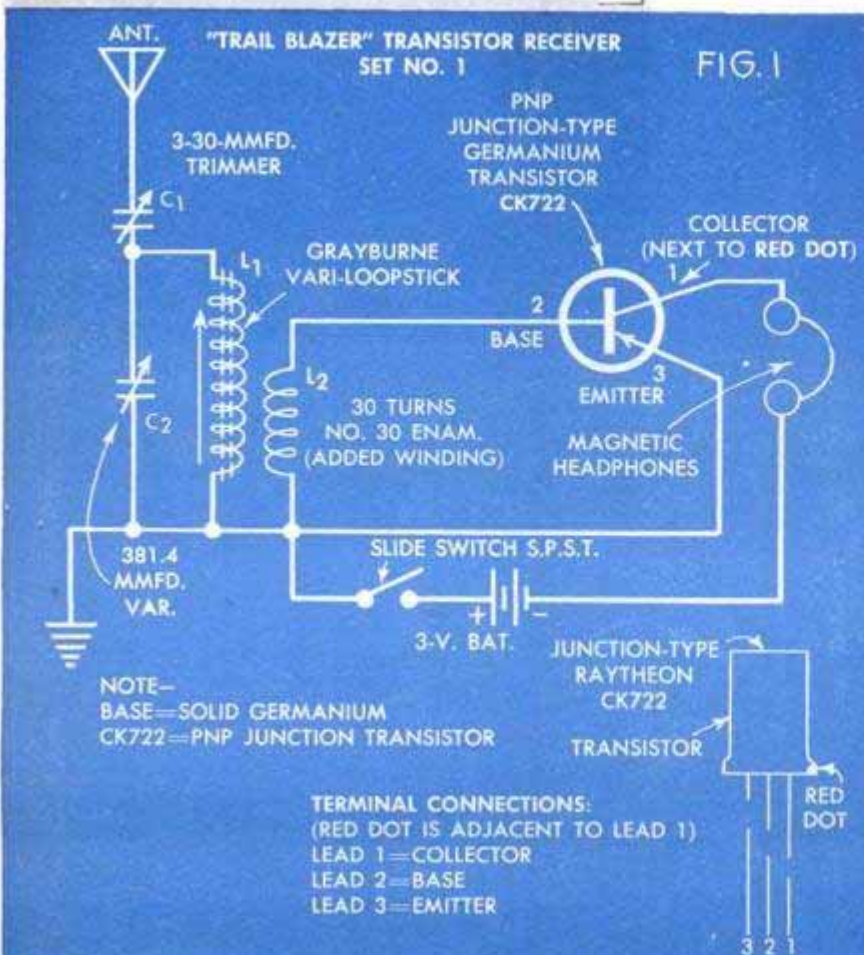
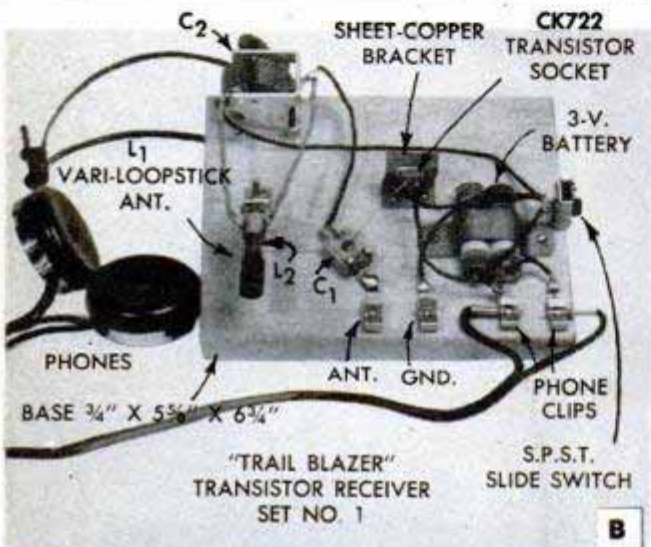
## TV-SUBSCRIBER SYSTEM

SUBSCRIPTION-TELEVISION is proposed to bring to millions of TV set owners many additional opportunities and choices in entertainment and education which they do not now enjoy. One of the new systems to bid for the approval of the Federal Communications Commission is known as Skia-tron's Subscriber-Vision. This system, recently given operational tests in cooperation with station WOR-TV New York, is claimed to be free from objectionable interruptions. The subscriber will pay only for viewing the special S-V (Subscriber-Vision) program he selects.

Signals are transmitted by the TV station through an electronic unit known as the coder. This unit, illustrated in the photo B, scrambles the TV waves. Each subscriber will have one of the small electronic units shown in photo A. This decoder unit, which can be connected to a standard TV receiver, has a slot in its top for the insertion of a special subscription card on which is listed the weekly programs. To connect the decoder for a specific program, the card is inserted and the proper button on the front of the decoder is pressed. This punches a hole in the card and completes the circuit. The new system is detailed pictorially in the sketch below.



# HOW TO BUILD EXPERIMENTAL



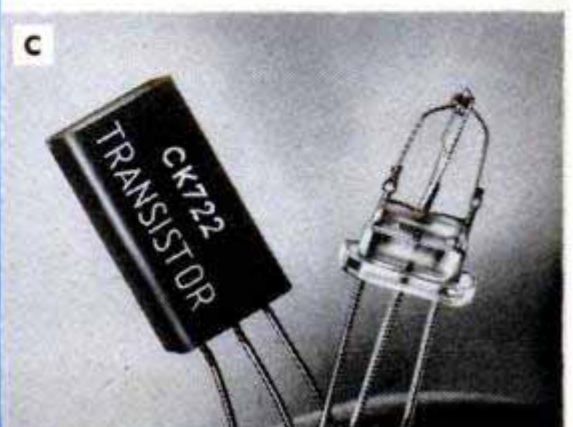
**T**RANSISTORS were developed by the engineers of the Bell Telephone Laboratories in a series of experiments with germanium that began in 1948. The original contact types were used to replace tubes in certain telephone and radar applications, but they were highly variable in their characteristics and of uncertain reliability.

Under the direction of Dr. William Shockley and J. A. Morton, an improved unit known as the junction type was developed, and this new unbelievably small, low-voltage amplifying device was announced in 1951, and described in *Popular Mechanics Magazine*.

The transistor is the first practical solid device that, like the vacuum tube, could amplify an electric signal. The new Raytheon CK722, photo C, junction or "sandwich" type used in these experimental receivers has recently been made available to students and experimenters. Transistors are still in limited supply and quite expensive, this CK722 junction type being one of the least costly.

These experimental transistor receivers are for the dyed-in-the-wool experimenter. Please remember, that transistors are still in the experimental stage although they replace tubes in some special, commercial applications.

Set No. 1, photos A and B, Fig. 1, is a very simple transistor receiver for headphones only. It will receive local broadcast stations with comfortable volume. It uses a vari-loopstick antenna coil, with an added winding wound right at the end of the raised cardboard cylinder. Once the wiring is completed, check the set over very carefully. Mark the transistor socket to properly position the transistor in relation to the red dot. If the transistor is inserted in reverse it will be ruined. Check and recheck leads 1, 2 and 3

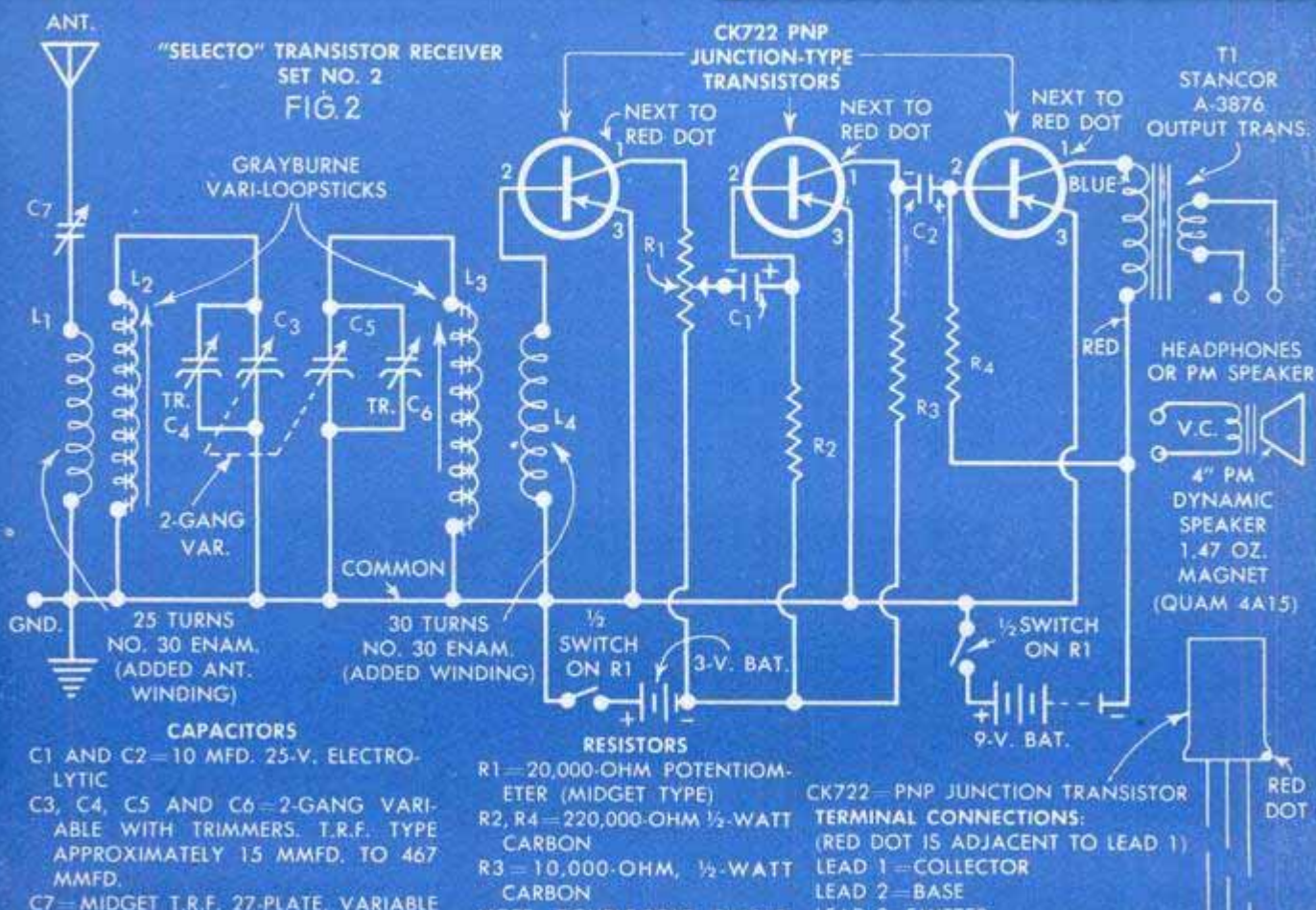
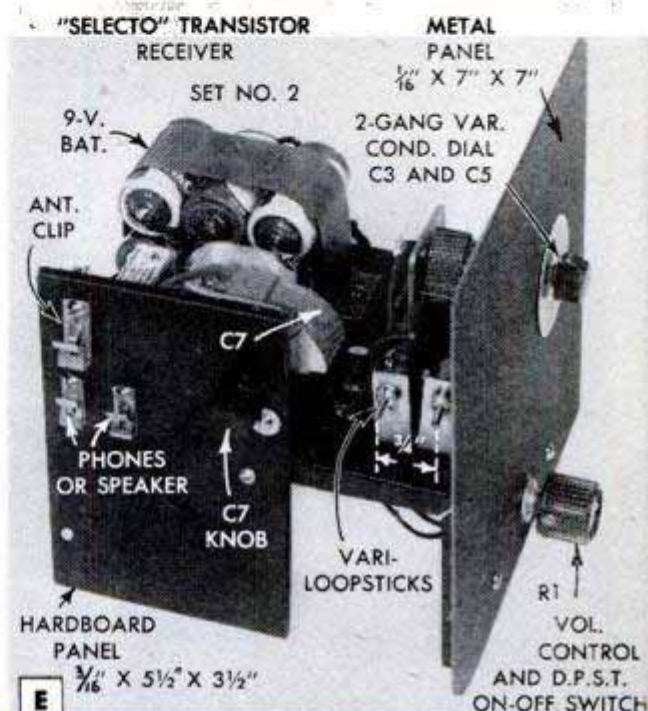
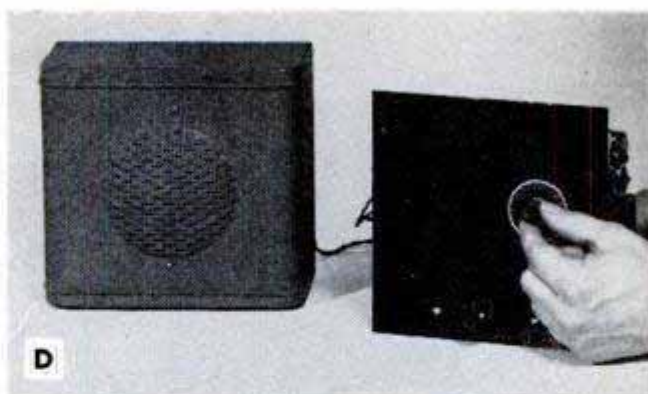


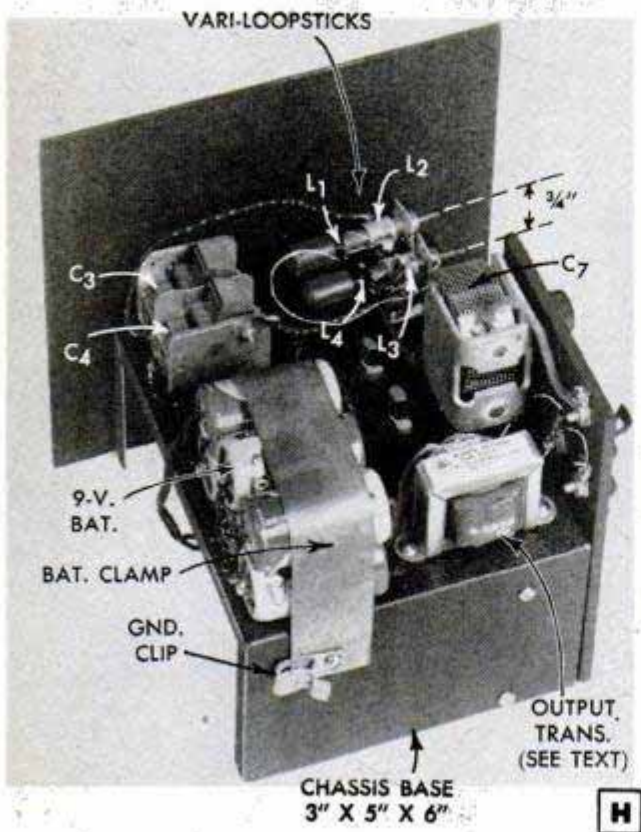
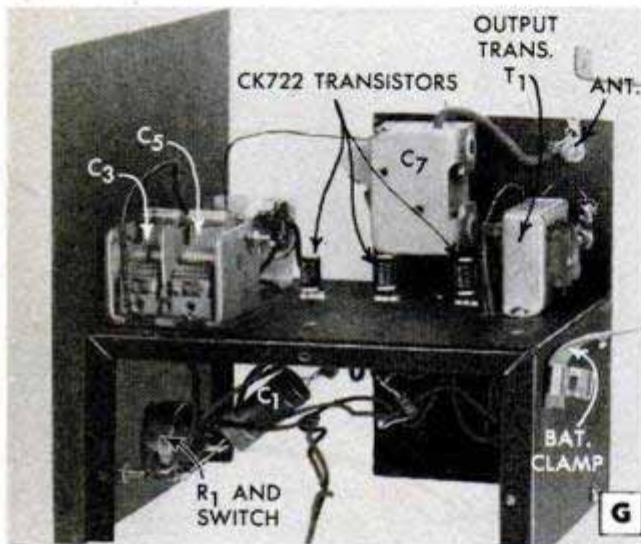
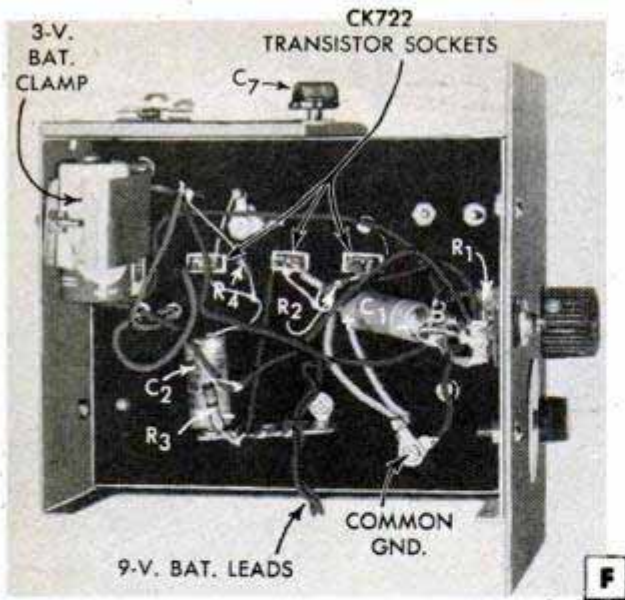


# TRANSISTOR RECEIVERS • • •

before throwing the switch. The outdoor antenna should be at least 75 ft. long. The antenna trimmer condenser C1, is adjusted for best volume, and all tuning is done with the main variable condenser.

Set No. 2 is definitely not for beginners, and even greater care should be taken not to accidentally reverse any of the transistors in their sockets. These CK722 junction-type transistors cost \$7.60 each, and a wrong circuit connection, or a reversal would be an expensive accident. All specifications are given in Fig. 2. A long outdoor antenna, and a good ground should be used. Set condenser C7 at half capacity, and turn the set on. Rotate the 2-gang variable condenser to a station on the low end of the band and adjust the slugs in the vari-loopsticks for maximum signal. Antenna coupling is critical; load up right to point of distortion. Next tune to a station on the high end and adjust the trimmers (Tr.) for maximum signal on that end. Transistors are essentially voltage amplifying devices, and not capable of a great amount of power; but they have amazingly low battery drain and real gain on low voltage. The volume of the detector-amplifier 3-unit set cannot be compared to even a 2-tube receiver, but it is sufficient for a small room. Study diagram Fig. 2, and photos D, E, F, G and H carefully. The loudspeaker should have a very large baffle.

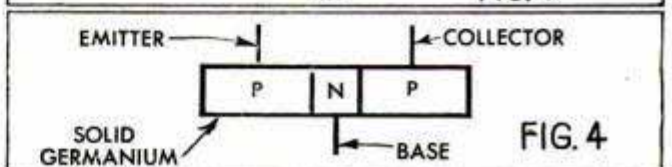
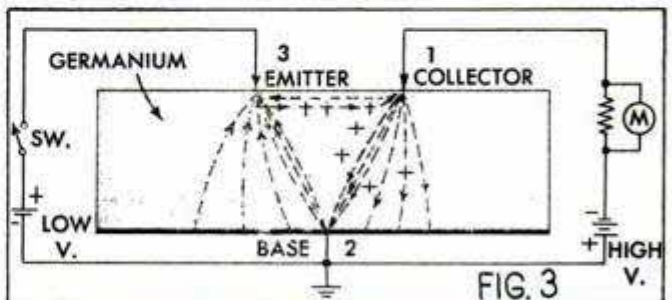




Omit output transformer if headphones are used, and connect as in Fig. 1.

Transistor theory represents a radical departure from vacuum-tube theory. Space does not permit a complete theoretical explanation, but sketch Fig. 3 illustrates the basic idea of the point-contact type. The arrangement shows a small block of semiconductor material (germanium) placed in electrical contact with a conducting metal base which is then grounded, as shown at 2. On top of the block, spaced a few thousandths of an inch apart, are the two cat whiskers 1 and 3. Collector cat whisker No. 1 is negative with respect to the germanium block by virtue of the high-voltage battery (about 10 volts). A milliammeter is shown in series with this connection. Observing the sketch, it appears that the electrons flow from the collector cat whisker (1) to the base (2) within the semiconductor material under the influence of this applied battery voltage. The electron flow produces a meter reading. High gains are possible because of the very high ratios of output circuit to input circuit impedance. Emitter cat whisker (3) is at opposite polarity to collector (1) as it connects to the positive side of the low-voltage battery. When switch (SW) is closed, a meter placed in this circuit would indicate a current in the No. 2 to No. 3 circuit. Since the diode (cat whisker) on the No. 3 side is connected in the forward (low resistance) direction, a very small potential at low-voltage battery will cause current to flow. A study of the current flow cannot be explained on the basis of electron flow alone. A new concept of "hole conduction" must be adopted to understand transistor action. When the switch is closed, the positive plus signs indicate positively charged "holes" that migrate from emitter No. 3 to collector No. 1.

The internal construction of the new PNP junction type is illustrated in Fig. 4. It differs from the point-contact type in that the rectifying barrier layers are formed by boundaries, or junctions, between different types of germanium semiconductor material. ★ ★ ★



# It's the sportsman's movie camera

Little film stretches a long way

Uses economical 8mm. roll film with easy, no-thread loading. Enough film in each roll to shoot 30-40 average-length movie scenes!



## Movies, rain or shine

Your choice of an f/2.7 lens . . . plenty fast for cloudy-day shooting . . . or a super-speed f/1.9 job that can see in the rain. Both Lumenized (hard-coated), of course.



## Built to take it

Rugged die-cast aluminum body. Your "Reliant" thrives on rough going — yet it's sweet-running as a custom-made reel.



## Takes color shots, too

"Reliant" movies are easy and inexpensive. Kodachrome movie film costs but \$3.95 a roll (8mm.) — including processing! (Only \$3.25 for black-and-white.)

## CINE-KODAK RELIANT CAMERA

With f/2.7 lens, \$89.50  
With super-speed f/1.9 lens, \$110

Other Kodak movie cameras, from \$39.75 . . . at your Kodak dealer's. Prices include Federal Tax and are subject to change without notice.

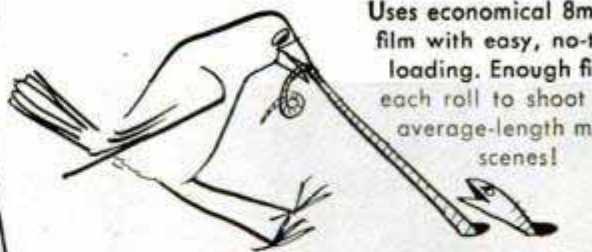
## Slows fast action

Really cuts fast action down to size. Use slow-motion setting with any film, either lens, for those extra detailed effects.



## Exposure guide knows the answers

Built-in exposure guide takes out all the figuring, leaves only the fun . . . makes sure exposure's right every time!

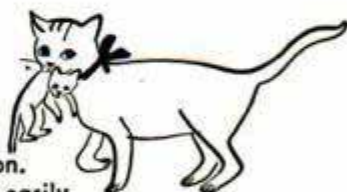


## Telephoto for close-ups

An accessory lens magnifies 3 times to let you come up close on those hard-to-reach shots. View finder shows fields for standard or telephoto lens.

## A delight to carry

Light and compact . . . slips in a jacket pocket ready for action. Swings and points as easily as your own 12-gauge.



Eastman Kodak Company, Rochester 4, N. Y.

### "LET'S MAKE MOVIES"

A free and fascinating booklet that tells how to make color movies . . . how to make movies indoors as well as out . . . how to choose the right camera for

Dept. 6: Please send free copy of "Let's Make Movies" to—

Name \_\_\_\_\_

Address \_\_\_\_\_

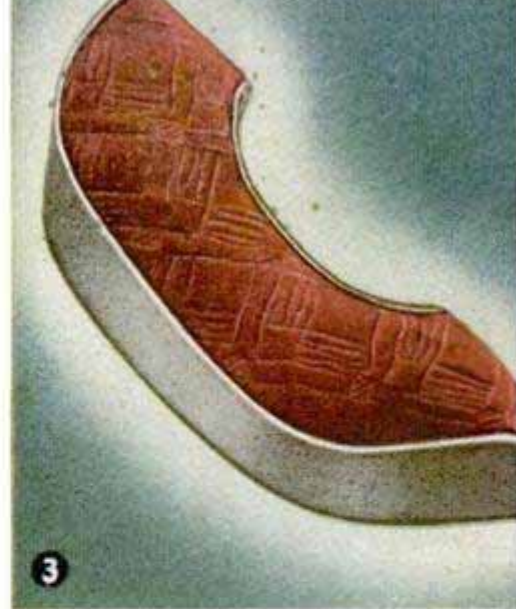
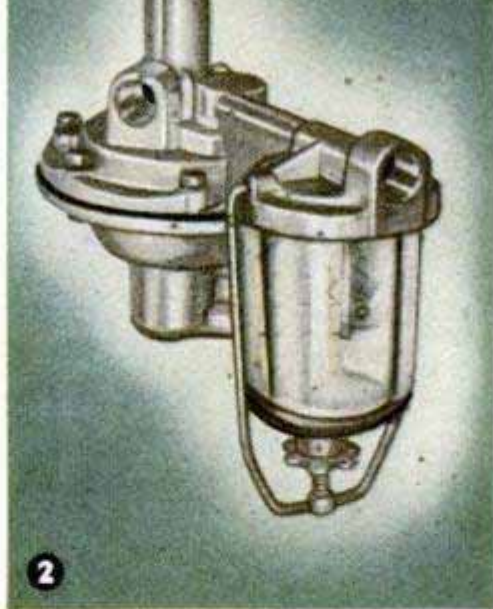
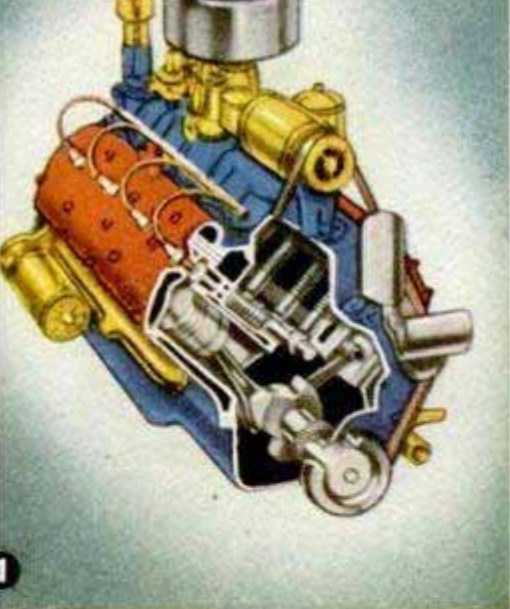
City \_\_\_\_\_ Zone \_\_\_\_\_



See "Photographic Equipment and Supplies"



Kodak



**Why risk an overhaul?** Replace your worn-out engine with a Wizard-ized Engine—get up to 3 times the miles! All moving parts brand new or fully remanufactured like new. New-car engine guarantee. Installation arranged. For all popular cars. As low as (Exch.) . . . . **\$142.50**

**Wizard fuel pumps**, guaranteed for long, dependable service. Original equipment replacement. Diecast body; precision machined surfaces and parts; fully tested for correct pressure. Diaphragm of extra high quality for longer life, top performance. For most popular cars . . . **\$1.79 to \$2.49**

**Bright, new arm rest covers** snap on quickly, without removing the arm rests. Made of beautiful quilted Vinyl plastic. Choice of 5 popular colors—yellow, gray, blue, green or red—to harmonize with any seat cover or interior trim. Attractive pin-point Vinyl trim. Pr. (2N2899-2913) . **\$1.59**



## New Power...New Beauty.

Over 40 Years... Headquarters



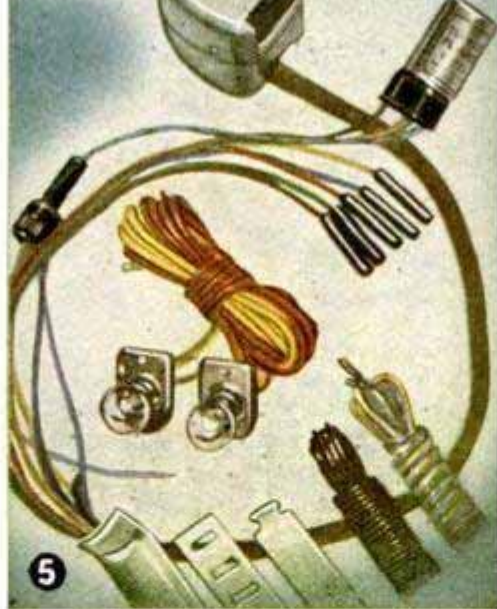
**Replace thermostat every year** for maximum heater efficiency and better cooling system performance. Quality built original equipment replacement. Rust proof. Easy to install. Either Alcohol type or Permanent Antifreeze type for most popular cars from **\$1.28 to \$2.10**

**Keep your car new-looking all year** for less than one dollar—with Simoniz Paste Wax. In only 2 hours give your car a durable, weather-resistant finish. Remove dirt, grease, with Simoniz Paste Kleener before waxing. Simoniz Paste Wax, 7 oz. . . . **.75c**  
Simoniz Paste Kleener, 11 oz. **.69c**

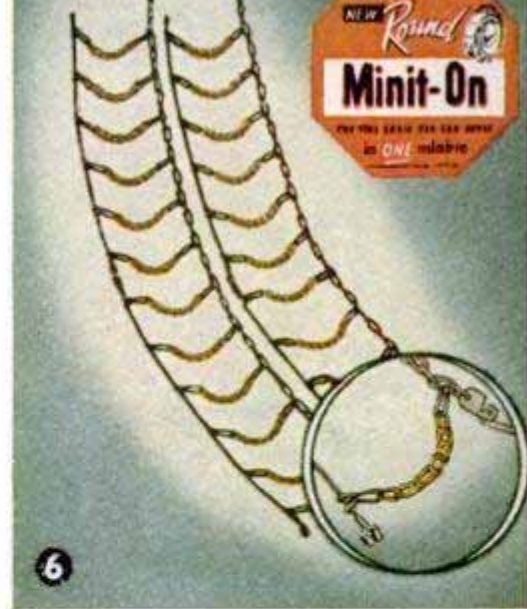
**Enjoy cozy "living-room" warmth.** Supreme EA Double-Flow Heater with 7½" dual fan delivers 250 cu. ft. of air per minute. Heavy-duty motor. Illuminated variable speed switch. Original equipment styling. (Defroster kit available.) (21134) **\$32.95**  
**Deluxe EA Hot Wave** (21132) **\$21.95**



**Don't be stranded** by a worn-out fan belt. Replace now with a Western Auto extra-quality fan belt. Inner core of endless cable cords. Tough rubber cushion reduces heat, assures long life, cooler-running performance. Can't warp, slip, or stretch. Guaranteed fit **65c to \$1.95**



**Reduce driving hazards** with this turn signal set. Automatically returns to neutral position when turn is completed. Blends with dash and steering wheel. Flashing red indicator light on switch. (21R6176) . . . . . **\$6.45**  
**Wiring kit**, with all installation material. (21R6177) . . . . . **\$2.98**



**"Minit-On" Tire Chains** — so revolutionary you can put them on in just *one* minute. Install anywhere—in snow, on ice, or on a hill. Not "snap-ons", but complete, patented chains with adjusters. Tough, wear-resisting links. Plastic coat sleeve protectors included. Pr. from **\$13.95**

# New Safety For Your Car At Western Auto

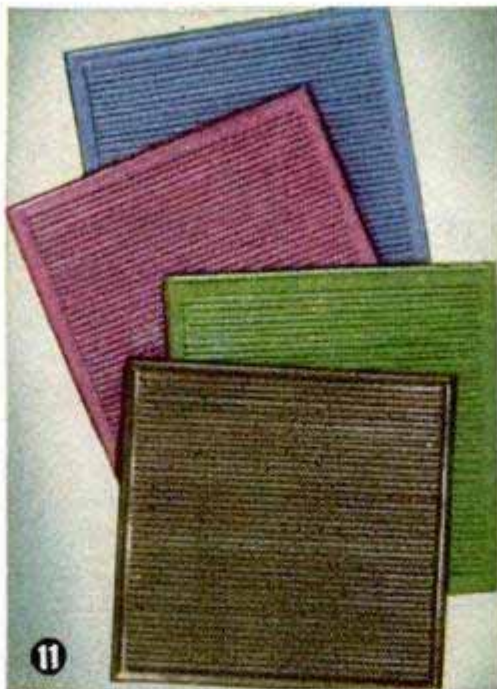
STORES AND ASSOCIATE STORES

For Top Quality Auto Supplies.

NOTE: Western Auto Associate Dealers own their stores and set their own prices, terms and conditions. Prices may vary due to difference in local conditions. (PM103)



**Guaranteed to fire in oil.** Aldor spark plugs have bi-metallic thermostat control that keeps spark plug always at peak efficiency for smoother running, easier starting. Adjusts to any heat range requirement automatically. Special non-burning electrodes. Each in set. **95c**



**Add new beauty and style** to your car's interior, and protect your floor mat from excessive wear with these handy rubber utility mats. Also has many uses around the house. Easy to clean. Black, blue, red, or green.  
 17" x 17" (2N1105-8) . . . . . Ea **89c**  
 17" x 20" (2N1105-10) . . . . . Ea **\$1.19**



**Top quality brake fluid** meets S.A.E. standards. Permanent-type, for all cars and trucks. Mixes with any fluid. Perfect all-weather performance—no loss at extremely hot temperatures or freezing at cold temperatures.  
 Quart (S5555) . . . . . **\$1.09**  
 4 quart (S5555) . . . . . **25c**

# POPULAR MECHANICS SHOP NOTES

REG. U. S. PAT. OFF.

**\$1.00**

\$1.25 IN CANADA



**THIS GREAT 240 PAGE BOOK**  
*on Sale NOW at Your Newsstand only \$1.00*  
**ALSO SEE** **WHAT TO MAKE 1954**  
**100 BEAUTIFUL PIECES OF FURNITURE**  
**WATCH FOR POPULAR MECHANICS BOOKS AT YOUR NEWS DEALERS**  
**TOYS YOU CAN MAKE**



## "POWER-TOOL ROUNDUP"

**By James R. Ward**

*Craftsman Editor, Popular Mechanics Magazine*

**A BUYERS' GUIDE TO HOME-WORKSHOP MACHINES**

**PERFORMANCES \* SPECIFICATIONS \* PRICES**



**OLD TIMERS KNOW** the value of a reliable, smooth-running, long-lasting motor. They get all this and much more in the all-new G-E Utility Motor for shop, farm and home!

# Why take less... make sure you get the all-new G-E motor!

Now available through your local dealer — the completely new G-E Utility Motor gives you more for your motor dollar! Packed with more power per pound, it's smaller, lighter, easier to handle, mount and wire! You can use it with shaft up,

down or at any angle — it will maintain the right lubrication and *no* oil leakage! Designed for home workshops by the world's biggest motor manufacturer, why take less? Ask your dealer about the all-new G-E Utility Motor today!

*You can put your confidence in—*

**GENERAL  ELECTRIC**



**FREE**

Section 674-167, General Electric Co., Schenectady 5, N. Y.

Send me the new 16-page booklet that gives general tips on motor selection and tells about the all-new G-E Motor.

Name \_\_\_\_\_

Street and address \_\_\_\_\_

City \_\_\_\_\_ Zone \_\_\_\_\_ State \_\_\_\_\_

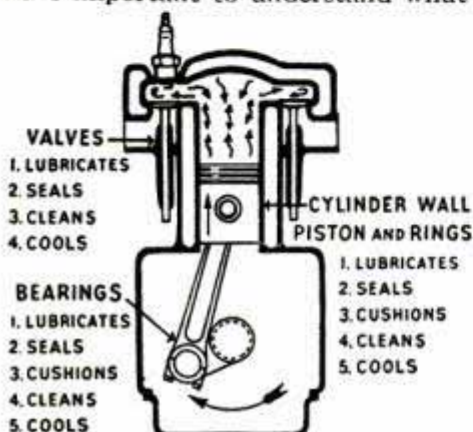


# Care and Feeding of Engines

BY S. P. CORP

## HOW OFTEN TO CHANGE OIL?

Operating conditions have a lot to do with the need for oil changes in your engine. To judge conditions, it is important to understand what the oil must do.



OIL AT WORK

The oil in your engine must do five important jobs: (1) lubricate moving parts; (2) cushion rings, pistons and bearings; (3) seal rings against heat and compression; (4) clean bearings, valve stems, and pistons; (5) keep all these parts cool, dissipating heat in the oil pan.

Frequent starting and stopping without giving the engine time to heat up is rough on oil. So is long idling. A cold-running engine is hard to lubricate and contaminates oil quickly. The engine that is driven a long time at an average speed in hot weather is using oil under the most favorable conditions.

To make oil last longer and to increase engine life (1) keep the oil filter clean, and (2) be sure the engine thermostat is set for 160 to 170° F.

## OVERHEATING

Overheated fuel mixture causes loss of power. Check the thermostatic manifold heat control valve in the exhaust manifold below the carburetor. This valve deflects hot exhaust gases to the intake manifold when the engine is cold, and changes position as the engine warms up, leading the hot exhaust gases away. If this valve sticks in the cold position, fuel mixture becomes overheated. Operate valve by hand to see if it moves freely. If it does not, a few drops of acetic acid or vinegar should clear the shaft. If it does not, remove manifold and have condition corrected.

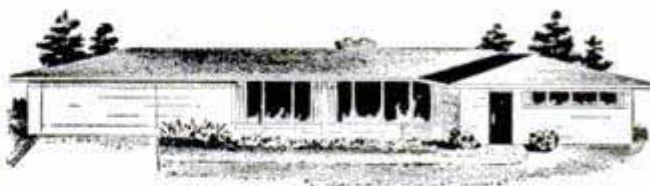


## SEND FOR FREE BOOKLET

You will find many helpful ideas on car care in the new free illustrated booklet "MORE POWER, Less Oil, Less Gas." Address a post card to Sealed Power, Dept. G-10, Muskegon, Michigan, for your copy. And be sure to use Sealed Power KromeX Ring Sets when you re-ring. These are the finest piston ring sets ever made, and include the famous MD-50 Steel Oil Ring, best for oil control even in badly tapered and out-of-round bores.



# Clinic for Homemakers



As a service to our readers in solving the hundreds of problems pertaining to a home—inside or out—the editors of *Popular Mechanics* invite you to present your problems to The Clinic Editor for help and advice. Address your questions to The Clinic Editor, *Popular Mechanics Magazine*, 200 East Ontario Street, Chicago 11, Ill.

## Tile Joints Open



Q—Recently I laid a cork-tile floor in my new home, and lately I've noticed that the joints are opening between the tiles. The tiles are laid on a wooden subfloor. The open joints are irregularly spaced, some still remaining tight and others opening as much as 1/8 in. Judging from the appearance of the floor, it looks as though the whole thing would have to be relaid. But what has caused the trouble, and is there any simple remedy?—W. T., Miss.

A—At this distance it is impossible to say with certainty what is the cause, but we're going to guess that the opening of the joints is due to shrinkage of the wood in the subfloor. Unfortunately there is no simple remedy if this is the case. About the best you can hope for is stabilization of the wood at some point where no further shrinkage will take place. However, when this trouble occurs, it often is possible to correct the open joints by re-laying only a part of the floor. Usually the open joints take some pattern, either diagonally or at right angles to the wall, and generally it is possible to work out a procedure for re-laying a certain number of tiles to correct the defective joints. In some instances this will not work out, as the "gain" at each joint will be too great. In this case it is possible to effect a fairly satisfactory repair by patching. At each open joint cut away about 1/2 in. of the tiles on one side, or alternate sides of the joint. Use a sharp razor blade and a straightedge. Then remove the waste pieces. Cut strips from a cork tile of the correct width to fill the opening. Cement these in place. If care is used to make straight, clean cuts both in the tiles and the strips, the repair will be apparent only on the closest examination.

Renewing Old Luggage

Q—I have two leather bags and a suitcase which seem too good to discard and yet are unfit for use in their present shabby condition. Due to long use, the leather is worn at the corners, scuffed and discolored and seems rather hard and lifeless. Isn't there some way of reconditioning such items—a dye or some similar product that will soften and recolor the leather and improve its appearance? I tried shoe polish but this did not seem to do the job.—T. J., Okla.

A—We are assuming, of course, that you are referring to luggage with coverings of genuine leather, and not to plastic or other imitation-leather coverings. There are several types of permanent leather dyes available, but we are rather doubtful that you would find these satisfactory on leather

## Renewing Old Luggage

(Continued to page 256)



**More Room, More Time, More Fun...**

All over the house with

# TORIDHEET

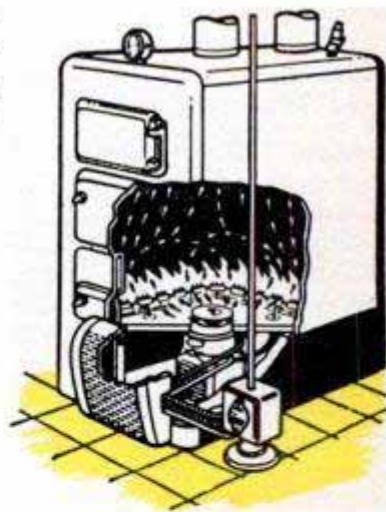
## Automatic Heating

You'll have more time for hobbies and outside activities . . . more room for family fun when a compact TORIDHEET unit replaces your antiquated, inefficient furnace and dingy coal bin. For modern TORIDHEET is the work-free, worry-free way to enjoy clean, healthful, even heat simply by setting a thermostat. It's tops for economy, too . . . practically pays for itself with up to 50% savings on fuel and cleaning bills.

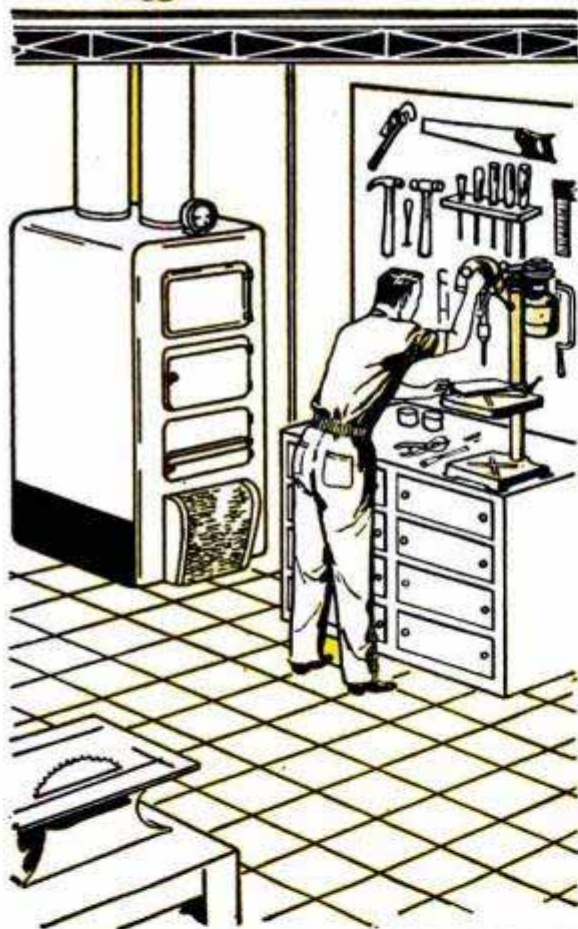
Whether you're planning on building or remodeling, there's a TORIDHEET gas or oil unit built to fit your needs. No home is complete without TORIDHEET — Brand New Furnace or Conversion Burner.

**Direct heating action  
insures top fuel efficiency**

TORIDHEET'S Wall Flame Burner concentrates an intense-blue flame directly on the heat absorbing surfaces, providing fast, efficient fuel utilization.



**SAVE UP TO 50% ON FUEL BILLS — MAIL THIS COUPON TODAY!**



TORIDHEET DIVISION  
CLEVELAND STEEL PRODUCTS CORP.  
7312 Madison Avenue, Cleveland 2, Ohio

Please rush me complete facts on the TORIDHEET Wall Flame Burner with direct heating action.

Name \_\_\_\_\_

Address \_\_\_\_\_

City \_\_\_\_\_ Zone \_\_\_\_\_ State \_\_\_\_\_

# No Sanding! No Finishing!



Lay it  
right over  
your old floor

## Bruce PREFINISHED Oak Floors

**BLOCK, STRIP OR RANCH PLANK**—Now it's easy and economical to give your home the new beauty of modern oak floors... with all the glamour of nationally-famous Bruce Prefinished Hardwood! In only a few hours, your living room, bedroom, dining room—or that unfinished room upstairs—will glow with a style as modern as tomorrow. You can choose Block, Strip or Ranch Plank design.

**It's EASY!** These floors are completely finished—even waxed—at the factory. Just cover old floor or smooth subflooring with felt paper and nail down this highest quality oak (or install in mastic over concrete). No sanding or finishing... no mess or smell. Ready for use as soon as it's laid... and your home will have the rich style and beauty chosen by leading decorators.

**It's ECONOMICAL!** A new Bruce Hardwood Floor will cost you less than a good rug or carpet... and will last the life of your home. The famed Bruce "Scratch Test" proves this durable finish doesn't scratch, chip or mar. Ask your lumber dealer for an estimate. Mail coupon below for colorful literature.

### MAIL FOR FREE LITERATURE

E. L. Bruce Co., Box 397-J, Memphis 1, Tenn.

Send me complete, free information on prefinished Bruce Hardwood Floors.

Name.....

Address.....

City..... State.....



**Bruce Hardwood Floors**

Product world's largest hardwood flooring maker

(Continued from page 254)

goods in the condition you describe. In order to recondition the leather and conceal defects it will be necessary to use a colored finish containing a pigment in sufficient amount to cover like paint and yet not hide the grain of the natural leather. A flexible leather finish of this type is available, comes in colors and we are told that it has proved most effective in making old luggage look like new. The surface over which it is applied must be clean, dry and free of wax and oil. On old leather goods it is advisable to apply a specially prepared sealer as the first coat, then one or two coats of the finishing material in the color desired.

### Refrigerator Cycle

**Q**—My refrigerator is about 18 years old and lately it is operating almost continuously. It runs for a period ranging from 20 to 30 minutes with only an interval of a couple of minutes or so when it is off. What kind of refrigerant was used? Is it possible for a portion of it to leak out? How can I correct the trouble?

R. B., Kans.



**A**—We are assuming from your description that your refrigerator is of the mechanical type, that is, the refrigerating unit is electrically operated. After 18 years service it would not be unusual for some minor trouble to develop. You should have the unit checked by a competent serviceman who is experienced in servicing the older models. He will have equipment for checking the pressure on the high and low sides of the lines and also the adjustment of the expansion valve. If the high-side pressure is above normal, this condition may reduce the capacity of the compressor to the point where it is no longer sufficient for proper refrigeration at the regular operating cycle. It may be necessary to purge the unit of air or add refrigerant. High head pressures may also be due to a clogged condenser, that is, the fins are heavily coated with dust and lint. An insufficient charge of refrigerant can cause continuous, or near-continuous operation. Also, the condition of the door gasket should be carefully checked. A leak at the gasket can cause the unit to operate abnormally. Your serviceman can easily determine the type of refrigerant used and can replace any loss.

### Hanging Garage Door

**Q**—My two-car garage has doors of an older type consisting of four sections, or doors, hinged at the center in pairs, each of which fold outward to open. One end of each pair is carried on a hanger which runs in a metal track. Lately, one of the sections which is hinged to the building has sagged and the center and lower joints have opened, making it impossible to fully close the door. Is there a way to repair this defect without dismantling and regluing? I have no clamps.—M. Y., Conn.



**A**—Unscrew the hinges from both sections so that you can remove the defective one and place it on sawhorses. Straighten it by tapping the ends of the stiles. Now, bore 1-in. holes to a depth of about 1½ in. in the edges of both stiles, the holes centering opposite the ends of the rails. Counterbore these holes with a ¾-in. bit through the stiles only. Counterbore again with a ¼-in. bit into the ends of the rails, the total depth of the counterbored holes being sufficient to take a ¾ x 6 or 8-in. lag-screw. Slip a washer over each lag screw. Then turn the lag screws into the holes with a socket wrench, drawing up the screws until the joints are uniformly tight.

# Texaco Tips



## on car care



### How to get smooth engine performance

Weak or worn out spark plugs make your engine sluggish—waste gasoline, too. To get full engine power and smooth performance, drive in and see your Texaco Dealer for a spark plug check-up. For a nominal charge, he will remove all plugs, clean out carbon and reset the spark gap to the correct specifications. He will replace any worn out plugs. Expert car care like this adds more pleasure to your driving.

### How to get that "cushiony" ride

When Marfak is given the "whirl test," it won't pull apart — as would an ordinary grease. That's proof of why Marfak protects your car's chassis longer. It clings firmly to vital points of wear and friction. And Marfak is especially compounded to resist squeeze-out, jar-out and wash-out, too. When you get Marfak lubrication, you get cushiony riding for 1,000 miles or more. For longer lasting Marfak lubrication, see your Texaco Dealer, the best friend your car has ever had.



THAT "CUSHIONY" FEELING LASTS LONGER WITH

THE TEXAS COMPANY  
**TEXACO DEALERS**

in all 48 states

Texaco Products are also distributed in Canada and in Latin America

## We Drive a Foreign Car

(Continued from page 141)

ease of parking and the short turning circle (33 feet) are all pleasant and convenient features. On the other hand, the American driver, accustomed to an automatic choke and a fast-warming engine, may have difficulty becoming accustomed to the engine's penchant to conk out at the first traffic light. The engine is "cold" if it hasn't been running recently and for short runs in winter the choke must stay pulled out.

Engine oil capacity is only four quarts. We change it every 2000 miles. Transmission and differential hold one quart each. The only part replacement we have made was a plastic piece for the wiper switch. The only repair job was a broken exhaust pipe and this was welded at a neighborhood garage. We live in a small town that does not have foreign-car service, but have had no problems thanks to the trouble-free operation of the Minx.

In summary, the Minx is not only a different car—it is a different kind of car. While our experience may be illustrative without being typical, we would say after a year with the Minx that if you are stout

### Summary of one year's operation

|  |                  |
|--|------------------|
| Total mileage.....                               | 10,167           |
| Miles per gallon in Britain<br>(3917 miles)..... | 26 $\frac{1}{3}$ |
| Miles per gallon in U.S.A. (6250 miles).....     | 23 $\frac{2}{3}$ |
| Miles per gallon on long trips.....              | 31               |
| License and insurance<br>(Britain and U.S.)..... | \$145.40         |
| Gasoline .....                                   | 132.48           |
| Lubricants and service.....                      | 26.43            |
| Repairs and replacement.....                     | 12.39            |
| <b>Total expense*</b> .....                      | <b>\$316.70</b>  |
| Over-all cost per mile.....                      | 3.1 cents        |
| Operating cost per mile.....                     | 1.7 cents        |
| * Depreciation not included.                     |                  |

or tall you would not be happy with it. Nor would you be happy if you like your car to be flattering, to enhance your social prestige or boost your ego. You have to possess a somewhat unconventional spirit to enjoy a small foreign car in the average American community.

On the other hand, if you take just a little interest in the mechanics of your car, if you are willing to take a more active part in driving (shifting more often, for instance), if you don't demand a superabundance of power and competitive acceleration, you could be very satisfied with the small English car.

Moreover, if you happen to be one who analyzes his transportation costs and is

(Continued to page 260)



**GET WILDROOT  
CREAM-OIL CHARLIE**



GIRLS WON'T GO WITH A GUY WHO HAS MESSY HAIR! KEEP YOUR HAIR NATURALLY WELL GROOMED WITH WILDROOT CREAM-OIL. IT'S NON-ALCOHOLIC, NON-GREASY. CONTAINS LANOLIN, SO MUCH LIKE THE NATURAL OILS OF THE SCALP AND HAIR. TRY A BOTTLE OR HANDY TUBE TODAY!

29¢ and 59¢



**IT NEVER FAILS!**



# \$20 Gift Merchandise Certificate

WITH PURCHASE OF ANY **SKIL** HOME SAW!



*Once-in-a-lifetime chance to own a SKIL portable saw . . . plus a combination table saw, sander and shaper unit . . . at amazingly low cost!*

Want the greatest value for your power tool dollars? Buy any SKIL Home Shop or Builders Saw and you get a Merchandise Certificate worth \$20 on the SKIL Saw Table and Sander-Shaper kit—an unbeatable combination.

You have a *portable saw*—the preferred tool for building an extra room or garage. You're equipped to fit doors and storm windows, cut plywood panels, sheeting, siding—even stone, metals or compositions with special blades.

You have a *bench saw combination* for the precision sawing, shaping and sanding required in building cabinets, furniture and other such home projects.

Here—in this SKIL combination that costs *less* than a one purpose tool—is proof to you that it is not necessary to put big outlays into motors, belts, pulleys, to have a *complete* saw shop. See your SKIL Home Shop Dealer and save \$20 on this wonderful SKIL portable saw, bench saw, sander and shaper combination!

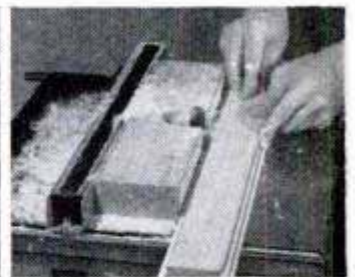
**SKIL Saw Table** Quickly converts your SKIL Saw to tilting arbor table saw. Makes all cuts—bevels, miters, cross cuts, rips. Actually doubles use of saw.

**SKIL Sander and Shaper Kit.** Quickly converts SKIL Home Shop Saw Table into shaper and drum sander for all drum sanding, grooving, moulding, shaping.

**\$20 Gift Certificate applies on this complete SKIL Sawing, Shaping, Sanding Combination.**



**3** Converts to Drum Sander



**4** Use as a Shaper

## SKIL Home Shop and Builders Saws—World's Finest For Remodeling, Home Construction, Home Workshops

Why be satisfied with ordinary saws when SKIL gives you so much, much more? You get greatest accuracy, maximum ease of handling with SKIL balance. You make fast, easy cuts with SKIL plus power. You make quick, simple bevel or depth adjustments and you're ready for any and every cut needed!

**No Other Saws at Anywhere Near the Price Have All These Features!**

Oversize Motor • Ball and Anti-friction Bearings • Built-in Bevel and Depth Adjustment • Telescopic Safety Guard Sturdy Die Cast Aluminum Housing • Trigger-type Switch

There are six SKIL Home Shop and Builders Saw models. 6"—7¼"—8¼" blade sizes. Priced from \$43.95.

**Act Now!** You must buy your SKIL Home Saw by December 31, 1953. See your dealer displaying SKIL Home Shop Tools. Sold by leading Hardware, Appliance and Department stores.

# SKIL

HOME SHOP TOOLS

Made only by SKIL Corporation, Chicago 30, Illinois, formerly SKILSAW, Inc.,

In Canada: SKILTOOLS, Ltd., Toronto 9. Factory Branches in All Leading Cities

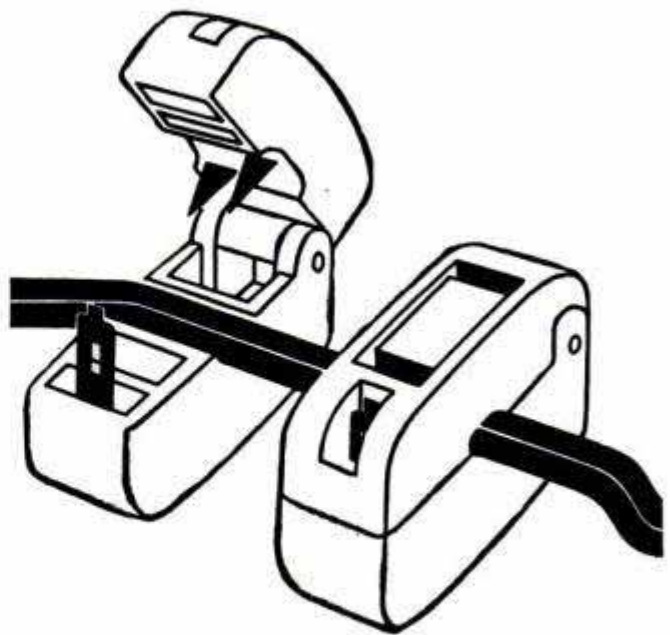
looking for corners to cut, then the small English car is well worth your interest.

There are two special groups for whom such a car ought to have special appeal. For the city family, the Minx would make an ideal second car, especially for the woman driver. But the difference in the gear-shifting pattern may be discouraging and perhaps American women, like many of their husbands, prefer their cars big, bright and powerful.

We discovered another group, much smaller than the first, for which the English car has appeal. That is for the family that plans to tour Britain or the Continent. One sees American cars in Britain but they look rather out of place. The British car is geared to the British road. And there is a financial advantage in buying a car for touring. We estimated that the use of the Minx for two months in Britain saved us an outlay of at least \$300 in other modes of transportation, besides giving incalculable pleasure to ourselves and friends. We figured that the net cost of the car (after deducting the \$300) delivered to us in New York was about \$1300—a pleasing figure.

Should you ask us about trade-in values and resale markets, we would reply that so long as the Minx maintains its present level of performance we have no interest in either one. ★ ★ ★

## Plastic Clamp-On Outlet Taps Electric Cord



You can tap a standard electrical cord at any point with an outlet that is clamped to the wire. Two metal points pierce the insulation and establish contact. As the insulation is not removed, no shocks or short circuits are possible. Made of plastic, the small device fits number 18 wire.

# It's easy to make these REPAIRS

You can make loose metal, wood, or plastic parts tight; anchor bolts in concrete to stay; seal cracks in metal; tighten loose screws and fixtures in wood, metal or tile—with Smooth-On No. 1, the iron cement of many uses. Just mix, and fix. Smooth-On No. 1 hardens quickly like iron, and expands as it sets. Forced into any opening, its unique expanding action makes the repair. Keep a can on hand, it will not deteriorate. Smooth-On No. 1 is at your hardware store.

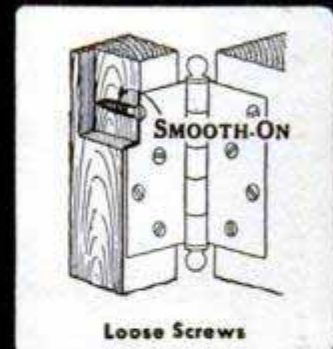
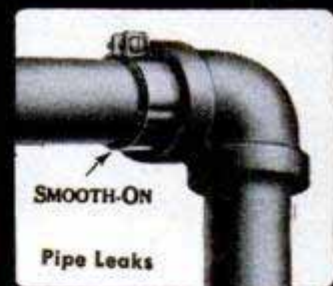
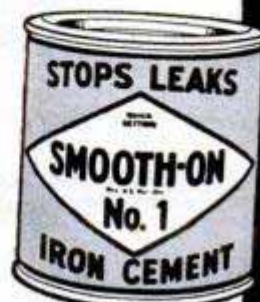
## FREE Repair Handbook

40 pages, many illustrations, easy directions for ingenious time and money saving repairs you can make yourself. Write for your free copy.

SMOOTH-ON MFG. CO., Dept. 37K  
570 Communipaw Ave., Jersey City 4, N. J., U.S.A.

# SMOOTH-ON

THE IRON CEMENT OF MANY USES



**TRY MY "GIFT FORMULA" FOR  
GETTING YOUR COMPLETE WORKSHOP**



*Build your one-motor*  
**DELTA SHOP** *this ideal way—*  
**A TOOL AT A TIME!**

**FIRST I BOUGHT THE  
BASIC SAW AND STAND**



... and that gave me the tool to do the sawing operations that are needed on every job. The DELTASHOP'S big tilting blade saw does many other important operations, too—such as cutting grooves, decorative moldings, etc.—and its accuracy helps me do work like a professional.

Saw and stand, less motor **\$109<sup>80</sup>**

**LATER, MY WIFE GAVE ME  
THE COMPANION JOINTER-PLANER**



To do any finished-looking job you must plane the edge of a board right after you rip it. The Delta jointer planes boards up to 4" wide . . . does operations such as tapering and rabbeting, too.

Jointer, complete **\$49<sup>15</sup>**

**THE DRILL PRESS WAS A  
GIFT FROM MY FOLKS**



In addition to doing accurate drilling, the Delta drill press made it possible to make mortises, do routing, carving, sanding, polishing, make beautiful shaped edges . . . actually it's a "master of all trades."

Drill Press.. **\$57<sup>50</sup>**

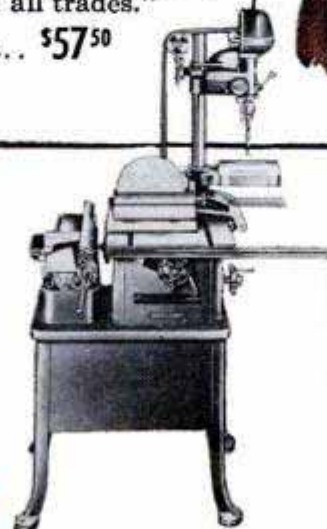
**MY KIDS JOINED FORCES TO  
GIVE ME THE SANDER**



This handy, low cost tool is perfect for finish-sanding jobs —has many other uses, too.

Sander.. **\$17<sup>55</sup>**

Ask about the DELTASHOP "tool-at-a-time" plan today—at your Delta dealer, department store or IRHA hardware store. Then start planning your Christmas for this perfect gift. Delta Power Tool Division, Rockwell Manufacturing Company, 502K N. Lexington Avenue, Pittsburgh 8, Pennsylvania.



Prices slightly higher west of the Rockies

**DELTA** QUALITY POWER TOOLS

Another Product by **Rockwell**



**DELTA QUALITY  
MAKES THE DIFFERENCE**



# Here's how for Home Painters

**Ceilings** are no longer difficult to paint. A paint roller eliminates dripping down the arm, gets the job done 2 to 4 times as fast. Here are some handy time-saving tips.

**Loosen the base plate** of light fixtures. Drape with cloth to prevent splattering. Cover floor and rug with paper.



**Put furniture in little groups.** Cover each group with drop cloths. (Eliminates trouble of removing furniture from room.)



**Tape roller tray with newspaper.** (Makes cleaning pan a cinch.) Fill half way with Devopake, a one-coat soft-sheen paint.



**Paint edge of ceiling first** with 2-inch Superkleen brush. Use 18-inch piece of cardboard to keep from getting paint on wall.



**Do the rest of ceiling with roller.** Work away from light. Easier to see lap marks. For best results, use a Superkleen roller.



**Dip roller into edge of paint.** Roll back and forth until evenly coated. If roller drips when you use it, you are overfilling it.



If you are painting the outside of your house, use Devoe Wonder-1-Coat House Paint . . . gives 2-coat beauty and protection in just one coat, cuts repainting time and costs practically in half. Your Devoe dealer (in Classified Phone Book) will help you with all your painting needs.



## When You Plan That House

(Continued from page 152)

should be two living spaces in the house—one a "quiet" living room for relaxation, for reading and for the reception of guests. On the other hand, there is a definite need for a "noisy" living room which may be labeled game or rumpus room. The noisy room seems especially useful for a family with young children and teen-agers. In planning your living room make certain that it will not become a hallway.

**Dining Room.** As economic pressure made it necessary to reduce the size of the house, the dining room was often eliminated and the combined living-dining room resulted; however, experience has shown that a dining space located in the living room should not be the only dining space in the house. Studies of family housing likes indicate that families want some form of dining space in the kitchen.

**Multipurpose Room.** The all-purpose room may serve for playroom, dining room, spare bedroom or den. The room is sometimes located adjacent to the living room where it may be opened to give a larger living room or closed to form a bedroom. The space is most valuable if it is located adjacent to the kitchen so that it can be used for child play or dining.

**Kitchen.** Basically the kitchen is for food preparation. Of course, many other activities may be carried on in this area—eating, laundry, ironing, child play and, in some instances, the heating unit is located here. The final design of your kitchen will depend upon the activities which you wish to accommodate there. The idea that the kitchen is a part of the house that must be hidden is disappearing. Open kitchens are being used more and more. This ties in with our informal way of living. Many new homes are being designed with extraordinarily large kitchens. Only a portion of the kitchen is the actual cooking space. The other area serves for dining, lounging and general activities in this "living kitchen."

**Bedrooms.** For sleeping and dressing, the bedroom may be small; but the bedroom many times becomes the child's "own room" and should be large enough to function as a secondary living room or playroom. Incidentally, your house will have much greater resale value if you have at least three bedrooms.

**Bathroom.** The standard bathroom is being replanned to give better accommodations. One suggestion is the divided bath in which there is a lavatory and water closet in one section and a lavatory and bathtub in a second section.

(Continued to page 266)





# Don't put in a drop of anti-freeze...

UNTIL YOU'VE CLEANED OUT RUST WITH

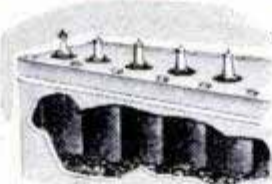
## DU PONT *Cooling System* CLEANSER



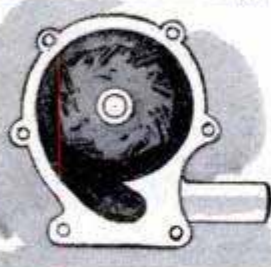
**HOW RUST AND ACID CORROSION WASTE ANTI-FREEZE . . . CAUSE TROUBLE AND EXPENSE**



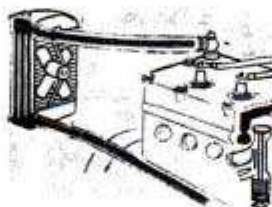
Accumulated rust, scale and corrosion plug radiator passages. This slows down circulation, may cause leaks. Anti-freeze may leak out . . . or "boil out" as motor overheats.



Acid corrosion and rust take place in engine block, too. Circulation slows down, proper cooling becomes impossible. Motor overheats and causes "boiling out" or creeping of anti-freeze.



Water-pump impeller blade is often attacked and eaten away by rust and corrosion. This causes failure of circulation in cooling system and dangerous overheating.



The heater is also part of your car's cooling system. Rust, scale and acid corrosion can impair its operation by clogging passages or destroying vital parts such as tubes.

Before you put in anti-freeze, your car's cooling system needs a careful check-up.

Clean out rust and scale—safely, easily, thoroughly—with Du Pont Cooling System Cleanser.

Simply pour Du Pont cleanser in the radiator and run the motor. It works even while you're driving . . . dissolves rust so it can be drained out. No reverse flushing necessary. Neutralizer is included in each can to complete the job. Insist on the original and genuine Du Pont Cleanser, marketed only by Du Pont in a package bearing the red Du Pont oval trade mark.

Ask about the complete Du Pont pre-anti-freeze service at your service station today and assure trouble-free driving this winter. Or get a can of Du Pont Cooling System Cleanser at your auto supply store . . . \$1.25 at most dealers.

Insure against leaks that waste anti-freeze with DU PONT Cooling System SEALER

Even though your cooling system seems watertight, many permanent anti-freezes will "creep" through tiny pinholes. You can stop this seepage immediately with Du Pont Cooling System Sealer. Simply pour it into your radiator. It can't clog or harm hose or metal parts.

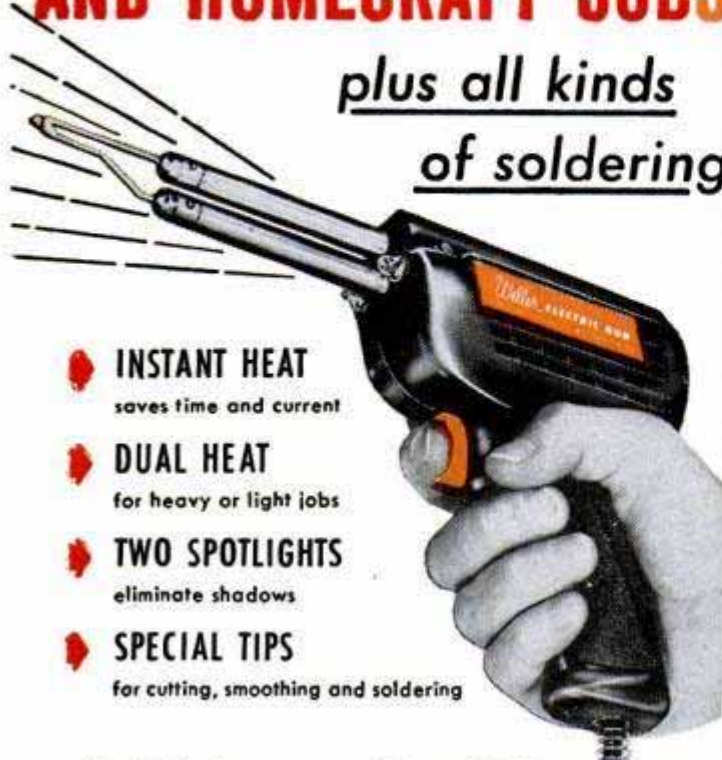


BETTER THINGS FOR BETTER LIVING  
... THROUGH CHEMISTRY

Don't forget fuel line anti-freeze—Du Pont Gas Guard.

# FOR DOZENS OF HOBBY AND HOMECRAFT JOBS

plus all kinds  
of soldering



- ▶ **INSTANT HEAT**  
saves time and current
- ▶ **DUAL HEAT**  
for heavy or light jobs
- ▶ **TWO SPOTLIGHTS**  
eliminate shadows
- ▶ **SPECIAL TIPS**  
for cutting, smoothing and soldering

Here's the fastest, most efficient soldering tool ever, and by simple interchange of tips it does dozens of other money-saving jobs. Thousands are in use by Radio and TV technicians and professional mechanics. 4 models up to 275 watts. See them at your Hardware Dealer, or write for catalog describing uses.



Cuts plastic tile



Seals freezer packages



Removes hard putty



Repairs furniture scratches

# Weller ELECTRIC GUNS

816 Packer Street, Easton, Pa.

Available at Better Hardware Stores Everywhere

## You'll Never Need to Use a Dull Kitchen Knife Again!

Stainless Steel, Regular,  
or Hollow-ground



**Aladdin**  
**Carbide KNIFE SHARPENER**

... puts a sharp edge on dull knives with 3 or 4 light-pressure strokes between Aladdin's diamond-cut Carbide "Jewels". Thereafter, a single touchup keeps it sharp.

Jewels are mounted in sturdy plastic, choice of red or yellow. Attaches easily to steel, wood or tile.

Post'd to you for only \$1.95. **MONEY BACK GUARANTEE.** Sold in many stores — special display unit offer for retailers.



**NEW ENGLAND CARBIDE TOOL CO., INC.**  
60-12 Brookline St., Cambridge, Mass.



**BUILD  
YOUR OWN  
MACHINE TOOLS  
CASTINGS - DRAWINGS**



Catalog with complete construction drawings of this bench milling machine or six inch shaper 25 cents per set postpaid or send one dollar for drawings of shaper, three millers and three lathes. Refund on castings order.

**POOTATUCK CORPORATION, 100 Sammis Pl., Stratford, Conn**

## BOAT KITS

Models from  
39.25 complete

12 ft.  
Runabout

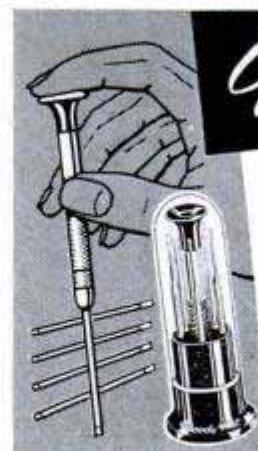
- Assemble your own boat
- No experience necessary
- Save 1/2 to 2/3 "factory built" prices
- Prices include freight and paint



Marine  
Hardware &  
complete accessories

Free Catalog of all models

**LUGER INDUSTRIES** 3207 FREMONT AVE. SO.  
MINNEAPOLIS 8, MINN.



# Moody Kits®

The Most Practical and Fascinating small tool sets in the world. Regardless of your sport, hobby or trade, you'll find a Moody Kit that is perfectly suited for small precision work and does your job right. Perfect for:

**Cameras, Guns, Fishing Reels, Model trains, Boats, Airplanes, Sewing machines, Eye glasses, Carburetors, Electric razors, Canvas, Rope and Sail sewing**

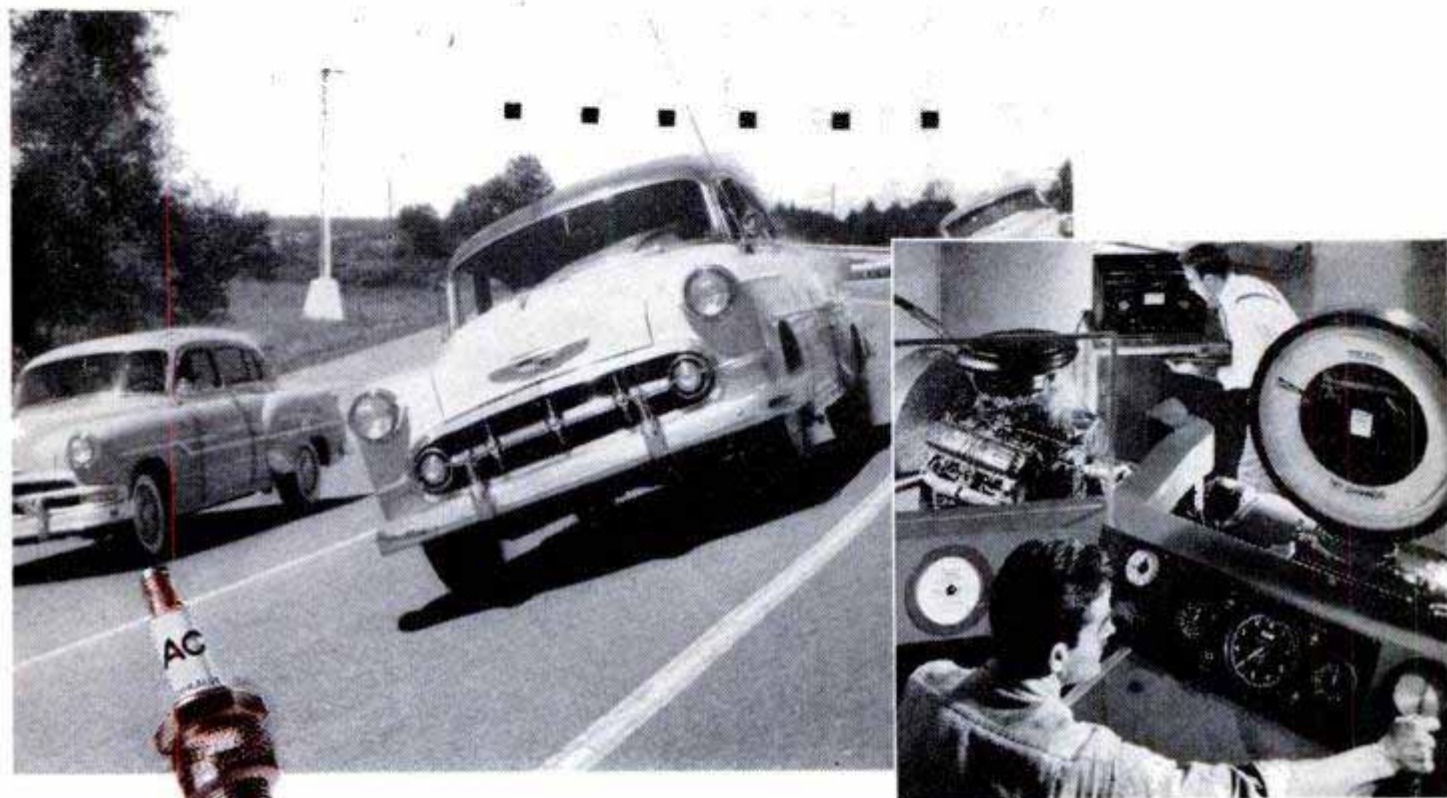
Screwdriver Kit (3" high) shown contains five tiny blades sizes .100", .80", .70", .55", .40" and chuck type handle.

Write for free folder that completely describes all Moody Kits. You can buy them from your dealer or postpaid from:

**Moody** MACHINE PRODUCTS CO. INC.  
32 Dudley Street, Providence 5, R. I.

# GENERAL MOTORS RESEARCH

*makes the difference!*



*Engineered to*  
General Motors  
standards for  
ALL makes of cars,  
trucks and tractors



Day after day, year after year, teams of AC and GM engineers at the famous General Motors Proving Grounds punish AC Spark Plugs in all makes of cars—over all kinds of hills and highways. ACs are also subjected to laboratory tests far more severe than actual driving conditions.

One of your big benefits from this "grass roots" research is AC's patented CORALOX Insulator. CORALOX resists, to a greater degree than any previous insulator, the formation of oxide and carbon deposits, which are major causes of shorting and misfiring—especially during acceleration and hill climbing. Result:

- More Power
- Better Gas Mileage
- Longer Plug Life

Yes, scientific General Motors Research makes a *big difference*. Be sure your next plugs are ACs—the spark plugs that are standard equipment on nearly as many new cars as all other makes combined!

**Utility Room.** The name "utility room" means many different things to many persons. This room may include space for the furnace, the water heater, washer, drier, ironer, plus space for bulk storage. An important consideration is the increasing desire for main-floor laundry space.

**Storage.** Storage is one of the basic problems in the house. There are different kinds and types of articles and equipment that must be stored, and you will have to tailor your storage to your own measurements. Generally speaking, however, these guides can be used: It is desirable to have a minimum of four feet of clothes-hanging space for each person in the bedroom; it is also desirable to have a closet this size near the front entrance. There should also be storage for cleaning equipment, linens and, of course, for food, dishes and other items in the kitchen.

Besides these basic storage units, one should consider special units for hobbies, sewing, sports, books and records. Be sure to include enough space for garden equipment, storm doors and windows, screens, etc. This bulk storage may be handled nicely in the garage or basement, or an outside storage unit may be provided.

**Hallways, Entrances.** Locate the front entrance so that it leads to a central area of the house. Consider its proper relationship

to the street and driveway. Whenever possible, the front entrance should lead into a hallway rather than the living room. If this cannot be done, arrange the entrance so that only a small portion of the living room functions as a hall. Halls should be planned so that the bathroom may be reached without crossing any living space. Locate the service entrance near the garage and driveway if possible.

**Arrangement of the Rooms.** Having determined the rooms you want in your house, you are ready to consider some of the factors which will influence their final assembly.

It is usually desirable to group the rooms into a quiet zone and a noisy zone. Bedrooms and studies belong in the quiet zone; kitchen, dining, playroom, etc., belong in the noisy zone. The living room may be located in either or both groups. In many cases it may serve as a buffer between the two groups, but its location depends upon how you expect to use it.

Today there is a greater emphasis on planning for privacy. Major rooms are often oriented away from the street; service rooms and rooms of lesser importance face the street. The "turned around" house presents, in many cases, an almost blank wall to the street. In these houses, the

(Continued to page 268)

*A woodworker's dream  
come true...*

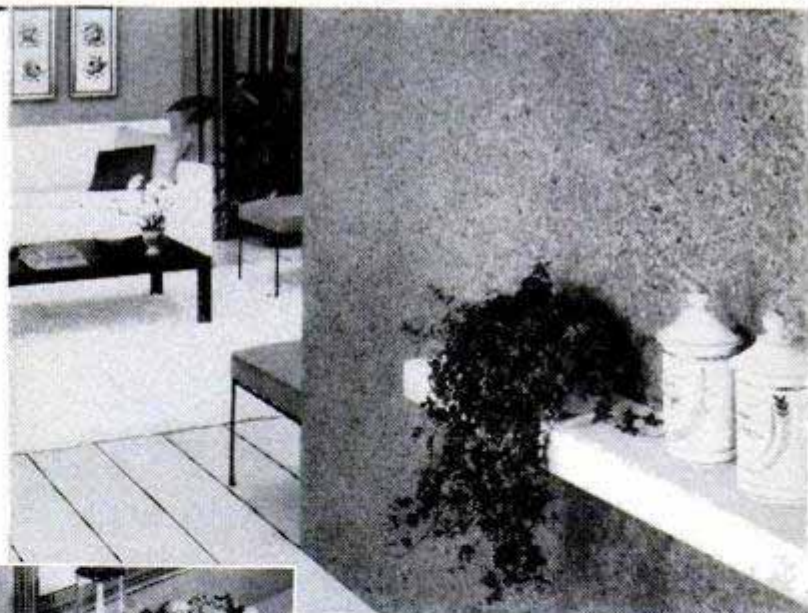
## NOVOPLY

**Gives you beautiful walls and distinctive furniture**

The beautiful redwood Novoply® wall on the right, all 64 sq. ft. of it, cost only about \$23.00 for material. It's all wood—with a rich "textured" look... yet it's smooth and flat because of the special bonding process. Install it yourself with ease. For finishing—wax, polish or stain. No upkeep. Ideal for remodeling or for new homes. *And—real wood at low cost!*

**WANT DISTINCTIVE FURNITURE?** New Novoply in either pine or redwood will set your rooms apart from the crowd. As easy to "work" as ordinary wood. Takes beautiful finish. Low cost,  $\frac{3}{8}$ " and  $\frac{3}{4}$ " thick.

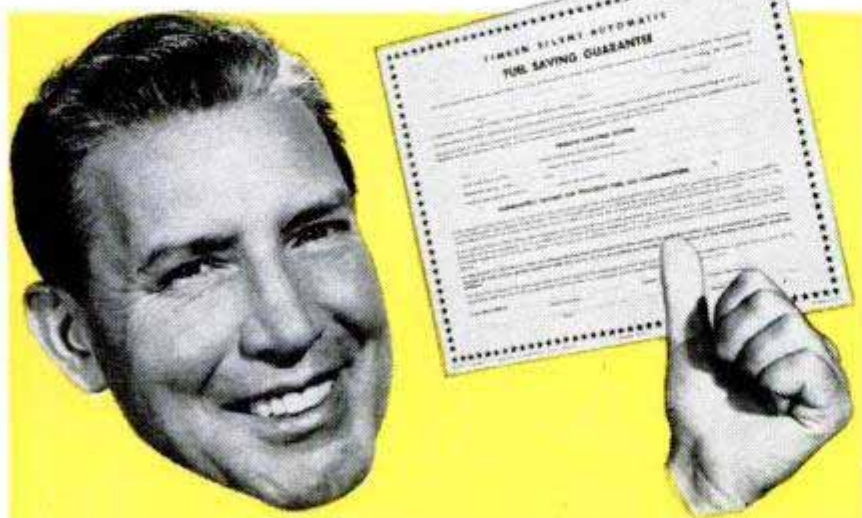
See Novoply at your local lumber dealers today. Free sample on request.



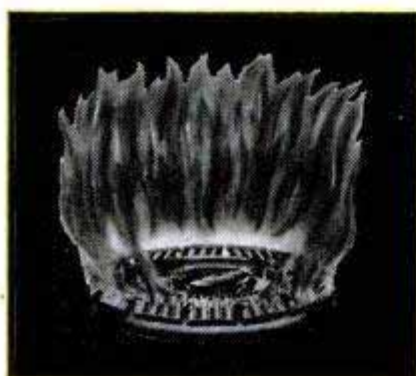
Novoply by  
**Weldwood®**

UNITED STATES PLYWOOD CORPORATION  
World's Largest Plywood Organization  
Weldwood Building, 55 West 44th St.  
New York 36, N. Y.  
U. S. -MENGEL PLYWOODS, INC.  
Louisville, Kentucky

# Fuel oil savings guaranteed in writing!



**ONLY TIMKEN  
SILENT AUTOMATIC  
DEALERS MAKE YOU  
THIS MONEY-BACK,  
BURNER-BACK OFFER!**



## HERE'S HOW THE WALL-FLAME BURNER SAVES YOU MONEY!

This burner *blankets* heating plant walls with a quiet, unforced, blue-hot flame. Owners enjoy savings of up to 25%—often more—over gun-type burners. The *wall-flame* burner is the heart of Timken Silent Automatic Oil Furnaces, Boilers and Conversion Burners.

Let the others make rash, unsupported promises of fuel savings—Timken Silent Automatic Dealers guarantee them *in writing!* We're so sure a new Timken Silent Automatic Wall-Flame Oil Burner will save you fuel oil that we have authorized our direct factory dealers to make you this money-back, burner-back offer: At no obligation to you, your Timken Silent Automatic Dealer will scientifically test your heating plant and tell you how much fuel oil you can expect to save by replacing your present gun-type oil burner with a Timken Silent Automatic Wall-Flame Oil Burner. Then, if you decide to buy, he'll *guarantee those savings in writing.* If you do not realize the savings, your money will be returned and your old burner reinstalled upon your request—absolutely free! It's the *only* factory-backed, written guarantee of its kind in the entire heating industry!

Whatever your heating needs may be, investigate Timken Silent Automatic! Your dealer is listed in the "yellow pages."

**CHOOSE FROM 64 MODELS OF OIL AND GAS  
FURNACES, BOILERS AND CONVERSION BURNERS**

**TIMKEN**  
*Silent Automatic*  
**HEAT**

TIMKEN SILENT AUTOMATIC DIVISION  
The Timken-Detroit Axle Company • Jackson, Michigan  
The Timken-Detroit Axle Company of Canada, Ltd., Toronto, Ont.



## MAIL COUPON TODAY

Timken Silent Automatic Products PM-1053  
Jackson, Michigan  
Please mail illustrated literature. I am interested in:

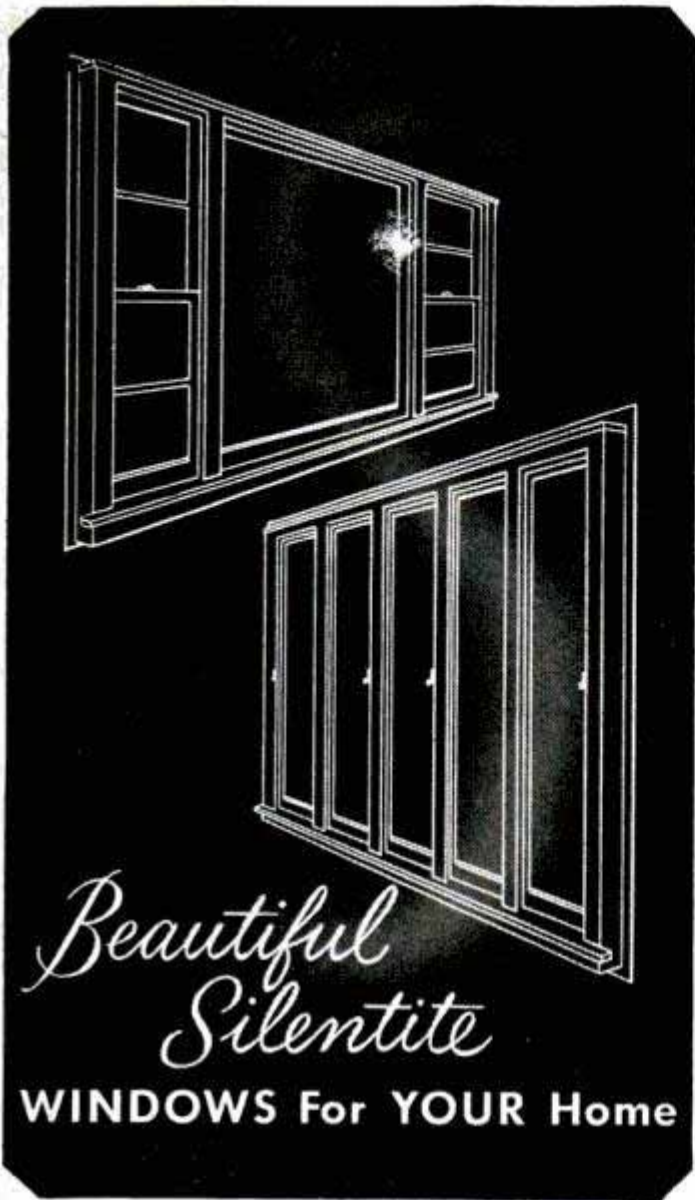
(type of equipment) \_\_\_\_\_

NAME \_\_\_\_\_

STREET ADDRESS \_\_\_\_\_

CITY and STATE \_\_\_\_\_

If you are a student, please check here ( ) for special information.



**COMPLETE—EASY TO INSTALL**

Here's the quick, sure way to have easy-to-operate and weathertight windows for your home! Curtis Silentite wood windows come as glazed, pre-fitted units, ready to install with the very minimum of time. Silentite windows—known as the most weathertight, trouble-free wood windows made today, come in wide variety for every taste and need—picture windows—double-hung windows—casements—awning windows—panel windows—circle windows. Send for free window idea booklet. Have fun choosing windows for *your* home!



Curtis Companies Service Bureau  
PM-10 Curtis Building  
Clinton, Iowa

Please send Silentite window  
booklet for building and remodeling:

Name.....

Address.....

City.....State.....

emphasis is in the back yard with outdoor living space and garden screened by walls, fences and hedges.

The open plan involves the use of rooms which are separated from each other by half partitions, storage units, or merely by a furniture group. This type of planning allows the eye to see a greater distance and, thereby, gives a greater feeling of space. It is especially useful in the small house.

The flexible plan allows you to readjust your house at will to meet varying conditions. In the ultimate flexible plan only the kitchen and the bathroom will have fixed partitions, while the other rooms are formed by movable storage and wall units. It may be some time before this method is available to everyone, but it has wonderful possibilities in making a house more adaptable to our changing pattern of living.

There are several special arrangements that you may consider in assembling the rooms in your house. One is the solar house, in which all major rooms are arranged in an east-west row with large glass on the south side. The rooms are usually connected by a hallway running along the north side of the house. Solar orientation, with proper overhangs, will prevent the entrance of the sun during the hot summer months, while allowing its benefit during the winter.

**Exterior.** The exterior grows out of your previous decisions. Your basic choice of the site, the type of house, plus what might be called fashion, dictate the appearance. In the realm of fashion, consider some of the characteristics of the contemporary home. It has the long, low look. The roof types are usually low, either low gables or hip roofs or flat or shed roofs. There are large glass areas which allow the sun to enter, which frame a beautiful view, or serve to give visual extension of the space in the house and tie the inside and the outdoors more closely together. Another characteristic of today's house is the emphasis on natural finishes; another is use of the many new and interesting materials, as well as use of old standby materials that have appeared with new finishes and new designs. Your selection of the plan and of the basic type will enable your architect to design this house to suit your tastes.

**Construction.** Part of your planning problem is to consider the type of construction you will use—for the floor, for the walls, for the roof.

Concrete floor slabs are becoming more and more popular for the basementless house. Slab construction helps with the long, low look; also, it is usually slightly cheaper, especially where many houses of

(Continued to page 270)

# GET A SMOOTHER, QUIETER ENGINE... MORE PUNCH ON THE PICK-UP...with the

## MARVEL INVERSE OILER



Install it and see! Your car takes a new lease on life, when vital upper cylinder areas are lubricated automatically by the Marvel Inverse Oiler.

Operating off the intake manifold, this completely automatic oiler feeds to the upper cylinder areas in exact proportion to engine load and speed.

Install it. Fill it. Adjust it. And forget it! There's no maintenance worry with the Marvel Inverse Oiler. Fully automatic operation and full quart capacity give you 1000 miles of carefree motoring on each filling.

### Here's how Fully Automatic Operation Improves your car's performance!

Notice how the Marvel Inverse Oiler feeds oil just exactly as your engine needs it. Throttle open, under load or speed...more oil. Throttle closed, less oil.



# EMEROL

MANUFACTURING CO., INC.

Dept. 122

242 West 69th Street

New York 22, N. Y.

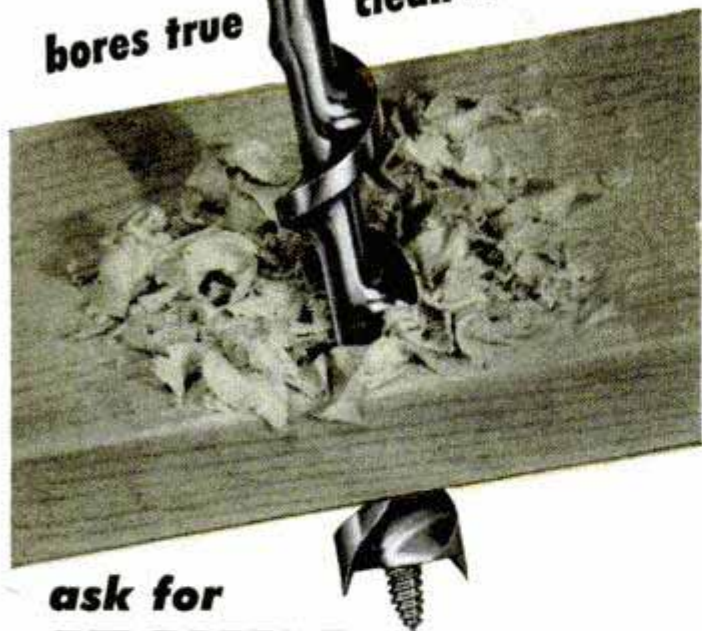
### Use only **MARVEL Mystery Oil** in the Marvel Inverse Oiler

Time-tested secret formula gives you everything you want in an upper cylinder oil. Especially blended and refined to keep sludge-forming components in emulsion, and prevent oil rupture.

Marvel Mystery Oil reduces cylinder wall and piston wear. It keeps piston rings at their proper wall tension. Prevents excessive wear on intake valves, and keeps exhaust valves from sticking.



bores true  
clean through!



ask for  
**IRWIN** auger bits  
World's finest wood-boring tools

Irwin Auger Bits make any boring job easier. They're precision made of special bit steel—heat-treated, tempered, hardened full length for longer life. Cutting heads stay sharp job after job. Original solid center design adds extra strength for steadier, cleaner, more accurate cuts. No binding, no clogging. Ask for Irwin at your independent hardware dealer—the auger bit that bores true... clean through.

**IRWIN 62T Solid Center Auger Bit**— sizes  $\frac{1}{4}$ " to  $1\frac{1}{2}$ ". Double cutter head. Open throat for quick chip clearance. No binding, no chewed edges.

**IRWIN All-Purpose Expansive Bits**— two types, small and large sizes. Boring range  $\frac{5}{8}$ " to 3". Accurate, easily adjusted. Two cutters with each bit. Individually packaged.

**IRWIN Bit Sets**— in hardwood box or plastic rolls. 6, 10 or 13 bit assortments. Sizes  $\frac{1}{4}$ " to 1". Ideal gift for handyman or professional.



**FREE!** Useful booklet tells, How to Select, Use, Care for Auger Bits. Send name and address to IRWIN, Dept. 15, Wilmington, Ohio.

**IRWIN**

the original solid center auger bit  
screw drivers  
screw driver bits



the same type are being built at one site. Concrete floor slabs have some limitations. Certain types of flooring cannot be used over slabs; be sure to check with your architect or your flooring supplier on this point. In colder climates concrete floor slabs must be insulated at the edge to prevent excessive heat loss and the resulting discomfort.

When standard wood-floor construction is used for basementless houses, certain improvements in construction are now considered necessary. A layer of heavy roll-roofing paper over the ground under the floor will prevent moisture rise and, thereby, eliminate a major source of undesirable moisture in the house. In colder climates insulation is desirable, either around the foundation walls or immediately under the floor.

Don't be surprised if your builder uses some unfamiliar construction techniques. Basically, frame walls are much the same as they have been, but the method of erection is different. To speed up construction, builders now often construct the wall flat on the floor of the house and then tip it up in place. The more work done in the horizontal position, the greater the saving.

For roofs, many builders are now using truss construction to span the entire roof from outside wall to outside wall. [Editor's note: See page 156.] This eliminates the need for interior load-bearing walls and allows the placement of partitions wherever desired without consideration of roof support. Truss construction is also useful in that it allows the house to be enclosed quickly so that construction may go on inside in spite of inclement weather.

**Prefabrication.** The prefabrication of houses is becoming more and more important every year. Many different prefabricated houses of varying sizes and accommodations are on the market. Certain prefabricated parts are readily available. Preassembled closet units, windows and ready-hung doors, are three examples.

**Heating.** The general trend of present-day heating for homes shows that most heating systems are being designed to deliver the heat at the outside perimeter of the room where most of the heat is lost. This is effective in overcoming high heat losses through large glass areas. Warm-air perimeter systems and hot-water baseboard systems are designed on this basis; these systems are very good for heating concrete-slab floors. An alternate may be panel (radiant) heating with pipe coils or air channels in floor or ceiling, but these systems must be selected cautiously. In general, a panel system does not respond

(Continued to page 272)



# Cuts ALL with SAME Blade!

ONE SYNCRO BLADE CUTS ALL THESE MATERIALS—ALL SO SMOOTHLY NO SANDING NEEDED! NO "SPLINTERING!"



Blade CUTS ALL SAFELY because it does not "pull" finger toward it like belt driven jig saws do!

## WORLD'S MOST Versatile JIG SAW!

This truly amazing, versatile Syncro Electric Jig Saw actually cuts all the different materials pictured here with the same blade and so smoothly sanding is not needed! This one feature alone is worth Syncro's modest cost. NOW—all the forests of the world are yours to select wood from for your own projects—most of the excitingly different plastics are yours to work with—thin metals like copper, brass, aluminum—even copper tubing, cardboard, tile, linoleum can ALL be cut smoothly without "splintering" by this really remarkable saw. SYNCRO is also so QUIET it can be used in apartments—so PORTABLE you use on a table, a chair—anywhere—so POWERFUL it's ideal for Dad's workshop. SAFE FOR CHILDREN—blade does not pull finger toward it! Stroke is adjustable. Arm swings to take any length cut! Thousands used in schools, homes, hospitals, Cub Dens, Scout Troops. Get this sturdy, precision-made "wonder" tool now—just plug it in any 110-120 Volt A.C. wall outlet—and saw for fun or profit! Remember—Syncro never needs oiling, has no gears or belts! Its new Reciprocating Electric Motor is BUILT-IN and is GUARANTEED against burn-out all during your ownership or replaced FREE.



### MAKE ALL THESE:



SYNCRO POWER UNITS GUARANTEED AGAINST BURN-OUT DURING YOUR OWNERSHIP OR REPLACED FREE!

**THE MOST POWERFUL SAW OF ITS KIND**

**SAFE!**

for even small kids, yet the POWERFUL, Basic Workshop Tool!

Get Your

**SYNCRO** JIG SAW  
ELECTRIC

See Syncro at your favorite hardware store! If store has none or no store near you — send coupon enclosing only \$24.95 — we will ship your Syncro postpaid. Return it postpaid after 10 Days' Trial for prompt refund unless it pleases you. Buy, enjoy your amazing Syncro Electric Jig Saw TODAY! It should last you and thrill you for life! (Or mail coupon for Free Catalog of Saws and Sanders!)

A BARGAIN AT ONLY \$24.95 BELIEVE ME!



**SYNCRO CORPORATION**  
Dept. D-103, OXFORD, MICHIGAN, U.S.A.  
Syncro Electrical Precision Products  
Have Been Made for 30 Years.

**SYNCRO CORPORATION**  
Dept. D-103, Oxford, Michigan, U.S.A.

ORDER. I enclose \$24.95. Send No. 201 Saw postpaid on 10 Day Money Back Trial. Built-In Motor, cord, plug, 6 blades INCLUDED in price.

FREE SAW & SANDER CIRCULARS. Send new SYNCRO CIRCULARS showing new electric JIG SAW and SANDERS!

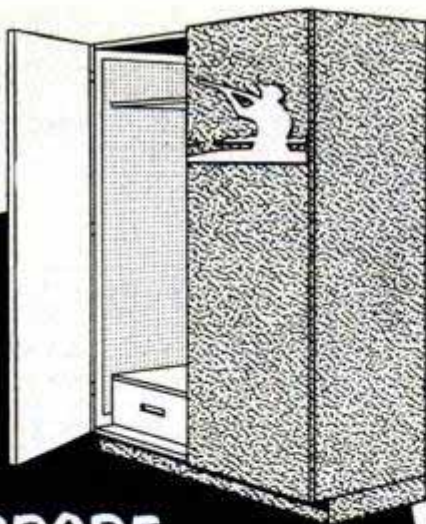
No. 504 SYNCRO ELECTRIC SANDER

Name \_\_\_\_\_

St. & No. \_\_\_\_\_

City \_\_\_\_\_ Zone \_\_\_\_\_ State \_\_\_\_\_

Masonite  
week-end  
project



**YOU**  
can make  
this  
**SPORTSROBE** locker

Send for free plan!

### with MASONITE PRESWOOD

Where do *you* store your sports clothing and equipment? Here is a compact, efficient locker for clothing, boots, etc., plus room for fishing and hunting gear, skates, golf clubs, etc. Build it with attractive Masonite Leatherwood, the Presdwood® with the surface that looks like Spanish-grain leather. Also included are Peg-Board\* panels and metal hangers you can change in a jiffy.

These smooth, all-wood hardboard panels never snag or splinter. Won't rot or decay. Easy to cut and fit with ordinary hand tools. Take paint, enamel beautifully. Send for free plans of Sportsrobe and other week-end projects. Mail coupon today!

See your local building materials dealer for  
**MASONITE PRESWOOD PRODUCTS**

\*T.M. Reg. B. B. Butler Mfg. Co. Inc.

#### A type and thickness for every job!

- Standard Presdwood—  
1/8", 3/16", 1/4" and 5/16" thick.
- Tempered Presdwood—  
brown, 1/8", 3/16", 1/4" and 5/16"  
thick. Black in all but 5/16".
- Temptrite®—1/8".
- Tempered Duolux—both  
sides smooth! 4-ft. and 5 ft. widths.  
1/8", 3/16" and 1/4" thick.
- Leatherwood—1/8".
- Panelwood—3/16" and  
1/4" thick.

Better Hardboards for Better Home Projects

**MASONITE**®  
**CORPORATION**

Dept. PM-10, Box 777, Chicago 90, Illinois.

"Masonite" signifies that Masonite Corporation  
is the source of the product

Please send me free plan on the Sportsrobe

Name.....

Address.....

City.....Zone.....

County.....State.....

rapidly to changes in outdoor temperature and this may result in long warm-up and cool-down periods.

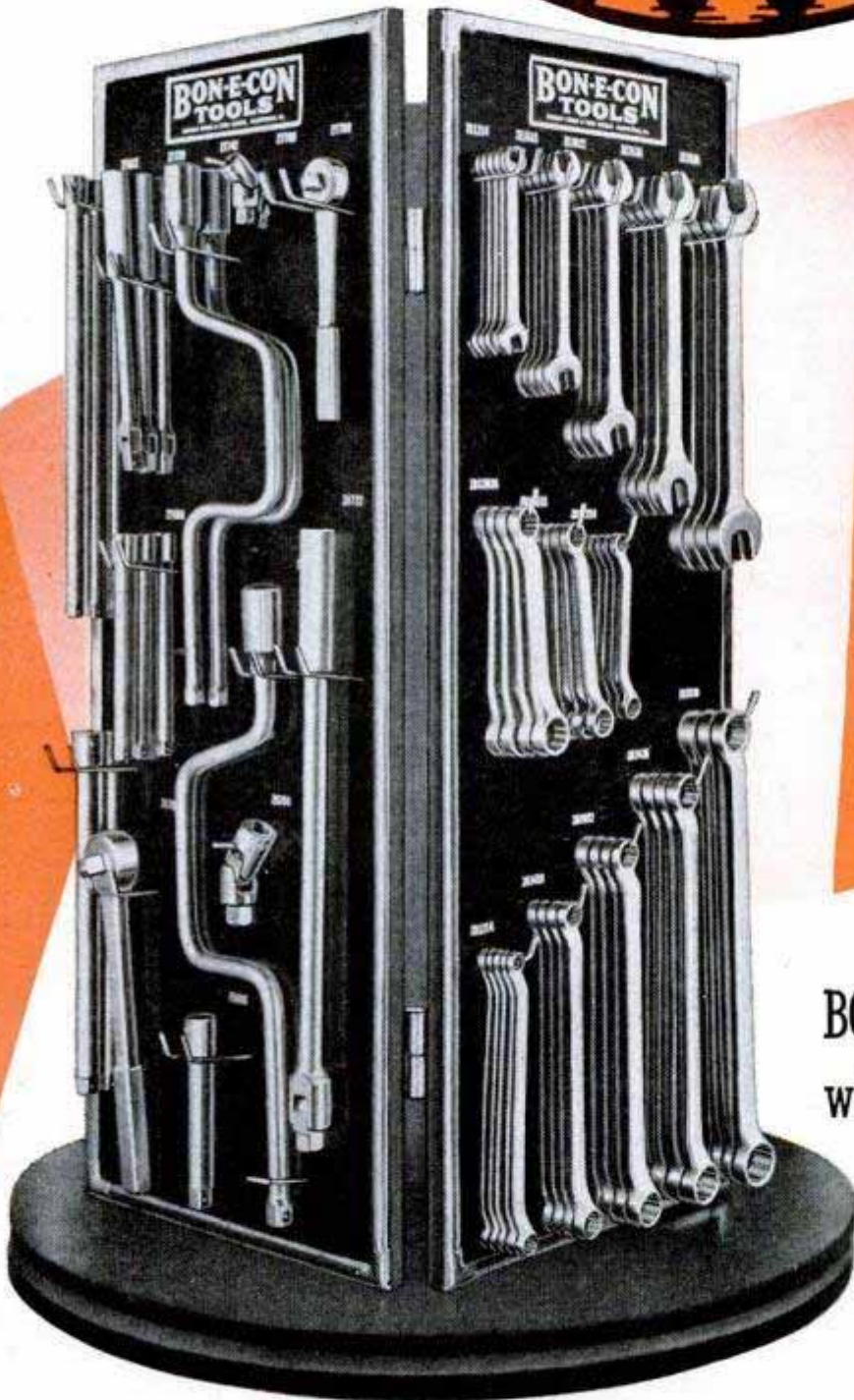
Forced warm-air heating systems are adaptable to summer cooling; hot-water systems can also be adapted to summer cooling, but the problem is much more difficult. Panel systems are not generally adaptable to residential summer cooling.

**Remodeling.** Perhaps you have the choice of remodeling your present home or designing a new one. This is, of course, a difficult choice to make. At present building costs, it is often difficult to get as much space in your new home as you now have; however, if the space in the old house is not conveniently arranged and is not suitable for your purposes, it may be advisable to build a new home or rearrange the old one. If you decide to remodel, be sure to check the basic structure of your house and see that it is firm and will have a long life. Check to see that the structure will allow you to adjust your plan so that it will meet your needs. Will you need a new heating system? Will you need more storage? Check what costs will be involved. Your own opinion determines whether you will remodel or build a new house. ★ ★ ★

### Trimming Board



Instead of a dangerous handle blade, a new paper-trimming board uses a wheel cutter guided along an I-beam track at the right side of the board. The self-sharpening wheel cutter is mounted in a hand-size housing which is kept in a vertical position by the I-beam track. A metal rule at the top edge of the board and scored grid lines on the board itself insure accuracy. Made in several sizes, the board has a handy carrying handle.



TOOLS  
any mechanic  
would value  
...at prices  
anyone can  
afford!

Look for this  
BON-E-CON display  
wherever fine tools  
are sold.

**BONNEY FORGE & TOOL WORKS • ALLENTOWN • PENNSYLVANIA**

only  $\frac{1}{2}$   
the  
weight of wood



## Werner ALUMILADDERS

Save your strength—

Protect your safety

—and Last a lifetime!

You'd never believe you, *alone*, could move a ladder around so easily—yet Werner Alumiladders are strong enough for even the most rugged work! Built like an airplane of tough, tempered aluminum alloy—light but rugged—Alumiladders make jobs like fitting storm windows or painting easier, help get them done faster. You'll feel far *less* tired at day's end.

Rustproof, weatherproof Alumiladders give you a lifetime of dependable service, too. Safety Warranted. See a Werner Alumiladder at your dealer's.

Write us today for free booklet;  
R. D. Werner Co., Inc., 295 Fifth Ave.,  
New York 16, New York, Dept. L-17

Extension ladders 20 to 52 feet,  
Single ladders 6 to 20 feet,  
Stepladders 4 to 10 feet,  
Step stools 26 inches.

Also Ask For:  
Werner Chromtrim  
Metal Moulding



# Werner

ALUMILADDERS

## Let's Look at the Prefabs

(Continued from page 173)

to three units, which produce a complete five-room house. The mobiles are a happy medium between the shortcomings of trailer houses and the troubles of buying and selling houses for anyone who must move often. They can be disassembled and hauled to new sites via truck or rail.

As a general rule, panel and sectional prefabs are sold through local dealers. The dealer builds for you, assembling the house package shipped by the factory. He also takes care of the foundation, masonry, wiring, heating, plumbing and other on-the-site work. He will help you buy the lot, get the necessary building permits and obtain financing. One panel-prefab manufacturer, National Homes Corporation, is known to finance or handle the mortgages on its houses itself. A few prefab manufacturers build only to sell to realtors.

The pre-cut house manufacturers sell direct to the consumer; at least one of the panel manufacturers, the Pease Woodwork Company, Cincinnati, Ohio, sells its partially finished panel houses direct. Another adaption of the prefab is built by Nelson Way Homes of Santa Barbara, Calif. Under this plan, the outside shell of the house is completed from panels or sections built at the factory. All other materials needed to complete the house are delivered to the site, together with detailed instructions (and expert help if necessary).

Some unique prefabs, too, have been developed—one a panel-type cabin shipped to the United States from Sweden. You can put it together yourself in about 60 hours. Designed for use as a summer cottage or guest house, the cabin has wall panels that are fastened together by three built-in ratchet locks, which are tightened with a special wrench. A steel house has been developed in Los Angeles that can be erected in two days. It is made of two sheets of steel separated by 6 inches of rockwool insulation; the prefab panels are joined together at the site by a slotted device, then the joint is spot-welded. An unusual design is the "accordion" house of Acorn Homes, East Acton, Mass. The house is built around a main core, with the walls, floors and ceilings folded up against the core for shipment. At the site, the walls are pulled out and bolted into place on a special foundation of steel beams and concrete posts.

The prefab manufacturers are most alert in using new developments and new construction methods. Their houses today are sound, and you may well find your new home pictured in the pages of a prefab manufacturer's catalog. ★ ★ ★

**NOW...save \$20 to \$40!**

# 8" TILT ARBOR<sup>®</sup> SAW

**ALL METAL  
TABLE AND  
BASE**

**"TILT THE BLADE — NOT THE TABLE"**

**CUTS  
2 x 6's  
IN 2½  
SECONDS**

**\$19<sup>95</sup>**

Blade \$2.95 Extra

West of the  
Mississippi \$21.95

*DOES WORK  
of  
60 SAWS*



**RIPS**

Any length, any type, rough or finished lumber, plywood or composition panels, any thickness up to 2½".



**MITRES**

Smooth, accurate cuts from a perfect right angle up to 45° either way, compound angles, too.



**BEVELS**

Blade tilts, table stays level — safer, no binding because wood doesn't fall against blade.



**DADOS**

Removable throat insert lets you use dado or molding cutters, grinding wheels, sanding discs, etc.



**PATENTED**

¼ or ½ h.p. motor rides on ball-bearing rollers, keeps belt tight, transmits full power to blade. Use your own motor.

*A PROFESSIONAL  
PRECISION  
TOOL*



**ONLY REAL IMPROVEMENT  
IN TILT ARBOR SAWS IN 75 YEARS!  
PLANA CENTRIC  
SUSPENSION**

That's the secret . . . this revolutionary invention slashes costs to the bone yet gives you rugged, accurate, lifelong service. No ex-

pensive worm gears or winding wheels . . . saw blade, arbor and tilting-raising-lowering mechanism are mounted on one simple unit that adjusts instantly for height and tilt, locks rigidly, exactly where you set it. That's how it's possible for us to mass produce this professional quality power saw at such amazingly low cost. Buy now . . . While we can hold our price!

**MONEY BACK GUARANTEED IF NOT SATISFIED!**

\*Patent Number 2590035

Rush me your new ALL-METAL 8-INCH TILT ARBOR POWER SAW. I enclose ( ) check ( ) money order for \$19.95 (\$21.95 West of the Mississippi) plus \$1.00 for postage.

Budget if you choose: send \$5.00 with coupon, \$5.00 per month thereafter. (Your money back if not satisfied in 10 days.)

**YOLAND'S PRECISION TOOL CO., Dept. PM10-3**  
20 Boylston Street, Boston 16, Mass.

Name.....

Address.....

City.....Zone....State.....

If 8" combination Rip and Cross Cut Blade is desired enclose \$2.95 extra and check here ( ).

# look

## HOW HANDY YOU CAN GET!



### SPEEDY RIVETS

... Do jobs you never thought you could do yourself... fasten cloth, leather, paper, plastic sheeting... repair luggage, work-clothes, straps, dog collars... ideal for craftwork, too



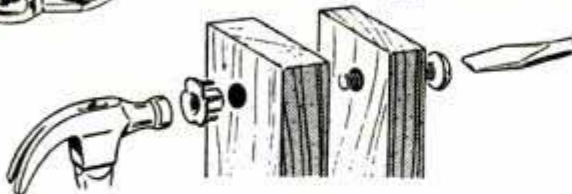
... quick, secure, permanent. Simply punch a hole in each part to be fastened, push rivet together through holes, place on firm surface and swat with a hammer. Gilt, nickel, black, brown finishes. Large or small sizes.

### TEENUTS<sup>®</sup> steel threads in wood

Industry proven TEENUTS, now available for home handymen... provide flush mounting without



counter-boring. Excellent for new work or repairs. Ideal for wood to metal applications and



where old screw holes have become useless. You simply drill hole size of TEENUT barrel, hammer home TEENUT and its steel prongs provide rigid, permanent anchorage. Same size hole for bolt. Complete line to fit standard bolt sizes.

AT HARDWARE COUNTERS EVERYWHERE 15¢

THE **DOT** LINE

3229 South Ashland Avenue, Chicago 8, Illinois

## Mr. House Expert, We Have a Question

(Continued from page 166)

architectural design, uniqueness, location; all those things have value to some people. The same amount of money—let's take \$15,000 as an example—will buy a certain amount of space; on a custom-built basis you would have uniqueness of design, the individuality they prize and are willing to pay for. That becomes valuable to them, location and size of the lot, and so on. The same couple might say: "We will sacrifice architectural design and location because value, to us, represents space." Value is the thing you must talk about.

**Q: If a buyer can fit his needs into a mass-produced house, is that where he could get the best buy?**

**YOST:** There is no absolute yes or no; but I think it stands to reason that a house produced in quantity is going to be a better value than one which is individually built and individually designed. We all know that the pilot house we build for a group development costs more than the house will cost after it is in production. The pilot house is just the same as the custom-built house, in many ways, as to cost. When they build them in quantity, builders pre-cut or use other methods of money-saving mass production.

**HAEGER:** I think a house should fit the needs of a family, rather than vice versa.

**YOST:** That is right.

**BARTLING:** It is true, though, today, that all the successful builders are producing mass-produced houses which fit the needs of 85 or 90 percent of the buying public in certain price categories. You have a three-bedroom house, a four-bedroom house, a two-bedroom house; and the average family's living requirements are outlined in that package as to room size, circulation, location of kitchen fixtures.

**SMITH:** I think you can capsule a lot of this in a little phrase we use in our shop: "We want our customers to own their homes; we do not want the homes to own the customers."

**Q: What has been your experience with partly finished or shell houses?**

**BARTLING:** It is a question of financing.

**YOST:** It is just a question of a man's being able to put his own labor in.

**BARTLING:** It tends to build a neighborhood of shacks. One man works like mad; the other says: "I will work next week." So they hang blankets up for partitions and, two years later, they are still living in a shell house.

**YOST:** But, if a man wants to finish off

(Continued to page 278)

**NOW**  
a power tool that's

*Really New!*



**JUST TURN TO RIP**  
No need to disassemble and reassemble when changing from cross-cutting to ripping. Just turn head 90° . . . you're all set to rip!

BUILT-IN  
BLOWER

TABLE  
TILTS  
TO 45°

NEW SHOE  
HOLD-DOWN  
DESIGN



FULL-ROTATING  
ARMATURE AC  
MOTOR

MASTER-VIEW  
CONTROLS

**SHOPMASTER'S**

*Sensational* **20" JIG SAW**  
with **Self-Contained Motor**

Think of it—this rugged 20-inch jig saw has its own built-in motor! Not a solenoid or a vibrator, but a full-rotating armature, powerful AC motor.

A rugged, professional power tool that cuts up to 2½" stock with ease, this newest of all power tools makes precision woodworking actually easy. Shopmaster's EXCLUSIVE COMBINATION MITRE GAUGE AND RIP FENCE accessory sees to that!

Want to rip? Just turn saw head 90°. It's that simple. Truly the most outstanding QUALITY power tool value on the market today!



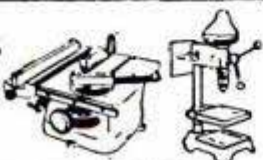
Just plug  
it in

(Exclusive combination mitre gauge and rip fence available at slight extra cost.)

**\$39<sup>95</sup>** Motor included

Slightly higher in zone 2

OTHER FAMOUS  
SHOPMASTER  
TOOLS



FAMOUS UNIVERSAL  
COMBINATION TOOL

**WRITE FOR FREE CATALOG**  
There's a Shopmaster power tool for every need. Write today for catalog of complete line.

**SHOPMASTER, INC.** Room 10D  
1214 South 3rd St. • Minneapolis, Minn.



his attic in an otherwise completed house, or add a room or a garage, that is fine.

**Q: What type of house is the best long-time investment? Is it the one-story peak-roof ranch, flat top modern, or traditional?**

**SMITH:** There, again, you have no one answer. We come back to what the man and his wife consider value. I think any well-designed, well-constructed house in any of the categories, designwise, which you have mentioned, properly located and purchased at the right price, will always be of good value if maintained. I think the traditional forms will always be with us.

**YOST:** I do not think Mr. Smith means a so-called Georgian house. I think that is dying, and dying fast. A house which is built in the actual Georgian style, or Georgian prototype, is going to be a very old house 10 years from now.

That is going to vary with the area in which it is built, too; but our modern methods of living (the automobile, the home laundry, the large glass areas, air-conditioning, the sun shields, overhangs of roofs, playrooms, all those things) just do not lend themselves to what is actually a Georgian or a Cotswold cottage, or whatever. So the traditional house, as such, is not going to continue any longer than lending institutions and others of ultraconservative minds force it to.

**Q: What about a good, traditional exterior with an interior that has been adapted to modern design?**

**YOST:** We are always going to have modification, but it's usually a botched job.

**SMITH:** I think we all agree that the modern, or contemporary, form, the simpler form, by its very nature, offers more house for the dollar. Out in our area (California) we have been able to prove very conclusively that we can offer space and comfort in our contemporary house, 23 percent more than the same space enclosed in the ranch house. We can prove it with facts and figures. Ten or fifteen years from now the contemporary house will have a greater resale value.

**YOST:** The modern house does not have to be extreme. We can have a conservative modern house which still has a lot of tradition: Traditional materials, traditional concepts of family life, all that sort of thing which makes a homey house. It need not be angular, it need not be severe, it need not be cold. It should not be.

**BARTLING:** In fact, that house is as dead as the colonial or Georgian house.

**YOST:** Or the stylized type—that is, the "moderne" with an "e" on the end of it.

**BARTLING:** Angular corners, glass blocks.

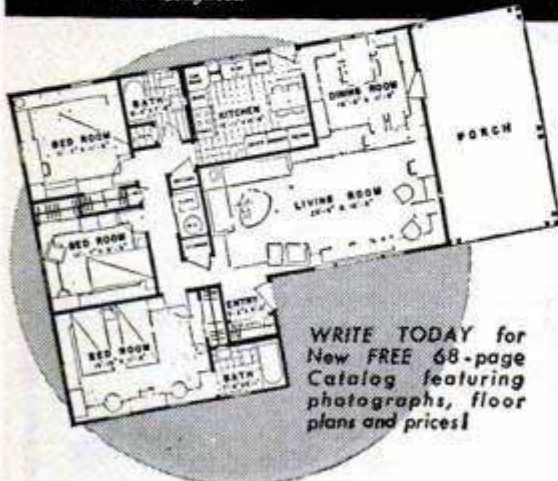
(Continued to page 280)

## SAVE MORE THAN \$1,000 with a PEASE home!



"The Longwood"

**BUILD IT YOURSELF E·A·S·I·L·Y**



WRITE TODAY for  
New FREE 68-page  
Catalog featuring  
photographs, floor  
plans and prices!

Don't let high costs end your dream of owning a spacious, distinctive home. Build a PEASE Home yourself! PEASE pre-construction makes it possible for you to build it just like hundreds of others already have . . . easily and economically. You save more than \$1,000 in building costs . . . more than 60 days building time.

Engage a contractor and still save money. There's a 2, 3 or 4 bedroom PEASE Home to suit your needs, tastes and budget.

### PEASE-FABRICATED HOMES

TRADE MARK REG. U. S. PATENT OFFICE

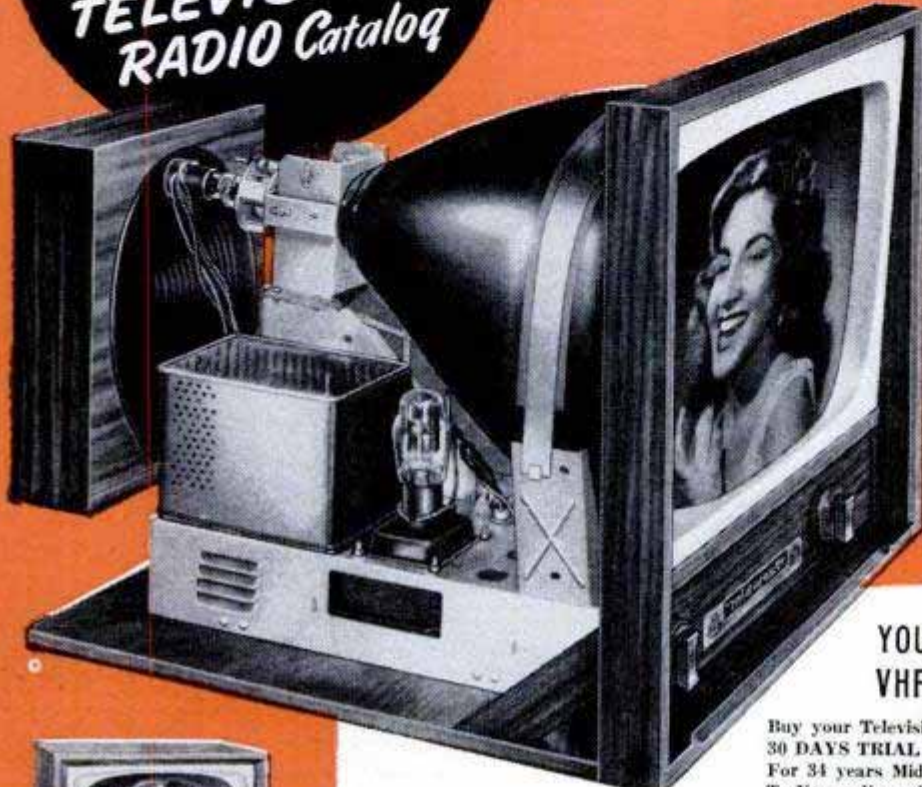
PEASE WOODWORK COMPANY • Pease-Fabricated Homes Division  
920 Forest Avenue • Hamilton, Ohio



Send for Your  
**FREE**  
 Copy of the **NEW 1954**  
**MIDWEST**  
**TELEVISION and**  
**RADIO Catalog**

# MIDWEST *Presents*

For 1954 a Completely NEW LINE of  
**21" and 27" TELEVISION**



CONSOLES  
 TABLE MODELS

and  
**COMPLETE CHASSIS**

at  
**LOW FACTORY PRICES**

YOUR CHOICE OF EITHER 12 CHANNEL  
 VHF or All-Channel VHF-UHF Models

Buy your Television or Radio Direct from the Midwest Factory . . . on  
**30 DAYS TRIAL . . . Easy Terms . . . and at LOW FACTORY PRICES.**  
 For 34 years Midwest, the world's largest and oldest exclusive Factory-  
 To-You radio and television manufacturer, has served hundreds of thou-  
 sands of satisfied customers all over the world.



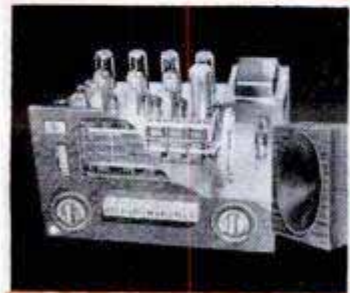
**EASY TERMS**  
 . . .  
**30 DAYS TRIAL**



## FACTORY-TO-YOU

Also—Powerful New 1954 World-Ranging  
**MIDWEST Series 16 RADIOS**  
 In Beautiful Consoles and Complete Chassis

All models available in your choice of mahogany, walnut finish or blond lined oak.



Once again Midwest offers its famous series 16 five band AM-FM radio chassis and the magnificent new Symphony Grand Radio-Phonograph with 3-Speed Automatic Intermix Record Player. Also, a complete line of clock radios, table radios, and portables.



**MIDWEST RADIO & TELEVISION CORP.**  
 DEPT. C-25, 909 BROADWAY, CINCINNATI 2, OHIO

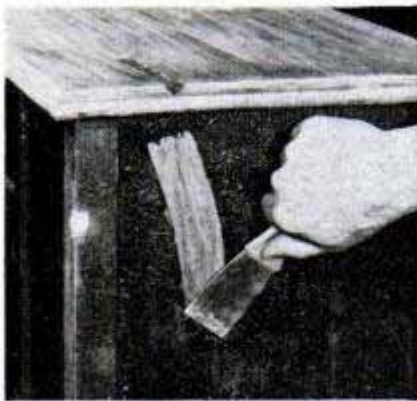
● **WRITE IN NAME AND ADDRESS (PLEASE PRINT) ON COUPON OR 2c POSTCARD** ●

**MIDWEST RADIO & TELEVISION CORP.**  
 Dept. C-25, 909 BROADWAY • CINCINNATI 2, OHIO  
 Please send me your new FREE 1954 Catalog.

NAME \_\_\_\_\_  
 ADDRESS \_\_\_\_\_  
 CITY \_\_\_\_\_ ZONE \_\_\_\_\_ STATE \_\_\_\_\_

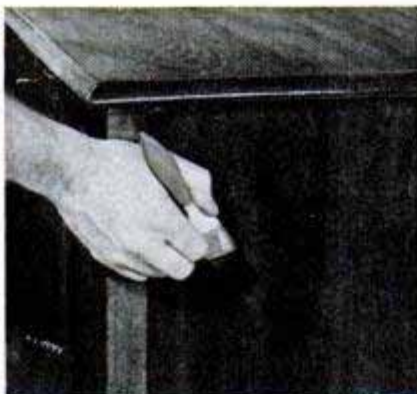
# Hints on How to Refinish Furniture

**Step 1. Remove old finish**—quickly, easily, with fast-acting Strypeeze. Brush on, let it set . . . off comes the old finish. (hint: sprinkle sawdust over Strypeeze. "Roll off" sawdust, Strypeeze and old finish.)



**Step 2. Fill all holes, nicks** — permanently and simply with Savogran Wood Putty. Tools easily, won't shrink. Now, sand entire surface with 6/0 sandpaper. (For cracks in plaster, use Savogran Crack Filler. It's the original patented quick-hardening water putty.)

**Step 3. Refinish**—before you start, be sure brush is clean. Savogran Kwikkeeze really cleans varnish brushes. Leaves no specks of old varnish, dirt in brush to mar finish. Apply stain, thinned shellac seal, then spar varnish or dull "rubbed effect" varnish in finishing.



# SAVOGRAN

**PRODUCTS . . . at better paint & hardware stores**  
**Write for free helpful literature**  
 SAVOGRAN CO., Dept. 40, 25 Huntington Ave., Boston 16, Mass.

**SMITH:** We always have the publicity seekers who do these things. But I think the trend definitely is in the direction of what Morgan Yost is talking about.

**YOST:** We should think of modern not as a style, but a way of thinking and living. We want to think what this house is going to do for the family. In my custom house, I never show the people what the outside of the house is going to be like until I have shown them the plan and gotten them to approve. When I show them the perspective of the house, they say: "Of course, it has to be that way." It is just a natural outgrowth of the plan and their way of life.

**SMITH:** Planned from within, meeting their requirements of space and living.

**YOST:** That is what a true using of a traditional house cannot do. The traditional plan means symmetry, of a sort at least; it means a certain type of window, a certain kind of entrance. That is not planning from within; it is crowding into a shell. At any rate, the exterior should come last in a well-planned contemporary house.

**BARTLING:** There is an architectural expression that "form follows function." You work it out and it just falls into place.

**Q: Would you advise a two-bedroom or a three-bedroom house?**

**SMITH:** You have to relate it to a family's income and ability to purchase. Out in our area (California) we are dealing with the working man with modest income; down-payment variation is rather slight. A man pays 5 percent down, using the FHA title. We find that between 25 and 30 percent of our buyers buy a two-bedroom house.

**BARTLING:** Isn't it true that most builders have found the demand for the three-bedroom house, even for the family without a child, exceeds the demand for the two-bedroom.

**SMITH:** No denying the desire.

**BARTLING:** In our area (Tennessee) the builders around Knoxville, regardless of price range and without exception, are building three-bedroom houses.

**YOST:** I think it would be a good idea for any young couple to stretch themselves to get a three-bedroom house.

**Q: Would you advise building a basement or not?**

**SMITH:** You must consider, first of all, which part of the country we are speaking of. In some parts we have freezing conditions where the design of a structure calls for having concrete go down into the ground to get beyond the frost line; having had to go that far, it becomes fairly sense-making to go a little farther and create a basement. Out in California, I do not think

(Continued to page 282)

# 5 Woodworking Exclusives

...yours with **AMF DeWalt "Power Shop"!**

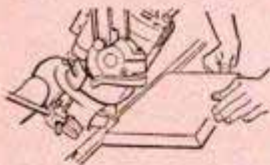
- 1. 12 POWER TOOLS IN 1**—all run on *one* direct-drive motor!
- 2. "RADIAL ACTION" OPERATION IN 3 DIMENSIONS**  
—makes it simplest and safest to learn—easiest to operate!
- 3. SAWS THE EXPERTS' WAY**—blade moves, material doesn't. You *see* what you do—no guesswork!
- 4. PROFESSIONAL PRECISION**—it's a home workshop version of same famous AMF machine preferred by experts for over 30 years!
- 5. COMPLETE HOME WORKSHOP**  
—does *everything* in woodworking—makes every cut and joint! Big capacity—cuts 2½" deep, rips to center of 4-foot panel—yet fits in a 3 foot square area.

Price, \$229 delivered (saw blade and custom-built motor included). Easy terms available to fit your budget. Now on sale in department stores, hardware stores, mill supply houses.

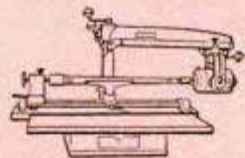


**12 power tools in 1—it does everything!**

**Makes every cut and joint!**



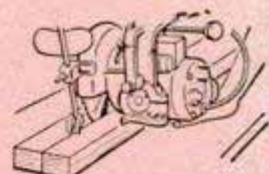
PROFESSIONAL SHAPER!



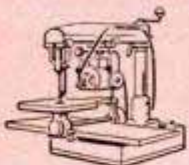
CRAFTSMAN'S LATHE!



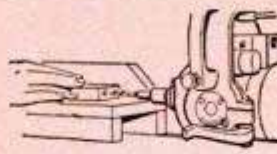
MITER CUT!



RIP CUT!



BIG-CAPACITY JIG SAW!



POWERFUL DRILL!



LOCK JOINT!



MORTISE AND TENON JOINT!

And it's a dado, sander, router, grinder, metal cutter!

18 different operations with saw blade alone!



products are better ... by design

AMERICAN MACHINE & FOUNDRY COMPANY

## SAVE 80% ON FINE FURNITURE!

Send for "Make It Yourself" booklets!  
28 pages...20 pieces of furniture.  
Exact make-it-yourself savings.  
Finishing tips. Complete DeWalt®  
"Power Shop" instructions.



Send 25c—Save Hundreds of Dollars!

AMF DeWalt Inc., Dept. PM-10, Lancaster, Pa.  
Please send "Make It Yourself" booklet(s) checked  
below. Enclosed find 25c (in coin) for each one.

- Early American and Juvenile furniture. (25c)  
 Modern and Outdoor furniture (25c)

Name \_\_\_\_\_

Address \_\_\_\_\_

City \_\_\_\_\_ Zone \_\_\_\_\_ State \_\_\_\_\_

**"Cake" - not wood  
mellows  
your smoke**

**and the  
exclusive  
honey lining  
cakes Yello-Bole  
imported briar far faster  
than any pipe at any price!**



The yellow in Yello-Bole is real honey—and honey cakes faster! This great Yello-Bole exclusive builds up "cake" from the first puff . . . holds the cake fast to fine imported briar. One pipeful—and you're smoking cool and sweet. No break-in. No tongue sting! It's the pipe that takes the cake!

**PROOF?**

**Yello-Bole is the world's  
largest selling pipe . . . BY FAR!**

**YELLO-BOLE**

**\$1.00  
TO  
\$2.50**



one house in 10,000 built today has a basement. We can much more readily create space which will accommodate the functions which are normally found in the basement; not the same amount of space you would find in a basement-type New England house. Anyway, many families use that space for an accumulation of junk they should have thrown out. The laundry, a little play area for the children, the heating equipment, and so forth, can be accommodated very comfortably in a smaller space built topside.

**YOST:** The split-level house has become very popular just for that reason. It allows you to use the full depth of your footings for the actual wall of the house.

**BARTLING:** The biggest fault of the house without a basement (that is all I build) is that in most cases we do not have the equivalent of the space we have displaced. We will stick on a four-by-four storeroom and say that will take care of everything. Actually, the storage space does not have to be as big as a conventional basement, but you do have to think of the lawn mower, the bicycle, the garden tools, the workshop.

**YOST:** The lack of storage space is one of the most common faults of houses, either custom-built or tract-development.

**HAEGER:** Anyone building or buying should think carefully about his storage requirements—then double whatever he has figured out.

**BARTLING:** This is a good time to bring up the advent of the so-called storage wall or working wall.

**YOST:** A bedroom, for instance, with built-in storage wall or built-in cabinets or drawer cases can be much smaller than one into which mammoth store-bought things have to be moved. It also means the buyer gets the built-ins with his down payment as part of the house.

**Q: What advice can you give on new materials?**

**HAEGER:** New materials which are acceptable will get into the houses simply because some architect, engineer or builder has analyzed them and become aware of their potentials. Price is important, too.

**BARTLING:** It is simply a question of economics. If a new material is reasonable in price and good stuff, it will be used. There is no so-called miracle material which I know of on the market today—steel, plastic, aluminum or what have you—which will do all things for all people.

**Q: What are the most significant new features in postwar houses?**

**SMITH:** Better planning, period! You can break that down.

(Continued to page 284)

**RELIEVES  
HEADACHE  
NEURALGIA  
NEURITIS PAIN**

**FAST**



**Here's Why...**

Anacin® is like a doctor's prescription. That is, Anacin contains not one but a combination of medically proved active ingredients. Anacin is specially compounded to give FAST, LONG LASTING relief. Don't wait. Buy Anacin today.

Our 653rd Advertisement

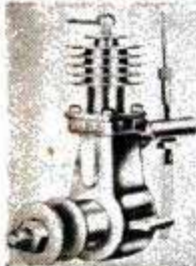
**REAL DIESEL ENGINE**

**\$3.95**

- for planes, boats, midget cars
- 7500 RPM; 1/7 HP; ht. 3 1/2"; wt. 5 oz.
- precision machined for smooth operation

You just can't beat this price for a precision diesel engine! Streamlined, compact, easy to install. Thousands of satisfied users all over the world. Fast delivery if you ORDER TODAY! Send \$3.95 plus 25c postage.

**GOTHAM HOBBY CORP.** Dept. P. 107 E. 126th St. New York 35, N. Y.



**WOOD LASTS LONGER  
WHEN WOODLIFE TREATED**

WOODLIFE protects wood against swelling, shrinking, warping, checking, decay and termites. Clean—odorless when dry. Improves paintability. Contains Pentachlorophenol. Buy WOODLIFE-treated lumber or apply it yourself. See your lumber dealer.

**PROTECTION PRODUCTS MFG. CO.**  
Kalamazoo 5-2, Michigan



**SEND FOR FREE LITERATURE**

**Say You Saw It in Popular Mechanics**

**FILE SAWS FOR PROFIT!**

**BeMaCo Rapid Saw Filer**

**MAKES SAW FILING EASY.** Opens the door to extra profits. A power driven filer that takes the work out of saw filing. Anyone can operate it. Gives full control to the operator. Priced Right. Write for literature today!

**BeMaCo Automatic Saw Set** — Uniformly sets 400 teeth per minute on hand or band saws. Perfect hammer and anvil action. Acclaimed by saw shops across the country.

**BEAVER MFG. CO.**

Saw Machine Div. 6-C

800 S. ISIS AVE. • INGLEWOOD, CALIF.



**START EARNING TODAY!**

**TUNE 'ER NOW FOR**

**Winter Driving!**



**With Super-Hot-Spark**

**NIEHOFF**

**Warranted  
IGNITION PARTS**



Drive in now, *before* the snow flies, and have your certified Niehoff Dealer tune your car for hot-spark fast starts, carefree driving, the winter through. There's a Niehoff expert nearby—42,000 of them in the U. S. Replace needed parts with Niehoff ignition—the parts master mechanics install in their own cars. Precision fit for all popular makes and models—cars, trucks, buses.

**Ask About NIE-TRON Super Heavy-Duty Coil, at Right, Warranted 100,000 Miles!**

Replaces any coil on any car produced in the past five years without changing condenser or mounting brackets. A hot spark high speed coil to meet top demands of today's improved engines.

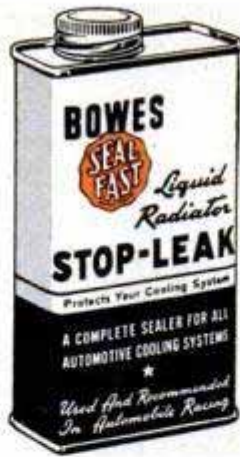
**See Your Niehoff Dealer Now**



**C. E. NIEHOFF & CO.**  
4925 LAWRENCE AVE.  
CHICAGO 30, ILLINOIS

**30th  
ANNIVERSARY  
YEAR**

Save  
Money,  
Trouble  
with



**BOWES**



# STOP-LEAK

Come winter you will have to buy some sort of anti-freeze for your car, or else you won't "run." Anti-freeze is expensive. If your radiator or any part of your cooling system is leaking, you will quickly lose your expensive anti-freeze. Put a can of BOWES STOP LEAK in your radiator today and make sure that you will have "smoother motoring" this winter.

BOWES Stop Leak will not clog your radiator. It's SURE . . . SAFE . . . PERMANENT.

## YOUR CAR DESERVES THE WINTER SAFETY OF BOWES RADIATOR CHEMICALS

### RADIATOR KLEN-ZUR

Removes rust, scale, lime, oil and grease . . . contains no harmful acid . . . gets cooling system clean as new.



### RADIATOR RUST-ROUT

Prevents trouble-making accumulation of rust in cooling system . . . also lubricates water pump.

**DRIVE IN  
Where You  
See This Emblem...**

**BOWES**



BOWES "SEAL FAST" CORP., INDIANAPOLIS 7, IND.

**YOST:** Open planning, flexible planning, multiuse of the same space, ease of circulation (so the family can get from one place to the other without going through certain rooms or without walking long distances); attention to children, for example enabling them to come into the house and go to the bathroom without tracking through living rooms; better kitchen planning, so that meals can be gotten without kids traipsing back and forth, and the kitchen is closer to the eating area. Also, houses are being planned remembering that we enter and leave our houses by automobile. The garage or carport has become an important part of the house. Modern houses are just turned around from what used to be so that the outdoor space, such as a rear garden, can be used as an extension of the actual living space; even in the wintertime, it is visually a part of the inside.

**BARTLING:** I think we should mention the more extensive use of glass to increase the apparent size of a small room.

**SMITH:** Glass walls and big windows should be used with care, taking into consideration orientation in relation to sun and shelter.

**YOST:** Let's castigate specifically the picture window on the front, in which we always see the ruffled lamp shade—absolutely useless. A house should be closed off from the street and the big windows put in the rear where they belong.

**BARTLING:** There is another school of thought on that. There was a survey at South Bend, Ind., which incorporated what everybody thought was a good idea, putting the living room to the rear. The man who tried it found that about 80 percent of the people wanted the big window on the street.

**HAEGER:** To me, the greatest thing which has happened since the war is the recognition of changing family living habits. One of these is indoor-outdoor living. Before the war, the notion of outdoor-living spaces was really gaining headway. But, since the war, the designers have made use of the device, and have actually done everything possible to bring the outdoor-indoor living together.

**Q:** Would you advise a builder to consider seriously air conditioning a house?

**BARTLING:** I certainly would.

**SMITH:** I hate to see these blanket recommendations.

**BARTLING:** If they can afford it.

**SMITH:** That is right. It is an added amenity.

**YOST:** I think it may be well to say that, in some climates there are so few days when air conditioning is actually needed,

(Continued to page 286)

# CUT HEAT BILLS UP TO 25%

***It's easy! Insulate your attic  
with Gold Bond Rock Wool!***

**Y**OU can cut your fuel bills as much as 25% just by insulating your top floor! Besides keeping furnace heat in during the winter, Gold Bond Rock Wool Insulation keeps summer heat out. You'll have a cooler, more comfortable home...and a safer home, too. Walls filled with Gold Bond Rock Wool resist fire as much as a half hour longer. This could mean the saving of your home!

Gold Bond makes it easy for you to do the insulating job yourself. Rugged, easy-to-handle Gold Bond Rock Wool Blankets go up fast between studs, joists and rafters of the usual 16", 20" or 24" spacing. For unfloored attics with floor joists of different spacing than these, simply spread Gold Bond Pouring Wool between the joists.

Mail coupon with 10¢ for a fact-packed booklet on Gold Bond Insulation...tells how it cuts your heating bills, makes your home more comfortable the year 'round. Your Gold Bond lumber and building material dealer will be glad to show you samples of Gold Bond Rock Wool. See him today.



*Leading builders specify Gold Bond Rock Wool Blankets because they're rugged, are easy to handle and go up fast!*

**You'll build or  
remodel better with**

**Gold Bond**

**MAIL  
COUPON  
TODAY**

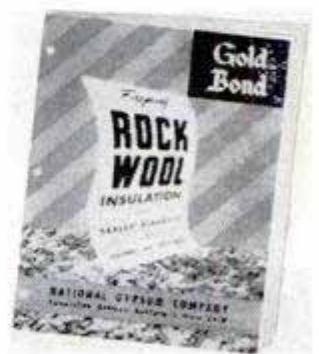
NATIONAL GYPSUM COMPANY, DEPT. PM-103, BUFFALO 2, N. Y.

I enclose 10¢ for the illustrated, 24-page Gold Bond Home Insulation Handbook.

NAME.....

ADDRESS.....

CITY.....ZONE.....STATE.....



# Biggest Oil News In 50 Years!

**NEW**

## 3-IN-ONE OIL

**"PUSH-BUTTON" spra-gun**



## Lubricates and Protects with Amazing "MIST-ACTION"

**NOW!** Big news for mechanics, home craftsmen, gardeners, etc.! New 3-In-One Oil *spra-gun* is easier, faster, cleaner, *more effective!*



## Spray Tools To Keep 'Em CLEAN!



**IDEAL** for mowers, shears, clippers, other garden tools!

**IN SECONDS...** spray saws, chisels, planes, locks, hinges, springs, etc.

*No messy rags... oily fingers!*



## Contains Special Rust Inhibitor!

**ACTUAL TESTS** by immersion show that 3-IN-ONE Oil prevents rust where other oils fail!

**JUST PUSH VALVE—OUT COMES FINE MIST OF OIL!**

3-IN-ONE Oil also available in the familiar Spout Cans in 10c, 25c, and 50c Sizes



**New 3-IN-ONE spra-gun**

that it is not economically sound for the lower-income family.

**BARTLING:** It is in Texas.

**YOST:** That is another thing. But I think it is sound for a man to have an attic fan.

**HAEGER:** We have not said anything about neighborhoods. I have some real advice for any young couple. People very often look for the house itself, without ever considering the neighborhood, the community they are moving into. The house can be perfectly planned, economically within reach, and all of that; but, if they are in an environment unlike one they should be in and want to be in, they are really an unhappy family.

A homeowner must consider all the obvious things: transportation, schools, churches, shopping centers. If I went out searching for a new house, I would decide first which community I wanted to live in. You might say the solution is the right house in the right place for the right price.

**Q:** Can a buyer or builder of a new home make some sort of check list to be reasonably sure he is getting a sound house? What fundamentals would you stress?

**HAEGER:** If you are talking about construction, I would discourage any sort of check list. I would rather see the family make a check list which went to all these things of environment, family needs, and all that sort of thing, and put their trust, constructionwise, in the hands of a good architect or a good builder.

**BARTLING:** Don't you think it would be safe to assume that, constructionwise, the typical house with a mortgage on it is essentially sound?

**YOST:** Here is one thing I think we might emphasize, that the good house is almost invariably a simple house: Simple use of materials, not changing materials just for the sake of some false idea of design, not a lot of gables, a lot of gimcracks and dove-cotes.

**SMITH:** It goes without saying that the simpler design is going to wear much better architecturally and retain its value much longer. ★ ★ ★

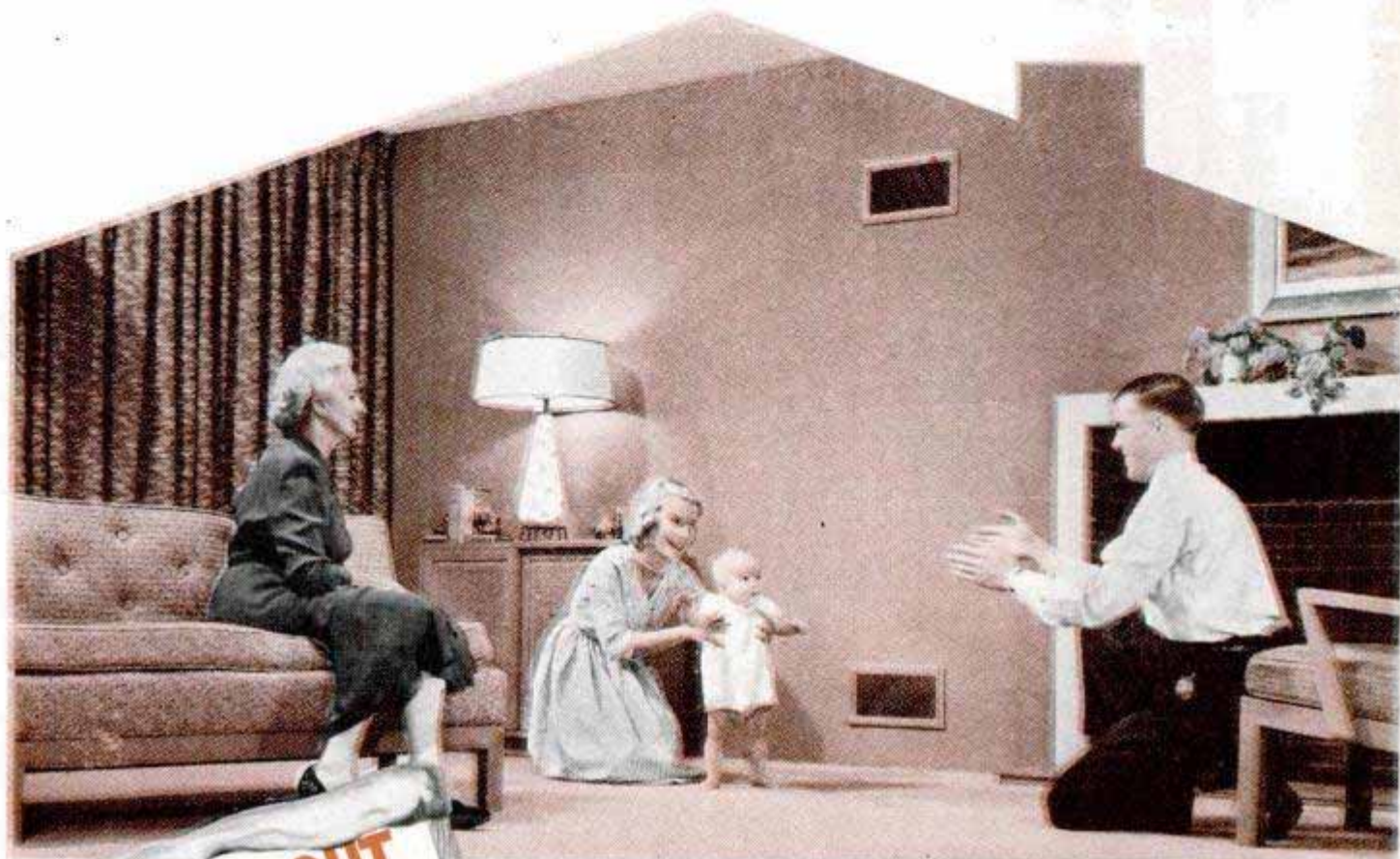
## Rocket Camera Snaps Sun From 50-Mile Altitude

Fired 50 miles above the earth to take pictures of the sun, a rocket-borne camera successfully photographed the sun's spectrum in the extreme ultraviolet wavelengths. University of Colorado physicists, who conducted the experiment, claim the first such photographs of the powerful ultraviolet radiation emitted by the hydrogen of the sun's atmosphere.



# Now... your heating comfort guaranteed...

## \$1,000.00 Bond backs Coleman Blend-Air!



**COME IN OUT  
OF THE COLD**  
Enjoy real comfort  
with  
Coleman Blend-Air

Coleman can furnish this Bond in *your* name covering *your* installation, because its Magic Blenders provide a new kind of warm air circulation that conditions each room for health as well as comfort. *No* stale hot air! *No* heat packed at the ceiling with floors freezing cold! Blend-Air's thorough circulation keeps floors warm; keeps temperature uniform from floor to ceiling. Fully automatic with over-all temperature control and control in each room *independently*. Blend-Air, with small 3½-inch air tubes, brings you guaranteed comfort in a package. Ask your Coleman dealer. Look him up in the Yellow Pages of your telephone book or write us for free literature. The Coleman Company, Inc., Wichita, Kansas.



### THE MAGIC BLENDER DOES IT

*In winter it blends room air with freshly heated furnace air to maintain comfort. In summer, room air is blended with cool, dehumidified air for dry mountain-air coolness.*

"COMFORT COSTS SO LITTLE WITH A COLEMAN"

The Coleman Company, Inc.  
Dept. 711-PM, Wichita 1, Kansas  
Please send me free literature on the revolutionary Blend-Air Comfort Bond.

Name \_\_\_\_\_  
Address \_\_\_\_\_  
City \_\_\_\_\_ Zone \_\_\_\_\_ State \_\_\_\_\_

**Coleman**®

**Blend-Air**®

OIL  
GAS  
LP-GAS

Central Heating and Air Conditioning System

# HERE'S PROOF IT'S BETTER!

## Six car makers adopt **MONROE POWER-GUIDE**



Break-neck runs through axle-deep sand, gravel and water produced no trace of wheel fight or shock.



**Industry's top  
engineers prove new  
Power Steering unit  
Surest, Safest,  
Simplest!**

There's a great new development in the automotive world—Power Steering. Many car manufacturers, in response to public demand, now make power steering available to purchasers of their cars. Six of these car makers, after exhaustive tests and thorough study, have made Monroe Power-Guide their choice for optional factory equipment. Monroe Power-Guide—surest, safest, simplest—is the power steering for you. Built by Monroe, builders of over 50,000,000 hydraulic units for the automotive field. Monroe Auto Equipment Company, Monroe, Michigan.

**DEALERS CAN INSTALL.** Your car dealer or service garage can install Monroe Power-Guide in a few hours. Available now for 1952-'53 Fords and Mercurys and 1950-'53 Cadillacs. Units for other makes and models will be available soon.

### **Surest • Safest • Simplest**

**Complete Control**—Monroe Power-Guide gives you the "feel of the road"—eliminates road shock and wheel fight. Takes the strain out of day-long trips.



**New Safety** on soft shoulders, through gravel or sand, mud or snow. Blowouts, too, are robbed of danger when your car is equipped with Monroe Power-Guide.

**Effortless Parking**—Monroe Power-Guide takes the work out of parking. Wheels turn easily even when car is standing still for easy, effortless parking.



## More House for Less Money

(Continued from page 161)

3500) occupy 11 tracts, are the so-called ranch type—a loose term generally indicating a one-level house—and run from two bedrooms (\$8845) to a four-bedroom two bath luxury home (\$16,000). Even the smallest ones feature things like sliding glass walls, built-in range and oven, shower stalls and forced-air heat. Big ones are loaded with electrical trickery including radio-controlled garage doors, floodlighted yard, touchplate light switches, electric house numbers and garbage disposal units. To astound his customers, Cox built a model "home of the century" that does everything but go to the office and make a living for its owner. The three-bedroom, two-bath showplace has a service and laundry area, lanai room (a partially enclosed patio) fluorescent Tahitian wall mural, and a swimming pool. Time clocks turn on the outdoor floods at night; off in the morning. Touch a switch plate at the headboard of your bed, and a coffemaker starts in the kitchen. Sliding glass walls, facing the pool in the lanai room, open and close electronically. Tape recorded music is piped to all the rooms as well as outdoor areas. Ozone lamps kill kitchen odors and an intercom system connects every room, the front door, and the pool area. Though this house is not for sale on a tract basis, many of its electrical wonders are found in Cox' mass-produced luxury homes.

Less spectacular, perhaps, but well-planned, spacious, and far more extensive is Nathan Manilow's town of Park Forest, occupying 2400 acres outside of Chicago. On curved, grass-covered malls, right now, Manilow is building 5000 single-family homes, plus 3010 "town and country" rental units. Land is ready for schools, churches, recreation and a 100-store shopping center (with theater). The builder has mapped out a 500-acre Industry Park, where light industries will be invited to move in and set up shop—just as would happen in any American town allowed to grow up normally over 100 years.

Typical lot size in Park Forest is 60 feet by 120 feet (some larger), and a wide variety of houses grace the winding lanes. Latest are the "growing homes"—two-bedroom houses with semi-finished second floors, priced at \$10,995. They are complete with automatic washer, drier and other accessories. Other two and three-bedroom varieties of brick and frame construction have sold for \$11,995 to \$16,550, featuring gas heat, metal kitchens and garbage-disposal units. Already some 20,000 people

(Continued to page 290)

# Are You Gambling \$500\* on Your Anti-Freeze?



**Yes, new improved  
U.S.I. PERMANENT is the world's  
safest anti-freeze — and here's why!**

**1** U.S.I. PERMANENT contains *more ethylene glycol* — acknowledged the world's best anti-freeze agent. Protects against freeze-ups even in coldest weather!

**2** U.S.I. PERMANENT'S Special Inhibitors, a top trade secret, protect all 7 metals in a car's cooling system; stop rust, corrosion, foaming, and clogging.

**3** U.S.I. PERMANENT gives uninterrupted protection from Fall till Spring on one filling, because it won't evaporate, even in the hottest weather.

That's why the U.S.A. goes for U.S.I.! It's weatherproof, worry-free, and guaranteed! — Get U.S.I. right after Labor Day.

**NEW, IMPROVED U.S.I. PERMANENT ANTI-FREEZE**



*\$507 is the average cost of replacing engine and cooling system ruined by corrosion, in 10 leading makes of cars.*

## Warning!

Don't re-use last year's anti-freeze! Any anti-freeze may become corrosive after a winter's use, and cause costly damage, say U. S. Government scientists.

*(National Bureau of Standards Circular 506)*



making finer anti-freezes since 1907 — U.S. INDUSTRIAL CHEMICALS COMPANY, Division of National Distillers Products Corp.

## How to get more mileage out of your motoring dollar

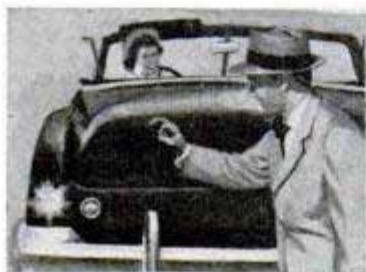


WIPE SPARK PLUG PORCELAIN

**Guard against ignition failure** during damp weather by keeping outside of spark plugs and wires clean. Dirt

picks up moisture; causes "shorts"; makes starting engine difficult or impossible; runs down batteries. In this case, as in so many others—preventive maintenance can save you the cost of emergency repair calls.

**Check rear lights regularly.** Your tail lights, stop lights, direction signals—all have the job of warning cars behind you. Check them frequently to see they are functioning properly. It may save a smashed bumper . . . or a life!



DO THEY LIGHT?



THIS MEANS TROUBLE!

**Check your oil filter regularly, too.** In 5000 miles—or less—of driving, your filter can become so clogged it can't trap any more dangerous grit and sludge which damage costly engine parts. Get a new Purolator\* Refill before that happens. Accordion-pleated, plastic-impregnated element has up to

10 times more filtering area than ordinary filters . . . stops dirt you can't see. The Purolator Micronic\* is specified as original equipment on more makes of cars than any other oil filter. There's a Purolator for every make of car or truck. Refills cost as little as \$1.60.

\*Reg. U. S. Pat. Off.

Check your oil filter every time you change your oil

# PurOlator

World's finest OIL FILTER



live in privately owned Park Forest homes, and 12,000 live in rented apartments, where 3½ rooms bring \$75 a month; six rooms \$117.

Another Chicago variation on the mass housing theme is Joseph Merrion's 1600-unit Hometown—a neatly laid-out array of duplex homes costing \$9975 for a two-bedroom unit, or \$11,200 for three. By putting his homes in pairs, Merrion is able to set them on 40-foot frontage plots. Since the dwellings are attached, the minimum distance between units is a good 20 feet. "We find," he says, "that building duplex enables us to give people a larger and better building on less property. We can add quality items like durable, washable Sanitas wall covering in all our units and give people things like perimeter heating."

Like most carefully planned communities, Hometown is broken into curved streets, has parks, a large area reserved for community facilities and eventually will be incorporated as a self-sustaining village.

How do these fellows put out more house for less money than a private contractor? Many savings are obvious ones—bulk buying shaves prices, mass production makes for the most efficient use of labor and, when things are really rolling, timesaving stunts save plenty of money. Merrion, for instance, used to build concrete slabs for his duplexes. Chicago weather kept jamming the schedule; slabs couldn't be poured fast enough on the good days. Today, wooden floors with a crawl space foundation can be put in any time, and speed up the operation enough to save money on what would ordinarily be a more expensive job.

Many big savings in a mass development are pointed out by Dave Bohannon. "The buyer cashes in on our architectural planning," he points out. "Our full-time staff of architects, draftsmen and land-planning specialists, plus outside consultants, would cost a prohibitive figure for an individual homeowner. But prorated over hundreds of homes built from the same basic plans, the cost is relatively small per house. We're up on latest methods and materials. The buyer gets a house with more eye appeal, maximum utilization of interior space, a tested floor plan designed to meet every need of the average family. We maintain our own timberlands and mills, thus controlling quality and supply. Raw materials are shipped in bulk right to the site, thus saving freight."

Greatest saving, though, is in actual construction on new assembly line methods. Many mass builders, like Bohannon in California, Merrion in Chicago, and Tom Lively, president of the booming Center

(Continued to page 292)



Golden  
Anniversary  
Twin



HERE'S the *one* motorcycle that every rider wants to own . . . the fabulous Harley-Davidson Golden Anniversary Twin for '54. Powered . . . to lead the way to new thrills in motorcycling. Engineered . . . to give a ride of luxurious comfort. Designed . . . to bring new quiet performance, new safety to the greatest sport in the world. And *color-styled* . . . to set new beauty standards. See it at your dealer's now. Let him tell you about his easy-pay plans. For a copy of the picture-filled ENTHUSIAST Magazine and illustrated literature, send 10¢ to Harley-Davidson Motor Company, Dept. P, Milwaukee 1, Wis.

**HARLEY-DAVIDSON**  
**HYDRA-GLIDE®**

- 45 degree V-type Overhead Valve Engine — 55 horsepower.
- The only motorcycle engine in the world with Hydraulic Valve Lifters.
- Hemispherical Combustion Chambers for maximum performance.
- Valve Rotators prevent carbon on valve seats and hot spots on valves.
- Aluminum-bronze cast-in valve seat inserts reduce valve wear and assure proper valve seating.

Construction Company, Inc., in Dallas, prefabricate things like roof trusses, walls, window frames, chimneys and plumbing assemblies. "Our trusses," says Bohannon, "are prefabbed on a jig. On the site, a roof is up and ready for sheathing in 40 minutes. Wall framing is a table operation—including bracing, fire blocking and double plating. Sections are stacked on pallets and moved right out to the subfloor in one operation. Besides saving skilled labor and virtually all waste, this gives the buyer a precision-built house."

Some of the best architects in the business are designing homes for mass builders. Cliff May and Chris Choate have designed some prize winners for the Valley Realty Company, Cupertino, Calif., which are the talk of the West Coast. They have a two-bedroom house (850 square feet) with carport for \$7850 and a modern three-bedroom two-bath home for \$10,500.

Mechanization in mass housing can soar to dizzy heights. At Lakewood, when houses were popping up hundreds at a time, workers operated in small teams, each responsible for one or two operations. Materials arrived on each site in exact amounts. Expeditors prowled the area in radio cars, unjamming bottlenecks by prompt reports to headquarters. Automatic nailing machines helped workers slap in

subfloors in one fourth the time it would take manually, and did a better job. Belt conveyors carried shingles to the roof.

But according to Bill Levitt, the man who really started all this, prefabrication is not the answer. Instead of making a house in a factory, where the assembly goes past the worker, Levitt makes a factory of the entire building site and moves his workers past the houses. The 26-major-construction operations start only after all site grading and improving is complete, and concrete streets are all poured.

Once the site is ready, machines roar in to excavate for hundreds of footings and slabs at a time. Teams of baby bulldozers, about the size of Junior's pedal-pumping auto, spread gravel bedding in the holes.

You'll never see a saw on a Levitt job. In a vast "shop" area, every stick of lumber is precut to size. Entire assortments for one complete house are "combat loaded" (stacked in the order they'll be used) on a single truck, and whipped out to the site.

While Levitt prefabs no chunks of house, he uses plenty of stunts for preparing materials so there's no wasted time on the site. On a simple jig consisting of two pylons a few yards apart, you can watch men wrap precut lengths of radiant-heat copper tubing into "figure eight" bundles.

(Continued to page 294)

**A Completely Different Radial Arm CONTROL**

**THE SENSATIONAL NEW SHOPMASTER**

# Universal

**\$269<sup>95</sup>** LESS MOTOR  
(slightly higher in zone 2).

**ALL MOVING PARTS GLIDE ON BALL BEARINGS**

Easy-to-read calibrations permit quick, precise setting. Locks in any position.

**COMPLETE WITH STAND**  
Mounts work table, provides ample storage for attachments. Tilts back on casters for easy moving.

# CHECK YOUR SHOCK ABSORBERS EVERY 10,000 MILES

WRITE FOR FREE BOOKLET  
Telling "WHY AND HOW"

**THE GABRIEL CO.**

1146 EUCLID AVENUE • CLEVELAND, OHIO



## SILVER SOLDER TORCH & KIT \$7.95

JOINS ALL METALS PERMANENTLY

Do your own repairing. KIT includes one tube silver solder paste and 10 5-in. lengths silver solder alloy. Hot-test ALCOHOL TORCH known. 2700° F. flame. Operates in any position, indoors or out. Pint of special fuel included. Complete outfit ready for use \$7.95 postpaid. TORCH alone with pint of special fuel \$6.85. KIT alone \$1.65. Instructions included. AMERICAN PRODUCTS CORP., 422 S. Dearborn, Dept. 3-H, Chicago

Say You Saw It in Popular Mechanics

## TREASURE -- \$10,000

New locator detects metals, valuable minerals and buried treasure. Money-back guarantee of superiority.



Also geiger counters. Govt. reward of \$10,000 for uranium discovery. Write for FREE information.



## THE GOLDAK COMPANY

1542 W. GLENOAKS BLVD., GLENDALE 1, CALIF.

*How To  
Paint Easily,  
Quickly,  
Professionally*

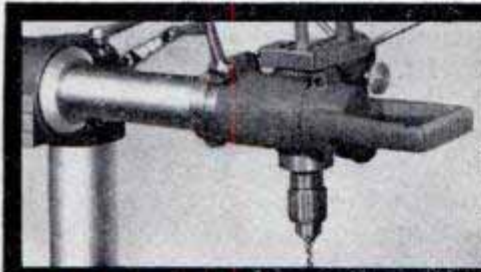


THOMAS PAINT ROLLERS apply all paints perfectly on any surface... and save you time, money, effort, fatigue. No experience necessary—just roll it on!

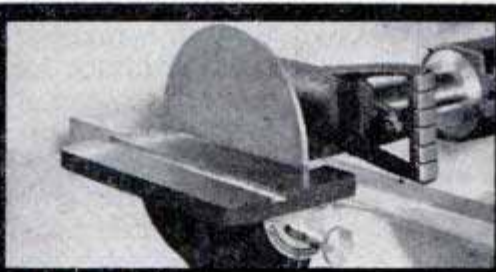
BE SURE YOU BUY THOMAS at your Paint, Hardware, Lumber dealer.



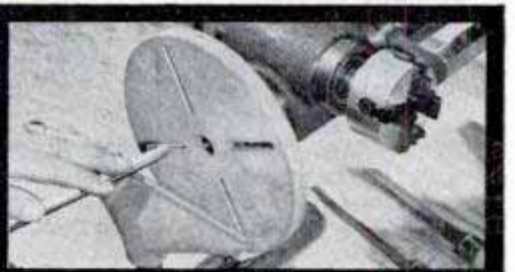
**THOMAS PRODUCTS COMPANY**  
8490 Lyndon Ave. • Detroit 21, Michigan



**DRILL PRESS.** 3" stroke, 18" throat. Drill, rout or mortise at any angle, in 36" circle.



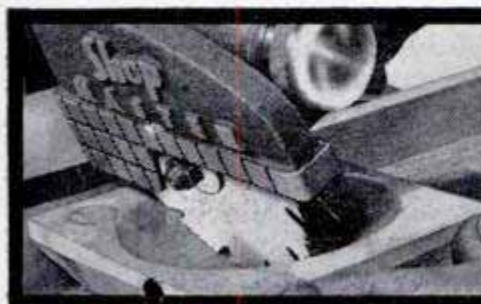
**SANDER.** Either belt or disc locks in vertical or horizontal position, or at any angle.



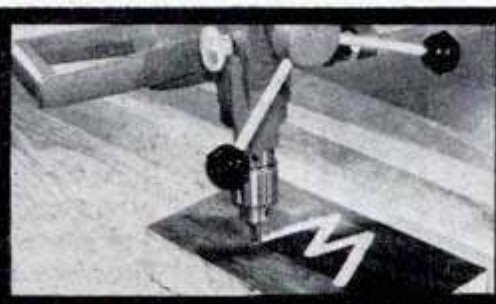
**LATHE.** 10" swing, handles work up to 31" long. Uses standard lathe accessories.

# Power Tool

IT'S A CIRCLE SAW,  
DRILL PRESS, LATHE,  
SANDER, ROUTER,  
SHAPER, ALL IN ONE!



**CIRCLE SAW.** Mitres, compound mitres, cross-cuts, dados, rips, cups, grooves. 8" blade, 2 3/8" cut.



**ROUTER.** Work remains stationary, head moves in any direction to rout letters or any desired pattern.

## WRITE FOR CATALOG

Please send information on new Shopmaster Universal Power Tool and complete line of quality power tools and accessories.

Name.....

Address.....

City..... State.....

## SHOPMASTER, INC.

Room 10-Da 1214 Third Street South  
Minneapolis, Minnesota

# TIME SAVING TIPS

ALL YOU NEED IS A TUBE OF

## DU PONT DUCO CEMENT

REG. U. S. PAT. OFF.



**SCREWS HOLD FAST** in plaster walls when they're coated with easy-to-apply Du Pont "Duco" Cement.



**THREAD ON THE RUN** stops short when a dab of transparent Du Pont "Duco" Cement is applied.



**SCUFFED SHOES,** leather heels and inner soles can be repaired in a wink with Du Pont "Duco" Cement.



**MEND BELTS TO LAST.** When two layers of leather come apart, use "Duco" Cement. It's flexible and tough.



**WOBBLY PICTURE FRAMES** can be quickly reinforced with strong "Duco" Cement. Mends broken frames, too.



**BROKEN RULE** back in service in minutes. "Duco" Cement joins pieces quickly, neatly—almost invisibly.



**HOBBYIST?** It doesn't take a master craftsman to cement parts neatly with Du Pont "Duco" Cement.



**GOING TRAVELING?** Repair torn and scuffed leather luggage with strong Du Pont "Duco" Cement.



A HOUSEHOLD FAVORITE FOR 25 YEARS



BETTER THINGS FOR BETTER LIVING  
... THROUGH CHEMISTRY

REG. U. S. PAT. OFF.

On the site, workers just stretch out the package and it falls into precise folds, all ready for cement to be poured over it.

Rafters are cut eight at a time on preset saws. Tricky truss-type rafters, that will be bolted to tie beams on the site, require steel rings sunk into both members where they'll join. These add strength to the joint and prevent splitting. Despite precision needed to drill the circular grooves and bolt holes, no fancy jigs are used. "We just set up two drill presses the right distance apart on a long bench, lay the two by four in there against stops, bring down both drills at once and we never miss," explains Irwin Jalonak, Levitt's top construction chief.

The outfit comes up with brilliant ideas for labor saving and cost cutting. Undercoating and hand painting home interiors would be costly. Levitt solved it by getting a paint company to invent a white base paint in which emulsion-coated flecks of green are floated. The emulsion keeps the colors from mixing. But when shot from a high-powered sprayer, the emulsion skin on the green droplets bursts. The result is an even pattern of uniform flecks. The walls have an expensive-looking four-toned effect on a surface that is rugged and washable. Except for windows and fireplace, the whole interior gets a dose of this spray in one fast operation.

Setting shingles costs money, and although a manufacturer fabricated specialized shingles for Levitt, which were long enough to span studs, they still didn't go up fast enough. Today, Levitt houses are weather-coated with huge asbestos panels, striated with color to hide the seams. They go up much faster and are just as durable.

Bored with the wasted and costly utility space required for the standard furnaces, Levitt badgered York-Shipley into fabricating a complete kitchen-counter-height furnace and boiler no bigger than an automatic washing machine. He puts it in the kitchen, where its stainless-steel top not only matches the counters, but becomes an extension of them. "Our heating system costs less than any system we could put in," says Jalonak. "Yet radiant heat is a luxury item on an individual house basis. But because ours saves building a utility room, makes usable kitchen counter space, and works at top efficiency, we actually save money with it."

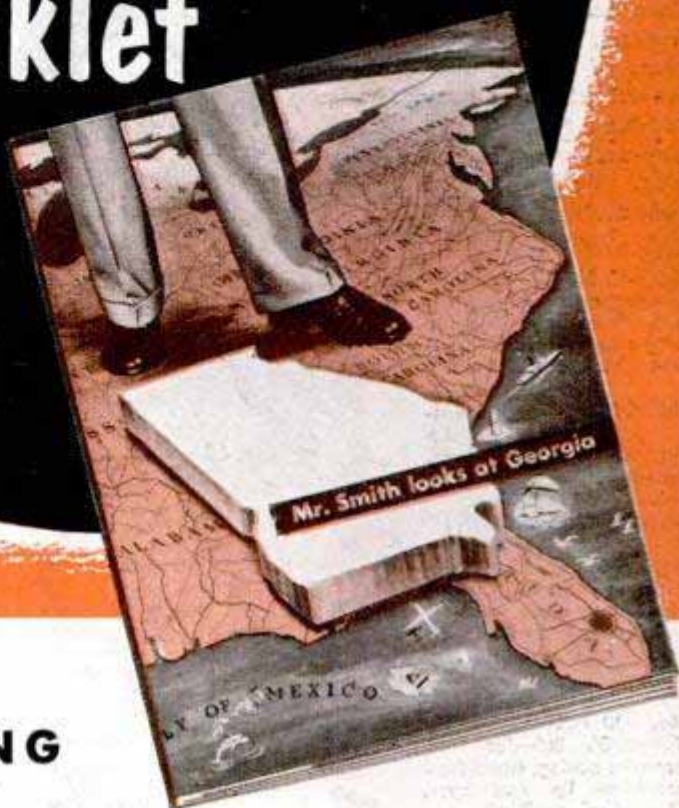
Alfred Levitt's right-hand man John Sierks, who worries about architectural features, sings the second verse to this song. "Thermopane window walls are a luxury item," he points out. "But they—along with top-grade insulation—make it possible for us to use a smaller output

(Continued to page 296)



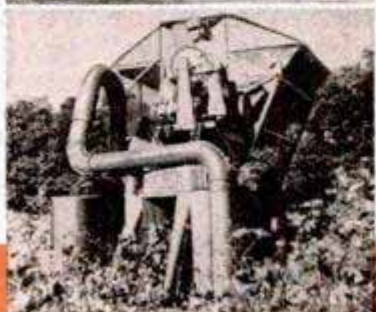
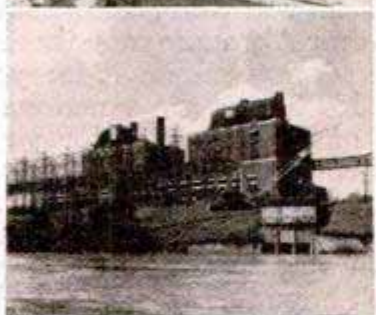
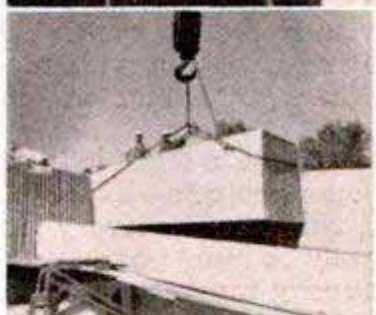
# Get YOUR copy of this **FREE Booklet**

It takes you on an exciting  
tour, and gives you  
**INSIDE FACTS** about  
a great **STATE**



## "SEEING IS BELIEVING"

That's why we prepared this interesting picture story of GEORGIA, and its amazing growth and opportunities. It's written for you—and the thousands of other "Mr. Smiths" who will appreciate an inside look at the success stories of an industrious people. We still have a limited number of copies of "Mr. Smith Looks at Georgia" available. Write for your copy today.



**CLARK GAINES, Secretary Dept. 10M**  
100 State Capitol—Atlanta, Georgia  
Please send copy of "Mr. Smith Looks  
at Georgia" to:

Name \_\_\_\_\_

Address \_\_\_\_\_

City \_\_\_\_\_ State \_\_\_\_\_

**GEORGIA DEPARTMENT OF COMMERCE**

# Do it better with **STANLEY TOOLS**

Stanley and "Yankee"® Tools help you do the job right, and faster. Favorites of professional woodworkers, they are built to give years of service. Stanley Tools are available in a complete range of prices for the professional user and handyman. Buy them at your dealer's.

**No. 4 PLANE**—standard with carpenters. Finest steel cutter fully adjustable for coarse or fine work. Rosewood handle and knob.

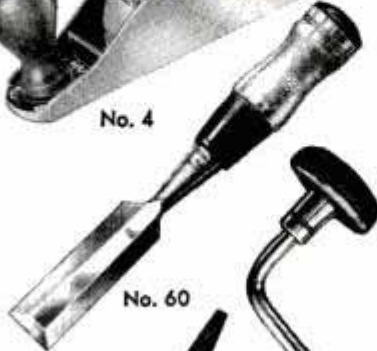
**No. 60 CHISEL**—tough plastic handle with metal cap that centers hammer blows. Long-life steel blades that hold an edge. Sizes 1/4" to 2".

**No. 923 BIT BRACE**—built for years of accurate, heavy-duty work. All-steel box ratchet, ball-bearing head and self-centering jaws.

**No. 100 RUSSELL JENNINGS BIT**—for fast, accurate boring. Hand filed extension lip and spur. Sizes 3/16" to 32/16".



No. 4



No. 60



No. 923

No. 100

100th  
YEAR  
1853  
1953

## "YANKEE"® TOOLS

"Yankee" Spiral Ratchet Screw Driver—famous the world over for faster driving and faster drawing. Quick-return spring repositions handle automatically. A wide selection of accessories broadens its utility.



Standard Screw Driver Bit

Phillips Screw Driver Bit

Bit with Centering Sleeve

Chuck and Drill Points

Combination Socket

Countersink

Send for Stanley Tool Guide on care and use of tools. 25c postpaid.

**STANLEY TOOLS**  
New Britain, Conn.  
THE TOOL BOX OF THE WORLD

**STANLEY**

**STANLEY TOOLS**  
3103 Elm St., New Britain, Conn.  
(In Canada: Send to Stanley Tool Co. of Canada, Ltd.,  
3103 Stanley St., Roxton Pond, Quebec)  
Please send:  Stanley Tool Guide (I enclose 25c.)  
 Free "Yankee" Tool Book

Name.....  
Street.....  
City..... State.....

HARDWARE • TOOLS • ELECTRIC TOOLS • STEEL STRAPPING • STEEL

(94,000 BTU) heating unit at much less cost than we'd have to otherwise. Hence, we actually save money with the double-barreled glass."

And so it goes. Revolutionary finishing touches cut costs. Levitt's huge closets have no doors. Instead, they're shut off by sliver-thin bamboo curtains that ride back and forth on overhead tracks. "They don't get in the way, and women like them better anyway," says Bill Levitt. Bricks for the chimney and the three-way fireplace are oversize (3 inches by 10 inches) so masons build faster while laying fewer.

Savings like this enable Alfred and John to add eye-catchers like the stainless-steel tiled bathroom. The tiles, incidentally, measure 8 inches by 8 inches, so fewer need be set, "and it takes no expert to do it," says Sierks.

Add it all up, and out comes a vast city of new housing at bargain prices. What are the disadvantages, if any? Some people feel they'd hate having neighbors crowding in on all sides. Others talk about "monotonous sameness" of houses. In well-planned communities, these old "real estate development" complaints seem to lose validity. Lots in Levittown, Pa., measure at least 70 feet by 120 feet. Even the Levittowner, most numerous of the houses, with the same basic floor plan in every unit, has four exterior designs in which the carport plays a variety of drastic changes. You'll find it in seven different colors, alternating broadside and lengthwise to the lot front. Hills and dales, woods and plains, provide more housing variety than you'll find on most town streets.

Community spirit plays a big role in any locality, and in some projects—like Levittown—a book of rules awaits every purchaser. No wash may be hung out on weekends, it says. Laundry must go on drying trees—not lines. If you don't mow your built-in lawn, Father Abraham may threaten to send his boys around, do it for you and send a bill. No fences are sanctioned. These are some of the penalties for your bargain-priced home in Levittown. Most mass builders put you strictly on your own good manners. And, actually, the Levitts have no intention of enforcing their regulations. "We don't have to," they say. "The neighbors keep each other in line. We just give them a rule book to follow." Having invested time and money in these ventures, and maintaining an interest in the shopping centers which bring them fat rent, the Levitts don't care to see values tumble around them.

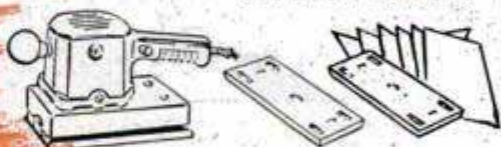
Bill Levitt thinks he's done a pretty good job, too. "Ninety percent of the people in Levittown pray for us," he claims. ★ ★ ★

# NEW DREMEL **STRAIGHT-LINE ACTION** SANDER

A PROFESSIONAL TOOL AT A HANDYMAN'S PRICE!



A COMPLETELY NEW TYPE OF SANDER



Price includes Dremel "53" Straight-Line Action, professional-type Sander, two sanding pads, and 6 assorted abrasives. Extra pads \$2.75 each.

**\$34.85**

Here's a heavy-duty sander built for the industrial woodworker and professional craftsman, and priced for the home handyman! The new Dremel "53" Straight-Line Action Sander weighs only 5¼ lbs., is driven by a powerful rotary motor (110 V. 60 cycle AC) . . . 6,900 strokes per minute . . . has no gears, belts, brushes or commutator to wear out and replace. Dremel Straight-Line Action guarantees satin-smooth finishes you'll be proud to show. Detachable paper holder speeds up paper changes. Use it for WET or DRY, coarse, medium or fine sanding . . . the Dremel "53" is positively the most versatile . . . the greatest sander value in today's market.

PAT. APPLIED FOR

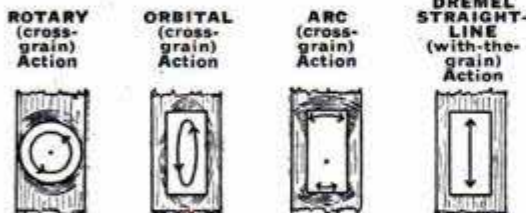
**EASY ON!  
EASY OFF!**

Unique paper holder is detachable. Grits can be switched quickly without bothersome paper change.



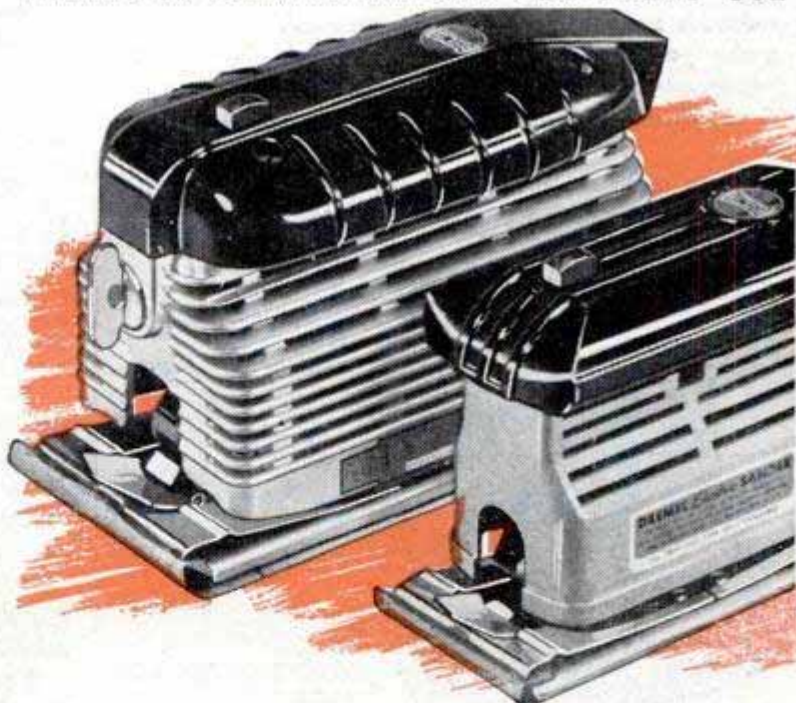
**Here's Why Craftsmen Approve... Use... Only Straight-Line Action Sanding!**

Wood fibers lie with-the-grain . . . are directional. Sanding cross-grain is much like brushing a suede jacket against the nap. It leaves marks or "scratches." Sanding with-the-grain is like brushing the suede with the nap . . . leaving a velvet-smooth surface, entirely scratch-free. Shown below are four common types of sanding actions. Only Dremel "Straight-Line Action" sands 100% with the grain . . . Only Dremel can guarantee 100% scratch-free finishes.



**SEE YOUR FAVORITE DEALER:** Dremel Tools are sold at better dealers everywhere. If your dealer can't supply, order direct on a five-day trial, money-back guarantee. Remit in full, and we will ship postpaid. Or, send only \$2.00 now, pay postman balance plus postage and C.O.D. fee.

**THERE'S A DREMEL SANDER FOR EVERY USE**



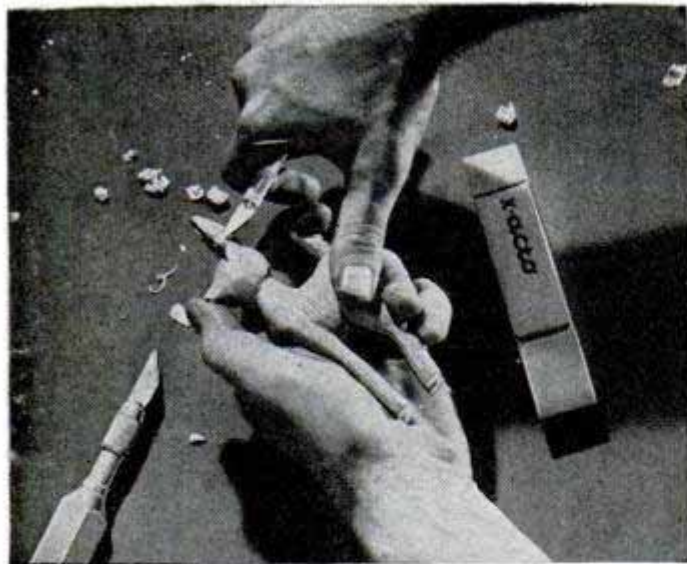
**DREMEL MODEL "2000" SANDER-POLISHER**

Perfect for small shop use, home repair, and workshop projects. Choice of craftsmen for fine finishing operations. Features Dremel "Straight-Line Action": 14,400 strokes per min.; 5 lb. wt., 21 sq. in. (3½"x7") sanding surface. Model "2000" Sander-Polisher, 25 asst'd. abrasives, 1 polish pad in sturdy steel carrying case. **\$24.50**

**DREMEL MODEL "A" SANDER-POLISHER-MASSAGER**

Lighter capacity model, a favorite for general home maintenance, hobbycraft, furniture polishing, etc. Effective body massager. Features Dremel "Straight-Line Action." Wt. 2½ lbs.; 12 sq. in. (2¾"x5½") sanding surface. Model "A" Sander-Polisher-Massager, 6 abrasives, 1 polish pad, 1 massage pad. **\$14.85**

**DREMEL MANUFACTURING COMPANY, Dept. 113-K, Racine, Wisconsin**



## make your *HANDS* *MORE CREATIVE* with **X-acto Knives and Tools**

Creative hands can be your greatest asset... X-acto knives and tools help the intelligent coordination of active minds and agile fingers... they can develop skill and dexterity in any art or handicraft you select.

Whether it's boat whittling, model airplanes, wood-carving, leathercraft, model railroads or any other handicraft, you can make your hands more creative with "designed-for-the-job" precision-engineered X-acto knives, tools and handicraft kits.

X-acto offers the complete line of handicraft knives, interchangeable blades, tools and attractive kits

From 25¢ to \$30.—at dealers everywhere.



No. 82  
X-ACTO KNIFE CHEST  
\$4.20



Send 20c to cover postage  
for our new illustrated  
28-page Catalog.



**X-acto Crescent Products Co., Inc.**  
440 Fourth Avenue, New York 16, New York

## How to Finance Your Home

(Continued from page 175)

prudent lenders will suggest that the veteran refer the contract, before signing, to an attorney.

On a 20-year loan on the above-mentioned \$10,000 mortgage at 4½ percent interest the payment for principal and interest would be \$63.27 per month, to which is to be added a monthly reserve for fire and other hazard-type insurance, and for taxes. These two items will add between \$10 and \$20 a month to principal and interest payments.

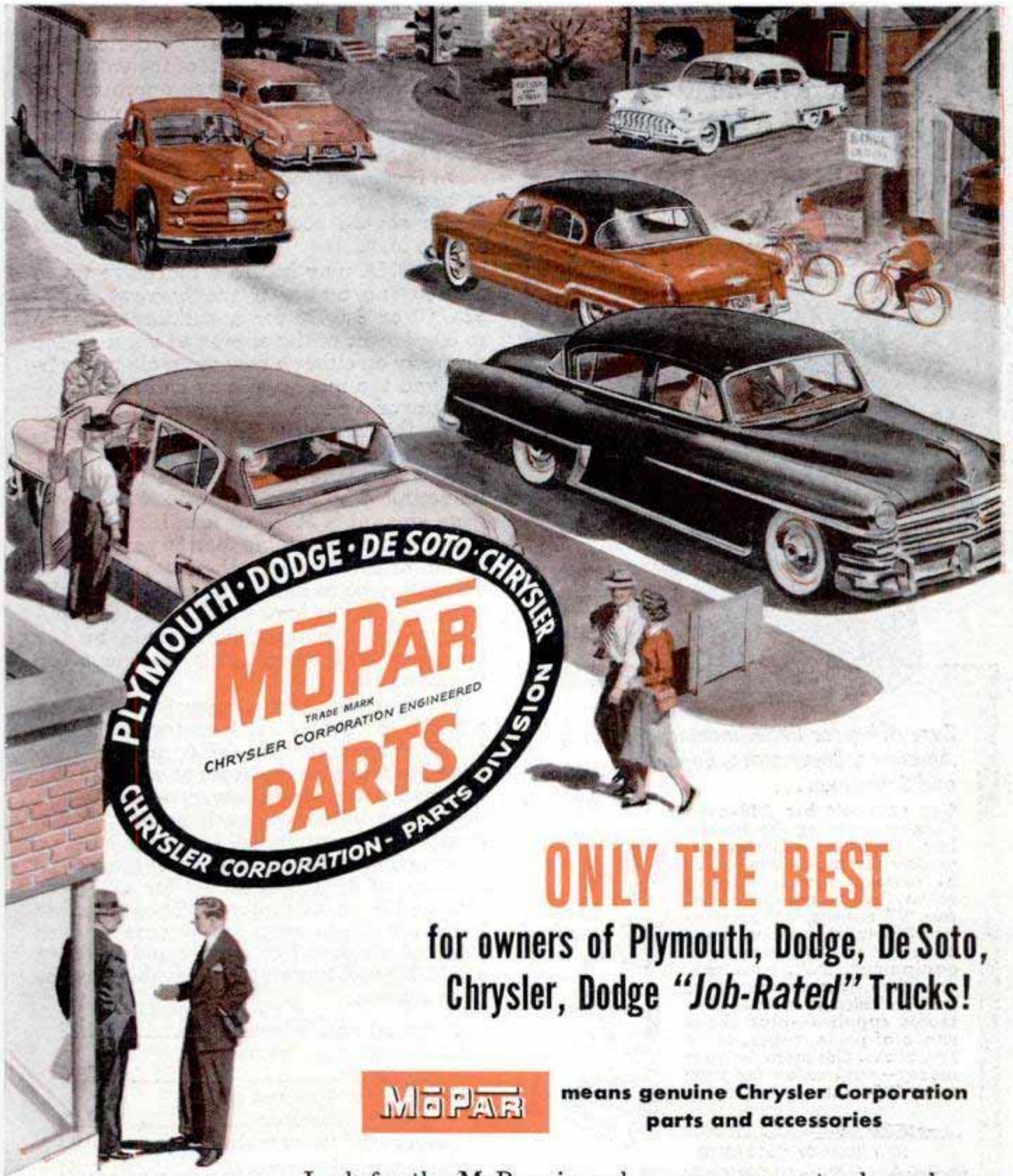
Usually, a lending institution feels that the monthly wage of the borrower should be 4 or 4½ times his monthly mortgage payments. This, of course, may vary with the number of dependents and other obligations of the borrower and, therefore, the ability of the borrower to meet his payments is quite a determining factor in arriving at the ratio between payments and income. However, using the 4 or 4½ times income figure as a yardstick, the average borrower's income should be approximately \$330 per month in order to support the \$10,000 loan.

**FHA Loans.** These loans are to be obtained from a lending institution for the FHA is not a bank or a loan association. In the case where a prospective borrower is building a new home, he should submit plans to the lender, specifications, contractor's bid, the location and size of the lot and the cost of lot before construction is commenced. The applications for the loans sought must be referred to the local office of the FHA before construction has started. If construction has been started and advanced, the lending institution must wait until the house is substantially completed before submitting the application to the FHA. This is intended to mean that the house is habitable and that such minor items as decorating, the hanging of electric fixtures, sidewalks and the final coat of exterior painting is about all that remains to be done. Then, of course, the FHA inspector does take into consideration the reputation of the contractor and the general type of construction in determining the advisability of insuring the loan.

From this you can readily see where it is advisable to hold off construction until the loan has been approved, for after its approval the building is subject to the periodic inspections by the FHA inspector in the neighborhood who can see that the owner is getting approved-construction.

Under the FHA-type of loan it does not matter to the lender what the borrower

(Continued to page 300)



**CHRYSLER  
CORPORATION**  
**PARTS DIVISION**  
**DETROIT 31, MICH.**

## ONLY THE BEST

for owners of Plymouth, Dodge, De Soto,  
Chrysler, Dodge "Job-Rated" Trucks!

**MOPAR**

means genuine Chrysler Corporation  
parts and accessories

Look for the MoPar sign when your car or truck needs new parts—be sure of the best! Only highest quality materials and finest workmanship are good enough for MoPar—only the *best*, meeting exactly the same high standards as original parts.

MoPar parts fit right and work right because they're made right. They perform better, last longer, because they are engineered *especially* for your car or truck. So remember the MoPar sign—the sign of satisfaction, that identifies the dealer or general shop that recommends and installs *genuine Chrysler Corporation parts and accessories*.

**FREE**

**GET THE WORLD'S LEADING  
TV & RADIO CATALOG**

# ALLIED'S 1954 ELECTRONICS BUYING GUIDE

**268  
VALUE-  
PACKED  
PAGES**



**SAVE ON  
EVERYTHING  
IN TV AND  
RADIO**

**Everything for Experimenters, Builders,  
Amateurs, Servicemen, Engineers  
and Soundmen . . .**

Get ALLIED'S big 268-page Catalog featuring the world's largest selections of latest top-quality electronic equipment at lowest, money-saving prices. See the newest in custom TV chassis, TV accessories, FM and AM radios, High-Fidelity sound, Amateur equipment, P.A. systems, recorders, test instruments, builders' kits, industrial electronic supplies—plus thousands of parts, tubes, tools and books. Get more for your money—send today for your **FREE 1954 ALLIED Catalog!**



**NEW HOME OF ALLIED RADIO  
ultra-modern facilities TO SERVE YOU BEST**

**ALLIED RADIO**

**SEND FOR  
FREE  
CATALOG**

**ALLIED RADIO CORP., Dept. 5-KK-3  
100 N. Western Ave., Chicago 80, Illinois**  
 Rush **FREE 1954 ALLIED 268-Page Catalog**

Name \_\_\_\_\_

Address \_\_\_\_\_

City \_\_\_\_\_ Zone \_\_\_\_\_ State \_\_\_\_\_

has to pay for the prospective home. The amount of the loan is determined on a basis of not over 80 percent of the valuation of the land and building as appraised by the FHA. Second mortgages are not permissible on FHA loans. The borrower must state in his application that his down payment is coming from his cash or liquidation of assets listed in his financial statement which should accompany the application for the loan.

The FHA may insure a mortgage up to \$16,000 (no matter if the borrower pays \$25,000 or \$45,000 for a building) and up to 80 percent of the appraised value of the property on either a new or an older dwelling, and the mortgage may call for repayment over a period of 20 years or less; but when the mortgage is approved for insurance before construction starts it may have a longer term and, if the home is to be occupied by the owner and if the mortgage amount is \$9450 or less, it may merit a rating of higher value than 80 percent. On a loan of \$5700 or less, the ratio of loan to value may be as high as 95 percent and the term may be as long as 30 years, thus reducing the down payment made by the borrower and his monthly payments on the loan.

Let us assume that a buyer is purchasing a home for \$22,000. It is conceivable that for loan appraisals the FHA might be inclined to appraise the home at only \$20,000. (Actually, it might be lower, depending on detracting influences such as age or the proximity of commercial buildings.) Let us assume that on this \$22,000 purchase a commitment of \$16,000 is issued for a 20-year loan at 4½ percent interest. Therefore, the borrower will be required to come up with \$6000 of his own free money and the loan of \$16,000 will therefore be payable monthly as follows:

|   |                 |
|---|-----------------|
| Principal and interest.....                         | \$101.28        |
| FHA mortgage insurance<br>premium.....              | 6.36            |
| Reserve for fire and other<br>hazard insurance..... | 3.00            |
| Reserve for taxes (estimated)....                   | 20.00           |
| <b>Total monthly payment.....</b>                   | <b>\$130.64</b> |

In addition to the \$6000—and this also applies to veterans' loans—the borrower must pay his share of title expenses, recording of the mortgage, deposits for back taxes, insurance, etc., as well as the usual fee charged by the lender for arranging the loan, all of which the lending institutions are willing to estimate in an itemized form before the prospective borrower obligates himself.

**Conventional loans.** These are sometimes

(Continued to page 302)

**STOP FAUCET LEAKS**

ATTACHMENT OR A REFUND OF MONEY  
**Guaranteed by Good Housekeeping**  
 IF NOT AS ADVERTISED THEREIN

two for 48¢

**SNAP-in**

U.S. Pat. No. 2,443,012

Featured in **READER'S DIGEST**

## SNAP-in SWIVEL WASHERS & FAUCET SEATS

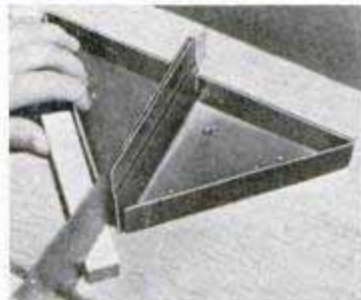
A lasting "do-it-yourself" repair—Ideal for hot or cold water faucets! Lasting—economical—easy to install. Lasts 10 to 20 times longer than ordinary bibb washers. Stainless steel and corrosion resistant metal parts—molded neoprene washer disc.

See your local hardware dealer

### SNAP PRODUCTS CORPORATION

3615 S. JASPER PLACE

CHICAGO 9, ILLINOIS.



### BELRUS MITRE-BOX

At last, a sensibly priced mitre-box! Heavy gauge steel cadmium plated for durability. Offers 45° & 90° angles. Easily mounted on bench or board. A pleasure to use. Post-paid only. **\$2.25**

FREE ATALOG  
 "Do-it-better-easier" Tools

Eagle Products

BOX 84 A

Meriden, Conn.

Say You Saw It in *Popular Mechanics*

## BRIKCRETE



## Local Manufacturers Have Broad Opportunities

Brikrete manufacturers operate compact, self-contained plants under franchise privileges in protected territories. Each is an independently owned unit in a country-wide chain, using local materials and local labor to supply the world's most modern masonry for local building needs.

Brikrete is rich in sales appeal because it is ahead in design, style, size, color, economy. Easily the preferred masonry. But because local production eliminates economic wastefulness, Brikrete can be sold at a lower-than-lumber price. Yet still allow a generous profit margin.

Brikrete offers much to men looking for a community enterprise on a nominal investment. We supply complete equipment; easy terms when desired. Liberal cooperation. Write today for Brikrete Book No. 2—while territory is still open.

**BRIKCRETE ASSOCIATES, INC.**

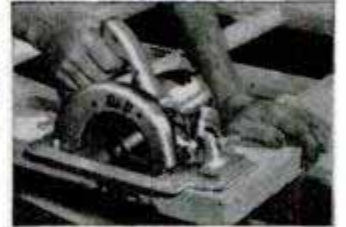
4679 Division Avenue, S.  
 Grand Rapids 8, Mich. 82



Bob Davis says:

## Black & Decker Utility Tools let you do it yourself and save high labor cost!

FOR SNUG FIT on storm windows and doors, trim them at same angle as outside jamb and stiles. Find angle by placing saw shoe against jamb and adjusting bevel setting.



UTILITY 6" Heavy-Duty Deluxe Saw is 10 times faster than hand sawing. Has built-in depth- and bevel adjustments, telescoping guard and instant-release trigger . . .

**\$76.50**



ADDING A ROOM? Install wiring boxes faster! 1. Cut openings in wallboard. 2. Place wallboard against studing to mark positions for boxes. 3. Wire, then nail wallboard.



UTILITY PORTABLE JIG SAW makes curved, straight or irregular cuts in most every material. Cuts own "entrance" hole for pocket cuts in wood. Complete with 5 blades . . .

**\$49.50**



FOR SATIN FINISHES, sand object and then wet thoroughly with water. Drying causes grain to swell, after which one more sanding gives super-smooth surface.



UTILITY NO. 44 SANDER — A fast-cutting, powerful, lightweight orbital sander. Gives a satin-smooth finish and eliminates hand sanding. 3 5/8" x 9" sanding plate. **\$46.95**

BUY THE BRAND THE EXPERTS CHOOSE! For 43 years, Black & Decker has made portable electric tools for industry . . . has pioneered many "firsts," like the trigger switch, pistol grip, and universal motors. Quality workmanship guarantees the performance, strength and stamina you need to do professional-like jobs. Accept no substitutes—demand Black & Decker!

**FREE!** "Handy Tips for Handy Men" — Booklet packed with helpful ideas for home repairs and projects. Write: Bob Davis, Dept. H10M, THE BLACK & DECKER MFG. CO., Towson 4, Maryland.



Whatever  
 you prune  
 there's an  
**ATKINS**  
 pruning saw  
 that does it  
 better



Sold by hardware stores  
 and building supply  
 dealers everywhere.



**ATKINS SAW DIVISION**

Borg-Warner Corp., Indianapolis 9, Ind.

Please send me free booklet, "Tree, Shrub and Hedge Pruning."

NAME.....

ADDRESS.....

CITY..... STATE.....

less costly to the borrower for a number of reasons. One principal reason is that loans which do not require monthly payments, save on bookkeeping, or servicing costs. Also, if the borrower has a substantial amount of cash toward the purchase price of a home, he may be able to obtain a conventional loan at a lower rate of interest due to the reduced risk. Borrowers who have business dealings with banks or insurance companies sometimes are able to secure a low rate of interest as customer relations are often a factor in determining rates.

The amount banks will loan on conventional loans secured by improved real estate is limited by law in most states. The Federal Reserve Bank suggests that loans be limited to 60 percent of the appraisal, and the National Banking Act limits the national banks likewise to 60 percent. Federal Reserve member banks and national banks are not permitted to carry loans having a maturity in excess of 10 years. However many banks renew loans on the expiration date.

Savings and loan associations and other institutions not under the Federal Reserve or National Banking Act may grant considerably higher loans for longer periods of time. These associations also permit open-end mortgages which make it possible for the owner to borrow additional funds (frequently needed for improvements or repairs) without refinancing. If you are borrowing from a savings-and-loan association, find out if they make construction inspections to protect both your and their investments. Some associations have more rigid inspection practices than the FHA ordinarily provides.

The accepted arrangement on most conventional loans today is to permit the borrower to make additional payments each year during the life of the loan without penalty. Make sure of this privilege before signing final papers. FHA permits a borrower to make prepayments of up to 15 percent of the original mortgage in any one year.

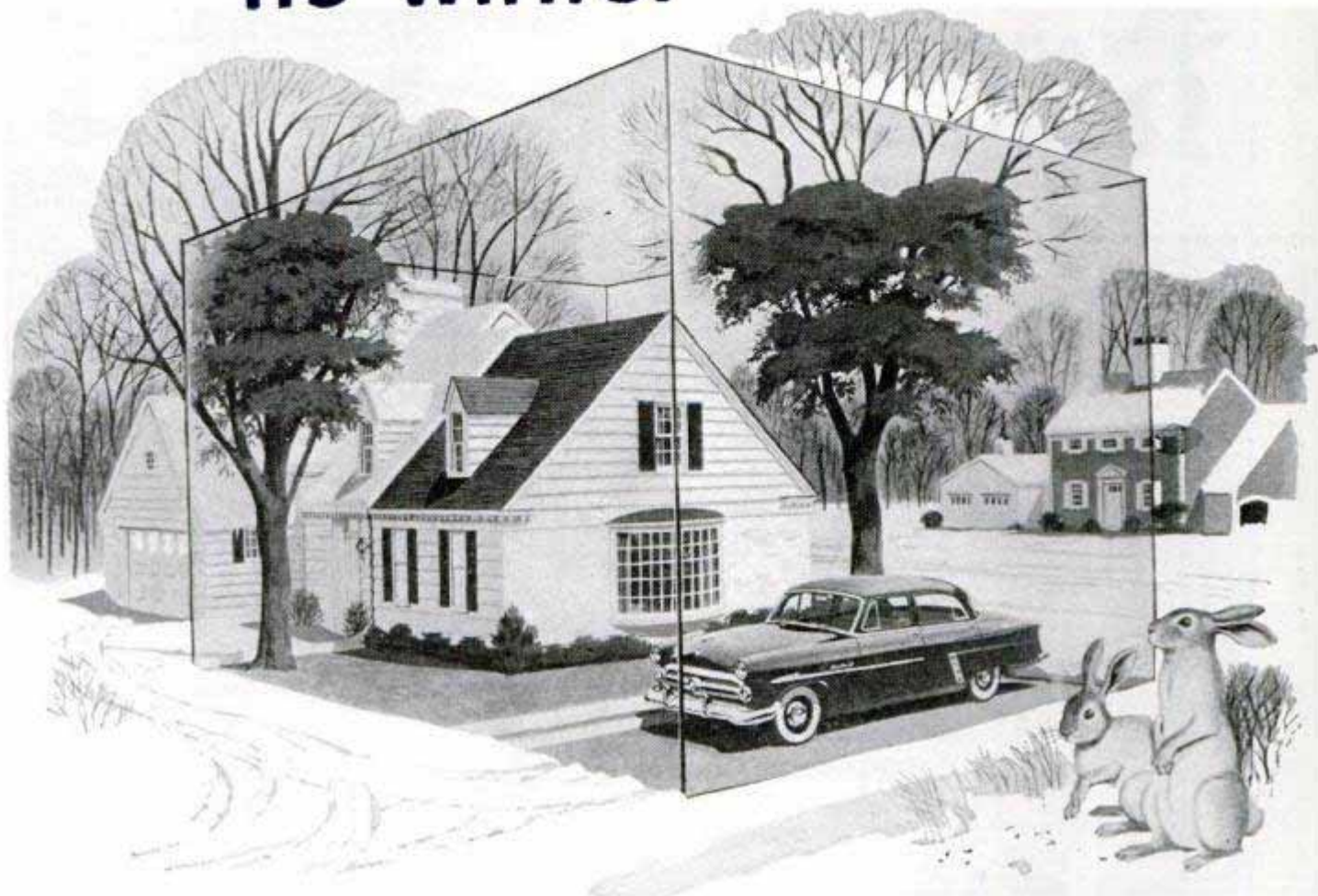
We have not gone into the matter of fees or commissions or requirement for insurance and many other items that are often required by a lender. These matters should be weighed by the borrower and discussed by him with his attorney or someone familiar with mortgage banking. ★ ★ ★

**Free How-To-Make-It Index**

Write the Bureau of Information, Popular Mechanics Magazine, 200 East Ontario Street, Chicago 11, for your free copy of the latest index to all the how-to-do-it sections of Popular Mechanics



# Your Ford won't even know it's winter -



***...if you use parts you can trust!***

When you get your Ford ready for winter . . . and find that replacements will add to its zip . . . insist on Genuine Ford Parts like the three below. Here's why they make a big difference:

**Ford oil filter cartridges** are Track Tested from 20,000 to 40,000 miles. Both full-flow and by-pass filters are designed to remove dust, and other oil contaminants quickly and thoroughly *without* removing useful detergents!

**Keep your Ford all Ford**



**Ford batteries** are tested to start at 30 below, shake-tested, dust-tested, and cycled from charge to discharge 275 times, before approval for manufacture to keep your Ford ready to go at all times!



**Ford spark plugs** are made to *exact* Ford specifications . . . designed and balanced to your Ford's ignition system to give your engine smooth performance and high gasoline mileage. And they're made right to last *longer* in your Ford!

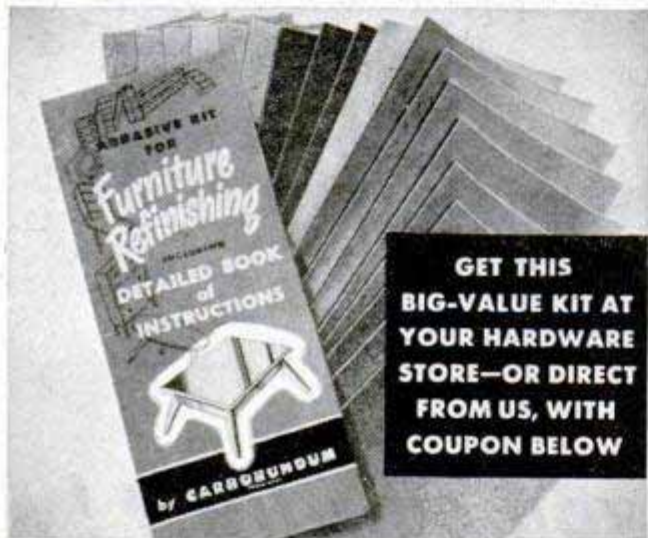
Available at all Ford Dealers and the selected independent garages where you see the Genuine Ford Parts sign.

## Refinishing Furniture?



Here's a kit-full of  
**GOOD  
SHORT-CUTS**  
from "Handy" SANDY

Best news of the year for all you home-craftsmen is CARBORUNDUM's just-out "Furniture Refinishing Kit" — man, it's a dandy! A big 16-page instruction book takes you step by step . . . removing the old finish — staining, filling, sealing—sanding and rubbing final finish coats. There are 22 sheets of sandpaper, already cut to fit a sanding block—in-8 different grits and grades. Not just "sandpapers", but the top-quality papers the professionals use . . . garnet, silicon carbide waterproof, aluminum oxide moulding cloth.



GET THIS  
BIG-VALUE KIT AT  
YOUR HARDWARE  
STORE—OR DIRECT  
FROM US, WITH  
COUPON BELOW

It's worth over a dollar of anybody's money, but your hardware store or building material dealer sells it at about 90c. All stores **should** have it in stock, but of course there'll be some who won't. If your store is out, send me his name and address, and a dollar bill, and I'll send your Kit direct to you, postage paid. Use the handy coupon below — and please give me your dealer's name and address, so he'll have stock next time you go back. And you **will** go back, I'm sure — that's how good these sandpapers and easy instructions are!



CLIP AND MAIL THIS TO ME

"Handy" SANDY  
**CARBORUNDUM®**  
Niagara Falls, New York

I usually buy my hardware and building materials at

Name of Store .....

Street.....City.....State.....

Enclosed is \$1.00. Send me your "Furniture Refinishing Kit"

My Name.....

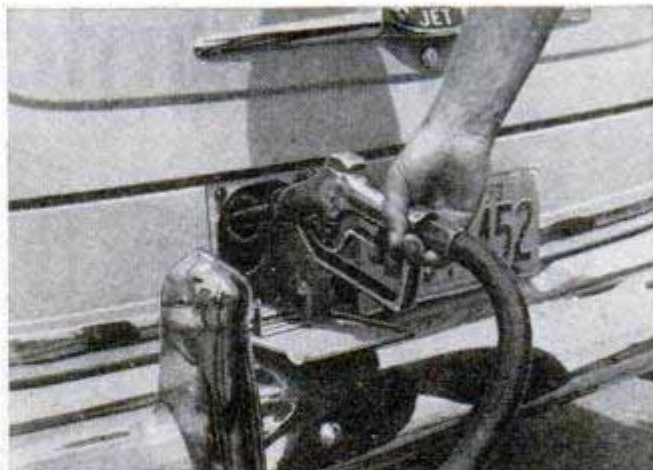
Street & Number.....

City.....Zone.....State.....

90-327

## The Owners Report on The Hudson Jet

(Continued from page 122)



Some owners disliked high lip on trunk, but location of gas-filler cap below rear deck makes it necessary

high-speed braking or mountain driving. Due to the soft front end, rear-wheel braking (without the car loaded) could be better. The front end has a tendency to drop down abruptly when the brakes are applied quickly.

The steering is excellent, with four turns of the wheel from lock to lock. Steering-wheel road shock is almost nil. Center-point steering contributes to easy turning of the wheel.

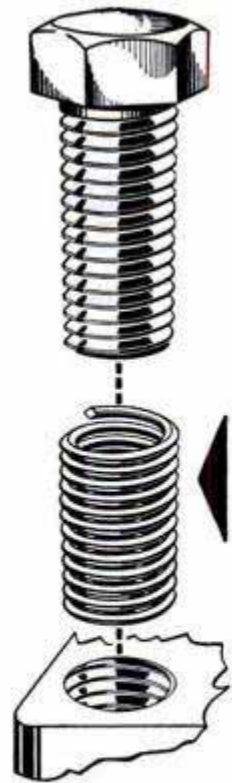
Terrific head and side winds were encountered through Oklahoma with rain and hail. The Jet body is tight and no squeaks or rattles developed, although a small water leak in the left window was noticed when driving in a heavy rainstorm. As in larger Hudsons, the body and frame are welded together in one piece. The step-down feature is retained, although not as pronounced as in the larger Hudsons.

The solid doors open easily by push-button handles. Rotary latches make for easy operation. Three turns of the cranks open or close the windows—an excellent ratio. Road noise and body rumble seem to be less than in many higher-priced cars.

The excellent instrument panel is plastic-topped to prevent sun glare. The large speedometer dial is easy to read and well located with no obstruction of any kind, as Hudson has eliminated the useless top half of the horn ring. Front vision is excellent and the wrap-around rear window affords good rear vision, too.

The springing and cushions are average. There is sufficient legroom in front for a tall person, but lack of legroom in the rear. Headroom is satisfactory. Legroom is a problem with any short wheelbase car—either trunk space or legroom in the rear

(Continued to page 306)



# Worn or Damaged THREADS

**Better than new in seconds**

With *Heli-Coil\** Screw Thread Inserts, your worn or damaged threads are *better, stronger than new* in seconds. Just...

- 1 Drill out old threads.
- 2 Tap new threads with *Heli-Coil* tap.
- 3 Install *Heli-Coil* inserts with simple inserting tool.

Simple *Heli-Coil* tooling — that will never wear out — costs as little as \$15 per thread size. Inserts as low as 3¢ each. Available for all machine screw sizes, also spark plug and pipe threads.

Your better-than-new threads use original size screw and give more strength than ever before.

\*Reg. U.S. Pat. Off.

## HELI-COIL CORPORATION

390 Shelter Rock Lane, Danbury, Conn.



Please send illustrated literature on *Heli-Coil* Screw Thread Inserts and their use.

Name \_\_\_\_\_

Address \_\_\_\_\_

City \_\_\_\_\_ State \_\_\_\_\_ 

**MAIL COUPON NOW!**

## SHEET METAL BRAKES

Angles, flanges, Pittsburgh locks, 24 G. steel, heavier aluminum. Cam locking, mount on bench, truck or floor stand. Truss braced steel. Express collect. 30", 65



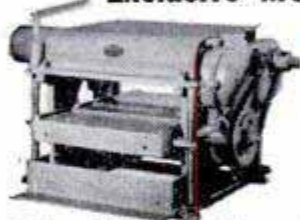
75 lbs., \$28.50. 36", 48", 100 lbs., \$48.00. Portable stands, 32" hi., 35 lbs., \$7.00. 15", 40 lbs., capacity 16 gauge, \$21.50. IRON BENDER forms hooks, angles, eyelets, etc. Capacity 1/4 x 2", 5/16 x 1 1/2". All steel. . . . . \$9.50 30" CURVE FORMER. Forms straight and tapering pipes 2" to 2 ft. in diameter. 20 gauge, express collect \$9.50

(Immediate delivery. Order direct, cash or C.O.D., or send for folder)

**VYKE BRAKE CO., P-2439 15th St., Denver 11, Colo.**

## DO MORE PLANING JOBS WITH LOW COST BELSAW

Exclusive MONEY-MAKING features:



- Full 12 1/4 in. x 6 in. capacity
- Power feeds at 24 ft. a minute. (Easily adjusted for lower feed rate)
- Machined cast iron bed; adjustable rolls, total bed length 42 in.
- Provides for Grinding Knives in the Cutterhead.
- Attachments for Jointing, Rabbeting, Tongue, Groove, Matching.

Belsaw Multi-Duty Planer for cabinet shops, builders, lumber yards, woodworking plants and spare time work shops... Now you can convert low cost rough and random size lumber into high priced cabinet finished stock... Easy to make flooring and popular patterns. Belsaw quickly returns cost with savings on raw material... profits on finished stock.

Send Today for FREE literature on Belsaw, the LOW COST, high speed production planer.

**BELSAW MACHINERY CO**

1010 Field Bldg. Kansas City 11, Missouri

LOW DOWN  
PAYMENT  
EASY  
TERMS

# GOOD-BY LEAVES!



**GET RID OF A HARD JOB THE PARKER WAY!**

Sweep, gather, and carry away leaves—all in one operation. Lift out basket, fold-away storage—the Parker lawn sweeper has *all* the features. Manual and motorized models on display at nearby dealers.

**\$33.50 and up, zone 1.**

## PARKER LAWN SWEEPERS

Parker Sweeper Co., 80 Bechtle Ave., Springfield, Ohio

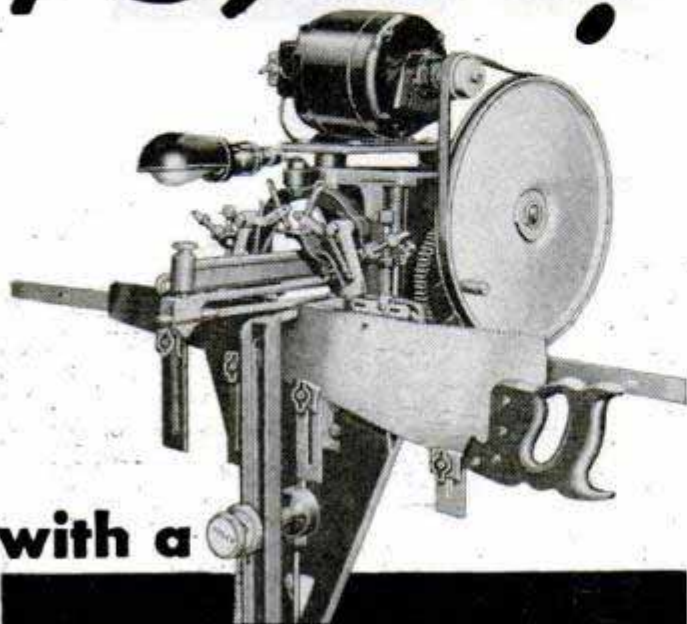
Please send me free illustrated Parker sweeper booklet and name of nearest dealer.

Name \_\_\_\_\_

Street or R.F.D. \_\_\_\_\_

City and State \_\_\_\_\_

# Last Year's Profit \$3,000!



with a

## FOLEY automatic SAW FILER

"Last year's profit amounted to \$3,000. Not so bad for a one-man outfit" — from Chas. C. Hough. James B. Williams wrote us—"I made \$765 last year filing saws, and it sure comes in handy. I do this work in my spare time." Men in communities of all sizes make up to \$3 or \$4 an hour with the Foley Saw Filer working full time or part time.

It's no trick to take care of the saw filing for your neighborhood hardware or lumber dealer — plus looking after the saws for farmers, townspeople, manual training departments and factories. The Foley files all hand saws, also band and cross-cut circular saws. It's a cash business, no canvassing, no eyestrain and no experience needed.

### FREE BOOK Shows How to Start

"MONEY MAKING FACTS" shows just how you can start at home in your spare time working in your basement or garage. It's an immediate cash business that can develop into a full-time repair shop. Send coupon today — no salesman will call.



Send Coupon for **FREE BOOK**

**FOLEY MFG. CO., 1016-3 Foley Bldg.  
Minneapolis 18, Minn.**

Send me free book  
"MONEY MAKING FACTS"

Name.....

Address.....

must be sacrificed. The Jet trunk is quite large and even though it has little rear leg-room, some larger club coupe models of various makes actually have no more.

The brake and throttle pedals are well located, although a wider brake pedal could be used. The hood is rather stubby. The hood ornament gives the appearance of being an air scoop but actually is nonfunctional. I'd like to see a few holes punched in it to permit fresh air to flow under the hood and over the engine.

It is fun to drive the Jet and anyone who likes a little competition now and then can

#### 1953 HUDSON JET SPECIFICATIONS

|                        | ENGINE   | Optional Equipment                               |
|------------------------|--|--|
| Type .....             | 6-cyl., in-line; L-head                                |  |
| Bore and stroke.....   | 3.0 in. x 4.75 in.                                     |  |
| Piston displacement..  | 202 cu. in.  |  |
| Cylinder-head material | Cast alloy iron  | Cast alloy aluminum                              |
| Compression ratio....  | 7.5:1  | 8.0:1  |
| Carburetor .....       | Single downdraft                                       | Two downdraft<br>(Twin H-Power)                  |
| Brake horsepower.....  | 104 at 4000 r.p.m.                                     | 106 at 4000 r.p.m.<br>(cast iron head)           |
|                        |  | 114 at 4000 r.p.m.<br>(alloy head Twin-H)        |
| Transmission .....     | Conventional 3-speed<br>unit standard on all<br>models | Overdrive or Dual-<br>Range Hydra-Matic<br>Drive |

#### CAPACITIES

|                |         |
|----------------|---------|
| Oil .....      | 5½ qt.  |
| Water .....    | 15 qt.  |
| Gasoline ..... | 15 gal. |

#### GENERAL

|                                  |  |
|----------------------------------|--|
| Steering ratio (over-all).....   | 20.2:1   |
| Steering wheel (lock to lock)... | 4 turns  |
| Turning diameter.....            | 36 ft.   |
| Brakes .....                     | Conventional hydraulic with riveted<br>linings |
| Tire size.....                   | 5.90 x 15 (Jet) 6.40 x 15 (Super Jet)          |
| Shipping weight.....             | 2700 lb.                                       |
| Wheelbase .....                  | 105 in.  |
| Tread, front.....                | 54 in.   |
| Tread, rear.....                 | 52 in.   |
| Over-all length.....             | 180 <sup>1</sup> / <sub>16</sub> in.           |
| Over-all width.....              | 67 <sup>1</sup> / <sub>16</sub> in.            |
| Over-all height.....             | 60 <sup>7</sup> / <sub>8</sub> in.             |
| Road clearance.....              | 8 <sup>1</sup> / <sub>4</sub> in.              |

#### INTERIOR DIMENSIONS

|                       |                   |
|-----------------------|-------------------|
| Front-seat width..... | 58 in. (hip room) |
| Rear-seat width.....  | 58 in. (hip room) |
| Front headroom.....   | 36.375 in.        |
| Rear headroom.....    | 35.625 in.        |
| Front legroom.....    | 41.875 in.        |
| Rear legroom.....     | 38.5 in.          |

surprise other drivers with Jet performance. In many instances I made faster average time between certain points than I have made in past tests with more powerful cars. One day we drove 740 miles with little fatigue. I consider it far above average and it is certainly an economical automobile to operate.

Drivers of longer and heavier cars, once accustomed to the Jet, will find the performance and maneuverability refreshing, both in traffic and over winding roads.

The Jet price is not so low as some people expect it to be, but perhaps the convenience of a smaller car plus the economy features will offset the price situation with some purchasers.

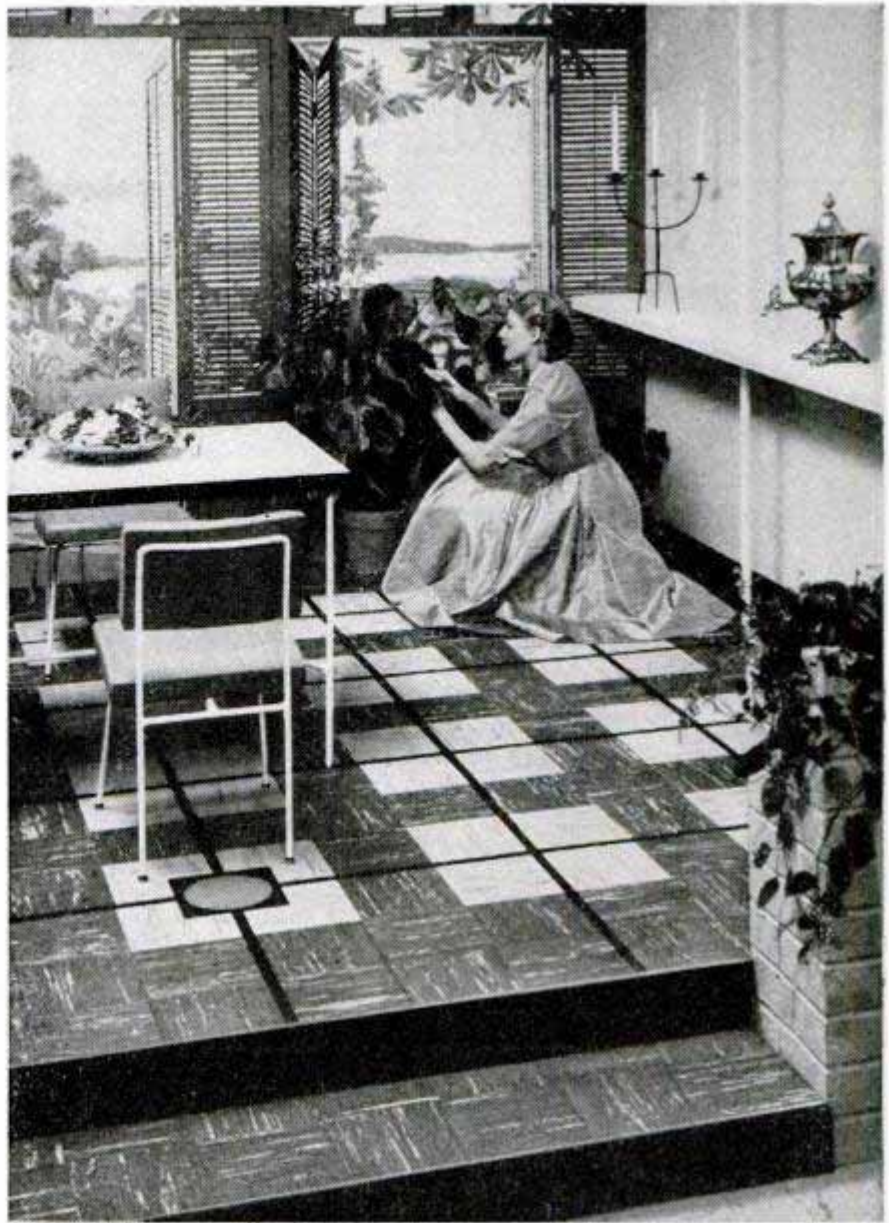
★ ★ ★

# Why pay more?

You can install  
a guaranteed

## KENTILE FLOOR

like this for only \$27<sup>50</sup>\*



**A KENTILE FLOOR LIKE THIS COSTS  
\$9 to \$22 LESS THAN TILE FLOORS  
OF MANY OTHER MATERIALS...  
YET KENTILE IS GUARANTEED!**

You can't imagine how easy it is to install your own Kentile Floor until you've actually done it. Mix or match your choice of the 25 "lovely-to-live-with" colors. Kentile resists soil and stains. And, after parties or just family-fun, Kentile is easy to mop clean.

It's easy to keep glistening like new with an occasional no-rub waxing, too. These modern colors can't get dull or wear off . . . they go clear through the rugged, durable tile. That's why more people buy Kentile . . . because Kentile gives more value.

**Only KENTILE DEALERS have these money-saving buys in GUARANTEED FLOORS**

\*Price quoted is for a floor approximately 11'6" x 9'3" installed by you. Your floor may cost less or slightly more depending on size, colors and freight rates. See your local Kentile, Inc. Dealer for FREE estimate. His name is listed under FLOORS in your Classified Telephone Directory. In Canada, T. Eaton Co., Ltd.

KENTILE, INC., 58 2nd Avenue, Brooklyn 15, N. Y.

### KENTILE

#### GUARANTEE

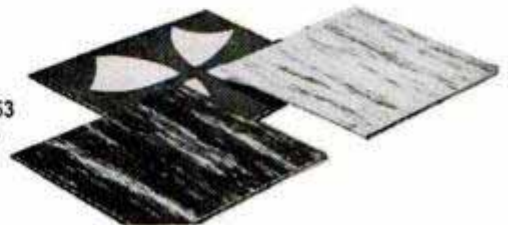
Kentile, Inc., will furnish new tile without charge for any Kentile that wears out . . . and on which colors wear off . . . during your own occupancy of your own home wherein you have installed Kentile or have had it installed by an authorized Kentile Dealer. This guarantee does not apply to damage caused by your improper handling or your failure to follow the instructions for installation and/or maintenance available at your Kentile dealer's. This guarantee must be presented if claim is made for new tile.

## KENTILE®

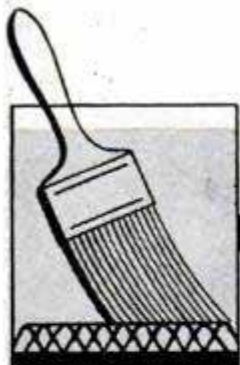


Copyright 1953  
Kentile, Inc.

**The Asphalt Tile of  
Enduring Beauty**



# WEEK-END DECORATORS!



Now it's easy to clean brushes

## PAINT TRAP

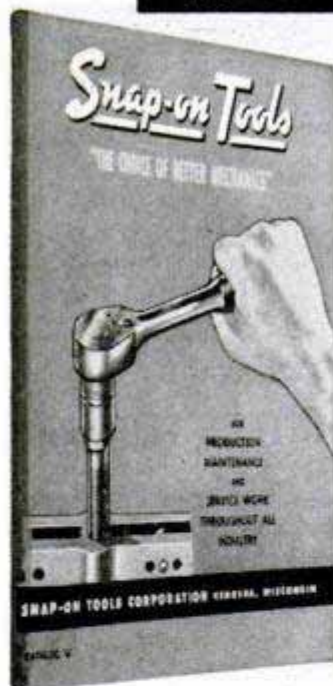
Reconditions old hard brushes  
Thoroughly cleans after using

• Place brush in can of PAINT TRAP and work back and forth on the "Stay-Clean" Paint Trap. Emulsifying action washes away any paint, varnish or shellac. Old paint settles in paint trap—liquid can be used over and over. It's safe for all bristles. No fire hazard. Buy PAINT TRAP Brush Cleaner where you buy paint, or write:



**The Klean-Strip Co., Inc.**  
2340 S. Lauderdale, Memphis 6, Tenn.

send for **FREE CATALOG**



America's Foremost  
*money-making*  
**MECHANICS'**  
**TOOLS**

It's easy to own the same "pay-off" tools used and endorsed by America's top-earning mechanics throughout the automotive, aviation and industrial fields! Snap-on tools help you handle every repair job faster, easier, better. And they LAST... pay for themselves over and over again! Start building your own tool set now with basic Snap-on units—add others any time. Genuine Snap-on tools are never sold in stores—direct to users only. Mail coupon for free catalog.

**Snap-on Tools**  
THE CHOICE OF BETTER MECHANICS

Snap-on Tools Corporation  
8062-J 28th Ave., Kenosha, Wis.

Send me free catalog. Occupation \_\_\_\_\_

Name \_\_\_\_\_

Address \_\_\_\_\_

City \_\_\_\_\_ Zone \_\_\_\_\_ State \_\_\_\_\_

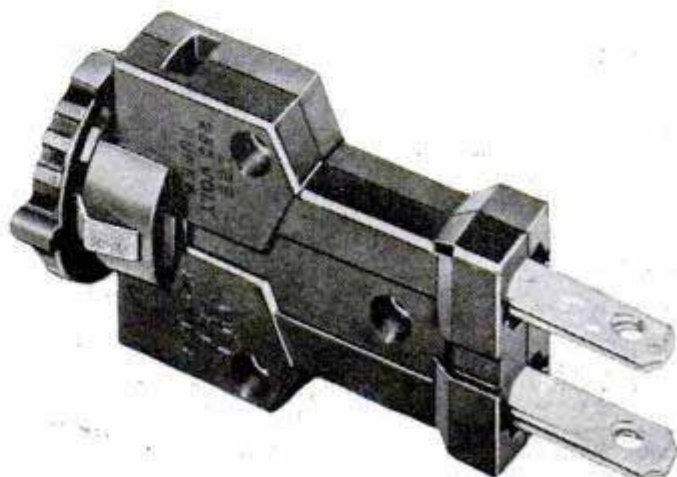


## Lawn-Mower Sprayer Attachment

Any four-cycle power lawn mower can now be converted into a lethal weapon against insects. A quickly attached sprayer uses exhaust heat and motor power to create a penetrating fog that kills mosquitoes, flies and other bug life. A quart of the liquid insecticide is enough for two hours of spraying. The attachment can also be fitted to garden cultivators and light tractors.

## Safety Appliance Plug

Two replaceable fuses built into the shank of an appliance plug prevent overloading of the household electrical system. For use with appliances of 750 watts or less, the plug eliminates trips to the basement to replace damaged fuses. Connection is made to the cord by inserting the wires in an opening at the rear and then twisting a knob which locks the wires in place.



World's Finest Always...Sensational for 1953!

# LIONEL TRAINS

## WITH MAGNE-TRACTION

MAGNE-TRACTION  
MEANS . . . .

MORE CLIMB, MORE SPEED  
MORE PULL,  
MORE CONTROL...  
AND ONLY LIONEL  
HAS IT!

**NEW**

**BIG SCALE-MODELED  
FREIGHT CARS!**

Cable car, oil car, pipe  
car...6 of them!

**NEW**

**GIANT "O" GAUGE  
STREAMLINERS!**

3 types, illuminated, 15" long!

**NEW**

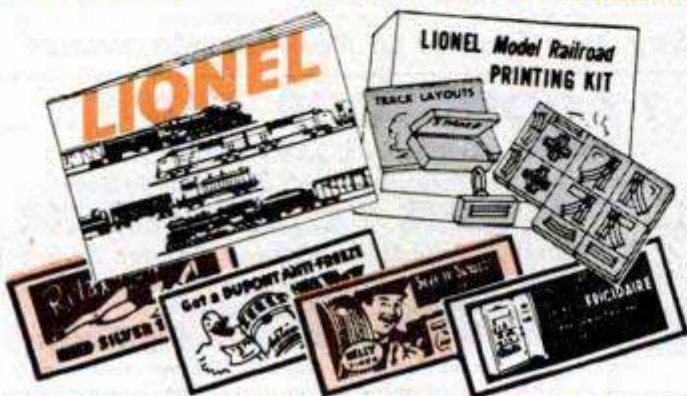
**EXCITING ACCESSORIES!**

This new Coaling Station has  
four remote control actions. It's  
Lionel for action-packed accessories!

There's nothing like the thrilling *action* of LIONEL TRAINS...with exclusive *Magne-Traction* that makes them take steep grades and sharp curves, pulling more cars faster. And every Lionel operating car and accessory puts on its own great act. Excitement, thrills that no other trains can match.

There's nothing so *real* as LIONEL TRAINS...smoke-puffing steam locos sounding their built-in, two-tone whistle ...horn blaring Diesels. Built for lifetime action...solid steel wheels, heavy-duty trucks. And *all* LIONEL TRAINS have real R.R. remote-control knuckle couplers!

**SPECIAL BIG-3 OFFER! ALL FOR ONLY 50¢ postpaid**



**New Track Layout Printing Kit PLUS Set of  
Eight Full Color Billboards With The New  
1953 Lionel Catalog—40 pages in full color!**

LIONEL TRAINS, P.O. Box 9, Dept. W, N.Y. 46, N.Y.

- I enclose 50¢ for Big 3 Coupon Offer Above.
- 10¢ for Catalog Only.

Name \_\_\_\_\_

Address \_\_\_\_\_

City \_\_\_\_\_ Zone \_\_\_\_\_ State \_\_\_\_\_

# HOW TO HAVE EXTRA WORK GLOVE COMFORT and WEAR IN ONE EASY LESSON



Triple-tanned buckskin soft, to dry soft—stay soft, yet cost less to wear. A new pair FREE if they dry out

hard or stiff under normal drying conditions. See your dealer TODAY.

## FREE NEW 64-PAGE HANDYMAN'S BOOK

Big—brilliantly illustrated! Contains 212 tested kinks and hints for home, shop, hobby and car. Over 200 photos and drawings. Write for your FREE copy today. No cost or obligation. A postcard will do. Dept. KI-10 Wolverine Shoe & Tanning Corp., Rockford, Mich.



## BERNZ O-MATIC TORCH

Solders in a jiffy, burns paint, antiques furniture—lets you do hundreds of jobs yourself and saves you money.

Instant lighting, lightweight, compact. Disposable cylinder contains enough fuel for months of normal use.

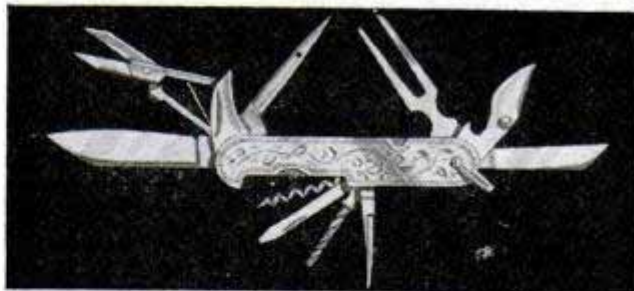
Torch complete  
**ONLY \$6.95**  
at your hardware store. Replacement cylinder...\$1.95

FREE BOOKLET SHOWS YOU HOW TO USE TORCH FOR MANY JOBS

Send for booklet today. Write:

**OTTO BERNZ COMPANY, Inc.**  
283 Lyell Avenue • Rochester 6, New York

## ALL-PURPOSE KNIFE



Imported pocket-sized knife weighs only 3 1/2 oz., has engraved silver handle. Closed, it's 3 1/4 inches long. Razor-sharp blade 2-3/15 inches long and 11 stainless steel blades—scissors, draw knife, punch, corkscrew, file, drill, can opener, cap puller, needle, 2 curring blades. Sorry, no C.O.D.'s.

**Vicron Trading Company**  
115 New Montgomery St.  
San Francisco 5, Calif.

**ONLY 798**  
Post paid  
Fed. Tax inc.

## ACCURATE, gas powered



CROSMAN ARMS CO., Fairport, N. Y., Dept. 45

Single shot or 10 shot repeater, precision rifled barrel, push type safety, adjustable sight, power adjustment, .177 or .22 cal. AT DEALERS EVERYWHERE

## FREE CRAFT CATALOG



120 PAGES... Craft Supplies, Tools, Designs, Instruction Books from America's Largest, Most Complete Handcraft Stock.

Send for your free copy NOW!

**GRIFFIN CRAFT SUPPLIES**

5626-A Telegraph Ave • Oakland 9, Calif.

**MAGNETS** OF ALL TYPES — 10c UP  
AMAZINGLY POWERFUL!!  
6 ounce horseshoe magnet—\$1.50.  
Our Leader, 1 lb. magnet lifts 25 lbs. \$2.95. New alloy—will not weaken! Useful for lifting valuables from tanks, lakes, or rivers easily! 7 small magnets \$1.25 with list of many shop and home uses. Satisfaction guaranteed.  
R. EYRICH, 1091 N. 48 STREET, MILWAUKEE-8, WISC.

## MAKE BIG MONEY

Sharpening Lawn Mowers

SPARE OR FULL TIME

Mr. G. E. of Ark. writes, "I have had my Universal Grinder 2 mos. and made a net profit of \$227." Be your own boss in a business of your own in your garage or basement with the Universal Lawn Mower Grinder. No experience necessary. Send today for proven success plan FREE.

**ROGERS MFG. CO. Dept. M-103 LINDSEY, OHIO**

Say You Saw It in Popular Mechanics

## ?? DOES YOUR CAR ??

SMOKE - DRINK - LOAF - STUMBLE

Because of A Weak, Low-volt Electrical System

## SELECT-A-CHARGE WATTAGE REGULATOR

With EZ Adjustable Voltage Booster Switch

A SURE-CURE for most chronic generator, regulator and battery troubles...

**Salesmen Wanted!! Big Profits**

Write for Free Details - How you can get a Select A Charge Regulator on your car for introducing.  
**SCIENTIFIC ELECTRIC CO. P. O. BOX 2162-C CLEVELAND 8, OHIO**





## HEATING & VENTILATING FAN

(Item 10) Easily installed in furnace pipes. Forces even heat to all rooms. Over range removes kitchen smoke and odors. Powerful, continuous duty motor, 110-120v. AC. Mount in wall or ceiling to ventilate any area. Quiet, super-efficient fan moves huge volume of air. (400 to 600 CFM).

8" Fan, wt. 5 lb. .... \$6.85  
9" Fan, wt. 6 lb. .... \$7.85  
10" Fan, wt. 7 lb. .... \$8.85  
12" Fan, wt. 8 lb. .... \$9.85

**HEAVY DUTY FAN.** Semi-enclosed motor, suitable for spray booths, restaurant exhausts, poultry houses, etc. 10" Fan, wt. 8 lbs. (Item 10E) ..... \$11.95  
12" Fan, wt. 10 lbs. (Item 10D) ..... \$12.95

**FLEXIBLE SHAFT.** A precision built, heavy duty tool with amazing flexibility. Replaces a dozen individual tools—drills, buffs, grinds, sands, saws—handles jobs in impossible places. Fits any 3/8" shaft on lathe, drill press, grinder motor, spare gas or electric motor, etc. Heavy duty 3/8" piano wire core encased in tough rubber housing. Handle and arbor have rugged industrial type precision ball bearings for years of service. Arbor takes all 1/2" bore wire wheels, grindstones, etc. 1 1/2"-20 standard threads. Use with any 1/4, 1/2 or 1/2 hp. motor. (Item 240). Wt. 10 lbs. Reg. \$29.95. .... **\$15.95**

**EXTENSION CORD.** Heavy duty, made of Buna rubber insulated #14, 2 conductor stranded wire encased in a treated braid jacket; tough, flexible and resists oil, grease or water. Use indoors or out. Complete with heavy rubber plug and outlet. .... **\$1.99**  
let. (Item 16) 40 ft. 2 1/2 lbs. ....  
Combination 2-40 ft. and 1-20 ft. (total 100 ft.) ..... (Item 16c) **\$4.95**  
100 ft. length piece ..... (Item 16p) **\$4.85**

**NEOPRENE EXTENSION CORD.** #16, 2 conductor stranded wire, extremely flexible. Ideal for hedge trimmers, lawn mowers, power tools, etc. Tough and rugged, withstands any abuse. Complete with rubber plug and outlet. 40 ft. (Item 17a) wt. 2 1/2 lbs. Regularly \$4.95. SPECIAL. .... **\$2.49**  
Combination 2-40 ft. and 1-20 ft. (total 100 ft. (Item 17b)) ..... **\$5.95**  
100 ft. length (1 piece) ..... (Item 17c) **\$5.85**  
Wire only. No fittings. 100 ft. (Item 17d) **\$5.00**

**NEOPRENE CABLE** #14-2 (Item 183) Heavy duty, very flexible. 20 year quality. Wt. 9 lbs. 100 ft. Complete with rubber plug and outlet. A terrific buy at only ..... **\$8.95**

**NO. 12-2 POWER CABLE.** Very flexible rubber covered, special outside shield for grounding power tools, etc. 50 ft. (Item 199) wt. 8 lbs. **\$6.95**. 100 ft. (Item 200) ..... **\$12.95**

**HEAVY DUTY D-C ARC WELDER.** Use as portable or shop welder. Up to 300 amps. Senior model. Made for years of trouble-free, continuous service. Will handle light or heavy jobs. Easily welds up to 1/2" plate using 1/4" rods. Built-in air cooling system. Arc is easy to strike and hold, because of specially designed arc stabilizer. Hi-lo switch and dial control gives wide range of welding heats. Run welder at 2600 rpm, with tractor, jeep or 15 hp. gas engine, or 7 hp. elec. motor. Complete with instructions, guar. and triple V belt or flat pulley. You can pay more, but you can't buy a better **\$99.75**  
welder. Wt. 110 lbs. \$400 value at \$99.75

**DUAL CONTROL MODEL** same as above but with built-in dual rheostat for low heat **\$119.50**  
soldering, brazing, welding, Spec. **\$119.50**  
**WELDING KIT.** Two 10 ft. leads, welding helmet, electrode holder, ground clamp. Sold only with welder at **\$10.50**

Write for Prices on A.C. Arc Welders

**MASTER AIR COMPRESSOR.** (Item 209) High pressure type for large volume of air for heavy duty service. For paint spraying, inflating truck and auto tires, greasing and the hundreds of other jobs done by compressed air. Piston type, 2" bore compressor with built-in air filter. Master built with high strength alloys and precision bearings. Stainless steel tank, 12"x24", 2100 cu. in. cap. Safe up to 500 lb. Equipped with automatic switch that starts and stops motor to maintain desired pressure (up to 150 lb.) and check valve, safety valve, gauge, shut-off valve, 20 ft. air hose and tire chuck. Beautifully balanced on ball bearing wheels and rubber tires. Low factory prices. With 1 1/2 hp., 110 v. A.C. motor. (Reg. \$175.00) **\$109.50**  
(Item 209p) With 1 1/2 hp. motor. Reg. **\$129.50**  
**\$109.50** (Item 209Ap)  
With 2 hp. Briggs Gas Engine. **\$119.50**  
Reg. \$199.50 (Item 209Bp)

**37 Pc. SOCKET SET.** Highest quality, guaranteed non-breakable sockets made by Husky. Beautifully matched chrome alloy, absolutely the best. Complete range of 17 sockets from 1/4" thru 1 1/2" (1/4" drive) and 7/16" thru 1-1/16" (1/2" drive), 1 extension, reversible 1 1/2" ratchet, adapter bit, sliding "T" handle, "L" handle, 1 1/2" speeder, 3 pc. alloy combination wrench set, 8 pc. Allen wrench set, and a big doghouse tool box. We challenge anyone to match this value. Easily worth **\$16.95**  
\$41.95. Wt. 14 lb. (Item 59)

**44 Pc. SOCKET SET.** (Item 506) Same unconditionally guaranteed, non-breakable sockets as above—but with added sizes. Complete range of 21 sockets from 1/4" thru 7/16" (1/4" drive) and 7/16" thru 1-1/16" (1/2" drive). Two extensions, reversible 1 1/2" ratchet, 3 drift punches, sliding "T" handle, all angle coupling, 1 1/2" speeder, 1/4" breaker, 3 pc. high chrome alloy combination wrench set and 8 pc. offset wrench set in big doghouse tool box with ample room for other tools. Reg. \$49.50. **\$21.95**  
Wt. 16 lb.

**52 Pc. SOCKET SET.** (Item 205) Contains a complete set of sockets in 1/2" drive, 3/4" drive and 1/2" drive, plus all necessary extensions, handles, speeders, reversible ratchets, etc.; all uncond. guaranteed against breakage. Beautifully matched chromed thin wall alloy sockets in a sturdy handsome steel tool box. Wt. 17 lbs. **\$27.95**  
List Price \$62.00. Factory Special

Send check or M.O. Prices f.o.b. Factory. 10 day Money back guarantee. Send 10c for BIG Catalog. **MASTER MECHANIC MFG. CO., DEPT. 38D Burlington, Wis.**

SAVE up to 85%—DIRECT from FACTORY

## MASTER GARDENER SELF-PROPELLED

It's a snow-blower It's a rotary mower  
It's a power sickle It's a rotary tiller  
It's a cultivator It's a plow

Where can you get a power tool that does so many jobs? Works for you the year 'round. Does terrific job of cleaning snow from walks, drives, etc. without backbreaking work. Also prepares deep mellow seed beds, cuts weeds, lawns, etc. The Master Gardener performs better—does more than tractors costing twice as much. Converts in minutes to Tiller, Power Sickle, etc. Basic self-propelled 2 hp tractor. Briggs or Clinton engine. **\$119.50**  
Snow Blow... **\$39.50** Rotary Tiller... **\$42.50**  
Cultivator... **\$8.75** Disc Harrow... **\$15.75**  
Purrowing Tool... **\$8.75** Plow... **\$15.00**  
Rotary Lawn Mower... **\$42.50**  
Sickle Bar Mower... **\$42.50**  
Lawn Mower Hitch... **\$4.50**  
Freight prepaid to most areas. Easy payment plan available.

**SAVE \$125 on LIGHT PLANT**

## LITTLE GIANT

**FREIGHT FREE! in OCT.** Imagine—65 compact pounds of portable power that goes with you anywhere—easier to carry than an outboard motor. Provides plenty of current for lights, portable radios, 1/4" drills, small power saws, electric shavers, etc. Perfect for hunters, campers, contractors' service trucks, wreckers, etc. 350 Watts, 115v. DC. Ruggedly constructed with 1 1/2 HP Briggs Engine. List price \$224.75. Special this month only (Item 273) at the terrific factory price **\$99.75** (freight free) of only.

## JET FLOW BLOWER

Tremendous air movement (1700 CFM) and quiet operation make this double inlet 10" turbine blower unbeatable for heating, cooling, drying and air conditioning. Ideal for attic or barn ventilation, converting cravie heat into to forced air; spray booth exhausts, etc. Operates with any 1/4, 1/2 or 1 1/2 HP motor. Oversized, long life bearings. Includes variable speed motor pulley and belt. Dimensions 19" hi x 8" x 16 1/2". Outlet opening 13 x 11 3/4". Wt. 45 lb. Item 245. Reg. \$54.50. **\$27.50**  
Factory Special. **\$27.50**  
HEAVY DUTY 1/4 HP motor for above **\$16.95**

## NEW MOTOR BIKE

Our Commando Motor Bike is trouble-free—carries amazing 5 yr. guarantee. Goes up to 150 miles per gal. on all roads. Speed to 40 mph. Easy automatic pedal or pull starting and smooth automatic transmission. Accelerates quickly. Complete motor and kit ready to attach to your bike in one hour. Get FREE folder. Factory Price **\$125.00**  
Complete bike and motor. **\$199.50**

**37 Pc. SOCKET SET.** Highest quality, guaranteed non-breakable sockets made by Husky. Beautifully matched chrome alloy, absolutely the best. Complete range of 17 sockets from 1/4" thru 1 1/2" (1/4" drive) and 7/16" thru 1-1/16" (1/2" drive), 1 extension, reversible 1 1/2" ratchet, adapter bit, sliding "T" handle, "L" handle, 1 1/2" speeder, 3 pc. alloy combination wrench set, 8 pc. Allen wrench set, and a big doghouse tool box. We challenge anyone to match this value. Easily worth **\$16.95**  
\$41.95. Wt. 14 lb. (Item 59)

**44 Pc. SOCKET SET.** (Item 506) Same unconditionally guaranteed, non-breakable sockets as above—but with added sizes. Complete range of 21 sockets from 1/4" thru 7/16" (1/4" drive) and 7/16" thru 1-1/16" (1/2" drive). Two extensions, reversible 1 1/2" ratchet, 3 drift punches, sliding "T" handle, all angle coupling, 1 1/2" speeder, 1/4" breaker, 3 pc. high chrome alloy combination wrench set and 8 pc. offset wrench set in big doghouse tool box with ample room for other tools. Reg. \$49.50. **\$21.95**  
Wt. 16 lb.

**52 Pc. SOCKET SET.** (Item 205) Contains a complete set of sockets in 1/2" drive, 3/4" drive and 1/2" drive, plus all necessary extensions, handles, speeders, reversible ratchets, etc.; all uncond. guaranteed against breakage. Beautifully matched chromed thin wall alloy sockets in a sturdy handsome steel tool box. Wt. 17 lbs. **\$27.95**  
List Price \$62.00. Factory Special

Send check or M.O. Prices f.o.b. Factory. 10 day Money back guarantee. Send 10c for BIG Catalog. **MASTER MECHANIC MFG. CO., DEPT. 38D Burlington, Wis.**

## DIESEL LIGHT PLANT

(Item 1660) Diesel Master—11-12 kw. 115/230 v. AC single or 3 phase, 1800 rpm direct connected. Electric Self-starting. Engineered for permanent power where continuous, low-cost, heavy duty service is important. Wt. 1350 lb. Reg. list \$3650.00. **\$1895.00**  
Factory Price

**10-11 kw. GAS DRIVEN PLANT.** 115-230 v. 60 cyc. AC, single or 3 phase, powered by 4 cylinder Wisconsin air cooled engine. Belt driven. Constructed similarly to Hi-Line 6 KW shown below but much larger. (Item 217) (with crank start) **\$1075.00**  
Wt. 900 lb. Factory price. .... **\$1145.00**  
Same plant with elec. self-starter. .... **\$1145.00**

## PORTABLE LIGHT PLANTS

**PUSH BUTTON START**  
AC Plant 600-700 Watts—115 v., 60 cyc. Powered by a rugged 2 hp. easy-starting Briggs gas engine. No wiring necessary; just plug in and operate. Plenty of current for any oil burner, freezer, brooder, emergency lights, etc. which require up to 700 w. Ideal for Civil Defense, Fire Depts., trailers and camps. Complete with Voltmeter and built-in winding to charge 6 v. auto batteries. Item 24. Wt. 73 lbs. Be prepared if war or storm knock out power lines. Reg. \$275.00 value. **\$143.50**  
**700-800 Watt Plant (Item 44)** same as above but larger engine. .... **\$169.95**  
**1000-1200 Watt Plant (Item 45)** same as Item 24 but with larger generator and engine—50% greater output. .... **\$199.50**  
**1500-1700 Watt Plant (Item 20)**—Similar to Item 24, but has three times more capacity. Wt. 73 lb. Factory price **\$279.50**

## MASTER-LITE 2500 Watt PLANT

110/120 v. 60 cyc. AC. A powerful plant, ruggedly constructed and yet designed for easy portability. Can be started by rope or built-in 12 v. electric push button starter. Built-in winding to charge battery. Powered by a big 5.10 Briggs engine, complete with all accessories. Includes control box, voltmeter and handy plug-in power receptacle. Ideal for permanent or stand-by service. Wt. 225 lb. Reg. **\$329.50**  
ular price \$645.00. Factory price. .... **\$379.50**  
**3500 Watt Plant Push Button Start (Item 23)** 115 v. 60 cyc. AC. Similar to above, but larger and 33% more capacity. Wt. 270 lbs. Reg. \$760. Factory Price. .... **\$379.50**  
**GIANT 2000-2500 Watt Plant—110/120 v. AC.** belt driven so that engine may easily be utilized for other purposes. Powered by a rope start 6 HP engine. Wt. 210 lb. Regular list price \$585.00. **\$299.50**  
Factory price (Item 31) ..... **\$299.50**  
Generator only and control box (Item 31a) **\$169.50**

## HI-LINE 6000 WATT PLANT

(Item 162) Push Button Start. 115-230 v. 60 cycle AC. A brute of a power plant with a rugged 14 hp. Wisconsin engine. Plenty of electricity for ranges, water heaters, freezers, pumps, machinery, etc. Provides both 110 and 220 volts. Ideal where heavy current is needed. Wt. 590 lbs. Easily worth \$995.00. With self starter. **\$645.00**  
Spec. .... **\$645.00**  
Same plant **\$585.00**  
but with Crank Start (Item 166) **\$345.00**  
Generator and control box only, belt driven. Use your own engine or tractor. Wt. 240 lbs. (Item 163) Factory price **\$345.00**

We make fully automatic controls to operate any of above light plants. Write for details. We make all sizes up to 25,000 Watts—Write.

## 1 1/2 TON MASTER HANDEE DUMP

Here at last is an all-purpose 1 1/2 ton dump trailer. Can be used anywhere, inside or out for hauling sand, gravel, dirt, coal, grain, trash, industrial scrap, etc. Unloads, tilts, dumps to either side with one pull of the handle—yet trailer cannot tip. Ruggedly built, girder type frame equipped with pneumatic 4:00x12x8 ply tires and Timken roller bearings. Easily towed by any car, truck, jeep, tractor, etc.—has universal ball hitch front and rear—several "Handee-Dumps" are instantly coupled together. Capacity 1 1/2 ton—34 yd., overall length 104", Width 40", wheel base 84". (Item 237) Wt. 460 lb. **\$350.00**  
Factory Spec. .... **\$350.00**  
**DUAL TIRE** (8 wheel) model, similar to above, 510 lb. .... **\$450.00**

Write for details. We make all sizes up to 25,000 Watts—Write.

Write for details. We make all sizes up to 25,000 Watts—Write.

Write for details. We make all sizes up to 25,000 Watts—Write.

In just a few minutes—  
**PROTECT YOUR HOME**  
 for LIFE against  
**CONDENSATION DAMAGE!**



Any one who can use a drill can do a professional, permanent job . . . protecting against PAINT BLISTERING, SWEATING and the DESTRUCTIVE DANGERS OF CONDENSATION AND DAMPNES.

You can ventilate the danger spots quickly and positively, with ingenious new MIDGET LOUVERS. These rust-proof, all-aluminum ventilating units allow air to circulate properly through sidewalls, flat roofs, eaves, soffits, unexcavated areas, gable ends, etc. . . . wherever there is danger of destructive condensation and moisture blistering.

Protect your home against this ever-present damage. Eliminate the trouble and expense of blistered paint. Ask your dealer for genuine MIDGET LOUVERS.

- EASY TO INSTALL—Just drill a hole and tap into place.
- No nails or screws—but MIDGETS fit right, stay in place forever.
- 6 SIZES—1" to 4" diameter.
- 2 STYLES—Regular (with rain deflectors)—"LD" (without deflectors). Both styles screened to keep out insects.
- Sold thru paint, hardware and lumber dealers.

Write for descriptive literature

**the MIDGET LOUVER Co.**  
 8 WALL STREET • NORWALK, CONN.



**DO EVERY JOB**  
*better-faster-  
 cheaper-*  
 WITH  
**COMPRESSED AIR**

Paint Buildings, boats, tractors, trucks; refinish furniture and fenders; inflate tires; grease and lubricate motors, engines, implements. Destroy weeds. Rid livestock, poultry and pens of pests with portable air power.

Free Literature explains relative advantages of 4-cylinder **PRESSURE QUEEN** and single-cylinder **PRESSURE PRINCESS** spray painting outfits. Tells how to save material, time and money by using the proper outfit at the right price.

*It Is Yours For The Asking  
 Write Today*

**THE CAMPBELL-HAUSFELD CO.**  
 1046 RAILROAD AVE. HARRISON, O.

**STOP THAT SQUEAKY  
 FAN BELT for only 50c**



★ A few drops of Cling-Surface stops slipping, stops squeaks, makes belts last longer. Good for all belt driven power tools and appliances, too! Sold at service stations, auto parts and hardware stores. If your dealer can't supply you

Send 50¢ to:  
**CLING-SURFACE CO., INC.**  
 1047 Niagara St. Buffalo, N. Y.  
 CANADIAN READERS SEND 75¢

**make your own Gems 29<sup>50</sup>**  
 F.O.B.

The Gem Maker comes complete with all necessary equipment, including a super-charged diamond blade for sawing, and all wheels for grinding, shaping and polishing; also complete instructions. The complete equipment as shown, less motor and belt, for only \$29.50, f.o.b., Burlington, Wisconsin. Write today for information and literature.

**B & I MANUFACTURING CO.**  
 Dept. S Burlington, Wis.



**Build your own JET ENGINE!**

Order these plans today

1. JET PROPELLED BICYCLE. Assemble your own. Photo and instructions, \$1.00.
2. HOW TO MAKE EXPERIMENTAL JET ENGINES. Seven sheets drawings with information and instructions \$2.95.
3. BOTH OF ABOVE in one order \$3.75. SEND NO MONEY. Order both at once \$3.75 C.O.D. in USA plus c.o.d. postage. Send check or Money Order and we pay postage. Get other information too, Rush Order.

**J. HOUSTON MAUPIN, Dept. 55, Tipp City, Ohio**



SEND NO MONEY

**VALUE "PLUS"**

Extra value is built into every Gerstner Chest. Ask the men who use them. Free Catalog.

**GERSTNER TOOL CHESTS**  
 453 Columbia St., Dayton 7, Ohio

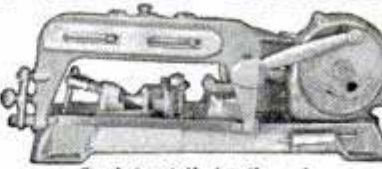


**POWER HACKSAW \$55.75**  
 LESS MOTOR  
 F.O.B. Benton Harbor

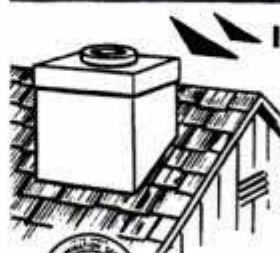
• Rugged cast iron construction. Wt. 56 lbs. bronze bearings. Draw cut. Auto. return lift. Auto. shut-off. Vise swivels 45°. Cap. 4"x4".

Send for full details and name of nearest dealer.

**EXCEL MACHINE TOOLS** Dept. PM-103 BENTON HARBOR, MICHIGAN



**Need a Chimney?**



**INSTALL IT YOURSELF**

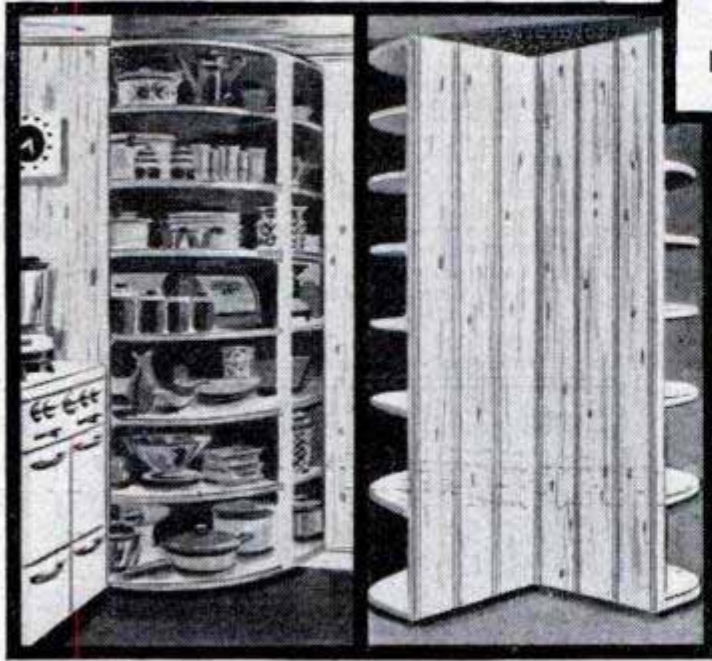
Light weight, no foundation required. Shipped complete, all parts furnished.

**SAFE.** Underwriter listed—F. H. A. accepted—Bldg. Code approved. For gas, oil or coal in any type home. Costs third to half less than brick. Immediate delivery.



**WRITE FOR FREE BOOKLET** describing fully The Van-Packer Packaged Chimney.

**VAN-PACKER CORPORATION**  
 Dept. 15 • 209 S. LaSalle St. • Chicago 4, Illinois



lazy-susan pantry open

lazy-susan pantry before installation

get complete detail drawings, photographs, and directions in **FREE Idea Packet 248!**

*you'll be proud of this*

## LAZY-SUSAN PANTRY!

This space-saving lazy-susan pantry, made of the woods of the Western Pines\*, will win you endless praise!

Seven shelves provide easy-to-reach storage space—door panels hide the pantry when closed. The Western Pines prove perfect for detail projects like this—they cut clean and accurately with hand or machine tools and take all sorts of finishes without grain-raising.

Ask your local lumber dealer for the Western Pines—he'll be glad to help you select them!

# the Western Pines

- \* IDAHO WHITE PINE
- \* PONDEROSA PINE
- \* SUGAR PINE

Write for **FREE Idea Packet 248**—including the booklet, "Enchanting Homes of Western Pines"—to **WESTERN PINE ASSOCIATION**, Dept. 248-N, Yeon Building, Portland 4, Oregon.

## BABY YOUR HANDS!

### WATERLESS DL HANDI-CLEANER



*just apply and wipe dry*

**NO WATER NEEDED!**

Dissolves dirt instantly . . . Prevents soreness due to chapping . . . Fortified with Lanolin . . . Guards against skin infection . . . Contains no harsh grit or abrasives . . . Ideal for home workshop, home, car and office.

**SOLD AT SERVICE STATIONS, AUTO PARTS, AND HARDWARE STORES,**

in 14 oz., 3 lb., 5 lb., and 5 gal. containers.

**BANITE CO., BANITE BLDG., BUFFALO 4, N. Y.**

## Custom-made for the home work shop!

### PLASTIC COVERS



Tough, long-lasting vinyl plastic covers keep your valuable power tools free from dirt, moisture, tiny hands. Custom fit for all popular brands. Send make and model of your machine with check or money order to

**POLO PLASTICS CO., Milwaukee 1, Wis.**

#### COVER PRICES

|                |        |
|----------------|--------|
| Tilt Table Saw | \$1.45 |
| Jig Saw        | 1.95   |
| Tilt Arbor Saw | 2.95   |
| Drill Press    | 2.95   |
| Wood Lathe     | 2.95   |



# NEW

# Mall

## "1000 & 1" DRILL KIT

You get the world-famous MALL Model 149B 1/4" drill (with geared chuck) plus ALL these attachments . . . for drilling, sanding, grinding, buffing, polishing, wire brushing, mixing paint, etc.—for just a little more than the cost of the drill alone. And remember—you're getting MALL quality! See your MALL dealer or write.



40 branch warehouses and thousands of dealers, coast to coast.

**ONLY \$31.95 complete**

GET THE FACTS

NOW

### MALL TOOL COMPANY

7805 S. Chicago Ave., Chicago 19, Illinois

Send me more information about the new MALL "1000 & 1" Drill Kit.

Name \_\_\_\_\_

Address \_\_\_\_\_

HU-61

# SAKRETE

READY-MIXED  
CONCRETE  
& MORTAR

*in a bag!*

- CONCRETE MIX
- SAND MIX
- MORTAR MIX



© 1953  
Sakrete, Inc.

BUILD IT! REPAIR IT!  
**YOURSELF!**

**IT'S EASY—  
JUST ADD WATER**



New!  
**Pella®**  
WOOD  
FOLDING  
DOORS

**Decorative • Convenient • Economical**

Now you can use the floor and wall space that swinging doors waste. Pella Wood Folding Doors fold compactly against the door jamb like an accordion. Ideal for closets, bedrooms, kitchen . . . and as folding partition between living and dining rooms. Anyone can install, quickly, easily. Completely packaged with hardware, fittings, installation instructions. Heights to 10', widths to 30'. Natural wood finishes and unfinished. Investigate today!

CLIP AND MAIL TODAY

**ROLSCREEN COMPANY**  
Dept. E-46, Pella, Iowa

Please send complete literature and prices on Pella Wood Folding Doors.

NAME \_\_\_\_\_

ADDRESS \_\_\_\_\_

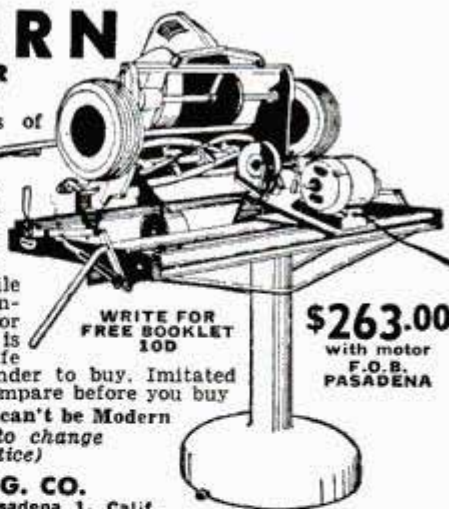
CITY \_\_\_\_\_

ZONE \_\_\_\_\_

STATE \_\_\_\_\_

## MODERN LAWN MOWER SHARPENER

Service departments of leading Lawn Mower manufacturers use the Modern Lawn Mower Sharpener. One lever moves lawn mower into grinding position. Gasoline and oil remain in engine while sharpening, no dismantling of wheels, roller or handle. The Modern is a precision bed knife grinder—no extra grinder to buy. Imitated but never equaled—Compare before you buy. If it isn't a Modern it can't be Modern.  
(Prices subject to change without notice)



WRITE FOR  
FREE BOOKLET  
100

**\$263.00**  
with motor  
F.O.B.  
PASADENA

**MODERN MFG. CO.**

160 N. Fair Oaks - Pasadena 1, Calif.

Send FOR this **Giant AUTOMOTIVE Catalog**  
& Save to 50% on All Parts & Accessories  
**1953 EDITION JUST OUT**



World's largest Auto Accessory & Parts Catalog. Over 50,000 items:—Hollywood Accessories, Hi-Speed Equipment, Rebuilt Engines, Everything for all cars & trucks. We have that Hard-To-Get part. Jam packed with bargains. Completely illustrated (134 pages). Send 25c (refundable).

**J. C. WHITNEY & CO.** 1917xp Archer, Chicago 16



## G E A R S

**In Stock - Immediate Delivery**  
Gears, speed reducers, sprockets, thrust bearings, flexible couplings, pulleys, etc. A complete line is carried in our Chicago stock. Can also quote on special gears of any kind. Send in your blueprints and inquiries.

Send for Complete Catalog No. 10  
**CHICAGO GEAR WORKS**  
440-50 N. Oakley Blvd., CHICAGO 12, ILL.



**BUILD FINE GRANDFATHER CLOCK NOW**

The simple sensible Red-Kut way, as thousands have — **SAVE HALF. SHOP TESTED PLANS "SPIRIT OF THE CENTURY"** Narrow waist 83" tall or stately straight side **"SPIRIT OF AMERICA."** **EASY-TO-FOLLOW photopack PLANS** tell all—plus **BROCHURE** of heavy brass weight Westminster, tube chime, movements, gorgeous dials, 3/4" solid mahogany case kits. Send \$1.00 today — Both plans \$1.50 NOW.  
**KUEMPEL CHIME CLOCK CO., #7 Kuempel Bldg., Minneapolis 16, Minn.**



**ELECTRIC WELDER** AC or DC  
110 Volts

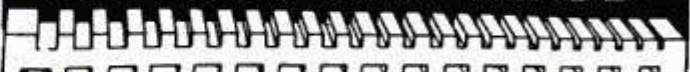
The "Little Marvel" all-metal welder. 5-year written guarantee. Welds 1/8" metal or money back. Repairs tanks, tools, fenders, machine parts, etc. Complete with everything—rods, unit, eye shield, directions.

\$6.45 plus 50c postage. Flame torch accessory for soldering, cutting, brazing \$3.95 complete with carbons, brass rods, flux. Sorry no C.O.D. Buy direct and save.

**ESSAY MFG. CO., Dept. 51, Quincy 69, Mass.**

**\$6.45**  
Com-  
plete

**CUT PERFECT GROOVES  
WITH Warren WASHERS  
ON YOUR SAW BLADE!**



**NOT ONE — NOT TWELVE — BUT  
40 DIFFERENT CUTS**

Engineered to cut clean, accurate, parallel grooves—just dial the desired width—40 micromatic adjustments—leave on saw for straight cuts. **GUARANTEED.** At your dealers or order direct. Arbor sizes 1/2", 3/8", 3/4", 1". Send for free booklet



ONLY  
**\$4.95**  
per  
doz.

**WARREN WASHERS COMPANY**

Dept. 30, Box 98, North End Station, Detroit, Michigan

# GENERATORS Many Sizes From 350 Watts to 25 KVA

Item #183—3000 to 4000 Watt Generator Set



**FEATURES**—Power for your home or business. Simply connect to power panel or house circuit.

- Constant voltage regardless of load.
- Push button start or stop.
- Easily made full automatic start or stop.

**SPECIFICATIONS**— Sizes 19" x 30" x 48". Steel skids, weatherproof housing. Requires no building. Wt. 725 lbs. • Hercules 4-cyl. 10 HP gasoline engine. Load governor. Oil filter. Quiet muffler. 6-volt starter, generator. • Hobart 115 volt, 60 cycle, 3000 to 4000-watt generator. Furnishes either single or three-phase power, 2 or 3 wire. • Panel contains oil gauge, voltmeter, ammeter, circuit breaker, voltage regulator, start button. Today's cost over \$1200.00. **SALE PRICE, F.O.B. Chicago..... 465.00**

ITEM #183

contains oil gauge, voltmeter, ammeter, circuit breaker, voltage regulator, start button. Today's cost over \$1200.00. **SALE PRICE, F.O.B. Chicago..... 465.00**

## D. C. GENERATORS



Item #176—Type L-3. Rated 25 amps., 24 volts. Manufactured by Leeco-Neville Co. Shpg. wt. 30 lbs. Dimensions 12" x 6 1/2" x 5 1/2". **F.O.B. Chicago... 16.50**

Item #90—Type P-1, rated 200 Amps.—28 Volts, 2500 RPM. Mfd. by General Electric, Ford, Delco-Remy and Westinghouse. Gov't. Acq. Cost \$300.00. Shpg. wt. 55 lbs. Dimensions 15" x 9" x 6". **F.O.B. Chicago... 22.50**



Item #192—12 volts, 15 amps. For use with external voltage regulator. Model GFU 4105. Autolite D.C. Generator. 4 bolt flange mounting. L 8 1/2", W 4", H 6". Removable drive gear. Shpg. wt. 14 1/2 lbs. **\$15.00** with voltage regulator

Item #91 — Type R-1, rated 300 Amps. — 30 Volts. Mfd. by Jack & Heintz. Gov't. Acq. Cost \$380.00. Shpg. wt. 55 lbs. Dimensions 16" x 10" x 7". **F.O.B. Chicago..... 35.00**

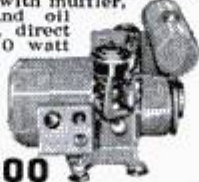


# FREE

**FALL EDITION 1953 CATALOG, 52 Pages, chock-full of unsurpassed War Surplus Equipment Bargains for farm, home, factory and workshop. Every item is unconditionally guaranteed. You save on everything! Write today.**



Item #178—350 Watt—110 Volt—60 Cycle A.C. Model MS-35-3, made by Mideo Mfg. Co. 1 cylinder, 4 cycle engine complete with muffler, starting rope and oil bath air cleaner, direct coupled to a 350 watt generator with voltage control rheostat and twin outlets. Engine speed 1800 R.P.M. Shipping weight 116 lbs. **F.O.B. Chicago 125.00**



## ELECTRIC GENERATOR SET — MODEL 2510

2500 watts, 115 volts, 60 cycles, single phase, A.C. electric generating plant, powered by dependable 5.5 H.P. Wisconsin engine—Two pole ball bearing belt driven high efficiency generator with heavy duty windings for high torque motor starting loads. Rated 3000 watts for intermittent service. Light weight portable rugged unit, easily transported to job site. Consumes 3 quarts of gas per hour at rated load. Dimensions: 24" x 20" x 24", ship. wt. 220 lbs. Complete with fused outlet box and voltmeter. **F.O.B. CHICAGO..... 329.00**



Item #2510  
3000 watts for intermittent service. Light weight portable rugged unit, easily transported to job site. Consumes 3 quarts of gas per hour at rated load. Dimensions: 24" x 20" x 24", ship. wt. 220 lbs. Complete with fused outlet box and voltmeter. **F.O.B. CHICAGO..... 329.00**

## GOV'T. SURPLUS! JUST RELEASED!

### TWO TON 6-WHEEL HYDRAULIC LIFT TRAILERS

**USE FOR:** Conveyor ramp • Boat trailer • Lumber • Pipe • Pole trailer • Machinery trailer • Hydraulic dump for grain wagon • Coal truck • Lift Truck • Variable height hydraulic work table • Removable rack permits use of hydraulic lift for other installations. Outstanding features of these Trailers are: — 4000 lbs. payload. 2 individual hydraulic lifts complete with hand pumps & valves. 6—18" x 5.5 pneumatic tires. Manual screw-down brakes. Ball-bearing axles. V-shape load rack — 8' long. Towing tongue, 54" lift. Wheelbase 98". Ground clearance — 4 1/2". Tread width — **ITEM #356** 52". Overall width — 58". Overall length including drawbar — 167". Gov't. cost \$685.00. Ship. wt. 1400 lbs. **F.O.B. Chicago..... 169.50**



Use the adjustable height load rack for boats, lumber, poles or pipe. By adding a plate, you have a ramp adjustable to freight car or truck body height. Add a grain wagon body to the frame for a perfect self-contained hydraulic dump wagon. Mount work-in-process on trailers, permitting adjustment of work height for maximum efficiency. Easy launching and recovery of boats from sloping beaches is done by hydraulically raising and lowering either end of load rack.

## HEAVY DUTY HYDRAULIC and AIR EQUIPMENT

Large supply of new labor-saving, economical hydraulic equipment in many types and sizes. Use these positive, highly efficient smooth pressure hydraulics on presses, arbors, lifts, loaders, power control, positioning, brakes, plastic dies, auto frame alignment, etc.

### ALL ITEMS BRAND NEW — UNCONDITIONALLY GUARANTEED

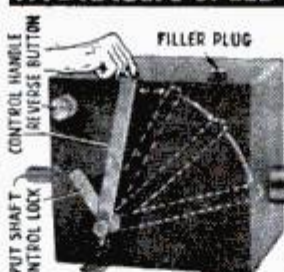
## BRAND NEW — BERRY — HEAVY DUTY HYDRAULIC PUMP OR MOTOR

Item #166 — use on farm equipment, road machinery, vibrators, paper mills, wire reels, hydraulic brakes. Ball bearing construction, balanced cam design assures high efficiency performance. When used as a pump: delivers 1.1 G.P.M., 1000 P.S.I., 8 H.P. At 1800 R.P.M. as a HYDRAULIC MOTOR: Rated up to 12 H.P., up to 2400 R.P.M. Standard 3/4" pipe thread ports, 3/4" shaft with keyway. Dimensions: 14 1/2" x 8" x 7". Weight 63 lbs. Regular price today \$212.00. Our money saving price **F.O.B. Chicago, ea. .... 59.50 2 for 110.00**

Item #150—Double acting hydraulic cylinder, 2 3/8" bore, 12" stroke. Use either foot or clevis mounting. Will lift 4400 lbs. using 1000 P.S.I. Overall length 19 1/2". Shpg. wt. 8 lbs. Postpaid..... **18.00**

**QUICK DISCONNECT HYDRAULIC HOSE COUPLER** — Item #309 — Self sealing, for uncoupling oil lines under pressure. Made by the Brunning Company. Each end threaded for 1/2" pipe connection. Rugged three piece precision steel construction. 4" long, 1 1/2" dia. Ship. Wt. 2 lbs. Regular price \$12.50. Special price **Each — Postpaid..... 5.75**

## HYDRAULIC SPEED REDUCER



Item #115 — hydraulic motor. Adjustable relief valves set at factory for 100 inch pounds of torque may be reset up to 180 inch pounds. Independent reverse control allows full output power and speed selection in either direction of rotation. Shafts measure 5/8" diam., include keyway. Input rotation is counter-clockwise facing shaft. Recommended input speed not to exceed 750 R.P.M. Over-all dimensions, 7 1/2" x 7 1/2" x 11 1/2". Gov't acquisition cost \$428.00. Shpg. wt. 31 lbs. Complete with 2 qts. of oil and full instructions. **F.O.B. Chicago..... 54.50**

**WITH FINGERTIP CONTROL**

**USE FOR:** • Reamer Drives • Midget Cars • Feed Mills • Canning Machines • Conveyors • Lathes • Milling Machines • Motor Boats • Cream Separators • Garden Tractors • Pumps

Variable output speeds from 0 to input speed available by moving control handle. Locking handle maintains setting. Use input power of 1/4 to 1 1/2 H.P. This Westinghouse-Oil Gear Unit consists of a variable displacement hydraulic pump feeding a fixed displacement hydraulic motor. Adjustable relief valves set at factory for 100 inch pounds of torque may be reset up to 180 inch pounds. Independent reverse control allows full output power and speed selection in either direction of rotation. Shafts measure 5/8" diam., include keyway. Input rotation is counter-clockwise facing shaft. Recommended input speed not to exceed 750 R.P.M. Over-all dimensions, 7 1/2" x 7 1/2" x 11 1/2". Gov't acquisition cost \$428.00. Shpg. wt. 31 lbs. Complete with 2 qts. of oil and full instructions. **F.O.B. Chicago..... 54.50**

Item #126—Four-way, open center control valve with built-in adjustable relief valve. Factory set at 1000 P.S.I., spring loaded neutral position, for use with one double acting cylinder. In neutral position cylinder is locked and pump unloaded. Fully balanced plunger type, smooth, positive, easy operation. Can be used as single unit or mounted in series of any combinations desired. Has 3/4" pipe thread inlet and outlet, 1/2" pipe thread cylinder ports. Newly manufactured to our specifications. Ship. wt. 8 1/4 lbs. An outstanding **ITEM #126 21.50** buy! **F.O.B. Chicago**

Item #1036—Double acting hydraulic cylinder, 3" bore, 36" stroke, 1/2" pipe thread ports, 1 1/4" solid steel shaft. Overall length closed 49", clevis mounting at base and shaft. **FEATURES** • Cup & Chevron Packing • All Welded Construction • Precision Ground and Honed Construction • Will lift 7000 lbs. using 1000 P.S.I. line pressure. Wt. (net) 57 1/2 lbs. **F.O.B. Chicago..... 50.00**

Item #16C—Double acting hydraulic cylinder, 1 1/2" bore, 26" stroke. Will lift 1760 lbs. with 1000 P.S.I. line pressure. Weight 8 lbs. A \$55.00 value. Now only **Postpaid..... 16.95**

## CENTRIFUGAL PUMP

**General Motors — Allison 200 GALLONS PER MINUTE**

For Draining Basements • Fire Fighting Irrigation • Fuel Transfer Swimming Pools • Home Water Systems • Dewatering

For high volume commercial, home and industrial use. Standard 2 1/2" pipe thread inlet, twin 1 1/4" pipe thread outlets. Ball bearing supported 3/4" shaft. Easy priming. Rotation, counter-clockwise facing shaft. Gov't. acq. cost \$145.00. Complete with full instructions. Ship. wt. 35 lbs. **39.50**

Will deliver 200 gals. per min. against 65 foot head using 5.2 H.P. at 3500 R.P.M.

ITEM #130



## EXTRA HEAVY DUTY Double Action HYDRAULIC CYLINDER

Item #224. 3 1/2" bore, 24" stroke, will lift 8250 lbs. with 1000 P.S.I. line pressure. 1 1/4" pipe thread ports—1 3/4" stress-proof ground, polished & plated solid steel shaft. Overall length closed 36". 1 1/4" steel wall cylinder barrel clevis mounting at base and shaft. Features — Tie Rod construction. Honed barrel. Ship. wt. 50 lbs. **F.O.B. Chicago. 39.60**

## ROSS 4-WAY FOOT OPERATED AIR VALVE

**BRAND NEW—Item #60—**For double-acting pneumatic devices. Fine for operating presses, air vises, air machinery of many types. Heavy duty cast construction. No neutral position. Maintains pressure against the piston when the foot control is in the "Up" position. Threaded for 1/2" pipe. Dimensions of valve body: 7 3/4" long x 4 1/4" width x 7 1/2" high. Net weight 28 lbs. A \$84.00 value for only **19.50** **F.O.B. CHICAGO**



## NEW AIR FORCE SURPLUS — SHATTERPROOF AIR TANK

Item #303 — Use for air compressors, surge tanks, CO-2 tanks, liquid containers, floats, buoys. 2 1/4" long — 4" diameter — 1 1/2" pipe thread port. Ship. Wt. 10 lbs. **F.O.B. Chicago..... 2.50**

**TO PLACE PHONE ORDERS CALL WEBSTER 9-3793**

**ORDER DIRECT FROM AD — SEND PAYMENT OR PURCHASE ORDER TODAY — SATISFACTION GUARANTEED**

**GROBAN SUPPLY CO. 1139 SO. WABASH AVE., CHICAGO 5, ILL. DEPT P.M.10**

# YOUR **P & C** WRENCH

**TIGHTENS PIPE  
WITH SPEED  
AND EASE**

You stop that drip quick with a P & C pipe wrench. Tough, special analysis steel lets you really cinch up on them. Sharp, hardened jaws take a real bite and prevent slipping. Every P & C Tool is fully guaranteed and is "the BEST tool money can buy"



Buy your P & C Tools from this handy display.

Send 10c today for P & C's complete catalog. All info on over 300 tools.

**P & C HAND FORGED  
TOOL COMPANY**

Dept. H-1053, Box 5926  
Portland 22, Oregon

# WOODS

## Get This BIG Manual And Bargain Book

Loaded with how-to-do it articles on wood-finishing, veneering, making inlay pictures and cabinets. Contains 83 distinct inlay designs and borders, plus a wood identification panel of 60 different varieties. All shown in full natural color suitable for framing.



### A MULTITUDE OF MATERIALS

**Lowest Prices On**  
Veneers Period Furniture Hardware  
Inlays Modern Picture Frame Molding  
Lumber Upholstery  
Plywood Hand and Electric Tools  
Plans Finishing Materials  
Supplies Decorative Metals  
Plastics Leather

Albert Constantine & Son, Inc.  
Dept. PM-17, 797 E. 135th St., N.Y. 54

● VISIT US at our N.Y. Plant. Demonstrations every Saturday on making inlay pictures, wood finishing and other crafts. Everyone invited.

## SEND THIS COUPON!

Albert Constantine & Son, Inc., Dept. PM-17  
797 E. 135th St., New York 54, N.Y.

Enclosed find 50c (refunded on 1st order) for your copy of "Manual For Craftsmen" No. 52.

Name \_\_\_\_\_

Address \_\_\_\_\_

City \_\_\_\_\_ State \_\_\_\_\_

boost your income with the

# IDEAL LAWMOWER SHARPENER

You can earn extra cash with the Model 300 Ideal Lawnmower Sharpener. Used and recommended by leading manufacturers and service shops, the Ideal has everything you need, nothing else to buy. Grinds reel and bed knife, also reconditions. Get started now in this highly profitable business. Write for catalog today.

**The Fate-Root-Heath Co.**  
Dept. PM-10, Plymouth, Ohio

## BRONZE FOUNDRY

Schools and Home Workshops

Make your own castings of aluminum, copper, bronze, silver. Foundry sets are available in three sizes including 2400 Deg. F. blast Furnaces. \$22.50; \$29.50; and \$42.00. f.o.b. Kansas City. Free Circular.

**KANSAS CITY SPECIALTIES CO.** P. O. Box 6022, Dept. P-10  
KANSAS CITY, MO.

## Treasure - Minerals - COINS

Easily located with new Light-weight M-Scope Detector. Superior performance, lowest price, monthly payment plan.

FREE LITERATURE  
**FISHER RESEARCH LAB., INC.**  
PALO ALTO CALIF.

## LAWN ORNAMENT-NOVELTY PATTERNS

28 Lawn Ornament Patterns, 25c. Other Patterns: 15-20" high; Dutch Girl, Dutch Boy, Pirate, Bull Terrier, Mexican Girl, Mexican Boy, Dwarf, Penguin, Flower Girl, 15c each. 25 Novelty Patterns, 30c. All 62 Full Size Patterns, \$1.00.

Strother Pattern Service, Dept. DM-8, Box 128, Belington, W. Va.

## WORLD'S BEST SMALL TRENCHERS

Portable DITCH-WITCH digs 2" to 6" clean, even ditches to 36" depth in all types of soil. Complete unit—self propelled—outdigs 8 men. Four rugged models. Write for illustrated literature.

**THE CHARLES MACHINE WORKS**  
620 B Street Perry, Oklahoma

Say You Saw It in Popular Mechanics

## TINT YOUR WINDSHIELD

Give Your Car the New Expensive Look



**ONLY \$2.50**  
BIG 5 OZ. CAN  
More Than Enough  
for Your Car

**SPRAY ON FAST  
AND EASY**

**Send No Money!** Just send name, address. Pay postman only \$2.50, plus usual C.O.D. charges... or send \$2.50 with order and we pay postage for you. Satisfaction guaranteed or money back.

Amazing new invention! Now you can give your car that \$80-look of the smart new tinted windshields you see on new autos... at a tiny cost! Just spray on Tint-Shield. Eliminates blinding sun and headlight glare. Washable, will not peel... stays on smooth and clear for years... Rush your order today.

**TINT SHIELD** 210 WEST MADISON STREET  
DEPT. PM-10, CHICAGO 4, ILL.



## You Can Make DRAIN TILE

and Build a Profitable Community Enterprise

Farm drainage, home building, reclamation projects, highway construction. From these and other sources come the biggest demand for drain tile in history. More local plants are urgently needed.

Millions of dollars' worth of drain tile are used annually. Much of it, ordinarily, is shipped from far distant points. Local manufacturing is economical, logical, profitable. The Champion Drain Tile Machine makes manufacturing easy. Pares production costs. Requires no skilled labor. Makes all sizes from 3" to 12". Yet requires only a moderate investment.

### Outstanding Manufacturing Opportunity

Champion-made cement tile are dense, strong, and truly round. No distortion, no shaling. Worth more than clay tile, but can be sold for less — and still leave a handsome profit margin.

Write for the Drain Tile Book. Tells about cement tile as a local manufacturing enterprise. Tells about easy-payment terms. Write today.

**Concrete Equipment Company**  
522 Ottawa Ave., Holland, Michigan



E2

## RICH carburetor ROBS MOTORIST



Car owners who are wasting money, getting poor mileage due to over-rich mixtures, will be pleased to learn how to save gasoline by **VACU-MATING OVER-RICH MIXTURES**. Vacu-Matic fits all cars, trucks and tractors. Automatic and operates on the supercharge principle. Easily installed in a few minutes. **SALESMEN WANTED! Big Profits**

For FREE particulars, how you can install one on your own car for introducing, just send your name and address on a postcard to **VACU-MATIC, 7617-10 W. State St., WAUWATOSA, WIS.**

## BATTERIES! — START

— a factory at home and re-cast junk batteries into new; latest achievement. We supply complete instructions and everything needed. Large daily profits!

BATTERY LABORATORIES, Dept. PM, Minneapolis 4, Minn.



## ONE-MAN SAWMILL LOW \$50.00 AS... DOWN



Take BELSAW Portable Sawmill right to the trees — turn out valuable lumber for home and farm — sell to local yards — make up to \$50 a day custom sawing for neighbors. BELSAW lasts a lifetime. No crew needed. Power with tractor or auto engine. Beginners get excellent results. Send today for FREE BOOK, "HOW TO MAKE LUMBER".

**BELSAW MACHINERY CO.**  
8118 Field Bldg. Kansas City 11, Missouri

## Small-Tough-

Just right for carrying or storing — it's palm size! Made of heavy gauge metal. Switch glows in the dark. Uses 2 standard 1 1/4" batteries. See \$1.89 less bats. your dealer . . . .

DELTA ELECTRIC CO., Marion, Ind.

**Bright!**



**Delta BUDDY** LITTLE ELECTRIC LANTERN

## NEW ELECTRICAL TROUBLE SHOOTER!

Mechanic's Net Price, at your electrical or refrigeration wholesaler.

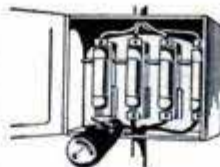
**\$19.85** including voltage test leads



**AMPROBE**

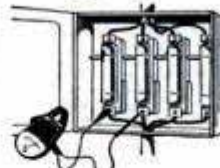
*Junior*  
VOLT-AMP TESTER ®

**ONE POCKET TESTER DOES THE COMPLETE JOB**



### IT'S A SNAP-ROUND AMMETER

Measures current instantly without shutdowns or ammeter connections. Just snap the trigger-operated jaws around one conductor (insulated or un-insulated) and you have your reading.



### IT'S A VOLTAGE METER

To measure voltage, simply plug the test leads into instrument and clip to load. You get an accurate voltage reading on a full-size calibrated scale without doubt or guesswork.

Combines tester ruggedness with instrument accuracy.

### YOU PICK THE RANGE THAT FITS YOUR JOB:

|             |               |                    |
|-------------|---------------|--------------------|
| MODEL "10"  | 0-10 AMPS AC  | 0-150/600 VOLTS AC |
| MODEL "25"  | 0-25 AMPS AC  | 0-150/600 VOLTS AC |
| MODEL "50"  | 0-50 AMPS AC  | 0-150/600 VOLTS AC |
| MODEL "100" | 0-100 AMPS AC | 0-150/600 VOLTS AC |

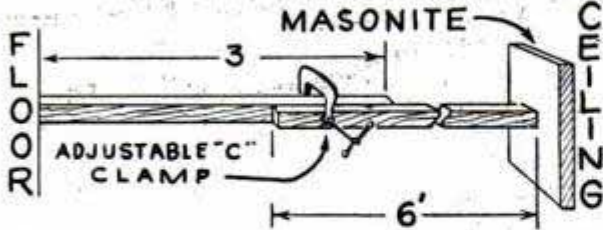
With the Amprobe Junior, you can diagnose service calls faster under actual load, check line voltage, determine if wiring is adequate, balance loads, locate grounds, trace shorts, check motor overloads, etc. Ask your wholesaler for a demonstration. For descriptive literature, write to **PYRAMID INSTRUMENT CORPORATION, Dept. PM 103, Lynbrook, N. Y. (Export Div.: 458 Broadway, N. Y. 13. Cable: Morhanex).**

# How To . . .

## BY MASTER

Two new "How To" ideas, short cuts to speedy, efficient woodworking and carpentry. For literature on the complete Master line of fine rules, write to: Master Rule Co., Mulberry Street, Middletown, N. Y.

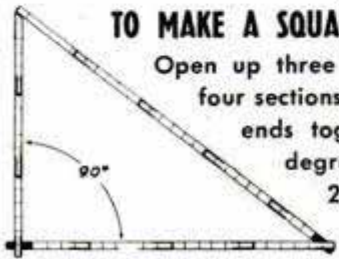
### HOW TO INSTALL CEILING SHEETS, SINGLEHANDED



Joseph F. Boardman of 2 Linsay Estate, Unanderra N.S.W., Australia, gets a "Tufboy" for this one.

### TO MAKE A SQUARE, USING A FOLDING RULE

Open up three sections (as indicated.) Then four sections. Then five sections. Butt open ends together. Point indicated is 90 degree angle. Raymond Stevenson, 21 W. Ohio St., Sharon, Pa., gets an X-6 for this one.



Nothing's Too Complicated for the

## STREAMLINE

. . . by Master



Called by users: "The Rule That Sees in the Dark." You will be using the world's most versatile steel tape when you use the Streamline by Master. It has more exclusive advantages than any other steel tape rule made today. Count them. 1. Rule graduated on both edges. 2. Comfortable pistol grip case design. 3. Blade printed on both sides. Top side for regular, one reading inside-outside measurements, reverse side for bench work. Lever-lock holds any measurement. Extra long tip makes for extra utility. Available in 6, 8 and 10 ft. lengths, in white "Brite Blade" or satin finish.

TIME AND WORK SAVERS: Each month we will print the best in home workshop short cuts. Why not make a card index of them for handy reference?

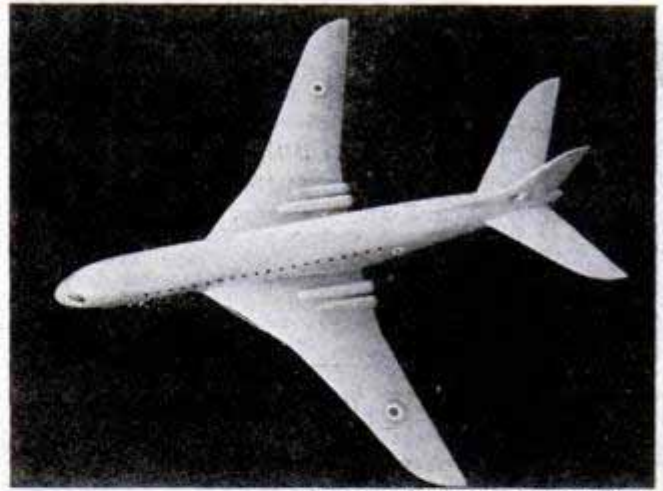
WIN A MASTER RULE! If you have a short cut which you feel is worthwhile, send it to us. If we use it in one of our "How To" series, you get a bonus, your choice of any wood rule or steel tape in the Master line. All entries become the property of the Master Rule Co., and will not be returned.

MASTER RULE CO., Mulberry Street, Middletown, N. Y.

Please send literature . I am enclosing a "HOW TO" item . If you use it, please send me a \_\_\_\_\_ rule.

NAME \_\_\_\_\_

ADDRESS \_\_\_\_\_



British Information Services photo

### Fuel-Saving Jet Engines For Trans-Atlantic Transport

Four bypass jet engines will power Britain's new Vickers 1000 military transport. Planned for long flights at high subsonic speeds, it will be 146 feet long and have a 140-foot wingspan. In a bypass engine only part of the air intake is heated; the remainder goes around the combustion system and turbine to rejoin the heated gases in the jet pipe. This lowers the temperature of the mixture before it is ejected at a lower velocity than in a simple jet engine, making possible fuel savings of as much as 30 percent. A 150-seat civilian version of the plane is also planned.

### Meter Shows Photographer How to Take Portraits

Portraits can be taken by the amateur with almost any camera when he uses a handy meter. The meter is keyed to a series of portraits printed in the instruction book. The photographer simply selects the type of portrait he wants to take and instructions below the portrait give him shutter and lens settings, number and location of lights. Built into the meter is a telescoping rule and scales to show proper placement of lights.





# give your hair that "JUST-COMBED" LOOK all day long

Only 'Vaseline' Cream Hair Tonic has it! Viratol—\*the special compound that makes hair look natural, feel natural . . . stay in place for hours.

Try this wonder-working hair tonic today. You'll be amazed how long that natural, fresh-combed look lasts and lasts.

'Vaseline' Cream Hair Tonic contains Triple-A Lanolin, too . . . and it's homogenized for easy flow.



## Vaseline CREAM HAIR TONIC

TRADE MARK ®

VASELINE is the registered trade mark of the Chesebrough Mfg. Company, Cons'd



### Custom-Craft THE ORIGINAL "PACKAGED" BOAT KITS

SEND 25c for BIG CUSTOM-CRAFT CATALOG. See the world's finest, most complete line before you decide. Rated tops in design, styling and performance by the experts! Save over 20%! 27 New models! Easy to assemble! Mahogany parts, brass screws. \$45 up! Catalog plus booklet "Boat Selection, Operation & Maintenance" \$1.00 (Refunded on purchase). DEALERS INQUIRE!

#### BOAT PLANS AND FULL-SIZE: PATTERNS

Over 100 Modern plans and full size patterns. Racing classes, cruisers, inboards, outboards, sail boats. By famous designers. 6' to 30'. DESIGN CATALOG only 35¢. For Design Catalog plus boat building handbook send \$1.00.

CUSTOM-CRAFT (DEPT. A) BUFFALO 7, N. Y.



Ludlow Electric Paint Remover.

### Glo-Torch

#### WILL END YOUR PAINT-REMOVING TROUBLES

Strip off thick coats of paint fast, safely, from houses, furniture, boats. Glo-Torch metal sheathed heating unit gives blowtorch heat without hazards . . . saves time, labor. See your paint or hardware dealer now!

**LUDLOW PRODUCTS CORPORATION**  
1416 Broadway Schenectady 6, N. Y.

**\$10<sup>95</sup>**

OCTOBER 1953

**FREE** 24-page booklet  
shows how to weather-strip  
your home effectively!



Seal Up Drafts, Keep Fuel Costs Low!

with

*Bridgeport*  
**INNER-SEAL**  
*Live Rubber*

**WEATHER STRIPPING**



Effective weather-stripping means lower fuel bills, greater comfort! Use flexible, tight-sealing, INNER-SEAL to draft-proof your home! New illustrated booklet shows you how. INNER-SEAL's exclusive patented construction—spring steel molded in live sponge rubber—makes a pressure-tight seal that keeps heat IN, cold OUT. Tough neoprene coat makes INNER-SEAL water-proof, abrasive-resistant, durable. INNER-SEAL is adjustable, easy to install, fits perfectly even on doors and windows that are warped and worn. Has many extra uses for the handyman.

Get your FREE copy of the new 24-page booklet "Why & How to Weather-Strip" today. Available where you buy your hardware or building supplies.

Or, write direct to Dept. PM 10

**BRIDGEPORT FABRICS, INC., BRIDGEPORT 1, CONN.**

**BUILD IT**

**FIX IT**

with  
**AMBROID**



- Ready-to-use
  - Fast drying
  - High tensile strength
  - Transparent
  - Waterproof
- IT STAYS STUCK**

Dries entirely by evaporation of the solvent. Quick setting—no distortion. Ideal for assembling, repairing, home crafts, electrical work, factory, workshop or household use. Send postcard for free literature.



Try Ambroid in your business, too. For over 40 years recognized as the leading industrial adhesive of its type.

Art galleries, museums, and leading industrial concerns, rely on AMBROID

**TRY A TUBE TODAY**—At most hardware stores and hobby shops. If your dealer cannot supply you, send 30c for big 2 oz. tube, postpaid. Money back guarantee.

**AMBROID** 303 FRANKLIN ST. BOSTON 10, MASS.

**REPLACE YOUR OLD WORN OUT CHUCK WITH A**



- ENTIRE CHUCK BODY HARDENED
- JAWS NICKEL CHROME MOLY ALLOY STEEL
- INDIVIDUALLY TESTED FOR ACCURACY
- STURDY ONE PIECE CONSTRUCTION

**SOLD BY HARDWARE DEALERS**

**SUPREME PRODUCTS, INC.**, 2222 S. Calumet Ave. Chicago 16, Illinois  
The chuck that lives up to its name... SUPREME

**PUMP WATER FAST!**



DRAIN WASH TUBS, CELLARS, CISTERNS: Famous #7 pumps 2800 GPH. 420 GPH at 75' high or 1600 GPH from 25' well. Sturdy, rustproof Alloy Metal. Six Blade impeller. Uses any 1/8 to 1/2 H.P. Motor. Will not leak or clog. Fits any garden hose. Immediate money back guarantee. **\$8.95** IN U.S.

IRRIGATE, FILL TANKS, DRAW WELL WATER. Heavy duty #8. Pumps 7000 GPH. 1000 GPH 75' high—3000 GPH from 25' well. Rustproof Alloy Metal. 8 blade impeller. 1" inlet—1" outlet. Standard **\$11.95** IN U.S. Pipe Threaded ...

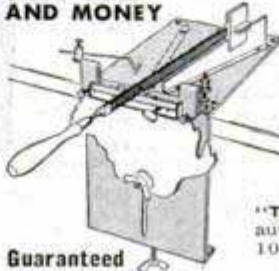
#7 or #8 pump mounted on base with Westinghouse 1/4 H.P. Motor. Portable unit can be readily moved. Pumps maximum figures listed. Immediate money back guarantee. With #7 pump **\$29.95**. With #8 Pump **\$32.95**

ALSO GEAR PUMPS—DEEP AND SHALLOW WELL PUMPS

**MOORE MANUFACTURING CO.** SWEDSBORO 1 NEW JERSEY

**JOINT AND SHARPEN ALL SAWS**

**SAVE TIME AND MONEY**



Sensational new Super Filer joints and sharpens—both hand and circular saws 6" to 10" with all teeth the correct height, depth, pitch and bevel. Easy to use—when file hits hardened steel roller, teeth are finished. Saw runs true and smooth with no side pull. Complete with special 8" file **\$9.95 ppd. FREE FOLDER.**

Hand Saw Jointer and Filer, separate **\$2.95 ppd.**

"TRU-CIRCLE" saw set automatically sets teeth at 10° or more **\$2.95.**

Guaranteed

A. D. McBURNEY, 5908 Hollywood Blvd., Hollywood 28, Calif., Dept. A-34

**6 GREAT SHAW "DU-ALL"**

- Plow
- Plant Cultivator
- Mow
- Rake
- Cut Trees
- Saw Wood

**SHAW Mfg. Co.** 4510 Front St., Galesburg, Ks. 668-G N. 4th St., Columbus, O.

Walking or Riding Tractors 1 1/2, 3, 5 H.P. walking models. 5, 8, 12 H.P. riding tractors. Get just the power you need in Shaw extra strength superior traction machines. All wanted tools, attachments. Dependable for nearly 50 years. See a Shaw dealer. Write for **FREE literature**, low prices—today.

**VARIABLE SPEED HYDRAULIC POWER TRANSMISSION**



It has Infinite Speeds 0 to 550. Reverse. Automatic Overload Protection. Adjustable Torque up to 180 inch pounds. 3/8" Input and Output Shafts. It will handle 1/2 to 1 1/2 H.P. Motor. Case measures 7 1/2" long, 7" high 6 1/2" wide. **VALUE OVER \$300.** Shipping Wt. **\$54.50** 25¢. On C.O.D. Orders we require a 10% only Fob. Chicago Deposit.

DIRZIUS MACHINE SHOP "G" 1423-25 So. 52nd Ave., Cicero 50, Ill.

Say You Saw It in Popular Mechanics

**MODEL MAKERS! GADGETEERS! SAVE MONEY!**

**MINIATURE ELECTRIC MOTORS.** Run on 1 1/2 to 6 volt battery. Weight only 2 oz.; speed 2000 to 10,000 RPM. Bronze bearings. 3/32" shaft. BRAND NEW, with instructions. **POSTPAID \$1.75 ea.**

**6 VOLT MINIATURE WET BATTERIES.** The famous NT-6 2.4AH 6 volt battery. A standard for model control, etc. Plastic case; only 3 3/8" long, 1-13/46" wide, 2 3/8" high. Uses standard electrolyte. Ship. wt. 2 lbs. **NEW \$2.45**, or 4 for **\$8.75**

**TELEPHONE DIALS.** Standard 10-holders, complete mechanism. For radio controls, etc. Ship. wt. 1 lb. **EXC. USED... \$3.75 ea.**

**800:1 OIL SEALED GEAR MOVEMENTS.** 3 1/2" dia., 3 1/2" high, complete with frame. Easy to mount. Use flea power to generate powerful torque. Ship. wt. 1 lb. **NEW \$1.45 ea.**

**2 RPM TIMER MOTORS.** Oil sealed movement, 1 1/2" shaft. Run on 12 V 60 cy AC, 1/2 amp. Has very powerful torque. Only 2 1/4" x 2 1/4" x 2 1/4". Ship. wt. 1 lb. **NEW 89c ea.**

**SUPER SPECIAL:** Six of these motors plus 110 V 60 cy AC transformer to run all six at once. Ship. wt. 9 lbs. **\$5.95**

**THROAT MIKES.** Each contains 2 carbon buttons. Use for intercoms, vibration pick-up, etc. **POSTPAID 29c** or 4 for **\$1.00**

Order direct from this ad. All FOB except **POSTPAID** items. No C.O.D.'s, please! Calif. Buyers include 3% sales tax.

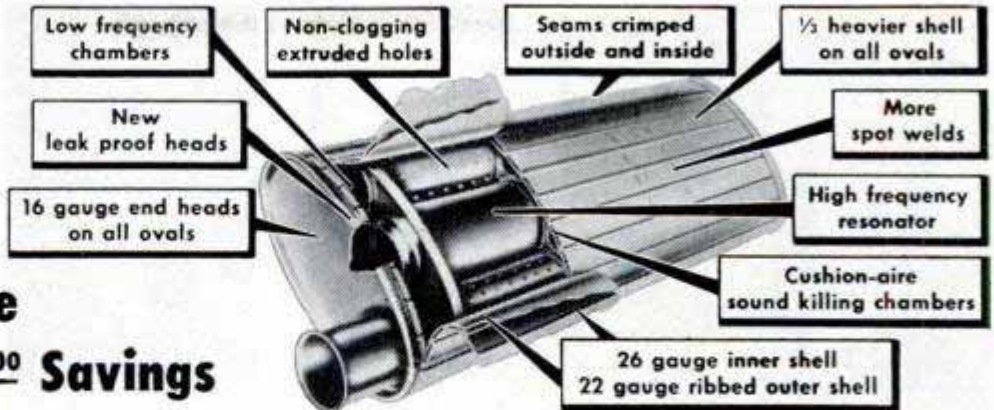
**G.L. ELECTRONICS, Dept. ME-9**

905 South Vermont Ave. Los Angeles 6, Calif.

# All Mufflers are NOT Alike

**SILENTONE**  
gives you

- ★ Safety
- ★ Power
- ★ Long Life
- ★ Up to \$8<sup>00</sup> Savings



These features show why Silentones are the highest quality mufflers. They're made to car factory specifications or better • scientifically designed to lower back pressure which robs your engine of

power • made of heavy steel inside and out. Because Silentone Mufflers are sold only through leading automotive chain stores, you save as much as \$5.00—up to \$8.00 if you install it yourself.

## DYNATONE

### The Deep, Mellow Tone Muffler That's Engineered—Not Packed

Tuned for each make of car . . . costs less than "Hollywoods" • lower back pressure • more gas mileage • longer life. Ask about Dynatone duals for greater power and gas savings.

Write Dept. 27-J for name of your nearest Silentone dealer

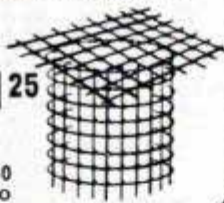
## SILENTONE

SOLD ONLY BY AMERICA'S LEADING AUTOMOTIVE CHAIN STORES • TOLEDO 1, OHIO

FREE YOUR DRAIN PIPES SO WATER WILL FLOW DOWN  
**Save Money! Avoid Repair Bills!**

INSTALL GOODMARK "DOWN SPOUT GARDS" NOW . . .

Keep leaves and debris from clogging roof drains! "DOWN SPOUT GARDS" will do it! Rustproof wire mesh—shape and insert at each opening. Complete instructions included. Fully guaranteed. Order NOW!



Set of 4 for \$1.25

**GOODMARK inc.** postpaid at once  
Dept. E-40  
21 E. 2nd ST. DAYTON 1, OHIO

Say You Saw It in Popular Mechanics

**HOW MANY TOOLS DOES A HANDYMAN NEED?**

HERE'S A WHOLE TOOL KIT IN ONE TOOL!



No. 10-W  
\$2.60

**WISE-GRIP WRENCH**

You need fewer tools, get far more done, when you use a Vise-Grip Wrench! Locks to any size work with Ton-Grip. Won't slip! Turns, twists, pulls, bends, holds, ratchets, cuts. A Super-Pliers, Locking Wrench, Toggle Press, and many more—in 1 trim tool! 7" and 10", only \$1.85 to \$2.60, at your dealer.

Manufactured Only By

**PETERSEN MFG. CO., Dept. M-10, DeWitt, Nebr.**

OCTOBER 1953

**BUILD YOUR OWN GARAGE DOOR...**

**SAVE MONEY!**

WORK FROM A PAPER PATTERN — STEP-BY-STEP DIRECTIONS



With Easi-Bild® Build It Yourself Pattern No. 86 you can have a garage door with Stanley Swing-Up Hardware — for less than 1/2 present cost! Pattern tells what materials to buy, where and when each is used. No special tools or skill required. Install the Stanley Garage Door Set with hand tools.

You'll be amazed at how easily and economically you can build a professional looking door by following the step-by-step procedure outlined in this pattern. Ask your dealer for Simplified Directions for installing Stanley Garage Door Hardware, and Easi-Bild Pattern — or send coupon below.

\*Trade Mark Reg. U. S. Pat. Off — Easi-Bild Pattern Co.

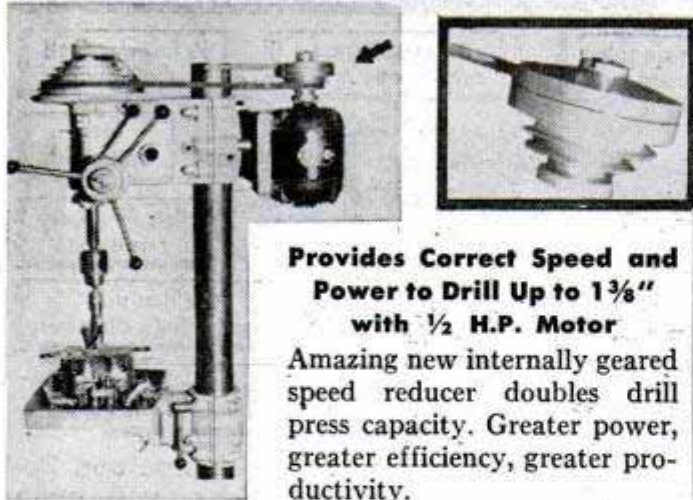
**EASI-BILD PATTERN CO., Dept. S-4, Pleasantville, N. Y.**

Enclosed is 50c in Coin, Money Order, Check for Single and Double Garage Door Pattern No. 86.

Please send Simplified Directions for installing  
 Single  Double Garage Door Hardware

Name.....  
Address.....  
City..... State.....

## New "PULL-GEAR" SPEED-REDUCING PULLEY



**Provides Correct Speed and Power to Drill Up to 1 3/8" with 1/2 H.P. Motor**

Amazing new internally geared speed reducer doubles drill press capacity. Greater power, greater efficiency, greater productivity.

Provides the correct speed and power for larger drilling, reaming, tapping and boring on light presses. Easily installed in five minutes. Adaptable to all type machines. Spindle speed range approx. 45 to 3000 RPM. Made in 3 motor shaft sizes: 1/2" - 5/8" - 3/4". Write for literature.

WRITE FOR LITERATURE

**THE PULL-GEAR CO.**

4120 E. 8-Mile Rd.  
Detroit 34, Mich.

## BUILD YOUR OWN POWER TOOLS - TILT/ARBOR SAW

### Exclusive GIL-BILT Build-It-Yourself Features

- No machining—build easily with hand tools only
- No blueprint reading—step-by-step pictorial plans, full scale patterns, actual photographs
- Sturdy wood, aluminum and steel construction
- Capacity and performance of commercial saws selling for \$60 and up
- Proved performance. Nationally advertised and sold for 6 years. Satisfied customers around the world.

**BANDSAW  
BELT SANDER  
SAVE \$50.  
OR MORE**

### GIL-BILT 10-INCH TILTING ARBOR SAW



- 27x28 in. table, 13 1/2 in. capacity in front of blade
- 10 in. blade cuts 3 1/4 in. deep, tilts full 45 degrees
- Floor model 34" high, table always stays level

- New Departure ball bearing arbor, 3/4" precision shaft turned down for 5/8" bore blades, alum. housing, shipped ready to run
- Jackscrew and 4 1/2 in. dia. handwheel lowers and raises blade
- Cast aluminum miter gauge and self-aligning rip fence guide

GIL-BILT Metal Parts Kit includes Plans, ball bearing arbor, miter gauge and bar, rip fence guide, dado insert, lock knobs, jackscrew mechanism and handwheel, and all other metal parts (less blade).....\$22.95  
Same Kit with 10" Combination Blade \$25.90  
Same Kit with 8" Combination Blade \$24.90

### GIL-BILT 12-INCH BAND SAW



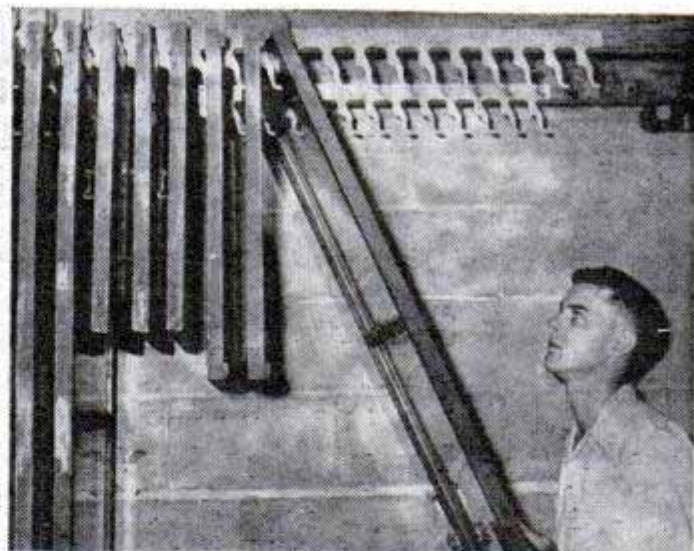
- Cuts to center of 24 inch circle
  - Handles stock up to 6 inches thick
  - 18x18 inch table tilts 45 degrees
  - Lower wheel and drive pulley runs on sealed New Departure Ball Bearings: Upper wheel runs on two 5/8" bore Oilite Bronze bearings.
  - Upper wheel tension and tilt mechanism of cast aluminum, completely assembled.
  - Upper and lower blade guides. Each has ball thrust bearing, self-lub bronze jaws.
  - Rigid cast aluminum wheels fully machined ready-to-install. Heavy rubber tires.
  - Uses standard 78 inch blades up to 3/8 in. wide.
  - Fully enclosed mechanism for utmost safety.
- GIL-BILT Metal Parts Kit includes Plans, rubber tires, aluminum wheels, 1/4 in. blade, ball bearing spindle-tilt mechanism, blade guides, table tilt segments, and all other metal parts.....\$23.95

Return Kits in 10 days for refund if not satisfied.

For shipment up to 600 miles, add 5%; over 600 add 10%. Amount in excess of actual postage will be refunded.

Also available—Plans and Parts Kit for 18" Band Saw, Belt Sander and 8" Tilt/Table Saw. Order Plans at \$1.00 each—sent postpaid anywhere in the world or write for FREE descriptive catalog.

**GILLIOM POWER TOOLS** P. O. Box 1-PK, Lambert Field St. Louis 21, Missouri



**STOR-A-WAY** A tidy way to store and protect your storms and screens! Stor-A-Way safely holds large or small standard wood sashes, from 7/8" to 1-3/16" thick. Keeps them off damp floors, prevents rotting and warping. Reduces glass breakage. Saves space. Easy to nail to joists or rafters. Made of heavy gauge aluminum. No. P.S. 820 holds 20 windows . . . \$3.95, postpaid. No. P.S. 820A holds 6 windows . . . \$1.49, postpaid. Send for free catalog. The Burgess House, 428 So. 6th St., Minneapolis 15, Minnesota.

## Clark EXPANSIVE BIT



**CUTS BETTER • COSTS LESS!**

Accurate, fast; cuts smooth holes in hard or soft wood. Chrome vanadium steel blades, all chrome body. No. 250, 1/2"-1 1/2", \$1.89; No. 251, 3/4"-3", \$2.19. **GUARANTEED.** At your dealer or write Dept. PM10

**ROBERT H. CLARK COMPANY • Beverly Hills, California**

## STOP RADIO & TV NOISES INSTANTLY!

**NEW ELECTRONIC DESIGN**

Bell-Tronic line filter eliminates noisy interference caused by motor appliances, autos, oil burners, etc. Simply plug radio or TV cord into filter and filter into wall socket. Enjoy Bell Clear reception. Send \$1 ppd. No C.O.D. Try 5 days. Money back guarantee.

**\$100 PPD.**



**TUBE WHOLESALERS CO.**  
Box 364, Dept. PM1, Rockville Centre, N. Y.

## INSTALL YOUR OWN ELECTRIC GARAGE DOOR OPERATOR

ORDER DIRECT AT FACTORY PRICE — SELLS REGULARLY AT \$169.

Complete with remote control. Sold on money back guarantee. Simple installation instructions included. Write for details. No obligation.

**VERDIER BROS. INC.**

310 E. RUSSELL RD.  
SIDNEY, OHIO



**YOUR PRICE \$115.00**

## INVISIBLE MENDING KIT FOR PLASTIC

**LARGE DOUBLE SIZE \$1.00 ppd.**

FOR FURNITURE, INFLATED TOYS, RAIN-COATS, SEAT COVERS, WADING POOLS, CURTAINS, BABY PANTS, ETC.

At last—the perfect home repair kit for holes and tears in your Vinyl plastic furnishings. Invisible, permanent patch resists water, oil, heat—cuts to fit. All you need in one handy kit: 30"x1" mending material, 2 vials fusing fluid. Save by ordering today! No C.O.D.'s.



**MEND IN A MINUTE —  
USE IMMEDIATELY!**

**LOUVE RAY CORP.**  
17PM Lewis Wharf Boston, Mass.

# EVERY HANDYMAN NEEDS MOLLY

Molly Screw Anchors are a "must" for installing fixtures securely exactly where you want them — not where the studs are. Molly will hold where nails and screws won't — anywhere in any hollow wall construction. Mollys are neat, easy to use, inexpensive. And fixtures can be removed for cleaning and be replaced. Are they really good? More than 50 million have been installed without a complaint!



ASK YOUR HARDWARE DEALER  
Write for FREE Folder!

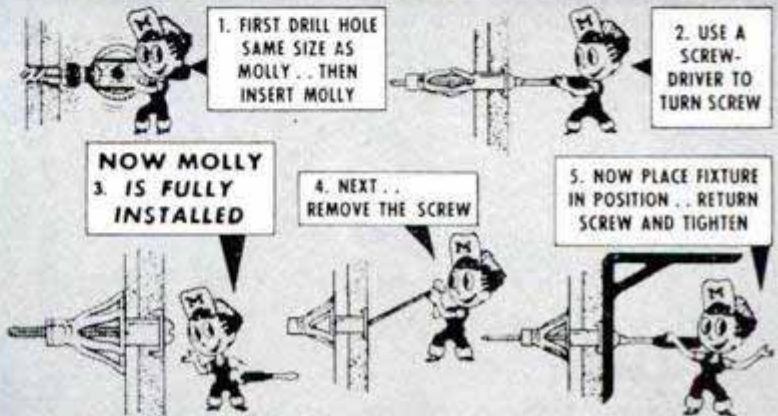


MOLLY CORPORATION • DEPT. J7 • READING, PA.

WHERE NAILS AND SCREWS  
WON'T HOLD -- MOLLY WILL!



EASY TO INSTALL • NO SPECIAL TOOLS NEEDED



## CASH IN YOUR SPARE TIME

UP TO \$40 A DAY IN YOUR OWN BUSINESS. Easy to start repeat cash business at home with the New BELSAW...sharpening and setting circular saws, grinding planer and jointer knives. Low Cost, only \$15 down...Start to work the day your BELSAW arrives. No experience needed. Hundreds of jobs in your neighborhood. Send Today for Free Book, "Lifetime Security".

BELSAW MACHINERY CO  
3705 Field Bldg., Kansas City 11, Mo.



FREE BOOK  
TELLS HOW

## HASTINGS STEEL-VENT PISTON RINGS

The best money you can spend on your car!

### BRAND NEW Power Tool Accessories

#### 20 ROTARY CUTTERS

\$15.00 Value \$5.25 Post Paid

3/8" to 3/4" dia. cutters, on 1/8" or 3/32" shanks. Will fit all hand grinders. Ideal for cutting wood, metal or plastic.



#### FLEXIBLE SHAFT — Only \$4.75



For use in all lathes, drill presses, electric drills, etc. For shop or home use, 40" long, made of the finest long lasting materials. Chuck capacity 1/2". 25 accessories included if you order now.

#### 6 H. S. S. Plastic Carving Drills

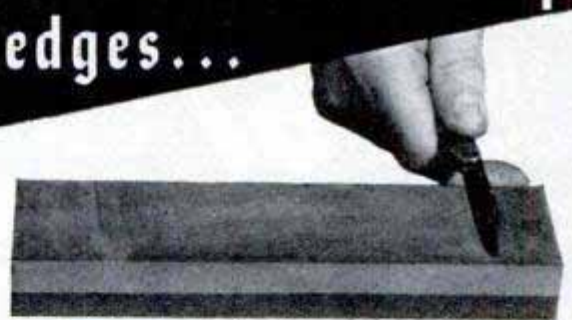


1 slow spiral, 1 fast spiral. In 1/16" — 3/32" and 1/8" diameters. Can be used in all types of electric grinders and drills. Order yours \$3.50 per set now for only.....

Catalog of 1000's of useful tools free. Dealers Wanted.

RICO SUPPLY CO. BOX 828, DEPT. PM1, SAGINAW, MICHIGAN

## For craftsman-sharp edges...



### NORTON INDIA BENCH STONE

It's easy to get a real keen edge on knives and workshop tools with this professional quality sharpening stone. Coarse aluminum oxide grit on one side, fine on the other. Pre-filled with oil for longer life. Order IB-8, \$2.45, at hardware stores or direct.

"How to Sharpen" makes sharpening easy for everyone. Send 10c to Behr-Manning Corp., Troy, N. Y., Dept. PM-10.



C-5



## BEHR-MANNING

division of NORTON Company

Coated Abrasives • Sharpening Stones • Masking Tapes

# Buy the Best...WISS!



for all sheet metal cutting

## WISS Metal Master Compound Action Snips

#M-3; Easily cuts 18 gauge sheet metal. Cuts curves and circles as well as straight. Ideal for the home workshop. \$4.25. Rubber grips recommended, 60¢ extra.

## WISS Straight Cut Snips

#9. Crucible steel inlaid blades. The basic snips for straight metal cutting. Gun metal handles. Overall length 12½". \$5.25.

## WISS Combination Snips

#V-13. Solid steel, with gray japanned handles. Cuts curves and irregular shapes with ease. Handy pocket size. 7" long. Accurately tempered jaws and strong bolts. \$1.85.



Prices slightly higher Denver and West



Quality for more than a Century

J. WISS & SONS CO. • NEWARK 7, N. J.

# INSULATE NOW

for as **\$67.60**  
low as **cost for average attic**

Do it Yourself in One Afternoon!



## ZONOLITE®

### VERMICULITE INSULATION

Easiest of all insulations to install... save as much as \$100 installation costs. Cuts fuel bills up to 40%. Fireproof, rotproof, permanent.

### LIFETIME GUARANTEE!

Zonolite is guaranteed to last the lifetime of the building in which it is installed. No further maintenance is ever required.

Write for **FREE**

How to Insulate **BOOKLET**

Zonolite Company, Dept. PM-103  
135 So. LaSalle St., Chicago 3, Ill.

Please rush your FREE Booklet, HI-20 with details on How to Insulate.

Name.....  
Address.....  
City..... Zone..... State.....

AT LUMBER OR BUILDING MATERIAL DEALERS

# PREVENT LEAKS



It's so easy to stop water damage! Just drop a Handi-talk cartridge in the gun, press the trigger. Protect your investment. Write for leaflet.

# Handi-talk

2370 Woodhill Rd.

Cleveland 6, Ohio



AT HARDWARE, PAINT AND LUMBER DEALERS



## Find HIDDEN TREASURES

GEIGER COUNTERS (as shown) for Uranium Detection. TREASURE DETECTORS for gold, silver, etc. Lightweight, ultra sensitive. Best at any price. Also mineralights. • INFORMATION FREE •

Detectron Co.

5420 Vineland, North Hollywood, Calif



## STARRETT "Tools and Rules" BOOK

Describes and illustrates the precision methods skilled mechanics use. Only one dime. Write Dept. AF.

THE L. S. STARRETT CO., Athol, Mass., U. S. A.



## NEW, IMPROVED CALCULATOR FOR WOODWORKERS only 25c

Instantly gives information on lumber, nails, concrete mixes, painting materials, etc. Convenient, simple to read. Just set dial for nail specifications, to convert linear to board feet, find bit sizes for screws, compare characteristics of woods. 6" diameter heavily varnished cardboard. Send 25c, no stamps, please to Greenlee Tool Co.,

2110 Columbia Avenue, Rockford, Illinois.

## KEUFFEL & ESSER

### "WYTEFACE" Steel Tapes At Less Than Half Their Original Cost

#### FEATURES

- BLACK ON WHITE MARKINGS, EASY TO READ.
- MARKINGS IN FEET, INCHES AND 1/8ths SHOWS THE FT. NUMBER AT EVERY INCH IN RED.
- HARD-WEARING RED LEATHER CASE WITH NICKEL-PLATED MOUNTINGS.



**BRAND NEW Fully Guaranteed**  
This tape has been preferred for years in the industry. A permanent & durable measure built to last a lifetime.

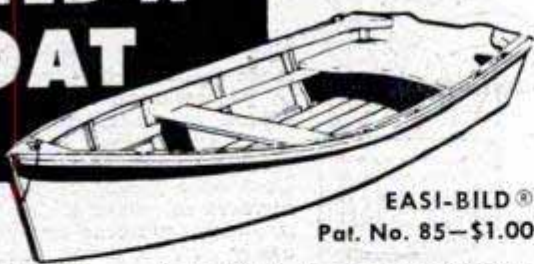
50 FT. (Formerly \$7.50) **3.95** Parcel Post 25c

100 FT. (Formerly \$12.60) **5.50** Parcel Post 25c

No C.O.D.'s, Send Check or Money Order to Dept. PM 2

**JOB LOT TRADING 53 Vesey St. NYC**

# BUILD A BOAT



EASI-BILD®  
Pat. No. 85—\$1.00

**EASY!** Build this sturdy 11½ ft. rowboat with an Easi-Bild full-size pattern. Finishing becomes simple with amazing Plastic Wood, because it handles like putty... hardens into wood! Insures a smooth, sturdy, water-tight job throughout!



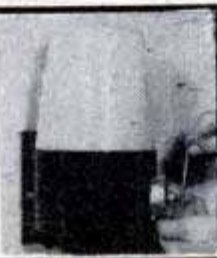
Get pattern #85 at hardware or boating stores. Or send \$1.00 to: Plastic Wood, Box 215, Pleasantville, N. Y.

*P.S.* Pulleys, hinges, locks and latches work better with 3-IN-ONE OIL

## Do You Use Mechanics' Soap?

Get the only satisfactory mechanics' soap dispenser on the market. Handles any emulsion type, mechanics' grit soap, paste or protective cream. Easy to use. Holds approx. 10 lbs. Stops waste. Over 3,000 in use. Ask your jobber or write.

**NATIONAL SOAP DISPENSER CO.**  
Dept. P-10, 10216 LaSalle Ave.  
Los Angeles 47, Calif.



## SET-UP - KNOCKDOWN SAWHORSE with Jiffy BRACKETS



No nails or bolts... use 2x4's for legs, 2x4 or wider for crossbar. Rugged, sturdy, easy to move, saves storage space. Sold by hardware and building material dealers, or order direct.

**GRAND HAVEN STAMPED PRODUCTS CO., Grand Haven, Mich.**

## Take The "PAIN" Out of PAINTING!



Basements . . .



Fences . . .



Furniture . . .

## USE A BECKER CO<sub>2</sub> SPRAY GUN

Take It Anywhere! No Compressor . . . No Electric Cords Needed. Sprays: Paints, Oil, Varnishes, Insecticides, etc.

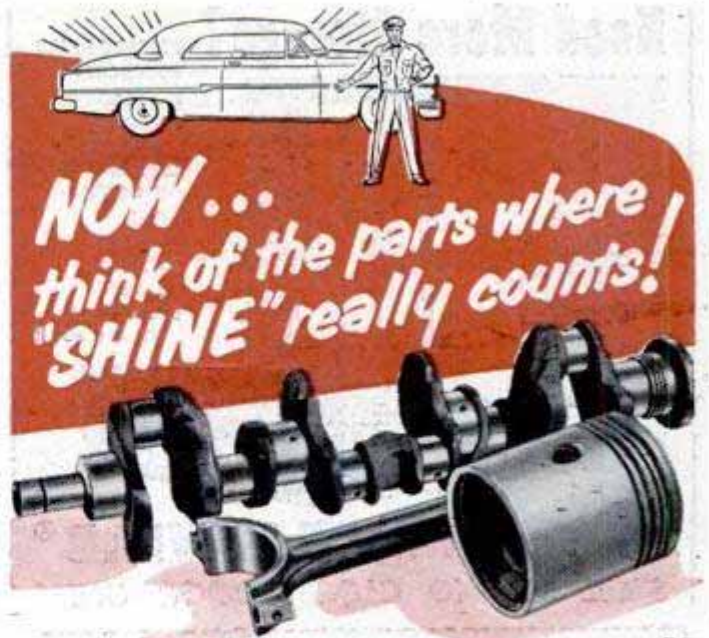
Men! Women! Here's the easy way to lick those tough, tedious, tiresome paint jobs. Becker Spray Gun is fun to use, requires no electricity or compressors—pressurized by low-cost CO<sub>2</sub> cartridges each sprays up to 21 oz. containerful. Used 5 years successfully in industry.

SEE YOUR DEALER! If he cannot supply, order direct for postpd. sht. Extra cartridges 10 for \$1.

**SULLIVAN-BECKER CO.**  
Dept. 113-K Kenosha, Wis.



ONLY  
**\$19.95**  
with box of 10 cartridges



NOW... think of the parts where "SHINE" really counts!

## DON'T LET WEARMITES DESTROY THE POLISHED PERFORMANCE IN YOUR CAR!

Wearmites are the grit, dirt and tarry sludge in dirty motor oil that slowly but surely mar the mirror-like surfaces of the moving parts **INSIDE** your car engine. These mites of destruction score bearings, pistons and cylinder walls, turning lubrication into RUBrication. Remove these Wearmites and curb this costly abrasive wear with—



**wix**  
ENGINEERED FILTRATION



A WIX HEVI-DUTY Cartridge in your oil filter gives you abrasion-free, clean oil . . . traps all the Wearmites without removing valuable detergent additives in today's heavy duty oils. For polished performance, longer, more economical engine life, check your filter when you check your oil — and change to WIX.



LOOK FOR TWO THINGS WHEN YOU BUY YOUR NEXT OIL FILTER CARTRIDGE  
WIX — it means Engineered Filtration. HEVI-DUTY — it guarantees highest performance on heavy duty oils.

✓ CHECK YOUR FILTER WHEN YOU CHECK YOUR OIL!

WIX CORPORATION · GASTONIA, N. C.  
IN CANADA: WIX ACCESSORIES CORP. LTD., TORONTO

# Need More Storage?

STORAGE WALLS  
WARDROBES  
PANTRIES  
BASEMENT  
STORAGE  
GARAGE  
STORAGE  
ATTIC  
CLOSETS  
BATHROOM  
CLOSETS  
LAUNDRY OR  
UTILITY ROOM



**'BUILD THEM  
YOURSELF**

It's Easy With **AMWELD®**  
STEEL SLIDING CLOSET DOOR UNITS

## EASI-BILD\* CLOSET PATTERN No. 430

Easy-to-follow instructions—step-by-step assembly directions and illustrations. Take complete list of materials furnished to your lumber dealer—SEE how little it costs to build it yourself.

Obtain Easi-Bild Closet Patterns at Amweld or Easi-Bild Dealers . . . or enclose 50c for Easi-Bild Pattern No. 430.

**THE AMERICAN WELDING & MFG. CO.**  
AMWELD PATTERN DEPT. 16 • DIETZ ROAD • WARREN, OHIO

\* T. M. Easi-Bild Pattern Company



## Make Your Own!

ASSEMBLE AMERICA'S

**Most Beautiful  
ALL-ALUMINUM  
DOOR CANOPIES  
AND WINDOW  
AWNINGS**

● THE ONLY TOOL YOU NEED IS A SCREWDRIVER

● These awnings are pre-treated, ready for paint. It's easy! Just do the top—the sides are assembled. Designed and engineered by Herbert's— with experience and machinery to sell you a better awning.

● AVAILABLE COMPLETELY ASSEMBLED WITH BAKED ENAMEL FINISH.



DIRECT FROM FACTORY

WRITE FOR FREE MEASURING CHART AND LITERATURE

**Save 50%**

8974 St. Charles Rd. **Herbert's** St. Louis 14, Mo.

ALUMINUM AWNING

NAME \_\_\_\_\_

ADDRESS \_\_\_\_\_

CITY \_\_\_\_\_ ZONE \_\_\_\_\_ STATE \_\_\_\_\_



# HANG WALLPAPER

the professional way

You can hang paper better and more easily with Adhesium— used by professionals for over 50 years. Added to paste, Adhesium makes paper stick tighter— helps prevent cracking and opening at seams. Used as a sizing, it prepares wall surfaces so paper slides into place smoothly, patterns can be matched easily . . . At paint, hardware and wallpaper stores.

Write for informative leaflet

**ADHESIUM®**

Colonial Works, 227 Norman Ave., Brooklyn 22, N. Y.

## Oxwall TOOL KITS are Wonderful Gifts

Handy Tool Kits for use in every home, car and workshop. High quality tools in plastic kits. Priced from 98c up. Sold at your local hardware and chain store.



# 600

\$2.98

retail

Oxwall

**Oxwall TOOL CO., LTD.**

928 Broadway New York 10, N. Y.

## "SNOOPER" GEIGER COUNTER



Super-sensitive! Only 1 1/4 lbs.! Fits pocket— uses flashlight battery. Find a fortune in uranium. Order Now! Send \$5.00, balance C.O.D. MONEY BACK GUARANTEE. FREE CATALOG—scintillator and larger uranium and metal detectors DEALERS WANTED.

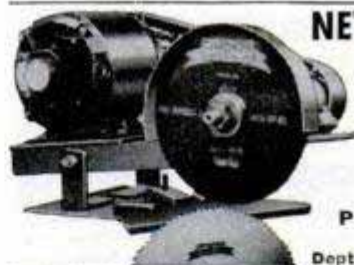
2995

COMPLETE

**PRECISION RADIATION INSTRUMENTS**

2235 PM S. LA BREA, LOS ANGELES 16, CALIF.

## Say You Saw It in POPULAR MECHANICS



### NEW SAW SHARPENER

Improved #64 Hand Gummer sharpens all types circular saws 4" to 20" diam. Ideal for saw shops. Self-Centering adjustment for quick, easy set-ups. Complete with 1/4 HP motor, 1 grinding wheel & cord. \$79.50 FOB Portland. Wt. 70#. SEND FOR FREE LITERATURE.

**P. T. HOBBS MACHINERY**  
8375 N. INTERSTATE AVE.

Dept. P.M.-61, PORTLAND 17, OREGON



### MICRO-VOX WIRELESS MICROPHONE

With built-in transmitter for operating through any radio (without wires) within 50 feet as a PA system, Baby Listener, Detectophone, etc. Supplied complete ready to use with simple instructions. Shpg. wt. 3 lbs. No. 20A920.....

\$6.50 (Plus Parcel Post)

**FREE CATALOG**

156 pages of everything in Radio and Electronics.

**BURSTEIN-APPLEBEE CO. 1012-14 McGEE, KANSAS CITY, MO.**

## MONEY for MEN ALL FREE

THE PLASTEX Industry needs manufacturers on small scale and for big production of Lamp and Clock Stands, Art Goods and Novelties in Plastex and Marble imitation. Experience unnecessary. 1 1/2¢ material makes regular 10¢ store sellers. Rubber moulds furnished for speed production. Small investment brings good returns. We are now placing big Chain Store Orders with manufacturers. Ambitious men have chance for real prosperity. Our Free booklet will interest and benefit you.

**PLASTEX INDUSTRIES, Dept. A**  
3400 Third Ave. New York 56, N. Y.



Now... with just ONE BIT  
DRILL - SAW - REAM



Yes, one bit does it all! Drills own starting hole—upper part of bit is used to cut, saw, ream circles, ovals, squares, or scrolls. International's new Hi-Speed Cope Saw Drill Bit turns your electric drill, drill press, lathe or milling machine into a more versatile tool. Equally good for metal, wood, pipe, plastic, transite, etc. Easily operated. Ideal for carpenters, mechanics, electricians, plumbers, hobbyists, many others. Abrasive resistant, high speed steel. Flutes ground from solid. Withstands severe continuous use. Resharpener at no charge. 1/2" diameter, 2" cutting section, total length 3 1/2". Available in 3 types—All Purpose, Wood, Heavy Metal. Specify type desired. Set of 3, \$11.50. Shipped same day. Money-back guarantee. Distributor inquiries invited. ORDER NOW SEND CASH, CHECK OR MONEY ORDER.

Manufactured and Distributed by  
INTERNATIONAL TWIST DRILL CORP.  
618 Wyandotte, Rm. 639 Kansas City 5, Mo.

only  
**\$3.95**  
POST PAID

**DRAINS Cellars, Laundry Tubs;  
CIRCULATES Oil; IRRIGATES Gardens**

Original "Type P" Pump has 2400 GPH capacity. 360 GPH 75' high, or 1500 GPH from 25' well. Use any 1/8 to 1/2 HP motor. DOES NOT CLOG. 1" intake; 3/4" outlet.

Postpaid if cash with order. (West of Miss. add 50c.) Motor coupling included.

MONEY BACK GUARANTEE  
Also Gear Pumps in all sizes.

LABAWCO PUMPS, BELLE MEAD 7, N. J.



**\$6.95**

**FREE MONOGRAM WITH UNIFORM.** Matched uniform of pants and shirt. 8 oz. Sanforized herringbone twill. Six months guarantee or money refunded. Choice of color: medium blue or marine tan. Send waist size, leg length of pants, shirt size, and name for monogram. Send check, or money order. Reference: National State Bank of Orange  
**UNITED UNIFORM COMPANY**  
28 Buckingham Road West Orange, New Jersey

**\$5.98**

**3 CU. FT. MIXER \$35**  
DIRECT FROM MFR.

Fills long felt need for small mixer for concrete, feed, fertilizer, seed and many other materials. Saves 3/4 cost of ready mixed concrete. Pays for itself on first job. Combination belt pulley and crank for hand operation. Also power mixers. Write for circular.

3 Cu. Ft. Drum—Mixes 2 1/2 Cu. Ft. Concrete \$35.00  
5 Cu. Ft. Drum—Mixes 3 Cu. Ft. Concrete 50.00

FOB Pulaski, N. Y. Cash, Check or M. O. Money back guarantee.  
**UNITED STATES FORGE AND FOUNDRY CO.**  
CONSTRUCTION EQUIPMENT DIV. PULASKI, NEW YORK



**CHAMPIONS**

**CHOICE of the EXPERTS**

for  
Dependability, Performance  
and Long Life

INSIST ON CHAMPIONS  
FOR YOUR CAR!

CHAMPION SPARK PLUG COMPANY, TOLEDO 1, OHIO



**YOU'LL EARN BIG MONEY**  
with  
**HOBART**  
"Simplified" **ARC WELDING**



**AC Welding and DC Power**

Double your earnings doing repair and construction work, away from power lines. "Build Your Own" gives you AC welding—plus electric power for operating tools, lights, etc. Use a gasoline engine, or hook to drive shaft with V belt.

**Welds Anywhere!**  
Air Cooled Portable  
Engine Drive

With the "Husky Boy" 200 amp. arc welder you can do profitable general shop and outside repair work; emergency service work; on pickup trucks—all on a low investment. It's compact and lightweight—easy to transport. For extra convenience when used inside, wheels and handles easily bolt to the unit, and are available at slight extra cost.



**300 Amp. Electric  
Portable Arc Welder**

Superior performance with true economy should make this welder your choice for 9 out of 10 welding jobs.  
Remote Control • 1000  
Welding Heat Gradations •  
Oversize 4 Pole Exciter •  
Sirocco Type Cooling Fan •  
Vibrationless Steel Shaft •  
Polarity Control are Hobart features that assure faster, better, low cost welds.



**The Hobart  
Welding School**

America's most modern. Every type of training. Equipment latest and best.



**You'll like Hobart Electrodes**

Hobart's complete line, precision made and rigidly inspected, solves every welding problem.

**Hobart Brothers Co., Box M-103, Troy, O.**  
"One of the world's largest builders of arc welders"

**HOBART BROTHERS CO., BOX M-103, TROY, O.**

Send complete details on items checked.

Electric Drive  Gas Drive  Generator  
 Only  Air Cooled Gas Drive  Hobart  
 Trade School  Electrodes  Accessories

NAME \_\_\_\_\_

ADDRESS \_\_\_\_\_

CITY \_\_\_\_\_ STATE \_\_\_\_\_

**FREE!**

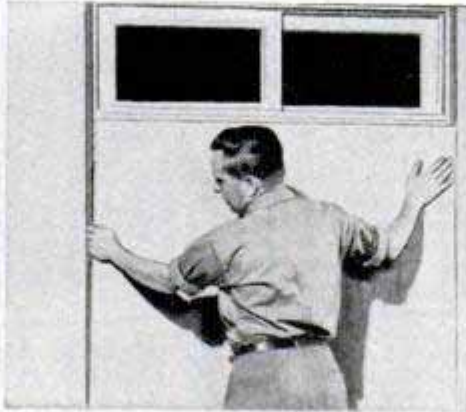


Check here for your vest pocket welding guide

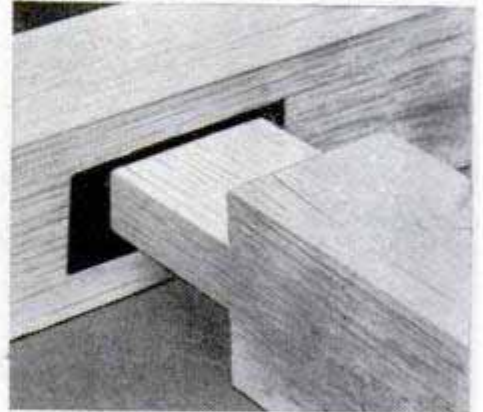


**Stumped  
by woodworking  
problems  
like these?**

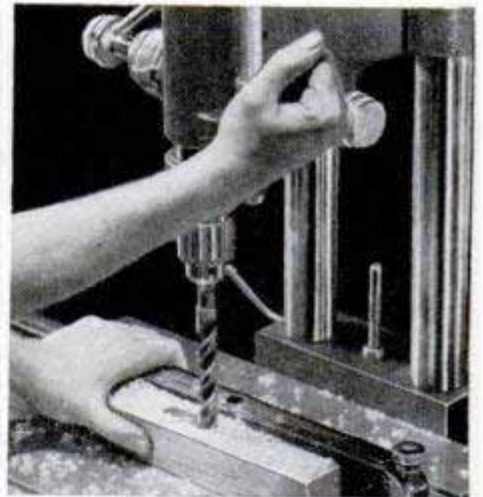
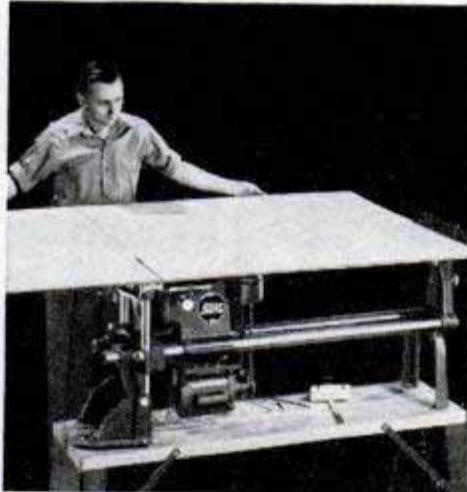
*Ripped big panels  
that aren't square*



*Mortises that  
are oversize*



**with  
SHOPSMITH  
they're  
a breeze!**



**GET THE  
NEW McGRAW-HILL  
WOODWORKING BOOK!**

The most complete  
power woodworking  
book ever published!

The best "how-to-do-it" book on the market; lets you enjoy SHOPSMITH — the best "do-it-yourself" tool—much more. 283 pages of valuable information. 560 photographs and drawings. Only \$4.95. Ask for *Power Tool Woodworking for Everyone* at any book store, or at your SHOPSMITH dealer.

**SEE HOW MANY MORE JOBS YOU  
CAN DO BETTER WITH SHOPSMITH**

See SHOPSMITH demonstrated at leading hardware and dept. stores or any Montgomery Ward store.

**ONLY A BIG SAW CAN RIP BIG PIECES** with accuracy. SHOPSMITH's 8" Circular Saw has an effective table size of 54" x 17". With it you can rip an 8' panel through its *exact* center into two 4' sections. By using the fence, you're assured of a square, clean cut. Maximum depth of cut of 2 1/4" comes in handy when you're doing heavy work. Large miter gauge has automatic spring stops from 0° to 60°.

**New SHOPSMITH 4" Precision Jointer!**

Extra-long 28" table. Attaches quickly, easily; yet it doesn't interfere with SHOPSMITH flexibility. Can be operated simultaneously with saw as conventional saw-jointer combination. Three-knife cutter head runs on grease-sealed ball bearings. Unique Allen-wrench adjustment is easiest method ever devised for jointer knife adjustment. Fence tilts 45°-45°; automatic stops. Width of cut, 4"; depth of rabbet, 5/16". Only \$44.95 (mounting kit, \$9.95).

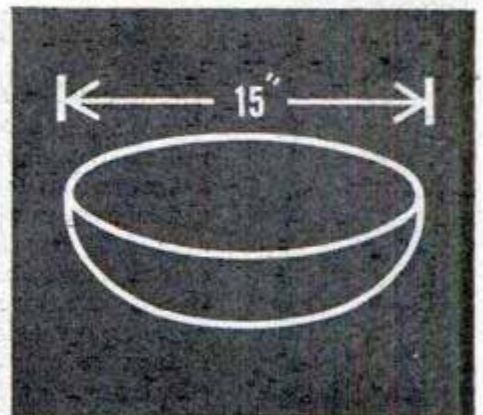
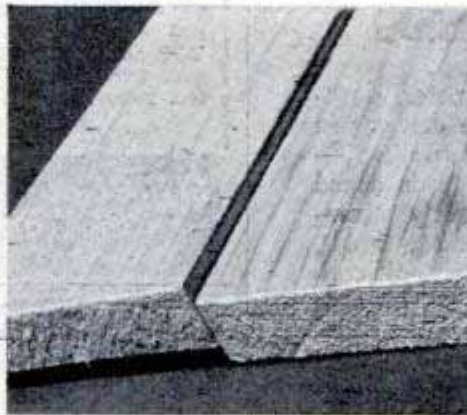
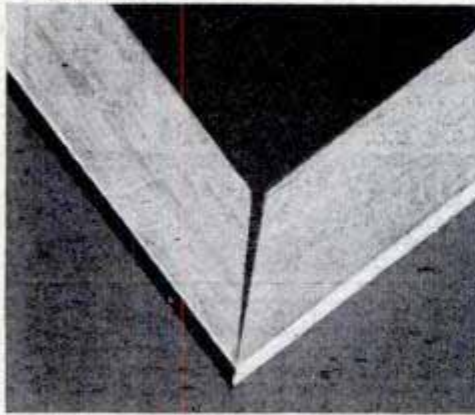
**OVERSIZE MORTISES ARE NO REAL PROBLEM** when you can drill truly "in-line" holes. With SHOPSMITH it's easy to line up holes because fence and table, working as jigs, assure accurate parallel drilling. You can even convert SHOPSMITH into a floor drill press, to mortise large doors for locks. Spindle is supported by *four* grease-sealed ball bearings, is stress-proofed with induction-hardened tip.



Mitered joints  
that don't quite fit

Doweled pieces  
that won't line up

Bowls that are  
too big to be turned



**TO MAKE REALLY ACCURATE MITERED JOINTS** you have to take into account "creeping" of the wood and saw blade deflection. By finish-sanding mitered pieces with the **SHOPSMITH Disc Sander**, you easily eliminate these errors. No mitered joint is as accurate as a finish-sanded joint—and **SHOPSMITH alone** has a Sanding Disc that can be fed into the work. Make duplicate parts quickly and accurately.

**FOR PERFECTLY DOWELED JOINTS**, the **SHOPSMITH Horizontal Drill Press** is the perfect answer! Rigid fence support and adjustable table height make drilling for dowels easy as A, B, C—and absolutely accurate. No time-wasting setup of doweling jig necessary. Miter gauge serves as guide, particularly for precise right-angle drilling. Jacobs key chuck takes drills from 5/64" to 1/2" in diameter.

**NOT MANY LATHES HAVE A 15" SWING**, but **SHOPSMITH** does. With 4" more capacity than other lathes (except for a few expensive types), it's easy to turn beautiful, *big* bowls. You face the work on a **SHOPSMITH Lathe**; this greater convenience is your guarantee of greater accuracy. Centerless-ground tubular steel ways are heavy-walled and rigid. And, now they're chrome rust-proofed, too!

COMPLETE 5-TOOL UNIT

ONLY **\$199.50**

Motor\* and bench extra

Chrome rust-proofing is now standard on all **SHOPSMITHS**.

\*Special **SHOPSMITH** heavy-duty ball bearing motors: 1/2 hp. \$34.50; 3/4 hp. \$44.50.

**MAGNA ENGINEERING CORPORATION**

Dept. 251-B at factory nearest you:  
12819 Colt Rd., Cleveland 8, Ohio,  
or Menlo Park, California.

Please send my free copy of the **SHOPSMITH** illustrated booklet.

Name \_\_\_\_\_

Address \_\_\_\_\_

City \_\_\_\_\_ State \_\_\_\_\_



Get low-cost, high-precision small-hole production with



## DUMORE AUTOMATIC DRILL HEADS

FOR small-diameter, deep-hole, precision drilling in metal, wood or plastic — Dumore Drill Heads speed production, virtually eliminate drill breakage. Small, compact, completely self-contained—Dumore Drill Heads need no outside air or hydraulic supply . . . easily adapt to an infinite variety of setups. For details, write for Bulletin 1004-52.

## DUMORE PRECISION TOOLS

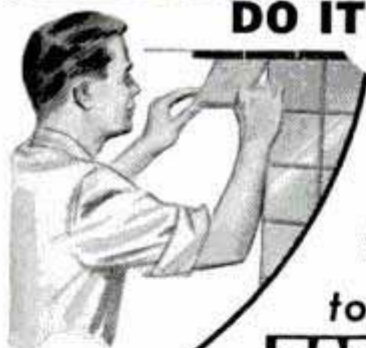
The Dumore Company

1300 Seventeenth Street, Racine, Wisconsin

Builders of a precision line of Grinders, Automatic Drill Heads, Tool Post Grinders, Drill Grinders, Light Drilling Equipment, Flexible Shaft Tools, Hand Grinders, Fractional-hp Motors and Gear Motors.



## DO IT YOURSELF.



with the only **PLASTIC TILE**

that **LOCKS** to the **WALL!**

# Wilson LOCKBACK® TILE

See those 45° undercuts on edges and ribs . . . they lock LOCKBACK with mastic like an anchor locks into sea-bottom. Ribs prevent "dishing", too.

All plastic wall tile looks alike from the front . . . but only LOCKBACK® has the 45° undercuts on the back that lock the tile mechanically to your wall . . . insure a smooth, permanent job even when installed by beginners. Carries the Hallmark of U. S. Dept. of Com. Bur. of Standards for flawless, uniform quality. Comes in many harmonizing colors in standard 4-1/4" field tile and full range of accessory tiles to work out any design you wish. No special kit or tools needed, your dealer has easy instruction booklet.

Or, for budget installations, use WILSON's ECON-O-TILE . . . just dab mastic on the 4 dots on back and press tile in place.

Write for WILSON Booklet S-103 and name of your nearest dealer

**WILSON PLASTICS, INC.**  
SANDUSKY, OHIO

## PARTS FOR MILITARY TRUCKS

and **JEEPS** 4 & 6 WHEEL DRIVE. WRITE FOR PARTS CATALOG STATING MAKES

### JEEP TOPS and CURTAINS

All Brand New . . . Not Surplus

Made of Heavy Canvas Duck . . . Waterproof MILITARY TYPE models, Top and Curtains, complete, **\$59.50** less bows . . . . .

TOP and CURTAINS, HALF CAB . . . MODELS CJ2A and CJ3A, complete with hardware, **\$65.00** less bows . . . . .

TOP and CURTAINS Complete, MODELS CJ2A and CJ3A, with hardware for entire Jeep **\$88.80** less bows . . . . .

When ordering please state exact model  
All prices F.O.B. K.C. 25% dep. on COD's

## American AUTO PARTS CO. INC.

1830 LOCUST—DEPT. PM-9  
KANSAS CITY, MISSOURI



## MACHINE SHOP EQUIPMENT



The NEW edition of the famous Center Tool Co. Catalog is now ready! Every workshop owner should have a copy. 240 pages full of illustrations, descriptions, and prices of the latest tools made by best known manufacturers in U.S. You pay the cost of printing—\$1.00. We refund your \$1.00 with first order of \$25.00 or more. Prompt delivery on most tools. Send check or money order today!

**CENTER TOOL CO.**

153 Centre St., Dept. C, New York 13

## 36 1/2" HIGH 30 DRAWER ALL-PURPOSE STEEL SMALL PARTS STORAGE CABINET

WONDERFUL GIFT FOR CHRISTMAS. Solves all storage problems. Ideal for office, home, factory, toolroom, den, workshop! 100% uses. Sturdy welded construction. Fire-Resistant. Protects, organizes small articles, papers, machine parts, tools, etc! 36 1/2" high, 29 1/4" wide, 12" deep. Grey or green. Send check or M.O. No C.O.D.'s. FOB, NYC. **\$35.95** Money-back if not satisfied. . . . .



**NEW YORK STEEL CO.**  
Dept. PM-10, 35 Maiden Lane, N.Y. 38, N.Y.

## Huge 52-Page Full-Color Booklet! ALL ABOUT ELECTRIC TRAINS

Today send for this colorful catalog picturing American Flyer Trains and Accessories! Mail 10c to Gilbert Hall of Science, Dept. I, Erector Square, New Haven, Connecticut.

## A USEFUL GAGE THAT IS NEW AND DIFFERENT



MADE OF BRASS & ALUMINUM.  
PRICE \$1.00 P. P. NO STAMPS

SPRAGUES LABORATORY, P. O. BOX 534  
EL MONTE, CALIFORNIA

## HELPFUL BOOKS

Send post card asking for FREE catalog  
Popular Mechanics Press, 200 E. Ontario, Dept. 601, Chicago 11

## The QUICK-WAY to SHARPEN CIRCULAR SAWS



Now you can do it yourself—save time and money. The new QUICK-WAY Index Plate Circular Saw Sharpener makes your own power table a precision saw sharpener. Guarantees accurate grinding and spacing of every tooth. Complete unit only \$16.50 postpaid, including patented Index Plate block for mitre and \$3.00 grinding wheel. . . . Nothing else to buy!

Send check, cash or money order. We pay postage.

Model 6-12P  
**\$16.50** Postpaid

**QUICK-WAY Saw Company**  
11 Riverside Corning, N.Y.

# STOP CHANGING MOTOR OIL!

End this needless expense forever with

**RECLAIMO** Today's most advanced OIL RE-REFINING filter FOR CARS, TRUCKS, TRACTORS.

Continuously cleans and RE-REFINES motor oil as you drive by utilizing motor heat — keeps oil in high grade lubricating condition at all times.

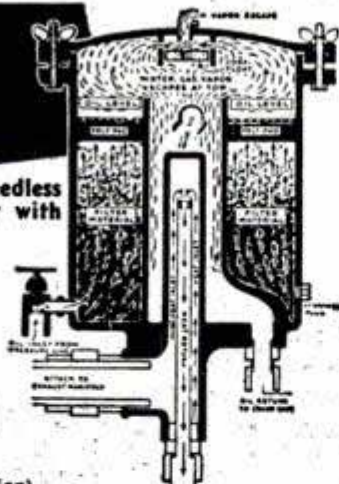
### "RECLAIMO"

- REMOVES SOLIDS (by filtration)
- REMOVES WATER (by distillation)
- PREVENTS Excess fuel dilution
- PREVENTS Acid and Sludge Formation
- ADDS Thousands of Miles to Engine Life

**MAINTAINS** Stable Viscosity **ELIMINATES** All Oil Changes  
 FREE 32-page book "OIL FACTS" with bonafide \$1,000.00 offer on page 30. Gives you the complete "Reclaimo" story and details of our extraordinary 90-DAY NO-RISK TRIAL OFFER. Write for your copy today!

**RECLAIMO MFG. CO., INC.**

5083 Elston Ave., Dept. M-10, Chicago 30, Ill.  
 Wm. Schwalgo, U.S. Pat. 1757228, 1834654, 2068473.



DEALERS WANTED

U. S. BUREAU OF STANDARDS, Bul. 86 States, "Oil does not wear out mechanically."

## Only HULL AUTO COMPASSES

Give You This . . . .



Patented compensators make the Hull Auto Compass the easiest to adjust on the market. Even a child can obtain pin-point accuracy — quickly, surely. Why accept less? Write for local dealer's name, free literature.

**MORE HULLS IN USE THAN ALL OTHERS COMBINED**

**HULL MFG. CO.** P.O. Box 246, D10  
 Warren, Ohio

Beaconlite \$6.95  
 Illuminated STREAMLINE \$4.95  
 non-illuminated

## STOPS BOAT LEAKS FOREVER!

**BARNACLE RESISTANT FIBERGLAS** APPLY IT YOURSELF

Saves Money. Saves Work. Pays for Itself. This new permanent armor protection for boat hulls, decks, cabin tops, is quick and easy to apply yourself. No skill or special tools needed. Light, yet has 5 times tensile strength of steel! Used for making Navy boats, also bulletproof vests, etc. Ev-R-Shield Fiberglas Coating stops leaks and boat worms. Non-rotting. Can't stretch or shrink. Ends yearly boat hauling and bottom painting. Adds years of life to old or weak hulls! Makes boats drier than new. **FREE!** Complete instruction kit and sample of material. **WRITE** EV-R-SHIELD PRODUCTS, Box 43-L, Joppa, Md.



Say You Saw It in Popular Mechanics



Home is where you take it!

A beauty to see . . . a breeze to move . . . a bargain to own . . . America's "time-tested" trailer home . . . the HOWARD Mansion Coach! Design-built to guarantee a lifetime of living pleasure, all-steel HOWARD Coaches are valued everywhere for low upkeep, high trade-in values! Demand top quality, see your HOWARD Dealer now — or write: Department 21 • BOX 2163

**HOWARD INDUSTRIES, INC.**  
 SAGINAW, MICHIGAN



...When you use these WIZARDS with WOOD!

Down at your hardware, paint or lumber dealer's are 3 magical products for mending things, making things, finishing things. Mail coupon for everything you want to know about Weldwood Glue, Firzite and Satinlac.

Gets that blond or pickled effect—



Produces those magical "woody" effects—on hard wood or soft, plywood or solid lumber. For light pastel tones, tint White Firzite with Colors-in-Oil. (On fir plywood stain jobs, tame that wild grain with Clear Firzite.)

**WHITE FIRZITE®**

Gets that Natural-Wood Finish



—without shellac or varnish. On furniture, panelling or woodwork, there's nothing like Satinlac. Brings out natural grain and color beauty of any plywood or solid wood. Avoids that "built-up" look. "Water-clear," easy to brush or spray, dries ready for next coat in 2 or 3 hours.

**SATINLAC®**

The Wood Glue you can rely on!



To make things or fix things, use Weldwood Glue for all wood-to-wood bonds. Makes joints stronger than the wood itself. Mixes easily with water. Stain-free, rot-proof...highly water-resistant!

**WELDWOOD®**  
 PLASTIC RESIN GLUE

United States Plywood Corporation,  
 Dept. 238, 55 West 44th St., New York 36, N.Y.

Send me free leaflets on Weldwood Glue, Firzite and Satinlac.

NAME \_\_\_\_\_

ADDRESS \_\_\_\_\_

# Save that PAINT BRUSH

— now more valuable than ever

Perfect  
for  
NYLON BRUSHES

**BEFORE**



**AFTER**

10c  
25c

KEEP  
BRUSHES  
LIKE  
NEW  
WITH  
DIC-A-DOO

At Paint,  
Hardware, Dept.,  
and 5 & 10¢ Stores



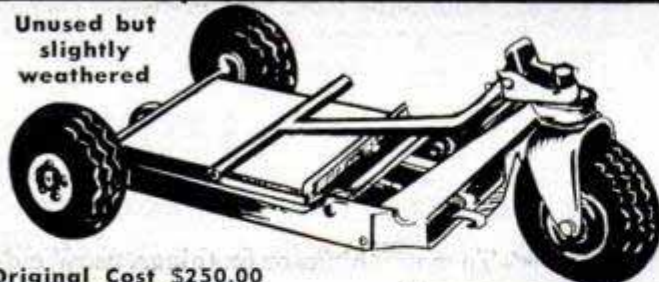
Patent Cereals Co.

Geneva, New York

## LIMITED QUANTITY OF MULTI-PURPOSE ARMY SURPLUS HYDRAULIC TOWING AND LIFT TRUCKS—

Ideal for: Transmission Jacks, Warehouse Trucks,  
Factory & Shop Use, Boat Trailers, Mounting Weld-  
ing Equipment, Farm Use, Factory Trailers, Yard  
Equipment for Portable Use.

Unused but  
slightly  
weathered



Original Cost \$250.00

Roller Bearing Wheels

59" long x 33" wide

Platform 17 1/2" x 23 1/2"

Tire Size 13 x 5.00

Platform Raised 13"

Platform Lowered 6 3/4"

Capacity 2000 lbs.

Length of Draw Bar 31 1/2"

Total Weight per unit 285 lbs.

Pneumatic Airplane Type Tires

Mail check or money order—or  
will ship on open account to  
accredited firms.

**DON'T MISS THIS  
VALUE—ONLY**

**\$39.50**

DELIVERED  
WE PAY  
FREIGHT  
(U.S.A. ONLY)

Sturdy and well made.  
Order yours today.

**Satisfaction Guaranteed.**

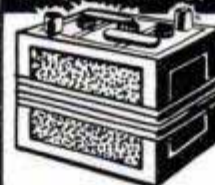
**FULTON AUTO  
EXCHANGE**

2235 STEWART AVE.  
DEPT. PMN ATLANTA, GA.



**THE HEAD CAN'T FLY OFF!** Estwing "Unbreak-  
able" hammers and hatchets are forged in one piece  
from tough tool steel. Grip is genuine leather,  
proven most comfortable and durable. Used by the  
carpenters for 30 years. Ax \$4.50, hammer \$3.65.  
At all leading hardware stores. Write for FREE  
catalog. **ESTWING MFG. CO** Dept. P, Rockford, Ill.

### DON'T BE CAUGHT WITH A DEAD BATTERY



Amazing "New Life" battery rejuvenator  
stops build-up of plate sulfates . . . keeps bat-  
tery automatically charged. Use lights, heater,  
radio, as much as you like. Get faster starting!  
Greater power! **RECHARGING IS UN-  
NECESSARY!** Only one treatment needed!  
Money back guarantee. Rush \$1.00 to:

**JSM PRODUCTS CO.** • 11186 Castleton Rd., Cleveland 21, OHIO

### Get This TOMLEE SHOP BOOK

28 picture pages of how-to-make-it with power tools.  
Illustrates 50 handicraft patterns. Send  
25c, stamps or coin, to TOMLEE TOOLS,  
723 N. Washington, Minneapolis 1, Minn.

**25¢**



### TRAILER COACH PARTS CATALOG

Newest and most complete—36 pages. All  
parts and supplies for all coaches—

**MOBILE HOME PARTS, INC.**

1034 Grey Ave., Evanston, Ill.

Phone: DAVIS 8-6401

**Immediate Shipment**

**LOW PRICES!**

send **25¢** to cover  
postage

SAY YOU SAW IT IN  
POPULAR MECHANICS

### BOLT AND STEEL CUTTER HIGH SPEED—CUT IT, DON'T SAW IT



SMOOTH, clean cut in seconds.  
Bolts, steel or cable stock to 1/2".  
Use in any vise; dozens of uses  
for home, shop, factory or home.  
Tool steel blades replaceable.

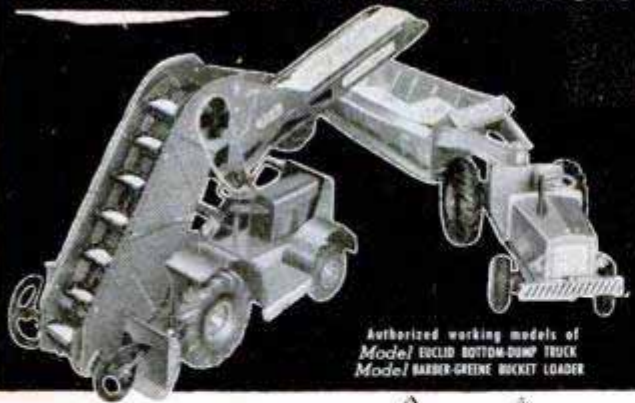
... Guaranteed!

**ORDER NOW—SPECIAL CASH WITH ORDER \$2.95**

Postpaid in U. S. In Calif. add 9¢ tax. (Please no COD's)

**IN-A-VISE CUTTER CO.** 8541 Amelia St., Oakland 21, Calif.

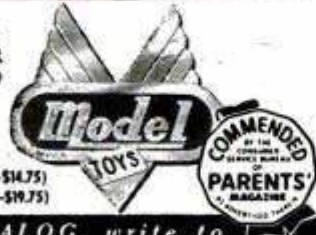
## THRILLING IN PERFORMANCE!



Authorized working models of  
Model EUCLID BOTTOM-DUMP TRUCK  
Model BARBER-GREENE BUCKET LOADER

What fun with these big, exciting toys! The BUCKET LOADER scoops up earth for the EUCLID TRUCK to haul and dump. Constructed of heavy-gauge steel, they outlast other toys 3 to 1.

Euclid Truck—\$13.95 (11 Western States—\$14.75)  
Bucket Loader—\$18.95 (11 Western States—\$19.75)



For FREE CATALOG, write to  
**THE CHAS. WM. DOEPKE MFG. CO., Inc.**  
ROSSMOYNE 2, OHIO

## HELPFUL BOOKS

Send post card asking for FREE catalog—

Popular Mechanics Press, 200 E. Ontario, Dept. 601, Chicago 11

## ...Wood Carvers!



"HERE'S THE  
NEWEST  
IN THE  
CARVING FIELD!

\$9.95 PER SET!  
OVERALL LENGTH OF  
EACH TOOL 6½".  
PLASTIC HANDLES



6 PIECE CARVING SET

Most Complete Line of Chisels and Gouges

CATALOG  
AVAILABLE!"

**BUCK BROS. INC.**  
RIVERLIN WORKS MILLBURY, MASS.

## Save Time & Money with LEVELALL



THE NEW IMPROVED WATER LEVEL  
FOR SIMPLEST ONE MAN OPERATION  
ANYTHING YOU NEED LEVEL

LEVELALL DOES IT.

**EASIER & FASTER THAN \$100 ENGINEER INSTRUMENTS**  
A sturdy instrument that can be left on the job for any workman to use. Cannot be put out of adjustment and even with the most casual handling its principle is so simple anyone can level points quickly and accurately.

For FOOTINGS, forms, batter boards, sills, lintels, floors, ceilings, roads, driveways, lawns, piping, farm contouring and all general construction work normally needing an expensive instrument.

COMPLETE with instructions, high quality vinyl polychloride tubing filled with Level-Flo Liquid, plated shut-off valves, threaded mounting brackets, and metal case.

10 day money back guarantee cash orders postage prepaid — C.O.D. accepted.

See Your Hardware or Building Supply Dealer

**REGULAR**  
50 FEET  
EXTRA PINT  
LEVEL-FLO LIQUID  
**\$9.95**

**DELUXE**  
75 FEET  
EXTRA QUART  
LEVEL-FLO LIQUID  
**\$12.95**

or order from LEVELALL 87L WEBSTER ST. ROCKLAND, MASS.  
in Canada order from LEVELALL INC. 5485 DECARIE BLVD. MONTREAL, QUE. prices higher.

# BIG MONEY

*in your hands!*



**BE YOUR OWN BOSS!** Men who are determined to get ahead in something for themselves will find this opportunity hard to beat! Where else can a man turn his own labor so quickly and easily into BIG MONEY! Earn as high as \$50 and more a day sanding floors with an easy-to-run American Machine—and YOU ARE BOSS. Prospects everywhere—old and new homes and remodeling. Pleasant indoor work—steady the year round. No schooling—no experience needed. Age makes no difference—men 18 to 80 are active and successful. Send coupon for "money-making" booklet entitled "Opportunities in Floor Surfacing"—enclose 25c in coin or stamps to cover handling.



## AMERICAN

FLOOR MACHINES

SEND

The American Floor Surfacing Machine Co.  
535 So. St. Clair St.  
Toledo 3, Ohio

Enclosed find 25c in stamps or coin for booklet "Opportunities in Floor Surfacing", telling me how I can start my own floor sanding business.

Name \_\_\_\_\_

Street \_\_\_\_\_

City \_\_\_\_\_ State \_\_\_\_\_

# Watch the Leaves

# VANISH!



## New GRAVELY LEAF MULCHER-

**SELF-PROPELLED!** Power Reverse! Powerful 5-HP Gravely Tractor does *all* the work. Cleans under shrubs, low trees, backs out with power . . . clears 30" swath!

**O**NE of 21 tools for the Gravely Tractor. Leaf Mulcher detaches from Rotary Knife Mower and you mow lawns and weeds . . . attach Chain or Circular Saw for land clearing, timber cutting. In winter, Snowblower and Blade Snow Plow solve snow removal problems. Spring and summer, plow, plant, cultivate, mow, haul . . . your choice of 21 tools powered by the same Gravely Tractor!

Write today for Dealer name, FREE literature!

### GRAVELY TRACTORS, INC.

BOX 1063, DUNBAR, W. VA.

## Putty Your Own Windows

It's Easy with the **DUD-FAST** Putty Knife

The Professional Skill is built right in!

Makes a hard job easy. Anyone can use it. Patented end packs, shapes, trims putty with one stroke. Get yours today.

Only **\$1.00** Postpaid

AT YOUR DEALER OR ORDER DIRECT

Blade End Makes Handy Scraper

### FASTENER CORP.

860 FLETCHER ST., CHICAGO 14, ILL.



Take along **COMFORT and SAFETY!**

For Every Hour in the Open



**MARBLE'S** OUTING EQUIPMENT



**Marble's Woodcraft No. 49**  
Beautiful leather handle. Extra keen 4 1/2 in. forged steel blade, with sheath. \$3.25.



**Marble's Expert No. 545**  
Hunters' and Trappers' favorite. 5 in. blade. With sheath, \$3.75.  
No. 60 Sport Knife—4 in. blade. With sheath, \$2.75.



**Marble's Ideal No. 45**  
All-purpose for field, forest and camp. Extra sturdy. With sheath, 5 in. blade, \$3.75; 6 in. blade, \$4.25.



**Marble's Water-proof Match Box**  
Keeps matches dry, even under water. Price 85c



**Compasses**  
Pin-on, Pocket and Wrist models. No. 182 Pin-on shown—\$2.00

Ask your Dealer, or write for Catalog (A-264)

**Marble Arms & Mfg. Co.** Gladstone, Mich., U.S.A.

## CRESCENT TOOLS

Give Wings to Work

ASK YOUR HARDWARE DEALER

## TELEPHONES

Desk Stand style

Slightly used and in excellent condition.

Many Valuable Uses—

- Inter-house phones
- Loud Speakers
- Microphones
- Educational purposes
- Toys, etc.

**\$1.95**

Postpaid

Come complete, ready to use in U.S.A. Wiring Diagrams Furnished. Please add 75c shipping and handling cost.

**MICROPHONE** Dept. X-702  
1760 W. Lunt Ave., Chicago 26, Ill.



Say You Saw It in Popular Mechanics

## ARMSTRONG LATHE TOOLS

There is a correct ARMSTRONG TOOL HOLDER for every operation on Lathes, Planers, Slotters and Shapers. Shown at left are:

1. *Turning Tool*—for roughing, finishing and fillet work.
2. *Boring Tool*—for boring and internal threading.
3. *Threading Tool*—for thread cutting.
4. *Cutting-off Tool*—for lathe cutting-off work.

ARMSTRONG Lathe Tools are designed to give greater strength, maximum clearance and correct cutting angle. They are the most efficient and economical lathe tools you can buy. Write for Catalog



OVER 250 SIZES AND TYPES **ARMSTRONG BROS. TOOL CO.**  
5268 W. ARMSTRONG AVE. • CHICAGO 30, ILL.



# GOOD NEWS! THIS BEAUTIFUL VINYL-PLASTIC TILE FLOORING RESISTS GREASE, ACID, ALKALI YET COSTS YOU LESS!

## MATICO ARISTOFLEX

The New Low-Cost Tile  
Flooring Made of Vinyl—  
The Wonder Plastic!

Costs Less To Begin With! Aristoflex—in economical standard gauge — is produced especially by MATICO to meet the needs of homeowners everywhere. It resists dirt, grease, acid and alkali... stays sparkling clean with occasional damp moppings... is quiet and comfortable underfoot... comes in 13 radiant Coronation Colors... lasts for years and years. Best of all, Aristoflex costs less than any other flooring of comparable quality... gives you far more for your money. See Aristoflex at your friendly MATICO dealer — he's listed in your local classified telephone directory!



install  
**ARISTOFLEX** yourself  
**SAVE STILL MORE!**

Yes, you can save \$25, \$30 or more on every room by installing Aristoflex yourself. It's easy, too, with MATICO's tested install-it-yourself method—special tool kit—and illustrated instruction booklet. And you can install Aristoflex in any room from basement to attic because it's rugged vinyl-plastic throughout — there's no felt backing to wear off or deteriorate.



**MASTIC TILE CORPORATION  
OF AMERICA**

Member: Vinyl Flooring Institute  
Joliet, Ill. • Long Beach, Calif.  
Newburgh, N. Y.

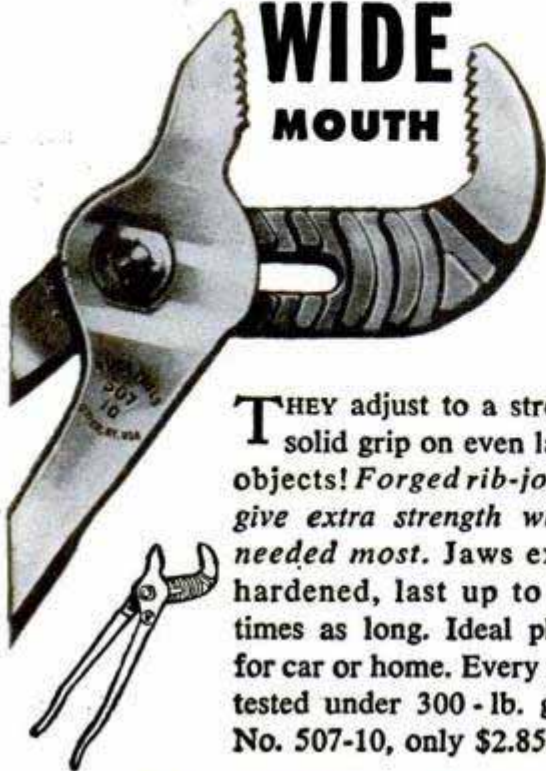
3C99



# UTICA®

UTILITY PLIERS  
WITH THE

**WIDE  
MOUTH**



THEY adjust to a strong, solid grip on even large objects! *Forged rib-joints give extra strength where needed most.* Jaws extra hardened, last up to ten times as long. Ideal pliers for car or home. Every pair tested under 300-lb. grip. No. 507-10, only \$2.85.



IT PAYS TO BUY QUALITY TOOLS  
and the world's best tools are made in U.S.A.

SEND 10c TODAY FOR THE BOOKLET  
"1001 Uses for the Simpson Model 260" in your home-garage-shop or hobby

Find out how you can check and trouble shoot faulty circuits in • TV sets • radios • transmitters • broad-casting equipment • home appliances • two-way radio communication systems • phone lines • air conditioning systems • starter controls • auto ignitions, generators, batteries • movie equipment • panel instruments • TV cameras • auto lighting systems • generators • voltage sources • "ham" radio equipment • cables • connectors • audio frequency sound currents

**Simpson "260" Volt-Ohm-Milliammeter reads voltage, current and resistance only \$38.95**

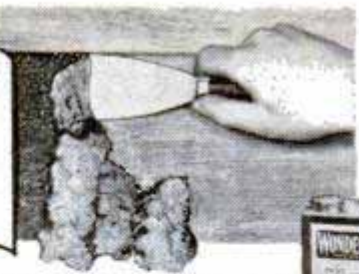


USE THIS AD AS YOUR COUPON.

Print your name and address in the margin. Mail to  
**Simpson ELECTRIC COMPANY**

5200 W. KINZIE ST., CHICAGO 44 • ESTEBROOK 9-1121  
IN CANADA: BACH-SIMPSON, LTD., LONDON, ONT.

Easy way  
to strip  
paint...

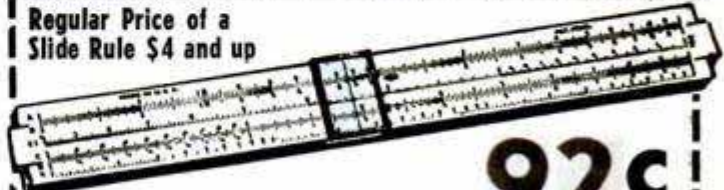


## WONDER-PASTE

softens up the toughest paint, varnish, enamel or shellac. Comes off clean at every stroke of your putty knife. At paint and hardware stores.

Write for leaflet and advice on your removing problem  
Wilson-Imperial Company, 119 Chestnut Street, Newark 5, N. J.

Regular Price of a  
Slide Rule \$4 and up



## Slide Rule

**92c**  
and this coupon  
Add 8c Postage

If you can use a pencil you can use a slide rule. For bookkeepers, accountants, salesmen (figuring commissions, cost, etc.), farmers, housewives, etc. For Armed Forces highly important. Men's most useful tool. Easy to calculate instantly. Multiplying, proportions, division, roots, etc. "High Vision" Clear View Slide. Full 10" Rule. A, B, C, D, C1 and K scales. 28-page instruction book on how to get correct answers instantly without pencil or paper.

**FREE** Gene Loewy, 545 5th Ave., Dept. 43 F, N.Y. 17  
Limit three rules to each coupon



HAVE A BIGGER — MORE EFFICIENT HOME WORKSHOP

Popular Mechanics **PLANNING YOUR HOME WORKSHOP** shows you how to make use of every inch of space in your workshop: detailed floor plans, wiring layouts and power tool hookups plus actual photographs of famous home workshops you can use as models. Save money by building your own shop furniture. Special Where-to-Buy-It Guide, 450 Illustrations, Cloth Bound, Working Diagrams. Order your copy today from

**\$2.50**  
POPULAR MECHANICS PRESS  
200 E. Ontario Street Chicago 11

## HELPFUL BOOKS

Send post card asking for **FREE** catalog  
Popular Mechanics Press, 200 E. Ontario, Dept. 601, Chicago 11

SILENCE IT WITH

# CONTACT

Amazing NEW Lubricator

SAVE MANY DOLLARS ON REPAIRS **\$1.00**

**\$1.00**  
P.P.

INSTANTLY RESTORES and LUBRICATES ALL MOVING PARTS—TV and Radio contacts, push buttons, switch contacts, rheostats. Quiets and lubricates electric motors, clocks, shavers, typewriters, adding machines, electric trains, etc.

CONTACT a hydrocarbon colloidal suspension is forced into inaccessible places by capillary action. Does not affect inductance, capacitance or resistance. Harmless to precious metals. Cleans, forms a durable, non-greasy, non-sticky, hard-bonded lubricating surface. Complete with applicator and instructions. Satisfaction guaranteed or your money refunded.

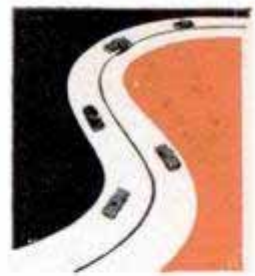


**\$1.00**  
P.P. A FEW DROPS THAT'S ALL!

SEND \$1.00 (check or cash) to

**BEAVER LABORATORIES, Inc.**  
Box 152, White Plains, N.Y.

What every Automobile man  
should know about



# Power Steering

(Number 1 of a Series)

You've probably been hearing a great deal about Power Steering lately. It is attracting more attention in the automotive field than anything since automatic transmission. For the most part, comment has been extremely favorable. However, as with any new product, there have been some misconceptions due to incomplete or faulty information.

That's why we, as the world's largest producer of power and manual steering gears, are publishing this series of messages to help answer some of the questions most frequently asked about Power Steering. Let's start with a basic one.

## 1. IS POWER STEERING HERE TO STAY?

Definitely *yes!* No other major automotive development (not even automatic transmission) has won such rapid public acceptance. Its principles have already been perfected by years of use in heavy vehicles—such as buses, trucks and road-building equipment—and in ships and aircraft.

## 2. IS IT TROUBLE-FREE AND DURABLE?

Again, *yes!* Engineering tests over many years have proved that Saginaw Power Steering will easily outlast the average car with nothing but an infrequent adjustment or addition of oil.

## 3. WHY IS SAGINAW POWER STEERING

**SAFER?** Saginaw Power Steering is safer because it helps you drive relaxed and tension-free. It resists and absorbs wheel-twist from ruts or chuckholes—enables you to keep your car under safe control even in case of a blowout at high speed. Saginaw Power Steering also provides quicker steering response in any emergency.

Because of its simple and sturdy construction, there's practically *no chance of power failure*. But just in case, you always have the assurance that you can guide your car by manual steering—an extra built-in safeguard that prevents any possibility of loss of control.

Another vital safety feature of Saginaw Power Steering is the comforting "*feel of the road*"—the subject of our next message.

**MEANTIME**—if you'd like to learn more, we'll be delighted to send you "THE FACTS ABOUT POWER STEERING"—an interesting little booklet we've prepared to help give you a better understanding of this important new development. It's yours for the asking—just use the handy coupon.

**Saginaw**  
**POWER STEERING**



Saginaw Steering Gear Division  
General Motors Corporation  
Saginaw, Michigan (Dept. M)  
Please send a free copy of "The Facts About Power Steering."

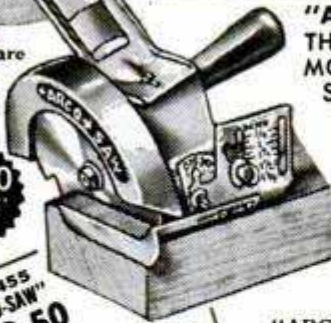
NAME \_\_\_\_\_  
ADDRESS \_\_\_\_\_  
CITY \_\_\_\_\_ ZONE \_\_\_\_\_ STATE \_\_\_\_\_

# HOW TO HAVE A REAL POWER SAW FOR ONLY \$12.50

At Better Hardware Stores Everywhere

**ARCO SAW**

No. 455 "ARCO-SAW" \$12.50 with ALL GAGES & 5" SAFECUT Blade.



"ARCO-SAW" HAS ALL THE FEATURES — OR MORE — THAN POWER SAWS COSTING 3 OR 4 TIMES AS MUCH!

Saws 2x4's in 1 Cut  
Attaches in one minute to any 1/4" electric drill.  
Toss away that old-fashioned handsaw! Don't put in hard-working hours to do a simple job that should take minutes.

"ARCO-SAW," the only geared saw attachment to whiz thru 2x4's in one cut, does the work 8 times faster than handsawing.

In seconds it is attached to any 1/4" drill. All you need is a screwdriver. Just tighten the Worm Drive Clamp & Strong Safety-Yoke around drill. Then you can run this powerful, vibration-free electric saw with one hand, freeing the other to hold workpiece. You can build anything from a bookcase to a bungalow!

You get straight, square cuts or any depth cut up to 1 3/4" by a quick adjustment of the Graduated Depth Gage. By turning the Graduated Bevel Gage you can cut any angle. And to follow a line, you get a Rip Gage & Visual Guide (not shown).

Included is the sensational fast-cutting 5-inch SAFECUT Blade which zips thru heavy lumber, wallboard, plywood, etc. You'll find "ARCO-SAW" with its tough steel gears practically indestructible.

90-DAY FACTORY GUARANTEE  
REPLACEMENT BLADES: Specify 5" Safecut, or Combination, or Rip, or Crosscut Style. . . . . \$1.75

## NEW! 'ARCO STAND 'N TABLE'

MAKES A WORKSHOP OUT OF EVERY 1/4" ELECTRIC DRILL!

HAS TILTING TABLE FOR Sanding, Grinding, Buffing, etc.



Sturdy Aluminum Castings hold complete unit vibration-free, allows operator to use both hands.

No. 400 \$7.95

Consists of strong Drill Stand with Worm Drive Clamp and adjustable Table. Tilts to 45°, adjusts up and down for various jobs. Rubber cushioned Sander for beautiful sanding, can also be used in drill alone or drill press. 6 Sanding Discs and "Speed Cement."

No. 401 "ARCO STAND" consists of Drill Stand & Worm Drive Clamp only. . . . . \$2.75

BUY THE BEST—see your hardware dealer now! Don't accept inferior substitutes without the famous "ARCO" features. If not available, try "ARCO" tools on our 10-DAY NO RISK GUARANTEE. You must be completely satisfied or your money refunded. Send us check or M.O. (Postpaid). C.O.D.'s—postage extra.

DEALERS Write for nearest jobber.

**ARROW METAL PRODUCTS CO.**

DEPT. PM-10, 140 WEST BROADWAY, NEW YORK 13, N. Y.

The Chief

# WORK BENCH

Built to Last a Lifetime!

With Bottom Shelf and 18" Sq. Drawer. 2"x6", Solid Plank, Grooved and Dovetailed Top and 1"x8" Back Rail, Shellacked to a Smooth, Satiny Finish.

MOHAWK LUMBER CO. Dept. 33  
14525 W. Chicago Blvd. Detroit 27, Mich.  
Enclosed  Check  Money Order for \$.....  
Ship..... CHIEF WORK BENCHES at  
Quantity  
\$19.95 each, F.O.B. Detroit, Mich.  
 Send C.O.D., \$5 Deposit Enclosed.

• 6 Ft. Long • 34" High • 26" Deep. Shipped Knock-down, with Bolts, Nuts and Screws and ABC Chart for Quick, Simple Assembly.

Prompt Delivery  
**MOHAWK LUMBER CO.**  
14525 W. Chicago Boulevard  
DETROIT 27, MICHIGAN



\$19.95 F.O.B. DETROIT

Send Check or Money Order, or Will Ship C. O. D. (\$5 Deposit)

# POWER HYDRAULICS for SNOW PLOWS

Use on



TRUCKS

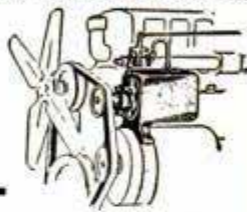


JEEPS



TRACTORS

**HY-LO-JACK** does the job **FASTER-EASIER**



- Lifts average snow plow in 3 to 10 seconds.
- 1,000 lbs. per square in. pressure
- Quick, easy installation on new or existing equipment.
- Complete kit form, including the pump, tank, hose lines, etc.
- Electric unit also available for 6 or 12 volt systems.

★ Write for Circular. See your Road Machinery, Jeep or Farm Equipment dealer.

**MONARCH ROAD MACHINERY CO.**

Quality Machinery since 1856

333 Front Ave., N.W., GRAND RAPIDS, MICH.

**WELD BRAZE**

**SOLDER CUT**



**4WAY**

ONLY \$14.75

f.o.b. factory

**WELDER**

Complete with Twin Carbon Arc Torch and accessories... to handle all metal-craft work.

Acclaimed by thousands of Homeowners, Mechanics and Hobbyists as the welder of 1001 uses. Easily operated from properly wired 110 volt AC or DC line. The ideal gift with a life-long use... Order today on 10 day money back guarantee.

**FOUR-WAY WELDER CO., Dept. F2-K**  
2326 S. Michigan Ave. • Chicago 16, Ill.

SAY YOU SAW IT IN POPULAR MECHANICS

Your YOUNGSTER WILL LOVE IT!

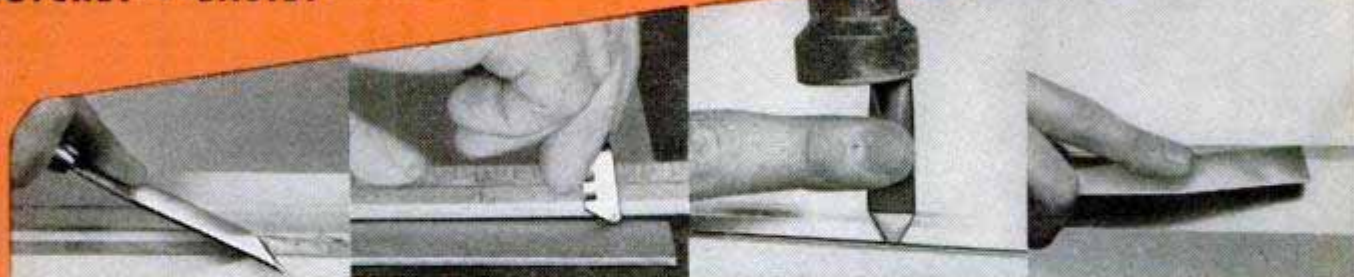


Give your youngster a TRACTALL for the joy-ride of a lifetime! Looks just like a man-size Tractor. The perfect gift for boys, girls, up to 12 years old. Chain Drive. Exciting Attachments available. Write for FREE Literature TODAY.

**INLAND MFG. CORP., Dept. PM-10, 164 Ellicott St., Buffalo 3, N.Y.**

# FIX BROKEN WINDOWS

QUICKLY • EASILY



Clean out old putty and glaziers' points with Red Devil P-1 Putty Knife or P-17 Putty Chisel. Paint channel with paint or linseed oil.

Measure and cut glass with Red Devil Glass Cutter (see "How To Cut Glass" in last month's issue or send for Red Devil Booklet #1 on "How To Cut Glass").

Line channel with putty. Place glass in channel. Secure with Red Devil Glaziers' Points—you'll find a driving tool in each box of Red Devil Glaziers' Points.

Finish with putty and paint immediately

Easy as this, if you have the right tools and know how to use them.

your...

## Red Devil

Hardware or Paint Dealer can take care of both these needs. Get full details by getting your FREE copy of Red Devil's "How To Fix Broken Windows" from your dealer or mail the coupon today.

Remember—you want Red Devil Tools—the kind professionals use.



### Red Devil Tools.

Box 602  
Irvington 11, N. J.

Please send me "How To Fix Broken Windows"

Name \_\_\_\_\_

Address \_\_\_\_\_

City \_\_\_\_\_ State \_\_\_\_\_ 3034

## ELECTRIC MOTOR BARGAINS Brand New

WE GUARANTEE THESE BUYS CAN'T BE MATCHED!!

COMPARE PRICES—Then Order Fast  
Limited Supply — SAVE OVER 1/2

|                          |              |                              |              |
|--------------------------|--------------|------------------------------|--------------|
| 1 HP <sup>3450</sup> RPM | <b>39.50</b> | 1 1/2 HP <sup>3450</sup> RPM | <b>47.50</b> |
| 2 HP <sup>3450</sup> RPM | <b>72.50</b> | 3 HP <sup>3450</sup> RPM     | <b>90.00</b> |

All prices F.O.B. Immediate Delivery 100% GUARANTEE...YOU CAN'T LOSE

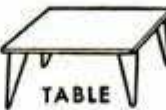
Heavy Duty, Repulsion Induction and Capacitor types. 110-220 Volts (except 2 and 3 HP which are straight 220). 60-cycle. Single phase. Famous makes (G.E., Wagner, Leland, Westinghouse, etc.) Brand new. Don't miss out. Rush order TODAY!

SEND FOR FREE CATALOG of other Motor Bargains

ROBERTS ELECTRIC CO., 849 W. Grand, Dept. 104, Chicago 22, Ill.

SAY YOU SAW IT IN POPULAR MECHANICS

## Smart, Modern, Sturdy WROUGHT IRON LEGS



Do-it-yourself in seconds... last forever

Child's play for any man-about-the-house — these wrought iron legs can be attached to anything to achieve the new-look in modern furniture. A three foot square of 1" plywood becomes a coffee table of matchless beauty with smart, graceful, wrought iron legs. These are 1-piece construction—no welds to break. They're full 1/2" diameter with guaranteed rust-proof longlasting baked black enamel semi-glossy finish. Dozens of smart uses waiting around YOUR house.

SETS OF FOUR LEGS

complete with necessary screws

|                    |                     |
|--------------------|---------------------|
| 6" tall.....\$4.95 | 10" tall....\$ 5.75 |
| 12" tall..... 5.95 | 16" tall.... 6.95   |
| 21" tall..... 7.95 | 28" tall.... 10.95  |

BY MAIL ONLY—Modernize your chests, beds, tables, desks, TV stands, in a single evening. 100% money-back guarantee. No C.O.D.'s. We pay postage. Immediate delivery—send your order today.

CHICAGO

Sales-Engineering Co.

53 W. Jackson Blvd., Dept. 210, Chicago 4, Ill.

Over 2,000 Bargains for SPORTS • FARM • HOME • WORKSHOP • INDUSTRY



U.S. GOV'T. SURPLUS "BARGAIN BOOK" UP TO 85% SAVINGS ARE Yours!

JUST OFF THE PRESS!

100,000 satisfied customers have discovered terrific savings on Clothing, Hardware, Sporting Goods. Nationally advertised brands. U. S. Government Surplus just released! Now available to you at less than 1/2 original cost Send 10c. GET YOUR BARGAIN BOOK BY RETURN MAIL.

# Fisler's

1329 MAIN  
Dept. PM1  
KANSAS CITY, MO.

# FINE WOOD DESERVES



*a fine*  
**OIL  
FINISH**



**Archer**  
*Pol-mer-ik*  
**LINSEED OIL**

- PROTECTS
- PRESERVES
- FINISHES

AMONG ITS 101  
*Handy Uses*

- Refinishing Antiques
- Glazing Windows
- Protecting Tool Handles
- Preserving Paint Brushes
- Protecting Ladders

**Is there a painter  
in the house?**

Yes, for preserving fine woods . . . and for an unending variety of other daily uses both indoors and out . . . you'll find Archer Pol-mer-ik the *handiest* single item in your home or shop.

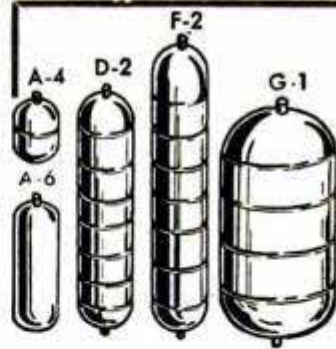


Archer Pol-mer-ik is the choice of most professional painters for paint reducing and brush conditioning. And with good reason . . . for Pol-mer-ik's special heat processing rearranges and locks together the oil molecules, giving you a tougher, more durable paint film than ordinary linseed oil. Paints reduced with Pol-mer-ik brush out easier . . . level better . . . establish a smoother surface that collects less dirt, and gives you a longer-lasting job! For better results, use Archer Pol-mer-ik *whenever* you paint!



**FREE!**  
**101 MONEY-SAVING IDEAS**

Get your copy today. Shortcuts and pointers from the "pro's", based on practical experience. Free—no obligation. Just drop a card to: Archer-Daniels-Midland Co., 603 Roanoke Building, Minneapolis, Minn.



# STEEL AIR TANKS

Steel pressure tanks suitable for compressors, pneumatic units, gases, hydraulics, and liquids. Rated at 500 lbs. per square inch pressure. 1/4" standard pipe thread openings on tank ends as shown.

|      |                 |      |  | Size           | Wt. Lbs. | Internal Volume | Price  |
|------|-----------------|------|--|----------------|----------|-----------------|--------|
| A-4  | Carbon Steel    | —New |  | 7 1/2"x5 1/4"  | 1 1/2    | 104 cu. in.     | \$1.50 |
| A-6  | Carbon Steel    | —New |  | 14 1/2"x5 1/2" | 3 1/4    | 280 cu. in.     | 3.50   |
| D-2  | Stainless Steel | —New |  | 24"x6"         | 5        | 500 cu. in.     | 5.50   |
| D-2A | Carbon Steel    | —New |  | 24"x6"         | 5        | 500 cu. in.     | 4.50   |
| F-2  | Stainless Steel | —New |  | 45"x6"         | 11       | 1000 cu. in.    | 9.50   |
| F-2A | Carbon Steel    | —New |  | 45"x6"         | 11       | 1000 cu. in.    | 8.50   |
| G-1  | Stainless Steel | —New |  | 24"x12"        | 18       | 2100 cu. in.    | 11.50  |

Prices F.O.B. Chicago. Include approx. postage on orders paid for in advance. C.O.D. orders enclose 25% balance sent C.O.D.

**U. A. S. Corp.** Dept. PM10, 5637 W. 63rd Pl., Chicago 38, Illinois

**DON'T LET WATER PIPES FREEZE EVEN AT 50° BELOW ZERO**

**ORDER FUSED ELECTRIC THERMOTAPE Now!**

Thermotape is safe, easy to use. Simply wrap it around pipe, secure it with tape, plug it in. Protects to 50° below zero. Shockproof, fireproof, waterproof. Made to last. Cheap to use. 20 foot roll, \$6.15; 40 feet, \$9.85; 60 feet, \$13.35. Smith-Gates thermostat for \$5.95 makes operation automatic, cuts operating cost. Save time, trouble, costly repairs. **SEND CHECK OR MONEY ORDER TODAY!**

**POSTMART**  
DEPT. J48 • FORESTVILLE, CONN.

Ask for **Rosco** Precision-Made **SCREW DRIVERS**

"AMERICA'S GREATEST SCREW DRIVER VALUE!"

Rosenberg Bros. & Co.  
Smithtown, L. I., N. Y.

**BUILD YOUR OWN ARC-WELDER**

We show you how to build NEW powerful welder. No rewinding. Uses most any surplus aircraft generator. Easy to build. 75-300 amps. Complete PLANS 25c. Send today and we'll include FREE our Big War Surplus & Electrical Catalog.

**LEJAY MFG. CO.** 1247 LeJay Bldg., Minneapolis 8, Minn.

**2 DRILLS in 1**

**\$11.95** post paid

This attachment gives you two drills in one. It converts any 1/4 inch electric drill to 1/2 inch capacity. Reduction gears reduce the drill speed 5 to 1, the average speed of a 1/2 inch drill, and thereby increases the power. Absolutely indispensable for all shop work and home craftsmen.

**G. M. CO. MANUFACTURING, INC.**  
1308 43rd AVE.  
LONG ISLAND CITY 1, NEW YORK

Send check or Money Order • Satisfaction guaranteed • Order yours now

Now You Can Have  
**A Dry Basement**  
 with beautiful colored walls  
 and floor

PLASTEX gives long-lasting protection against water. Also bright, colorful, easily washable walls and floors. Basements painted with PLASTEX in 1939 are still dry and attractive. Water up to 10 ft. has been successfully kept out by PLASTEX.

PLASTEX is not a water mixed material. It is formulated of synthetic resins especially to resist water pressure. The hard glossy PLASTEX finish is not easily soiled.

PLASTEX is also excellent for use in kitchens, bathrooms and for interior trim—where resistance to water, grease, etc., is necessary. PLASTEX is available in many colors making possible lovely color combinations. Easily applied by brush.

Color chart and complete information will be sent on request.



Steel Protection & Chemical Co., Inc.  
 1053 Bridge St.  
 Mooresville, Indiana

**PLANS! BEAUTIFY YOUR GARDEN**



3 Distinctive Lawn Chair Plans for ONLY \$1.25  
 40" high Dutch Windmill Detailed Plan, ONLY .75c  
 Send 10c for illustrated Catalog.

- DUTCH WINDMILLS
- LIGHTHOUSES
- LAWN CHAIRS
- BIRD HOUSES
- LAWN FIGURES

**CRAFTSMAN'S MODEL CO.** Dept. P-57 DELAFIELD, WIS.

Say You Saw It in Popular Mechanics

**HOBBYISTS! SHOPMEN! Special** **ONLY \$54.50**

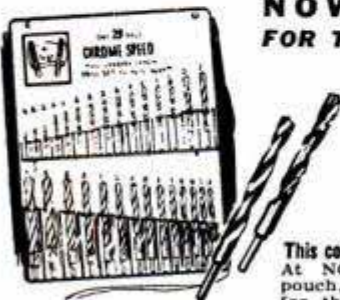
**PALMGREN "HOBB-E" Rotary, Index, Milling Table**  
 Ideal for Model Parts or Shop Work

Mill-Grind-Drill-Index-Rout curved or straight-Rabbit and Mortise on drill press or lathe. 8" Table, 4" Cross Feed, 360° Rotation, Accurately Graduated. Bolts to table. Order NOW! SAVE \$100. Only \$54.50. Less Rotary Feed \$39.75. Write for "HOBB-E" Tool Circular.



**CHICAGO TOOL and ENGINEERING CO.**  
 8365 South Chicago Ave. Chicago 17, Ill.

**YOU CAN DRILL ANY SIZE HOLE UP TO 1/2" WITH YOUR PRESENT 1/4" CAPACITY POWER DRILL. NOW AVAILABLE FOR THE FIRST TIME . . .**



The COMPLETE SET of CHROME SPEED HI-TEST TWIST DRILLS—ALL 29 SIZES . . . from 1/16" to 1/2" . . . with Shank diameters limited to 1/4".

This complete set for a low-low At NO EXTRA COST a pouch, specially designed for this set is included. **9.98**

FREE CATALOG OF OTHER TOOL BUYS ON REQUEST  
**COASTAL ABRASIVE & TOOL CO.**

An Affiliate of DENTAL SPECIALTY & SALES CO.  
 Dept. PMD P.O. Box 692 Great Neck, N. Y.



Change NOW for Engine Magic

It's Fram CLEAN OIL MONTH . . . time to add life, keep power in your car

Put a new Fram Cartridge in your oil filter for real engine magic. Fram helps you keep your engine in tip-top shape . . . add thousands of extra miles . . . make repair bills disappear. That's because Fram Oil Filter Cartridges cut engine wear like magic.

Wear kills your engine. Dirt, dust, grit and sludge go to work on your car the minute you start it. A leading oil company recently reported that 85% of engine failure was due primarily to excessive wear. And car factory engineers say that when you trap dirt from the oil, you cut engine wear and protect car life.

But since the cartridge inside the filter does all the work, cartridge quality is what really counts. That's why you want genuine Fram Cartridges . . . guaranteed best or your money back. So see your Fram Dealer now, during CLEAN OIL MONTH for clean winter oil and a new Fram Cartridge to keep it clean. Fram Filters . . . best life insurance your car ever had.

**FRAM CORPORATION**, Providence 16, R. I.  
 In Canada: Fram Canada Ltd., Stratford, Ont.

Call Western Union (by number) and ask Operator 25 for the name of your nearest Fram Dealer

**FRAM**  
 OIL • AIR • FUEL • WATER  
**FILTERS**



**FREE** 24-page book tells you how to paint like an expert



You can do a fine home painting job the very first time you try! It's easy when you know how—and this FREE book tells you. Here are the simple, basic facts about quick, streak-free paint jobs on furniture, walls, your whole house inside and out. Yes, it's easy to do the job yourself... and do it right.

**USE BAKER BRUSHES AND FEEL THE DIFFERENCE!**

You'll get smooth, streak-free results with a Baker Brush because it's scientifically designed for better painting.



BETTER BRUSHES FOR BETTER PAINTING

**BAKER BRUSH CO., INC.**  
83 Grand Street, New York 13, N. Y.

Please send me your FREE book, "How to do a GOOD Paint Job."

Name \_\_\_\_\_

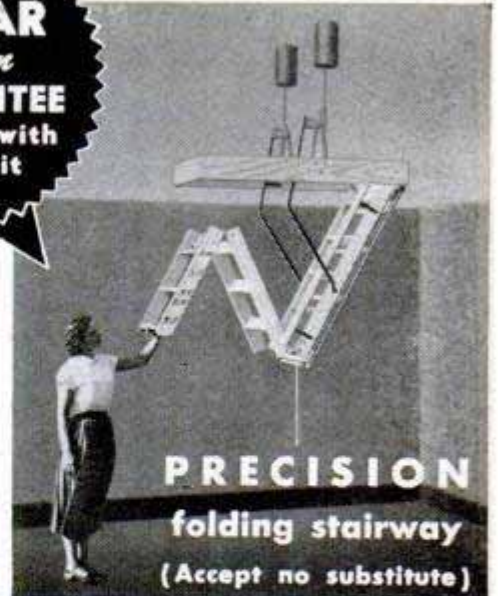
Address \_\_\_\_\_

City \_\_\_\_\_

Zone \_\_\_\_\_ State \_\_\_\_\_

(Please Print)

**5 YEAR**  
*written*  
**GUARANTEE**  
furnished with  
each unit



**USE YOUR ATTIC**

The most economical way to extra room and storage space. Install the finest of all attic stairways, the original PRECISION folding stairway with these 5 EXCLUSIVE FEATURES:

1. Actuated by counterweight.
2. Operates on roller bearings which make raising and lowering practically effortless.
3. Insulated door panel to prevent loss of heat to attic.
4. Full width safety treads.
5. Finest grade lumber and aluminum alloy construction.

All parts secured by bolts and screws.

**SIMPLE AND EASY TO INSTALL.**

For complete information write today.

Mfd. by **PRECISION PARTS CORPORATION**  
400PM North First Street

Nashville 7, Tenn.

**Say You Saw It in Popular Mechanics**

**NOW YOU CAN DO FINE FURNITURE FINISHING**

*with this new "all-in-one" Kit*

Would you like to refinish antique furniture like an expert? Or save money by buying unfinished furniture, then finishing it with the rich, glowing tone of antique pine and maple? Or mahogany? **Now you can do it!** And you needn't shop for doubtful materials or take the amateur advice of well-meaning friends. Here, in one combined package, are detailed instructions, plus all the materials needed for building an antique pine and maple, or mahogany, finish just as the experts do. Instruction pamphlet gives easy, one-two-three steps for producing a finish you can be proud of. All materials of highest professional quality: 1/2 pint rich, Duxbury antique pine and maple stain (or mahogany), one pint special rubbing varnish, soft brush, finest wax, extra-fine sandpaper and superfine steel wool not usually available in stores. **Enough to do several pieces of furniture.** Don't be timid about this satisfying, money-saving hobby. It's easy with The Duxbury Craftsmen's Furniture Finishing Kit. Only \$4.95 Postage Prepaid. (West of the Mississippi, \$5.20.) Be sure to specify whether you prefer pine-maple stain or mahogany. Send check or money order today. **Your money back if not fully satisfied.**

The Duxbury Craftsmen, Box 110, South Duxbury, Mass.



# "Do-it-Yourself" and SAVE HUNDREDS of DOLLARS!



**LOOK AT ITS SIZE!  
TABLE IS 42" LONG!**



No chance for big, wide, or long boards to tip up, slew sideways, or slip on this big, solid 42" precision-ground table! 32" fence is longer than most jointer tables!

**QUICK, EASY BLADE  
ALIGNMENT!**



Blade-height adjustment screws permit quick, accurate positioning of cutter head and blades. Accurate alignment with the stationary rear table is a quick, easy job.

## Do a BETTER JOB of Building or Remodeling with this Big *Atlas* Jointer

Ready to handle all your planing, beveling, edging, and rabbeting — cut step mouldings — give your work an accurate, satin-smooth surface in seconds! . . . this Atlas 6" jointer-planer can save you plenty on work for your home. It's big enough to finish out a house or remodel a room — has the accuracy you need for the finest cabinets and furniture. The exclusive cutter head, sealed-for-life ball bearings, and massive table and fence are but three of its many outstanding features. Send the coupon below *today* for a free Atlas catalog with *complete* details.



### EASIER TO USE

Front table adjusts fast and accurately to scale graduated in 16ths. Rear table is *stationary* — always in perfect alignment. *Exclusive* width-of-rabbit scale graduated in 16ths! Fence tilts 45° both ways, has positive stops.

**NEW**

**20 PLAN BOOK**

**ONLY 50¢**



New, practical plans for furniture and home furnishings. Drawings, photos, step-by-step instructions. Send cash or check (no stamps). 65c outside U.S.A.

**ATLAS PRESS CO.**

1024 N. PITCHER STREET • KALAMAZOO, MICH.

**SEND THIS COUPON FOR CATALOG**

- Please send woodworking tool catalog.  
 Inclosed is \_\_\_\_\_ for \_\_\_\_\_ Plan Books.

Name \_\_\_\_\_

Address \_\_\_\_\_

City, State \_\_\_\_\_

# NEW!

## DO-IT-YOURSELF CARBURETOR CLEANING KIT

Everything\* you need to clean your own carburetor right on the engine without taking it apart

\*Includes pint of GUMOUT and easy-to-use applicator.



Get better engine performance—smoother idling, faster pick-up, greater gasoline economy. Eliminate engine stalling, bucking, and fuel waste caused by a dirty gummed-up carburetor.

Keep your carburetor clean all the time. *Do it yourself* with GUMOUT and KIT—sold by leading auto supply stores, service stations, car dealers. GUMOUT refills always available from your dealer.

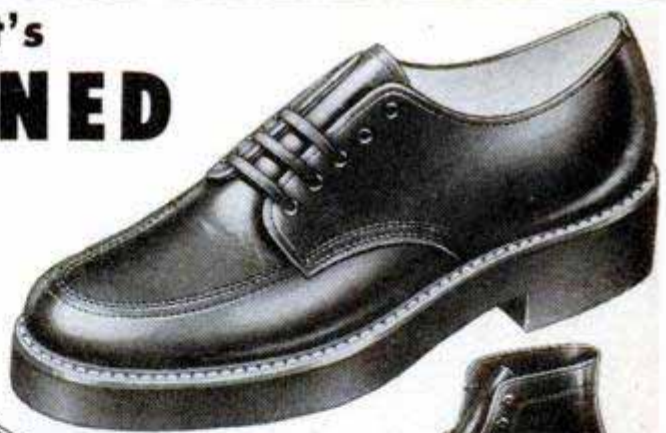
If your local dealer can't supply you, order direct. \$3.95 postpaid.

GUMOUT DIVISION  
PENNSYLVANIA REFINING COMPANY  
2682 LISBON ROAD, CLEVELAND 4, OHIO

## the 10 Feature shoe that's **DOUBLE CUSHIONED** *extra Comfort for*

- MECHANICS
- TRUCKERS
- CARPENTERS
- RANCHERS
- FILLING STATION OPERATORS

Here is real comfort for the man that works on his feet all day. Both oxford and high shoe have extra thick oil-resistant Neoprene Crepe cushion soles and cushion insoles.



Stock No. 4093  
to retail at  
about \$12.95



Stock No. 4063  
to retail at  
about \$13.95

### 10 FEATURE VALUE FACTORS

- 1 CUSHION INSOLE... soft as a pillow
- 2 QUALITY LEATHER CONSTRUCTION in Hidden Parts
- 3 COOKIE ARCH... for proper foot balance
- 4 STEEL SHANK... will not break... firmly secured
- 5 NEOPRENE CUSHION CREPE HEELS AND SOLES... oil-resistant, non-slip



- 6 ELK FINISHED UPPER LEATHER... takes a good polish
- 7 FIRST QUALITY DRILL LININGS
- 8 STITCHED with 4 ROWS LINEN THREAD... will not rip apart
- 9 SNUG HEEL FITTING... combination fitting
- 10 METATARSAL PAD... extra comfort... balances foot.

For name of nearest dealer write to

Dept. PM-10, Peters Shoe Company • Division: International Shoe Company • St. Louis

# Mr. Fisherman!

## YOU need "Goin' Fishin'!"

• You haven't LIVED until you have read the hottest fishing book ever published for fishermen by 20 top-name authors . . . all the game fish spectacularly reproduced in full color . . . a riot of tall-tale fish cartoons in color . . . THE FISHING HALL OF FAME . . . Maps of Fish Hot Spots . . . 1,000 Better Places To Fish . . . Florida . . . Alaska . . . Pacific Coast . . . Atlantic . . . Great Lakes Region . . . Rockies . . . Texas, etc. All the best fishing gear on parade. ALL THIS FOR A DOLLAR. FREE! New secret method to catch more game fish. If tackle dealer cannot supply, write direct.

Joe Godfrey • Dept. III • Goin' Fishin' Everywhere  
422 South Dearborn St. • Chicago 5, Ill.



## EASY TO ASSEMBLE BOAT KITS 30 MODELS

### NEW 18 FT. OUTBOARD CABIN CRUISER

Other models 8 to 23 Ft.  
Rowboats, Outboards, Inboards



NEW CATALOG Only 35c, SEND COIN TODAY  
U-MAK-IT PRODUCTS 725-WHITTIER ST.  
Bronx 59, N. Y. City

## SIGHT LEVELS INSTANTLY!

### STRATEX SURVEYING Hand Level

\$10



Positive slopes, elevations, drainage—form, for-est or construction. Built for life—simple to use—lets you plan, build, excavate with confidence; ad-justs instantly from outside of instrument even in gusty weather! Put it to work now. It pays for itself on one job—fully guaranteed. \$2 cash, bal. C.O.D., or \$10 with order, we pay charges. Saddle leather case included. FREE price list.



IN U.S.A.

STRATEX INSTRUMENT CO., INC.  
1861C Hillhurst Ave., Los Angeles 27, Calif.

## TOOLS AT WHOLESALE

### PROFESSIONAL MECHANICS HAND TOOLS

Farm, Household and Special Tools

### TOP QUALITY, FACTORY GUARANTEED

Write Today for  
FREE CATALOG

MECHANICS CO-OP  
Dept. X Oakland 8, Calif.

## SAW WOOD

with a big, powerful

### Springfield Garden Tractor

Saw wood, remove snow, plow, cultivate, etc. Exclusive features, new reverse. Also new model priced as low as \$109.50.

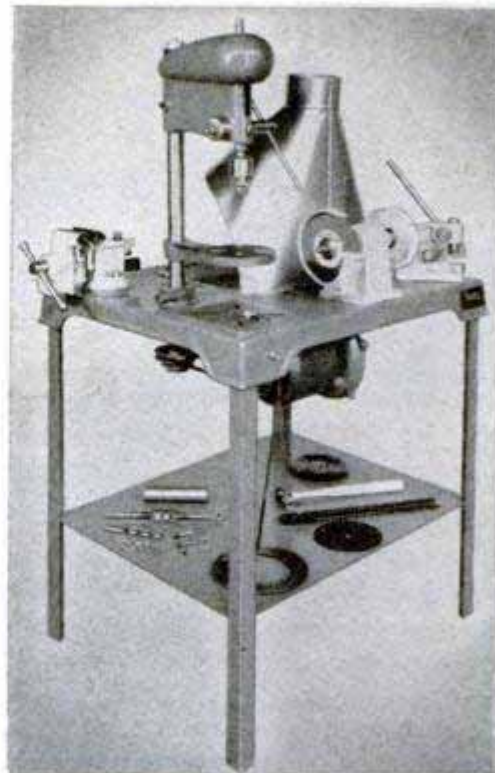
At your dealers  
or send for

FREE  
CATALOG



Quick Manufacturing, Inc.,  
3257 E. Main St., Springfield, Ohio

## NEW for Your Workshop!



Original  
•  
Complete  
•  
Ready  
to  
Use!

Only  
\$269.50

F.O.B.  
Lancaster, Pa.  
Ship. Wt. 240 lbs.

## The Champion FORGE SHOP

Works Iron, Sheet Metal,  
Aluminum, Brass for  
Homeshop, Farm, Factory  
Estates, Repair Shops, etc.

Includes: 1/3 h.p. Motor; 15" x 20" Forge with air blast regulator; electric blower; 3 1/2" machinists vise; 14" two speed radial bench drill press; Grinder & Polisher with emery, cut-off, polishing and wire wheels; 3" lever operated Shear; Hammer; Fire Tong; Tap Wrench; Set of 1/4", 3/8", 1/2" taps and drill bits to match; 1/2" steel burr; complete assembly & instruction book.

Make your own furniture, signs,  
railings, trellises, repairs, etc.

See the FORGE SHOP today at your hardware store or Hobby Shop—OR write for Free Catalog to Champion Blower & Forge Co., Dept. P, Lancaster, Penna.

Name \_\_\_\_\_

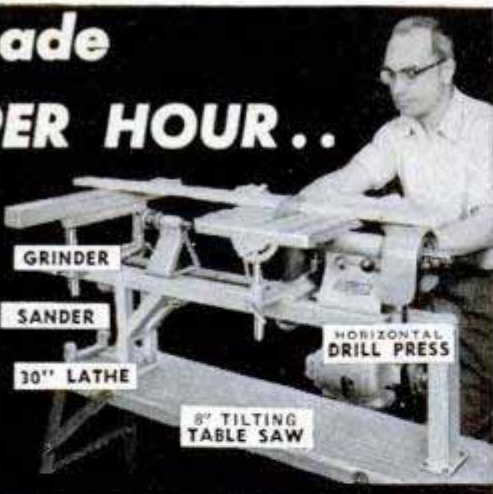
Street \_\_\_\_\_

City \_\_\_\_\_

State \_\_\_\_\_

**I Made  
\$15 PER HOUR..**

**with  
my  
SUPER-  
SHOP**



Every hour spent with SUPER-SHOP has been worth \$15 to me. Making it yourself is fun. SUPERSHOP is a complete, precision-built workshop. 100% ball bearing. Rugged tubular steel frame. Big capacity. 8 inch saw. Factory to you only \$79.95. Free trial. Easy pay plan. FREE catalog.



**VERTICAL  
DRILL PRESS**

**Write for FREE Catalog  
on Money Saving SUPERSHOP**

**POWER TOOLS INC.** 152 Yates Ave.  
BELOIT, WISCONSIN

**own your own business! earn up to  
\$75 A DAY CLEAR PROFIT  
in your back yard or basement!**

**MAKE CONCRETE BLOCKS With Amazing New  
LOW PRICED GENERAL BLOCK MACHINE**

**NOW! Big Building Boom  
Profits Within Your Reach**  
You don't need much cash to cash in on the building boom! New high speed, low cost General Block Machine produces up to 1,000 concrete blocks a day for homes, factories, buildings, garages. Your profit mark-up is 100% to 150%! Fool-proof, easily operated, sturdy steel machine can make any size from 4" to 12". These superior 3-core blocks meet all building code requirements for foundation, chimney, corner, sash and many other types of blocks. Works indoors or out. Sand, cement and water available anywhere! Simple operating instructions and mixing formulae for cement and cinder blocks supplied FREE. Get full details, no obligation!



R.L.T. of New York City Reports: "My General Block Machine PAID FOR ITSELF IN FIRST 2 WEEKS!"

**HOW TO BUILD YOUR OWN CONCRETE BLOCK HOME**  
Duly Prepared

Thousands now in use the world over!  
Write for FREE details TODAY

**EXTRA!**  
Amazing illustrated book gives floor plans for 6 sensational concrete block bungalows. Tells how to lay blocks, lay out building lines, mix concrete, build steps, porch and concrete floors all at great savings. Written by experts. Can save many times the cost of the machine! Get it now! No strings attached.

SEND \$1 — Refunded if you buy machine!

**GENERAL ENGINES COMPANY**  
Dept. M-103, 307 HUNTER STREET, GLOUCESTER, N. J.

**MAGIC HAND  
CLEANER**

**7-11 LIQUID HAND SOAP  
INSTANTLY REMOVES**

- GREASE • TAR • PAINT
  - INK • CHEMICAL STAINS
- FROM THE HANDS!**

A heavy duty hand cleaner that cleans without abrasives! Shake ten drops or so of speedy acting "7-11" on the hands — work in — and rinse off. Grime, grease and stains—even paint, tar and ink — wash off like magic. No need of harsh abrasives that damage the skin and promote infection. Non-allergic, amazing "7-11" HAND CLEANER does not dry out the skin or injure it in any way. Indispensable to every workman, mechanic, painter, printer or hobbyist. At your dealers or send \$1.00 with name of your nearest dealer for full 12 oz. self-dispensing can, sent postpaid. Money-back guarantee. Send today!



**DEALERS —  
DISTRIBUTORS**  
Write for full particulars and quantity prices!

**KNOX SOAP COMPANY**  
3300 W. Cermak Rd., Chicago 23, Ill.

**BUILD YOUR OWN ARC WELDER  
OR LIGHT PLANT**

**D-C GENERATOR**  
Save \$250 to \$500  
**\$15.50** used, good cond. Instruct. incl. for Comb. welder & light plant. 200 amps. 28 Volts. 2500 to 4500 R.P.M. Or Brand New.....Price \$21.50  
**PRICE F.O.B. K.C., MO.**

CONVERTS TO ARC WELDER 200-250 AMP.  
OR LIGHT PLANT CAP. LOAD 5000 WATTS

Stock No. 711 D. C. Generator R-1 Jack & Heintz, rated 300 Amp. 30 Volts. Gov't. cost \$300.00. Instruction for converting to welder or light plant incl. .... **\$25.50**

**CUNO OIL FILTER—BRAND NEW**  
Aircraft type. Filters oil without cartridge replacements. Just turn handle and cartridge is clean. Std. 3/8" inlet & outlet ports. **\$4.95** paid  
Instructions incl. ....

Send check or M. Order. Prices f.o.b. KCMo Except when marked postpaid U.S.A.  
**GENERAL SALVAGE CO., Dept. 703, 2922 E. 27 St., Kansas City, Mo.**

**BEAM ROTATOR MOTOR**  
New Applicable for 110V. A.C. or 24V. D.C. Powerful geared motor for TV aerials, Ham FM antennas etc. Approx. 9 R. P. M., free swing

Instructions incl. Stock # AJ31 **\$7.50**  
\$50.00 value

**FIRE EXTINGUISHER** 1 Quart size, brass finish. Ideal for emergency use, handy size. Used, good tested condition. **\$3.95** wt. 4 lbs. (add postage).

**RHEOSTAT** #R-21 heavy duty recommended for regulating the voltage on the converted electric welder. **\$6.95** (for P-1 or R-1) postpaid

**Say You Saw It in  
POPULAR MECHANICS**

**LUTHY AERO TYPE SPARK PLUGS**

**Aluminum Oxide Insulators**  
Material developed during World War II for high speed combat aircraft. Aluminum Oxide insulator cools very rapidly, is stronger, has greater resistance to moisture and reduces breakage to a minimum. Correct Gap setting and proper heat range for your automobile, truck, tractor, hot-rod and stock car.

**Packed In Engineered Sets**  
PACKED IN SETS OF 6 OR 8 - CORRECTLY GAPPED FOR THE MODEL AND YEAR OF ALL CARS

**ORDER YOUR SETS NOW**

|                           |                           |
|---------------------------|---------------------------|
| 8 cyl. set<br><b>7.12</b> | 6 cyl. set<br><b>5.34</b> |
|---------------------------|---------------------------|

Satisfaction Guaranteed  
Longer Life More Economy  
High Speed Performance



Luthy Aeronautical Sales Company  
JACKSON, MICHIGAN (Canadian address, Box 394, Hamilton, Ontario)  
Send me a set of \_\_\_ plugs. Enclosed is \$ \_\_\_ Check here if you want us to ship COD.   
Name..... Address.....  
Year of Car..... Make and Model.....



**REMODELING?**

DO IT YOURSELF WITH

**Marlite**

PREFINISHED WALLPANELS

Modernize your kitchen, bathroom, utility and recreation room easily and economically with Marlite plastic-finished wall and ceiling panels . . . eliminate plastering, painting, and periodic redecorating. Wall-size panels 5/32" thick in 4' widths and lengths to 12' go up fast with ordinary carpenters' tools. High-heat-baked finish unharmed by alcohol, fruit juices, and boiling water. Quickly cleaned with a damp cloth. Choose from a wide variety of colors and patterns. See genuine Marlite at your building materials dealer.

Write for free "How-to-do-it" Instructions and Color Folder.  
**MARSH WALL PRODUCTS, INC., Dept. 1042, Dover, Ohio**  
 Subsidiary of Masonite Corporation

**Perform near-miracles with this really new TOOL**

Reaches around the tubing or pipe and down on the fitting . . .

**SLASHES WORKING TIME!**

Now you can own a TAC Open End ratchet Wrench set, complete with your most needed sizes of TAC snap-in open end sockets. Slips over and around pipe, tubing, cable, conduit, spark plugs, long studs, etc. —then down on the fitting. Fast ratcheting action saves up to 85% of your time. Especially good in tight working areas; will ratchet with as little as 7° handle swing. Tremendous torque strength. A favorite in Army-Navy-Air Force, and Industry. Now available to you. Write for catalog, prices and name of nearest dealer.



**TAC**

TUBING APPLIANCE COMPANY  
 Dept. 96  
 10321 Anza Ave.  
 Los Angeles 45, California

**TAC OPEN-END ratchet wrench**



**HOW IT WORKS**



Over the Tubing



Down on the Fitting



Now Ratchet!

**MODERN INSULATION**

**MAGIC**

YOU'LL BE AMAZED WITH

REYNOLDS ALUMINUM

**REFLECTIVE INSULATION**



Take it home

500 sq. ft. under his arms



Put it up

Easy to tack or staple

Work a "miracle" in your walls or attic with this aluminum foil bonded to tough kraft paper. Costs only about \$40 to put up over ceiling of average 6-room house. Reflects up to 95% of radiant heat. Summer heat bounces off; interiors often 15° cooler. Winter heat reflects back inside. Clean, odorless, pliable. Tack or staple over ceilings or under rafters, between wall studs, under ground floors. Perfect vapor barrier. Fire-retardant. Two types. foil on both sides for double air space; one side, to face single air space. Rolls 250 sq. ft., 25", 33", 36" wide. Also makes wonderful reflectors for radiators, photo lights, etc. Mail coupon for free samples.

**Aluminum Sheet for Rust-proof Flashing, Termite Shielding, General Shop Work!**  
 New all-purpose carton of ten 18" x 48" sheets, .019" thickness. Best for flashing, also great idea for over sink or stove, door kicks, etc., etc.



**Aluminum gutters—cost much less than other rust-proof materials. Non-staining. Put them up yourself—slip joints, no soldering.**  
**Aluminum nails—rustproof, never stain.**

See your Building Supplies or Hardware Dealer

**REYNOLDS *Lifetime* ALUMINUM BUILDING PRODUCTS**

MAIL THIS COUPON NOW!

Reynolds Metals Company  
 Building Products Division  
 2035 So. Ninth St., Louisville 1, Ky.

Send full information and FREE SAMPLES of Reflective Insulation. Also full details about

Gutters & Downspouts;  Nails;  Flashing

Name \_\_\_\_\_

Address \_\_\_\_\_

City \_\_\_\_\_ State \_\_\_\_\_

Superior's New Model 670-A

# SUPER-METER

A COMBINATION VOLT-OHM MILLIAMMETER PLUS CAPACITY REACTANCE INDUCTANCE AND DECIBEL MEASUREMENTS



**SPECIFICATIONS:**  
**D.C. VOLTS:** 0 to 7.5/15/75/150/750/1,500/7,500 Volts.  
**A.C. VOLTS:** 0 to 15/30/150/300/1,500/3,000 Volts.  
**OUTPUT VOLTS:** 0 to 15/30/150/300/1,500/3,000 Volts.  
**D.C. CURRENT:** 0 to 1.5/15/150 Ma. 0 to 1.5/15 Amperes.  
**RESISTANCE:** 0 to 1,000/100,000 Ohms. 0 to 10 Megohms.  
**CAPACITY:** .001 to 1 Mfd. 1 to 50 Mfd. (Quality test for electrolytics).  
**REACTANCE:** 50 to 2,500 Ohms, 2,500 Ohms to 2.5 Megohms.  
**INDUCTANCE:** 15 to 7 Henries 7 to 7,000 Henries.  
**DECIBELS:** -6 to +18 +14 to +38 +34 to +58

The Model 670-A comes housed in a rugged, crackle-finished steel cabinet complete with test leads and operating instructions. Size 6 1/4"x9 1/2"x4 1/2".

**ADDED FEATURE:** The Model 670-A includes a special **GOOD-BAD** scale for checking the quality of electrolytic condensers at a test potential of 150 volts.

**\$28.40 NET**  
**SOLD ON EASY PAYMENTS**  
**AT THE NET CASH PRICE**

No interest or carrying charges added.

**MOSS ELECTRONIC DISTRIBUTING CO., INC.**  
 Dept. B-81, 38 Murray Street, New York 7, N. Y.

Please rush 1 Model 670-A SUPER METER. I am enclosing the down payment of \$7.40 and agree to pay balance, \$3.50 per month for 6 months.

Name \_\_\_\_\_  
 Address \_\_\_\_\_  
 City \_\_\_\_\_ Zone \_\_\_\_\_ State \_\_\_\_\_



Save Money on

**TV Purchase, Repair and Service**

**ALL ABOUT TELEVISION**

You can actually save \$50 to \$100 when you buy a TV set. You can save that much more every year on service with Popular Mechanics ALL ABOUT TELEVISION to guide you. Do 9 out of 10 service jobs yourself. Complete simplified instruction and 220 pictures show you how. No previous experience or knowledge of electronics required. Cloth bound edition only \$3.00 postpaid. Money back if not pleased. Paper covers 75 cents at newsstands.

POPULAR MECHANICS PRESS, Dept. PM11, 200 E. Ontario St., Chicago 11

**NOW . . . a louvred window you can easily install yourself!**



**SUN-SASH . . . America's Largest Selling Lowest Cost Louvred Window!**

Your neighbors will envy you when you install Sun-Sash louvred windows in your home. Sun-Sash blends perfectly with any style of interior or exterior design. The ideal window for porches, breezeways, interior partitions, patios, and anywhere throughout the home Sun-Sash comes in sizes to fit any opening and can easily be installed in a matter of minutes.

**INSTALLATION IS EASY AND INEXPENSIVE**



Screw on SUN-SASH Slide glass louvres in- Close end of clips over Install 3/4" stop top fittings to side of win- to rattle-proof spring glass to hold blades and bottom. Window clip holders. firmly in position. stool may be used for bottom stop.

For free catalog and literature write:

**SUN-SASH Company, Dept. PM-2**  
 38 PARK ROW, NEW YORK 38, N. Y.

Enjoy the Fascinating Story of the Horseless Carriage in

Popular Mechanics

**AUTO ALBUM**

166 Illustrations

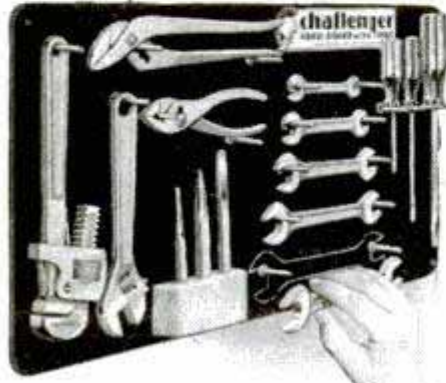
The most intriguing book about the automobile ever printed. It's thrilling, fascinating and informative. From the very first gasoline-propelled buggy to the cars of today and the atomic auto of the future. The first cars — the men who made them — the scrambled start and the development of the fabulous auto industry—the story of auto racing—the growth of the Nation's highways. 166 thrilling action pictures—old-time cars—racing cars—early auto advertising—automotive oddities. Roll call of names of more than 2000 autos made in the U.S. included. Ideal gift book. Cloth bound, only \$3.00 by mail. Money back if not pleased. Paper covered edition \$1.00 at newsstands.

POPULAR MECHANICS PRESS, Dept. PM14  
 200 East Ontario Street Chicago 11, Illinois



**IDEAL CHRISTMAS GIFT** for yourself . . . and friends

**Challenger "Handi-Board" Tools**



FOR 1001 "DO-IT-YOURSELF" JOBS... TOOLS ALWAYS READY FOR INSTANT USE! Every household needs this super-compact "Tool Center"... to handle countless mechanical, electrical, plumbing and general fixing jobs. For turning all kinds of nuts, bolts, screws... also bending, chiseling, punching, cutting wire, etc. Tools lift off instantly from pegs on Handi-Board... and you can't miss putting tools back in proper places because positions are outlined on board. Makes a handsome permanent fixture on wall. Comes with 15 Fine Quality Challenger Tools plus Handi-Board in rich maroon. Only \$12.95 complete... at your local hardware or tool dealer—or write address below. Also ask for FREE Brochure on Challenger's complete line of over 2,000 Top-Quality Low-Cost Tools.

**PENENS CORPORATION, Dept. P.M., Schiller Park, Ill.**

FOR HANGING ON ANY WALL



# this **ONE** GOVERNOR

fits ALL popular  
farm & industrial  
gasoline engines



## **PIERCE** LONG RANGE Universal Governor

● Instant variable speed selection and accurate engine control at any speed setting within 1200 to 2600 RPM. Higher and lower ranges obtainable by simple change of pulley. Also "constant speed" operation.

● Accurate, dependable speed control for engines operating corn shellers, drag lines, hoists, arc welders, trucks and tractors with power take-offs, etc.

Write for Complete Information

**DEALERSHIPS  
AVAILABLE**

"World's Most  
Experienced Governor  
Manufacturer"

ONLY  
**\$39.50**

Pulley extra  
Send Check or  
Money Order.  
State Make,  
Model of engine.

**THE PIERCE  
GOVERNOR CO., Inc.**  
1652 Ohio Avenue, Box 1000  
Anderson, Indiana, U. S. A.

## **PAY ONLY \$1 A WEEK!** JUST RELEASED — NEW JET MODEL All-Metal **SPRAY GUN** Electric

Save Hundreds of Dollars  
On Your Painting & Spraying

The new, non-corrosive jet piston action, efficient spray-control dial and eye-level nozzle mean this: just plug in, press trigger and you're painting! Hundreds of tough tasks are made easy. No compressor needed. ALL METAL, including 25-oz. polished aluminum container. Compares with spray guns selling up to \$49.95. Clog-proof, fool-proof, trouble-free, this Jet Model is available only from us. Sprays all paints—including rubber-base paints—lacquers, enamels, varnishes, chemicals, oils, insecticides, deodorants, shellacs; for waxing, rust-proofing, waterproofing, etc. Built for heavy duty. AC current. Entire unit, every part, fully UL Approved, including 8-ft. S.J. Neoprene Cord & Plug Set. Included: 5 extra nozzle discs; 232 pg. "Home Fixit Guide."



No Carrying  
Charges or  
Interest Added!  
Entire Sprayer  
UL Approved!  
25-oz. Polished  
Aluminum  
Container

**\$19.95**

Complete—Nothing  
Else to Buy!

**MAIL 15-DAY FREE HOME-TRIAL COUPON**

**WALDORF SALES CO., Dept. PG-2410**  
363 Central Park Ave., Yonkers, N. Y.

Send Spray Gun, including Free Book. I enclose \$1. Will pay postman \$18.95 plus postage. If not delighted can return Spray Gun within 15 days for purchase price refund.

I enclose \$19.95, you pay postage. Same refund guarantee.

I enclose \$3 deposit. Will pay at rate of \$1 weekly after delivery (no interest or carrying charges added). Refund guarantee.

Will pay weekly.  Will pay monthly.

Name .....

Address .....

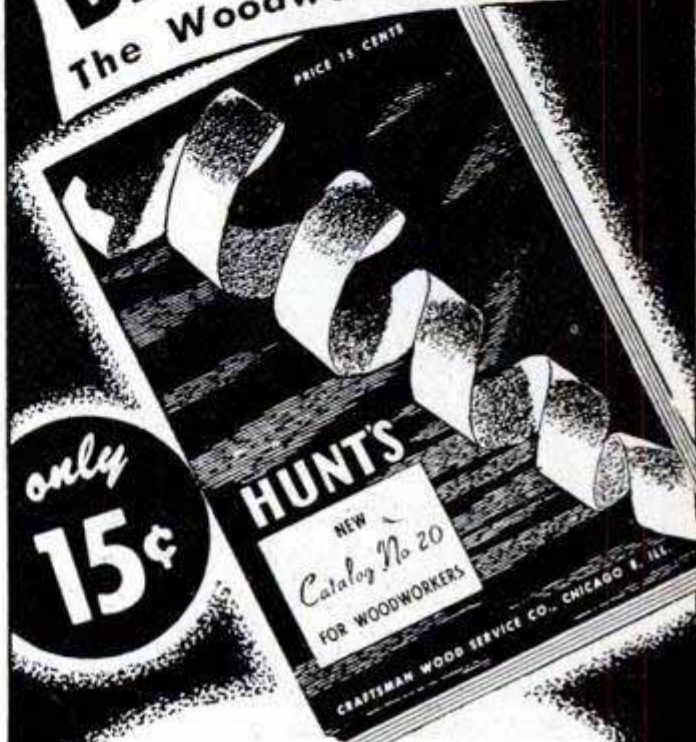
City .....

State .....

APO, FPO, Canada &  
Foreign—No COD's

Save Time! Save Money!  
Get this--

## **BIG NEW BOOK** The Woodworker's "Bible"



only  
**15¢**

- 144 PAGES OF BARGAINS AND HELPFUL INFORMATION
- 1500 ITEMS AND IDEAS FOR THE WOODWORKER

Whether you're a beginner or an advanced wood craftsman--this famous big, new book will show you how you can make hundreds of valuable items in wood. It's literally filled with step-by-step instructions, how-to-do-it information, dozens of time and money saving hints and ideas, plus all kinds of projects you can make for fun or profit--at real bargain prices you can afford.

### Guide for Amateur and Expert

Offers the world's finest selection of imported and domestic woods. Illustrates 32 rare and fancy woods in color..43 veneer designs...multi-colored bandings, inlays, overlays...275 scroll patterns... all kinds of tools, machinery, cabinet hardware, ornaments, mouldings. All woods properly seasoned, kiln dried, correctly graded. Quick delivery --a board or a carload. Everything guaranteed. Thousands of others all over the world have sent for this famous book. Mail coupon and 15c today --you'll be glad you did.

**MAIL THIS COUPON--TODAY!**

**CRAFTSMAN WOOD SERVICE CO.**  
2729 S. Mary Street, Dept. A10  
CHICAGO 8, ILLINOIS

Please send me Hunt's BIG, NEW time and money saving Catalog No. 20 for Woodworkers. Enclosed is 15c.

Name .....

Address .....

City..... Zone..... State.....



# CEILINGS CRACKED? NEED MORE ROOM? WANT TO Modernize YOUR HOME?

Do the job easily,  
quickly at low cost with  
**UPSON PANELS**

or CEILING TILE

### For Cracked Ceilings:

No messy replastering! No ordeal of housecleaning! Apply **Upson Kuver-Krak Panels** on furring strips right over old plaster. Unique floating fasteners eliminate face nailing. Waterproofed and washable, **Upson Ceiling Tiles** are 12-in. sq., applied with matching color pins! Both give you a beautiful new crackproof ceiling in a matter of hours!

### For Modernization:

Upson Panels saw like wood. Take screws, nails, fixtures. Available in a variety of widths, thicknesses and surfaces—at your lumber dealers! **Strong-Bilt Panels** for new construction,  $\frac{3}{8}$ " panels for lighter work. Pebbled or smooth surfaces—plus new **Striated Panels** for a modern look! Trademarked for uses.



### THE UPSON COMPANY

51110 Upson Point, Lockport, N. Y.

I enclose 10c for 32 page Idea Booklet. Include Instruction Sheet for applying Upson Ceilings and working drawings for Storage Wall FREE.

Name \_\_\_\_\_

Street \_\_\_\_\_

City \_\_\_\_\_

State \_\_\_\_\_

## BARRON Drill Press TOOLS



FOR WORKSHOP AND INDUSTRIAL USES...

### ROTARY PLANER

- Planes • Rabbits
- Tenons • Panels
- Routs • Bevels

Only \$7.50 COMPLETE

Over 40 precision built woodworking tools and accessories... HI-Speed Router Bits—Rotary Surface Sanders & Drum Sanders—Safety Shaper Cutters—Dovetail Cutters—Large Auxiliary Metal Tables—All Metal Shaper Fences—Spindle Adapters—Handy Bench Vises. Many other items indispensable for accurate, useful, versatile workshop use. Every tool sold on complete satisfaction or your money back. See your Barron Dealer. Ask for special folder — "24 Extra Uses for Your Drill Press."

FREE Workshop Guide & Catalog

BARRON TOOL CO. INC.  
365 Architects Bldg., Detroit 1, Mich.

Say You Saw It in  
POPULAR MECHANICS

## Look what you can do with the NEW WILLIAMS MULTISOCKET

You'll Use It Everyday on

- LAWN MOWERS
- BICYCLES
- POWER TOOLS
- WASHING MACHINES
- AUTOMOBILES
- TRACTORS
- APPLIANCES
- FARM EQUIPMENT

for assembly,  
adjustments, etc.



MULTISOCKET is the handiest tool you can own. Each of two revolving heads has 4—12 pt. openings... the small head 7/16, 1/2, 9/16 and 19/32 inches... the large 5/8, 11/16, 3/4 and 7/8. Grips hex heads on 6 sides—no slipping—no rounding of bolt or nut corners. Operates at any angle. Retains the working opening you set. Drop-forged and heat-treated. Chrome finish. 10" length fits glove compartment, tool kit. Balanced weight, solid construction.

\$4.98

at most leading hardware stores.

J. H. WILLIAMS & CO.  
562 Vulcan Street, Buffalo, N. Y.

Enclosed is 10c. Send me Catalog A-50.

Name.....

Street.....

City and State.....

I usually buy my tools at:

Name of Store.....





# THIS ALADDIN 5-ROOM HOUSE



**\$1974**

**FREIGHT PAID**

Slightly Higher West of Missouri River

## BUILD THIS ALADDIN READI-CUT HOUSE YOURSELF... and Save!

Imagine receiving a COMPLETE HOUSE IN ONE SHIPMENT... ready to erect! You get everything needed... finest lumber, THOROUGHLY DRY... cut to EXACT SIZE on fast machines. No stopping to measure and saw each piece! (You save up to 30% on labor... 18% on waste) 99 INDIVIDUAL PLANS TO CHOOSE FROM... all sizes and styles. Aladdin's 47 Year Old Guarantee: Satisfaction or Your Money Back.



## BEAT THE HIGH COST OF BUILDING!

**BUILD YOUR OWN HOME** Why pay carpenters \$24 a day when you can build your own Aladdin house! Carpentry work totals 300 to 1200 hours. Even if you hire help you save because the slow work of measuring and sawing has been done at the mill. You get complete, easily-followed instructions plus All the Lumber, Siding, Flooring, Doors, Hardware, Paint, Trim, Millwork, Mouldings, Windows, Glass, Roofing, Nails... everything you need! Hundreds of buyers have erected Aladdin houses themselves.

## GOOD HOUSES NEVER GROW OLD—ALADDIN HOUSES ARE NOT PREFABRICATED

**SEND 25¢ FOR CATALOG No. CM-19A**  
A beautiful 4 color book of the latest Aladdin Houses

## THE ALADDIN CO. BAY CITY MICHIGAN

## FREE AMAZING NEW BOOK "HOW TO ANSWER ADS"



Never before have you seen anything like this. Tells you in simple language the correct way to answer ads. Gets you quicker replies—better results, and greater satisfaction. Will save you time and money and it's ABSOLUTELY FREE. No obligation whatever. Every reader of advertising should have this booklet. Send a postcard for your copy NOW. Advertising Department, Popular Mechanics Magazine, Room 602, 204 East Ontario Street, Chicago 11, Ill.

## MAKE-YOUR-OWN PORTABLE EMERGENCY OXYGEN OUTFIT

Easy Instructions Furnished

### Steel Co2 Tank

Ideal for Oxygen, Aqua Lung Bottles, Co2, Compressed Air 295 cu. in. capacity. 1800 P.S.I. Size 1 1/2"x5-11/32". Made of 4130 steel, specs AN8025-6. Hydro, tested, current dating, ICC-3A-1800. Fitted with high pressure valve, 5/8" and 1/2" pipe ports. Factory reconditioned. Shpg. wt. 12 3/4 lbs. **ONLY \$10.95**

### High Pressure Regulator for Oxygen Therapy.

Has high pressure gauge and liters per min. dispersal gauge. Fits any std. oxy. tank. UL appd. New... **\$30.50**

Prices F.O.B. St. Louis, Mo. Send check or M.O. Money Back Guarantee!  
**Ed. Aguado Trdg. Co., Dept. X**  
Box 4525 Plaza Sta., St. Louis, Mo.



### A Necessity for —

- Ambulances
- Hospitals • Doctors
- Dentists • Firemen
- Police • Others

### M A S K S

- No. A14 — Pressure-demand type. Has exhaust check valve assy. Wt. 1 1/2 lbs. ... **\$3.95**
- No. A8B — Pressure type with breather bag. Wt. 1 1/2 lbs. ... **\$3.95**

### OXYGEN HOSE

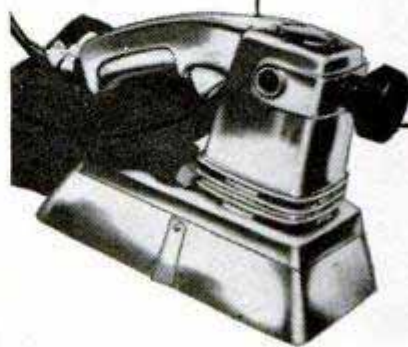
- Corrugated, flexible. 2 ft. lgth., 90c. 4 ft. lgth., ... **\$1.80**
- Hose Clamps. 1 1/2". Thumbscrew adjustment. Ea. ... **15c**

### FREE CATALOG!

Big values in outdoor equipment.

# NEW Dustless Finishing Sander

Now... sand in your home without messing!



Porter-Cable Model 127

ONLY

**\$59<sup>50</sup>**

Porter-Cable's new Dustless Finishing Sander snuffs up 91% of the dust... prevents it from drifting about the house. Keeps cellar workshops clean. Eliminates the usual mess when doing inside repairs and remodeling. Enables you to work on hobbies, re-finish furniture, right in your living quarters.



Ideal for cabinet work

### Super-fast—Super-smooth

Outspeeds hand sanding 10 to 1—actually surpasses it for fine finishing. Abrasive pad rotates at high speed in 1/4" orbits. Won't scar or mar. Flat surfaces are made satin-smooth. Plywood is edged or rounded without chipping. Butt joints and inlays are polish-sanded with no hatch marks. On drywall joints and plaster patches, you're no longer exposed to the annoying, choking dust.



Keeps dust off work

### Important Features

Motor-driven for long, hard usage. AC/DC—4,000 RPM under load. Gearless drive—no troublesome operation, no expensive repairs. Patented paper clamp—keeps abrasive smooth and tight. Light—weighs only 6 lbs. Oversized dust bag available at extra cost.



### See Your Porter-Cable Dealer

Instant abrasive change

• Get all the facts and a free demonstration. Or mail coupon for illustrated descriptive folder.

**Porter-Cable**

*Quality Electric Tools*

### PORTER-CABLE Machine Co.

1450 N. Salina St., Syracuse 8, N. Y.  
(In Canada, send to Strongridge, Ltd., London, Ont.)

Send me description and uses of new Dustless Finishing Sander...also name of my nearest dealer.

Name.....

Address.....

City.....County.....State.....

Manufacturers of SPEEDMATIC and GUILD Electric Tools

# DO IT YOURSELF!



## CALK WITH *Nu-CALK* SPEED LOAD

It's easy to calk those cracks around window and door frames. Just slip a Speed Load into the gun and you're ready! It's the fastest, most economical way to apply Nu-Calk — the world's finest calking compound.

## REPAIR ROOFS WITH *Nu-Phalt* PLASTIC ASPHALTIC CEMENT

Don't put up with leaky roofs or flapping shingles. Use Nu-Phalt—the ready-to-use asphalt base cement—on chimney flashing, gutters and general roof repairs. Has outstanding adhesive qualities on wet or dry surfaces. Can be applied with a calking gun, or with a putty knife.



On Sale at all Leading Hardware, Lumber and Building Supply Dealers

AVAILABLE WITH OR WITHOUT PLASTIC NOZZLE

**MACKLANBURG DUNCAN CO.**  
MANUFACTURERS OF  
**QUALITY BUILDING SPECIALTIES**

**MACKLANBURG DUNCAN CO.**  
OKLAHOMA CITY, OKLA.

AVAILABLE WITH OR WITHOUT PLASTIC NOZZLE

# SURPLUS TO SAVE YOU UP TO 85% SAVE BY MAIL ORDER TODAY

### NEW SLITTING SAWS WITH MANDREL

**SET H5A** Ass't. of 18 unpolished Slitting and Slotting Saws, plus universal mandrel for 1/4" and 1/2" chucks. Diam. 1 1/4" to 2 3/4" Thickness from .015 to .102. Limited quantities. Special Price . . . . . **\$4.49**

**SET H4A** Complete set of 10, from 1/4" to 1 1/2" by sixteenths. Both N.C. and N.F. \$11.00 value for only . . . . . **\$2.98**

A-1 MERCHANDISE—SATISFACTION GUARANTEED OR MONEY REFUNDED

### HIGH SPEED STRAIGHT SHANK DRILLS

**SET H1A** 30 selected H. S. Straight Shank Drills 1/4" to 1 1/4". Lengths up to 4", only . . . . . **\$2.49**

**SET H2A** 12 Different Size H. S. Straight Shank Drills 1/4" to 1 1/2". Lengths up to 5", only . . . . . **\$3.49**

**SET H8A** 10 Different Size H. S. Morse Taper Shank Drills. Up to 1", only . . . . . **\$8.95**

ALL ITEMS PREPAID FREE WAR SURPLUS CATALOG

### HIGH SPEED STRAIGHT SHANK CHUCKING REAMERS

**SET H10A** 20 Different Size H.S. Straight Shank Chucking Reamers up to 9/16", only . . . . . **\$6.95**

**SET H11A** 15 Different Size H.S. Straight Shank Chucking Reamers 1/4" to 1", only . . . . . **\$7.95**

**SET H12A** 5 Different Size H.S. Drills 1/2" to 1". These H.S. Precision Drills with 1/2" Shanks can be used in a 1/2" Electric Drill or a 1/2" capacity lathe or Drill Press, only . . . . . **\$7.95**

**Practical Engineering Co.** 707 N. Sheridan Tulsa, Okla.

# GIGANTIC MAIL SALE

**AIR SUPPLY UNITS**  
Build your own air unit. • DeLuxe Air Kit. Compressor, tank, valves, gauges, etc., \$45.49. • Air Items, 1-cyl. compressor \$20.50. Pressure switch, \$4.95. Regulator, \$2.95. Pop-off valve, \$1.95. 100-lb. gauge \$1.89. Air tank (400 lb.) 10"x18" \$5.95. 12"x24" \$11.95.

**HYDRAULIC EQUIPMENT**  
War surplus and direct from factory. Build loaders, diggers, presses, lifts, etc.  
• Tractor Pump \$45.50. • Hand Pump \$10.50. • Cylinders, 1-way 3"x8", \$11.95; 2-way, 2"x10", \$22.85. • Valves \$18. • Break-away quick couplers, \$6.59.

**WATER PUMPS and SYSTEMS**  
Small pumps for every use. Free advice.  
• Centrifugals, 25 g.p.m., \$19.95  
• Rubber Paddle, 6 g.p.m., \$14.75  
• Hi-Pressure (200 lb.), \$34.50  
• Pressure System (110-volt) \$69.50

**POWER PLANTS and GENERATORS**  
War surplus units . . . Save to 70%.  
• Plant 25 KW, 115-v AC \$1191.00  
• Plant 5 KW 115-v AC \$169.50  
• Plant 3 KW 115-v DC \$531.95  
• Plant 1.5 KW 32-v DC \$72.50  
• Plant 500 W 32-v DC \$69.50  
• Gener. 3 KW 115-v DC \$49.50  
Many other values. Send for catalog.

**SUPER CLOSEOUT BARGAINS**  
• Rural Magneto Phones . . . . . \$9.95  
• City Wall Phones . . . . . \$4.99  
• Gas Chain Saw, 3 h.p. . . . . \$149.50  
• Precision Stop Watch . . . . . \$12.95  
• Inspection Magnifier . . . . . \$2.89  
• Portable Air Tank Unit (complete) \$14.95  
• Wind Power Plant (6 volt) . . . . . \$33.95  
• Power Products Engine (1 h.p.) . . . . . \$29.50  
• Tarpaulin, 8'x10' finest army duck \$8.79  
• Army Parts Washer (\$115) . . . . . \$29.50  
• Hand Winch, 1000 lbs. . . . . \$19.95  
• Stainless Steel 7-row Weed Spray \$129.50  
• Engineers' Hand Level . . . . . \$5.84  
• Mechanics' Drills, chrome steel, 29-pc. . . . . \$9.95  
• Electric Drill, 1 1/2" (\$39.95) . . . . . \$26.95

## SPECIAL for the month!

(Repeated by popular request)  
**115-VOLT GENERATOR**

• This August special was so popular we are repeating it for October!  
• Scoop of the year! NEW guaranteed 3000-Watt, 115-Volt direct current ball bearing generator. Genuine Delco and Westinghouse.  
• Use for portable drills, saws, other tools. Emergency lights, stoves, etc. Gov't. cost over \$195.00. **SALE, \$49.50.** Prepaid in U.S.A.

**ELECTRONIC CLOSEOUTS**  
• Relays, sensitive 2 m.a. . . . . .89  
• Photo Cells, Western Electric . . . . .29  
• Hand Generators, 90-v AC . . . . . \$5.49  
Many other remarkable values.  
We pay shipping charges except 25 KW Plant.

**BURDEN SALES COMPANY**  
812 "O" ST. LINCOLN, NEBR.  
POPULAR MECHANICS

FREE CATALOG

**TOOL TIPS**

**DOUBLE CIRCLE Carbide-Tipped Masonry Drills for use with Brick—Stone—Marble—Concrete—Slate—Cinder Blocks**

You can make those tough rugged jobs of cutting through brick, stone, concrete easy-to-do by using a Double Circle Carbide Tipped Masonry Drill... a quality drill that has the necessary strength to cut fast and stand up under hard usage. You get greater cutting mileage... save time and tool costs... You'll find a selection at better Hardware Stores everywhere.



**CHICAGO-LATROBE**

411 W. ONTARIO ST. CHICAGO 10

DRILLS • REAMERS • COUNTERSINKS • COUNTERBORERS • CARBIDE TOOLS • SPECIAL TOOLS

**NEW CATALOG FREE**

Hundreds of famous how-to-do-it books. Big, new 1953 Popular Mechanics 40-page catalog free. Books for TV, auto, radio owners; home shops, hobbies, home builders, repairs, farming, better jobs, trades, skills, hunting, fishing, making money at home, concrete work, welding, mail order, power tools, plastics, painting, carpentry, photography, boat building, gardening, etc. Write Dept. CT1,

Popular Mechanics Press, 200 E. Ontario, Chicago 11

CUSTOM MADE

**BRANDING IRON**

YOUR OWN PERSONAL IRON

Only **\$2.95**

Complete

The **PROFESSIONAL** Way to **PERMANENTLY & BEAUTIFULLY** Brand Your—

Tools, Sporting Equipmt., Farm Equipmt., Leather Goods, Belts, Tires, Books, Etc.

WOOD, RUBBER, PLASTIC, LEATHER WILL PREVENT THEFT AND ADD THAT SMART PERSONAL TOUCH.

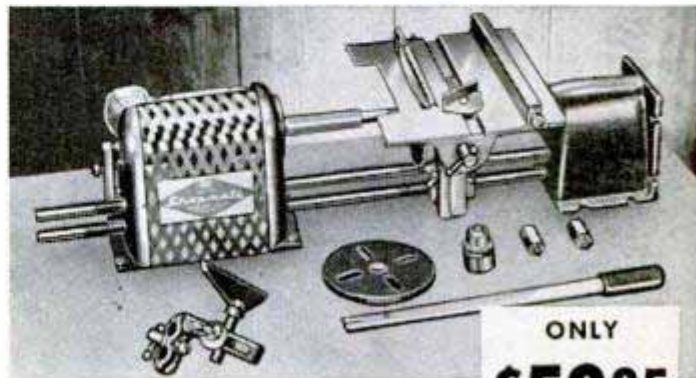
—ORDER YOURS TODAY—

SEND YOUR MONEY ORDER OR CHECK, NO C.O.D.'s, TO—**BURNING BRAND ELECTRIC CO.** 4554 N. Broadway Ave. Chicago, Ill.

New **PET** Shopmate

**The Complete Motorized Home Power Shop**

Lathe • Grinder • Bench Saw • Sander-Polisher  
Vertical Drill Press • Horizontal Drill Press  
Portable Drill • Router



ONLY **\$59.95**

POWER UNIT INCLUDED

Never before a complete motorized home power shop at such a low price!

With the all-new PET Shopmate you'll do precision wood turning on a sturdy lathe. Cut wood accurately on a real bench saw. You'll sand and polish wood or metal; sharpen tools. Vertical or horizontal drill press ready for use any time. Use as a router to cut grooves, make moldings. Powerful portable drill easily detached from lathe for use anywhere.

Ask your dealer to show you the new PET Shopmate—America's first complete motorized home power shop.



Accurate bevel gauge in use. Rips, cuts mitres, too.



Between-center turning. Tool rest and face plate furnished.

New **PET** Electric Saw with exclusive **TRU-GUIDE\***!



ONLY **\$32.00**

\*Guide and level index calibrated after each saw is assembled. TRU-GUIDE guarantees right-to-the-line cutting!

Light (only 6 lbs.); ideal for overhead work. Cuts plywood, sheathing, all interior trim. Cuts any angle 90° to 45°—and 1/8" to 1 3/8" deep. See it at your dealer's now.

64-Page Power Tool Guide! \$1 Value... Yours for Only 15¢ With This Coupon!

PORTABLE ELECTRIC TOOLS, INC. PM-103  
320 W. 83rd St., Chicago 20, Ill.

- Enclosed is 15¢ for 64-page book of helpful hints on use of portable power tools.
- Send free literature only on tools shown above.

Name.....  
Street.....  
City.....Zone....State.....

Add comfort, convenience and value to your home with

# SpeedWay Speed Tools

Clean up, modernize, repair and build



No. 150 SpeedSander (only)

\$34.50

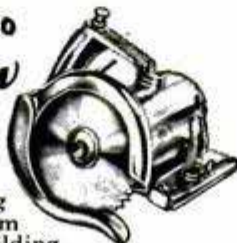
No. 150K SpeedSander in steel carrying case with attachments, accessories and stock of abrasive covers. \$49.50

Professional type (motor-driven, orbital motion, all-ball-bearing) SpeedSander smooths rough walls, makes plasterboard joints invisible. Sand-off old finishes from woodwork or furniture. Smooths, cleans, buffs, rubs and polishes (wet or dry) to a piano finish—makes tedious work easy and fast.

## No. 1000 SpeedSaw \$29.95



Save half the cost, by fitting your own storm windows, building cabinets, shelves and furniture—it's easy to saw straight, square and accurately with a SpeedSaw. 5" blade, 3500 RPM AC-DC series wound motor. Cast aluminum body and self-closing blade guard. Rip fence and angle adjustment.



## WITH A SpeedDrill

No. 400 1/2" SpeedDrill \$39.50

you can drill holes in wood, metal, steel or concrete (as illustrated) Can build, install, anchor, repair most anything about the house, yard, garage or basement. The portable electric drill has become the basic tool of the modern home for it not only drills holes but with available attachments does a hundred everyday home jobs.

No. 200 1/4" SpeedDrill \$16.50



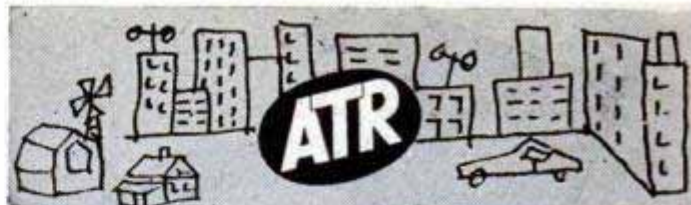
## SpeedWay Painters and Householders Kit \$19.95



Complete with high speed 1/4" SpeedWay Drill, grinding wheel, wire brush, cotton buff, backer plate, abrasive discs, and paint stirrer, this useful kit costs only \$19.95

Write for Bulletin describing over 40 SpeedWay power tools and kits.

**SpeedWay MANUFACTURING CO**  
1863 So. 52nd Ave., Cicero, Ill.



for A.C. current ANYWHERE!

AT NEW LOW COST

\$25.55 and up retail price

## INVERTERS



For Inverting D.C. to A.C. . . . Specially Designed for operating A.C. Radios, Tape Recorders, Wire Recorders, Record Changers, Television Sets, Amplifiers, Address Systems, Radio Test Equipment and most small electrical and electronic devices from D. C. Voltages in Vehicles, Ships, Trains, Planes and in D. C. Districts.

| Type      | Input DC Volts | A.C. Output 60 Cycles | Output Wattage |       | Consumer Net Price |
|-----------|----------------|-----------------------|----------------|-------|--------------------|
|           |                |                       | Int.           | Cont. |                    |
| 6-LIF     | 6              | 110 volts             | 40             | 35    | \$25.55            |
| 12-LIF    | 12             | 110                   | 50             | 35    | 25.55              |
| * 6-RSD   | 6              | 110                   | 85             | 75    | 39.25              |
| *12-RSD   | 12             | 110                   | 125            | 100   | 39.25              |
| 32-RSD    | 32             | 110                   | 150            | 100   | 39.25              |
| 110-RSD   | 110            | 110                   | 250            | 150   | 39.25              |
| *12T-HSG  | 12             | 110                   | 250            | 200   | 96.45              |
| 110AT-RHE | 110            | 110                   | 325            | 250   | 56.95              |

There is an ATR model for most any application.

\* Available with leather carrying handle at \$1.00 additional optional.

See your jobber or write factory

AMERICAN TELEVISION & RADIO CO.  
Quality Products Since 1931  
SANTA PAUL 1, MINNESOTA—U.S.A.

- NEW MODELS
- NEW DESIGNS
- NEW LITERATURE



## Pays for Itself 100 Times Over

Beat the high cost of home upkeep. Save hundreds of dollars every year on carpentry, electrical, painting, plumbing and other jobs around the house with **POPULAR MECHANICS GUIDE TO HOME REPAIRS**. Simplified how-to-do-it instruction and 646 pictures make all jobs, inside and out, easy. Covers construction, remodeling, modernizing, repairing that you can do yourself at small cost. 192 page cloth bound book only \$2.50 postpaid. Order today under our money back guarantee.

**POPULAR MECHANICS PRESS, Dept. PM16**  
200 EAST ONTARIO STREET CHICAGO 11, ILLINOIS

Say You Saw It in Popular Mechanics

## TEST THIS Amazing AUTOMATIC MECHANIC FREE ON YOUR OWN CAR!



Purges carbon—Lubes upper cyl. area—Stops valve sticking—Keeps rings free—AUTOMATICALLY! Precision injector meters correct charge of tune-up fluid every 100 miles while you drive. Keeps engine running free, clean and cool, for only 1/20 cent per mile!

**Send No Money—Try before you buy!** Use for 10 days Free then, if you like it, remit \$14.95 (full price), or just return it, and you owe us nothing—no questions asked!

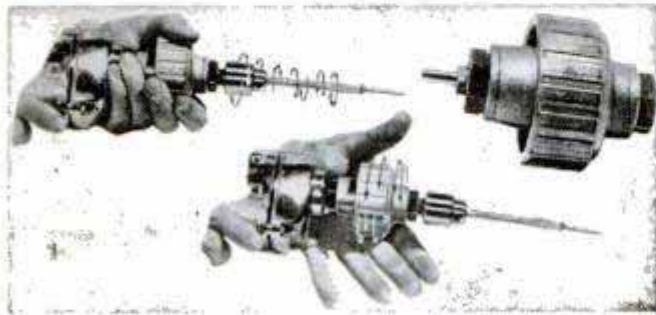
Write today for Automatic Tune-Up Injector (Includes line, fittings, fluid, etc. and instructions).

**NEWHOUSE AUTOMOTIVE INDUSTRIES**  
5805 E. Beverly Blvd., Dept. 87, Los Angeles 22, Calif.



### Babco Right Angle Drive for 1/4" Drills

Close coupled, fits on drill spindle. Remove chuck, attach to angle drive. Twice drill speed for sanding or half for polishing. Easy to drill in close spaces. \$4.95 ppd. Heavy-duty angle drive for 1/2" elec. drills \$19.95 ppd.



### Babco 5-to-1 Speed Reducer Fits 1/4" Drills

Convert your 1/4" electric drill to electric screwdriver—drill holes to 1 1/4" in wood, 1/2" in masonry. Planetary gear system gives tremendous torque increase. Adapters furnished to use 1/4" or 1/2" chuck. Instant starting, stopping with hand clutch control. To operate tool, grip reducer, release to stop. \$9.95 ppd. At hdw. stores and tool dealers or from Babcock Mfg. Co., 6251 Claremont Ave., Oakland 18, California.

### Say You Saw It in Popular Mechanics

**WAR SURPLUS** AND OTHER BARGAINS SAVE UP TO 90%

#### LOW VOLTAGE CIRCUIT TESTER

Made for U.S. Ordinance to rigid specification. Portable steel carrying unit, self-contained trouble shooting device makes complete & rapid check of generator battery circuit incl. any circuit & voltage regulators. Battery voltage, regulators, cut-out settings & generator performance easily determined. Any 6 or 12 volt system. Great for garages, mechanics, truck fleet owners, boat & marine mechanics. Every set checked out in our lab & in perfect condition. Shpg. Wt. 20 lbs. Approx. GOVT COST \$175. NEW. Complete with instruction book—\$38



#### D.C. GENERATORS



Finest aircraft quality. Heavy duty. Lifetime grease-sealed ball bearings. Ideal for truck & marine use, for welders, plating, D.C. appliances, lights, etc. Type P-1 Mfd. by Electric Auto-Lite. Rated 200 Amps., 28 Volts. 2500 RPM., can be "revved" up to 300 Amps. Shpg. Wt. 53 lbs. Approx. Govt. Cost \$350. NEW, now only \$21.50

**MAKE YOUR OWN ARC WELDER** Complete make-up package consisting of one New P1 Generator 200 Amps, one giant toggle switch, one voltage regulator and a wiring diagram chart showing conversion of Aircraft Generator to Arc Welder. Nothing else to buy. Special—WHILE THEY LAST—\$32.50

**MICROMETERS** Chrome plated, precision engineered, carefully tooled to give long life. All new 0-1" cap. \$2.25 ea., 1-2" cap. \$3.50.



Send 25¢ for big 1953 catalog. Bargains for everyone. Check, Money Order or Cash. 25% deposit on C.O.D. orders. Prices F.O.B. Culver City, Calif., Unless otherwise stated.

**AIRBORNE SALES CO., INC.**, Dept. PM 1053  
8501 Stellar Dr., Culver City, Cal.



In a nutshell, it's the exact replica of the famous professional 4 x 5 Graphic scaled down to half the size! Here, by the miracle of Graflex precision craftsmanship is every feature you could possibly need for prize-winning pictures — any time, any subject, any place. And thanks to its Graflok Back, your "23" takes more accessories — gives a wider film choice — than any other camera of its size, type and price. See both Pacemaker models, Speed and Crown, from \$210.90, depending on lens and shutter. Also the popular Century Graphic "23", now only \$108.

(Prices subject to change.)

Graflex Inc., Dept. 85A  
Rochester 8, New York  
Please send FREE booklet on the  
Graphic "23"

Name \_\_\_\_\_

Street \_\_\_\_\_

City \_\_\_\_\_ State \_\_\_\_\_

County or Zone \_\_\_\_\_

**GRAFLEX®**  
*Prize-Winning Cameras*

# SAVE MONEY WORK TIME WITH

## MILLERS FALLS TOOLS

SINCE  
1868



**No. 814** with  
**\$19.85** Millers Falls  
Precision Chuck  
As shown with Jacobs  
Geared Key Chuck — \$22.35

### Biggest Value in 1/4" Drills

The last word in modern design—a rugged fistful of power that drills up to 1/4" in steel — to 1" in wood with the new power bits. Also operates many time and work saving accessories.



**12-piece  
Drill Kit  
\$29.95**

**25-piece  
Drill Kit  
\$42.25**

**Right-Angle  
Drive  
\$4.95**

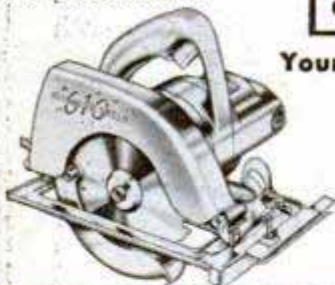
**Buffing &  
Sanding  
Attachment  
\$8.45**

### Most Powerful 1/2" Utility Drill

For men who want full 1/2" drilling capacity in steel. A real husky—yet it weighs only 8 lbs. Ideal for the home shop, for farm use, for repair and service men.



**No. 912  
\$40.95**  
with Jacobs  
Geared Key Chuck



**No. 610** No. 700 7" Saw  
**\$59.50** with capacity  
of 2 3/8" — \$67.95

### Your Best Buy in Portable Saws

Compact, safe, easy to use — this 6" heavy-duty saw will handle 90% of all sawing jobs. Maximum cut: 1 7/8". Adjustable for depth and angle. Full 1/2 h.p. Weighs only 10 1/2 lbs.

### Most Versatile Tool You Can Own

It buffs, sands, grinds, polishes, waxes, wire brushes, drills, mixes paints. And, it's the only tool of its kind that's made for doing both rotary disc and fine-finish orbital sanding.



**No. 966  
with 6"  
rubber**

**pad, 6"  
lamb's  
wool  
bonnet,  
three 6"  
sanding  
discs**

**\$37.50**

Send for Free Booklet  
**MILLERS FALLS COMPANY**  
GREENFIELD, MASSACHUSETTS

# STOP STORM WINDOW RUST

with

## Alumi-gard

Clear all-weather plastic coating

- This Amazing New Discovery stops rust, corrosion and pitting on all metal storm windows and tools.
- Apply with brush or cloth. Quick; fast drying; no mess; absolutely no discoloration.

### ORDER ALUMI-GARD TODAY

Half pints 79c Pint \$1.39 Quart \$2.49

MONEY-BACK GUARANTEE. Send check, cash or money order (postage prepaid). If C.O.D., pay postman postage.

## Alumi-gard COMPANY

1638 W. 79th St., Chicago 20, Ill.  
Distributor and dealer inquiries invited  
Write for details of introductory offer



# HELPFUL BOOKS

Send post card asking for FREE catalog

Popular Mechanics Press, 200 E. Ontario, Dept. 601, Chicago 11

## SAVE MIDDLEMAN'S PROFITS ...buy DIRECT from C&H

### LIGHT PLANTS



1000-2000 w AC, 115 v, 60 cyc. Powered by rugged 2 1/2 hp easy-starting Continental gas engine. No wiring. Just plug in, ready to go. Complete with 12 v starting winding. Easily connected for push-button battery starting. Fully guaranteed, easily worth \$325. Your Factory Price only \$194. Other bargain price models in stock, 300, 1500, 2500, 5000 w etc. SEND FOR FREE BOOKLET WITH VITAL FACTS ON HOW TO SELECT PROPER SIZE FOR YOUR JOB.

### BOOSTER FANS



Fit any 8" to 12" furnace pipe. Mounting frame, 7" blade, 110v motor, 60 cyc. 1550 rpm with 6' cord. Silent operation. Easy to install. Warm those rooms with long runs. List \$11.95. Our price . . . \$6.95; two for \$11.95; three for \$14.95. Buy one for each room!

REGISTER FAN for hot or cold air with bracket ready to mount: motor, 7" blade, 8' cord ONLY . . . \$7.50; two for \$12.95; three for \$16.95.

More than 1100 big \$\$\$ saving buys. These are only a few of the many items at sensationally low prices! Send for FREE 68 page catalog!

|                |                   |                  |                 |
|----------------|-------------------|------------------|-----------------|
| Air Compressor | Delta Tools       | Gas Engines      | Mail Grinder    |
| Air Tank       | Drop Cords        | Generators       | Pumps           |
| Block & Tackle | Electric Hoists   | Grinders         | Reduction Gear  |
| Blowers        | Electric Motors   | 1/2 Ton Wagon    | Rubber Cable    |
| Bomb Trailer   | Electric Switches | Male Fire Pump   | Rubber Wheels   |
| Buzz Saw       | Elevator          | Hand Truck       | Saw Tables      |
| Compressor     | Drawing           | Hydraulic        | Shower Sprays   |
| Accessories    | Elevator Incline  | Cylinder         | Starters        |
| Clutches       | Fans, Exhaust     | Hydraulic        | Tools           |
| Conveyors      | Fans, Heat        | Stacker          | Transformers    |
|                | Booster           | 1 Beam Trolley   | Whiting Hoist   |
|                |                   | Lawn Mower       | Wilton Vise     |
|                |                   | Sulky            | Winch, Electric |
|                |                   | Magnetic Starter | Winch, Hand     |
|                |                   | Mail Chain Saw   |                 |

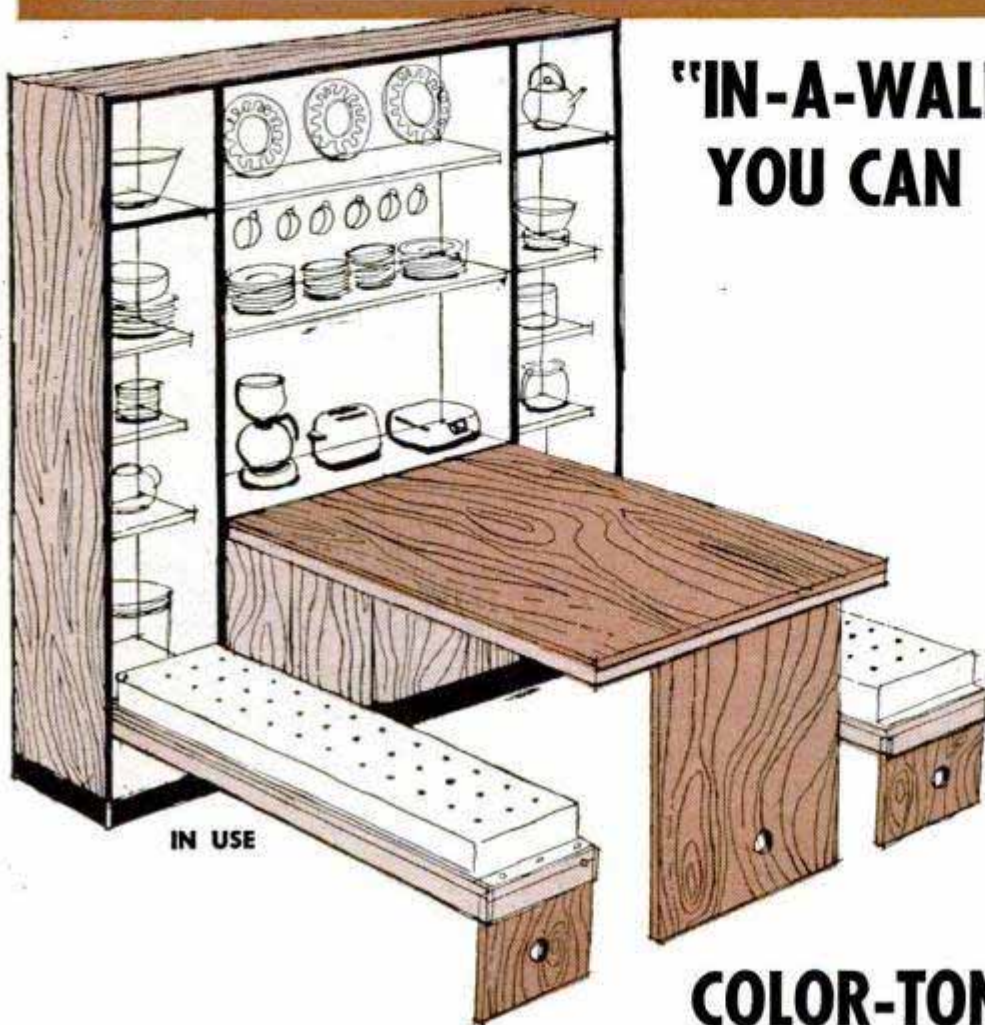


Fire Extinguisher 4 Wheel Trailer

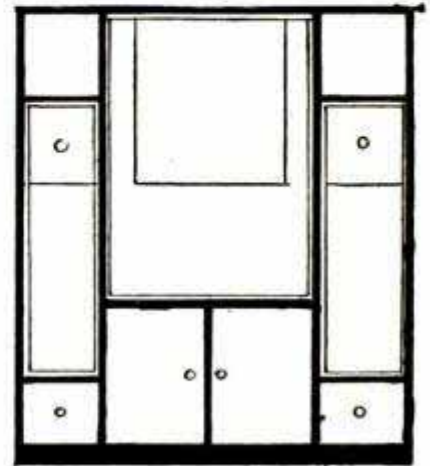
**C&H ELECTRIC  
MACHINE Co. Inc.**

434 1/2 W. Juneau Ave., Milwaukee 3, Wisconsin

## "IN-A-WALL" DINING SET YOU CAN BUILD YOURSELF



IN USE



CLOSED

## COLOR-TONED WITH *Rez*

This smart unit has two space-saving features. As a divider wall, it creates a cozy nook in your living-dining room, kitchen, porch or breezeway. And it contains a built-in bench and table set! Easy...inexpensive to make. Write for complete plans today.

Use Rez to finish the unit. Rez—which primes, seals and

gives you the natural wood finish decorators recommend.

Rez Color Tones, such as the Redwood Rez shown here, bring you ultra-modern natural colors: *Redwood, Cedar, Sage, Driftwood* and *Mahogany*. *White Rez* provides a 1-coat blond finish. Just put it on and wipe with a cloth. *Clear Rez* beautifies grain in the original wood color.

You can paint like a professional with Rez. Brushes, sprays or wipes on like water

...can't leave streaks or brush marks.

Rez protects wood, too. It seals out moisture, checks warping and swelling. Ends the nuisance of "sticking" drawers, doors and windows.

So many places to use Rez! Paneling, siding, flush doors, fencing, furniture... wherever you want a modern natural wood finish. See the beauty of Rez Color Tones soon. Ask your dealer for color samples!

*Laux Rez: Reg. U. S. Pat. Off.*

### MAIL COUPON AND 25¢ CASH FOR PLANS

MONSANTO CHEMICAL COMPANY  
Merchandising Division  
1700 South Second Street  
St. Louis 4, Missouri

Enclosed find 25 cents (25¢) for which please send plans and specifications for "In-A-Wall" Dining Set (Monsanto Rez Moderns, Plan No. 8).

Name.....

Street.....

City..... Zone..... State.....

# LAUX Rez

CLEAR, WHITE  
AND COLOR TONES

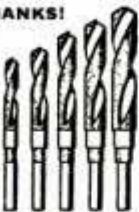


SERVING INDUSTRY... WHICH SERVES MANKIND

**GUARANTEED VALUES!** THOUSANDS MORE IN STOCK - WRITE FOR NEW CATALOG!

**HIGH SPEED DRILLS**

**1/4" to 17/32" WITH 1/4" SHANKS!**  
**SET 10** different size H.S. Drills, 1/4" to 17/32", all with 1/4" shanks. PPD. . . . . **\$7.20**  
**Set 36L** will fit any 1/4" Drill.



**HIGH SPEED DRILLS**

**1/2" to 1-3/16" WITH 1/2" SHANKS!** 5 Drills for less than one new Drill!

**SET 5** different size H. S. Drills **32** 1/2" to 1-3/16" . . . . . **\$11.50**

**SET 10** different size H. S. **33** Drills 1/2" to 1-3/16" . . . **\$20.40**

These new and used H. S. precision Drills with 1/2" shanks can be used in a 1/2" elec. drill or a 1/2" capacity lathe or drill press.

**HIGH SPEED**

**STRAIGHT SHANK DRILLS**

**SET 30** selected H. S. Straight Shank Drills **6** from 1/8" to 1/2", lengths up to 7". **\$15** value, only . . . . . **\$2.98**

**SET 100** HIGH SPEED **19** DRILLS: 1/4" down. **30** new std. H. S. Drills - 70 slightly used sharp drills, lengths up to 7". **\$30** value. . . . . **PPD. . . . . ONLY \$7.98**



**HIGH SPEED WOODRUFF KEY SEAT CUTTER**

**SET 5** different size cutters. Can be used as mounted milling cutter or circular saw. All with 3/8" and 1/2" shanks, widths up to 3/2", dia. up to 1". New and used. Ppd. Priced at only . . . . . **\$3.95**



**NEW ROTARY FILE MIX**

**7** different pcs., High Speed 1/4" shank. PPD. . . . . **\$4.49**



**SET 14** different pcs., as above. PPD. . . . . **\$8.79**

**NEW CONTINUOUS DUTY 1/20 HP MOTOR**



110-V 60 Cy. 1750 RPM. Bronze bush bearings - 1/4" shaft. For fans, other long-running uses. Wt. 4 lbs. Only . . . . . **\$4.95**

**YOUR MONEY BACK** if not satisfied. All mdse. mixture of new and reconditioned unless specified new.

**DRILL MIX - 300 PIECES**

Used high speed Drill Bits - to 1/4". Some have to be sharpened. Ideal for pin punches, drift pins, etc. Over 300 pieces in the mix - less than 1c each . . . . . **\$2.98**



- **GRINDING WHEEL MIX**—30 pieces. 1/4" arbor—up to 2" diameter. With mandrel. . . . . **\$3.29**
- **SPRING MIX**—300— all types and sizes. . . . . **\$1.79**
- **FILE MIX**—12 files up to 12" long. Real buy. . . . . **\$3.69**
- **HAND TAP MIX** — 8 H. S. Taps — standard and pipe— up to 3/8" . . . . . **\$2.95**

**7 SLITTING SAWS WITH MANDREL**

**SET 7** Different Size High **34H** Speed Slitting Saws, 5 pcs. 23/4" dia. x 1" arbor. Thickness from .040 to .071. Cuts wood, aluminum, brass, steel, etc. PLUS **SPECIAL MANDREL** which enables use of saws in 1/4" or 1/2" elec. drill. **\$25** value. PPD. Only . . . . . **\$4.95**



**T & T TOOL CO.** Dept. 7667 GRAND RIVER 117 DETROIT, 4 MICH.

**DIRECT CURRENT WELDERS at AC Transformer Welder Prices**



**\$350.00 VALUE ONLY \$85.00**  
 Fully Guaranteed F.O.B.

**BELT DRIVEN Model #LG**  
 Easier to Use  
 Pays for itself immediately!

Operated at 3000 RPM off any tractor, jeep, truck or 5 HP electric motor . . . any engine of 10 HP or more (old auto engine is excellent). Use indoors or out for all light or heavy jobs. **WELDS, CUTS, BRAZES** steel, cast iron, galvanized, bronze, aluminum, tool steels and stainless steels. Welds straight or reverse polarity. Welds 1/32 to 1/2-in. plate, cuts 3/8-in. plate. Make your own special equipment for farm, shop or factory. Does 1,001 jobs. **COMPARE FEATURES:** Brand new. Compact. Specially designed reactor-type series winding for EVEN ARC. Rheostat for perfect pinpoint heat control. Large oversize brushes for extra long life. Oversize ball bearings. Air cooled by internal fan. Complete with V pulley. Direct current makes arc striking and welding easier. Uses 1/16 to 3/16-in. electrodes (incl.). Output is 20 to 200 amps. (intermittent 250). **COMPLETE WITH ACCESSORIES:** Everything you need. 15-ft. welding and ground cables. Insulated ground clamp. 300 amp. electrode holder. 3 lbs. assorted electrodes. Dual-lens Helmet. Simplified instruction booklet. Outfit complete with accessories (shipping wt. 95 lbs.) only \$98.50. **1 YEAR GUARANTEE** against electrical and mechanical defects. Nowhere can this sensational price and guarantee be equalled. **BOTH THESE WELDERS ARE THE FINEST QUALITY MACHINES MADE UNDER \$400.**

**MOTOR-WELDER #A-2**  
 Just plug it in. No separate motor or engine required.  
**\$350.00 VALUE!**  
**For Farm, Shop, Garage and Factory \$8500 F.O.B.**  
**Full 1-Year Guarantee**



Economical, precision welder with "portable" carrying handle . . . can be taken to the job. Self-contained GE motor-generator operates on AC or DC, 110 or 220 volts, 25-60 cy. Assures smooth flow of power and even arc. Straight or reverse polarity. Brand new. Heavy-duty construction. Self cooled by internal fan. Oversize ball bearings. **WELDS, CUTS, BRAZES.** Has 7 welding ranges from 0 to 150 amps. and is controlled by positive switch action. Welds 1/2" steel with 1/8" rod. **EXTRA!** Motor can be used as power unit (with pulley incl.) for running shop tools. Sanding disk and buffing wheel also incl. make this the most versatile machine at the price. **WITH ACCESSORIES:** Same equipment as model #LG above. Complete outfit (shipping wt. 95 lbs.) only \$98.50.

**10-DAY FREE TRIAL OFFER**

Examine and use either of these Welders for 10 days. If at the end of that time, you are not 100% satisfied that this is the greatest welder bargain, your money will be refunded in full.

**BIG MONEY MAKERS!** Cash in by getting your welder now. Save money . . . and make money. Start earning hundreds of extra dollars. These welders enable you to do better, faster, lower cost work. Send your order today! **FREE CATALOG OF ELECTRICAL BAGGAINS**  
**ROBERTS ELECTRIC COMPANY, Dept. 101**  
 849 WEST GRAND AVE. CHICAGO 22, ILL.

**100 BEST Woodworking Projects**

**SELECTED FOR YOU BY POPULAR MECHANICS EDITORS**  
 Enjoy the fun — the pride — of making things. Get **100 BEST WOODWORKING PROJECTS**, complete with simplified instruction, plans, diagrams and more than 400 how-to-do-it pictures. Make all kinds of furniture, baby carriages, clocks, lamps, book shelves, fireplaces and other useful articles at little or no cost. Send only \$2.00 with name and address. Money back if not pleased.

POPULAR MECHANICS PRESS, Dept. PM6, 200 E. Ontario St., Chicago 11

**Save on all PLUMBING JOBS**

When You Build · When Making Improvements · Repairs · Maintenance

Get POPULAR MECHANICS Home Plumbing Guide



How to plan plumbing installations, select materials and fixtures.

How to save money on all plumbing jobs using approved methods.

Easy to Do Professional-Like Jobs and Save Over One-Half

Get the Popular Mechanics **HOME PLUMBING GUIDE**. It shows how you can do every kind of plumbing job yourself and save from a few to hundreds of dollars. Covers plans, layouts, installation, maintenance and repair. Shows what materials to get and use, where to get them and how to do a proper job with approved methods. Few, other than the simplest tools are required and some of these can be rented. Don't pay high prices for work you can do yourself. Get the **HOME PLUMBING GUIDE** for only \$3.50. You will be amazed how jobs you thought difficult are simplified.

Clip This Ad and Mail. Money Back if Not Pleased

Invest only \$3.50. Use the book for 7 days. Then if you are not satisfied return it for full refund of your money. Sent C.O.D. (U.S.A. only) if you prefer.

**15 Ways to Save Money**

- All about modern home plumbing
- How to use plumbing tools
- Getting acquainted with pipe
- Planning home plumbing systems
- Installing and maintaining home drainage systems
- Private sewage disposal systems
- Causes and cures of drainage troubles
- Installing home water lines
- Private water supply systems
- Water Heaters
- Water Conditioning
- Water system troubles and cures
- Installing and caring for fixtures
- What to do with valves and faucets

Over 500 How-to-do-it Pictures Guide You



POPULAR MECHANICS PRESS, Dept. HPG-10, 200 E. Ontario St., Chicago 11



## **EDITORS' IMPARTIAL TESTS PROVE:**

# **New Self-Charging Battery Outlasts, Outperforms Others 221%**

A few months ago, we started producing a new battery which we frankly believe to be many years ahead of its time. When we announced that this new battery developed 15 amperes more power than other batteries and would automatically bounce back to life again and again after being deliberately and completely discharged, technical editors of leading magazines raised their eyebrows.

We named it the *Lifetime Battery*—not because we expected it to last forever, or even the life of the owner—but because of its *life* (power) and the *time* it would last. We guaranteed it for *six years*; a test battery is still in daily use after 11 years! Editors said—and we don't blame them for being skeptical—"sounds too good to be true." One publisher even refused our advertising until he personally tested every claim we made.

One of the editors said: "Let us test this battery, any way we see fit. If it does what you claim, it's news our readers will be interested in. If it's no good, our readers will be interested in that, too, and that's the way we'll write the story." We said "go ahead" and they took a standard *Lifetime Battery* off the production line and went to work.

You may have read the result of the first test in a famous automotive magazine (name on request). Using two well-known batteries (possibly the best-known high-quality batteries in the world) for comparison, they first ran the *Lifetime Battery* down completely and let it re-charge itself automatically. They repeated this test 43 times the first day, then compared its strength with the other two batteries. Results: the *Lifetime Battery* was 204% stronger than the strongest of the other two batteries. They discharged the *Lifetime Battery* another 20 times, allowing it to re-charge itself automatically each time, and compared all batteries again: the *Lifetime Battery* was now 213% stronger than one battery, 221% stronger than the other! Next, they put a punishing 300-amp load on the *Lifetime Battery*; it survived that in good shape. So they repeated the self-recharging test again and finally concluded: "... unprecedented life expectancy... remarkable recuperative characteristics... outperformed the others in every respect and by a comfortable margin... an outstanding value."

The editor of another magazine (name on request) heard about the tests and asked to "give the thing a *real* test, one that would burn up the average battery." We gave him the *same battery* and challenged him to "finish it off." He installed it in his own car and drove the car on the *battery alone*, shifting gears as he would normally, until his "fingers were sore from holding the starter key... I hate to admit it, but I was outlasted by a battery."

Still another editor wrote: "... definite battery improvement... greater recuperative power, greater initial output... obviously high quality."

*During independent tests in Alaska and the U.S., the Lifetime Battery was intentionally discharged under sub-freezing conditions, recharged itself automatically & started car at once!*



### **Engineered for Cold Climates**

Soon after the *Lifetime Battery* went into production, we selected a few dealers in northern U.S. and Alaska, shipped them a few batteries and waited to see how the dealers and the public would react. Our Alaska dealer told us that before presenting it to his customers, he was going to give the battery an Arctic test: discharge it completely then freeze it at 30 below zero for 72 hours. Result: the battery had recharged itself and immediately started the car. Immediately we received a telegraphed order from Alaska for \$6,043 worth of *Lifetime Batteries*!

### **6-Year Guarantee Saves You Up to \$107**

The average deluxe battery lasts 1.4 years at a typical cost of \$25.00, or \$107.00 for a 6-year period. This arithmetic is making sense to people who are tired of throwing money away on batteries that just won't hold up. We believe it will make sense to you, too—particularly since the *Lifetime Battery* you buy now can easily be transferred to your new car whenever you trade in.

### **12-volt and 6-volt Available**

Here's more arithmetic that makes sense: the *Lifetime Battery* sells in the U.S. at one price for all cars: \$29.95 for 6-volt, \$34.95 for 12-volt including excise tax.



### **Supply Limited: Order Today by Mail!**

Although plant facilities are being expanded, supply is still limited. If your dealer can't supply you, order direct by mail from the factory; we pay freight.

## **CONTINENTAL MANUFACTURING CORPORATION (Marketing Division, Consolidated Engineers)**

Dept. BM-10, Washington Boulevard at Motor Avenue, Culver City, California

### *Dealers* **NOW BEING APPOINTED TO HANDLE DEMAND**

Dealerships are now being awarded to take care of demand generated by \$1,000,000 advertising campaign plus articles in national magazines. Write today for full information, including reprints of editors' tests and case histories from present dealers.

Continental Manufacturing Corporation, Dept. BM-10  
Washington Blvd. at Motor Ave., Culver City, Calif.

Please ship *Lifetime Battery* at once:

- 6-volt (\$29.95 including tax)  
 12-volt (\$34.95 including tax)

for \_\_\_\_\_

(make, model, year of car)

- I enclose cash, check, or money order: you pay shipping cost.  
 I enclose \$5 deposit, will pay balance & shipping costs C.O.D.

Name \_\_\_\_\_

Address \_\_\_\_\_

City \_\_\_\_\_ Zone \_\_\_\_\_ State \_\_\_\_\_

# WONDERFUL CHRISTMAS

# GIFTS



Von Stueben  
25 to 1200 Power  
\$89.50 postpaid



Model 635  
150-300-600 Power  
\$29.95 postpaid



Heidelberg  
20 to 2000 Power  
\$319 postpaid

Complete range  
for hobbyists and  
professionals.

FREE Micro-Handbook  
sent with catalog.



Send Now For Giant Catalog—Free!



Model 800  
20X to 600X  
\$39.95 postpaid



Model 300  
100-200-300 Power  
\$9.95 postpaid



### Mark III

20 Power Telescope, spiral  
focus, coated lens,  
in fitted hardwood case  
\$9.95 postpaid

### MICROSCOPES

Send postcard for free catalog. Any  
of above instruments may be or-  
dered directly from this advertise-  
ment. All shipped in fitted hardwood  
cases. Mechanical stages where  
shown above are extra accessories.  
Prices in catalog. Calif. residents  
add 3% state tax.

AKRON

48 Akron Bldg., 4379 Sunset Blvd.  
Los Angeles 27, Calif.

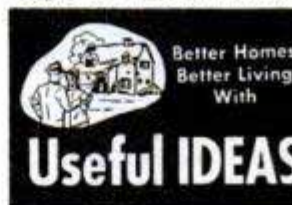
## GIANT CATALOG FREE



Hundreds of money-saving, money-  
making books in the new 1953 Pop-  
ular Mechanics 40-page Book Cata-  
log. Learn how to build your own  
home workshop, make a "Stradi-  
varius" violin, build your own home  
or garage, do your own upholster-  
ing and auto repairing, build boats,  
toys, furniture and other wood-  
items. Send for your free copy of  
working projects and many other  
the giant new catalog at once!  
Write Dept. CT4.

POPULAR MECHANICS PRESS, 200 E. ONTARIO, CHICAGO 11

## Popular Mechanics Home Improvement Help!



Now Ready! Brand new 1953 edition  
of USEFUL IDEAS. 160 pages of help  
for better homes and better living.  
Things to do and make for the home;  
for recreation; for fun and profit; tips  
and ideas that have made and saved  
hundreds of dollars for others. Spe-  
cial features show how to hang wall-  
paper, refinish Venetian blinds, dry  
wet basements, etc. Hundreds of pic-  
tures. Pictorial cover edition only 50  
cents by mail or at your news dealer.

POPULAR MECHANICS PRESS, Dept. PM6, 200 E. Ontario St., Chicago 11

Say You Saw It in  
POPULAR MECHANICS

## Only ROTEX OFFERS these Multi-Purpose, Low-Cost Saws

for any 1/4" electric drill



B-T HACK SAW  
ONLY \$4.95

The B-T Hack Saw—powerful,  
portable, pocket size! Saws wood,  
plastic, steel and sheet metal,  
pipe, plaster board, celotex.  
Ideal for scroll work. Full 5/8"  
chip clearance. Weighs only 11  
oz., folds up into pocket or tool  
box with blade protected. A  
"must" for home craftsmen,  
electricians, carpenters, plumb-  
ers, etc.

The 4-in-1 Hole Saw cuts 1",  
1 1/2", 2", 2 1/2" holes through any  
3/4" stock. Used by craftsmen  
and tradesmen everywhere to  
cut holes for plumbing, conduits,  
pipe, outlets, drains, etc. A real  
help when making modern fur-  
niture and fixtures in your shop.  
Comes complete with 4 blades  
yet costs less than you would  
expect to pay for one—only \$4.95!



4-IN-1 HOLE SAW  
ONLY \$4.95

At your dealer, or send cash, check or M.O. for prepaid shipment

THE ROTEX COMPANY

835 W. DAVIS ST.

DALLAS, TEXAS

Complete with 4 blades

# SPECIAL SALE

## WELLWORTH Portable Spray Outfit



Includes 1/2 H.P. Heavy Duty Motor and External Spray Gun Paint Sprayer mounted on 7x27 inch tank, 1/2 H.P. 110 V. 60 cycle Heavy duty motor with overload relay, 10 ft. cord and plug, V belt drive. Piston type Compressor with 2 Compression rings, 1 oil ring, 2 inch bore, 1 3/4 inch stroke, displacement 2.86 C.F.M. at 60 lbs. pressure. Safety Valve, Gun external atomizing. Flat and round spray, quart cup; maintains 35 to 40 lbs. at 2 to 4 C.F.M. working pressure. Oil and water extractor, 1 air gauge, 20 ft. heavy duty 2-braid air hose with

Kit Form  
\$47.95

leak proof fittings, complete with carrying handle. Net weight 54 lbs., ship. wt. 60 lbs. Sold on Money Back Guarantee. Complete Outfit #W100 \$67.50  
Outfit less motor #W101 \$52.00  
Compressor only #W102 20.50  
Spray Gun only #W103 9.95

## WELLWORTH BLOWER at a bargain price!

BRAND NEW—For heating, ventilating, cooling, air washing, exhausting and forced draft. Quiet operating. Double wheel inlet, double width blower. 10" wheel; outlet 1 3/8" x 1 1/8", inlet 8 3/4". Height 19". Width 18". Depth 16 1/2". C.F.M., 1/4" S.P. 1600; outlet vel. 1575; wt. 45 lbs. Blower With Motor and Drive... #2000 \$29.95  
Blower furnished with 1/2 h.p. motor, belt and pulleys... \$45.00



## "WELLWORTH" 140 CFM

Single-inlet blower for heating, ventilating, exhausting, cooling, drying and similar applications. 5 1/2"x4" mounting flange with 2 1/2" square discharge. 3 1/2" diameter blower wheel powered by direct-connected 1 1/8 H.P., 110 V., 60 C., A.C. motor with conduit box and 20' leads. 7 1/2" wide less flange by \$16.20  
50 CFM BLOWER—2 1/2" discharge #2020 \$10.95

## SPRAY GUN VALUES

**AIR CYLINDER and MOISTURE TRAP**  
5"x8" tank, 400 lb. test with 1/4" air regulator, gauge, safety valve and shut-off cock. #2053. Ship. wt. 6 lbs. \$12.95

**UTILITY PAINT CONTAINER**  
3-gallon Utility Pressure Paint Tank with hose and fittings. All steel tank—lead coated and corrosion resistant. Doubles working area, saves time and effort. 6 in. opening for easier cleaning. Hung on ladder by hook-type handle. 10 ft. air hose and 10 ft. material hose. #W24. Shipping wt. 17 lbs. \$19.95

**WELLWORTH SPRAY GUN**  
with 20 ft. Hose. Pressure feed type. Internal atomizing. One quart cup. Fan and round spray nozzle included. #W20. Wt. 5 lbs. \$10.45

## Do it yourself Kits

**AIR REGULATOR and EXTRACTOR**  
1/4" Air Regulator. Gauge and filter. Wt. 5 lbs. #2050. New... \$8.95  
#2051 Regulator and Gauge... 5.95  
#2052 Air Filter only... 3.25

**POP TYPE VALVES**  
150 lbs. pressure. Has a close range of closing after pop-off pressure is reached. 1/4" pipe thread. #2054 \$1.50

**1/4" Shut-off Valve for air or water**  
—Ship. wt. 1 lb. #2055 \$1.95

**Dash Pot Check Valve**  
Prevents leakage after pressure stops. Quiet operating.  
3/4" \$ 3.25  
1/2" 3.75  
1/4" 4.75  
3/4" 10.50  
1" 10.50

**AIR HOSE AND FITTINGS**—Heavy Duty. 20 ft. with 1/4" fittings. Leak proof. Wt. 5 lbs. #2059 \$2.95  
With Air Chuck—50c extra. #2063 \$4.74

**HEAVY DUTY TROUBLE-LITE CORD SET**  
Steel guard, flexible rubber handle, 2 tool outlet taps, service cord, male plug, guaranteed full length. Wt. 5 lbs. #2063 \$4.74  
**WELLWORTH 1/4" REDUCING VALVE & GAUGE**—Oil resistant, pressure 0- to -200 lb. Reduced pressure 0-to-75 lb.; 3 outlets 1/4". Wt. 2 lbs. #2056 \$5.95

## AUTOMATIC PRESSURE SWITCHES

For Air or Water—Double pole, with 2-way release valve. For use on compressor units 1/2 to 3 h.p. Pressure range 20-200 lbs. 125-150 lbs. pressure. Wt. 4 lbs. #2060 \$13.75  
Same without unloader. Wt. 4 lbs. #2061 \$8.95  
20 to 40 lbs. adjustable to 80 lbs. for air or water. Wt. 2 lbs. #2062 \$6.50

## AUTOMATIC COMPRESSOR UNIT with 22 Gal. Tank

A PORTABLE SPRAY OUTFIT for paint spraying, tire inflation, dust-cleaning, insecticide spraying, and 1001 uses on the FARM... in the HOME... in the FACTORY... wherever air pressure is required.

1/2 H.P. heavy duty capacitor motor. 110 volt A.C., compressor 2" bore, 1 3/4 stroke, piston type, splash feed lubrication. 1 1/2" x 3 1/2" tank, automatic pressure switch. CFM 2.8 at 100 lb. pressure. Check valve, safety valve, air regulator with gauge and filter, 20 ft. air hose with air chuck for inflating tires. V-belt drive. Ball bearing wheels with 2" x 8" rubber tires. Portable with handle. Ship. wt. 150 lbs. With 1 1/2 h.p. gas engine, reg. price \$200  
With 1/2 h.p. motor, reg. price \$175. Item #W302 \$98.50  
Regulator, gauge, and filter sold separately, price for the 3 items... Item #W303 \$8.95



\$72.50 Kit Form

## WELLWORTH Compressor Outfit... Every FARM and HOME WORKSHOP



Both valves in head, bronze bearings, splash lubrication, "V" belt drive, intake muffler and cleaner. Has 2" bore, 1 3/4" stroke. 2.8 cfm up to 150 lbs. pressure. Motor required: 1/4 h.p. at 150 lbs. or equivalent gas engine. Guaranteed!

Includes: Compressor, pressure tank, air gauge, air chuck, 20-ft. hose, pop-valve, copper tubing, with 4 brass flared fittings for connecting compressor to tank, 4-way cross and 3 nipples.  
Complete Outfit, wt. 30 lbs. \$32.45  
With 6"x24" tank #W829 \$32.45  
With 12 1/2"x24" tank #W820 \$38.50  
Compressor only #W800 - wt. 18 lbs. \$20.50  
Equipment less Compressor #W812 - wt. 14 lbs. \$12.45



## WELLWORTH COMPRESSORS

### Single Cylinder Compressor

Cool-Flu Cylinder Head; Stainless Steel Valves; Solid Brass Valve Retainers; Aluminum Piston; Three Piston Rings. One Year Guarantee. Ship. wt. 24 lbs. You Save 33 1/3% #W200 \$29.95

### Bargain - Twin Cylinders

Aluminum Alloy Connecting Rod; Positive Lubrication; Sure Seal Crankcase; Unicast Cylinder and Crankcase; Semi-steel cast Bushings; Dimple-oiled Bronze Bushings. One Year Guarantee. Ship. wt. 45 lbs. Model W-7 \$59.95

### Model 7 SPRAY GUN

With model 81-500 qt. attachable siphon cup. Furnished with 4 1/2 or 8 c.f.m. nozzle. #W7 Shipping wt. 3 1/2 lbs. \$42.20

### Model 8 SPRAY GUN

Bleeder type. For spraying slow drying materials from 1/4 and 1/2 H.P. air compressors. Furnished with 1.9 C.F.M. nozzle. Operates on 25 to 50 lbs. pressure. Fan spray nozzle. #W8. Weight 4 lbs. \$12.70

### Model 16 SPRAY GUN

With model 81-500 qt. attachable siphon cup. Furnished with 3 or 7 c.f.m. nozzle. #W16 Shipping wt. 3 1/2 lbs. \$30.50

### Model 19 SPRAY GUN

With model 81-500 qt. attachable siphon cup. Furnished with 4 or 8.4 c.f.m. nozzle. #W19. Shipping wt. 3 1/2 lbs. \$36.45

## 5000 Watt Electric Light Plant

Remote Control—Government Surplus Signal Corps Power Unit. Size of unit—46" long, 24" wide, 32" high. Net weight 875 lbs. Shipping weight 1000 lbs. Regular price was \$1,600.00. Now—while our supply lasts. #500 \$745.00  
All brand new equipment F.O.B. Chicago

## 2000 Watt Belt Driven Light Plant

2000 Watt, WW 3090—115 Volts. Weight 180 lbs. \$299.50  
WW 4094—115/230 Volts. Weight 195 lbs. \$325.00

## GENERATORS

Brand NEW 1952 Electric 2500 Watt Generator. Produces power for emergency or constant requirements. 120 volts, 60 cycle, single phase, 1800 r.p.m. Shipping weight 135 lbs. List Price \$420.00  
SPECIAL PRICE ONLY \$195.00

## Flock Gun and Insect Dust Sprayer

For dusting plants, shrubbery, etc. Easy-to-use, light weight for spraying powder insecticides. Invaluable for farms, homes and shops. Operates on Compressed Air, requires 2 c.f.m. at 40 lbs. pressure. Approximately 14" in length. Weighs only 2 lbs. \$5.00 Value, only \$2.95

Prices F.O.B. Chicago. MONEY BACK GUARANTEE. Send check or money order TODAY! Prompt shipment.



## WELLWORTH Model 2800 W SPRAY GUN

Furnished with 4 spray nozzles—1 fluid nozzle. For spraying all types of materials, both slow or quick drying, such as house paint, lacquers, varnishes, water paints, whitewash, dyes, etc., furnished with both internal and external nozzle assemblies. Designed for use with Portable Compressors, internal and external nozzles are quickly and easily interchangeable on the same head. Supplied with 1 qt. cup. Nozzles use approximately 2 to 4 C.F.M. The air nozzle (internal atomization) has an adjustable fan spray of from 4" to 8" at 35 to 45 lbs. pressure. Complete—an unusual buy! \$14.95

## WELLWORTH V-BELT CLUTCH

Simple, trouble-free, low-priced, v-belt clutch that takes starting load off gas engines or electric motors. Handles "A" belts, 2.35" pitch diameter, 3/8" bore. Ideal for use with lawn mowers, garden tractors, home workshop motors, etc. 3 1/4" long. #2X350. V-Belt Clutch (25 A) Ea. \$7.50  
Same clutch furnished with 3/4" bore... \$8.50  
#1X868. Bushing for 1 1/2" Shafts. Each 15c

Write for our FREE CATALOG

**WELLWORTH TRADING CO.**  
1832 S. Wabash Ave. • Chicago 16, Ill.  
Order Today!  
Dept. PM-10

# Schupack's Amazing Tool Bargains! All Brand New! Save up to 100%!

**75 Pieces \$4.50** Post-Paid  
For work on Wood, Plastic or Metal. Reg. \$9.00 Value.  
26 mounted wheels and points on 3/32" mandrel; 24 miniature cutters on 3/32" mandrel, 25 short shank min. cutters. Will fit all electric drills and hand grinders.

**FLEXIBLE SHAFT - ONLY \$4.95** Post-Paid  
Fits all electric drills & hand power tools. 35 3/4" long. Oilite bearings. Core of specially wound, high carbon steel wire in flexible steel casing. Will accommodate tool shafts up to 1/8" dia. For lathes, electric drills, etc.

**SURPRISE VALUE 100 PIECES \$1.00** Post-Paid  
FOR ELECTRIC GRINDERS  
Grinding Wheels, Cut-off Wheels, Sanding Discs, Mounted Stones, Sharpening and Honing Stones, Rotary Cutting Burs, Abrasive Cartridges, Mandrels, and many other items.

**20 ABRASIVE ROLLS, \$1.00** Post-Paid  
cloth, and 1/8" mandrel for grinding, sanding, deburring metal, plastic, wood or rubber, ONLY

**2 CIRCULAR SAWS \$1.50** Post-Paid  
ON 2 MANDRELS - ALL AT ONE LOW PRICE  
1" diameter saws on 1/8" Mandrels. For cutting wood, plastic, or soft metals. Order at once! Send Check or Money Order.

**Woodworkers' Drills \$2.00** P.P. U.S.A.  
4 drills, from 5/16" to 1/2" with 1/4" shanks. Brand new, popular sizes. Set #14.

**5 Woodworkers' Drills \$4.50** P.P.  
From 1/4" to 3/4". Set #15 Only..... Ppd. \$4.50

**7 High Speed Twist Drills \$1.00** P.P.  
15 DRILLS \$2.00!  
7 Popular sizes—up to 1/4". Brand new. Set #16.  
5 Drills from 1/4" to 1/2" Dia. .... Ppd. \$1.95

**15 Assorted Drills \$3.95** P.P.  
For 1/16" to 1/2". High speed, and carbon. Set #17 Only..... Ppd. \$3.95

**10 Twist Drills \$10.95** P.P.  
Brand New. From 1/4" to 1-1/4". High speed, and carbon steel. Set #18 Only..... Ppd. \$10.95

**5 All New Drills \$7.50** P.P.  
From 1/2" to 1-1/4". High speed, and carbon. Set #19 Only..... Ppd. \$7.50

**30 Assorted Drills \$2.75** P.P.  
All new. Mixed high speed, and carbon. Up to 1/4" dia. Set #20..... Ppd. \$2.75

NEW ILLUSTRATED CATALOG 10c

**12 MOUNTED WHEELS and points on Shank. \$2.95** Post-Paid  
For grinding on plastic, wood, soft and hard metals. Regular List Value \$8.40.  
12 MTD. WHEELS ON 1/4" SHANK..... \$3.60  
18 MOUNTED POINTS ON 3/32" SHANK..... \$2.50

**ADAPTER CHUCK \$1.50** Post-Paid  
With 2 interchangeable collets, opening from 3/32" to 0, on 1/4" mandrel. Price each only.

**4 GR. WHEELS WITH ARBOR - Only \$1.75** Post-Paid  
3 grits—fine, med., coarse. 2—4" gr. wheels; 1—3" gr. wheel; 1—1 1/2" gr. wheel. 1 arbor for above to fit 1/4" drill and all chucks. A \$4.50 value.

**4 HIGH SPEED SLITTING SAWS \$2.95** Post-Paid ONLY  
From 1 1/2" to 3" dia. 3/8" to 1" arbor hole. For cutting hard and soft metals, wood, or plastic. Ass'td. thicknesses. A regular \$8.00 value.

**3 ROLLS ABRASIVE CLOTH - Only \$5.45** Post-Paid  
For less than the price of one. 50 yds. per roll. 1 1/2" wide—3.20 grit; 1/2" wide—2.40 grit; 3/8" wide—50 grit.

**AUTO TRUNK AIR CONDITIONER \$4.00** Post-Paid ONLY  
Fits in side of trunk — looks like gas tank cap. Easily installed — does not mar appearance of new car. Carry dog safely in trunk. Regulates flow of air—positively no exhaust fumes can enter. Carry fruit, vegetables, fish or game in trunk—keeps them fresh—takes out bad odors. Deluxe Chrome.

SCHUPACK SUPPLY CO., 7331 COTTAGE GROVE AVE., DEPT. M-47 CHICAGO 19, ILL. SEND CHECKS OR M. O. NO COD'S PLEASE

**20 "SEE THRU" DRAWERS!**  
LOWEST COST — HANDIEST STORAGE

MODEL J-20 ..... \$7.95  
Useful in every shop, lab., home, office, etc. For Radio, T.V. or ignition work. KEEPS SMALL ITEMS HANDY. No other cabinet can compare in price, construction strength. "SEE-THRU" durable plastic drawers can't spill accidentally. Strong welded steel cabinet. Drawers 5 3/4" L x 2 3/4" W x 1-7/16" D divide into 2 or 3 LENGTHWISE or CROSSWISE compartments. Sent complete, postpaid. Money back if not satisfied within 10 days. Free catalog on other sizes.

J-24, 24 drawers \$ 9.95  
J-32, 32 drawers 12.95  
J-64, 64 drawers 24.95

Contents always fully visible, clean, dustproof, organized and orderly indexed.

MFG. BY AKRO-MILS, INC., 818 E. MARKET, AKRON 5, O.

**DO IT Yourself!**  
**MAKE your black tires INTO WHITE WALLS**  
with **WHITE WALL Marvel**

**RENEW FADED WHITE WALLS, TOO!**  
Brush on WHITE WALL MARVEL! This Pure White Liquid Rubber actually becomes part of the tire — permanent, won't chip or crack. Takes repeated scrubbing. Dries to a smooth factory-like white—ready to drive — in 15 minutes. Supply for 5 large tires, including brush..... \$2.89

At better Service Stations, Garages, Car Dealers, Auto Accessories Stores

The R-Cote Company 1861 S. Washtenaw Chicago 8, Ill.

## Say You Saw It in POPULAR MECHANICS

**BUY DIRECT MANUFACTURER TO YOU!** New MOTOR BARGAINS for Home, Farm & Industry

**AUTOMATIC AIR COMPRESSOR**  
1/2 H.P. Heavy Duty Motor, 115-V, 60 cy., 1 ph., 1725 RPM, overload protected. Quincy X2 — 3 CFM — 100-150 lbs. Compressor — 2 in. x 1 3/4 bore & stroke. Furnas Automatic Adjustable Pressure Switch. Tank 8" x 26". Rubber Tired Wheels and Handle. Speedy External Atomizing Quart Spray Gun, Pressure Regulator, Filter, Gauge, Hose & Tire Chuck, Check Valve, Safety Valve, V-Belt Drive. Completely Assembled into a Compact Balanced Unit. Ready To Use, 1/2 H.P. #S-55 Fob Chicago..... Only \$89.00  
SAVE \$10.00 ..... 1/2 H.P. Outfit, knocked down, you assemble, #SK-55 ..... Fob Chicago..... Only \$79.00

**KNOCK DOWN LARGER PORTABLE UNITS**  
#SK-75—3/4 H.P. Motor 12" x 24" Stainless Steel Tank One Cyl. 4.5 CFM Compressor. All Accessories. You Assemble ..... \$123.50 Fob.  
#SK-100—1 H.P. Motor 15"x30" Tank Twin Cylinder 9 CFM Compressor. All Accessories. You Assemble \$169.50 Fob.

**C. MARSHALL SALES**  
Dept. P-10 Chicago 47

3546 W. Fullerton Ave.

**16 TO 1 SPEED REDUCERS**  
For Display Table — Barbecue Spits — Toy Auto Gear Box — Experimental Uses, Etc. Gears Enclosed in Aluminum Housing. Bronze Gear, Hardened Worm, Input Shaft 1/4 in. Output Shaft 3/8 in. Speed Reducer #R 161..... \$5.95 Post Paid

**SPECIAL BARGAIN OFFER**  
Brand New! 2 H.P. Repulsion Induction Single Phase Late Style—Name Brand—220 V 60 Cy. 3450 Rpm 3/4 Shaft... Only \$65.00. Weight approx. 100 lbs.

Write for CIRCULAR: Listing Motors; ALL SIZES: Fans and Air Compressors — ALL SIZES.

## BARGAIN HOBBY MOTOR

399 299  
Here's a real value for the hobbyist or home-mechanic. This powerful little motor turns 2500 to 3600 RPM. Has a double-end shaft fitted with an arbor for mounting small stones, wheels, buffers, etc. and a hand chuck for 3/32" and 1/8" shanks. MOTOR complete with arbor & chuck — **399**

**FLEXIBLE DRIVE-SHAFT for HOBBY MOTOR**  
36 inches long and complete with necessary adapters to take, grinding, buffing, polishing, wheel, etc. Shaft is 7/32" dia. Makes this motor a very versatile bench tool. **299**

## 100-200-300 POWER 'HYPOWER' MICROSCOPE

**NEW**  
A VALUE UNSURPASSED ANYWHERE! Triple objective revolving lenses allow selection of 100, 200 or 300 power magnification. Has built-in micro adjustment. Adjustable sub-stage mirror. Body is made to incline through 90°. Complete in dovetailed hardwood case. Ideal for student, lab, study of insects, etc. **995**

**SPECIAL 995**

## FAMOUS SURPLUS MIXES

Another Palley Bargain Mix. 24 assorted hose clamps of various sizes & types. Ideal for use on autos, trucks, tractors, boats, planes, pumps, etc. All are finest, aircraft quality. Be Prepared. **289**

**GADGET MIX** - Another SURPLUS BARGAIN!  
This amazing mix includes a 'TREASURE' of small parts such as: Cogs, Worm Gears, Wheel Bearings, Rivets, Spacers, Bolts, Screws, Springs and Clamps. 5 pounds for ONLY **119**

## BRITISH ARMY PACK RACK

The famous Everest Pack Carrier. Has an all steel frame with a canvas covered, fold-up bottom pack shelf. All straps are genuine leather. Designed so there is a minimum of rubbing and weight is evenly distributed. Strap across lower section acts to absorb shock and sway. Folds flat when not in use. Weight only 3-1/2 pounds! **695**

## NEW RADIO SPEAKER

A very popular model for all types of radio, TV, public address systems, lab work, etc. Has a full tone range and true quality. Rim is 10 inch diameter with standard hole mounting. Dynamic type with transformer. **295**  
4 INCH ALNICO - Permanent magnet type speaker. **249**

## SAVE UP TO 85% WAR SURPLUS

**9 PIECE DRAWING SET**  
Suitable for the architect, student, draftsman, artist, etc. Contains 9 separate pieces including: one 5 1/2" divider; one each: - 3/4" bow divider, bow pencil, bow pen with wheel adjustment & reversible needle point; one 4 1/2" ruling pen with extra handle; capsule of extra leads. All in a 2 flap, velvet lined pocket book case. **598**

**AIR CORPS SURPLUS PLASTIC PARALLEL RULER**  
Heavy durable plastic with guide knobs on top and rubber pads on bottom to prevent slipping. Has beveled edges for pen & pencil use. **98¢**

**NEW BERNZ-O-MATIC TORCH**  
Makes the old "Slow-torch" obsolete. Here is a self-contained fuel & burner unit that does a job where intense heat from a concentrated flame is needed. Absolutely SAFE! (ICC approved). High quality steel - lightweight - replaceable fuel cyl. **695**  
PENCIL FLAME TYPE - with 10 hour cylinder & 1 burner unit - ONLY. **195**  
EXTRA FUEL CYLINDERS - **195**

## ARMY D-12 MAGNETIC COMPASS

A real WAR SURPLUS BARGAIN! Was standard navigational equipment on all Army Aircraft. Has a rotating verge range ring, calibrated in 1 degree increments from 0 to 360°. Two parallel grid wires for N-S alignment. Ideal for airplane, boat, etc. **1750**

## SURPLUS JEEP CANS

FOR RESERVE GAS SUPPLY. Holds 5 Gallons. Has screw top and will take standard flexible nozzle. **139**  
FLEXIBLE NOZZLE . . . . . 49¢

**ARMY CANTEEN & BELT**  
A MUST for the camper, hiker, Boy Scout. A regulation Army Canteen with cover, attached to a G.I. web type, ammo belt with buckle. **199**

## NAVY FLIGHT BOOTS

Fully lined with SHEEPSKIN! Can be worn with or without shoes. Has genuine leather uppers and rubber lowers. Laces up back for snug fit, has zipper front, heavy non-skid tread. The ideal rough weather boot. Sizes Small, Med, Large. **1395**

## NEW WATERPROOF NON-SKID BOOTS

10 inch, sturdy leather uppers and genuine, all rubber shoe with a felt inner sole. Wear it over ordinary shoes. Protection from water, etc. **795**

## AIR CORPS SEXTANT

Bubble Type. AN-5851-1. Made by Bendix Aviation for use in aerial navigation. Has a built-in artificial horizon and an altitude averaging device. Scale marker is operated by spring wound motor and has a visible degree counter. Contains many valuable lenses & prisms. Can be used all navigational purposes. **1250**

## NEW MOSSBERG RIFLESCOPE

**4 POWER**. Optical system has 5 coated lenses which give bright illumination and clear definition without distortion. Has medium, cross hair reticle (.001) and external adjustment for sharp definition. Also has a "fine click" adjustment for computing Windage and Elevation. Fits many well known rifles. Easily mounted and dismounted. **995**  
We also stock a complete line of fine optical items such as Cameras, Binoculars, Microscopes, etc.

## SPECIAL HUNTERS SLEEP BAG

Covered in amazing plastic Miracle Cloth. Sheds water, repels dust. Inner lining is closely woven, glossy green, quilted sateen. Filled with 3 lbs. or 100% WOOL. Has a dble pull zipper-down one side & across the bottom and forms one double-up bag when two are zipped together. Has two, full size, air-mattress pockets. Large headflap with two built-in pockets. Finished size is 34" by 78" and weighs only 7-1/2 pounds. **1995**

## 7 TO 1 HANDY HOIST

Strongest hoist for its weight on the market. Will LIFT 1000 lbs. but weighs only 1 lb. Handy at home, on farm, in shop etc. Consists of 2 pulley blocks, 100 feet of Nylon Cord, 2 Nylon slings & canvas bag. Easy to pack & carry. Ideal as a hunters' game hoist. ONLY **1150**

## NEW 1954-320Pg. CATALOG

Packed with SENSATIONAL VALUES in WAR SURPLUS, FACTORY CLOSE-OUTS and GENERAL MERCHANDISE! Fully illustrated. Thousands of items in Hand & Power Tools, Outdoor & Sporting Equipment, Hardware, Photo Supplies, Foam Rubber, Industrial Tools, Aircraft Parts, Metals, Plastics, Gadgets, Hydraulic Supplies & many, many more. **Only 50¢** We'll refund it on your first order of \$1.00 or more.

**PALLEY SUPPLY CO.** 2263 EAST VERNON AVENUE DEPT. PM-10 LOS ANGELES 59, CALIF.

Order From This Ad. Pay by M.O. or check. P.O.'s. acceptd. from D&B firms. 1/2 deposit with C.O.D.'s. All Prices FOB Los Angeles.

# NO-TANK PUMP! SAVE on tank and fittings



**New conveniences no other pump offers**  
**Goulds Balanced-Flow Jet** brings you a remarkable advance in water pump engineering. It's easy to install almost anyplace — no costly, bulky tank, fewer fittings! It's self-priming, self-adjusting — automatically delivers all the water you want to all outlets at same time, within capacity! Quiet, compact, trouble-free — only one moving part; corrosion-resistant coated. Send coupon today!

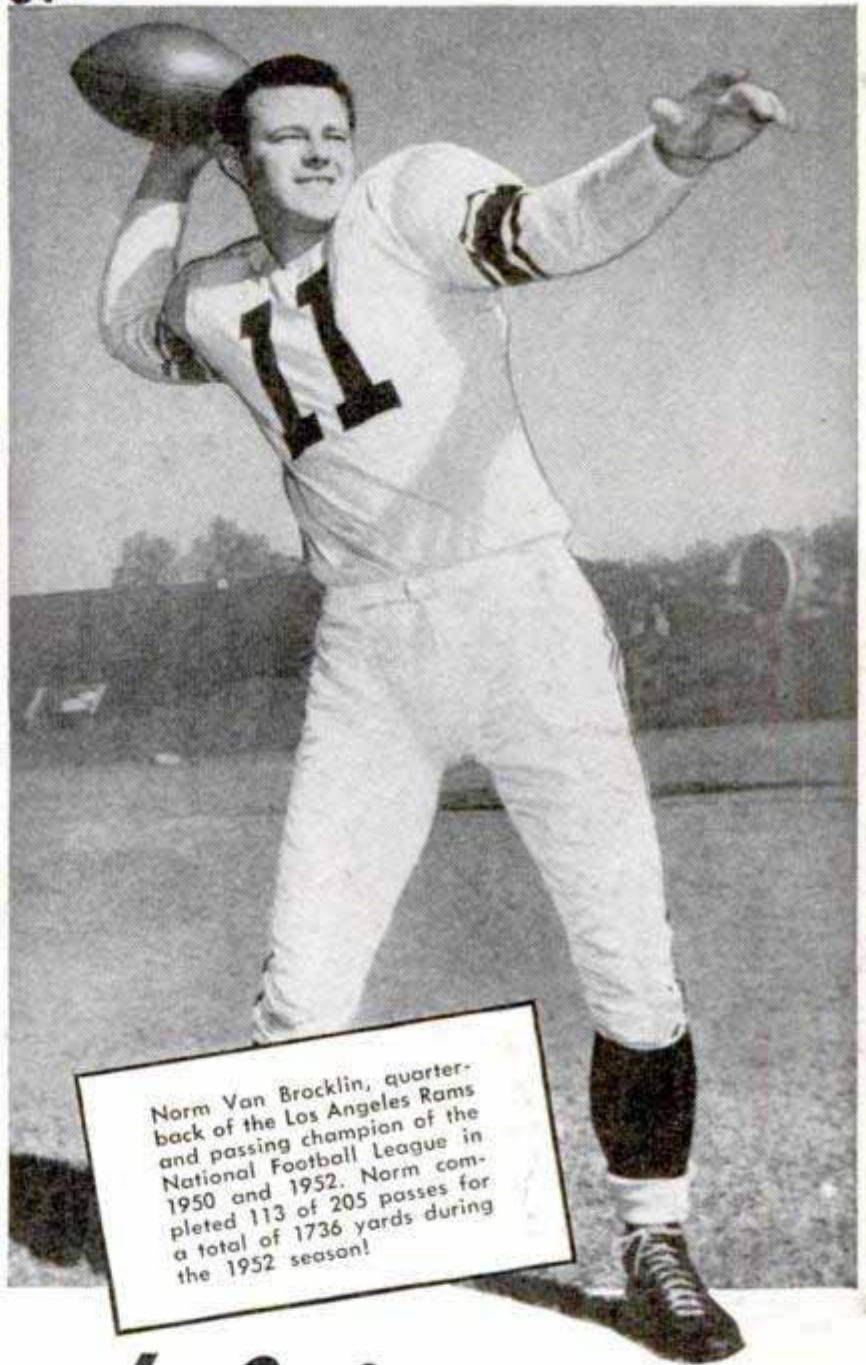
**GOULDS water systems**  
Goulds Pumps Inc., Dept. PM-3  
Seneca Falls, New York.  
Send free, 20-page booklet on Balanced-Flow and other Goulds Pumps. Also distributor name.  
Name.....  
Address.....



*Norm Van Brocklin SAYS...*

*"Buy*

**Prest-o-lite  
hi-level  
Battery...**



Norm Van Brocklin, quarterback of the Los Angeles Rams and passing champion of the National Football League in 1950 and 1952. Norm completed 113 of 205 passes for a total of 1736 yards during the 1952 season!

*needs water only 3 times a year*

IN NORMAL CAR USE

**...lasts longer, too!"**



*See your  
Prest-O-lite Dealer  
for  
Free Pro-Football  
Schedules*

PREST-O-LITE BATTERY COMPANY, INC.

TOLEDO 1, OHIO



## Spend More Time in your Home Workshop

(If you're lucky enough to be a truck driver)

drive a

**REO**

Over the hills and far away—back again without delay . . . because Reo climbs hills 15% to 20% faster than similarly rated trucks carrying the same payload. What's more, you'll arrive at trip's end with plenty of pep, thanks to that comfortable Reo cab. New full 30" doors, new comfortable steering wheel angle with

unobstructed driver viewing, new dependable electric windshield wiper with 103° action, spacious utility compartment and corner pockets, full foam rubber seats in all tractor models. Reo power, dependability\* and comfort hit the nail on the head with handyman truck drivers.

\* Have you heard about Reo's Polar Plan of guaranteed maintenance?

**REO MOTORS, INC.**