

ANC



POPULAR MECHANICS

MAGAZINE

WRITE WHAT YOU CAN UNDERSTAND IT

REGD. TRADE MARK, GREAT BRITAIN, NO. 80228

REG. U.S. PAT. OFF.

NBC's \$62,000 CADILLAC
—Page 102

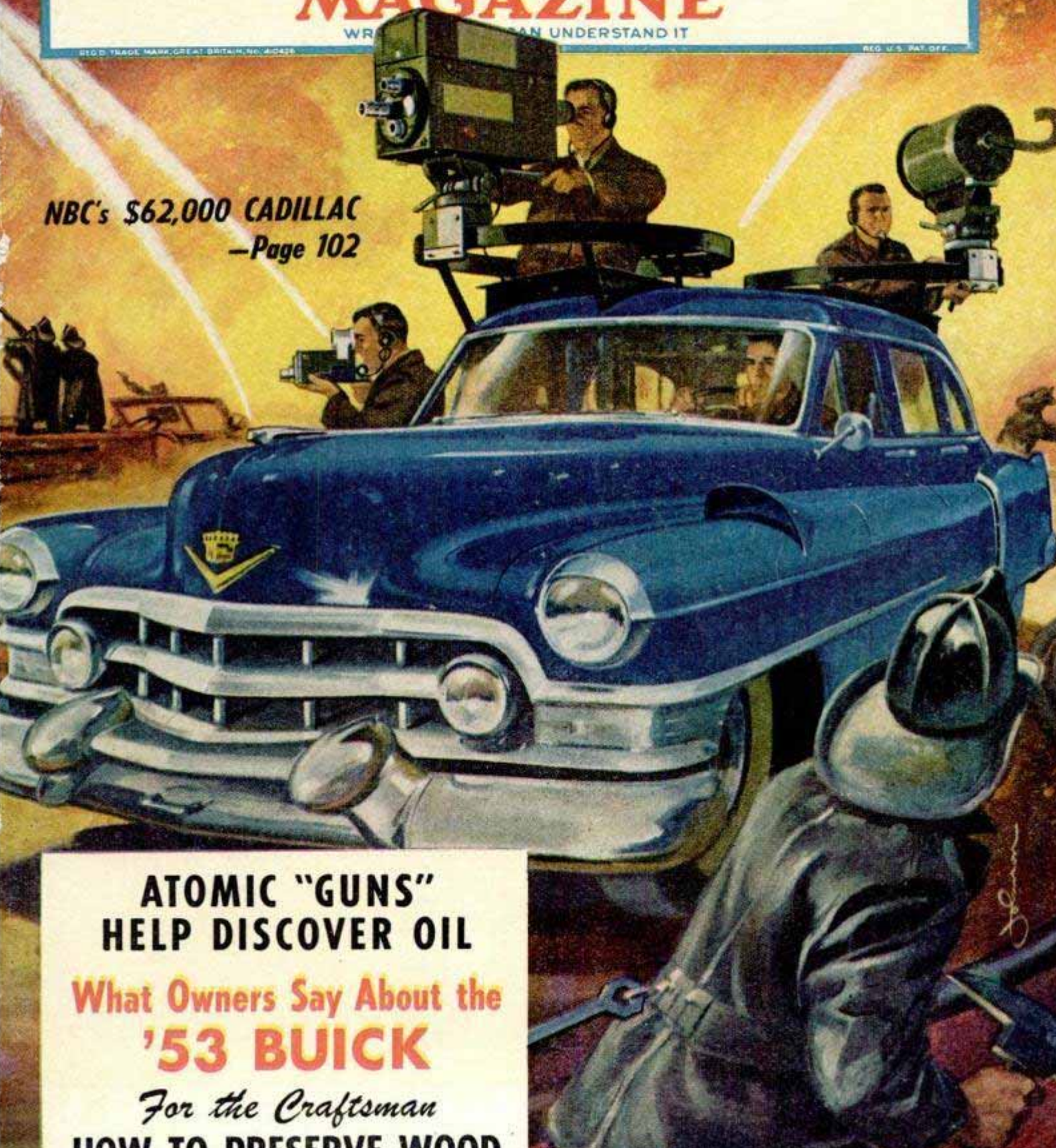

**ATOMIC "GUNS"
HELP DISCOVER OIL**

**What Owners Say About the
'53 BUICK**

For the Craftsman
HOW TO PRESERVE WOOD

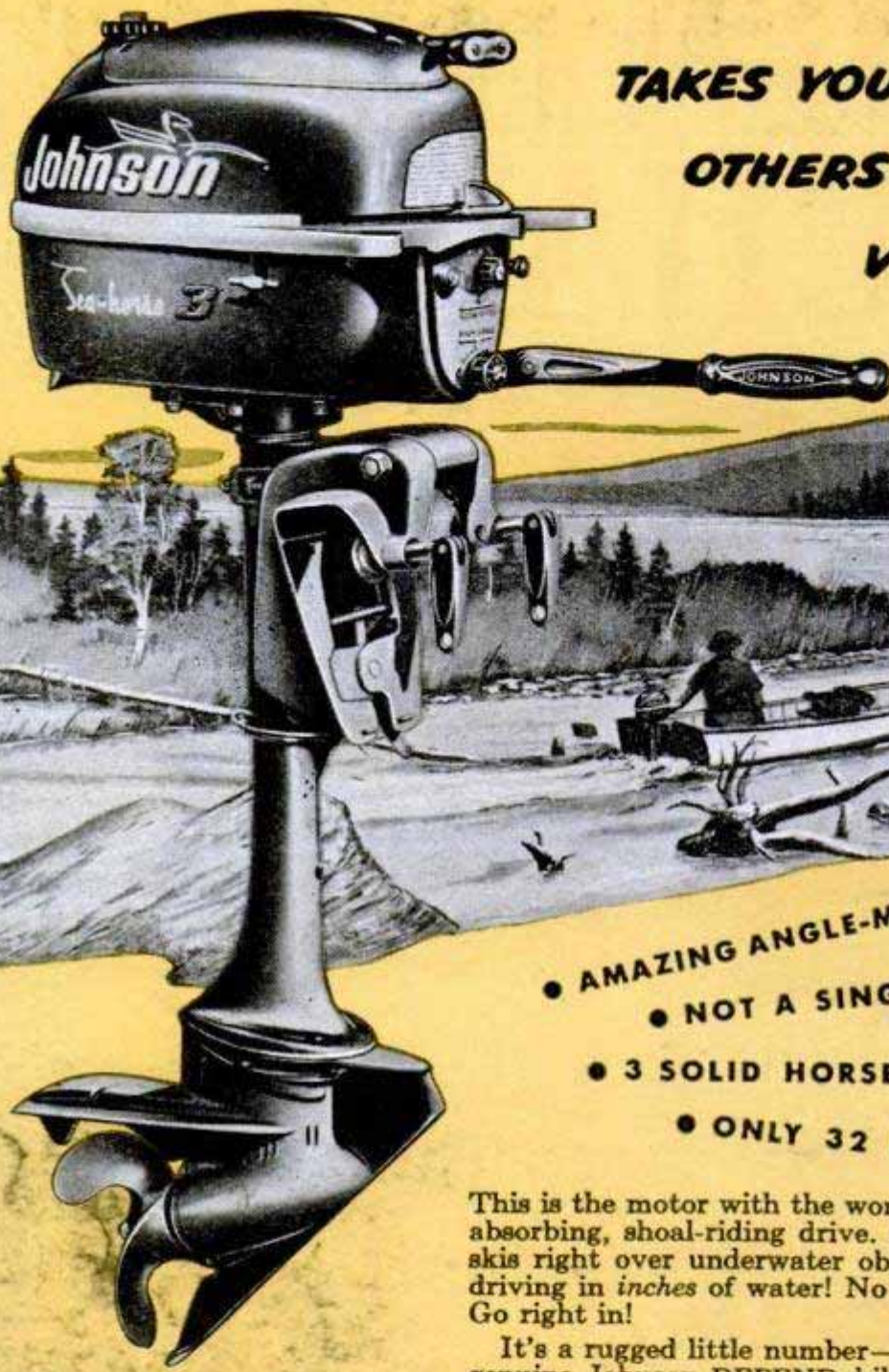

**TAKES YOU WHERE
OTHERS DARE NOT
VENTURE!**

- AMAZING ANGLE-MATIC DRIVE
- NOT A SINGLE, BUT A TWIN
- 3 SOLID HORSEPOWER
- ONLY 32 POUNDS

This is the motor with the wonderful weed-free, shock-absorbing, shoal-riding drive. It slides through weeds, skis right over underwater obstructions and keeps on driving in inches of water! No more fishin' the fringes. Go right in!

It's a rugged little number—a genuine Johnson with genuine Johnson DEPENDability. A smooth Perfected Alternate Firing Twin that gives you the punch of 3 solid horsepower. Yet it weighs only 32 pounds! Pick it up, carry it, stow it—like a tackle box! You'll agree it's the handiest package of power you ever clamped onto a boat.

FREE! Write for new Sea-Horse Catalog. Describes the 4 great Johnsons for 1953. See your Johnson Dealer. Look for his name under "Outboard Motors" in your classified phone book.

JOHNSON MOTORS, 400 Pershing Road, Waukegan, Illinois
In Canada: Manufactured by Johnson Motors, Peterborough

FOR 1953 — 4 GREAT ALTERNATE FIRING TWINS

SEA-HORSE 3—3 hp. A great take-along fishing motor!... \$145.00*

SEA-HORSE 5—5 hp. Neutral Clutch. No shear pin. America's largest selling outboard \$187.50*

SEA-HORSE 10—10 hp. Gear Shift. Mile-Master Fuel System. Twist-Grip Speed Control. Brilliant Performance!..... \$275.00*

SEA-HORSE 25—25 hp. 98 lbs. Gear Shift. Mile-Master. Twist-Grip. Over 30 mph!... \$390.00*

SHIP-MASTER REMOTE CONTROL—Shift-and-throttle. Snap fittings on Sea-Horses "10" and "25" \$29.50*

*Prices are f.o.b. factory, subject to change. OBC Certified brake hp at 4000 rpm. Weights are approximate.

Johnson

SEA-HORSE 3



**THE ONLY MANUFACTURER
WHO HAS BUILT A MILLION
OUTBOARD MOTORS**

Don't get caught with your **Battery down**



A BATTERY out of "juice" is of very little use! So don't take chances. Stop in at your Goodyear dealer's today - have your battery checked free with the portable, accurate, Goodyear All-Purpose Tester. It's the **SURE** way to avoid delays caused by battery failure. While there - ask about the Goodyear Dry Proof Double Eagle Batteries, too.

Goodyear, Battery Dept., Akron 16, Ohio

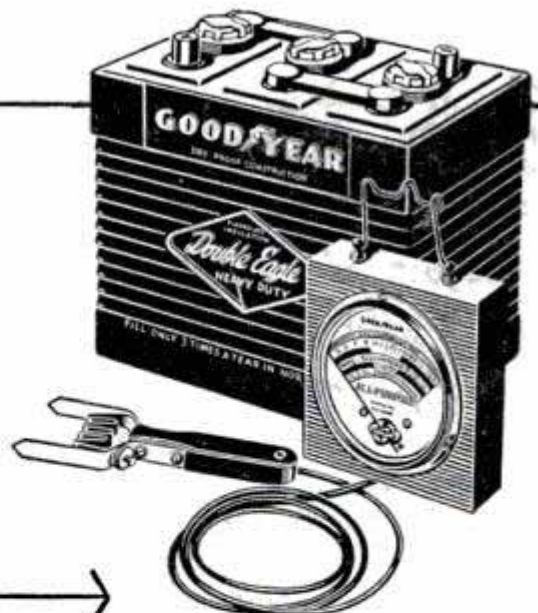

Double Eagle—T. M. The Goodyear
Tire & Rubber Company, Akron, Ohio

GOODYEAR
DRY PROOF • DOUBLE EAGLE BATTERIES

We think you'll like *THE GOODYEAR TELEVISION PLAYHOUSE*—every other Sunday—NBC TV Network



Both Featuring AC's

THE CORVETTE, Chevrolet's sleek, low-slung sports car — and the *PARISIENNE*, Pontiac's exciting experimental car — are taking their bows before record crowds at every showing of General Motors' Motorama in its nation-wide tour. Both feature AC Spark Plugs.

ACs were specified to spark the performance of these special show cars — just as they are being used on more new cars than any other make. Whether your car is brand new, or several seasons old — you'll find AC Spark Plugs with patented *CORALOX* Insulators improve gasoline mileage . . . step up acceleration . . . smooth out performance . . . increase spark plug life. Get the benefit of the best — get ACs.

Original Equipment on Nearly as Many New Cars as All Other Makes Combined

PATENTED
CORALOX
INSULATOR



Popular Mechanics Magazine

Registered in U. S. Patent Office and Canada

H. H. WINDSOR, Founder

H. H. WINDSOR, JR., Editor and Publisher



this month's cover

RIGHT UP to the edge of the inferno rolls the sleek Cadillac. Hatches in the roof slide open and two figures pop up to man the camera and antenna. Seconds later, television viewers 3000 miles across the country have a front-row seat at a major disaster. The strange vehicle is NBC's \$62,000 Cadillac, a standard auto pulled off the assembly line and packed with a ton of telecasting equipment. The steel rings of standard Army machine-gun turrets are mounted on the roof. One supports a camera, the other a barrel-shaped antenna. Inside the limousine's trunk a generator whirs out the electric power to run this studio on wheels, which can bounce a signal 20 miles to the home station for relay across the country. This wandering and wonderful studio can move anywhere a fire truck or ambulance can go. For more details, with news on TV's new "industrial monkey" and hand camera, see page 102

Published monthly by Popular Mechanics Company, 200 E. Ontario St., Chicago 11, Ill. H. H. Windsor, Jr., president; William Harrison Petridge, vice-president; D. F. Windsor, vice-president and secretary-treasurer; H. H. Windsor III, vice-president; Clover L. Perkins, advertising manager; Alan M. Devoe, circulation manager. Single copy in the United States and Canada, 35 cents; subscription rates in the United States and possessions, Canada, Philippines and countries of the Pan-American Postal Union, 1 year \$3.50; 2 years, \$6.00; 3 years \$8.00. To all other countries add \$1.00 a year over United States prices for overseas postage. If you plan to move, notify us at least 30 days in advance so you will not miss an issue. Give both your old and new addresses. Entered as Second Class Matter, September 15, 1903, at the Post Office at Chicago, Illinois, under Act of March 3, 1879. Entered as Second Class Matter at Post Office Dept., Canada. Registered as Second Class Matter at the Post Office at Mexico, D. F., Mexico, June 20, 1950. Copyright 1953 by Popular Mechanics Company. Copyright under International Copyright Union. Copyright in France. All rights reserved under Pan-American Copyright Union. Printed in the United States of America.

Volume 99

JUNE 1953

Number 6

Address all communications to:
200 East Ontario Street, Chicago 11, Illinois

Managing Editor.....Roderick M. Grant
Assistant Managing Editor.....Wayne Whittaker
Shop Notes and Crafts Editor.....James R. Ward
Radio-Television, Electronics Editor.....Frank L. Brittin
Associate Editor, Aviation.....Aubrey O. Cookman, Jr.
Associate Editor.....Clifford B. Hicks
Associate Editor, Automotive.....Arthur R. Railton
Assistant Shop Notes and Crafts Editor.....Wayne C. Leckey
Assistant Editor, Makeup.....John C. Dalen
Automotive Correspondent.....Siler Freeman
Art Director.....Frank Beatty

Assistant Editors
W. Clyde Lamme Leonard F. Hilts Frank N. Stephany
Theodore A. Daum Elsie L. Domin Elliott H. McCleary
Eastern Editor.....Richard F. Dempewolff
Empire State Bldg., Room 2906, New York City 1
Western Editor.....Thomas E. Stimson, Jr.
London Manager.....Douglas W. Wedderspoon
Eagle House, Jermyn St., London S. W. 1, England
Director, Bureau of Information.....Allan Carpenter
200 E. Ontario St., Chicago 11

IN THIS ISSUE

Those Fabulous Flying Fords - - - - -	65
10-Minute Service for a Streamliner - - - - -	72
The Frontier Lives Again - - - - -	82
Now They're Hunting Oil With Atomic "Guns" - - - - -	87
What's Happening in TV Around the World - - - - -	93
NBC's \$62,000 Cadillac - - - - -	102
Robots Sort the Mail - - - - -	106
What's New for Your Home - - - - -	110
The Owners Report on the '53 Buick V8 - - - - -	118
Will America Win at Le Mans? - - - - -	126
Lumber From "Toothpicks" - - - - -	134
Tools for Your Lawn and Garden - - - - -	140

For the Craftsman

Panel Your Home With Plywood - - - - -	150
The Ghost of Old No. 278 - Part II - - - - -	158
Beating Wood Rot to the Punch - - - - -	172
Make Your Own Surf Rod - - - - -	177
Lightweight Tent for Hikers - - - - -	182
12 Ways to Save Gas - - - - -	187
35-mm. Carrying Case - - - - -	192
Special-Purpose Planes and Scrapers - - - - -	197
Vacuum-Cleaner Motor Drives Flexible-Shaft Tool - - - - -	203
Shopping for Tools - - - - -	208
Radio, TV and Electronics - - - - -	211
Clinic for Homemakers - - - - -	218

Other items, and manufacturers of available products described, are listed on pages 12, 14 and 16

Do You Know?

How Nash Airliner Reclining Seats Turn into Twin Beds in 30 Seconds?



1 At lever touch either front seat back adjusts to any of five comfortable positions. Right-hand seat, fully reclined, makes a wonderful "couch" for children's or passenger's naps.



2 No longer need the driver sit rigidly in one position. Just touch a lever and change the angle of the seat back. Tall men say it's the greatest idea yet for comfort on long drives.



3 All the comforts of home! Your Nash dealer offers easy-to-inflate air mattresses and special window screens at small cost—providing a wonderful home on the road for you.



4 Twin Beds in 30 seconds! Both front seat backs recline to fill space between front and rear seats, creating roomy Twin Beds for hunters, fishermen—everyone who travels.



Reclining Seats and Twin Beds are just two of the scores of exclusive Nash features available. See and drive the new 1953 Airflytes, styled by Pinin Farina, at your Nash dealer's. Take the key and see—"there's none so new as Nash for 1953."

Nash Motors, Division Nash-Kelvinator Corporation, Detroit, Mich.

Here's why— *it's so easy*
to buy

TIMKEN

Silent Automatic

HEAT

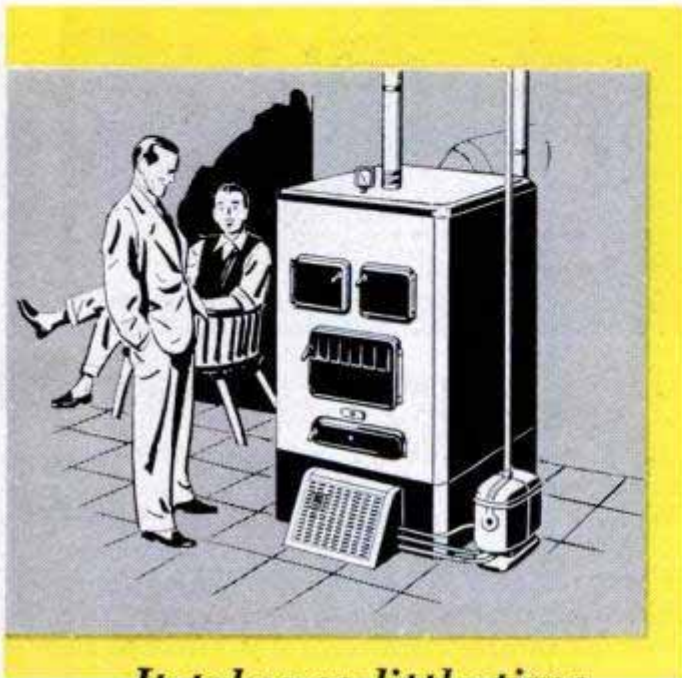

*It takes so little time
to gain a lifetime of
thrifty heating comfort!*

There's no fuss, no muss, no bother when you install Timken Silent Automatic Heat. Factory-trained mechanics can install a conversion burner expertly in your present furnace or boiler in less than a day. Naturally, it will take a little longer if a complete unit is needed. And there's a complete line of oil- and gas-fired furnaces and boilers, oil and gas conversion burners to choose from!

EASY TERMS AVAILABLE!
NOTHING DOWN—36 MONTHS TO PAY!

Why wait! *Now* is the time to buy the finest home improvement of all—Timken Silent Automatic Heat! You can install this money-saving, work-saving heating equipment in your present home *now* and enjoy the clean, convenient comfort of automatic heat for years to come. It's easy as one-two-three! (1) It takes only a few hours to convert your present heating plant to thrifty Timken Silent Automatic Oil or Gas Heat. (2) You can make use of easy credit terms, if desired—nothing down, up to 36 months to pay! (3) Once your Timken Silent Automatic is installed all you need do is set the thermostat—and forget it! You'll get all the heat you want—when you want it—automatically!

Take advantage of this easy way to an easier home life now! Your local Timken Silent Automatic Dealer is listed in the "yellow pages." Phone him today or mail the coupon below.

TIMKEN

Silent Automatic

HEAT

OIL • GAS • COAL
TIMKEN SILENT AUTOMATIC DIVISION
The Timken-Detroit Axle Company • Jackson, Michigan
The Timken-Detroit Axle Company of Canada, Ltd., Toronto, Ont.



MAIL THIS COUPON TODAY FOR ILLUSTRATED LITERATURE!

Timken Silent Automatic, Jackson, Michigan
Please mail illustrated literature. I am interested in

PM 6



NAME _____

This One

STREET ADDRESS _____



CITY and STATE _____

F6YL-WUY-W821

If you are a student, please check here for special information.

FORMULA for Smoother Driving

a few ounces of PYROIL in the
gas tank ... a few ounces of PYROIL
in the crankcase ...

If you're not already a Pyroil user, try the Pyroil formula for smoother driving. The Pyroil formula is so simple and so economical, too. Here's all you do. Next time you stop for gas or oil, have the gas station attendant add Pyroil. You'll be surprised at the difference in your motor performance. Because Pyroil causes oil to cling to piston rings and cylinder surfaces, your motor becomes friction-free. Pyroil improves lubrication—and assures you a ready flow of lubrication at all times. This means "easy starts", and less battery drain. Pyroil removes sludge and keeps your motor clean.

For smoother driving and longer life for your car—add Pyroil—add miles to your car.

PYROIL FOR AIRCRAFT ENGINES

Use Aircraft Pyroil B for lubricating oil, Aircraft Pyroil A for gasoline.

GIVEN! An attractive Pyroil metal savings bank—takes coins up to 50¢ pieces. **MOTORISTS**, it's yours for the asking—sent postage paid.



Manufactured and Guaranteed
by Pyroil Company, 216 Pyroil
Bldg., La Crosse, Wisconsin

Canadian Distributors:
Central Purchasing Agencies,
Ltd., Toronto, Ontario

PYROIL COMPANY
216 Pyroil Bldg., La Crosse, Wisconsin

I want my car to last and run properly. Please tell me more about Pyroil and how it can accomplish this for me.

Name _____

Address _____

City or Town _____ State _____



in this corner.....

THE EDITORS



To the Editor:

Just to let you know we have completed the Sea Craft 25-ft. cruiser as shown in your magazine some time ago (Mar. 1948). We started planning this job in April 1951



and decided to build it. We laid the keel in June 1951. Using only spare-time hours, Saturdays and holidays, we completed the cruiser in one year, or about 1000 hours.

We are well pleased with the performance of this cruiser. It will make 15½ miles per hour using a 95-horsepower Chris Craft engine with a 14 x 12 prop. We increased the thickness of the planking (by mistake in lumber lists) by 1/8 inch, thus making the planking 7/8 inch instead of 3/4 inch. We used light Philippine mahogany for the planking, structural fir for the keel and white oak for ribs and framing inside. This job carries 38 gallons of gasoline and 40 gallons of fresh water in a copper tank. We made four bunks in it instead of the two shown in the plans. We changed the windshield design due to the lack of proper materials; this was the only big change. We followed the plans issued by *Popular Mechanics* and things worked out swell.

Leon H. Preston
Thomas N. Cox
Paintsville, Ky.

To the Editor:

In reply to the readers who disagree with the three Detroit automotive engineers:

I am an English automobile mechanic now living in this country. Having worked on all English and most Continental and American cars, I think I am in a position to reply to readers who compare American cars with such names as Hispano-Suiza, Mercedes-Benz, etc. Let's be fair and compare prices as well. A Bentley sells for \$15,000 to \$20,000 and a Packard sells for \$2700. A reader asks why a European

(Continued to page 8)



To the man who wants to enjoy
an ACCOUNTANT'S CAREER



IF you're that man, here's something that will interest you.

Not a magic formula—not a get-rich-quick scheme—but something more substantial, more practical.

Of course, you need something more than just the desire to be an accountant. You've got to pay the price—be willing to study earnestly, thoroughly.

Still, wouldn't it be worth your while to sacrifice some of your leisure in favor of interesting home study—over a comparatively brief period? Always provided that the rewards were good—a salary of \$4,000 to \$10,000?

An accountant's duties are interesting, varied and of real worth to his employers. He has *standing*!

Do you feel that such things aren't for you? Well, don't be too sure. Very possibly they *can* be!

Why not, like so many before you, investigate LaSalle's modern Problem Method of training for an accountancy position?

Just suppose you were permitted to work in a large accounting house under the personal supervision of an expert accountant. Suppose, with his aid, you studied accounting principles and solved problems day by day—easy ones at first—then more difficult ones. If you could do this—and could turn to him for advice as the problems became complex—soon you'd master them all.

That's the training you follow in principle under the LaSalle Problem Method.

You cover accountancy from the basic Principles right up through Accountancy Systems and Income Tax Procedure. Then you add C. P. A. Training and prepare for the C. P. A. examinations.

As you go along, you absorb the principles of Auditing, Cost Accounting, Business Law, Statistical Control, Organization, Management and Finance.

Your progress is as speedy as you care to make it—depending on your own eagerness to learn and the time you spend in study.

Will recognition come? The only answer, as you know, is that success *does* come to the man who is really *trained*. It's possible your employers will notice your improvement in a very few weeks or months. Indeed, many LaSalle graduates have paid for their training—with increased earnings—before they have completed it! For accountants, who are trained in organization and management, are the executives of the future.

Write For This Free Book

For your own good, don't put off investigation of *all* the facts. Write for our free 48-page book, "Accountancy, The Profession That Pays." It'll prove that accountancy offers brilliant futures to those who aren't afraid of serious home study. We'll also include "Ten Years' Promotion in One"—a book which has helped many men. Send us the coupon *now*.

**LASALLE EXTENSION
 CHICAGO 5, ILL.**

Over 3500 Certified
 Public Accountants among
 LaSalle alumni

- Other LaSalle Opportunities**
- Higher Accountancy
 - C.P.A. Coaching
 - Bookkeeping
 - Law: LL.B. Degree
 - Business Management
 - Salesmanship
 - Traffic Management
 - Foremanship
 - Industr'l Management
 - Stenotypy
 (Machine Shorthand)

LASALLE EXTENSION UNIVERSITY
 A CORRESPONDENCE INSTITUTION

417 S. Dearborn St. Dept. 664-HR Chicago 5, Ill.

I want to be an accountant. Send me without obligation, "Accountancy, the Profession that Pays"—also "Ten Years' Promotion in One."

Name.....Age.....

Address.....

City, Zone & State.....



Mister—can your hair pass the **CARESS TEST?**



**GROOMS
HAIR,
NEVER
GREASES
IT!**

Do you shrink from that moment when she runs her fingers through your hair—afraid she'll find it oily? Then switch today to Mennen Cream Hair Oil. Lightly blended—leaves no trace. Contains lanolin. Helps remove dandruff scales, relieve dry scalp. Get it today—pass her Caress Test tonight!



MENNEN
Cream Hair Oil **FOR MEN**

(Continued from page 6)

engineer gets 125 horsepower from a 91-cubic-inch engine. I wonder if he knows how many revs these engines do to produce that horsepower and also how much maintenance it requires to keep it producing the horses.

Forgetting the Alfas and Mercedes, etc. (let me say that I think these cars are in a class of their own in price, performance and engineering), the workmanship, design and materials used on the lower-priced European cars are far inferior to ours. One only has to inspect them closely to see that.

Finally, it is my opinion that this country, dollar for dollar, is far ahead in design, workmanship and materials. If you want proof just look at the number of English manufacturers who are trying to copy American design.

John R. Nightingale,
Norwalk, Conn.

To the Editor:

Reading your Editor's column in the April issue, I was very surprised at some of the readers' comments.

I sincerely believe the article ["American Engineers Look at Foreign Cars," Feb. 1953] was written strictly from an American engineer's point of view and was not intended as a cross section of the average layman's ideas. After all, those foreign cars were designed for an entirely different terrain and are used in circumstances that are nonexistent in this country.

As for a "mushy" ride, I would certainly prefer a softer ride such as given by American cars to a buckboard ride like those of the majority of foreign cars. After all, as bad as our roads are, they do not consist of hairpin, mountainous roads and all of our driving does not consist of "correcting a bad skid with a car that has to have five turns of the steering wheel."

Our cars are designed to please the customer. If our engineers didn't please the customer, they wouldn't be working long. As for boulevard rides and automatic shift, I can't see spending upward of \$2500 for an automobile and still having to shift gears. Ask anyone who lives in a reasonably large city and has to do any amount of traffic driving what he thinks of automatic transmissions. Thank goodness, someone had the initiative to invent an automatic transmission.

Of course, some will stick with the gear-shift, just as there were some who said "get a horse" when the first automobile came out. After all, we don't use candles or gaslights when electricity is available.

(Continued to page 10)

GO FARTHER FASTER!

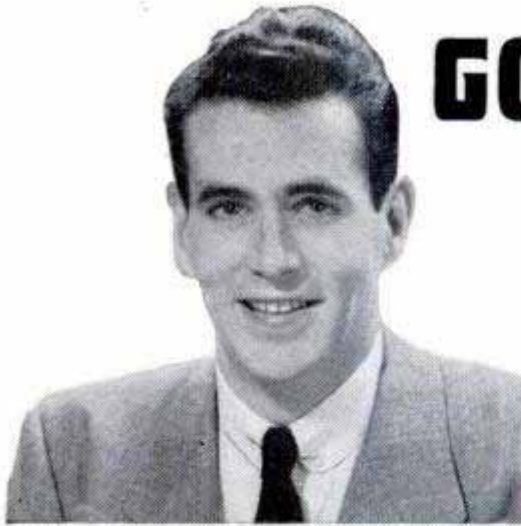

You will make good—*eventually!* But why wait until you're 50 or older? Start now to enjoy the things you want. *Go farther faster!* Win promotion over more experienced men. Gain the respect and admiration of others. Use the hours they waste to put yourself ahead. Famous International Correspondence Schools can lead you step by step up the unmarked path to personal triumph. Doubt it? Then just let I. C. S. prove it—*without cost or obligation.*



WIN PROMOTION! As an I. C. S. student, your chances of promotion go up fast. I. C. S. keeps employers informed of progress of students. Many report new jobs while still enrolled.



NEW CAR! You can afford it on the higher pay you get as a *trained man.* Raises come regularly to I. C. S. students. During one 30-day period, 635 reported increases in take-home pay.



NEW HOME! Want real security? Listen—99% of today's active I. C. S. students are holding down jobs while they study. Graduates include leaders in *every American industry.*

ONLY I. C. S. can offer you 391 up-to-date courses to choose from. The coupon lists 114. Check one that interests you. We'll send you complete infor-

mation including special catalog on field of your choice plus helpful, 36-page guide to advancement, "How to Succeed." Here's that famous coupon:—

INTERNATIONAL CORRESPONDENCE SCHOOLS



BOX 5583-L, SCRANTON 9, PENNA.

Without cost or obligation, send me "HOW TO SUCCEED" and the booklet about the course BEFORE which I have marked X:

- | | | | | |
|-------------------------------------------------------------------------------------------------------------------------------------------------------------------------------------------------------------------------------------------------------------------------------------------------------------------------------------------------------------------------------------------------------------------------------------------------------------------------------------------------------------------------------------------------------------------------------------------------------------------------------------------------------------------------------------------------------------------------------------------------------------------------------------------------------------------------------------------------------------------------------------------------------------------------------------------------------------------------------------------------------------------------------------------------------------------------------------------------------------------------------------------------------------------------------------------------------------------------------------------------------------------------------------------------------------------------|-----------------------------------------------------------------------------------------------------------------------------------------------------------------------------------------------------------------------------------------------------------------------------------------------------------------------------------------------------------------------------------------------------------------------------------------------------------------------------------------------------------------------------------------------------------------------------------------------------------------------------------------------------------------------------------------------------------------------------------------------------------------------------------------------------------------------------------------------------------------------------------------------------------------------------------------------------------------------------------------------------------------------------------------------------------------------------------------------------------------------------------------------------------------------------------------------------------------------------------------------------------------------------------------------------------------------------------------------------------------------------------------------------------------------------------------|-----------------------------------------------------------------------------------------------------------------------------------------------------------------------------------------------------------------------------------------------------------------------------------------------------------------------------------------------------------------------------------------------------------------------------------------------------------------------------------------------------------------------------------------------------------------------------------------------------------------------------------------------------------------------------------------------------------------------------------------------------------------------------------------------------------------------------------------------------------------------------------------------------------------------------------------------------------------------------------------------------------------------------------------------------------------------------------------------------------------------------------------------------------------------------------------------------------------------------------------------------------------------------------------------------------------------------------------------------------------------------------------------------------------|---------------------------------------------------------------------------------------------------------------------------------------------------------------------------------------------------------------------------------------------------------------------------------------------------------------------------------------------------------------------------------------------------------------------------------------------------------------------------------------------------------------------------------------------------------------------------------------------------------------------------------------------------------------------------------------------------------------------------------------------------------------------------------------------------------------------------------------------------------------------------------------------------------------------------------------------------------------------------------------------------------------------------------------------------------------------------------------------------------------------------------------------------------------------------------------------------------------------------------------------------------------------------------------------------------------------------------------------------------------------------------------------------------------------------------------|---------------------------------------------------------------------------------------------------------------------------------------------------------------------------------------------------------------------------------------------------------------------------------------------------------------------------------------------------------------------------------------------------------------------------------------------------------------------------------------------------------------------------------------------------------------------------------------------------------------------------------------------------------------------------------------------------------------------------------------------------------------------------------------------------------------------------------------------------------------------------------------------------------------------------------------------------------------------------------------------------------------------------------------------------------------------------------------------------------------------------------------------------------------------------------------------------------|
| <p>ART</p> <ul style="list-style-type: none"> <input type="checkbox"/> Commercial Art <input type="checkbox"/> Magazine and Book Illustrating <input type="checkbox"/> Cartooning <input type="checkbox"/> Show Card and Sign Lettering <input type="checkbox"/> Fashion Illustrating AUTOMOTIVE <input type="checkbox"/> Automobile, Mechanic <input type="checkbox"/> Auto-Elec. Technician <input type="checkbox"/> Auto Body Rebuilding and Refinishing <input type="checkbox"/> Diesel—Gas Engines AVIATION <input type="checkbox"/> Aeronautical Engineering Jr. <input type="checkbox"/> Aircraft Engine Mechanic <input type="checkbox"/> Airplane Drafting BUILDING <input type="checkbox"/> Architecture <input type="checkbox"/> Arch. Drafting <input type="checkbox"/> Building Contractor <input type="checkbox"/> Estimating <input type="checkbox"/> Carpenter and Mill Work <input type="checkbox"/> Carpenter Foreman <input type="checkbox"/> Reading Blueprints <input type="checkbox"/> House Planning <input type="checkbox"/> Plumbing | <ul style="list-style-type: none"> <input type="checkbox"/> Heating <input type="checkbox"/> Steam Fitting <input type="checkbox"/> Air Conditioning <input type="checkbox"/> Electrician BUSINESS <input type="checkbox"/> Business Administration <input type="checkbox"/> Certified Public Accountant <input type="checkbox"/> Accounting <input type="checkbox"/> Bookkeeping <input type="checkbox"/> Stenography and Typing <input type="checkbox"/> Secretarial <input type="checkbox"/> Federal Tax <input type="checkbox"/> Business Correspondence <input type="checkbox"/> Personnel and Labor Relations <input type="checkbox"/> Advertising <input type="checkbox"/> Retail Business Management <input type="checkbox"/> Managing Small Business <input type="checkbox"/> Sales Management <input type="checkbox"/> Salesmanship <input type="checkbox"/> Traffic Management CHEMISTRY <input type="checkbox"/> Chemical Engineering <input type="checkbox"/> Chemistry <input type="checkbox"/> Analytical Chemistry <input type="checkbox"/> Petroleum—Nat'l Gas <input type="checkbox"/> Pulp and Paper Making <input type="checkbox"/> Plastics | <p>CIVIL, STRUCTURAL ENGINEERING</p> <ul style="list-style-type: none"> <input type="checkbox"/> Civil Engineering <input type="checkbox"/> Structural Engineering <input type="checkbox"/> Surveying and Mapping <input type="checkbox"/> Structural Drafting <input type="checkbox"/> Highway Engineering <input type="checkbox"/> Reading Blueprints <input type="checkbox"/> Concrete Construction <input type="checkbox"/> Sanitary Engineering DRAFTING <input type="checkbox"/> Aircraft Drafting <input type="checkbox"/> Architectural Drafting <input type="checkbox"/> Electrical Drafting <input type="checkbox"/> Mechanical Drafting <input type="checkbox"/> Structural Drafting <input type="checkbox"/> Sheet Metal Drafting <input type="checkbox"/> Mine Surveying and Drafting ELECTRICAL <input type="checkbox"/> Electrical Engineering <input type="checkbox"/> Electrician <input type="checkbox"/> Electrical Maintenance <input type="checkbox"/> Electrical Drafting <input type="checkbox"/> Electric Power and Light <input type="checkbox"/> Lineman HIGH SCHOOL <input type="checkbox"/> High School Subjects | <ul style="list-style-type: none"> <input type="checkbox"/> College Preparatory <input type="checkbox"/> Mathematics <input type="checkbox"/> Commercial <input type="checkbox"/> Good English MECHANICAL AND SHOP <input type="checkbox"/> Mechanical Engineering <input type="checkbox"/> Industrial Engineering <input type="checkbox"/> Industrial Supervision <input type="checkbox"/> Foremanship <input type="checkbox"/> Mechanical Drafting <input type="checkbox"/> Machine Design-Drafting <input type="checkbox"/> Machine Shop Practice <input type="checkbox"/> Tool Design <input type="checkbox"/> Industrial Instrumentation <input type="checkbox"/> Machine Shop Inspection <input type="checkbox"/> Reading Blueprints <input type="checkbox"/> Toolmaking <input type="checkbox"/> Gas—Electric Welding <input type="checkbox"/> Heat Treatment—Metallurgy <input type="checkbox"/> Sheet Metal Work <input type="checkbox"/> Sheet Metal Pattern Drafting <input type="checkbox"/> Refrigeration POWER <input type="checkbox"/> Combustion Engineering <input type="checkbox"/> Diesel—Electric <input type="checkbox"/> Electric Light and Power | <ul style="list-style-type: none"> <input type="checkbox"/> Stationary Steam Engineering <input type="checkbox"/> Stationary Fireman RADIO, TELEVISION, COMMUNICATIONS <input type="checkbox"/> General Radio <input type="checkbox"/> Radio Operation <input type="checkbox"/> Radio Servicing—FM <input type="checkbox"/> Television <input type="checkbox"/> Electronics <input type="checkbox"/> Telephone Work RAILROAD <input type="checkbox"/> Locomotive Engineer <input type="checkbox"/> Diesel Locomotive <input type="checkbox"/> Air Brakes <input type="checkbox"/> Car Inspector <input type="checkbox"/> Railroad Administration TEXTILE <input type="checkbox"/> Textile Engineering <input type="checkbox"/> Cotton Manufacture <input type="checkbox"/> Rayon Manufacture <input type="checkbox"/> Woolen Manufacture <input type="checkbox"/> Loom Fixing <input type="checkbox"/> Finishing and Dyeing <input type="checkbox"/> Textile Designing |
|-------------------------------------------------------------------------------------------------------------------------------------------------------------------------------------------------------------------------------------------------------------------------------------------------------------------------------------------------------------------------------------------------------------------------------------------------------------------------------------------------------------------------------------------------------------------------------------------------------------------------------------------------------------------------------------------------------------------------------------------------------------------------------------------------------------------------------------------------------------------------------------------------------------------------------------------------------------------------------------------------------------------------------------------------------------------------------------------------------------------------------------------------------------------------------------------------------------------------------------------------------------------------------------------------------------------------|-----------------------------------------------------------------------------------------------------------------------------------------------------------------------------------------------------------------------------------------------------------------------------------------------------------------------------------------------------------------------------------------------------------------------------------------------------------------------------------------------------------------------------------------------------------------------------------------------------------------------------------------------------------------------------------------------------------------------------------------------------------------------------------------------------------------------------------------------------------------------------------------------------------------------------------------------------------------------------------------------------------------------------------------------------------------------------------------------------------------------------------------------------------------------------------------------------------------------------------------------------------------------------------------------------------------------------------------------------------------------------------------------------------------------------------------|-----------------------------------------------------------------------------------------------------------------------------------------------------------------------------------------------------------------------------------------------------------------------------------------------------------------------------------------------------------------------------------------------------------------------------------------------------------------------------------------------------------------------------------------------------------------------------------------------------------------------------------------------------------------------------------------------------------------------------------------------------------------------------------------------------------------------------------------------------------------------------------------------------------------------------------------------------------------------------------------------------------------------------------------------------------------------------------------------------------------------------------------------------------------------------------------------------------------------------------------------------------------------------------------------------------------------------------------------------------------------------------------------------------------|---------------------------------------------------------------------------------------------------------------------------------------------------------------------------------------------------------------------------------------------------------------------------------------------------------------------------------------------------------------------------------------------------------------------------------------------------------------------------------------------------------------------------------------------------------------------------------------------------------------------------------------------------------------------------------------------------------------------------------------------------------------------------------------------------------------------------------------------------------------------------------------------------------------------------------------------------------------------------------------------------------------------------------------------------------------------------------------------------------------------------------------------------------------------------------------------------------------------------------------------------------------------------------------------------------------------------------------------------------------------------------------------------------------------------------------|---------------------------------------------------------------------------------------------------------------------------------------------------------------------------------------------------------------------------------------------------------------------------------------------------------------------------------------------------------------------------------------------------------------------------------------------------------------------------------------------------------------------------------------------------------------------------------------------------------------------------------------------------------------------------------------------------------------------------------------------------------------------------------------------------------------------------------------------------------------------------------------------------------------------------------------------------------------------------------------------------------------------------------------------------------------------------------------------------------------------------------------------------------------------------------------------------------|

YEAR OF THE SIX MILLIONTH STUDENT

Name _____ Age _____ Home Address _____
 City _____ Zone _____ State _____ Working Hours _____ A.M. to _____ P.M.
 Occupation _____

Special tuition rates to members of the Armed Forces. Canadian residents send coupon to International Correspondence Schools Canadian, Ltd., Montreal, Canada

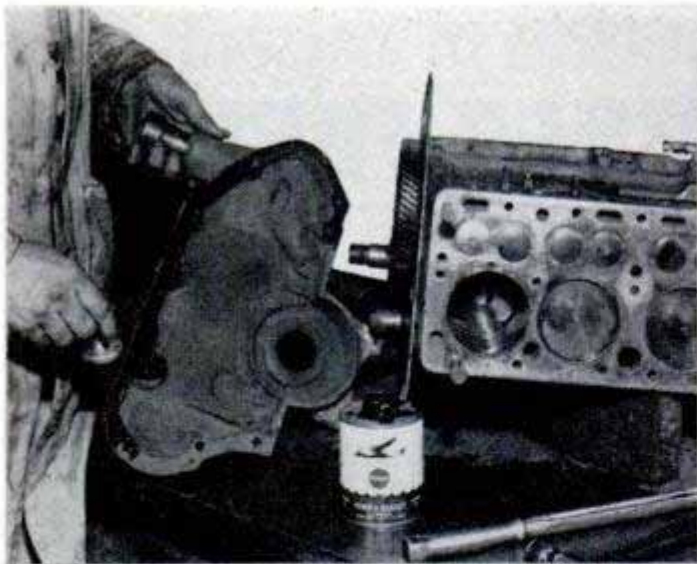

"No Leaks with PERMATEX FORM-A-GASKET"



— SAY
AUTO MANUFACTURERS
AND MECHANICS
EVERYWHERE

Here is a typical quotation from Al Linz of Northeastern Auto Supply of Baltimore, Md. "We use Permatex Aviation Form-A-Gasket on every gasket, joint, thread and connection. We just cannot take a chance of having a leak in any engine we rebuild!" Keep Form-A-Gasket handy in your workshop as an all-purpose gasket and pipe-fitting compound.



3 TYPES for your convenience

No. 1 sets quickly, dries hard. No. 2 sets slowly, is non-hardening. Aviation No. 3 is a brushable liquid that sets to a paste. All three make leakproof, pressure-tight seals in threaded, hose and flange connections.

PERMATEX COMPANY, INC.
Brooklyn 35, New York

(Continued from page 8)

Keep up the good automotive work and congratulations on printing an article that tells the truth. Tell anyone for me that if they like their cars foreign, they can go to Europe. When in America, do as the Americans do.

Pvt. Robt. E. Smith,
Camp Breckinridge, Ky.

To the Editor:

My opinion of the current cars gets lower with each new model. . . . I recently had occasion to see a few new foreign cars and inspect them to my satisfaction. Included were a Morris Minor, Singer, Jaguar and the Bentley. As I suspected, the buyer that can see past the speedometer would see a few features of quality, such as doors that fit and close without a mighty slam that requires . . . training and a prodigious windup.

I also noticed that the upholstery was of top quality and put in straight, not like the "glamorous" American car where it looks like tinted cheesecloth tacked in at an amateur dart throwers' convention. The hardware is like comparing something from Tiffany's to the merchandise at the local five-and-dime store. I could go on and mention the fact of economy, of better gas and tire mileage, but I'll save that for my discussion of the past and present as far as Detroit is concerned.

My own car is a 1940 Plymouth and is a gem. I get good gas and oil mileage (20 miles per gallon and 800-1000 miles per quart of oil). I have no squeaks, leaks, rattles or "sass" from it. So do you know what I am going to do when it starts showing its age? Unless Detroit starts building cars like before the war, I will buy a noisy, efficient, well-built import. Or else I will spend \$1000 to have the old car rebuilt. I don't think there is enough good steel in our cars to make a fistful of self-respecting bolts for a Rolls-Royce. . . . American designers have lost sight of the primary purpose of a car, to wit: A travel device.

In our cars, it seems that the thickness of the fender decreases with each addition of horsepower. The chrome on my car is 13 years old and is in better shape than that on many of the 1952 models which show rust after only one year. The first manufacturer who announces that he is out of the horsepower race and in the quality and economy races may sell me his product. . . . I don't care if I get somewhere 10 minutes sooner, I want to be able to keep going there in a dependable car that will keep a presentable appearance without an excess of automotive cosmetics.

Edward Levy,
Bowling Green, Ohio

Read AUDELS MECHANICS GUIDES for profit



STEP UP YOUR SKILL with the Facts and Figures of Your Trade To Earn More—Learn More

Audels Mechanics Guides contain Practical Inside Trade Information in handy form. Fully Illustrated. Easy to Understand. Highly Endorsed. Check book you want for 7 DAYS' FREE EXAM. Send No Money. Nothing to pay postman. Carpentry \$6 Auto \$4 Oil Burners \$1 Sheet Metal \$1 Welding \$1 Refrigeration \$4 Plumbing \$6 Masonry \$6 Painting \$2 Radio \$4 Electricity \$4 Mathematics \$2 Steam Engineers \$4 Machinist \$4 Blueprint \$2 Diesel \$2 Drawing \$1. If satisfied you pay only \$1 a month until price is paid. AUDEL, Publishers, Dept. P-6, 49 W. 23 St., N. Y. 10, N. Y.

WHAT Every MACHINIST Wants to Know

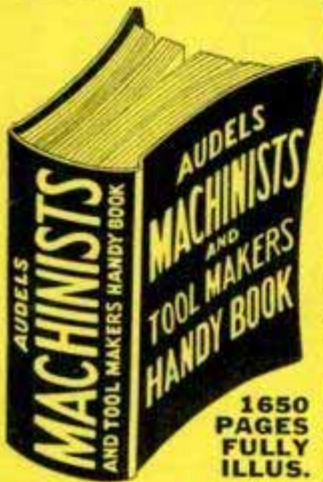

1650 PAGES FULLY ILLUS.

automatic screw machines; How to calculate—How to Use Slide Rule. How to read Blueprints, etc. A timely Book and ready helper.

\$4 COMPLETE • PAY ONLY \$1 A MONTH Get This Information For Yourself. Mail Coupon Today. No Obligation Unless Satisfied. ASK TO SEE IT!

AUDELS Carpenters and Builders Guides 4 vols. \$6



Inside Trade Information for Carpenters, Builders, Joiners, Building Mechanics and all Woodworkers. These Guides give you the short-cut instructions that you want—including new methods, ideas, solutions, plans, systems and money saving suggestions. An easy progressive course for the apprentice and student. A practical daily helper and Quick Reference for the master worker. Carpenters everywhere are using these Guides as a Helping Hand to Easier Work, Better Work and Better Pay. To get this assistance for yourself, simply fill in and mail FREE COUPON below.

Inside Trade Information On:

How to use the steel square—How to file and set saws—How to build furniture—How to use a mitre box—How to use the chalk line—How to use rules and scales—How to make joints—Carpenters arithmetic—Solving mensuration problems—Estimating strength of timbers—How to set girders and sills—How to frame houses and roofs—How to estimate costs—How to build houses, barns, garages, bungalows, etc.—How to read and draw plans—Drawing up specifications—How to excavate—How to use settings 12, 13 and 17 on the steel square—How to build hoists and scaffolds—skylights—How to build stairs—How to put on interior trim—How to hang doors—How to lath—lay floors—How to paint.



WHAT ALL AUTO MECHANICS WANT TO KNOW

1800 PAGES

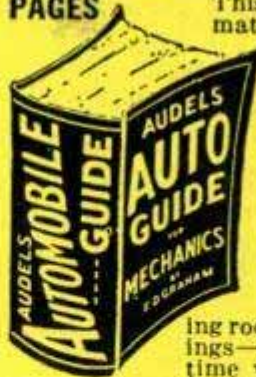

This Big Practical Book gives full information with working diagrams covering the principles, construction, ignition, service and repair of modern cars, trucks and buses.

Diesel Engines, Hydrumatic & Fluid Drives Fully Explained.

A complete Guide of 1800 pages, with over 1500 illustrations showing inside views of working parts, with instructions for service jobs.

IT PAYS TO KNOW

How to fit pistons—How to locate engine knocks, How to fit connecting rod bearings—How to service main bearings—How to recondition valves—How to time valves—How to adjust fan belts—How to adjust carburetors and chokes. How to rebuild a clutch—How to service automatic transmissions—How to service brakes—How to adjust steering gear—How to cope with ignition troubles—How to service distributors—How to time ignition—How to "tune up" an engine.



\$4 COMPLETE • PAY \$1 A MO. TO GET THIS ASSISTANCE FOR YOURSELF SIMPLY FILL IN AND MAIL COUPON TODAY.

Step up your own skill with the facts and figures of your trade. Audels Mechanics Guides contain Practical Inside Trade Information in a Handy Form. Fully illustrated and Easy to Understand. Highly Endorsed. Check the book you want for 7 DAYS' FREE EXAMINATION. Send No Money. Nothing to pay postman.

MAIL ORDER



Check NOW!

You Can Look Over Any Guide In Your Own Home — Start the Easy Payments If Satisfied

MAIL THIS TODAY

AUDEL, Publishers, 49 W. 23 St., NEW YORK 10, N. Y.

Please send me postpaid for FREE EXAMINATION books marked (x) below, if I decide to keep them I agree to mail \$1 in 7 Days on each book or set ordered and further mail \$1 monthly on each book or set until I have paid price, otherwise I will return them.

- AUTOMOBILE MECHANICS GUIDE, 1800 Pages \$4
- TRUCK & TRACTOR GUIDE, 1299 Pages 4
- DIESEL ENGINE MANUAL, 575 Pages 2
- MACHINISTS HANDY BOOK, 1650 Pages 4
- WELDERS GUIDE, 400 Pages 1
- BLUE PRINT READING, 416 Pages 2
- MATHEMATICS & CALCULATIONS, 700 Pages 2
- SHEET METAL PATTERN LAYOUTS, 1100 Pages 4
- SHEET METAL WORKERS HANDY BOOK, 388 Pgs. 1
- MECHANICAL DRAWING GUIDE, 160 Pages 1
- MECHANICAL DRAWING & DESIGN, 480 Pages 2
- AIRCRAFT WORKER, 240 Pages 1
- TELEVISION SERVICE MANUAL, 384 Pages 2
- RADIOMANS GUIDE, 914 Pages 4
- ELECTRONIC DEVICES, 216 Pages 2
- ELECTRIC MOTOR GUIDE, 1000 Pages 4
- ELECTRIC WIRING DIAGRAMS, 272 Pages 1
- ELECTRICIANS EXAMINATIONS, 250 Pages 1
- ELECTRIC POWER CALCULATIONS, 425 Pages 2
- HANDY BOOK OF ELECTRICITY, 1440 Pages 4
- ELECTRIC DICTIONARY, 9000 Terms 2
- ELECTRIC LIBRARY, 7000 Pages (12 Book Set) 18
- MARINE ENGINEERS HANDY BOOK, 1258 Pgs. 4
- SHIPFITTERS HANDY BOOK, 250 Pages 1
- REFRIGERATION & Air Conditioning, 1280 Pgs. 4
- MILLWRIGHTS & MECHANICS GUIDE, 1200 Pgs. 4
- POWER PLANT ENGINEERS GUIDE, 1500 Pages 4
- ENGINEERS & FIREMANS EXAMS, 525 Pages 1
- PUMPS, Hydraulics & Air Compressors, 1658 Pgs. 4
- ENGINEERS LIBRARY (3 Book Set) 9
- MECHANICAL DICTIONARY, 950 Pages 4
- GARDENERS & GROWERS GUIDES (4 Book Set) 6
- CARPENTERS & BUILDERS GUIDES (4 Book Set) 6
- PLUMBERS & Steamfitters Guides (4 Book Set) 6
- MASONS AND BUILDERS GUIDES (4 Book Set) 6
- PAINTERS & DECORATORS MANUAL, 450 Pgs. 2
- HOUSE HEATING GUIDE, 1000 Pages 4
- OIL BURNER GUIDE, 384 Pages 1

Name _____
 Address _____
 Occupation _____
 Employed by _____

All Chinese Eat Chop Suey



—OH, YEAH?

When most people order Chinese food, the only dish they can remember is Chop Suey. And yet nobody in China ever heard of it. It's an American dish for Americans.

When many people are asked about Macmillan Ring-Free Motor Oils, they think of them as oils to clean carbon out of sluggish engines—to reduce ping.

But that's just another popular misconception.

Actually the regular use of Macmillan Ring-Free Xtra Heavy Duty Oil prevents *hydraulic valves from sticking* and more than pays for itself in the gasoline it saves!

LOOK AT THESE FIGURES:

Average oil drain 1500 miles
At 15 miles per gallon, gas consumed . . 100 gallons
8% saving on 100 gallons gasoline . . . 8 gallons
Gasoline average cost* . . . 28.63 cents per gallon
Savings (.08 x 28.63¢) \$2.29
*Includes premium and regular grade.

**This \$2.29 more than pays for your oil drain
of 5 quarts at 45¢ per quart.**

Compared to other brands—under the same load, speed and road conditions—Macmillan Ring-Free Xtra Heavy Duty Motor Oil in hundreds of tests in cars of many makes showed an average reduction in gasoline consumption of 8 per cent over all other brands of oil tested.

Start using Macmillan Xtra Heavy Duty Oil because it does such a wonderful job of cleaning. But keep on using it—month in and month out—because it reduces friction inside your engine, *prevents hydraulic valves from sticking*, saves wear and tear and repair bills, makes your car stay newer longer *and more than pays for itself in the gas it saves!*

Macmillan President

MACMILLAN PETROLEUM CORPORATION

530 W. 6TH STREET, LOS ANGELES

624 S. MICHIGAN, CHICAGO 50 W. 50TH, NEW YORK

CLIP OUT AND MAIL TODAY!

R. S. Macmillan, President, Dept. P4
Macmillan Petroleum Corporation
530 West Sixth St., Los Angeles 14, California

Please send me your folder—"The Oil that Pays for Itself in the Gas It Saves." Also tell me my nearest Macmillan Oil dealer.

Name _____

Address _____

WHERE-TO-BUY-IT INDEX

Source of supply appears after items commercially available

AUTOMOTIVE

Spark plugs cleaned in engine (Sharon Mfg. Co., 1685 N. Milwaukee Ave., Chicago 47) 70
Chrysler's D'Elegance has pop-up spare tire 92
Electrostatic ignition won't burn spark plugs (Heckethorn Mfg. & Supply Co., Littleton, Colo.) 105
Sports car evolves from Indianapolis racer (Kurtis-Kraft, Inc., 4625 Alger St., Los Angeles 36, Calif.) 108
Detroit Listening Post 109
Traffic safety light on truck gives motorists signal to pass (Edward's Air Hose Bracket Co., Box 860, Sapulpa, Okla.) . . . 123

HOUSE AND HOME

Portable humidifying unit (Admiral Corp., 3800 Cortland St., Chicago 47) 110
Aerosol dust catcher (Endust Corporation, 418 6th St., N.W., Washington 1, D. C.) 110
Tumbler holder (Downs & Co., 1326 Greenleaf, Evanston, Ill.) . 110
Compact dishwasher (Cribben & Sexton Co., 700 N. Sacramento, Chicago 12) 110
Decorative table (Olde Mill Products, 112 Vermont Ave., Clarksburg, W. Va.) 111
Cookie cutter (Artistic Glass Studios, Box 544, Freeport, N. Y.) 111
Sash holder (Sash-Jack Co., 1326 30th St., Rock Island, Ill.) . 111
Disappearing holder (Hall-Mack Co., 1344 W. Washington, Los Angeles, Calif.) 111
Rubber tabs (House of Morrow, Box 117, Wilmette, Ill.) . . . 112
Indoor barbecue (Odin Stove Mfg. Co., Erie, Pa.) 112
Plastic scoop (Lloyd Disher Co., Box 1164, Decatur, Ill.) . . . 112
Scratchproofing pad (Forest City Products, Inc., 722 Bolivar Rd., Cleveland 15, Ohio) 112
Freezing guide (National Frozen Food Locker Institute, Elizabethtown, Pa.) 113
Pattern marker (Mrs. Berta Nack, 2580 N. Moreland Blvd., Shaker Heights 20, Ohio) 113
Bottle opener (Hartford Co., 955 Asylum Ave., Hartford, Conn.) 113
Translucent awning (Reverso Products Co., 1333 39th St., Brooklyn, N. Y.) 113
Portable electric clothes drier has a variety of uses (Braman Mfg. Co., Inc., 2228 E. Highland, Shawnee, Okla.) 117

INDUSTRY

Precision gauging machine speeds laying of railroad track (Nordberg Mfg. Co., 3073 S. Chase Ave., Milwaukee, Wis.) . 71
X rays inspect canned food 77
"Toy" machines aid planning at fountain-pen factory 80
Iraq-to-Paris pipe line for natural gas 99
Abrasive metal cutter won't cut rubber (S. S. White Industrial Div., 10 E. 40th St., New York City 16) 124
Ultrathin steel alloy 125
Wind-tunnel model aids air-pollution studies 138
Mobile power plants serve emergency needs (Caterpillar Tractor Co., Peoria 8, Ill.) 139

LAWN AND GARDEN

Edger-trimmer attachment driven by electric drill 99
Antigrowth-chemical treatment for lawn edges keeps grass short (Loamium Company of America, Harrison, N. J.) . . . 116
Quickly erected flexible-steel pickets make unbreakable fence (Flexifence Co., 801 Plymouth Ave., N., Minneapolis, Minn.) 116
Garden caddy (Bower Mfg. Co., Goshen, Ind.) 140
Sit-down mower (Henry Disston & Sons, Inc., 5032 Tacony, Philadelphia 35, Pa.) 140
Water tender (Luthe Corp., Dept. C-34, 206 W. Washington St., Milwaukee 4, Wis.) 140
Power sprayer (Food Machinery & Chemical Corp., John Bean Div., Grand Rapids, Mich.) 140
Powerful mower (Goodall Mfg. Corp., 401 St. Anthony Blvd., Minneapolis, Minn.) 141
Aluminum trellis (Old Copper Mine Farms, Inc., R.D. 2, Box 198, Plainfield, N. J.) 141
Power edger (Edgit, 1480 N.E. 130th St., North Miami, Fla.) . 141
Fertilizer spreader (Roll-On Corp., Dept. X, Box 242, Azusa, Calif.) 141
Two-nozzle sprinkler (Elkay Mfg. Co., 1401 West 8th St., Los Angeles 17, Calif.) 141
Cultivator 142
Mulching mower (Sensation Mower, Inc., Ralston, Neb.) . . . 142
Big-wheel mower (Yetter Mfg. Co., Colchester, Ill.) 142
Garden tractor (Food Machinery & Chemical Corp., Bolens Products Div., Port Washington, Wis.) 142
Reel attachment (Jari Products Inc., 2938 Pillsbury Ave., Minneapolis, Minn.) 143
Yard power (Simplicity Mfg. Co., Port Washington, Wis.) . . 143
Triple-tube sprinkler (Industrial Synthetics Corp., Garwood, N. J.) 143
Electric mower (Huffman Mfg. Co., Dayton 1, Ohio) 143
Fog generator (Kileze Co., Inc., York, S. C.) 143

MILITARY AND NAVAL

Army water conditioner mounted on truck 71
Bazooka battery 71
Develop automatic high-altitude suit 114
Mechanical wire splicer cuts exposure to enemy fire (Aircraft-Marine Products, Inc., Harrisburg, Pa.) 115
Army stratosphere chamber tests weather equipment (York Refrigeration Corp., York, Pa.) 124
Dual air and hydraulic brake for 97-ton amphibian (Federal Fawick Corp., 5780 Federal Ave., Detroit 9, Mich.) 144

(Continued to page 14)

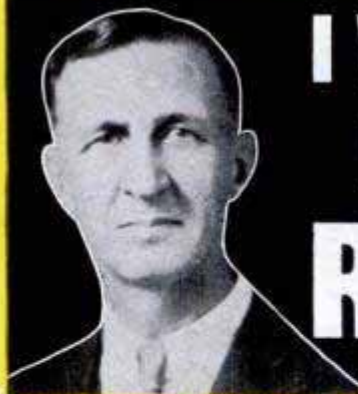

I WILL TRAIN YOU AT HOME FOR GOOD PAY JOBS IN RADIO-TELEVISION

J. E. SMITH has trained more men for Radio-Television than any other man.

America's Fast Growing Industry Offers You

2 FREE BOOKS SHOW HOW MAIL COUPON

I TRAINED THESE MEN



LOST JOB, NOW HAS OWN SHOP
"Got laid off my machine shop job which I believe was best thing ever happened as I opened a full time Radio Shop. Business is picking up every week."—E. T. Slate, Corsicana, Texas.

GOOD JOB WITH STATION

"I am Broadcast Engineer at WLP. Another technician and I have opened a Radio-TV service shop in our spare time. Big TV sales here . . . more work than we can handle."—J. H. Bangley, Suffolk, Va.



\$10 TO \$15 WEEK SPARE TIME

"Four months after enrolling for NRI course, was able to service Radios . . . averaged \$10 to \$15 a week spare time. Now have full time Radio and Television business."—William Weyde, Brooklyn, New York.



AVAILABLE TO VETERANS UNDER G.I. BILLS

WANT YOUR OWN BUSINESS?

Let me show you how you can be your own boss. Many NRI trained men start their own business with capital earned in spare time. Robert Dohmen, New Prague, Minn., whose store is shown at left, says, "Am now tied in with two Television outfits and do warranty work for dealers. Often fall back to NRI textbooks for information."



1. EXTRA MONEY IN SPARE TIME

Many students make \$5, \$10 a week and more EXTRA fixing neighbors' Radios in spare time while learning. The day you enroll I start sending you SPECIAL BOOKLETS that show you how. Tester you build with kits I send helps you make extra money servicing sets, gives practical experience on circuits common to Radio and Television. All equipment is yours to keep.

2. GOOD PAY JOB

NRI Courses lead to these and many other jobs: Radio and TV service, P.A., Auto Radio, Lab, Factory, and Electronic Controls Technicians, Radio and TV Broadcasting, Police, Ship and Airways Operators and Technicians. Opportunities are increasing. The United States has over 105 million Radios—over 2,900 Broadcasting Stations—more expansion is on the way.

3. BRIGHT FUTURE

Think of the opportunities in Television. Over 15,000,000 TV sets are now in use; 108 TV stations are operating and 1800 new TV stations have been authorized . . . many of them expected to be in operation in 1953. This means more jobs—good pay jobs with bright futures. More operators, installation service technicians will be needed. Now is the time to get ready for a successful future in TV! Find out what Radio and TV offer you.



You Learn Servicing or Communications by Practicing With Kits I Send

Keep your job while training at home. Hundreds I've trained are successful RADIO-TELEVISION Technicians. Most had no previous experience; many no more than grammar school education. Learn Radio-Television principles from illustrated lessons. You also get PRACTICAL EXPERIENCE. Pictured at left are just a few of the pieces of equipment you build with kits of parts I send. You experiment with, learn circuits common to Radio and Television.

Mail Coupon—find out what RADIO-TELEVISION Can Do for You

Act Now! Send for my FREE DOUBLE OFFER. Coupon entitles you to actual Servicing Lesson; shows how you learn at home. You'll also receive my 64-page book, "How to Be a Success in Radio-Television." Send coupon in envelope or paste on postal. J. E. SMITH, Pres., Dept. 3FA, National Radio Institute, Washington 9, D.C. Our 39th Year.



Television Is Today's Good Job Maker

TV now reaches from coast-to-coast. Quality for a good job as a service technician or operator. My course includes many lessons on TV. You get practical experience . . . work on circuits common to both Radio and Television with my kits. Now is the time to get ready for success in Television!

This Is Just Some of the Equipment My Students Build. All Parts Yours to Keep.

Good for Both—FREE

MR. J. E. SMITH, President, Dept. 3FA
National Radio Institute, Washington 9, D. C.

Mail me Sample Lesson and 64-page Book, FREE (No salesman will call. Please write plainly.)

Name Age
Address
City Zone State

VETS write in date of discharge

The ABC's of SERVICING



NOW! HERE'S HOW TO
Fix ANY Car
IN LESS TIME . . .
and do a better job too!



BRAND-NEW 1953 Edition of MOTOR'S Manual Shows You How To Repair — Quickly and Easily—Any Car Built from 1935 THROUGH 1953!

NO job is too tough when you've got MOTOR'S brand-new AUTO REPAIR MANUAL. Shows how to save work on "ornery" jobs. Helps you make **MORE MONEY** by doing more jobs in less time! Now covers 1953 models; up-to-date information on all new automatic transmissions, carburetors, power steering, etc.

COMPILED FROM 189 OFFICIAL SHOP MANUALS!

This great book—over 850 BIG 8 1/2" x 11" pages—brings you the complete "dope" from 189 Official Shop Manuals, boiled down in simple easy-to-understand language. 2500 cut-away photos, diagrams, drawings show **WHAT** to do, **HOW** to do it. 227,000 service and repair facts! 907 car models! Now YOU can try it **FREE**—for 7 days.

SEND NO MONEY

Mail coupon below — *without money!* When your book arrives—*make it show you what it's got!* Unless you agree it's the greatest time and work saver you've ever seen—return book in 7 days, pay nothing. Mail coupon NOW! MOTOR Book Department, Desk 16, 250 West 55th Street, New York 19, N. Y.

- COVERS 907 MODELS BUILT SINCE 1935!**
- | | |
|-----------|------------|
| Buick | Mercury |
| Cadillac | Nash |
| Chevrolet | Nash |
| Chrysler | Rambler |
| Crosley | Oldsmobile |
| De Soto | Packard |
| Dodge | Plymouth |
| Ford | Pontiac |
| Frazer | Studebaker |
| Henry J | Terraplane |
| Hudson | Willys |
| Kaiser | |
| Lafayette | Includes |
| La Salle | ALL 1953 |
| Lincoln | Cars! |

Same FREE Offer On MOTOR'S Truck and Tractor Manual

Latest Edition! Covers EVERY job on EVERY popular make gasoline truck, tractor, stock engine made from 1936 thru 1952. 960 big facts, 3287 pictures. Check proper box in coupon. **FREE 7-Day Trial.**

MAIL COUPON NOW FOR 7-DAY FREE TRIAL

MOTOR BOOK DEPT.
Desk 16, 250 W. 55th St., New York 19, N. Y.

Rush to me at once (check box opposite book you want):

MOTOR'S New AUTO REPAIR MANUAL. If O.K., I will remit \$1 in 7 days, \$2 monthly for 2 months and a final payment of 35c (plus 35c delivery charges), one month after that. Otherwise I will return the book postpaid in 7 days. (Foreign price, remit \$8 cash with order.)

MOTOR'S New TRUCK & TRACTOR REPAIR MANUAL. If O.K., I will remit \$2 in 7 days, and \$2 monthly for 3 months, plus 35c delivery charges with final payment. Otherwise I will return book postpaid in 7 days. (Foreign price, remit \$10 cash with order.)

Print Name.....Age

Address

City.....State

Check box and save 35c delivery charge by enclosing WITH coupon entire payment of \$5.95 for Auto Repair Manual (or \$8 for Truck and Tractor Repair Manual.) Same 7-day return-refund privilege applies.

(Continued from page 12)

PHOTOGRAPHY

- Miniature television camera connects directly to receiver (Allen B. DuMont Laboratories, Inc., 750 Bloomfield Ave., Clifton, N. J.).....105
- Rapid-sequence camera takes big pictures.....144
- Develop three-dimensional X-ray motion pictures.....244
- Rocket camera snaps sun from 50-mile altitude.....246

RECREATION

- Portable swimming pool can be erected in 30 minutes..... 70
- Two-piece plastic speedboat requires minimum of upkeep..... 86
- Portable beach pen keeps children safe while parents swim... 86
- Aluminum sports trailer sleeps four persons (Sportrailer Mfg. Co., Stephenson Bldg., Detroit 2, Mich.).....114
- Watch tells sportsmen best times for fishing and hunting....124
- French nautical bicycle permits cycling in the Seine.....125
- Wheeled launching platform trains water skiers.....125
- Telescoping trailer cabin.....145
- Waterproof belt for fish lures (Riverside Mfg. Co., Woodstock, Va.).....228
- Stationary line guide permits easy casting (Ocean City Mfg. Co., 3850 Coral St., Philadelphia 24, Pa.).....228

MISCELLANEOUS

- Tie conceals tiny microphone of miniature recording device.. 70
- Carbon ink letters glass.....77
- Commander Sigler's private fleet.....78
- Fluoroscope view of X-ray is bright enough for TV.....80
- German "kangaroo" rescue ship.....81
- Lightweight shield protects fire fighters.....86
- Plastic toothless "Zipper" makes watertight closure.....92
- Retractable launching pod gives Sabre Jet a 24-rocket "punch".....99
- Ceramic brakes for aircraft.....99
- Chicago builds a three-story underground garage.....100
- Sponge-rubber sanding pad speeds boat finishing (Carborundum Co., Merchandising Div., Niagara Falls, N. Y.).....105
- Postman gets a lift with experimental three-wheel motorcycle.115
- Homemade lift eases wheel-chair patient into or out of car...116
- Army "duck" fights fires ashore and in harbor.....123
- U-boat detectors track whales.....125
- Robot records trains.....131
- Sweden works underground.....132
- Model oil rig demonstrates drilling techniques for students.138
- Ditcher-terracer blade on farm tractors adjusts to many positions (Armor Farm Implement Co., Box 785, Vancouver, Wash.).....144
- College for plumbers.....146
- Inventors hit television jackpot.....148
- Lightweight engine does big job (Food Machinery & Chemical Corp., Bolens Products Div., Port Washington, Wis.).....226
- Propeller-driven tricycle.....232
- Reinforcing corner mesh snaps into position.....232

Craftsman and Shop Notes Index

AUTOMOTIVE

- Apron secures seat cushion.....176
- Locating oil or gasoline leaks.....196
- Fork-lift truck used for automobile parking lot.....201
- Rewired car heater operates only when generator is charging.201
- Pulley hub fitted with washer to stop front-end oil leaks....207

DRAWING TIPS

- Matchboxes provide "cabinet" to hold artist's supplies.....166
- Hand rest for sign painter improvised from T-square.....196
- Tape tab on end of T-square permits tacking to board.....206

FARMING

- Faucet drains into hole in ground.....170
- Handy self-locking post puller made from flat steel.....206
- Mobile water tank simplifies filling of stock waterer.....207
- Feed lot back scratcher from old tractor tire.....210

FISHING

- Popping plug attracts fish.....157
- Aluminum foil lines camping pans.....166
- Fish kept fresh in carton lined with aluminum foil.....176
- Fishline repaired with nail polish.....184

HOUSE AND HOME

- Hardware cloth on screen door reinforces lower section.....157
- Solving home problems.....164
- Cleaning plastic wall tile.....170
- Cement for patching concrete.....171
- Weather-resistant mailbox post made from welded pipe lengths.....184

LAWN AND GARDEN

- Tall flowers protected in wind.....163
- Grass seeder made from can assures even distribution.....166
- Collar from strip of fencing provides tree guard.....170
- Wooden basket serves many uses in garden.....181
- Beach umbrella supports tray that holds small articles....185
- Tomato spoilage prevented by improvised racks.....201

NOVELTIES AND GAMES

- Making plastic money clip.....157
- Scorekeeper for horseshoe court.....166
- Personalized switch plates.....171

(Continued to page 16)



INVENTORS

Learn how to protect your invention. The U. S. Patent Laws provide that any new and useful art, machine, article of manufacture, or composition of matter, or any new and useful improvement thereof, may be patented if the act of invention is involved. Therefore, every inventor with a valuable invention should take advantage of the Patent Laws and proceed for patent protection in order to safeguard his rights.

A patent gives the inventor the exclusive right to prevent others from making, using, or selling the invention claimed in the patent for a period of seventeen years.

The Patent Laws were enacted for the benefit of the inventor to give him protection for the features of his invention which are patentable. These features must be properly and concisely set forth and claimed in a formal application for patent, in order to comply with the requirements of the Patent Laws. For that reason, unless the inventor is familiar with patent matters, he should engage a competent registered patent attorney or agent to represent him. We are registered to practice before the U. S. Patent Office and are prepared to serve you in the handling of your patent matters.

A specially prepared booklet entitled "Patent Guide for the Inventor", containing detailed information with respect to patent protection and procedure, together with a "Record of Invention" form will be promptly forwarded to you without obligation upon request.

CLARENCE A. O'BRIEN & HARVEY JACOBSON

Registered Patent Attorneys

31-F DISTRICT NATIONAL BUILDING

WASHINGTON 5, D. C.

NEWS from SCIENCE

ABOUT YOUR HAIR

Laboratory discovery outdates messy hair oils!



"V-7," completely new greaseless grooming agent, now in Vitalis Hair Tonic. It's not an animal, vegetable or mineral oil!

Hair stays neat all day

No gummy film, no oily or matted-down look with new Vitalis!



HAVE HANDSOMER HAIR!

Kills dandruff germs, too!



New Vitalis kills on contact germs many doctors associate with infectious dandruff. Feels "tingling good" on scalp!

NEW FINER
VITALIS[®]
HAIR TONIC

WITH V-7

Product of Bristol-Myers

(Continued from page 14)

OFFICE, SHOP AND STORE

Wallpaper rolls tied easily when placed on inverted stool.....	166
Wire replaces standard fuse for experimental work.....	184
Glue cup has disposable liner.....	185
Eyelet-type envelopes used to separate tiny parts.....	185
Portable welding stand used outside of shop.....	196
Repairing stuffing-gland seat on steam-engine cylinders.....	201
Folded slip keeps sheet aligned for insertion in typewriter.....	206
Vacuum-gauge connectors kept at hand in shop.....	207
Improvised paper hold-down.....	210
Wooden ring supports brush in cutting-oil can.....	210

PAINTING

Concrete floor acid-etched to prepare for painting.....	163
Book-end "feet" for paint can helps prevent upsetting.....	176
Tube fitted over brush ferrule adjusts spread of bristles.....	181
Interchangeable jars for spray gun hold variety of colors.....	202
Painting hot surfaces.....	210

PHOTOGRAPHY

Storing print tongs.....	191
Camera turned on pan head to shoot unusual angles.....	191
Improvised reflector stand.....	191
Tape anchors printing paper for borderless enlargements.....	191

TOOLS

Collet for 4-jaw chuck.....	202
Chain-saw conversion unit (Surgi Mfg. Co., 206 Joplin St., Joplin, Mo.).....	208
Beveled sanding disk (Maynard D. Lee, 100 Chestnut Hill Drive, Rochester, N. Y.).....	208
Soft vise jaws (Magne-Grip Tool Co., 4900 W. Madison St., Chicago 44).....	208
Two-way drill guide (Roy Silver Corp., 561 Bridgeport Ave., Devon, Conn.).....	208
12-point spline (12-Point Fastener Corp., 741 Hanna Bldg., Cleveland 15, Ohio).....	209
Rubber molds (Buffalo Products, Inc., 304 Washington Loan & Trust Bldg., Washington 4, D. C.).....	209
Pencil-size soldering iron (Lenk Mfg. Co., 30 Cummington St., Boston 15, Mass.).....	209
V-belt dressing (Sling-Surface Co., 1048 Niagara St., Buffalo 13, N. Y.).....	209
Resistance-type soldering unit (Sunrise Products Co., Box 173, Hawthorne, N. J.).....	209
Lathe center drives small work.....	210

WOODWORKING

Cart for your outboard motor.....	167
Plan of the month—porch swing.....	168
Rolling shop cabinet.....	195

WORKSHOP HINTS

Tape wrapped around tubing prevents kinking when bent.....	157
Magnet tests genuineness of brass hardware.....	157
Improvised drill bit.....	166
Straightening small-gauge wire.....	170
Flatiron preheats large work for soldering with small iron.....	170
Rubber hose on setscrew wrench provides cushioned handle.....	170
Solder melted more quickly if flattened beforehand.....	185
Teeth filed on back edge of saw blade used for cutting nails.....	186
Thin work chucked to run true on metal lathe by drill pad.....	196
Paper cup serves as jig when soldering wire.....	206
Tobin bronze used for brazing extensions on drills.....	207

MISCELLANEOUS

Removing blisters from veneers.....	157
Nylon bristle on tone arm cleans phonograph record.....	176
Picket fencing used as ramp when beaching small boat.....	176
Both liquid and wax polishes used for better shoeshine.....	181
Underseat rack for folding chair.....	185
Three-in-one flagstone mold.....	186
Carry combination square in toy-gun holster.....	196
Ice lowers heavy equipment.....	196
Potato peeler strips insulation.....	202
Hole in screwdriver blade aids in forming wire eyes.....	206
Dust cloth knotted at corner for tucking into rule pocket.....	206
Testing sand for impurities.....	210

Radio-Television, Electronics

Electronic computer (General Electric Co., Electronics Park, Syracuse, N. Y.).....	211
Miniature transistor hearing aids (Maico Company, Inc., 401 WCCO Bldg., Minneapolis, Minn.).....	211
TV signal booster features "golden grid" tube.....	212
Tiny radio receiver for motor scooter.....	215
Handi Micro-Talkie transmitter (Motorola Inc., 4545 W. Augusta Blvd., Chicago 51).....	215
Learn by listening code records (Raybrun Co., Box 66, Orangeburg, N. Y.).....	215
Selective signaling system (Motorola Inc., 4545 W. Augusta Blvd., Chicago 51).....	215
Radio has plated circuit (Motorola Inc., 4545 W. Augusta Blvd., Chicago 51).....	215
Self-helps for TV-set owners.....	216

IMPORTANT NOTICE—It is the intention of this magazine to provide its readers with information regarding the latest developments in the mechanical arts. We take no responsibility as to whether the disclosures contained in our articles are covered by patents and advise readers to investigate this subject before making, using, or selling any of the products, machines, or processes described in order to avoid possible liability for patent infringements.



Picture yourself going places



You've done it often. Call it day-dreaming if you like, but you've seen yourself in a bigger job — giving orders and making decisions — driving off in a smart new car — buying your family a fine home.

There's nothing wrong with dreams. But how about making them come true? *You can do it*, if you're willing to try!

Look around you. The men who are going places are the *trained* men. They've learned

special skills that bring them better jobs and higher pay. It's the men *without* training whose dreams never come true.

What are you going to do about it? Just wait and wish? If you really *want to succeed*, you can get the training you need by studying at home in your spare time. International Correspondence Schools offer you a course in just about any field you choose, giving you the practical plus the bedrock facts and theory. No skimming or skimping! And you'll be earning while you learn. Students report better jobs and more pay within a few months.

Look over the list of subjects in the coupon below. Pick out the one that interests you most — the one that holds the greatest future for you. Then mark the coupon, and mail it today. *Find out* what I. C. S. can do for you. It costs only a stamp or postcard, but it's the first step if you want to go places!

DON'T let these poor excuses make you **FAIL**

1. I never got started.
2. I want a good time.
3. I don't want any responsibility.
4. I can't stick to it.
5. I haven't enough education.
6. I don't know where to get training.



SMARTEST THING HE EVER DID

"I noticed that the trained men held the better jobs. That's when I decided to take an I. C. S. course. Enrolling with I. C. S. was one of the smartest things I ever did. The position as Plant Engineer I hold today is largely due to the 'know-how' derived from my I. C. S. texts. I. C. S. can help any man who will study."

L. P. S., Elkhart, Ind.

GOING INTO THE ARMY OR NAVY?

Earn more pay, win a higher rating, quicker promotion by having this specialized knowledge and credit. I. C. S. courses have helped thousands advance in the services.

INTERNATIONAL CORRESPONDENCE SCHOOLS



BOX 5584-L, SCRANTON 9, PENNA.

Without cost or obligation, send me "HOW to SUCCEED" and the booklet about the course BEFORE which I have marked X:

- | | | | | |
|-------------------------------------------------------------------------------------------------------------------------------------------------------------------------------------------------------------------------------------------------------------------------------------------------------------------------------------------------------------------------------------------------------------------------------------------------------------------------------------------------------------------------------------------------------------------------------------------------------------------------------------------------------------------------------------------------------------------------------------------------------------------------------------------------------------------------------------------------------------------------------------------------------------------------------------------------------------------------------------------------------------------------------------------------------------------------------------------------------------------------------------------------------------------------------------------------------------------------------------------------------------------------------------------------------------------------|-----------------------------------------------------------------------------------------------------------------------------------------------------------------------------------------------------------------------------------------------------------------------------------------------------------------------------------------------------------------------------------------------------------------------------------------------------------------------------------------------------------------------------------------------------------------------------------------------------------------------------------------------------------------------------------------------------------------------------------------------------------------------------------------------------------------------------------------------------------------------------------------------------------------------------------------------------------------------------------------------------------------------------------------------------------------------------------------------------------------------------------------------------------------------------------------------------------------------------------------------------------------------------------------------------------------------------------------------------------------------------------------------------------------------------------------|-----------------------------------------------------------------------------------------------------------------------------------------------------------------------------------------------------------------------------------------------------------------------------------------------------------------------------------------------------------------------------------------------------------------------------------------------------------------------------------------------------------------------------------------------------------------------------------------------------------------------------------------------------------------------------------------------------------------------------------------------------------------------------------------------------------------------------------------------------------------------------------------------------------------------------------------------------------------------------------------------------------------------------------------------------------------------------------------------------------------------------------------------------------------------------------------------------------------------------------------------------------------------------------------------------------------------------------------------------------------------------------------------------------------|---------------------------------------------------------------------------------------------------------------------------------------------------------------------------------------------------------------------------------------------------------------------------------------------------------------------------------------------------------------------------------------------------------------------------------------------------------------------------------------------------------------------------------------------------------------------------------------------------------------------------------------------------------------------------------------------------------------------------------------------------------------------------------------------------------------------------------------------------------------------------------------------------------------------------------------------------------------------------------------------------------------------------------------------------------------------------------------------------------------------------------------------------------------------------------------------------------------------------------------------------------------------------------------------------------------------------------------------------------------------------------------------------------------------------------------|------------------------------------------------------------------------------------------------------------------------------------------------------------------------------------------------------------------------------------------------------------------------------------------------------------------------------------------------------------------------------------------------------------------------------------------------------------------------------------------------------------------------------------------------------------------------------------------------------------------------------------------------------------------------------------------------------------------------------------------------------------------------------------------------------------------------------------------------------------------------------------------------------------------------------------------------------------------------------------------------------------------------------------------------------------------------------------------------------------------------------------------------------------------------------------------------------------------|
| <p>ART</p> <ul style="list-style-type: none"> <input type="checkbox"/> Commercial Art <input type="checkbox"/> Magazine and Book Illustrating <input type="checkbox"/> Cartooning <input type="checkbox"/> Show Card and Sign Lettering <input type="checkbox"/> Fashion Illustrating AUTOMOTIVE <input type="checkbox"/> Automobile, Mechanic <input type="checkbox"/> Auto-Elec. Technician <input type="checkbox"/> Auto Body Rebuilding and Refinishing <input type="checkbox"/> Diesel—Gas Engines AVIATION <input type="checkbox"/> Aeronautical Engineering Jr. <input type="checkbox"/> Aircraft Engine Mechanic <input type="checkbox"/> Airplane Drafting BUILDING <input type="checkbox"/> Architecture <input type="checkbox"/> Arch. Drafting <input type="checkbox"/> Building Contractor <input type="checkbox"/> Estimating <input type="checkbox"/> Carpenter and Mill Work <input type="checkbox"/> Carpenter Foreman <input type="checkbox"/> Reading Blueprints <input type="checkbox"/> House Planning <input type="checkbox"/> Plumbing | <ul style="list-style-type: none"> <input type="checkbox"/> Heating <input type="checkbox"/> Steam Fitting <input type="checkbox"/> Air Conditioning <input type="checkbox"/> Electrician BUSINESS <input type="checkbox"/> Business Administration <input type="checkbox"/> Certified Public Accountant <input type="checkbox"/> Accounting <input type="checkbox"/> Bookkeeping <input type="checkbox"/> Stenography and Typing <input type="checkbox"/> Secretarial <input type="checkbox"/> Federal Tax <input type="checkbox"/> Business Correspondence <input type="checkbox"/> Personnel and Labor Relations <input type="checkbox"/> Advertising <input type="checkbox"/> Retail Business Management <input type="checkbox"/> Managing Small Business <input type="checkbox"/> Sales Management <input type="checkbox"/> Salesmanship <input type="checkbox"/> Traffic Management CHEMISTRY <input type="checkbox"/> Chemical Engineering <input type="checkbox"/> Chemistry <input type="checkbox"/> Analytical Chemistry <input type="checkbox"/> Petroleum—Nat'l Gas <input type="checkbox"/> Pulp and Paper Making <input type="checkbox"/> Plastics | <p>CIVIL, STRUCTURAL ENGINEERING</p> <ul style="list-style-type: none"> <input type="checkbox"/> Civil Engineering <input type="checkbox"/> Structural Engineering <input type="checkbox"/> Surveying and Mapping <input type="checkbox"/> Structural Drafting <input type="checkbox"/> Highway Engineering <input type="checkbox"/> Reading Blueprints <input type="checkbox"/> Concrete Construction <input type="checkbox"/> Sanitary Engineering DRAFTING <input type="checkbox"/> Aircraft Drafting <input type="checkbox"/> Architectural Drafting <input type="checkbox"/> Electrical Drafting <input type="checkbox"/> Mechanical Drafting <input type="checkbox"/> Structural Drafting <input type="checkbox"/> Sheet Metal Drafting <input type="checkbox"/> Mine Surveying and Drafting ELECTRICAL <input type="checkbox"/> Electrical Engineering <input type="checkbox"/> Electrician <input type="checkbox"/> Electrical Maintenance <input type="checkbox"/> Electrical Drafting <input type="checkbox"/> Electric Power and Light <input type="checkbox"/> Lineman HIGH SCHOOL <input type="checkbox"/> High School Subjects | <ul style="list-style-type: none"> <input type="checkbox"/> College Preparatory <input type="checkbox"/> Mathematics <input type="checkbox"/> Commercial <input type="checkbox"/> Good English MECHANICAL AND SHOP <input type="checkbox"/> Mechanical Engineering <input type="checkbox"/> Industrial Engineering <input type="checkbox"/> Industrial Supervision <input type="checkbox"/> Foremanship <input type="checkbox"/> Mechanical Drafting <input type="checkbox"/> Machine Design-Drafting <input type="checkbox"/> Machine Shop Practice <input type="checkbox"/> Tool Design <input type="checkbox"/> Industrial Instrumentation <input type="checkbox"/> Machine Shop Inspection <input type="checkbox"/> Reading Blueprints <input type="checkbox"/> Toolmaking <input type="checkbox"/> Gas—Electric Welding <input type="checkbox"/> Heat Treatment—Metallurgy <input type="checkbox"/> Sheet Metal Work <input type="checkbox"/> Sheet Metal Pattern Drafting <input type="checkbox"/> Refrigeration POWER <input type="checkbox"/> Combustion Engineering <input type="checkbox"/> Diesel—Electric <input type="checkbox"/> Electric Light and Power | <ul style="list-style-type: none"> <input type="checkbox"/> Stationary Steam Engineering <input type="checkbox"/> Stationary Fireman RADIO, TELEVISION, COMMUNICATIONS <input type="checkbox"/> General Radio <input type="checkbox"/> Radio Operation <input type="checkbox"/> Radio Servicing—FM <input type="checkbox"/> Television <input type="checkbox"/> Electronics <input type="checkbox"/> Telephone Work RAILROAD <input type="checkbox"/> Locomotive Engineer <input type="checkbox"/> Diesel Locomotive <input type="checkbox"/> Air Brakes <input type="checkbox"/> Car Inspector <input type="checkbox"/> Railroad Administration TEXTILE <input type="checkbox"/> Textile Engineering <input type="checkbox"/> Cotton Manufacture <input type="checkbox"/> Rayon Manufacture <input type="checkbox"/> Woolen Manufacture <input type="checkbox"/> Loom Fixing <input type="checkbox"/> Finishing and Dyeing <input type="checkbox"/> Textile Designing |
|-------------------------------------------------------------------------------------------------------------------------------------------------------------------------------------------------------------------------------------------------------------------------------------------------------------------------------------------------------------------------------------------------------------------------------------------------------------------------------------------------------------------------------------------------------------------------------------------------------------------------------------------------------------------------------------------------------------------------------------------------------------------------------------------------------------------------------------------------------------------------------------------------------------------------------------------------------------------------------------------------------------------------------------------------------------------------------------------------------------------------------------------------------------------------------------------------------------------------------------------------------------------------------------------------------------------------|-----------------------------------------------------------------------------------------------------------------------------------------------------------------------------------------------------------------------------------------------------------------------------------------------------------------------------------------------------------------------------------------------------------------------------------------------------------------------------------------------------------------------------------------------------------------------------------------------------------------------------------------------------------------------------------------------------------------------------------------------------------------------------------------------------------------------------------------------------------------------------------------------------------------------------------------------------------------------------------------------------------------------------------------------------------------------------------------------------------------------------------------------------------------------------------------------------------------------------------------------------------------------------------------------------------------------------------------------------------------------------------------------------------------------------------------|-----------------------------------------------------------------------------------------------------------------------------------------------------------------------------------------------------------------------------------------------------------------------------------------------------------------------------------------------------------------------------------------------------------------------------------------------------------------------------------------------------------------------------------------------------------------------------------------------------------------------------------------------------------------------------------------------------------------------------------------------------------------------------------------------------------------------------------------------------------------------------------------------------------------------------------------------------------------------------------------------------------------------------------------------------------------------------------------------------------------------------------------------------------------------------------------------------------------------------------------------------------------------------------------------------------------------------------------------------------------------------------------------------------------|---------------------------------------------------------------------------------------------------------------------------------------------------------------------------------------------------------------------------------------------------------------------------------------------------------------------------------------------------------------------------------------------------------------------------------------------------------------------------------------------------------------------------------------------------------------------------------------------------------------------------------------------------------------------------------------------------------------------------------------------------------------------------------------------------------------------------------------------------------------------------------------------------------------------------------------------------------------------------------------------------------------------------------------------------------------------------------------------------------------------------------------------------------------------------------------------------------------------------------------------------------------------------------------------------------------------------------------------------------------------------------------------------------------------------------------|------------------------------------------------------------------------------------------------------------------------------------------------------------------------------------------------------------------------------------------------------------------------------------------------------------------------------------------------------------------------------------------------------------------------------------------------------------------------------------------------------------------------------------------------------------------------------------------------------------------------------------------------------------------------------------------------------------------------------------------------------------------------------------------------------------------------------------------------------------------------------------------------------------------------------------------------------------------------------------------------------------------------------------------------------------------------------------------------------------------------------------------------------------------------------------------------------------------|

YEAR OF THE SIX MILLIONTH STUDENT

Name _____ Age _____ Home Address _____
 City _____ Zone _____ State _____ Working Hours _____ A.M. to _____ P.M.
 Occupation _____

Special tuition rates to members of the Armed Forces. Canadian residents send coupon to International Correspondence Schools Canadian, Ltd., Montreal, Canada

WHAT SECRET POWER DID THIS MAN POSSESS?

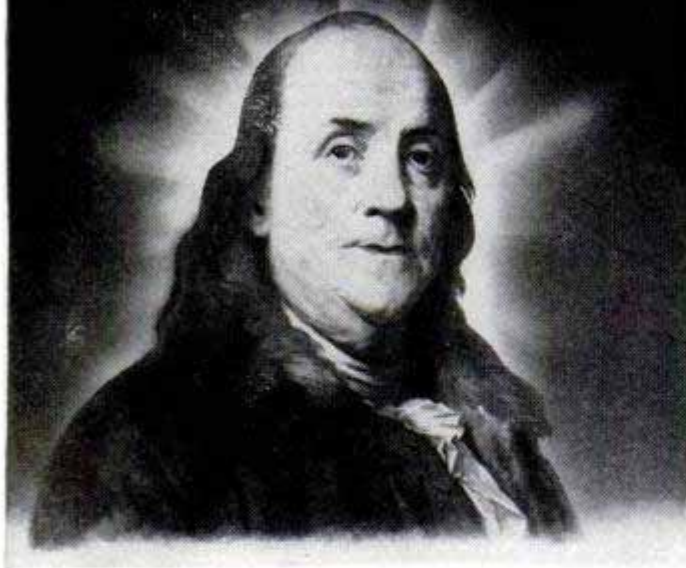

BENJAMIN FRANKLIN
(A Rosicrucian)

WHY was this man great? How does anyone—man or woman—achieve greatness? Is it not by mastery of the powers within ourselves? Know the mysterious world within you! Attune yourself to the wisdom of the ages! Grasp the inner power of your mind! Learn the secrets of a full and peaceful life!

Benjamin Franklin—like many other learned and great men and women—was a Rosicrucian. The Rosicrucians (NOT a religious organization) first came to America in 1694. Today, headquarters of the Rosicrucians send over seven million pieces of mail annually to all parts of the world. Write for YOUR FREE COPY of "The Mastery of Life"—TODAY. No obligation. No salesmen. A non-profit organization. Address: Scribe V.C.T.

THIS BOOK FREE!

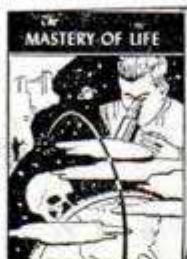

The ROSICRUCIANS

SAN JOSE • (AMORC) • CALIFORNIA

—SEND THIS COUPON—

Scribe V.C.T.
The ROSICRUCIANS (AMORC)
San Jose, California
Please send me the free book, *The Mastery of Life*, which explains how I may learn to use my faculties and powers of mind.

Name _____
Address _____
City _____



OWN a Business

\$5 HOURLY Profit
Even if NOW Employed

Alert dealers can average \$5 hourly gross profit on services they render and \$3 on EACH of their servicemen at National Price Guide charges. You can profitably operate part time while building a full time business with servicemen.

Clean & Mothproof, Rugs & Upholstery

Duraclean cleans by absorption! No scrubbing, soaking or shrinkage. Dirt and grease vanish as if by magic . . . matted pile rises . . . colors revive. Furnishings ready for use the same day.
Duraproof protects against moths and carpet-beetles. Makes materials resistant to both. Backed by an International Money-Back 4-Year Warranty.

No experience needed. Easy to learn. Quickly established. Nationally Advertised Services rendered "in the home." No Shop Needed. We furnish enough materials to return your TOTAL investment. Territories limited. Write today for FREE booklet explaining details and Easy Terms. . . . Don't delay!

DURACLEAN CO., 3-166 Duraclean Bldg., Deerfield, Ill.

TELEVISION ELECTRONICS SHOP TRAINING

In only 5½ months we can prepare you to enter this rapidly growing BIG PAY field. No previous experience or special training necessary. We help you find full or part-time jobs while training. Est. 1936.

Write now for **FREE CATALOG** **BAILEY TECHNICAL SCHOOLS**
1632 S. Grand Ave. • St. Louis 4, Mo.

TASOPE PHOTO-ENGRAVING PLANTS



Material Cost
Of This Cut 3/4c
Selling Price
\$1.00 And Up

Establish your own profitable PHOTO-ENGRAVING business. Make cuts for newspapers, printers, and advertisers. Make etched name plates, plaques etc. Instructions furnished, no experience necessary. Sold direct from factory since 1931. First five hundred cuts sold locally or by mail will pay for plant and pay you well for your time. Write for FREE catalog.
TASOPE DEPT. PM6, AURORA, MO.

MAKE Raising CHINCHILLAS! MONEY

YOU RAISE THEM — WE BUY THEM

Send for free booklet of success stories
NATIONAL CHINCHILLAS, Fullerton 13, California

Would You Like to Make **\$1,000 A MONTH?**



That's what Stanley Hyman made selling the amazing new Presto Fire Extinguisher! Many others "cleaning up" — so can you! Amazing tiny new extinguisher ends fires fast as 2 seconds. Guaranteed for 20 years! Sells for only \$3.98! Write for Free sales kit. Merlite Industries, Inc., Dept. 56, 201 E. 16th St., New York 3, N. Y. (If you want a regular Presto to use as a demonstrator send \$2.50. Money back if you wish.)



Say You Saw It in Popular Mechanics

MAKE EXTRA MONEY

PLASTICS

LEARN AT HOME

LEARN HOW TO MAKE fast-selling PLASTIC NOVELTIES FURNITURE JEWELRY

There are RICH OPPORTUNITIES for MEN and WOMEN with "know-how" in Plastics. Interstate's new Plastics course tells and shows how to make hundreds of fast selling items out of Plastics. Gives complete training in fabrication, casting, lamination, molding, internal carving, etc., in simple, easy, step-by-step language and pictures. Plastics and Fabricating Kits for 23 valuable Plastic items come with training at no extra cost. **START A PLASTICS BUSINESS OF YOUR OWN.** No other industry holds such promise for the future. You can make big money manufacturing novelties, toys, signs, etc., in your own home in spare or full time. Don't wait! Learn NOW how Interstate's Plastics Training qualifies you for success in the Plastics field.



PLASTICS AND SUPPLIES FURNISHED FOR 23 VALUABLE PROJECTS

INTERSTATE TRAINING SERVICE
Dept. C3F Portland 13, Oregon

INVENTORS

If you believe that you have an invention, you should find out how to protect it. The first step is to have a search made of the prior pertinent U. S. patents. If a report on this search indicates that the invention appears patentable you can apply for a patent, and the specifications and claims should be prepared.

The firm of McMorrow, Berman & Davidson, with offices in Washington, D. C., is qualified to take the necessary steps for you. We can make a preliminary search on your invention, advise you whether we think it can be patented, and prepare your application for

patent.

Unless you are fully familiar with the U. S. Patent Laws, we recommend that you engage the services of a Registered Patent Attorney to protect your interests. The patent laws are *your* laws. A patent gives you the right to prevent others from making, using or selling the invention claimed in your patent for a period of 17 years.

Use these patent laws for your protection. Investigate whether your invention can be patented. If you have what you believe to be an invention, we suggest that you have this firm make a search for you.

Send for a copy of our Patent Booklet entitled "How To Protect Your Invention," containing information about patent protection and patent procedure. Along with this we will also send you an "Invention Record" form, for your use in writing down and sketching details of your invention. We will mail them promptly. No obligation. They are yours for the asking.

McMORROW, BERMAN & DAVIDSON

Registered Patent Attorneys

PATENTS • COPYRIGHTS • PATENTS

135-M VICTOR BUILDING, WASHINGTON 1, D. C.

(Check the Kind of Body YOU Want!)

Want! RIGHT IN THE COUPON BELOW

...and I'll Prove How EASILY You Can Have It!

Charles Atlas

Twice winner and holder of the title "The World's Most Perfectly Developed Man."

JUST tell me where you want it—and I'll add **SOLID INCHES** of powerful muscle **SO FAST** your friends will grow bug-eyed with wonder. I'll **PROVE** you can be a new man in just 15 minutes a day—in your own home—or it won't cost you a penny!

I myself used to be a 97-lb. weakling. Men called me "Skinny." Girls made fun of me. THEN I discovered my great muscle-building system—"Dynamic Tension." It turned me into such a specimen of **MANHOOD** that today I hold the title "**THE WORLD'S MOST PERFECTLY DEVELOPED MAN.**"

"Dynamic Tension" is the easy, **NATURAL** method you can practice in your own room—**JUST 15 MINUTES A DAY**—while your chest and shoulder muscles begin to swell . . . those arms and legs of yours bulge . . . and your whole body starts to feel "alive," full of zip and go!

FREE My 32-Page Illustrated Book Just Mail the Coupon

Send **NOW** for my famous book "Everlasting Health and Strength," 32 pages, packed with photographs, valuable advice, answers many vital questions. This book is a real prize for any fellow. Yet I'll send you a copy absolutely **FREE**. Just glancing through it may change your life! Rush coupon to me personally: **Charles Atlas, Dept. 86, 115 East 23rd St., New York 10, N. Y.**



**CHARLES ATLAS, Dept. 86
115 East 23rd St., New York 10, N. Y.**

Dear Charles Atlas: Here's the Kind of Body I want: (Check as many as you like)

- | | |
|----------------------------------------------------------------|----------------------------------------------------|
| <input type="checkbox"/> More Weight—Solid—in The Right Places | <input type="checkbox"/> Powerful Arms and Grip |
| <input type="checkbox"/> Broader Chest and Shoulders | <input type="checkbox"/> Slimmer Waist and Hips |
| | <input type="checkbox"/> Powerful Leg Muscles |
| | <input type="checkbox"/> Better Sleep. More Energy |

Send me absolutely **FREE** a copy of your famous book "Everlasting Health and Strength"—32 pages, crammed with photographs, answers to vital health questions, and valuable advice. I understand this book is mine to keep and sending for it does not obligate me in any way.

NAME _____ AGE _____
(please print or write plainly)

ADDRESS _____

CITY _____ STATE _____

Tells How You Can Learn to MOUNT BIRDS!

Learn At Home
Men, Boys, Hunters, Fishermen, mount and save your lovely wild-game trophies. Be a Taxidermist. Mount Birds, Animals, Heads, Fish, Tan skins. YOU learn easily, quickly in spare time. Have a grand home-museum. The finest and the greatest hobby known, for sportsmen. Fun, real profits.

FREE BOOK Yes, **FREE**, Beautiful strange, valuable **Book**, telling all about Taxidermy. Contains over 100 beautiful game-pictures. And it's yours **FREE**, if you rush your request. You can mount all kinds of wild-game, and common specimens too. We can positively **TEACH YOU**. So **GRASP** this opportunity. **RUSH** letter or postal for this amazing **FREE BOOK**. Don't delay. State your **AGE**. **N. W. SCHOOL OF TAXIDERMY, 2506 Elwood Bldg., Omaha 2, Neb.**

AVIATION!

Pays you more with a schooling at Parks College. B.S. degree in 3 yrs. from Saint Louis University—Aero. Eng., Maint. Eng., Aero Administration. Non-credit courses for Private, Commercial, Instrument, Flight Instructor and Multi-Engine Ratings. Also A & E Mechanics Course.

All Parks schooling approved for G.I. training. Write today.
PARKS COLLEGE DEPT. M-33 EAST ST. LOUIS, ILL.

SEE HOW EASY IT IS Step by Step!

FREE TEST REVEALS YOUR TALENT FOR ART
Write for test—and booklet "Art for Pleasure and Profit." Both free. Prove your ability in commercial art, cartooning, lettering—at home. Send postcard stating name, age, address. Washington School of Art, Studio 126K, Washington 5, D. C.

REAL ESTATE BE A BROKER

FREE BOOK TELLS HOW
PAYS BIG! SEND FOR **FREE, BIG, ILLUSTRATED CATALOG NOW!** Graduates report making substantial incomes. Start and run your own business quickly. Men, women of all ages, learn easily. Course covers Sales, Property Management, Appraising, Loans, Mortgages, and related subjects. **STUDY AT HOME** or in classrooms in leading cities. Diploma awarded. Write **TODAY** for free book! No obligation.
WEAVER SCHOOL OF REAL ESTATE (Est. 1936)
Suite 300 Law Bldg. Dept. PM Kansas City, Mo.

INSURED TIRE SERVICE POPULAR BRANDS

FREE INSURANCE POLICY given with each used tire sold. We guarantee the amount of service you pay for.
Tube Given Free with Each Used Passenger Tire Upon Request

SPECIAL! Deduct 10% on orders for Two or More used tires
YOU CAN'T LOSE!!

Super Quality	Rugged Performance	15 Months Insured Service
450x20 \$4.55	670x15 \$5.25	700x16 \$5.55
600x16 4.95	670x16 5.35	760x16 6.45
650x16 5.45	700x15 5.40	820x15 6.45
		850x17 7.45

Supreme Quality	Nothing Finer	30 Months Insured Service
450x20 5.95	450x21 6.25	700x15 (6) 10.45
600x16 5.65	650x15 5.75	750x16 8) 15.95
650x16 5.85	670x15 5.95	900x20 19.95
700x16 7.75	700x15 5.75	1000x20 20.45
750x16 12.50	710x15 6.50	1100x20 26.75
550x17 5.75	760x15 6.95	1200x22 19.50
525x18 5.45	820x15 7.50	1300x22 24.75
640x15 5.75	475x19 5.75	1450 1200x20 23.50
		1100x24 22.75

MIDLAND TIRE SALES Speedy shipments on Mail Orders. F.O.B. Chicago. Insurance policy sent with each order. Deduct 10% on orders for 2 or more used tires. Send **CHECK** or **MONEY ORDER**.—No COD's.
3701 S. Normal Ave., Dept. PM-11, Chicago 9, Ill.

LEARN ELECTRICITY AND ELECTRONICS

ON REAL EQUIPMENT
IN THE GREAT SHOPS
OF **COYNE**



RADIO-TELEVISION
A GREAT BOOMING INDUSTRY

**ALL TRAINING
GIVEN IN CHICAGO
TRAINING SHOPS**
Practical Technical
method gives practical
experience on
massive outlay of
equipment plus necessary
technical
training. No advanced
education or
experience needed.



The tremendous growth of this new field is almost unbelievable. TV has been given the "go-ahead" in 1227 new communities, with 1845 new stations to be built. Unusual opportunity to get in on ground floor. RADIO-TELEVISION and ELECTRONICS are vital to our Defense Program. And they offer a world of opportunities for a real future when the emergency is over. **Train quickly** on actual equipment at Coyne by practical-technical methods. Get big Free Book today.

ELECTRICITY-

The Power Behind Our Industrial Program

A great opportunity field and vital to Defense. Thousands of trained Electrical and Electronics men needed in good jobs and a real future. Why be satisfied with a "no future" job? Get Free Book that tells how thousands have prepared quickly for Electricity and Electronics at Coyne.

TRAIN QUICKLY AT COYNE FOR VITAL FIELDS

ELECTRICITY-RADIO-TELEVISION-ELECTRONICS-VITAL in Industry and Armed Forces. **TRAIN QUICKLY** for better rating, if drafted—vital job in Industry, if not. Trained men whether 17 or up to 45 needed. Prepare now for steady, well paid, essential jobs in A FIELD THAT ALSO OFFERS A REAL FUTURE WHEN THE EMERGENCY IS OVER.

FINANCE PLAN— START NOW—PAY LATER

Enroll now, pay most of tuition later. Monthly payment plan especially designed for K-Vets. If you need part-time work to help out with living expenses while at Coyne, we'll help you get it. Special tuition plan for men of Draft Age.

**APPROVED
FOR
VETERANS**



1 You are TOLD the how and why of each job.



2 You're shown how to do typical jobs by trained instructors.



3 You DO practical job YOURSELF on equipment.



Mail Coupon for Big Free Book

Whether you prefer Electricity or Television-Radio, train on actual equipment, at Coyne. Fill in and mail coupon TODAY. Paste it on a postcard if you wish. A big fully illustrated booklet and complete details will come by return mail. No salesman will call.

B. W. COOKE, President

COYNE SCHOOL TECHNICAL TRADE INSTITUTE
CHARTERED NOT FOR PROFIT
Established 1899
500 S. Paulina Dept. A3-72H
Chicago 12, Illinois
ELECTRICITY ★ TELEVISION ★ RADIO ★ REFRIGERATION ★ ELECTRONICS

B. W. COOKE, President
COYNE SCHOOL
500 S. Paulina St., Chicago 12
Dept. A3-72H

Send your BIG FREE BOOK and details of your training offer. This does not obligate me and no salesman will call. I am interested in
 ELECTRICITY TELEVISION-RADIO

NAME.....

ADDRESS.....

CITY.....STATE.....

THIS BOOK CAN SAVE YOUR LIFE!



by A. J. White, director of Motor Vehicle Research



only \$1.00 ppd.

Here's the book that only MVR could write! It's "The TRUTH about American cars"!

If you want to know the truth about today's automobiles, this is the book that will give it to you! Motor Vehicle Research's dynamic director, A. J. White, has ripped away the veil of public indifference that threatens to sabotage automotive design. Here are all the facts, in 73 sensational chapters, about the cars that come off Detroit's drawing boards and assembly lines. Every feature, every fault is brought out clearly and coldly for every motorist to see and read. If you own a car, you need this book! Don't gamble your life away . . . get your copy of "The Truth About American Cars" today! Only \$1 ppd.

Project No. MVR-71 - "Carbon Monoxide, Your Car — and YOU" \$1 ppd.

Project No. MVR-167 - "Behind The Scenes in Scientific Car Testing" \$2 ppd.

Project No. MVR-210 - "The Big 3 in '53 — and 1 More Makes 4" \$1 ppd.

(The first unbiased test-by-test report on the Big 3, as well as the industry's "sleeper"! The only scientific comparison available to the public of all 4 popular low-price American cars . . . with findings that will shock and startle you! This book is a "must"!)

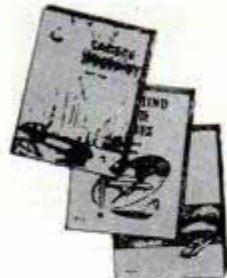

MOTOR VEHICLE RESEARCH, INC. DEPT. 105

234 HUNTINGTON AVENUE BOSTON 15, MASS.

Enclosed is \$_____ for which send me _____ copies of "THE TRUTH ABOUT AMERICAN CARS" (\$1.00 each) ppd.

and _____ copies of MVR-71 (\$1.00 each) MVR-167 (\$2.00 each) MVR-210 (\$1.00 each)

money order

ORDER TODAY!

check

Name _____

cash

Address _____

City _____ State _____

SUCCESS • BIG PAY in Aviation

MASTER A & E MECHANICS urgently needed

Maximum training in minimum time! Thorough, practical instruction backed by more than 25 years of aviation technical experience. Training authorized under G.I. Bill.

Write today!
Illustrated Catalog
Registrar, Dept. 99,
Miami 30, Florida



TRAIN IN MIAMI -- AIR CAPITAL OF THE WORLD

DAN LURIE
"America's Most Muscular Man"
—on television's "Big Top."



FAMOUS DAN LURIE

BARBELLS

with 4 courses—low factory prices
50 lb. set... \$ 8.48 | 150 lb. set... \$20.48
100 lb. set... 13.98 | 200 lb. set... 25.98

Write for Free Catalog Extra wts. 13c per lb., F.O.B. plant

DAN LURIE BARBELL CO.

107-M-6 Pitkin Ave., Dept. 359-F, Brooklyn, N. Y.

Become a MENTAL SUPERMAN

OVERNIGHT! It's uncanny! Revolutionary! FREE LITERATURE!
BIJOU STUDIO, BOX 1727-M-7, HOLLYWOOD 28, CAL.

CASTING SECRETS REVEALED

Now—learn to make big money casting 1000's of perfect plaques, book ends, figurines, etc. with X.L. rubber molds. No exper.—little capital needed. X.L. Rubber, Pts. \$2.50; Qts. \$4 (postage extra). Models, rubber for 3 molds, \$1.50 ppd. Send 25c (refundable) for informative catalog (40 pps.) describing this wonderful Profit Making business. PLASTIC ARTS STUDIO, Dept. 3, 3403 S. Madison St., Muncie, Ind.



HUGE PROFITS! MORE MONEY!

LEARN WATCH REPAIRING



AT HOME. By our modern and original system of instruction you can learn every part of the **WATCH REPAIRING TRADE AT HOME.** Prepare yourself for a well-paying position or start in business after completing our course of instruction. Good watch repairers are in demand and generally earn very good salaries. For particulars apply to the

WISCONSIN SCHOOL OF WATCH REPAIRING
759 N. Milwaukee St., Milwaukee 2, Wis.

HELPFUL BOOKS

Send post card asking for FREE catalog

Popular Mechanics Press, 200 E. Ontario, Dept. 601, Chicago 11

POWER MOWERS & KITS

FREE PLANS

LOW FACTORY PRICES DIRECT TO YOU



Build your own quality mower with our LOW COST KITS, Parts, Engines, Free Plans guide you. 3 and 4 Wheel Kits, complete. Parts precision finished, ready to use. Write TODAY for Free Plans, Low Prices, Parts List and Guarantee.

3-WHEEL KIT NO. T-800

America's Finest Power Mowers completely assembled in 3 and 4 wheel models. Belt or direct drive, 18" and 20" sizes. Nationally known make engine. Latest improved features, sturdy construction and money back guarantee fully described in color folder. Write today.



▼ TRIANGLE MANUFACTURING CO., Box M-23, Fort Scott, Kansas

GET SHOP-METHOD HOME TRAINING

for **SUCCESS** in Today's Top Industries!



SEND COUPON
TODAY
for FREE
BOOK and
COMPLETE
SAMPLE LESSON!

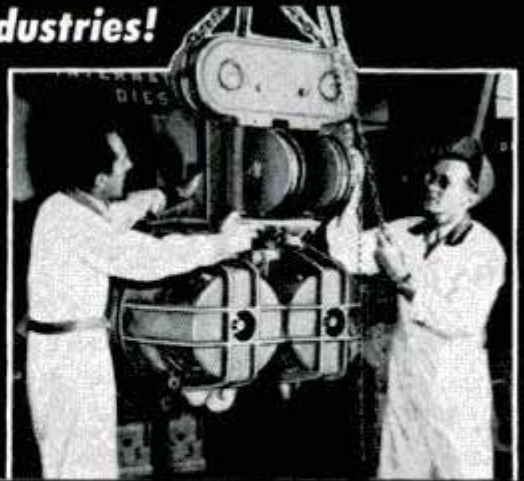

RADIO-TELEVISION & ELECTRONICS OR AUTOMOTIVE-DIESEL & ALLIED MECHANICS

Like a business of your own... or a good job with a big firm... and get paid for what you know? Shop-Method Home Training in Radio, Television, Electronics will bring you the job...money...you've always wanted. 105 million Radios, 3100 stations...16 million TV sets, over 100 TV stations...many more, now Govt. restrictions are off. Defense industries want trained men for interesting, good pay jobs. Get into this opportunity-making industry...advance fast. Find out how...mail coupon...**TODAY!**

I GIVE YOU STANDARD PARTS! INCLUDING TUBES!

—they are yours to keep. You actually learn by doing, build generators, receivers, a big Super-Het radio.

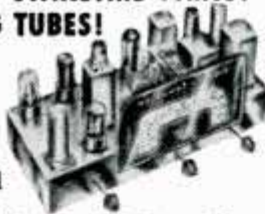

THIS PROFESSIONAL FACTORY-MADE MULTI-TESTER IS YOURS!



Valuable equipment every Radio-TV man needs. Yours to keep!

BOTH RESIDENT AND HOME STUDY COURSES OFFERED!

Want to be your own boss... or get into booming industries? 8 million older cars need big, profitable services and repairs. Farm machinery is going Diesel. Defense industry begs for more and more trained mechanics for high-pay jobs. National Schools Shop-Method Home Training prepares you for all Automotive, Diesel, Allied Mechanics opportunities. Helps you get the security, good pay you've always wanted. Send coupon for your Free Book and Sample Lesson now!



LET NATIONAL SCHOOLS of Los Angeles, California, a Resident Trade School for almost 50 years, train you at home for today's unlimited opportunities. Pick your industry—mail coupon below now!

EARN EXTRA MONEY WHILE YOU LEARN!

I show you how to earn extra money *while learning!* Many men have paid for their entire course in this way. You can, too. Remember: Shop-Method Home Training covers *every phase* of the industry—in an interesting step-by-step way. Why wait—take the first step to success—mail the coupon today!

DRAFT AGE? Training helps you get the service branch you want, advance fast. That means higher pay and grade, more prestige—right away! Don't take a chance—mail coupon *now!*



I GIVE YOU THE TOOLS OF YOUR TRADE!

Big professional-quality kit of tools of your trade—and all-metal tool box. All yours to keep—part of your course; they help make your training more practical—start you off right!



NATIONAL SCHOOLS

LOS ANGELES 37, CALIFORNIA
Technical Trade Training Since 1905
In Canada: 193 East Hastings Street
Vancouver 4, B. C.



FREE!
RADIO-TV
BOOK &
LESSON!

FREE!
AUTO-DIESEL
BOOK &
LESSON!

APPROVED FOR
G.I. TRAINING

**DON'T
PUT IT OFF
GET THE
BIG SALARY
YOU'VE
ALWAYS
WANTED!**

MAIL TODAY—YOU'RE "ON YOUR WAY"!

NATIONAL SCHOOLS, Dept. B-63
4000 S. Figueroa Street
Los Angeles 37, California

Mail in envelope
or paste on
postal card

I want to "get going"! Send me Free Book I checked and Free Sample Lesson. I understand no salesman will call.

- My Future in Radio-Television & Electronics
 My Future in Automotive-Diesel & Allied Mechanics

NAME _____ AGE _____

ADDRESS _____

CITY _____ ZONE _____ STATE _____

- Check here if released from service less than 4 years ago.
 Check here if interested in Resident School Training.

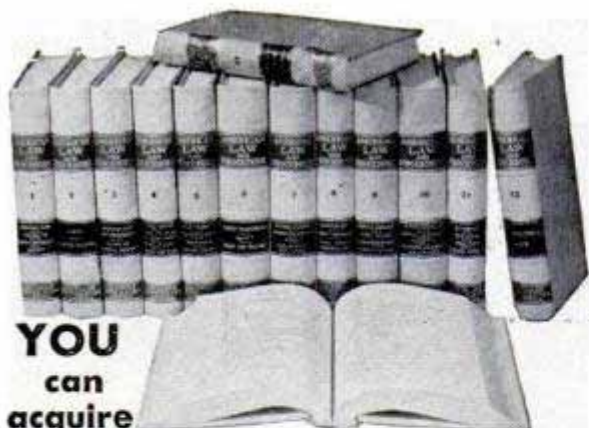

YOU
can
acquire

LAW NIGHTS AT HOME! L. B. DEGREE

LaSalle's famous Law Library—used as reference in many Law libraries and Law offices—has enabled thousands to master Law surprisingly fast, in spare hours at home, for business and professional advancement.

These 14 remarkable volumes, compiled by leading professors and lawyers, cover the whole basic field of Law in condensed, orderly, simplified manner.

You advance rapidly with this great library, plus special lectures furnished. We guide you step-by-step with personalized Problem Method of instruction . . . you learn by doing—handling legal problems—not by memorizing rules.

Send for two FREE 48-page booklets, "Law Training for Leadership," and "Evidence," answering questions about Law and its value to you, and telling how LaSalle Law graduates are winning rapid advancement in business and public life. Mail coupon below. No obligation.

LA SALLE EXTENSION UNIVERSITY A Correspondence Institution

417 S. Dearborn St. Dept. 664L Chicago 5, Ill.

Send me your two FREE booklets described above, without obligation.

Name..... Age.....
Street.....
City, Zone & State.....



ITALIAN ACCORDIONS AT LOWEST WHOLESALE PRICES

**5-DAY
FREE
TRIAL**

**"PAY AS
YOU PLAY"**
Small Down Payment
As Little As
\$10 per
month

**DIRECT from
Importer to You!**

SATISFACTION GUARANTEED, or your money back! NOW you can save up to 50% by direct purchase from America's leading distributor of famous genuine ITALIAN ACCORDIONS.

Send for FREE Illustrated Catalog!

ACCORDION MANUFACTURERS & WHOLESALE OUTLET
2003 West Chicago Ave. Dept. R-63, Chicago 22, Ill.



How to Make Money in PHOTOGRAPHY

**EARN
WHILE
YOU LEARN
AT HOME**

If you are OVER 17—good pay, fascinating work await you in photography! Start making money quickly in sparetime — step into your own studio or exciting job. LEARN-BY-DOING method trains you at home! Write TODAY for FREE catalog. Also Resident Training, 43rd Year! GI Approved.
NEW YORK INSTITUTE OF PHOTOGRAPHY
Dept. 49, 10 W. 33 St., New York 1, N.Y.

Send for
**FREE
BOOK**

Secrets of VENTRILOQUISM Now Revealed!



Easy to learn in 60 to 90 days with our Home Study Course. **RESULTS GUARANTEED.** Make Money! Be Popular! Have Fun! Big Opportunity! Radio, Television, Stage Appearances! For FREE Information regarding price and terms, WRITE. You must state your age. Dummy Catalog, 25c.
FRED MAHER SCHOOL OF VENTRILOQUISM
Box 36, Studio F Kensington Station
Detroit 24, Michigan

BIG LEATHER & CRAFT CATALOG!

1000's of items for Leathercraft, Textile Painting, Copper Tooling, Kits, Projects, Tools, Supplies, Etc. Send 25c (refunded with 1st order) to:
RUSSO HANDICRAFT SUPPLIES Dept. 12CD, 245 S. SPRING
LOS ANGELES 12, CALIF.



LEARN LOCKSMITHING

Learn Locksmithing and Keymaking from Experts in Your Spare Time at Home!
Locksmiths in big demand! No layoffs, no slow seasons! Age no disadvantage. Year-round, steady income in this permanent, respected field. Full or part time. Practical, illustrated lessons show how to make money even while learning! All materials, special tools supplied.
(Send for FREE BOOKLET.)
INSTITUTE OF LOCKSMITHING, Dept. P43
15 PARK AVE. RUTHERFORD, N. J.
Lic. & Approved State of N.J. VA Approved

GET UP TO 40% OFF! BUY IT WHOLESALE!

START A BUYING SERVICE at home, spare time. Get big-name merchandise for clients (and yourself) at up to 40% and more below the regular list price. Make fat commissions. Folks eagerly buy through you to get sizeable discounts. Send postcard for details.
AMERICAN BUYERS' SERVICE, 631-R Linden Ave., Buffalo 16, N. Y.

Say You Saw It in Popular Mechanics

WORK FOR THE



GOVERNMENT

START AS HIGH AS \$3,795.00 YEAR
Many Appointments To Be Made. Experience Usually Not Required. **MEN—WOMEN.** Mail Coupon Today—Sure.
FRANKLIN INSTITUTE, Dept. Z-83, Rochester 4, N. Y.
(Not Government Controlled) Sirs: Rush without charge, (1) 32-page book with list of U. S. Government Jobs. (2) Tell me how to get one of these jobs.
Name.....
Address..... Age?.....



Here's Why IT'S SO PRACTICAL!

Has only 2 moving parts
• No hidden springs • Hygienic
• Perspiration Proof • Non-Corrosive
• Non-Magnetic • Conforms to the wrist — most comfortable to wear
• Fully guaranteed
RESILIENT STAINLESS STEEL

No. 1 Stainless Steel adjustable Plain Clips **\$3.95**
"The Guardsman"
No. 2 With Beautifully Embossed Stainless Steel Clips **\$4.95**

Contour CLASP-ON WATCH BAND FOR MEN

WRIST SIZES
Small 6 1/4" — Medium 6 3/4" — Large 7"
At your Jeweler or write direct Illustrated Brochure on request

Don Juan WATCH BANDS 29 E. MADISON ST. CHICAGO 2, ILL.

NOW...from D.T.I.'s MILLION DOLLAR TRAINING CENTER

Learn to master TELEVISION

RADIO - ELECTRONICS

by getting EVERYTHING YOU NEED!

NOW—
get training
to suit your NEEDS

TAKE YOUR
CHOICE

Come to
D.T.I.'s
great CHICAGO
LABORATORIES

...one of the Nation's FINEST!

Now, in the heart of the nation's TV Center, you can get all of your preparation in D.T.I.'s big, modern, wonderfully equipped training laboratories. Loads of commercial equipment and ample, well qualified instructors help you get a thorough, practical preparation in the SHORTEST POSSIBLE TIME. Part time student Employment assistance can help you pay your way while in training.

EMPLOYMENT SERVICE

As soon as you complete either the Chicago Laboratory or Home Training, you'll find D.T.I.'s grand Employment Service ready to help you start earning real money. Get full facts. Mail coupon today.

MILITARY SERVICE: If subject to military service, the training information we have for you should prove very helpful. Mail coupon today.

89 WAYS TO EARN MONEY
IN TELEVISION
RADIO ELECTRONICS

ACT NOW! MAIL COUPON TODAY
Get this publication FREE!

DeFOREST'S TRAINING INC. Dept. PM-6-J
2533 N. ASHLAND AVE., CHICAGO 14, ILL.

I would like your Opportunity News Bulletin showing "89 Ways to Earn Money In Television-Radio-Electronics"; also, complete facts about the training opportunity made possible by your organization.

Name _____ Age _____
Address _____ Apt. _____
City _____ Zone _____ State _____

America's amazing multi-billion dollar Television field now offers you a chance of a lifetime to get started toward a grand job or your own business. With TV station limit now raised from over 100 to 2053, Television is headed for almost every community. Mail coupon today. See how you may prepare to cash in on the coming TV BOOM.

Get ALL of your training
AT HOME!...including setting
up your own HOME LABORATORY



ABOVE: You build and keep this big 5 INCH commercial-type oscilloscope — one of the most useful test units used in TV today.



See how you may now get one of today's most complete, effective combinations of major home training aids—including (1) well illustrated lessons, (2) the wonderful aid of HOME TRAINING MOVIES and (3) 21 big shipments of electronic parts for setting up your own HOME LABORATORY. You work over 400 construction and test procedures to get the practical experience you need. This includes building and keeping a 5 INCH "SCOPE", jewel bearing MULTI-METER and a big 21 INCH TV SET. (D.T.I. offers another home training in Television-Radio-Electronics, but without the TV set.) Mail coupon today for exciting facts.

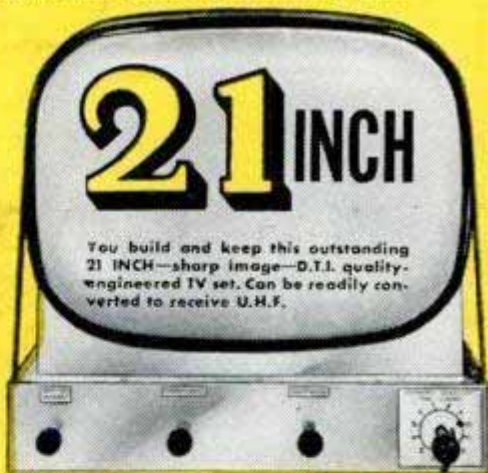

Use 16 mm. **MOVIES** Only D.T.I. provides you with the loan of visual training movies at home to help you master important basic points faster . . . easier . . . better!

"ONE OF AMERICA'S FOREMOST
TELEVISION TRAINING CENTERS"
— Established 1931 —



De FOREST'S TRAINING, INC.
AFFILIATED WITH
De VRY Technical INSTITUTE
CHICAGO 14, ILLINOIS

Hi there, Pal! Win Some of these
100 Silver Anniversary Prizes!
 I just won \$100. and this 15" tall Silver Trophy
 I just won this \$1,000,000 Body and a Gold Medal

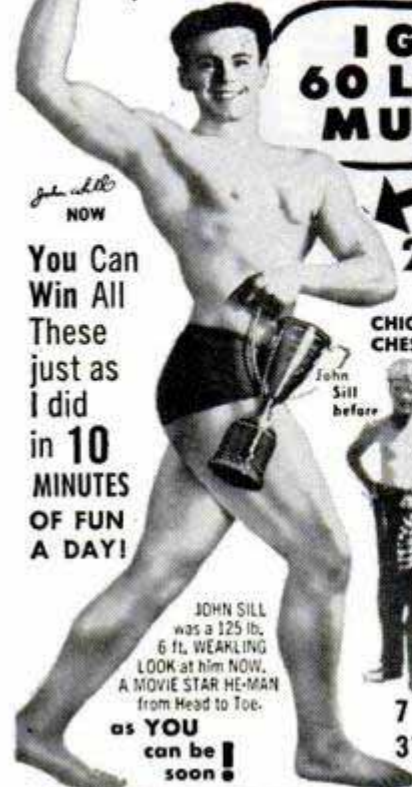

I GAINED 60 LBS. OF HANDSOME HARD-HITTING MUSCLES!

Which of these
2 ME'S is YOU?
 that 125 lb.-6 ft.
CHICKEN WEAKLING BELOW
 A FEW SHORT WEEKS AGO



NO! friend you don't have to be **SKINNY** anymore. Just mail NOW the **FREE** coupon below as I did. Soon YOU can add 7 inches to your **CHEST**, 3½ inches to each **ARM** and the rest in proportion as I did.

COME On, PAL, NOW YOU give me
10 PLEASANT MINUTES A DAY IN YOUR OWN HOME and I'll give YOU A NEW HE-MAN BODY for your OLD SKELETON FRAME



NO! I don't care how skinny or flabby you are. I'll make you OVER by the SAME method I turned myself from a wreck to the strongest of the strong. Why can't I do for you what I did for MANY THOUSANDS of skinny fellows like you?

Develop YOUR 520 MUSCLES
 Gain Pounds, INCHES FAST!
 YES! You'll see INCHES of MIGHTY MUSCLE added to your ARMS and CHEST. Your BACK and SHOULDERS broadened. From head to heels, you'll gain SIZE, POWER, SPEED. You'll be a WINNER in EVERYTHING you tackle.

THIS MAY BE YOUR LAST CHANCE TO GET ALL 5 PICTURE PACKED COURSES MILLIONS HAVE BEEN SOLD FOR \$1 AND MORE

FOR 10¢

- How to Build MIGHTY ARMS
- How to Build A MIGHTY CHEST
- How to Build A MIGHTY BACK
- How to Build MIGHTY LEGS
- How to Build A MIGHTY GRIP

FREE PHOTO BOOK HOW to Achieve Nerves of Steel, Muscles of Iron

FREE HOW to BECOME A MIGHTY HE-MAN

BOTH FREE FOR QUICK ACTION!
 1. Photo Book of STRONG MEN 2. MUSCLE METER

Dept. PM 36
 Tell Me How To Win \$100, etc.

Jowett Courses greatest in World for Building All-Around HE-MEN" — R. F. Kelley Physical Director

JOWETT INSTITUTE OF PHYSICAL TRAINING
 220 FIFTH AVENUE, NEW YORK 1, N. Y.

Dear George: Please mail to me FREE Jowett's Photo Book of Strong Men and a Muscle Meter, plus all 5 HE-MAN Building Courses: 1. How to Build a Mighty Chest. 2. How to Build a Mighty Arm. 3. How to Build a Mighty Grip. 4. How to Build a Mighty Back. 5. How to Build Mighty Legs—Now all in One Volume "How to become a Mighty HE-MAN." ENCLOSED FIND 10c FOR POSTAGE AND HANDLING (no C.O.D.'s).

NAME.....AGE.....
 ADDRESS.....
 CITY.....ZONE.....STATE.....

LOW OVERHEAD-LARGE VOLUME SALES & SMALL PROFITS
 BRING YOU THESE "LOWEST PRICES."
 WHAT GOOD IS A TIRE WITHOUT A TUBE?
TUBE GIVEN WITH EVERY TIRE AT NO EXTRA COST

Why Pay More!

SPRING SPECIALS—AT LOW PRICES
 SAVE TIME — SAVE MONEY — SEND THIS AD
 GOOD USED TIRES — NOT RECAPS
 19 YEARS AT THIS ADDRESS
 Be Wise—A TRIAL OF ONE TIRE WILL CONVINCE YOU.
 EVERYBODY MAY TAKE **10% off** ON EVERY TIRE
20 MONTHS WRITTEN GUARANTEE

600-16	\$4.12	820-15	\$5.32	800-20	\$7.02	32x8(8)	\$8.52
650-16	5.52	700-15	4.52	650-20	7.82	32x6(10)	9.82
700-16	5.02	670-15	4.42	700-20	8.42	900-20	13.12
650-15	4.32	710-15	4.62	750-20	8.52	1000-20	13.72
760-15	4.92	1550-17	4.42	825-20	14.62	1100-20	13.82

EXTRA SPECIAL — 30 MONTH WRITTEN GUARANTEE

600-16	\$5.32	475-19	\$4.82	700-15(6)	\$8.92	700-20	\$11.02
600-16(6)	6.42	640-15	5.02	750-16(8)	10.72	750-20(10)	15.42
650-16	5.82	670-15	5.52	700-17	9.92	750-20(8)	15.02
650-16(6)	7.32	710-15	5.72	750-17	11.72	825-20	18.32
700-16	6.42	760-15	6.02	750-15	13.92	900-20	17.22
750-16	9.22	800-15	6.52	825-15	12.92	1000-20	17.72
525-18	4.72	820-15	6.62	600-20	8.72	1100-20	19.52
550-17	4.32	670-16	6.32	650-20	10.22	1000-22	19.42
650-15	5.32	760-16	7.12	32x6(8)	11.12	1100-22	20.42
700-15	5.42	700-16(6)	7.62	32x6(10)	11.72	1100-22	20.42

White Walls \$1.00 extra Military treads 750-20 16.12

Thousands of tires shipped all over U.S.A. All tires shipped F.O.B. Phila. Send Check or M.O. with this ad. Dept. 2.

STANDARD 834 N. Broad St., Philadelphia 30. Pa.

LEARN MEAT CUTTING

Train quickly in 8 short weeks at Toledo for a bright future with security in the vital meat business. Big pay, full-time jobs—HAVE A PROFITABLE MARKET OF YOUR OWN! Pay after graduation. Diploma given. Job help. Thousands of successful graduates. Our 28th year! Send NOW for FREE catalog. No obligation. GI approved.

NATIONAL SCHOOL OF MEAT CUTTING, Dept. 50-5, Toledo 4, Ohio

STUDY TO BE A DOCTOR
 of Psychology or Metaphysics

Obtain a Ps.D., Ms.D., or Ph.D. degree. Be a Teacher, Lecturer, or Accredited Practitioner. Teach others how to achieve Health, Happiness and Contentment. Chartered by State. Write for FREE book telling how.

THE NEOTARIAN FELLOWSHIP
 Desk 8, Pickwick Building Kansas City 6, Missouri

RADIO

Engineering. All phases radio & electronics theory & practice; television; FM; broadcasting; servicing; aviation, marine & police radio. Prepare for high pay; 18-month course. Graduates in demand by major companies. Enter Jan., March, June, Sept. Regular campus life. Write for catalog.

VALPARAISO TECHNICAL INSTITUTE, Dept. D, Valparaiso, Ind.

A "GOOD HAND" HELPS YOU SUCCEED!
LEARN TO WRITE WELL

Handwriting quickly improves with our easy-to-understand picture lessons! Put your spare time to good use; send today for FREE BOOKLET, "How to Become a Good Penman," or check volumes wanted below at \$1 each: Business Writing Artistic Writing Card Writing Bird & Design Flourishing Engraving Alphabets. COMPLETE SET \$4.50. Ask for price list of penman's supplies.

OUR 53rd YEAR
TAMBLYN SCHOOL of PENMANSHIP
 S.A. Ziller, Pres., 442 Ridge Bldg., Kansas City, Mo., U.S.A.

SAY YOU SAW IT IN POPULAR MECHANICS

NEW V.B.L. MACHINE
 GIVES YOU \$50.00 FOR SPARE TIME

GET THE EXTRA INCOME YOU NEED THIS QUICK WAY AT HOME

There is BIG MONEY in the amazing new business of cleaning Venetian Blinds under mass production method with new patented Venetian Blind Laundering Machine. Homes, hotels, offices, institutions give you their blinds to clean regularly. Machine bringing \$50.00 to \$100.00 for spare evening, ours in a single week—\$1,000 a month and more to full time operators. No experience needed. Low down payment starts you at once and lets you pay as you grow. Write for amazing facts at once.

VENETIAN BLIND LAUNDRY EQUIPMENT CO.
 442 N. Seneca St. Dept. 10-H Wichita 12, Kansas

FREE..10 HITLER STAMPS



10 Scarce Stamps—All Different—Sent Free

TO SECURE NAMES FOR OUR MAILING LIST

MAIL coupon at once. We'll send you this fascinating set of 10 Hitler stamps. Different sizes, colors, values. **NO COST TO YOU.**

These valuable stamps were issued by the short-lived nation of Bohemia-Moravia. They are much sought after. Now they are becoming **SCARCE**. And since the nation is no longer in existence—no new issues can be minted. Our supply is limited. So, don't ask for more than one set.

FREE 32-Page Book

In addition to the **FREE** Hitler Stamps, we'll also include other interesting offers for your inspection—**PLUS** a **FREE** copy of our helpful, informative book, "How To Collect Postage Stamps." It contains fascinating and true stories such as the one about the 1c stamp (which a schoolboy gladly sold for \$1.50) and which was later bought for **FORTY THOUSAND DOLLARS**.

This Free Book also contains expert advice on collecting; shows how to get started; where and how to find rare stamps; how to tell their real value; how to mount them, trade them; how to start a stamp club; exciting stamp games, etc. It has pictures galore! Full pages of pictures showing odd stamps depicting native men and women from faraway lands; ferocious beasts, etc.

MAIL COUPON NOW

Be the first in your neighborhood to have this valuable set of Hitler Stamps. Your friends will envy you for it and want to buy the set from you. It will become one of the most prized sets of any stamp collection. But you must hurry if you want to get the 10 Hitler Stamps **FREE**. This special offer may have to be withdrawn soon. If coupon has already been used, write direct to **Littleton Stamp Co., Dept. 6-PM, Littleton, New Hampshire.** (Enclose 10c to help cover postage and handling).

Also Free



Supply Limited
Mail Coupon At Once!

**LITTLETON STAMP CO.,
DEPT. 6-PM, LITTLETON, N. H.**

Send—**AT NO COST TO ME**—the valuable set of 10 Hitler stamps and the informative booklet, "How To Collect Postage Stamps." I enclose 10c to help cover postage and handling.

Name _____

Address _____

City _____ State _____

BECOME AN Electrical Engineer

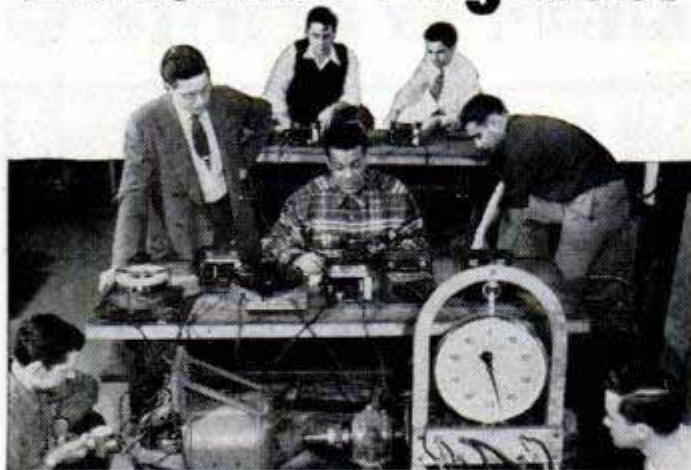

- Major in Power or Electronics
- Earn B. S. Degree in 36 months

Over 50% of the nation's industrial leaders began their careers with engineering training. Today, the demand for young, trained Electrical Engineers and Technicians is constantly expanding. Eight separate programs give you a wide range of career opportunities.

Plan Your Career From these Courses in Electrical Technology

ENGINEERING COURSES

Electrical Engineering — Bachelor of Science Degree
Save a valuable year through optional year 'round study.
Electronics major 36 months
Power major 36 months

TECHNICIAN COURSES

Electro Technician 12 months
Electronics Technician 12 months
Radio Technician 12 months
Radio and Television Technician 18 months

SERVICE COURSES

Electrical Service 6 months
Radio and Television Service 12 months

Terms open July, October, January, April

Approved for veterans. Prior Military, Practical or Academic training evaluated for advanced credit. Faculty of specialists. 50,000 former students. Annual enrollment from 48 states and 23 overseas countries. 50th year. Non-profit. Send handy coupon for complete information.

MECHANICAL TECHNOLOGY COURSES — Also available, Service Technician courses 6 to 18 months — Heating, Refrigeration, Welding, Air Conditioning and Mechanical — Mechanical Engineering with a major in Design, Metal Fabrication or Plant Engineering.

Also, general 3-month preparatory course.



MILWAUKEE SCHOOL OF ENGINEERING

MILWAUKEE SCHOOL OF ENGINEERING
Dept. PM-653, 1025 N. Milwaukee
Milwaukee 1, Wisconsin

Send: Free 160-Page Catalog
 "Your Career" Booklet

I am interested in name of course

Name Age

Address

City Zone State

If veteran, indicate date of discharge



new, easy way to.. STRIPE with PAINT

Do Perfect Paint Striping at Home with New Kind of PAINT STRIPING TOOL

This Master Painters' Striping Tool makes it easy to do expert striping on furniture, bikes, model planes, autos, signs, toys, linoleum, wallboard, etc. Makes plain, painted walls look like tile. Paint straight lines... curved... circular or evenly spaced parallel lines the same way a professional painter does. Simply fill Tubular-Glass Paint Fountain with any color paint and wheel tip feeds paint evenly. Tips interchangeable— jaws split apart for easy cleaning. Tool complete with tips for 1-16 in. stripe only \$1.00, postpaid. Other complete tools with 1-64, 1-32, 3-64, 5-64, 3-32, 1-8 inch tips, \$1.50 ea. Extra tips — 75c each.

COMPLETE KIT with tool and 7 tips, \$5.00. Here's the handiest tool in your whole painter's kit. C.O.D.'s post, coll.

DEALERS Paint Striping Tool packed in attractive display cartons of 1 doz. Fast, profitable seller. Write for illus, circular, discounts.



\$1 ONLY POSTPAID ATTENTION Home Craftsmen and Hobbyists

Just the tool you've been waiting for! New PAINT STRIPING tool gives "professional" results every time, yet simple and easy to use as a fountain pen. Adjustable guide keeps lines straight as an arrow. Just as easy to make curves or free hand designs. Adds new beauty and finished look to everything you paint. Send dollar today.

WENDELL MFG. CO., 4234 N. Lincoln Ave., Dept. 36, Chicago 18, Ill.

BECOME AN EXPERT IN

TRAFFIC

Traffic men earn \$4,000 to \$10,000 and up. Thousands of firms need experts on rates, tariffs, regulations. We train you thoroughly in spare time at home for executive traffic jobs. Personal training under traffic authorities. Placement counsel and help. Write for free 48-page book "Traffic Management—the Fast Growing Profession."

LASALLE Extension University, 417 So. Dearborn St. A Correspondence Institution Dept. 664T Chicago 5, Ill.



MECHANICAL DENTISTRY

To make Crowns, Plates, Bridgework, etc., for Dentists. Easy practical way to learn mechanical dentistry at home in spare time. FULL EQUIPMENT OF TOOLS AND MATERIALS INCLUDED WITH COURSE. Low tuition. Easy terms. Write for FREE BOOK about this money making profession that is not affected by machine age.

McCARRIE SCHOOL OF MECHANICAL DENTISTRY
207 N. Broad St., Dept. 18, Philadelphia 7, Pa.

SHORTHAND IN

Famous Speedwriting Shorthand. 120 words per minute. No symbols; no machines; uses ABC's. Easiest to learn, write and transcribe. Low cost. 150,000 taught by mail. For business and Civil Service. Also typing. 30th Year. Write for FREE booklet to:

Speedwriting
Dept. 1506-3
55 W. 42 St., N.Y. 36, N.Y.

6 WEEKS AT HOME

RUPTURED?

We Offer You Something NEW!



TURN THE KEY "LOCK-O-MATIC"

And lock cushion against the opening

LOCK-O-MATIC holds rupture under all conditions of work or play... prevents nervousness, gas pains and backache caused by uncontrolled rupture... helps nature rebuild weakened muscles. Give up your old strap and spring trusses that enlarge the opening. End your troubles now with the amazing LOCK-O-MATIC. MONEY-BACK GUARANTEE... Write for FREE booklet: "RUPTURE FACTS"

LOCK-O-MATIC SALES CO.
21 So. Third St. Dept. P-6, Minneapolis, Minn.

AT LAST! A CHROME RESTORER THAT WORKS!

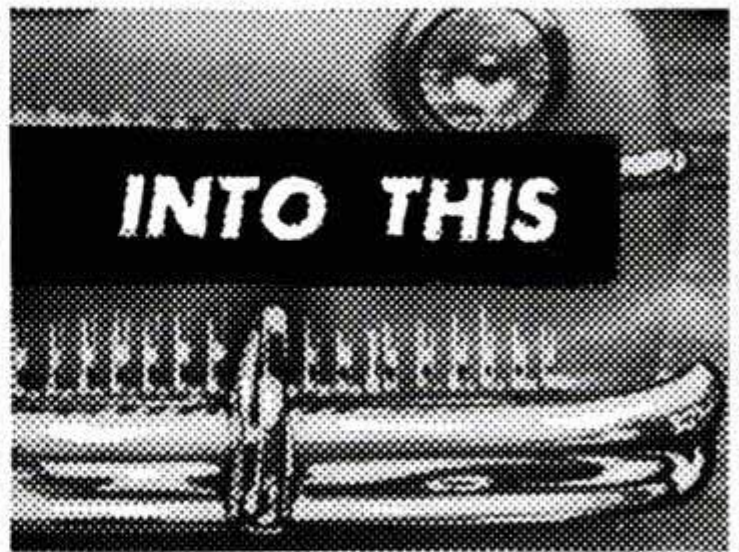
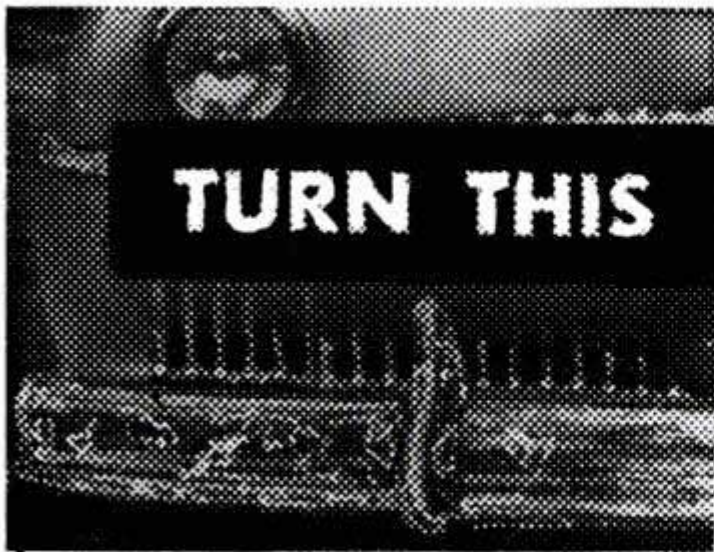

Amazing new 2-way chrome protector wipes away rust — pits — corrosion — in just 2 minutes! Stops rust from forming! Keeps chrome mirror-bright!

Now keep your bumpers, grillwork, window-frames, all chrome on your car sparkling bright as the day you bought it! Keep it rust-free for years! No matter how badly pitted or scarred, this sensational new 2-Way Chrome Protector wipes it Mirror-Bright, prevents new rust and corrosion from forming!

only **\$2**

ONE APPLICATION LASTS ENTIRE SEASON—gives you safe, foolproof protection against vicious biting erosions of **SALT AIR — SUN — RAIN — SLEET** — etc. **101 USES** — for fishing reels, boat trims, bicycles, sporting equipment, etc.

NOW—YOU GET 2-WAY CHROME PROTECTION

Complete Chrome Protector Kit containing:

1—Bottle of **RUST REMOVER** chemical with special applicator. Enough to remove all rust from car.

2—Can of **PROTECTOR** chrome rust preventer and applicator. Enough for years of safe protection.

ABSOLUTE GUARANTEE

RESULTS ABSOLUTELY GUARANTEED OR MONEY BACK! Enclose \$2, check or money order with your name and address.

**H. SEARS INDUSTRIES, INC., Dept. C-161
799 Broadway New York 3, N. Y.**

CLIP THIS COUPON NOW!

H. SEARS INDUSTRIES, Inc.
Dept. C-161, 799 Broadway
New York 3, N. Y.

Please send me a complete Chrome Protector Kit. I enclose \$2. I understand that if I am not completely satisfied with the kit, my money will be refunded.

NAME _____

ADDRESS _____

CITY _____

STATE _____

**TOOL DESIGNERS • TOOL PLANNERS
PATTERNMAKERS • TOOL & DIE MAKERS
JIG & FIXTURE BUILDERS • MACHINISTS**

Here's Your

FREE TICKET TO SAN DIEGO

Convair, builders of world-famed Convair Liners, military aircraft, guided missiles, needs tool designers, tool planners, pattern makers, tool & die makers, jig & fixture builders, machinists, template makers.

Excellent working conditions: Here's your great opportunity to work in a modern plant on long-range projects at excellent wages. Top-notch retirement plan. Fine health and life insurance.

Wonderful California living: San Diego offers you and your family incomparable living. Ideal climate. Sports aplenty. Beaches, bays, mountains, desert, Mexico and Pacific Ocean surround you. Plenty of good housing — reasonable rents. It's a new way of life — pleasant, refreshing, happy.

Send coupon now for free booklet, "You and Convair" plus your application form. Travel expense to San Diego paid if you qualify.

H. E. Pasek, *Employment Manager*

Convair, 3302 Pacific Hiway, San Diego, Calif., Dept. PM-62

Please send me FREE "You and Convair" and my application form:

NAME _____

OCCUPATION _____

ADDRESS _____

CITY _____ STATE _____

ENGINEERING DEGREE IN 27 MONTHS

Big Demand for Graduates

Aeronautical, Chemical, Civil, Electrical, Mechanical and Radio Engineering (inc. TV and Electronics)

Hundreds of young men are earning B. S. ENGINEERING DEGREES annually in this recognized institution — year around operation. New terms start quarterly. Many students earn a major part of their college expenses in this large industrial center.

Low tuition. Competent instruction. Thorough, intense, practical program. Modern, well-equipped laboratories including new physics laboratory and modern wind tunnel. Individualized instruction emphasized.

Government approved for G.I.'s. Engineering preparatory courses. Students from 48 states and 21 foreign countries. Enter June, September, December, March. Send coupon for free catalog and full information. Enroll now.

SEND COUPON TODAY

INDIANA TECHNICAL COLLEGE

563 E. Washington Boulevard
Fort Wayne 2, Indiana

Please send me free information on B.S. Engineering Degree in 27 months as checked.

Aeronautical, Chemical, Civil, Electrical,
 Mechanical, Radio-Television

Name _____

Address _____

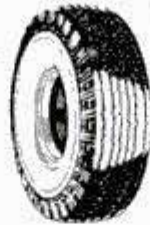

**QUALITY TRUCK & PASSENGER TIRES
LOW PRICES - GUARANTEED
FREE TUBE WITH EACH PASSENGER TIRE**

Buy first quality used tires direct from wholesaler and save money. Each tire triple inspected and guaranteed. Free tube with each passenger tire. Order today.

**QUALITY PASSENGER TIRES
1 YEAR WRITTEN GUARANTEE**

600x16\$5.59 | 670x15\$5.95
650x16 5.79 | 700x15 5.59

EXTRA VALUE TRUCK TIRES | MUD & SNOW TRUCK TIRES

1 YEAR WRITTEN GUARANTEE | 2 YEAR WRITTEN GUARANTEE
700x20 \$12.50 | 750x20(10) \$18 | 600x16 \$6.95 | 650x16 \$7.50
750x20(8) 14.50 | 825x20 21.50 | 900x16 12.95 | 750x20 15.95

Complete line of High Mileage Tires in stock. Write for price list for sizes not listed. Take off 10% on orders for two or more tires. All prices F.O.B. Richmond, Virginia.

THE SAFTYRE CO., INC.

MAIL ORDERS PROMPTLY FILLED. Send check or money order with this ad.

"FOR THAT SAFE TIRE"
Dept. PM, 1801 E. Broad Street
P.O. Box 2254, RICHMOND, VA.

You Can "Imitate" Any Star!

Make-believe you're a Movie Actor or TV Comedian! Have fun—be the STAR of the party—Girls will love you! **BUDDY LEWIS**, World Famous Mimic, reveals his amazing-simple-lifetime "SECRETS"—illustrated with 33 "show-how" photos in his brand new book—"GET INTO THE ACT!" Only \$1.00 postpaid. GET more FUN out of LIFE! GET INTO THE ACT! SEND for yours NOW! Money Back Guarantee. FREE; 5 Professional Comedy SCRIPTS included if you ACT AT ONCE!



Posed by **Buddy Lewis**

Encore Publications, Dept. P, 267 S. 10th St., Phila. 7, Pa.

"How to Make Money with Simple Cartoons"



A book everyone who likes to draw should have. It is free; no obligation. Simply address

FREE BOOK

CARTOONISTS' EXCHANGE
Dept. 96D Pleasant Hill, Ohio



GROW MINIATURE TREES

Grow authentic, LIVE dwarf trees!
Fascinating hobby! Fabulous profit!

SEND FOR FREE SEED & INSTRUCTIONS!

MINIATURE NURSERY CLUB
Dept. 5-K, Box 4112, Village Station
Los Angeles 24, California

Unusual & Unique items!

The mail-order house for **MEN**

Send only \$1.00 for Surprise Sample, Lists, and Catalogue.

HOLLYWOOD SALES CO. Dept. A
3414 W. Magnolia Blvd., Burbank, Calif.

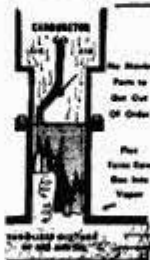

UP TO 6 MILES MORE PER GALLON

Reported by Hundreds Using
MIRACLE ACTION TUR-B-LIZER

Carburetor specialists say Tur-B-lizer is best patented improvement they have seen. Tested in millions of miles of driving in cars, trucks and tractors. Easily installed. Send \$3.00 for six cylinder type, \$4.50 for eight cylinder type. Try Tur-B-lizer for 30 days, if you are not enthusiastically satisfied as claimed by hundreds of users, your money will be promptly refunded.

Mechanics-Salesmen! Make big money selling and installing. Write for full facts.
UNIVERSAL TUR-B-LIZER CO.
621 E. STATE ST. MILWAUKEE 2, WISC.

Learn BAKING At Home

Baking is one of America's high industries in wages. Nearly depression-proof. Thorough basic home course lays sound foundation. If you have aptitude, write for FREE BOOKLET. "Opportunities in Commercial Baking."

NATIONAL BAKING SCHOOL
835 Divorsey Parkway Dept. 135A Chicago 14, Ill.



SAVE 70%

SACRIFICE SALE!

**MUST RAISE CASH!
CREDITORS DEMAND PAYMENT!**

Frankly, we're in a tight fix! Thousands of 17 jewel precision-built watches came in too late for last Christmas and far too early for the next! Our creditors won't wait! They demand payment NOW. Our misfortune is your lucky break! Buy now! Save up to \$70.00 on one watch!

10 DAY FREE TRIAL

Examine... check... appraise any THORESEN watch for 10 days at no risk whatsoever! Full price back if not delighted. **SEND NO MONEY**—Pay price plus postage on arrival. Or send check, cash or money order for quick, prepaid delivery and **SAVE MORE!** Given: **COBRA** Expansion band with every watch, also instructions, Guarantee Certificate and gift shown. Rush coupon now! Prices subject to rise after present over-stock is exhausted. References: Jewelers Board of Trade, Better Business Bureau or any national bank. Buy with confidence! Thoresen's is a reliable, nationally known firm. Address:

THORESEN DIRECT SALES, Dept. 6-F-200

131 WEST 33rd STREET

NEW YORK 1, N. Y.

FAMOUS RECIPRO-REGISTER

CHRONOGRAPH 19⁹⁵

TIMES: SPORTS • PHOTOGRAPHY • LAB WORK • SHOP WORK, ETC.

This is the **Recipro-Register Chronograph**—the BEST brand available anywhere in the world today! Thousands of proud owners paid much, much more because this is the **Prince** of modern watches—the last word in magnificent styling. Case made of Triple Chroming with lasting **Stainless Steel** back! Precision engineered in the highest traditions of Swiss craftsmanship! A smart, slim unusual timepiece of functional beauty. It's the **"CHRONOGRAPH THAT REMEMBERS!"** Freezes result while movement continues to keep time!

CHECK FEATURES WITH \$71.50 WATCHES!

- 5 Multifunction Dials
- Luminous No.'s & Hands
- Hairline Sweep Second
- Unbreakable Crystal
- 17 Jewels
- Chrome & Steel
- 5 Hands
- Incabloc
- Split Second Calibration
- 2 Clutch Operation
- Anti-Magnetic
- Shock Protected

DON'T PAY \$71.50 or more to a credit jeweler around Christmas time! Get the Genuine, Original **RECIPRO-REGISTER** at our **SACRIFICE PRICE** for cash—\$19.95 plus 10% tax, total **\$21.95** (while stocks last). **YOU SAVE OVER \$41.00.** Given: Nationally advertised **\$4.95 COBRA** expansion band, gift case, instructions and our written guarantee as well as German made **KLARO-VIS** field glasses! Don't lose this bargain of a lifetime—send **TRIAL COUPON**—NOW! Check Number **233.**



17 JEWELS • EXTRA-THIN • 14⁹⁵ plus tax
AUTOMATIC CALENDAR WATCH

The month, date, weekday, hour, minute and second are yours at a glance with this Swiss engineering triumph! An impressive, very thin timepiece of real excellence!

Date Changes Automatically! Gears are precision and quality. Patented design for smooth long-life operation.

SPECIAL QUALITY FEATURES

- 17 Jewel Swiss movement
- Stainless Steel Back • Unbreakable Crystal • Thin, Streamlined Design • Luminous Hands & No.'s • Rugged Construction

Compare with other calendar watches selling with its performance and rich, modern appearance, return for full price refund while they last, we're sacrificing them at only **\$16.45**. Where, tax, a total of only **\$16.45**. Where, oh where can you get a value like this? Better rush that Coupon now! Order by number **243-C.**

17 Jewel Incabloc WATER & SHOCK Resist Watch 12⁹⁵ plus tax

A favorite with Marines, Sailors, Soldiers, Aviators and sportsmen! Drop it, wet it, jolt it at work or play! It actually runs **under water!** This is no ordinary watch. It is a splendid timepiece made according to exacting standards in reputable Swiss factories. Thousands sold at much higher prices.

COMPARE WITH WATERPROOFS AT \$59.50

- Incabloc Protected • Shock Absorbing • Water Gasket • 17 Jewels—Accurate!
- Luminous Hands & No.'s • Unbreakable Crystal

It's smaller, thinner, more accurate, better made than many competitors' watches selling for much more. **DO NOT CONFUSE** with cheap models! This is a guaranteed quality timepiece with money refunded at once if not satisfied! Best of all, you save **\$46.55** during our sensational Sacrifice Sale! Only **\$12.95** plus **\$1.50** tax, total: **\$14.25**. Quantity limited! Order at once by number **224.**

SEND NO MONEY! Mail Coupon now for home trial!

THORESEN DIRECT SALES, Dept. 6-F-200

131 West 33rd Street, New York 1, N. Y.
RUSH watches) checked on 10 DAY TRIAL. Send following **FREE** of extra cost with each and every watch purchased: 1. Reg. 4.95 **COBRA** Band, 2. **KLAROVIS** German Glass, 3. Guarantee Certificate 4. Gift Box, 5. Instructions.

- Payment enclosed, Send prepaid. Send C.O.D., plus post.
- No. 233 **CHRONOGRAPH**—\$21.95 No. 224 **INCABLOC**—\$14.25
- No. 243-C **CALENDAR**—\$16.45

You are to refund **FULL PURCHASE PRICE** if I am not delighted, keeping the "Klarovis" as your gift to me.

NAME _____
ADDRESS _____
TOWN _____ STATE _____

UNCONDITIONAL GUARANTEE EXCLUSIVE OF PARTS!

FREE repair service ANYTIME if needed by skilled watchmakers—for the **LIFETIME** of this firm. No cost ever for "handling," adjustment or service. **FREE** annual oiling and timing service. **THORESEN** makes **LIFETIME FRIENDS!** Remember: If you are not satisfied with your purchase after 10 day trial, return for full price refund. Our written **Guarantee Certificate** enclosed with every watch!

EARN MORE IN DRAFTING



More Opportunities for Employment and Promotion

"Here I am at work making good money as a draftsman. I'm glad I sent the coupon to Chicago Tech for that Free Trial Lesson and found out how easy it is to learn Drafting in spare time at home. Today I feel secure in my job because the draftsman's work comes first on any new project. And, in addition, draftsmen can't be replaced with machines. What's more, I feel I'm slated for promotion and more pay, because I see so many draftsmen advancing to high-pay jobs."

LEARN IN SPARE TIME — AT HOME!

(or at the College in Chicago)

A few hours of pleasant home study every week—that's all. No interference with your present job. All the tools you need: drawing outfit included. With Chicago Tech's help, you train yourself step by step. This tested method—developed over 48 years of C.T.C. progress—prepares men quickly for good positions in industry.



FREE INFORMATION—SEND COUPON

To prove to you how easy it is to learn Drafting at home by the Chicago Tech method, we will send you this FREE TRIAL LESSON. No charge for this lesson, now or later. Fill out and mail coupon, or send post card today.

CHICAGO TECHNICAL COLLEGE

G-251 Tech Bldg., 2000 So. Michigan Ave., Chicago 16, Illinois

Mail me FREE Lesson with information about big opportunities in DRAFTING.

Name _____ Age _____

Address _____

City _____ Zone _____ State _____

WATCHMAKING

Learn at home • FREE sample lesson

CHICAGO SCHOOL OF WATCHMAKING
2330 N. Milwaukee Avenue Dept. 163 Chicago 47, Ill.

Say You Saw It in Popular Mechanics

High School at Home

Many Finish in 2 Years

No classes. No time wasted going to and from school. Progress as fast as your time and abilities permit. Standard H. S. texts supplied. Thousands enroll each year in this 56-year-old school. Send for FREE descriptive booklet.

AMERICAN SCHOOL, Dept. HA45
Drexel at 58th St., Chicago 37, Ill.

Without obligation, please send FREE descriptive booklet.

Name _____

Address _____

STUDY LAW FREE AT HOME .BOOK!



Prepare for the Bar!

Write today for a copy of our FREE book, "The Law-Trained Man," which gives the bar rules in your state and tells how ambitious men and women since 1890 have been preparing at home in spare time for the practice of law by studying the famous Blackstone bar-training course. All needed instruction material is furnished including big 16-volume law library. Law diploma awarded. Moderate tuition; easy monthly terms. Write for FREE book today!

BLACKSTONE SCHOOL OF LAW

225 N. Michigan Ave., Dept. 50-A, Chicago 1, Illinois

ELECTRIC APPLIANCE REPAIRMEN

ELECTRIC APPLIANCE SERVICE NEWS

GET SAMPLE COPY

Write

Find all the sources of supply for parts on all ELECTRIC APPLIANCES... Washing Machines, Vacuum Cleaners, Ranges, Sewing Machines, Small Appliances, etc.

The Only Publication Especially for the Appliance Repairman

SEND ONLY 20¢ IN STAMPS OR COINS FOR SAMPLE COPY

ELECTRIC APPLIANCE SERVICE NEWS
Dept. M-30 176 W. Adams St., Chicago 3, Ill.

Catalog of 3000 Novelties 10c

Send 10c for amazing catalog of novelties, live animals, scientific supplies, hobbies, funmakers, planes & boats, looms, magic tricks, joke articles, unusual seeds, gadget timesavers, cameras, optical goods, projectors, movies, lucky jewelry, religious novelties, disguises, musical instruments, stamps, coins, puzzles, fortune tellers, radios, auto & bike accessories, telescopes, magnifiers, compasses, banks, smokers' gadgets, artists' supplies, printing sets, engines, motors, shockers, knives, billfolds, fireworks, guns, rifles, sports, books, games, plants, etc. Send name, address & 10c to: JOHNSON SMITH & CO., Dept. 651, Detroit 7, Michigan

Get the FACTS!



Write for complete information. Dept. 3206
SCHULT CORP., ELKHART, IND.

SCHULT
TRAILERS



FINE BOWS and ARROWS
SELECTED RAW MATERIALS

Catalog 5c Send for it
HAND BOOK—Illustrated
Instructions on Making and
Shooting Archery Tackle—75c
L. E. STEMMLER CO.
Manorville (Box 3) L. I. N. Y.

SAVE \$200 — BUILD YOUR OWN GARAGE

Plans for 1 1/2 or 2 Car Garage or 20'x20' Cottage — Only \$1.98

Material list and estimated cost included FREE. Sizes 14'x20' or 20'x20'. Hood or Gable Roof. Specify type and size when ordering. Postage prepaid with check or money order; otherwise C.O.D.
B.C. Co., 17122 Scottsdale, Cleveland 20, Ohio.



Weights less than 1 lb.!

HIP POCKET GYM

Skinny? Build yourself up! Fat? Reduce—turn fat to muscle! Helps body build itself. Simple—Easy! Women—even children can use it. No nailing on walls—no crawling on floors! A few minutes a day rids you of "tired, run-down feeling". Builds health in Veterans Hospitals. Made of pure natural rubber. Light, compact—take it wherever you go! 5 Day Money Back Guarantee PLUS FREE Health & Strength Instructions.
MAJOR LEAGUE SUPPLIERS, DEPT. PM6, 58 EAST 11th ST., N. Y. 3, N. Y.

Now Only \$3.95
Postpaid
Sold at \$5.95
Nationally

Haven't you put up with Stammering long enough?

● Stammering holds you back. It hampers your business and social life. It cuts you off from pleasures and profits that are rightfully yours. Every day you see others—no smarter than you—getting advancements and advantages you should have. And all because *you cannot speak for yourself.*

Now, what are you going to *do* about your stammering? From my long experience, diagnosing and correcting thousands of cases of speech disorders, I know that the difficulty becomes *more firmly implanted* as years go by. Few “out-grow” stammering. But in all probability your

condition can be completely corrected. I cannot say for sure until I study your answers to the 22 questions listed in the Speech Chart below. If you really want to rid yourself forever of this crippling affliction, write your answers in the space below. Then mail the Chart to me today. When I have studied your case, I will write you personally—answering all of the points that are in your mind. I will tell you clearly and frankly *what can be done*

about your particular type of speech defect. If I am not completely confident I can help you, I will say so at once. But in 98 cases out of 100 *there is every hope for prompt relief.*

So, take this easy way to throw off the chains that bind you. Break *that first link* this very day—by mailing me the completed Speech Chart. No charge. No obligation.

BENJAMIN N. BOGUE, Director
Bogue Institute for Stammerers—Estab. 1901
5 East Market St., Indianapolis 4, Ind.

**Break the Chains that Bind you . . .
MAIL THIS TODAY!**



SPEECH CHART

Name in full.....

Street or R.F.D.....

City..... State.....

Occupation..... Telephone Number.....

1. Age.....Date and year of birth.....	9. Do you stammer while reading aloud when alone?.....	16. At times is it impossible for you to utter a sound?.....
2. Nationality.....	10. Do you stammer while talking in the dark?.....	17. What sounds give you the most difficulty?.....
3. Weight.....Height..... Married?.....	11. Do you stammer when whispering?.....	18. Are you of a nervous disposition?.....
4. At what age did you begin to stammer?.....	12. Do you stammer when singing?.....	19. Have you any physical deformity?..... If so, describe.....
5. What in your opinion was the cause of your stammering?.....	13. When you do not stammer can you speak your words distinctly?.....	20. State the condition of your general health.....
6. Have you any organic defect in the organs of speech?.....	14. At times do you hesitate and stick and are you unable to start to talk?.....	21. How far did you go in school?..... Average grades?.....
7. Does your impediment increase when you are angry?.....	15. Do you repeat one syllable or word before the following one can be uttered?.....	22. Describe further details of your stammering on another sheet.
8. At times do you talk better than at other times?.....		

Form 4

Insist on KNICKERBOCKER REPEATING WATER PISTOLS!

"Western
Style"

Ask for them at
your favorite
toy counter.



Authentic Western six-shooter
style. Fires 300 shots without
reloading. 7 7/8 inches
long. Assorted colors. **\$.49**

"Super
Jet"



Fires 250 shots without reload-
ing. Transparent plastic
allows view of water. 7
inches long. Colors:
red, yellow **\$.49**
or green.

"Space
Jet"

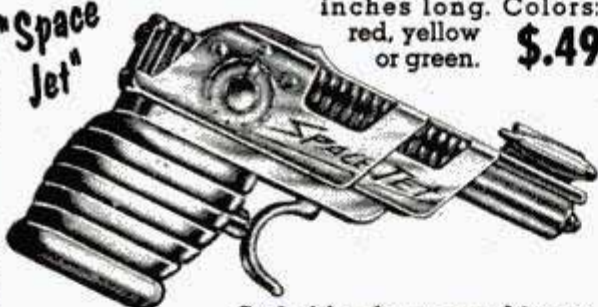

Styled for the space ship era.
Fires 150 shots without re-
loading. 6 3/4 inches long.
Assorted colors. **\$.39**

"Sneaker
Model"



Palm Size
Fires 150 shots without reload-
ing. Transparent plastic
allows view of water. 4 3/4
inches long. Colors:
red, yellow **\$.39**
or green.

Available at toy, novelty and variety
stores or write for the name of your
nearest dealer. No mail orders, please.



KNICKERBOCKER PLASTIC COMPANY

4101 San Fernando Road, Glendale 4, California

PEEL 6-10 FT. OF PAINT PER MINUTE
Down to Bare Wood...



PAINT DOZER
\$11.50
complete

You can peel paint fast and easily! With Paint Dozer you soften and peel old paint in one continuous stripping action. You get a clean, bare surface ready for repainting. And, there's no hard scraping, no messy or dangerous chemicals or flame!

In tests, Paint Dozer peeled 43 coats of paint in *one* stroke! Flat, curved or grooved surfaces . . . house siding, boats, cabinets, floors, woodwork . . . you can peel them all better and easier with Paint Dozer!

Paint Dozer operates on 115-120V A.C. or D.C. household current. Its sturdy stamped-steel casing and heavy-duty ceramic element assure long life, even under daily use.

Order from your hardware or paint store, or write today for fast delivery. *You must be satisfied or your money back!*

LECTRO DIVISION, OTTO KONIGSLOW MFG. CO.
Dept. 2-C, 2189 West 26th Street • Cleveland 13, Ohio

LEARN — Trades that Pay More

WATCHMAKING or ENGRAVING

Trades You Enjoy — by HOME STUDY



BEST THOROUGH, PRACTICAL TRAINING
IN THESE DEPENDABLE, HIGH-PAYING
TRADES. Earn extra money as you learn, re-
pairing clocks and watches, or engraving silver
and jewelry. YOU WILL BE BUILDING YOUR
OWN BUSINESS RIGHT AT HOME.

KANSAS CITY SCHOOL OF WATCHMAKING

ADMIRAL & TRACY

KANSAS CITY 6, MO.

STUDY INDUSTRIAL DESIGN

You can train at Art Center School in California with practicing-professionals for upper-level jobs in INDUSTRIAL DESIGN. Recent graduates have been added to the staff at General Motors, Chrysler, Raymond Loewy, Henry Dreyfuss, etc. Majors in transportation, general product design, structures, community development, furniture design, packaging, display, 4-year degree courses. Learn to combine imaginative design with technical proficiency, coordinate utility and beauty. Stimulating environment. Field trips. Advantages of mild Southern California climate and nearby holiday spots. Coed. Placement service. Write for catalog.

ART CENTER SCHOOL, Edward M. Adams, Director
5353 WEST THIRD STREET, LOS ANGELES 5, CALIFORNIA



Play GUITAR in 7 DAYS

OR GET YOUR MONEY BACK! Let Ed Sale teach you to play with his famous 60 page diagram photo system. Contains 52 photos, 87 diagrams, showing exactly how to place your fingers. Over 100 Hillbilly, Popular, and Western songs, words and music—along with complete, easy to learn instructions. Imagine your joy when you find after 7 days you are playing beautiful music! Amaze your friends! Be the life of the party! SEND NO MONEY. Pay Postman \$1.98 Plus Postage or send \$2 and I pay postage. (Same guarantee.) ED SALE, Studio 1905, Bradley Beach, N.J.

BE A HIGH-PAID MAN IN YOUR COMMUNITY WITH THIS LONG NEEDED INVENTION

Earn up to \$10,000 or more per year!
Nothing to invest! Be your own boss!

U.S. Pat.
D 153853-
D 153854

A worldwide product needed by every home, business and farm . . . priced to sell quickly at long profit! Automatic Red Comet goes into action as soon as fire starts . . . smotherers fire without human aid. It's a sales 'natural'!

FREE SALES KIT

Demonstrator units, sales literature, etc., furnished you FREE. Handsome leather-type kit. Tried and proved, it will make you an independent businessman. ACT NOW! Someone in your community will be appointed soon. Write for details, today!

RED COMET, INC.

Dept. 358-F, R.C. Bldg., Littleton, Colo.



POPULAR MECHANICS

SILVERED OPTICAL PRISMS

Solid glass with 1 silvered facet precision ground and polished—3 3/4" long, base 2 1/2 in. wide, sides 1 1/2 inches. Use in any type optical system—photography, telescopes, etc. Weight each 3 1/2 lb. A \$25.00 value. Stock No. **\$2.00** Four for \$5.00 Each. **\$5.00**

MESS KITS, CANTEENS, ETC.

Regulation two-piece Army Mess Kits with folding handle. Used, but perfect. Weight 2 lbs. No. **69c** A116—Ea.

CANTEENS

Reg. U.S. issue canteens. Plastic screw top chained to body. Slightly used but perfect. Wgt. 1 lb. 117—Meta—Ea. **69c** 118—Plastic—Ea.

CANTEEN COVERS

Heavy canvas. Button fastener. New No. 530—Each..... **69c** Used No. 119—Each..... **35c**

CAVALRY SPURS

Genuine Wish-bone type cavalry spurs. Nickel brass. A102, Wt. 1 lb. Pair with straps.. **98c**

RADIO HEAD-PHONES

Extremely sensitive with 4000 ohms resistance. Slightly used but guaranteed perfect. With moisture-proof cord and phone plug. A splendid value for the radio serviceman and experimenter. A106—Pair... **\$2.95**

WIRE CUTTER

Heavy duty, compound leverage. Cuts up to 1/4 inch wire. Upper jaw acts as feeder to cutting edges. Insulated handles. Ideal for farm fence work and shop use. Shp. wgt. 2 lbs. Stock No. **\$1.95** 392—Each.

G. I. PISTOL BELTS

Of heavy canvas webbing. Adjustable. Eweleted all around. Used but perfect. Wgt. 2 lbs. No. 131, Each... **49c**

SUPERRENCH

New Automatic World's Wonder Wrench Fits all size nuts up to 1 1/4". A tool kit of wrenches in one. Shp. wt. 1 lb. Stock No. 378... **\$1.45**

ASSORTED GRINDING WHEELS

Meets most grinding needs. Grind coarse, rough, fine; hard and soft metals, wood, plastic, etc. Mounted on 1/2" shaft. Real heavy duty workers. A famous make. Not all exactly as illustrated, but all a complete assortment. Shn. wt. 2 lbs. No. 407, Each, 39c. 12 asst. for... **\$4.50**

MOUNTED LENS SET

4 mounted lenses. Can be set up into various types of optical systems with various degrees of magnifying power. Three lenses are of compound design consisting of two glass elements in each mount. The fourth lens is of pupillary type for use as an eye-piece. Lenses range from 1/4" to 1" in diam. Shp. wt. 2 lbs. Stock No. 434 per set of four... **\$5.00**

SPARKLET CARTRIDGES

May be used with life belts and hundreds of other uses. In boxes of 10. Wt. 1 lb. Stock No. 254. Per Box... **50c**

SATCHEL POUCH

Heavy canvas pouch. Ideal for toting lunches, shopping, books, etc. Has 1 x 1 1/2 inch pocket. Brand New, guaranteed perfect. Has oversize flap with single strap fastener. A113—EACH **\$1.69**

ARMY BANDO-LEERS

Of fine heavy khaki. Big roomy pockets with snap button fasteners. Fine for hunters, campers, boy scouts, etc., also for shop work in carrying small parts, etc. Can be used by spinning fishermen to carry tackle. Material alone is worth this price. Shp. wt. 1 lb. 11 Pocket **49c** 5 Pocket **29c** Type No. 129 Each Type No. 128 Each

READING GLASSES

Top quality, accurately ground and polished. Handle in black finish, gracefully tapered and balanced. Encased in metal ring attractively finished in chrome. Sizes indicate lens diameter. Shp. wt. 1/2 lb. each. 2"—No. 468..... **\$.98** 2 1/2"—No. 469..... **1.49** 3"—No. 470..... **1.69** 3 1/2"—No. 471..... **1.95** 4"—No. 472..... **2.49**

NINE-PIECE TWIST DRILL SET

Nine popular sizes for home craftsmen, shop, industrial worker. 1 1/2" to 2 3/4" in length. Diam. from 1/16" to 1/4". Carbon tool steel, hardened and tempered. Plastic container. Shp. wt. 1/2 lb. Stock No. 210—An Unequaled Value. Only... **49c**

HEAVY DUTY CAMERA TRIPOD

Hardwood; slightly used—need adjusting and cleaning; adjustable; folds to 32" length, extends to 58"; equipped with mud spikes; carrying strap; for all large cameras; 1/2" mounting stud; extra sturdy design. Shp. wt. 10 lbs. Stock No. R-190. Price, Each... **\$2.95**

FIELD TRANSMITTER SET



Complete; includes transmitter with pair of head phones, sending telegraph key, buzzer, double throw switch. Original cost of this instrument to English government well over \$100.00. Shp. wt. 20 lbs. each. Allow sufficient postage or will be shipped express charges collect. Two 4 1/2 volt C batteries needed in each set. Batteries 45c each extra. No. 438. Complete set... **\$7.95** Two sets for... **\$15.00**

U. S. Govt. BOLO KNIFE



Extra heavy. For farm, home or jungle use. Blade of Govt. formula cutlery steel. Walnut riveted handle. 3 1/2 inch hilt. 10 1/2 inch blade. You'll find hundreds of uses for a Bolso knife. Blade will take and hold a keen cutting edge. **\$2.95** Wt. 2 lbs. A112—

ARMY SLIDE RULE



An accurately calibrated slide rule with two extra slides—for quick computation of range for artillery fire. Measures 18 x 3 inches. Provides for wind direction, deflection, trajectory, etc. Shipping weight 2 lbs. No. 544. Each only... **\$2.50**

GENUINE GERMAN SABRE

Genuine sabres with 21 1/2 in. high quality steel blades, 4 1/2 in. handle grip. Comes with protective sheath, can be worn on belt. Decorative for den, and dependable tool for many uses such as cutting underbrush, pruning, etc. Fine for hunters, campers. Used but in perfect condition. Shp. wt. 5 lbs. No. 309. Complete, Sabre and Sheath, only... **\$2.95**

GENIE TOOL SET



The Genie Tool Set every craftsman having need such exacting tools will be proud to possess. Included is Genie Tool ejector-type handle—1/16" Notch knife with chip ejector—1/4" wide Notch knife—Right angle "V" knife—1/16" Drill chuck—Razor-thin Outlining blade—3/32" Radius Gouge—3/16" Diameter Hole knife—1 1/2" long Saw, fine cut—Heavy duty blade—3/16" wide, flat Chisel—1/4" radius Gouge—3/32" Gouge with side-cutting edge. \$6.50 Value. Shp. wt. 2 lbs. No. 442. Set, Only... **\$2.95**

U.S. WAR SURPLUS AND HUNDREDS OF OTHER BARGAINS

SPORTSMAN'S OUTDOOR SET

4x power field glass shows brilliant image with wide angle of view. Adjustable for eye spacing. Attractive black finish. Also included in the kit is an accurate wrist compass. Makes fine outfit for boy scouts, hikers, campers, etc. In attractive cellophane front gift box. Shp. wt. 2 lbs. No. 217, Only... **\$1.95**

MICROPHONE

Famous Press-to-Talk T-17B type hand microphone. New. Complete with 6 ft. cord and connector. Wt. 1 lb. No. 439 **\$2.29** Only

POST COMMAND WALL TENTS

A "best buy" for campers, construction engineers, outdoorsmen. Big and roomy, 7x12 ft. in ground space, 7 ft. high at center and 6 ft. high walls. Olive drab color. Treated to provide fire, water and mildew resistance. Used but complete and perfect in every way. Available with or without poles as listed below. Poles consist of 6 upright 7 1/2 in. poles, 2 upright 8 1/2 in. poles jointed and one jointed ridge pole 142 1/2 in. long, plus 10 16-inch rope stakes. Shp. wt. 75 lbs. with poles 100 lbs. **TENT, LESS POLES No. 399 \$29.95** **TENT, WITH POLES No. 400 \$39.95** Each

BAYONET BLADE

Fine forged steel. Ground but not polished. May be made into throwing or hunting knife or spear. Blade 6 3/4 x 7 3/4 inches, 1 1/4 inches overall. Will take and hold a fine edge. Shp. wt. 1 lb. No. 664-R—Each... **49c**

NYLON PARACHUTE CORD

500 lb. breaking strength. 7 strands of nylon incased in nylon cover. 25 ft. to 3000 ft. length. No. 310. Per foot, only... **2c**

7 LB. EXPERIMENTER PARTS ASSORT. KIT

Valuable radio and electronic parts by weight—resistors, trimmers, condensers, capacitors, etc., plus stamped out metal chassis. Shipped in chassis form with parts ready to demount as needed. A real bargain surprise pack. No. 130R—7 lbs. **\$1.79** No. 130Y—12 lbs. **\$2.95**

VEEDER-ROOT COUNTERS

Three wheel type—counts to 999 and repeats. Has hundreds of uses. All brand new. A splendid value. Shipping weight 1 lb. **98c**

Please Include Enough Postage On All Orders

ORDER DIRECT FROM THIS AD

Values galore! Hundreds of hard-to-find items for home, shop and outdoors. Make remittances by money-order, bank draft or personal check. Send 25% deposit on C.O.D. orders. No C.O.D.'s on orders for less than \$5.00. Include sufficient postage on parcel-post orders—any overage will be promptly refunded. All quotations F.O.B. Chicago. Used items and materials are guaranteed serviceable and as described. Your money back if not more than satisfied.

NEW CATALOG 10c To Cover Postage and Mailing

STARK'S Dept. PM-653 509 S. State St. CHICAGO 5, ILL.

MEDICAL STERILIZER



Consists of alcohol burner and sterilizing tray in hinged metal case 1 1/2 x 1 1/2 x 2 5/8 inches. Burner may be used separately. Bright nickel finish. All brand new. **69c** A125—Ea.

INVENTORS

Your first step—if you consider your invention to be something of importance—is to have a search made of pertinent, prior U. S. patents. If our search report indicates probable patentability of your invention, you may apply for a patent which gives you the right to exclude others from making, using or selling your invention as claimed for a term of 17 years.

This firm is registered to practice before the U. S. Patent Office and is available to assist in the preparation of the necessary drawings, specification and claims.

Ask for a copy of our instructive booklet "Patent Protection for Inventors" and our convenient "Evidence of Invention" form. No obligation.

VICTOR J. EVANS & Co. *Merlin M. Evans*
REGISTERED PATENT ATTORNEY
830-G MERLIN BUILDING, WASHINGTON 6, D. C.



SHOOT TELEVISION FILMS

FOR YOUR LOCAL TV STATION...make Extra Profits with the "Cine-Voice" Sound-On-Film 16mm Camera. \$695⁰⁰ Write for free information.

BERNDT-BACH, Inc.

7333 Beverly Blvd., Los Angeles 36, Calif.

SOUND-ON-FILM SINCE 1931

FOR YOUR

TECHNICAL AND VOCATIONAL TRAINING

Come to the
UNIVERSITY OF HOUSTON

One of America's large and most modern universities. Select from these fascinating fields: aeronautics air conditioning & refrigeration auto body and paint auto mechanics auto upholstery & trim diesel drafting electricity electronics machine shop photography radio stationary engineering television welding woodworking furniture upholstery.

PREPARE FOR YOUR FUTURE NOW . . . with very latest methods and equipment, at modern U. of Houston College of Technology. Entrance: high school diploma, or over 18 and ability to profit from instruction. Beautiful campus—250 wooded acres in Houston, Texas—city of tomorrow. Full college activities, sports, social life. Day or night, short or longer courses. Co-op work-study programs . . . earn part of tuition and expenses with part-time job in your own career field, while you learn. Personal vocational counselling. Diploma on completion and all credits apply towards Bachelor of Applied Science Degree. Job placement assistance. Feb., June, Sept. semesters. Mail ad now for Free fully-illustrated brochure. No obligation. Mark X before choice of subject. **Do it today!**



ADMINISTRATION BUILDING

University of Houston, College of Technology
Dept. 163 — HOUSTON 4, TEXAS

INVENTORS

IF YOU WISH TO PROTECT YOUR INVENTION, You should take steps to protect it by a U. S. Patent. Write me for "INVENTION RECORD" form

CARL MILLER
REGISTERED PATENT ATTORNEY

WOOLWORTH BLDG., 35th FLOOR, 63A
NEW YORK CITY

PATENTS

C. A. SNOW & CO.

REGISTERED PATENT ATTORNEYS
WRITE FOR INFORMATION TO
428 SNOW BUILDING, WASHINGTON 1, D. C.

INVENTORS

Whether an invention is patentable can be substantially determined by a search of the U. S. Patent records. Without obligation, write for information explaining the steps you should take to secure a patent.

JOHN N. RANDOLPH

Registered Patent Attorney

201 Columbian Building, Washington 1, D. C.

HELPFUL BOOKS

Send post card asking for FREE catalog

Popular Mechanics Press, 200 E. Ontario, Dept. 601, Chicago 11

INVENTORS

Send for
PATENT INFORMATION
Book and

INVENTOR'S RECORD
without obligation

GUSTAVE MILLER
63-PM WARNER BUILDING
WASHINGTON 4, D. C.

REGISTERED PATENT
ATTORNEY

Patent Attorney & Advisor
U. S. NAVY DEPT. 1930-1947

ASSOCIATE EXAMINER
U. S. PAT. OFF. 1922-1929
PATENT LAWYER

CASH-IN-ON-YOUR-IDEAS

Get step by step helpful instructions before you go to expense and patents. "The Inventors Guide" tells how to develop, protect, make money from your inventions. We receive inquiries from manufacturers interested in inventions for new products. Send only \$1.00 for your guide, includes list of needed products, "Record of Invention" form.

INVENTORS CREATIVE SERVICE
Dept. PM, 354 South Spring St., L.A. 13, Calif.

INVENTORS

I shall be pleased to furnish you, upon request, with full information relative to patent procedure—without any obligation on your part.

PATRICK D. BEAVERS

Registered Patent Attorney

934 Columbian Building Washington 1, D. C.



FULLY GUARANTEED TIRES COST LESS!

Nationally famous FIRESTONE, GOODRICH, U. S. ROYAL, GOODYEAR, and other makes. Every tire selected and inspected for your safety.

FREE TUBE WITH PASSENGER TIRE NEW TREAD TIRES GUAR. 24 MO.

(MUD & SNOW or WHITE WALL TIRES \$1 EXTRA)	
550x16 7.98	600x16(6) 9.98
550x17 7.98	650x15 9.98
600x15 7.98	650x16 10.48
600x16 7.98	650x16(6) 12.48
650x20(8) 19.95	700x16(6) 14.48
640x15 8.98	710x15 10.48
670x15 9.98	760x15 11.48
700x15 11.48	820x15 12.98

AAA PREMIUM GRADE GUARANTEED 18 MONTHS

550x16 5.48	700x15 5.98	760x15 5.58	750x20(10) 14.98
600x16 5.28	700x16 6.78	550x17 5.48	825x20 18.68
600x16(6) 6.58	700x16(6) 7.98	600x20 9.78	900x20 18.98
640x15 5.68	750x16(6) 8.98	650x20 10.88	1000x20 19.98
650x16 5.78	800x15 6.88	700x20 12.88	1000x22 21.98
650x16(6) 6.98	820x15 7.48	32x6(8) 8.84	825x20 14.24
650x15 5.98	710x15 6.09	32x6(10) 10.84	900x20 13.34
670x15 6.18	550x18 5.98	750x20(8) 8.54	1000x20 14.14
		750x20(10) 9.94	1100x20 16.14

GOOD TIRES GUARANTEED 12 MONTHS

600x16 4.14	700x15 5.14	32x6(8) 8.84	825x20 14.24
650x16 4.54	670x15 4.74	32x6(10) 10.84	900x20 13.34
650x15 4.34	650x20 7.84	750x20(8) 8.54	1000x20 14.14
700x15 4.64	700x20(8) 8.94	750x20(10) 9.94	1100x20 16.14

MILITARY SPECIAL AA Guaranteed 12 Months—

900x16 10.69	1000x20 19.98	600x16 8.98
750x20 10.98	1100x20 21.98	600x16(6) 9.98
AAA GUARANTEED 18 MONTHS		700x15(6) 15.95
900x16 14.95	750x20 16.48	750x20(8) 24.98

Largest stock of used tires in the East. Thousands of satisfied customers. Write for Free Catalogue. MONEY ORDER OR CHECK WITH ORDER. NO C.O.D.'s

PYRAMID TIRE CO.
1333-35 North 5th St.
Dept. M., Phila. 22, Pa.

RUPTURED?

Get Relief This Proven Way

Why try to worry along with trusses that gouge your flesh—press heavily on hips and spine—enlarge opening—fail to hold rupture? You need the Cluthe. No leg-straps or cutting belts. Automatic adjustable pad holds at real opening—follows every body movement with instant increased support in case of strain. Cannot slip whether at work or play. Light. Waterproof. Can be worn in bath. Send for amazing FREE book, "Advice To Ruptured" and details of liberal truthful 60-day trial offer. Also endorsements from grateful users in your neighborhood. Write:

CLUTHE SONS, Dept. 31, Bloomfield, New Jersey.

CARTOONING

HAVE FUN! MAKE MONEY! Cash in on your sense of humor AT HOME—BY MAIL! No experience needed to start. Write today FOR FREE TRIAL LESSON and full particulars. Moon Gag Cartoon School, Dept. L, Fall Creek, Wis.

New SCREW DRIVER Power!

Patented LEVERAGE CROSS BAR feature gives TURN-TITE Screw Drivers extra leverage power, positive control and accurate aim. It makes tough jobs easy. Can be used as screw driver or chisel. One complete unit, precision made with solid aluminum handle, heat treated and ground nickel-plated blade. Used by the Marine and Aircraft industries. Order yours today! INTRODUCTORY OFFER \$1.00 ppd. Money back guar. Dealer inquiries invited.

CALIFORNIA MARINAS CO.
742 SO. HILL ST. LOS ANGELES 14, CALIF., DEPT. PM

AQUA-LUNGS FROGMEN SUITS SPEAR GUNS

Self-Contained Diving—A comprehensive diving digest reviewing various types of equipment and a thorough study of underwater pressure and its effects. Includes a decompression table showing how much time can be safely spent at various depths. Send now 60c in coin to receive this 95c booklet. Diving Gear—A 16 page beautifully illustrated catalogue showing the latest available foreign and domestic diving equipment: frogman suits, masks, spear guns, snorkel tubes, swim fins and "Aqua-Lungs." Send only 15c in coin. SEND FOR THESE VALUABLE BOOKLETS TODAY U. S. DIVERS CO., 1045 Broxton Ave., W. Los Angeles 24, Cal.

BIG VALUES from ALLIED'S TV-RADIO CATALOG & SUPPLEMENT



FREE! SEND FOR BOTH!



KNIGHT PORTABLE RADIO KIT

Build this powerful 3-way super-het portable for AC, DC or battery operation. Tunes 535-1650 kc broadcast band; has built-in antenna, PM speaker, handsome carrying case. Easy to assemble from illustrated manual. High-quality kit includes all parts, tubes and case (less batteries). Shpg. wt., 6 lbs.

83-730. Only.....\$18.75
Battery Kit.....\$ 3.64

PHILMORE RADIO CONTROL KIT

Build your own remote-control transmitter and receiver! Operates model airplanes, boats, autos, etc. Crystal-controlled transmitter for 27.255 mc. (requires easily obtained FCC operating permit). High-gain receiver. Easy to build. Complete with all parts, antenna, crystal and cabinet; less batteries.

83-034. Only.....\$41.47
Complete Set of Batteries....\$ 7.15

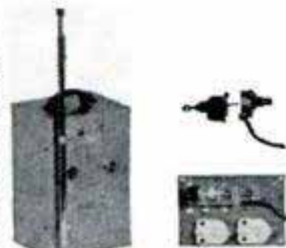

BARGAIN TV BOOSTER

Precision designed printed-circuit TV booster—at less than half original price. Gives uniform gain on all 12 VHF TV channels. Easy to tune—improves reception. For 110-120 v., 60 cy. AC. 4 lbs. 97-233. While they last, only.....\$9.95



WELLER SOLDERING GUNS

Squeeze the trigger—you solder in 5 seconds! Latest heavy-duty instant-heat gun; with 2 spotlights that light up working area. Air-cooled transformer. 3½ lbs. 46-642. 250 watts, single-heat, only. \$ 9.75 46-641. 200-275 w., dual-heat, only. \$11.71



MICRO-VOX WIRELESS MICROPHONE

Mike with built-in midget radio transmitter plays magically (without wires) through any radio within 50 feet. Easy to use for home entertainment or as small P.A. system. Provides endless amusement. Complete with built-in batteries and instructions. 3 lbs. 99-485. Only.....\$6.50



ALLIED RADIO

FREE Catalogs

ALLIED RADIO CORP., Dept. 5-F-3
833 W. Jackson Blvd., Chicago 7, Ill.

Send FREE Catalog and Supplement

Enter order for \$_____ enclosed.

Name _____

Address _____

City _____ Zone _____ State _____

LURE, TRAP, KILL

Nasty FLIES
By the Gallon

BIG STINKY

Outdoor

FLY TRAPS

BIG STINKY complete with gal.
jar and Control Fluid - - \$4.95
Same with 1/2 gal. jar - - \$4.49

Here's how it works...

You supply a small amount of raw meat or raw fish for starting only. Control Fluid included with Trap, plus water, on the bait produces a gas generation that attracts a few flies. These are digested producing a potent scent that will attract flies by the gallon. Operation of Trap becomes regenerative — the Trap literally feeds on flies themselves.

With Big Stinky Outdoor Fly Traps you'll catch thousands of vicious flies this summer before they get in buildings, and the escape-proof design of the top keeps flies in. Be sure you have this modern aid to fly control for the summer ahead.



LITTLE STINKY

Trap less jar with Control Powder - - \$2.95

and **WEE STINKY**
Slightly smaller trap with Control Powder - \$1.69



at **Leading Dealers**
Everywhere

Manufactured by: DIOPTRON CO • Milwaukee



BRAND NEW!
Firestone TIRES

SAVE UP TO 50%

BRAND NEW FIRST LINE
HEAVY DUTY
TRUCK TIRES
FIRST QUALITY
FIRESTONE CHAMPION

Delivery Size	Full Price
700x15 8 ply	\$24.04
700x15 6 ply	26.22
600x16 6 ply	16.01

Send For Free Catalog

650x16 6 ply	\$19.56	750x20 10 ply	\$47.12
700x17 6 ply	29.21	825x20 10 ply	55.92
700x18 8 ply	33.65	825x20 12 ply	66.34
600x20 6 ply	23.23	900x20 10 ply	67.39
600x20 8 ply	25.44	900x20 12 ply	78.35
650x20 6 ply	25.94	1000x20 12 ply	85.31
650x20 8 ply	31.47	1100x20 12 ply	100.06
700x20 8 ply	34.30	1000x22 12 ply	89.85
700x20 10 ply	39.71	1100x22 12 ply	105.79
750x20 8 ply	43.14	1100x24 12 ply	109.99

WHITE WALL TIRES — BRAND NEW —
(Factory Blemish) First Line, 4 ply Passenger
Special! Special!

670x15	\$15.65	760x15	\$18.95
710x15	17.32	800x15	20.92

BRAND NEW
FIRST QUALITY
FIRESTONE TIRES

640x15	\$12.11
650x15	14.62
670x15	12.82
710x15	14.17
760x15	15.49
600x16	11.40
650x16	15.09

(all prices f.o.b. plant)

All tires covered by Famous Firestone Unconditional Guarantee

S & S TIRE CO. 1400 HADDON AVE.
CAMDEN 3, N. J.

BREED TROPICAL FISH
RARE FOR PROFIT! ... AT HOME!

HELP US FILL HUGE DEMAND... Wonderful \$\$\$\$ Opportunity. No experience. No expensive equipment needed. **SOME SELL FOR \$75 PAIR AND MORE!** Fascinating! Beautiful! Entertaining! We supply everything. Make Big Money spare-time at home.

FREE! HOME-BUSINESS PLAN, Illustrated Folder, all DETAILS
Write: **TROPICAL FISH BREEDERS OF AMERICA**
Dept. D6, Los Angeles 15, California
Give your age and, IF HOBBYIST list your equipment if any.

ENGINEERING DEGREE IN 27 MONTHS

INDIANA TECHNICAL COLLEGE

B. S. DEGREE, Aeronautical, Chemical, Civil, Electrical, Mechanical and Radio Engineering (inc. TV and Electronics). Drafting, 1-yr. G.I. Gov't approved. Low rate. Earn board. Large industrial center. Students from 48 states, 21 countries. Demand for graduates. Enter June, September, December, March. Write for catalog, 1663 E. Washington Boulevard, Fort Wayne 2, Indiana.

\$750 BUILDS 4 ROOMS & BATH!

WHY PAY RENT? For Seven Hundred Fifty Dollars and 30 days of your spare time, you can build yourself this Beautiful Home.



Living Room 11x15, Front bedroom 9x11, Back bedroom 10x12, Kitchen 9x11, Bath 5x8, Hall 3x4. Wind out steel casement windows, Concrete block, stuccoed. Step-by-step illustrated instructions, blueprint and material list \$1.00 ppd. No COD. Moneyback guarantee. Farrow Economy Home, Dept. C, Box 645, Columbus 16, Ohio

High Power BINOCULARS

FREE 14-PAGE BOOK & CHART

Know the facts! Learn meaning of Power, Field, Coating. Latest data. 33 Models sold on



\$9.95 UP

30 DAY FREE TRIAL



BUSHNELL'S, 666 Bushnell Bldg., Pasadena, Calif.

Say You Saw It in Popular Mechanics

Learn **PHOTOGRAPHY** at Home

Splendid opportunities. Prepare in spare time. Practical basic training. Long-established school. Send for free book, "Opportunities in Photography." No obligation. AMERICAN SCHOOL OF PHOTOGRAPHY, 835 Diversy Pkwy., Dept. 135A, Chicago 14, Ill.

NEW INVENTION **REPLATES** by **ELECTROPLATING** RESTORES HOME, AUTO METALS **CHROME-SILVER-GOLD!**

BRILLIANT NEW METAL LIFE — NEW BEAUTY WITH JUST 1 PLATING!

SILVER-CHROME-GOLD



REPLATED, Quickly, Easily
Now—with an amazing new invention, **APPL-I-COTER**, you plate hundreds of items, using the mild, safe current of 2 flashlight batteries in its handle. **ALL YOU DO** is simply attach clamp to item—dip brush into solution—press button on **APPL-I-COTER**—then coat.

RESTORES METALS LIKE NEW
Replates Silver, Chrome, Nickel, Steel, Gold and Brass—all worn Spots, Stains, "Blisters." Silverware, Trays, Teapots, Rims of Holloware and other items can look like new again with this exclusive Electroplating process. Restore all your valuable Gold jewelry with amazing **APPL-I-COTER**. The plating you apply becomes an indestructible part of the metal itself!



QUICKLY BUILDS-UP A THICK NEW PLATING WITH EACH APPLICATION.



COMPLETE SETS WITH APPLICATOR
MET-L-COTE or SILV-R-COTE with Applicator — **\$3.75**
COMBINATION SET
Both **MET-L-COTE and SILV-R-COTE** with Applicator — **\$5.95**
GOLD-COTE with Special Gold Brush Applicator — **\$5.95**



BRILLIANT AUTO TRIM — You'll be mighty proud of the Dazzling new finish on your car's bumpers and trim after replating with **MET-L-COTE**. And remember, each time you electroplate with the **APPL-I-COTER**, you build up a lasting layer of coating that tremendously lengthens the life of original trim.

MET-L-COTE is constantly used in leading hospitals, and in doctors and dentists offices to Replate surgical instruments—Also in hotels and restaurants to **RESTORE** cutlery.

CASH REFUND IF NOT COMPLETELY SATISFIED

EMPIRE MERCHANDISING CO., Dept. J-6
63 Central Ave., Ossining, N. Y.
Please rush the New Pocket Applicator and replating solutions I have checked below. I enclose full price, send postpaid, or send C.O.D. plus postage.

MET-L-COTE — \$3.75 **SILV-R-COTE** — \$3.75
 Combination MET-L-COTE & SILV-R-COTE — \$5.95
 GOLD-COTE with Gold Applicator — \$5.95

NAME.....
ADDRESS.....
CITY..... STATE.....



A THICKER PLATING WITH EACH COAT!

MET-L-COTE—Replates, Restores **CHROME, NICKEL, BRASS, COPPER, STEEL, IRON or BRONZE.**
SILV-R-COTE—Replates, Restores **SILVER.**
GOLD-COTE—Pure 24 Karat **GOLD** Solution. Restores original luster to worn or tarnished valuable Gold jewelry and other Gold items.

HERE'S HOW EASY IT IS TO REPLATE WITH THE APPL-I-COTER

RESTORE YOUR TREASURES... MAKE THEM VALUABLE AGAIN

MAKE BIG MONEY at HOME!

BEFORE **INVISIBLE REWEAVING** **AFTER**

Pays Up to \$10 an Hour at Home!
Here's financial security for life! Be **THE** expert **INVISIBLE REWEAVER** in your community. Make cuts, burns, tears, rips in dresses, coats, suits, **DISAPPEAR!** Do it at home—in spare time. Big demand from tailors, cleaners, laundries, homes—and reweavers are scarce!

Anyone can learn with complete, professional home study course! Write for **FREE DETAILS!**
FABRICON CO., Dept. 326, 8342 S. Prairie Ave., Chicago 19, Ill.

FREE
Big, complete **FRENCH INVISIBLE REWEAVING** Course, yours **FREE** while you learn the **FABRICON METHOD.** It's a \$75 value—write today!

MAKE \$5 PER HOUR WITHOUT A PRINTING PRESS

PRINTING **REVOLUTIONARY NEW SCREEN METHOD**

FREE complete "BIG MONEY" Plan and SAMPLE!

PRINT colorful signs, posters, banners, fabrics, wall paper, show cards—**ANYTHING!** Print on any surface. **NO** printing press or special equipment is needed with this amazing "approved" new printing secret. **300% profit** on nearly every job. Easy to learn —**NO EXPERIENCE** or art ability necessary. Exceptional opportunity. Complete illustrated detailed plan and colorful sample **FREE**—Write.

EARN AT HOME SPARE or FULL Time

SCREEN-PRINT COMPANY, Dept. 211
1010 So. Los Angeles St., Los Angeles 15, Calif

CAPABLE YOUNG MEN prepare now for a ...

SECURE and SATISFYING CAREER in the HIGH-PAYING AUTOMOTIVE SERVICE BUSINESS

You don't need experience—let Sun's 12 week course in MODERN AUTOMOTIVE SERVICE open the door to a bright, successful future.

Even if you lack experience, **SUN**, the world's largest manufacturer of scientific automotive test equipment, can help you make a successful start in automotive service. A critical need for trained men means unlimited opportunities for alert, high caliber young men to earn big incomes in this fast-growing field. **Not** a correspondence course, **not** merely "another course in mechanics"—but a practical, well-rounded resident school, focusing attention on scientific testing—the only way to avoid guess-work in servicing cars. Quickly get an over-all, bird's-eye picture of modern service procedures. Learn the basic operating principles of the entire automotive vehicle and how to service it scientifically. In just 12 weeks build a firm foundation for future advancement. Recommended by leading car and truck manufacturers and approved for GIs.

Sun Electric Corporation, Dept. PM-2
6323 Avondale Ave., Chicago 31, Illinois
Please send free details on **MODERN AUTOMOTIVE SERVICE** course.

NAME.....
ADDRESS.....
CITY..... ZONE..... STATE.....

Classes scheduled in ... Detroit Technical Training Center

SEND FOR FREE BROCHURE . . . ALL DETAILS . . . NO OBLIGATION

to make boring jobs easier

ask for **IRWIN** auger bits

Irwin—the original solid center auger bit. Precision made of special bit steel. Hardened and tempered full length to stay sharp. Cuts fast, clean, accurate holes in any wood. Sold by independent hardware dealers only. Ask for the best—ask for Irwin auger bits.



Irwin Bit Sets—hardwood box, or plastic rolls. 6, 10, or 13 bit assortments. Sizes 1/4" to 1". An ideal gift for the handyman.



IRWIN
62T Solid Center Auger Bit—sizes 1/4" to 1 1/2". Double-cutter type. No clogging, no binding, no chewed edges.



IRWIN
Expansive Bits—two types, small and large sizes. Boring range 5/8" to 3". Drop forged, accurate, easily adjusted. Two cutters with each bit. An excellent all-purpose wood-boring tool.

IRWIN wood boring tools
the original solid center auger bit screw drivers • screw driver bits

FREE BOOKLET tells how to select, use, care for wood auger bits. Mail name and address on postcard to Irwin, Dept. 10, Wilmington, Ohio, for your copy.

FREE AVIATION BOOK...

You can cash in on America's fast-expanding industry—AVIATION. SPARTAN has trained thousands for well-paid jobs. You can qualify in a remarkably short time for employment with an airline, manufacturer of planes or aviation equipment. SPARTAN has calls for more graduates than are available. If you have ability, ambition and the necessary training, there is no limit to the success you can achieve.

Investigate the many opportunities and training required. Write for FREE BOOK

SPARTAN
SCHOOL OF AERONAUTICS
TULSA, OKLAHOMA

MAIL COUPON TODAY

Spartan School of Aeronautics
Tulsa, Oklahoma Dept. PM-63
Please send me complete information on: Course _____
Name _____ Age _____
Street _____
City _____ State _____



LEARN to PAINT SIGNS & SHOW CARDS



Men, Women: Big Opportunities COAST TO COAST. No Experience Necessary. Earn \$15 to \$50 a Day!

Regardless of conditions, age, sex, or physical limitations, IF YOU CAN USE YOUR HANDS you can fit yourself for this LIFETIME PROFESSION by following our unique method of teaching you HAND LETTERING in your spare time, AT HOME! Never before has Hand-Lettering been taught by such an efficient, easy-to-follow method. You can learn in remarkably short time to letter Show Cards, Posters, Signs on Trucks, Doors, Windows, Walls, etc. The uses of Hand-Lettering are endless. BE YOUR OWN BOSS—put your future in your own hands! When you can letter PROFESSIONALLY—you can travel around, make a living in almost any town, live in about any climate you like. EARN WHILE YOU LEARN! Our unique Course, designed by Mrs. Roulier, nationally noted Lettering Man, teaches you to letter professionally in about one-fifth of the time ordinarily required. When you have mastered only the second lesson you will be able to SELL YOUR WORK—make EXTRA CASH in your spare time. We tell you how! DEMAND FOR TRAINED SIGN WRITERS NEVER WAS SO GREAT—and is INCREASING. Jobs at high wages are constantly available in Sign Shops, Outdoor Advertising Plants, Dept. Store Advertising Depts., etc. Get ahead FAST. Start YOUR Training NOW!

FREE This illustrated book tells you all about opportunities in the Sign Painting field—how others have cashed in on them—how you can, too. Write today for YOUR copy of: "Lettering For A Living." A postcard will do. State your age.



UNITED SCHOOL OF LETTERING
DEPARTMENT K 941 BANNOCK ST. DENVER 4, COLO.

Learn ACCOUNTING Business Administration

Bookkeeping, secretarial and allied subjects at home in your spare time or attend nationally approved resident school. Write for FREE Success Book giving complete information about courses, plans, rates and employment opportunities.

Hills BUSINESS UNIVERSITY AND EXTENSION SCHOOL
629 W. MAIN ST. OKLAHOMA CITY 2, OKLAHOMA

Become a Doctor of PSYCHOLOGY

Win the degree of Ps.D. Learn the secret of contentment, happiness. Solve mental worries. Experience the revelation of truth. Chartered college. Individual help. Write for FREE book. COLLEGE OF UNIVERSAL TRUTH, 5038-B Broadway, Chicago.

NOW LEARN TV-RADIO Servicing AT HOME!

EARN WHILE YOU LEARN! No previous training needed. New, simplified lessons with complete parts kits. Build your own TV set! A leading school, approved for Korean vets. Also Residential Course (day & eve. classes). Send for FREE sample lessons and full details on a profitable, thrilling career. Write Dept. B6

CRESCENT SCHOOL
500 PACIFIC ST. BROOKLYN 17, N. Y.

HELPFUL BOOKS

Send post card asking for FREE catalog
Popular Mechanics Press, 200 E. Ontario, Dept. 601, Chicago 11

Ball-Bearing SPEED WHEELS

JUVENILE WHEELS (No bearing, solid tires)	
5"	45c
6"	65c
7"	75c
(Semi-pneumatic tire, ball bearing)	
8x1.25	\$1.85
8x1.75	1.95
8x2	2.20
10x1.25	\$2.20
10x1.75	2.30
10x2	2.65
12x1.75	3.45
INDUSTRIAL WHEELS	
Lug Base, Semi-Pneumatic tire	
6x2 SW	\$3.45
6x2.00	4.00
8x2.00	5.20
8x2.50	5.40
10x2.00	\$6.10
10x2.75	5.15
12x2.00	6.90
12x3.00	9.20
16x4.00	15.15
Smooth Base, Pneumatic tire and tube	
8x3.00	\$11.00
10x2.75	6.80
10x3.50	10.55
12x4.00	\$12.10
14x4.50	13.40

Available Now — CASTERS
Write for circulars on all wheels.
No c.o.d. orders. Prices F.O.B. our plant.
JIM BROWN TOY COMPANY
1095 HOME AVENUE PM-653 AKRON 10, OHIO

Get More out of Your Hobby...with Your Camera

TAKE ADVANTAGE OF THIS

GET-ACQUAINTED OFFER

This attractive Hardwood File for your 2x2 slides

YOURS as a GIFT

with your one-year subscription to
PHOTOGRAPHY
MAGAZINE

The Most Important Magazine of its Kind in the Whole World!



Thousands of Saturday carpenters, week-end mechanics, experimenters, and hobbyists are also camera users, and regular readers of Photography Magazine, the world's greatest magazine devoted exclusively to photography. Month in and month out they enjoy exciting pictures, helpful how-to-do-it articles, picture-taking hints, new technique and new product reports, and a thousand other features covered by this most fascinating magazine. It's a 'natural'... because reading Photography Magazine gives them not only more use and fun out of their cameras, but extra satisfaction out of their activities as well.

A VALUABLE GIFT FOR YOU!

We want you to find out for yourself why so many of your fellow hobbyists subscribe to and read Photography Magazine. And so, as a special introductory offer, we give you a handsome Hardwood File for your 2x2 color slides, absolutely FREE. It holds approximately 180 slides in ready mounts or 90 mounted in glass. It is beautifully finished and will keep your slides safe and clean for many years. (It also makes a swell chest for small parts; machine screws, taps, dies, etc.)

LOOK WHAT THIS OFFER MEANS TO YOU!

- You will enjoy seeing and studying the most wonderful pictures of our times with 'how-it-was done' explained by foremost experts.
- You will read articles of travel, adventure, science, business, sports, etc., in terms of men who take pictures.
- You will learn from the experiences of the world's greatest photographers... the Bourke-Whites, the Westons, the Steichens, the Stackpoles, and dozens of others.
- You will profit tremendously from the helpful hints, the 'how-to-do-it' articles and all the other information which finds its way into the many pages of Photography Magazine.
- You will avoid picture failures. You will learn how to make every exposure, every roll of film count. You will learn how to put your camera to real use—in your business, in your profession and in your hobby.

... and REMEMBER

As part of your subscription, you will also receive the MAMMOTH DIRECTORY ISSUE and Famous CHRISTMAS ISSUE, each of which regularly sells for 50¢.

Get your Subscription Now... and remember also, that a Photography Magazine Subscription is an ideal and exciting gift.

PHOTOGRAPHY is The Hobbyist's Magazine

Every issue has something for the build-it enthusiast—for the man, the woman, and for the boys and girls too. If you own a still camera, a movie camera, a stereo camera—any kind of camera—or if you plan to buy one, Photography Magazine belongs in your home. It will give your hobby a new outlet and a new value.

The regular newsstand price is \$4.50 per year. The regular one-year (12-issue) subscription price is \$4.00. During this Introductory Offer we will give you the one-year (12-issue) subscription PLUS a valuable Hardwood Slide File, at no extra charge, and at the regular subscription price of \$4.00. Send in your subscription NOW... while the supply of these fine files holds out.

PHOTOGRAPHY MAGAZINE, Dept. PM-63
366 Madison Avenue, New York 17, N. Y.

I like your "Get-Acquainted" Offer. Enclosed is \$4.00.

Check Money Order

Please send the next 12 issues of Photography Magazine including the Mammoth Directory and Christmas Issues to:

Name.....

Address.....

City..... Zone..... State.....

I understand that you will send me, immediately, the Hardwood Slide File described in this offer.

MAIL THIS COUPON NOW!

Capra Gems

more dazzling than diamonds

Free Booklet Shows
How You
Can Own
A CAPRA GEM
For 1/30 The Cost
Of A Diamond!



Get full facts, FREE, on the most amazing discovery by modern science—CAPRA GEMS. A miracle of science described in recent issues of *Saturday Evening Post* and *Reader's Digest*. They're more dazzling than diamonds, yet cost much less. CAPRA GEMS' refractive quality is actually higher than diamonds! Brilliantly beautiful, dazzling CAPRA GEMS are hand cut, hand polished and hand selected . . . priced within the reach of all who love fine gems. A 1-carat diamond stone costs you approximately \$1000. A comparable choice selected, 1-carat CAPRA GEM is yours for \$24, federal tax included . . . and can be bought in small easy payments.

GET THE FACTS NOW

Valuable illustrated booklet shows a wide selection of men's and women's rings. Gives full details, including prices and settings . . . shows all CAPRA GEMS actual size. Limited supply, so send today without delay. No charge, no obligation. Get all the facts on CAPRA GEMS . . . more dazzling than diamonds.

SEND NO MONEY

CAPRA GEMS, INC., Dept. PM 62, Philadelphia 41, Pa.
Without Cost or obligation, send me your FREE booklet containing complete information on CAPRA GEMS.

NAME _____
ADDRESS _____
CITY _____ ZONE _____ STATE _____

Hand Guide!

POSITIVELY controls movement of hand until one's Penmanship is quickly corrected. Inexpensive. Write,

OZMENT (INVENTOR), 34-P, ST. LOUIS, MO. (BX665)

UNLIMITED OPPORTUNITIES IN ENGINEERING

DEGREE
IN 27 MONTHS

Study Engineering in this world-famed school. Established 1884. Demand for our graduates exceeds supply. Approved for Korean Vets.

Bachelor of Science Degree in Mechanical, Civil, Electrical, Chemical, Aeronautical, Radio (Television) Engineering; Business Administration and Accounting. Also 36-weeks certificate courses in Surveying and Drafting.

Personalized Instruction. Accelerated courses. Non-essentials eliminated. For ambitious, earnest students. Earn your degree in the shortest possible time. Preparatory courses. Placement service.

Extensive Campus. Well equipped, new and modernized buildings; up-to-date labs. Low cost. New terms start quarterly. Enter June, September, January, March.

Mail Coupon Today

TRI-STATE COLLEGE

463 College Avenue, Angola, Indiana

Please send me free catalog and special information. I am particularly interested in courses as checked:

- Mechanical Civil Electrical Chemical Aeronautical
 Radio (Television) Business Administration Accounting
 Short Diploma Courses

Name _____
Address _____

Develop Hidden Earning Power

STUDY LAW

at home! LL.B. Degree

Qualify yourself in spare time for advancement, greater earnings, business success. Now, more than ever, legal ability is in demand! Easy-to-understand step-by-step lessons and text material furnished — invaluable for permanent reference. Over 40 years expert instruction. 114,000 students enrolled. Easy payments. Find out now, at no cost, how study of law can help you. Write today for FREE Book "Law and Executive Guidance."

AMERICAN EXTENSION SCHOOL OF LAW

Dept. PM-63, 664 N. Michigan Ave., Chicago, Ill.



GIANT BALLOONS

Genuine Govt. surplus weather, target balloons. For FUN or PROFIT. Great sport in the backyard; or for parties, picnics, dances, fairs, MONEY-MAKERS. Use these balloons to attract crowds to civic events, conventions, exhibitions, trade shows. TERRIFIC for high school and college PROMS. Special purchase makes these low prices possible.

3 ft. dia. 49c—6 ft. dia. 79c—13 ft. dia. \$1.59
20 ft. dia. \$1.95

* Calif. residents please add sales tax.

WAR ASSETS DIV. VOLUME SALES CO.

Dept. M-6-53 3930 Sunset Blvd. Los Angeles 29, Calif.

EASY TO LEARN CODE

Learn to increase speed with an Instructograph — the Radio-Telegraph Code Teacher that takes the place of an operator-instructor and enables anyone to master code without further assistance. Available tapes from beginners alphabet to typical messages on all subjects. Speed range 5 to 40 WPM. Always ready—no QRM. Thousands have "acquired the code" with the Instructograph System. Write today for convenient rental and purchase plans.



INSTRUCTOGRAPH COMPANY

4701-V Sheridan Road, Chicago 40, Illinois

HELPFUL BOOKS

Send post card asking for FREE catalog

Popular Mechanics Press, 200 E. Ontario, Dept. 601, Chicago 11

HULA POPPER • GETS BIG BASS

Surface popping lure. Ideal combination of noise, action, casting and hooking qualities. Pops, plunks, jerks, twitches — obeys your slightest wrist command. Rubber Hula Skirt imitates live bug. At your dealer 5/8 oz. or 1/4 oz., \$1.25. Fly rod size, 75c.



FRED ARBOGAST & Co., Inc., 2256 W. North St., Akron 3, Ohio

FREE WRITE TODAY FOR YOUR BIG FREE ARBOGAST COLOR CATALOG — FULL OF PICTURES OF CATCHES

Get FREE SAMPLE CASE Make UP TO \$15.00 in a Day!



If you want to make more money, full time or spare time, write us today for big valuable Tailoring Sample Case, packed with 150 beautiful, big-value suit and overcoat fabrics. Take orders from friends, fellow-workers, and others for fine quality made-to-measure clothes at low prices. Pocket BIG CASH PROFIT ON EVERY ORDER.

Your Personal Suits Without 1c Cost

When men see the fine fit, quality, and value, THEY ORDER! So we make it easy for you to get your own personal suits, overcoats, without 1c cost. No experience needed. Satisfaction guaranteed. Send no money. For FREE SAMPLE CASE, rush name, address, age—today!

STONE-FIELD CORP., 532 S. Throop Street
DEPT. X-816 CHICAGO 7, ILLINOIS

New Amazing Invention—"Magic Art Reproducer"

DRAW

Anyone Can Draw With This Amazing New Invention—Instantly!



Complete For Only **\$1.98**
De Luxe Model

ANY PERSON IN ONE MINUTE

NO LESSONS! NO TALENT!

You Can Draw Your Family, Friends, Anything From REAL LIFE—Like An Artist Even if You CAN'T DRAW A Straight Line!

Yes, anyone from 5 to 80 can draw or sketch or paint anything now . . . the very first time you use the "Magic Art Reproducer" like a professional artist—no matter how "hopeless" you think you are! Anything you want to draw is automatically seen on any sheet of paper instantly! Then easily and quickly follow the lines of the "picture image" with your pencil . . . and you have an accurate original drawing that anyone would think an artist had done. Also make drawings larger or smaller as you wish. Anyone can use it on any desk, table, board, etc.—indoors or outdoors! No other lessons or practice or talent needed!

HAVE FUN! BE POPULAR! Everyone will ask you to draw them. You'll be in demand! After a short time you may find you can draw well without the "Magic Art Reproducer" because you have developed a "knack" and feeling artists have—which may lead to a good paying art career.

Also Excellent for Every Other Type of Drawing!

- Human Figures • Outdoor Scenes, landscapes, buildings
- Still life, vases, bowls of fruit, lamps, furniture, all objects • Copy photos, other pictures, portraits, etc.
- Copy blueprints, designs, decorations, for woodwork, machines, for needlework, crocheting, knitting • Copy all cartoons.



FREE!

"How to Easily Draw Artists' Models"

This valuable illustrated guide is yours free with order of "Magic Art Reproducer." Packed with pictures showing all the basic poses of artists' models with simple instruction for beginners of art. Includes guidance on anatomy, techniques and figure action.

Create Your Own Designs for All Hobbies! Reproduce on anything.



Outdoor Scenes, landscapes, buildings.



SEND NO MONEY!
Free 10-Day Trial!

Just send name and address. Pay postman on delivery \$1.98 plus postage. Or send only \$1.98 with order and we pay postage. You must be convinced that you can draw anything like an artist, or return merchandise after 10-day trial and your money will be refunded.

NORTON PRODUCTS, Dept. 5806B, 296 Broadway, New York 7, N. Y.



TV Receiver takes up to 21-inch picture tube

VETERANS—CIVILIANS PREPARE FOR NEW JOBS IN

TELEVISION



L. C. Lane, B.S., M.A.
President, RTTA & Pierce Schools

Many New TV Stations to be Built Soon in Every State Earn While You Learn. My modern training prepares you at home in your spare time . . . often within months. You learn the practical easy way by using actual parts and equipment. Many of my students make \$25.00 a week repairing Radio-TV sets in their spare time while learning . . . start their own profitable service business.

GET MORE! LEARN MORE! EARN MORE!

1. MORE EQUIPMENT! You build and keep this **BIG SCREEN TV RECEIVER**, plus Super-Het Radio Receiver, RF Signal Generator, Combination Voltmeter-Ammeter-Ohmmeter, C-W Telephone Receiver, AC-DC Power Supply. Complete with all tubes, including big TV picture tube.

2. NEW YORK ROUND TRIP! Only RTTA gives you a **ROUND TRIP TO NEW YORK CITY** at **NO EXTRA COST!** Yes, from anywhere in the continental U.S. or Canada, I'll pay your way to New York and return after you finish your complete Radio-TV course. Get 2 **FREE** weeks, 50 hours of advanced study at our affiliated **PIERCE SCHOOL** of Radio.

3. FCC LICENSE COACHING COURSE! Prepares you at home for better pay jobs that require an FCC License. Given to all my students at **NO EXTRA COST** after TV Theory and Practice.

4. ADVANCED FM-TV TRAINING! For men with previous Armed Forces or civilian radio experience. Advanced Course comes complete with kits, including **BIG SCREEN TV RECEIVER** and **FREE FCC License Coaching Course**.

VETERANS!

MY SCHOOLS FULLY APPROVED TO TRAIN VETERANS UNDER NEW G.I. BILL! If discharged after June 27, 1950—CHECK COUPON BELOW! Also approved for RESIDENT TRAINING in New York City . . . qualifies you for full subsistence allowance up to \$160 per month.

NO SALESMAN WILL CALL!

Mr. Leonard C. Lane, President
RADIO-TELEVISION TRAINING ASSOCIATION
1629 Broadway, New York 19 Dept. M-6

Dear Mr. Lane: Mail me your New Free Book & Sample Lesson. Show me how I can make Big Money in Television. I understand I am under no obligation.
(PLEASE PRINT PLAINLY)

Name _____ Age _____

Address _____

City _____ Zone _____ State _____

CHECK HERE IF: VETERAN NON-VETERAN

RADIO-TELEVISION TRAINING ASSOCIATION
1629 Broadway, Radio City Station, New York City 19, N. Y.
LICENSED BY THE STATE OF NEW YORK

MAIL COUPON TODAY for FREE Illustrated Book and Sample Lesson

I'LL GIVE YOU... THESE AUTO SEAT COVERS AS A BONUS!

And pay you well besides
if you will show them
and take orders from car
owners in spare time only!

**Just 1 sale
a day can pay
you up to \$16.50
daily in profits!**

It's no trick at all to make extra money day after day when you can offer car owners America's greatest seat cover values... and a choice of patterns, styles and materials that will fit their car such as no one else in your territory could possibly offer! Free Sample Outfit that fits into your pocket... complete with swatches of the gorgeous new materials... will start you taking orders at once. No one can compete with you in wide choice, in quality—and in expert tailoring that makes covers fit like a pair of gloves. And when you quote the low direct prices that are only a fraction of what the customer expects to pay you'll find you can make money hand over fist writing up the fast orders! Line includes nationally advertised sensations like BLACK EBONY Saran, in the new Black and Silver Watermelon Stripe, beautiful beyond description BAMBOO, luxurious, brilliant FIESTA, colorful BULL-FIGHTER PLAIDS, plus many other exclusive patterns to choose from, all at unbelievably low prices. It's no trick at all to make

big money, whether you sell full time or just in spare time. OPPORTUNITY TO SELL AT WHOLESALE TO GARAGES, SERVICE STATIONS, ETC.

\$45.00 SET OF COVERS

For Own Use

GIVEN AS BONUS

GIVE MAKE, YEAR AND MODEL OF YOUR CAR. No experience needed.

KEY PRODUCTS CORP., 800 N. Clark St., Dept. 436, Chicago 10, Ill.

RUSH NAME FOR FREE OUTFIT!

KEY PRODUCTS CORP., Dept. 436

800 N. Clark St., Chicago 10, Ill.

Rush Free Sample Outfit at once.
(If you own a car include the following information):

Make..... Year..... Model.....

Name.....

Address.....

City..... Zone..... State.....



**WORLD'S
BEST
WANT AD
MEDIUM**

CLASSIFIED Advertisements



Advertisements in this section 85 cents per word, each insertion, minimum 10 words, payable in advance.

To be inserted under proper classification, copy must be in our office the 20th of the second month preceding date of issue

F. W. Johnson, Manager, Classified Advertising
Popular Mechanics Magazine, 200 East Ontario Street, Chicago 11, Illinois

YOU'LL PROFIT

By reading and answering the classified ads in this section. Hundreds of opportunities for you to make and save money

AUTOMOBILES. MIDGET CARS

HI-Mileage-Speed equipment from the world's largest supplier. Also dual manifolds, finned heads, electric doors, lowering sets, chrome panels, thousands of items for all cars. 1953 catalog 25c (illustrated literature free). Wholesale to garages. Newhouse Automotive Industries, Los Angeles 22.

HOW To hop up your Ford! Includes V-8's, Model A's, 6's, V-12's, 60's. Clear, concise directions by California Bill, producer of the world's most accurate speed manuals. 128 pages. Satisfaction guaranteed! \$2.00 postpaid. Box 41138, Los Angeles 41, Calif.

MAKE Your own sports car body. Polyester-Fiberglas. Instructions. New catalog 10c. Airmailed 25c. Gem-O'-Lite, Box 6863A, North Hollywood, California.

INTERESTED In antique automobiles? Send for free sample copy. Franson's Motor News, Box 254, Eugene, Oregon.

AUTOMOBILE Literature; old, new and foreign; glossy photos; dealer books; repair manuals; free motor magazines. Contact auto nuts everywhere. Write today; get on free mailing list. Auto Maniacs, Stockbridge, Mich.

"FIBERGLAS Auto Body Construction"—bound book. How to construct models, molds; make moldings. Complete information used by professionals. Comprehensive photographs, sketches, text—by original developer. \$3 postpaid. Post Books, Arcadia 1, California.

OFFENHAUSER Power equipment for Ford, Mercury, Chevrolet, Cadillac. Others soon. Send 25c for 1953 catalog. Offenhauser Equipment Corp., 5054-Y Alhambra Avenue, Los Angeles 32, California.

HYDRA-Matic specialist, any question answered \$1. Diagnosis checklist \$1. Fordomatic too. Box 774, Ramona, Calif.

HOT Rod drawings, six large beautiful lithographs of famous hot rods. Send \$1.00 to Rex Burnett, Dunwoody, Georgia.

BUILD Custom sports car from old model car bodies. Illustrated book gives step by step operation using inexpensive materials and parts. \$2.00 postpaid. Satisfaction guaranteed. Tasope Publishing Co., Aurora, Missouri.

FREE—"Amazing new book"—"Profits From Classified Advertising." Tells how and what to advertise. Be sure to read this book before you invest one cent in advertising. Remember—it's free. Write for your copy now. F. W. Johnson, Classified Adv. Manager, Popular Mechanics Magazine, Room 602, 200 East Ontario Street, Chicago 11, Illinois.

HOW To buy new or used cars; analyze repair orders; check for hidden charges; all in "How to Deal With Your Dealer." Book full of automobile repair, maintenance tips. \$1.00. Exposé, Box 3, Radio City Post Office, New York 19.

AUTO SUPPLIES AND EQUIPMENT

BUMPER Lite strips. Reflects a brilliant red beam. Protects cars, trucks, trailers, bicycles at night. \$1.00 ppd. 36"x1". Rainway Products, 800-B Delaware St., Berkeley, Calif.

ATTENTION! New Model "T" Ford parts. Phil Palker, Unionville, Conn.

DUAL Ignition points for Fords, Mercurys, Chevrolets. Du-L-Spark Adapter Plates quickest, easiest method without removing distributor from car. Adjustable for average driving up to full-race. Hotter spark at high speeds, smoother take-off zip. One set always clean; if one set fails booster points take over. Send \$1.50 for Ford, Mercury; \$2.00 for Chevrolet Du-L-Spark Adapter Plate kit to Hove Engineering Company, 1503 Hennepin Avenue, Minneapolis 3, Minnesota. Money back guarantee.

OPEN Garage doors (overhead sectional) automatically. Press button from car—door opens, closes automatically. Make it yourself. Low cost. Simple parts. Complete plan \$1.00. D. W. Engineering, Box 473, Syosset, N. Y.

SAVE—California custom accessories headquarters. Buy direct from original designers. Electric push button door-trunk conversions, bull noses, custom grilles, speed dress-up equipment. 40 page catalog, hundreds of photos. Send 25c to Eastern Auto, 3319A South Grand, Los Angeles 7, Calif.

THOUSANDS Of readers have asked for it! Here is Build Your Own Garage, \$3.50, by Wayne C. Lecky. The amateur, without any previous building experience, can choose from 25 different designs and build an attractive, sturdy garage. Step-by-step instructions, photographs, drawings and diagrams. 128 pages of complete and detailed instructions. Order now from Popular Mechanics Press, 200 E. Ontario, Chicago 11, Ill.

LIST 1000 Auto shops \$5.00. Schroeder, 757 Delta, Cincinnati 26, Ohio.

AUTO Radios at wholesale. Standard brands. List 10c refundable. Regent, 801 West Erie, Philadelphia.

AUTOMATIC Key case snaps key from ignition when turned off. Guaranteed. 50c. Keymatic, Mason, Michigan.

LUBRIWICK Safety wheel pack. Autos \$1.50, trucks \$11.04, per set two wheels. No c.o.d. Douglass Products Co., 2410 Auburn Blvd., Sacramento 21, Calif.

AUTOMOBILE Chrome durably cleaned. Fran-o-lene, pint \$1.00. Fanoll Co., 6708 Parnell Avenue, Chicago 21, Ill.

LACHAPPELLE'S Treatment. (Patented.) For a better motor for \$3.00. It puts bearings on the cylinder walls for the pistons to slide on. Write, Ferns Products, 8120-B Walnut Dr., Los Angeles 1, Calif., for free information.

CHANGE Oil yourself on your car, truck, tractor or boat. Save up to \$1.25 per change. Clean and fast with our vacuum-operating economy oil changer. Complete unit \$6.95 postpaid. Details free. Bender Company, 7964-A South Chicago Avenue, Chicago 17, Illinois.

GRIFFIN-Ize liquid car wax local franchises available. Sample 25c. John J. Griffin Company, 7934 Bustleton Avenue, Philadelphia 15, Penna.

CHEVROLET Owners; complete soup up kit, under \$100. Write Wellsandt Speed Supplies, De Sart, North Dakota.

NOW You can tell other drivers what you think with hand signs held out car window. "Thanks," "Quiet," "Real Cool," man thumbing nose, all four \$1.00 postpaid. Be first in your area. Fun at parties too. Fansigns, 210 Murphy Bldg., Detroit 26, Mich.

GENUINE Motor treatment, Lachapelle's. (Three United States patents.) Restores older motors. Restores compression, power. Saves gas, oil. Keeps new motor new. Only \$3.00 delivered. Money back guarantee. No tool required. Free circular write Joe Dillon, Authorized Warehouse and Agents Distributor, Box 323-H, Bridgeport, Ohio. Distributors and agents wanted. Exclusive territory. Beware of imitations.

CAR Burning oil? Losing compression? Try Clifford's Compression Seal. \$2 postpaid. Clifford's Engineering, 1329 Seventh, Aurora, Illinois.

BRAKES, Linings for most cars and trucks. Write for prices. Hudco Brake Service, Box 37, Elmira, N. Y.

MAKE \$12.50 Each sale selling new invention. Saves gas, oil: Filters cooling system. Cleans carbon and gives more power. Free information. Jos. Dunningan, 401 S. Central Ave., Baltimore 2, Md.

CLEAN A spark plug, one minute. Quick, easy method. Amazing results. Instructions, \$1.00. Clean-A-Plug, Box 92-P, Kalamazoo, Michigan.

CUSTOM Radios for 1952 and 1953 Fords \$44.50 postpaid. Write for literature. Nordic Radio Company, Box 582, Evanston, Illinois.

"COMPRESSION-Riser" head gaskets. Increases compression, power, mileage! Copper "thins," all cars, \$5.95-\$8.95. Information free. (Speed equipment catalog 25c.) Alquist Engineering, Milford 6P, Pennsylvania.

MOTORIST Save gasoline by Vacuumating overrich mixtures. Fits all cars. For free particulars write Vacuumatic, Dept. 2017, Wauwatosa, Wis.

CUSHMAN Wizard speed camshafts. \$6.50 exchange. Weber Cams, 4200 White-side, Los Angeles, Calif.

AUTO Trunk light—Complete kit. Mercury switch, bulb, socket, wire and hardware with instructions. Price \$2.00 per kit postpaid. No c.o.d's. Electro-Devices, Inc., 247 Broadway, Paterson 1, N. J.

BUY Speed equipment without money. No selling. Information free. Newhouse Industries, Los Angeles 22.

MOTORISTS, Truck owners, hot rod and sport car enthusiasts. Here's what you've been looking for. Largest and most complete automotive parts and accessories catalog in America. 1953 edition—132 pages (illustrated) shows all parts, from a cotter pin to a complete motor and accessories for all makes, all years, including 1953, all models cars and trucks. Pages and pages for hot rod and sport car enthusiast. Hollywood accessories to give your car individual styling. 50,000 items listed at savings up to 50%! Don't miss it! Send 25c now (refundable). J. C. Whitney & Co., 1919 W. Archer, Chicago 16, Ill.

"WATER Injection." Free descriptive, illustrated, information. Neher Industries, LaVerne, California.

HI-Compression heads \$15.95 up. Write Auto Parts Service, West Salem, Ohio.

ELECTROPLATE Auto parts, novelties, mirrors. Easy, inexpensive home processes. Free booklet. Tyco Metals, Box 13231-BG, Houston 19, Texas.

GM71 Discarded injector parts wanted. Bares, 7120 Carnegie, Cleveland, Ohio.

NEW And used guaranteed parts for civilian and army cars and trucks. Largest stock in America. Mail orders. Pioneer Auto Wrecking Co., 734 W. 13th Ave., Denver, Colorado.

BRUSH Plating outfits connect to a battery. No tanks or shop required. Free particulars. Gunmetal Co., Ave. J., Decatur, Ill.

FIBERGLAS—Plastics for bodies and hardtops. Complete building instructions. New low prices. Nationally known suppliers. Industrial Plastics, 4425 Linden, Oakland 8, Calif.

BE Independent, save money. Grind crankshafts without disassembling engine. New hand operated tool \$3.75. Literature. D. McGee, 719 Cascade, Wenatchee, Wash.

CHEVROLET Owners: Stop tappet noise with Kaye Tappet Silencers. Quality product. Easy to install. Complete set \$5.95. Kaye Products, P.O. Box 1423B, Milwaukee, Wis.

CARBON Is blasted from combustion chambers with Tricoelene the water emulsion fluid. Poured into carburetor on idle, it steam cleans engines. Frees rings and valves. 8 oz. bottle \$1.00 p.p. Free literature. Competition Chemicals, 704 Wash., Iowa Falls, Iowa.

AUTO TRAILERS

TRAILERCOACH Blueprints. All kinds. Slip-on coach for pickups. Three-in-one utility, boat, sleeper trailer. Illustrated catalog 10c. Comstock Trailers, 585, Parsons, Kansas.

TRAILER Building. Illustrated 20c. Craftsman Books, Box 1153, Milwaukee 1, Wis.

BUILD Your own trailer! Plans for all kinds. Illustrated catalog 10c. Jim Dandy, 125-M, Wausau, Wisconsin.

EXCEPTIONAL Expanding eight foot trailer. Accommodates family of five. Build yourself. Literature 10c. Fra-Mar Company, Jones Ave., Wilmington, Mass.

MOTORCYCLES, BICYCLES, MOTORSCOOTERS AND SUPPLIES

NSU Motorcycles, motorbikes, 1953 NSU-Lambretta motorscooters. Seven models (100cc-500cc). Fast parts service. Ask for folder. Some dealerships open. Butler & Smith Trading Corp., 117 West 63rd St., Dept. P, New York, N. Y.

REBUILT Gasoline engines \$17.00 to \$37.00. Cauffiel Motor Industries, Temperance, Michigan.

MOTORCYCLES And parts, new and used, early and late models. Harley Davidson, 813 Ohio, Wichita Falls, Texas.

BUZZZZ — The motorcycle magazine. Lots pictures. Worldwide coverage. \$2.00 year. Sample 20c. 5424-A Sawyer, Chicago 25.

HARLEY-Davidsons — America's best used buys! We pay shipping on motorcycles. Genuine new, used, parts, accessories for current and obsolete models. Send 25c for bulletin, catalog. Knuth's (Harley-Davidson factory dealer) 1753 Muskego, Milwaukee, Wis.

WHIZZER \$20; Servicycle (good tires) \$20; motorbike conversion kit \$25; Cushman motorscooter \$25; Harley twin \$25. Rush 25c (35c first class mail) for catalog #954 listing many other amazing bargains in motors, midget cars, motorscooters, motorbikes, construction plans. Associated, Box 1764-CS, Toledo, Ohio.

U. S. Govt. surplus "45" Harley Davidson motors, complete with carburetor and generator, in running condition — \$69.50 f.o.b. Chicago. 25% deposit with order. Parts and accessory catalog 25c. Triangle, 2157 Harrison, Chicago.

RECONDITIONED Motorcycles and motors. Chromium accessories. Complete stock Indian parts. Expert rebuilding. Fast service. Indian Motorcycle Sales, Kansas City 27, Mo.

MUSTANG Motorcycle \$30, midget racer \$45, less engines; Doodlebug motorscooter \$20; Servicycle \$25; engines \$4.50 up. (Mailorder only). Send 25c for new Directory-Catalogue Number 53, just out listing these and hundreds of other bargains in new and used midget cars, motorscooters, engines, parts and plans for homebuilders, etc. (35c by first class mail). Midget Motors Directory, Athens, Ohio.

WHIZZERS \$20; Midget car \$15; motor-scooter belt drive \$6; 3-wheel scooter car \$39.50. Send 25c (35c first class mail) for catalog #23 jammed with sensational bargains in wheels, motors, motorscooters, midget cars, motorbikes, construction plans, etc. Gail, 538 Erie, Toledo, Ohio.

FOR Sale—40 reconditioned Harley-Davidson motorcycles, reconditioned by Harley-Davidson Factory trained men, serving the motorcyclist over 35 years, 28 years a Harley-Davidson factory dealer. Large stock of genuine Harley-Davidson parts and accessories for old and late model Harley-Davidson. Send 25c for bargain sheet and accessories catalogue. Bill Thede, The Motorcycle Man, 7577 West Lake Street, River Forest, Illinois.

FORTY Percent discount on new Harley-Davidson parts for models 1940 and older not interchangeable with later models. Complete stock. Lauby Cycle, Marshfield, Wis.

AVIATION

HOME-Built aircraft information. \$1.00. Complete design and construction data \$5.00. Money back guarantee. William Bentley, Box 2056, Pensacola, Florida.

GLIDER Plans — CAA approved utility glider. \$5.00 complete. Airport Equip. Co., Denver, Colo.

AMERICAN Triplane, U. S. patents, featuring safety, simplicity, economy. Plans \$10. Build, fly your own. Lillian Holden, P.O. Box 1614, Ft. Worth, Texas.

PROPELLERS, plans, supplies — For snow sleighs, air boats. Immediate delivery, highest quality. Catalog 25c. Banks-Maxwell, Box 3301E, Ft. Worth, Texas.

LIGHTPLANE Circular, illustrated, 20c. Craftsman Books, Box 1153, Milwaukee 1, Wisconsin.

PROPELLERS, Plans for snow sleighs, air boats. Lowest prices, fastest service. Literature. Gano Propeller, Box 3284A, Ft. Worth, Texas.

PRIMARY Glider plans \$1.00. Literature 15c. McFarland Aircraft, Greenville, Ohio.

BATTERIES, GENERATORS

EDISON Nickel odorless storage batteries. 12 to 600 ampere hour. Any voltage. Long guarantee. Literature. Hawley Smith Co., Croton Falls 1, N. Y.

ELECTRICAL SUPPLIES

FREE—War surplus catalog. Bargains galore. Welders, motors, generators, hydraulics, pumps, kits for assembling your own, other items. Save. LeJay Company, Minneapolis, Minnesota.

MOTOR Rewinding supplies. Magnet wire, insulation. Silicon transformer steel. Morton Electrical Service, Round Lake, Ill.

AIRCRAFT Electrical. P-1 generator, 28V, 200A, \$11.95 used. Voltage regulator, \$3.95. Reverse current relay, \$4.95; 200A relay, \$2.00. All new, 24V. Aero Parts Supply, Municipal Airport, Houston, Tex.

FREE Surplus circulars and catalog information. Card's Wholesale, Edgewood Drive, Niagara Falls, N. Y.

LAMP Supplies, wholesale, any amounts. Prompt shipment on all parts for repairing and building lamps. Illustrated catalog 15c. Brown Lamp Co., Box 501 Wellston Sta., St. Louis 12, Missouri.

LAMPS—25c Brings bargain parts catalog containing instructions for electrifying oil lamps, vases, etc. Gyro Lamps, 5402P Clark, Chicago 40.

ELECTRIC Pencil: Engraves all metals \$1.50. Beyer Mfg., 10511-H Springfield, Chicago 43.

WELDING, SOLDERING, PLATING

"BUILD-Ur-own" a.c. welder and a.c. power plant with a good used engine and low cost Hobart generator. Welds anywhere and supplies 5KW stand-by power for any emergency. Write Hobartweid, Box M-633, Troy, Ohio.

ACETYLENE Welding outfits, new \$49.00, used \$29.00; arcwelders \$49.50. Eagle Welding, Dept. PM, 5085 Broadway, Chicago 40, Ill.

WELDERS — Electric, various models, \$28.50 to \$235.00, direct from manufacturer. Free literature. Champion Welder Mfg., 193MP Centre St., New York 13, N. Y.

A.C. Welders, four sizes, lowest prices. Free literature. Holgerson's Service, Canton 1, Kans.

FARM, Garage welders, 220 a.c., \$59.00. Morris, 1070 Inner Drive, Schenectady 3, N. Y.

ELECTRO-Plating equipment—New and used. Complete assemblies. All sizes for all types of plating. Baby shoe metallizing sets. Mounts, supplies, instructions. Free catalog. We buy used plating equipment. Send description. Hollywood Bronze Supply, Dept. 2A, 1624 E. First Street, Los Angeles 33, Calif.

MACHINERY, TOOLS, SUPPLIES

LATHES, Shapers, millers — Build 'em yourself from unfinished castings. Send 25c for single construction drawings. \$1.00 for drawings of shaper, three millers, three lathes. Pootatuck Corporation, 150 Sams Place, Stratford, Conn.

FILES: Set of 10 assorted shapes. Five to twelve inch. Postpaid \$1.50. Fultool, 426 Wythe Ave., Brooklyn 11, N. Y.

GOOD Machines for your shop; 20"x8' lathe \$380.00. 14"x6' lathe \$280.00. Cincinnati #2 1/2 Universal milling machine, motor, Drive-All, dividing heads \$1600.00. Lodge Shipley Q.C. 16"x12" engine lathe, Drive-All, motor, chuck \$1200.00. Fellows #6 gear shaper motorized \$700.00. Brown Sharpe #3 milling machine \$640.00. Horizontal boring machine \$450.00. 24" drill \$320.00. 18" Flather shaper \$520.00. Hand turret lathe \$150.00. Money back if not satisfied. Conversion Parts Co., 278 Adams St., Boston 22, Massachusetts.

TOOL Bargains: 6 1/2" steel tipped oak handles for chisels, files, etc. \$2.00 per dozen; Lincoln grease gun \$1.25; 12 Pluto needle files 5 1/2" \$3.35 per set; postpaid. Send check or money order. Shamrock, 1800 NW Le Jeune, Miami, Florida.

JOINTER, Craftsman, 4", \$12.50; 7" bench saw \$15.00; large jigsaw \$10.00; 6" metal lathe \$25.00. Rush 25c for catalog #49 jammed with hobby equipment bargains — photographic, woodworking, etc. Homecraft Exchange, 6028 Rosslyn, Indianapolis 20, Indiana.

NEW Air compressors, 2.8 cubic ft., piston type, 140 lbs. pressure, \$19.00. Other sizes comparable prices. McCarthy Co., 2930 W. Burleigh, Milwaukee 10, Wis.

BLACK AND Decker 1/4" drills, regular \$22.95, \$19.90. Send 25c for power tool catalogue at discounts. Norko Distributors, Box 6539, Philadelphia, Penna.

BRAND New surplus portable machine tool coolant pumps. Regular \$49.50. Hurry \$20 each complete. Write for details. Hasco Products Company, 14849 Livernois, Detroit 21, Michigan.

GRITCLOTH — Super abrasive that doesn't clog 25c. Narco, Marblehead, Mass.

POWER Tools, equipment wholesale prices. Free bulletin. Homecrafters Cooperative, Grand Rapids 6, Michigan.

GEM Toolmakers, diemakers indicators Model 223 (.001) \$19.50 or Model 333 (.0005) \$27.50. Sybrandt Company, 4500 Euclid, Cleveland 3, Ohio.

CONCRETE Block machines. Standard sizes. Free catalog. Concrete Machine Company, 5129 South Compton, St. Louis 11, Missouri.

ENGINES, MOTORS, DYNAMOS

REVERSING Switch. Absolutely free trial. Not c.o.d. Free literature. No money with order. For motors maximum 3/4 hp. After ten days, send \$2.98 or switch. Best Tools Inc., Box 92, Berwyn, Illinois.

ALTERNATING Current generators, 750 watt, \$38.50; 5000, \$185. Motors 1/2 horse, \$15; 3/4, \$22; 1, \$35. Butler, 1885 Milwaukee, Chicago 47.

REBUILT Gasoline engines \$17.00 to \$37.00. Cauffiel Motor Industries, Temperance, Michigan.

WINDING Data, listing 225 motors, single and three phase, \$1.00. Motor Data Co., Box 7631, Kansas City 3, Mo.

SELF-Oiler for electric motors. 3 for \$1.00. United States Petroleum Co., Dept. C, Clifton, N. J.

BOATS, OUTBOARD MOTORS

PLYWOOD Boat plans, twenty for \$1.00. Catalog boat building plans 25c. The Rudder, 15 Murray Street, New York 7.

IT'S A cinch with a winch. All bronze winches. Perfect for boat trailers, etc. \$15.95. Write Demco Supply, P.O. Box #1046, New Orleans 8, La.

BOAT Owners—See "Change Oil" ad under Auto Supplies—Bender.

PERMANENT Boat protection—Use Castoglas (liquid plastic and glass cloth). Apply it like paint to new or old boats. Forms plastic skin. Lighter than aluminum, tougher than steel. Once on, stays. Makes boats stronger, permanently leak-proof, rot-proof, mildew-proof, weather-proof. Won't rust, corrode, crack. Unaffected by gasoline, oil, alcohol, salt water, hot sun. Also used for sealing leaks, patching, caulking. Free folder. Marine Division, Dept. MG-101, Castolite, Woodstock, Illinois.

NOW Faster than ever! Champion Boats — the choice of champions now available to you! Easy-to-read plans; easy-to-assemble kits; or easy-to-afford custom built speed boats. (18-models, outboard and inboard). Send 25c today for multicolored, illustrated catalogue. Champion Boats, 1524 W. 15th St., Long Beach, Calif. Dept. 22-F.

PERFECT Boat coating. Polyester-Fiberglass. Permanent protection. New catalog tells you how—how much. 10c. Airmailed 25c. Gem-O'-Lite, Box 6862Z, North Hollywood, California.

COMPLETE 12' Boat kit only \$59.00. Semi-vee, cartop. Wooden parts. Accurately cut. Assembled frames. Brass screws. Write for literature. Penney Woodcraft Industries, Defiance, Ohio. Dept. C-10.

STEERING Wheels, windshield brackets, from \$7.95. Attractive polished fittings. "Waterskis," aquaplanes. Guaranteed satisfaction. Bargains galore. Hundreds accessories. Folder free. Marine, Box 681-M, Mendota, Minnesota.

MARINE Conversions. Request deluxe catalog with photographs of our products 25c. Gershel Engineering, Oceanside, N. Y.

MARINE Conversion parts, most complete line on market. Parts for Ford to Cadillac, manifolds, water pumps, transmission conversions, reverse gears, etc. Barr Marine Products, 2706 Castor Avenue, Philadelphia 34, Penna.

JOHNSON Outboard specialists. Used parts for all models at substantial savings. Prompt quotations. Specify model serial. Crandall-Hicks, 910 Commonwealth, Boston, Mass.

BUILD Marine engines with Federal conversion kits. Federal Marine Motors, 9011 Cottage Grove Ave., Chicago 19, Illinois.

"BELLY Tanks," \$9.95. Free picture. Buck's Auto Wrecking, Merced, California.

PLANS: Inboard-outboard runabouts, cruisers, sail. Wood, plywood, welded steel. Advise requirements. John B. Clark, N.A., 329 Kenmore, Bay Village, Ohio.

OUTBOARD Motor parts—New, used for all makes. Send stamp for price quotation, listing parts needed. Outboard Motor Mart, Inc., 229A State Street, Boston, Mass.

NEW, Used, rebuilt marine motors. Marine conversions, fittings. Free catalog. Stokes Marine Supply, Dept. 24, Coldwater, Michigan.

MARINE Conversions for Ford and Jeep engines. Catalog 10c. Lehman Manufacturing Company, 972D Broad Street, Newark 2, New Jersey.

CURE That leaking boat with Fiberglass-plastic covering. Ends caulking and painting. Nationally approved process. Complete instructions. New low prices. Industrial Plastics, 3807 Harrison, Oakland 11, California.

CONVERT Fords and Jeeps to 100% marine engines with Osco's world famous Convo-Kits. Deluxe catalogue 25c (coin). Oscomotors, 3627B Lawrence, Philadelphia 40, Penna.

FULL Size, cut to shape boat patterns, blueprints, 7½-38 feet. Illustrated "Build a Boat" catalog, 25c (coin). "How to Build Boats" book, \$1.00. PolyWog houseboat plans \$10. Cleveland Boat Blueprint Co., 3107 Detroit Ave., Cleveland 4, Ohio.

REBUILT Guaranteed outboard motors at clearance prices—3 to 33 h.p. hundreds in stock. Big 1953—52 page marine catalog. Send only 50c. Masters, 210 W. Chicago, Chicago 10.

LEAKPROOF Your boat with amazing Fiberglass-plastic. Ends soaking, caulking, painting forever. Forms tough, lightweight covering. Won't rust, corrode, chip, crack. Unaffected by marine growths, weather, gasoline, salt water. Make sport car bodies, tops; others. Complete instructions 25c, refundable. Plastic Parts, 1157M South Kingshighway, St. Louis 10, Mo.

BOAT Patterns, kits, 8'-50'. Descriptive literature and illustrated boat construction book 50c. Germain Boat Company, West Saginaw 3, Michigan.

ATHLETIC EQUIPMENT, BODY BUILDING COURSES

GREAT Strength easily obtained. Send \$2 for complete course and apparatus. Noticeable results guaranteed in 7 days or money refunded. Joseph Dryer, Box 5527-P, Chicago 80.

"POLICE Jiu Jitsu," "Scientific Boxing," both courses \$1 postpaid. Books, 3100 Ocean Parkway, Brooklyn 35.

BARBELLS. Exercise equipment. Courses. Free booklet. Good Barbell Co., Reading, Penna.

SPORTING GOODS, GUNS, FISHING TACKLE, ARCHERY, TRAPPING

CAMPING Supplies at wholesale! Join Campers Discount Club. Receive special discounts for members only on tents, sleeping bags, binoculars. Send for your free membership, catalog and confidential price list. Fox Department Store, Dept. P.M. 1560 E Street, San Bernardino, California.

FISHWORM Culture — This booklet "Raising Worms for Pleasure or Profit" tells how to fix beds indoors, outdoors; small or commercial scale; what, when, how to feed, water, harvest, package, sell. \$1.00 postpaid. Tennessee Worm Hatchery, 1237 McAlpine Section 4F, Nashville 6, Tenn.

FISHERMEN! Buy, sell, swap bulletin. 20 word ad \$1. Information free. Anglers' Exchange, PM6, Box 285, Bettendorf, Iowa.

RECOIL Pads. Close-outs. Standard price \$2.25. While they last \$1.25. Small size only. Fray Wholesale Corporation, Glendale 5, California.

YOU Too can catch catfish with our battery lit bobber lure. Two for \$1.00 postpaid. Glo Lite Bobbers, Inc., Detroit 1, Michigan.

POWERFUL, Accurate, hunting "Sling-Bow" slingshot. Shoots arrows-pellets. Checkered gunstock plastic handle. Free catalog circular. Midstate Supply Co., Dept. 63-p, Owen, Wis.

SAVE Money—Reload your ammunition. Complete reloading handbook, 75c postpaid with free catalog listing supplies. Precision Tool & Gun, Ithaca 19, New York.

ALUMINUM Camp trailer kit. Campers, hunters, fisherman. Sleeps four. Compact, folding. 560 lbs. Photo folder 10c. Master Camper, West Sayville, N. Y.

FOR Revolvers—"Sure Grip" adapters improve shooting. Regular price \$1.75. While they last (slightly imperfect) only \$1.00. Write for catalog. Fray Wholesale Corporation, Glendale 5, California.

IMPORTED Knives, high quality. Write for illustrated literature. D. J. Clinton, Mt. Clemens, Mich.

FISHERMEN Fish-Bait-Odours get more fish. Four terrific gypsy formulas for \$1.00. Ayres, 101 Station K, Toronto 12, Ontario.

RAISE Red and bran worms. Complete booklet 50c. Jack Trussell, Route 2, Opelika, Alabama.

64-PAGE Illustrated bargain packed catalog 50c. Westerns, Kentuckies, Indian relics, swords, medals, Lugers, Mausers, gunsmithing, accessories. Agramonte's 201 Warburton, Yonkers 2G, N. Y.

BLOWGUN, 6 Steel darts, large aluminum mouthpiece \$5.00 prepaid. Hal Wilder, 3236 Pearl Street, Joplin, Missouri.

THREE Imported German fishing lures; \$1.00. Two spinning, one regular. P.O. Box 1051, Oak Park, Illinois.

CONVERT Cigarette lighter to .22 pistol. Unique principle! Simple, copyrighted plans. \$1.00. JR Seidman, Box #25-PM, New York 67, N. Y.

LEARN Gunsmithing! Information, interesting gun, gunsmith's catalog. 25c. Gunsmith, 4233 N. Harlem, Chicago.

TENTS, Camping equipment. 100 page free catalogue. Mor-San Sales, 10-21R 50th Avenue, Long Island-City 1, New York.

CAST Iron molds—For casting fishermen's sinkers. Free illustrated booklet. Reading Instrument Co., Box 78, Reading, Penna.

120 PROFUSELY Illustrated pages antique pistols, swords, daggers, armor, etc. 50c. Robert Abels, M860 Lexington Ave., New York 21.

MOLDS: Handled and hinged for fishermen to make their own sinkers, jigs, squids and casting or spinning lures. Entertaining and profitable. 400 sizes and styles from \$2.95 up. Special molds made to order. Free catalogue. Sweet's Molds, Tonawanda 1, N. Y.

SHOTGUNS, Rifles, Revolvers, 500 models, obsolete. Also cartridges. Each list 10c coin. Ed Howe, 52 Main, Coopers Mills, Maine.

5000 BARGAINS, Firearms, binoculars, war relics. Catalog 50c. Smith Firearms, Rummene, N. J.

SAVE On gunsmithing, Jap conversions, scopes, loading tools. Catalog 10c. Cougar Arms Company, 587 Ferris Street N. W., Grand Rapids, Michigan.

FISHERMEN Save money! Startling new bait-catcher stampedes choice night-crawlers from holes like mad. Send \$1 today for Flusheim. Gets 500 fat worms. Make fish drool! Money-back guarantee. Bayou Specialties, 1921 Bayou Grande, MP-4 St. Petersburg, Fla.

FISHERMEN, Our formula guarantees anytime, finest worms, quick, easy—25c coin. 19409 Cherokee Ave., Cleveland 19, Ohio.

BINOCULARS, TELESCOPES, MICROSCOPES, MAGNIFIERS

GIANT Telescopes and telescope makers kits. Don't buy until you have our price list. Perfect merchandise. Terrific savings. Riverhead Telescope Company, Calverton 1, N. Y.

BINOCULARS, Telescopes, microscopes. Terrific values \$3.95 up. Request free money-saving catalog. Criterion, Hartford, Conn. Dept. P12.

100X TERRESTRIAL Telescope complete with tripod, extra eyepiece. Tremendously clear images. \$10.00. Riverside Telescope Co., Riverhead, N. Y.

BINOCULARS. Lowest prices. 8x30. \$32.00 guaranteed telescopes, microscopes. Free catalog: All sizes. Joe's Binocular Sales, 4827 Second Blvd., Detroit 1, Mich.

6" PYREX Telescope mirrors, 4" optical flats, 8" comparator mirrors, custom work optical manufacturing. Donald Ellison, Ludlow, Vermont.

POWERFUL 100X Telescope lens kit. Perfect lenses. Instructions for making giant telescope \$1.00. Telescopic Company, Manorsville, N. Y.

PARADISE For hobbyists! Microscopes, binoculars, telescopes. Free catalog! Nassau Optical, 9 West Greenwich Ave., Roosevelt, L. I.

WAR Surplus bargains, binoculars, telescopes, sextants, millions of lenses, prisms, reticles, eyepieces, objectives, etc. Mail 10c for big "Catalog CH." Send \$1.00 for Stock CH-10-piece lens kit and big instruction booklet. Edmund Scientific Corp., Barrington, N. J.

FREE 40-Page, 3 color catalog! 67 different models! United Binoculars, 9043 S. Western, Dept. A-5608, Chicago 20.

REFLECTOR Telescope kits—Precision eyepieces, mirror cells, diagonal holders, tubing, other optical bargains. Free illustrated bulletin. Esco Products, 911 Willow Ave., Hoboken, N. J.

POWERFUL Giant telescopes easily made. Lenses, erector, focusing tube and instructions for making 40X, 100X, 200X and 400X telescope; \$5.00. Riverside Telescope Co., Riverhead, N. Y.

GIANT 100X terrestrial telescope complete with hardwood tripod. Tremendously clear, erect images day and night. Heliocope. Extra eyepiece. \$10.00 f.o.b. Riverhead. Riverside Telescope Co., Riverhead, N. Y.

AMAZING Prices, binoculars, telescopes, microscopes. Free trial. Folder, "Binocular Selecting," optical catalog free. Prentiss Importers, Mercury Bldg., West Los Angeles 25, Calif.

REFLECTING Telescopes, 60X, completely assembled \$29.75. Guaranteed observatory clearness. Free information. Skyscope, 475 Fifth Avenue, New York 17.

MAKE Your 6" telescope reflector. Glass, abrasives, instructions—\$9.50. F. Cameron, Box 65, Inwood 96, N. Y.

PETS—DOGS, BIRDS, RABBITS, HAMSTERS, ETC.

BEAUTIFUL Pure white pedigreed police puppies. Ansonia Kennels, Mose, N. Dak.

PUREBRED New Zealand Whites and Chinchillas. Write, Wilson's Rabbitry, Greer, South Carolina.

HAMSTERS—Cages and equipment. Free illustrated details. Lakeview Hamster Colony, Newfield, New Jersey.

ANGORAS, Chinchillas, White Giants! World's most profitable rabbits! Catalog free. Grinstead's, Edwardsville, Illinois.

MADE \$28,000 With rabbits. Folio reveals everything—\$1.00. Hutch plans, \$1.00. White's Rabbitry, Newark 1, Ohio.

STEADY Earnings with Angora rabbits. Free illustrated booklet tells how, lists markets, successful raisers. Angoraville, 170 E. Butler West, St. Paul 16, Minn.

BIG Profits! Raise real Chinchillas on our new lease plan. You raise them, we buy them. Small capital can show terrific profit possibilities. Booklet free. Chinchilla, Dept. 505, 303 Lexington Ave., New York City.

EARN Up to \$400 monthly raising white rats and mice, plenty markets. Send 35c raising rats and mice particulars. Poultry Farm, Armada, Mich.

HAMSTERS—Delightful small pets. Free illustrated details. Anderson's Hamstery, 35 Oneida, Pontiac, Michigan.

EARTHWORM Raising pays worthwhile profits! Illustrated booklet explains raising, feeding, packing, marketing. 25c. Ozark Worm Farm—J. Willow Springs, Mo.

GOLDEN Hamsters. Pedigree stock. Breeders, laboratory or pet stock shipped express anywhere. Price list free. Charles E. Bowser, Smoke Run, Penna. Dept. H.

STANDARD Rabbit Journal, B-241-M, Milton, Penna. Year \$1.00, sample dime, beginner's manual 25c.

HAMSTERS—Virgin stock; young, \$3.00 pair; fully developed, \$4.00 pair. Adiron-dack Hamstery, Prospect 2, New York.

BOOKLET "Treatise on Breeding and Raising Canaries"—\$1.00. Audubon Publishing Co., 3449-PM N. Western, Chicago 18, Illinois.

MAKE Big money! Raise Chinchilla rabbits. Cash markets supplied. Write today! Rockhill Ranch, Sellersville 15, Penna.

MINK Raising information free. Complete. Lake Superior Mink Farm, Superior, E.E. Wisconsin.

RAISE Highly-profitable Angora and New Zealand rabbits. Particulars free. White's Rabbitry, Newark, Ohio.

YOUNG Parrots—Make fine talkers. Herb Miller, 1911-N, Lubbock, Texas.

PLANTS, SEEDS, NURSERY AND GARDEN SUPPLIES

PLANT Mutations. Colchicine solution and instructions to treat seedlings, plants, producing wonderful variations \$4.50 from "Westwood," Box 1495, Duncan, British Columbia.

FARMS, FARM LANDS, REAL ESTATE

UNITED Farm Agency's big free summer catalog of farm and country real estate bargains can help you plan soundly for your future security in the country. Good pictures, many states, easy terms, many equipped, growing crops included. For special service, state requirements, desired location. Write for your catalog today—it's free! United Farm Agency, 1408-PM Consumers Bldg., Chicago 4, Ill.

FLORIDA Beckons for fishing—vacationing—living. 5 acre baby farms about 60 miles from St. Petersburg. Fine for homesites, farm or camp; close to finest hunting, bathing, boating, deep sea fishing. Only \$345.00. \$10.00 down, \$10.00 month. For information write G. B. Potterfield, Department C, Union Building, Charleston, West Virginia.

FLORIDA Highway estates—\$345. Payable \$15 monthly. Big, beautifully wooded tracts on U. S. highway. In famous Panama City pleasure resort area. Finest beaches, fishing, hunting. Winter gardens. Desirable community. Free booklet. Wendell Wood, Box 873, Houston, Texas.

SELLING Shingled houses like rent; nothing down. Perry, Brier Hill 32, Penna.

FARM & Business catalog free! Big edition. Hundreds of bargains from \$1000 up. Maine to Florida. West's, M-6, Pittsburgh 17, Penna.

STROUT Farm catalog free! Farms, homes, businesses, etc. Over 3200 bargains described, 31 states. World's largest, 53 years service. Strout Realty, 7-M So. Dearborn St., Chicago 3, Ill.

MISSOURI Land \$5.00 acre. Warranty deed. John Calvert, Box 162, Harrison, Arkansas.

FLORIDA? Ages 50 to 85? Undecided about moving south? Write me! Ross, Wakeman, Ohio.

FARMS, Homes, businesses bought, sold, traded anywhere. Free details. Mr. Toole, Box 84, Evansville, Indiana.

CALIFORNIA Ranch lands. 50c to \$5 acre minimum bid. Farm-ranch-hunt-fish-retire. 10c brings illustrated land catalog, outline maps. Tax Land Sales, Box 2350 BW, Hollywood 28, Calif.

\$5.00 MONTHLY Buys 40 acres near town. Price \$200. Free list. Box 425-P, Carthage, Missouri.

HOMESITES \$400—Convenient payments. California's finest garden section. On Morro Bay's scenic shores. Wonderful fishing, boating, bathing. Fertile soil, softest water, temperate climate, congenial community. Free literature. Richard Otto, Department M, San Luis Obispo, Calif.

FARM-Ranch opportunities. Favorable conditions. Washington, Minnesota, Montana, Idaho, Oregon, North Dakota. Literature, farm descriptions. Specify which state. J. W. Haw, 119 Northern Pacific Ry., St. Paul 1, Minn.

LARGE Lake, 40 acres, \$7.00 acre. \$10.00 payments. Get big free listings. Write Mr. Armstrong, Shook 34, Mo.

POULTRY, FARM SUPPLIES

SALVAGE Fire hose, 15 to 50 ft. lengths, 2½" double jacket without couplings for irrigation, drainage, contractors use, etc., fits over 2" pipe; 15c ft. Bate's Rubber, Box 501, Wildwood, N. J.

KNOW How to raise poultry for profit. Read Poultry Industry. Every issue packed with helpful hints and practical suggestions. Latest articles on breeding, feeding and management. Subscribe now, 1 year 50c, 3 years \$1.00. U. S. funds or checks payable at a New York or Boston bank. Poultry Industry, Dept. PM, 376 Boylston St., Boston 16, Mass.

PROFITABLE OCCUPATIONS

BOOKLET On breeding and raising canaries for a profitable business. \$1.00. McKenzie, 1310—8 Ave., Albany, Ga.

"EVERYBODY Likes candy." Learn to make professionally. (Our 43rd year.) Ragsdale Candies, D6, East Orange, New Jersey.

SECRET Investigation. Experience unnecessary. Investigators' particulars free. Write Wagoner, 125-M West 86th, New York 24.

AUCTIONEERING! Easy with "Auctioneer's Pitch!" Complete proven format! \$10.00. "Mart," Box 575, Hollywood 28, California.

ALASKAN Jobs! Over 100 new construction projects with names, addresses companies hiring. Thousands needed. Highest wages. Military, private construction, mining, fishing, lumbering, aviation, railroads, homesteading. Skilled, unskilled workers. Salary information. Government map included. \$1.00 complete. Alaskan Opportunities (PM), Box 362, Kenmore, Washington.

MAKE Sell exquisite artificial flowers, woodfibre corsages, chenille novelties, dolls, costume jewelry, leathercrafts. Complete supplies, beginners kits. Wholesale catalog 10c. Profitkrafts, 4509T292 Lorain, Cleveland 2, Ohio.

MUSHROOMS Grown boxes, barrels. Manureless process 50c. Spawn \$1.00. Gordons, 553 William, Winnipeg, Manitoba.

"HOW And Where to Obtain Employment." Copyrighted, guaranteed. \$1.00. Scholl, 1224 15th Way, SW, Birmingham 11, Alabama.

SELL To opportunity seekers. Instructional, self help book. Free information. Tower, Box 8456, Kansas City, Missouri.

FOREIGN Jobs. Contracts underway and soon starting in Africa, South America, Canada, England, Europe, South Pacific, Middle East, Mexico and Alaska. Send \$1.00 for foreign job news, information, application forms, etc. DCS Foreign Job News, Dept. 268-SI, Bridgeport, Ill.

SEND For big, new 1953 illustrated catalog that will show you how to turn your spare time into cash—making quick-selling, highly profitable lamps. Every home a prospect. Hundreds doing it, you can, too. No experience or special tools required. Catalog No. 7 contains 56 pages filled with shades, shade frames, figurines and bases, oil lamp converters, boring compound, and dozens of similar items. Also all kinds of sockets, cords, pipes, harps, finials, bases, and hundreds of other parts—everything you need. Special 8-page section shows 6 beautiful lamps in kit form, ready to assemble. You buy wholesale, sell at retail. Make big profits. Send 25c today for new 1953 catalog and wholesale price list, you'll be glad you did. The 25c will be refunded on your first order. Gearon Co., Dept. 500-B-6, 27 S. Desplaines, Chicago 6, Ill.

\$10,800 PROFITS! Your own mailorder business! No capital risk! "Success plan" (worth \$2) free! Write today! Treasury, 709 Webster, New Rochelle L-12, New York.

WELDING Pays big money. Learn easily at best equipped school in country. Non-profit school with low cost training. G.I. approved. Write Hobart Trade School, Box M-632, Troy, Ohio.

ALASKA! Last American frontier. \$1.00 brings 1953 business directory and government map. Military and civilian construction; homestead and highway facts; mining, aviation, fur farming, grazing, timber, travel directions. List of firms hiring. How to apply. Alaska Opportunist, Box 92-P, Hollywood 28, Calif.

OVERSEAS Jobs. Big pay, transportation, expenses. Clerical, professional, mechanical workers. Most all trades. Latest listings airline, construction, manufacturing, oil, steamship companies, government agencies, many other opportunities. Up to date information on securing employment, contracts, income tax, application forms. \$1.00. Overseas Jobs, Box 335-A10, Baton Rouge, La.

CONSTRUCTION Job list. Published monthly. \$1.00. Dempster's Construction Scout News, Dept. 268-SK, Bridgeport, Ill.

BUY Wholesale thousands nationally advertised products at big discount. Free wholesale plan. American Buyers, 628-R Linden, Buffalo, N. Y.

FROG Raising; Season just starting! Get this year's eggs. New book tells how. Free folder. Broel-A, 1035 Marlborough, Detroit 15, Michigan.

\$1300.00 MONTHLY For truck drivers, \$1400.00 monthly for carpenters, electricians, plumbers and mechanics. \$1200.00 for clerks and laborers, over \$2000.00 for superintendents. Limited hiring now being done. Full information and complete foreign listings, \$1.00. \$1,200,000,000.00 stateside project, over 15,000 will be hired. Complete information, opportunities, living conditions, etc., and domestic listing, \$1.00. Specify listing, Dept. 3-F, Opportunities Unlimited, 1110 Commerce Bldg., St. Paul, Minn.

FREE Booklet reveals amazing secrets behind 301 new profitable enterprises! Many mailorder! Includes confidential instructions for starting wholesale buying service. Deumant Business Surveys, 85-R Deumant, Kenmore 23, N. Y.

EARN \$3,000-\$5,000 Annually in your spare time. Become a tax consultant. Booming year 'round business. Free details. Union Institute, Lakewood 5, N. J.

FREE Information. Profitable home business, manufacturing plaster novelties. Mertz Plastercrafting, San Bernardino, California.

SELL Popular Mechanics and all other magazine subscriptions. Free catalog supplies. Subscription Service Company, Dept. B, P.O. Box 2070, Birmingham, Ala.

WORK In Detroit. Big help wanted pages (both sexes) from Detroit Sunday paper offering thousands of jobs weekly. Many ask written applications. Airmailed, \$1.25 one week, \$2.00 two weeks. Flying Saucer, 22423 Grand River, Detroit 19, Mich.

OPPORTUNITIES For you. Chicago newspaper help column, hundreds of fine paying jobs, suited to your skill, \$1.00. Opportunity News, 2118-A, North Halsted St., Chicago.

FOREIGN Construction jobs. \$500-\$2000 monthly! (All trades) folio \$2. Airmailed-ppd. Foreign Job Service, 750 Winter, Jackson, Miss.

CREDIT Correspondents wanted. Work furnished. Easy, pleasant, very profitable. Write National Correspondent Service, 1518 Randolph St. Paul 5, Minn.

WANTED! Intelligent investors. Raise and sell Chinchillas part time. \$900 monthly possible. Guaranteed market. Colonel Richardson, Dept. 363, 65 Lucille, Manchester, New Hampshire.

MERCHANT Marine opportunities! Free details. Seaways, Box 1231M, Baltimore 3, Maryland.

RAISE Pheasants on \$100 week plan. Little capital and space can make you independent. Free details. Great Central System, Columbus 1, Kansas.

FOREIGN And Latin American employment. 1953 "Foreign Service Directory" gives up-to-minute facts on military and civilian construction, government jobs, major oil listings, aviation, transportation, steamship lines, mining, importers, exporters, how-when-where to apply, application forms, hot list firms hiring. \$1.00 postpaid. Global Reports, Box 883-P, Hollywood 28, Calif.

GROW Mushrooms. Cellar, shed, and outdoors. Spare, full time, year round. We pay \$3.50 lb. We paid Babbitt \$4,165 in few weeks. Free book. Washington Mushroom Ind., Dept. 99, 2954 Admiral Way, Seattle, Wash.

MAKE Flexible molds! Cast plaques, bookends, figurines! Free sample! H. Tooker, 630-M Chestnut, Hamilton, Ohio.

BE The Popular Mechanics representative in your neighborhood and earn big profits in your spare time. Write Popular Mechanics Magazine, Room 408M, 200 E. Ontario St., Chicago, Ill.

FREE Book "505 Odd, Successful Businesses." Work home. Expect something odd! Pacific, Oceanside, Calif.

\$40.00 WEEKLY, Made growing mushrooms. Dominion patent 331,583. Free spawn with order. North American, 169P Yonge, Toronto, Canada.

GEESSE—Raise for profit. 24 page instruction booklet 25c. Army needs feathers. Northnode, West Rutland, Vermont.

CALIFORNIA Job opportunities are wide open! Complete current report: Jobs, pay, opportunities, housing, living costs, maps. Only \$2.00. Pacific Industrial Associates, Dept. G-8, Box 832, Santa Barbara, Calif.

BOOKS, PERIODICALS, PICTURES, POSTCARDS

JOIN The Americana Eagle Club. No fees or minimum purchase plan. Receive club newspaper "Americana Eagle." Just send in your name. We will also send complete details how to get the Americana Annual—new 1953 edition—without cost to you. Mail Order Division, Americana Corporation, Dept. PM6, 333 N. Michigan Avenue, Chicago 1, Ill.

GEMOLOGY, Horology books! Catalog 10c. Atlantic Books, Lawrence Avenue, Charlestown 29, Mass.

AMAZING New science-fiction, fantasy, book bargains. Send dime. Philip Vallon, 63 Perry, New York 14.

PICTURE Post cards from your photograph. 1000, \$11.00. Raun's, 4154 Fifth Street, Philadelphia, 40.

MAP Postcards, write Ward-Sharp, 56 Kendall Ave., Rutland 2, Vermont.

BOOKS—Unusual. All subjects. Free list. National Publications, Box 1214-M, Omaha 1, Nebraska.

BOOKHUNTERS! All subjects. Send wants! Jaher Book Service, 620-P East 178 Street, New York 57.

BOOK "Breeding of Parakeets" and cage-bird magazine—\$1.00. Audubon Publishing Co., 3449-PM N. Western, Chicago 18, Illinois.

SPARETIME Profits taking subscriptions, all magazines. Wholesale catalog free. Cassell Agency, Westfield 2, New Jersey.

BOOKS, Self help, instructional. Many mint editions, collectors items. Free list. Mutual, Section 2, Wilhott Building, Springfield, Missouri.

NATIONAL Geographic Magazines, 1888-1952. Periodical Service, Box 465-PM, Wilmington, Delaware.

OLD Books, value guide to old books. Listing approximate value on more than 2000 old and out of print books. Send \$1.00 for this value guide. Clinton Book Exchange, D30 Box 311, Clinton, Mass.

BIG Catalogue: 1500 bargains, send 10c. Books, 3100 Ocean Parkway, Brooklyn 35.

FREE Catalogue. Special interesting books. Powers, 1324 Wilshire, Hollywood 17, California.

BACK Issues all magazines. Cherokee Bookshop, 1656 Cherokee, Hollywood, Calif.

MAGIC TRICKS, PUZZLES, JOKER NOVELTIES

GENUINE Wooden nickels, magic catalog, trick, only 35c. Fun 'n Magic, 511-P North St. Marys, San Antonio 5, Texas.

MAGIC—Parlor, stage. Joker's supplies. Lower prices. Giant catalog 25c (refunded). Top Hat Magic, Evanston, Illinois.

INTRODUCTORY Offer—Sensational magic for beginners. Complete amazing trick and illustrated catalogue 35c. Kaye's Enterprise, Box 8084, Clinton Hill Station, Newark, New Jersey.

AMAZE Your friends with mystifying phone book stunt. 25c. Hoag, 4539 Ventura, Fresno 2, Calif.

WE Supply every noted magician. Large professional catalog \$1.25. Holden's, 120 Boylston Street, Boston, Mass.

JOKER'S Novelties. Send 10c for new list and free joke item. Garden City Fun Shop, 654 Franklin Ave., Garden City, N. Y.

PROFESSIONAL Catalog, 150 pages, 25c. Williams, 900 Plymouth, Eliwood City, Penna.

VENTRILOQUISM Selftaught. My quick, easy instructions, 25c. "Ventriloquist," CalAllen, Texas.

FOR The most amazing values in magic ever offered, send name and address to Ecomag, Box 494, Detroit 31, Michigan.

500 TRICKS, Douglas famous 120-page catalog, only 10c. Fastest service to magicians for 30 years. Send 10c today. Douglas Magicland, Dept. 1, Dallas, Texas.

2500 TRICK Catalogue (512-pages), pocket, parlor, stage. World's finest magic. Catalogue \$2.00 (dollar trick included free). Kanter's, M-1311 Walnut, Philadelphia 7.

FREE Trick and large illustrated catalog 35c. Lerro Magic, 8111 Fifth Avenue, Brooklyn 9, N. Y.

BIG Fun kit! Tricks, jokes, novelties, books. Real gay stuff. Howls galore. \$1.00. Johnson, 414 McRae, Wilmington, N. C.

PROFESSIONAL Catalog and free trick 35c. Terry's Magic Studio, 1921 66th Street, Brooklyn 4, New York.

VANISHING Key trick and catalog, 35c. Stirling Magic, Royal Oak, Mich.

STAMP COLLECTING

PLEASURE Is yours for pennies when you select from our big books of 1000 stamps. Clean and neatly arranged stamps for your selection. Scott's catalog number and price under each stamp, but large discounts allowed. Write today and watch your collection grow. Wolverine Stamp Service, Dept. C-4, Fruitport, Michigan.

SOMETHING New, something different, something terrific. Try our books of 1000 different and see for yourself. Mostly 1c and 2c, but Scott's catalog number and price under each stamp. Big discounts. Modern Stamp Co., Dept. A-4, Ferrysburg, Michigan.

DIRECTORY Of missions selling stamp mixtures! 25c. William Lotz, 89-21—88th Street, Woodhaven 21, New York.

1/10 CATALOGUE While our supply lasts on many over-stocked foreign stamps. Try them on approval. Premiums on purchases. Roseland Stamp Co., Dept. 10-E, Spring Lake, Michigan.

NEPAL—Grotesque collection of Nepal, remote Himalayan country, cataloging \$2.20, just 10c to new approval applicants. Viking, 130-ZZ, Clinton St., Brooklyn, N. Y.

66 DIFFERENT United States 10c. Approvals. Utechts, 1143D North Keeler, Chicago 51.

WORLDWIDE Mixture! 350 colorful stamps 25c. Approvals. Garrow, Chula Vista, California.

1000 FOREIGN Stamps off paper \$1.00; 5000, \$4.00. Anderson, Box 855, Mountain Home, Tennessee.

UNITED States—58 different including 8 airmails, 15 commemoratives, 10c. Approvals. Sunset, Dept. 104-S, Box 47, South Gate, Calif.

TRADE Stamps. Interesting, exciting. Write Pyramid, 2143 Grace, Chicago 18, Ill.

GIGANTIC Surprise packet, contains hundreds, catalog to 40c each, only 10c. Bargainful approvals. Dresel, Box 270-G, New York 25, N. Y.

SAN Marino triangles, 10c. Price list free. Walter Flesher, Jr., Garwood, N. J.

BRITISH Colonies packet, 20c. General approvals. W. Milnes, 27 Becker, Manton 9, Rhode Island.

LIQUIDATING Tremendous stock foreign. Catalog values disregarded. 100 var. 25c. C. W. Ritchie, Watertown, So. Dak.

GIGANTIC Collection free. Includes triangles, early United States, animals, commemoratives, British Colonies, high value pictorials, etc. Complete collection plus big illustrated magazine all free. Send 5c for postage. Gray Stamp Company, Dept. PM, Toronto, Canada.

FREE 15 Different Norway approvals. Lincoln Stampco, 8820 Aberdeen, Chicago 20.

FINE Approvals. Fast, personal service. What countries do you prefer? I'll send their stamps. Skinner, 438 Locust, Long Beach 12, California.

TRIANGLES, Congo, Nigeria, \$10,000 airmail, Philippine, Erie, Kiwi bird, midget, others, 3c to approval buyers. Seabrook Stampco, Washington 10, D. C.

WOW! 203 All different Germany 15c. Zeppelins, semi-postals, airmails, high values. Big bargain lists and approvals included. Jamestown Stamp, Dept. 512, Jamestown, N. Y.

FREE Complete set of famous Americans, flags, parks and presidentials to approval buyers. Send 3c for 15 of the above stamps plus full particulars. Triboro Stamp Company, 145 Nassau Street, Dept. 106, New York 38, N. Y.

LOOKING For bargains? Try out 1c & 2c approvals mounted in books of 1,000. We believe in both quantity and quality. First try will satisfy. Clark Stamp Co., Dept. P-2, Muskegon Heights, Mich.

PACKETS World different 2,000, \$3.00; 3,000, \$6.00; 5,000, \$15.00; 10,000, \$47.00; 20,000, \$200.00. Russell Smoky Mountain, Box 2011D, Natural Bridge Station, St. Louis 15, Mo.

TRADE Duplicates; plan, sample sheet 40c. S. Penniston, Norborne, Missouri.

AMERICAN Airmail assortment! 24 different U.S. airmails, including map, beacon, transatlantic, U.P.U., seldom offered, only \$1.00 with approvals. Wm. Kuehl, 3125 East K, Tacoma 4, Wash.

LION Triangle, elephant, 28 others 3c. K&S, 303 Clinton Ave., Newark, N. J.

JAMAICA Mixture catalogs, \$2.00 for 25c. No approvals. Anthony Daley, Buckland, Conn.

500 U. S. Foreign, 50c. Approvals. AG Stamps, 143 Boylston, Malden, Mass.

100 DIFFERENT Italy 10c. Sadler, Box 8189 Plaza, Kansas City, Mo.

FREE! \$10,000 Airmail! Canadians! Colonials! Commemoratives! Approvals. Keating, 2520 Boulevard, Jersey City, N. J.

ISRAEL Values—All different—25, 65c; 50, \$2.30; 75, \$7.00. Commco, Box 56, Brooklyn 29.

GIVEN! 5 Italian East Africa. Approvals. Super Stamps, 2 Madison, Greencastle, Indiana.

COMPLETE Or short sets on approval. The Knuts, 325 E. Arques, Sunnysvale, Calif.

ARMENIA, 10 Different large bicolored mint stamps. 30 year old complete set. 25 cents. Robert Boger, 3401 Oakmont Ave., Philadelphia 36, Penna.

SENSATIONAL Offer! 100 different Italy 10c. Approvals. Norge, Ho-Ho-Kus, N. J.

FOR \$1.00—200 Diff. Bulgaria plus sets, singles worth another dollar. Maximchuk, Box 831, Flin Flon, Man., Canada.

APPROVALS—Sets, singles. Colorful pleasing stamps. Ward, 241 South Winchester, Campbell, Calif.

FOLDING World map. Ideal for collectors and students. 35c coin, postpaid. Fold-O-Globe, Box 408, Burbank, Calif.

25 DIFFERENT French colonies 5c with approvals. Adlez, 367 Park Ave., Newark 7, N. J.

50 DIFFERENT U. S. covers \$1.00. Metzger, 937 Riverview, St. Louis 15, Mo.

100 NETHERLANDS. All different. Beautiful assortment, 10c with approvals. Thomson's, Box 4074-P, Miami, Florida.

DIFFERENT 500, 35c; 1000, \$1.00; 2000, \$2.00; 5000, \$10.00 with approvals at wholesale to clear. K. S. Holmes, London, Can.

CASH For stamps. Free buying list. Watts, Box 139, Bangor 2, Maine.

SENSATIONAL U.S. Confederate states catalogue free. Stone, 45-P Bromfield, Boston 8, Mass.

"GOYA Nude" set (worth 55c) 20c with approvals. Royal Stamp Company, Tam-aqua, Penna.

ALASKAN Covers, lists free. Alaska Stamp Co., Sitka 2, Alaska.

FREE! Monaco nude set 3 stamps. To new approval applicants. Moublow, Box 278M, East Northport, N. Y.

SERIOUS Collectors! Custom-made approvals. State needs. Brooks, 2352M East 23rd Street, Brooklyn 29, New York.

222 ALL Different 10c to approval applicants. Jayne, Gravesend Sta., Brooklyn 23, N. Y.

FISH, Lion, earthquake triangles, Belexiands 25 different, all 5c. Approvals. Hathaway, P.O. Box 145P, Garden City, N. Y.

REGULAR U. S. mixture 500, 20c; 1000, 35c. Unpicked mission mixture lb., \$1.25; 5 lbs., \$6.00; 10 lbs., \$11.00. Sibley, Mendon, Mass.

50 YEAR Old collection—U. S. classics, 15 selected old-timers each 50 or more years old—Most of 'em missing in even the biggest collections! Get all 15 of these unusual classics for less than 1c each. All yours for just 10c! With your request for approvals. Jaro Stamp Co., Box 246-G Church St. Annex, New York 8.

107 IRON Curtain stamps! Sensational offer includes large pictorials from Russia, Hungary, Poland, Czechoslovakia, Bulgaria, Rumania, East Germany and Siberia—lands cut off from the western world by ruthless Russian Communism. All different. Our booklet "How to Recognize Rare Stamps" included free. Rush 25c today. Offer limited. Kenmore, Milford I-176, N. H.

MINT, Unused United States approvals. Patrick Agencies, 3650 Central, Indianapolis 5, Indiana.

SENSATIONAL Guaranteed bargains! 1,000 different colorful, attractive mounted stamps, 1 and 2c each. Rushed immediately. Niagara Stamps, Niagara-on-the-Lake 71, Canada.

FREE To approval applicants—Israeli, British, French Colonies, Latin American, U. S. packet. Hobbies, 1463 Drexel, Miami Beach 39, Florida.

25 BRITISH Colonies 10c. Completely illustrated pictorial folders. Beautiful bi-colored mint stamps. Real bargains. Special discounts. Many free sets. Stoll Stamp Service, 2632 Burnett, Louisville 10, Ky.

WONDERFUL Offer — 7 complete mint sets only 10c with approvals. Reich (M26), 4647 Kenmore, Chicago 40.

UNITED States approvals. Select copies. Used, mint. Kingsbury, So. Woodbury 2, Vermont.

PAY Less—Get more. Packets by country or subject. Mammoth list free. Introductory special, 100 different Canada 39c. Econostamps, Box 168, Riverside 9, Calif.

BETTER Grade U.S. or foreign approvals. Ocean Stamp Co., Box 64-M, Brooklyn 29, N. Y.

PENNY Approvals that satisfy. Robert Moed, 245 Kosciusko St., Brooklyn 21, N. Y.

MINT King George Coronations from 5 different British Colonies only 10c with approvals. Walter Welles, Box 1246-R, Church St. Station, New York City 8.

50%-75% DISCOUNTS! Approvals from 33,000 collection—1/2c up! Schur, Box 245, Buffalo 12, N. Y.

AMAZING Offer! 200 United States stamps— including commemoratives, airmails, high denominations to \$5.00, only 10c to approval applicants! Illustrated bargain lists free. Mystic Stamp Co., Dept. 80, Camden, New York.

OLD U. S. on approval. Low prices. MacG., 2905 Observatory, Cincinnati 8, Ohio.

VALUABLE Airmail book plus gorgeous world-wide airmail collection 10c. Includes \$10,000 stamp, zeppelin, scarce triangle, many others with beautifully illustrated book, only 10c with choice approvals and bargain lists. Jamestown Stamp Co., Jamestown 708, New York.

FREE! Powerful magnifying glass for 5c post. Bargain lists and approvals. Jamestown Stamp Co., Dept. 207, Jamestown, New York.

NUDES Set; colorful approvals—10c! Atlas, 2830-M Eisenhower, Racine, Wis.

GREAT Free offer—Weird mosquito stamp, thrilling bicycle race, gorgeous orchid, colorful native drummer, gigantic diamond airmail, stamp albums, all to our approval buyers. Bell Stamp Service, Dept. S-4, Bell, California.

300 STAMPS For only 10c.—This mammoth value includes airmails, pictorials; stamps from strange countries cataloguing up to 25c each! Also approvals. Mystic Stamp Company, Camden 80, New York.

FLAG Stamp—Free with hydrate U. S. approvals. Wenigman, 1933 Patterson, Chicago 13.

200 DIFFERENT Including Roosevelt triangle, 5c to approval applicants. M. Avalon Stamp Company, Springfield, Mass.

STAMPS Wanted. Collections, duplicates, surplus stock, mint and used. Good grades only. Buy outright if bargain. What have you? Write us details. Vanroy Shirk, Lebanon, Penna.

1/2—1—2c APPROVALS, Bargains galore! Cole, 43A Rinewalt, Buffalo 21, N. Y.

FREE Sample—Interesting, informative, illustrated! National Stamp News, Anderson, South Carolina.

POLAR Bear triangle, giant George Washington, six colored Ecuador, Arctic triangle, first American commemorative, Corsica, Devils Island, others. Everything free with approvals. Capital Stamps, Little Rock 2, Ark.

FREE. Scott's International Album. Other big premiums. Full particulars with approvals. Raymax, 68-Z Nassau St., New York 38.

100 DIFFERENT Spain 25c. Penny approvals included. Reed, Box 980, Chicago 90, Ill.

WORLD'S Largest stamp (7 1/2 x 14 inches). A real curiosity! Retail for 50c, only 3c to approval applicants. Tatham Stamp Co., Springfield 30, Mass.

OLD Scarce U.S. seconds on approvals. Slight imperfections, lowest prices. Hernefield, Clintonhill Sta., Newark 8, N. J.

FREE Bahawalpur jubilee set with approvals. Lighthouse, Box 1516B, Colorado Springs, Colorado.

FREE—Italy pictorial set of 15 stamps to approval applicants. (We pay return postage). Frank Newman, 3539 Hartford St., St. Louis 18, Mo.

UNITED States—40 different 10c; 40 different commemoratives 25c. No approvals. Seldenberg, Appleton 944, Wis.

50,000 STAMP Grabbags 25c each. Anderson, 630B Bingham, Reading, Penna.

FREE Stamp 200! Rhinoceros, snake, giant, pygmy, emu, kangaroo, koalabear, kookaburra and other wild animals. Free with exciting approvals. Niagara Stamp Co., Niagara-on-the-Lake 51, Canada.

327 DIFFERENT Stamps 25c! Including early Canada, Newfoundland, British Colonies, Vatican, Red Russia, Hitler heads, Indian states, animals, airmails, French Colonies, rarities, unusuals. Every stamp different. Rare bargain only 25c with our bargain approvals. Money back guarantee. Niagara Stamp Co., Niagara-on-the-Lake 61, Canada.

50 DIFF. Finland 10c with approvals. Carroll's, E. 1817-A Sprague, Spokane, Wash.

50 DIFFERENT Worldwide 3c! Approvals. Vinny Jo, Box 3062, Seattle 14, Wash.

GUARANTEED Unpicked world mixture from sealed kilo lots. 1/4 lb. \$1.50, 1/2 lb. \$2.75, 1 lb. \$5.00. Satisfaction or refund. Nazareth Stamp Clearance, Dept. P. R. D. 3, Nazareth, Penna.

GUATEMALA, 25 Different, 10c with approvals. Fred Pittsley, South Montgomery, Napa, Calif.

RARE Bargain, \$1.25 Cat. alluring South Pacific Islands 10c with approvals that satisfy. H. Offerlee, 1920 Palmgrove, Los Angeles 16, Calif.

GERMANY Beautiful mint pictorial sets, over \$1.50 catalog, 25c, approvals. Pomykala, 3110 West 40, Chicago 32, Ill.

MIXTURES—Packets, kiloware. Catalog free. Tower, 1714 South Ashland, Chicago 8.

OPPORTUNITY, Gorgeous lot with triangles, giants, midgets, flags, airmail and railroad stamps. Also Brunel, Mongolia, Sarawak, etc. Everything only 10c to approval applicants. Evden, Valley Stream 10, N. Y.

5000 UNSORTED Worldwide, many rare, \$3.00. 5000 U.S. \$2.00. Kuhn, 81-10 Broadway, Elmhurst 73, New York.

COINS, TOKENS, CURRENCY

WHAT Are your coins worth? Amazing Fell's new 1953 United States coin book. Everything on every single coin minted—Worth, value, how to sell, speculating, investment; other valuable facts. Cloth-bound. 150 illustrations. Send no money. Pay postman only \$1.50 (plus postage) or \$1.50 postpaid (refundable). Order now! Fell Publishers, 386-M-13 4th Ave., New York City 16.

OLD Money wanted. Will pay \$100.00 for 1894 dime, S. mint, \$50.00 for 1913 liberty head nickel (not buffalo). Big premiums paid for all rare coins. Send 4c for large coin folder. May mean much profit to you. Numismatic Co., Dept. 20, Fort Worth, Texas.

BUYING U. S. gold coins, 50% above face value. Baevitz, 229-04 Hillside Ave., Bellerose, N. Y.

TWENTY Different Indian head or three large cents \$1.00. Edgar, 18 Twain, Baldwin, N. Y.

INDIAN Cent with bargain lists 10c. Hutchinson, 3463 "I" Street, Philadelphia 34, Penna.

FOREIGN Bills: 10 different Mexico \$1. 100 different Germany \$1. Dwight Musser, Dunbar, West Virginia.

VALUABLE Coins bought. Descriptive catalogue 30c. E-1119 Chestnut, Saginaw W.S., Michigan.

FLYING Eagle cents, 2 different, \$1. Two cent piece, three cent nickel and large cent, \$1. Delmaco, Box 1123, Wilmington, Del.

66 COINS And bills \$1.00. Oddehon, Box 482, St. Louis, Mo.

1953 COIN Handbook, 127 pages, 380 illustrations, \$1.25. Cook Coins, Jackson 5, Mississippi.

BARGAINS At auctions, \$50,000 sold monthly. Free catalog. Hollinbeck Coin, Des Moines, Iowa.

COIN Collector's Magazine. Largest independent, over 1000 pages per year. Sample copy 30c; \$3.00 per year. Hewitt, 7320-J Milwaukee Ave., Chicago 31.

FREE! Foreign coin, banknote and coin collectors illustrated catalog to approval service applicants. Send 3c postage. Tatham Coinco, Springfield 30, Mass.

5-IN-1 Special, \$1.00. 1893 Columbian half dollar; coin album; wooden nickel; check list and coin catalog. Ben's, PM Dept., 31 North Clark, Chicago 2.

SET Japanese invasion notes for United States, \$2.00. Burma note and coin catalogue, 25c. Shultz, Salt Lake 10, Utah.

GET Profit and pleasure in collecting old coins. Send 10c for 56 page illustrated coin catalog. You'll be delighted with it. Send for it now. B. Max Mehl, 370 Mehl Bldg., Fort Worth, Texas. Largest rare coin establishment in U. S. Established 53 years.

WE Pay \$5 to \$500 each for hundreds of old or odd U. S. and foreign coins. Keep all until posted. Send 25 cents for illustrated coin value book with bargain lists. 45 years in business. Coin Exchange, Le Roy, 101, N. Y.

WANTED—1894-S dime pay \$500.00. Certain 1913 nickel \$1,000.00. 1901-S quarter \$20.00 to \$150.00. Hundreds of others. Know their true value. Complete illustrated catalogue 25c. Worthycoin Corporation, (D-325), Boston 8, Mass.

PRECIOUS STONES, MINERALS

UNDERGROUND Red, or blue steel iron ore specimens. \$1.00. A. Bugni, 307 Maple St., Hurley, Wis.

PETRIFIED Wood. Attractive specimens. 25c and 50c each. Capital Gems, P.O. Box 141, Orange, N. J.

GEMOLOGY, Horology books! Catalog 10c. Atlantic Books, Lawrence Avenue, Charlestown 29, Mass.

"GENUINE" Red Arizona rubies (garnets). Send quarter for packet. Bitner's, Box 1025B, Scottsdale, Arizona.

GEM Cutting equipment. Books, The Art of Gem Cutting, \$2.00. Jewelry You Can Make, jewelry designs, \$2.75 postpaid U.S. Catalog 25c. R & B Art-Craft, 11019B S. Vermont, Los Angeles 44, Calif.

DIAGEMS, Newest and hardest synthetic jewels. Brilliant blue-white, all diamond shapes, 1/2 to 5 carats for your setting. \$12.00 carat (tax incl.). Free catalog. Diagems, Hampton Bays 7J, Long Island.

COLOR Agates permanently; red, yellow, blue, green, black. Instructions \$1.00. Herrmann, Box 146, Seaside, Oregon.

GEMSTONES, Mineral specimens. Every variety. Lowest prices. Postcard brings free booklet. Plummer's, 4720 Point Loma Ave., San Diego 7, Calif.

GEMS, Precious and semi-precious, genuine, from world-wide sources. Deal direct, no overhead, save money. Catalog 10c. Hill Co., 5450-G Portland Rd., Salem, Oregon.

FIND Tungsten, mercury, uranium with Mineralight. Free brochure. Write Dept. PM8 Ultra-Violet Products, South Pasadena, California.

GEMS And minerals, beautiful magazine tells how to cut and collect. Brochure and book list free. Gembook Co., Palmdale, Calif.

ANTIQUES, RELICS, INDIAN GOODS, CURIOS

4 PERFECT Arrowheads \$1.00. Good grooved tomahawks \$2.00. List free. Lear's, Glenwood, Arkansas.

ANTIQUE, Firearms, pistols, percussion, flintlock, list 25c coin. Westbrook, 738 Royal Street, New Orleans 16, La.

4 PERFECT Arrowheads \$1.00. Flint knife 50c. Hide scraper 50c. Stone axe \$3.00. Perfect pipe \$3.00. Flint hoe \$1.00. List 10c. H. Daniel, Lamar, Arkansas.

HOBBIES AND COLLECTIONS

MATCHBOOK Cover album holds 240 standard size without paste or stickers. Gay looseleaf binder illustrates matchbooks in colors. New master album \$3.25 postpaid. Matchless Album Co., Box 121PM, Long Branch, New Jersey.

NAZI, Soviet, campaign ribbons. Big packet, lists, \$1.00. Medcrafts, 1923 34th St. S.W., Calgary 2, Canada.

WANTED—Cigarette, tobacco cards. Write Charles Bray, East Bangor, Penna.

COLLECT Tourist pennants or decals, 10 different city or state \$1.00. Green, BD1, 6785 Imperial Ave., San Diego 14, Calif.

50 DIFFERENT Army embroidered patches \$1. Other bargains. Insignia Mart, 703A Broadway, New York 3, N. Y.

LEATHERCRAFT Is fun especially now. Make your own leather belts, billfolds, purses, hats, dresses, blouses from durable low-priced leathers. Supplement your seasonal wardrobe with leather articles. Free catalog. Tandy Leather, Box 397-C, Tulsa, Oklahoma.

EXCITING Hobby; collect authentic military patches, insignias, campaign ribbons, navy rates, etc. 57 assorted \$1.00. Free gift. Pritt, Dept. M-6, 12 West 27th, New York City.

CIGAR Store Indians. Reproductions made to order. Peter Meindl, Raymond, N. H.

UNUSED Matchbook covers—100 different \$1.00 36-page catalog 25c. Charles Edelman, 1311C East 84, Cleveland 3, Ohio.

INVENTING Can be an interesting and profitable hobby. Write for complete particulars. Institute of American Inventors, Dept. 40-E 631-E St. N.W., Washington 4, D. C.

CAMERAS, PHOTO SUPPLIES

ARGUS C-3 \$51.75. New. Brownie movie camera \$30.75. Other terrific savings. Free catalog. Camera Shoppe, Box 601-M, Mount Vernon, New York.

20 TO 40% Discount. Cameras, projectors, recorders, everything photographic. Send us your needs. Dart Sales, 3812 Atlantic Ave., Brooklyn 24, N. Y.

SEND \$1.00 For mammoth 275-page illustrated catalog. Dollar refunded with first order. Bloom's Photo Supply, 1657 Main, Springfield, Mass.

MINIATURE Album holds twelve 3 1/4 x 4 1/4 snaps in transparent pockets. Three albums postpaid \$1.00. Matchless Album, Long Branch, New Jersey.

EARN Money selling cameras. Send for free dealers bulletin. University Camera Exchange, 11-C Waverly Place, New York 3, N. Y.

FILMS, Surplus, excellent results: 35 mm. 4 rolls \$1.00. 116, 6 rolls \$1.00 postpaid. MDW Films, G.P.O. Box 1459, New York City.

BUY Wholesale nationally advertised cameras, photo supplies, thousands other products at big discount. Free "wholesale plan." American Buyers', 629-RR Linden, Buffalo 16, N. Y.

BASS Says: Trading since 1910. Used but good as new buys: 8mm. B.&H. Sportster \$52.50; 16mm. Keystone A-7, F:2.5 lens \$37.50; Voigt. 35mm. Vito II, flash shutter, Skopar F:3.5, like new \$38.50; Kodak Reflex F:3.5 lens, like new \$88.50; Contax I, F:2 Sonnar \$87.50; 3 1/4 x 4 1/4 Speed Graphic, Skopar F:4.5, Ibsor shutter, \$52.50. Satisfaction guaranteed. Bass Camera Co., Dept. AG, 179 W. Madison St., Chicago 2.

IMPORTED 35MM. cameras with leather case, 3.5 lens, 50mm. coated \$69 value. Sample \$25.50. Write for quantity prices. Bleier, 1022 Main, Neenah, Wis.

NEW Cameras! Loaded with film. \$2.00 postpaid. Wallace Jewelry, 3763 S. Wabash, Chicago 15, Ill.

PHOTO FINISHING

JUMBO Size deckle edge prints in album, 8 exposure 35c, 12 exposure 50c. Send money, free mailers. Photoprint, Box 906, Enid, Okla.

TWO Beautiful prints from each picture on 8 exposure roll 35c. Thirty-one years of satisfied customers. Quick service. Lens Photos, Dept. J-4, Janesville, Wis.

OVERSIZE Prints no extra charge. 8-exposure roll, 30c. 12-exposure, 45c. 16-exposure, 55c. Reprints oversize 4c. Finest quality. Mail Order Photo Service, Box 297, Watertown, Wisconsin.

FREE Mailers. 8 contacts 30c, jumbos—40c. 12—45c. Jumbos 55c, reprints—4c. Jumbos—5c. Western Photo, Dept. PM63, Box 298, San Francisco 1, Calif.

8 EXPOSURE Roll 25c; reprints 3c. Fast service. The Photo Nook, Box 2134, Billings, Montana.

BEAUTIFUL Enlargement from each picture on 8 exposure roll 35c. Cut Rate Photos, Dept. B-4, Janesville, Wis.

THE Photo Mill. Immediate service. No delay. Eight exposure roll developed and two prints from each negative—40c; or eight jumbo prints 38c. Single reprints 3c each; jumbo reprints 4c each. Write for complete price list and roll film mailers. The Photo Mill, Dept. K, 1511 Hennepin, Minneapolis, Minn.

DOUBLE Size prints—8 exposure roll 30c; 12, 45c; 16, 55c. Prompt service. Free mailers. Emerson Photo, Emerson, N. J.

TWO Prints each good negative, 8 exp. 35c; 12 exp. 50c; 16 exp. 65c. Reprints 4c. Mayfair Photo Service, Box 617-K, Toledo, Ohio.

SATISFACTION Guaranteed! Eight jumbo size prints mounted in album. 35c—12 to 16 exposure rolls, 50c. Free mailers, quick service, finest developing, finishing. Crown Studios, Box 1223-PM, Dallas, Texas.

12 JUMBOS 25c, 16 Jumbos 35c, from any size roll or negatives, with this ad. Skrudland S. Lake Geneva, Wis.

ENLARGEMENTS! Eight 5 x 7's or five 8 x 10's, \$1.00. Wilart Enlargers, Box 967, Little Rock, Ark.

CUSTOM Photo finishing guaranteed. 8 exposures 35c; 12, 50c. Bound in beautiful plastic ringed album. Special! 35mm., 36 exposure \$1.00. Free mailer. Flash Foto, Box 36M, Brooklyn 4, N. Y.

FAST—Same day service! 8 oversized prints in attractive plastic-bound book only 35c; 12-50c; 16-60c. Satisfaction guaranteed. Free exposure guide with first order. Pic-Sure, Box 899-B, Philadelphia 5, Penna.

6 OR 8 Picture roll 35c, 12 or 16 picture roll 55c. Each roll printed and developed. Handy album pack. If you fail to get pictures on your film a new roll will be sent you without extra cost. Send coin with roll. No c.o.d.'s. Mailing containers sent free. DeLux Film Service, Box 1268-A, Shreveport, Louisiana.

TOP Quality. Fast service. 8 jumbos 35c in beautiful Super Pak Album. 16 contacts 40c. Reprints—Jumbos 4c; contacts 3c. Satisfaction guaranteed. Write for free mailers and circulars. Fast-X-Foto, Box A, Jersey City, N. J.

GUARANTEED Quality. Fast service. Eight jumbos in beautiful super pak plastic ring binder albums only 35c. Send for free mailers and particulars of our complete photo finishing service. Grand Fotos, G.P.O. Box 1410, New York 1, N. Y.

MOTION PICTURES AND SOUND EQUIPMENT

8MM And 16mm home movies of beautiful national parks in Kodachrome, free list. Ideal Service Supply, 2101 Barclay, Oklahoma City 14, Oklahoma.

EARN Up to \$15.00 daily with your movie projector! Metcalf, 10806 Glenroy, Chicago 43.

WILD Life films. Exciting, dramatic action in the natural habitat of animals of forest and plain. 8mm. or 16mm. in beautiful color or B & W. Also 2" x 2" color slides. Write for free illustrated literature. Wild Life Films, 5151AF Strohm Ave., North Hollywood, California.

5000 NEW-Used 8-16mm. silent-sound films. International-B, 2120 Strauss, Brooklyn 12.

BARGAINS 16MM. sound films. Also for exchange. Bedner, 5300 So. Talman, Chicago.

RENT 16MM. sound films. 50c reel. Large selection; free catalog. Film Service, 128 Chestnut St., Roselle Park, N. J.

MOVIE Camera film: 8mm. roll \$1.50, 16mm. 100' \$3.00. Free processing. Better Films, 742 New Lots, Brooklyn, N. Y.

GUARANTEED Fresh 8mm. roll, magazine; 16mm. roll, magazine movie films. Color. b&w. Free catalog. ESO-S, 47th Holly. Kansas City 2, Missouri.

TAPE Recorders, tapes, accessories. Unusual values. Dressner, 624-M East 20th Street, New York City 9.

"**ENTIRE** Life Story of Christ." 8mm., 16mm., sound and silent, purchase or rent, state projector. Hemenway Film, 31F Church St., Boston 16, Mass.

BELL & Howell 16mm. sound projectors. Castle sound films, splicers, reels, other supplies. Free catalog. Ideal Service Supply, 2101-PM Barclay, Oklahoma City 14, Okla.

MUSIC AND MUSICAL INSTRUMENTS

POEMS Wanted for musical setting. Send poems. Free examination. Crown Music Company, 1476 Broadway, New York City 36.

POEMS Wanted for musical setting. Send poems for free examination. Five Star Music Masters, 630 Beacon Bldg., Boston, Mass.

PLAY Musical saw for pleasure, profit, popularity. Professional musical saw, hammer, saw bag, instructions, \$9.95 postpaid U.S.A. Robert Celaya, Brownsville, Texas.

WORLD'S Best offer to song writers. Send 25c coin. E-Z, 1133 Broadway, New York 10.

SONGWRITERS! Protect your ideas! Hold all songs, poems! Write for safe correct procedure first! Song Service, Dept. P. 333 W. 56th St., New York 19, N. Y.

MUSIC Arranged, songs printed. Frank Wildt, Music Publisher, Lancaster, Penna.

ACCORDIONS—Save 50% and up. Cash or terms. New and used. All brands. Wholesale to everyone. Free catalogue. Del Principe, 29 South Cicero, Chicago 44, Ill.

POPULAR Songs. How to write and sell them. Write for free booklet Successful Songwriting. Gateway Songs, Box 2470, Hollywood 28, Calif.

SONGWRITERS! Send poems, songs. Music Service, 243 West 72nd St., PM, New York 23.

POEMS Wanted to be set to music. Free examination. Send poems. McNeil, Master of Music, 510-PM S. Alexandria, Los Angeles, California.

WANTED! Poems for musical settings. Write Songwriters' Service, Clifton, N. J.

WRITE Songs. Big money and reputation. Write for information. J. Gordon Pub. Co., 4700 South California Avenue, Chicago.

SONGPOEMS Wanted. Mail to: Tin Pan Alley, Inc., 1650 Broadway, New York 19, N. Y.

POWERFUL, Dynamic voice quickly developed with diaphragm exerciser. Write, Voice Developer, Box 665 (34V), St. Louis, Mo.

POEMS Wanted for musical setting. Send poem for immediate consideration and free rhyming dictionary. Richard Brothers, 24 Woods Building, Chicago 1.

1953 **ACCORDIONS**—Wholesale. Free catalog. American Accordion Center, 5329 Belmont, Chicago.

ELECTRIC Guitars, accordions, amplifiers. Wholesale. Free catalog. Carvin, Baldwin Park, Calif.

FREE Record of your song. Your words—my melody. Free information. Johnny Mack, 1094-A West 39 Street, Los Angeles 37.

RADIO AND TELEVISION

AMAZING Newly developed, permanently fixed crystal detector with warranty guarantee and complete plans for building crystal radios, only \$1.00 postpaid. Allen, 427-PM10, Clinton, Missouri.

ANNOUNCING New circuits for builders. Receivers, experimental computer, brain and control circuits, many others. Many samples, catalog, \$1.00. Money back guarantee. William Bentley, Box 2056, Pensacola, Florida.

EXPERIMENTER'S Plans, diagrams, booklets. All kinds. Dittofax, 5208-A Onacrest, Los Angeles 43.

MAKE Louder crystal radio. Plans, mounted crystal, catwhisker, 25c. Complete kit \$1.00. Mallory, Box 1031-P, Tacoma, Wash.

SIMPLE Radio television trouble analyzer. Do profitable service work. \$1.00 postpaid. Stegotronics, Colchester, Conn.

ANTENNAS, Towers, boosters. All makes, complete supplies. Easy credit, lowest prices. Allied, 2503 N. 3rd, Milwaukee, Wis.

BUILD 15 Radios—Only \$19.95 complete. Free radio tester, tools, soldering iron. No experience required. Enclose 25c for valuable Radio-TV Repair Guide and kit catalog. Progressive Electronics, 497 Union Ave., Dept. PM-6, Brooklyn 11, N. Y.

REPAIR Your own radios. Complete simplified instructions only \$1.00. Details free. Slate's Radio Service, Corsicana, Texas.

CRYSTAL Operates loudspeaker. Illustrated instructions, 25c. Hulet, R4, Lakewood, N. J.

ENJOY 3 Color television filter screen now. Changes dull eye straining black-white pictures into beautiful color tones. Seconds to attach. Send \$1.50 for 16" or under; \$2.00 size 17"; \$2.50 size 20"; \$3.00 size 21"; \$4.00 size 24". Money back guarantee. Zingo Products, Johnstown 7, New York.

USED Television receivers \$10 up. Price lists, descriptions 30c. Ace Television, Kalamazoo, Michigan.

15 TESTED One-tube circuits 25c, including "Radiobuilder," catalog. Laboratories, 1131-C Valota, Redwood City, Calif.

NEW! Just out. Simplest capacity operated relay yet! Uses one tube, low power. Complete schematic, instructions \$1.00. Free details. Chemi-Technix Labs, 568RC Riley, Buffalo 8, New York.

ELECTRONIC Ear—\$1.00. Obeys spoken commands. Turns lights, radios, etc., on or off. Not a toy. Plans, Mail \$1.00 to Dept. M-1, National Industries, Inc., 951 No. La Cienega, Los Angeles, California.

"AIR Condition" your television set! Prevent over-heating, interference, expensive breakdowns. Remove "boxed-up" chassis heat. Complete unit, \$10.00 postpaid. Video Vent, 662 Perkins, Sacramento 18, Calif.

CLEARCO Crystal radio kit \$1.50; pre-assembled \$1.75. Free catalogue. Clearco Crystal Co., Box 1857, Milwaukee, Wis.

BUILDER'S Pictorial plans. Free list. Alena, Box 24, Astoria 6, New York.

AMAZING Television antenna eliminator. Small device attached to rear of set where it's out of sight. Outperforms outdoor aerials. No snow, no ghosts. Send only \$2.95 or write for free details. Arrow Sales, 2306 S. Howell, Milwaukee 7, Wis.

PICTURE Tube revitalizer makes dim pictures bright. \$2.95. T.V., 6225 Market St., Philadelphia.

CRYSTAL Radio needs no antenna. ground. Receives while carrying. Ideal on bicycles. Plans \$1.00. Box 6008, Kansas City, Mo.

BUSINESS OPPORTUNITIES

NEWEST Spare, full-time home business. \$5 to \$10 hour possible. Paint with suede—The finish with touch and eye-appeal. Beautify auto dashboards, signs, radios, toys, figurines, lamps—1001 others. Complete, step-by-step instructions sent for no-risk examination. Free details. Coast, 1004-HR So. Los Angeles St., Los Angeles 15.

HAVE Fun, make money—Learn metal casting at home. You can make anything of metal. Send 10c for first article on metal casting. Literature free. "How To Do It" Co., P.O. Box 124, Lynwood, Calif.

FOR Pleasure and profit. Send for free illustrated instruction book and business plan; how to permanize, metalize, ceramize, porcelainize baby shoes, mittens, booties, cloth, lace, etc. No equipment, no firing, no baking. Professional Art Products, Dept. PM-6, 825 South Wabash, Chicago, Illinois.

ADVERTISING Book matches—Cash in on big demand; sell union label matches. Cuts for all businesses and political parties. Free powerhouse selling kit, low prices, protection guaranteed on repeat orders. Cash commissions. Superior Match Co., Dept. MX-653, 7530 Greenwood, Chicago.

START Your own business on credit. Your own boss. 1586 of our dealers sold \$5000 to \$27,500 in 1951. We supply stocks, equipment on credit. 200 home necessities. Sales experience unnecessary. Pleasant, profitable business backed by world-wide industry. Write Rawleigh's, Dept. F-U-PPM, Freeport, Ill.

IMPORT-Export! Opportunity, profitable, world-wide, mail-order business from home, without capital; or travel abroad. Established World Trader ships instructions for no-risk examination. Experience unnecessary. Free details. Mellinger 26, Los Angeles 24.

WANT A diesel job? New opportunities to increase income. Higher pay. More money. We can help you qualify. Tools. Shop method home training. Write today! Diesel, Tractor, Heavy Equipment Division, Interstate Training Service, Dept. B3F, Portland 13, Oregon.

ARTKOTE Stone facing molds can help you become independent. Sample mold \$2. Literature free. Dividend Company, Liverpool, N. Y.

800% PROFIT With our O.R. mail order plan. Complete plan, ad copy, etc., just 25c. Mann-Sales, 17 William, Hillsdale, New Jersey.

START Your own business at home, make extra money spare time taking subscriptions to popular magazines. Liberal commissions and valuable prizes. For details and supplies, write Dept. PM, Home Reading Circle, 25 So. Center St., Springfield, Ohio.

BOOKKEEPERS, Increase earnings operating sensational bookkeeping service. C.P.A. system. Kern, 4942 Vineland, North Hollywood, Calif.

SPECIALIZED Magazines covering your field of interest help you to greater success. Get latest copies through our easy-to-get-acquainted service. Hundreds of business, trade, professional, educational, sport, hobby, gift, grocery, health, historical, horticulture, hospital, hotel, humor, insurance, jewelry and others covering all interests. Send for list today. It's free. Commercial Engraving Publishing Company, 34C North Ritter, Indianapolis 19, Indiana.

BE A jobber without investment, without inventory. Discounts 50% and more—Even on small orders. Draw from \$250,000 stock. Sell stores, individuals. Profits up to 100%. Terrific line of toys, novelties, jewelry. Free catalog. Modern Merchandise, Dept. 36, 169 W. Madison, Chicago 2, Illinois.

SIDELINE Salesman, auctioneers, agents. Free wholesale list. Watches \$3.88, jewelry sets \$4.20, also name brands jewelry, merchandise. Everything guaranteed. Casey Hoeffler Corp., Dept. 70, 618 Jackson, Chicago 6.

FREE Electroplating information. Money making plans. Send postcard for your copy. Highly paid, interesting, uncrowded field. Plater M. Hyde, 327 West 120th Street, Los Angeles 61, California.

LIQUID Marble—Colorful, glossy! Molded, brushed, sprayed! Cast novelties, statuary, colored tiles. Flexible molds. Composition floors. Particulars free. Marbleizing Service, Edwardsville, Illinois.

BIG Profits weaving rugs—Send 10c for our catalog, sample card, and low prices on carpet warps, rug fillers, looms, parts, inexpensive beam counter. If you have a loom, give make and width please. Or. Rug Company, Dept. 6396, Lima, Ohio.

HOW To raise the money you need. Free details. Enterprise Bureau, Syracuse 2-P, N. Y.

"MAKE Perfume." Catalogue free. "International," 6347 Parnell-PM-6, Chicago 21, Illinois.

MAKE Tough, durable plastic—1c pound. Makes attractive floors, walls, built-ins, roof. Build good home \$150.00 room. Bays Laboratory, Oklahoma City 9.

START The ideal small town home business. Floor sander rentals. Little capital required. Pay for machines as you go. Make up to \$5000 operating from your home. Man or woman. Details free. Rader, Box 8456, Kansas City, Missouri.

MAKE Products—Sell mailorder formula catalogue free. "Imso," 6347 Parnell-PM-6, Chicago 21, Illinois.

FRANCHISES Make profits! Become exclusive distributor or agency operator. Nationwide opportunities. For immediate action write National Franchise Reports, 452 Pure Oil Building, Chicago 1, Illinois.

PROFITABLE Mailorder business! Learn how. Many lines. Catalog 10c. Mann-Sales, 17 William, Hillsdale, New Jersey.

MAKE Perfumes at home, write "Carey Laboratories," 1914 Chouteau PM-6, St. Louis 3, Missouri.

SOIL Analysis—Fascinating new business, every homeowner a customer. Write Soiltest, 307E Woodland, Lake Bluff, Ill.

HOW And where to obtain capital? Free details. Star Service, Wapakoneta, Ohio.

LEARN Sewing machine repair, electrify, rent, trade, sell. Make up to \$150 week spare time setup. Motor kits, zigzag machines, etc. wholesale. Free particulars. Taylor Service, Hamilton PM-6, Ohio.

FLEXIBLE Rubber moulds for plaster and Marbleite figurines. Sample and large illustrated catalog 25c. refunded on first order. K-C Novelties, Dept. 43, Easthampton, Mass.

START Home mailorder business. Details. Gedgard, Box 798-L, New York 1, N. Y.

MAIL Order money making information free. Write Buckner, Box 175, Mount Pleasant, Texas.

WANT Extra money? Learn to sell by mail. Write: Carlton's, 3007 Wharton, Philadelphia 46, Penna.

WHOLESALE Catalog! Over 400 nationally advertised items. 20c. Kennedy's, Dept. 8, 216 "F" Street, Anniston, Ala.

START A buying service, buy wholesale thousands nationally advertised products. Make big profits selling at sizable discounts. Postcard brings details. American Buyers, 627-R Linden, Buffalo, N. Y.

BE Your own boss pioneering new concrete waterproofing your town. You get material wholesale and also make fine profit on contract jobs. All or part time. Rex Aquadry, 5511 W. North Ave., Chicago 39, Ill.

QUICK Sign painting. Use letter patterns, avoid sloppy work, wasted time. Write for sample. John Rahn, A1330 Central, Chicago 51.

BIG Mail. Receive thousands of money making opportunities. One listing 25c. Three 50c. Thomas Jerdon, Hermansville, Maryland.

BIG Profits making keys, spare or full time. New, inexpensive machine makes these keys. Details free. Starrett Mfg. Co., 3038 Adams Avenue, San Diego 16, Calif.

BIG Profits! Raise real Chinchillas on our new lease plan. You raise them, we buy them. Small capital can show terrific profit possibilities. Booklet free. Chinchilla, Dept. 505, 303 Lexington Ave., New York City.

PROFITABLE Mailorder plan. Free advertising. Mailing. Small ad brings quarters, half-dollars. Big profits 50c. Rorick, Box 86, Cincinnati 26, Ohio.

PLASTIC Engraving, carving machine—"Dupliscaler." Profits to \$5 hour engraving plastics. Details, sample 25c. Desco Distributors, 6334-R Sepulveda, Van Nuys, Calif.

MAKE \$6.73 Every time you sell one—And they're amazingly easy to sell! We have new adding machines in original factory cartons you can sell for only \$14.95 and you make 45%. They're executive model portables, precision built with automatic clearance, direct subtraction, fully guaranteed. Send for life size color photo with full details. Write today to Lightning Adding Machine Co., Inc., Dept. P30, 1260 West Second Street, Los Angeles 26, Calif.

START Your own thrilling mail-order business, anywhere, on small capital; proven plans. Write Paragon, Box PM-1794, Houston, Texas.

ADDITIONAL Income. Want to own a collection agency? Mail \$1 for instructions. Sterling, Great Neck 7, N. Y.

PROFIT! Without investment! Through our watch-clock-jewelry repair service. Inquire. Modern Technical Supply, 55-PM-West 42nd Street, New York 36.

MAKE Money mailing to sportsmen. Supplies furnished. Details 10c. Zamboni's, Box 1138, Longview 33, Washington.

WANTED—Interested person to act for foreign shippers. Learn business. Ezzo, 725 Highland Ave., Kenmore 23, New York.

WANT A new car; fine clothes; more money? These can be yours! Complete home plans for making-selling many sought after articles, \$1.00 (truly different). No special ability needed. Profit unlimited. Send today! Master Skills, 118-M Ashland Avenue, River Forest, Illinois.

BUY At genuine wholesale prices direct from large New Jersey wholesale distributor. Full dealer discount on nationally advertised standard brands of power tools, housewares, bicycles, watches, jewelry, radios, appliances, refrigerators, cameras, auto supplies, sporting goods, musical merchandise, etc. Go into business for yourself—we supply you. Shipment made direct to your customer. Supply your own and friend's needs. Send \$1.00 for set of five different catalogs and wholesale price lists. \$2.00 refund certificate given. If not satisfied this is the best deal you ever had, return everything for full refund. Nobody does, nobody can undersell Passaic Valley Distributors, P.O. Box 1543, Paterson, N.J.

SELL Perfumed stationery by mail. Own exciting home business. Rienzi Press, 24-R North Seventh, Newark 7, New Jersey.

EARN Big money by mail. Depression-proof income. Circular 10 cents. Complete starting deal \$3.00 postpaid. Reho, Box 21A, Whitsett, Penna.

START Your own business with a route of nut, candy or gum vendors. No experience necessary. Full or part time. Send for catalog 100. Rake, 609-S Spring Garden St., Philadelphia 23, Penna.

MAKE Money selling merchandise by mailing cards. Paton, Box 55-M, New York 23, N. Y.

BIG Money! Start your own plastic business at home. Spare or full time. (Also valuable liquid marble information.) Free catalog. Write: Bing Products, PM-653, Watertown 72, Mass.

BUY 250,000 Articles wholesale. Directory 25c. Publishers, Box 1486-P6, Detroit 31.

NO Equipment, big profits selling, glass, wall, waterless hand cleaner. Add water to concentrates. Donnell Sales Co., P.O. Box 321, San Bernardino, Calif.

START Your own profitable home mail-order business! We supply everything! Write today! Studio Products, Box 564-A, Glendale 5, Calif.

START Profitable lumber, wood products business. Sell by mail. No investment. Chas. Webster, Guttenberg, Iowa.

SELL By mail to automobile owners. Millions of prospects. Fast selling items. Everything furnished. Write: Eastern, Box 142-P, Dorchester 24, Mass.

FLORIDA Opportunities! Hundreds of jobs, businesses, farms, groves, ranches, homes. Free details! Florida Opportunity Bulletin, Box 456-N14, Coconut Grove, Miami 33.

500 RADIO Broadcasting stations, who advertise on commission basis. Complete list nationwide, \$1.00. Dennett's Products, Box 165-A, Providence 1, R. I.

PROFITABLE Home business, manufacturing plaster novelties. Free information. Mertz Plastercraft, San Bernardino, Calif.

SELL Popular Mechanics and all other magazine subscriptions. Free catalog, supplies. Subscription Service Company, Dept. A, P.O. Box 2070, Birmingham, Alabama.

FREE Booklet reveals amazing secrets behind 301 new profitable enterprises! Many mailorder! Includes confidential instructions for starting wholesale buying service. Deumant Business Surveys, 79-R Deumant, Kenmore 23, N. Y.

LET Others sell for you. Earn steady from home. No mail order. Full set up service from idea to success. Free information. Hermes Company, 152 West 42 Street, New York.

MAIL Order business using profitable free advertising method reaching 66 1/2 million. Revealing information free. H. P. Seidel, 7070 Hollywood Blvd., Hollywood 28, California.

START Business without capital! Reliance, 15-A, Park Row, New York 38, N. Y.

NEWSPAPERS. Turn them into cash. Eighteen methods. Instructions 50c. Charles Company, 12-DBE, Norwood, Ohio.

PROFIT With garden golf. Instructions on locating, building, operating. Write Brockway, Seaside, Oregon.

LIVING Miniature ("Ming") trees only 10 to 20 inches tall. Grow at home. Big profits! Spare time opportunity. Fascinating! Amazing! Write for free seed and plan. National Nursery, Dept. FC, Inglewood 4, California.

YOUR Own business in your basement. Very profitable. Sideline or full time. Patterson, 2518 Beaver, Des Moines 10, Iowa.

MY Husband, college professor, devised a scientific mail order plan that brings \$1000 monthly to our mailbox. Since the plan works anywhere, we bought a beautiful ranch, operate here. Anyone intelligent can apply our plan. Details free. Eveningshade Ranch, Helotes, Texas.

NATURAL Molding latex. New low prices. Extra thick. Free sample. W. Wooley, 115-A Donald, Peoria, Ill.

GET Dollars in your mail—Keep every cent. Orders filled free. Genmerco, Box 142, Boston, 24B, Mass.

LEARN Silk screen printing; invisible reweaving; repair dolls; make rubber stamps. Rubber for molds. Large catalogue free. Universal, Box 1076-A, Peoria, Ill.

\$50 AN Hour in spare time. Johnson, 351-B, Ithaca, New York.

HAVE Big time mail business. Get ideas, help, inspiration from others who made fortunes. Fern, 513-A West 61st, Chicago 21, Illinois.

BUY It wholesale! Manufacturers, distributors offer 850,000 items. Literature free. Olsen, 1231-A East Third St., Duluth 5, Minn.

BREED Rare tropical fish at home. Earn big money! Learn secrets! Help fill huge demand. Amazing opportunity! Free plan. Tropicals, 1008-F Los Angeles St., Los Angeles 15.

EXTRA Dollars. Spinning angora wool for us. Angora House, PM, Springfield, Illinois.

INCOME From local information. No selling. Write Neherco, La Verne, Calif.

BOOKKEEPERS, Keep books, small firms spare time. Manual latest technique by C.P.A., \$3.00. Modern Business, Box 406, Youngstown 1, Ohio.

MADE \$24,500 Using money making plans from Schemer Magazine, world's oldest mailorder publication. Box 275M, Canfield, Ohio. Year \$1.00. Sample 20c.

\$46 FROM Square foot plywood; jigsaw necessary. Write: Woodarts, X-154, Bridgewater, Mass.

FREE Particulars "Profitable Home Business Projects" plus wholesale sources 740,000 items. Cottage Industries, Omaha 12, Nebr.

FREE Vending machines; if used to sell our profitable nuts. Continental, Box 1361-A, Milwaukee 1, Wisconsin.

WHOLESALE Of sensational nationally advertised appliances, silverware, watches, cameras, etc. Start your own business. Full details. Send 25c for catalogue. International Sales Co., 175 Fifth Ave., New York 10, N. Y.

EARN Extra money with profitable home business projects, free particulars. Chamberlain, Box 894, Manchester, New Hampshire.

PROFITABLE Home business, electroplating novelties, giftwares, auto parts, mirrors. Easy, inexpensive home processes. Free booklet. Tyco Metals, Box 13231-MJ, Houston 19, Texas.

COLOR Concrete with chemicals. Marble-glaze cement benches, pottery, garden ornaments. Home — shop. 10c brings sample, pictures. Hollywood Cementcraft, 8527-R Wonderland, Hollywood 46, Calif.

MAKE Gifts, novelties, jewelry, from sea shells, fish scales, plastics! Wholesale, illustrated catalog 10c. Giftcrafts, Box 4550-PM, Coral Gables, Florida.

PROFITABLE Home business. Make fast-seller chenille monkey trees, dolls, flowers. Terrific holiday demand. Information free. Velva, Bohemia 16, N. Y.

TO \$35.00 Weekly. Spare time, home operated, mailorder business. Successful "beginner's" plan. Everything supplied. Lynn, 10420-M National, Los Angeles 34, Calif.

LIQUID Rubber, make flexible molds. Free sample. Chaney, 1130 E. 16th St., Jacksonville 6, Fla.

RAISE Fishworms. Easy, profitable. Complete instructions 25c. Huffmans Worm Ranch, Rives Junction, Mich.

FIX Typewriters. Free booklet describes our modern, inexpensive home-study course. Factory methods taught. Write: Typewriter, Building 1, Tarentum, Penna.

\$25 WEEKLY Working two hours daily. No canvassing. No manufacturing. Lycke, Box 2471-A, Cleveland 12, Ohio.

RESILVERING Mirrors, formula 50c; two-way lookout mirrors. (No one sees you), 50c; coppered mirrors. 50c. All \$1.00. Nelko-Mir, Box 3462-J, Chicago 54.

FIGURINE Molds and many others, liquid rubber, statuary plasters, flock finishes, Glo-candle wax, etc. Illustrated catalog and "Plastercraft" manual free. Blue Rapids Supply, Blue Rapids, Kansas.

START Home manufacturing business. Make cleaners, soaps, polishes, cosmetics. Free literature. Kemix, Park Ridge, Ill.

BIG Profits making new greaseless doughnuts. Start in kitchen. Wholesale to grocers and cafes. Free plans. M. Ray Company, 3605 South 15th Ave., Minneapolis 7, Minnesota.

MAKE Money spare or full time, casting metal toys and novelties. Big wholesale and chain store demand for autos, soldiers, ashtrays, banks, etc., keeps manufacturers busy. Production moulds furnished for up to 100 and more castings per hour. No experience or special place necessary. Write for information and illustrations of patterns needed. Metal Cast Products Co., Dept. A, 1696 Boston Road, New York 60, N. Y.

NEW Exceptionally profitable plans, ideas for home operated mail business. Rush name. Miller, 1772-P Carlyon Road, East Cleveland 12, Ohio.

MAKE Flexible molds! Cast plaques, bookends, figurines! Free sample! H. Tooker, 630-R Chestnut, Hamilton, Ohio.

RECAST Old batteries into new. Latest achievements. Battery Laboratories, Minneapolis.

READ "Advance"—The voice of mail order. Offers money-making opportunities, sources of supply, personal guidance, etc. Issued monthly. Sample copy 35c. Yearly subscription \$2.00. Advance Publishing Company, 313 East 21st Street, Suite 450, New York 10, N. Y.

GOOD Paying business silvering mirrors, plating autoproducts, reflectors, bicycles, bathroom fixtures, etc., by late method. No tanks or shop required. Outfit furnished. Free booklet. Gunmetal Co., Ave. H, Decatur, Illinois.

BUY Wholesale. Thousands articles. Supply directory, 10c. Idealco, Park Ridge, Illinois.

EARN Extra money! "Homeworker Magazine" tells how. Sample 25c. Sizemore, Box 7, 4917 Kostner, Chicago 30.

EXTRA Money—No selling, operate vendors. Amazing profits, details free. Silver King, Suite 220, 622 Diversey, Chicago 14.

OPERATE Profitable mail order business. Write Walter Service, 4159-A East 112th, Cleveland 5, Ohio.

DOLLARS in personalized baby record books. Sell by mail. Use same literature we do. No-Co-Ro, Oakland 6, Calif.

MINK Raising information free. Complete. Lake Superior Mink Farm. Superior, EE1, Wisconsin.

COPUBLISH Leading m.o. paper. Latest copy. Mail Sale Advertiser, details, dime. Vanroy Shirk, Lebanon, Penna.

COLORGLAZED Concrete pottery made without molds. Patented method. Cemetery products, novelties, tiles. Basement leak-sealing. Money-making projects. Booklet, details free. Men only. National Potteries Company, Grand Rapids, Minnesota.

FREE Book "505 Odd, Successful Businesses." Work home. Expect something odd! Pacific, Oceanside, Calif.

POPCORN And potato chip equipment. Long Eakins Company, 5360 High, Springfield 99, Ohio.

START Venetian blind laundry. Profitable lifetime business. New machine. Free booklet. F. C. Co., 442 N. Seneca, Wichita 12, Kansas.

SELL Books by mail! Wholesale catalog, 25c. Monarch, Auburn, New York.

MAKE Money from newspaper clippings. Siegel, Box 183 PM, New York 2.

VENDING Machines—No selling. Operate a route of coin machines and earn amazing profits. 32-page catalog free. Parkway Machine Corporation, Dept. 72, 715 Ensor St., Baltimore 2, Md.

BE Independent. Small investment. Full-time or part-time. "Reel chair" for jobs large or small. Cleaning, painting, repairing, window-washing, etc. Write Finney Co., Platteville, Wisconsin.

137 PLANS For starting home business. Details: Elite Co., 220 Grand St., New York 13.

WANTED! Home producers, by manufacturers in our clearing house service. Become a sub-contractor, casting plastic products for these companies. Thousands of easy-to-make items required for consumer and industrial use. Cash in at home, without previous experience. Write Plastic Service Associates, Dept. PM5, East Boston 28, Mass.

MAKE Perfume. Sell on smell. Mail order or local. Wilson made \$7200.00 first year. Free sample, plan revealed. McCann, 4019-21 Rio Grande, Amarillo, Texas.

FREE Wholesale catalog. Make up to 500%. Be your own boss, work full or spare time. Everyone a prospective customer. Sell costume jewelry, wrist watches, religious items, novelties, toys, gifts and prizes. Write today, specify catalog PM4, Heath Distributing Company, 3253 Vineville Avenue, Macon, Georgia.

OPERATE "Escalator" mailorder system, selling our products or any products. Fastest, most revolutionary mailorder system known. Write: Selbyco, Decatur 156, Ill.

MAKE Money at home as renewal headquarters for all magazines. Liberal commissions. No experience, no capital needed. Supplies furnished. Write for free catalog. McGregor Magazine Agency, Dept. 500B, Mount Morris, Ill.

OPERATE Profitable mailorder business. Details. Natel, 411-C Paulsion, Passaic, N. J.

WHERE To buy at wholesale 100,000 articles. Free list. Also extra-income information. Maywoode, 1135 Broadway, New York.

"FLOATING Henryburger" Systems franchise. Rare opportunity. Small investment. Box 936PM, Wichita, Kansas.

LEARN Metalizing baby shoes, gifts, etc. Bronze, gold, silver. Folio free. Kiktavi, 7217-PM South Broadway, Los Angeles 3.

\$200 WEEK Possible! Sensational new hand cleaner. Manufacture, distribute. Easy. Free plan! Keenelo, 2445 Larimer, Denver 2, Colorado.

EARN Money with typewriter, sewing machine! Details free. Edwards, 3915-PM, 12th, Des Moines 13, Iowa.

HAVE Home mail business. Big earnings. Everything furnished. Start low as \$150. NMD. Agency, Box 88, Dorchester, 22-A, Mass.

50 PLANS For home mail business. Proven money-makers. Personal help assures success. Verdo, R1, Box 37-A, Huntsville, Missouri.

PEARL Finishing. New amazing home, full-time business. Free success plan. Pearllette, Box 73136, Los Angeles 3.

EARN \$2.00 Hour, I do, making sandals. Chas. Youngs, 1308 S. First, Arcadia, California.

EARTHWORM Breeding? First, get unusual story. "An Earthworm Turned His Life." Free. Earthmaster, Dept. 14, El Monte, Calif.

MONEYMAKING OPPORTUNITIES

SELL Snowballs. You make them. Big profits. Free circulars of needed supplies. Snowball Company, 9534 Lemturner, Jacksonville 8, Fla.

BE Independent, be secure, have your own profitable business—Earn \$20.00 and more a day making beautiful, fast-selling lamps at home. No equipment needed. Illustrated course teaches you quickly. Course, parts catalog, wholesale price list—only \$2. Gearon Co., Dept. 200-B-6, 27 S. Desplaines, Chicago 6, Ill.

\$10,800 PROFITS! Your own mailorder business! No capital risk! "Success plan" (worth \$2) free! Write today! Treasury, 709 Webster, New Rochelle PM-12, New York.

NOTARY Public commands more money. Be one. Stationers, Helotes, Texas.

"THANK You, call again" and 1999 other ultra-blue 7"x11" signs—Comedy, general, religious. Retail 50c each! 15 samples, \$1.00. Lowy, 812 Broadway, Dept. 735, New York 3.

EARN Money evenings, copying and duplicating comic cartoons for advertisers. Adservice, Argyle 1, Wisconsin.

SELL By mail. Chamberlain Books, 87 Arizona Place, Chandler, Arizona.

RAISE Earthworms. Easy, profitable. Free instructions. Earthworm Gardens, 224 West Valley, El Monte, California.

WIN Contest money. General Contest Bulletin gives hundreds of tips. Lists current contests and rules. Sample 25c. General Contests, 1609 1/2 East 5th, Duluth, Minnesota.

TIE-Breaker picture puzzles exposed, \$5.00. Wenograd, Box 1495, Philadelphia 5, Penna.

FREE! Your own mailorder business! Everything furnished! No investment! Terrific profits! Write today. California Vitamins, 2910PM Beverly Blvd., Los Angeles 4, California.

FREE Booklet reveals amazing secrets behind 301 new profitable enterprises! Many mailorder! Includes confidential instructions for starting wholesale buying service. Deumant Business Surveys, 83-R Deumant, Kenmore 23, N. Y.

500,000 ITEMS Wholesale! Sources, plans, formulas, tips in big "Profitmaker" folio. 25c. United, Box 87-M, Detroit 2.

THE Miracle cleaner for upholstery, rugs, woodwork. Write Mom's Products, West, 1011 Carlisle, Spokane 17, Wash.

SELL Your own ideas copy magazine. Details dime. Zen Publications, Elkhart, Ind.

MAILORDER Dollars unlimited. No investment. Reimer, 161 a Weirfield, Brooklyn 21, N. Y.

START A buying service, buy wholesale thousands nationally advertised products. Make big profits selling at sizable discounts. Postcard brings details. American Buyers, 630-R Linden, Buffalo, N. Y.

WHITE Tire cleaner—Concentrated powder, add water. \$1.00 postpaid. Menyo, Box 234, Inyokern, Calif.

MEN—Women. Make money spare time plus new car as bonus for encouragement. Amazing hosiery guaranteed to wear without holes, snags, and runs, or replaced free. For example, lovely 60 gauge nylons guaranteed for as long as 1 1/2 years, or replaced free. Write Wilknit, 1736 Wash., Greenfield, Ohio.

FREE Success plan. Any business—Spare, full time. Shocker! Write: Trends-B36, Box 5564, Crosstown Station, Memphis, Tennessee.

PARTNERS Wanted. Patented appliances. Dr. Roberts, 111 N. Stevens St., Valdosta, Ga.

SELL Hydrocaps increases battery life 25%. Good profit, every car owner buys, real spare time money maker. Write for details today. Aviaparts, Box 884, Coral Gables, Fla.

GROW Miniature dwarfed trees, instructions 50c. Metro, Box 103c, Berwyn, Ill.

WE Pay cash for boxtops, labels, wrap-pers, coupons, etc! Particulars free. Box-tops, PM-983 E. Main, Columbus 5, Ohio.

BUY Wholesale! Nationally advertised appliances, housewares, jewelry, watches, etc. Free information concerning tremendous discounts. Econ-O-Mart, Box 535, Morristown, New Jersey.

INSTALL Hand railings on stairs, ter-aces, porches. Unlimited applications. Provides safety. Cast aluminum universal joints lock with set screws. 1 1/2 inch aluminum tubing will not rust. Easy to assemble. Fits any angle or grade. Install in wood, stone, ground or concrete. Profitable. Send for folder. Kloppenborg Aluminum Foundry, Dept. PMC-3, Davenport, Iowa.

400 RADIO Stations active. Free radio advertising. Pay commission only on orders received. Free information. Mishek, 2, Waseca, Minn.

ASSEMBLE Electric fans. Exhaust and circulating for home, attic, kitchens, restaurants, offices, factories. Sells easily. You furnish electric motors; we furnish all fan parts. Send for wholesale parts catalog. Kloppenborg Aluminum Foundry, Dept. PMC-3, Davenport, Iowa.

CASH In your ideas. Complete information now available. Prepared by experienced engineer-inventor. \$1.00. Full refund provision. O. W. Wood, 100 Church Street, Liberty Corner, New Jersey.

MAKE Money at home! New folio "Homework as a Profitable Endeavor" tells how. Only 25c (refundable). Opportunities, Folio-A, Box 209, New York 28.

SELL Titania gems; \$9.75 carat whole-sale. More brilliant than diamonds. Free catalogue. Diamonite, 1404-M Mitchell, Oakland 1, California.

SCHUHMACHER Matmakers. Convert old tires into dollars. Devote full or spare time. S and S Patents, Inc., 1307 North Clark St., Chicago 10, Ill.

50,000 ARTICLES Wholesale. Source directory, dime. Nelko, Box 3462-DR, Chicago 54.

PUBLISH Your own magazine. Handsome 52 page format, well edited, illustrated. Cost low as \$1.00 month. Brings you prestige, profits, 25c brings sample, details. National, Ord, Nebr.

137 PLANS To make money, local mail-order. Details: Elite Co., 220 Grand St., New York 13.

READ Progressive Mailtrade, the maga-zine that tells how to make money by mail. Dime brings sample and special offer. Progressive Mailtrade, Box 357, Sheboygan, Wisconsin.

FREE Book "505 Odd, Successful Busi-nesses." Work home. Expect something odd! Pacific, Oceanside, Calif.

SPARETIME Profits taking subscrip-tions, all magazines. Wholesale catalog free. Cassell Agency, Westfield 2, New Jersey.

HOBBYISTS! There's profit in hobbies. Investigate. Cramer, 11 Hanna Road, Worcester 2, Mass.

EXPERIENCED Roof repairer. Franchise protection. Luster-Kote, 19417 Derby, Detroit, Mich.

\$5.00 PER Hour assembling driftwood lamps. Sam Patchett, 2187 N.W. 24 Court, Miami, Florida.

CHURCHES, Women's clubs, receive \$100.00 to \$500.00 and 24-card tables. Unique plan. Pine Hill, New Jersey.

SPARE Time homework opportunities, easy, profitable. Stamped envelope brings details. Alfred Hasemann, Beecher, Ill.

FORMULAS, PLANS, ETC.

FORMULA, Special welding and solder-ing flux. Information 25c. Refund. Deicha, Box 1324, Mobile, Ala.

PRODUCT Analysis. Manufacturing formulas and processes developed. Plastics, Box 1574, Boston 4, Mass.

FREE Formula catalog. Anything analyzed \$35. Western Chemical, Salem, Ore.

HEADQUARTERS For: Formularies, references, engineering handbooks. Literature free. Paulin, 109PF, Loudonville, Ohio.

ANY Formula \$3.00. Chemical Instruction Sheet—catalog 10c. J. Belfort, 216 W. Jackson, Chicago 6.

YOU Can make big money with the right formulas. Write Alliance Sales, 568-M, Alliance, Nebraska.

RESEARCHER, Information, formulas, supply sources. Consultation fee, fifty dollars, up. A. Di Grezio, Research Bureau, 43 Washington Street, Boston, Mass.

MILLER'S Modern manufacturing for-mulas make fast-selling products that get the business and pay. Fifty years supplying the best. Late literature free! Miller, Consulting Chemist, Tampa, Florida.

REAL Manufacturing formulas. Lists free. Cummings, Chemist, Gordon Ave., Syracuse 4, N. Y.

FORMULAS; All kinds. Latest, best. Literature free. Kemixal, Park Ridge, Ill.

GENUINE Manufacturing formulas. Latest. Literature free. Nelko, 3462-P Merchandise Mart, Chicago 54.

PLASTICS

MODELING Plastic. Looks and molds like modeling clay. Bakes in kitchen oven to hard plastic. Make toys, figurines. Kit, 6 colors, \$2.00. Plastibake, Dept. 6M, 700 2nd Ave., San Francisco 18, Calif.

PLASTIC Scrap—5 lb., \$2.50, 100% use-able. Boin Company, Morristown, N. J.

PLASTICS Home-craft course for men and women. Tells and shows how to make hundreds of fast selling plastics products. All plastics and materials for 23 projects included in course. No special tools needed. Course pays for itself. Write for free booklet. Interstate Training Service, Dept. D3F, Portland 13, Oregon.

PLASTICS—Lucite, Plexiglas, Acetate, Vinylite, Polyester-Fiberglas. Low, low prices. Value-packed, bargain-filled catalog 10c. Airmailed 25c. Gem-O'-Lite, Box 6862Y, North Hollywood, California.

LAMINATED Plastics, special parts; projects; drill jigs, etc. Free estimate. Harry Smith Specialties, Box 9378, Akron, Ohio.

NEW Liquid casting plastic. Clear. colors. Embed flowers, insects, coins. Saw, drill, carve. Send 25c for Castolite Creations Manual and proved success plan showing how to make money at home. Castolite, Dept. G-101, Woodstock, Ill.

FREE List—Jewelry findings, lucite, plexiglas, internal carving drills, dyes, supplies, pens, emblems, medallions, insignia, chain, ear wires; many others. Caraday, Dept. PM2, Box 71, Ryder Station, Brooklyn 34, New York.

LIQUID Plastics, clear 68c, Lucite 52c, others. Plastic dough, hardeners, promoters, liquid rubber. Where to buy direct, wholesale; directory \$2.98. Castle's Co., Box 2139, Paterson, New Jersey.

LUCITE Plexiglas. Any size sheets, masked. Square foot (12 x 12) cost, 1/16", \$1.20; 1/8", \$1.40; 3/16", \$1.75; 1/4", \$2.08. Include 10% postage. Almac Plastics, 600 Broadway, New York City.

PLASTIC Sheets, rods, tubes, etc. Free list. Plastic Supply Co., 2901 N. Grand Blvd., St. Louis 7, Mo.

CHEMISTRY

CHEMICALS, Supplies. Catalog 15c. Laboratory Sales, Box 161-T, Brighton, Mass.

SPECTROSCOPE For quick chemical analysis \$3.00. Book 200 electric stunts \$1.00. Kutting Sons, Los Altos, Calif.

AMAZING New book of science. Experiments, formulas and catalogue of laboratory supplies. Only 25c. National Scientific Co., Dept. 16, 2204 W. North Ave., Chicago 47, Ill.

SECOND Printing, improved version, spectacular chemical fireworks experiments manual. Contains complete set-ups, formulas, instructions on thermites, fulminates, explosive powders, etc. Still \$1.00. Free details. Chemi-Tech Laboratories, 568CA Riley, Buffalo 8, New York. Chemical questions answered. Your start for July 4th, now!

NEW Idea chemical and apparatus outfits for home experimenting. Photo-scales, microscopes, chemicals, biological and laboratory supplies in small quantities. Catalog 25c. Established 1931. John H. Winn, 124A West 23rd Street, New York, N. Y.

ILLUSTRATED Catalog: Chemistry, mineralogy, biology. 10c. Tracey Laboratories, Evanston, Illinois.

CHEMICALS And apparatus for industrial, analytical, and private laboratories. Catalog 25c. Dept. M-50, Biological Supply Co., 1176 Mt. Hope Ave., Rochester 20, N. Y.

AGENTS WANTED

MAKE Extra money for yourself, club or church. Up to 100% profit selling Christmas, all-occasion greeting card assortments to friends, others. Leading 21 card \$1.00 boxes, religious and novel, gift wrappings, ribbons, stationery, animated books, unusual gift items. Deluxe imprinted personal Christmas cards. Experience unnecessary. Write for samples on approval, special offers, extra 5% bonus plan. Hedenkamp, 361 Broadway, Dept. PM-27, New York.

AMAZING Profits selling exclusive Sunshine Christmas cards: Nature prints, scripture text, imprints, nationally famous. 21 for \$1.00 assortments all sell on sight! Many others! Also gift wraps, stationery, etc. Send for samples on approval. Sunshine Art Studios, Inc., Dept. PM-6, Springfield 1, Mass.; Pasadena 3, California. (Note: East of Rockies address Springfield office.)

MEXICAN Feather pictures. High profit! Fast sellers! Adelphi, Box 57-B, Bellerose 26, N. Y.

MAKE Money introducing world's cutest children's dresses. Big selection adorable styles. Low prices. Complete display free. Rush name. Harford, Dept. J-7341, Cincinnati 25, Ohio.

SALESMEN, Distributors, fast selling costume jewelry direct from factory. Big picture catalog, free. Pickcraft, M19 Bank, Attleboro, Massachusetts.

GOLD, Silver lacquered letters. Windows, doors, trucks. Standard sizes. Penny and up. Big profits. Samples. Atlas-D, 544 West 79th, Chicago 20.

500% PROFIT Selling multicolor, ready-made cardboard signs for every business. Dynamic samples and catalog, 25c. M. Velvetex, 200 W. 34 St., New York 1.

MEN'S Dress Sox \$1.25 dozen. Free catalog. Gainer, 760 Book Bldg., Detroit 26, Michigan.

BALL Pens \$10.00 gross, d.e. s.e. blades \$4.20 M. assorted plastic aprons \$1.50 dozen up. Lutzker, 871-JP East 170th, New York City 59.

CLARESA Chrome polish cleans and sells in a hurry. Claresa Chemical Co., Irwin, Penna.

BUY Wholesale, 25,000 items. Catalogue 25c. Matthews, 1472-B-8 Broadway, New York City 36.

MEXICAN Feather pictures. Sell on sight; 200% profit! Free details. Sample 20c stamps. (No coins). Sylviap, Apartado 9036, Mexico City.

SELL Amazing new bug remover cloths to service stations, etc. Terrific possibilities. Send 60c for sample and information. Maurice DeClerg, Portland, Michigan.

MAGAZINE Subscription agents. Highest commissions. Bonus. Qualified Publications, 451H Kingston, Brooklyn 25, N. Y.

BUY Wholesale thousands nationally advertised products at big discount. Free wholesale plan. American Buyers, 629-R Linden, Buffalo, N. Y.

\$50.00 MADE Selling occasional cards. 2 dollar boxes \$1.35. Diehl's, Buffalo 5, N. Y.

SELL Big money maker to men and women. Easy handwork makes fast-selling useful articles. Sample free. Sunmade Company, Brockton 64, Massachusetts.

SELL Every home attractive mail box name plate. Write. Nelson's, 720 East 73rd, Chicago 19, Illinois.

POWER Mowers—\$32.20 net. Home agents. Farmco PM, Excelsior Springs, Mo.

EARNINGS Unlimited. Million prospects. Repeats. No investment. Reimer, 161 b Weirfield, Brooklyn 21, N. Y.

DOLLARS In easy to take orders for photostatic copies. A real year 'round money maker. Every call a prospect. House to house agents looking for additional line will welcome this. Get full information. Quick Copy Service, 175 West Jackson Blvd., Room A-414, Chicago 4, Illinois.

KILL Flies, insects (all kinds) instantly. For homes, restaurants, hotels, hospitals. Amazing (low priced) invention. Whirlwind seller. Tremendous profits. Walko Industries, Dept. 63-C, Highland Park, Ill.

STYLISH. Cheap. Sensational plan, stamp. Spectacles, 112 Adams, Hoboken 8, New Jersey.

MAKE Extra money. Sell front door name plates to friends, neighbors. Retail \$1.98; you make \$1.00! Free selling kit. Modern Engraving Co., P.O. Box 194, Boston 14, Mass.

AMAZING Nylon stockings guaranteed to one year or replaced free if they run or snag! Complete line men's and children's hosiery also guaranteed one year or replaced free! Earn to \$3 an hour spare time. Pay nothing. Risk nothing. Just write orders. We deliver and collect. Advance cash plus huge 40% bonus. Watkins sent 92 orders one day. Armstrong earned \$202 in 9 days. Opportunity become manager appointing others. Rush postcard for free samples and money-making outfits. Kendex, Babylon 13, N. Y.

FAST Profits—No investment. Plastic aprons, tablecloths, etc., 300 sure-fire items. We guarantee sales. Free information. Halliday Co., Dept. PM, 15 Pennington Ave., Passaic, N. J.

WHOLESALE Catalog. Nationally advertised appliances, cameras, watches, etc. Cam Co., 1717PM—58th St., Brooklyn 4, N. Y.

ABSOLUTELY Free—Sales kit. Yours for the asking. Send postcard today requesting kit showing new line, belt buckles with your name or personal initials, cap badges, choice 3000 different emblems. Write Hook-Past, Box 1425PM, Providence, R. I.

'53 WHOLESALE Dealer kit on appliances, typewriters, recorders, cameras, giftware, etc. Free. Write Arrow Distributing, 154-B Nassau Street, New York.

CALIFORNIA Sweet smelling beads. Sensational sellers. Free particulars. Mission, 2328PM West Pico, Los Angeles 6, Calif.

YOUR Own business—Used suits \$1.50, overcoats 65c, mackinaws 35c, shoes 12½c, ladies coats 30c, dresses 15c. Enormous profits. Catalog free. Moro, 558-AA Roosevelt, Chicago 7.

AGENTS: Stamping names on key protectors. Sample 25c. Stamping outfits, checks, social security and name plates. Hart Mfg. Co., 303 Degraw St., Brooklyn, N. Y.

AGENTS—300% Profit selling genuine gold window letters; stores and offices. Free samples. Metallic Sign Letter Co., 431-D North Clark, Chicago.

EXCELLENT Sideline for printing and advertising salesmen. Decalcomania name plates in small quantities. Great demand. Also, make money with our line of automobile initials and sign letters. Free samples. "Ralco" XL-Roxbury, Boston 19, Mass.

JOKESTER'S Printed novelties. Fifty—\$1.00. Sebastian, 10934-X Hamlin, North Hollywood, California.

HAND Cleaners and other specialties. Sell industrial plants, institutions, etc. Liberal commissions. Dytex Chemical, India Street, Providence, R. I.

BUY Wholesale from nationally advertised manufacturers, distributors. Literature free. Carter Publications, Box 6011-G, Chicago 80.

BE A money maker. Use your home as magazine headquarters. Liberal commissions. No experience. No capital needed. Everything furnished. Write for free catalog. McGregor Magazine Agency, Dept. 500A, Mount Morris, Ill.

PRINTING, Salesbooks, envelopes. Free illustrated catalog. Ersco, Dept. PM, Bronx 72, New York.

REPEAT Business and high commissions raising dwarf trees for pleasure and profit. This field practically untouched by salesmen. Handle our growing kits with complete instructions on what until recently was an oriental secret. Write today for free sales plan. Don Pedro Farms, Dept. 10, Rte. 2, Box 1007, Stockton, Calif.

\$50 WEEKLY Selling finest razor blades, other items. Free details. Edisans, Box 274, Far Rockaway, N. Y.

BUY Wholesale! Big profits! Name brand—Appliances, watches, gifts, silverware, etc. Free catalog. Bergen Novelty Sales Co., 59 S. Dean St., Englewood, New Jersey.

SELL Harmar's French fried popcorn to stores and taverns. Fast repeater. Harmar Products Co., Hammondsport, N. Y.

BIG Profits selling ties (\$2.00 values). \$6.50 dozen. Free catalog. Empire Cravats, 648 Broadway, New York 12.

SALESMEN—DISTRIBUTORS

ADVERTISING Book matches—Cash in on big demand; sell union label matches. Cuts for all businesses and political parties. Free powerhouse selling kit, low prices, protection guaranteed on repeat orders. Cash commissions. Superior Match Co., Dept. M-653, 7530 Greenwood, Chicago.

SALESMEN Make up to \$50 in a day selling brand new item going to every type of food and beverage store, factories, laboratories, hospitals, etc. Samples furnished. Utility Durawear, 53 West Jackson Blvd., Dept. PM6, Chicago, Illinois.

NYLON Stockings best source. Rich Supply, 215a W. 98th, New York 25.

ANYONE Can sell Hoover DuPont nylon uniforms for beauty shops, waitresses, doctors, nurses, others. In white and colors. Exclusive styles. Top quality. Low priced. Exceptional income. Real future. Equipment free. Write fully. Hoover, Dept. N-100, New York 11, N. Y.

AD Matches! Sell amazing designs—20, 30, 40 and 240-light book matches. Bigger spot cash commissions; every business a prospect. Low prices for high quality. Repeats. Start without experience; men, women; full, part time. Buy nothing! Sales kit furnished. Match Corp., Dept. PM-42, Chicago 22, Illinois.

MAKE Money selling brake fluid. Excellent profit. Loreman Products, Salisbury 3, Maryland.

POCKET Combs; gross \$1.50. Joe's Products, Southwick Street, Fitchburg, Massachusetts.

AMAZING Westinghouse equipped electronic deodorizers sell on sight. 100% profit on every sale. Send for free selling plan. Rid-All Corp., Hoosick Falls, N. Y.

DISTRIBUTORS And salesmen. "Griffin-ize" fast selling liquid car wax. Manufacturer setting up local franchises. Sample 25c. For details: John J. Griffin Company, 7934 Bustleton Avenue, Philadelphia 15, Penna.

RUST Absorbent roof preservative coating. Luster-Kote, 19417 Derby, Detroit, Mich.

SELL Name brand 1953 television sets. Buy at cost; pocket the difference. Materials furnished. C.E.T., 609 W. North Ave., Chicago.

NEW Jobs open in selling! Send name, address for five free issues of Opportunity Magazine's money-making guide, listing hundreds of companies who'll pay you well, full or part-time. No experience needed. Opportunity, 28 E. Jackson, Dept. 17, Chicago 4, Ill.

NEWLY Patented, self-filling brush and ink combination. Storekeepers can't resist. Sign-Riter, Inc., 261 Great Arrow, Buffalo 7, New York.

DISTRIBUTORS, Dealers, wanted, for Lubriwick Safety Wheel pack. Douglass Products Co., 2410 Auburn Blvd., Sacramento 21, Calif.

EDUCATIONAL AND INSTRUCTION

IT'S Fun learning a language by Lingua-phone. At home, quickly, easily master French, Spanish, German, Norwegian, Russian, Japanese—29 languages by Lingua-phone World's Standard Conversational Method. You listen; you hear men and women speak; you understand; you speak. Save time, work, money. Gain job, school, travel, cultural opportunities. Write for free book. Lingua-phone Institute, 8306 Mezz., Rockefeller Plaza, New York 20, N. Y.

HIGH School—No classes. Study at home. Spare time. Diploma awarded. Write for free-catalog HF-33, Wayne School, 2527 N. Sheffield, Chicago 14, Ill.

LEARN Public speaking quickly! Amazing new way. Increase income. Perhaps become famous. No lessons. No arduous work. MB, 405P Gorham Bldg., Minneapolis 3, Minn.

FOR An extremely profitable lifetime business, operate a collection agency. Quickly learned. Write Cole Associates, Syracuse 2, N. Y.

WELDING Training pays at Hobart Welding School, Box M-631, Troy, Ohio. VA contract. Best equipment. Catalog free.

WANT A diesel job? New opportunities to increase income. Higher pay. More money. We can help you qualify. Tools. Shop method home training. Write today! Diesel, Tractor, Heavy Equipment Division, Interstate Training Service, Dept. B3F, Portland 13, Oregon.

INCREDIBLE! Become mental superman overnight! Free booklet! Bijou, Box 1727-M6, Hollywood 28, California.

EARN \$7,500-\$15,000 Annually in fascinating traffic management. Details free. Union Institute, Lakewood 20, N. J.

STRUCTURAL Draftsmen in big demand. 60,000 jobs available. Learn at home. High wages to start. Free information. Roth Technical Institute, Dept. M6, Box 2283, Youngstown, Ohio.

CAN A man my age become a hotel executive even though he has no previous hotel experience? Would you like to step into a well-paid position as hotel or club manager, purchasing agent, social director or assistant manager, etc.? The success of Lewis graduates from 20 to 50 proves you can—though you have no experience in hotel work. Louis M. Reny says: "I took the Lewis Course after leaving the Air Force. Before graduation I had accepted a position through your placement department. Now assistant manager of a Washington, D. C. hotel. All this could not have happened without the help of the Lewis Training School." Our free book explains how you can qualify for a well-paid position in leisure time; how you are registered free of extra cost in Lewis National Placement Service. Write today. Course approved for veteran training. Lewis Hotel Training School, Desk WH-324, Washington 7, D. C.

USED Correspondence courses and educational books bought, sold, rented, catalog free. Educational Exchange, Summer-ville, Ga.

LEARN Upholstering at home. Tools, supplies included. Make over old furniture, sell for many times cost. Big profits. Free booklet explains plan. Send name, address. Commercial Trades, 1400 Greenleaf, Dept. UPL-6, Chicago 26, Ill.

"THE Keys to Broadway"—Self preparation for theatrical career! Producers, agents, television, summer theatres. Where to live, how to learn and earn. N. Y. News calls authors "practical young women, not theorists!" \$1.00. Theatre Information, 122 East 42nd St., New York.

GET Government position! \$9.95, complete home training for exam. Refunded if don't pass. Write Instructions, Box 665 (34CS), St. Louis, Mo.

U.S. Gov't. jobs! Men-women, 18-55, start high as \$316 month. Prepare now! 420,000 jobs open. Experience often unnecessary. Get free 32-page Civil Service book showing jobs, salaries, sample tests. Write today! Franklin Institute, Dept. A-24, Rochester, N. Y.

TIME Travel past or future—Your own personal time machine. Tested, approved by hundreds. Send 25c for complete details. Eidetic Foundation, Box 345X, Fairhope, Alabama.

PIANO Tuning pays. Learn this profitable profession at home. Our Tonometer and mechanical aids make learning easy. No knowledge music necessary. Diploma granted. Largest and oldest school—55th year. G.I. approved. Write for booklet. Niles Bryant School, 78 Bryant Bldg., Washington 16, D. C.

HOME Study course, drugless therapy. Free literature. Institute of Drugless Therapy, Tama, Iowa.

MEDICAL Laboratory technicians in great demand. We train you in your own home. Catalogue free. Imperial Technical Institute, Box 973-J, Austin, Texas.

SECRET Investigation. Experience unnecessary. Investigators particulars free. George Wagner, M125 West 86th, New York 24.

INVESTIGATOR Training. Phillips Secret Service System, 1917-B North Ken-neth, Chicago 39.

BE A real estate broker. Study at home or in classrooms in leading cities. Write for free book today. Weaver School of Real Estate, 304 Law Bldg., Kansas City, Mo.

BOOKKEEPERS! Increase your earnings! Operate your own simplified "Dollar-A-Week" bookkeeping and tax service. Full or spare time. Details free. No obligation. Ellis, Box 200, Cedar Grove, North Carolina.

USED Correspondence courses and books sold and rented. Money back guarantee. Catalog free. (Courses bought.) Lee Mountain, Pisgah, Alabama.

GARAGEMEN: Take or advertise low-priced home diesel course. W.P.H.I., Pittsburgh 12, Pennsylvania.

PLAYS, STORIES, MANUSCRIPTS

HOW To write short stories, mysteries, articles. Learn at home for career or extra part-time income. (A. Aretz sold first 2 stories for \$255.) Professional writers show you how. Send today for free book which explains opportunities. Palmer Institute of Authorship, Desk TM-63, 1680 N. Sycamore, Hollywood 28, Calif.

"HOW To write a best seller." \$3.49. Guaranteed. Olympic Publishing Co., 1912 Lincoln-Park-West, 216-PA, Chicago 14, Ill.

COPYRIGHTS Procured promptly. State nature. Russell B. Tupper, 18 Lyman, Beverly, Mass.

NO Luck finding a book publisher? Write for free Booklet PM. Vantage Press, 120 W. 31, New York.

BEGINNING Writers: Get \$1 to \$20 checks daily writing simple children's stories, articles, poetry in your sparetime. Experience unnecessary. Our instructions reveal how. Details free. W. Herman, 7016 Euclid, Cleveland 3, Ohio.

SPECIAL SERVICES

HEALTHFUL, Sunny, outdoor Florida! Reliable, free information. Classified ad sections Miami, West Palm Beach, Tampa, Ft. Lauderdale papers airmailed, \$1.00 each, any three for \$2.00. Letters remailed, 20c each. Fifteen Florida photography post-cards, \$1.00. Pleaservice, 813 S.W. First St., Ft. Lauderdale, Florida.

CANADA, Letters remailed 25c. Charles Polz, Temagami, Ontario, Canada.

NOME, Alaska. Letters reairmailed 50c. Robert Scott, Box 14, Nome.

DENVER Remail—25c each letter. From the snowcapped Rockies. Box 6544, Denver 16, Colorado.

BARGAINS. Wonderful books; courses on drawing, painting, cartooning, lettering. Free catalog. Art Book Shop, Arnold 8, Mo.

YOUR Questions answered. Research; business; social. Any subject. Confidential. Write, Dougherty, Box 88J, Van Nuys, California.

"QUEBEC" Letters remailed from historic city 50c. Bellet Service, 29 St. Helene, Quebec, Canada.

HOLLYWOOD Or Los Angeles remails 25c. Any part Sunday Times classified, air mailed \$1. Corex, Los Angeles 8.

INFORMATION On any matter. Ferguson Research, 116-14 141 St., South Ozone Park 36, N. Y.

4 TAHITI Postcards. Remailed free. \$1.00. Yves Jarsailion, Poste Restante, Papeete, Tahiti.

NIAGARA Falls postmark—Remails 25c each—Niagara postcards 3 for \$1.00. Coin. Marr, Box 145, Fonthill, Ontario, Canada.

ENVELOPES Addressed to your specifications. Reasonable rates, fast dependable service. Hicks Service, 5216 Just St. N.E., 303, Washington 19, D. C.

CARTOONING, COMMERCIAL ART, SHOWCARD WRITING, SIGN PAINTING

"HOW To Make Money With Simple Cartoons"—A book everyone who likes to draw should have. It is free; no obligation. Simply address Cartoonists' Exchange, Dept. 96-C, Pleasant Hill, Ohio.

DISPENSAPPOINT—New development. Improved draftsman's pencil pointer, \$1.00. Illustrated information. Reed Co., 3601 Fourth, Boulder, Colorado.

SIGN Painting—Gold leaf work. Complete home course including sign painters kit only \$25.00. Details 6c. Ramshaw, 19 S. Wells, Chicago 6.

CARTOONISTS: Amateur, professional. Prepare for animation with Max Fleischer's plan. Write Vera Coleman, Lincoln Building, New York, N. Y.

CHALK Talks. Laugh producing program, \$1.00. Catalog 10c. Balda The Cartoonist, Oshkosh, Wisconsin.

9 ALPHABET, 3 Numeral pattern sets and raised wood letter catalog, \$1.00. Sign Letter Distributors, P.O. Box 101, Mineola, N. Y.

ADVERTISING AGENCIES, LETTER WRITERS, FOR ADVERTISERS

ADVERTISING That sells—Consultants, artists, copywriters. Advertising Unlimited, Burlington, Wisconsin.

USE Sales letters that click! Lettermaster, 9A Clifton, Natick, Mass.

OPPORTUNITY Names that pay off. 500 only \$1.00. Thomas Jerdon, Hermansville, Maryland.

SENSATIONAL Offer! We distribute your literature to all mothers of new babies. Exceptionally low rates! Keep-sake Plastics, P.O. Box 7, Warren, R. I.

ADVERTISE: 24 Words, 100 Canadian newspapers \$5.50. Lists free. Advertising Bureau, 10511-C Springfield, Chicago 43.

ADS Placed in out of town newspapers and magazines. Low rates. Catalogue free. Ideas that pay. Baker Advertising Agency, Successors Ankrum Agency, 189 W. Madison, Chicago 2.

ADVERTISERS! Reach nearly 18,000,000 readers. 25 Sunday national key newspapers. 18 words, \$59.00. "Terrific pullers." 20 popular newspapers. \$11.50. Free booklet. Special—One inch display 2,-821,198 circulation. \$51.10. Newmark's Advertising Agency, (Established 1893), 217-7th Ave., New York 11.

MAILING Lists: \$5.00-1000 up. Write Dixie Service, King, N. C.

FREE Copy, layout service. Mailorder ad, 1,700,000 nationwide circulation, \$27.30 inch. 24-word classified, 20 big Sunday newspapers, \$30.00. Advertising ratebook free. Chicago Advertising Agency (established 1900), Chicago 4.

TYPEWRITERS, DUPLICATORS, OFFICE DEVICES

NOW! Protograph checkwriter only \$21.95 postpaid! Free literature. Model Service, 216 W. Jackson, Chicago 6.

INKED Ribbons never die, they just need Ribbonew to bring back freshness. Applied in a jiffy right on machine. Send \$1 for long lasting supply. Galco, Box 221, Ft. Lee, N. J.

TYPEWRITERS, Adders, filing cabinets, office equip. Wholesale, retail. Free catalog. Dept. M. Eskay, 718 Flushing Ave., Brooklyn 6, N. Y.

RECONDITIONED Typewriters, printing devices, office machines, equipment. DixieGraph, King, N. Car.

RUBBER STAMPS AND OFFICE SUPPLIES

SEND For samples—Free catalog. Low prices. Rubber stamps 50c up. 1000 2-color embossed business cards \$3.30. Eversharp retractable pens \$1.29 imprinted. Esco 63 Print, 8 Holt, Dayton 7, Ohio.

DATING, Numbering, addressing, endorsing, signatures, stamps. Royal Ford, West Sand Lake, New York.

RUBBER Stamps. Send for catalog. Excello, Box 500, Shreveport, Louisiana.

PRINTING, MULTIGRAPHING, MIMEOGRAPHING GUMMED LABELS

QUALITY Letterheads, envelopes. Low rates. Free samples. Whicor Printing Co., 1251 Ormewood Avenue, Atlanta, Georgia.

MIMEOGRAPHING—Instructions, letters, price lists, two or three color programs. Eagle Publications, 849 Monmouth, Gloucester, N. J.

100 LETTERHEADS, Envelopes, or statements \$1.00. Immediate service. Weco, Box 8717, Fort Worth, Texas.

1000 EMBOSSED Business cards, \$4.25. Samples free. Lane, 1094 Paradise Blvd., Hayward, Calif.

500 TWO-Color 3 line name and address stickers. \$1.00 prepaid. Sample gladly sent. Emory Beach, 1519 Vera Ave., Arbutus 27, Md. (PM).

WHOLESALE Printing, guaranteed. Free samples. C. Earl, 208 Florida Ave., Jacksonville 2, Fla.

LABELS, Gummed, printed for-u. Samples? Stamp. Arthur Fisher, Taylorville 8, Illinois.

MIMEOGRAPHING—Reasonable. Any copy. Mallers Service, Box 606-E, Chicago 90, Ill.

COLOR-Offset-printing. Salesletter Specialist, Angora House, PMI, Springfield, Illinois.

100 ENVELOPES Or letterheads \$1.00. Two colors \$1.50. Salesbooks. Broadbrook, Botsford, Conn.

5000 6 $\frac{3}{4}$ ENVELOPES Printed \$3 per thousand, 1000 \$4. Michel, Central Village, Conn.

100 8 $\frac{1}{2}$ x11 LETTERHEADS And 100 envelopes \$2.00 postpaid. Fast service. Samples free. Catalpa Press, 5519 N. Clark, Chicago 40, Illinois.

FREE Catalog, samples. Dealers wanted. We fill orders at wholesale prices. Sutton Printing, Box 853-M, Waycross, Georgia.

QUALITY Printing. Anything in any quantity. Samples, prices free. Willcox, Nicholls, Georgia.

125 8 $\frac{1}{2}$ x11 LETTERHEADS And 125 envelopes \$2.00 postpaid. 250 of each \$3.50. Edraco Press, Box 1961, Tulsa 1, Oklahoma.

NEW Method prints up to 6 colors. lowers small and large run cost. Present maximum size 8x5. Estimates free. Color Press, 1320 S. Pulaski Road, Chicago 23, Illinois.

TWO Color printed 8 $\frac{1}{2}$ x11 letterheads, 6 $\frac{3}{4}$ envelopes, 100 each \$3.00 postpaid. Fisherprint, Hartland 4, Maine.

100 LETTERHEADS (8 $\frac{1}{2}$ x 11 Printed) \$1.00 postpaid. Envelopes same. Race Printers, Hudson, New York.

1000 BUSINESS Cards \$2.50 prepaid. Samples free. Reliable Print Shop, 905 E. Jefferson, Louisville 6, Ky.

MIMEOGRAPHING—Letters, pricelists, formulas, instructions. Lowest prices. Lem's Letter Shop, 5710 Stanton, Detroit 8.

500 3 $\frac{1}{2}$ x2 $\frac{1}{4}$ FOUR Line gummed stickers 50c. Red border \$1.00. Moritz Printery, Saginaw, Mich.

1000 BUSINESS Cards raised printing \$3.95. Regularly \$5.00. Offset letters. Samples free. Tuttle Publ., Rutland, Vermont.

TWO Color 8 $\frac{1}{2}$ x11 letterheads, 500—\$3.50. Samples. D'Yarmett Printing, Newark, Ohio.

PRINTING OUTFITS AND SUPPLIES

MAKE Your own self-molding rubber printing cuts. Plexirubber, Argyle 1, Wis.

PRESSES, Type, cabinets, supplies. List for stamp. Lincoln Press Company, 220-U Hartwell, Fall River, Mass.

PRINTING Presses, type, supplies. Lists 3c. Turnbaugh Service, Loysville, Penna.

DO Your own printing. Save money. Simple rules. We supply everything. Print for others; good profit. Raised printing like engraving too. Have home shop. Details free. Kelsey Presses, V-11, Meriden, Connecticut.

PRESSES, Supplies, paper. Catalog 10c. Custom, Box 211-P, Springfield, Missouri.

PATENT ATTORNEYS

INVENTORS—If you consider your invention to be something of importance, take steps to protect it with a United States Patent which gives you the right to exclude others from making, using and selling your invention as claimed. "Patent Protection for Inventors" outlines steps to take to secure patent protection. Mailed promptly without obligation. Victor J. Evans & Co., Merlin M. Evans, Registered Patent Attorney, 831-G Merlin Building, Washington 6, D. C.

INVENTORS—If you believe you have an invention, we can make a preliminary search on your invention and advise you whether we think it can be patented. Send for copy of our patent booklet "How to Protect Your Invention" and "Invention Record" form. No obligation. McMorro, Berman & Davidson, Registered Patent Attorneys, 134-K Victor Building, Washington 1, D. C.

INVENTORS! For "Copyright, Design and Patent Guide" contact Patent Attorney Metzler, 11 West 42nd, New York 18.

HERMAN Lewis Gordon, registered patent attorney. Patent investigations and opinions. Invention record form furnished on request. Warner Building, Washington 4, D. C.

INVENTORS: When you are satisfied that you have invented something of value write me, without obligation, for information as to what steps you should take to secure a patent. Write Patrick D. Beavers, Registered Patent Atty., 935 Columbian Bldg., Washington 1, D. C.

INVENTORS: Learn how to protect your invention. Unless the inventor is familiar with patent matters, he should engage a competent registered patent attorney or agent to represent him. We are registered to practice before the U. S. Patent Office and prepared to serve you in handling your patent matters. "Patent Guide for the Inventor" containing detailed information concerning patent protection and procedure with "Record of Invention" form will be forwarded to you upon request—without obligation. Clarence A. O'Brien & Harvey Jacobson, Registered Patent Attorneys, 313-D District National Building, Washington, D. C.

PATENTS—Irving L. McCathran, 315 McLachlen Bldg., Washington 1, D. C. Registered Patent Attorney.

PATENTS. "Proof of Invention" free. E. E. Vrooman, Registered Patent Attorney, 507 McKim Building, Washington 5, D. C.

INVENTORS: Without obligation, write for information explaining the steps you should take to secure a patent. John N. Randolph, Registered Patent Attorney, 203 Columbian Bldg., Washington 1, D. C.

C. A. Snow & Co.—M427, Snow Building, Washington 1, D. C. Registered Patent Attorneys. Write for information.

"INVENTOR'S GUIDE" free. Frank P. Ledermann, Registered Patent Attorney, 154 Nassau Street, New York.

REGISTERED Patent attorney offers services. Sanders, 6430 Evans, Chicago 37, Ill.

INVENTORS—For "Invention Record" form, contact Carl Miller, Registered Patent Attorney, Woolworth Building, New York.

CANADA—Ramsay Company Registered, 273 Bank Street, Ottawa, Canada.

FOR INVENTORS

INVENTORS—If you have a valuable invention, you are advised to authorize a preliminary search through appropriate classes of United States patents. This firm is registered to practice before the Patent Office and is available to make such search and report to you concerning the probable patentability of your invention. Instructive booklet with "Evidence of Invention" form sent upon request. Victor J. Evans & Co., 832-G Merlin Building, Washington 6, D. C.

INVENTORS: Obtain patents without assistance. "Inventor's Patent Handbook," \$3.50. International Patent Library, P.O. Box 7412, Washington, D. C.

INVENTORS! For "Copyright, Design and Patent Guide" contact Mr. Metzler, 11 West 42nd, New York 18.

INVENTORS—If you believe you have an invention, we can make a preliminary search on your invention and advise you whether we think it can be patented. Send for copy of our patent booklet "How to Protect Your Invention" and "Invention Record" form. No obligation. McMorro, Berman & Davidson, Registered Patent Attorneys, 134-H Victor Building, Washington 1, D. C.

PATENT Searches, \$5.00, including patent copies. Reliable, accurate reports. Free protection forms, 48 hour service. Patent Service Institute, 945-A Pennsylvania Avenue, Washington 4, D. C.

SHALL I apply for a patent? Is mine an improvement? Can I make my own search? Should I forget the whole thing? An inventor for 40 years answers many other questions. Free information sheet. Fred Roth, 657 East 26 St., Brooklyn 10, New York.

NEED Help? Send name to Inventors Aid, Doniphan 60, Mo.

CASH For your idea, 280 manufacturers need inventions, patented or unpatented. List free. Invention Bureau, 208M Clinton, Oak Park, Ill.

INVENTORS—Send for free patent information book and inventor's record. Registered Patent Attorney, Associate Examiner, Patent Office 1922-29; Patent Attorney & Advisor, Navy Department 1930-47. Gustave Miller, 63A Warner Building, Washington 4, D. C.

ENGINEERING Drawings. Artist's sketches. Free information. Designers, 5909 E. Central, Wichita 15, Kansas.

INVENTORS: Learn how to protect your invention. Unless the inventor is familiar with patent matters, he should engage a competent registered patent attorney or agent to represent him. We are registered to practice before the U. S. Patent Office and prepared to serve you in handling your patent matters. "Patent Guide for the Inventor" containing detailed information concerning patent protection and procedure with "Record of Invention" form will be forwarded to you upon request—without obligation. Clarence A. O'Brien & Harvey Jacobson, Registered Patent Attorneys, 31A-D District National Building, Washington, D. C.

SEARCHES—Put your patent searches in the hands of a registered patent attorney or agent, as he qualifies to give a worthwhile patentability report. Record of invention form upon request and information on patent protection. Patrick D. Beavers, Registered Patent Attorney, 936 Columbian Bldg., Washington 1, D. C.

"INVENTOR'S GUIDE" free. Frank P. Ledermann, Registered Patent Attorney, 154 Nassau Street, New York.

INVENTORS—For "Invention Record" form, contact Carl Miller, Registered Patent Attorney, Woolworth Building, New York.

INVENTORS: Without obligation, write for information explaining the steps you should take to secure a patent on your invention. John N. Randolph, Registered Patent Attorney, 203 Columbian Bldg., Washington 1, D. C.

INVENTORS: If you have an invention for sale, patented or unpatented, write Institute of American Inventors, Dept. 40A, 631-E St. N.W., Washington 4, D. C.

PATENT Owner representative. Years of experience. Can I help you? Charles A. Scott, 773PM Garson Avenue, Rochester 9, N. Y.

PATENT Searches \$5.00. Reports airmailed within 48 hours. Inventions marketed. Free protection forms. Write Miss Ann Hastings, P.O. Box 176, Washington 4, D. C.

PATENT Searches \$5.00. 48-hour service. Inventions marketed and promoted. Free record of invention. Write Raymond L. Smith, Patent Searcher, 622 Sheraton Building, Washington 5, D. C.

PATENT Searches \$5.00. 48-hour airmail service. Invention protection forms free. Patent drawings prepared. Write Patent Engineering Service, 711 14th Street N.W., Washington 5, D. C.

"STORY Of a Patent" itemizes inventor's expenditures, outlines procedures. Chart compares your probable patent cost. \$1. Miller, Box 3, Red Lion, Penna.

INVENTIONS WANTED

PROGRESSIVE, Reputable company wants inventions now in production or ideas fully worked out. Prefer wrenches, tools or attachments for electric drills. Will purchase or lease on royalty basis. Send pictures with full data. The Drilo Corporation, 201 East Carson Street, Pittsburgh 19, Penna.

INVENTIONS Wanted. Prefer simple items. Pyramid Co., Antioch, Calif.

INVENTIONS Wanted. Patented, pending only. Inventors Patent Exchange, Hartford 1, Conn.

INVENTIONS Wanted. Patented; unpatented. Tremendous manufacturers lists. Global Marketing Service, 1404 Mitchell, Oakland 1, California.

MARKETING Aid—Nation wide. Patented, patent pending. Booklet free. Market Contacts, 719-A2 Magnolia, Tupelo, Miss.

INVENTIONS Wanted. Patented or patent pending. 21 years experience promoting inventions. National Service Bureau, 3120 Meramec, St. Louis 18, Mo.

INVENTORS: Hundreds of manufacturers have requested our assistance in locating marketable new products. Complete information free. Institute of American Inventors, Dept. 40-D, 631-E St. N.W., Washington 4, D. C.

INVENTIONS Promoted. Patented or unpatented. Established 1911. Write Adam Fisher Company, 61 Enright, St. Louis, Mo.

CASH Buyers for ideas and inventions. Write National Inventors Institute, 4097 East 131st St., Cleveland 5, Ohio.

PATENTS FOR SALE

PATENT No. 2,633,887. Resiliency without air, puncture and blowout proof inner tube that saves rubber tire life. Safe and economical. Eliminates danger of "exploding" rims on heavy vehicles. Easily installed. Box 453, Painesdale, Mich.

PATENTED Fountain type screen painter. Paints average screen in three minutes without clogging holes. Held in palm of hand. Sale or royalty. J. Beyers, 583 Harding, Perth Amboy, N. J.

ATTENTION Manufacturers: Pocketsize new shielded flash light mirror. U. S. patent number 2,621,282 just granted. Novak Brothers, P.O. Box 368, Rahway, N. J.

FOR Sale or royalty, patent curtain bracket holding three curtains at one time. Joseph McMahon, Olyphant, Penna.

HANDY Golf ball carrier, patent pending. Alderic Lefebvre, 475 Villeneuve West, Montreal, Canada.

INVENTORS: Test the commercial value of your patented or unpatented inventions, quickly and inexpensively. Write for free information. Institute of American Inventors, Dept. 40-B, 631-E St. N.W., Washington 4, D. C.

MANUFACTURING

INVENTORS: Models built for your inventions and experimental work. Free estimate. Futurair Engineering, Box 8, Parkville Sta., Brooklyn, N. Y.

MODELS—Small lot manufacturing. Metals, plastics, etc. Milburn, Burlington, Kentucky.

MODELS, MODEL SUPPLIES

MINIATURE. Stagecoaches, surreys, horses, buckboards. Free folder. Tontz, Elsinore 9, Calif.

1953 **CAR Models**, 1/25 scale, all metal, chrome trim. Send for catalogue. Ajax Toy Co., 2637 W. Division St., Chicago 22.

MODEL Airplanes, engines, railroads, cameras, practically as gifts. Details 10c. Hobbycraft, 104PM, Brooklyn 30, New York City.

SHIP Models—Most complete line in New England. Kits, fittings, plans, books, tools, engines, motors. Illustrated catalogue 25c. James Bliss & Co., Inc., 342 Atlantic Ave., Dept. SM, Boston 10, Mass.

SHIP And yacht model fittings; blueprints. Send 25c for illustrated catalogue No. 28—listing hundreds of items. A. J. Fisher, 1002-1 Etowah Ave., Royal Oak, Mich.

STEAM Locomotives, 1½", 1", ¾", ½" ¼" scales. Castings, rail, steam fittings! Thorough drawings with instructions. Catalog 50c. Little Engines, Wilmington, California.

ILLUSTRATED Lionel catalog, 10c; American Flyer, 10c; H. O. gauge, 10c. Ben's PM Dept., 134 North Dearborn, Chicago 2.

BALSA Wood, Grade AAA. Free sample, price list. Sig Mfg. Co., Montezuma, Iowa.

HOME CRAFTSMEN

LEATHERCRAFT For pleasure or profit. Make easy-to-assemble purses, belts, gloves, woolskin toys, 100 other items for gifts or to sell. Send 10c today for big catalog. Largest leathercraft stock in U.S. J. C. Larson Co., 820 S. Tripp, Dept. 3150, Chicago 24.

ASH, Birch, cherry, maple, etc. Short dimension lumber price list. Mainesburg Lumber Co., Millpac Division, Covington, Penna.

90 ALL New, full size lawn ornament and novelty patterns, up to 20" high. Only \$1.00. Mastercraft 62M, 7041 Olcott, Chicago 31, Illinois.

SWISS Music movements—Make musical toys, boxes, novelties. Send \$2.50 for Christmas or nursery unit and free pattern. It's a profitable hobby. Free tune list. Maritime, 13 E. 60, New York 22.

16 NEW Lawn chairs, 22 picnic tables, benches, trellises, etc. All 38 plans with necessary full size patterns, \$1.00. Mastercraft 63M, 7041 Olcott, Chicago 31, Ill.

ARTISTIC Wall shelves. Sixteen full scale patterns \$1.00. C. Schoenberger, 4144 Lawndale St., Philadelphia 24, Penna.

LAMP Size cypress knee \$1.00. Cy Products, Dept. 1, Lafayette, La.

PLASTICS Home-craft course for men and women. Tells and shows how to make hundreds of fast selling plastics products. All plastics and materials for 23 projects included in course. No special tools needed. Course pays for itself. Write for free booklet. Interstate Training Service, Dept. D3F, Portland 13, Oregon.

OUR Biggest leather and craft catalog yet! 1000's of items. Send 25c (refunded with first order). Russo Handicraft Supplies, Dept. 18C, 245 S. Spring, Los Angeles, California.

LEATHERCRAFT. Tremendous stock of leather, tools, supplies, and kits. In leather business over forty years. Send 10c for big catalog. Sax Bros., 1111 N. 3rd, Dept. PM6, Milwaukee 3, Wisconsin.

89 FULL Size jig saw patterns of beautiful shelves, ornaments, toys, novelties. Plus "How, Where to Sell." Only \$1.00. Mastercraft 64M, 7041 Olcott, Chicago 31, Illinois.

THE Cream from 9 best-selling Popular Mechanics Press titles comprises an invaluable collection of information, projects and plans for the homeowner and craftsman in the new title Home Workshop Projects, \$1.00. There are 240 pages of workshop layouts, power tools and their uses, painting and finishing hints and ideas, concrete kinks, TV information and lathe operation. Popular Mechanics Press, Dept. H.W., 200 E. Ontario, Chicago 11, Ill. Order today!

10 FULL Size shelf patterns 35c. Connolly's, 825a Randolph, Saint Paul 2, Minn.

HOW To refinish your own furniture, \$1.00. Krafters, Box 86, Hubbard, Ohio.

93 "ORIGINAL Idea" jig saw patterns \$1.00. Professional drawing, quality printing. Full size shelves, toys, lawn ornaments, novelties. Walker Studio PM-6, 4343 Lindell, St. Louis 8, Mo.

HOBBYIST-Craftsmen—High quality mandrels, polishing heads, power saws. Catalog. Box 404, Compton, Calif.

CIRCULAR Saws sharpened perfectly, professionally whenever necessary with 2 simple home tools. Plans \$2.00. Kidrich, 2547 Farge, Chicago 45.

VIOLINMAKERS. Amateurs, professionals. Fine tone European wood, materials, supplies, instructions. Tools. Patterns. Illustrated catalogue 10c refunded. Premier Violin Supplies, Dept. VZ, 430 South Broadway, Los Angeles 13, California.

MAGNETS—Permanent Alnico. Never loses magnetism. Many uses. 12 for \$1.00. Pritt Co., Dept. MM-6, 12 West 27th, New York City.

STERLING Silver jewelry. Free illustrated directions for buttons, earrings, cufflinks you can make without soldering. Write for leaflet P. Craft Service Department, Handy & Harman, 82 Fulton Street, New York 38, N. Y.

MAKE Your own leather articles for seasonal use. Your leather belts, billfolds, purses made at home brings pleasure to all members of the family. Free catalog. Tandy Leather, Box 397C, Tulsa, Oklahoma.

KNOCKDOWN Cedar chests and lumber. Free price list. Bedford Lumber Company, Shelbyville, Tennessee.

"TOPS" In everything for leathercraft. Lowest prices. Genuine "Crafter" stamps. Catalog 10c. Crown Leather Company, 22 Spruce Street, New York 38.

KNOCKDOWN Cedar chests. Lumber and veneers. Free price list. Giles & Kendall Company, Huntsville, Ala.

BUY Wholesale nationally advertised power, hand tools, thousands other products at big discounts. Free wholesale plan. American Buyers', 629-PP Linden, Buffalo 16, N. Y.

FREE Seashell catalog. Shellcraft instruction book 35c. "Secors," Bradenton Beach, Fla.

LEATHERCRAFT—New stylecraft folder free. New kits illustrated. Filigree belts, billfolds, purses, etc. Send 25c new catalog. Refunded first order. Apache Leather Co., 2804 East Washington St., Phoenix, Arizona.

STENCILS, 15 Assorted for textiles, furniture, etc., \$1.00. Catalog 300 designs 25c, refundable first order. Marion Specialties, Box 141, Halesite, N. Y.

MINIATURE Furniture kits. Colonial reproductions. Solid cherry. Catalog 20c. Culver Miniatures, 194 61st St., Dept. A, Niagara Falls, N. Y.

30 LAWN Ornament patterns. Ready cut. Full size. Color indicated. \$1.00 postpaid. Lincoln Craft Studio, Columbia, Conn.

FREE Information. How to make money with jig saw. Write Jigsaws, 117-M Worth, New York 13.

\$46 FROM Square foot plywood; jig saw necessary. Write: Woodarts, PM-252, Bridgewater, Mass.

LEATHERCRAFT, Metal tooling, textile painting, beadcraft, shellcraft. Many other crafts. Send for free, big, illustrated catalog today! Kit Kraft, Hollywood 46, Calif.

REFLECTORIZED Novelties bring big, easy profits. Samples and plans, 25c (refundable). Highlight, 352-A Stewart, Turtle Creek, Penna.

LEARN Metalizing baby shoes, gifts, etc. Bronze, gold, silver. Folio free. Kiktavi, 7217-PC South Broadway, Los Angeles 3.

MAKE IT YOURSELF

BUILD Crystal radios. Sensational Melomite crystal and detector with instructions and plans—50c postpaid. Satisfaction guaranteed. Allen, 427-PM5, Clinton, Missouri.

PORTABLE Barbecue pits and grills sold separately. You assemble, save 40%. Free catalogue. C. B. Specialties, 5415 W. 120 St., Inglewood, Calif.

GRANDFATHER Clock easily built. Big savings. See ad on page 243.

AIR Condition your home. Build a unit yourself for few dollars, and save hundreds. It's easy with my complete copy-righted plans and instructions. Send \$1 today. Williams Little Co., Danvers, Mass.

PRIVATE Swimming pool plans, instructions. Save hundreds of dollars. Davrim Engineers, Dept. A. N. Kenova, Ohio.

CERAMIC Tile for walls-floors. You-do-it, with adhesive. Artistic Tile Co., 2562 First Ave. No., St. Petersburg, Fla.

BOOKLET Describes machines you can build—25c. Kimo, RCS-PM, New York 19.

TELESCOPE Plans and star guide 50c. Alan Sales, Box 15, Glen Ellyn, Ill.

MAKE F.H.A. approved splash blocks, enormous demand, two buckets concrete returns two dollars. Literature. Forms. Howell, Box 206, Bridgeport, Penna.

BUILD Your own "tractor". Free information. Eltraco, D-I, Camptonville, California.

MAKE Lace-like ceramic lamp shades. Directions \$1.00. The Vesta Hearth, 545 Santa Ynez Way, Sacramento, Calif.

SEND 25c Today for new large catalogue of supplies for 21 popular crafts. Dept. D-11, Dearborn Leather Company, 8625 Linwood Avenue, Detroit 6, Michigan.

WINDOW Fan kits—All parts necessary to make 30 inch fan except motor and box. \$16.50 postpaid. Free circular. McDonald's, Bay Saint Louis, Mississippi.

MAKE Your own "stone-veneer." Economical. Easily made, quickly applied. Looks like genuine stone. Transforms any home into one of excellent beauty. Formulas, illustrations, patterns. Alburg, Box 17, Carrollton, Mich.

LIVE In your home while building it. No mess. Invest one-half. Use any plan. Illustrated folio my tested method \$1.00. William Kiewel, Crookston, Minnesota.

WATCHES, OLD GOLD, JEWELRY

10 HIGH-Grade Swiss ladies' and gents' wristwatches needing minor repairs. \$18.00. Write for prices. B. Lowe, Holland Bldg., St. Louis 1, Mo.

RHINESTONES. Jewelry settings, cameo, sequins, beads. Send 10c for illustrated catalog. J & M Novelties, Dept. CG-3, Griffith, Ind.

5000 JEWELRY Styles, you can easily make yourself—Pins, earrings, bracelets, rings, matched ensembles. Instructions and catalog 10c. Barrys, 147 Ardsley Court, Newark, N. J.

WATCHMAKERS'—Jewelers' complete informative catalogue 20c. Bengale Company, Culver City, California.

JEWELRY Making can be a profitable hobby—Send 20c for our latest illustrated catalog. Milady-Fair Co., G.P.O. Box 1328, New York City.

HIGHEST Cash paid for old, broken jewelry, gold teeth, watches, silverware, diamonds, spectacles, platinum. Free information. Satisfaction guaranteed. Rose Smelting Company, 29-A East Madison, Chicago.

UNREDEEMED Diamond, 1-carat, \$295, 30-day refund. Free catalog. Broff's Diamond Loan Association, 411 Smithfield, Pittsburgh, Penna.

TOBACCO, SMOKERS' SUPPLIES

NEW! Nicotine stain off! Harmlessly remove the dirty yellow cigarette stain from your fingers \$1.00. Sharon Sales Co., Phoenix, N. Y.

CIGARETTES—Roll 200 mild, tasty, guaranteed to please for 75c. Details free. Pete Moberly, Box 868, Owensboro, Ky.

RAZORS, BLADES, SHARPENING

\$20 ELECTRIC Shavers—\$4.95. Write Sheldon Mail Order, Sheldon, Iowa.

80 DOUBLE-Edge rust-resisting blades. \$1.00. Fully guaranteed. Send 10c for sample. Franklin Merchandising Co., Dept. A, 441 Elizabeth Ave., Elizabeth 1, N. J.

FOR THE HOME

"SAFETY-Set" window locks absolutely burglar-proofs all wooden windows. Safe ventilation, easy installation, guaranteed. Withstands 90,000 p.s.i. 50c each, or 6 locks \$2.50 ppd. Count all your windows—Buy in sets of 6 and save money! Send check, cash, to "Locks," Box 19125, Los Angeles 43, Calif.

COMPLETE Detailed information on the requirements, design, installation, operation, maintenance, and repair of home plumbing systems, including the proper use of tools and materials, is given the layman in Home Plumbing Guide, \$3.50. It's the first book for the layman in its field and one that answers a long-felt need. Easy to understand! Hundreds of illustrations, diagrams and drawings! Order today. Popular Mechanics Press, 200 E. Ontario, Chicago 11, Ill.

PLUMBING And heating supplies direct from factory to you at wholesale prices. Why pay more? Everything guaranteed. What do you need? Write us. J. Klein & Son, 4548 Cottage Grove, Chicago.

FOAM Rubber furniture cushions. Factory seconds. 50% discount. Prices free. Perma-Foam, 140-C Main Street, East Orange, New Jersey.

FREE Blueprint Catalog! Hundreds of projects—Motor scooter, furniture, toys, birdhouses, radios, garden furniture, power tools, boats, work benches, home freezer, many more! Send postcard to Popular Mechanics Press, Dept. 103, 200 E. Ontario, Chicago 11, Ill.

OF INTEREST TO WOMEN

INVISIBLE Reweaving in big demand! Cash in servicing laundries, cleaners, stores, homes. Make tears, holes, cuts disappear from all fabrics. Earn up to \$10.00 an hour. Get full details free. Fabricron, Dept. C-6, 8342 S. Prairie, Chicago, 19, Illinois.

NYLON Corsets: All essentials for making 10 to 15. Prepaid, \$1. Quantities wholesale. A & T Sales, Dept. 11, P.O. Box 1973, Greensboro, N. C.

FOR SALE—MISCELLANEOUS

USED Pocket novels, condition good, your choice author-title. 35c or trade 3 and 15c for three different. Details for stamp. Odd-Ends, 888 Washington, Stoughton, Mass.

SAVE 20% On gifts. Giant new catalog free. Sanford Sales Co., Room 201-A, 170 Broadway, New York 38, N. Y.

SAVE Money on army, navy and factory surplus. Write today for new 52-page illustrated catalog. Tennusa Sales Co., Dept. C, 1451 Market, Chattanooga, Tenn.

FREE Catalog on government surplus bargains from country's largest surplus organization specializing in outdoor, sporting goods, clothing, camping equipment. Tents, rubber boats, tarpaulins, hundreds of other items. Rockaway Sales Co., Route 6, Rockaway 7, New Jersey.

SEMI Pneumatic wheels. 4500 10x1.75 with 1/2" ball bearings 90c each. 1000 10x1.25 with 1/2" Oillite bearings 70c each. Walter Bates Steel Corp., 500 Mills Rd., Joliet, Ill., or phone 5223.

WANTED—MISCELLANEOUS

WANTED Steam engine, from pop corn wagon, or similar size. Herbert Jones, Parma, Michigan.

QUICKSILVER—Highest prices paid. Free containers. Wholesale Terminal, Norwood, Massachusetts.

SCRAP Mercury (quicksilver) containers supplied—Tantalum, bismuth, tungsten. Metallurgical Products Company. Established 1909, 35th and Moore Sts., Philadelphia 45, Penna.

PERSONAL

BORROW By mail. Loans \$50 to \$600 to employed men and women. Easy, quick. Completely confidential. No endorsers. Repay in convenient monthly payments. Details free in plain envelope. Give occupation. State Finance Co., 323 Securities Bldg., Dept. C-14, Omaha 2, Nebraska.

LETTERS Retailed 25c, classified ads airmailed \$1.00. Charles Memegalos, 87-76 160 St., Jamaica 32, N. Y.

AMAZING Book by psychologist reveals secret of freedom from nervousness and personality difficulties. Send only four dollars. Living Arts, 21 Lexington Ave., Dayton, Ohio.

LETTERS Retailed 25c. Private mailing-receiving address at monthly rates. McLaughlin, 369 Welch, Columbus 7, Ohio.

ALASKA Remail service, dime per letter. Box 591, Spenard, Alaska.

LETTERS Retailed from historic post-office 25c. Private mailing and receiving address at monthly rates. California employment, business opportunity or real estate ads airmailed \$1.00. For other service, write Personal Service, Box 33, Kaweah, Calif.

REMAIL Your letters from historical Philadelphia or playground of the East, Atlantic City, N. J. 25 cents each, view cards either city 8 for one dollar. Arnold, Box 7214, Philadelphia 1, Penna.

LETTERS Retailed San Francisco postmark 25c. Private receiving-forwarding address available. Shanks, Box 3110-D, San Francisco 19, California.

NEED Vital information? Let our experts help you! Any subject, domestic—foreign. Reasonable fees! Kenson Research, Box 2009, Tampa 1, Florida.

PRETEND You are on a vacation. Letters remailed from Denver 25c each. Six beautiful Rocky Mountain scenic post cards 50c. Classified newspaper section 75c. Mile-High Service, 330 15th Street, Denver 2, Colorado.

LETTERS Retailed from United Nations, N. Y. UN postage, 30c, 4 for \$1.00. George Company, 30-11 29th Street, Long Island City, N. Y.

MEXICAN Law. General Practice Attorney, 1203 Arizona St., El Paso, Texas.

REARMAIL From Casablanca 2 for \$1. Open for deals. Drown, Boite Postale 2054, Casablanca, Morocco.

LETTERS Retailed 25c, private receiving address \$7.00 monthly. Gleason, Box 25, New York 72, N. Y.

BIBLE Reveals time of end. Free. Write: Harvest. Jefferson City, Missouri.

"HOW Can I find out?" You can! Information confidentially developed. Any matter, person, problem. Worldwide. Officially licensed. Established 1922. William Herman, 170 Broadway, New York City.

ENDLESS Energy "Secrets of Tiredness" \$1.00. Eidetic Foundation, Fairhope, Ala.

LETTERS Retailed from Washington, D. C. 25c each. 5 for \$1.00. Hicks Service, 5216 Just St., N.E. 303, Washington 19, D. C.

REMAILING Letters, Chicago 25c, relayed from other cities 75c. Package service, and storage. Business and personal address. C. Mack's Mail Order, 5656 N. Hermitage, Chicago 26, Ill.

MISCELLANEOUS

BRONZE Your own baby shoes. Buy material at neighborhood store. Inexpensive, beautiful, lifetime, preservation. Complete instructions, \$1.00. Masterseal, 2709 Lyon Blvd. N.W., Oklahoma City, Okla.

MAKE Your underwater diving equipment. Exclusive handbook on use and construction of spear gun, diving mask, snorkel, helmet, self contained units, compressors. Newest diving, spearfishing techniques. Send dollar to: Underwater World, Box 475B, Huntington, New York.

HOME Water systems, etc. Wholesale well supplies. Catalog \$1.00, refunded first order. Dealers wanted. Ellis Well Supply, Lovelaceville, Ky.

PANNING Gold lesson; catalogue of maps, beginners mining and mineral books, blueprints, free. Old Prospector, Box 729D1, Lodi, Calif.

STUDY For game warden, park, fish, forestry, lookout, guide, wildlife conservation, immigration and highway patrol service. Details free. Write Delmar Institute, C5, Whittier, Calif.

SHARPEN Your hand lawn mower, power mower—Simple precision lapping. Buy nothing! Instructions \$1.00. George Steele, 269 South 4th East, Provo, Utah.

10 POUNDS Stainless steel sheets assorted sizes only \$7.50 prepaid. Send m.o. L. J. Michies Co., Box 111, Fremont, Ohio.

NO More scrubbing, scouring, cleaning of toilet bowls. Let an automatic device do the messy work. For details write General Sales, 6518 Chambers, Cleveland 5, Ohio.

NEW Redwood knick-knack shelves, 2 1/2" x 15" square, \$2.00 plus postage. James R. Hamilton, 6562 Vesper, Van Nuys, Calif.

"X-Ray mind." Adults. Entire course, \$2.98. Krishnar Institute, 1912 Lincoln Park-West, MP-6, Chicago 14.

TREASURE Of invaluable information for anyone planning a vacation trip is John P. Arnold's Motor Tourists Guide. Complete with 12 pages of maps, the Guide tells how to pick the right place to go, the most effective way to travel, how to budget the trip, choose the right clothes to take along, motor courts and how to choose the one to stay in, what to do in case of accident, and what equipment to take along. The book, \$1.00, shows highways, scenic roads, recreational and sport areas. Popular Mechanics Press, Dept. M.T., 200 E. Ontario, Chicago 11, Ill. Send in your order today!

UNIQUE Playing cards. Life-like. All different. Brochure free. Beaumart's, Box 608B, Morristown, N. J.

VENETIAN Blinds—Flexible steel rust-proof, \$2.98 each. All sizes, 18" to 36" wide, 64" long. All white. Cash with order. Shipped express collect. Nola, 2600 Baird Blvd., Camden, N. J.

PLASTIC Wall tile—Beautiful marble-ized colors. Fadeproof and chipproof. Permanent beauty for bath and kitchen walls. 42c sq. ft. Mastic cement \$4.50 gal. Cash with order. Shipped express collect. Nola, 2600 Baird Blvd., Camden, N. J.

INCREDIBLE! Become mental superman overnight! Free booklet! Bijou, Box 1727-M6, Hollywood 28, California.

PENMANSHIP Courses: Plain writing. Shaded writing. Oblique penholders. Professional pens. Free literature. Tevis, A-25, Chillicothe, Mo.

70 BIBLE Lessons, 25c. Bulletin, Box 87, Cathedral Station, New York 25.

29 PIECE Twist drill set. From 1/16" to 1/2" by 64ths. Finest quality imported chrome vanadium steel for speed, accuracy, durability. Complete with stand, only \$10. Sanford Sales Co., PMJ, 170 Broadway, New York 38, N. Y.

URANIUM Simple new field test identifies uranium on-the-spot. Saves assay fees—approved by AEC. Kit includes rare lithium fluoride. Free list radioactive minerals. \$5.00 postpaid. Atomic Chemists, Box 1524, Stanford University, Calif.

WHOLESALE Bargains; price lists free. Auctioneers, 5976 Cote Brillante, St. Louis, Mo.

SMASH Worry, fear, inferiority and failure. Wake up your mind. Be what you desire. Write for free lecture and home study details. Personal Psychology, Inc., Box 1924-M, Louisville 1, Ky.

"SNOOPER" Geiger counter. Only \$24.95 complete. Super-sensitive. Pocket size. Find a fortune in uranium. Order now. Send \$5.00, balance c.o.d. Money back guarantee. Free catalog—Scintillator and larger uranium and metal detectors. Precision Radiation Instruments, 2235CPM So. LaBrea, Los Angeles 16, Calif.

MARBELCRETE—Stops all dusting and wearing away of cement floors. Permanent treatment. Information free. Becker Paint & Varnish Co., Bay City, Michigan.

"MYSTERY Mirror" see through from the back. Formula, instructions, \$1.00. Mystery Mirror, 514 Smith St., Stevens Point, Wis.

100 IDEAS For shop and home illustrated. \$1.00. Shoppe, Box 42, Sheboygan, Wisconsin.

NYLONS \$2.00 Doz. (rejects). Limited supply. Quality, 408 N. 14 Pl., Springfield, Ill.

WHOLESALE Furniture plan. Buy in your city. Service charge only. Listed Dun & Bradstreet. Furniture, Box 321, Pipestone, Minn.

BIG Mails magazines, plans, samples, offers. 3 months 25c. Providence, 3708 W. Lexington St., Chicago 24, Ill.

GAGE Checks, 38 screws. Details free. Longer lasting perfume sample 25c. Sniffy new game 25c. Faas Research Laboratory, 13-B Dogwood Road, West Orange, N. J.

INTERESTED In mailorder? Mail Gazette reveals much. Copy 10c. Havlicek, 564 Oak, Kansas City 6, Mo.

MAKE Your own cigarettes. Save money. Amazing little machine rolls them fast. Machine complete with 200 filter tip tubes \$1.00. Free circular. Kohrin, 1514-PM Decatur, Brooklyn, N. Y.

TERMITES—Treat them yourself save hundreds of dollars. Send \$1.00 for booklet. Money back guarantee. J. R. Wynne & Co., 426 Transportation Bldg., Cincinnati 2, Ohio.

RECEIVE Magazines, samples, catalogues. Mails from everywhere. Offers, hundreds. Get listed 25c. Rorick, Box 86, Cincinnati 26, Ohio.

SELECTIVE Metal and mineral detector. Revolutionary design. Distinguishes metals from black magnetic sands. Readily detects metals under salt water. Also Geiger counters. Free literature, Gardiner Electronics Company, 2018 N. Dayton, Phoenix, Arizona.

LUMINOUS Reflective paints glow day and night in technicolor! New angle money maker. Assorted color samples 25c. Research, 1842-PM Byron, Chicago 13.

HEARING Aid batteries, wholesale. Free list. Habs, Box 51, York, Penna.

300 **BIG Mails** guaranteed. Samples, plans, offers, propositions, 12 months listing. \$1.00 (refundable). Wright Publications, 2270 Hubbard, Memphis 8, Tenn.

YOUR Leather jacket renovated expertly. Free circular. Berlew Mfg. Co., Dept. 8, Freeport, N. Y.

TREASURE—M-Scope Geiger counters, mineral locators. Why buy something inferior when you can buy the best at a lower price? Backed by years of experience. Fully guaranteed by factory. Detects minerals, metals, gold, silver, coins. Payment plan available. Proven superior performance. Free 16 page illustrated booklet. Fisher Research Lab., Inc., Palo Alto, California.

UP-To-date Alaska information, authentic, reliable; 224 pages of facts; where to go, what to see; mileage charts, transportation, cost of trip, detailed review of cities, industries, business, opportunities, Alaska Highway; hundreds of pictures, maps, etc. Only recognized, established guidebook of all Alaska; \$2; guaranteed best or refund. Guide to Alaska, 6015 Santa Monica Blvd., Los Angeles 38, Calif.

GOLD, Silver, metal detectors. Geiger counters for uranium. Mineralights. Sensational new fully guaranteed models. None finer. Information free. Detection Co., 5420 Vineland Ave., North Hollywood, California.

LOCKSMITHS Exclusively. Send name of your supplier and proof of occupation for details regarding the new Manual of Locksmithing. McLean, 2701 E. 3rd Ave., Denver 6, Colo.

STAMMER? New hope. Reliable. Edwin Ptak, 225 N. Fairmount St., Pittsburgh 6, Penna.

TREASURE Finders for gold, silver and minerals. Money back guarantee, best available. Also Geiger counters for uranium prospectors, free information. Write Goldak Company, 1541 West Glenoaks, Glendale 1, Calif.

CLOGGED Drains opened by new powerful chemical called Sursolvent. Removes grease, soap, tree roots, etc., without expensive digging and electric rodding machines. Simple to use. Mix with water and pour down sink. Postal brings free details. Electric Sewer Cleaning Co., Allston 34, Mass.

OIL Painted portrait from your photograph 12"x16" \$25.00. Brady's Art Studio, 204 Wolf, Wadsworth, Ohio.

Be a FROGMAN

JOIN!
JOIN!

Join the new **NATIONAL FROGMAN CLUB** today! Send \$1.00 with your name and address to the club headquarters. Here is what you will get:



1. **FREE COUPONS** totalling \$1.00 in value which can be used toward the purchase of official Frogman equipment, redeemable in your local sporting goods store or department.
2. A miniature rubber replica of a pair of **FROG FEET** water flippers for your key chain, lapel or windshield.
3. Attractive membership card certifying you are a **FROGMAN**.
4. A **FROGMAN** decal.
5. A booklet on "How to Swim Underwater" and "The Supreme Sport of Spearfishing."
6. Complete catalog of **FROGMAN** equipment.
7. Periodic newspapers for a year of club news, pictures and articles about **FROGMAN** activities, equipment and instruction.

Send your \$1.00 **TODAY!**

NATIONAL FROGMAN CLUB

Dept. PM6

1428 S. Maple Avenue
Los Angeles 15, California

Gentlemen: Attached is \$1.00 in cash, check or money order. Enroll me in the **NATIONAL FROGMAN CLUB** for one year, and send me the above items.

Name _____

Address _____

City _____

State _____

Learn TELEVISION-ELECTRONICS

2 Big Books
FREE

Train at Home—Get Big Kits of Radio Parts!
Prepare now in spare time. Practical instruction.
Approved for Veterans. Write for details and 2
Radio Books—**ALL FREE!** Rush name today!
SPRAYBERRY ACADEMY OF RADIO
Dept. 10-X 111 No. Canal Chicago 6, Illinois

RADIO

Say You Saw It in Popular Mechanics

Here Is Proof MILLIONS Are Paying Too Much for VITAMINS!

Vitamins are costing Americans over three hundred million dollars a year. Much of this vast sum is spent needlessly. It's time folks taking vitamins should be told the plain facts. Stop taking vitamin products just on faith, prestige and with the mistaken belief that "high price" means "quality." You can learn the truth and be informed! No longer need you complain about the high cost of vitamins. Now you can get quick proof if you are getting your money's worth.

Without cost or obligation you may get the answers to all the vitamin questions. Do you know just what vitamins can do for you? Do you know the sole test of "quality" in vitamins is "correct unitage"? Is it desirable to use a supplement of minerals along with vitamins? How effective is the new wonder vitamin B-12 and Folic Acid in building rich, red blood? Are the lipotropic factors Inositol, Choline and vitamin B-6 of value in arteriosclerosis (hardening of the arteries)? If your hair is turning gray, can vitamins be of help? If you are just fagged out about 4 o'clock every afternoon, what's this got to do with vitamins? Is there such a thing as an "anti-sterility" vitamin or what have vitamins to do with sex? Can you be immune from avitaminosis by hoping to get your vitamins in cereals, bread, butter, meats, vegetables and concocted drinks? These questions and many others which have perplexed thousands of people are answered in the most informative **FREE** book on vitamins that has ever been written. It is simple, easy to understand and fascinating, and most important of all, it will tell you how you may save many dollars on your vitamin needs. You should not miss this opportunity to get the facts about vitamins without cost or any obligation. Do not spend a single penny for vitamins until you get this book. Stop buying vitamins blindly. Send postcard today for this free book and catalog of over 100 products to **VITAMIN-QUOTA**, Dept. 228, 880 Broadway, New York 3, N. Y., or Dept. 228, 1125 Crenshaw Blvd., Los Angeles 19, California.

FREE

**VALUABLE CATALOG OF BUSINESSES,
FARMS OR RANCHES AND INCOME
PROPERTY—FOR SALE OR TRADE—
THROUGHOUT WEST AND MID-WEST**

Over 2000 offerings, approx. 200 pages. Contains vital information, prices, terms, earnings, lease, rent, names and addresses so that you can deal direct with owners. **ALL TYPES—FROM \$1000 to \$1,000,000** Retail, Wholesale, Industrial Plants, Factories, Service Businesses, Farms, Ranches, Groves, etc., large and small. No salesman will call. No commission to pay us. Simply write today for Free Catalog No. 76-F to **NATIONAL BUSINESS & PROPERTY EXCHANGE**, Dept. 76-F, 4101 West 3rd St., Los Angeles 5, Calif. (*Extra Free Service:* Write us exactly what and where you want to buy and we'll advise owners of your requirements.)

RUPTURE-EASER

Reg. in U.S. Pat. Off. **FOR MEN, WOMEN AND CHILDREN**
Pat. No. 2608551

A strong, form fitting, washable support. Back lacing adjustable. Snaps up in front. Adjustable leg strap. Soft, flat groin pad. No steel or leather bands. Unexcelled for comfort. Also used as after-operation support. Give measure around the lowest part of the abdomen. State right or left side or double. We pay postage except on COD's. **PIPER BRACE CO.**
811 Wyandotte Dept. PM-63 Kansas City 5, Mo.

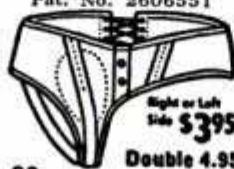

Right or Left Side \$3.95

Double 4.95

MAKE CRIME YOUR BUSINESS

ON THE SIDE OF THE LAW!

Help fight crime! . . . Earn steady good pay as a Finger Print Expert or Investigator. I. A. S. trains you—by easy, low-cost home study lessons. Learn this exciting work in spare time. Write for full details now!

OVER 800 POLICE BUREAUS . . . Employ I. A. S.-trained men . . . proof of what I. A. S. can do. Write today (state age) for details. No obligation. No salesman will call. **INST. OF APPLIED SCIENCE, 1920 Sunnyside Ave., Dept. 135A Chicago 40, Ill.**

MONEY IN HAMSTERS

EASY, PROFITABLE. RAISE IN ANY CLIMATE. THOUSANDS NEEDED FOR LABORATORY & PET MARKET. BEAUTIFUL, GENTLE PETS. **WRITE FOR FREE BOOKLET!**
SOUTHERN HAMSTERY • BOX M 685 • GAFFNEY, S.C.



FREE LEARN TV the practical way—
CATALOG of TV KITS

Assemble a **TRANSVISION TV KIT** in easy stages. Pay as you wire—only \$39 for Starting Package #1. Learn while building a superb 17" to 21" screen TV Set with latest features. Ideal for Fringe Areas, adaptable to UHF. Easy—no instruments or technical knowledge required. Free Catalog describes 6 great **TRANSVISION TV KITS**.
Write today to Educational Dept. at—
TRANSVISION, INC., Dept. PM, NEW ROCHELLE, N. Y.



PORTABLE GARAGE

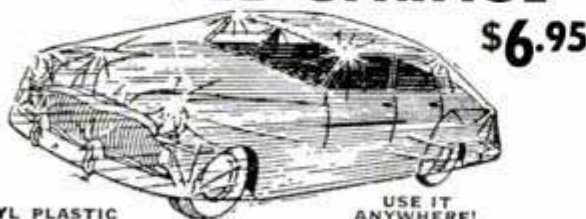

\$6.95

VINYL PLASTIC

USE IT ANYWHERE!

• Goes wherever your car goes • Folds compactly • Keeps rain, snow, dust, salt air, sun or sleet away • Protects your car's finish • Durably constructed of vinyl plastic that is long wearing and tough • Nylon threads for extra security • Springtite elasticized bottom, holds securely in all kinds of weather • Fits all makes and models • Direct from manufacturer • Enclose check or money order for \$6.95, or sent C.O.D. **10-DAY MONEY BACK GUARANTEE**

MARDO SALES CORP.

480 Lexington Ave., Dept. G-201, New York 17, N. Y.

10 POWER POCKET BINOCULAR



UNITED
SEAL OF QUALITY

Etched into your United Binocular—Insist On It!

ACTUAL PHOTO

"TITAN MIDGET" 3"x3 1/4" Weighs 6 1/2 oz.! Yet, a **FULL 10 POWER** with color corrected Achromatic lens. Interior surfaces of **VITAL** front and rear Achromatics are **COATED** to assure brighter, sharper, clearer images! Made by skilled optical craftsmen of precision, quality materials to rigid **UNITED** requirements. It explains why Price is **LOW**, Quality is **HIGH**. With genuine leather case, straps, \$24.95. **OTHER POCKET MODELS.** 6x Duo-Tone—\$17.95, 7x All Chrome—\$19.95.

16 x 50 — \$69.50

Weighs only 27 ounces!

The ultimate in high powered binoculars. Easy to hold—Easy to focus. 2" wide objective lens assures brighter, sharper, clearer images. Water-Dustproofed. Height only 7 inches.

6x30	15 oz. Economy	\$34.50
7x35	5"x6 1/2" All purpose	45.50
7x35	CENTER FOCUS	49.50
7x40	CENTER FOCUS	52.50
7x50	31 oz! Bargain!	36.00
7x50	CENTER FOCUS. SALE	39.50
8x30	18 oz! Favorite	39.50
8x40	More Power	54.50
8x40	CENTER FOCUS	59.50
10x30	Compact Power	45.00
10x50	CENTER FOCUS.	59.50
12x50	CENTER FOCUS.	67.50



ALL Are Uni-Coated®

UNI-COATED® Interior sides of **VITAL** prisms and front and rear achromatics have been **COATED** with Magnesium Fluoride to assure brighter, sharper, clearer images. FROM 3 CONTINENTS come **UNITED'S "Best-By-Test"** binoculars. Made in Japan, unless stated otherwise, by skilled optical craftsmen of precision quality materials.

8 x 30 GERMAN \$39.50

ONE OF WORLD'S LIGHTEST!



Prismatic "Whisper Weight" (11 oz!) binoculars from Germany, optical center of the world! 4"x5 1/4". Water-Dustproofed. Their performance will amaze you. Interior surfaces of **VITAL** front and rear Achromatics are **COATED** for that extra sharp, precise viewing. Quality, Economy priced. **7x35** Weighs 16 oz. — \$69.50
20x56 — Weighs 27 oz. — Size 9 1/2"x6 1/4" — \$99.50.

6 Telescopes in one. American Wolensak. Instant focusing at 15x, 20x, 30x, 40x, etc. Turn power tube to click—no guess work. Measures 9" closed, 27" extended. 18 oz. Rust proof chrome tubes. Objective 40 mm! All 12 optic surfaces **COATED!** See .22 bullet holes at 300 ft. Leather case included. Federal tax **FREE**.

20 POWER POCKET

Easy to hold, Easy to focus. Weighs only 7 1/2 ounces! 8 3/8" closed, 13 1/2" extended. Threaded fittings throughout. **ALL METAL.** Achromatic. Ideal for accurate range checking, close or distant viewing. Federal tax **FREE.** Leather case \$1.00 extra.



15 Power to 40x \$33.50

\$8.95

FREE 40 page, 3 color fully illustrated Binocular Catalog. 75 different models from \$14.95 to \$270.00.
RUSH NAME

DEALERS WANTED

30 DAY NO RISK TRIAL. If not satisfied return for full refund. Cash orders postpaid. C.O.D.'s require \$2.00 deposit. Add Federal tax. Leather case, straps included with all binoculars.
UNITED BINOCULAR CO. United Bldg., 9043 S. Western Ave., Dept. ARF-6308, Chicago 20
DISPLAY SALES ROOMS OPEN 9:00-3:30 MON. thru FRI.

SAY YOU SAW IT IN POPULAR MECHANICS

Old Town . . .



"walks" easily to the next lake

• Light to carry, yet sturdy champion in the water! Next trip, try an Old Town.

FREE CATALOG shows canoes for paddling, sailing or outboards. Also outboard boats, big all-wood family boats, sailboats, rowboats, dinghies. Old Town Canoe Co., 946 Middle Street, Old Town, Maine.

"Old Town Canoes"



**KNOW YOUR
COASTER BRAKE
INSIDE and OUT!**



**Ride
a Bike
- it's
Fun!**

Unmatched construction features make the Bendix* Coaster Brake the outstanding performer in its field. That's why Bendix Coaster Brakes—stop quicker—pedal easier—coast farther—last longer. Your bicycle dealer will put on the brake you want—so just say "Bendix Coaster Brake."
*REG. U. S. PAT. OFF.

**DOUBLE THE FUN
WITH A *Bendix*
COASTER BRAKE**

ECLIPSE MACHINE DIVISION of 
Elmira, New York



**MEN! TRAIN NOW FOR
A BIG PAY FUTURE IN
DIESEL
& SCIENTIFIC MOTOR TUNE-UP**

- Diesel Construction
- Diesel Engine Repairman
- Diesel Operator
- Industrial Maintenance
- Auto Engine Rebuilding
- Bus & Truck Maintenance

Be a Trained Diesel Man

Go places with DIESEL! Farms, factories and power plants, trains, ships, trucks, busses all use DIESEL POWER... all need DIESEL-trained men! You can start your DIESEL training at home, in spare time, with tested, proved U E I training. Course includes practical work on Diesel engines under skilled instructors. You learn the operation, maintenance, servicing of all types of Diesel engines, PLUS Scientific Motor Tune-up. **ACT NOW!** If you have mechanical ability, you'll like Diesel! High School diploma not necessary. Write now for FREE book, "EARNING POWER IN DIESEL." Act Today!



MAIL NOW FOR FREE BOOK! 

UTILITIES ENGINEERING INSTITUTE, Dept. DC-29,
2521 Sheffield Ave., Chicago 14, Ill. (Founded 1927)
O. K.! Rush, without obligation, FREE Book on DIESEL.

NAME _____
ADDRESS _____
CITY _____ ZONE _____ STATE _____
 Check here for information if under 17.

Complete PUMPING UNIT with MOTOR



Ready For Use! **\$18.50**
REGULARLY \$28.75 **PRE-PAID**

Tremendous buy for farm, home, shop and garden. PUMPS 1,500 GALLONS PER HOUR 5 FT. HIGH!

A powerful 1/4 HP motor, 110 volts, 60 cy., propels this whirlwind pump to do 1,001 suction and lifting jobs. Drains cellars, wash tubs—lifts waste water to overhead sewers, etc. up to 15 ft. high. Have running water system—lifts water from well to upper floors. Irrigates gardens. Waters livestock. Boat pumping. Circulates and transfers oil, liquids, etc. NON-CLOGGING! NON-RUSTING! Neoprene seal keeps pump from leaking. Attach any 3/4" garden hose. Anyone can operate it. A permanent investment of real value. Satisfaction guaranteed 100% OR MONEY BACK. Limited supply. Order NOW! WE PAY POSTAGE!!

Send for FREE CATALOG

ROBERTS ELECTRIC CO., Dept. 65, 849 W. Grand, Chicago 22, Ill.

MONEY for MEN ALL FREE
DATA

THE PLASTEX Industry needs manufacturers on small scale and for big production of Lamp and Clock Stands, Art Goods and Novelties in Plastex and Marble imitation. Experience unnecessary. 1/2c material makes regular 10c store sellers. Rubber moulds furnished for speed production. Small investment brings good returns. We are now placing big Chain Store Orders with manufacturers. Ambitious men have chance for real prosperity. Our Free booklet will interest and benefit you.

PLASTEX INDUSTRIES, Dept. A
3400 Third Ave. New York 56, N. Y.

**New WHIRL-A-WAY
JET-PROPELLED Car Washer**

Waterpower makes this brush WHIRL, just like it makes dynamos go 'round! Thick, long bristles of finest horsehair whirl away dirt, dust, road haze; 4-ft. aluminum handle has built-in regulator and shut-off. Pays for itself over and over.

\$4.95

YOUNG PRODUCTS,
Dept. 1479, 2605 Elmhurst, Detroit 6, Mich.

AMAZING HEADLOC

Now you can fish from high bridges, piers, or party boats without losing that "big one" with the amazing new invention Headloc (U. S. Pat. # 2620590). Simply attach your baited hook to cross-bar slider of the Headloc. Your fish automatically closes pincers as you reel him in

\$1 PPD

FREE 30 day trial Money refunded

HEADLOC CO., 254 Greenwich St., N. Y. 7, N. Y.
Liberal Consideration to Dealers

COPIES — PRINTED

WE WILL MAKE 100 QUALITY COPIES OF ANYTHING THAT YOU CAN PRINT, DRAW, TYPE, ETC. FOR THE FOLLOWING PRICES: First 100 Additional Copies per 100 copies

Size	8 1/2"x11"	\$ 5.00	\$0.60
	11"x17"	9.75	1.20
	17"x22"	19.25	2.40
	24 1/2"x33"	43.75	5.40
	34"x44"	78.50	9.60

Above prices are for one side printing. For two sides, double the one side price and deduct 5%.

ACME COPY CORP.
WABASH 2-6742, 53 W. JACKSON BLVD., CHICAGO 4, ILLINOIS

**Fabulous Profits
At Home... Raising
ORCHIDS**

World's most thrilling hobby — most profitable home business. A single Orchid plant may multiply into HUNDREDS—each as valuable as the first. Famous grower shows you how! Raise gorgeous Cattleyas, Cymbidiums, Epidendrums on living-room table. Big-profit orders come from Homes, Florists, Gift Shops, etc.—also Mail Orders. Illustrated secrets of the experts in simple "show-how" language—INCLUDING actual Orchid plants—all you need to start at home, sent at no risk. FREE—full details—SEND NO MONEY. Write today.

**TROPICAL FLOWERLAND, Dept. 13-J,
601 South Vermont Avenue, Los Angeles 5, California.**

YEAR 'ROUND ANY CLIMATE NO EQUIPMENT

When is wood glue really WATERPROOF?

ANSWER: when it meets Military Specification tests for gluing wood for marine use.

Cascophen is a resorcin resin—the only cold-setting glue that passes these tests and is nationally available in small packages!

Use Cascophen for permanent wood bonds on boats, outdoor furniture, fishing tackle, archery and other wood sports equipment. Write for free descriptive folders. The Borden Co., Chemical Div., Dept. PM-63, 350 Madison Avenue, New York 17, N. Y.



IF IT'S *Borden's* IT'S GOT TO BE GOOD!

WHY DON'T YOU WRITE?

Writing short stories, articles on business, sports, hobbies, travel, shop crafts, local, club and church activities, etc., will enable you to earn extra money. In your own home, on your own time, the New York Copy Desk Method teaches you how to write the way newspaper men learn—by writing. Our unique "Writing Aptitude Test" tells whether you possess the fundamental qualities essential to successful writing. You'll enjoy this test. Write for it, without cost or obligation.

NEWSPAPER INSTITUTE OF AMERICA

SUITE 5593-H, ONE PARK AVENUE, NEW YORK 16, N. Y.

HULA DANCER • GETS BIG FISH

Small but mighty, this deadly open-water hooker is heavy enough to make long casts easier. Sinks and runs medium depth. Special "lip" gives special action—fools the wise ones. 5/8 oz. At your dealer. \$1.25 ea.



FRED ARBOGAST & Co., Inc., 2276 W. North St., Akron 3, Ohio

FREE WRITE TODAY FOR YOUR BIG FREE ARBOGAST COLOR CATALOG—FULL OF PICTURES OF CATCHES

HELPFUL BOOKS

Send post card asking for FREE catalog

Popular Mechanics Press, 200 E. Ontario, Dept. 601, Chicago 11

WHAM-O SPORTSMAN*

\$1.50 POSTPAID 35-LB. PULL!

HITS LIKE A RIFLE—KILLS RABBITS, SQUIRRELS. Powerful, silent, accurate. For hunting, target, routing pests. Sportsman's choice sold world over!

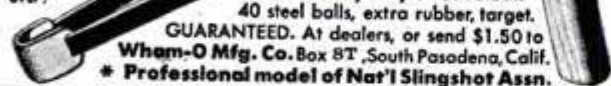

HUNTING SLINGSHOT

Heavy duty 7" ash stock.

40 steel balls, extra rubber, target.

GUARANTEED. At dealers, or send \$1.50 to Wham-O Mfg. Co., Box 87, South Pasadena, Calif. * Professional model of Nat'l Slingshot Assn.



TRAILER COACHES

Here's everything you want to know about trailers, with plenty of pictures and plans and instructions for building three different types. Covers also, history of trailers, trailer parks, camps and overnight-stops information, furniture, furnishings, materials and engineering data. If you want to build a trailer, live in a trailer, or just want to know more about trailers, get this book. Only \$1.50 postpaid. Rush order to:

POPULAR MECHANICS PRESS • Dept. 350, 200 E. Ontario St., Chicago

Build it Yourself!

Complete Trailer Book and Construction Data for 10, 16 and 22 Foot Trailers — Only \$1.50

Partial Contents

Trailer Parks—Living in a Trailer—Towing a Trailer—Floor Plans—Service—Classifications—Balance—Dollies—Jacks—Weight Distribution—Construction—Working Drawings for a Two-Place, Standard Travel and Standard Dwelling Trailers. Size 8 1/2 x 11 1/4 inches.

Save Repairs! Save Gas!

SAVE MONEY EVERY MILE YOU DRIVE!



Mile-O-Meter . . . the ONLY instrument on your dash that gives a visual report on engine condition and performance. Warns when engine adjustments are necessary to avoid breakdowns. Miles-per-gallon scale helps you improve your mileage, indicates when you're wasting gas. Simple to install without drilling any holes . . . all directions and fittings included. Sold on firm money-back guarantee. Mile-O-Meter pays for itself over and over again . . . a "must" for engine tune-ups and repairs. Order today.

\$14.95

SEND DELUXE STANDARD MILE-O-METERS AT \$

Before illuminated. 1 1/2" diameter. Chrome trim.

NAME _____

ADDRESS _____

\$9.95

CITY _____ ZONE () STATE _____

Check Enclosed Money Order Enclosed Send C.O.D.

Standard Model. 2 1/2" diameter. Plated trim.

Orders are shipped within 24 hours anywhere in the U. S. A. We pay postage when payment accompanies order. Add 35c for special delivery, if desired. Each Mile-O-Meter is gift-packaged, with all accessories and instructions included.

ORDER NOW

GALE HALL ENGINEERING, INC. DEPT. 368 NORTH HAMPTON, NEW HAMPSHIRE

Say You Saw It in Popular Mechanics

RAISE GIANT FROGS BIG DEMAND

Nuford Giants



MILLIONS USED YEARLY!

Frogs sell \$5 dozen. Breeder lays up to 20,000 eggs yearly. Season just starting! Men & Women get ready now for this year's eggs. Small pond starts you. New book tells how! Send for illustrated FREE folder today. Write to

MARLBORO HOUSE-7

1035 Marlborough Detroit 15, Mich.

SAVE \$65 ON THIS LUXURIOUS \$100 CONTOUR CHAIR \$34.95

Genuine FOAM RUBBER

For Everything needed complete to

PUT IT TOGETHER IN ONE EVENING!

Make Money Selling and assembling contour chairs for friends



Scientifically correct design for restful, healthful, relaxing. Adjusts for perfect sitting or reclining comfort. Proved beneficial to heart, nerves . . . most popular chair in every home. Firestone foam rubber and washable, pliable genuine Duran upholstery. Would cost \$100 or more in any store. Shipped all ready to put together in less than one evening by anyone who can use a screwdriver. No cutting, no drilling, no skill needed. A woman can do it. Order now! Everything needed for only \$34.95, f.o.b. Balto. State color wanted: forest green, sapphire blue, lipstick red, walnut brown. Enclose \$5 deposit, pay balance on arrival. Money back guarantee. If not satisfied, return in 10 days.

Bestcraft, Dept. 33, Mathieson Bldg., Baltimore 2, Md.

Here's the *All-purpose* "1001" RE-BLADE KNIFE

... with the 1001 uses!

- KEEN, EVER-READY
- ACTUAL KNIFE SIZE 6"
- PERFECT BALANCE
- LIGHT-WEIGHT
- YOU'LL LOVE THE FEEL OF IT

Regular
\$1.59
value
NOW!
~~\$1.00~~

EXCLUSIVE
PATENTED CHUCK
MAKES BLADES
SIMPLE TO
CHANGE -
KEEPS BLADES
FIRMLY
LOCKED!



COMPLETE WITH
THREE BLADES
AND
UNBREAKABLE
HONER!

If not satisfied in 5 days, your
MONEY BACK! Mail your dollar to-
day for the "1001" Kit complete with
3 blades and unbreakable honer to
Dept. P. M.

Please,
No C.O.D.'s.

MARSTAN SALES CO.
DANVERS, MASS., U.S.A.

The BIG PAY JOBS IN AMERICAN INDUSTRY ARE:

- TOOL ENGINEER
- TOOL DIE DESIGNER
- MACHINE DESIGNER
- DRAFTSMAN
- MASTER MACHINIST
- TOOL & DIE MAKER

Shortages of Draftsmen, Designers,
Tool Engineers, Machinists, Tool &
Die Makers are so widespread that you
can pick a highly paid key job and look
forward to Achievement and Security.
Industry is clamoring for Allied
Trained men to fill important jobs!
You can begin your training in Short
Courses and continue progressively to
a Bachelor Degree in 26 months.

ALLIED is approved by Industry, The Am. Society
of Tool Engineers, Dept. of Education and Regis-
tration, the Dept. of Public Instruction - State
of Illinois and the Veterans Administration.
Accredited by the Central Schools Association.

ALLIED SCHOOL of 1338-42 S. Michigan Ave.
Mechanical Trades Chicago 5, Ill., Dept. PM-6

SEND ME WITHOUT OBLIGATION YOUR FREE BOOKS EXPLAINING
ALLIED'S COURSE OF INSTRUCTION.

I AM INTERESTED IN RESIDENT HOME STUDY TRAINING

I AM A VETERAN NON-VETERAN

NAME _____ AGE _____

ADDRESS _____

CITY _____ STATE _____

Yours... A Blazing NEW Gem...
Blue-White and Perfect!

SEND
FOR FREE
CATALOGUE

Dazzlingly brilliant...
harder than steel... bril-
liantly blue white... here
is the final triumph of science
over Nature! Yes, after years
of study... thousands of experi-
ments... International Gem Cor-
poration now brings you an exciting,
new, amazing gem... the most
beautiful, the most perfect science
has ever produced. Not to be confused
with earlier advertised soft and yellow
synthetics, this amazing gem is un-
believably, richly BLUE WHITE...
THE COLOR NATURE
RESERVES FOR ONLY HER MOST PRECIOUS DI-
AMONDS! Every gem is registered...
WARRANTED
FOR A FULL 10 YEARS against scratching! Money back
guarantee! Full 58 faceted unset gems, \$10 per carat
plus 20% tax. One carat gem set in 14K yellow or
white gold man's or woman's setting, \$25 plus 20% tax.
WRITE FOR FREE, FULLY ILLUSTRATED CATALOG OF
GEMS AND SETTINGS.



INTERNATIONAL GEM CORPORATION
18 John Street New York 38 N.Y.

2-BEDROOM HOME \$890

BUILD YOUR OWN



Living room 12x14. Master bedroom
10x12. Nursery-den 10x11. Kitchen
7x10. Bath 5x8. Concrete block built.
Blue prints, material lists, exact in-
structions for 3 designs.

Complete \$1 ppd.

SUNNY-CAL HOMES, Box 309-D-6 Hollywood 28, Calif.

MASTER MIND!



Learn Short-Cut Mathematics

Juggle figures, do baffling number tricks. Make peo-
ple gasp at your marvelous lightning-quick mind.
Multiply 4 figures by 4 figures without using old-fashioned
multiplication! Big cloth-bound volume; fully illustrated
course.

Sharpen up Your Brain Power

Includes worked out problems, answers, etc. Sensational
bargain, only \$2.95, postpaid or COD plus postage. Satis-
faction guaranteed or refund. Order this amazing "Short-
Cut Mathematics" today!

NELSON-HALL CO., 210 S. Clinton St.
DEPT. 2FX-2 CHICAGO 6, ILL.

\$2.95
Complete

250 POWER.....

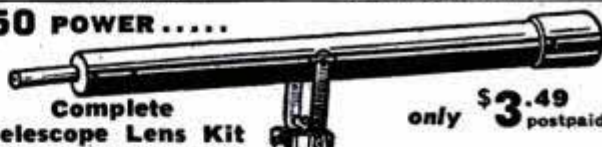

Complete
Telescope Lens Kit only **\$3.49**
postpaid

Conquer Space, Explore the Universe, Planets, Moon Craters, New
Stars, etc. Complete Lens Kit consists of 80 inch focal length ground
and polished objective lens, eyepiece lenses for 50 POWER, 100
POWER, 150 POWER, 200 POWER, 250 POWER, and all necessary
lens fittings. Easy to make from simple step by step instructions.
(Tripod and mount not included.) Money back guarantee.

BUSSE SALES CO., Hartford, Conn., Dept. PM 13

A Service Station Under Your Hood!

Auto Flate

**AMAZING INVENTION PUMPS AIR
WHILE YOUR MOTOR IDLES!**

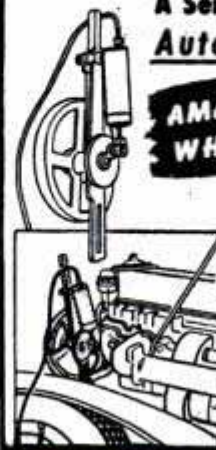

Sensational New
Automatic Air Compressor
Auto Flate makes possible first aid road tire
inflation wherever and whenever needed. No
more changing tires in the middle of nowhere!
New, inexpensive appliance attaches simply and
permanently to motor with one bolt. Simply tilt
Auto Flate lever against fan belt, insert air hose
on tire valve - start the motor and stand by while
tire inflates to desired pressure! Then release the
lever - tuck away the hose - and you're on your
way! Works on cars of all makes and ages. For
use by motorists, farmers, builders, industrial
plants, etc. FULLY GUARANTEED. Shipped by
return mail. \$9.95... POSTPAID, complete
with air hose. With spray gun... \$13.95
POSTPAID.

T. C. TOR

Dept. PM-63, 2113 Bellevue St. Phila. 40, Pa.

STOPS PING! ADDS POWER! OR YOUR MONEY BACK!

Amazing New PING-OUT VALVE Ends Knock, Permits Spark Advance

Mechanics Report: "PING-OUT has immediately eliminated ping & knock in many stubborn cases, and delivered Extra Power, Smoother Engine Performance, Faster Getaway!" Successfully used by Authorized Dealers & Garages on late-model & older cars & trucks. PING-OUT synchronizes spark to speed; gives premium performance on regular fuel; SAVES YOU \$\$ ON TUNE-UPS, GAS. If it doesn't satisfy, return in 10 days for full refund.

P-B PRODUCTS Dept. 1-B
7958 Beverly Boulevard
Los Angeles 48, California

DEALER AND JOBBER INQUIRIES INVITED



EASY TO INSTALL
No Special Tools Needed. Do It Yourself!

FITS ON VACUUM LINE BETWEEN CARBURETOR & DISTRIBUTOR

ORDER TODAY!
FULL PRICE ONLY **\$2.95**

We'll rush PING-OUT postpaid, with complete installation instructions. Or order C.O.D., pay postman \$2.95 plus charges.

U.S. PATENT 2247520

**Wheels
Wheels**



**Wheels
Wheels**

- 7" Disc Wheel 3/4" Tire 3/8" sleeve.....45c ea.
- 8" Disc Wheel 1 1/4" Tire 1/2" sleeve.....70c ea.
- 7" Disc Wheel 1" Tire 1/2" ball bearing.....80c ea.
- 10" Disc Wheel 2.75 semi-pneum. T. 5/8" B.B.....\$3.50 ea.
- 8" Disc Wheel 2" semi-pneum. T. 1/2" B.B.....\$1.50 ea.
- 10" Disc Wheel 1.75 semi-pneum. T. 1/2" B.B.....\$1.50 ea.
- 6" Disc Wheel 1.50 semi-pneum. T. 1/2" B.B.....\$1.35 ea.

Above wheel prices includes hub cap. Plus Postage. C.O.D.'s accepted. AXLES—Sizes 5/16 in., 3/8 in., 1/2 in.—Cut to size—End holes drilled.

UNITED WHEEL STAMPING CO.
12131 S. PEORIA STREET PM6 CHICAGO 43, ILLINOIS

LEARN PHOTO COLORING RETOUCHING AIRBRUSHING

By one of America's foremost magazine and national advertising artists. A specialized field with a scarcity of good photo retouchers. Men and women making \$5,000 to \$25,000 a year. Avail yourself of a rare opportunity to participate in a course by mail of this profitable profession. WRITE

PROFESSIONAL ART INSTITUTE

DEPT. PM6, 5653 1/2 HOLLYWOOD BLVD., HOLLYWOOD 28, CALIF.

LEARN AT HOME INDUSTRIAL ELECTRICITY

Practical training program includes all the following: (1) Full simplified course on Industrial Electricity—this is the same text used by a large Midwest University. (2) Experiment laboratory type assignments so that you actually have the opportunity to work on Electrical Equipment right in your own home. (3) Experiment Kit of meters and other equipment which is yours to keep. Get facts now about this modern practical training program in Industrial Electricity. Write for Free Information today.

HAMMOND TRAINING SERVICE, Box 787, Hammond, Indiana

A BUSINESS OF YOUR OWN with a Money Back Guarantee

\$712 investment gives you your own independent business operating a route of new money-making 5c dispensers handling new fast-moving confections in drug stores, cafes, clubs, bus depots, etc. Route set up for you by our experts. You must have car, references and \$712 which is protected by an iron-clad 100% Money-Back Guarantee. Devoting a few of your spare hours each week you should earn up to \$80.00 weekly spare time, full time more. Liberal financing assistance to aid expansion. For personal interview write giving phone number and address to

SUPERIOR DISTRIBUTING CO.
Suite 506-A, 1030 15th St., Denver 2, Colo.
References: Dun & Bradstreet

The WONDERS of LIQUID PLASTICS

MANUFACTURE WITHOUT TOOLS OR MACHINERY!

We believe this is one of the most astonishing and important offers ever made to ambitious people everywhere . . . because we **TEACH YOU** and actually show you how to make the most remarkable, the most unusual line of beautiful and useful things of **ENDLESS VARIETY** with enormous possibilities for **PROFIT AND PLEASURE!**

NO SPECIAL ABILITY REQUIRED! No previous experience or special ability is required! **NO TOOLS OR MACHINERY** are required . . . the entire process is about as easy as pouring water out of a glass! The **WONDERS OF LIQUID PLASTICS** make all this possible!

UNLIMITED POSSIBILITIES! Work with **LIQUID IVORY, LIQUID GLASS, LIQUID MARBLE, LIQUID EBONY, LIQUID PORCELAIN, LIQUID WOOD, LIQUID GEMSTONE** and many other **LIQUID PLASTICS** and in a matter of minutes turn them into an endless and valuable procession of beautiful imbedded jewelry, novelties, ornaments, statues, bookends, lamps, pens, pensets, lighters, ashtrays, keychains, figurines, curios, souvenirs, art and gift products, fishing lures, boats, **GADGETS** galore, exquisite **GEMS!** Make gears, tools, dies, forms, handles, dials, knobs, **MACHINE PARTS**, models of inventions, pistol grips . . . the list is endless! The only **LIMITATION** is your **IMAGINATION!**

WE SUPPLY EVERYTHING! We supply everything: the materials, the ideas, and the free instructions! If you have the need or the desire to make any of the products mentioned above (and countless others), as well as your own pet gadget or invention, then take advantage of our remarkable materials, our unusual process and this great offer today! The possibilities for pleasure and profit are practically unlimited!

VALUABLE BOOK GIVEN! Just send 25c and we will send you our book, **HOW TO MANUFACTURE WITHOUT TOOLS OR MACHINERY.** We will also send you our big 64-page catalog describing all the materials mentioned above. Do it today . . . we want you to share in these wonderful opportunities as soon as possible!

PLASTICAST CO., (Dept. C)
P.O. Box 6737 P.O. Box 987
Chicago 80, Ill. Palo Alto, Calif.
(Write to either address)



GEARS



FISHING LURES



PEN SETS



HANDLES KNIVES - DIALS



STATUES FIGURINES



JEWELRY GEMS



NOVELTIES GADGETS

Say You Saw It in POPULAR MECHANICS

MEN WANTED!

Make \$15-\$20 in Few Hours
Spare Time—up to \$21000 a Week FULL TIME—with Amazing D-FROST-O-MATIC!

Millions of housewives want this sensational new Automatic Refrigerator Defroster! No more messy hand defrosting! Just plug in **D-FROST-O-MATIC** and refrigerator is defrosted *automatically* every night! Sales easy, sure when you leave **D-FROST-O-MATIC** on **FREE TRIAL**—housewives won't let you take it out! Saves money, food, time, work! **Big profits for you**—up to \$210.00 a week full time—\$15 to \$20 in just a few spare hours! Start spare time and build big, prosperous business . . . quickly, easily!

Rush Name Today for Profit Details and FREE TRIAL PLAN!
More than 29,000,000 prospects waiting! Rush your name and address today. We'll airmail exciting facts, proof and sure-profit Free Trial plan. No obligation. Write today. **D-FROST-O-MATIC, Dept. C-6**
173 W. Madison Street, Chicago 2, Ill.



SELLY of California started in his spare time and now sells 1500 D-Frost-O-Matics a month!

Experimenters' Specials

TACHOMETERS



Stewart Warner direct indicating. Supplied with two interchangeable rubber tips. 0-2000 rpm Stock #P-388 and 0-4000 rpm Stock #P-389.

Price P-388 \$5.95 ea.
Price P-389 \$6.95 ea.



P-397
P-398

UNIVERSAL AC/DC MOTORS

115 VOLTS. DELCO No. 68008. 1/40 horsepower. 7,000 rpm loaded. Dual shaft extension. Has two hole mounting base for bench mounting. Ideal for high speed grinder-polisher in home shop. Stock #P-397.

Price \$6.95 ea.



P-396

DELCO No. 84567

Identical to 68008 described above, but is 4 wire reversible. Ideal for low power, high speed reversible applications. Stock #P-398.

Price \$7.80 each.

DELCO TYPE 5047140

1/50 horsepower motor. 7,000 rpm. Dual shaft extension. No mounting base. Ideal for hand model type grinders and polishers. Make your own hand held tool for buffing, reaming, etc. May be used for sewing machine motor conversion. Stock #P-396. Price \$4.95 each.

ELECTRONIC MOTOR SPEED CONTROL KIT AND MOTOR
Industrial electronic motor speed control—1/20 hp. 1750 rpm dual shaft motor, Thyatron tube, transformer, chassis, all parts, tubes and instructions. Similar to Thymotrol and Mototrol. Build and learn. Stock #P-1001. Complete price \$39.50 each.

Mercury switch—tilt to activate. Special, four for \$2.00.
Mallory D.P.D.T. momentary switch. Panel mt. Pushbutton. 3 for \$1.00

Send 25c for big catalogue of electronic, electric, hydraulic and aircraft bargains. Full credit on first order. Above prices are all F.O.B. destination for your convenience. No C.O.D. shipments. Send payment in full with order. Satisfaction guaranteed—money refunded.

Electro Devices

4-6 Godwin Ave.
Paterson, N. J.
DEPT. P-10

\$100.00 A WEEK IN YOUR SPARE TIME!

Assemble and Install Buckeye Screen and Glass Combination STORM WINDOWS

(Glass and screen panels are interchangeable in summer and winter)

Install 10 Storm Windows —
Make \$100.00 Profit!

- Shipped in Knocked-Down Form.
- Tens of Thousands Already Sold.
- Either Redwood or Aluminum Types.
- No Finer Quality Available.

Here's your golden opportunity to turn spare hours into big money! In just a few hours a day you too can make more money than you ever dreamed possible—in both summer and winter—assembling Buckeye Combination Storm Windows.

Imagine making \$10.00 or more on every Buckeye Combination Storm Window you assemble and install! Yes, that's the kind of clear profit you can make. Assemble 10 windows, make \$100.00 (about 7 hours time after a little experience).

This is no get-rich-quick-scheme but a legitimate, sound way for you to make additional money in your spare time. You risk nothing—no tools to buy, no big inventory needed. Just order storm windows as orders pour in.

We have been in business twenty years, sold tens of thousands of these top quality redwood or aluminum storm windows. Our reputation is your guarantee of quality.

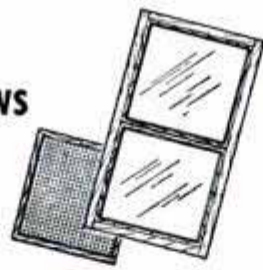

You Pay Only
\$6.65

for a redwood combination storm window to fit a house window 28 1/2" x 56 1/2" (Screening and glass not included)

FHA FINANCING THROUGH YOUR BANK

Yes, Buckeye Storm Windows can be financed on FHA Plan. You, or your customers can pay as little as \$5.00 a month for these storm windows, take up to 36 months to pay! No down payment. Your local bank will be pleased to give you full information.

WRITE FOR DETAILED
INFORMATION TODAY!

SOME ATTRACTIVE
DEALER TERRITORIES
STILL AVAILABLE!

BUCKEYE SCREEN & WEATHERSTRIP CO.
1380 S. 22nd Street, Columbus, Ohio

MONTH AFTER MONTH, YEAR AFTER YEAR, YOU SEE OUR AD.

CHECK AND DOUBLECHECK BEFORE YOU BUY ANYWHERE!

- 1 Are These Tires "Family-Safe"? Our Families Use Them.
- 2 Are They Recaps, (Or "New Treads" (Recaps)? Ours Are Not.
- 3 Will I Get Goodyear & Other Famous Brands? From Us — Yes.
- 4 Is The Guarantee "Unconditional"? See Our Fine Offers Below.
- 5 Can Good Tires Be Bought Cheaper? It's Dangerous To Pay Less.
- 6 Most Miles Per Dollar Make Our Tires Cost Less!

GOODYEAR Firestone

GOODRICH, U. S., ARMSTRONG & OTHERS. BEST USED TIRES
DOUBLE WARRANTY & FREE TIRE INSURANCE. YOU CAN'T LOSE.

Our Policy is to select your tires so carefully, as if our very future depended on the service given by that particular tire.

FREE TUBE WITH EVERY GOOD & FINEST GRADE TIRE		BE WISE—BE CONVINCED	
		SAVE TIME, SAVE \$	
GOOD SUPER GRADE, 20 MOS. GUARANTEE BOND			
600-16 \$3.84	670-15 \$4.24	600-20 \$6.74	750-20 \$8.24
650-16 4.24	710-15 4.44	650-20 7.34	825-70 13.64
700-16 4.84	760-15 4.74	700-20 8.24	900-20 13.94
650-15 3.94	800-15 5.04	32x6(8) 8.34	1000-20 13.34
700-15 4.14	820-15 5.14	32x6(10) 9.64	1100-20 13.64

FINEST PREMIUM GRADE, 30 MOS. GOLDEN RULE GUAR. BOND		THESE MADE THE BLATT NAME "WORLD FAMOUS"	
600-16 \$5.14	640-15 \$4.84	30 MONTH GUAR. TRUCK TIRES	
650-16 5.64	680-15 5.14	XTRA VALUE, XTRA MILEAGE	
650-16(6) 6.64	670-15 5.04	700-15(6) \$9.94	32x6(8) \$11.94
700-16 6.34	710-15 5.54	750-15 10.44	32x6(10) 13.24
700-16(6) 7.64	760-15 5.74	750-16 9.34	825-20 17.84
750-16 6.84	800-15 6.84	700-18 15.84	900-20 17.04
650-19 9.94	820-15 6.74	600-20 8.54	1000-20 18.24
550-17 4.34	700-15 5.64	650-20 10.34	1100-20 18.24
Whitewalls \$1 ea.	Extra 700-20	10.44	1000-22 17.24
DeLuxe Whitewalls \$2 Extra	750-20	12.44	1100-22 17.24

YOU GET WHAT WE ADVERTISE	MILITARY MUD-GRIP TREAD
Std. Guar. 20 Mos.	Rugged Guar. 32 Mos.
750-20Std \$11.44	750-20Rg. \$16.04
900-16Std 11.94	900-16Rg. 15.94
750-16Rg. \$17.64	600-16Std 8.44
	600-16Rg. 9.94

BLATT BLATT BLDG., GIRARD & LANCASTER AVES.
DEPT. PM, PHILADELPHIA 31, PA.
SEND CHECK OR MONEY ORDER & THIS AD.
Thousands Of Shipments Rushed North, East, South, West, F.O.B. Phila.

NO TANKS USED
NEW SIMPLIFIED METHOD

ELECTROPLATE

ANY OBJECT IN HOME, SHOP, GARAGE OR STAIR
YOUR OWN WELL PAYING ELECTROPLATING BUSINESS.



NOW, using NEW plating kit.

It's easy to electroplate any object. Complete kit and instructions on plating metal and non-metal objects, with nickel, copper, chrome, gold, etc., plus full data on obtaining all the business you desire and make BIG MONEY full or spare time. ONLY \$4.95. SEND NO MONEY—everything sent C.O.D. plus postage—OR send \$4.95 now and receive it postpaid. Money back in 7 days if not satisfied.

M. Z. NATIONAL SALES CO., 113-Y West 42 St., N. Y. 18, N. Y.



Spindle & Blade

BUILD YOUR OWN

POWER MOWER

With Parts We Furnish

Why break your back mowing field or lawn? Now anyone can save time, money and effort by building their own Power Mower. Build it to fit your needs, in a short time without special tools.

PULLS ITSELF, STEERS ITSELF

WRITE FOR FREE BUILDING INSTRUCTIONS—NO OBLIGATION!

T & H Mfg. Co., 811 E. 31 St., Dept. S-17, Kansas City, Mo.

Say You Saw It in Popular Mechanics

REVERSIBLE AUTO SEAT COVERS

Made of FLEXTON plastic.
Choice of: SNAKE-ZEBRA DESIGN
or LEOPARD-COWHIDE DESIGN



ORDER FROM MFR. AND SAVE

Colorful SNAKE AND ZEBRA DESIGN AND LEOPARD-COWHIDE DESIGN. Can Be Used On Either Side. Water And Stainproof. Tailored With Side Grip Panels For Tight Fit. Sewn With NYLON Thread For Long Wear. Simple To Install. Dress Up Your Car With A Set Of Either Of These Colorful Expensive Looking Covers!

10 DAY MONEY BACK GUARANTEE

Choice Of SPLIT Or SOLID Front Seat Only \$2.98. Complete Set For Both Front & REAR ONLY \$5.00. When Ordering Specify Choice Of Design Wanted, Make of Car And Seat Style. Enclose Payment And Save Postage Or Sent COD.

Each Only

\$2.98

MARDO SALES CORP., Dept. DS-193
480 Lexington Ave., New York 17, N. Y.

NEW AUTOMATIC DEFROSTER

ONLY
\$795

**YOU MAKE UP TO \$4
ON EVERY FAST SALE!**



Millions of defroster attachments sold at \$12.50. Now — with new guaranteed HOLWIN at \$7.95, sales breaking all records! Men selling as many as 10 and 12 a day — right now. Your profits big — as high as \$4.00 cash on every sale. Converts any old style refrigerator into automatic defroster in 10 seconds. Just plug in. Terrific demonstrator. Women crazy for it at this price. Sell 4 out of 5 calls.

NO CHARGE for complete selling kit and offer of sample demonstrator. Rush name. If you've ever sold anything you'll clean up with HOLWIN. All mailed Free. Send name today for \$140-a-week opportunity and offer of demonstrator.

DEFROSTER SALES CO., 415 LaSalle St., Dept. H-86 Chicago 10, Ill.

FREE SEND NAME

Rush name for free sales kit and offer of demonstrator sample. Sales skyrocketing. Send name. Get in on big money.



**Don't Work For Peanuts!
Earn Up To \$1000 a MONTH!**

Sell X-TING the sensational new hand-size Fire Extinguisher. Uses miracle wartime secret fire-fighting chemical. Sells for only \$3.95. Fully guaranteed. Every home needs 3 or more. Send for FREE sales kit and liberal profits plan. For regular size X-TING to use as demonstrator send only \$2.50. Money back if desired. The GARY LYNN Co., Dept. G, 926 York St., Cincinnati 14, Ohio.



60 POWER TELESCOPE \$3.95

VARIABLE EYEPIECE 20 x 40 x 60 — BRASS BOUND

NEW! Three telescopes in one. 3 different magnifications. 20 power for ultra-bright images with 40 and 60 power for extra long range. Guaranteed to bring distant objects, people, sports events, ships, moon, stars, etc. 60 times as close.



Most powerful for anywhere near the money. 5 sections. Closes to 1 ft. long. Contains 4 ground and polished lenses. Also used as a powerful compound microscope. Directions included. Mass production enables us to offer this instrument at amazing price of \$3.95 complete. Ready for immediate use. We pay postage. Get yours now.

CRITERION CO.
DEPT. PMB 13

331 CHURCH ST.
HARTFORD 3, CONN.



AMAZING NEW POCKET SIZE RADIO!

NO TUBES, BATTERIES OR ELECTRIC "PLUG-INS" NEEDED. "TUNES IN" MOST LOCAL RADIO STATIONS WITH STATIC-FREE CLEAR TONE. Has new perma-crystal diode and TINY SELF-CONTAINED SPEAKER PHONE—A marvelous real tiny pocket size radio to take with you anywhere you go FOR REAL FUN AND ENJOYMENT. GUARANTEED TO WORK and should last for years! **SEND \$1.00** (Cash, M.O., Ck.) and pay postman \$3.99 C. O. D. postage or send \$4.99 for p.p. delivery. COMPLETE ready to play. By mail only from: Midway Company, Dept. PPM-6, Kearney, Nebr.

MONEY IN HAMSTERS



Easy—Profitable raise in any climate. Thousands used for laboratory and pet trade. Beautiful pets. Write for free booklet. **SOUTHERN HAMSTERY, Box 685M, GAFFNEY, S. C.**

HOW TO WORK WITH PLASTICS ...AND WHERE TO BUY THEM

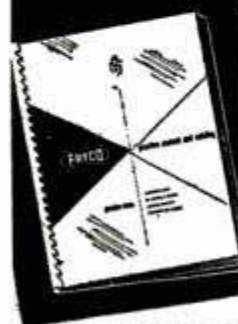

Over 100 pages packed with practical plastics facts—materials—equipment—supplies. Includes actual samples, manual with charts, definitions, properties of plastics and the latest information on this amazing new field. Plus, the most complete catalog of all types of plastics materials and supplies ever offered. A must for everyone interested in plastics—hobbyists—industry—modelers—schools, etc. How to cast, laminate and fabricate all plastics for both fun and profit. Money-back Guarantee if returned within 7 days

\$1

Postpaid

FRY PLASTICS CO.

Dept. M-8 7826 S. Vermont Ave., Los Angeles 44, Calif.

Mutual Funds

Investors MUTUAL, INC.

An open-end management type mutual fund diversifying its investments among common stocks, preferred stocks and bonds.

Investors SELECTIVE FUND, INC.

An open-end management type mutual fund diversifying its investments among bonds, preferred stocks, and other senior securities.

Investors STOCK FUND, INC.

An open-end management type mutual fund diversifying its investments among common stocks and other equity securities.

Face-Amount Certificate Company

Investors

SYNDICATE OF AMERICA, INC.

A face-amount certificate company issuing installment certificates having 6, 10, 15 and 20 year maturity and fully paid face amount investment certificates.

This is not an offer to sell these securities. They are subject to the registration and prospectus requirements of the Federal Securities Act. Information about the issuer, the securities and the circumstances of the offering is contained in the prospectus which must be given to the buyer. Copies of the prospectus relating to the shares of capital stock or certificates of the above companies may be obtained from the national distributor and investment manager:

Investors Diversified Services, Inc.

211 Roanoke Building Minneapolis 2, Minnesota

Send me the prospectus relating to the company I've checked:

- Investors Mutual, Inc. Investors Selective Fund, Inc.
 Investors Stock Fund, Inc. Investors Syndicate of America, Inc.

NAME _____

ADDRESS _____

CITY _____ STATE _____

MODERN ELECTRICAL SERVICING—

Learn at Home—Revolutionary New Audio Method of Training teaches you quickly and easily. \$3.50 and UP PER HOUR often earned while learning. Write today for **BIG, FREE** Book and Illustrated Literature.

ADVANCE TRAINING INSTITUTE, Dept. 1001
5944 N. NEWARK AVE. CHICAGO 31, ILL.

NOW OPEN TO SALESMEN!

Profits
Big

New Advertising Machine Prints and Illustrates Gov't Post Cards

FREE Send name — learn how all types of business are boosting sales with Postcard Advertising. We'll also send **FREE** illustrated book of money making ideas for every business. Learn how unique advertising plans make sales fast, easy. All free. **CARDMASTER, 1924 SUNNYSIDE AVE.** DEPT. S-136 CHICAGO 40, ILLINOIS



5 year
Guarantee



MOTOR NOISE

IT'S COSTING YOU TOO MUCH

LOSS OF POWER • BURNED VALVES • POOR MILEAGE

STOP ALL THIS WITH

LOW COST Q-T VALVE SCREWS



Absolutely Guaranteed for the Life of the Motor

Install smooth, wonder-working Q-T Valve Screws in your car. Instantly valve clatter will vanish. Instantly you'll begin to reap all the benefits of quiet valve operation; better mileage, faster get-away, smoother, more powerful performance. Because of Q-T Valve Screws' exclusive spring and ball action, valve stems are pressed by tappets—not hammered. Thousands of car owners have installed Q-T Valve Screws. Join these happier motorists who write, "... my car has more soup on take-off," and, "... Q-T has done wonders..." Anyone can install Q-T Valve Screws. Each box includes clear, do-it-yourself instructions and feeler gauges. Q-T Valve Screws are available for Chevrolet and Ford 6, \$4.95; Nash 6 \$6.45; Nash 8 and Buick, \$8.45, Postpaid. NOTE: Q-T Valve Screws are not recommended for motors with hydraulic valve lifters. See your Dealer or send check or M.O. to

Q-T DISTRIBUTING COMPANY
1223-A N.E. Alberta • Portland 11, Ore.

New Low Cost Electric Water Heater Gives You HOT WATER AUTOMATICALLY

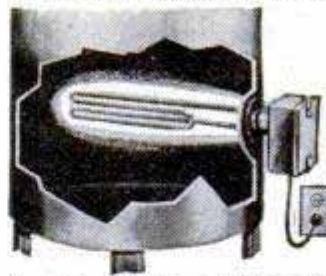

From Your Present Tank!

- No dirt, grime, soot, flame!
- SAFE! Every part UL approved!
- Install in 10 Minutes, or less!
- No new tanks or plumbing required!
- Works automatically—saves on fuel bills!

Complete—Ready to **\$19.95**
Plug In — Only

atically when water is heated. To install, simply shut off water. Remove plug from water tank. Screw LECTROMATIC into opening (as shown), then PLUG IN any 110 volt A.C. outlet. Uses 1250 watts. Plenty of hot water all day long. Uses only 1/4-1/2 c electricity per gal. of hot water. Temp. adjustable from 100 to 180 degrees. Save postage. Send check or money order for \$19.95 now. Money back in ten days if not delighted. Full one year guarantee! ORDER NOW!

COLLOID EQUIPMENT CO., INC. Dept. PM-6, 50 CHURCH STREET NEW YORK 7, N. Y.



BIG MONEY IN ELECTRIC APPLIANCE REPAIRING!

Learn at home in your spare time. New Master Shop Home Training Method teaches you by having you learn by doing. Heating element Kit, Electronic Testing Kit and illustrated lesson manuals sent to all who enroll, Special Pay-Later Plan. Rush name for FREE Illustrated BOOK and full facts.

CHRISTY TRADES SCHOOL
4432 N. Kedzie Ave., Dept. D-1903, Chicago 25, Ill.

GET INTO PRECISION TOOL BUSINESS!

Permanent! Very Profitable! No investment. Sell direct to factories, plants, laboratories, engineers, scientists, schools, students. Make big money selling to fellow employees. World's best known, biggest demand precision tools. Lowest prices. Full or part time. Write today!

TRANSCON SALES CO. (Dept. 23) 947 S. B'way Los Angeles



BE YOUR OWN MUSIC TEACHER

Send for Free Book Telling How Easily You Can Learn Piano, Guitar, Accordion, ANY Instrument This EASY A-B-C Way

NOW IT'S EASY to learn music at home. No tiresome "exercises." No teacher, just START RIGHT OUT playing simple pieces. Thousands now play who never thought they could. Our pictured lessons make it easy as A-B-C to learn to play popular music, hymns, classical and any other music. Only a few cents a lesson. Over 900,000 students! (Our 55th successful year.)

FREE BOOK and LESSON-SAMPLE

Find out why our method can teach you quickly, easily, inexpensively. Write for Free Book and free Lesson-Sample. No obligation. Mention your favorite instrument. Just Mail Coupon below.



U.S. SCHOOL OF MUSIC
Studio C306
Port Washington, N. Y.



U. S. SCHOOL OF MUSIC, Studio C306, Port Washington, N. Y.
Please send me Free Booklet and Lesson-Sample. I would like to play (Name Instrument).

Instrument _____ Have you Instrument? _____
Name _____ (Please Print)
Address _____

**EASIER
QUICKER
BETTER**

ROOF FRAMING

Rafter Length and Cuts Without Use of Square!

Lay out any type of roof more accurately and in only one-fifth of the time required by other methods. Get the **POULSEN METHOD OF ROOF FRAMING**. It will save your time and make money for you. Valuable tables—54 of them—starting with one-quarter inch rise per foot of run—simplify all roof framing problems. Tables give common, hip, valley and jack rafter length and necessary cuts in a jiffy without calculation. Learn also how to measure rafters from top and edge—definitely and accurately. No need to bother with centers and making adjustments for cuts.

For Amateur and Professional

Every handyman, repairman, amateur carpenter and professional builder needs this **POULSEN METHOD** book. It saves four-fifths of all roof layout time and labor. Everything is already worked out for you in simple, easy-to-use tables. Cloth bound. Book has 90 pages and many illustrations. Besides the tables it contains every other bit of roof information a carpenter, whether amateur or journeyman, should have.

Money Back Guarantee

Send your name and address and \$3.00 for your copy postpaid today, or order C.O.D. if you prefer. Money back if not fully satisfied.

POPULAR MECHANICS PRESS

DEPT. RF 200 E. ONTARIO ST. CHICAGO

ARE YOU AFRAID TO
OPEN YOUR DOOR?
Why take chances



with the

**WONDER
MIRROR**

you can see
who is on the
outside without
you being seen

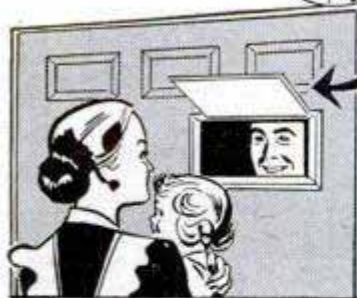

\$4.95
COMPLETE

To the person on the outside it appears as a mirror, but you on the inside can see clearly through it. Two piece telescope like frame of unfinished wood, fits thickness of any door. Outside moulding and mirror completely assembled as one unit. Inside moulding and small door to complete inside finish are assembled as one unit. Easy to install, simply cut out hole, put on outside and inside units. Screws and complete instructions sent with each order. Outside measurements 6 3/4 in. by 4 1/2 in. Useful in office, and shop doors, to observe unnoticed; also in photographic dark rooms. Money back guarantee if not satisfied. Send check or money order today.

THOMPSON SPECIALTY CO. DEPT. P.—BOX 327 HIGH ST.
SEAFORD, DELAWARE

© 1953. Frame Pat. Pend.



**BOYS BUILD YOUR OWN
CRYSTAL RADIO**

It's easy and lots of fun to build your own crystal radio set. You need no batteries or tubes when you use a "Melomite" Crystal and detector. Wonderful performance. "Melomite" crystal and detector with instructions and plans for building your own Crystal radio set—All for only 60c postpaid. Rush your order today, immediate delivery.

ALVA ALLEN RADIO, Dept. PM-56, Clinton, Mo.

TELEPHONES

Desk Stand style

Slightly used and in excellent condition.

Many Valuable Uses—

- Inter-house phones
- Loud Speakers
- Microphones
- Educational purposes
- Toys

\$1.95

Table Lamps, etc. **Postpaid**
Come complete, ready to use in U.S.A.
Wiring Diagrams Furnished

MICROPHONE Dept. X-402
1760 W. Lunt Ave., Chicago 26, Ill.



GREER SHOP TRAINING
2230 So. Michigan Blvd.
Chicago 16, Illinois

**Leader in Practical
Training for 50 Years**

Gain success by learning a trade offering security and high pay—go into business for yourself.

Get the "Know-how" at Greer

You learn in our new, large, modern shops by working with latest tools and equipment of the trade — tear down, inspect, repair and rebuild... under supervision of experts. Greer founded 1902. Over 51,000 successful grads. Part time, full time, day and evening. E-Z terms. Mail coupon today.

CLIP COUPON . . . MAIL TODAY
Greer Shop Training—2230 South Michigan
Chicago 16, Illinois Desk 213

Please send information about trade checked:

- | | |
|-----------------------------------------------------------|-------------------------------------------|
| <input type="checkbox"/> In our Chicago Shops: | <input type="checkbox"/> Auto Mechanics |
| <input type="checkbox"/> Body, fender Repair | <input type="checkbox"/> Diesel Mechanics |
| <input type="checkbox"/> Welding—Arc, gas | <input type="checkbox"/> Tool & Die |
| <input type="checkbox"/> Refrigeration & Air-conditioning | |
| <input type="checkbox"/> Machine Shop | <input type="checkbox"/> Piano tuning |
| G.I. appr. for Vets dischgd. after 7-25-47 | |

Or learn at home—extension courses:

- | | | |
|-------------------------------------------|----------------------------------------|-----------------------------------|
| <input type="checkbox"/> Diesel | <input type="checkbox"/> Refrigeration | <input type="checkbox"/> Plastics |
| <input type="checkbox"/> Check if Veteran | <input type="checkbox"/> Civilian | |

Name _____
Address _____
City _____
State _____ Age _____

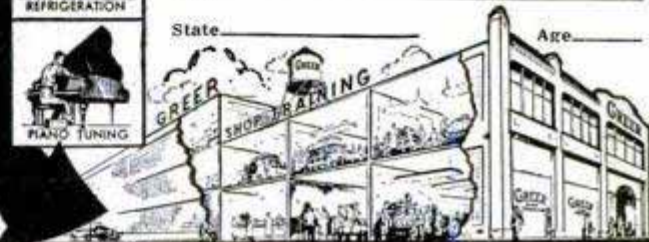

SAY YOU SAW IT IN POPULAR MECHANICS

Malayan THROWING DAGGER

BALANCED TO STICK! **\$1.98** postpaid

MALAYAN HUNTING KNIFE
used for killing game.
Exciting Target Sport,
Easy to learn! Fun
indoors or out-
doors!

EASY TO
THROW!



Fun,
Thrills,
Excitement!
Indoors—outdoors.
Learn this Sport! Easy
to throw accurately with our
clear instructions. Beautiful, heavy-
duty 10" knife. Tempered steel. Tough,
rawhide-bound handle. Rare souvenir, unusual
bargain. Limited quantity. At dealers or send \$1.98

WHOLESALE IMPORT CO. Dept. K, 604 Marengo, Alhambra, Calif.

Get
into..

PLASTIC LAMINATING AT HOME!

Get **ORDERS** and **CASH** from your mailman—do work in **SPARE TIME** at home — or expand into **FULL TIME** business. Send coupon for Free facts about the newest and most fascinating of all home operated businesses. For the first time a simplified machine brings the fabulous profits of **Plastic Sealing and Plastic Laminating** within the reach of the small operator. Anyone can learn to operate the machine with a few minutes practice—then with our **Magic Mail Plan** can get mail orders pouring in daily with cash in every envelope. **No canvassing—no selling.** We even

**Make \$20 to \$30 a Day by..
MAGIC MAIL PLAN!**

supply the circulars you mail to bring back cash and orders. Don't waste a minute. Rush your name. We'll send you **FREE** and postpaid, pictures, prices, details, and all the facts you need to start. Mail coupon or send name on postcard. No charge. **Warner Electric Co., 1512 Jarvis Av., Dept. L-106, Chicago 26, Ill.**

Make Thousands of Beautiful Art Creations

- COSTUME JEWELRY • CIGARETTE BOXES
TRAYS • CANDLESTICKS • COASTERS
LAMP BASES • BOOK ENDS...ALL IN
SPARKLING COLORED PLASTIC**



THIS MAN . . .
... is taking out of the machine a Plastic Sealing Job—ordered by mail—only 11c in material cost brings back \$2.58 in cash by mail. Capacity of machine: **\$25.00 profit per hour of operation.**

**WARNER ELECTRIC CO., 1512 Jarvis Av.
Dept. L-106, Chicago 26, Ill.**
At no cost to me, please rush complete details! postage prepaid. I am under no obligation.

Name _____
Address _____
City _____ Zone _____ State _____

Amazing Sewing Machine Offer Save Time-Labor

Electrify

YOUR SEWING MACHINE
 Kit fits any machine. Installed in a jiffy. You receive all new parts. Guaranteed for one year.

- AC-DC 115V 60 c
- Motor & Bracket
- 7 speed ft.
- Electric cord set & block
- Steel Pulley & Belt control
- Simple instructions

FREE: \$3.95 value CHROME SEWLITE & NEEDLE THREADER given with each order.

10 DAY FREE TRIAL — ORDER NOW
 Send no money, pay COD or send money order & we'll pay postage. Please state whether wheel on your sewing machine turns toward or away from you. Shipping wt. 6 lbs. Dept. P.M.

\$9.95

ELECTRIC MACHINE SERVICE
 185 Hewes St., Bklyn 11 N.Y.

WARN HUB CAPS MAKE 2 JEEPS OUT OF 1

End front wheel drag on all 4-wheel drive Willys and Dodge vehicles

Save gas to 5 miles per gallon, reduce wear on front tires, axles; increase speed and power, stop front wheel shimmy—front wheels coast out of gear! 4-wheel drive handles, performs, climbs like 2-wheel. Install or remove in 10 minutes. Polished aluminum, guaranteed. Thousands in use. Prices quoted. **NEW AUTOMATIC CAP** available! Permits use as 2 or 4-wheel drive automatically, all speeds. **LOCKING CAP** also available which converts from 2 to 4-wheel drive or back with simple turn of lock. Fully guaranteed. See your Willys dealer, or if no dealer near you rush check, M.O., C.O.D. to:

WILYS \$20.00
Dodge \$23.00
 Prod. U.S., Canada

WARN MFG. CO., Riverton Box 6064-A2, Seattle 88, Wash.

CAMERA & LIGHTER \$19.95 PPD.

THE ONLY CAMERA-LIGHTER IN EXISTENCE

Imagine a never-miss lighter with a built-in highly precision made camera—all in one handsome case, no larger than usual size lighter. Features f/3.5 lens with iris openings of f/3.5, 5.6 & 8. Two shutter speeds: for indoors and outdoors. Uses 16mm film—20 exposures. Package includes 2 rolls of film. Easy picture taking—easy lighter operation. 5 day money back guarantee—Send check or money order.

WESTCHESTER SALES Dept. PM-6, P.O. Box 304 Larchmont, N. Y.

NOW CONVERT YOUR BICYCLE

Save \$15.00 to \$20.00 by converting your old bike for smaller brother or sister. No special tools or skill required. Can be changed back to original model. State size, make of bicycle and type of crossbar wanted. G for girls — B for boys

Satisfaction guaranteed or money returned **\$2.98** Postpaid

H & M PRODUCTS, 69 Rosewood Terrace, Rochester 9, N. Y.

EARN \$10 PER HOUR GROWING MIDGET TREES!

AT HOME! • SPARE TIME! • NO EXPERIENCE NEEDED!

It's New! Amazing! FULL GROWN living dwarf trees—only 12 INCHES HIGH! Elm, orange, oak, cypress—any kind! All BLOOM and even BEAR FRUIT! Perfect, healthy specimens, but miniature! Make costly home decorations and beautiful expensive centerpieces (sold for over \$1,500 each). It's easy! Fun! A new fascinating artistic HOBBY — a new fabulous \$\$\$\$\$\$ BUSINESS! Real seed and sensational new growing secret plan details. BOTH FREE!

FREE! GENUINE SEED AND PLAN

NATIONAL NURSERY GARDENS, Dept. M6
 8463 SO. VAN NESS, INGLEWOOD 4, CALIFORNIA

HOW TO LEARN GROWING SECRETS
FREE SEEDS

French STYLE DUELING SWORDS

Once used in deadly combat—now an exciting sport! Learn right at home. Fun—SAFE*—educational. These swords are made of fine blue spring steel, polished metal

SET OF TWO \$3.98
 41" long

guards, turned handles, rubber safety tips. Fencing teaches quick thinking, develops coordination, posture. Since the Middle Ages, Europeans have enjoyed the sport of dueling. *Now advocated by U.S. colleges. Set includes 2 swords booklet "Fencing Art". Special price. **MONEY BACK IF NOT COMPLETELY SATISFIED** if your sporting goods dealer can't supply you, send \$3.98 to

TECHRITE CORP., Box 27F, South Pasadena, Calif

TOOLS WHOLESALE

MAKE EXTRA MONEY

Start Your Own Business. Sell tools to your friends, neighbors, etc., in your spare time. **A MILLION DOLLAR INVENTORY AT YOUR FINGERTIPS.**

Send \$1.00 for Dealer's Card and Wholesale Catalog to 50% off.

SILVO HARDWARE CO., Dept. M, 108 Market St., Phila. 6, Pa.

Stanley, Millers Falls, Plumb, Disston, Wiss, Skil and others at 30% to 50% off.

PAINT THIS EASY WAY!

Why wear yourself out using Expensive old-fashioned brushes? **Mistifier Sprayer** quickly, smoothly and evenly sprays glossy finishes, lacquers, insecticides, mothproofers and oils. All in one self contained unit that requires no compressor, motor or accessories. All metal non-corrosive working parts make this unit a **LIFELONG** useful tool. Sturdily constructed, weighs only 2 lbs., uses standard replaceable Mason jar. Spray volume is adjustable. **80 POUNDS PRESSURE**, fingertip control. AC-110 volts. **FOR PAINTING, SPRAYING, DISINFECTING, MOTHPROOFING.** Mistifier Sprayer works wonderful when painting wicker and all other furniture, cars, metal cans, partitions, concrete brickwork, rough wood, boats, wagons, screens, cabinets, venetian blinds. Wonderful for Mothproofing clothes, rugs, drapes, storage closets, etc. Mistifier is Safe and Easy to use.

SPRAY FURNITURE **PAINT AUTOS**

Complete—No Extras to Buy

We Guarantee that Mistifier Sprayer will apply paint smoothly, quickly, easily — or return it within 10 days for full purchase price refund. Only \$9.95 Postpaid or sent C.O.D. plus postage. Full instructions. Order Now.

JUST PLUG IN—PRESS THE BUTTON—& PAINT OR SPRAY!

10 DAYS FREE TRIAL Unconditionally Guaranteed

Only 9.95

IMPERIAL SALES
 480 Lexington Ave., Dept. S-473, New York 17, N. Y.

POCKET COMPARATOR

Check, Measure
Inspect Small
Parts and
Dimensions
with 6 POWER
MAGNIFICATION

MEASURES
• Angles • Circles
• Radii • Linear
in both decimal inches
and millimeters

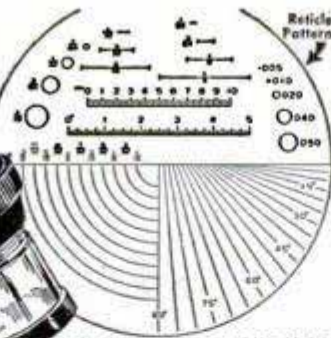

First time available at such low price! EDSCORP POCKET COMPARATOR. Fine, imported measuring magnifier — approx. size 1 1/2" x 2" — for fast, accurate inspection of intricate parts. Used to check layouts, machining on tools, dies, gauges—to check threads, chamfers, small holes. In optical work for checking flaws such as bubbles, seeds, scratches, pits and digs. For scientists—in determining width of spectrograph lines. In photography—measuring and focusing at ground glass. Instrument comes in protective leather case. Money back guarantee! Stock No. 30,061-H. \$22.50 Postpaid

Order by Stock No. Send check or M.O.

EDMUND SCIENTIFIC CORP., Barrington, N. J.

HE-MAN VOICE!

STRENGTHEN your voice this tested scientific way. Yes—you may now be able to improve the POWER of your speaking and singing voice . . . in the privacy of your own room! Self-training lessons, mostly silent. No music required.

FREE BOOK Write TODAY for Eugene Feuchtinger's great booklet "How to Develop a Successful Voice." It's absolutely FREE! You must state your age. Booklet mailed postpaid in plain wrapper. No salesman will call. Send your name and age RIGHT NOW! Perfect Voice Institute, 210 S. Clinton St., Studio FX-2, Chicago 6, Ill.



SPARE TIME PROFITS EARN MONEY AT HOME

Cash in on this pleasant and profitable business. Re-string Rackets full or spare time. No experience or skill required. Easy to learn. Full line of finest quality, guaranteed Stringing Tools, Frames, Gut and Nylon Strings.



FREE CATALOG
INSTRUCTIONS
WRITE TODAY

W. A. BICKEL & CO., 803 South Blvd., Dept. PM-6, Oak Park, Ill.

JITTERBUG • CATCHES MORE FISH

Noisy surface bait. World's best hooker — day or night. Gurgling, paddling action of the double-lobed lip makes fish strike hard. 5/8 oz. or 3/8 oz. or 1/4 oz. spinning size \$1.25. Musky size \$2.00.



FRED ARBOGAST & Co., Inc., 2246 W. North St., Akron 3, Ohio

FREE WRITE TODAY FOR YOUR BIG FREE ARBOGAST COLOR CATALOG—FULL OF PICTURES OF CATCHES

Popular Mechanics Practical and Helpful
Home Workshop and Craftsman's Guide

Got a home workshop? Got any power tools? Expect to get power tools some day? Then you need POWER TOOLS AND HOW TO USE THEM. Prepared by Popular Mechanics Shop Editor. Tells how to select, install and use all kinds of motorized tools and what you can do with them. Dozens of exciting projects—things you can make from all materials—included. 375 pictures, plans and diagrams. Send only \$2.50 with name, address and this ad. Money back if not pleased. POPULAR MECHANICS PRESS, Dept. PM10, 200 E. Ontario St., Chicago 11



POWER TOOLS

and how to use them

HOW TO SEAL THOSE PISTONS WITH POWER!

STOP OIL BURNING!
Restores **POWER & ZIP!**
SAVE \$75
Overhaul Your Car in 10 Minutes!
AT YOUR HOME FOR JUST \$3.95 postpaid
MORE GAS MILEAGE OR YOUR MONEY BACK—

Fisher's Compression SEAL in the big tube is now used by over 100,000 drivers who made the simple application in their garages—put \$50 to \$100 apiece they saved in their pockets.

BLUE-BRONZE PLATE—F. C. S. and only F. C. S. contains tough, resilient blue-bronze Fisherite which builds up evenly and seals excessive clearance between piston and bore. It plates and seals your pistons while you drive. SIMPLE TO APPLY—Remove plugs, squeeze specified amount into each cylinder, replace plugs and drive. Simple? You bet!

SEND \$3.95 TODAY in check, cash or M.O. COD's accepted!
CAR-LIFE SUPPLY CO., Dept. PM-6
4756 S. CENTRAL AVE. LOS ANGELES 11, CALIF.

PREPARE FOR BETTER JOB, BIGGER PAY IN SPARE TIME AT HOME

Today, choose the job you want—and prepare for it in time you might otherwise waste. Or if you are already in the work you like best, start training now for quicker promotion and increased pay. During more than 50 years AMERICAN SCHOOL has helped ambitious people to reach higher goals. Check subject that interests you and mail coupon for full information.

AMERICAN SCHOOL, Dept. GA45, Drexel at 58th, Chicago 37, Ill.

Without obligation, please send FREE and postpaid, full particulars about the subject checked below.

Accounting
Air Conditioning
Architecture & Building
Automotive Technician
Better Foremanship
Bookkeeping
Business Management
Contracting
Diesel Technician

Drafting—Building Trades
Drafting—Machine Trades
Electrical Engineering
Electricity—Practical
Electronics—Industrial
High School Courses
Machine Shop Operations
Mathematics & Slide Rule
Mechanical Engineering

Plastics Engineering
Plumbing—Practical
Private Secretary
Refrigeration
Retail Merchandising
Salesmanship—Outside
Sheet Metal Work
Tool Making

NAME OCCUPATION
HOME ADDRESS AGE
CITY STATE

MAIL COUPON NOW



LEARN FASCINATING

Leathercraft

Make your own bags, belts, wallets, etc. Learn fascinating, profitable leathercraft in spare time. Send 25c for valuable Catalog, has over 200 photographs. (refunded first purchase).



BURTONS LEATHERCRAFT

Dept. PM-6, 1727 Glendale Boulevard, Los Angeles 26, Calif.

DON'T LET CONDENSATION BLISTER YOUR HOUSE PAINT

VENTILATE DANGER SPOTS
with "MIDGET" LOUVERS

Give your house room to breathe. Install all-aluminum "MIDGET" LOUVERS and allow air to circulate properly through sidewalls, flat roofs, eaves and soffits, unexcavated areas, gables . . . wherever there is danger of destructive sweating and dampness. This modern low-cost method of preventing condensation and moisture blistering will protect the beauty and looks of your home . . . and protect you against costly repainting due to blistering.

EASY TO INSTALL—no nails . . . no screws. Just drill hole; tap into place. 2 styles—with rain deflectors for exterior use . . . without rain deflectors for interior use. SIZES: 1"—1 1/2"—2"—2 1/2"—3"—4" in diameter. At leading paint, hardware or lumber dealers.

the "MIDGET" LOUVER Co.
8 WALL ST., NORWALK, CONN.

WILD HOT NEWS for Fishermen!

KIEKHAEFER

MERCURY Mark 5 with

Push-Button Neutral Clutch

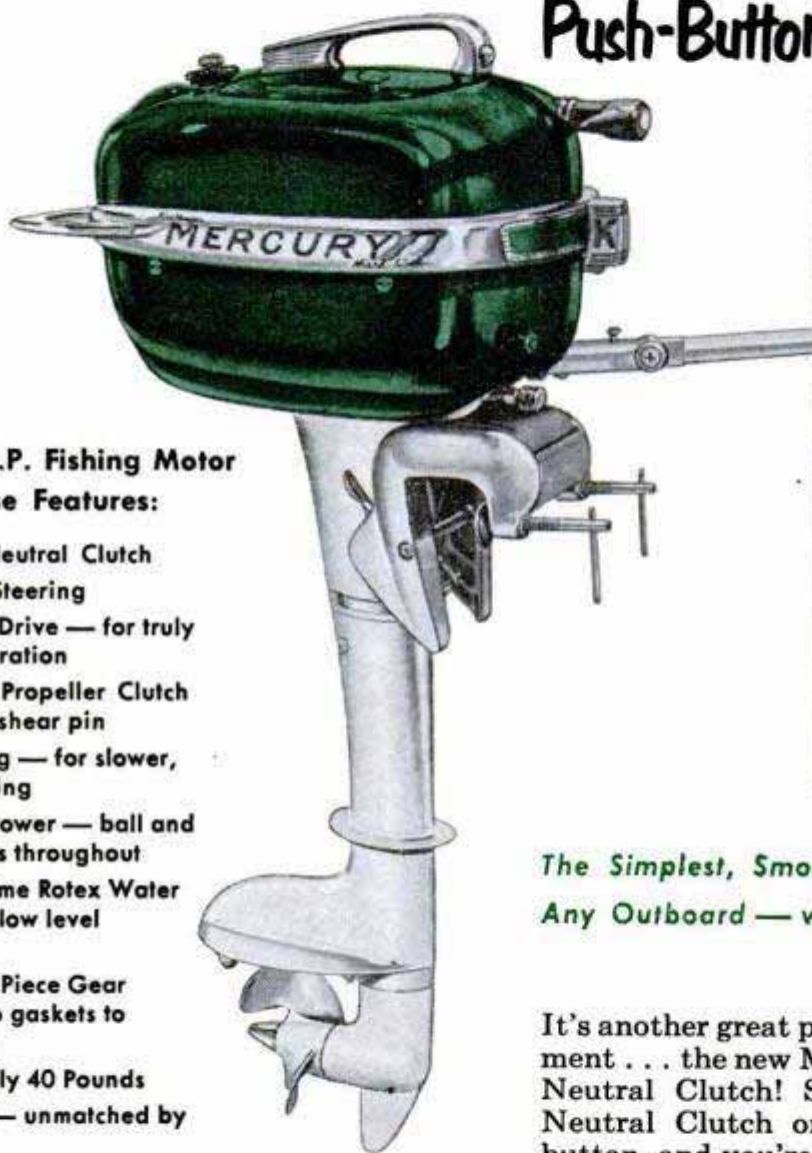

The Only 5 H.P. Fishing Motor with All These Features:

- Push-Button Neutral Clutch
- 360 Degree Steering
- Dual-Purpose Drive — for truly weedless operation
- Multiple Disc Propeller Clutch — eliminates shear pin
- Superior Idling — for slower, smoother trolling
- Full Jeweled Power — ball and roller bearings throughout
- Variable Volume Rotex Water Pump — with low level water inlet
- Uni-Cast One-Piece Gear Housing — no gaskets to leak or soften
- Weight — Only 40 Pounds
- Performance — unmatched by any five!

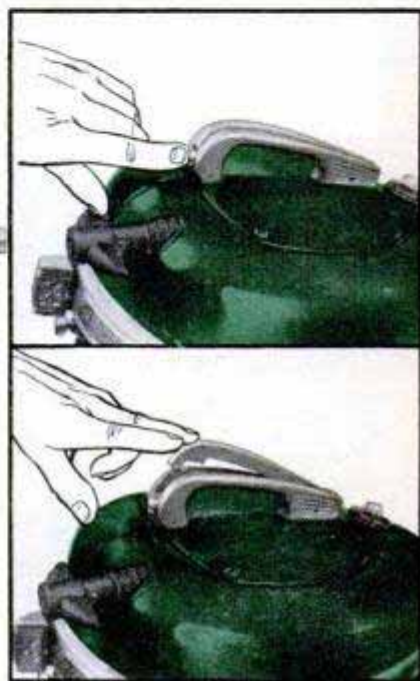

The Simplest, Smoothest Neutral Clutch On Any Outboard — with FINGER-TOUCH ACTION!

It's another great pace-setting Mercury development . . . the new Mark 5 with new Push-Button Neutral Clutch! Simplest, smoothest-working Neutral Clutch on any outboard—touch the button, and you're in neutral. Touch the handle lever—and away you go!

Kiekhaefer determination to make the best outboard today even better tomorrow . . . that's the tradition that makes Mercury a leader in the outboard field, makes Mercury America's most-wanted outboard!

See your dealer for a demonstration of the new Mark 5 with Push-Button Neutral Clutch. He's listed in the yellow pages of your phone book.



Write for **FREE** illustrated catalog! Kiekhaefer Corp., Fond du Lac, Wis.

Features of Mercury motors are protected by issued or pending patents.



Bob Towers photos

Behind Bill Stout is the famed Ford Tri-Motor he designed in the 1920s

By
Joseph
Stocker



THOSE FABULOUS FLYING FORDS

ON A HOT, BRIGHT Sunday a short time ago, at an Air Force jet base in Arizona, something happened that nobody had anticipated. The base was holding open house for the public. Its sleek 600-mile-per-hour jet fighters stood on display in sparkling rows. But it wasn't the jets that caught the fancy of the crowd as much as a large, ancient, odd-looking transport plane with three engines and a corrugated skin.

Some thought it was a cardboard replica of one of America's early airplanes, put there for contrast with the jets. They discovered otherwise when, about midafternoon, a civilian pilot climbed into the plane and gunned the engines. Not even deigning to use the long runway, he took off from one end of the taxi ramp, jumping the big ship into the air before it had rolled more than four plane lengths. Then he put the clumsy craft through three ponderous loops that brought gasps from the crowd.

The aerial antique which stole the show from the fancy-pants jets that day was a Ford Tri-Motor, hardy survivor of one of America's first and most distinguished families of aircraft. By all the rules of a swiftly advancing science which makes today's airplane obsolete tomorrow, the Ford should have been dead and forgotten a long time ago. It was built back in the late 1920s, when Lindbergh flew the Atlantic, Coolidge

Corrugated-metal skin and external controls are in sharp contrast to today's smooth, shining fuselages



*A Special Feature in the
Golden Anniversary of Flight*

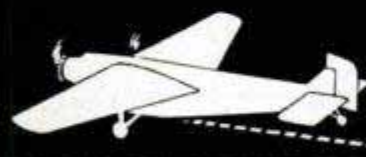
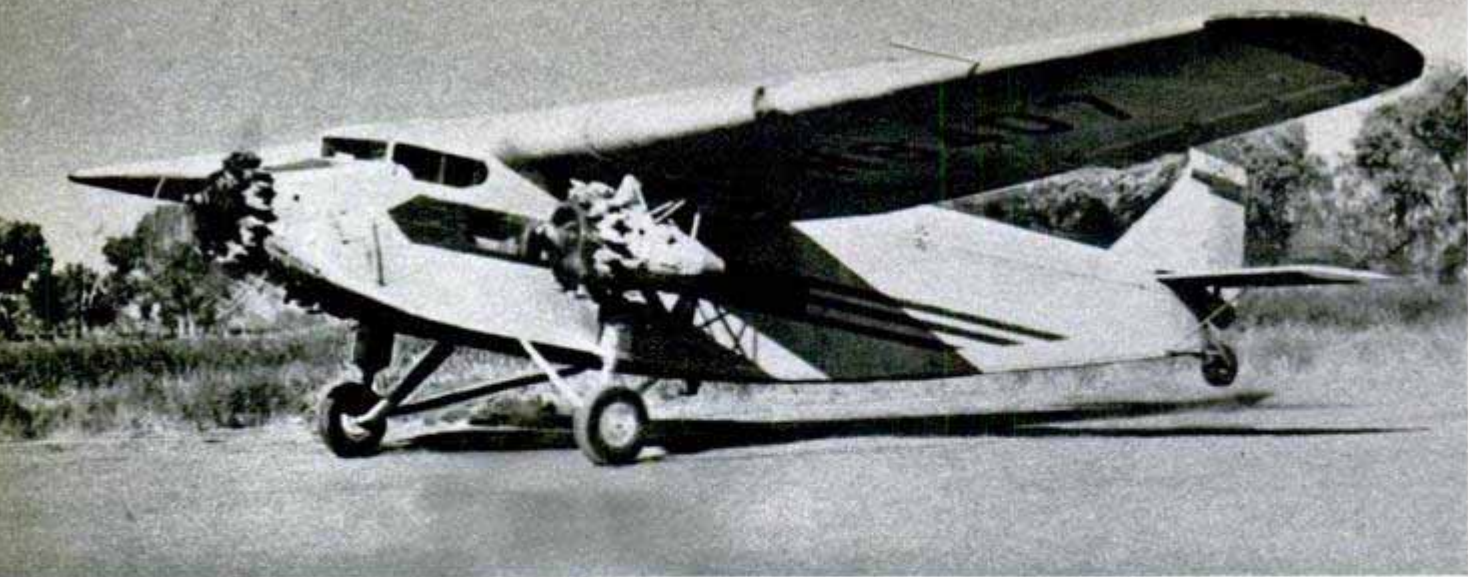

Take-offs are made in a Ford in about six seconds and within 200 feet, or approximately four plane lengths

was in the White House and anybody was daft who said the stock market might crash.

The Ford was the first all-metal passenger aircraft ever produced. It became the grandfather of the modern airliner and served as the bridge across which America marched into the era of fast commercial air transport. It was also the airplane which flew Adm. Richard E. Byrd across the South Pole in 1929.

Since then, hundreds of other types of planes have been built and flown, then passed into limbo. But the invincible old Ford refuses to be put out to pasture. Of the 200 Tri-Motors turned out by the Ford Motor Company, 40 are still in service.

Most of them are used in foreign lands—in isolated and backward sections of China, Russia, Africa and South America. In places like that, the modern-day airport, as we know it, is nonexistent. Air transport must be geared to short, makeshift airstrips carved out of the bush, the jungle or a mountain clearing. A plane, whatever its size or load, must be able to take off and land within a scant few hundred feet.

The venerable Ford fits these specifications to perfection—and for the very reason that caused Henry Ford to make the Tri-Motor like he did. A quarter century ago, capacious airports were unknown in America, too. An airplane had to be able to get into and out of a farmer's pasture or it was of no use to anybody. The pasture was good enough for the Ford. It landed and took off at 40 to 50 miles per hour—even 30 miles per hour, given a little head-

wind—and with a dozen passengers or a ton or so of cargo. And, in the process, it helped make a whole nation airborne.

The ship which stole the show that day at the jet base is owned by Rex Williams, a Tolleson, Ariz., crop duster. Williams bought it from Jesse Bristow, manager of the Miami (Fla.) All-American Air Maneuvers, who in turn acquired it from the president of the Dominican Republic. Bristow's pilot took it out of Ciudad Trujillo on two of its three engines.

Flying the Ford is mainly a hobby with Williams. "It's just a plane I always wanted to own," he says.

But he also makes it available on charter to hunters and fishermen. He can haul them and their gear into out-of-the-way mountain-locked airstrips in an hour or two. If they packed in by tedious muleback, it would take at least a day. The only other plane that could use those airstrips is a Cub, but a Cub can't carry the load a Ford carries.

In place of the 200-horsepower engines for which the Ford originally was designed, Williams' plane is fitted with 450-horsepower Wrights. He paid \$4500 for his Tri-Motor. Later he was offered \$14,000 for it by a Mexican mining outfit that needed something big and nimble for short, heavy hauls into mountainous country. The Ford, capable of flying on two engines with a sizable pay load or one engine with a light load, was just what the doctor ordered. But Williams wouldn't part with it. "There isn't a month goes by that someone doesn't

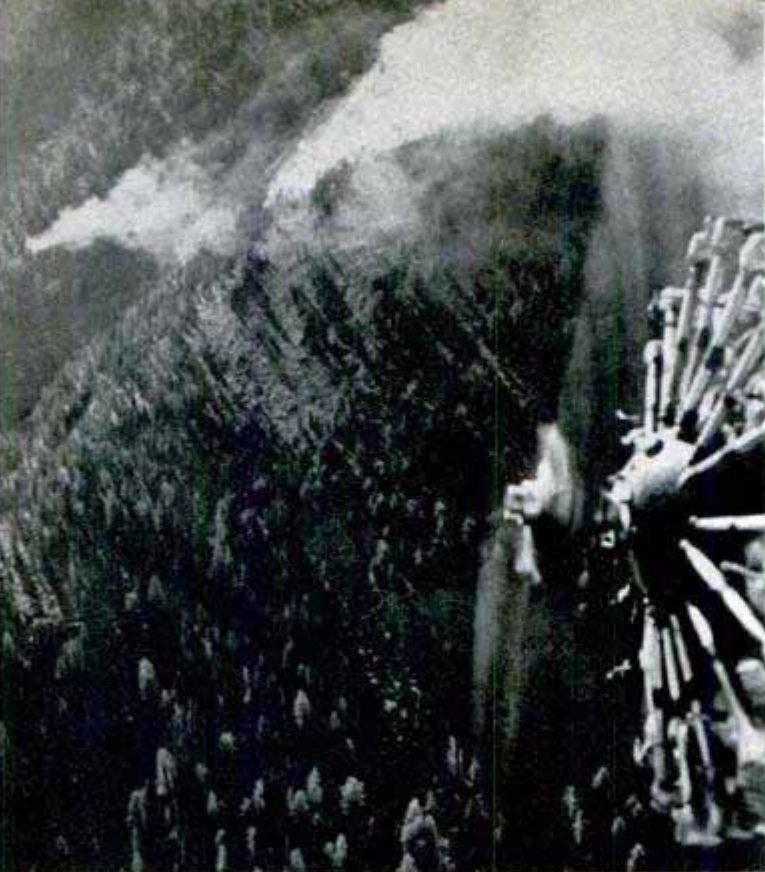

Tri-Motors are being used now in Montana to drop fire-fighting parachutists directly at blaze scene

try to buy it from me," he proudly states.

Two more Tri-Motors are flying out of Orofino, Idaho, carting vacationers and sportsmen into the remote hill country. And at Missoula, Mont., the Johnson Flying Service uses four for timber-spraying, hauling freight to the mines and dropping smoke jumpers into forest fires. Jumpers like the Ford because its stabilizer is high and there's no danger of snagging their chutes as they leap free.

In the Great Lakes country, from his flying-service base at Put-in-Bay, Ohio, Milton Hershberger keeps a couple of Fords busy island-hopping around Lake Erie. In midwinter, when the lakes are frozen tight and boat traffic is paralyzed, the island folk depend on Hershberger's trusty Tri-Motors for food, hay and the latest newspapers.

There is something warmly symbolic in the fact that the man who designed the Tri-Motor and supervised its construction for Henry Ford is still alive and working, just like the intrepid old airplane itself. He's William B. Stout, one of the greatest of aviation's pioneers.

Stout developed the first strutless wing and built the first all-metal airplane, a single-engine ship which predated the Ford. That was at a time when nobody thought that anything would ever take the place of fabric and plywood. Stout also built one of the first "roadable" planes with folding wings for air or road travel, and designed one of the first family-type airplanes, a ship with tricycle landing gear



Photos on this page by Robert M. Catlin for Johnson Flying Service
Inside a Ford, a crew chief, above, helps direct the pilot over the jump spot. Smoke jumpers like the Tri-Motor because its stabilizer is high and there is no danger of snagging their chutes as they leave

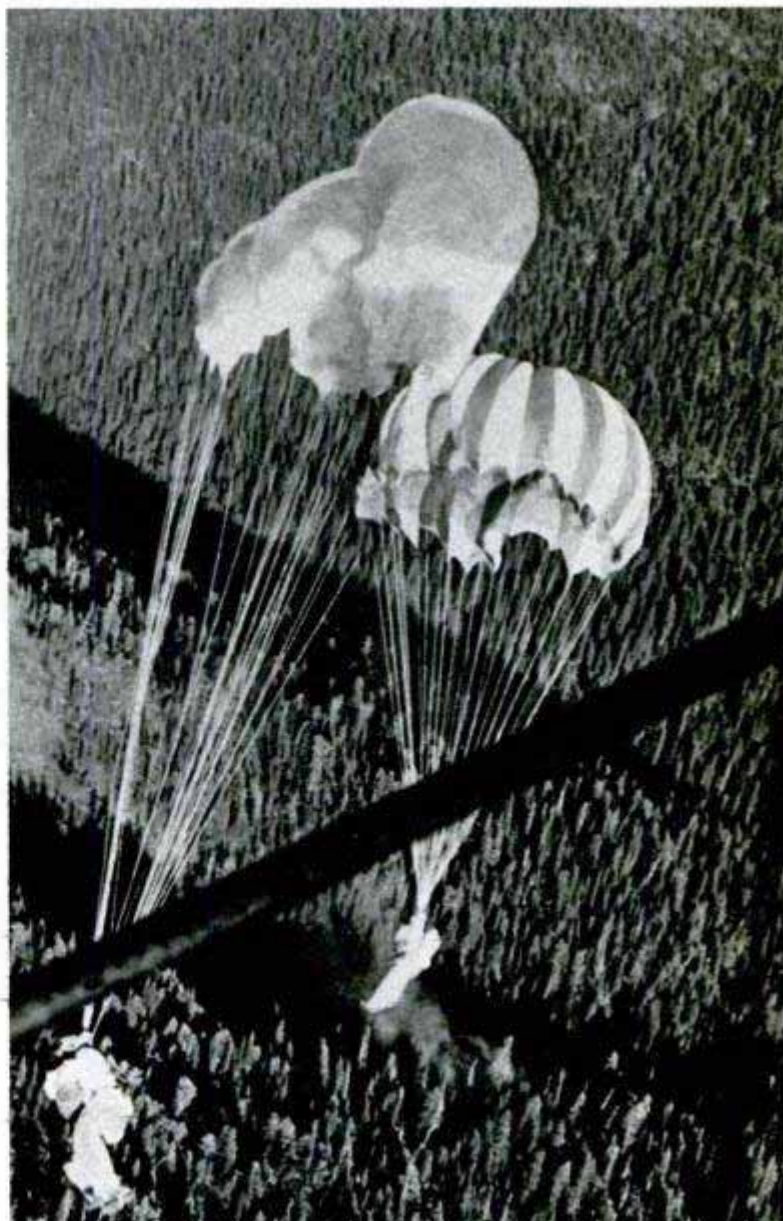

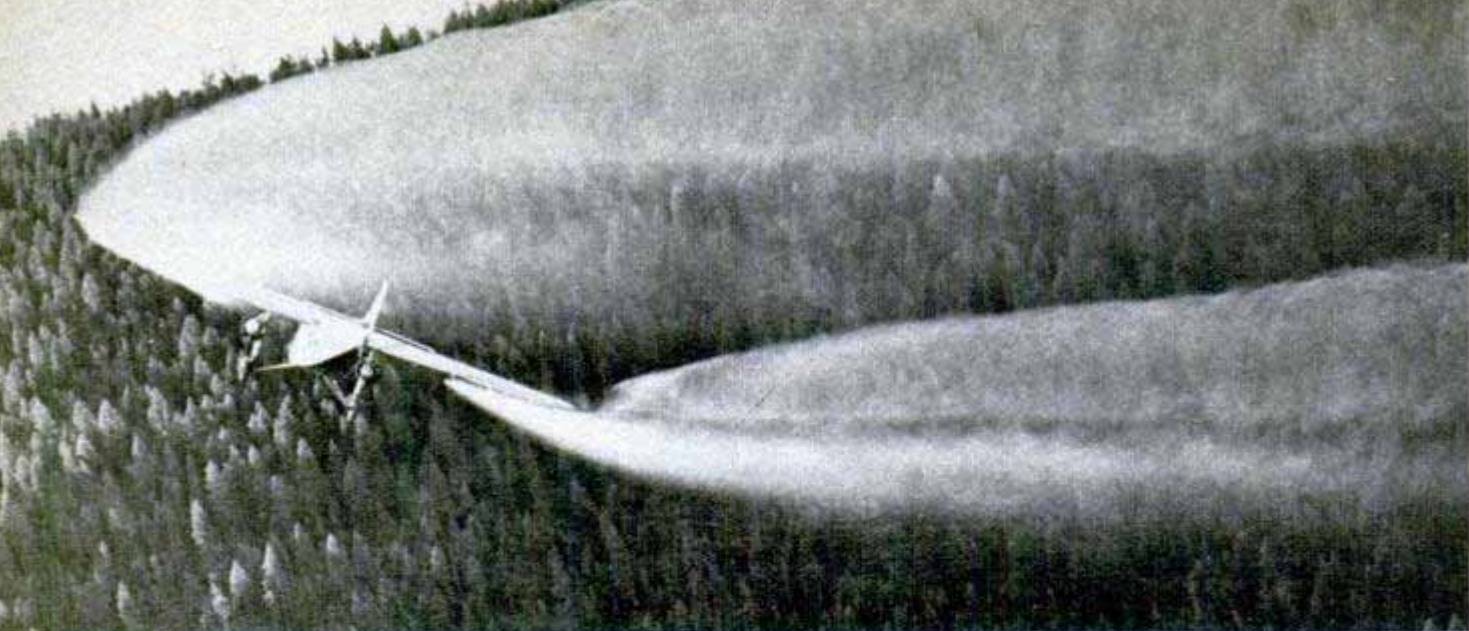

Twisting into a deep gully, a Tri-Motor swings low above the tree tops on a timber-spraying assignment

which he called the Sky Car. Branching out into other fields, he conceived a prototype of our modern streamlined trains and constructed a streamlined, rear-engine bus.

Today, at 73, Bill Stout continues to search for new answers to the problems of flight. At his laboratories in Phoenix, he is working on a brand-new and revolutionary concept—an airplane with flapping wings that can land and take off without airports.

Even as he keeps one eye on the future, Stout gets a nostalgic satisfaction from knowing that the airplane he built 25 years ago is still serving mankind all over the world.

"It was the leviathan of its day," he says proudly, "and a real engineering achievement with what we had to go on. I don't

think there's a safer airplane in the world. The Civil Aeronautics Administration tells me there has never been a record of a structural failure in the Ford. Its controllability and flight characteristics are better than any present-day transport ship. In an emergency you could land it in front of my office here. I could sell 100 of them a month right now if I could make them."

The story of Bill Stout and the Ford Tri-Motor is an epoch of success salvaged out of failure. In the middle 1920s he had built a torpedo plane for the Navy. It cracked up on a test flight. Broke and neck-deep in debt, Stout decided to do something brash. He wrote a letter to 100 Detroit business leaders, asking them for \$1000 each as an investment in aviation and promising only one thing: They'd never get it back!

His candor carried the day. Enough money came in to launch the Stout Metal Airplane Company. The firm turned out an all-metal plane, the Maiden Dearborn I, with a single Ford-built Liberty engine. Henry Ford was so impressed that he bought out Stout and made him head of the airplane division of his company.

Stout's original stockholders got their money back after all — \$2000 for every \$1000 invested. Many years later he expressed his conviction that "the greatest single thing I accomplished for aviation was getting Mr. Ford interested in it. . . . From that moment on, Wall Street took aviation seriously and it became a business, not a state-fair exhibition."

Furnishings inside Stout's early airliners were simple, but his sturdy, 14-seat planes flew 200,000 miles the first year without an accident

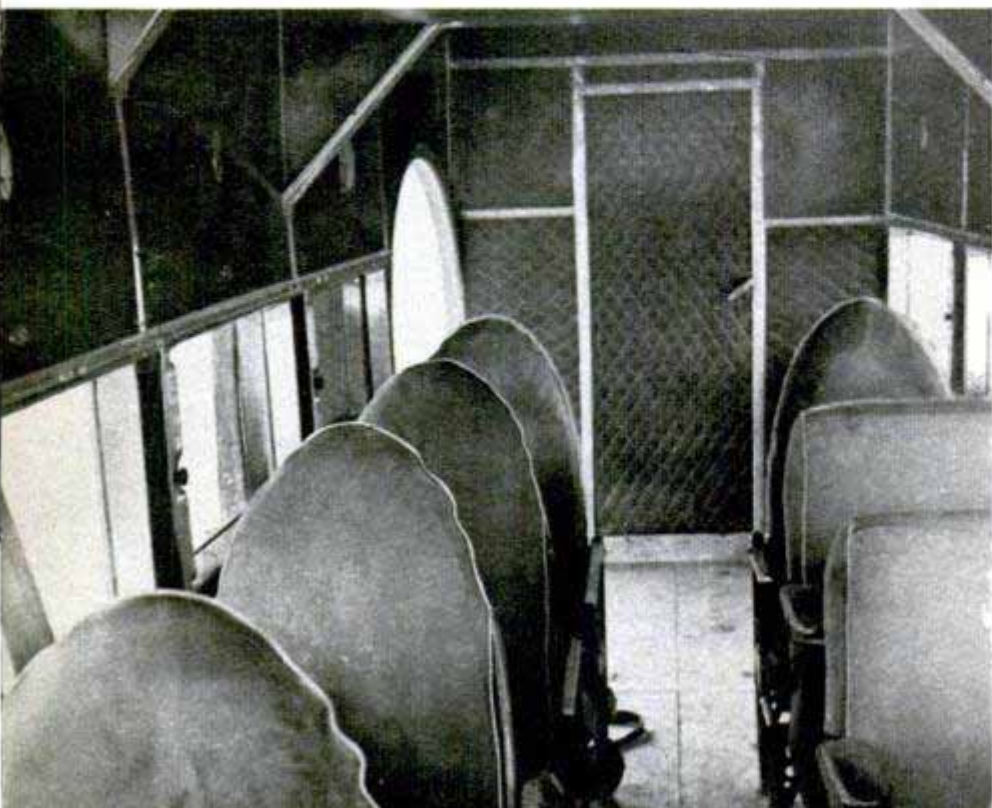



Flyable on two or even one engine, Tri-Motors are still sought for hauling jobs in mountainous regions

Under Ford's banner, Stout produced the famous and incredibly durable Ford Tri-Motor. Only one other ship bore any resemblance to it. That was the three-engine, fabric-covered Fokker. But where the Ford still flies, the Fokker long since has become a memory.

The first Ford had an open cockpit and its outboard engines planted in the wing. The open cockpit was a concession to the pilots—they wouldn't fly unless they could feel the wind on their cheeks so they could tell if they were side-slipping. They also thought the Ford was landing too fast—nearly 60 miles per hour! So they persuaded Stout to give the ship more drag by bringing the outboard engines down below the wing, suspended from struts.

Stout won out on one point, however.

Oil-pressure and revolutions-per-minute indicator are on strut above an outboard engine, visible to pilots

After a midwinter flight to Houston in which pilot and mechanic almost froze to death, he set to work enclosing the cockpit. This time not a single murmur of objection came from the men who flew the Ford.

The tough, phlegmatic Tri-Motor proved itself time and again. Stout used it to launch America's first regularly scheduled commercial airline—the Stout Air Service, serving Detroit, Chicago, Cleveland and Grand Rapids. In its initial year of operation, the Fords traveled 200,000 miles without an accident. Several pilots of the old Stout Air Service are now top executives of great American airlines.

Even under adverse conditions, when everything else was grounded, the Ford flew. Stout remembers the time when an

(Continued to page 222)

Stout and Rex Williams, Arizona crop duster who now owns it, look over tail assembly of a venerable Ford

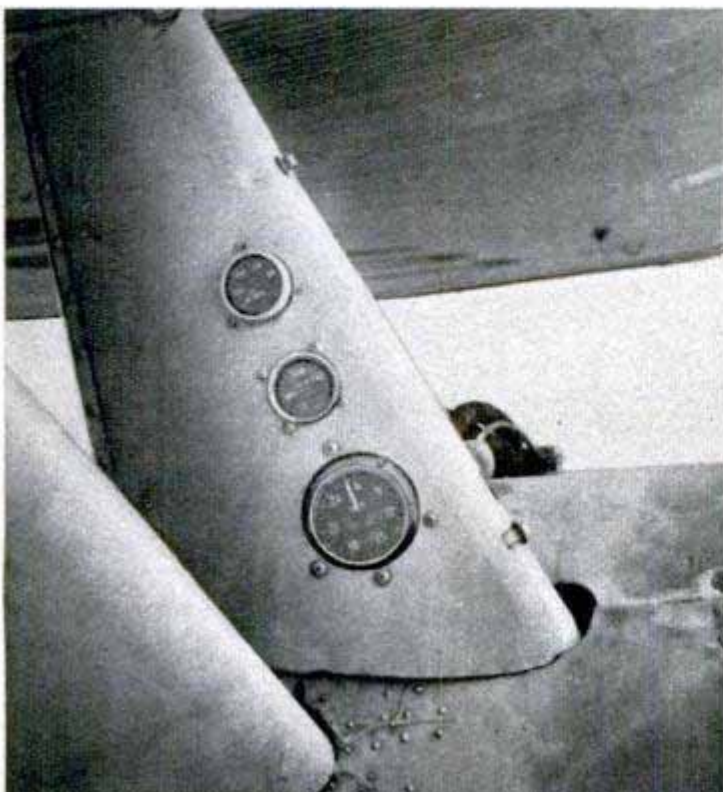



Portable Swimming Pool Can Be Erected in 30 Minutes

Next time you're invited to a dull party, you can brighten the evening considerably by bringing your own swimming pool. A portable swimming tank comes in a box 4 by 5 feet by 15 inches, weighs only 200 pounds disassembled, and can be put together by two men in a half hour. Five feet high, 13 feet across, it has a capacity of 4750 gallons and can be filled in one to four

hours. The walls consist of 10 lightweight aircraft-alloy aluminum sections held together with drop pins. The pool is lined with Vinylite plastic, which forms the bottom when it rests on the ground. Clear-plastic windows are built into two of the sections; at the bottom are small ports through which the tank can be lighted at night. A serving tray fits onto the rim of the pool.



Tie Conceals Tiny Microphone Of Miniature Recording Device

Through a tiny microphone that can be secreted under a tie, recordings 2½ hours long can be made by what is described as the world's smallest recording device. The German-made gadget is known as a miniature magnetophone, or minifon. It is operated by two batteries and weighs slightly over two pounds.

Spark Plugs Cleaned in Engine

Motorists clean spark plugs right in the engine with an aluminum spacer that contains a small quantity of sand. The plug is removed from the engine and screwed into one end of the spacer which is then screwed into the engine. When the engine is started, the compression blasts the sand against the base of the plug cleaning it of accumulated deposits of carbon.

Precision Gauging Machine Speeds Laying of Railroad Track

Clockwork precision in track maintenance results when railroad gangs work with a mechanized gauger. A gang of six or seven men can gauge from 70 to 110 rails per hour when the machine is used. First, tie plates are pregauged. The gauger, riding on a conical wheel on the rail already in place, then positions tie plates into accurate gauge. After positioning the tie plates, the machine drills two holes in the tie. Men following the unit drive wooden pegs into the holes to hold the plates in place until the rail is laid, bolted and spiked. The machine,

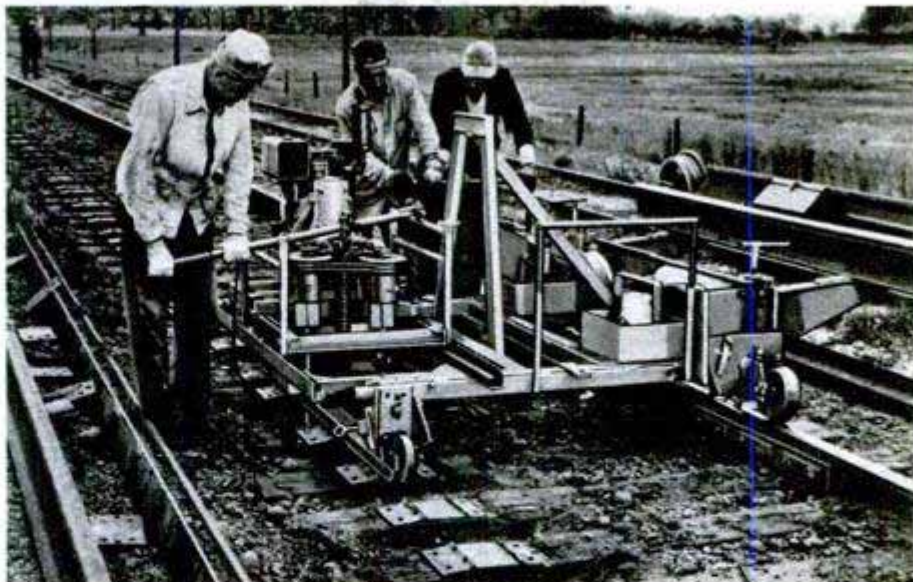

equipped with a spirit level, can be adjusted for width and inclination.

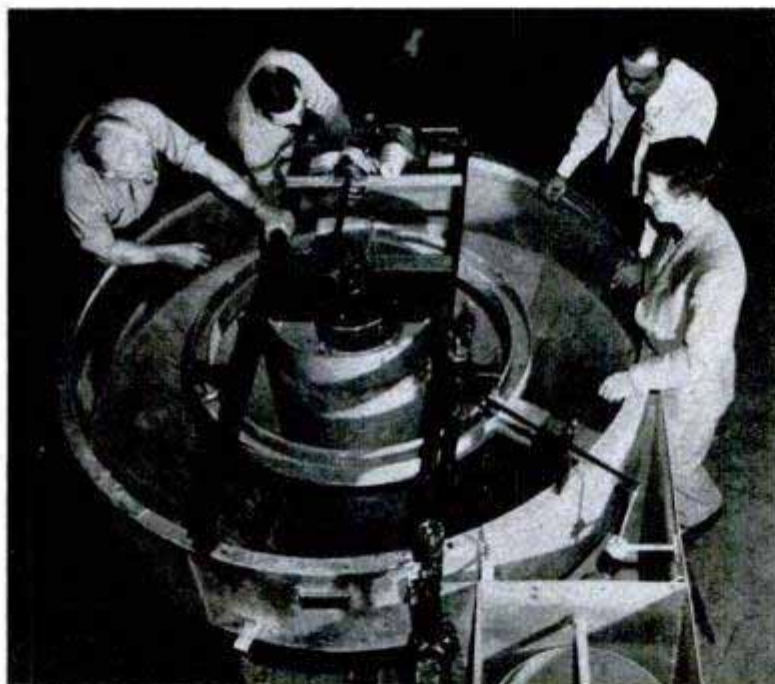

U. S. Army photo

Army Water Conditioner Mounted on Truck

Polluted water is purified at a rate of 3000 gallons per hour by a new truck-mounted unit developed by the Army. The purification unit can be transported in a cargo-type plane and operates in temperatures as low as 40 degrees below zero. The water is conditioned and filtered to remove silt, destroy bacteria and eliminate the organisms which cause dysentery and schistosomiasis, a serious water-borne disease found in the Far East. Polluted water can be pumped into the unit and discharged as potable water in 20 minutes. It contains its own power source and can be operated by one man.

Bazooka Battery

Four bazookas mounted on a portable rig form a reservoir of effective firepower for an Army unit in Korea. Capt. Albert J. Barron devised the weapon, which can be trailed behind a Jeep or truck. In principle, it is similar to the multiple-tube rocket launchers now in use.

Latin America takes about 40 percent of all United States chemical exports.

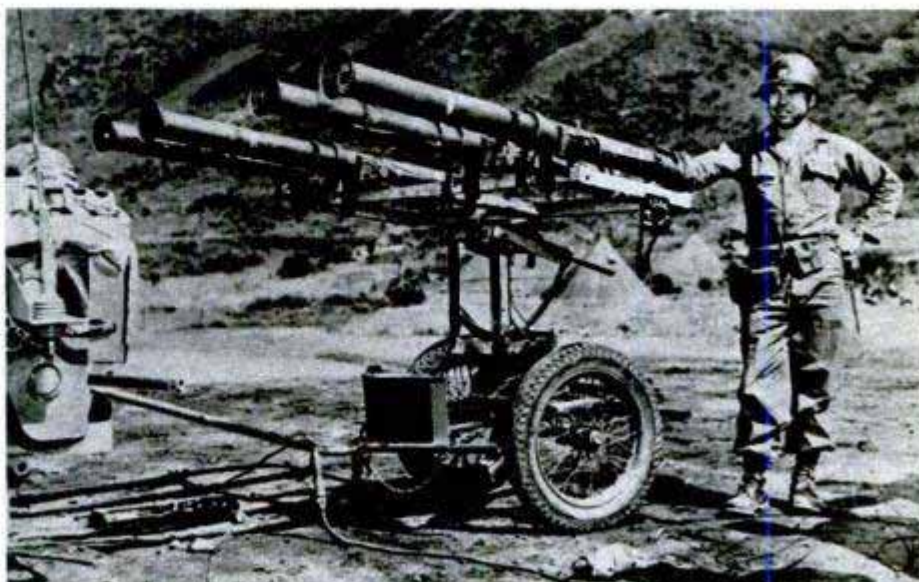

What goes on in that brief interval when your transcontinental train pauses for refreshment? It's groomed and inspected, restocked and washed from eyebrows to taillight. Here's what happens in that



Crew member, working on a split-second schedule, pours 350 gallons of water into a diesel unit. These units need water the same as steam locomotives, for each has a small steam boiler that helps heat the train

10-Minute Service





Twelve-car train requires 2000 gallons of water for passenger cars, which have their own water systems

Mobile washer swishes down one side of the train, back on the other, scrubbing all windows during stop

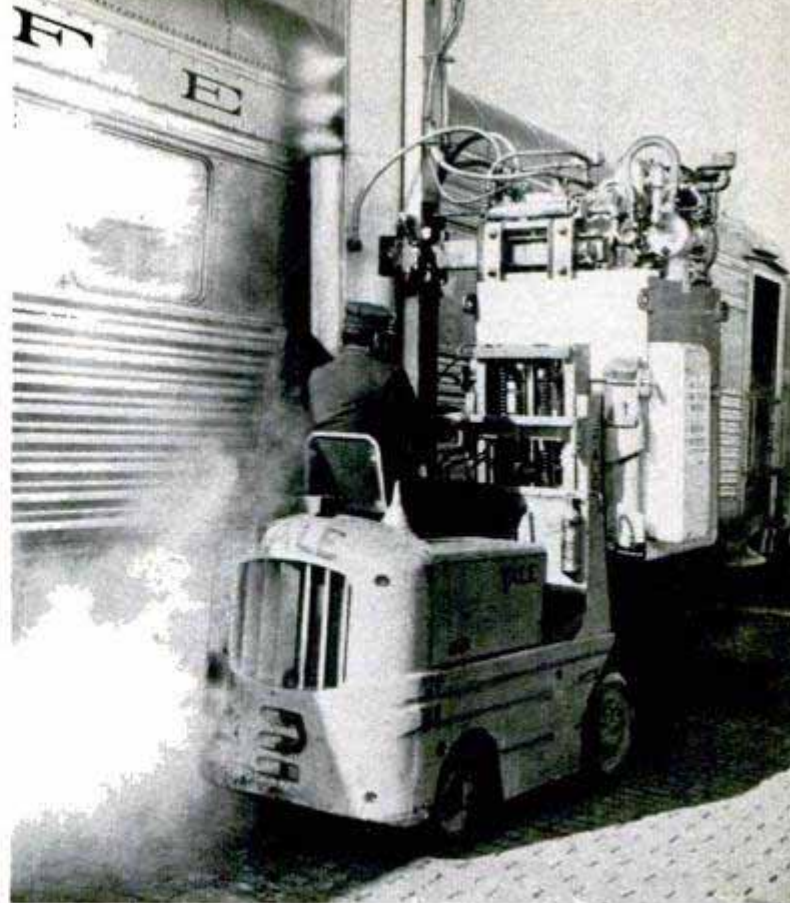

for a Streamliner

By Thomas E. Stimson, Jr.

BBETTER NOT go for a stroll when your streamlined train makes one of its infrequent stops!

There'll be barely time for you to look over the magazines at the station newsstand and climb aboard again before the train is on its way, picking up speed as it clears the yards. A modern streamliner hasn't any time to waste.

Yet a lot of things happen during one of these short halts. Your train is taken out of service, temporarily. It gets a thorough inspection and is given various safety tests. It is repaired if necessary, watered, refueled, washed and restocked with supplies. Then it goes back into service again with a new engine and a different crew aboard. Time: 10 minutes.

That's the way it goes at Albuquerque, one of the division points on the Santa Fe system. The Albuquerque inspection and servicing crew handles 12 transcontinental passenger streamliners every 24 hours, grooming each for the next 1000 miles or so of high-speed travel. During the stop, passengers are hardly aware that more than a dozen experts swarmed over their train, each doing a special job.

Inspection begins, actually, before the train comes to a halt. The car electrician squats down beside the track as the cars roll by. There's a flashlight in his hand after dark. He has a brief look at the wheel V-belt that drives the electric generator under each car. The generator supplies power to the battery that operates the car's lights, fans, drinking-water pumps, air conditioner and buzzer systems. He can tell at a glance if a belt needs replacement.

As a final check, the electrician makes his way from car to car after the train has stopped and opens the control compartment in each car for a visual inspection of the air-conditioning and heat-control apparatus.

Meanwhile other members of the inspection crew, who had been standing alongside the track, clamped a blue flag to each end of the train as soon as it stopped. The blue flags, or blue lamps at night, are a warning that the train is being serviced and may not be moved for any reason.

From service pits beside the track, the crew snake out fuel and water lines and attach them to openings in the side of each of the diesel units. The average high-speed train has four diesel-power units and about

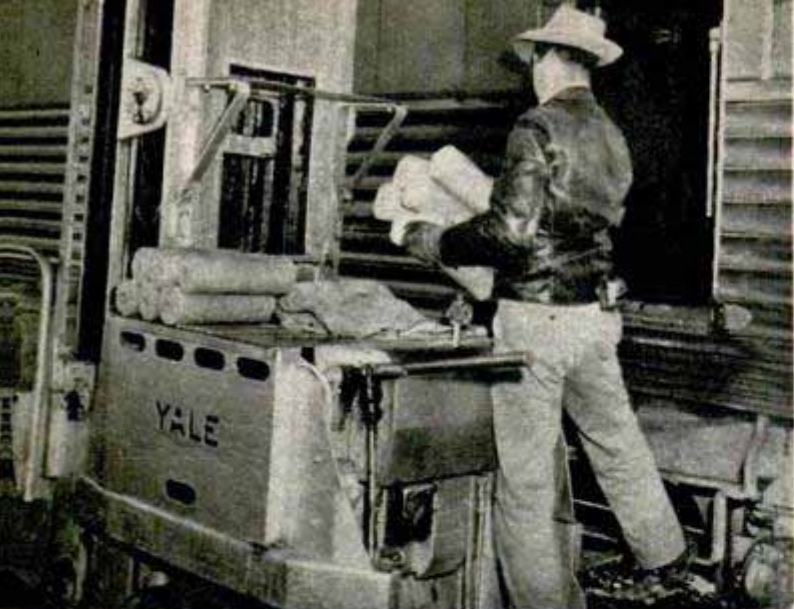

Logs of compressed sawdust (used in cooking ranges), ice and food are hustled aboard dining car while . . .

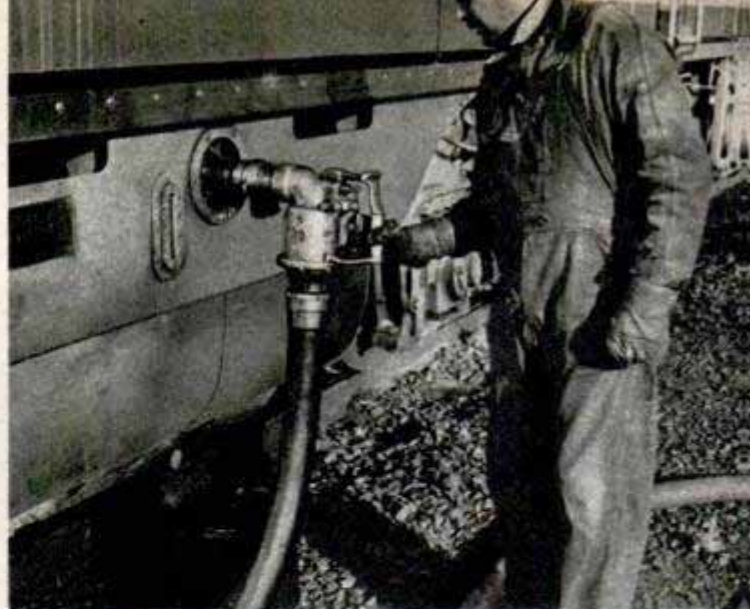

fuel for each diesel unit surges through high-pressure hoses. Each unit requires 600 gallons of fuel

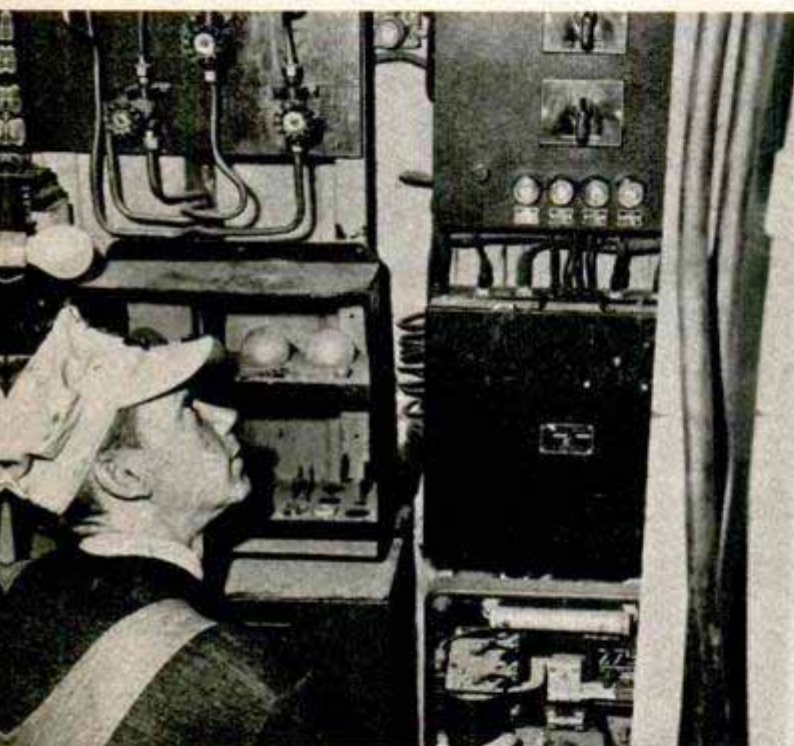

Electrician swings aboard as soon as streamliner pulls in, unlocks and inspects each air-conditioning unit. Below, in winter, ice piles up beneath diesels. Here an inspector pulls off chunks to check valves



Meanwhile another crew member inspects valves of the air-conditioning systems, which blow off surplus steam while train is at rest. Below, temperature of wheel bearings is checked by feeling them with hand

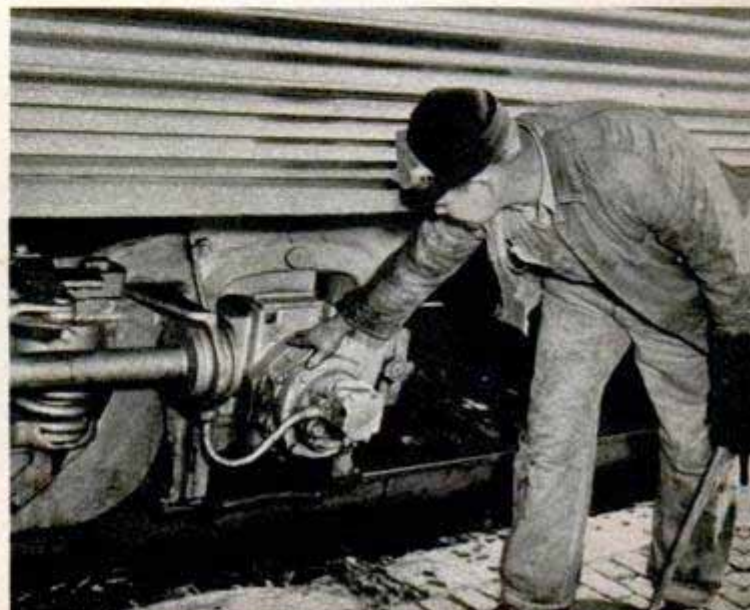

a dozen cars. Each diesel unit gets some 600 gallons of fuel and 350 gallons of water at Albuquerque, the water being supplied to the automatic flash boilers that provide steam for heating the passenger cars.

Down along the train at the same time the diesels are being serviced, other men are plugging water lines into the side of each car, replenishing the separate water-supply systems. The passenger cars take a total of some 2000 gallons of water.

While the diesels are being serviced they are also inspected. The inspection crew walks through each unit, checking all fuses and automatic switches. The amount and quality of the crankcase oil in each of the two diesel engines in each unit is checked, as is operation of the automatic boilers. Switches and controls can be adjusted if necessary but no major repairs are made. An engine that appears to have a major malfunction is merely shut down. The loss of power from one engine unit alone will hardly be noticed by the engineer.

While all this is going on, a train inspector walks the length of the train, giving all the exterior running gear a thorough inspection. He taps the wheels and brake shoes with a "short bar" that he carries, listening to the ring of the metal. A brake shoe can be replaced in a couple of minutes if it is excessively worn and new brake shoes are lying alongside the track for that purpose.



With an induction coil the inspectors check operation of the automatic-control device which stops the train if it should run through red signal in block system

Each wheel bearing should feel slightly warm to the bare hand. If an inspector finds that a bearing is above normal temperature he reports the fact at once to his inspection chief. A hot bearing means that all passengers in that car will be transferred to other cars and the "hot" car will be left behind. This happens possibly once in five years.

Following the car inspector is the operator of a mobile window-washing vehicle who drives his rig up close to the windows

Ten minutes have passed—almost to the second—and inspection and servicing have been completed. Inspector removes blue flag, waves it and off rolls train

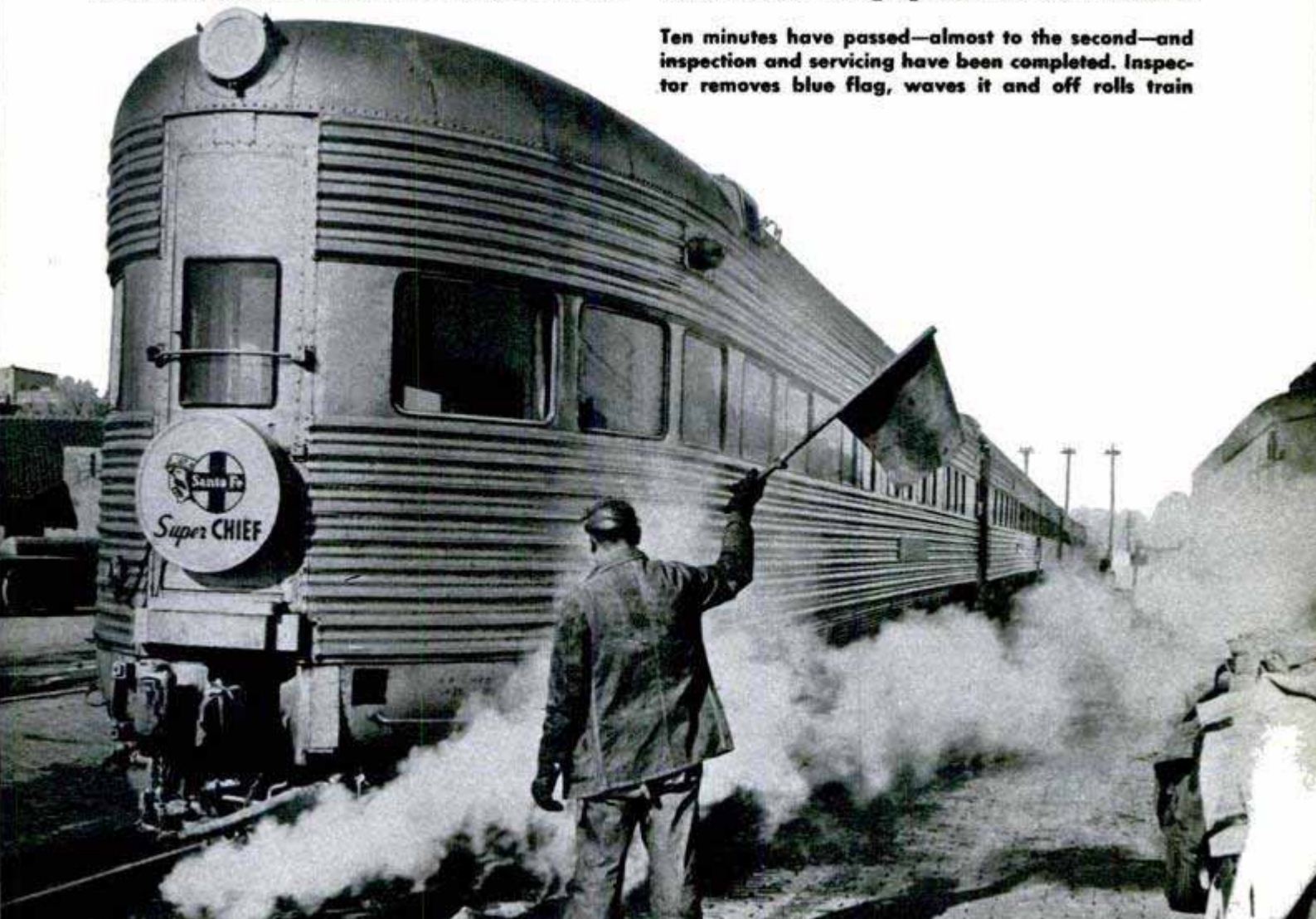

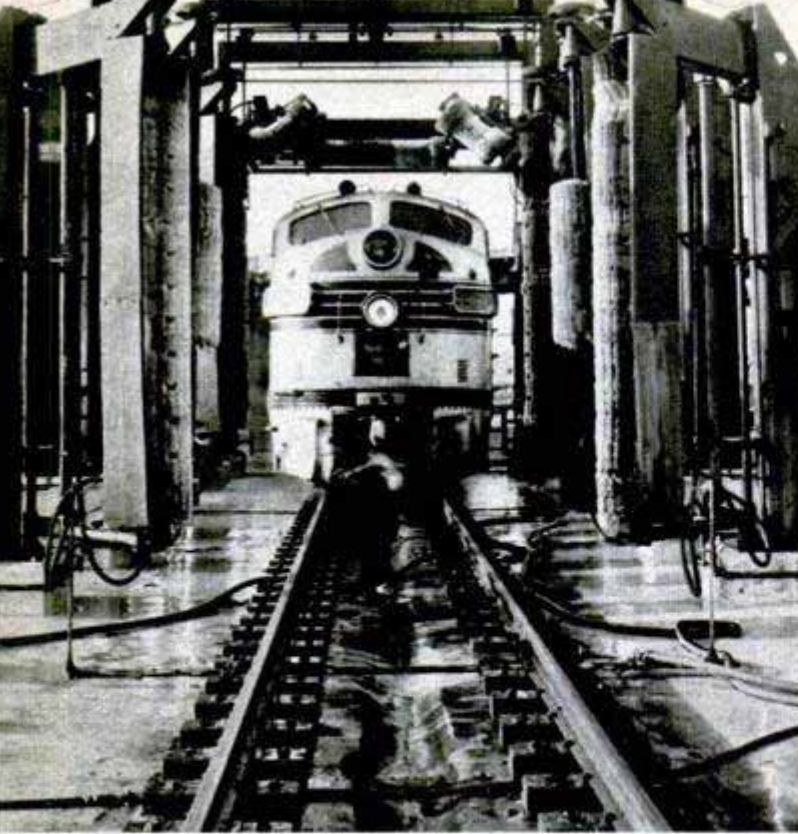

Locomotive of a Burlington Zephyr rolls through the wash rack. High-pressure jets of water and train-high brushes suddenly go into action. Moments later the locomotive rolls out, scrubbed sparkling clean

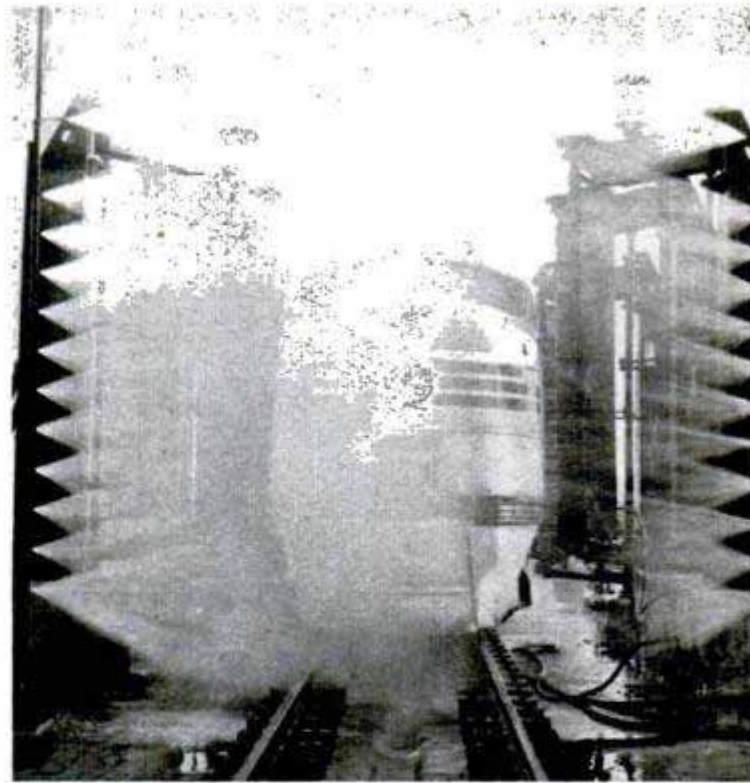

of each car, turns on his spray and the rotating brush, and gives the exterior of each window a thorough scrubbing.

Santa Fe streamliners normally stock up with enough food at the Chicago and Los Angeles terminals to last the full trip, yet occasionally a dining car may run short of such perishables as milk, pies or bread. A

Main purpose of a Vista Dome car is to give passengers a good view of the scenery, so it is important windows be kept clean. In this section of wash rack, brushes drop down to wash car's curved panes

telegram is dispatched to Albuquerque, in this case, from one of the stations along the line. The food is delivered on board at the time the rest of the servicing of these streamliners takes place.

Two kinds of ice, wet ice to cool the drinking water and Dry-Ice for refrigeration, are delivered to the diner. The cooks prefer logs of compressed sawdust to other fuels for their stoves; several arm loads of this wood are loaded on, as are additional supplies of charcoal for the broilers.

Soiled dining-car and lounge linen are discharged from the train and new supplies are taken on board. Linen for the Pullman cars is stocked for the full trip at either terminal. Four station employees in the meantime have been loading whatever mail and baggage are due to leave with the train and have been receiving any baggage and mail destined for Albuquerque.

There are still a couple of minutes left out of the scheduled 10-minute stop. The diesel inspectors use them to wind up their routine test of the automatic train control, a device that automatically stops the train if it should happen to run through a red block, and to complete their terminal air-brake test by which they make positive that the air brakes are working properly on each car.

By now the engineer, fireman, conductor and brakeman, who will operate the train to the next division point, have climbed aboard and the train running orders that are to be followed have been delivered to them. With all inspection and maintenance work completed, the blue signal flags are





Just before the train reaches Denver it makes a 14-minute trip through the long wash rack. Each car is laundered thoroughly with 530 gallons of water and the mechanical action of the huge vertical scrub brushes

removed from each end of the train, the engineer has another look at his watch and moves the train out.

Other rail lines handle their streamline trains in and out of the service and inspection points with similar dispatch. One unique service that the Burlington performs is to wash completely its daily California Zephyr when it stops at Denver, en route between Chicago and San Francisco. Train washing ordinarily is performed only between trips; the Zephyr gets an extra scrubbing along the way to keep spotless all the windows of its Vista Dome cars.

At Denver, the entire train goes right through the wash rack just before it pulls into the station. Most of the washing operation is performed by high-pressure jets of water and by enormous brushes that rotate against the sides of the cars. Similar overhead brushes clean the glass roofs and windows of the Vista Dome cars. A number of railroads are using or installing these wash racks.

The Zephyrs also receive a window washing after leaving the Moffatt Tunnel that crosses under the Continental Divide in Colorado. Dirt and dust that collect on the windows during the ride through the long tunnel are removed so passengers can enjoy the mountain scenery.

Not only do the streamliners receive streamlined servicing these days, they also receive similar streamlined inspection and servicing between trips. The railroads can't afford to let high-priced, luxury equipment sit idle in the yards.

An outstanding example of this is on Burlington's Chicago-Minneapolis run. Here the Twin Zephyr that arrives at Minneapolis at midday is cleaned, refueled, inspected, turned around, loaded with Chicago-bound passengers and started on its return trip all within 30 minutes of its arrival. Fast servicing like this permits the train to cover 974 miles per day at an average speed of 66 miles per hour, including station and terminal time. ★ ★ ★

Carbon Ink Letters Glass

Lettering on glass and smooth plastics is possible with a carbon ink that has the covering power of India drawing ink and can be applied with a fountain pen. Tests show strong wear and heat stability and indicate that the ink trace is not flaked by repeated bending or rolling of the plastic. Its nonclogging qualities also suit it to general-purpose drawing.

X Rays Inspect Canned Food

X rays are used to detect improperly filled cans of food as they race past on a conveyor at the rate of 900 per minute. The process, which will detect an under-filled or overfilled can within $\frac{1}{64}$ inch, shoots a thin X-ray beam into the side of the can. If the beam gets through, it activates a unit which knocks the can off the conveyor line with a powerful air blast.

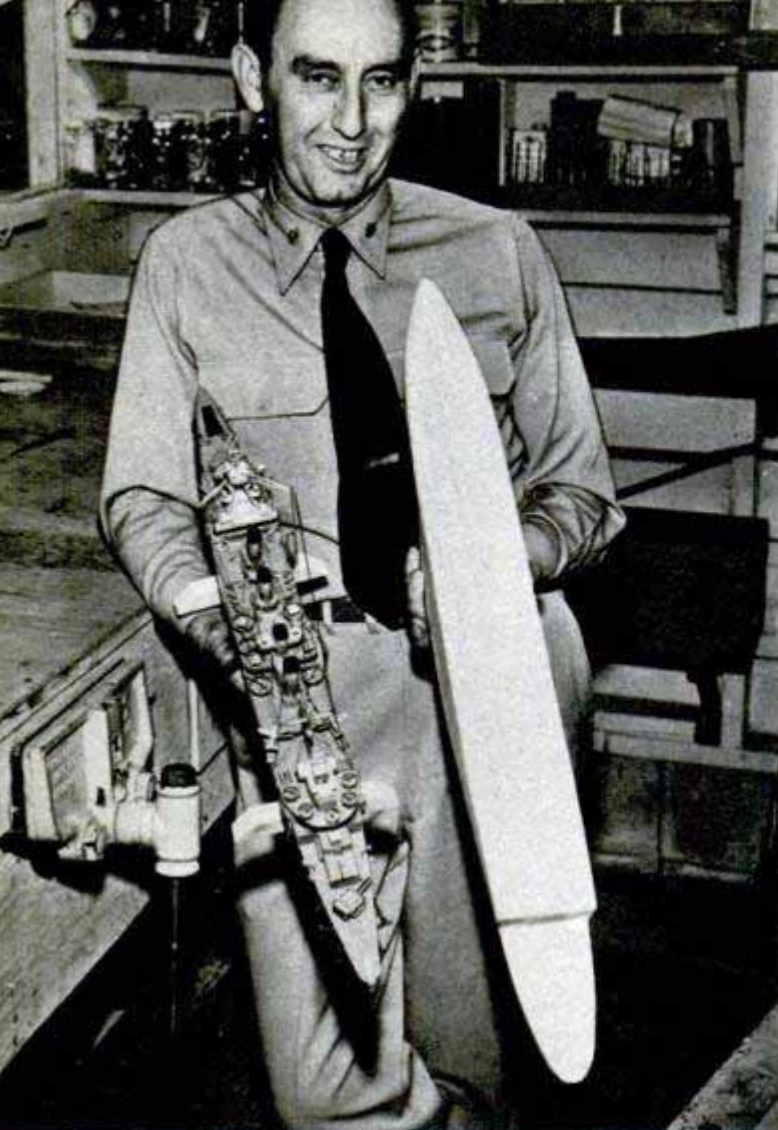

Model-builder Sigleer holds a completed cruiser of the Omaha class alongside the bare hull of a larger vessel in an early stage of construction. Below, the ship he is proudest of is the battleship *Missouri*. Photo shows the careful detailing of the battlewagon

Commander SIGLEER'S PRIVATE FLEET

IT TOOK HIM 15 years, but Lt. Comdr. Harry L. Sigleer of the United States Navy now has a fleet of his own. And it's one that would please an admiral.

The fleet consists of 53 scale-model vessels, ranging from big aircraft carriers down to the small mine sweepers and landing craft. All are on a scale of one inch to 20 feet. Most are carved in sugar pine.

Such a hobby takes much more time than money and while at sea even commanders have time to spare. Materials used include thread, string, tape, cardboard, paper clips, pins and brass sheeting.

Queen of his fleet is a 42-inch model of the mighty battleship *Missouri*, built by Sigleer in 3½ months. It bristles with 181 guns and boasts radar antennas, paravane cables and catapult airplanes.

In three years, Commander Sigleer plans to retire from the Navy, but he'll still be on fleet duty—with his own fleet, that is. ★ ★ ★

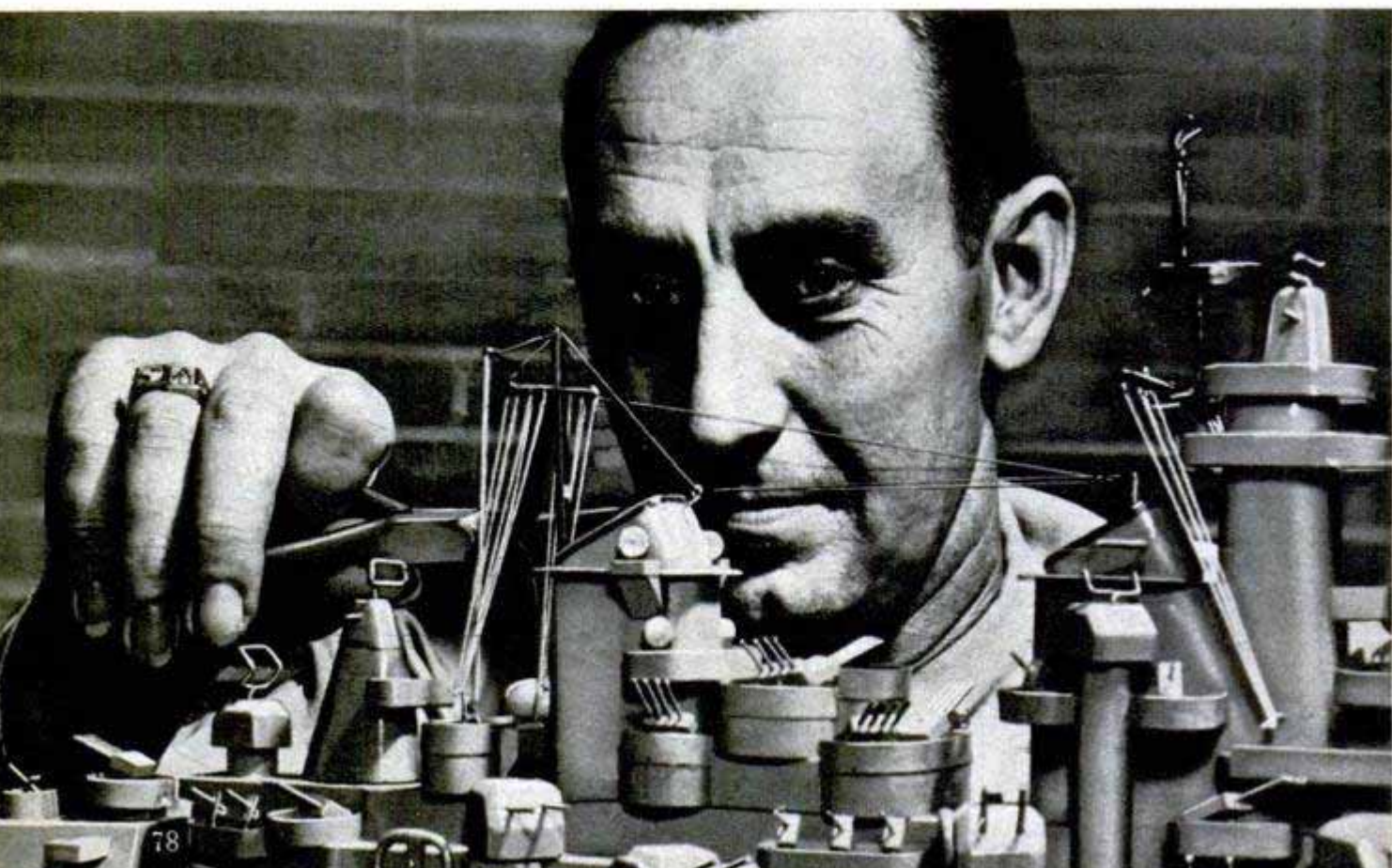



There are 53 scale models in Sigleer's private fleet. On display here are examples of the various types. He is holding a carrier of the Essex class. Also in the fleet are cruisers, submarines, landing craft, cargo ships and destroyer escorts. Below left, Sigleer installs an antiaircraft gun on a cargo ship. Right, a gun mount is added to a battleship of the South Dakota class. A battery of 16-inch guns is in foreground

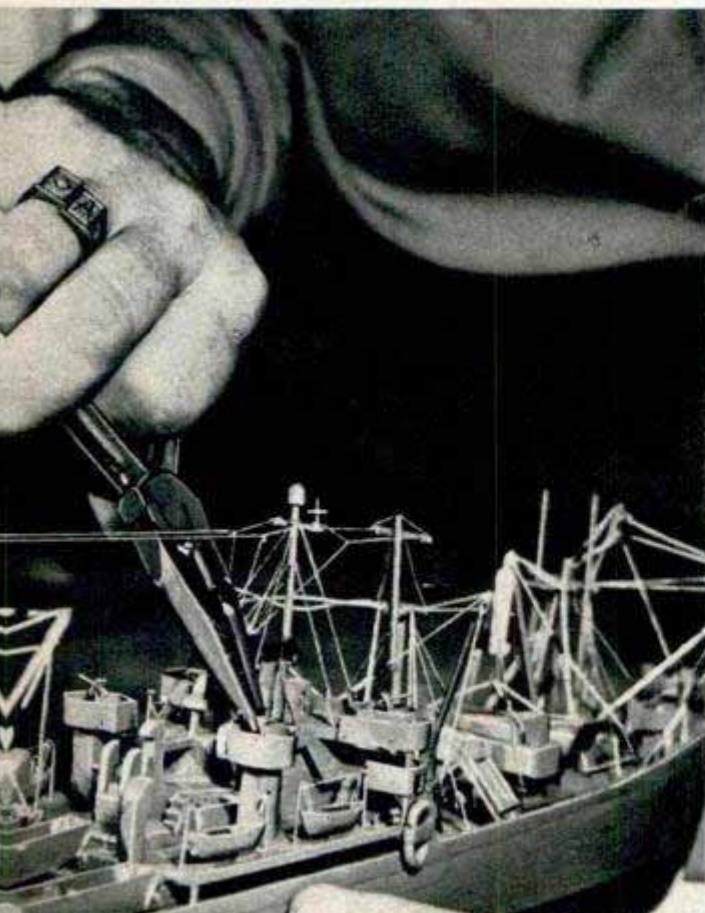

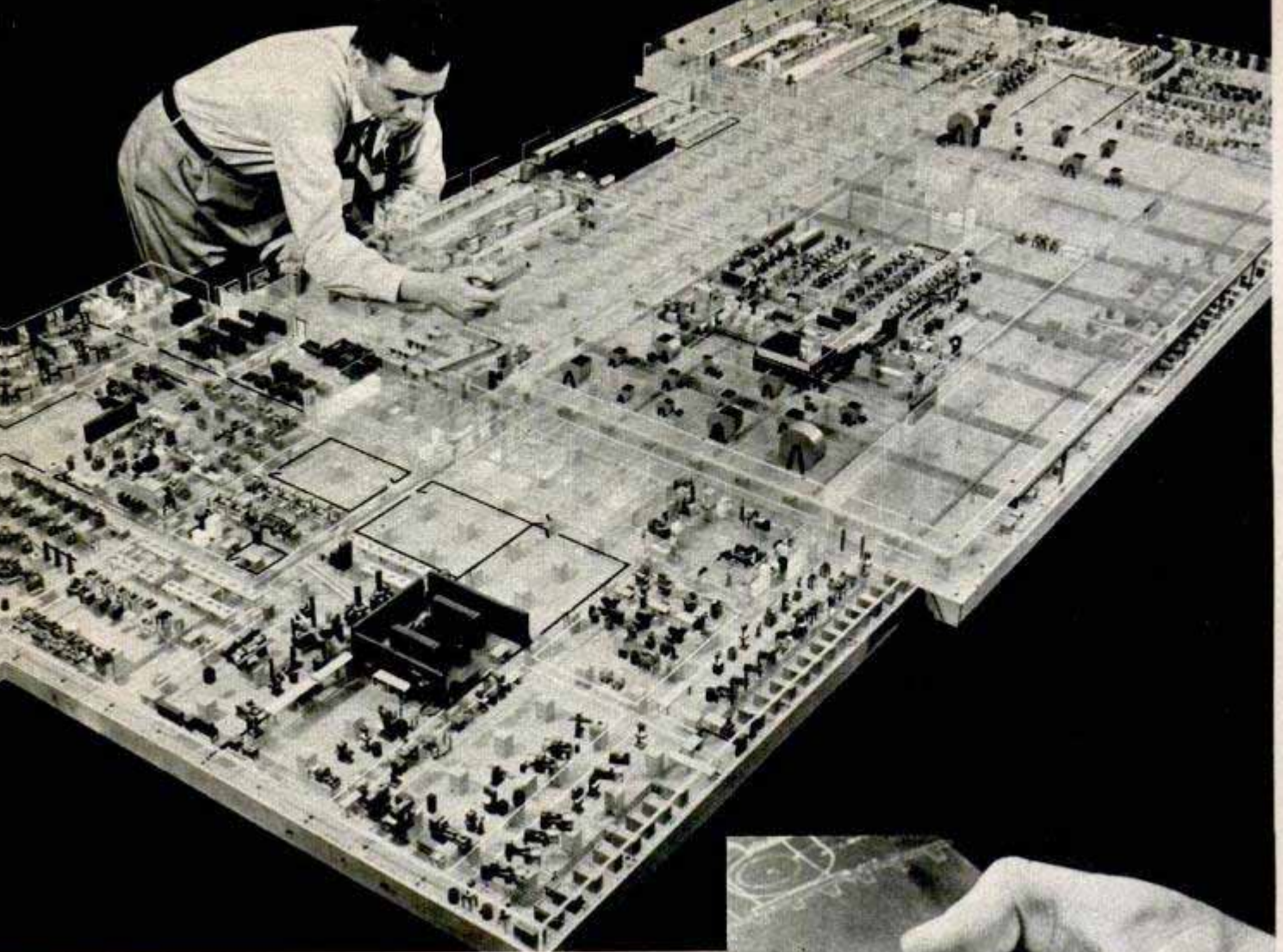

"Toy" Machines Aid Planning At Fountain-Pen Factory

When engineers planned the installation of the new Parker Pen factory in Janesville, Wis., they were aided by a $\frac{1}{48}$ -scale model of plant and equipment. Two thousand tiny replicas of pen and pencil-manufacturing equipment were carefully maneuvered to determine the best working positions. Transferring equipment from the old plant to the new without a decrease in production was one problem the engineers expected to solve with the 6 by 12-foot table model.

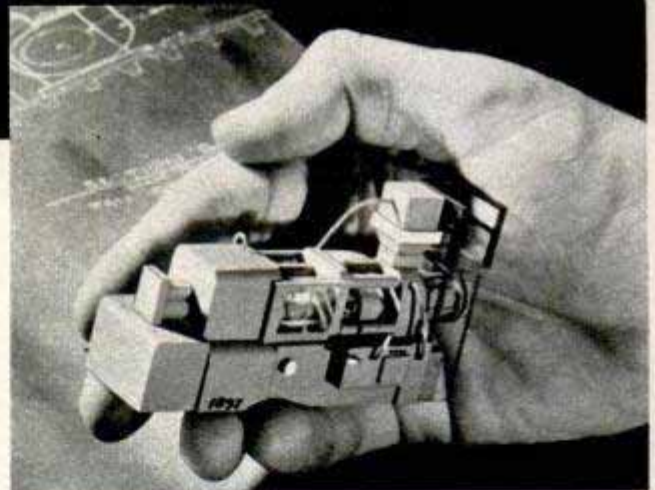

Machines working one day in the old plant were expected to be operating the next day in the new factory.

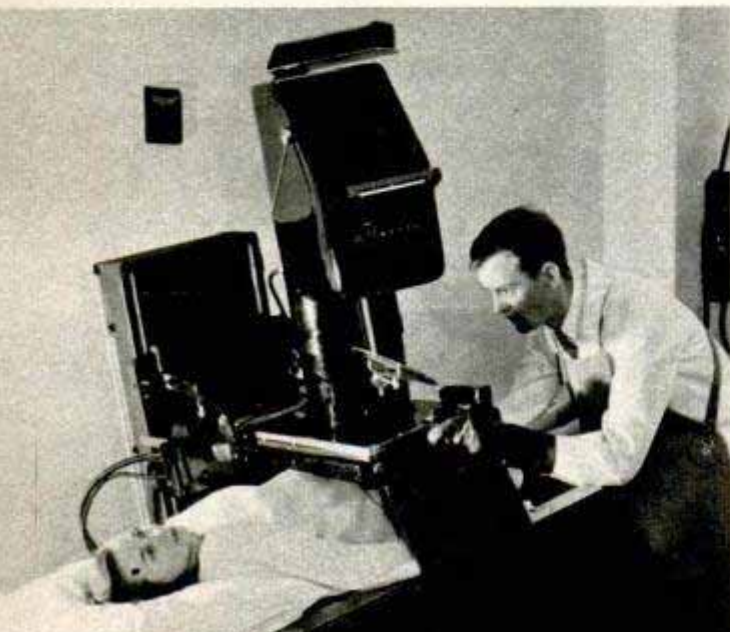

Fluoroscope View of X-Ray Image Is Bright Enough for TV

Capable of brightening X-ray images 200 times, a fluoroscope viewer gives a movielike view of the body interior. The X rays strike a fluorescent screen and release light rays which pass through the screen and illuminate a photo-sensitive coating on the other side which emits electrons. The electrons are given a tremendous voltage boost as they leave the screen and strike a much smaller fluorescent screen which releases the flood of light rays viewed by the physician. Bright enough to be televised, the picture can permit diagnosis of internal ailments by physicians hundreds of miles away from the patient.

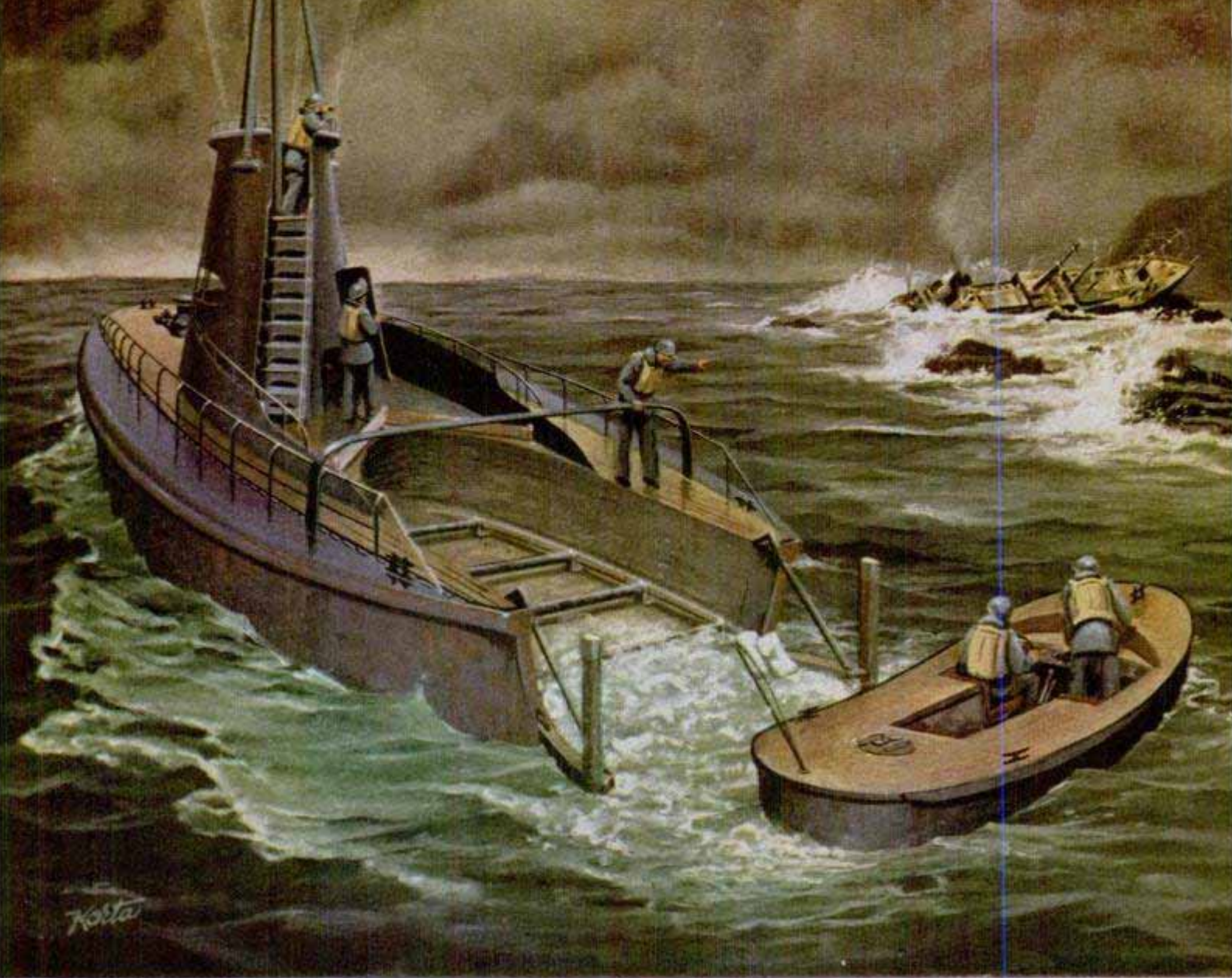

Small motorboat, launched from stern of rescue vessel, can cross dangerous shoals which bar mother ship

GERMAN "KANGAROO" RESCUE SHIP

OFF THE GERMAN COAST a freighter breaks up on the rocks while an angry North Sea threatens to claim its crew at any moment. First on the scene is a schooner dispatched from a near-by coast-patrol station, a strange-looking vessel with superstructure like a submarine and a small motorboat nested in its stern. Its rear bulkhead slaps into the water. Two men jump into the smaller boat, which rolls smoothly into the sea and heads for the stranded vessel, passing over rocks that could tear the bottom out of the mother ship. Life lines are rigged, and the crew saved. The 37 by 15-foot "kangaroo" ship, the *Bremen*, was built for just such emergencies. Two 150-horsepower motors drive it at 20 knots; a 1200-horsepower motor takes over for rescue work and ice breaking. Sole air inlet is at the top of its high tower, out of the reach of high seas. The 19-foot "daughter" boat is driven at 12 knots by dual motors.

Lifesaving *Bremen* is operated by German Red Cross





Excited visitors joggle into town in coach after witnessing holdup no more'n a holler down Dry Gulch Trail

The Frontier Lives

By **Richard F. Dempewolff**

Color photos by **Richard K. Dean**

ETHAN ALLEN and his Green Mountain Boys would feel at home this year if they came back to haunt the woods near Fort Ticonderoga, where they once made history fighting the Redcoats. In a clearing near North Hudson, N. Y., there's a genuine hand-hewn log village that looks like a drawing from an old book. The manned blockhouse, log schoolhouse, church and smithy buzz with colonial activity. The village potter twirls his wheel and the forge rings to the smithy's hammer. Cabins are occupied by frontiersmen and their wives, busy at the rugged chores of pioneer living. Women in Mother Hubbard dresses card wool and spin it on their wheels. There's the clatter of ancient hand looms weaving fabrics.

Outside, men in leather jerkins clean muzzle-loading muskets or cut wood on an ingenious saw turned by a horse on a creaking old treadmill.

Mail is carried in and out of town in Pony-Express saddlebags. Stagecoaches laden with travelers rattle along near-by roads. Lawbreakers (they have them here) get their just deserts in the pillory or stocks. Or they may be sentenced to three dips on the ducking stool that hovers above the pond in the center of the village.

Ride the old Concord Coach through the forest, into the clearing where this cluster of log buildings nestles against its Adirondack Mountain backdrop, and you step back 200 years in history.

Nevertheless, Frontier Town (its official



↑ Captured, the desperado is locked in the pillory awaiting trial. The village isn't just a museum—all the equipment is put to work to add to the fun of the visitors

Right, Pony Express rider gallops past, snagging a packet of letters mailed in Frontier Town. He is a real postal employee who totes mail to a near-by post office



Below, convicted desperado strapped to the ducking stool, is given three dips in the town pool as punishment. It's all part of an action-packed show given every hour or so

Again

Photo by George Bolster





Here's the robbery scene that startles the visitors. Later during the trial, several visitors—usually children—are called on to act as witnesses

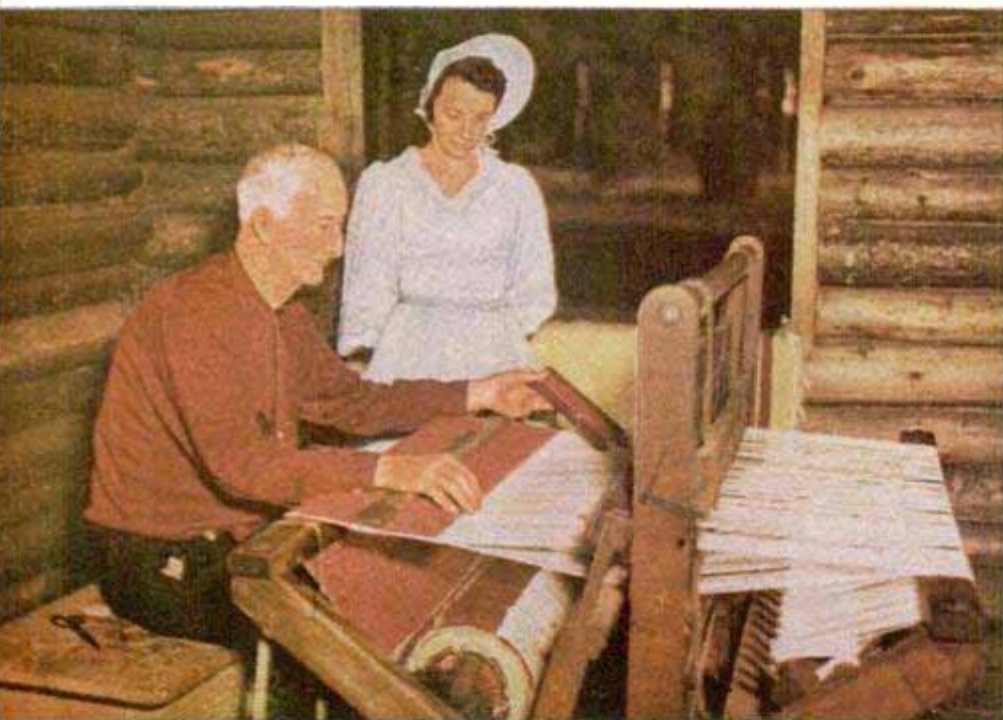

Benson has roamed the countryside to find authentic furnishings for the town buildings. Here's a hand-shuttle loom that not only works, but turns out cloth for the homespun clothing of the actors. Below, covered wagon stands ready to make long haul west with frontier family



name on the map) is far from ancient. It's the spanking-new brainchild of Arthur L. Benson, a Staten Island Norseman who, until two years ago, was an installation man for a telephone company. Benson was browsing through the reconstructed colonial towns and plantations between Virginia and Florida during a recent vacation trip. "They were like museums," he says. "Everything was on exhibit but you couldn't touch the stuff, and nothing worked."

Why not build an authentic colonial village, full of colonial equipment, plus people who could make the village really work?

"For instance, the idea of having a ducking stool that would work tickled me," he recalls. "That meant my village had to be in New England where those things were used to punish witches in the early 1700s."

He toured New England, quizzing gas-station attendants and store proprietors in quest of the right location. Thirty miles from historic Ticonderoga he found it. Visiting among the local people, he came across Jim Liberty — a 67-year-old logger who as a youth followed the timber camps from Penobscot to Tillamook. Jim had built bunkhouses for the timber men, using nature's raw materials, an ax, an adz and sweat—just the way his forebears had done. What he didn't know about making log cabins wasn't worth knowing.

With a crew of 10 men, old Jim Liberty went to work. From surrounding woods he and his boys selected tall, straight balsam and pine trees at least nine inches across the butt. They felled them with axes, as the pioneers did, peeled the bark with big spoon-shaped spuds. Within a year 10 log buildings squatted in the clearing—a church of unpeeled cedar logs, a schoolhouse, a rugged blockhouse, assorted cabins

and shops used for village maintenance.

Collecting all the things that went to make an early pioneer village work was no easy job. Benson scoured the countryside, digging in barns and attics, pleading and cajoling aged farmers into parting with ancient equipment. His Concord Coach, an old Western stage, and a John Stevenson coach were bought at auctions and hauled into Frontier Town for refurbishing by an aged coachmaker.

He bought and rejuvenated a horse treadmill used by pioneers to power a saw. Another discovery was a dog treadmill that activates a rocker arm that spins a paddle back and forth in a tub. Old-timers made the dog work to wash clothes or churn butter. Today it churns again in Frontier Town.

Once the town was equipped, Benson turned to finding people who could man his village like true pioneers and make his antique gadgets work. A Benson relative who had carded wool in the old country came up and gave lessons. A schoolteacher from near-by Schroon became the village potter. Old Jim Liberty stayed on to attend building and expanding the village. Sixty-six-year-old Willy Bryan, who drove the last stage between Westport, on Lake Champlain, and Lake Placid until it went out of business in 1912, is in charge of the village rolling stock.

Visitors are part of an active show that follows a leisurely cycle every hour or so. It starts with a stage ride through the country for anyone who wants to pay the extra fee. On every trip out, Willy Bryan drives

his load of travelers through a deep ravine where a robber on horseback charges from the bushes, six-shooter banging away, holds up the stage, snatches a bag of "gold" from the driver's seat and makes off with it. The coach clatters back to town where the robbery is reported. Later, the robber is caught by the sheriff and the man may be sentenced to three dips on the ducking stool—a chair tied to the end of a long, hinged beam which can be rocked in and out of the pond like a big seesaw.

The major difference between this colonial village and most other reconstructed historic tourist meccas is Benson's insistence that every piece of ancient equipment must be operative—and put to use by his hired villagers in just the way the old-timers used it. Instead of browsing through a colonial cabin and looking at rows of candle molds on shelves, the visitor watches a pioneer wife actually making candles—which are used when they're made. The horse treadmill produces wood for the big fireplaces where iron kettles on ancient cranes are often simmering. Products from the spinning wheels and looms can and do turn out homespun clothes for the actors in the town.

The idea is paying off, too. Late last summer the village opened for the first time. Although it was far from complete, some 70,000 people streamed through the unique town to join the fun.

Benson plans to keep things popping on Ethan Allen's old stamping grounds. ★ ★ ★

Horse walks old-fashioned treadmill that operates the saw

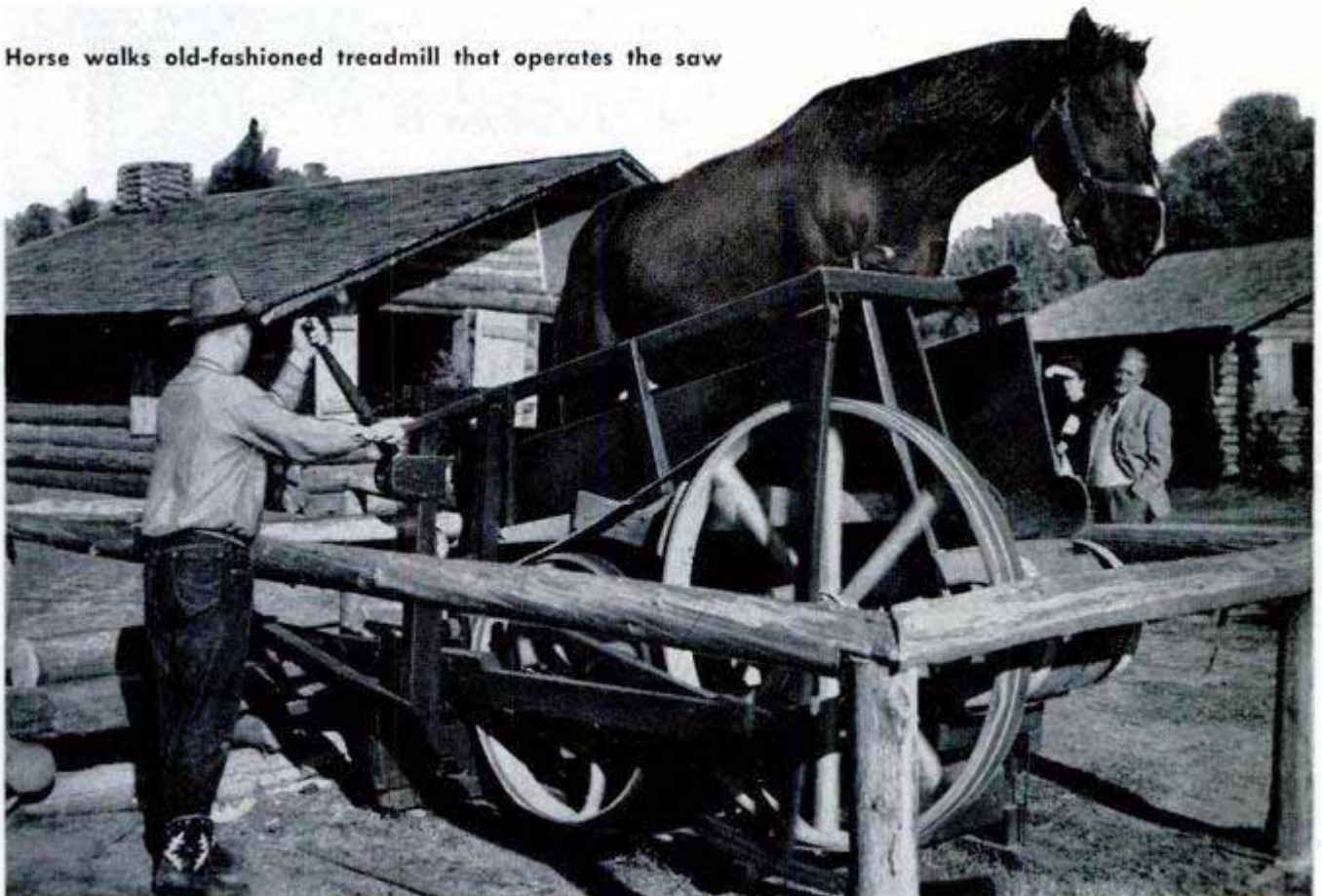

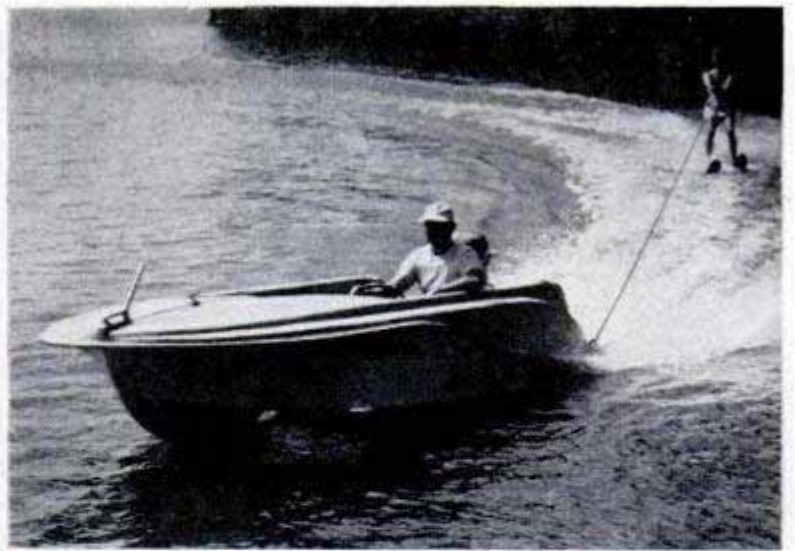

Two-Piece Plastic Speedboat Requires Minimum of Upkeep

Made of molded glass fiber, there are just two parts to a new 14-foot water runabout—top and bottom. The reinforced plastic boat has molded seats and deck, a recessed

motor well and a sweeping flange that forms a spray rail. A smaller version for fishermen is 12 feet long, has a 50-inch beam and 3 thwart seats.

Lightweight Shield Protects Fire Fighters

Allowing a fire fighter to work within two feet of hot flames, a portable glass-fiber shield offers protection from searing radiant heat. A blanket of glass-fiber insulation, mounted on a tubular frame, forms the effective barrier. The unit gives protection from the front and side and permits firemen to direct hose crews or turn off valves. Easily carried on the run, the shield weighs only 26 pounds. The resilient glass-fiber blanket is held with copper-wire mesh.



Portable Beach Pen Keeps Children Safe While Parents Swim



Anchored in the sand, a portable beach pen for small children keeps them safe while parents swim. Bright-green cloth net forms the four sides. Posts driven into the ground at the corners are held firm by taut rope braces connected to tent pins stuck in the sand. Rolled into a tiny bundle, the portable pen can be carried in one hand and takes little storage space in car trunk, trailer or apartment.

Information not listed on articles in the index often is listed in the WHERE-TO-FIND-IT LIST, available at no cost from the Bureau of Information, *Popular Mechanics*, 200 E. Ontario, Chicago 11

Only a few feet from the ground, Scherb uses small scintillometer to check a "hot spot" that showed on big unit at 50 feet



By Michael Day

The quest for oil has taken an amazing turn—to the sky! Scientists have discovered mysterious atomic "halos" that pin-point oil pools deep in the earth and can be spotted from a helicopter

NOW THEY'RE HUNTING OIL WITH ATOMIC "GUNS"

HOVERING no more than five feet off the ground, a weird craft moved slowly across a stretch of desolate Eastern countryside recently. A quick look might have tagged it as a helicopter—but no helicopter ever looked like this thing. Instead of tail boom and torque propeller, a conventional airplane-tail assembly with twin rudders brought the rear of the chunky cabin to an abrupt end. Above the cab, a pair of 48-foot rotors, one atop the other, beat the air in opposing directions like big contrarotating choppers. At the controls, a crash-helmeted pilot guided his charge this way and that, sometimes standing stock-still, sometimes creeping ahead.

A passenger at the open side acted no less strangely than the machine. Earphones spanned his cranium. With one hand he adjusted a cable, from which dangled a long cylinder sweeping a few feet above the ground as they went. His other hand

Surface checker registers radiation on meter that emits crackling noises

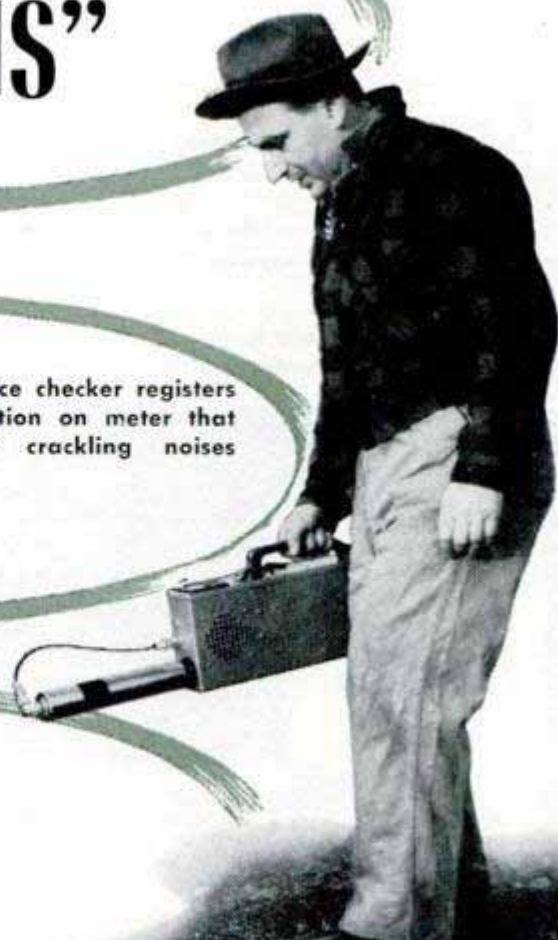

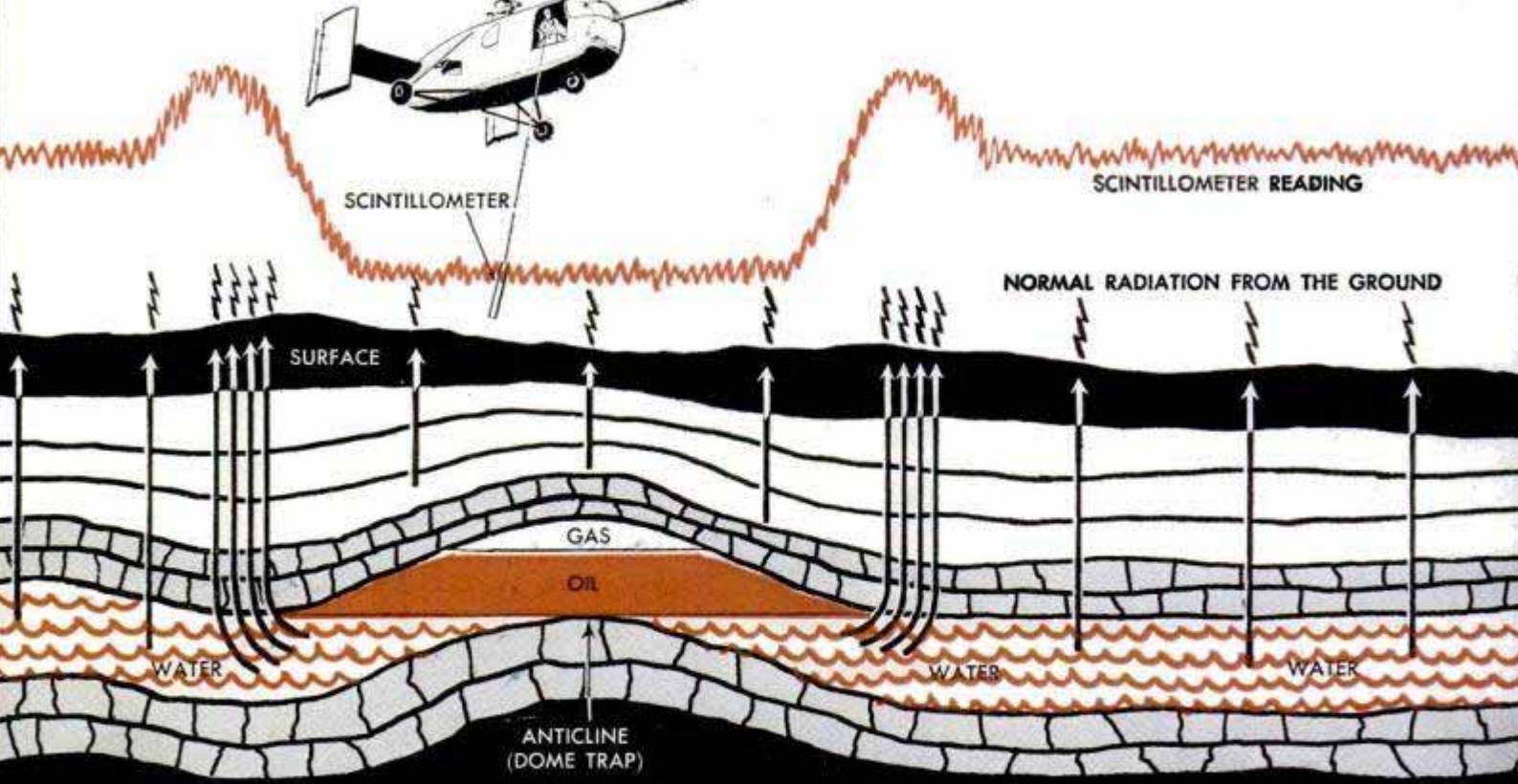

Red graph line indicates scintillometer reading. Radiation is low over oil pools, high at edges

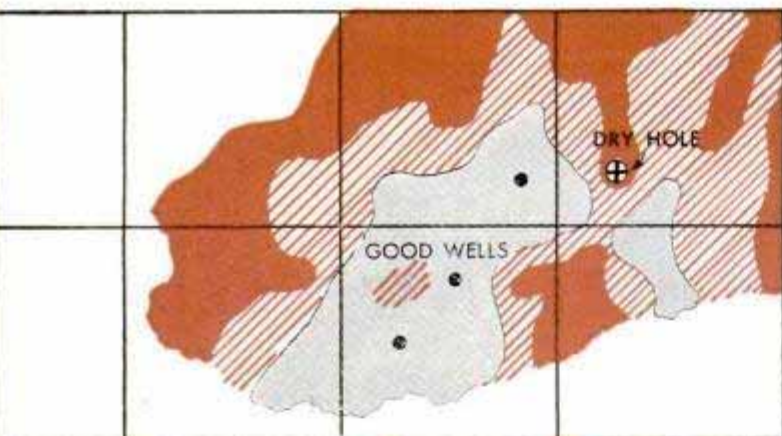

LOW-RADIATION COUNT HIGH-RADIATION COUNT MEDIUM-RADIATION COUNT

Radioactivity survey made of actual oil field shows good wells within radioactive "halo," dry hole at edge

Soil sample from field is placed on tiny metal disk and shoved into "castle" which measures beta rays



clutched the pistol grip of a gleaming aluminum object—reminiscent of a Buck Rogers atom-ray gun—which he pointed toward the earth.

A casual observer might have thought he was either dreaming or watching a streamlined flying farmer on the prowl for groundhogs. Actually, he was seeing in action a combination of new tools—from Gyrodyne's fantastic coaxial helicopter to the latest in atomic-detection instruments—that show exciting promise of slashing the element of chance in oil exploration. Under the atomic eyes of an array of new supersensitive instruments searching from the air, the ground, and even underground, hidden subterranean oil pools are now being detected via the giveaway static of nuclear bombardment that seems to surge from the earth around edges of oil traps.

Until now, oil prospectors have had to rely largely on seismic research to steer them to black gold. Shock waves from surface explosions penetrate the earth's crust, bounce off different layers of rock and echo back to the surface. By timing the echoes, the explorer gets a picture of subsurface structure. If he finds domeshape wrinkles, he may find oil. Or, he may not.

Magnetometer as well as gravity-meter surveys are other methods of oil hunting. These involve flying or carrying instruments over the ground to determine the magnetic effect and gravity pull of various subterranean layers, and then calculating the structure. If it looks promising, it might (or might not) yield oil.

All these methods are fine for locating exciting underground formations. But just because the traps are there doesn't guar-

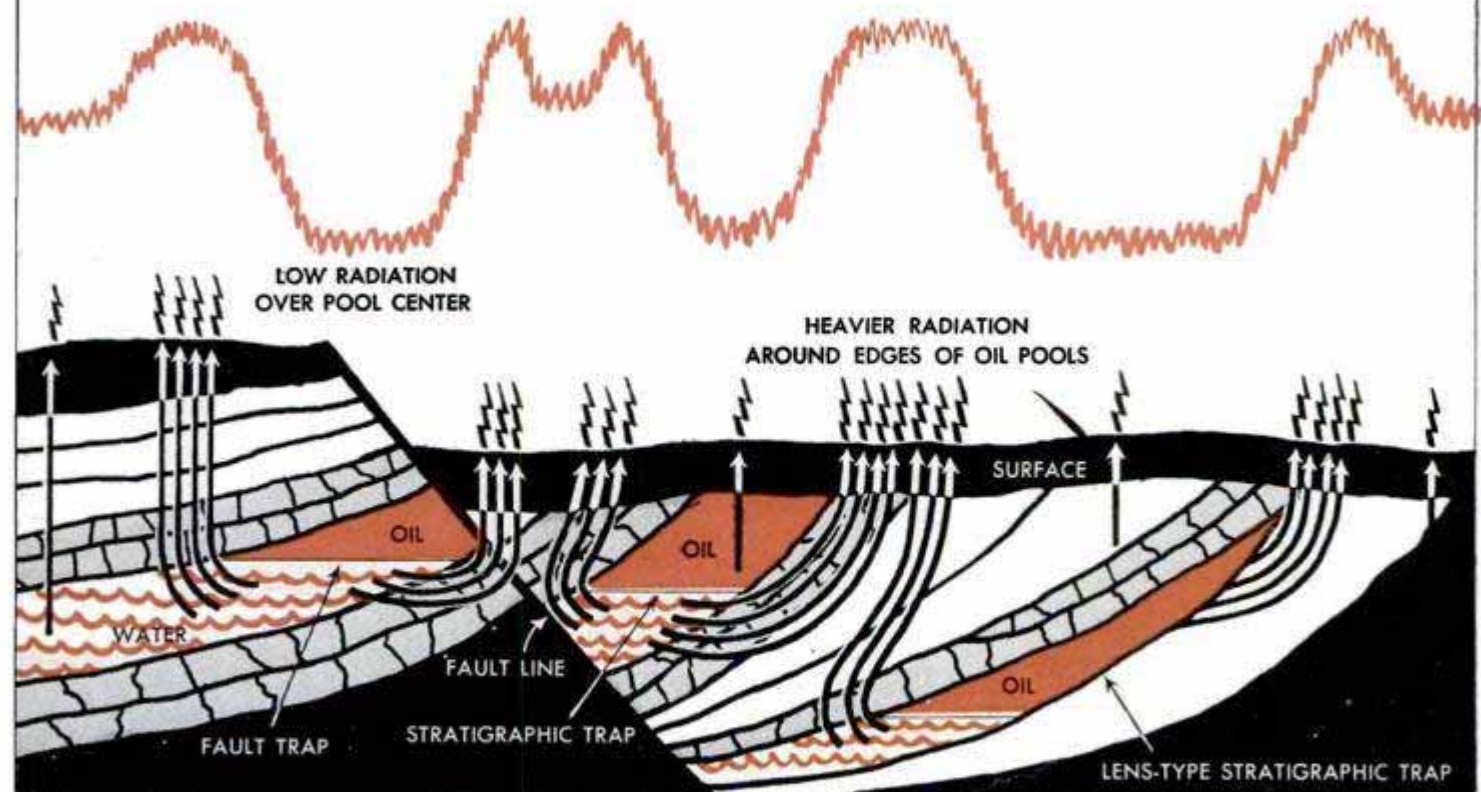

antee that the oil is, too. What's worse, none of these systems can help the geologist when oil may be right under his feet in a formation known as a stratigraphic trap—such as an upward-sloping series of sediments, sliced off near the surface and sealed by flat, impervious surface rock.

"Only the bit proves the presence of oil" has always been a favorite remark among oilmen. And you can't blame them when you know that all but 13 percent of the oil wells drilled today are dry holes—sunk at an average cost of about \$100,000 per, even after extensive surveys. Only three percent of wildcat locations come in.

The new atomic method, however, seems to detect radiation associated with oil itself. Actually, there is a certain amount of radiation everywhere. Cosmic particles shoot in on us like rain from outer space all the time. And uranium, found in small amounts everywhere in the earth, shoots particles upward in a fairly steady barrage. It's when this steady barrage of "background noise" increases or slows that something unusual may be indicated. Geophysicists first noticed such changes in oil territory about 10 years ago. Bruno Pontecorvo, a former Italian nuclear physicist, devised a nuclear counter in 1942 which he dropped into wells that were being drilled. The changes in radiation count as the instrument descended helped indicate type of strata through which the bit was chewing. Today, such counters are widely used in "logging" wells. Other geophysicists using similar instruments noticed something else: when they lugged their counters on the surface, across edges of known oil fields in operation, the crackling

Hand scintillometer for ground surveys registers nuclear bombardment on dial at base of instrument





Scintillometer is suspended by cable so it can skim along close to ground and pick up only direct radiation

of atomic particles piercing the Geiger tubes behaved oddly. Above the steady background of cosmic particles and the normal radiation from the earth were a few additional crackles, or pulses, that had no business there. And in some places there were less than there should have been. The men couldn't prove much except that these microscopic variations existed. Their Geiger-type instruments were too insensitive, so little came of the discovery.

Recently, however, the whole picture changed when a group of Westinghouse and Princeton University scientists—followed by a Canadian group and many others—hunched over their laboratory tables and came up with a new kind of supersensitive radiation detector called a scintillation counter. What makes it better than a Geiger? If atomic rays are present near a Geiger counter, some of the particles pierce the tube, excite a gas, and set up an electrical discharge that is heard as a static-like crackle or registered on a meter. But only a few particles are powerful enough to be heard; many go through uncounted. The scintillation counter is based on a crystal that fluoresces, or glows faintly, under bombardment from flying atomic particles. The glow is picked up by a photomultiplier tube where it sets off whole showers of photoelectrons which, in turn, trigger secondary electron showers in a sort of chain reaction. These electron showers can be highly amplified, so that even the weaker particles that hit the crystal make a big enough splash to be detected.

GO RICHMOND W. TORONTO,
 With this supersensitive counter, a number of geophysicists, including Hans Lundberg, president of Lundberg Explorations, Ltd., in Canada, flew crisscross patterns over known oil territory. What they found set off a buzz of excitement in oil circles. Lundberg reported that as he flew over the center of known oil fields, his airborne scintillation counter registered a radioactive "low." But around the fringes of the underground oil pools, atomic particles rocketed up from the earth to produce what he calls a "halo" of increased radioactivity.

Back home, Lundberg plotted his readings on maps of the areas over which he had flown. Out came a series of contour lines in a saucer-shaped pattern of radioactivity. Those high readings seemed to encircle the areas where producing wells gushed their best.

Outside the saucer's rim were the dry holes. Some poor oil wells sat in places that showed up under the scintillation counter's atomic eye as fringe areas. Coincidence? Lundberg set out to see. In one year he flew his crackling instruments over Canadian oil territories for 800 hours—100,000 miles of tedious recording. Flying at 100 to 500 feet, and at 100 to 175 miles per hour, his results were good enough to heighten cautious optimism.

Exciting as it seems, geophysicists are saying little. Teams of experts all over the country are busy combing the skies and ground to test the new theory. One of these pioneer groups is the geonuclear division of the Radiac Co., in New York City.



Checking influence of cosmic radiation, Scherb places "gun" on lead shield to block radiation from ground



Instruments inside helicopter show radiation picked up by trailing detector, here retracted before take-off

Recently, Dr. M. V. Scherb, director of the division, and M. M. Reiss, the company's general manager, invited representatives of *Popular Mechanics* to accompany an experimental-survey team that was making airborne, ground and laboratory investigations of radioactivity patterns over a large area of Eastern land. A fantastic array of Radiac instruments went along, including odd-shaped scintillation counters and Geiger counters.

The new coaxial helicopter, hot from its experimental hangar at the Gyrodyne Company's testing grounds in St. James, L. I., was hauled out especially for the job. Its stacked rotors, eliminating need for a torque prop, give it what test pilot Jim Ryan calls "easy symmetrical control."

"You don't have to make half a dozen corrections for every move," he explains. "She's stable as a rock in any position and any altitude."

Unlike most helicopters that are flying at touchy "critical altitude" at anything under 50 feet, this big five-man "chopper" can hover on a dime—or move steadily in any direction—at just two feet above the ground. "It's ideal for this type of work," explains Reiss, formerly with the Air Force and a Manhattan Project officer.

While Jim Ryan warmed up the chopper, Scherb loaded two scintillometers—one, the portable aluminum-encased outfit with pistol grip; the other a long tubular instrument on a cable. A new supersensitive Geiger counter went aboard, along

with an array of dial-studded amplifiers.

With a roar, the helicopter rose to a height of about 50 feet and the big scintillometer went over the side. "It's lead-shielded to keep out cosmic rays from space," Scherb explained. "The tube is open at the bottom to allow the crystal to pick up rays emanating from the ground."

The system, described by the nuclear physicist, is simple but tedious. A grid pattern is flown across a suspected oil area in a series of parallel lines at right angles to each other and about 300 feet apart. If you drew a picture looking down on the craft's course from above, it would look like lines on a piece of graph paper. Every few seconds radioactivity readings are logged. If an interesting change in nuclear count pops up on the dials or in the physicist's crackling earphones, he may signal the pilot for a closer look. Down goes the helicopter; the hand scintillometer is poked over the side while the pilot hovers a foot or two above the ground. This closer examination may verify the unusual reading, or prove that the craft merely ran through a sudden shower of cosmic particles from outer space. Underneath the helicopter's belly, a long super-Geiger tube is triple-checking the nuclear counts.

After the air survey, the geophysicist grids the surface of the same ground by Jeep or on foot. Tramping across the fields, clutching the pistol grip of his scintillometer in one hand, and listening to the crackle

(Continued to page 250)



With uncovered wheels and a long, low hood line, the Chrysler D'Elegance is in the European tradition

Chrysler's D'Elegance Has Pop-Up Spare Tire

That messy chore of unloading the spare tire when you have a flat has been refined in Chrysler's advanced-style automobile, D'Elegance. All you do is push a button and the spare tire and its protective cover are automatically lifted from their place inside the rear deck. The tire then moves rearward and down to stop just behind the rear bumper where you easily remove it. Nothing has been done to put the spare wheel on the axle—you still have to do that for yourself. The new car is not destined for the production line. It uses standard Chrysler parts and stands only 54½ inches high. Recessed headlights and downward-sloping long hood are in the European tradition; however, it was designed by Chrysler's engineers in the United States.

Un-European is the spare tire, however. Push a button and it pops up, then it swings down for easy removal

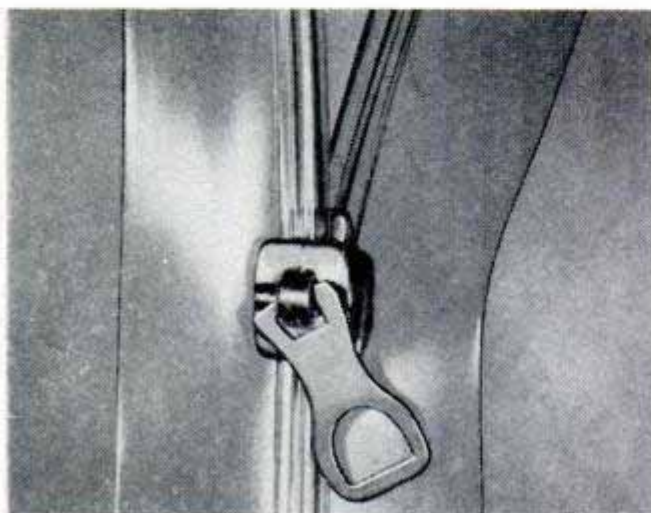
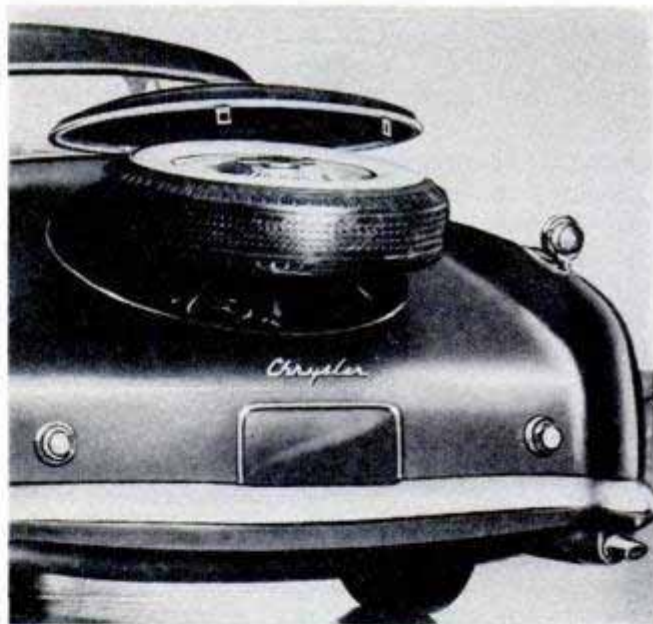

Plastic Toothless "Zipper" Makes Watertight Closure

Resembling a metal Zipper, a new all-plastic fastener has a slide mechanism instead of teeth to close interlocking strips. It is being used as a closure for plastic pillowcases, blanket covers, wallets, brief cases and raincoats. One edge of the material to be closed has grooves resembling parallel ruts in a dirt road, the other has ridges similar to the runners of a sled, and the fastener presses them tightly together. The toothless fastener is also available in metal, nylon or several other plastics.

What's Happening in TV Around the World

By Elliott H. McCleary

WITH THE POMP of ages, the procession from Buckingham Palace wends its way along the streets of London to Westminster Abbey. There a new sovereign of the British Empire receives her crown—as millions watch.

And countless others, scattered all over the earth, also watch the coronation within a few hours, for TV at last is spreading 'round the world.

In a Paris cafe, a businessman watching a live telecast sees an ermined peer step forward. Outside a Brussels television shop, Belgian school children shout as prancing horses draw a gilded coach past their eyes.

Across England, Scotland and Ireland the microwaves flash their pictures.

Within hours, films of the coronation appear on the picture tubes of 23,000 receivers in Rio de Janeiro. Tokyo citizens watch the rites on their American-made sets, and a station in West Berlin hurls microwaves through the Iron Curtain to give a handful of East Berliners a view of the most widely televised event in history.

In Moscow, Milan and Mexico City, the television age has begun. TV abroad is still

Another national sport goes on TV as camera picks up bullfight in Mexico. Below, Berlin TV "on location"

RCA photo



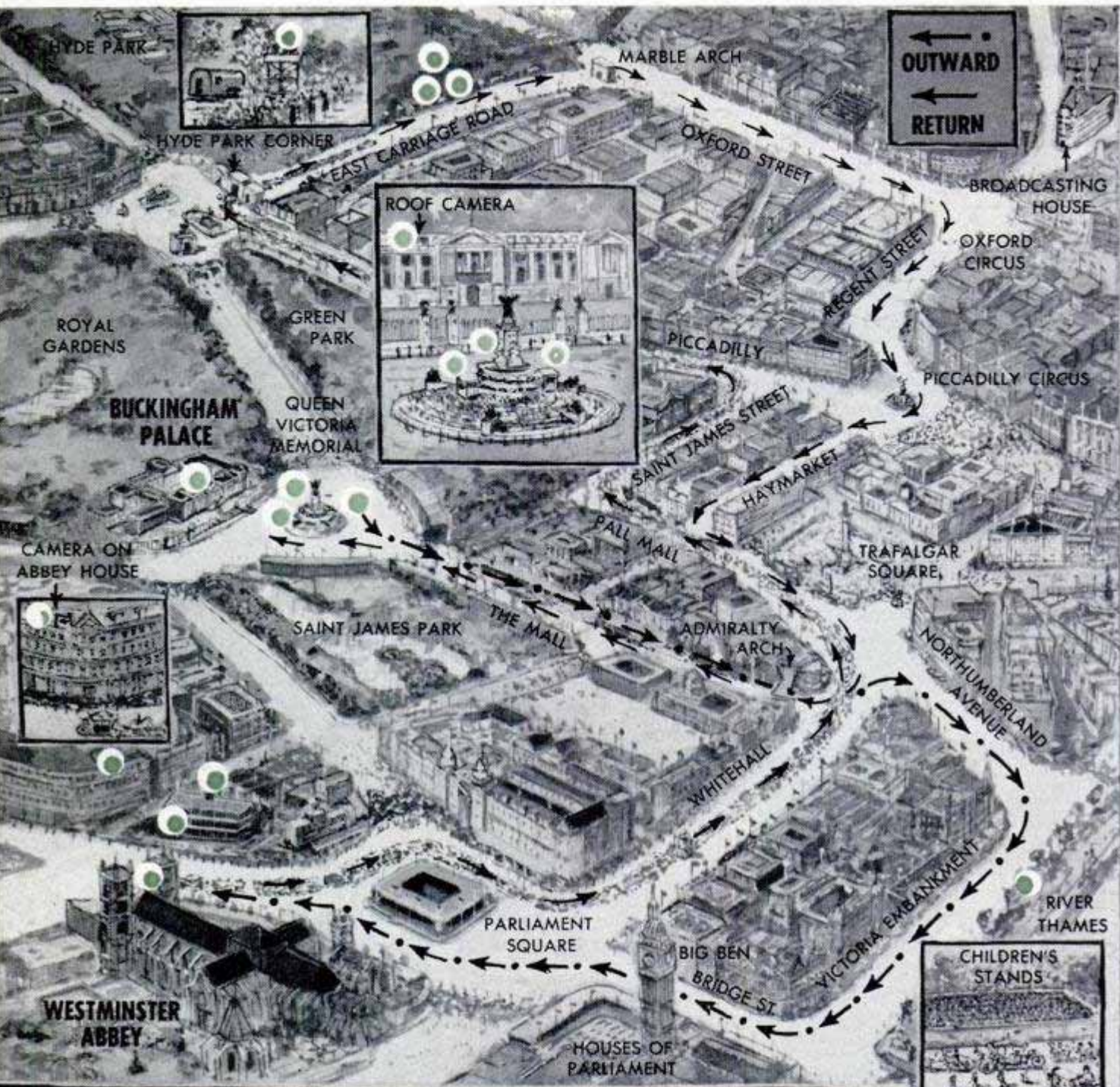

TV cameras spotted along the coronation route and inside Westminster Abbey will record the spectacle. Linked by coaxial cable to Broadcasting House and Alexandra Palace, their output will be monitored in mobile vans and control huts located beside Westminster Abbey and at the base of Queen Victoria Memorial. As the two-mile-long procession wends through the streets of London, cameras will peer from the roof of Buckingham Palace, from high stands erected along the route and from the windows of buildings facing the abbey. Microwaves will relay the scenes to north and west Britain and over a planned hookup to Europe. Planes will rush film to America

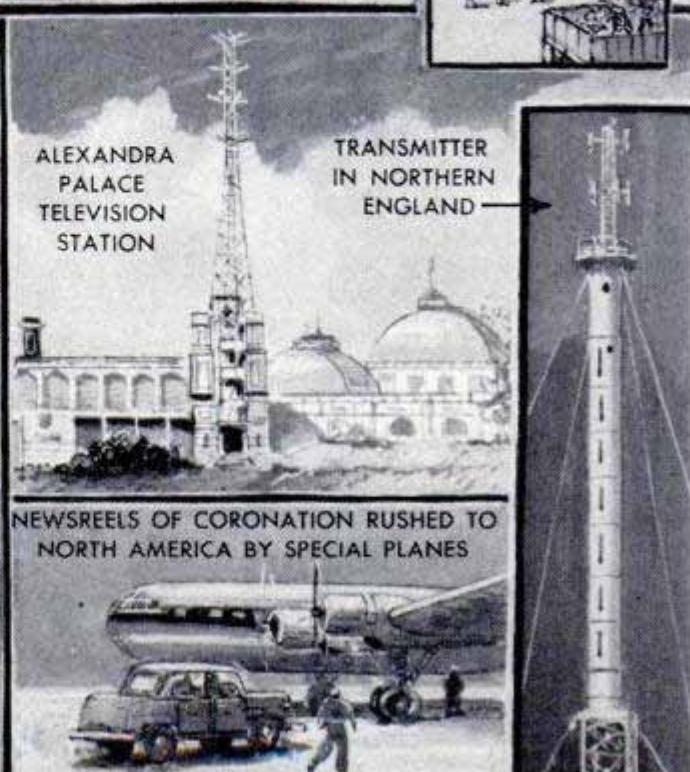

CONTROL-HUT INTERIOR

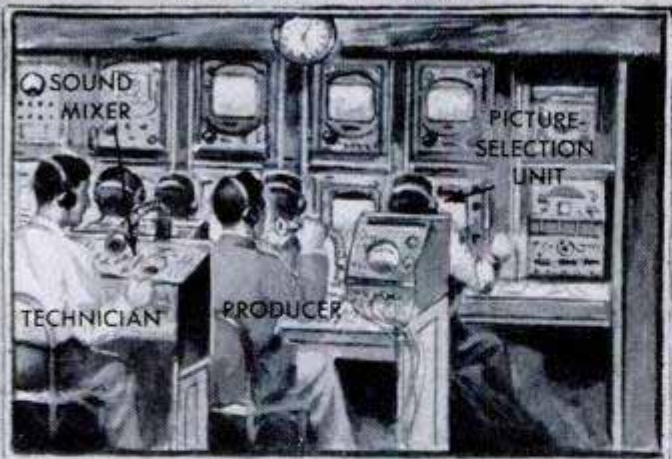

SOUTH TOWER

NORTH TOWER

WESTMINSTER ABBEY

SOUTH TRANSEPT

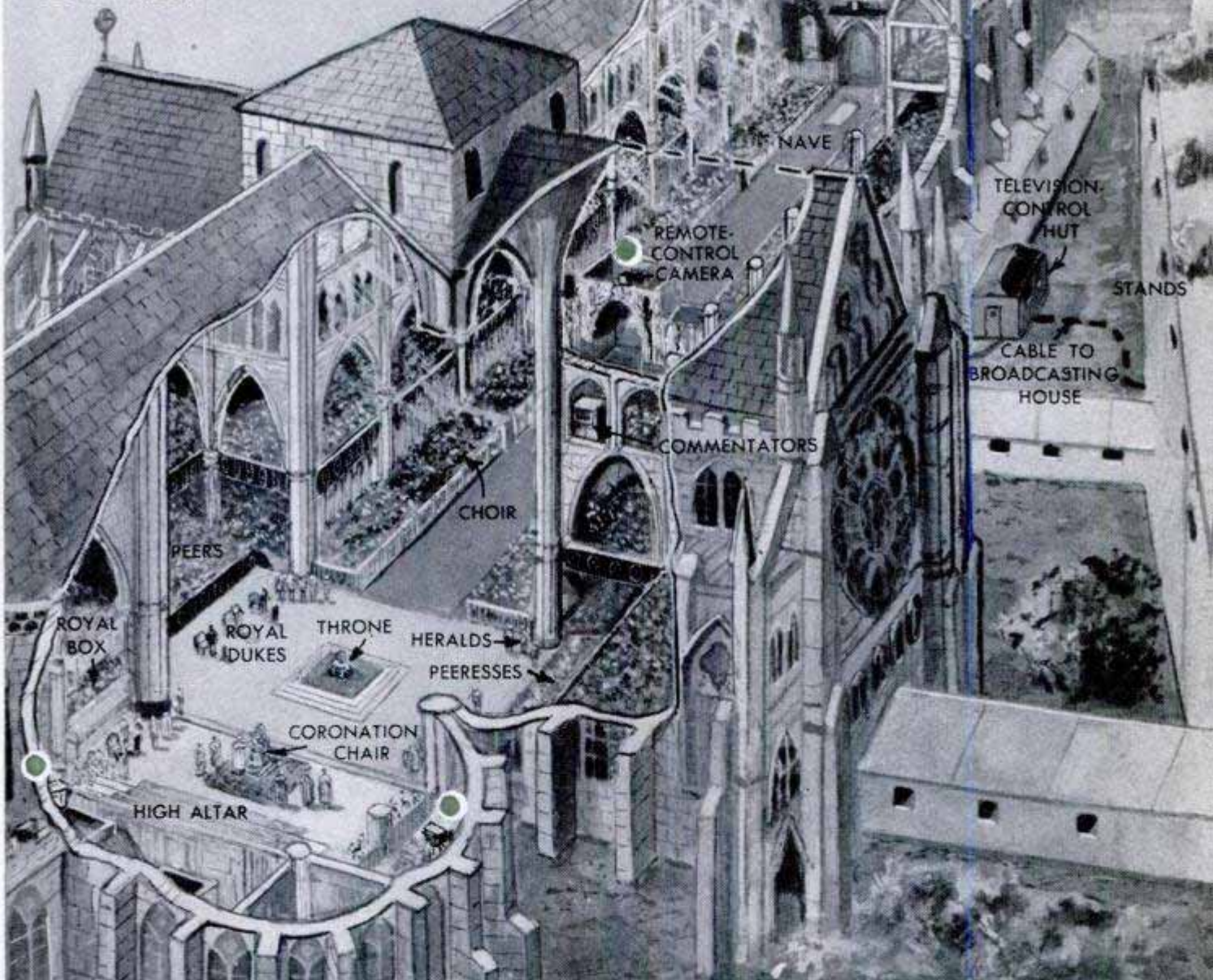

QUEEN'S ENTRANCE

NAVE

REMOTE-CONTROL CAMERA

TELEVISION CONTROL HUT

STANDS

CABLE TO BROADCASTING HOUSE

COMMENTATORS

CHOIR

PEERS

ROYAL BOX

ROYAL DUKES

THRONE

HERALDS

PEERESSES

CORONATION CHAIR

HIGH ALTAR

Copyright Popular Mechanics Company

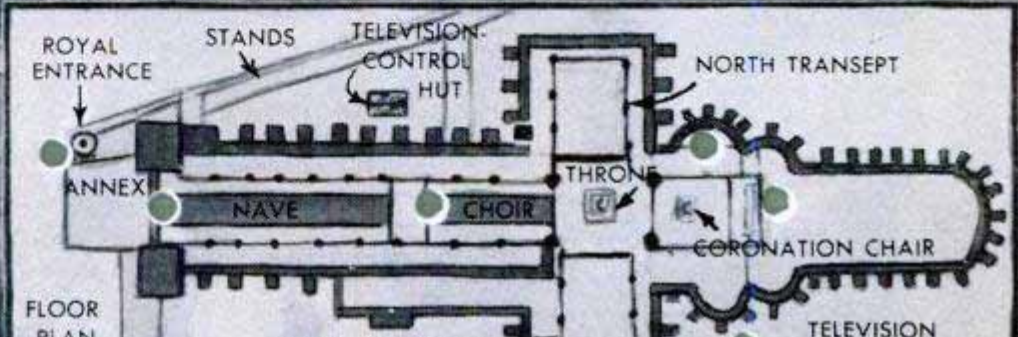

ROYAL ENTRANCE

STANDS

TELEVISION CONTROL HUT

NORTH TRANSEPT

ANNEX

NAVE

CHOIR

THRONE

CORONATION CHAIR

FLOOR PLAN

TELEVISION

in its infancy by United States standards: In all the rest of the world there are about 2,350,000 receivers compared to around 21,000,000 here. But the "baby" is growing fast.

At last count, eight countries in the Western Hemisphere and eight in the Eastern Hemisphere enjoyed television regularly. A dozen other lands have experimental stations. And at least 30 more nations are currently making plans for video.

Great Britain has more television sets—1,700,000 of them—than all other foreign countries put together. Microwaves and coaxial cable carry London programs to viewers all over England, to Wales, Scotland and across the Irish Sea to Belfast, the new Irish station scheduled to open in time for the coronation.

England is abuzz with plans for greatly increased television service. Although at present 70 percent of the population is within range of TV, there's only one channel to watch. Like almost all television and radio systems outside the Americas, Britain's video is state-controlled. Each set owner must pay a license fee equivalent to \$5.60 yearly. Detection vans, staffed by government personnel, track down unreported sets.

But commercial TV has been proposed in England. Up to 50 stations backed by major advertising agencies may be in the wind, each to have a radius of from 10 to 15 miles.

Zenith Corporation's Phonevision, a plan to telecast movies to paying watchers, is also under scrutiny.

English television equipment ranks with the world's best. Practically all foreign TV stations are built by either American or British firms. Britain is also a leader in

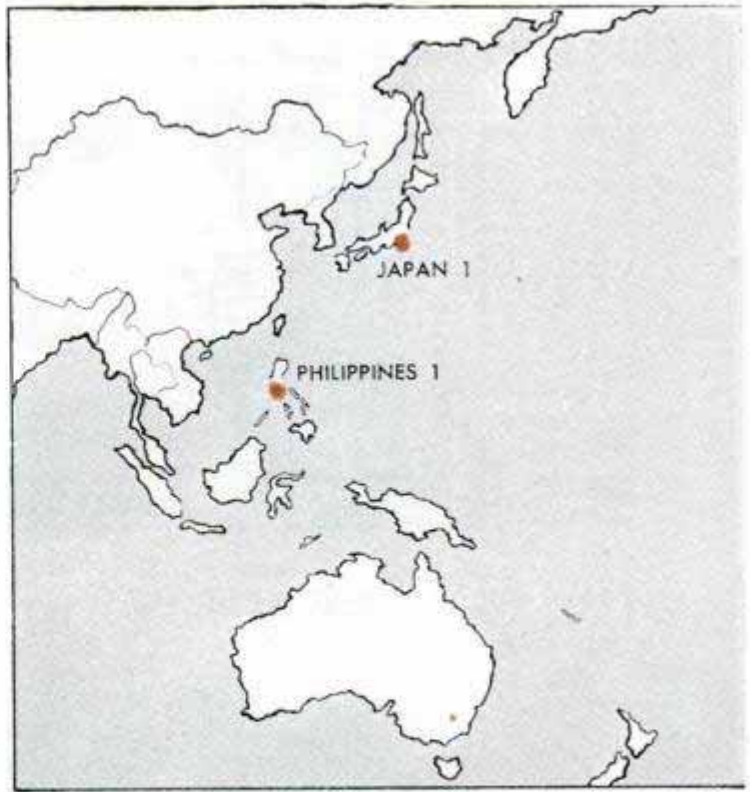

industrial and educational TV—in one London bank you may examine your balance sheet on a TV screen, though the files are kept 12 miles away. The army, navy and universities teach classes by TV.

First in the world to inaugurate regular television service, the British Broadcasting Company started telecasting a short program daily in 1936 from its Alexandra Palace studios.

Today, as then, the BBC telecasts a 405-line picture at the rate of 25 frames per second, using AM sound. Americans who have seen English TV say it compares favorably with our system, which uses a 525-line picture at the rate of 30 frames per second, with FM sound.

When special television programs are



Operas aren't the only fare on Italian TV. Slapstick dancers in Milan stumble through their routine before the camera
International General Electric photo

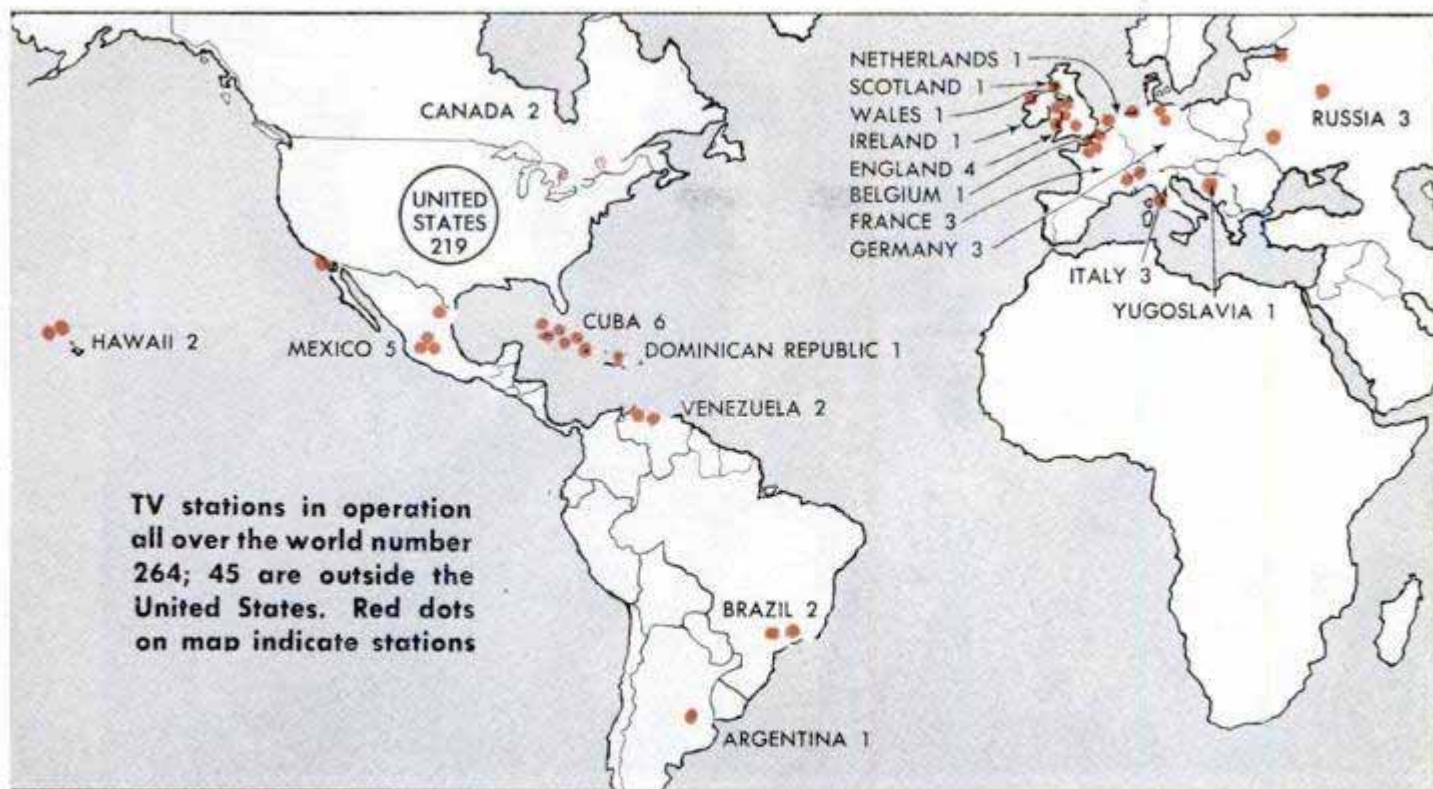

beamed across the English Channel to France, they must be rescanned by a special converter to change the picture to an 819-line standard. For transmission to other European countries, with the exception of French-speaking Belgium, the image has to be changed once more, this time to 625 lines. By this time, it may, understandably, be a little fuzzy.

BBC officials are talking hopefully of a hookup linking Brussels, Berlin, Rome, Paris and London by the end of 1954.

The largest number of receivers on the continent of Western Europe is in France,

where 55,000 sets operate, some of them for the benefit of community viewing groups sponsored by the French League for Education. Two stations transmit from the Eiffel tower in Paris. Another is at Lille, linked to Paris by relay. Six more are proposed or under construction.

Italy expects to have five modern stations by the end of 1953, and expects the number of receivers to jump from 5,000 to 60,000 during the year. A Vatican City station, one in Milan and one in Turin are telecasting now. An elaborate network stretching the length of the boot and jogging over

Tokyo citizens jam department-store exhibit of television receivers. Regular telecasts began there in February





Closed-circuit television in Melbourne enabled over 500 Australian doctors to witness unusual surgery at close range during a recent medical convention. Below, TV transmitter and antenna atop Eiffel tower

Radio-Television Francals photo

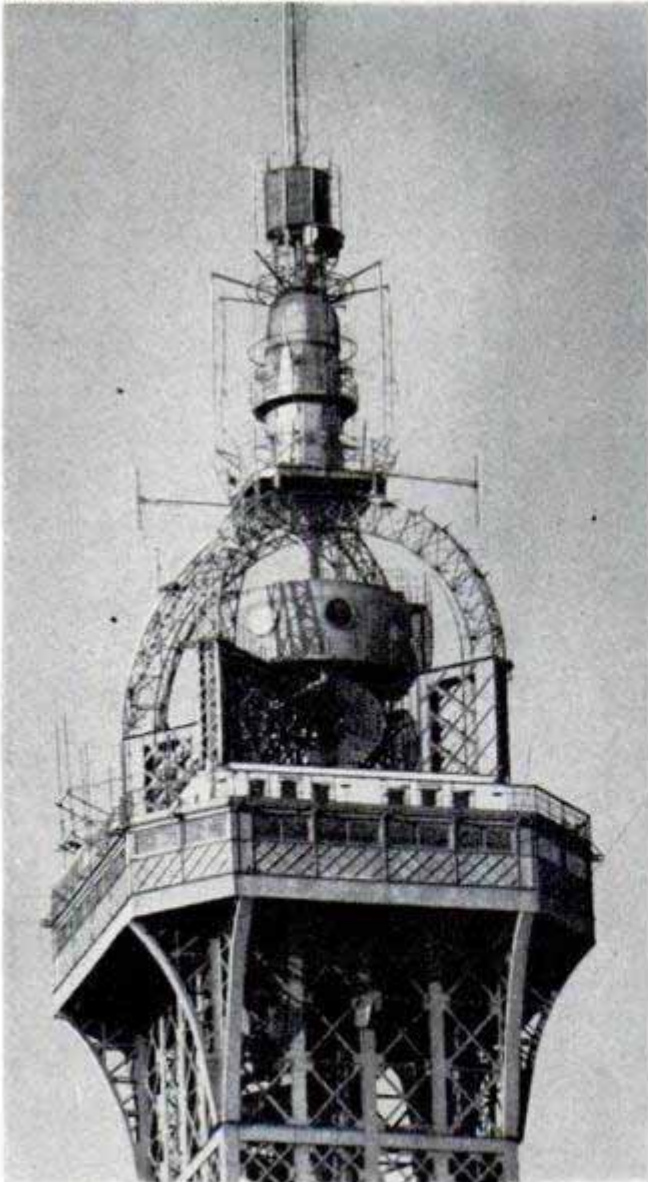

to Sicily will probably cover the country by 1954 or 1955.

Germany is beginning to hit its stride in TV, although few programs are being telecast now. Hamburg and West Berlin stations are operating, and Hamburg and Cologne were linked last December by microwave. Frankfurt is scheduled to join the hookup by mid-1953. Four other stations are planned, one of which would connect with Zurich, Switzerland.

Switzerland, like many another small European country, is beset with problems caused by small population and the high cost of TV-station installation and operation. Sets cost far more than the average European can afford. Revenue must come from license fees, not advertising budgets, since most Europeans are horrified by the thought of United States type commercial programs. (Italy, which started out with privately owned television, recently took control of the stations away from the owners and put them under government supervision.) An added Swiss difficulty is the nation's three languages—French, German and Italian.

Belgium has the same problem, with French and Flemish the two official languages. The newly opened Brussels station is bilingual, and the proposed station at Liege will be Flemish. A peculiar problem in Belgium—the fact that some receivers use the French standard to pick up French telecasts, others use a 625-line standard—has been solved by two stations under construction which will operate on either the 819 or 625-line system.

Television was almost booted out of Denmark last year, after experimental telecasts

(Continued to page 254)

Retractable Launching Pod Gives Sabre Jet a 24-Rocket "Punch"

One volley of rockets from a new retractable launching pod that pops out from the belly of an F-86D Sabre Jet will shoot down the world's largest bomber. Immediately after firing, the pod snaps back into the airplane to restore its streamlined surface for near-sonic flight. It holds 24 rockets, each roughly equivalent to a 75-mm. artillery shell and traveling to the target at about 2000 miles per hour. A Sabre Jet fully loaded with rockets streaked to a world's speed record of 698.5 miles per hour last November.

Iraq-to-Paris Pipe Line To Carry Natural Gas

Proposed by an American firm, a pipe line connecting Iraq and Paris would transport natural gas a distance of 1800 miles. Intermediate cities served would include Ankara, Istanbul and Trieste. Compressors in 15 stations distributed along two parallel lines would push through 1,000,000,000 cubic feet of gas daily. The line, which would cost around \$775,000,000, would make natural gas the cheapest fuel in the Paris area, it is said. An alternate longer line would originate in Saudi Arabia, cross northern Africa to Morocco and veer northward to Paris by way of Spain.

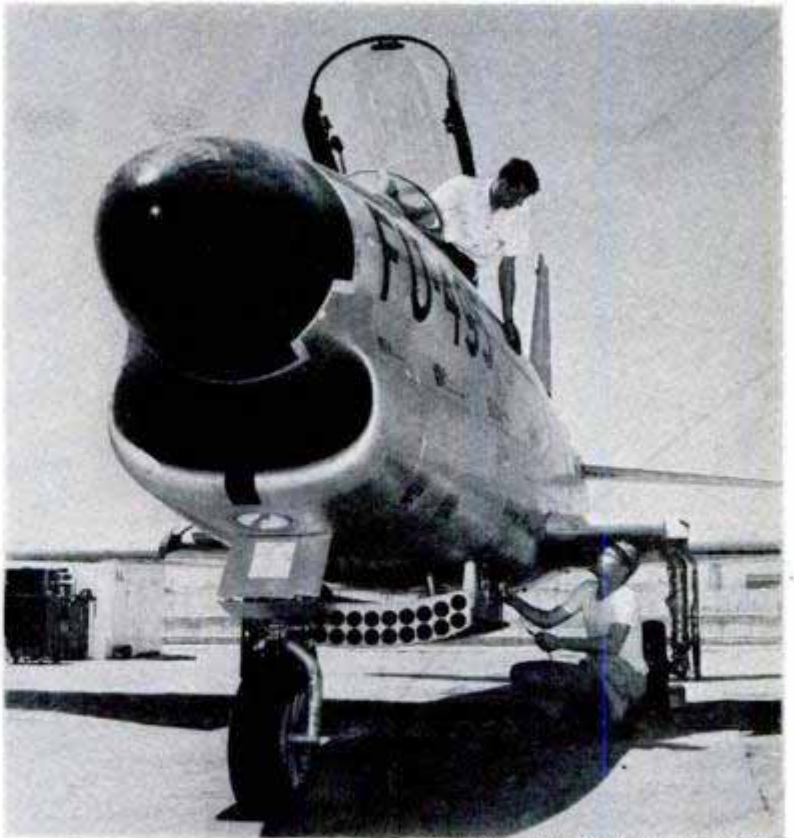

North American Aviation, Inc., photo

Ceramic Brakes for Aircraft

Fired clay is the main ingredient of a brake lining which withstands the terrific heat caused by the sudden stop of a jet plane or transport. The lining meets the need for a brake which could stop 17 tons of plane in 20 seconds from a ground speed of 135 miles per hour.

Edger-Trimmer Attachment Driven by Electric Drill

By chucking a new attachment into any 1/4-inch electric drill, the homeowner forms a power-operated lawn edger and hedge trimmer. The whirling blade cuts grass close along the edges of sidewalks, walls and fences. A long handle takes the stoop out of lawn work and can be quickly removed when the tool is used as a trimmer.

The Drag Strip

Ever heard the phrase? A drag strip is an isolated stretch of pavement where heavy-footed hot-rod drivers can race from dawn to dusk—safely, legally and with a big audience. There are more than 30 such strips scattered across the country, roaring proof that street racing can be taken off the street. Supersouped-up stock cars, motorcycles, homemade cars—anything on wheels—zoom down the strips at speeds up to 130 miles per hour in a race against the clock. In the July issue, "Lightning Hits the Drag Strip" tells the story of these unique straightaways and how they contribute to highway safety.

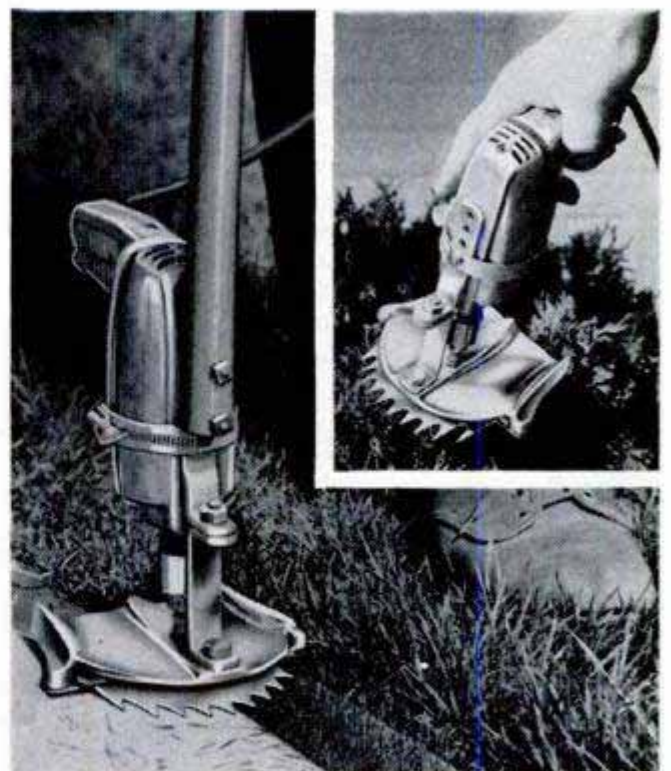

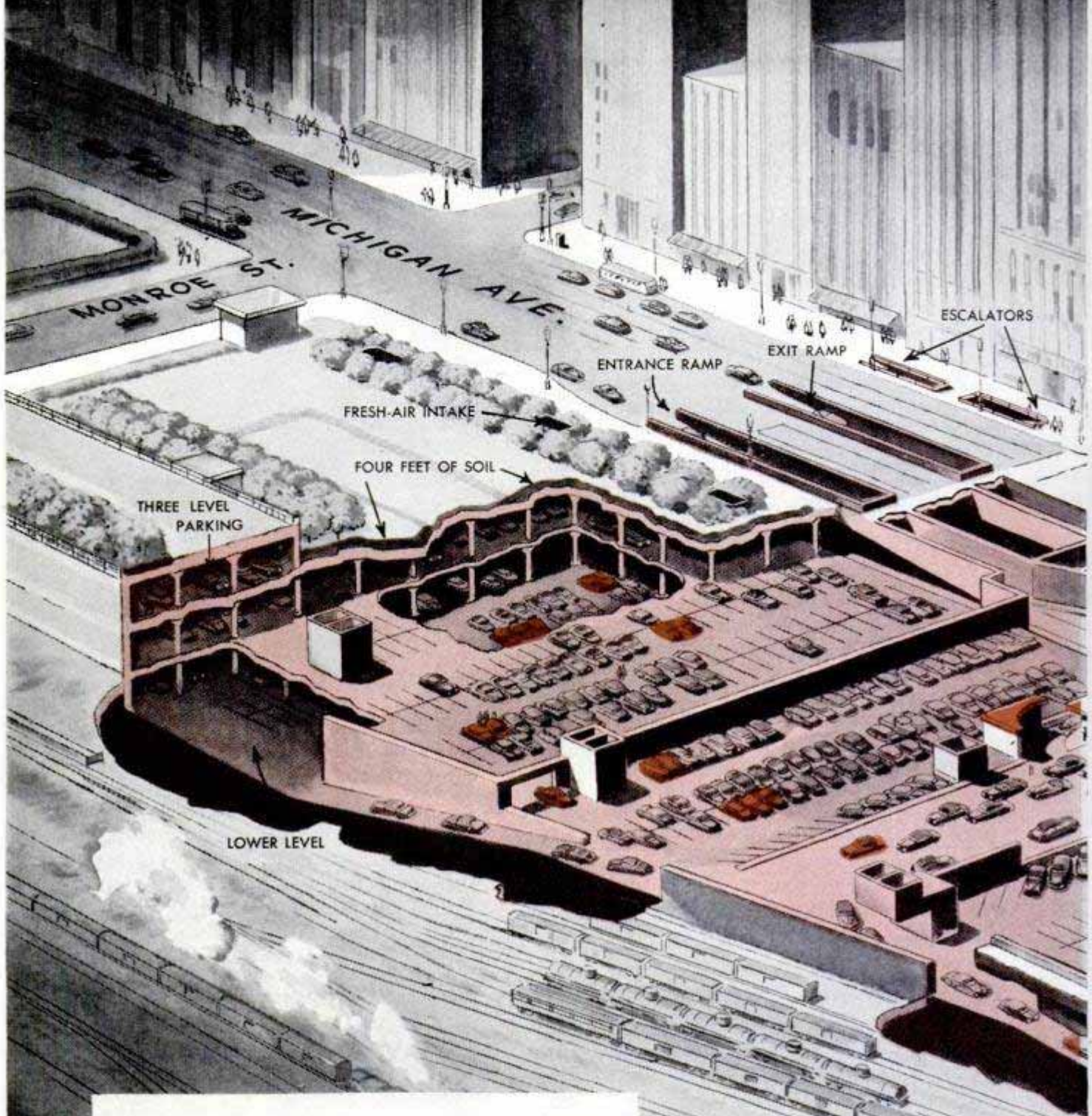

Using computers, totalizers and an intercommunication system, a master traffic controller will speed movement underground by routing cars directly to empty areas and by providing emergency handling for breakdowns and accidents. As a safety precaution, the area at the base of the ramps will be lighted to an intensity which will minimize contrast with outside daylight. Green and red lights will readily indicate which stalls are occupied or unoccupied. Escalator stairs will carry patrons to and from the street level. Walls and doors will divide the garage's 873,000 square feet into fire-resistant areas adequate for two-hour protection, according to Ralph H. Burke, Inc., consulting engineers. It will be ventilated by mechanical means, providing for a full change of air every four minutes

Chicago Builds a Three-Story Underground Garage

THREE BLOCKS of Chicago's lake-front park and a like section of its most heavily traveled street are temporarily uprooted as the city digs its first underground garage. The three-level subterranean building will accommodate 2359 automobiles. Cars using it will stream directly into and from traffic on Michigan Avenue over four ramps kept snow and ice-free by radiant-heating panels. After parking tests by nonprofessional drivers, the storage bays were built 27 feet wide for three cars and the aisles made 22 feet wide. After completion of the garage next year, Michigan Avenue and Grant Park will be restored approximately four feet above the roof of its upper level. ★ ★ ★

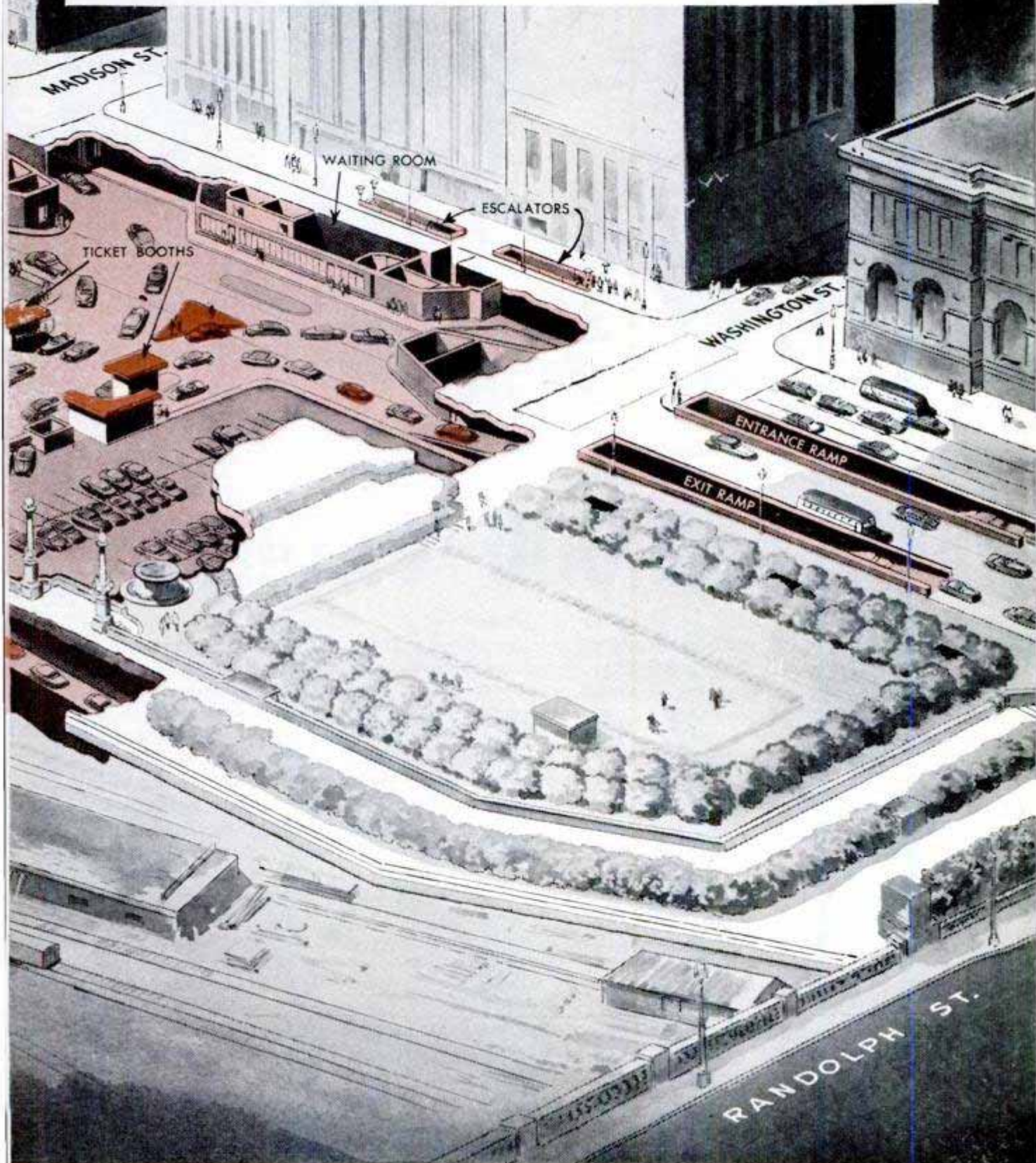

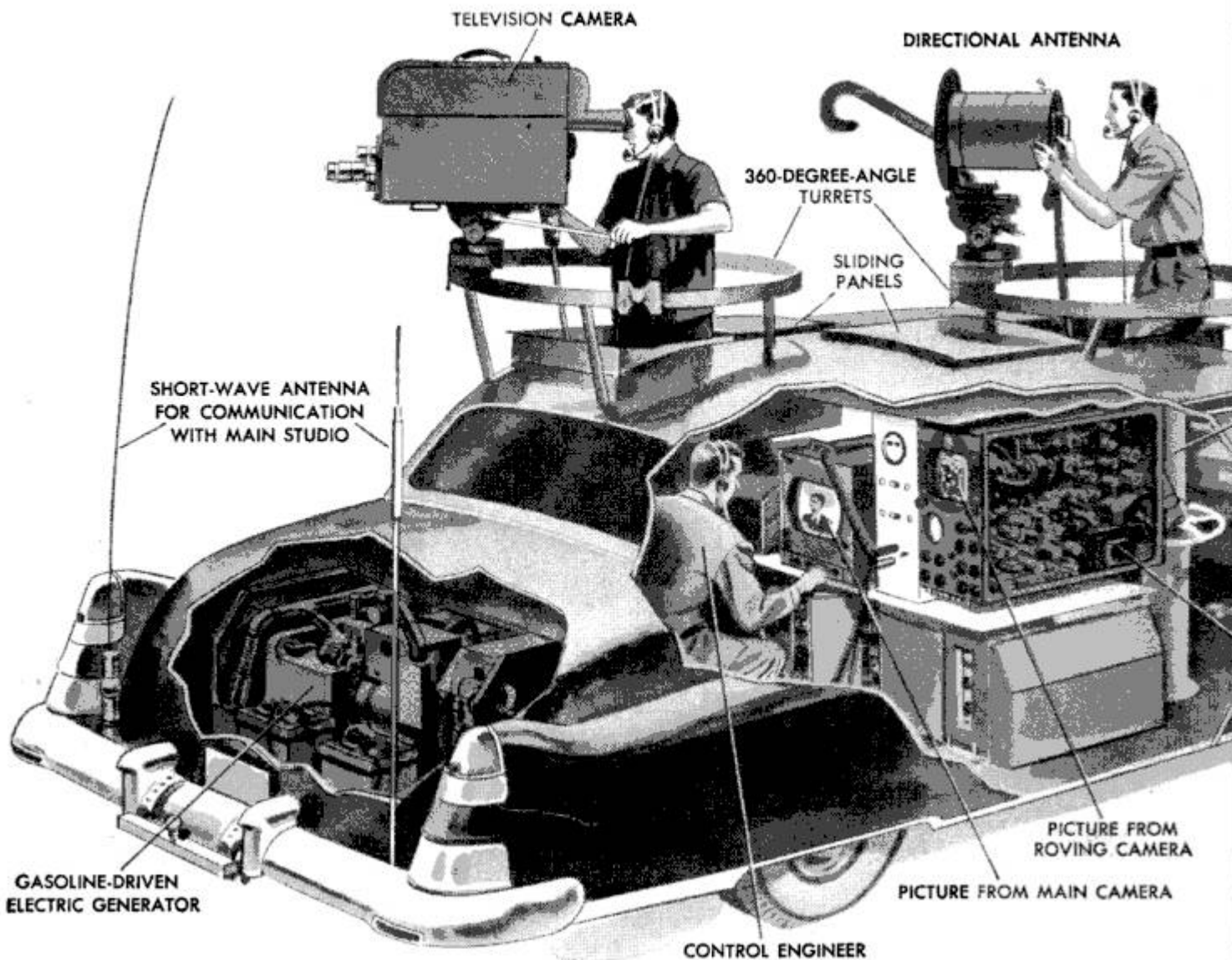

NBC's \$62,000 CADILLAC

BOOOOOM! An ugly rumble thunders through the canyons of New York City. Fifteen miles away, across the Hudson River, a huge ball of dirty black smoke billows upward over New Jersey's industrial valley. Something big has exploded!

Within minutes, sirens wail as fire and rescue apparatus, along with speeding press and radio cars, head for the river tunnels to converge on the disaster area. Most of this rocketing horde is familiar. But, within the past few weeks, a brand-new mystery car has joined the pack. It's a sleek, black Cadillac limousine with blacked-out rear windows. It weaves through traffic with the supple ease of a frightened deer. From a pair of low hatches in its roof, the heads and torsos of two men jut through steel rings of standard Army tank machine-gun turrets. But they handle no guns. One circular track supports a television camera mounted on rollers that permit it to sweep in a full 360°. On the

other sits a big, barrel-shaped antenna whose "question mark" can be aimed in any direction to maintain continuous line-of-sight contact with a studio antenna atop a skyscraper. Packed in the limousine's trunk, a generator whirs up the electric power to run its ton of special electronic equipment. Behind blacked-out windows, video and audio engineers control what its designers claim as the most compact monitoring studio ever devised. A sardine couldn't gain space in this gleaming vehicle.

The mystery car is NBC's self-contained mobile studio, packed in the narrow confines of a standard production-line automobile. On the way to a disaster like that hypothetical explosion, it may telecast on the run. Once there, it can be set up in stationary position and bounce a signal for 20 miles to the home station for relay.

Along with other new developments—including a midget eight-pound TV camera a little larger than a box-type Brownie, and

a special "industrial monkey" that can lift a cameraman and his complete outfit here and there over a scene like a Lilliputian in the hand of a Gulliver—the unit is designed to carry TV's roving eye into tight places where massive vans and tons of equipment could never go.

"Television," says C. H. Colledge, NBC's Director of Engineering Operations who

They require the use of a big trailer generator—or else there's a hunt for power and permission to string cable.

To illustrate, Colledge recalls the time a big airliner coming into Washington's National Airport undershot its approach and wound up in the water. "The big unit we had then," he says, "couldn't squeeze through a narrow place in the road that led to the water's edge. We couldn't drive it off the road because the monster would have bogged down in mud. We had to park, string yards of cable, rig up a temperamental trailer generator, set up our massive 100-pound cameras and then try to shoot over the heads of the crowd as victims were brought ashore. We got some swell shots of Homburg hats and backs of bald heads. With the Cadillac, we could have rolled right up to the edge of the water. The cameraman on the roof turret could have shot right down on the people coming ashore and you'd have been able to see the expressions on their faces."

Colledge can cite dozens of similar frustrating assignments, like the time his crew spent an hour power hunting and cable laying before they could televise the scene of the train that crashed through Union Station in Washington. "In spite of it, we were on the air an hour and seven minutes after it happened," he recalls. "But with the limousine studio, we could have wheeled right up to the station, hooked up the hand camera, and sent a man inside the station with it. We'd have been telecasting ten minutes after the crash."

Last winter, Colledge and a group of

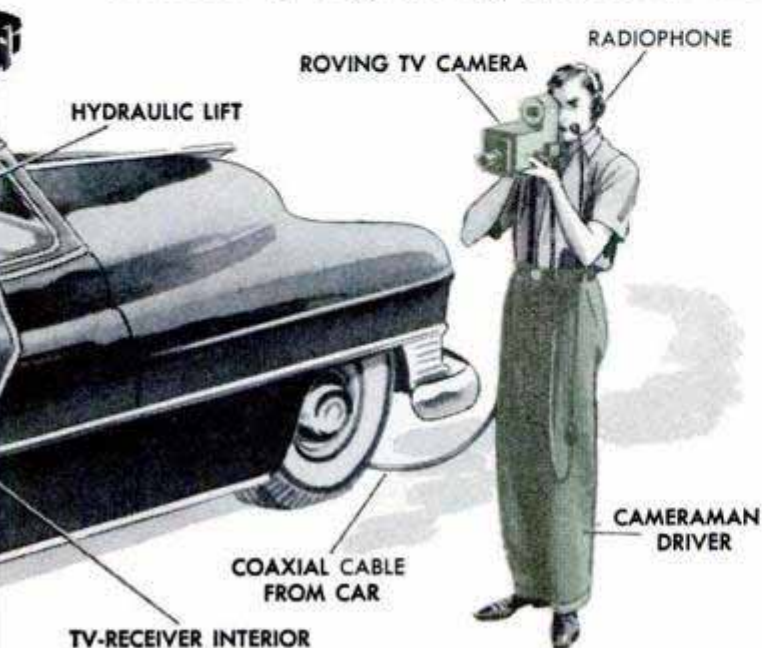

Mobile unit set up for action, with roving camera in use. Antenna is aimed at relay on near-by building

conceived the idea for the limousine studio, "should be as mobile as newsreels." Most mobile units are as big as moving vans. They're paralyzed in traffic. They can't get down narrow alleys or crooked streets. They bog down on muddy roads and fields.

Camera and directional antenna are mounted in tank-type turrets, revolving in full circle on top of Cadillac

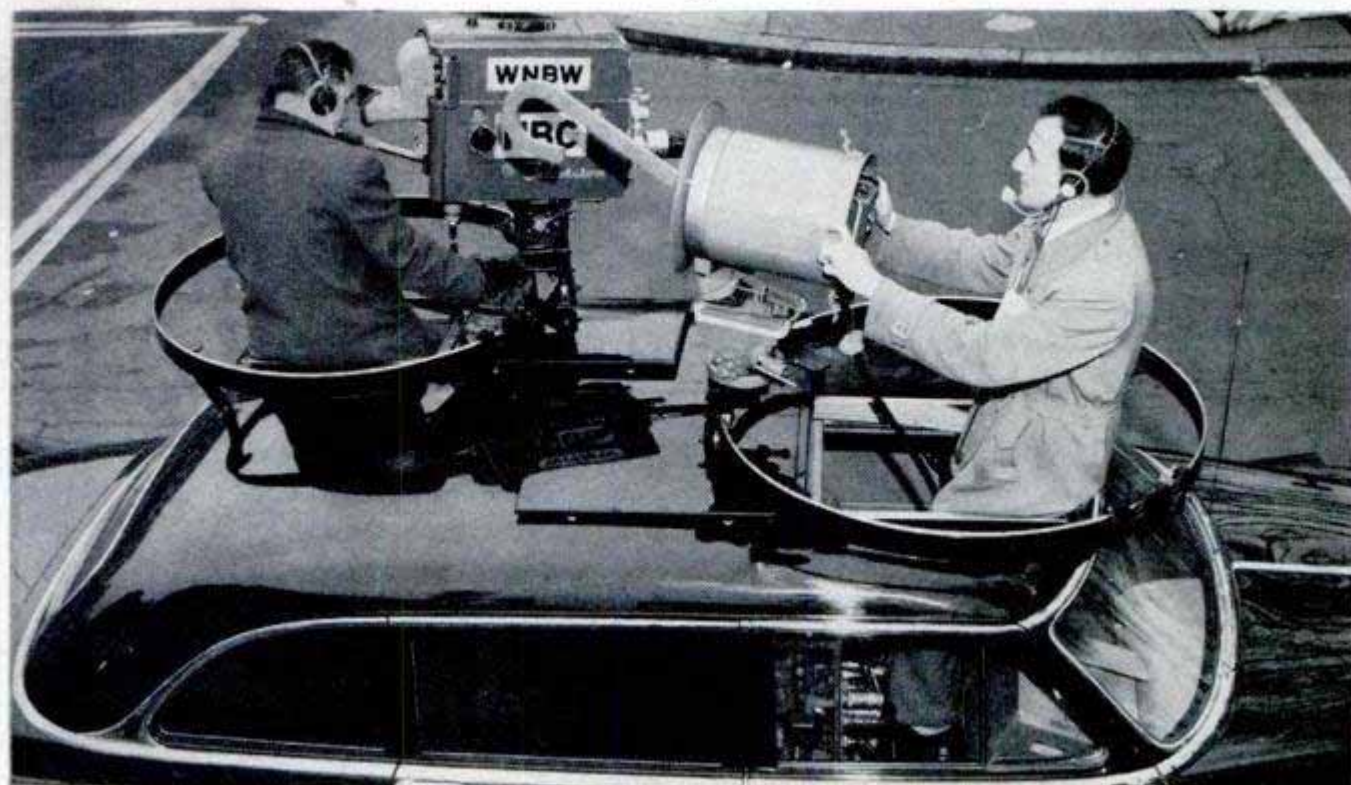

General Motors engineers had put their heads together. A standard seven-passenger car was pulled off the line. Its insides were ripped out. Two months and \$62,000 later, TV's wandering midget studio was a reality—just in time to make its debut covering the inauguration of President Eisenhower last January.

Manned by four engineers and a commentator, huddled around nearly one ton of incredibly compact telecasting equipment, the unit slithered in and out among elephants, tanks, cowboys, diplomats and blaring bands of the 10-mile inaugural parade—passing along everything it saw to TV watchers from coast to coast.

There couldn't have been a better opportunity to test the vehicle—which the men had dubbed "the traveling eye." Cameraman and antenna engineer shoved back the sliding panels that covered the turret holes like hatches on a small boat.

(Continued to page 262)



The "industrial monkey," consisting of hydraulically operated boom, swivel-mounted on a truck bed, gives the modern TV cameraman a sky hook. Above, cameraman rides in a bucket. Right, he stands on platform. With a touch of a toe button, he can soar upward 40 feet or extend himself in any position above truck

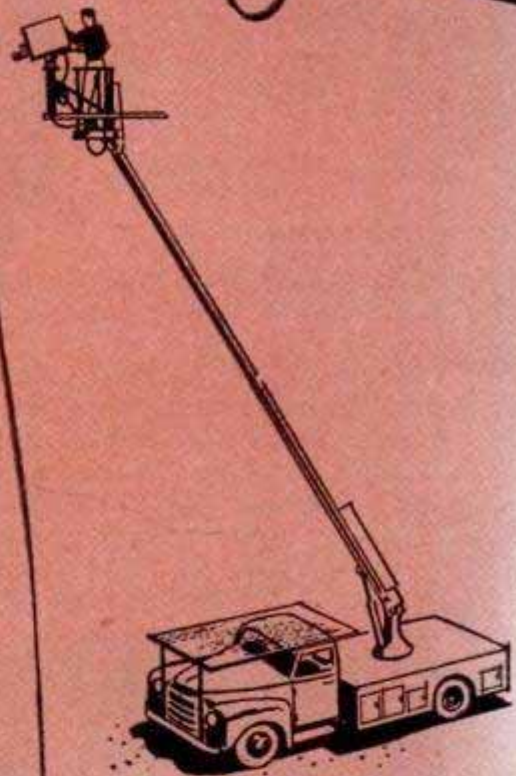
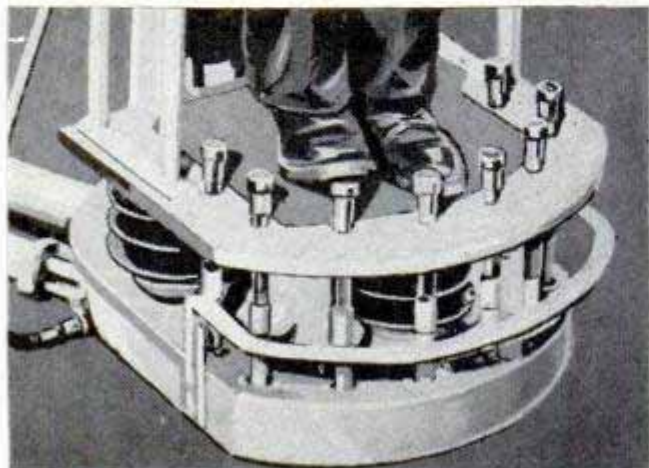

Miniature Television Camera Connects Directly to Receiver

Industrial television has received a large shot in the arm with the introduction of a miniature TV camera which connects directly to a standard TV receiver. All associated power, synchronizing, monitoring and output equipment, plus the camera itself, is housed in a unit no more bulky than a portable typewriter. A coaxial cable from the camera unit connects to the TV receiver, which is plugged into a wall outlet. Pictures are received in any one of the 12 standard TV channels. It will reportedly feed multiple TV receivers with excellent pictures at distances up to 2000 feet. Simple to operate, the portable unit eliminates the bulky and expensive auxiliary equipment which took hours to install and required operation by



trained technicians. Both RCA and DuMont have announced production of similar miniature units.

Sponge-Rubber Sanding Pad Speeds Boat Finishing



Mounted on the shaft of a portable workshop drill, a disk with a sponge-rubber face forms the backing for various grades of sandpaper. Made especially for boat finishing, it conforms to every curve of hull, spars, deck and cabin top, sands down old paint, cuts down protruding seam compound and sands between coats when new paint is applied. Because it does not cut into the wood around the edges, it permits smooth and rapid work by the amateur craftsman. Two types of disks are available, one of soft and one of firm rubber. The sandpaper is held in place with adhesive.

Electrostatic Ignition Won't Burn Spark Plugs

Fouled spark plugs and shorts caused by moisture and grease won't bother motorists anymore, according to the inventor of an electrostatic ignition system. Combining the best features of battery ignition and magneto ignition, the system produces the same high-voltage, low-amperage spark at all engine speeds. Because high amperage burns spark-plug electrodes, the low-amperage system should mean spark plugs that last the life of the engine. No current is drawn from the battery and that makes quicker starts in extremely cold weather. There is no shock hazard in handling the high-voltage wires because of their low amperage. The system was brought to the United States from France where the generator, which is mounted beneath the distributor and is the heart of the system, was invented.

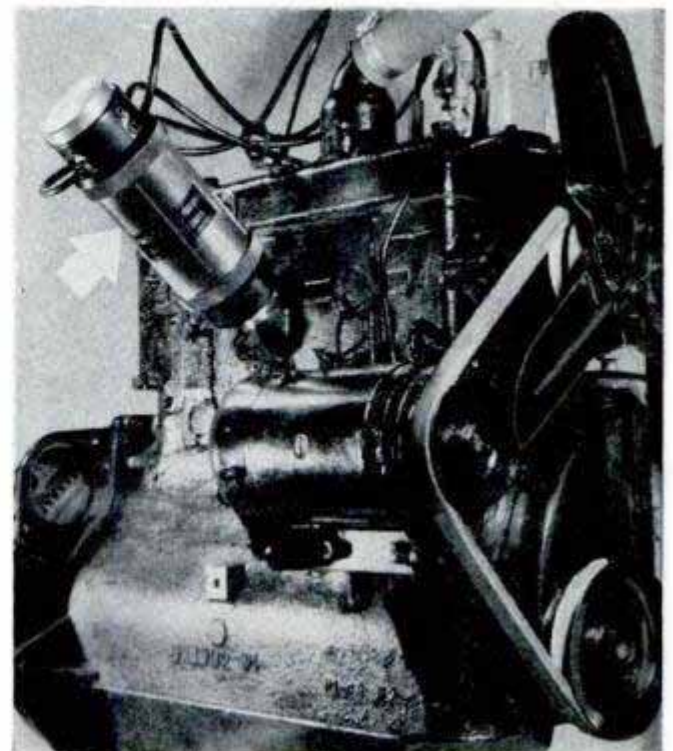

ROBOTS SORT

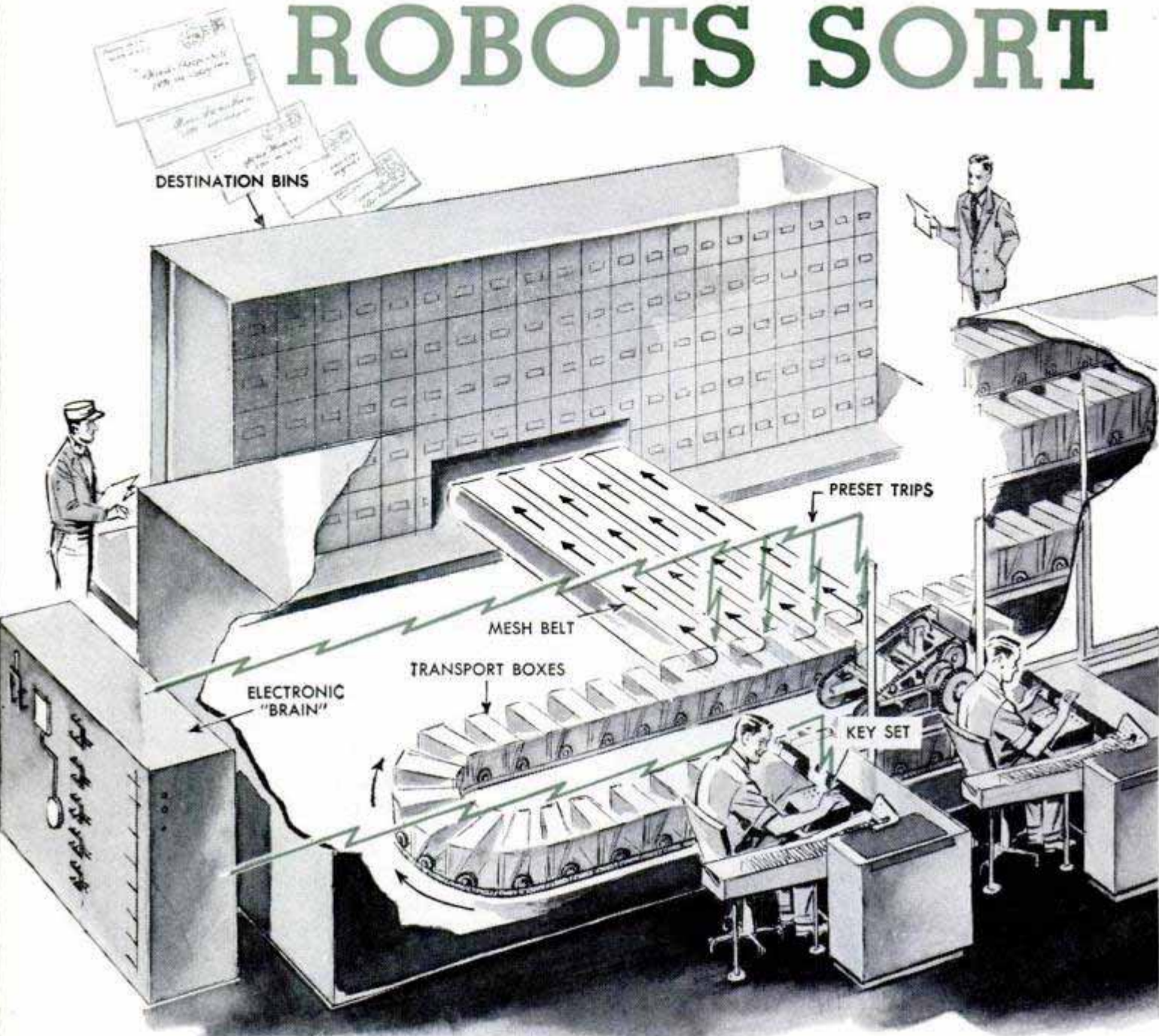

Letters on ramp feed into conveyor which carries them in front of operator, who taps out destination code

Pneumatic tube darts out of hole in perforated plate, grabs a single letter and drops it into conveyor

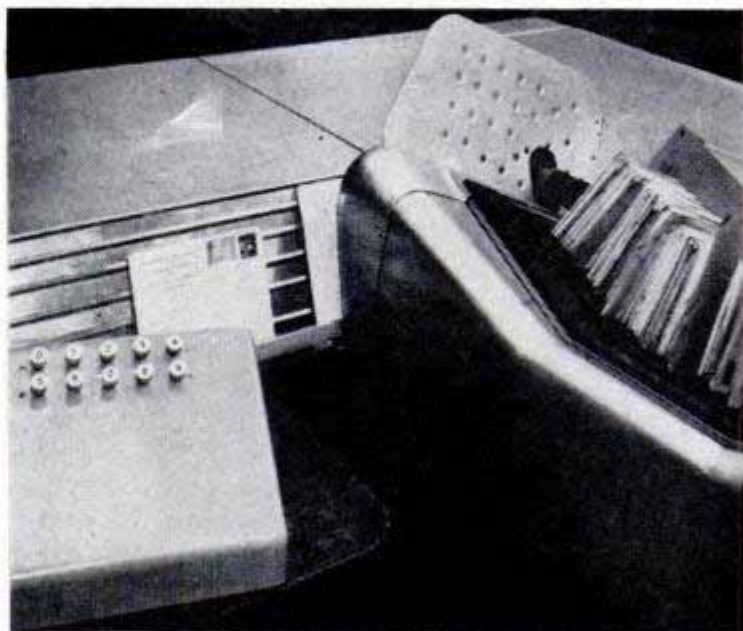
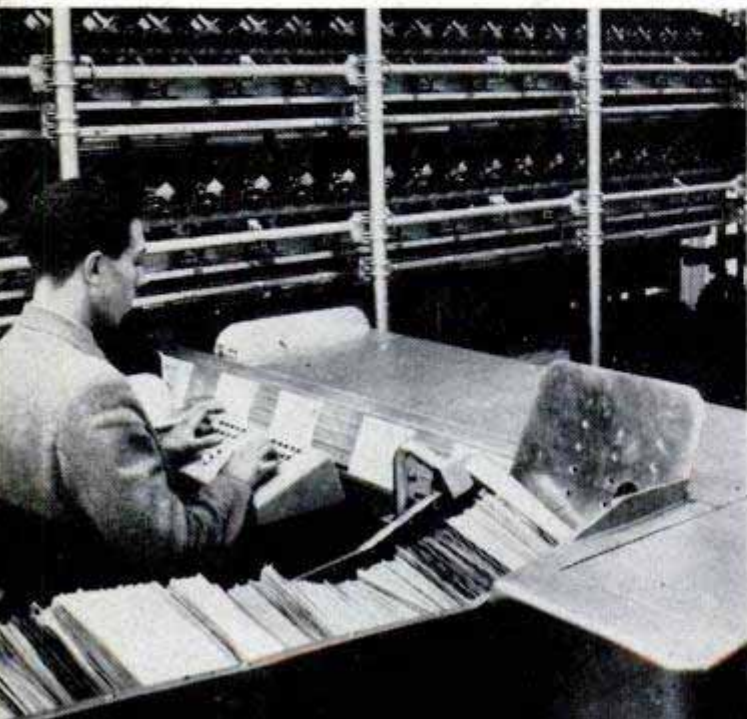

THE MAIL

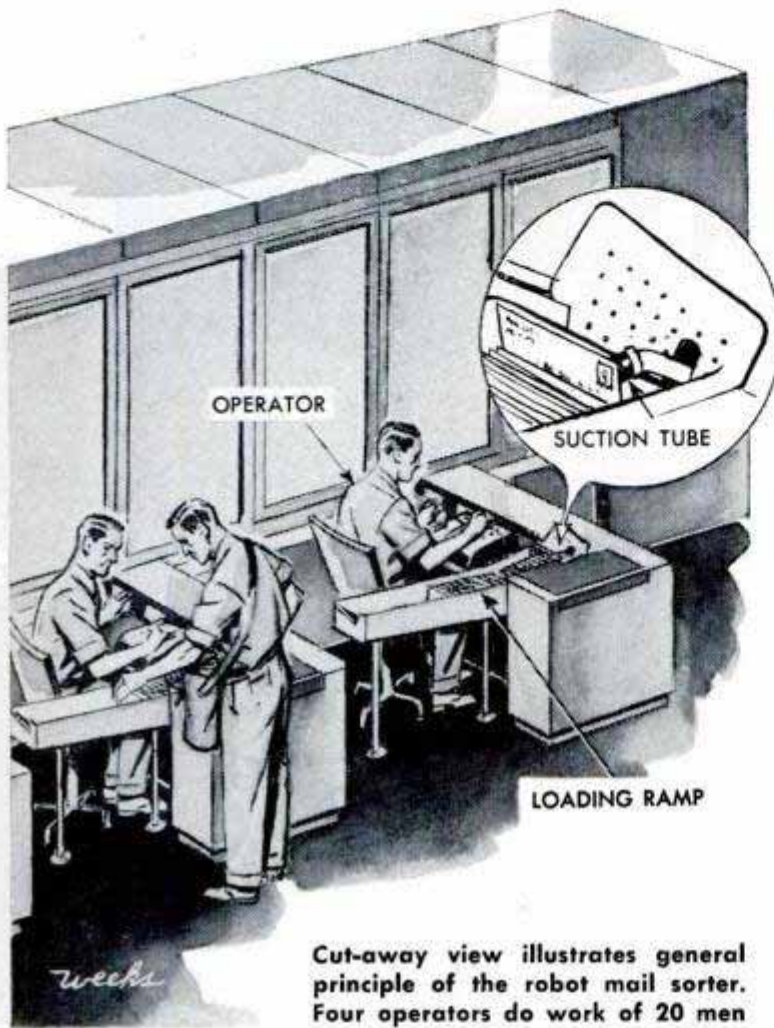

Cut-away view illustrates general principle of the robot mail sorter. Four operators do work of 20 men

ELMINATING human bottlenecks in mail-sorting work, an electromechanical machine in the Antwerp and Brussels, Belgium, post offices allows four operators to distribute up to 16,800 letters

per hour among 300 different boxes. Three-foot stacks of mail placed beside each seated operator feed down a ramp to a suction tube which pops out, grabs a letter and drops it into a groove that runs across in front of the operator. Tiny hooks moving along the groove catch the bottom corner of the letter and push it in front of the operator, stopping long enough for him to read the address and punch out a destination code number for that address on the small key set in front of him.

Snaking through the frame of the huge machine beside the operator is a continuously moving endless chain of 626 transport boxes, spaced six inches apart, which are carried past the operator on silent rubber rollers. The letter drops into its individual box and is carried through the machine until it reaches the spot where a metallic mesh belt will carry it to its proper destination box. There, the electronic code tapped out by the operator and relayed through rotary switches in near-by bays has preset a tripping device which opens the box and allows it to dump the letter. When the destination box is filled with letters, it rings an alarm which summons an attendant to empty it. The machine was developed by the Bell Telephone Manufacturing Company in Antwerp, an affiliate of International Telephone and Telegraph. ★ ★ ★

After leaving operator, letter drops into trough mechanism which feeds it to proper transport box

Sorted into 300 different categories, mail is removed from destination bins and sent out for delivery

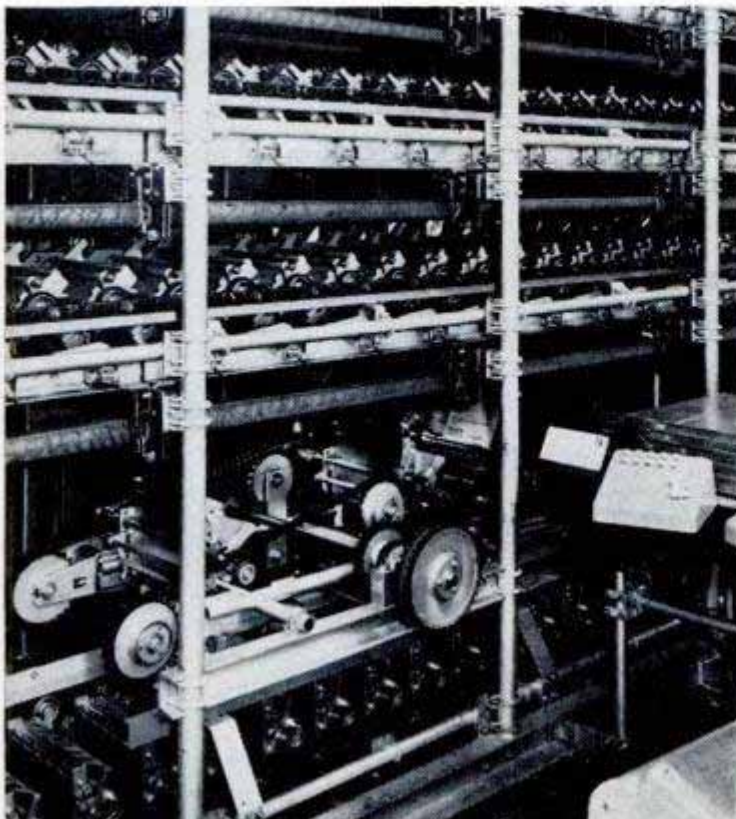



Sports car, left, is patterned after racer beside it. Fenders, lights and other refinements dress car up

Sports Car Evolves From Indianapolis Racer

SPORTS-CAR ENTHUSIASTS now can own a competition car patterned after the record-breaking racer in which Billy Vukovich led the pack for 375 miles in the 1952 Indianapolis Race. Potential speed of the car, built by Kurtis-Kraft, a famous name in racing circles, has been estimated at 120 to 165 miles per hour, depending upon the engine used. Models are now being built to order with any of the following engines: Cadillac, Chrysler, DeSoto, Dodge, Hudson, Lincoln or Mercury. The chassis of the new car is similar to that of its racing prototype, but the body has been refined for passenger use. Lights, bumpers, fenders and doors have been added. The aluminum body is mounted on a two-inch-tubing frame. Suspension is transverse torsion

bars front and rear. Magnesium wheels and brakes with air scoops for cooling are used. The frame tubing has been perforated throughout to reduce weight without sacrificing strength. Being custom-made, the car can be ordered in a variety of dimensions. The wheelbases available range from 92 to 100 inches. Tread is 54 to 58 inches. Weight of the sports model is also variable, depending upon size and engine selected. It will be approximately 1900 pounds. Height of the car at the cowl is only 36 inches. In addition to this open-cockpit model, Frank Kurtis, car designer, plans to produce a closed-coupe model. If you like to work on cars, Kurtis will deliver the sports car in kit form and you can put it together yourself.

Left, scoops cool front brakes. Right, engine is mounted well behind wheels for good weight distribution

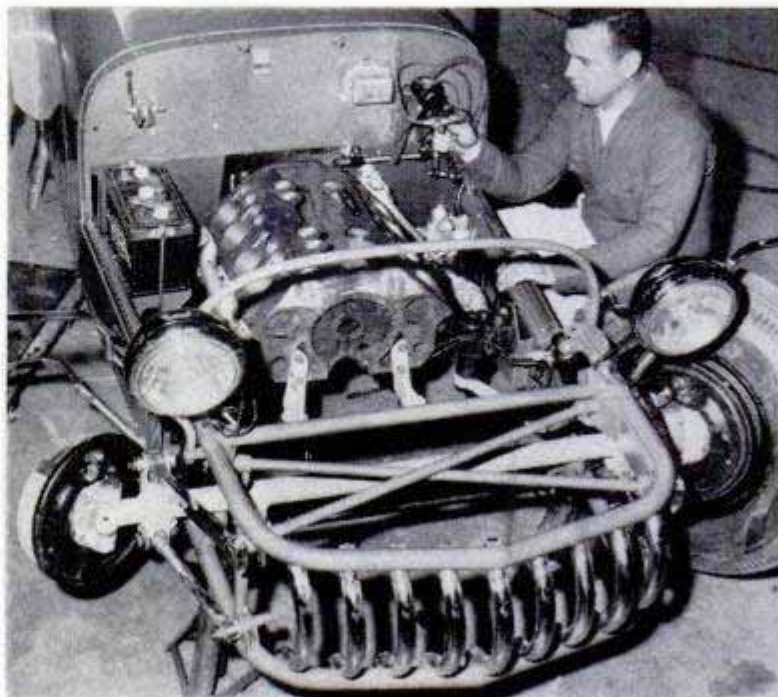



Detroit Listening Post

By Siler Freeman

COMING DOWN the stretch in the first half of one of the highest production years in the industry's history, the manufacturers are turning their eyes toward the new models. But that doesn't mean next year's. It is the 1955 line on which the industry's attention is now fixed.

Easing of the machine-tool situation has made it possible to get needed large tools for carrying out V8-engine plans. Most of the companies which have not yet gone into this program are looking to complete it in time for the 1955 models.

Among them prominently is Chevrolet. Now and then the report gets around that Chevrolet will change to the more compact and more powerful V8 for 1954. That is absolutely not so and you have the word of Thomas H. Keating, general manager of the division, for it.

But what you will have, and soon, is Chevrolet's newest model, the two-seater sports car, the Corvette. The first plastic body is to be delivered to Chevrolet in June. It is expected to have a terrific impact not only on the Chevrolet future, but on that of the whole industry.

Chevrolet has sort of caught its competitors napping with the Corvette. It is well known throughout the industry that everyone watches the other fellow in his price class and tries to keep abreast of what is going on in the other shop. But under the smoke screen of the V8 program, Chevrolet was able to go ahead with its sports-car preliminaries without its rivals waking up to it until it was too late.

If Chevrolet gets the Corvette out in June, it will be something of a triumph for General Motors' technical and procurement genius, because the new car will come out without gumming up the works on preparations for 1954 models. It will be a "plus" model which, if it goes over as expected, will be followed by a much larger schedule for next year. If it fizzles, it can be dropped without too much cost. It must be remembered that Chevrolet once spent \$17,000,000 on a light car which never saw the light of day. The Corvette, were it dropped tomorrow, would represent only a fraction of this cost.

Kaiser-Frazer is due with its plastic car next month. It will be a near-miracle if it accomplishes this schedule. Chevrolet has taken away one of its best plastic sources.

The power-steering movement is spreading all through the industry. It will be even more prevalent in the next models.

First sign of a trend toward the merchandising of power steering as a garage-installed accessory (as opposed to present factory installation) came from the Monroe Auto Equipment Co. Its hydraulic power unit replaces the draglink in the steering linkage. It is a direct-acting type with fewer parts than previous units—and it will probably sell for much less than present units. If it works out, you will be able to drive into a garage with your car (new or old) and have them install power steering.

Chrysler is getting set to produce its own unit. Present power-steering equipment in Chrysler cars is Gemmer-built. It provides full-time power steering as opposed to the General Motors' system that requires the driver to exert the first four pounds of effort himself. Unconfirmed rumor has it that the new Chrysler-built unit may abandon the full-time steering and move toward the General Motors type. If so (and this is strictly rumor), it will be a complete switchover for Chrysler which has been describing the General Motors system as "parking only" power steering.

The pricing situation should clear itself in the near future. If there is any tendency for other makers to drop prices following the lead of Chrysler Corporation, it will be after July 1. That is when the pinch is expected to show in new-car sales.

Used cars hold the key to maintaining high-production rates in the industry. They have not moved the way they should this season. Dealers may ask factories to restore the old-time devices (like "junk" bonuses) for speeding prewar cars to the scrap pile. This is a way of getting rid of a lot of cars still in use. The factory gives the dealer a bonus for each car he scraps instead of resells. It was used in the '30s to stimulate sales and may come again if production stays up at record levels.

WHAT'S NEW FOR Your Home

Four pages of household innovations

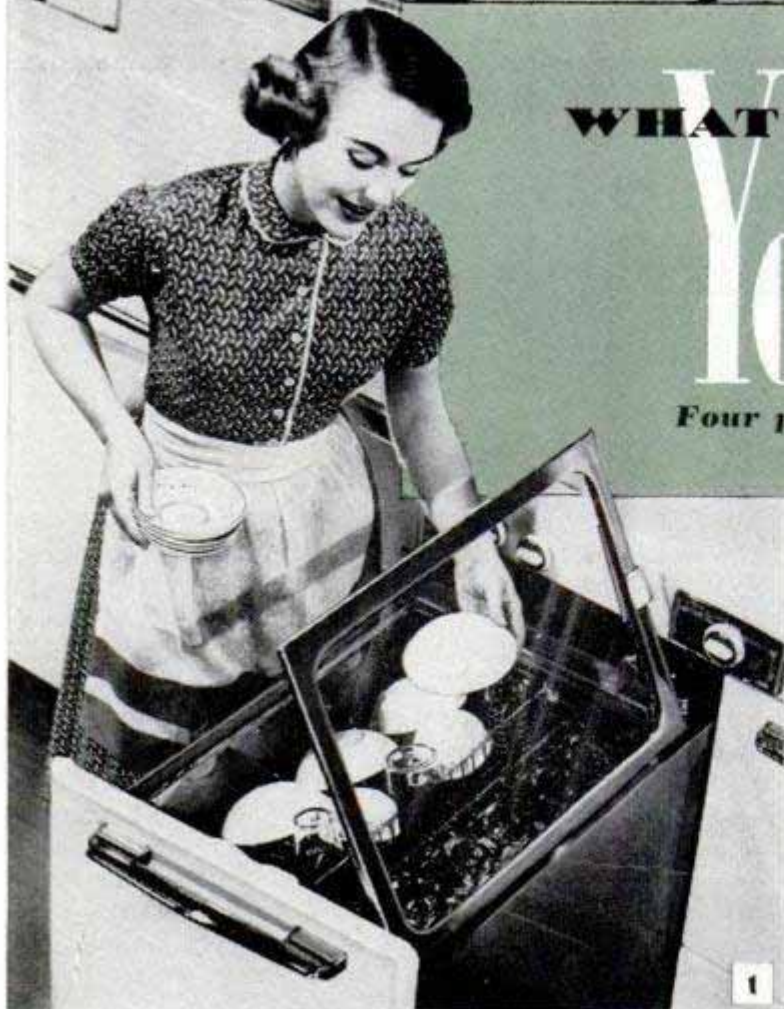

1. COMPACT DISHWASHER built into gas range saves space in small kitchens. Hidden inside stove most of the time, it automatically washes dishes in extended or inserted position, can be wheeled away from the stove for use anywhere within reach of an electrical outlet and faucet

2. TUMBLER HOLDER mounts on underside of cupboard shelf, holds eight glasses of various sizes in compact, out-of-the-way arrangement, pulls out when glasses are to be stored or removed. Strong rubber-coated clamps hold glasses separately and securely, prevent chipping and scratching

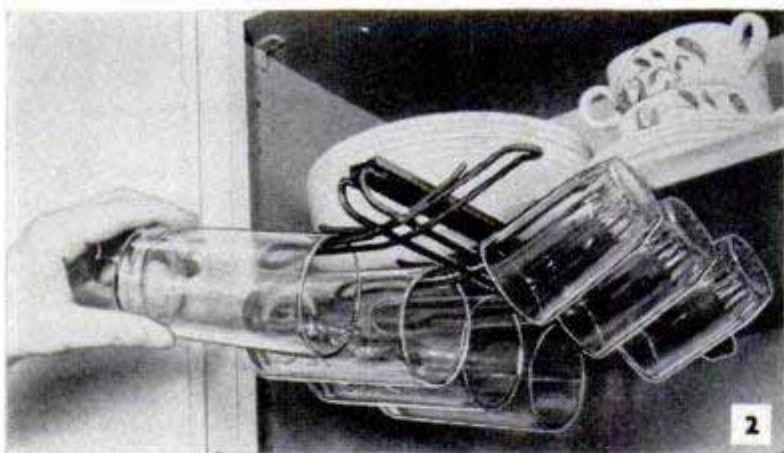

3. AEROSOL DUST CATCHER is sprayed on dust mop or cloth from pressurized can, picks up dust "like a magnet," converts it into heavy lint which shakes off easily and neatly into newspaper or wastebasket — without dust scattering. Dust mop needs to be treated only once every 10 days or so

4. PORTABLE UNIT small as a hassock humidifies air in winter, dehumidifies it in the summer, plugs into any standard electric outlet. Electric heater inside plastic water container evaporates three gallons of water a day. In summer, water is removed from air by condensation coils

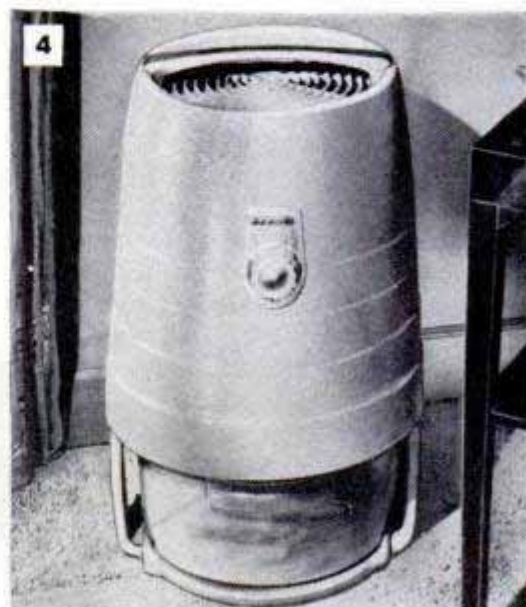

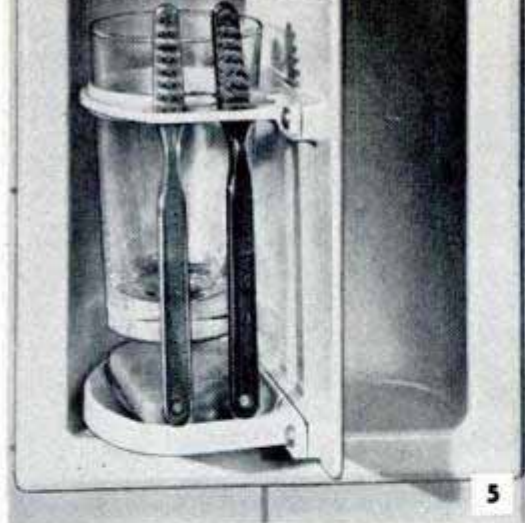

5. DISAPPEARING HOLDER for soap, toothbrushes and drinking glass swivels inside pocket recessed in bathroom wall. Touch of the panel carrying toilet items revolves them out of sight and away from dust, leaving smooth panel flush with wall. Porcelain finish makes for easy cleaning

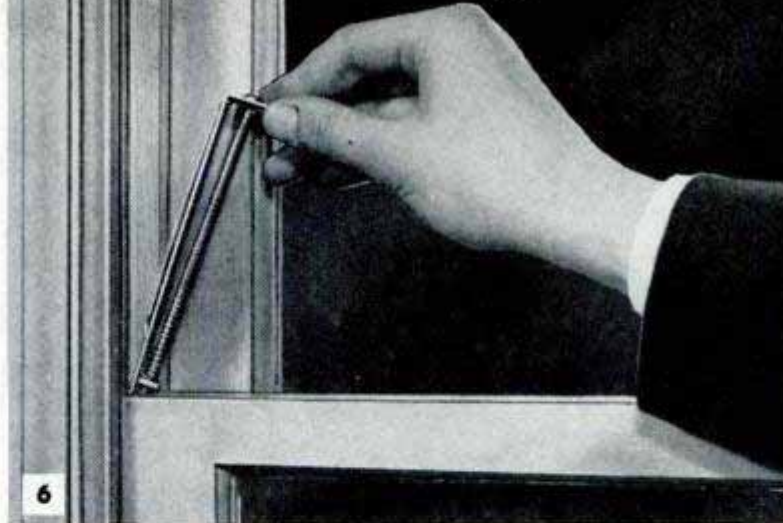

6. SASH HOLDER replaces a broken sash cord and holds window firmly in any vertical position, permits easy sliding and stops all rattle. The fixture slides between sash and jamb and is fastened by two screws without removing window. Flat steel spring presses against window jamb

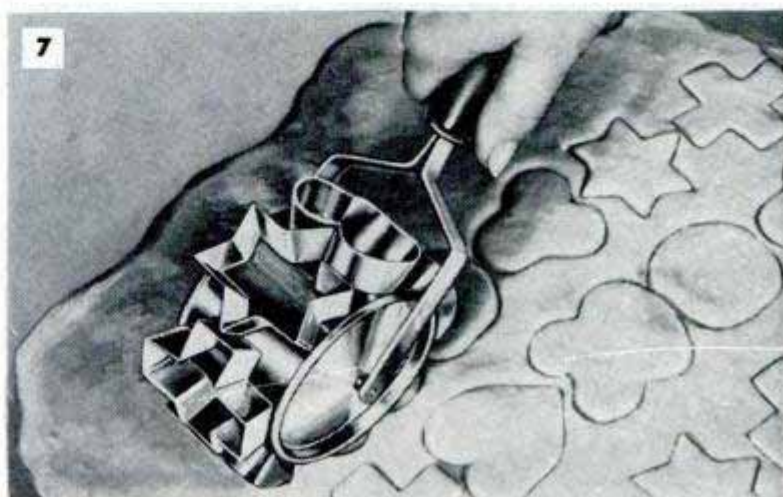

7. COOKIE CUTTER forms six different shapes in a row as it is rolled swiftly over a sheet of dough. Large handle fixed to axle of rotating section allows firm grip and steady pressure. Sharp, sturdy pattern cutters slice through nuts and raisins, are mounted on removable drum

More on pages 112 and 113 →

8. DECORATIVE TABLE hangs on wall when not in use. Framed underside of table top forms a shadow box around iron knick-knack shelf which serves as outside support when table is in down position. Hinged to wall, table is unhooked at top and swings down for use. Iron shelf forms sturdy leg



WHAT'S NEW FOR Your Home

Continued from page 111



9

9. SCRATCHPROOFING PAD carries its own adhesive, is applied by removing the gauze backing, pressing cloth in place and then trimming to fit. The green or brown flannel cloth forms protective surface on bases of lamps, figurines and bookends

10. PLASTIC SCOOP designed for ice cream, cottage cheese and other foods contains a hole in the bottom which is closed like a trap door by the pusher end of an S-shaped lever. Flick of the lever ejects food in neat ball. Lever then springs back

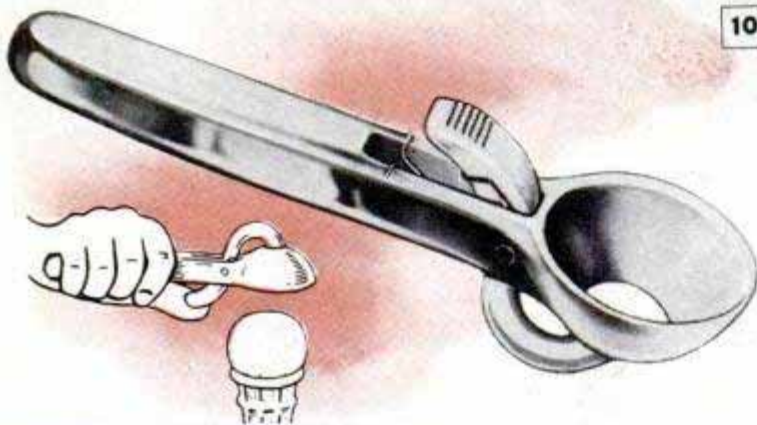

10

11. INDOOR BARBECUE consists of a motor-driven spit which is mounted in a new electric radiant oven. Small turkeys, medium hams and chickens are turned for even broiling. With unit removed, oven is used for broiling or roasting

12. RUBBER TABS placed on underside of picture frame or mirror permit air to circulate freely behind picture, ending wall smudge. Self-adhering foam-rubber tabs are skidproof, keep picture straight at all times, protect wall from scratches



11

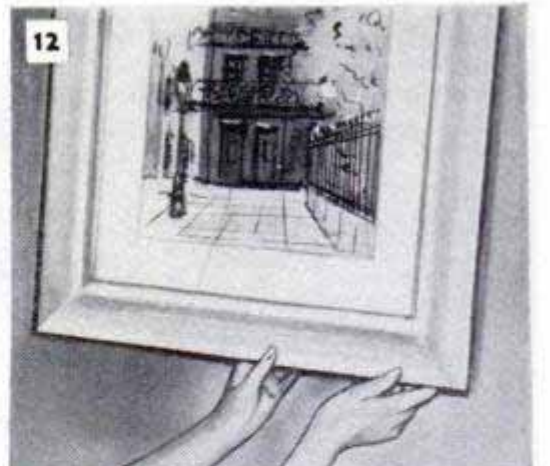

12

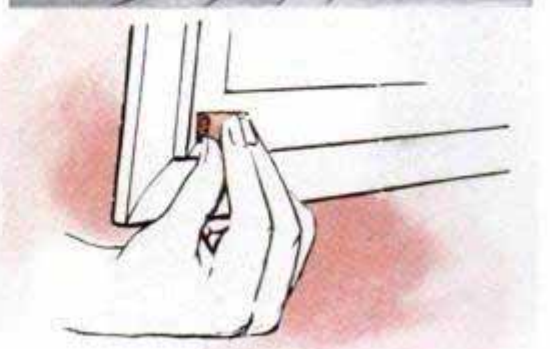

13. TRANSLUCENT AWNING, designed for year-round use, stops heat and glare but permits the passage of soft, diffused light. Its plastic panels, 5½ inches wide in alternating colors of red and green, slide in and out of slots for easy cleaning and replacement. Lightweight and easy to handle, the structure has an aluminum and steel frame and it reportedly can be assembled, bolted and erected in 30 minutes



13

14. BOTTLE OPENER opens any size of jar or bottle and completely reveals crimp tops. Hook on top removes bottle caps. Adjustable gear-locked jaws and nonslip teeth on bottom exert heavy pressure to unscrew lids or seal bottles by recrimping caps. Projection at base of tool is used to jimmy open catchup-bottle caps and may even be used to open paint cans. Made of heavy chrome-plated steel, it resists stains

14

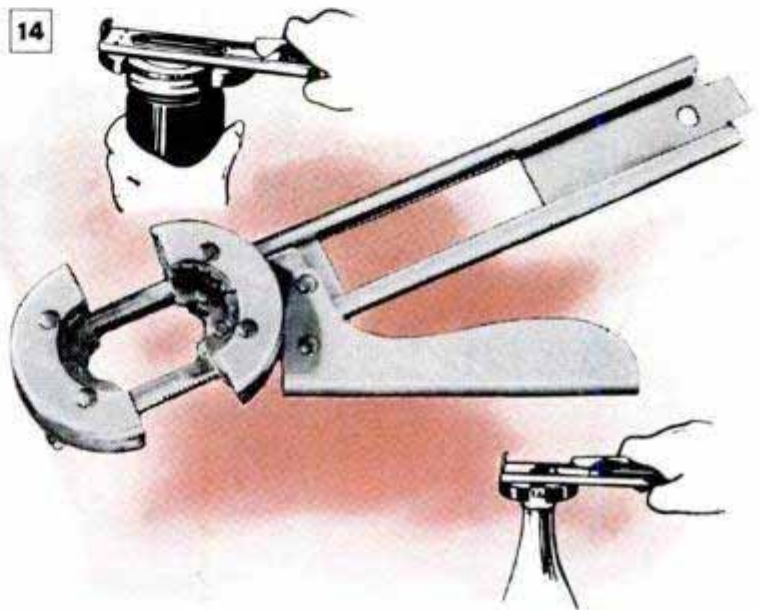

15. PATTERN MARKER eliminates needle, thread and pins, saves professional and home dressmakers' time. Made of plastic, the device is tong-shaped, scissor-handled. Chalked points are placed over perforations in the pattern and light pressure applied to the handles as marker is directed along pattern. Chalked dots appear on both sides of the material regardless of its thickness or thinness, serve as clear cutting guides

16. FREEZING GUIDE tells you how to prepare almost any kind of vegetable or fruit for quick freezing. Tab is moved up or down until arrow points to food you want to prepare, and instructions appear automatically. Complete information on more than 60 fruits and vegetables includes tips on what kinds to buy. The handy index is small enough to be hung up on the wall to provide instant, reliable information

16

FREEZING Slide Guide
GENERAL INSTRUCTIONS

- Use standard measurements in the food recipes, regardless of size quantities for your products.
- Always use standard and the best preparation method available in the product.
- Preparation instructions are for the preparation method in the product or in a group of products.

BEST PREPARATION

PREPARATION	BLANCH	CODE
VEGETABLES		
Asparagus	Yes, 5 minutes	10
Beans (Green)	Yes, 5 minutes	10
Beans (Lima)	Yes, 5 minutes	10
Beets	Yes, 5 minutes	10
Broccoli	Yes, 5 minutes	10
Broom Broccoli	Yes, 5 minutes	10
Cabbage	Yes, 5 minutes	10
Cauliflower	Yes, 5 minutes	10
Corn (Ear)	Yes, 5 minutes	10
Corn (On-the-cob)	Yes, 5 minutes	10
Peas	Yes, 5 minutes	10
Spinach	Yes, 5 minutes	10
Tomatoes	Yes, 5 minutes	10
Winter Squash	Yes, 5 minutes	10
FRUITS		
Apples	Yes, 5 minutes	10
Pears	Yes, 5 minutes	10
Peaches	Yes, 5 minutes	10
Plums	Yes, 5 minutes	10
Raspberries	Yes, 5 minutes	10
Strawberries	Yes, 5 minutes	10
Blueberries	Yes, 5 minutes	10
Blackberries	Yes, 5 minutes	10
Cherries	Yes, 5 minutes	10
Oranges	Yes, 5 minutes	10
Lemons	Yes, 5 minutes	10
Limes	Yes, 5 minutes	10
Guavas	Yes, 5 minutes	10
Pineapples	Yes, 5 minutes	10
Mangoes	Yes, 5 minutes	10
Avocados	Yes, 5 minutes	10
Tomatoes	Yes, 5 minutes	10
Onions	Yes, 5 minutes	10
Garlic	Yes, 5 minutes	10
Herbs	Yes, 5 minutes	10

15





In two minutes the lightweight trailer, right, is converted into a comfortable two-room camp, above

Aluminum Sports Trailer Sleeps Four Persons

It takes only two minutes to open a compact two-wheel trailer into a comfortable tent-trailer combination that sleeps four persons. Weighing less than 1000 pounds, the trailer is only 44 inches high and creates no towing problem even with small cars. The upper rear section of the aluminum

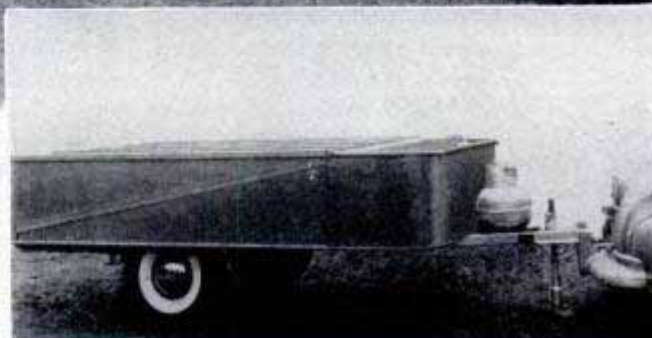

trailer body swings up and over to form an insect and water-proof floor. A duck tent forms the roof and side walls. The trailer comes equipped with twin beds, storage for two extra cots and a two-burner bottled-gas stove with small room heater optional.



Develop Automatic High-Altitude Suit

Full protection for pilots flying above 50,000 feet is provided by a new rubber and Plexiglas suit that has its own automatic oxygen and pressure systems. Developed by the B. F. Goodrich Company for the Navy, it has already been successfully tested at 70,000 feet in a pressure chamber. It offers pilots more mobility than any previous suit of its kind. Even if the plane's oxygen supply is damaged at 100,000 feet or higher, the suit contains enough pressure and oxygen to permit the pilot to fly down to lower altitudes where the atmospheric pressure is high enough for him to survive. The suit takes over automatically in emergencies, pressuring itself and furnishing oxygen without any action on the pilot's part.

☐ The planet Saturn, with its rings and satellites, is 95.33 times as bulky as the earth.



U. S. Army photos
Soldier holding wire with two completed splices. Crimped connector cartridge is shown at the right

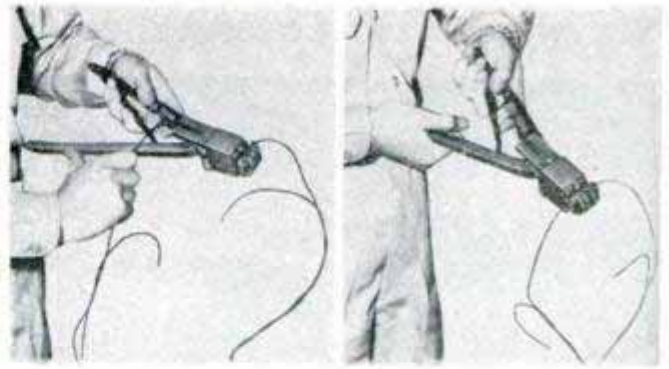

Stripper on handle of tool, left, scrapes ends of wire. Bare wire ends are then put into cartridge and crimped. Below, tool and carrying case



Mechanical Wire Splicer Cuts Exposure to Enemy Fire

Perfect wire splices are made in less than 30 seconds with a lightweight tool developed by the Signal Corps and Aircraft-Marine Products, Inc. It reduces by several precious minutes the time a repairman is exposed to enemy fire. The new tool looks like a long pair of pliers. In place of ordinary jaws, it has a small case which feeds 10 repair cartridges in triggerlike fashion. Instead of scraping off the insulation from both ends of the wire by hand, the repairman puts the broken ends of the wire in a stripper attached to the handle and

squeezes. Then he feeds the bare wires into each end of a connector cartridge in the jaws of the tool and squeezes again to complete the splice. Both ends of the cartridge and its center are crimped together, making a perfect insulation and waterproofed joining. The hand-repair method takes a trained man three to four minutes under perfect conditions.

Postman Gets a Lift With Experimental Three-Wheel Motorcycle

United States postal authorities are conducting tests on a variety of small vehicles for the use of postmen. Among the models being tested is a three-wheel motorcycle with an enclosed rear compartment. In all, 25 different models are in the experiment, ranging from caddy-type carts such as are used on golf courses to light trucks.

Ⓢ Applied hot, a long-wearing plastic stripe may replace paint in the marking of traffic lanes.

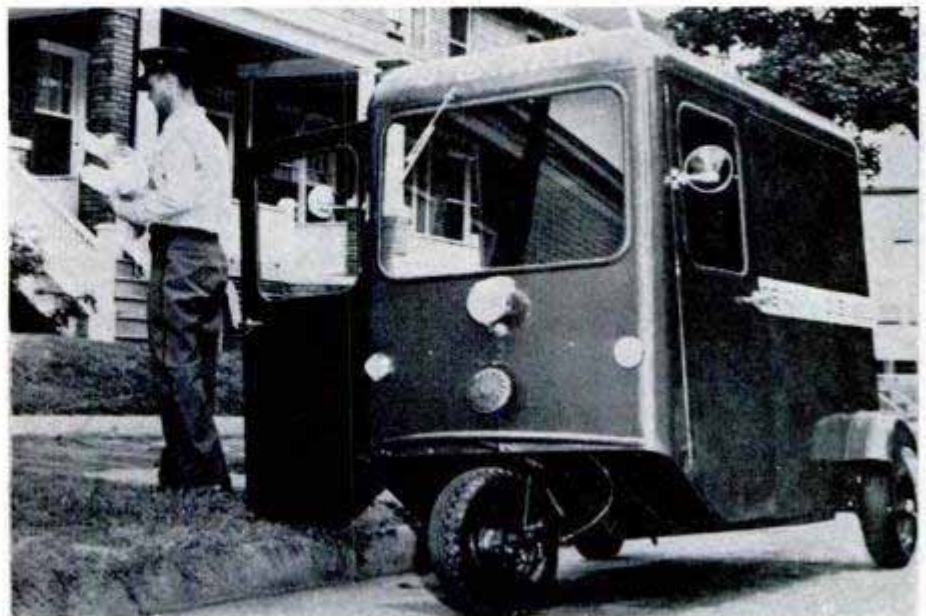

Homemade Lift Eases Wheel-Chair Patient Into or Out of Car

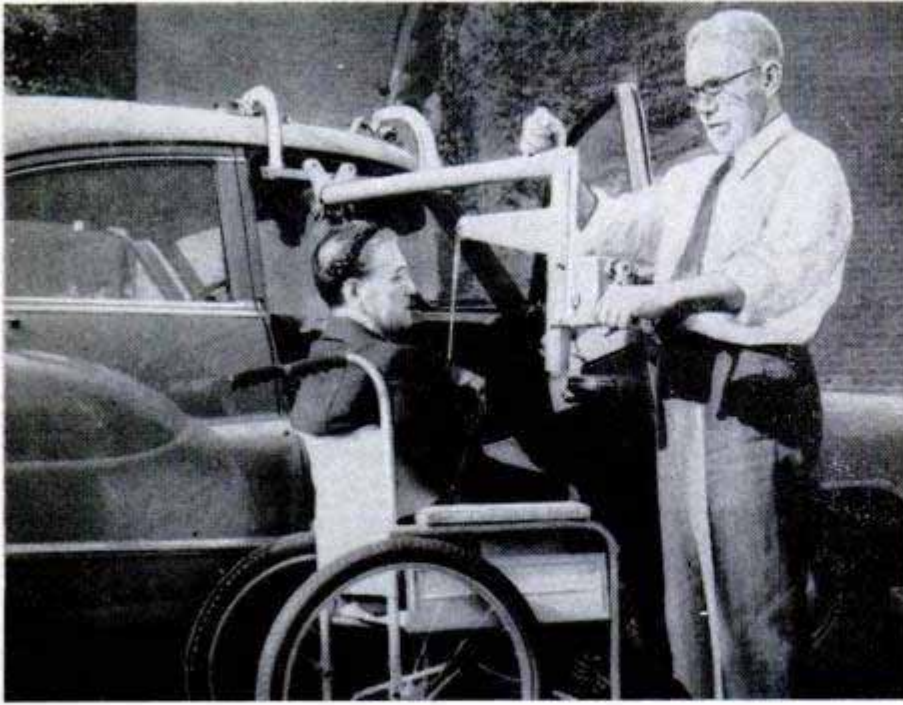

Designed to move a wheel-chair patient into or out of a car, a homemade lift takes only minutes to install. It consists of two main sections. A pipe above the front seat is suspended on the driver's side by a hook out the window and over the drip edge, and on the right side by two arms connected to suction cups which rest on the roof. A second pipe which slides inside the first carries the lifting mechanism. Patient sits in canvas slings and is hoisted to proper level by a crank-operated winch. Then patient is easily pushed inside the car.

Antigrowth-Chemical Treatment for Lawn Edges Keeps Grass Short

Now you can eliminate the hardest part of grass-cutting—hand-trimming the strips and edges along flower beds, driveways and other hard-to-cut places—with a chemical which retards the growth of grass for a full season. Dissolved in water, the substance is applied to the grass with a garden watering can and given a trimming a week later. The grass then stays short for the full season. Eventually, the homeowner may be able to treat his entire lawn with the chemical if a suitable low-pressure sprayer is developed to give even distribution of the substance. It is harmless for children, pets, flowers and bushes and a one-ounce package is ample for the average home lawn.



Quickly Erected Flexible-Steel Pickets Make Unbreakable Fence

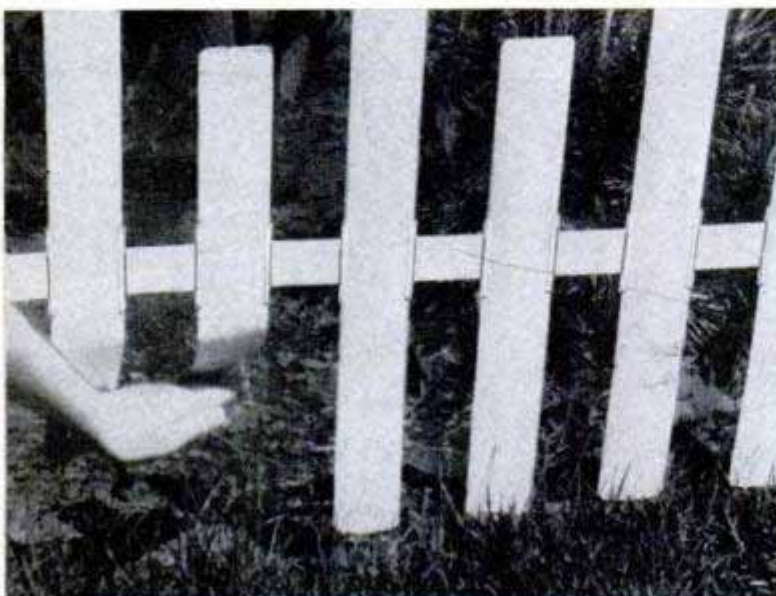

Simple to put up and easy to maintain are the claims for an all-steel picket fence. Posts that support the fence are easily pushed into the ground and a horizontal crosspiece attached. The spring-steel pickets then slip into pockets on the crosspiece. There is no nailing or bolting required. The pickets have a baked-enamel finish and do not require painting. A variety of colors is available. Lawn trimming is simplified; flexible pickets push aside for mowing.

☐ Insects cost the United States a total of \$4,000,000,000 a year in crops and livestock.

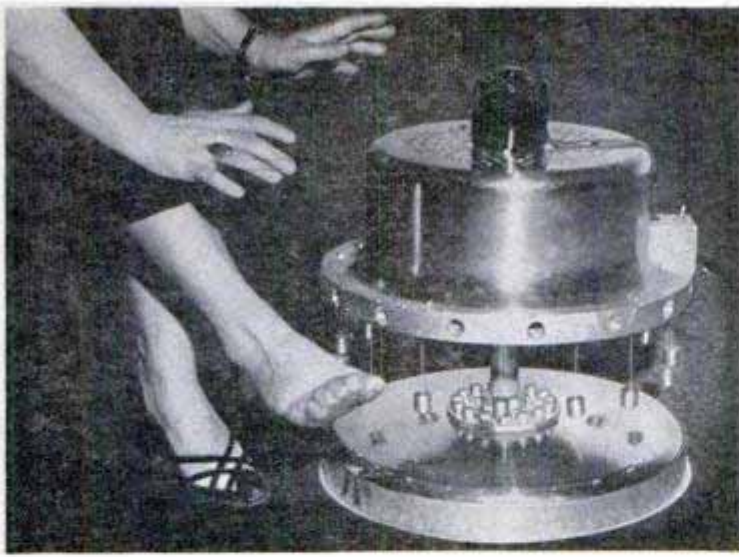

Above, with rods and pedestal removed, drier is foot warmer. With heat off, it's a cooling fan. Right, it is portable

Portable Electric Clothes Drier Has a Variety of Uses

IF YOU'RE LOOKING for a clothes drier that can do a variety of jobs, then Russell R. Braman of Shawnee, Okla., has the one you want. It not only dries clothes, it will also warm a room on cool days, dry hair after a shampoo, serve as a cooling fan on hot days and, with a few changes, can be used as a safe, dependable chicken brooder.

The arms of the electric drier, over which the wet clothing is draped, have a total length of 30 feet, providing ample "clothes-line" in wet or dry weather. The whole unit folds into a small space for storage in a hall closet and takes up less space than a vacuum cleaner. It is made of aluminum and weighs about 25 pounds, making it light enough to move around easily. The manufacturer claims that it will dry clothes just about as fast as the average washing machine will turn them out.

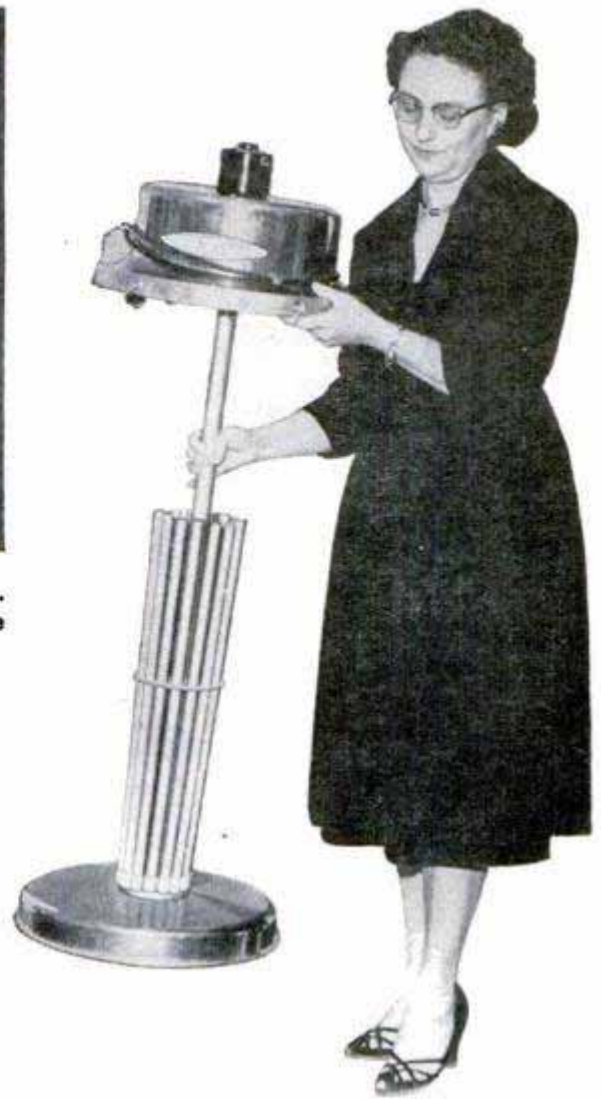

The top of the drier contains a small electric motor and fan. A heating coil in the top keeps the circulating air well over 110 degrees. This heated air is forced through the hollow arms and out a series of small holes into the wet clothing. When used for other purposes the arms can be removed and the air flow controlled by small plugs, if necessary. It produces about 1500 BTUs and costs four to six cents per hour to operate.

Fan and heater are in top. Plugs block openings to divert flow of air. Right, the drier has 30 feet of "line"

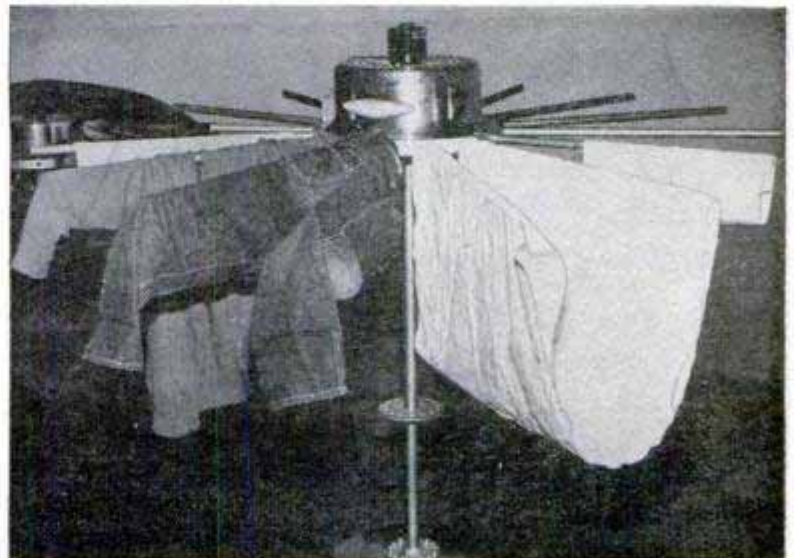

The OWNERS REPORT on

EXACTLY
AVERAGE: 15.5 M.P.G.

POPULAR MECHANICS OWNERS POLL CONDUCTED BY FLOYD CLYMER

1. I own a 1953 Buick: Special Super Roadmaster Speedometer reading **3700**
2. I use regular gasoline Premium (high test) gasoline in country **15.5 m.p.g.**
3. Average gasoline mileage in city: **14** m.p.g.; **1000 miles (approx)**
4. Oil consumption: One quart every **500** miles. I change oil every **1000** miles.
5. My Buick is equipped with: Conventional 3-speed transmission Twin-Turbine Dynaflo Drive
6. If you own a Buick V8, what is your opinion of the new V8 engine? **OIL CONSUMPTION IS BAD BUT AM TOLD BY DEALER IT WILL IMPROVE**
- Excellent Good Fair Poor Comment: **OIL CONSUMPTION IS BAD BUT AM TOLD BY DEALER IT WILL IMPROVE**

BIG COMPLAINT

BRAINTREE, MASS.
SALES MANAGER

79% AGREED

7. If your Buick has Power Steering has it proved to be worth the added cost? **Sold on power steering for big cars**
- Yes No Comment: **Sold on power steering for big cars**
8. Roadability at high speeds: Excellent Good Unsatisfactory
9. Maneuverability in traffic: Excellent Good Unsatisfactory
10. If you have Dynaflo comment on: a. Acceleration from 0 m.p.h. **good** Excellent - will beat anything
- b. Acceleration from 50 m.p.h. **good** Unsatisfactory
11. **WILMINGTON, DEL., SALESMAN** c. Performance in traffic **very good**
- Story cruising speed of your Buick? **65** m.p.h.

POPULAR REASONS FOR BUYING

12. Reasons for buying a Buick: **I like styling and riding qualities but there is room for improvement**
13. Rate these points:
- | | | | |
|--------------------------------|------------------------------------------|------------------------------------------------|----------------------------------|
| The 12-volt electrical system: | Like <input checked="" type="checkbox"/> | Acceptable <input type="checkbox"/> | Dislike <input type="checkbox"/> |
| "Step-on" parking brake: | Like <input checked="" type="checkbox"/> | Acceptable <input type="checkbox"/> | Dislike <input type="checkbox"/> |
| Horsepower output: | Like <input type="checkbox"/> | Acceptable <input checked="" type="checkbox"/> | Dislike <input type="checkbox"/> |
| Riding qualities: | Like <input checked="" type="checkbox"/> | Acceptable <input type="checkbox"/> | Dislike <input type="checkbox"/> |
| Exterior body styling: | Like <input type="checkbox"/> | Acceptable <input type="checkbox"/> | Dislike <input type="checkbox"/> |
| Visibility, forward: | Like <input type="checkbox"/> | Acceptable <input checked="" type="checkbox"/> | Dislike <input type="checkbox"/> |
| Visibility, rear: | Like <input type="checkbox"/> | Acceptable <input checked="" type="checkbox"/> | Dislike <input type="checkbox"/> |
| Ease of parking: | Like <input type="checkbox"/> | Acceptable <input checked="" type="checkbox"/> | Dislike <input type="checkbox"/> |
14. Specifically, what are your complaints? **Won't take curves at high speed or build up enough torque fast enough in drive when passing fast - moving cars. Poor gasoline mileage**
- CLEVELAND, OHIO, BUS DRIVER**

48% AGREED

15. Have you ever owned a Buick before? Yes No Comment: _____
16. Would you buy another Buick? Yes Possibly No Comment: _____
17. How is your dealer service? Excellent Good Average Poor
18. An overall rating of your Buick: Excellent Good Average Poor
19. What improvements do you want in your next car? **quieter power steering Improved acceleration**

LONG ISLAND ENGINEER

tabulated fairly and your name will be held in confidence. Thank you.

write additional comments here: **I think it's time they changed their body style along with clearing the knobs off the dash. Power steering is lousy at high speed. Wouldn't get it again unless they find a way to cut it out at 40 m.p.h. Too tricky after 60 m.p.h.**

the '53 BUICK V 8

By Floyd Clymer

BIG NEWS AT BUICK for 1953 is its V8 engine with the highest compression ratio in the business. The V8 owners responding to the *PM* survey mixed praise with criticism in describing the new power plant.

Returned questionnaires prove the value of Buick's slogan, "When better cars are built, Buick will build them." Owner after owner gave this quotation as the reason for buying a Buick.

"I have driven and owned nearly every other make of car since 1930," wrote a Lehi, Utah, resort maintainer, "but have found that Buick still is the best buy and will always believe that 'when better cars are built, Buick will build them.'"

"The reason I purchased a 1953 Buick," wrote a circus electrician, "was because of the merits of a 1951 model I owned. With it I pulled a 28-foot trailer all summer over all kinds of roads and mountains and never was stuck once. Dynaflo is the only thing for pulling it."

A Hastings, Neb., realtor wrote: "Tremendous improvement in Dynaflo and with power steering it is as easy to park as the smallest car."

An Atlanta, Ga., owner said his 1953 Super is his 34th Buick! That sets a record for the surveys to date.

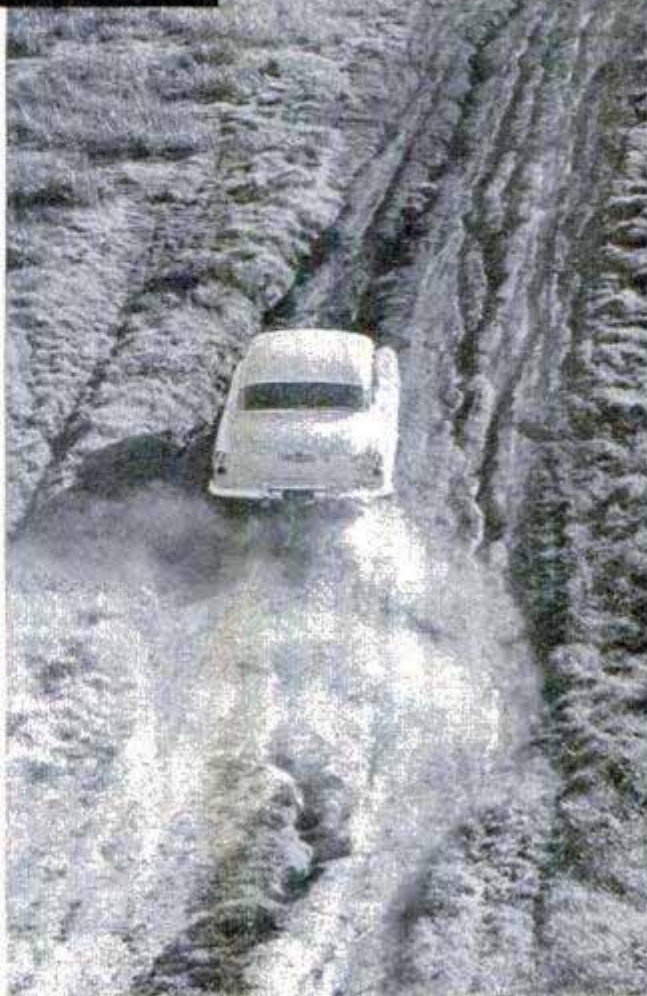

Above, the Super climbs a steep, rutted hill in a test of both power and traction. Below, Floyd Clymer stops off at the *Popular Mechanics* building in Chicago on his test drive from Detroit to Denver

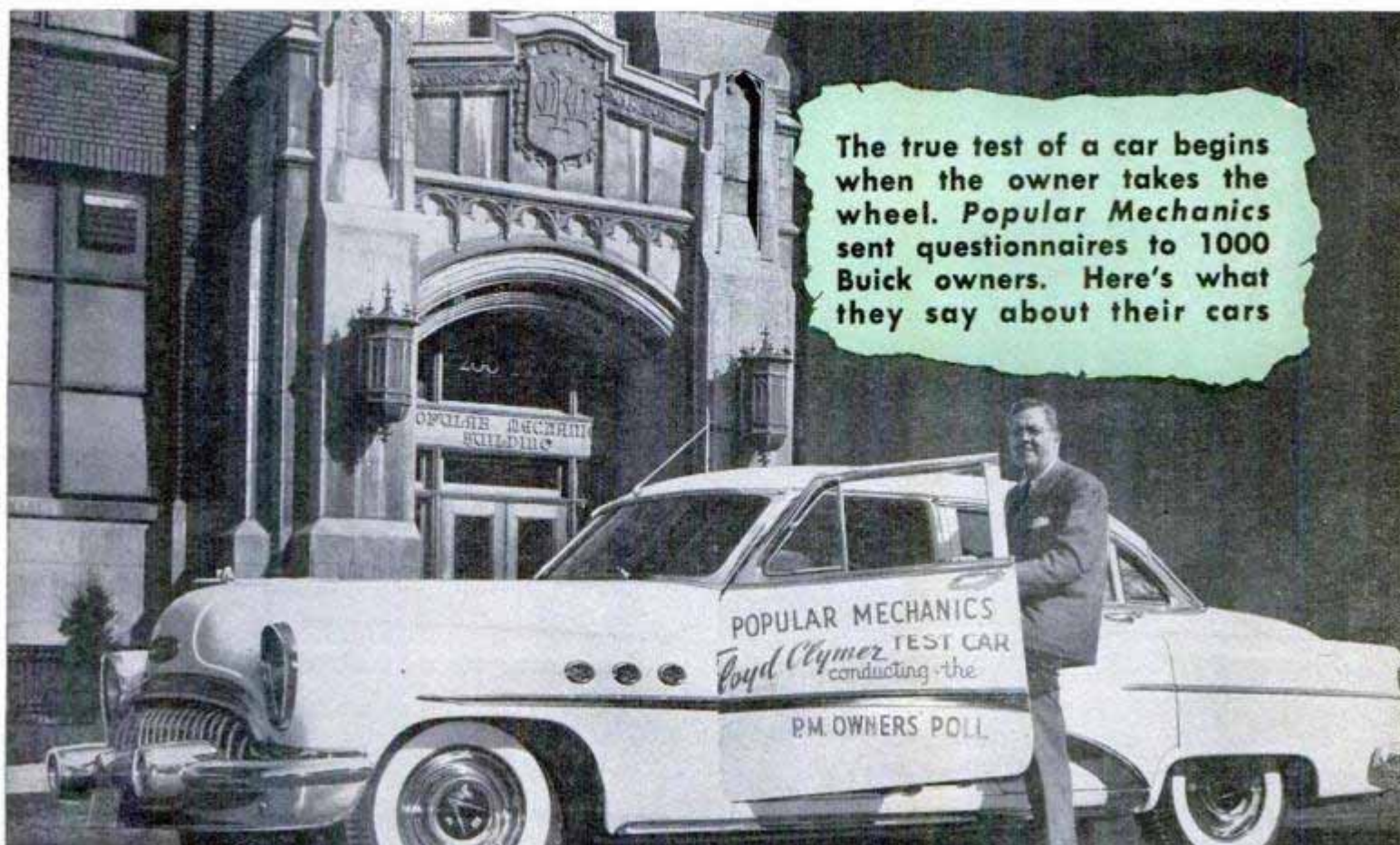

The true test of a car begins when the owner takes the wheel. *Popular Mechanics* sent questionnaires to 1000 Buick owners. Here's what they say about their cars

Percentages from PM Poll of Owners

Buick Special owners reporting: 47% Super V8 owners: 37% Roadmaster V8 owners: 16%

All Buick Owners Reporting

Average speedometer mileage.....	2117
Roadability excellent	69%
good	29%
unsatisfactory	2%
Maneuverability excellent	71%
good	27%
unsatisfactory	2%
Dealer service excellent	44%
good	26%
average	20%
poor	10%
Previous Buick owners	79%

RATINGS OF PARTICULAR FEATURES

	Like	Acceptable	Dislike
Visibility forward.....	91%	9%	0%
Riding qualities.....	89%	10%	1%
Step-on parking brake....	88%	10%	2%
Visibility, rear.....	86%	9%	5%
Horsepower output.....	81%	19%	0%
Exterior styling.....	80%	19%	1%
12-volt system.....	79%	20%	1%
Ease of parking.....	74%	24%	2%

CHIEF PURCHASE REASONS

(in order of frequency)

1. Previous Buick ownership
2. Purchase conditions (price, trade in, dealer relations, etc.)
3. Mechanical features (engine, transmission, etc.)
4. Riding qualities
5. Styling features (interior or exterior)

IMPROVEMENTS DESIRED IN NEXT CAR

(in order of frequency)

1. Increased fuel economy
2. Quieter engine or transmission
3. Improved body fitting
4. Easier steering (power-assisted)
5. Minor styling improvements
6. Better chrome or paint

Buick Owners by Engine Type

	Special 8	V8 models
Use premium gasoline.....	66%	96%
regular gasoline.....	34%	4%
Average gasoline mileage—		
city	13.8 m.p.g.	12.2 m.p.g.
country	17.0 m.p.g.	15.5 m.p.g.
Add no oil per 1000 miles....	87%	44%

Special 8 V8 models

Add one quart or more per 1000 miles.....	13%	56%
Add 3 quarts or more per 1000 miles.....	0%	21%

(Most owners reporting had driven their cars less than 2500 miles so excessive oil consumption may be due to break-in)

Power-steering owners reporting		
Unit worth the extra cost		79%
Unit not worth extra cost		21%
Over-all rating of V8 engine		
Excellent		61%
Good		20%
Fair		12%
Poor		7%

Will buy another Buick?		
Yes	72%	70%
Possibly	26%	23%
No	2%	7%

Over-all rating of car		
Excellent	50%	48%
Good	45%	36%
Average	5%	11%
Poor	0%	5%

Dynaflo acceleration		
From 0 m.p.h.:		
Excellent	50%	46%
Good	38%	39%
Fair	8%	10%
Poor	4%	5%
From 50 m.p.h.:		
Excellent	40%	63%
Good	51%	30%
Fair	9%	6%
Poor	0%	1%

Dynaflo performance in traffic:		
Excellent	63%	49%
Good	35%	43%
Fair	1%	3%
Poor	1%	5%

Most frequent objections of Special owners		
Gasoline economy poor.....		15%
Noisy Dynaflo.....		9%
Noisy engine.....		8%
Steering and handling.....		7%
Forward vision.....		4%
Acceleration		4%
Poor chrome.....		4%

Most frequent objections of V8 owners		
Oil consumption high.....		27%
Noisy engine (ping, tappets, etc.)..		23%
Gasoline economy poor.....		21%
Noisy Dynaflo.....		7%
Interior finish and details.....		7%
Rear vision.....		4%



Power steering is worth its cost, say 79 percent of those who have it. Clymer reports that the upper half of horn ring blocks driver's view of speedometer

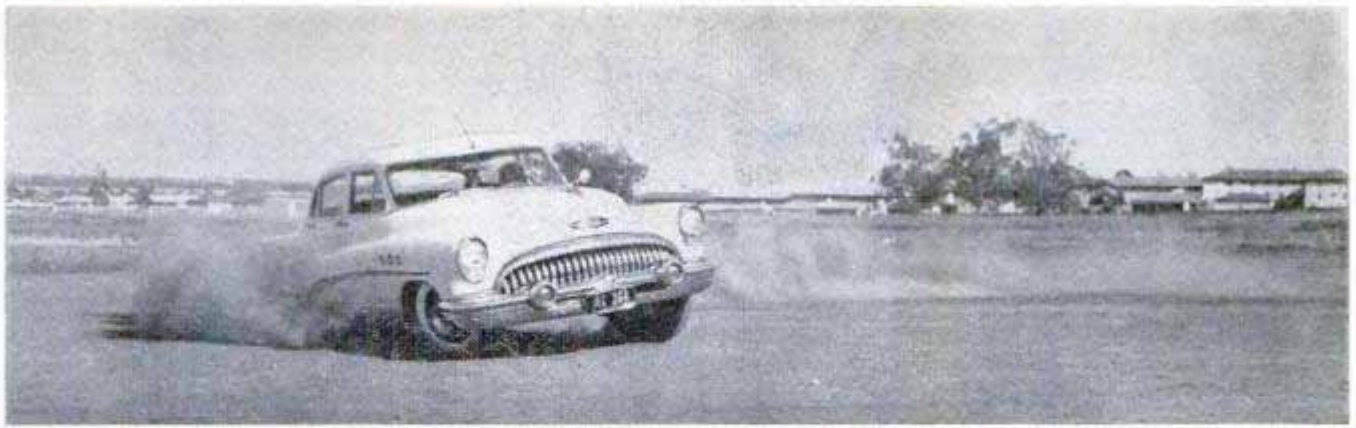

Clymer does a fast circle with wheels cramped to left. Test proved that the Super has good stability

Of the owners reporting, 79 percent are previous Buick owners. One of the characteristics of American car buyers that the *PM* poll has pointed up is the tremendous loyalty of owners toward car makes. Many owners even give parental ownership as reason for buying a certain make! But none was so terse about it as a Lynn, Mass., restaurant owner who gave only one word as his reason for buying a Buick: "Habit."

Of the V8 owners, 81 percent rated the new engine as either excellent or good; 19 percent described it as fair or poor.

Owners of the Special series (which retains the veteran straight-8 engine) had fewer complaints than the Super and Roadmaster owners. Asked for an over-all rating of their cars, only a tiny 5 percent of the Special owners said average or poor. Of the V8 owners 16 percent rated their new cars over-all in one of these categories.

Buick owners came up with a surprise when asked about power steering. An astonishing 21 percent of those whose cars have power steering said it is not worth the added cost! This contradicts the enthusiasts who say that once you've used power

Step-on parking brake holds car on steep hill. Only two percent of owners disliked the step-on feature



steering you'll never go back to the old-fashioned muscle method.

A Kansas City engineer wrote, "I made my own tests on the new Dynaflow as against a friend's Special with the old Dynaflow. There is a lot of improvement. I like my Special except for the torque drive—too much unsprung weight at rear end. Buick's power steering is the best yet!"

Here are some comments by owners of 1953 Roadmasters:

"The only car that could compare with the 1953 V8 Roadmaster in performance was the 1937 Cord. It is the most dependable car ever built."—South Ogden, Utah, railroad conductor.

A Rock Falls, Ill., retailer gave as his reasons for buying a Buick its "investment and high resale value."

Buick gives a "comfortable ride along with conveniences without cost of frequent repairs," according to a Hamilton, Ohio, woodworker.

A toolmaker in Elyria, Ohio, says about everything that can be said for a car when he praises its "roadability, riding qualities, style, dependability and good trade in."

Buick's V8 was rated excellent or good by 80 percent of owners. Big complaint was oil consumption

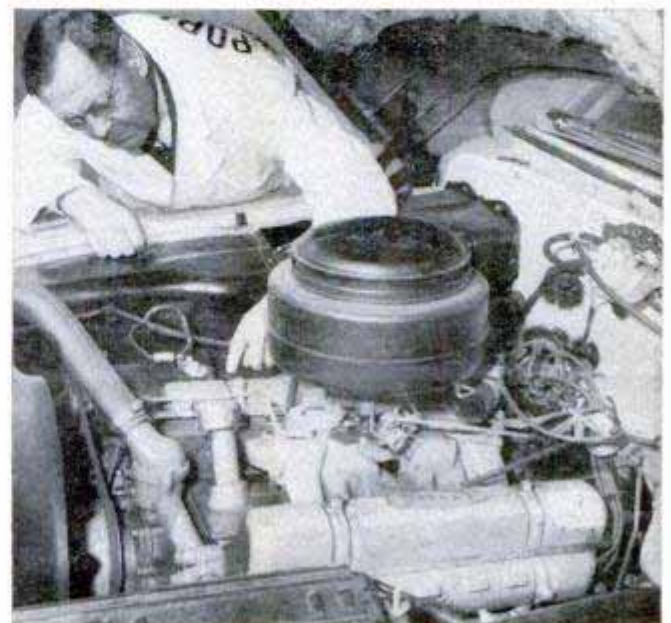

ACCELERATION TEST

¼ mile from zero	21.4 sec.	—Drive and Low
½ mile from zero	32.1 sec.	—Drive and Low
0 to 30 m.p.h.	4.9 sec.	—Low only
0 to 60 m.p.h.	15.4 sec.	—Drive only
	14.5 sec.	—Low and Drive

Top speed (by speedometer) 113-115 m.p.h.
 Actual top speed, about 8% less (speedometer variation)
 (In tests using both Low and Drive shift was made at about 30 m.p.h.)



Backup lights are still in rear bumper. Parking lights are out of front bumper this year

ECONOMY TEST

1953 BUICK SUPER V 8 4-DOOR SEDAN
 WITH TWIN-TURBINE DYNAFLOW DRIVE

MILES PER GALLON

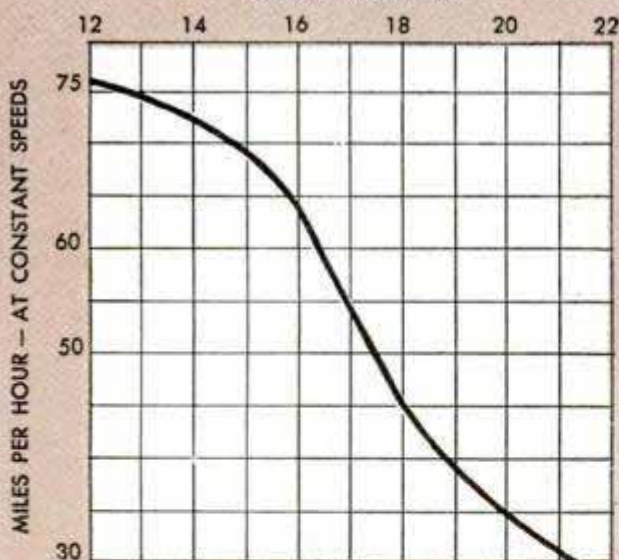

Constant-Speed Mileage

At constant 30 m.p.h.	21.2 m.p.g.
At constant 50 m.p.h.	17.4 m.p.g.
At constant 60 m.p.h.	16.5 m.p.g.
At constant 75 m.p.h.	12.6 m.p.g.

Cross-Country Mileage

Flint, Mich., to Chicago, Ill. (new car, traffic)	16.1 m.p.g.
Chicago to Kansas City, Mo. (strong headwind)	16.5 m.p.g.
Kansas City to Denver, Colo. (Regular gasoline used to Kansas City, premium gas from Kansas City to Denver)	19.2 m.p.g.

A Paramus, N. J., textile executive said he bought his Buick Super because he "likes overhead valves and Dynaflow and styling. Also the various small accessory items which are well planned. Feel price is moderate compared with other similar-size makes."

A Rochester, N. Y., owner gave "good performance and exceptionally reasonable upkeep on previous Buick" as reasons for buying a 1953 Super.

"The Buick Special is a lot of car for the money. It closes in on the low-price three in price, yet has the weight and size of a big car."—Camden, N. J., minister.

"My Special uses more gas but I find it cheaper in the end to own and operate than the previous low-price car I owned. Brakes fade some in mountain driving, but Dynaflow is far better in mountains than those 'jerk-o-matic' transmissions on some cars."—Boulder, Colo., farmer.

"The new Dynaflow adds pep and economy to the Special. Best car built for my money."—Cheyenne, Wyo., salesman.

But not all Buick owners are satisfied. As with all makes there are complaints. The owners of 1953 Buick models with the V8 engine seem to have many more than the Buick Special owners.

Most frequent complaint made by V8 owners was excessive oil consumption. Of these owners, 27 percent listed that objection to the new engine. Next most frequent complaint among V8 owners was engine noise, a mixture of tappet-noise complaints and spark-knock complaints. Even with premium gas, there were complaints of bothersome spark "ping." Poor gasoline economy was also given as an objection by V8 owners, but this is a standard complaint of all car owners. Every driver seems to feel he should get more miles per gallon no matter what make of car he drives.

Here are some complaints by V8 owners:

"Noisy, burns oils, gas consumption too high. Doesn't seem to have the rated power."—Paterson, N. J., Roadmaster owner.

"On high-test gasoline, no matter what is done to retard the spark, still have a bad ping in the motor," complains a Chicago businessman.

"Motor pings, noisy valves, easy to get out of tune."—Cleveland, Ohio, appraiser.

"A Buick dealer told me that the '53 models will get more than 18 miles to the gallon and then doesn't do anything about it when I complain."—Tyler, Tex., oilman.

"The engine pumps oil and accumulates carbon rapidly, lowering gas mileage."—Minneapolis, Minn., supervisor.

There were so many complaints of excessive oil consumption that *Popular Mechanics* asked Buick for a statement. Because

(Continued to page 230)

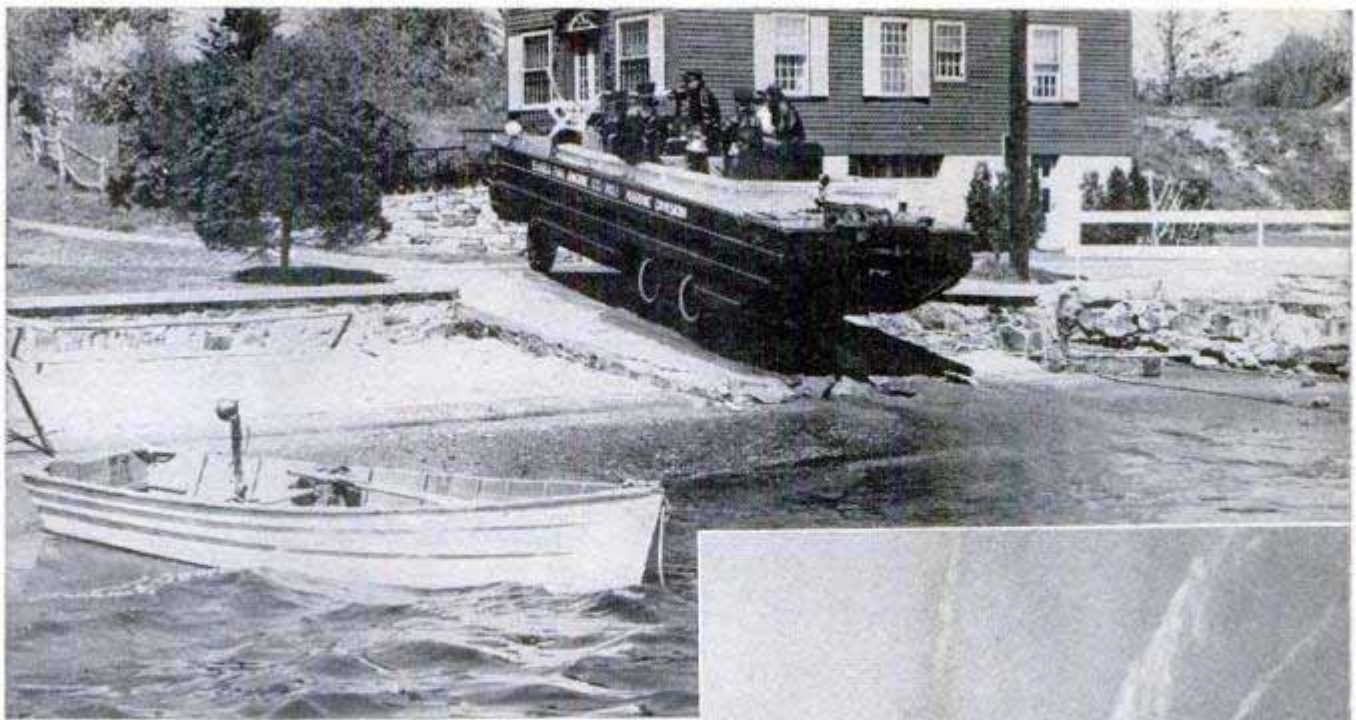

"Duck" takes to the water for a test run. Three hoses can throw hundreds of gallons per minute on a fire

Army "Duck" Fights Fires Ashore and in Harbor

Firemen of Essex, Conn., cover the water front in a converted Army surplus DUKW that now serves as a highly mobile "fire amphibian." Pooling their skills, the smoke-eaters transformed the "duck" into a compact fire-fighting unit that performs equally well on land or sea. Onto it went special marine fittings and hardware, bilge pumps, navigation and search lights, sirens, ship-to-shore radio, life preservers and anchors. Emergency gear includes first-aid equipment, blankets, axes, boat hooks, pikes, rope, grappling irons, steel cable and a power-operated winch. Heart of the fire fighter is a gasoline pump, located in the stern, that can deliver 500 gallons of water per minute. There's a powerful deck gun in the bow, and three hoses adaptable to water, fog, foam or carbon dioxide. When



water-borne, the eight-ton craft is driven at speeds up to 10 knots by a three-blade propeller. On land, it can speed 60 miles per hour over rough terrain. Already, it's been used to quench fires in shipyards and barnyards, tow disabled yachts to safety, and stop water-front fires that were inaccessible from land.

Traffic Safety Light on Truck Gives Motorists Signal to Pass



Mounted on the rear of a truck, a red-green signal light tells motorists whether traffic ahead of the truck is "all clear" for passing or congested. The driver operates the signal from a hand switch on the dashboard. Corresponding lights in miniature light up on the switch; thus the trucker knows at all times whether the safety light at the back of the truck is functioning.

☐ Magnesium available in the oceans would cover the entire world's land area to a depth of nine feet.

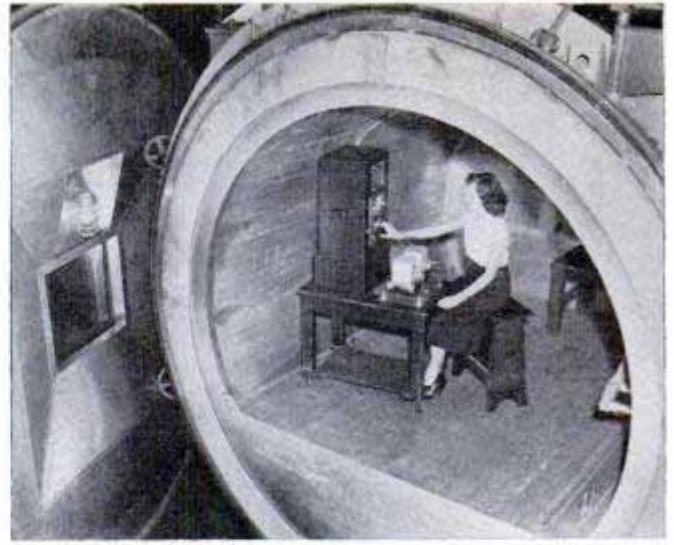

Army Stratosphere Chamber Tests Weather Equipment

Simulating pressure and temperature conditions a weather balloon would encounter while rising to 150,000 feet above the earth, a Signal Corps test chamber at Fort Monmouth, N. J., is used to study meteorological equipment. With aluminum lining, foot-thick glass-wool insulation and an outside shell of reinforced nickel steel,

the unit can decrease pressure to $\frac{1}{1000}$ of an atmosphere and temperature to -150 degrees Fahrenheit. Engineers may watch experiments through a nine-ply, two-foot square glass window set in the huge door. The refrigerating system employed, the Army says, is equivalent to a plant capable of producing 85 tons of ice a day.

Abrasive Metal Cutter Won't Cut Rubber

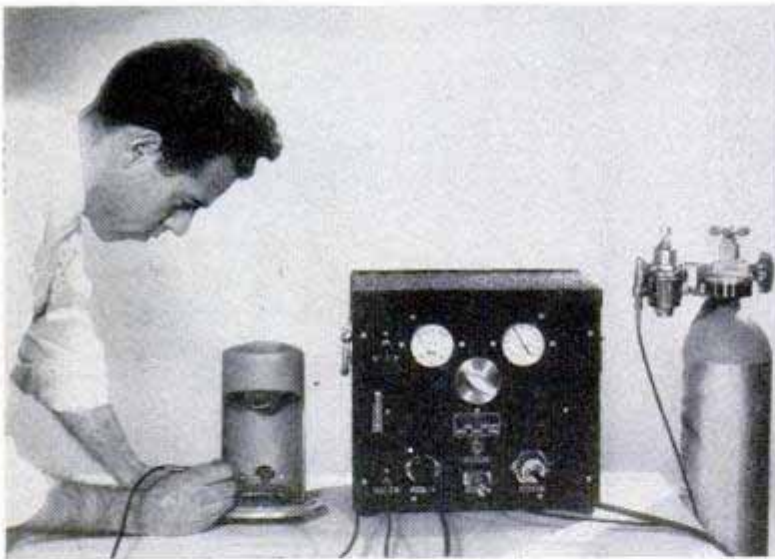

Abrasive particles, propelled by gas at the rate of 1100 feet per second—effectively cut hard materials without harming resilient materials such as rubber. In fact, the operator can momentarily stick his hand under the streaming abrasive without injury to the skin. The unit—somewhat similar to the recently introduced painless method of dental drilling with air—can be used to drill, cut, etch, deburr and polish many different materials. The unit uses any inert gas, particularly carbon dioxide as it is most readily available. The unit weighs 42 pounds.

Watch Tells Sportsmen Best Times for Fishing and Hunting

Sportsmen can coordinate a new watch with local tide conditions to indicate the best times of the day for hunting and fishing. The 17-jewel watch has a small dial which is set to correspond with local tide tables. A pair of pointers then indicates the best times for finding fish or game, as the feeding habits of wildlife are believed to correspond to the various phases of the moon and the tides.

☐ In the United States alone, 10,000 tons of steel wire are used each year in the production of hairpins and bobby pins.



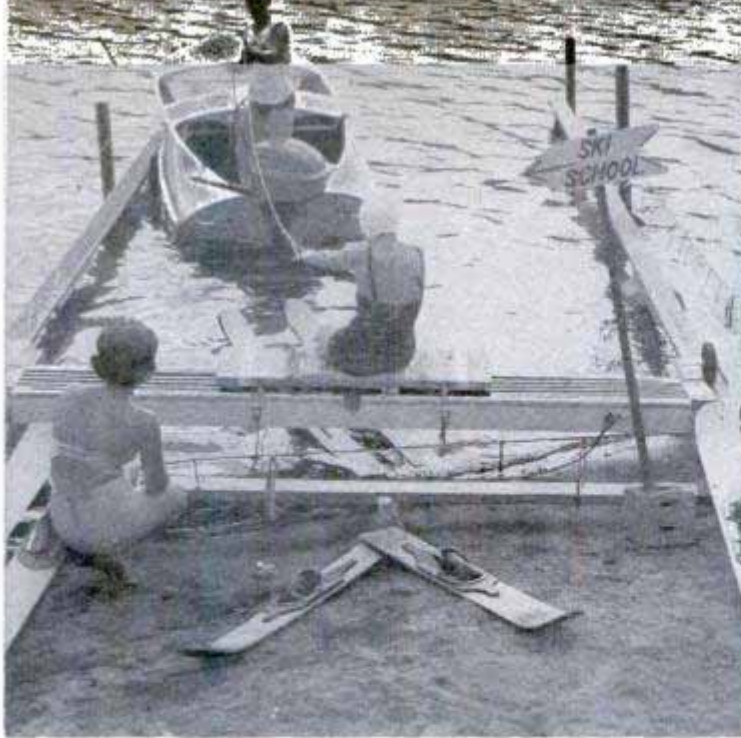

Wheeled Launching Platform Trains Water Skiers

Novice water skiers achieve success on their first try with a launching platform that gets them off to a balanced start. With skis in the water, the trainee grasps the towline and sits in the middle of a plank supported on each end by small wheels

resting on wooden rails. As the towing boat gathers speed, skier and carriage are propelled forward until a rope stops the carriage and the erect skier skims away from the platform. Plans for the manufacture of an all-steel launcher are now underway.

U-Boat Detectors Track Whales

British whaling expeditions to the Antarctic are using ultrasonic sound pulses to track down the seagoing mammals. Employing the method developed in World War II for detecting enemy submarines, the ships send out underwater pulses which strike whales and rebound to the ship, revealing the location of the leviathans. The ultrasonic whale finder can follow a whale for distances up to 2000 yards, it is reported.

Ultrathin Steel Alloy

Sheets of nickel-alloy electrical steel $\frac{1}{20}$ the thickness of a human hair are filling a specialized demand in electronics. Rugged and reliable, the new metal is finding uses in radar equipment, the "memory" sections of mechanical "brains" and in radio vacuum tubes. It becomes electromagnetized in about $1/1,000,000$ second. Though it costs only a few cents a foot, per pound it is more expensive than gold.

French Nautical Bicycle Permits Cycling in the Seine

Pedaling down the river on a Sunday afternoon not so long ago, a French inventor demonstrated his method of combining two favorite sports. The nautical bicycle he developed consists of two compartmentalized pontoons joined by a metal framework

with a watery saddle. The operator rotates pedals to drive a propeller. A sail and a jib may be added for increased speed and thrills. Lightweight and easy to operate, the boat adjusts to fit child or adult, and folds into a small package.





Drivers sprint to their cars for the famous Le Mans start. The first three cars, left, are Cunninghams

24 Hours of Speed - -

WILL AMERICA WIN AT LE MANS?

EVERY YEAR on an 8.38-mile circuit of French highway about 150 miles southwest of Paris, men and machines undergo one of the world's great endurance tests—the 24-hour Le Mans Race.

Since 1923, the finest sports cars have put their reputations on the line in a tortuous competition of speed and endurance. So tough is Le Mans that in 1952, only 17 of the 58 starters were running at the end of the 24 hours. Average speed for the winning Mercedes-Benz was 96.67 miles per

hour for the 24 hours from 4 o'clock Saturday afternoon to 4 o'clock Sunday afternoon—its total distance was a fabulous 2320 miles!

So far, America has not won at Le Mans. Closest was the dual-valve Stutz of America's golden sports-car era in 1928. It placed second.

Carrying America's hopes in 1953 will be four cars—two Cunninghams and two Nash-Healeys. Both had entries in 1952 and both did well, but not quite well enough.

Here are the chassis and Chrysler engine of last year's Cunningham. This year's is lower and lighter

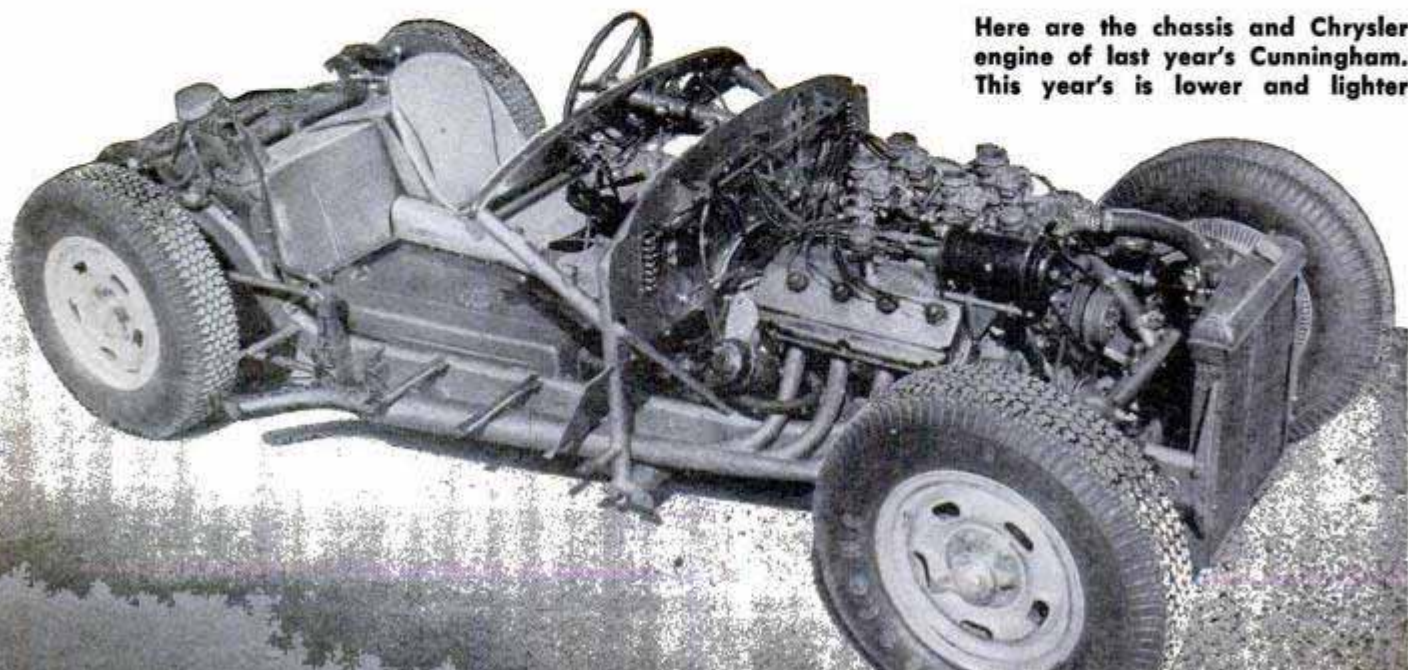

The Nash-Healey (driven by British drivers) placed third behind the two Mercedes-Benz cars. A Cunningham, driven by its builder and America's best-known sports-car manufacturer, Briggs Cunningham, finished fourth. Two other Cunningham starters were forced out with valve trouble.

This year, the Nash Motor Company will sponsor the two Nash-Healey entries, making them officially American. Because last year's team was British, the Nash-Healey had sort of a dual nationality. Cunningham, of course, will race under the American flag again this year.

So Uncle Sam has a good chance of winning in a race where the odds are long at best! Time—24 hours of it—alone will tell.

There are several factors that make Le Mans the outstanding race it is. First, obviously, are its 24 hours. A race in which the winning car travels 2320 miles in 24 hours is inevitably a tough one. Drivers are permitted substitutes for rest periods, but some try to make it the whole distance without relief. In last year's race, Pierre Levegh, driving without relief for almost 23 hours, was leading by about 30 miles with 90 minutes to go, when his car was forced out by mechanical trouble.

Briggs Cunningham, the American threat, drove 19 consecutive hours before taking time out for a rest. After four hours in the rest area,

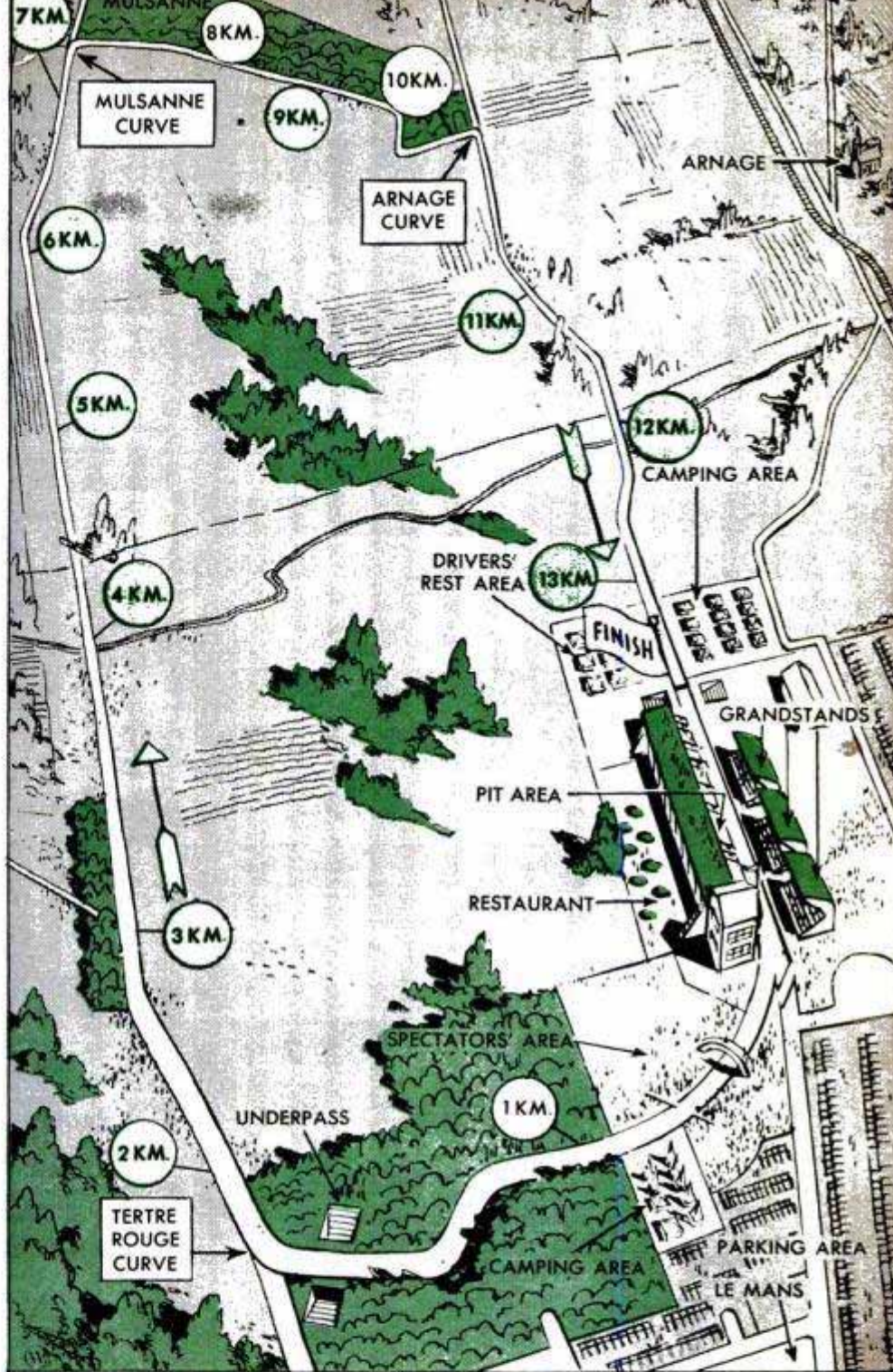

Map of Le Mans course. Figures in circles are kilometers. Below, Briggs Cunningham and a Mercedes (rear) speed through an S-curve



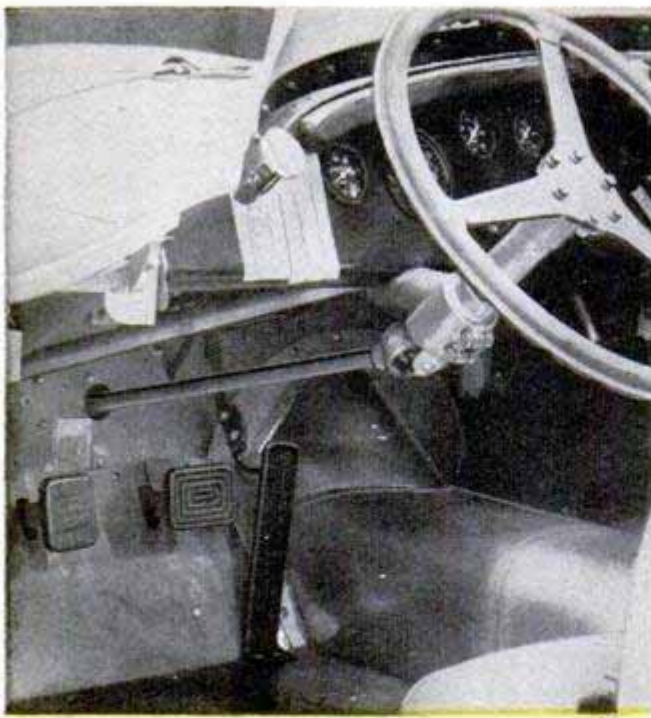

Cockpit of the Cunningham C4R with universal-jointed steering column and the wooden-grip aluminum wheel preferred for endurance races. Note the total absence of decoration and trim

Excellent brakes are essential in competition racing. Cunningham uses finned drums and an air scoop to cool them and prevent fading. Photograph made at the Watkins Glen race

he took over from his relief driver, Bill Spear, and drove the final 60 minutes, finishing in fourth place.

Driving at high speed all night around a winding course is a supreme test of driving skill and physical endurance. But Le Mans is not merely a test for drivers. The cars have to stand up under tremendous abuse. Mechanical breakdowns are frequent as every part, from connecting rods to brakes, is stressed to its limit.

The course is no symmetrical oval with banked turns to ease cars around without strain. It is 8.38 miles of paved highway used for normal traffic on all except race days. There are seven right-angle turns, each straining brakes, steering and wheels to their utmost. There are two excellent straightaways for high-speed performance and one wide sweeping turn. The course is not level, but the slopes are mild.

Permanent grandstands accommodate only a fraction of the crowd. Thousands of fans line the course. Paid admissions in 1952 were estimated at 175,000, but there were probably more than 300,000 in attendance around the track. The spectators sleep in cars, tents, or on the grass. It is a full week end for them as well as for the drivers.

The winner is the car that covers the most miles during the 24 hours. Handicaps on

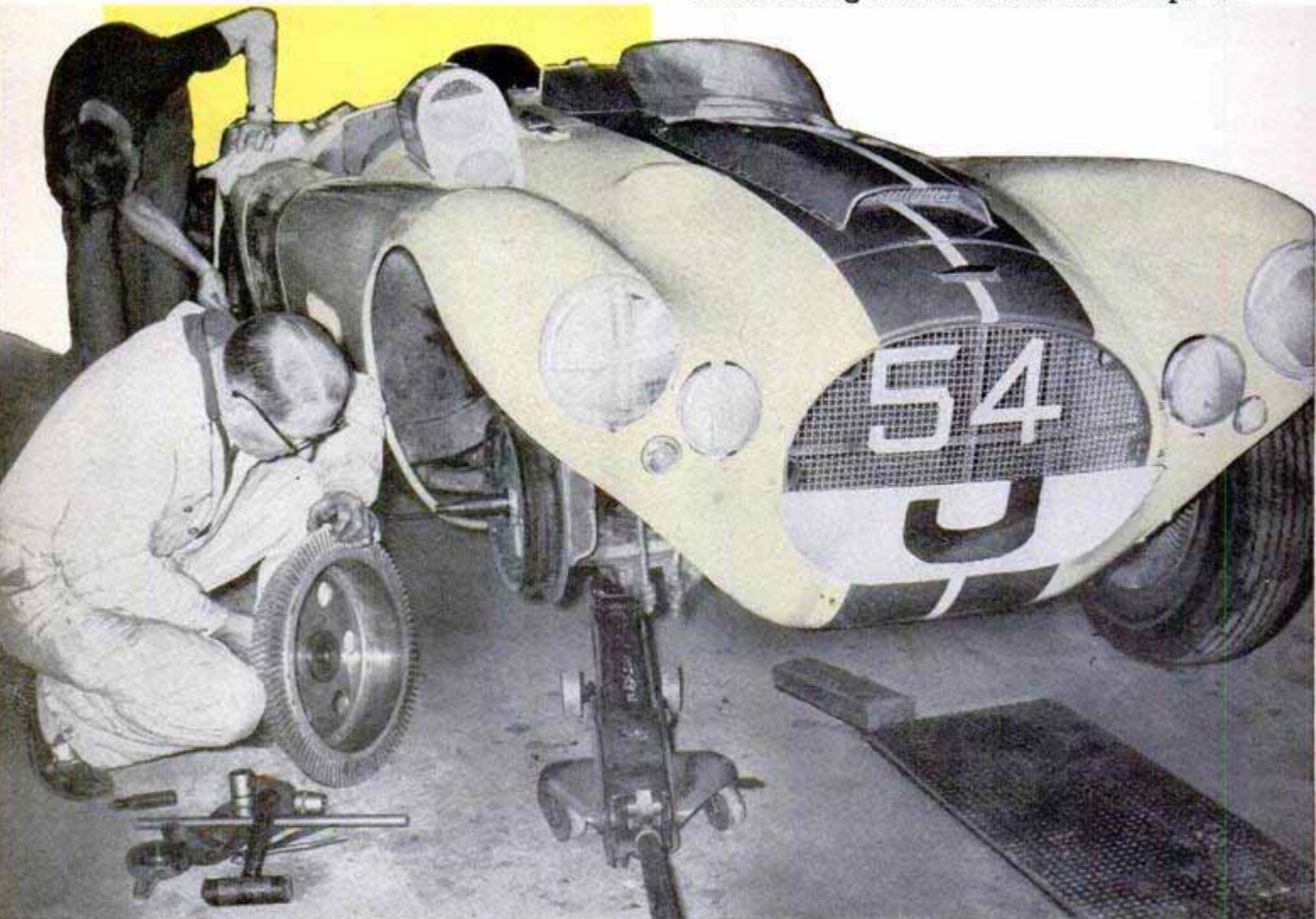



Last year, Nash-Healey, right, was third in over-all classification at Le Mans. Cunningham, left, was fourth

piston displacement give smaller cars a chance to win prizes in various categories. But the big honor is the winner of the over-all classification—the one Cunningham and Nash will be shooting for this June.

Unlike many American races, Le Mans begins from a standing start. The cars are backed into their pits diagonally and the drivers line up across the track opposite their cars. When the starting signal is given, each driver sprints across the track, jumps into his car, fastens his safety belt and starts the engine—all under the supervision of officials. Then each driver pours on the petrol as he makes a desperate bid

to get away first and avoid the jam of speeding cars in the first lap.

Gasoline, water and oil ports are sealed before the race starts and can be opened only under official supervision. Only official 80-octane Le Mans gasoline can be used. No water can be added during the race. Each car must travel a minimum of 234 miles before its first refueling. No mechanical work can be done on the cars except by the driver or riding mechanic.

One Cunningham entry had trouble last year because of this no-help rule. Duane Carter slid off a corner into a protective sand pile and spent 90 minutes digging his

Cunningham's Le Mans coupe was powered by a Chrysler V8 engine, made accessible by a front-hinged hood

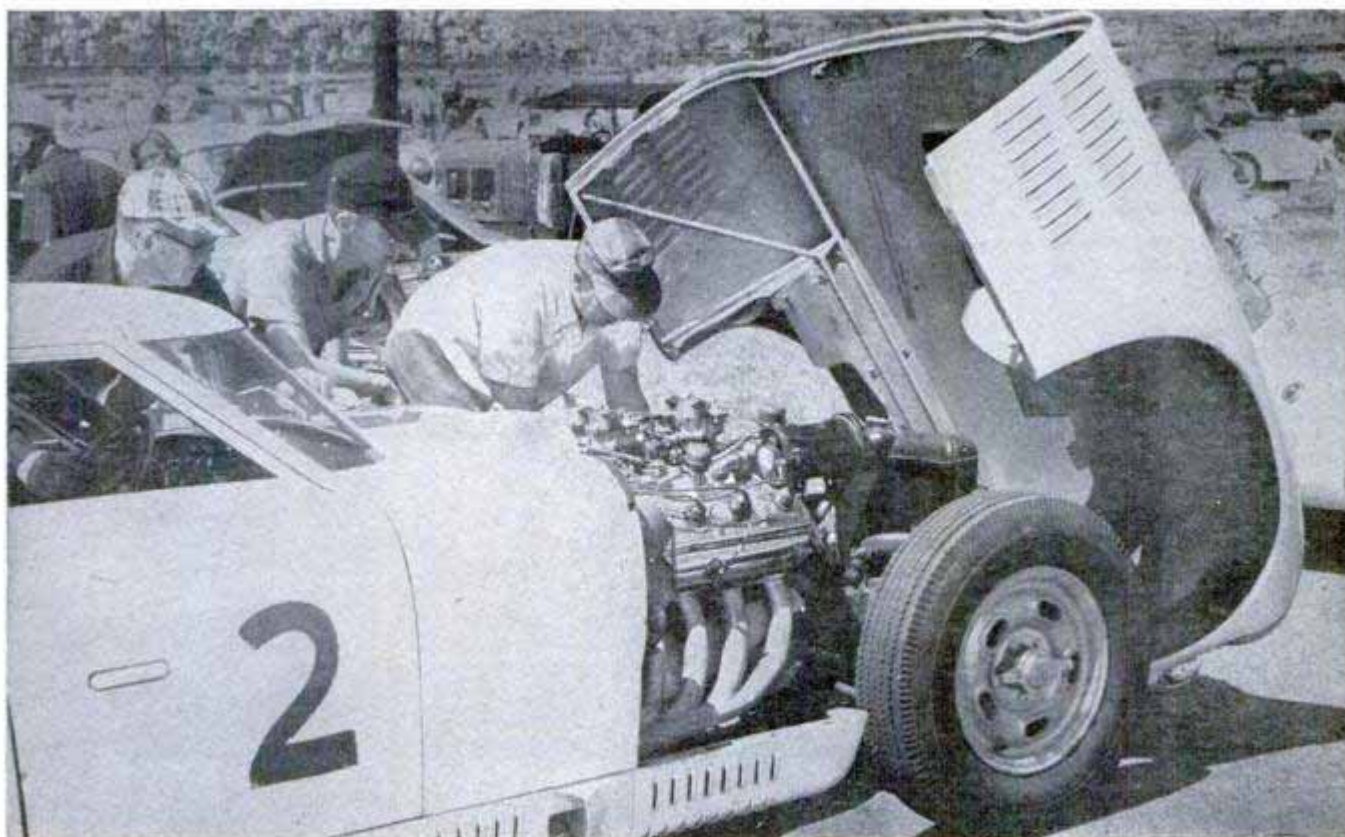

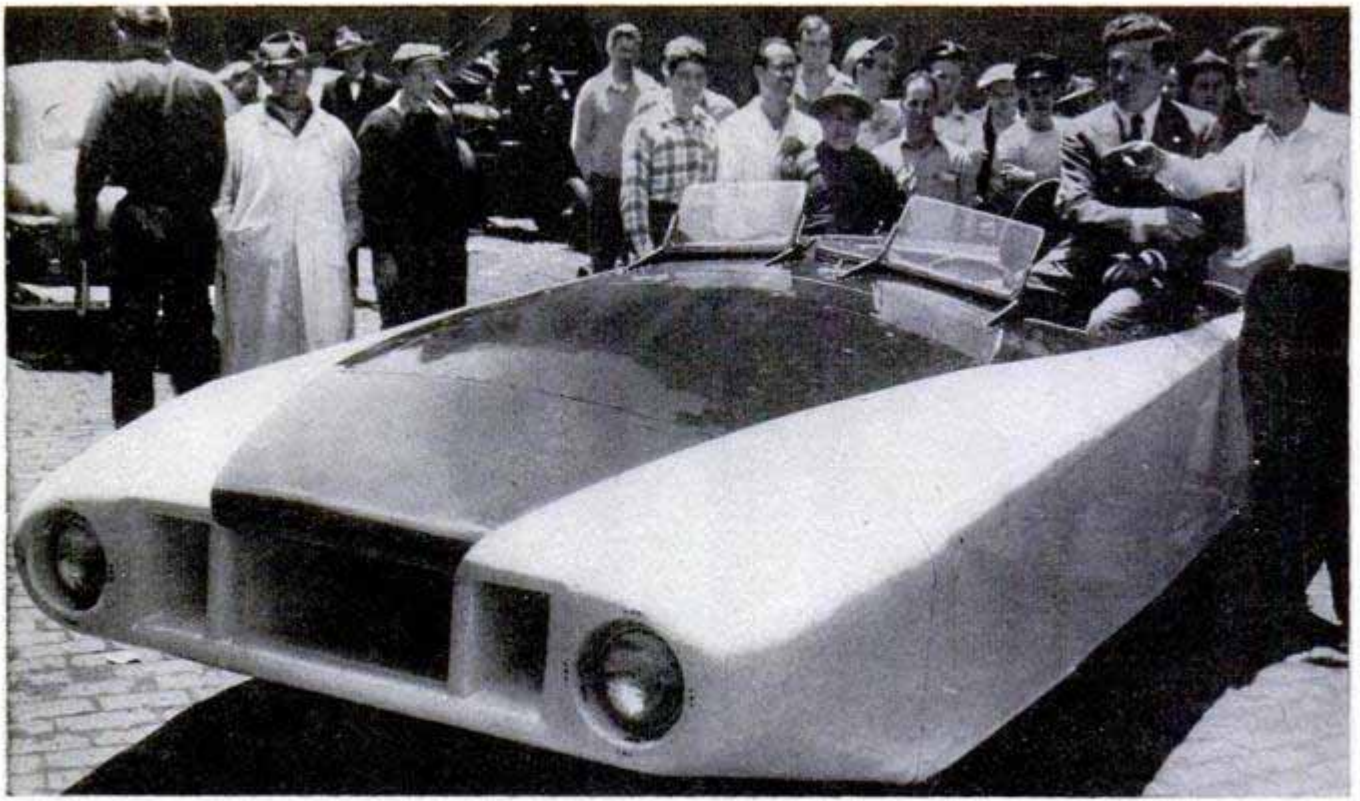

First car Cunningham designed for Le Mans was called "The Monster" by French race fans because of its size

car out. Another driver pushed his disabled car for two miles to return to the pits.

Of the first 10 cars to finish in 1952, eight were six-cylinder jobs. Two of them were V6s. The Chrysler-powered Cunningham that finished fourth was a V8. The only other non-six-cylinder car was the fifth-place winner, the Ferrari V12.

The majority of cars finishing had engines developed from standard production models (like the Chrysler and Nash en-

gines). The special racing engines failed to stand up under the terrific punishment.

The Nash-Healey was powered by the Nash Ambassador Dual Jetfire six-cylinder engine with a standard aluminum 8:1 head, dual carburetion and a slightly modified camshaft. The 1953 Nash entries will use the same souped-up engine, now called the Le Mans engine by the company.

Briggs Cunningham is putting his 1953
(Continued to page 248)

Along the straightaways at Le Mans, the Nash-Healey (10) hit 140 miles per hour. Its race average: 91.5



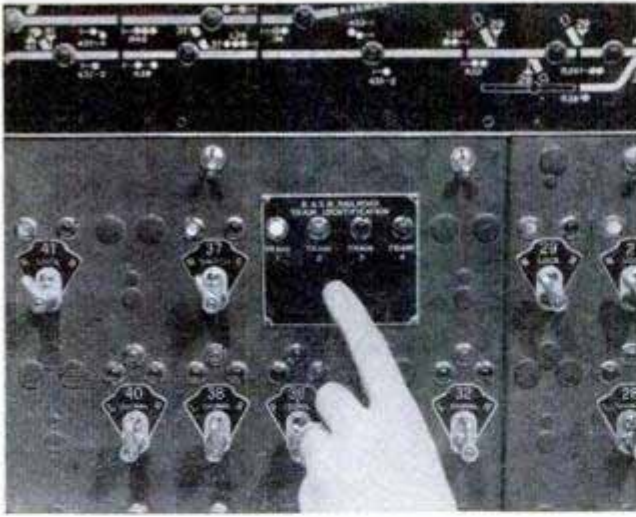

Panel light shows which train has entered main line

Robot Records Trains

TRAINS 22 MILES AWAY are automatically identified and traced by an electronic system installed on the Erie Railroad. Beneath the caboose of each train is an identifying coil, which returns radio waves in a certain pattern to an energizing coil between the tracks. The signal then is transmitted 22 miles to an electronic panel before the dispatcher.

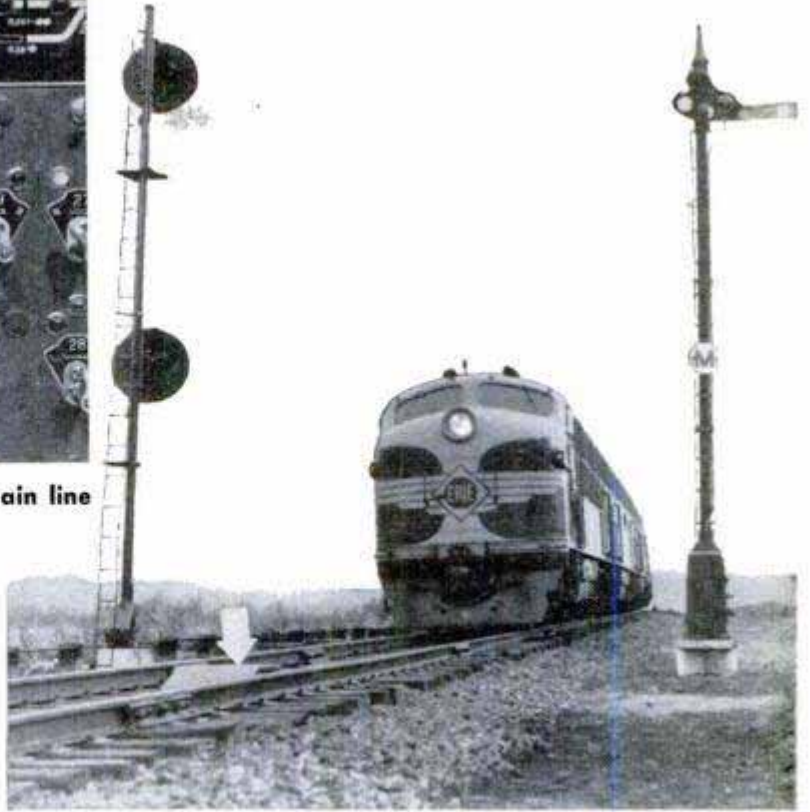

Arrow shows energized coil between tracks which identifies train by its return-wave pattern, transmits information to dispatcher

Hung beneath each caboose is a coil wound in a particular pattern. Waves from track coil are returned according to this pattern

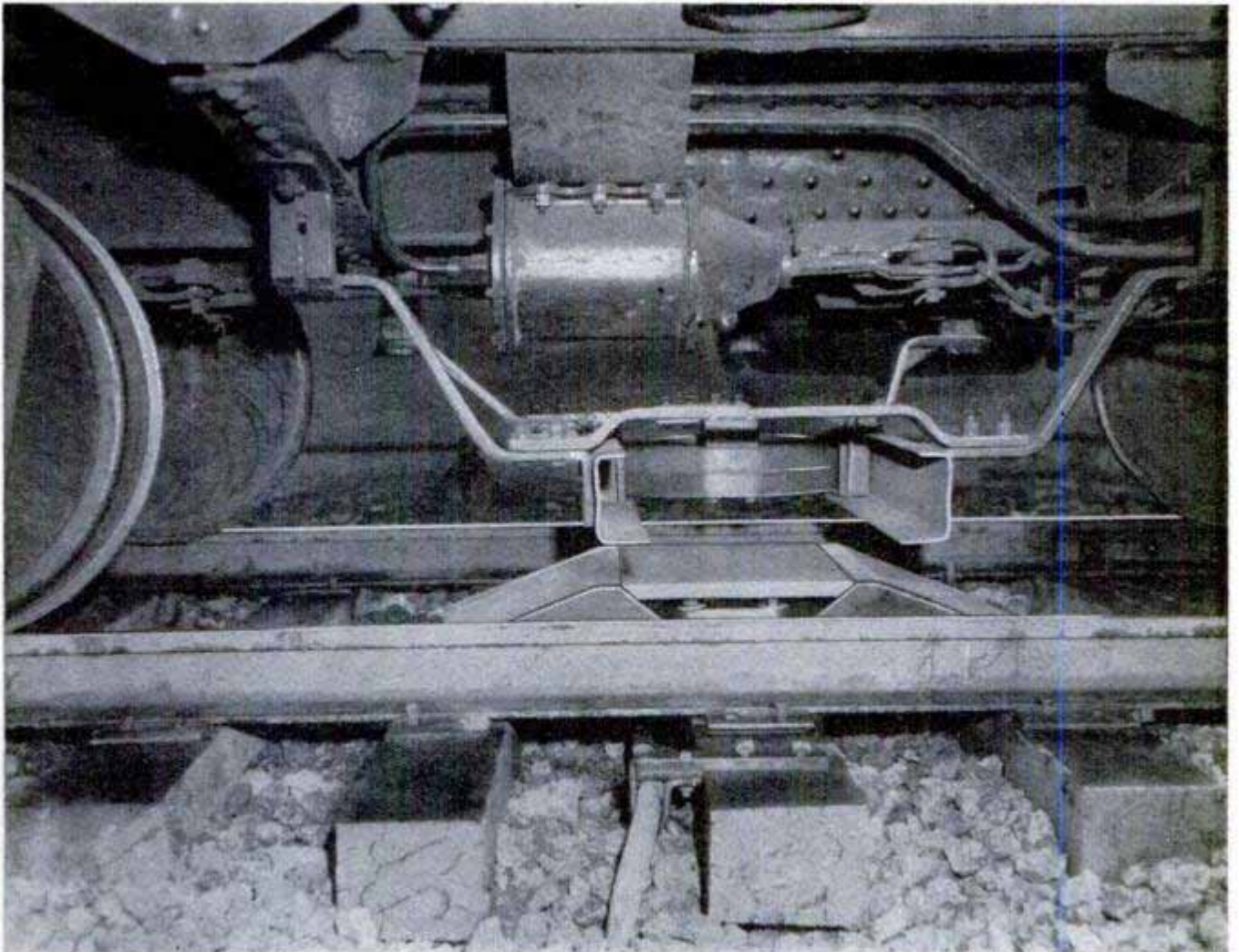

SWEDEN WORKS UNDERGROUND



Visitors enter atomicproof factory through this gate, descend by stairs and Escalators to working area

FAR BENEATH the Swedish town of Linköping, an underground aircraft factory hums with vital defense work. Trucks loaded with raw materials and parts descend to the subterranean plant through a long sloping tunnel. From the tunnel emerge gleaming airplanes—small planes ready to fly and large planes complete except for wings.

Just 30 minutes by jet bomber from Soviet territory, the buried plant is ready for the worst that modern war may bring. Housed in mammoth manmade caves blasted from solid rock, it is part of the new pattern for Swedish industry.

Since Hiroshima, Swedish builders have burrowed into the thick granite and gneiss mantel which covers most of the country to construct plants, hospitals, hangars, military headquarters, munitions and fuel dumps. Along the coast, Swedish submarines will eventually weigh anchor in huge grottos that will be torn from the sides of rocky cliffs.

Across the country, civilian A-bomb shelters are being tunneled from the rock. Impervious to concussion and shock waves, they are protected from falling material by arched roofs of reinforced concrete, supplied with their own water and power, and equipped with air-conditioning systems to

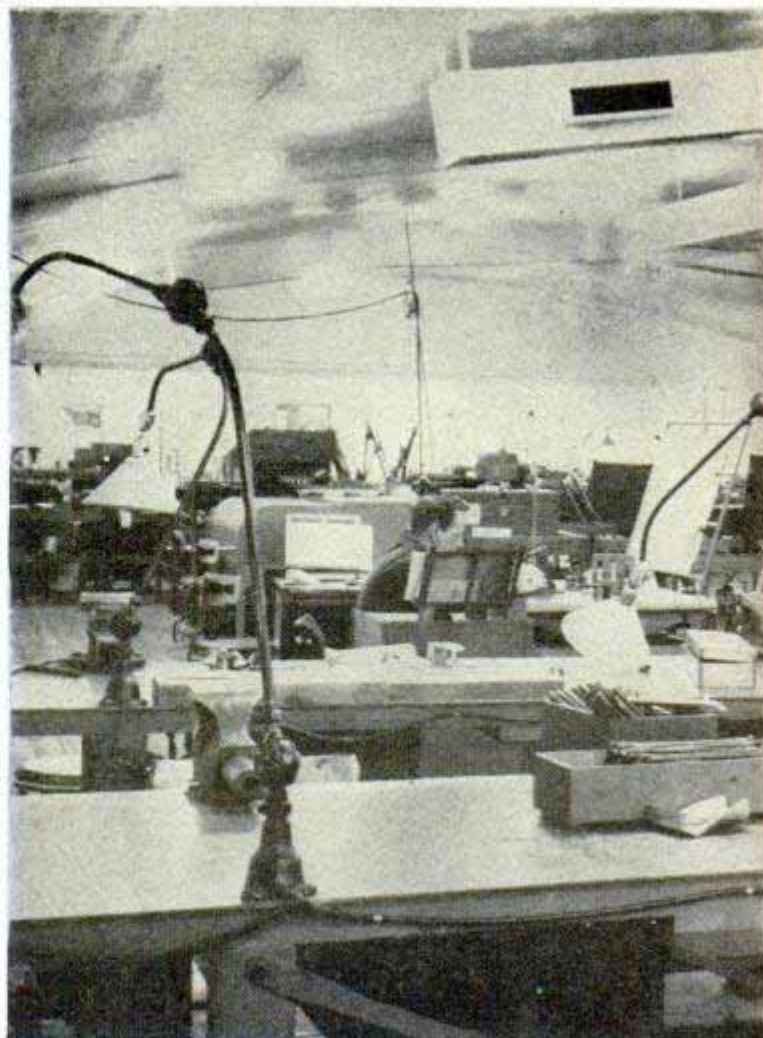

filter out harmful ingredients. A luxury hotel being built in Vasteras, 525 miles due west of Leningrad, will be housed completely in rock, and even boasts a large underground gymnasium.

If an atomic bomb falls near the Linkoping aircraft plant, a typical subterranean industrial installation, the blast wave would be moderated by baffles and pockets inside the tunnel. Filters in the plant's air-conditioning system can stop flying radioactive particles and even block poison gases. The factory's self-contained water system would be unimpaired and an emergency power plant would switch into operation.

The manufacturing plant itself is housed in a concrete building resting on the bed rock of the main tunnel. A row of columns down the middle of the ground floor supports the second story, aided by steel columns along the sides and pillars of concrete block firmly embedded in the tunnel rock. Walls are lightly reinforced-concrete slabs. A reinforced-concrete roof guards against rocks jarred loose by concussion. ★ ★ ★

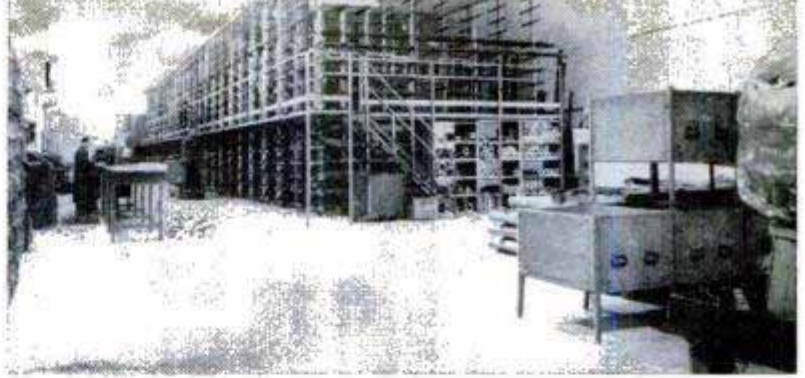

Parts are stored in air-conditioned area, heavy equipment and materials in large pockets cut from solid rock. Warehouses, an inspection section and testing laboratory, offices and an employee's restaurant are all included in the underground plant



Subterranean factory can maintain production during worst air raids. Well-lighted and comfortable, it has low labor turnover

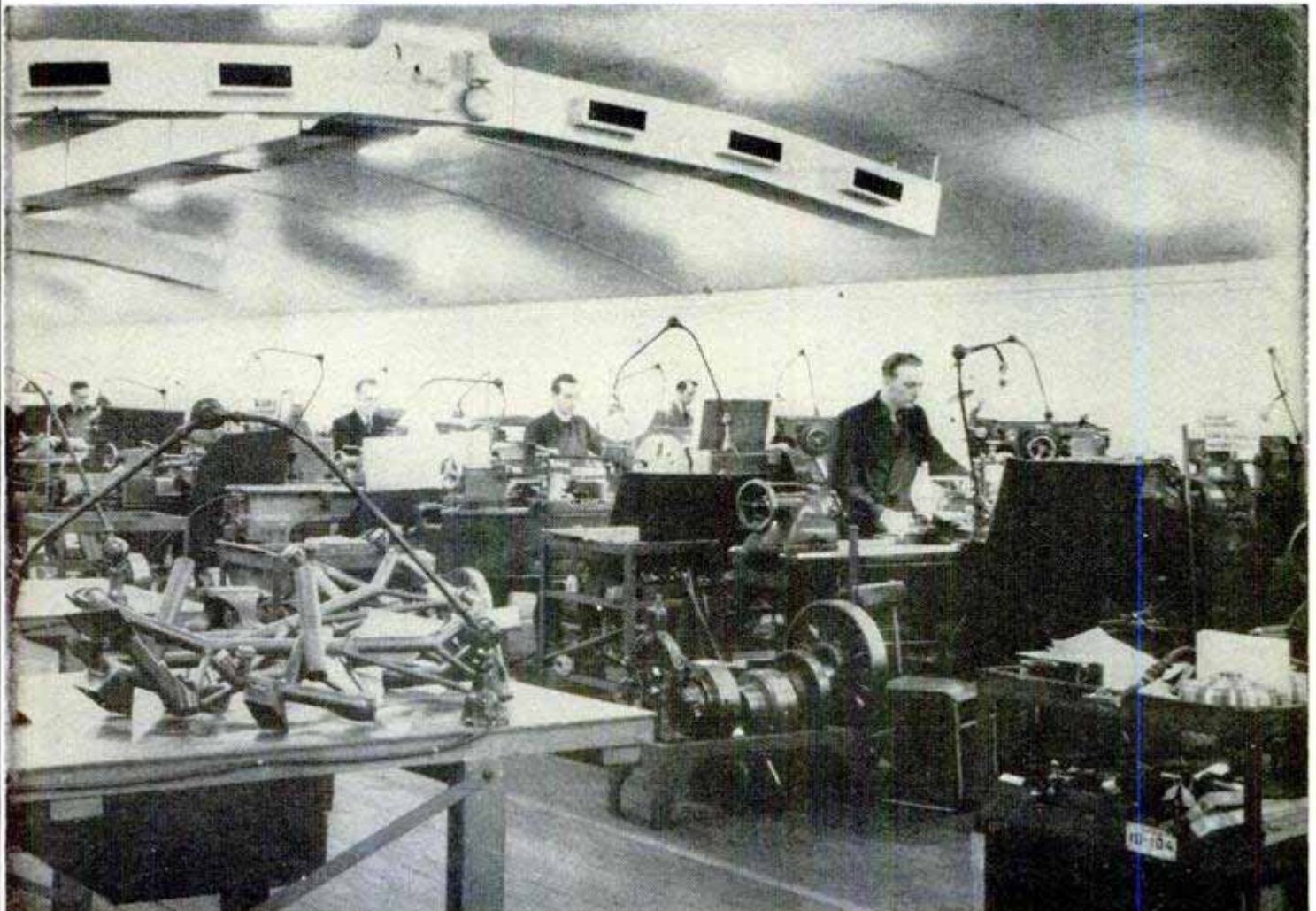



U. S. Forest Service photo

Too many trees, too little lumber—that was the lodgepole-pine story until mechanization came to the forests

LUMBER FROM “TOOTHPICKS”

JUST LITTLE BITS o' trees they're cuttin' down here! It ain't right, is it?" questioned Carl Hjarne when he saw the men of Biles-Coleman Lumber Company logging lodgepole-pine trees so small he could almost circle them with one of his big hands. Logger Carl was visiting in the

By
Robert H.
Forbes

Okanagan Mountains of eastern Washington. He lives in the lowlands near Lilliwaup on the west side of the state where it rains at least half the year. Douglas-fir trees, several feet in diameter, thrive there because of plentiful moisture.

But the eastern Washington company is

Loader hoists lodgepole logs aboard truck in middle of forest. These logs will be used to make paper

U. S. Forest Service photo

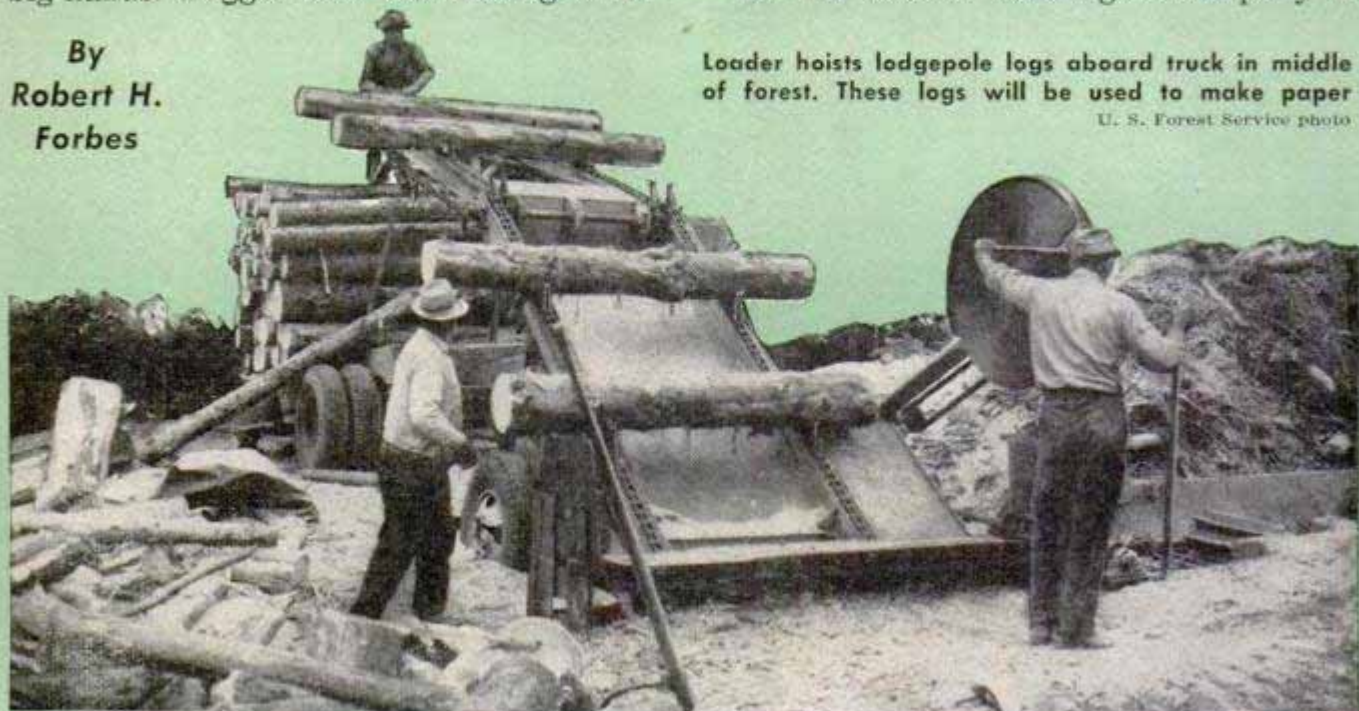

logging tiny lodgepole pines, few of which are more than a foot thick at the base.

"These pines are stagnated, Carl," pointed out Emmet Aston, forester of the lumber company. "Hundreds of them popped up after a forest fire. They're too thick. They aren't growing very big, but they aren't dying either. There's just too much competition for sunlight and water."

Emmet bent over the end of a lodgepole-pine log 11 inches in diameter and started to count rings in the wood. "One hundred and thirty years to grow to this size!" he said finally. "Over in your section—where forests never get stagnated—almost any tree that age would be at least five times as large. By cutting down the little pines, we're giving a new forest a chance to grow under foresters' management."

The little pines not so long ago were called "weed" trees. They were of almost no importance other than as scenery in vacation spots like Yellowstone Park. In the old days, Paul Bunyan used lodgepole pines only for toothpicks, but now the Biles-Coleman company is manufacturing lumber from them.

Harvey Jolley, a modern Paul Bunyan, shoves the small pine logs 7½ feet long into a horizontal bandsaw at the sawmill in Omak, Wash. He splits them in half. Half logs then whiz on a merry-go-round of rollers and endless chains to Boyd Ogden, who slips them in the other side of the same bandsaw and slices a slat one inch thick from the bottom of each.

Partly sawed logs and one-inch slats next go on another ride. John Calvin snatches out slats and sends them on a belt for fur-

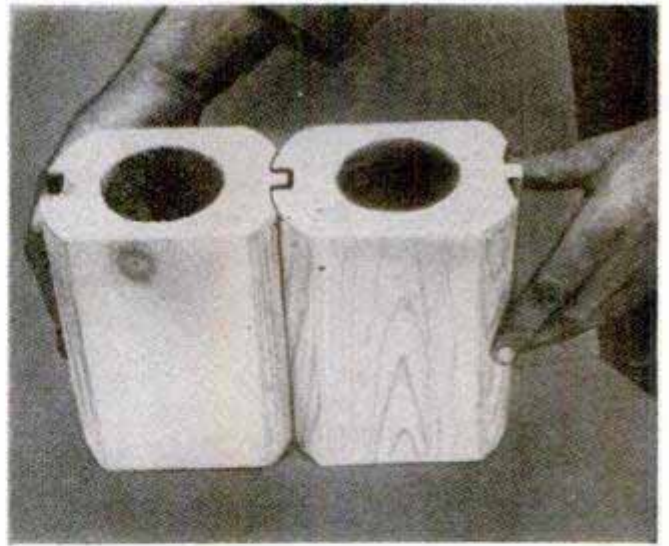

Logs are milled to lock together, with a big hole drilled through each to aid drying and insulation

ther processing. Whittled-down logs keep on traveling 'round and 'round as long as the bandsaw can cut a slat two inches wide.

The horizontal bandsaw is a newcomer to American sawmilling, borrowed from Europe where primary cuts of logs by horizontal bandsaws have been made for years. The saw is essential in cutting lumber from "toothpick size" trees.

Slats zip out of the lodgepole mill at the rate of 175 to 185 linear feet per minute, considerably faster than boards are turned out by other sawmills of its size.

Lodgepole-pine slats, two inches to twelve inches wide, are not in the final form of lumber until they have gone on another merry-go-round ride in the plant. As many as a dozen slats are fastened together by their edges to make a piece of lumber three

Factory-made dormitory is built from the straight logs tongued and grooved and set vertically on a foundation Haynes Studios Inc. photo





Telephone poles made from the tall, straight pines are stacked like jackstraws for shipment from forests

feet wide. Slats on the second merry-go-round are joined by a machine which puts a dovetail joint in slat edges, then glues the slats together.

The whole edge-joining job is done automatically by the machine at the rate of 60 feet of joint per minute.

Little lodgepole pines have risen in lumber production from a bare 25,000,000 board feet per year in the 1930s to over 100,000,000 board feet annually now. Hundreds of other wood products, which cannot be measured in board feet, are also built from the trees. In 1935, about 60,000 telephone and telegraph poles were made of lodgepole pine.

Last year the total was about 250,000 poles.

Lumber products from lodgepole pines and other small trees are also rolling out of the high-speed Tyson Creek Sawmill near Santa, Idaho. The specialty here is two-by-four timbers eight feet long, to be used for studs in building construction.

Logs enter the mill in a near-continuous flow and are stacked for processing. Each log tumbles into a trough and is then shoved into four circular headsaws. These cut three timbers, either two or four inches thick, that are easily converted into lumber of the desired dimension.

Recent discoveries of wood chemistry

Unique machine cuts dovetail joints in edges of slats, then glues and joins them to make a panel of wood



also have boosted the use of lodgepole-pine trees for pulp and paper. "Pulp of lodgepole pine mixed with Douglas-fir pulp makes superior kraft paper—brown wrapping paper—for many uses," states Harold Olson of American Forest Products Industries, Inc.

Tens of thousands of new-timber acres in the West, many of them stagnated, have thus been discovered without much searching. Lodgepole pines are found from near the Pacific Ocean to the Black Hills of South Dakota, from the Yukon River to the mountains of Mexico.

"Until recent years, lodgepole pines in these parts served only as excellent fuel for the toughest forest fires we ever saw," says I. V. Anderson, chief of the Forest Utilization Service in Missoula, Mont.

In fact, the trees are called forest-fire trees. They have the peculiar ability of seeding land soon after the embers of a fire have died—before other trees get a chance to do so. It was even believed for years that the cones would not open and scatter their seeds unless they had been roasted by flames.

Once cones have loosed seeds, the trees are so aggressive that as many as several thousand wispy little seedling pines may strive for life on an acre of land.

Unusual products add to the demand for lodgepole-pine timber. A radically different kind of log cabin is being produced from the trees, with well-peeled logs set vertically on a foundation. It is manufactured at a plant in Thompson Falls, Mont.

The pines have always been favorites for log cabins. They grow straight and tall, often only $\frac{1}{4}$ inch smaller at one end of a

(Continued to page 246)

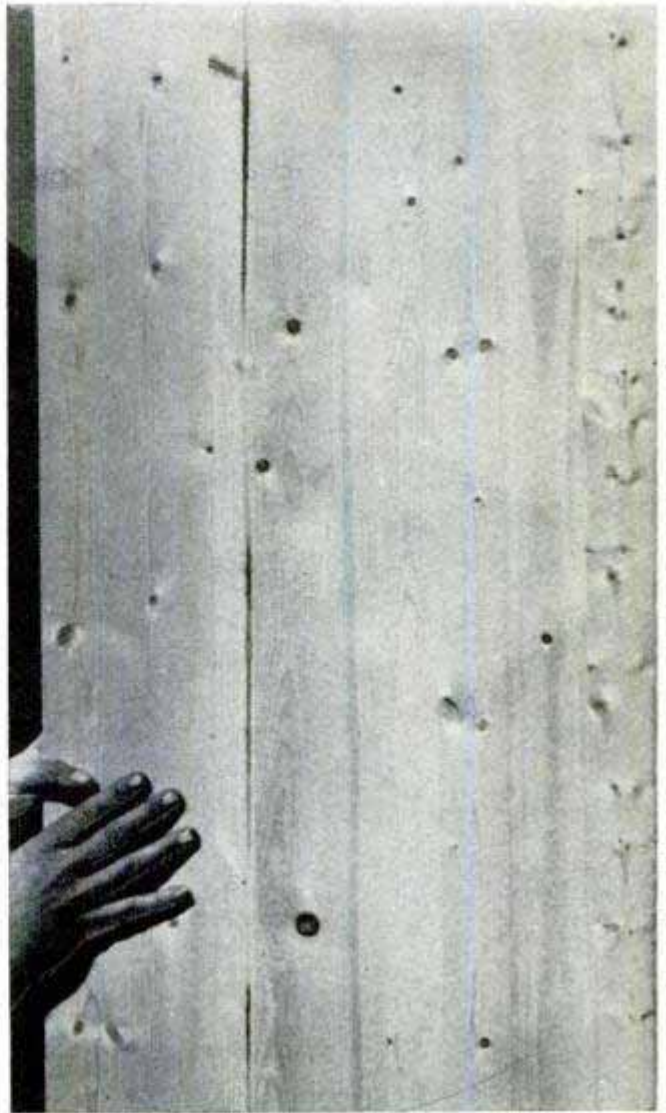

Nine narrow slats of lodgepole pine were joined by machine to make this sheet of lumber 27 inches wide

Small logs move through four saw blades which cut them to the correct dimensions for two-by-four studs

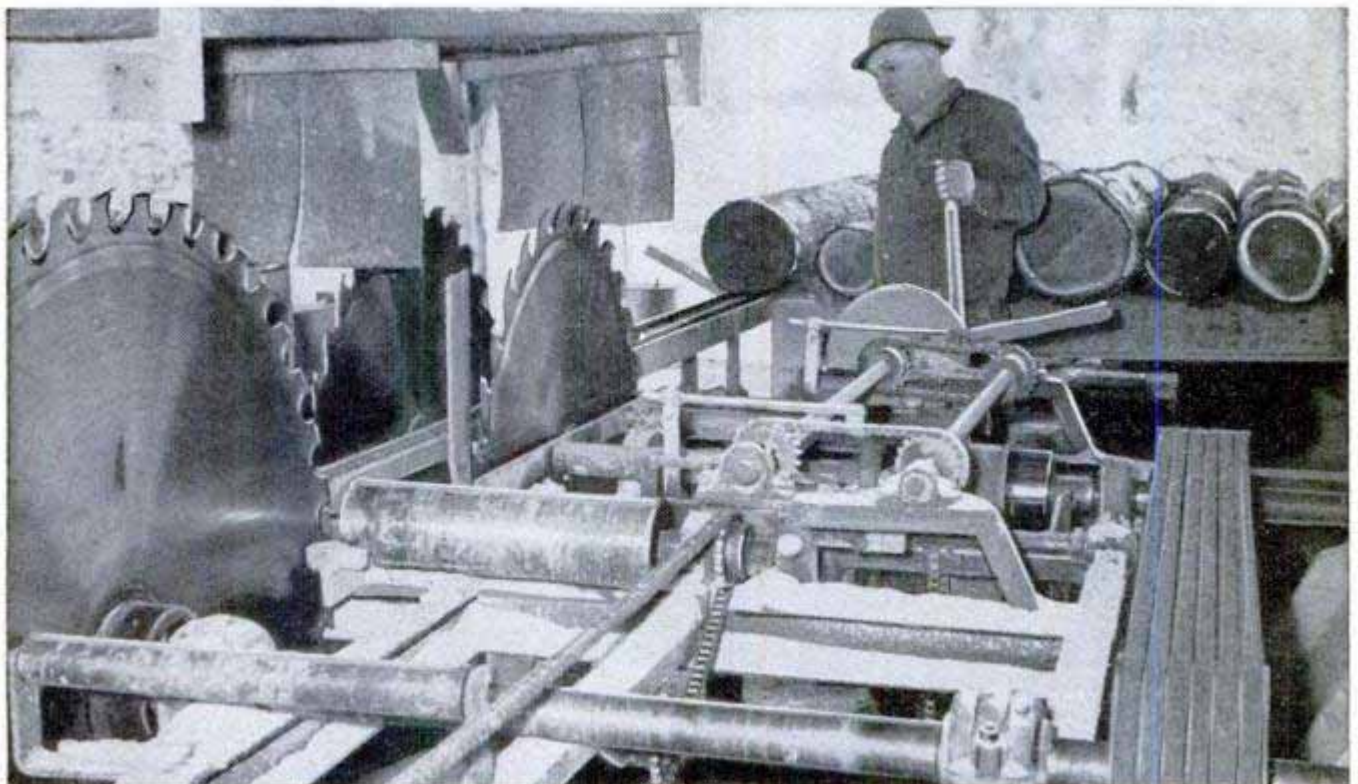

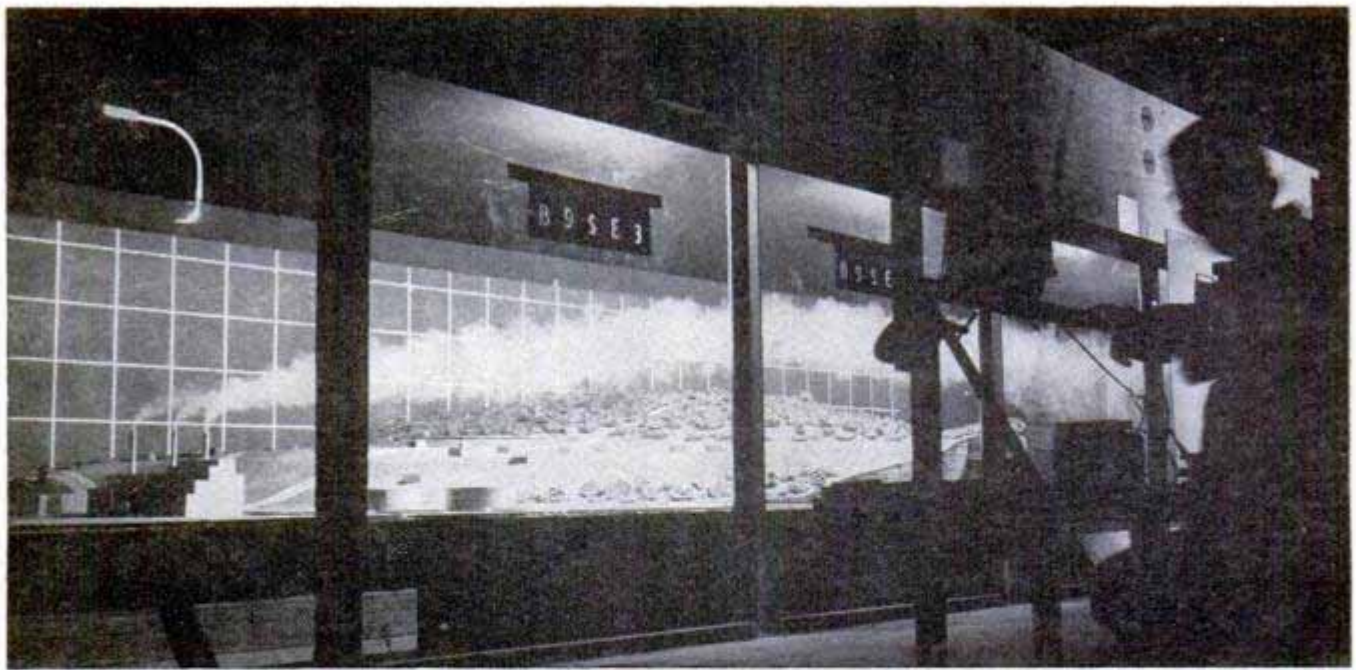

Wind-Tunnel Model Aids Air-Pollution Studies

Air pollution caused by a factory can be determined before the plant is built. One New York electric-generating company wanted to add to its facilities, but feared that the addition would increase air pollution. The problem was turned over to consulting engineers who enlisted the aid of New York University's College of Engineering and its low-speed wind tunnels. By building models of the new facilities along with the old, the surrounding buildings and

terrain inside the tunnel, it was possible to study the behavior of smoke and gases from the smokestacks under a variety of wind conditions. By varying the design, the engineers devised a structure that would not add to air pollution. Furthermore, by suggesting changes in existing stacks air pollution was somewhat reduced. In the study, smoke emanating from the models flows past a grid which can be photographed for accurate measurement.

Model Oil Rig Demonstrates Drilling Techniques for Students

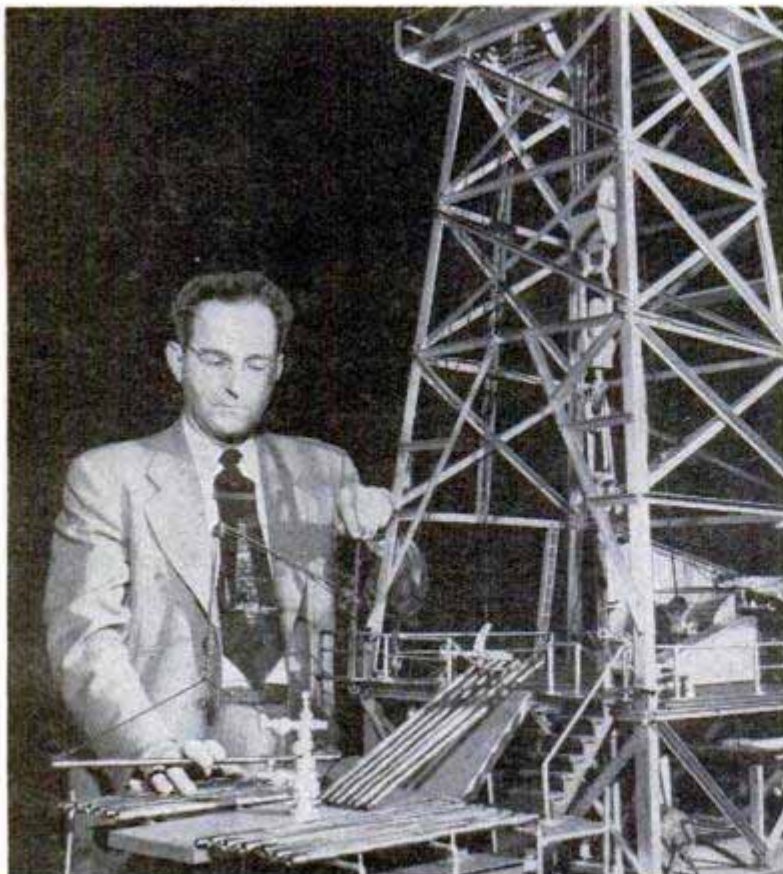

Students at Southwest Louisiana Vocational and Technical School learn about oil drilling from a scale model which duplicates the real article in every respect. And though it hasn't struck "pay sand" as yet, in one demonstration it sank a 52-foot shaft. The rig is mounted on a barge which floats in a tank during demonstrations, thus duplicating the typical Louisiana installation of a well in offshore and marshy areas. A "heavy duty" boom like the ones used to transfer pipe from supply barges handles the miniature pipes. Directly below the pipe rack are fresh-water tanks. These hold a water supply for cooking, drinking and other purposes. The substructure conceals mud lines, drill-line spools and other pieces of equipment. With working parts powered by a $\frac{1}{10}$ -horsepower electric motor and complete with a $6\frac{1}{2}$ -foot derrick, it was constructed by students with the help of manufacturers.

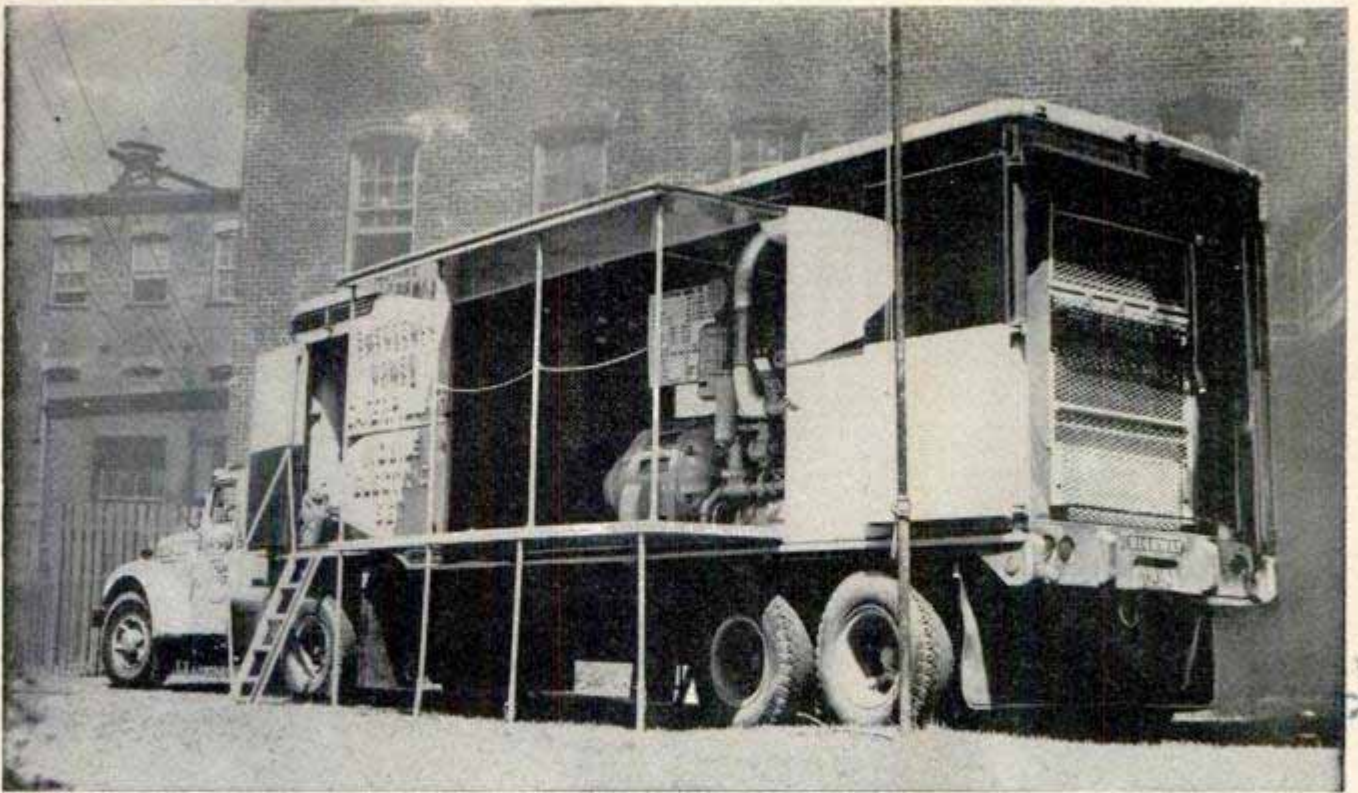

Truck unit, available to communities that suffer from critical electricity shortages, has proved its worth

Mobile Power Plants Serve Emergency Needs

TWO MOBILE POWER units, one set in a semitruck-trailer and the other mounted on a railroad flatcar, are equipped to go almost any place in the United States to serve emergency needs. The "semi" houses a diesel-electric generator, which is used to boost the current of power-short commu-

nities. After solving a critical power shortage in South River, N. J., last year, the 28-ton rig moved on to Sioux Falls, S. D. The flatcar unit develops steam to operate steam pumps, clean tanks and supply heat. Oil is burned to produce up to 20,000 pounds of steam per hour.

Fifty-foot flatcar steam plant was designed to meet needs of expanding industrial operations in Pennsylvania

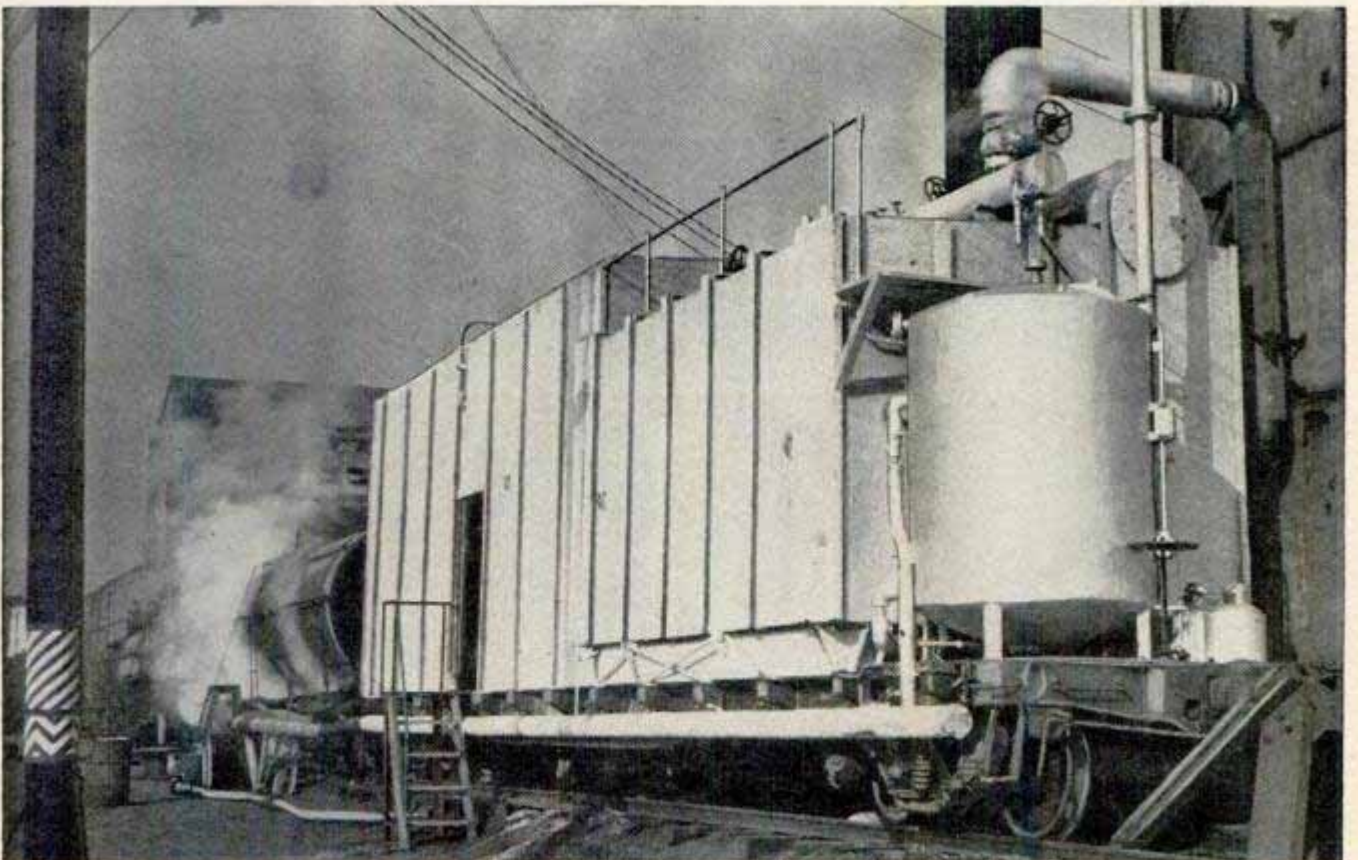

TOOLS FOR YOUR Lawn and Garden

1. POWER SPRAYER is easily wheeled about the lawn and develops up to 200 pounds of pressure. At low pressures it sprays lawns and spreads weed-killing mixtures; at high pressures it fogs insect-control chemicals into the trees

Lansing

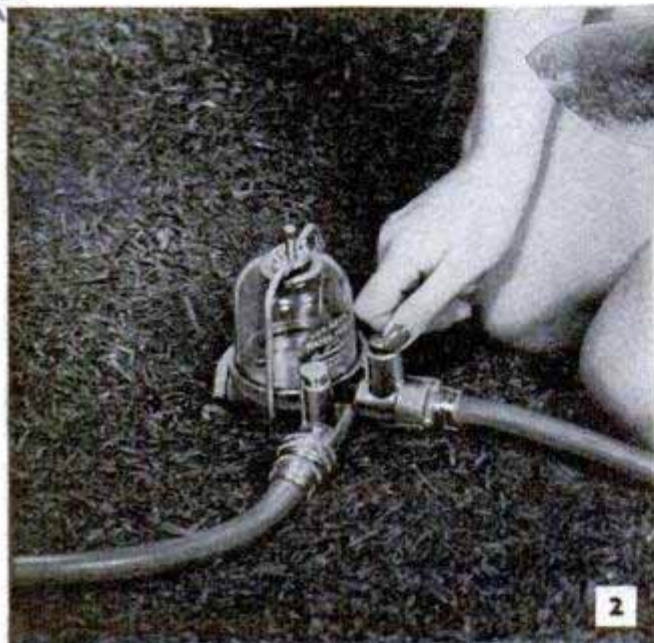

2. WATER TENDER, connected to hose, meters out water for a preselected time, then automatically shuts itself off. Dial permits time variation from five minutes to four hours. Just set it and forget it

3. SIT-DOWN MOWER has a sulky attachment that lets the homeowner mow in comfort. A skid at the front of the machine guides the mower so it glides over uneven spots without biting or scalping the turf

4. GARDEN CADDY helps tote tools around the yard. Rubber-tired cart has a steel compartment to hold long-handle tools. Elastic band holds hand tools and gloves, and clamp secures pail or box between wheels



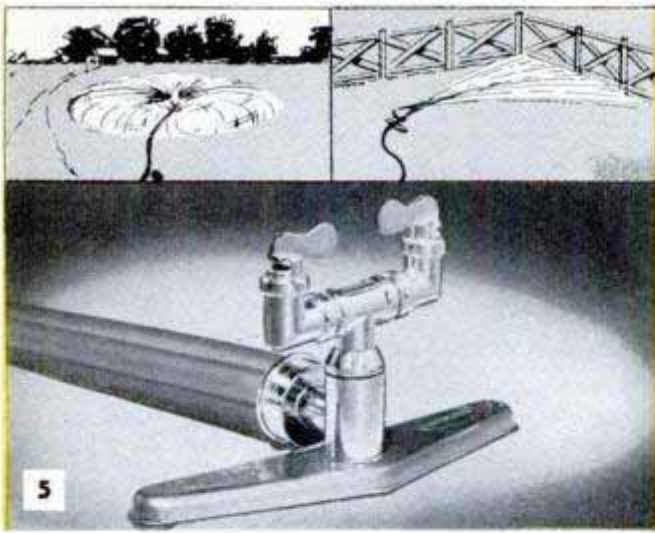

5. TWO-NOZZLE SPRINKLER can be adjusted to spray in circular, semicircular or rectangular patterns. The gardener can also vary the elevation and force of the water to reach across driveways or deep under trees



6. FERTILIZER SPREADER sifts manure or peat moss as it moves. Fertilizer is loaded into the hopper. Speed determines coverage: If operator walks slowly, deposit is light; fast walk leaves heavy blanket

7. POWER EDGER, driven by gasoline motor, trims grass along sidewalks, flower beds and walls. For edging sidewalks, blade is in vertical position. With blade horizontal, cutter trims within $\frac{1}{4}$ inch of wall



8. ALUMINUM TRELLIS won't rust, never needs painting or repairing. Six legs simply are pushed into the ground to support the trellis and rosebush or vine. Trellis measures six feet tall, four feet wide

9. POWERFUL MOWER of the self-propelled rotary type is driven by a six-horsepower engine. It cuts tall grass, weeds or even light brush $1\frac{1}{2}$ feet high. Speed of blade is constant, regardless of mower speed



TOOLS FOR YOUR Lawn and Garden



10. GARDEN TRACTOR is light enough for a housewife to maneuver. A 2½-horsepower engine provides the power. It cultivates soil to the desired depth in a swath 12 inches wide. Speed can be adjusted



11. BIG-WHEEL MOWER is easy to control on any kind of terrain. Its rotary blade cuts a 21-inch swath even through tough weeds. Front caster wheel keeps mowing depth constant from one to five inches

12. MULCHING MOWER blows cut grass across uncut portion of the lawn. Next time around, mower cuts same blades again to form a mulch for lawn. Mulching feature also is available in an electric mower

13. CULTIVATOR weighs 85 pounds, delivers all its power directly to its rotary tines. It crumbles and stirs soils to a depth of 10 inches. Same machine with attachments becomes a complete garden tractor





14

14. FOG GENERATOR can be wheeled about the garden to spread insecticides and other chemical solutions in a fine mist. With plants covered, fog spreads over surface of each leaf in effective film



15

15. ELECTRIC MOWER cuts grass or weeds up to two feet high. At the end of a swath, operator flips handle on over mower and starts back—mower cuts in either direction and cord stays outside path

16. TRIPLE-TUBE SPRINKLER is actually perforated three-channel hose that lays flat on ground, can be curved around flower beds and walks. Each channel sprays in a different direction for full coverage

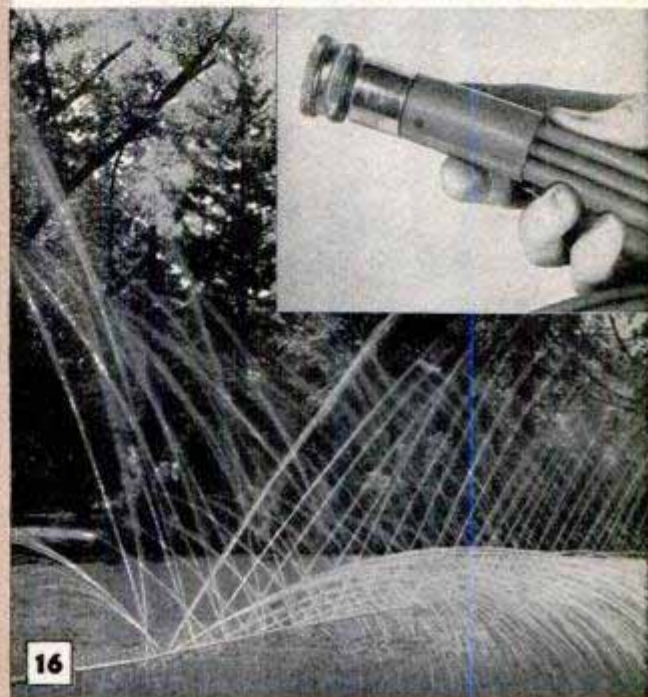

16

17. YARD POWER is provided in a two-horsepower unit which has five attachments: Rotary mower (shown here), reel-type mower, snow plow, weed cutter and cultivator. Attachments easily changed

18. REEL ATTACHMENT now available for rotary snow plow makes machine useful the year 'round. Mower is 20 inches wide. Also available is 28-inch sickle-bar attachment to convert unit into scythe



18



17



Fast-sequence camera takes roll film about 2¾ inches wide. Series at left was taken at 50 shots a second



Rapid-Sequence Camera Takes Big Pictures

Providing the advantages of both movie and still photography, a 70-millimeter high-speed camera takes as many as 50 large negatives per second. Designed principally for research work, the camera will expose 25 five-inch frames or twice as many 2½-inch frames per second. It is equipped with reflex focusing, variable frame-speed control, electric braking and provisions for changing frame size in less than two minutes. Camera weight is 32 pounds. A double rotating disk-type shutter makes exposures of 1/1200 second. Operated with a 110-volt power supply, the camera takes standard 70-millimeter film in 100-foot daylight-loading rolls. No lens is supplied. Lenses with focal lengths from 7 to 40 inches can be used. The camera is especially suited for recording high-altitude-missile flights.

Dual Air and Hydraulic Brake for 97-Ton Amphibian

Separate air and hydraulic systems can be applied independently or together to brake the Army's new amphibious Barc, a 97-ton big brother of the World War II DUKW. The air system is used as a service brake, with the hydraulic system always available for emergencies.

Ditcher-Terracer Blade on Farm Tractors Adjusts to Many Positions

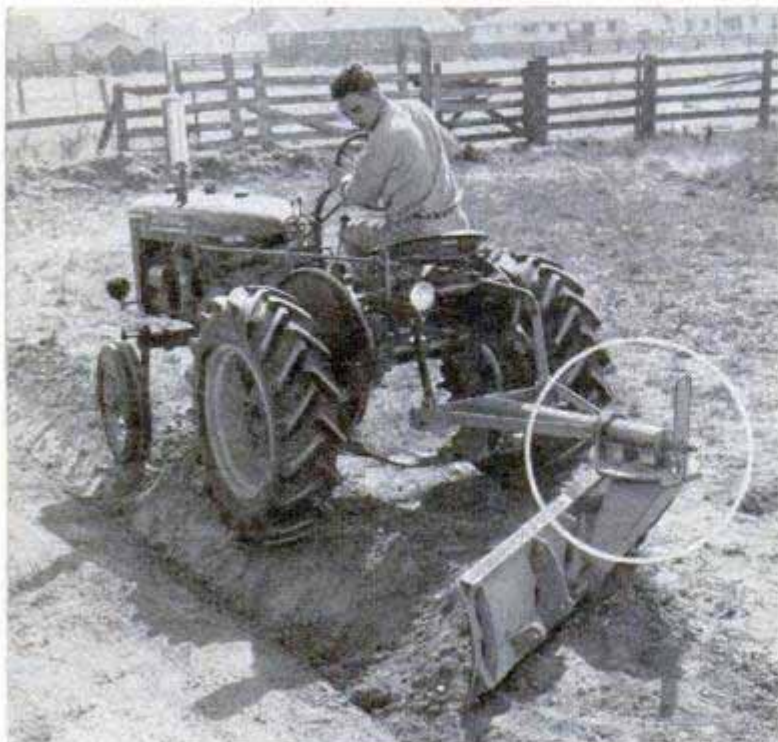

Ditches up to five feet deep can be dug with a new earthmoving blade for farm tractors. The six-foot blade, raised or lowered by the tractor's hydraulic system, swings completely around and can be locked in any one of 14 positions to throw the dirt either right or left. It also can be tilted to any degree by loosening a wing nut, disengaging the toothed locking mechanism, tilting the blade as desired and tightening the nut. In digging a ditch, the blade cuts up to 16 inches deep in its first pass. The resulting V-bottom ditch is suitable for drainage tile, with the topsoil saved on one side of the cut and the subsoil on the other. In terracing, the blade can be swung completely around and used for back-filling. The cutting edge can be reversed if desired after a period of use.



Top telescopes to standing height and the sides swing out to accommodate bunks. Rear awning supplies shade

Telescoping Trailer Cabin

HUNTING AND FISHING trips make wonderful vacations, Carl Pister believes—if you don't have to sleep in a tent. His solution is a telescoping cabin that fits onto a pickup truck or trailer chassis. At the camp site, the top of the 600-pound unit raises two feet to standing height and hinged sides, into which bunks slide, swing out for a width of nine feet. High screened windows provide light and air. In a front niche is a portable range and kitchen table. Built at a cost of \$600, the cabin has a frame of angle iron and square steel. It is covered with waterproof plywood.

In expanded position, cabin is kitchen and bedroom for two. Below, ready for travel, trailer is compact and roadable

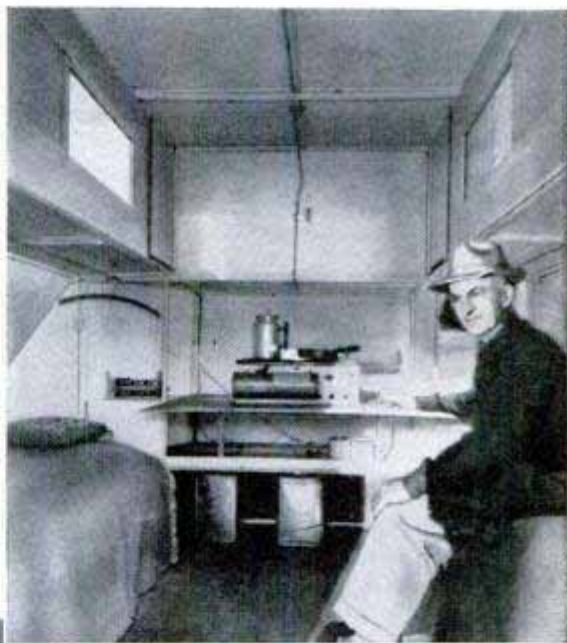

COLLEGE FOR PLUMBERS

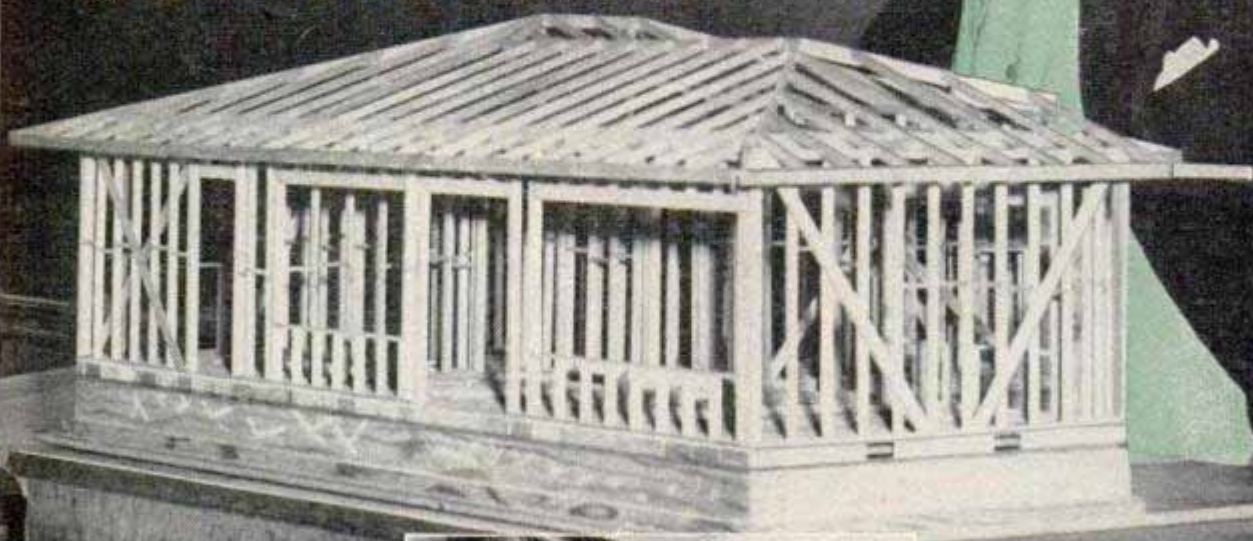

Model of partially finished house is surveyed by student who will then map plumbing



Practical instruction includes basic tasks like threading and fitting strap to a pipe hanger

Training in sheet-metal work is needed to install heating and air-conditioning systems



IT MAY BE some time before you'll need a bachelor's degree to fix kitchen faucets, but in Los Angeles they've set up a four-year college curriculum for would-be plumbers.

Actually, plumbing can be a pretty complicated business, especially when you're designing the water system for a large factory or office building, with its miles of pipe lines. A person familiar with all phases of plumbing can save thousands of dollars and eliminate costly changes on a large job. Recognizing this, a group of master plumbers in the Los Angeles area worked with the faculty of Los Angeles City College in creating a course in plumbing engineering to give students an over-all, detailed knowledge of the field.

Subjects in the two-year basic course include mathematics, physics, chemistry, surveying, plumbing problems, engineering drawing and general courses like English, history and economics. Following this is an intensive two-year program at Los Angeles State College, with fluid mechanics, sanitation bacteriology, law for plumbers, hydraulics, plumbing-construction estimating, heating, ventilation, refrigeration, air conditioning, fire-sprinkler systems, thermodynamics and allied subjects. During summer vacations each student works as a plumber's apprentice for academic credit.

Upon graduation, he will be equipped with practical and academic knowledge to beat the many complex, as yet unsolved, problems which await. ★ ★ ★

Student operates a pipe cutter, standard equipment in the average plumbing shop



Trainee dons goggles and asbestos gloves to learn use of a cutting torch. Students work as plumbers' helpers during summer

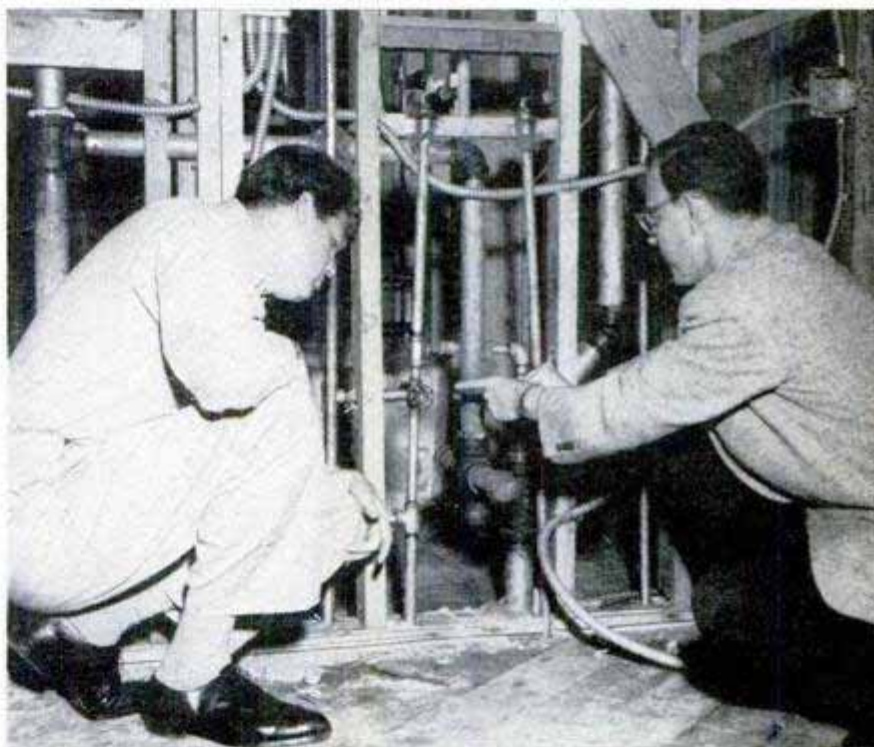

City plumbing inspector tells what he looks for when checking a system. All plumbing must pass city or county inspection. Below, trainee operates large automatic pipe threader. Many contractors cut and thread pipe before taking it out to job

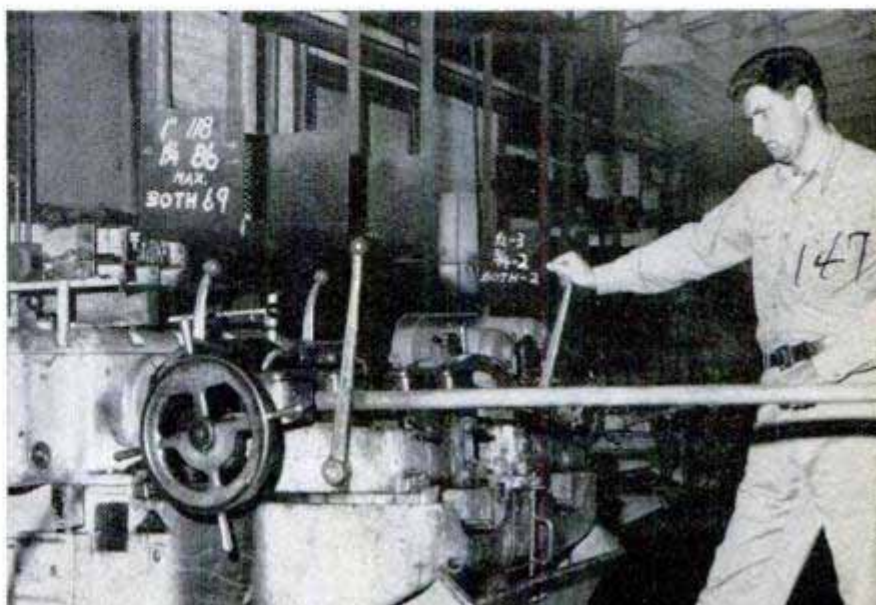
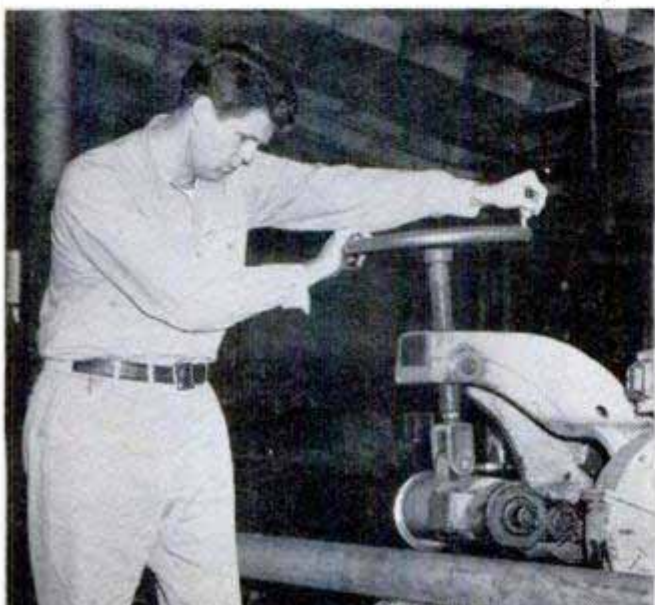

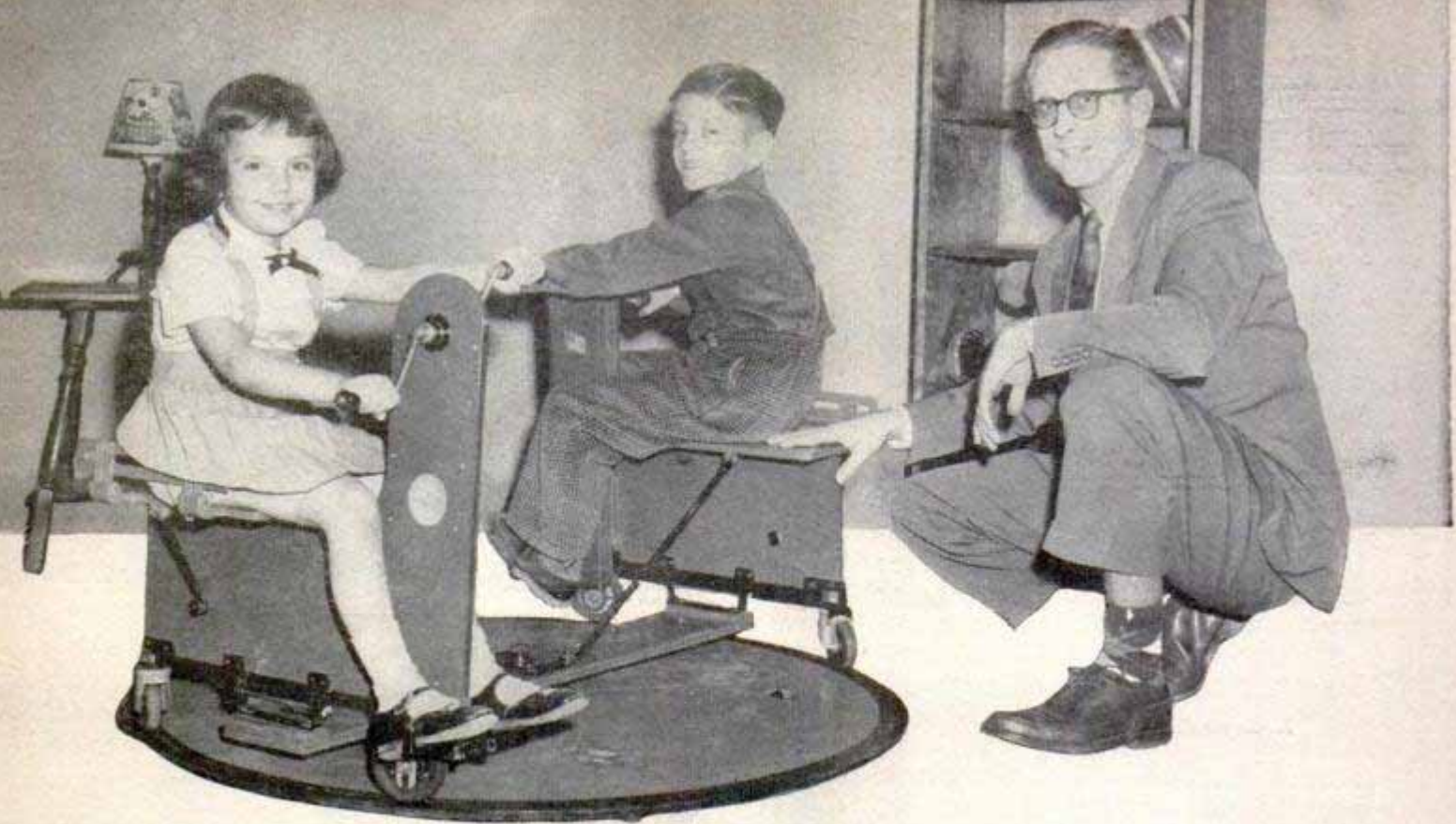

Whirlmobile, a collapsible indoor merry-go-round, was one of four inventions shown on the first program

Inventors Hit Television Jackpot

APPARENTLY, many good inventions end up in attics instead of the market place because only three percent of all patents are used. However, "The Big Idea," a Du Mont television program that serves as a showcase for independent inventors with bright ideas, is knocking these discouraging statistics for a loop. In the first seven weeks the program was on the air, 28 inventions were shown. Of these, 16—or 57 percent—have been purchased or are in negotiation with investors and manufacturers. Ex-engineer Donn Bennett, the program's host, brings four inventors to the nation's video screens

each week and invites them to exhibit their "brain children." The first programs included the Whirlmobile, a portable, collapsible merry-go-round that can be set up in the living room on rainy days; a coin chute which separates and stacks all coins from a penny to a half dollar; a hydraulic automobile piston said to eliminate the need for overhauling; and a buoy which would float free of sinking ships and planes, flashing a light for five miles to guide rescuers to survivors. Other devices included a hot-plate lunch box, a design-printing paint roller and a portable washing and drying machine.

From left to right are coin separator, long-wearing automobile piston and a blinker buoy featured on TV



the

POPULAR
MECHANICS

CRAFTSMAN



**SEE STORY
NEXT PAGE**



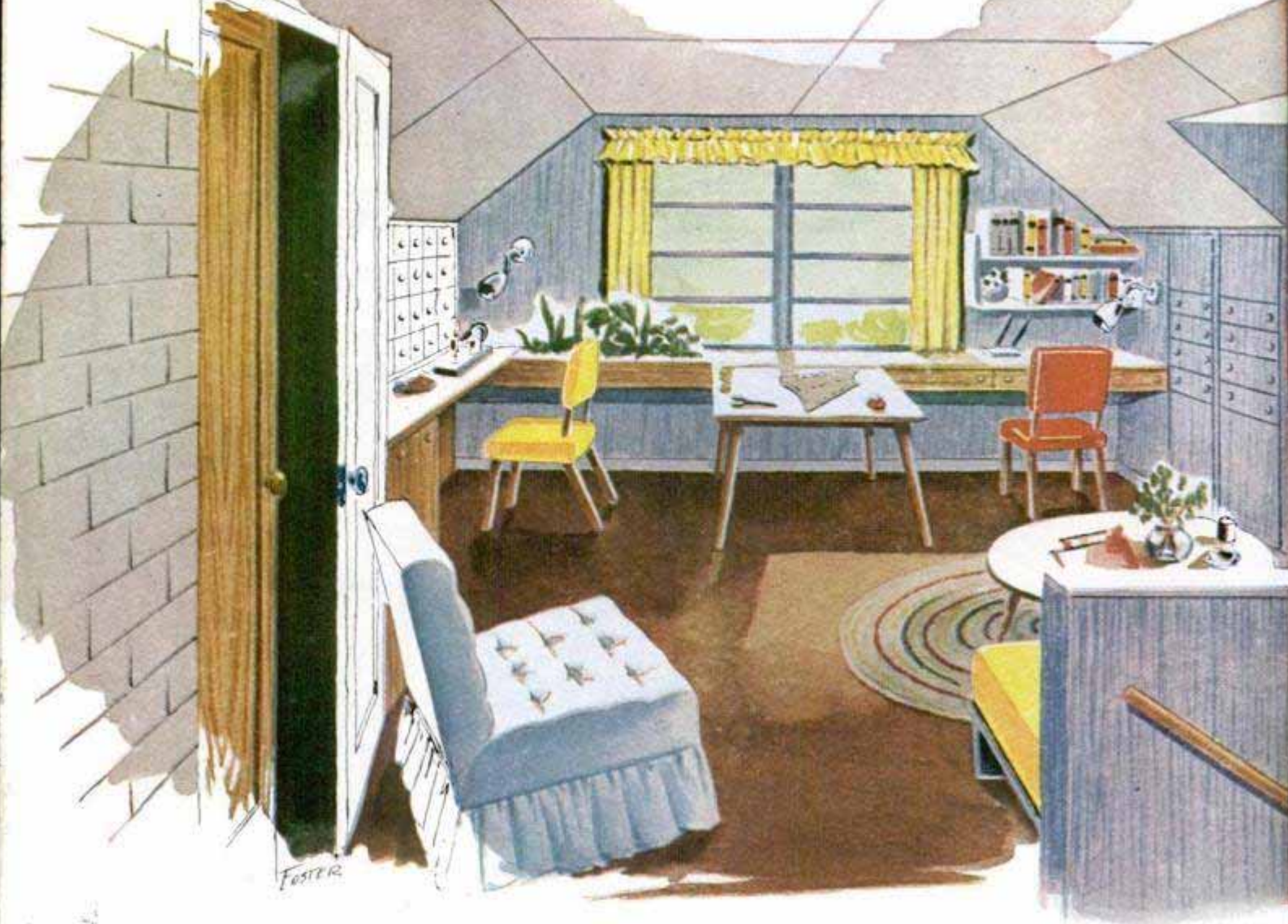

PANEL YOUR HOME WITH

ARE YOU INTERESTED in refinishing a room, paneling the attic or basement or completing the interior of a new home? If so, plywood in one of its many textures and finishes can do an excellent job and, best of all, it is easy for the amateur to apply.

Today, plywood is being used extensively on walls and ceilings with striking results—another of the countless applications to which this versatile building material naturally lends itself.

As there is a wide variety of types and price ranges from which to choose, selecting the plywood best suited for your particular purpose becomes but a matter of personal taste and budget. Common fir is the most inexpensive of the plywoods and will make attractive walls and ceilings if finished correctly. At only a slight additional cost, you

can have fir plywoods with special surface textures—Plyweave, striated (combed) or sandblasted. Then there are the vertical-grain, or rift, fir panels; fir plywood that is quarter-sawed from logs in the same way as a select board, with tone and grain as rich as many a hardwood. Highly attractive softwood paneling is available in redwood and knotty-pine plywoods. Finally, there are many hardwood plywoods—gum, oak, birch, mahogany, walnut, korina—each distinctive in its grain and coloring, and providing a selection to blend with any interior decorating.

Plywood panels are worked easily with ordinary tools, are exceptionally strong and will provide the most scuffproof and crackproof of dry-wall construction. The major problem with plywood is that it goes

Seven of the many plywoods now available are pictured below. The samples, from left to right, are redwood Plyweave, fir Plyweave, rift-grain fir, rift-grain redwood, walnut, smoky birch and African mahogany



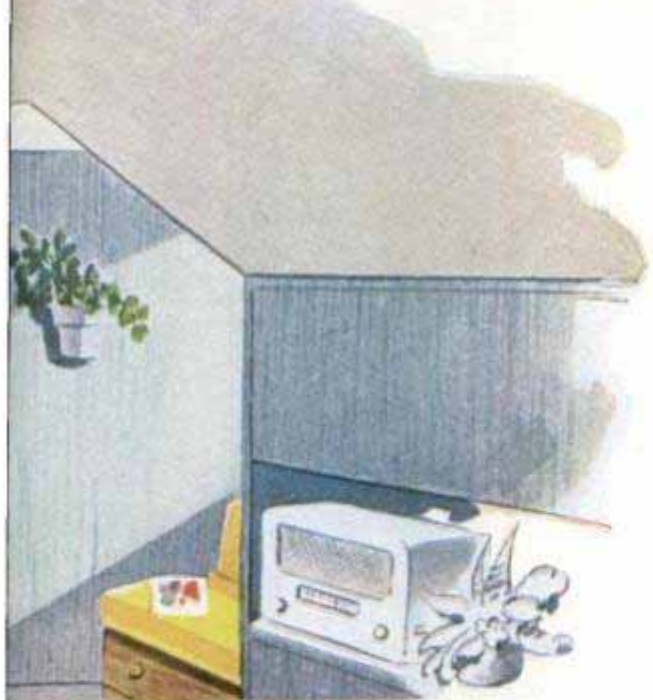

Wall in living room of *Popular Mechanics* ranch house is of 1/4-in. walnut plywood toned with a red-mahogany oil stain

By
Tom Riley

Color photos courtesy
M & M Plywood Corp.

PLYWOOD

on the walls so quickly that you are tempted to be careless. However, when you take time to use a good paneling method and finishing procedure, there will be no gaping joints or somber finishes.

The common 4 x 8-ft. panel is the right height for most walls and fits standard studding. Smaller panels also are fairly common, and extra-long panels (up to 12 ft.) are available for covering high walls as well as spanning the width of ceilings. Common fir plywood is available in two types—interior and waterproof exterior. The latter is necessary only around the bathtub and shower. Each type is graded (A, B, C and D) depending on the defects in the panel faces. As only one face is exposed, interior A-D plywood, which has one clear face (A grade) and the other



The tasteful use of plywood in cabinets and wall paneling adds warmth to the room and sets off the stone fireplace



Kitchen cabinets are of rift-grain redwood plywood and exposed wall areas are of enameled rift-grain fir plywood





Fireplace wall of modern bedroom is of 24-in. squares of $\frac{1}{4}$ -in. birch plywood over $\frac{5}{16}$ -in. underlayer. Other walls are of full-sized panels

knotty (D grade), is the type to buy. There are also "reject" panels. These are satisfactory for cabinetwork where defects can be cut out, but they are not economical for wall paneling, as the full sheet usually is required.

Two methods of wall paneling: The center detail on page 154, shows two ways to panel your walls economically with plywood. With the single-layer method, sheets of $\frac{3}{8}$ -in. plywood are fastened directly to the studs with 4d finishing nails. It is important to apply a good glue, preferably a plastic resin, liberally along the studs before nailing down the fitted panels. For the sake of economy, $\frac{1}{4}$ -in. plywood can be used, but the panels will have a tendency to "boom" when struck and perhaps to bulge between the studs. This is especially true if the studs are spaced farther apart than the usual 16 in. on centers. The $\frac{1}{4}$ -in. thickness, however, frequently is used under wallpaper and similar coverings.

The double-layer method is the best one to use with the more expensive hardwood plywoods, because it produces an excellent wall with only $\frac{1}{4}$ -in. finish plywood. The underlayer is usually of $\frac{5}{16}$ -in. Plyscord, which is simply a C-D grade (knotty on both sides) of fir plywood that has been left unsanded. This is the cheapest underlay, but if it is not available, you can substitute $\frac{1}{4}$ -in. fir plywood or good, dry $\frac{3}{4}$ -in. lumber. The underlay is secured to the studs with 6d common nails, without gluing, and is installed crosswise to the direction of the finish panels. The $\frac{1}{4}$ -in. finish layer is nailed to the underlay and studs with 4d finishing nails or $\frac{3}{4}$ -in. brads, with glue under all joints and at spots in between. Try to avoid having joints in both the underlay and finish paneling on the same stud. With both the single and double-layer methods, the nails are spaced 6 in. apart along all edges and are driven at 10-in. intervals to the studs in be-

tween. It is recommended practice to leave the paneling unglued but nailed at the room corners to permit expansion in case the wall framing should shift or settle. The double-layer method also should be employed whenever small squares or narrow boards are used for paneling, as the underlay allows the smaller pieces to be nailed and glued securely regardless of whether or not their edges fall on a stud.

On new construction: In the open walls of a new house or unfinished attic, insert short sections of 2 x 4 horizontally between the studs at a height of 4 ft. above the floor. If the panels are applied horizontally, the inserts will provide a backing for the joints; if not, the inserts will form additional bracing and also serve as fire stops. If using single-layer paneling, insert 2 x 4 backing pieces similarly at any spot where a joint will occur.

On old plaster walls: You will find it necessary to apply furring strips over plaster walls before paneling. These can be lengths of 1 x 2 or 2 to 3-in. strips of 1/4 or 3/8-in. plywood. Full-length horizontal strips should be spaced 24 in. apart and short strips nailed vertically over the studs between the horizontal strips. Fasten the paneling to the strips with glue and nails.

On masonry or concrete walls: Use heavier furring strips, 1 x 2 or 2 x 2 stock, on concrete or masonry, spacing the strips as on plaster walls or simply nailing them ver-

tically on 16-in. centers. Use concrete nails or drill the wall, plug the holes with dowels and nail the furring to the plugs.

Masonry or concrete basement walls often are damp, so asphalted building paper should be applied underneath the furring strips. If the wall is definitely damp, it should be given a coat of waterproof cement paint and the backs of the plywood panels coated with aluminum paint. In extreme cases, waterproof plywood should be used.

Paneling layouts: The way in which the paneling is laid out on the walls is entirely a matter of the type of effect you desire. When you intend to accent the panel joints, always panel above and below the openings first, using vertical joints from floor or ceiling to the openings. Then divide remaining wall spaces into the desired pattern.

Joints: When using smooth paneling, the finished wall usually will be most attractive if the joints are accented rather than concealed. Plyweave and striated plywoods present no joint problem, as their texture makes any joint practically invisible. For perfect fitting flush joints, plane the back edge of each panel at the joint to produce a slight bevel. This will assure a tight fit at the front edge, glue filling in the space behind. On painted panels, flush joints may be taped the same as plasterboard. All wall paneling should clear the floor by 1/4 to 1/2 in., the lower joints being covered by the baseboard.

Traditional wall paneling in this room consists of 3/8-in. rift-grain fir plywood glued and nailed to the studs. Panels are outlined by nailing 3/4-in. boards over the plywood and adding stock or picture molding





Recessed shelves and paneling of 1/4-in. oak plywood form distinctive entrance to this living room

1/4" OR 3/8" PLYWOOD GLUED AND NAILED TO STUD 1/4" FINISH PLYWOOD, GLUED AND NAILED

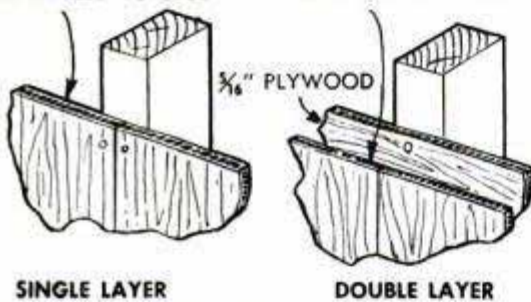

Ceilings: Plywood is applied to ceilings in the same way as to walls. However, because ceiling joists usually are lengthy beams with some warp and due to the fact that 2 x 4 blocking between the joists would be required at all panel joints, it usually is easier to apply furring to the ceiling joists in all cases. It is best to install 1 x 3s crosswise to the joists, spacing them 24 in. apart and nailing short lengths of 1 x 3 along alternate joists. Glue and nail the ceiling panels to the furring strips, spacing the nails at 6-in. intervals on the joints and 10 in. between them. Often, ceiling panels are applied in small rectangles or squares to obtain a tiled pattern, but it is easier to simulate tile by scoring full-size panels with a portable electric router or saw. Cut the grooves to the same 24 x 32-in. pattern as the furring so you can nail the panels in the grooves. Ceilings also can be paneled with any of the joints shown for the walls. Always panel the ceiling before the walls, as it is easier to fit the wall panels to the ceiling panels. To handle a large ceiling panel by yourself, build a "horse" like the one detailed on page 156.

Finishing: The finish on any wood-paneled wall is important. On rotary-cut fir plywood and also on rift-grain fir, redwood, gum and birch, a good natural-wood finish is obtained by applying a coat of thinned clear shellac or resin sealer, followed by a coat of white sealer or white paint which is rubbed on with a cloth and wiped off to the desired tone. Third, a finish coat of dull varnish, shellac or lacquer is applied. The white coat softens any orange coloring and

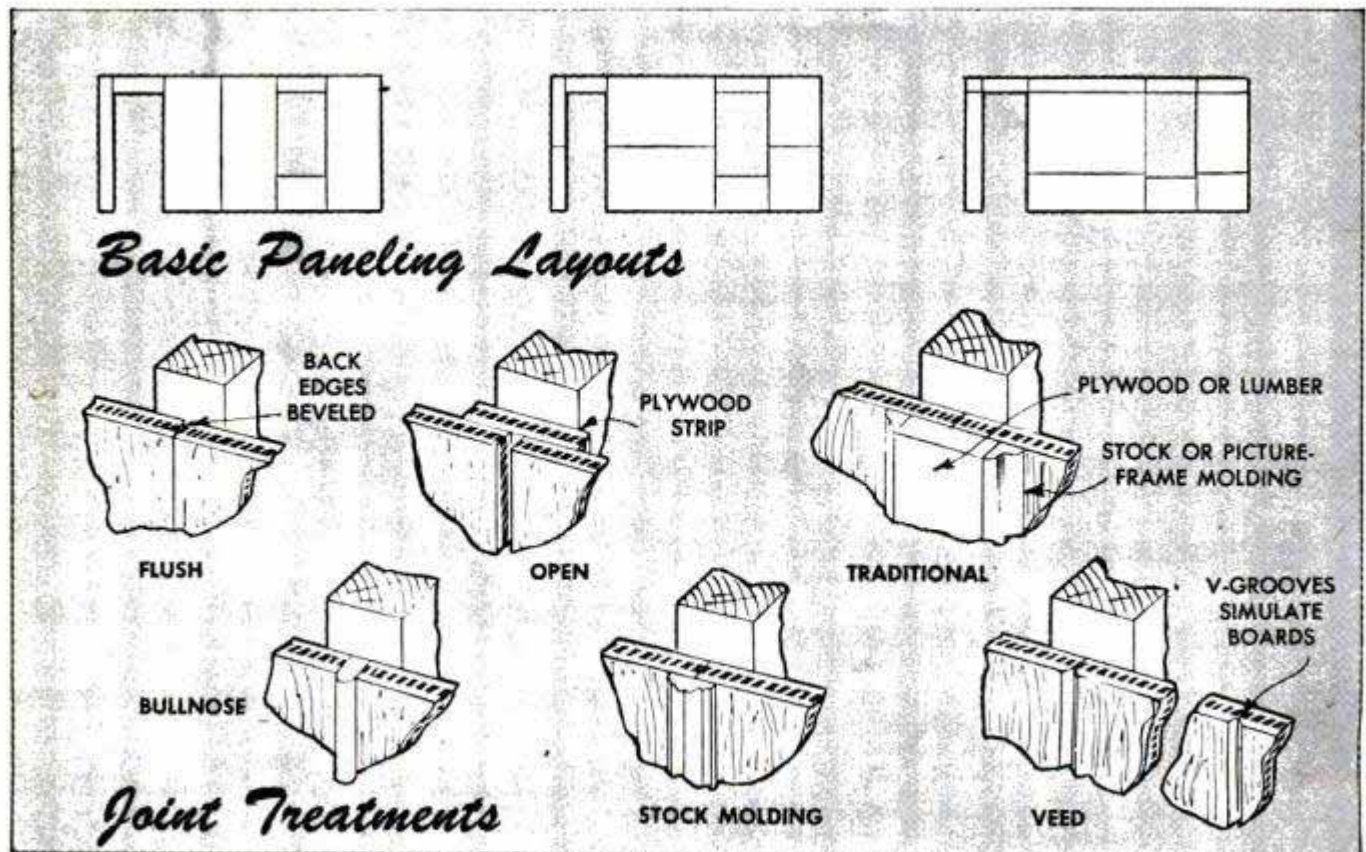



Ceiling-Wall Trim

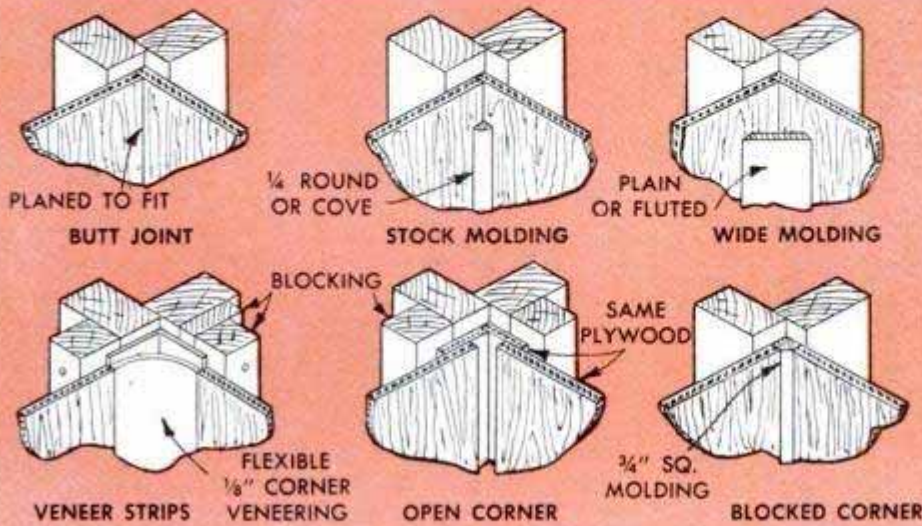

Inside Corners

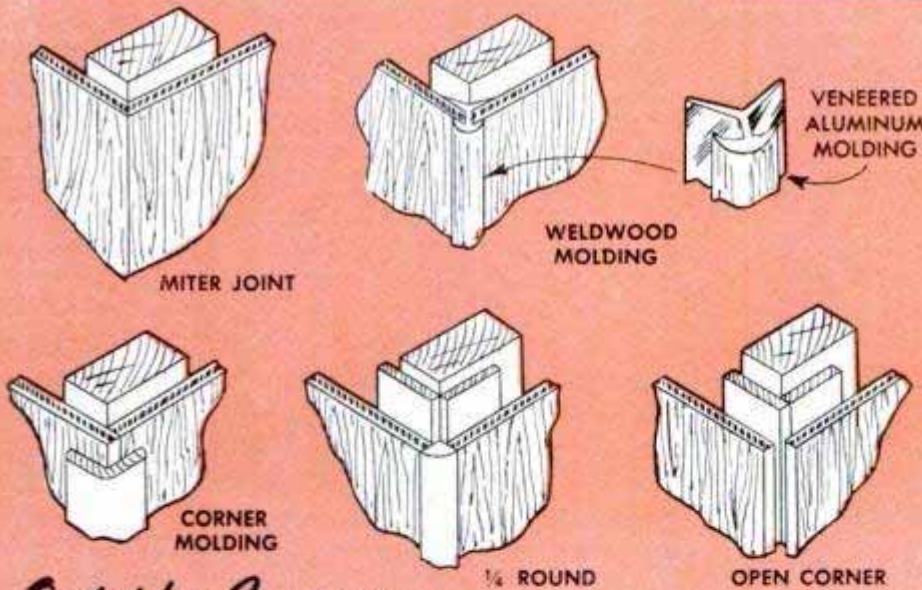

Outside Corners

Door and Window Trim

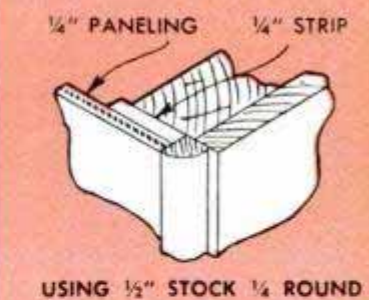
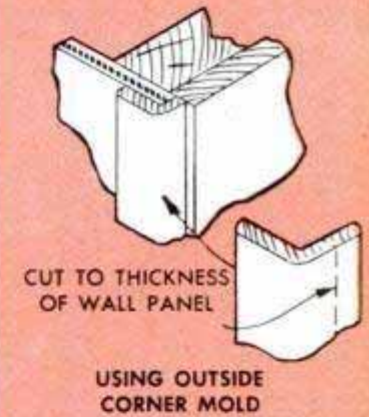
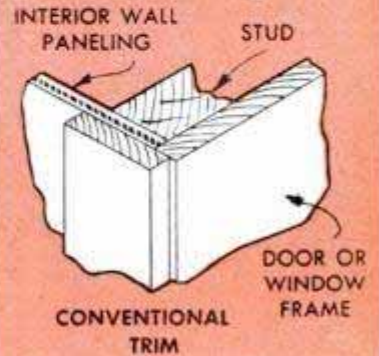

Wall-Floor Trim

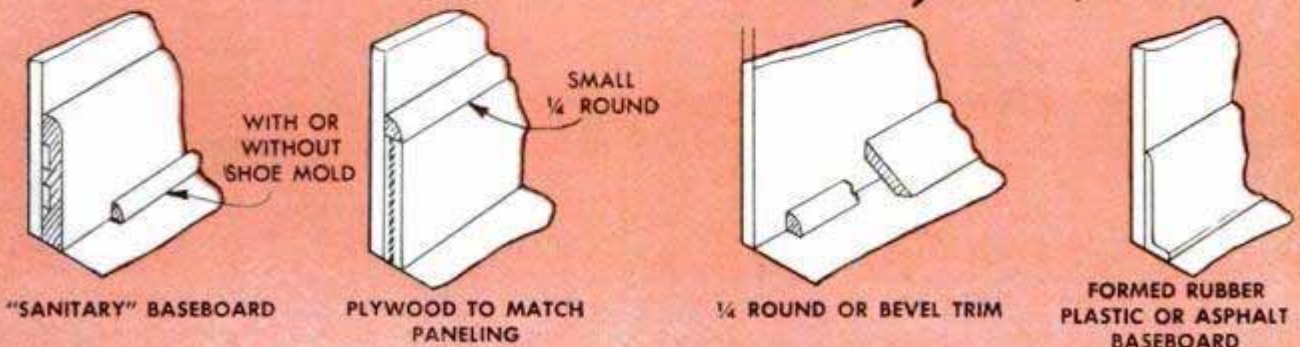



Note in photo at left how plywood panels are fastened to 1 x 3 furring strips nailed to ceiling joists

CEILING PANELED WITH 4' X 8' SHEETS

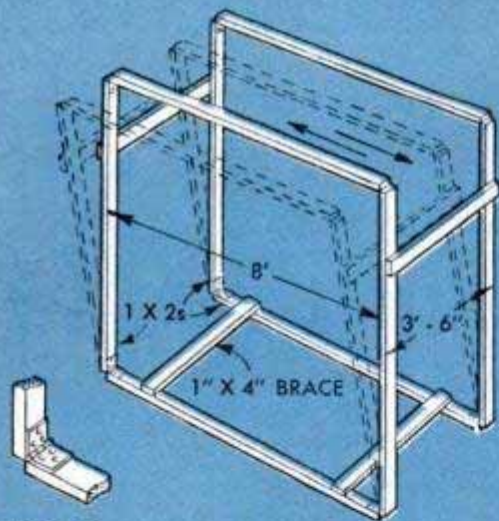
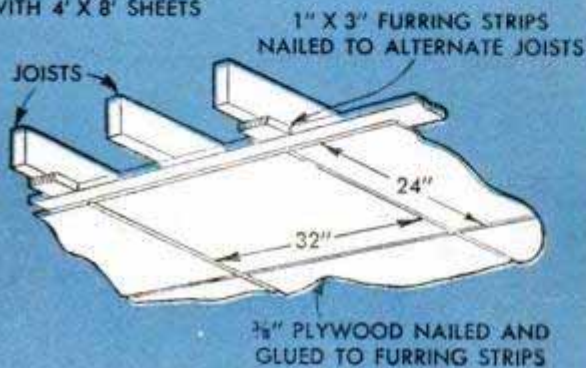

HINGED AT CORNERS

CEILING HORSE ALLOWS ONE MAN TO APPLY LARGE PANELS



neutralizes the tendency of fir to darken. Walls of oak and mahogany can be finished similarly, except that a white filler should be added to the second coat.

For a simple blond finish, brush on a first coat of white resin sealer or thinned undercoat. After a few minutes, rub this down with rags to the tone desired and follow, when dry, with a finish coat of shellac or lacquer. A rich, natural finish on the various hardwood panels is obtained easily by applying one coat of wallpaper lacquer.

An excellent way to stain common fir and any other plywood in a variety of pastel tones is to use ordinary oil paint. Brush on a first coat of any color paint or enamel undercoat, thinned half and half with turpentine. After approximately 15 min., wipe it down to the tone desired and apply a finish coat of varnish, shellac or lacquer. The photos on page 152 show various effects of this method on rotary-cut redwood plywood. The sample at the top is a natural redwood panel; A, stained with dark-yellow paint; B, green; C, gray paint; D, red-mahogany stain; E, light-yellow paint. Various finishes and grain effects are obtained by using different grain colors and varying the amount of wiping. Another attractive finish is achieved by applying any of the new wax stains and rubbing them to the tone desired. With any staining or toning, experiment first on scraps of plywood. On Ply-weave or striated plywood, a soft two-tone finish is produced by applying a white undercoat and then a coat of the color desired. The latter is wiped down to expose the white on the high spots.

For glass-smooth enameled walls, rift-grain fir, gumwood and birch plywoods are best. Apply a first coat of resin sealer to prevent grain rise; next, apply undercoat, 1 part, and enamel, 1 part; then, a finish coat of enamel. For a smooth, enameled surface on rotary-cut fir, first prime the plywood with thin white paint and apply painter's muslin over it, using wallpaper paste. When dry, glue-size the muslin and then apply any conventional enamel finish.

Common fir plywood, with its joints glued, is an excellent base for wallpaper. Apply rough-textured papers directly to the sized panels, and smooth papers to a layer of wallpaper liner or felt. Ceilings can be finished in the same way as walls; however, they usually are preferred in a neutral, plasterlike finish. Here, plastic or resin-base texture paints should be used, applying them with a roller or brushing on and stippling. ★ ★ ★

To obtain plastered effect, texture paint is brushed on heavily and then surfaced with flat rubber sponge

Making Plastic Money Clip

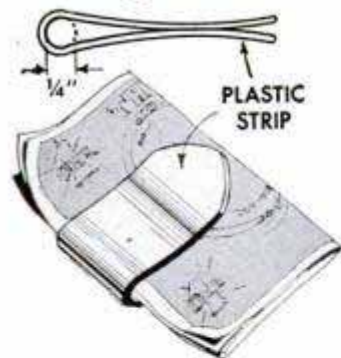

Made from a $1\frac{1}{4}$ x $4\frac{1}{2}$ -in. piece of $\frac{1}{16}$ -in. plastic, this money clip for personal use or gift purposes is a neat "quickie" project for the home craftsman. Round the corners of the plastic and smooth all edges with fine

sandpaper. Heat the plastic 1 in. back from each end and make a slight bend. Then heat and bend the center portion over a $\frac{1}{4}$ -in. dowel. To add a smart finishing touch, cement chrome initials to the clip.

Frank Shore, New York City.

Tape Wrapped Around Tubing Prevents Kinking When Bent

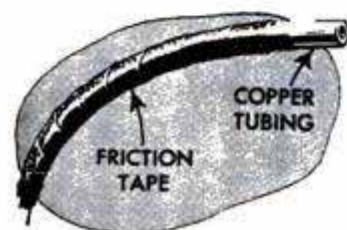

If you wish to bend a length of copper tubing without kinking it, wrap the portion to be bent with several thicknesses of friction tape.

The tape, which is wrapped spirally, will yield to the bending but will offer sufficient resistance to support the tube equally at all points. This minimizes the possibility of excessive strain at any one point.

Magnet Tests Genuineness Of Brass Hardware

One way of telling whether or not hardware, such as doorknobs, drawer pulls, etc., is brass or simply plated steel is to hold a magnet against it. The magnet will cling to steel, whereas brass or aluminum will have no effect upon it.

R. F. Donovan, Guttenberg, N. J.

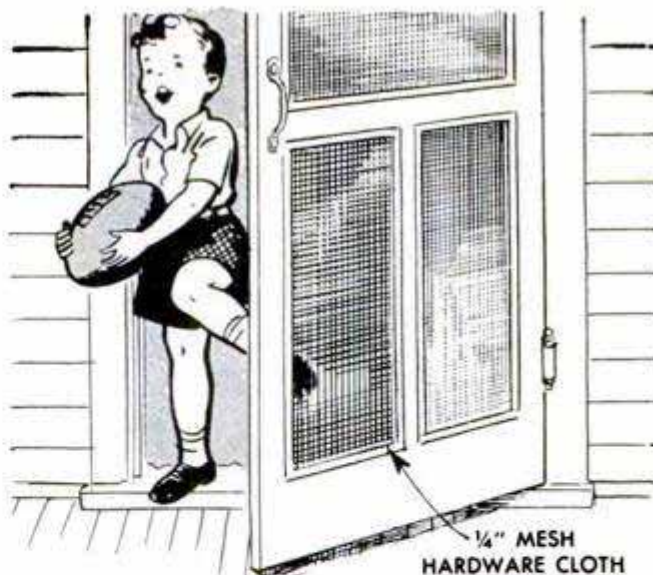
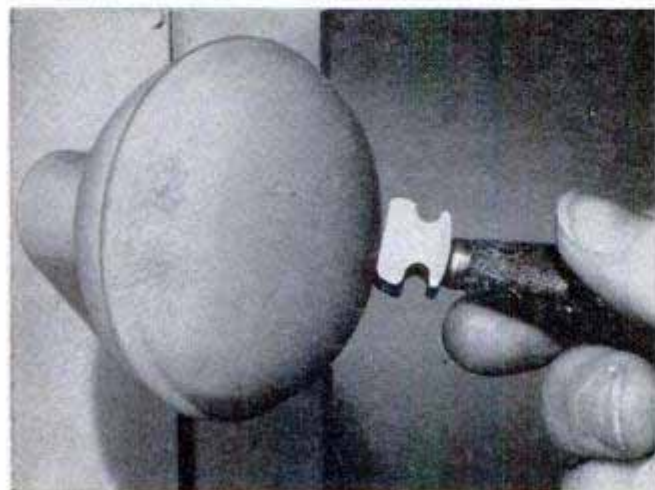

Hardware Cloth on Screen Door Reinforces Lower Section

Sooner or later youngsters will puncture and sometimes tear out the lower section of a screen door, usually by kicking or pushing hard against the door before it is fully released from the catch. One way in which this may be forestalled is by reinforcing the lower panel with $\frac{3}{8}$ or $\frac{1}{2}$ -in. galvanized hardware cloth. To install it, simply remove the molding, tack the cloth over the door screening and then replace the molding.—R. M. Woodbury, Natick, Mass.

Popping Plug Attracts Fish

Any wooden or plastic fishing plug can be converted into a popping bait by drilling three $\frac{1}{4}$ -in. holes $\frac{1}{2}$ in. apart diagonally

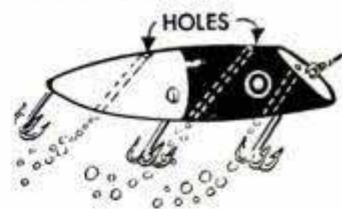

through the body of the plug. These holes will cause the bait to pop and gurgle and leave a trail of bubbles, which will attract fish as the bait is reeled in.

Russ Jenkins, Chicago.

Removing Blisters From Veneers

To remove blisters from newly varnished veneers, split the blister lengthwise with a razor blade and insert liquid hide glue under the raised portion, using a stick or small brush. Next, cover the break with several layers of newspaper and place a weight on it. When the glue has set, remove the paper from the blister by soaking it with olive oil and scraping lightly with a razor blade. Then sand the area carefully, starting at the center and working toward the edges. If the patched surface is discolored, touch it up with varnish or shellac.

John A. Comstock, Wellsboro, Pa.

THE GHOST OF OLD No. 278

PART II

In this issue we present full-size plans for four cars, the rolling stock that old No. 278 pulls on her daily hauls. Included are a tank car, a boxcar, a refrigerator car and a caboose you can build for your HO-gauge layout

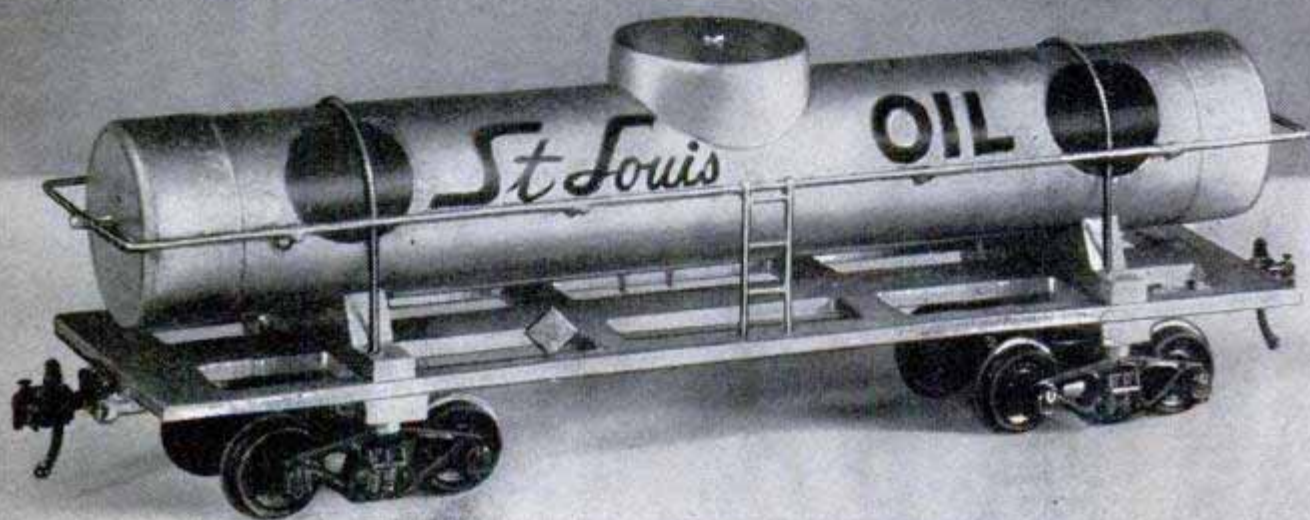
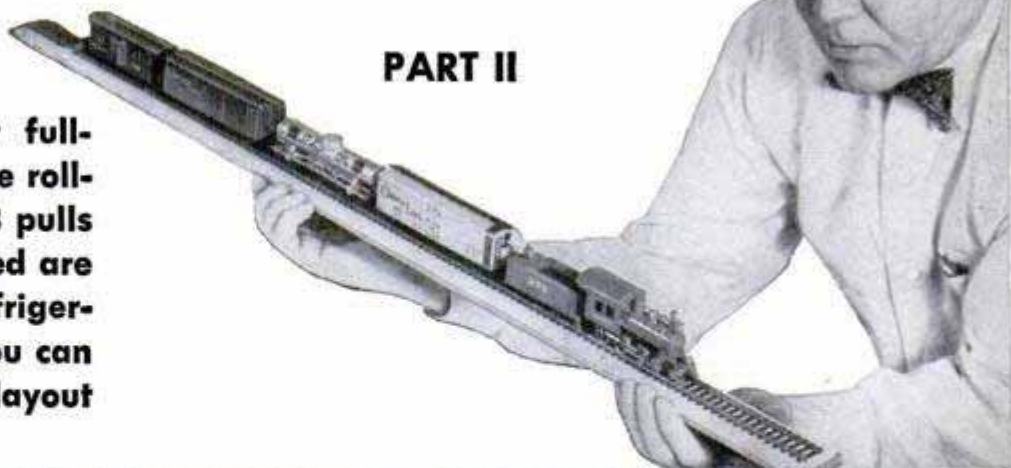

**By Frank Beatty
and
Leonard F. Hilts**

BY NOW the HO model of old No. 278, the Chicago and Northwestern Railroad's little narrow-gauge engine described last month, is operating smoothly on your layout and eagerly looking for work. This month we present full-size plans for the construction of four cars—rolling stock so No. 278 can start hauling pay loads for you.

Tank car: The underframe of the tank car is cut from $\frac{1}{16}$ -in. sheet zinc or brass according to the full-size pattern on the opposite page. As shown, it is tapped at each end for attaching the couplers, which are purchased, and for the 2-56 screws by which the trucks are pivoted. Holes are drilled for the four 1-72 screws which pass through the truck bolsters. Located slightly inboard of these, smaller holes receive the ends of the wire tank straps. Pinholes are made for the ends of the ladder rails, and a small hole is drilled to take the diamond-shaped marker plate, which can be seen in the photograph.

The tank is an aluminum cigar tube with the rounded end cut off, leaving a cylinder $4\frac{7}{8}$ in. long. A $\frac{3}{4} \times 4\frac{7}{8}$ -in. dowel is inserted in the cylinder and the cigar-tube caps are cemented over each end. The tank dome is a third cigar-tube cap, cut to fit the curve of the tank and held in place by a small wood screw. The truck and tank bolsters are shaped from solid brass, following the patterns given. The tank bolster is tapped in the center for the 2-56 truck screw, and at each side for a 1-72 screw. The truck bolster is drilled but not tapped for the same screws. To begin assembly of the car, the brass truck and tank bolsters are located on the frame. Then the 1-72 screws are pushed up through the truck bolsters and the frame and threaded into the tank bolsters. The tank now is fastened to the frame by means of two wire tank straps. The wires are passed through the holes drilled for them on one side and then bent around the truck bolsters. The other ends are brought around the tank, passed through holes on the other side and pulled tight. They are bent around the bolsters on that side. Four straight pins are

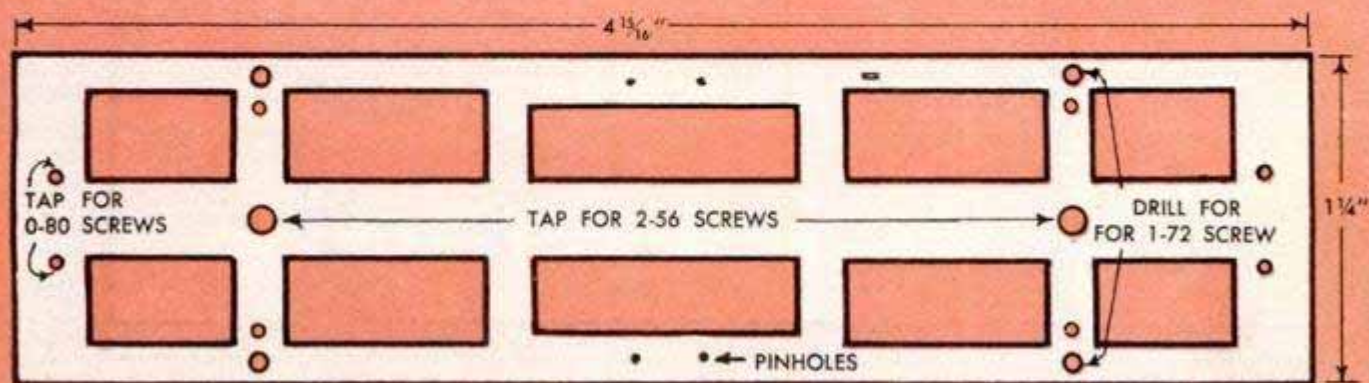
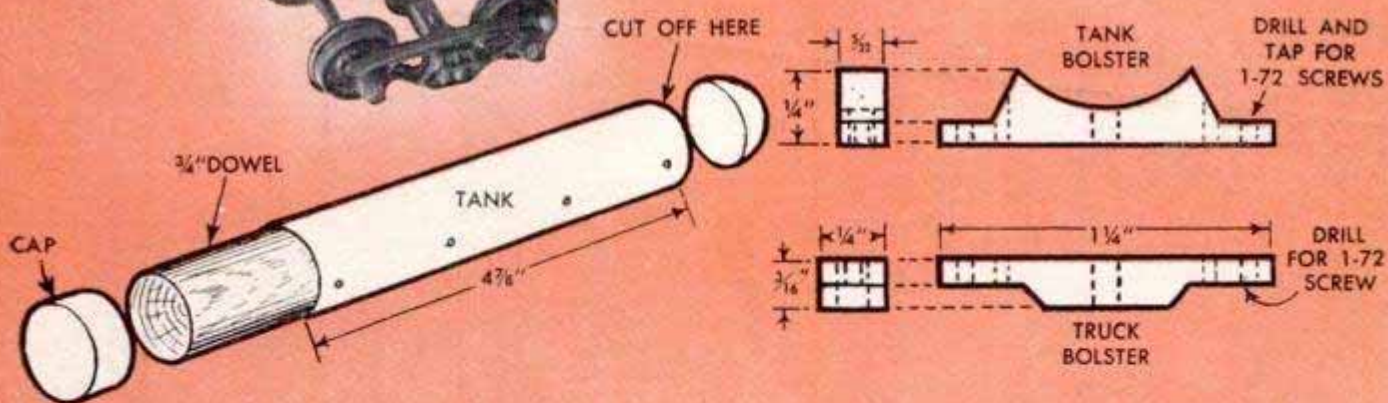
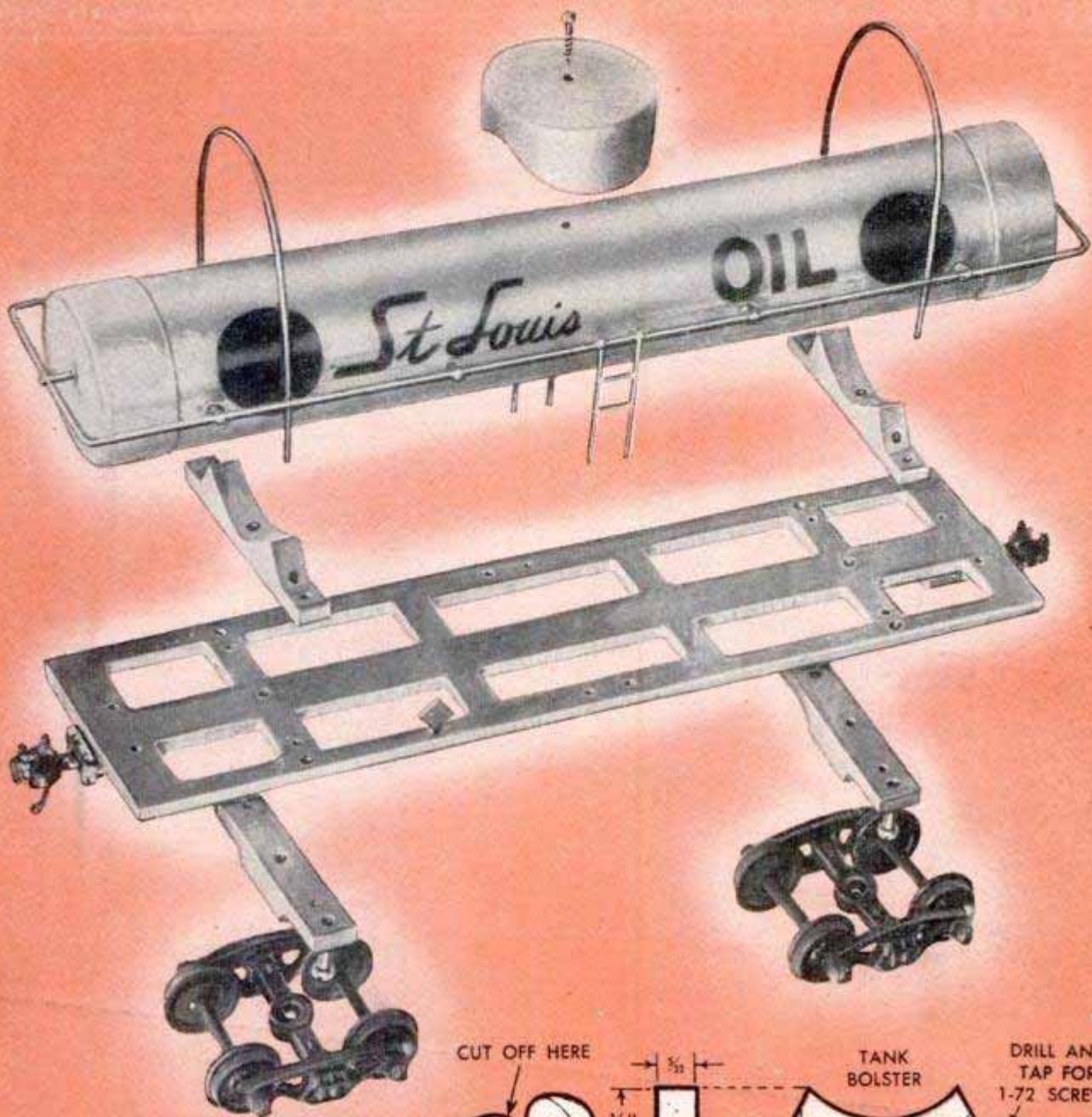

UNDERFRAME

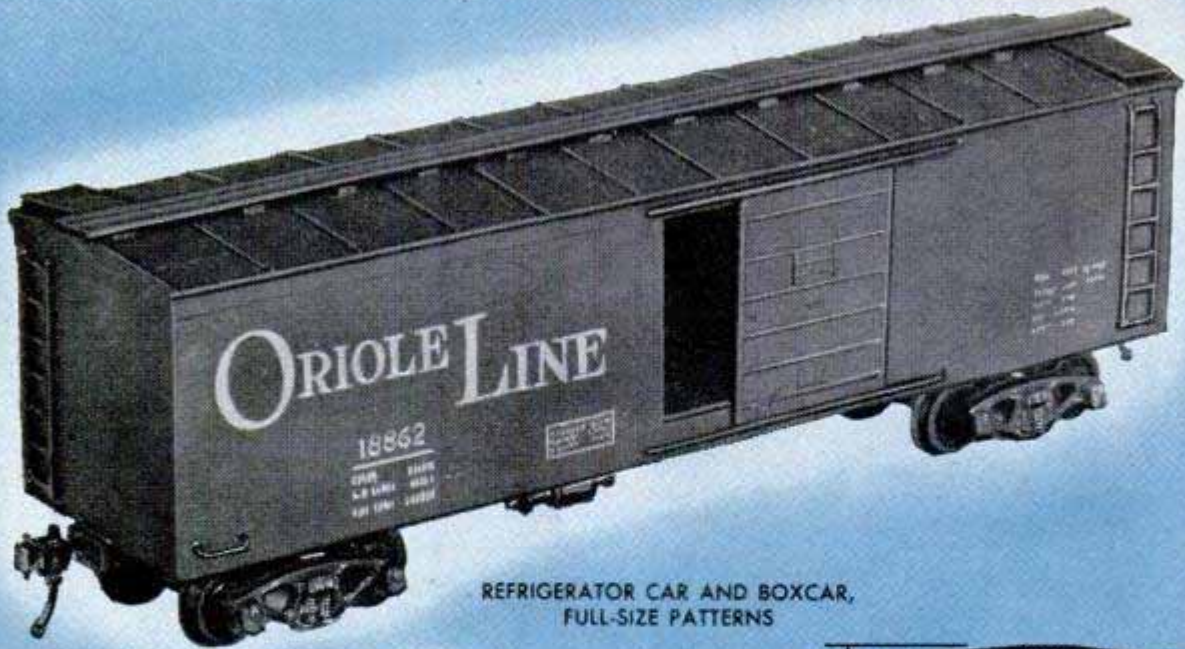

REFRIGERATOR CAR AND BOXCAR,
FULL-SIZE PATTERNS

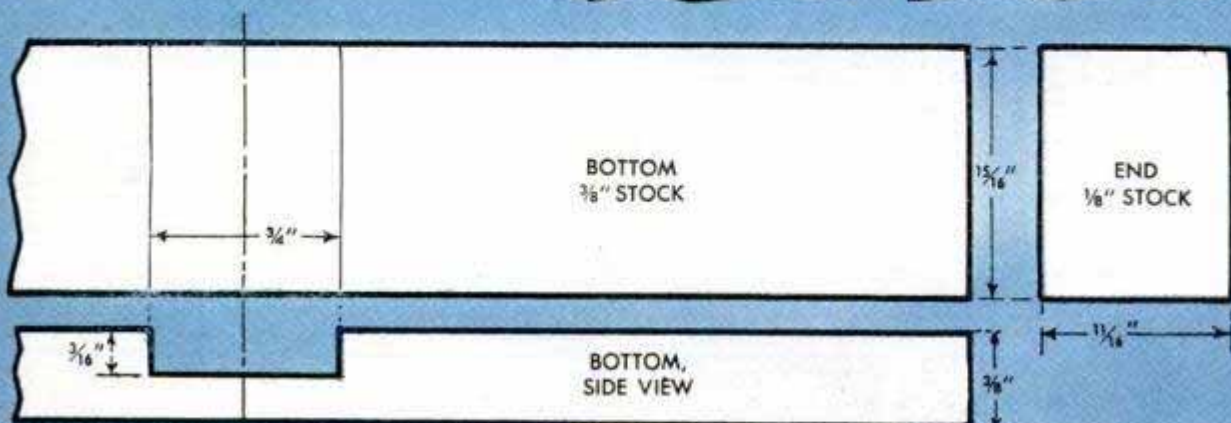
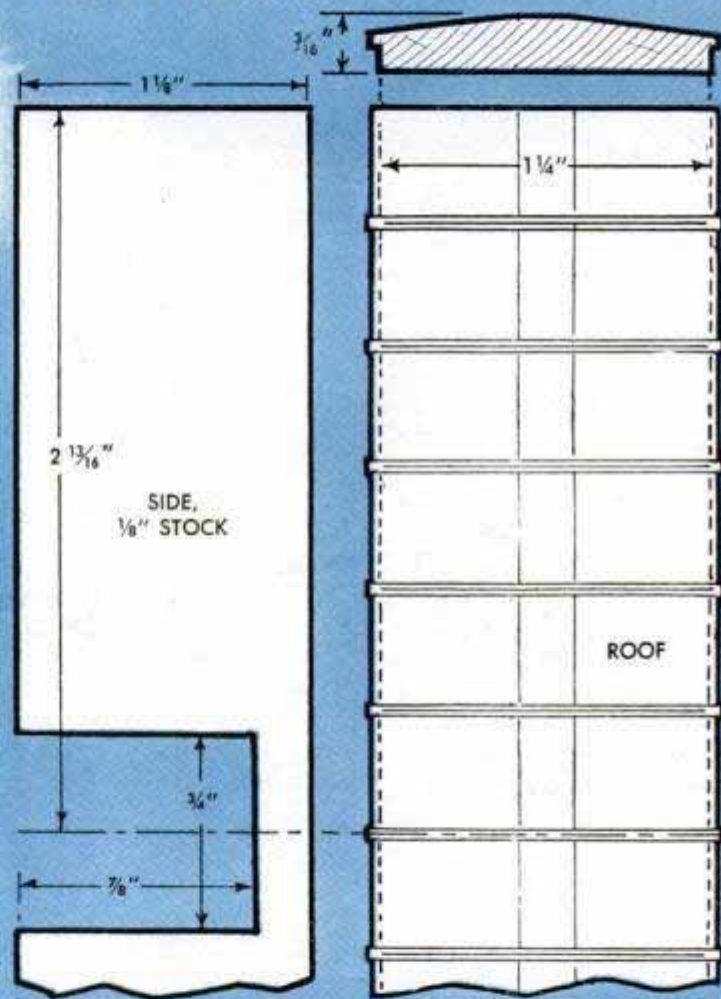
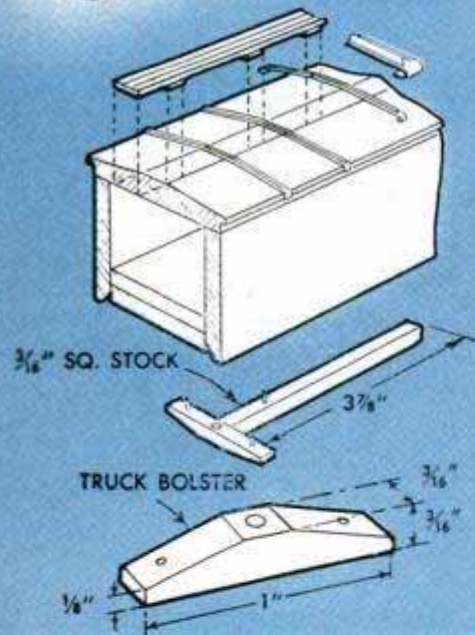

inserted in each side of the tank, and one at each end, to serve as braces for the handrail which circles it. These pins project $\frac{1}{8}$ in. from the tank, and the rail is soldered to them. The bottom ends of the side ladders are passed through the holes in the underframe and bent over, and the tops of the ladders are soldered to the handrail. After the couplers and trucks are screwed in place, the entire car is painted silver and lettered.

Boxcar and refrigerator car:

The boxcar and the refrigerator car are constructed in the same manner, the main difference being that the former has doors that open. Full-size patterns for the roof, bottom, ends and sides of the boxcar are shown on the opposite page. The same patterns are used for the refrigerator car, except that the cutouts in the sides and bottom for the doors are not made. The roof is a standard item that can be purchased preshaped from any hobby shop. The body of the car is assembled by cementing the endpieces to the bottom first, then gluing the sides in place, and finally adding the roof. Pins can be inserted through the sides into the bottom to reinforce the joints. Two doors, measuring $\frac{7}{8} \times 1\frac{1}{8}$ in., can be purchased already embossed or they can be cut from Bristol board and painted the same color as the car. In this case the embossed design is drawn in with India ink after the paint is dry. The doors move freely in door slides (small brass channels) that are mounted on the car at the top and bottom of each door, as in the exploded detail above. The stamped-brass roof ribs, which are purchased, are laid across the roof $\frac{7}{16}$ in. on centers and their ends are pinched around the edge of the roof. As supports for the roof walk, $\frac{1}{32} \times \frac{1}{16} \times \frac{3}{16}$ -in. wooden cleats are cemented between the ribs. The roof walk is a strip of wood or plastic, scored to simulate boards running the length of the car, and is cemented directly to the support blocks. It is $\frac{3}{16}$ in. wide and projects $\frac{1}{8}$ in. over each end of the car. End walks, $\frac{1}{32} \times \frac{1}{4} \times \frac{1}{2}$ in. are cemented to supports in the same manner as the roof walk, on opposite sides of each end of the car. In the refrigerator car, cast-plastic ice doors are purchased and used in place of the end walks. The body of the car

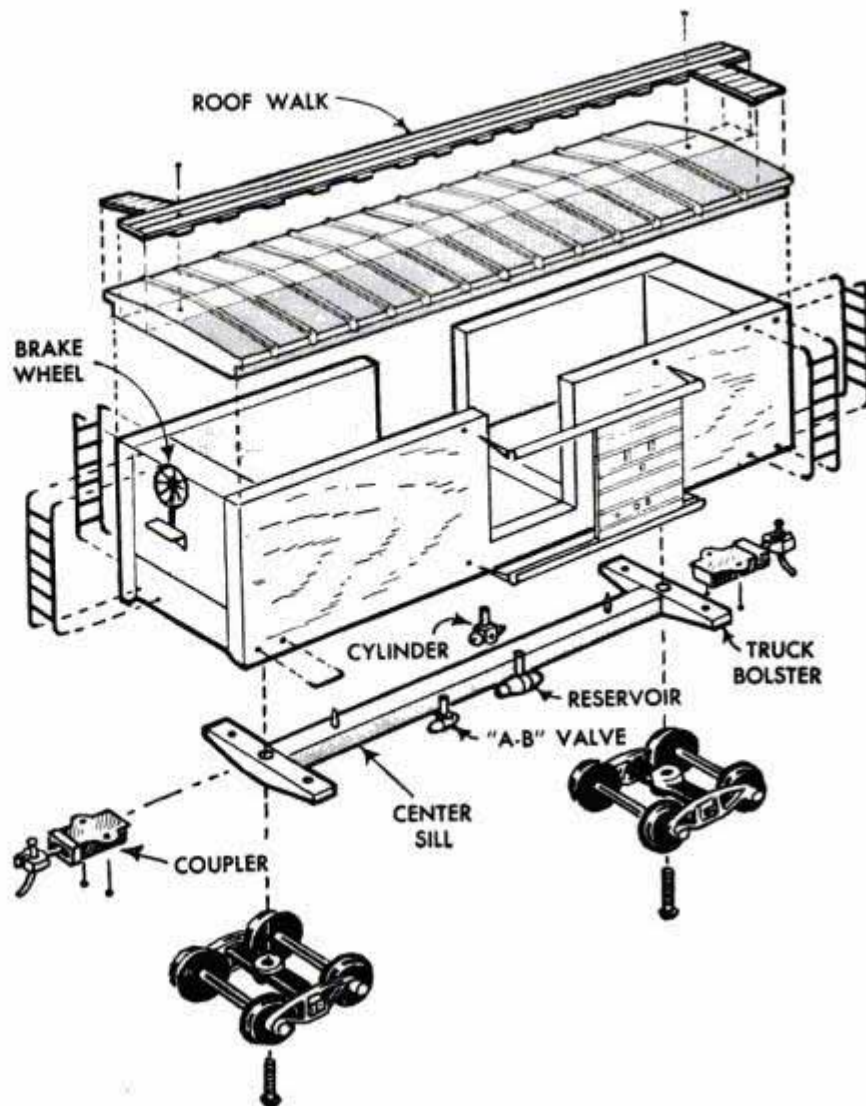

is now painted, the boxcar a standard brown or red, and the "reefer" yellow. The door design is drawn on the side of the refrigerator car in India ink after the paint dries. You can hand-letter your cars, or purchase decals for the purpose from any hobby shop. Now truck bolsters are cut from type lead, using the pattern shown, and are mounted across the bottom of the car, $\frac{3}{4}$ in. on centers from each end. Running between them is the center sill, a $\frac{3}{16}$ -in.-sq. strip of type lead, $3\frac{7}{8}$ in. long. The underside detail is now added and the underside is painted black. Couplers and trucks are put in place, and the final details are added before the car is put on the rails.

Caboose: The method of construction for the caboose is the same as for the boxcar and refrigerator car. The roof, sides and bottom are cut according to the full-size patterns. The endpieces are of $\frac{1}{8}$ -in. stock cut to the dimensions given. They are cemented to the bottom, the sides are glued in place and finally the roof is installed. The roof of the caboose is a standard HO-scale roof cut down to fit the pattern. The bay windows can be bought or they can be shaped as shown from sheet brass and cemented in place. Frames for the car windows can be purchased and inserted in the

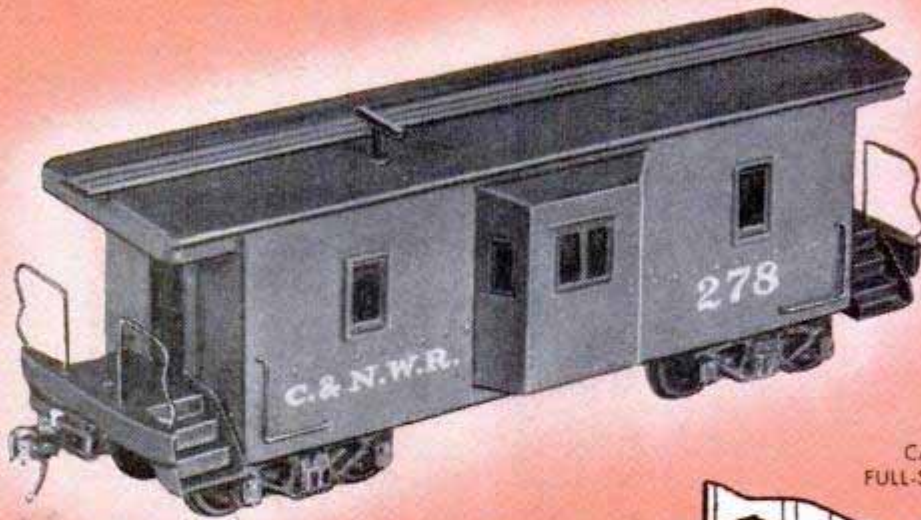

CABOOSE,
FULL-SIZE PATTERNS

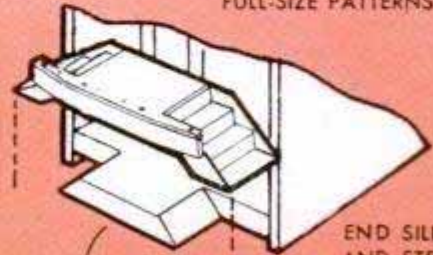

END SILLS
AND STEPS
CAST IN
ONE PIECE

24-GA. SHEET BRASS

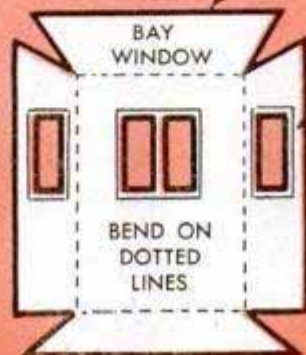
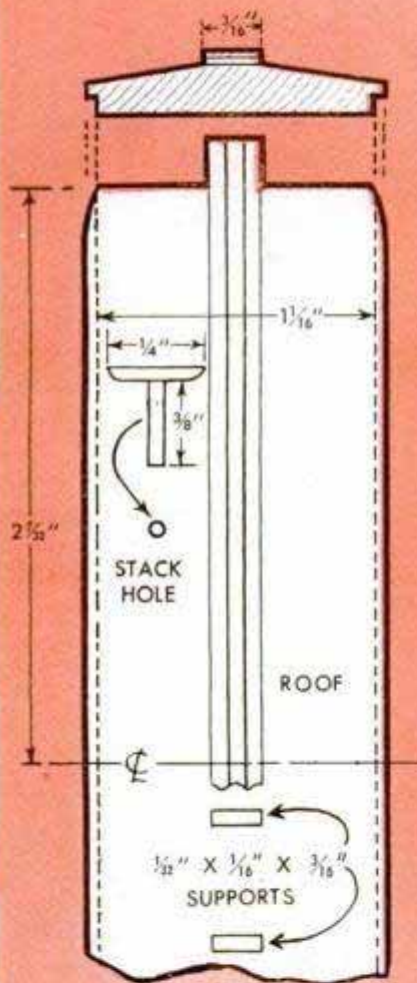

WINDOW OPENINGS
3/16" X 1/4"

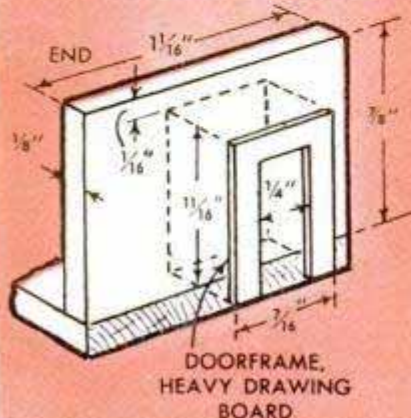
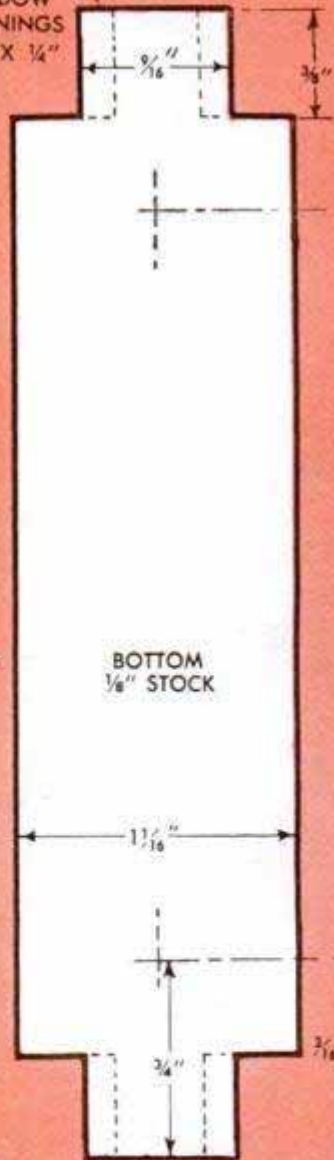

window openings, or frame can be simulated by drawing around the opening with India ink. The doorframes are Bristol board cemented to the car ends. The end platforms and steps are one-piece castings that are purchased and fitted over the tongues on the car bottom. The roof walk can be cemented directly to the car roof, or small cleats, as used on the boxcar, can be put down first, $\frac{7}{16}$ in. on centers. The roof walk projects $\frac{1}{8}$ in. beyond each end of the car. The lead center sill shown in the pattern is tapped to take the 2-56 screws which hold the trucks in place. Truck bolsters can be added and the center sill cut to allow for them if desired. The body of the caboose is painted red, while the underside and end platforms are dull black. Finally the wire handrails on the platforms, the grab irons and the stack are put on. Then the couplers are added and the car is finished. ★ ★ ★

Material List

Tank car

- 1 pc.— $\frac{1}{16}$ " x $1\frac{1}{4}$ " x $4\frac{1}{16}$ "—sheet brass
- 1—empty aluminum cigar tube
- 3—caps from cigar tubes
- 1— $\frac{3}{4}$ " dowel, $4\frac{7}{8}$ " long
- 2 pcs.— $\frac{3}{16}$ " x $\frac{1}{4}$ " x $1\frac{1}{4}$ "—solid brass
- 2 pcs.— $\frac{3}{16}$ " x $\frac{1}{4}$ " x $1\frac{1}{4}$ "—solid brass
- 4—0-80 screws for bolster assemblies
- 4—1-72 screws for bolster assemblies
- 4—2-56 screws for trucks
- 2—HO-gauge couplers
- 2—4-wheel trucks
- 2—ladders, $\frac{3}{8}$ " long
- 12"—soft wire for tank handrail
- 8"—soft wire for tank straps
- 10—pins for handrail braces
- 1 pc.— $\frac{1}{4}$ " x $\frac{3}{16}$ "—Sheet brass for marker

Boxcar

- 1 pc.— $\frac{3}{8}$ " x $1\frac{1}{16}$ " x $5\frac{1}{2}$ "—wood
- 1 pc.—HO-scale roofing, $5\frac{1}{2}$ " long
- 2 pcs.— $\frac{1}{8}$ " x $1\frac{1}{8}$ " x $5\frac{1}{2}$ "—wood
- 2 pcs.— $\frac{1}{8}$ " x $1\frac{1}{16}$ " x $1\frac{1}{16}$ "—wood
- 1 pc.— $\frac{3}{16}$ " sq. wood, $3\frac{7}{8}$ " long
- 11—stamped-brass roof ribs
- 1 pc.—wood or plastic, $5\frac{3}{4}$ " long, for roof walk
- 16 pcs.— $\frac{1}{32}$ " x $\frac{1}{16}$ " x $\frac{3}{16}$ "—wood or plastic roof-walk supports
- 2— $\frac{1}{4}$ " x $\frac{1}{2}$ " wood or plastic end walks
- 2—doors, $\frac{3}{8}$ " x $1\frac{1}{8}$ "
- 4—door slides, $1\frac{3}{4}$ " long
- 4—ladders, $1\frac{1}{8}$ " long
- 1—brake wheel, scale size
- 2—HO-gauge couplers
- 2—HO-gauge 4-wheel trucks
- 2—wire grab irons
- 2—2-56 screws for trucks
- 4—0-80 screws for couplers
- 1—set of underside fittings

Refrigerator car

Material list is the same as above, except that no doors or door slides are needed, and molded plastic ice doors are used in place of end walks

Caboose

- 1 pc.—HO-scale roofing, $4\frac{7}{8}$ " long
- 1 pc.— $\frac{1}{8}$ " x $1\frac{1}{16}$ " x $4\frac{7}{8}$ "—wood
- 2 pcs.— $\frac{1}{8}$ " x $\frac{7}{8}$ " x $1\frac{1}{16}$ "—wood
- 2 pcs.— $1\frac{1}{8}$ " x $3\frac{5}{8}$ "—heavy drawing board
- 2 pcs.— $\frac{7}{16}$ " x $1\frac{1}{16}$ "—heavy drawing board
- 4—cast window frames
- 2—bay window castings
- 1 pc.—plastic or wood, $5\frac{1}{8}$ " long, for roof walk
- 9 pcs.— $\frac{1}{32}$ " x $\frac{1}{16}$ " x $\frac{3}{16}$ " plastic or wood roof-walk supports
- 2—cast caboose platforms with steps
- 2—HO-gauge couplers
- 2—HO-gauge 4-wheel trucks
- $1\frac{1}{2}$ "—steel rod, $\frac{1}{16}$ dia., for stack
- 1 pc.— $\frac{3}{16}$ " sq. lead, $3\frac{1}{8}$ " long
- 2—2-56 screws for trucks
- 4—0-80 screws for couplers
- 8"—wire for grab irons and handrails
- $1\frac{1}{2}$ "—steel rod, $\frac{1}{16}$ dia., for stack



Concrete Floor Acid-Etched To Prepare for Painting

Both exterior and interior concrete floors should be acid-etched prior to painting, to improve paint adhesion and to neutralize alkalis which have a destructive action on paint. A solution of muriatic acid, 1 part, and water, 3 parts, is mixed in a wooden or enameled pail and applied, 1 gal. per 100 sq. ft. of floor area. Scrub well with a stiff-bristled, long-handled brush and allow it to remain on the floor until bubbling stops. Then flush the floor thoroughly with clean water. If the surface does not dry in a few hours, it should be flushed again. *Caution:* When mixing the solution and also when working with it, rubber gloves and rubber overshoes should be worn, as contact with it will cause burns.

Tall Flowers Protected in Wind

To prevent wind damage to hollyhocks and other tall flowers, a supporting trellis of wire and short sections of discarded garden hose can be constructed. Drill holes through one side of each hose section and slit these open length-

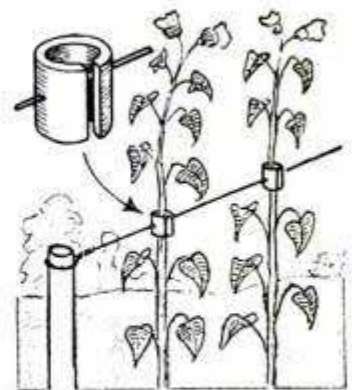

wise. String the sections on the wire, which is then stretched between two posts at a height of two ft. or more above the ground. Space the hose sections so that each one will engage a flower stalk, as shown.

☐ To remove dents from table-tennis balls, drop them in boiling water for a few minutes, turning them to heat evenly.

Solving Home PROBLEMS

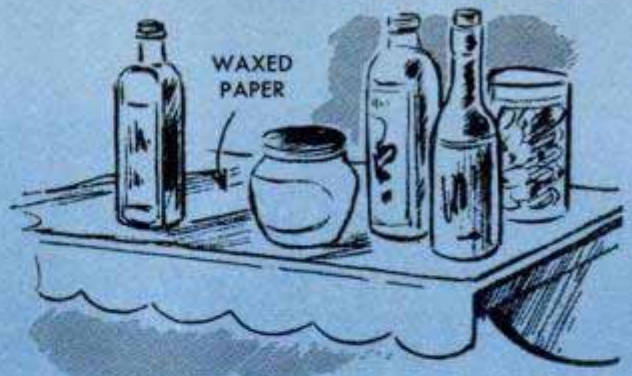

WAX PAPER protects shelf paper where syrup, salad oils, etc., are stored and eliminates need for replacing paper soiled by drippings



OLD ALARM CLOCK attached to toy wagon or tricycle can be set to ring at whatever time child is to return from play away from home. Ideal for child as yet unable to read time

164

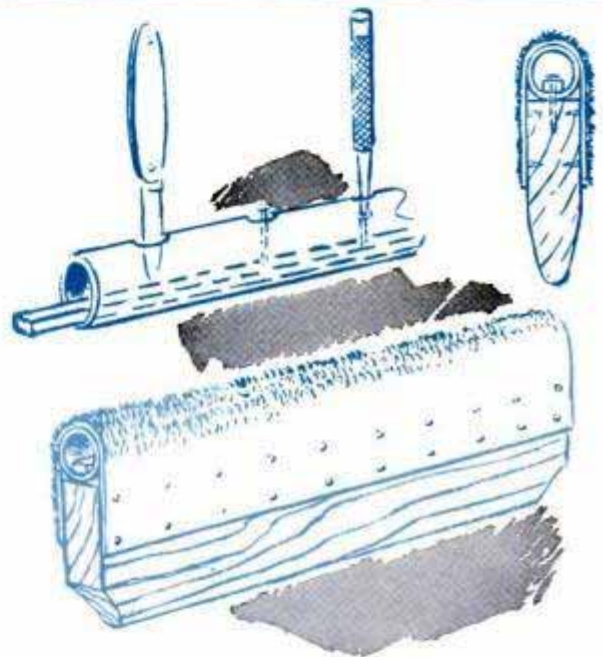

PAPERHANGER'S "BRUSH" can be improvised from board having length of hose nailed to one edge over which strip of discarded rug is tacked. Rug preferably should have long nap



PAINTBRUSH BRISTLES won't become misshapen when left in cleaner if brush is held by spring-type clothespin rested on can rim

POPULAR MECHANICS

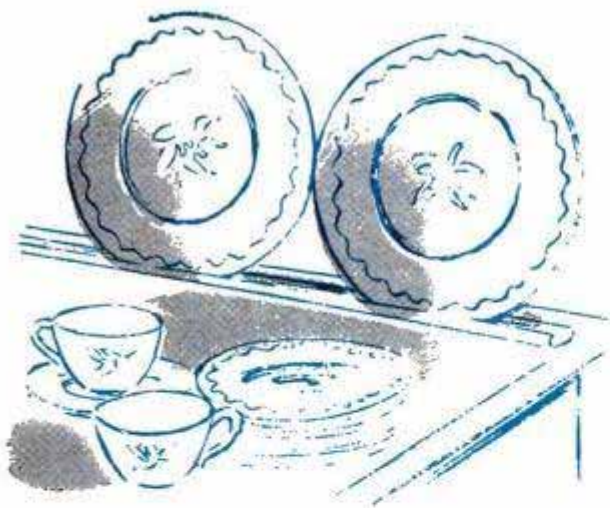

PLATE RAILS for cupboard shelves can be provided from sections of flat curtain rods by cutting off the curved ends and tacking the rods to shelves with the open sides up



INEXPENSIVE VEGETABLE GRATER reinforced at one end with wooden handle will make quick work of shredding laundry soap and paraffin



SMALL BLACKBOARD mounted inside door of cabinet provides handy kitchen reminder that can be stored out of sight when not in use

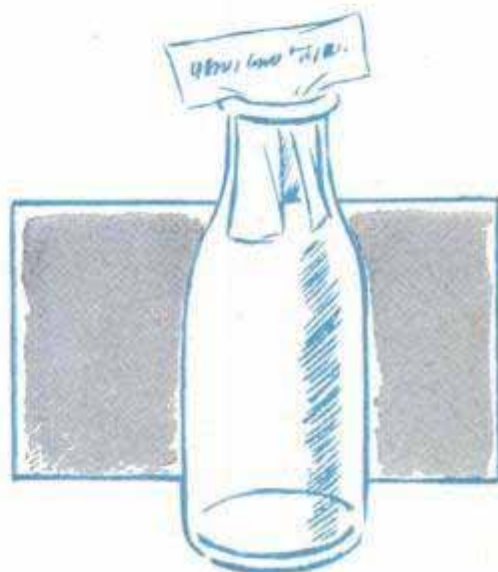

NOTE FOR MILKMAN won't fall in bottle if slits are cut in paper from opposite sides almost to the center so that the upper portion forms tabs that rest on rim of bottle



SMALL C-CLAMP is ideal for unscrewing caps that stick on jars and small bottles. Too much pressure, however, may cause cap to bind, or possibly break neck of container



PLASTIC PLACE MAT beneath dresser scarf protects finish on dresser top from liquid cosmetics that might spill and cause stains

Grass Seeder Made From Can Assures Even Distribution



To assure even distribution of grass seed when seeding parts of his lawn, one homeowner uses a giant "shaker" made from a large can having a press-fit cover. The first step in preparing the can is to place the cover inside up on a round block and punch slits with a hammer and cold chisel. The slits should be about 1 in. long and spaced an inch apart. Next, holes are punched in the center of the cover and the bottom of the can to take a $\frac{3}{16}$ -in. bolt which, together with a wing nut, is used to secure it in place. Hi Sibley, Nuevo, Calif.

Scorekeeper for Horseshoe Court

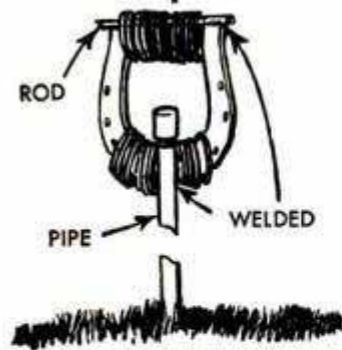

An unusual scorekeeping device for horseshoe games can be made by slipping harness rings over a horseshoe and welding a rod across the heel of the shoe to keep the rings in place. The shoe is welded to a steel stake for anchoring in the ground. One scorer is used at each end of the court and the score recorded by flipping the rings stored on the rod to the lower end of the shoe on either side of the stake.

Aluminum Foil Lines Camping Pans

Aluminum foil, used to line skillets and baking pans on a camping trip, will cut down the cleanup work after a meal. To line the pans in this manner without puncturing holes in the foil, first shape the foil around

the outside of the utensil to be used, then place it inside and shape again.

John Krill, North Lima, Ohio.

Improvised Drill Bit

A small drill bit for use in soft wood can be made from a nail. The head and point are cut off and one end flattened to the desired width. This end then is filed to produce a spur point and cutting jaws, the latter being filed at angles of 30 deg. A drill of this type is for emergency use only, as it will dull rapidly.

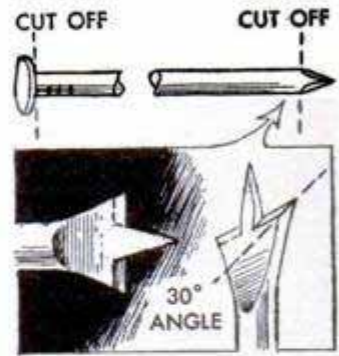

Ed Packer, Chicago.

Wallpaper Rolls Tied Easily When Placed on Inverted Stool

When tying rolls of wallpaper into bundles, use an inverted stool as a rack to hold the rolls. Also, use of the rack will lessen chances of the rolls being damaged when wallpapering rooms.

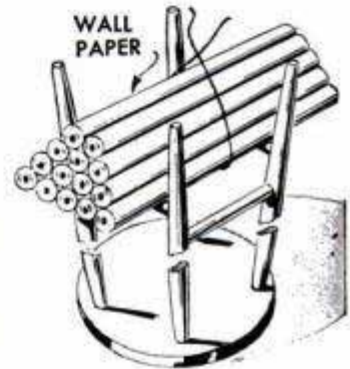

Matchboxes Provide "Cabinet" To Hold Artist's Supplies

One amateur artist finds that a miniature "cabinet" made by binding several matchboxes together as shown is useful for storing pen points, thumbtacks, razor blades, etc. The boxes may be either glued together or bound with friction or adhesive tape. If desired, the ends of the "drawers" may be labeled to identify the contents.

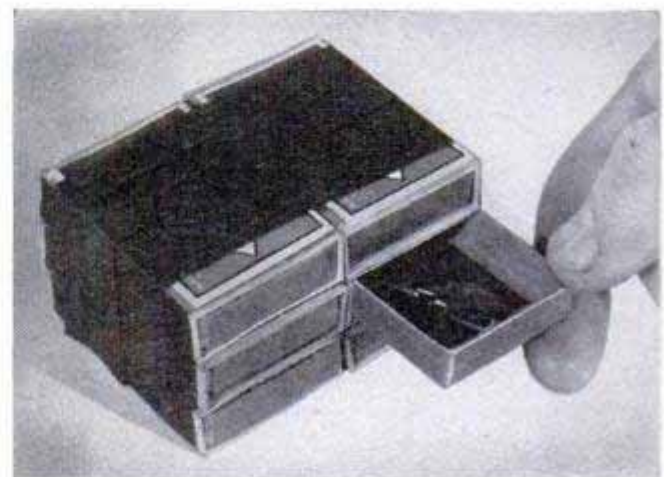

A Cart for Your OUTBOARD MOTOR

LIGHTWEIGHT and easy to handle, this outboard-motor cart not only simplifies stowing the motor in the trunk or back seat of the car and carrying it to the boat, but also serves as a handy storage rack when the motor is not being used. The cart frame is made of thin-wall conduit, as detailed below, and fitted with a pair of wooden or semi-pneumatic wheels. One section of the frame swings outward to form legs when using the cart as a vertical motor stand. This section is hinged to the upper motor block with two pipe straps. The flat-steel legs bolted to the main frame serve as stops for the leg section while a spring clip fastened to the lower motor block holds the stand closed. Canvas belting is cemented to the wooden mounting blocks to prevent marring the motor. Dimensions given are for a 10-hp. motor and may be varied to suit.

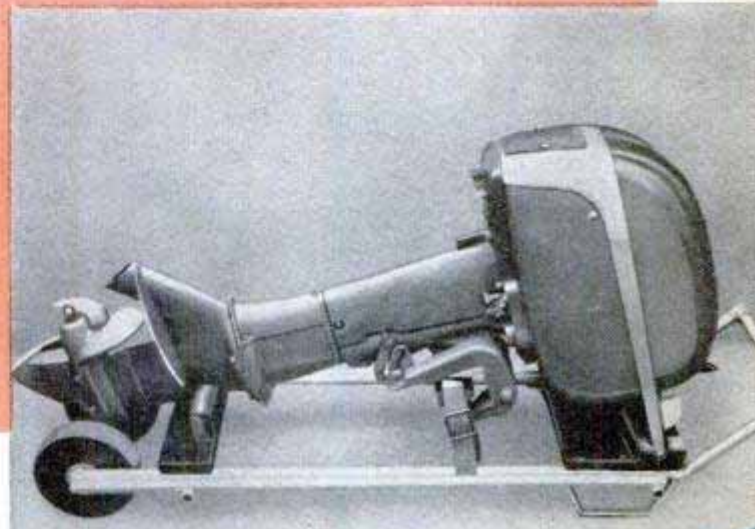
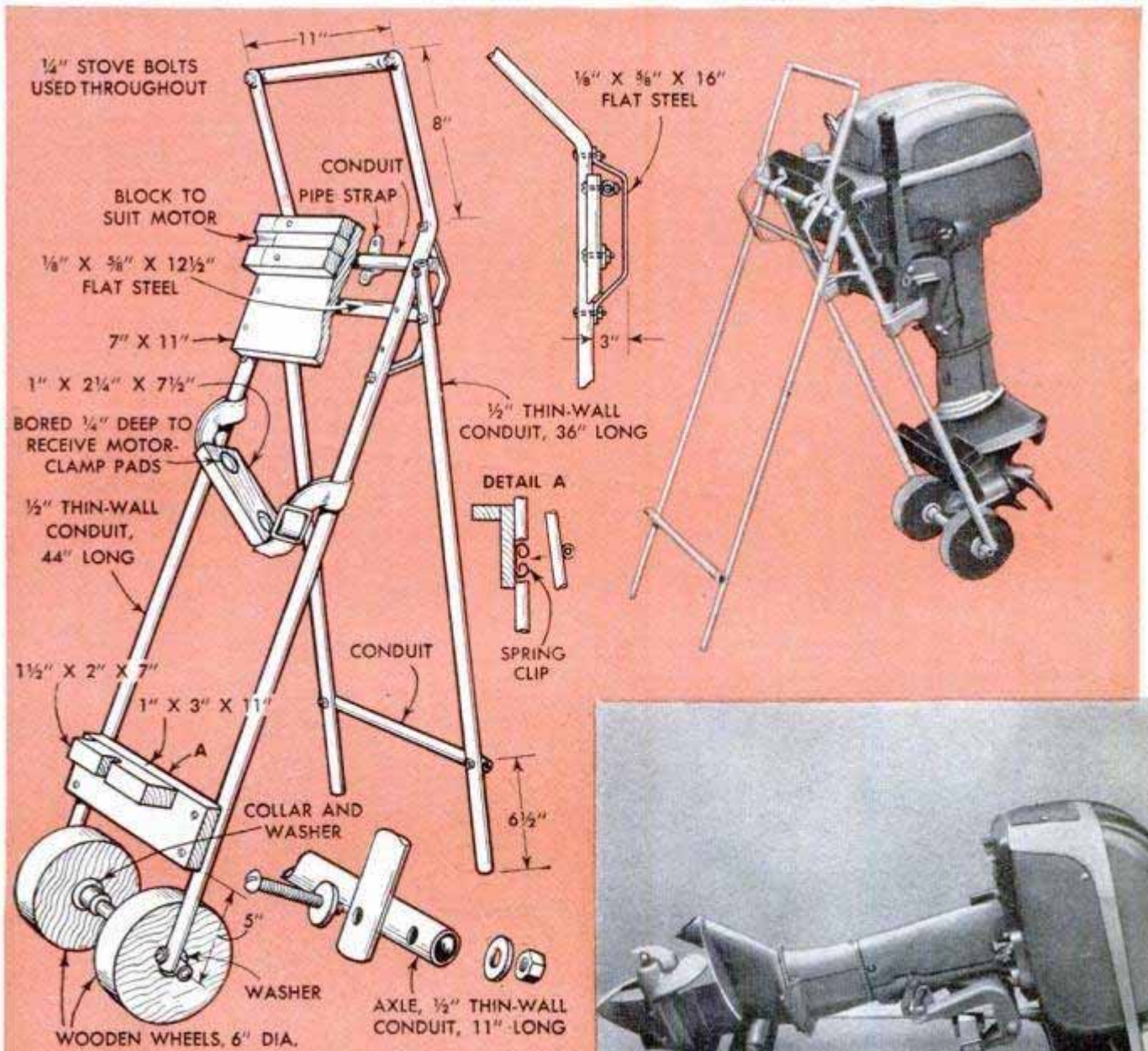

PLAN of the MONTH...

Designed by John Bergen, this neat-appearing, comfortable porch swing features a seat and back of eye-catching decorative webbing

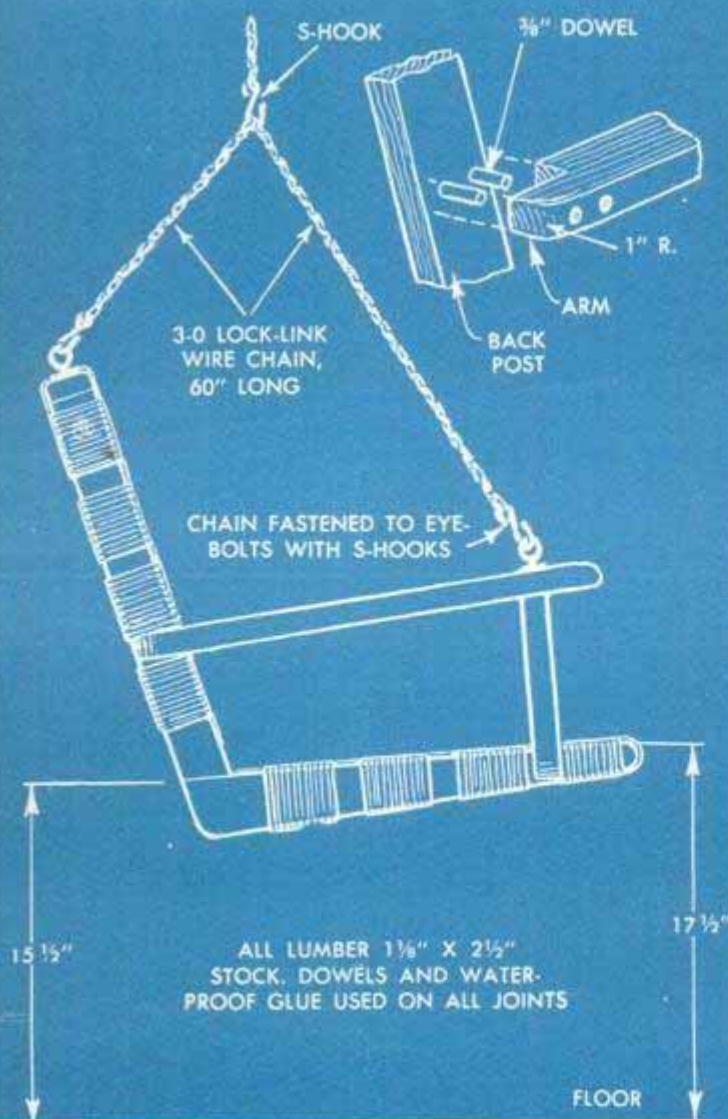
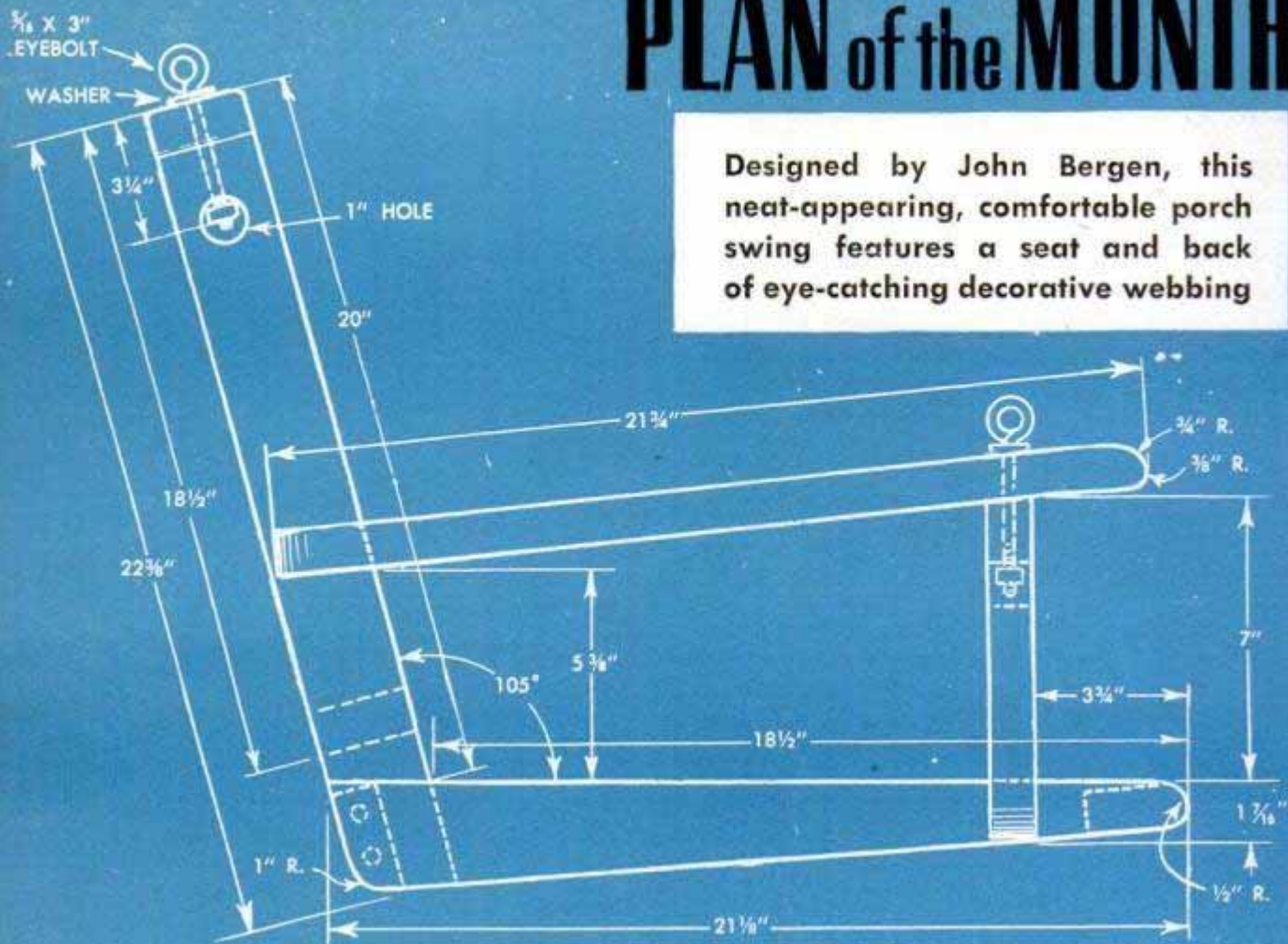

W T M 233

The porch-swing frame is made up of clear white pine or redwood; all the joints are doweled and glued. The rear corner joints are half-lapped and the arm members are notched to fit around the seat rails and back posts. Note in the details how the eyebolts for hanging the swing are mounted in the back and arm, the wooden members being drilled to permit inserting the nuts. After the swing frame has been finished, cotton or plastic webbing, 3 in. wide, is interwoven between the rails of both the seat and the back frames. Hang the swing from a pair of ceiling hooks as in the lower left-hand detail, with lengths of chain.

BILL OF MATERIALS

Clear white pine or redwood

- 3 pcs.—1 $\frac{1}{8}$ " x 2 $\frac{1}{2}$ " x 40"—Seat and lower back rails
- 1 pc.—1 $\frac{1}{8}$ " x 2 $\frac{1}{2}$ " x 42 $\frac{1}{2}$ "—Top back rail
- 2 pcs.—1 $\frac{1}{8}$ " x 2 $\frac{1}{2}$ " x 22 $\frac{3}{8}$ "—Back posts
- 2 pcs.—1 $\frac{1}{8}$ " x 2 $\frac{1}{2}$ " x 21 $\frac{1}{8}$ "—Side seat rails
- 2 pcs.—1 $\frac{1}{8}$ " x 2 $\frac{1}{2}$ " x 8-7/16"—Arm stumps
- 2 pcs.—1 $\frac{1}{8}$ " x 2 $\frac{1}{2}$ " x 21 $\frac{3}{4}$ "—Arm boards

Miscellaneous

- 4—5/16" x 3" eyebolts
- 4—3/8" washers
- 6—S-hooks
- 2—ceiling hooks
- 2—60" lengths of 3-0 lock-link wire chain, plus enough chain to suspend swing from ceiling

Porch Swing

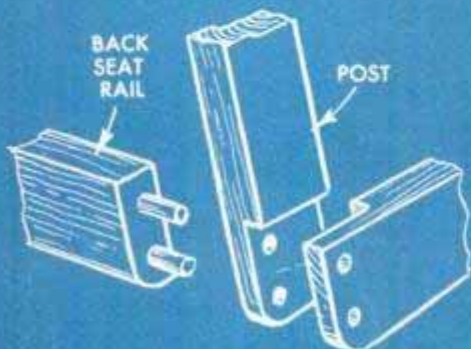
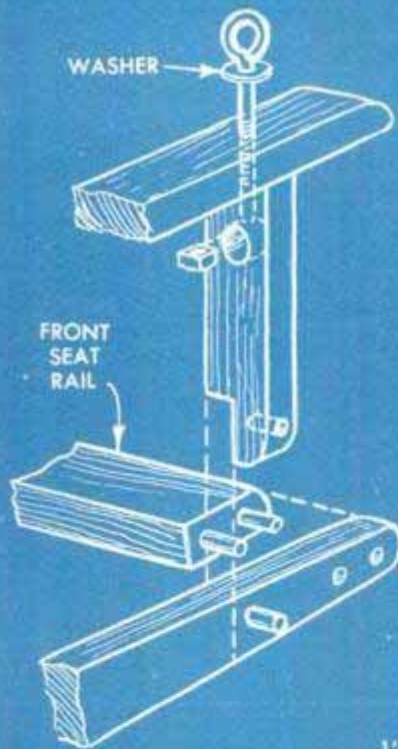
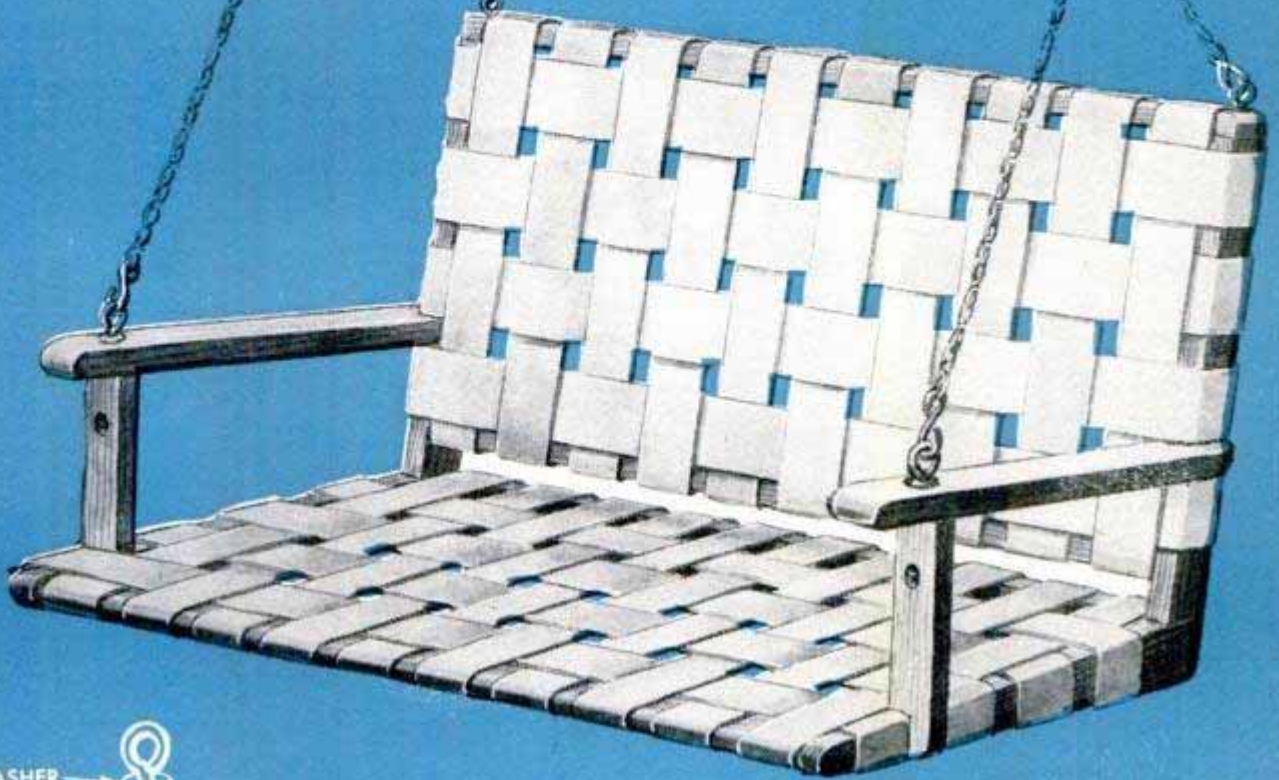

HALF-LAPPED JOINT
DOWEL OR WOOD SCREW

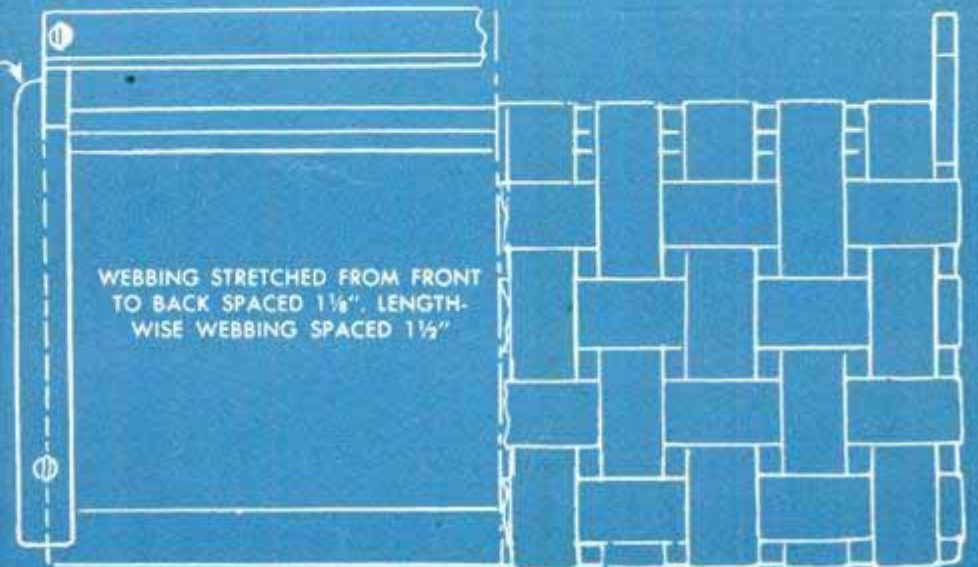
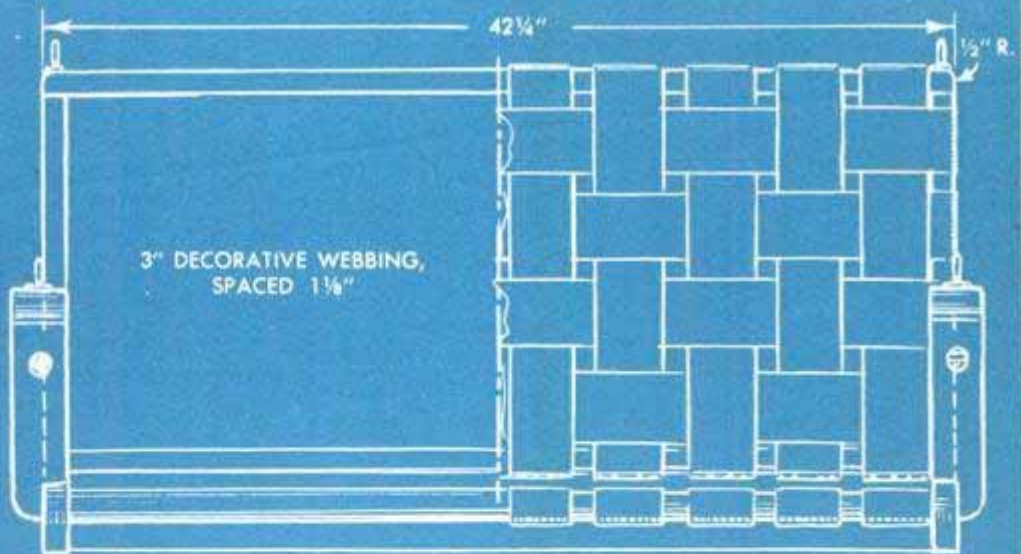

Collar From Strip of Fencing Provides Tree Guard



To protect his trees from cats and squirrels, one homeowner stapled a collar of poultry wire around each trunk, several feet above the ground. The lower ends of the vertical wires were bent at an angle from the trunk, as in the illustration, to serve as a barrier, discouraging the most venturesome animals from climbing.

Straightening Small-Gauge Wire

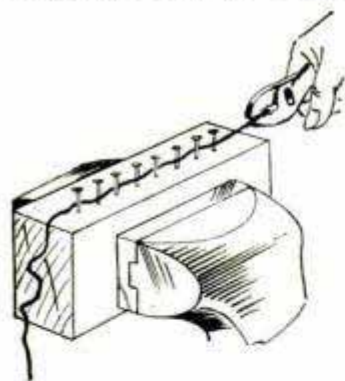

Wire of small gauge that has become kinked can be straightened by pulling it through a row of nails driven into a 2-in. wooden block. The nails are spaced about $\frac{3}{4}$ in. apart and are driven in a straight line. After the block is clamped in a bench vise, the wire is threaded between the nails as shown, and drawn through under steady pressure.

Cleaning Plastic Wall Tile

Dried paint and varnish can be removed from plastic tile with a solution consisting of pure gum turpentine, 1 part, and rubbing alcohol, 3 parts. Do not use turpentine substitutes in this formula, as they may damage the tile. The slight dulling of the tile resulting from this treatment can be eliminated by polishing the tile for a moment or two with a thick paste of powdered chalk and water and then wiping with a clean dry cloth. Plastic tile which has been dam-

aged by solvents such as nail-polish remover and paint remover also can be restored. In such cases, the damaged area is rubbed briskly with a paste of fine or medium pumice and water. When the mark is removed, the tile must be polished again with powdered-chalk paste. This same treatment can also be used where the tile has been scratched or scarred.

Fred D. Johnson, Cliffcrest, Ont., Can.

Faucet Drains Into Hole in Ground

To prevent the formation of a mudhole around his outdoor faucet, one farmer dug a hole under the spout and filled it with gravel. With ordinary usage, waste water falling into the hole will drain off through the gravel.

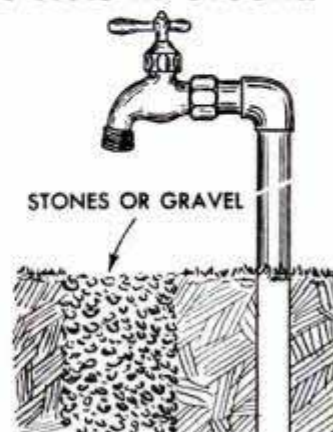

Flatiron Preheats Large Work For Soldering With Small Iron

When you are faced with a soldering job that is beyond the capacity of your soldering iron, the difficulty can be overcome by using an electric flatiron to preheat the work. Just clamp the flatiron in a vise with the sole plate up, lay the work on top as shown and plug in the cord. As a result of this preliminary heating, the work does not dissipate heat from the soldering iron as readily as it would ordinarily, thus making it possible for the job to be done with a smaller soldering iron.

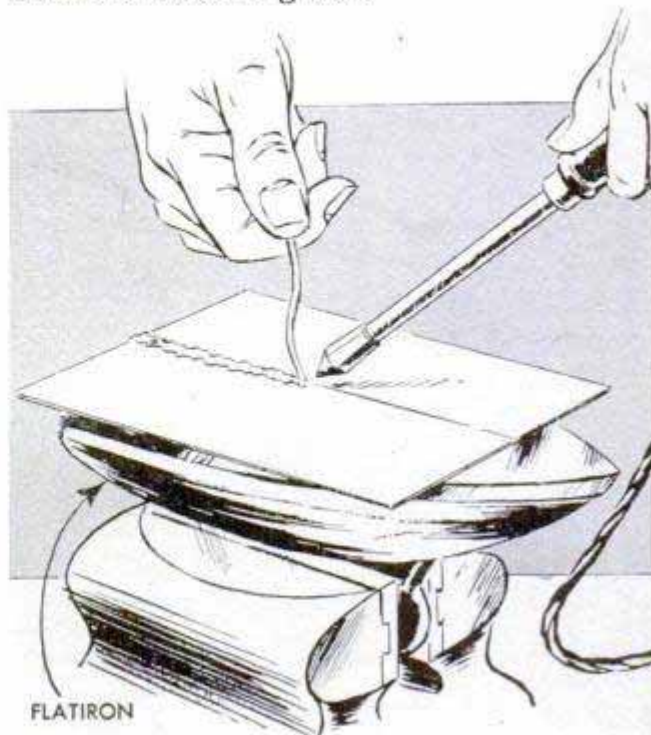

Personalized SWITCH PLATES

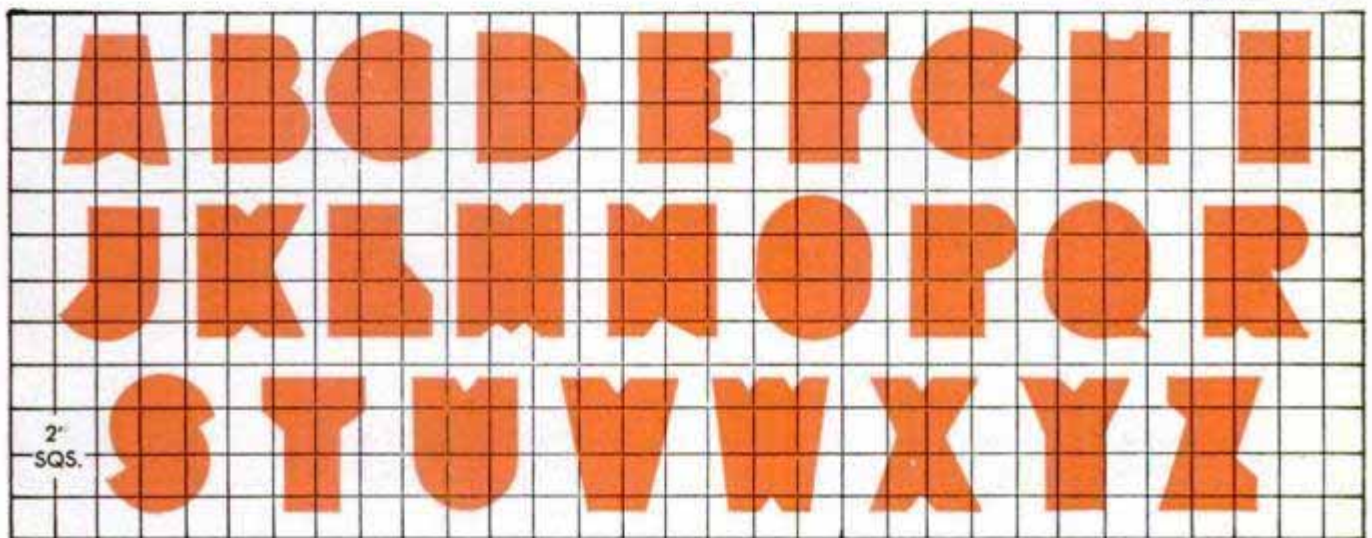
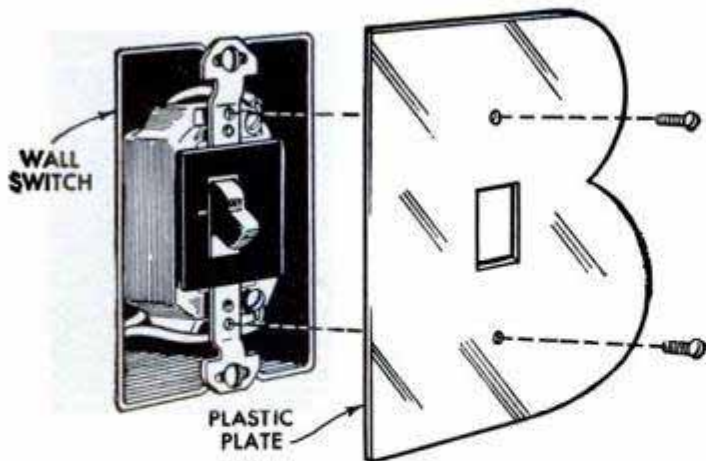

You can get away from the old standard ideas in decorating a child's bedroom or playroom by adding these unusual personalized switch plates, which are big, colorful initials cut from 1/16-in. sheet plastic. All letters can be traced on 5 x 6-in. opaque colored sheets, except "I", which requires a 3½ x 6-in. piece, using the pattern pictured above. The plastic is cut easily with a coping or jig saw, interior cuts being made by first drilling a hole in which to insert the saw blade and then following the pattern. The edges are filed and then finished with sandpaper, steel wool or a buffing wheel.—L. W. Shapiro, Chicago

Rubber Hose on Setscrew Wrench Provides Cushioned Handle

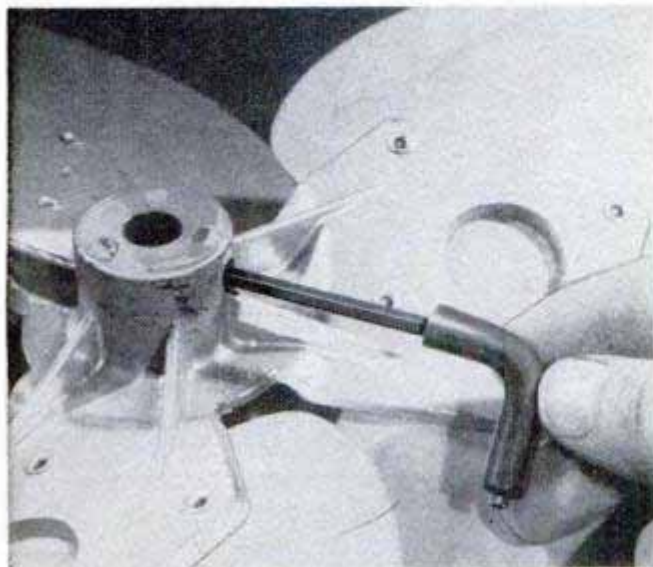

To cushion the fingers from the edges of a setscrew wrench, slip a short length of rubber tubing over one end as illustrated. The tubing should be loose enough so it can be slid around the bend for use at either end.—Ken Murray, Colon, Mich.

Cement for Patching Concrete

A waterproof cement for patching or coating cellar walls can be made by mixing portland cement and sour milk to form a paste. Do not use homogenized milk. For patching cracks, use a thick paste of the mixture, and for coating walls, thin it to a brushing consistency.—Edward G. Wid-dis, San Francisco, Calif.

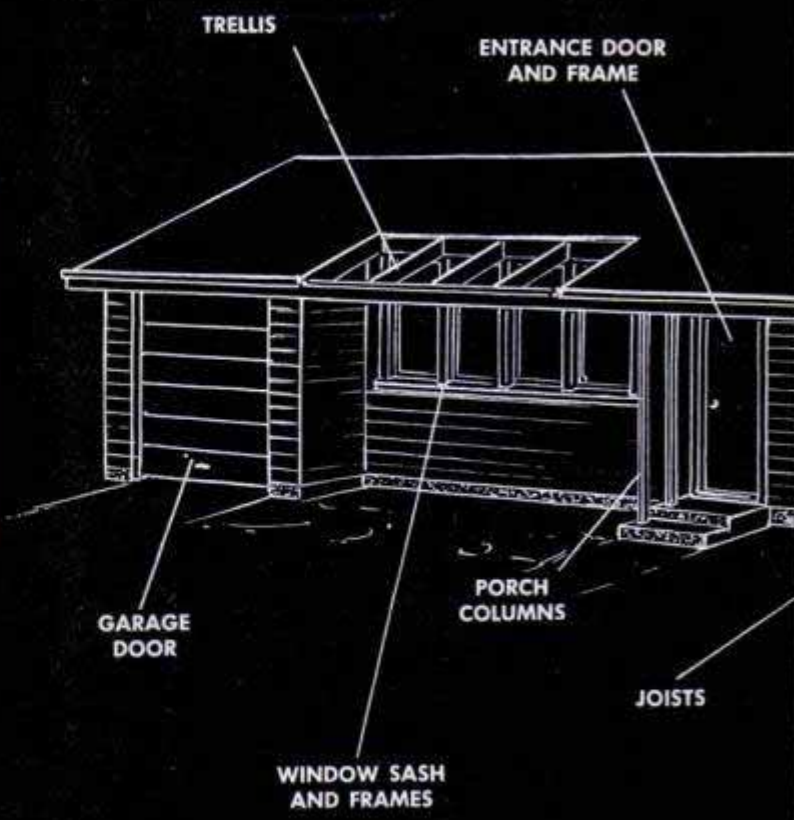

BEATING WOOD ROT

Wood is the universal building material, but when left exposed to the weather or in constant contact with the ground, in time it rots and crumbles. Chemical preservation now makes it possible for the homeowner to arrest decay and make wood unsavory dish for hungry termites

NO DOUBT you'll give that new lawn chair, picnic table, sandbox or other product of your basement workshop a couple of coats of paint and feel it's sufficient to preserve and protect it from wood rot. Actually, paint offers little or no protection against wood rot and wood-eating insects for the simple reason that paint, in itself, is not a wood preservative.

There was a time when creosote was the only type of wood preservative available. Now, a comparatively new liquid preservative, called pentachlorophenol, or penta for short, has been made available to the homeowner and can be applied easily to new wood by dipping, brushing or spraying. Unlike creosote, which has a lasting objectionable odor and cannot be painted over, penta

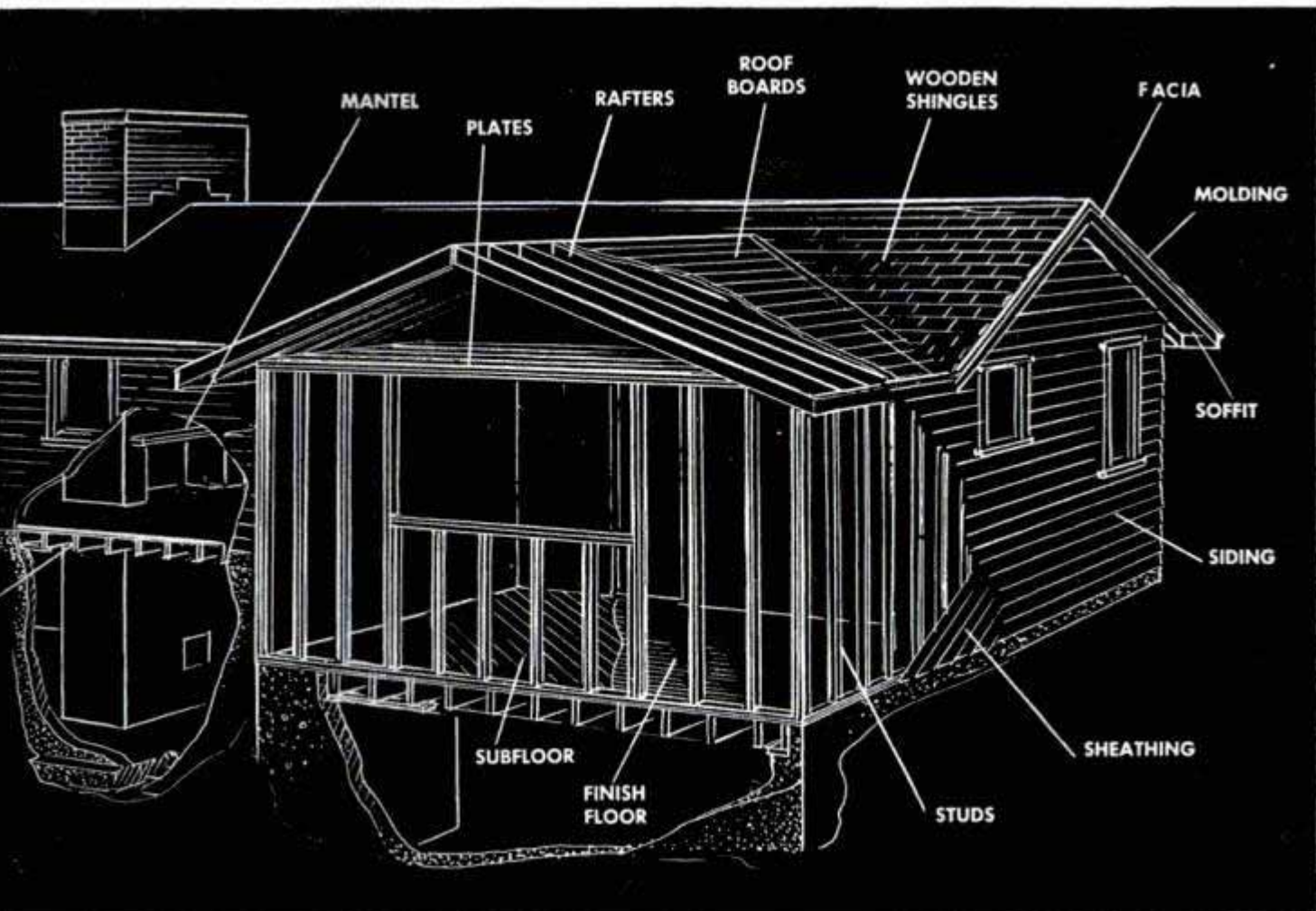

TO THE PUNCH By Wayne C. Leckey

is an odorless, water-clear, nonstaining solution that leaves a clean, paintable surface. Used for years in preserving railroad ties, utility poles, car decking and bridge planking, this new, highly penetrating chemical preservative has been thoroughly tested by industry. Recently the makers of windows and doors and other millwork have begun to use treated wood to insure dimensional stability and high toxicity to rot, termites and other wood destroyers. All of which means longer life, more positive protection to these parts of your home.

Penta and new construction: If you are planning to build a new home, by all means plan to use treated lumber for such vulnerable structural members as the sills, studs, joists and other parts that are subjected to a great degree of moisture, fungus growth or insect attack. Preserving these vital parts as well as all the other members that go into the building of a house is one of the best insurance investments you can make. Ordinarily, the cost adds only about two percent to the total investment.

As a homeowner you'll be more concerned with treating the lumber that you may be using in a new porch, garage, fence

or a pair of steps. Here, if you are unable to buy preservative-treated lumber in your locality, you can get the jump on the ravages of moisture and insects by painting the wood yourself with a good preservative.

Choice of preservatives: There are two types of penta-preservative solutions available which are packaged in quart, gallon, 5-gal. and 55-gal. amounts. The gallon size retails for around \$3 and may be purchased at most hardware and lumber dealers. One type is labeled water-repellent and paintable and is recommended for flooring, siding, studs, lawn furniture, trellises, fences and the like. Applied to such millwork products as doors, windows and interior woodwork, the preservative not only prolongs their life but also provides freedom from warping, sticking, swelling and shrinking. Building authorities now recommend it as a prime coat before painting.

Where the wood is not to be painted, a lower-cost general-purpose solution is available. This comes in concentrated form and is diluted, 1 part penta and 10 parts diesel fuel, kerosene or No. 2 fuel oil. In these proportions, one gal. of wood preservative makes 11 gal. of solution. Its low cost

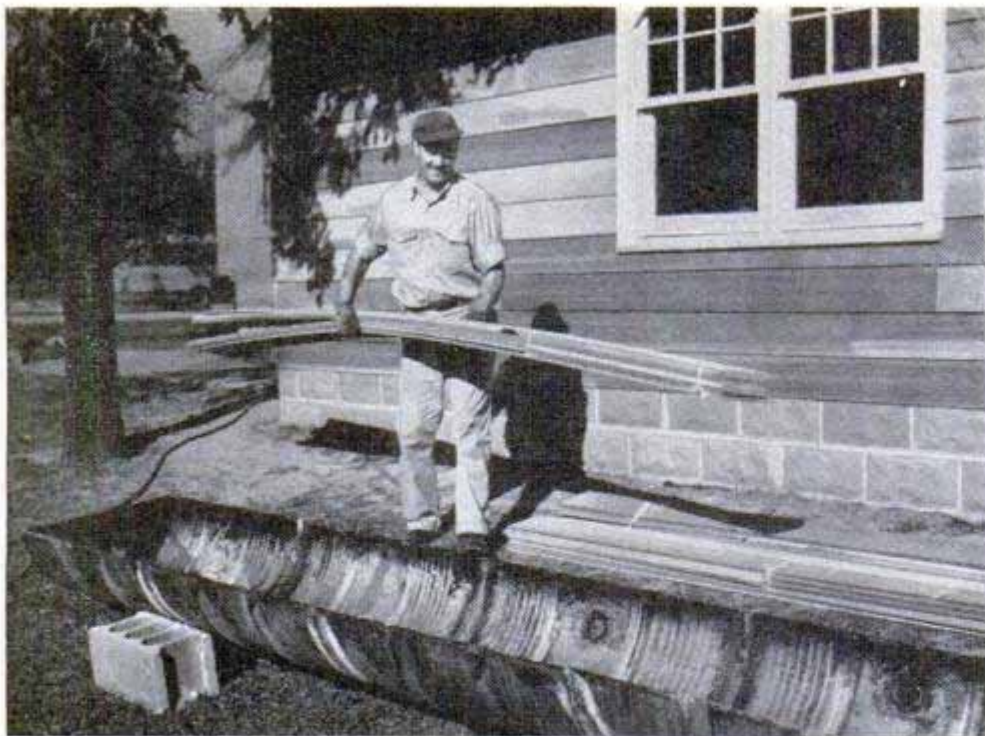

Left, improvised tank of oil drums takes long lengths of siding and lumber. Complete penetration of siding requires approximately three minutes



Above, three gal. of preservative in oil-drum tank will treat about six 4-in. posts

Photos courtesy The Dow Chemical Co.

makes it both practical and economical to treat large numbers of farm fence posts where a volume of solution is required. Rustic ornamental fences may be given a rich natural tone and preserved at the same time. The farmer will find that a spray application of the solution to the roosts, floor and walls of his poultry house will kill chicken mites on contact, and because of its low cost, the solution is particularly effective as a soil poison for subterranean control. Where termites are especially rampant in coastal regions and the South, the ground on the outside of the foundation wall is soaked with a diluted solution of general-purpose preservative. In houses without basements, but with crawl spaces beneath the floors, the entire area is saturated with the solution. Since termites can enter the house only from the ground, such treatment keeps them away before they ever have a chance to get to the wood.

Methods of application: If you do your own treating, obviously the greatest penetration and protection are obtained by the immersion, or cold-soak, method. A suitable soaking trough for long lengths of lumber and siding can be improvised from several 55-gal. drums, as above, the drums being cut in half lengthwise, the ends removed and then welded end-to-end to form a trough. Construction lumber and posts to be used in the ground or in close contact with the soil should receive the soaking treatment. It is best to treat the wood after all sawing, planing and boring have been completed. If any

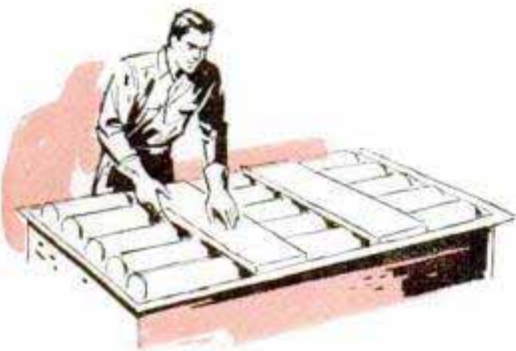

Below, sawed ends of treated lumber are re-treated to protect exposed end grain



cutting is done after treatment, the exposed surfaces should be re-treated. Make sure that the wood is absolutely dry, for the drier it is the more preservative it will absorb and the more effective the treatment.

Where the immersion of wood is not practical, as in the case of existing structures, the preservative is flowed freely onto the surface of the wood, either with a brush or spray equipment. At least two applications are recommended, three being still better. If application is done by spray, use a low-pressure-type gun having a coarse nozzle. The important thing is to be sure the solution reaches thoroughly into cracks and crevices where moisture could collect. Don't be stingy with the preservative. Apply it generously—all that the wood will absorb. Since decay is likely to occur more rapidly at points of contact with the ground, use special care in covering such areas.

After treatment, let the material stand in a well-ventilated place until dry. This usually requires at least 48 hrs., the length of time depending particularly on the weather and the degree of humidity. When thoroughly dry, the wood may be painted in the usual manner. When applied by brush, 1 gal. of preservative will cover approximately 150 to 200 sq. ft. of surface. Where the soaking treatment is used, 5 to 10 gal. of solution are required per 1000 board feet of lumber.

Prime targets for wood rot: Rot-producing fungi breed under moist and humid conditions. Gutters left clogged with muck will soon rot the wooden trim and roof boards along the eaves and, therefore, the gutters should be cleaned periodically and coated with asphaltum paint. Stringers for porch steps also are vulnerable members, as is any stock that is below or at ground level. Lawn furniture, especially the legs, is subject to wood rot, as are a fence and its supporting posts. The lower ends of the supporting posts in your basement are prime targets for wood rot. Water used to scrub the floor is absorbed by the posts, wood rot sets in and soon the wood begins to crumble, resulting in cracks appearing in plastered walls due to settling of the structure by the rotting posts. Wooden window boxes, the bottom edge of your upward-acting garage door, corn cribs, watering troughs and grain bins are easy prey to wood rot.

Caution: In using pentachlorophenol solutions, avoid excessive inhalation of vapors and contact with skin. It is best to wear rubber gloves and observe precautions and handling instructions on can label. ★ ★ ★

Information courtesy The Dow Chemical Co. and Chapman Chemical Co.

Increased resistance in the steering assembly of an automobile sometimes is an indication the front brakes are dragging.



Above, preservative can be applied to an existing structure with portable sprayer. If desired, both stain and preservative may be applied at same time. Mask widows as preservative adheres to glass

Right, storm and window sash often are treated at mill before shipping to dealer. Homeowner can dip own by "rotating" frame in tank of penta



Below, prime target for wood rot is joint at window sill and casing. Apply preservative liberally with a brush or oil can

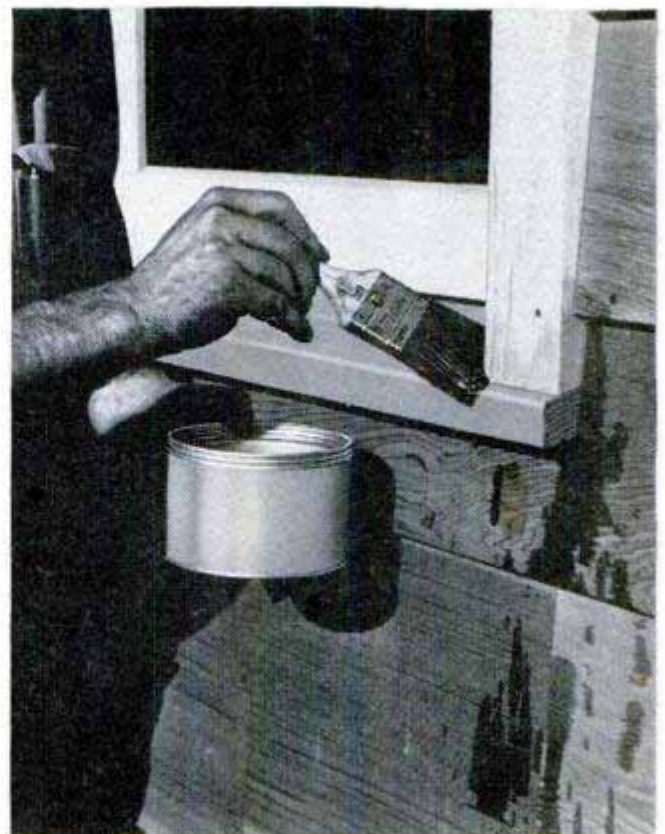

Picket Fencing Used as Ramp When Beaching Small Boat

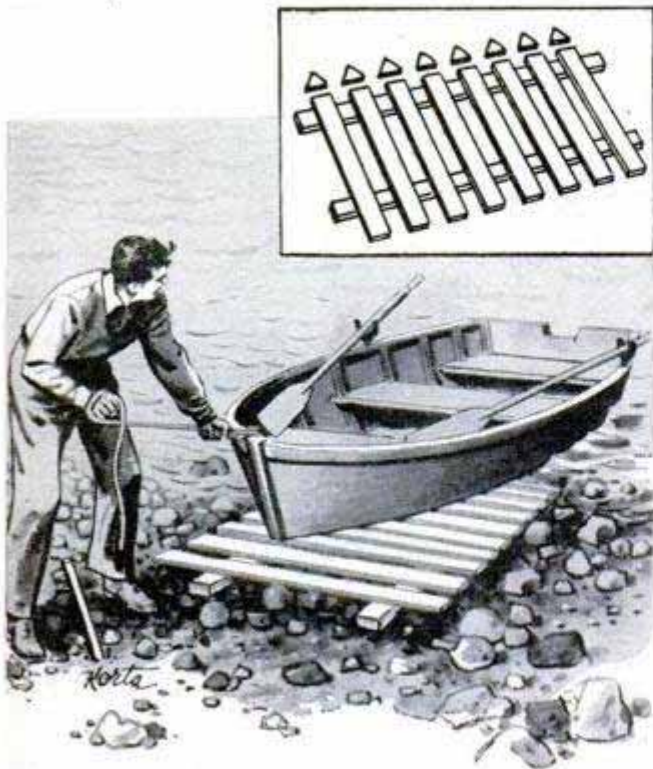

To prevent damage to his rowboat when beaching it on the rock-covered shore near his cottage, one sportsman uses a discarded section of picket fencing to provide a ramp. After sawing off the pointed ends of the pickets, he partly submerged one end of the section and drove stakes to anchor it in place.—Dick Godin, Lindenhurst, N. Y.

Book-End "Feet" for Paint Can Help Prevent Upsetting

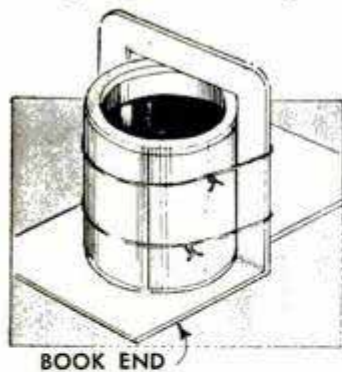

A can of paint is less likely to be tipped over accidentally if it is secured to a metal book end as shown. This can be done by using wire, heavy rubber bands or several turns of string. If a book end is unobtainable, a thin block of wood may be nailed upright to another similar to the book end and used in the same manner.

Nylon Bristle on Tone Arm Cleans Phonograph Record

Attached with adhesive tape just ahead of the needle on the tone arm of a phonograph, a single bristle from a stiff-nylon toothbrush or hairbrush can be adjusted so it will dislodge any dust particles in the groove about to be played. This assures

eliminating any dust particles that possibly may have been missed by the soft-nylon brush on the tone arm with which many phonographs are equipped for this purpose.

C. M. Cole, New Orleans, La.

Apron Secures Seat Cushion

Motorists who use a cushion on the front seat will find that a flap or apron sewed to one hem of the cushion and tucked down between the seat and the back will keep it firmly in place. If a more secure anchorage is required, the loose end of the flap can be hemmed to receive a dowel, which is then forced down into the seat crevice.

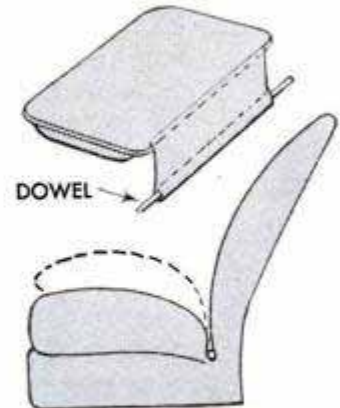

Fish Kept Fresh in Carton Lined With Aluminum Foil

When lined with aluminum foil, a corrugated-cardboard carton will provide an excellent "refrigerator" for bringing home extra fish and game caught or bagged during a vacation. Before packing, however, it should be cleaned, dried and either chilled thoroughly or frozen. This can be done at an icehouse or frozen-food locker in the vicinity of your camp. Then the fish or meat is wrapped loosely in several layers of the foil, which may be purchased at most grocery stores. Next, one or two pieces of Dry



Ice are wrapped in a piece of woolen cloth and packed with the meat. If Dry Ice is not available, two 5-lb. salt or sugar sacks can be filled with sawdust, soaked in water and then drained until they no longer drip, after which they are frozen. This may be done when locating an icehouse where the sacks may be left for freezing and picked up later. Do not use ordinary ice, however, because it will melt quickly and damage the box.

X667

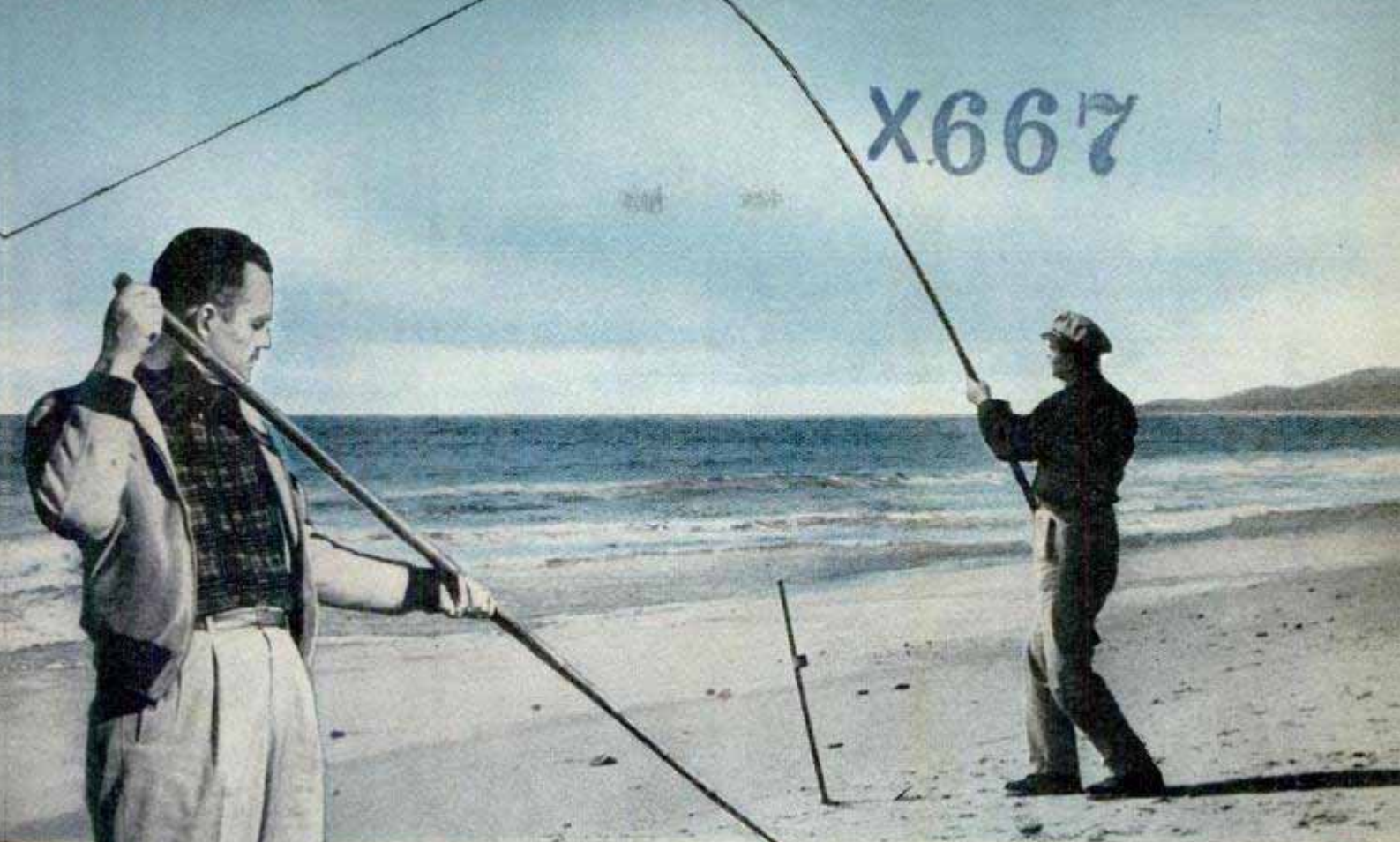

WIMOSS

MAKE YOUR OWN Surf Rod

By *Shep Shepherd*

Surf fishermen use sand spike to hold rod

EXPERIENCED SURF FISHERMEN say they like the feel of a natural-bamboo rod and that's why many make their own from a selected bamboo pole, or "Calcutta," as it is sometimes called. Preference in length may vary, but 13 to 15 ft. will fit nearly all requirements. When squidding from a wide beach or shoal, the longer rod is an aid in getting artificial lures into the deeper water beyond the breakers. Of course, the precise butt and tip lengths of the rod are determined to some extent by conditions and, for this reason, determining the rod length is largely a matter for the individual fisherman to decide for himself.

The first step in selecting the bamboo pole from which the rod is to be made is to hold it as in the lower photo above, and turn it slowly to locate the "spine," or point, where the pole takes a natural bend. Notch the butt so that you can locate this point later. Inspect each joint for defects and irregularities in





Start wrapping at butt with one color of cord. Add the second color 1 in. from butt and continue as pictured. It's essential to wrap tightly and uniformly



Tape reel seat only at center, leaving ends clear for the wrapping. Continue butt wrapping 6 to 8 in. above the reel seat. Use the same color, or colors

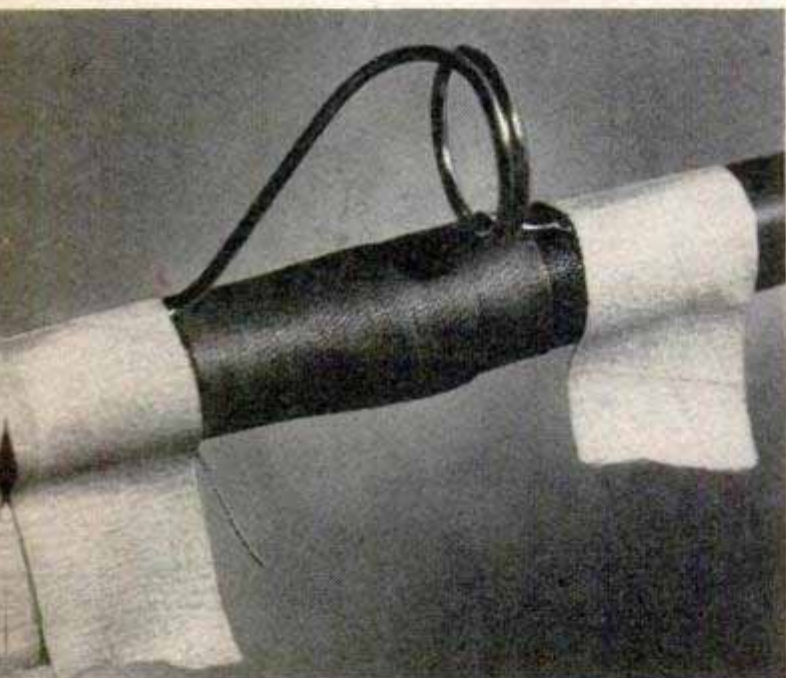

Foulproof guides of type shown are installed after second wrapping of joints. Remove rear (left in photo) tape first and wrap with thread. Then wrap front leg

Wrap joints "uphill," starting from tip side of each joint. In this way turns of fine thread will not open. Before wrapping joints, smooth with file



Be sure tip is installed in line with reel seat. Pass line through guides and tie free end to tip. Position guides so line runs through center of eyes

To secure end of wrapping, pass a loop of thread under three or four turns of wrapping. Insert end of wrapping through loop and pull under turns

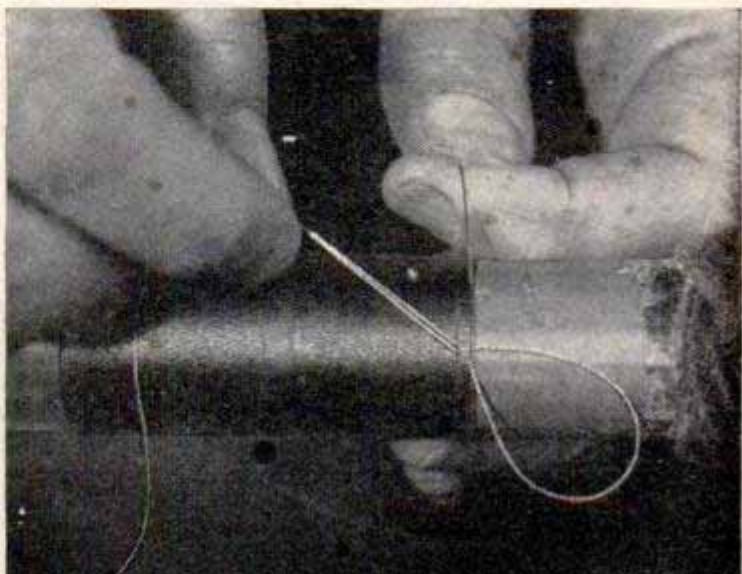
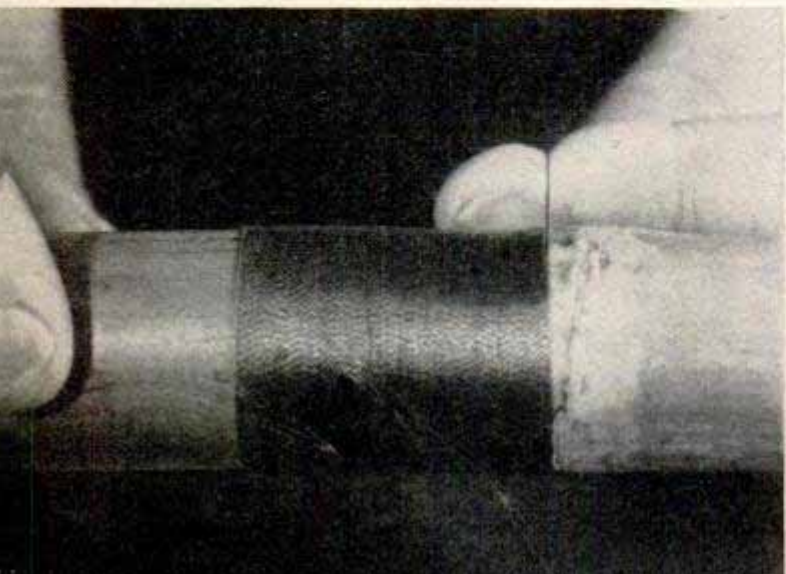

size. If the pole passes a close inspection then you're ready for the next step in making a surf rod. Suspend the pole from cords spaced about 3 ft. apart in the garage or basement workshop. Adjust the cords so that the pole hangs at a convenient height over a table or bench, as in the upper photos on the opposite page.

Tape the reel seat in place, keeping in mind that your right thumb normally rests on the reel spool as you cast. On this type of rod, most surf casters will want the reel located about 30 in. from the butt. The seat should be located in line with the spine of the rod. Pass the tape over the center of the seat, leaving the ends clear for the wrapping. Next, fit the metal tip, making sure that it lines up with the reel seat. Smooth all joint irregularities with a fine file, and then begin wrapping at the butt, using standard butt-wrapping cord made for the purpose. Two colors were used on the original, but this is a matter of choice. Start the wrapping by making three or four turns of the cord over its own end which is laid lengthwise along the butt. If you use two colors, start the second color by wrapping the first cord over the loose end of the second. Wrap one color for a distance of 1 in. or more from the butt before starting the second. Then hold the two cords side by side between the thumb and forefinger of the left hand, turning the rod with the right. The trick in making wrappings of this type is in maintaining a uniform spacing of the cord, or cords, and at the same time keeping the tension the same throughout each complete turn. When the reel seat is reached, cut the second cord and wrap over the loose end with the first one. Two or three turns before you reach the end of the wrap, lay a short loop of separate cord parallel with the axis of the rod and continue wrapping over it. Now cut the wrapping cord and pass the free end through the loop of the separate cord. Pulling on the looped cord brings the free end of the wrapping cord under two or three turns of the wrapping and anchors it firmly. Begin wrapping again above the reel seat, starting the wrap in the same manner as at the butt. Continue wrapping 6 to 8 in. above the seat, using one or two colors as desired.

Next, each joint is wrapped, using size-EE nylon thread. The wrap must extend at least 1 in. in each direction from the approximate center of the joint. Some rod makers will extend the wrap 1½ in. When wrapping the joints, work from the tip side. The reason is that almost all bamboos (Calcuttas) have a fairly sharp downward slope on the upper side of the joint, and only by wrapping from the upper side can you prevent the thread turns from opening. Joint wrapping must be done with special care as



When joint wrappings are completed apply a special color preservative with finger tip. Be careful to spread a uniform coating and apply sparingly. After first coat is thoroughly dry, apply a second

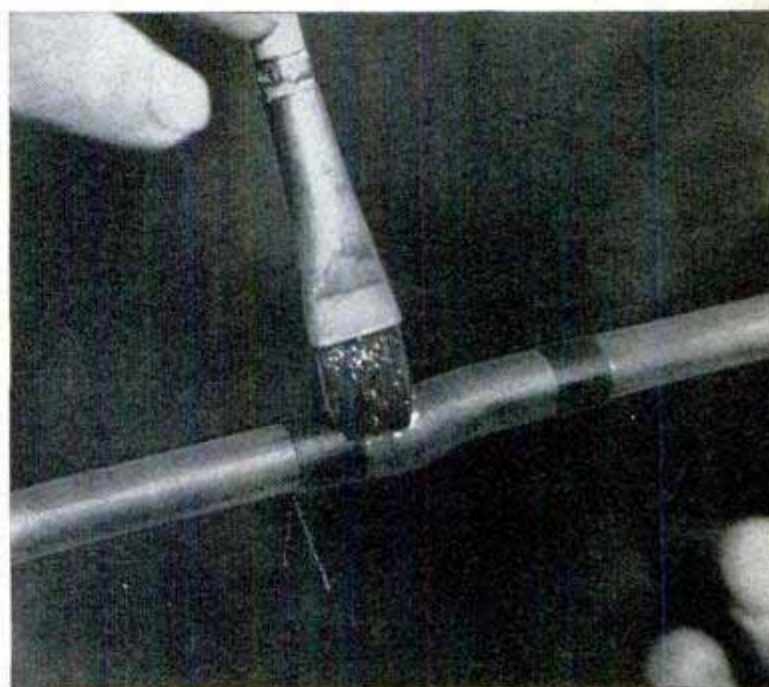

Apply third, fourth and fifth coats of a color preservative with a fine-bristle brush. Be especially careful with brush to spread thin, uniform coating

Last step before varnishing rod is clipping loose ends of joint wrappings with a fingernail clipper. Ends should be trimmed closely to prevent raveling

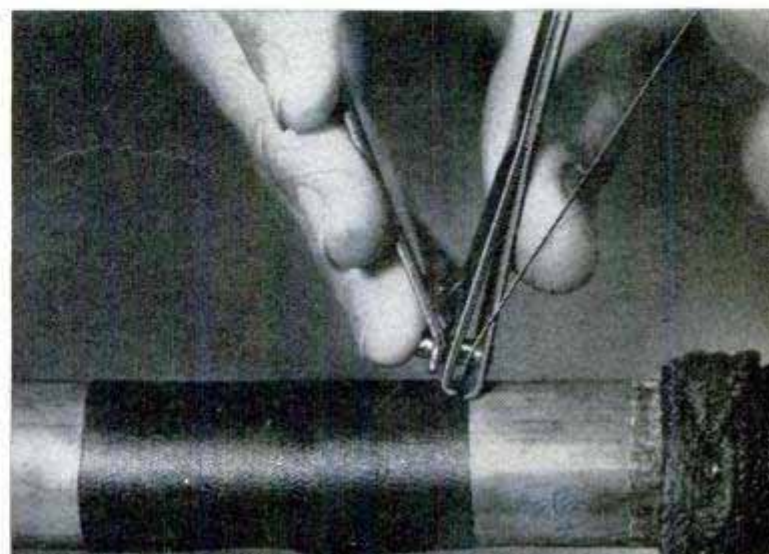



Choice of reel is up to individual surf caster. Many prefer the spinning reel of the type shown

the strength and drive of the finished rod depend on the wrappings. After single-wrapping, the joints are double-wrapped, but before this is done the location of the guides must be determined. Attach the loaded reel and pass the free end of the line through each guide in the order of its position on the rod. Pass the line through the tip, lock the reel spool and fasten the line securely to the tip. Now locate each guide, the first one being taped in place about 36 in. above the reel. Tape the next guide about 18 in. above the first and then shorten the distance between those remaining about 2 in., or whatever approximate distance gives a fairly uniform spacing. Primarily, of course, each guide should be fitted on a wrapped joint. If new foulproof guides having widespread legs are used, then the second wrapping should be installed before positioning the guide. On old-style guides, the second wrapping is made over the legs. The color of the thread used on these wrappings is a matter of choice, but contrasting colors make the rod more attractive.

After the wrappings have been completed, treat with a special color preservative. Apply this material sparingly preferably by wetting the cord with the finger tip as in the upper photo on page 179. Allow the first coat to dry, then apply another in the same manner. When the second coat is dry, apply a third coat with a soft brush. When applying with the brush, turn the rod slowly and be sure that the material is brushed out to a thin, uniform coating. Apply the fourth and fifth coat of preservative in the same manner.

Now rig the line as you would for actual fishing and make a few practice casts across, with and against the wind. When doing this, select a spot where the line will not become fouled with sand or mud when retrieving. While you will only be simulating actual

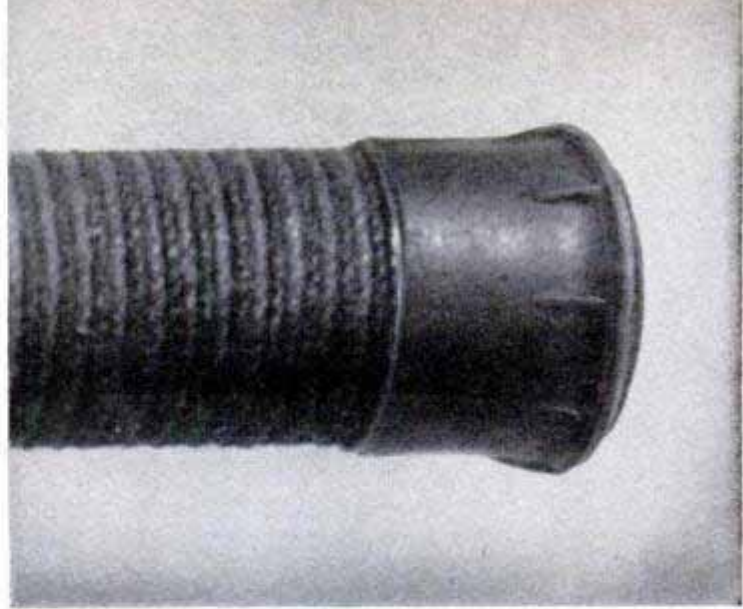

After varnishing entire rod with several coats of rod varnish, finish the job by fitting a rubber tip

conditions, the practice casts will indicate quite accurately the spring and driving power of the rod and enable you to get the feel of it on a long cast. Keep in mind that the coats of protective varnish yet to be applied will stiffen the rod slightly and that you can stiffen it still more by adding spaced wrappings. While a rod of this type is not generally regarded as the most suitable for maximum long-distance casting, it should put out 150 ft. of line, even when it's handled somewhat less than expertly. However, it should be kept in mind that the full drive of the rod is utilized only by correct thumbing of the reel. If thumbed too late, the spool may overrun the line. If thumbed too early in the cast, the initial drive will be lost. Also, remember that a new line must be "broken in" before attempting long-distance casting. Thumb the casts short until you get the feel of the rod. Inexperienced casters should keep in mind that it's the driving power of the rod in the final half of the swing that sends the bait far out over the surf. There should be no sense of take-up or lack of spring at any point in the swing, and when you release the spool as the rod straightens, the rig should lead a taut line right out to the limit of the cast. If the rod seems capable of turning in this performance consistently, it has what it takes.

Now finish with rod varnish, applying as many coats as necessary to produce a smooth protective film. Then add a rubber butt tip as in the photo above. When fishing from a beach many surf fishermen like to use a sand spike to support the rod and line as in the lower photo on page 177. It's made from a pointed length of flat steel having a ring welded on to support the rod butt. ★★★

☞ Rain-spotted window sills can be restored by wiping with a cloth dipped in alcohol.

Wooden Basket Serves Many Uses in Garden

You are sure to find many uses in the garden or the back yard for this attractive wooden basket made of dowels and plywood. Not only will it come in handy for carrying plants and seedlings as well as several small garden tools, but it also may be used when gathering weeds and branch prunings for disposal. Still another use for the basket is that of a firewood container for an outdoor barbecue. After cutting exterior-grade plywood to the dimensions indicated, drill holes along the sides and bottom of each endpiece to take the ends of $\frac{3}{4}$ -in. dowels. Insert the dowels and pin with brads driven in the edges of the plywood. Allow the ends of the dowels to project $\frac{3}{8}$ in. beyond the endpieces. Finish the assembled basket with clear shellac and a coat or two of exterior paint. If desired, a detachable wooden frame may be built that

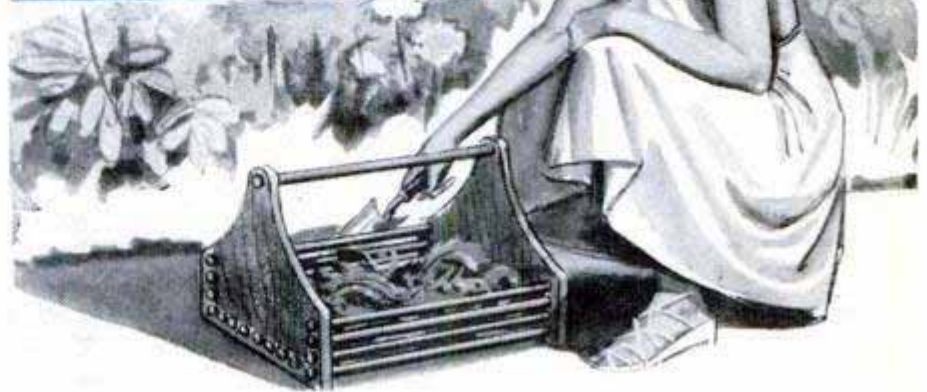
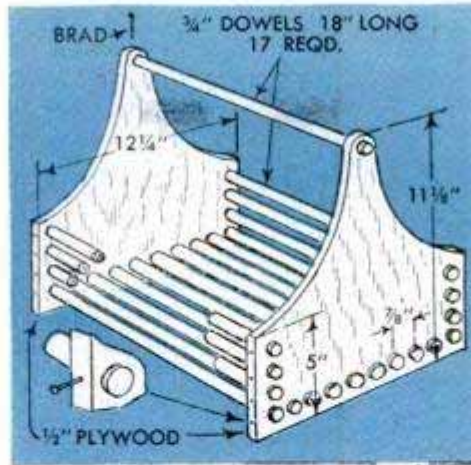

can be either hooked or screwed to the basket endpieces to provide a magazine rack for indoor use during the winter months.

Dick Hutchinson, San Gabriel, Calif.

Both Liquid and Wax Polishes Used for Better Shoeshine



You can give your shoes a more effective shine by using liquid and paste polishes together. The liquid polish, usually referred to as self-polishing, is applied liberally so that every crevice and indentation is coated. After the coating has dried thoroughly, apply the paste wax in the usual manner. With all pores and openings in the leather sealed, the paste wax remains on the surface and, as a result, requires little rubbing to obtain a high polish. A clean, soft cloth should be used for best results.

Tube Fitted Over Brush Ferrule Adjusts Spread of Bristles

For certain types of work a paintbrush on which the spread of the bristles can be regulated will come in handy for reaching through narrow openings into inaccessible places. All that's needed to adapt an ordinary brush is a short piece of metal tubing that will press-fit over the ferrule of the brush, forming a sleeve as illustrated. As the sleeve is pushed down over the flared bristles, it gradually compresses them. The sleeve also may be used as a keeper whenever the brush has been cleaned and is ready for storing.

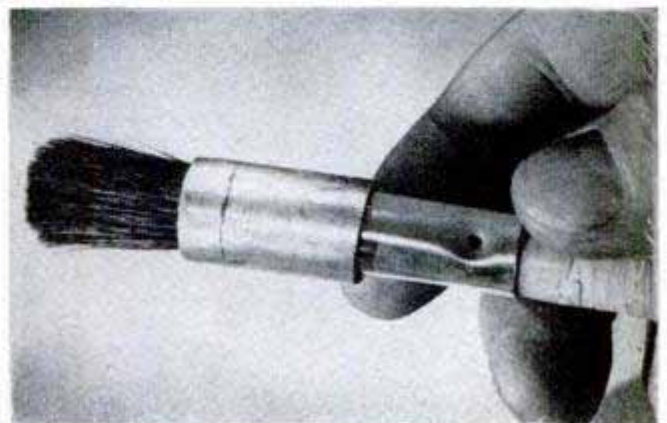

Lightweight

TENT FOR



Complete tent with canopy, provides adequate shelter in rainy weather. A fire of dry hardwood located just beyond outer edge of canopy warms interior of tent to a comfortable temperature

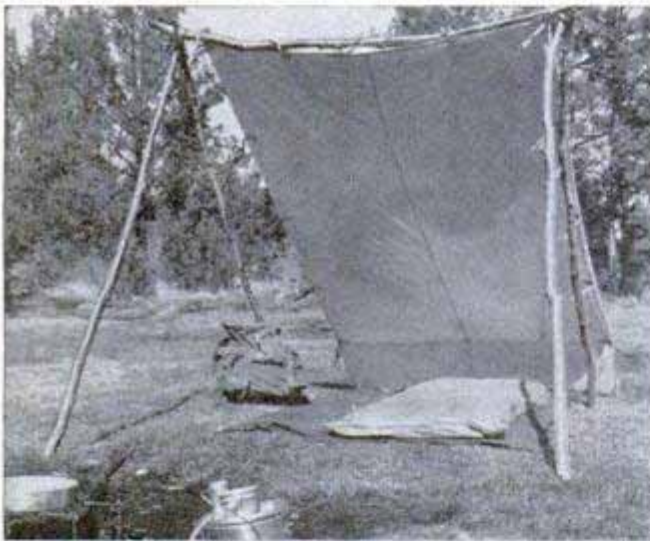

Above, top section alone gives overnight protection in mild weather. Note 12-in. wall at the back
Below, by adding two walls and pitching tent with top to windward you can keep dry in a driving rain



Above, one wall breaks a strong wind and provides comfortable summer sleeping quarters for one or two persons. Below, by pitching top section side-wise you get a low lean-to with one closed end



HIKERS

By Joe Van Wormer

AN OUTDOORSMAN who takes to the back trails selects his gear with an eye for utility and easy portability. When all the equipment is carried on his back between camp sites it must be light and good. Old hands on the trail usually prefer to make their own shelter tents, a typical example being the sectional tent pictured on the opposite page. It's made of unbleached muslin treated with a water repellent, and the sectional feature permits it to be pitched five different ways as the weather and temperature may require. The total weight is a little under 5 lb. less, of course, the poles which are cut at the camp site. During warm summer months you'll need only the roof section, which weighs about 2 lb. and is pitched as a lean-to. By carrying the side panels you can set up a shelter that will turn both wind and driving rain. With the canopy or fly added you can have the warmth of a protected campfire even in a downpour.

The materials required for the sectional tent of the size detailed at the right are approximately 18 yd. of 160-thread unbleached muslin 39 in. wide, 24 yd. of cotton tape and sufficient No. 40, 6-strand cotton thread to quadruple-stitch all seams and hems. The tape loops and ties are secured under 2-in. square patches of tent material quadruple-stitched at the edges and then crossed-stitched through the tape for maximum resistance to tearing. The tape ties are 20 in. long with the fold placed under the patches. The tape loops are 10 in. long and have the free ends folded under the reinforcing patches. Note that the sides tie to the top in such a way as to provide a 2-in. overhang. If desired, additional ties can be added to the side panels and top so that the latter can be drawn down over the sides and tied for a more effective weather seal.

Note in the details at the right that the ties on the sides and upper edge of the top panel are centered about 2 in. in from the edges, and that loops are placed to provide a 6-in. dew cloth and a 12-in. back wall. This wall makes the entire 6 x 7-ft. floor area usable for sheltering both bed and gear.

Carry nylon cord for pitching the tent and lashing the poles cut at the camp site. Note particularly the arrangement of the poles when pitching the tent in any of the five positions. When cutting the poles, select only live saplings. Always select a camp site on high ground so that there is adequate drainage. ★ ★ ★

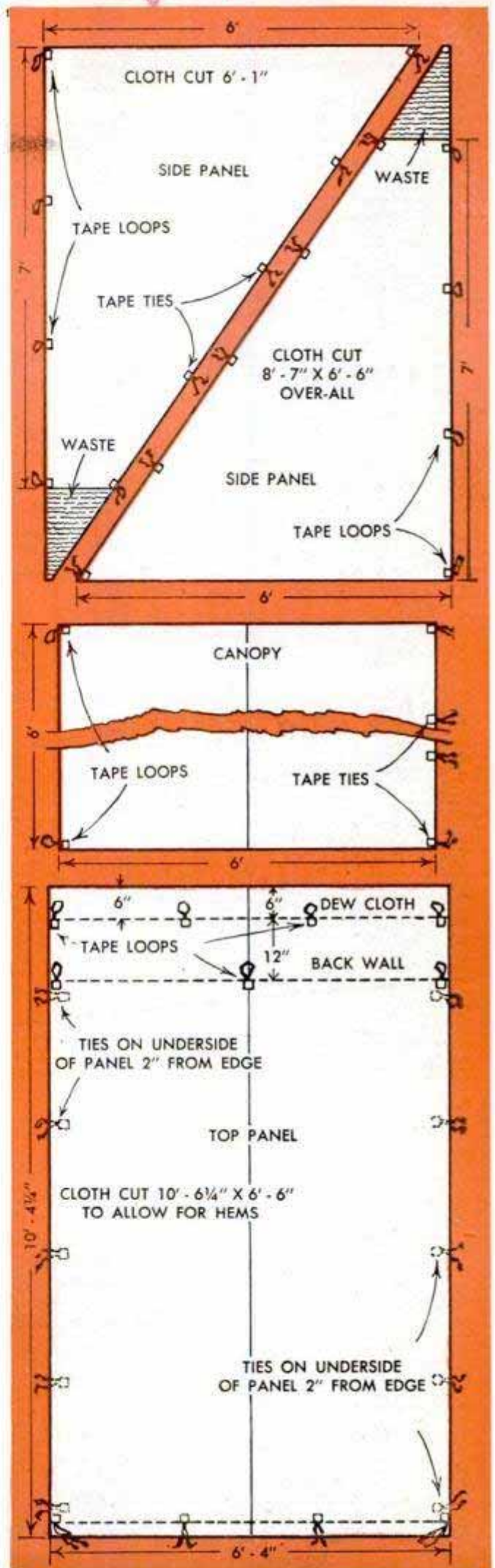

Weather-Resistant Mailbox Post Made From Welded-Pipe Lengths

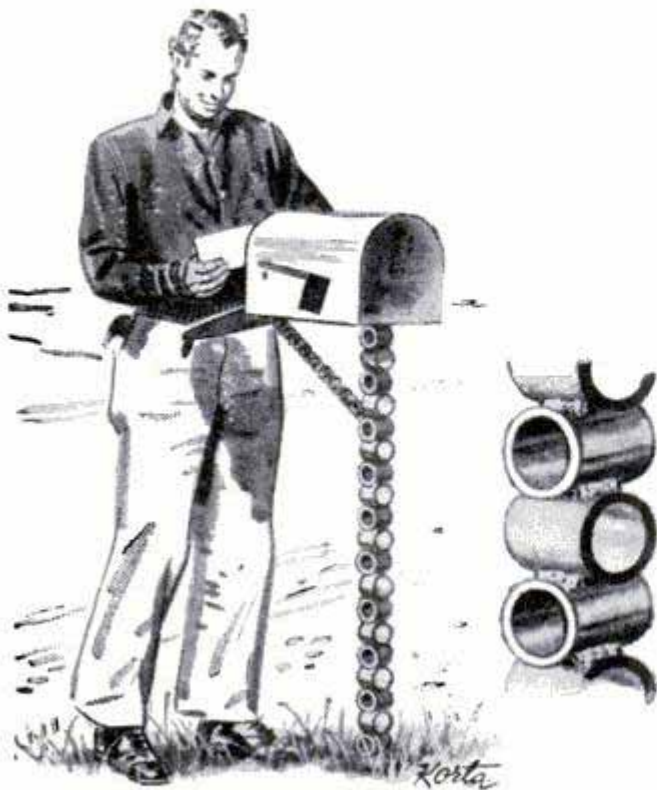

Neat appearing as well as weather-resistant, this unique mailbox post consists of 3-in. lengths of 3-in. pipe welded one above the other as shown. The post in turn is welded to a 3-ft. length of steel pipe vertically embedded in the ground. The brace under the front end of the box is made in the same manner, except that $\frac{3}{4}$ -in. lengths of $\frac{3}{4}$ -in. pipe are used. After setting the post

in concrete in the ground, both the post and brace are given a coat of aluminum paint to prevent rust.

Kenneth Hadenfeldt, Storm Lake, Iowa.

Wire Replaces Standard Fuse For Experimental Work

When doing experimental electrical work during which fuses are likely to be blown frequently, it is less expensive and more convenient to replace the standard fuse with fuse wire. Use an ordinary electric screw plug as the fuse base, into which is inserted a regular male plug wired as in the illustration. Fuse wire may be purchased in any capacity, but the most convenient is 5 amp. If a 10-amp. fuse is needed, two strands of wire are used; three for a 15-amp. fuse, and so on.

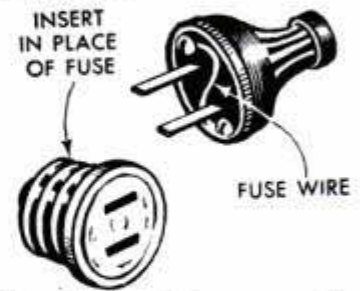

Ed Packer, Chicago.

Fishline Repaired With Nail Polish

When the finish on an enameled fishing line became cracked, one fishing enthusiast used clear nail polish to seal the damaged portion against moisture. He has also found it effective for temporarily repairing the finish on corks and plugs, as well as for covering chipped areas on a rod.

Robert Unghemah, White Plains, N. Y.

Popular Mechanics Bookshop

Fancy Yourself a Chef?

Then here's your dish — the brand-new *Popular Mechanics How to Build and Use Your Own Outdoor Kitchen*. It's a roundup of the latest ideas on outdoor kitchens and cooking, with instructions for making everything from grills and ovens to barbecued ribs and roasts. Drawings and photos detail the construction of fireplaces, complete kitchens, barbecue pits, portable grills and Chinese and Mexican ovens. Here, too, are fire-tested recipes for such delicacies as barbecued fowl, fish, shishkebab and special sauces. Order now from Popular Mechanics Press, 208 East Ontario St., Chicago 11. The price is \$2.00.

Even Fishermen Have to Eat . . .

. . . and here's a book that's bound to bring trout and walleyes into the frying pan. *How to Tempt a Fish* is a handbook of angling lore and know-how, illustrated with full-

color photos, diagrams and drawings. There are separate how-to-do-it chapters for the fly caster, bait caster and salt-water angler, along with hundreds of fishing hints and kinks. *How to Tempt a Fish* makes a fine gift for any sportsman. The price is \$2.00 from Popular Mechanics Press, 208 East Ontario St., Chicago 11.

And You'll Want to . . .

. . . photograph those back-yard get-togethers and fishing expeditions this summer. *Photokinks* is an annual handbook to help you get the perfect picture. Included are picture-taking hints, new equipment and techniques for the darkroom, four sections of salon photos, a section on color photography and pages of special information on motion pictures and slide projectors. *Photokinks* is available at your local newsstand, or order for 75c from Popular Mechanics Press, 208 East Ontario St., Chicago 11.

All books available from Popular Mechanics Book Department, 208 E. Ontario St., Chicago 11

Eyelet-Type Envelopes Used To Separate Tiny Parts

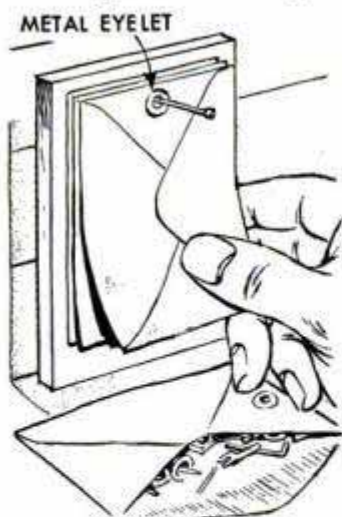

Small Manila envelopes of the type having metal eyelets are used by one hobbyist to keep tiny parts separated when working with models or making repairs on cameras or other intricate equipment. Available from any florist, the envelopes are sealed and identifying data

written on the front, after which they are slipped over a finishing nail driven in a block of wood for attaching to the wall or storing flat, as most convenient.

Glue Cup Has Disposable Liner

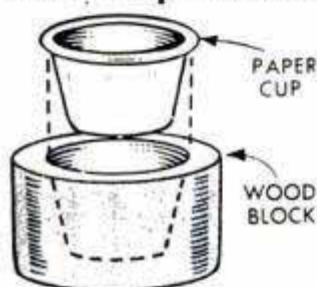

Craftsmen who often mix small amounts of resin or casein glue will appreciate this wooden glue cup with its inexpensive throw-away liners. The water-

proof liners are paper candy cups of the type used at parties, and these are merely slipped into a recessed wooden base. The base can be turned in a lathe, the center being bored to suit the taper and depth of the cup, or it may be a square block cut from a length of 2 x 4. In this case the recess is cut with an expansive bit.

Robert Funk, Sacramento, Calif.

Underseat Rack for Folding Chair



With this simple underseat rack for folding chairs, those sitting in the chairs will not have to hold hats and parcels in their laps. Heavy cloth is cut to fit between the rungs of each chair, and ties are sewn to the corners for tying the rack to the legs. The cloth will not hamper folding the chair and can be removed for washing.

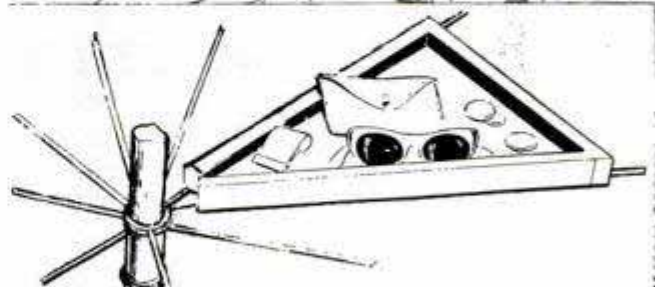

Beach Umbrella Supports Tray That Holds Small Articles

A wooden tray resting on the struts supporting the ribs of a beach umbrella is handy for holding cigarettes, matches, sunglasses, cameras and other things that must be kept dry and out of the sand. The sides of the tray extend below the bottom to form flanges that prevent the tray from slipping out of position. The bottom of the tray is glued into dado grooves in the sides.

Bertram Brownold, Cedarhurst, N. J.

Solder Melted More Quickly If Flattened Beforehand

On delicate soldering operations where solder must be melted instantly to avoid overheating the work, try hammering it flat beforehand. This will enable you to make it flow with little more than a touch of the iron. This trick works with cored as well as plain solder.

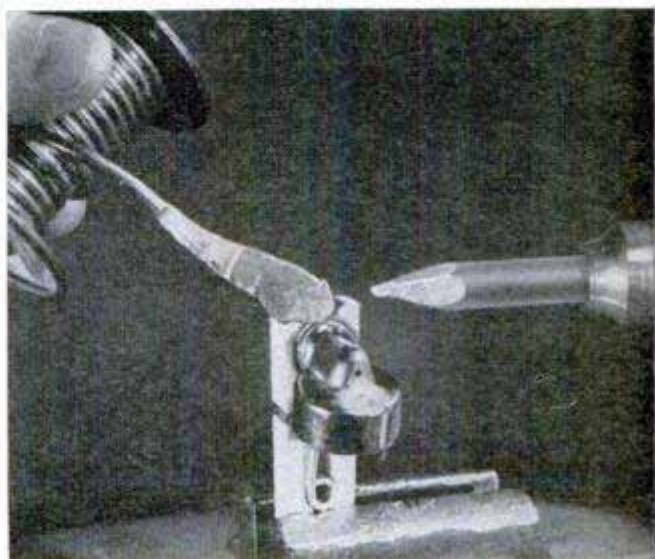

Three-in-One FLAGSTONE MOLD

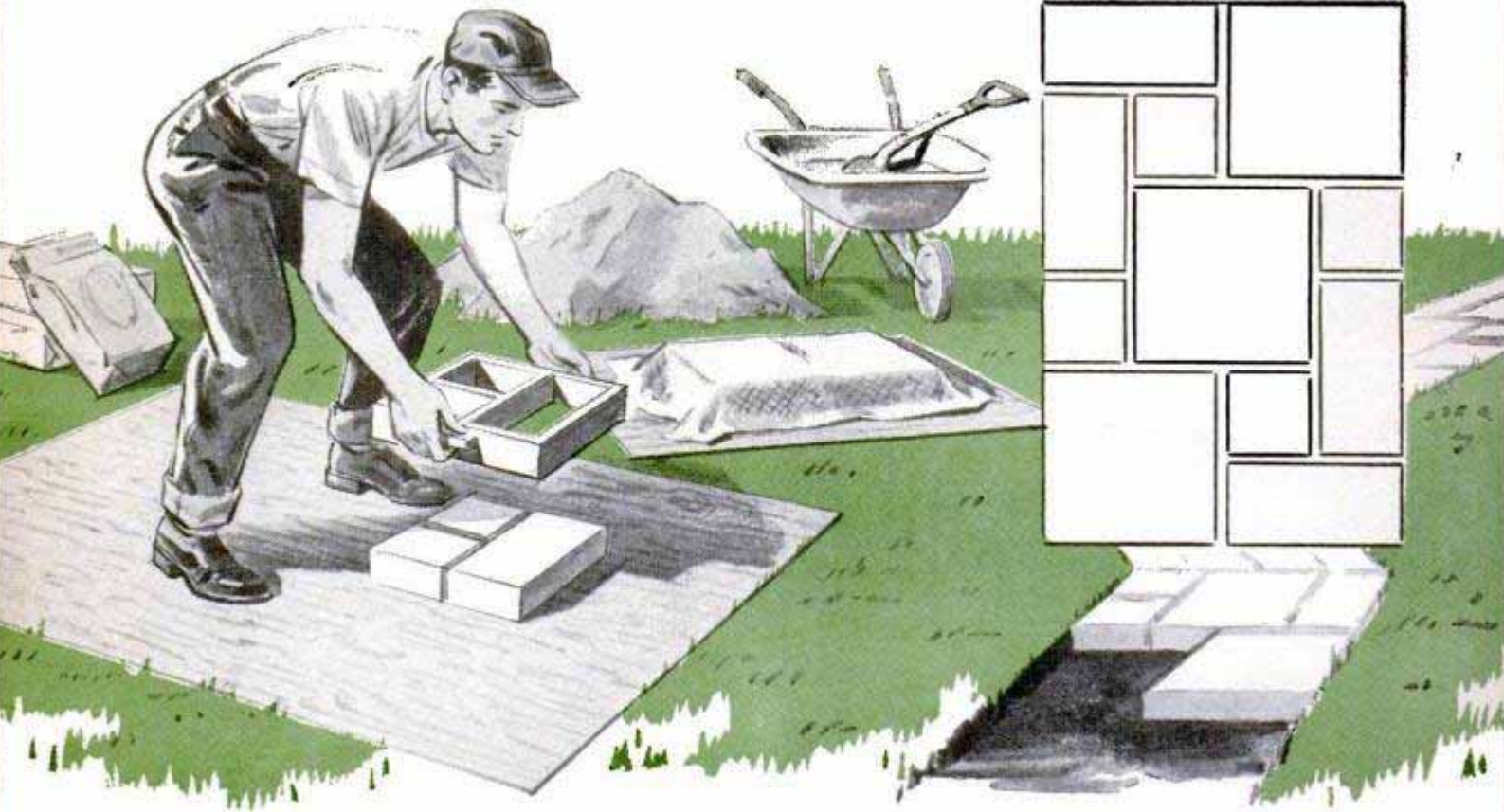

By Hi Sibley

FITTED WITH REMOVABLE dividers for making flagstones in three sizes, this simple mold will enable you to work out a variety of interesting patterns when laying out a walk or terrace. The frame is $\frac{3}{4}$ -in. stock, mitered at the corners and assembled with steel angle irons. Each divider may be two thin pieces joined together to prevent warping that are beveled and later oiled for easy removal from the concrete. The concrete consists of cement, 1 part, clean dry sand, 2 parts, and pea gravel, 3 parts. While curing, the blocks should be covered with burlap or a tarpaulin and sprinkled periodically. To provide drainage, the blocks are laid so they project $\frac{1}{2}$ in. aboveground.

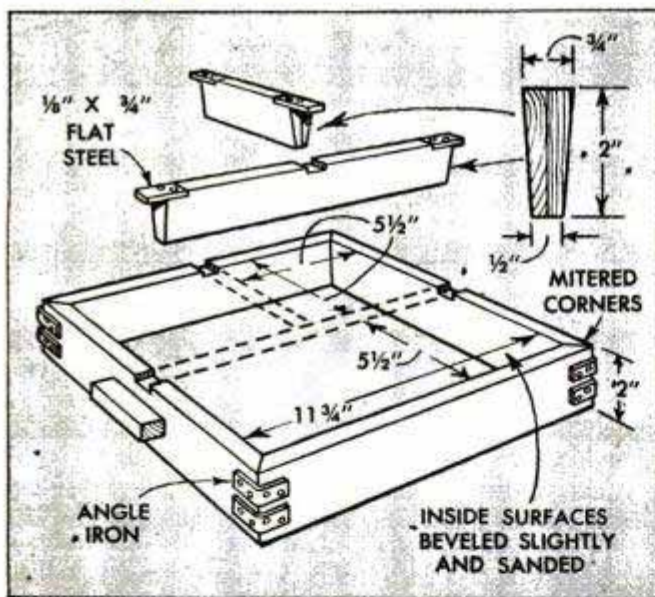

Teeth Filed on Back Edge of Saw Blade Used for Cutting Nails

Teeth filed on the back of a handsaw blade will come in handy for cutting nails embedded in old lumber. However, for best results, the teeth should be filed at right angles to the blade and must not be set. When a nail is encountered, simply reverse the blade and cut through it. If desired, the section where the extra teeth are cut may be hardened.

☐ To keep a throw rug from slipping, cut a piece of oilcloth to the exact size of the rug and place it under the rug with the glazed side down.

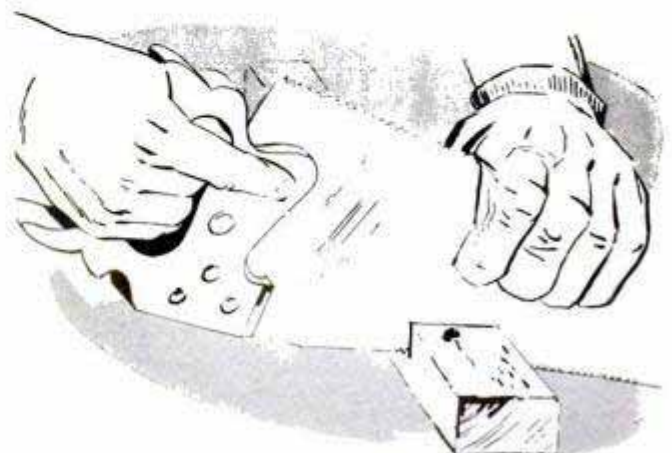

Right, cars being selected from dealers' stocks by officials for Economy Run. After selection, cars were given a 2500-mile break-in. No alterations were permitted



Center, immediately after selection by officials, cars were impounded and hoods sealed. After sealing, hoods were opened only under supervision of technicians

All photos courtesy General Petroleum Corp.

12 WAYS TO SAVE GAS

By Ed Packer

ALTHOUGH ordinary good-driving practices always produce appreciable fuel savings, it's consistent observance of the little things that runs up an impressive average in miles per gallon. Motorists who like to think they drive with an eye on the fuel gauge still can profit from the practices employed by drivers in the annual Economy Runs sponsored by the General Petroleum Corp., makers of Mobiloil products. In a recent Run stock cars covered over 1400 miles at elevations ranging from below sea level to more than 8000 ft., and in temperatures varying from below freezing to over 100 deg. F. State and local traffic regulations were rigidly observed. The cars covered the distance at an average speed of nearly 41 miles per hour and turned in an average of 22



miles per gal. Note the results in the brief chart on page 190.

Hard braking at stop lights, jack-rabbit starts, improperly inflated tires, dragging brakes, wheel misalignment and an incorrectly adjusted carburetor are well-known

Hard stops not only ruin brakes but can seriously damage other car parts



Throttle-to-floor-board starts waste fuel, cut miles-per-gallon averages

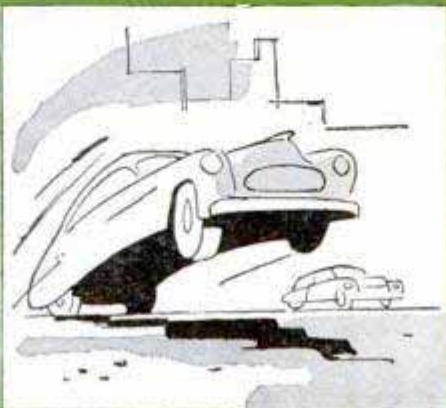

On a cold morning tires are always "low." Drive slowly for a few miles

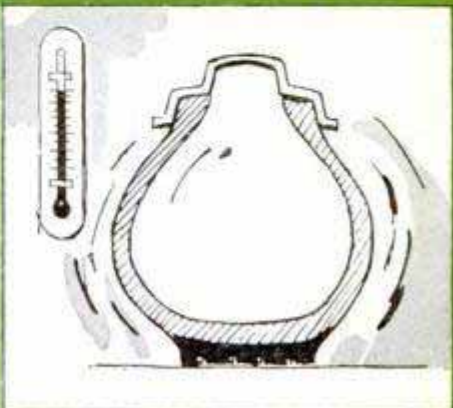



Technicians dismantle and inspect a carburetor to make certain that all parts and adjustments meet factory specifications for each car entered in the Run



Members of technical staff verify distributor adjustment and vacuum-spark advance. Careful check is made of spark as it must fall within certain tolerances

causes of low gas mileage, but there are others less familiar to drivers that cause an unnecessary fuel waste. For example, when you back out of the garage on a cold morning the tires are "low." The air in the tubes has contracted and, in effect, lowered actual pressure. Until the tires are warmed by friction, the effect is that of driving with slightly underinflated tires. Slow speeds for the first few miles with easy stops and starts at the lights will offset the fuel loss.

Sharp turns not only make the tires squeal, but raise fuel consumption due to tire slippage, power loss through the differential and actual spilling of fuel from the tank and carburetor. Free-rolling resistance of tire treads on a flat turn is quite high even at moderate speeds. When the turning speed is so high that the sidewalls of the casings fold over the rims, the resistance is equal to light braking of the wheels.

Many drivers unconsciously "pump" the accelerator pedal slightly while driving.

This should be avoided as it is one of the major "hidden" causes of low gas mileage. When cruising, the driver should form the habit of relaxing so that he can maintain a steady throttle for long periods.

Other little things frequently overlooked are the resistance set up by tires having varying degrees of tread wear, and also installing tires of different tread types on the same car. If you purchase less than a full set of new or used tires, be sure that the individual casings are of the same tread type and also that they match the tires already on the car.

If you have an older car, lift the hood and examine the fan closely. There you will see another of the little things that contribute to fuel waste. It takes power to drive the fan and a coating of lint, mud and hardened oil on the leading edges of the blades can increase power requirements as much as 20 percent. Percentagewise, about the same thing is true when you make frequent use

Tight turns scuff off rubber and waste fuel in measurable amounts



Shift tires regularly to equalize tread wear and sidewall stresses

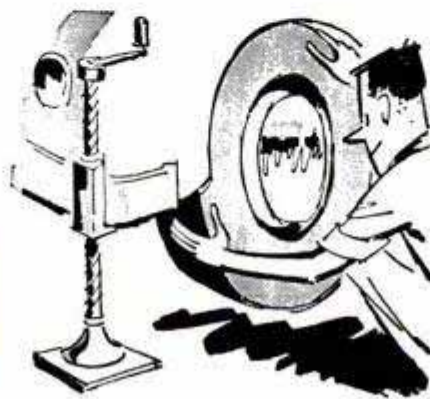

To minimize rolling friction always use tires of same tread type

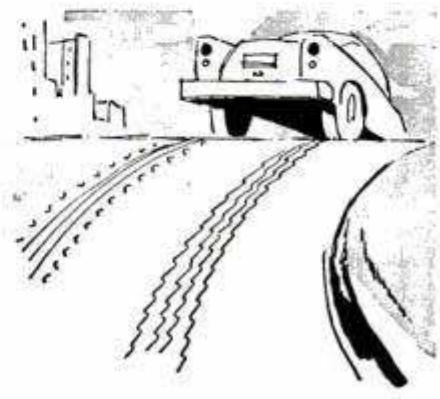



Technician making final inspection of timing and carburetor settings with test stand. Cars are under constant official supervision after selection



Checking leveling mark for filling fuel tank. At end of Run each car was placed in same position to obtain precise check on the amount of fuel consumed

of the lighter, radio, heater and cooling fan. The generator must replace the high battery drain of these accessories, especially when they are used in combination. This takes added power and increases fuel consumption proportionately. Careful drivers use accessories sparingly.

One of the heavier cars delivering an exceptionally high mileage in a recent Economy Run was equipped with an automatic transmission. Manufacturers of cars fitted with automatic transmissions usually give complete directions for operation in the owner's manual furnished with the car. As a rule, points that will be stressed are the proper use of the high and low ranges and maintenance of the engine at its highest efficiency. Careful observance of the instructions for operation in the high, or drive range, and the low, or power range of the transmission, and special attention to the acceleration and deceleration practices recommended, will pay off in mileages equal

to, or even surpassing, those of cars with conventional shift-type transmissions.

Continuous high-speed driving tends to thicken crankcase oils, even those designed for sustained high-speed service. Drivers who operate a car from 500 to 1000 miles a week at moderately high cross-country speeds should time oil changes accordingly. The length of time or the miles between oil changes depend on the driving conditions, such as the type of roads, temperatures and so on. Car manufacturers make definite recommendations for these special conditions and these should be followed as closely as possible. High-speed driving in warm climates builds up crankcase sludges and certain other gummy deposits quickly when the oil is nearing the end of its normal service period. This creates a condition sometimes referred to by mechanics as "oil drag." If not corrected immediately it can reduce engine efficiency and increase fuel consumption as much as 20 percent. When

"Pumping" accelerator while driving is hidden cause of fuel waste



First step to appreciable fuel savings is carburetor adjustment

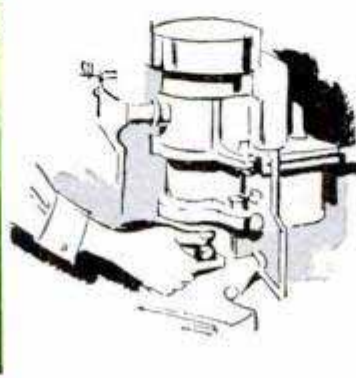

Among other fuel-saving measures is maintenance of wheel alignment

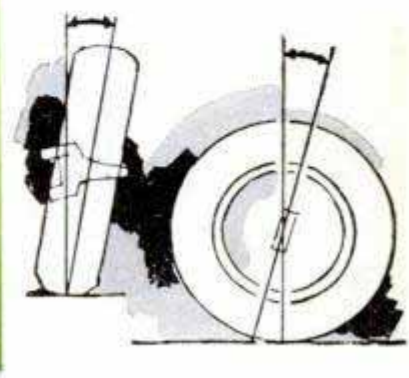



First car in 1952 Economy Run gets flag from starter, A. C. Agajanian. Others followed at two-minute intervals. First day's run was 515 miles in 12 hrs., 53 min.; second day's run 575 miles with 14 hrs. allowed

ECONOMY RUN AT A GLANCE

Average weight, all cars	3889.40
Oil consumption total of all cars	44 pints
Most oil consumed by one car	6 pints
Most gasoline consumed by one car	87.1755
Least gasoline consumed by one car	45.8714
Cars adding water	5 cars
Highest ton m.p.g.	59.7118
Lowest ton m.p.g.	40.8065
Highest m.p.g.	30.8558
Lowest m.p.g.	16.2362
Over-all m.p.g. average of all cars	22.0057
Average gasoline consumed	
by all cars	66.1326 gal.
Average speed	40.846

you replace spark plugs be sure to obtain the type suitable for your car and the kind of driving you do. Use "cold" plugs for high-speed driving and "hot" plugs for intermittent use in a cool climate.

Drivers who observe regular good-driving practices consistently keep an eye on chassis-lubrication schedules, engine tem-

perature and the condition of the ignition system, wheel alignment and regular tire changes from wheel to wheel, front and rear. Periodic checks catch defects early, keeping service and repair costs to a minimum from year to year.

Many carburetors have fuel valves controlled by manifold vacuum. When vacuum drops, as on sudden acceleration or when climbing a steep grade, the mixture is enriched automatically. To prevent fuel waste under these conditions, careful drivers avoid sharp acceleration and never permit the engine to "lug" when climbing a hill.

Gasoline forms a gum deposit on all surfaces in the fuel system with which it comes in contact, and in time this builds up to a point where it restricts fixed openings in the carburetor, making it difficult to maintain smooth idling of the engine. Solvents available in special containers make it possible to thoroughly clean gums from the carburetor without removing or dismantling the unit. After cleaning carburetor

Oil changes are determined by car usage. Short runs in cold weather mean very rapid oil contamination

Keep a close check on electrical system, especially parts of distributor and vacuum-spark control

When driving keep an eye on engine temperature. Check up immediately on sudden, wide variations

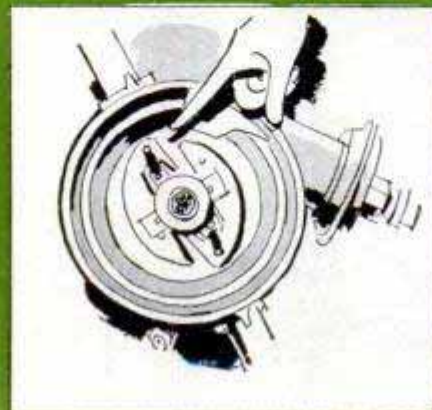

both inside and out with solvent, check carefully for air leaks at the flange, the throttle-valve shaft and also at the intake manifold. A slight air leak at any of these three points can cause serious carburetion irregularities. If the car is hard to start, especially in warm weather, an air leak is among the possible causes.

In older cars it's wise to keep a close check on the condition of the ignition system. Check the condition of the breaker points frequently and take a close look at the breaker-arm springs. A spot of rust on either one of the springs can cause trouble. It's also a good idea to have the spark timing checked frequently. ★ ★ ★

Tape Anchors Printing Paper For Borderless Enlargements

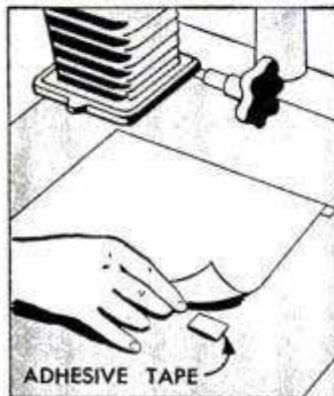

Four pieces of adhesive tape fastened to the baseboard of an enlarger with rubber cement can be used to anchor the printing paper when making borderless enlargements. They are placed to fit under the corners of the

paper. Being white, the squares of tape are visible under the darkroom safelight so that new sheets of paper may be placed on them rapidly.—H. Klein, Pittsburgh, Pa.

Improved Reflector Stand



No longer do I lose valuable time devising suitable supports for clamp-on photo reflectors since hitting upon an idea for making an extra reflector do the job. The extra reflector simply is placed face down on a flat surface in

the position desired, after which the other reflector is clamped to it.

Eugene Lee Burner, Morgantown, W. Va.

Riding the Waves

Racing towards shore on the crest of a giant wave while balancing on a surfboard can't be beaten for thrills and sheer fun! Now it's possible for you to construct a lighter, more buoyant board of foam plastic—as described next month!

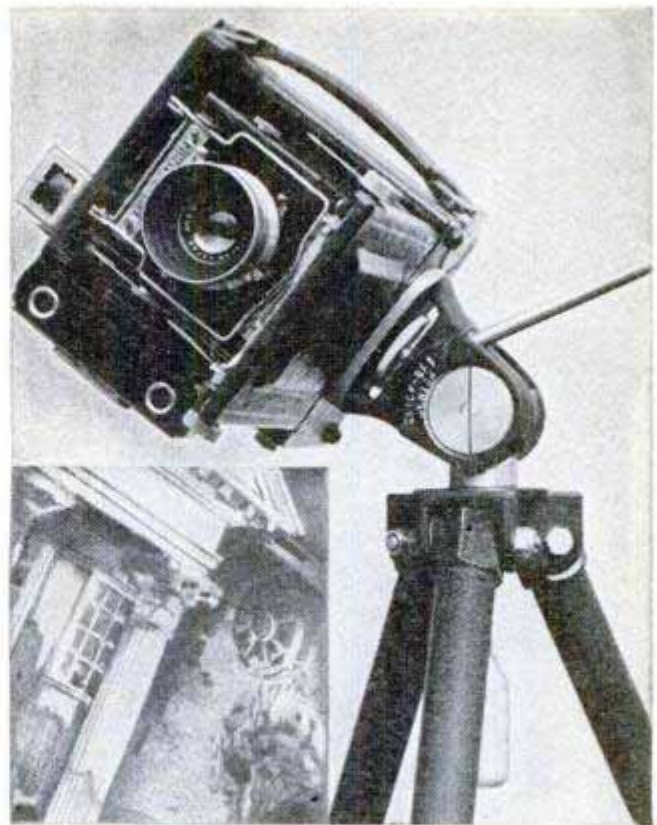

Camera Turned on Pan Head To Shoot Unusual Angles

Architectural-design studies and dramatic portraits sometimes require framing far from the usual vertical composition, and it is occasionally impossible to get the necessary degree of side tilt with the camera mounted on a tripod in the normal way. To remedy this, simply turn the camera sideways on the pan head, utilizing the vertical tilt of the head to angle the camera either to the right or left. However, with the camera mounted in this way, any vertical adjustment of the camera angle will have to be made by extending or retracting the tripod legs.—Jack Wilson, Hollywood, Calif.

Storing Print Tongs in Darkroom

The staple plate of a large hasp provides a convenient hanger for storing print tongs in the darkroom. It is fastened to the wall or inside a cabinet with wood screws, after which one handle of the tongs is slipped into the staple as shown.

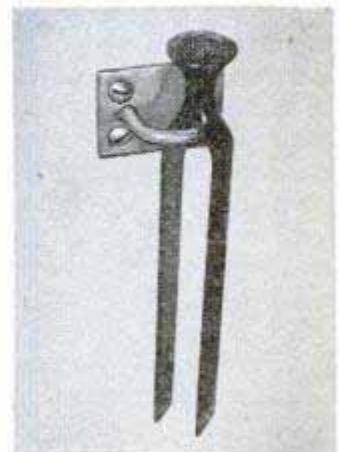

☞ Extremely dense negatives often may be used if a photoflood bulb is substituted for an ordinary one in the printer.

35-mm. CARRYING



Left-hand photo shows the finished case with camera and accessories in place. Right-hand photo pictures lined metal box and pull-out straps attached to metal liner, which has been partially bent to shape. Note that the liner is lined inside with a pile plush

SEVERAL HANDY REFINEMENTS distinguish this camera case from the ordinary leather gadget bag. A sheet-metal box provides a rigid form for the leather covering and also storage space for four rolls of film, a light meter, a bottle of lens cleaner, lens tissues, exposure guide, extra lens holder, cable, hood and camera. Use sheet aluminum for the metal form. An .032-in. sheet is just right for the purpose. From the details in Fig. 1 you can get a clear idea of how the form is made, but before you cut any materials note the dimensions in Fig. 2 and then measure the over-all size of your camera to make sure that it will fit. In measuring, allow for the thickness of the inner fabric lining of the metal form, or liner, Fig. 3. Before making the metal form, decide on the type of fabric lining you prefer to use. A standing-pile fabric, such as brown velvet, is probably the best choice. Of course, soft leather can be used.

Now lay out the pattern for the metal box, or compartment, Fig. 1, and the metal liner, Fig. 2. Care must be used to obtain an accurate layout so that all accessories will fit easily into place. When nothing else is available, the metal can be bent quite accurately over a square-edged hardwood block. Note the

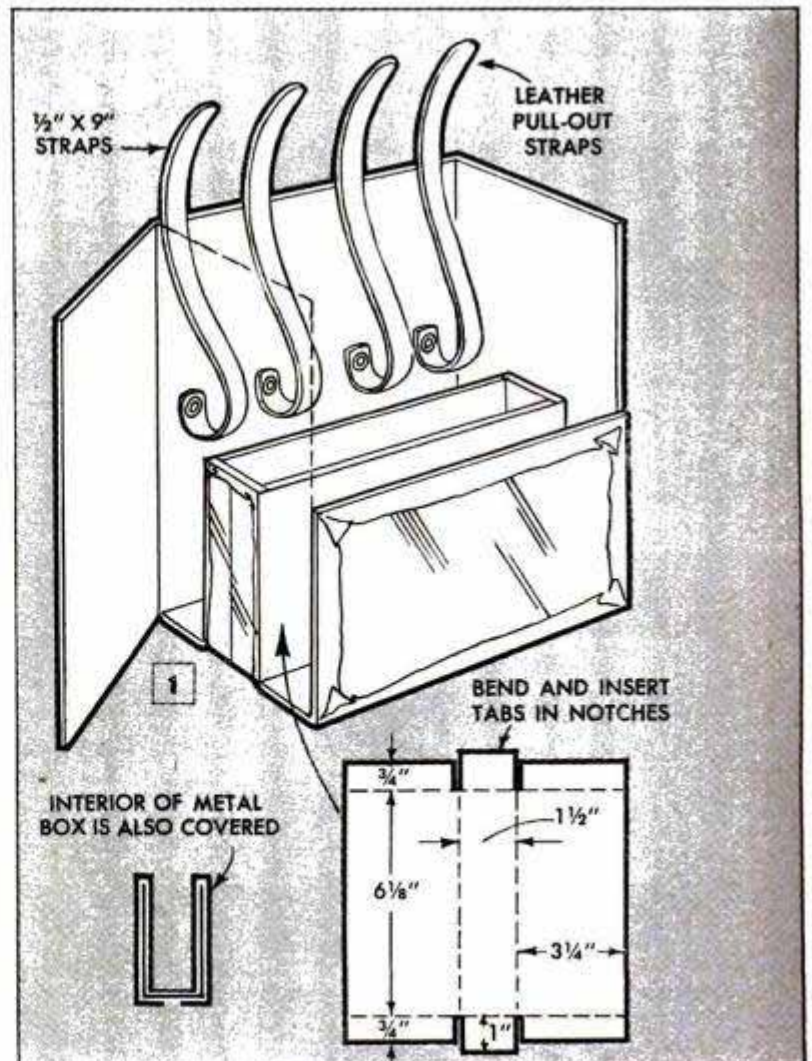

CASE

By Albert P. Belanger



All the accessories you see in this photo fit inside the case, including the camera. Pull-out straps lift rolls of film from the back of the compartment. Three pairs of snap fasteners close the case securely

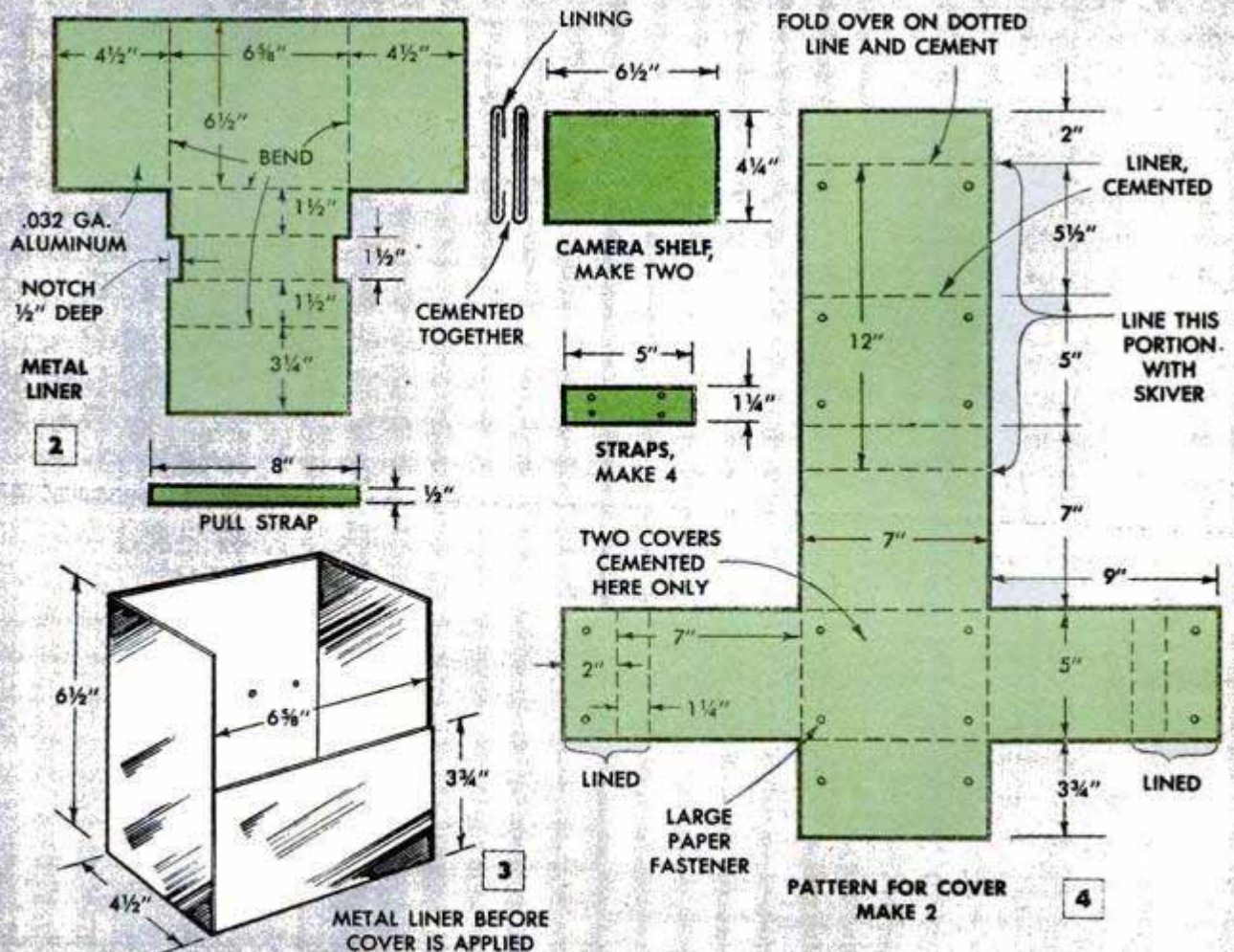

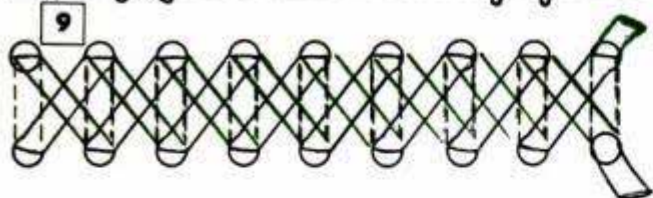
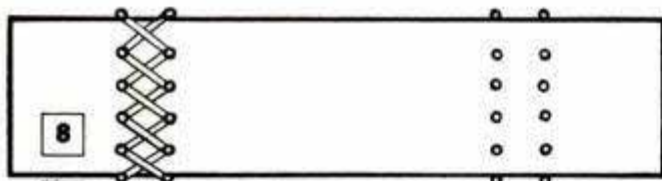
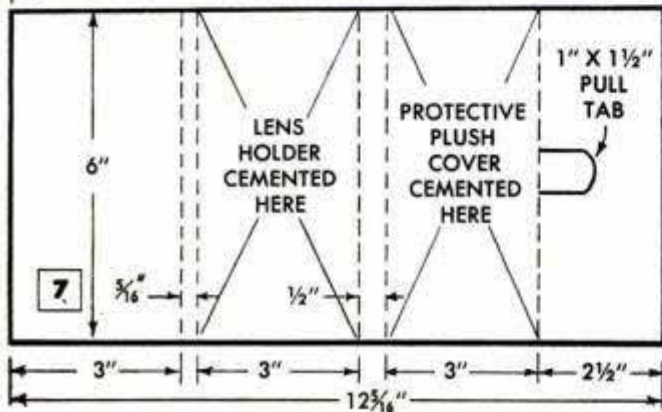
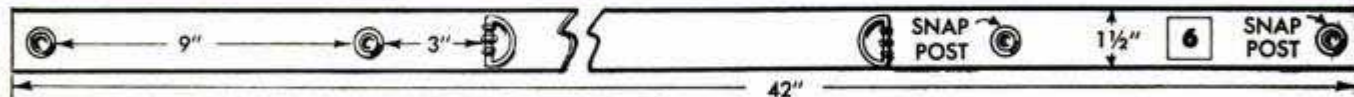
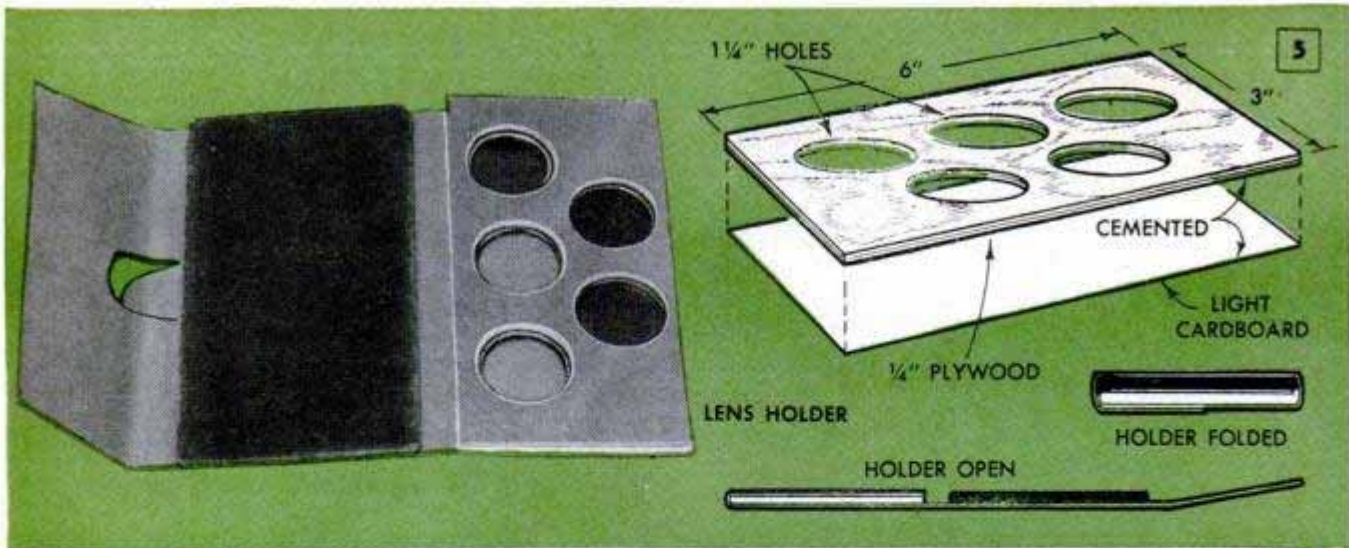

$\frac{1}{2}$ x $1\frac{1}{2}$ -in. notches cut in the metal liner, Fig. 2. These are designed to house the sling strap which passes under the metal bottom and between it and the outside leather covering. If you prefer a short hand strap for carrying, then the sling strap, Fig. 2, can be $\frac{1}{2}$ in. wide as indicated. However, if you use a shoulder sling, Fig. 6, cut the sling strap $1\frac{1}{2}$ in. wide. Either the hand strap or the shoulder strap can be attached to the sling with snap fasteners or by lacing as shown in the left-hand photo, page 192.

Due to the narrow width of the metal storage box, Fig. 1, it probably will be easier to line it before bending to shape. Cut the lining slightly oversize and cement in place. Note that both the inside and outside of the box are lined, making it neces-

sary to leave tabs when cutting the fabric. Fold these over the ends and cement them in place. The fabric is not cemented to the metal tabs which are bent down and inserted in notches in the metal liner, Fig. 2. In the assembly, the metal tabs are bent flat against the bottom of the liner to hold the storage box in place. Before cutting the fabric lining for the interior of the metal liner, drill holes for the rivets holding the pull-out straps, Fig. 1, in place. Note how these straps are riveted over the lining in the right-hand photo on page 192. Here the lining is shown cemented in place with the metal box in position and the liner partially bent to shape. Cut the fabric lining oversize so the edges can be folded over and cemented to the outside of the metal liner as indicated in Fig. 1.

With this done and the metal liner bent to final shape, cut the leather covering, using the dimensions on the pattern, Fig. 4. Note especially the location of the holes for the snap fasteners. In the pattern, Fig. 4, the corners of the inside flaps are shown square. Before lacing, the corners are rounded to a radius of about $\frac{1}{2}$ in. See the photos of the finished case on pages 192 and 193. Lace the cover with a leather lacing of your color choice, following the lace pattern in Figs. 8 and 9. Then add the snap fasteners. The camera shelves and eye straps are made as in the details in Fig. 4. The latter can be riveted in place after the covering has been finished. Cement the covering to the ends and back of the metal liner.

Fig. 5 details an auxiliary lens holder made especially to fit this case. The plywood frame of the holder is detailed in Fig. 5 and the leather cover in Fig. 7. Note the positions of the holder and the protective plush lens cover. Both are cemented to the leather cover. ★ ★ ★

SN 56

ROLLING SHOP CABINET

By Robert Hoppough

IF WORKSHOP AREA is limited, especially when it comes to convenient storage, you will want this little roll-away shop cabinet. Mounted on four casters, it is moved effortlessly wherever desired and tucked away in a corner when not in use. Sides of the cabinet consist of storage doors which swing outward for easy selection of small parts.

Although the original cabinet was designed purely to hold small parts and used in addition to other shop facilities, the cabinet can be adapted to serve as a self-contained shop by fitting one or both doors as tool panels and using the inside shelves for the small parts and supplies. When the doors are used for small-parts storage, as detailed, two types of racks or bins are mounted on them. One door is fitted with slanted shelves for boxes of bolts, screws, etc., and the other door is lined with rectangular cans for holding unpackaged parts.

The doors are held closed with a pair of self-locking latches cut and bent from sheet metal. Each latch is drilled, slotted and notched, and then pivoted to a door with a bolt or screw. A second screw driven through the slot holds the latch in locking position, while the notched end of the latch engages a screw driven into the cabinet front.

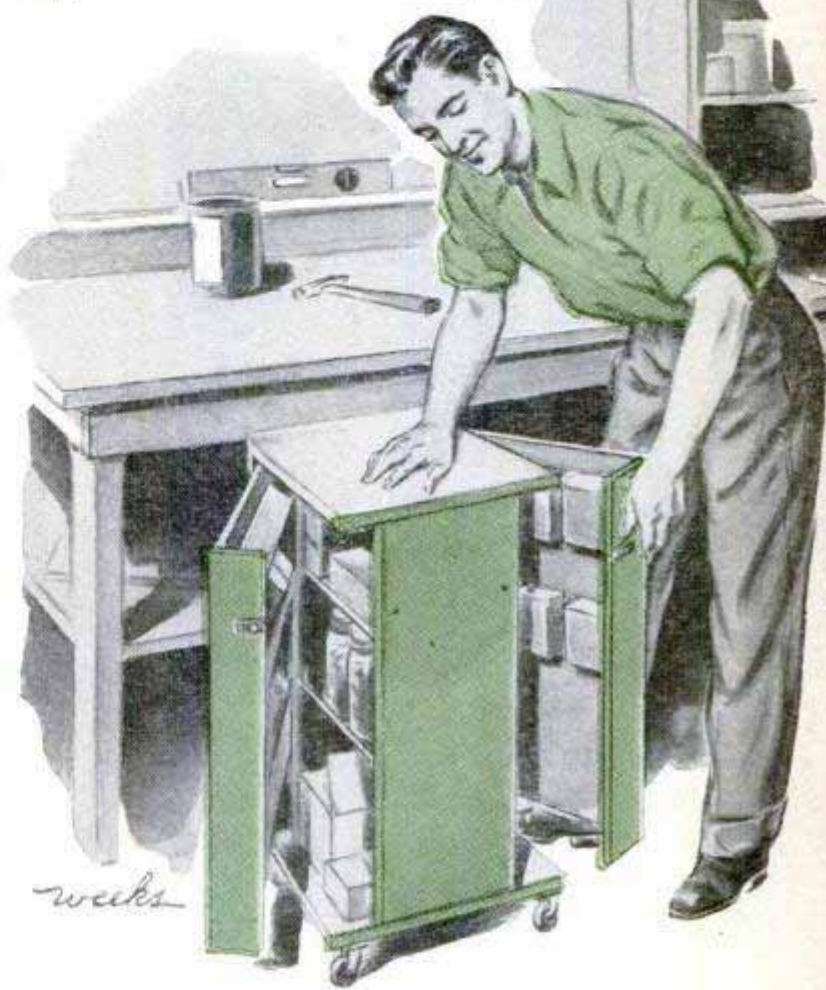
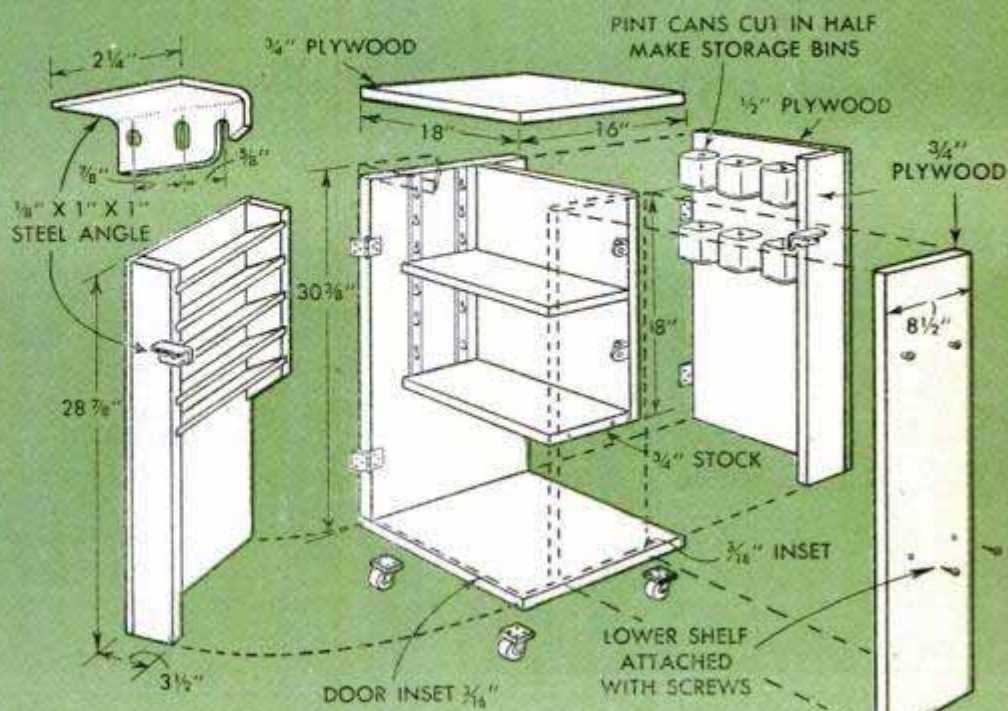
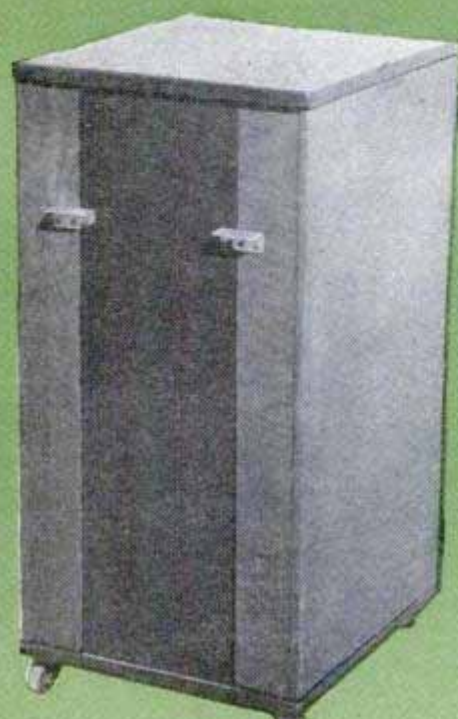

Illustration above shows how the sides of the rolling cabinet swing open for easy selection of small parts



Hand Rest for Sign Painter Improvised From T-Square

PAINT STOP



This convenient hand rest for sign painters may be improvised easily from a T-square and several rubber bands. Simply slip one or two bands over each end of the T-square head to help prevent slipping and employ the square in the manner indicated.

Thin Work Chucked to Run True On Metal Lathe by Drill Pad

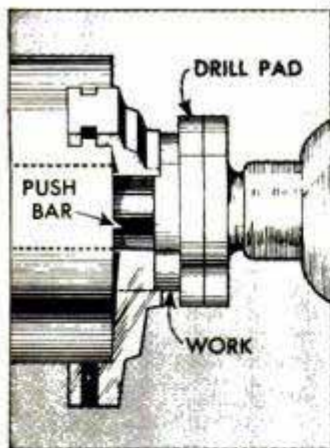

Thin metal disks and squares can be chucked quickly to run true for facing operations in the lathe by mounting a drill pad in the tailstock and moving it close to the chuck jaws. The work then can be pushed firmly against the drill pad with a rod run through the head-

stock spindle. When the chuck jaws are tightened with the work in this position and the drill pad removed, the work will project slightly beyond the jaws and the face of the work will run true.

Ice Lowers Heavy Equipment

A heavy piece of equipment that was to be lowered into a cement-lined pit, 30 in. deep, presented a problem, as the location of the installation did not permit use of a hoist. The problem was solved by first filling the pit with 300-lb. cakes of ice. The machine was then moved into position on

the ice, and the latter quickly melted by hot water. As the ice melted, the machinery was gradually lowered into place.

Charles Niehuis, Phoenix, Ariz.

Locating Oil or Gasoline Leaks

If the housing of the transmission, carburetor, or other casting on your car has a crack in it that is difficult to locate, coat a little bearing blue over the suspected areas to simplify locating the breaks. First, clean the areas to be treated and then coat them with a solution of bearing blue in alcohol. This done, carefully examine the opposite side of each treated surface for traces of blue stain. In the case of small objects such as the carburetor bowl, the results usually are quicker and more positive if the part is filled with the solution.

Portable Welding Stand Used Outside Of Shop

This handy welding stand is light and easy to carry for use in repairing equipment outside of the shop. The base is a wheel from an old car, to which a 3-in. pipe is welded to serve as the post. The table is a rectangular frame of angle steel covered with sheet steel. A stop is welded to the back of the table with a clamp mounted on it. A short cross rod is welded across the post high enough from the base to serve conveniently as a hook on which to hang the torch.



A. M. Wettach, Mt. Pleasant, Iowa.

Carry Combination Square In Toy-Gun Holster

I find that the holster for a toy cowboy gun is ideal for carrying a combination square. Strapped to my belt within reach of either hand, the holster frees both hands for working from a ladder. — R. M. Woodbury, Natick, Mass.

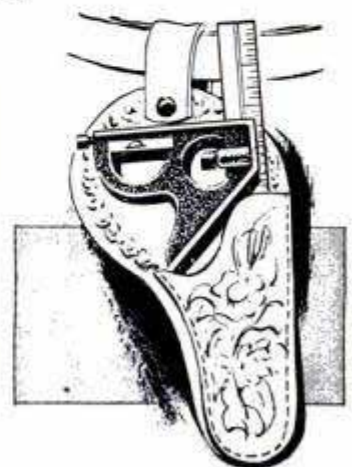

Special-Purpose PLANES and SCRAPERS

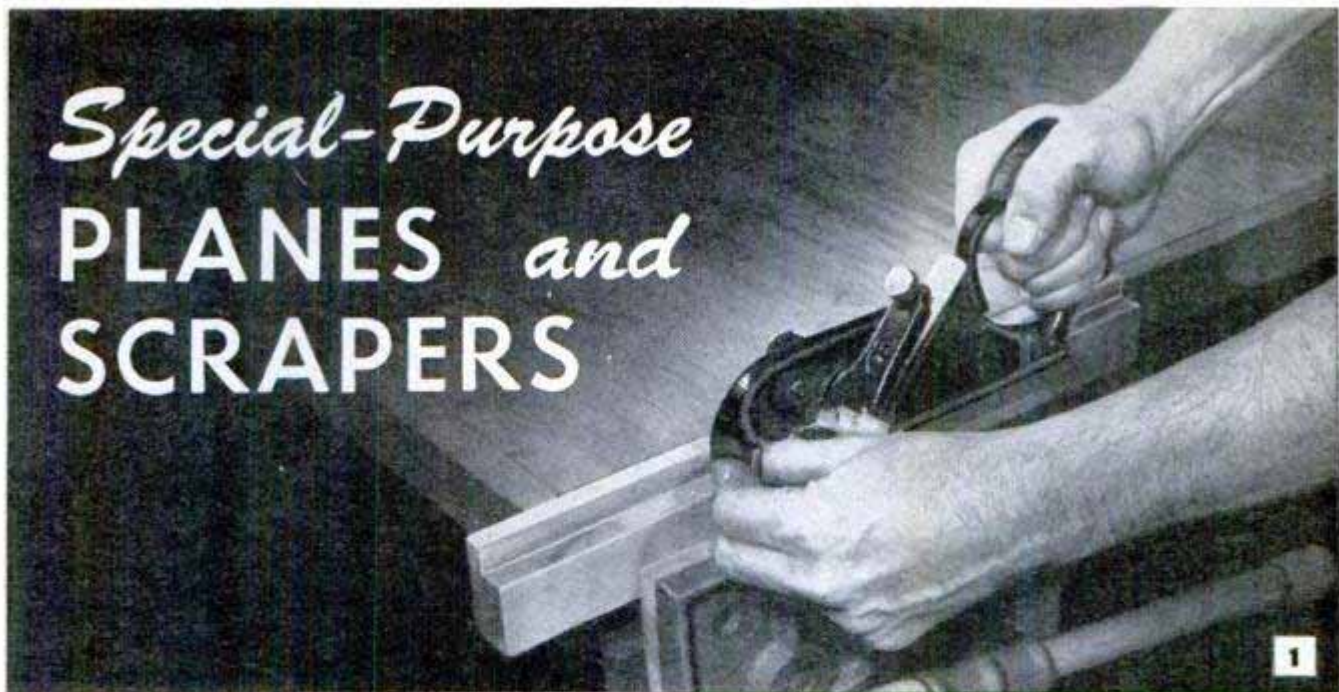

By E. R. Haan

SPECIAL-PURPOSE PLANES do unusual jobs for which ordinary planes are not designed, and their cost is low compared to that of motorized planes for the same work. A typical job for special-purpose planes is the making of lip-type cabinet doors and drawers involving rabbets and grooves. They are indispensable for the installation of weather stripping, and are the best hand tools for shaping various types of moldings. The basic technique of handling planes and the methods of adjusting and sharpening blades, described in "Plane Know-How" in the May issue, also applies to special-purpose planes.

Rabbeting: Figs. 1 and 2-A show a regular plane for cutting rabbets. Its blade extends flush with the side of the body so the plane can descend into the cut. The duplex type, Fig. 2-A, has two blade seats; one for regular work and the other at the toe for bull-nose work—such as working close to the end of stopped rabbets, after which it is a simple matter to square the end of the cut with a chisel. An adjustable knifelike spur is provided ahead of the blade for use when rabbeting across the grain. The spur makes an advance cut in line with the edge of the blade and slightly deeper, to assure a clean-cut edge. An adjustable fence controls the width of the rabbet and assures a cut square with the side of the work. There is also an adjustable depth stop.

Small one-hand rabbeting planes, either regular or bull-nose type, detail B, are designed for accurately finishing rabbets that already have been cut to approximate depth. They are handy for relieving the binding of cabinet doors when the binding occurs on the bottom of the rabbet. No fence

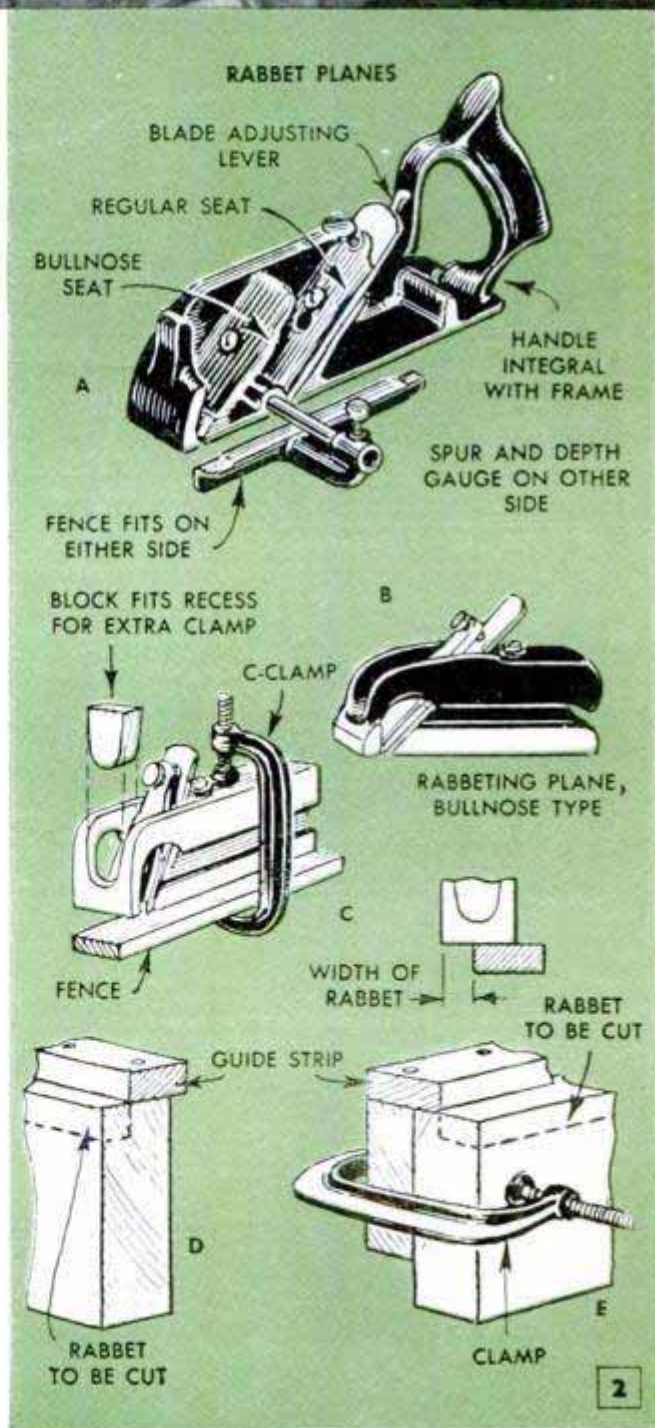

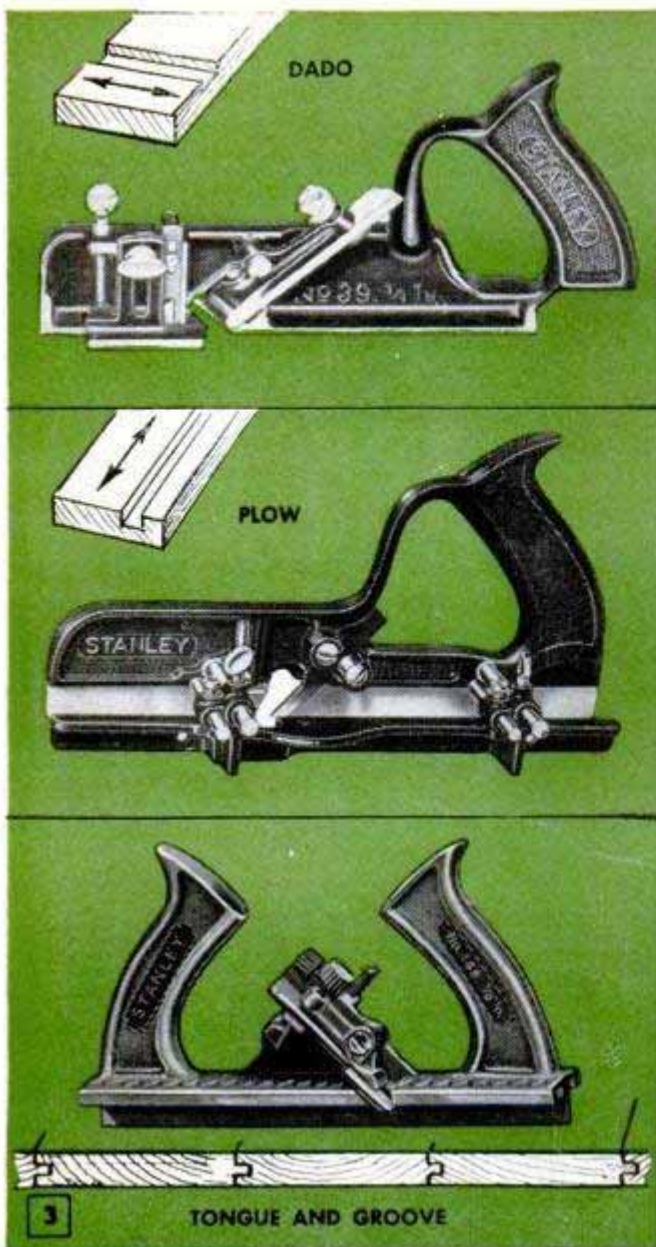

or depth gauge is provided. In an emergency these small planes can be used to cut the entire rabbet. Detail C shows how a strip of wood can serve as a fence; details D and E show wood tacked or clamped to the edge of the work as a guide.

Dado and plow planes: Planes for cutting square grooves have narrow runner-shaped stocks or bottoms that can descend into the cut. A dado plane is used for cutting grooves across the grain. It has a skew blade, usually $\frac{1}{2}$ or $\frac{3}{4}$ in. wide, two adjustable spurs to assure clean-cut edges and is fitted with a depth gauge. A straightedge clamped across the work helps to start the cut straight. A plow plane for cutting with the grain usually has a set of interchangeable blades from $\frac{1}{8}$ to $\frac{3}{8}$ in. wide, an adjustable fence and a depth gauge. A tongue-and-groove matching plane has two blades, one to cut a tongue and the other to cut a matching groove. The blades are located on opposite sides of a fence which extends along the center of the bottom. These three types of planes are shown in Fig. 3.

Router planes: The sides of a dado can be cut with a saw in a miter box, and the waste wood between the cuts removed with a router plane. This tool may have an open throat which can be closed for narrow work. It has two blade seats, one for regular work and the other for bull-nose work. A fence may be attached to follow the bottom edges of a cut on either straight or curved work. To bridge spans wider than the tool, an extra wooden bottom can be attached. Don't attempt to remove the waste to its full depth with a single cut when routing if a smooth bottom is desired, but use two or three cuts. A V-shaped or skew-edge blade is used to get smooth finishing cuts. A small router is useful for inlay work, routing dadoes for shelves, recessing for lock plates and similar jobs. Types of hand routers are shown in Fig. 4-A.

Combination planes: Combination planes offer a maximum variety of operations in a single tool. The light model shown in Fig. 4-B can be used as a dado, plow, beading, matching or rabbet plane, and is fitted with spurs for cross-grain cutting. It also includes a fence, depth gauge, other attachments and a variety of cutting blades. Fig.

Photos courtesy of Stanley Tools

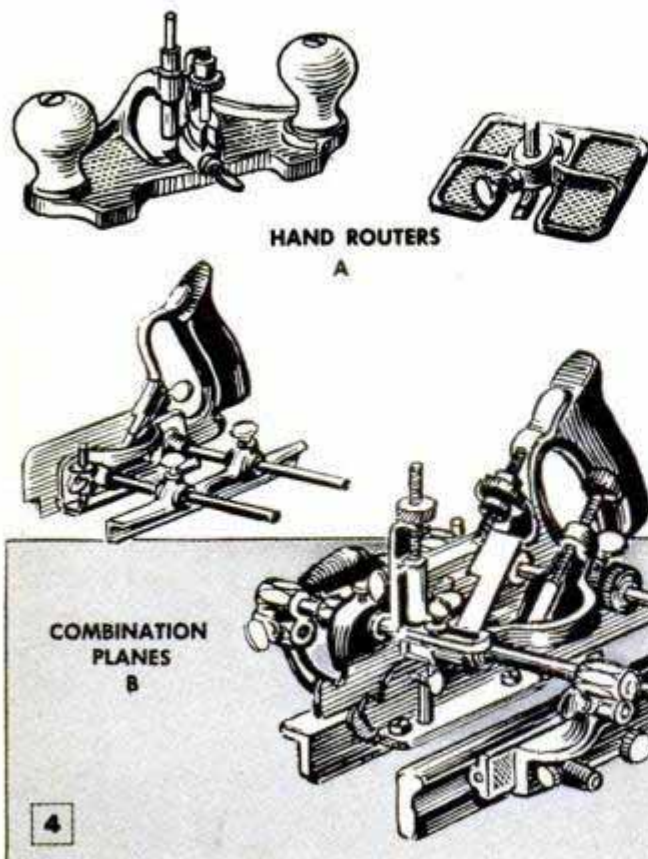

ADJUSTABLE PLANE FOR CURVED WORK C



4-B also shows a heavier model that will do all the work of the lighter one, plus cutting molding shapes. Many shapes of cutting edges are available, or they can be ground from blanks.

Circular planes: Shown in Fig. 4-C, a circular plane has a flexible steel bottom. A vertical screw at the center varies the radius of the bottom for planing either concave or convex surfaces. The blade and lever-cap assembly is similar to that of a regular jack plane, which assures smooth, clean cutting without chatter.

Spokeshaves: Concave or convex edges are usually smoothed with a spokeshave, Figs. 5 and 6-A. One with a flat bottom is used for long curves, and one with a convex bottom is best for concave curves of small radii. The blade of a spokeshave is adjustable and is sharpened like a regular plane iron. Usually a spokeshave is pushed forward but it also can be pulled. Care must be taken to cut with the grain of the wood, especially on reverse curves, Fig. 6-B. A model having two blades, one straight and one convex, detail C, is also available.

Scrapers: Final smoothing of fine woodwork prior to sanding is done with scrapers such as shown in Fig. 7. These remove the ridges left by machine or hand planing. Scrapers cut thinner shavings than planes, and will cut smoothly against the grain. Veneered surfaces are not planed, but should be smoothed by scraping. A cabinet scraper, detail A, resembles a spokeshave. Details B and C show hand scrapers for straight and curved surfaces. Scrapers like the one in detail D are handy for floor work, for getting into corners when removing paint and varnish, and for dressing down ridges caused by warped floor boards. This one has a coil spring in the head assembly which serves as a cushion and eliminates chatter. A couple of small scrapers of the kind shown in details E and F should be in every homeowner's tool kit. Scrapers are used with two hands, Fig. 8. Hold a cabinet scraper like a spokeshave, detail A, a hand scraper with the fingers, details B and C, and a floor scraper as in detail D. Hand and cabinet scrapers may be either pushed or pulled, the blade being inclined at an angle of 75 deg. to the work surface in the same direction as it is moved, detail E.

Cutting edges of scrapers: Fig. 9 shows how the cutting edges of scraper blades are made slightly hook-shaped by burnishing. Detail A shows square and beveled blades. Hand scrapers have square, double-cutting blades. Blades cut best when the center is bowed slightly toward the leading edge. On cabinet scrapers this is done by means of a tension screw. On hand scrapers pulled as in Fig. 8-B, the blade is bowed by the index fingers exerting more pressure at the center

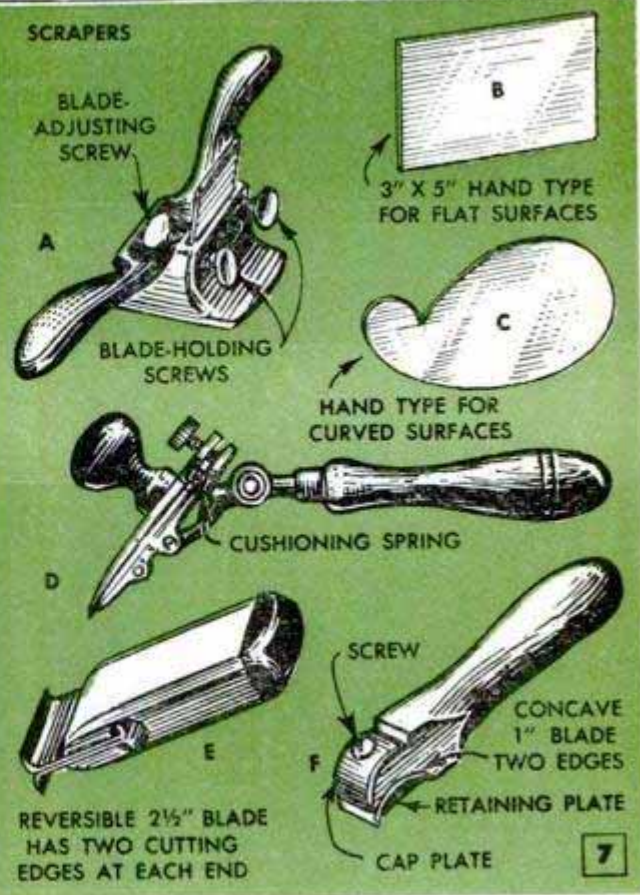
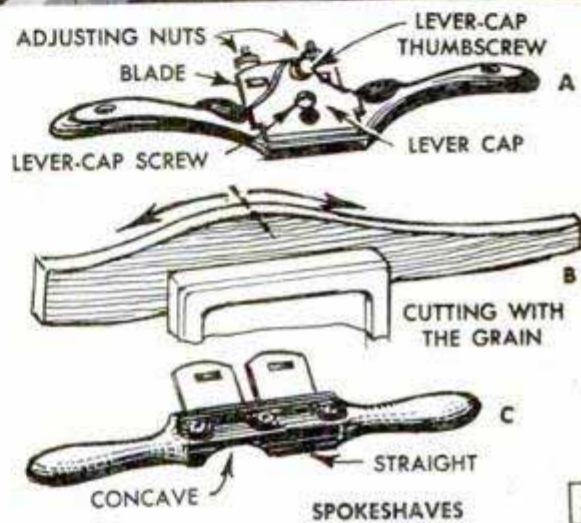

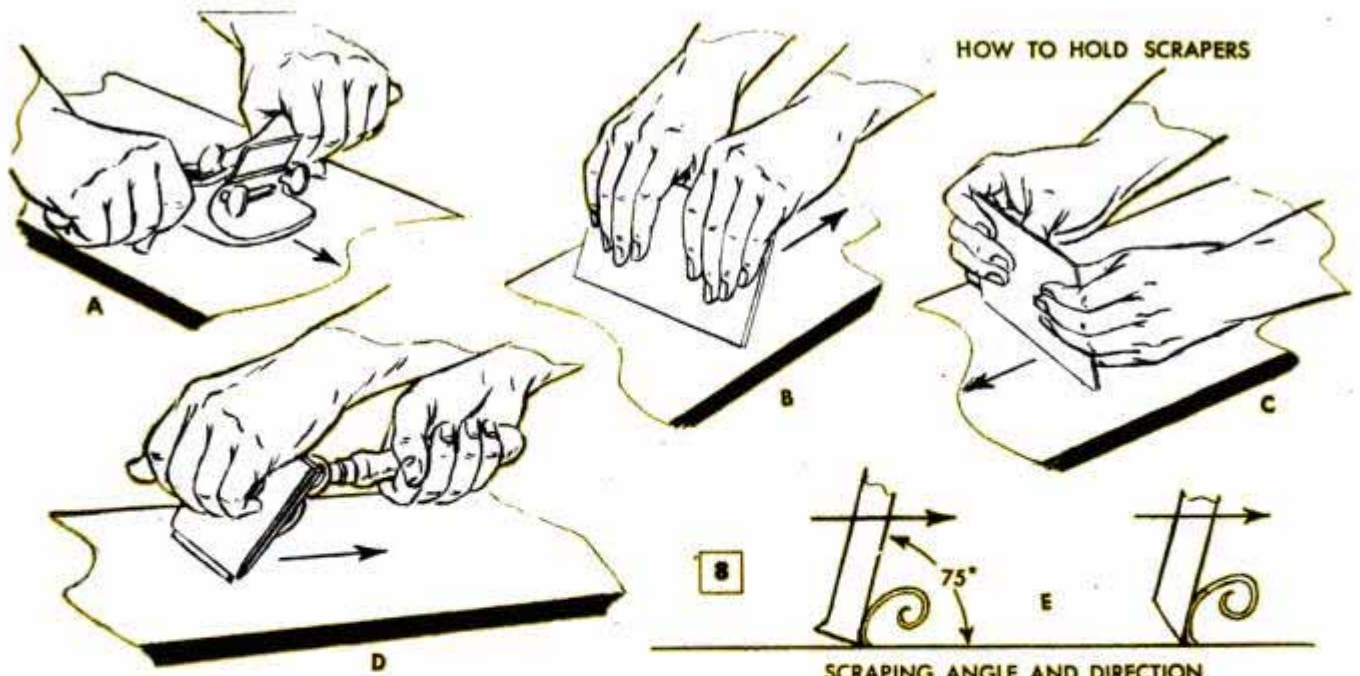

SCRAPING ANGLE AND DIRECTION

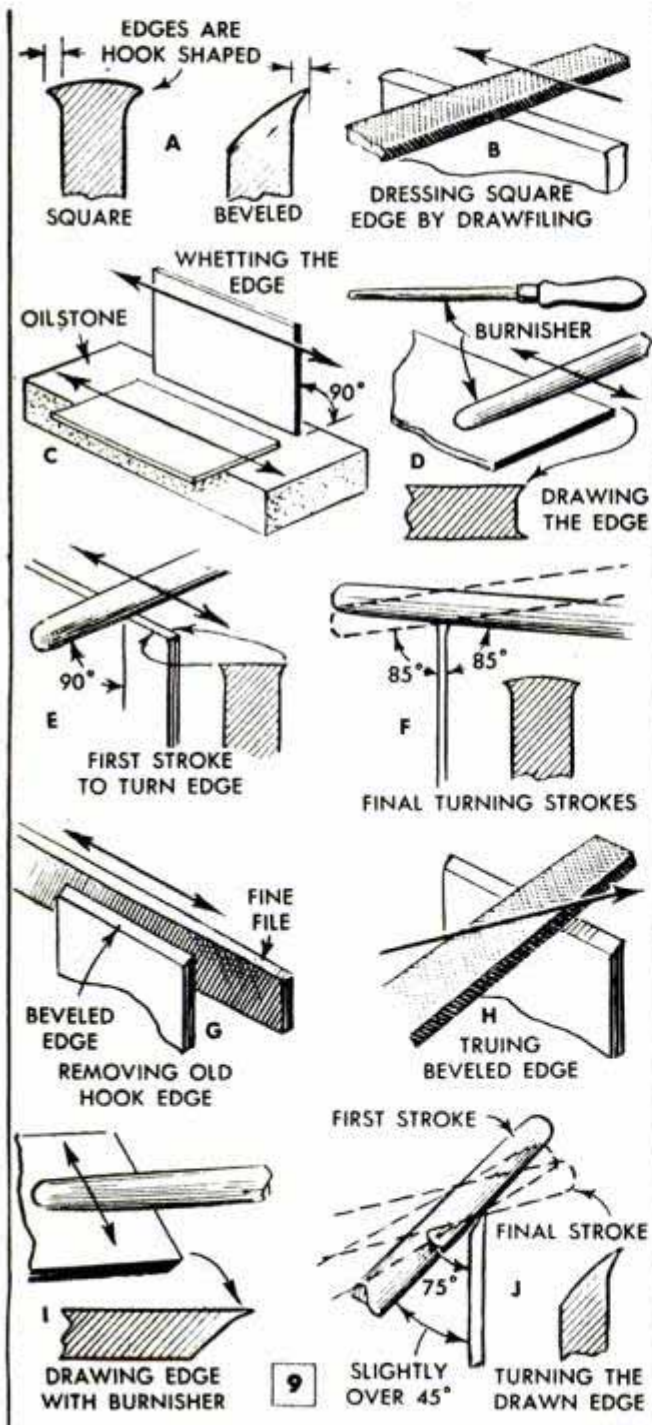

of the blade. When the blade is pushed, it is bowed by pressing with the thumbs at the center while pulling the edges with the fingers, Fig. 8-C.

Sharpening scrapers: Scraper blades must be resharpened and burnished frequently to assure clean, smooth work. When they produce dust instead of shavings, they need sharpening. To sharpen a square-edge scraper blade, proceed as follows: (1) Drawfile the edge square and straight with a fine mill file, Fig. 9-B; (2) Whet the edge on an oilstone, keeping the blade at right angles to avoid rounding the edges. Remove the burr by rubbing the flat sides of the blade on the stone so that the edges become very sharp. See detail C. (3) Use a burnisher (a smooth, hardened-steel rod), firmly stroking the blade with the burnisher held flat against its sides as in detail D. Three or four strokes will draw the edges as indicated in the detail. (4) Start turning the drawn edges by stroking the burnisher over the edge of the blade, the first stroke at 90 deg. as in detail E, and the following ones at 75 deg., detail F. For beveled scraper blades the sharpening process is as follows: (1) Use a fine mill file on the side of the blade to remove the old hook edge, detail G. (2) Dress down the beveled edge, which should be 45 deg., until it is straight and without nicks. Strokes should be crosswise and toward the edge as shown in detail H. (3) Whet the beveled edge to a fine finish and remove the burr. (4) Firmly stroke the burnisher three or four times along the flat edge of the blade to draw the edge, detail I. (5) Rub the burnisher along the edge to turn it as in detail J, holding the burnisher at a slightly greater angle than the 45-deg. blade angle, and increasing the angle gradually on succeeding strokes until the last one is 75 deg. ★ ★ ★

Fork-Lift Truck Used for Maneuvering Automobiles Into Parking-Lot Stalls

In one parking lot, a fork-lift truck is used for parking cars and for jockeying cars parked in the runways into stalls as they are emptied. This was made possible by mounting an angle-steel cradle to pivot on a bracket that slips over the ends of the forks. In use, the cradle is hooked beneath the front bumper of a car, after which the front end is raised for maneuvering the car where desired.



Repairing Stuffing-Gland Seat on Steam-Engine Cylinders

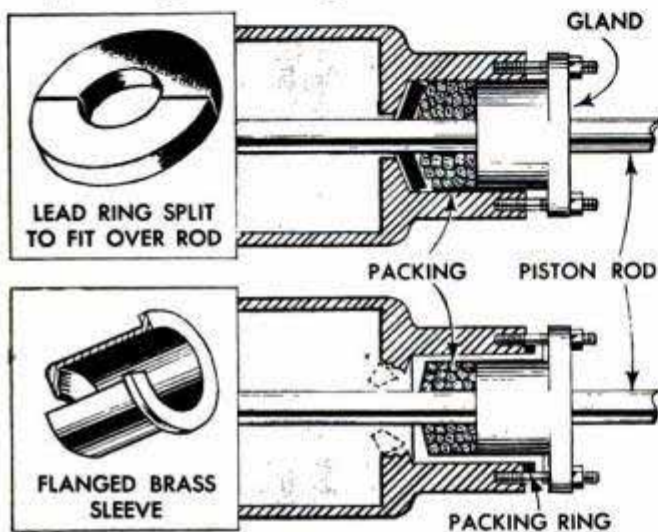

Frequently the stuffing glands on cylinders of steam engines and compressors will wear to the point where the packing pushes through and causes constant trouble. This can be prevented by splitting a lead ring of the proper size, fitting it over the piston rod and driving it tight against the seat. The ring will effectively stop the leak but will not cause the rod to wear. If wrenching on the stuffing gland has fractured the seat, make a brass sleeve with an inner and outer flange as shown in the lower detail. Place a packing ring under the rear of the outside flange and the rod packing inside as usual. Tightening of the gland will make both packings tight.

Rewired Car Heater Operates Only When Generator is Charging

Whenever a car engine is idling or operating at low speeds, the generator stops charging and permits the entire electrical load of the car, such as the heater, radio, headlights, etc., to come from the battery. To alleviate this condition somewhat, I rewired the heater and the defroster-blower motors, both of which require considerable current, to the generator terminal on the regulator.

As a result of this, they now operate only when the generator is charging. This has raised the average level of the battery charge, while the reduction in hot air has not been noticed. An additional advantage of the arrangement is that the blower no longer draws in the exhaust fumes of the car ahead while waiting at a stoplight.

J. E. King, College Park, Md.

Tomato Spoilage in Home Garden Prevented by Improvised Racks

When left in contact with the damp earth, ripening tomatos eventually will rot on the vines or are damaged by worms and insects. In most cases this can be prevented by shoving planks under overhanging portions of the plants and raising them on bricks or wooden blocks so the plants are supported off the ground.

☐ Beeswax can be used as a lubricant when tapping or turning brass, copper, aluminum and other similar metals.



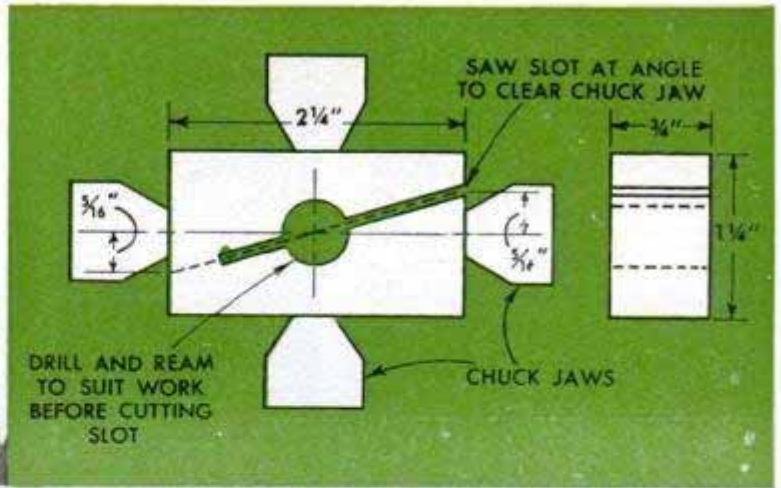

COLLET FOR 4-JAW CHUCK

By C. W. Woodson

To speed up a repetitive job requiring shouldering and cutting-off operations on small-diameter rods, one machinist in a job shop came up with this collet for use in a 4-jaw chuck. It's simply a rectangular piece cut from $\frac{3}{4} \times 1\frac{1}{4}$ -in. tool steel and center-drilled to the diameter of the rod to be machined. After drilling, the collet is slotted diagonally to a point about $\frac{3}{8}$ in. beyond the center hole. Although none is shown, a chip-clearance hole can be drilled at the stopped end of the slot if desired. In use, the collet is centered and locked in position with three chuck jaws. Then the rod is passed through the collet and the upper chuck jaw tightened.

Interchangeable Jars for Spray Gun Hold Variety of Colors

The owner of a repair shop where a large variety of paint colors was used, but only in small amounts, found this spray gun ideal. Small salad-dressing jars were used on the gun, which made it possible to store the paint right in them. Whenever a certain

color or shade was needed, it was just a matter of selecting and screwing the jar to the gun. Cleaning consisted only of rinsing the small vacuum tube in paint solvent. The end of the air tube is closed with a drop of solder and filed square. Then it is center-drilled with a No. 60 drill. The small hole concentrates the air stream directly over the end of the vacuum tube. Adjust the air tube by bending it slightly near the end until a smooth, round spray pattern is produced on the work.

Richard Somerville, Corona, Calif.

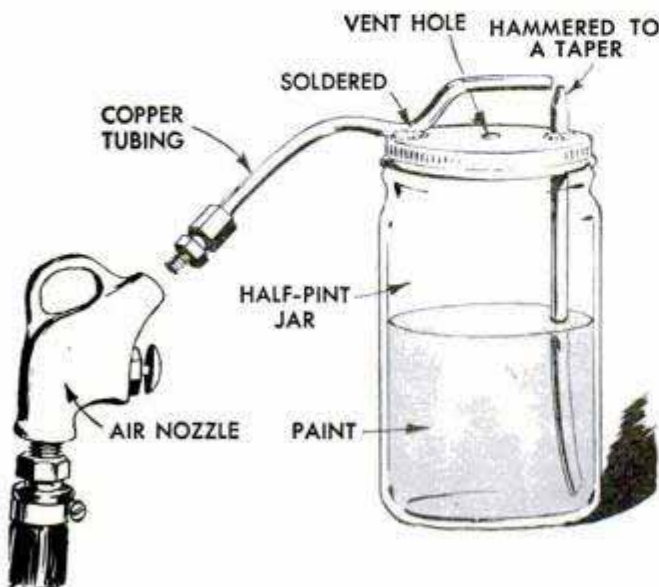

Potato Peeler Strips Insulation

Electricians using plastic or rubber-covered wire of the heavier gauges sometimes find it difficult to strip the insulation with regular tools. One electrical company experimented and found that the old-style potato peeler, with its slotted center and facing knives, seemed more effective than electrician's wire strippers for removing this insulation.—L. Cleary, Grosse Ile, Mich.

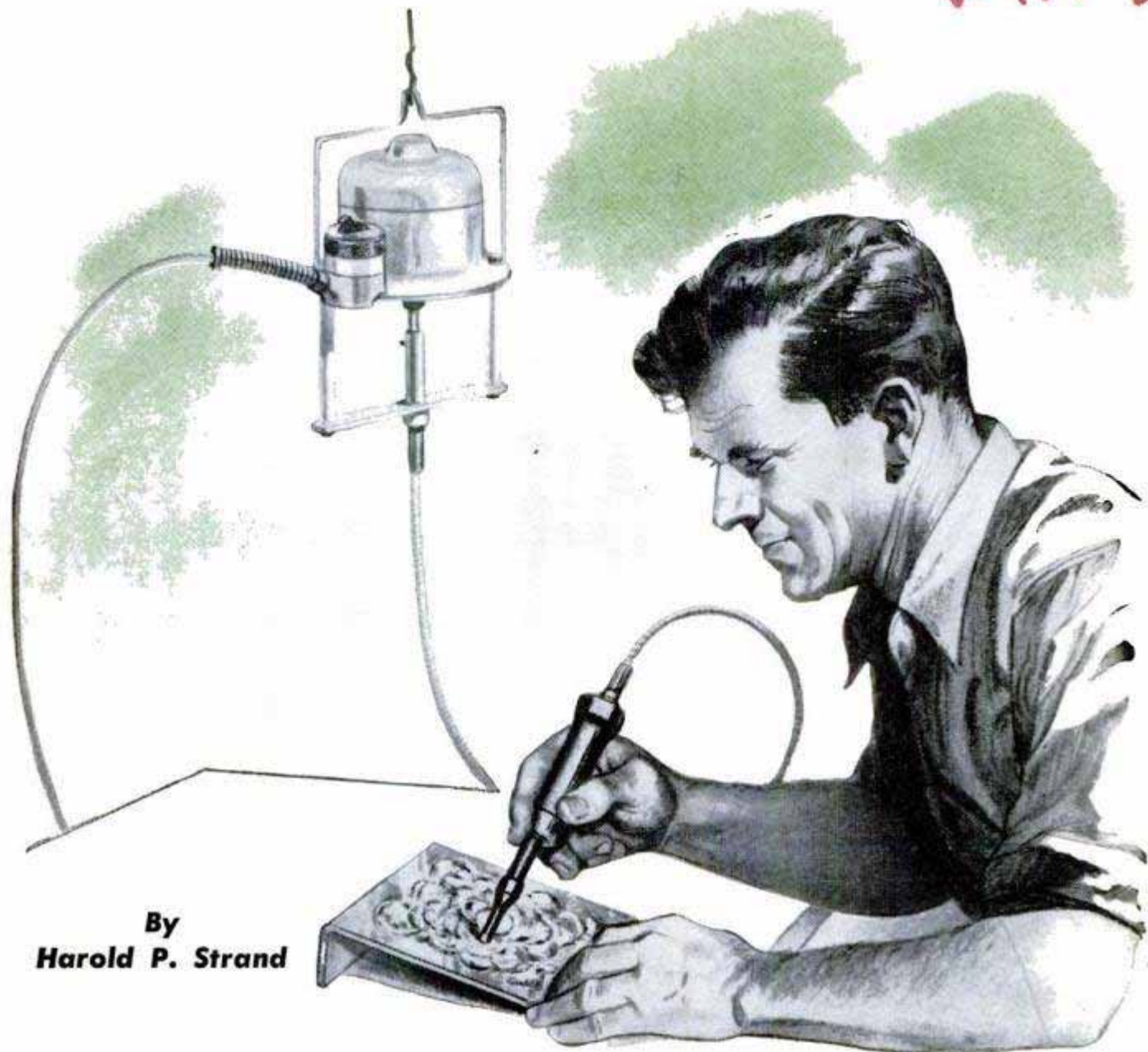

By
Harold P. Strand

Vacuum-Cleaner Motor Drives FLEXIBLE-SHAFT TOOL

FEATURING a hanging drive unit that incorporates a motor taken from an old vacuum cleaner, this handy flexible-shaft carving tool can be assembled for practically nothing from common materials found in the average home shop. The motor used in the original was taken from an old Hoover vacuum cleaner which has a toggle switch already mounted on its base. No changes need be made in the motor itself. It is suspended in a frame of $\frac{1}{8}$ -in. soft-iron or steel wire, as shown in the drawing, and the support bar for the flexible shaft is mounted below it by means of long 10-32 stove bolts inserted through pipe spacers. The supporting bar is a piece of cold-rolled flat steel in which a hole is tapped in the center for a flanged brass bushing to which

the coupling flange of the flexible shaft is attached. The size of this bushing will depend on the flexible shaft at hand. The flexible shaft can be purchased with a shaft the same size as that of the motor, but should the shaft be smaller, a reducing coupling, turned from brass stock as detailed on page 205, is used. This piece is fastened to the motor shaft with a hollow setscrew. The male extension at the other end is a press fit in the flexible-shaft coupling, where it is locked with a small taper pin. The hole in the flanged bushing is reamed to clear this coupling. With the parts in position and lined up properly, the pipe sleeves are cut to the required length and the supporting bar is secured to the wire motor hanger. It should be

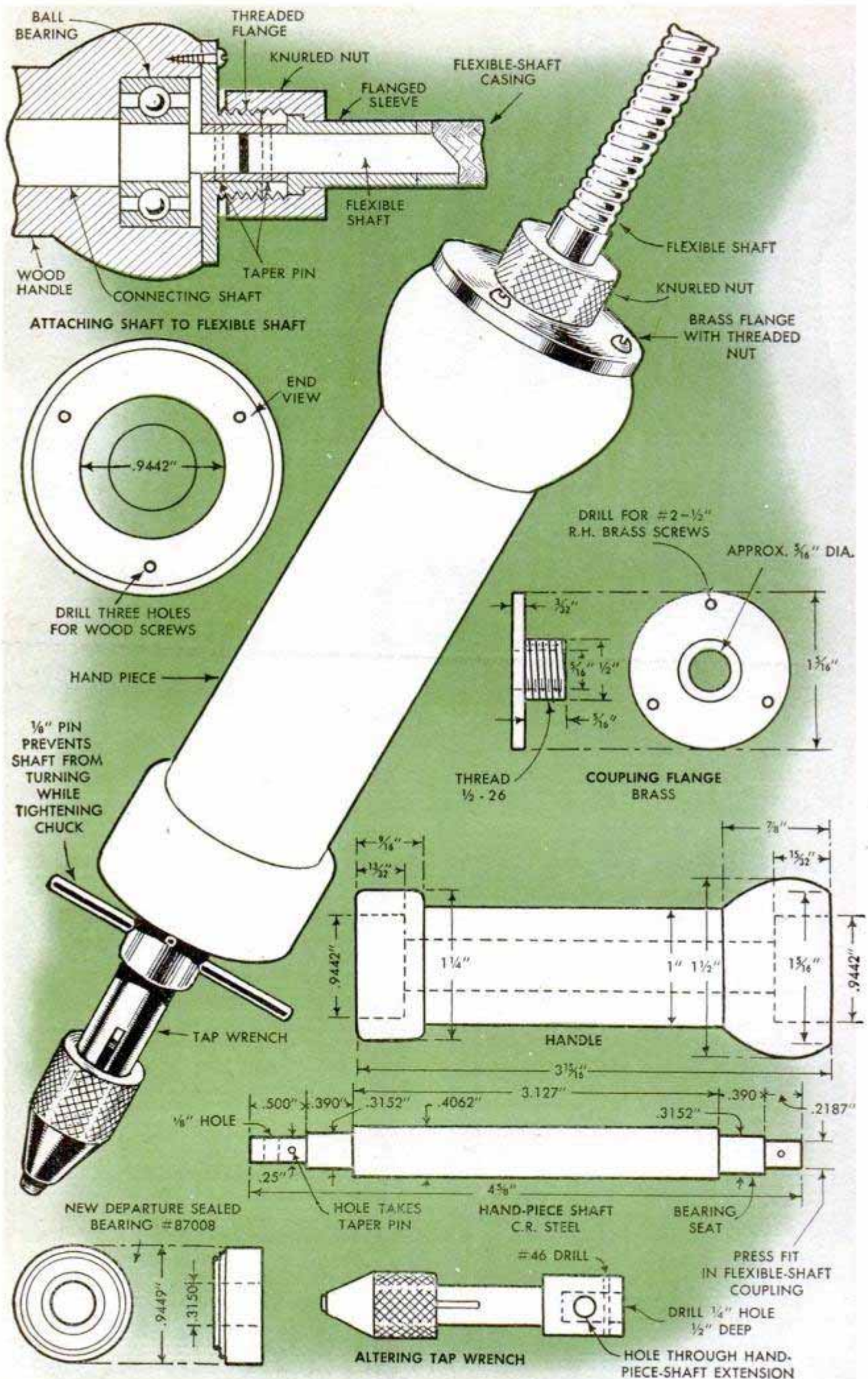

remembered that the fittings for coupling the shaft and the motor will vary, depending on the type of flexible shaft you use.

Next the hand piece is constructed. It consists of a shaped hardwood handle, a steel shaft, two sealed ball bearings, a threaded coupling flange and an altered tap wrench to serve as a chuck. If you don't have a wood-turning lathe in your shop, the handle can be turned in a small metal lathe by pressing a short $\frac{3}{8}$ -in. shaft into a drilled hole in one end of the block and chucking the shaft. The other end of the work is supported in the tailstock center. The machine feed can be used with close-grained hardwoods, such as birch or maple, and final turning to shape can be done by working the feeds by hand. Better yet, clamp a temporary tool rest to the front of the lathe bed and use wood-turning chisels. The picture at the top of the page shows how the ball-bearing seats are counterbored in each end of the hand piece to receive the bearings as a press fit. The hole through the center of the hand piece is $\frac{7}{16}$ in. in dia., to clear the shaft. The shaft is turned from cold-rolled steel to the dimensions given in the drawing on page 204. The coupling flange is turned from brass to the size given and threaded to take the knurled nut of the flexible shaft. After the flexible shaft has been pinned to the sleeve, it is inserted in flanged bushing. Then the shaft with the bearing in place

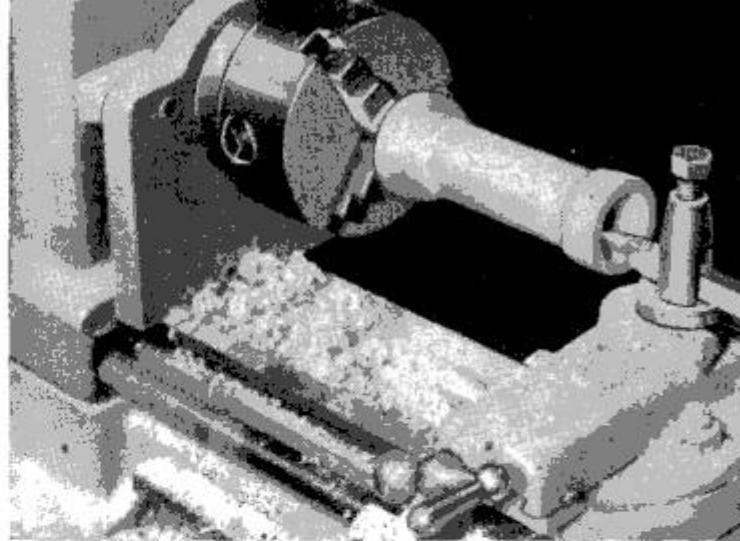

is also pinned to the sleeve, the knurled nut is tightened and the shaft is inserted in the handle. Finally, the flange is secured to the handle. The chuck is made by altering a small tap wrench as shown. The original T-handle is removed, a blind hole is centered and drilled in the end of the head and the chuck is secured to the shaft with a taper pin. This must be accurately drilled so that the chuck will turn true. Using the original hole in the head of the wrench as a guide, a $\frac{1}{8}$ -in. hole is drilled through the hand-piece shaft. A pin temporarily inserted in this hole prevents the shaft from turning while the chuck is tightened. If desired, a small drill chuck can be used in place of the altered tap wrench. ★ ★ ★

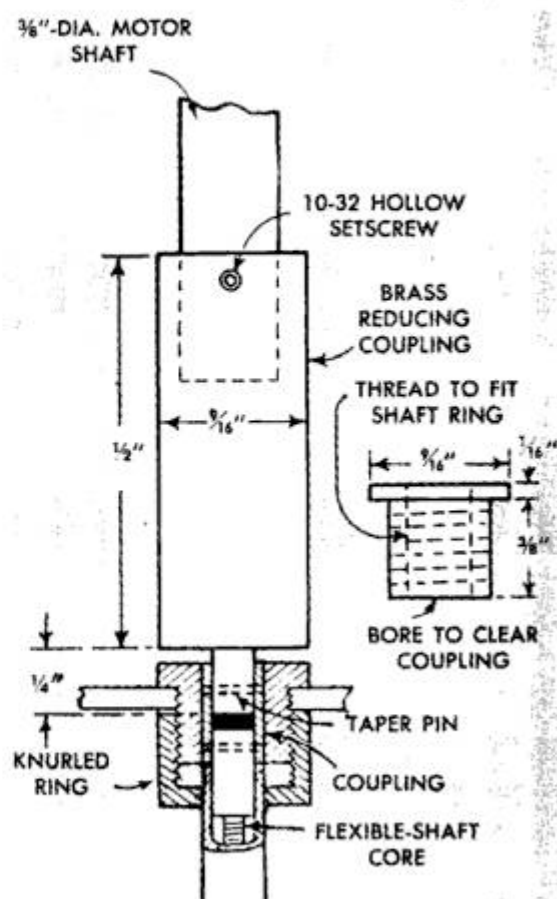
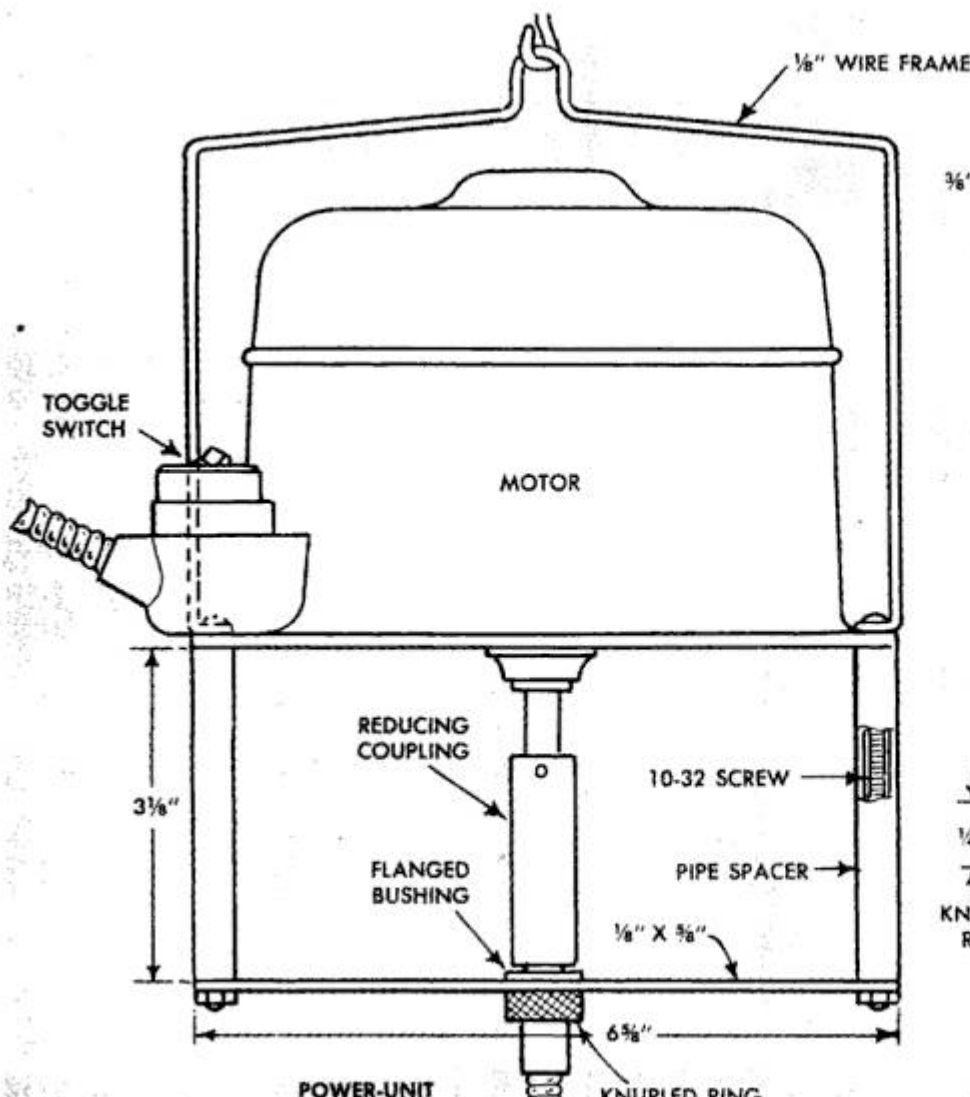

Handy Self-Locking Post Puller Made From Flat Steel

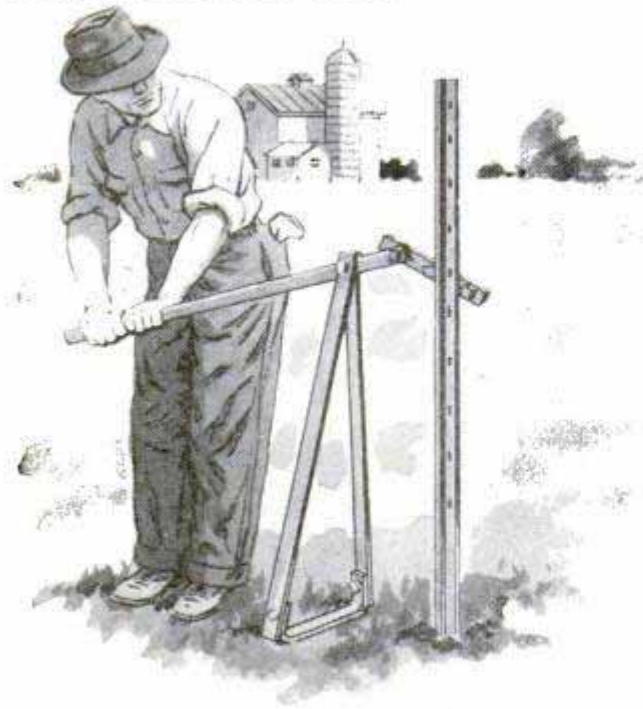

Pivoted to a triangular base made of flat or angle steel, this self-locking fence-post puller consists of a 10-in. link having two pins extending from the side to grip the post that is pivoted to the end of a lever. Both the link and lever also are made of flat steel. The pins may be welded to the link or may be short bolts inserted through holes drilled in the link. The pins are spaced just far enough apart to allow them to slip over the post when the link is held horizontally, but which will grip it securely when the link is drawn up at an angle.

Hole in Screwdriver Blade Aids Forming Wire Eyes

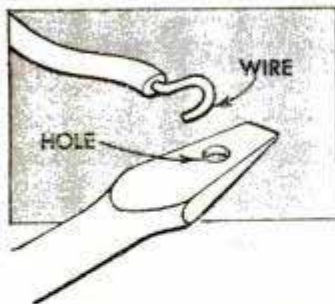

One electrician found that a small hole drilled in the blade of a screwdriver simplified making eyes on the ends of electrical wires. He inserts the wire in the hole and rotates the handle of the screwdriver to form a hook on the end, thus eliminating the need for a long-nose pliers. The wire is then ready for fitting over the terminal post.

Dust Cloth Knotted at Corner For Tucking Into Rule Pocket

To keep a dust cloth handy while at the same time leaving his hands free for other work, a janitor ties a large knot in one corner of the cloth and inserts it in the rule pocket

pocket of his overalls. Fitting the pocket snugly, the knot serves to support the rest of the cloth which is allowed to dangle.

G. E. Hendrickson, Argyle, Wis.

Tape Tab on End of T-Square Permits Tacking to Board

Artists who use a T-square as a hand rest when lettering, can prevent the square from slipping by attaching a tab to the end through which a thumbtack is forced into the drawing board. A strip of tape two or three in. long is folded in the center and the ends applied to both sides of the square as shown. The remainder then is pressed together to form the tab.

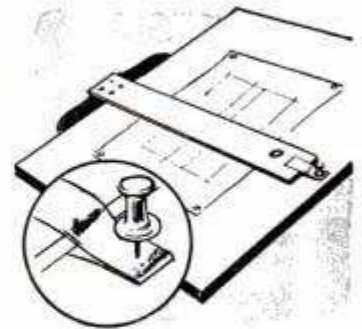

Folded Slip Keeps Sheets Aligned For Insertion in Typewriter

To save time when inserting several sheets of paper and carbons in a typewriter, I fold a slip of paper over the top edges to help guide them around the roller. The slip is removed after it clears the machine, leaving the sheets perfectly lined up for typing.

Victor H. Lamoy, Upper Jay, N. Y.

Paper Cup Serves as Jig When Soldering Wires

A jig for holding wires that are to be soldered together can be made from a paper drinking cup. A 1/2-in. slit is cut in the lip of the cup for each wire to be included in the splice, and the tips of all the wires brought together over the center as shown. This will leave the hands free for handling the solder and the iron.



Mobile Water Tank Simplifies Filling of Stock Waterers

This mobile 500-gal. water tank is elevated several feet above its chassis to simplify filling stock water tanks in the field. Of welded sheet-steel construction, the tank is filled by pump or windmill and emptied by means of a quick-release valve fitted in one end as shown. A shutoff valve is located just ahead of the quick-release valve to prevent complete loss of water should cattle open the latter by rubbing against it. The tank, which is fitted on top with a center hoisting hook, rests in strap-steel slings welded to upper ends of the channel-steel support. These, in turn, are welded to the chassis. The chassis is assembled from the rear axle and drive-shaft housing from an old car, and a Model-T Ford



front axle with a channel-steel bolster welded to the spring pads is used for the front end. The drive-shaft housing serves as the reach of the chassis, while steel angle is used for bracing members.

L. H. Houck, Jefferson City, Mo.

Pulley Hub Fitted With Washer to Stop Front-End Oil Leaks

Leaks in the front oil seal of an automobile engine can be stopped temporarily by installing a large washer inside the crankshaft-pulley hub. Loosen the heavy cap screw that holds the pulley hub and force the hub forward, being careful not to bend the chain cover or break the pulley. Slide the hub off the shaft and place a $\frac{1}{8}$ -in. washer inside of it. Place the cap screw

through it and reinstall the pulley assembly. When tightened, the pulley will be $\frac{1}{8}$ in. farther forward than originally, giving a new bearing surface for the oil seal. However, if this causes too much misalignment of the fan belt, remount the water pump with enough extra gaskets to equal the distance that the crankshaft pulley has been moved forward.

Vacuum-Gauge Connectors Kept at Hand in Shop

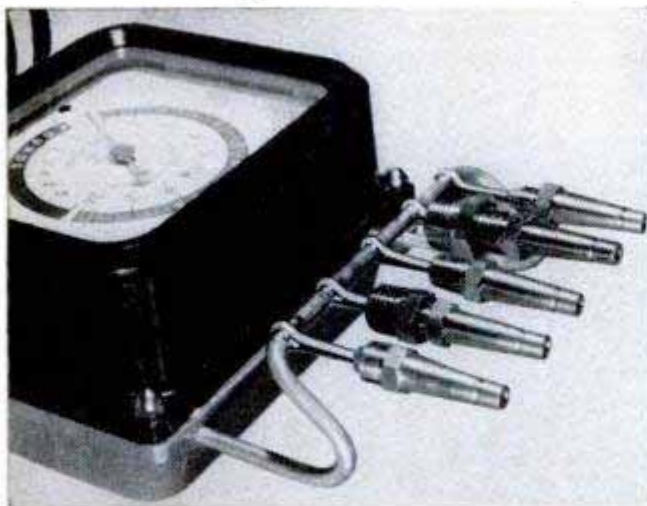

Vacuum-gauge fittings will not be lost or mislaid in the shop, and will be kept at hand ready for immediate use, if five large cotter keys are soldered to the handle of the gauge to hold them, as shown in the illustration. The spring action of the cotter keys is great enough to hold the fittings securely. The two bushings which come with the set are best stored by screwing them to two of the fittings before the fittings are placed over the cotter keys. Whenever the gauge is to be stored, the presence of an empty key on the handle will immediately call attention to the fact that one of the fittings has been mislaid.

Tobin Bronze Used for Brazing Extensions on Drills

Tobin bronze is superior to other metals for brazing an extension on a drill when greater length is required. The preparations consist of applying the bronze and filing or grinding off the surplus material, after

which it is polished with a fine emery cloth. Tobin bronze will give greater strength, due to its lower melting temperature which doesn't draw the temper of the drill or cause the drill to break.

SHOPPING FOR TOOLS

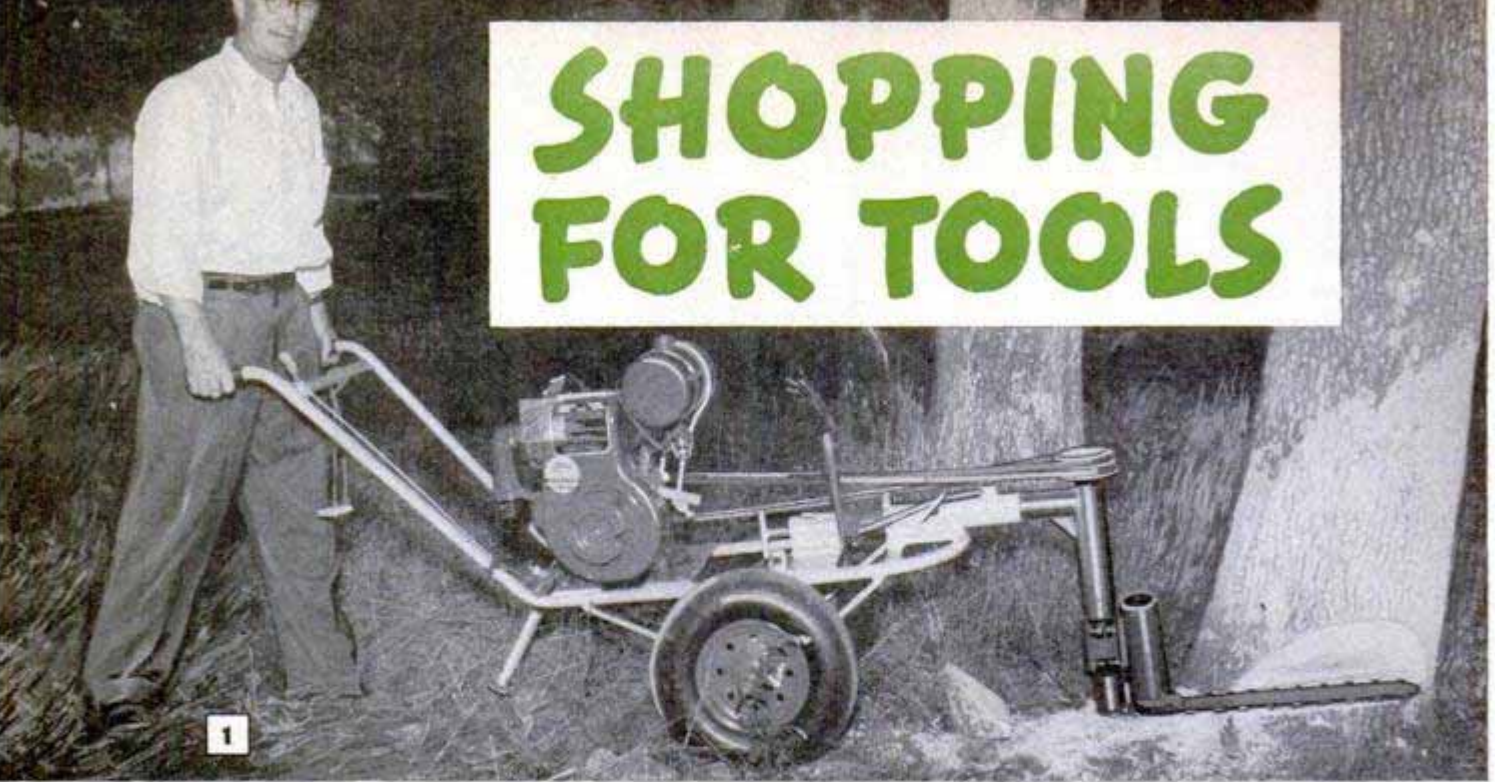

1. CHAIN-SAW CONVERSION UNIT fits most tree saws of the wheelbarrow type. Chain-saw drive sprocket fits lower end of saw mandrel, or arbor, and chain-saw bracket clamps to the arbor housing. Bracket contains oil reservoir for lubricating saw chain



2. TWO-WAY DRILL GUIDE positions the drill both vertically and laterally. A quadrant calibrated from zero contacts the work and the drill is squared laterally at a glance. A circular level on the saddle attached to drill body squares drill bit vertically

3. SOFT VISE JAWS have built-in permanent magnets that snap them into position instantly as auxiliary jaws on any common type of machinist's vise. Made from a soft alloy that won't scratch or mar highly polished surfaces. Available in sizes from 3 to 4½ in.

4. BEVELED SANDING DISK for use on circular-saw arbors enables operator to edge stock to precise width by passing it between the disk and ripping fence. Long bevels at edge of disk prevent tearing of abrasive when starting stock between fence and disk. Disks are made of aluminum; available in 8 and 10-in. dia.

2

3

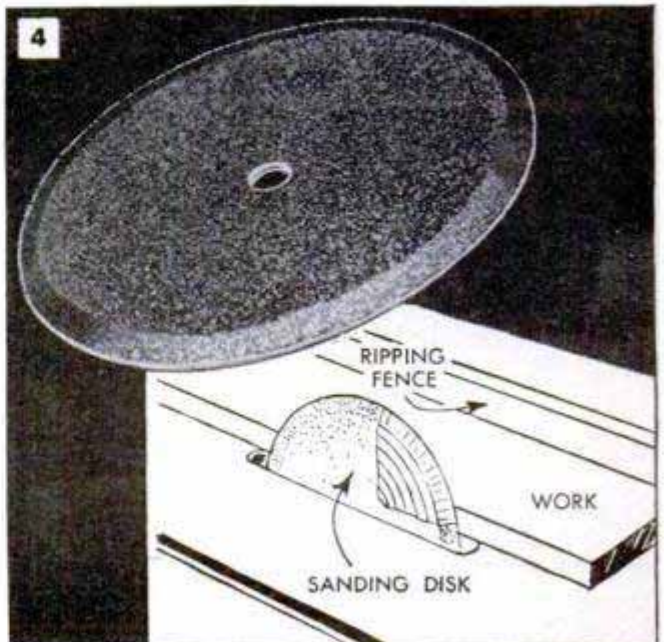
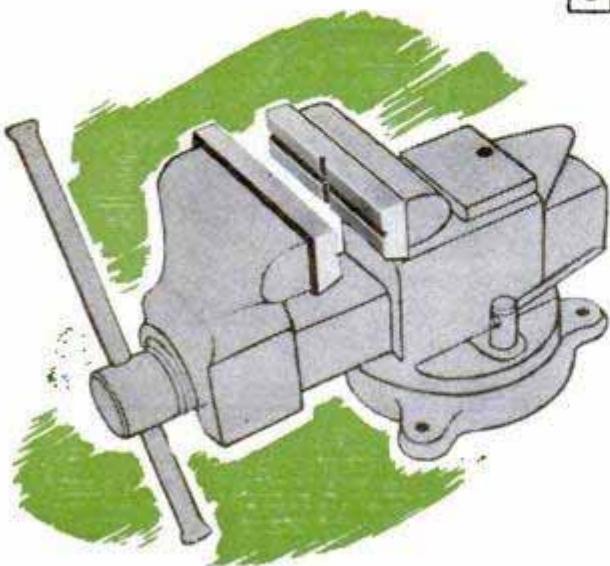

5. RESISTANCE-TYPE SOLDERING UNIT is made for fine work on jewelry, radios and instruments. Operates on 110-volt a.c. with current consumption of only 6 amp. at full load. Electrical unit is housed in a small metal cabinet and single knob controls current from stand-by to full capacity. Carbon tips come in 3 sizes, $\frac{1}{8}$, $\frac{1}{4}$ and $\frac{5}{16}$ -in. dia. Holder is 6 in. long

6. V-BELT DRESSING dissolves the glaze which forms on belts in normal use and prevents slippage under heavy loads. Material clings to belt, does not pile up on pulleys. Cannot be thrown from belt or pulleys even at high speeds. Comes in handy can with applicator-type spout that makes it easy to apply a few drops to the wear surfaces where it distributes evenly

7. PENCIL-SIZE SOLDERING IRON has a $\frac{1}{8}$ -in. tip which permits placement of a drop of solder almost anywhere you can insert a pencil point. Designed and engineered for small electrical-parts assembly and laboratory work. Metal parts are of stainless steel for exceptionally long life. Heating elements are furnished in 25 and 40-watt sizes, both with a $\frac{1}{8}$ -in. tip

8. RUBBER MOLDS form undercut recesses in concrete for anchoring the plaster coats. The molds, or disks, are about 2 in. in dia. and $\frac{3}{8}$ in. thick and are nailed to the wooden forms in a regular pattern. When the concrete has set and the forms are removed, the molds pull out of the recesses without breaking the undercut edges. Molds can be reused

9. 12-POINT SPLINE on screwhead prevents wrench slippage and eliminates hand starting in nearly all applications where power drivers can be used. Available in machine-screw types and in ferrous and nonferrous metals. Tapered head adds decorative touch to products on which screws can be used. Resistance of head to breakage permits higher torque

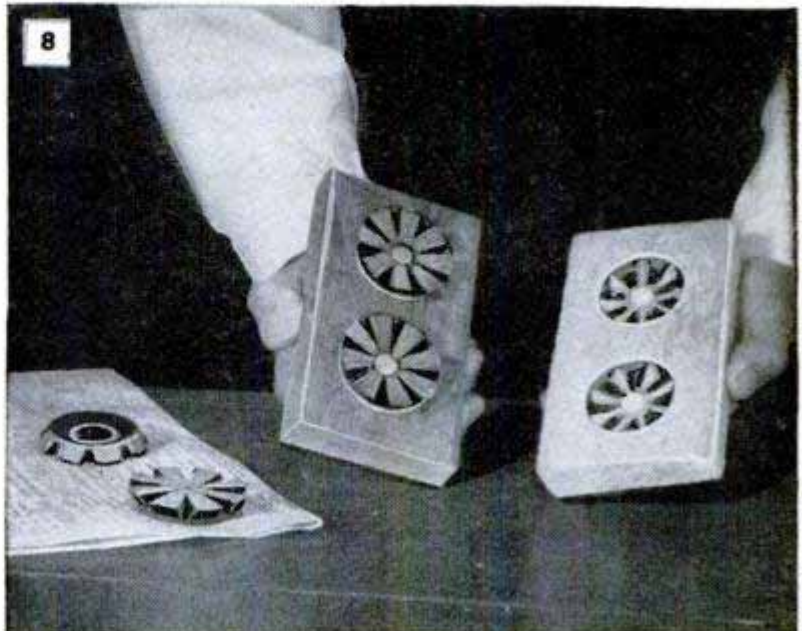
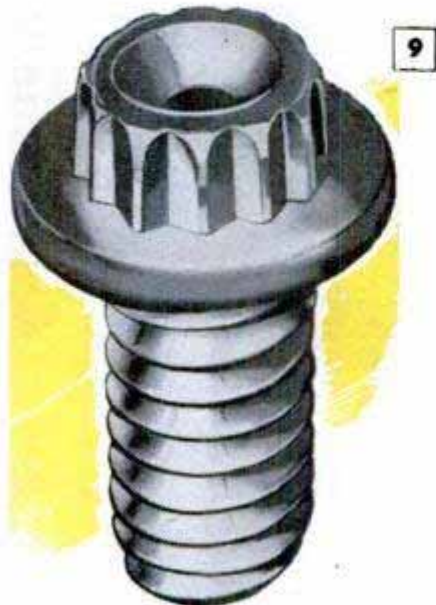
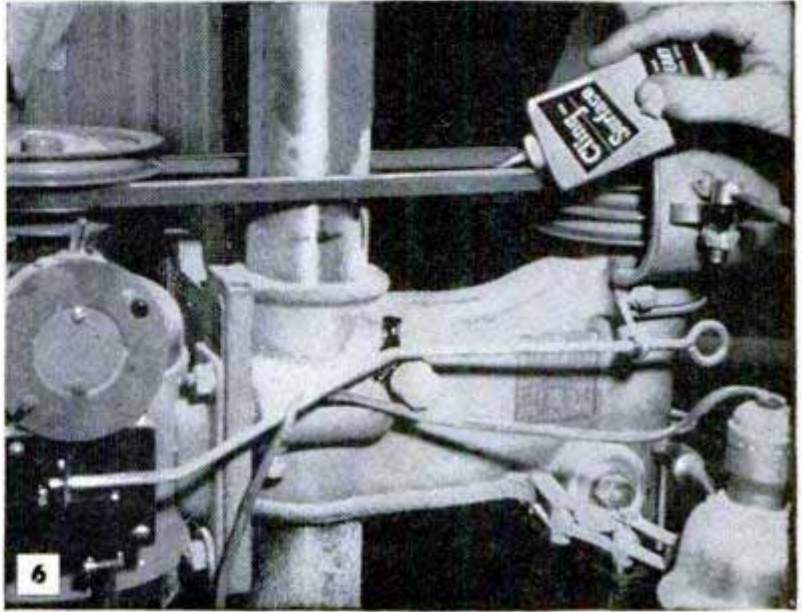
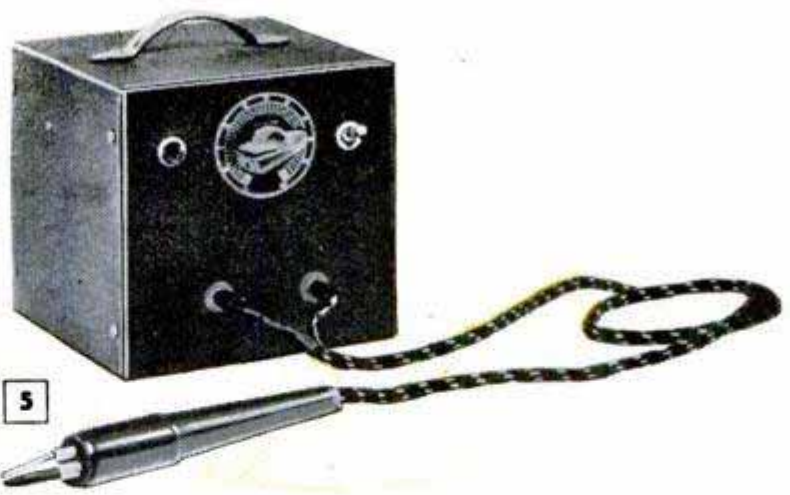

Feed Lot Back Scratcher From Old Tractor Tire



A section cut from an old tractor tire and bolted securely to heavy posts set in the corner of the feed lot makes a good back scratcher for cattle confined to the lot for long intervals. The posts that support the tire section should be set in deep holes, and either soil or, better still, crushed stone firmly tamped around them. The distance between the posts should approximate the center-to-center diameter of the tire, so that when bolted in position it will take its natural curve without kinking.

Improved Paper Hold-Down

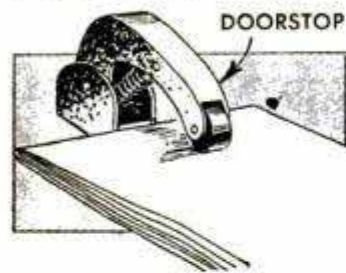

To prevent instruction blanks and order sheets from blowing off his desk, one service manager uses a screen-door catch of the type shown. Although

held firmly by the strong spring tension, papers can be removed with little difficulty due to the rubber roller.

Testing Sand for Impurities

Before sand is used for making concrete, it should first be tested for impurities. This may be done in the following manner: Dissolve lye, 1 heaping teaspoonful, in clean water, $\frac{1}{2}$ pt., contained in a glass jar. After pouring sand, $\frac{1}{2}$ pt., into the jar, replace the

cap and shake the jar vigorously. If, after 24 hr., the water appears no darker than apple-cider vinegar, the sand will be suitable for use.

Wooden Ring Supports Brush In Cutting-Oil Can

One large machine shop saved more than half of its cutting-oil bill, and kept its tools and work much cleaner, by using this wooden ring to support the brush in the cutting-oil can. The

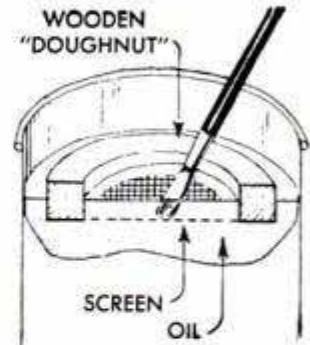

ring is of soft wood, $\frac{1}{2}$ in. thick, with a disk of screen wire tacked to the bottom of it. After assembly, the entire unit is given a coat of shellac. In use, the ring floats in the cutting oil, supporting the brush so that just the right amount of oil is on the brush. A stiff-wire brush rest may be bent and hooked or soldered to the can to hold the handle of the brush at the proper angle.

A. L. Jewett, Woodbridge, Conn.

Lathe Center Drives Small Work

When light work is to be machined its full length while held between centers on the lathe, it can be driven by the lathe center shown in the detail. The center is drilled longitudinally and counterbored to

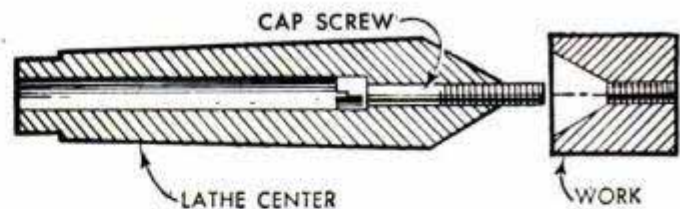

receive a small-diameter flisterhead cap screw. The end of the work is drilled and tapped to receive the screw. The work is then screwed onto the end of the screw, after which the center is mounted in the headstock spindle of the lathe.

Painting Hot Surfaces

One of the most economical ways of painting surfaces that reach temperatures above 350 deg. F., such as smokestacks and boilers, is to give them a coat of black asphaltum varnish. Although this may not last very long if the temperature is extremely high, the cost of renewing the finish is comparatively low inasmuch as the varnish is inexpensive. Oil paints are not satisfactory because temperatures above 350 deg. are harmful to the linseed-oil binder.

ELECTRONICS TODAY

A SYRACUSE, N. Y., housewife, Connie Hodgson, photo A, dropped a one and lost a trillion in a test of skill against General Electric's electronic computer, OARAC.

She was one of six intelligent adults who pitted their multiplication skills against this digital computer soon to be delivered by this manufacturer to the U. S. Air Force's Research and Development Command.

OARAC can multiply 8,645,392,175 by 8,645,392,175 in approximately $\frac{1}{1000}$ second. In a test, the average time for the six human contestants was more than eight minutes, the fastest, $4\frac{1}{2}$ minutes. None of their answers coincided. Like Mrs. Hodgson, who forgot to carry a one in the row to which she is pointing and came out one trillion off, none of them got the correct answer—which is 74,742,805,859,551,230,625.

The center section of the OARAC, photo B, contains the operations panel and tape mechanisms; this panel is flanked on either side by rows of plug-in turrets containing the 1400 tubes used in the computer.

Transistors energized by a pill-sized "energy capsule" replace A and B-batteries in the new tubeless Maico Transist-Ear hearing aid. Cleverly concealed in one of her Hear-Rings, photo C, is a tiny receiver, which in turn is connected to a small hearing-aid amplifier unit hidden in her hair; transistors replace the conventional tubes. Photo D shows this complete miniature hearing aid in operation under a swimming cap.

The progressive reduction in size of hearing aids is illustrated in photo E. From the quaint old ear trumpet to this tiny 1953 transistor hearing aid, that the young lady is pointing to, it appears that real progress started about 1945.

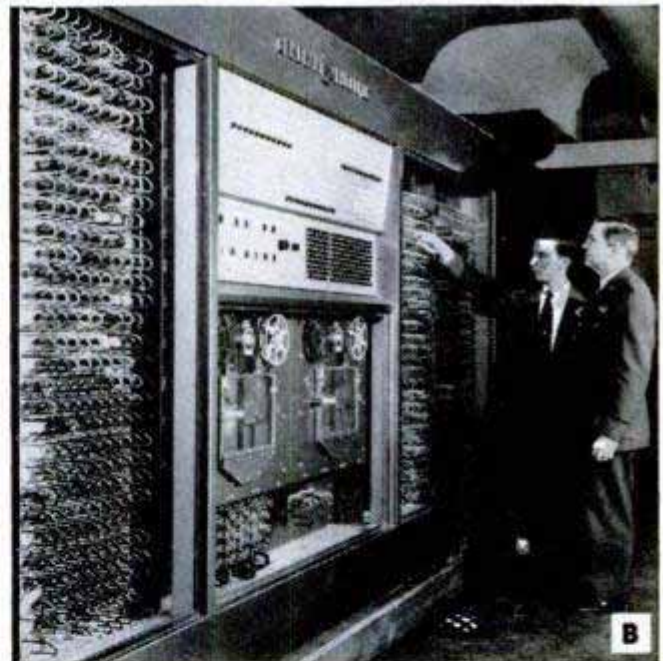
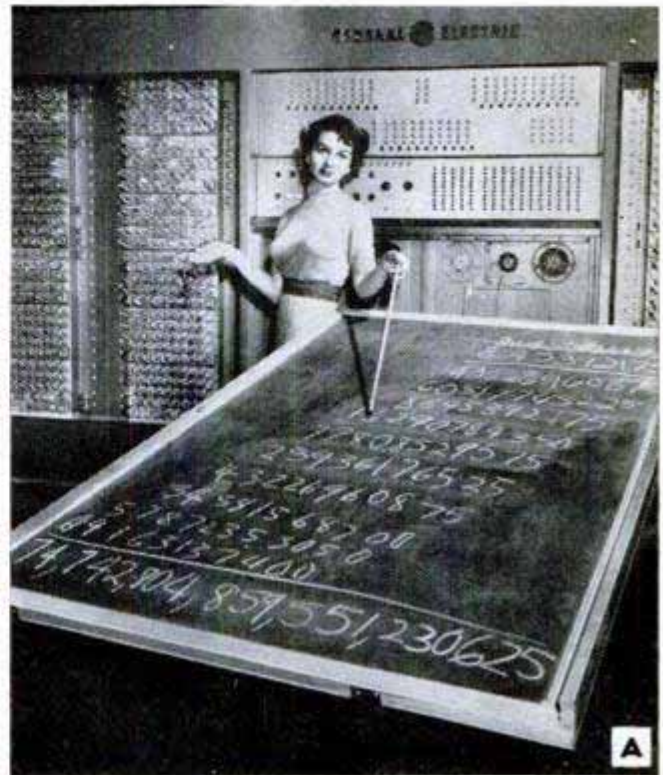

TV SIGNAL BOOSTER FEATURES

By S. A. Johnson WØLBV

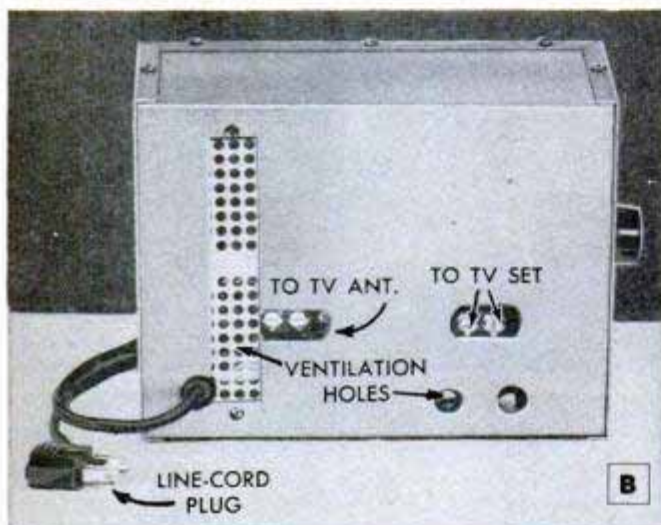
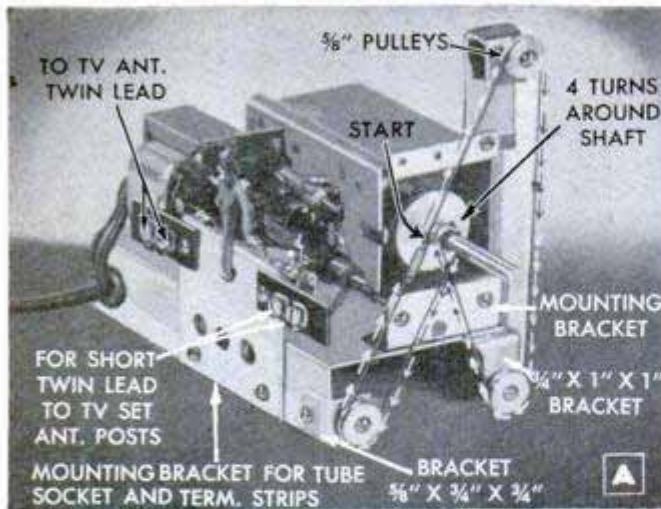

HERE is a television booster that will extend the fringe area as much as 20 miles in many cases, and is effective on all 12 VHF channels. It uses the well-known golden-grid tube—the low noise 6BQ7 twin triode. The tube is a 9-pin miniature type with gold-plated grids.

The booster illustrated and described for construction utilizes one of the popular "cascode" circuits, which have justly earned their reputation for excellent gain with a minimum of noise. Although definitely not designed for beginners, the circuit is quite simple; owing to its necessarily compact design to insure extremely short leads, it presents more of a mechanical job than a wiring assignment. Many of the component parts are very tiny as compared with ordinary broadcast-receiver construction.

The booster is continuous tuning—covering all the VHF-TV channels from 2 to 13

CAPACITORS

C1 AND C2—.5 TO 3-MMFD. TUBULAR-TYPE TRIMMER (MALLORY No. CT565 OR No. CT565A)

C3 AND C4=3.3-MMFD. ZERO TEMP. CERAMIC (MALLORY No. ZT5533)

C5, C6, C7 AND C8 ARE ALL .001-MFD. DISK CERAMIC TYPE
C9 AND C10, A DUAL 20-MFD. 250-V. TUBULAR-TYPE ELECTROLYTIC

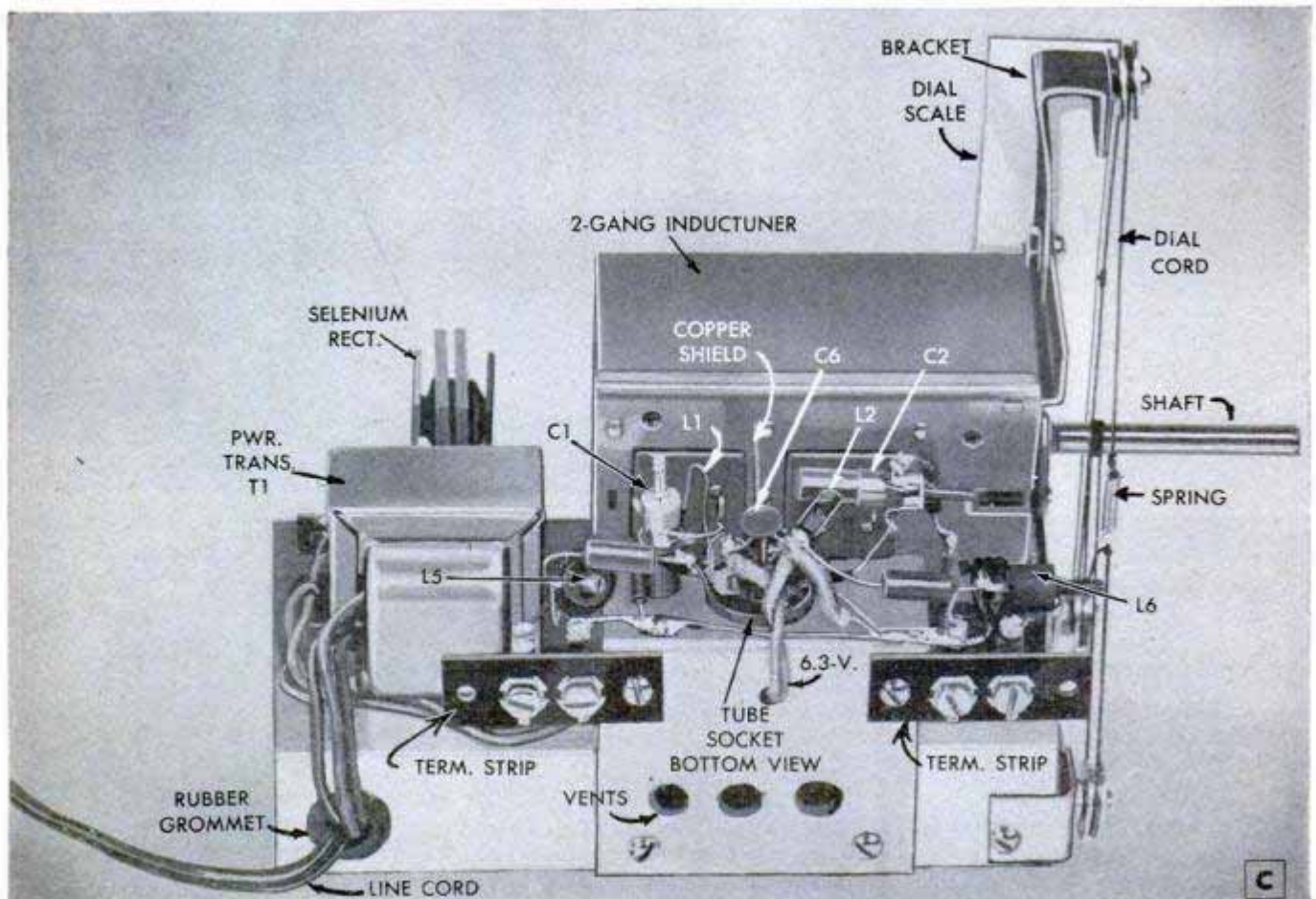

"GOLDEN GRID" TUBE

inclusive and, in addition, it tunes the FM bands in between. In order to solve the very difficult problem of providing a suitable tuning device, the 2-gang Mallory spiral inductuner was chosen. This unit is smooth in operation, and makes possible a compact and efficient layout. It is connected in series with the 300-ohm antenna twin lead and the antenna posts on the TV receiver.

Power for the unit is provided by a very simple a.c.-d.c. power pack, unlike most a.c.-d.c. circuits, it is entirely aboveground, thus there is no "hot chassis" or cabinet. Furthermore, it provides some circuit isolation which is desirable in high-frequency equipment. This power pack delivers about 150 volts, sufficient to operate the tube with good efficiency, but low enough to discourage spurious oscillation. Thanks to the compact layout, the booster fits into a standard, readily available Flexi-Mount aluminum case that is listed in all radio-parts house catalogues.

The actual working parts of the booster are mounted on the small aluminum chassis and brackets detailed in the lower sketch in

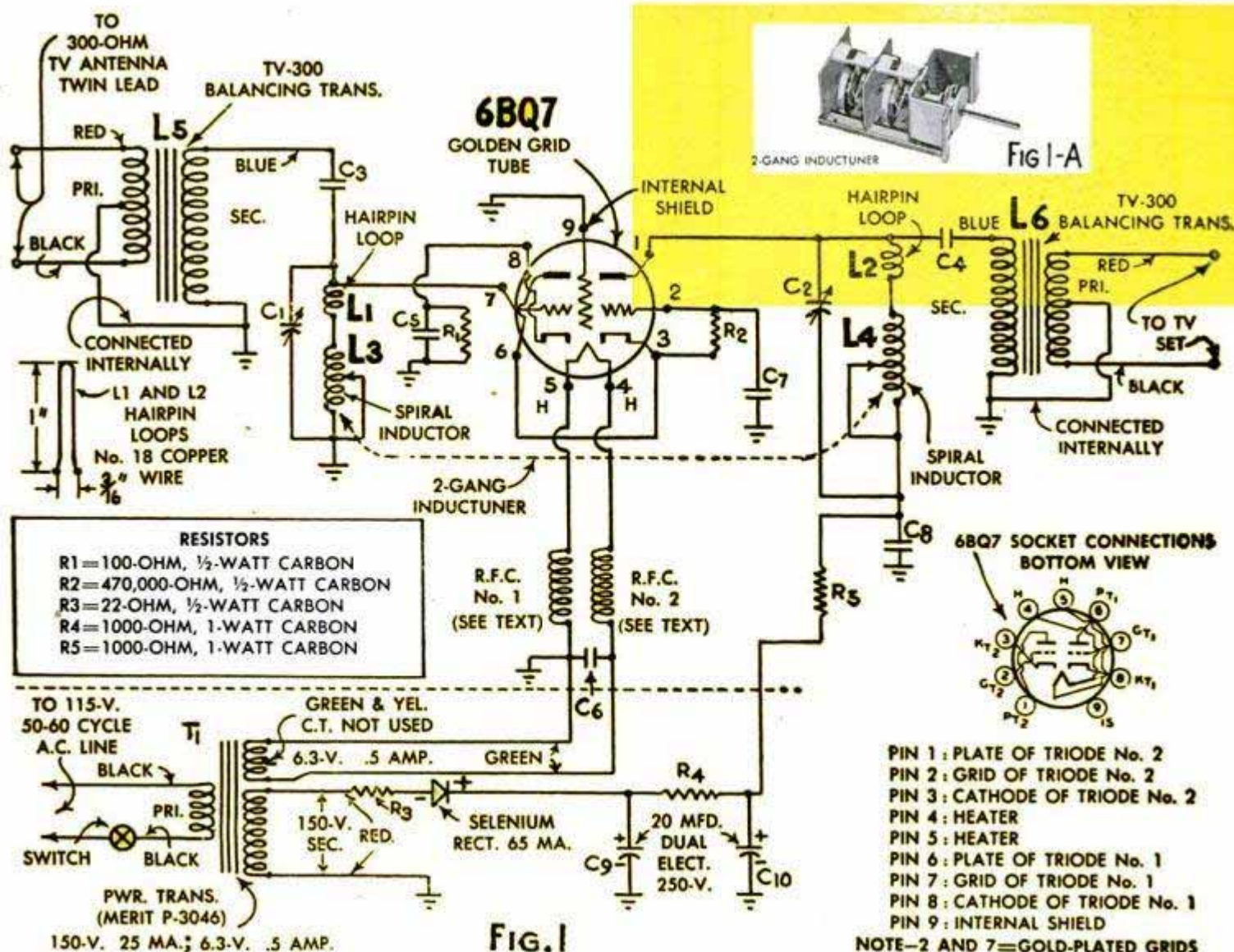
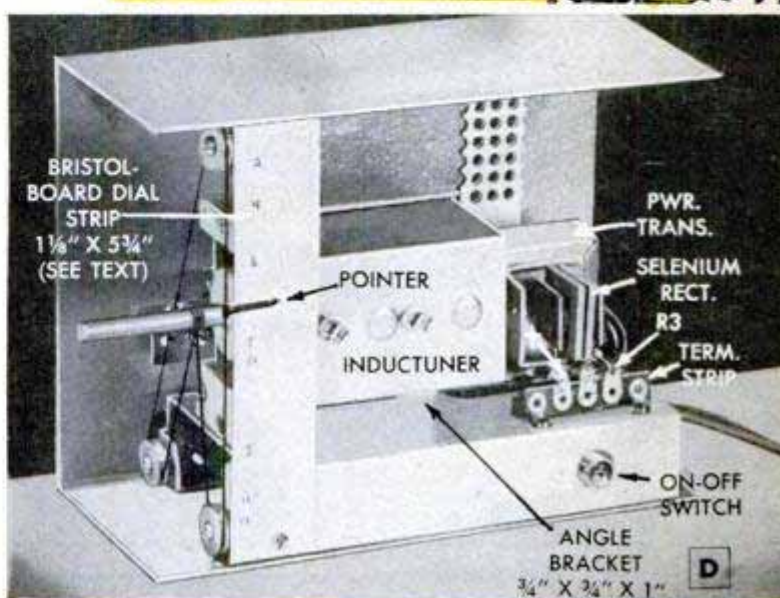
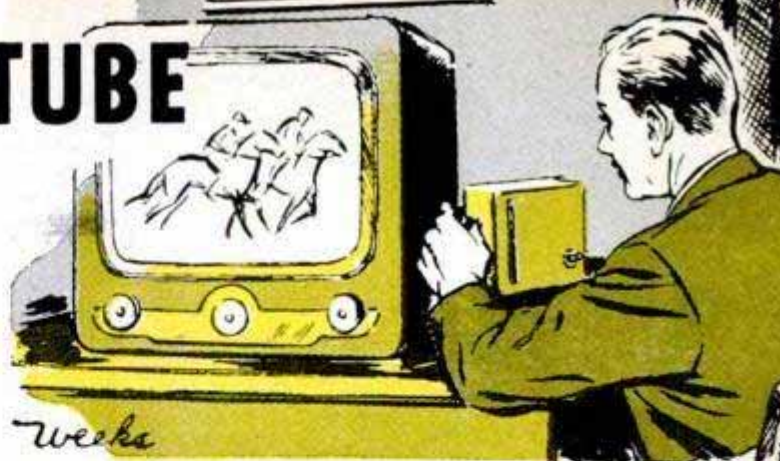

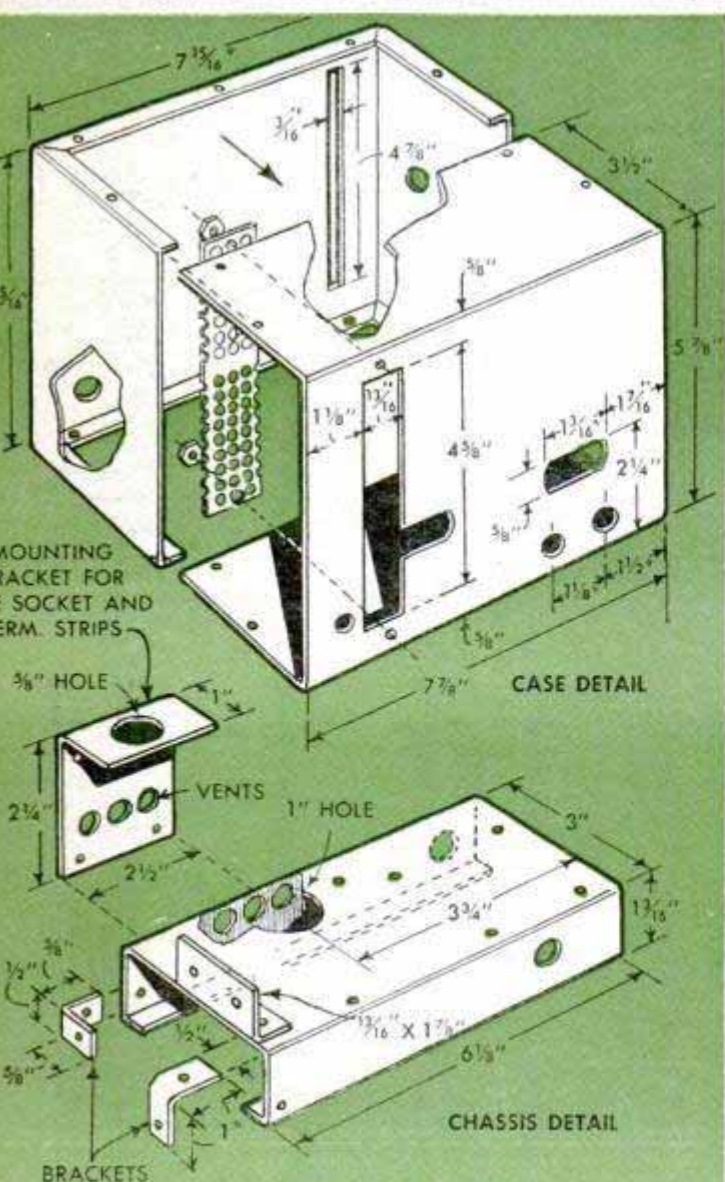
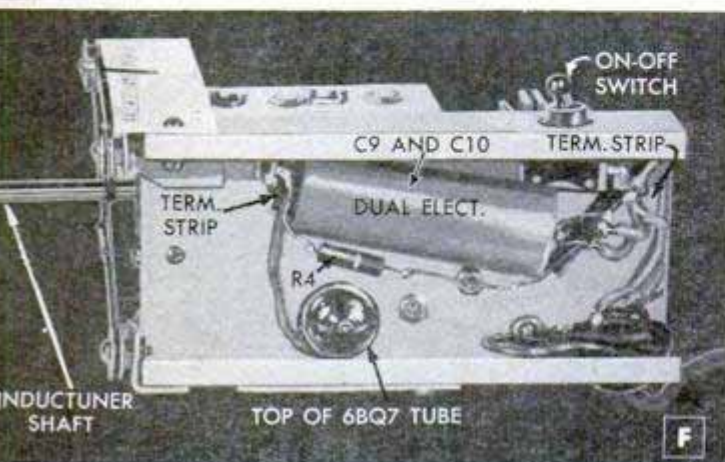
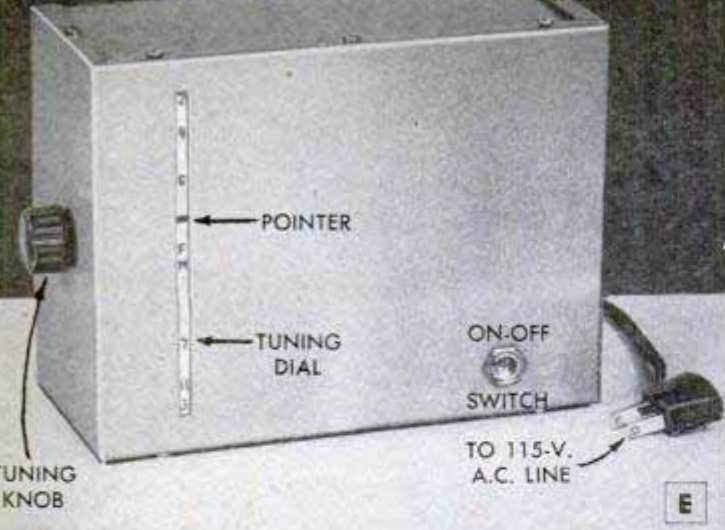

Fig. 2. The standard-size chassis base and homemade mounting brackets are sheet aluminum. Note that the tube is mounted upside down, in order to keep the highly critical r.f. leads as short as possible. Its location on the large mounting bracket is clearly shown in photo C. Case details are given in the sketch above the chassis base in Fig. 2. Front and back views of the completed booster are shown in photos B and E. Good ventilation must be provided as indicated in photos B and C. If the perforated metal-strip material is not at hand, merely drill a series of small holes in the rear cabinet section in the same location.

In the actual wiring, leads in the usual sense should just about be eliminated; the various parts in the r.f. section of the schematic circuit diagram Fig. 1 being mounted as close as possible to the tube element pins on the tube socket. All grounds in the portion of the circuit above the dotted line should be made to a single point, the center post of the tube socket. The parts must be close together, so use a small iron to avoid shorts in soldering; soldering being done with rosin-core wire solder.

The tiny thin-copper shield, see photos A and C, is the last part to be put in place. It should be connected by soldering it between the center ground post on the tube socket and the ground terminal on the inductuner. The shield is $\frac{3}{4}$ in. wide and $1\frac{1}{8}$ in. high, cut away slightly at the lower front edge. R.f.c. 1 and r.f.c. 2 consist of 4 turns each close wound on a $\frac{3}{16}$ -in. polystyrene rod, $\frac{3}{4}$ in. long, connected close to socket.

The dial arrangement is entirely homemade. It consists of a few cents' worth of dial pulleys, cord and a small dial spring—plus a few metal brackets. Bracket and stringing details are shown in photo A. The dial pointer can be salvaged from an old radio or made as shown with a small scrap of copper painted black and crimped to the dial cord, see photo D. The important point is to see that it is light enough so it will be carried on the dial cord. The top pulley bracket, shown in photos A and C, is $\frac{3}{4}$ in. wide and $1\frac{7}{8}$ in. high.

The inductuner provides most of the tuning inductance. However, some additional inductance is provided by the small metal "hairpins" (see L1 and L2 in Fig. 1 for detail of these copper hairpin loops), which serve as an adjustable ganging device for the high-frequency band. An underside view of the completely wired chassis base appears in the photo F.

The dial strip, photo D, is made from Bristol board and is calibrated for channel locations in ink as the various local channels are tuned in. In testing the booster, first

(Continued to page 244)

Radio at Work and Play

ADVANCED METHODS of radio communication now are providing law-enforcement, civilian-defense and other public-safety organizations with several new and highly efficient "working tools." For example: The tiny Handi Micro-Talkie transmitter, shown in photo A, is designed to operate in the 152-174 mc. frequency band. This complete transmitter uses eight subminiature-tube stages with printed associated circuits. The rigid loop antenna also doubles as a carrying handle.

Another radio aid for workers in civilian defense, public safety and transportation communications systems is the new Motorola single-tone selectivity-signaling system illustrated in photo B. The system enables any operator to initiate an operation at one or more remote points through an intervening communication system. Operator selects particular car receiver, or group, by remotely controlled panel lights or alarms.

The next table-model broadcast receiver in your home will probably employ a completely plated circuit, especially if it is a very small, compact type. The one at left in photo C uses the same number of tubes and components as the standard set at the right.

This country has no monopoly on tiny receivers for entertainment purposes. The young lady on the motorcycle in photo D enjoys local programs while she rides through the countryside near Milan, Italy.

The code records and instruction book shown in photo E, enable beginner hams and Boy-Scout groups to qualify for licenses.

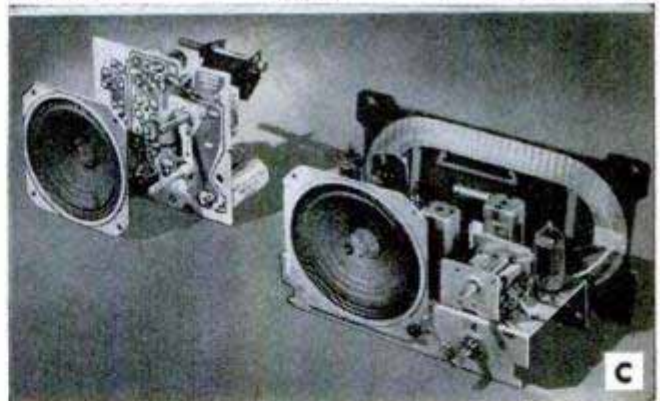
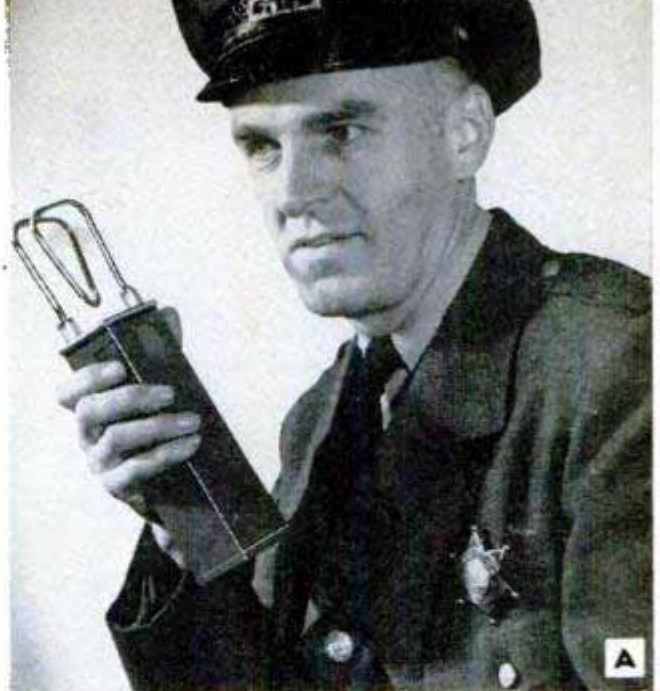

SELF-HELPS FOR TV-SET OWNERS

PERHAPS the screen on your television console is positioned too low for easy viewing. Furthermore, the console may not be placed where you would like it in the room, but owing to its weight and lack of casters it is not easy to move around.

It is not difficult to construct an attractive low box, or platform, from several pieces of $\frac{3}{4}$ -in. plywood, four heavy-duty casters and a little stain and varnish. Exact dimensions will, of course, depend upon the height, width and depth of your console. In most cases it should be about 8 in. high, as wide as the console and perhaps a few inches deeper. The platform shown in photos A and A-1 is open at the back and partitioned for greater supporting strength. The front panel can be made removable as shown in photo A-1, the platform thus providing handy storage space.

Many TV receivers are arranged to play records through the sound section. This is done by connecting a turntable by means of a shielded lead and plug to a phono jack on the set. A switch of the type shown in photo B is thrown to "PH" for this purpose. If your TV picture tube does not brighten, check this switch as it may have been left in the phono position after playing records.

Always keep the back of a TV receiver away from the wall to permit proper air circulation. Photo C shows the use of doorstops on the baseboard to insure proper spacing. Interference streaks across the picture tube are often caused by entangled cords to lamps, clocks and other devices near TV-antenna lead-in cable, as illustrated in photo D. Desk gliders are a good substitute for casters in an emergency moving operation, as shown in photo E.

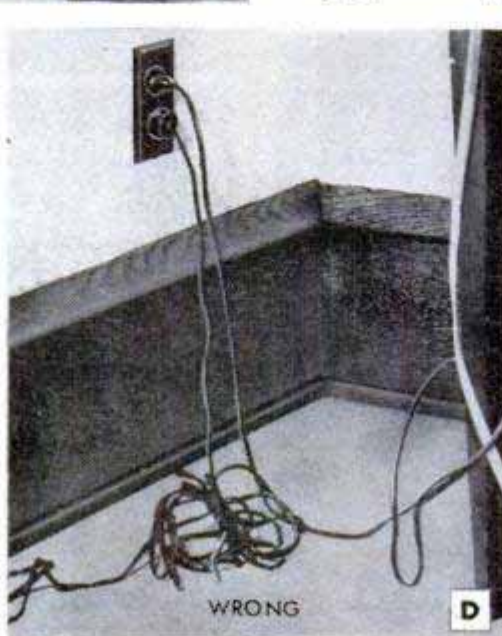
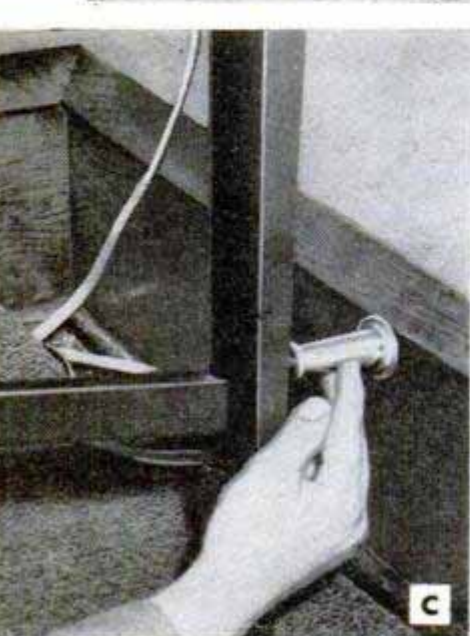
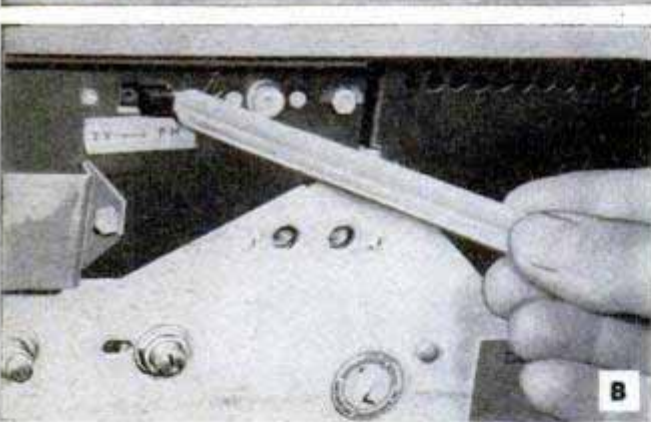
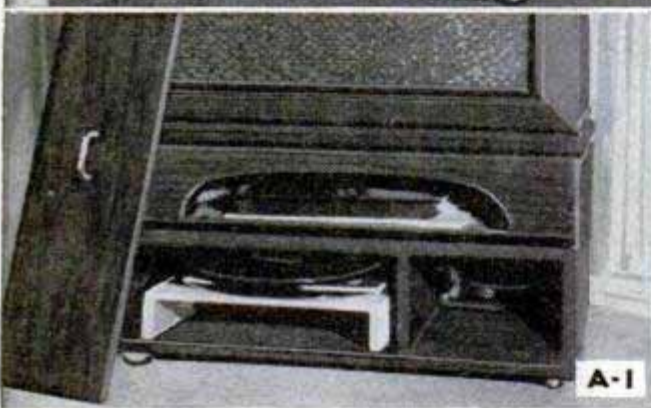

"Bill, you're really proud of that

Superior Mechanics
Guild sticker."



"I sure am, kid. As proud as you are of your reputation as a hotshot trouble-shooter. I'm proud of the tools in that kit too.

I felt lucky when they picked me for that award. You'll be the next in the shop to get it—so save your wise talk. You're smart at using your head. Be smart with your hands, too, and never use anything but those Bonney knuckle-savers.

Here's some more good advice: 'If you're short, buy BON-E-CON* tools.' Either way, they're topnotch tools at the right price."



* The new Bonney
economy-priced line

Remember. Your local Bonney Jobber, as well as Bonney, stands behind the tools you buy. He has Bonney tools priced to fit your needs as well as your pocketbook.

See how Kodachrome Film opens up all the ways to enjoy the magic of color

Kodachrome is one of the most rewarding of all films. Here are all the ways you can enjoy it. And on opposite page are moderately priced Kodak cameras for Kodachrome pictures—and other special color equipment. Color is easy and inexpensive the Kodak way.



↑
A Kodachrome transparency costs as little as 16¢ complete

You can project it →
for brilliant,
large-group shows



You can enjoy convenient
↓ viewing for
small groups



↑ You can give
Kodachrome Prints to
friends and relatives



And Kodachrome ↑
Enlargements up to 8 x 10
inches make handsome
gifts for special occasions



Brilliant, inexpensive slide projector—The Kodaslide Merit Projector features the new-type slide feeding in *top* to prevent jarring projector when changing slides. Large-size lamphouse of new design assures efficient cooling. Built-in elevating mechanism. Powerful 150-watt lamp. \$26.10. Carrying Case, \$7.50.

Thrifty color camera—The famous Kodak Pony 135 is a lightweight, heavy-duty 35mm miniature. Makes superb color slides on 20- or 36-exposure Kodachrome Film. Kodak Anaston *f*/4.5 Lumenized Lens; built-in flash synch. Speeds to 1/200. \$35.75. Flashholder, \$8.25.

Wonderful "miniature"—The Ektar *f*/3.5 Lens on the Kodak Signet 35 Camera gives you *extra* color purity in each Kodachrome shot. The only miniature with ball-bearing action for ultra-smooth focusing. Spring-loaded bearings in range-finder mechanism eliminate play, insure supreme accuracy. Unusually compact. Built-in flash synch. Speeds to 1/300. Automatic film count, stop, and double-exposure prevention. Only \$92.50.



New 300-watt slide projector complete with quiet fan cooling—The Kodaslide Highlux III Projector has two condensers, 300-watt lamp, Kodak Projection Ektanon Lens *f*/3.5. All combine to produce extra brilliance, extra color purity throughout slide area. Fan cooling. New-type slide feeding in *top*. \$56.50, including carrying case.



Versatile "flash" system (*left*) permits use of extension units, remote release. Battery-condenser power. Kodak Ektalux Flashholder only, \$29.75.



Kodaslide Table Viewer 4X (*right*) enlarges slides more than four times. \$49.50. Case, \$15.50.



For Kodachrome shots—Kodak Tourist Adapter Kit (*left*) adapts deluxe Tourist Cameras for Kodachrome pictures. \$13.25.

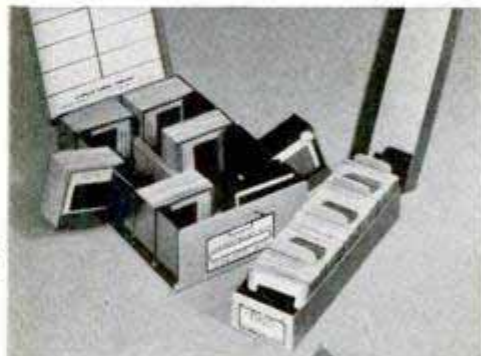

Kodaslide File Box holds 150 cardboard or 53 glass slides. \$1.57. Kodaslide Compartment File holds even more. \$3.94.

Your Kodak dealer will be glad to help you choose the right equipment for taking color pictures. Be sure to see him soon.

Prices subject to change without notice and include Federal Tax where applicable

Eastman Kodak Company, Rochester 4, N. Y.

Kodak

YOUR BEST BUYS IN GARDENING SUPPLIES

THE **VIGORO*** FAMILY OF GARDENING AIDS

Vigoro is the trade-mark for Swift & Company's complete, balanced plant food.

End-o-Weed
2,4-D Selective Lawn Weed Killer destroys dandelions, over 100 different kinds of lawn weeds without harm to ordinary lawn grass.

End-o-Weed CRAB GRASS KILLER
checks and kills crab grass and chickweed without permanently harming lawn grass.

End-o-Pest
... gives quick, 3-way protection against chewing insects, sucking insects, fungus diseases.

End-o-Pest ARC
kills lawn Ants, Roaches, Chiggers, and many other lawn pests. Effective for as long as 90 days.

NEW instant VIGORO
Vigoro... in handy, water-soluble form! You mix it with water and apply as a liquid. Contains all the food elements plants need from soil.

VIGORO*
complete, balanced plant food—so effective that by actual test it can make plants grow and thrive even in plain sand!

all you need to make all you grow.. grow its best!

Here's a job you can do yourself

ADD "QUIET" TO YOUR HOME with Armstrong's Cushiontone



Your whole house will be quieter when you've installed ceilings of Armstrong's Cushiontone in your noisiest rooms. This low-cost tile is the same material used to stop noise in radio stations, restaurants, and theatres.

Cushiontone is a wood fiber material drilled with hundreds of tiny perforations. These holes actually soak up sound so it can't bounce around the room and become disturbing. Cushiontone's smoothly painted surface makes a handsome ceiling, too. It can be repainted without loss of acoustical efficiency. You'll find the 12" x 12" tiles easy to install—either by nailing to wood strips or cementing right to the old ceiling.

Your lumber dealer will give you full details on Armstrong's Cushiontone. For your free booklet describing this sound-absorbing material, write to the Armstrong Cork Company, 9006 Stevens Street, Lancaster, Penna. 

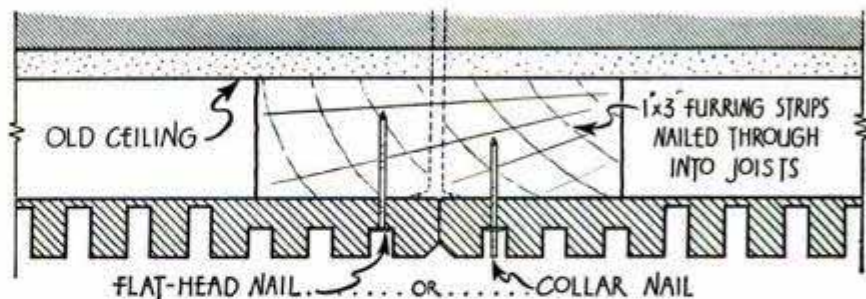
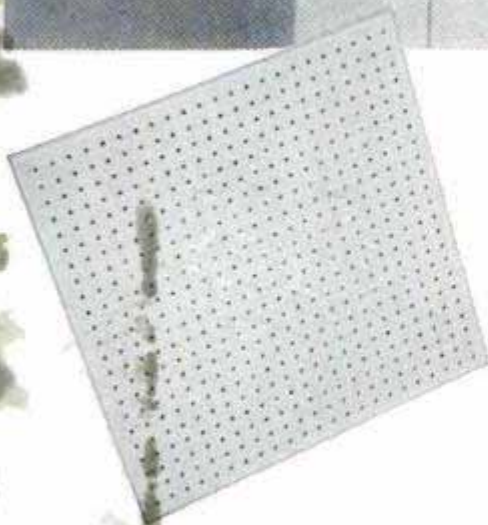

Apply Cushiontone over 1" x 3" furring strips nailed to the old ceiling. Nail through the shallow-drilled holes at corners. Flat-head nails, if used, are set. Collar nails are driven flush with surface of tile. Start nails before positioning tile.

ARMSTRONG'S BUILDING MATERIALS

Temlok® • M-67 Monowall® • Cushiontone® • Insulating Wool • Hardboards



Care and Feeding of Engines

BY S. P. CORP

SPARK PLUG STORY

When your engine misbehaves, look to your spark plugs for evidence. Here are some clues you may find on the porcelain and the electrodes:

Brown powdery deposit is normal with regular fuels.

White or yellow powdery deposit is normal when using leaded fuels.

Black-wet deposit indicates an excessive amount of oil is getting above the piston or plug is too cold.

Black-fluffy deposit indicates carburetor needs adjusting; mixture is too rich or plug is too cold.

White blistered condition indicates too-lean mixture, faulty timing, leaky valves, or too-hot plug.

The design of a spark plug determines whether it is hot or cold. "A" is a hot plug because heat is farther from water. "B" is a cold plug, dissipating heat faster because closer to water.

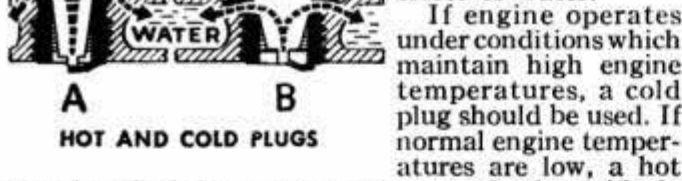

If engine operates under conditions which maintain high engine temperatures, a cold plug should be used. If normal engine temperatures are low, a hot plug is called for. Always use a spark plug with the heat range recommended by engine manufacturer.

VACATION PREPARATIONS

Before starting your trip, check: **Brakes**, hydraulic system, brake linings, hand-brake cable; **Battery**, test specific gravity; clean, tighten, and coat terminals with petroleum jelly; **Cooling System**, drain, flush, add rust-inhibitor; check hose, pump, and fan belt; **Crankcase**, change oil, replace filter; **Cylinder Head**, tighten bolts to correct torque; **Fuel System**, clean fuel pump bowl, adjust pump and carburetor; **Generator** and voltage regulator; **Lubricate** wheel bearing, universal joints (every 10,000 miles); **Steering**, rotate tires, check alignment; **Starter**, check amperage draw, inspect brushes.



FREE, FOR YOU!

A postal card will bring your free copy of the new illustrated manual of car care, "MORE POWER, Less Gas, Less Oil." Tells all about Sealed Power KromeX Ring Sets and the famous MD-50 Steel Oil Ring with the Full-Flow Spring. Sealed Power Corporation, Dept. G-6, Muskegon, Michigan.



Clinic for Homemakers

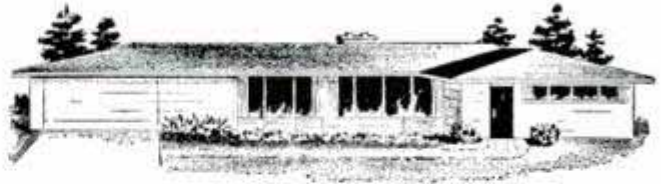

As a service to our readers in solving the hundreds of problems pertaining to a home—inside or out—the editors of *Popular Mechanics* invite you to present your problems to The Clinic Editor for help and advice. Address your questions to The Clinic Editor, *Popular Mechanics Magazine*, 200 East Ontario Street, Chicago 11, Ill.

Coloring Concrete



Q—I want to color my basement floor a soft gray-green and the question has arisen whether I should use paint or stain. Floor is in good condition, except for one or two small rough spots, and is smoothly troweled. I'm told that the stain requires much more

time to apply than the paint. Is this right? What would you recommend?—D. B., S. Dak.

A—We'd recommend rubber-base paint especially formulated for use on concrete. Applying either the stain or paint to concrete is not as simple as painting wood, as the floor requires special preparation, particularly when smoothly troweled. The first step is to etch the surface with a muriatic-acid solution. In some cases it is advisable to wash the floor with a trisodium-phosphate solution before etching. A gal. of muriatic acid added to 2 gal. of water will make about the right strength and will etch about 200 sq. ft. of floor area. Mix the solution only in an earthenware container and apply to the floor with a large cloth swab. Do not permit the acid solution to come in contact with the bare skin, as it may cause quite severe burns. After the solution "works," flush the floor with clear water and allow to dry thoroughly. This may require a week to 10 days. A window fan will speed up drying of the floor. When applying rubber-base masonry paint, follow the manufacturer's instructions in all details. Clean the brush in the special thinner that you use to reduce the paint to a brushing consistency. When applying two coats allow at least 24 hr. drying time between coats. The paint should be thoroughly dry before being walked on.

Pickled-Pine Finish

Q—I have an heirloom piece made of pine which I would like to refinish, and have thought of applying what is called a pickled-pine finish, that is, if this is possible. The piece is quite old and the wood is a grayish color but seems to be sound. Is it possible to refinish in a light color?—T. Y., N. Y.



A—From your description, we're a little doubtful about the pickled-pine finish proving a success. However, if the wood is sound, as you say, then it may be possible to scrape the surfaces sufficiently

(Continued to page 220)

\$10,000.00 IN PRIZES

ENTER RAYTHEON'S TRANSISTOR APPLICATION CONTEST!

Here's the chance-of-a-lifetime to win a big cash prize while gaining valuable "know-how" on the latest electronic development — transistors. Raytheon is offering 17 cash prizes to the seventeen contestants who produce the most ingenious applications of the Raytheon CK722 Junction TRANSISTOR.

Here's all you have to do! Simply build equipment that uses one or more Raytheon CK722 Transistors which you have purchased from your local Raytheon Tube Distributor. Then send a photograph of the unit you have built, a completed official entry blank and a 500 word minimum, 1000 word maximum constructional article on the equipment to Raytheon, P. O. Box 6, Newton 58, Mass. All entries will be carefully judged and prizes will be awarded on the basis of ingenuity of application. Duplicate equipment to be judged on basis of descriptive material. Decision of the judges is final and all entries and their ideas become the exclusive property of Raytheon.

Here's how to enter! Go to your nearest Raytheon Special Purpose Tube Distributor. Get your official entry blank which *must* accompany each entry and which contains complete contest rules or get the official entry blank by writing directly to Raytheon, P. O. Box 6, Newton 58, Mass. Enter today — the contest closes on Midnight August 31, 1953.



Excellence in Electronics

RAYTHEON MANUFACTURING CO.

Receiving Tube Division

POST OFFICE BOX 6, NEWTON 58, MASSACHUSETTS

How To . . . BY MASTER

Our #1 contest winner is Andre Senecal of 475 Lansdowne, Montreal, Canada, who gets a Streamline rule for this one:

ACCURATE ARCS WITH A RULE



Cut a piece of pliable material as indicated. Slide the tongue into case under tape. Insert pin as indicated. Pull out tape to radius desired. Insert sharp pencil into rivet hole and draw your arc.

Contest winner Thomas Ryan of Stone St., New Hamberg, N. Y. requests a "Guardsman wood rule"

TO ESTIMATE HEIGHT OF TREE OR POLE

Place a mark on the object to be measured 6 ft. from ground. Now back off until this 6 ft. mark coincides with the 1" mark on your rule. Using 1 ft. to 6" ratio as a guide proceed to measure approximate height.



Richard Baudeck of Buhl, Minnesota, has a dandy entry. He asks for a Tufboy.

TO MAKE TIGHT SCREENS



Cut screen $\frac{1}{2}$ " shorter than is necessary for two screens. Nail to opposite ends of each screen. Stretch and nail the other ends. Then cut screen.



retails for \$1.85

A sturdy 6 foot wood rule with an extendable 6" solid brass insert for short extra measuring chores. The X-6 eliminates guess work, gives exact, accurate inside measurements every time. Simply expand the rule to closest measurement possible, slide out the brass insert with free hand. A spring catch keeps the slide rigid in the extended position. Figures and graduations are etched in the extension, will never wear off.

AS A SERVICE TO YOU:

Each month we will print the finest building short-cuts used by professionals and amateurs. You'll want to keep a scrap book or file for these handy references. IF YOU HAVE A SHORT-CUT YOU CAN WIN A PRIZE! Send it to "HOW TO," care of Master Rule Co., Mulberry Street, Middletown, F4, N. Y. If we use it, we will send you, free of charge, your choice of any wood or steel rule in the Master line. All entries become the property of Master Rule Co. and will not be returned.

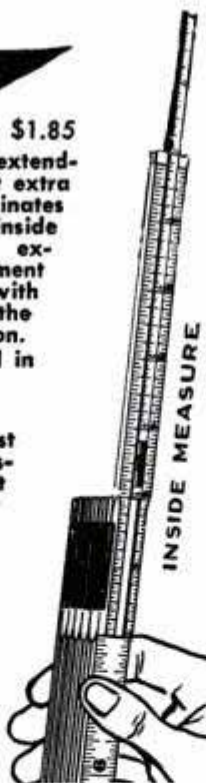

Please send literature . I am enclosing a "HOW TO" item . If you use it, please send me a _____ rule.

NAME _____
ADDRESS _____



(Continued from page 218)

to expose new wood. You did not say what type of piece you are referring to which makes it difficult for us to tell you how to proceed. However, in a general way, we'd first try scraping with a cabinet scraper to expose new wood. If this works out and the wood turns up a fairly uniform color, then give all surfaces a thorough sanding. Now mix paste white lead, 3 parts, and fine silica, 1 part. Thin the mixture with equal parts of turpentine and japan, to the consistency of heavy cream. Tint to an old-ivory color, then apply to the wood with a paintbrush. Just as the material begins to set, rub off across the grain as you would a filler. After rubbing across the grain, rub lightly with the grain until the wood is the color you desire. Allow to dry for 10 days, then finish with paste wax. This finish is only one of several, but in some ways is the simplest to apply. It also is quite effective on woods other than pine.

Stoker Problem

Q—During the last heating season I had trouble with my stoker. The main difficulty was in removing the clinker which always seemed to form deep in the firebox. My neighbor said that there was too much air, but adjustment didn't appear to make any difference. Can you tell me what is wrong and how I should remedy the trouble?—A. N., Ill.



A—We think your neighbor is at least partially right. The fact that the fire burns continually lower would indicate not only too much air but a thin fire due to a coal feed set too slow. This in turn lowers the plastic zone—the point where the coal is reduced to a state of plasticity in the process of combustion—thinning the fuel bed continually and resulting in the formation of a clinker deep in the retort. Judging from your description of the problem, we believe you should adjust the air and coal feed and also check the operation of the damper and the hold-fire control. Correct adjustment of the hold-fire unit is especially important. Most stokers of the later types are equipped with hold-fire units operated by an electric time clock, but some are equipped with a stack-type thermostatic control. The former has two adjustments, one governing the frequency of stoker operation during a hold-fire period in mild weather, the other, the time the stoker will run during each separate operation. These adjustments determine the hold-fire cycle. The latter-type control operates by stack temperature and both types are quite flexible. Satisfactory operation of the stoker depends to a great extent on the proper adjustment of the hold-fire control, especially when different types and grades of stoker coal are used. Of course, the proper functioning of all units of the heating system must be correlated in order to obtain the best results. This means adjustment of the fuel-and-air ratio, proper cleaning of the fire at regular intervals, correct adjustment of the firebox draft with the atmospheric damper, and adjustment of the hold-fire control.

Chalking Paint

Q—I'm advised to use a self-cleaning paint on my house. What is this product?—T. A., Ore.

A—Probably you are referring to the so-called chalking paint which, stated simply, is a paint for outside use containing certain ingredients that permit what might be termed a slow disintegration of the paint film at the surface. This process continually releases particles of pigment which are washed away, carrying with them accumulations of the dust and grime that cause discoloration of the walls. Because of this, such paints are sometimes referred to as self-cleaning. This feature of the paint appeals to homeowners located in areas where house paint is subjected to discoloration due to dust and other causes.

"13 cross-country trips and she's still singing sweet!"



**"Sure, I've had to use replacement parts! But not often—
because I've always insisted on GENUINE FORD PARTS!"**



They're made right to fit right because they are made exactly to Ford specifications—by the men who designed and built your Ford. So they're easy to install—save repair time.



They're Track Tested and proved in the most punishing tests imaginable by Ford engineers before they win the Genuine Ford Parts label. They're *really* built to take it.

They're easy to get, too!
They're available at all Ford Dealers and the selected independent garages where you see this sign.



Keep your Ford ALL Ford

"Handy" SANDY says:



Save work with these
**GOOD
SHORT-CUTS**
... clip and save 'em!

You can make a small file in a jiffy—to remove metal burrs, clean up metal surfaces, or sharpen tools. Take a sheet of Emery Cloth and tear a strip from it—the 11" way. Tack or cement the strip to a stick of wood the size of the file you need, and go to work! If you're cleaning or sharpening with it, try squirting a little lubricating oil on the surface or edge you're working on. Gives a finer finish—and, if you're filing plastics or soft metals, the oil keeps your "file" from clogging up. Emery Cloth, a top-notch product by CARBORUNDUM, comes in grit sizes from #3 (very coarse) to #3/0 (fine). Get it at your hardware or lumber dealer's.

Keep your work-piece from slipping in the vise when you're filing or drilling holes. It's no problem—just wrap a piece of Flint Paper by CARBORUNDUM around the work piece (grain side out). Put it in the vise and tighten 'er up. This just proves my point that you should always have CARBORUNDUM's Flint Paper on hand—it's useful in so many different ways.

A lot of folks don't realize that grinding wheels are actually made by CARBORUNDUM thin enough to saw metal. Industry uses millions of them each year—calls 'em "cut-off wheels," for that's exactly what they do. They're getting more and more popular in home workshops, too, because you don't need any special equipment to use this type of wheel. It's made to fit your bench saw, grinder or portable saw. Want to cut steel, aluminum, brass, bronze, copper—in a jiffy? Just replace your rotary saw or grinding wheel with an "MX" Aluminum Oxide Cut-Off Wheel. What's more, you can use the side of this "MX" Cut-Off Wheel to sharpen or finish grind your edge tools, cutlery, chisels, planer knives, drills and other hand tools. Want to cut plastics, fiberboard, hardboard, asbestos, and such, too? An "MX" Silicon Carbide Wheel will cut them all. "MX" Cut-Off Wheels by CARBORUNDUM are strongly reinforced for top safety—yet they are flexible. They cut fast, and finish as they cut. You just can't beat them as worksavers! Better get a pair today from your hardware or lumber dealer... Aluminum Oxide (for metals) in the red envelope—Silicon Carbide (for non-metallics) in the green envelope.

My boss will send you \$5.00 for each home or workshop short-cut you send me, provided I can use it in my column. Send one idea on a postcard. Even if I can't use it (because of duplicates, and such) I'll send you a useful gift for your trouble, anyhow.

Send for a new free pamphlet. It's called "HOW TO SAND." The CARBORUNDUM folks want you to have it—without charge. Ask for it on a separate postcard addressed to me.



"Handy" SANDY
CARBORUNDUM

Niagara Falls, New York

"CARBORUNDUM" AND "MX" ARE REGISTERED TRADEMARKS
OF THE CARBORUNDUM COMPANY, NIAGARA FALLS, NEW YORK

Those Fabulous Flying Fords

(Continued from page 69)

aerial cavalcade was staged into northern Michigan. One day, at a small landing field, the wind died suddenly and nothing could get off the ground—nothing, that is, except the Ford. Stout asked the pilot later how he did it.

The pilot was a man of few and picturesque words. He explained it thus:

"I says to my mechanic, 'Hold the brakes,' and he held the brakes. I opened the throttle and I says, 'Let 'er go. Either she does or she doesn't.'"

"She did."

The Ford even altered the Army's ideas about airplanes. In those days the Army insisted that cockpits be placed back toward the tail, to give the pilot a chance of survival in case of a crash. All its pursuit planes were built that way. Then something happened to change the Army's mind.

A squadron took off from Detroit for Seattle. A Ford went along with mechanics and tools. The pursuit pilots presumed that the big, sluggish Tri-Motor would trail far behind. Instead, the Ford reached Seattle three days ahead of them. Snowstorms had grounded the pursuits because the pilots, perched far aft along the fuselage, had no visibility. The Ford, with its cockpit up front, plowed on through.

Shortly afterward the Army began shoving its cockpits forward.

The Ford rang up another "first" by carrying Admiral Byrd to the South Pole, with Bernt Balchen at the controls. Only by tossing out 250 pounds of precious provisions were Balchen and Byrd able to squeak the indomitable Tri-Motor over one towering mountain barrier. That famous ship is now on exhibition in the Ford Museum at Dearborn.

Recently two incidents have given Stout renewed pride in his rugged offspring.

One involved a package received in the mail, containing a piece of corrugated metal. With it came a letter from an Air Force general.

He said the piece of corrugated metal was cut from the tail of a Ford Tri-Motor. The plane—then 15 years old and long obsolete—was used to evacuate civilians off Bataan peninsula in the Philippines in that fateful year of 1942. Designed originally for 14 people and a 250-mile range, the plucky old crate was lurching off the ground with 24 people aboard and flying 500 miles over water twice a day. The Japanese finally strafed it and left it a heap of rubble and the Air Force general salvaged a piece from the tail.

(Continued to page 224)

Texaco Tips



on car care



How to keep your engine running cool

When your engine overheats—it means trouble. To keep it operating at the right temperature, see your Texaco Dealer. He will check for rust, draining and cleaning the radiator if necessary. If the fan belt or water hoses show signs of wear, they will be replaced. He will check water pump; drain cocks, gaskets and cylinder head bolts for leaks. See your Texaco Dealer—the best friend your car ever had.



How to get that "cushiony" ride

Here's proof of why Marfak gives your car top chassis protection. Rub Marfak with your finger—it forms a tough, fluid film and builds up a "collar" to seal out road grit and grime. And Marfak stays put . . . clings to bearings and points of wear.

Marfak's longer lasting protection means cushiony riding ease for 1,000 miles or more. For Marfak lubrication, see your Texaco Dealer.

THAT "CUSHIONY" FEELING
LASTS LONGER WITH



THE TEXAS COMPANY
TEXACO DEALERS IN ALL 48 STATES

Texaco Products are also distributed in Canada and in Latin America

WANT BETTER PAINT JOBS?

Use *Pol-mer-ik* LINSEED OIL

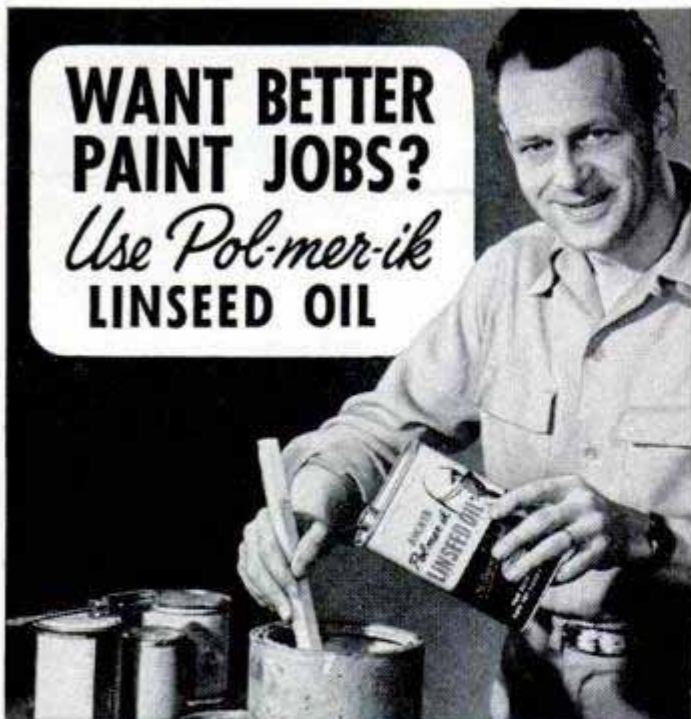

● For years Archer Pol-mer-ik has been the linseed oil chosen by more professional painters than any other for paint reducing and brush conditioning. Pol-mer-ik has been

super-treated by a special polymerization process which reshuffles the oil molecules so they are interlocked. This gives you a tougher, more durable paint film than ordinary linseed oil. When you reduce your paints with Pol-mer-ik, they brush out easier, level out better, have a smoother, more dirt-resistant surface, and give you a longer-lasting job! Next time you paint, use Archer Pol-mer-ik Linseed Oil. You'll get better results!



BRUSHES OUT BETTER

TOUGHER SURFACE

BETTER GLOSS

ARCHER *Pol-mer-ik* LINSEED OIL



PROTECTS MOST ANYTHING

A few of the **101** HANDY USES:

- Preserves tools and handles.
- Refinishes antiques.
- For natural wood finishes.
- Softens stiff putty.

Yes, Archer Pol-mer-ik is a real Handy-Andy helper that saves you time and money by doing the job of a dozen specialized products. The handiest single product in your home!

FREE! 101 Money-Saving Ideas!



Get your copy today. Shortcuts and pointers from the "pro's" based on practical experience. Free! No obligation—just drop us a card today. ARCHER-DANIELS-MIDLAND Co., 603 Roanoke Building, Minneapolis, Minnesota

The other incident occurred not long ago. Williams took Stout for a ride in his Ford and I went along as a passenger. It was a sentimental journey for me, too. The first airplane in which I ever flew—back in 1935—was a barnstormer's Ford Tri-Motor. Since then I have flown in everything from aerial flivvers to jets. I came full circle that day when Stout and I went aloft in Williams' treasured old Ford.

Stout, too, must have felt a charge of emotion. "Darn, this takes me back," he exclaimed as we climbed aboard.

Williams taxied out on his private dirt strip to take-off position, just abreast of a tall cottonwood tree. From the copilot's seat I could see another big tree at the far end of the strip. "From here to there is a quarter mile," Williams said as he warmed the engines. "We'll need only about half that distance to get off."

The big Ford rumbled into motion, gained speed and hopped into the air almost like a helicopter. By the time we came abreast of the second tree, we were 25 feet above its topmost branches.

While we flew at a pokey 90 miles per hour, I reflected on the contrast between air transport in the 1920s and as we know it now. The low wing of the modern airliner is an annoying obstruction to the sight-seeing passenger, but the Ford's high, bridge-like wing yielded a wholly unimpeded view of everything around us. And the plane had wide, airy windows instead of the tiny airliner portholes that give today's travelers only a tantalizing glimpse of scenery. Against my ears pounded the thunder of the engines. For the Ford there were no such fripperies as soundproofed walls.

At a little mountain cow town called Payson, we landed on a strip that no other transport the size of the Ford would have dared to use. The Ford, with its slow landing speed, rolled to a stop before it had traveled half the strip's length.

Out of Payson, Bill Stout himself took the controls. He said he hadn't flown a Ford in 10 years. Williams paid him a pilot's finest tribute: He stepped back out of the cockpit and let Stout go it alone. Bill Stout wore a grin like a kid on his first airplane ride.

Three quarters of an hour later Stout climbed out and gave the Tri-Motor a last proud look. "Those Fords will fly as long as anyone wants to fly them," he said.

Today, in the United States and in obscure places all around the world, people are taking Bill Stout at his word. Come war or peace, jets, rockets or guided missiles, the unconquerable old Ford Tri-Motor flies on—an airplane that is too tough to die. ★★★



“Company pays \$1200 for cost-cutting idea!”
“Employee wins \$350 for suggestion!” Ever wonder how *you* can cash in on *your* company’s suggestion system? Check these Bostitch case histories. There may be an idea here for *you* — and *your* company.

BUSINESS: Cabinetmaker
SUGGESTION: Fasten bottoms and sides of small chests with Bostitch foot-powered stapling machine and $\frac{3}{8}$ " staples.
RESULTS: Five times faster than old method of nailing. Stapling more secure. Workers like it better.

BUSINESS: Gasoline Pump Manufacturer
SUGGESTION: Instead of solder, use $\frac{3}{8}$ " staples to fasten No. 8 mesh on foot valve bottom of pump.
RESULTS: Production jumped from 20 an hour by soldering to 90 an hour with Bostitch.

BUSINESS: Tile Contractor
SUGGESTION: Instead of nailing metal lath to wood studs and joists, use Bostitch hammers and tackers.
RESULTS: One man can now lath 4 bathrooms in 2½ hours compared to 5 hours the old way.

BUSINESS: Garage Door Manufacturer
SUGGESTION: Metal stitch aluminum panels together with Bostitch wire stitcher. Old method: drill and screw.
RESULTS: Plant turns out 500 doors a day as against 50 before. Stitcher and special table jigs for positioning panels save space, material.

BUSINESS: Vacuum Cleaner Manufacturer
SUGGESTION: To fasten metal discs inside fiber cylinders, use Bostitch metal stitcher instead of punching holes and riveting.
RESULTS: Manufacturer saved \$6250 the first year.

BUSINESS: Frozen Food Locker
SUGGESTION: Replace cellophane tape with Bostitch desk-type stapler for fastening ends of frozen food packages.
RESULTS: Labor and material costs cut 50%. Bostitch method gives tight, permanent seal. Unlike tape, will not loosen at low temperatures.

TO HELP YOU find ways to apply Bostitch savings to *your* business, send for the 16-page illustrated booklet, "Time and Money-Saving Case Histories." It's *free*—and full of cost-cutting ideas!



BOSTITCH 546 Mechanic Street, Westerly, R. I.
 Please send me a free copy of the Bostitch book of case histories.

Name _____
 Address _____
 City _____ State _____
 Company _____ Position _____

Here's how for home painters



Handy container! A gallon paint can is awkward to handle. Here is a hand-size container made from a coffee can. Stiff wire, run through holes punched in the edge, gives you a place to wipe the brush without having paint running down the

outside. For touching up trim, Devoe Trim & Shutter Colors brush easily, cover in one coat.



When painting basement, test for dryness to insure good job! For walls: seal a 1-foot square of cellophane to wall with adhesive tape. No moisture droplets under cellophane after 2 days means okay to paint. For concrete floors: throw

down a solid rubber mat for 2 or 3 days. If no moisture is on underside, go ahead and paint.



Save time, temper, and paint remover! When removing paint from furniture, catch excess paint remover in can cover or shallow pan placed under furniture leg. Remover can be re-used and the work area will be kept clean. When repainting

furniture, be sure and use Devoe Mirrolac Enamel—it's easy to apply, leaves no brush marks, and is extremely fast-drying.



Splatter control! Now—no more splatter when you hammer the lid back on a paint can. Secret: place a cloth over lid to catch the splatter while you hammer. Another trick: punch nail holes in rim channel. Paint simply trickles back.

When repainting your house, use Devoe Wonder-1-Coat House Paint . . . gives 2-coat beauty and protection in just one coat, cuts repainting time and costs practically in half. Your Devoe dealer (in Classified Phone Book) will be glad to help you with all your painting needs.

**DEVOE
PAINT**

REPLACE YOUR OLD WORN
OUT CHUCK WITH A



- ENTIRE CHUCK BODY HARDENED
- JAWS NICKEL CHROME MOLY ALLOY STEEL
- INDIVIDUALLY TESTED FOR ACCURACY
- STURDY ONE PIECE CONSTRUCTION

SOLD BY HARDWARE DEALERS



SUPREME PRODUCTS, INC., 2222 S. Calumet Ave.
Chicago 16, Illinois
The chuck that lives up to its name... SUPREME

SAY YOU SAW IT IN
POPULAR MECHANICS



**KIT
BOAT
OWNERS**

SAVE with "Kits for Kits"

**FREE
CATALOG**
Specify boat kit,
size and make.

Buy all your marine paint, fittings and marine hardware in kit form and save dollars. Everything for your boat. Buy with confidence from the nation's most complete marine supply store.
SOUTH COAST COMPANY Since 1908
2212 Newport Blvd., Newport Beach, California

SPRAY WHITE

**NEW! EASY
WAY TO CLEAN
WHITE TIRES**

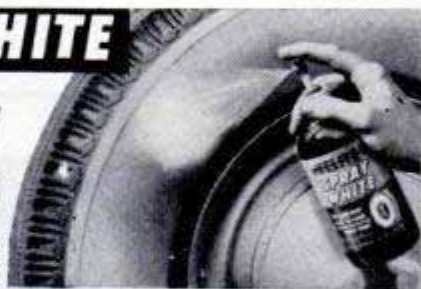

This amazing new compound (not a paint) gets dirtiest whitewall tires snowy-white-as-new! Just wet the tire, spray with SPRAY WHITE, swish suds around... and rinse. No scrubbing or abrasives needed. Harmless to hands, tires. Bottle cleans 50 tires: \$1.00, sprayer included, post-paid. MONEY BACK GUARANTEE.

\$1.00
PPD.
No CODs

DEALER & JOBBER INQUIRIES INVITED
KELITE PRODUCTS, INC., DEPT. P-4
Box 2917, Los Angeles 54, California

GOOD NEWS! THIS BEAUTIFUL VINYL-PLASTIC TILE FLOORING RESISTS GREASE, ACID, ALKALI YET COSTS YOU LESS!

MATICO ARISTOFLEX

The New Low-Cost Tile
Flooring Made of Vinyl—
The Wonder Plastic!

Costs Less To Begin With! Aristoflex—in economical standard gauge — is produced especially by MATICO to meet the needs of homeowners everywhere. It resists dirt, grease, acid and alkali... stays sparkling clean with occasional damp moppings... is quiet and comfortable underfoot... comes in 13 radiant Coronation Colors... lasts for years and years. Best of all, Aristoflex costs less than any other flooring of comparable quality... gives you far more for your money. See Aristoflex at your friendly MATICO dealer — he's listed in your local classified telephone directory!



install
ARISTOFLEX yourself
SAVE STILL MORE!

Yes, you can save \$25, \$30 or more on every room by installing Aristoflex yourself. It's easy, too, with MATICO's tested install-it-yourself method—special tool kit—and illustrated instruction booklet. And you can install Aristoflex in any room from basement to attic because it's rugged vinyl-plastic throughout — there's no felt backing to wear off or deteriorate.



**MASTIC TILE CORPORATION
OF AMERICA**

Member: Vinyl Flooring Institute
Joliet, Ill. • Long Beach, Calif.
Newburgh, N. Y.

3C99





Waterproof Belt for Fish Lures

Anglers carry their lures conveniently at hand when they "wear" them around the waist in a new waterproof carrier. Made of waterproof Velon, the carrier fits on an ordinary belt and has nine pockets of various sizes. Each pocket contains a waterproof plastic vial and the entire carrier weighs less than 10 ounces.

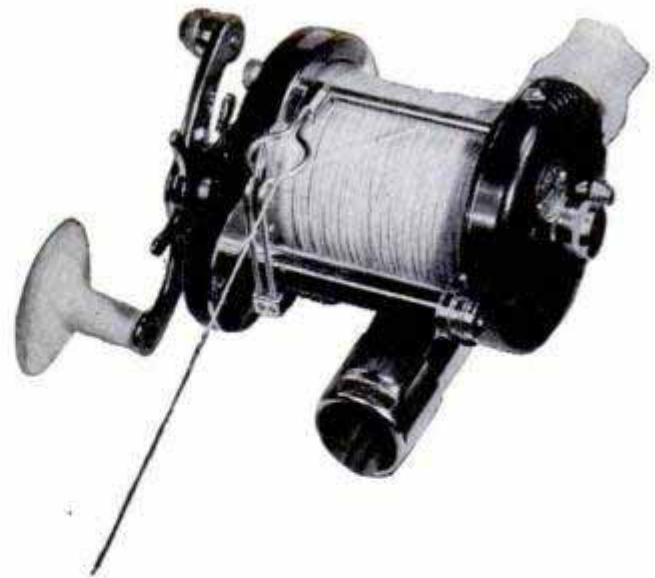

Stationary Line Guide Permits Easy Casting

Aiding casting distance, a simple line guide on a level-winding surf reel permits line to run unimpeded through a large eye in the guide during the cast. Stationary during casting, the guide traverses during the retrieving process. The line feeds back onto the spool through a narrow slot in the guide, lying down uniformly and cleanly. Prepositioning of the guide before casting is unnecessary.

A Craftsman's Gift for Father's Day!

DREMEL

STRAIGHT-LINE ACTION

SANDERS

Only DREMEL Offers All These Features:

WORLD'S FINEST FINISHING SANDERS — Patented Straight-Line Action sands with the grain of the wood—eliminates cross grain scratches and orbital swirls.

MORE SANDING SURFACE PER DOLLAR means more work done. Faster action (14,400 sanding strokes per min.); more than three times as fast as other type sanders!

POWERFUL, high-speed, Lifetime reciprocating motor (110 V. 60 cycle A.C.)

EASY, ONE-HAND OPERATION less tiring on vertical and overhead operations. Sands into corners—other tight places.

TROUBLE-FREE USE assured. Only two moving parts; never needs oiling. No armatures, brushies, gears or bearings to wear out and replace.

FREE SANDING GUIDE—A handy, 16-page "How-to-do-it" booklet containing helpful hints on sanding and refinishing procedures packed FREE with each Dremel Sander. Extra copies, 25c.

MAKE THIS REVEALING COMPARISON TEST
Sand a piece of wood by hand, using the four distinct sander motions shown below. Note how small scratches and swirl marks appear whenever the slightest cross-grain motion is used. Now compare these results with the beautiful, satin-smooth, absolutely scratch-free surface produced only by straight-line, with-the-grain sanding. You'll see why we guarantee professional-quality, scratch-free finishes. You'll be convinced that Dremel Straight-Line Action produces the results you want. Try it before you buy!

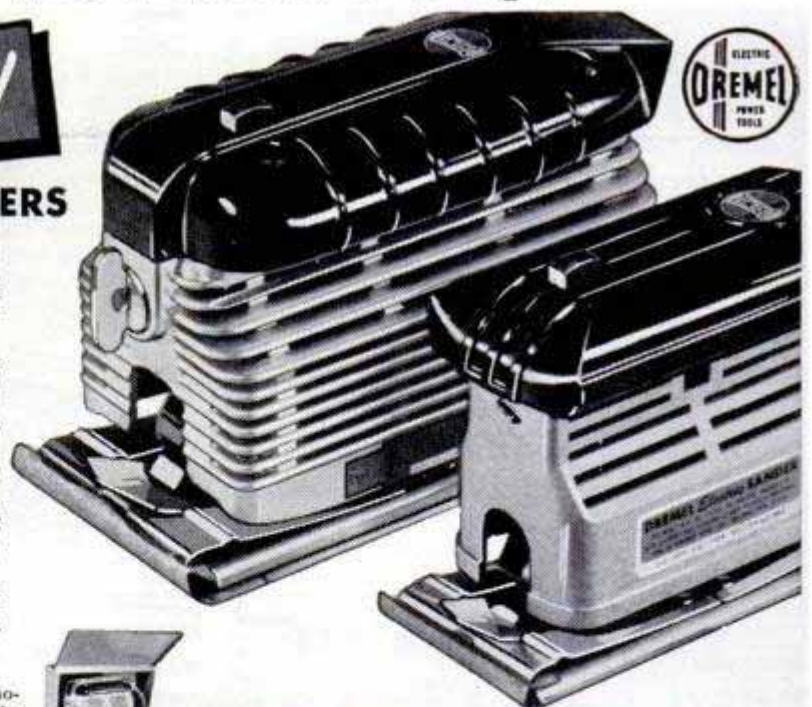

MODEL 2000
Heavy-duty model: 21 sq. in. (3 1/8" x 7") sanding base. Price includes sturdy steel storage case, 25 asst'd. abrasives \$24.50
1 polishing pad.

MODEL "A"
Hobby and household model sander, polisher, massager (above, right): 12 sq. in. (2 3/4" x 5 3/8") sanding base. Price includes 6 abrasives; 1 polishing pad, 1 massage pad. \$14.85

SEE YOUR LOCAL DEALER: Dremel Tools are sold at better dealers everywhere. If your dealer can't supply, order direct on a five-day trial, money-back guarantee. Remit in full, and we will ship postpaid. Or, send only \$2.00 now, pay postman balance plus postage and C.O.D. fee.

DREMEL MFG. CO. Dept. 113-F Racine, Wis.

AERO SHAVE LATHER BOMB

THE BIGGEST SHAVE NEWS IN 50 YEARS!



JUST PUSH VALVE
...OUT COMES
LATHER!

- Richer, Creamier Lather
- No Brush Needed
- No Greasy Cream
- 3 Beard Softeners
- Built-in Lano-Lotion



AERO SHAVE Lather Bomb



MAKE EXTRA MONEY installing ATTIC STAIRS

It's easy to make big money in your spare time installing nationally advertised Hollywood Disappearing Attic Stairs. No special training or tools needed. You need not invest one cent. Write today.

HOLLYWOOD DISAPPEARING ATTIC STAIRS
5627-A YALE BLVD. • DALLAS, TEXAS

Write today for complete **FREE** information

CASH IN YOUR SPARE TIME

UP TO \$40 A DAY IN YOUR OWN BUSINESS. Easy to start repeat cash business at home with the New BELSAW... sharpening and setting circular saws, grinding planer and jointer knives. Low Cost, only \$15 down... Start to work the day your BELSAW arrives. No experience needed. Hundreds of jobs in your neighborhood. Send Today for Free Book, "Lifetime Security".
BELSAW MACHINERY CO
3705 Field Bldg., Kansas City 11, Mo.



FREE BOOK TELLS HOW

Say You Saw It in Popular Mechanics

Need a Chimney?



INSTALL IT YOURSELF

Light weight, no foundation required. Shipped complete, all parts furnished.

SAFE. Underwriter listed—F. H. A. accepted—Bldg. Code approved. For gas, oil or coal in any type home. Costs third to half less than brick. Immediate delivery.

WRITE FOR FREE BOOKLET describing fully The Van-Packer Packaged Chimney.

VAN-PACKER CORPORATION
Dept. 15 • 209 S. LaSalle St. • Chicago 4, Illinois

MODERNIZE YOUR HOME

Do it Yourself at low cost with UPSON PANELS



CEILING CRACKED? Apply Upson Kuver-Krak Panels on furring strips directly over old plaster. In a matter of hours, you have a beautiful new ceiling that is forever crack-proof! No messy replastering! No visible face nailing... because Upson Kuver-Krak Panels are anchored from the back with "floating fasteners," which allow for normal structural movement.



NEED MORE ROOM? Build a storage wall (above)... finish your attic as an extra bedroom, study or playroom. Six-ply laminated Upson Strong-Bilt Panels are easy to work, take nails, screws, fixtures, saw like wood. One coat of paint covers beautifully. For ceilings, use 12-in. sq. Upson Ceiling Tile. Easily applied with matching color pins; washable with soap and water. Other Upson panels available in a variety of lengths, widths, thicknesses. Each marked for specific use.

Send 10c for 32 page Idea Booklet. Working drawings for storage wall included.



THE UPSON COMPANY
5116 Upson Point, Lockport, New York

I enclose 10c for 32 page Idea Booklet. Include working drawings for Storage Wall.

Name _____

Street _____

City _____ State _____

Owners Report on the '53 Buick V8

(Continued from page 122)

few of the cars had gone over 5000 miles, it was felt that this oil burning may have been due to slow wearing-in of piston rings. Here is the statement from Buick:

"In early production models of its new V8 engine, Buick used a slow-seating ring and during the break-in period the oil consumption in some cars was higher than normal. In many instances, this fault had corrected itself by the time the engine was broken in and the rings had seated themselves properly. Now Buick is using a faster-seating ring in order to avoid excessive oil consumption during the break-in stage."

Other complaints included:

"The 12-volt system burns out light bulbs fast."—Phoenix, Ariz., insurance agent, and others. (However, of all V8 owners, 79 percent reported they liked the 12-volt system.)

"The hood release is too close to the brake-release button. Several people who have driven my car have pulled the wrong button."—Northville, Mich., civil-service supervisor.

"To park the Super, I have to rotate the

steering wheel many more times than I did on the 1947 Buick."—Brooklyn, N. Y., store manager.

"The steering wheel and horn ring interfere with reading the instrument panel at a glance."—Sabraton, W. Va., molder.

"There is a hum in Dynaflow that sounds just like a car with the rear end gone."—Brooklyn, N. Y., Super owner.

"Would like to be able to see both front fenders."—Nebraska City, Neb., grocer.

"Step-on parking brake is added hazard in stopping and starting on hills, especially on conventional-transmission models."—Portland, Ore., Super owner.

"Step-on brake gets in the way of the dimmer switch."—Harlingen, Tex., pilot.

"Most important item overlooked is the very poor factory inspection. Over 75 percent of bolts, nuts, screws, etc., were loose."—Kenmore, N. Y., mechanical engineer. (This is a complaint common to all makes today, according to our Owners Reports.)

One interesting reply came from a Buick auto salesman in Illinois. He described the car he sells as "a solid car with good resale value," but said he would like "more change in styling" in his next car.

(Continued to page 234)

1953 BUICK SPECIFICATIONS

ENGINE

Type	Special	Super	Roadmaster
Bore and stroke	3 ³ / ₁₆ in. x 4 ¹ / ₈ in.	V8 OHV 4.0 in x 3.2 in.	V8 OHV 4.0 in. x 3.2 in.
Piston displacement	263.3 cu. in.	322 cu. in.	322 cu. in.
Brake horsepower	125 at 3800 r.p.m. standard 130 at 3800 r.p.m. Dynaflow	164 at 4000 r.p.m. standard 170 at 4000 r.p.m. Dynaflow	188 at 4000 r.p.m.
Compression ratio	7.0 : 1 standard 7.6 : 1 Dynaflow	8.0 : 1 standard 8.5 : 1 Dynaflow	8.5 : 1
Transmissions	3-speed conventional standard on Special and Super models, Dynaflow optional. Dynaflow standard on Roadmaster.		

GENERAL

Steering ratio (over-all)	29.0 : 1 standard 26.0 : 1 power steering	29.0 : 1 standard 26.0 : 1 power steering	29.0 : 1 standard 26.0 : 1 power steering
Steering, lock to lock	5.25 turns 4.85 power steering	5.25 turns 4.85 power steering	5.25 turns 4.85 power steering
Turning diameter	39.5 ft.	39.5 ft. 41.5 ft. Riviera Sedan	39.5 ft. 41.5 ft. Riviera Sedan
Brakes	Conventional hydraulic with riveted linings, 12-in. drums		
Tire size	7.60 x 15	7.60 x 15	8.00 x 15
Recommended tire pressure	24 lb.	24 lb.	24 lb.
Shipping weight (4-dr.)	3710 lb.	3905 lb.	4100 lb.
Wheelbase	121 ¹ / ₂ in.	125 ¹ / ₂ in.	125 ¹ / ₂ in.
Tread, front	59.1 in.	60.0 in.	60.0 in.
Tread, rear	59.0 in.	62.2 in.	62.2 in.
Height (4-dr.)	65.3 in.	64.8 in.	64.8 in.
Width (4-dr.)	76.0 in.	79.9 in.	79.9 in.
Length (4-dr.)	205.8 in.	207.6 in.	207.6 in.
Road clearance	6.8 in.	211.6 in. Riviera Sedan 6.8 in.	211.6 in. Riviera Sedan 7.0 in.

CAPACITIES

Oil	5.5 qt.	6 qt.	6 qt.
Water (with heater)	13.5 qt. standard 15 qt. Dynaflow	18 qt. standard 19.5 qt. Dynaflow	19.5 qt.
Gasoline	19 gal.	19 gal.	19 gal.

INTERIOR DIMENSIONS

Front-seat width	63.1 in.	64.5 in.	64.1 in.
Rear-seat width	63.4 in.	64.8 in.	64.3 in.
Headroom, front	35.5 in.	36.3 in.	35.6 in.
Headroom, rear	35.0 in.	35.6 in.	34.8 in.
Legroom, front	43.1 in.	43.2 in.	44.7 in.
Legroom, rear	41.5 in.	43.1 in.	43.4 in.



You'll Love STRUNK

(Chain saws - of course)

You'll love Strunk because it's designed for you—for anybody who's got wood to cut (and who hasn't?). Watch a Strunk turn trees into money-making logs, cordwood, fenceposts, or clear ground, trim trees, cut firewood for yourself. No other piece of equipment will pay for itself so quickly!

You'll love Strunk because you won't have to fuss with "gadgets" or complicated parts. The Strunk's reliable engine starts quickly, has a simple one-finger trigger control. Its 28 lbs. handle easily. Its rugged aluminum-and-steel construction will take all the hard wear you can give it! And the Strunk is priced for you—no other manufacturer offers such a top-quality 19" saw for such a low price! Write for our descriptive booklet. We'll tell you where you can buy a money-making Strunk Chain Saw, too!

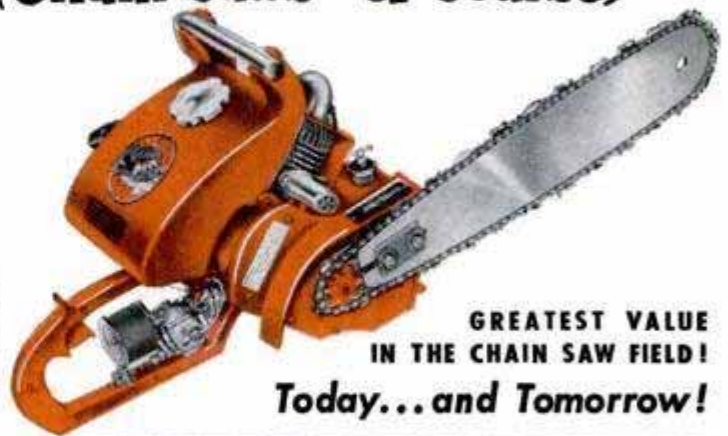

GREATEST VALUE
IN THE CHAIN SAW FIELD!

Today... and Tomorrow!

STRUNK CHAIN SAWS

STRUNK EQUIPMENT CO., Coatesville 15, Pa.

Please send me your booklet about money-making Strunk Chain Saws, and the name of my nearest dealer.

Name _____

Address _____

Town _____ State _____

Dealer inquiries invited.

MAGNETS

GENUINE ALNICO - NEVER WEAKENS

225 lb. PULL

AMAZING, PERMANENT MAGNETS—WILL NOT WEAKEN! NON-ELECTRIC
Retrieve guns, tackle, tools and other steel items from lake, river, plating tanks, drains or other hard-to-reach spots. Recover drills, taps, etc. from sweeping. Clear alley of harmful tacks, nails. Many other uses. Pays for itself quickly. **GUARANTEED.** Try any magnet one week. Money refunded if you are not well pleased.
No. M-725 (Weighs 54 oz.) Has pull of 225 lbs. on steel block. \$15.00
No. M-675 (Weighs 49 oz.) Has pull of 175 lbs. on steel block. \$10.50
No. M-650 (Weighs 41 oz.) Has pull of 150 lbs. on steel block. \$ 8.50
No. M-500 (Weighs 15 oz.) Has pull of 50 lbs. on steel block. \$ 4.00
No. M-30 Hobbyist assortment of six small magnets. \$ 1.50
Send Money Order or Check. We pay postage. No C.O.D.'s.
MIAMI MAGNET COMPANY, 3240 N. W. 27th Ave., Miami 42, Fla.

Take The "PAIN" Out of PAINTING!



Basements . . . Fences . . . Furniture . . .

USE A BECKER CO₂ SPRAY GUN

Completely self-contained—No "Extras" to Buy! Sprays: Paints, Oils, Varnishes, Insecticides, etc.

Men! Women! Here's the easy way to lick those tough, tedious, tiresome paint jobs. Becker Spray Gun is fun to use, requires no electricity or compressors—pressurized by low-cost CO₂ cartridges each sprays up to 21 oz. containerful. Used 5 years successfully in industry.

SEE YOUR DEALER! If he cannot supply, order direct for postpd. sht. Extra cartridges 10 for \$1.

SULLIVAN-BECKER CO.
Dept. 113-F • Kenosha, Wis.



ATR

for A.C. current
ANYWHERE!



STANDARD and
HEAVY DUTY

INVERTERS

For Inverting D. C. to A. C. ... Specially Designed for operating A. C. Radios, Television Sets, Amplifiers, Address Systems, and Radio Test Equipment from D. C. Voltages in Vehicles, Ships, Trains, Planes and in D. C. Districts.

See your folder in write factory



NEW MODEL
NEW SIZES
NEW LITERATURE

"A" Battery Rechargers, DC-AC Inverters, Auto Radio Voltmeters
AMERICAN TELEVISION & RADIO CO.
Quality Products Since 1951
SAINT PAUL 1, MINNESOTA—U. S. A.

TIME SAVING TIPS

ALL YOU NEED IS A TUBE OF

DU PONT DUCO CEMENT

REG. U.S. PAT. OFF.



CAMERA EXPOSED? Peeling leatherette on cameras, binoculars and other equipment can be mended like new with "Duco" Cement.



TORN BASEBALL MITTS can stay in the game longer when leather is repaired with strong, flexible "Duco" Cement.



RIDING A HOBBY? Maybe you make toys, scale models—build 'em for the fun of it. Use fast-drying "Duco" Cement.



CRACKED LENSES on flashlights will hold fast until they're replaced, when you mend them with transparent "Duco" Cement.



LEAKY AQUARIUMS call for quick, dependable repairs. A dab of waterproof, transparent "Duco" Cement seals leaks easily.



TORN WALLPAPER need not be a household catastrophe. Just mend it neatly, quickly with handy "Duco" Cement.



LEAKY TENTS can spoil camping fun. Waterproof, flexible "Duco" Cement seals tiny holes... prevents them from enlarging.



REPLACE FELT on bases of candlesticks, vases, and bric-a-brac—to protect finish of tables. Use Du Pont "Duco" Cement.



A HOUSEHOLD FAVORITE FOR 25 YEARS



BETTER THINGS FOR BETTER LIVING
... THROUGH CHEMISTRY

This Chaise is easy to build



NO SPECIAL SKILL OR TOOLS NEEDED!

For comfort under the sun or in the shade, it's easy to build this Chaise on Wheels. Easi-Bild* full-size Pattern No. 324 simplifies building Chaise from Weldwood Exterior Plywood. Be sure—use Weldwood for years of lasting service.

By building it yourself you save more than half retail costs. No special skill or tools required. Trace the Pattern on Weldwood, saw and assemble.

SEND 35¢ IN CASH OR MONEY-ORDER FOR BUILD-IT-YOURSELF CHAISE PATTERN NO. 324. SEND 35¢ ADDITIONAL FOR 32-PAGE PATTERN BOOK, ILLUSTRATING OVER 170 OTHER PATTERN PROJECTS.

TO: UNITED STATES PLYWOOD CORPORATION
PATTERN DEPARTMENT • P. O. BOX 215, PLEASANTVILLE, NEW YORK
WORLD'S LARGEST PLYWOOD ORGANIZATION

*T.M. Reg.

Hunter Screw Holding Screw Driver

HOLDS SCREW AGAINST 30 lb. PULL!

STARTS THE SCREW ...
DRIVES THE SCREW ...

... in most difficult places. No projections—nothing wider than screwhead. Fully automatic mechanism all internal. Illustrated, standard size—8 1/4" long, .040 thick point for #7 to #10 slots, shock proof plastic handle. 7 other basic sizes available. Satisfaction or refund. Send today, Dept. H.



\$1.98 POSTPAID

HUNTER TOOLS

HUNTER TOOLS

BOX 7395 LUGO STATION • Los Angeles 23, California

DO 8 HOURS WORK IN 15 MINUTES

Edge Your Lawn with an RMC Lawn Edger

Takes the drudgery out of lawn edging. Heat-treated, retractable blades give a clean cut along straight or curved edges. Rugged, well-designed unit is so easy to handle that a child can operate it. Tested for five years by commercial gardeners and fully guaranteed.

Free Literature

Write today for information on the ONE edger that's guaranteed to save you time and money in caring for your lawn.

MODEL 500
\$124.50
F.O.B.
HOUSTON



Shipping Weight 62 lbs.

LAWN EQUIPMENT SALES CO.
2030 Westheimer • Houston 6, Texas

TRY **MONTA MOWER**
on YOUR OWN LAWN
on *Approval!*
8 1/4 LBS.



TRIMS AS IT MOWS!
VASTLY IMPROVED, NEW 1953 MODEL

Amazing new-type cutting discs save time and labor! Actually "Two-Tools-In-One", the versatile MontaMower is an amazing work saver! Try it on your own lawn, on approval, for an extended trial period. Its live, precision mechanism first gathers, then smoothly cuts a clean 16" swath through grass, dandelions, tall lawn weeds. Cuts right up to walls, fences, trees and under over-hanging shrubs... practically eliminates hand trimming! Cuts steep banks easily! Cutting discs are now both Self-Cleaning and Self-Sharpening. Drive shaft mounted on permanently lubricated, sealed bearings. Hundreds of thousands in use. Buy direct from factory and save. Owners Cooperation Plan can repay cost. Write today for full details on limited "Special Price... Extended Trial Offer". Sold Direct Only.

MONTAMOWER DISTRIBUTING CO.
P.M.36 KEELER BLDG., GRAND RAPIDS 2, MICH.

RETAIL PRICE \$125.00
FACTORY TO YOU \$79.95

SUPERSHOP includes precision-built 8" tilting table saw, vertical and horizontal drill press, 30" lathe, sander, grinder. 100% BALL BEARING. Write for FREE catalog, full details, trial plan. Easy Pay Plan.

POWER TOOLS, INC.

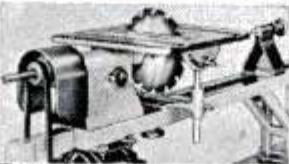

148 YATES AVENUE
BELOIT, WIS.

SILVER SOLDER TORCH & KIT \$7.95
JOINS ALL METALS PERMANENTLY



Do your own repairing. KIT includes one tube silver solder paste and 10 5-in. lengths silver solder alloy. Hot-test ALCOHOL TORCH known. 2700° F. flame. Operates in any position, indoors or out. Pint of special fuel included. Complete outfit ready for use \$7.95 postpaid. TORCH alone with pint of special fuel \$6.85. KIT alone \$1.65. Instructions included.

AMERICAN PRODUCTS CORP., 422 S. Dearborn, Dept. 3-F, Chicago

SET-UP - KNOCKDOWN SAWHORSE with *Jiffy* BRACKETS



No nails or bolts... use 2x4's for legs. 2x4 or wider for crossbar. Rugged, sturdy, easy to move, saves storage space. Sold by hardware and building material dealers, or order direct.

GRAND HAVEN STAMPED PRODUCTS CO., Grand Haven, Mich.

Say You Saw It in Popular Mechanics

boost your income with the

IDEAL LAWNMOWER SHARPENER

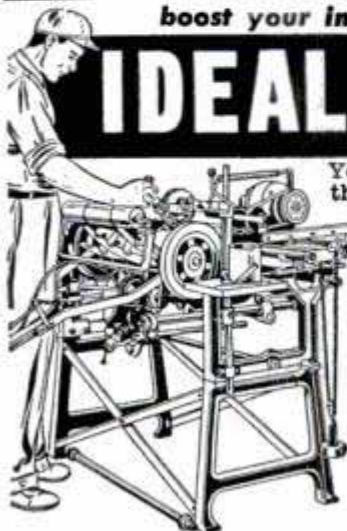

You can earn extra cash with the Model 300 Ideal Lawnmower Sharpener. Used and recommended by leading manufacturers and service shops, the Ideal has everything you need, nothing else to buy. Grinds reel and bed knife, also reconditions. Get started now in this highly profitable business. Write for catalog today.

The Fate-Root-Heath Co.
Dept. PM-6, Plymouth, Ohio

you'll be money ahead when you discover

**THERE IS A
DIFFERENCE IN
HOUSE PAINTS!**



In this age of scientific progress you are entitled to house paint on your home that provides the *maximum* in lasting beauty and protection. Sherwin-Williams makes SWP House Paint in only *one* grade... the best we know how to make. You benefit four ways when your home is painted with SWP...

 **1. LASTING BEAUTY**—When you paint with SWP House Paint in 1953, you can expect longer lasting beauty than ever before.

 **2. MAXIMUM PROTECTION**—Building and repair costs today are the highest in history. You want to protect the investment you have in your home. SWP House Paint will give it greater protection than ever before.

 **3. LOW COST - PER - YEAR**—The real cost of painting your house is determined by how often you must re-paint it. You will find that you have to paint *less frequently* when SWP House Paint is used.

 **4. ASSURANCE OF QUALITY**—More homes have been painted with SWP since 1880 than any other brand of house paint. Constant research has kept SWP the world's standard of house paint quality.

Why risk disappointment when you are sure of satisfaction if SWP House Paint is used? There are substitute house paints that sell for less than SWP, but don't let that fool you! *Insist upon SWP, and be sure!*

Write for the free booklet, "The Truth About House Paint"... The Sherwin-Williams Co., 1205 Midland Building, Cleveland 1, Ohio.

Go to the store that displays
this famous trademark...:

**SHERWIN-WILLIAMS
HOUSE PAINT**

© The Sherwin-Williams Co., Cleveland, Ohio



SW-5311

YOU can make ANY belt driven

★ **TOOL**

★ **MACHINE**

★ **or APPLIANCE**

WORK BETTER

for only
50¢



V-belts all start slipping eventually, get squeaky and noisy and fail to deliver FULL POWER from the motor. This slippage is caused by a hard "glaze" that forms on the belt. Cling-Surface dissolves this glaze, returns the belt to its original pliable condition and makes it LAST MUCH LONGER.

Slipping belts on home workshop tools can put nicks and gouges in valuable projects. Slipping belts on cars, washers, dryers and furnace blowers get squeaky and noisy. On your power mower or snow plow, slipping belts only deliver part of the power of the motor and make your job harder to do. NOW . . . you can treat all these belts with one can of Cling-Surface.

Get it at your service station,
auto parts or hardware store.

MONEY BACK GUARANTEE

There were many V8 owners, of course, who had no complaints. Some even went further and complained that the Buicks were getting too good! For example, a restaurant owner in Flushing, N. Y., wrote that her complaint was "that they make them prettier every year and I have to keep changing them every year to keep up with the style."

Among the Buick Special owners, complaints were infrequent. The well-tested straight-8 engine has few faults for them. The most frequent complaint was poor gasoline mileage, but that is common for almost all cars.

There were complaints about the small back seat in two-door models. Here is one from a Chrisman, Ill., bank teller: "My car is a two-door hardtop; back-seat room is the same size (very, very limited) as some of the 'dwarf' cars on the market."

Dynaflow noise was also mentioned by a number of Special owners. Another complaint is summed up by a South Dakota retail merchant who is "finding it somewhat difficult to accustom myself to rapid engine speed compared to slow getaway from standing start with Dynaflow."

Poor vision to the rear with the rear-view mirror was also a complaint of some owners of all models.

"I don't like the rear window as you have a hard time seeing a car any distance behind unless it gets right up to your car."—Wisconsin insurance salesman.

"Defroster for the rear window."—Canton, Ohio, mechanic.

"Make the glove compartment more accessible to the driver—possibly in the center of the dash."—from an Evanston, Ill., insurance man.

A number of owners wrote that a light should be added to the Dynaflow selector quadrant.

"Better rear springs. In the '53 models they hold the car too high when it is empty and too low when it is loaded."—Kewanee, Ill., distributor.

A Detroit arc welder wrote: "My Special has tremendous pickup and power and it handles well in traffic or on the road. My only complaint is that road noises seem to telegraph into the interior through the steering column or firewall. The car could be better insulated in the cowl or floor."

Power-steering owners were asked if they felt the accessory was worth the added cost now that they have been using it. As mentioned above, an amazing 21 percent said it was not worth the cost.

There were many others who were enthusiastic about the device. A Coral Gables, Fla., merchant said: "I personally believe

(Continued to page 236)

STOP CHANGING MOTOR OIL!

End this needless expense forever with

RECLAIMO Today's most advanced OIL RE-REFINING filter FOR CARS, TRUCKS, TRACTORS.

Continuously cleans and RE-REFINES motor oil as you drive by utilizing motor heat — keeps oil in high grade lubricating condition at all times.

"RECLAIMO"

- REMOVES SOLIDS (by filtration)
- REMOVES WATER (by distillation)
- PREVENTS Excess fuel dilution
- PREVENTS Acid and Sludge Formation
- ADDS Thousands of Miles to Engine Life

MAINTAINS Stable Viscosity **ELIMINATES** All Oil Changes
 FREE 32-page book "OIL FACTS" with bonafide \$1,000.00 offer on page 30). Gives you the complete "Reclaimo" story and details of our extraordinary 90-DAY NO-RISK TRIAL OFFER. Write for your copy today!

RECLAIMO MFG. CO., INC.

5083 Elston Ave., Dept. M-6, Chicago 30, Ill.
 Wm. Schwalge, U.S. Pats. 1757223, 1834654, 2068473.

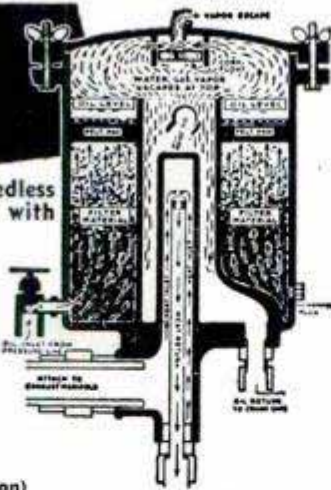

DEALERS WANTED

U. S. BUREAU OF STANDARDS, Bul. 86
 States, "Oil does not wear out mechanically."

CHOOSE FROM PROFESSIONAL QUALITY

WESTCRAFT TOOLS

AT WESTERN AUTO

UNMATCHED

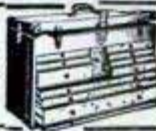

Beauty of appearance and skill of construction are the sure marks of genuine Gerstner Chests. Free Catalog.

GERSTNER TOOL CHESTS
 453 Columbia St., Dayton 7, Ohio



Clark EXPANSIVE BIT

CUTS BETTER • COSTS LESS!

Accurate, fast; cuts smooth holes in hard or soft wood. Chrome vanadium steel blades, all chrome body. No. 250, 1/2"-1 1/2", \$1.89; No. 251, 7/8"-3", \$2.19. GUARANTEED. At your dealer or write Dept. PM6

ROBERT H. CLARK COMPANY • Beverly Hills, California

Say You Saw It in Popular Mechanics

ROTO-HOE

America's Most Usable Garden Tool

Now You Can ENJOY Gardening!

You'll find fun and healthful relaxation in gardening with ROTO-HOE. It was first and it still leads with a quality front-tiller power garden tool at a reasonable price. You can still buy this tested, proven tool at the low, low 1947 price!

Inexpensive attachments give you year 'round usefulness—extra dividends on your ROTO-HOE investment. Thousands of satisfied customers swear by ROTO-HOE quality and satisfaction. Write today for free illustrated color folder and name of nearby dealer.

Useful All Year Around Complete Interchangeability

2 h. p. (as shown) only \$134.

ROTO-HOE & Sprayer Co., Box 19, Newbury, Ohio

Take The Monroe

30-DAY FREE RIDE!



Prove Your Car Rides Better Than New with

MONRO-MATIC

SHOCK ABSORBERS*

If your car rides rough, shows uneven tire wear, is hard to steer on curves, chances are your shock absorbers need replacing . . . 2 out of 5 cars need new shocks. Monro-Matic shocks give you a smoother, safer ride on any road—longer car life—increased tire mileage. If not convinced in 30 days Monro-Matics make your car ride better than new, your money refunded. See your Monroe dealer today!

Send 10¢ FOR NEW SHOCK ABSORBER MANUAL

Informative, instructive, tells the right shock for your car. Detailed instructions for removing old worn shocks, installing new. Send only a dime to cover handling cost.



Automatically adjusts to all road and load conditions.

MONROE AUTO EQUIPMENT CO.

Monroe, Michigan • Dept. D

World's Largest Maker of Ride Control Products

Hints on How to Refinish Furniture

Step 1. Remove old finish—quickly, easily, with fast-acting Strypeeze. Brush on, let it set . . . off comes the old finish. (hint: sprinkle sawdust over Strypeeze. "Roll off" sawdust, Strypeeze and old finish.)

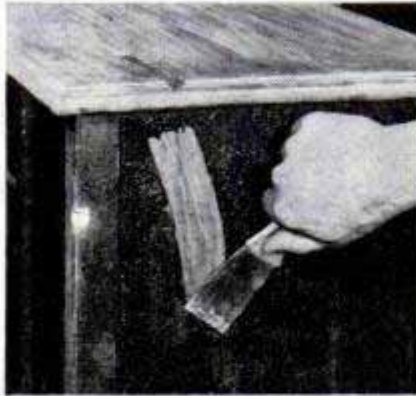

Step 2. Fill all holes, nicks — permanently and simply with Savogran Wood Putty. Tools easily, won't shrink. Now, sand entire surface with 6/0 sandpaper. (For cracks in plaster, use Savogran Crack Filler. It's the original patented quick-hardening water putty.)

Step 3. Refinish—before you start, be sure brush is clean. Savogran Kwikleeze really cleans varnish brushes. Leaves no specks of old varnish, dirt in brush to mar finish. Apply stain, thinned shellac seal, then spar varnish or dull "rubbed effect" varnish in finishing.



SAVOGRAN

PRODUCTS . . . at better paint & hardware stores
Write for free helpful literature
 SAVOGRAN CO., Dept 36, 25 Huntington Ave., Boston 16, Mass.

power steering is the finest improvement made for the motoring public. It takes the labor out of driving a heavy car."

Another plug for power steering came from a soldier stationed in Kansas: "Ease of parking is well worth the additional cost."

But there were some who were not satisfied with the hydraulic steering aid. Here are some of the reasons why they felt it was not worth the added cost:

"Too sensitive on corners." — Chicago businessman.

"Too much noise." — Ridgewood, N. J., accountant.

"Will not straighten out after turning." — Lima, Ohio, businessman.

Average gasoline mileage, according to the owners, is 13.8 miles per gallon for the Special and 12.2 miles per gallon for V8 models in city driving. In country driving, the averages are higher, of course. Owners report 17.0 miles per gallon for the Special and 15.5 miles per gallon for the Super and Roadmaster V8s.

Only two percent of the Special owners said they would not buy another Buick; seven percent of the V8 owners said they would not.

And now for my own test: I drove a Super V8 test car from the factory in Flint, Mich., to Denver, Colo., via Kansas City, a distance of 1525 miles, which included side-road testing en route and still more tests in another Super in California. The models used were four-door sedans.

The Super's new Fireball overhead-valve V8 engine develops 170 horsepower at 4000 revolutions per minute. (The Roadmaster boasts a 188-horsepower V8.) The engine is "over square" inasmuch as the diameter of the bore (4.00 inches) is larger than the length of the stroke (3.20 inches). Such a design lessens travel and wear on pistons and rings.

I gave the Buick a beating for most of the distance. It is a brute for punishment and a car that handles exceptionally well. It has lots of zip due to the combination of the new V8 engine and Twin-Turbine Dynaflo. I rate it as one of the three fastest United States stock cars. A top speed of 113-115 miles per hour by speedometer was hit. Buick's speedometer, like all installed today, is fast by about 8 percent at top speed. Once top speed is reached you can back off on the throttle to about 75 percent opening and still loaf along at 100.

The car was equipped with Buick's power steering. As with all power steering, one is inclined to oversteer (turn the wheel too much), but Buick's has about four pounds' pressure when driving in a straight line and gives a positive feel of the road. Another

(Continued to page 238)

FIRST

*to meet demands
of today's
high powered engines*

Gives you

QUICK STARTS

DOUBLE LIFE

SMOOTHER

PERFORMANCE



First Resistor-Type Spark Plug APPROVED AS ORIGINAL EQUIPMENT by leading car manufacturers.

AUTO-LITE SPARK PLUGS—PATENTED U.S.A.

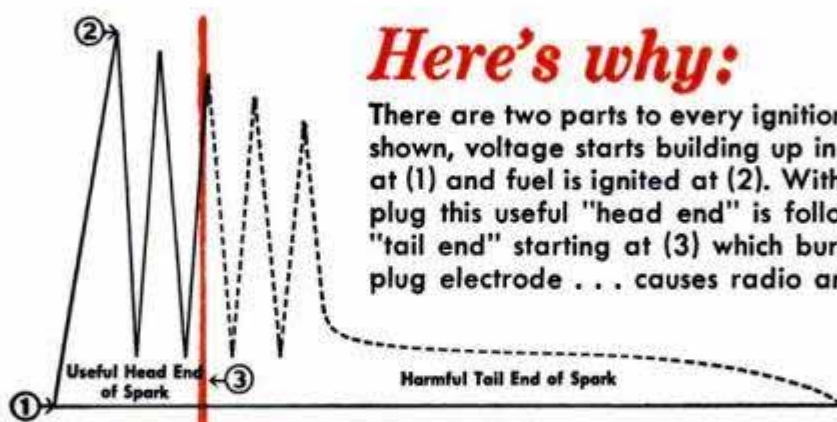

Here's why:

There are two parts to every ignition spark. In the chart shown, voltage starts building up in the ignition system at (1) and fuel is ignited at (2). With an ordinary spark plug this useful "head end" is followed by a harmful "tail end" starting at (3) which burns away the spark plug electrode . . . causes radio and TV interference.

With the ignition engineered Auto-Lite Resistor Spark Plug there's this difference. The built-in resistor controls the spark. Voltage starts building up in the ignition system at (1), delivers a super-spark to ignite the fuel at (2) for quick starts and smoother performance. But it filters out the harmful "tail end" spark from (3) on to eliminate radio and TV interference . . . protects electrodes to double spark plug life.

Tune in

"SUSPENSE!"

CBS Radio Monday

CBS Television Tuesday

Auto-Lite RESISTOR Spark Plugs are one of a complete line of spark plugs

There is **ONE**
SURE, SAFE Way
 to repair an innertube

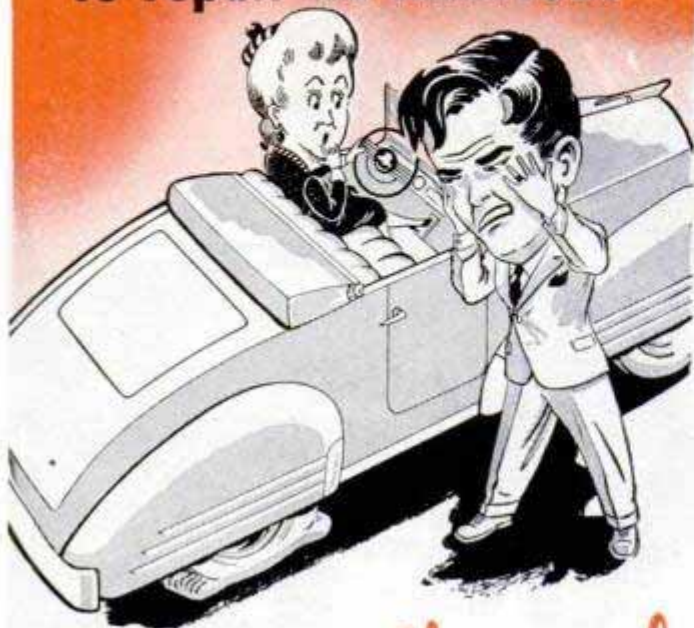

BOWES *Chemical*
PROCESS
TUBE REPAIR METHOD

• There are other methods of tube repair . . . the "cold patch" . . . the "vulcanized patch" . . . and . . . in most cases they work—but

**If You Want the ONE SAFE,
 SURE METHOD . . . Drive In
 Where You See BOWES
 This Emblem . . .**



• When you go to a station that displays the BOWES emblem, you are assured of *Sure, Safe* Tube repairs by the BOWES Chemical Process tube repair method.

Don't take chances . . . look for the BOWES emblem and be **SURE** of **SAFE** tire repairs.

BOWES "SEAL FAST" CORP., INDIANAPOLIS 7, IND.

feature of the Buick is that the wheels straighten themselves after turning a corner. The 4.85 turns of the steering wheel from lock to lock with power steering should be cut to about 4 turns.

Power steering is fascinating to drive and, while many still prefer a car without it, it is here to stay, especially on heavier cars.

For a large American car, the Super handled well on corners. There seems to be less "sponginess" or roll when cornering than in previous Buicks I have tested. The rear end, with torque tube and coil springs, still hops around a little in high-speed cornering. And the tendency to hit bottom on hard bumps when fully loaded is still a Buick characteristic. As regular readers know, I prefer leaf rear springs, although thousands of owners like Buick's rear-end design with its coil springs.

The torque-tube drive transmits the thrust of the wheels directly to the frame of the car, not through the rear springs as in Hotchkiss-drive design. Certainly this makes for a strong rear end, though at times one can feel the movement of the unsprung weight of the torque tube and radius rods that brace the rear axle and torque tube in a rigid T-square lockup, keeping the rear wheels always in true alignment.

The Dynaflow torque converter is greatly improved for 1953. The Twin-Turbine gives faster torque multiplication, and acceleration is much better than in previous years. Coupled to the V8 engine, this unit has increased acceleration from 15 to 26 percent at different speeds from zero to 40 miles per hour over the previous underpowered Super. Dynaflow is the smoothest of automatic transmissions with no evidence of gear changes in acceleration or deceleration.

There still is some "mushiness" when accelerating from zero to 35 miles per hour. However, it is less than in earlier models. This mushiness or slippage is magnified by a rather loud hum during acceleration. Actually, the driver is being fooled. The car is gaining speed much faster than it seems to be (see acceleration chart). Because there is no positive lockup while accelerating, there isn't the sensation of a quick take-off.

Dynaflow drivers can use the transmission for braking when descending steep hills. Place the lever in Low. Even at high speeds there is no downshift jerk when you make the shift as there is in some units.

Dynaflow is so popular that 87 percent of the Buicks for 1952 were so equipped and 82 percent of 1953 owners answering our survey own Dynaflow models.

(Continued to page 240)

All Mufflers are NOT Alike

SILENTONE

gives you

- ★ Safety
- ★ Power
- ★ Long Life
- ★ Up to \$8⁰⁰ Savings

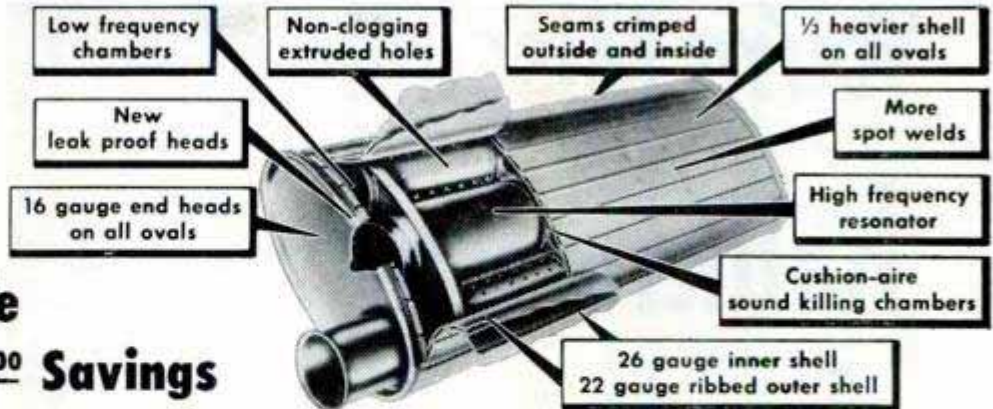

These features show why Silentones are the highest quality mufflers. They're made to car factory specifications or better • scientifically designed to lower back pressure which robs your engine of

power • made of heavy steel inside and out. Because Silentone Mufflers are sold only through leading automotive chain stores, you save as much as \$5.00—up to \$8.00 if you install it yourself.

DYNATONE

The Deep, Mellow Tone Muffler That's Engineered—Not Packed

Tuned for each make of car . . . costs less than "Hollywoods" • lower back pressure • more

gas mileage • longer life. Ask about Dynatone duals for greater power and gas savings.

Write Dept. 27-F for name of your nearest Silentone dealer

SILENTONE

SOLD ONLY BY AMERICA'S LEADING AUTOMOTIVE CHAIN STORES

TOLEDO 1, OHIO

How a New GRAPHIC Can Pay For Itself!

Big Opportunities for Extra Money!

Owning a Graphic marks you as a man who is out of the "snapshot class". . . a man who knows the secrets of making great pictures. With it you can earn enough in your spare time to pay for the camera itself. In fact, a Graphic opens wide the door of opportunity in the profitable photography profession.

That's because it's a professional, precision camera built to take clear, sharp, professional quality pictures. No matter in what exciting branch of photography you're shooting—news, fashion, advertising, portrait, industrial—you'll find your Graphic gets the pictures that get the money.

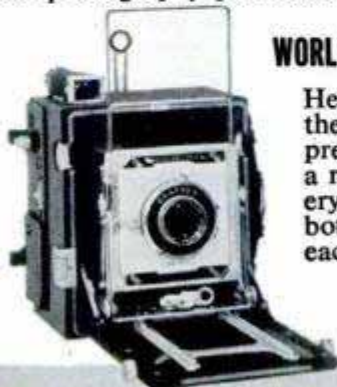

WORLD'S FINEST PROFESSIONAL CAMERA!

Here's the only camera that's passed the acid test of daily use by 95% of press photographers. It's the Graphic, a rugged dependable performer on everything from action to portraits. See both the Speed and Crown Graphics—each in three sizes—and the Century Graphic now only \$108 with color corrected f/4.5 lens.

Prices subject to change

GRAFLEX®

Prize-Winning Camera

Graflex Inc., Dept. 23A
Rochester 8, New York

Please send me the new FREE 48-page GRAFLEX booklet.

Name _____

Street _____

City _____

County or Zone _____ State _____

Hear What You're Missing

Get a hallicrafters



Enjoy the thrills of short-wave at down to earth prices. Now, for no more than you'd expect to pay for an ordinary radio, you

hear regular broadcasts plus London, Paris, Moscow — ships at sea, aircraft and police calls — amateur broadcasts, emergency frequencies — and much more.

These are radios made by Hallicrafters, for years the leading manufacturer of precision communications equipment for the armed services, and for years the favorite of America's ham operators. Write for FREE information on the Hallicrafters line of outstanding receivers and transmitters.



HALLICRAFTERS
MODEL S-53A—Only \$89⁹⁵

hallicrafters

World's Leading Manufacturer of Precision Radio
Communications Equipment for the Armed Forces

Hallicrafters, Dept. PM-63, 4401 W. Fifth Avenue
Chicago 24, Illinois

Please send me complete information on Hallicrafters Short
Wave.

Name

Address

City State

There should be a light on the indicator quadrant for night driving to show the position of the lever. Low and reverse positions are next to each other, which makes it easy to rock the car in snow or mud.

The Dynaflo-equipped Buick Super has a 322-cubic-inch engine with a compression ratio of 8.5 to 1, higher than ever before. The valves operate vertically instead of at an angle as in typical modern V8 design. The car pings quite a bit on regular gas, which I used for about 800 miles. Premium gas should be used for best performance in the V8. Considering the size of the engine, the weight of the car and the speeds at which I traveled, Buick's gas economy is not bad. Dynaflo owners can waste gas by improper use of the throttle. For quick pickup from zero to 40, it is unnecessary to open the throttle wide. To do so wastes gasoline. The car will take off almost as fast if the driver pushes the throttle wide open for a few feet and then backs off half way.

The hypoid rear-axle ratio of 3.6 (3.9 on regular-transmission models) gives the car a nice cruising ratio, comparable to that of overdrive in some other makes. Hydraulic valve lifters help reduce engine noise.

Despite the complaints of many owners, I found no great oil consumption. I added only one quart of oil on my test of over 1500 miles. Not bad for a new engine!

All 1953 Buicks except the Special have a 12-volt electrical system. The increased voltage gives a hotter, faster spark for high-compression performance and is better suited for the accessory electrical load of modern cars, such as radio, heater and defroster fans, clock and electric windows, to name a few.

The brakes could have a little more pedal "cushion." I am glad to see that a wider brake pedal is used, as I objected to the narrow one when I tested the 1951 Buick. I would rate the brakes as average. With ever-increasing top speeds, engineers should do something about reducing brake fade. Better brakes must come on all makes of cars. Even though power braking makes for easier pedal movement, it is not the answer and something must be done at the wheels to increase braking efficiency at high speeds—and I am not referring to Buick specifically. Brakes are no better on American automobiles today than when cars were 20 miles per hour slower.

Buick continues its unusual step-on parking brake lever that is operated by the left foot. Once accustomed to it, I prefer it to a hand-operated brake. The Buick driver has two foot brakes in an emergency and while using them he can keep both hands on the wheel. The release for the parking brake

(Continued to page 242)

**RELIEVES
HEADACHE
NEURALGIA
NEURITIS PAIN**

FAST



Here's Why...

Anacin® is like a doctor's prescription. That is, Anacin contains not one but a combination of medically proved active ingredients. Anacin is specially compounded to give **FAST, LONG LASTING** relief. Don't wait. Buy Anacin today.



ELECTRIC WELDER AC or DC 110 Volts

The "Little Marvel" all-metal welder. 5-year written guarantee. Welds 1/8" metal or money back. Repairs tanks, tools, fenders, machine parts, etc. Complete with everything—rods, unit, eye shield, directions.

\$6.45 postpaid. Flame torch accessory for soldering, cutting, brazing \$3.45 complete with carbons, brass rods, flux. On C.O.D. postage extra. Buy direct and save.

ESSAY MFG. CO., Dept. 51, Quincy 69, Mass.

\$6.45
Complete

**SOUTH BEND LATHES • SHAPERS
DRILL PRESSES**



Send for catalog on Lathes (9" to 16-24"), Shapers or Drill Presses. **SOUTH BEND LATHE** South Bend, Ind.

Say You Saw It in Popular Mechanics

**MODERN
LAWN MOWER
SHARPENER**

Service departments of leading Lawn Mower manufacturers use the Modern Lawn Mower Sharpener. One lever moves lawn mower into grinding position. Gasoline and oil remain in engine while sharpening, no dismantling of wheels, roller or handle. The Modern is a precision bed knife grinder—no extra grinder to buy. Imitated but never equalled—Compare before you buy. **If it isn't a Modern it can't be Modern**

(Prices subject to change without notice)

MODERN MFG. CO.

160 N. Fair Oaks - Pasadena 1, Calif.

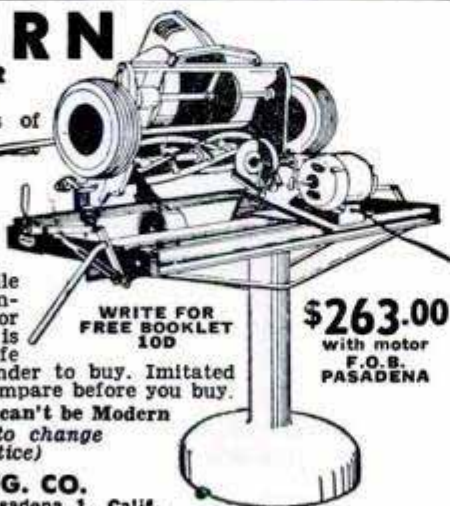

WRITE FOR
FREE BOOKLET
100

\$263.00
with motor
F.O.B.
PASADENA

LOW SPEEDS! HIGH SPEEDS!

**Performance
means TIMING!**

—at 5000ths of a second and less per hot spark!



Tune 'er sharper!

SMOOTH OUT YOUR ENGINE

with plus-built

NIEHOFF

warranted IGNITION PARTS

—the parts master mechanics install in their own cars

Discover the *difference* these units can make in restoring your tired motor to NEW-MOTOR efficiency. Precision built to fit all popular makes of cars, trucks, buses, Niehoff parts carry that extra wallop that boosts motor *energy* to racing performance.



**See Your Nearby
NIEHOFF DEALER**

for a tune-up—NOW

There are more than 42,000 Certified Niehoff Dealers in the U. S.—one near you. Make him your friend. He knows ignition and he'll treat you right. Look for the Niehoff Service sign.

**WHEN NEW IGNITION PARTS ARE NEEDED,
REPLACE WITH PLUS-BUILT NIEHOFF PARTS**

New Panoramic Folder FREE

MAIL COUPON NOW



C. E. NIEHOFF & CO.
4925 Lawrence Ave., Chicago 30, Ill.

I'd like free illustrated folder giving details on Niehoff Ignition

Name _____
Address _____
City _____ Zone _____ State _____

How to get more mileage out of your motoring dollar



CHECK OIL PRESSURE

Glance at your oil gauge when starting engine, and at intervals while driving. Below-normal reading may indicate

leakage, very dangerously low oil level, or pump trouble. Stop before lubrication failure seriously damages your engine! *Warning:* Your oil gauge can register "normal" even though crankcase oil level is below danger mark.

Check the oil level whenever you gas up.

Oil level is as vital as oil pressure; and *only* the dip stick shows you if there's plenty of oil in the crankcase. Oil consumption varies with speed and temperature; and there's always the possibility of leakage. To be safe rather than sorry, check dip stick frequently.



CHECK OIL LEVEL

Keep a clean Purolator* Refill on the job.

You need a good filter to keep the road dust, hard carbon and sludge that get into the oil stream from harming delicate engine parts. In time, your filter loads up . . . gets so clogged it can't keep up its money-saving



CHECK OIL FILTER

work. *Before* that happens, get a new Purolator Micronic*—with 10 times more filtering area than ordinary types. Purolators are specified on more makes of cars than any other filter. Refills cost as little as \$1.60 . . . take just a few minutes to install.

*Reg. U. S. Pat. Off.

Check your oil filter every time you change your oil

PurOlator
World's finest OIL FILTER



is too close to the hood-lock release lever.

There has been little change in the Fisher body, which is tight and solid. No squeaks or rattles developed during my test and I found no water leaks. Buick's sweepspear body style, with lots of metal and chrome, does have some practical value in a parking lot when the owner of an adjacent car swings his door recklessly.

The parking and directional lights in front have been moved from the vulnerable spot in the bumper to a location just beneath the headlights. Backup lights remain in the bumper.

Buick's 1953 hood is long and rather high by modern standards and now opens from the front in conventional manner. I prefer this arrangement to the side-hood opening on previous Buicks.

In my previous Buick report I mentioned a dislike for a left-hand-operated switch key. I am glad to see that the key is now operated by the right hand, even though it still can be removed with the engine running, a feature I do not like. The same key is used for doors, ignition and trunk lid—a fine idea.

Interior finish is excellent and foam-rubber seat cushions make a comfortable ride. As on previous Buicks, the massive bumpers offer good protection. Trunk space is large and the self-locking lid opens easily.

The speedometer numerals go up to 120, which is good on a car having the speed of the Super or Roadmaster. One thing I don't like is that the upper portion of the full-circle horn ring is located so that it obstructs the view of the speedometer. I suppose stylists feel that the full-circle horn ring should be used for artistic reasons, but from the practical view the upper portion should be eliminated. The needle also partially obstructs mileage figures.

I have much praise for the new V8 engine and certainly little criticism. I can't say the Dynaflo Buick uses less gas than any similar car I have driven because it doesn't, but with proper use of the throttle, Buick mileage is satisfactory. My average on the test run certainly was.

I found an improvement in Buick's assembly this year over previous models and rate Buick's final assembly and inspection above the average.

By the way, you can get an air conditioner to keep you cool in your new Buick—another extra at \$594! ★ ★ ★

☞ Five million deaths and 100,000,000 serious illnesses have been prevented in 10 years by use of DDT in control of insect-borne diseases, according to Edward F. Knipling, president of the American Association of Economic Entomologists.

AIR COMPRESSORS

Portable 2-Cyl. Piston Type
WESTINGHOUSE

Reg. \$60.50 **25.95**

Model T-1 Complete

Brand new surplus special at an amazing low price. Westinghouse double-piston type 6.54 CFM volume, 2" bore, 1 1/2" stroke. Runs off power take-off or 1/2-hp motor. Equipped with the V-type direct-drive pulley.

For farm, home, industry, painters. Instructions, parts manual, repair wrench and V-belt included. Send check or money order (parcel post weight 23 lbs.). A complete line of genuine Westinghouse spare parts.

AIR HOSE—to fit, 25-ft. length with fittings & chuck \$4

PRESSURE SWITCH—Cuttler Hammer Automatic, for electric motors up to 1 H.P. Complete with overload control. \$12.50 Value. **\$5.00**

AIR PRESSURE TANK ASSEMBLY, complete..... **\$10.95**
Includes 6" x 24" tank, 160-lb. gauge, relief valve, tubing, all necessary fittings & hose. We prepay shipping charges.

"CARRY TANK" Single 6" x 45" with 3 ft. hi-pressure hose, fittings, tire chuck and filler check valve. Fill at any service station—carry anywhere. Fills 4 tires. Only..... **\$6.80**

NATIONAL EQUIPMENT CO. 2669 MONROEVILLE ROAD
TURTLE CREEK, PA.

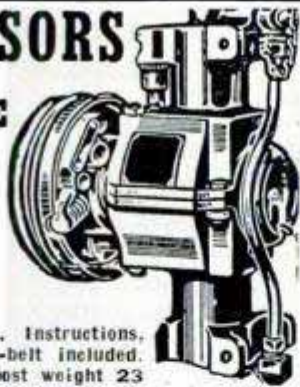

Find HIDDEN TREASURES

GEIGER COUNTERS (as shown) for Uranium Detection. **TREASURE DETECTORS** for gold, silver, etc. Lightweight, ultra sensitive. Best at any price. Also mineralights.
* INFORMATION FREE *

Detectron co.

5631 Cahuenga, No. Hollywood, Calif.



BUILD FINE GRANDFATHER CLOCK NOW

The simple sensible Red-i-Kut way as thousands have — **SAVE HALF. SHOP TESTED PLANS "SPIRIT OF THE CENTURY"** Narrow waist 83" tall or stately straight side **"SPIRIT OF AMERICA."** **EASY-TO-FOLLOW** *photopack* PLANS tell all—plus **BROCHURE** of heavy brass weight Westminster, tube chime, movements, gorgeous dials, 3/4" solid mahogany case kits. Send \$1.00 today — Both plans \$1.50 NOW.

KUEMPEL CHIME CLOCK CO., 27 Kuempel Bldg., Minneapolis 16, Minn.

15-inch Swing

Four inches more than other heavy-duty lathes. 33" between centers. Extra features. Compare **SHOPSMITH!** It's a saw, sander, vertical and horizontal drill, too. Write for free catalog.

SHOPSMITH, Dept. 237-B
12819 Coit Rd., Cleveland 8, O.



STOP WOOD ROT

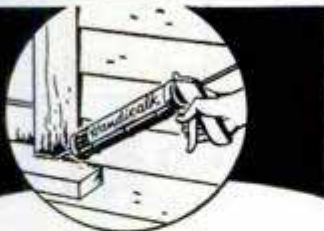

It's so easy! Just drop a Handi-talk cartridge into the gun, press the trigger—protect your home against rust, rot, decay. Write for leaflet.

Handi-talk

2370 Woodhill Rd.

Cleveland 6, Ohio



AT HARDWARE, PAINT AND LUMBER DEALERS



shake it on
every morning
then...

every step
of the day

QUINSANA FIGHTS ATHLETES FOOT INFECTION

QUINSANA works full-time—and fast! 9 out of 10 report amazing results.

91% of foot specialists interviewed used it on their patients. For burning, itching feet—cracking, peeling skin... get QUINSANA quick!

Soothes, cools
tired feet!



MENNEN
QUINSANA

FOR
ATHLETES
FOOT

49¢
TAX FREE

MECHANICS if you service...

Mechanics who get the best jobs — *and the biggest pay checks* — always use Starrett Tools. Starrett precision tools will help you do better, more accurate work *faster and easier*. Choose the right tools for your job from the complete line of Starrett Tools for automotive, marine, aviation and farm equipment maintenance. Send the coupon below for free catalog.

Starrett TOOLS FOR SERVICE MECHANICS



Ignition Spacing Gage No. 571



No. 224-A Micrometer with interchangeable anvils.



Cylinder Gage No. 452-B



Inside Micrometer No. 823-A

SEND FOR THIS FREE BOOKLET

STARRETT PRECISION TOOLS CATALOG A — 42 pages packed with helpful service hints — describes and illustrates a complete line of tools for better, more profitable servicing. Send coupon for your free copy.



THE L. S. STARRETT CO.
Dept. AP, Athol, Mass., U. S. A.

Please send my free copy of Starrett Catalog A.

Name..... Position.....

Type Equipment Served.....

Address.....

City.....Zone....State.....

TV Signal Booster Features

(Continued from page 214)

make certain the tube is lighting properly, and if a voltmeter is available, measure the power-supply output, which should be approximately 150 volts. Now connect the booster to the TV-receiver antenna posts with a short length of 300-ohm line, and connect the antenna twinline to the terminal posts shown in photo B. Be sure that antenna wires do not contact the metal cabinet at any point. Now tune the TV set to a channel on the low end, say 2 or 4 or whatever your low channel happens to be. Next, rotate the dial on the TV booster as far as possible in a counterclockwise direction. Watching the TV screen for "snow" or for an image, adjust the grid-circuit trimmer C1, for best pickup. Do the same with trimmer capacitor C2. A tiny screwdriver is necessary for this purpose. Rotate the dial as far as possible clockwise.

Now set the TV receiver for your highest channel, say 11 or 13. Peak the grid circuit by spreading or contracting the legs of the hairpin inductor L1. Spreading the legs will result in an increase in inductance and a decrease in frequency. Moving the legs closer together will decrease inductance and increase frequency. Repeat the process with loop L2. Once the alignment process is completed, the booster is ready for use. It may be worth-while, however, to repeat the process once again to insure best alignment. *Caution:* a high-frequency unit of this type may refuse to work if there is a poorly soldered connection or a lead is longer than it should be. Extreme care is necessary in wiring the circuit, and the layout should be followed as closely as possible. Detailed student material list R-420 is available from *Popular Mechanics* Radio and Electronics department upon receipt of ordinary letter postage. ★★★

HARD ALUMINUM



STRAIGHT EDGE-RULES

LIGHT
STRONG
NO RUST
NO EYE-STRAIN
SHARP BLACK NUMBERS

12" to 144"
GRADUATED T-SQUARES

ALL PRECISION MADE

See Your Dealer

THE FAIRGATE RULE COMPANY

177 PACIFIC STREET—BROOKLYN 2, N. Y.

WRITE FOR
CATALOG



**"All the wheels go for LUMA-RIM
Cause it makes the nicest trim"**

See and be seen with LUMA-RIM®

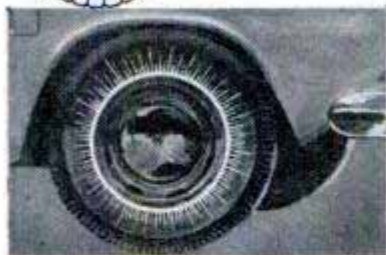

It is a **PROVEN FACT** that LUMA-RIM, the bright red reflective wheel trim, puts drivers of on-coming cars **ON THE ALERT** when your car is crossing street or roadway, or leaving curb at night. **PRECISION** die-cut ring of finest material. (Tiny glass beads bonded to plastic.) Reflects light from any angle. Easy to apply. Lasts for years. (Road tested.) LUMA-RIM **FILLS A NEED** for a distinctive light for the sides of cars that is useful and attractive. For 15" and 16" rims. Order by rim or tire size. **\$2.95**

© L-R Corp.

LUMA-RIM CORP., Pacific Bldg., Dept. D5, OAKLAND 12, CALIF

STOP BURNING OIL!

GET NEW CAR PERFORMANCE WITHOUT OVERHAUL with **RING-RE-NU**

Stops oil burning, restores compression and power. Write for **FREE Folder**

RICHIE DISTRIBUTING, INC.
11916 MADISON AVE., DEPT. A6, CLEVELAND 7, O.

HASTINGS STEEL-VENT PISTON RINGS

The best money you can spend on your car!

MAKE BIG MONEY SHARPENING LAWN MOWERS

SPARE OR FULL TIME

Mr. G. E. of Ark. writes, "I have had my Universal Grinder 2 mos. and made a net profit of \$227." Be your own boss in a business of your own in your garage or basement with the Universal Lawn Mower Grinder. No experience necessary. Send today for proven success plan **FREE**.

RUGERS MFG. CO. Dept. M-63 LINDSEY, OHIO

NOW—40 different CUTS with AMAZING, NEW Warren

DADO SAWING WASHERS On Your Saw Blade

Just dial widths to cut parallel grooves perfectly smooth. No warp, vibration or trick screws. Strengthens blade, perfect balance. **GUARANTEED!** At your dealer's or order direct. Give arbor size— $\frac{1}{2}$ ", $\frac{3}{8}$ ", $\frac{3}{4}$ ", 1". **ONLY \$4.95 PER SET**

Send for free booklet

WARREN WASHERS COMPANY
Dept. 26, Box 98 North End Station, Detroit, Mich.



No need to fuss with "blown-out" fuses!



Modernize with **MINI-BREAKER®**

... the amazing new Permanent Circuit Protector that fits like a fuse in standard Edison base fuse sockets!

Imagine! A brand new permanent type circuit protective device that can actually be used as a direct replacement for expendable "one-shot" fuses! That's **MINI-BREAKER!** Fits right into your present fuse box. No additional equipment to buy, no special wiring required, no installation or service costs!

● **GIVES YOU PERMANENT, POSITIVE PROTECTION!** No danger of electrical fires with **MINI-BREAKERS** on the job. Because this thoroughly tested device safely interrupts excessive overloads and short circuits... tripping instantly on "shorts," but with a built-in time lag to handle temporary starting loads and line surges. 100% trip-free. Yet, as soon as the circuit is safe again, all you have to do to restore electrical service is press in and release the shock-proof reset button! No fuss, no bother. Never need be replaced!



LISTED BY U.L.! Yes, **MINI-BREAKER** is a precision-built, pre-tested, permanent "Circuit Protector." It's safe, convenient, economical. And it's the only device of its kind ever to be listed by Underwriters' Laboratories, Inc.!

AVAILABLE IN 3 RATINGS! 15, 20, and 30 ampere for A.C. service only up to 125 volts maximum.



\$1.50

SEE YOUR LOCAL DEALER or send for complete information today!

MECHANICAL PRODUCTS, INC.
1824 River Street • Jackson, Michigan

Please rush me full details on new **MINI-BREAKER** today!

NAME _____

ADDRESS _____

CITY _____ ZONE _____ STATE _____

Pointers for Home Painters



Choose the right brush for the job!

When you're painting window frames, screens or other narrow areas, the right brush to use is a sash brush. Sash brushes—either flat or oval-shaped—are designed for the job . . . help you get better results. And a brush with bristles of Du Pont nylon makes trim work easier . . . neater.

When painting windows, protect glass with a piece of cardboard or masking tape. Leave window slightly open during drying, so it won't stick shut.



When painting lattice-work, fences, radiators, always do the hard-to-get-at areas first. This saves you time, trouble and a lot of cleaning up . . . means better work.



When painting edge-wise on narrow surfaces, use a sash brush. It's designed for the job. Using a large brush causes "fingering" (see insert), ruins the brush.

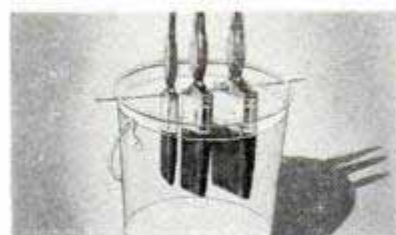

Clean brushes with thinner after daily use. Suspend brush in thinner overnight. Bristle tips should not touch bottom of can. Work out thinner before re-painting.

For best results use NYLON PAINT BRUSHES

JOB AFTER JOB, you'll get best results with a well-tipped nylon paint brush. Durable Du Pont nylon bristles paint smoother . . . are clean and sanitary . . . never get brittle . . . don't break off even under the roughest treatment. And nylon bristles last from 3 to 5 times longer than ordinary bristles. Leading manufacturers make nylon paint brushes in all types and sizes. Look for the name NYLON on the handle. Be sure to pick the size brush designed for the job.



Better Things for Better Living
... through Chemistry

The best brushes have
**DU PONT NYLON
BRISTLES**

Lumber From "Toothpicks"

(Continued from page 137)

20-foot-long section than at the other. This growth habit made the Indians favor the trees as supports for their tepees or lodges, which is how the trees were named.

Log houses in the past have been made of logs laid horizontally. The vertical-log buildings are examples of a new technique. The centers of the logs also are bored out to make a four-inch-diameter air space. This helps dry the logs, provides a place for electric wires and also improves the logs' insulating value.

"To cut holes in logs we invented a 6½-foot-long cylindrical bar and cutting head which rotate at high speed," says Stephen Babcock, general manager of the Montana company. "With this we bore holes from both ends of our eight-foot-long house logs in less than a minute."

John Stark, a craftsman living in the western Montana forest, is building lodge-pole-pine furniture without power tools.

He even has to make all of his dowels by hand with a hollow auger used in a regular bit brace. This tool has been out of demand for so long it cannot be found in most hardware catalogues.

Stark selected lodgepole pine for making home, summer-resort and lounge furniture because of the trees' local abundance, ease of working and slight taper. He enlists nature's help in finishing the furniture.

"I season all of my pine logs for about six months with the bark on," he says. "Then I strip off all the bark, but leave on small patches of the living layer (cambium layer) immediately beneath the bark. These patches darken like leopard spots and adhere firmly to the wood upon further drying, even when a wood-oil finish is given to furniture before it leaves the shop."

Lodgepole pine, ignored for centuries by everyone but the Indians, at last is earning its own way in the lumber industry. ★ ★ ★

SEND THIS COUPON—today!

Delta Power Tool Division
Rockwell Manufacturing Company
502F North Lexington Ave., Pittsburgh 8, Pa.

Here's my \$1 bill (attached to this coupon) for one year's subscription to your DELTAGRAM (6 big issues per year*), with over a dozen project plans in each issue . . . ideas for furniture, games, home repairs and toys . . . easy-to-read, easy-to-make!

Name _____ Enclose
Address _____ \$1.00
City _____ Zone _____ State _____ Bill!
*2 years (12 issues) for only \$1.75.

DRILL SAW REAM CUT

INTERNATIONAL

HI-SPEED COPE SAW DRILL BIT

DRILL, SAW, REAM . . . metal, pipe, wood, plastic, Transite, etc. Use with any electric drill, slow drill press, lathe or milling machine. Drills own starting hole—upper part of bit is used to cut, saw or ream circles, ovals, squares or scrolls. Easy to operate. Ideal for carpenters, mechanics, electricians, plumbers, hobbyists, many others. Abrasive resistant, high speed steel. Flutes ground from solid. Will withstand severe continuous use without breaking. Resharp-ened at no charge. Takes place of up to \$50 in tools. 1/4" diameter, 2" cutting sections, total length 3 1/2". Available in three types—All Purpose, Wood, Heavy Metal. Specify type needed. Set of 3, \$11.50. Details on request. Shipped same day. Money-back guarantee. Dealer inquiries invited. **ORDER NOW! SEND CASH, CHECK OR MONEY ORDER.**

Manufactured and distributed by
INTERNATIONAL TWIST DRILL CORP.
618 Wyandotte, Rm. 634, Kansas City 5, Mo.

only \$3.95 POST PAID

\$2.50 VALUE 2 LURES \$1.00

GUARANTEED TO CATCH MORE FISH

All Plastic lures 2 1/2" long... 5 sure fish getting colors... Frog, Perch, Black with white, White with black or red. Choice of 1/4 oz. Spinning or 1/2 oz. Casting and Trolling Wts. No COD's.

CATCH-EM BAIT CO.
Dept. 55 • Box 273 • Main P. O.
ST. LOUIS 3, MISSOURI

Special Offer 5 for \$2.00

DO MORE PLANING JOBS WITH LOW COST BELSAW

Exclusive MONEY-MAKING Features: • Full 12 1/2" x 6" capacity • Power feeds at 24' a minute • Provides for Grinding Knives in the Cutterhead • Attachments for Jointing, Rabbeting, Tongue, Groove, Matching. Convert low cost rough lumber into high priced cabinet finished stock... Easy to make flooring and popular patterns. Send today for free literature and prices.

LOW DOWN PAYMENT EASY TERMS

Belsaw Machinery Co., 1010 Field Bldg., Kansas City 11, Mo.

DRAINS Cellars, Laundry Tubs; CIRCULATES Oil; IRRIGATES Gardens

Original "Type P" Pump has 2400 GPH capacity. 360 GPH 75' high, or 1500 GPH from 25' well. Use any 1/4 to 1/2 HP motor. **DOES NOT CLOG.** 1" intake; 3/4" outlet.

Postpaid if cash with order. (West of Miss. add 50c.) Motor coupling included. **\$6.95**

MONEY BACK GUARANTEE
Also Gear Pumps in all sizes.

LABAWCO PUMPS, BELLE MEAD 7, N. J.

KING MIDGET

WORLD'S LOWEST PRICED 2 PASSENGER AUTO

JUST OUT — NEW CONVERTIBLE!
Operate it for 75c per week. Amazing performance. Surprising comfort. All steel construction. Ready to run or assemble it yourself with our bolt together parts. Rider Agents wanted, earn your car free. Send 25c for detailed literature or \$1 (refunded first order) for actual assembly book and service manual filled with photos, drawings, specifications, etc.

MIDGET MOTORS MFG. CO., ATHENS, OHIO

Has Your Tongue Been STUNG Lately?

NO TONGUE-STING IN YELLO-BOLE PIPES

Let the Honey Girl show you why

Look! It's lined with PURE HONEY!

- ★ STARTS SWEET!
- ★ SMOKES SWEET!
- ★ STAYS SWEET!

Don't smoke a pipe that tortures your tongue! Light up a Yello-Bole... and feel the difference. Thanks to that pure honey lining... you can smoke your Yello-Bole to your tongue's content. No "Break-In Blues!" No stung tongue or irritated throat. Switch to a cool, sweet-smoking Yello-Bole... today!

YELLO-BOLE

\$1.00 TO \$2.50

WIDE VARIETY OF SHAPES... IMPORTED BRIAR

USE IT IN THE DARK

THE P & C TORQUE WRENCH

Now you can get just the right torque on critical nuts and bolts and do it without watching dials or listening for clicks. Just set, lock, and pull Releases and re-sets *automatically*. See it today and be amazed. It's another P&C guaranteed tool, "the BEST tool money can buy."

Buy your P&C Tools from this handy display.

Send 10c for P&C's complete 48-page catalog. All info on over 300 tools.

P&C HAND FORGED TOOL COMPANY
Dept. H-653, Box 5926
PORTLAND 22, ORE.

WOODS

Get This BIG Manual And Bargain Book

Loaded with how-to-do it articles on wood-finishing, veneering, making inlay pictures and cabinets. Contains 83 distinct inlay designs and borders, plus a wood identification panel of 60 different varieties. All shown in full natural color suitable for framing.

A MULTITUDE OF MATERIALS
Lowest Prices On

Veneers	Period Furniture Hardware
Inlays	Modern Picture Frame Molding
Lumber	Upholstery
Plywood	Hand and Electric Tools
Plans	Finishing Materials
Supplies	Decorative Metals
Plastics	Leather

Albert Constantine & Son, Inc.
Dept. PM-13, 797 E. 135th St., N.Y. 54

● VISIT US at our N. Y. Plant. Demonstrations every Saturday on making inlaid pictures, wood finishing and other crafts. Everyone invited.

SEND THIS COUPON!

Albert Constantine & Son, Inc., Dept. PM-13
797 E. 135th St., New York 54, N.Y.

Enclosed find 50c (refunded on 1st order) for your copy of "Manual For Craftsmen" No. 52.

Name _____
Address _____
City _____ State _____

24 Hours of Speed — Will America Win at Le Mans?

(Continued from page 130)

hopes on two cars built in his small but remarkable automobile factory at West Palm Beach, Fla. The cars will be powered by Chrysler V8 engines again this year. They will have roller cams, special tappets, headers, manifolds, valves and heads. The compression ratio is 7.5:1 and the engines develop well over 300 horsepower on the 80-octane gasoline required at Le Mans.

The Cunninghams have steel-tube frames, special brakes, ultralight bodies and four-speed gearboxes, all engineered by the B. S. Cunningham designers.

Le Mans 1953 will be Cunningham's fourth try for the sports-car crown. His first, in 1950, was with a car that the French called "The Monster" because of its huge, squat appearance. That year he finished 11th, just behind another of his cars, a souped-up Cadillac with five carburetors and specially cooled brakes. For the following year, Cunningham knew that his cars would have to be lighter and have better brakes. And they should be handsome and well sprung. They were. The four 1951 entries he built cost a total of \$100,000 despite the use of stock parts throughout the special 100-inch-wheelbase frames. These cars were the C2 models. Three entered the race. Only one finished—in 18th position.

When 1952 race day came around, Cunningham was back at Le Mans with three brand-new cars—the C4Rs. One was a coupe, the other two were racy roadsters. All pushed out more than 300 horsepower. But engine trouble forced two out and Cunningham himself brought the third car in to finish fourth with a 24-hour average of 87.8 miles per hour.

And now comes 1953—once again America will attempt to cop the big honor at Le Mans. Other countries and auto companies are in there fighting, too. Proof of the vast importance attached to such a win is evident from the fact that the 1952 German Mercedes-Benz racing team (which won the race) had on the spot 40 mechanics, 5 racing cars (two of them spares) and two trailers completely fitted as workshops. Cunningham himself took 40 men and a reported 40 tons of equipment to France last year. It's the toughest of competitions. Both Cunningham and Nash realize it and will be in there at full throttle.

Winning *les 24 heures du Mans* is the biggest prize of the sports-car year. This year, 1953, may see that prize come to the United States. Only time will tell—24 hours of it at Le Mans. ★ ★ ★



Stay out **FRONT** on a
HARLEY-DAVIDSON
HYDRA-GLIDE®

HERE'S more power than you'll ever need . . . power that "steps out" over country highways and "loafs" through city traffic . . . plus luxurious riding comfort that means mile after mile of tireless travel. Yes, the '53 Harley-Davidsons are packed with features to give you more pleasure, greater safety and more

comfort . . . it's the handsomest two-wheeler on the road. See this beauty at your dealer's soon . . . and bring along a buddy. Or, send for your copy of the thrilling, action-filled **ENTHUSIAST** Magazine and illustrated literature. Enclose 10 cents. Harley-Davidson Motor Company, Dept. P, Milwaukee 1, Wisconsin.

Now They're Hunting Oil With Atomic "Guns"

(Continued from page 91)

of atomic collisions in the Geiger counter held in his other hand, he watches for tell-tale variations in counts that may help paint a picture of a saucer-shaped radioactivity halo on his map. At suspected points, he may dig a trench and stick his instruments right into the soil.

"Getting a true picture is no snap," Scherb explains. "Differences in readings are almost microscopic, even with these supersensitive instruments. All kinds of things can foul up the counts. Bodies of water shield atomic radiations rising from the earth—so do swamps and large outcrops of rock. A small deposit of radioactive ore can send them soaring."

When he has finished his air-and-ground survey with scintillometer and Geiger counters, the geophysicist has just begun.

"There are," explains Scherb, "four kinds of atomic particles flying around us all the time—cosmic particles from space, and three others from the earth. All of the latter three seem associated with oil-bearing formations. There are alpha particles—so weak that they won't penetrate a piece of paper; beta particles that will go through

a thin sheet of aluminum, but not much more; gamma particles so powerful that it takes heavy lead shields to stop them. Sensitive as it is, even the scintillometer provides a good picture of only the gamma radiation."

To get alpha and beta readings, the geophysicist resorts to special tricks. Alpha particles are found in the soil in a radioactive gas called radon. The oil explorer sticks long vacuum tubes into the soil at various points around his suspected oil field, opens petcocks and sucks the gas into the tubes. Back in his laboratory, the gas is run through a Geiger-type tube where its radiations are picked up and counted.

To count the beta rays, prospectors collect tiny soil samples from all over the field, cart them to the laboratory and sprinkle them on tiny metal disks. The disks are shoved into a "castle," which is a lead chamber about the size of a gallon Thermos jug. Inside the castle, a thin aluminum shield or "window" keeps any stray alpha particles from going through to the counter. But the betas manage to get in, and are counted.

If all goes well when he plots his nuclear counts, the geophysicist may find himself with a contour map showing lines of higher radioactivity of all three types surrounding

(Continued to page 252)

give your hair that "JUST-COMBED" LOOK all day long

Only 'Vaseline' Cream Hair Tonic has it! Viratol—*the special compound that makes hair look natural, feel natural . . . stay in place for hours.

Try this wonder-working hair tonic today. You'll be amazed how long that natural, fresh-combed look lasts and lasts.

'Vaseline' Cream Hair Tonic contains Triple-A Lanolin, too . . . and it's homogenized for easy flow.



Vaseline CREAM HAIR TONIC

TRADE MARK ®

VASELINE is the registered trade mark of the Chesebrough Mfg. Company, Cons'd

MASTER GARDENER

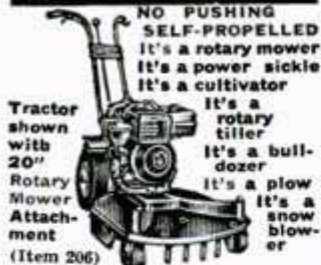

NO PUSHING
SELF-PROPELLED
It's a rotary mower
It's a power sickle
It's a cultivator
It's a rotary
tiller
It's a bull-
dozer
It's a plow
It's a
snow-
blower

Tractor
shown
with
20"
Rotary
Mower
Attachment
(Item 206)

Where else can you get a power tool that does so many jobs? Works for you year 'round. Does terrific job cutting grass or weeds. Or prepares mowed deep seed bed without labor. Built-in power take-off to drive pumps, saws, generators, etc. Safety clutch—can't burn out. More versatile and efficient than tractors costing twice as much. Converts in minutes to Tiller, Power Sickle, etc. Basic self-propelled 2 hp tractor with Briggs or Clinton famous **\$119.50**

Rotary Lawn Mower.....\$42.50
Sickle Bar Mower.....\$42.50
Lawn Mower Hitch.....\$ 4.50
Cultivator.....\$ 8.75
Rotary Tiller.....\$42.50
Furrowing Tool.....\$ 8.75
Disc Harrow.....\$15.75
P.ow.....\$ 8.75
Snow Blow.....\$39.50
Freight prepaid to most areas.
Easy payment plan available.

NEW MOTOR BIKE

Our Commando Motor Bike is trouble-free—carries amazing 5 yr. guarantee. Goes to 150 miles per gal. on all roads. Speed to 40 mph. No oil or gas fumes. Easy automatic pedal or pull starting. Has new principle of automatic transmission. No belts or chains—power transmitted directly to rear wheel. Accelerates quickly. Complete motor and kit ready to attach to your bike in 1 hour. Get free folder. Factory Price, **\$125.00**
Complete Motor and Chassis.....**\$199.50**

Variable Speed Selector

Heavy duty, made by **B. F. GOODRICH** for industrial use. Provides instant speed changes for any drive. For machine tools, dryers, printing, conveyors, production lines, hoists—any operation requiring variable speed. Ideal for midget autos. Employs reliable "trouble free" planetary system. No hydraulic power losses or creeping. Infinite range, smooth operation, easy installation (data included). 3 sizes: 1/2-1 hp, wt. 36 lbs.; 1-2 hp, wt. 55 lbs.; 2-3 hp, wt. 105 lbs. Reg. list \$228, \$252 and \$352. Our prices **\$79.50, \$89.50 and \$114.50.**

3-Pc. ADJUSTABLE WRENCH SET
Made of finest steel alloy, chrome plated. Prices are exactly half actual value. Takes the place of a whole set of tools. Packed in leatherette pouch.
Set A—4-inch, 6-inch, and 8-inch wrenches, (Item 107), wt. 2 lbs., only **\$2.95**
Set B—8-inch, 10-inch, and 12-inch wrenches, (Item 108), wt. 4 lbs., only **\$6.45**

3-Pc. PIPE WRENCH SET
Made of finest German Tool Steel. Completely drop forged. Pipe sizes clearly marked for easy one-hand setting. Heavy sharp jaws will never slip. Ideal for master craftsmen. Set includes 8"-10" and 14" wrenches. Covers most pipe sizes. A combination of brute strength and precision workmanship. Will pay for themselves on one job. Item 12. Wt. 6 lbs. Easily worth **\$11.95.** While they last..... **\$6.55**

BUY FACTORY DIRECT

SAVE MIDDLEMAN PROFITS

WORLD'S FINEST GUARANTEED LIGHT PLANTS

PUSH BUTTON START A.C. PLANT 500-700 watts—115 v. —60 cyc. A.C. Powered by a rugged 2 hp. easy-starting Briggs gas engine. No wiring necessary. Just plug in and operate. Plenty of current for any oil burner, freezer, brooder, emergency lights, etc., which require up to 700 watts. Ideal for Civil Defense, Fire Depts., trailers and camps. Complete with Voltmeter and built-in winding to charge 6 v. auto batteries. Item 24. Wt. 85 lbs. Be prepared if war or storm knocks out power lines.
Reg. \$275 value.....**\$143.50**
700-800 Watt Plant (Item 44)
same as Item 24 but larger engine.....**\$169.95**
1000-1200 Watt Plant (Item 45)
same as Item 24 but larger generator & engine.....**\$199.50**

1500-1700 Watt Plant (Item 20)—Same as Item 24, but has three times more capacity. Wt. 173 lbs. Factory price.....**\$279.50**

MASTER-LITE 2500 Watt PLANT (Item 21)
110/120 v. 60 cyc. A.C. A powerful plant, ruggedly constructed and yet designed for easy portability. Can be started by rope or built-in 12 v. electric push button starter. Built in winding to charge battery. Powered by a big 5.10 HP Briggs engine. Complete with all accessories. Includes control box, voltmeter and handy plug-in power receptacle. An ideal plant for permanent or stand-by service. wt. 235 lb.
Regular price \$645.00. Factory price.....**\$329.50**

GIANT 2000-2500 Watt PLANT (Item 162)
110/120 v. A.C. belt driven so that engine may easily be utilized for other purposes. Powered by a rope start. 6 HP engine wt. 230 lbs. Regular list \$585.00. Factory price.....(Item 31) **\$299.50**
Generator only and control box.....**\$169.50**

3000-3500 WATT PLANT (Item 198)
Wts. Engine. Push button start. Wt. 370 lbs. Heavy duty.....**\$399.50**
Generator only for belt drive, Wt. 115 lbs. (Item 198A) **\$239.50**
3000-3500 Watt Plant (Item 23) 115 v. 60 cyc. A.C. Push Button Start. Direct Drive. Wt. 270 lbs. Factory Price **\$379.50**

HI-LINE 6000 WATT PLANT (Item 162)
Push Button Start, 115-230 v. 60 cycle A.C. A brute of a power plant with a rugged 13 hp. Wisconsin engine. Plenty of electricity for ranges, water heaters, freezers, pumps, machinery, etc. Affords both 110 and 230 volts. Ideal where heavy current is needed. Wt. 590 lbs. Easily worth \$995.00. With self starter. Factory price.....**\$645.00**
Same plant but with Crank Start. (Item 166).....**\$585.00**
Generator and control box only belt driven. Use your own engine or tractor. Wt. 240 lbs. (Item 163) Factory price.....**\$345.00**
We make fully automatic controls to operate any of above light plants. Write for details.

MASTER AIR COMPRESSOR

(Item 209) High pressure type for large volume of air for heavy duty service. For paint spraying, inflating truck and auto tires, greasing, and the hundreds of other jobs done by compressed air. Piston type. 2" bore compressor with built-in air filter. Master built with hi-strength alloys and precision bearings. Stainless steel tank, 12"x24", 2100 cu. in. cap. Safe up to 500 lbs. Equipped with automatic switch that starts and stops motor to maintain desired pressure (up to 150 lbs.) and check valve, safety valve, gauge, shut-off valve, 20 ft. air hose and tire chuck. Beautifully balanced on ball bearing wheels and rubber tires. Low factory prices. With 1/2 hp. 110 v. A.C. motor (Reg. \$175.00).....**\$98.50**
With 1/2 hp. motor. Reg. **\$119.50**
\$139.50 (Item 209A)
With 2 hp. Briggs Gas Engine. (Reg. \$199.50).....**\$109.50**
(Item 209B)
Write for prices of compressors only. A complete line of spray guns and air tanks available.

MASTER SHOP COMPRESSOR

Big and rugged. This stationary compressor provides 8 c.f.m. — plenty air for industrial uses, powered by heavy duty repulsion induction 3/4 HP 115/230 v. motor. Factory type twin cylinder compressor designed for continuous operation. Mounted on heavy 20 gal. steel tank. Complete with unloader type automatic switch, pressure relief valve, check valve, gauge, shut-off valve, and 20 ft. heavy duty air hose. (Item 209h) Regular retail **\$319.50**, factory price... **\$189.50**

Prices f.o.b. Factory. 10 day Money back guarantee. Send check or Money Order
MASTER MECHANIC MFG. CO., DEPT. 60-C Burlington, Wis.

EXTENSION CORD



Heavy duty made of Buna insulated #14, 2 conductor stranded wire encased in a treated braid jacket moderately flexible and ideal where frequent coiling is not required. Resists oil, grease or water. Use indoors or out. Complete with heavy rubber plug and outlet. **\$1.99** (Item 16) 40 ft. 2 1/2 lbs. Comb. 2-40 ft. and 1-20 ft. (total 100 ft.).....**\$4.95**
100 ft. length (1 piece).....**\$4.85**

NEOPRENE EXTENSION CORD

#16, 2 conductor stranded wire, extremely flexible, ideal for hedge trimmers, lawn mowers, power tools, etc. Tough and rugged, withstands any abuse. Complete with rubber plug and outlet. 40 ft. (Item 16a) wt. 2 1/2 lbs. reg. **\$2.49**
100 ft. length (17pc).....**\$5.85**

NEOPRENE CABLE #14-2 (Item 18a)

Heavy duty, very flexible. 2 year quality. Wt. 9 lbs. 100 ft.....**\$8.95**
NO. 12-2 POWER CABLE. Very flexible rubber covered, special outside shield for grounding power tools, etc. 50 ft. (Item 199) wt. 8 lbs.....**\$6.96**
100 ft. (Item 200).....**\$12.95**

32 Pc. SOCKET SET



Highest quality guar. non-breakable sockets made by Hnsky. Beautiful, matched chrome alloy, absolutely the best. Complete range of 21 sockets from 1/4" thru 7/16" in 1/4" drive and 7/16" thru 1-1/16" in 1/2" drive; 2 extensions, reversible 1/2" ratchet, adaptor bit, slide head, all angle coupling, 2 end wrenches, 1/2" speeder handle and sturdy metal tool box. For prof. mechanics who want the best. Wt. 14 lbs. (Item 59) Easily worth **\$16.95**
\$41.50

37 Pc. SOCKET SET

Consists of above described set, but includes a big doghouse tool box with ample room for other tools plus a 5 pc. hi-chrome alloy combination wrench set. Easily worth \$49.50. (Item 59b).....**\$19.95**

45 Pc. SOCKET SET

(Item 205) Contains a complete set of sockets in 1/2" drive, 3/4" drive and 1" drive, plus all necessary extensions, handles, speeders, reversible ratchets, etc.; all uncond. guaranteed against breakage. Beautiful matched chrome thin wall alloy sockets in a sturdy hand-some steel tool box. Wt. 17 lbs. List price \$62.90. **\$26.95**
Factory Special.....

VENTILATING FAN

(Item 10) Mount in wall or ceiling to ventilate any area. Over range removes kitchen smoke and odors. Easily installed in furnace pipes. Forces even heat to all rooms. Powerful continuous duty motor, 110-120 v. A.C. Quiet, super efficient fan moves huge volume of air (400 to 500 c.f.m.) 8" Fan, wt. 5 lbs. **\$6.85**; 9" Fan, wt. 6 lbs., **\$7.85**; 10" Fan, wt. 7 lbs., **\$8.85**; 12" Fan, wt. 8 lbs., **\$9.85**.

HEAVY DUTY FAN

Semi-enclosed motor, suitable for spray booths, restaurant exhausts, poultry houses, etc. 10" Fan, wt. 8 lbs. Item 10E **\$11.95**. 12" Fan, wt. 10 lbs. Item 10D.....**\$12.95**

HYDRAULIC JACKS

Heavy duty, precision built, smooth, positive acting with built-in relief valve. Hi-Lift with screw extensions. Govt. surplus at a fraction of orig. cost. (Handle included.) 2 ton (Item 208A) **\$9.45**
Wt. 15 lbs.....
5 ton (Item 208B) Wt. **\$11.45**
17 lbs.....

You can make
this picnic table and chair
with MASONITE PRESWOOD



Send for
free plan!

Have more fun outdoors this summer! Enjoy picnic lunches, play cards, etc., on this sturdy table with smooth, durable Masonite Tempered Preswood® on top and seats. And for sun-soaking, the roomy lawn chair is ideal.

These tough, grainless, all-wood hardboard panels take plenty of knockabout punishment. Weather extremes won't bother them. Never splinter, splinter, or crack. Won't snag clothing and they withstand rain and snow. Easy to cut and fit with ordinary hand tools.

Masonite Preswood can do scores of jobs around the house, quickly and at low cost. Send for complete information and free home craft plans.

See your local building materials dealer for
MASONITE PRESWOOD PRODUCTS

A type and thickness for every job!

- Standard Preswood—1/8", 3/16", 1/4" and 5/16" thick.
- Tempered Preswood—black or brown. 1/8", 3/16", 1/4" and 5/16" thick.
- Tempertile®—1/8"
- Duolux—both sides smooth! Tempered. 4-ft. and 5-ft. widths. 1/8", 3/16" and 1/4" thick.
- Leatherwood—1/8"
- Panelwood—3/16" and 1/4" thick.

Better Hardboards for Better Home Projects

MASONITE® CORPORATION

Dept. PM-6, Box 777, Chicago 90, Ill.

"Masonite" signifies that Masonite Corporation is the source of the product

Please send me free plans for:

- Picnic table and chairs
- Built-in linen closet

Name.....

Address.....

City.....Zone.....

County.....State.....

an area of low radioactivity. Under that low there should be oil if the new theory is correct.

What makes this radioactive halo around an oil deposit? And why is there low radioactivity in the center? No one knows for sure. One theory, held by Lundberg, Scherb, Reiss and others, is that oil vapors, which are known to rise in a halo pattern from deep oil pools, may carry with them concentrations of radioactivity that they have absorbed on the way up.

There's still plenty to find out. "For instance," says Scherb, "how do you account for surveys where the radioactivity over the center of an oil field was greater than that around the edges? Thousands of surveys must be made before we'll know how to interpret the readings we get. Perhaps they'll reveal not only oil, but types of traps when we know how to read them."

No one is ready to say that the method is foolproof or that it can be used alone. "A good scientist will use all the tools and data available to him before plunging," says Scherb. "If a radioactivity survey shows a low over an area that magnetometer and seismic work indicates to be a possible oil trap, the chance of hitting oil there is just that much better. Even if atomic oil prospecting only betters the batting average of the explorers, it will be worth-while."

Several big oil companies think so, too. Their planes have been flying atomic instruments over oil fields everywhere for the past several months. Some results have been startling. Several outfits have cautiously reported the familiar halo pattern on several test runs. No one is talking, but this much is certain: Three wells, drilled in the center of a radioactive ring that showed up on a scintillometer survey in Creek County, Okla., have come in strong. The only other well in that field—drilled before the survey was made—shows up on the map beyond the low radioactive center of the pool. It was a dry hole!

All the wells in the center of a radioactive halo that bloomed from an atomic survey of Naval Reserve Pool in Osage County, Okla., are the big producers. Those that sit on the fringes beyond the radioactive rim are poor or dry.

Can you get a scintillometer and go scouting in the back yard for a bonanza? The answer is yes—if you've got the \$495 that the little Buck Rogers pistol-grip outfit costs. A good radioactivity survey of a possible oil field, backed up by proper seismic and magnetometer work, can save money for an experienced oil prospector, all right. "But it takes people who know what they're doing," Scherb says. ★ ★ ★

HOME HOBBYISTS! MECHANICS! CARPENTERS! FARMERS! THE POWER SAW YOU'VE ALWAYS WANTED!

Sensational Summer Special!

NATIONALLY FAMOUS



QUALITY ALL METAL

8-inch TILT ARBOR SAW

BLADE TILTS TO 45° ANGLE! TABLE ALWAYS LEVEL!

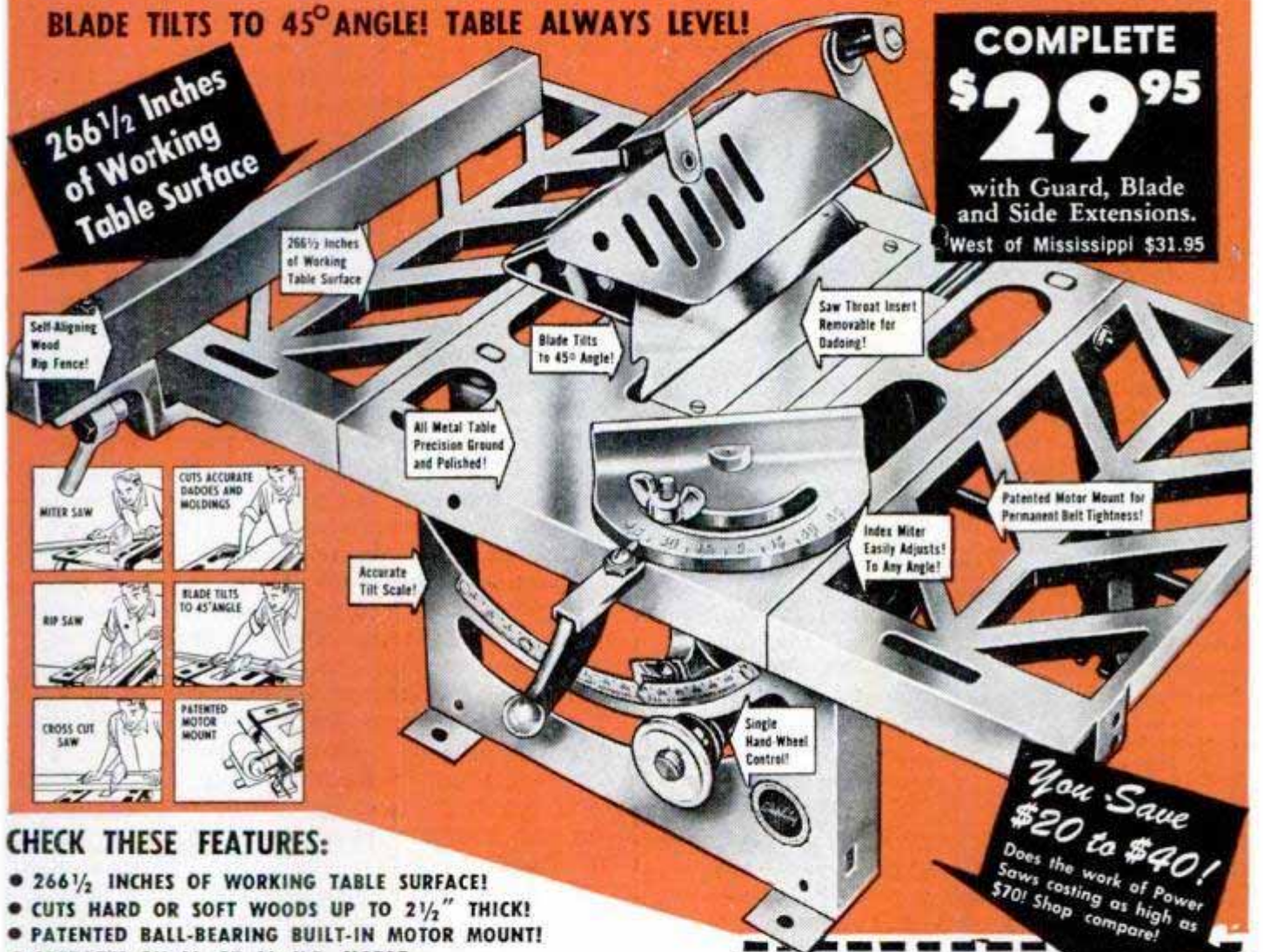

CHECK THESE FEATURES:

- 266 1/2 INCHES OF WORKING TABLE SURFACE!
- CUTS HARD OR SOFT WOODS UP TO 2 1/2" THICK!
- PATENTED BALL-BEARING BUILT-IN MOTOR MOUNT!
- OPERATES ON 1/4 OR 1/2 H.P. MOTOR

A bargain if there ever was one! This big new 8-inch Tilt Arbor Saw *does everything* — yet costs \$20 to \$40 less! It cuts 2x6's in 2 1/2 seconds! Cuts hard or soft woods up to 2 1/2 inches thick. Cuts joists, sidings, rafters, frames, joints, slots, etc. Accurately rips wide or narrow panels, and cuts at a compound angle. Has height lock for dadoing. It features

the only improvement in tilt arbor saws in 75 years — a patented method of planar-centric cradle suspension. One simple adjustment tilts the blade up to 45°. Mounts on any kind of tool bench.

Money back guaranteed if this 8" Tilt Arbor Saw does not please you in every way. Mail the coupon at once while this offer lasts.

YOLANDS PRECISION TOOL CO., 20 BOYLSTON STREET, Boston 16, Mass.

YOLANDS PRECISION TOOL CO., Dept. PM 101
20 Boylston Street, Boston 16, Mass.

Please rush your new ALL-METAL 8-INCH TILT ARBOR POWER SAW complete with Guard, Blade and Side Extensions. I enclose Check, Money Order for \$29.95 plus \$1 shipping charge. West of the Mississippi the price is \$31.95 plus \$1 shipping charge.

Name.....

Address.....

City.....Zone.....State.....

MODERN INSULATION

MAGIC

YOU'LL BE
AMAZED
WITH

REYNOLDS ALUMINUM REFLECTIVE INSULATION

Take it home



500 sq. ft. under his arms

Put it up



Easy to tack or staple

Work a "miracle" in your walls or attic with this aluminum foil bonded to tough kraft paper. Costs only about \$40 to put up over ceiling of average 6-room house. Reflects up to 95% of radiant heat. Summer heat bounces off; interiors often 15° cooler. Winter heat reflects back inside. Clean, odorless, pliable. Tack or staple over ceilings or under rafters, between wall studs, under ground floors. Perfect vapor barrier. Fire-retardant. Two types, foil on both sides for double air space; one side, to face single air space. Rolls 250

Aluminum Sheet for Rust-proof Flashing, Termite Shielding, General Shop Work!

New all-purpose carton of ten 18" x 48" sheets, .019" thickness. Best for flashing, also great idea for over sink or stove, door kicks, etc., etc.



sq. ft., 25", 33", 36" wide. Also makes wonderful reflectors for radiators, photo lights, etc. Mail coupon for *free samples*.

Aluminum gutters—cost much less than other rust-proof materials. Non-staining. Put them up yourself—slip joints, no soldering.

Aluminum nails—rustproof, never stain.

See your Building Supplies or Hardware Dealer

REYNOLDS *lifetime* ALUMINUM BUILDING PRODUCTS

MAIL THIS COUPON NOW!

Reynolds Metals Company
Building Products Division
2032 So. Ninth St., Louisville 1, Ky.

Send full information and FREE SAMPLES of Reflective Insulation. Also full details about

Gutters & Downspouts; Nails; Flashing

Name _____

Address _____

City _____ State _____

What's Happening in TV Around the World

(Continued from page 98)

failed to stimulate more than a few hundred people to buy television sets (at \$560 each) and pay license fees.

The Netherlands, with 7000 receivers, has a station operating near Amsterdam.

Belgrade, Yugoslavia, is said to have an operating TV station, and two more stations are planned.

All other stations in Western Europe are either experimental or proposed. The Saar has an experimental station. So do Oslo, Madrid and Stockholm. Two more are proposed in Sweden (which now has only about 100 receivers), three more in Spain.

Istanbul has an experimental station, and one is under construction at Casablanca, French Morocco.

But what's happening behind the Iron Curtain? Russia, with limited equipment, is getting into the act. The first programs from the Reds' East Berlin station were telecast Dec. 21, 1952. According to recent report, the studio has only one television camera and broadcasts only from 8 to 10 p.m. The only receiving set on the East German market costs a year's income for an average workman. As a result, practically all are in public places and meeting halls. Like the Prague station scheduled to begin operation this year and an experimental Warsaw station operating intermittently, entertainment consists chiefly of propaganda films.

Russia itself has a station in Moscow, where 60,000 sets are reported; one at Leningrad, with 15,000 receivers; and one at Kiev, with 2000 sets. The Russian stations operate on a 625-line standard, like most of Europe. Most receivers have a nine-inch picture tube, although new 12-inch receivers are appearing. Color sets for experimental programs may be available this summer.

Japan's government-owned television system envisions a 30-station hookup blanketing the islands within five years. Soon, seven relay stations will link Tokyo transmitters with sets 300 miles away. One Tokyo station began telecasts in February, featuring sports coverage, Voice of America films, newsreels, variety shows, lectures, cooking courses, dramas and puppets.

American-installed and using the American 525-line standard, the Japanese stations are presently being picked up by only a few thousand receivers, most of them American. But Japanese manufacturers will soon start turning out low-cost receivers aimed for a potential mass market.

(Continued to page 256)

10 times more powerful than all other present day TV antennas!

- Guaranteed 10 times more powerful than stacked 10 element Yagis.
- Receives channels 2 thru 83 from all directions without a rotomotor.
- Broadband UHF-VHF and FM, motorless; all direction reception.
- Pat. #2,585,670-2,609,503-2,625,655 others pending.
- All aluminum flip-out assembly.
- Simple, easy to install.

The only TV antenna that instantly beams the television set directly to the signal without a rotor. This simple, easy to install antenna brings strong UHF & VHF signals from all directions to weak signal areas instantly... with a flick of the nine position switch located near the television set.

MONEY BACK GUARANTEE

Model AD 2-8 antenna is unconditionally guaranteed to outperform and unquestionably bring in clearer, stronger and sharper pictures than any and all other television antennas on UHF, VHF and FM.

For any reason if it fails to do this, we agree to refund to the jobber to whom we sold and shipped it, his full purchase price.

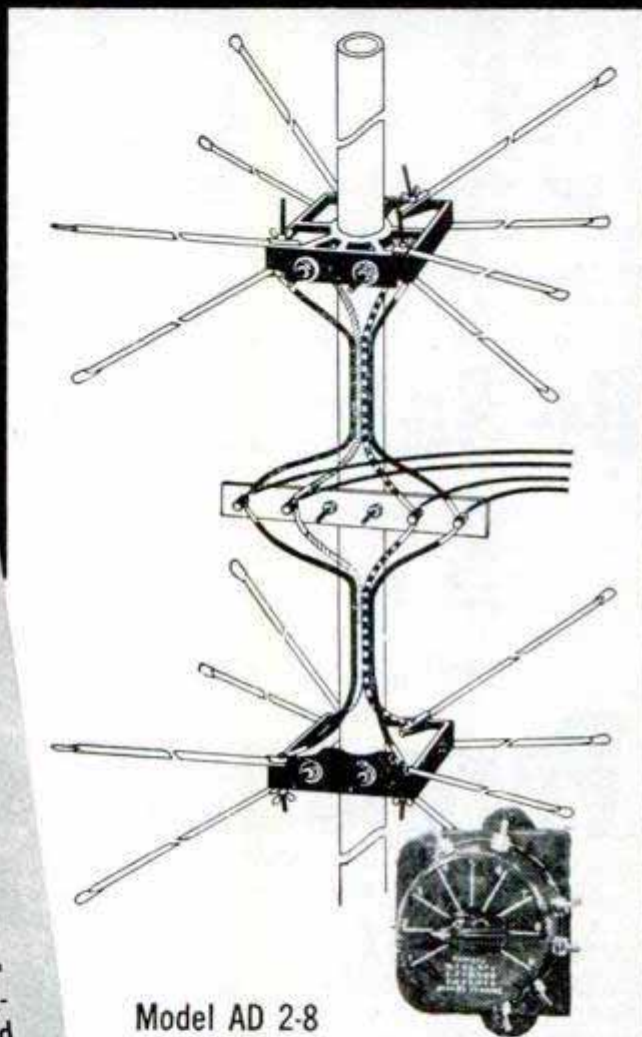

Model AD 2-8

Includes Stacked Antenna Array, 9 position switch. Completely wired stacking harness, AIM — Automatic Impedance Matching coupler.

\$36⁵⁰

LIST PRICE

ALL CHANNEL ANTENNA CORP.

70-07 Queens Blvd., Woodside 77, N.Y. • Hickory 6-9399

SEE YOUR LOCAL DEALER,
OR WRITE FOR THE NAME
OF NEAREST JOBBER.

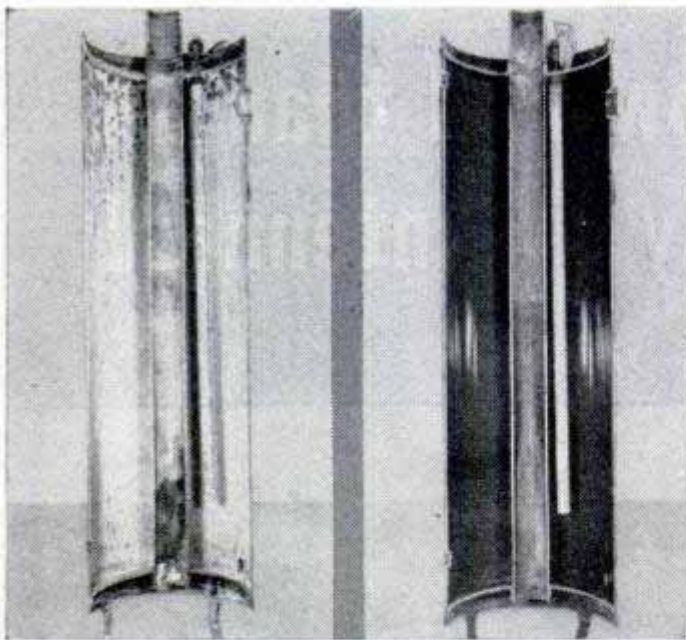

ORDINARY WATER HEATER INTERIOR

Unretouched photo shows how rust eats away unprotected metal in just one year of use. Note deep rust pits!

PERMAGLAS WATER HEATER INTERIOR

Unretouched photo shows that Permaglas glass-surfaced steel tank does not rust ... because glass can't rust.

Be Safe from

RUST

With an A. O. Smith

Permaglas[®]

Automatic Water Heater

If you could see the insides of an ordinary water heater, you'd shudder to think of using water heated in so rusty a tank.

To be safe from rust, buy an A. O. Smith Permaglas water heater. Enjoy all the clean, hot water you need for health protection and cleanliness. Permaglas costs no more than ordinary water heaters. Its glass-surfaced steel tank can't rust because glass can't rust!

Write for "Murder . . ." booklet of pictured facts.—A. O. Smith Corp., Dept. PM-653, Kankakee, Illinois. International Division: Milwaukee 1. In Canada: John Inglis Co., Ltd.



A. O. Smith also manufactures Gas Conversion Burners, Home-heating Boilers, Warm Air Furnaces and Commercial Water Heaters.



A.O. Smith

PERMAGLAS-HEATING PRODUCTS

A privately owned station is planned for Bangkok, Thailand. Due in April was Manila's first station, owned by Juan Quirino, brother of the Philippines president.

In Australia, the fight between commercial and state TV has stalled operations.

The only other TV stations operating in the Pacific area are in Hawaii, where regular programs began last December on two stations in Honolulu.

Far more active than any country in Asia or continental Europe, however, is little Cuba, where a five-station network covers the entire island, and the most remote hamlet can enjoy regular TV. There, where TV sets are in demand and tariffs exceptionally high, smugglers last year engaged in a roaring video trade. Fast cutters loaded up at Miami or Key West with American TV receivers and swiftly transported them to isolated coves along the Cuban coast. A few months ago, planes flying around the clock dumped as many as 600 sets a day in Cuba, where smuggled receivers are estimated to number one fourth of the island's total of 125,000 sets.

The Dominican Republic boasts a television station, located in Ciudad Trujillo and completed last August.

Brazil, with three television stations, two of them in the Sao Paulo area and one in Rio de Janeiro, has big plans—six more stations are under construction and 45,000 sets are in use. Brazil, according to Edmund A. LaPorte, RCA Chief Engineer, may be the first country outside the United States to use UHF channels.

Venezuela has two stations in operation. Another will open by the end of the year.

President Peron of Argentina recently opened a powerful million-dollar station in Buenos Aires. Uruguay has postponed work on its TV station. Guatemala is expecting developments in Guatemala City in the near future.

Mexico, which is just finishing a \$3,000,000 "television city" and a 500-foot transmitting tower in the capital, already has five stations and has issued construction permits for 27 more. At least 35,000 sets are in use. The new studios in Mexico City would make any television producer happy: One of the four large studios is big enough for a circus or a basketball game, and the potential audience of one Mexico City station is 3,000,000. Possibly a relay will be established on the side of near-by Popocatepetl to transmit TV to large population centers within range.

Possibly microwave relay will connect Mexico City, Monterey and San Antonio, so that Mexicans can get American network programs and Americans can receive

(Continued to page 258)

GOOD TIP for FATHER'S DAY!

(June 21)



Parade the family past a PET Power Tool display. Complain a little about your old hand drill and saw. Because you *know* they'll buy a gift. And it'll be so much better if you're *both* pleased!

Why PET Tools? Because they give you *plus power per pound!* They're *easy* to work with... extra fast on "do-it-yourself" jobs... and easy on the pocketbook too! So start hinting. And don't forget to act surprised! You'll find PET Power Tools at all leading hardware stores.

**PLUS
POWER
PER
POUND**

*...and the price
is right!*

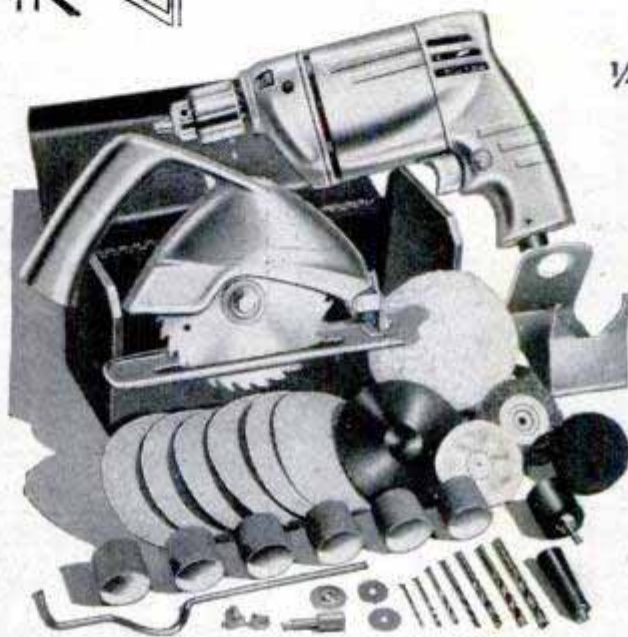

1/4-inch DRILL & SAW KIT

Rugged pistol-grip drill with gear-type chuck. Special-duty design for ample power. Ball thrust bearing takes drilling load. Forced ventilation. Drill saw attaches to drill, cuts up to 1" deep, angles from 90° to 45°. All attachments to grind, sand, polish, mix paint. Durable "hip-roof" steel case.

Model 1440GDK.
Complete... **\$4500**



SANDER-POLISHER KIT

For furniture, the car, every waxing, polishing, sanding job. Powerful motor, trigger switch, instant release lock. Lamb's wool polisher, complete set of sanding discs, rubber backing pad and adapter, and drill chuck. Two packages of world-famous Johnson's Wax—liquid and paste.

Model 1540K **\$3000**



1/4-inch ELECTRIC DRILL. Same as with kit.

Choice of pistol grip (Model 1440G) or saw grip (Model 1490G)..... **\$25.00**

Either drill but with hand-type chuck **\$22.00**



PORTABLE ELECTRIC TOOLS, INC.
320 W. 83rd St., Dept. PM-63, Chicago

In Canada: Portable Electric Tools, Ltd.,
452 Birchmount Rd., Toronto

Prices slightly higher in Canada

BIG MONEY

in your hands!



BE YOUR OWN BOSS! Men who are determined to get ahead in something for themselves will find this opportunity hard to beat! Where else can a man turn his own labor so quickly and easily into **BIG MONEY!** Earn as high as \$50 and more a day sanding floors with an easy-to-run American Machine—and **YOU ARE BOSS.** Prospects everywhere—old and new homes and remodeling. Pleasant indoor work—steady the year round. No schooling—no experience needed. Age makes no difference—men 18 to 80 are active and successful. Send coupon for "money-making" booklet entitled "Opportunities in Floor Surfacing"—enclose 25c in coin or stamps to cover handling.



AMERICAN FLOOR MACHINES

SEND

The American Floor Surfacing Machine Co.
535 So. St. Clair St.
Toledo 3, Ohio

Enclosed find 25c in stamps or coin for booklet "Opportunities in Floor Surfacing", telling me how I can start my own floor sanding business.

Name _____
Street _____
City _____ State _____

Mexican shows. Meanwhile, a television station is operating opposite Brownsville, Tex., beaming English-language programs to American audiences. The station has the commercial advantage of broadcasting to a United States audience without having to abide by FCC regulations.

On the other hand, American border stations under construction in upper New York and Vermont will beam to the Canadian market. As of now, no private Canadian stations can be built except in areas where the Canadian Broadcasting Company prefers not to build. The CBC differs from American and European television in that programs are produced by the state-owned system and then sold to advertisers. Montreal and Toronto opened TV stations last September. Ottawa may be the site of the first private TV station.

CBC stations are also planned for Vancouver, Windsor, Halifax and possibly Quebec City. A microwave-relay system to link Montreal, Ottawa, Toronto and Buffalo will be completed some time in 1953.

Canadian receivers are expensive, partly because of a sales tax which helps to pay for the government-owned CBC. Imported American receivers suffer from heavy duties. But apparently, Canadians, like millions of people all over the world, believe that television is worth its cost. ★★

LIMITED QUANTITY OF MULTI-PURPOSE ARMY SURPLUS **HYDRAULIC TOWING AND LIFT TRUCKS—**

Ideal for: Transmission Jacks, Warehouse Trucks, Factory & Shop Use, Boat Trailers, Mounting Welding Equipment, Farm Use, Factory Trailers, Yard Equipment for Portable Use.

Unused but slightly weathered

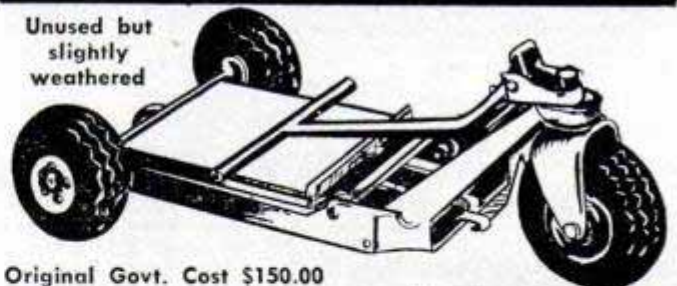

Original Govt. Cost \$150.00

Roller Bearing Wheels

Size Overall 59" Long, 33" Wide

Platform 17½" x 23½"

Tire Size 13 x 5.00

Platform Raised 13"

Platform Lowered 6¾"

Capacity 2000 lbs.

Length of Draw Bar 31½"

Total Weight per unit 285 lbs.

Pneumatic Airplane Type Tires

\$10 Deposit required each order or will ship on open account to accredited firm.

DON'T MISS THIS VALUE—ONLY

\$3250

F.O.B. ATLANTA
Lots of 6 or More
10% Discount

Sturdy and well made.
Order yours today.
Satisfaction guaranteed.

FULTON AUTO EXCHANGE

Dept. PM, 190 Edgewood Avenue, Atlanta, Ga., Phone: Main 2134; Calhoun 7161

HYDRAULIC SPEED REDUCER

(ITEM #115) WITH FINGERTIP CONTROL

USE FOR: • Reamer Drives • Midget Cars • Feed Mills • Canning Machines • Conveyors • Lathes • Milling Machines • Motor Boats • Cream Separators • Garden Tractors • Pumps



Variable output speeds from 0 to input speed available by moving control handle. Locking handle maintains setting. Use input power of 1/4 to 1 1/2 H.P. This Westinghouse-Oil Gear Unit consists of a variable displacement hydraulic pump feeding a fixed displacement hydraulic motor. Adjustable relief valves set at factory for 100 inch pounds of torque may be reset up to 180 inch pounds. Independent reverse control allows full output power and speed selection in either direction of rotation. Shafts measure 3/8" diam., include keyway. Input rotation is counter-clockwise facing shaft. Recommended input speed not to exceed 750 R.P.M. Overall dimensions, 7 1/2"x7 1/2"x11 1/2". Gov't acquisition cost, \$428.00. Ship. wt. 31 lbs. Complete with 2 gts. of oil and full instructions. F.O.B. Chicago. **54.50**

SHOP by MAIL
and **SAVE**
at **GROBAN'S**



TINY TIM BATTERY CHARGER

Item #301 Model 125 to charge 6 and 12 volt batteries — 12 volts — 300 Watts; Heavy Duty Generator; Push button self-starter; Sturdy single cylinder air cooled Continental 1.3 H.P. engine; 2 qt. gasoline tank in base; Ammeter; Generator cut-out; Concealed coil, etc.; Speed and charging rate control; Attractive orange finish; Weight 93 lbs.; Length 15 1/2", width 11 3/4", Height 14 3/4". F.O.B. Chicago. **89.00**

CENTRIFUGAL PUMP

General Motors — Allison
200 GALLONS PER MINUTE

Brand New

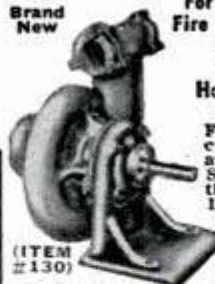

(ITEM #130)

For Draining Basements
Fire Fighting • Irrigation
Fuel Transfer
Swimming Pools
Home Water Systems
Dewatering

For high volume commercial, home and industrial use. Standard 2 1/2" pipe thread inlet, twin 1 1/4" pipe thread outlets. Ball bearing supported 3/4" shaft. Easy priming. Rotation, counter-clockwise facing shaft. Gov't. acq.

cost \$145.00. Complete with 1/4 full instructions. Ship. wt. 35 lbs. F.O.B. Chicago. **39.50**

Suction Lift	Head Pressure	Gal. Per Min.	H.P.	R.P.M.
10'	75'	260	6.0	3500
10'	65'	200	5.2	3500
10'	80'	40	1.5	2500
10'	50'	140	5.0	3500
10'	30'	100	3.0	2500

FREE 1953 CATALOG 48 pages, chock-full of unsurpassed War Surplus Equipment Bargains for farm, home, factory and workshop. Every item is unconditionally guaranteed. You save on everything! Write today.



Item #126 — Four-way, open center control valve with built in adjustable relief valve. Factory set at 1000 P.S.I., spring loaded neutral position, for use with one double acting cylinder. In neutral position cylinder is locked and pump unloaded. Fully balanced plunger type, smooth, positive, easy operation. Can be used as single unit or mounted in series of any combinations desired. Has 3/4" pipe thread inlet and outlet. 1 1/2" pipe thread cylinder ports. Newly manufactured to our specifications. Shipping weight 8 1/4 lbs. An outstanding buy! F.O.B. Chicago. **21.50**

Item #1000—Double action Hydraulic Cylinder, 3" bore, 10 3/4" stroke, 1 1/2" chrome plated steel shaft, 3/8" standard pipe thread ports. Maximum lift capacity, 7100 lb. with 1000 PSI line pressure. Clevis mounting at both ends. Overall length closed 20 1/4". Shipping weight 18 lbs. F.O.B. Chicago. **27.50**

EXTRA HEAVY DUTY DOUBLE ACTION HYDRAULIC CYLINDER

Item #224, 3 1/4" bore, 24" stroke, will lift 8250 lbs. with 1000 P.S.I. line pressure. 1 1/2" pipe thread ports—1 3/8" stressproof ground, polished & plated—solid steel shaft. Overall length closed 36". 1/4" steel wall cylinder barrel, clevis mounting at base and shaft. Features—Tie Rod construction. Honed barrel. Ship wt. 50 lbs. F.O.B. Chicago. **39.60**

Self-sealing Hydraulic Hose Coupler
Ideal for use where hydraulic systems are frequently disconnected or changed, as on towed farm implements. Each half has 1/2" female pipe thread at ends. Length—3 3/4", Width—1 1/2". Shipping Weight 1 1/2 lbs. Price, F.O.B. Chicago. **4.95**

High Pressure Hydraulic Hose
6600 PSI burst pressure tested. Equipped with standard Male pipe thread fittings at both ends.
6' length with 1/4" MPT. 3.95 Ea. F.O.B. Chicago
6' length with 3/8" MPT. 4.95 Ea. F.O.B. Chicago
6' length with 1/2" MPT. 5.95 Ea. F.O.B. Chicago

GENERATORS Many Sizes From 350 Watts to 25 KVA

Item #183 — 3000 to 4000 WATT GENERATOR SET — FEATURES — Power for your home or business. Simply connect to power panel or house circuit. • Constant voltage regardless of load. • Push button start or stop. • Easily made full automatic start or stop. • SPECIFICATIONS—Sizes 19"x30"x48". Steel skids, weatherproof housing, requires no building. Wt. 725 lbs. • Hercules 4-cyl. 10 HP gasoline engine. Load governor. Oil filter. Quiet muffler, 6-volt starter generator. • Hobart 115 volt, 60 cycle, generator. • Furnishes either single or three-phase power, 2 or 3 wire. • Panel contains oil gauge, voltmeter, ammeter, circuit breaker, voltage regulator, start button. Today's cost over \$1200.00. SALE PRICE, F.O.B. Chicago. **465.00**

Item #300—Model C18—3 KW—110 Volts D.C. This mighty mite develops 3 KW—28.5 amps. D.C. Standard Delco generator direct coupled to a Model Z2P Briggs and Stratton 1 cylinder, 5-7 HP, air cooled, rope starting gas engine. Instruments include voltage control rheostat & voltmeter. Ideal for Power Tools. Wt. 275 lbs. F.O.B. Chicago. **295.00**

HEAVY DUTY HYDRAULIC and AIR EQUIPMENT

Large supply of new labor-saving, economical hydraulic equipment in many types and sizes. Use these positive, highly efficient smooth pressure hydraulics on presses, arbors, lifts, loaders, power control, positioning, brakes, plastic dies, auto frame alignment, etc.

ALL ITEMS UNCONDITIONALLY GUARANTEED



Item #1036—Double acting hydraulic cylinder, 3" bore, 36" stroke, 1 1/2" pipe thread ports. 1 1/4" solid steel shaft. Overall length closed 49". Clevis mounting at base and shaft. FEATURES • Cup & Chevron Packing • All Welded Construction • Precision Ground and Honed Construction • Will lift 7000 lbs. using 1000 P.S.I. line pressure. Weight (net) 57 1/2 lbs. F.O.B. Chicago. **50.00**

Item #150—Double acting hydraulic cylinder, 2 3/8" bore, 12" stroke. Use either foot or clevis mounting. Will lift 4400 lbs. using 1000 P.S.I. Overall length 19 1/2". Shipping weight 8 lbs. Postpaid. **18.00**

Item #42—Double action hydraulic cylinder, 4" bore, 18" stroke. Rated lift capacity with 1000 PSI line pressure is 12,500 lbs. Ship. wt. 30 lbs. F.O.B. Chicago. An Excellent Buy for. **32.50**

Item #16C—Double acting hydraulic cylinder, 1 1/2" bore, 26" stroke. Will lift 1760 lbs. with 1000 PSI line pressure. Weight 8 lbs. A \$55.00 value. Now only. **16.95**

D.C. ARC WELDER NEW MODEL 353—DUAL RANGE

For Stationary or Portable Use
HEAVY DUTY RANGE TO 250 AMPS.
New 'Magic Terminal' for Low Current 30 to 100 Amps.

- Ideal for
- FARM
- GARAGE
- FACTORY
- WORKSHOP



Welds Anything From Auto Fenders To Tractor Frames
Shipping weight 107 lbs. \$350.00 Value. Item #65. F.O.B. Chicago. **119.50**

NEW GROBAN MANUFACTURE MODEL 251

2500 watts, 115 volts, 60 cycles, single phase. A.C. electric generating plant, powered by dependable 6.5 H.P. Wisconsin engine—Two pole ball bearing belt driven high efficiency generator with heavy duty windings for high torque motor starting loads. Rated 3000 watts for intermittent service. Light weight portable rugged unit, easily transported to job site. Consumes 3 quarts of gas per hour at rated load. Dimensions: 24"x20"x24". ship. wt. 220 lbs. Complete with fused outlet box and voltmeter. F.O.B. Chicago. **329.00**



CONTINENTAL "RED SEAL" 1 1/2 H.P. ENGINE

Item #97—Power for lawn mowers, garden tractors, pumps, generators, compressors, tillers, rakes, plows, feed mills, milking machines and motor scooters. Brand new Continental "Red Seal" 1 1/2 H.P. gasoline engine, Model AA-7, single cylinder, 4 cycle, with 5:1 gear reducer. At 1800 RPM engine speed, shaft turns at 300 RPM. Complete with muffler, starter rope, oil bath air cleaner, killer button and governor. Economical to operate—runs 5 hours on one gallon of gas. Shipping weight 60 lbs. SATISFACTION GUARANTEED. A \$74.00 value. Order now. Limited quantities. F.O.B. Chicago. **47.50**

ORDER DIRECT FROM AD — SEND PAYMENT OR PURCHASE ORDER TODAY — SATISFACTION GUARANTEED

GROBAN SUPPLY CO. 1139 SO. WABASH AVE., CHICAGO 5, ILL. DEPT. PM 6



GET THE SQUEAKS THE GREASE MAN MISSES

My next door neighbor is a real automobile doodler—he loves to fool around with his car—take things apart and put 'em together again.

And brother, let me tell you, last week I could tell when he started to work on it. When he raised the hood there was a squeak like the wail of a tortured banshee. I went over to him and said, "Joe—for crying out loud, why don't you put something on those hood fasteners to stop that gosh-awful squeak?"

"I've tried," he says, "Nothing works. Got any suggestions Mr. Expert?" "I sure have," I says. "Try some Lubriplate on it." "Lubriplate," he says, "That's that white lubricant you told me about for my lawnmower, isn't it? Never thought about it for my car."

"It'll work," I says, "and what's more, it takes the squeak out of many other spots the grease man misses on your car such as seat tracks, speedometer cables, door hinges, switches, locks, trunk hinges, heater fans for example.

He got out his handy tube of Lubriplate, put some on the hood fasteners, worked the hood up and down a couple of times, and there she was—quiet as a mouse.

Next time you're down at your Sporting Goods, Hardware, or Auto Supply store, ask for a handy 35¢ tube. If he doesn't have it, ask him to write to LUBRIPLATE DIVISION, Fiske Brothers Refining Company, Newark 5, New Jersey.

BeMaCo Dependable

AUTOMATIC SAW SET

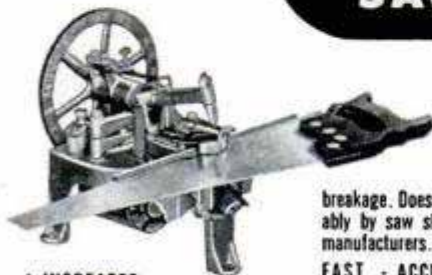

Sets 400 teeth per minute on hand or band saws 4 1/2 to 16 point. Hammer and anvil action sets teeth accurately and uniformly. . . . No tooth breakage. Does a perfect job. Used profitably by saw shops everywhere and saw manufacturers. Every machine guaranteed!

FAST - ACCURATE - DEPENDABLE

★ INCREASES
PROFITS

BEAVER MFG. CO.
Saw Machine Div. 4-C

800 S. ISIS AVE. • INGLEWOOD, CALIF.



You Can Make DRAIN TILE

and Build a Profitable Community Enterprise

Farm drainage, home building, reclamation projects, highway construction. From these and other sources come the biggest demand for drain tile in history. More local plants are urgently needed.

Millions of dollars' worth of drain tile are used annually. Much of it, ordinarily, is shipped from far distant points. Local manufacturing is economical, logical, profitable. The Champion Drain Tile Machine makes manufacturing easy. Pares production costs. Requires no skilled labor. Makes all sizes from 3" to 12". Yet requires only a moderate investment.

Outstanding Manufacturing Opportunity

Champion-made cement tile are dense, strong, and truly round. No distortion, no shaling. Worth more than clay tile, but can be sold for less—and still leave a handsome profit margin.

Write for the Drain Tile Book. Tells about cement tile as a local manufacturing enterprise. Tells about easy-payment terms. Write today.

Concrete Equipment Company
522 Ottawa Ave., Holland, Michigan



E2

SHEET METAL BRAKES

Angles, flanges, Pittsburgh locks, 24 G. steel, heavier aluminum. Cam locking, mount on bench, truck or floor stand. Truss braced steel. Express collect. 30", 65 lbs., \$28.50. 36", 75 lbs., \$33.00.

48", 100 lbs., \$48.00. Portable stands, 32" hi., 30 lbs., \$7.00. 8 ft. brake, similar, 26 gauge steel, \$115.00. IRON BENDER forms, hooks, angles, eyelets, etc. Capacity 1/4" x 2", 5/16" x 1 1/4". 10 parts, all steel, express collect. . . . \$9.50
12" PRESS BRAKE. Fits any drill press. Open ends, forms compound bends. Freight paid. . . . \$9.50
(Immediate delivery. Order direct, cash or C.O.D., or send for folder)



VYKE BRAKE CO., P-3016 Leavenworth, Omaha 5, Nebr.

HELPFUL BOOKS

Send post card asking for FREE catalog
Popular Mechanics Press, 200 E. Ontario, Dept. 601, Chicago 11

HAWAIIAN WIGGLER #1

WORLD-FAMOUS FISH-GETTER

Deep runner. No snag-up in pads and brush. Easy to cast. Rubber Hula Skirt acts alive. At your dealer 5/8 oz. or 1/4 oz., \$1.15 each.



FRED ARBOGAST & Co., Inc.
2216 W. North St., Akron 3, Ohio

FREE WRITE TODAY FOR YOUR BIG FREE ARBOGAST COLOR CATALOG—FULL OF PICTURES OF CATCHES

PUT EXHAUST WASTE TO WORK

"CLEAR-EX" fits any Car, Truck, Tractor



Already standard equipment on many fleets of Metropolitan squad cars! Amazing invention guaranteed to give cleaner, smoother, more powerful engine. You notice beneficial results in first hour of operation including 15-30 lb. compression rise on old engines. Easy installation on any gasoline engine.

● MONEY-BACK GUARANTEE

- Clears exhaust for better performance
- Raises and maintains equalized compressions
- Cleans plugs continuously
- Cleans valves as you drive
- Lessens exhaust "back pressure"
- Boosts gasoline octane

DEALERS
AGENTS
WANTED!

The only basic exhaust improvement in 50 years. Write for complete, free details, plus findings of official Navy Report.

FLINT CORP., Dept. P-6

1323 N. Water St. Milwaukee, Wis.

U.S. NAVY

Official Report
"40% of fuel energy is wasted through exhaust. . . . Much of this can be harnessed."

CELEBRATION SALE!

WE'RE CELEBRATING OUR MOVING TO DETROIT BY OFFERING YOU A CHANCE TO **SAVE UP TO 85%!**

HIGH SPEED WOODRUFF KEY SEAT CUTTER



SET 5 different size cutters. 4J Can be used as mounted milling cutter or circular saw. All with 1/4" and 1/2" shanks, widths up to 1/2", dia. up to 1". New and used. Ppd. Priced at only **\$3.95**

NEW ROTARY FILE MIX



7 different pcs. High Speed 1/2" shank. PPD. \$4.49
SET 14 different pcs. as above. PPD. \$8.79

NEW MOUNTED STONES



SET 27L Mixture of 12 Mounted Stones with 1/4" shanks. Post-paid **\$2.95**

10 DIFFERENT SIZE H.S. DRILLS—SET 33L

Drills 1/8" to 1 1/2". These new and used H. S. precision Drills with 1/2" shanks can be used in a 1/2" elec. drill or a 1/2" capacity lathe or drill press **\$14.50**

HIGH SPEED STRAIGHT SHANK DRILLS



SET 100 HIGH SPEED DRILLS: 1/2" down 9L 30 New std. H. S. Drills—70 slightly used sharp drills, lengths up to 7". \$30 value PPD. ONLY **\$7.98**

SET 12 different size H. S. straight shank Drills. 1/4" to 1/2" lengths up to 7". Only **\$3.98**



PRECISION BEARINGS

DIAMETER	WIDTH	HOLE	PRICE	DIAMETER	WIDTH	HOLE	PRICE
3/8	3/8	3/8	.15	1 1/2	3/8	3/8	.25
1 1/2	1/4	1/2	.20	1 3/4	3/8	3/8	.55
1 1/4	1/4	3/8	.20	1 5/8	3/8	3/8	.55
1 3/4	3/8	3/4	.20	2 1/4	1/2	3/8	.60
1 1/2	3/8	3/4	.25	2 1/4	3/8	3/8	.60
1 1/4	3/8	3/4	.25	2 1/4	3/8	3/4	.60
1 1/2	1/2	3/4	.25	2 1/4	1/2	1 1/4	.60

Minimum order \$1.00—Free Postage with order of \$10.00 or more.

YOUR MONEY BACK if not satisfied. All mdse. mixture of new and reconditioned unless specified new. All orders (except those specified F.O.B. Detroit) shipped postpaid saving you up to 35% on total delivered cost.

T & T TOOL CO.

Dept. 101 7667 GRAND RIVER DETROIT, 4 MICH.

Write for Free Catalog Describing Thousands of Bargain Cutting Tools.

BEAUTIFUL LUSTROUS PLASTIC WALL TILES

Only 5¢ Ea. 4 1/4 x 4 1/4

Easily cemented on any wall. Save money installing it yourself. Earn money commercially. Ideal for bath-room, kitchen, hotels, stores, etc. This tough tile comes in gorgeous colors. Finished jobs look exactly like expensive vitreous! For free details, instructions: BEACON'S, Inc., Anderson Ave., Grantwood, N. J.

Bring Your Work to that Particular Working Position

21J Head "THIRD HAND" JUNIOR VISE



Very practicable for all who use their hands—hobbyists, machinists, jewelers, stone-setters, silver smiths, engravers; especially for home work shop. The only complete flexible vise. Locks rigid in any position. Price of JUNIOR VISE only \$12.95 with either jaw head, or \$15.90, complete with both heads. 22J Head has leather pads for holding polished materials and all sizes of rings to be set or engraved. Shipped prepaid if check or money-order enclosed. LARGER MODEL ALSO AVAILABLE... convertible from bench work to drill press, milling machine, and surface grinding.

BELLOWS MANUFACTURING CO.

1017 N. CENTRAL EXPRESSWAY DALLAS, TEXAS

Now You Can Have a Clean as New PAINT ROLLER in 30 seconds with SAV-A-ROLLER

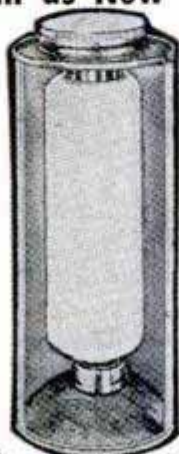

Cleans paint roller in 30 seconds—saves cost over and over again. Saves time—always have clean roller ready. Use same roller to paint as many different colors as you wish without waiting. Roller quickly, easily installed in special container. Patented container eliminates job of cleaning roller twice because roller is never submerged in paint residue. New scientifically compounded solution works like a miracle. No muss—no fuss. The finest and fastest way of cleaning and storing paint rollers. Fits all standard sizes. Allows color change in 30 seconds! Sold ready to use. Comes complete including container and quart of liquid for only **\$2.00** C.O.D.'s Accepted—or send cash with order, save C.O.D. Charges. Order today!

SARNO-SALES Dept. PM-6 9045 Claremont, Chicago, Ill.

SAY YOU SAW IT IN POPULAR MECHANICS

New, faster way to strip off finishes



Non-inflammable **KLEAN-STRIP** peels off paint, varnish, lacquer, enamel, synthetics.

IT'S CLEAN—NO AFTERWASH!

Sold at leading paint, hardware and department stores.

Product of

The KLEAN-STRIP Co., Inc.

2340 S. Lauderdale • Memphis 6, Tenn.

TRAPPED

The dangerous and wily Bengal Tiger—popular attraction in zoos and circuses—is often caught in traps like this. These traps protect the hunter without harming the tiger.

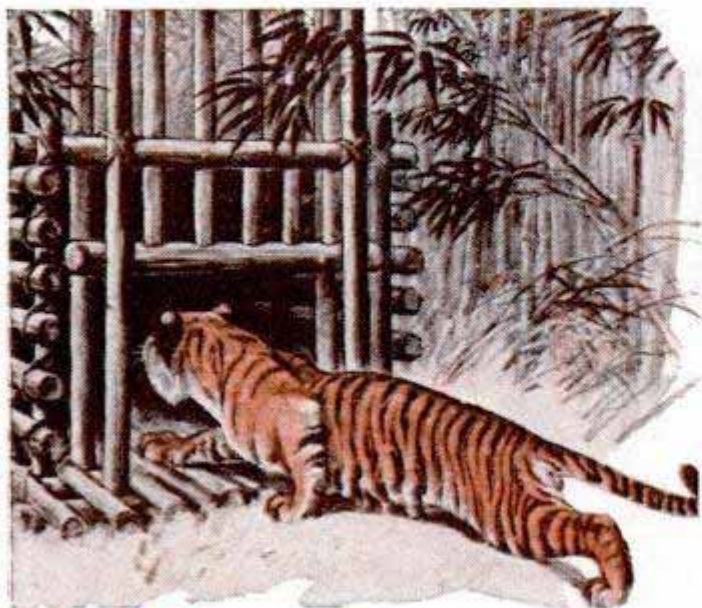

AC Aluvac Is The Best Trap for Dangerous Engine Oil Dirt

Another trap—just as ingenious—just as efficient—is your AC Aluvac Oil Filter Element—trapper of dangerous dirt, sludge and other impurities in your car's engine oil.

- AC ALUVAC keeps oil clean . . . removes particles as small as 1/100,000 of an inch.
- AC ALUVAC has greater filtering area . . . ten times greater than ordinary elements.
- AC ALUVAC has no harmful chemicals . . . won't remove detergents in heavy-duty oils.
- AC ALUVAC is durable . . . resists the action of harmful acids, gasoline or water.

Money Can't Buy Better Engine Protection.

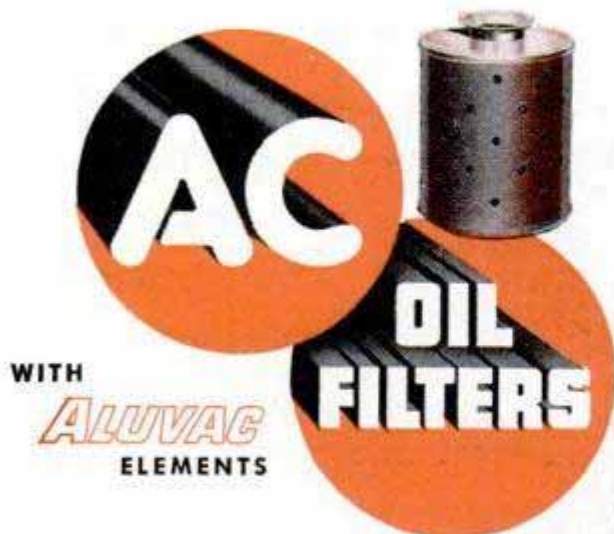

Protecting More New Car Engines Than Any Other Brand



AC SPARK PLUG DIVISION

GENERAL MOTORS CORPORATION

NBC's \$62,000 Cadillac

(Continued from page 104)

sat on their bicycle-type seats and pushed buttons that activated hydraulic pistons raising them into position through the roof. Behind them, in the soundproof trunk and spare-tire space, a three-kilowatt generator, silent and vibrationless, whirred out the watts that allowed them to televise everything in sight with complete freedom of movement.

In his turret at the rear, the cameraman's standard RCA Image Orthicon camera wheeled around the steel track that ringed him, picking up events first on one side of the moving car, then the other. Up forward, the antenna man was busy beaming the camera's signals to a receiving antenna atop the Capitol dome where they were bounced to the station's regular transmitter. He does this with a rotating horn-type parabola antenna that looks like a five-gallon paint can with a huge hook on one end. Through an eyepiece like a gunsight, the transmission man kept the massive dome of the Capitol right on the cross-hairs.

The new mobile unit becomes as flexible as a newsreel outfit when used in conjunction with the new Vidicon camera. The secret of this miniature affair is a new-type picture tube, only one inch in diameter and six inches long.

At the inauguration, the driver of the limousine studio handled the Vidicon. Whenever he saw something interesting, he would drive right up to it, lean out the window with his hand camera and, like a tourist snapping roadside shots of the scenery, start banging away.

One of the most spectacular machines that recently stuck its long boom into the TV business, is the industrial monkey, hydraulically operated double-jointed arm, swivel-mounted on the bed of a big service truck. Extended, the arm will reach out 40 feet in any direction, including up. Each of two waist-high buckets at the end of the boom accommodates one man, plus a TV camera and audio equipment. Public-utility companies, airlines, fruit pickers and other industries have been using "monkeys" to hoist men up in the air to do jobs where ladders would be impractical. No one ever thought of it for TV, until NBC's Hit Parade crew had to shoot a sequence showing skaters and crowds at the rink in Rockefeller Center Plaza last Christmas. Crews found that no matter where the camera sat, something was always in the way. Then someone thought of the monkey, and one was quickly borrowed from a local utility. A camera was mounted on the self-

(Continued to page 264)

High output! Compact! Low cost!

NEW ONAN "CW"
ELECTRIC PLANTS
 5,000 or 10,000 watts A.C.

YEARS AHEAD in design, performance, value! Give you regular 110-volt current for trailers, homes, farms, cabins, resorts. Air-cooled, heavy-duty engine. Costs less than any other complete electric plant.

WRITE FOR FOLDER.
D. W. ONAN & SONS INC.
 8566 Univ. S.E. • Minneapolis 14, Minn.

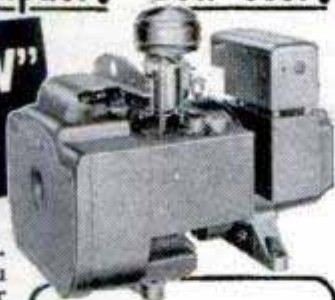

- Quiet-running • Fits in small space • Vacuum air-cooled engine and generator • Lightweight
- Completely equipped

GEARS

In Stock - Immediate Delivery
 Gears, speed reducers, sprockets, thrust bearings, flexible couplings, pulleys, etc. A complete line is carried in our Chicago stock. Can also quote on special gears of any kind. Send in your blueprints and inquiries.

Send for Complete Catalog No. 10
CHICAGO GEAR WORKS
 440-50 N. Oakley Blvd., CHICAGO 12, ILL.



Treasure - Minerals - COINS

Easily located with new Light-weight M-Scope Detector. Superior performance, lowest price, monthly payment plan.

FREE LITERATURE
FISHER RESEARCH LAB., INC.
 PALO ALTO CALIF.



HEADQUARTERS for CARBIDE!

Write for Free Catalogue of Tools and Conversion Kits
TIME SAVER TOOLS, INC., Dept. 26, MUNDELEIN, ILLINOIS

MAKE ANY SIZE FOLDAWAY TABLE, WORK BENCH ETC.

with **FOLDAWAY** TUBULAR STEEL FOLDING LEGS!

COMPLETE 30" LEGS \$7.98 PLUS POSTAGE FOR 12" WEIGHT OR SHIPPED EXPRESS COLLECT ORDER TODAY!

SHIPPED COMPLETE, READY TO FASTEN TO YOUR TOP STORE • RUBBER TIPPED • MAKE A SMART PING PONG TABLE, BILLIARDS TABLE, TABLE, etc.

THE DIAMOND MFG. CO. Dept. P.M. 1100 ALTAMONT AVE. SCHENECTADY 7, N. Y.

Build Your Own Walks, Driveway, Outdoor Fireplace, Steps, Etc.

What to Make With CONCRETE

The terrific high costs of even little concrete jobs are mostly for labor. Get Popular Mechanics WHAT TO MAKE WITH CONCRETE and save all the labor costs while making your home or farm ship-shape. You can lay foundations, sidewalks and driveways; build steps, outdoor fireplaces, sandboxes, tennis courts, garden and swimming pools and other installations at very little cost. Book shows all — tells all — how to make the right mixture, plan, apply and gives 50 professional short cuts. Hundreds of pictures. Only \$2.00 postpaid. Order today. Money back if not pleased.

POPULAR MECHANICS PRESS
 Dept. PM17, 200 E. Ontario Chicago 11, Ill.



New 8 1/4" saw

by **Porter-Cable**

Quality Electric Tools

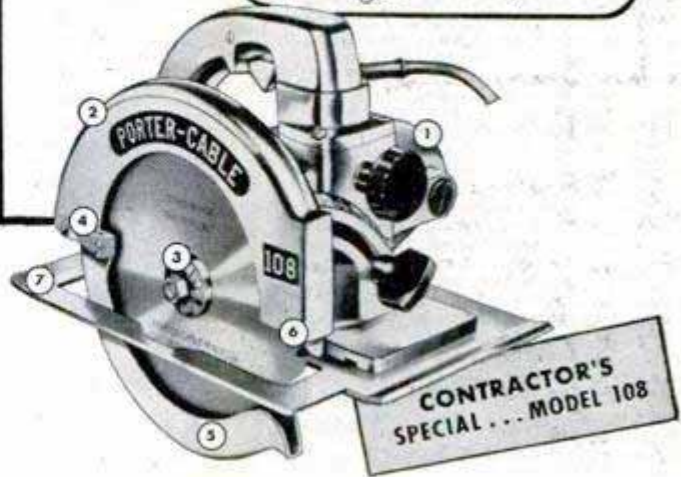

CONTRACTOR'S SPECIAL... MODEL 108

No other saw gives you **ONLY** so much for your money \$ **95.**

This professional Porter-Cable Saw incorporates more advanced features than any other saw — at any price!

It cuts deeper than comparable 8 1/4" saws — a full 2 3/4" at 90°. It's safer four ways. Its power whizzes it through long rip cuts — heavy cross cuts — accurate compound mitres. Cuts off 1" x 10" pine in 1 second — 12 times faster than ordinary hand saw! It's an investment that really pays off.

More-For-Your-Money-Features:

1. **More Power**—Bigger motor with higher amperage develops 10% more power.
2. **Lighter**—Lightest saw of its type on the market. Weighs only 13 1/2 lbs. — takes less muscle.
3. **Kick-proof Clutch**—Exclusive — eliminates dangerous kick-back when blade hits hard spots.
4. **Blade Guard Lift Lever**—Pulls back guard without risk while blade is spinning.
5. **Cam-Action Guard** (patented)—Provides steady, full retraction — gets rid of extra push to overcome "hitching."
6. **Auxiliary Front Guard**—Exclusive! Automatically covers section of blade exposed when set for light cuts.
7. **Extended Base**—Lets you cut in either direction, on either side, when notching or trimming roof overhang.

Get all the facts on Porter-Cable's new "Contractor's Special" — see your dealer . . . or mail coupon today.

Porter-Cable Machine Co.
 1446 N. Salina St., Syracuse 8, N. Y.
 (In Canada: Strongridge, Ltd., London, Ont.)
 Please send complete information on your new "Contractor's Special," also name of nearest dealer.

Name _____
 Street _____
 City _____ Zone _____ State _____

Manufacturers of Speedmatic and Guild Electric Tools.

own your own business! earn up to
\$75 A DAY CLEAR PROFIT
 in your back yard or basement!

**MAKE CONCRETE BLOCKS With Amazing New
 LOW PRICED GENERAL BLOCK MACHINE**

**NOW! Big Building Boom
 Profits Within Your Reach**

You don't need much cash to cash in on the building boom! New high speed, low cost General Block Machine produces up to 1,000 concrete blocks a day for homes, factories, buildings, garages. Your profit mark-up is 100% to 150%! Fool-proof, easily operated, sturdy steel machine can make any size from 4" to 12". These superior 3-core blocks meet all building code requirements for foundation, chimney, corner, sash and many other types of blocks. Works indoors or out. Sand, cement and water available anywhere! Simple operating instructions and mixing formulae for cement and cinder blocks supplied FREE. Get full details, no obligation!

EXTRA!

Amazing illustrated book gives floor plans for 6 sensational concrete block bungalows. Tells how to lay blocks, lay out building lines, mix concrete, build steps, porch and concrete floors all at great savings. Written by experts. Can save many times the cost of the machine! Get it now! No strings attached.

**HOW TO
 BUILD
 YOUR OWN
 CONCRETE
 BLOCK
 HOME**
Only 1 Required

R.L.T. of
 New York
 City Reports:
 "My General
 Block Machine
**PAID FOR ITSELF IN FIRST
 2 WEEKS!**"
 Thousands now in use
 the world over!
 Write for FREE details
 TODAY

**SEND \$1 — Refunded
 if you buy machine!**

GENERAL ENGINES COMPANY

Deot. M-63A, 397 HUNTER STREET, GLOUCESTER, N. J.



leveling platform of the big skylift. Camera and audio men climbed in the buckets. By using eight foot-pedal switches—six for controlling movement of the boom, one for signaling the truck driver with horn beeps, another for emergency stop—they could swing themselves high over the crowd, out over the rink, dip down into the arena and, in fact, put their camera eye in just about any position desired.

The monkey was such a success that, when they planned the inauguration coverage, Colledge and William McAndrew, NBC-TV special-events chief, decided to use this machine as well as the traveling eye. It couldn't have come in handier.

"Crowds were so thick," recalls Colledge, "that unless a camera was on stilts it couldn't see anything but people's backs. We put the industrial monkey in a side street. The boom arched out over everyone, peering around the corner like the head and neck of a dinosaur. Cameras got an unobstructed view of the marchers."

One more development that is helping to bring the world to your living-room TV screen in double-quick time is NBC's "hot developer" for kinescope film. Fastest motion-picture-developing unit ever built (according to NBC engineers), it can turn out nearly a quarter mile of negative film in an hour.

★ ★ ★



Get complete detail drawings, photographs and directions for this recreation room in FREE Idea Packet 209

*remodel your
 basement!*

The easy-to-work woods of the Western Pines* show up all through this room—in the log siding and random width paneling, the drop ceiling and its scalloped trim. They're used for the doors—and the built-in desk and cabinets they hide, for the casement window that frames a photo-mural.

You'll find the Western Pines cut clean and accurately with hand or machine tools. Smooth and even-textured, they take stains, paints, enamels or varnish—wax to a handsome natural finish.

See the Western Pines at your retail lumber dealer—use them in your next woodworking project!

the **Western Pines**

- * IDAHO WHITE PINE
- * PONDEROSA PINE
- * SUGAR PINE

Send for FREE IDEA PACKET 209—including the booklet, "Enchanting Homes of Western Pines"—to WESTERN PINE ASSOCIATION, Dept. 209-N, Yeon Building, Portland 4, Oregon



HAN-DE-HORSE Saves Time—Trouble—Storage Space Strong • Compact • Portable

FOLDED, FITS IN CAR TRUNK

HAN-DE-HORSE cuts costs—eliminates wood sawhorse nuisance—PAYS FOR ITSELF IN SHORT TIME—practically lasts forever. Helps make home work pleasant. RIGID welded construction with HEAVY ANGLE IRON LEGS. Will NOT collapse. Brace Rods hold legs rigid. Supports great weight. RUBBER FEET prevent scratching. Takes little room in average car trunk. Everything furnished except 2 x 6 plank top. Includes simple assembly instructions. Complete without plank: \$13.50. A pair \$25.00. Send check or money-order. No C.O.D.'s. Prepaid anywhere in U.S. Fully GUARANTEED. Return in 10 days for refund if not completely satisfied.



TESTED TO 5,000 LBS.

ASHTON MACHINE WORKS, 5711 WEBSTER, ARVADA, COLO.

CARBURETOR TOO RICH MAKES MOTORIST TOO POOR



Car owners who are wasting money, getting poor gas mileage due to over-rich mixtures, will be pleased to learn how to save gasoline by VACU-MATING OVER-RICH MIXTURES. Vacu-Matic fits all cars, trucks and tractors. Automatic and operates on the supercharge principle. Easily installed in a few minutes.

SALESMEN WANTED! Big Profits

For FREE particulars, how you can install one on your own car for introducing, just send your name and address on a postcard to VACU-MATIC, 7617-2018 W. State St., WAUWATOSA, WIS.



Make your own Gems

The Gem Maker comes complete with all necessary equipment, including a super-charged diamond blade for sawing, and all wheels for grinding, shaping and polishing; also complete instructions. The complete equipment as shown, less motor and belt, for only \$29.50, f.o.b. Burlington, Wisconsin. Write today for information and literature.

B&I MANUFACTURING CO.
Dept. S Burlington, Wis.

29.50
f.o.b.

Make Money SELLING Eshelman Tractors and doing GARDEN WORK



ESHELMAN
Low as \$69 Plus Tools

FOR BETTER LAWNS and GARDENS

Also Power Reverse. Women can operate it. Free Catalog, Write: ESHELMAN, Dept. 56, 119 Light St., Balto., Md., 333 N. Michigan Ave., Chicago 1, Ill., 7070 Hollywood Blvd., Los Angeles 28, Cal.

BEAUTIFY YOUR CAR!

Para-Ven® AUTO-BLINDS

Smart • Distinctive
Does Not Interfere with Drivers' Vision! Dims Annoying Headlight Glare!
Everybody wants this distinctive auto-blind that keeps hot sun off backs of rear seat passengers and protects your upholstery or seat covers from fading! Made of plastic and aluminum — you install it yourself in minutes with only a screwdriver! To



order yours, give year, make and model of car and only enclose check or money \$5.95 order No COD. 10 day money back guarantee. postpaid

PARAMOUNT VENETIAN BLIND CO. Dept M-6
151 East 126th Street, New York 35, N.Y.

The NEW Model 50 UTILITY TESTER FOR REPAIRING ALL ELECTRICAL APPLIANCES-MOTORS

an all-around electrical trouble shooter

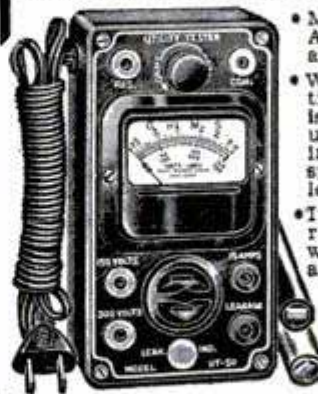

- Measures A.C. and D.C. Voltages, A.C. and D.C. Current, Resistances, etc.
- Will measure the current consumption while the appliance under test is in operation. The appliance or utility may be plugged directly into the front panel receptacle. A special pair of insulated clip-end leads is included for motors, etc.
- Incorporates a sensitive direct-reading resistance range which will accurately measure all resistances commonly used in electrical appliances, motors, etc. This range will enable continuity checks and tests for shorts and opens.
- Will test thermostats, radio tube filaments, bulbs, fuses, fluorescents, condensers, switches, field coils, circuit breakers, lighting systems, etc.

Handsome round cornered molded bakelite case 3 1/8" x 5 1/8" x 2 1/4". Complete with all test leads and instructions.

\$13.90

SHIPPED ON APPROVAL No Money With Order — No C.O.D.

Try it for 10 days before you buy. If completely satisfied send \$3.90 and pay balance at rate of \$2.00 per month for 5 months —No Interest or Carrying Charges Added. If not completely satisfied, return to us, no explanation necessary.

SUPERIOR ELECTRONIC CO., INC.
Dept. D-62, 227 Fulton Street, New York 7, N. Y.

Please rush 1 Model 50. I agree to pay \$3.90 within 10 days after receipt and \$2.00 per month thereafter.

Name _____
Address _____
City _____ Zone _____ State _____

Say You Saw It in Popular Mechanics

Make Garden Masonry for Spare-Time Profits

Millions of homes can use these Ornamental products — urns, vases, flower boxes, bird baths, lawn seats, flagstones, etc. Easily made of sand and cement. Permanently glazed in a range of smart colors. Distinctive — attractive — quick selling.



Eye-Appeal Makes for Cash-and-Carry Sales



Selling prices allow 200% to 300% mark-up on basic costs. Only a small investment needed for supply of molds. Easily set up in shed or garage. Write immediately for catalogue OM and price list.



Colorcrete Industries, Inc.
710 Ottawa Ave., Holland, Mich.

NEW POND GARDEN TRACTOR

\$119⁶⁰
LIMITED TIME ONLY
FULL 2½ H.P.

'ALL IMPLEMENTS AVAILABLE: WRITE TODAY FOR FREE 12-PAGE CATALOG!



DEALERS WANTED—MAKE EXTRA MONEY
17" ROTARY POWER MOWER
\$66⁰⁰
LIMITED TIME ONLY
MAIL THIS COUPON NOW

THE POND COMPANY
Box 216E5, Ravenna, Ohio

- Send 12-page tractor catalog.
 Send data on power mower.

NAME _____
ADDRESS _____
CITY & STATE _____

Build Your Own GARAGE



PLANS AND INSTRUCTIONS ONLY
35¢

14'x 20' WITH 2-FOOT OVERHANG 9-FOOT GARAGE DOOR

Save Money by "Doing it yourself"—Complete Plans Drawn to Scale and Detailed Instructions Show You How To Do It

K-D GARAGE DOOR SALES
19466 FITZPATRICK, • DETROIT 28, MICHIGAN

PARTS FOR MILITARY TRUCKS

AND **JEEPS** 4 & 6 WHEEL DRIVE. WRITE FOR PARTS CATALOG STATING MAKES

JEEP TOPS and CURTAINS

All Brand New . . . Not Surplus
Made of Heavy Canvas Duck . . . Waterproof
MILITARY TYPE models, Top and Curtains, complete, **\$59.50**
less bows
TOP and CURTAINS, HALF CAB . . . MODELS CJ2A and CJ3A, complete with hardware, **\$65.00**
less bows
TOP and CURTAINS Complete, MODELS CJ2A and CJ3A, with hardware for entire Jeep **\$88.80**
less bows

When ordering please state exact model
All prices F.O.B. K.C. 25% dep. on COD's

American AUTO PARTS CO. INC.
1830 LOCUST—DEPT. PM
KANSAS CITY, MISSOURI

2¼ CU. FT. MIXER \$35

DIRECT FROM MFR.
Fills long felt need for small mixer for concrete, feed, fertilizer, seed and many other materials. Saves ¾ cost of ready mixed concrete. Pays for itself on first job. Combination belt pulley and crank for hand operation. Also Power Mixers. Write for circular.
2¼ cu. ft. Mixer—3 cu. ft. Drum, Direct Factory Price \$35.00
3 cu. ft. Mixer—5 cu. ft. Drum, Direct Factory Price \$0.00
FOB Pulaski, N. Y. Cash, Check or M. O. Money back guarantee.
UNITED STATES FORGE AND FOUNDRY CO.
CONSTRUCTION EQUIPMENT DIV. PULASKI, NEW YORK



Weegee's Secrets
OF SHOOTING WITH PHOTOFLASH
To get this new 64-page booklet, mail 25¢ and the wrapper from a carton of Westinghouse flash bulbs to Westinghouse Lamp Division, Dept. PM6, Bloomfield, New Jersey.

Send for AUTOMATIC "ON-OFF" CONTROL

"ROBOT" Portable Timer, for electric appliances.
No tools, no wiring! Just plug in a ROBOT TIMER, set the dial, and forget it! Operates at times you select. Dozens of uses for home, shop, hobby. Accurate automatic operation of radio, TV, heaters, roasters, fans, etc. Turns lights "OFF-ON" while you're out of town, for burglar protection. Full 24 hour dial. U.L. Approved. Send \$16.95, postpaid. Or C.O.D. plus shipping. Satisfaction or your money back.

The EDDY-HILD CO., DEPT. 63, P. O. BOX 222, WATERTOWN, WISCONSIN

NEW SAW SHARPENER

Improved #64 Hand Gummer sharpens all types circular saws 4" to 20" diam. Ideal for saw shops. Self-Centering adjustment for quick, easy set-ups. Complete with ¼ HP motor, 1 grinding wheel & cord. \$79.50 FOB Portland, Wl. 70¢. SEND FOR FREE LITERATURE.
P. T. HOBBS MACHINERY
8375 N. INTERSTATE AVE.
Dept. P.M.-61, PORTLAND 17, OREGON

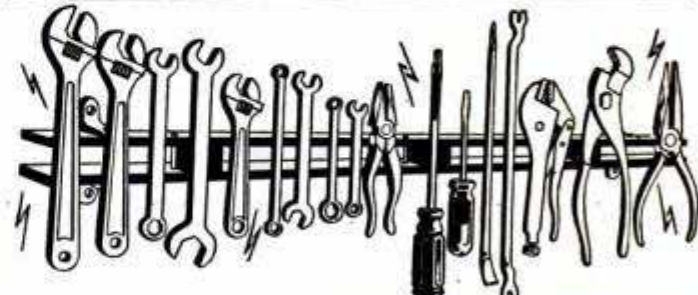

The **TOOLMASTER**. A permanent magnetic tool rack designed to hold your tools within convenient reach. Requires no electricity. No cost to operate. Never weakens. Simply touch the tools to the TOOLMASTER and the powerful Alnico magnets hold them there—before your eyes—at your fingertips. Select the tool you need quickly—without loss of time—easily removed. Constructed for many years of constant use. For industrial plants, machine shops, garages, home work shops, etc. Order now. If after one week's trial you are not completely satisfied, return it to us and we will promptly refund full purchase price.

CAT. NO. M-363 "TOOLMASTER" 36" LONG—\$12.95 ea.
CAT. NO. M-242 "TOOLMASTER" 24" LONG—\$ 8.95 ea.
Complete with mounting brackets and screws. Send money order or check. We pay postage. No C.O.D.'s.
MIAMI MAGNET COMPANY, 3240 N.W. 27th Ave., Miami 42, Fla.

Only AMF builds a "Power Shop" that does everything in woodworking...

with one direct-drive motor!

EASY...to operate and learn. Adjusts in seconds to miter, rip, bevel.

SAFE...cuts the PROPER way...above the work...blade does the moving, work remains stationary.

PRECISE...calibrated scales let you position cutting attachment accurately for any cut.

COMPACT...a complete, big-capacity home workshop, (cuts 2½" deep, rips to center of 4-foot panel). Fits in a 3-square-foot area.

PRICE, \$229 delivered (saw blade and custom-built motor included). Easy low payment plan to fit your budget.

 **DE WALT**
"Power Shop"



Now on sale in department stores, hardware stores, mill supply houses.

12 power tools in 1—it does everything!

Makes every cut and joint!



PROFESSIONAL SHAPER!

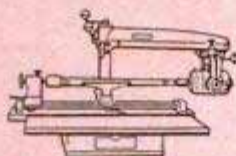

CRAFTSMAN'S LATHE!

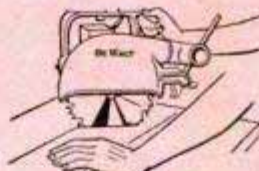

MITER CUT!

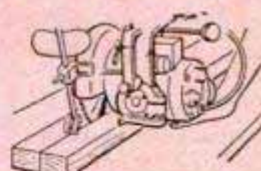

RIP CUT!

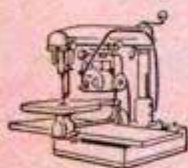

BIG-CAPACITY JIG SAW!

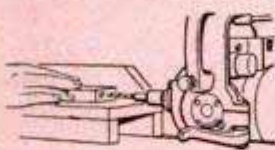

POWERFUL DRILL!

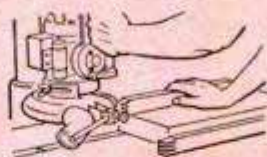

LOCK JOINT!

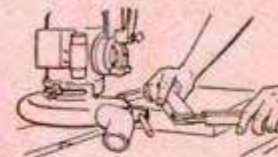

MORTISE AND TENON JOINT!

And it's a dado, sander, router, grinder, metal cutter!

18 different operations with saw blade alone!



products are better... by design

AMERICAN MACHINE & FOUNDRY COMPANY

SAVE '80% ON FINE FURNITURE!

Send for "Make It Yourself" booklets!
28 pages...20 pieces of furniture.
Exact make-it-yourself savings.
Finishing tips. Complete DeWalt®
"Power Shop" instructions.



Send 25c—Save Hundreds of Dollars!

AMF DeWalt, Dept. PM-6, Lancaster, Pa.
Please send "Make It Yourself" booklet(s) checked below. Enclosed find 25c (in coin) for each one.
 Early American and Juvenile furniture. (25c)
 Modern and Outdoor furniture (25c)

Name _____

Address _____

City _____ Zone _____ State _____



TEENUTS®

STEEL THREADS IN WOOD!

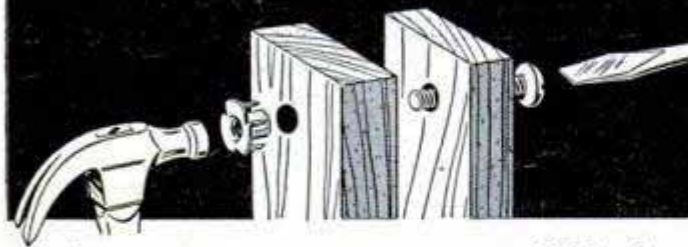

Industry proven TEENUTS, now available for home craftsmen . . . provide flush mounting without counter-boring. Excellent for new work or repairs. Ideal for metal-to-wood applications and where old screw holes have become useless. You simply drill hole size of TEENUT barrel, hammer home TEENUT and its steel prongs provide rigid, permanent anchorage. Same size hole for bolt. Complete line to fit standard bolt sizes. Show your hardware dealer this ad. No mail orders please.

AT HARDWARE
COUNTERS EVERYWHERE

15¢



COLUMBIA FASTENER CO.
Chicago 8, Illinois

Send for this
BIG NEW
Hunt's
WOODWORKERS
CATALOG NO. 19

ONLY **15¢**

NEW LOW PRICES

Offers greatest selection of fine domestic and imported woods--and hundreds of woodworkers items at bargain prices!

You'll save time and money with this big, new catalog. Contains everything wood craftsman needs. Shows 32 rare and fancy woods in color...43 veneer designs...275 scroll patterns...multicolor inlays, overlays, bandings...all kinds of tools, machinery, cabinet hardware, ornaments, mouldings...and pages of valuable tips, ideas, information, instruction. Send for your copy NOW. Only 15c--refundable on your first order.



144 PAGES
QUICK
DELIVERY

on maple, poplar, oak, mahogany, red cedar, cherry, walnut, and many others--all properly seasoned and kiln dried.

MAIL THIS COUPON--TODAY!

CRAFTSMAN WOOD SERVICE CO.
2729 S. Mary St., Dept. A6
Chicago 8, Illinois

Send me the big, new, money-saving Catalog No. 19. Enclosed is 15c--refundable on my first order.

Name _____
Address _____
City _____ Zone _____ State _____

Explore the MICRO-JUNGLE!

Triple-turret microscopes
as low as . . . **\$9.95**
New Quadruple-turret
models (as shown) **\$16.95**



All slide materials. Other optics from \$1. Send postcard.
FREE 44-PAGE

CATALOG!

World's greatest values in quality microscopes, telescopes, binoculars. All hobby and professional models.



the **AKRON**

33 Akron Bldg., 4400 Sunset Blvd.
Los Angeles 27, California

Send FOR this Giant AUTOMOTIVE Catalog

& Save to 50% on All Parts & Accessories

1953 EDITION JUST OUT



World's largest Auto Accessory & Parts Catalog. Over 50,000 items--Hollywood Accessories, Hi-Speed Equipment, Rebuilt Engines. Everything for all cars & trucks. We have that Hard-To-Get part. Jam packed with bargains. Completely illustrated (134 pages). Send 25c (refundable).

J. C. WHITNEY & CO. 1917xp Archer, Chicago 16

VARIABLE SPEED HYDRAULIC POWER TRANSMISSION



It has Infinite Speeds 0 to 550, Reverse, Automatic Overload Protection; Adjustable Torque up to 180 inch pounds. $\frac{3}{8}$ " Input and Output Shafts. It will handle $\frac{1}{2}$ " to $1\frac{1}{2}$ " H.P. Motor. Case measures $7\frac{1}{2}$ " long, 7" high $6\frac{1}{2}$ " wide. VALUE OVER \$300. Shipping Wt. **\$54.50** we require a 10% only Deposit. Fob. Chicago

DIRZIUS MACHINE SHOP "C" 1423-25 So. 52nd Ave., Cicero 50, Ill.



Print Your Own

Cards, Stationery, Advertising, labels, circulars, photo and movie titles, church work, tags, etc. Save money. Sold direct from factory only. Raised printing like engraving, too. **Print for Others, Good Profit.** Have a home print shop. Easy rules supplied. Pays for itself in a short time. Write for free catalog of outfits and all details.

Kelsey
EXCESSOR
Presses

KELSEY PRESSES, N-37 MERIDEN, CONN.

HELPFUL BOOKS

Send post card asking for **FREE** catalog

Popular Mechanics Press, 200 E. Ontario, Dept. 601, Chicago 11

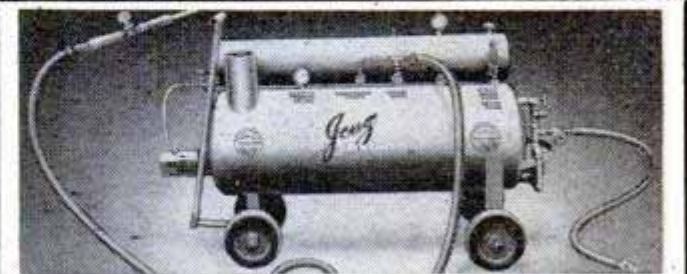

EARN \$6.00 PER HOUR

In a depression-proof business with the NEW JENZ SUPER CHIEF STEAM CLEANER. Portable--No moving parts -- Cleans anything -- Any place -- Motors -- Chassis--Machinery--Floors--Buildings--Oil Rigs, etc. --Oil fired--Economical--Fully tested and warranted, 75 lbs. steam in ten min. **\$463.50** --Model 90, Complete as illustrated....

F.O.B. shipping point
HI-PURE LABORATORIES, Evansville, Ind.

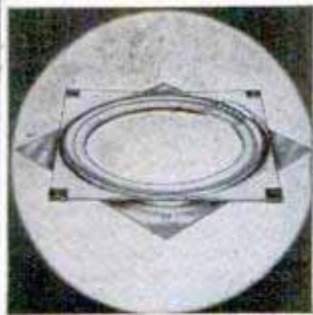

NEW!
Lazy Susan
Bearing

\$1.60 BY MAIL
POSTPAID

Make "Lazy Susan" trays, revolving corner cupboard shelves, TV turn-tables, swivel boat seats, revolving stool seats and toys with the Lazy Susan Bearing! Seventy precision-made ball bearings are evenly distributed around the race for maximum load-carrying capacity and smooth operation. Simple installation. 6 1/8" square, 3/8" high. Order No. H-6347. Satisfaction guaranteed.

WRITE NOW FOR FREE CATALOG
OF TOYS, GIFTS, HOUSEWARES!

Miles Kimball

42 BOND ST., OSHKOSH, WISCONSIN

NEW SPRINKLER

Sprays Area Up To 50 Feet All Around—Can Be Twisted, Wound Around Bushes and Flower Beds. Use As "Soaker"—Saves Water and Time. Durable, lightweight, made from flexible plastic. Will not rot or mildew, even if stored wet. Complete with brass connector.
20 ft. length... **\$2.50**
50 ft. length... **\$4.75**
7-Day Free Trial—Send payment now for sprinkler you want. We pay postage. C.O.D.'s also accepted (you pay postage). Money back within 7 days if not absolutely delighted. Order NOW!



Homecrafts, 799 Broadway, Dept. SS6, New York 3, N. Y.

MAGNETS OF ALL TYPES — 10c UP
AMAZINGLY POWERFUL!!
1/2 ounce horseshoe magnet—\$1.50.
Our Leader, 1 lb. magnet lifts 40 lbs. \$2.95. New alloy—will not weaken! Useful for lifting valuables from tanks, lakes, or rivers easily! 7 small magnets \$1.25 with list of many shop and home uses. Satisfaction guaranteed.
R. EYRICH, 1091 N. 48 STREET, MILWAUKEE-8, WISC.



**"BEST SANDER I'VE USED
IN 40 YEARS OF
DECORATING"**

Follow Master-Decorator Jokela's advice—get amazing "504" SYNCRO—perfect for vertical sanding—best for dry wall sanding! Low cost. At dealers or send for Circular. SYNCRO Corp., Dept. D-63, Oxford, Michigan, U.S.A.

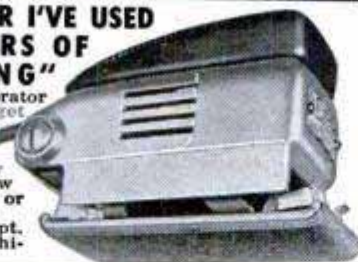

FILE SAWS THE RIGHT WAY

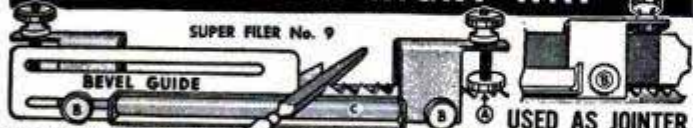

SO EASY with this new filing jig and jointer anyone can now sharpen any handsaw like new! When file hits hardened steel rollers teeth are finished and EXACTLY THE SAME HEIGHT. All teeth cut and saw runs true and smooth. Jig and instructions \$2.95 postpaid. FREE FOLDER.

SHARPEN YOUR CIRCULAR SAWS

The RIGHT WAY on your own saw table. Sharpens rip cutoff, hollow ground and combination blades—8" to 10" Saws stay round with correct bevel. Precision made, easy to use. GUARANTEED. Only \$8.95. Includes \$3.00 Grinding wheel.

"TRU-CIRCLE" saw set automatically sets teeth at 10° or more. \$2.95

AT DEALERS OR POSTPAID

A.D. McBURNEY, 317 E. 4th St., Los Angeles 13, Calif., Dept. A-30

Extra-hardened at points of extreme wear. Last longer.

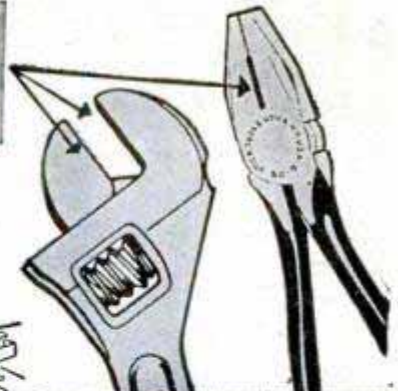

**WHEN YOU
DO IT YOURSELF**

USE GOOD TOOLS

For those 101 jobs around the house, the auto and the yard, *good* tools get the job done faster and easier.

UTICA pliers and adjustable wrenches are *good* tools, skillfully forged for rugged strength. And UTICA's own process *extra-hardens* the tools at points of extreme wear.

Ask your dealer for UTICA pliers and adjustable wrenches. It will pay you to remember the name—UTICA. ®



IT PAYS TO BUY QUALITY TOOLS

(and the world's best tools are made in U.S.A.)

SAY YOU SAW IT IN
POPULAR MECHANICS

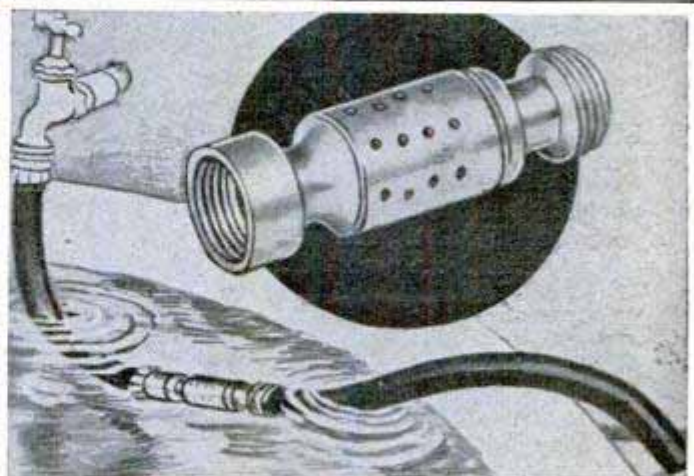

DRAINMASTER. Without electricity or moving parts this suction drainer pumps 300 gallons of water per minute from flooded cellars, pools, trenches, etc. Just attach with a garden hose to any screw-type faucet, attach another section of hose to the discharge end, turn on the water and it goes to work. Solid brass, non-rusting.

Only
3⁹⁵

Write for free Novelty Catalog.

NOVELTY MART, 59 EAST 8th ST., NEW YORK 3, N. Y., DEPT. 150

Made

\$900 IN SPARE TIME

"I did very well last year with my Foley equipment, about 950 saws, in my spare time. About \$900 for me." — Leo H. Mix.

You can make up to \$3 or \$4 an hour in Spare Time. With a Foley Automatic Saw Filer you can file hand, band and circular saws better than the most expert hand filer. Cash business—no canvassing. No eyestrain, no experience needed.

FREE BOOK "MONEY MAKING FACTS"

shows just how you can start at home in spare time, with small investment, no overhead—and develop into a full-time repair shop. Send coupon today for this practical plan. No salesman will call.

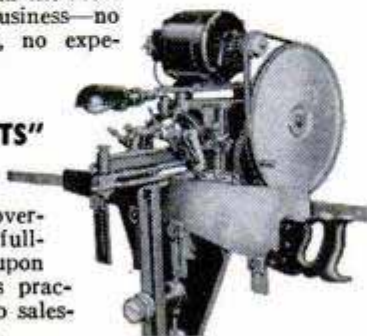

Send Coupon for **FREE BOOK**

FOLEY MFG. CO. 630-3 FOLEY BLDG. MINNEAPOLIS 18, MINN.

Send **FREE BOOK** — "Money Making Facts".

Name _____

Address _____

TRIPLE PROTECTION

- 100% Pure Pennsylvania
- Specially Refined
- Scientifically Fortified

WOLF'S HEAD is the richest, toughest, "oiliest" oil you can use. It cleans engines and keeps them clean... protects against unnecessary wear, engine deposits and corrosive acids.

Insist on **WOLF'S HEAD** for smoother engine performance, added power, reduced oil consumption. **WOLF'S HEAD** Motor Oil is scientifically fortified to meet the requirements of all makes of cars and for all types of service.

FREE! "Guide to the Weather" Folder shows how cloud formations forecast weather. Write for a copy.

WOLF'S HEAD OIL REFINING CO., INC.
Oil City, Pa. New York 10, N. Y.



WOLF'S HEAD MOTOR OIL

100% Pure Pennsylvania Scientifically Fortified



Member, Penna. Grade Crude Oil Association

Have an OUTDOOR FIREPLACE



Easy to Build—Fun to Use

A real "entertainment spot" for family or guests! Everyone enjoys food cooked outdoors! Following simple instructions you just add masonry in your choice of design or material to a Majestic all-metal unit—and you have the perfect operating, lowest cost outdoor fireplace. Lasts for years! Choice of units from \$20.95. See your dealer or write today.

SEND ONLY
25¢



The Majestic Co., Inc.
350 Erie Street
Huntington, Indiana

for 56 page, fully illustrated
BOOK of DESIGNS and IDEAS



Our 613th Advertisement

REAL DIESEL ENGINE

\$3.95

- for planes, boats, midget cars
- 7500 RPM; 1/7 HP; ht. 3 1/2"; wt. 5 oz.
- precision machined for smooth operation

You just can't beat this price for a precision diesel engine! Streamlined, compact, easy to install. Thousands of satisfied users all over the world. Fast delivery if you ORDER TODAY! Send \$3.95 plus 25c postage.

GOTHAM HOBBY CORP. Dept. P, 107 E. 126th St. New York 35, N. Y.

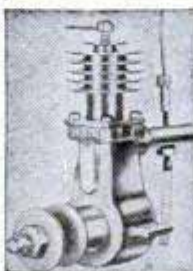

FREE! "HANDY TIPS FOR HANDY MEN"

BOOK OF HINTS to make home repairs and hobby projects easier. Write to: **THE BLACK & DECKER MFG. Co.**, Home Service Dept. H6M, Towson 4, Maryland.

Build your own JET ENGINE!



Order these plans today

1. JET PROPELLED BICYCLE. Assemble your own. Photo and instructions. \$1.00.
2. HOW TO MAKE EXPERIMENTAL JET ENGINES. Seven sheets drawings with information and instructions \$2.95.
3. BOTH OF ABOVE in one order \$3.75. SEND NO MONEY. Order both at once \$3.75 C.O.D. in USA plus c.o.d. postage. Send check or Money Order and we pay postage. Get other information too. Rush Order.

J. HOUSTON MAUPIN, Dept. 55, Tipp City, Ohio

BUILD YOUR OWN FAN



One-piece cast aluminum propellers for cooling and ventilating.

Size Inches	Polished 2 Blade	Polished 3 Blade	Unpolished 2 Blade	Unpolished 3 Blade	Bore Inches
15	\$3.00	\$4.00	\$2.50	\$3.00	1/2, 5/8, 3/4
18	3.75	5.00	3.00	4.00	1/2, 5/8, 3/4
20	4.00	5.50	3.25	4.50	1/2, 5/8, 3/4
24	4.50	6.50	4.00	5.50	1/2, 5/8, 3/4

Write for pamphlet on larger fan blades, wire guards, fan bases, shutters, pillow blocks, exhaust fan frames, etc. Dealers write for discount. Shipped prepaid if money accompanies order.

KLOPPENBORG ALUMINUM FDY., Dept. PM-53, Davenport, Iowa

HANGING WALLPAPER?

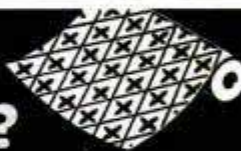

Hang wallpaper more quickly and accurately by using **ADHESIUM**. This remarkable product prepares the wall surface so paper slides into place smoothly—patterns can be matched easily. Added to paste, it makes paper adhere tightly, prevents cracking and opening at the seams. Get **Adhesium**—at paint and hardware stores.

Write for informative leaflet

Colonial Works, Inc., 227 Norman Ave., Brooklyn 22, N. Y.

ADHESIUM®

Worth its weight in **GOLD**

BRONZE OIL FILTER GUARANTEES:



- ✓ 10,000 Miles Without Changing Oil!
- ✓ 200,000 Miles Without Changing Filter!

The sensational FILTERALL permanent oil filter is so designed that all your oil is forced through a porous bronze element that never wears out. Recently perfected for aircraft use, it filters out dirt particles as small as 39 millionths of an inch, insuring a continuous flow of clean, grit-free oil, regardless of

engine temperature. FILTERALL allows no loss or bypass and does not rob your oil of valuable protective additives . . . even saves you the quart usually soaked up by old type filter packs. Your FILTERALL high-efficiency filter will pay for itself over and over by saving oil, engine repair and the expense of "old fashioned" filter element replacements. Easy installation for all cars and light trucks—can be transferred to your new car when you trade. To clean, just rinse the bronze cartridge in gasoline. Order your permanent filter by mail today.

Please specify on all orders make, year and model of your car and make of old filter, if any. Postpaid (or send \$2.00 deposit; balance C.O.D.)

Dealer inquiries invited

ENGINE PRODUCTS MFG. CO.

5801 E. BEVERLY BLVD., DEPT. 32, LOS ANGELES 22, CALIF.



FILTERALL Complete Filter Unit for all cars except those few using full flow type..... 1.295

FILTERALL Kit for converting your present filter to permanent unit..... 695

FILTERALL Full-Flow type (for foreign cars, some Chrysler models, etc.) Complete heavy duty Model including case..... 1.995



FULL 10 YEAR Guarantee!

HANDIEST TOOL YOU CAN OWN!

No. 10-W, \$2.60

Locks to Work with Ton-Grip!



WISE-GRIP WRENCH

Does so MANY jobs EASIER! A squeeze of the hand locks jaws to work with **Ton-Grip**. Won't slip! Turns, twists, bends, pulls, cuts, ratchets. A whole tool kit in 1 trim tool! 7" and 10", only \$1.85 to \$2.60 at your dealer.

Made Only By PETERSEN MFG. CO., Dept. M-6, DeWitt, Nebraska

Say You Saw It in Popular Mechanics

Stop TERMITES yourself at a big saving — with amazing new product, ARAB U-DO-IT

A packaged product is now available for you to knock out subterranean termites yourself by the modern, soil-treatment method. This product is ARAB U-DO-IT Termite Control, a liquid concentrate with a Chlordane base. One gallon mixed with water makes 100 gallons ready-to-use termite killer and will treat average 5-room house. Easy to apply. Non-inflammable, no objectionable odor. Will not harm grass, flowers, shrubs or trees. Long-lasting effectiveness proved since 1946 by leading exterminators. If your dealer cannot supply, send postcard for prices and FREE folder showing how termites get into your house, where to look for them, how to kill them. No obligation.

FEDERAL CHEMICAL CO., Dept. PM-63
Indianapolis, Indiana

JOIN THE FUN—SAVE 50%

PACKAGED BOAT KITS



OUTBOARD CRUISERS from \$349.50

EASY TO ASSEMBLE

SEND 25c FOR BIG 1953 CATALOG

See our complete line before you Buy! World's most complete line of real Performance Boats: Dinghies, Skiffs, Pontoon Racers, Runabouts, Outboards, Cruisers. Exclusive features, mahogany parts plus brass screws. Also marine hardware, fittings, accessories and quality paints.

Catalog plus booklet "Boat Selection, Operation & Maintenance" \$1.00 DEALERS! Write for details on "Protected Dealer Plan."

SEND 35c for World's most complete Catalog of Full Racing and Speedboat Accessories, general boat hardware, fittings, paints, conversions and conv.kits. Also new "ARMOR-GLASS" covering material for boats. Catalog plus booklet "How to Paint, Outfit and Care For your Boat" send \$1.00

BOAT PAINT, ACCESSORIES and FITTINGS

BOAT PLANS AND FULL-SIZE PATTERNS

Over 100 Modern plans and full size patterns. Racing classes, cruisers, inboards, outboards, sail boats. By famous designers. 6' to 30'. DESIGN CATALOG only 35c. For Design Catalog plus boat building handbook send \$1.00.

CUSTOM-CRAFT (DEPT. A) BUFFALO 7, N. Y.

BUILD IT! RUN IT! DISPLAY IT!



Actual photograph of model built from Kit

Chris-Craft

BUCCANEER 47' PERFECT SCALE MODEL

SO REAL—YOU'LL FEEL YOURSELF AT THE WHEEL! SO COMPLETE, ALL YOU NEED IS PAINT, GLUE AND A MOTOR!

- Authentic in every detail
- Completely prefabricated
- Die-cut parts... Carved Hull
- Step-by-step instructions

TO ORDER:

If not available at your dealer's send cash, check or M.O. No C.O.D.'s. Add 30c for packing, postage and insurance.

Other Powered Model Boat Kits from \$2.95 to \$11.95.

STERLING MODELS • Dept. M
1530-34 N. Hancock St., Phila. 22, Pa.

One of America's Largest Manufacturers of Scale Model Airplane and Boat Kits.

\$7.95
(Including all marine fittings)

Length, 19". Beam, 5"



Length 12" \$3.25
Kit B-4

For descriptive literature of Model Boat and Airplane Kits, send self-addressed, stamped envelope.

2 DRILLS in 1

\$11.95 POST PAID

Send check or Money Order • Satisfaction guaranteed • Order yours now

This attachment gives you two drills in one. It converts any 1/4 inch electric drill to 1/2 inch capacity. Reduction gears reduce the drill speed 5 to 1, the average speed of a 1/2 inch drill, and thereby increases the power. Absolutely indispensable for all shop work and home craftsmen.

G. M. CO. MANUFACTURING, INC.
1308 43rd AVE.
LONG ISLAND CITY 1, NEW YORK

ACCURATE, gas powered

WRITE FOR CATALOG

Crosman

Single shot or 10 shot repeater, precision rifled barrel, push type safety, adjustable sight, power adjustment, .177 or .22 cal.

AT DEALERS EVERYWHERE

CROSMAN ARMS CO., Rochester 20, N.Y., Dept. 45

"SHOOPER" GEIGER COUNTER

Super-sensitive! Only 1 1/4 lbs! Fits pocket—uses flashlight battery. Find a fortune in uranium. Order Now! Send \$5.00, balance C.O.D. MONEY BACK GUARANTEE, FREE CATALOG—scintillator and larger uranium and metal detectors **DEALERS WANTED.**

2495 COMPLETE

PRECISION RADIATION INSTRUMENTS
2235 PM S. LA BREA, LOS ANGELES 16, CALIF.

NEW TOOL WITH 1000 USES!

New DRILSAW

Send for **FREE** booklet. **DRILL** then **SAW** practically any material with the sensational new **DRILSAW**. Work in any direction with just **ONE HAND**. Made of finest **IMPORTED STEEL**—won't clog. **GUARANTEED**. Many more special tools. Write today. **COLONIAL MERCHANDISE CO., Dept. P, Box 232, Hamburg, N. Y.**

Say You Saw It in Popular Mechanics

COMPENSATING COMPASS

*** **SHERRILL** ***

ARMY and NAVY COMPASSES
were on every beachhead and battle front all over the world.

The "Air-Way" is a precision-built, all-purpose compass, only 2 x 3 inches in size, may be used in automobile or on camping trips. Rubber suction cup permits instant mounting on dash or windshield of car or boat. Remove only one screw, reduces compass to 2 x 2 inches, slips into coat pocket for fishing, hiking or hunting trips. The large easy-to-read aviation dial is direct reading. Simple compensating mechanism with instructions. Guaranteed.

BRAND NEW

\$1.98 POSTPAID

adds to your...
... security ... relaxation ... pleasure

★ HOLLYWOOD SALES CO.
3414 W. MAGNOLIA BLVD., BURBANK 22, CALIF.

The easy way to paint!

Speedy Sprayer

Favorite of home owners and craftsmen for 20 years! **SPEEDY SPRAYER** gives your work that professional paint finish everyone admires. Sprays paint, enamel, varnish, lacquer, etc. . . . 4 to 7 times faster than hand brushing! Lightweight, portable, uses any 1/4 H.P. motor. Improved diaphragm principle assures clean, oil-free air. You'll find dozens of time and money saving uses for **SPEEDY SPRAYER**, including spraying insecticides 2-4-D and DDT. Complete outfit, without motor, only \$36.50.

ONLY \$36.50
LESS MOTOR

At leading hardware, lumber, and auto supply dealers. **FREE**—write for handy booklet "How to Spray."

W. R. BROWN CORPORATION
2635 N. Normandy • Chicago 35, Ill.

BOAT KITS BY U-MAK-IT



18 FT. and 21 FT. OUTBOARD and INBOARD CABIN CRUISERS

Roomy cabins, sleep 2.
Fast Vee bottom hulls.

30 Models
8 TO 23 FEET

ROWBOATS
8 to 14 Ft.
OUTBOARDS 12 to 21 Ft.



INBOARDS
16 to 23 Ft.

U-MAK-IT PRODUCTS 703P-WHITTIER ST., BRONX 59, N. Y. CITY

NEW 1953 CATALOG

44 PAGES, shows construction details. Incl everything to build your own—hardware, engines, conversions, paint & color chart. Also Fibreglas covering for all Kit Boats, Cabin Roofs and Decks
SEND 35¢ COIN TODAY



MAKE YOUR OWN POWER LAWN MOWER \$13.95

with this DRIVE CUTTER ASSEMBLY

Constructed for those who desire to build their own mower or to replace your old cutter assembly. Complete with 18" blade and double ball bearing drive . . .

Add 50¢ to cover handling & shipping anywhere in U.S.A.
Send Check or M. O.



ATLAS KEEN MOWER

229 S. W. BLVD. Dept PM 6 KANSAS CITY, MO.

SHOPMASTER'S

NEWEST SENSATION

COMBINATION POWER TOOL



For Complete Information Write Dept. PM 6
1234 S. 3rd St., Minneapolis, Minn.

SHOPMASTER, INC.

LAWN ORNAMENT-NOVELTY PATTERNS

28 Lawn Ornament Patterns, 25¢. Other Patterns; 15-20" high; Dutch Girl, Dutch Boy, Pirate, Bull Terrier, Mexican Girl, Mexican Boy, Dwarf, Penguin, Flower Girl, 15¢ each. 25 Novelty Patterns, 30¢. All 62 Full Size Patterns, \$1.00.
Strother Pattern Service, Dept. D1-8, Box 128, Belington, W. Va.

END CESSPOOL TROUBLES

SAVES DIGGING, PUMPING, MOVING!
CESSPOOLS • SEPTIC TANKS

CLEANED — DEODORIZED

PEPS-IT Prevents overflowing . . . Removes obstructions • Starts disposal action in new systems . . . Stays on the job • Helps your septic tank or cesspool handle the waste load from electric garbage disposal units • Restores bacterial action after tanks and cesspools are overloaded with soaps and detergents from sinks, washing machines and electric dishwashers • Harmless to plumbing, animals and humans . . . Promotes safe, sanitary disposal all year long • Easy to use . . . Apply PEPS-IT every six months to keep your system at peak efficiency — more often if you use large amounts of soaps and detergents or have an electric garbage disposal unit.



FREE TRIAL
Send name and address for convincing free-trial sample and complete details as to proper procedure . . . eliminate all that worry about objectionable odors, overflowing of septic tanks, cesspools, and sluggish disposal systems. PEPS-IT does it the easy way at low cost. Write
ELECTRIC SEWER CLEANING CO. 294 LINCOLN STREET, ALLSTON, MASS., TODAY.

DON'T PACK AND WRINKLE YOUR CLOTHES



Just hang them on
KAR-RAK
your auto valet.

HOLDS UP TO 33 GARMENTS FULL LENGTH! So convenient, no more packing problems. Saves cleaning and pressing bills too! Fits any car in a jiffy, no tools needed. Won't obstruct rear view. No door or window interference. Made of sturdy rust-resistant steel to last for years. May be used as an extra non-sagging rod in home or office. Only \$4.49 postpaid. (Agents wanted.) Write now:

Melaire Distributing Co. 420 Lexington Ave., Dept. 9-PM, New York 17

The New Improved Model 38-98 DYNAMIC POWER TOOL COMBINATION



INCLUDES: Cummins 1/4" Pistol-Grip Electric Drill; Cummins Saw Attachment; Combination Saw Blade; Set of Drills; Lambs Wool Bonnet; 13 Sanding Discs; Steel Arbor and Attachments; Cloth Buffing Wheel; Grinding Wheel; Wire Wheel Brush; Steel Paint Mixer; Steel Bench Stand; Portable Steel Carrying Case.

Price of Dynamic Power Tool Combination complete is \$29.95

SHIPPED ON APPROVAL

No Money With Order — No C. O. D.

Try it ten days before you buy. If completely satisfied then send \$4.95 and pay balance at rate of \$5.00 per month for 5 months — **No Interest or Carrying Charges Added.** If not completely satisfied, return to us, no explanation necessary.

KAPNER HARDWARE, INC.

Dept. A-79, 2248 Second Ave., New York 29, N. Y.

Please rush 1 Dynamic Power Tool Combination. I agree to pay \$4.95 within 10 days after receipt and \$5.00 per month thereafter.

Name _____
Address _____
City _____ Zone _____ State _____

TIGHTEN LOOSE FIXTURES



Smooth-On No. 1 Iron Cement applied to your loose hinges, door handles, coat hooks, drawer pulls, knobs, casters, bathroom fixtures, tool and cutlery handles, will tighten them and keep them tight. • Get Smooth-On No. 1 in 1 1/4 oz., 7 oz., 1 lb. or larger sizes at your hardware store. If they haven't it, write us.

FREE Repair Handbook

40 pages, 140 illustrations. Shows you how to make numerous household repairs quickly and easily. Directions are simple, brief.

SMOOTH-ON MFG. CO., Dept. 37-F
570 Communipaw Ave., Jersey City 4, N. J.

SO 347

Do it with
SMOOTH-ON
THE IRON REPAIR CEMENT OF MANY USES



NOW! SAW 2x4's IN ONE EASY CUT WITH NEW LARGER 'ARCO-SAWS'

AT BETTER HARDWARE STORES EVERYWHERE

ARCO SAW

No. 455 "ARCO-SAW" For Depth & Bevel Cuts. \$12.50 with ALL GAGES & 5" "ARCO SAFECUT" Blade.

No. 444 "ARCO-SAW" For Straight Cutting. Smaller model than above, cuts 1-5/16". Same features, less gages. Has 4" "Hecat. bon" Crosscut Blade. \$9.95

Amazing New Safecut Blade Allows Any 1/4" Drill To Whiz Thru Heavy Lumber, Wall-board, Plywood, etc.

At last, here are the first—the only—gear driven saw attachments to whiz thru 2x4's in one cut! Imagine, now you can build anything from bookcases to a bungalow with these sensational new saws. A moderately priced drill will do the job because of new "ARCO SAFECUT" Blade.

ONLY "ARCO" GIVES YOU THESE FEATURES:

5-inch Safecut Blade—cuts faster—uses 30% less power, Graduated Depth & Bevel Gages for cuts to 1 3/4"—bevels from 0 to 45°. Adjustable Rip Gage & Visual Guide, Sturdiest and Easily Adjusted Safety-Yoke keeps drill steady. Worm Drive Clamp releases drill in seconds, Precision Gear Box with Steel Gears.

90-DAY FACTORY GUARANTEE
REPLACEMENT BLADES: Specify 5" Safecut, or Combination, or Rip, or Crosscut Style. \$1.75

UNCONDITIONAL 10-DAY MONEY-BACK GUARANTEE

DEALERS: Write for nearest jobber
BUY THE BEST—see your hardware dealer now! Don't accept inferior substitutes—if not available send us check or M.O. (Postpaid), C.O.D.'s—postage extra.

ARROW METAL PRODUCTS CO.
Dept. PM-6, 140 WEST BROADWAY, NEW YORK 13, N. Y.

BUILD YOUR OWN ARC WELDER OR LIGHT PLANT



Save \$250 to \$500
\$15.50 Instructions incl. for combination welder & light plant. 200 Amps. 28 Volts, 2500 R.P.M. Wt. 50 lbs. No. 709. PRICE F.O.B. K. C., MO.

CONVERTS TO ARC WELDER 200-250 AMP. OR LIGHT PLANT CAP. LOAD 5000 WATTS

Stock No. 711 D. C. Generator R-1 Jack & Heintz, rated 300 Amp. 30 Volts. Gov't. cost \$300.00. Instruction for converting to welder or light plant incl. \$25.50



Cuno Oil Filter—Brand New Aircraft type. Filters oil without cartridge replacements. Just turn handle and cartridge is clean. Standard 3/4" inlet and outlet ports to accommodate 14 gallons per minute. STOP CHANGING OIL. Instructions \$4.95 post-incl.

Send check or Money order. Prices FOB KCMO except when marked postpaid.
GENERAL SALVAGE CO.
DEPT. 763, 2922 E. 27 ST., KANSAS CITY, MO.

INSECTICIDE PUMP SPRAYER AND FIRE EXTINGUISHER. Four gallon size. Includes approx. 3 ft. of high pressure hose with fine mist nozzle. Used, good condition built to give years of heavy duty service. Wt. 15 lbs. ea. add postage \$2.50 Price F.O.B. KCMO.

ELECTRIC MOTOR Stock No. 4949 is 1/2 H.P. 24 V. D.C. 2000 R.P.M. Mfg. by Pesco, applicable for 115 V. A.C. instructions in-Base mounted. \$3.95

RHEOSTAT #R-21 heavy duty recommended for regulating the voltage on the converted electric welder. \$6.95 (for P-1 or R-1) postpaid

Sensational NEW TUBE SQUEEZER

ROLL-IT-OUT! Quick and Easy Pays for itself in a hurry



Needed in Every Home

• SAVES •
—No Waste
—No Mess
Beautiful Colors
Choice: Gold, Red, Blue

Dispenses Tooth Paste, Creams, Ointments, Colors in oil, etc., from collapsible tubes with amazing ease. Excellent for traveling and home. Made of compact Aluminum with Ball to hold tube. Permanent Anodized Colors. FOR EVERY MEMBER OF THE FAMILY.



MAIL ORDER 3 only \$2.50 ppd. TODAY SAMPLE \$1.00 ppd.

J. F. MOELLER, WADSWORTH, ILL.

CRESCENT TOOLS

Give Wings to Work

ASK YOUR HARDWARE DEALER

SIGHT LEVELS INSTANTLY!

STRATEX SURVEYING Hand Level

\$10 IN U.S.A.



Positive slopes, elevations, drainage—farm, forest or construction. Built for life—simple to use—lets you plan, build, excavate with confidence, adjust instantly from outside of instrument even in gusty weather! Put it to work now. It pays for itself on one job—fully guaranteed. \$2 cash, bal. C.O.D., or \$10 with order, we pay charges. Saddle leather case included. FREE price list.

STRATEX INSTRUMENT CO., INC.
1861 C Hillhurst Ave., Los Angeles 27, Calif.

PLYWOOD BARGAIN PRICES

Over 3,100 Ready Cut Selections in Plywood & Lumber
Fir • Birch • Mahogany • Walnut • Oak
For Cabinets—Furniture—Wall Panels—Repairing

Thicknesses 1/4", 3/8", 1/2", 3/4"
AVAILABLE SIZES
Widths 12" 16" 18" 20" 24" 36" 48"
Lengths 24" 30" 36" 48" 60" 72" 96"

WROUGHT IRON TABLE LEGS AND CHAIR FRAMES
AT BARGAIN INTRODUCTORY PRICES
Money-Back Guarantee of Satisfaction

PLYWOOD CENTER, 215 N. ABERDEEN ST., CHICAGO 7, ILL.

Lanco MULTIPLE PLUG-IN UNIT 1 Plug with 5 Outlets

Ideal for home work shops, photographic dark rooms and photographic lighting, any electrical appliances, wherever there are numerous units to plug in and not enough available outlets. 3 of the 5 outlets are conveniently controlled by switches; 2 are connected directly to line. Red neon pilot light tells when unit is plugged in. Avoid messy wire tangles, awkward climbing on or under furniture to reach outlets. Fused for only 15 amps to protect building fuses. Complete with 8 ft. of heavy duty cord and rubber feet to protect table tops, bright ivory enamel finish. Send money order or check with order. No C.O.D.'s. ORDER NOW. Model No. PM129-21. Each. \$11.95



ARTHUR S. LAPINE and COMPANY **LAPINE** 6001 S. KNOX AVE., CHICAGO 29, ILL.
LABORATORY SUPPLIES, EQUIPMENT

DRAIN CLOGGED?

✓ Saves Time
✓ Saves Trouble
✓ Saves Money

USE

Quick Drain

PRESSURE CLEANER
Cleans Clogged Drains in a Jiffy!

\$18.9

ORDER BY MAIL
HURON-LA SALLE CORP.
P. O. BOX-117 BARRINGTON ILL.

HOBBYISTS! SHOPMEN! Special ONLY \$54.50

PALMGREN "HOBB-E" Rotary, Index, Milling Table
Ideal for Model Parts or Shop Work

Mill-Grind-Drill-Index-Rout curved or straight-Rabbit and Mortise on drill press or lathe. 8" Table, 4" Cross Feed, 360° Rotation, Accurately Graduated. Bolts to table. Order NOW! SAVE \$100. Only \$54.50. Less Rotary Feed \$39.75. Write for "HOBB-E" Tool Circular.

CHICAGO TOOL and ENGINEERING CO.
8365 South Chicago Ave. Chicago 17, Ill.

Say You Saw It in
POPULAR MECHANICS

BRONZE FOUNDRY
Schools and Home Workshops

Make your own castings of aluminum, copper, bronze, silver. Foundry sets are available in three sizes including 2400 Deg. F. blast Furnaces. \$22.50; \$29.50; and \$42.00. f.o.b. Kansas City. Free Circular.

KANSAS CITY SPECIALTIES CO. P. O. Box 6022, Dept. P-6
KANSAS CITY, MO.

EXTRA WEAR-COMFORT!

Genuine WOLVERINE PIGSKIN WORK GLOVES

Genuine Pigskin, tanned by the Secret Wolverine triple-tanning process. Amazing comfort and extra wear!

A New Pair FREE If They Dry Out Hard or Stiff!

Just try on a pair. No other work gloves in the world like them. Just drop us a postcard for name of your nearest dealer and a useful gift FREE to you besides.

Wolverine—Box K1-6—Rockford, Mich.



Drive out
Basement dampness
—with the amazing **FRIGIDAIRE**
ELECTRIC DEHUMIDIFIER

Only 18¼" high — 20½" long — 11¾" wide

Positively controls moisture in linen closets, basements, store-rooms, bank vaults, workshops, or any closed area up to 8,000 cu. ft. where moisture is a problem.

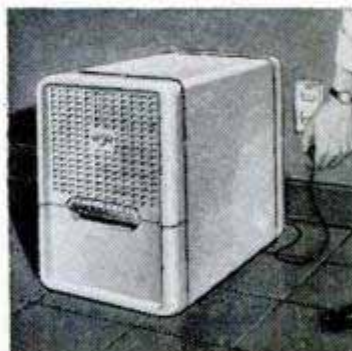

Fan circulates air over refrigerated coil. Moisture is condensed and collected in container. May be connected to drain. Dry, filtered air flows into room.

HOW DEHUMIDIFIER WORKS

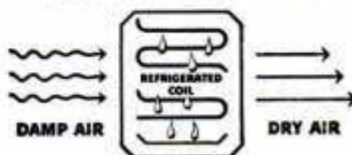

See your Frigidaire Dealer for further details. Or write for free folder to Frigidaire Division of General Motors, Dept. 2088, Dayton 1, Ohio. In Canada, Toronto 13, Ontario.

Built and backed by General Motors

LEVELALL
FASTER THAN \$100 ENGINEER INSTRUMENTS

Up to 50 Feet or more

The New Improved Water Level For Simplest One Man Operation. Anything you need level Levelall does it. Dealer inquiries invited.

Regular 50 Feet \$8.95

DeLuxe 75 Feet \$12.95

A sturdy instrument that can be left on the job for any workman to use. Cannot be put out of adjustment and even with the most casual handling its principle is so simple anyone can level points quickly and accurately.

Complete with instructions, high quality vinyl polychloride tubing filled with Level-Flo Liquid, mounting brackets, and metal case.

For footings, forms, batter boards, sills, lintels, floors, ceilings, roads, driveways, lawns, piping, farm contouring and all general construction work normally needing an expensive instrument.

1 qt. extra Level-Flo Liquid shipped with Deluxe Model only.

LEVELALL, 76 Webster St., Rockland, Mass.
Mail me 75' Deluxe Levelall @ \$12.95
Mail me 50' Levelall Instruments @ \$8.95 you guarantee satisfaction or money back upon return of Levelall within ten days.

Name _____
Address _____
City _____ Zone _____ State _____

Send C.O.D. I will pay postman full purchase price plus delivery charge on arrival.
 Full purchase price is enclosed. Send postpaid. (Postage prepaid on orders in U.S.A. only).

HOW TO... SET UP and KNOCK DOWN SAWHORSES FAST!

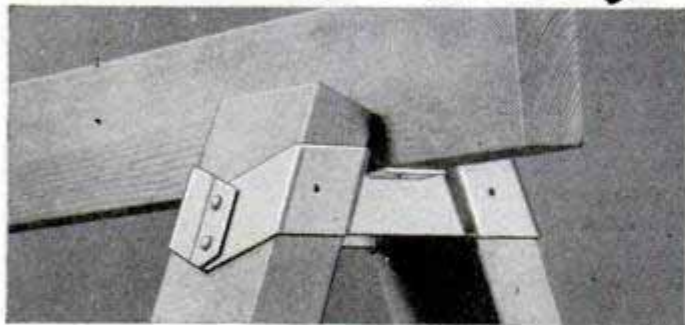

USE STRONG, PRECISION-ENGINEERED
NU-WAY SAWHORSE BRACKETS

Set up or knock down sawhorses in jig time! Carry them in your car—or store them easily—the modern way . . . the NU-WAY!

SEE Your Hardware, Lumber or Paint dealer NOW!

ONLY **\$1.50** Pair
(\$1.60 West of Rockies)

THOMAS PRODUCTS CO., 8490 Lyndon Ave., Detroit 21, Mich.



The new Evans "White-Tape" has everything you'll find in tapes costing over \$1.50—plus.

- snow-white blade with bold, legible, jet-black numerals and graduations. Graduated in 32nds for first 6 inches.
- sturdy die-cast case heavily chrome-plated, calibrated for quick reading inside and outside measurements.
- blade 1/2" wide made of finest high carbon steel—tempered—Bonderized—enamelled—baked.
- blade replaceable in seconds—without tools—without even opening case. And Evans replacements cost far less.
- every Evans "White-Tape" is unconditionally guaranteed.
- exclusive Evans automatic brake gives smoother push-pull action with absolutely no "creeping" of tape into case.
- underside is white, too. Mark with ordinary pencil, remove mark with flick of thumb.
- unheard-of low price*: 10-ft. \$1.49; 8-ft. \$1.19; 6-ft. 98c. Prices higher in far west and Canada.

Evans & CO. • Elizabeth, N.J. • Montreal, Que. © 1959
Makers of Evans 6-ft. Folding Rule and Folding Yardstick

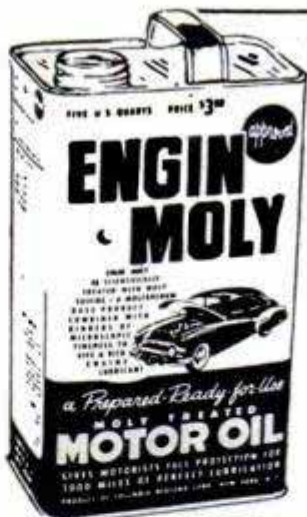

NEW MIRACLE MOTOR OIL doubles car engine life

ENGIN-MOLY

Contains full treatment of Molybdenum (MoS2) that plates every friction surface of your car engine.

5 QT. **\$1.98** Can
Fed. Tax Paid Reg. Price \$3.00

ENGIN-MOLY motor oil is a combination of the highest quality premium oils plus Molybdenum (MoS2) in complete suspension. A perfect lubricant. Sold with a money back guarantee.

AVAILABLE AT YOUR LEADING ACCESSORIES STORE OR GARAGE
COLUMBIA-BEDFORD CORP.
N. Y., N. Y. EST. 1889

The QUICK-WAY to SHARPEN CIRCULAR SAWS



Now you can do it yourself—save time and money. The new QUICK-WAY Index Plate Circular Saw Sharpener makes your own power table a precision saw sharpener. Guarantees accurate grinding and spacing of every tooth. Complete unit only \$16.50 postpaid, including patented Index Plate block for mitre and \$3.00 grinding wheel . . . Nothing else to buy!

Send check, cash or money order. We pay postage.

Model 6-12P
\$16.50 Postpaid

QUICK-WAY Saw Company
11 Riverside Corning, N.Y.

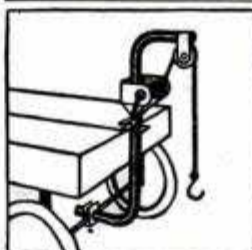

KIDDY WRECKER

Makes your wagon into a wrecker in a jiffy—fits any wagon—no holes to drill—durable steel construction.

Send cash, check or money order to **\$2.98**

KIDDY WRECKER POSTPAID
Box 193, Downers Grove, Ill.



NEW, IMPROVED CALCULATOR FOR WOODWORKERS only 25c

Instantly gives information on lumber, nails, concrete mixes, painting materials, etc. Convenient, simple to read. Just set dial for nail specifications, to convert linear to board feet, find bit sizes for screws, compare characteristics of woods. 6" diameter heavily varnished cardboard. Send 25c, no stamps, please to Greenlee Tool Co., 2106 Columbia Avenue, Rockford, Illinois.

Say You Saw It in Popular Mechanics

FURNITURE for YOUR BEDROOM



SAVE MONEY, be the envy of your neighbors by making this beautiful bedroom suite yourself! Only a power saw and jointer are needed to turn out this smart suite, featuring bed with storage space, three-piece vanity with cosmetic compartment and makeup mirror, Mr. and Mrs. dresser, and twin night stands with drawers. Letters demanding detailed plans poured in after this furniture was pictured in Popular Mechanics Magazine. Now the 4 plans are ready—easy-to-follow scale drawings—and they're yours for only \$2.00! Send for a complete set today.

POPULAR MECHANICS PRESS
200 EAST ONTARIO STREET, CHICAGO 11, ILL.

BUY DIRECT MANUFACTURER TO YOU!

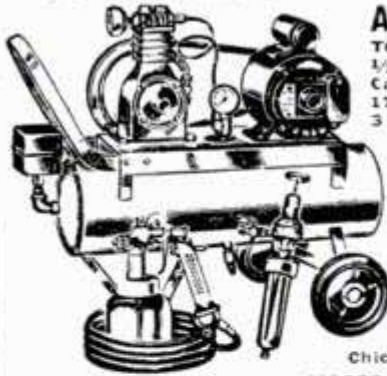

AUTOMATIC AIR COMPRESSOR

TOP QUALITY NAME BRAND COMPONENTS
 1/3 H.P. Extra Heavy Duty Westinghouse Capacitor Motor, 115/230-V, 60 cy., 1 ph., 1725 RPM, overload protected. Quincy X2—3 CFM—100-150 lbs. Compressor—2 in. x 1 3/4 bore & stroke. Furnas Automatic Adjustable Pressure Switch. Tank 8" x 26". Rubber Tired Wheels and Handle. Speedy External Atomizing Quart Spray Gun, Pressure Regulator, Filter, Gauge, Hose & Tire Chuck, Check Valve, Safety Valve, V-Belt Drive. Completely Assembled into a Compact Balanced Unit. Ready To Use, 1/3 H.P. #A-33 Fob. Chicago. Only \$89.00
 SAVE \$10.00 . . . 1/3 H.P. Outfit, knocked down, you assemble, #K-33 . . . Fob. Chicago. Only \$79.00



**BIGGER, EXTRA HEAVY DUTY, AUTOMATIC AIR COMPRESSOR UNIT. BIG 1/2 H.P. HEAVY DUTY CAPACITOR A.C. 110/220-V Motor, Giant Stainless Steel Tank, 12 x 24 inches, 500 lb. test. Bigger Precision Air Compressor, 2 in. bore x 2 in. stroke, 3.5 CFM, pressures to 150 lbs. Big 10 x 175 Rubber Tired Ball Bearing Wheels, plus all accessories and parts listed above. Completely assembled into a Compact Balanced Unit. Ready to use, 1/2 H.P. #A-55 Fob. Chicago. Only \$117.00
 SAVE \$10.00 . . . 1/2 H.P. Outfit, knocked down, you assemble, #K-55 . . . Fob. Chicago. Only \$107.00**

VERTICAL STATIONARY COMPRESSOR UNIT

Air for Dentists, Laboratories, Gas Stations, Garages, Farms & Factories. Neat, Compact, takes minimum of space. 1/3 H.P. 110/220-V-AC Westinghouse Capacitor Motor. 3 CFM-100 lbs. Quincy X2 Compressor. Furnas Automatic Pressure Switch. 12 x 24 in. Stainless Steel Tank. Complete Vertical Stationary Automatic Compressor Unit #VSA-55 . . . Fob. Chicago. Only \$97.00

C. MARSHALL SALES

3546 W. Fullerton Ave., Dept. P-6 Chicago 47

New MOTOR BARGAINS for Home, Farm & Industry

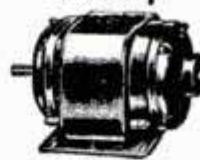

1/2 H.P. } Dayton, 3450 RPM
 IND type . . . \$18.50
 Westinghouse, DBL shafts, 1725 RPM \$22.50
 Westinghouse, dbl. shafts, 3450 RPM \$23.50
 3/4 H.P. } Ecor, capacitor type ball brg., 1725 RPM \$32.50
 General Electric, cap. ball brg. dbl. shafts, 1725 RPM . . . \$34.50
 General Electric, cap. type, 3450 RPM \$34.50

Above are 110 V. or 110/220 V. 60 cy. 1 ph. A.C. Motors. All Motor Prices are F.O.B.



Write for FAN CIRCULAR: Listing Blades, Guards, Motors, ALL SIZES: Attic, Window or Room Cooler.

16 TO 1 SPEED REDUCERS

For Display Table—Barbecue Spits—Toy Auto Gear Box—Experimental Uses, Etc. Gears Enclosed in Aluminum Housing. Bronze Gear. Handed Worm. Input Shaft 1/4 in. Output Shaft 3/8 in. Speed Reducer #R 161 \$5.95 Post Paid

VOLUME BLOWERS FOR HEATING, VENTILATING, EXHAUSTING



Blowers for forced drafts, heating boosters, exhausters, coolers, dryers and dust collectors, 110 volt A.C., 50/60 cycle motors. 75 cu. ft. per min. Blower and Motor, Postpaid, Only \$9.75
 150 cu. ft. per min. Dust Collector Blower with hi-speed Motor, Postpaid Only \$12.50
 250 cu. ft. per min. Blower, 5 in. Wheel, Only . . . \$22.50
 Giant Dust Collector, 2000 cu. ft. per min.—14"x14"x12" overall, 1/2 H.P., 110 V-AC Motor, Hi-speed 3450 RPM, 6 in. non-clogging Aluminum Impeller. Shipping wgt. 60 lbs. FOB Chicago. Only \$55.00

STOP RADIO & TV NOISES INSTANTLY

NEW ELECTRONIC DESIGN

Bell-Tronic line filter eliminates noisy interference caused by motor appliances, autos, oil burners, etc. Simply plug radio or TV cord into filter and filter into wall socket. Enjoy Bell Clear reception. Send \$1 ppd. No C.O.D. Try 5 days. Money back guarantee.



\$100
PPD.

TUBE WHOLESALE CO.
Box 364, Dept. PM, Rockville Centre, N. Y.

MARVEL

Mystery Oil

- Frees Sticky Valves
- Stops Hydraulic Valve Clatter

Buy it at your favorite gas station

Get This TOMLEE SHOP BOOK

28 picture pages of how-to-make-it with power tools. Illustrates 50 handicraft patterns. Send 25c, stamps or coin, to TOMLEE TOOLS, 723 N. Washington, Minneapolis 1, Minn. **25¢**

1903—GOLDEN ANNIVERSARY—1953

Low-Cost **SHAW** Dependable "DU-ALL"

Walking and Riding Tractors

Standard of quality for many years. Rugged 1 1/2, 2 1/2, 3 and 5 H.P. Walking Models. Powerful 5, 8, 12 H.P. Riding Tractors. A machine for every need from small garden to substantial farm. All wanted tools for complete ground preparation and cultivation.

Power take-off attachments for many other jobs. See the Shaw dealer. Write for FREE CATALOGS, low prices on complete Shaw line.

SHAW MANUFACTURING CO.
4506 Front St., Galesburg, Kansas.
668-G N. 4th St., Columbus, Ohio

HULL AUTO COMPASSES ALSO SAVE THE DAY IN STRANGE CITY TRAFFIC

• Watching for road signs in city traffic calls for an extra pair of eyes . . . and every intersection is an opportunity to make a wrong turn. Here, as on the open road, Hull Auto Compass drivers sail confidently through.

WRITE FOR LOCAL DEALER'S NAME, FREE LITERATURE

HULL MFG. CO. P.O. Box 246-D6 WARREN, OHIO

Beaconlite \$6.95
Illuminated

Streamline \$4.95
non-illuminated

Say You Saw It in Popular Mechanics

now...make your own REFLECTING SIGNS

You too can make your own reflecting signs and displays... with *SAFE-T-GLOW* products!

Ideal for Trucks, Service Shops, Motels, Restaurants, Farms, and similar uses. Now you can have the advantages of the new reflecting signs and displays—get sales results 24 hours a day—with the amazing new Safe-T-Glow products.

DIE CUT LETTERS—NUMERALS
Complete with full instructions and symbols to construct signs of professional quality.

Specify red or silver.

1 INCH WIDE STRIPS—30c per ft.

2 inch	10c ea.
3 inch	18c ea.
4 inch	25c ea.
6 inch	50c ea.

FOR SALE

Write for the complete line of *SAFE-T-GLOW* reflective materials and products.

SAFE-T-GLOW PRODUCTS

Box 2467 Dept. PM5 Gary 5, Indiana

this **ONE** GOVERNOR

fits ALL popular
farm & industrial
gasoline engines



PIERCE LONG RANGE Universal Governor

● Instant variable speed selection and accurate engine control at any speed setting within 1200 to 2600 RPM. Higher and lower ranges obtainable by simple change of pulley. Also "constant speed" operation.

● Accurate, dependable speed control for engines operating corn shellers, drag lines, hoists, arc welders, trucks and tractors with power take-offs, etc.

Write for Complete Information

**DEALERSHIPS
AVAILABLE**

"World's Most
Experienced Governor
Manufacturer"

**THE PIERCE
GOVERNOR CO., Inc.**
1652 Ohio Avenue, Box 1000
Anderson, Indiana, U. S. A.

ONLY
\$39.50

Pulley extra
Send Check or
Money Order.
State Make,
Model of engine.

PALM-SIZE GENUINE RADIO

- Covers 550 to 1600 KC with Exclusive Tuning Unit
- 250 mile Daytime reception, 1000 miles received at night
- Low drain powerful acorn tube
- Loud clear tone
- Hearing Aid Battery Powered
- Ideal for schools
- Picture diagram and instructions for radio beginners
- All parts fit within case
- Assembling time 1 hour



\$5.99
Postpaid

This neatly engineered little KIT was designed to give you a real personal, portable radio that you can enjoy anywhere without disturbing others. Use it on camping trips, in bed, in your office or just anywhere. Remember this is not a weak crystal set but a powerful VACUUM TUBE receiver that will give you good local and long distance reception. Set, less batteries, ONLY \$5.99 postpaid. A deposit of \$1.00 is acceptable in U.S. and possessions on COD orders. If batteries are desired we will supply at only \$1.50 per set including extra "A" battery. These are obtainable at local hearing aid concerns. 1,500 ohm Alnico magnet receiver \$1.45 only, when purchased with KIT. All parts fully guaranteed.

PRECISION ELECTRONICS LABORATORY

33 years in radio

Dept. M, PLACERVILLE, CALIF.

STEEL AIR TANKS

Steel pressure tanks suitable for compressors, pneumatic units, gases, hydraulics, and liquids. Rated at 500 lbs. per square inch pressure. 1/4" standard pipe thread openings on tank ends as shown.

			Size	Wt. Lbs.	Internal Volume	Price
A-4	Carbon Steel	New	7 1/2" x 5 1/4"	1 1/2	104 cu. in.	\$1.50
A-6	Carbon Steel	New	14 1/2" x 5 1/2"	3 1/4	280 cu. in.	3.50
D-2	Stainless Steel	New	24" x 6"	5	500 cu. in.	5.50
D-2A	Carbon Steel	New	24" x 6"	5	500 cu. in.	4.50
F-2	Stainless Steel	New	45" x 6"	11	1000 cu. in.	9.50
F-2A	Carbon Steel	New	45" x 6"	11	1000 cu. in.	8.50
G-1	Stainless Steel	New	24" x 12"	18	2100 cu. in.	11.50
G-1A	Stainless Steel	Used	24" x 12"	18	2100 cu. in.	9.50

Prices F.O.B. Chicago. Include approx. postage on orders paid for in advance. C.O.D. orders enclose 25%, balance sent C.O.D.

U. A. S. Corp.

Dept. PM6, 5637 W. 63rd Pl.
Chicago 38, Illinois

PUMP WATER FAST!

DRAIN WASH TUBS, CELLARS, CISTERNS
IRRIGATE—FILL TANKS—DRAW WELL WATER

Pumps 2800 GPH. 420 GPH at 75' High or 1600 GPH from 25' well. Sturdy, Rustproof Alloy Metal. Six Blade Impeller. Uses any 1/8 to 1/2 H.P. Motor. Will not leak or clog. Fits any garden hose. Immediate Money Back Guarantee. Send Check, M.O., or C.O.D.

8.95
IN U.S.

MOORE MANUFACTURING CO.
SWEDSBORO 1 NEW JERSEY

HELPFUL BOOKS

Send post card asking for FREE catalog
Popular Mechanics Press, 200 E. Ontario, Dept. 601, Chicago 11

40 BIG PAGES
OF
"WOODWORKING WISDOM" only **25¢**

A "Stanley Tool Guide" — shows care and use of tools for all woodworking jobs plus diagrams of wood joints and cuts, charts on metal working. Over 200 illustrations. Send 25c today to: Stanley Tools, 363A Elm Street, New Britain, Connecticut.



STOP DRIP

caused from sweating or condensation on cold water pipes. Turn idle basement space into play, work or store rooms. Just wrap cork-filled NoDrip Tape around pipes and joints and the job's done—permanently.

NoDrip TAPE

Roll covers about 10 feet of 1/2" pipe, \$1.69.

Higher west of Rockies and Canada. Get at Hardware, Paint, Dept. Stores, or sent postpaid. Write for free circular. J. W. Mortell Co., 522 Burch St., Kankakee, Ill.



BRIKCRETE



Local Manufacturers Have Broad Opportunities

Brikrete manufacturers operate compact, self-contained plants under franchise privileges in protected territories. Each is an independently owned unit in a country-wide chain, using local materials and local labor to supply the world's most modern masonry for local building needs.

Brikrete is rich in sales appeal because it is ahead in design, style, size, color, economy. Easily the preferred masonry. But because local production eliminates economic wastefulness, Brikrete can be sold at a lower-than-lumber price. Yet still allow a generous profit margin.

Brikrete offers much to men looking for a community enterprise on a nominal investment. We supply complete equipment; easy terms when desired. Liberal cooperation. Write today for Brikrete Book No. 2—while territory is still open.

BRIKRETE ASSOCIATES, INC.

4679 Division Avenue, S.
Grand Rapids 8, Mich. 82

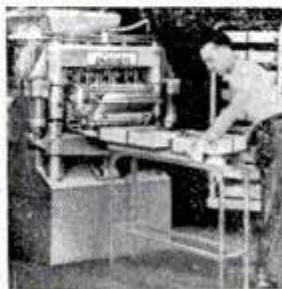

MOTORIZE YOUR LAWNMOWER!



Attach the famous LeJay MidgeTractor to your OWN LAWNMOWER and relax! No more backaches or dreaded tasks. Easy as wheeling a go-cart. Backs up and maneuvers like a dream! Priced amazingly low! Save half. Only \$63.00 complete. Or \$31.20 less engine... use your own engine (any make 3/4 to 1 1/2 H.P. or 1/2 H.P. electric motor). Free literature. Guaranteed with money-back 5-day trial offer.

LESS ENGINE
\$31.20

Order From This Ad

If you are a handyman, send 35c for PLAN "Build Your Own Midget Tractor." Literature included.

LEJAY MANUFACTURING CO.
1247 LeJay Bldg., Minneapolis 8, Minn.

WORLD'S BEST SMALL TRENCHERS



Portable DITCH-WITCH digs 2" to 6" clean, even ditches to 36" depth in all types of soil. Complete unit—self propelled—outdigs 8 men. Four rugged models.

Write for illustrated literature.
THE CHARLES MACHINE WORKS
620 B Street Perry, Oklahoma

SELF SPRAYING

STATILIM

TRADE MARK
for
RELIEF FROM
STATIC ELECTRICITY

Just press button and spray lightly on any surface—textile, fabric, clothes, seat covers, hardware, wood, or any moving parts, rollers, machine belts, etc.

Made by the manufacturers of famous STATIKIL

Order STATILIM \$1.69 (6 oz.) for home, office or store.
Order STATIKIL \$3.00 (12 oz.) for mill, factory or shop.

JUST WRITE

STATIKIL

1220 W. 6th ST., CLEVELAND 13, OHIO

WAR SURPLUS AND OTHER BARGAINS SAVE UP TO 90%



D.C. GENERATORS

Finest aircraft quality... heavy duty... lifetime grease-sealed ball bearings. Terrific for truck and marine use, for welders, plating, D. C. Appliances, lights, etc. ITEM No. 90—Type P-1. Mfd. by Ford, General Electric, Westinghouse & Delco-Remy. Rated 200 Amps., 28 Volts, 2500 RPM., can be "reved" up to 300 Amps. Shpg. Wt. 53 lbs. Approx. Govt. Cost \$350... New to you... **\$21.50**

GE 300 Amp. Generator. 24 to 32 volts. 2500 RPM. For building your own arc welder, lighting plant or mobile radio communication unit. Weight, 50 lbs. Approx. GOVT. COST \$450. Yours now for **\$29.75.**

MAKE YOUR OWN ARC WELDER Complete make-up package consisting of one New P1 Generator 200 Amps, one giant toggle switch, one voltage regulator and a wiring diagram chart showing conversion of Aircraft Generator to Arc Welder. Nothing else to buy. Special—WHILE THEY LAST—**\$32.50**

Carbon Pile Generator VOLTAGE REGULATOR



Like new. Adjustable from 24 to 32 volts. For use with 24 or 32 Volt D.C. Generators; also 200 AMP-300 AMP type generators to build your own light plant. Delco Remy. Weight 2 1/2 lbs. Approx. GOVT. COST \$50. From Airborne only **\$5.50 ea.**

PURULATOR OIL FILTERS



The perfect filter to keep motor oil or hyd. fluid clean at all times. Permanent type. No. G159J-32. Protect your pump, engine, midget racer or boat with this unit. To clean element, just turn handle. Inlet and outlet ports take pipe or straight threads up to 3/8" male pipe. Accommodates 16 GPM at 30 PSI. Mtg. brackets. Wt. 4 lbs. A \$15 value. NEW to you, with 2 FREE male reducer connectors for only **\$3.85.**

MICROMETERS

Chrome plated, precision engineered, carefully tooled to give long life. All new 0-1" capacity—**\$2.25 ea.**, 1-2" capacity—**\$3.50.**



RIVET SETS Universal type, case hardened tips. Set of dies will head up only brazier or round head rivet from 1-1/8" to 1/4". With adapters for air gun or hand use. All new—cost Govt. approx. \$27.00. Complete 15 piece set (wt. 2 lbs.)—**\$5.00.**

SEND 25c for BIG • NEW • 1953 CATALOG

Bargains for everyone. Check, Money Order or Cash. 25% deposit on C.O.D. orders. Prices F.O.B. Culver City, Calif., unless otherwise stated.

AIRBORNE SALES CO., INC., Dept. PM 653
8501 Stellar Dr., Culver City, Cal.

Say You Saw It in Popular Mechanics

STOP FAUCET LEAKS

SNAP-in

★ REFLECTIVE OR A REFUND OF MONEY
Guaranteed by Good Housekeeping
IF NOT AS ADVERTISED THEREIN



Featured in **READER'S DIGEST**

U.S. Pat. No. 2,443,012

SNAP-in SWIVEL WASHERS & FAUCET SEATS

A lasting "do-it-yourself" repair—Ideal for hot or cold water faucets! Lasting—economical—easy to install. Lasts 10 to 20 times longer than ordinary bibb washers. Stainless steel and corrosion resistant metal parts—molded neoprene washer disc.

See your local hardware dealer

SNAP PRODUCTS CORPORATION

3615 S. JASPER PLACE

CHICAGO 9, ILLINOIS.

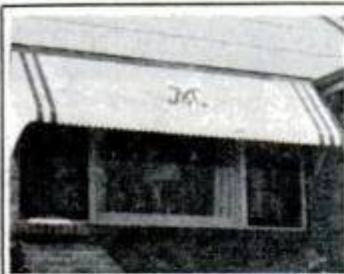

Make Your Own!

The Only Tool
You Need
Is A Screwdriver!

DOOR CANOPY—SPECIAL
47½" WIDE
18" DROP
GRADUATED SIDES
43" PROJECTION
\$21.50—F.O.B. ST. LOUIS



DIRECT FROM FACTORY

Save 50%

ASSEMBLE AMERICA'S Most Beautiful ALL-ALUMINUM DOOR CANOPIES AND WINDOW AWNINGS

They're pretreated, ready for paint. It's easy! Just do the top — the sides are assembled.

Designed and engineered by Herbert's — with experience and machinery to sell you a better awning.

**Also Available Completely Assembled
With Baked Enamel Finish!**

WRITE FOR FREE MEASURING CHART AND LITERATURE

8974 St. Charles Rd. *Herbert's* St. Louis 14, Mo.

ALUMINUM AWNINGS

Congress Pulleys

Standard equipment on leading home appliances — clothes dryers, washers, air conditioners, power lawn mowers, etc.



YOU PAY NO MORE for CONGRESS QUALITY

Congress quality costs no more! Insist on the drive preferred by most original equipment manufacturers. There is a difference! Congress Drives are electrolytically plated, diamond-bored and tested for trueness.

Buy Congress V-Belts and Pulleys from your local supplier.



LOOK FOR THIS DISPLAY

You'll see it at leading suppliers throughout the United States.



Q-D Sheaves — Heavy Duty and Steel Cable V-Belts—FHP Drives

CONGRESS DRIVES DIVISION

TANN CORPORATION
World's Largest Manufacturer of FHP Pulleys
DETROIT 34, MICHIGAN

SEND FOR
**FREE
CATALOG**



Money-Making Tools!

It's easy to own the same "pay-off" tools used and endorsed by America's top-earning mechanics! You can start building your own kit with basic Snap-on sets—add others any time. Never sold in stores—direct to users only. Send today for free catalog!

Snap-on Tools Corporation
8062-F 28th Ave., Kenosha, Wis.



CAPE COD CHAIRS TRELLISES • ARBORS DUTCH WINDMILLS

Chairs style B-C-A PLANS 50c Ea., all 3 only \$1.00. 12 different trellis designs PLAN of all 12 only 50c. Authentic 40" high Dutch Windmill Detailed PLAN only 75c. Unique 40" high Lighthouse having copper lantern, ideal for garden or on lake shore of summer home. Large detailed PLAN 75c.

SPECIAL all plans above \$3.00 val. Only \$2.50. Send 10c for catalog Craftsman's Model Co. Dept. P-53 DELAFIELD, WIS.

MOTORIZE YOUR BARBECUE!

Easily rigged up by anyone. Handles whole ham or 4 small chickens. Commercial-quality thruout — enclosed gear-head motor (110V-AC) — spring-tension bronze bearing permits spit removal —

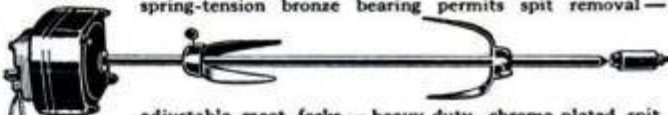

adjustable meat forks — heavy-duty, chrome-plated spit. Limited time, introductory offer. Only \$12.95 (\$13.95 Denver and West).

B & R SALES CO. — Box 952 — Muncie, Indiana

SUPER DRILL GRINDER

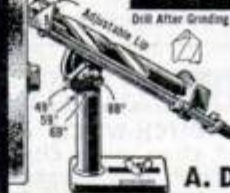

Sharpens round shank drills from 3/32" to 1/2" in diameter, up to 6" long. Grinds old drills like new in 4 different point angles, using hand or power grinding wheels. Money-back guarantee. Only \$2.95

At Dealers or Postpaid
A. D. McBURNEY 317 E. 4th St., Dept. A-30
Los Angeles 13, Calif.

AUTO RACING BOOKS AT NEW LOW PRICE

Automobile Racing — Fifth Edition by Ray F. Kuns.

This is a book for auto racing fans. It covers construction and specifications of racing cars and tells and shows how you can build your own. It also contains regulations for midget auto racing and describes roadster racing in California. A number of Indianapolis races are described and pictured.

Formerly \$1.00 per copy. Now just..... **50c**

Automobile Racing — Fourth Edition by Ray F. Kuns.

Includes eight working drawings and complete building instructions for standard midget racers as well as drawings for midget road cars. Miller Ford V8 front-drive racers are illustrated and described and other big-time data given. Large, clear pictures give inside information. Was \$1.00—Now only **50c**

POPULAR MECHANICS PRESS

200 E. Ontario St.
Chicago 11, Ill.

HANDIEST CABINET EVER MADE FOR STORING SMALL PARTS

What a relief! No more frantic searching for misplaced items. No other cabinet has so many desirable features. Maximum strength, crystal-clear plastic drawers can't spill accidentally. Strong, all-steel welded cabinet with baked-on gray finish. 32 drawers subdivide into 96 compartments — lengthwise or crosswise. Drawers 5 7/8" long, 2 3/4" wide, 1-7/16" deep. Sent complete, postpaid. Money back if not satisfied within 10 days.

Catalog FREE!
J-32 32 drawers \$12.95
J-64 64 drawers 24.95
J-48 48 drawers 20.95
J-24 24 drawers 10.95
J-16 16 drawers 7.75
Model J-32 \$12.95
Illustrated

**CONTENTS
VISIBLE
Crystal-Clear
Drawers**

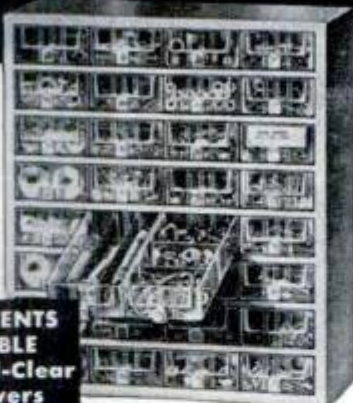

Mfd. by
AKRO-MILS, INC. 818 E. MARKET ST. 32-drawer illustrated
AKRON 5, OHIO 15 1/4" high, 12 1/2" wide, 6" deep

MINERALIGHT

Magic fluorescent ultra-violet rays make valuable minerals glow with mysterious, fascinating colors under Mineralight. An intriguing, profitable hobby! Write Dept. PM for FREE Bulletin.

ULTRA-VIOLET PRODUCTS, INC.
South Pasadena, California



Amazing NEW LIGHTWEIGHT TRIMS
Triple Duty POWER MOWER MOWS
and MULCHS

TOPS IN PERFORMANCE—LOW IN PRICE
Take the hard work out of lawn care with a power-packed, triple-action B-M Rotary Power Mower. Eight models to choose from, including two self-propelled types. LOW direct-from-factory-to-you price. Prompt shipment. Fully Guaranteed. **FREE LITERATURE.**
B-M MOWER CO., Box 66-PM, Blue Mound, Kansas

HELPFUL BOOKS

Send post card asking for **FREE** catalog
Popular Mechanics Press, 200 E. Ontario, Dept. 601, Chicago 11

FREE CRAFT CATALOG



120 PAGES... Craft Supplies, Tools, Designs, Instruction Books from America's Largest, Most Complete Handcraft Stock.
Send for your free copy NOW!
GRIFFIN CRAFT SUPPLIES
5626-A Telegraph Ave • Oakland 9, Calif.

WELD-BRAZE CUT-SOLDER

4 Ways to Handle 1001 Repairs Around Home-Garage-Garden

Complete welder with Twin Carbon Arc Torch and all operating accessories to do all types of metalcraft work. Easy instructions for work on iron, steel, bronze, brass and aluminum. Plugs into any properly wired AC or DC line. Low cost pays for itself in money saved and earned. A wonderful practical gift of a lifetime. Order now!

only \$14.75
f.o.b. factory
Larger Models Available on request.

4 way welder
Yours on a money back
10 DAY TRIAL

FOUR WAY WELDER CO.
2326 S. Michigan Ave.
Chicago 16, Ill., Dept. F2-F

Here's How We Paint!

You and your wife, together, can paint an average room in two hours -- or less. AND, you'll get professional results . . . EASILY, AT LOW COST!

BE SURE YOU GET THOMAS ROLLERS from your Paint, Hardware, Lumber dealer.

THOMAS PRODUCTS COMPANY

8490 Lyndon Ave. • Detroit 21, Michigan

Say You Saw It in Popular Mechanics

BUILD YOUR OWN POWER TOOLS—TILT/ARBOR SAW

Exclusive GIL-BILT Build-It-Yourself Features

- No machining—build easily with hand tools only
- No blueprint reading—step-by-step pictorial plans, full scale patterns, actual photographs
- Sturdy wood, aluminum and steel construction
- Capacity and performance of commercial saws selling for \$60 and up

BANDSAW
BELT SANDER
SAVE \$50. OR MORE

GIL-BILT 10-INCH TILTING ARBOR SAW

- 27x28 in. table, 13 1/2 in. capacity in front of blade
- 10 in. blade cuts 3 1/4 in. deep, tilts full 45 degrees
- Floor model 34" high, table always stays level
- New Departure ball bearing arbor, 3/4" precision shaft turned down for 5/8" bore blades, alum. housing, shipped ready to run
- Jackscrew and 4 1/2 in. dia. handwheel lowers and raises blade
- Cast aluminum miter gauge and self-aligning rip fence guide

GIL-BILT Metal Parts Kit includes Plans, ball bearing arbor, miter gauge and bar, rip fence guide, dado insert, lock knobs, jackscrew mechanism and handwheel, and all other metal parts (less blade) \$21.95
Same Kit with 10" Combination Blade \$24.90
Same Kit with 8" Combination Blade \$23.90

GIL-BILT 12-INCH BAND SAW

- Cuts to center of 24 inch circle
- Handles stock up to 6 inches thick
- 18x18 inch table tilts 45 degrees
- Lower wheel and drive pulley runs on sealed New Departure Ball Bearings; Upper wheel runs on two 5/8" bore Dillite Bronze bearings.
- Upper wheel tension and tilt mechanism of cast aluminum, completely assembled.
- Upper and lower blade guides. Each has ball thrust bearing, self-lub bronze jaws.
- Rigid cast aluminum wheel's fully machined ready-to-install. Heavy rubber tires.
- Uses standard 78 inch blades up to 3/8 in. wide.
- Fully enclosed mechanism for utmost safety.

GIL-BILT Metal Parts Kit includes Plans, rubber tires, aluminum wheels, 1/4 in. blade, ball bearing spindle, tilt mechanism, blade guides, table tilt segments, and all other metal parts \$21.95
Return Kits in 10 days for refund if not satisfied.
(Prices include postage within 300 miles. Over 300 add 5%)

Also available—Plans and Parts Kit for 18" Band Saw, Belt Sander and 8" Tilt/Table Saw. Order Plans at \$1.00 each—Sent postpaid anywhere in the world or write for FREE descriptive catalog.

GILLIOM POWER TOOLS P. O. Box 1-PF, Lambert Field St. Louis 21, Missouri

CONTOUR COPY

Carpenters, Bricklayers, Welders, Mechanics, Linoleum Layers, many, many others—USES UNLIMITED—Every worker needs this NEW Contour Copy. The workman simply releases the easy acting lock, places it against the contour to be copied, then presses each blade forward so they fit snugly. Once locked, the contour outline can be copied onto any desired surface. SIMPLE AND FAST. Made of life-lasting ALUMINUM.

SIZE	PRICE
4 1/4" x 4 1/4"	\$4.00
5 1/4" x 4 1/4"	4.90
6 1/4" x 4 1/4"	5.80
8 1/4" x 4 1/4"	7.60
9 1/4" x 4 1/4"	8.50
10 1/4" x 4 1/4"	9.40

Special lengths made to order \$1.00 per in.

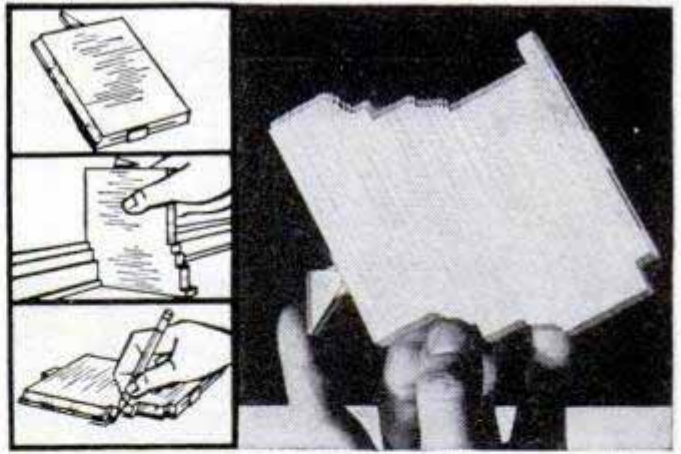

W. L. BUSH & COMPANY

1570 NORTHWESTERN BANK BUILDING
MINNEAPOLIS 2, MINNESOTA

HOBART "all 'round" WELDING... gets BIG PAYING jobs!

Go anywhere with trailer type gas drive welder

Don't let opportunity pass you by! Set up your own welding shop—get in on one of today's fastest growing, biggest paying businesses. Opportunities are unlimited.

Have your own BIG PAYING business

Hobart "simplified" welding makes learning easy, yet gives you an all 'round welder of top performance and dependability. Write for free booklet "Better Welds."

Build a GOOD business reputation with

Write today!

HOBART BROTHERS CO., BOX M-63, TROY, OHIO

HOBART WELDERS

BUY from C&H you'll save and be sure

HUNDREDS of SENSATIONAL BARGAINS!



HOT ROD SUPERCHARGER

Extra soup and go at a price you can't afford to miss! Mfr'd by Borg Warner. Specifications: 7 1/2" deep, 7" high. Wgt. 17 lbs. Compact and sturdy, 4 base mounting holes, 3/4" outlet, 5/8" shaft with female Lovejoy coupling. Priced today at \$85. Our Special SALE PRICE, NEW \$31.00. Used \$18.95

80-1 ratio Gear Reducer

Double reduction, reduces 1/6 to 1/2 HP electric motors 1750 rpm to 22 rpm. Reg. \$45. NOW \$26.00



CENTRIFUGAL CLUTCH — Ball Throw-out type. A or B belt pulley. 3/4" bore \$9., 1" bore \$11.

WATER PUMPS

7500 gal. per hr. self-priming Marlow centrifugal pumps. Driven by 2 HP B&S gas engine. 2" dia. discharge & suction. \$175. value. Now \$130.

LIGHT PLANTS (Easily portable)

300 Watt 110-220 volt AC. Wgt. 40 lbs.—portable \$99
750-1000 Watt 110v. AC Briggs & Str'n. eng. \$169
1000-1200 Watt 110v. AC only \$194.00
3000 W with Delco generator & Briggs & Stratton engine. 115v. DC. Ideal for contractor's portable tools. NEW \$279.

Before you buy—write for information on complete line of plants from 5 to 100 KW.

RUBBER HOSE

Long wearing GOODRICH 2 ply 2" I.D. 25 ft. lengths worth \$25.00, Only \$4.95. 3 lengths for \$12.00.



ELEVATORS

Build your own dumb waiter for store, shop, home, restaurant, or incline elevator for hills, and steep shores at factory prices. We furnish Steel Car—Guide Rails—Worm Gear—Electrical Controls—Steel Cable. SEND 25c for completely diagrammed instructions with price list.

ALARM HORNS SIRENS

Heavy duty motor driven; high, med. or low tone. 110v. AC Weatherproof. For alarm or signal horn for boats, school yards, factories, air raids, etc. Lists at \$47. NEW \$24.95



POWER & HAND WINCHES AT FACTORY PRICES!

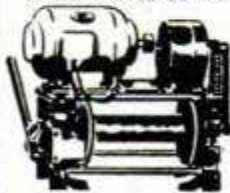

For—BOATS, TRUCKS, FARMERS, LOGGERS, CONTRACTORS, ETC. Hand Winch, 3-1 ratio, 600 lb. pull, drum has 1 1/2" spool. 6" flange, takes 7/8" of 3/16" cable, stop locking pawl, wgt. 26 lbs. \$16.95
Ball Bearing Hand Winch, low ratio 1-1, high ratio 3-1, 600 lb. pull. \$29.50
Same as above with bronze worm gear, 12-1 ratio and hand-brake \$39.50
1/2 HP electric ball bearing model; compact gear box, 12 rpm drum speed. \$145.00
3/4 HP, same as above, 3" drum \$165.00
Heavy duty, 10-1 ratio, double drum model with jaw type clutch, wgt. 280 lbs. \$49.95
CABLE, 3/4" preformed stainless steel aircraft, 100 ft. or less 17c/ft. Over 100 ft. 15c/ft.



SEND TODAY FREE CATALOG

Hundreds of \$5 saving buys. These are a few of the many items at sensationally low prices!

Pumps Drop Cords Compressors Clutches
Tools Generators Saws Air Tanks

C&H ELECTRIC MACHINE Co. Inc.

434t W. Juneau Ave., Milwaukee 3, Wisconsin

STAINLESS STEEL TANK

96 cu. in. capacity, 1800 lbs. pressure. Size 16" x 3 1/2". Fitted with high-pressure brass shut-off valve, 5/8" and 7/8" pipe ports. Formerly loaded with oxygen. Suitable also for compressed air, CO2 gas. Brand new! Shpg. wt. 7 1/2 lbs. \$25 value. ONLY \$4.95
Aviator's Oxy. Mask—Demand type. Type A-14. 24" rubber tube. New! Only \$3.95
Prices F.O.B. St. Louis. Incl. postage with check or M.O. Money Back Guar.



ORDER TODAY Ed. Aguado Trdg. Co. Dept. St. Box 4525 Plaza Sta., St. Louis, Mo.

Underwater Swimmers—Outdoorsmen!

New FREE Catalog jam packed with finest underwater swimming equipment. Also, sensational values for camping, hiking, fishing. Write today!

"BULLDOG GRIP" NEW TIP WRENCH

Grips, reaches, starts, tightens, loosens, in one setting. Simple thumb pressure controls nut, bolt, screw. Knurled, hardened steel, sliding jaws. Shockproof handle. Three models—4 1/2", 8 1/2", 8 3/4" long, cap's #2 to #12. Complete satisfaction or refund. Any single wrench \$1.95.



Complete Set \$5.00 ppd

TIP WRENCH 5865 Wilmington, Los Angeles, California

BIG 20" ROTARY LAWN MOWER

Powerful 2 H.P. world famous Lauson or Clinton Engine. Remote throttle control. Strong steel base and handle. Hardened steel cutting knives. Direct drive. Well guarded for safe operation. Cutting height adjustable 1" to 3". A top quality all purpose mower—outvalues them all. Satisfaction guaranteed or money back. *With recoil starter—\$4.50 extra. Dealer inquiries invited. Write or order now!

ONLY \$89.50 F.O.B. LANSING



KROY MANUFACTURING CO. So. Lansing Box 53 Lansing, Michigan

GIVE YOUR CAR THAT 1953 LOOK!



Miracle TINT-SHIELD Sprays On, Gives your Car that "Custom Look" Without Usual \$80 Cost of Tinted Glass;

TINT-SHIELD sprays on, eliminates sun-glare and headlight glare. SEND NO MONEY! Pay postman \$2.50 plus usual COD charges (or remit with order and we pay postage for you).

LASTS FOR YEARS! BIG 5oz. SPRAY CAN \$2.50

TINT SHIELD Dept. PM-6 210 W. MADISON CHICAGO, ILL.

POPULAR MECHANICS

WELLWORTH COMPRESSORS

2" x 1 3/4" up to 150 lbs. pressure 2.8 c.f.m. Operates with 1/4 or 1/3 HP motor . . . \$20.50; with 12" x 24" tank and accessories as shown. **\$38.25**



Compressor 2 1/2" x 2" motor required 1/2 HP 3.8 c.f.m. Price \$27.95. Price with tank and accessories. **\$45.70**
12" x 24" tank, 12 gal., air gauge and chuck, 20 ft. hose, pop-off valve, copper tubing with 4 brass flared fittings, 4 way cross, 3 nipples. Price. **\$17.75**
Price of tank only. **\$11.50**

GEAR HEAD MOTORS

Right Angles, 110V., AC
1/40 h.p. 135 RPM (no housing). **\$8.95**
1/30 h.p. 1250 RPM. **\$10.25**
1/20 h.p. 24 v. 75 RPM. **\$13.50**



PRICES F.O.B. CHICAGO. MONEY BACK GUARANTEE. SEND CHECK OR MONEY ORDER TODAY. PROMPT SHIPMENT. WRITE FOR FREE CATALOG. SEND 10c FOR POSTAGE.

WELLWORTH TRADING CO.

1832 S. Wabash Avenue, Dept. D-653, Chicago 16, Illinois

PAY ONLY \$1 DOWN— Only \$1.50 a week for Famous Brand Cummins DRILL-SAW KIT... Over 40 Pcs.

\$39.95 value . . . what savings! Here's what you get: Cummins 1/4" Pistol-Grip Electric Drill; Saw Attachment and 4" Blade; Bench Stand; Handy Carrying Case; Hand-Tite Chuck; 18 Sanding Discs; 12 Carbon Twist Drills; Grinding Wheel; Sanding Disc Pattern; Lambs Wool Bonnet; Rubber Packing Pad; Paint Mixer; Arbor Set; Guaranteed by the manufacturer and us. Included at no extra cost—9 additional Assorted Drills and a 232-page book, "Home Fixit Guide." You're "Mr. Fixit" with this Drill-Saw Kit! Over 40 pieces, it lets you change from drilling to sawing, sanding, polishing, etc., etc. Cummins outlasts ordinary drills and saws — runs quieter, smoother. Now with



these easy terms you can do your home jobs yourself and save seeds of money.

Only \$1 down—\$1.50 a wk.

No Interest or Carrying Charges added **Complete, Only \$26.95**

— MAIL 10-DAY FREE HOME-TRIAL COUPON —

WALDORF SALES CO., Dept. D-106
363 Central Park Ave., Yonkers, N. Y.

- Send Drill-Saw Kit, include extra drills and book. I enclose \$1. Will pay postman \$25.95 plus postage. If not delighted can return Drill-Saw Kit within 10 days for purchase price refund.
- I enclose \$26.95, you pay postage. Same refund guarantee.
- I enclose \$1 deposit. Will pay at rate of \$1.50 weekly after delivery (no carrying charges added).
- Will pay wkly. Will pay monthly.

Name _____
Address _____
City _____
State _____
APO, FPO, Canada & Foreign—No C.O.D.'s

BOAT KITS

Models from 12 ft. Runabout 39.25 complete

- Assemble your own boat
- No experience necessary
- Save 1/2 to 2/3 "factory built" prices
- Prices include freight and paint



Marine Hardware & complete accessories

New Catalog of all models 10c

Kit Division 3207 FREMONT AVE. SO. LUGER INDUSTRIES MINNEAPOLIS 8, MINN.

BUILD YOUR OWN WINDOW or ATTIC FAN

— IT'S EASY! SAVE UP TO 75% No Special tools or skill necessary Can be mounted in window or attic



Kits contain Fan spider, Masonite blades, Rubber-mounted bearings, Shaft, Pulleys, Belt, Bolts, and instructions. You furnish lumber and 1/4 HP motor. 24" Window Fan Kit (Cools office, apt., etc.), \$14.95 pp.

30" Size Parts Kit **\$15.95** P. P.

Cools average home

36" Attic Fan (Cools homes, churches, etc.), \$19.50 pp. Money-back guarantee. Order today and keep cool this summer. Immediate shipment. Brochure free. FAN KIT CO., 154-A NO. BELVEDERE, MEMPHIS, TENNESSEE

ABSORB DAMPNESS!

In Basements, Closets, etc. with the **SOLVAY AIR-DRYETTE, JR.** and SOLVAY CALCIUM CHLORIDE



Absorbs moisture — the cause of rust, warping, mildew in workshops, darkrooms, closets, playrooms, storage rooms, vaults. Built to last for years. Big capacity. Works fast, absorbs up to 3 1/2 qts. per day. Compact, inexpensive, clean, safe, odorless. Thousands in use. Write for booklet and name of your nearest dealer. Not available on Pacific Coast. Dept. 89-6, SOLVAY PROCESS DIVISION Allied Chemical & Dye Corporation 61 Broadway, N. Y. 6, N. Y.

Modern End Table

DESIGNED BY NORMAN CHERNER

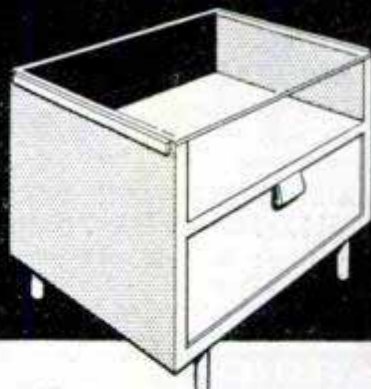

easy to follow Plans only 10¢

From plans to finished job in a single week-end. This smart new table is that easy to build with Douglas fir plywood. All you need are ordinary tools. Douglas fir plywood takes any finish. Won't split, chip or crack. Get step-by-step plans from your lumber dealer or send 10c to Douglas Fir Plywood Association, Tacoma 2, Washington.

Douglas Fir Plywood

Lumber dealers now have new small-size Handy Panels in self-service racks. Easy-to-use Handy Panels are quality-tested, grademarked Douglas fir plywood.



NEW Atlas GRINDER-HONE



Slickest Tool You've Ever Seen!

This unique new combination grinder and hone enables you to put a perfect edge on almost any tool or implement—from knives, scissors, hatchets, garden tools to plane blades, chisels, drills. Add a wire brush or buffing wheel and you're set to clean and polish a host of equipment.

The 6" grinding wheel turns 3000 RPM, the 5" oilstone hone (with 120 and 320 grits) turns 110 RPM. Tool is ruggedly built—grey-iron base, sealed-for-life ball bearings and Oilite bearings. Weighs 22 lbs. Operates from 1/4 to 1/2 HP, 1725 RPM motor. See your Atlas dealer, or write for literature. Price F.O.B. Kalamazoo \$31.50.

ATLAS PRESS COMPANY
624 N. PITCHER ST. KALAMAZOO, MICHIGAN



DEPENDABLE QUALITY TOOLS SINCE 1911

Dayton SPINNING Float!

GET MORE DISTANCE.....
GET MORE ACCURACY...

Adjustable weight DAYTON water bubble float makes it easy to spin-cast light lures just where you want!



AIR ESCAPE VALVE PERMITS FLEXIBLE WATER FILLING!

Pressing in both end plungers lets both water and air in and out freely—enabling fast, precise water weight adjustment. Transparent, leakproof!

AT LEADING DEALERS EVERYWHERE!

EVER GLASTING FIBERGLAS BOAT ARMOR FOR ALL BOATS



New simplified method designed for easy application. New laminator X-97 requires no experience. It's safe! Assures perfect job first time. X-97 comes ready mixed! Requires no curing or sunlight. Can be used in normal temperatures. Has unlimited shelf life. Applied in morning, ready for use same day. X-97 available in colors, also clear, which can be painted. Apply glass cloth yourself! Make hulls watertight. Permanently stop leaks on decks, cabin roofs. Add structural strength, value, beauty. Keep new boats new longer, used boats in use longer. Save money on upkeep and repair bills.

SEND 10¢ (coin) postage for interesting, illustrated booklet and detailed instructions.
EVER GLASTING DIV. U-MAK-IT PRODUCTS
703 P - Whittier Street, Bronx 59, N. Y. C.

STEP UP PERFORMANCE OF YOUR OUTBOARD



WRITE FOR OUTBOARDER'S BIBLE—our 1953 catalog. It's FREE! Contains much valuable information on how to get MORE SPEED, for racing or pleasure, from motors of 7 1/2 to 50 HP; better performance and load carrying capacity from any motor old or new. Easily understood recommendations enable you to choose a propeller virtually custom-built for your motor and boat combination—much more rugged and damage resistant than the original. Write NOW. Michigan Wheel Co., Dept. P - 66, Grand Rapids 3, Mich.

MAKE YOUR OWN TRAILER

or shop wagon with this sturdy aero. tire, tube and wheel with bearings for \$8.50 complete. Tires OD 10 1/2" high, 3 1/2" wide. Bore for axle 5/8".

WRITE FOR FREE CATALOG on other sizes with stub axles and other farm tires. Wheel barrow and Trailer manufacturing inquiries invited.



HARMO TIRE & RUBBER CO.

Part #218
804 HAMMOND BLDG.,
Dept. PM
DETROIT 26, MICH.

Say You Saw It in Popular Mechanics

GIGANTIC MAIL SALE

WAR SURPLUS EXCESS INVENTORY BANKRUPT STOCK

AIR COMPRESSOR UNITS

Build your own air unit. • DeLux Air Kit. Compressor, tank, valves, gauges, etc. \$45.49. • Air Items, 1-cyl. compressor, \$20.50, motor pressure switch, \$4.95. Adj. pressure regulator \$2.65. Pop off valve \$1.95. 160-lb. gauge, \$1.89.



WATER PUMPS and SYSTEMS

Small pumps for every use. Free advice. • Centrifugals, 25 g.p.m., \$18.90. • Rotary bronze self priming 6 g.p.m., \$14.75. • Hi Pressure (400 lb.) for cattle, orchards, \$54.50.



POWER PLANTS and GENERATORS

Save to 70% on 115-v, 60-c plants. • 5 KW, \$531; 2 KW, \$289; 1 KW, \$179. • Generators, 5 KW, \$259; 3 KW, \$189; 2 KW, \$139; 1 KW, \$121. Many other values.



HYDRAULIC BARGAINS

Build loaders, diggers, presses. Save to 50%. Brand new units. • Tractor Pump (1000 PSI) \$45.50. • Hand Pump, \$10.50. • Cylinders, 3" bore by 3" stroke, one-way, \$11.95. • 3"x24", \$39.90. (two way). • 2 1/2"x36", \$34.95. (one way). • Control Valves, \$18. (one way or two way).



SUPER SPECIAL—WEED SPRAY OUTFITS

Factory closeout! World's finest stainless steel 7-row, 13-nozzle, 20-ft. outfit. Complete with pump, push button selector valve, hose, etc. List \$250.00. Money back guar. SALE.....ppd, \$129.50



HAND WINCHES—HOISTS

• 1000 lb. winch, \$19.95
• 2000 lb. winch, \$29.95
• Chain hoist (lever type) 3000 lb, \$19.48
• Aviation hoist, \$17.44



Special for the Month ARMY PARTS CLEANER

• Marvelous Air-Solvent Cleaner-Washer, cleans dirty-greasy parts perfectly in few seconds.
• For garages, factories, filling stations, farms.
• Heavy galvanized tank 25"x20"x20" on pipe legs. Cylinder operated lid. Air turbulator. Parts tray, etc.
Cost over \$100.00 (wt. 105 lbs.) SALE, \$29.95 Ppd.



SUPER CLOSEOUT BARGAINS

• City Phones \$4.99; Rural Phones \$13.90
• Air Power Grease Guns (\$60)..... \$23.85
• Gas Chain Saw (24 in.)..... \$259.50
• Electric Drill, 1/2", Jacobs Chuck, \$29.95
• Precision Hand Level..... \$5.95
• 10"x18" Air Tank for compressors, \$5.95
We pay shipping charges. Send for catalog.

BURDEN SALES COMPANY

808 "O" ST.

LINCOLN, NEBR.

POPULAR MECHANICS

Another in the series of Monsanto Rez "Modern" functional selections developed by Kim Obata—one of the country's leading contemporary designers.

Combination unit for functional living

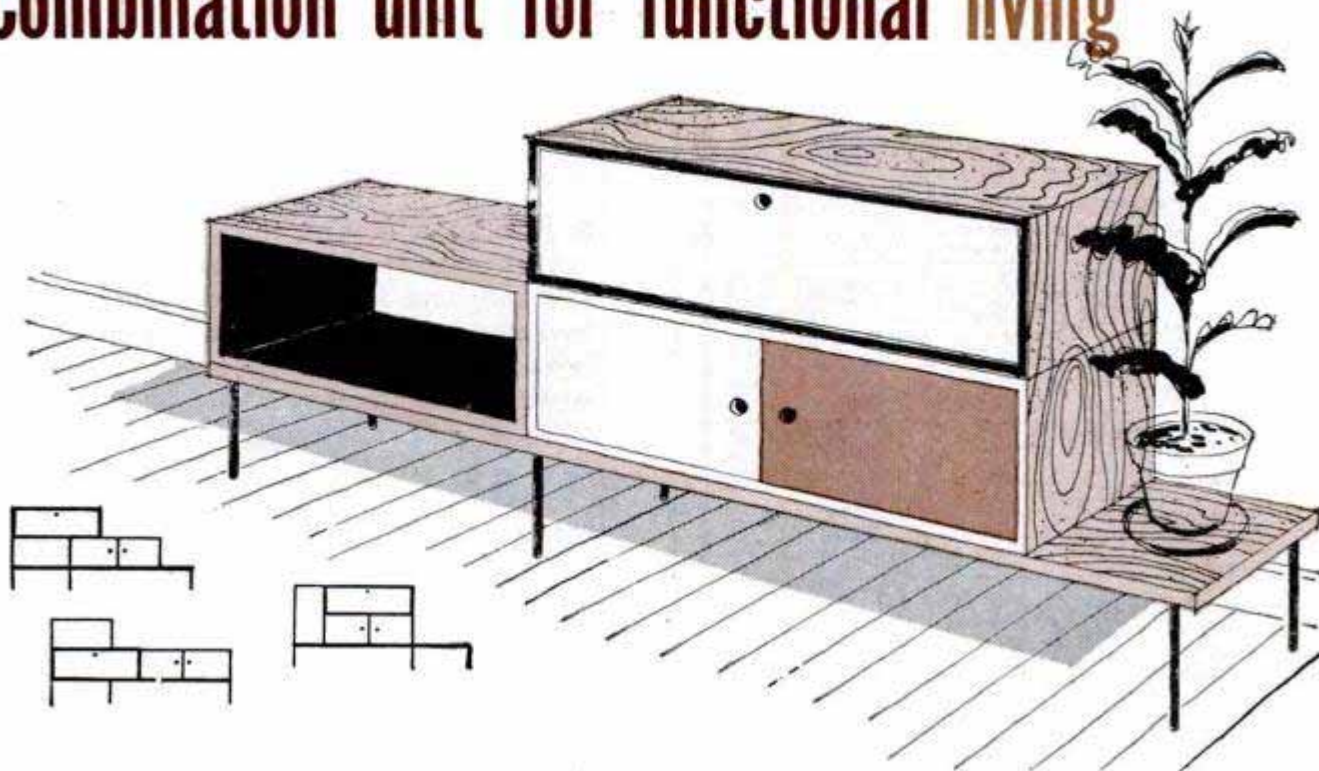

Designed to be functional as well as an attractive addition to the modern living room, this combination desk and storage unit has many features to recommend it. Easily built of available materials, using only simple tools, it combines flexibility of arrangement with maximum utility.

Essentially, this combination unit consists of three elements—(1) Base, with either wood or wrought-iron legs; (2) Combination drop-leaf and sliding-panel cabinet; (3) Storage area with open front and back, that can be placed either vertically or horizontally.

Detailed plans and specifications are available. They in-

clude exact cutting diagrams, all dimensions, hardware specifications, as well as alternate construction suggestions. Mail the coupon for your copy.

Ease of giving the entire assembly a "professional" finish is a highlight of this unit. Rez is recommended for this purpose. Use either clear Rez for achieving a "natural" wood effect, or any of the 5 color-toned Rez products to capture the soft beauty of nature's colors—Redwood, Driftwood, Sage, Cedar, Mahogany. Also available in White Rez for achieving one-coat bleached or blond effects.

Rez is easy to apply with brush, spray or wipe-on cloth

... All Rez products seal and prime the surface to which they are applied. Their penetrating action equalizes the surface density of the wood—preserves beauty of grain by preventing streaks and blotches. Sealing action checks grain raise—minimizes warping, swelling and twisting by keeping out moisture.

At your paint, hardware or lumber dealer—ask for color samples. Or, write MONSANTO CHEMICAL COMPANY, Merchandising Division, 1700 So. Second Street, St. Louis 4, Mo. In Canada, Monsanto Canada Limited, Montreal, Toronto, Vancouver.

Laux Rez: Reg. U. S. Pat. Off. Copyright 1953, M. C. C.

COMPLETE PLANS AND SPECIFICATIONS AVAILABLE

This specially designed combination unit can be easily constructed from standard plywood panels. Send 25¢ for completely detailed plans and specifications. Use coupon.

.....

• Merchandising Division
• MONSANTO CHEMICAL COMPANY
• 1700 South Second Street
• St. Louis 4, Missouri

• Enclosed find 25 cents (25¢) for which please send combination unit plans and specifications to:

• Name.....
• Street.....
• City..... Zone..... State.....

.....

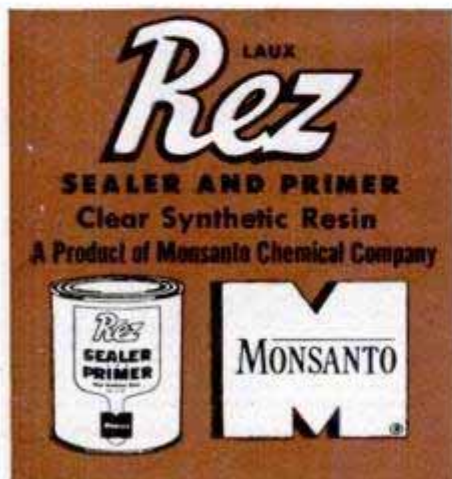

AMAZING TOOL BARGAINS!

12 MOUNTED WHEELS and points on 1/8" Shank. **\$2.95** Post-paid



For grinding on plastic, wood, soft and hard metals. Regular List Value \$8.40.
12 MTD. WHEELS ON 3/4" SHANK... \$3.60
18 MOUNTED POINTS ON 3/32" SHANK... \$2.50

7 HIGH SPEED STEEL DRILLS **\$1.00** Post-paid

15 DRILLS FOR ONLY \$2.00! Order Today!
 7 Popular Sizes — up to 1/4". Brand new, ideal for home or shop use. Fits all standard chucks.

5 DRILLS FROM 1/4" TO 1/2" DIAMETER... \$1.95
4 WOODWORKER'S DRILLS, 5/16" TO 1/2" on 1/4" shank—\$2.00

2 CIRCULAR SAWS **\$1.50** Post-paid in U.S.A.

ON 2 MANDRELS — ALL AT ONE LOW PRICE
 1" diameter saws on 1/4" Mandrels. For cutting wood, plastic, or soft metals. Order at once!

FLEXIBLE SHAFT — ONLY \$4.95 Post-paid

Fits all electric drills & hand power tools. 35 3/4" long. Oilite bearings. Core of specially wound, high carbon steel wire in flexible steel casing. Will accommodate tool shafts up to 1/4" dia. For lathes, electric drills, etc.

18 ROTARY CUTTERS **\$5.85** Post-paid

Value \$13.50
 Illustrated 1/2 actual size
 Assorted sizes cutter on 1/8" or 3/32" shank. Will fit all hand grinders. Ideal for cutting wood, metal, or plastic. Brand new.

SCHUPACK SUPPLY CO., 7331 Cottage Grove, Dept. M-43
 Chicago 19, Ill.
 NEW 1953 Illustrated Catalog 10c

SAY YOU SAW IT IN POPULAR MECHANICS

Save Hundreds of Dollars with this NEW ALL-METAL ELECTRIC SPRAY GUN—Pay Only \$1 a Week

ENTIRE UNIT UL APPROVED!

Hundreds of tough tasks are made easy with this NEW, All-Metal Spray Gun. The finished work cannot be told from high-costing professional jobs. Just press the trigger and you're doing the job evenly, cleanly and easily. No compressor needed. Use for spraying paints, including rubber-base paints — lacquers, enamels, varnishes, chemicals, oil, insecticides, deodorants, shellacs; for waxing, rust-proofing, waterproofing, etc. Built for heavy duty. AC current. Entire unit, every part, fully UL Approved, including 8-ft. S. J. Neoprene Cord & Plug Set. Given at no extra cost: 5 extra nozzle discs; 232 pg. "Home Fixit Guide."



\$17.95 No Carrying Charges Added
 25-Oz. Polished Aluminum Container — No Plastic or Glass Used!
 This New Model Available Only from Us.
\$1 DOWN — \$1 WEEKLY

MAIL 10-DAY FREE HOME-TRIAL COUPON

WALDORF SALES CO., Dept. AG-2406
 363 Central Park Ave., Yonkers, N. Y.

Send Spray Gun, include Free Book. Name _____
 I enclose \$1. Will pay postman \$16.95 plus postage. If not delighted can return Spray Gun within 10 days for purchase price refund. Address _____
 I enclose \$17.95, you pay postage. Same refund guarantee. City _____
 I enclose \$1 deposit. Will pay at rate of \$1 weekly after delivery (no carrying charges added). State _____
 Will pay wkly. Will pay monthly. APO, FPO, Canada & Foreign—No COD's

Pocket size NAIL PULLER

A POWERFUL, EASY TO USE NAIL PULLER—
 HANDY AS A HAMMER

Satisfaction guaranteed up to ten-penny nails.

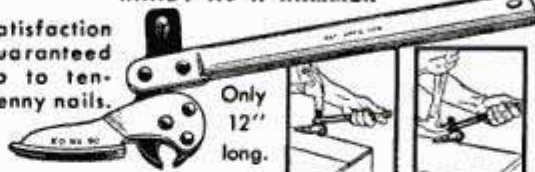

Only 12" long.

A favorite with Carpenters because of convenience in tight places. Tool Steel Counteracting Jaws are driven into wood by hammer which is also used for double leverage as illustrated. Rustproof finish. At Hardware stores or direct.

K-D No. 90

\$1.59

POSTPAID U.S.
 No stamps;
 No C.O.D.

Free Catalog

Over 100 tools described, illus. Special time savers for general workshop; auto, valve, ring, ignition service. Tool chart for Ford valves. K-D Tools oldest line valve tools in U.S.



K-D Mfg. Co., Dept. 90, Lancaster, Pa.

AMERICA'S BIGGEST FAN VALUE!!

WESTAIR 24" BELT DRIVE

Precision built belt drive Fan — for Homes, Stores, Factories, Barns, etc. Fan frame, welded steel Blade Dia. 24". R. P. M. 550. CFM 5400

Attic FAN

\$39.95 Less Mtr.

Reconditioned 1/4 GE Mtr. \$8.95
 New Delco Motor \$15.95
 Aluminum Side Wall Shutter \$12.95
 Aluminum Counterbalanced Ceiling Shutter \$14.95

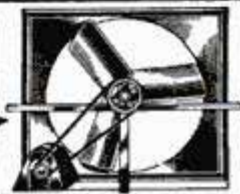

5 YEAR GUARANTEE

Kitchen Ventilators, Exhaust Fans, Attic Fans, Blowers, Heat Boosters, Desk Fans, Window Fans, Blades Guards, Shutters, Motors, etc.
 Free illustrated catalogue, dealers inquiries invited



EDWARDS BROS. **WESTAIR FAN & BLOWER CO.**
 Etab. 21 yrs. 5650 Grand River, Dept. M Detroit 8, Mich.

Say You Saw It in Popular Mechanics

Powerful Midget "DYNA-MITE" ELECTRIC MOTOR

WATCH IT WORK WONDERS!

GEAR BOX

Forward Reverse

REMOTE CONTROL

POWER PLANT

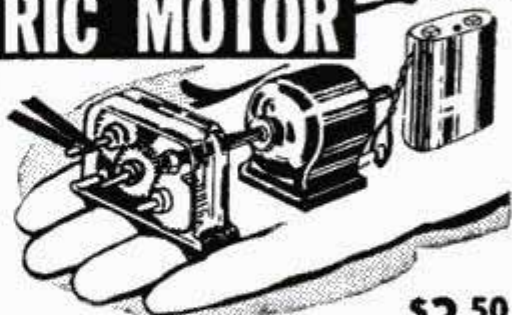

ALL 3 UNITS COMPLETE **\$3.50** p.p.d.

The most powerful midget motor ever built! Will drive your model trains, boats, planes, cars and construction sets with high speed... real power. Measures only 1"x1"x1 1/4", but turns up to 6800 r.p.m. ... top speed for any midget motor! REMOTE CONTROL—reverses quickly with the new Power Plant holding two standard flashlight batteries. REDUCTION GEARS reduce speed as low as 50 r.p.m. Aids INVENTORS, GADGETERS, HOBBYISTS, etc. Works perfect with gears, belt drive, or direct drive. Endless hours of fun... educational, too! Non-shock, safe! ORDER TODAY! This terrific midget motor, gear box, and remote control battery power plant is yours complete for only \$3.50 (add 25c if batteries are desired). Send check or money order and save on postage.

ELECTRO-KRAFT CO.

DEPT. B-9, BOX 237 OLD CHELSEA STATION, NEW YORK 11, N. Y.

SURPLUS LIGHTS

NAVY Sealed Beam LAMP

U.S. NAVY portable search-spot light. Has pistol-grip & aiming sight. Makes an ideal search, spot or emergency light for auto, boat, etc.

12V. light - 4" lens ... **4.29**

24V. light - 5" lens ... **4.79**

Set of 3 filters: red, green, amber (specify type lamp) ... **.99c**

4-WAY SWIVEL LAMP

A handy lamp for desk, work bench, chart table, engine room, etc. May be used on 6-12-24 or 110 volt current by simply changing the bulb. Has 3 foot shaft with four movable joints to adjust light. **3.95**

ELECTRONICS & RADIO MIX

A Jumbo Surprise Package containing controls, coils, switches, wire and a variety of other valuable radio and electronic devices. **A BARGAIN BUY! 2.25**

CHEMISTRY SET

Made for Chemical Warfare Division for testing, water, etc. A handy addition to the chemistry lab, or an exciting experiment for the amateur. Set includes test tubes, complete instructions, 15 different items. Packed in attractive lucite box with cover and dividers ... **1.89**

NYLON ROPE

5/8" diameter. 16 strand. Easy to handle. Extra strong. Long lasting. A bargain at ... **21¢ PER FT.**

AIRCRAFT CABLE

Rust resistant, alloyed steel. Extra flexible. Pre-formed, 7 x 19 strand. On reels

1/16" - 4 1/2 ft. (7x7)	7/32" - 11 1/2 ft.
5/64" - 5 ft. (6x7)	1/4" - 12 1/2 ft.
3/32" - 5 1/2 ft. (17x7)	5/32" - 15 ft.
1/8" - 7 1/2 ft. (7x19)	5/16" - 16 1/2 ft.
5/32" - 8 1/2 ft.	3/8" - 18 ft.
3/16" - 10 1/2 ft.	1/2" - 20 ft.

Stainless Steel Cable

1/16" ... 7 ft.	5/32" ... 20 ft.
1/8" ... 18 ft.	3/16" ... 23 ft.

Bronze Cable - Not Pre-Formed

1/16" - 5 ft.	5/16" - 23 ft.
1/4" - 17 ft.	1/2" - 38 ft.

PRESSURE TANKS

G-1 Type - Stainless Steel, shatterproof & rustless. Has reinforcing ribs and is pressure tested up to 400 PSI. Has high safety factor. Both ends have 1/4" pipe ports.

Ideal for use as a buoy, drinking water supply, underwater fishing, diving, painting, cooking, or spraying.

G-1 - 12 1/2" x 24" ONLY **10.95**

D-2 Tank - 500 cu. in. cap. ... **3.95**

A-4 Tank - 104 cu. in. cap. ... **1.95**

FIRE EXTINGUISHER

Kiddle Lux - CO₂ Type - Built to Gov't specifications. Has heavy, shatter-proof case. Recent hydrostatic test. Reconditioned and fully charged. LIKE NEW! All are READY FOR INSTANT USE!

3 1/2 lb. size with Swing Nozzle ... **\$14.95**

7 1/2 lb. size with Horn ... **21.75**

10 lb. size with new Squeeze Grip Handle & 3/5 ft. flex hose with Horn **27.75**

15 lb. size with Wheel Control ... **35.75**

15 lb. size with Squeeze Grip Handle, 4 ft. flex hose, Plastic Horn ... **39.95**

SAVE UP TO 85% ON WAR SURPLUS FROM WORLD FAMOUS 'GADGETEER'S' HEAVEN

TREMENDOUS SAVINGS ON PALLEY HYDRAULICS

Here at Palley's we carry the WORLD'S LARGEST supply of special Hydraulic Equipment. Our huge stocks of Hydraulic Cylinders alone feature over 20,000 units in 61 sizes and types. We also stock thousands of accessories such as Hydraulic Pumps, Transmissions, Valves, Tanks, Fittings, Hose, etc.

HYDRAULIC CYLINDERS

No. 3 - Double Action Cylinder. Bore is 1", Shaft 1/2", Stroke adjusts from 2-1/2" to 4" with internal sleeve stops. Length overall 8-1/2". Will take 1500 lbs. continuous - 3000 lbs. intermittent. Will lift or push 1100 lbs. ... **5.75**

No. 42 - Double Action Cylinder. Bore is 3-1/4", Shaft 1-1/8", Stroke 9-1/8". Length 17-1/2". Lift capacity with 1500 PSI line pressure approx. 12,441 lbs. **18.75**

No. 4 - Double Action Cylinder. Bore 3", Shaft 1-1/8", Stroke 3-1/2", Length 8 1/2". Lift capacity with 1500 PSI line pressure 10,500 lbs. **18.75**

No. 53 - Double Action Cylinder. Bore is 2-3/8", shaft 1 1/4", stroke 1 1/2", length 26". Gives 6645 lbs. lift with 1500 lbs. line pressure. ... **20.50**

No. 29 - Double Action Cylinder Special Gives 20,000 lbs. lift with 1500 PSI line pressure, or will give 40,000 lbs. thrust on intermittent 3000 lb. line pressure. Has 4" bore, 1-1/2" dia. piston shaft, 18" stroke, 30-1/2" length. Ideal for presses, road, farm and shop equipment. Cost Gov't \$390. **29.95**

BENDIX HYDRAULIC PUMP AND MOTOR 13.95

Has 3 1/2 GPM capacity at 600 PSI. Motor is 1 1/2 HP, 24V, DC. Operates on either 12 or 32V, DC current. Has built-in relief valve adjustable to 1500 PSI. This unit ideal for bait tanks, hyd. lifts, portable loaders, etc. Cost Gov't approximately \$350.00.

VICKERS HYDRAULIC TRANSMISSION

Self contained, 2 H.P., constant torque at all speeds with variable volume reversible, piston pump (controlled by outside lever) supplying piston hydraulic motor. Automatic pressure, dash pot for smooth control. Power output RPM -0 to 1/3 input RPM in both directions. Input RPM 1800 continuous. 4000 intermittent. Dash pot can be removed for greater RPM. Ideal for lathes, duplicator set-up of mills, conveyors, small cars, drives, gearings, etc. ... **42.50**

4" SPLINE SHAFTS for input & power take-off ... **2.50 PR**

Pulley Adapters - Bearing Block. Set \$20.00

P-1A PESCO GEAR PUMP

Capacity, 1 1/2 GPM at 1500 RPM at 1500 PSI. Pressure limit is 1500 PSI continuous, with intermittent maximum of 1875 PSI for 15 seconds. Manual operating speed is 3750 RPM with an intermittent maximum speed of 4500 RPM. Rotates right-hand only. **Now 8.95**

BENDIX 4-WAY VALVE

Poppet type. Off at neutral. Has pressure inlet, and return & 2 pressure outlets for operating two cylinders independently. Position of handle selects either cylinder. Can also be used with hydraulic motors. Has 1/4" internal ports with 7/16-20 thread. Overall size is 3" in diameter & 1" thickness. **6.75**

No. V-4AA MANUAL CHECK VALVE

Cam Piston type. Permits free flow in one direction while checking any 'back flow' until control handle has been positioned to allow free flow in both directions. Has 1/2", tube size ports (3/4"-16 thread) **2.25**

Send 25c Today for Illustrated Catalog of thousands more Hydraulic Bargains.

CUNO OIL FILTER

An aircraft type oil filter which can easily be adapted to autos, etc. Will keep oil clean without a cartridge replacement. Can be installed in minutes. Has two mounting braces. **7.95**

A real SURPLUS BARGAIN. **6.95**

AUTO PULSE ELECT. PUMP

A self-contained, electrically operated pump for use with gas, alcohol, fuels, light liquids, etc. Ideal for boats, trucks, etc. having a 24 volt system. Can be changed to 6 or 12 volt by rewinding solenoid. **4.95**

Hydraulic PUMP

Has built-in, variable flow control valve in head. Positive displacement, piston type. Displaces .450 cubic inches per revolution. Capacity is 2 GPM at 1400 PSI. Operates at 3750 RPM, intermittent maximum is 4500 RPM. Rotates in either direction. 1" ports. **27.50**

230 PAGE CATALOG

1000's of ITEMS! Fully ILLUSTRATED! For THE MECHANIC, SPORTSMAN, HOBBYIST, HOME OWNER, etc. War Surplus - Factory Closeouts and General Merchandise Values! Save on Hardware, Hand & Power Tools, Gadgets, Sports Equipment, Hydraulics, etc. **SEND 25c for HANDLING & MAILING.**

3 SPEED TRANSMISSION

Converts a high speed, low power input into low speed, high power take-off. Has 2 take-off shafts at 4 to 1 and 16 to 1 ratios. Gear box has a worm drive, bronze gears and a throw-out clutch. Will operate in either forward or reverse directions. Adaptable to many uses on power machinery. ... **19.95**

RIGHT ANGLE DRIVE

Has direct 1 to 1 ratio through 90° bevel gears. The drive and take-off shafts are 3/8" dia. Gears are self-lubricating, hi-speed steel. Ideal for use on power tools, flex drives, etc. Length 3-1/2", width 2-3/4", thickness 1-1/4". A Fly at **2.25**

UNIVERSAL JOINT

Rotates with full flexibility from 90 to 180 degree angle. Body is solid bronze. Drive shaft is 1" dia. steel. Joint is Ball and Socket type. Ideal for use on boats and heavy machinery. **5.95**

ELECT. ACTUATOR

No. EA-E2 **Only 14.95**

Made by Emerson. Has a 1/10 HP, 24 volt DC, 7500 RPM motor with integral push-pull actuator. Motor drives the actuator in a 10-1/2" travel through a high reduction gear box. Ideal for use in opening or closing, lifting or lowering, remote controls, etc. Unit is complete with control box & adjustable limit switches. Overall length, extended 26-1/2", retracted, 16"

GEAR HEAD MOTORS

Heavy duty, G.E. motor. 2 HP, 24V, DC, 125 amp., reversible motor to drive a reduction gear unit giving 36 to 1 ratio at take-off. Unit will operate on 6 or 12 volts

36 to 1 G.E. (306 shaft RPM)	10.95 EACH
28 to 1 Eclipse (130 shaft RPM)	
40 to 1 Eclipse (110 shaft RPM)	

GHM-528 Lear GEAR HEAD MOTOR

Lear 24 volt DC, 7.6 amp, series wound reversible motor with overload clutch. Motor turns 11,000 RPM driving thru a 10 to 1 gear reduction box which turns the final take-off shaft 1000 RPM. Adjustable limit switches control limit of travel. Take-off drive adapts to flex or rigid shaft. Size: 10"x4" ... **9.95**

MAGNETIC BASE INDICATOR HOLDER

Time saver for precision checking. Magnetic base fits curved or flat surface. Has 45-50 lb. pull. 6 1/2" stainless steel rod which is mounted in ball socket to permit universal settings. **3.95**

REPAIR KIT

An all-purpose kit! 6 useful tools - a fine steel trimming knife - pair of genuine WISS heavy duty scissors - a steel roller for cementing seams in fabric, wallpaper, etc Two 12" half round files - a wire burnishing brush. Complete in cloth case. Ideal for wallpaper and linoleum. A 9.50 VALUE **3.29**

LEATHER BELT KITS

Made of bark tanned, top grain cowhide. Worn on your belt. Convenient & handy for carrying your small tools. Sturdy & durable. Reinforced with rivets.

"A" - ELECTRICIANS KIT - 7 POCKETS. For tools, tape, pencil etc. ... **3.99**

"B" - RADIO & TV REPAIRMANS KIT - Has 1 large & 2 small pockets. For use by all mechanics, technicians etc. - **2.79**

PALLEY SUPPLY CO. 2263 EAST VERNON AVENUE DEPT PM-6 LOS ANGELES 58, CALIF.

Do **YOU** get **30** to **50** miles per gallon?

OTHERS DO . . . YOU CAN TOO!

ZOOM AHEAD

FROM A DEAD STOP TO
60 MILES in 12 SECONDS



AMAZING DISCOVERIES OF AUTO ENGINEERS REVEALED!

OVER 1000 SECRETS NOW YOURS!

Extra Pep, Speed, Power, Economy yours with ANY make car!



READ THIS BOOK
10 DAYS

FREE!

NEW
1953
EDITION

NOW . . . get the latest "dope," up-to-date inside information, new revolutionary methods! Save hundreds of dollars annually . . . drive 30, 40, even 50 miles on a single gallon . . . up top speed 30 miles . . . go 8000 miles without oil change . . . enjoy 25 or more horsepower . . . lightning fast get-a-way! Over 1,000 of these new ideas, auto tricks, engineering secrets and plans are now yours to read and use in the new 1953 edition of "Higher Speed & Extra Power." It's the genuine **original**—the best and **latest!** Chock full of show-you-how pictures! No need to be a mechanic with expensive tools! For instance, with an ordinary screwdriver you can step up compression, reduce gas consumption and give your engine new pep and vitality—in barely **5 minutes!** Another idea shows you how to save up to **30%** gas with an old mason jar & 15 cents rubber hose! Another shows you how to drive 8000 miles without changing oil!

OVER 1000 PICTURES, SECRETS, IDEAS
YOURS ON 10 DAY FREE TRIAL!

Try some of the easy tricks the first day you receive your book! In less than one hour you can give your car more pep, speed, power, economy . . . be it a '53 Cadillac or a '39 Chevy! You learn about the discoveries of famous American engineers, scientists, oil companies, government bureaus, the army, navy & air force! You learn of 20 ways to save gas & oil, alcohol-water injectors, easy speed and power tuning, how to get 10,000 more miles for your tires, save on "sucker" auto repairs, enjoy 30, 40, 50 miles per gallon with any car, any make! New plastic methods for removing body dents, **NEW**, sensational way to restore compression, stop burning oil, avoid expensive ring job, plus **HUNDREDS** of ideas to repair, paint, upholster, maintain top performance, and save money and aggravation! This wealth of information was gleaned from famous speed champions, renowned auto engineers and experts! Now yours for only **1.98**—if you **KEEP** the book! Mail coupon **NOW!** Over **25,000** other drivers are now getting greater speed, pep and miraculous gas economy. You can too . . . beginning the first day . . . **ACT NOW!** Leave 'em in the dust with a higher compression car!

THE ENGIN-METER & 4 MANUALS YOURS
TO KEEP EVEN IF YOU RETURN BIG BOOK!

FREE

NEW, AMAZING ENGIN-METER

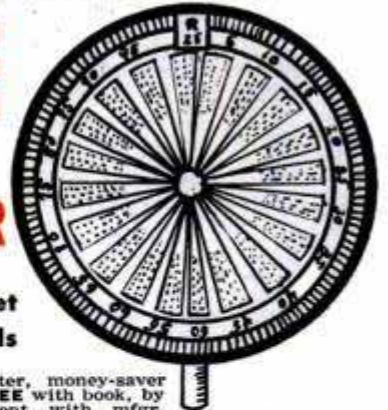

plus 4 pocket
auto manuals



This trouble-shooter, money-saver meter is yours **FREE** with book, by special arrangement with mfr. Use on dashboard. Watch top "window." Flashes **RED** for danger; **AMBER** for caution; **GREEN** for safe. Easy Alphabet Indicator refers you to complete answer. Result: You save on **GAS, OIL, "SUCKER" REPAIRS.** Also **FREE: 4 MANUALS**, as follows: 1. Pocket "Trouble Shooter," helps you find cause of defects, with repair advice. 2. "SAVE ON ACCESSORIES"—saves on tires, accessories, gadgets. 3. "ECONOMY DRIVING TECHNIQUE"—tells about famous Indianapolis driving techniques that gave 150 miles a gal. 4. "33 WAYS to Increase Trade-In Value." May be worth hundreds to you! Stock limited! You can make many adjustments & repairs yourself with the **ENGIN-METER** and these manuals—saving many \$\$\$! You **KEEP** the **METER** and **4 MANUALS** even if you return the big book for refund. You have nothing to lose—everything to gain! Send no money now. Pay postman **1.98** plus postage on arrival of everything. Enjoy 10 days. Your money back **QUICK** if not thrilled! Demand is great and our stock of **METERS** is limited. Please rush coupon now!

SPEEDWAY BOOKS, Dept. 6-F-999

127 West 33rd Street, New York 1, N. Y.

RUSH Hi-Speed & Extra Power Manual on 10 day trial, money back guarantee. I will pay \$1.98 plus postage on arrival. Also send **FREE** the following: "Trouble Shooter," "Save on Accessories," "Economy Driving Technique" and "33 Ways to Increase Trade-In Value" and the amazing **ENGIN-METER**, mine to keep even if I return manual for refund.

Name _____

Address _____

Town _____ State _____

SAVE MORE—by sending \$2 check, m.o. or cash, in which case we pay postage and enclose a MOTOR COMPASS. Same money-back guarantee!

SPEEDWAY BOOKS, Dept. 6-F-999

127 WEST 33rd STREET, NEW YORK 1, N. Y.



THE REAL "WINNER" AT INDIANAPOLIS IS YOUR CAR!



... *Because* from this world famous 500-Mile Race have come a great many of the major developments and improvements now used in your car. Advancements in spark plug engineering are a perfect example. Champion-equipped engines have won the vast majority of these races. The knowledge and experience gained in this toughest of all testing grounds is used by our engineers to produce constantly improved, better performing more dependable Champions for your car. So try a set! You will never again be satisfied with ordinary spark plugs.

CHAMPION SPARK PLUG COMPANY, TOLEDO 1, OHIO



Better by Far for **EVERY CAR** *Regardless of Make or Year!*

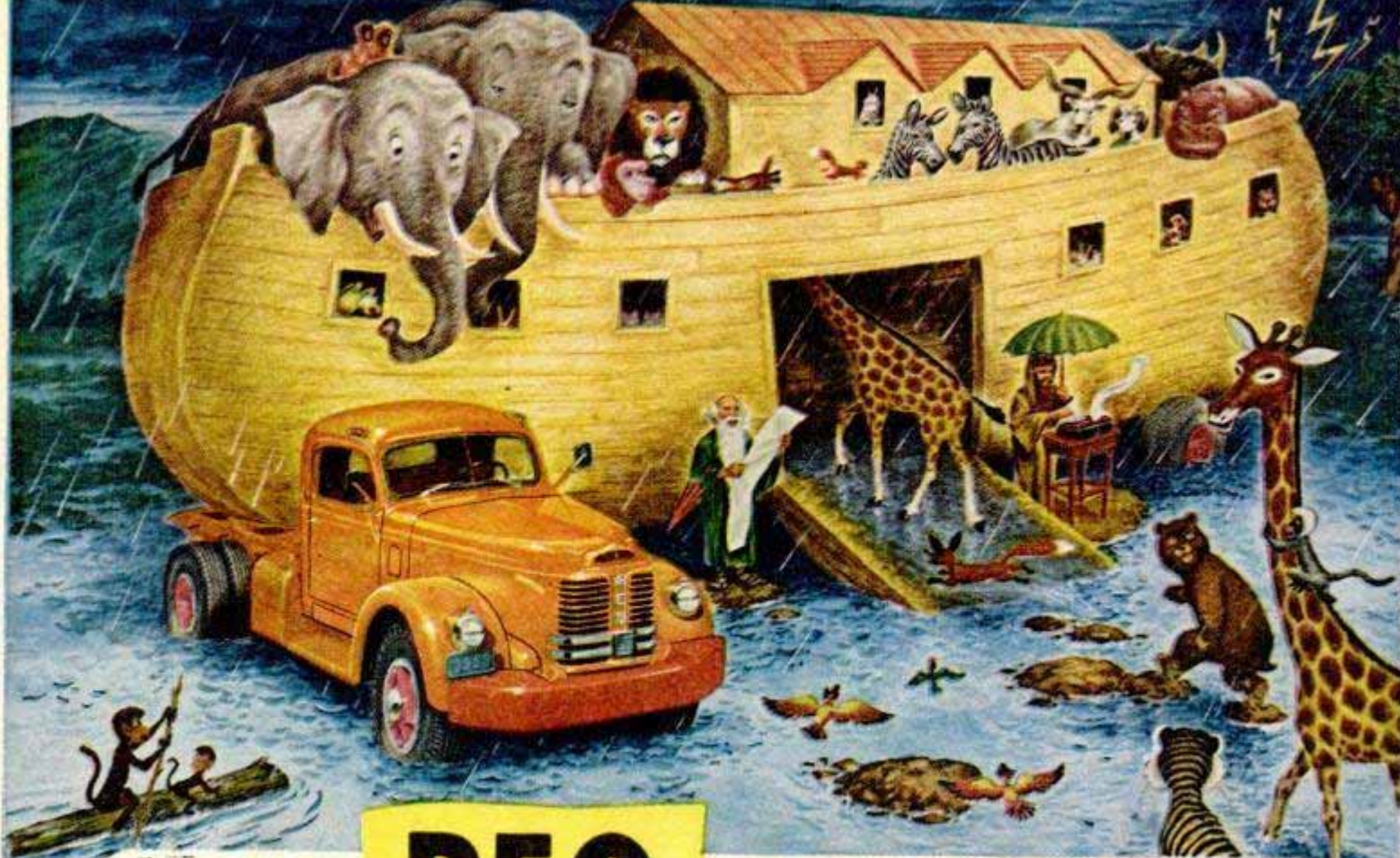

JOIN THE

REO

Haul of Fame!

Old Noah knew a thing or two;

His basic idea was fine.

It pointed the way to what's known today

As Reo's More-Pay-Load Design.



NOAH SAYS:

"Biggest truck news since the Flood. Reo's new 160-h.p. *Super Gold Comet*, the most efficient engine ever built for 50,000-lb. g.c.w. service. Reo's more-pay-load design now means more than ever before."

NOW!

A COMPLETELY NEW 160-H.P. REO SUPER GOLD COMET...THE MOST EFFICIENT 50,000-LB. G. C. W. TRUCK ENGINE EVER BUILT...ASK ABOUT IT

REO MOTORS, INC., Lansing 20, Michigan