

ANC



POPULAR MECHANICS

MAGAZINE

WE WRITE SO YOU CAN UNDERSTAND IT

REG'D TRADE MARK GREAT BRITAIN No. 410436

BY U.S. PAT. OFF.



This Great Sport . . .
SPIN FISHING
Page 81

What Owners Say About the
PLYMOUTH
How to Install Dormers
Build an Auto-Top Sleeper



Studebaker Commander V-8 Starliner hard-top convertible. White sidewalls, chrome wheel discs and glare-reducing tinted glass optional at extra cost.

The new American car with the European look!

**It's the breath-taking 1953 Studebaker!
Excitingly new in continental styling!
Impressively down to earth in price!**

THE dramatic 1953 Studebaker sparkles with the verve and flair of Europe's most distinguished cars—but it's thoroughly American in comfort and handling ease.

You have your choice of 9 thrillingly styled sedans, coupes and hard-tops—and each comes to you at a down-to-earth price—with Studebaker low operating cost!

Order your '53 Studebaker now—a Champion in the lowest price field—a brilliant-performing Commander V-8.

An exclusive new Studebaker kind of Power Steering is available in the Commander at moderate extra cost.



**It's sensational! It's less than 5 feet high!
The new Studebaker Starliner hard-top!**

New 1953 Studebaker

"PROUD? YOU BET I AM!"
 (AND IT'S SO EASY TO INSTALL!)



"WHEN I installed Goodyear VINYL-TILE Flooring in the first room in my house—the neighbors were amazed at the 'professional-looking job' I made of it. "But the thing that really tipped them off to what a good deal this new VINYL-TILE really is was when my wife told them how easy this new flooring material was to keep up, how it *never needs waxing!*"

"So I'm doing the children's rooms now — and the handy installation kit makes laying this tile fast-moving and fun.

"The only problem we had was choosing the colors—there are 24 of them, and they're all beauties!"

WHY NOT SEND FOR THE FREE VINYL-TILE "SELF-INSTALLATION BOOKLET"

—it shows the step-by-step method of installing your own floor—and with the New Pre-Polished Goodyear VINYL-TILE it is so easy TO DO IT YOURSELF. Send a postcard for your copy today: Goodyear, Flooring Dept. 6-M, Akron 16, Ohio.



HANDY GOODYEAR VINYL-TILE FLOR-MASTER INSTALLATION KIT

provides the simple tools required to do a professional job in jig time — available at all better flooring dealers', furniture and department stores where Goodyear VINYL-TILE is a featured item.

Flor-Master—T. M. The Goodyear Tire & Rubber Company, Akron, Ohio

GOODYEAR  **Vinyl-Tile**

By the Tile • By the Roll • for FLOORS • WALLS • COUNTER TOPS

Listen—12 years old and she “runs like new”!



Naturally a car may need replacement parts in that period of time ...but not as often when you insist on **GENUINE FORD PARTS!**



They're made right to fit right because they're made by the same men who made the original parts for your Ford—so they're naturally the *best* parts you can buy for it. And because they're made right to *fit* right, they're easy to install—save you valuable repair time.



They're Track Tested and proved by Ford engineers, using Ford cars and trucks on Ford test tracks in Dearborn and Arizona. These tests prove that Genuine Ford Parts are built to *take it!* And remember, they're easy to get. Just stop in where you see this famous blue sign.

Keep your Ford all Ford
A sure sign of savings



Available at all Ford Dealers and selected independent garages where you see this sign.

Popular Mechanics Magazine

Registered in U. S. Patent Office and Canada

H. H. WINDSOR, Founder

H. H. WINDSOR, JR., Editor and Publisher



this month's cover

IF YOU WANT to pop the eyes of your fishermen friends just try the bow-and-arrow cast as depicted on our cover. It's the cast to use when overhanging branches make it impossible to flip a lure the overhand way. Just hold the line, flex the rod by pulling back the lure, then suddenly release the lure and it will zing out straight as an arrow toward your target. This unique cast—and others just as strange—are made possible by the new spinning reels. Spin fishing is becoming so popular that in many prime fishing areas the bait caster or fly fisherman is as out-of-date as a bamboo pole. Beginners like spin fishing because they can't backlash a spinning reel; old-timers like it because of its versatility. You'll find a big eight-page color story on spin fishing, its reels, rods and lures, starting on page 81. Here's the history of spin fishing, the equipment required, how-to-do-it hints—everything you need except some water where swims a fish

Published monthly by Popular Mechanics Company, 200 E. Ontario St., Chicago 11, Ill. H. H. Windsor, Jr., president; William Harrison Petridge, vice-president; D. F. Windsor, vice-president and secretary-treasurer; H. H. Windsor III, vice-president; Clover L. Perkins, advertising manager; Alan M. Deyoe, circulation manager. Single copy in the United States and Canada, 35 cents; subscription rates in the United States and possessions, Canada, Philippines and countries of the Pan-American Postal Union, 1 year \$3.50; 2 years, \$6.00; 3 years \$8.00. To all other countries add \$1.00 a year over United States prices for overseas postage. If you plan to move, notify us at least 30 days in advance so you will not miss an issue. Give both your old and new addresses. Entered as Second Class Matter, September 15, 1903, at the Post Office at Chicago, Illinois, under Act of March 3, 1879. Entered as Second Class Matter at Post Office Dept., Canada. Registered as Second Class Matter at the Post Office at Mexico, D. F., Mexico, June 20, 1950. Copyright 1953 by Popular Mechanics Company. Copyright under International Copyright Union. Copyright in France. All rights reserved under Pan-American Copyright Union. Printed in the United States of America.

Volume 99

MAY 1953

Number 5

Address all communications to:
200 East Ontario Street, Chicago 11, Illinois

Managing Editor.....	Roderick M. Grant
Assistant Managing Editor.....	Wayne Whittaker
Shop Notes and Crafts Editor.....	James R. Ward
Radio-Television, Electronics Editor.....	Frank L. Brittin
Associate Editor, Aviation.....	Aubrey O. Cookman, Jr.
Associate Editor.....	Clifford B. Hicks
Associate Editor, Automotive.....	Arthur R. Railton
Assistant Shop Notes and Crafts Editor.....	Wayne C. Lecky
Assistant Editor, Makeup.....	John C. Dalen
Automotive Correspondent.....	Siler Freeman
Art Director.....	Frank Beatty

Assistant Editors

W. Clyde Lamme	Leonard F. Hilts	Frank N. Stephany
Theodore A. Daum	Elsie L. Domin	Elliott H. McCleary
Eastern Editor.....	Richard F. Dempewolff	
	Empire State Bldg., Room 2906, New York City 1	
Western Editor.....	Thomas E. Stimson, Jr.	
London Manager.....	Douglas W. Wedderspoon	
	Eagle House, Jermyn St., London S. W. 1, England	
Director, Bureau of Information.....	Allan Carpenter	
	200 E. Ontario St., Chicago 11	

IN THIS ISSUE

He Goes Banging Through Sound - - - -	65
Giant Jaws Unload Ore Boat - - - -	74
They Call It Spin Fishing - - - -	81
The 500 as the Experts See It - - - -	94
What Became of the Shelter Belt? - - - -	102
The Owners Report on the '53 Plymouth - - - -	110
Industry's Private Detectives - - - -	120
New Zealand Harnesses Its "Yellowstone" - - - -	130

For the Craftsman

Basket-Weave Fence and Gate - - - -	149
Contemporary Bamboo Furniture - - - -	150
Ghost of Old No. 278 - - - -	158
How to Install Dormers - - - -	172
Car-Top Sleeper - - - -	182
Reducing Flood Damage to Your Car - - - -	186
Charger Overhaul - - - -	197
Plane Know-How - - - -	201
Shopping for Tools - - - -	208
Radio, TV and Electronics - - - -	211
Clinic for Homemakers - - - -	222

Other items, and manufacturers of available products described, are listed on pages 12, 14 and 16

**Pipes
that
grew
without
getting
bigger**



Cross-section of coaxial cable. To triple capacity, Bell Laboratories and Western Electric engineers had to make 1000 amplifiers work perfectly in tandem . . . feed repeater power along the same cable that carries messages . . . put signals on and off the line at numerous cities along the route without distortion.

Pencil-size pipes carry telephone messages and television across country through the Bell System's coaxial cable. Once, each pipe could carry 600 voices, or one television program. Now it can carry 1800 voices, or 600 voices plus a broadcast quality television program.

Yet the pipes aren't any larger. They are being made into triple-duty voiceways by new repeaters, new terminal equipment and other transmission advances developed by Bell Laboratories engineers.

The conversion expense is less than the cost of laying extra coaxial cables. But it calls for highly refined manufacturing procedures, made possible only by close co-operation of Bell Laboratories and Western Electric, manufacturing unit of the Bell System.

In improving the coaxial cable system, they created more than 20 years ago, engineers at Bell Telephone Laboratories devised a new way to give America still better telephone service, while the cost stays low.

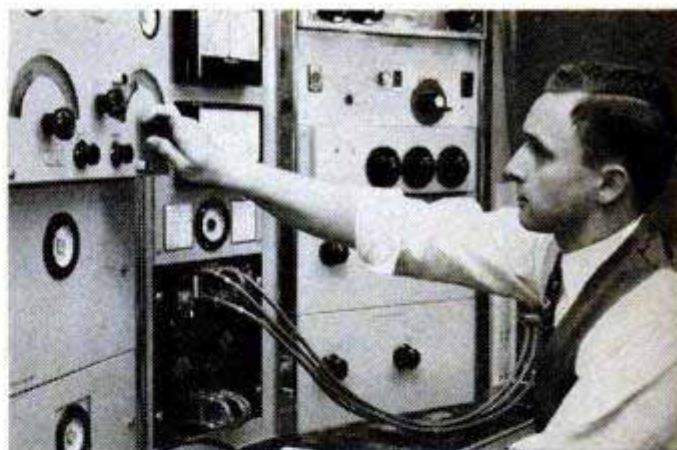

Laboratories engineer tests new triple-duty coaxial system. It marks the first time that telephone conversations and television can travel through the same pipes at the same time. With a wider frequency band being transmitted, big problem was to eliminate interference between the two types of signals.



**BELL TELEPHONE
LABORATORIES**

Improving telephone service for America provides careers for creative men in scientific and technical fields

here's why —

they're so efficient,
so economical,
so dependable!

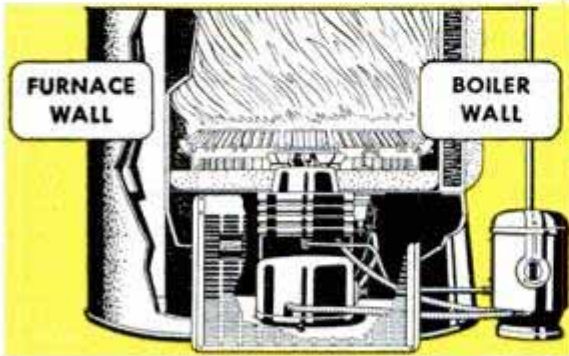

FOR OIL HEATING

Wall-flame oil burner blankets heating plant walls with a high-efficiency flame. Burner has only one moving part (self-lubricated) and uses all residential types of oil.

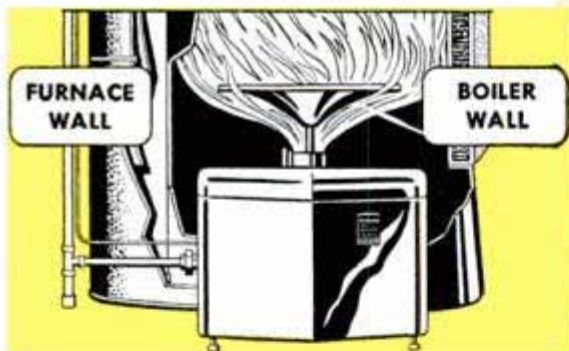

FOR GAS HEATING

Wall-flame gas burner is especially constructed to direct blue-hot flame to heating surfaces. Burns natural, manufactured, mixed or LP gases. Burner is clog-proof.

TIMKEN *Silent Automatic* HEATING UNITS

are fired by famous
Wall-Flame Burners!

Experience-engineered to provide the finest automatic home heating money can buy! That's the big reason for the superiority of the Timken Silent Automatic oil and gas wall-flame burners! The flame is placed close to the heat absorbing surfaces—right where it does the most good! The air-fuel mixture is completely prepared before it is ignited, providing a natural-burning flame. The result: Exceptionally quiet, efficient and economical operation! Whether you need to convert an existing heating plant or install a complete furnace or boiler, you'll find your local Timken Silent Automatic Dealer is a heating expert you can depend on! See or phone him today for a no-obligation demonstration! Or, mail the coupon below for illustrated literature.

TIMKEN *Silent Automatic* HEAT

OIL • GAS • COAL

TIMKEN SILENT AUTOMATIC DIVISION

The Timken-Detroit Axle Company • Jackson, Michigan
The Timken-Detroit Axle Company of Canada, Ltd., Toronto, Ont.



MAIL THIS COUPON TODAY FOR ILLUSTRATED LITERATURE!

PMS-53

Timken Silent Automatic, Jackson, Michigan

Please mail illustrated literature to:

_____ This One

NAME _____

STREET ADDR _____

CITY and STAT _____



4TEQ-ZBZ-59A3

If you are a student, please check here () for special information.



IF YOU LIKE A DIRTY MOTOR... DON'T USE PYROIL

• If you don't value the life of your car—if you don't care how much you spend on repairing expensive engine parts, then don't use Pyroil. If you don't care how much carbon and sludge accumulates in the motor, or how much your battery wears out from "dry, hard starts," then Mister, Pyroil's not for you. All of which, of course, is plain silly talk. Because every car owner wants to lengthen the life of his car. He wants to keep those piston rings and cylinder walls protected from corrosion. He wants to keep his car out of the repair shop and improve car performance.

Pyroil does all this and more. For Pyroil contains the very special property of making ordinary oil adhere to exposed motor surfaces. It protects these parts against metal-to-metal wear at all times. Pyroil cleans the motor and keeps it clean. When you add gas or oil, add Pyroil—add miles to your car.

PYROIL FOR AIRCRAFT ENGINES

Use Aircraft Pyroil B for lubricating oil, Aircraft Pyroil A for gasoline.

GIVEN! An attractive Pyroil metal savings bank—takes coins up to 50¢ pieces. **MOTORISTS**, it's yours for the asking—sent postage paid.

Manufactured and Guaranteed by Pyroil Company, 210 Pyroil Bldg., La Crosse, Wisconsin

Canadian Distributors: Central Purchasing Agencies, Ltd., Toronto, Ontario



PYROIL COMPANY
210 Pyroil Bldg., La Crosse, Wisconsin

I want my car to last and run properly. Please tell me more about Pyroil and how it can accomplish this for me.

Name _____

Address _____

City or Town _____ State _____



in this corner.....

THE EDITORS



To the Editor:

Very sincere congratulations, belatedly, on 50th anniversary of *Popular Mechanics Magazine*. I am quite attached sentimentally to your magazine because I have been a continuous contributor for 40 years. Incidentally, some of the payments for my articles in *Popular Mechanics Magazine* aided in defraying my expenses in college. I am wondering if I am not the oldest, in the point of service, contributor to *Popular Mechanics*.

S. R. Winters,
Orlando, Fla.

Editor's note: Mr. Winters' latest contribution is the "minnow harvest" item on page 117 of this issue.

To the Editor:

We read, with much interest, Floyd Clymer's piece on the new 1953 Dodge (PM, March 1953). We think it a very nice handling of the car and think that Mr. Clymer has done a very good job.

May we invite your attention to one point which we would like to see corrected? On page 272 there occurs the sentence, "... when the switch-starter key is turned, the engine will start whether the car is in gear or not."

The context makes it apparent that Mr. Clymer is referring to cars equipped with Gyro-Torque, our new torque converter. Actually, there is an interrupter switch incorporated in the vehicle, the purpose of which is to prevent the engine from starting when the car is in gear.

A. E. Horne,
Advertising Manager—
Passenger Cars,
Dodge Division
Chrysler Corporation
Detroit, Mich.

To the Editor:

In regard to your article on "Headaches of a Jet Designer" (PM, Jan. 1953), you stated that the AD Skyraider can carry only 8000 pounds ordnance. The correct weight is 9000 pounds bomb load not to mention 20-mm. cannon shells. . . . Being an ordnance man, having to load them, I just wanted to see 'em get the credit due.

Cpl. Edward T. Stach,
Marine Attack Squadron 121,
c/o Postmaster, San Francisco, Calif.

(Continued to page 8)

5 reasons why ACCOUNTANCY

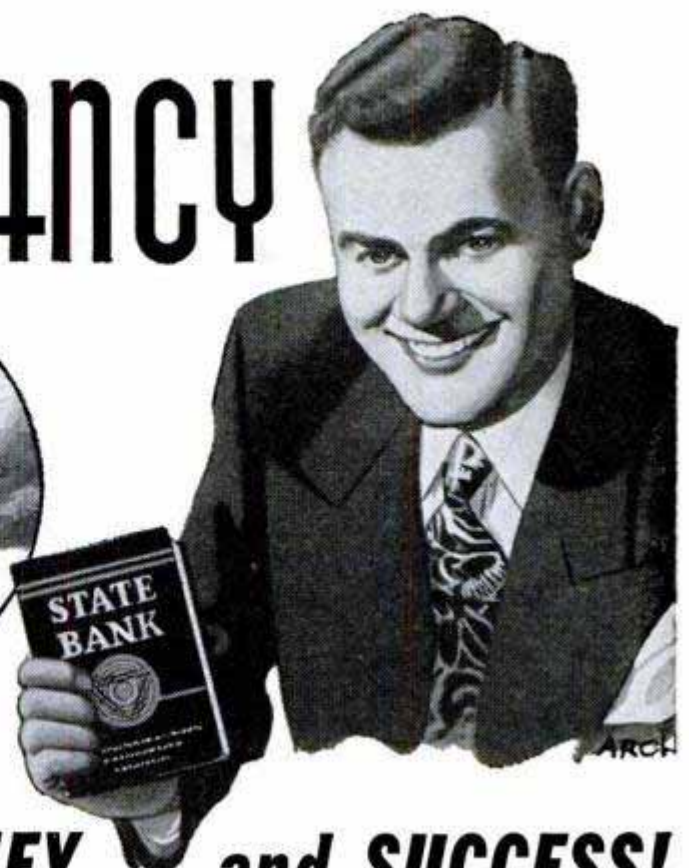
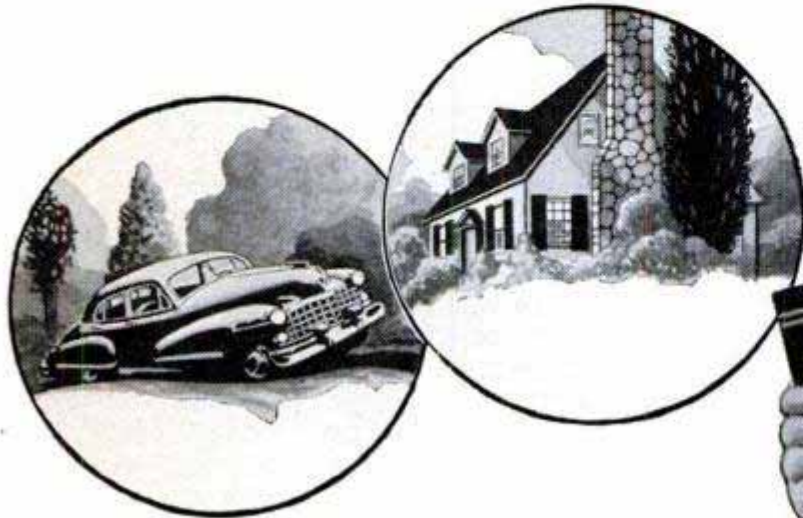

offers you MORE MONEY... and SUCCESS!

REASON #1. If you were an expert accountant right now, chances are you would find yourself among the highest-paid of all professional men and women. Even back in "depression years," surveys showed that accountants earned more on the average than men in other major professions.

REASON #2. The demand for accountants is great—everywhere. All businesses must have trained accountants to cope with ever-growing requirements. It's a profession offering wide opportunity—always—to the man who knows.

REASON #3. You can fit into any business, anywhere in the country—because accounting principles are universal. Think what this means in terms of security and independence!

REASON #4. Accountancy is open to all. Any man or woman of good intelligence, who enjoys figure work and is willing to follow LaSalle's systematic "problem method" plan, can rapidly qualify for a highly profitable, enjoyable lifetime career... and he doesn't have to finish his training before beginning to "cash in."

REASON #5. Without losing a day from your present work, you can prepare in spare hours at home, at low cost, under LaSalle's step-by-step "Problem Method" of "learning by doing." This famous plan accounts for LaSalle's remarkable record of having trained nearly 10 per cent of all Certified Public Accountants in the U. S. . . . and of having put many thousands of others into high-paying careers.

Send today for LaSalle's interesting booklets, "Accountancy, the Profession That Pays," and "Success Reports." Learn about the five great fields of opportunity . . . and LaSalle's time-tested plan for helping men and women to rapid advancement, higher income, greater prestige and professional standing. The coupon below will bring these fact-filled booklets to you—without cost or obligation—also, a free sample lesson showing LaSalle's famous "Problem Method" plan of instruction.

→ **GET FREE SAMPLE LESSON** ←

LASALLE
417 S. Dearborn St.,
CHICAGO 5, ILL.

**WHICH . . . ?
can help you most ?**

- Accounting—Elements to C.P.A. Coaching
- Bookkeeping
- Cost Accounting
- Auditing
- Income Tax
- C.P.A. Coaching

LaSalle Extension University
— A Correspondence Institution —

Dept. 564-HR, 417 S. Dearborn St., Chicago 5, Ill.

Please send me, free of all cost or obligation, a sample lesson in Accounting . . . also, your 48-page illustrated books, "Accountancy, the Profession that Pays," and "Success Reports."

Name Age
Address
City, Zone, State

NEWS from SCIENCE

ABOUT YOUR HAIR

Laboratory discovery outdates messy hair oils!

"V-7," completely new greaseless grooming agent, now in Vitalis Hair Tonic. It's *not* an animal, vegetable or mineral oil!



Hair stays neat all day

No gummy film, no oily or matted-down look with new Vitalis!



HAVE HANDSOMER HAIR!

Kills dandruff germs, too!



New Vitalis kills on contact germs many doctors associate with infectious dandruff. Feels "tingling good" on scalp!

NEW FINER
VITALIS[®]
HAIR TONIC
WITH "V-7"

Product of Bristol-Myers

(Continued from page 6)

Editor's note: We referred Corporal Stach's comment to Mr. E. H. Heinemann, Chief Engineer, Douglas Aircraft Co. at El Segundo, author of the article, who writes:

The Marine corporal is correct . . . The 8000-pound figure, as I recall, consisted of a mixed load of bombs and rockets; whereas, when all bombs are carried, a normal bomb load of 9000 pounds results.

To the Editor:

I'd like to have my say about Floyd Clymer's "Owners Report on the Hillman Minx" (*PM*, Jan. 1953).

When I bought my present car, I was shown a Hillman Minx and a Morris Minor. After comparing prices (Morris Minor is cheaper) and driving both, I chose the Morris. And there was nothing to regret in the choice. Here are a few of my opinions regarding the Morris Minor and British cars in general.

One thing I was glad, in a way, to learn was that I am not the only one to experience the "maniac" drivers who hate the sight of a small car. Three times cars have passed me in the city and then have tried to force me into the curb. Another type is the driver who passes you even though you are driving at the speed limit. To verify this, I have driven 35 in a 30-mile zone and 40 in a 35-mile zone. You can depend on as many as six idiots passing at anywhere up to 60 miles per hour. I don't know what it proves, since I always meet them at the next red light.

As for the good features of these small cars, I think the ease of parking and the maneuverability are the finest features. I will never again drive an American car around town. The Morris is giving me 33-35 miles per gallon in the city against the 8 miles per gallon of my previous American car, which was the primary reason for buying it. The difference in my bill at the filling station more than makes the payments for me.

The Morris Minor still uses a floor shift and I find there is no difficulty in learning the gearshift positions.

I may be particularly lucky in this regard, but I have found that the dealer service in Denver can be rated as extraordinary. They are always courteous and do rapid but thorough work. The prices on parts occasionally stun me but, after all, there is always the matter of importing them to take into consideration. As long as I have no trouble with availability of parts, I won't complain about the cost too much.

Another nice feature is the excellent quality of workmanship inside and out . . .

(Continued to page 10)

Now They Earn 103% More!

WOULDN'T YOU LIKE to increase your present income by 103%? Think what this could mean to you and your family! To be free at last from the pressure of money worries . . . to be able to afford new home furnishings, new clothes, a new car, when you need them . . . to be able to plan now for a comfortable retirement income!

Yet you will note (in the results of an I.C.S. Survey printed here) that 103% is the average increase. Many of these I.C.S.-trained men have increased their pay by much more than that. For example, a Michigan man who was making \$2500 is now making \$6800. An Alabaman's income jumped from \$1800 to \$4000.

And even these impressive figures do not tell the whole story. The truth is that I.C.S. training can help you go as far as you WANT to go. Among former I.C.S. students who have risen all the way to the top are men like Eddie Rickenbacker, President of Eastern Airlines; Charles P. Hook, Chairman of Armco Steel Corporation; Harry W. Morrison, builder of Coulee Dam; Wayne A. Johnson, President of Illinois Central Railroad.

Others Do It—Why Not You?

Why not increase your income the same way so many thousands do? Right at home, in your own most convenient spare time, you can acquire the additional "know-how" you need from your choice of 296 I.C.S. subjects. One or more of 154 I.C.S. instructors—experts in their field—will give you the individual, personal attention which makes learning faster and more pleasant. Yet because I.C.S. is the world's LARGEST school (over 5,970,000 students so far), the cost to you is surprisingly little — only a few cents a day!

FREE—2 INTERESTING BOOKS

Mail coupon for FREE BOOK on subject you're interested in. Also free, "How to Succeed" — our 36-page manual of advice on Why People Fail, How to Pick Your Goal, How to Develop Hidden Talents, etc. Don't miss out on

today's exciting new opportunities for trained men! Mail coupon NOW — no cost or obligation.



Recently I. C. S. made a survey of a sample group of I. C. S. graduates in order to determine how much their earnings have been increased.

HERE ARE THE IMPRESSIVE RESULTS:

Age	Occupation	I.C.S. Course	State	Yearly Earnings	
				BEFORE I.C.S.	NOW
49	Electrician	Electric Power	Alabama	\$1800	\$4000
39	Supervisor	Yarn, Reeling, etc.	New Jersey	\$1500	\$5600
45	Sales Prom.	Steam Engineering	Ohio	\$1400	\$6500
38	Field Supt.	Architecture	Texas	\$1800	\$4200
44	Signal Maint.	Railway Signalman	New York	\$1500	\$5000
36	Draftsman	Mech. Engineering	N. Carolina	\$4000	\$4300
30	Accountant	C. P. A.	Nebraska	\$3000	\$4500
37	Barber	Copy Writing	New York	\$3500	\$3800
35	Welder	Reading Blueprints	Wisconsin	\$3500	\$5500
41	Supervisor	Practical Telephony	Texas	\$ 720	\$6120
35	Design Eng'r.	Mech. Engineering	Georgia	\$1950	\$4000
59	Civil Eng'r.	Map Survey; Sewerage	Mass.	—	\$5500
36	Tool Eng'r.	Mech. Engineering	Mass.	\$3500	\$5500
34	Tool Designer	Tool Makers	Iowa	\$1040	\$5400
32	Foreman	Diesel Engine	Ontario	\$2400	\$3200
42	Electrician	Elec. Elevators	New York	\$2200	\$5800
41	Draftsman	Elec. Distribution	New York	\$1820	\$4500
47	Asst. Maint.	Spec. Electrical	Oklahoma	\$4195	\$5628
31	Prod. Clerk	S. U. Foreman	Conn.	\$3000	\$3200
37	Boilermaker	Boilermaker Appr.	N. Carolina	\$1000	\$3500
37	Asst. Supt.	Marine Engineering	Quebec	\$4800	\$7200
40	Chief Engineer	Steam-Elec.	Minn.	\$2000	\$6000
37	Personnel	—	Quebec	\$1800	\$6000
44	Head Oper. Eng.	Steam Engineering	Michigan	\$2500	\$6800
49	Plant Maint.	S. U. Electrical	Texas	\$3000	\$3500
27	Draftsman	Highway Eng.	Oregon	\$2484	\$4368
35	Coppersmith	Sht. Mtl., Boilermaking	New Jersey	\$2000	\$5100
36	Equip. Service	Aero Engineering	Maryland	\$3000	\$4000
47	Foreman	Cotton Mfg.	New Hampshire	\$1144	\$4000
44	Proprietor	Mech. Engineering	Mass.	\$1500	\$6000
55	Govt.	(Several)	Mexico	\$8000	\$24,000
50	Millwright	Blueprint Reading	Quebec	\$2021	\$6193
62	Housekeeper	Foods & Cookery	New York	\$ 300	\$ 600
34	Engine Tester	Diesel Engines	Illinois	\$3650	\$4680
31	Accountant	Accounting	Ontario	\$2460	\$3300
65	(Disabled)	C. P. A.-Arch. Eng.	California	—	\$ 150
42	R. R. Rate Clerk	C. P. A.	Idaho	\$2750	\$3700
53	Test Engineer	Int. Comb. Engines	Iowa	\$1800	\$5200
38	Elec. Engineer	Elec. Engineering	New York	\$1200	\$5800
33	Elec. Helper	Elec. Maintenance	Maryland	\$3521	\$3521
28	Carpenter	Bldg. Contractor	Alberta	\$1800	\$3848
Totals:				\$95,555	\$209,708
Average:				\$2514	\$5114

AVERAGE INCREASE WAS \$2600—AVERAGE % OF INCREASE WAS 103%

INTERNATIONAL CORRESPONDENCE SCHOOLS



BOX 5580-L • SCRANTON 9, PENNA.

Without cost or obligation, send me "HOW TO SUCCEED" and the booklet about the course BEFORE which I have marked X:

- | | | | | |
|---|--|---|---|--|
| <input type="checkbox"/> ART
<input type="checkbox"/> Commercial Art
<input type="checkbox"/> Magazine and Book Illustrating
<input type="checkbox"/> Cartooning
<input type="checkbox"/> Show Card and Sign Lettering
<input type="checkbox"/> Fashion Illustrating | <input type="checkbox"/> Heating
<input type="checkbox"/> Steam Fitting
<input type="checkbox"/> Air Conditioning
<input type="checkbox"/> Electrician | <input type="checkbox"/> CIVIL, STRUCTURAL AND SHOP ENGINEERING
<input type="checkbox"/> Civil Engineering
<input type="checkbox"/> Structural Engineering
<input type="checkbox"/> Surveying and Mapping
<input type="checkbox"/> Structural Drafting
<input type="checkbox"/> Highway Engineering
<input type="checkbox"/> Reading Blueprints
<input type="checkbox"/> Concrete Construction
<input type="checkbox"/> Sanitary Engineering
<input type="checkbox"/> DRAFTING
<input type="checkbox"/> Aircraft Drafting
<input type="checkbox"/> Architectural Drafting
<input type="checkbox"/> Electrical Drafting
<input type="checkbox"/> Mechanical Drafting
<input type="checkbox"/> Structural Drafting
<input type="checkbox"/> Sheet Metal Drafting
<input type="checkbox"/> Mine Surveying and Drafting | <input type="checkbox"/> College Preparatory
<input type="checkbox"/> Mathematics
<input type="checkbox"/> Commercial
<input type="checkbox"/> Good English
<input type="checkbox"/> MECHANICAL AND SHOP
<input type="checkbox"/> Mechanical Engineering
<input type="checkbox"/> Industrial Engineering
<input type="checkbox"/> Industrial Supervision
<input type="checkbox"/> Foremanship
<input type="checkbox"/> Mechanical Drafting
<input type="checkbox"/> Machine Design-Drafting
<input type="checkbox"/> Machine Shop Practice
<input type="checkbox"/> Tool Design
<input type="checkbox"/> Industrial Instrumentation
<input type="checkbox"/> Machine Shop Inspection
<input type="checkbox"/> Reading Blueprints
<input type="checkbox"/> Toolmaking
<input type="checkbox"/> Gas—Electric Welding
<input type="checkbox"/> Heat Treatment—Metallurgy
<input type="checkbox"/> Sheet Metal Work
<input type="checkbox"/> Sheet Metal Pattern Drafting
<input type="checkbox"/> Refrigeration | <input type="checkbox"/> Stationary Steam Engineering
<input type="checkbox"/> Stationary Fireman
<input type="checkbox"/> RADIO, TELEVISION, COMMUNICATIONS
<input type="checkbox"/> General Radio
<input type="checkbox"/> Radio Operation
<input type="checkbox"/> Radio Servicing—FM
<input type="checkbox"/> Television
<input type="checkbox"/> Electronics
<input type="checkbox"/> Telephone Work
<input type="checkbox"/> RAILROAD
<input type="checkbox"/> Locomotive Engineer
<input type="checkbox"/> Diesel Locomotive
<input type="checkbox"/> Air Brakes
<input type="checkbox"/> Car Inspector
<input type="checkbox"/> Railroad Administration
<input type="checkbox"/> TEXTILE
<input type="checkbox"/> Textile Engineering
<input type="checkbox"/> Cotton Manufacture
<input type="checkbox"/> Rayon Manufacture
<input type="checkbox"/> Woolen Manufacture
<input type="checkbox"/> Loom Fixing
<input type="checkbox"/> Finishing and Dyeing
<input type="checkbox"/> Textile Designing |
| <input type="checkbox"/> AUTOMOTIVE
<input type="checkbox"/> Automobile, Mechanic
<input type="checkbox"/> Auto-Elec. Technician
<input type="checkbox"/> Auto Body Rebuilding and Refinishing
<input type="checkbox"/> Diesel—Gas Engines | <input type="checkbox"/> BUSINESS
<input type="checkbox"/> Business Administration
<input type="checkbox"/> Certified Public Accountant
<input type="checkbox"/> Accounting
<input type="checkbox"/> Bookkeeping
<input type="checkbox"/> Stenography and Typing
<input type="checkbox"/> Secretarial
<input type="checkbox"/> Federal Tax
<input type="checkbox"/> Business Correspondence
<input type="checkbox"/> Personnel and Labor Relations
<input type="checkbox"/> Advertising
<input type="checkbox"/> Retail Business Management
<input type="checkbox"/> Managing Small Business
<input type="checkbox"/> Sales Management
<input type="checkbox"/> Salesmanship
<input type="checkbox"/> Traffic Management
<input type="checkbox"/> CHEMISTRY
<input type="checkbox"/> Chemical Engineering
<input type="checkbox"/> Chemistry
<input type="checkbox"/> Analytical Chemistry
<input type="checkbox"/> Petroleum—Nat'l Gas
<input type="checkbox"/> Pulp and Paper Making
<input type="checkbox"/> Plastics | <input type="checkbox"/> ELECTRICAL
<input type="checkbox"/> Electrical Engineering
<input type="checkbox"/> Electrician
<input type="checkbox"/> Electrical Maintenance
<input type="checkbox"/> Electrical Drafting
<input type="checkbox"/> Electric Power and Light
<input type="checkbox"/> Lineman
<input type="checkbox"/> HIGH SCHOOL
<input type="checkbox"/> High School Subjects | <input type="checkbox"/> MECHANICAL
<input type="checkbox"/> Machine Design-Drafting
<input type="checkbox"/> Machine Shop Practice
<input type="checkbox"/> Tool Design
<input type="checkbox"/> Industrial Instrumentation
<input type="checkbox"/> Machine Shop Inspection
<input type="checkbox"/> Reading Blueprints
<input type="checkbox"/> Toolmaking
<input type="checkbox"/> Gas—Electric Welding
<input type="checkbox"/> Heat Treatment—Metallurgy
<input type="checkbox"/> Sheet Metal Work
<input type="checkbox"/> Sheet Metal Pattern Drafting
<input type="checkbox"/> Refrigeration
<input type="checkbox"/> POWER
<input type="checkbox"/> Combustion Engineering
<input type="checkbox"/> Diesel—Electric
<input type="checkbox"/> Electric Light and Power | <input type="checkbox"/> Stationary Steam Engineering
<input type="checkbox"/> Stationary Fireman
<input type="checkbox"/> RADIO, TELEVISION, COMMUNICATIONS
<input type="checkbox"/> General Radio
<input type="checkbox"/> Radio Operation
<input type="checkbox"/> Radio Servicing—FM
<input type="checkbox"/> Television
<input type="checkbox"/> Electronics
<input type="checkbox"/> Telephone Work
<input type="checkbox"/> RAILROAD
<input type="checkbox"/> Locomotive Engineer
<input type="checkbox"/> Diesel Locomotive
<input type="checkbox"/> Air Brakes
<input type="checkbox"/> Car Inspector
<input type="checkbox"/> Railroad Administration
<input type="checkbox"/> TEXTILE
<input type="checkbox"/> Textile Engineering
<input type="checkbox"/> Cotton Manufacture
<input type="checkbox"/> Rayon Manufacture
<input type="checkbox"/> Woolen Manufacture
<input type="checkbox"/> Loom Fixing
<input type="checkbox"/> Finishing and Dyeing
<input type="checkbox"/> Textile Designing |

YEAR OF THE SIX MILLIONTH STUDENT

Name _____ Age _____ Home Address _____
 City _____ Zone _____ State _____ Working Hours _____ A.M. to _____ P.M.
 Occupation _____

Special tuition rates to members of the Armed Forces. Canadian residents send coupon to International Correspondence Schools Canadian, Ltd., Montreal, Canada

SURE, BUT THAT'S NOT ALL!

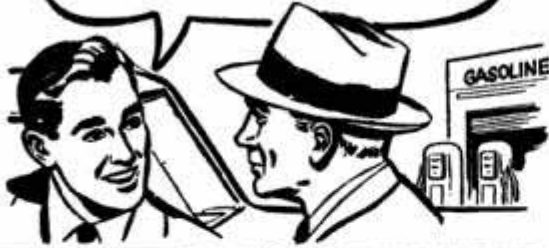

"Did you say you use Macmillan Ring-Free Motor Oil only when your car's engine needs a good cleansing? Then, brother, you're missing a lot!



and because it reduces engine friction so that I get more mileage out of every gallon of gas...



"Use Macmillan Oil always... not just as a special-purpose oil."

"I use it because it saves so much in repair bills,



and because it reduces ping and makes my car engine stay newer longer.



Know where to get it? Look for the big red M. 25,000 dealers sell it from coast to coast!"



THE regular, normal, continuous use of Macmillan Oil saves you so much on gas! By reducing engine friction, it saved an average of 8% of gas in tests made in hundreds and hundreds of cars.

Over an average change period that means enough saving to pay for a refill of Macmillan Ring-Free Motor Oil.

Start using Macmillan Oil for any reason, but keep on using it month in and month out because it removes carbon, reduces ping, helps keep valves from sticking, reduces engine friction, saves on wear and tear and repair bills and makes your car stay newer longer.

Use Macmillan Ring-Free Motor Oil regularly because it pays for itself in the gas it saves.

LOOK AT THESE FIGURES:

Gasoline—average cost per gallon 25¢
 8% saving on 25¢ (.08 x .25) 2¢ per gal.
 Average oil drain period 1500 miles
 At 15 miles per gal. (gas consumed) 100 gals.
 2¢ per gal. saving on 100 gals. of gas \$2.00

This \$2.00 pays for your oil drain of 5 quarts at 40¢ per quart.

Macmillan President

MACMILLAN PETROLEUM CORPORATION
 530 W. 6th Street, Los Angeles • 50 W. 50th Street, New York
 624 S. Michigan, Chicago

CLIP OUT AND MAIL TODAY!

R. S. Macmillan, Pres. Macmillan Petroleum Corporation
 530 West Sixth St., Los Angeles 14, California—Dept. P3
 Please send me your folder—"The Oil that Pays
 for Itself in the Gas It Saves."
 Also tell me my nearest Macmillan Oil dealer.

Name _____

Address _____

(Continued from page 8)

and I don't feel quite so much like a peasant after reading the other day that the British aircraft genius, De Havilland, drives a Morris Minor. I am quite sure he could afford any car on the market.

Harry B. Bateman, Jr.
 Denver, Colo. (20)

1135 Poplar St.

To the Editor:

In your January issue you had a feature on deep-sea diving by the Danish ship *Galatea* at the depth of six miles.

As compared to deep-sea diving by the Russians, six miles just isn't anything at all.

In the Black Sea, they descended to a depth of eight miles and, after scraping the bottom, brought up what the Russians thought to be an entirely new species of bird life. What they thought were birds had no feathers at all, but the body was covered with very thin and hard translucent bony substance in the form of scales. The tail was thin, flat and very flexible, mounted edgewise and used to steer the "bird." Instead of wings, its method of locomotion was by fin-like projections, and on the end of the slender body, opposite the end carrying the tail, the head was mounted. But instead of having a beak, it had a very small mouth with thick, fleshy lips that were used for attaching itself to solid objects. Instead of breathing air, it breathed water.

Here in Portage County, Ohio, the fishermen call this "bird" by the common name of *Sucker*.

With no sense of humor, I remain

Francis J. Baldwin,
 Ravenna, Ohio

Editor's Note:

Inquiries from readers have asked the location of "The \$500,000 Puppet Show," featured in our color section in September 1952. The theater is in Kungsholm restaurant, 100 E. Ontario St., Chicago.

20,000 Mile-Per-Hour Jets Predicted for Near Future

Jet-plane speeds of 20,000 miles an hour, 15 times faster than the earth rotates, are possible within the foreseeable future, asserted Prof. Frederick K. Teichmann, head of New York University's Guggenheim School of Aeronautics. Professor Teichmann based his prediction on the expectation that jet engines of 500,000-pound thrust, equal to 125 times the power of today's aircraft piston engines, will be developed soon.

WHAT Every MACHINIST

Wants to Know

A SHOP COMPANION

For Every Machinist, Toolmaker, Machine Operator, Draughtsman, Metal Worker, Mechanic and Student. A Key to Modern Shop Practice in All Branches.

SOLVES YOUR PROBLEMS ANSWERS 1001 QUESTIONS

Tells How to Make tools, How to Operate and Set-Up Lathes, How to Lay Out Screw & Milling Machines, Shapers, Drill Presses & All Machine Tools.

QUICK READY REFERENCE PRACTICAL INSIDE INFORMATION

Highly Endorsed—covers How to lay out, How to cut threads; How to make taps & dies, gears, etc.; How to operate boring & milling machines; How to set up grinders, automatic screw machines; How to calculate—How to Use Slide Rule, How to read Blueprints, etc. A timely Book and ready helper.

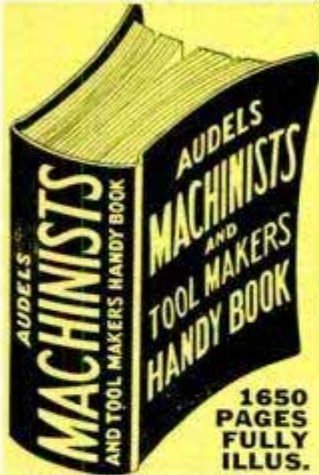

1650 PAGES FULLY ILLUS.

automatic screw machines; How to calculate—How to Use Slide Rule, How to read Blueprints, etc. A timely Book and ready helper.

\$4 COMPLETE • PAY ONLY \$1 A MONTH

Get This Information For Yourself. Mail Coupon Today.

No Obligation Unless Satisfied. ASK TO SEE IT!

FREE EXAMINATION COUPON

AUDEL, Publishers, 49 W. 23 St., New York 10, N. Y.

Mail AUDELS MACHINISTS & TOOLMAKERS HANDY BOOK. Price \$4 on 7 Days Free Trial. If O.K. I will remit \$1 in 7 days and \$1 monthly until \$4 is paid. Otherwise I will return it.



Name _____

Address _____

Occupation _____

READ FOR PROFIT!

Employed by _____ P-5

AUDELS Carpenters and Builders Guides

4 vols. \$6



Inside Trade Information for Carpenters, Builders, Joiners, Building Mechanics and all Woodworkers. These Guides give you the short-cut instructions that you want—including new methods, ideas, solutions, plans, systems and money saving suggestions. An easy progressive course for the apprentice and student. A practical daily helper and Quick Reference for the master worker. Carpenters everywhere are using these Guides as a Helping Hand to Easier Work, Better Work and Better Pay. To get this assistance for yourself, simply fill in and mail FREE COUPON below.

Inside Trade Information On:

How to use the steel square—How to file and set saws—How to build furniture—How to use a mitre box—How to use the chalk line—How to use rules and scales—How to make joints—Carpenters arithmetic—Solving mensuration problems—Estimating strength of timbers—How to set girders and sills—How to frame houses and roofs—How to estimate costs—How to build houses, barns, garages, bungalows, etc.—How to read and draw plans—Drawing up specifications—How to excavate—How to use settings 12, 13 and 17 on the steel square—How to build hoists and scaffolds—skylights—How to build stairs—How to put on interior trim—How to hang doors—How to lath—lay floors—How to paint.



AUDEL, Publishers, 49 W. 23rd St., New York 10, N. Y.

Mail Audels Carpenters and Builders Guides, 4 vols., on 7 days' free trial. If O.K. I will remit \$1 in 7 days and \$1 monthly until \$6 is paid. Otherwise I will return them. No obligation unless I am satisfied.

Name _____

Address _____

Occupation _____

Employed by _____ P-5

WHAT ALL AUTO MECHANICS WANT TO KNOW

1800 PAGES

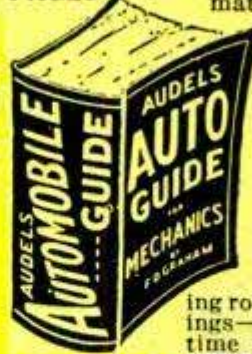

This Big Practical Book gives full information with working diagrams covering the principles, construction, ignition, service and repair of modern cars, trucks and buses.

Diesel Engines, Hydrumatic & Fluid Drives Fully Explained.

A complete Guide of 1800 pages, with over 1500 illustrations showing inside views of working parts, with instructions for service jobs.

IT PAYS TO KNOW

How to fit pistons—How to locate engine knocks, How to fit connecting rod bearings—How to service main bearings—How to recondition valves—How to time valves—How to adjust fan belts—How to adjust carburetors and chokes, How

to rebuild a clutch—How to service automatic transmissions—How to service brakes—How to adjust steering gear—How to cope with ignition troubles—How to service distributors—How to time ignition—How to "tune up" an engine.



\$4 COMPLETE • PAY \$1 A MO. TO GET THIS ASSISTANCE FOR YOURSELF SIMPLY FILL IN AND MAIL COUPON TODAY.

Step up your own skill with the facts and figures of your trade. Audels Mechanics Guides contain Practical Inside Trade Information in a Handy Form. Fully illustrated and Easy to Understand. Highly Endorsed. Check the book you want for 7 DAYS FREE EXAMINATION. Send No Money. Nothing to pay postman.

MAIL ORDER

AUDEL, Publishers, 49 W. 23 St., NEW YORK 10, N. Y.

Please send me postpaid for FREE EXAMINATION books marked (x) below. If I decide to keep them I agree to mail \$1 in 7 Days on each book or set ordered and further mail \$1 monthly on each book or set until I have paid price, otherwise I will return them.

- AUTOMOBILE MECHANICS GUIDE, 1800 Pages \$4
- TRUCK & TRACTOR GUIDE, 1299 Pages . . . 4
- DIESEL ENGINE MANUAL, 575 Pages . . . 2
- MACHINISTS HANDY BOOK, 1650 Pages . . . 4
- WELDERS GUIDE, 400 Pages . . . 1
- BLUE PRINT READING, 416 Pages . . . 2
- MATHEMATICS & CALCULATIONS, 700 Pages. 2
- SHEET METAL PATTERN LAYOUTS, 1100 Pages 4
- SHEET METAL WORKERS HANDY BOOK, 388 Pgs. 1
- MECHANICAL DRAWING GUIDE, 160 Pages . . 1
- MECHANICAL DRAWING & DESIGN, 480 Pages 2
- AIRCRAFT WORKER, 240 Pages . . . 1
- TELEVISION SERVICE MANUAL, 384 Pages . . 2
- RADIOMANS GUIDE, 914 Pages . . . 4
- ELECTRONIC DEVICES, 216 Pages . . . 2
- ELECTRIC MOTOR GUIDE, 1000 Pages . . . 4
- ELECTRIC WIRING DIAGRAMS, 272 Pages . . 1
- ELECTRICIANS EXAMINATIONS, 250 Pages . . 1
- ELECTRIC POWER CALCULATIONS, 425 Pages. 2
- HANDY BOOK OF ELECTRICITY, 1440 Pages. . 4
- ELECTRIC DICTIONARY, 9000 Terms . . . 2
- ELECTRIC LIBRARY, 7000 Pages (12 Book Set) 18
- MARINE ENGINEERS HANDY BOOK, 1258 Pgs. 4
- SHIPFITTERS HANDY BOOK, 250 Pages . . . 1
- REFRIGERATION & Air Conditioning, 1280 Pgs. 4
- MILLWRIGHTS & MECHANICS GUIDE, 1200 Pgs. 4
- POWER PLANT ENGINEERS GUIDE, 1500 Pages 4
- ENGINEERS & FIREMANS EXAMS, 525 Pages . 1
- PUMPS, Hydraulics & Air Compressors, 1658 Pgs. 4
- ENGINEERS LIBRARY (3 Book Set) . . . 9
- MECHANICAL DICTIONARY, 950 Pages . . . 4
- GARDENERS & GROWERS GUIDES (4 Book Set) 6
- CARPENTERS & BUILDERS GUIDES (4 Book Set) 6
- PLUMBERS & Steamfitters Guides (4 Book Set) 6
- MASONS AND BUILDERS GUIDES (4 Book Set) 6
- PAINTERS & DECORATORS MANUAL, 450 Pgs. 2
- HOUSE HEATING GUIDE, 1000 Pages . . . 4
- OIL BURNER GUIDE, 384 Pages . . . 1

Check NOW!

You Can Look Over Any Guide In Your Own Home — Start the Easy Payments If Satisfied

MAIL THIS TODAY

Name _____

Address _____

Occupation _____

Employed by _____ P-5

New... All-Purpose Snips with PROTO Professional Quality!



MULTIPLE-LEVERAGE SNIPS

For daily use on intricate cutting jobs. Patented double compound action greatly increases power. Left, right, straight cut models.

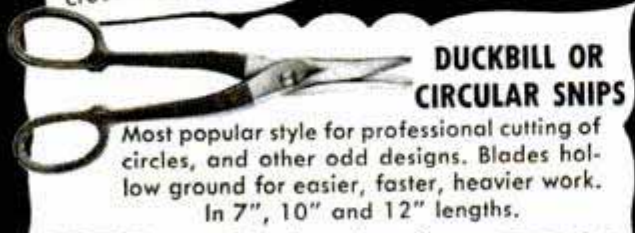

DUCKBILL OR CIRCULAR SNIPS

Most popular style for professional cutting of circles, and other odd designs. Blades hollow ground for easier, faster, heavier work. In 7", 10" and 12" lengths.

COMBINATION SNIPS

Also favored by professional users for straight and moderately irregular cuts. Blades individually fitted to secure positive, free-cutting action. In 10" and 12" lengths.



STRAIGHT OR REGULAR SNIPS

Fine for shops, farms and homes where a handy cutter is needed. Streamlined with easy, graceful curves and well rounded edges. In 7", 10" and 12" lengths.

Truly all-purpose, PROTO's new snips fill the needs of practically all industries, mechanics and craftsmen. Four basic styles cut hundreds of materials. And you get true professional quality in PROTO snips! They give smooth, fast, accurate cuts... produce better finished work, clean and unbent... have great strength and toughness... are sturdily built. Buy these professional, all-purpose snips from your PROTO dealer. Send 10¢ for 68-page catalog of entire line to

The PROTO Line Includes Wrenches, Pliers, Screwdrivers, Punches, Chisels, Sockets & Attachments, Pullers, Industrial Tools, Many Others.

Remember! PROTO means Professional TOOLS

PLUMB TOOL COMPANY

2255Y Santa Fe Ave., Los Angeles 54, Calif.

5382



Eastern Factory—Jamestown, N.Y.

WHERE-TO-BUY-IT INDEX

Source of supply appears after items commercially available

AUTOMOTIVE

Handmade sports body fits Henry J chassis..... 93
 Nash-Healey adds LeMans hardtop to sports line.....101
 Waterproof compound for brakes makes them wear longer (Abbott-Kiple Co., 11005 Santa Monica Blvd., West Los Angeles, Calif.).....101
 German aircraft manufacturer now builds small automobiles.108
 Detroit Listening Post.....109
 Jumbo-size rear-view mirror attached with clamps (Skylark Automotive Corp., 3834 Willat Ave., Culver City, Calif.)...115
 Auto-trunk ventilator assures canine comfort (Schupack Supply Co., 7331 Cottage Grove Ave., Chicago).....124
 Front-seat shock absorber reduces hazards of automobile crashes.....124
 Automatic starter switch (Automo Corp., 1840 N. Michigan, Saginaw, Mich.).....128
 1908 National still rolls along the highways.....133
 Electric compressor pumps air into tires as car is driven....133
 Sports cars have a field day.....134
 Automobile snack bar holds food and beverage (Gotham Industries, Inc., 538 S. Wabash Ave., Chicago).....147
 Taillights that "talk".....148
 Synthetic-rubber tires may outwear the car.....244

AVIATION

20,000 mile-per-hour jets predicted for near future..... 10
 Bags sprayed on jet engines..... 72
 Quicker stop for jets?..... 73
 Test firing pilot and seat through jammed airplane canopy.. 80
 Punched tape flies airplane in routine operation (Minneapolis-Honeywell Regulator Co., 2954-4th Ave., South, Minneapolis 8, Minn.)..... 89
 Dancing sand detects flaws in honeycombed panels.....125
 Jet noise is loud enough to break down tissues of body.....242

FARMING

Bulb planter cuts and removes dirt core (Vanrich Products Corp., 9000 Madison Ave., Cleveland 2, Ohio)..... 72
 Rotary mower cuts 60-inch swath (Taylor Machine Works, Louisville, Miss.)..... 78
 "Synthetic sow" warms and feeds young pig brood..... 79
 He harvests minnows from former pasture land.....117
 Giant celery harvester packs crop in field (A. Duda & Sons, Oviedo, Fla.)..... 125
 Mechanical hoe has electronic brain to eliminate weeds (Hewlett-Packard Co., Palo Alto, Calif.).....142

HOBBIES AND NOVELTIES

Homemade "snorkel"..... 73
 French four-in-one musical instrument has single sounding board..... 79
 Submarine sled..... 92
 Lab model tells H-bomb effects.....117
 Bank on wheels takes to the road in Puerto Rico.....118
 Back-yard express.....119
 Gasoline-powered flying disk.....138
 Gas-fired infrared lamps barbecue entire steer.....139
 Monstrous molar made of plastic.....234

HOUSE AND HOME

Asphalt strip applied to sheathing gives siding deep shadow-line (Ruberoid Co., 500-5th Ave., New York City 18).....107
 Juicer (American Transmarine Corp., 95 Madison Ave., New York City 16).....126
 Combination kitchen tool (Nu-Age Products Co., Brooklyn, Mich.).....126
 Supersonic washer (Fairbanks Ward Industries, Inc., 666 N. Lake Shore Drive, Chicago 11).....126
 Decanter (American Transmarine Co., 95 Madison Ave., New York City 16).....126
 Sewing machine (Rich Marrus Associates, 192 Lexington Ave., New York City 16).....127
 Wobble-stopper (Ever-Level Glides, Inc., 227 Nevins St., Brooklyn, N. Y.).....127
 Tiny salt shakers (Morton Salt Company, Chicago).....127
 Cocktail table (Furniture Industries, Merchandise Mart Plaza, Merchandise Mart, Chicago).....127
 Cream whipper (Southern Enterprises, 1550 Cleveland Ave., S.W., Birmingham 11, Ala.).....127
 Water-system pressure is utilized to open garage door (Cozy Homes, 11628 Ventura Blvd., Studio City, Calif.).....139
 Safety thermal switch (Thermal Switch Co., Petersham, Mass.).....142

MACHINERY

"Old Smokey" forging press forerunner of bigger machines.. 70
 Motorless sweeper speeds cleaning (Handling Devices Co., Inc., 581 Boylston St., Boston 16, Mass.)..... 73
 Ultrasound inspects tires.....142
 Mobile hydraulic jack gives workmen big lift (Hamlin-Klock Corp., 28 N. Marengo Ave., Pasadena, Calif.).....148

OFFICE, SHOP AND STORE

Interest calculator gives rapid-fire answers to intricate problems (Rol-A-Factor Div., Forster Mfg. Co., 1425 McLean Blvd., Wichita, Kans.)..... 70
 Lock of many combinations..... 73
 Circular "slide rule" calculates dates weeks in advance (Graphic Calculator Co., 633 Plymouth Ct., Chicago 5).... 78

(Continued to page 14)

YOU PRACTICE COMMUNICATIONS with Kits I Send You

Build This Transmitter

As part of my Communications Course I send you parts to build the low power Broadcasting Transmitter shown at the right. Use it to get practical experience putting a station "on the air," perform procedures required of Broadcast Station operators. You build many other pieces of equipment with kits I send. I train you for your FCC Commercial Operator's License.



J. E. Smith
has trained more men
for Radio-TV
than any other man.

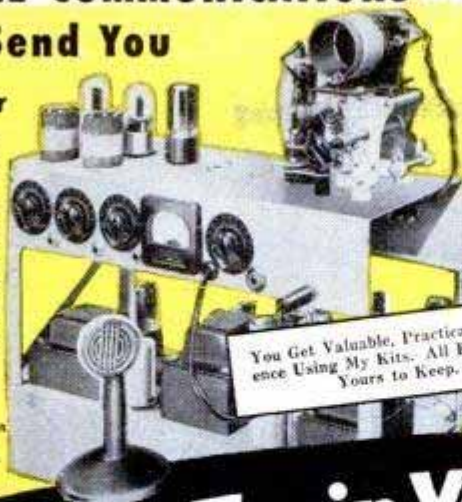

You Get Valuable, Practical Experience Using My Kits. All Equipment Yours to Keep.

YOU PRACTICE SERVICING with Kits I Send You

Build This Tester

You build this Multitester from parts I send, use it to earn extra money in your spare time fixing neighbors' Radios. I also send you speaker, tubes, chassis, transformer, loop antenna, everything you need to build a modern Radio and other equipment. You get practical experience working with circuits common to both Radio and Television. All equipment is yours to keep. See and read about it in my FREE 64-page book. Just cut out and mail coupon below!



I Will Train You at Home to be a RADIO-TELEVISION Technician

TELEVISION

Today's Good Job Maker

TV now reaches from coast-to-coast. Over 15 million TV sets are now in use; 108 TV stations are operating and 1800 new TV stations have been authorized. This means more jobs, good pay jobs with bright futures. Now is the time to get ready for success in TV. Find out what Radio-Television offers you. Mail coupon now for my 2 Books FREE!



America's Fast Growing Industry Offers You Good Pay, Success

Do you want a good pay job, a bright future, security? Then get into the fast growing RADIO-TELEVISION industry. Hundreds I've trained are successful RADIO-TELEVISION TECHNICIANS. Most had no previous experience, many no more than grammar school education. Keep your job while training at home. Learn RADIO-TELEVISION principles from easy-to-understand lessons. Get practical experience on actual equipment you build with parts I send you.

Make Extra Money in Spare Time While Training

The day you enroll I start sending you SPECIAL BOOKLETS that show you how to service neighbors' Radios in spare time while training. Use MULTITESTER you build to help service sets, get practical experience working on circuits common to both Radio and Television. Find out how you can realize your ambition to be successful in the prosperous RADIO-TELEVISION industry. Even without Television, the industry is bigger than ever before. 105 million home and auto Radios, over 2900 Radio Stations, expanding Aviation and Police Radio. Micro-Wave Relay, FM and Television are making opportunities for Servicing and Communications Technicians.

Mail Coupon — Find Out What Radio-TV Offers You

Send for my FREE DOUBLE OFFER. Cut out and mail coupon below. Send in envelope or paste on postal. You will get actual Servicing Lesson to prove it's practical to learn at home. You'll also receive my 64-page Book, "How to Be a Success in Radio-Television." Read what my graduates are doing, earning, see photos of equipment you practice with at home. J. E. Smith, President, Dept. 3EA National Radio Institute, Washington 9, D. C.

Good for Both—FREE

MR. J. E. SMITH, President, Dept. 3EA
National Radio Institute, Washington 9, D. C.
Mail me Sample Lesson and 64-page Book,
FREE. (No salesmen will call. Please
write plainly.)

Name Age
Address
City Zone State

VETS write in date of discharge



I TRAINED THESE MEN



Has Growing Business

"I am becoming an expert Teletician as well as Radiotician. Without your practical course I feel this would have been impossible. My business continues to grow."
—Philip G. Brogan, Louisville, Ky.

Good Job with Station

"I am Broadcast Engineer at WLPN. Another technician and I have opened a Radio-TV service shop in our spare time. Big TV sales here. As a result we have more work than we can handle."
—J. H. Bangle, Jr., Suffolk, Va.



Praises NRI as Best Course

"I was a high school student when I enrolled. My friends began to bring their Radios to me. I realized a profit of \$300 by the time I completed the course."
—John Hopper, Nitro, West Va.

NRI Training Leads to Good Jobs Like These



Broadcasting: Chief Technician, Chief Operator, Power Monitor, Recording Operator, Remote Control Operator, Servicing: Home and Auto Radios, P.A. Systems, Television Receivers, Electronic Controls, FM Radios. In Radio Plants: Design Assistant, Transmitter Design Technician, Tester, Serviceman, Service Manager. Ship and Harbor Radio: Chief Operator, Assistant Operator, Radiotelephone Operator. Government Radio: Operator in Army, Navy, Marine Corps, Coast Guard; Forestry Service Dispatcher, Airways Radio Operator. Aviation Radio: Transmitter Technician, Receiver Technician, Airport Transmitter Operator. Television: Pick-up Operator, Voice Transmitter Operator, Television Technician, Remote Control Operator, Service and Maintenance Technician.



AVAILABLE to all qualified **VETERANS** UNDER G. I. BILLS

Tested Way to Better Pay

**NOW YOU GET
MARLIN
RIFLE CLEANING KIT
RETAIL VALUE \$2.75**

FREE
OF EXTRA COST
WHEN YOU BUY A FAMOUS
MARLIN
.22 CAL. BOLT ACTION REPEATER

Model
81-C

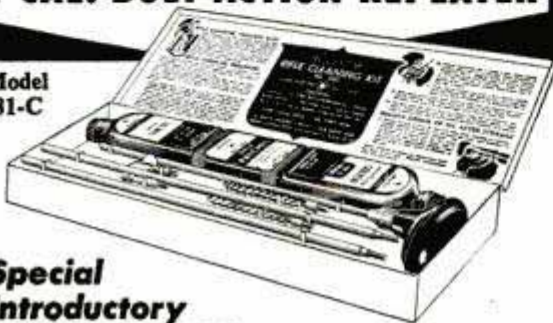

**Special
Introductory
Offer! Look What You Get:**

1. Complete .22 Rifle Cleaning Kit. Includes Duraluminum cleaning rod, slotted and jagged cleaning tips; 2 Phosphor Bronze brushes; Nitro Powder solvent; Gun Oil; Cleaning Patches; instructions included. Retail Value \$2.75—but yours **FREE** of extra cost.
2. A Marlin Model .22 Bolt Action Repeater. Choice of *Model 81-DL*—de luxe 25-shot tubular magazine model, \$30.95*; *Model 81-C*, standard version Model 81-DL, \$28.95*; *Model 80-DL*, de luxe, 8-shot clip-magazine type, \$26.95*; *Model 80-C*, standard version Model 80-DL, \$24.95*.

*Prices slightly higher west of the Rockies.

See your local dealer. If none available, write us for name and address of nearest one.

THE NAME FOR GAME **Marlin** FINE GUNS SINCE 1870

VALUABLE COUPON—MAIL TODAY!

The Marlin Firearms Co.,
Dept. PM-5, New Haven, Conn.

Send me catalogue with information and photo-illustrations of Marlin Guns. I understand you will also send me a pack of (check) . . . single or . . . double-edge Marlin Razor Blades. I enclose 10¢ for handling.

Name _____

Street _____

City _____ Zone _____

County _____ State _____

(Continued from page 12)

Tiny mercury pulse switch..... 80
Telescoping desk adjusts to fit child or adult (Peninsular Mfg. Co., 1017 Cottage Grove St., S.E., Grand Rapids 7, Mich.)107

SCIENCE

"Sun gazing" machine measures solar energy for paint research 78
Seismograph may prove earth's core is molten.....108
Antistatic spray prevents shock in cold, dry weather (Braun Laboratories, 206 S. Hutchinson St., Philadelphia 7, Pa.)...116
Grafts speed hybrid pines.....128
They weigh the dew.....140

SPORTS AND RECREATION

Lightweight golf bag mounts folding seat (Sit-N-Rest Golf Bag Co., 2404 W. Clybourn St., Milwaukee 3, Wis.)..... 79
Magnetic bin holds fish flies (Clarke Enterprises, Box 413, Janesville, Wis.)115
Galloping marksmen "tilt at ring".....128
Homemade steam-powered grill even whistles guests to dinner.129
They're off143
Electric starter for outboard motor (Lausen Specialty Co., 522 S. Grand, Gainesville, Tex.).....148

MISCELLANEOUS

Two-nation power pool..... 71
Dual flash unit from one contact..... 72
Self-illuminated razor 72
Voice that crosses the Pacific..... 90
Quickly mounted pump makes truck or tractor a fire fighter..107
Lightweight motorcycle weighs only 100 pounds.....108
Instrument converts voice into color panels (Malco Co., Inc., 25 N. 3rd St., Minneapolis 11, Minn.).....116
Modern pilot ladder has rungs that allow quick repair (Stanley V. Ehrlich, 3400 N.E. 54th Ave., Portland, Ore.).....124
Houses built of reeds (Dutch Building Panels, Ltd., Portage La Prairie, Man., Can.).....144
1218-foot radio tower for Air Force radio-wave tests (Truscon Steel Co., Youngstown, Ohio).....147

Craftsman and Shop Notes Index

AUTOMOTIVE

Handy brake-fluid dispenser.....199
Extra gasket stops plug fouling.....200
Oil cup on car air-filter cover aids gas priming of carburetor.200
Electric heater warms engine for easy winter starting.....207
Fuel pump may cause slow starts.....210
Garage car-washing kink.....210

FARMING

Rabbit brooder made from keg.....185
Sturdy rack for holding tank from farm-implement wheels...196
Novel cap warns of overflow when refueling tractor.....196
Outdoor "broody coop" on farm given legs to speed function..196
Barbed wire unwound safely from harrow-disk reel.....198
Boxed-in studs of poultry house provide simple feed hopper..199
Sickle from mowing machine makes handy weed cutter.....200
Poultry waterer refills when water level lowers.....200
Lifting and carrying hoist mounted on small tractor.....207
Low-bed farm trailer has loading winch.....210

HOUSE AND HOME

Wallpaper removed easily when soaked thoroughly.....156
Rubber shield prevents door from locking unexpectedly.....157
Signal automatically indicates mail delivery.....157
Solving home problems.....164
Clothes held over radiator by wooden drying rack.....170
Staple anchors flowerpot on sill.....170
Calcimine removed from wall with paint cleaner.....179
Cool water provided for invalid by altering vacuum bottle..181

LAWN AND GARDEN

Success with new nursery stock depends on proper care.....157
Oil barrier stops slugs and snails.....163
Lawn-party ash trays from coffee cans.....166
Window-cleaner spray used to apply insecticide.....170

OFFICE, SHOP AND STORE

Simple paintbrush holder.....156
Infrared lamp heats tile.....170
Method for increasing capacity of electrical outlet.....179
Disposal of staples made easy when remover is magnetized...181
Repairing broken heater element.....181
Paint-can rims cleaned easily with small contour scraper..198
Holder for magnifying glass attaches to artist's lamp.....199
Wire holder for hammer hooked over belt.....199
Handy paddle for shop figuring.....200
Chain end held extended by hose to hook in out-of-reach eyebolt210

OUTDOOR RECREATION

Cans protect campfire stakes from spreading flames.....163
Ice-filled jar in basket chills food for picnic.....170
Camp water supply strained through punctured pail.....170

(Continued to page 16)

IMPORTANT NOTICE—It is the intention of this magazine to provide its readers with information regarding the latest developments in the mechanical arts. We take no responsibility as to whether the disclosures contained in our articles are covered by patents and advise readers to investigate this subject before making, using, or selling any of the products, machines, or processes described in order to avoid possible liability for patent infringements.

INVENTORS

Learn how to protect your invention. The U. S. Patent Laws provide that any new and useful art, machine, article of manufacture, or composition of matter, or any new and useful improvement thereof, may be patented if the act of invention is involved. Therefore, every inventor with a valuable invention should take advantage of the Patent Laws and proceed for patent protection in order to safeguard his rights.

A patent gives the inventor the exclusive right to prevent others from making, using, or selling the invention claimed in the patent for a period of seventeen years.

The Patent Laws were enacted for the benefit of the inventor to give him protection for the features of his invention which are patentable. These features must be properly and concisely set forth and claimed in a formal application for patent, in order to comply with the requirements of the Patent Laws. For that reason, unless the inventor is familiar with patent matters, he should engage a competent registered patent attorney or agent to represent him. We are registered to practice before the U. S. Patent Office and are prepared to serve you in the handling of your patent matters.

A specially prepared booklet entitled "Patent Guide for the Inventor", containing detailed information with respect to patent protection and procedure, together with a "Record of Invention" form will be promptly forwarded to you without obligation upon request.

CLARENCE A. O'BRIEN & HARVEY JACOBSON

Registered Patent Attorneys

31-E DISTRICT NATIONAL BUILDING

WASHINGTON 5, D. C.

WEEGEE'S SHORTCUTS TO PRIZE-WINNING PHOTOFLASH PICTURES

#3 . . . Putting Life into Party Pictures BY WEEGEE

Getting people to act natural for party and wedding pictures is hard. But here are some tricks I use.

When everybody arrives, announce you're taking pictures. Pose everyone in a group. After three or four photos, put away your camera, and join the party. 10 or 15 minutes later, quietly get your camera. You'll find you're now less of a novelty.

If someone is particularly difficult, stand behind him and call his name. Shoot as he turns around. Or ask the difficult party to pose. Raise your camera and lower it as though you've snapped a picture. Wait until he relaxes, and then shoot.

There's more about photographing parties in my new booklet, **WEEGEE'S SECRETS OF SHOOTING WITH PHOTOFLASH**. This 64-page booklet is not sold at any store. But you can get a copy by sending 25¢ and the wrapper from a carton of Westinghouse Photoflash Bulbs to Westinghouse.

Regarding cameras, I've never seen one yet that couldn't take good flash pictures. But flash bulbs are different. You can't beat Westinghouse bulbs for dependability. Every picture in my new book, **NAKED HOLLYWOOD**, was shot with Westinghouse flash bulbs. Pick up a carton of Westinghouse flash bulbs on my recommendation.



Weegee, the world's foremost flash photographer. Author of **NAKED CITY**, and **NAKED HOLLYWOOD**.



**YOURS FOR A
WESTINGHOUSE FLASH BULB
CARTON WRAPPER AND 25¢**

PARTIAL LIST OF CONTENTS

- Photographing children
- Putting "Life" into party pictures
- Putting Character into portraits
- Drama in news photographs
- Selling your pictures
- Photographer's place at a fire

YOU CAN BE SURE...IF IT'S **Westinghouse**

THIS 64 PAGE BOOKLET CANNOT BE BOUGHT IN ANY STORE.
YOU CAN GET YOUR COPY ONLY WITH THIS COUPON.

WESTINGHOUSE LAMP DIVISION, DEPT. PM-5
Bloomfield, New Jersey.

Rush my copy of WEEGEE'S SECRETS OF SHOOTING WITH PHOTOFLASH. I am enclosing the wrapper from a carton of Westinghouse flash bulbs, and 25¢ to cover postage and handling.

NAME _____

ADDRESS _____

CITY _____ ZONE _____ STATE _____

(Continued from page 14)

PHOTOGRAPHY

Camera fitted with extension to eliminate reflections.....	192
Clipped corner of transparency aids positioning in projector.....	192
"Pincushion" on bottle cap holds retouching materials.....	192
Rubber tips for tripod legs from medicine-dropper bulbs.....	192
Rectangular paint can converted into inexpensive print box.....	192
Light-spot pointer.....	193
Safelight on enlarger lens saves darkroom time.....	194
Strengthening photo developer.....	194

TOOLS

Wood welder (Wood Welder Mfg. Co., 2578 Whittier Blvd., Los Angeles 23, Calif.).....	208
"Endless" hacksaw (Alpha Tool & Supply Co., Box 119, Westwood, N. J.).....	208
Air-driven countersink (Severance Tool Industries, Inc., 781 Iowa St., Saginaw, Mich.).....	208
Pump attachment (Kiekhaefer Corp., Fond du Lac, Wis.).....	208
Wheel-mounting tool (Thomas Jamieson, Buck Road, Holland, Pa.).....	208
Heavy-duty solder pot (Dee Electric Co., 1101 N. Paulina St., Chicago 22).....	209
Portable power-tool stand (J. N. Mackenzie Mfg. Co., Bear Ridge Rd., R. D. 1, North Tonawanda, N. Y.).....	209
Speed-reducing pulley (Pull-Gear Co., 21125 Dequindre, Hazel Park, Mich.).....	209
Calking compound (Calbar Paint & Varnish Co., 2612 N. Martha St., Philadelphia 25, Pa.).....	209

WOODWORKING

Bluebirds attracted to "apartment" house rid garden of cutworms.....	156
Floor fan doubles as end table.....	166
Plan of the month—magazine stands.....	168
Jigsawed wren house.....	171
Built-in bins utilize waste space in rooms.....	179
C-clamps and scrap wood form jig to simplify picture framing.....	179
Camper's cabinet kitchen.....	180
Shelves installed on bassinet keep baby supplies handy.....	181

WORKSHOP HINTS

Nail substitutes for drill.....	157
Burnishing wheel for hand grinder.....	163
Nail in groove anchors shelves.....	163
Inch scale on bench saves time.....	166
Worn force cup nailed to handle.....	181
Improvised pouring spout.....	196
Loose screw is tightened by notching thread.....	198
Depth-stop nuts on drill press kept tight by lock washer.....	199
Measuring old drill shanks.....	199
Outer edge of washer machined by mounting in lathe chuck.....	207
Removing worn bushings.....	207
Auger shank squares round holes.....	210

MISCELLANEOUS

Spikes support reinforcing rods.....	156
Shingle anchors boat-seat pad.....	166
Tab formed out of page margin serves as bookmark.....	166
Rewinding dried fishline.....	185
Pocket minnow "bucket".....	185
Jeep dozer.....	195
Paper-tape adhesive renewed by moisture in kitchen.....	196
Increasing life of dry cells.....	198

Radio-Television, Electronics

Wire recorder used by wirepondents (Webster-Chicago Corp., 100 W. Monroe St., Chicago 3).....	211
How to build an applause meter.....	212
TV-antenna system coupler (Technical Appliance Corp., Sherburne, N. Y.).....	215
Telescoping TV tower (Tele-Vue Towers Inc., 701 49th St., St. Petersburg, Fla.).....	215
TV light in planter (Parnell Co., 2904 Woodburn Ave., Cincinnati 6, Ohio).....	215
TV interference filter (Grayburne Corp., 20 S. Broadway, Yonkers 5, N. Y.).....	215
Mirror-type TV periscope.....	215
TV-telephone demonstration in England.....	215
Record compensator for old recordings (General Electric Co., Electronics Park, Syracuse, N. Y.).....	216
Bedroom radio (Dahlberg Co., Golden Valley, Minneapolis 22, Minn.).....	216
Noise eliminator for radio controls (Grayburne Corp., 103 Lafayette St., New York City 13).....	216
VHF radio-transmission experiment.....	216

Virus Lives After 35 Years

Discovery of a deadly virus still alive after 35 years in a lost test tube recently startled bacteriologists at the University of Michigan. Most of the 100 viruses known to science die within a few days or weeks after removal from living tissue. The effect of the virus upon humans is unknown.

Let This Famous Key OPEN THE DOOR TO THE JOB YOU WANT

SO OFTEN a man finds it hard to get the job he wants because he "lacks the experience" — yet can't get the experience until he has the job!

It's a common problem — but the I.C.S. "success plan" can answer it for you. Just pick the job you want — then pick the I.C.S. course especially designed to help you get it.

No need to give up your present job. Learn RIGHT AT HOME in your most convenient spare time. 296 courses to choose from. 154 skilled instructors. Yet the cost to you is only a few cents a day. And results, in case after case, are amazing:

Charles L. Moore, Pasadena, Cal.: "I was a carpenter and not making much money. Am now Chief Architectural Draftsman for contracting company."

Maynard H. Groves, Washington, D. C.: "I was a water-tender earning 76 cents an hour. Today I am Chief Engineer at the Gallinger Municipal Hospital."

J. J. Pelham, Sylacuga, Ala.: "When I enrolled in your textile engineering course 7 weeks ago, I was a loom fixer. Last week I was promoted to Assistant Foreman, at a 33 1/3% increase in pay."

Frank Bachtik, Jr., Chicago, Ill.: "I was a junior draftsman with an income of \$125 per month. Presently I am employed as a Plant Layout Technician— income \$395.25 per month."

Dr. S. Carl Traegde, Los Angeles, Cal.: "When I enrolled in your Analytical Chemistry, I was a farm laborer. I continued with such subjects as Advanced Organic Chemistry and Physical Chemistry. This enabled me to advance to Senior Research Chemist."

FREE — 2 INTERESTING BOOKS

Mail coupon for FREE BOOK on subject you are interested in. Also free, "How to Succeed"—36-page gold-mine of factual advice on Why People Fail, How to Pick Your Goal, How to Develop Hidden Talents, etc. Don't miss out on today's tremendous opportunities—mail coupon NOW.



INTERNATIONAL CORRESPONDENCE SCHOOLS



BOX 5581-L • SCRANTON 9, PENNA.

Without cost or obligation, send me "HOW TO SUCCEED" and the booklet about the course BEFORE which I have marked X:

- | | | | | |
|---|---|--|---|--|
| <p>ART</p> <ul style="list-style-type: none"> <input type="checkbox"/> Commercial Art <input type="checkbox"/> Magazine and Book Illustrating <input type="checkbox"/> Cartooning <input type="checkbox"/> Show Card and Sign Lettering <input type="checkbox"/> Fashion Illustrating <p>AUTOMOTIVE</p> <input type="checkbox"/> Automobile, Mechanic <input type="checkbox"/> Auto-Elec. Technician <input type="checkbox"/> Auto Body Rebuilding and Refinishing <input type="checkbox"/> Diesel—Gas Engines <p>AVIATION</p> <input type="checkbox"/> Aeronautical Engineering Jr. <input type="checkbox"/> Aircraft Engine Mechanic <input type="checkbox"/> Airplane Drafting <p>BUILDING</p> <input type="checkbox"/> Architecture <input type="checkbox"/> Arch. Drafting <input type="checkbox"/> Building Contractor <input type="checkbox"/> Estimating <input type="checkbox"/> Carpenter and Mill Work <input type="checkbox"/> Carpenter Foreman <input type="checkbox"/> Reading Blueprints <input type="checkbox"/> House Planning <input type="checkbox"/> Plumbing | <ul style="list-style-type: none"> <input type="checkbox"/> Heating <input type="checkbox"/> Steam Fitting <input type="checkbox"/> Air Conditioning <input type="checkbox"/> Electrician <p>BUSINESS</p> <input type="checkbox"/> Business Administration <input type="checkbox"/> Certified Public Accountant <input type="checkbox"/> Accounting <input type="checkbox"/> Bookkeeping <input type="checkbox"/> Stenography and Typing <input type="checkbox"/> Secretarial <input type="checkbox"/> Federal Tax <input type="checkbox"/> Business Correspondence <input type="checkbox"/> Personnel and Labor Relations <input type="checkbox"/> Advertising <input type="checkbox"/> Retail Business Management <input type="checkbox"/> Managing Small Business <input type="checkbox"/> Sales Management <input type="checkbox"/> Salesmanship <input type="checkbox"/> Traffic Management <p>CHEMISTRY</p> <input type="checkbox"/> Chemical Engineering <input type="checkbox"/> Chemistry <input type="checkbox"/> Analytical Chemistry <input type="checkbox"/> Petroleum—Nat'l Gas <input type="checkbox"/> Pulp and Paper Making <input type="checkbox"/> Plastics | <p>CIVIL, STRUCTURAL ENGINEERING</p> <ul style="list-style-type: none"> <input type="checkbox"/> Civil Engineering <input type="checkbox"/> Structural Engineering <input type="checkbox"/> Surveying and Mapping <input type="checkbox"/> Structural Drafting <input type="checkbox"/> Highway Engineering <input type="checkbox"/> Reading Blueprints <input type="checkbox"/> Concrete Construction <input type="checkbox"/> Sanitary Engineering <p>DRAFTING</p> <ul style="list-style-type: none"> <input type="checkbox"/> Aircraft Drafting <input type="checkbox"/> Architectural Drafting <input type="checkbox"/> Electrical Drafting <input type="checkbox"/> Mechanical Drafting <input type="checkbox"/> Structural Drafting <input type="checkbox"/> Sheet Metal Drafting <input type="checkbox"/> Mine Surveying and Drafting <p>ELECTRICAL</p> <ul style="list-style-type: none"> <input type="checkbox"/> Electrical Engineering <input type="checkbox"/> Electrician <input type="checkbox"/> Electrical Maintenance <input type="checkbox"/> Electrical Drafting <input type="checkbox"/> Electric Power and Light <input type="checkbox"/> Lineman <p>HIGH SCHOOL</p> <ul style="list-style-type: none"> <input type="checkbox"/> High School Subjects | <ul style="list-style-type: none"> <input type="checkbox"/> College Preparatory <input type="checkbox"/> Mathematics <input type="checkbox"/> Commercial <input type="checkbox"/> Good English <p>MECHANICAL AND SHOP</p> <input type="checkbox"/> Mechanical Engineering <input type="checkbox"/> Industrial Engineering <input type="checkbox"/> Industrial Supervision <input type="checkbox"/> Foremanship <input type="checkbox"/> Mechanical Drafting <input type="checkbox"/> Machine Design-Drafting <input type="checkbox"/> Machine Shop Practice <input type="checkbox"/> Tool Design <input type="checkbox"/> Industrial Instrumentation <input type="checkbox"/> Machine Shop Inspection <input type="checkbox"/> Reading Blueprints <input type="checkbox"/> Toolmaking <input type="checkbox"/> Gas—Electric Welding <input type="checkbox"/> Heat Treatment—Metallurgy <input type="checkbox"/> Sheet Metal Work <input type="checkbox"/> Sheet Metal Pattern Drafting <input type="checkbox"/> Refrigeration <p>POWER</p> <input type="checkbox"/> Combustion Engineering <input type="checkbox"/> Diesel—Electric <input type="checkbox"/> Electric Light and Power | <ul style="list-style-type: none"> <input type="checkbox"/> Stationary Steam Engineering <input type="checkbox"/> Stationary Fireman <p>RADIO, TELEVISION, COMMUNICATIONS</p> <input type="checkbox"/> General Radio <input type="checkbox"/> Radio Operation <input type="checkbox"/> Radio Servicing—FM <input type="checkbox"/> Television <input type="checkbox"/> Electronics <input type="checkbox"/> Telephone Work <p>RAILROAD</p> <input type="checkbox"/> Locomotive Engineer <input type="checkbox"/> Diesel Locomotive <input type="checkbox"/> Air Brakes <input type="checkbox"/> Car Inspector <input type="checkbox"/> Railroad Administration <p>TEXTILE</p> <input type="checkbox"/> Textile Engineering <input type="checkbox"/> Cotton Manufacture <input type="checkbox"/> Rayon Manufacture <input type="checkbox"/> Woolen Manufacture <input type="checkbox"/> Loom Fixing <input type="checkbox"/> Finishing and Dyeing <input type="checkbox"/> Textile Designing <p>YEAR OF THE SIX MILLIONTH STUDENT</p> |
|---|---|--|---|--|

Name _____ Age _____ Home Address _____
 City _____ Zone _____ State _____ Working Hours _____ A.M. to _____ P.M.
 Occupation _____

Special tuition rates to members of the Armed Forces. Canadian residents send coupon to International Correspondence Schools Canadian, Ltd., Montreal, Canada

WHAT SECRET POWER DID THIS MAN POSSESS?

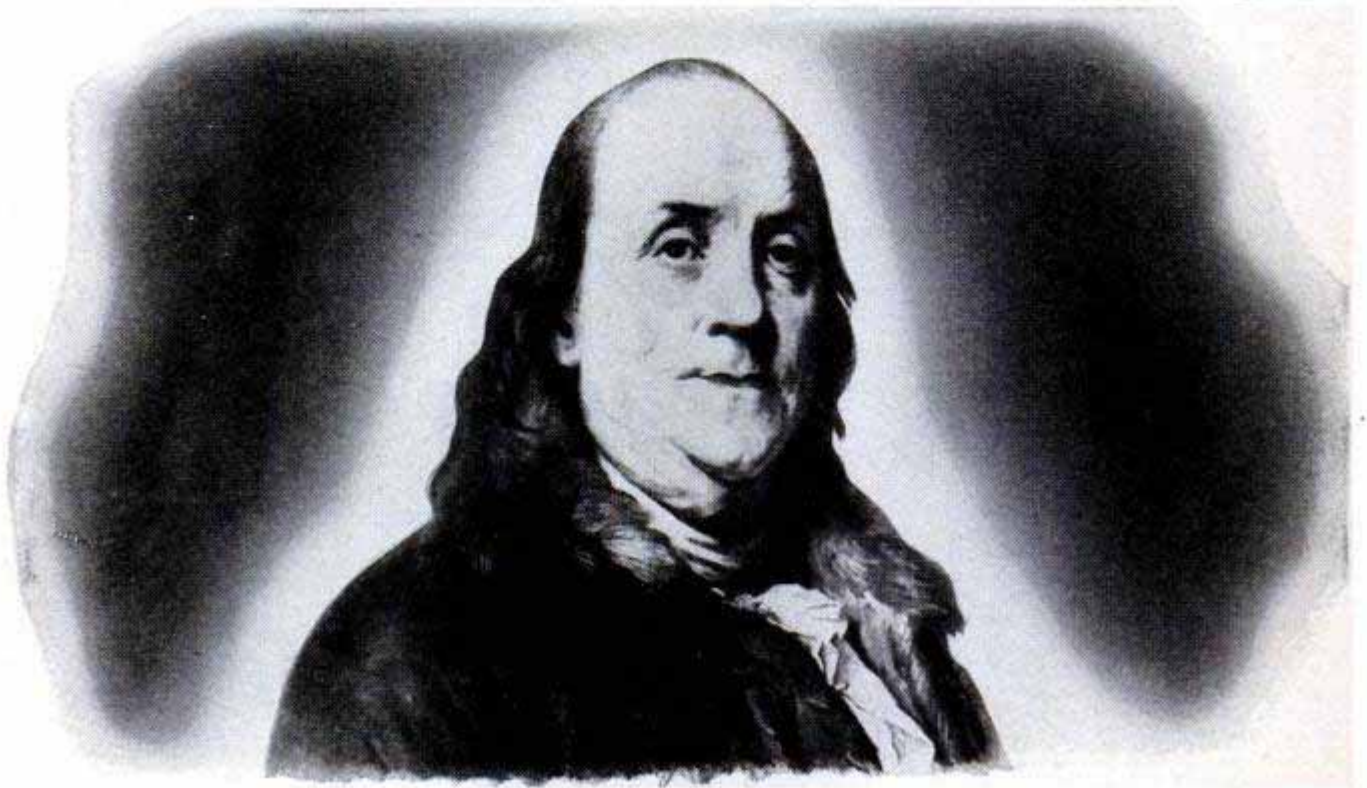

Benjamin Franklin
(A Rosicrucian)

WHY was this man great? How does anyone—man or woman—achieve greatness? Is it not by mastery of the powers within ourselves?

Know the mysterious world within you! Attune yourself to the wisdom of the ages! Grasp the inner power of your mind! Learn the secrets of a full and peaceful life! Benjamin Franklin—like many other learned and great men and women—was a Rosicrucian. The Rosicrucians (NOT a religious organization) first came to America in 1694. Today, headquarters of the Rosicrucians send over seven million pieces of mail annually to all parts of the world.

The Rosicrucians

SAN JOSE • (AMORC) • CALIFORNIA

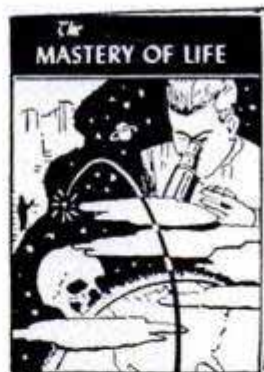

THIS BOOK FREE!

Write for YOUR FREE COPY of "The Mastery of Life"—TODAY. No obligation. No salesmen. A non-profit organization. Address: Scribe T.E.S.

SEND THIS COUPON

Scribe T.E.S.

The ROSICRUCIANS (AMORC)

San Jose, California

Please send me the free book, *The Mastery of Life*, which explains how I may learn to use my faculties and powers of mind.

NAME _____

ADDRESS _____

CITY _____

ZONE _____ STATE _____

INVENTORS

If you believe that you have an invention, you should find out how to protect it. The first step is to have a search made of the prior pertinent U. S. patents. If a report on this search indicates that the invention appears patentable you can apply for a patent, and the specifications and claims should be prepared.

The firm of McMorrow, Berman & Davidson, with offices in Washington, D. C., is qualified to take the necessary steps for you. We can make a preliminary search on your invention, advise you whether we think it can be patented, and prepare your application for

patent.

Unless you are fully familiar with the U. S. Patent Laws, we recommend that you engage the services of a Registered Patent Attorney to protect your interests. The patent laws are *your* laws. A patent gives you the right to prevent others from making, using or selling the invention claimed in your patent for a period of 17 years.

Use these patent laws for your protection. Investigate whether your invention can be patented. If you have what you believe to be an invention, we suggest that you have this firm make a search for you.

Send for a copy of our Patent Booklet entitled "How To Protect Your Invention," containing information about patent protection and patent procedure. Along with this we will also send you an "Invention Record" form, for your use in writing down and sketching details of your invention. We will mail them promptly. No obligation. They are yours for the asking.

McMORROW, BERMAN & DAVIDSON

Registered Patent Attorneys

PATENTS • COPYRIGHTS • PATENTS

135-L VICTOR BUILDING, WASHINGTON 1, D. C.

HOW TO FIX ANY PART OF ANY CAR

QUICKLY--EASILY--RIGHT!

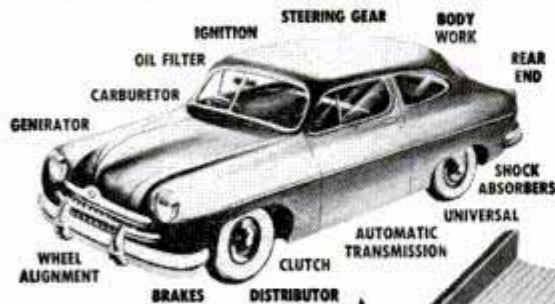

FREE 7-DAY TRIAL

Whether you're a beginner or an expert mechanic — now you can "breeze through" any "fix-it" job from simple carburetor adjustment to complete overhaul. Just look up job in index of MOTOR'S Brand-New 1953 Auto Repair Manual. Follow simple step-by-step directions, clear pictures. Presto—the job is done!

No guesswork! MOTOR'S MANUAL takes you from "scratch" — shows WHERE to start, WHAT tools to use Covers EVERY job on EVERY car built from 1935 thru 1953!

Everything You Need to Know "Boiled Down" from 189 Official Shop Manuals

NEW, REVISED, ENLARGED. 1953 Edition contains the "meat" from over 189 OFFICIAL shop manuals — simplified for YOU. 37,000 essential repair specifications on 907 car models. Over 850 big pages. More than 2500 "this-is-how" pictures. 227,000 service and repair facts. Leads beginners every step of the way. Time-saving factory repair procedures for experts. Instructions and pictures so clear you CAN'T go wrong. Used by U. S. Army and Navy.

Try Book FREE 7 Days

SEND NO MONEY! Pay postman nothing. Make Manual show you what it's got. Unless you agree this is the greatest time and work saver you've ever seen—return book in 7 days and pay nothing. Mail coupon today to: MOTOR — Book Dept., Desk 15, 250 W. 55th St., New York 19, N. Y.

MOTOR'S AUTO REPAIR MANUAL

Covers 907 Models All These Makes

- | | |
|-----------|------------|
| Buick | La Salle |
| Cadillac | Lincoln |
| Chevrolet | Mercury |
| Chrysler | Nash |
| Crosley | Nash |
| De Soto | Rambler |
| Dodge | Oldsmobile |
| Ford | Packard |
| Frazer | Plymouth |
| Henry J | Pontiac |
| Hudson | Studebaker |
| Kaiser | Terraplane |
| Lafayette | Willlys |

Same FREE Offer On MOTOR'S Truck and Tractor Manual

Covers EVERY job on EVERY popular make gasoline truck, tractor made from 1936 thru 1952. FREE 7-Day Trial. Check proper box in coupon.



Develop Hidden Earning Power STUDY LAW at home! LL.B. Degree

Qualify yourself in spare time for advancement, greater earnings, business success. Now, more than ever, legal ability is in demand! Easy-to-understand step-by-step lessons and text material furnished — invaluable for permanent reference. Over 40 years expert instruction. 114,000 students enrolled. Easy payments. Find out now, at no cost, how study of law can help you. Write today for FREE Book "Law and Executive Guidance."

AMERICAN EXTENSION SCHOOL OF LAW
Dept. PM-62, 664 N. Michigan Ave., Chicago, Ill.

AVIATION!

Pays you more with a schooling at Parks College. B.S. degree in 3 yrs. from Saint Louis University—Aero. Eng., Maint. Eng., Aero Administration.

Non-credit courses for Private, Commercial, Instrument, Flight Instructor and Multi-Engine Ratings. Also Proposed A & E Mechanics Course.

All Parks schooling approved for G.I. training. Write today.

PARKS COLLEGE DEPT. M-33
EAST ST. LOUIS, ILL.

'How to MAKE MONEY with Simple CARTOONS'



A book everyone who likes to draw should have. It is free; no obligation. Simply address **FREE BOOK**

CARTOONISTS' EXCHANGE
Dept. 95D Pleasant Hill, Ohio

WATCHMAKING

Learn at home • FREE sample lesson
CHICAGO SCHOOL OF WATCHMAKING
2330 N. Milwaukee Avenue Dept. 153 Chicago 47, Ill.



Bar Bells

Buy Direct From Factory **\$8.95**
up

Write for free booklet and price list
INDEPENDENT IRON WORKS
2416 East 23rd Street, Dept. B-5
Los Angeles 58, Calif.

MAIL COUPON NOW FOR 7-DAY FREE TRIAL

MOTOR BOOK DEPT.
Desk 15, 250 W. 55th St., New York 19, N. Y.

Rush to me at once (check box opposite book you want):

MOTOR'S New **AUTO REPAIR MANUAL**. If O.K., I will remit \$1 in 7 days, \$2 monthly for 2 months and a final payment of 95c (plus 35c delivery charges) one month after that. Otherwise I will return the book postpaid in 7 days. (Foreign price, remit \$8 cash with order.)

MOTOR'S New **TRUCK & TRACTOR REPAIR MANUAL**. If O.K., I will remit \$2 in 7 days, and \$2 monthly for 3 months, plus 35c delivery charges with final payment. Otherwise I will return book postpaid in 7 days. (Foreign price, remit \$10 cash with order.)

Print Name..... Age.....

Address

City..... State.....

Check box and save 35c delivery charge by enclosing WITH coupon entire payment of \$5.95 for Auto Repair Manual (or \$8 for Truck & Tractor Repair Manual.) Same return-refund privilege.



QUALITY TRUCK & PASSENGER TIRES
LOW PRICES - GUARANTEED
FREE TUBE WITH EACH PASSENGER TIRE

Buy first quality used tires direct from wholesaler and save money. Each tire triple inspected and guaranteed. Free tube with each passenger tire. Order today.

QUALITY PASSENGER TIRES
1 YEAR WRITTEN GUARANTEE

600x16\$5.59	670x15\$5.95
650x165.79	700x155.59

EXTRA VALUE TRUCK TIRES | **MUD & SNOW TRUCK TIRES**

1 YEAR WRITTEN GUARANTEE	2 YEAR WRITTEN GUARANTEE
700x20 \$12.50	750x20(10) \$18
750x20(8) 14.50	825x20 21.50
900x16 12.95	750x20 15.95

Complete line of High Mileage Tires in stock. Write for price list for sizes not listed. Take off 10% on orders for two or more tires. All prices F.O.B. Richmond, Virginia.

THE SAFTYRE CO., INC.

MAIL ORDERS PROMPTLY FILLED. Send check or money order with this ad. "FOR THAT SAFE TIRE" Dept. PM, 1801 E. Broad Street P.O. Box 2254, RICHMOND, VA.

THESE MEN ARE GETTING PRACTICAL TRAINING

IN ELECTRICITY

—ELECTRONICS

On Real:



**A.C. and D.C. MOTORS
GENERATORS
SWITCHBOARDS
CONTROLLERS
WIRING JOBS
APPLIANCES
ELECTRONIC UNITS**

(Shown at left—Instructor explaining operation and testing of a large Motor Generator in our A.C. Department.)

AND TELEVISION-RADIO

On Real:

**TELEVISION SETS
RADIO RECEIVERS
F.M.
(Frequency Modulation)
ELECTRONICS
RECORD CHANGERS
AUTO RADIOS
PUBLIC ADDRESS Systems**

(Right—Instructor helping students check the wiring and trace circuits of television receivers.)



You can train in the great SHOPS of COYNE For These Opportunity Fields!

Trained men needed whether 17 or up to 45. Prepare quickly at Coyne for better rating, if drafted—a vital job in industry, if not, in a FIELD THAT ALSO OFFERS A REAL FUTURE WHEN THE EMERGENCY IS OVER.

FINANCE PLAN Enroll now, pay most of tuition later. Special plan for men of draft age.

WE TRAIN YOU IN CHICAGO. At Coyne you learn on real, full-size equipment. Trained instructors show you how, then you do typical jobs yourself.

CLIP COUPON NOW for big new illustrated Coyne book. Check whether interested in ELECTRICITY or TELEVISION-RADIO or both. No obligation; no salesman will call. Get vital facts now!

B. W. COOKE, President

COYNE

SCHOOL

**A TECHNICAL TRADE INSTITUTE
CHARTERED NOT FOR PROFIT
Established 1899
500 S. Paulina Dept. 53-72H
Chicago 12, Illinois**

ELECTRICITY ★ TELEVISION ★ RADIO ★ REFRIGERATION ★ ELECTRONICS



**Mail Coupon for
BIG FREE BOOK!**

**APPROVED
FOR
VETERANS**

B. W. COOKE, President
COYNE SCHOOL
500 S. Paulina St., Chicago 12, Ill. Dept. 53-72H

Send BIG FREE book and details of your training offer. This does not obligate me and no salesman will call. I am interested in:

ELECTRICITY TELEVISION-RADIO

NAME

ADDRESS.....

CITY.....STATE.....



70% to 90% Off List!

SENSATIONAL Tube Buys

All Tubes Individually Boxed!
Check this list for Rigidly-Tested, Full 1-Year Guaranteed Tubes.

Type	Price	Type	Price	Type	Price
1A5GT	.30	6BJ6	.39	12AZ7	.69
1A6G	.30	6BK7	.59	12BA6	.38
1A7GT	.47	6BQ6GT	.59	12BD6	.45
1AB5	.30	6BQ7	.95	12BE6	.39
1B3	.65	6BZ7	.95	12BF6	.39
1B5	.30	6C4	.37	12BH7	.63
1B7GT	.30	6C5GT	.39	12BY7	.65
1C5GT	.43	6C6	.58	12J5GT	.42
1E7	.29	6CB6	.44	12S8	.70
1G6	.30	6CD6G	1.11	12SA7GT	.44
1H4G	.30	6D6	.45	12SF5	.50
1H5GT	.40	6E5	.48	12SG7GT	.52
1L4	.46	6F5GT	.39	12SJ7	.44
1LC5	.51	6F6	.37	12SK7GT	.48
1N5	.46	6G6G	.52	12SL7GT	.47
1P5	.57	6H6GT	.41	12SN7GT	.52
1Q5	.58	6J5GT	.37	12SQ7	.44
1R5	.45	6J6	.52	12SR7	.49
1S5	.39	6J7G	.43	14J7	.30
1T4	.45	6J8	.30	14W7	.30
1T5	.53	6K5	.47	19BG6G	.95
1U4	.45	6K6GT	.37	19C8	.70
1U5	.39	6K7GT	.44	19T8	.79
1V	.60	6L6GA	.64	19V8	.89
1X2	.63	6Q7	.45	24A	.63
2A3	.70	6S4	.38	25AV5	.83
2X2	1.50	6S8	.53	25BQ6GT	.62
3A4	.45	6SA7GT	.43	25L6GT	.39
3E5	.46	6SD7GT	.41	25W4	.56
3Q4	.48	6SF5GT	.46	25Z5	.40
3Q5GT	.49	6SG7GT	.41	25Z6GT	.37
3S4	.46	6SH7	.73	26	.45
3V4	.47	6SJ7GT	.41	27	.39
5U4G	.45	6SK7GT	.41	32L7	.89
5V4	.73	6SL7GT	.48	35B5	.40
5W4	.50	6SN7GT	.52	35C5	.39
5X4	.40	6SQ7GT	.37	35L6GT	.41
5Y3G	.32	6SR7GT	.45	35W4	.37
5Y3GT	.32	6SS7	.42	35Z4	.39
5Y4G	.35	6T8	.56	35Z5GT	.37
5Z3	.46	6U4	.60	36	.60
6A7	.59	6U5	.44	41	.42
6A8	.62	6U6	.63	42	.42
6AB4	.44	6U8	.61	43	.55
6AG5	.43	6V6GT	.39	45	.55
6AJ5	.90	6W4GT	.44	45Z5	.49
6AK5	.75	6W6GT	.44	50B5	.39
6AL5	.38	6X4	.37	50C5	.39
6AQ5	.39	6X5GT	.37	50C6	.59
6AQ6	.37	6X8	.61	50L6GT	.41
6AR5	.37	6Y6G	.48	50Y7	.50
6AS5	.50	7A4	.47	56	.50
6AT6	.37	7AF7	.53	57	.58
6AU6	.38	7B4	.44	58	.60
6AV5	.83	7C6	.40	70L7GT	1.09
6AV6	.37	7E6	.30	75	.41
6AX4	.53	7N7	.52	76	.44
6B4G	.64	7X7	.70	77	.57
6BA6	.39	12A8	.61	78	.47
6BA7	.57	12AL5	.37	80	.35
6BC5	.44	12AT6	.37	83	.68
6BD5GT	.59	12AT7	.56	85	.59
6BD6	.45	12AU6	.38	117L7	.99
6BE6	.39	12AU7	.43	117Z3	.37
6BF5	.41	12AV6	.39	807	1.50
6BF6	.37	12AV7	.59	1274	.99
6BG6G	1.25	12AX4	.48	2050	1.85
6BH6	.46	12AX7	.48	6113	1.00

TERMS: A 25% deposit must accompany all orders—balance C.O.D. All shipments F.O.B. Irvington warehouse. Subject to prior sale.

ORDERS UNDER \$10.00—\$1.00 HANDLING CHARGE. DON'T DELAY—ORDER TODAY!



Rad Tel TUBE CO.
"Integrity Is Our Chief Asset"
Phone: Essex 5-2947

**DEPT. PM5-53
115 COIT ST.
IRVINGTON 11, N. J.**

HIT THE JACKPOT!

WITH SECRET FORMULAS THAT HAVE MADE MILLIONS

BUILD SPARE TIME INCOME OF OVER \$200 PER WEEK, AS MUCH AS \$500 PER WEEK FULL TIME!

Make your own products... carefully selected chemical formulas for the home, farm and workshop. Now available for the first time! Laboratory Institute reveals the world's best, most closely guarded chemical formulas, complete with detailed, easy-to-follow instructions... no previous training necessary for success.

Hundreds of much sought after products including: Cosmetics, Drugs, Paint, Putty, Auto Polish and Chemicals, Fly and Insect Killers, Ink, Glue, Cement, Lubricants, etc.

EARN THE MONEY YOU'VE ALWAYS WANTED

...own your own business. Read of the fabulous success achieved by others, with no experience, no complicated equipment. Learn the truth behind making money with chemistry.

Don't sit back while others make big money. Act Now! Get in the swim... rush name today for free, complete information. A post card will do!



LABORATORY INSTITUTE

8762 Holloway Drive • Los Angeles 46, California



King Shot PERFECT GRIP SLANTED HANDLE

HUNTING SLING SHOT
SILENT • POWERFUL
Kill Small Game and Pests
Interchangeable
Use in Right or Left Hand.

EXTRA RUBBER and BIRD SHOT included.

5 Steel Pointed ARROWS

Mail CHECK or CASH **ONLY \$1.50 POSTPAID**

MOFFITT & DREYER King Shot Mfrs., Dept. P, 12025 S. E. Market, Portland, Ore.



EARN WHILE YOU LEARN AT HOME!

If you are OVER 17—good pay, fascinating work await you in photography! Start making money quickly in sparetime—step into your own studio or exciting job.

LEARN-BY-DOING method trains you at home! Write TODAY for FREE catalog. Also Resident Training. 43rd Year! GI Approved.

NEW YORK INSTITUTE OF PHOTOGRAPHY
Dept. 49, 10 W. 33 St., New York 1 N.Y.

Send for **FREE BOOK**

STUDY TO BE A DOCTOR of Psychology or Metaphysics

Obtain a Ps.D., Ms.D., or Ph.D. degree. Be a Teacher, Lecturer, or Accredited Practitioner. Teach others how to achieve Health, Happiness and Contentment. Chartered by State. Write for FREE book telling how.

THE NEOTARIAN FELLOWSHIP

Desk 8, Pickwick Building Kansas City 6, Missouri



ITALIAN ACCORDIONS AT LOWEST WHOLESALE PRICES

5-DAY FREE TRIAL

"PAY AS YOU PLAY"
Small Down Payment As Little As **\$10** per month

DIRECT from Importer to You!

SATISFACTION GUARANTEED, or your money back! NOW you can save up to 50% by direct purchase from America's leading distributor of famous genuine ITALIAN ACCORDIONS.

Send for **FREE Illustrated Catalog!**

ACCORDION MANUFACTURERS & WHOLESALE OUTLET
2003 West Chicago Ave. Dept. R-53, Chicago 22, Ill.

GET SHOP-METHOD HOME TRAINING

for **SUCCESS** in Today's Top Industries!

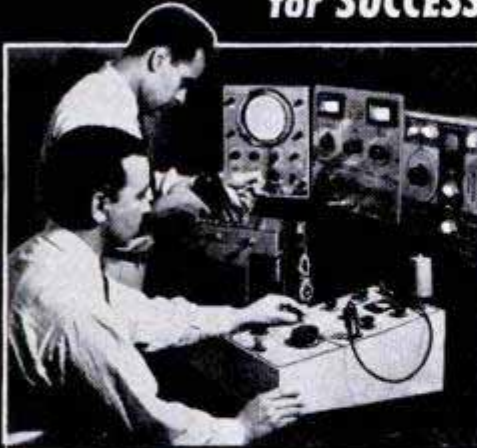

SEND COUPON
TODAY
for **FREE**
BOOK and
COMPLETE
SAMPLE LESSON!

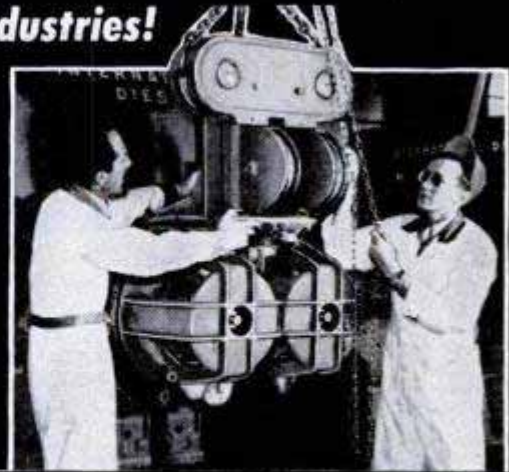

RADIO-TELEVISION & ELECTRONICS OR AUTOMOTIVE-DIESEL & ALLIED MECHANICS

Like a business of your own... or a good job with a big firm... and get paid for what you know? Shop-Method Home Training in Radio, Television, Electronics will bring you the job... money... you've always wanted. 105 million Radios, 3100 stations... 16 million TV sets, over 100 TV stations... many more, now Govt. restrictions are off. Defense industries want trained men for interesting, good pay jobs. Get into this opportunity-making industry... advance fast. Find out how... mail coupon... **TODAY!**

I GIVE YOU STANDARD PARTS! INCLUDING TUBES!

—they are yours to keep. You actually learn by doing, build generators, receivers, a big Super-Het radio.

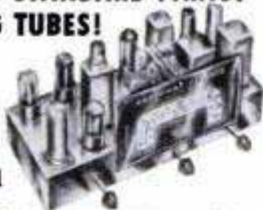

THIS PROFESSIONAL FACTORY-MADE MULTI-TESTER IS YOURS!



Valuable equipment every Radio-TV man needs. Yours to keep!

BOTH RESIDENT AND HOME STUDY COURSES OFFERED!



LET NATIONAL SCHOOLS of Los Angeles, California, a Resident Trade School for almost 50 years, train you at home for today's unlimited opportunities. Pick your industry—mail coupon below now!

EARN EXTRA MONEY WHILE YOU LEARN!

I show you how to earn extra money while learning! Many men have paid for their entire course in this way. You can, too. Remember: Shop-Method Home Training covers every phase of the industry—in an interesting step-by-step way. Why wait—take the first step to success—mail the coupon today!

DRAFT AGE? Training helps you get the service branch you want, advance fast. That means higher pay and grade, more prestige—right away! Don't take a chance—mail coupon now!



Want to be your own boss... or get into booming industries? 8 million older cars need big, profitable services and repairs. Farm machinery is going Diesel. Defense industry begs for more and more trained mechanics for high-pay jobs. National Schools Shop-Method Home Training prepares you for all Automotive, Diesel, Allied Mechanics opportunities. Helps you get the security, good pay you've always wanted. Send coupon for your Free Book and Sample Lesson now!

I GIVE YOU THE TOOLS OF YOUR TRADE!

Big professional-quality kit of tools of your trade—and all-metal tool box. All yours to keep—part of your course; they help make your training more practical—start you off right!



NATIONAL SCHOOLS

LOS ANGELES 37, CALIFORNIA

Established 1905

In Canada: 193 East Hastings Street
Vancouver 4, B.C.

APPROVED FOR
G.I. TRAINING

DON'T PUT IT OFF GET THE BIG SALARY YOU'VE ALWAYS WANTED!

MAIL TODAY—YOU'RE "ON YOUR WAY"!

NATIONAL SCHOOLS, Dept. B-53
4000 S. Figueroa Street
Los Angeles 37, California

Mail in envelope or paste on postal card

I want to "get going"! Send me Free Book I checked and Free Sample Lesson. I understand no salesman will call.

- My Future in Radio-Television & Electronics
 My Future in Automotive-Diesel & Allied Mechanics

NAME _____ AGE _____

ADDRESS _____

CITY _____ ZONE _____ STATE _____

- VETS!** Check here if released from service less than 4 years ago.
 Check here if interested in resident school training.



FREE!
RADIO-TV
BOOK &
LESSON!

FREE!
AUTO-DIESEL
BOOK &
LESSON!

Some make more, some less;
GEO. HELD reports—

\$350 gross in single
WEEK
IN MY OWN BUSINESS

Here's wonderful opportunity to start money-making business of your own —with electric upholstery cleaner.

● Here's YOUR chance to start a money-making, year-round business of your own and make the success you've dreamed about. R. O. Donnley took in \$40 in seven hours. O. W. Ware landed a \$750 hotel job. J. S. Corbit grossed \$279.50 his first month. And so it goes. Homes, hotels, offices, clubs, all places where furniture is used, offer you big profit possibilities. Auto upholstery also.

NO SHOP OR OFFICE NECESSARY

● You clean furniture on customers' premises. No hauling. No high rents. Supplies are inexpensive, you operate at low cost from your home. What you take in is mostly profit.

DON'T DREAM—DO SOMETHING NOW

● It costs nothing to investigate an opportunity like this. If you want to be your own boss—free from layoffs, strikes and bosses, we will help you to start and succeed. Don't delay . . . read the facts, then decide for yourself.

MAIL COUPON TODAY FOR FREE BOOK

● **VON SCHRADER MFG. CO.** ●
● 1550 "D" Pl., Racine, Wisconsin ●
● Send at once (no obligation) your **FREE** ●
● booklet containing information about your ●
● Electric Upholstery Cleaner and how I can ●
● own my own permanent, profitable business. ●
● Name _____ ●
● Address _____ ●
● City _____ Zone _____ State _____ ●

Say You Saw It in Popular Mechanics

High School
at Home

Many Finish in 2 Years

No classes. No time wasted going to and from school. Progress as fast as your time and abilities permit. Standard H. S. texts supplied. Thousands enroll each year in this 56-year-old school. Send for FREE descriptive booklet.

AMERICAN SCHOOL, Dept. H545
Drexel at 58th St., Chicago 37, Ill.

Without obligation, please send FREE descriptive booklet.

Name _____

Address _____

Famous 15 and 17 Jewel
BULOVA WATCHES \$16.95 PLUS TAX
PRACTICALLY WHOLESALE TO YOU



UNLIMITED SERVICE GUARANTEE

Why Pay
\$59.50
SAVE \$42.55

ALSO CHOICE OF
● BENRUS ● GRUEN
● WALTHAM OR
● ELGIN WATCHES

You get these unredeemed SERVICE guaranteed Bulova and other movements in latest style Yellow Gold Cases at this sensationally low price because we bought out SURPLUS STOCKS of leading New York and Md. Jewelers. Order now while they last. Specify make preferred and whether men's or ladies'. Only \$16.95, plus \$1.70 tax. Order right now.

FREE TRIAL OFFER! WEAR AT OUR RISK!
Money back guarantee in 10 days if not delighted!

SEND ONLY \$1 with order. Pay balance C.O.D. plus postage. Or we pay postage if you enclose \$16.95 plus \$1.70 tax.

FREE! Handsome Expansion band with orders at no extra cost.

MARYLAND DISTRIBUTORS, Dept. 509

501 E. BALTIMORE ST., BALTIMORE 2, MD.
Write for Free Watch and Diamond Ring Catalog — Practically Wholesale Prices.

SERVICE Guaranteed

—17 Jewel Swiss

WRIST WATCH

Worn by Army, Navy & Marines
Thousands sold for \$35 under O.P.A.

\$14.95 Plus \$1.50 Tax

New Incublock, Shock-Protected, Damp & Dust resist.

DO FALSE TEETH
Rock, Slide or Slip?

FASTEETH, an improved powder to be sprinkled on upper or lower plates, holds false teeth more firmly in place. Do not slide, slip or rock. No gummy, gooey, pasty taste or feeling. **FASTEETH** is alkaline (non-acid). Does not sour. Checks "plate odor" (denture breath). Get **FASTEETH** at any drug store.

LEARN CARTOONING at home in spare time

Simplified Landon Picture Chart Method makes progress quick, exciting, easy. Former Landon students include creators of "Steve Canyon," "Freckles," "Out Our Way," "Winnie Winkle," "Regular Fellers," "The Neighbors," "Strange as it Seems" and many others. Earn while learning. Rush 10c for Picture Chart (to test your ability) and full details. Please state age.



Landon School of Cartooning, 5305 CTS Bldg., Cleveland, O.

SHORTHAND IN

Famous Speedwriting Shorthand. 120 words per minute. No symbols; no machines; uses ABC's. Easiest to learn, write and transcribe. Low cost. 150,000 taught by mail. For business and Civil Service. Also typing. 30th Year. Write for FREE booklet to:

Speedwriting
Dept. 1505-3
55 W. 42 St., N.Y. N.Y.

6
WEEKS
AT HOME

INSURED TIRE SERVICE
POPULAR BRANDS

FREE INSURANCE POLICY given with each used tire sold. We guarantee the amount of service you pay for.
Tube Given Free with Each Used Passenger Tire Upon Request

SPECIAL!
Deduct 10% on orders for two or more used tires

YOU CAN'T LOSE!!

Super Quality — Rugged Performance — 15 Months Insured Service			
600x16	\$4.55	670x15	\$5.25
650x15	4.95	670x16	5.35
650x16	5.45	700x15	5.40
700x16	5.55	700x16	5.45
760x16	6.35	760x17	6.45
820x15	6.45		
850x17	6.75		
Supreme Quality. Nothing Finer — 30 Months Insured Service			
450x20	5.95	450x21	6.25
600x16	5.65	650x15	5.75
650x16	5.85	670x15	5.95
700x16	7.75	700x15	5.75
750x16	12.50	710x15	6.50
550x17	5.75	760x15	6.95
525x18	5.45	820x15	7.50
640x15	5.75	475x19	5.75
700x15(6)	10.45	750x16(8)	15.95
600x20	10.95	900x20	19.95
650x20	11.75	1000x20	20.45
700x20	12.50	1100x20	26.75
32x6(8)	11.95	1000x22	19.50
32x6(10)	12.75	1100x22	24.75
750x20	14.50	1200x20	23.50
825x20	21.50	1100x24	22.75

MIDLAND TIRE SALES
Speedy shipments on Mail Orders. F.O.B. Chicago. Insurance policy sent with each order. Deduct 10% on orders for 2 or more used tires. Send CHECK or MONEY ORDER.—No COD's.
1141 W. Randolph St., Dept. PM-10, Chicago 7, Ill.

NOW...from D.T.I.'s MILLION DOLLAR TRAINING CENTER

Learn to master

TELEVISION

RADIO - ELECTRONICS

by getting **EVERYTHING YOU NEED!**

**NOW—
get training
to suit your NEEDS**

**TAKE YOUR
CHOICE**

Come to
D.T.I.'s
great **CHICAGO
LABORATORIES**

...one of the Nation's **FINEST!**

Now, in the heart of the nation's TV Center, you can get all of your preparation in D.T.I.'s big, modern, wonderfully equipped training laboratories. Loads of commercial equipment and ample, well qualified instructors help you get a thorough, practical preparation in the **SHORTEST POSSIBLE TIME**. Part time student Employment assistance can help you pay your way while in training.

EMPLOYMENT SERVICE

As soon as you complete either the Chicago Laboratory or Home Training, you'll find D.T.I.'s grand Employment Service ready to help you start earning real money. Get full facts. Mail coupon today.

MILITARY SERVICE: If subject to military service, the training information we have for you should prove very helpful. Mail coupon today.

**89 WAYS
TO
EARN
MONEY
IN TELEVISION
RADIO ELECTRONICS**

**ACT NOW! MAIL COUPON TODAY
Get this publication FREE!**

DeFOREST'S TRAINING INC. Dept. PM-5-J
2533 N. ASHLAND AVE., CHICAGO 14, ILL.

I would like your Opportunity News Bulletin showing "89 Ways to Earn Money in Television-Radio-Electronics"; also, complete facts about the training opportunity made possible by your organization.

Name _____ Age _____
Address _____ Apt. _____
City _____ Zone _____ State _____

America's amazing multi-billion dollar Television field now offers you a chance of a lifetime to get started toward a grand job or your own business. With TV station limit now raised from over 100 to 2053, Television is headed for almost every community. Mail coupon today. See how you may prepare to cash in on the coming TV BOOM.

Get **ALL** of your training
AT HOME!...including setting
up your own **HOME LABORATORY**



ABOVE: You build and keep this big 5 INCH commercial-type oscilloscope — one of the most useful test units used in TV today.



See how you may now get one of today's most complete, effective combinations of major home training aids—including (1) well illustrated lessons, (2) the wonderful aid of **HOME TRAINING MOVIES** and (3) 21 big shipments of electronic parts for setting up your own **HOME LABORATORY**. You work over 400 construction and test procedures to get the practical experience you need. This includes building and keeping a 5 INCH "SCOPE", jewel bearing **MULTI-METER** and a big 21 INCH TV SET. (D.T.I. offers another home training in Television-Radio-Electronics, but without the TV set.) Mail coupon today for exciting facts.

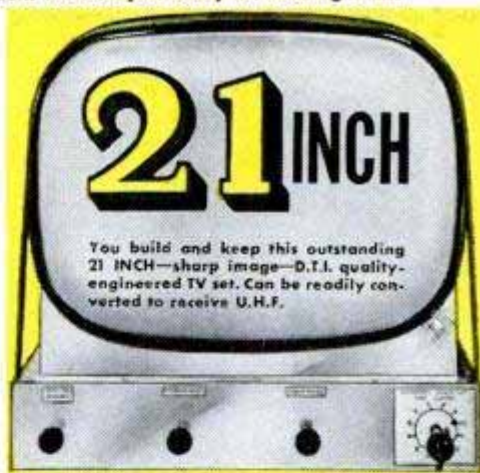

21 INCH

You build and keep this outstanding 21 INCH—sharp image—D.T.I. quality-engineered TV set. Can be readily converted to receive U.H.F.

Use 16 mm. MOVIES Only D.T.I. provides you with the loan of visual training movies at home to help you master important basic points faster . . . easier . . . better!

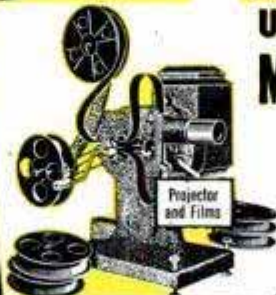

"ONE OF AMERICA'S FOREMOST
TELEVISION TRAINING CENTERS"
— Established 1931 —



De FOREST'S TRAINING, INC.
AFFILIATED WITH
De VRY Technical INSTITUTE
CHICAGO 14, ILLINOIS

BETTER JOBS BETTER PAY FOR SKILLED MEN!

QUICK TRAINING BOOKS SHIPPED for Examination

SEND NO MONEY! Prepare for a better job at bigger pay by sending the coupon NOW for any set of easy-to-understand self-training text books. These great books, prepared by long experienced experts, can help you to acquire the "know how" that wins promotions and puts more money in your pocket. Any set of books sent for 10 days' examination.

AUTOMOBILE ENGINEERING

4 Big, Thick Books
Over 2700 Pages



These wonder books tell how — step by step — to make the repairs and adjustments that keep any make of car at maximum operating efficiency. More than 2000 illustrations, wiring diagrams, data sheets, etc. Total price only \$18.50. Low monthly payments. Sent on trial.

BUILDING, ESTIMATING and CONTRACTING

Up-to-Date Edition
9 Volumes — 4000 Pages

These 9 practical books can help you to make more money by becoming foreman, superintendent, or running your own business. Drawing plans, estimating, masonry, carpentry, building, remodeling, heating, painting and many other subjects included. 2750 illustrations. Total price only \$34.80. Low monthly payments. Sent on 10 days' trial.



APPLIED ELECTRICITY INCLUDING RADIO AND REFRIGERATION

19th Edition
8 Books — 3700 Pages



This up-to-date edition contains many new subjects in detail, including blueprint reading, electronics, F.M. radio, fluorescent lighting and other modern electrical topics as well as full range of standard practices. 2700 illustrations.

134 tables. Total price only \$34.80. Low monthly payments. Sent on trial.

Publishers since 1898

(A year's consulting privileges with our engineers, now given with these books at no extra charge.)

AMERICAN TECHNICAL SOCIETY

Dept. X519 Drexel at 58th St. Chicago 37, Ill.

CLIP AND MAIL COUPON TODAY

AMERICAN TECHNICAL SOCIETY, Dept. X519

Drexel at 58th Street, Chicago 37, Ill.

Send for 10 days' free use, the following set of books:

I will pay the delivery charges only, and if fully satisfied, will send you \$1.00 plus postage in 10 days and then \$4.00 a month until the total price of \$34.80 is paid. If I return the books in 10 days I will owe you nothing. You are to include a Year's Consulting Privileges with your engineers without extra charge.

Name _____

Address _____

City _____ State _____

Please attach letter stating age, occupation and name and address of employer, and at least one business man's name and address as reference. Men in service also please give home address.

Tells How You Can Learn to MOUNT BIRDS!

FREE BOOK
Learn At Home
Men, Boys, Hunters, Fishermen, mount and save your lovely wild-game trophies. Be a Taxidermist. Mount Birds, Animals, Heads, Fish, Tan skins. YOU learn easily, quickly in spare time. Have a grand home-museum. The finest and the greatest hobby known, for sportsmen. Fun, real profits.

FREE BOOK
Yes, FREE. Beautiful strange, valuable Book, telling all about Taxidermy. Contains over 100 beautiful game-pictures. And it's yours FREE, if you rush your request. You can mount all kinds of wild-game, and common specimens too. We can positively TEACH YOU. So GRASP this opportunity. RUSH letter or postal for this amazing FREE BOOK. Don't delay. State your AGE. N. W. SCHOOL OF TAXIDERMY, 2565 Elwood Bldg., Omaha 2, Neb.

MANAGEMENT PRODUCTION

Production experts earn big money. Thousands of firms need them. We train you thoroughly at home in spare time for management positions. Previous experience unnecessary. Personal training under supervision of production management authorities. Placement counsel and help. Write for FREE book "Industrial Management."

LASALLE Extension University, 417 So. Dearborn St.
A Correspondence Institution, Dept. 564 IM, Chicago 5, Ill.

DAN LURIE
"America's Most
Muscular Man"
—on television's
"Big Top."

FAMOUS DAN LURIE

BARBELLS

with 4 courses—low factory prices
50 lb. set... \$ 8.48 | 150 lb. set... \$20.48
100 lb. set... 13.98 | 200 lb. set... 25.98

Write for Free Catalog
Order by Mail: 50% with order, bal. C.O.D.
Extra wts. 13c per lb., F.O.B. plant

DAN LURIE BARBELL CO.

107-M-5 Pitkin Ave., Dept. 359-E, Brooklyn, N. Y.

Hand Guide!
POSITIVELY controls movement of hand until one's Penmanship is quickly corrected. Inexpensive. Write, OZMENT (INVENTOR), 34-P, ST. LOUIS, MO. (BX665)

Secrets of VENTRILOQUISM Now Revealed!



Easy to learn in 60 to 90 days with our Home Study Course. RESULTS GUARANTEED. Make Money! Be Popular! Have Fun! Big Opportunity! Radio, Television, Stage Appearances! For FREE information regarding price and terms, WRITE. You must state your age. Dummy Catalog 25c. FRED MAHER SCHOOL OF VENTRILOQUISM Box 36, Studio E Kensington Station Detroit 24, Michigan

MAKE EXTRA MONEY

PLASTICS

LEARN AT HOME

LEARN HOW TO MAKE fast-selling PLASTIC NOVELTIES FURNITURE JEWELRY



There are RICH OPPORTUNITIES for MEN and WOMEN with "know-how" in Plastics. Interstate's new Plastics course tells and shows how to make hundreds of fast selling items out of Plastics. Gives complete training in fabrication, casting, lamination, molding, internal carving, etc., in simple, easy, step-by-step language and pictures. Plastics and Fabricating Kits for 23 valuable Plastic items come with training at no extra cost. START A PLASTICS BUSINESS OF YOUR OWN. No other industry holds such promise for the future. You can make big money manufacturing novelties, toys, signs, etc., in your own home in spare or full time. Don't wait! Learn NOW how Interstate's Plastics Training qualifies you for success in the Plastics field.

PLASTICS AND SUPPLIES FURNISHED FOR 23 VALUABLE PROJECTS

INTERSTATE TRAINING SERVICE
Dept. C3E Portland 13, Oregon

Yours ALMOST AS A Gift!

ONLY 25¢ FOR THIS VALUABLE U. S. COMMEMORATIVE SET OF

30 History IN THE Making STAMPS

Guaranteed to be Worth **THREE** Times as Much!



GENERALS—Portraits of 3 famous Civil War Generals—U. S. Grant, Sheridan, and Sherman. Color, purple.



COMMEMORATES centenary of first stamps issued by U. S. Pictures Washington and Franklin. Color, blue.



FOUR CHAPLAINS—Honors 4 chaplains who sacrificed lives in sinking of SS Dorchester in World War II. Color, black.



FREEDOM—Pictures Statue of Liberty and Jos. Pulitzer, famous exponent of freedom and press. Color, purple.



FRANCIS SCOTT KEY—Pictures famous author of our national anthem, *Star Spangled Banner*. Color, red.



CIVIL WAR—Adm. Farragut and his foster-father, Comm. Porter, led opposing forces. Color, purple.



OLD IRONSIDES—Stamp commemorates 150th anniversary of launching of Frigate Constitution. Color, green.



OLDEST U. S. COMMEMORATIVE STAMP (issued 1893) pictures landing of Columbus. Color, purple maroon.

MAIL COUPON TO GET THESE 8 STAMPS

PLUS 22 Other Great U. S. Stamps on this Amazing Offer!

MAIL coupon at once. We'll send you this fascinating set of 30 famous historic U. S. stamps—ALMOST AS A GIFT! All different. Each stamp tells a real, exciting story about an important event in American history. Each stamp is worth REAL MONEY. Our supply is limited. So please don't ask for more than one set.

FREE 32-Page Book

In addition to these 30 commemorative stamps, we'll also include other interesting offers for your inspection—PLUS a FREE copy of our helpful, informative book, "How to Collect Postage Stamps." Contains fascinating and true stories such as the one about the 1c stamp (which a school-boy sold for \$1.50) and which was later bought for FORTY THOUSAND DOLLARS.

Free book also contains ex-

pert advice on collecting; how to get started; where and how to find rare stamps; how to tell their real value; how to mount them, trade them; how to start a stamp club; exciting stamp games, etc. It has pictures galore! Full pages of pictures showing odd stamps depicting natives from far-away lands; ferocious beasts, etc.

MAIL COUPON NOW

Be the first in your neighborhood to have this valuable set of stamps. Your friends will envy you for it and want to buy the set from you. It will become one of the most prized sets of any stamp collection. But you must hurry. This special offer may have to be withdrawn soon. Rush coupon NOW!

If coupon has already been clipped, send 25c DIRECT to:

LITTLETON STAMP COMPANY
Dept. 5-PM, Littleton, N. H.



If you mail coupon AT ONCE, we will send you, free, this fascinating booklet. Supply limited. So rush coupon NOW!



Littleton Stamp Co.,
Dept. 5-PM, Littleton, N. H. —

I enclose 25c. Please send set of 30 historic U.S. Stamps. Also send FREE—while supply lasts—the fascinating booklet, "How to Collect Postage Stamps."

Name _____

Address _____

City _____ Zone _____ State _____

BECOME A Mechanical Engineer



B. S. Degree in 36 months



50% of the nation's industrial leaders started their careers with engineering training. Today, young men like you are being urged to prepare for careers in these rapidly expanding fields. Nine separate programs give you a wide range of career opportunities.

Choose From These Courses

ENGINEERING 36 months,
Bachelor of Science Degree
... optional year
"round study."

- Mechanical Engineering with a major in Design, Metal Fabrication or Plant Engineering.
- Electrical Engineering with a major in Electronics or Power.

TECHNICIAN 12 to 18 months

- Radio and Television
- Electronics
- Electrical Power
- Mechanical
- Air Conditioning
- Welding

General preparatory course — 3 months

SERVICE 6 to 12 months

- Radio
- Welding
- Refrigeration
- Heating
- Electricity
- Television

Terms open July, October, January, April
Faculty of specialists. 50,000 former students. Annual enrollment from 48 states and 23 overseas countries. Approved for Veterans. Your Military, Practical or Academic training evaluated for *advanced credit*. Send coupon for complete information.

MILWAUKEE SCHOOL OF ENGINEERING

50TH YEAR • NON-PROFIT

MILWAUKEE SCHOOL OF ENGINEERING
Dept. PM-553, 1025 N. Milwaukee
Milwaukee 1, Wisconsin

- "Your Career" booklet
- Free 160-page Catalog
- I am also interested in

Name name of course Age

Address

City Zone State

If veteran, indicate date of discharge



PAINT STRIPING TOOL

Works Like a Fountain Pen
Stripes with PAINT instead of INK!

New Master Painters' STRIPING TOOL makes it easy to do expert striping on furniture, bikes, model planes, autos, signs, linoleum, toys, wall board, etc. Makes plain, painted walls look like tile. Paint straight lines, curved, circular or evenly spaced parallel lines the same way a professional painter does. Simply fill Tubular Glass Paint Fountain with any color paint and wheel tip feeds paint evenly. Tips interchangeable — jaws split apart for easy cleaning. Tool complete with tip for 1-16 in. stripe only \$1 postpaid. Other complete tools with 1-64, 1-32, 3-64, 5-64, 3-32, 1-8 in. tips, \$1.50 ea. Extra tips, 75c. Complete Kit with tool and 7 tips, \$5.00. Handiest tool in painter's kit. Get it now. C.O.D. postage collect.

WENDELL MFG. CO.
4234 N. Lincoln Avenue
Dept. 35, Chicago 18, Illinois
Paints Curved, Circular or Straight Lines



\$1.00
POST PAID

DEALERS
Paint Striping Tool
Packed in attractive Display Cartons of one dozen. Fast, profitable seller. Write for illustrated circular, discounts.

LEARN MEAT CUTTING



Train quickly in 8 short weeks at Toledo for a bright future with security in the vital meat business. Big pay, full-time jobs—HAVE A PROFITABLE MARKET OF YOUR OWN! Pay after graduation. Diploma given. Job help. Thousands of successful graduates. Our 28th year! Send NOW for FREE catalog. No obligation. GI approved. NATIONAL SCHOOL OF MEAT CUTTING, Dept. 50-R, Toledo 4, Ohio

BUY IT WHOLESALE!

GET UP TO 40% OFF!

START A BUYING SERVICE at home, spare time. Get big-name merchandise for clients (and yourself) at up to 40% and more below the regular list price. Make fat commissions. Folks eagerly buy through you to get sizeable discounts. Send postcard for details. AMERICAN BUYERS' SERVICE, 631-PM Linden Ave., Buffalo 16, N. Y.

SAVE \$200 — BUILD YOUR OWN GARAGE

Plans for 1 1/2 or 2 Car Garage or 20'x20' Cottage — Only \$1.98

Material list and estimated cost included FREE. Sizes 14'x20' or 20'x20'. Hood or Gable Roof. Specify type and size when ordering. Postage prepaid with check or money order, otherwise C.O.D. B.C. Co., 17122 Scottsdale, Cleveland 20, Ohio.



RUPTURED?

We Offer You Something NEW!



TURN THE KEY "LOCK-O-MATIC"

And lock cushion against the opening

LOCK-O-MATIC holds rupture under all conditions of work or play... prevents nervousness, gas pains and backache caused by uncontrolled rupture... helps nature rebuild weakened muscles. Give up your old strap and spring trusses that enlarge the opening. End your troubles now with the amazing LOCK-O-MATIC. MONEY-BACK GUARANTEE ... Write for FREE booklet: "RUPTURE FACTS"

LOCK-O-MATIC SALES CO.
21 So. Third St. Dept. P-5, Minneapolis, Minn.



JOHN HARRINGTON
Research Director
Autosphere Corp.

Let me tell you how you can TEST YOUR CAR

Amazing new imported device makes it simple for anyone to road test a car's performance. It saves money on gas and repairs; completely replaces "guesswork" with car facts.

Would you like to know the truth about your car?
For example:

- Actual Road Horsepower
- Stopping Distances in feet
- Pick-up ratings at any speed
- Engine pulling power
- Hill climbing ability
- Best gas for your car
- Condition of your brakes
- Cause of any motor trouble
- Actual results of repair jobs
- Effect of wind and other resistance
- Wheel alignment and chassis checks

New Type of Device

I am going to tell you about a precision instrument that quickly gives you all of this information and much MORE. But let's get one thing clear — it is NOT a vacuum gauge of any kind! I tell you this because some people have confused my PERFORMETER with the common vacuum gauge since—at first glance—they may look similar. THE COMPARISON ENDS RIGHT THERE!

No Connections to Make

The PERFORMETER requires NO CONNECTIONS of any kind to the engine, transmission etc., and is quickly mounted on steering column or dash with the chrome mountings provided. The PERFORMETER operates by man's oldest law—the pendulum principle. It is the most accurate car testing device ever to come on the market at a price the average man can afford. What's more, anyone can understand and USE the PERFORMETER every day!

Quality Instrument

The PERFORMETER lasts a lifetime and is as important to the wise car owner as the speedometer, oil gauge or ammeter. It is made by European craftsmen with the integrity and precision of a jeweled movement. It is an entirely self-contained unit. When you hold it in your hands, believe me YOU KNOW you have a real, quality, professional instrument everyone admires. It contains a balanced pendulum dampened by baffles in oil and is hermetically sealed. It even has an automatic temperature and pressure compensator for any climatic and altitude variations.

To get the basic operating idea of the PERFORMETER, just visualize a pendulum hanging in your car. When you step on the gas the force of inertia overcoming gravity will push the pendulum backward. On the other hand, when you step on the brake, the same force will push the pendulum forward. These two basic, universal motions are translated to simple dial readings which provide you with all of the facts about your car's performance.

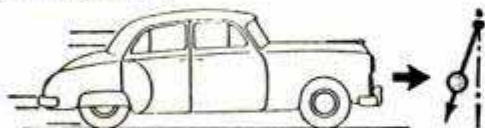

Step on the gas, the pendulum swings backward. The amount it moves indicates car performance and power.

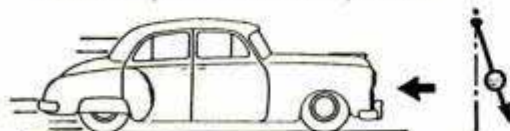

Step on the brakes, the pendulum swings forward. The amount it moves precisely indicates condition of brakes.

Anyone Can Use

Whether you are technical minded or not; whether you do your own repairs or not; whether you are a "bug" on cars or not; YOU find the PERFORMETER gives you endless information, endless pleasure, endless savings.



View of unit mounted on steering column. Also can be easily mounted on dash.

Variety of Uses

This remarkable device has uses extending from the man who wants to be sure his wife is driving a car with safe brakes, to the sports car fan who is interested in actual brake horsepower and optimum gear shift positions.

Unconditionally Guaranteed

The PERFORMETER is UNCONDITIONALLY GUARANTEED to please you or the full purchase price is promptly refunded. Every major motor magazine in the U.S. has tested and praised the PERFORMETER and many motorists have written us that this wonderful instrument fills a long felt need.

Free Book on Car Testing

With every PERFORMETER you receive as a gift a free copy of a 64 page book which tells you all about road testing. Whether you want to become a professional expert, or just learn about your car and have fun, this book tells you how. Also contains COMPARATIVE TEST DATA on all major U.S. and foreign cars.

Immediate Shipment

Act now. PERFORMETER is still in limited supply in the U.S. Fill out coupon below and send your order today. Enclose payment with order and we ship POSTPAID. If you prefer, we will send C.O.D., you pay postman purchase price plus postage and C.O.D. fee. But either way, DON'T DELAY. Each unit sent complete with both dash and steering column chrome mountings plus 64 page book on road testing.

PERFORMETER

TRADE MARK

Autosphere Corp., Dept. M5
11 East 48th Street, New York, N. Y.

Gentlemen:
Rush me PERFORMETER at \$22.50 each.
I enclose payment of

Name

Address

City Zone State.....

Send COD, I will pay postman \$22.50 plus postage charges.

It is understood that the PERFORMETER is UNCONDITIONALLY GUARANTEED and that if I am not satisfied my money will be promptly refunded.

Jobbers Inquiries Invited

C. T. C. TRAINING IN DRAFTING

PREPARES FOR
PROMOTION
MORE MONEY
SUCCESS

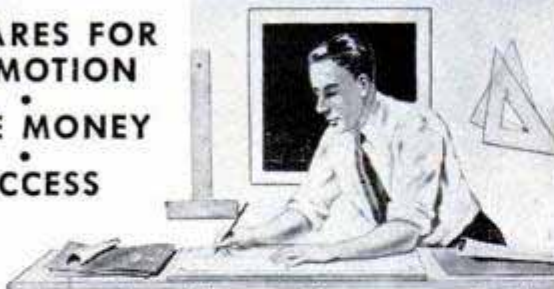

"Here I am at work making good money as a draftsman. I'm glad I sent the coupon to Chicago Tech for that Free Trial Lesson and found out how easy it is to learn Drafting in spare time at home. Today, I feel secure in my job. What's more, I feel I'm slated for promotion and more pay."

LEARN IN SPARE TIME—AT HOME!

(or at the College in Chicago)

A few hours of pleasant home study every week—that's all. All the tools you need; drawing outfit included. This tested method—developed over 48 years of C.T.C. progress—prepares men quickly for good positions in industry.



FREE INFORMATION—SEND COUPON

To prove to you how easy it is to learn Drafting at home, we will send you this FREE TRIAL LESSON. Mail coupon or send post card today.

CHICAGO TECHNICAL COLLEGE

E-251 Tech Bldg., 2000 So. Michigan Ave.
Chicago 16, Illinois

Mail me FREE Lesson with information about big opportunities in DRAFTING.

Name _____ Age _____

Address _____

City _____ Zone _____ State _____

ENGINEERING DEGREE IN 27 MONTHS

Big Demand for Graduates

Aeronautical, Chemical, Civil, Electrical, Mechanical and Radio Engineering (inc. TV and Electronics)

Hundreds of young men are earning B. S. ENGINEERING DEGREES annually in this recognized institution—year around operation. New terms start quarterly. Many students earn a major part of their college expenses in this large industrial center.

Low tuition. Competent instruction. Thorough, intense, practical program. Modern, well-equipped laboratories including new physics laboratory and modern wind tunnel. Individualized instruction emphasized.

Government approved for G.I.'s. Engineering preparatory courses. Students from 48 states and 21 foreign countries. Enter June, September, December, March. Send coupon for free catalog and full information. Enroll now.

SEND COUPON TODAY

INDIANA TECHNICAL COLLEGE

553 E. Washington Boulevard
Fort Wayne 2, Indiana

Please send me free information on B.S. Engineering Degree in 27 months as checked.

Aeronautical, Chemical, Civil, Electrical,
 Mechanical, Radio-Television

Name _____

Address _____

WELD YOUR WAY AHEAD!

Learn Arc and Gas Welding In Spare Time

Your opportunities are greater when you learn to use this great tool of modern industry. Training in welding opens the door to many key industries. Now you can train at home with UEI's practical course. Includes techniques, metallurgy, blueprints, shop practices, other important phases.



Write For FREE Facts! You can follow home-study training with actual shop practice. High school diploma not necessary. Write NOW!

UTILITIES ENGINEERING INSTITUTE

2523 Sheffield Ave., Dept. WC-2, Chicago 14, Ill.

STUDY LAW FREE AT HOME . . . LAW BOOK!

Prepare for the Bar!

Write today for a copy of our FREE book, "The Law-Trained Man," which gives the bar rules in your state and tells how ambitious men and women since 1890 have been preparing at home in spare time for the practice of law by studying the famous Blackstone bar-training course. All needed instruction material is furnished including big 16-volume law library. Law diploma awarded. Moderate tuition; easy monthly terms. Write for FREE book today!



BLACKSTONE SCHOOL OF LAW

225 N. Michigan Ave., Dept. 55, Chicago 1, Illinois



LEARN LOCKSMITHING

Learn Locksmithing and Keymaking from Experts in Your Spare Time at Home!

Locksmiths in big demand! No layoffs, no slow seasons! Age no disadvantage. Year-round, steady income in this permanent, respected field. Full or part time. Practical, illustrated lessons show how to make money even while learning! All materials, special tools supplied.

(Send for FREE BOOKLET.)

INSTITUTE OF LOCKSMITHING, Dept. P-42
15 PARK AVE. RUTHERFORD, N. J.
Lic. & Approved State of N.J. VA Approved

CASTING SECRETS REVEALED

Now—learn to make big money casting 1000's of perfect plaques, book ends, figurines, etc. with X.L. rubber molds. No exper.—little capital needed. X.L. Rubber, Pts. \$2.50; Qts. \$4 (postage extra).

**HUGE PROFITS!
MORE MONEY!**

Models, rubber for 3 molds, \$1.50 ppd. Send 25c (refundable) for informative catalog (40 pps.) describing this wonderful Profit Making business. PLASTIC ARTS STUDIO, Dept. 3, 3403 S. Madison St., Muncie, Ind.



BE A HIGH-PAID MAN IN YOUR COMMUNITY WITH THIS LONG NEEDED INVENTION

Earn up to \$10,000 or more per year! Nothing to invest! Be your own boss!

U.S. Pat.
D 153853-
D 153854

A worldwide product needed by every home, business and farm . . . priced to sell quickly at long profit! Automatic Red Comet goes into action as soon as fire starts . . . smotherers fire without human aid. It's a sales 'natural'!

FREE SALES KIT

Demonstrator units, sales literature, etc., furnished you FREE. Handsome leather-type kit. Tried and proved, it will make you an independent businessman. ACT NOW! Someone in your community will be appointed soon. Write for details, today!



RED COMET, INC.

Dept. 46-F, R.C. Bldg., Littleton, Colo.

Mandl's new

TELEVISION SERVICING

▶ pinpoints the trouble for you

▶ shows you exactly how to correct it

YOU'LL EASILY LEARN FROM THIS BOOK

It is written in the clearest, simplest, most practical terms by a man who is nationally known for his helpful articles on radio and TV servicing. From these step-by-step explanations and illustrations you'll clearly understand just how each unit in the TV receiver functions, how it is set up by the various manufacturers, what flaws may occur in it, what points in the circuitry cause these flaws, how they affect the other components in the unit, and how they show up on the TV screen. All faults likely to occur, including those hard-to-find troubles are fully dealt with. And you won't be confused by unnecessary theory. Only the essentials actu-

ally needed for practical servicing are given, in clear, easy-to-follow terms.

THE NEW REPRINT of this book includes the latest innovations and circuits. You'll find, for instance, explanation of the proposed color systems, the principles of the cascode ("Golden Grid") tuner and the latest technical data on this and on automatically focused tubes; the servicing of UHF-VHF receivers and of new types of high-frequency I.F. systems; the cause and cure of pulling and weaving; the functions, applications, and servicing of transistors; and the assigned frequencies of carrier and sound for UHF stations.

A COMPLETE MASTER TROUBLE INDEX

makes it easy for you to locate the source of trouble quickly. In the form of a handy chart it lists the various hums, sound distortions, streaks, bars, focus defects and 100 other trouble symptoms in sound and picture together with the possible causes of each and the page on which servicing instructions are given.

HUNDREDS OF HELPFUL ILLUSTRATIONS

Original photographs, especially made for this book, show you what appears on the screen when there is a defective picture tube, diathermy interference and dozens of other causes of imperfect pictures. Scores of scope patterns aid you in signal tracing and analysis of circuit performance. Hundreds of large, clear schematics, many from the major manufacturers, show you every detail of circuit arrangement.

- If you want to learn how to adjust your own set, this book will show you exactly how to get the results you want.
- If you want to go into profitable, professional TV servicing, this book will teach you what you have to know.
- If you are in TV servicing, this book will help you get the most satisfactory results in the minimum time on any job.

Eagerly chosen by servicemen everywhere as the most helpful guide yet published, highly praised by TV authorities, you'll want to see this book. Mail the coupon today for your on-approval copy.

SEE THEM ON 10-DAY FREE TRIAL

The Macmillan Co., 60 Fifth Ave., New York 11

Please send me the books checked below. I will either remit in full or return the books in 10 days.

- Mandl's TV Servicing \$5.50 Radio & TV Math. \$6.75
 TV & FM Antenna Guide \$6.25

Signed

Address

This offer good only within continental limits of U.S.A.)

with new data on transistors cascode tuners automatically focused tubes and other recent developments

You'll learn

simple signal tracing procedures

how to improve reception in fringe areas

How to use the oscilloscope and other test equipment

How to trouble-shoot keyed A.G.C. and synchroguide circuits; align I.F. stages

And many trade tricks for diagnosing troubles in minimum time

Have you got these important service aids?

RADIO & TV MATHEMATICS

By Bernhard Fischer

Shows you, step-by-step, how to solve every problem requiring mathematics in the FCC Study Guide for licenses of all classes and hundreds of other problems commonly arising in radio and TV work.

TV & FM ANTENNA GUIDE

By E. M. Noll & M. Mandl

Full, accurate technical data and complete instruction on how to get the most out of the antenna system at any location. All types of antennas and allied equipment fully discussed.

SEE THEM ON APPROVAL →

Give ME 15 MINUTES A DAY To Prove I Can make YOU a NEW MAN!

That's all I want — just 15 minutes a day to prove I can give you a powerful body of

might and muscle—with my quick "Dynamic-Tension" method. Mail coupon below—and I'll

send you, absolutely free, my new book, "Everlasting Health and Strength." Reveals secrets that changed me from a 97-pound weakling to winner of title, "World's Most Perfectly-Developed Man." Shows how I can build you a champion body the same easy way!

I've taken thousands of flabby men and given them powerful muscles, increased measurements, amazing strength, vitality, pep. My natural "Dynamic-Tension" method develops real men!

Send NOW for free copy of my book filled with pictures and body facts. Find out how I can make you the husky, big-muscled NEW MAN you can be! Mail coupon TODAY. Charles Atlas, Dept. 85, 115 East 23 St., N. Y. 10, N. Y.

CHARLES ATLAS, holder of title, "World's Most Perfectly-Developed Man."

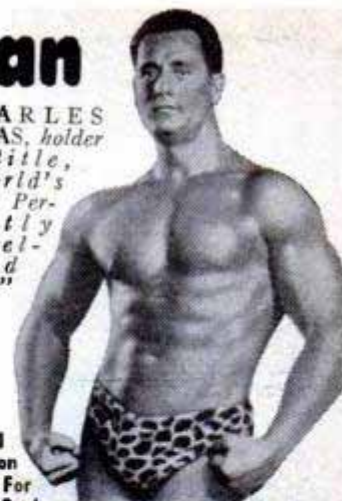

Mail Coupon Now For Free Book

CHARLES ATLAS, Dept. 85
115 East 23rd Street, New York 10, N. Y.

Send me your Free Book which proves how "Dynamic Tension" can make me a NEW MAN.

Name..... Age.....

Address.....

City..... State.....

10 POWER POCKET BINOCULAR



Bears the famous UNITED Best-By-Test "Seal of Quality."



ACTUAL PHOTO!

"TITAN MIDGET" 3"x3 1/4"! Weighs 6 1/2 oz.! Yet, a FULL 10 POWER with color corrected achromatic lens. Interior surfaces of VITAL front and rear Achromatics are COATED to assure, brighter, sharper, clearer images. Made in Japan by skilled optical craftsmen of precision, quality materials to rigid UNITED requirements. It explains why Price is LOW, Quality is HIGH. With genuine leather case, straps, \$24.95.

FREE 75 different models from \$14.95 to \$270.00. 30 DAY NO RISK TRIAL. If not satisfied return for full refund. Cash orders postpaid. C.O.D.'s require \$2.00 deposit. Add Federal Tax. UNITED BINOCULAR CO., 9043 S. Western Ave., Dept. ARF-6208, Chicago 20. Display Sales Rooms open 9:00-3:30 Mon. thru Fri.

DEALERS WANTED

Say You Saw It in Popular Mechanics



BE YOUR OWN MUSIC TEACHER

Send for Free Book Telling How Easily You Can Learn Piano, Guitar, Accordion, ANY Instrument This EASY A-B-C Way

NOW IT'S EASY to learn music at home. No tiresome "exercises." No teacher, just START RIGHT OUT playing simple pieces. Thousands now play who never thought they could. Our pictured lessons make it easy as A-B-C to learn to play popular music, hymns, classical and any other music. Only a few cents a lesson. Over 900,000 students! (Our 55th successful year.)

FREE BOOK and LESSON-SAMPLE

Find out why our method can teach you quickly, easily, inexpensively. Write for Free Book and free Lesson-Sample. No obligation. Mention your favorite instrument. Just Mail Coupon below.

U.S. SCHOOL OF MUSIC
Studio C305
Port Washington, N. Y.

FREE BOOK

U. S. SCHOOL OF MUSIC, Studio C305, Port Washington, N. Y. Please send me Free Booklet and Lesson-Sample. I would like to play (Name instrument).

Instrument..... Have you Instrument?.....

Name..... (Please Print)

Address.....

LEARN — Trades that Pay More WATCHMAKING or ENGRAVING Trades You Enjoy — by HOME STUDY

BEST THOROUGH, PRACTICAL TRAINING IN THESE DEPENDABLE, HIGH-PAYING TRADES. Earn extra money as you learn, repairing clocks and watches, or engraving silver and jewelry. YOU WILL BE BUILDING YOUR OWN BUSINESS RIGHT AT HOME.

Approved under P.L. 550, 16 and 346.

KANSAS CITY SCHOOL OF WATCHMAKING
ADMIRAL & TRACY KANSAS CITY 6, MO.

STUDY INDUSTRIAL DESIGN

You can train at Art Center School in California with practicing-professionals for upper-level jobs in INDUSTRIAL DESIGN. Recent graduates have been added to the staff at General Motors, Chrysler, Raymond Loewy, Henry Dreyfuss, etc. Majors in transportation, general product design, structures, community development, furniture design, packaging, display. 4-year degree courses. Learn to combine imaginative design with technical proficiency, coordinate utility and beauty. Stimulating environment. Field trips. Advantages of mild Southern California climate and nearby holiday spots. Coed. Placement service. Write for catalog.

ART CENTER SCHOOL, Edward M. Adams, Director
5353 WEST THIRD STREET, LOS ANGELES 5, CALIFORNIA

Learn ACCOUNTING Business Administration

Bookkeeping, secretarial and allied subjects at home in your spare time or attend nationally approved resident school. Write for FREE Success Book giving complete information about courses, plans, rates and employment opportunities.

Hills BUSINESS UNIVERSITY AND EXTENSION SCHOOL
619 W. MAIN ST. OKLAHOMA CITY 2, OKLAHOMA

FREE

VALUABLE CATALOG OF BUSINESSES, FARMS OR RANCHES AND INCOME PROPERTY—FOR SALE OR TRADE—THROUGHOUT WEST AND MID-WEST

Over 2000 offerings, approx. 200 pages. Contains vital information, prices, terms, earnings, lease, rent, names and addresses so that you can deal direct with owners. ALL TYPES—FROM \$1000 to \$1,000,000 Retail, Wholesale, Industrial Plants, Factories, Service Businesses, Farms, Ranches, Groves, etc., large and small. No salesman will call. No commission to pay us. Simply write today for Free Catalog No. 76-F to NATIONAL BUSINESS & PROPERTY EXCHANGE, Dept. 76-F, 4101 West 3rd St., Los Angeles 5, Calif. (Extra Free Service: Write us exactly what and where you want to buy and we'll advise owners of your requirements.)

NEW 1953 MANUAL SHOWS YOU HOW TO SQUEEZE 45 MILES ▶ FROM ONE GALLON OF GAS

ZOOM AHEAD



0 to 60 in 12
Seconds

●
Faster Get-Away

●
Increase top speed
20 Miles

Extra Pep, Speed, Power, Economy yours with ANY make car!

Raceway Secrets Revealed!

Here at last—after long careful preparation—the latest 1953 automotive manual that shows you how to save \$\$\$ on gas, tires, repairs, accessories. This amazing book, hot off the presses is the **NEWEST** now available in America! It gives you the down-to-earth facts on how to get 30, 40, 50 miles on a single gallon of gas. No longer need you get rattled to see "tin can jalopies" beat you at the light everytime... leave you in the dust on the highway! Now you can give your car greater pep, add up to 30 miles per hour to its top speed, surge ahead from 0 to 60 miles in 12 seconds flat. You can save hundreds of dollars annually, burn water with gas, extend car life by simple easy tricks, quickly recondition cylinder walls without removing the motor! It seems incredible but it's true! Many of these methods have been tested by huge industrial and oil firms, special laboratories, government bureaus. Some are used by the Army, Navy and Air Force. Some have come from the Indianapolis Speedway champions. Now this information is yours in the new 1953 book: "High Speed & Extra Power"—hot off the presses.

SPEEDWAY BOOKS — 127 W. 33rd St., Dept. 6-SE — New York 1, N. Y.



Easy Pictures Show you How!

No need to be a mechanic! Easy directions & clear pictures show you how to get more speed, extra power, greater economy with only a screwdriver. Tells of cheap gadgets that work miracles with any motor, a 1953 model or a junkyard derelict! Shows you how to **SAVE up to \$500.00** a year, increase resale value of your car, reduce repair costs.

Hundreds of Valuable Money Saving Secrets!

Here is some of the amazing information given you: 20 ways to save gas or oil; alcohol-air injection systems; mixing air & fuel; car super-charging ideas; speed and power tuning; how to increase top power & speed, get instant starts in winter, better pick-up on hills; 10,000 extra tire miles, make minor repairs yourself and save plenty, new plastic methods for removing body dents; new paints that go right over rust. **PLUS: HUNDREDS** of other ideas on adjustment & maintenance of your car inside and out! Thousands of wide-awake Americans have this money saving knowledge. Have you? Get your "Higher Speed and Extra Power Manual" now! Stop wasting gas and oil. Stop paying for sucker repairs! Get more power, more speed! Get faster get-a-way! Leave 'em in the dust with a higher compression car!

Read it at our risk!

This great new book is yours to try 7 days without obligation! Only **ONE** of its ideas may begin to save you money the day received, for instance: a screwdriver tune-up trick that gives you added power, pep and economy—in a few minutes! But be sure you get the genuine **ORIGINAL** and very latest! Remember: We don't sell automotive supplies! This is not a catalog! No "coupons"! No deception! This book tells **THE TRUTH**. Send no money. Pay only **1.98** plus post. on arrival. Read 7 days at our risk. Let **RESULTS** talk for themselves. You must be delightfully surprised or your money back! **Act NOW!** Mail coupon today!

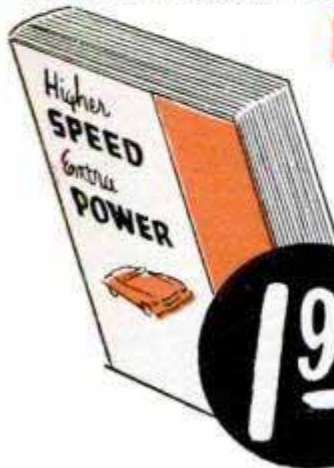

1.98

MAIL COUPON

U. S. Gov't. Scientist
reveals how to



BURN WATER & SAVE GAS!

Here's only **ONE** of over a thousand secrets that show you how to get marvelous new power and save gas too! Make your own "Super Charger" with a cheap mason jar and 15¢ rubber hose! So simple—so easy—yet it can actually save you up to 35% more gas! You'll be dazzled with the terrific new power you get with this moderate water injector!

DRIVE 8000 MILES WITHOUT OIL CHANGE!

Do you need help to stopping power waste? A quarter's worth of graphite will work wonders for you! This method used by thousands. Try it... you'll be amazed! There's over 1000 more ideas for you—easy to understand with pictures that show you how! Busy executives or ladies can let their service station attendant make many changes shown in this book. Most fellows, however, prefer to have the fun and satisfaction of doing it themselves. After all it's so simple with the easy instructions & step-by-step pictures! Remember, you must be satisfied or this manual costs you nothing!

FREE!

even if you return manual!

1. Pocket "TROUBLE SHOOTER" helps you find cause of motor defects, with repair advice.
2. "SAVE ON ACCESSORIES" — saves plenty on tires, accessories, gadgets. Not a catalog—absolutely impartial.
3. "ECONOMY DRIVING TECHNIQUE" — tells about famous Indianapolis driving techniques that gave 150 miles per gallon!
4. "33 WAYS TO INCREASE TRADE-IN VALUE." May be worth hundreds to you! Stock limited! Rush coupon TODAY for 7 day trial!



SPEEDWAY BOOKS

127 West 33rd Street, Dept. 6-SE, New York 1, N. Y.

RUSH Hi-Speed & Extra Power manual on 7 day trial money back guarantee. I will pay 1.98 plus postage on arrival. Also send **FREE** the following: "Trouble Shooter", "Save on Accessories", "Economy Driving Technique" and "33 Ways to Increase Trade-In Value", mine to keep even if I return manual for refund.

Name _____
Address _____
Town _____ State _____

SAVE MORE—GET MORE by sending \$2 check, m.o. or cash, in which case we pay postage and include **MOTORISTS' COMPASS** at no extra cost. Same money-back guarantee!



shake it on
every morning
then...



every step
of the day

QUINSANA FIGHTS ATHLETES FOOT INFECTION

QUINSANA works full-time—and fast! 9 out of 10 report amazing results. 91% of foot specialists interviewed used it on their patients. For burning, itching feet—cracking, peeling skin... get QUINSANA quick!

Soothes, cools
tired feet!



49¢
TAX FREE

LOW OVERHEAD-LARGE VOLUME SALES & SMALL PROFITS
BRING YOU THESE "LOWEST PRICES."

WHAT GOOD IS A TIRE WITHOUT A TUBE?

TUBE GIVEN WITH EVERY TIRE AT NO EXTRA COST

Why Pay More!



SPRING SPECIALS—AT LOW PRICES
SAVE TIME — SAVE MONEY — SEND THIS AD
GOOD USED TIRES — NOT RECAPS
19 YEARS AT THIS ADDRESS

Be Wise—A TRIAL OF ONE TIRE WILL CONVINCE YOU.

EVERYBODY MAY TAKE 10% off ON EVERY TIRE

20 MONTHS WRITTEN GUARANTEE



600-16	\$4.12	820-15	\$5.32	600-20	\$7.02	32x8(8)	\$8.52
650-16	5.52	700-15	4.52	650-20	7.82	32x6(10)	9.82
700-16	5.02	670-15	4.42	700-20	8.42	900-20	13.12
650-15	4.32	710-15	4.62	750-20	8.52	1000-20	13.72
760-15	4.92	550-17	4.42	825-20	14.62	1100-20	13.82

EXTRA SPECIAL —		30 MONTH WRITTEN GUARANTEE	
600-16	\$5.32	475-19	\$4.82
600-16(6)	6.42	640-15	5.02
650-16	5.82	670-15	5.52
650-16(6)	7.32	710-15	5.72
700-16	6.42	760-15	6.02
750-16	9.22	800-15	6.52
525-18	4.72	820-15	6.62
550-17	4.72	870-16	6.32
650-15	5.32	760-16	7.12
700-15	5.42	700-16(6)	7.62
White Walls	\$1.00 extra	Military treads	750-20
700-15(6)	\$8.92	700-20	\$11.02
750-16(8)	10.72	750-20(10)	15.42
700-17	9.92	750-20(8)	15.02
750-17	11.72	825-20	18.32
750-15	13.92	900-20	17.22
825-15	12.92	1000-20	17.72
600-20	8.72	1100-20	19.52
650-20	10.22	1000-22	19.42
32x8(8)	11.12	1100-22	20.42
32x6(10)	11.72	1100-22	20.42
		1100-22	20.42

Thousands of tires shipped all over U.S.A. All tires shipped F.O.B. Phila. Send Check or M.O. with this ad. Dept. 2.
STANDARD 834 N. Broad St., Philadelphia 30, Pa.

BECOME AN EXPERT IN TRAFFIC

Traffic men earn \$4,000 to \$10,000 and up. Thousands of firms need experts on rates, tariffs, regulations. We train you thoroly in spare time at home for executive traffic jobs. Personal training under traffic authorities. Placement counsel and help. Write for free 48-page book "Traffic Management—the Fast Growing Profession."

LASALLE Extension University, 417 So. Dearborn St.
A Correspondence Institution Dept. 564-T Chicago 5, Ill.

"I HAVE EARNED \$15.20 AN HOUR"
AN AVERAGE OF



with Science's New Midget Miracle, the Presto Fire Extinguisher, says W. F. Wydallis, Ohio

Many others "cleaning up" — so can you! Amazing tiny new extinguisher ends fires fast as 2 seconds. Guaranteed 20 years! Sells for only \$3.98! Write for FREE Sales Kit. No obligation. Merlite Industries, Inc., Dept. 55, 201 East 16th Street, New York 3, N. Y. (If you want a regular Presto to use as a demonstrator send \$2.50. Money back if you wish.)



Become a MENTAL SUPERMAN

OVERNIGHT! It's uncanny! Revolutionary! FREE LITERATURE!
BIJOU STUDIO, BOX 1727-M-6, HOLLYWOOD 28, CAL.

You can earn a
HIGH SCHOOL DIPLOMA

IN YOUR
SPARE TIME,
IN YOUR
OWN HOME!

No classes—all materials furnished. Certified teachers. Diploma awarded. Write today for complete information.

SOUTHERN STATES ACADEMY
BOX 144-M, STA. E ATLANTA, GA.

LEARN WATCH REPAIRING



AT HOME. By our modern and original system of instruction you can learn every part of the WATCH REPAIRING TRADE AT HOME. Prepare yourself for a well-paying position or start in business after completing our course of instruction. Good watch repairers are in demand and generally earn very good salaries. For particulars apply to the

WISCONSIN SCHOOL OF WATCH REPAIRING
759 N. Milwaukee St., Milwaukee 2, Wis.

Learn PHOTOGRAPHY at Home

Splendid opportunities. Prepare in spare time. Practical basic training. Long-established school. Send for free book, "Opportunities in Photography." No obligation.
AMERICAN SCHOOL OF PHOTOGRAPHY, 835 Diversey Pkwy., Dept. 1355, Chicago 14, Ill.

Now YOU can PICK your JOB with a BIG PAY Future in INDUSTRY

TOOL ENGINEER
•
TOOL & DIE DESIGNER
•
MACHINE DESIGNER
•
INDUSTRIAL ENGINEER
•
INDUSTRIAL DRAFTSMAN
•
MASTER MACHINIST
•
TOOL & DIE MAKER

Yes, you can pick your job now! Industry is expanding so rapidly there are more good paying jobs than there are trained men to fill them. Shortages of Draftsmen, Designers, Tool Engineers, Machinists, Tool & Die Makers are so widespread that you can pick one of these highly paid key jobs—and then look forward to a lifetime of Achievement and Security!

Due to the enormous present-day expansion in the field of Tool Engineering, Industry has been clamoring for Allied-trained men to fill important jobs in the industrial fields.

Allied courses are integrated so that you can either study at your home or at the Allied Institute. You may enroll in our short term courses — or you may continue with training that will lead you progressively to a degree of Bachelor of Tool Engineering in twenty-six months.

ALLIED is approved by Industry, the American Society of Tool Engineers, Department of Education and Registration, the Department of Public Instruction — State of Illinois and the Veterans Administration.

Accredited by the Central Schools Association.

Free employment service and housing assistance all through your training period and after your graduation. Our industrial contacts cover the U. S. A.



send for **FREE BOOKS**

ALLIED SCHOOL of Mechanical Trades

1338 42 S. Michigan Ave.
Chicago 5, Illinois



ALLIED TRAINED MEN GET GOOD PAYING KEY JOBS

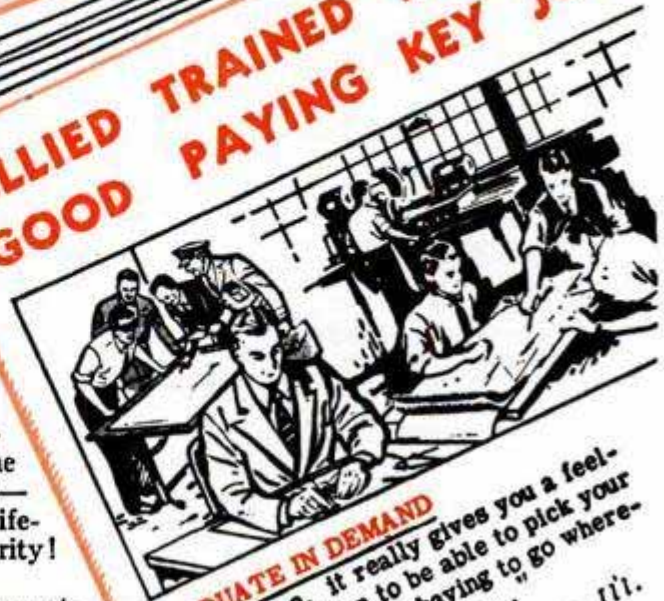

GRADUATE IN DEMAND

"Believe me, it really gives you a feeling of satisfaction to be able to pick your employer instead of having to go wherever you can to get a job...."

Dave Nickels, Dundee, Ill.

PRACTICAL TRAINING

"I am employed as an aircraft draftsman and junior engineer. Thanks to Allied and the excellent instruction I received there..."

R. Clugston, Joliet, Ill.

EMPLOYER IMPRESSED

"My employer was impressed with my practical knowledge and drafting skill. Both of these I learned at Allied having never worked in the die design field..."

Frank E. Myers, Maywood, Ill.

ALLIED SCHOOL of MECHANICAL TRADES
ALLIED INSTITUTE of TECHNOLOGY
1338-42 S. MICHIGAN AVE., Dept. PM-5
CHICAGO 5, ILL.

GENTLEMEN.

I WANT TO GET INTO IMPORTANT INDUSTRIAL TRADES AND PROFESSIONS.

SEND ME WITHOUT OBLIGATION YOUR FREE BOOKS EXPLAINING ALLIED'S COURSE OF INSTRUCTION.

I AM INTERESTED IN RESIDENT TRAINING.

I AM INTERESTED IN HOME STUDY TRAINING.

I AM ELIGIBLE I AM NOT ELIGIBLE FOR TRAINING UNDER G. I. BILL.

Name _____ Age _____

Address _____

City _____ State _____

INVENTORS

Your first step—if you consider your invention to be something of importance—is to have a search made of pertinent, prior U. S. patents. If our search report indicates probable patentability of your invention, you may apply for a patent which gives you the right to exclude others from making, using or selling your invention as claimed for a term of 17 years.

This firm is registered to practice before the U. S. Patent Office and is available to assist in the preparation of the necessary drawings, specification and claims.

Ask for a copy of our instructive booklet "Patent Protection for Inventors" and our convenient "Evidence of Invention" form. No obligation.

VICTOR J. EVANS & Co. *Merlin M. Evans*
REGISTERED PATENT ATTORNEY
830-E MERLIN BUILDING, WASHINGTON 6, D. C.

LOCKSMITHING & Key Making



PRACTICAL UP-TO-DATE COURSE—ONLY \$4.95

Easy-to-learn modern information for self-instruction. How to work on locks, de-code, make master-keys, repair, install, service, etc. For every handyman, home owner, carpenter, mechanic, service station operator, fix-it shop, hardware dealer, gunsmith, 53 plain illustrated lessons. **FULL PRICE ONLY \$4.95. SEND NO MONEY.**

Just pay postman plus C.O.D. postage. Or send \$4.95 with order, we'll ship postpaid. Satisfaction guaranteed or refund.

NEELSON-HALL CO., 210 S. Clinton Ct., Dept. EX-2, Chicago 5, Ill.

SAY YOU SAW IT IN POPULAR MECHANICS

Learn **ELECTRIC APPLIANCE REPAIR** IN YOUR SPARE TIME AT HOME

START YOUR OWN BUSINESS WITH A POTENTIAL MARKET OF 50,000,000 CUSTOMERS

ONE BUSINESS THAT IS NOT AFFECTED BY STRIKES, DEPRESSIONS OR POLITICS

New shop-method, home-training system gives you electrical know-how that used to take years to learn. Learn at home by building valuable testing kits, repairing your own and neighbors' appliances. It is not unusual for appliance repairmen to charge on the basis of \$5.00-\$6.00 an hour.

FREE ILLUSTRATED BOOK
Shows you how you learn every phase of electrical appliance. How to make money while you learn. Write today for your FREE copy.

CHRISTY TRADES SCHOOL
Dept. D-1803
4432 North Kedzie Ave., Chicago 25

INVENTORS

IF YOU WISH TO PROTECT YOUR INVENTION, You should take steps to protect it by a U. S. Patent. Write me for "INVENTION RECORD" form

CARL MILLER
REGISTERED PATENT ATTORNEY

WOOLWORTH BLDG., 35th FLOOR, 53A
NEW YORK CITY

PATENTS
C.A. SNOW & CO.
REGISTERED PATENT ATTORNEYS
WRITE FOR INFORMATION TO
428 SNOW BUILDING, WASHINGTON 1, D. C.

INVENTORS

Whether an invention is patentable can be substantially determined by a search of the U. S. Patent records. Without obligation, write for information explaining the steps you should take to secure a patent.

JOHN N. RANDOLPH

Registered Patent Attorney

201 Columbian Building, Washington 1, D. C.

INVENTORS

Send for **PATENT INFORMATION** Book and **INVENTOR'S RECORD** without obligation

GUSTAVE MILLER
53-PM WARNER BUILDING
WASHINGTON 4, D. C.

REGISTERED PATENT ATTORNEY
Patent Attorney & Advisor
U. S. NAVY DEPT. 1930-1947
ASSOCIATE EXAMINER
U. S. PAT. OFF. 1922-1929
PATENT LAWYER

INVENTIONS WANTED AT ONCE

If you want to market, or sell, your invention for cash or royalties, Write for our Free Booklet. Send no drawings. We also welcome hearing from firms, or private capital, wishing to review inventions in any field. We will be glad to send notice of our clients' inventions.

GLOBAL MARKETING SERVICE

1404 Mitchell Street Dept. PD Oakland 1, Calif.

CASH-IN-ON-YOUR-IDEAS

Reputable manufacturers, nation-wide look to us for your gadgets, patented or not. Get step by step helpful instructions before you go to expense of patents. "The Inventor's Guide" tells how to develop, protect, make money from your inventions. Send only \$1.00 for your book. Includes list of needed products, "Record of Invention" form. Act today!

INVENTORS CREATIVE SERVICE
Dept. PM, 354 South Spring St., L.A. 13, Calif.

INVENTORS

I shall be pleased to furnish you, upon request, with full information relative to patent procedure—without any obligation on your part.

PATRICK D. BEAVERS

Registered Patent Attorney

934 Columbian Building Washington 1, D. C.

HOT WATER AUTOMATICALLY FROM YOUR PRESENT TANK!

With Thermostat-Controlled Electric Heater

- Clean, reliable! No dirt, grime, soot, flame!
- SAFE! Every part UL approved!
- Install it yourself in 10 minutes! — No New Tanks or Plumbing Required!
- No watching! Set thermostat at temperature desired. Adjustable from 100-180 degrees.
- Save on fuel bills!
- Works automatically, only when needed . . . no wasted electricity!
- Fits all 20 to 80-gallon tanks!

No matter what kind of heating system you own—now you can have HOT WATER automatically — 24 hours a day — from your present hot water tank! The secret is LECTROMATIC, amazing new UL-approved heating element that changes your present gas, coal or oil-burning water heater into a modern ALL-ELECTRIC unit. Nothing could be simpler to install and maintain; simply screw the unit into the most convenient tap flange in your tank, plug the cord in nearest 110-volt AC outlet. (220-volt model also available at same price.) The rest is automatic because thermostat turns unit on and off as water is used, doesn't waste one second of power! Uses only 1/4 to 1/2c electricity per gallon of steaming hot water. Heater is 9 1/2" long. Thread 1" pipe size, outside dimension 1 1/4", same as your tank. Guaranteed to fit!

LECTROMATIC HEATER is built for years and years of trouble-free service and is fully guaranteed for one year. Send no money, pay postman only \$19.95 plus delivery on arrival. You must be completely delighted with your unit, or you may return it for full refund within 10 days. You risk nothing, so ORDER NOW! Just fill in and MAIL THE COUPON TODAY!

PLENTY OF HOT WATER ALL DAY LONG!

COMPLETE
Ready to plug in.
ONLY \$19.95
(also 2,000 watt 220-volt model for BX cable \$19.95.)



How to Install In 10 Minutes

1. Shut off water.
 2. Remove plug from water tank.
 3. Screw LECTROMATIC into opening (as illustrated).
 4. Plug in!
- (Simple illustrated instruction sheet included with each order).

COLLOID EQUIPMENT CO., Inc., Dept. PM-5, 50 Church St., New York 7, N.Y.

Please send me 110-volt LECTROMATIC Water Heater with instructions. I will pay only \$19.95 plus delivery charges on arrival. I must be completely satisfied or I may return the unit for full refund within 10 days. If I keep it, I understand it is guaranteed for 1 year against defects of any kind, and warranted for 10 years.

- Check here if 220-volt model is desired, \$19.95.
- I enclose \$19.95 to save delivery charges. Same refund privilege, guarantee and warranty!

Name _____
Address _____
City _____ Zone _____ State _____

NEW V.B.L. MACHINE -GIVES YOU \$50.00 FOR SPARE TIME

GET THE EXTRA INCOME YOU NEED THIS QUICK WAY AT HOME

There is BIG MONEY in the amazing new business of cleaning Venetian Blinds under mass production method with new patented Venetian Blind Laundering Machine. Homes, hotels, offices, institutions give you their blinds to clean regularly. Machine bringing \$50.00 to \$100.00 for spare evening hours in a single week—\$1,000 a month and more to full time operators. No experience needed. Low down payment starts you at once and lets you pay as you grow. Write for amazing facts at once.

VENETIAN BLIND LAUNDRY EQUIPMENT CO.

442 N. Seneca St. Dept. 10-E Wichita 12, Kansas

HAVE MORE FUN TRAVELING

DINSMORE AUTO COMPASSES are a constant source of information, interest and education. Passengers love it! Saves time, worry. No back-track, no wrong turns. Quickly installed. You'll enjoy every minute of driving with America's first and finest auto compass. Precision made and fully jeweled with micromatic compensator. Only \$5.49. ILLUMINATED. Send for name of nearest dealer.

FREE Folder on compasses for the hunter, camper, fisherman, sailor, plus a history of the compass, "Pants, knives and Compasses." Send for your copy today.



DINSMORE INSTRUMENT COMPANY 1802-29 Kelso St. Flint 1, Michigan

Weights less than 1 lb.!

HIP POCKET GYM

Skinny? Build yourself up! Fat? Reduce—turn fat to muscle! Helps body build itself. Simple—Easy! Women—even children can use it. No nailing on walls—no crawling on floors! A few minutes a day rids you of "tired, run-down feeling". Builds health in Veterans Hospitals. Made of pure natural rubber. Light, compact—take it wherever you go! 5 Day Money Back Guarantee PLUS FREE Health & Strength Instructions. MAJOR LEAGUE SUPPLIERS, DEPT. PM5, 58 EAST 11th ST., N. Y. 3, N. Y.

Now Only \$3.95 Postpaid Sold at \$5.95 Nationally

PREPARE FOR BETTER JOB, BIGGER PAY IN SPARE TIME AT HOME

Today, choose the job you want—and prepare for it in time you might otherwise waste. Or if you are already in the work you like best, start training now for quicker promotion and increased pay. During more than 50 years AMERICAN SCHOOL has helped ambitious people to reach higher goals. Check subject that interests you and mail coupon for full information.

AMERICAN SCHOOL, Dept. G545, Drexel at 58th, Chicago 37, Ill.

Without obligation, please send FREE and postpaid, full particulars about the subject checked below.

- | | |
|--------------------------|----------------------|
| Accounting | Plastics Engineering |
| Air Conditioning | Plumbing—Practical |
| Architecture & Building | Private Secretary |
| Automotive Technician | Refrigeration |
| Better Foremanship | Retail Merchandising |
| Bookkeeping | Salesmanship—Outside |
| Business Management | Sheet Metal Work |
| Contracting | Tool Making |
| Diesel Technician | |
| Drafting—Building Trades | |
| Drafting—Machine Trades | |
| Electrical Engineering | |
| Electronics—Practical | |
| Electronics—Industrial | |
| High School Courses | |
| Machine Shop Operations | |
| Mathematics & Slide Rule | |
| Mechanical Engineering | |

NAME _____ OCCUPATION _____
HOME ADDRESS _____ AGE _____
CITY _____ STATE _____

MAIL COUPON NOW

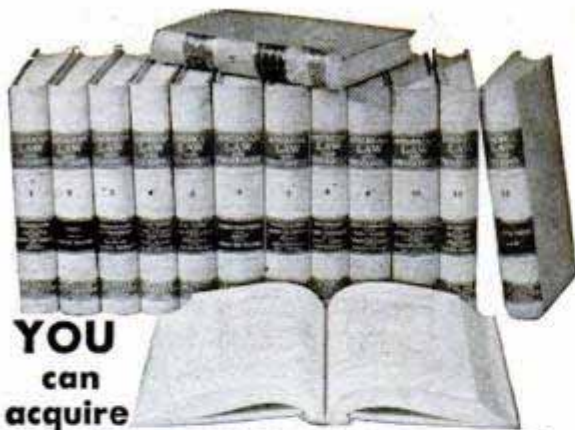

**YOU
can
acquire**

**LAW NIGHTS AT HOME!
L. B. DEGREE**

LaSalle's famous Law Library—used as reference in many Law libraries and Law offices—has enabled thousands to master Law surprisingly fast, in spare hours at home, for business and professional advancement.

These 14 remarkable volumes, compiled by leading professors and lawyers, cover the whole basic field of Law in condensed, orderly, simplified manner.

You advance rapidly with this great library, plus special lectures furnished. We guide you step-by-step with personalized Problem Method of instruction . . . you *learn by doing*—handling legal problems—not by memorizing rules.

Send for two FREE 48-page booklets, "Law Training for Leadership," and "Evidence," answering questions about Law and its value to you, and telling how LaSalle Law graduates are winning rapid advancement in business and public life. Mail coupon below. No obligation.

**LA SALLE EXTENSION UNIVERSITY
A Correspondence Institution**

417 S. Dearborn St. Dept. 564-L Chicago 5, Ill.

Send me your two FREE booklets described above, without obligation.

Name.....Age.....

Street.....

City, Zone & State.....



Aren't YOU as SICK and Tired as I was of being SKINNY-

Then DO as I did. Mail Coupon below I gained 53 lbs. of Mighty Muscle I added 6 1/2 inches to my CHEST 3 inches to each ARM by using the JOWETT SYSTEM

That's what Roger Hirsch a 112 lb. 6 ft. weakling did—Look at him NOW in a few short weeks. In 10 pleasant minutes a day in your own home—Let me make you a winner at anything you tackle with progressive power. I'll give you a NEW HE-MAN Body for your OLD SKELETON FRAME.

Send me only **10¢**

And Get All 5 Picture-Packed HE-MAN BUILDING COURSES and also get

JOWETT Builder of HE-MEN



FREE PHOTO BOOK of Strong Men and a MUSCLE METER

JOWETT INSTITUTE, Dept. PM-35 220 Fifth Avenue, New York 1, N.Y.

Dear George: Please mail to me prepaid FREE Jowett's Photo Book of Strong Men, a Muscle Meter, plus all 5 Muscle Building Courses, "How to Become a Mighty He-Man." ENCLOSED FIND 10¢ in complete payment for EVERYTHING.

NAME.....AGE..... (Please print plainly, include Zone Number)

ADDRESS.....No C.O.D.'s

CITY.....ZONE & STATE.....

A BIG BUSINESS FOR YOU FREE!

You Can Be The Maryland BOOK MATCH BROKER IN YOUR TERRITORY

If you are now selling anything at all to business men write us at once for plan to make every call pay **double** profits. One of greatest names in industry has openings for more Book Match Brokers. Write your own ticket on income—get in on this big money business. **Only Maryland offers Double Book Matches with Famous Glamour Girl Covers.** We give you the greatest line ever seen. Huge quantity buyers in every territory. Big Sales Kit puts you in a business of your own at once—full time, spare time or sideline. Write for Free Selling Outfit today.



MARYLAND MATCH CO., Dept. 65
1100 S. EUTAW STREET, BALTIMORE 30, MARYLAND

NOW LEARN TV-RADIO Servicing AT HOME!

EARN WHILE YOU LEARN! No previous training needed. New, simplified lessons with complete parts kits. Build your own TV set! A leading school, approved for Korean vets. Also Residential Course (day & eve. classes). Send for FREE sample lessons and full details on a profitable, thrilling career. Write Dept. B5

CRESCENT SCHOOL

500 PACIFIC ST. BROOKLYN 17, N. Y.



MECHANICAL DENTISTRY

A profession offering unlimited opportunities. Most modern and complete course embracing every branch from Plate to Porcelain Work, which prepares you to work for Dentists or start your own business. Individual instruction—practical training in day or night school. No books—no classes. Catalog upon request.

McCARRIE SCHOOL OF MECHANICAL DENTISTRY, 207 N. Broad Street Dept. 17 Philadelphia 7, Penna.



You can play the GUITAR!

COWBOY-FOLKSONG STYLE

IN TEN EASY LESSONS WITH MY NEW, AMAZING, SIMPLE METHOD, KNOWLEDGE OF MUSIC IS NOT NECESSARY. IMAGINE YOURSELF PLAYING "HOME ON THE RANGE" IN JUST A FEW HAPPY HOURS OF PRACTICE. . . . ONLY \$1.00 (ADD 10¢ FOR POSTAGE) • SEND TO PIERCE GUITAR METHODS-5812 MARKET ST. SAN DIEGO 14, CALIF.



Here's Why IT'S SO PRACTICAL!

- Has only 2 moving parts
- No hidden springs • Hygienic
- Perspiration Proof • Non-Corrosive
- Non-Magnetic • Conforms to the wrist — most comfortable to wear
- Fully guaranteed

RESILIENT STAINLESS STEEL Contour CLASP-ON WATCH BAND FOR MEN

No. 1 Stainless Steel adjustable Plain Clips **\$3.95**

"The Guardsman" No. 2 With Beautifully Embossed Stainless Steel Clips **\$4.95**

WRIST SIZES Small 6 1/4" — Medium 6 3/4" — Large 7" At your Jeweler or write direct Illustrated Brochure on request

Don Juan WATCH BANDS 29 E. MADISON ST. CHICAGO 2, ILL.

ONE MAN FACTORY AT HOME

*you can learn
in one hour!*

Let me show you how to make \$20 to \$30 a day in your own spare time

PLASTIC LAMINATING BUSINESS

Start on a shoestring... Fascinating, light work that can turn into a family enterprise!

If you've been looking for a way to increase your income without giving up your regular job... or have ever given thought to starting a business of your own that you could easily operate from your home—but which can grow into a big, independent business... then send your name and address to me now for complete facts on how to get into the fabulous new field of Plastic Sealing and Plastic Laminating for pleasure and profit! Here is a business opportunity that is brand new. There is almost no competition... and yet the amazing fact is that you can get into it "on a shoestring" and join the few men who are already making good steady money. It's so intriguing... so fascinating... that others in your family will be begging for the opportunity to help! Anyone... regardless of age, education or experience... can turn out professional work after one hour's practice and start at once getting orders and money by mail!

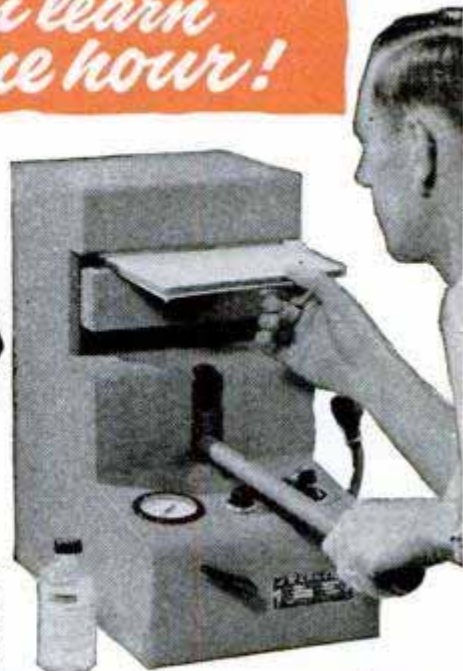

MAKE BIG MONEY ... THESE THREE WAYS

We show you exactly how to sell the things you make. No house-to-house canvassing. No face-to-face selling. Scores of stores take orders for you. Business men buy from you. We tell you how to contact them... how to get business by seven different plans in 3 enormous markets.

MAGIC MAIL PLAN
brings business to you
Imagine a business where orders and \$5, \$10 and \$20 bills come to you in the mail. No time wasted "selling" your products in person! Warner's Magic Mail Plan gets you money and business all over America. Facts are free!

HUGE PROFITS in Sealing! Millions of people want to protect valuable cards, photographs, documents and papers against wear, soil and damage. Details of the plan for this market will amaze you. Mail orders in this one market can keep you busy!

BIG VOLUME IN SIGNS! This market is bigger than you ever imagined! Merchants and businesses of all kinds require signs for windows and counters. THE WARNER PLAN tells you how to cash in on this big market.

GIFTWARE MARKET IS LIMITLESS! It's impossible to list or catalog the thousands of gorgeous giftwares that can be made by Laminating—Costume Jewelry, Trays, Cuff Links, Lamp Bases, Cigarette Boxes, etc... breathtakingly beautiful art creations stores will eagerly sell for you.

FACTS ARE FREE! SEND NAME! You don't have to wonder whether this opportunity to gain independence in a family-owned home operated business is for you. We won't even consider setting a man up in this business until he's gotten all the facts... until he's thoroughly investigated it and has proof for himself that with the amazing Warner Laminator he can get into this one-man manufacturing business that pays \$10 to \$20 for each dollar of material cost. Get the facts at once. All information, fully illustrated with pictures, is free. Send the coupon—or your name on a postcard. Everything we send you now is FREE and by mail. No salesman will call. You decide alone!

WRITE TODAY!
**WARNER
ELECTRIC CO.**
DEPT. L-105
1512 Jarvis Avenue
Chicago 26, Ill.

**WARNER ELECTRIC CO., Dept. L-105
1512 Jarvis Ave., Chicago 26, Ill.**

At no cost to me, please rush complete details on the money possibilities in Plastic Laminating, postage prepaid. I am under no obligation whatsoever.

NAME _____
ADDRESS _____
CITY _____ ZONE _____ STATE _____



If Ruptured

and No Lasting Relief, even after surgery, practice holding back your rupture or ruptures with both hands and fingers as illustrated. If this Delightful No Rupture Sensation Is What You Want write for Free literature now! Why keep on experimenting until you become another Rupture invalid!

FRED B. MILLER, Mfr.
Dept. 61, Hagerstown, Maryland.



Learn BAKING At Home

Baking is one of America's high industries in wages. Nearly depression-proof. Thorough basic home course lays sound foundation. If you have aptitude, write for FREE BOOKLET, "Opportunities in Commercial Baking."

NATIONAL BAKING SCHOOL
835 Diversey Parkway Dept. 1355 Chicago 14, Ill.



LOCK! A MILLION THRILLS!



**High Power
BINOCULARS**
30 DAY FREE TRIAL

Finest Precision Optics
Featherlight
Guaranteed Savings
Money Back Guarantee
Easy Pay Plan

Compare Before You Buy!
Dealer Name on Request.

BUSHNELL Binoculars FREE BOOK & COLOR CATALOG

Bushnell Bldg., Dept. M65
Pasadena 1, Calif.

FREE BOOK AND COLOR CATALOG
NAME _____ CITY _____
ADDRESS _____ STATE _____

Insist on KNICKERBOCKER REPEATING WATER PISTOLS!

"Western
Style"

Ask for them at
your favorite
toy counter.



Authentic Western six-shooter
style. Fires 300 shots without
reloading. 7 $\frac{7}{8}$ inches
long. Assorted colors. **\$.49**

"Super
Jet"



Fires 250 shots without reload-
ing. Transparent plastic
allows view of water. 7
inches long. Colors:
red, yellow or green. **\$.49**

"Space
Jet"



Styled for the space ship era.
Fires 150 shots without re-
loading. 5 $\frac{3}{8}$ inches long.
Assorted colors. **\$.39**

"Sneaker
Model"



Palm Size
Fires 150 shots without reload-
ing. Transparent plastic
allows view of water. 4 $\frac{1}{8}$
inches long. Colors:
red, yellow or green. **\$.39**



Available at toy, novelty and variety
stores or write for the name of your
nearest dealer. No mail orders, please.

KNICKERBOCKER PLASTIC COMPANY

4101 San Fernando Road, Glendale 4, California



BRAND NEW! Firestone TIRES

SAVE
UP TO 50%

BRAND NEW FIRST LINE
HEAVY DUTY
TRUCK TIRES
FIRST QUALITY
FIRESTONE CHAMPION
Delivery Sizes Full Price
700x15 6 ply \$24.04
700x15 8 ply 26.22
600x16 6 ply 16.01

650x16 6 ply	\$19.56	750x20 10 ply	\$47.12
700x17 6 ply	29.21	825x20 10 ply	55.92
700x18 8 ply	33.65	825x20 12 ply	66.34
600x20 6 ply	23.23	900x20 10 ply	67.39
600x20 8 ply	25.44	900x20 12 ply	78.35
650x20 6 ply	25.94	1000x20 12 ply	85.31
650x20 8 ply	31.47	1100x20 12 ply	100.06
700x20 8 ply	34.30	1000x22 12 ply	89.85
700x20 10 ply	39.71	1100x22 12 ply	105.79
750x20 8 ply	43.14	1100x24 12 ply	109.99

BRAND NEW FIRST QUALITY FIRESTONE TIRES

640x15	\$12.11
650x15	14.62
670x15	12.82
710x15	14.17
760x15	15.49
600x16	11.40
650x16	15.09

WHITE WALL TIRES — SPECIAL!
(Factory Blemish) First Line, 4 ply Passenger
670x15 \$15.65 | 760x15 \$18.95
710x15 17.32 | 800x15 20.92
SPECIAL! — SPECIAL!
BRAND NEW —
4 ply Passenger \$18.95
(all prices f.o.b. plant)

All tires covered by Famous Firestone Unconditional Guarantee

S & S TIRE CO.

1400 HADDON AVE.
CAMDEN 3, N. J.



A "GOOD HAND" HELPS YOU SUCCEED! LEARN TO WRITE WELL

Your Name
beautifully
written, plus
special pen-
point for
shaded
writing.
Only 10¢

Handwriting quickly improves with our easy-to-
understand picture lessons! Put your spare time
to good use; send today for FREE BOOKLET
"How to Become a Good Penman," or check vol-
umes wanted below at \$1 each: Business
Writing Artistic Writing Card Writing
 Bird & Design Flourishing Engraving
Alphabets. COMPLETE SET \$4.50. Ask for
price list of penman's supplies.

OUR 53rd YEAR
TAMBLYN SCHOOL of PENMANSHIP
S.A. Ziller, Pres., 442 Ridge Bldg., Kansas City, Mo., USA

TASOPE PHOTO-ENGRAVING PLANTS



Establish your own profitable PHOTO-EN-
GRAVING business. Make cuts for newspapers,
printers, and advertisers. Make etched name
plates, plaques etc. Instructions furnished, no
experience necessary. Sold direct from factory
since 1931. First five hundred cuts sold locally
or by mail will pay for plant and pay you well
for your time. Write for FREE catalog.

Material Cost
Of This Cut 3/4¢
Selling Price
\$1.00 And Up

TASOPE DEPT. PMS, AURORA, MO.

GET INTO TELEVISION

BIG JOBS AT TOP PAY

Earn to \$125 as a TV service man! Over 20,000 jobs
waiting now—100,000 by 1955! C.T.I. trains you at
home. You build (and keep) a 17-in. receiver. Parts
sent. Free job placement. Write for valuable booklet.

COMMERCIAL TRADES INSTITUTE, Dept. T2-5
1400 Greenleaf Avenue • Chicago 26, Illinois

\$199 STARTS YOUR OWN BUSINESS

WITH A Jetspray VENETIAN BLIND LAUNDRY



1,000 LBS. FREE DETERGENT!!
MAKE UP TO \$75.00 A DAY
In This New Fast Growing Industry

Use latest lowest priced professional
unit engineered by inventor, world's larg-
est manufacturer of venetian blind clean-
ing equipment. Beware of imitations.
JETSPRAY is incomparable—re-uses de-
tergent. Cleans quickly without rubbing or
taking blind apart. Homes, factories, etc.,
want this fast low cost service. Start in
basement or garage — expand as business
grows.

BIG PROFITS - - - UNLIMITED OPPORTUNITIES
NO EXPERIENCE NECESSARY - WE SHOW YOU
Write today—learn how you can be independent in your own business.

L. C. ROBINSON MFG. CO.
522 N. Rural St. Dept. M-5 Indianapolis 1, Indiana

POPULAR MECHANICS

MEN WANTED!



Make \$15-\$20 in Few Hours
Spare Time—up to \$21000 a
Week FULL TIME — with Amazing
D-FROST-O-MATIC!

Millions of housewives want this sensational new Automatic Refrigerator Defroster! No more messy hand defrosting! Just plug in D-FROST-O-MATIC and refrigerator is defrosted automatically every night! Sales easy, sure when you leave D-FROST-O-MATIC on FREE TRIAL—housewives won't let you take it out! Saves money, food, time, work! **Big profits for you**—up to \$210.00 a week full time—\$15 to \$20 in just a few spare hours! Start spare time and build big, prosperous business . . . quickly, easily!

SELLY of California
started in his spare time and now sells 1500 D-Frost-O-Matics a month!

Rush Name Today for Profit Details and FREE TRIAL PLAN!

More than 29,000,000 prospects waiting! Rush your name and address today. We'll airmail exciting facts, proof and sure-profit Free Trial plan. No obligation. Write today.
D-FROST-O-MATIC, Dept. B-6
173 W. Madison Street, Chicago 2, Ill.

FOREIGN EMPLOYMENT

MEN-WOMEN all ages, higher pay, greater opportunities to work in foreign countries. All trades and professions needed in Africa, Asia, South America, Europe, Australia, Canada, Alaska. **MEN, WOMEN** send for FREE information, no obligation.

TURNER FOREIGN BUREAU CO., Dept. 66
---246 FIFTH AVE., NEW YORK CITY---

MAKE CRIME YOUR BUSINESS

ON THE SIDE OF THE LAW!

Help fight crime! . . . Earn steady good pay as a Finger Print Expert or Investigator. I. A. S. trains you—by easy, low-cost home study lessons. Learn this exciting work in spare time. Write for full details now!

OVER 800 POLICE BUREAUS . . . Employ I. A. S. trained men . . . proof of what I. A. S. can do. Write today (state age) for details. No obligation. No salesmen will call.
INST. OF APPLIED SCIENCE, 1920 Sunnyside Ave., Dept. 1355 Chicago 40, Ill.

Unusual & Unique items!

★ The mail-order house for **MEN**
★ Send only \$1.00 for Surprise Sample, Lists, and Catalogue.

HOLLYWOOD SALES CO. Dept. A
3414 W. Magnolia Blvd., Burbank, Calif.

Have an OUTDOOR FIREPLACE



Easy to Build—Fun to Use

A real "entertainment spot" for family or guests! Everyone enjoys food cooked outdoors! Following simple instructions you just add masonry in your choice of design or material to a Majestic all-metal unit—and you have the perfect operating, lowest cost outdoor fireplace. Lasts for years! Choice of units from \$20.95. See your dealer or write today.

The Majestic Co., Inc.
350 Erie Street
Huntington, Indiana

SEND ONLY
25¢

for 56 page, fully illustrated
BOOK of DESIGNS and IDEAS



COME TO THE UNIVERSITY OF HOUSTON FOR YOUR TECHNICAL AND VOCATIONAL TRAINING

ONE OF AMERICA'S LARGE AND MOST MODERN UNIVERSITIES

Select from these fascinating fields

- | | |
|---|---|
| <input type="checkbox"/> Aeronautics | Industrial mechanics |
| <input type="checkbox"/> Air conditioning and refrigeration | <input type="checkbox"/> Drafting |
| Automobile trades | <input type="checkbox"/> Machine shop |
| <input type="checkbox"/> Body and paint | <input type="checkbox"/> Welding |
| <input type="checkbox"/> Mechanics | <input type="checkbox"/> Woodworking |
| <input type="checkbox"/> Upholstery and trim | <input type="checkbox"/> Photography |
| <input type="checkbox"/> Diesel | <input type="checkbox"/> Radio |
| <input type="checkbox"/> Electricity | <input type="checkbox"/> Stationary Engineering |
| <input type="checkbox"/> Electronics | <input type="checkbox"/> Television |

PREPARE FOR YOUR FUTURE NOW . . . with the very latest methods and equipment, at the modern University of Houston School of Technology. For entrance: high school diploma, or over 18 and ability to profit from instruction. Beautiful campus—250 wooded acres in Houston, Texas—the city of tomorrow. Full college activities . . . sports . . . social life. Day or night, short or longer courses. Cooperative work and study programs . . . earn part of tuition and expenses with part-time job in your own career field, while you learn. Personal vocational counselling. Diploma or B.A.S. degree on completion—and job placement assistance. Feb., June, Sept., semesters. G.I. approved.—V. A. on campus. Send for Free illustrated brochure now!

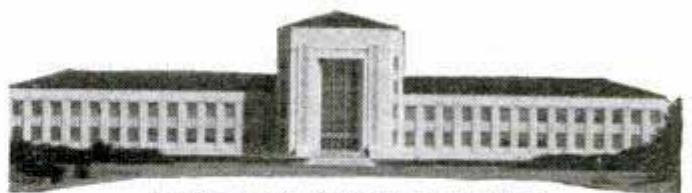

EZEKIEL W. CULLEN BUILDING

University of Houston, School of Technology
Dept. 153—HOUSTON 4, TEXAS

Without cost or obligation, please send me fully-illustrated brochure and full particulars. I am interested in subject marked X above.

Name Age

Address

City State

Save Repairs!

Save Gas!

SAVE MONEY

EVERY MILE YOU DRIVE!



Now you can save on gas—save on repairs! Install a Mile-O-Meter on your dashboard . . . this amazing instrument warns you when you're wasting gas, when your engine needs adjustments to avoid breakdowns. Mile-O-Meter gives you a continuous report on engine condition and performance. Shows you how to get the best mileage your car can deliver. Pays for itself over and over on gas savings alone! Invaluable for engine tune-ups. All fittings and directions are included for simple installation in any car. Send your order in now . . . start saving money every mile you drive!

\$14.95

Deluxe Illuminated.
• 3 1/2" diameter.
• Chrome trim.

\$9.95

Standard Model.
• 2 1/2" diameter.
• Plated trim.

ORDER NOW

SEND DELUXE STANDARD
MILE-O-METERS AT \$

NAME

ADDRESS

CITY

ZONE () STATE

Check Enclosed Money Order Enclosed Send C.O.D.

Orders are shipped within 24 hours anywhere in the U. S. A. We pay postage when payment accompanies order. Add 35c for special delivery, if desired. Each Mile-O-Meter is gift-packaged, with all accessories and instructions included.

GALE HALL ENGINEERING, INC. DEPT. 349
NORTH HAMPTON, NEW HAMPSHIRE

SAY YOU SAW IT IN
POPULAR MECHANICS

GO PLACES
LEARN ANOTHER
LANGUAGE
EASILY - QUICKLY
IN 20 MINUTES A DAY
by **LINGUAPHONE**

World's-Standard CONVERSATIONAL METHOD

FRENCH
SPANISH
GERMAN
RUSSIAN
JAPANESE
NORWEGIAN

—any of
29 Lan-
guages.

Are interesting job, travel, armed services', cultural opportunities passing you by because you speak only one tongue? Learn AT HOME the same natural easy way you learned English long before you went to school. YOU LISTEN—you hear native men and women speak—you understand—YOU SPEAK. World-wide educational, business endorsement; over a million home-study students of all ages. FREE BOOK gives fascinating facts. WRITE TODAY! LINGUAPHONE INSTITUTE, 143-05 Mezz., Rock. Plaza, N. Y. 20.

LINGUAPHONE INSTITUTE, 143-05 Mezz., Rock. Plaza, N. Y. 20, N. Y.

Send me your FREE book. I want to learn _____ language.

Name _____

Address _____

City _____ Zone _____ State _____

OWN
Your Own
Business

\$5 per hour



PATENTED
PORTABLE
EQUIPMENT

Clean and Mothproof rugs and upholstery "in the home" or public buildings. If now employed, you can operate in spare time and build up a permanent profitable full-time business.

Alert dealers can average \$5 hourly gross profit on service they render and \$3 on EACH of their servicemen at National Price Guide charges. Easy to learn . . . quickly established.

DURACLEAN cleans by absorption! No scrubbing, soaking or shrinkage. Dirt and grease vanish . . . matted pile rises . . . colors revive. Furnishings used again same day.

DURAPROOF resists moths and carpet beetles. Your service backed by a National Money Back 4 Year Warranty.

We furnish enough material to return your total investment in War-proof Business. EASY TERMS. Send for FREE booklet TODAY.

DURACLEAN CO., 3-165 DURACLEAN BLDG., DEERFIELD, ILL.

60 POWER TELESCOPE \$3.95

VARIABLE EYEPIECE 20 x 40 x 60 — BRASS BOUND

NEW! Three telescopes in one, 3 different magnifications. 20 power for ultra-bright images with 40 and 60 power for extra long range. Guaranteed to bring distant objects, ships, moon, stars, etc. 60 times as close.



Most powerful for anywhere near the moon. ey. 5 sections. Closes to 1 ft. long. Contains 4 ground and polished lenses. Also used as a powerful compound microscope. Directions included. Mass production enables us to offer this instrument at amazing price of \$3.95 complete. Ready for immediate use. We pay postage. Get yours now.

CRITERION CO. 331 CHURCH ST. DEPT. PMB12 HARTFORD 3, CONN.

Finish HIGH SCHOOL AT HOME

Complete 4 Yrs. in 12 Months

Learn More! Earn More! Enter professional or technical schools. Advance Socially. Live a Happier, Fuller Life. Individual Courses or complete schedule. WRITE FOR SCHOOL BULLETIN.

ACADEMY FOR ADULTS

30 W. Washington, Dept. 53, Chicago, Ill.

MAKE Raising CHINCHILLAS!
MONEY YOU RAISE THEM — WE BUY THEM

Send for free booklet of success stories

NATIONAL CHINCHILLAS, Fullerton 13, California

RUPTURE



RELIEF...OR YOUR MONEY BACK
Original, patented Web,
copied but never matched.
Users say it's best ever. Relief
or no cost to you. Write:

WEB TRUSS CO., Dept. M-5, Hagerstown, Md.



2 WAY ELECTRONIC
INTERCOM SYSTEM

CALLS UP TO 1/2 MILE!

\$2.98

for HOME, CAMP,
SHOP, FARM, OFFICE

PREPAID
COMPLETE
with WIRE

Genuine precision-made electronic phone system, patented after U. S. Armed Services equipment. Not to be confused with toys using string or cord. Clear phone communication house to house; outdoors; outdoors to indoors or vice versa; room to room; top floor to basement. Convertible as microphone or radio-speaker headset. No batteries. Never wears out. Two cabinets & 50 feet finest insulated DOUBLE copper wire (100 ft.), ready to use. No license needed. Try 7 days at our risk. SATISFACTION or your \$2.98 back. Free 4 Power Binoculars and all postage prepaid if you send cash with order; or we ship C.O.D. plus postage. Extra 100 ft. wire free with 2 sets. Write today.

NOT A TOY

FUTURONICS CO., P.O. Box 677, Dept. 103, St. Louis, Mo.

MAKE \$100 A WEEK— SPARE TIME!

Assemble & Install Buckeye Screen & Glass Combination STORM WINDOWS

- Shipped Knocked-Down. Glass & Screen
- Thousands Sold. Panels Interchangeable Summer or Winter
- Redwood or Aluminum.
- Finest Quality.

Make up to \$10.00 an hour SPARE TIME, assembling Buckeye Storm Windows. Sell year 'round—no slack period. Quick, easy to assemble. A sound, legitimate business. You risk nothing; no tools to buy; no big stock needed. We're 20 year-old company, A-1 financially.

Some Attractive Dealer Territories Still Open—Write!

FHA FINANCING THROUGH YOUR BANK
Buckeye Storm Windows can be financed on F.H.A. Plan. Add them to any home for as little as \$5.00 a month. No down payment. See your bank.



You Pay Only \$6.65

For Redwood Storm Window to fit 28 1/2" x 56 1/2" window (screen & glass not included)

THE BUCKEYE SCREEN & WEATHERSTRIP CO.

1380 S. 22nd Street, Columbus, Ohio

HE-MAN VOICE!

STRENGTHEN your voice this tested scientific way. Yes—you may now be able to improve the POWER of your speaking and singing voice . . . in the privacy of your own room! Self-training lessons, mostly silent. No music required.

FREE BOOK Write TODAY for Eugene Feuchtinger's great booklet "How to Develop a Successful Voice." It's absolutely FREE! You must state your age. Booklet mailed postpaid in plain wrapper. No salesman will call. Send your name and age RIGHT NOW! Perfect Voice Institute, 210 S. Clinton St., Studio EX-2, Chicago 6, Ill.



BIG LEATHER & CRAFT CATALOG!

1000's of items for Leathercraft, Textile Painting, Copper Tooling, Kits, Projects, Tools, Supplies, Etc. Send 25c (refunded with 1st order) to:

RUSSO HANDICRAFT SUPPLIES Dept. 11-CD, 245 S. SPRING LOS ANGELES 12, CALIF.

Say You Saw It in Popular Mechanics

Grow with Diesel

and SCIENTIFIC MOTOR TUNE-UP
—One of America's
Fastest-Growing Big-Pay Industries!

Get ready now . . . Make a place for yourself in the mighty Diesel industry. Be there to take advantage of the opportunities ahead. The U.E.I. Plan for learning Diesel is simple, practical and is based upon the principle of learning-to-do-by-doing. Includes Auto Engine Tune-Up. You get fundamentals through spare-time home-study, followed by actual shop practice on modern Diesel engines. Experienced instructors guide you step-by-step — you learn the HOW and WHY of Diesel operation, service and maintenance. Get all the facts—mail the coupon and we'll send you a free copy of "Earning Power in Diesel." Mail coupon today!



UTILITIES ENGINEERING INSTITUTE

Dept. DC-28, (Founded 1927) Chicago 14, Ill.

UTILITIES ENGINEERING INSTITUTE, Dept. DC-28
2521 Sheffield Ave., Chicago 14, Illinois

Please send me, without obligation, your free book, "Earning Power in Diesel."

NAME (print).....AGE.....

ADDRESS

CITY..... Zone..... State.....

Check here for information if you are under 17



TV Receiver takes up to 21-inch picture tube

VETERANS—CIVILIANS PREPARE FOR NEW JOBS IN TELEVISION



L. C. Lane, B.S., M.A.
President, RTTA & Pierce Schools

Many New TV Stations to be Built Soon in Every State Earn While You Learn. My modern training prepares you at home in your spare time . . . often within months. You learn the practical easy way by using actual parts and equipment. Many of my students make \$25.00 a week repairing Radio-TV sets in their spare time while learning . . . start their own profitable service business.

VETERANS!

MY SCHOOLS FULLY APPROVED TO TRAIN VETERANS UNDER NEW G.I. BILL! If discharged after June 27, 1950—CHECK COUPON BELOW! Also approved for RESIDENT TRAINING in New York City . . . qualifies you for full subsistence allowance up to \$160 per month.

- 1. MORE EQUIPMENT!** You build and keep this BIG SCREEN TV RECEIVER, plus Super-Het Radio Receiver, RF Signal Generator, Combination Voltmeter-Ammeter-Ohmmeter, C-W Telephone Receiver, AC-DC Power Supply. Complete with all tubes, including big TV picture tube.
- 2. NEW YORK ROUND TRIP!** Only RTTA gives you a ROUND TRIP TO NEW YORK CITY at NO EXTRA COST! Yes, from anywhere in the continental U.S. or Canada, I'll pay your way to New York and return after you finish your complete Radio-TV course. Get 2 FREE weeks, 50 hours of advanced study at our affiliated PIERCE SCHOOL of Radio.
- 3. FCC LICENSE COACHING COURSE!** Prepares you at home for better pay jobs that require an FCC License. Given to all my students at NO EXTRA COST after TV Theory and Practice.
- 4. ADVANCED FM-TV TRAINING!** For men with previous Armed Forces or civilian radio experience. Advanced Course comes complete with kits, including BIG SCREEN TV RECEIVER and FREE FCC License Coaching Course.



NO SALESMAN WILL CALL!

Mr. Leonard C. Lane, President
RADIO-TELEVISION TRAINING ASSOCIATION
1629 Broadway, New York 19 Dept. M-5
Dear Mr. Lane: Mail me your New Free Book & Sample Lesson. Show me how I can make Big Money in Television. I understand I am under no obligation.
(PLEASE PRINT PLAINLY)

Name.....Age.....

Address.....

City..... Zone..... State.....

CHECK HERE IF: VETERAN NON-VETERAN

MAIL COUPON TODAY for FREE Illustrated Book and Sample Lesson

RADIO-TELEVISION TRAINING ASSOCIATION
1629 Broadway, Radio City Station, New York City 19, N. Y.
LICENSED BY THE STATE OF NEW YORK

**TOOL DESIGNERS • TOOL PLANNERS
PATTERNMAKERS • TOOL & DIE MAKERS
JIG & FIXTURE BUILDERS • MACHINISTS**

Here's Your

FREE TICKET TO SAN DIEGO

Convair, builders of world-famed Convair Liners, military aircraft, guided missiles, needs tool designers, tool planners, pattern makers, tool & die makers, jig & fixture builders, machinists, template makers.

Excellent working conditions: Here's your great opportunity to work in a modern plant on long-range projects at excellent wages. Top-notch retirement plan. Fine health and life insurance.

Wonderful California living: San Diego offers you and your family incomparable living. Ideal climate. Sports aplenty. Beaches, bays, mountains, desert, Mexico and Pacific Ocean surround you. Plenty of good housing — reasonable rents. It's a new way of life — pleasant, refreshing, happy.

Send coupon now for free booklet, "You and Convair" plus your application form. Travel expense to San Diego paid if you qualify.

H. E. Pasek, *Employment Manager*

Convair, 3302 Pacific Hiway, San Diego, Calif., Dept. PM-51

Please send me FREE "You and Convair" and my application form:

NAME _____

OCCUPATION _____

ADDRESS _____

CITY _____ STATE _____

UNLIMITED OPPORTUNITIES IN ENGINEERING

**DEGREE
IN 27 MONTHS**

Study Engineering in this world-famed school. Established 1884. Demand for our graduates exceeds supply. Approved for Korean Vets.

Bachelor of Science Degree in Mechanical, Civil, Electrical, Chemical, Aeronautical, Radio (Television) Engineering; Business Administration and Accounting. Also 36-weeks certificate courses in Surveying and Drafting.

Personalized Instruction. Accelerated courses. Non-essentials eliminated. For ambitious, earnest students. Earn your degree in the shortest possible time. Preparatory courses. Placement service.

Extensive Campus. Well equipped, new and modernized buildings; up-to-date labs. Low cost. New terms start quarterly. Enter June, September, January, March.

Mail Coupon Today

TRI-STATE COLLEGE

453 College Avenue, Angola, Indiana

Please send me free catalog and special information. I am particularly interested in courses as checked:

Mechanical Civil Electrical Chemical Aeronautical
 Radio (Television) Business Administration Accounting
 Short Diploma Courses

Name _____

Address _____

HUGE
VALUABLE
COLLECTION
OF...

BRITISH EMPIRE STAMPS for 25¢

includes Rare MAURITIUS
1935 George V Jubilee!



SOUTHERN RHODESIA
Royal Family Set!

Finest collection ever offered at this low, low price! Includes the rare stamps shown—plus classics from the reign of Queen Victoria (some 65 years old); modern pictorials of George VI; complete set picturing the new Queen Elizabeth! You'll find many hard-to-get stamps from far-away colonies—India, Tokelau Is., etc. A grand total of 139 all-different stamps (reg. \$2.50 value)—all yours for only 25¢ with Bargain Approvals. Money back guarantee. Included, FREE—"Midget Encyclopedia of Stamps."

SEND 25¢ TODAY ASK FOR LOT F0-6
ZENITH CO., 81 Willoughby St., Brooklyn 1, N. Y.

REAL ESTATE BE A BROKER

PAYS BIG! SEND FOR FREE, BIG, ILLUSTRATED CATALOG NOW! Graduates report making substantial incomes. Start and run your own business quickly. Men, women of all ages, learn easily. Course covers Sales, Property Management, Appraising, Loans, Mortgages, and related subjects. STUDY AT HOME or in classrooms in leading cities. Diploma awarded. Write TODAY for free book! No obligation.

WEAVER SCHOOL OF REAL ESTATE (Est. 1936)
Suite 300 Law Bldg. Dept. PM Kansas City, Mo.



Learn CARTOONING

HAVE FUN! MAKE MONEY! Cash in on your sense of humor at HOME — BY MAIL. No experience needed to start. Write today for FREE TRIAL LESSON and full particulars.

Moon Gag Cartoon School, Dept. K, Fall Creek, Wis.



RAISE RABBITS A FULL TIME BUSINESS OR WELL PAID HOBBY

Thousands of Raisers Needed To Meet The Tremendous Demand For MEAT — FUR — LABORATORY — BREEDING STOCK.

Know the Facts Illustrated Book Describing 25 Breeds, Breeding and Care, Markets, Etc. 10 Cents. We Are Association of Breeders who want to see you start right!

AMERICAN RABBIT ASS'N. 36 ARBA Bldg., Pittsburgh, Pa.

**NO RISK
10 DAY
TRIAL OFFER**

**NEW Nite-Clip
NIGHT DRIVING
GLASSES**



**STOP
HEAD LIGHT
GLARE**

Now, when driving at night, you can AVOID the hazardous glare of blazing head lights simply by snapping Nite-Clip

glasses over your eye glasses. Here's real protection against highway accidents! Made of special oculus-type, amber-tinted, unbreakable Plexiglass plastic, Nite-Clip glasses block out light halations and reflections, eliminates head light glare. YOU CAN SEE THE ROAD AHEAD, OBJECTS ARE MORE DISTINCT, YOU PASS OTHER CARS SAFELY! Nite-Clip glasses give you better vision in fog and rain; will not distort colors. They're handsomely styled, featherweight, fit all eye glass frames. If your drug, department or accessory store cannot supply, send \$1.50 direct and we'll ship post-paid by return mail.

MAKE THIS TEST

Our MONEY BACK GUARANTEE protects you. Try Nite-Clip glasses for 10 days, IN ANY WEATHER. If not delighted, return to the factory for full refund.

DOMAR PRODUCTS, Inc., 5001 N. Erie St., Massillon, O.

Tells How You Can Learn to MOUNT BIRDS!



FREE BOOK

Learn At Home

Men, Boys, Hunters, Fishermen, mount and save your lovely wild-game trophies. Be a Taxidermist. Mount Birds, Animals, Heads, Fish, Tan skins. YOU learn easily, quickly in spare time. Have a grand home-museum. The finest and the greatest hobby known, for sportsmen. Fun, real profits.

FREE BOOK

Yes, **FREE**, Beautiful strange, valuable Book, telling all about Taxidermy. Contains over 100 beautiful game-pictures. And it's yours **FREE**, if you rush your request. You can mount all kinds of wild-game, and common specimens too. We can positively **TEACH YOU**. So **GRASP** this opportunity. **RUSH** letter or postal for this amazing **FREE BOOK**. Don't delay. State your **AGE**. **N. W. SCHOOL OF TAXIDERMY, 2505 Elwood Bldg., Omaha 2, Neb.**

3 SPEED HOBBY MOTOR Hundreds of uses!

For Bar-B-Ques, metal spinning, polishing, winding, etc. Complete with 30" chrome spit; four, 1/2" shafts; 120 volts; enclosed gears.

5-200-4000 rpm.

Only **\$16.95** prepd.

Gov't. cost over \$50.



Send check or money order to: **Calif. Res. add sales tax Lind Sales Co. 1619 1/2 S. La Cienega Blvd., Los Angeles 35, Calif.**

TOOTHACHE?

Ask your Druggist for **DENT'S**

TOOTH GUM TOOTH DROPS POULTICE

RAISE GIANT FROGS BIG DEMAND



MILLIONS USED YEARLY! Frogs sell \$5 dozen. Breeder lays up to 20,000 eggs yearly. Season just starting! Men & Women get ready now for this year's eggs. Small pond starts you. New book tells how! Send for illustrated **FREE** folder today. Write to **MARLBORO HOUSE-7 1035 Marlborough Detroit 15, Mich.**

WHAM-O SPORTSMAN*

\$1.50 POSTPAID

35-LB. PULL!

HITS LIKE A RIFLE—KILLS RABBITS, SQUIRRELS. Powerful, silent, accurate. For hunting, target, routing pests.

Sportsman's choice sold world over!

HUNTING SLINGSHOT

Heavy duty 7" ash stock.

40 steel balls, extra rubber, target.

GUARANTEED. At dealers, or send \$1.50 to

Wham-O Mfg. Co. Box 8T, South Pasadena, Calif.

* Professional model of Nat'l Slingshot Assn.



MOST GENEROUS OFFER!

We offer men and women everywhere what we believe is the greatest and most generous offer ever made to ambitious people in the U.S.A.! It's like receiving an inheritance or being remembered in your rich Uncle's will! We show you how to make an endless variety of beautiful things. We supply all the materials and instructions and show you how to dispose of your products at tremendous profits! It's a fascinating business and simple to operate. **NO TOOLS OR MACHINERY REQUIRED!** The casting process is as easy as pouring water out of a glass! Work at home or in your garage!

FASCINATING BUSINESS OR HOBBY!

Make extremely beautiful imbedded jewelry, bookends, figurines, planters, ceramics, statues, ash trays, lighters, banks, lamps, exquisite gems, fishing lures, keychains, novelties, curios, gadgets, souvenirs, pensets and an unlimited variety of useful and wonderful products! This work is so pleasant and fascinating that many take it up as a grand and profitable hobby.

UNLIMITED POSSIBILITIES!

The **ONLY** limitation is your imagination. No special talent, no previous experience, no special tools or machinery required! We will supply you with raw materials or finished products, start you in business and **GUARANTEE** your sales or money refunded!

HOW TO START

We can't hand you cash . . . but we offer you something that ordinarily takes thousands of dollars and many years to establish; yet it's all yours for the asking! We urge you to investigate this unusual offer today. You'll be excited and thrilled over the many wonderful opportunities we hand you **ABSOLUTELY FREE!** Send only 25c for our big 56 page Catalog describing the fascinating process of creating and manufacturing mentioned above. Do it today . . . don't delay anything that could be so important to your future!

PLASTICAST CO. (DEPT. C)

P.O. Box 6737 Chicago 80, Ill.

(Write to nearest address)

P.O. Box 987 Palo Alto, Calif.

CANADIAN READERS: Please send 35c to: Canadian Ind. Plastics, 1056 1/2 W. Pender St., Vancouver, B. C.



CAPABLE YOUNG MEN prepare now for a . . .

SECURE and SATISFYING CAREER in the HIGH-PAYING AUTOMOTIVE SERVICE BUSINESS



You don't need experience—let Sun's 12 week course in **MODERN AUTOMOTIVE SERVICE** open the door to a bright, successful future.

Even if you lack experience, **SUN**, the world's largest manufacturer of scientific automotive test equipment, can help you make a successful start in automotive service. A critical need for trained men means unlimited opportunities for alert, high caliber young men to earn big incomes in this fast-growing field. *Not* a correspondence course, *not* merely "another course in mechanics"—but a practical, well-rounded resident school, focusing atten-

tion on scientific testing—the only way to avoid guess-work in servicing cars. Quickly get an over-all, bird's-eye picture of modern service procedures. Learn the basic operating principles of the entire automotive vehicle and how to service it scientifically. In just 12 weeks build a firm foundation for future advancement. Recommended by leading car and truck manufacturers and approved for GIs.

Sun Electric Corporation, Dept. PM-1
6323 Avondale Ave., Chicago 31, Illinois

Please send free details on **MODERN AUTOMOTIVE SERVICE** course.

NAME _____

ADDRESS _____

CITY _____ ZONE _____ STATE _____

SEND FOR FREE BROCHURE . . . ALL DETAILS . . . NO OBLIGATION

Classes scheduled in . . . **Detroit Technical Training Center**

Heike's 1953 Hobby Catalog-35c



Collector's Catalog of historical and scientific items.—

Selling: 450 historical firearms — 20,000 Indian Relics — Collectors Cartridges — Coins — Confederate Money. — Revolutionary, Civil War, Indian Wars, Flintlocks, percussion muskets, Swords, Bayonets, Pistols, Revolvers, Ramrods, Bullet Molds, Percussion Caps, Powder

Flasks, Powderhorns, Blunderbusses, Civil War Handgrenades, — Stagecoach Carabines, Winchester Rifles, Kentucky Rifles, Pepperboxes, Gun Barrels—Locks—Nipples.—**ARROWHEADS**, Tomahawks, Battle Axes, Gempoints, Spearheads, Peace Pipes, Arrow making Stones, Discoidals, Bannerstones, Gorgets.—**Steerhorns**, Buffalo Horns, Eagle Feathers, Deer Horns, Elk Antlers, Bo-wood, Blohorns, Mounted Squirrels, Pheasants, Ducks, Owls, Quails.—**AGATES**, Fossils, Minerals, Marine Shells, Violin Wood — Daguerreotypes, Ambrotypes, Scalping Knives, Dueling Pistols, Gold Dollars, Frontier Colts, etc., too numerous to mention.

SPECIAL: 5 Arrowheads, \$1.65—Tomahawk, \$4.88—Scalper, \$1.88 — Hammerstone, \$2.40 — Civil War Musket, \$28.65 — Sword, \$16.40—Bayonet, \$1.98—Powderhorn, \$8.75—25 Indianhead Cents, \$1.98—Agate, Fossil, Rattler Geode, Galena, Pyrite, Gastropod, Brachiopod, Molybdenum, Crinoid, Chalcopyrite, Barite rose, Petrified wood, each \$.48, all 13, \$5.00.

Send 35c for your profusely illustrated 1953 catalog today.

R. HEIKE, 553 M Street, Wenona, Ill.



LEARN HOW TO BUILD A SHIP IN A BOTTLE

Start this new hobby today. For amazing hobby kit and simple instructions send only \$3.00 to

DuBOUCH CO., Box 1553, Chicago 90, Ill.



New Easy Way STOPS SMOKING HABIT

TOBACCO BREATH TOBACCO NERVES TOBACCO HEART

Banish forever the tobacco habit with its health killing effects on heart, throat and lungs. Don't be fooled by today's cigarette advertising with its tricky sayings and catchy jingles. Nicotine IS poisonous and a real danger to good health. Tobacco smoke DOES dry out the throat and make you cough! Sensational SMOK-NO-MOR Tablets must break the smoking habit within one short week or money refunded. Break your tobacco habit today . . . feel better . . . eat better . . . sleep better. Send no money, pay postman \$3.00 plus postage for liberal supply, cash orders we pay postage. Write to:

**CURTIS PHARMACAL CO., Dept. 49 E
53 W. Jackson Blvd., Chicago 4, Ill.**



Easy-to-Build Home Plans—Find your dream home in this collection of plan books. Get more in comfort, design, construction. Owners, amateur builders and contractors have long used HBPS plans. Blueprints designed to meet FHA needs available for all homes at low-cost. Any one above books—\$1; all 3 just \$2.

HOME BUILDING PLAN SERVICE

STUDIO 5, 2454 NE SANDY PORTLAND 12, ORE.



CORONATION SOUVENIRS DIRECT FROM LONDON

One pair Dessert Knife & Fork. Chromium plated, stainless. CROWN embossed, xylonite handles. One Dollar only—Duty FREE. Send International MIO \$1.00 direct to

CROWN permanently EMBOSSED

John Bull (PM) 246 HIGH ST. HARLES DEN LONDON N.W.10 ENGLAND

MONEY IN HAMSTERS



Easy—Profitable raise in any climate. Thousands used for laboratory and pet trade. Beautiful pets. Write for free booklet. **SOUTHERN HAMSTERY, Box 685M, GAFFNEY, S. C.**

**Wheels
Wheels**



**Wheels
Wheels**

- 5" Disc Wheel 5/8" Tire 5/16" or 3/8" sleeve 30c ea.
 - 6" Disc Wheel 5/8" Tire 5/16" or 3/8" sleeve 35c ea.
 - 7" Disc Wheel 3/4" Tire 3/8" sleeve 45c ea.
 - 8" Disc Wheel 1 1/8" Tire 1/2" sleeve 70c ea.
 - 7" Disc Wheel 1" Tire 1/2" ball bearing 80c ea.
 - 8" Disc Wheel 1 1/4" Tire 1/2" ball bearing \$1.00 ea.
 - 8" Disc Wheel 2" semi-pneum. T. 1 1/2" B.B. \$1.50 ea.
 - 10" Disc Wheel 1.75 semi-pneum. T. 1 1/2" B.B. \$1.50 ea.
 - 12" Disc Wheel 1.75 semi-pneum. T. 1 1/2" B.B. \$1.85 ea.
- Above wheel prices includes hub cap. Plus Postage. C.O.D.'s accepted. AXLES—Sizes 5/16 in., 3/8 in., 1/2 in.—Cut to size—End holes drilled.

**UNITED WHEEL STAMPING CO.
12131 S. PEORIA STREET PM-5 CHICAGO 43, ILLINOIS**

POWERMASTER* HUNTING CROSSBOW

postpaid \$19.95

KILLS ALL BIG NORTH AMERICAN GAME-DEER, BEAR ETC.

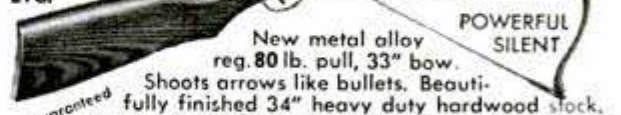

POWERFUL SILENT
New metal alloy reg. 80 lb. pull, 33" bow.
Shoots arrows like bullets. Beautifully finished 34" heavy duty hardwood stock.
Crafted to meet highest archery requirements. **As large manufacturers we can mass produce this \$45 value crossbow for only \$19.95.** Precision trigger action, flat trajectory, pinpoint accuracy. Hunters knock down game at 200' Cocks easily. Beginners with crossbow shoot more accurately than professional archers. Silent, this powerful weapon permits extra shots at game. Adaptable for harpooning. Instructions included. Arrows 60c each. **MONEY BACK IF NOT COMPLETELY SATISFIED.** If your sporting goods dealer can't supply you, send \$19.95 in check, cash, or MO. to **TECHRITE CORP., Box K12, South Pasadena, Calif.**
***Professional Model of National Crossbow Ass'n.**

MONTH AFTER MONTH, YEAR AFTER YEAR, YOU SEE OUR AD.

CHECK AND DOUBLECHECK BEFORE YOU BUY ANYWHERE!

- 1 Are These Tires "Family-Safe"? Our Families Use Them.
- 2 Are They Recaps? Ours Are Not (Except Passenger Snow-Tires)
- 3 Will I Get Goodyear, U. S. & Famous Brands? From Us, You Must!
- 4 Is The Guarantee Unconditional? See Our Fine Offers Below.
- 5 Can Good Tires Be Bought Cheaper? It's Dangerous To Pay Less.
- 6 Is A Tube Included Free? Yes, We Do. See OUR Free Tube Offer.

GOODYEAR  **Firestone** 

GOODRICH, U.S. & OTHERS, USED TIRES (NO, NOT RECAPS)
DOUBLE WARRANTY & UNCONDITIONAL GUAR. ON PASS. TIRES

Our Policy is to select your tires so carefully, as if our very future depended on the service given by that particular tire.

FREE TUBE		WITH EVERY GOOD GRADE & FINEST GRADE PASSENGER AND TRUCK TIRE			
GOOD GRADE 20 MONTHS GUARANTEE BOND		FINEST GRADE 30 MONTHS GOLDEN RULE GUARANTEE BOND			
600-16 \$4.02	820-15 \$5.30	600-20 \$ 6.92	32x6(8)	\$8.50	
650-16 4.40	700-15 4.22	650-20 7.52	32x6(10)	9.80	
700-16 5.00	670-15 4.40	700-20 8.40	900-20	13.10	
650-15 4.00	710-15 4.60	750-20 8.40	1000-20	13.62	
760-15 4.90	550-19 6.54	825-20 13.92	1100-20	13.94	

THIS GRADE MADE THE "BLATT" NAME WORLD FAMOUS.		30 MONTH GUAR. TRUCK TIRES	
600-16 \$5.12	700-15 \$5.32	700-15(6)	\$9.92
600-16FA 7.00	475-19 5.85	750-16(6)	10.92
650-16 5.92	640-15 5.82	825-15	18.36
650-16(6) 7.92	670-15 5.22	750-15	13.22
700-16 6.52	710-15 5.72	825-20	18.22
700-16(6) 8.72	760-15 5.92	750-16(8)	13.82
750-16 7.02	800-15 6.62	700-18	15.82
550-17 4.52	820-15 6.72	600-20	8.72
650-15 5.12	450-21 5.08	650-20	11.22
		32x6(8)	11.60
		32x6(10)	13.42
			1100-22
			20.42

Buy the "Right" Truck Tires for "Your" Job.	Std. Guar. 20 Mos.	Rugged Guar. 32 Mos.
750-16Std \$13.52	900-16Std 10.58	750-20Rg. \$14.52
750-16Rg. 17.64	600-16Std 6.48	600-16Rg. 9.95

BLATT BLATT BLDG., GIRARD & LANCASTER AVES.
DEPT. PM, PHILADELPHIA 31, PA.
SEND CHECK OR MONEY ORDER & THIS AD.
Shipments RUSHED Down South, Far-West & Up North

BUY VITAMINS DIRECT!

We pack and sell Vitamins and Vitamin-Mineral combinations at DOWN TO EARTH PRICES. You SAVE MORE than 50% by buying direct.

FREE! PRICE LIST and PROOF of the amazing values we offer. SEND NAME and ADDRESS right now.

HUDSON VITAMIN PRODUCTS CO.
199 Fulton St., Dept. 881, New York 7, N. Y.

YES! SEND

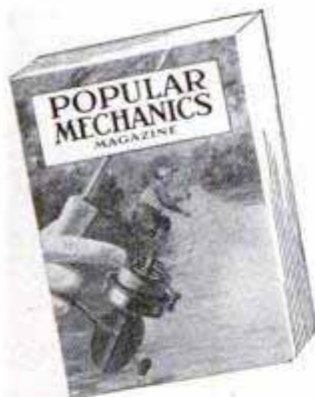

directly
to my door
every month

I am enclosing

- \$3.50 for 1 year
- \$8.00 for 3 years

name _____
address _____
city _____ zone _____ state _____ A-53

Hand this order to your newsdealer or send it to

POPULAR MECHANICS
200 East Ontario St. Chicago 11, Ill.

**Art Lesson
FREE!**



Seriously interested in art? 14 or over? Let us send you a full-length, richly illustrated art lesson — free! Shows how to draw figures, heads, cartoons. Mailed without charge or obligation. Write for yours TODAY!



Send name, age, address (including county) to
ART INSTRUCTION, INC., Dept. L-5133
500 S. 4th St., Minneapolis 15, Minn.

**THIS GUIDE
120 PAGE
FOR AMBITIOUS MEN
FREE!**



Have you had your copy? 120 pages of guidance to best-paid positions. Up-to-the-minute information for men who want to climb to the top. Tells how to get promotion, security and better pay through home study courses. This handbook "Engineering Opportunities" is free and entirely without obligation. Send the coupon. Make this your big year! Describes over ninety courses including:

- | | | |
|--------------|---------------|---------------------|
| Mechanical | Electrical | A.F.R.Ae.S. |
| Aeronautical | Radio | A.M.I.C.E. |
| Television | Automobile | B.S. (Pure Science) |
| Building | A.M.I.Mech.E. | |

--- SEND COUPON TODAY ---

Canadian Institute of Science & Technology Limited, 561 Century Building, 412, 5th Street, N.W., Washington, D.C.

Please forward free of cost or obligation your handbook, "ENGINEERING OPPORTUNITIES".

Name.....
Address.....
Course interested in..... Age.....

Canadian Address: Canadian Institute of Science 561 Garden Building, 263 Adelaide St. W., Toronto, Ont.

Makes Painting Easy—Quick—Economical! New 1953 Burgess Electric Sprayer with Sapphire Nozzle and Full Approval!



FLOORS — Spray floors, walls, from cellar to attic!



FURNITURE—Quickly paint or varnish chairs, tables.



AUTOS — Sprays smooth, glossy finish on any car.



INSECTS — Sprays all type liquids to exterminate bugs.



SCREENS — Paints window screens four at a time.

Sensational Low-Priced Home Painting Outfit

NOW — paint your walls, doors, floors, screens, furniture, porch in half the time — and get professional results every time! Touch up the car, repaint toys, chairs, cabinets in minutes . . . paint cellar, fences, stairs, and garage for a fraction of the usual cost! The new SPECIAL DELUXE BURGESS ELECTRIC SPRAYER makes painting a cinch. Just plug in to any 110-125 volt, 50-60 cycle outlet, pull the trigger, and spray! Use any kind of paint — oil or water base, flat wall paint or enamel—and watch it go on smoothly, quickly, effortlessly! Spray varnish, shellac, water, weed killers, insecticides, moth repellent, light oils, too!

NEW SAPHIRE NOZZLE

FOOL-PROOF! CLOG-PROOF! TROUBLE-FREE!

This wonderful new SPECIAL DELUXE BURGESS SPRAYER is built to give you years of service. Equipped with exclusive SAPHIRE NOZZLE . . . made of the same type of jewel as is used in fine watches! Can't be harmed by abrasive action of any spraying material . . . even ceramic glaze! Sliding spray-adjuster regulates spray volume. Fast-action trigger switch. Corrosion-proof pump assembly. Full 25-oz. graduated jar. Entire sprayer approved by Underwriters Laboratories — not just the cord!

TRY IT 10 DAYS FREE!

We want to send you a brand-new BURGESS ELECTRIC SPRAYER for 10 days FREE trial! Rush the coupon! WE will ship COD plus postage, or if you send cash with order we will send sprayer postpaid to your door. Try the sprayer in your own home. If you aren't completely satisfied in every way, return the sprayer within 10 days and we'll send your money back! Mail coupon today!

JOHN H. FAIR COMPANY
DEPT. S-432 27 EAST LAKE ST. CHICAGO 1, ILL.



ONLY \$12.95 COMPLETE

ENTIRE SPRAYER . . . NOT JUST THE CORD . . . LISTED BY UNDERWRITERS' LABORATORIES, INC.

10 DAY TRIAL COUPON

JOHN H. FAIR CO., Dept. S-432
27 East Lake Street, Chicago, Ill.
Please send me a complete New 1953 Burgess Special DeLuxe Home Electric Sprayer (U. L. Approved) with sapphire nozzle. On arrival I will pay postman \$12.95 plus small delivery charge.

Check here if you enclose \$12.95 now. We pay all delivery charges. It is understood that whether I order COD or enclose remittance you guarantee satisfaction or money back upon return of sprayer within 10 days.

Name.....
Address.....
City..... Zone..... State.....

**WORLD'S
BEST
WANT AD
MEDIUM**

CLASSIFIED Advertisements



Advertisements in this section 85 cents per word, each insertion, minimum 10 words, payable in advance.

To be inserted under proper classification, copy must be in our office the

20th of the second month preceding date of issue

F. W. Johnson, Manager, Classified Advertising

Popular Mechanics Magazine, 200 East Ontario Street, Chicago 11, Illinois

YOU'LL PROFIT

By reading and answering the classified ads in this section. Hundreds of opportunities for you to make and save money

AUTOMOBILES. MIDGET CARS

SAVE—California custom accessories headquarters. Buy direct from original designers. Chrome dash panels, electric push button door-trunk conversions, fender skirts, dual mufflers, lowering kits, speed-dress up equipment. 40 page catalog, hundreds of photos—25c. Eastern Auto, 3319A South Grand, Los Angeles 7, Calif.

HI-Mileage-Speed equipment from the world's largest supplier. Also dual manifolds, finned heads, electric trunks, doors, lowering sets, chrome panels, thousands of items for all cars. 1953 catalog 25c (illustrated literature free). Wholesale to garages. Newhouse Automotive Industries, Los Angeles 22.

SPECIAL Offer—Hot rod cam shaft re-grinding. Many \$19.50 exchange. Auto Electric Service, Box 54, Anderson, Ind.

ANTIQUE, Classic, and foreign cars for sale. Up to date list published monthly. Present list includes Stanley Steamer, Bugatti, Duesenberg, and over 100 others. Single copy 50c, 3 months \$1.00. Motorart, Box 144, Station H, Toledo, Ohio.

HOT Rod drawings, six large beautiful lithographs of famous hot rods. Send \$1.00 to Rex Burnett, Dunwoody, Georgia.

USE 120 Octane propane. Save engine, oil, and money. Top performance. Unationed last war. Details \$2.00. Lpg, 932 Eugene, Baton Rouge, La.

MAKE Your own sports car body. Polyester-Fiberglass. Instructions. New catalog 10c. Airmailed 25c. Gem-O-Lite, Box 862U, North Hollywood, California.

AUTO Body, refinishing shops, personal, "profitable sidelines," complete \$1.25. Lawrence Andre, Sag Harbor, N. Y.

NON-Profit organization offers automobile literature—Old, new, foreign; glossy photographs; repair manuals, dealer books; and free motor magazines. Contact auto clubs everywhere. Write today; get on free mailing list. Auto Maniacs, Stockbridge, Mich.

MELECTRO Precision—Electronic engine balancing gives you a vibration-free engine with faster acceleration, increased horsepower, longer life. Write to Merrill Engineering Laboratories, 1236 Lincoln, Denver, Colorado.

INTERESTED in antique automobiles? Send for free sample copy. Franson's Motor News, Box 254, Eugene, Oregon.

MOUNT Any quad carburetor on your present manifold with "Quadri-dapter" \$12.95. Speed Mart, 2104 National, San Diego 2, Calif.

BUILD Midget auto. Complete drawings, pictures and list of parts \$1.00. Lee's Midget Autos, 3301 Dupont Ave., So., Minneapolis, Minnesota.

BUILD Custom sports car from old model car bodies. Illustrated book gives step by step operation using inexpensive materials and parts. \$2.00 postpaid. Satisfaction guaranteed. Tasope Publishing Co., Aurora, Missouri.

FREE—"Amazing new book"—"Profits from Classified Advertising." Tells how and what to advertise. Be sure to read this book before you invest one cent in advertising. Remember—it's free. Write for your copy now. F. W. Johnson, Classified Adv. Manager, Popular Mechanics Magazine, Room 602, 200 East Ontario Street, Chicago 11, Illinois.

AUTO SUPPLIES AND EQUIPMENT

LUBRIWICK Safety wheel pack. Autos \$1.50, trucks \$11.04 per set two wheels. No c.o.d. Douglass Prod. Co., 2410 Auburn Blvd., Sacramento 21, Calif.

CUSHMAN Wizard speed camshafts, \$6.50 exchange. Weber Cams, 4200 White-side, Los Angeles, Calif.

COMBINATION Map light and cigarette lighter. Plugs into lighter socket. \$2.75 postpaid. J. Grant, 721 28th, South Bend 15, Indiana.

AUTO Trunk light—Complete kit. Mercury switch, bulb, socket, wire and hardware with instructions. Price \$2.00 per kit postpaid. No c.o.d.'s. Electro-Devices, Inc., 247 Broadway, Paterson 1, N. J.

BUY Speed equipment without money. No selling. Information free. Newhouse Industries, Los Angeles 22.

MOTORISTS, Truck owners, hot rod and sport car enthusiasts. Here's what you've been looking for. Largest and most complete automotive parts and accessories catalog in America. 1953 edition—132 pages (illustrated) shows all parts, from a cotter pin to a complete motor and accessories for all makes, all years, including 1953, all models cars and trucks. Pages and pages for hot rod and sport car enthusiast. Hollywood accessories to give your car individual styling. 50,000 items listed at savings up to 50%! Don't miss it! Send 25c now (refundable). J. C. Whitney & Co., 1919 W. Archer, Chicago 16, Ill.

AUTO Radios at wholesale. Standard brands. List free. Regent, 801 West Erie, Philadelphia.

"WATER Injection" Free descriptive, illustrated, information. Neher Industries, LaVerne, California.

HI-Compression heads \$15.95 up. Write Auto Parts Service, West Salem, Ohio.

ELECTROPLATE Auto parts, novelties, mirrors. Easy, inexpensive home processes. Free booklet. Tyco Metals, Box 13231-BG, Houston 19, Texas.

GM71 Discarded injector parts wanted. Bares, 7120 Carnegie, Cleveland, Ohio.

NEW And used guaranteed parts for civilian and army cars and trucks. Largest stock in America. Mail orders. Pioneer Auto Wrecking Co., 734 W. 13th Ave., Denver, Colorado.

BRUSH Plating outfits connect to a battery. No tanks or shop required. Free particulars. Gunmetal Co., Ave. J., Decatur, Ill.

FIBERGLAS—Plastics for bodies and hardtops. Complete building instructions. New low prices. Nationally known suppliers. Industrial Plastics, 4425 Linden, Oakland 8, Calif.

3 MINUTE Auto waxing. Guaranteed five ways. No rubbing or wiping. Lasts longer than hand-applied waxes, because it can't wash-off. Complete electric outfit includes pure wax for waxing 42 cars \$23.45. Write for trial offer. Clinton Spray Wax Corp., 3651 Albion, Lincolnwood 45, Illinois.

LIGHT Your Powerglide dial. Kit \$1.50. Dynaflo kit \$1.50. M. Gaiser, Box 25J, Kokomo, Indiana.

FOR A Better motor for \$3.00, write, Ferns Products, 8120-B Walnut Dr., Los Angeles 1, Calif.

AUTOMOBILE Chrome durably cleaned. Fran-o-lene, pint \$1.00. Franoll Co., 6708 Parnell Ave., Chicago 21, Ill.

LIQUI-Moly, one treatment \$1.65 postpaid. Free literature. Paul Howland, Mulvane 4, Kansas.

ATTENTION! New Model "T" Ford parts. Phil Palker, Unionville, Conn.

CUSTOM Radios for 1952 and 1953 Fords \$44.50. Write for literature. Nordic Radio Co., Box 582, Evanston, Ill.

LACHAPELLE'S Treatment. (Patented.) Puts babbitt on the cylinder walls for the pistons to slide on. \$3.00. Write, Ferns Products, 8120-B Walnut Dr., Los Angeles 1, Calif., for free information.

TRICLONE—A concentrated oil additive formulated with 3 extreme pressure agents. Plates out on rubbing surfaces. Absolutely non-corrosive. Possesses phenomenal film strength. Designed by an I. G. Farben chemist for competition engines. 8-oz. bottle \$1 postpaid. Competition Chemicals, Box 141, Iowa Falls, Iowa.

YOU Save dollars. Wire wheel discs \$20.95 up. Free information. Tennessee Tires and Accessories, LaFollette 2, Tenn.

BE Independent, save money. Grind crankshafts without disassembling engine. New hand operated tool \$3.75. Literature. D. McGee, 719 Cascade, Wenatchee, Wash.

NEW Mall drills with Jacobs chucks. 1/4", \$15; 3/8", \$25; electric saws 5", \$29.95; 7", \$49.50. Wilt Surplus, 7829 S. Racine, Chicago 20, Ill.

CLEAN A spark plug, one minute. Quick, easy method. Amazing results. Instructions, \$1.00. Clean-A-Plug, Box 92-P, Kalamazoo, Michigan.

CHEVROLET Owners: Stop tappet noise with Kaye Tappet Silencers. Quality product. Easy to install. Complete set \$5.95. Kaye Products, P.O. Box 1423B, Milwaukee, Wis.

REPEATING Successful sale: Genuine chamois. World's finest from France. Large skins \$1.00. Sold everywhere \$4.95. Money back guarantee. A. Frank, 45 Vesey, New York City 7.

MOTORIST Save gasoline by Vacuumating overrich mixtures. Fits all cars. For free particulars write Vacuumatic, Dept. 2011, Wauwatosa, Wis.

STOPS Leak—For leaking radiators, freezeout plugs, heaters, blocks, etc. Send \$1.00. Enough for car or truck. Zunz, 455 Paul Brown Bldg., St. Louis 1, Mo.

BRAKES—Reline your own. Hygrade linings complete with rivets for Chevrolet 1936-48; Ford 1939-48, \$4.95 postpaid. Brake lining sets furnished for any car or truck. Write for prices. Hudco Brake Service, Box 37, Elmira, N. Y.

SHOCKS From car? Eliminate, kit \$1.00. Guaranteed. Auto Devices, 710 Venice Blvd., Los Angeles 15.

AMAZING Invention. Lachapelle's genuine motor treatment. Renews old motors. Restores compression, power. Saves gas, oil. Keeps new motors new for only \$3.00 delivered. Money back guarantee. Free circular. Write: Joe Dillon, Authorized Warehouse and Agents Distributor, Box 323-G Bridgeport, Ohio. Distributors and agents wanted. Exclusive territory. Beware of imitations.

NASH Owners: Enjoy privacy in your Nash bed, use our special curtain hooks, \$2.00 postpaid. Midwest Products, Box 223, Pocatello, Idaho.

WOLF Whistle auto horn \$3.00. Charter Oak, 256A 145 Ave., St. Petersburg 6, Fla.

HYDRAULIC Window and top parts. Motors, pumps, switches, cylinders, frames, etc. Catalog available. Mayflower, 1053 Bedford, Brooklyn 16, N. Y.

NU-SHINE — Amazing Norub chrome cleaner. Large jar 98c. Master, Box 3, Station C, Hamilton, Ont., Canada. Agents wanted.

SPEED Equipment Edelbrock, Offenhauser, Winfield cams, equipment. Speed catalogue 25c. Urzi's Auto Supply, San Jose, California.

SPEED Equipment catalog. Just out! Save 50%. 1000's items, pictures, souping instructions! Send 25c. Almquist Engineering, Milford 5P, Pennsylvania.

AUTO TRAILERS

BUILD Your own trailer! Plans for all kinds. Illustrated catalog 10c. Jim Dandy, 125-M, Wausau, Wisconsin.

EXCEPTIONAL Expanding eight foot trailer. Accommodates family of five. Build yourself. Literature 10c. Fra-Mar Company, Jones Ave., Wilmington, Mass.

TRAILERS. Build-it-yourself. Telescoping and regular models. Slip-on coach for pickup trucks. Campers. Illustrated catalog 10c. Comstock Trailers, 585, Parsons, Kansas.

MOTORCYCLES, BICYCLES, MOTORSCOOTERS AND SUPPLIES

REBUILT Gasoline engines \$17.00 to \$37.00. Cauffiel Motor Industries, Temperance, Michigan.

BUZZZZ — The motorcycle magazine. Lots pictures. Worldwide coverage. \$2.00 year. Sample 20c. 5424-A Sawyer, Chicago 25.

MOTORCYCLES And parts, new and used, early and late models. Bulletin 25c. Harley Davidson, 813 Ohio Street, Wichita Falls, Texas.

PAINT Remover—Quick-Dip. The fastest dip paint remover on the market. One package of "Quick-Dip" in hot water strips paint on metal surfaces almost instantly. Makes 10 gallons. \$1.50 postage paid or send c.o.d. \$1.50 plus postage. Leonards Products Co., Dept. 300, Marlton, N. J.

HARLEY-Davidsons — America's best used buys! We pay shipping on motorcycles. Genuine new, used, parts, accessories for current and obsolete models. Send 25c for bulletin, catalog. Knuth's (Harley-Davidson factory dealer) 1753 Muskego, Milwaukee, Wis.

WHIZZER \$20; Servicycle (good tires) \$20; motorbike conversion kit \$25; Cushman motorscooter \$25; Harley twin \$25. Rush 25c (35c first class mail) for catalog #954 listing many other amazing bargains in motors, midget cars, motorscooters, motorbikes, construction plans. Associated, Box 1764-CS, Toledo, Ohio.

U. S. Govt. surplus "45" Harley Davidson motors, complete with carburetor and generator, in running condition — \$69.50 f.o.b. Chicago. 25% deposit with order. Parts and accessory catalog 25c. Triangle, 2157 Harrison, Chicago.

RECONDITIONED Motorcycles and motors. Chromium accessories. Complete stock Indian parts. Expert rebuilding. Fast service. Indian Motorcycle Sales, Kansas City 27, Mo.

WHIZZERS \$20; Midget car \$15; motor-scooter belt drive \$6; 3-wheel scooter car \$39.50. Send 25c (35c first class mail) for catalog #23 jammed with sensational bargains in wheels, motors, motorscooters, midget cars, motorbikes, construction plans, etc. Gail, 538 Erie, Toledo, Ohio.

MUSTANG Motorcycle \$30, midget racer \$45, less engines; Doodlebug motorscooter \$20; Servicycle \$25; engines \$4.50 up. (Mailorder only). Send 25c for new Directory-Catalogue Number 53, just out listing these and hundreds of other bargains in new and used midget cars, motorscooters, engines, parts and plans for homebuilders, etc. (35c by first class mail). Midget Motors Directory, Athens, Ohio.

PARTS, pistons, new, used, cheap. Harley, Indian, Henderson, list 10c. Ballak, 811 N. 9th, St. Louis 1, Missouri.

FOR Sale—40 reconditioned Harley-Davidson motorcycles, reconditioned by Harley-Davidson Factory trained men, serving the motorcyclist over 35 years. 28 years a Harley-Davidson factory dealer. Large stock of genuine Harley-Davidson parts and accessories for old and late model Harley-Davidson. Send 25c for bargain sheet and accessories catalogue. Bill Thede, The Motorcycle Man, 7577 West Lake Street, River Forest, Illinois.

GENUINE Moto-Scoot replacement parts, assembly kits. American Moto-Scoot Co., Chicago 25, Ill.

FORTY Percent discount on new Harley-Davidson parts for models 1940 and older not interchangeable with later models. Complete stock. Lauby Cycle, Marshfield, Wis.

AVIATION

PROPELLERS, plans, supplies — For snow sleighs, air boats. Immediate delivery, highest quality. Catalog 25c. Banks-Maxwell, Box 3301E, Ft. Worth, Texas.

LIGHTPLANE Circular, illustrated, 20c. Craftsman Books, Box 1153, Milwaukee 1, Wisconsin.

PROPELLERS, Plans for snow sleighs, air boats. Lowest prices, fastest service. Literature. Gano Propeller, Box 3284A, Ft. Worth, Texas.

PROPELLERS: For snowsleeds, boats. Literature. Standard Aerocraft, Box 387, Ft. Worth, Texas.

PRIMARY Glider plans \$1.00. Literature 15c. McFarland Aircraft, Greenville, Ohio.

BATTERIES, GENERATORS

EDISON Nickel odorless storage batteries, 12 to 600 ampere hour. Any voltage. Long guarantee. Literature. Hawley Smith Co., Croton Falls 1, N. Y.

ELECTRICAL SUPPLIES

ELECTRIC Clock repairs simple, profitable. Most Telechron-G.E. rotors \$2.15. Sessions, Ingraham, \$2.45. Free parts list. Time Service Company, Dept. P-7, 710 Boush Street, Norfolk, Virginia.

FREE—War surplus catalog. Bargains galore. Welders, motors, generators, hydraulics, pumps, kits for assembling your own, other items. Save. LeJay Company, Minneapolis, Minnesota.

LAMPS—25c Brings bargain parts catalog containing instructions for electrifying oil lamps, vases, etc. Gyro Lamps, 5402P Clark, Chicago 40.

ELECTRIC Pencil: Engraves all metals \$1.50. Beyer Mfg., 10511-H Springfield, Chicago 43.

REVERSING Switch. Free trial without obligation. No money with order. For fractional motors, maximum 3/4 hp. After 10 days remit \$2.98 or return switch. Best Tools Inc., Dept. M2, Box 92, Berwyn, Ill.

MOTOR Rewinding supplies. Magnet-wire, insulation. Silicon transformer steel. Morton Electrical Service, 756, Round Lake, Ill.

LAMP Supplies—Wholesale, any amounts. Prompt shipment on all parts for repairing and building lamps. Illustrated catalog 15c. Brown Lamp Co., Box 501, Wellston Sta., St. Louis 12, Missouri.

WELDING, SOLDERING, PLATING

WELDERS — Electric, various models, \$28.50 to \$235.00, direct from manufacturer. Free literature. Champion Welder Mfg., 193MP Centre St., New York 13, N. Y.

A.C. Welders, four sizes, lowest prices. Free literature. Holger's Service, Canton 1, Kans.

"BUILD-UR-OWN" a.c. welder and a.c. power plant with a good used engine and low cost Hobart generator. Welds anywhere and supplies 5KW stand-by power for any emergency. Write Hobartweld, Box M-533, Troy, Ohio.

ACETYLENE Welding outfits — New \$49.00; used \$29.00; arcwelders \$49.50. Eagle Welding, Dept. PM, 5085 Broadway, Chicago 40, Illinois.

SURPLUS New welding generators and supplies. Free information. Blackhawk Distributors, Olathe, Kansas.

FARM, Garage welders, 220 a.c., \$59.00. Morris, 1070 Inner Drive, Schenectady 3, N. Y.

MACHINERY, TOOLS, SUPPLIES

NEW Mail drills with Jacobs chucks, 1/4", \$15; 1/2", \$25; electric saws 5", \$29.95; 7", \$49.50. Wilt Surplus, 7829 S. Racine, Chicago 20, Ill.

GENEROUS Supply aluminum tube, bar, extrusion, sheet, \$1.75 p.p. Mechanical Products Company, 511 East Mulberry, Phoenix, Arizona.

GEM Toolmakers, diemakers indicators Model 222 (.001) \$19.50 or Model 333 (.0005) \$27.50. Sybrandt Company, 4500 Euclid, Cleveland 3, Ohio.

CONCRETE Block machines. Standard sizes. Free catalog. Concrete Machine Company, 5129 South Compton, St. Louis 11, Missouri.

VERNIER Height gauges up to 36". Vernier calipers up to 48". Jo-Blocks sets from 17 to 84 pieces. Anything in precision tools, domestic and imported. Krueger's, St. Clair Shores, Michigan.

NEW Nail holder starts and sets even roofing and finishing nails in corners, outlet boxes, etc. \$1.00. Satisfaction or refund. Dealers wanted. Pollock Engineering Co., 10342-A Church St., Chicago 43.

INDISPENSABLE Screw gage. Details free. Paas Research Laboratory, Dogwood Road, West Orange, N. J.

SPECIAL Tools for woodworking machines, also metal turning attachment for Shopsmith. Free lists. Dixieng, 7301-F N.W. 10th Ave., Miami 38, Fla.

BUILD Your own machine tools! Famous Lewis castings again available for building shapers, mills, drill presses, etc. 10c covers cost of mailing recent catalog. Thure Machine Tool Co., 12833 Los Nietos Road, Whittier, California.

POWER Tools, equipment wholesale prices. Free bulletin. Homecrafters Co-Operative, Grand Rapids 6, Michigan.

NOW You can own your own tool sets. No more will you have to borrow from friends. For \$3.50 postpaid, you can have your choice of the following nationally known tool sets: 20 piece 1/4" to 15/16" sockets, complete with ratchet handle, or 8 piece ignition set, in metal box or, 6 piece selected steel combination Key Tite wrench set. Send money order today to Capitol Sales Co., 5524 N. Campbell Ave., Chicago 25, Illinois.

ENGINES, MOTORS, DYNAMOS

ALTERNATING Current generators, 750 watt, \$38.50; 5000, \$135. Motors, 1/2 horse \$15; 3/4, \$22; 1, \$35. Butler, 1885 Milwaukee, Chicago 47.

REBUILT Gasoline engines \$17.00 to \$37.00. Cauffiel Motor Industries, Temperance, Michigan.

WINDING Data, listing 225 motors, single and three phase, \$1.00. Motor Data Co., Box 7631, Kansas City 3, Mo.

REWIND Single phase motors, diagrams, instructions, \$1.00. Box 1583, Sandusky, Ohio.

BOATS, OUTBOARD MOTORS

STEERING Wheels, windshield brackets, from \$7.95. Attractive polished fittings. "Waterskis," aquaplanes, prefabricated boat kits—Complete. Skiffs \$32.00, runabouts \$97.00. Guaranteed satisfaction. Bargains galore. Hundreds accessories. Folder free. Marine, Box 681-M, Mendota, Minnesota.

MARINE Conversion parts, most complete line on market. Parts for Ford to Cadillac, manifolds, water pumps, transmission conversions, reverse gears, etc. Barr Marine Products, 2706 Castor Avenue, Philadelphia 34, Penna.

JOHNSON Outboard specialists. Used parts for all models at substantial savings. Prompt quotations. Specify model serial. Crandall-Hicks, 910 Commonwealth, Boston, Mass.

BUILD Marine engines with Federal conversion kits. Federal Marine Motors, 9011 Cottage Grove Ave., Chicago 19, Illinois.

"BELLY Tanks," \$9.95. Free picture. Buck's Auto Wrecking, Merced, California.

PLANS: Inboard-outboard runabouts, cruisers, sail, wood, plywood, welded steel. Advise requirements. John B. Clark, N.A., 329 Kenmore, Bay Village, Ohio.

OUTBOARD Motor parts—New, used for all makes. Send stamp for price quotation, listing parts needed. Outboard Motor Mart, Inc., 229A State Street, Boston, Mass.

NEW, Used, rebuilt marine motors. Marine conversions, fittings. Free catalog. Stokes Marine Supply, Dept. 24, Coldwater, Michigan.

MARINE Conversions for Ford and Jeep engines. Catalog 10c. Lehman Manufacturing Company, 972D Broad Street, Newark 2, New Jersey.

CURE That leaking boat with Fiberglass-plastic covering. Ends caulking and painting. Nationally approved process. Complete instructions. New low prices. Industrial Plastics, 3807 Harrison, Oakland 11, California.

NOW You can get a Coronado Dinghy Pram kit with hull assembled! Why struggle from scratch when \$49.50 buys an 8 ft. Coronado Dinghy Pram with hull precision assembled at factory including—Marine fir plywood bottom, sides, transoms; oak keel and chines? Takes no skill to attach the pre-cut rails, seats, cleats, hardware and paint. You save time, money, and costly errors. Shipped from factories in Wisconsin and Florida. Send 10c for literature! Coronado Industries, P. O. Box 1031, Dept. 12, Daytona Beach, Fla.

IT'S A cinch with a winch. All bronze winch. Perfect for boat trailers, etc. \$15.95. Write Demco Supply, P.O. Box 1046, New Orleans, Louisiana.

PERFECT Boat coating. Polyester-Fiberglass. Permanent protection. New catalog tells you how—how much. 10c. Airmailed 25c. Gem-O-Lite, Box 682T, North Hollywood, California.

NOW Faster than ever! Champion Boats — the choice of champions now available to you! Easy-to-read plans; easy-to-assemble kits; or easy-to-afford custom built speed boats. (18 models, outboard and inboard). Send 25c today for multicolored, illustrated catalogue. Champion Boats, 1524 W. 15th St., Long Beach, Calif. Dept. 22-E.

CONVERT Fords and Jeeps to 100% marine engines with Osco's world famous Convo-Kits. Deluxe catalogue 25c (coin). Oscomotors, 3627B Lawrence, Philadelphia 40, Penna.

POROUS Rubber boats made airtight. Complete instructions one dime. Ort, Dept. B2, Thomasville, Penna.

FULL Size, cut to shape boat patterns, blueprints, 7½-38 feet. Illustrated "Build a Boat" catalog, 25c (coin). "How to Build Boats" book, \$1.00. PolyWog houseboat plans \$10. Cleveland Boat Blueprint Co., 3107 Detroit Ave., Cleveland 4, Ohio.

BUILD Beautiful fiberglass plastic boats, of any design without using molds. New patented process. No experience or special tools needed. For detailed illustrated instructions, including material prices, send \$3.00 to Speedcraft, 2450 Emerson, Off Square Lake Road, Pontiac, Michigan.

NEW, Rebuilt engines. Free catalog supplies, conversions, instructions. Lind Supply, Farmington, Michigan.

PERMANENT Boat protection—Use Castoglas (liquid plastic and glass cloth). Apply it like paint to new or old boats. Forms plastic skin. Lighter than aluminum, tougher than steel. Once on, stays. Makes boats stronger, permanently leak-proof, rot-proof, mildew-proof, weather-proof. Won't rust, corrode, crack. Unaffected by gasoline, oil, alcohol, salt water, hot sun. Also used for sealing leaks, patching, caulking. Free folder. Marine Division, Dept. ME-101, Castolite, Woodstock, Illinois.

NOW Faster than ever! Champion Boats — the choice of champions now available to you! Easy-to-read plans; easy-to-assemble kits; or easy-to-afford custom built speed boats. (18 models, outboard and inboard). Send 25c today for multicolored, illustrated catalogue. Champion Boats, 1524 W. 15th St., Long Beach, Calif. Dept. 22-E.

ATHLETIC EQUIPMENT, BODY BUILDING COURSES

BARBELLS. Exercise equipment. Courses. Free booklet. Good Barbell Co., Reading, Penna.

SPORTING GOODS, GUNS, FISHING TACKLE, ARCHERY, TRAPPING

FISHING Plugs. Write S. R. Blackstone, 344 West Dayton St., Madison 3, Wis.

JAP Rifle altering American shells \$6.00. Catalog 5c. TP Shop, West Branch 11, Mich.

SAVE Money—Load your ammunition. Complete reloading handbook 75c postpaid, with free catalog listing supplies. Precision Gun, Ithaca 19, New York.

TENTS, Camping equipment. 100 page free catalogue. Mor-San Sales, 10-21R 50th Avenue, Long Island City 1, New York.

LEARN Gunsmithing! Information, interesting gun, gunsmith's catalog. 25c. Gunsmith, 3118 Montrose, Chicago, Ill.

TRAPPERS Use terrific new blood bait good for predators and fur animals. Only \$1.25 for large can postpaid. Seymour Packing Company, BP-PM, Topeka, Kans.

BOWS And arrows! Raw materials. Send 5c for catalog. Illustrated handbook—"How to Make and Shoot Archery Tackle," 75c. Stemmler Co., Dept. 3, Manorville, Long Island, N. Y.

MOLDS: Handled and hinged for fishermen to make their own sinkers, jigs, squids and casting or spinning lures. Entertaining and profitable. 400 sizes and styles from \$2.95 up. Special molds made to order. Free catalogue. Sweet's Molds, Tonawanda 1, N. Y.

CAST Iron molds—For casting fishermen's sinkers. Free illustrated booklet. Reading Instrument Co., Box 78, Reading, Penna.

120 PROFUSELY illustrated pages antique pistols, swords, daggers, armor, etc. 50c. Robert Abels, M860 Lexington Ave., New York 21.

SHOTGUNS, Rifles, Revolvers, 500 modern, obsolete. Also cartridges. Each list 10c coin. Ed Howe, 52 Main, Coopers Mills, Maine.

5000 BARGAINS, Firearms, binoculars, war relics. Catalog 50c. Smith Firearms, Runnemed, N. J.

SAVE On gunsmithing, Jap conversions, scopes, loading tools. Catalog 10c. Cougar Arms Company, 587 Ferris Street N. W., Grand Rapids, Michigan.

POACHERS' Secret! Fish-bait-odours catch more fish. Three amazing formulas only \$1.00. Ayres, Box 101, Station K, Toronto 12, Ontario.

SPECTACULAR Fish bait formula only 25c. Ward, Westbrook, 12, Connecticut.

FISHWORM Culture—This booklet "Raising Worms for Pleasure or Profit" tells how to fix beds indoors, outdoors; small or commercial scale; what, when, how to feed, water, harvest, package, sell. \$1.00 postpaid. Tennessee Worm Hatchery, Section 4E, Box 265, Nashville 2, Tenn.

FISHERMEN Save money! Startling new bait-catcher stampedes choice night-crawlers from holes like mad. Send \$1 today for Flushem. Gets 500 fat worms. Make fish drool! Money-back guarantee. Bayou Specialties, 1921 Bayou Grande, MP-4 St. Petersburg, Fla.

FREE, Giant sporting goods catalog. 10c, refundable, for handling. Sports, 451 Post Road, Tuckahoe, New York.

2,000 GUNS—50c Brings illustrated catalog. Colts, Kentuckles, Westerns, Lugers, Mausers, sporting arms, gunsmithing, swords, medals, relics. Agramonte, 201 Warburton, Yonkers 2G, N. Y.

BINOCULARS, TELESCOPES, MICROSCOPES, MAGNIFIERS

FREE Giant optical catalog—New-illustrated. Nassau Optical, 9 W. Greenwich Ave., Roosevelt, L. I., N. Y.

FREE 40-Page, 3 color catalog! 67 different models! United Binoculars, 9043 S. Western, Dept. A-5608, Chicago 20.

BINOCULARS, Telescopes, microscopes, terrific values, \$3.95 up. Request free, money saving catalog. Criterion, Hartford, Conn., Dept. P10.

REFLECTOR Telescope kits—Precision eyepieces, mirror cells, diagonal holders, tubing, other optical bargains. Free illustrated bulletin. Esco Products, 911 Willow Ave., Hoboken, N. J.

POWERFUL Giant telescopes easily made. Lenses, erector, focusing tube and instructions for making 40X, 100X, 200X and 400X telescope; \$5.00. Riverside Telescope Co., Riverhead, N. Y.

BINOCULARS. Lowest prices. 8x30. \$30 guaranteed, telescopes. Free catalog: All sizes. Joe's Binocular Sales, 4827 Second Blvd., Detroit 1, Michigan.

GIANT 100X terrestrial telescope complete with hardwood tripod. Tremendously clear, erect images day and night. Heliocope. Extra eyepiece, \$10.00 f.o.b. Riverhead, Riverside Telescope Co., Riverhead, N. Y.

GIANT 100X Telescope and hardwood tripod. \$12.00 f.o.b. factory. Telescopic Company, Manorville, N. Y.

POWERFUL Giant telescopes easily made. Lenses, erector, focusing tube and instructions for making 40X, 100X, 200X and 400X telescope \$6.00. Telescopic Company, Manorville, N. Y.

WAR Surplus bargains, binoculars, telescopes, sextants, millions of lenses, prisms, reticles, eyepieces, objectives, etc. Mail 10c for big "Catalog CH." Send \$1.00 for Stock CH-10-piece lens kit and big instruction booklet. Edmund Scientific Corp., Barrington, N. J.

POWERFUL Astronomical telescopes easily made. Full power clear vision guaranteed. Instructions and lenses for making 45X, 100X, 200X and 400X telescope—\$5.00. Suffolk Science Service, Riverhead, New York.

AMAZING Prices, binoculars, telescopes, microscopes. Free trial. Folder, "Binocular Selecting," optical catalog free. Prentiss Importers, Mercury Bldg., West Los Angeles 25, Calif.

REFLECTING Telescopes, 60X, completely assembled \$29.75. Guaranteed observatory clearness. Free information. Skyscope, 475 Fifth Avenue, New York 17.

GIANT Astronomical telescope complete with 6 ft. tripod. 45X and 100X (10,000 area magnification) eyepieces and sun projector lens. Full power, clear vision guaranteed. \$15.00 f.o.b. factory. Suffolk Science Service, Dept. BT, Riverhead, New York.

MAKE Your 6" telescope reflector. Glass, abrasives, instructions—\$9.50. F. Cameron, Box 65, Inwood 96, N. Y.

PETS—DOGS, BIRDS, RABBITS, HAMSTERS, ETC.

CHINCHILLAS—Profitable "package starter plan" with purchase 2 more pairs chinchillas. Top, graded, N.C.B.A. stock, unusual guarantees. Free folder. St. Clair Farm, 4564 Eastway Sec C, Toledo 12, Ohio.

EARTHWORM Raising pays worthwhile profits! Illustrated booklet explains raising, feeding, packing, marketing. 25c. Ozark Worm Farm-J, Willow Springs, Mo.

ST. Bernards, Boxers. Hof Kennels, 5136 Cascade Rd. S.E., Grand Rapids 6, Mich.

GOLDEN Hamsters. Pedigree stock. Breeders, laboratory or pet stock shipped express anywhere. Price list free. Charles E. Bowser, Smoke Run, Penna. Dept. H.

STANDARD Rabbit Journal, B-241-M, Milton, Penna. Year \$1.00, sample dime, beginner's manual 25c.

HAMSTERS—Virgin stock; young, \$3.00 pair; fully developed, \$4.00 pair. Adiron-dack Hamstery, Prospect 2, New York.

HAMSTERS—Golden or spotted. Cages and equipment. Free illustrated details. Lakeview Hamster Colony, Newfield, New Jersey.

BOOKLET "Treatise on Breeding and Raising Canaries"—\$1.00. Audubon Publishing Co., 3449-PM N. Western, Chicago 18, Illinois.

MAKE Big money! Raise Chinchilla rabbits. Cash markets supplied. Write today! Rockhill Ranch, Sellersville 15, Penna.

MINK Raising information free. Complete. Lake Superior Mink Farm, Superior, EE1, Wisconsin.

RAISE Highly-profitable Angora and New Zealand rabbits. Particulars free. White's Rabbitry, Newark, Ohio.

YOUNG Parrots—Make fine talkers. Herb Miller, 1911-N. Lubbock, Texas.

BUY Your monkey from the leading dealer—New book, "Monkeys, Their Care, Training, and Feeding," 40 species described and pictured—\$1.00 postpaid. Tropical Hobbyland, 1525K N.W. 27 Ave., Miami, Fla.

BEAUTIFUL Pure white pedigreed police puppies. Ansonia Kennels, Mose, N. Dak.

RABBITS. Money making sideline. Booklet free. Tayco Rabbitry, Hapeville, Georgia.

RAISE Waltzing mice, make profit on first litter. Price \$5.95 pair delivered. Write for particulars. They act like crazy. S. E. Keegan, 7855 Mill Road, Philadelphia 17, Penna.

"RAISING Chinchillas For Profit," 141 page book. Authentic. Illustrated. \$3.50. Ellsworth, Box 6P, San Mateo, Calif.

\$28,000.00 PROFIT With rabbits. Folio reveals everything—\$1.00. White's Mon-eymaker, Newark, Ohio.

RAISE Rabbits. Start right. See advertisement on page 44. American Rabbit Breeder.

GOLDEN Hamsters \$2.75 pair, Pandas \$5.00 pair. Write for folder. Everett Engle, PM, Farmersburg, Indiana.

GUINEA Pigs. Highly profitable. Booklet free. Taylors, B426A, Hapeville, Ga.

PLANTS, SEEDS, NURSERY AND GARDEN SUPPLIES

100 EVERGREEN Tree seedlings \$5.00 postpaid, 3 year old, 4 to 10 inches. Cash with order. Write for complete price list and planting guide. Suncrest Evergreen Nurseries, Dept. PM, Johnstown, Penna.

GINSENG, Goldenseal roots bring \$2-\$12 pound. Full information. F. M. Collins, Viola, Iowa.

NEW Patented aluminum "gardener's thumb" water hose nozzle with adjustable stream and spray, \$1.00 prepaid. No c.o.d.'s. Consumer Needs, Box 16821 Rimpau Station, Los Angeles 19, California.

FARMS, FARM LANDS, REAL ESTATE

FLORIDA Highway estates—\$345. Payable \$15 monthly. Big, beautifully wooded tracts fronting on U. S. highway 231. In famous Panama City pleasure resort area. Finest beaches, fishing, hunting. Winter gardens. Desirable, fast growing community. Free booklet. Wendell Wood, Box 873, Houston, Texas.

\$5.00 MONTHLY Buys 40 acres near town. Price \$200. Free list. Box 425-P, Carthage, Missouri.

HOMESITES \$400—Convenient payments. California's finest garden section. On Morro Bay's scenic shores. Wonderful fishing, boating, bathing. Fertile soil, softest water, temperate climate, congenial community. Free literature. Richard Otto, Department M, San Luis Obispo, Calif.

CANADIAN Tax sale lands for two dollars an acre and up. Small monthly payments. Farms, timber, hunting and fishing camps, minerals. Limited number of properties. Write at once for free catalogue. Tax Sale Service, Room 105, 120 Bloor St., W., Toronto 5, Canada.

FARM-Ranch opportunities. Favorable conditions. Washington, Minnesota, Montana, Idaho, Oregon, North Dakota. Literature, farm descriptions. Specify which state. J. W. Haw, 119 Northern Pacific Ry., St. Paul 1, Minn.

CHEAP Homes, lands, farms, in beautiful, healthful, Ozarks. Free literature, lists, full information. Write, Barnsley, Clarksville, Ark.

STROUT Catalog—free! Farms, homes, businesses, 31 states, coast-to-coast, over 3200 bargains described. World's largest; 53 years service. Strout Realty, 7-M So. Dearborn St., Chicago 3, Ill.

NEW List farms, auto courts, homes, Missouri Ozarks. Johnson Realty-PM, Marshfield, Missouri.

UNITED Farm Agency's new free summer catalog of farm and country real estate bargains, just off press, can help you plan soundly for your future security in the country. Good pictures, many states, easy terms, many equipped, growing crops included. For special service, state requirements, desired location. Write for your catalog today. It's free! United Farm Agency, 1408-PM Consumers Bldg., Chicago 4, Ill.

FLORIDA Beckons for fishing, vacationing, living. 5 acre baby farms about 60 miles from St. Petersburg. Fine for homesites, farm or camp; close to finest hunting, bathing, boating, deep sea fishing. Only \$345.00. \$10.00 down, \$10.00 month. For information write G. B. Potterfield, Department C, Union Building, Charleston, West Virginia.

FARM And business catalog free! Big edition. Hundreds of bargains from \$1000 up. Maine to Florida. West's, M-5, Pittsburgh 17, Penna.

I'LL Sell your property. Write Mr. Toole, Box 84, Evansville, Indiana.

LARGE Lake, 40 acres, \$7.00 acre, \$10.00 payments. Get big free listings. Write Mr. Armstrong, Shook 34, Mo.

SELLING Shingled houses like rent; nothing down. Perry, Brier Hill 32, Penna.

SALVAGE Fire hose, 15 to 50 ft. lengths, 2 1/2" double jacket without couplings for irrigation, drainage, contractors use, etc., fits over 2" pipe; 15c ft. Bate's Rubber, Box 501, Wildwood, N. J.

POULTRY, FARM SUPPLIES

KNOW How to raise poultry for profit. Read Poultry Industry. Every issue packed with helpful hints and practical suggestions. Latest articles on breeding, feeding and management. Subscribe now, 1 year 50c, 3 years \$1.00. U. S. funds or checks payable at a New York or Boston bank. Poultry Industry, Dept. PM, 376 Boylston St., Boston 16, Mass.

MAGAZINE Of ducks and geese (quarterly). \$1.50 a year. R2DM, Duluth, Minn.

RAISE Turkeys the new way. Write for free information explaining how to make up to \$3000 in your own backyard. Address—National Turkey Institute, Dept. 3, Columbus, Kansas.

PROFITABLE OCCUPATIONS

OPERATE Profitable screen printing shop. J. Jones, Box 321, Meridian, Miss.

MERCHANT Marine opportunities! Free details. Seaways, Box 1231M, Baltimore 3, Maryland.

\$35.00 OR More weekly. Upholstering spare time. Complete instructions 50c. Custom Upholstering, Oxford, Penna.

RAISE Pheasants on \$100 week plan. Little capital and space can make you independent. Free details. Great Central System, Columbus 1, Kansas.

MUSHROOMS Grown boxes, barrels. Manureless process. 50c. Spawn \$1.00. Gordons, 553 William, Winnipeg, Manitoba.

SELL Popular Mechanics and all other magazine subscriptions. Free catalogue, supplies. Subscription Service Company, Dept. B, P.O. Box 2070, Birmingham, Ala.

ALASKA! Last American frontier. \$1.00 brings 1953 business directory and government map. Military and civilian construction; homestead and highway facts; mining, aviation, fur farming, grazing, timber, travel directions. List of firms hiring. How to apply. Alaska Opportunist, Box 92, Hollywood 28, Calif.

FLAGPOLE And smokestack painting. Perfect part time trades. Details free. Skyline Co., Fairchance 1, Penna.

ALASKAN Jobs! Over 100 new construction contracts with names, addresses companies hiring. Thousands needed. Highest wages. Military, private construction, mining, fishing, lumbering, aviation, railroads, homesteading. Skilled, unskilled workers. Accurate information. Government map included. \$1.00 complete. Alaskan Opportunities (PM), Box 362, Kenmore, Washington.

FOREIGN And Latin American employment. 1953 "Foreign Service Directory" gives up-to-minute facts on military and civilian construction, government jobs, major oil listings, aviation, transportation, steamship lines, mining, importers, exporters, how-when-where to apply, application forms, hot list firms hiring. \$1.00 postpaid. Global Reports, Box 883-P, Hollywood 28, Calif.

GROW Mushrooms. Cellar, shed, and outdoors. Spare, full time, year round. We pay \$3.50 lb. We paid Babbitt \$4,165 in few weeks. Free book. Washington Mushroom Ind., Dept. 99, 2954 Admiral Way, Seattle, Wash.

MEN—Women. "Everybody likes candy." Learn to make professionally. Tools and supplies. (Our 42nd year.) Ragsdale Candies, D6, East Orange, New Jersey.

MAKE Flexible molds! Cast plaques, bookends, figurines! Free sample! H. Tooker, 630-M Chestnut, Hamilton, Ohio.

BE The Popular Mechanics representative in your neighborhood and earn big profits in your spare time. Write Popular Mechanics Magazine, Room 408M, 200 E. Ontario St., Chicago, Ill.

FREE Book "505 Odd, Successful Businesses." Work home. Expect something odd! Pacific, Oceanside, Calif.

\$40.00 WEEKLY. Made growing mushrooms. Dominion patent 331,583. Free spawn with order. North American, 169P Yonge, Toronto, Canada.

WANTED! Intelligent investors. Raise and sell chinchillas part time. \$900 monthly possible. Guaranteed market. Colonel Richardson, Dept. 353, 65 Lucille, Manchester, New Hampshire.

GEESE—Raise for profit. 24 page instruction booklet 25c. Army needs feathers. Northnode, West Rutland, Vermont.

LEARN Cartooning at home, for fun and profit. Send for free details. Mail-order Mart, Box 5067-PM, Nashville 6, Tenn.

WANT A diesel job? New opportunities to increase income. Higher pay. More money. We can help you qualify. Tools. Shop method home training. Write today! Diesel, Tractor, Heavy Equipment Division, Interstate Training Service, Dept. B3E, Portland 13, Oregon.

START Floor surfacing machine rental business. Profitable. Man or woman. Home or store. Send \$1.00, "How to Operate," course; where to buy equipment, no down payment. Satisfaction guaranteed. Rader, Box 8456, Kansas City, Mo.

FROG Raising; Season just starting! Get this year's eggs. New book tells how. Free folder. Broel-A, 1035 Marlborough, Detroit 15, Michigan.

WELDING Pays big money. Learn easily at best equipped school in country. Non-profit school with low cost training. G.I. approved. Write Hobart Trade School, Box M-532, Troy, Ohio.

FREE Booklet reveals amazing secrets behind 301 new profitable enterprises! Many mailorder! Includes confidential instructions for starting wholesale buying service. Deumant Business Surveys, 85-PM Deumant, Kenmore 23, N. Y.

SEND For big, new 1953 illustrated catalog that will show you how to turn your spare time into cash—making quick-selling, highly profitable lamps. Every home a prospect. Hundreds doing it, you can, too. No experience or special tools required. Catalog No. 7 contains 56 pages filled with shades, shade frames, figurines and bases, oil lamp converters, boring compound, and dozens of similar items. Also all kinds of sockets, cords, pipes, harps, finials, bases, and hundreds of other parts—everything you need. Special 8-page section shows 6 beautiful lamps in kit form, ready to assemble. You buy wholesale, sell at retail. Make big profits. Send 25c today for new 1953 catalog and wholesale price list, you'll be glad you did. The 25c will be refunded on your first order. Gearon Co., Dept. 500-B-5, 27 S. Desplaines, Chicago 6, Ill.

\$10,800 PROFITS! Your own mailorder business! No capital risk! "Success plan" (worth \$2) free! Write today! Treasury, 709 Webster, New Rochelle L-11, New York.

OVERSEAS Jobs. Big pay, transportation, expenses. Clerical, professional, mechanical workers. Most all trades. Latest listings airline, construction, manufacturing, oil, steamship companies, government agencies, many other opportunities. Up to date information on securing employment, contracts, income tax, application forms. \$1.00. Overseas Jobs, Box 335-A9, Baton Rouge, La.

\$1300 MONTHLY For truck drivers, \$1400.00 monthly for carpenters, electricians, plumbers and mechanics, \$1200.00 for accountants, \$1100.00 for clerks and laborers, over \$2000.00 monthly for supervisors. Hiring (limited) now for Greenland. For full information and complete foreign listings, \$1.00. Also domestic listings \$1.00 including detailed information, opportunities, etc., on \$1,200,000,000 project for which over 15,000 will be hired. Construction Workers Service, 1111 Commerce Bldg., (PM-5), St. Paul, Minn.

CALIFORNIA Job opportunities are wide open! Complete current report: Jobs, pay, opportunities, housing, living costs, maps. Only \$2.00. Pacific Industrial Associates, Dept. G-8, Box 832, Santa Barbara, Calif.

ALASKA Facts from Alaska Information Service, 408 Polaris, Fairbanks, Alaska.

FOREIGN Employment construction men, building trades, helpers, office men, others, interested in foreign projects. High wages, quarters, transportation. Send \$1 for foreign construction compendium and application forms. Foreign Service Bureau, Dept. PM-5, Metuchen, New Jersey. (Not an employment agency—No fees.)

CONFUSE Friends! Three Alaska picture postcards airmailed to you for message then remailed from Alaska \$1.00; eight only \$2.00. Letters remailed 50c each. Ely, 408 Polaris, Fairbanks, Alaska.

BUY Wholesale thousands nationally advertised products at big discount. Free wholesale plan. American Buyers, 628-PM Linden, Buffalo, N. Y.

CONSTRUCTION Job list. Published monthly. \$1.00. Dempster's Construction Scout News, Dept. 268-SI, Bridgeport, Ill.

JOBS On ships. Excellent pay. Foreign traveling. Free details. Davenport's, Box 1354, GPO New York 1, N. Y.

FOREIGN Jobs. Contracts underway and soon starting in Africa, South America, Canada, England, Europe, South Pacific, Middle East, Mexico and Alaska. Send \$1.00 for foreign job news, information, application forms, etc. DCS Foreign Job News, Dept. 268-SJ, Bridgeport, Ill.

EARN \$7,500-\$15,000 Annually in fascinating traffic management. Route to top executive position. Write, Union Institute, Lakewood 22, New Jersey.

LIVE Abroad as export representative! Unlimited job opportunities! Information \$1.00. Foreign Job Service, Dept. E5, 750 Winter, Jackson, Miss.

BOOKS, PERIODICALS, PICTURES, POSTCARDS

BOOKHUNTERS! All subjects. Send wants! Jaher Book Service, 620-P East 178 Street, New York 57.

BOOK "Breeding of Parakeets" and cage-bird magazine—\$1.00. Audubon Publishing Co., 3449-PM N. Western, Chicago 18, Illinois.

BOOKHUNTERS! Scarce, unusual, miscellaneous books supplied. Atlantic Book Service, Lawrence Avenue, Charlestown 29, Massachusetts.

SPARETIME Profits taking subscriptions, all magazines. Wholesale catalog free. Cassell Agency, Westfield 2, New Jersey.

BOOKS, Self help, instructional. Many mint editions, collectors items. Free list. Mutual, Section 2, Wilhoit Building, Springfield, Missouri.

NATIONAL Geographic Magazines, 1888-1952. Periodical Service, Box 465-PM, Wilmington, Delaware.

"POCKET Readers," mail 10 and \$1.00, receive 10 others. "Comics," mail 20 and \$1.00 receive 20. Or \$1.50 cash for 9 "readers." Benoit Distributing Company, Plainville, Conn.

AMAZING New Book bargains. Send dime. Adam Vallon, 63 Perry, New York 14, N. Y.

FREE Books, 5000 pages mechanics, science, sports, health. Directory 50c. Alert, Box 30M, New York 52, N. Y.

OLD Books, value guide to old books. Listing approximate value on more than 2000 old and out of print books. Send \$1.00 for this value guide. Clinton Book Exchange, D30 Box 311, Clinton, Mass.

MAP Postcards, write Ward-Sharp, 56 Kendall Avenue, Rutland, Vermont.

BIG Catalogue; 1500 bargains, send 10c. Books, 3100 Ocean Parkway, Brooklyn 35.

HOBBY, Novel, handicraft books, novelties, free trick, literature 25c. Rothleder, 102PM Cathedral Station, New York 25.

GAMES, TOYS, NOVELTIES

MATHEMATICAL Mystery kit. Educate yourself, amuse friends with amazing one-edged bands. One assembled Mobius band, five to make yourself, illustrated instructions by mathematicians. Send \$1 to Metricks, Box 248, Cathedral Station, New York 25, N. Y.

MAGIC TRICKS, PUZZLES, JOKER NOVELTIES

JOKER'S Novelties. Send 10c for new list and free joke item. Garden City Fun Shop, 654 Franklin Ave., Garden City, N. Y.

PROFESSIONAL Catalog, 150 pages, 25c. Williams, 900 Plymouth, Ellwood City, Penna.

VENTRILOQUISM Selftaught. My quick, easy instructions, 25c. "Ventriloquist," CalAllen, Texas.

FOR The most amazing values in magic ever offered, send name and address to Ecomagic, Box 494, Detroit 31, Michigan.

500 TRICKS, Douglas famous 120-page catalog, only 10c. Fastest service to magicians for 30 years. Send 10c today. Douglas Magicland, Dept. 1, Dallas, Texas.

2500 TRICK Catalogue (512-pages), pocket, parlor, stage. World's finest magic. Catalogue \$2.00 (dollar trick included free). Kanter's, M-1311 Walnut, Philadelphia 7.

200 ELECTRIC Stunts, 110 volts, \$1.00. Kutting Sons, Los Altos, Calif.

WE Supply every noted magician. Large professional catalog \$1.25. Holdens, P220 West 42nd Street, New York.

FREE Trick and large illustrated catalog 35c. Lerro Magic, 8111 Fifth Avenue, Brooklyn 9, N. Y.

BIG Fun kit! Tricks, jokes, novelties, books. Real gay stuff. Howls galore. \$1.00. Johnson, 414 McRae, Wilmington, N. C.

PROFESSIONAL Catalog and free trick 35c. Terry's Magic Studio, 1921 66th Street, Brooklyn 4, New York.

VANISHING Key trick and catalog, 35c. Stirling Magic, Royal Oak, Mich.

JUMBO Catalogue! Tricks! Puzzles! Funmakers! 10c. Andersen's, 6815P Ardmore, Chicago 31.

MAGIC—Parlor, stage. Joker's supplies. Lower prices. Giant catalog 25c. Refunded. Top Hat Magic, Evanston, Illinois.

MAIL-Order business like ours can be yours. Particulars free. "Marean" Magic Shop, Hopewell, Virginia.

LEARN Ventriloquism. 3c stamp brings particulars. Smith, 801 Bigelow, Peoria 5, Ill.

BE A magician. Large professional magic catalog of latest tricks, 35c. Ireland, C-109 North Dearborn, Chicago 2.

FREE Catalog! Magic tricks, jokes. Kar-del, Box 2058, Santa Fe, New Mexico.

STAMP COLLECTING

MINT, Unused United States approvals. Patrick Agencies, 3650 Central, Indianapolis 5, Indiana.

GENUINE Bargain, 100 different stamps, 25c. Williams Stamps, Box 187, Toronto 1, Canada.

WOW! 203 All different Germany 15c! Zeppelins, semipostals, airmails, high values, etc. to new customers. Jamestown Stamp, Jamestown 512, New York.

SENSATIONAL Guaranteed bargains! 1,000 different colorful, attractive mounted stamps, 1 and 2c each. Rushed immediately. Niagara Stamps, Niagara-on-the-Lake 71, Canada.

FREE To approval applicants—Israeli, British, French Colonies, Latin American, U. S. packet. Hobbies, 1463 Drexel, Miami Beach 39, Florida.

PROTECTIVE Mounts protect stamps, beautiful collections. Send 35c for package U. S. large comm. size. A. L. McClellan, 2711 Oak St., Shreveport, Louisiana.

FINE Approvals. Fast, personal service. What countries do you prefer? I'll send their stamps. Skinner, 438 Locust, Long Beach 12, California.

25 BRITISH Colonies 10c. Completely illustrated pictorial folders. Beautiful bi-colored mint stamps. Real bargains. Special discounts. Many free sets. Stoll Stamp Service, 2632 Burnett, Louisville 10, Ky.

AFRICAN Beauties—Savages, exotic lands, "queer countries." Everything 3c with approvals! Saxon, Vista, California.

"GOYA Nude" set (worth 55c) 15c with approvals. Royal Stamp Company, Tamaqua, Penna.

WONDERFUL Offer—7 complete mint sets only 10c with approvals. Reich (M26), 4647 Kenmore, Chicago 40.

850 MIXED U. S. old, new, 25c. Lists. Weatherby, Medina, Ohio.

UNITED States approvals. Select copies. Used, mint. Kingsbury, So. Woodbury 2, Vermont.

NEW Sensational all nation stamp finder-dictionary, 15c to approval buyers. Noel Stamps, 3916P W. 26th, Chicago 23, Ill.

PAY Less—Get more. Packets by country or subject. Mammoth list free. Introductory special, 100 different Canada 39c. Econostamps, Box 168, Riverside 9, Calif.

BETTER Grade U. S. or foreign approvals. Ocean Stamp Co., Box 64-M, Brooklyn 29, N. Y.

PENNY Approvals that satisfy. Robert Moed, 245 Kosciuszko St., Brooklyn 21, N. Y.

1000 FOREIGN Stamps off paper \$1.00, 5000, \$4.00. Anderson, Box 855, Mountain Home, Tennessee.

MINT King George Coronations from 5 different British Colonies only 10c with approvals. Walter Welles, Box 1246-R, Church St. Station, New York City 8.

1000 MIXED United States. Guarantee 170 varieties. \$1.05 insured. Quaintance, Box 178F, Upper Sandusky, Ohio.

UNITED States price list free. James Cunningham, 101C Terrace, Hasbrouck Heights, N. J.

96 PAGE Illustrated U. S. price list free. James, Louisville Trust Bldg., Louisville 2, Ky.

PRIZE Contest! Everybody wins! 10c brings premium, approvals, entry blank. Seminole Stamps, Box 1138-P, Coral Gables, Florida.

50%-75% DISCOUNTS! Approvals from 33,000 collection—1/2c up! Schur, Box 245, Buffalo 12, N. Y.

AMAZING Offer! 200 United States stamps—including commemoratives, airmails, high denominations to \$5.00, only 10c to approval applicants! Illustrated bargain lists free. Mystic Stamp Co., Dept. 80, Camden, New York.

200 DIFFERENT, Triangle, airmail, pictorials, etc.; 10c. Carlton's, Tujunga, Calif.

OLD U. S. on approval. Low prices. MacG., 2905 Observatory, Cincinnati 8, Ohio.

VALUABLE Airmail book plus gorgeous world-wide airmail collection 10c. Includes \$10,000 stamp, zeppelin, scarce triangle, many others with beautifully illustrated book, only 10c with choice approvals and bargain lists. Jamestown Stamp Co., Jamestown 708, New York.

200 EXOTIC Japan stamp—10c. Kenmore, Milford K57, N. H.

FREE! Powerful magnifying glass for 5c post. Bargain lists and approvals. Jamestown Stamp Co., Dept. 207, Jamestown, New York.

NUDES Set; colorful approvals—10c! Atlas, 2830-M Eisenhower, Racine, Wis.

GREAT Free offer—Weird mosquito stamp, thrilling bicycle race, gorgeous orchid, colorful native drummer, gigantic diamond airmail, stamp albums, all to our approval buyers. Bell Stamp Service, Dept. S-4, Bell, California.

300 STAMPS For only 10c.—This mammoth value includes airmails, pictorials; stamps from strange countries cataloguing up to 25c each! Also approvals. Mystic Stamp Company, Camden 80, New York.

FLAG Stamp—Free with hydrate U. S. approvals. Wenigman, 1933 Patterson, Chicago 13.

200 DIFFERENT Including Roosevelt triangle, 5c to approval applicants. M. Avalon Stamp Company, Springfield, Mass.

STAMPS Wanted. Collections, duplicates, surplus stock, mint and used. Good grades only. Buy outright if bargain. What have you? Write us details. Vanroy Shirk, Lebanon, Penna.

1/2-1-2c APPROVALS. Bargains galore! Cole, 43A Rinewalt, Buffalo 21, N. Y.

FREE Sample—Interesting, informative, illustrated! National Stamp News, Anderson, South Carolina.

POLAR Bear triangle, giant George Washington, six colored Ecuador, Arctic triangle, first American commemorative, Corsica, Devils Island, others. Everything free with approvals. Capital Stamps, Little Rock 2, Ark.

FREE—Illustrated catalog! Kenmore, Milford, C-57, N. H.

FREE. Scott's International Album. Other big premiums. Full particulars with approvals. Raymax, 68-Z Nassau St., New York 38.

100 DIFFERENT Spain 25c. Penny approvals included. Reed, Box 980, Chicago 90, Ill.

81 MULTI-Colored flags of the world; only 15c. Kenmore, Milford F-57, N. H.

WORLD'S Largest stamp (7 1/2 x 14 inches). A real curiosity! Retail for 50c, only 3c to approval applicants. Tatham Stamp Co., Springfield 30, Mass.

OLD Scarce U. S. seconds on approvals. Slight imperfections, lowest prices. Hernefield, Clintonhill Sta., Newark 8, N. J.

FREE Bahawalpur jubilee set with approvals. Lighthouse, Box 1516B, Colorado Springs, Colorado.

FREE—Italy pictorial set of 15 stamps to approval applicants. (We pay return postage). Frank Newman, 3539 Hartford St., St. Louis 18, Mo.

UNITED States—40 different 10c; 40 different commemoratives 25c. No approvals. Seldenberg, Appleton 944, Wis.

50,000 STAMP Grabbags 25c each. Anderson, 630B Bingham, Reading, Penna.

500 MIXED U. S. airs, coils, etc., 20c. Sibley, Mendon, Mass.

FREE Stamp zoo! Rhinoceros, snake, giant, pygmy, emu, kangaroos, koalabar, kookaburra and other wild animals. Free with exciting approvals. Niagara Stamp Co., Niagara-on-the-Lake 51, Canada.

327 DIFFERENT Stamps 25c! Including early Canada, Newfoundland, British Colonies, Vatican, Red Russia, Hitler heads, Indian states, animals, airmails, French Colonies, rarities, unusuals. Every stamp different. Rare bargain only 25c with our bargain approvals. Money back guarantee. Niagara Stamp Co., Niagara-on-the-Lake 61, Canada.

50 DIFF. Finland 10c with approvals. Carroll's, E. 1817-A Sprague, Spokane, Wash.

OBTAIN New issues of most countries as they appear. Almost at cost. Write for particulars. Pat Patterson, 6300 Oakland, Indianapolis 20, Indiana.

FREE Complete set of famous Americans, flags, parks and presidentials to approval buyers. Send 3c for 15 of the above stamps plus full particulars. Triboro Stamp Company, 145 Nassau Street, Dept. 105, New York 38, N. Y.

CANADIAN Collection free—Includes early Victorian issues, jubilees, high values, commemoratives, special issues. Newfoundland, pictorials, etc., etc., together with Philatelic Magazine all free. Send 5c postage. Empire Stamp Company, Dept. PM, Toronto, Canada.

PAYING High prices for approvals? If your collection numbers under 15,000 try our 1c and 2c approvals. In books of 1,000 different. Lots to choose from at lowest prices. Also special offer to customers. Clark Stamp Co., Dept. P-1, Muskegon Heights, Mich.

BIG Bag mixed stamps. Enormous quantity, \$1.00. Longacre Shop, 583y Sixth Avenue, New York City 11.

200-COUNTRY Collection—Big package of all-different stamps from 200 different countries! Expand your collection, get this rare bargain package (\$5 value), only 50c with attractive approvals. Wolverine Stamp Service, Dept. C-3, Fruitport, Mich.

HANDSOME Album pages can be filled from our 1,000 variety approval books. Get rid of those blank spaces, at 1c and 2c each! Ask to see a book today. References appreciated. Roseland Stamp Co., Dept. 10-C, Spring Lake, Michigan.

FREE: Mint British Colonies from Tonga, Seychelles, Brunei, Transjordan, Sarawak, Solomon Islands, Caymans, Gilbert Ellice. Free with approvals. Viking, 130-Z, Clinton St., Brooklyn, N. Y.

50 DIFFERENT Worldwide 3c! Approvals. Vinny Jo, Box 3062, Seattle 14, Wash.

77 DIFFERENT United States—25c. Approvals. Utechts, 1143-D North Keeler, Chicago 51.

MINT Foreign sets on approval. Norm's, 330 Forest Dr., Union, N. J.

APPROVALS? U. S. Mint or used. Foreign. Hotchkiss Stamps, Montpelier, Vermont.

PACKETS World different, 2,000, \$3.00; 3,000, \$5.00; 5,000, \$13.00; 10,000, \$45.00; 20,000, \$200.00. Russell, Smoky Mountain, Box 2011D, Natural Bridge, St. Louis 15, Mo.

TOPICAL Mixture free! Lists. Set approvals. Edward Hammond, Box 328, Dunedin, Florida.

FREE Pictorials with bargain approvals. Emil Auer, Buffalo 10, N. Y.

GUARANTEED Unpicked world mixture from sealed kilo lots. 1/4 lb. \$1.50, 1/2 lb. \$2.75, 1 lb. \$5.00. Satisfaction or refund. Nazareth Stamp Clearance, Dept. P, R.D. 3, Nazareth, Penna.

FREE 50 Uruguay with each order of 250 from South America for \$1.50. Many more as San Marino 50, 75c, Vatican 25, 50c, worldwide 500, 60c. Write for price list. Casilla Correo, 1343, Montevideo, Uruguay.

FREE! Surprise packet to approval applicants. Pioneer, Box 414, Pasadena 18, Calif.

PHANTOM Plane airmails—Genuine flown copies from French West Africa (C12-14) handsome, mammoth stamps, with high catalog value, plus packet stamps from 50 different countries, all for 25c! Interesting approvals. Modern Stamp Co., Dept. A-3, Ferrysburg, Michigan.

GUATEMALA, 25 Different, 10c with approvals. Fred Pittsley, South Montgomery, Napa, Calif.

BEAUTIFUL Swiss stamps free to approval applicants. Mile High, Box 326, Boulder, Colorado.

50 MINT, Foreign, including Monaco bicolours, given approval applicants. Broadmoor Company, Pittsburgh 34, Penna.

SPAIN 100 Different 10c to approval applicants. Morrel, 203 Fenimore Street, Brooklyn 25, N. Y.

FREE! First stamps issued by 10 countries. These hard-to-get stamps free to new approval applicants. Moulblow, Box 278N, East Northport, N. Y.

10 FOREIGN Mint sets 10c. Sadler, Box 8189, Plaza, Kansas City, Mo.

RARE Bargain, \$1.25 Cat. alluring South Pacific Islands 10c with approvals that satisfy. H. Offerlee, 1920 Palmgrove, Los Angeles 16, Calif.

BEAUTIFUL New Zealand 1943 triangular set picturing British Princesses only 10c to approval applicants. George Richie, 1539 Sixth, Alameda, Calif.

ADULTS—Fine singles on approval. Free gift. References necessary. Sharp, 1002 Park, Temple, Penna.

FREE Set to approval applicants. E. W. Mange, 307 W. Walnut St., Hanover, Penna.

SENSATIONAL Illustrated U.S. and Confederate catalogue free. Stone, 45-P Bromfield, Boston 8, Mass.

FREE U.S. plate block with each \$3.00 packet purchase. Commco, Box 56, Brooklyn 29.

U. S., British airmails. Personalized approvals. Want lists filled. Brooks, 2352A East 23rd Street, Brooklyn 29, New York.

SPECIAL Bargain 100 different Jugoslavia 25c with approvals. Beginners write for plan collecting more stamps for least money. Ward, 241 South Winchester, Campbell, Calif.

250 STAMP Hinges and 20 different Japan free with approvals. Jaydee, 218 Dickinson S.W., Grand Rapids 7, Mich.

NEW Cambodia! Dancers set with 100 different 10c. Approvals. Sunset, Dept. 115-A, Box 47, South Gate, Calif.

103 DIFFERENT, Including triangles 10c. Approvals. Philatelic House, Rockville Centre 1, N. Y.

50 DIFFERENT Worldwide absolutely free, just to introduce our incomparable approvals. Kent Stamp Service, GPO Box 87, Brooklyn, N. Y.

GERMANY Beautiful mint pictorial sets, over \$1.50 catalog, 25c, approvals. Pomykala, 3110 West 40, Chicago 32, Ill.

U. S. Mint 797 SPA sheet 10c to U. S. approval applicants. D. Kelly, 235M-86th St., Brooklyn 9, N. Y.

FREE "Stamp Finder." Tells instantly country to which any stamp belongs. 32 pages profusely illustrated. Garcelon, Calais 17, Maine.

GIGANTIC Stamp surprise packet, containing hundreds, catalog to 35c each, only 10c. Bargainful approvals. Dresel, Box 270-G, Cathedral Station, New York 25, N. Y.

BARGAIN, 125 Different commemoratives, air mails \$1.00. Ekman, Box 578, San Carlos, Calif.

PACKETS 500 China \$1.00; 150 South America \$1.00; world specials 1000, \$1.00; 3000, \$5.00; 5000, \$12.00; 10,000, \$45.00. Midwestern, 4628 Hollywood Ave., Milwaukee 11, Wisconsin.

WE Buy stamp collections! Send by insured mail for our offer. New-Way Stamp, Lawrence 3, Mass.

TRIANGLES, 10 Topical, different, 15c. Approvals. Cooper, Box 44, Quincy 69, Mass.

FISH, Lion, earthquake triangles, Beluxlands 25 different, all 5c. Approvals. Hathaway, P.O. Box 145P, Garden City, Long Island, N. Y.

CIPEX Souvenir sheet plus 25 different U. S., 10c. Approvals accompany. Village Stamps, 90-39P 214 St., Queens Village 28, N. Y.

1/2c APPROVALS. Povilauskas, 212 E. 3rd St., New York 9, N. Y.

MIXTURES—Packets, kiloware. Catalog free. Tower, 1714 South Ashland, Chicago 8.

BEAT This if you can! Over 520 different stamps, catalog over \$11 for only 25c to serious adult approval applicants. Free illustrated price list. Cosmophilatelist, Andover, N. J.

BETTER Grade British Colonials at popular prices. Borgen, Box 812A, Yreka, Calif.

SPECIAL! Used U. S. commemoratives. (852 to 1016) 165 all diff. \$5.00. Send today! Money-saving catalog free! "Stamps By Mail," 2133 Lunt, Chicago 45.

222 ALL Different 10c to approval applicants. Jayne, Gravesend Sta., Brooklyn 23, New York.

OPPORTUNITY, Gorgeous lot with triangles, giants, midgets, flags, airmail and railroad stamps. Also Brunei, Mongolia, Sarawak, etc. Everything only 10c to approval applicants. Evden, Valley Stream 10, N. Y.

CHOICE Foreign quality approvals for beginners and advanced collectors. Alcuri, Box 1013P, Coral Gables, Florida.

COINS, TOKENS, CURRENCY

TWO U. S. large cents, different dates, \$1. Five for \$2. Four Indianhead cents 25c. Delmaco, Box 1123, Wilmington, Dela.

BARGAINS at auctions, \$50.00 sold monthly. Free catalog. Hollinbeck Coin, Des Moines, Iowa.

COIN Collector's Magazine. Largest independent, over 1000 pages per year. Sample copy 30c; \$3.00 per year. Hewitt, 7320-J Milwaukee Ave., Chicago 31.

FREE! Foreign coin, banknote and coin collectors illustrated catalog to approval service applicants. Send 3c postage. Tatham Coinco, Springfield 30, Mass.

5-IN-1 Special, \$1.00. 1893 Columbian half dollar; coin album; wooden nickel; check list and coin catalog. Ben's, PM Dept., 31 North Clark, Chicago 2.

SET Japanese invasion notes for United States, \$2.00. Burma note and coin catalogue, 25c. Shultz, Salt Lake 10, Utah.

GET Profit and pleasure in collecting old coins. Send 10c for 56 page illustrated coin catalog. You'll be delighted with it. Send for it now. B. Max Mehl, 370 Mehl Bldg., Fort Worth, Texas. Largest rare coin establishment in U. S. Established 53 years.

OLD Money wanted. Do you know that coin collectors pay up to \$100.00 for certain U. S. cents? And high premiums for all rare coins? We buy all kinds. Send 4c for large coin folder. May mean much profit to you. Numismatic Co., Dept. 20, Fort Worth, Texas.

WHAT Are your coins worth? Amazing Fell's new 1953 United States coin book. Everything on every single coin minted—worth, value, how to sell, speculating, investment; other valuable facts. Cloth-bound, 150 illustrations. Send no money. Pay postman only \$1.50 (plus postage) or \$1.50 postpaid (refundable). Order now! Fell Publishers, 386-M-12 4th Ave., New York City 16.

WE Pay \$5 to \$500 each for hundreds of old or odd U. S. and foreign coins. Keep all until posted. Send 25 cents for illustrated coin value book with bargain lists. 45 years in business. Coin Exchange, Le Roy, 101, N. Y.

FIFTY Indian cents \$3.00. \$5 gold \$13.50. Cook Coins, Jackson 5, Mississippi.

40 DIFFERENT Selected coins. \$1.00. Oddehon, Box 482, St. Louis, Mo.

100 DIFFERENT Foreign coins, \$5.00. 20 different foreign bills, \$1.00. Claud Denney, 3633 Colonial, Dallas 15, Texas.

WANTED—1894-S dime pay \$500.00. Certain 1913 nickel \$1,000.00. 1901-S quarter \$20.00 to \$150.00. Hundreds of others. Know their true value. Complete illustrated catalogue 25c. Worthycoin Corporation, (D-325), Boston 8, Mass.

15 DIFFERENT Foreign bills, \$1.00. Russell, 1551 Arrowhead, San Bernardino, California.

SENSATIONAL Grabbags! \$3.50, \$5.00 and \$6.50. We buy everything! List 10c. Fairway Company, Rye, N. Y.

PRECIOUS STONES, MINERALS

GEMCUTTING, Silvercraft authority. Illustrated magazine tells how. Cut rocks, make jewelry. 150 ads illustrating equipment, offering gems for collectors, cutters. Postal brings literature. Lapidary Journal, Drawer B, Palm Desert, Calif.

GEMSTONES, Mineral specimens. Every variety. Lowest prices. Postcard brings free booklet. Plummer's, 4720 Point Loma Ave., San Diego 7, Calif.

GEMS, Precious and semi-precious, genuine, from world-wide sources. Deal direct, no overhead, save money. Catalog 10c. Hill Co., 5450-G Portland Rd., Salem, Oregon.

PROSPECT For profit, fun and health. Industrial minerals, uranium, tungsten, metals. Free literature tells how, write today! Stratex Instruments, 1861M Hillhurst, Los Angeles 27.

FIND Tungsten, mercury, uranium with Mineralight. Free brochure. Write Dept. PM8 Ultra-Violet Products, South Pasadena, California.

GEMS And minerals, beautiful magazine tells how to cut and collect. Brochure and book list free. Gembook Co., Palmdale, Calif.

CEYLON Gems airmailed \$25 up. Sapphires, moonstones, topaz, etc. John Rajapakse, Negombo, Ceylon.

ANTIQUES, RELICS, INDIAN GOODS, CURIOS

4 PERFECT Arrowheads \$1.00. Fine grooved tomahawk \$3.00. List free. Lear's, Glenwood, Arkansas.

ANTIQUE Pistols, flintlocks, muskets, swords, list 25c coin or stamps. Westbrook, 5537 Lafayette Street, New Orleans, La.

4 PERFECT Arrowheads \$1.00. Flint knife 50c. Hide scraper 50c. Stone axe \$3.00. Perfect pipe \$3.00. Flint hoe \$1.00. List 10c. H. Daniel, Lamar, Arkansas.

HOBBIES AND COLLECTIONS

CIGAR Store Indians. Reproductions made to order. Peter Meindl, Raymond, N. H.

BIG Packet foreign campaign ribbons. Colored catalogues. \$1.00. Medcrafts, 421 6A St. N.E., Calgary 2, Canada.

UNUSED Matchbook covers—100 different \$1.00 36-page catalog 25c. Charles Edelman, 1311C East 84, Cleveland 3, Ohio.

INVENTING Can be an interesting and profitable hobby. Write for complete particulars. Institute of American Inventors, Dept. 40-E 631-E St. N.W., Washington 4, D. C.

MATCHBOOK Collectors. New safety series and lists 25c. Yeingst, Parkway Road, Harrisburg, Penna.

UNITED Nations cards, New York cards with United Nation postmark. I furnish United Nation stamps. One card 10c, three 25c. W. Segert, 305 East 75 St., New York 21.

LEATHERCRAFT Is fun especially now. Make your own leather belts, billfolds, purses, hats, dresses, blouses, from durable low-priced leathers. Supplement your spring wardrobe with leather articles. Free catalog. Tandy Leather, Box 397C, Tulsa, Oklahoma.

VIEW Cards used, unused, good condition, choice of kind. 25—25c and 15c. Darcy, 888-Y Washington, Stoughton, Mass.

PRESERVE Flowers fresh and alive looking almost indefinitely. Easy, enjoyable, profitable hobby. Details free. Armstrong Productions, 822 Richmond Ave., Silver Spring, Md.

EXCITING Hobby; collect authentic military patches, insignias, campaign ribbons, navy rates, etc. 57 assorted \$1.00. Free gift. Pritt, Dept. M-5, 12 West 27, New York City.

TROPICAL Fish—Information 25c. Clarke Enterprises, Box 413, Janesville, Wisconsin.

CAMERAS, PHOTO SUPPLIES

BASS Says: Trading since 1910. Used but good as new buys: 8mm. B.&H. Sportster \$52.50; 16mm. Keystone A-7, F:2.5 lens \$37.50; Voigt. 35mm. Vito II, flash shutter, Skopar F:3.5, like new \$38.50; Kodak Reflex F:3.5 lens, like new \$88.50; Contax I, F:2.8 Sonnar \$87.50; 3 1/4 x 4 1/4 Speed Graphic, Skopar F:4.5, Ibsor shutter, \$52.50. Satisfaction guaranteed. Bass Camera Co., Dept. AG, 179 W. Madison St., Chicago 2.

BUY Wholesale nationally advertised cameras, photo supplies, thousands of other products at big discount. Free "wholesale plan." American Buyers, 629-RR Linden, Buffalo 16, N. Y.

PHOTOMURALS. Your negative or ours. Catalogue 25c. Photomammoth Murals, Dept. M, 12048 Vanowen Street, North Hollywood, California.

BOLSEY B-2 \$53.50 new. Cameras, projectors, photo equipment, typewriters. Terrific savings. Specify your needs. Camera Shoppe, Box 601-M, Mt. Vernon, N. Y.

NEW Cameras! Loaded with film. \$2.00 postpaid. Wallace Jewelry, 3763 S. Wabash, Chicago 15, Ill.

NEW 12 Picture economy camera. Film loaded. Guaranteed. \$2.00 postpaid. David Ward, 1290 Berkshire Ave., Indian Orchard, Mass.

PHOTO FINISHING

WHOLESALE Photographic supplies. Cameras, films, projectors, enlargers. Write for free catalog. Capitol Photo Supplies, 2428 Guadalupe, Austin, Texas.

ENLARGEMENTS—Six 5x7, \$1.00; four 8x10, \$1.00. Brownell, 4315-M Eastside, Dallas 4, Texas.

8 CONTACTS 30c, Jumbos 40c, 12-45c, jumbos 55c, reprints 4c, jumbos 5c. Western Photo, Dept. PM43, Box 298, San Francisco 1, Calif.

DOUBLE Size prints—8 exposure roll 30c; 12, 45c; 16, 55c. Prompt service. Free mailers. Emerson Photo, Emerson, N. J.

JUMBO Prints (deckle edge)—8 to 12 exposure film 39c per roll, developed and printed. Same-day service. Dean Studios, Dept. 6, Des Moines 2, Iowa.

TWO Prints each good negative. 8 exp. 35c; 12 exp. 50c; 16 exp. 65c. Reprints 4c. Mayfair Photo Service, Box 617-K, Toledo, Ohio.

SATISFACTION Guaranteed! Eight jumbo size prints mounted in album, 35c—12 to 16 exposure rolls, 50c. Free mailers, quick service, finest developing, finishing. Crown Studios, Box 1223-PM, Dallas, Texas.

12 JUMBOS 25c, 16 Jumbos 35c, from any size roll or negatives, with this ad. Skrudland S, Lake Geneva, Wis.

GIANT Size deckle album prints. 8 exposure roll, 35c, 12 exposure 50c. Send money. Free mailers. Dowl Photo Co., P.O. Box 2077, Ft. Worth, Texas.

ENLARGEMENTS! Eight 5 x 7's or five 8 x 10's, \$1.00. Wilart Enlargers, Box 967, Little Rock, Ark.

CUSTOM Photo finishing guaranteed. 8 exposures 35c; 12, 50c. Bound in beautiful plastic ringed album. Special! 35mm., 36 exposure \$1.00. Free mailer. Flash Foto, Box 36M, Brooklyn 4, N. Y.

FAST—Same day service! 8 oversized prints in attractive plastic-bound book only 35c; 12-50c; 16-60c. Satisfaction guaranteed. Free exposure guide with first order. Pic-Sure, Box 899-B, Philadelphia 5, Penna.

6 OR 8 Picture roll 35c, 12 or 16 picture roll 55c. Each roll printed and developed. Handy album pack. If you fail to get pictures on your film a new roll will be sent you without extra cost. Send coin with roll. No c.o.d.'s. Mailing containers sent free. DeLux Film Service, Box 1268-A, Shreveport, Louisiana.

TOP Quality. Fast service. 8 Jumbos 35c in beautiful Super Pak Album. 16 contacts 40c. Reprints—Jumbos 4c; contacts 3c. Satisfaction guaranteed. Write for free mailers and circulars. Fast-X-Foto, Box A, Jersey City, N. J.

GUARANTEED Quality. Fast service. Eight jumbos in beautiful super pak plastic ring binder albums only 35c. Send for free mailers and particulars of our complete photo finishing service. Grand Fotos, G.P.O. Box 1410, New York 1, N. Y.

YOUR Picture on photostamps plus valuable free gift. Free information. Howell, Box 915, Brooklyn 12, N. Y.

DYE Transfer color prints from 35mm Kodachrome will do justice to your finest slides. 5x7, \$10.00; reprints \$3.50. 8x10, \$15.00; reprints \$5.00. Remit with order. Satisfaction or your money back. Percival E. Walsh, 232 Raines Pk., Rochester 13, N. Y.

JUMBO Prints 8, 50c; 12, 75c; 16, \$1.00. Art's Deluxe Service, Box 273A, LaCrosse, Wisconsin.

MOTION PICTURES AND SOUND EQUIPMENT

16MM Sound projectors, Castle sound film subjects, splicers, screens, lamps, etc. Projector repairs. Ideal Supply Service, 2101 Barclay Road, Oklahoma City 14, Oklahoma.

5000 NEW-Used 8-16mm. silent-sound films. International-B, 2120 Strauss, Brooklyn 12.

BARGAINS 16MM. sound films. Also for exchange. Bedner, 5300 So. Talman, Chicago.

8-16MM. Silent-sound films. Complete rental library. All latest subjects. Free catalogue, sample film 10c. Garden Film, 317 West 50th, New York 19.

RENT 16MM. sound films, 50c reel. Large selection; free catalog. Film Service, 138 Chestnut St., Roselle Park, N. J.

MOVIE Camera film: 8mm. roll \$1.50, 16mm. 100' \$3.00. Free processing. Better Films, 742 New Lots, Brooklyn, N. Y.

GUARANTEED Fresh 8mm. roll, magazine; 16mm. roll, magazine movie films. Color. b.&w. Free catalog. ESO-S, 47th Holly, Kansas City 2, Missouri.

NEWEST 8mm.-16mm. Film bargains at Blackhawk! New 150' 8mm. film, \$2.98; new 300' 16mm. silents often available at \$3.98; new 300' 16mm. sound regularly \$11.95—Postage extra. Tremendous bargain stock used films. 100' 16mm. used Panoram musicals, six for \$4.99. Good used 16mm. sound projectors, Ampros, Bell & Howells, Victors, often available at \$129.95. Lowest prices on reels, cans, editors, splicers, supplies. Big 24-page catalog free. Blackhawk Films Inc., 1222 Eastin Bldg., Davenport, Iowa.

TAPE Recorders, tapes, accessories. Unusual values. Dressner, 624-M East 20th Street, New York City 9.

STARTLING Rear projection screen of translucent material, unnecessary to darken room. Project motion pictures or slides color or black and white, make trick shots, pictorial backgrounds, etc. 10"x12" \$4.90 prepaid, brochure other sizes, items, 15c. Klearcite Screen Co., 1943 Fullerton, Chicago 14.

WILD Life films. Exciting, dramatic action in the natural habitat of animals of forest and plain. 8mm. or 16mm. in beautiful color or B & W. Also 2" x 2" color slides. Write for free illustrated literature. Wild Life Films, 5151AB Strohm Ave., North Hollywood, California.

EARN Up to \$15.00 daily with your movie projector! Metcalf, 10806 Glenroy, Chicago 43.

"ENTIRE Life Story of Christ." 8mm., 16mm., sound and silent, purchase or rent, state projector. Hemenway Film, 31F Church St., Boston 16, Mass.

BELL & Howell 16mm. sound projectors. Castle sound films, splicers, reels, other supplies. Free catalog. Ideal Service Supply, 2101-PM Barclay, Oklahoma City 14, Okla.

MUSIC AND MUSICAL INSTRUMENTS

PLAY Accordion the modern way from records. No instructor necessary. Send for circular O. Pagani, 289 Bleecker, New York 14, N. Y.

POEMS Wanted for musical setting. Send poems for free examination. Five Star Music Masters, 630 Beacon Bldg., Boston, Mass.

SONGWRITERS! Protect your ideas! Hold all songs, poems! Write for safe correct procedure first! Song Service, Dept. P, 333 W. 56th St., New York 19, N. Y.

MUSIC Arranged, songs printed. Frank Wildt, Music Publisher, Lancaster, Penna.

ACCORDIONS—Save 50% and up. Cash or terms. New and used. All brands. Wholesale to everyone. Free catalogue. Del Principe, 29 South Cicero, Chicago 44, Ill.

POPULAR Songs. How to write and sell them. Write for free booklet Successful Songwriting. Gateway Songs, Box 2470, Hollywood 28, Calif.

SONGWRITERS! Send poems, songs. Music Service, 243 West 72nd St., PM, New York 23.

POEMS Wanted to be set to music. Free examination. Send poems. McNeil, Master of Music, 510-PM S. Alexandria, Los Angeles, California.

WANTED! Poems for musical settings. Write Songwriters' Service, Clifton, N. J.

WRITE Songs. Big money and reputation. Write for information. J. Gordon Pub. Co., 4700 South California Avenue, Chicago.

SONGPOEMS Wanted. Mail to: Tin Pan Alley, Inc., 1650 Broadway, New York 19, N. Y.

POWERFUL, Dynamic voice quickly developed with diaphragm exerciser. Write, Voice Developer, Box 665 (34V), St. Louis, Mo.

POEMS Wanted for musical setting. Send poem for immediate consideration and free rhyming dictionary. Richard Brothers, 24 Woods Building, Chicago 1.

POPULAR Piano chords—Symbols, formation. Simplified. \$1.00. E. Smith, Box 217, Hackensack, N. J.

YOUR Words—Our music. Song Promotion Guild, 350-M Broadway, New York 13.

COLLABORATION Offer. Newart Publications, GPO Box 1226, Syracuse, N. Y.

POEMS Wanted for musical setting. Send poems. Free examination. Crown Music Company, 1472-F Broadway, New York City 36.

1953 **ACCORDIONS**—Wholesale. Free catalog. American Accordion Center, 5329 Belmont, Chicago.

ELECTRIC Guitars, accordions, amplifiers. Wholesale. Free catalog. Carvin, Baldwin Park, Calif.

FREE Record of your song. Your words—my melody. Free information. Johnny Mack, 1094-A West 39 Street, Los Angeles 37.

RADIO AND TELEVISION

MAKE Simple television picture tube rejuvenator. Illustrated instructions 25c. Complete kit \$2.00. Wagman Electronics, 223-A Degraw Ave., Teaneck, N. J.

REPAIR Your own radios. Complete, simplified, instructions only \$1.00. Details free. Slate's Radio Service, Corsicana, Texas.

EXPERIMENTER'S Plans, diagrams, blueprints, booklets. All kinds. Free catalog. Dittotax, 5208-A Onacrest, Los Angeles 43.

CLEARCO Crystal radio kit \$1.50; preassembled \$1.75. Free catalogue. Clearco Crystal Co., Box 1857, Milwaukee, Wis.

THEATRE-Like audio reception at home on your radio, TV, etc. Cross-over network kit, with only 1 1/4 decibel loss at 12KC, \$2.00 postpaid (money back if not pleased). Write for free wiring diagrams, specifications and charts. No obligation to buy. Audio Improvements, 252 Greenwich St., New York 7.

BUILD 15 Radios—Only \$19.95 complete. Free radio tester, tools, soldering iron. No experience required. Enclose 25c for valuable Radio-TV Repair Guide and kit catalog. Progressive Electronics, 497 Union Ave., Dept. PM-5, Brooklyn 11, N. Y.

FLASHLIGHT Battery radio, plans 25c. Boscia, 39 Spencer Road, Rochester 9, N. Y.

SCIENTIFIC Telecolorvision screen changes plain television pictures into beautiful exciting, life-like colors. Double money-back guarantee. Write National Telecolorvision Screen Co., Box 708, Brownsville, Texas.

CRYSTAL-Radio experimenters. Write Leslie Hulet, R4, Lakewood, N. J.

BUILDER'S Pictorial plans. Free list. Alena, Box 24, Astoria 6, New York.

F.C.C. commercial operator licenses in a hurry. Correspondence and residence courses. Free placement. Grantham School, 6064-R Hollywood Blvd., Hollywood 28, Calif.

BUILD Any 630 television set with Brooks life-size easy to follow step-by-step instructions \$2.49. Television literature package \$1. Instructions for installing a Cascade tuner in any television set 50c. Catalogs with wholesale offers on television, radios, equipment, parts, tubes, etc. Free with each order. Popular Electronic, 250 Crown St., Brooklyn 25, N. Y.

ELECTRONIC Ear—\$1.00. Obeys spoken commands. Turns lights, radios, etc., on or off. Not a toy. Plans. Mail \$1.00 to Dept. M-1, National Industries, Inc., 951 North La Cienega, Beverly Hills, Calif.

NEW! Just out, simplest capacity operated relay yet! Uses one tube, low power. Complete schematic, instructions \$1.00. Free details. Chemi-Technix Labs., 568RB Riley, Buffalo 8, New York.

ANTENNAS, Towers, boosters. All makes, complete supplies. Easy credit. Lowest prices. Allied, 2503 N. 3rd, Milwaukee, Wis.

AMAZING Television antenna eliminator. Small device attached to rear of set where it's out of sight. Outperforms outdoor aerials. No snow, no ghosts. Send only \$2.95 or write for free details. Arrow Sales, 2306 S. Howell, Milwaukee 7, Wis.

TUBES, Etc. Free list. Wholesale Electronics, 224 E. 204th Street, New York City 6.

PICTURE Tube revitalizer makes dim pictures bright. \$2.95. T.V., 6225 Market St., Philadelphia.

FREE Blueprint Catalog! Hundreds of projects—Motor scooter, furniture, toys, birdhouses, radios, garden furniture, power tools, boats, work benches, home freezer, many more! Send postcard to Popular Mechanics Press, Dept. 103, 200 E. Ontario, Chicago 11, Ill.

BUSINESS OPPORTUNITIES

LIVING Miniature ("Ming") trees only 10 to 20 inches tall. Grow at home. Big profits! Spare time opportunity. Fascinating! Amazing! Write for free seed and plan. National Nursery, Dept. FC, Inglewood 4, California.

YOUR Own business in your basement. Very profitable. Sideline or full time. Patterson, 2518 Beaver, Des Moines 10, Iowa.

MY Husband, college professor, devised a scientific mail order plan that brings \$1000 monthly to our mailbox. Since the plan works anywhere, we bought a beautiful ranch, operate here. Anyone intelligent can apply our plan. Details free. Eveningshade Ranch, Helotes, Texas.

NATURAL Molding latex. New low prices. Extra thick. Free sample. W. Wooley, 115-A Donald, Peoria, Ill.

NEED Capital? Where and how. 41 ways! Free details! Vault, 3757-B Wilshire, Los Angeles 5.

GET Dollars in your mail—Keep every cent. Orders filled free. Genmerco, Box 142, Boston, 24B, Mass.

START Home business. Fix (patch) dents, scratches, cracks, blemishes on all varnished wood surfaces. Experience unnecessary. Small investment. Amazing profits. Literature free. Monarch Specialties, 3449 N. Pulaski, Chicago 41.

NO Equipment, big profits selling, glass, wall, waterless hand cleaner. Add water to concentrates. Donnell Sales Co., 430 Base Line, San Bernardino, Calif.

LEARN Silk screen printing; invisible reweaving; repair dolls; make rubber stamps. Rubber for molds. Large catalogue free. Universal, Box 1076-A, Peoria, Ill.

OWN, Operate, route—"Wishing wells." Place these new \$7.50 skill games on counters in cafes, luncheonettes, clubs, etc., collect coins weekly. Legalchar, Box 929, Long Beach 1, California.

START Your own business on shoe-string, and earn a substantial income by mail, in your spare time at home. Full details free. Standout Products, 141-T North LaBrea, Los Angeles 36, California.

MAKE Money mailing cards, circulars. Peaceful, profitable. Paton, Box 55-E, New York 23, N. Y.

\$50 AN Hour in spare time. Johnson, 351-B, Ithaca, New York.

HAVE Big time mail business. Get ideas, help, inspiration from others who made fortunes. Fern, 513-A West 61st, Chicago 21, Illinois.

BUY It wholesale! Manufacturers, distributors offer 850,000 items. Literature free. Olsen, 1231-A East Third St., Duluth 5, Minn.

BREED Rare tropical fish at home. Earn big money! Learn secrets! Help fill huge demand. Amazing opportunity! Free plan. Tropicals, 1008-F Los Angeles St., Los Angeles 15.

NEW Fabulous home-business. Pearlize baby shoes. Free money-making plan. Pearl-Art, 7216F Bear, Bell, Calif.

MINIATURE Golf. Exceptionally profitable business. Detailed plans of 18 holes, \$2.98. Dixieland, 2924 Douglass, Memphis, Tenn.

EXTRA Dollars. Spinning angora wool for us. Angora House, PM, Springfield, Illinois.

MAILORDER Instructions. Get. "Dollars in the Mail." Eliminate expensive mistakes. Ransie, Box 1719, Richmond 14, Virginia.

USED Oil re-refining. Free facts about this amazing business. Severs, 3909 67th, Des Moines, Iowa.

INCOME From local information. No selling. Write Neherco, La Verne, Calif.

BOOKKEEPERS, Keep books, small firms spare time. Manual latest technique by C.P.A., \$3.00. Modern Business, Box 406, Youngstown 1, Ohio.

MADE \$24,500 Using money making plans from Schemer Magazine, world's oldest mailorder publication. Box 275M, Canfield, Ohio. Year \$1.00. Sample 20c.

\$46 FROM Square foot plywood; jigsaw necessary. Write: Woodarts, X-154, Bridgewater, Mass.

FREE Particulars "Profitable Home Business Projects" plus wholesale sources 740,000 items. Cottage Industries, Omaha 12, Nebr.

PRINT Without printing press—Posters, banners, greeting cards, toys, glassware, neckties—anything! New "easy" revolutionary method. No special equipment or experience needed. Work full or spare time at home. No selling. We set up "your own local business." Wonderful moneymaking opportunity. Free sample. Profitable ideas, beautifully illustrated plan free. Write Screen-Print, 1010 South Los Angeles Street, Los Angeles 15.

FREE Vending machines; if used to sell our profitable nuts. Continental, Box 1361-A, Milwaukee 1, Wisconsin.

WHOLESALE Of sensational nationally advertised appliances, silverware, watches, cameras, etc. Start your own business. Full details. Send 25c for catalogue. International Sales Co., 175 Fifth Ave., New York 10, N. Y.

EARN Extra money with profitable home business projects, free particulars. Chamberlain, Box 894, Manchester, New Hampshire.

START Own business—Local mail order. Folder describes collection of 137 plans free. A Sales, 16P City Terrace, Newburgh, N. Y.

PROFITABLE Home business, electroplating novelties, giftwares, auto parts, mirrors. Easy, inexpensive home processes. Free booklet. Tyco Metals, Box 13231-MJ, Houston 19, Texas.

SELL Printing by mail! We fill orders. Free plans, samples. Sutton Printing, Box 853-G, Waycross, Georgia.

COLOR Concrete with chemicals. Marble-glaze cement benches, pottery, garden ornaments. Home—shop. 10c garden sample, pictures. Hollywood Cementcraft, 8527-R Wonderland, Hollywood 46, Calif.

MAKE Gifts, novelties, jewelry, from sea shells, fish scales, plastics! Wholesale, illustrated catalog 10c. Giftcrafts, Box 4550-PM, Coral Gables, Florida.

PROFITABLE Home business. Make fast-seller chenille monkey trees, dolls, flowers. Terrific holiday demand. Information free. Velva, Bohemia 16, N. Y.

TO \$35.00 Weekly. Spare time, home operated, mailorder business. Successful "beginner's" plan. Everything supplied. Lynn, 10420-M National, Los Angeles 34, Calif.

LIQUID Rubber, make flexible molds. Free sample. Chaney, 1130 E. 16th St., Jacksonville 6, Fla.

RAISE Fishworms. Easy, profitable. Complete instructions 25c. Huffmans Worm Ranch, Rives Junction, Mich.

FIX Typewriters. Free booklet describes our modern, inexpensive home-study course. Factory methods taught. Write: Typewriter, Building 1, Tarentum, Penna.

\$25 WEEKLY Working two hours daily. No canvassing. No manufacturing. Lycke, Box 2471-A, Cleveland 12, Ohio.

RESILVERING Mirrors, formula 50c; two-way lookout mirrors, (No one sees you), 50c; coppered mirrors, 50c. All \$1.00. Nelko-Mir, Box 3462-J, Chicago 54.

FIGURINE Molds and many others, liquid rubber, statuary plasters, flock finishes, Glo-candle wax, etc. Illustrated catalog and "Plastercraft" manual free. Blue Rapids Supply. Blue Rapids, Kansas.

START Home manufacturing business. Make cleaners, soaps, polishes, cosmetics. Free literature. Kemix, Park Ridge, Ill.

HOW And where to obtain capital? Free details. Star Service, Wapakoneta, Ohio.

BIG Profits making new greaseless doughnuts. Start in kitchen. Wholesale to grocers and cafes. Free plans. M. Ray Company, 3605 South 15th Ave., Minneapolis 7, Minnesota.

MAKE Money spare or full time, casting metal toys and novelties. Big wholesale and chain store demand for autos, soldiers, ashtrays, banks, etc., keeps manufacturers busy. Production moulds furnished for up to 100 and more castings per hour. No experience or special place necessary. Write for information and illustrations of patterns needed. Metal Cast Products Co., Dept. A, 1696 Boston Road, New York 60, N. Y.

NEW Exceptionally profitable plans, ideas for home operated mail business. Rush name. Miller, 1772-P Carlyon Road, East Cleveland 12, Ohio.

MAKE Flexible molds! Cast plaques, bookends, figurines! Free sample! H. Tooker, 630-R Chestnut, Hamilton, Ohio.

21 POPCORN, Candy apple formulas, proven money-makers. Send \$1 today for formulas, catalog of money-making ideas. Concession Supply, 3916 Secor, Toledo, Ohio.

RECAST Old batteries into new. Latest achievements. Battery Laboratories, Minneapolis.

READ "Advance"—The voice of mail order. Offers money-making opportunities, sources of supply, personal guidance, etc. Issued monthly. Sample copy 35c. Yearly subscription \$2.00. Advance Publishing Company, 313 East 21st Street, Suite 450, New York 10, N. Y.

GOOD Paying business silvering mirrors, plating autoparts, reflectors, bicycles, bathroom fixtures, etc., by late method. No tanks or shop required. Outfit furnished. Free booklet. Gunmetal Co., Ave. H, Decatur, Illinois.

BUY Wholesale. Thousands articles. Supply directory, 10c. Ideaco, Park Ridge, Illinois.

EARN Extra money! "Homeworker Magazine" tells how. Sample 25c. Sizemore, Box 7, 4917 Kostner, Chicago 30.

EXTRA Money—No selling, operate vendors. Amazing profits, details free. Silver King, Suite 220, 622 Diversey, Chicago 14.

OPERATE Profitable mail order business. Write Walter Service, 4159-A East 112th, Cleveland 5, Ohio.

DOLLARS in personalized baby record books. Sell by mail. Use same literature we do. No-Co-Ro, Oakland 6, Calif.

MINK Raising information free. Complete. Lake Superior Mink Farm, Superior, EE1, Wisconsin.

COPUBLISH Leading m.o. paper. Latest copy. Mail Sale Advertiser, details, dime. Vanroy Shirk, Lebanon, Penna.

COLORGLAZED Concrete pottery made without molds. Patented method. Cemetery products, novelties, tiles. Basement leak-sealing. Money-making projects. Booklet, details free. Men Only National Potteries Company, Grand Rapids, Minnesota.

FREE Book "505 Odd, Successful Businesses." Work home. Expect something odd! Pacific, Oceanside, Calif.

POPCORN and potato chip equipment. Long Eakins Company, 5360 High, Springfield 99, Ohio.

START Venetian blind laundry. Profitable lifetime business. New machine. Free booklet. F. C. Co., 442 N. Seneca, Wichita 12, Kansas.

BOOKKEEPERS, Increase earnings operating sensational bookkeeping service. C.P.A. system. Kern, 4942 Vineland, No. Hollywood, Calif.

SELL Books by mail! Wholesale catalog, 25c. Monarch, Auburn, New York.

MAKE Money from newspaper clippings. Siegel, Box 183 PM, New York 2.

137 PLANS for starting home business. Details: Elite Co., 220 Grand St., New York 13.

VENDING Machines—No selling. Operate a route of coin machines and earn amazing profits. 32-page catalog free. Parkway Machine Corporation, Dept. 72, 715 Ensor St., Baltimore 2, Md.

BE Independent. Small investment. Full-time or part-time. "Reel chair" for jobs large or small. Cleaning, painting, repairing, window-washing, etc. Write Finney Co., Platteville, Wisconsin.

LEARN Sewing machine repairing, etc. Everywhere our spare time men-women are cashing in. Parts, motors, zigzag, and other machines wholesale. Earnings confidential. Write Taylor Service, Hamilton, PM-5, Ohio.

ADVERTISING Book matches—Cash in on big demand; sell union label matches. Cuts for all businesses and political parties. Free powerhouse selling kit, low prices, protection guaranteed on repeat orders. Cash commissions. Superior Match Co., Dept. MX-553, 7530 Greenwood, Chicago.

START Your own business on credit. Your own boss. 1586 of our dealers sold \$5000 to \$27,500 in 1951. We supply stocks, equipment on credit. 200 home necessities. Sales experience unnecessary. Pleasant, profitable business backed by world-wide industry. Write Rawleigh's, Dept. E-U-PPM, Freeport, Ill.

SPECIALIZED Magazines covering your field of interest help you to greater success. Get latest copies through our easy-to-get-acquainted service. Hundreds of business, trade, professional, educational, sport, hobby, fashion, fertilizer, florist, food, foreign trade, forestry, fruit, funeral director, and others covering all interests. Send for list today. It's free. Commercial Engraving Publishing Company, 34C North Ritter, Indianapolis, Indiana.

IMPORT-Export! Opportunity, profitable, world-wide, mail-order business from home, without capital; or travel abroad. Established World Trader ships instructions for no-risk examination. Experience unnecessary. Free details. Mellinger 25, Los Angeles 24.

START Mail order business at home. Expert will show you how. Now owns \$100,000 business built in 4 years. Dime brings amazing proof and valuable information. No postals. Northmore, Ravinia, Illinois.

WANTED! Home producers, by manufacturers in our clearing house service. Become a sub-contractor, casting plastic products for these companies. Thousands of easy-to-make items required for consumer and industrial use. Cash in at home, without previous experience. Write Plastic Service Associates, Dept. PM5, East Boston 28, Mass.

START A buying service, buy wholesale thousands nationally advertised products. Make big profits selling at sizable discounts. Postcard brings details. American Buyers, 627-PM Linden, Buffalo, N. Y.

NEWEST Spare, full-time home business, \$5 to \$10 hour possible. Paint with suede—The finish with touch and eye-appeal. Beautiful auto dashboards, signs, radios, toys, figurines, lamps—1001 others. Complete, step-by-step instructions sent for no-risk examination. Free details. Coast, 1004-HP So. Los Angeles St., Los Angeles 15.

MAKE Perfumes at home. Write, "Carey Laboratories," 1914 Chouteau PM-5, St. Louis 3, Missouri.

SELL Popular Mechanics and all other magazine subscriptions. Free catalog, supplies. Subscription Service Company, Dept. A, P.O. Box 2070, Birmingham, Ala.

MAIL Order opportunities. Write F. Tyler, 528 Piqua Place, Dayton 7, Ohio.

MAKE \$6.73 Every time you sell one—And they're amazingly easy to sell! We have new adding machines in original factory cartons you can sell for only \$14.95 and you make 45%. They're executive model portables, precision built with automatic clearance, direct subtraction, fully guaranteed. Send for life size color photo with full details. Write today to Lightning Adding Machine Co., Inc., Dept. P-29, 1260 West Second Street, Los Angeles 26, Calif.

MAKE Perfume. Sell on smell. Mail order or local. Wilson made \$7200.00 first year. Free sample, plan revealed. McCann, 4019-21 Rio Grande, Amarillo, Texas.

"MAKE Products"—Sell mailorder formula catalogue free. "Imasco," 6347 Parnell-PM-5, Chicago 21, Illinois.

GOOD Pay making cement blocks. Bob's Workshop, 3228 So. Wabash, Chicago 16, Ill.

"HOW To Raise the Money You Need." \$2.98 postpaid. Refund if dissatisfied. Free details. Enterprise Bureau, Syracuse 2P, N. Y.

"MAKE Perfume." Catalogue free. "International," 6347 Parnell-PM-5, Chicago 21, Illinois.

FREE Booklet reveals amazing secrets behind 301 new profitable enterprises! Many mailorder! Includes confidential instructions for starting wholesale buying service. Deumant Business Surveys, 79-PM Deumant, Kenmore 23, N. Y.

FREE Wholesale catalog. Make up to 500%. Be your own boss, work full or spare time. Everyone a prospective customer. Sell costume jewelry, wrist watches, religious items, novelties, toys, gifts and prizes. Write today, specify catalog PM4, Heath Distributing Company, 3253 Vineville Avenue, Macon, Georgia.

OPERATE "Escalator" mailorder system, selling our products or any products. Fastest, most revolutionary mailorder system known. Write: Selbyco, Decatur 156, Ill.

FLEXIBLE Rubber moulds for plaster and Marbleite figurines. Sample and large illustrated catalog 25c, refunded on first order. K-C Novelties, Dept. 33, Easthampton, Mass.

MAIL Order business using profitable free advertising method reaching 66½ million. Revealing information free. H. F. Seidel, 7070 Hollywood Blvd., Hollywood 28, California.

MAKE Money at home as renewal headquarters for all magazines. Liberal commissions. No experience, no capital needed. Supplies furnished. Write for free catalog. McGregor Magazine Agency, Dept. 500B, Mount Morris, Ill.

TAKE Your choice of a profitable business of your own. A better job or high sparetime earnings in uncrowded, billion-dollar field of custom furniture upholstery. Earn while you learn at home to turn your hobby skill into a career, easily, quickly, through the famed N. Y. state-licensed Upholstery Trades School course. Course includes—Free of extra charge—4 big outfits of tools, complete frames and materials to make beautiful upholstered furniture you can keep, or sell for more than the cost of tuition. You can actually make and repair furniture soon after starting—earn money, get "set" for a steady prosperous future. Master craftsmen teach you custom upholstery, re-upholstery, car upholstery, furniture finishing—Plus 4 big extras—slip cover, cushion, window cornice and drapery making! Free book tells all about this ever-growing business, explains how you earn as you train at home. You don't leave your job until you're ready for a big pay, big profit opportunity. Write today to Upholstery Trades School, Dept. BE-1402, 721 Broadway, New York 3.

FOR Pleasure and profit. Send for free illustrated instruction book and business plan: how to permanize, metalize, ceramize, porcelainize baby shoes, mittens, booties, cloth, lace, etc. No equipment, no firing, no baking. Professional Art Products, Dept. PM-5, 825 South Wabash, Chicago, Illinois.

OPERATE Profitable mailorder business. Particulars free. George Lenhoff, Lincoln 8, Nebraska.

START Your own profitable home mail-order business! We supply everything! Write today! Studio Products, Box 564-AF, Glendale 5, Calif.

OPERATE Profitable mailorder business. Details. Natel, 411-C Paulison, Passaic, N. J.

SECURITY And profit in the country. Live happier. Earn comfortable income. Free facts. Hermes Publishers, 152-E West 42nd Street, New York.

WHERE To buy at wholesale 100,000 articles. Free list. Also extra-income information. Maywoode, 1135 Broadway, New York.

FABULOUS Florida—Cool in summer, warm in winter. Many opportunities in fast-growing Florida. If you are interested in going into business in fast-growing Florida, write State of Florida, indicating type of business you are interested in and stating your specific requirements. You will be put in touch with communities where opportunities exist. Get complete information, without cost or obligation. Write today. State of Florida, 4217B Commission Building, Tallahassee, Florida.

STAMINITE Offers you a lifetime money-making opportunity selling newest, greatest discovery of world-famous chemical corporation converted into products used by every householder, hobbyist; industrial, institutional and commercial establishment in U.S.A.! Earnings limited only by your initiative and sales ability. Don't miss this opportunity! It's the biggest news in a giant, basic industry. For details write Staminite Corp., Dept. P-5, New Haven 11, Conn.

\$5,000-\$10,000 YEARLY Breeding chinchillas in your home, garage, back-yard. Handbook 25c. Behnke Chinchillas, Guttenberg 99, Iowa.

BUY Wholesale—Thousands nationally advertised items. Save, make money! Free details. Durex Co., Box 672-U, Chicago, Ill.

START Home mailorder business. Details. Gedgard, Box 798-K, New York 1, N. Y.

STOP Money worries, own profitable business, mailing advertising literature. Write Specialty Products, Box 166, PM2, Mt. Holly Springs, Penna.

TIN-Cans. Turn them into cash. Nine methods. Instructions 50c. Charles Company, 12-DBC, Norwood, Ohio.

AMAZING Crushed redwood cedar! Cedarizes closets, drawers, trunks; prevents moth damage; applied like paint; stores, builders, contractors buy quantities; big profits; low cost; attractively packaged. Exclusive territory. Write for details. Manfr., 91-B Summit Ave., Brookline, Mass.

READ "Your Own Mailorder Business." Proven, tested, guaranteed, 25c. E. Merrill, Colebrook Road, Bangor, Maine.

LEARN Invisible reweaving! Reasonable. Harris, P.O. Box 7112, New Orleans, La.

SALTED-In-the-shell peanuts. Learn this unique and interesting process and establish yourself in a lucrative and dependable business with a future. Send \$5.00 for complete details of process and instructions to B. & W. Nut Co., 932 South Wilder St., St. Paul 5, Minn.

SAWDUST. Turn it into cash. Twenty methods. Instructions 50c. Charles Company, 12-DBA, Norwood, Ohio.

TRADE Your spare time for financial independence. Free literature. Earthworm Gardens, 224 West Valley, El Monte, Calif.

YOUR Name on labels and your own catalog insures repeat sales. We sell wholesale to you—28 sanitary chemicals, plus a complete array of janitorial supplies. Write today. Surety Laboratories, 3946 Olive, St. Louis 8, Missouri.

\$10,000 CAN Be in your bank by Sept. 1953 if you jump on the bandwagon now. We have the only automatic, 3-way, lifetime guaranteed, lowest cost, insect killer bulb on the market which is being introduced for the first time now. Write today for full free details, or send \$2.00 for sample and get started this week. Write, wire, phone, Insect Controls, Inc., 20th & Market Sts., Philadelphia 3, Penna. P.S.: This is a terrific mail order and direct selling item.

NEW! Develop profitable business. Convert merchants' electric signs to modern flasher type. Terrific demand! Simple installation. Big profit! Write for details. Stann & Co., 30 W. Washington, Chicago 2, Illinois.

SOIL Analysis—Fascinating new business, every homeowner a customer. Write Soiltest, 307D Woodland, Lake Bluff, Ill.

"FLOATING Henryburger" Systems franchise. Rare opportunity. Small investment. Box 936PM, Wichita, Kansas.

LEARN Metalizing baby shoes, gifts, etc. Bronze, gold, silver. Folio free. Kiktavi, 7217-PM South Broadway, Los Angeles 3.

PATENTED Tree saw which has been marketed long enough to assure practicability. Can be developed into large business with right initiative and sufficient capital. Write, Route 3, Box 1191, Springfield, Mo.

FRANCHISE Available. Parties with \$500. Secured by merchandise. Earnings \$8000 up. Miracle powder stops leak for automobiles, trucks, etc. Sells on dramatic demonstration. Testimonials leading operators. Sample \$8.00. Zunz, 455 Paul Brown Bldg., St. Louis 1, Mo.

\$28,000 PROFIT Using Future-Rich mailorder plan. Folio reveals everything—\$1.00. Particulars free. White's Money-maker, Newark, Ohio.

BUY Thousands articles wholesale. Directory, big mail 25c. Publishers, Box 1486-P5, Detroit 31.

MASTER Electroplating! State licensed correspondence course. Stamp brings details. Joseph Kushner Electroplating School, Stroudsburg 5, Penna.

EARN Money. Make beautiful figurines. Business. Hobby. Free information. Main Plan, Box 166, Bridgeport 2, Conn.

\$200 WEEK Possible! Sensational new hand cleaner. Manufacture, distribute. Easy. Free plan! Keenelo, 2445 Larimer, Denver 2, Colorado.

OPERATE Profitable collection agency. Become co-partner! Interesting details. Write: United States Protective Service, Box 4865, Atlanta 2, Ga.

BOOKKEEPERS — Complete manual. "Eleven Plans For Establishing Successful Bookkeeping and Tax Service," with licenses to operate. Only \$3.00. Commercial Business Service, 411 Fairfield Rd., High Point, N. C.

FRANCHISE Opportunities nationwide! Make no small plans! Secure exclusive distributorship or agency operation. Inquire today. National Franchise Reports, 452 Pure Oil Building, Chicago 1, Illinois.

EARN Money with typewriter, sewing machine! Details free. Edwards, 3915-PM, 12th, Des Moines 13, Iowa.

MAIL Postcards featuring real merchandise. Good earnings. Everything furnished. Write: R. Carroll Enterprises, 23P W. State St., Media, Pennsylvania.

HAVE Home mail business. Big earnings. Everything furnished. Start low as \$150. NMD, Madison, Box 88, Dorchester, 22-A, Mass.

SELL! Buy! Trade! Anything. Thru. "Trading Post Magazine." Details 3c. Thorne's, 575 Dewey, Jackson 15, Mich.

START Your own business with a route of nut, candy or gum vendors. No experience necessary. Full or part time. Send for catalog 100. Rake, 609-S Spring Garden St., Philadelphia 23, Penna.

START Business without capital! Reliance, 15-A, Park Row, New York 38, N.Y.

UNPAINTED Figures. Weaver Products, 840M 17th Street, Altoona, Penna. Catalog.

PERFUMES Direct from factory. \$500.00 profits per gallon on famous brands. Free catalogue. Murat, Inc., Murat Building, 2132 N.W. 11th Avenue, Miami 37, Florida.

50 PLANS For home mail business. Proven money-makers. Personal help assures success. Verdo, R1, Box 37-A, Huntsville, Missouri.

BLUEPRINTS. Inexpensive material makes fast sellers. Sample and list 25c. Walter E. Smith & Associates, Box 117, Florissant, Mo.

PEARL Finishing. New amazing home, full-time business. Free success plan. Pearllette, Box 73136, Los Angeles 3.

BIG Money! Start your own plastic business at home. Spare or full time. (Also valuable liquid marble information.) Free catalog. Write: Bing Products, PM-553, Watertown 72, Mass.

METALLIZED Baby shoes. The fabulous full or part time business that grows and grows with the ever increasing birth-rate. Instructions, equipment and supplies from world's oldest and largest supplier for the industry. Send now for your copy of "Your Guide to Success in the bronze baby shoe business." Plus complete wholesale catalog of equipment, supplies, and biggest selection of metal and onyx mountings. \$1 post paid. Hollywood Bronze Supply, 1624-A East First Street, Los Angeles 33, Calif.

BE Your own boss pioneering new concrete waterproofing your town. You get material wholesale and also make fine profit on contract jobs. All or part time. Rex Aquadry, 5511 W. North Ave., Chicago 39, Ill.

EARN \$2.00 Hour, I do, making sandals. Chas. Youngs, 1308 S. First, Arcadia, California.

MONEYMAKING OPPORTUNITIES

INSTALL Hand railings on stairs, terraces, porches. Unlimited applications. Provides safety. Cast aluminum universal joints lock with set screws. 1½ inch aluminum tubing will not rust. Easy to assemble. Fits any angle or grade. Install in wood, stone, ground or concrete. Profitable. Send for folder. Kloppenberg Aluminum Foundry, Dept. PMC-3, Davenport, Iowa.

400 RADIO Stations active. Free radio advertising. Pay commission only on orders received. Free information. Mishek, 2, Waseca, Minn.

ASSEMBLE Electric fans. Exhaust and circulating for home, attic, kitchens, restaurants, offices, factories. Sells easily. You furnish electric motors; we furnish all fan parts. Send for wholesale parts catalog. Kloppenberg Aluminum Foundry, Dept. PMC-3, Davenport, Iowa.

CASH In your ideas. Complete information now available. Prepared by experienced engineer-inventor. \$1.00. Full refund provision. O. W. Wood, 100 Church Street, Liberty Corner, New Jersey.

CHURCHES. Clubs, organizations, receive \$130, 12 card tables free. Unique Club Plan, Pine Hill, New Jersey.

MAKE Money at home! New folio "Homework as a Profitable Endeavor" tells how. Only 25c (refundable). Opportunities, Folio-A, Box 209, New York 28.

MAKE Money at home mailing literature to new mothers. Terrific possibilities. Information and material furnished. Write: Williams Sales, Burton, Wash.

PROFITABLE Home business. Write Chamberlain's, 87 Arizona Place, Chandler, Arizona.

MAKE Money selling by mail. Famous course teaches how. Free brochure. Manhattan House, Box 51-M, Saint Albans 12, N. Y.

WEAVING—Rugs, drapes, tweeds, etc. at home. Can be profitable and pleasant; part or full-time job. Free catalog. Newcomb Loom Company, Dept. PM, Davenport, Iowa.

DIME Brings our nationally advertised "opportunity packet." Rinehart, 235 Baltimore. Hanover, Penna.

MAKE To \$4.50 hour doing common pen lettering. National Artists, 801½ North Marsalis, A-5, Dallas 3, Texas.

SELL Titania gems; \$9.75 carat wholesale. More brilliant than diamonds. Free catalogue. Diamonte, 1404-M Mitchell, Oakland 1, California.

TIE-Breaker picture puzzles exposed, \$2.00. Wenograd, Box 1495, Philadelphia 5, Penna.

SCHUHMACHER Matmakers. Convert old tires into dollars. Devote full or spare time. S and S Patents, Inc., 1307 North Clark St., Chicago 10, Ill.

50,000 ARTICLES Wholesale. Source directory, dime. Nelko, Box 3462-DR, Chicago 54.

PUBLISH Your own magazine. Hand-some 52 page format, well edited, illustrated. Cost low as \$1.00 month. Brings you prestige, profits. 25c brings sample, details. National, Ord, Nebr.

137 PLANS To make money, local mail-order. Details: Elite Co., 220 Grand St., New York 13.

READ Progressive Mailtrade, the magazine that tells how to make money by mail. Dime brings sample and special offer. Progressive Mailtrade, Box 357, Sheboygan, Wisconsin.

FREE Book "505 Odd, Successful Businesses." Work home. Expect something odd! Pacific, Oceanside, Calif.

SPARETIME Profits taking subscriptions, all magazines. Wholesale catalog free. Cassell Agency, Westfield 2, New Jersey.

\$10,800 PROFITS! Your own mailorder business! No capital risk! "Success plan" (worth \$2) free! Write today! Treasury, 709 Webster, New Rochelle PM-11, New York.

BE Independent, be secure, have your own profitable business—Earn \$20.00 and more a day making beautiful, fast-selling lamps at home. No equipment needed. Illustrated course teaches you quickly. Course, parts catalog, wholesale price list—only \$2. Gearon Co., Dept. 200-B-5, 27 S. Desplains, Chicago 6, Ill.

START A buying service, buy wholesale thousands nationally advertised products. Make big profits selling at sizable discounts. Postcard brings details. American Buyers, 630-PM Linden, Buffalo, N. Y.

HOBBYISTS! There's profit in hobbies. Investigate. Cramer, 11 Hanna Road, Worcester 2, Mass.

BE Notary public. Rate higher. Details free. Stationers, Helotes, Texas.

FREE Booklet reveals amazing secrets behind 301 new profitable enterprises! Many mailorder! Includes confidential instructions for starting wholesale buying service. Deumant Business Surveys, 83-PM Deumant, Kenmore 23, N. Y.

ADDED Income selling by mail. Roblin Sales, 1001 Curtiss, Downers Grove, Ill.

FREE!—Radio advertising without investment! Jakiela, 2644-PM No. Western, Chicago 47.

EXPERIENCED Roof repairer. Franchise protection. Luster-Kote, 19417 Derby, Detroit, Mich.

EARN Money evenings, copying and duplicating comic cartoons for advertisers. Adservice, Argyle 1, Wisconsin.

FREE! Your own mailorder business! Everything furnished! No investment! Terrific profits! Write today. California Vitamins, 2910PM, Beverly Boulevard, Los Angeles 4, California.

FREE Details. Buy wholesale thousands items. Write United, Box 87-M, Detroit 2.

WE Pay cash for boxtops, labels, wrappers, coupons, etc.! Particulars free. Box-tops, PM-983 E. Main, Columbus 5, Ohio.

FIGURINES Painted, unpainted. Flock and finishes. Catalogue 25c with new plan. (Refundable). House of Bern, 221 South Ave., Syracuse 4, New York.

\$5.00 PER HOUR assembling driftwood lamps. Sam Patchett, 2187 N.W. 24 Court, Miami, Florida.

CHURCHES. Organizations, receive \$130.00—12 card tables. Unique Gift Plan, Pine Hill, New Jersey.

\$15 HOURLY! Sparetime, without investment! Mailway, Box 198-E1, State College, Penna.

TECHNICAL Writers needed by industry. Learn details, 25c. Mitchell, 22959 Allen, St. Clair Shores, Mich.

SPARE Time homework opportunities. Easy, profitable. Stamped envelope brings details. Alfred Haseman, Beecher, Ill.

MONEY And pleasure. Party favors, big demand. "Beginners Instructions" \$5.00. Marwal, Mp Jefferson, Iowa.

FORMULAS, PLANS, ETC.

MILLER'S Modern manufacturing formulas make fast-selling products that get the business and pay. Fifty years supplying the best. Late literature free! Miller, Consulting Chemist, Tampa, Florida.

REAL Manufacturing formulas. Lists free. Cummings, Chemist, Gordon Ave., Syracuse 4, N. Y.

FORMULAS; All kinds. Latest, best. Literature free. Kemixal, Park Ridge, Ill.

GENUINE Manufacturing formulas. Latest. Literature free. Nelko, 3462-P Merchandise Mart, Chicago 54.

METALIZE Your baby's shoes. Easy new method, formula \$1.00. Krysto, Felton, Calif.

PRODUCT Analysis, manufacturing formulas, and processes developed. Plastics, Box 1574, Boston 4, Mass.

CHANGE Varnish into luminous paint. Chemicals, formula \$1.00. C. & R. Ceramic Products, Box 6321, Birmingham 7, Ala.

FREE List of 75 money-making formulas and trade secrets. Davis Products, 16 Norwood, Long Branch, N. J.

AMAZING Book! 10,000 Formulas, 900 pages, \$3.98 postpaid. Guaranteed! Paulin, 109PE, Loudonville, Ohio.

PLASTICS

LUCITE, Plexiglas. Any size sheets, masked. Square foot (12 x 12) cost, 1/16", \$1.20; 1/8", \$1.40; 3/16", \$1.75; 1/4", \$2.00. Include 10% postage. Almac Plastics, 600 Broadway, New York City.

PLASTIC, Sheets, rods, tubes, etc. Free list. Plastic Supply Co., 2901 N. Grand Blvd., St. Louis 7, Mo.

DESIGNING, Manufacturing plastic parts, jigs, signs, letters, etc. Free estimate. Harry Smith Specialties, Box 9378, Akron, Ohio.

PLASTICS—Lucite, Plexiglas, Acetate, Vinylite, Polyester-Fiberglass. Low, low prices. Value-packed, bargain-filled catalog 10c. Airmailed 25c. Gem-O-Lite, Box 6862S, North Hollywood, California.

PLASTICS Home-craft course for men and women. Tells and shows how to make hundreds of fast selling plastics products. All plastics and materials for 23 projects included in course. No special tools needed. Course pays for itself. Write for free booklet. Interstate Training Service, Dept. D3E, Portland 13, Oregon.

PLASTIC Engraving, carving machine—"Dupliscafer." Profits to \$5 hour engraving plastics. Details, sample 25c. Desco Distributors, 6334-R Sepulveda, Van Nuys, Calif.

NEW Liquid casting plastic. Clear, colors. Embed flowers, insects, coins. Saw, drill, carve. Send 25c for Castolite Creations Manual and proved success plan showing how to make money at home. Castolite, Dept. E-101, Woodstock, Ill.

LIQUID Lucite, casting plastics, supplies, where to buy them wholesale, large savings, folio, \$2.00. Castle's Co. Box 2139, Paterson, N. J.

MODELING Plastic. Looks and molds like modeling clay. Bakes in kitchen oven to hard plastic. Make toys, figurines. Kit, 6 colors, \$2.00. Plastibake, Dept. 5M, 700 2nd Ave., San Francisco 18, Calif.

CHEMISTRY

NEW Idea chemical and apparatus outfits for home experimenting. Photo-scales, microscopes, chemicals, biological and laboratory supplies in small quantities. Catalog 25c. Established 1931. John H. Winn, 124A West 23rd Street, New York, N. Y.

ILLUSTRATED Catalog: Chemistry, mineralogy, biology, 10c. Tracey Laboratories, Evanston, Illinois.

CHEMICALS, Supplies. Catalog 15c. Laboratory Sales, Box 161-T, Brighton, Mass.

CHEMICALS And apparatus for industrial, analytical, and private laboratories. Catalog 25c. Dept. M-50, Biological Supply Co., 1176 Mt. Hope Ave., Rochester 20, N. Y.

SECOND Printing, improved version, spectacular chemical fireworks manual. Contains complete set-ups, formulas, instructions on thermites, fulminates, explosive powders, etc. Still \$1.00. Free details. Chemi-Tech Laboratories, 568Z Riley, Buffalo 8, New York. Chemical questions answered.

HELP WANTED

WANT To make more money? Have a real career with a lifetime of high salaries? I'll show you how to succeed in the growing automotive-diesel field that needs men. Write Ed-Howes, Chief, Dept. 253, 4000 S. Figueroa St., Los Angeles 37. No obligation.

AGENTS WANTED

NEW Plastic mending tape. Just press on! Repairs clothing instantly. Lightning seller. Samples sent on trial. Kristee 159, Akron, Ohio.

HOTTEST Seller ever! Get in on the ground floor! Huge profits await you as our agent selling full or part time new nationally advertised top quality Pennsylvania saw sets. Tempered steel saws for every use—all on one handle. Hacksaw, crosscut, frozen meat and bone saw, pruning saw, keyhole saw, dovetail saw. Tremendous value everyone can use—everyone wants! Sells on sight! Send for free illustrated catalogue. James R. Barnet Co., Dept. PM-4, Box 188, Wellesley Hills, Mass.

AMAZING New hand cleaner. Trial 2 1/2 pound can \$1.00. Bayco, Box 805, Pawtucket, R. I.

FAST Profits—No investment. Plastic aprons, tablecloths, etc., 300 sure-fire items. We guarantee sales. Free information. Halliday Co., Dept. PM, 15 Pennington Ave., Passaic, N. J.

WHOLESALE Catalog. Nationally advertised appliances, cameras, watches, etc. Cam Co., 1717PM—58th St., Brooklyn 4, N. Y.

ABSOLUTELY Free—Sales kit. Yours for the asking. Send postcard today requesting kit showing new line, belt buckles with your name or personal initials, cap badges, choice 3000 different emblems. Write Hook-Fast, Box 1425PM, Providence, R. I.

FREE Samples. Big profits showing amazing "Glow-in-the-dark" specialties. House numbers, pictures, plastic novelties, ashtrays, keyholders, religious and nursery objects, etc. Madison Plastics, 303 Fourth Ave., New York 10, N. Y.

'53 **WHOLESALE** Dealer kit on appliances, typewriters, recorders, cameras, giftware, etc. Free. Write Arrow Distributing, 154-B Nassau Street, New York.

BIG Profits selling sensational engine oil-vuer. Every motorist hot prospect. Details free. Rogers Automotive, Box 23, Station C., Pasadena, California.

SELL Fast—79c Baby necessity. Big repeater. Baby Gay, Beaver Dam 8, Wis.

CALIFORNIA Sweet smelling beads. Sensational sellers. Free particulars. Mission, 2328PM West Pico, Los Angeles 6, Calif.

COSTUME Jewelry will bring you fabulous profits, easy sales! Our terrific line includes popular-priced Coronation jewelry! Send for catalog and wholesale prices—for re-sale only! Penn Jewelry Co., Dept. P, 826 W. Lacka, Ave., Scranton, Penna.

NEW Car given as bonus. Make money spare time. Unusual nylon guaranteed to wear definite time or replaced free! Rush name and hose size. Lowell Wilkin, 1735 Wash., Greenfield, Ohio.

YOUR Own business—Used suits \$1.50, overcoats 65c, mackinaws 35c, shoes 12 1/2c, ladies coats 30c, dresses 15c. Enormous profits. Catalog free. Moro, 558-AA Roosevelt, Chicago 7.

AGENTS: Stamping names on key protectors. Sample 25c. Stamping outfits, checks, social security and name plates. Hart Mfg. Co., 303 Degraw St., Brooklyn, N. Y.

AGENTS—300% Profit selling genuine gold window letters; stores and offices. Free samples. Metallic Sign Letter Co., 431-D North Clark, Chicago.

BUY Wholesale thousands nationally advertised products at big discount. Free wholesale plan. American Buyers, 629-PM Linden, Buffalo, N. Y.

GOLD Lacquered and silver sign letters. Windows, doors, trucks. Standard sizes. Penny and up samples. Atlas-P, 544 West 79th, Chicago 20.

BUY Wholesale. 25,000 items. Catalogue 25c. Matthews, 1472-B-7 Broadway, New York City 36.

MEXICAN Feather pictures. Sell on sight; 200% profit! Free details. Sample 20c stamps. (No coins). Sylviap, Apartado 9036, Mexico City.

EXCELLENT Sideline for printing and advertising salesmen. Decalcomania name plates in small quantities. Great demand. Also, make money with our line of automobile initials and sign letters. Free samples. "Ralco" XL-Roxbury, Boston 19, Mass.

WANT A big share of Real Silk's millions? Just help fill growing demand for our top quality nylon hosiery, other apparel. Start spare time if desired. Sample outfit free. Write Real Silk Hosiery Mills, Inc., Dept. PM-5, Indianapolis 6, Indiana.

MAKE Money introducing world's cutest children's dresses. Big selection adorable styles. Low prices. Complete display free. Rush name. Harford, Dept. J-6341, Cincinnati 25, Ohio.

SELL Big money maker to men and women. Easy handwork makes fast-selling useful articles. Sample free. Sunmade Company, Brockton 64, Massachusetts.

JOKESTER'S Printed novelties. Fifty—\$1.00. Sebastian, 10934-X Hamlin, North Hollywood, California.

FREE Cosmetic sample kit. Bigger commissions. Complete, fast selling, high quality line sells itself. Mme. Rubinoff Cosmetics, Dept. PM-4, St. Louis 5, Mo.

NEED Extra money. Sell name plates this summer. Details free. Box 374, Milford, Conn.

BUSINESS Cards \$1.70, 1,000. Samples. Signal, Box 927E, Los Altos, Calif.

PAINTS—All kinds. 65c gallon up. Private label. Big profits. Certified Products, Louisville, Ky.

HAND Cleaners and other specialties. Sell industrial plants, institutions, etc. Liberal commissions. Dytex Chemical, India Street, Providence, R. I.

BUY Wholesale from nationally advertised manufacturers, distributors. Literature free. Carter Publications, Box 6011-G, Chicago 80.

GREATEST Selling sensation. \$5.00 hour profit easy. Tydorf, Whitesboro, New York.

BE A money maker. Use your home as magazine headquarters. Liberal commissions. No experience. No capital needed. Everything furnished. Write for free catalog. McGregor Magazine Agency, Dept. 500A, Mount Morris, Ill.

PRINTING, Salesbooks, envelopes. Free illustrated catalog. Ersco, Dept. PM, Bronx 72, New York.

COUNTY Agency. Power mowers; \$31.20 net. Prepaid. Guaranteed sales plan. Rotacut, PM, Excelsior Springs, Mo.

BALL Pens \$10.00 gross, d.e. s.e. blades \$4.20 M. novelty flashlights with battery \$2.25 dozen. Lutzker, 871-P East 170th, New York City 59.

REPEAT Business and high commissions raising dwarf trees for pleasure and profit. This field practically untouched by salesmen. Handle our growing kits with complete instructions on what until recently was an oriental secret. Write today for free sales plan. Don Pedro Farms, Dept. 10, Rte. 2, Box 1007, Stockton, Calif.

\$50 WEEKLY Selling finest razor blades, other items. Free details. Edisans, Box 274, Far Rockaway, N. Y.

FOR Opportunity of lifetime see Staminate advt. Business Opportunities column.

MEXICAN Feather pictures. High profit! Fast sellers! Adelphi, Box 57-B, Bellerose 26, N. Y.

AGENTS—Salesmen: Sell beautiful hand colored plastic enlargements and sensational new personalized photo compacts, rings, bracelets, lockets, etc. Experience unnecessary. 40% advance commissions. We deliver, collect. Wonderful sideline—Better full time. Free sample outfit. Novel Portrait Co., 3343 North Ave., Chicago, Ill.

KILL Flies, insects (all kinds) instantly. For homes, restaurants, hotels, hospitals. Amazing (low priced) invention. Whirlwind seller. Tremendous profits. Waiko Industries, Dept. 53-C, Highland Park, Ill.

MAKE Money selling photostamps. 300% profit! Send photo/negative (returned unharmed). \$1 for 100 photostamps, sales details. National Photostamp, Dept. 2, 654 Broadway, New York City 12.

MEN'S Dress hose \$1.25 dozen. Free catalog. Gainer, 760 Book Bldg., Detroit, Michigan.

BUY Wholesale! Big profits! Name brand—Appliances, watches, gifts, silverware, etc. Free catalog. Bergen Novelty Sales Co., 59 S. Dean St., Englewood, New Jersey.

\$50.00 MADE Selling occasional cards. Two dollar boxes, \$1.35. Diehl's, Buffalo 5, New York.

WHY Ordinary things? New Swiss tool. Thousands demanded. Big profits. Steen's, 811 Broadway, Long Branch, N. J.

SELL New all-purpose silver polish and plating liquids. (Cloth applied). 10 products. Up to 1400%. NuSilver, 508-PM5, Aurora, Illinois.

SELL Harmar's French fried popcorn to stores and taverns. Fast repeater. Harmar Products Co., Hammondsport, N. Y.

GET Into toys! Big money. Show free toy-gift line full or spare time. Take orders. Pocket juicy profits. Styleco, Dept. E378, Cincinnati 10, Ohio.

BUY Wholesale million articles supply directory. Literature free. United Buyers Service, 3400 Selma, Knoxville, Tenn.

BIG Profits selling ties (\$2.00 values). \$6.50 dozen. Free catalog. Empire Cravats, 648 Broadway, New York 12.

SALESMEN—DISTRIBUTORS

SALESMEN, Distributors, fast selling costume jewelry direct from factory. Big picture catalog, free. Pickcraft, M19 Bank, Attleboro, Massachusetts.

NEW Jobs open in selling! Send name, address for five free issues of Opportunity Magazine's money-making guide, listing hundreds of companies who'll pay you well, full or part-time. No experience needed. Opportunity, 28 E. Jackson, Dept. 17, Chicago 4, Ill.

DISTRICT Mgr. calendars, specialties. Klingstedt's, 425-509 Schroyer, Canton, O.

SERVICE Stations need magnetic gas cap holder for each pump. Saves time, eliminates lost caps. Acceptance proven, quick sales, good profit. Saleable sample \$2.50. Emppo Products Co., 359 McLean Boulevard, Paterson, N. J.

MAN—Earn \$500 month and up. National company. Unusual invention. Automatic fire extinguisher. Full or part time. Exclusive. Prospects everywhere. Free details. Write Superior Products, Inc., Dept. 135, 3410 Main St., Kansas City, Mo.

\$10,000 PROFIT Selling printing, matches, specialties! Gustav Kahn tells how he did it in giant free sales outfit. You can do it too—Without experience. Write Arrow Press, 515 Fourth Ave. So., Minneapolis, Minn.

ANYONE Can sell Hoover DuPont nylon uniforms for beauty shops, waitresses, doctors, nurses, others. In white and colors. Exclusive styles. Top quality. Low priced. Exceptional income. Real future. Equipment free. Write fully. Hoover, Dept. M-100, New York 11, N. Y.

CALENDARS, Advertising novelties, matches. All styles, including religious, varnished. 12 sheet, girls. Hundreds of advertising novelties, book matches, etc. Fleming Calendar Co., Sales Division, 6539 Cottage Grove, Chicago 37, Ill.

ADVERTISING Book matches—Cash in on big demand; sell union label matches. Cuts for all businesses and political parties. Free powerhouse selling kit, low prices, protection guaranteed on repeat orders. Cash commissions. Superior Match Co., Dept. M-553, 7530 Greenwood, Chicago.

BIG Money in selling novelties. Send 25c wholesale catalogue. Box 2929, Odessa, Texas.

NEWLY Patented, self-filling brush and ink combination. Storekeepers can't resist. Sign-Riter, Inc., 261 Great Arrow, Buffalo 7, New York.

SALESMEN Make up to \$50.00 in a day selling brand new item going to every type of food and beverage store, factories, laboratories, hospitals, etc. Samples furnished. Utility Durawear, 53 West Jackson Blvd., Dept. PM-5, Chicago, Illinois.

AD Matches! Sell amazing designs—20, 30, 40 and 240-light book matches. Bigger spot cash commissions; every business a prospect. Low prices for high quality. Repeats. Start without experience; men, women; full, part time. Buy nothing! Sales kit furnished. Match Corp., Dept. PM-40, Chicago 22, Illinois.

SELL At wholesale prices to grocers, drug, hardware, variety stores, etc. Wonderful 29c plastic kitchen item. "It really sells!" Excellent profit for you. Springmeier Co., 406 W. Rockdale Ave., Cincinnati 29, Ohio.

IS \$210 A week worth a postcard to you? Then rush card with name and address for special free trial plan that sells amazing new automatic refrigerator defroster "like hot cakes!" Write to Mr. Lewis, D-Frost-O-Matic Corp., Dept. B-102, 173 W. Madison, Chicago 2, Illinois.

PLASTIC "Eye catching" flasher displays. Sparkling, color lighted, lifelong, plastic titles. Desco Distributors, 6334-U Sepulveda, Van Nuys, Calif.

\$50 DAILY! Star Dust! Makes cars shine like stars! Sample free! Star Dust, 405 Madison, Fort Wayne, Indiana.

EDUCATIONAL AND INSTRUCTION

GET Into politics! Brand new course tells how. Get into the big money class. Details free. Realcraft Publishers, Post-office Box 137-A, New York 51, New York.

TIME Travel past or future—Your own personal time machine. Tested, approved by hundreds. Send 25c for complete details. Eidetic Foundation, Box 345X, Fairhope, Alabama.

PIANO Tuning pays. Learn this profitable profession at home. Our Tonometer and mechanical aids make learning easy. No knowledge music necessary. Diploma granted. Largest and oldest school—55th year. G.I. approved. Write for booklet. Niles Bryant School, 78 Bryant Bldg., Washington 16, D. C.

HOME Study course, drugless therapy. Free literature. Institute of Drugless Therapy, Tama, Iowa.

MEDICAL Laboratory technicians in great demand. We train you in your own home. Catalogue free. Imperial Technical Institute, Box 973-J, Austin, Texas.

SECRET Investigation. Experience unnecessary. Investigators particulars free. George Wagner, M125 West 86th, New York 24.

INVESTIGATOR Training. Phillips Secret Service System, 1917-B North Keneth, Chicago 39

BE A real estate broker. Study at home or in classrooms in leading cities. Write for free book today. Weaver School of Real Estate, 304 Law Bldg., Kansas City, Mo.

BOOKKEEPERS! Increase your earnings! Operate your own simplified "Dollar-A-Week" bookkeeping and tax service. Full or spare time. Details free. No obligation. Ellis, Box 200, Cedar Grove, North Carolina.

USED Correspondence courses and books sold and rented. Money back guarantee. Catalog free. (Courses bought.) Lee Mountain, Pisgah, Alabama.

PRACTICAL Nursing—Learn easily at home, spare time. Big demand, good earnings. High school not necessary. Write for free facts. Wayne School, Dept. FG-17, 2525 Sheffield, Chicago 14, Ill.

HIGH School—No classes. Study at home. Spare time. Diploma awarded. Write for free catalog HF-32, Wayne School, 2527 N. Sheffield, Chicago 14, Ill.

WELDING Training pays at Hobart Welding School, Box M-531, Troy, Ohio. VA contract. Best equipment. Catalog free.

FOR An extremely profitable lifetime business, operate a collection agency. Quickly learned. Write Cole Associates, Syracuse 2, N. Y.

U. S. Civil Service jobs! Start high as \$316.00 month. Men—women. 50,000 jobs open! Qualify now! Experience usually unnecessary. Get free 32-page book showing jobs, salaries, requirements, sample tests. Write today: Franklin Institute, Dept. Z-23, Rochester, N. Y.

BECOME A doctor of psychology or metaphysics. Learn secret of contentment, happiness. Win degree of PsD. or MsD. Solve mental worries. Free book. College of Universal Truth, 5038-C Broadway, Chicago.

AMAZING Book by psychologist reveals secret of freedom from nervousness and personality difficulties. Send only four dollars. Living Arts, 21 Lexington Ave., Dayton, Ohio.

RADIO-TV jobs. Get FCC licenses quickly. Correspondence and residence courses. Free placement. Grantham School, 6064 Hollywood Blvd., Hollywood 28, California.

STRUCTURAL Drafting and design. Study at home. Information free. Roth Technical Institute, Dept. M5, Box 2283, Youngstown 4, Ohio.

INCREDIBLE! Become mental superman overnight! Free booklet! Bijou, Box 1727-M5, Hollywood 28, California.

WANT A diesel job? New opportunities to increase income. Higher pay. More money. We can help you qualify. Tools. Shop method home training. Write today! Diesel, Tractor, Heavy Equipment Division, Interstate Training Service, Dept. B3E, Portland 13, Oregon.

GARAGEMEN: Take or advertise low-priced home diesel course. W.P.H.I., Pittsburgh 12, Pennsylvania.

INVESTIGATION Training. Resident course with successful placement. Free literature. Reed Institute, 928 Main, Kansas City, Missouri.

BECOME A tax expert. Study at home. Booming full or spare-time business. Write Union Institute, Lakewood 23, N. J.

MIDLAND Linotype School, Charles City, Iowa. Civilian and Veteran Courses. Free placement. Established 1909.

USED Correspondence courses and educational books bought, sold, rented. Catalog free. Educational Exchange, Summerville, Ga.

MASTER Those worries, fears and problems with our amazing home-study plan of "Human Behavior Control." Many helped. Write for unusual free lecture in plain, sealed wrapper, without obligation. Personal Psychology, Inc., Box 1924-E, Louisville 1, Kentucky.

WANT To make more money? Have a real career with a lifetime of high salaries? I'll show you how to succeed in the growing radio-television field that needs men. Write Ed Howes, Chief, Dept. 453, 4000 S. Figueroa St., Los Angeles 37. No obligation.

LEARN Public speaking quickly! Amazing new way. Increase income. Perhaps become famous. No lessons. No arduous work. MB, 405P Gorham Bldg., Minneapolis.

PLAYS, STORIES, MANUSCRIPTS

WRITE Science fiction. 32 magazines want stories, articles. Published authors help you. Revision, ghostwriting. All subjects, any market. Radio, screen, television, screen. H. Ballenger, 1509-M Crossroads of World, Hollywood, California.

NO Luck finding a book publisher? Write for free Booklet PM. Vantage Press, 120 W. 31, New York.

BEGINNING Writers: Get \$1 to \$20 checks daily writing simple children's stories, articles, poetry in your sparetime. Experience unnecessary. Our instructions reveal how. Details free. W. Herman, 7016 Euclid, Cleveland 3, Ohio.

HOW To write short stories, mysteries, articles. Learn at home for career or extra part-time income. (A. Aretz sold first 2 stories for \$255.) Professional writers show you how. Send today for free book which explains opportunities. Palmer Institute of Authorship, Desk TM-53, 1680 N. Sycamore, Hollywood 28, Calif.

SPECIAL SERVICES

LETTERS Remailed 25c. "Mail Me From St. Louis." Box 510-M, St. Louis 3, Mo.

4 TAHITI Postcards. Remailed free. \$1.00. Yves Jarsaillon, Poste Restante, Papeete, Tahiti.

PORTLAND Letters remailed 25c coin each. Brockway, 228 N.W. 22nd Ave., Portland, Oregon.

NEW York address for your mail. J. Reilly, 2013 Boston Rd., New York 60, N. Y.

LETTERS Remailed 25c. Minneapolis postmark. Kane, Box 994, Richfield Branch, Minneapolis 23, Minn.

LETTERS Remailed from Canada. 25c Queen Elizabeth stamps. J. Lauder, 1373 Tourangeau, Windsor, Ontario.

REMAILS 30c Coin, beautiful peach country. A. Hagen, 1019 16 St., Modesta, California.

INFORMATION On any matter. Ferguson Research, 116-14 141 St., South Ozone Park 36, N. Y.

QUEBEC. Letters remailed from historic city 50c. Bellet Service, 29 St. Helene Street, Quebec.

MAIL Your ties, blouses, hankies, etc., have them hand painted. 50c ea, add 25c for postage. M. Schwarz, 63 Post Ave., Base. Apt., New York City 34, N. Y.

NIAGARA Falls postmark—Remails 25c each—Niagara postcards 3 for \$1.00. Coin. Marr, Box 145, Ponthill, Ontario, Canada.

WILL Draw machine parts details from your sketches. Fred S. Enkler, 28 Lent St., Poughkeepsie, N. Y.

YOUR Questions answered. Research; business; social. Any subject. Confidential. Write, Dougherty, Box 88J, Van Nuys, California.

CARTOONING, COMMERCIAL ART, SHOWCARD WRITING, SIGN PAINTING

CARTOONISTS: Amateur, professional. Prepare for animation with Max Fleischer's plan. Write Vera Coleman, Lincoln Building, New York, N. Y.

CHALK Talks. Laugh producing program, \$1.00. Catalog 10c. Balda The Cartoonist, Oshkosh, Wisconsin.

9 ALPHABET. 3 Numeral pattern sets and raised wood letter catalog, \$1.00. Sign Letter Distributors, P.O. Box 101, Mineola, N. Y.

LEARN Sign painting at home. Test lesson free. Ben Kerns, Box 812-P.M., Greenville, S. C.

"HOW To Make Money With Simple Cartoons"—A book everyone who likes to draw should have. It is free; no obligation. Simply address Cartoonists' Exchange, Dept. 95-C, Pleasant Hill, Ohio.

FIGURE-Drawing. Learn after the famous European methods. Sample lesson with 600 illustrations \$1.00 (stamps). Dansco, Box 1315, Copenhagen, Denmark.

DISPENSAPPOINT—New development. Modern pencil pointer \$1, refills 15c. Reed Co., 3601 Fourth, Boulder, Colo.

ADVERTISING AGENCIES, LETTER WRITERS, FOR ADVERTISERS

ADVERTISE: 24 Words, 100 Canadian newspapers \$5.50. Lists free. Advertising Bureau, 10511-C Springfield, Chicago 43.

ADS Placed in out of town newspapers and magazines. Low rates. Catalogue free. Ideas that pay. Baker Advertising Agency, Successors Ankrum Agency, 189 W. Madison, Chicago 2.

ADVERTISERS! Reach nearly 18,000,000 readers. 25 Sunday national key newspapers, 18 words, \$59.00. "Terrific pullers." 20 popular newspapers, \$11.50. Free booklet. Special—One inch display 2.-821,198 circulation, \$51.10. Newmark's Advertising Agency, (Established 1893), 217-7th Ave., New York 11.

MAILING Lists: \$5.00-1000 up. Write Dixie Service, King, N. C.

FREE Copy, layout service. Mailorder ad, 1,700,000 nationwide circulation, \$27.30 inch. 24-word classified, 20 big Sunday newspapers, \$30.00. Advertising ratebook free. Chicago Advertising Agency (established 1900), Chicago 4.

FREE! Radio advertising without investment! Jakiela, 2644-PA No. Western, Chicago 47.

FREE Publicity. Radio deals. Guaranteed service—\$2.00. Smith Advertising-51, Excelsior Springs, Mo.

FOUR 20-Word ads free with 12-issue subscription \$2.00. Reaches church people 48 states. Mail first ad now. Christian Citizen, Wolverine Building, Ann Arbor, Michigan.

500 NAMES of new mothers \$1.00. Paul Reitmeir, 916 Crawford St., Bethlehem, Penna.

ENVELOPE Addressing \$5.00 thousand. Mailing lists \$5.00, 1000. Win Fox, 338 Carr, Jackson, Michigan.

MAILING Lists: 100 names 35c; any amount. States Company, Dundee, Mich.

RUBBER STAMPS AND OFFICE SUPPLIES

RUBBER Stamps. Send for catalog. Excello, Box 500, Shreveport, Louisiana.

SEND For your free catalog of high quality rubber hand stamps, any size, kind, style or quantity. Direct from factory at factory prices. Esco 53 Print, 8 Holt, Dayton-1, Ohio.

3-LINE Pocket stamp, self-inking, \$1.50! Dealers wanted. Morey's, 2499 Roosevelt, Redwood City, Calif.

TYPEWRITERS, DUPLICATORS, OFFICE DEVICES

RECONDITIONED Typewriters, printing devices, office machines, equipment. DixieGraph, King, N. Car.

USED Typewriters, adders, office machines. Fleury, 1633 Henry, Port Huron, Michigan.

PRINTING, MULTIGRAPHING, MIMEOGRAPHING, GUMMED LABELS

PRINTING That pleases. Letterpress, offset. Send copy for estimate. Mercury Press, Box 69M, Marengo, Iowa.

PROGRESSIVE Business printing. Prices, samples, free. Progressive, 400 Wooster, Akron 7, Ohio.

100 LETTERHEADS (8½ x 11 Printed) \$1.00 postpaid. Envelopes same. Race Printers, Hudson, New York.

1000 BUSINESS Cards \$2.50 prepaid. Samples free. Reliable Print Shop, 905 E. Jefferson, Louisville 6, Ky.

5000 6¾ ENVELOPES Printed \$3.10 per thousand, 1000 embossed business cards \$3.95. Free samples. Michel, Central Village, Conn.

MIMEOGRAPHING—Letters, pricelists, formulas, instructions. Lowest prices. Lem's Letter Shop, 5710 Stanton, Detroit 8.

500 ¾x2¼ FOUR Line gummed stickers 50c. Red border \$1.00. Moritz Printery, Saginaw, Mich.

PERSONALIZED Stationery, matching envelopes, monogram if desired. \$1 box postpaid. Benton Printing, Box 41197, Los Angeles 41, Calif.

1000 BUSINESS Cards raised printing \$3.95. Regularly \$5.00. Offset letters. Samples free. Tuttle Publ., Rutland, Vermont.

SPECIAL—500 6¾ (3½x6½) Top quality printed envelopes \$2.95 postpaid. Send copy to Ferrario Press, 728 South Webster Avenue, Scranton, Penna.

TWO Color 8½x11 letterheads, 500—\$3.50. Samples. D'Yarmett Printing, Newark, Ohio.

1000 BUSINESS Cards \$2.50 prepaid. Samples free. Gooch, 202PM, Hernando, Miss.

1000 BUSINESS Cards, look like engraved, \$4.95; gummed shipping labels, 2¾"x4", blue and red, \$6.50; postpaid. Ideal Printing, 2101-D Barclay, Oklahoma City 14, Okla.

FINE Printing—Prompt service, prepaid. Wide selection of type styles, colors, etc. Cuts furnished. Samples-prices free. Willcox, Nicholls, Georgia.

1000 THIN Plate business cards, any color ink, \$4.75 postpaid. Mackay Printing Service, 642 Eddy, San Francisco, California.

REPRODUCE Printed, typed, photographed copy. Color-offset-printing. Lowest prices. Angora House, PMI, Springfield, Illinois.

LETTERHEADS Or envelopes 100—\$1.00. Wieck, 667 Henry, Brooklyn 31, N. Y.

MIMEOGRAPHING—Reasonable. Any copy. Malters Service, Box 606-C, Chicago 90, Ill.

100 ENVELOPES Or letterheads \$1.00. Toy guns, salesbooks. Broadbrook, Botsford, Conn.

100 8½x11 LETTERHEADS And 100 envelopes \$2.00 postpaid. Fast service. Samples free. Catalpa Press, 5519 N. Clark, Chicago 40, Illinois.

ENVELOPES Addressed to your specifications. Reasonable rates, fast dependable service. Hicks Service, 5216 Just St. N.E., 303, Washington 19, D. C.

1000 EMBOSSED Business cards, \$3.75 postpaid. Free case. Johnson, 1129 State, Harrisburg, Penna.

PRINTING OUTFITS AND SUPPLIES

DO Your own printing. Save money. Simple rules. We supply everything. Print for others; good profit. Raised printing like engraving too. Have home shop. Details free. Kelsey Presses, V-11, Meriden, Connecticut.

PRESSES, Supplies, paper. Catalog 10c. Custom, Box 211-P, Springfield, Missouri.

PRINTING Presses, type, supplies. Lists 3c. Turnbaugh Service, Loysville, Penna.

CARBON-Interleaved forms. Shipped factory direct. 30% cheaper. Send for quotations on all business printing. Loudon's, Flora, Indiana.

MAKE Your own self-molding rubber printing cuts. Plexirubber, Argyle 1, Wis.

PRESSES, Type, cabinets, supplies. List for stamp. Lincoln Press Company, 220-T Hartwell, Fall River, Mass.

OLD Type remolded into new type, spacers. Low cost. Angora House, PM3, Springfield, Illinois.

PATENT ATTORNEYS

INVENTORS: When you are satisfied that you have invented something of value write me, without obligation, for information as to what steps you should take to secure a patent. Write Patrick D. Beavers, Registered Patent Atty., 935 Columbian Bldg., Washington 1, D. C.

INVENTORS: Learn how to protect your invention. Unless the inventor is familiar with patent matters, he should engage a competent registered patent attorney or agent to represent him. We are registered to practice before the U. S. Patent Office and prepared to serve you in handling your patent matters. "Patent Guide for the Inventor" containing detailed information concerning patent protection and procedure with "Record of Invention" form will be forwarded to you upon request—without obligation. Clarence A. O'Brien & Harvey Jacobson, Registered Patent Attorneys, 31B-D District National Building, Washington, D. C.

PATENTS—Irving L. McCathran, 315 McLachlen Bldg., Washington 1, D. C. Registered Patent Attorney.

PATENTS. "Proof of Invention" free. E. E. Vrooman, Registered Patent Attorney, 507 McKim Building, Washington 5, D. C.

INVENTORS: Without obligation, write for information explaining the steps you should take to secure a patent. John N. Randolph, Registered Patent Attorney, 203 Columbian Bldg., Washington 1, D. C.

C. A. Snow & Co.—M427, Snow Building, Washington 1, D. C. Registered Patent Attorneys. Write for information.

"INVENTOR'S Guide" free. Frank P. Ledermann, Registered Patent Attorney, 154 Nassau Street, New York.

REGISTERED Patent attorney offers services. Sanders, 6430 Evans, Chicago 37, Ill.

INVENTORS—For "Invention Record" form, contact Carl Miller, Registered Patent Attorney, Woolworth Building, New York.

CANADA—Ramsay Company Registered, 273 Bank Street, Ottawa, Canada.

INVENTORS—If you believe that you have an invention, you should find out how to protect it. The firm of McMorrow, Berman & Davidson is qualified to take the necessary steps for you. Send for copy of our Patent Booklet "How to Protect Your Invention" and "Invention Record" form. No obligation. McMorrow, Berman & Davidson, Registered Patent Attorneys, 134-G Victor Building, Washington 1, D. C.

INVENTORS—If you consider your invention to be something of importance, take steps to protect it with a United States Patent which gives you the right to exclude others from making, using and selling your invention as claimed. "Patent Protection for Inventors" outlines steps to take to secure patent protection. Mailed promptly without obligation. Victor J. Evans & Co., Merlin M. Evans, Registered Patent Attorney, 831-E Meriin Building, Washington 6, D. C.

HERMAN Lewis Gordon, registered patent attorney, patent investigations and opinions, Warner Building, Washington 4, D. C.

FOR INVENTORS

INVENTORS: Learn how to protect your invention. Unless the inventor is familiar with patent matters, he should engage a competent registered patent attorney or agent to represent him. We are registered to practice before the U. S. Patent Office and prepared to serve you in handling your patent matters. "Patent Guide for the Inventor" containing detailed information concerning patent protection and procedure with "Record of Invention" form will be forwarded to you upon request—without obligation. Clarence A. O'Brien & Harvey Jacobson, Registered Patent Attorneys, 31A-D District National Building, Washington, D. C.

INVENTIONS Properly handled pay off. Free literature. Inventor, Doniphan, Mo.

SEARCHES—Put your patent searches in the hands of a registered patent attorney or agent, as he qualifies to give a worthwhile patentability report. Record of invention form upon request and information on patent protection. Patrick D. Beavers, Registered Patent Attorney, 936 Columbian Bldg., Washington 1, D. C.

PATENT Searches, \$5.00, including patent copies. Same reliable searches as conducted for patent attorneys. Promotion and marketing services also offered. Free protection forms, 48 hour service. Patent Service Institute, 945A Pennsylvania Avenue, Washington 4, D. C.

NEED Help, inventor? Send name for free information. Stark Co., Grafton 1, Wisconsin.

INVENTORS! For "Copyright, Design and Patent Guide" contact Mr. Metzler, 11 West 42nd, New York 18.

"INVENTOR'S Guide" free. Frank P. Ledermann, Registered Patent Attorney, 154 Nassau Street, New York.

INVENTORS — For "Invention Record" form, contact Carl Miller, Registered Patent Attorney, Woolworth Building, New York.

INVENTORS: Without obligation, write for information explaining the steps you should take to secure a patent on your invention. John N. Randolph, Registered Patent Attorney, 202 Columbian Bldg., Washington 1, D. C.

INVENTORS: If you have an invention for sale, patented or unpatented, write Institute of American Inventors, Dept. 40A, 631-E St. N.W., Washington 4, D. C.

INVENTORS—If you believe that you have an invention, you should find out how to protect it. The firm of McMorro, Berman & Davidson is qualified to take the necessary steps for you. Send for copy of our Patent Booklet "How to Protect Your Invention" and "Invention Record" form. No obligation. McMorro, Berman & Davidson, Registered Patent Attorneys, 134-F Victor Building, Washington 1, D. C.

INVENTORS—This firm is registered to practice before the United States Patent Office and is available to assist you in the preparation and prosecution of your patent application. "Patent Protection for Inventors" booklet containing detailed information and steps to take toward patent protection will be sent upon request. No obligation. Victor J. Evans & Co., 832-E Merlin Building, Washington 6, D. C.

INVENTORS: Protect your inventions. Patent searches and patent applications by our patent attorney. Free "invention record" forms. Inventions promoted. Write National Inventors Institute, 4097 East 131st St., Cleveland 5, Ohio.

INVENTORS—Send for free patent information book and inventor's record. Registered Patent Attorney, Associate Examiner, Patent Office 1922-29; Patent Attorney & Advisor, Navy Department 1930-47. Gustave Miller, 53A Warner Building, Washington 4, D. C.

COPYRIGHTS Procured promptly. State nature. Russell B. Tupper, 18 Lyman, Beverly, Mass.

PATENT Owner representative. Years of experience. Can I help you? Charles A. Scott, 773PM Garson Avenue, Rochester 9, N. Y.

PATENT Searches \$5.00. Reports airmailed within 48 hours. Inventions marketed. Free protection forms. Write Miss Ann Hastings, P.O. Box 176, Washington 4, D. C.

INVENTORS: Obtain patents without assistance. "Inventor's Patent Handbook," \$3.50. International Patent Library, P.O. Box 7412, Washington, D. C.

PATENT Searches \$5.00. 48-hour service. Inventions marketed and promoted. Free record of invention. Write Raymond L. Smith, Patent Searcher, 622 Sheraton Building, Washington 5, D. C.

UNUSUAL — \$1.00 Brings list of 120 needed inventions, plus valuable starting information. Tudee, 546 N. Quince, Escondido, Calif.

PATENT Searches \$5.00. 48-hour airmail service. Invention protection forms free. Patent drawings prepared. Write Patent Engineering Service, 711 14th Street N.W., Washington 5, D. C.

PATENT Your invention. Details, record of invention form free. Inventors Patent Service, 208M Clinton, Oak Park, Illinois.

INVENTIONS WANTED

INVENTIONS Wanted. Patented; unpatented. Tremendous manufacturers lists. Global Marketing Service, 1404 Mitchell, Oakland 1, California.

MARKETING Aid — Nation wide. Patented, patent pending. Booklet free. Market Contacts, 719-A2 Magnolia, Tupelo, Miss.

INVENTIONS Wanted. Patented or patent pending. 21 years experience promoting inventions. National Service Bureau, 3120 Meramec, St. Louis 18, Mo.

INVENTORS: Hundreds of manufacturers have requested our assistance in locating marketable new products. Complete information free. Institute of American Inventors, Dept. 40-D, 631-E St. N.W., Washington 4, D. C.

INVENTIONS Promoted. Patented or unpatented. Established 1911. Write Adam Fisher Company, 61 Enright, St. Louis, Mo.

INVENTIONS Promoted, marketed. Patented or unpatented. G. J. Trost Co., 520 Fifth Avenue, New York 36.

CASH Buyers for ideas and inventions. Write National Inventors Institute, 4097 East 131st St., Cleveland 5, Ohio.

CASH For your idea. 280 manufacturers need inventions, patented or unpatented. List free. Invention Bureau, 208M Clinton, Oak Park, Ill.

PATENTS FOR SALE

INVENTORS: Test the commercial value of your patented or unpatented inventions, quickly and inexpensively. Write for free information. Institute of American Inventors, Dept. 40-B, 631-E St. N.W., Washington 4, D. C.

MANUFACTURING

MODELS — Small lot manufacturing. Metals, plastics, etc. Milburn, Burlington, Kentucky.

MODELS, MODEL SUPPLIES

SHIP Models—Most complete line in New England. Kits, fittings, plans, books, tools, engines, motors. Illustrated catalog 25c. James Bliss & Co., Inc., 342 Atlantic Ave., Dept. SM, Boston 10, Mass.

SHIP And yacht model fittings; blueprints. Send 25c for illustrated catalog No. 28—listing hundreds of items. A. J. Fisher, 1002-1 Etowah Ave., Royal Oak, Mich.

STEAM Locomotives, 1½", 1", ¾", ½" scales. Castings, rail, steam fittings! Thorough drawings with instructions. Catalog 50c. Little Engines, Wilmington, California.

ILLUSTRATED Lionel catalog, 10c; American Flyer, 10c; H. O. gauge, 10c. Ben's PM Dept., 134 North Dearborn, Chicago 2.

BALSA Wood, Grade AAA. Free sample, price list. Sig Mfg. Co., Montezuma, Iowa.

BALSA Wood. Tops for model airplanes, boats, autos, decoy ducks, etc. Low prices! Write: Remaco, 295 Armory St., Springfield 4, Mass.

IMMEDIATE Delivery on big 60 page "HO" model railway catalog of parts, car kits, locomotives, diesels, etc. Listing thousands of items in stock. Price 35c. "O" gauge catalog. 40 pages scale and toy trains. Price 35c. Dept. W, All-Nation Hobby Shop, 182 North LaSalle Street, Chicago 1, Ill.

HOME CRAFTSMEN

KNOCKDOWN Cedar chests and lumber. Free price list. Bedford Lumber Company, Shelbyville, Tennessee.

HANDICRAFTERS! Needlecrafters! Sell your handiwork profitably. Free details. Thompson, Loganville PM, Wisconsin.

"TOPS" In everything for leathercraft. Lowest prices. Genuine "Craftool" stamps. Catalog 10c. Crown Leather Company, 22 Spruce Street, New York 38.

LEATHER, Tools, lacings, supplies. Free catalog. National Handicraft, 199 William St., New York 7.

CLOGGED Drains opened by new powerful chemical called Sursolvent. Removes grease, soap, tree roots, etc., without expensive digging and electric rodding machines. Simple to use. Mix with water and pour down sink. Postal brings free details. Electric Sewer Cleaning Co., Allston 34, Mass.

LAMPCRAFTERS — Cypress knee debarbed for lamp \$1.00. Lamps, Box 218, Oakdale, Louisiana.

KNOCKDOWN Cedar chests. Lumber and veneers. Free price list. Giles & Kendall Company, Huntsville, Ala.

BUY Wholesale nationally advertised power, hand tools, thousands other products at big discounts. Free wholesale plan. American Buyers', 629-PP Linden, Buffalo 16, N. Y.

100 FULL Size jig saw patterns up to 20" high, only \$1.00. Pattern Service, Medway 9, Mass.

FREE Seashell catalog. Shellcraft instruction book 35c. "Secors," Bradenton Beach, Fla.

LEATHERCRAFT—New stylecraft folder free. New kits illustrated. Filigree belts, billfolds, purses, etc. Send 25c new catalog. Refunded first order. Apache Leather Co., 2804 East Washington St., Phoenix, Arizona.

STENCILS, 15 Assorted for textiles, furniture, etc., \$1.00. Catalog 300 designs 25c, refundable first order. Marion Specialties, Box 141, Halesite, N. Y.

MINIATURE Furniture kits. Colonial reproductions. Solid cherry. Catalog 20c. Culver Miniatures, 194 61st St., Dept. A, Niagara Falls, N. Y.

30 LAWN Ornament patterns. Ready cut. Full size. Color indicated. \$1.00 postpaid. Lincoln Craft Studio, Columbia, Conn.

FREE Information. How to make money with jig saw. Write Jigsawers, 117-M Worth, New York 13.

\$46 FROM Square foot plywood; jigsaw necessary. Write: Woodarts, PM-252, Bridgewater, Mass.

89 FULL Size jig saw patterns of beautiful shelves, ornaments, toys, novelties. Plus "How, Where to Sell." Only \$1.00. Mastercraft 54M, 7041 Olcott, Chicago 31, Illinois.

LEATHERCRAFT, Metal tooling, textile painting, beadcraft, shellcraft. Many other crafts. Send for free, big, illustrated catalog today! Kit Kraft, Hollywood 46, Calif.

LAMP Size cypress knee \$1.00. Cy Products, Dept. I, Lafayette, La.

90 ALL New, full size lawn ornament and novelty patterns, up to 20" high. Only \$1.00. Mastercraft 52M, 7041 Olcott, Chicago 31, Illinois.

HOBBYISTS, Homemakers and handy-men. Send for free illustrated catalog. Highbridge Co., 2450 Walton Ave., New York 68, N. Y.

OUR Biggest leather and craft catalog yet! 1000's of items. Send 25c (refunded with first order). Russo Handicraft Supplies, Dept. 17C, 245 S. Spring, Los Angeles, California.

LEATHERCRAFT. Tremendous stock of leather, tools, supplies, and kits. In leather business over forty years. Send 10c for big catalog. Sax Bros., 1111 No. 3rd, Dept. PM5, Milwaukee 3, Wisconsin.

WATER Softener, builders tanks, zeolite tops, yokes. McCarthy Company, 2930 West Burleigh Street, Milwaukee 10, Wis.

16 NEW Lawn chairs, 22 picnic tables, benches, trellises, etc. All 38 plans with necessary full size patterns, \$1.00. Mastercraft 53M, 7041 Olcott, Chicago 31, Ill.

CYPRESS Knee, select, and instructions for making lamp \$1.00. Quantity prices on orders of 25 or more. Craft Supplies, 2932 Eugene, Baton Rouge, Louisiana.

93 "ORIGINAL Idea" jig saw patterns \$1.00. Professional drawing, quality printing. Full size shelves, toys, lawn ornaments, novelties. Walker Studio PM-5, 4343 Lindell, St. Louis 8, Mo.

PLASTICS Home-craft course for men and women. Tells and shows how to make hundreds of fast selling plastics products. All plastics and materials for 23 projects included in course. No special tools needed. Course pays for itself. Write for free booklet. Interstate Training Service, Dept. D3E, Portland 13, Oregon.

10 FULL Size shelf patterns 35c. Connelly's 825 Randolph, St. Paul 2, Minn.

REFLECTORIZED Novelties bring big, easy profits. Samples and plans, 25c (refundable). Highlight, 352-A Stewart, Turtle Creek, Penna.

MAKE Your own leather articles for spring use. Your leather belts, billfolds, purses made at home brings pleasure to all members of the family. Free catalog. Tandy Leather, Box 397, C. Tulsa, Okla.

LEATHERCRAFT. Free list. Francis Byrd, 3406 Montrose Ave., Richmond, Virginia.

LEARN Metalizing baby shoes, gifts, etc. Bronze, gold, silver. Polio free. Kiktavi, 7217-PC South Broadway, Los Angeles 3.

VIOLINMAKERS. Amateurs, professionals. Fine tone European wood. Supplies, instructions, patterns, tools. Illustrated catalog 10c, refunded. Premier Violin Supplies, Dept. VZ, 430 South Broadway, Los Angeles 13, Calif.

MAGNETS—Permanent alnico, never loses magnetism. Many uses. 12 for \$1.00. Pritt Co., Dept. MM-5, 12 West 27, New York City.

BIRDHOUSES. Enjoy the beauty and songs of birds around your home this year. 20 proven plans for attractive homes and feeders you can build. Send \$1.00 today to Birdbox, Dept. M-5, 159 Clyde Avenue, Baltimore 27, Maryland.

80 FULL Sized patterns, toys, novelties, lawn ornaments, \$1.00. Modern Woodcraft, Saginaw, Michigan.

LEATHERCRAFT. Everything needed by beginners, advanced hobbyists and professional leatherworkers. Largest stock of supplies in U.S. Moderate-priced tooling leathers, top quality calfskins, tools, supplies, kits. Send 10c for big catalog. J. C. Larson Co., 820 S. Tripp, Dept. 3050, Chicago 24.

MAKE IT YOURSELF

MAKE F.H.A. approved splash blocks, enormous demand, two buckets concrete returns two dollars. Literature. Forms. Howell, Box 206, Bridgeport, Penna.

FIBERGLAS Car bodies, etc. Informative booklet of construction hints, "Where to Buy" \$1.00. Goldayne, 3356 Glendale, Los Angeles 39.

MAKE Permanent signs on glass, metal, wood. Beautiful gold and black 2 or 3 inch letters, numbers 5c each. Just wet and attach. Ur-Name Co., Box 508, Geneva, N. Y.

KIT To make hand lotion, brushless shaving, cold creams. Send \$1. Confro, Box 950, Washington 4, D. C.

BUILD With concrete, fieldstone, earth. Movable form system cuts costs. Construction simplified. Free literature. Smith, PM, Box 36, Eagle Creek, Oregon.

SEND 25c Today for new large catalogue of supplies for 21 popular crafts. Dept. D-11, Dearborn Leather Company, 8625 Linwood Avenue, Detroit 6, Michigan.

BUILD Your own "tractor." Free information. Eltraco, D-1, Camptonville, California.

"CONCRETE Block Homes." 32-page booklet, on how to build. \$1.00. H. C. Lightfoot, Civil Engineer, Richboro 1, Penna.

BUILD Real refrigerated room air conditioner from refrigerator parts. Plans \$1.00. Thomas B. Fairley, Fishery Road, Orangeburg, South Carolina.

\$200 BUILDS 12'x30' Swimming pool with automatic filter system. Plans, instructions, \$2.75. Satisfaction guaranteed. Davrim Engineers, 107 Lawrence Street, North Kenova, Ohio.

MAKE Lace-like ceramic lamp shades. Directions \$1.00. The Vesta Hearth, 545 Santa Ynez Way, Sacramento, Calif.

WINDOW Fan kits—All parts necessary to make 30 inch fan except motor and box. \$16.50 postpaid. Free circular. McDonald's, Bay Saint Louis, Mississippi.

BOOKLET Describes machinery plans. Gives tips—25c! Kimco, RCS-P, New York 19.

MAKE Your own "stone-veneer." Economical. Easily made, quickly applied. Looks like genuine stone. Transforms any home into one of excellent beauty. Formulas, illustrations, patterns. Alburg, Box 17, Carrollton, Mich.

BUILD Your own concrete block machine. Easy. Inexpensive. Motor or hand. Also build mixer. Write, C. Lee, Mountain View, Oklahoma.

ARTISTIC Wall shelf patterns. Sixteen patterns \$1.00. C. A. Schoenberger, 4144 Lawndale St., Philadelphia 24, Penna.

GRANDFATHER Clock easily built. Big savings. See ad on page 266.

LIVE In your home while building it. No mess. Invest one-half. Use any plan. Illustrated folio my tested method \$1.00. William Kiewel, Crookston, Minnesota.

WATCHES. OLD GOLD. JEWELRY

5000 **JEWELRY** Styles, you can easily make yourself—Pins, earrings, bracelets, rings, matched ensembles. Instructions and catalog 10c. Barrys, 147 Ardley Court, Newark, N. J.

WATCHMAKERS Journal contains instructive articles for watchmakers and beginners. \$1.00 year. Sample copy 20c. Dean Co., Box 3218, Daytona Beach, Fla.

WATCHMAKERS'—Jewelers' complete informative catalogue 20c. Bengale Company, Culver City, California.

JEWELRY Making can be a profitable hobby—Send 20c for our latest illustrated catalog. Milady-Fair Co., G.P.O. Box 1328, New York City.

HIGHEST Cash paid for old, broken jewelry, gold teeth, watches, silverware, diamonds, spectacles, platinum. Free information. Satisfaction guaranteed. Rose Smelting Company, 29-A East Madison, Chicago.

UNREDEEMED Diamond, 1-carat, \$295. 30-day refund. Free catalog. Broff's Diamond Loan Association, 411 Smithfield, Pittsburgh, Penna.

WATCHMAKERS' Tools, materials, supplies, watches. Catalog. Gales, Box 1000, Chicago 90, Ill.

5 **ELGIN**, Waltham, Illinois, Hampden gents' wristwatches needing minor repairs, \$18.00. Write for prices. B. Lowe, Holland Bldg., St. Louis 1, Mo.

RHINESTONES. Jewelry settings, cameos, sequins, beads. Send 10c for illustrated catalog. J & M Novelties, Dept. CE-3, Griffith, Ind.

TOBACCO, SMOKERS' SUPPLIES

CIGAR-Lovers! Free trial offer. All Havana filler. Full size blunt. Made in Tampa, Fla. Vacuum packed. 100 cigars for \$5.95. Smoke 5—if not delighted, return remainder for full refund. Send check or m.o. We pay postage. Ace Mail Order Co., 134 Eaton Pl., East Orange 5, N. J.

CIGARETTES—Roll 200 guaranteed to please for 75c. Particulars free. Pete Moberly, Box 864, Owensboro, Kentucky.

SUPERB Pipe blend. Unchanged 58 years. 7 oz. 30c. Box 3-M, Red Lion, Penna.

PIPE Stems replaced, \$1.50 postpaid. Bruyere Pipe Shop, Box 2321, Buffalo 23, N. Y.

RAZORS, BLADES, SHARPENING

100 **DOUBLE** Edge razor blades \$1.00 postpaid U.S.A. Satisfaction guaranteed. Sample on request. United Sales, Box 295, Union, Mo.

SMITH Razor blades. Finest chrome surgical steel. Introductory offer—free, one blade. If not satisfied, return unopened carton. Return postage guaranteed. 50 single or double \$1.00. John Barry, 584 Columbus Avenue, New York 24, N. Y.

\$20 **ELECTRIC** Shavers—\$4.95. Write Sheldon Mail Order, Sheldon 1, Iowa.

RAZOR Blades, double edge, 100 for \$1.00; 200, \$1.69; 300, \$2.25. Postpaid. Guaranteed. Bart Sales Company, 886 Frederick Blvd., Akron 20, Ohio.

80 **DOUBLE**-Edge rust-resisting blades. \$1.00. Fully guaranteed. Send 10c for sample. Franklin, Dept. A, 441 Elizabeth Ave., Elizabeth 1, N. J.

FOR THE HOME

FOAM Rubber furniture cushions. Factory seconds. 50% discount. Prices free. Perma-Foam, 140-C Main Street, East Orange, New Jersey.

OF INTEREST TO WOMEN

MAKE, Sell exquisite artificial flowers, woodfiber corsages, chenille novelties, dolls, costume jewelry, leathercrafts. Complete supplies, beginners kits. Wholesale catalog 10c. Profitcrafts, 4509T282 Lorain, Cleveland 2, Ohio.

INVISIBLE Reweaving in big demand! Cash in servicing laundries, cleaners, stores, homes. Make tears, holes, cuts disappear from all fabrics. Earn up to \$10.00 an hour. Get full details free. Fabricon, Dept. C-5, 8342 S. Prairie, Chicago 19, Illinois.

PRINCESS Nylon garters—Comfort, beauty. Hose last longer. 50c pair. Excelsior Pro. Co., 11000 E. McNichols, Detroit 34, Mich.

FOR SALE—MISCELLANEOUS

SAVE Money on army, navy and factory surplus. Write today for new 52-page illustrated catalog. Tennusa Sales Co., Dept. C, 1451 Market, Chattanooga, Tenn.

FREE Catalog on government surplus bargains from country's largest surplus organization specializing in outdoor, sporting goods, clothing, camping equipment. Tents, rubber boats, tarpaulins, hundreds of other items. Rockaway Sales Co., Route 6, Rockaway 7, New Jersey.

APPLIANCES, Mowers, tools, home supplies. Save. Send dime. Box 89, Troy 2, Ohio.

WANTED—MISCELLANEOUS

QUICKSILVER—Highest prices paid. Free containers. Wholesale Terminal, Norwood, Massachusetts.

SCRAP Mercury (quicksilver) containers supplied—Tantalum, bismuth, tungsten. Metallurgical Products Company, Established 1909. 35th and Moore Sts., Philadelphia 45, Penna.

PERSONAL

CALIFORNIA—Letters remailed 25c each. Oakland, help wanted, other classified columns \$1.00 each airmailed. Ron, 1565 170th Ave., Hayward, California.

BIBLE Reveals time of end. Free. Write: Harvest, Jefferson City, Missouri.

BORROW By mail. Loans \$50 to \$600 to employed men and women. Easy, quick. Completely confidential. No endorsers. Repay in convenient monthly payments. Details free in plain envelope. Give occupation. State Finance Co., 323 Securities Bldg., Dept. B-14, Omaha 2, Nebraska.

LETTERS Remailed 25c. Private mailing-receiving address at monthly rates. McLaughlin, 369 Welch, Columbus 7, Ohio.

LETTERS Remailed 25c. Received 25c. E. Wolf, 3416 Wrightwood, Chicago 47, Ill.

LETTERS Remailed, Kansas City postmark 25c. Private receiving. Monthly rates. Miller, Box 4313, Kansas City, Mo.

NEW YORK City or New Jersey. Remails 25c. Two help wanted columns \$1.00. Box 346, Montclair, N. J.

LETTERS Remailed from Minneapolis-St. Paul—25c. Confidential forwarding service. Details free. Le-Ron Co., 2626 Park Ave., Minneapolis 7, Minn.

"**HOW** Can I find out?" You can! Information confidentially developed. Any matter, person, problem. Worldwide. Officially licensed. Established 1922. William Herman, 170 Broadway, New York City.

WASHINGTON Remails 25c. Mailing address available. Kittrell, Box 1643, Washington, D. C.

LETTERS Remailed from New Orleans 25c. A. Rapp, 1527 Pace Blvd., New Orleans 14, La.

LETTERS Remailed 25c. J. Wilson, 200 East Franklin, Hillsboro, Texas.

LETTERS Remailed from Panama or Canal Zone \$1.00. O.B.L., Box 1830, Panama, R. P.

ENDLESS Energy "Secrets of Tiredness" \$1.00. Eidetic Foundation, Fairhope, Ala.

LETTERS Remailed from Washington, D. C. 25c each. 5 for \$1.00. Hicks Service, 5216 Just St., N.E. 303, Washington 19, D. C.

REDUCING Calorie book. Send 25c. Free slenderizing information. Gyro-Belt, Upper Darby 7, Pennsylvania.

LETTERS Remailed San Francisco postmark 25c. Private receiving-forwarding address available. Shanks, Box 3110-D, San Francisco 19, California.

EXPERT Research service: Information supplied, any subject! Wrenn, Box 63, Liberty, N. C.

HIALEAH, Miami remailed letters 25c. Turrill, 112 W. 15 St., Hialeah, Fla.

REMAILING Letters, Chicago 25c, relayed from other cities 75c. Package service, and storage. Business and personal address. C. Mack's Mail Order, 5656 N. Hermitage, Chicago 26, Ill.

MISCELLANEOUS

GIGANTIC Mails. Money-back guarantee. 5c month, 50c year. Fal-San, Box 1017, Bridgeport, Conn.

NEW! Nicotine stain off! Harmlessly remove the dirty yellow cigarette stain from your fingers \$1.00. Sharon Sales Co., Phoenix, N. Y.

RECEIVE Magazines, samples, catalogues. Mails from everywhere. Offers, hundreds. Get listed 25c. Rorick, Box 86, Cincinnati 26, Ohio.

SELECTIVE Metal and mineral detector. Revolutionary design. Distinguishes metals from black magnetic sands. Readily detects metals under salt water. Also Geiger counters. Free literature, Gardiner Electronics Company, 2018 N. Dayton, Phoenix, Arizona.

LUMINOUS Reflective paints glow day and night in technicolor! New angle money maker. Assorted color samples 25c. Research, 1842-PM Byron, Chicago 13.

HEARING Aid batteries, wholesale. Free list. Habs, Box 51, York, Penna.

300 BIG Mails guaranteed. Samples, plans, offers, propositions, 12 months listing, \$1.00 (refundable). Wright Publications, 2270 Hubbard, Memphis 8, Tenn.

YOUR Leather jacket renovated expertly. Free circular. Berlew Mfg. Co., Dept. 8, Freeport, N. Y.

TREASURE—M-Scope Geiger counters, mineral locators. Why buy something inferior when you can buy the best at a lower price? Backed by years of experience. Fully guaranteed by factory. Detects minerals, metals, gold, silver, coins. Payment plan available. Proven superior performance. Free 16 page illustrated booklet. Fisher Research Lab., Inc., Palo Alto, California.

GENUINE Buckskin jackets, gloves, moccasins. Send 50c for buckskin pouch and illustrated catalogue. Berman Buckskin Co., Dept. 55, Minneapolis, Minn.

PANNING Gold lesson and catalogue. Beginners supplies, books, "maps where to go" free. Old Prospector, Box 729D1, Lodi, Calif.

UP-To-date Alaska information, authentic, reliable; 224 pages of facts; where to go, what to see; mileage charts, transportation, cost of trip, detailed review of cities, industries, business, opportunities, Alaska Highway; hundreds of pictures, maps, etc. Only recognized, established guidebook of all Alaska; \$2; guaranteed best or refund. Guide to Alaska, 6015 Santa Monica Blvd., Los Angeles 38, Calif.

PORTRAITS Artistically drawn. Send us your photograph with \$3. Photo returned with finished portrait. Kates, Box 7903, Philadelphia 4, Penna.

HAWAIIAN Hardwoods. Exotic tropical Monkey Pod and Mango. Sample block of each 2x2 1/2x4 inches mailed parcel post prepaid, both for \$1. Nani Laau (House of Beautiful Woods), Room 334, Merchandise Mart Bldg., Honolulu, Hawaii.

IS Stuttering your problem? Everglades, Box 26, Hastings-on-Hudson, N. Y.

I Save up to 20% on stoker fuel. Details, what to buy and how to burn it \$1.00. Woody, Box 420, LaCrosse, Wis.

KEEP Cool: House coolers, as low as \$31.50. Free catalog. Write Beezy Distributors, 1217 Alameda, Tucson, Arizona.

GOLD, Silver, metal detectors. Geiger counters for uranium. Mineralights. Sensational new fully guaranteed models. None finer. Information free. Detectron Co., 5420 Vineland Ave., North Hollywood, California.

LOCKSMITHS Exclusively. Send name of your supplier and proof of occupation for details regarding the new Manual of Locksmithing. McLean, 2701 E. 3rd Ave., Denver 6, Colo.

BUILD Your own block house—Step by step, illustrated instructions by experienced builder with "know-how" will save you time and money. \$2.00 prepaid. Acme, P.O. Box 634, Los Alamos, New Mexico.

RHINESTONE Heart necklace, like television star's \$2.00. Bryant, 2139 Sullivant, Columbus, Ohio.

PARTY Records. Liven your party. Send \$1.00 for 2 records to Party Records, P. O. Box 7376, Dept. 25, Ft. Worth, Tex.

INCREDIBLE! Become mental superman overnight! Free booklet! Bijou, Box 1727-M5, Hollywood 28, California.

STAMMER? New hope. Reliable. Edwin Ptak, 225 N. Fairmount St., Pittsburgh 6, Penna.

BOOKS Found! Any author, old or new. Rush titles wanted; no obligation. International Bookfinders, Box 3003-PM, Beverly Hills, California.

SHARPEN Reel type mowers. No special tools: illustrated instructions as easy as mowing your yard. \$1.00. Steves, 212 1/2 W. 7th, Topeka, Kansas.

500,000 ITEMS Wholesale. Save 30%-70%. National brands. Supply catalog 25c. Box 1116, Arlington 7, Va.

IMPORTED Knives, hunting, fishing, etc. Free illustrated literature. J. D. Clinton, Mt. Clemens 2, Mich.

RECEIVE Big mails, catalogs, samples, surprises, offers. Deluxe listing year 25c. States Company, Dundee, 27PM, Mich.

70 BIBLE Lessons, 25c. Bulletin, Box 87, Cathedral Station, New York 25.

EXERCISE For health. Work confining? Over weight? All in? Past forty? Mild exercise will keep you fit. The Edwards System—Easy exercises, easiest possible way. No equipment. Proven effective. Full printed instructions, \$1.00. Clyde Edwards, Box 765, Omaha, Neb.

NEW! Magnetized 3/8" alnico ring on key chain. 25c. Gamecraft, Red Lion, Penna.

CONQUER That old worry habit. Wake up your mind with our amazing home-study plan of "Human Behavior Control." Many helped. Write for unusual free lecture in plain, sealed wrapper, without obligation. Personal Psychology, Inc., Box 1924-M, Louisville 1, Kentucky.

"POLICE Jiu Jitsu." "Scientific Boxing," both courses \$1 postpaid. Books, 3100 Ocean Parkway, Brooklyn 35.

AUCTION: Brand names, new general merchandise. Auctioneers, 5976 Cote Brillante, St. Louis, Missouri.

ORIENTAL Brocaded necktie. Beautiful, unusual. US \$1.00. Daluz, 38 Robinson Road, Hongkong.

TREASURE Finders for gold, silver and minerals. Money back guarantee, best available. Also Geiger counters for uranium prospectors, free information. Write Goldak Company, 1541 West Glenoaks, Glendale 1, Calif.

LEATHERCRAFT For pleasure or profit. Make easy-to-assemble purses, belts, gloves, woolskin toys, 100 other items for gifts or to sell. Send 10c today for big catalog. Largest leathercraft stock in U.S. J. C. Larson Co., 820 S. Tripp, Dept. 3051, Chicago 24.

I'LL GIVE YOU THESE AUTO SEAT COVERS



AS A BONUS

And Pay You Well Besides If You Will Show Them And Take Orders From Car Owners In Spare Time Only!

JUST 1 SALE A DAY CAN PAY YOU UP TO \$16.50 DAILY IN PROFITS!

Want extra money—plenty of it day after day? Then rush your name and address at once for Free Sample Outfit that will start you taking orders from car owners everywhere for Key expertly tailored Auto Seat Covers. **EXCLUSIVE NEW PATTERNS** to fit every make and model car. No one can compete with you, in wide choice, in quality—and

in expert tailoring that makes covers fit like a pair of gloves—and when you quote prices that are only a fraction of what the customer expects to pay, brother! You make money hand over fist writing up the fast orders! Line includes nationally advertised sensations like **BLACK EBONY** Saran, beautiful **BAMBOO**, brilliant **FIESTA**, colorful **BULL FIGHTER** PLAIDS, plus many other exclusive patterns to choose from, all at unbelievably low prices.

RUSH NAME for FREE OUTFIT
Give **MAKE, YEAR and MODEL** of YOUR CAR

No experience needed. Make all the extra money you need easily just by showing. Every car owner a "hot" prospect. **YEAR AROUND STEADY PROFITS.** No investment to make. Actual seat covers given to producers as a bonus for **OWN USE!** Write for Free Selling Kit valued at \$2.00 and actual samples **TODAY!**

KEY PRODUCTS CORP., 800 N. Clark St., Dept. 4-E, Chicago 10, Ill.



WEAR THE MASCOT OF THE SPEEDWAY DRIVERS! "LADY LUCK" in Four Colors

- 7" Felt Jacket Emblems.....50c
- 10" Felt Jacket Emblems.....\$1.00
- Decals—15c
- Stickers—15c
- "T" Shirts With Design.....\$1.50

Complete Catalog of Popular Emblems, including Club items, Racing Novelties, Garments, Decals, Special Emblems: 25c

Dealerships **SPOT ENTERPRISES**
Open P.O. Box 66 Culver City 1, Calif.

2-BEDROOM HOME \$890

BUILD YOUR OWN



Living room 12x14. Master bedroom 10x12. Nursery-den 10x11. Kitchen 7x10. Bath 5x8. Concrete block built. Blue prints, material lists, exact instructions for 3 designs.

Complete \$1 ppd.

SUNNY-CAL HOMES, Box 309-D-5 Hollywood 28, Calif.

AGENTS EARNING UP TO \$300 A WEEK
SELLING AMAZING NEW FLOOR FINISH REINFORCED WITH PLASTIC RESIN . . . REQUIRES NO WAXING OR LABORIOUS MAINTENANCE!

FREE SALES KIT!

Get in on the ground floor of one of the biggest money savers ever put out! Every home, office, store, restaurant, beauty parlor, church and factory a red hot prospect. Sells on sight. Anyone can apply. Just mop it on. Send for free sales kit today. Exclusive territory. Write Mr. Frost today.

CUSTOM PAINT & CHEMICAL CO., INC.
6517 Chestnut Ave. Pennsauken, N. J.

SPRAY WHITE

NEW! EASY WAY TO CLEAN WHITE TIRES



This amazing new compound (not a paint) gets dirtiest whitewall tires snowy-white-as-new! Just wet the tire, spray with SPRAY WHITE, swish suds around...and rinse. No scrubbing or abrasives needed. Harmless to hands, tires. Bottle cleans 50 tires: \$1.00, sprayer included, postpaid. MONEY BACK GUARANTEE.

\$1.00
PPD.
No CODs

DEALER & JOBBER INQUIRIES INVITED
KELITE PRODUCTS, INC., DEPT. P-3
Box 2917, Los Angeles 54, California

BREED RARE TROPICAL FISH FOR PROFIT!... AT HOME!



HELP US FILL HUGE DEMAND... Wonderful \$\$\$\$ Opportunity. No experience. No expensive equipment needed. SOME SELL FOR \$75 PAIR AND MORE! Fascinating! Beautiful! Entertaining! We supply everything. Make Big Money spare-time at home.

FREE! HOME-BUSINESS PLAN, Illustrated Folder, all DETAILS
Write: **TROPICAL FISH BREEDERS OF AMERICA**
Dept. DS, Los Angeles 15, California

GROW MINIATURE TREES

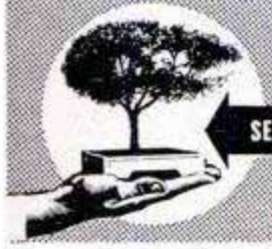

Grow authentic, LIVE dwarf trees!
Fascinating hobby! Fabulous profit!

SEND FOR FREE SEED & INSTRUCTIONS!

MINIATURE NURSERY CLUB
Dept. 5-J, P. O. Box 18696, Rimpau Sta.
Los Angeles 19, California

WRITE GAGS FOR \$\$\$\$

"HOW TO CREATE 1000 GAGS A YEAR" Shows you how to originate funny cartoon ideas that sell! Send \$2.00 Check or M.O. for this fully illustrated Book.
CARTOON CONSULTANTS
170 Broadway
New York 38, N.Y. Suite 205P

STUDY AT HOME

WITH AN EDUCATIONAL INSTITUTION
Courses in **ARTS AND SCIENCES:** Philosophy; Education; Letters; Public Health; Medical Jurisprudence; Psychology; Sociology; Physics; Chemistry; Geology; Pol. Science; Theology; Law; Business and Commerce; Accounting; Mathematics; Statistics; Agriculture.
ENGINEERING: Electrical, Civil, Mechanical, Drafting, Architectural, Steam, Diesel, Aeronautical, Radio, Structural, Mining, Industrial. Petroleum, Refrigeration, Air Conditioning, Chemical. Send for free catalog.
McKinley-Roosevelt Incorporated, 4610-K32, Sheridan Rd., Chicago 40, Illinois

SUCCESS • BIG PAY

in Aviation

MASTER A & E MECHANICS

urgently needed

Maximum training in minimum time! Thorough, practical instruction backed by more than 25 years of aviation technical experience. Training authorized under G.I. Bill.

Write today!
Illustrated Catalog
Registrar, Dept. 99,
Miami 30, Florida



TRAIN IN MIAMI -- AIR CAPITAL OF THE WORLD

PREVENT THIS



Install... yourself the GUARANTEED PROTECTION of Save-A-Life ELECTRIC DOOR LOCKS

Easy to install, ELECTRIC DOOR LOCKS are the protection that fearful parents want... and welcome... over 25,000 cars are now Safety Protected with ELECTRIC DOOR LOCKS.

Only
11.95
Postpaid

EASY TO INSTALL POSITIVE, AUTOMATIC SAFETY

Once installed, you have the safety of a 2-DOOR and convenience of a 4-DOOR. Turn on ignition, your rear doors are AUTOMATICALLY locked. Turn ignition off, they are unlocked. FINGERTIP DASH CONTROL permits doors to be opened while ignition is on. IF CAR OVERTURNS, locks are AUTOMATICALLY released. Passengers cannot be trapped!

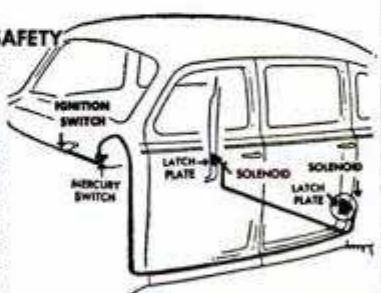

DON'T DELAY... get this PROVEN protection for your family! Complete Kit with detailed installation instructions, \$11.95. Money back within 10 days if not completely satisfied.
DEALERS INQUIRIES INVITED.

MURPHY SALES CO., Box 79, Lake St. Sta., Minneapolis 8, Minn.

Please send.....sets Save-A-Life Electric Door Locks at \$11.95 each, Postpaid. Check or money order enclosed.

Please send.....sets Save-A-Life Electric Door Locks at \$11.95 each, plus small C.O.D. Postal Charge.

MAKE OF CAR.....YEAR.....MODEL.....

PRINT NAME.....

STREET ADDRESS.....

CITY.....ZONE.....STATE.....

GREER SHOP TRAINING

2230 So. Michigan Blvd.
Chicago 16, Illinois

Leader in Practical Training for 50 Years

Gain success by learning a trade offering security and high pay—go into business for yourself.

Get the "Know-how" at Greer

You learn in our new, large, modern shops by working with latest tools and equipment of the trade — tear down, inspect, repair and rebuild... under supervision of experts. Greer founded 1902. Over 51,000 successful grads. Part time, full time, day and evening. E-Z terms. Mail coupon today.

CLIP COUPON... MAIL TODAY

Greer Shop Training—2230 South Michigan
Chicago 16, Illinois Desk 213

Please send information about trade checked:
In our Chicago Shops: Auto Mechanics
 Body, fender Repair Diesel Mechanics
 Welding—Arc, gas Tool & Die
 Refrigeration & Air-conditioning
 Machine Shop Piano tuning
G.I. appr. for Vets dischgd. after 7-25-47

Or learn at home—extension courses:
 Diesel Refrigeration Plastics
 Check if Veteran Civilian

Name.....
Address.....
City.....
State..... Age.....

EVERY MASON WILL WANT THIS
MASONIC QUIZ BOOK

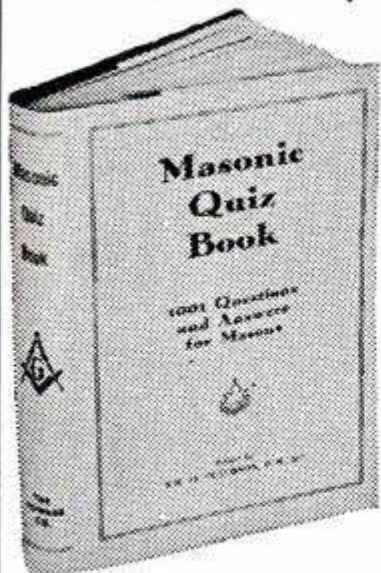

or
**"Ask Me
Another,
Brother"**

A real help to every Lodge Officer, Master Mason or Masonic Student.

Does not disclose any Secret Work, but gives authoritative information on Masonic history, ritual.

Includes such questions as:

- What did Masons have to do with the Boston Tea Party?
- What reference is made to the Catholic Church in Masonic teachings?
- Has every President of the United States been a Mason?

\$3

Postpaid

284 pages, 5 1/2 x 8", bound in cloth, and a distinct addition to the library of any man, even though he is not a Mason, or C.O.D. plus postal charges

A Gift that every Mason will appreciate
ORDER YOUR COPY TODAY

THE CHARLES T. POWNER CO.
Dept. PM-553, 407 S. Dearborn, Chicago 5, Illinois

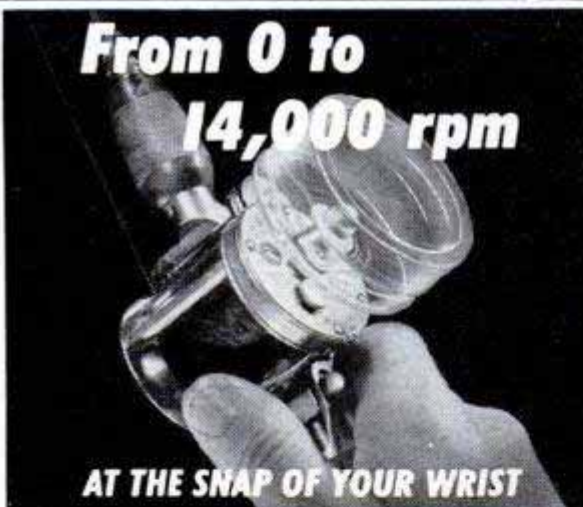

From 0 to **14,000 rpm**
AT THE SNAP OF YOUR WRIST

with a **PFLUEGER REEL**

Ever think how fast a bait travels through the air? Shooting out 80 to 100 feet in two seconds means peak speeds up to 40 miles per hour. And the spool that feeds out line turns up to 14,000 revolutions per minute!

Pflueger Reels are built to last—by the third generation of trained craftsmen. Pflueger Reels, from \$2.10 to \$35.00, mean better fishing. Ask your dealer.

THE ENTERPRISE MFG. CO., AKRON, OHIO
88 years making fishing tackle

PFLUEGER
(Pronounced "FLEW-GER")
A GREAT NAME IN TACKLE

**SAVE 75%
ON**



WORK CLOTHES!

SURPLUS STOCK FROM
MIDWEST SUPPLY FIRM!
Terrific values you've got to see to believe!

SHIRTS 89c

Made to sell for 2.99! Now only 4 for \$3.45

What a buy! 4 for the price of one! These shirts, though used, are washed, sterilized and ready for long, tough wear. Assorted colors. Send name, address, neck size.

PANTS to match

Sold for 3.95 now only
Unbelievable Bargains! Send waist
measure and inside leg length.

99c

4 for \$3.85

COVERALLS . . . wear 'em used

and save plenty! Originally 5.95. Now only .
Send chest measurement.

\$1.95

3 for \$5.75

SATISFACTION GUARANTEED! Money back if you're not convinced these are bargains you can't beat! You can't lose so order TODAY for immediate delivery! Pay postman or send money with your order and save postage.

GALCO SALES CO. Dept. 135
4064 East 71st Street • Cleveland 5, Ohio

Broken or Loose FALSE PLATE?



Make Plates Like New

Fix it Yourself EASILY in a Few Minutes

Your plates may become broken or loose just when you need them most. With FIX-IT-KIT you can repair your own broken plates. Also tightens loose fitting plates, easily. Get permanent comfort with professional material. Complete instructions. Satisfaction guaranteed or your money refunded. Order Now at a new low price only \$2.98 postpaid — or sent C.O.D.

DENT-FIX DENTAL PRODUCTS, Dept. PM-5,
P.O. Box 674 Kansas City 8, Missouri

Learn **TELEVISION·ELECTRONICS**

2 Big Books
FREE

Train at Home—Get Big Kits of Radio Parts!
Prepare now in spare time. Practical instruction.
Approved for Veterans. Write for details and 2
Radio Books—ALL FREE! Rush name today!
SPRAYBERRY ACADEMY OF RADIO
Dept. 10-W 111 No. Canal Chicago 6, Illinois

RADIO

• GROW WITHOUT SOIL •



YOU can grow vegetables, flowers or rare plants without soil (HYDROPONICS) every day of the year. Start this fast, clean EASY way to grow any plant for fun or PROFIT now. Big returns from small space. Send postcard today for FREE picture book showing how others from every state are succeeding in this new wide open field.

GILBERT CO., Box 22-M, San Diego 6, Calif.

Do a Real Professional-Like Job
Yourself and **SAVE**

HOW to PAINT
With Brush and Spray

Covers All Painting Methods and
Materials

You can do professional-like painting and finishing jobs yourself and save about two-thirds of the cost. Sam Brown, noted craft authority, makes it so easy for you in his book, **HOW TO PAINT WITH BRUSH AND SPRAY**. Order your copy now and enjoy this tremendous saving. It covers exterior painting, wall and interior decorating, furniture finishing, concrete painting — every type of painting with brush, spray gun, roller and other methods. Tells what finish is best; what materials to use, etc. No previous experience needed. Fully illustrated. Order by mail. Only \$2.50. Money back if not pleased.

POPULAR MECHANICS PRESS, Dept. PM18
200 E. ONTARIO ST., CHICAGO 11, ILL.



PEEL 6-10 FT. OF PAINT PER MINUTE
Down to Bare Wood...
PAINT DOZER
\$9.95 complete



You can peel paint fast and easily! With Paint Dozer you soften and peel old paint in one continuous stripping action. You get a clean, bare surface ready for repainting. And, there's no hard scraping, no messy or dangerous chemicals or flame!

In tests, Paint Dozer peeled 43 coats of paint in *one* stroke! Flat, curved or grooved surfaces . . . house siding, boats, cabinets, floors, woodwork . . . you can peel them all better and easier with Paint Dozer!

Paint Dozer operates on 115-120V A.C. or D.C. household current. Its sturdy stamped-steel casing and heavy-duty ceramic element assure long life, even under daily use.

Order from your hardware or paint store, or write today for fast delivery. *You must be satisfied or your money back!*

LECTRO DIVISION, OTTO KONIGSLOW MFG. CO.
Dept. 2-C, 2189 West 26th Street • Cleveland 13, Ohio

Nylon
ALL NYLON Auto Seat Cover!
NYLON auto seat cover that is **TOUGH!** Will Resist Rough Treatment Without Damage. No Installation Problem — No Tacks or Nails Needed. **GUARANTEED TO FIT OR MONEY BACK WITHIN 10 DAYS!** WASHABLE — Dries in One Hour. Split Style for Folding Front Seat and Solid Style for Either Front and Rear Seats. Price **ONLY \$2.98** For Front Split or Solid Seat and **ONLY \$5.50** For BOTH Front and Rear Seats. Enclose Payment for Prepaid Delivery or Shipped COD.
MARDO SALES CORP., Dept. NY-020
480 Lexington Ave. New York 17, N. Y.



PORTABLE GARAGE
\$6.95 Plastic Vinyl
USE IT ANYWHERE
• Folds compactly • Keeps rain, snow, dust, salt air, sun or sleet away • Protects finish • Constructed of vinyl plastic • Fits all makes • Enclose check or money order for \$6.95, or sent C.O.D. 10-Day Money Back Guar.
MARDO SALES CORP.
480 Lexington Ave. Dept. G-743 New York 17, N. Y.



GIANT BALLOONS
Genuine Govt. surplus weather, target balloons. For **FUN** or **PROFIT**. Great sport in the backyard; or for parties, picnics, dances, fairs. **MONEY-MAKERS**. Use these balloons to attract crowds to civic events, conventions, exhibitions, trade shows. **TERRIFIC** for high school and college **PROMS**. Special purchase makes these low prices possible.
3 ft. dia. 49c—6 ft. dia. 79c—13 ft. dia. \$1.59
20 ft. dia. \$1.95
• Calif. residents please add sales tax.
WAR ASSETS DIV. VOLUME SALES CO.
Dept. M-5-53 3930 Sunset Blvd. Los Angeles 29, Calif.



HELPFUL BOOKS
Send post card asking for **FREE** catalog
Popular Mechanics Press, 200 E. Ontario, Dept. 601, Chicago 11

Guide to HOME REPAIRS
Pays for Itself 100 Times Over
Beat the high cost of home upkeep. Save hundreds of dollars every year on carpentry, electrical, painting, plumbing and other jobs around the house with Popular Mechanics **GUIDE TO HOME REPAIRS**. Simplified how-to-do-it instruction and 646 pictures make all jobs, inside and out, easy. Covers construction, remodeling, modernizing, repairing that you can do yourself at small cost. 192 page cloth bound book only \$2.50 postpaid. Order today under our money back guarantee.
POPULAR MECHANICS PRESS, Dept. PM16
200 EAST ONTARIO STREET CHICAGO 11, ILLINOIS



World's Most Complete!
1953 ALLIED
TV & RADIO CATALOG

FREE!

Everything in TV & Radio
At Lowest Prices

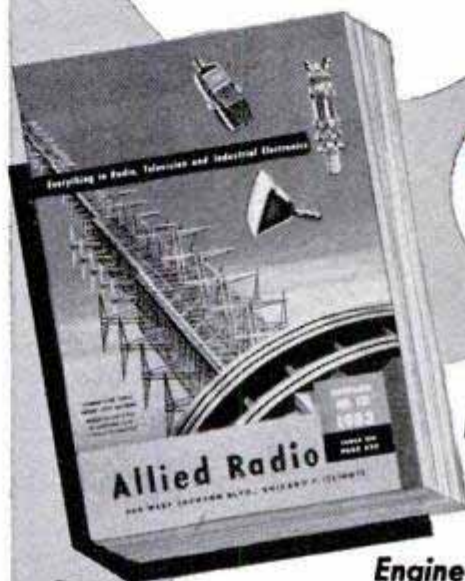

236 PAGES
VALUE-
PACKED

Everything for
Experimenters,
Builders,
Amateurs,
Servicemen,
Engineers, Soundmen

Send for ALLIED's big 236-page value-packed guide to *everything* in TV and Radio! Custom TV chassis, TV accessories, FM and AM radios, Amateur supplies, High-Fidelity Sound, P. A. Systems, recorders, test instruments, builders' kits—plus the world's largest stocks of electronic parts, tubes, tools and books. Get more for your money—send today for your **FREE 1953 ALLIED Electronics Catalog!**



SEND FOR
FREE
CATALOG

ALLIED RADIO

ALLIED RADIO CORP., Dept. 5-E-3
833 W. Jackson Blvd., Chicago 7, Illinois

Rush **FREE** 1953 ALLIED 236-Page Catalog.

Name _____

Address _____

City _____ Zone _____ State _____



OVER
3 FEET
HIGH

GIANT BEACH BALL \$1⁰⁰

100% Guaranteed Against Breakage!

Exciting new fun for young and old! Gay, multi-colored giant rubber ball features one piece seamless construction . . . is strong enough to stand on! Patented blow-up feature can't leak! Inflates easily by mouth or pump. Replaced without charge if you ever break it under ANY condition!

We pay postage — Send check, cash or Money Order. Your order rushed.

YOUNG PRODUCTS, 1407 2605 Elmhurst, Detroit 6, Mich.

**STOPS
OIL
BURNING!**

**Restores
POWER
& ZIP!**

Read This

HOW TO SEAL THOSE PISTONS POWER!

PACK 'EM
WITH

SAVE \$75
Overhaul
Your Car in
10 Minutes!

AT HOME for JUST
\$3⁹⁵
POSTPAID

**More Gas Mileage or Your Money Back
GUARANTEED!** Fisher's Compression Seal in the big tube is now used by over 100,000 wise and satisfied drivers who made the simple application in their own garages—and put the \$50 to \$100 apiece they saved in their pockets! Remember—it plates and seals your pistons while you drive. Here's how.

BLUE-BRONZE PLATE
FCS and only F.C.F. contains tough, resilient blue-bronze Fisherite which builds up evenly and seals excessive clearance between piston and bore. Detroit has known about it for many years—now it's yours for the first time. The semi-liquid carrier goes up in gas and out the exhaust.

SIMPLE TO APPLY—remove plugs, squeeze specified amount into each cylinder, replace plugs and drive. Simple? You bet! **SEND \$3.95 TODAY** in check, cash or M.O. C.O.D.'s Accepted! By return mail we send standard tube of Fisher's Compression Seal (for 6 or 8 cylinder car) plus FREE applicator, FREE test chart and iron-clad guarantee.

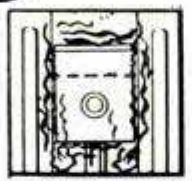

POWERLESS PISTON
(Before Application)

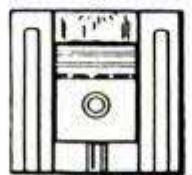

DYNAMIC POWER
(After Application)



CAR-LIFE SUPPLY CO., Dept. PM-5
4756 S. CENTRAL AVE. LOS ANGELES 11, CALIF.

Ball-Bearing **SPEED WHEELS**



Dealers, Jobbers, and Manufacturers! Our new prices will interest you.

JUVENILE WHEELS (No bearing, solid tires)

4"	40c	6"	65c
5"	45c	7"	75c

(Semi-pneumatic tire, ball bearing)

8x1.25 . . .	\$1.85	10x1.25 . . .	\$2.20
8x1.75 . . .	1.95	10x1.75 . . .	2.30
8x2	2.20	10x2.00 . . .	2.65
		12x1.75 . . .	3.45

INDUSTRIAL WHEELS
Lug Base, Semi-Pneumatic tire

5x1.75 . . .	\$3.65	10x2.00 . . .	\$6.10
6x2 SW . . .	3.45	10x2.75 . . .	5.15
6x2.00 . . .	4.00	12x2.00 . . .	6.90
8x2.00 . . .	5.20	12x3.00 . . .	9.20
8x2.50 . . .	5.40	16x4.00 . . .	15.15

Smooth Base, Pneumatic tire and tube

8x3.00 . . .	\$1.00	12x4.00 . . .	\$12.10
10x2.75 . . .	6.80	4.00x8 . . .	13.10
10x3.50 . . .	10.55	14x4.50 . . .	13.40

Available Now — **CASTERS**
Write for circulars on all wheels.
No c.o.d. orders. Prices F.O.B. our plant.
JIM BROWN TOY COMPANY
1095 HOME AVENUE AKRON 10, OHIO



Fabulous Profits At Home... Raising **ORCHIDS**

**YEAR 'ROUND
ANY CLIMATE
NO EQUIPMENT**

World's most thrilling hobby — most profitable home business. A single Orchid plant may multiply into HUNDREDS—each as valuable as the first. Famous grower shows you how! Raise gorgeous Cattleyas, Cymbidiums, Epidendrums on living-room table. Big-profit orders come from Homes, Florists, Gift Shops, etc.—also Mail Orders. Illustrated secrets of the experts in simple "show-how" language—INCLUDING actual Orchid plants—all you need to start at home, sent at no risk. FREE—full details—SEND NO MONEY. Write today. **TROPICAL FLOWERLAND, Dept. 13-H,** 601 South Vermont Avenue, Los Angeles 5, California.



DRAW The First Day!

NO LESSONS! NO TALENT!
New Amazing Invention—"Magic Art Reproducer." You Can Draw Your Family, Friends, Anything From REAL LIFE—Like An Artist Even If You CAN'T DRAW A Straight Line! Anything you want to draw is automatically seen on any sheet of paper thru the "Magic Art Reproducer." Then easily follow the lines of the "picture image" with a pencil for an original "professional looking" drawing. Also reduces or enlarges. SEND NO MONEY! Free 10 Day Trial! Pay postman on delivery \$1.98 plus postage. Or send only \$1.98 with order and we pay postage. Money Back Guarantee. **NORTON PRODUCTS, Dept. 5803E, 296 Broadway, N.Y.C.**

\$750 BUILDS 4 ROOMS & BATH!



WHY PAY RENT? For Seven Hundred Fifty Dollars and 30 days of your spare time, you can build yourself this Beautiful Home. Living Room 11x15, Front bedroom 9x11, Back bedroom 10x12, Kitchen 9x11, Bath 5x8, Hall 3x4, Wind out steel casement windows, Concrete block, stuccoed. Step-by-step illustrated instructions, blueprint and material list \$1.00 ppd. No COD. Moneyback guarantee. **Farrow Economy Home, Dept. C, Box 645, Columbus 16, Ohio**

Say You Saw It in Popular Mechanics

ELECTRIFY your **SEWING MACHINE**



NEW LOW PRICE!
\$10.50 1 YR. GUARANTEE

Buy direct from manufacturer and save! Kit comes fully wired, installed in a jiffy. Fits all machines! You get all-new parts:
• Motor & Bracket
• AC-DC 115v 60c
• Multi-speed foot control
• Cord set & block
• Easy instructions
• Steel pulley & belt

FREE . . . reg. \$2.95 chrome SEW-LITE given with every kit.
10 DAY FREE TRIAL — ORDER NOW!
Send no money, pay COD or send money order and we'll pay postage. Please state whether wheel on your machine turns toward you or away from you. Shipping wt. 6 lbs.
SENIOR SEWING MACHINE CO.
BOX 54 Dept. PM-48 BKLYN 5, N. Y.

make your own Driftwood LAMPS

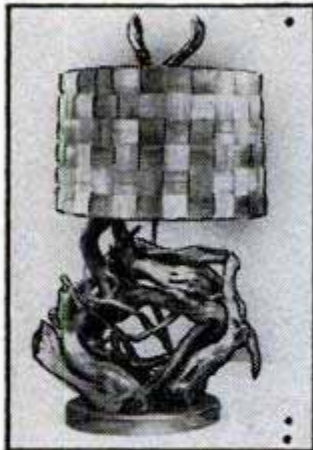

Here's the last word in natural beauty for your home — modern or traditional — at a fraction of its true value!

All the "makings," sand-blasted & ready for easy assembly and use. Can be stained, painted or waxed.

CRAFTS-KIT #201

Includes driftwood body, UL cord, rod, socket, Makes up to app. 25" high. Shade additional.

COMPLETE \$7.95
Ppd.

DELUXE KIT #401

Makes up to approx. 36-38" high. Includes driftwood body & finial, rod, UL cord, base, etc. Shade additional.

COMPLETE \$16.95
Ppd.

MONEY BACK GUARANTEE

Send Check or Money Order to Dept. PM53

INTERIORS | 76 BOWERY • NEW YORK 13, N. Y.

Kittridge

ENGINEERING DEGREE IN 27 MONTHS

INDIANA TECHNICAL COLLEGE

B. S. DEGREE, Aeronautical, Chemical, Civil, Electrical, Mechanical and Radio Engineering (inc. TV and Electronics). Drafting, 1-yr. G.I. Gov't approved. Low rate. Earn board. Large industrial center. Students from 48 states, 21 countries. Demand for graduates. Enter June, September, December, March. Write for catalog, 1653 E. Washington Boulevard, Fort Wayne 2, Indiana.

NOW YOU CAN GET 100 GENUINE THIN-FLEX \$2.00
RAZOR BLADES only

REGULAR VALUE \$5.00. YOU SAVE \$3.00



Yes, only \$2.00 for 100 genuine, deluxe quality THIN-FLEX double-edge razor blades. Finest blades money can buy. Thin, flexible, extra sharp and smooth. Chrome, surgical steel. Very finest workmanship. For those who want the best for less. TRY AT OUR RISK! COMPLETE SATISFACTION GUARANTEED! Send no money. Pay postman \$2.00 plus C.O.D. postage. Or send \$2.00 with order and we pay postage. Act now... offer may be withdrawn at any time! Order today from...

THIN-FLEX, Dept. P, 176 W. Adams St., Chicago 3, Ill.



UP TO 6 MILES MORE PER GALLON

Reported by Hundreds Using
MIRACLE ACTION TUR-B-LIZER

Carburetor specialists say Tur-B-lizer is best patented improvement they have seen. Tested in millions of miles of driving in cars, trucks and tractors. Easily installed. Send \$3.00 for six cylinder type, \$4.50 for eight cylinder type. Try Tur-B-lizer for 30 days. If you are not enthusiastically satisfied as claimed by hundreds of users, your money will be promptly refunded.

Mechanics-Salesmen: Make big money selling and installing. Write for full facts.

UNIVERSAL TUR-B-LIZER CO.
621 E. STATE ST. MILWAUKEE 2, WISC.

SAVE \$65 ON THIS LUXURIOUS \$100 CONTOUR CHAIR \$34.95

Genuine FOAM RUBBER



Make Money Selling and assembling contour chairs for friends

Shipped all ready to put together in less than one evening by anyone who can use a screwdriver. No cutting, no drilling, no skill needed. A woman can do it. Order now! Everything needed for only \$34.95, f.o.b. Balto. State color wanted: forest green, sapphire blue, lipstick red, walnut brown. Enclose \$5 deposit, pay balance on arrival. Money back guarantee. If not satisfied, return in 10 days.

Bestcraft, Dept. 25, Mathieson Bldg., Baltimore 2, Md.

For Everything needed complete to
PUT IT TOGETHER IN ONE EVENING!

Scientifically correct design for restful, healthful, relaxing. Adjusts for perfect sitting or reclining comfort. Proved beneficial to heart, nerves

... most popular chair in every home. Firestone foam rubber and washable, pliable genuine Duran upholstery. Would cost \$100 or more in any store.

HATE FLIES? Kill 'em by the Gallon



BIG STINKY Outdoor FLY TRAPS

The trap that gets flies before they get in buildings. Escape-proof design of top keeps flies in trap. Control Fluid kills them.

You supply a small amount of raw meat or fish for starting only. Control Fluid (included with Trap,) plus water, on the bait produces a gas generation that attracts a few flies. These are digested producing the potent scent that will attract flies by the gallon. Operation of trap becomes regenerative — trap literally feeds on flies themselves.

BIG STINKY with gal. jar and 8 oz. of Control Fluid **\$4.95**

Same with 1/2 gal. jar \$4.49



Plus 2 Great New Smaller Outdoor FLY TRAPS:

LITTLE STINKY

Trap less jar with 3 oz. of Control Powder **\$2.95**



WEE STINKY

Slightly smaller trap less jar with 1 1/2 oz. of Control Powder

\$1.69



at Hardware, Department, and Garden Supply Stores Everywhere

mfd. by: DIOPTRON CO., Milwaukee, Wis.

GET THEM FOR FLY CONTROL
this summer

FREE **SUNKEN SHIP TREASURE FOLDER**

MILLIONS OF DOLLARS IN TREASURE

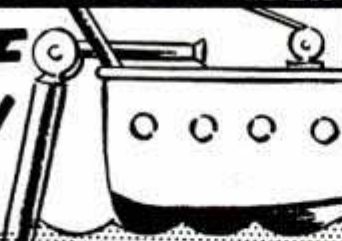

NEW Guy Underwater Exploration Club Sunken Treasure Folder is yours for the asking.

No man knows the true value of the millions of dollars worth of sunken treasure lying on the bottom of the Great Lakes.

The Guy Underwater Exploration Club will attempt to recover a portion of this vast treasure, using the new, improved waterscope that will be mounted on the Club's 2000 ton salvage ship, "Treasure Unlimited". Don't wait. Mail coupon below. No obligation.

GUY UNDERWATER EXPLORATION CLUB
602 Ford Bldg. Detroit 26, Mich.

Please send me without obligation, new sunken treasure folder.

Name _____
Address _____
City _____ Zone _____ State _____



MEMBERSHIPS ONLY \$10.00, INFORMATION FREE

FIVE WAYS TO MAKE MONEY

... on the farm
... at home with
arc welding

- REPAIR** ... broken steel and cast iron farm machinery, workshop tools, damaged car frames and axles.
- BUILD** ... all kinds of machinery for farm or tools for the home workshop.
- HARDSURFACE** ... tools to make them last longer.
- SOLDER** ... electrical wiring damaged car bodies.
- CHARGE BATTERIES** ... for neighbors.
... it's profitable work ... so easy with the new Lincoln arc welder.



LOW PRICED LINCWELDER 180 MAKES WELDING EASY

- Broad current range 20 to 180 amps handles $\frac{1}{16}$ " to $\frac{5}{32}$ " electrodes
- Operates from 230 volt single phase current
- Approved by Underwriters' Laboratories

Also "Linwelder 60" ... handles $\frac{1}{16}$ " and $\frac{3}{64}$ " electrodes. Operates on 115 volt grounded circuit. (No. 12 wire fused for 20 amps.)

ORDER YOUR WELDER NOW!

Fill out and mail TODAY!

The Lincoln Electric Co., Dept. 2903, Cleveland 17, Ohio.
 Ship me the "Linwelder" AC 180K \$201.
 Ship me the "Linwelder 60" \$48.
 Add State and Local sales tax. (Prices include accessories.)
 Arc Torch and Battery Charging Attachment extra.
 Enclosed is check money order
 Send me free bulletins on the "Linwelders".

Name _____
Address _____
City _____ State _____

POCKET COMPARATOR

Check, Measure
Inspect Small
Parts and
Dimensions
with 6 POWER
MAGNIFICATION

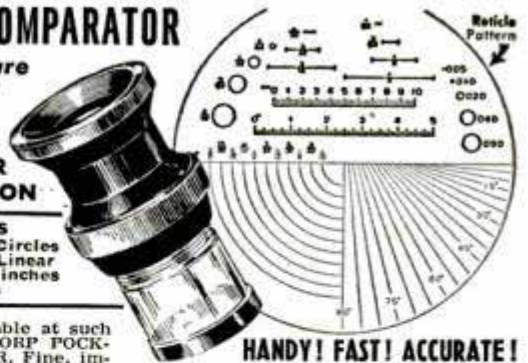

MEASURES
 • Angles • Circles
 • Radii • Linear
 in both decimal inches
 and millimeters

First time available at such low price! EDSCORP POCKET COMPARATOR. Fine, imported measuring magnifier — approx. size $1\frac{1}{2}$ " x 2" — for fast, accurate inspection of intricate parts. Used to check layouts, machining on tools, dies, gauges—to check threads, chamfers, small holes. In optical work for checking flaws such as bubbles, seeds, scratches, pits and digs. For scientists—in determining width of spectrograph lines. In photography—measuring and focusing at ground glass. Instrument comes in protective leather case. Money back guarantee! Stock No. 30,061-H. Price \$22.50 Postpaid. Order by Stock No. Send check or M.O.

EDMUND SCIENTIFIC CORP., Barrington, N. J.

250 POWER....



Complete Telescope Lens Kit only \$3.49 postpaid

Conquer Space, Explore the Universe, Planets, Moon Craters, New Stars, etc. Complete Lens Kit consists of 80 inch focal length ground and polished objective lens, eyepiece lenses for 50 POWER, 100 POWER, 150 POWER, 200 POWER, 250 POWER, and all necessary lens fittings. Easy to make from simple step by step instructions. (Tripod and mount not included.) Money back guarantee.

BUSSE SALES CO., Hartford, Conn., Dept. PM 12

Catalog of 3000 Novelties 10c

Send 10c for amazing catalog of novelties, live animals, scientific supplies, hobbies, funmakers, planes & boats, looms, magic tricks, joke articles, unusual seeds, gadget timesavers, cameras, optical goods, projectors, movies, lucky jewelry, religious novelties, disguises, musical instruments, stamps, coins, puzzles, fortune tellers, radios, auto & bike accessories, telescopes, magnifiers, compasses, banks, smokers' gadgets, artists' supplies, printing sets, engines, motors, shockers, knives, billboards, fireworks, guns, rifles, sports, books, games, plants, etc. Send name, address & 10c to:

JOHNSON SMITH & CO., Dept. 650, Detroit 7, Michigan



AMAZING NEW POCKET SIZE RADIO!

NO TUBES, BATTERIES OR ELECTRIC "PLUG-INS" NEEDED. "TUNES IN" MOST LOCAL RADIO STATIONS with STATIC-FREE CLEAR TONE. Has new perma-crystal diode and TINY SELF-CONTAINED SPEAKER PHONE—A marvelous real tiny pocket size radio to take with you anywhere you go — FOR REAL FUN AND ENJOYMENT. GUARANTEED TO WORK and should last for years!

SEND \$1.00 (Cash, M.O., Ck.) and pay postage or send \$4.99 for p.p. delivery. COMPLETE ready to play. By mail only from: Midway Company, Dept. PPM-5, Kearney, Nebr.



AUTO-SHOCKO Have some REAL FUN

with your car. AUTO SHOCKO gives anyone who touches the outside surface of your car a HARMLESS but VERY EFFECTIVE shock. When the switch is on, the entire outer surface of the car becomes charged. You can also charge your buddy's car by touching your bumper to his. He won't be able to get into his car until you turn off your switch. Can also be left on while car is parked to keep vandals from scratching or damaging your car. Will not run ever own. AUTO SHOCKO is the best FUN MAKER you will ever own. Easily installed in a few minutes. Available for both 6 and 12 volt systems (please specify). Complete with AUTO SHOCKO unit, wire, switch, etc. Price \$9.95 ppd., or COD plus postage. \$1 deposit required on COD orders. Dealer inquiries invited.

MORBARCO MFG. CO., Dept. P-1, 192 Arlington, Lawrence, Mass.

WARN HUB CAPS MAKE 2 JEEPS OUT OF 1



End front wheel drag on all 4-wheel drive Willys and Dodge vehicles

Save gas to 5 miles per gallon, reduce wear on front tires, axles; increase speed and power, stop front wheel shimmy—front wheels coast out of gear! 4-wheel drive handles, performs, climbs like 2-wheel. Install or remove in 10 minutes. Polished aluminum, guaranteed. Thousands in use. Prices quoted. NEW AUTOMATIC CAP available! Permits use as 2 or 4-wheel drive automatically, all speeds. LOCKING CAP also available which converts from 2 to 4-wheel drive or back with simple turn of lock. Fully guaranteed. See your Willys dealer, or if no dealer near you rush check, M.O., C.O.D. to:

WARN MFG. CO., Riverton Box 6064-A2, Seattle 88, Wash.

NEW AUTOMATIC DEFROSTER

ONLY
\$795

**YOU MAKE UP TO \$4
ON EVERY FAST SALE!**



Millions of defroster attachments sold at \$12.50. Now — with new guaranteed **HOLWIN** at \$7.95, sales breaking all records! Men selling as many as 10 and 12 a day — right now. Your profits big — as high as \$4.00 cash on every sale. Converts any old style refrigerator into automatic defroster in 10 seconds. Just plug in. Terrific demonstrator. Women crazy for it at this price. Sell 4 out of 5 calls.

NO CHARGE for complete selling kit and offer of sample demonstrator. Rush name. If you've ever sold anything you'll clean up with **HOLWIN**. All mailed Free. Send name today for \$140-a-week opportunity and offer of demonstrator.

**DEFROSTER SALES CO., 415 N. LaSalle St., Dept. H-85
Chicago 10, Ill.**

**FREE
SEND NAME**
Rush name for free sales kit and offer of demonstrator sample. Sales skyrocketing. Send name. Get in on big money.

Easy to handle



• It's a pleasure to paddle your own canoe — when it's an Old Town! Responsive, safe, sturdy, dependable.

FREE CATALOG shows all kinds of canoes for paddling, for sailing, for outboards. Also sailboats, outboard boats, dinghies, rowboats. Send for it today. Address Old Town Canoe Company, 945 Middle Street, Old Town, Maine.

"Old Town Canoes"

YOU'LL CATCH BIGGER FISH

and have more fun catching them after you read Popular Mechanics **HOW TO TEMPT A FISH**. Here is the experience of veteran guides and fishermen brought to you for hours of enjoyable reading. Many pages of brilliant full color Kodachrome plates. Covers every phase and style of fishing—even tells where to find the big ones and what baits to use. Hundreds of kinks and tips to make every trip more enjoyable. Endorsed by leading sportsmen throughout the country. 128 pages. 52¢ illus.

POPULAR MECHANICS PRESS \$2.00
200 E. Ontario Street, Chicago 11



TELEVISION-ELECTRONICS SHOP TRAINING

In only 5½ months we can prepare you to enter this rapidly growing **BIG PAY** field. No previous experience or special training necessary. We help you find full or part-time jobs while training. Est. 1936.

Write now for

FREE CATALOG

Veteran Approved.

BAILEY TECHNICAL SCHOOLS

1632 S. Grand Ave. • St. Louis 4, Mo.

For Permanent Boat Protection

Use **CASTOGLAS**
Liquid Plastic



Now YOU can apply it like Paint

... it's easy, economical!

Also use it
For **SEALING LEAKS**
For **PATCHING**
For **CAULKING**
For **SKID-PROOFING DECKS**

You won't have to paint and caulk your boat each year if you "plastic-plate" it with proved Castoglas (Liquid Plastic + Glass Cloth). It forms a light, almost indestructible skin which is lighter than aluminum and tougher

than steel. Once on, stays on. Makes boats permanently leak-proof, rot-proof, mildew-proof, waterlog-proof, weather-proof. Its tough, resilient, light weight plastic bottom increases protection against sharp, hidden rocks, logs, ledges.

Apply to old or new boats, big or small. Will not rust, corrode, crack. Unaffected by gasoline, oil, alcohol, salt or fresh water, hot sun or below zero temperatures. Fine for skid-proofing decks, sealing leaks, patching, caulking. Saves money; a little goes a long way and lasts as long as the boat.

FREE! Folder tells you all about New Castoglas. What it is, How to use, Where to get. It's free. Write to:

Marine Division, Dept. ME-1

The CASTOLITE COMPANY, Woodstock, Illinois

Serving Industrial Laboratories, Educational Institutions, Government Agencies and thousands of home workers in 48 States, Alaska, Hawaii and Canada.

Say You Saw It in Popular Mechanics

French DUELING SWORDS

Once used in deadly combat—now an exciting sport! Learn right at home. Fun—**SAFE**—educational. These swords are made of fine blue spring steel, polished metal

SET OF TWO \$3.98

guards, turned handles, rubber safety tips. Fencing teaches quick thinking, develops coordination, posture. Since the Middle Ages, Europeans have enjoyed the sport of dueling. *Now advocated by U.S. colleges. Set includes 2 swords booklet "Fencing Art". Special price. **MONEY BACK IF NOT COMPLETELY SATISFIED** if your sporting goods dealer can't supply you, send \$3.98 to **TECHRITE CORP., Box 27F, South Pasadena, Calif**

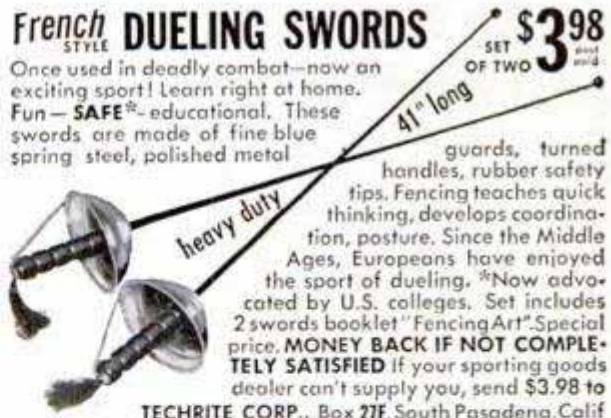

EARN BIG MONEY!

GROW "LIVING" MIDGET TREES!

AT HOME — SPARE TIME — NO EXPERIENCE NEEDED!

It's new! Amazing! At last, the secret of growing miniature (MING) trees can be yours. **FULL GROWN**, dwarf trees—only a few inches high. Beautiful miniature fir, orange, oak, Chinese elm, peach, pine, cypress—any kind! All **BLOOM** and even **BEAR FRUIT**. All perfect healthy specimens—but miniature in size! Make costly home decorations and expensive centerpieces. (SOLD FOR OVER \$1,500 EACH.) Big demand. Costs only pennies—takes only minutes per week. **IT'S EASY! Fun!** A new fascinating hobby—a new fabulous \$\$\$\$ business. Send for free secret plan details and real seed.

HELP US FILL HUGE DEMAND

These trees are being demanded by **STORES CLUBS - HOTELS - FLORISTS - HOUSEWIVES - INTERIOR DECORATORS - COLLECTORS - HOBBYISTS—** Big Money Opportunity for you.



HOW TO LEARN
GROWING
SECRETS

\$1 SEED
BOTH FREE

**MAIL TODAY FOR FREE
SEED AND PLAN!**

NATIONAL NURSERY GARDENS, Dept. M-5
8463 South Van Ness, Inglewood 4, California
Rush me **FREE PLAN** and **SEED** IMMEDIATELY!

Name _____
Address _____ Zone _____
City _____ State _____

SAVE 50%

8-PC. POWER TOOL SET

SAVE \$12 on This COMPLETE WORKSHOP

Get this complete outfit for the price of motor alone. Ideal for home, farm or shop.



1/6 H.P. MOTOR
Reconditioned
G.E. or Westinghouse
Arbor Stand, Pulley, Belt,
1/4" Chuck, Grinding Wheel,
Cloth Wheel, Wire Wheel

11⁷⁵

Limited supply at this introductory price. motor alone \$7.95

3-IN-1 SPORTSMEN'S KNIFE

1. CAN OPENER AND BOTTLE CAP LIFTER
2. FORK
3. KNIFE BLADE

For Hunters, Fishermen, Campers, Picnickers and Factory Workers!

First time offered! Useful 3-in-1 knife folds compactly to 3 1/2" long—carry in pocket. Easy to disassemble. Has bone handle and high carbon steel blades. Attractively gift boxed. Order yours today!

\$6.50 VALUE

\$2 IN GIFT BOX



easy open—slide up, slide down

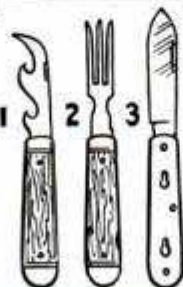

MAGNETIC AUTO PLUGS



Before Use

As described in February 1953 issue of Popular Mechanics. Complete set of 3 for TRANSMISSION

CRANKCASE REAR AXLE

FITS ALL CARS

set of 3

\$2

Marvelous new protection! These magnetic plugs remove from circulation even most minute iron or steel particles that get into the lubricant.

STEEL PARTICLES



After Use

Money back 10-day guarantee! Send check or money order, we pay postage. 25% deposit on COD's, you pay postage.

TIGER SALES

Dept. C

607 MICHIGAN AVE.
DETROIT 26, MICH.

This is the FREE booklet that started



Tom Dudley
on his successful

ART CAREER

Now he's a partner in a commercial art firm, thanks to WSA's step-by-step method of teaching. Use coupon below for this eye-opening booklet which tells how to master art at home in spare time, how much artists earn, how to sell your work. Realize your ambition to cartoon, draw, illustrate, to enjoy a relaxing hobby, to earn extra money, to begin a fascinating career. Act now (no salesman will call).



DRAW FOR FUN & MONEY . . . DETAILS FREE

WASHINGTON SCHOOL OF ART, Studio 125K
Washington 5, D. C.

- Send free booklet Tell about Trial Plan

Name _____ Age _____

Address _____

City, Zone, State _____

Got an Idea? An Inventive Mind? . . .
Want to Cash In on It? . . .

THEN GET

CLOTH
BINDING
\$2.50

MONEY from IDEAS

MONEY FROM IDEAS by Myron P. Laughlin, is a down to earth, informative and useful book for every man with an active, inventive mind, who believes he has ideas that can be patented.

Get this book to determine what inventions are needed for today's market, and how to go about inventing them; how to get a patent, protect it, sell it and make money out of it.

144 pages, well illustrated, indexed, and contains an appendix of patent forms, most valuable for the sale, assignment or licensing of patents.

Vital, Informative and Practical Help!

Inventions and How They Are Patented—What Inventions Can Do For You—The Growth of an Idea—Let Others Experience Guide You—An Invention, How It Was Developed—An Invention, How It Was Protected—An Invention, How It Paid Its Way in the World—How to Make Money From Inventions—Invention is a Business—Specialization—Sources of Information, A Where-to-Find-It Index—Records of Progress—Development Work—Starting a Business—Selling Patent Rights—Selecting a Patent Attorney—Patent Forms—Form of Assignment and Royalty Agreement—Form of License—Helpful Books.



POPULAR MECHANICS PRESS
DEPT. 28 — 200 E. ONTARIO ST.
CHICAGO 11, ILL.

SEND ME

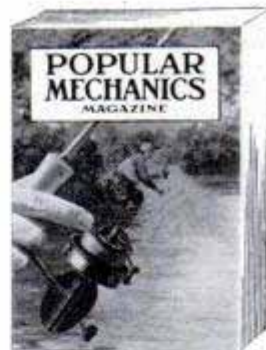

every month so I am sure to see each new issue. Here's

- \$3.50 for 1 year
 \$8.00 for 3 years

name _____

address _____

city _____

zone _____

state _____

Hand this order to your newsdealer or send it to

POPULAR MECHANICS
200 East Ontario St. Chicago 11, Ill.

you "UC" see **GLASS-WINDOWED STEEL CABINET STORES**



100's
OF SMALL ITEMS

6 BIN CABINET WITH DIVIDERS (makes 12 compartments)
\$4.95
POSTPAID

Here's that handy "UC" Cabinet for storing hundreds of those pesky, "hard-to-find" small items in home, workshop, office, plant, repair dept., etc. Glass-windowed bins. You see what you want before you reach — nuts, bolts, screws, nails, hooks, flies, etc. in full view — at your fingertips.

Patented "UC" (you see) Cabinet made of welded heavy steel throughout—steel back—lasts a lifetime. Individual glass-windowed, removable bins tilt out—never spill! Brown, green or silver hamertone baked enamel finish. Each bin 4 1/2 x 3 1/2 x 2 3/4" deep. Order this handyman's cabinet now—just \$4.95 complete, postpaid. Send cash, check or money order. Money back guarantee. Also, 12 bin cabinet (with dividers to make 24 compartments)—\$9.95. Add sales tax to California orders.

DISTRIBUTORS: Some territories still open!

BABBITT & COMPANY

Dept. P-5, 1002 W. Juniper St., San Diego 1, California.



KIT BOAT OWNERS

SAVE with "Kits for Kits"

Buy all your marine paint, fittings and marine hardware in kit form and save dollars. Everything for your boat. Buy with confidence from the nation's most complete marine supply store.

FREE LITERATURE: Specify boat kit, size and make.

SOUTH COAST COMPANY Since 1908
2212 Newport Blvd., Newport Beach, California

LEARN Modern Appliance and Electrical Servicing

Revolutionary New Method shows you how—at home—in YOUR SPARE TIME! We send you complete Home Training Kits and Latest Engineered Test Equipment. You can actually earn BIG MONEY WHILE LEARNING! Many men are making \$2.50—\$3.00 and more PER HOUR! RUSH name and address for big FREE book and full details—WRITE TODAY!

ADVANCE TRADES INSTITUTE, Dept. 901
5944 NO. NEWARK AVE. CHICAGO 31, ILL.

RUPTURE

THE LIGHTEST TRUSS I EVER WORE... NEVER FELT BETTER IN MY LIFE

AIR-FLO TRUSS

WEIGHS 2 1/2 OUNCES

- No Metal Pads
 - Washable
 - No Leg Straps
 - Non-Slip
- SEND FOR FREE CIRCULAR
WATKINS SURGICAL CORP.
130 West 42nd St. Dept. 4, N.Y.C.



YOU CAN BUILD A VIOLIN FOR PLEASURE OR PROFIT

Now you can build a rich toned mellow violin modeled after a famous "Strad." YOU CAN MAKE A STRADIVARIUS VIOLIN contains 8 full scale plans plus complete instructions. You work directly from the plans with no confusing scale of dimensions to translate. Detailed instructions for each step including varnishing and stringing—even shows how to build your own tools. Cloth bound. Order today from

POPULAR MECHANICS PRESS . . . \$3.50
200 EAST ONTARIO STREET, CHICAGO 11, ILLINOIS



NEW 1953 BOAT KITS BY U-MAK-IT

30 Models 8 TO 23 FEET

21 FT. OUTBOARD AND INBOARD CABIN CRUISERS

Roomy cabin sleeps 2. Includes full size toilet room, galley, sink & ice chest.



18 FT. OUTBOARD AND INBOARD CABIN CRUISERS

Fast Vee bottom hull, speeds up to 25 M.P.H. Accommodations for 2.



ROWBOATS OUTBOARDS INBOARDS

8 to 14 Ft. 12 to 21 Ft. 16 to 23 Ft.



NEW 1953 CATALOG

44 PAGES, shows construction details. Incl. everything to build your own—hardware, engines, conversions, paint & color chart. Also Fiberglass covering for all Kit Boats, Cabin Roofs and Decks

SEND 35¢ COIN TODAY

U-MAK-IT PRODUCTS 703P - WHITTIER ST. Bronx 59, N. Y. City

Malayan THROWING DAGGER

BALANCED TO STICK! \$1.98 postpaid

MALAYAN HUNTING KNIFE used for killing game. Exciting Target Sport, Easy to learn! Fun indoors or outdoors!
EASY TO THROW!

MONEY BACK GUARANTEE Fun, Thrills, Excitement! Indoors—outdoors. Learn this Sport! Easy to throw accurately with our clear instructions. Beautiful, heavy-duty 10" knife. Tempered steel. Tough, rawhide-bound handle. Rare souvenir. unusual bargain. Limited quantity. At dealers or send \$1.98
WHOLESALE IMPORT CO. Dept. K, 604 Marengo, Alhambra, Calif.



"I DOUBLED MY INCOME IN LESS THAN A YEAR as a CUSTOM UPHOLSTERER"



Alvin Lederkramer, formerly low-paid Auto Mechanic, earned extra money while learning! Now has BIG PAY JOB!

NOW - You Can Become An Expert UPHOLSTERER AT HOME

Right at home in your spare time YOU can become a skilled, expert, always-in-demand upholsterer. Not only can you EARN WHILE YOU LEARN, but your course includes—FREE of extra charge—FOUR BIG OUTFITS of tools, complete frames, all materials to make beautiful furniture that you can sell or use yourself.

Record-breaking building, home buying, refurbishing mean ever-increasing lifetime opportunities. You can quickly step into a well-paid job—BE YOUR OWN BOSS, or make big spare-time money. Previous experience unnecessary. Our thorough, N.Y. State Approved, practical training qualifies you. You will actually be upholstering furniture almost AT ONCE! Course includes all phases of custom furniture upholstery, car upholstery, furniture finishing, repairs—PLUS 4 big EXTRAS—slip cover, window cornice, cushion, and drapery making!



Our FREE book, "A New Way to A Successful Career" tells you all about this fascinating, big pay, big opportunity trade. WRITE TODAY!
UPHOLSTERY TRADES SCHOOL, Dept. BE-301, 721 B'way, N. Y. 3.

SEND FOR BIG FREE BOOK

UPHOLSTERY TRADES SCHOOL, Dept. BE-301, 721 Broadway, New York 3, N. Y.

Send me FREE book on Home Study Course

Name _____

Address _____

City _____ Zone _____ State _____

HUNDREDS OF NEW PROFIT SOURCES



Yours today in the New 1953 treasury of "NEW PRODUCTS AND SERVICES"

This exciting new Journal of Commerce 80-page handbook lists and describes 1,000 new money-making lines by 750 manufacturers. Yours to use, sell, produce or compete with. Get your copy now—then follow the daily "New Products" column in The Journal of Commerce. Your copy sent free with trial subscription of J-of-C — 52 issues for \$4.89, a saving of \$2.91. Mail coupon now — keep track of new profit sources.

THE Journal of Commerce

90 Varick St., New York 13, N. Y.

Send me the J. of C. for the next 52 issues plus my copy of "New Products and Services." Check for \$4.89 is enclosed.

Name _____

Address _____

City _____ Zone _____ State _____

PAY RAISING—EXTRA MONEY BOOKS

Use these books to prepare for a better job — bigger pay — to start a profitable spare time or full time business of your own, improve your home, or start a hobby. Popular Mechanics specializes in supplying outstanding self-help books on many subjects. Send for our FREE catalog.

- Outdoor Sports Manual
Hunters, Fishermen, Trappers, Campers, Archers, Boatmen, here is your book!... \$2.00
- Shop Notes Library
3 Vols.—1951, 50, 49, 48, 47 (No Dup. Matter)... \$3.98
- Shop Notes 1951... \$1.00
- Money From Ideas. Patent and sell your invention... \$2.50
- Photo Handbook
A complete guide to better pictures and darkroom technique. Dozens of handy gadgets you can make... \$2.00
- Practical Carpentry
New, easy-to-understand encyclopedia of building information, over 1,100 illus... \$5.00
- Automatic Transmissions Simplified. How to locate trouble, service all types... \$4.00
- Dyke's Auto Encyclopedia (World's Greatest Auto Book) New 1950 Edition... \$7.50
- Garden Book
Build own trellises, lawn furniture, fireplaces, ornaments, etc... \$1.50
- Diving, Cutting and Welding in Underwater Salvage Operations. Only book of its kind... \$2.00
- Picture Framing
Modern methods for making and painting picture frames. Fully illustrated... \$2.75
- Radio-TV and Electronics Handbook. How to service radio and TV sets; build receivers, phonographs, portables, student sets, etc... \$2.50
- Money Making Hobbies. 132 ways to make money... \$2.00
- 210 Deluxe Small Homes \$1.00
- Trailer Coaches by Kuns. Complete information for construction of trailers... \$1.50
- Concrete Handbook
New book on using concrete around home, garden, farm... \$2.00
- Veterinary Guide for Farmers by Stamm. What every farmer should know about taking care of farm animals. 288 information packed pages with more than 150 big illustrations. Covers ailments of cattle, hogs, sheep, horses, etc... \$3.50
- Welding, Brazing and Soldering 1950 Ed. How to build your own equipment and how to use it effectively... \$1.75
- Modern Electric and Gas Refrigeration. New 1950 Ed. includes sealed units — home freezers... \$5.00
- Complete Book of Home Repair and Improvements. Radio's famous "Fix-It" book. Everything about repairing and improving your home. Cloth Ed. \$2.98; Deluxe Binding \$3.98
- You Can Make A "Stradivarius" Violin. Instructions. 8 full scale plans... \$3.50
- Oil Burner Handbook... \$2.50
- 23 Boats You Can Build. Rowboats, canoes, sailboats, 25 foot cabin cruiser. Working diagrams, material lists. \$2.00
- House Wiring (No. 89)... 25c
- Turn Scrap Into Money
Convert old auto generators into motors, welders, etc... \$1.00
- Popular Mechanics Farm Manual
Packed with practical ideas and usable information that can easily be worth hundreds of dollars to every farm family and to homeowners everywhere. Send for free descriptive folder giving complete contents!... \$3.00
- Woodworking for Everybody... \$2.75
- Sheet Metal Work... \$3.00
- Tool and Saw Sharpening (No. 92)... 25c
- Forging Practice... \$1.50
- Action Toys (No. 66)
Plans for 21 easy-to-make toys... 25c
- Foundry Work... \$2.25
- Pattern Making
Wood, metal... \$2.25
- Forty Power Tools
Build own saw, drill, lathe, sander, etc., from scraps — save money... \$1.50
- Carpentry... \$2.50
- The Young Craftsman
Over 450 things boys can make... \$2.00
- Five Acres and Independence
How to make money on small farm... \$2.50
- Your Home and How to Build It Yourself. Step-by-step construction of the famous Popular Mechanics house. Wonderfully illustrated... \$3.00
- Manual for Plymouth Car Owners
How to get the most from your Plymouth and save on repair bills... \$3.50
- 100 Beautiful Pieces of Furniture You Can Build. Complete suites for living room, dining room, bedroom shown in brilliant color. Exclusive styles by John Bergen. Working diagrams... \$3.00
- Motorist's Handbook
Popular Mechanics scores again. A 160 page guide to automotive happiness... \$2.00
- Planning Your Home Workshop
How to use every inch of space. Build cabinets, benches, etc. How to wire... \$2.50
- What to Make for Children
Junior tough on toys? Build him playthings that will last... \$2.00
- LeJay Manual of Homemade Electric Equipment. How to construct 50 items that are scarce and valuable... \$1.50
- How to Estimate for the Building Trades: Material and labor costs for masonry, plumbing, electricity, carpentry, heating, hardware, painting, etc. 629 pages... \$5.50
- Auto Racing—6th Edition... \$2.00
- Tool Making... \$4.00
- Tool Design... \$4.50
- Plumbing Installation & Repair... \$2.00
- Ropp's Calculator
Figuring Made Easy... 50c
- Slide Rule Simplified... \$2.75
- Drake's Refrigeration Service Manual... \$2.00
- Power Tools and How to Use Them. Tools to start with; tools to add; how to use them and where to buy them... \$2.50
- America's Best Low Cost Homes 125 popular practical designs... \$1.00
- Toys You Can Make of Wood... \$2.50
- A.B.C. of Poultry Raising... \$2.50
- Lawn Furniture
Make attractive sturdy lawn furniture with Popular Mechanics big plans. Save over 50% of the usual cost. Four plans... \$2.00
- Furniture Joinery... \$2.00
- Essentials of Upholstery... \$3.25
- The Frog Industry by Hannaca. Covers every phase of frog farming; shows you how to make big money. Full of valuable information about this fascinating, profitable industry... \$2.00
- Home Haircutting Made Easy by Mercia. Instructions for cutting your family's hair... \$1.00



MAIL THIS COUPON TODAY

Check the books you want, write your name and address below, and mail this advertisement with money order or check. Outside U. S. A. include 15% additional for shipping charges. Books selected will be mailed promptly on our "money back if you're not entirely satisfied" guarantee.

Name _____

Address _____

City _____ State _____

Mail to **POPULAR MECHANICS PRESS**
 DEPT. 700—200 EAST ONTARIO ST., CHICAGO 11, ILL.



**SIMPLE DESIGN
and FEWER PARTS
MEAN TROUBLE FREE
PERFORMANCE!**



**Ride
a Bike
- it's
Fun!**

For lasting satisfaction you can't beat a Bendix* Coaster Brake. Built to give you quicker stops—easier pedaling and longer coasting—it's the outstanding performer in its field. Your bicycle dealer will put on the brake you want—so just say "Bendix Coaster Brake." *REG. U. S. PAT. OFF.

**DOUBLE THE FUN
WITH A  BENDIX
COASTER BRAKE**

ECLIPSE MACHINE DIVISION of
Elmira, New York



SAY YOU SAW IT IN POPULAR MECHANICS

POWER MOWERS & KITS **FREE PLANS**



3 & 4 Wheel Model

4 Wheel Direct Drive

America's Finest Power Mowers completely assembled in 3 and 4 wheel models. Belt or direct drive. 18" and 20" sizes. Nationally known make engine. Latest improved features, sturdy construction and money back guarantee fully described in color folder. Write today.

▼ TRIANGLE MANUFACTURING CO., Box M-22, Fort Scott, Kansas

Build your own quality mower with our LOW COST KITS, Parts, Engines. Free Plans guide you. 3 and 4 Wheel Kits, complete. Parts precision finished, ready to use. Write TODAY for Free Plans, Low Prices, Parts List and Guarantee.

3-WHEEL KIT NO. T-800



**Pack a lifetime of boating thrills
into your car trunk!**
**the
KLEPPER
unsinkable
AERIUS
folding
BOAT**



This great folding boat sets up into a trim, sleek 17 footer that carries as many as 4 people. In just 10 minutes, it's ready to cruise in any waters—salt or fresh, smooth or rough. No clubhouse or docking fees; the Aerius packs into your car trunk wherever you go.

UNSINKABLE. Air tubes built in all around the gunwales make the Aerius unsinkable. It's safe enough for a child to handle. The Aerius has a tough, resilient hull of multi-ply rubber-tire construction on rugged frames of seasoned mountain ash and plywood. Never needs painting or caulking.

VERSATILE. The Aerius tacks like a dream under sail, literally skims over the water with a light outboard, paddles better than a featherweight canoe. Perfect for shooting rapids!

Famous explorers including Byrd, Sven Hedin, Amundsen and others have chosen the Aerius for rugged dependability. Acclaimed by sportsmen everywhere for hunting and fishing, and for boating thrills!

**KLEPPER FOLDING BOATS \$159.
READY TO LAUNCH, from**

In New York, visit our showroom.
KLEPPER COMPANY
Dept. RS, 1472 Broadway,
New York 18, N. Y.

KLEPPER
THE ORIGINAL FOLDING BOAT
Write for FREE full-color folder today!

**Want a
Government?
Job**

START AS HIGH AS \$3,795.00 A YEAR

Prepare NOW for next exams

MEN—WOMEN

Thousands appointments being made. 32-page Book FREE.

Mail Coupon Today. SURE.

FRANKLIN INSTITUTE

(Not Gov't. Controlled)

Dept. Y-83, Rochester 4, N. Y.

Sirs: Rush without charge (1) 32-page book with list of U. S. Government Jobs; (2) Tell me how to qualify for one.

Name _____
Address _____ Age _____

GET FASCINATING NEW FREE PROFIT PLAN



SEND NO MONEY. I WANT YOU TO EXAMINE EVERYTHING WITHOUT RISKING A CENT.

BIG DEMAND FOR NEW MIRACLE FINISH. We show you every step. Filling huge year-round demand...easy to understand instructions tell you how. Earn up to \$5 an hour spare—full time. A few cents' worth of materials—brings you dollars!
GRASP THIS OPPORTUNITY TODAY. It's too good to miss... Fill out coupon, mail today. Get FREE sample, FREE plan, big IDEA booklet. No salesman will call! Do it NOW... be first in your community to cash in on this huge new market!

Tired of monotonous, low-pay jobs — of working for the other fellow? Tap rich profits in huge NEW field. Have your own lifetime business — earn REAL money —

say goodbye forever to time clocks bosses! Become part of tremendous expanding industry — yet work right at home!

LEARN IN A FEW DAYS THROUGH PROVED, TESTED METHODS

to start earning more money with this amazing MIRACLE finish—gives a velvety, luxurious surface to radios, lamps, toys, signs, store displays,

figurines, auto dashboards—hundreds of items. FREE PROFIT PLAN offers everything you need to start at once. Fill out coupon, mail today.

**PROFIT
UP TO
\$500
PER HOUR**

INVESTIGATE TODAY!

USE COUPON FOR FREE SAMPLE
COAST INDUSTRIES Dept. 25
1004 S. Los Angeles St., Los Angeles 15, Calif.
Gentlemen: Please rush me all details FREE

NAME _____
STREET _____
CITY _____ STATE _____

COAST INDUSTRIES Dept. 25, 1004 S. Los Angeles Street Los Angeles 15, California.

HULA POPPER

WORLD'S BEST SURFACE POPPING LURE

Here is Ralph Vestal with 3 fine 8-lb. bass taken at a small lake near Memphis, Tenn., on the new 1/4-oz. Spinning Hula Popper (Frog finish). Hula Popper is everything you want in a top-water lure. You make it twitch, jerk, pop or plunk under perfect control. When at rest colorful rubber Hula Skirt goes into wriggling, squirming action. Casting size (5/8 oz.) or spinning and light tackle size (1/4 oz.)—\$1.25 ea. Fly-rod size (1/16 oz.)—75c ea. Choice of body colors.

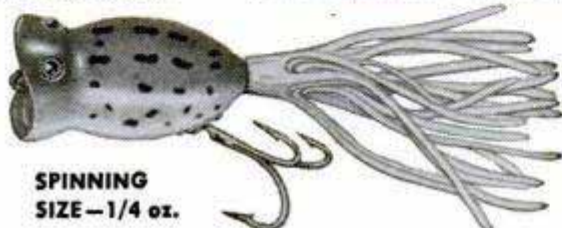

SPINNING
SIZE—1/4 oz.

FREE WRITE TODAY FOR YOUR BIG FREE ARBOGAST COLOR CATALOG OF BAITS—FULL OF PICTURES OF CATCHES
FRED ARBOGAST & CO., INC.
2255 WEST NORTH STREET • AKRON 3, OHIO

Experimenters' Specials



P-1002

RESISTOR KIT

A miracle of value. 99 carbon-on-ceramic deposited resistors. German made. 10% tolerance. 11 popular values 100 ohms to 100 K. Assorted 1/4, 1/2 and 1 watt. 9 compartment hinged covered clear plastic box. Stock #P-1002.

Special at only \$1.98



P-397
P-398

UNIVERSAL AC/DC MOTORS

115 VOLTS. DELCO No. 68008. 1/40 horsepower. 7,000 rpm loaded. Dual shaft extension. Has two hole mounting base for bench mounting. Ideal for high speed grinder-polisher in home shop. Stock #P-397.

Price \$6.95 ea.



P-396

DELCO No. 84567

Identical to 68008 described above, but is 4 wire reversible. Ideal for low power, high speed reversible applications. Stock #P-398.

Price \$7.80 each.

DELCO TYPE 5047140

1/50 horsepower motor. 7,000 rpm. Dual shaft extension. No mounting base. Ideal for hand model type grinders and polishers. Make your own hand held tool for buffing, reaming, etc. May be used for sewing machine motor conversion. Stock #P-396. Price \$4.95 each.

ELECTRONIC MOTOR SPEED CONTROL KIT AND MOTOR

Industrial electronic motor speed control—1/20 hp. 1750 rpm dual shaft motor, Thyatron tube, transformer, chassis, all parts, tubes and instructions. Similar to Thymotrol and Mototrol. Build and learn. Stock #P-1001. Complete Price \$39.50 each. Tachometer—Stewart Warner—0-4000 rpm. Special. \$6.95 each. Mercury switch—tilt to activate. Special, four for \$2.00. Mallory D.P.D.T. momentary switch. Panel mt. Pushbutton. 3 for \$1.00

Send 25c for big catalogue of electronic, electric, hydraulic and aircraft bargains. Full credit on first order. Above prices are all F.O.B. destination for your convenience. No C.O.D. shipments. Send payment in full with order. Satisfaction guaranteed—money refunded.

Electro Devices

4-6 Godwin Ave.
Paterson, N. J.
DEPT. P-10

BUILD THIS HOUSE Yourself



The Famous Popular Mechanics House

The picture below is from an actual photograph of the Build-It-Yourself House with breezeway and garage, as built by Jack Brownson, 23-year-old veteran, in Aurora, Illinois.

Mail Coupon for New Book and Plans!

Build It Yourself or Have It Built—Save Hundreds of Dollars!

Designed by Popular Mechanics and Famous Architects. Every Detail Simplified and Explained. No Previous Experience Needed!

Can you use everyday tools as well as the average Popular Mechanics reader? Then you, too, can easily build this modern house in any of its five designs, doing every part of the job yourself. The new Popular Mechanics Book, "Your Home—How to Build it Yourself" will show you how.

Space for Living and Family Growth

This beautiful, modern house is 1½ stories, with basement, living room, kitchen, dining nook, two bedrooms, bath, plenty of closets and space for two additional bedrooms on second floor. The house itself is 35' 9"x23' 11"; breezeway 20' 10"x8'; garage 20' 10"x12'.

The House That Has Everything

Designed for easy construction and the most living space for the least cost, the Build-It-Yourself House is also most attractive and suitable for any community and most income groups. The basic plan is adaptable to four other exterior designs.

Get Book and Plans Now—Build When You Can

You may never have thought about actually building a house yourself, but now that building restrictions have been lifted, it is easier than you think. So order book and plans today. Even if you engage a contractor to build for you, you will need the plans. And you certainly will want the book which can easily save you hundreds of dollars, whether you build this or any other house.

PLANS YOU CAN READ AND FOLLOW

Plans consist of ten working-size blueprints—floor plans, elevations, construction notes, framing, joints, lumber and mill list, specifications, plumbing and wiring diagrams. Every measurement is marked—every detail made clear as ABC. Book has 100 pages—three-fifths are photographs and drawings. Some sections in colors, showing just how your house will look when finished.

BIG BOOK
8½x11 inches

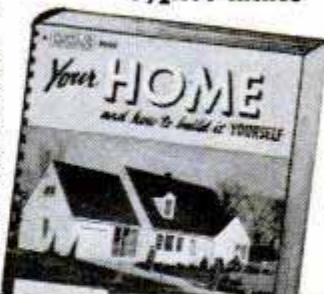

MAIL COUPON FOR BOOK AND PLANS

POPULAR MECHANICS PRESS, Dept. 16
200 E. Ontario St., Chicago 11

I enclose \$_____ Send me the items checked at once.

- Your Home and How to Build It Yourself.....\$ 3.00
 Complete set of plans for Popular Mechanics Home... 12.50
 Book and plans at reduced price..... 14.00
 Duplicate sets of plans..... 5.00

Name _____

Address _____

City _____ Zone _____ State _____

**MOST FAMOUS
KNIFE
IN HISTORY!**

Renowned from Dieppe to the Yalu by Anglo-American fighting men of two wars, this priceless collector's item is fast becoming a legend. Named the "Fairbairn," this beautiful knife of finest Sheffield steel was made for British ordnance in England. It was issued to Commando and Ranger units exclusively. Your knife shipped in original leather sheath for belt and boot. An authentic souvenir which will increase in value from year to year. Overall 12". Brand new. Send check, cash or m.o. (For U.S., A.P.O. and F.P.O., air mail, add 80c per knife.) Dealers inquire.

Calif. resid. add 3% state tax.
Pasadena Firearms Co.,
12 Sports Building
972 East Colorado St.
Pasadena 1, Calif.



AN IDEAL GIFT
FOR THE
SERVICEMAN
\$3.00
EACH
POSTPAID

RUPTURED?
Get Relief This Proven Way

Why try to worry along with trusses that gouge your flesh—press heavily on hips and spine—enlarge opening—fail to hold rupture? You need the Cluthe. No leg-straps or cutting belts. Automatic adjustable pad holds at real opening—follows every body movement with instant increased support in case of strain. Cannot slip whether at work or play. Light. Waterproof. Can be worn in bath. Send for amazing FREE book, "Advice To Ruptured" and details of liberal truthful 60-day trial offer. Also endorsements from grateful users in your neighborhood. Write:

CLUTHE SONS, Dept. 31, Bloomfield, New Jersey.

HELPFUL BOOKS
Send post card asking for FREE catalog
Popular Mechanics Press, 200 E. Ontario, Dept. 601, Chicago 11

FREE! IMPORTS
To New Members
FROM FOREIGN LANDS



Free to new members of the International Traders Guild—many unusual, useful products from France, Japan, Germany and other foreign lands, and trade bulletins listing hundreds of import bargains to sell at high U. S. prices. Also requests from overseas buyers for U. S. exports. Opportunity men—women, profitable, world-wide, mail order business at home; or travel abroad; no capital needed. 2,000 members in 42 countries. 7th successful year. FREE details. Mellinger Co., Suite 255, 1717 Westwood, Los Angeles 24, Calif.



sea-net

the official
**FROGMAN
EQUIPMENT**

For pool, lake or ocean, the finest in underwater swimming equipment. High speed flippers, masks and goggles in attractive marine blue pure gum rubber. Send for complete free catalog of underwater equipment today!

Face Mask
\$3.95*

Froggles
\$1.25*

Super
Frog Feet
\$7.95*

Official Equipment

**NATIONAL FROGMAN
CLUB**

At your dealer or
order direct.

sea net Mfg. Co., 1428 Maple Ave., Los Angeles 15, Calif.

Q. | A.

**Which Commercial
Art Pays Best?**

- Illustration
- Photo-Retouching
- Lettering
- Design

Photo retouching is the most profitable form of commercial art, because of scarcity of trained retouchers. Now, you can learn professional retouching—including black-&-white, color, air-brush, etc.—by mail; complete course personally supervised by recognized expert. Write for free information: Dept. PM5, Professional Art Institute, 5653 1/2 H'wood Blvd., H'wood 28, Calif.

RADIO Engineering. All phases radio & electronics theory & practice; television; FM; broadcasting; servicing; aviation, marine & police radio. Prepare for high pay; 18-month course. Graduates in demand by major companies. Enter Jan., March, June, Sept. Regular campus life. Write for catalog. **VALPARAISO TECHNICAL INSTITUTE, Dept. D, Valparaiso, Ind.**

\$5900
(BASIC KIT)
F.O.B. DEFIANCE, OHIO

BUYS YEARS OF BOATING PLEASURE

IN THIS 12 FOOT
PENNEY BOAT KIT

Mail this coupon TODAY for FREE literature

Please send me FREE brochure on the Penney 12 ft. Utility Boat Kit.

Name.....

Address.....

City..... State.....

PENNEY WOODCRAFT INDUSTRIES
208 Perry St., Dept. M5 Defiance, Ohio



**Yours...
ALMOST
AS A Gift!**
Send Only 25¢ FOR THIS
VALUABLE COLLECTION OF
**107 "Iron Curtain"
Stamps**

Guaranteed to be WORTH MORE THAN \$2.00 at Standard Catalog Prices!

This sensational BARGAIN OFFER is made to introduce the services of Kenmore Stamp Company. Each collection contains the dramatic, valuable stamps pictured here plus 102 other exciting varieties. All are from Russia, Hungary, Poland, Czechoslovakia, Bulgaria, Rumania, East Germany and Siberia — lands cut off from the western world by the ruthless "Iron Curtain" of Russian Communism. Rush your order today for these hard-to-get stamps. Other interesting offers will be included for your inspection.



Free Booklet IF YOU ACT NOW! Mail coupon today and we will include FREE our illustrated booklet: "How to Recognize Rare Stamps." Tells where and how to hunt for rare stamps, how to identify and sell them. May guide you to "finds" of stamps worth hundreds of dollars!

STAMP COLLECTING

is the world's most fascinating hobby!
If you are not collecting already,
START NOW!

KENMORE STAMP CO., Dept. PM5 Milford, N. H.

I enclose 25¢ for 107 Different Stamps from Countries behind the Iron Curtain. Be sure to include your FREE BOOKLET.

Name _____

No. & St. _____

City _____ Zone _____ State _____

FREE CATALOG

Over 300 books on Fishing, Hunting, Home Repairs and Improvements, Bricklaying, Welding, Home Workshop, Power Tools, Hobbies, Crafts, Home Building, Trades, Making Money at Home, Furniture Making, Woodworking, Carving, Photography, Art, Drawing, Mechanisms, Engineering, Refrigeration, Plumbing, Radio-TV, Electricity, Automobiles, Farming, Livestock, Gardening, Decorating, Painting, many, many more. Send for yours today.

POPULAR MECHANICS PRESS, 200 E. Ontario St., Chicago 11

PLYMOUTH SAVE MONEY!

Owners



Learn How to Make Your Car Run Better . . . Last Longer . . . and Save Hundreds of Dollars!

Get this book, written especially for you, without one penny of risk and get more out of your car. Mail coupon for MANUAL FOR PLYMOUTH OWNERS today. When the book comes, skip through the pages and see how your investment in one of America's most popular automobiles can be even a better investment than you thought. If you don't agree, send the book back and you'll get your money back.

A Popular Mechanics Book Written Just for You

Not a re-hash of service manuals. A complete new Popular Mechanics book written for the Plymouth owner by an outstanding automotive authority with the full cooperation of Plymouth engineers and service directors. It will save you money on repairs and service; make your Plymouth last longer; give you safe, economical and trouble-free motoring. And this is true whether you take your Plymouth to a regular service station or service it at home.

Prevents Trouble. Cuts Down on Repair Bills

Nothing like this manual anywhere. It covers all phases of operation, service and maintenance. It has entire chapters on the individual parts of your Plymouth—battery, ignition, starter, generator, regulator, lighting, fuel system, engine, lubrication, gasoline qualities, cooling systems, transmission, differential, rear axle, brakes, wheel alignment, tire care, body maintenance, trouble shooting on the road, etc. It covers your Plymouth, new and older models, step by step—bumper to bumper—showing you how parts operate; what can go wrong; how repairs and adjustments should be made and how to avoid all types of troubles.

Money Back if Not Satisfied

Mail the coupon today. Send only \$3.50 or you can pay postman. Money back guarantee protects you.

Official, Authoritative, Practical Information

Written by C. E. Packer, formerly service school instructor and auto show lecturer for automobile manufacturers, Member Society of Automotive Engineers, Special Services Editor of Automobile Digest, contributor to leading magazines, author of some of the biggest selling books on Automotive subjects. Prepared with the full authority and active cooperation of the Plymouth Division of the Chrysler Corporation.

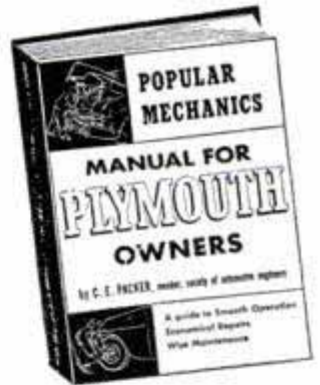

288 Pages. Hundreds of How-To-Do-It Illustrations and Diagrams

The entire book follows Popular Mechanics famous easy-to-read and easy-to-understand style. While primarily intended for the Plymouth owner, to help him get more out of his car at lower cost, it can be worth its weight in gold to the auto mechanic and service station operator who works, not only on Plymouths, but on all other makes as well, to which the information in the book can be easily applied.

Order on this Handy Coupon

POPULAR MECHANICS PRESS
200 E. Ontario St., Chicago 11, Ill.

Send Manual for Plymouth Owners at once. If not satisfactory I will return it within 5 days and you will refund full purchase price.

Remittance for \$3.50 enclosed. Send C.O.D.

Name _____

Address _____

City _____ State _____

**NEW
SCIENTIFIC
DISCOVERY**

**END YOUR
INSECT
PROBLEMS**

**NO MORE FLIES,
MOSQUITOS,
PESTS**

**PROTECT YOUR
HEALTH!**

Here's the
EASY
Inexpensive
Automatic
WAY TO

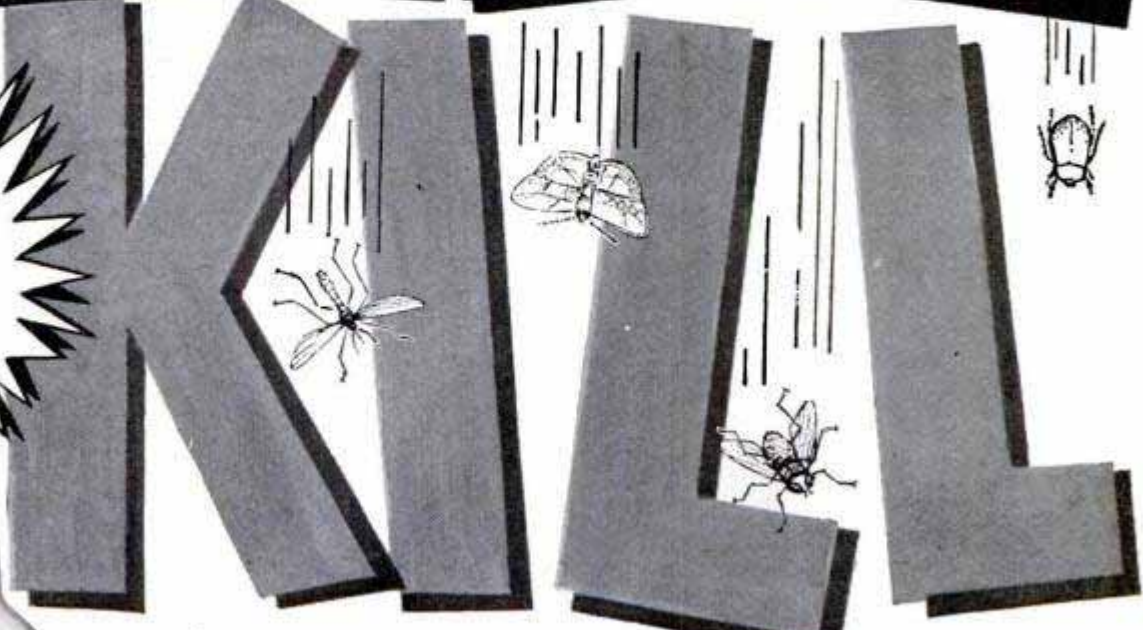

FLIES and INSECTS



**CHAMP
INSECT
BULB**
\$2.98
COMPLETE with
24 PELLETS
60 Day Supply



**CHAMP
INSECT BULB**
SILENT!
ODORLESS!
COLORLESS!
NO SERVICING!

**IT'S MURDER
IT'S MAYHEM
IT'S MIRACULOUS**

**COVERS
1500
CUBIC FEET**

**USE IT IN ANY
ROOM IN THE
HOUSE**

**FOR STORES,
RESTAURANTS,
FACTORIES, ETC.**

MONEY-BACK GUARANTEE

Amazing New Vaporizer Protects Family, Food, Customers, Employees From Disease Bearing Pests.

One Vaporization Lasts 15 Days — Assures Amazing Household Insect Control when used according to directions.

Revolutionary Design — Fits Any Socket

Now, say goodbye to flies, mosquitos, ants, spiders, silverfish, crickets, etc. The Champ Insect Bulb **KILLS** them all, rids your house of these disease-bearing pests. Never before has there been anything so powerful, so protective, so easy to operate, so inexpensive. Don't suffer another moment — order your **CHAMP INSECT BULB TODAY!**



MAIL THIS COUPON TODAY, MONEY BACK GUARANTEE

Insect Controls, Inc. DEPT. 1
20th and Market Sts., Phila 3, Pa.

Gentlemen: Enclosed please find \$2.98 for a Champ Insect Bulb complete with 60 days supply of Champ Pellets. If I am not satisfied I will return the Champ within 7 days and get my money back.

Name
Address
City Zone State

DEALER INQUIRIES INVITED

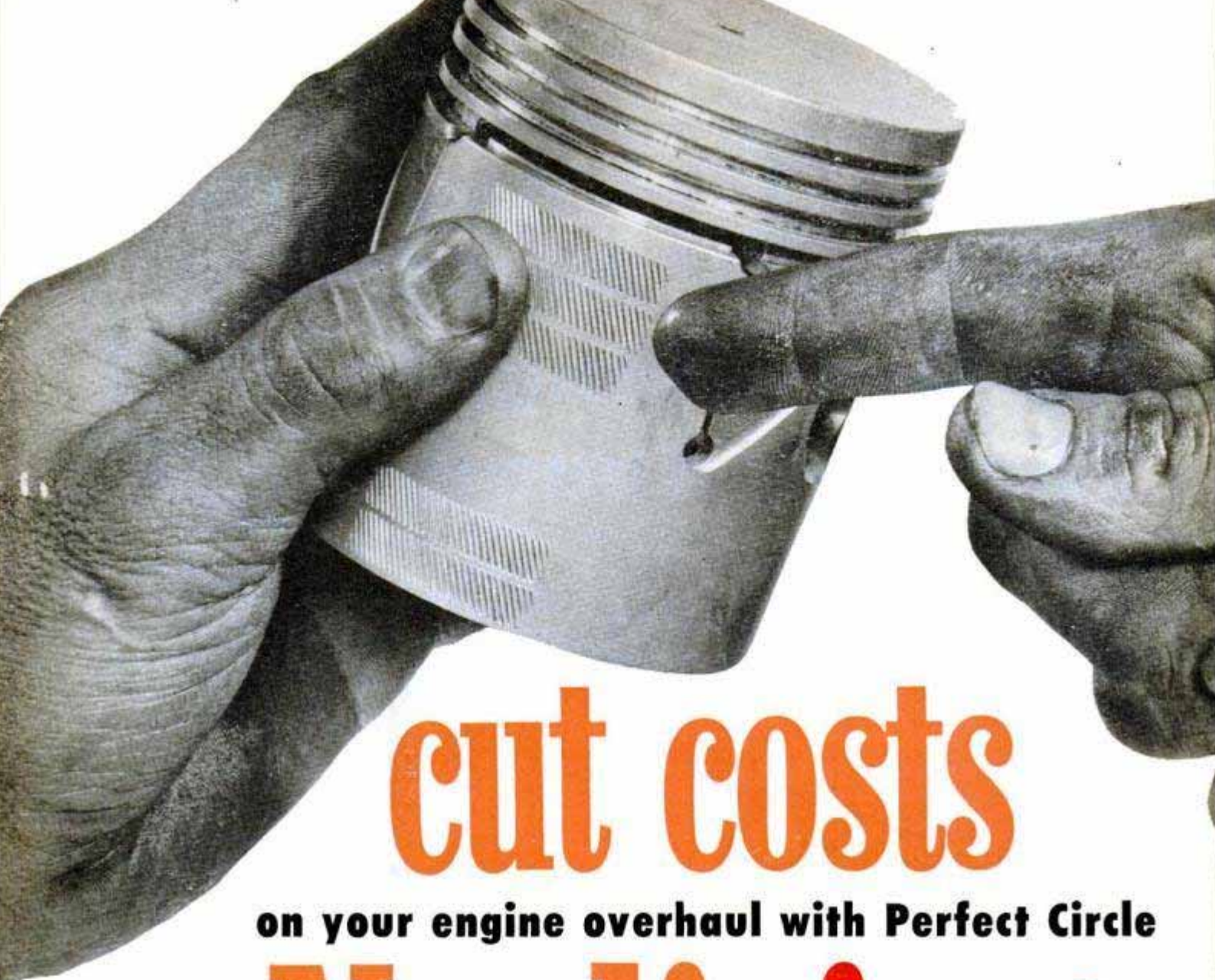

cut costs

on your engine overhaul with Perfect Circle

Nurlizing

Now worn pistons can be made like new again at only a fraction of the cost of replacing them!

Perfect Circle NURLIZING is the original knurling method of resizing and resurfacing worn pistons. Pistons are restored to their original close fit quickly, accurately and permanently . . . assuring increased power, better lubrication and lasting

freedom from piston slap.

More than 6,000,000 pistons have been NURLIZED to date . . . and Doctors of Motors recommend NURLIZING on re-ring jobs. Nurlizing service is available through Perfect Circle distributors everywhere. Perfect Circle Corporation, Hagerstown, Indiana; The Perfect Circle Co., Ltd., Toronto, Ontario.

Perfect Circle NURLIZING PISTON RINGS

The Standard of Comparison



Neville Duke is a British war hero who couldn't quit flying. His is the dangerous job of testing Britain's new supersonic jets, and frightening it is for the folks below when

POPULAR MECHANICS

MAY
1953

WRITTEN SO YOU CAN UNDERSTAND IT
VOL. 99 NO. 5

He Goes Banging Through Sound

NEVILLE DUKE is a British test pilot who flies faster than sound as casually and nearly as often as the average person drives a car 50 miles per hour. To most people, this is spectacular, frightening and dangerous. To Duke, chief test pilot of Hawker Aircraft, Ltd., it is "interesting."

Duke has become, much against his wishes, a hero to the English, because just as a hero creates publicity, publicity creates a hero. In Duke's case, it boils down to the supersonic frontier, a relatively new phenomenon in the relatively new age of jet aviation.

Supersonics—that is, speed faster than sound—first made its appearance shortly after World War II. An American Air Force captain, Charles Yeager, flying a Bell X-1, in October 1947, became the first man to fly through the sonic barrier. In England supersonics and Duke now are becoming increasingly well known, partly because of last fall's Farnborough air show and partly because of Duke's incessant banging through the sound barrier around the English countryside.

On the sixth day of the Farnborough show, John Derry, a close friend of Duke and the first Britisher to exceed the speed of sound, was killed along with 29 others when his de Havilland 110 jet fighter disintegrated in mid-air. Parts of it were sprayed on spectators lining the show's grounds in one of the greatest disasters in jet history.



By Norman Runnion

Within moments, however, Duke took off in his own plane, a Hawker Hunter, and dove through the sound barrier while far below him the wreckage of Derry's plane was still smoking. Ever since, he has been making headlines in the British press, still for his supersonic feats, but for a slightly different aspect of them—the "bang."

The bang of a jet going past the speed of sound is loud and if you've never heard

Neville Duke, in flying clothes, squeezes into the cockpit of a Hawker Hunter, shown in flight above

British Information Services photo





Duke makes as many as five flights a day in a Hunter, some supersonic, in attempting to push the swept-wing jet fighter to its maximum speed

it before, frightening. It has been interpreted variously as an earthquake, a building exploding, a thunderclap and even as the jet itself coming apart. Each time Duke bangs near a crowded area, newspapers, the police and various other officials are besieged with phone calls from indignant and worried citizens wanting to know when the war started again. To avoid all this as much as possible, Duke tries to distribute his bangs around the whole south coast. "They don't like me around here," he grins.

The bang is one of the mysteries of supersonic flight. No one is really positive of its cause, but ever since Farnborough, when it was heard so often, there have been many attempts to explain it.

One theory is that it is an acoustic effect due to an accumulation of noise coming from the aircraft. Another links it to shock waves formed when an aircraft flies at supersonic speeds; and a third, that it is caused by aerodynamic disturbances due to the aircraft. These disturbances, so goes the latter theory, enhance rather than cancel themselves as a plane moves at the speed of sound and be-

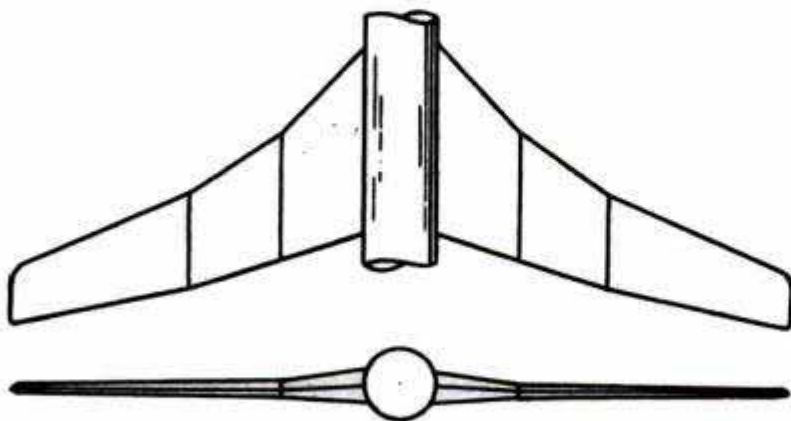

Front and overhead views, above, of swept-back, crescent-shaped wing of new Handley Page 80 bomber. Shown at right, four Sapphire jet engines give it more power than 25 modern express locomotives

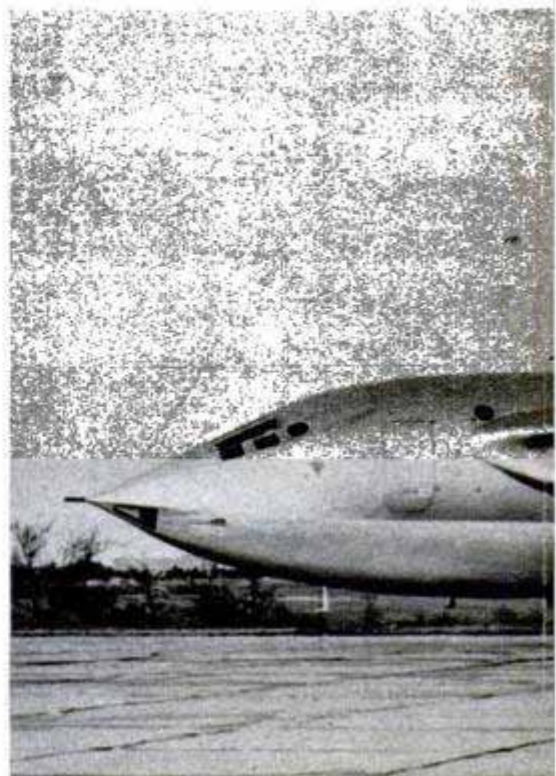



Duke, right, climbs up to give tips on the Hunter to Lt. Col. Richard L. Johnson, U. S. Air Force test ace

come a bang as the aircraft approaches the observer.

Although it frightens them if they're not expecting it, the bang is treated as somewhat of a novelty by the aviation-minded British. They order it like you would ask for a piece of cake. When an air demonstration is being held someplace, Duke is called and asked to bang, if he will, please, for the amusement of everyone present. Recently the Hunter was shown off to the Prime Minister of Turkey and, to the delight of those assembled, Duke banged quite satisfactorily.

The bang, of course, is just one aspect of

supersonic flight, but being one of the most obvious it is one of the most interesting. Duke himself can't hear it, partly because he already has passed it. Besides, even if he could, he would be too busy.

On every flight, for example, he has to record carefully everything that happens to himself and the airplane. He does this with a wire recorder. All he says—about instruments, the weather, the plane's behavior or even the pretty clouds—is recorded by wire. On the ground it is played back and his secretary takes it down in shorthand, transcribes it and gives it to Duke, who then writes his report.

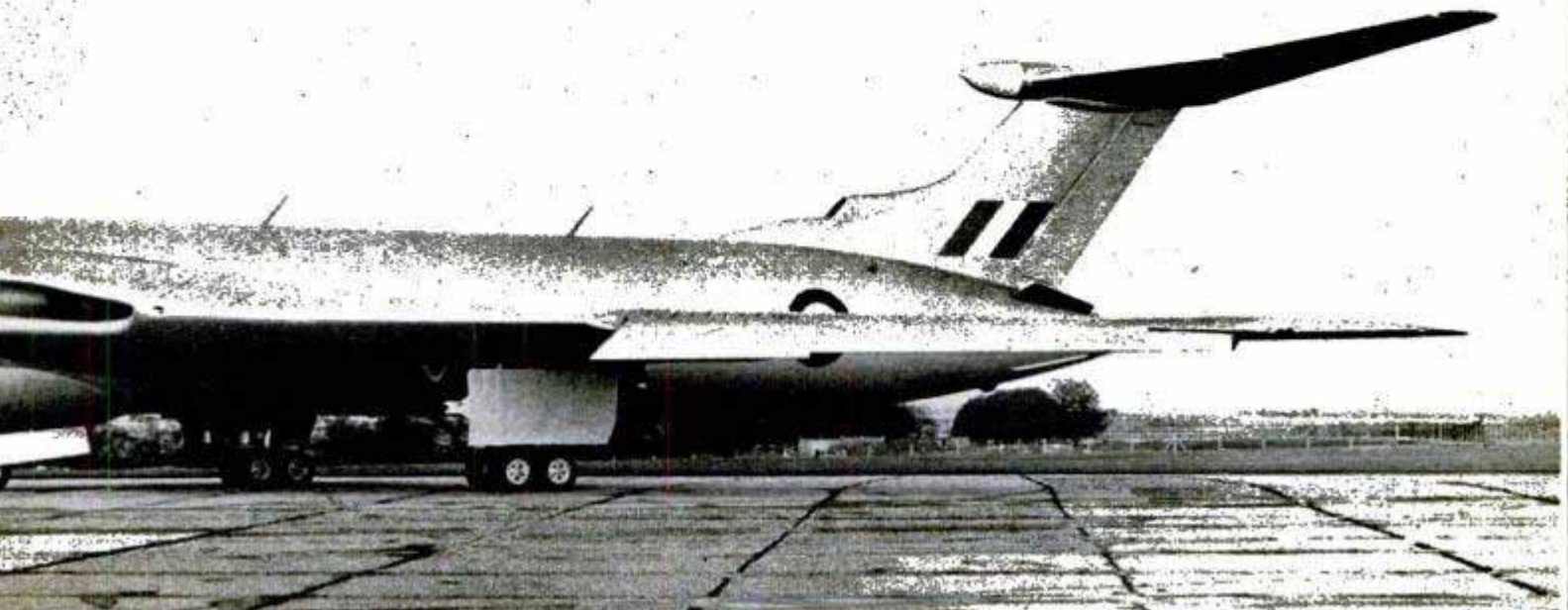

Duke is well equipped to be a test pilot. Now 30 years old, he was a wartime fighter pilot with 28 "kills" to his credit and holds the Distinguished Service Order, the Distinguished Flying Cross with two bars and the Air Force Cross. Early in the war he was a member of a Spitfire squadron stationed in England and later flew in the western African desert. He then was sent to Italy to command a squadron.

When the fighting was over, he went to the Empire Test Pilot School and, until 1948, served as a Royal Air Force test pilot. That year he joined Hawker as an experimental test pilot, becoming chief test pilot in 1951. Speed is nothing new to Duke. In 1949 he established a London-Rome-Karachi speed record in a Hawker Fury, and he still holds the London-Karachi record with an elapsed time of 15 hours.

Duke now is taking the kinks out of the Hunter, a sleek, swept-wing, single-seat interceptor that is in superpriority production for the R.A.F. Such a job is not simple. The Hunter has been flying for more than a year and still the testing continues. In early flights Duke looked for apparent troubles. Other flights tested stability measurements and performance rates, such as climb and speed. Now, he and the Hawker experts are trying to get the plane up to maximum speed.

In addition, the testing of the supersonic zone goes on and on. Duke sometimes makes as many as five flights a day, some supersonic, some subsonic, but all of which add more to the increasing knowledge of the sound barrier and what lies beyond.

One of the most important elements in this new frontier is the "why." There are, of course, practical reasons for flying faster than sound—that is, it's a nice thing to be able to do in a dogfight at 30,000 feet, and

John Derry was flying a D.H.110, below, when it fell apart at Farnborough show, killing him and 29 others

it may mean that in the future people can have breakfast in New York, lunch in London, and dinner in, say, Chicago. But to Duke there is something else.

"It's just there," he says.

That, simply, is it—man has overcome flight, so now man has to overcome speed. The sound barrier itself—a mass of turbulent air hit by an airplane flying fast as sound waves—now has been conquered in the sense that it has been surpassed. What lies ahead is to transform today's uncertainty into tomorrow's reality.

What faster-than-sound flight means to the public is easy to guess. For example, Roland Falk, chief test pilot of A. V. Roe and Co., Ltd., believes that within 50 years there will be a two-hour "commuter" service between London and New York. This will be done, he predicts, in a nuclear-powered aircraft, probably a delta shape, which will carry more than 100 passengers at speeds of around 2000 miles an hour and at heights 10 to 12 miles above the earth. The plane will make 10 trips a day and will land only when it needs servicing. Passengers, cargo and fuel will be carried to it by air taxis seating 25 people. Passengers will transfer between the two planes by means of a pressurized passageway.

The main plane, Falk contends, will not have windows because of the huge difference between atmospheric pressure inside and outside the cabin which would make window installation difficult. However, the passengers wouldn't have to be upset about this, because at a height of 10 miles they couldn't see much anyway.

The delta, Duke and others maintain, is the aircraft design of the near future because it is so adept at high speed. To travel into and in the supersonic zone, a plane needs a thin wing in relation to its over-all body to reduce drag. The delta, being practically a flying wing, has this. Other features which adapt it to high speed are easy controllability, easy construction and a large wing area with low wing loading.

Britain now has the Avro 698, a four-engine delta bomber which first flew last August. Its details are so top secret that not even the length is known. Already, however, plans are under way to convert it into a commercial transport, and British Overseas Airways Corporation and others have expressed interest in its possibilities. The 698 would seat more than 100 passengers, and would operate at long ranges and great speed.

So far England is leading the world in the development of jet transports. The de Havilland Comet, the world's first jet airliner, is operating on three world routes. Interest now is centered on the Comet III, and Pan American Airways has ordered

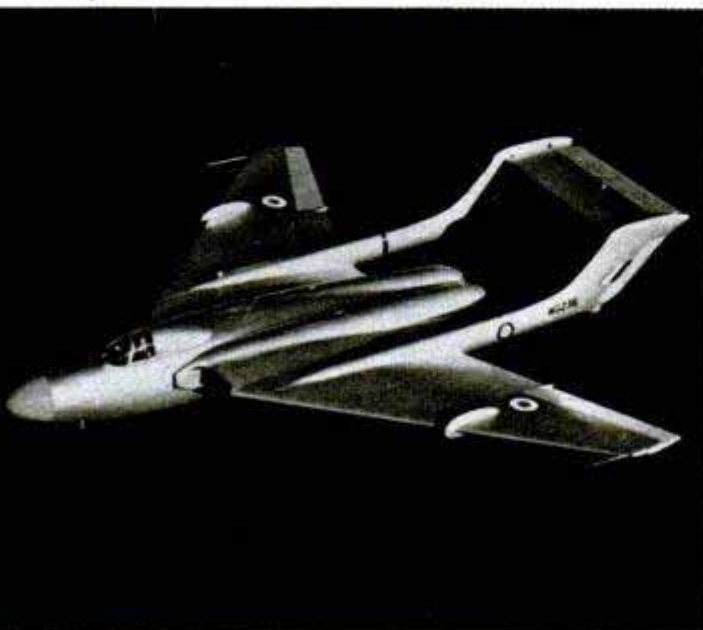

Many designers and test pilots believe a delta-wing design, like that of the Avro 698 below, is the best fitted for supersonic travel. Reportedly capable of near-sonic speed, the Avro is in production as a warplane and several airlines are said to be interested in it as a 100-passenger trans-Atlantic jet transport

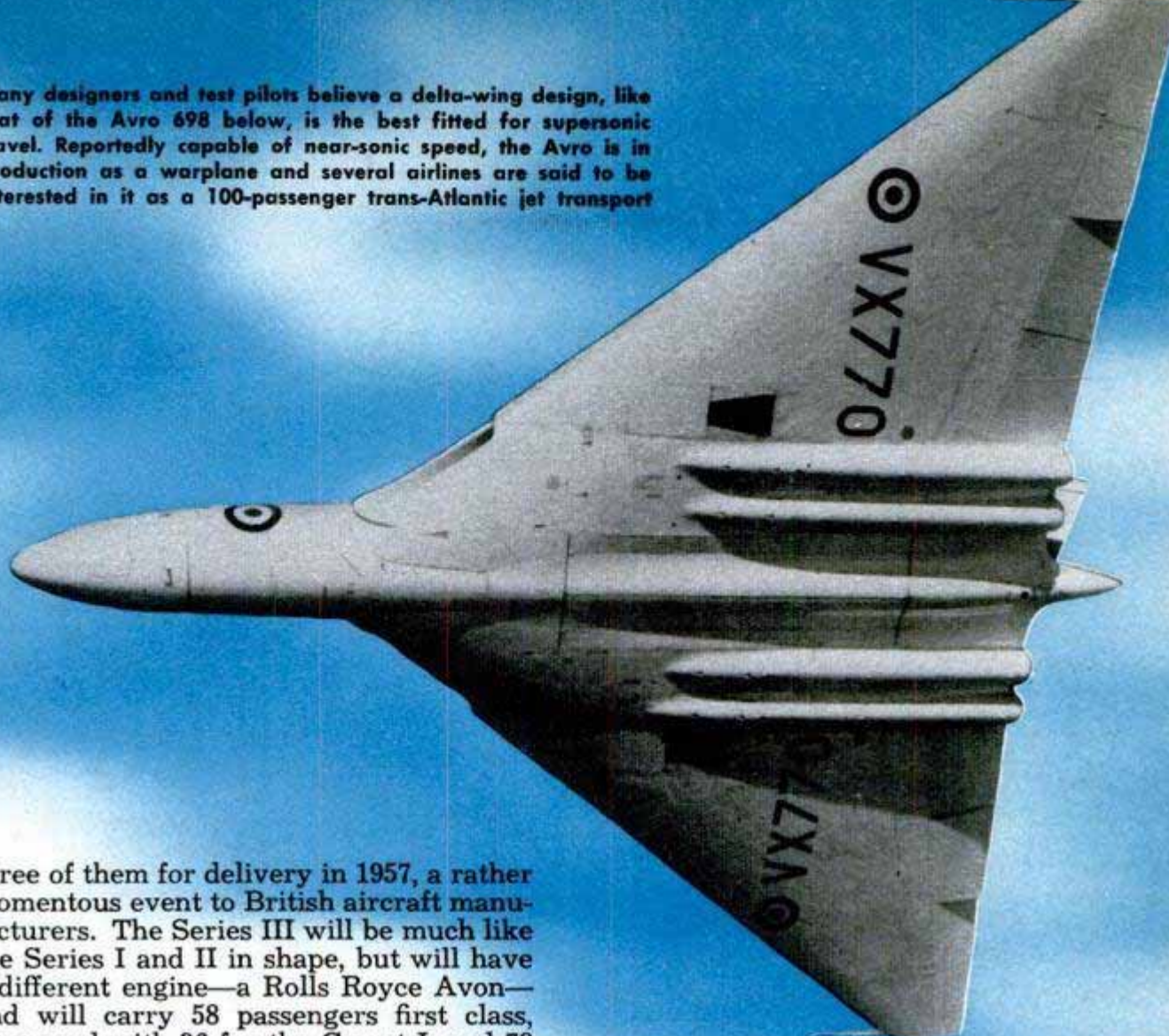

three of them for delivery in 1957, a rather momentous event to British aircraft manufacturers. The Series III will be much like the Series I and II in shape, but will have a different engine—a Rolls Royce Avon—and will carry 58 passengers first class, compared with 36 for the Comet I, and 78 tourist class. Without refueling, it will fly about 2800 miles, against 1750 for the Series I.

The Britannia with jet engines driving its propellers, was first flown last August and B.O.A.C. has ordered 25 for delivery next year. It will seat 90 passengers tourist rate and 60 on standard, and will be able to cross the Atlantic at around 360 miles per hour.

The Comet and the Britannia are, of course, the present. Recently a stewardess on the Comet was discussing its 500 mile-per-hour speed. "That's pretty slow for you, isn't it?" she asked Duke. He grinned, and agreed. And that, as well as anything else, is an indication of the future. ★ ★ ★



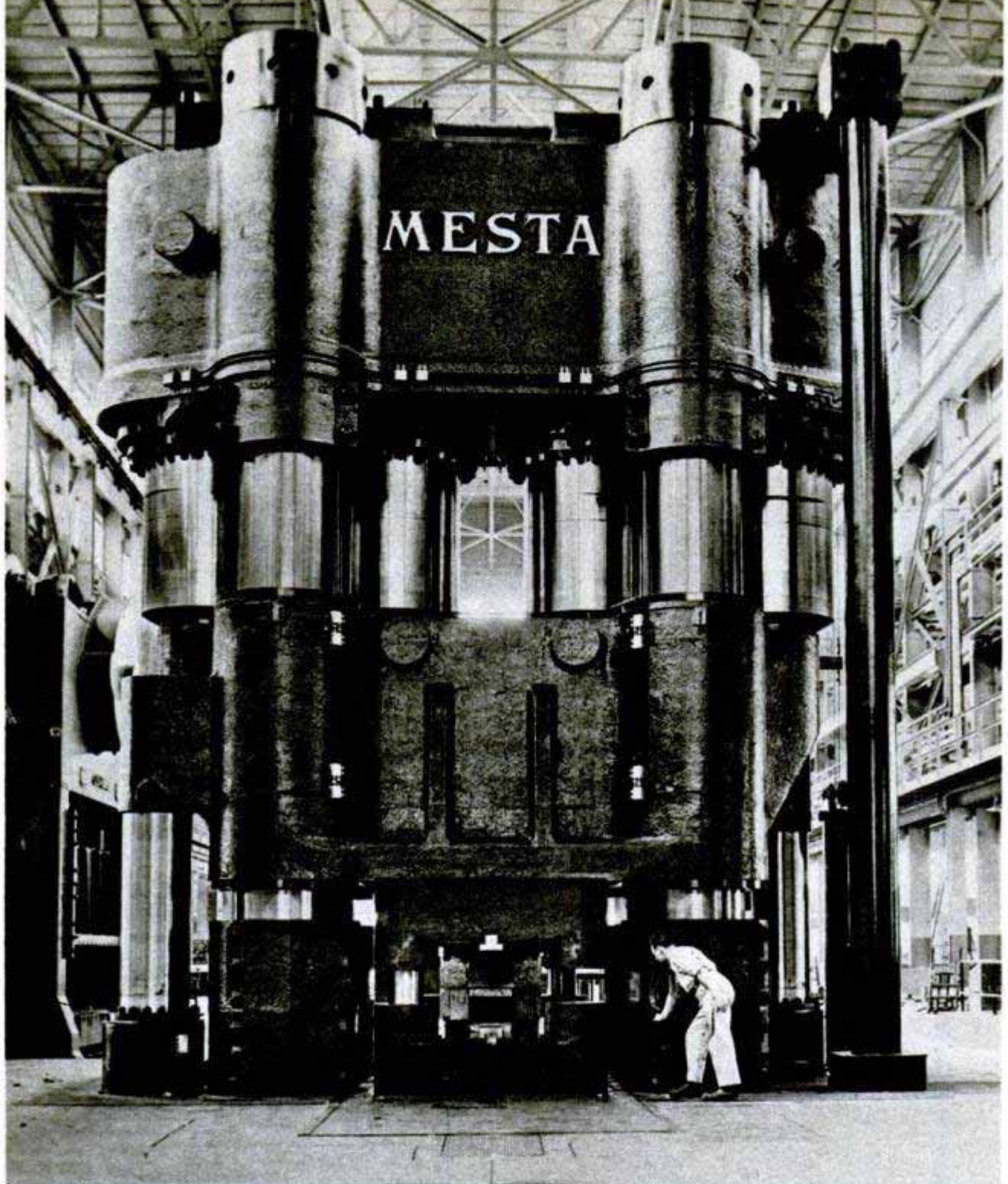

"Old Smoky" Forging Press Forerunner of Bigger Machines

"Old Smoky," said to be the largest die-forging press in the Western Hemisphere, packs a punch of 18,000 tons as it squeezes hot metal into huge dies. The squatting, black behemoth rises 32 feet above the floor of the Wyman-Gordon factory in Massachusetts and rests on bedrock 15 feet below

ground level. It's only a preview, however, of a giant die-forging press soon to be installed in the plant under the Air Force expansion program. The new machine will exert a force of 50,000 tons, will stand 48 feet above the floor and rest on a foundation 66 feet below the surface.

Interest Calculator Gives Rapid-Fire Answers to Intricate Problems

Answers are supplied in seconds for intricate interest-calculation problems by a new machine that even a novice can operate. In tests by the Bureau of Internal Revenue it was proved to be 100 percent accurate in all cases, with a savings of 70 to 90

percent of employees' time. A date selector chooses the various dates required and special doors close off undesired percentage readings, thus avoiding errors. The machine can be adapted to furnish calculations for various businesses.

Two-Nation Power Pool

Electric power may soon cross the English Channel between France and Britain to balance the peak loads of both countries' systems. Four single-phase undersea cables would span the 25 miles which separate the two coasts at the northern neck of the Channel. English electricity would help light French homes, and vice versa, as demands change. The "power shuttle" would smooth out the peaks of both systems and save electricity. In the event of a drought in France, causing hydroelectric power to shrink, or a power shortage in England, one nation could aid the other

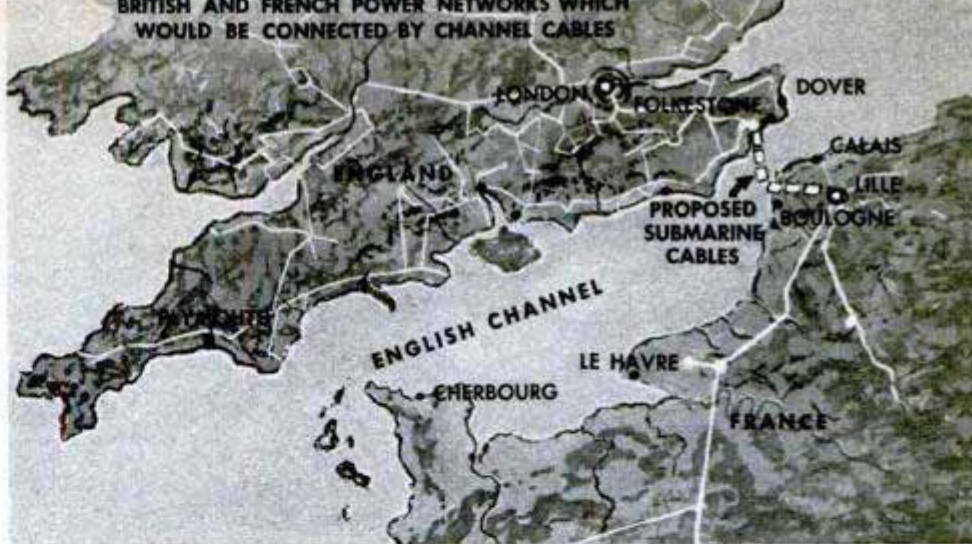

Planned cable would cross the Channel from near Folkestone in England to a point near Calais in France



RESERVE CABLE

FOUR CABLES TO BE LAID WOULD INCLUDE ONE RESERVE LINE

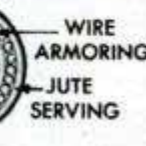
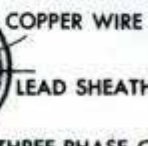
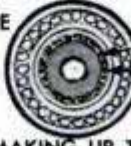
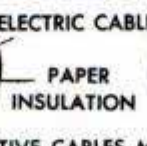
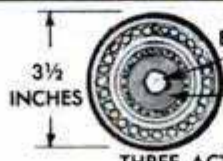

3 1/2 INCHES

THREE ACTIVE CABLES MAKING UP THREE-PHASE CONNECTION

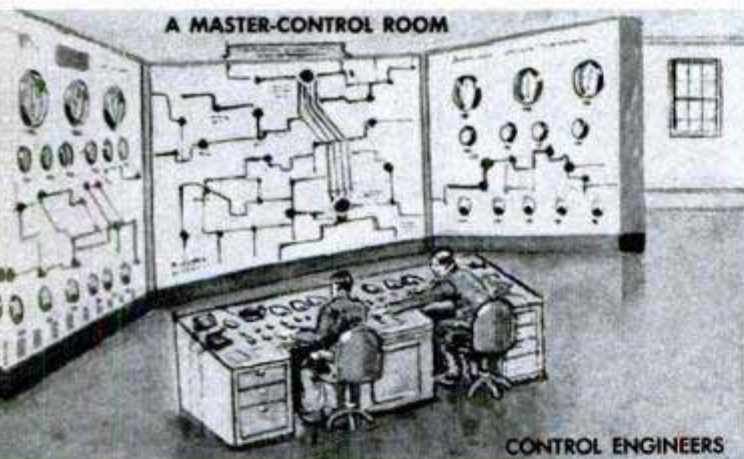

A MASTER-CONTROL ROOM

CONTROL ENGINEERS

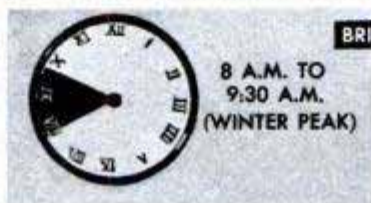

MORNING PEAK PERIODS

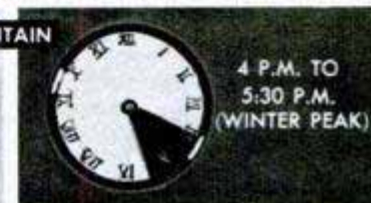

EVENING PEAK PERIODS

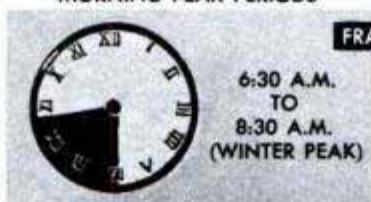

(WINTER PEAK)

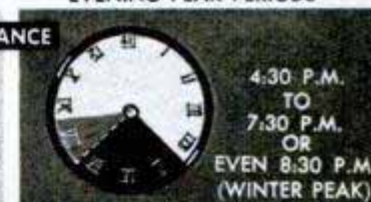

(WINTER PEAK)

Engineers in master-control room maintain constant watch to regulate voltage as demand ebbs and flows. British and French peaks differ because the English arise later and eat evening meal earlier than the French

MOST FRENCH POWER COMES FROM HYDROELECTRIC STATIONS

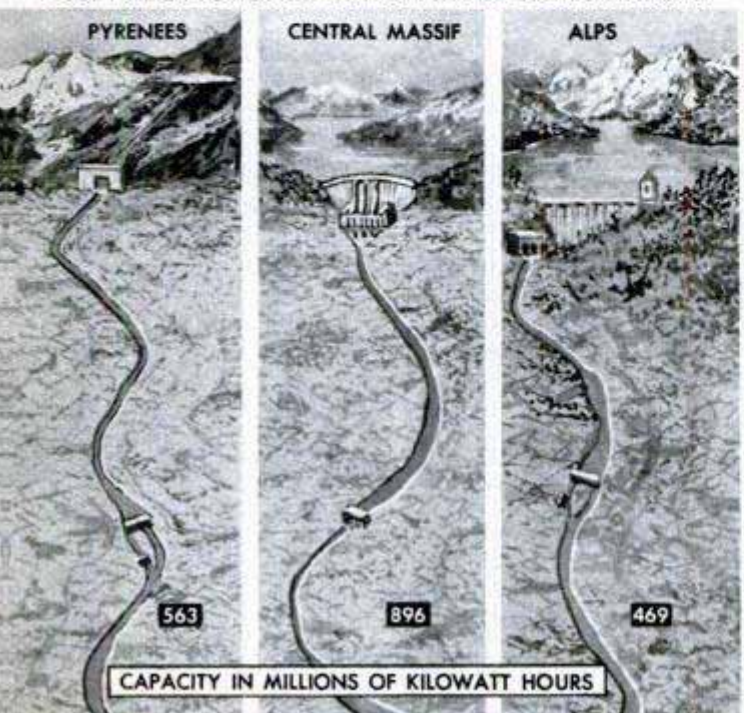

PRACTICALLY ALL BRITISH ELECTRICITY IS GENERATED BY FUEL-BURNING POWER PLANTS

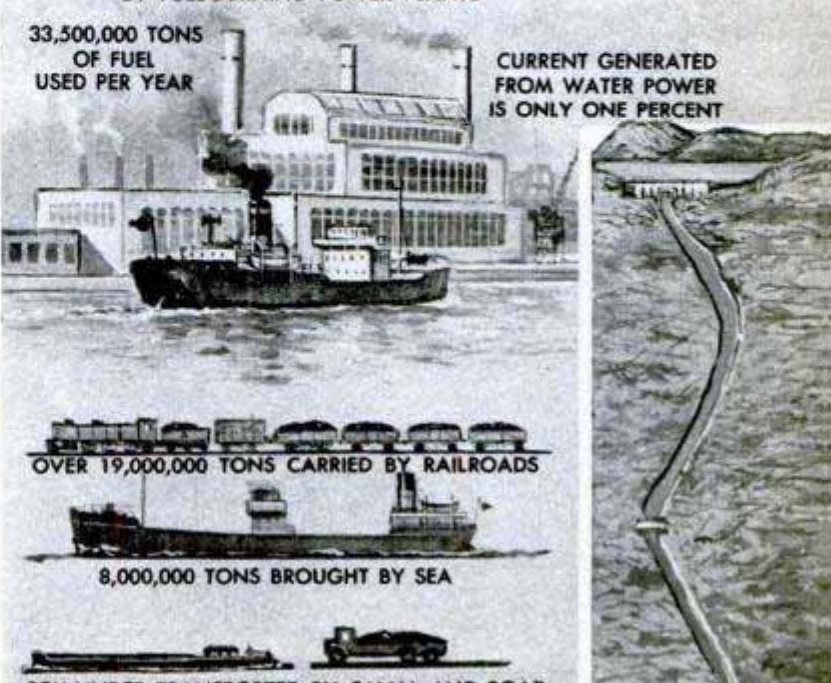



Bulb Planter Cuts and Removes Dirt Core

Stooping and hand-digging are eliminated by a bulb planter that cuts neat, round holes and extracts the dirt core. The gardener simply grasps the handle of the tool and steps down on a projection near the base. The tool insures that all bulbs are planted at the same depth.

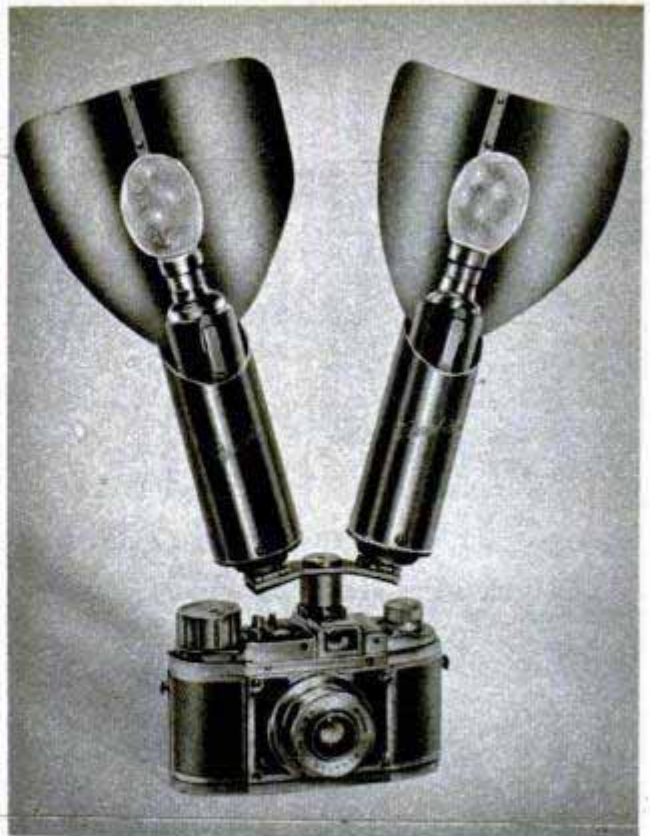
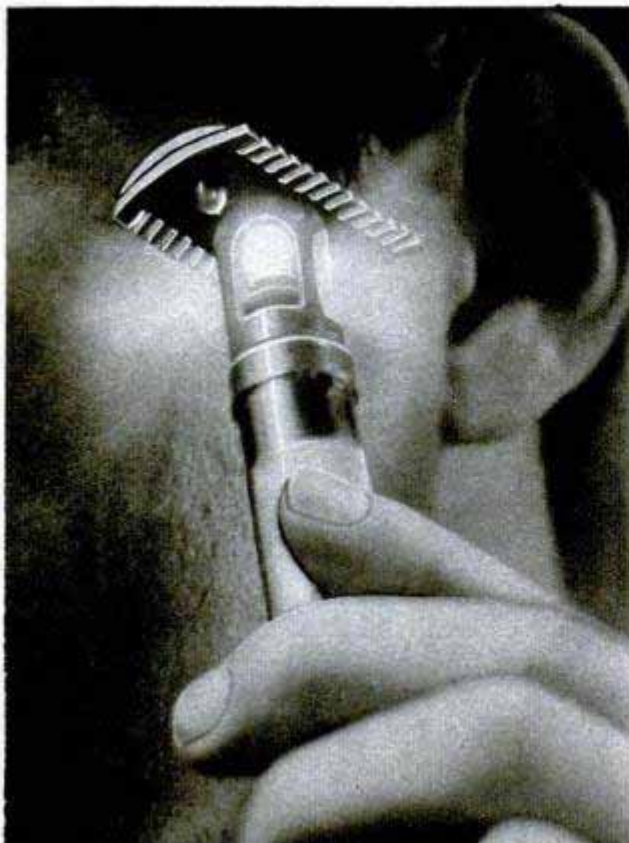

Dual Flash Unit From One Contact

With a new flash unit developed in Germany, two bulbs can be set off simultaneously even though there is only one contact. A contact shoe slips onto the camera and a two-unit bow is connected to it. The two flash guns then are fastened to the bow. The dual flash unit has a condenser with an ordinary 22½-volt battery. No wires are required to connect the unit to most cameras. The battery and condenser circuit is closed only when a bulb is in the holder. Thus there is no unnecessary load on the battery, increasing its service life.

Self-Illuminated Razor

Contained just below the head of a Japanese safety razor is a miniature lamp which illuminates the shaving area. Dry batteries in the razor's handle supply current for the tiny bulb. Designed for the traveler who has to struggle along with dimly lighted mirrors, the razor also serves as a flashlight once the head is removed.

Bags Sprayed on Jet Engines

Plastic bags are being sprayed on new jet engines to protect them during overseas shipment. A Zipper is laid over the engine and a quick-drying plastic sprayed on. The plastic forms a tough but pliable airtight coating over the engine's irregular contours and over the Zipper.



Homemade "Snorkel"

After escaping from a prison labor battalion, a 22-year-old Czech decided to attempt an escape from his homeland by swimming the Morava River. While in hiding he came across a German gas mask, fitted a rubber to it and camouflaged the end of the tube with glued-on twigs. After a 15-minute swim, part of it underwater with the aid of his homemade "snorkel," he came up in Austria, his escape a success.



Lock of Many Combinations

Four trillion different combinations — more if desired—are possible with a new lock designed by Swedish meteorologist Fabian Nilsson. No two locks will open with the same key. The standard keyhole is replaced by a thin slit; the key itself resembles a nail file and has a hole instead of notches. One drawback is the fact that you'd probably have to be a bit of a marksman to find the keyhole on a dark night.

Motorless Sweeper Speeds Cleaning

One worker can sweep 15,000 to 22,000 square feet of space in an hour with a motorless industrial sweeper that operates like carpet models. Using a push-broom, it would take him 2½ hours to cover the same area. The 48-pound sweeper picks up all kinds of debris — wet and dry paper, metal scraps, dirt and trash. A side brush attachment permits sweeping close to walls.

Quicker Stop for Jets?

Reversing the thrust of a jet engine has been proposed as a means of bringing planes to a quicker halt. When flaps devised by Swedish inventor Bo Klas Oskar Lundberg close over the rear of a jet, other flaps open and the blast exits in reverse.



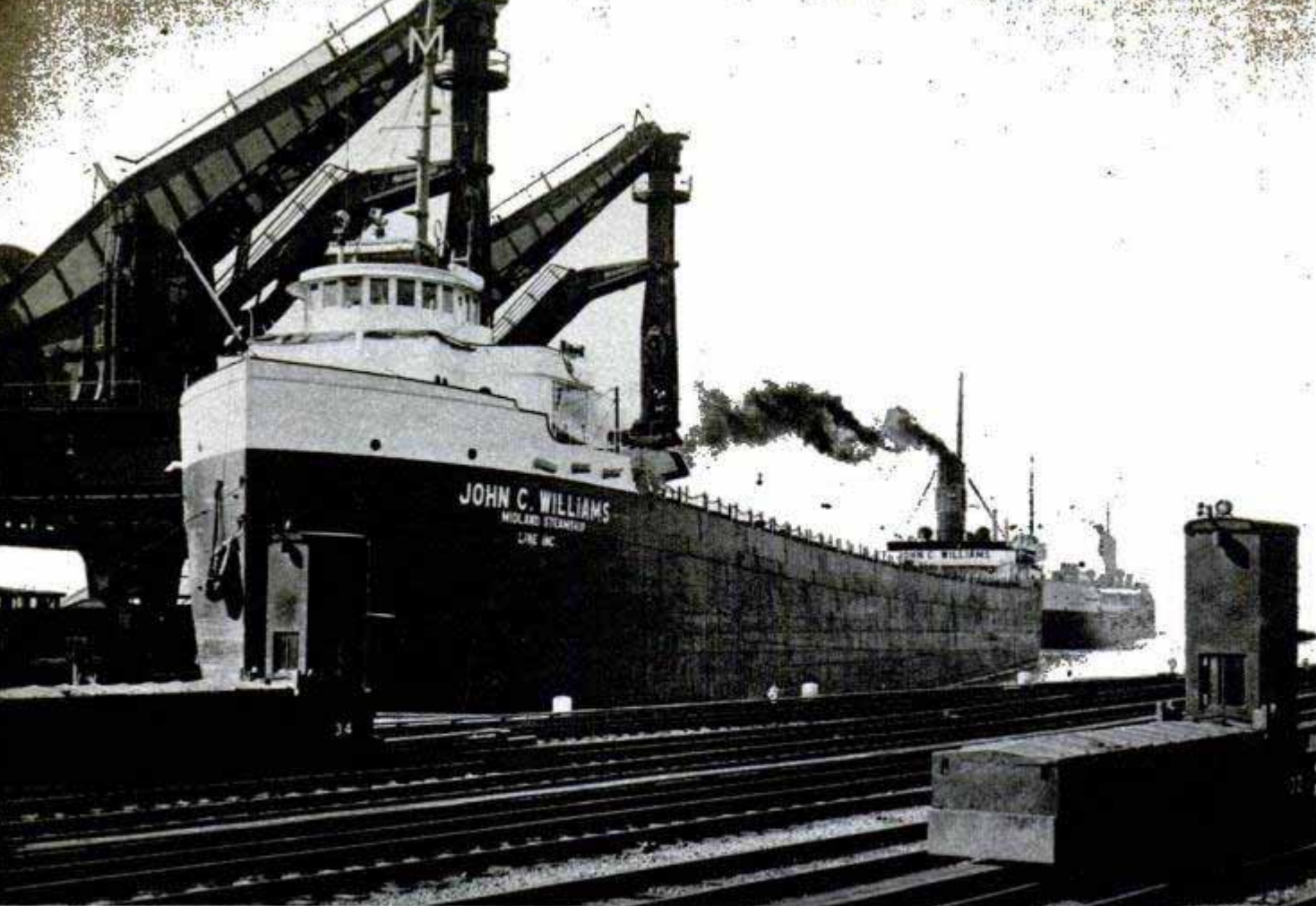

Huge unloaders dip endlessly into holds to scoop out "red gold." Last year they unloaded 75,000,000 tons

GIANT JAWS UNLOAD ORE SHIP

"Leg" man lowers bulldozer to scoop up last scraps of ore

By Dwight Boyer

FROM SPRING TO FALL, in a dozen Great Lakes ports, weird machines and brawny men dip constantly into the holds of the big freighters to scoop out more muscle for America.

Ever hear of "ore hogs"? The ore hog is a man whose clothes take on a rust-red hue and who finds iron ore in his shoes, hair, pockets and lunch box. A typical ore hog is a well muscled, high-speed, rough-and-tough individual who, with the help of his buddies and the assistance of a fantastic rig known as a Hulett unloader, performs an important and herculean task. He works hundreds of miles from the iron-ore mines in a noisy bedlam of grinding machinery, scraping shovels, roaring bulldozers and a weird screaming of whistles. Out of this come long trains of iron ore—food for hungry blast furnaces. Last year 75,000,000 tons moved across the Great Lakes.

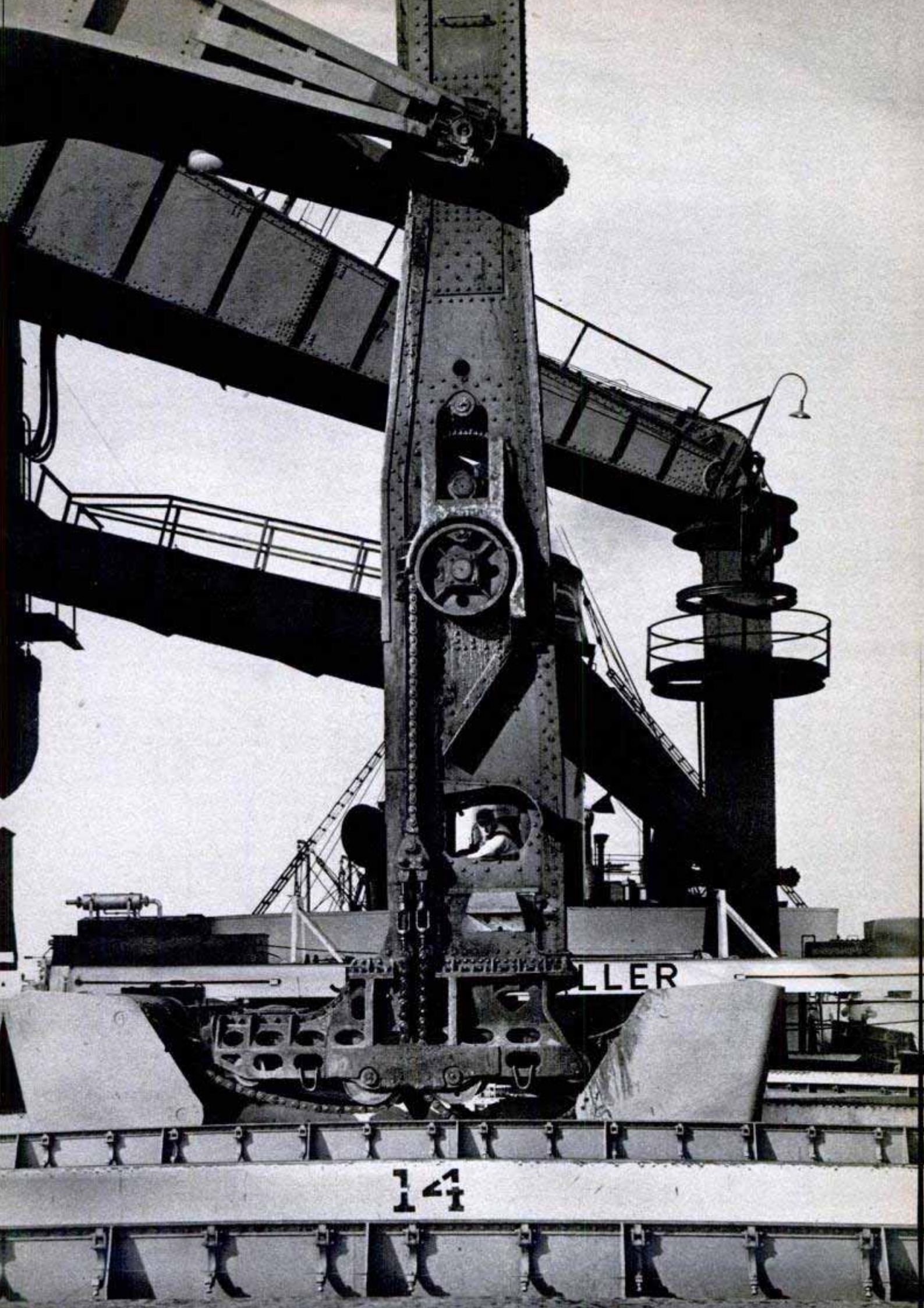

14

MILLER

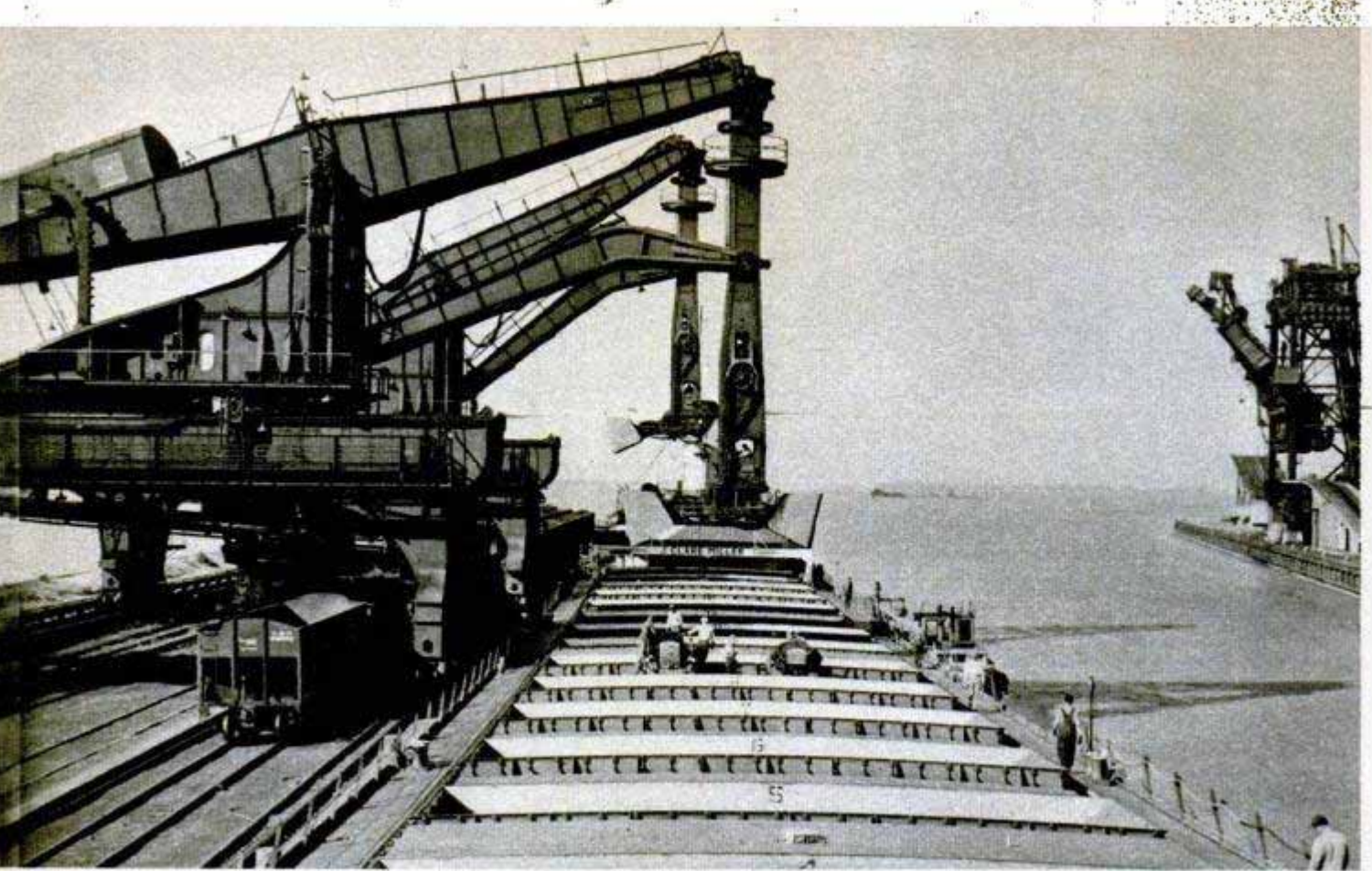

Here's a view aft of leg men unloading the cargo. Some lake ships are quite long; one measures 714 feet

During the nine-month Great Lakes shipping season, the ore hogs—shovelers, “larry” car weighers, bulldozer operators, car pushers and “leg” men—unite in this miracle of supply that stock-piles enough iron ore to last through the winter.

The leg man on a Hulett iron-ore unloader must possess a special blend of brawn, brains and a “go for broke” attitude.

Sweepers and shovelers glean last pound of ore from huge cargo hold. They must work under descending leg

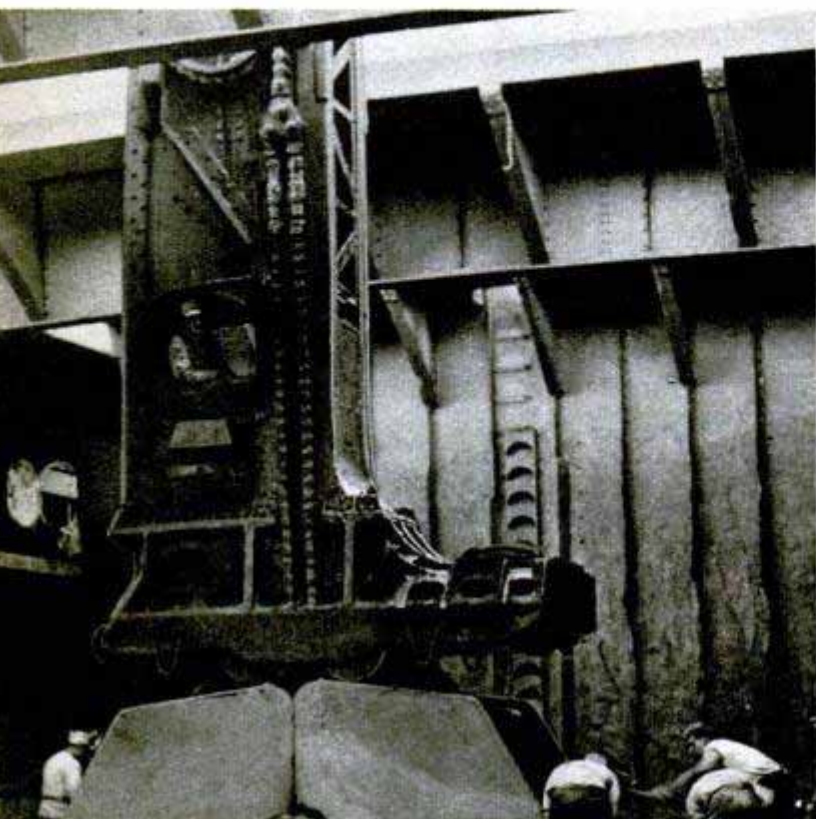

He must also be conscious of the safety of fellow workers below him as he deftly maneuvers a 75-ton vertical ramrod and iron-jawed grab bucket.

The Hulett iron-ore unloaders, ingenious creation of the late George H. Hulett, resemble clusters of potbellied vultures squatting along the waterfront while indulging in a feast. Sliding sideways on steel rails, moving from hatch to hatch, they dip deep into the holds of the long freighters. They are monsters of steel with the balance and precision of fine instruments, guided by the leg man whose control booth is inside the 60-foot leg.

It's a hazardous job at best. A steamer once broke her lines and toppled an entire 2500-ton Hulett machine over on the ship with fatal results. On another occasion the whole 75-ton leg broke away from its coupling and crashed down into the open hatch.

The leg man somehow avoids collisions with bulldozers, ship's gear and other ore hogs. Down on the floor of the hold work the shovelers—men who get the last pound of ore from corners, and bulldozers that scoop the ore from between hatch areas.

A little over a half century ago, ore was emptied by hordes of sweating shovelers and mule-powered hoists. It took days to unload a small schooner in the 1890s.

Today George Hulett's vultures snatch 18 tons of ore at a bit and, biting once per minute, they empty a freighter with a 16,000-ton capacity in eight hours. ★ ★ ★

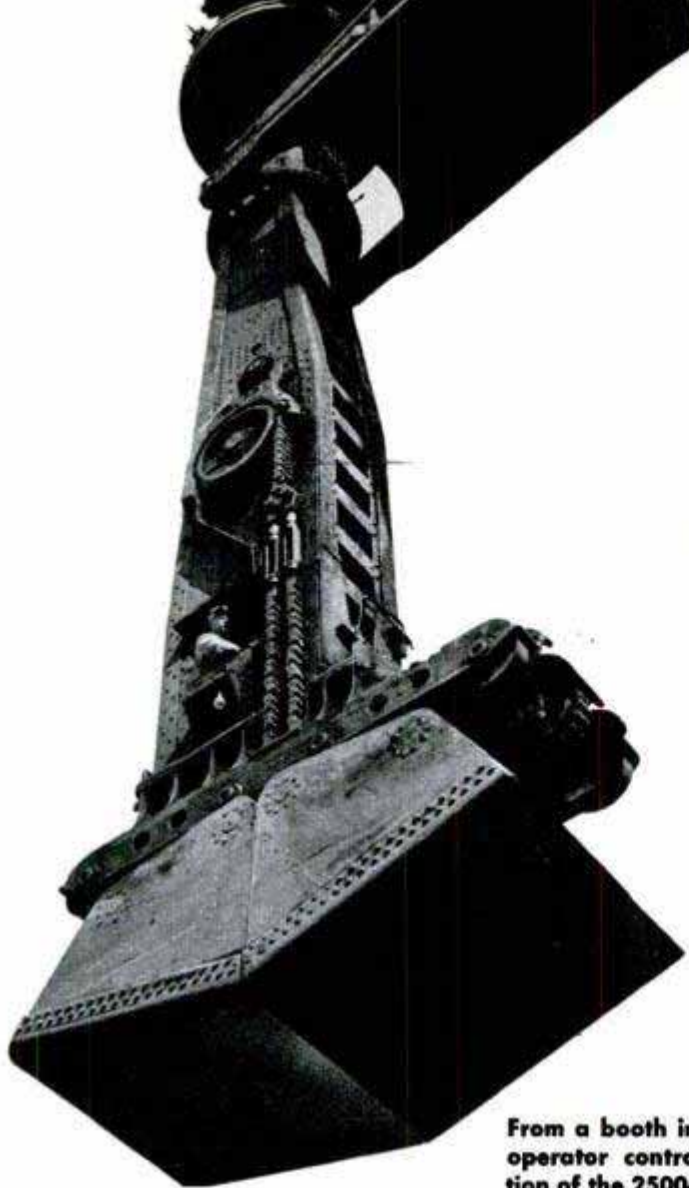

From a booth inside the leg, operator controls each motion of the 2500-ton unloader

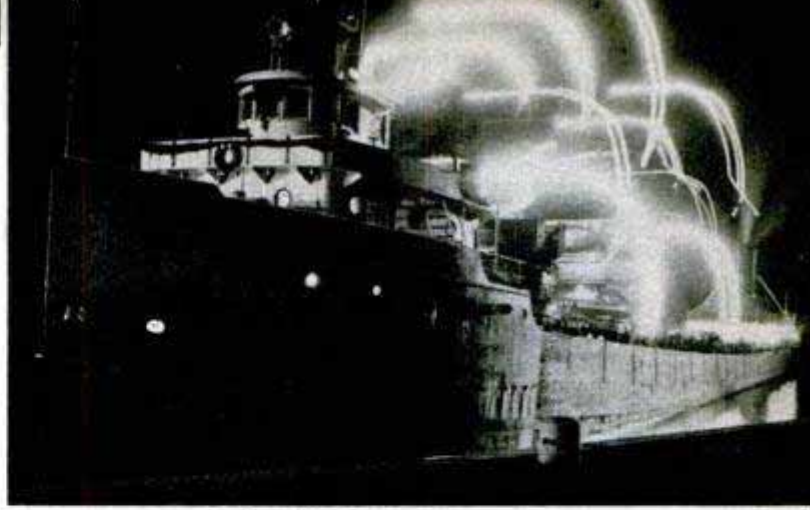

Unloaders work night and day to finish before lakes freeze. Time exposure shows machines' movements



Leg man is highly skilled worker. Most operators spend a year on job before fully mastering the machine

Below, working at night, bulldozer operator scoops ore from the area between hatches into reach of the unloader's jaws. Other "ore hogs" stand by to sweep up last of the ore, then ride leg up to the dock



"Sun Gazing" Machine Measures Solar Energy for Paint Research

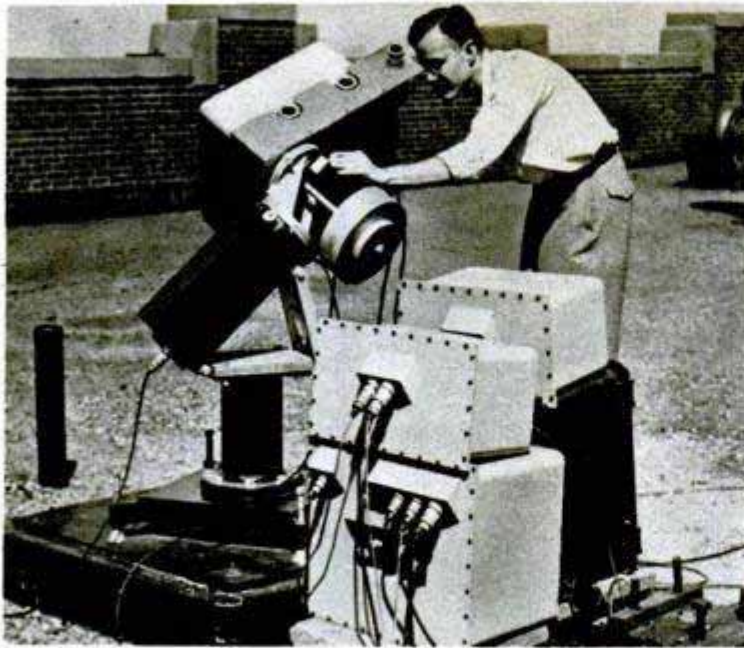

Mounted on apparatus which keeps it pointing at the sun, a spectroheliometer keeps careful track of the sun's rays. It measures distribution of the sun's energy, the variation of energy with time of day and season of year, and the intensity of rays from different parts of the sun's spectrum. Automatically recorded, the information is correlated with the weathering of automobile-paint samples in outdoor exposure racks. GM researchers will use the data to determine which parts of the sun's rays are most injurious to finishes. Findings from the study will enable them to develop more durable automobile paints by spotting the basic weaknesses of paints now in use.

Rotary Mower Cuts 60-Inch Swath

Hugging the ground closely, a tractor-drawn rotary-cutting device efficiently and economically mows pasture lands. It cuts a 60-inch swath with a single, revolving blade. The cutting height can be quickly adjusted. A double spring-loaded disk clutch, mounted on the main blade shaft, prevents shock impact on the power take off and eliminates the need of shear pins or field replacements.

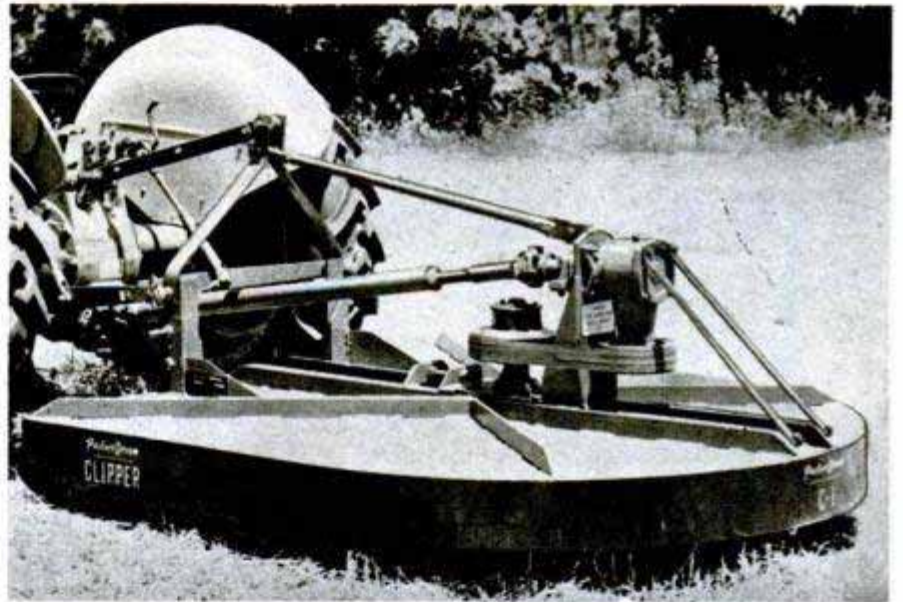

Circular "Slide Rule" Calculates Dates Weeks in Advance

Determining future dates and computing cubic volume are functions of plastic calculators made in three models. A four-inch disk tells the date any given number of weeks in advance. A larger eight-inch cal-

culator determines the date a certain number of days away. The cubic-content calculator provides a quick means of determining the cubic feet of space required for a package from length, width and height in inches.

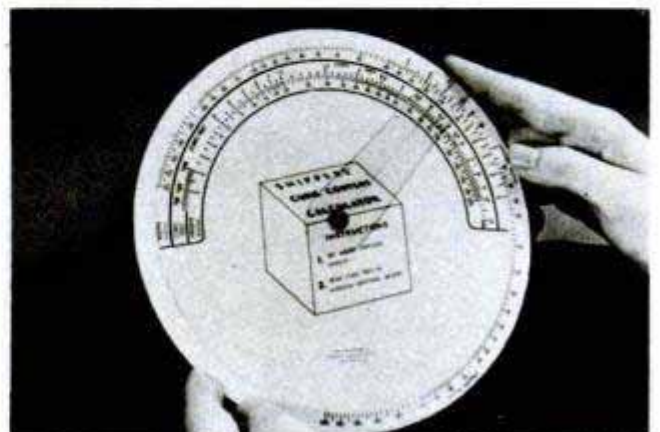
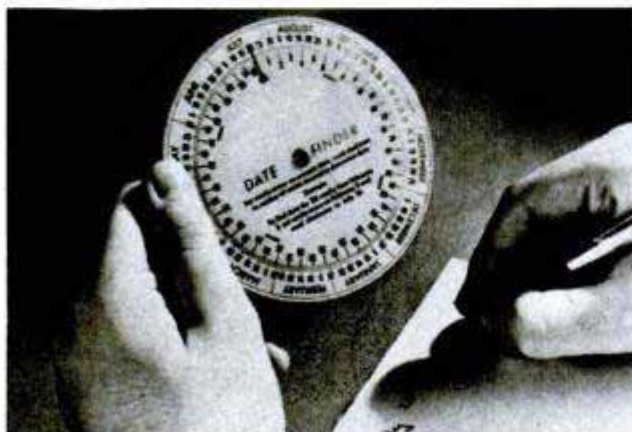

Synthetic Sow Warms and Feeds Young Pig Brood

Big news in the swine world is a mechanical mother for progressive piglets—an English invention which warms and feeds up to 14 young porkers. Taken from their real mothers when only a few days old, the pigs soon learn to extract the cow's milk supplied by two rows of nipples at the base of the device. An overhead infrared lamp provides warmth, promotes their appetites and protects their health. And there's no danger of being crushed or eaten by a thoughtless mother, a common occurrence in the average hog house. Experts claim that the new pig rearer boosts meat production by 50 percent.

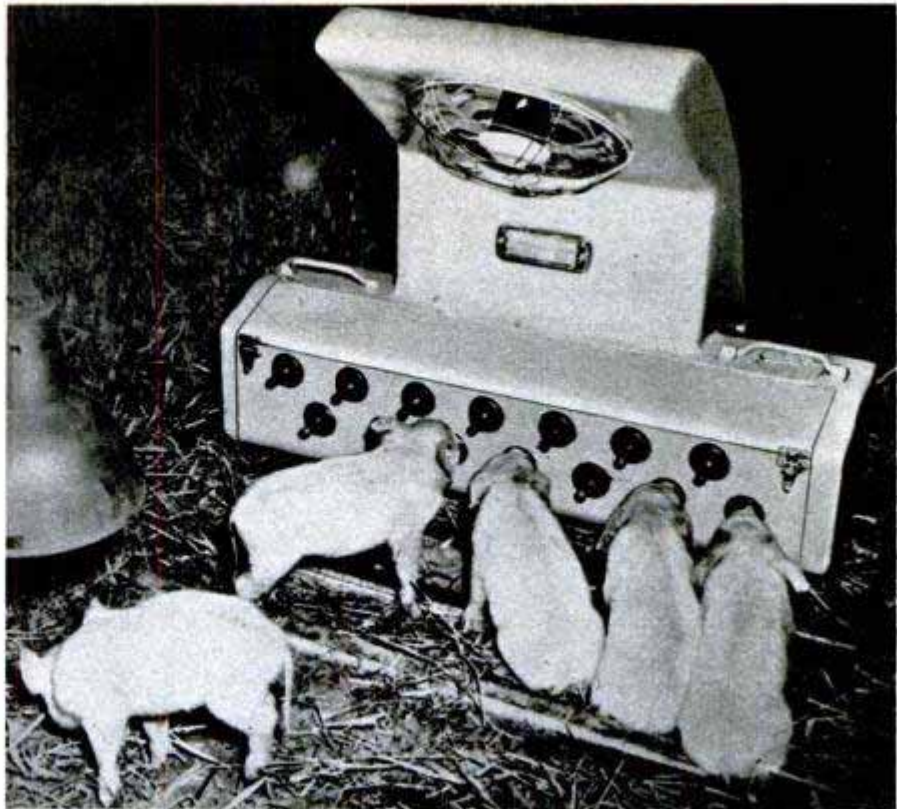

French Four-in-One Musical Instrument Has Sounding Board



For the versatile musician who changes instruments to suit his moods, a combination violin, mandolin, Hawaiian guitar and alto banjo offers a wide range of media. Shown at a Paris exhibition, the contrivance has a common sounding board for four sets of strings. The amount of music produced is limited only by the number of hands and the sensitivity of the player.

Lightweight Golf Bag Mounts Folding Seat

Weary golfers can rest between shots in a portable seat attached at one side to a lightweight golf bag. Two hardwood supports swing out to form a vee when in use. A wide padded strap connecting the sticks at the top provides a hammock seat which will support a 300-pound man. His feet complete a three-point support. The seat becomes a comfortable shoulder strap for carrying the bag between tees; a slide on the strap adjusts for sitting or carrying position.

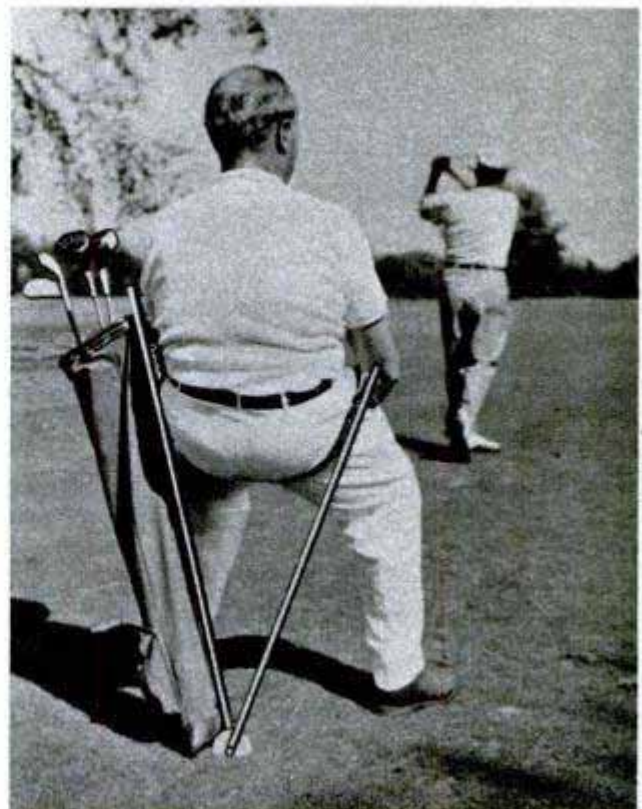

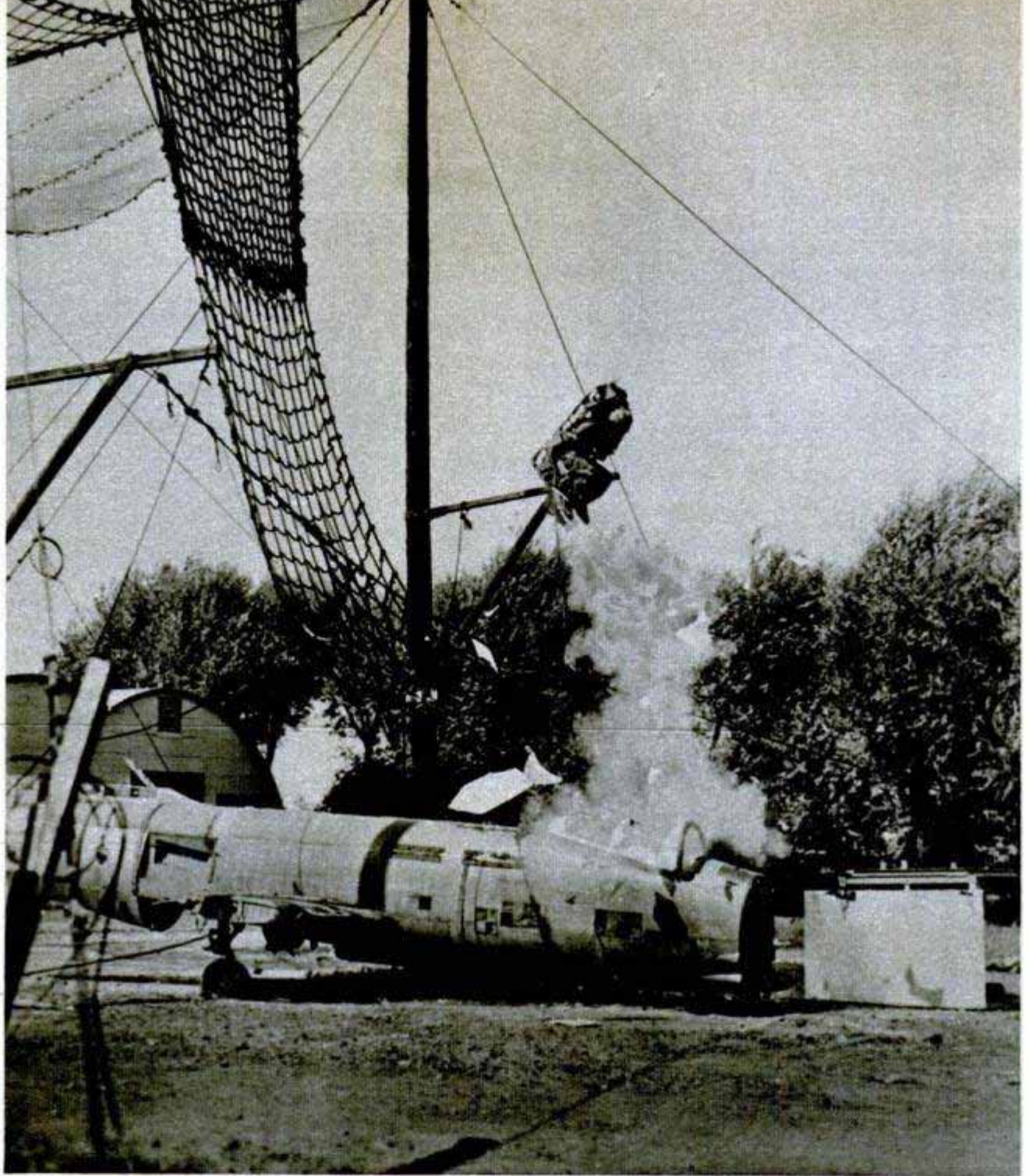

Test Firing Pilot and Seat Through Jammed Airplane Canopy

To help pilots escape when their canopy is jammed closed, the United States Navy is testing the feasibility of firing both the

pilot and his ejection seat through the canopy. In the experiments they use a dummy and a net to catch it.

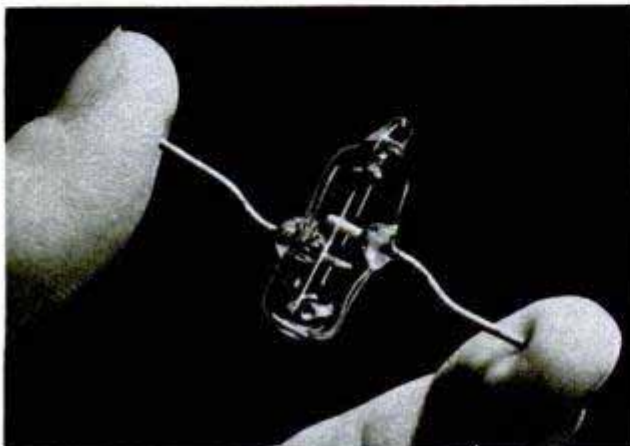

Tiny Mercury Pulse Switch

Able to open and close electric circuits instantly with little power and practically no friction, a mercury pulse switch provides a variety of useful functions. Mounted on a shaft powered by a small electric motor, a tiny tube containing two electrodes and a mercury droplet rotates at a determined speed. As the tube rotates, the mercury droplet rolls from one end to the other, each time passing between the electrodes and momentarily allowing the current to pass by acting as a conductor.



They Call It Spin Fishing

By Joe Godfrey
*Prominent Outdoor Writer,
Secretary, the Sportsman's
Club of America*

A NGLERS ALL around the world are being teased and tempted by a way of fishing that's brand new to most of them. Once they nibble at the bait they're as good as landed, for this new technique is so versatile and exciting it has an appeal the average angler can't resist.

They call it spin fishing, and experts who have been watching sportsmen rise to the bait say that within 10 years Americans will be a nation of spin fishermen, bar a few die-hards who refuse to try anything new.

What has made spin fishing (or just plain spinning) dart ahead in popularity during the past few years?

It completely licks the backlash bogey—you just

Portrait of the author spin fishing was painted by Robert Korta, staff illustrator

Korta



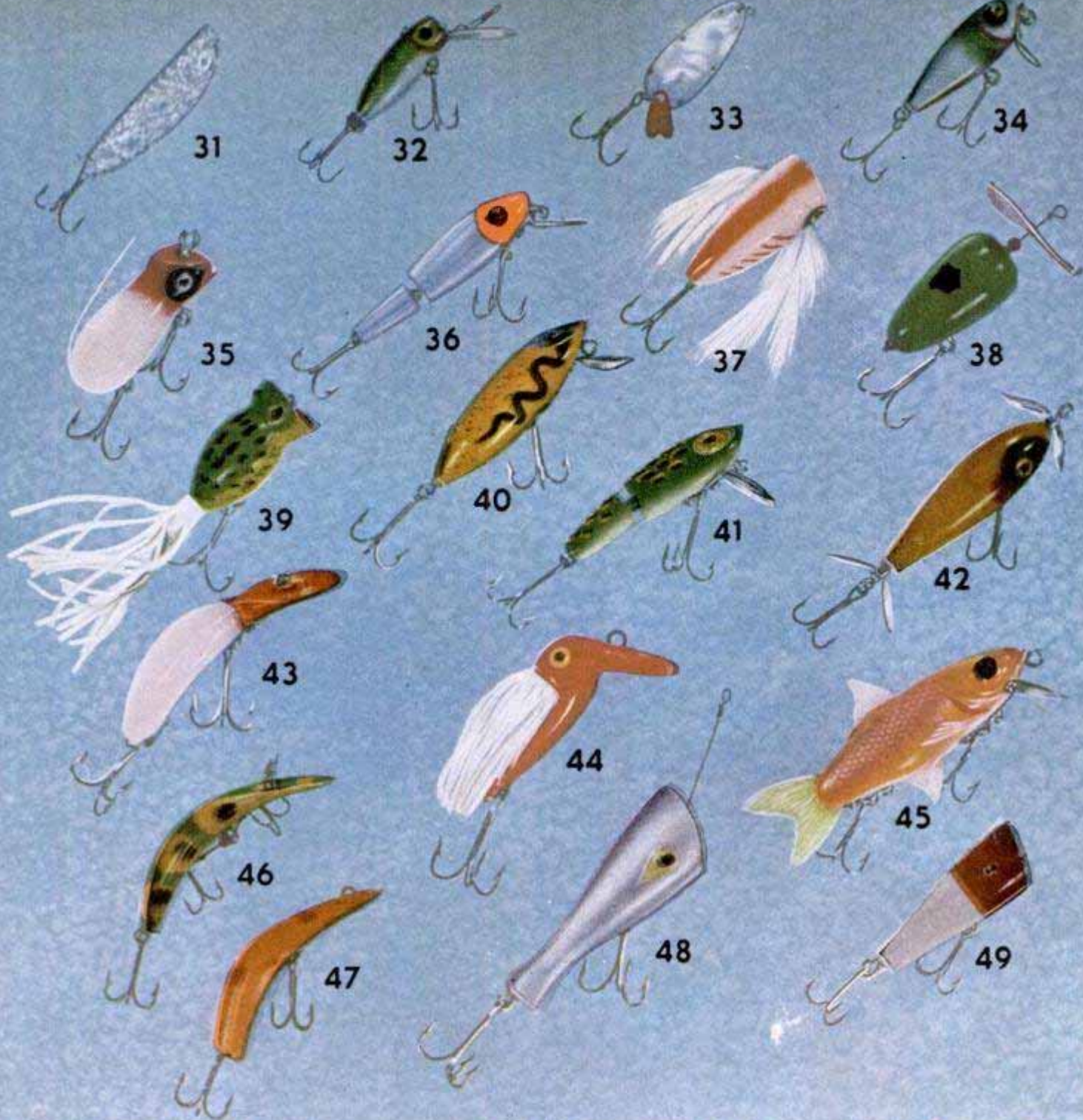

For identification of the numbered spin-fishing lures on these pages and the following page, see page 85

can't backlash or overrun a spinning reel. It enables a fly fisherman to stand on the bank and flip a weighted trout fly far out into a mountain stream. It enables the surf caster to reach out beyond the heavy surf. It enables the sportsman to use the lightest possible tackle in taking the largest possible fish. And any man, using just one rod and reel, can bait cast, fly fish, surf cast, troll, mooch, drift or still fish, using any type of lure from wet or dry flies to plugs, spoons, spinners and live or cut baits.

The fun of spin fishing is the lightness of the line against the pull of a big fish, and the heart of spin fishing is the reel. Essentially all fishing reels are spools, similar to a spool of thread. Ordinarily when you pull thread off a spool, the spool itself re-

volves. This is the principle of a conventional bait-casting reel. But if you hold a spool at one end and pull the thread directly off the other, the thread spirals out quickly and easily with the spool remaining stationary. This is the principle of a spin-fishing reel.

Because friction is virtually eliminated in a spinning reel, the angler can make extremely long casts with miniature lures. They can be weighted flies, streamers, small plugs or spoons and a great variety of new spinning, wobbling, limping and popping lures that are imported from France, Switzerland, England, Belgium, Sweden and Germany. By attaching a plastic float to the line near his lure, the spin fisherman can float his fly long distances

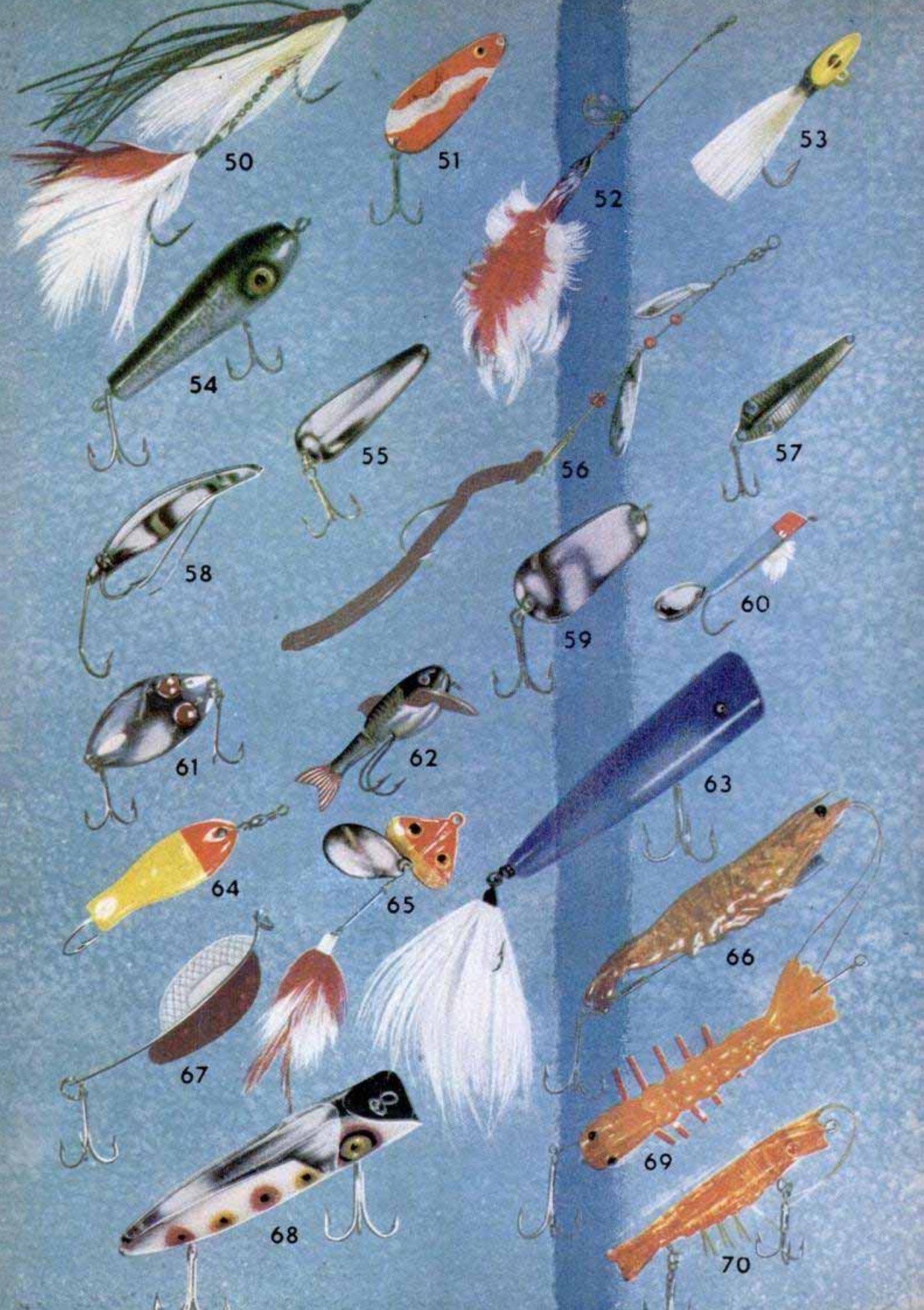

50

51

52

53

54

55

56

57

58

59

60

61

62

63

64

65

66

67

68

69

70

Domestic



DOMESTIC REELS, left to right: Waltco Ny-O-Lite, Good-All Star DeLuxe, Fre-Line, Heddon Spinpal, Shakespeare Spinning Reel, Langley Spinlite, H-I Bradco and Whirlaway. Some domestics are open-face, others closed

SPIN-FISHING LURES: 1—T-Dolly. 2—T-Fish. 3—Diver. 4—T-Fling Long. 5—B. & H. Spinner. 6—Butterfly. 7—Niftee-Spin. 8—Spinning Limpy. 9—Colored Spinner. 10—Itzaduzy. 11—Tail-Lite. 12—Abu Reflex. 13—Crippled Shad. 14—Spincaster. 15—Pixie. 16—Slim Jim. 17—Weaver. 18—Hot Shot. 19—Popit. 20—Rangelēy Minnow. 21—Voo-Doo. 22—Jitterbug. 23—Ubangi. 24—Fin Dingo. 25—Silver Minnow. 26—Miracle Minnow. 27—Reflecto. 28—Chum Spoon. 29—Highland Fling. 30—Sunrise Special. 31—Flat-Tail. 32—Deep-R-Doodle. 33—Pearl and Copper Spoon. 34—Super Midget. 35—Swimming Mouse. 36—Mirr-O-Lure. 37—Spin Popper. 38—Spinning Barney. 39—Hula Popper. 40—Fish-Obite. 41—Miracle Minnow. 42—Spin-I-Diddee. 43—Tad Polly Spook. 44—Lucky Bunny. 45—Strikee. 46—Flatfish. 47—Lazy Ike-2. 48—Walkie Talkie. 49—Spinning Plunker. 50—Bead-Buck Tandem Fly. 51—Gypsy King. 52—Baby Jig Feather. 53—Nylure. 54—BeBop. 55—Flasher Minnow. 56—Night Crawler. 57—Chelly. 58—Dipp-E-Minnow. 59—Wob-L-Rite. 60—Quilby Minnow. 61—Red Eye Wiggler. 62—Plucky. 63—C. C. Surf Spinner. 64—Duro Flash Spoon. 65—Shady Lady. 66—Actual Shrimp. 67—Multi-Wag. 68—King Andy. 69—Martin Shrimp. 70—Tasty Shrimp.

participating in the establishment of a new major outdoor sport. So many millions of just plain folks have gone in for spin fishing that the demand for spinning rods, reels, lines and lures has far exceeded the supply. There are at least 50 spinning reels now made in this country, Canada, Australia, England, France, Italy, Switzerland, Belgium, Sweden, Germany and Japan. Spin-fishing rods, from six to nine feet long, are made of hollow glass, bamboo, solid glass and tubular steel. Most of them have extremely large guides to decrease friction as the line whispers out. The lines themselves are mostly nylon monofilament, braided nylon and imported platyl monofilament.

Though fishermen in most parts of this country are just waking up to spin fishing, it isn't exactly a new sport. The English and French started spin fishing about 1905. There was an early French model of a spinning reel, but the most famous of the early fixed-spool reels was the Illingsworth which was made in England.

from shore or boat and cover water that would be impossible to reach with a fly rod.

In spin fishing, the lightest lines from two to ten-pound test are used without much fear of breakage, even by large fish, because the reel gives off line as fast as the fish jerks or pulls it. It's no surprise today to hear of an extremely large white marlin being taken on a 10-pound test monofilament line, or three-foot rainbows and 40-pound Chinook salmon brought in on six-pound test braided nylon.

The fishermen of North America are

In 1933 I had the pleasure of casting a Hardy Altex, an English reel, and at that time there were few sportsmen in America who had even heard of spin fishing. The reel was amazingly easy to use. A quick flip of the wrist sent out a beautiful and sparkling little invitation to a fish 120 feet across the bay.

In spinning, the line is wound around a fixed spool. The axis of the spool is parallel to the rod. When the handle of the open-face reel is turned after a cast, a mechanical finger (pickup bail) automatically picks up the line to rewind it on the spool. To

HOW TO CAST AN OPEN-FACE REEL: 1—Hold rod with two fingers on each side of reel stem, with the lure about a foot from tip of rod. 2—Hold line against rod with forefinger, turn reel to casting position.

3—With bail pickup disengaged, prepare to cast. 4—Bring rod to vertical position in a sweeping motion. 5—Flick wrist forward and point finger at target to release line. 6—Start your retrieve

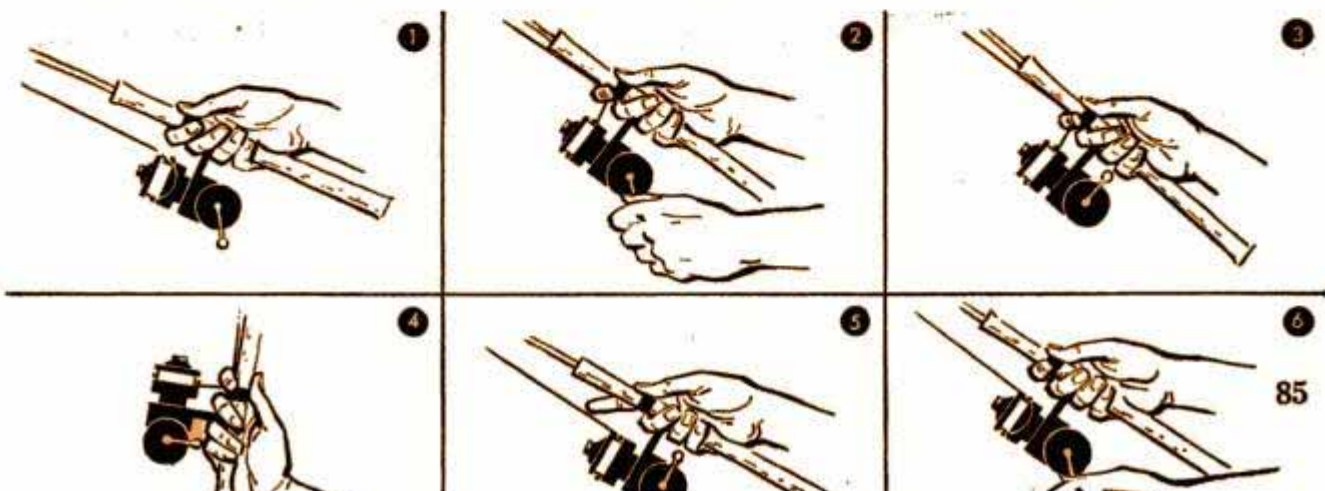

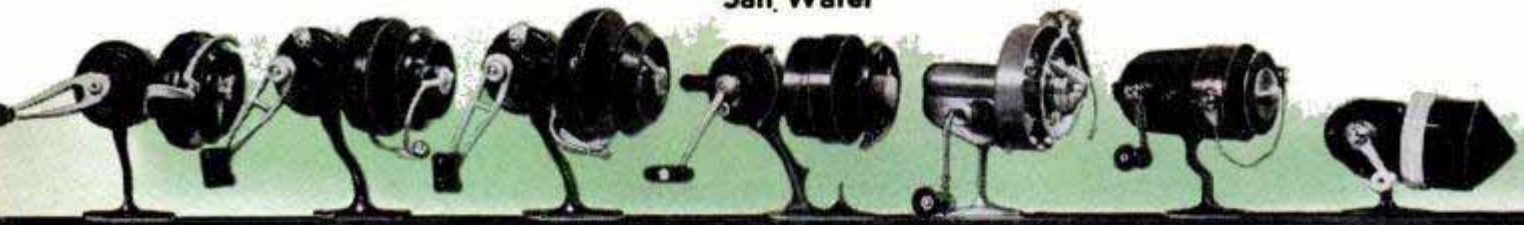

SALT-WATER REELS, left to right: Ru-Sport, Ru-Mer 50, Ru-Mer Atlantic, and Booth Centaure. Remaining reels, the Silent Spin-Flyte, Quick and South Bend Spincast, can be used either for fresh or salt-water spinning

prepare for the next cast, the bail merely is pushed out of the way so the line can spiral off the spool freely.

When a fish strikes, an automatic and adjustable clutch permits it to run line off the reel. Thus, if the angler is reeling in a fish and it decides to make a long run, the line spirals off under tension, despite the fact that the angler may still be retrieving. Thus, for the first time in fishing, there's a real balance between the fish and the tackle.

Though the theory of spin fishing hasn't changed much since the early days, the rods and reels, lines and lures are being made of new materials. One of the latest reels is made exclusively of nylon and glass fiber, weighs only four ounces, operates smoothly, requires no lubrication for the life of the reel and is impervious to salt-water. There's nothing in it to rust or corrode.

The best spinning rods are similar in action to a good rod designed for dry-fly fishing, but with more power in the midsection and the butt, and plenty of action in the tip. It's a rod that is between a bait-casting rod and a fly rod in length, being stiffer than a fly rod and much lighter in action than most bait-casting rods. Don't buy a rod with small guides for an open-face spinning reel. Big guides are essential because the line whirls off the spool at a terrific speed and small guides can't pass it that fast.

In selecting a spin-fishing reel, choose the one that suits your own type of fishing.

Ardent spin fisherman proudly shows off trout taken from a Washington stream on four-pound Monofilament

86

Don't send a boy to do a man's job; buy a larger reel if you plan to do heavy salt-water fishing. It's possible, though, to do some salt-water fishing with fresh-water spinning tackle, now so popular in all of the protected waters of Florida.

Most of the imported reels are open-face; that is, the spool has no cover. Some of the popular American and Canadian-made reels are covered, three of them with a cone-shaped casing.

Right-hand and left-hand reels are somewhat confusing. A right-handed person normally will buy a right-hand reel which, oddly enough, is so constructed that he or she turns the handle with the left hand. This is so the fish can be played with the stronger right hand on the rod while reeling in with the left. Sometimes a die-hard bait caster will deliberately buy a left-hand reel, merely because he can't overcome the habit of reeling with the right hand. One reel, the Ambidex, is so constructed that the handle can be installed on either side. And many reels are available with either a left or right-hand crank to suit the angler.

It's far easier to master a spinning outfit than a bait-casting outfit because there's no chance of backlash. When you're ready for your initial cast with an open-face reel, first check the drag adjustment. It should be set under the test strength of the line so if you get an unexpected strike your line won't snap. On the other hand, the drag should be firm enough to hook a fish.

Learn the overhand cast first. The lure should be about a foot from the tip of the rod. Now hold the rod in your right hand

HOW TO CAST A CLOSED-FACE REEL: 1—Hold line with forefinger, release nonreverse, turn crank to three o'clock position, then back to five o'clock. 2—Swing rod toward vertical position. 3—Whip rod forward and release the line. 4—Begin your retrieve

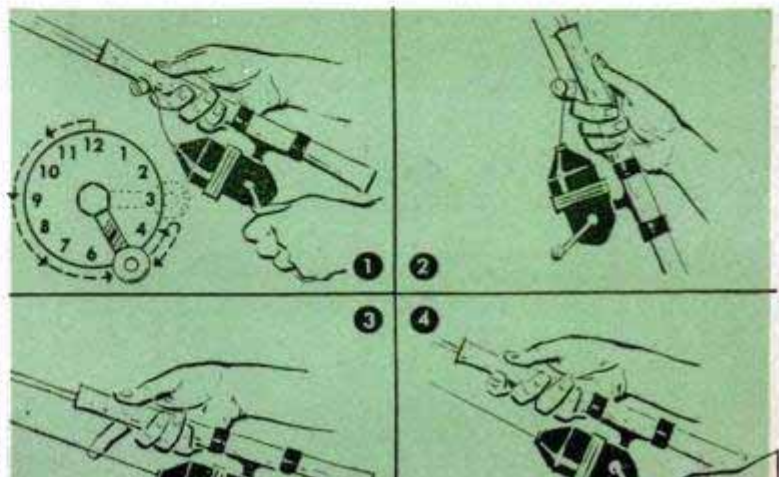
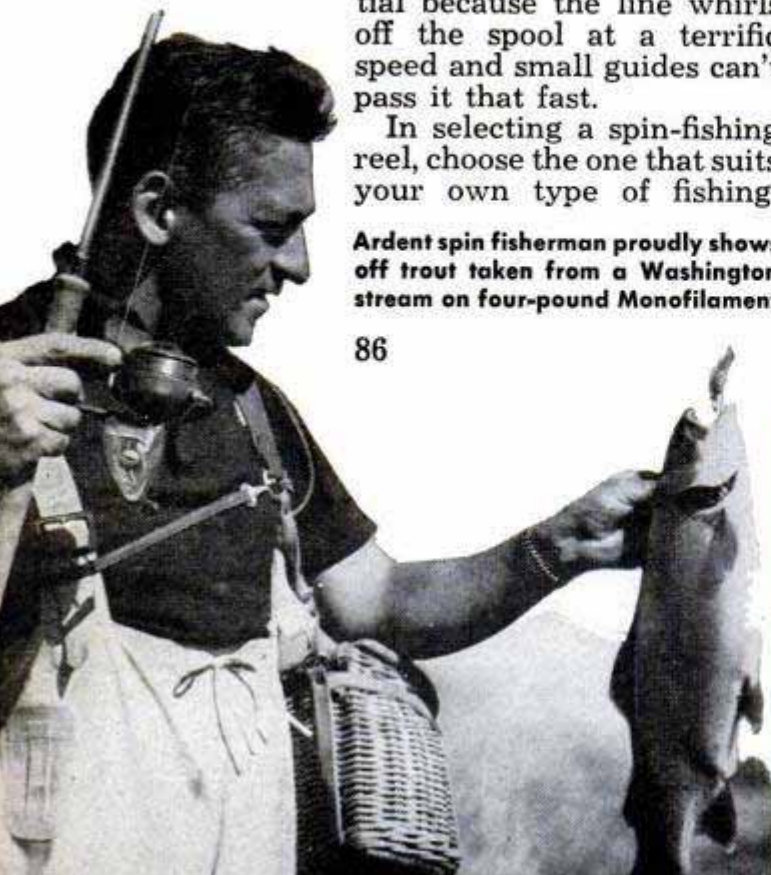

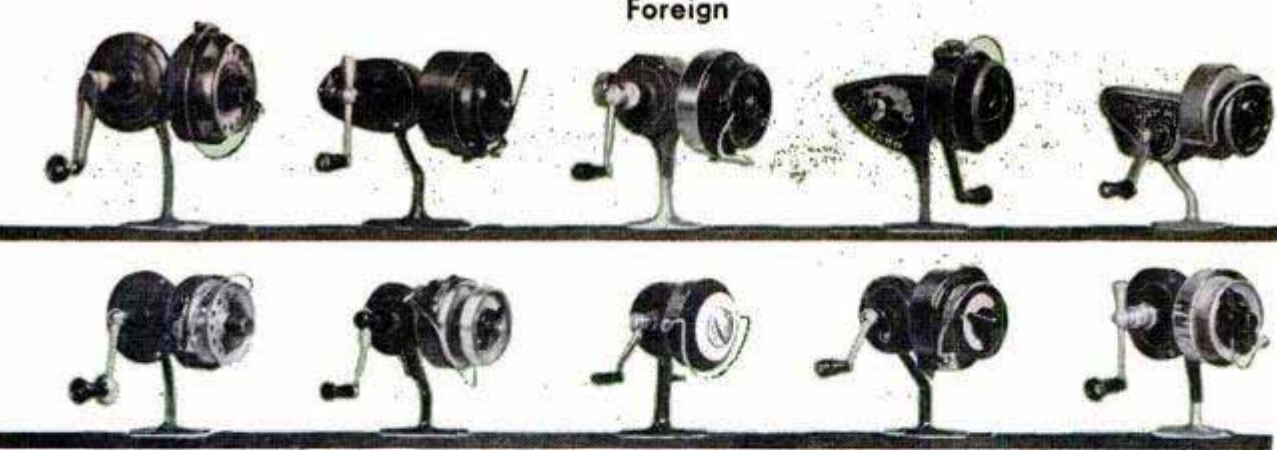

FOREIGN REELS: top row, left to right, the Luxor Supreme, Garcia Mitchell, Record Reel, Orvis 101 (Pelican) and Ambidex; bottom row, Luxor-Luxe, Pecos-Luxe, Swiss Whiz, C. A. P. and the Airex Mastereel

(assuming you are right-handed) with the reel hanging under the handle of the rod. Two fingers should be on each side of the stem that supports the reel. Next, press the line against the rod with your forefinger and disengage the bail pickup. This leaves the line free to spin off the reel as soon as you release it by straightening your finger as you finish the forward cast.

Bring the rod straight up to the 12 o'clock position with a sweeping, but quick, motion, and then flick the wrist forward until the rod is at a 45-degree angle. Point your finger at the target, which releases the line and permits the lure to shoot out. You'll be amazed at the distance you get with your first cast. The lure can be slowed down or stopped on the target by touching your forefinger to the reel spool.

When the bait has reached the water, reel in the slack line and drop the rod tip to a horizontal position preparatory to hooking a fish. If you get a strike, jerk the rod very gently. Most fish will run off the line and the drag of the reel will slow them down. Don't crank the handle while the fish is taking out line—wait until he tires or you'll put extra twists in your line.

A side cast will give you good distance if you have proper timing. In this cast, swing

Even the old-timers are switching to spin fishing. This experienced angler has new tackle box with plastic front for quick location of lures. Suspended from his shoulders is a two-tray, aluminum spin-fishing box



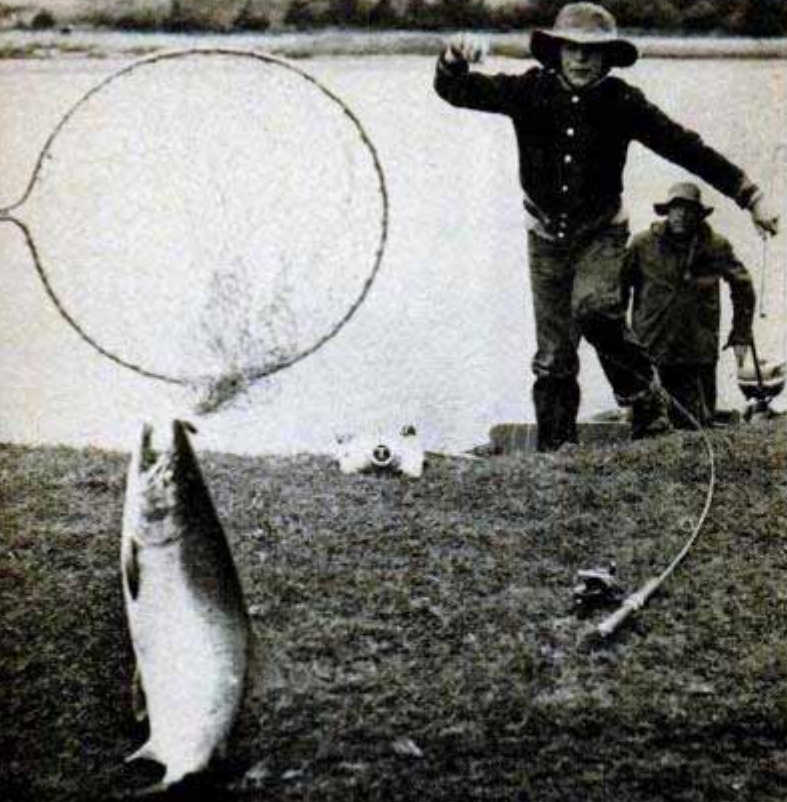

Young spin fisherman was so excited at landing a 15-pound silver salmon from a river bay that he tossed rod and reel, net and fish up on the bank

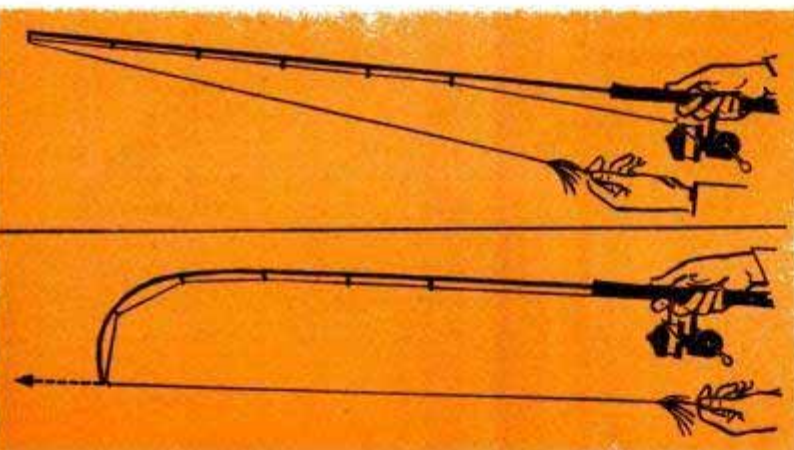

BOW-AND-ARROW CAST (see cover): Hold lure by curve of hooks, flex rod, release lure first, then line

Large-guide spinning rods are available in hollow and solid glass, steel and bamboo, from six to nine feet long

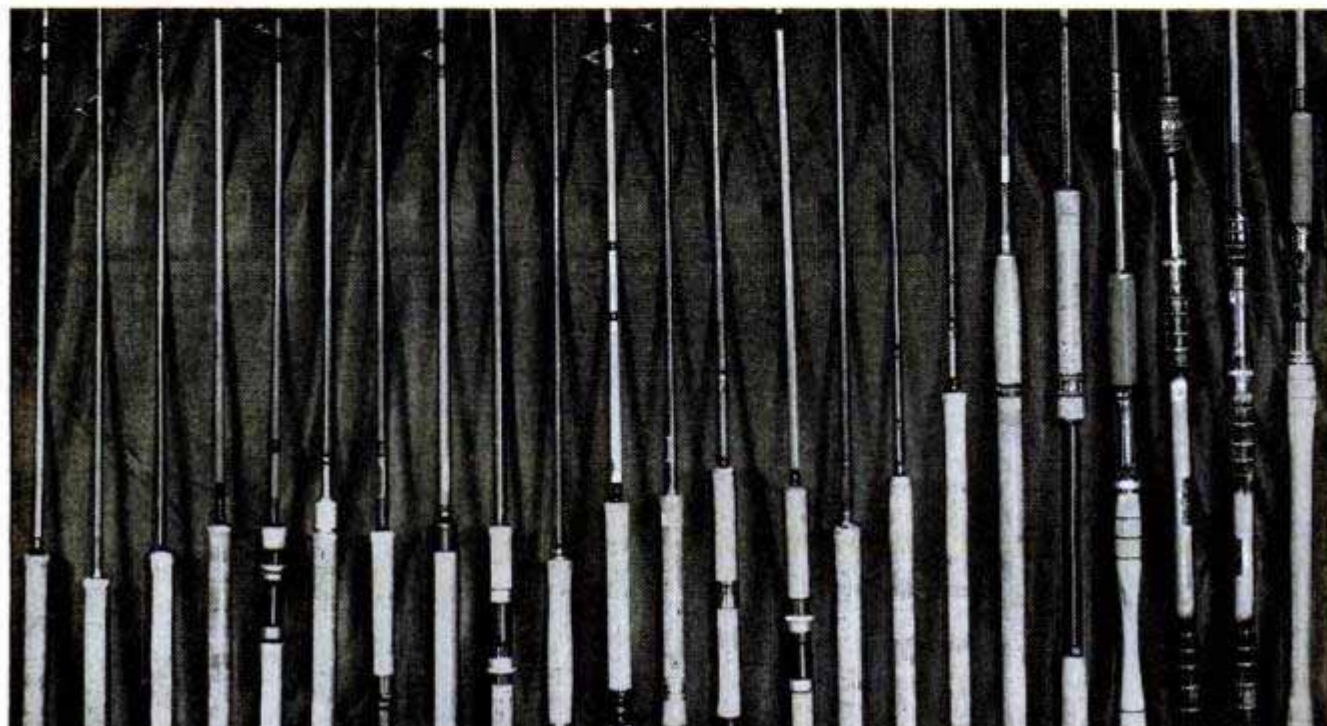

your rod tip out and up like a plane taking off, and when your rod tip has reached its maximum speed release the line. Raise the rod tip as the lure hits the water.

The underhand cast is used when shrubbery or trees prevent a conventional cast. Lower the tip of the rod and allow the lure to hang two feet from the rod tip. Start swinging the lure back and forth and then flip it out with a quick wrist motion.

In the lariat cast, the lure is twirled at the end of the rod until you can flip it. At that moment the rod tip must be pointed straight out.

If you really want to pop the eyes of your bait-casting friends, try the bow-and-arrow cast. Hold the lure carefully by the bend of the hook or hooks and pull it back beside the reel so the rod is flexed. Release it suddenly and the lure will shoot far out across the water powered by the snap of the rod.

There are a few basic differences in casting the closed-face reel. This type of reel eliminates line flapping and loss of line on a windy day. It also can be fitted to a fly rod, as the line pays out from one point and big guides aren't necessary. This permits the angler to pack a fly rod, a fly reel and a spinning reel for fishing variety on the same trip.

The nonreverse on some closed reels is operated by a knurled ring located between the crank and the cover plate. You adjust the drag on this type of reel by stripping off line with the crank in reverse. A clicking sound means the pickup is revolving although the crank is stationary. Set the drag just tight enough to retrieve your lure. Just before you cast, release the non-reversing crank. To find the casting position, turn crank forward to the position

(Continued to page 228)

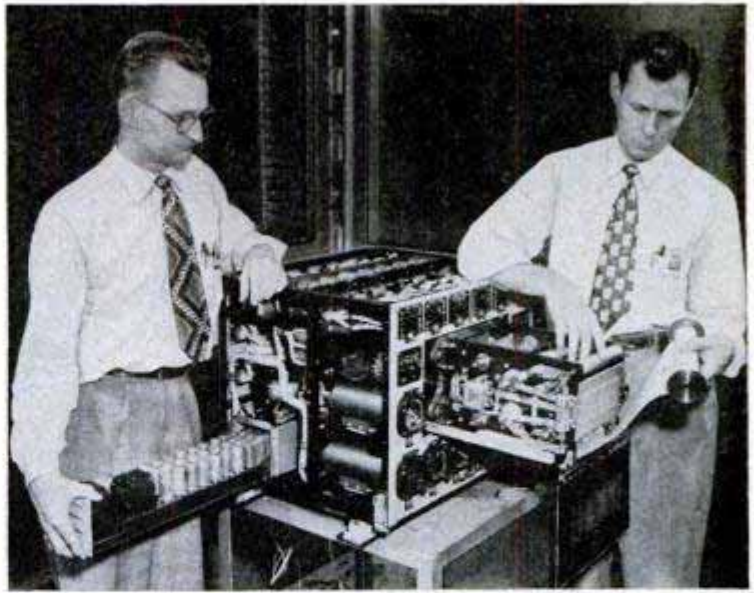

Punching flight plan into a tape. Man at right points to 430 sensing pins which detect data holes on tape

Punched Tape Controls Airplane in Flight

PUNCHED TAPE can now fly an airplane from coast to coast. It does the job while moving through an electrical "brain" in much the same manner that music rolls were run through the old-fashioned player piano. The device, developed by the Minneapolis-Honeywell Regulator Company and the Wright Air Development Center, is called an Automatic Master Sequence Selector. Here's how the robot works: A flight plan is made out in advance and divided into sequences. One sequence controls taxiing down the runway, another the take-off, a third directs the climbing and others handle the flight phases that follow. This flight plan is then punched into tape. As the tape moves through the selector, which has 430

metal pins among its 1000 parts, pins drop down on it and, like the fingers of a blind person, "interpret" the sequence of holes. The pins make electrical contacts where there are holes and these are converted into signals that operate the plane's controls. The purpose of the device is to eliminate the routine from flight operation, freeing the human pilot for over-all supervision of the trip. In any emergency, such as mechanical failure or an unforeseen obstacle in the flight path, the pilot can take over manual control instantly. While lighter and less complex than the equipment used for the first automatic flight in 1947, the new device can control a practically unlimited number of sequences.

Wiring diagram for electronic sequence selector was long enough to stretch from wing tip to wing tip of an F-38

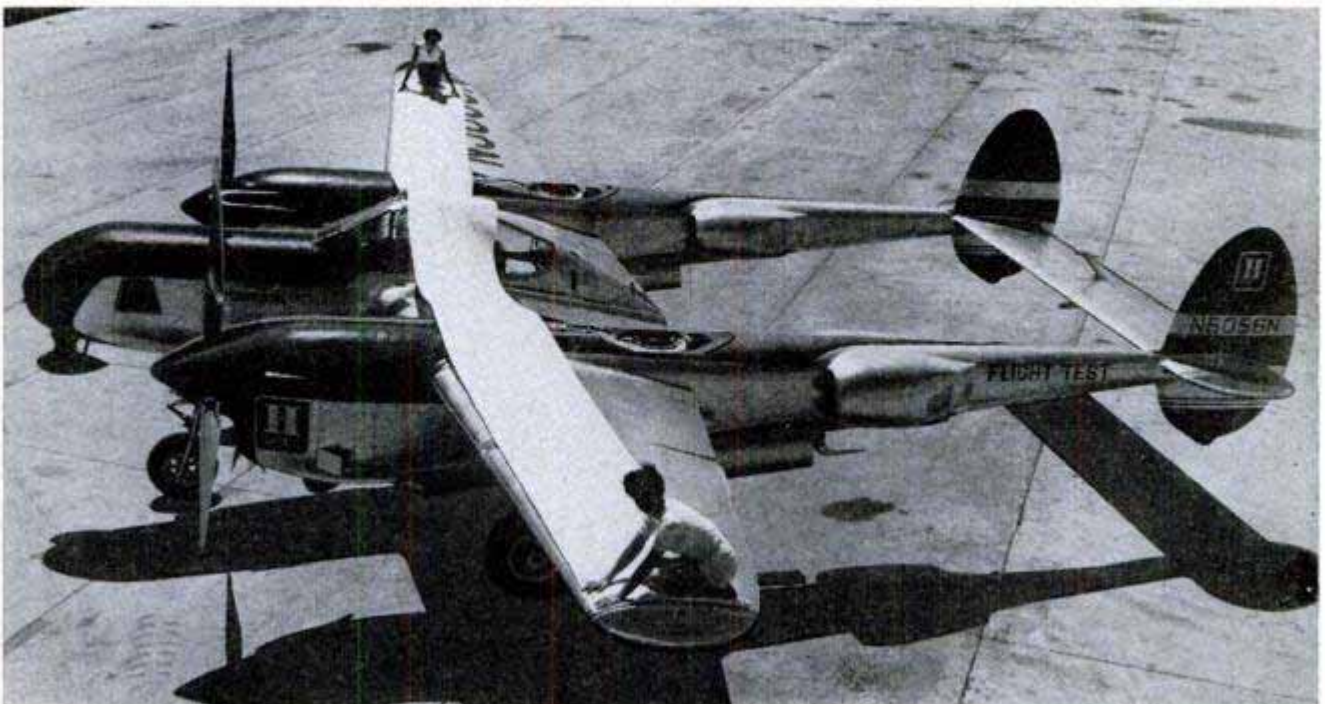

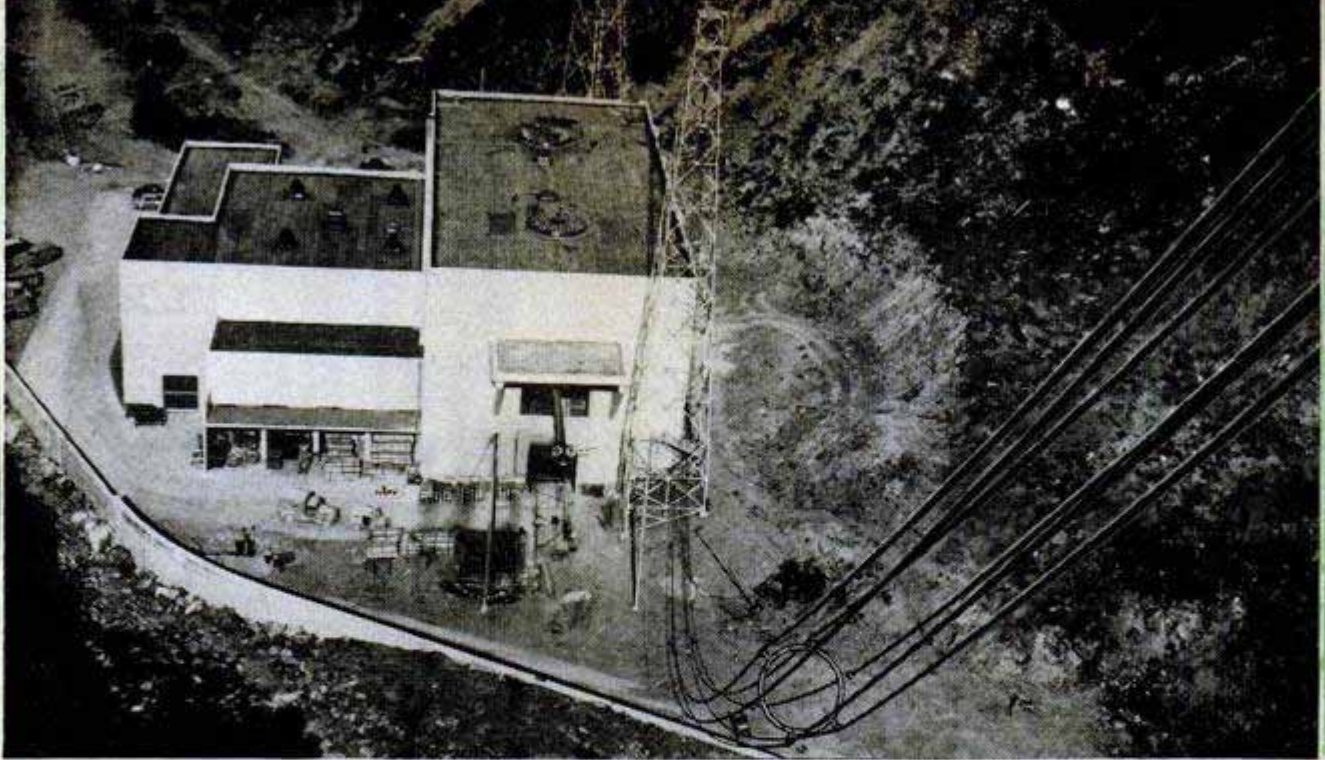

Transmitter building is reinforced concrete, copper-lined and copper-roofed. Half of antenna enters each side

Riggers unroll cable for cross-valley span. Three towers seen in lower picture support feeder lines

THE VOICE

BEAMING MESSAGES to ships in the farthest reaches of the Pacific Ocean, a new Navy radio station at Jim Creek Valley, Wash., will soon go on the air. One million watts will power the station to make it the most potent in the world, according to the Navy, which hopes to maintain constant contact with Navy vessels by means of a low-frequency, high-power wave. Before

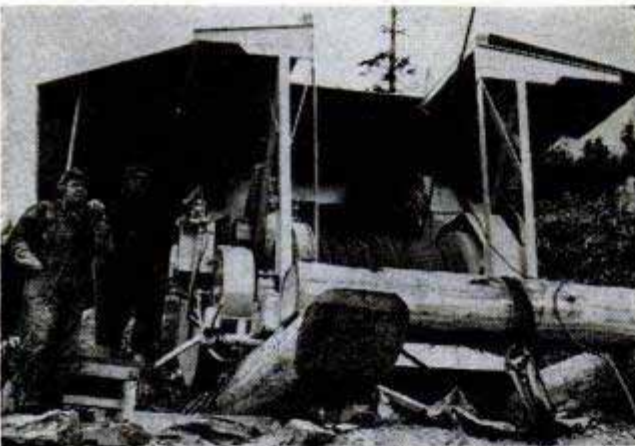

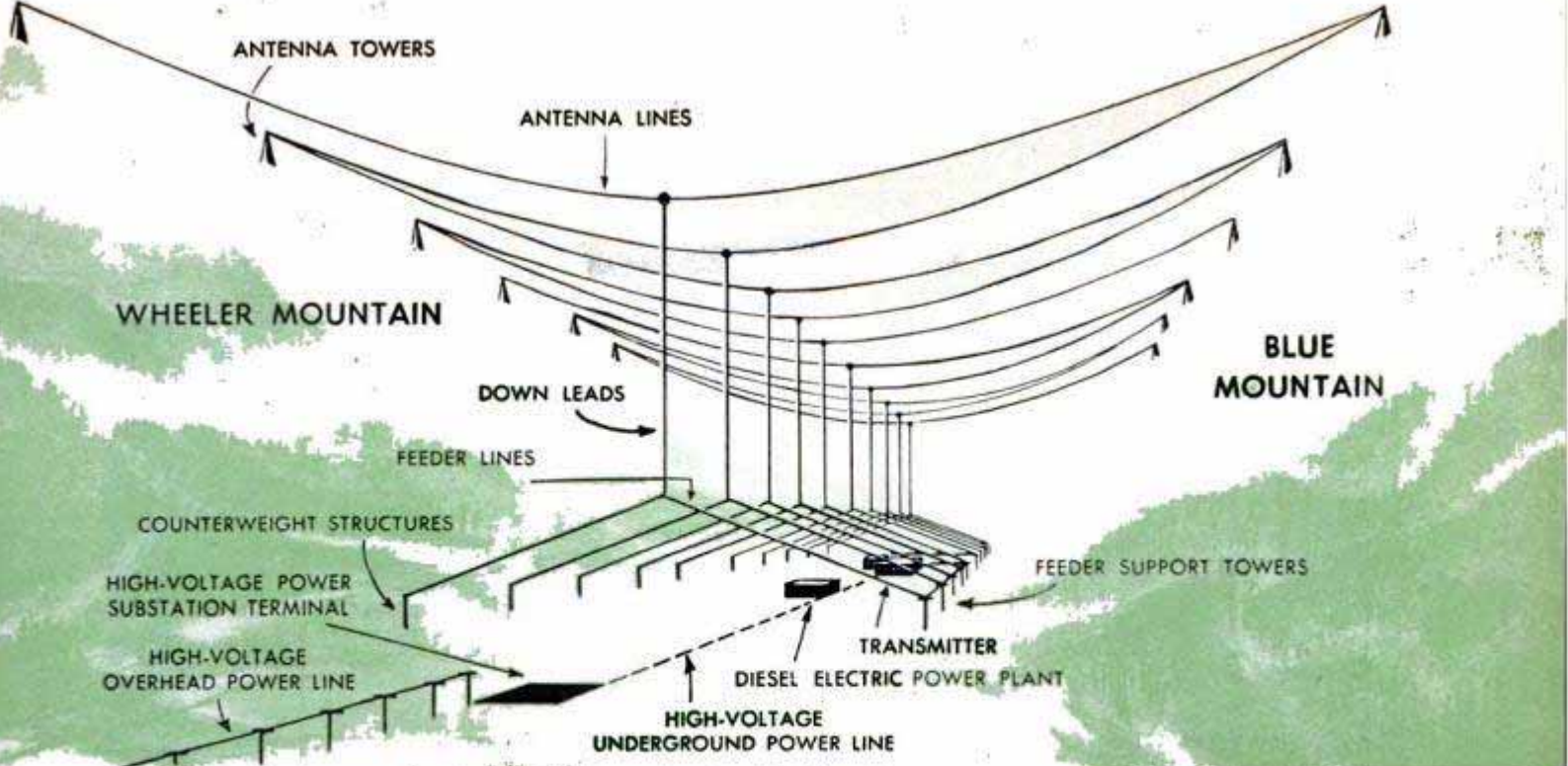

Antenna installation stretches for a mile down Jim Creek Valley. Antenna spans range from 7000 to 9000 feet

THAT CROSSES THE PACIFIC

the station was built, the rugged valley sides of two 3000-foot mountains were bulldozed clear of timber and the valley creek was re-routed to make way for the transmitter and an emergency diesel-electric power plant. Six 200-foot antenna towers were erected along the crest of each mountain ridge to support the 30 miles of antenna cable which would cross and recross the 1½-mile valley span. Vertical down-leads drop 900 feet from the center point of each span to feeder lines. The transmitter building is situated

in the middle of the installation, one half mile down the valley. Cables lead into each side of the building which is grounded by a circular web composed of 130 miles of copper wire. Radio waves from the transmitter travel along a transmission trunk supported by thirteen 145-foot towers on the side of Blue Mountain and are carried to the down-leads by diagonal feeder lines. Guy wires anchored to counterweight structures on facing Wheeler Mountain prevent damage by high winds and icing. ★★★

"Doughnuts" around antenna lead-in trunk prevent corona discharge. Right, ant's-eye view of transmitter tower

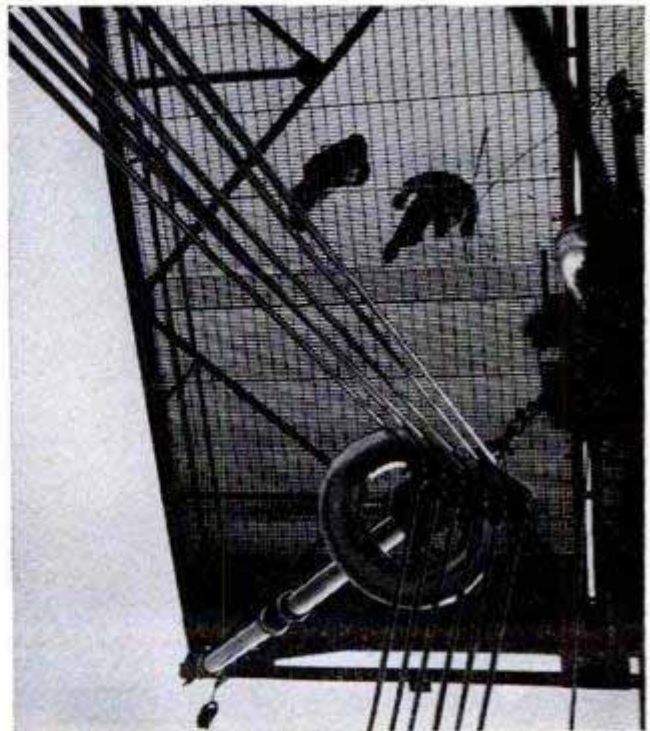
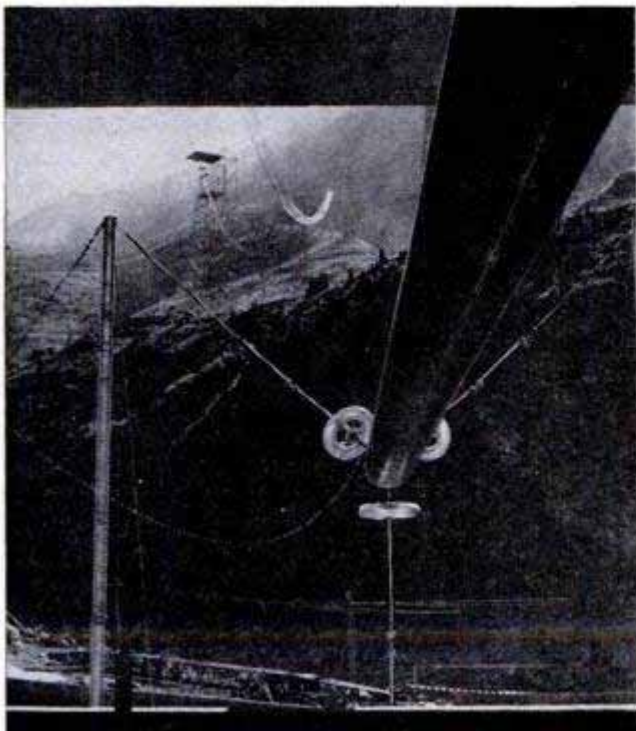



Diver gains speed just before plunging toward bottom. Inset at right is *Popular Mechanics* cover that inspired the sub

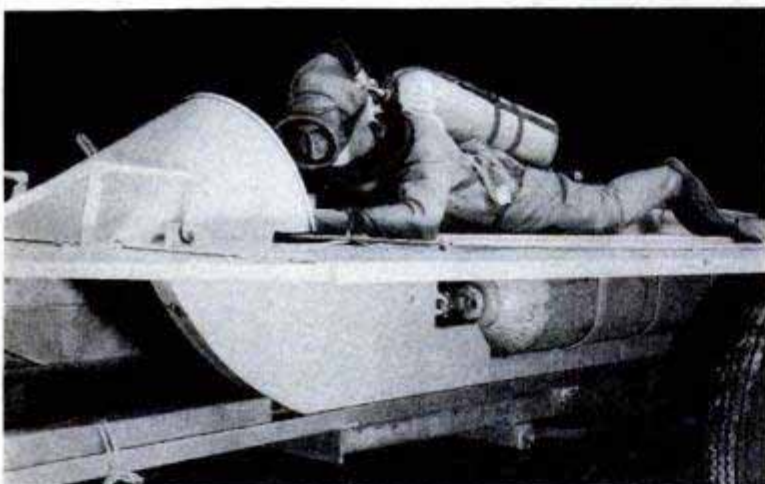

Twin compressed-air tanks are built into the runners. Frame of the submarine sled is made of wood covered with a skin of aluminum. Below, forward and aft diving planes are controlled by hands and feet. Holes near elbows give access to air valves

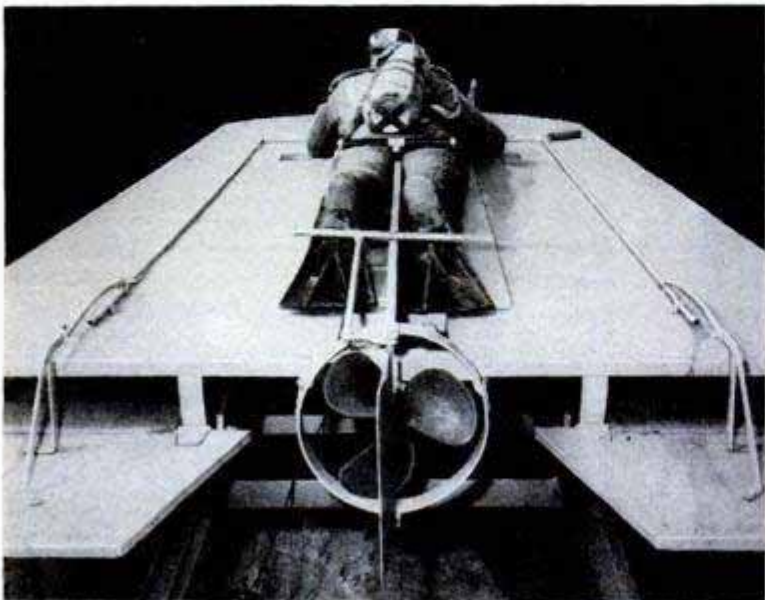

Submarine Sled

REMEMBER the article that ran in our October 1952 issue about the underwater glider that is towed by a speedboat? West Coast skin divers are using this glider as the model for one-man submarines driven by compressed air. The diver who pilots the sledlike craft shown here can descend several hundred feet and cruise the bottom for more than an hour. The craft was designed by J. R. Monroe of Bakersfield, Calif., and tested by Richard Anderson of the U. S. Divers Company of West Los Angeles. Two large tanks set into the runners below deck carry air at 2000 pounds' pressure, which drives a small air motor to spin the 12-inch propeller. The diver carries his own cylinder of air for breathing. He operates the submarine with leg and arm controls. The craft, made of wood and aluminum, is 13 feet long, 7 feet wide and weighs about 700 pounds.

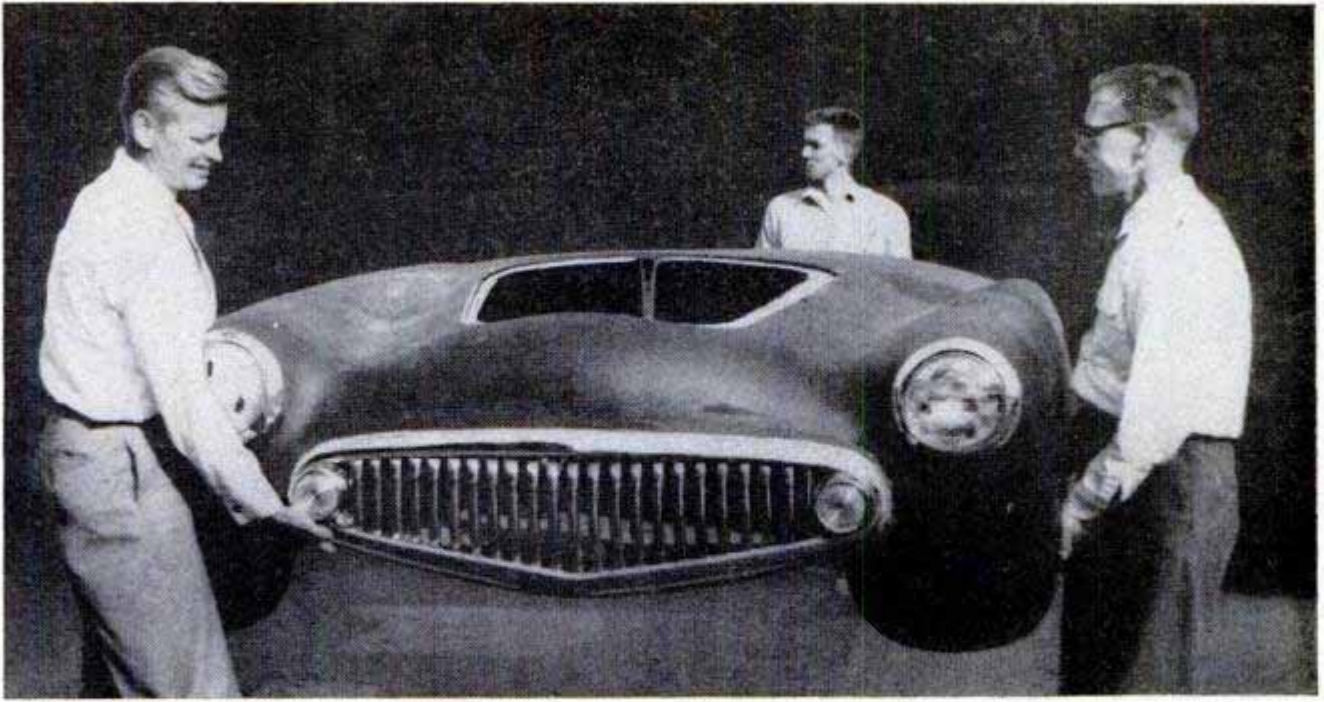

Three men easily carry the light, plastic body. Hood and door openings were cut after body was finished

Custom Sports Body Fits Henry J Chassis

Built for a Henry J chassis, a plastic sports body emphasizes trim, clean lines. The complete car weighs less than 1800 pounds. Over-all length is 174 inches and height is 54 inches. Tom Masano, Reading, Pa., automobile dealer who built the body, says that a plastic mockup was made on a Henry J chassis. Four layers of glass fiber and resin-impregnated mat were laid over the mockup and the mold was sawed in half for removal from the plaster. The doors and hood were cut out after the body was mounted on the chassis.

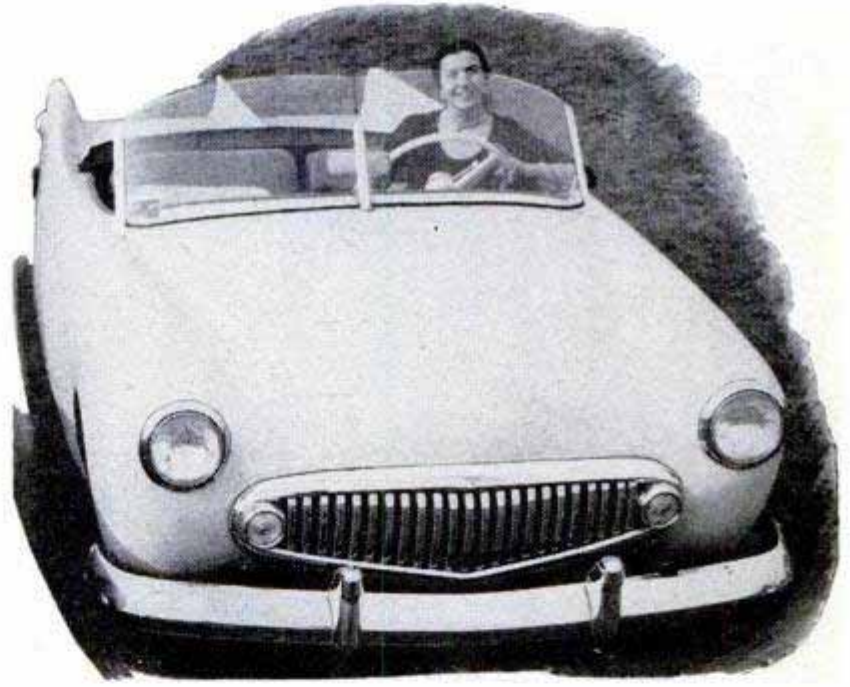

Front and side views show off the rakish yet uncluttered design

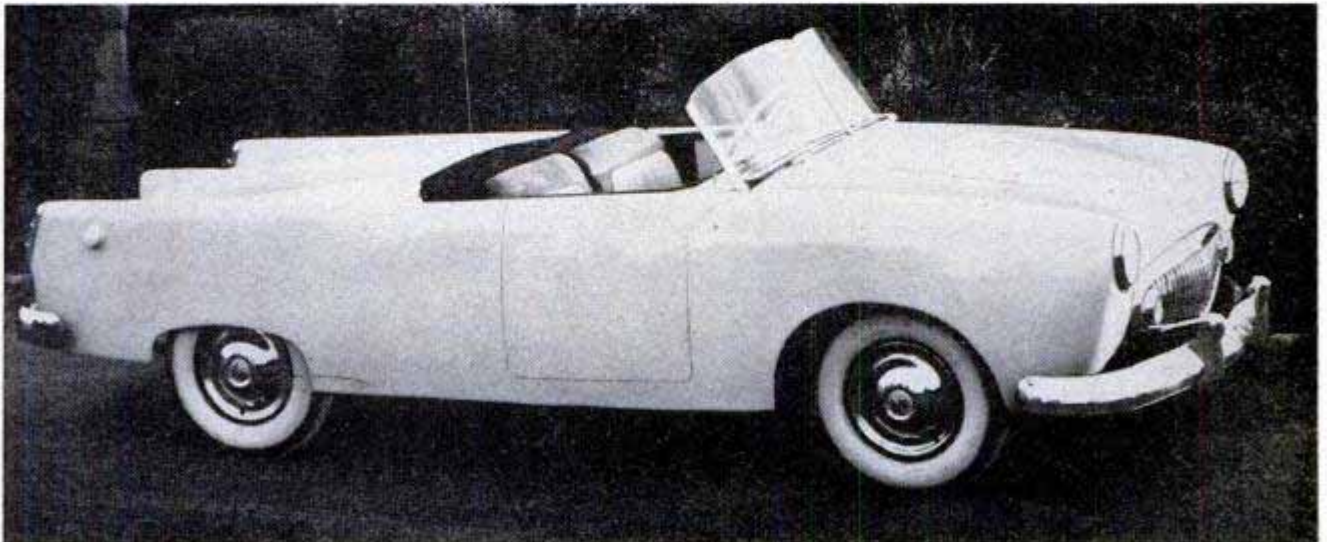

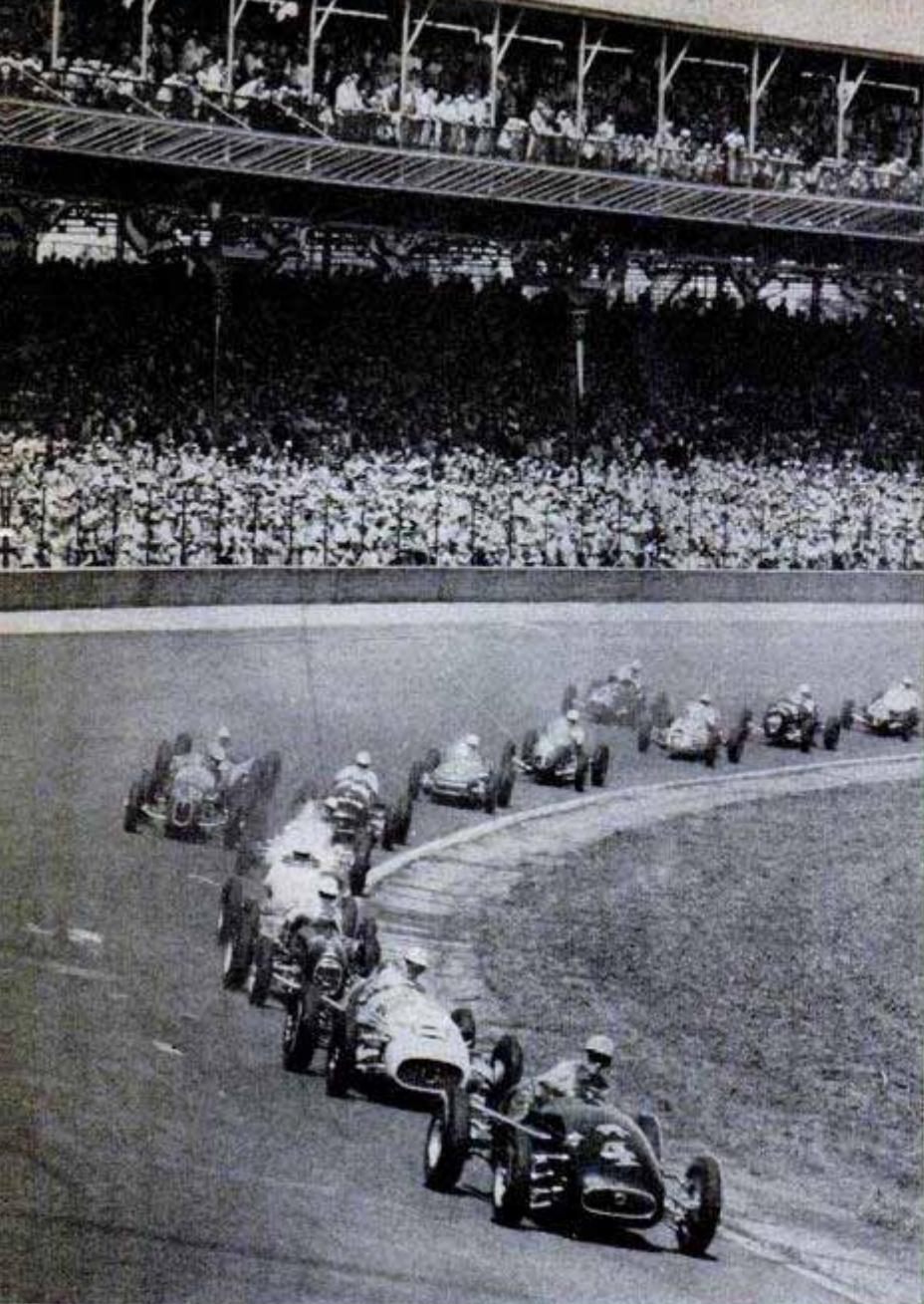

Is the Speedway classic headed for a slowdown? Every year fans jam the highways to Indianapolis for the Memorial Day race. As a preview of the '53 event, *Popular Mechanics* interviewed two famed Speedway personalities: Tommy Milton, two-time winner and former chief steward, and his associate, C. W. VanRanst, designer of Milton's first 500 winner. They bring you

THE 500

Left, McGrath leads the pack on the first turn in 1952. Below, VanRanst designed and Tommy Milton drove the Frontenac which won the 1921 classic
Chas. J. Bell photo

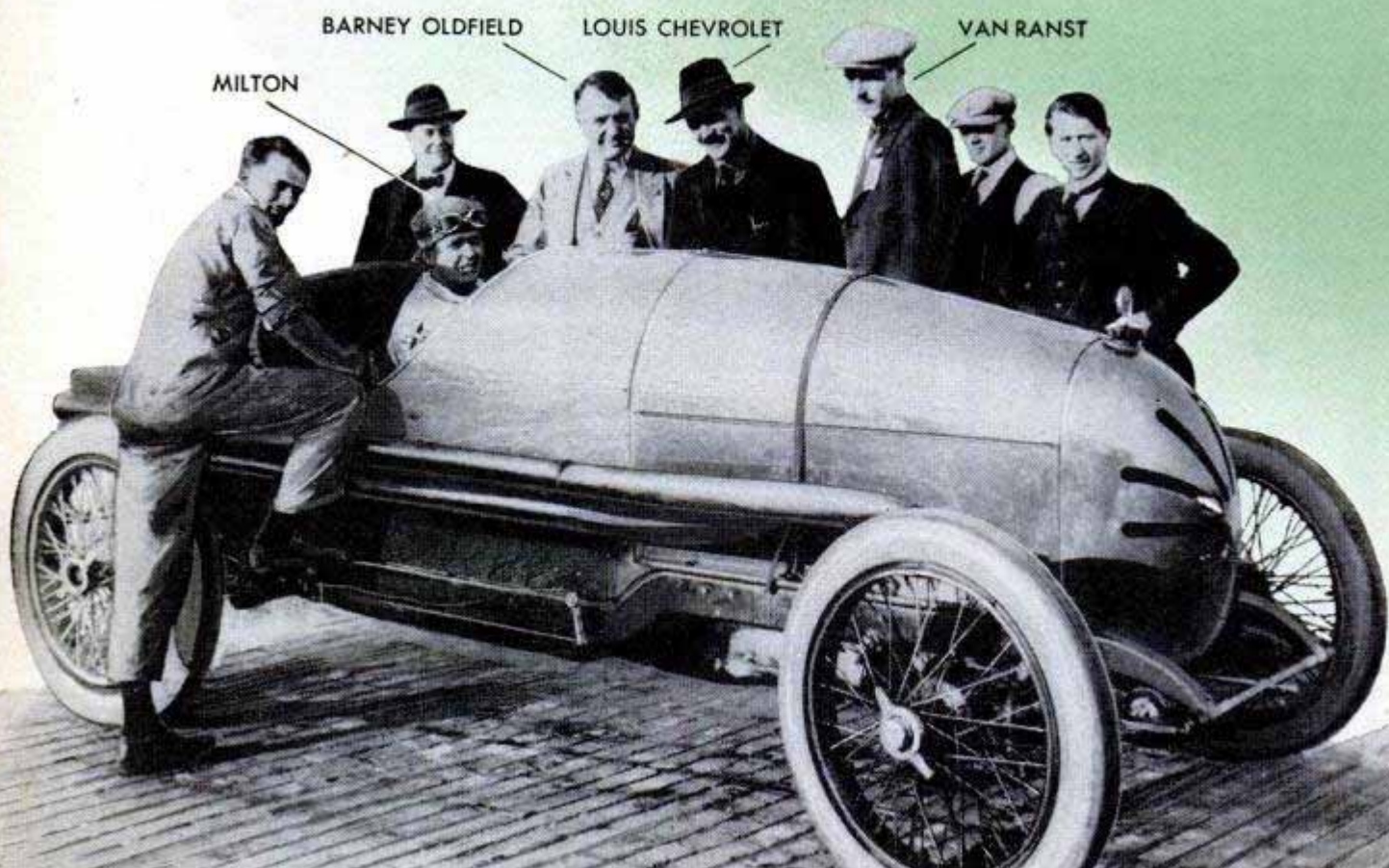



VanRanst, left, and Milton, both experts on the Indianapolis race, believe there may be a slowdown this year

AS THE EXPERTS SEE IT

QUESTION: What will be the biggest news story at Indianapolis this year?

MILTON: One interesting aspect will be the performance of modified passenger-car engines. I understand there are to be two or three race-car chassis fitted with Chrysler V8 engines which have been reduced in displacement to the limit allowable at Indianapolis. They are putting in a shorter-throw crank or reducing the bore to bring them to 270, the unblown-engine limit.

Another point that may make headlines is the use of so-called nitro fuel.

Q: Is there a rule against such fuel?

MILTON: There probably will be this year. I don't know how many cars used it last year. Reportedly, Vukovich had it in his car. So did Ruttman and Rathman and how many others I don't know, but these drivers were running one, two, three.

Q: What is this nitro?

MILTON: In most cases, I understand, the additive is nitromethane and alcohol is the base fuel. But there are several other forms of nitro which possibly could be used including nitrobenzene and nitropropane.

Q: Are these fuels dangerous?

MILTON: Yes. The bravest guy will win. Loosely, the driver who is willing to put the highest percentage of nitro in his fuel will go the fastest until the engine flies apart—too much will push the top off or the sides out or something.

Q: Are they going to eliminate nitro?

MILTON: They want to, but since the

entry blank made no provision, they are having to write each entrant and solicit his approval of the ban on nitro. But even so they are going to have a job trying to police the ban. I suspect that some of those fellows will come up with a method of adding it—at least for qualification and possibly for the race, to give them a burst of speed when it might count. You see they are all down there to win and that race is like the income tax. No matter how they change the rules, the minute the rules are out, everybody goes to work to find out how to beat them.

Q: Will there be any European cars in the race?

MILTON: There will be some European cars, but probably not from Europe. Some of the American-sponsored Ferraris may be back.

Q: Will the Ferrari be a threat?

MILTON: I don't think so. Friction is roughly proportional to the number of cylinders and a competitive car down there requires, above all else, acceleration, which is more a matter of torque than horsepower. In racing terminology, coming off the corners you have to be able to accelerate but quick. That is one of the reasons the four-cylinder jobs have done well. Their net torque—under certain conditions—is higher than that of a multiple-cylinder engine of the same displacement. The Ferraris last year had gearboxes that could be shifted at high speed, and Ascari and Johnny Parsons and others tried it, but it didn't work

out. On a straightaway they would probably run away from the four-cylinder jobs.

Q: In other words, if you take 270 cubic inches and spread them over 12 cylinders, you get three times as much friction as in a four-cylinder?

VANRANST: That is roughly the problem and it is almost proportional.

MILTON: Of course, we are oversimplifying it. In the four-cylinder jobs, the reciprocating weights are large. The boys who try to get the maximum out of their engines and "rev" them up a little too high actually stretch connecting rods. But to get back to this nitro thing, I am told that an Offenhauser four-cylinder 270-cubic-inch engine with the best possible combination they have been able to work out, exclusive of nitro, will develop 340 horsepower. When they add nitro, perhaps 10 or 12 percent, it immediately goes to 440, and if they put in additional amounts it jumps again. Another danger is that if the car catches fire, there isn't any way to put the stuff out.

Q: Is nitro simply mixed with fuel?

MILTON: Yes, I believe so. I have never used it. It is much after my time, of course, but I am told you just mix it with the fuel and, as the saying goes, "Away we go!"

Q: Every year the average speed goes up two or three miles. Will that continue?

MILTON: I don't think so. If you go through the records, you will find they go up for a while and then drop back before going up again. We have had an era of ascending averages, but if the elimination of nitro occurs this year, it will probably cause a drop in the average speed.

Q: You feel that if it is possible to police the nitro matter the winner's speed will be lower than in 1952?



Milton: "You just mix it with the fuel and, as the saying goes, 'Away we go!'"

MILTON: I think that is a reasonable estimate, unless someone comes along with some other development that we don't yet know about in terms of car handling or something else.

Q: What do you think will beat the four-cylinder engine at Indianapolis?

MILTON: I think a V8 might not be too bad a compromise or perhaps a V6 or flat six. The flat six would get the center of gravity down. But, of course, these four-cylinder jobs have been in the picture quite a while. They have gone through years of development and the boys like them.

Q: It looks as though Indianapolis is becoming a race of one type of car whereas ideally it would involve many different kinds of cars, wouldn't it?

MILTON: I think that observation is more or less sound. Actually, it isn't quite that, as witness the fact that Welch built the Novi V8s. And there are the Cummins diesel and the Ferraris.

Q: Will the diesel be in there this year?

MILTON: I think not. Cummins feels they need more than a year for further development. I am told that he voluntarily subscribed to a reduction in piston displacement. He felt that they no longer need 400 inches. But he said it would be two years or possibly three before they are ready to try again. They were about as fast as the fastest, which is mighty good performance. They had a turbo supercharger and what put them out of the race was that the turbo was so located that all the dirt from the track got into it and loaded it so it wasn't pumping sufficient air.

Q: If that had not happened, do you think the diesel might have won?

MILTON: Well, the car was pretty heavy

Chart of average winning speeds. There has been a steady climb since 1946. Will 1953's average be up or down?

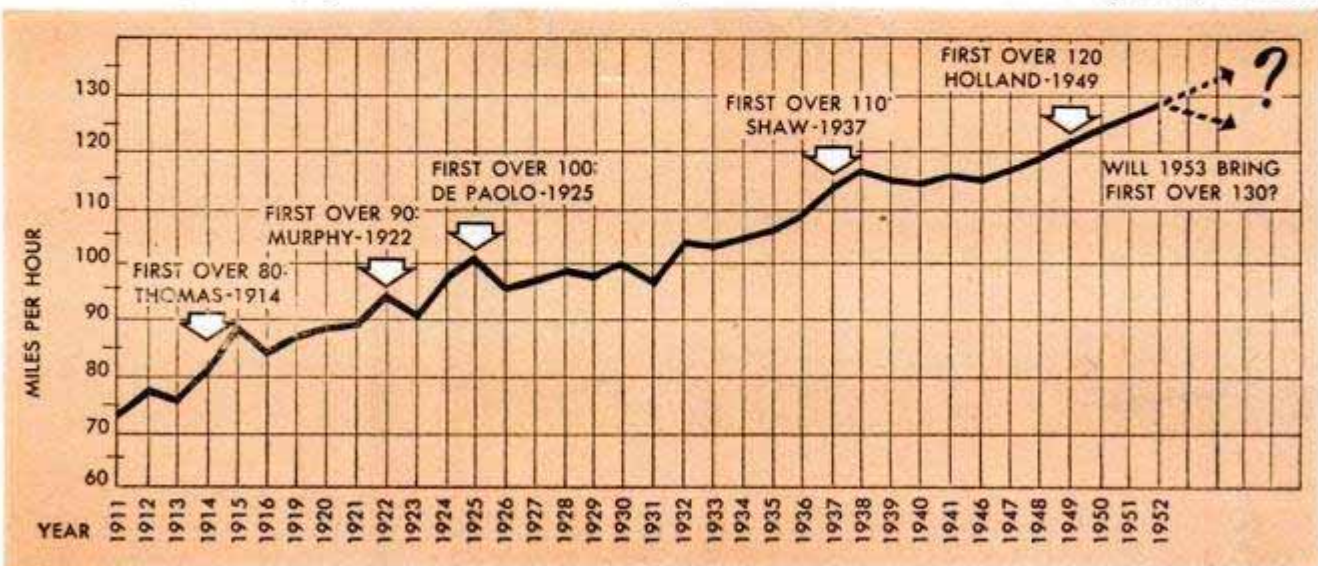

and what would have happened relative to tires, I don't know.

Q: What are the requirements of a racing tire?

MILTON: Of course, the first requirement is that it doesn't blow out! In the early days they used to blow out all the time. I am not a tire expert, but to get a tire that won't blow, one of the problems is heat dissipation. So they put no rubber on the side walls at all or virtually none so as to give better heat radiation. Tread design is unbelievably important. If you look at a new racing tire, you wouldn't believe it was a new tire, you would think it was one that had been on a car where the toe or camber or something else was off. It looks half worn out. Another problem is to get a tread compound with maximum resistance to wear.

Q: What is normal now—two tire changes during a race?

MILTON: For most cars, I think so. Some get by with one.

Q: Would you say that the speed is determined as much by tires as by the engine?

MILTON: That might not be too far afield, but it is also related to another factor



VanRanst: "Few would make good road racers . . . inadequate brakes, gearboxes"

and that is fuel. Every fellow down there—perhaps not every fellow, but the better drivers—and there are never too many good ones—(I have always kind of harbored the notion that in any given year there are not more than six who are really top flight, the rest are more or less scenery) knows to a nicety how fast and how far he can run on a set of tires. He also knows how far

he can go on his fuel, so he relates tire life to fuel mileage. They are interlocked. If he has to stop at 80 laps for fuel then he may just as well run at a speed that will require changing tires at 80 laps.

Q: Then the one or two tire changes mean the driver can be more wasteful of fuel?

MILTON: I don't think you ought to use the word wasteful because they vary the mixture of alcohol and gasoline to give the best combination of speed and mileage. They use about twice as much alcohol as gasoline and they are concerned about keeping the load variable at a feasible minimum.

Q: American Indianapolis racers are designed for counterclockwise motion on a circular track, aren't they?

Winner Ruttman gets tire change and fuel during the 1952 race. Note the unusual tread on racing tires

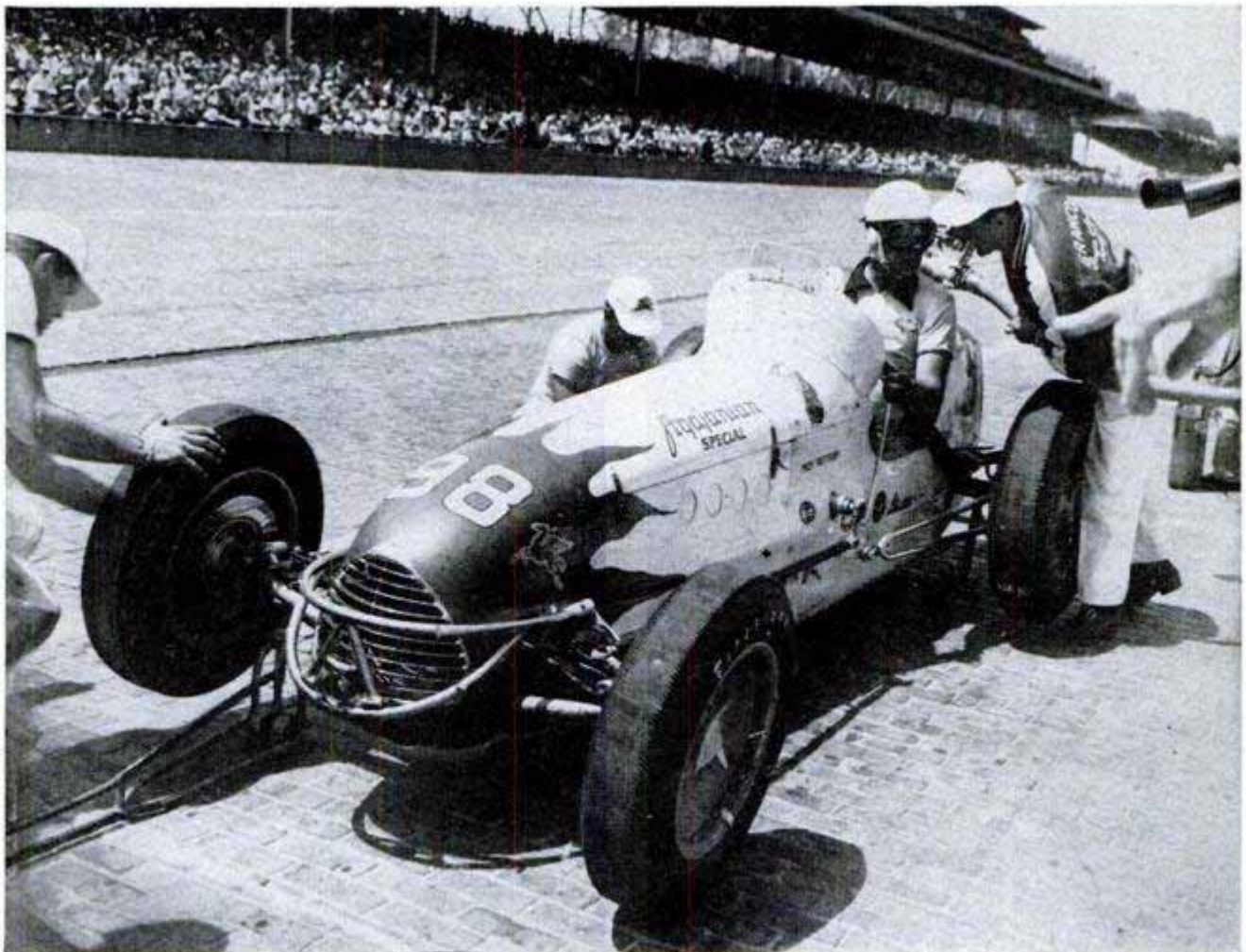

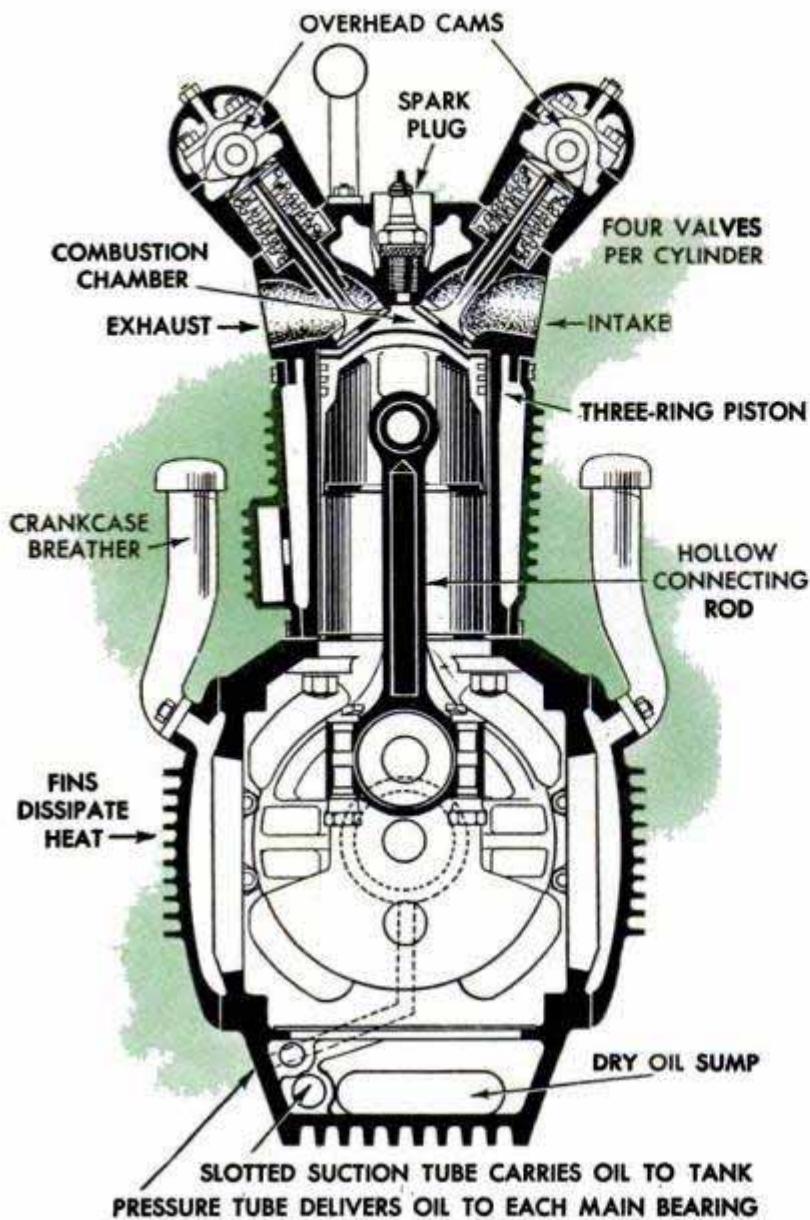

Cutaway of the famed Offenhauser. It is made in four sizes, the 270-cubic-inch model being most popular with Indianapolis drivers
Courtesy Meyer & Drake Engineering Corp.

Shown here ready for installation is an Offenhauser 270 with fuel injection. It develops 340 horsepower

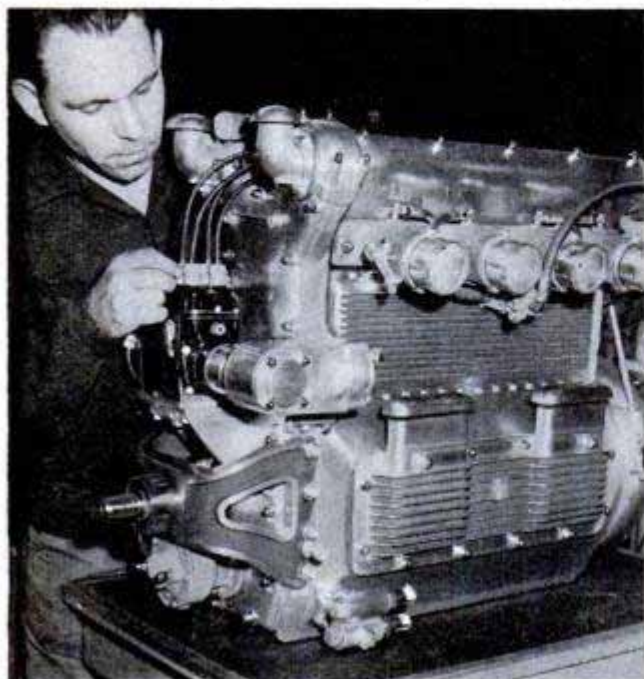

Milton says to watch the modified stock engines, like the Chrysler V8 being mounted in this race car

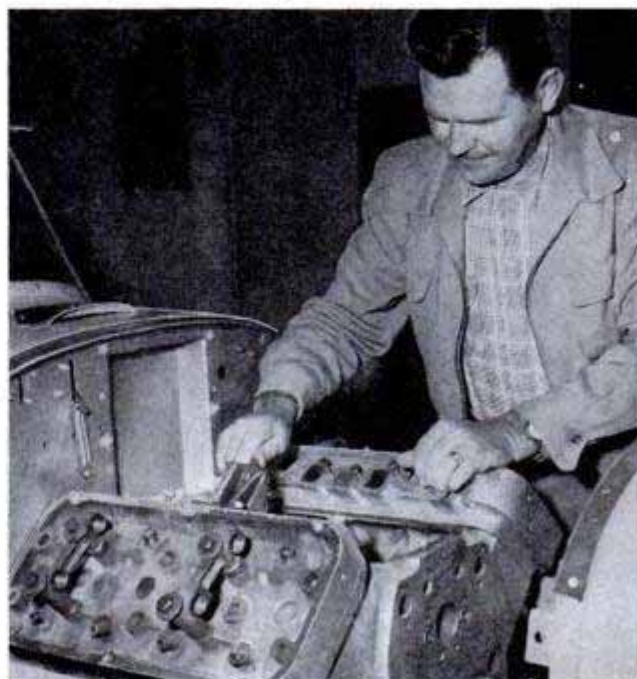

VANRANST: Only to a limited extent. Few of the cars would make good road racers because they haven't adequate brakes or suitable gearboxes.

MILTON: The only cars that I can think of designed particularly for the 500 are those in which the engines and related parts have been put in at a slant or angle to influence centers of gravity. The major proportion of Indianapolis cars are quite conventional with little digression from standard practice to accommodate that particular track. I am surprised that it hasn't been done more.

Q: Will there be a turbine entry in 1953?

MILTON: I think they have opened the race up to jet and turbos or a combination, but of course the energy must be geared to the wheels. It couldn't be just the thrust of the exhaust gas.

Q: Is there anything like that in prospect?

MILTON: I believe not for '53. I don't believe it is closer than 1954.

Q: A controversial question is this one: Has anything of value to Mr. Family Car Owner ever resulted from Indianapolis? What is your position on this?

MILTON: I am glad you said "what is my position" because I feel that I should take a position. Just what Indianapolis is depends

largely on how objective one is in his evaluation of it. There are those who say it is just a legalized bullfight, strictly entertainment. There are others who say that our passenger cars wouldn't be what they are today were it not for Indianapolis. I suspect the truth lies somewhere in the middle ground. I don't know just where that is. In earlier years many contributions were made to the automotive engine. Manufacturers didn't have proving grounds. They had no place to run a car continuously at high speed. I think it has helped tire development. I don't know how anyone could devise a tire test where so much could be learned. Around 1920, the 500 helped make heat treatment a focal point in engineering. I don't know how many cars broke steering arms that year and, as I recall it, immediately thereafter the industry in general became more concerned with metallurgical problems. I believe it contributed substantially to supercharger development. It is more or less common gossip that one V8 manufacturer has an engine on the shelf with a supercharger in the center of the V—just in case it is needed in sales competition. Certainly every year you will see engineers from almost every auto company snooping around the garages to see what the boys are doing. Most of them are quite vocal in praising the ingenuity of those fellows who use rule-of-thumb, cut-and-try methods generally.

Q: Would Indianapolis be a better race if instead of this rule-of-thumb engineering, more academic skills were used?

MILTON: Perhaps, but new gimmicks are not found in textbooks. Certainly, sound engineering is coming in more today. This fellow Keck out on the Coast has a

Johnny Parsons, Indianapolis winner in 1950, holds a frame of a Kurtis race car. The chrome-moly frame weighs 115 pounds, combining strength and lightness

couple of young graduate engineers who developed what they call fuel injection. It isn't direct injection, it is manifold injection. Vukovich and others used it with fine success.

Q: Do you think this might lead to fuel injection for the family car?

VANRANST: Oh, yes. The advantage of fuel injection is that you can get better control, better distribution. The jets are usually adjacent to each inlet valve so therefore the fuel is metered to that cylinder. You get better balance than you can when you take fuel from one source and use a manifold to distribute it. Of course, you have no float valve, a cause of trouble in most carburetors. Also, you don't have to use the energy of the air to pull the fuel off the jets, which takes away from your volumetric efficiency.

Q: Then fuel injection is coming?

VANRANST: It would be here now if they could afford it.

Q: Racing cars use torsion-bar suspension. Will that come on the family car?

MILTON: I think it will. Van doesn't.

VANRANST: The reason it won't is the extra cost. Most American manufacturers have built experimental cars with it. It's no secret.

Q: What are its advantages?

VANRANST: Lightness of weight is one important advantage and also the fact that you can vary the rate of your spring with a simple adjustment.

MILTON: That is, if you have a big car, a seven-passenger automobile, and you are running around the city with two persons in it, you can back off and get a soft ride.

(Continued to page 254)

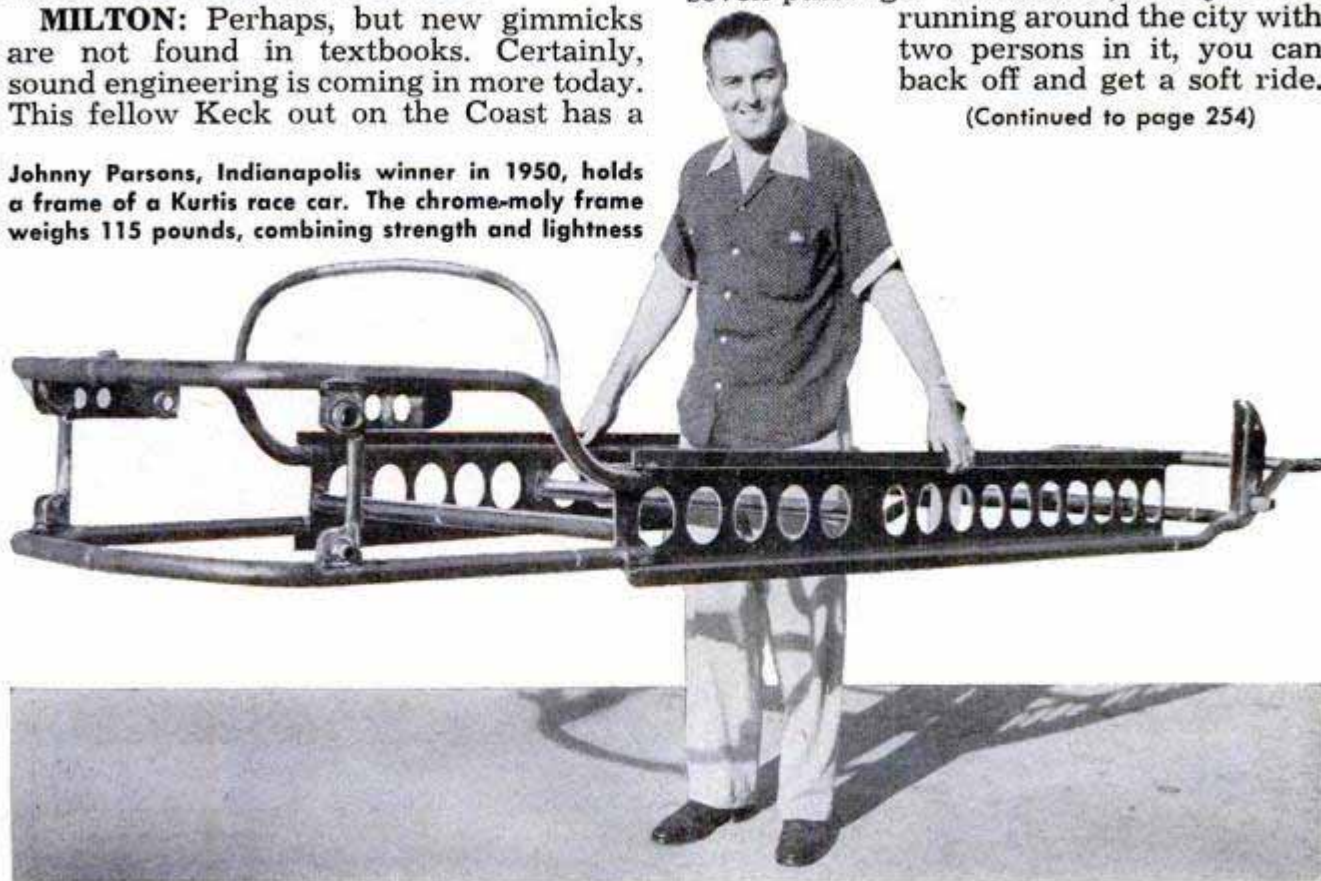



At left is a Jeep. Three other vehicles are Marine Mites, rigged as ambulance, gun mount, signal truck



Above, a Mite runs with a wheel off! Below, it zooms up the test hill. Right, comparison of Jeep (dotted line) and Mite

Marines Unveil Mighty Mite

U. S. MARINES have unveiled a tiny vehicle that promises to do everything the famed Jeep will and more. They call it the Mighty Mite—and with reason!

The 1500-pound car bristles with talent. Only 96 inches long, it will haul four Marines anywhere. It can be rigged as a combat ambulance, a recoilless cannon mount, a tractor for a rocket launcher or a field-radio station.

It has an air-cooled aircraft engine (test models use the Porsche sports-car engine). The three-speed transmission drives all four wheels, each independently sprung for roadability.

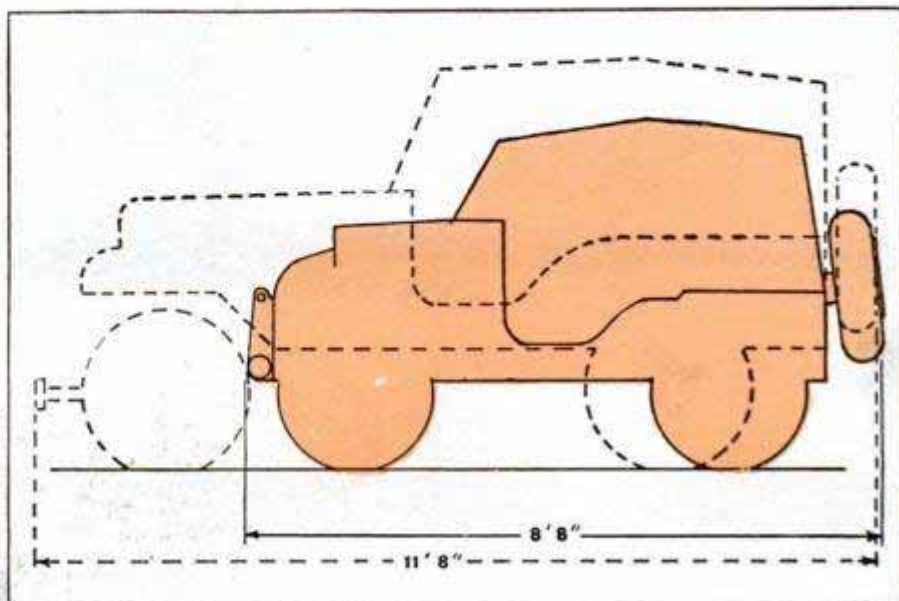

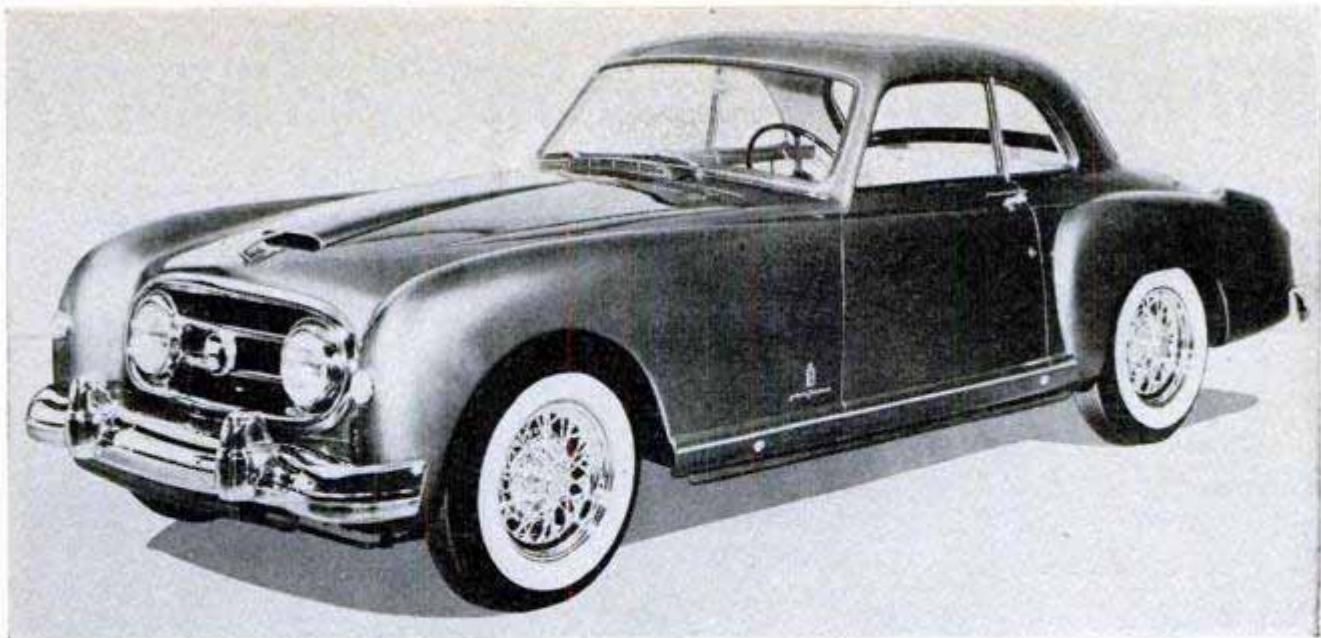

Nash-Healey Adds LeMans Hardtop to Sports Line

Named after the famous French 24-hour race, the Nash-Healey LeMans hardtop features the sleek styling of Pinin Farina. The name LeMans is a natural for this production-model sports car because Nash-Healey convertible models have performed creditably in the endurance race, finishing third in 1952. The LeMans, a genuine sports car, combines the skills of three countries. Engine and major mechanical parts are manufactured by Nash Motors in the United States. The chassis with its trailing-link front suspension is made by the

Donald Healey Company of England. The bodies are produced in Farina's custom body plant at Turin, Italy. Power plant in the LeMans is the Dual Jetfire Nash Ambassador engine that in the 1952 race averaged 91.5 miles per hour for 24 hours and was one of only 17 cars to finish from a starting field of 58 cars. It is an overhead-valve six, developing 140 horsepower. Compression ratio is 8 to 1. Two side-draft carburetors in conjunction with an oversize intake manifold and a seven-bearing crankshaft are also features of the engine.

SPECIFICATIONS OF NASH-HEALEY LeMANS HARDTOP

Wheelbase—108 in.
 Over-all length—178.75 in.
 width—64 in.
 height—55 in.
 Weight (approx.)—2970 lb.
 Suspension, front—-independent
 rear—coil

Engine—OHV 6
 Brake horsepower—140 at 4000 r.p.m.
 Bore and stroke—3½ x 4¾ in.
 Displacement—252.6 cu. in.
 Compression ratio—8 : 1
 Rear-axle ratio—4.1 : 1
 Forward speeds—4

Waterproof Compound for Brakes Makes Them Wear Longer

Brake linings are made waterproof and given increased useful life by a metallic compound that is applied with a brush. The linings are rasped before the compound is brushed on. After it has dried, the material is "bedded" in by driving the car for a few miles with the brakes lightly applied. The manufacturer claims brake linings last longer and have less tendency to fade and grab when treated with the compound.

British automobiles are shipped to Cape-town, South Africa, in parts and assembled in a new 110-acre plant which, it is hoped, will eventually manufacture cars entirely from South African materials.



WHAT BECAME of the SHELTER BELT?

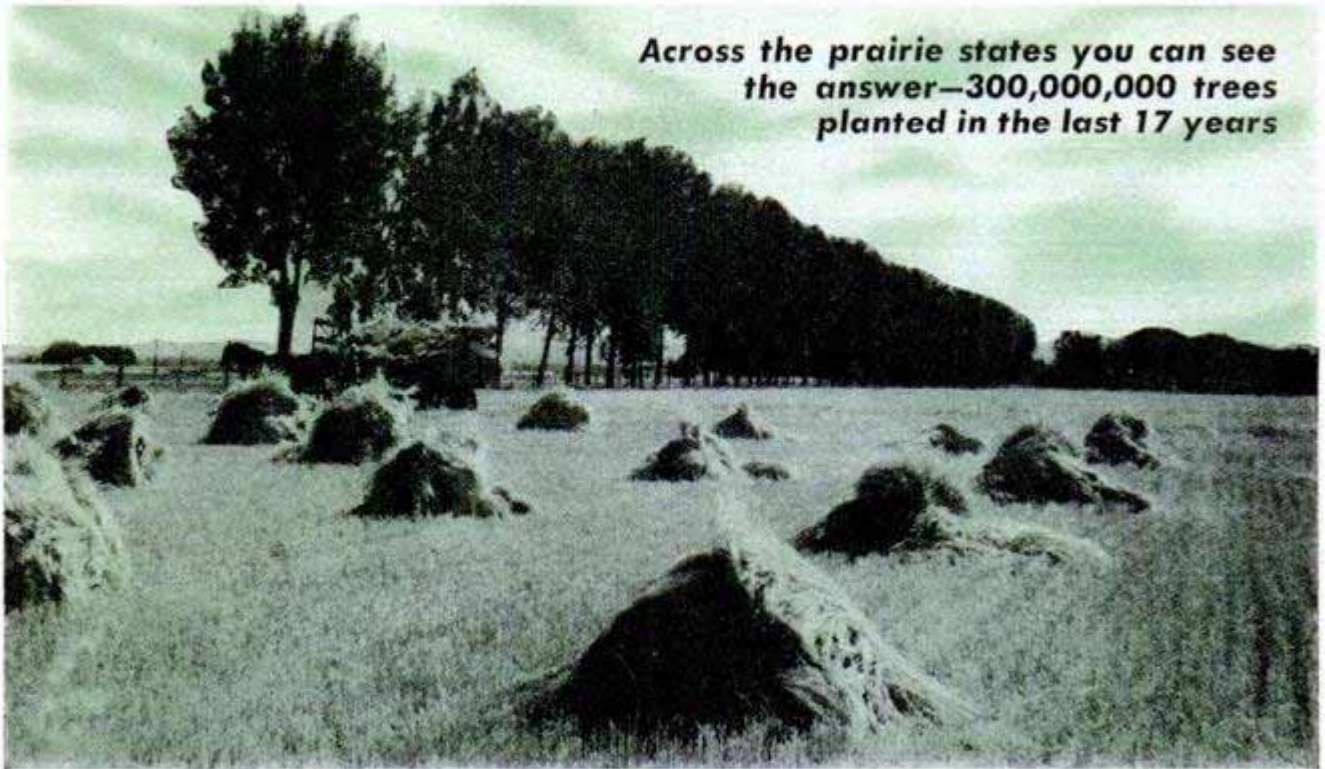

Across the prairie states you can see the answer—300,000,000 trees planted in the last 17 years

Long line of thriving trees—a typical windbreak—cuts strength of wind and whirls it up above the fields

IT WAS THE blizzard-plagued winter of 1950, and across Nebraska farms you knew the fence lines only by the waves of snow that had rolled over them. Hundreds of farmers couldn't get hay to their cattle and planes had to bomb bales to the stock. But near O'Neill, Clarence Ernst just hitched up a team each day, rumbled out to his haystacks, loaded up and fed his cattle.

By Rafe Gibbs

Ernst had easy sledding because of the mile of shelter-belt trees on his farm. The haystacks on the lee side of the belt were protected from the storm and so were the cattle.

Ernst's trees are among more than 300,000,000 which have been planted with federal aid in the last 17 years in Nebraska and neighboring states. They form shelter belts, or windbreaks, that are paying off both in

Photos here and directly opposite show a fast-growing windbreak. Trees below are just getting established



winter and summer. Throughout the states of North and South Dakota, Nebraska, Kansas, Texas, Oklahoma, Wyoming and Montana—where the wind in many parts blows only one way: Hard—more than 20,000 miles of windbreaks on more than 80,000 farms have been planted since 1935.

The man who would really smile broadly at these figures, if he were still alive, is President Franklin D. Roosevelt.

The story that broke July 1, 1934, stated that Roosevelt had approved a Forest Service plan, officially known as the Prairie States Forestry Project. A hundred windbreaks, each seven rods wide, were to be planted in a belt of land with a total width of 200 miles. This belt was to start in the middle of North Dakota and run south for 1200 miles in an almost straight line into the Texas Panhandle. Embraced were 20,000,000 acres of which 1,820,000 were to be devoted to the planting of trees. Time to complete: 10 years. Total-cost estimate: \$75,000,000.

That was in the dust-bowl and depression days of withered grain and money. Not only was much of the farm land in the prairie states blowing away, but yields from what was left brought little return. It was figured that 90 percent of the \$75,000,000 would go to farmers largely for the employment of labor for plowing, fencing, planting and caring for trees. Also for the acquiring of some land. The trees were to be supplied free to the farmers.

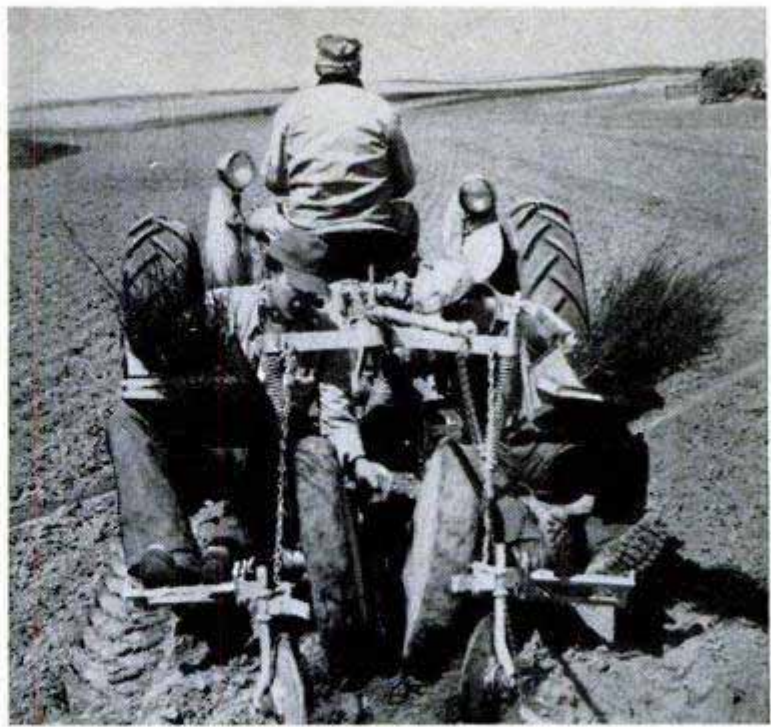

Tree-planting machine, available from the Soil Conservation Service, plants and packs dirt around 3200 trees in one day

Considering the time and situation, the idea of the vast belt of trees made sensational reading. Whether Roosevelt himself actually envisioned an unbroken line of trees is uncertain. It has since been learned that Forest Service officials never did, but for awhile at least, they were stuck with the original conception implanted in millions of minds.

There was no question that something was badly needed to help bridle the winds; to curb the shifting soil of farm lands; to keep the snow in areas where it was vital for spring moisture; to raise the water table of the soil around the trees; and also to give

Same farm view three years later shows how trees have flourished. They must be cultivated like other crops

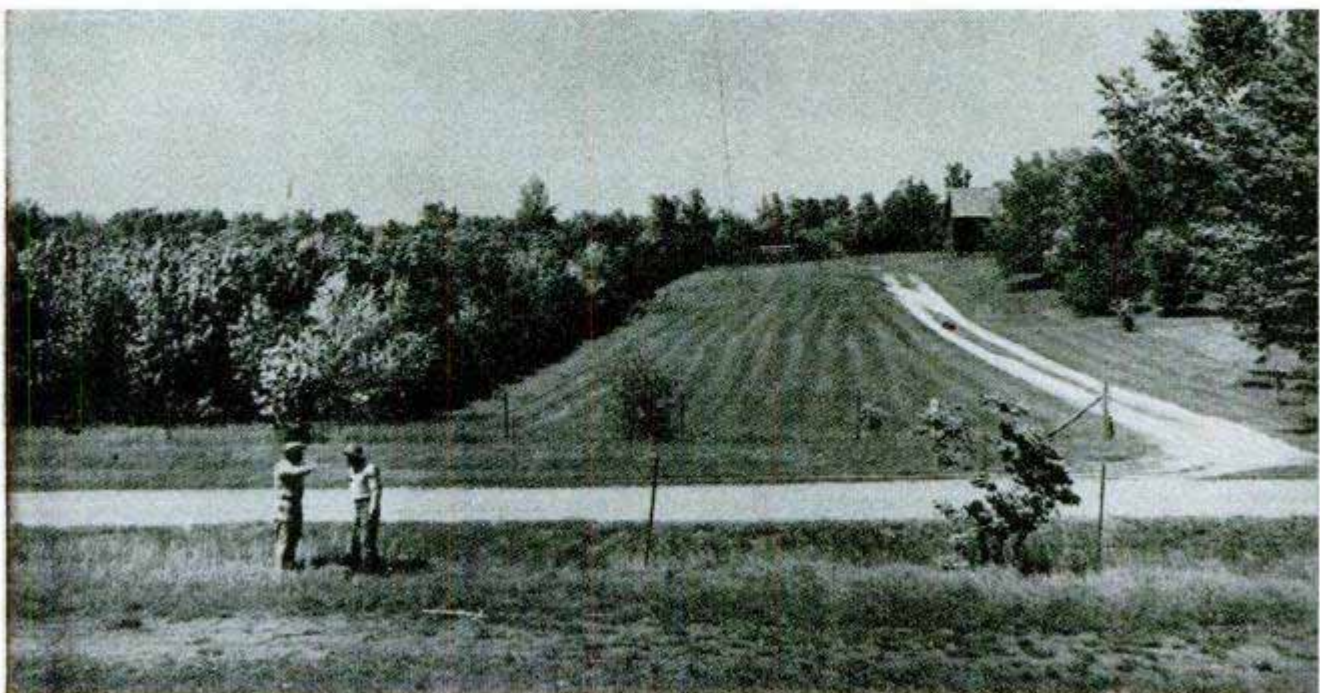

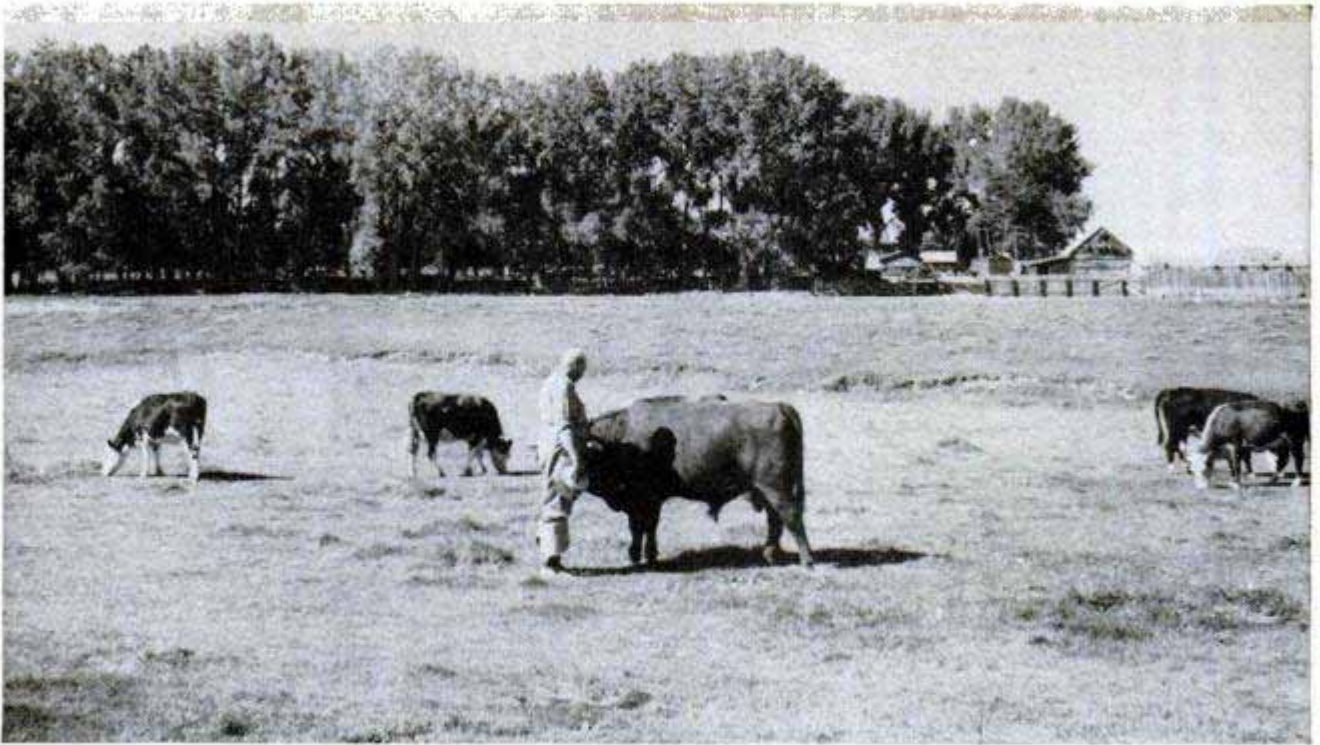

Here's a windbreak, old-style: Lofty cottonwoods grew from branches buried in furrows by the early settlers

jobs to the many jobless of that depression period.

Researchers had found that tree belts reduced the average wind velocity between strips by 35 percent in the summer and 20 percent in the winter. Evaporation of moisture between the strips was cut 30 percent. The Prairie States Forestry Project indeed seemed to be just what the middle states were waiting for.

Enough money was allocated from Roose-

velt's emergency funds to get the project started in 1935, but it had not gone a year when it was deep in trouble and Roosevelt was deep in ridicule. One writer referred to the project as "Roosevelt's folly." Another as his "dream belt."

Fatalities to trees planted in the first year were reported to have run in some areas as high as 80 percent. Many farmers failed to cooperate. Others cooperated too well. One farmer said:

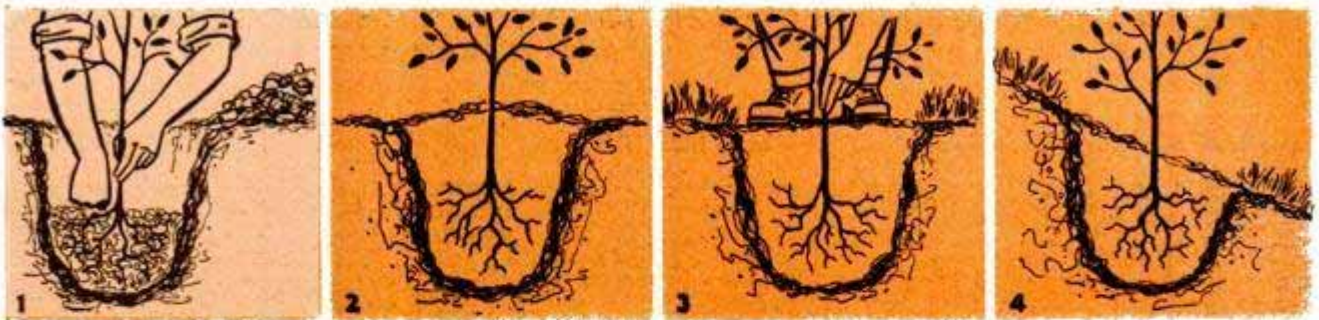

HOW TO PLANT A TREE: 1—Dig hole larger than the root structure, hold tree in position and tamp soil carefully around roots with fist. 2—Fill the hole with loose soil, heaping it above the natural level. 3—Tamp carefully with feet, leaving depression for water. 4—On hillside, continue slope of the ground

HOW NOT TO PLANT A TREE: 5—Tree has been planted too deep and the roots are crowded together. 6—Tree has been planted so shallow that some of the roots are exposed. 7—Sod, rocks or grass around the roots will dry them out and kill the tree. 8—Tree too deep on hillside will be covered by soil rolling from above

Drawings made from U. S. Forest Service sketches

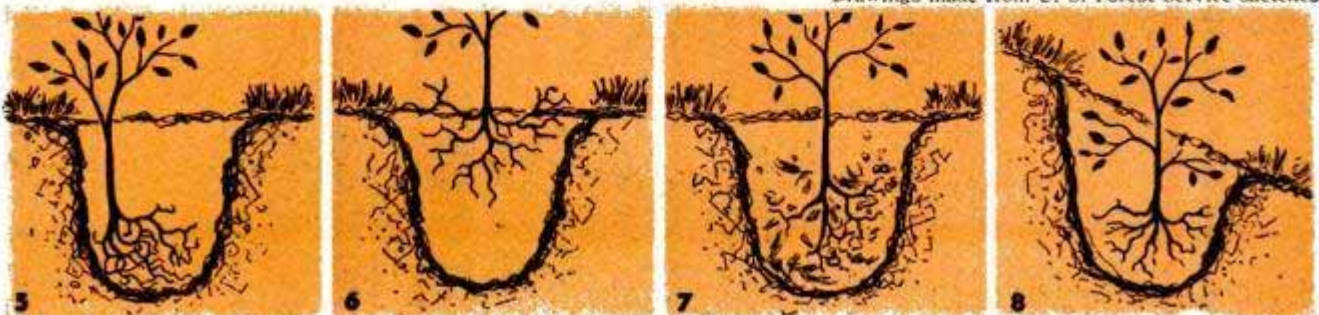

"I've got six different government agencies helping me now. I know trees won't grow on my land, but why not let a seventh agency try to make 'em and give me a job in the bargain?"

In 1936, Congress failed to appropriate \$1,000,000 requested in continuing funds, and the government was left holding a huge bag of 60,000,000 seedlings ready for planting. To let the trees out of this bag, Congress had to appropriate \$170,000 for the chore of giving them away to farmers.

Did the project then fold? Not by millions of trees, it didn't. Roosevelt dug into WPA funds year after year, and told the Forest Service: "Plant more trees."

Meanwhile, there were other important developments. The Forest Service made it clear that the idea of a continuous belt of trees was a misconception. The so-called shelter-belt zone was only the area within which the Prairie States Forestry Project was to operate. The plan was to plant field shelter belts to protect individual farms within that area, with the exception that all of the farms within the zone would eventually have adequate tree protection against the winds.

Also, the critics were rapidly becoming less critical. Thousands of trees that had been thought dead were perking up. So was Congress. In 1942, it thought enough of the project to appropriate money directly to maintain its administrative setup.

But before the year was over, the Prairie States Forestry Project was officially terminated — without loss of honor to the Forest Service. The United States was deep in World War II and many governmental shifts were being made. Federal responsibilities for helping farmers and ranchers in the Great Plains with tree planting were transferred to the Soil Conservation Service.

The final report of the Forest Service was a most creditable one. Its plantings from 1935 to 1942 covered 238,212 acres on 30,223 farms. They numbered 218,378,352 trees to form 18,600 miles of shelter belts. Of the belts, 78.4 percent were rated good or better; only 10.4 percent unsatisfactory.

And even as the war progressed



Soil Conservation Service photo

To insure growth, shelter belts are cultivated two or three times a year until trees are big enough to shade surrounding ground

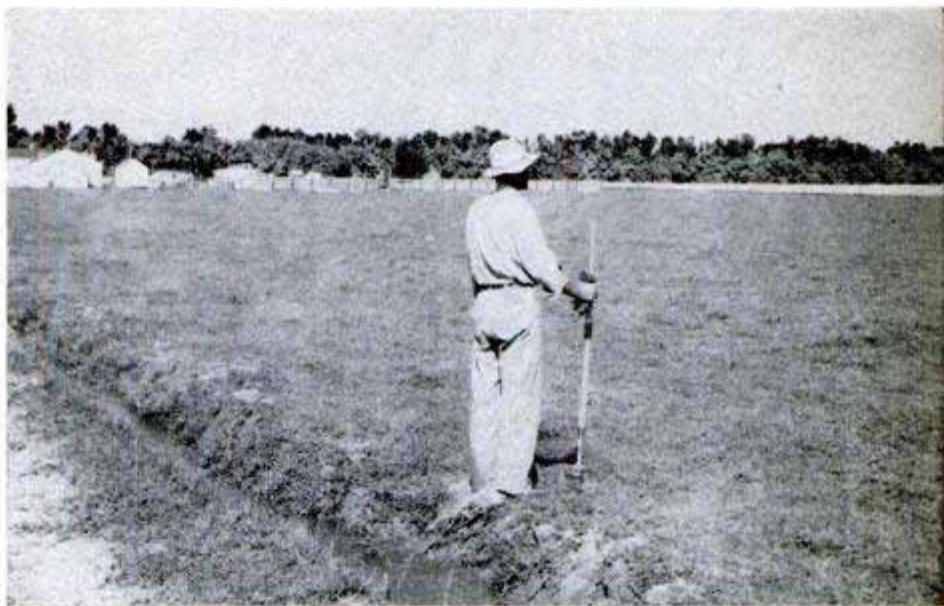

Twelve years ago this Wyoming farmer didn't have a tree on his land. Now he has a fine windbreak that stretches across horizon. [Most windbreaks have been planted in straight rows, but some farmers now plant in curves corresponding to cultivation pattern





Aerial view shows how shelter belts can protect fields in summer, highways and farm buildings in winter. Below, belts have become so popular some farmers have started their own nurseries. This one is in Idaho



so did the planting of trees—under the guidance now of the Soil Conservation Service.

The SCS was no novice organization at tree planting. Since 1934 the SCS has been aiding farmers and ranchers in the planting of field shelter belts, farmstead windbreaks, feed-lot windbreaks, wildlife areas and gully-control plantings as parts of complete, coordinated soil and water-conservation plans. Explains A. E. Ferber, regional forester for the SCS at Lincoln, Neb.

“The old Prairie States Forestry Project idea hasn’t changed much, except that it’s now on more of a cooperative basis. The Forest Service used to plant trees using WPA crews; the SCS did the same, usually with CCC crews. Today the farmers handle the planting themselves through rental of tree-planting machines with two-man crews from their soil-conservation districts.”

Not only that, but farmers and ranchers now are procuring more than half of the trees themselves. They furnish the land to start with, then cultivate it two or three times a year after the planting until the ground is completely shaded.

And this system of giving root to the land has spread far beyond the reaches of the so-called prairie states. It is going strong, for instance, in the Rio Grande Valley in Texas, in northeastern Arkansas and the Gulf Coast region of Texas and Louisiana. You don’t think of timbered Wisconsin as needing farm shelter belts, but it does—and is getting them. The Badger State has more than 6000 miles of such new plantings. California is now going into shelter-belt tree planting in a big way to protect its vast citrus groves.

In 1948, residents of the village of Shelly, Minn., decided to try a community shelter belt. The city fathers leased an L-shaped strip 150-feet wide and the residents planted trees in the approved pattern. Today the center trees are 20 feet high and the village already is feeling the benefits through lower fuel bills, less snow to plow and greater comfort.

Near Riverton, Wyo., D. D. Jarvis has a flourishing shelter belt dominated by Chinese elms and Russian olives. The SCS helped him get started in 1940 with the windbreak which now rises high above his farm buildings. Jarvis came to the newly irrigated section of Wyoming 14 years ago from a wind-swept area in Nebraska, and he needed selling on tree planting.

“My windbreak is a quarter mile long and covers about two acres,” says Jarvis. “That acreage is the most valuable I’ve got. If it weren’t for those trees, the wind would blow my farm right off the map. And in the spring the trees make a man mighty glad

(Continued to page 238)

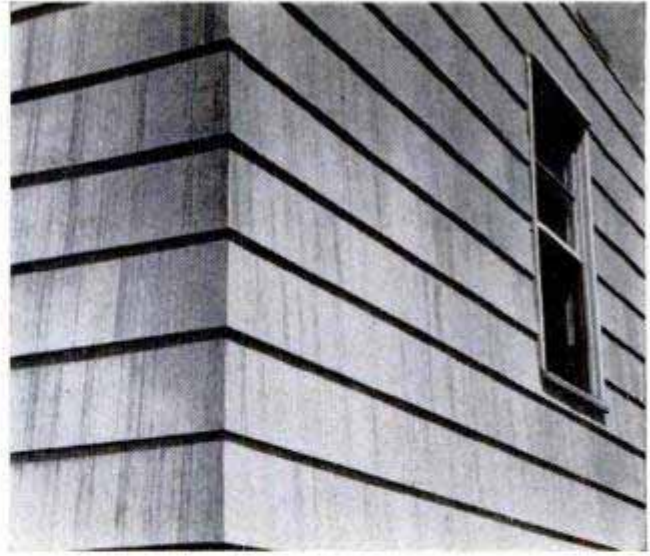
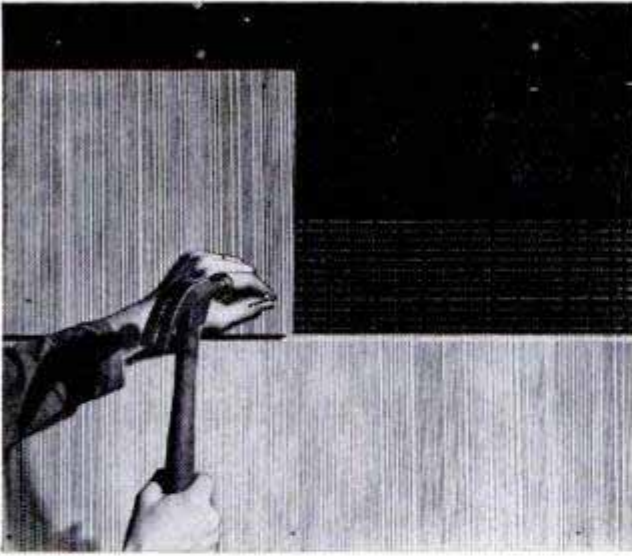

Asphalt Strip Applied to Sheathing Gives Siding Deep Shadowline

Nailed directly to the sheathing, an asphalt-composition strip is used as an underlayer for shingled or lapped-siding walls. It not only provides increased insulation and more protection from the weather, but it

also is tapered to move the lower edge of the shingle out, making a deeper shadowline. The bottom half of the composition strip is ridged to a thickness of $\frac{5}{16}$ inch and the over-all size is one by three feet.

Quickly Mounted Pump Makes Truck or Tractor a Fire Fighter



Mounted in three minutes, a centrifugal pump which connects to the crankshaft of a truck, or attaches to a tractor, transforms a vehicle into an auxiliary fire fighter. One large fire hose connected to the water supply attaches to the front of the pump. Water under pressure is supplied the firemen by a second hose. It is in use in Germany.

Telescoping Desk Adjusts to Fit Child or Adult

Designed to "grow with the child" is a study desk for school or home which has a telescoping tubular-steel framework. Seat height may be varied between 12 and 18 inches, desk height between 21 and 30 inches, and the distance between seat and desk a total of five inches. Seat depth and height of the back rest are also variable. Thus, the desk accommodates anyone from a small child to a full-sized adult. A large steel book box which is topped by a hinged wooden-lid writing surface holds 15 books and a lunch package.

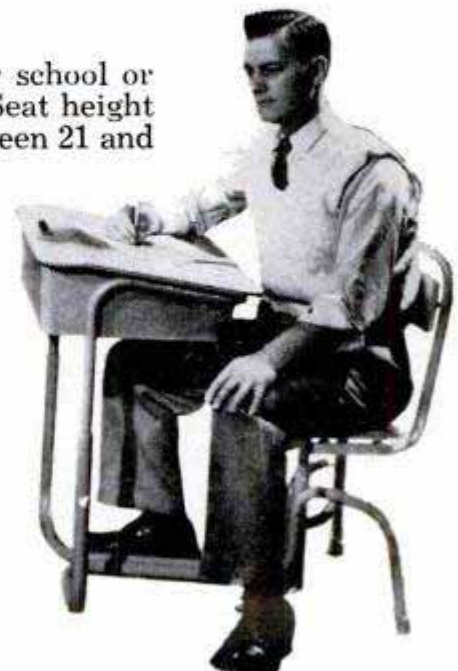
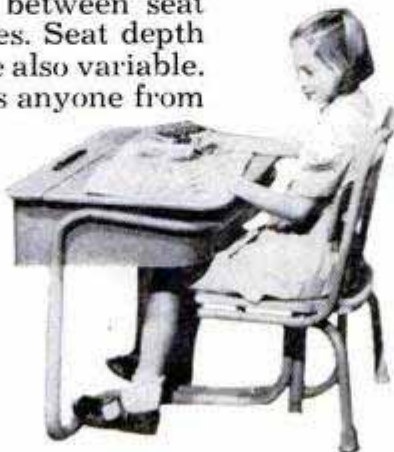

Busiest railroad junction in the world, claim the British Railways, is their Clapham junction, where 2500 trains pass every 24 hours.

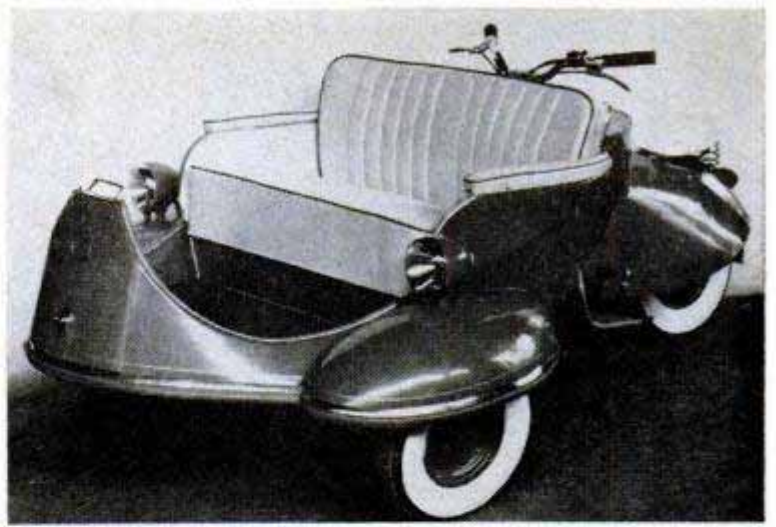
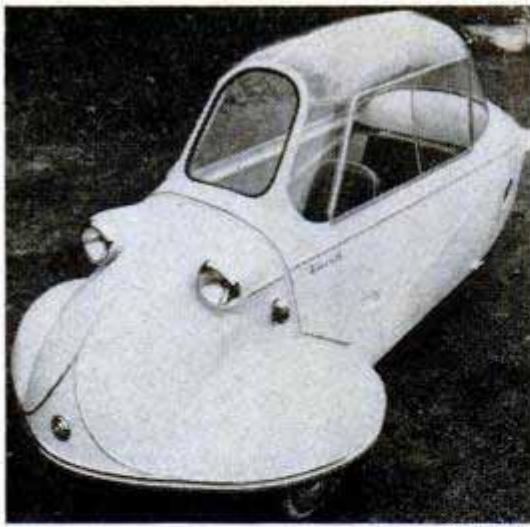

German Aircraft Manufacturer Now Builds Small Automobiles

Famous as an airplane manufacturer, Dr. Willy Messerschmitt of Germany is now building a line of small vehicles. One is an extremely small car that seats two persons in the same manner as a light plane—one behind the other. The all-plastic top swings upward like the lid of a suitcase for entry of the driver and passenger. The car's tiny

engine drives it along at about 45 miles an hour. Another Messerschmitt creation is called the German taxi and has a wide-open front seat for two passengers. The driver sits in the rear on the power plant which is designed like a motor scooter. A canvas cover is available for the passenger compartment for protection from sun and rain.

Seismograph May Prove Earth's Core Is Molten

Is the earth's core molten, or solid? That's a question a new seismograph developed by Columbia University may soon settle. First indications are that it's molten. The machine, an "ultra-long-period vertical seismograph," measures the extremely long and penetrating waves of a major quake. The first major test was during the Kamchatka quake of Nov. 4, 1952, which shook the earth for 20 hours. One group of shock waves traveled completely around the globe eight times, a distance of about 182,000 miles. The shorter waves, which did not penetrate the earth deeply, increased in velocity as they went deeper, indicating that the density of the earth's crust increases to a certain depth. But the extremely long waves, which the scientists believe penetrated the earth's core, slowed as they reached the center of the earth. If the center were solid, the waves should have increased in velocity.

Too Tough to Die!

That's the tribute paid the invincible old Ford Tri-Motor by an aviation expert. He recently took a nostalgic hop in one of the old-timers (remember their "barn roof" skin?) and comes up next month with a long look at one of the most fabulous contraptions in the history of aviation. You will find it in the June issue of *Popular Mechanics*. Don't miss it!

Lightweight Motorcycle Weighs Only 175 Pounds

Hailed as the "newest and safest" of motorcycles is the low-slung English Commander. The lightweight machine weighs only 175 pounds, but its radical design reportedly makes it tops in road safety. It was recently shown at London's cycle and motorcycle show.





Detroit Listening Post

By Siler Freeman

THE POPULARITY at auto shows of the plastic-bodied sports cars, with which General Motors is experimenting this year, has hurried Chevrolet into production of its Corvette. Plans call for production to begin in June with a first-year schedule being estimated at 300 to 1000 units.

Bodies will be of plastic (glass fiber) as was the model shown to the public at the auto shows. They will be made for Chevrolet by an Ohio plastic company. Prices are not definite yet. Estimates range from \$3000 to \$3500 with bets being on the top figure.

The stepped-up Chevrolet engine in the Corvette will have three carburetors to give it 160 horsepower. Although sports-car fans may object, Powerglide automatic transmission will be standard on the car. The hand-operated canvas top will be retained as will the snap-on side windows. The untried frills, like the hydraulic trunk and hood lifts, have been eliminated from the production model.

There are many things that GM wants to find out about plastic bodies before it goes further than that. It may appear mighty expensive even to put out 300 of these cars, but for a company which once spent about \$17,000,000 to tool up for a light car and then discarded the whole idea, it's a trifle!

But the sports car is not just another experiment—experimental though the Corvette may be. It is looked upon as a development and much more time, money and effort will be going into the field. Eventually, steel-bodied sports roadsters will emerge for the market in a serious way.

Like the hardtop convertible, the sports car may develop a much broader appeal than it has now. Originally, the hardtop was aimed at a small segment of the market, those who like the outdoorsy look of the convertible but who didn't want its drawbacks, including the higher price.

But the public took to it even beyond the expectations of manufacturers. It has become so established that the hardtop line now includes sedans as well as coupes. It is getting a bigger share of scheduling.

Studebaker may be cited as conducting a similar experiment with sports cars. It has two lines, one being the low-silhouette

sports line. It is not truly a sports car, but it has some of the attributes that make the sports car attractive and it appeals to more than the hard core of sports-car fans.

And don't think it hasn't opened the eyes of some competitors. They are watching public reaction to Studebaker's pioneering efforts. The South Bend company has shifted its production schedules to put more units into the hardtop or sports line and away from the more conservative regular line.

So, as in the case of the hardtop, other makers may join the trend toward the low, sporty look. It means some altering of the public taste and in some quarters there are pessimistic predictions of another flop like the Chrysler Airflow. But right now, the betting is the other way.

Studebaker had some difficulties with its sports line. It was a long time in getting into full-scale production because of difficulties with body dies that tore the steel sheets. The problem was ironed out, finally, about a month after dealers had been scheduled to show the cars publicly.

While the trend to V8 engines has been definite and prolonged, some manufacturers who had rushed plans to substitute them for present eights and sixes have slowed down. Tooling is more available, but they have discovered that sales are not entirely dependent upon engine shape where there are other compensating features.

A significant advance in 1953 (the model year with more changes than any in auto history) is the variety of optional-accessory equipment that has real value to the owner instead of merely providing the dealer an added source of revenue. As W. S. James of the Fram Corporation told the SAE:

"Such accessories provide the means of accelerating development and reducing the cost of items usually available only in high-priced cars."

Power steering, James said, will be simplified by manufacturing experience. This will cut the time required to make it standard equipment. Turn signals have just about completed the change to standard equipment and automatic transmissions are midway. Power brakes may follow.

THE OWNERS

average for poll was 1149 miles

POPULAR MECHANICS OWNERS POLL CONDUCTED BY FLOYD CLYMER

Speedometer reading 3714

1. I own a 1953 Plymouth:

Cranbrook Cambridge

2. I use regular gasoline

Premium (high test) gasoline

3. Average gasoline mileage in city: 17 m.p.g.;

in country: 19-20 m.p.g.;

4. Oil consumption: One quart every 650 miles.

I change oil every 1000 miles.

5. My Plymouth is equipped with:

Conventional 3-speed transmission
Conventional transmission with overdrive

Yes No

6. Would you like an automatic transmission in your Plymouth?
If so, what type would you prefer?

Excellent

Good

Unsatisfactory

7. Roadability at high speeds:

Excellent

Good

Unsatisfactory

8. Maneuverability in traffic:

Excellent

Good

Adequate Poor

9. Acceleration:

10. What is the most satisfactory cruising speed of your Plymouth? 47-55 m.p.h.

11. My main reasons for buying a Plymouth: I travel around 35000 miles a year and must have an economical car which I can depend upon. Plymouth cars have given me dependable service with little or no cost for repairs in the past. Future??

12. Which engine would you prefer in your next car?

In-line 6-cyl.

V-8

13. Would you prefer overhead valves rather than side valves, as your Plymouth is now equipped?

Yes

No

14. Rate these points:

Visibility, forward:

Like

Acceptable

Dislike

Visibility, rear:

Like

Acceptable

Dislike

Riding qualities:

Like

Acceptable

Dislike

Horsepower output:

Like

Acceptable

Dislike

Exterior body styling:

Like

Acceptable

Dislike

Traction on Snow, Ice:

Like

Acceptable

Dislike

Cold-weather starting:

Like

Acceptable

Dislike

High-speed wind noise:

Like

Acceptable

Dislike

Position of gas tank cap

15. Specifically, what are your complaints on the Plymouth? Gas tank cap & ash tray in wrong place. I have written Plymouth about this. Riding qualities do not equal other Plymouths I have owned.

16. Have you ever owned a Plymouth before? Yes No

How many? nine

17. Would you buy another Plymouth? Yes Possibly No

Average Poor

18. How is your dealer service? Excellent Good

Average Poor

19. An overall rating of your Plymouth: Excellent Good

Average Poor

20. What specific improvements do you want in your next car? Put the gas cap in the middle under the license or put it back on the fender. Put another ash tray under the radio speaker, a light under the hood would be great improvement.

Write additional comments on reverse side. This questionnaire will be tabulated fairly and your name will be held in strict confidence. Thank you.

MAIL PROMPTLY TO:
FLOYD CLYMER
Popular Mechanics Owners Poll
1268 S. Alvarado St.
Los Angeles 6, California

YOUR NAME [redacted]
STREET [redacted]
CITY & STATE Valley Stream, N.Y.
OCCUPATION Salesman

Owners have high praise for Plymouth economy

Plymouth is correcting filler neck and gasoline cap

87% rated car excellent or good

by Floyd Clymer

The true test of a car begins when the owner takes the wheel. Popular Mechanics sent questionnaires to 1000 Plymouth owners. Here's what they say about their cars

REPORT on the '53 PLYMOUTH



Owners say Plymouth hugs the road well. Clymer hit this abrupt incline at high speed and agreed with them

PLYMOUTH OWNERS are a faithful bunch—75 percent of the owners replying to our 1953 Plymouth questionnaire had previously owned one or more Plymouths. An amazing 18 percent stated they had owned five or more and 87 percent rated their cars “excellent” or “good.”

Answers to our survey question, “What were your main reasons for buying a Plymouth?” included one from a Sheboygan, Wis., sales manager, who wrote: “This is my fourth Plymouth. I have gotten 84,000, 64,000 and 52,000 miles respectively on the first three without any overhaul job and none of the cars ever used oil.” A Waupaca, Wis., salesman said: “Low maintenance cost. In 105,000 miles on my last Plymouth

I spent only \$27.05 on minor repair jobs.” Other comments included:

“Best car I’ve ever owned . . . economical to operate. Front seat back needs better springs and front springs are too soft. On quick stops, front end dips down too much. These are my only complaints.” — Las Vegas, Nev., salesman.

“My ninth Plymouth and the best I’ve owned. Like most modern cars, ‘bugs’ are in all new models and assembly could be better.”—Pasadena, Calif., gardener.

“Top of horn ring annoys me by partially obstructing instrument and speedometer vision. Otherwise, the car is excellent.”—Hollywood, Calif., doctor.

One characteristic of Plymouth owners

Maneuverability is rated “excellent” by 85 percent of owners. The shorter, 114-inch wheelbase contributes to it



Percentages From PM Owners Poll

Owners of Cranbrook models.....	81%
Cambridge models.....	19%
Average speedometer mileage reported.....	2832
Owners using regular gasoline.....	75%
premium gasoline.....	25%
Average gasoline mileage in country.....	20.1 m.p.g.
in city.....	16.7 m.p.g.
Average mileage for adding one quart of oil.....	1149
for change of oil.....	1578
Cars having conventional 3-speed transmission.....	58%
conventional with overdrive.....	42%
Owners desiring an automatic transmission on next car.....	33%
Type desired: Chrysler-made Fluid Drive.....	27%
Hydra-Matic Drive.....	25%
Borg-Warner Automatic Drive... ..	8%
Other makes.....	10%
No type specified.....	30%
Roadability excellent.....	64%
good.....	34%
unsatisfactory.....	2%
Maneuverability excellent.....	85%
good.....	15%
unsatisfactory.....	0
Acceleration excellent.....	44%
good.....	47%
adequate.....	6%
poor.....	3%
Average cruising speed.....	59 m.p.g.
Owners desiring six cylinders in next car.....	60%
a V8 engine in next car.....	40%
Owners preferring L-head (like Plymouth).....	65%
overhead valves.....	35%
Owners of Plymouth cars previously.....	75%
Owners of five or more Plymouths previously.....	18%
Owners who will buy another Plymouth.....	64%
might buy another Plymouth.....	32%
will not buy another Plymouth.....	4%
Owners rating dealer service excellent.....	51%
good.....	24%
average.....	18%
poor.....	7%

OWNER'S RATING OF PLYMOUTH

Excellent.....	47%	Average.....	12%
Good.....	40%	Poor.....	1%

OWNER'S COMMENTS ON SPECIFIED FEATURES

	Like	Acceptable	Dislike
Visibility, forward.....	97%	3%	0%
Visibility, rear.....	90%	8%	2%
Riding qualities.....	90%	8%	2%
Starting in cold weather.....	79%	18%	3%
Exterior body styling.....	70%	26%	4%
Horsepower output.....	60%	36%	4%
Traction on snow, ice.....	60%	37%	3%
High-speed wind noise.....	26%	43%	31%
Position of gas filler pipe.....	28%	24%	48%

CHIEF PURCHASE REASONS

1. Economy of operation and maintenance
2. Previous satisfactory Plymouth ownership
3. Riding qualities and seating comfort
4. Styling features of car
5. Original purchase price of car
6. Maneuverability and handling ease
7. Mechanical features—engine, transmission, etc.
8. Purchase conditions—trade-in allowance, dealer service, etc.

MOST FREQUENT COMPLAINTS

1. Arrangement of gas filler pipe (tendency of full tank to spill mentioned particularly)
2. Rattles, body squeaks
3. Excessive wind noise at high speeds
4. Styling generally—interior or exterior
5. Location of rear-view mirror (too low or tends to obstruct forward vision)
6. Light weight of car—heavier car desired
7. Insufficient acceleration at lower speeds

IMPROVEMENTS DESIRED IN NEXT CAR

1. Tighter body fitting, better workmanship
2. Increase in power output
3. Automatic transmission
4. Improved styling features—exterior or interior
5. Heavier, larger car
6. Relocate or redesign gas filler pipe
7. V8 engine
8. Improved paint work and chrome trim
9. Relocate ashtray or install two on instrument panel

Improved vision and access result from door design. Right, rear-deck gas cap brought complaints of spillage





Plymouth's fast window cranking is tops but you can pinch a finger on metal trim



Clymer pulls out overdrive control. A fluid torque converter is now available for Plymouth. Instrument panel is neat, easy to read

that sets them apart from those with other makes is: They are not too favorably disposed toward automatic transmissions. Plymouth does not feature this and only 33 percent said they want some form of automatic transmission in their next car.

However, Plymouth is now offering a fluid torque-converter unit called the Hy-Drive. It is basically the same as the converter used on the Dodge, but slightly smaller. It is used with conventional three-speed transmission. The clutch pedal remains and is used for initial starting. After the shift lever is engaged, the clutch is no longer used. Like the Dodge unit, it shares its oil supply with the engine, making oil changes necessary only twice a year. Its price is \$135. The converter was announced last month, too late to be covered in this survey.

A Grand Rapids, Mich., taxi driver wrote: "In the taxicab business you have to give your customers riding comfort and that is what the 1953 Plymouth has." Another taxi driver in Tupper Lake, N. J., cited "economy of operation and later trade-in value."

A Kenosha, Wis., life-insurance agent said "I've always been a big-car owner, but since I bought a new Plymouth I have been amazed at the ease with which it handles. My gas economy is much better and yet I can hardly tell the difference in riding qualities."

Another advocate of shorter and lighter cars said, "All United States cars are too long and bulky for present traffic conditions. I drive 20,000 miles a year and Plymouth rides and handles better than many larger cars. I hope future cars will have smaller instead of larger engines."

Virtually everyone seems to like such Plymouth features as the chair-height seats, but when we asked for complaints we en-

countered one outstanding dislike. Many owners pointed out that the new Plymouth's gas-tank cap and filler pipe are so located that fuel leaks out under certain driving conditions and that the gas tank is difficult to fill. In all, 48 percent of the owners replying in the survey expressed a dislike for the new gas-tank setup.

[Plymouth engineering states that changes are being made in the filler neck and cap to eliminate this leakage. It also states that if the gasoline-hose nozzle is inserted all the way in the filler neck the tank will take the full flow of the pump without spillage.]

Other complaints, most of them minor, included the following:

"Dash light reflects on windshield at night," writes a Topeka, Kans., Air Force chaplain.

"The rear-view mirror causes a blind spot in front vision which might be dangerous."—Colorado Springs, Colo., administrative assistant.

"The dashboard ashtray is in the way of switch keys and cigarette lighter. Also, it's too small."—Fayetteville, N. C., taxi driver.

"Wind noise is most disturbing at the top of the doors."—Columbus, Wis., field man.

"I am a loyal Plymouth fan, but the Plymouth assembly line is careless; I find 10 or 15 minor things such as one loose bolt on windshield wiper, cowl wouldn't come open until fixed, bolt drilled wrong in the transmission so it must be replaced, heater adjusted wrong."—Whitewater, Wis., school executive. ("Careless" assembly lines is a complaint which crops up in surveys of every make.)

"Steering wheel is too close to driver's chest."—Smithfield, N. C., cab operator.

"Rear window is pulled down to where it



On rough, mountain roads, Clymer found Plymouth's improved suspension reduced the tendency to roll on turns

is difficult to get a complete view on rolling or hilly terrain. Lowering the mirror isn't the solution, as it is already too low."—Parlin, Colo., cattle rancher.

Favorable comments include one from a Pomona, Calif., orange grower who wrote: "I like the shorter wheelbase. It rides excellently and is easy to drive in traffic. Cars should be smaller for present highways." A Los Angeles attorney said: "Plymouth, like all Chrysler products, is one of the few modern cars a man can enter without knocking his hat off, and the seating position is comfortable. It's best of 20 cars I've owned."

Car owners always have their own ideas as to specific improvements they would like next time. Some of them for Plymouth are:

"Redesign right side of dash panel and put something useful in that space, such as a clock or a second glove compartment."—Salem, Ohio, draftsman.

"More weight. The car is too light to drive in high winds at high speeds."—Muleshoe, Tex., department-store owner.

"The front seat should be wider and just a little deeper at the back."—Topeka, Kans., soldier.

"This occurs in all new automobiles: The curved one-piece windshield does give more visibility, but when it snows the windshield wipers can't clear the snow from the driver's left as well as when the glass wasn't curved. The snow packs to the left."—Kenosha, Wis., registered nurse.

"I would like to see Plymouth come out with an economical engine. . . . At the same time, the new Cambridge body style is the greatest improvement in years."—Kansas City, Kans., printer.

Theorizing on late-model American cars is an ever-popular pastime in these surveys. This came from a Plymouth owner in Orange, Tex.: "The American motorist has come to expect a poorly constructed car and is generally prepared to remove half a

dozen rattles and squeaks, but he is not prepared (either with tools or know-how) to make body parts fit. I fail to see why the automobile companies can't turn out cars that are equal to prewar models in paint, body and trim work."

And from a Cleburne, Tex., auto-parts salesman: "It's my opinion that the average American light car wears out too soon on the inside, that it weighs 500 to 700 pounds too much and that all in all we have too much 'junk' and not enough car."

In praising his Cranbrook, a Kalamazoo, Mich., traveling salesman said: "I buy the car that gives me the most for my money. . . . I have owned and driven Chrysler-engineered products exclusively since 1924. Why? They cost me less per mile to own than any car I know."

Is Plymouth underpowered? Of the owners responding, 60 percent said they like the present horsepower output; 36 percent said it is acceptable, only 4 percent dislike it. As for maneuverability in traffic, 85 percent rated the Plymouth "excellent," 15 percent "good," and none "unsatisfactory."

More miscellaneous comments:

"I am very well pleased with my 1953 Plymouth with the exception of four items: 1. high-speed wind noise; 2. slow-speed tire noise; 3. light cushion padding; 4. weak locks on trunk and doors."—Memphis, Tenn., mechanic.

"I really appreciate the wonderful handling and parking qualities since I do much town driving and must park many times a day. The car could be a little heavier, since strong winds make it have a tendency to wander."—Ft. Wayne, Ind., salesman.

"Traction on snow and ice is the best of any car I ever drove."—Racine, Wis., pharmacist. (The survey specifically asked about this and 60 percent of the owners liked the Plymouth's traction, 37 percent said it was acceptable and 3 percent disliked it.)

"One thing I like about the Plymouth is the brakes. . . quite a bit better than other cars in the same class. However, the car is overpriced."—Monroe, Mich., electrician.

The questionnaires as a whole were returned without much comment on gas mileage, which might mean that Plymouth is satisfactory in this respect. The over-all mileage average reported was 20.1 miles per gallon in country driving and 16.7 miles per gallon in the city. Owners of overdrive-equipped cars average 2 to 3 miles per gallon more. These figures are about the same as those of other cars in the same price range. Regular gasoline is used by 75 percent of the owners, high test by 25 percent.

(Continued to page 246)

ECONOMY TEST

1953 PLYMOUTH CRANBROOK 4-DOOR SEDAN
with overdrive

MILES PER GALLON

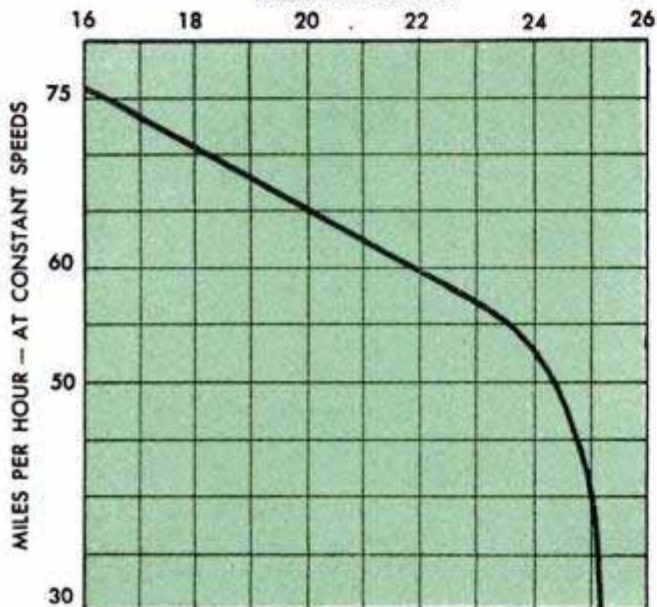

CONSTANT SPEED MILEAGE

At constant 30 m.p.h.	25.1 m.p.g.
At constant 50 m.p.h.	24.3 m.p.g.
At constant 60 m.p.h. (in overdrive)	21.8 m.p.g.
At constant 75 m.p.h. (in overdrive)	16.2 m.p.g.

CROSS-COUNTRY MILEAGE

Los Angeles to Lone Pine over winding mountain roads and Mojave Desert	19.4 m.p.g.
Lone Pine to Las Vegas, Nev. (through Death Valley)	20.3 m.p.g.
Las Vegas to Los Angeles	23.1 m.p.g.
(Non-premium gas, used from Los Angeles to Las Vegas. Premium gas from Las Vegas to Los Angeles)	

¼ mile from zero18.1 seconds

½ mile from zero (through all gears).....31.8 seconds

0 to 30 m.p.h. (low only)..... 5.2 seconds

0 to 60 m.p.h. (through all gears).....16.8 seconds

Top speed (by speedometer).....94.96 m.p.h.
Actual top speed about 6% less (speedometer variation)

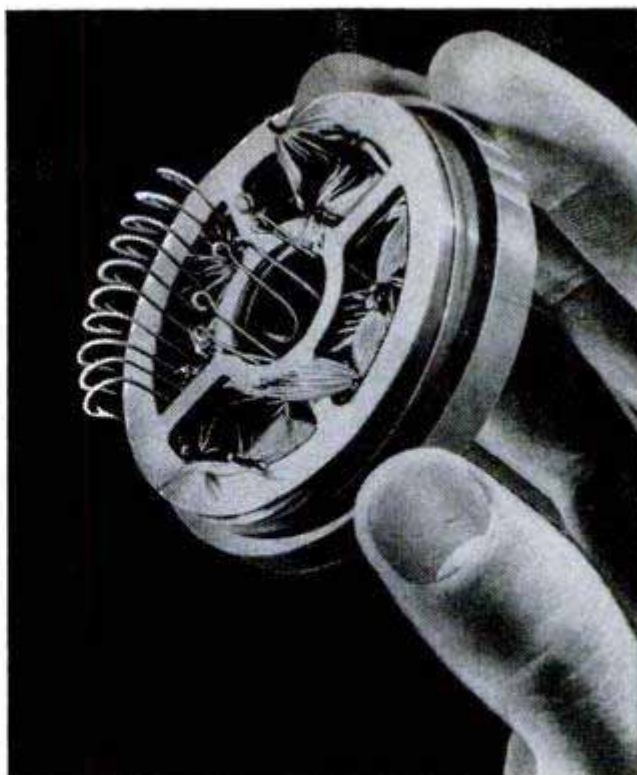

Magnetic Bin Holds Fish Flies

More than 70 hooks and fishing flies are held neatly and firmly inside a magnetic container. The cylindrical bin with a screw-on cover holds the hooks separately and vertically. Shakes or bumps won't alter their position. Built into the container is a hone for the angler to use in sharpening points and barbs.

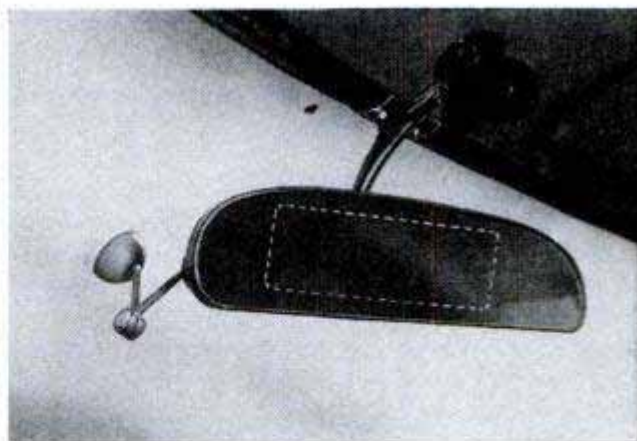

Jumbo-Size Rear-View Mirror Attached With Clamps

Attached to the standard rear-view mirror by spring clamps, an extra-large mirror provides full-width vision through the rear window of the modern car. A vibration damper that has one end secured to the windshield with adhesive eliminates jiggle and the resultant blurred vision. The plate-glass mirror is tinted to reduce glare and may be tilted up and down in the usual manner.

When child speaks into the microphone she sees the sound converted into colors. Panels below show typical color patterns for certain sounds

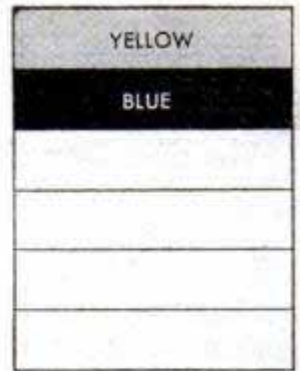

S

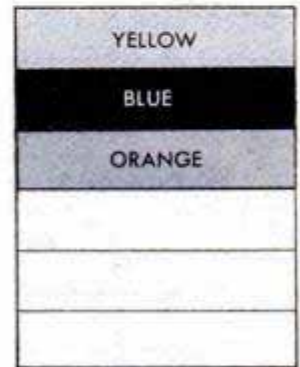

SH

Instrument Converts Voice Into Color Panels

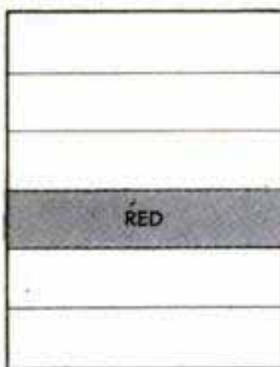

Z



E



AH

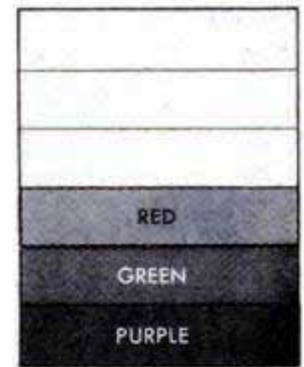

O

Speak a word into the microphone of a new instrument and your voice will be converted into a brilliant display of colors; utter another word and the color pattern will completely change. The instrument is designed to aid in speech correction. Since each sound produces a characteristic pattern of colors on the six lighted panels, faulty pronunciation can be immediately detected and corrected. The instrument is particularly valuable in teaching a deaf or hard-of-hearing child to enunciate properly.

The subject can practice by himself, and a child's interest is aroused by the flashing colors. It has been found that the color patterns of difficult sounds are retained in the child's memory, and even when he is away from the instrument he speaks in accordance with the remembered patterns. Each of the six channels in the instrument responds to a different voice frequency, and each operates a light of a different color. Some sounds operate only one or two of the panels and others activate all six colors.

Antistatic Spray Prevents Shock in Cold, Dry Weather

Static sparks that shoot between you and everything you touch on a cold, dry winter day can be eliminated by spraying a fine, colorless mist on your clothes and household fabrics. The spray, applied to clothing, chair or car upholstery, plastic seat covers and other static collectors chemically re-

moves their ability to generate a charge. One application lasts up to six months and requires less than five minutes to apply with an ordinary insect sprayer. Anything coated with it will cease to attract the dust that often collects due to an accumulated static charge.



He Harvests Minnows From Former Pasture Land

Pasture land near Camilla, Ga., now is yielding a huge harvest of shiners, a species of minnow. A flood left the land covered with ponds which soon became a shallow lake through natural drainage. Robert Hoggard, a part-time postal clerk, rented the lake from the landowner for \$5 per week. Now he's harvesting minnows, worth \$20 per thousand, and distributing them to fishing resorts through Georgia and Flor-

ida. With long poles, he places a 40 by 40-foot net in the water and lures the minnows with oatmeal. He and his assistants raise the net with pulleys and ropes, then scoop the catch into a transportable bait box. The shiners later are transferred to 300-gallon oxygen-fed tanks for transportation to the resorts. Hoggard estimates there are 10,000,000 minnows now available on the former pasture land.

Lab Model Tells H-Bomb Effects

Blast effects of an H-bomb are simulated on a model of a four-story building at Stanford University, providing new information on how buildings behave when hit by different intensities of blasts. The model building consists of four metal rectangles, one above the other and surrounded by rings, rods and gauges. Blast effect is provided by nine air-driven cylinders, four on each side of the building and one on top. Timed electrically, the pistons on the side nearest the assumed blast exert a simultaneous push against the rectangles, then the top piston presses down on the roof. Finally the building receives a push from the opposite side. The resulting distortion of the model is an indication of whether a build-

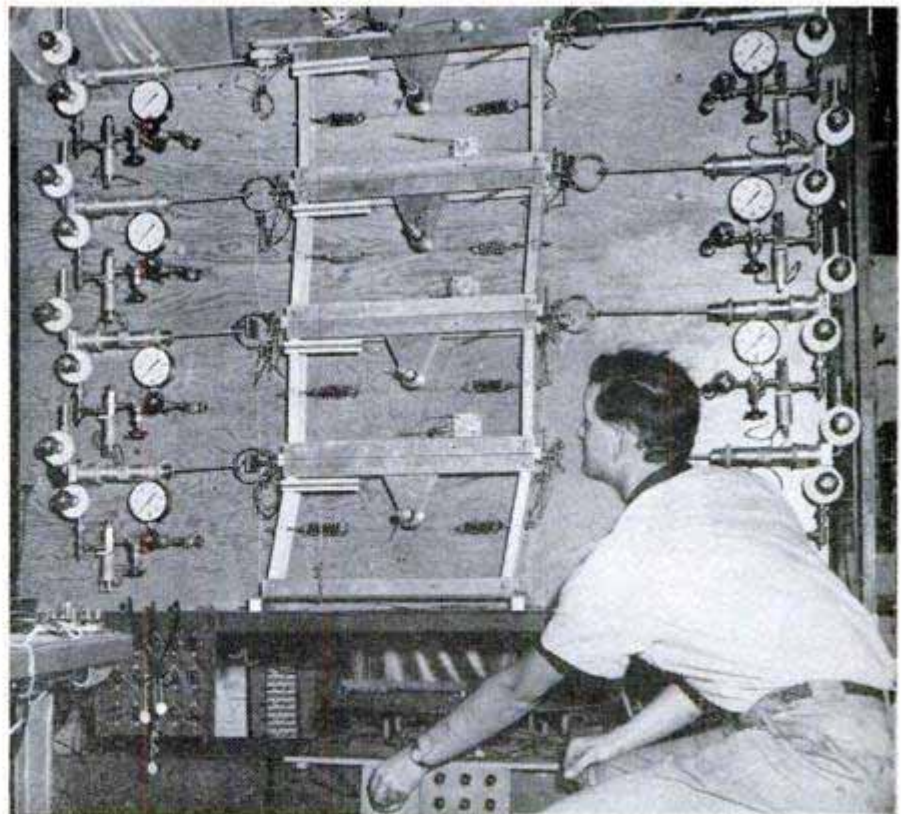

ing of a certain strength would collapse from or withstand the effects of a blast of a particular intensity.

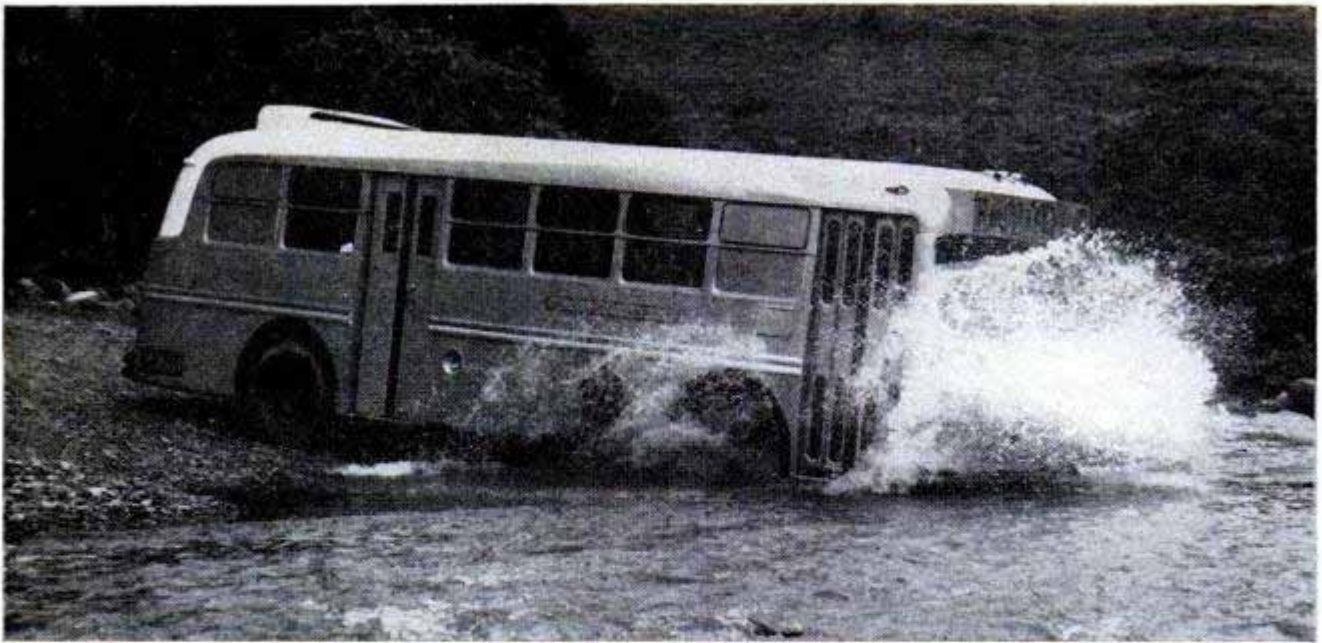

Bank on wheels fords stream en route to rural community. Units are converted diesel passenger busses.

Bank on Wheels Takes to the Road in Puerto Rico



Interior is like that of a conventional bank. Two teller's windows are provided. Below, customers queue up at bank's parking spot

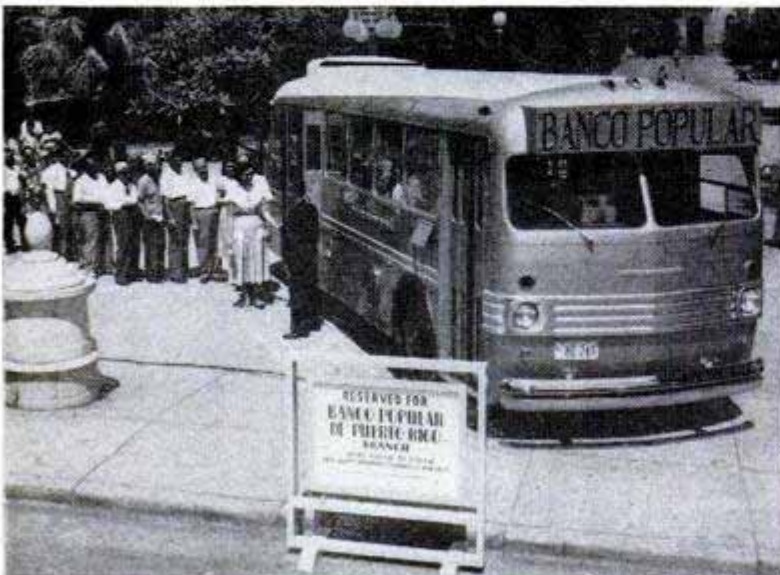

MOBILE BANKS travel to the customers in Puerto Rico where two units of a proposed fleet of 20 now serve rural areas. Eventually, 52 communities without local banking services will benefit from the system and millions of dollars of savings will be put to work drawing interest.

Equipped with their own internal phone systems that can be hooked up to regular telephone lines, the mobile banks can keep in touch with headquarters in San Juan from any point on the island, check last-minute information on investments, bond transactions, approval for "on the spot" loans and similar types of banking services. Each unit consists of a diesel-powered bus converted to include tellers' windows, a loan desk, and facilities for a bond counselor and other staff members.

Semiweekly schedules are planned to bring these units into all 52 communities at designated areas for established banking hours. Thus, banking business in many categories can be conducted at one town in the morning and at another in the afternoon, the unit returning at day's end to headquarters where deposits, loans, withdrawals and other transactions are permanently recorded. The entire system was designed and will be operated by Puerto Rico's Banco Popular.

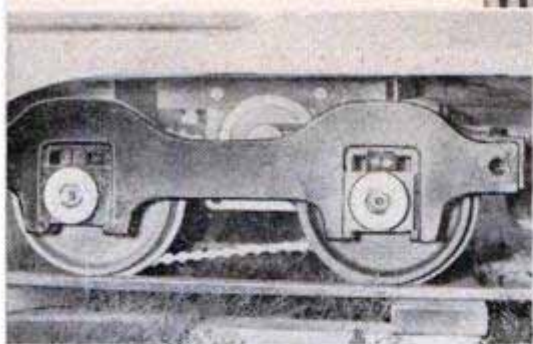

Truck assembly contains 5½-inch wheels. Dual chains connect motor, drive wheels. Locomotive and coach are constructed of ¾-in. plywood, reinforced with steel, clad in aluminum

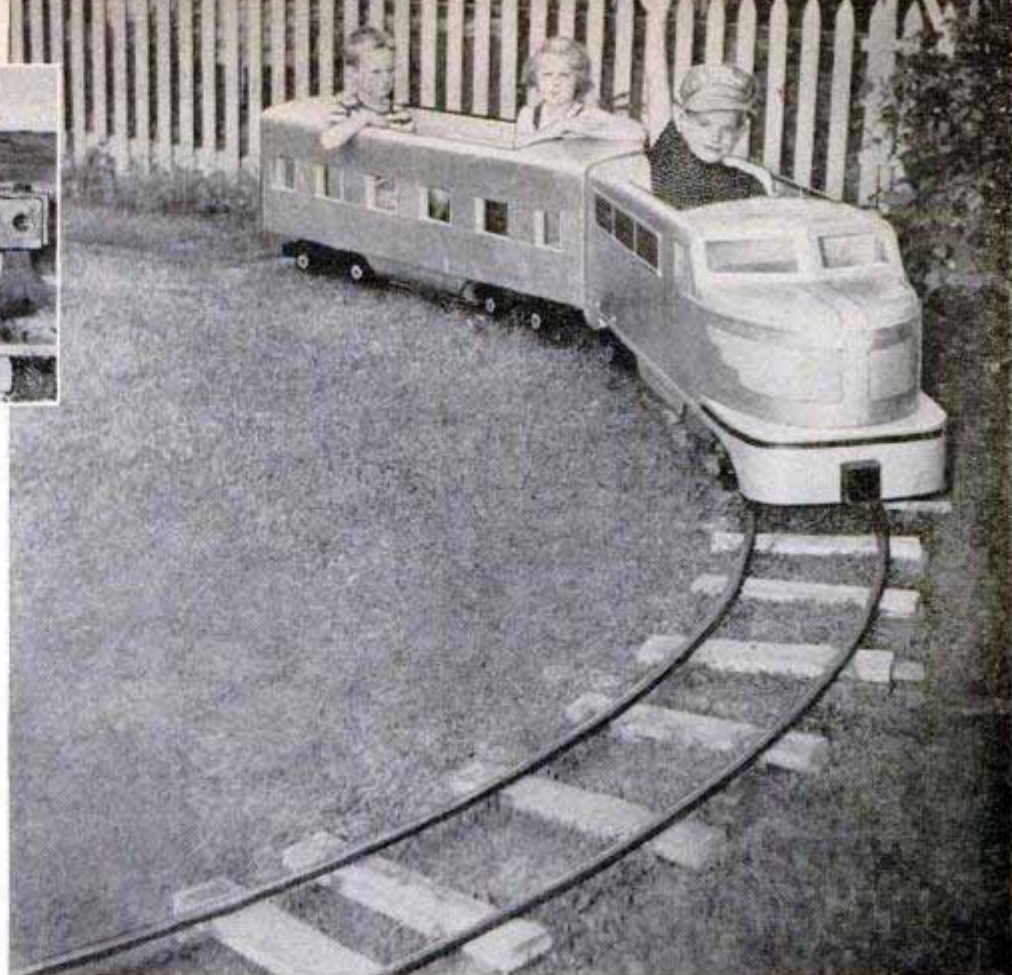

Back-Yard Express

IT'S A HECK OF A WAY to run a railroad, but Robert Ernestus, president and chief engineer of the Kent & Shorewood Lines, doesn't charge his passengers one red cent!

You see, all commuting on the K & S is on 150 feet of main line around the crab-apple tree and garage of Bobby's back yard. Besides, young Mr. Ernestus, who has yet to see his fifth birthday, operates his railroad as a philanthropy for his pals of the neighborhood sandbox society.

Rolling stock of the K & S, built by Bobby's father, A. W. Ernestus, a Milwaukee mechanical engineer, consists of a locomotive and a two-passenger coach, each 5

feet long, 18 inches wide and 2 feet tall. The aluminum, plywood and Plexiglas streamliner operates on the same principle as the big diesel-electrics that streak across the nation. A 1½-horsepower, 1-cylinder gasoline engine drives a 37-volt generator, and the generator runs the electric motor that turns the wheels. Dashboard instruments include a throttle, a forward and reverse lever and a voltage indicator. The nine-inch-gauge tracks are simply cold-rolled bar steel curved on a homemade rolling mill and screwed onto scrapwood ties. Wide open, the K & S can do eight miles per hour, and — when you're four years old—that seems like 80!

The 1½-horsepower engine is mounted behind driver's seat. Belt transmits power to generator under hood.

Forward-reverse lever is at left; voltage indicator, center; throttle and cutoff switch are at the right





Core drill obtains sample of new pavement. Contractor is paid on basis of thickness and quality

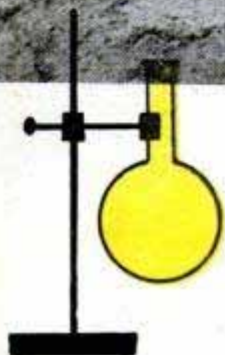

INDUSTRY'S PRIVATE

ANYONE at the Frederick S. Bacon Laboratories in Watertown, Mass., can tell you about the mystery of the pink candles. The smart detective work which broke that case illustrates the efficiency of its engineer-sleuths. Similar problems are being solved every day at commercial research and testing labs across the country.

If you ever want a job that combines the adventure of detective work, the thrill of scientific research, and the satisfaction of proving to yourself that man is still superior to the machine, get yourself a position in a commercial testing laboratory.

This machine tests toothbrushes and toothpaste. Heads of brushes are seen beneath cylindrical weights

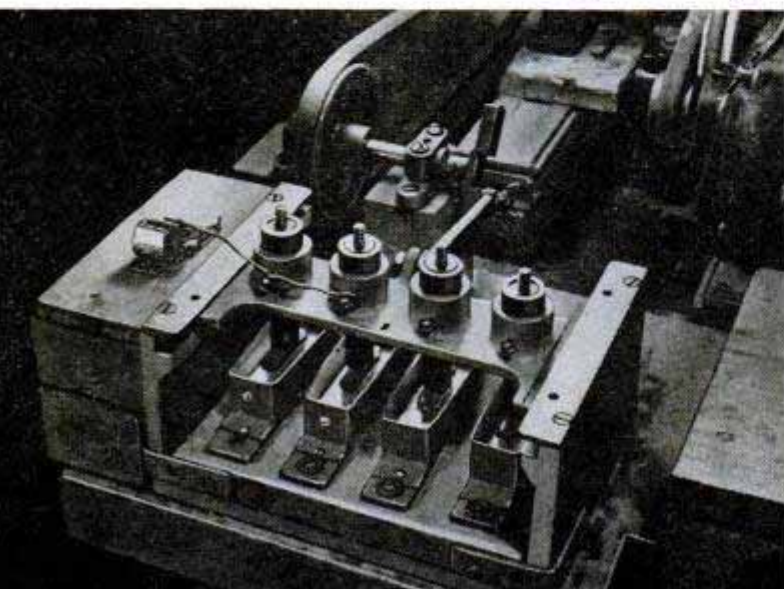

You'll get a special kick out of working there if you have an inquiring mind and know that no contraption can make a fool of you. But take warning, now. Some of them will until you track down what makes them tick—or prevents them from ticking—and you ring up another solution.

The industrial detectives who were put on the "pink candle case" admit it had them baffled for a while.

One of the laboratory clients who manufactures altar candles, traditionally ivory, found that every so often a batch of candles would slowly turn pink after coming out of the molds. Churches don't want pink candles. Engineers sent to the factory checked the quality of the raw material and took temperature readings, but found no variation which could account for the change in color. Tests showed that differences in sunlight had no effect. All equipment was checked for cleanliness, but no trace of dirt or oil drip which could contaminate the wax was found. Then a bright idea hit one of the technicians. The candles were handled by employees at several points.

"It's sweat—human perspiration—from their hands!" he shouted to his startled colleagues as they watched the candlemaking process for the umpteenth time on one particular morning.

So they ran more tests, but again the answer was "no." With machinery and em-

ployees eliminated as suspects, the engineers turned to the environment.

They began an intensive recording not only of the daily temperature, but of wind velocity and other weather data. Did more candles turn pink on rainy days than when the sun shone?

They set their figures in columns and studied them against the days when the candles turned pink. They noticed a connection between the "pink candle days" and the days when an east wind was blowing.

With this clue, and further testing of the dyestuff used to give the ivory-yellow color, the engineers found that sulphuric-acid vapors from a plant two miles east of the candle factory were combining with the yellow dyestuff to transform it into a pink dye. The laboratory's assignment was completed when it provided the client with yellow-dyestuff formulas which tests showed were unaffected by the acid vapors.

This case wasn't too unusual, although most commercial-laboratory work consists of putting new products through their paces

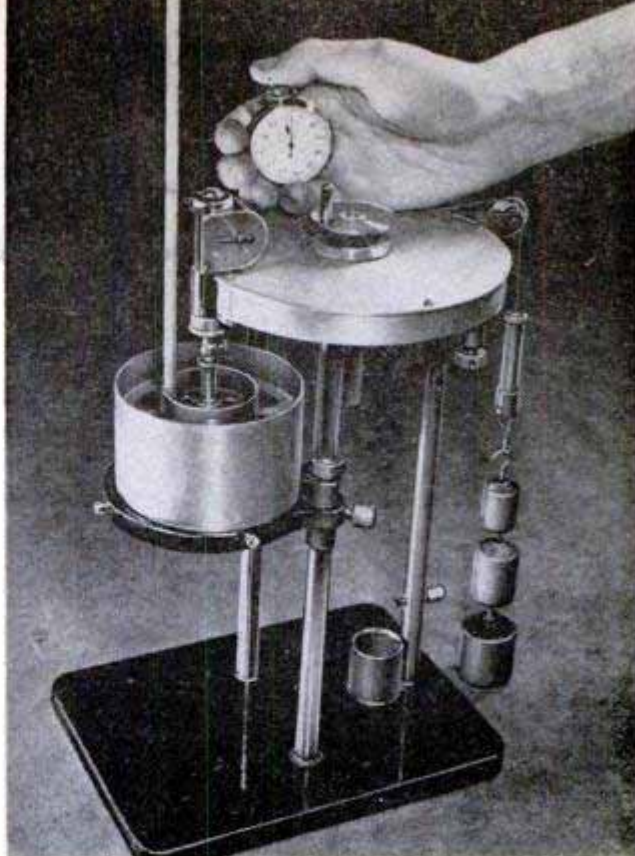

Oils and paints must have just the right consistency, which this instrument measures. Many products require day-to-day testing if quality is to be maintained

DETECTIVES

By John L. Kent

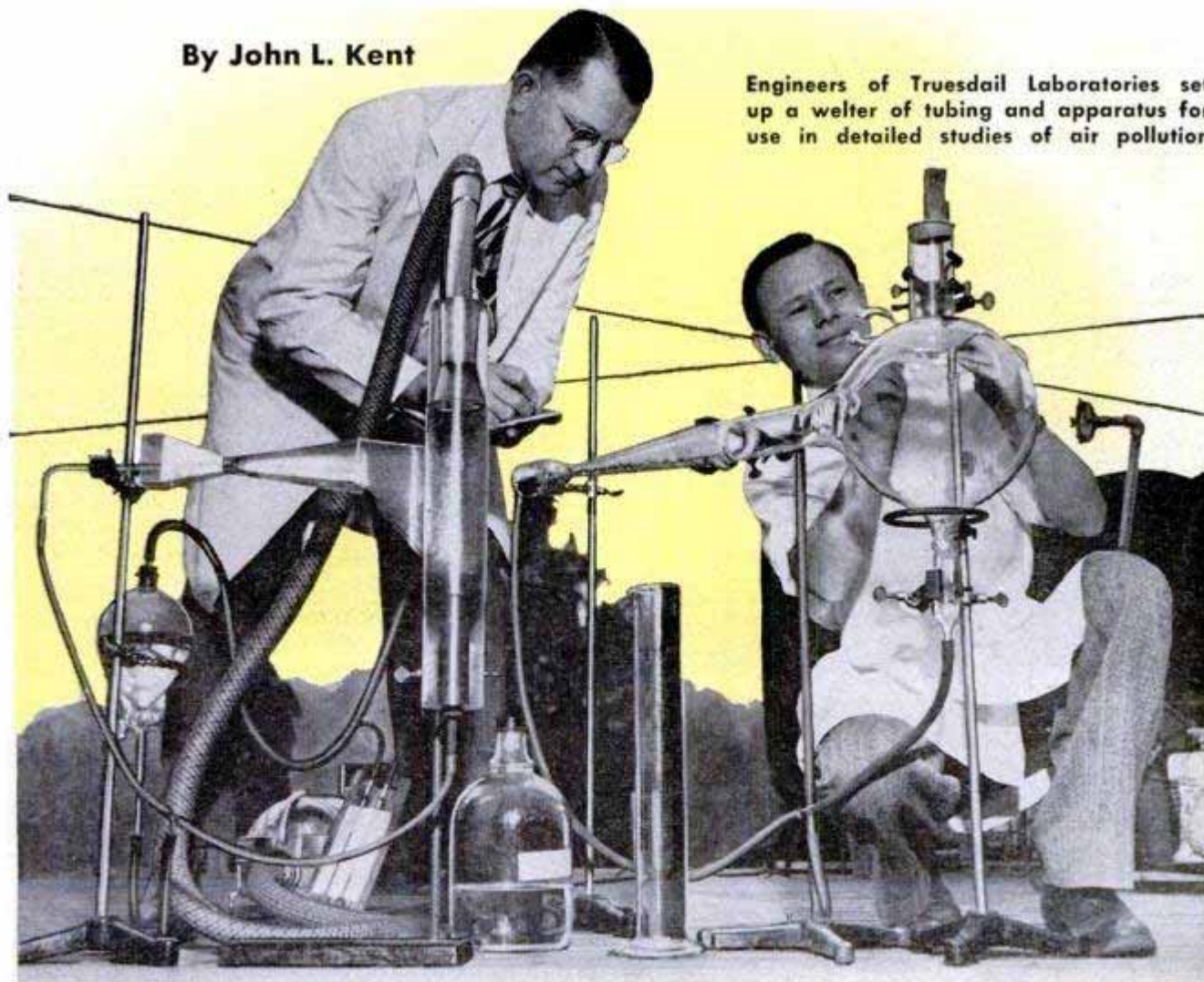

Engineers of Truesdail Laboratories set up a welter of tubing and apparatus for use in detailed studies of air pollution

and spotting the bugs in defective products. On the side, the labs solve crimes, aid the courts by unearthing scientific evidence, and answer questions which have stumped all previous experts.

Quite often a company will send its product to a commercial testing laboratory in the hope that the results will be so favorable they can be used for advertising purposes. That was the idea of one manufacturer who engaged a laboratory to test his newly developed vacuum cleaner. The laboratory bought all the competing makes of cleaners and compared them with the client's product in a dozen tests. Measured was the amount of dust, lint and dirt each cleaner collected. For one test, the engineers devised a contraption which pushed the cleaners across carpeted surfaces for a week without stopping. This told not only the durability of each cleaner, but how hard it was on the carpet.

When all facts and figures were assembled in the final report, the client's cleaner was not even among the top three! The amazed manufacturer swallowed his pride,

paid the bill and decided right then and there to improve his product. Of course, the lab's report was confidential.

Often embarrassing faults will be discovered in a product after it has been placed on the market. A manufacturer of cedar chests designed one for silverware, taking special pains in its construction to prevent the entrance of air and consequent tarnishing of silver. To his amazement and distress, the first purchasers complained that silver stored in the chest tarnished more rapidly than in the open air!

He took his problem to the Miner Laboratories of Chicago. The chemist assigned to the job studied each component of the chest and discovered that the guilty item was sulphur in the glue used to fasten the flannel lining to the wood. Sulphur-free glue was substituted and the tarnishing problem was solved.

Commercial testing laboratories are called in as fact-finders in some cases which are being prepared for legal action. Often the presumed guilty party is found blameless and the real culprit found.

Just after the hurricane in Miami, Fla., in October 1950, the South Florida Test Service was summoned to inspect a number of buildings in North Miami Beach. The paint

on the buildings was developing a serious discoloration following a flight in the area of an airplane which was spraying DDT. Residents complained that the spray from the plane was responsible.

Results of the investigation showed that only buildings painted with lead-and-oil paint were damaged. Further study showed that hydrogen-sulphide fumes generated in filled-in land adjacent to the buildings were the cause. High water during the hurricane resulted in deposition of seaweed on these filled-in lands and a few days later the gas started to generate as the seaweed began to rot.

In a Texas case, the death of several valuable dogs was blamed on an insecticide spray. The manufacturer was being sued for the value of the dogs.

At the trial, several dogs were sprayed profusely with the supposedly deadly insecticide in question, brought into the

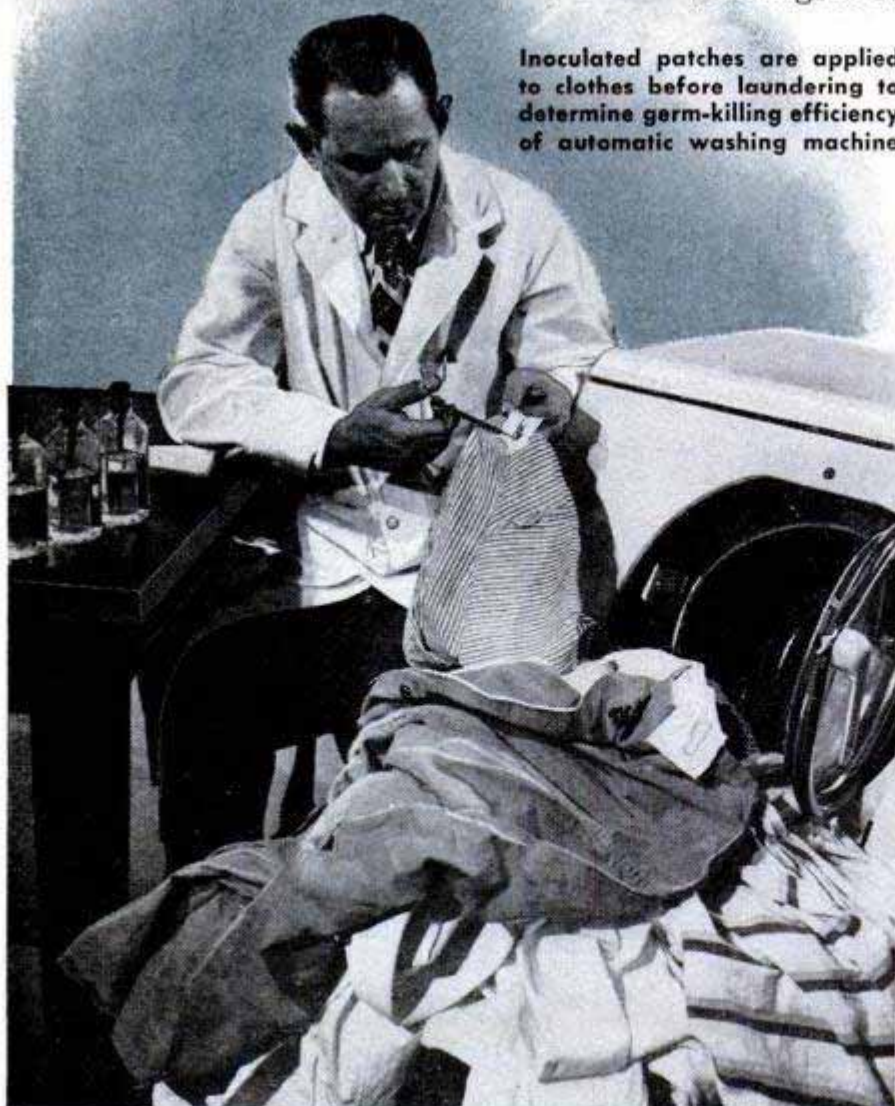

Inoculated patches are applied to clothes before laundering to determine germ-killing efficiency of automatic washing machine

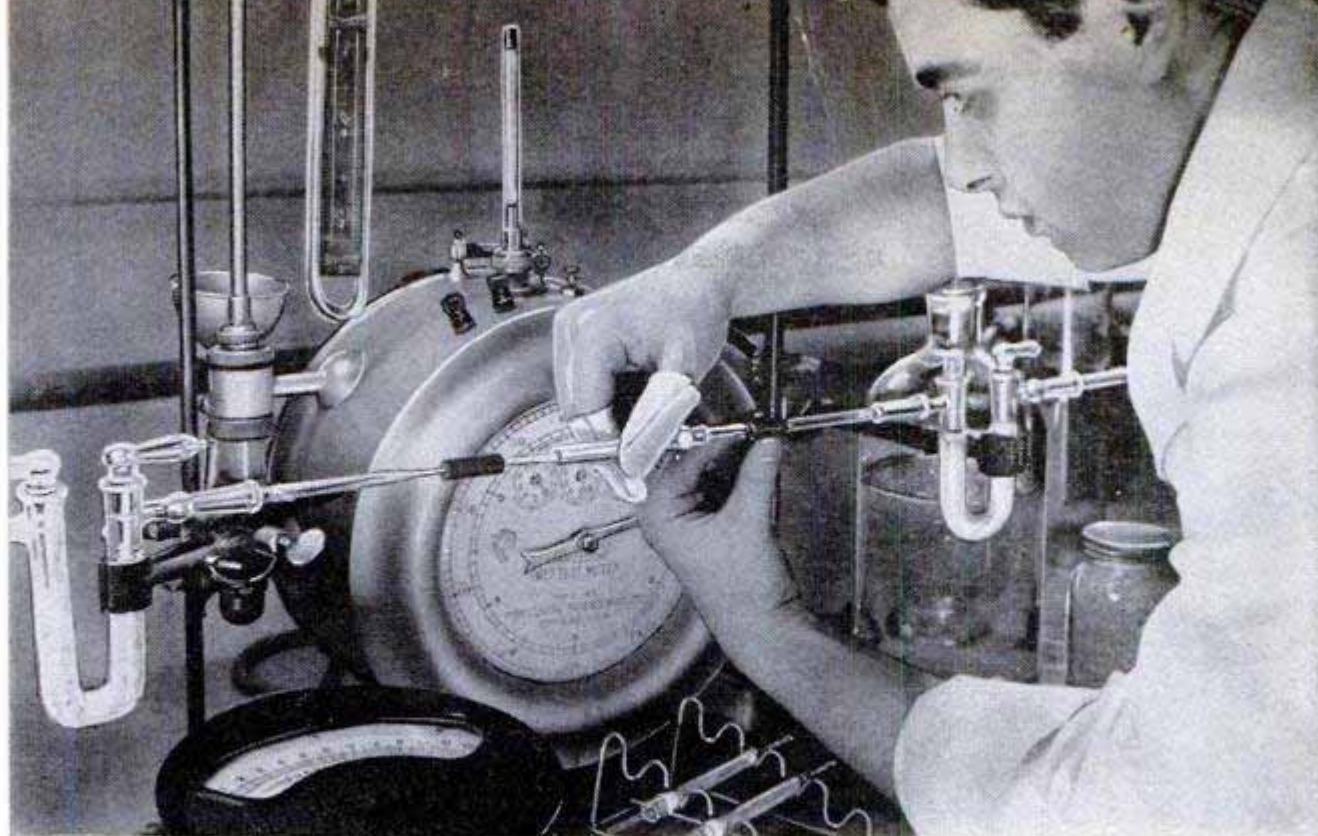

In cigarette-mildness test at Foster D. Snell, Inc., cigarettes are "smoked" and results indicated on meters

courtroom and made to sit near the jurors for the duration of the trial. The dogs seemed comfortable and left in good condition when the case was over. The jurors were convinced, and decided in favor of the manufacturer. A later autopsy of the stricken dogs showed they had died of worms.

A spectrograph owned by the Hornkohl Laboratories of Bakersfield, Calif., proved

which gun fired a murder bullet. The spectrograph "breaks down" an element into characteristic rainbow colors which are the element's "fingerprints."

The body of a woman who had been missing for three weeks was discovered in a field. A bullet had penetrated her skull and continued out the other side. The victim's

(Continued to page 244)

Mullen tester is used to discover breaking strength of paper. Meter records pounds per square inch

Will it wear? Material to be tested is placed on rotating platform which carries it under abrasives

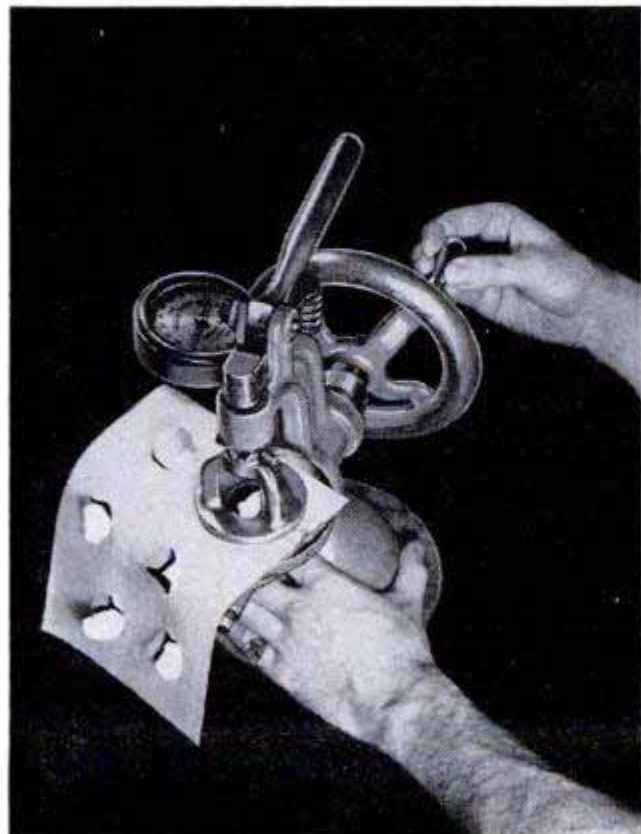

Modern Pilot Ladder Has Rungs that Allow Quick Repair

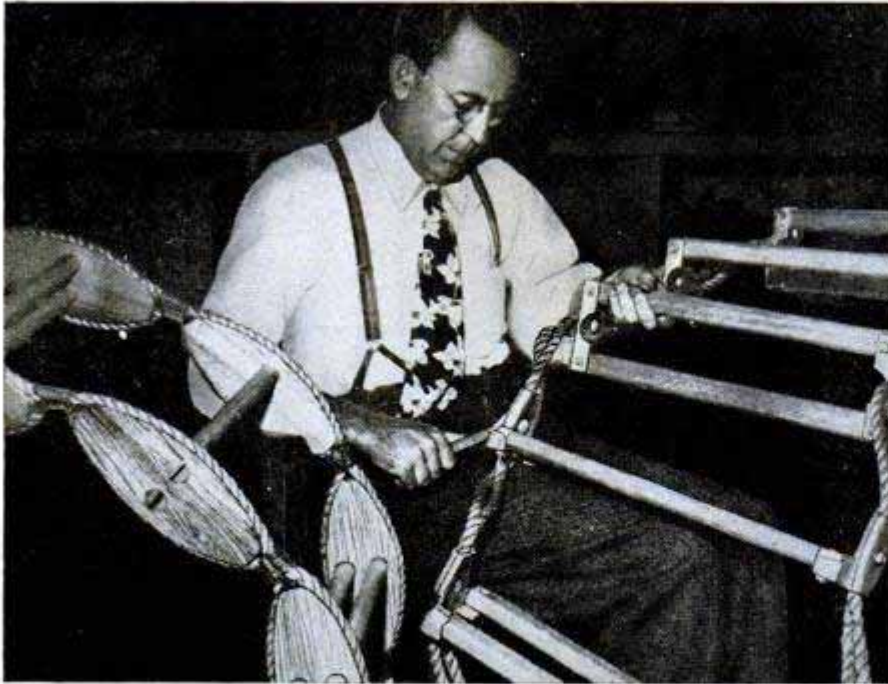

The steps, or rungs, of a new pilot ladder can be replaced in minutes and a full-length ladder built in three instead of sixteen hours. Pilot ladders, made of rope with wooden steps or double rungs, are flung over the side of a ship when the pilot is transferred between pilot boat and ship at the harbor's mouth. The older types required tedious and lengthy lashings to replace an individual step or rope, but the new ladder has its wooden rungs set in aluminum castings which simply clamp onto two vertical side ropes.

Front-Seat Shock Absorber Reduces Hazards of Automobile Crashes

Mounted directly ahead of the front-seat passenger, a rubber-coated steel frame prevents the rider from being slammed into the windshield in a crash. Manufactured in Germany, the device not only absorbs the shock of the crash, but prevents the passenger from being injured by broken glass.

☐ Airplane crashes may be reduced in the future by an automatic control system that feathers the propeller blades when an engine fails.

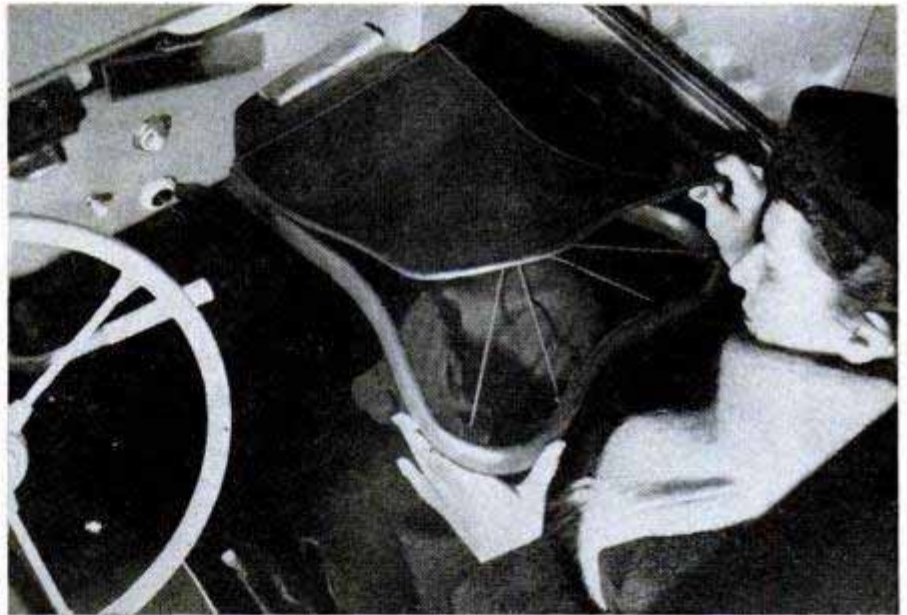

Auto-Trunk Ventilator Assures Canine Comfort

Dogs may be carried safely and conveniently in an automobile trunk that is ventilated with a simple air inlet. A hole is cut in the side of the trunk and the device inserted. Sliding inside a collar, which is bolted to the car body, the ventilator consists of a capped, chrome or nickel-plated cylinder with air slots along the sides, and may be pushed into or pulled out of the trunk to regulate air supply. Cool fresh air, free of exhaust fumes, is thus supplied to canine passengers.



Dancing Sand Detects Flaws in Honeycombed Panels

Dancing grains of sand, responding to extremely high-pitched "music," reveal defects in the bonding of honeycomb panels. Douglas Aircraft says it reduces the testing time of panels, honeycombed for lightness, by more than 50 percent. The panels are placed over a trumpet connected

to a tube similar to those used in electric organs. Sand is spread evenly over the panels and when the "mechanical larynx" vibrates, the jitterbugging sand traces a pattern closely following the unbonded structure of the panel. Sound waves from 16 to 50,000 cycles per second are used.

Giant Harvester Field-Packs Celery Crop to Preserve Freshness

Two thousand crates of celery a day are delivered by a mammoth harvester which cuts costs and packs the celery before it has time to lose its freshness. Creeping across the fields at a speed of 34 inches per minute, it keeps 24 workers busy pulling the celery out of the muck, slicing off roots and leaves and laying the bunches on the 27-foot belt conveyors, which extend from each side and a similar conveyor which juts out 18 feet

in front. Belts carry the celery under a spray of water and back to a gang of 30 workers who sort it into nine grades and pack it in paper-lined boxes or crates. The filled crates are sped over roller conveyors to a trailing truck which rushes the greenery to the warehouse for chilling and loading. A six-cylinder gasoline engine propels the heavy machine which moves over the soft fields on huge airplane-type tires.

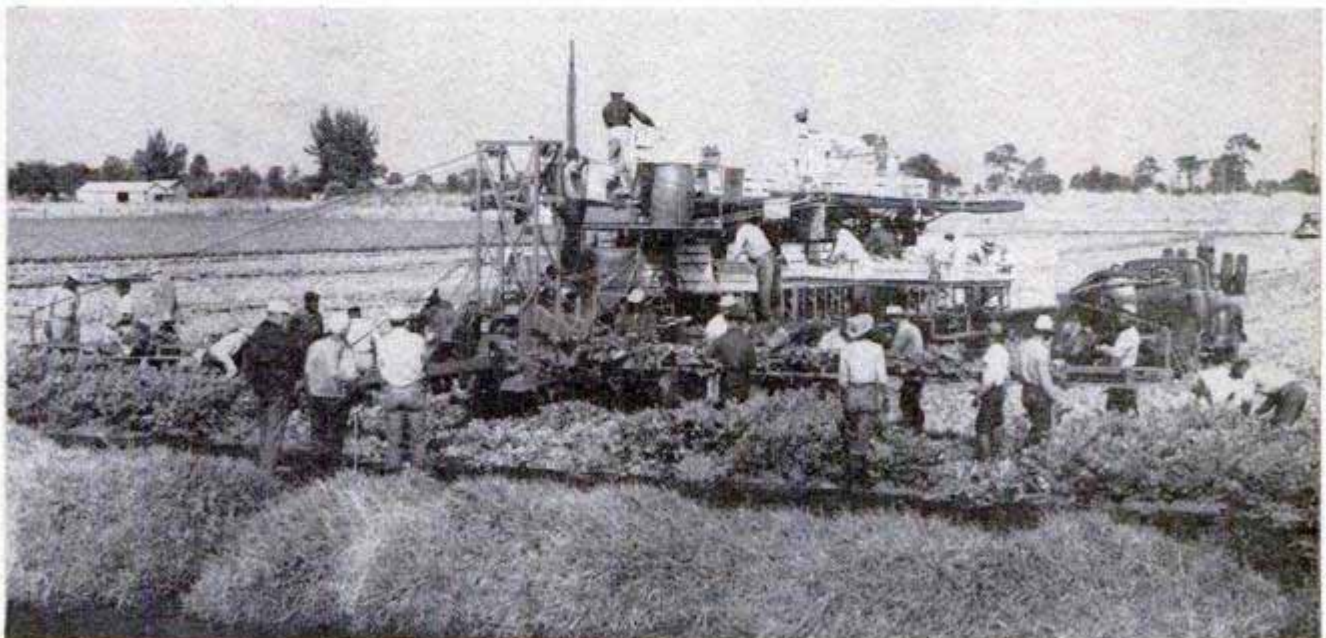

WHAT'S NEW FOR

Your Home

JUICER squeezes with one stroke of the handle, can be used to obtain vegetable puree or fruit juices. Constructed of sturdy aluminum, it is easy to clean, has handy pouring spout

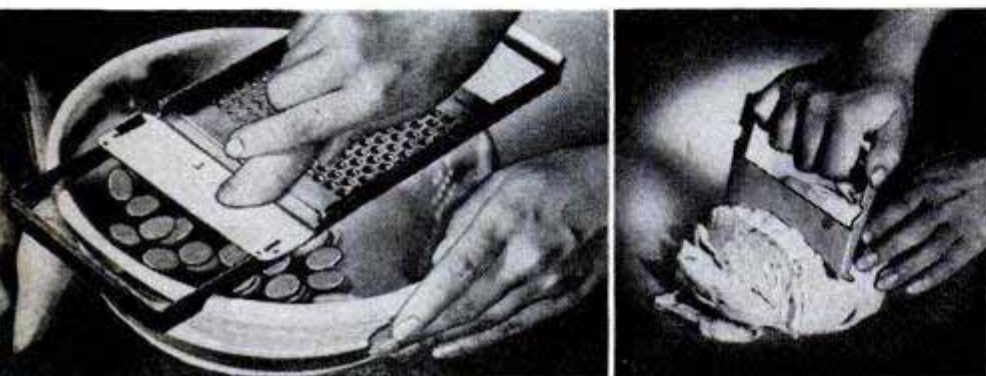
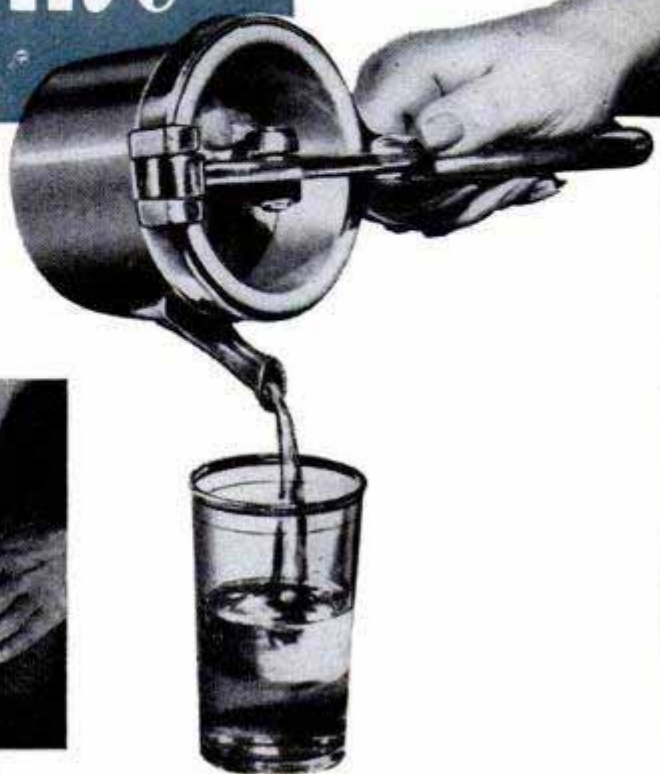

COMBINATION KITCHEN TOOL is a food grater, shredder, chopper and slicer. Notched to rest snugly on top of bowl, it permits food to fall directly into container. Top part is detached for use as chopper

SUPERSONIC WASHER shakes dirt loose from clothes with high-frequency sound waves instead of agitator

DECANTER contains built-in pocket for ice cubes so that they cool but do not dilute the contents





CREAM WHIPPER comes supplied with pressure cartridges for indefinite refilling. Ordinary cream is whipped instantly, kept fresh for week



COCKTAIL TABLE features hinged leaves which form table top until unfolded. "Handkerchief" design permits increase of 100 percent in table surface

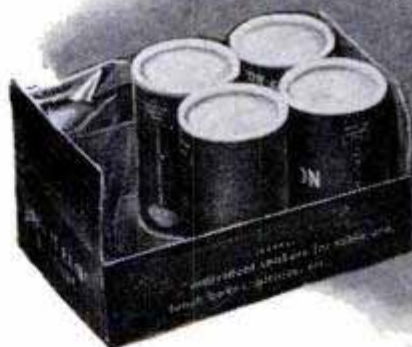
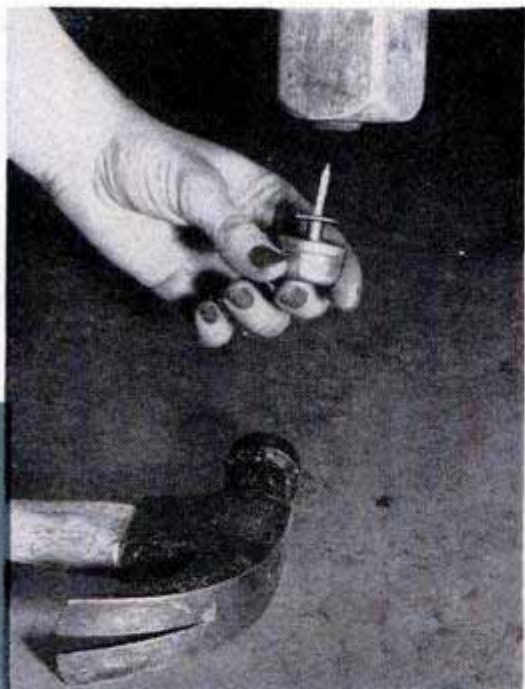

TINY SALT SHAKERS suitable for picnics, TV snacks and box lunches even have perforated plastic tops which can be rotated to regulate the flow of the salt

WOBBLE-STOPPER consists of sealed cylinder filled with silicon putty on which miniature piston sits. Putty expands to suit distance between table leg and floor

SEWING MACHINE features free arm over which socks may be slipped for darning and patching. Adjustable drive permits machine to operate in slow motion for intricate sewing and embroidery work



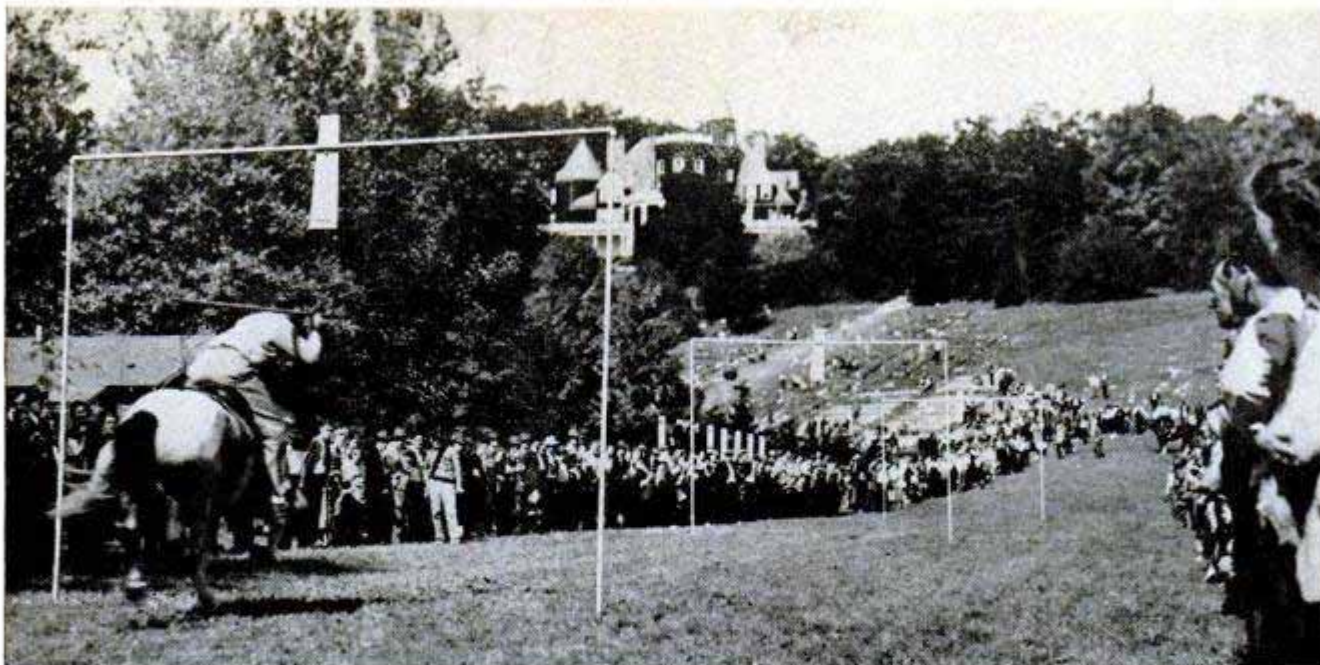

Arches are 60 feet apart. The contest is part of the annual Mountain State Forest Festival at Elkins, W. Va.

It's called "Tilting at the Ring" and takes a steady hand, careful aiming

Galloping Riders "Tilt at the Ring"

Spears in hand, modern knights in a West Virginia tournament charge at full gallop toward unique targets—tiny rings suspended by wire from each of three archways. If they can hook all three rings on their sharp, hardwood lances, they have a chance to try again. After each try, the rings are reduced from the original 1½-inch size until the opening of each ring has been dropped to ½ inch in diameter. The winner must complete all the passes successfully. Once a favorite sport in the mountain counties of the state, this carry-over from the contests of medieval knights takes place each year at Elkins, W. Va.

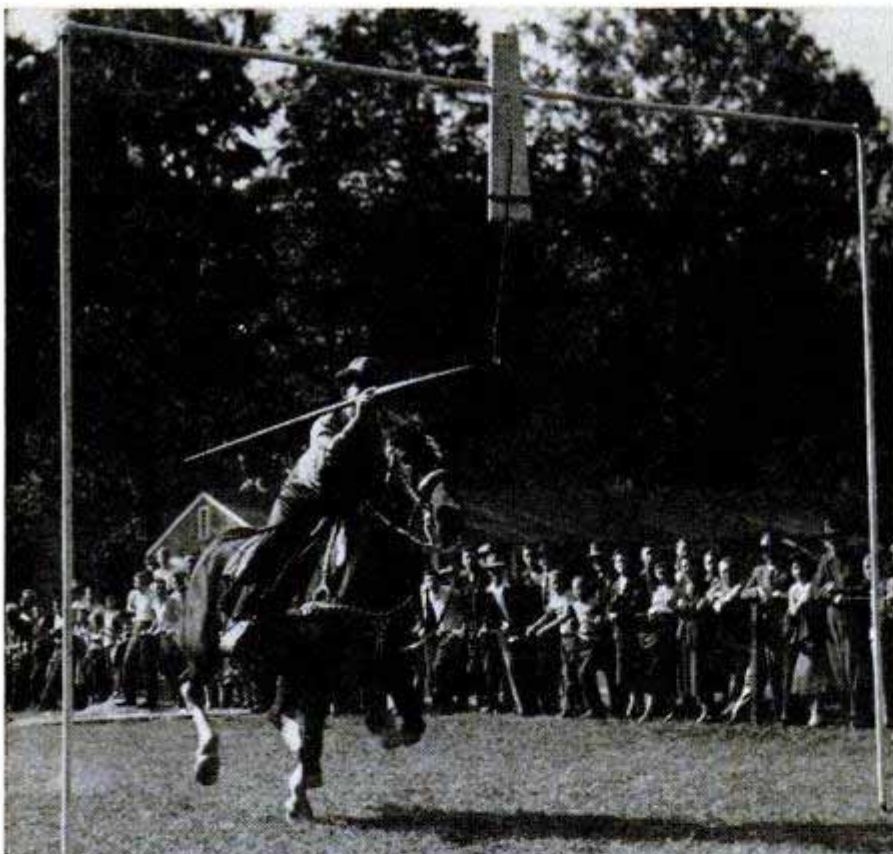

Automatic Starter Switch

Owners of cars with completely automatic transmissions can install an automatic starter switch that restarts a stalled engine as soon as the shift lever is placed in neutral. In traffic, the switch eliminates the confusion that often results from unexpected stalls. The unit can be installed by the owners in about 15 minutes. Internal safety devices prevent the switch from operating unnecessarily.

Grafts Speed Hybrid Pines

Speeding the production of hybrid pine seeds, the U. S. Forest Service is grafting inbred and crossbred seedlings to mature trees. Result: Each step in the process is shortened by 20 years, since it often takes that long for a normal seedling to develop into a mature, seed-producing tree. Another timesaving method used is a new germination process which produces a seedling equal to one-year stock in three months.



Smiling picnickers have fun while model steam engine on grill does the work of turning turkeys on spits

Homemade Steam-Powered Grill Even Whistles Guests to Dinner

KNOWN TO ADMIRERS in the vicinity of Sharon, Mass., as the Tobey Totable Toaster, a unique rotary-spit grill is powered by steam. The inventor and builder, F. S. Tobey, not only uses steam to turn the spit but to whistle his company to dinner. He made the grill out of galvanized iron and angle iron with a front consisting of the cast-iron grate of an old stove oven. Fastened to the frame is a one-foot length of

half-inch iron pipe which passes through the charcoal fire bed. This makes a flash boiler. A copper tube connects to a small two-cylinder model steam engine. Between the boiler and a three-pint water tank is an equalizer valve which provides an automatic water feed. A flexible chain drive operates two spits. Each holds two small chickens or turkeys. An oven on the back holds potatoes.

One or both spits can be used on the Tobey Totable Toaster. Tank holds enough water to operate three hours

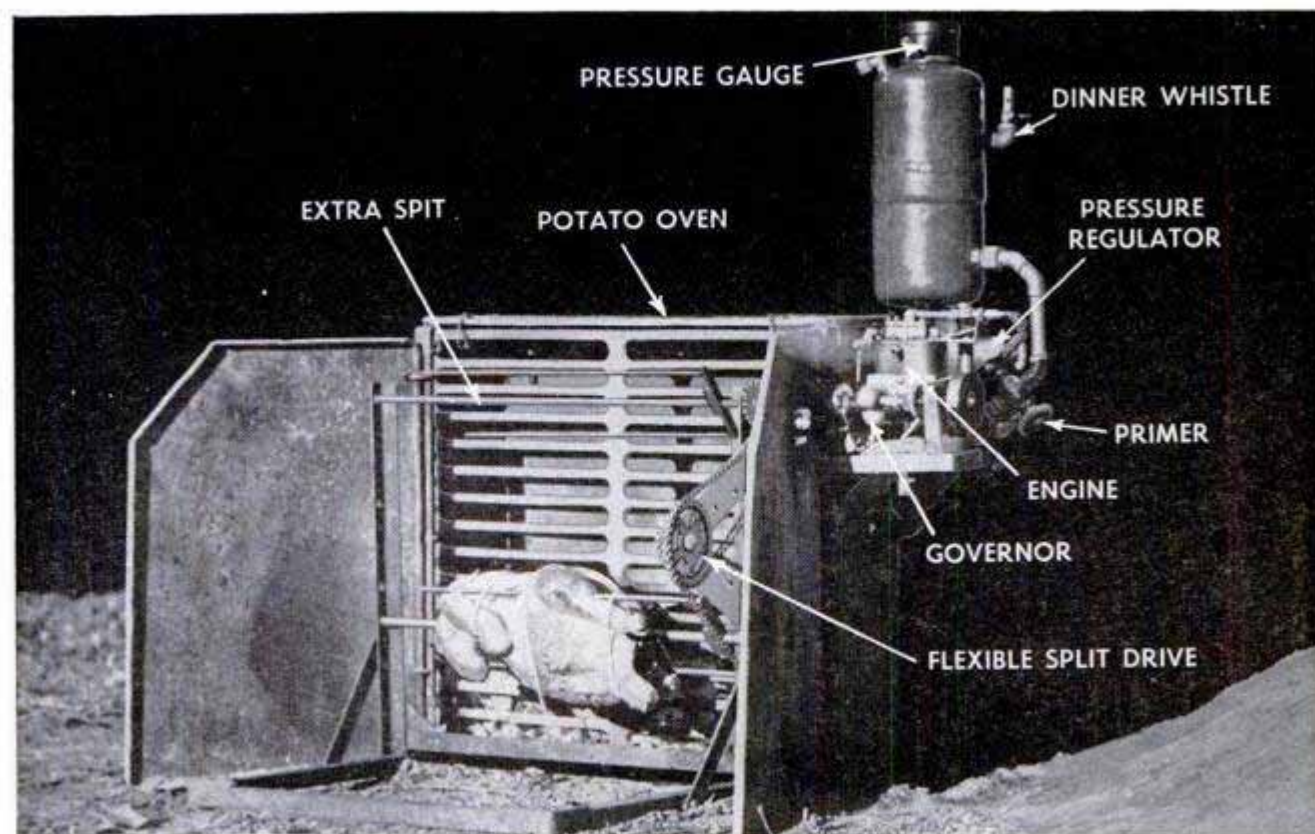

NEW ZEALAND HARNESSSES ITS "YELLOWSTONE"

By A. L. Kidson



Tense engineers uncap a geothermal test bore and steam explodes skyward. Basic project is to convert steam into electricity



For centuries the native Maoris have used the natural steam and hot-water pools for cooking and bathing

NEW ZEALAND, that progressive little nation with a population of 2,000,000, now is striving to convert underground steam into a vast producer of electric power.

Thousands of veterans of World War II who served in the Pacific will never forget the New Zealand thermal regions, an area where nature seems literally to have blown its top. Eerie lands, these, where the ground underfoot roars and trembles, where a stick thrust into the earth instantly takes fire and where 10,000-foot volcanoes belch lava and showers of stones. Boiling mud pools, steaming lakes and scalding geysers dot the landscape. There are some 4000 square miles in this inferno.

The native Maoris have used the boiling water for centuries to cook their food; they have bathed in the milder pools. Today the area is exploited by the white man, who has built health resorts beside the mineral-charged ponds.

Householders in the region sink small wells in their back yards and draw off an endless supply of steam and hot water that doesn't cost a penny. Larger institutions have set up elaborate

Guide shows tourist party the eerie, bubbling "Champagne Pool"





There are several fine bathhouses in the thermal area. Mineral waters are believed effective in treating many common ailments



Even private homes in the area have their own elaborate baths where children and adults can take mineral treatments daily. ↓ Heat is free and plentiful; bore in foreground taps underground pool, and the greenhouse is heated by naturally hot water

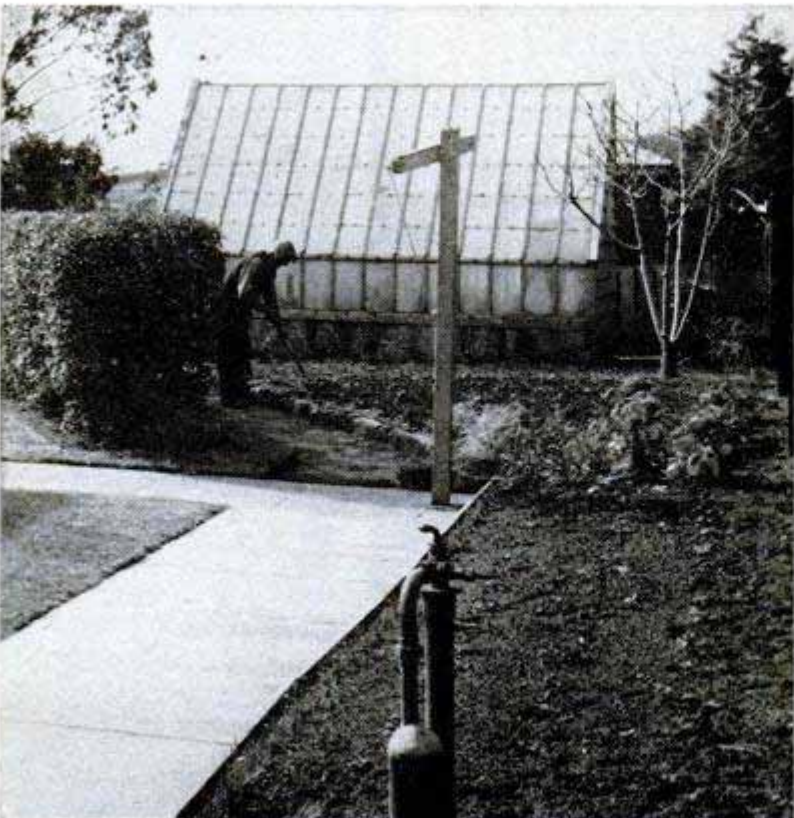

pipng systems to use underground steam for heating.

The New Zealand government now is sinking test bores to locate steam at high enough pressures to drive turbines. So far the tests have been highly successful; pressures up to 90 pounds per square inch have been found at depths ranging from 600 to 900 feet.

Converting natural steam into electric power is not a new idea. Italy has developed a successful technique. At Lardarello, near Florence, 150 steam bores generate up to 300,000 kilowatts. The power is used by the Italian State Railways and by large industrial plants near by.

New Zealand scientists recently visited Lardarello to study the methods used there and to discuss problems that may arise in their more ambitious project.

In Italy, one of the principal problems encountered was the corrosive action of the live steam. Another was the danger from violent explosions that occurred during the drilling. To prevent explosions, Italian engineers forced powerful jets of water into their wells to control the steam pressure. They also developed the "gomito" or elbow—a side valve to direct escaping steam away from the drillers.

New Zealand engineers hope to escape some of these difficulties by using techniques already evolved by the Italians.

The steam is there in New Zealand waiting to be harnessed. One manmade geyser shot a column of steam 200 feet high as the drill pierced the overlying strata of rock. Engineers on the job estimate that within 20 years New Zealand's thermal regions will generate enough power to supply electricity to the entire country. If successful, the project will cost only a fraction of the investment required by the vast hydroelectric systems in the United States.

The engineers are convinced their work will be a resounding success. But even if the power project should fail, New Zealand still will have, in her thermal regions, a unique attraction for visiting tourists. ★ ★ ★

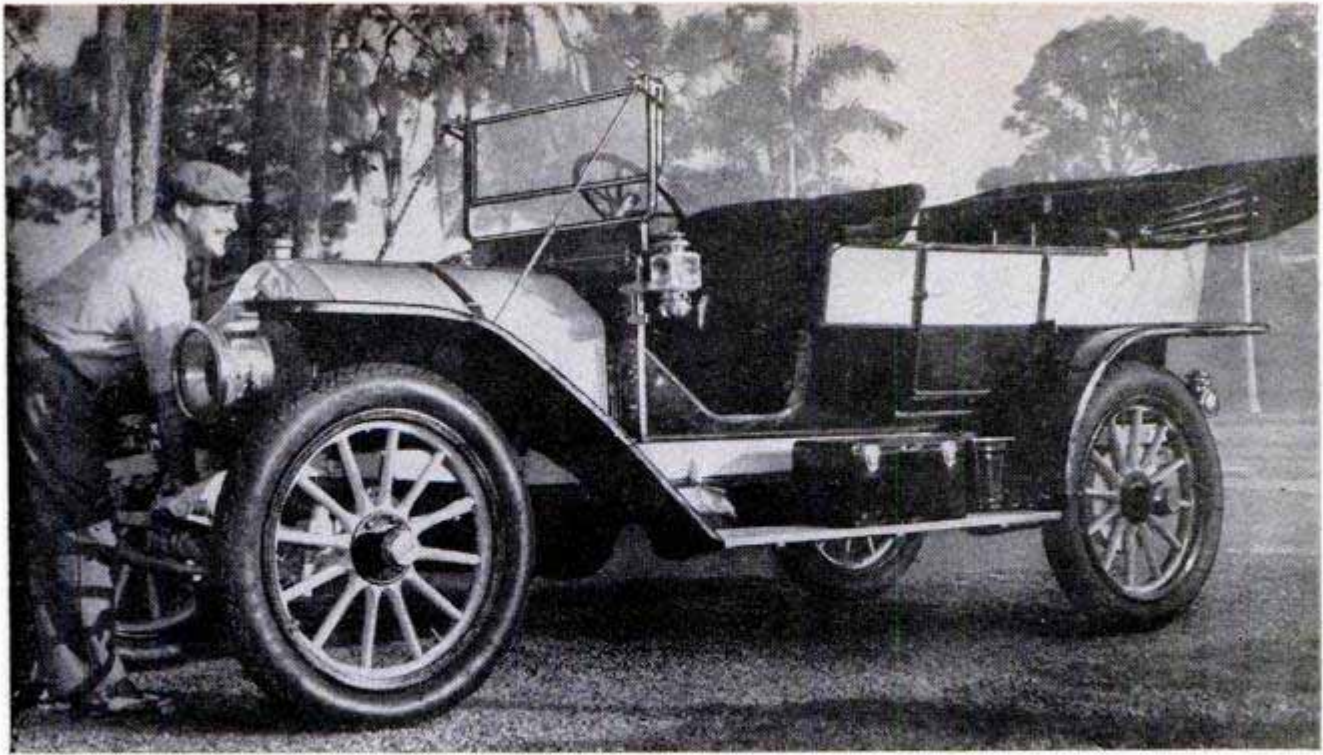

1908 National Still Rolls Along the Highways

Despite its age and rarity, the 1908 National seven-passenger touring car owned by M. C. Chase of Branford, Conn., is no museum piece. It will still pound the highway and recently made the 1400-mile trip from Connecticut to Florida without any trouble except a minor radiator leak. The trip took five days because night driving

was undesirable—its carbide lamps being too bright for oncoming traffic. The four-cylinder engine has dual ignition and is started with a hand crank. A comfortable cruising speed for the car is 40 miles per hour, but it will hit 60 for short stretches. Brake shoes are of cast bronze and are applied against steel drums.

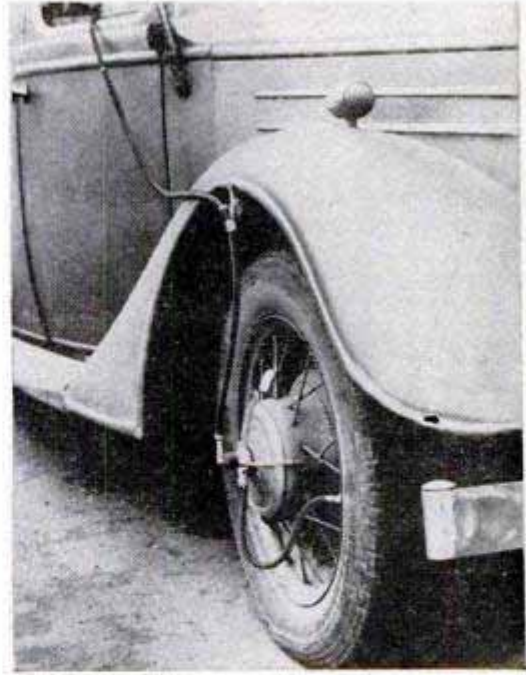

Electric Compressor Pumps Air Into Tires As Car Is Driven

There's no need for you to change a flat tire if you have an English device which pumps air into the tire as you drive to the nearest service station. Basic unit is a miniature air compressor powered by the

battery, which pumps air through a hose leading to a universal joint on the hub. The pump can be used to add a few extra pounds of air to unpunctured tires or for anything else requiring compressed air.



At the start of the run, speedometer readings of all cars are taken down

Sports Cars *Have a Field Day*

By Richard F. Dempewolff

Diagram of five typical courses used in a sports-car gymkhana. Drivers compete in these after they have completed the road course. Field days make driving a recreation as well as a means of transportation

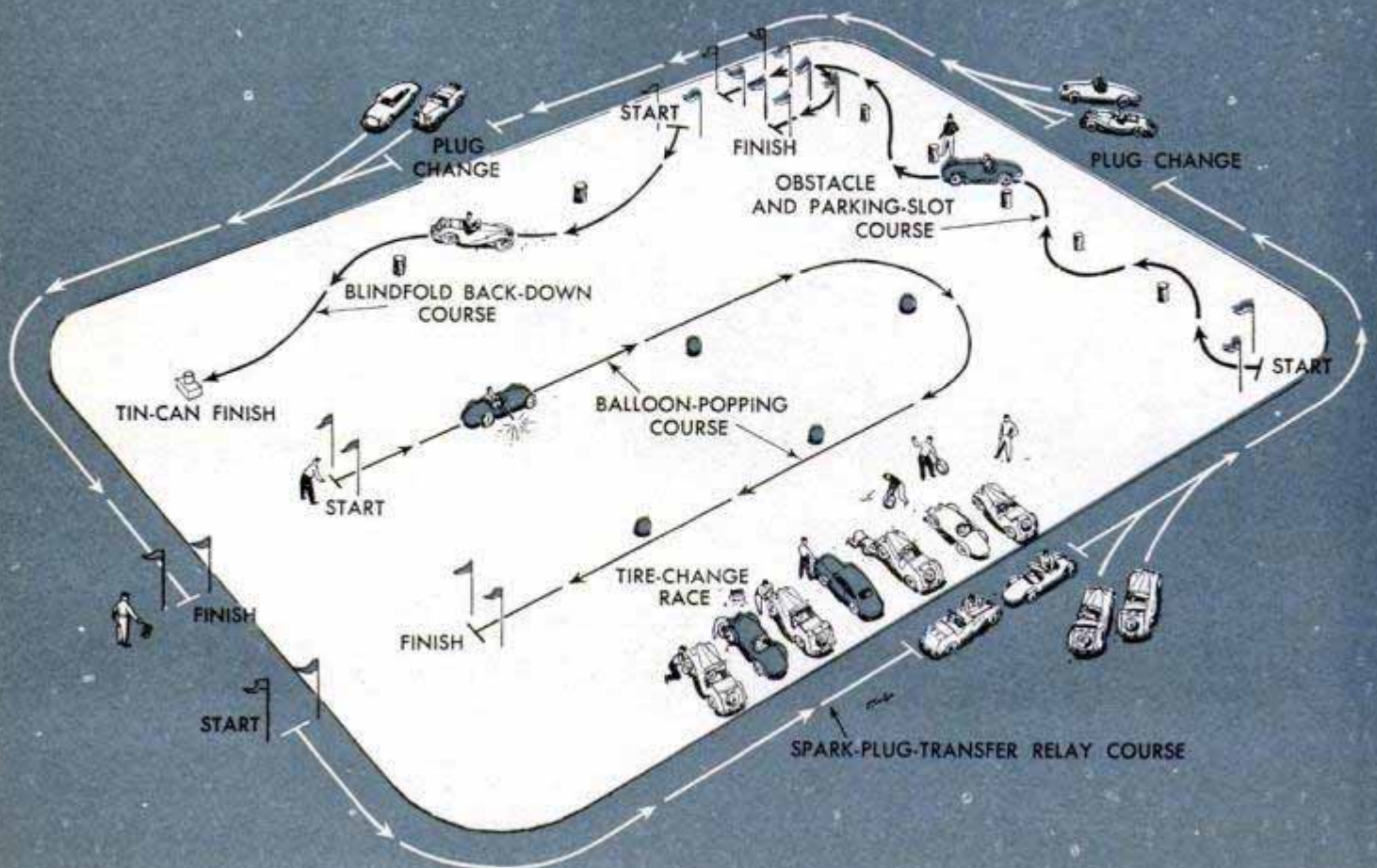



Drivers change spark plugs in one event. First to drive away wins. At extreme left is rear-engine Porsche

OVER THE HILL they go—40 to 100 glittering sports cars chasing each other in a ragged, dust-veiled chain several miles long. They're not breaking speed laws because that's against the rules. There's an intense look on the drivers' faces. "Navigators" beside them hunch over, making hurried calculations as the little cars hit straightaways, or clutch for the "fright bar" when the "pilot" guns around a corner as they bound down a forgotten dirt road that isn't on the map.

This is a sports-car rally, a sort of roving game reminiscent of a treasure hunt, imported from Europe along with most of the low-slung Allards, MGs, Singers, Jaguars, Morgans, Porsches and other specimens of a mushrooming automotive "aristocracy."

At the end of World War II, a sports car was a curiosity in America. Today, some 25,000 of them buzz along the highways. And the rallies, sponsored by local sports-car clubs, are gaining popularity with the acceleration of these junior-size but senior-performing autos.

A regional sports-car rally is not a race. It's an outing or picnic, which can and often does include the family—kids and all. Recently, at a typical affair sponsored by the Connecticut and Westchester (N. Y.)

sports-car clubs, two *Popular Mechanics* entries went along. A. R. Stahman, a *Popular Mechanics* advertising man, drove with his wife in their 1950 MG TD. Its 54-horsepower four-cylinder engine in stock condition is capable of kicking up 85 miles per hour. The writer, with wife, daughter and small friend, piloted a four-seater Vaughan Singer with all-aluminum body and a four-cylinder engine. Many of the other entries, like the lean Jaguars and Porsches, could outrun us by 20 to 40 miles per hour, but speed alone doesn't count in a rally.

Days before the affair, club officials scouted and mapped the 63-mile course, weaving down back roads, doubling back on this leg or that, taking off on a super-highway for a stretch, winding through towns and villages, bouncing across wagon tracks through a field, and finally ending up at a state woodland reservation in a vast clearing where contests would be held.

On rally day, some 50 cars poured into the starting area—a local airport. Polishing rags were broken out. Hoods went up for last-minute adjustments. Everyone was given a list of directions which would keep him on course, or get him lost—depending on how good his navigator (usually his wife) was. Cars were launched a minute



Driving backward past obstacles while blindfolded requires cooperation of driver and navigator

- 21.90 Right on B. T. Winding road. Caution!
- 22.65 Right at T intersection. N. Y. Route 120.
- 22.85 45° Left on B. T.
- 22.95 Sharp left.
- 23.00 Keep left.
- 24.40 Turn left on to B.T. at T intersection by stone pillars.
- 24.75 Dirt to B. T.—continue.
- 25.00 Caution—sharp S bend.
- 25.20 Caution—sharp left bend.
- 25.30 B. T. to dirt—continue.
- 26.12 Bear left—don't go thru stone pillars.
- 26.60 Turn right on to concrete by red brick wall.
- 26.95 Left on B. T. on to road with center island.
Caution! Slow! Private residences.
- 27.50 R. R. Crossing. Full stop. Caution.
- 27.55 Check point. Get instructions for leg 2.

Sample of route instructions. Figures show mileages. B.T. means blacktop road. Note the numerous warnings
Rear-engine Porsche goes through the figure-8 course

apart, each speedometer reading checked out. Off we roared. Our route instructions read like a pirate's map of buried treasure. Here's a five-mile sample:

- 7.45 Left at green with four shrubs
- 8.45 Bear left—Cox
- 9.45 45° left on B.T.
- 9.60 Straight

12.2 Left on B.T. at 18th hole

"B.T." is blacktop road. "Cox" turned out to be the name of a street—it might have been a name on a sign or mailbox. You don't know until you get there. The last clue was a left turn onto blacktop circling the 18th hole of a golf course. The flag was just visible from the road.

Those little numbers on the left are the jokers. They indicate progressive mileage in hundredths from point to point. By checking them against the trip meter, a navigator knows when to start looking for a check point. They are also the key to the time schedule—a vital factor in this game, since points are lost for coming to a check point too soon or too late. A 20-mile-an-hour average between points must be maintained for perfect scoring.

Converting each little mileage jump into the seconds it should take to get there at the designated speed calls for a slide-rule mind. One wrong turn means a time loss of seconds that must be made up, as well as hundredths of miles that must be added to or subtracted from the speedometer reading in all future calculations. More than a few such errors and you need a four-story Maniac computer to clean up the mathematical confusion.

Who knows if you cheat a little? At half-a-dozen spots along the route, as we barreled around corners trying to make up time lost on the last wrong turn, a club official stepped from the bushes like a cop





At surprise points along the route, officials stop drivers to check time and mileage. This is a Jaguar

in a speed trap, to flag us down, take our speedometer reading and note the time. On the basis of findings at these surprise check points, scores are figured. You'll lose a point for every minute you're late at a check-in point; two for every minute you're early. A point is lost for every extra mile on your speedometer at the end of a run; two points for every mile under the total distance (to discourage short-cutters). Miss one of the checkers and it costs 100 points. Failure to obey a traffic sign, a light, or a speed limit costs 25 points.

Everyone huddled around to compare notes at the end of the run. New cars were examined, criticized or praised. Some of the members' cars draw crowds at any gathering. A member may be asked to show his chromed engine block, chromed wire wheels, special fittings of one sort or another or maybe a motor that has been hopped up to cruise at 120 miles per hour. Like most sports-car rallies, this one wound

(Continued to page 236)

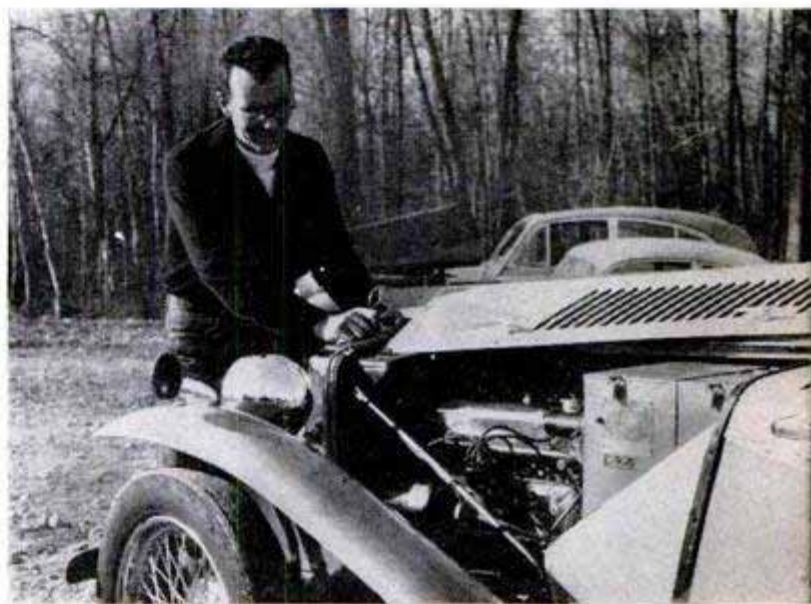

Above, sports-car owners are proud of their vehicles. This MG boasts a chrome-plated engine. Below, contestants and families watch an MG do the figure 8



Gasoline-Powered Flying Disk

MANY RESIDENTS of Van Nuys, Calif., can report truthfully that they have seen a flying saucer both in the air and on the ground. The saucerlike plane is a flying disk two feet in diameter and powered by a conventional model-airplane gasoline motor. Some earlier models of flying disks have been jet-powered with a rotating rim ("Flying Disk Aircraft," *PM*, May 1950). The Van Nuys model, built by Virgil Wood and George Harris, was designed to demonstrate maneuverability and speed, and is the result of several years of experimentation. The craft has a framework of balsa and is covered with silk. It is controlled by a wire. The engine is completely contained in the airfoil and the model flies equally well right side up or inverted. The disk will perform all the conventional maneuvers of a control-line craft, according to the inventors. In order to compete in model-airplane meets, a single-wheel landing gear was added. Mr. Wood, who is in charge of the model, calls it a Dis-cus.



Inventor Wood shows the egg-crate-type framework of newest flying disk which is made of balsa wood



The inventor and assistant prepare the two-foot model for flight. The craft is controlled by wire. Below, a real flying saucer in the air. Right, the inventor fuels his model in the conventional way





Overhead piston for small doors pulls door open or pushes it shut depending upon direction of water flow



Valve on top of post beside entrance is turned to open or shut door. Another valve is situated in house

Water-System Pressure Is Utilized to Open Garage Door

Pressure from your water system runs a garage-door "slave" that opens or closes the door at the turn of a control handle. The actuating mechanism is a long water-driven piston attached to the ceiling of a single-car garage, or a pair of pistons mounted at the sides of a two-car garage.

An electric solenoid permits push-button operation from inside the house. Similar oil-driven units are being designed for use in freezing climates. Now in limited production, the water-drive unit is about half the price of motor-driven garage-door-opening mechanisms.

Gas-Fired Infrared Lamps Barbecue Entire Steer

Roasting a 450-pound steer in 20 hours, an outdoor oven cooks with a battery of gas-fired infrared lamps. Mounted at one-foot intervals on a pipe framework, the lamps burn at 2300 degrees Fahrenheit, producing rays which penetrate deep into the meat, heating it from the inside. The giant beef roast required less than three minutes' cooking time per pound. Hand-operated valves regulate the flow of the gas to the burners. An electric motor turns the spit to revolve the meat. Open at two ends, the structure is protected by a sheet-metal roof; two sheet-metal sides are sufficient to contain the radiant heat.

More traffic than combined total of Panama and Suez canals is carried by the Soo canals at Sault Ste. Marie.

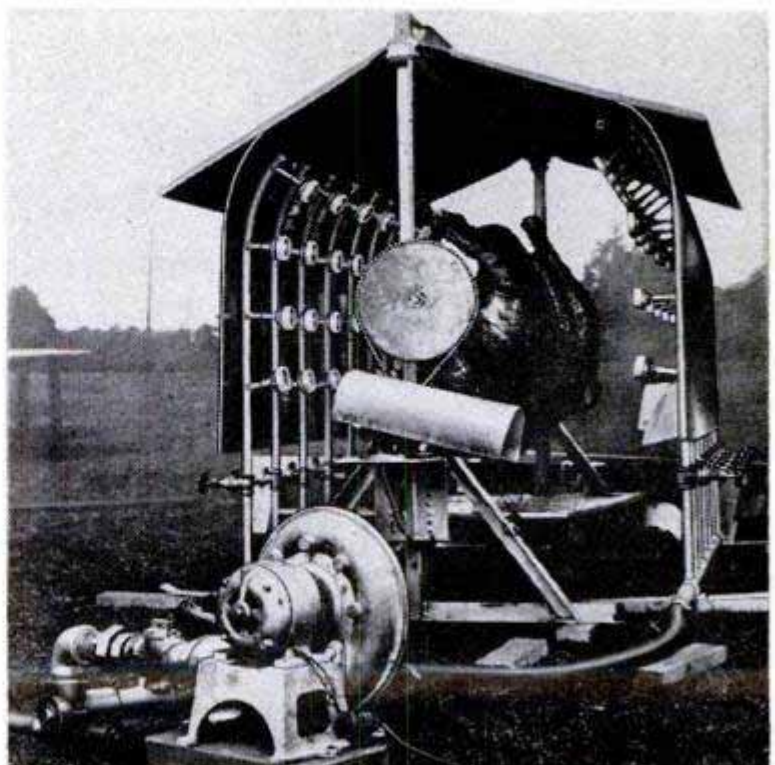



They Weigh the Dew

Dew shaken from alfalfa falls on scale which will weigh moisture and record loss of weight by evaporation

SCALES ARE routine equipment in soil-conservation research, but a huge scale near Coshocton, Ohio, actually weighs the dew.

Resting permanently on the beams of this giant scale is a 65-ton "block" of earth that was left undisturbed when the scale was ingeniously built beneath it. Every 10 minutes, day and night, a recording device ticks off the weight of the huge block of

By W. H. Lathrop

earth, plus the accumulation of morning dew or minus the transpiration from growing vegetation. The research is carried on by project supervisor Lloyd L. Harrold and his staff at the U. S. Soil Conservation research station.

The big scale's "ticker tape" is unwinding some of nature's most obscure secrets. How much rain does a heavy dew repre-

Strip-cropped field at research station demonstrates how farmers can save moisture and cut flood damage



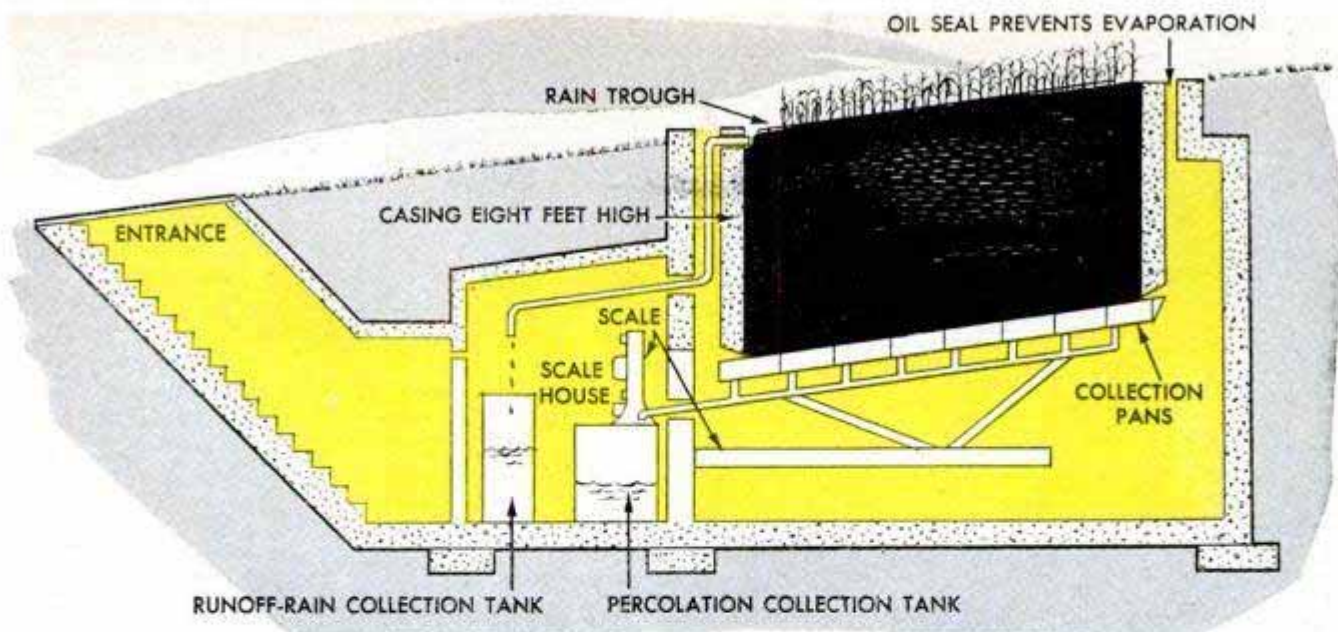

Scale built beneath 65-ton "block" of earth preserves natural drainage, yet weighs all moisture on the plot

sent? During August 1951, when only about $\frac{1}{2}$ inch of rain fell, dew totaled more than $1\frac{1}{2}$ inches.

Actually, three of the big measuring instruments — lysimeters the scientists call them — are in use at the station. One is on steep pasture, one is on rolling cropland and the third is on gently sloping cropland.

For a comprehensive approach to water control, scientists need to know how much water is lost by evaporation; how much is gained by condensation and absorption and how much is transpired by crops. Data collected by the lysimeters over more than 12 years is beginning to furnish some of that knowledge. The amount of water transpired and evaporated in the production of a corn crop has ranged from 17.4 to 24.6 inches; for wheat, 12 to 14.2 inches and for first year hay, 19.4 to 21.7 inches.

Corn uses the most water in July but wheat uses water heaviest during late May and early June. In the spring and early summer a good grass-legume meadow normally uses water faster than it falls. In 1948 the big scales showed that from April 15 to July 31 a grass-legume stand used all the rain that fell and borrowed eight inches more from the soil.

How much moisture is saved in a dry season by cultivating corn to break up the packed surface of the soil? So far the weighing lysimeters have been evasive on that point. Rain which fell just after cultivating jostled the scales several times and, in two trials worth examining, one showed less moisture lost, the other more. The greater loss of moisture probably was caused by abnormally dry winds.

On one occasion, examination of the scale's records showed an erratic reading ranging up to 300 pounds more than weather data would account for. A probing

flashlight soon revealed the culprit — a coiled blacksnake out near the end of one of the sensitive beams.

His records from the weighing lysimeters and his own experience have convinced Harrold that the vast storage capacity of our farm land can be used to much greater advantage. He describes an experiment in which two inches of runoff was lost from a corn plot that was nine inches short of its "insoak" capacity.

The Coshocton station's fame has spread beyond its own community and state. From an airplane its trademark of strip-cropped fields can be seen far into the distance — each winding strip a symbol of good conservation methods. ★ ★ ★

Every 10 minutes, day and night, weight of big block of earth is automatically stamped on recording tape

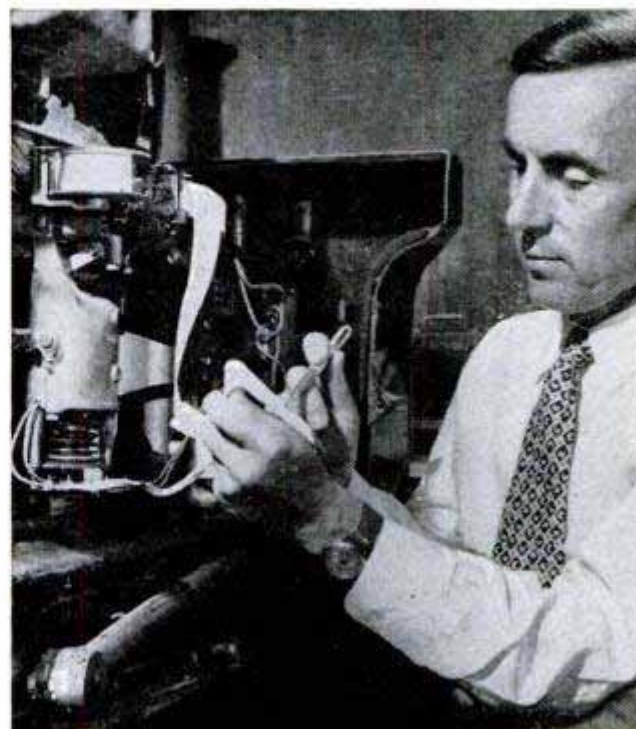

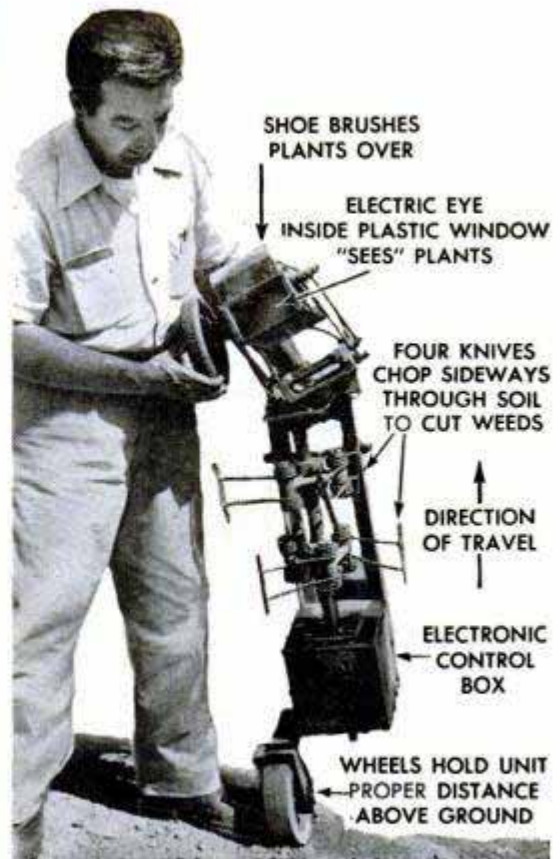

SHOE BRUSHES
PLANTS OVER

ELECTRIC EYE
INSIDE PLASTIC WINDOW
"SEES" PLANTS

FOUR KNIVES
CHOP SIDWAYS
THROUGH SOIL
TO CUT WEEDS

↑
DIRECTION
OF TRAVEL

ELECTRONIC
CONTROL
BOX

WHEELS HOLD UNIT
← PROPER DISTANCE
ABOVE GROUND

↑ Bottom view shows window for electric eye that spots improperly spaced plants

Above left, side knives chop out the weeds but skip plants properly spaced along row

← Hoes are installed in series beneath a tractor to cultivate four rows at once

Mechanical Hoe Has Electronic Brain to Eliminate Weeds

Built for cultivating sugar-beet fields in California, a mechanical hoe with an electronic brain "looks over" every plant to determine whether it is a weed. If it's a weed, sharp blades chop it out of the field immediately. The robot farm hand, which does the work of 20 men, also has been used successfully in cultivating broccoli and lettuce. Four of the mechanical hoes are attached under a tractor to cultivate four rows at a time. Each unit consists of two pairs of chopping knives that dig

through the soil as the tractor moves across the field. An electric-eye scanner in front of the knives picks up light reflections from the leaves of a plant. If the plant is properly spaced in the row, a "memory delay" causes the knives to skip the plant when they come abreast of it. If the plant is improperly spaced, it is immediately removed. In addition to removing weeds, the hoe can be adjusted to thin out plants that are spaced too closely together and is capable of day or night operation.

Safety Thermal Switch

Wired into the furnace-control circuit and installed on the ceiling above the furnace, a thermostatic unit shuts off the furnace and rings an alarm in case of fire or a dangerously high temperature. The alarm is placed in an upstairs hall or bedroom where it may be heard easily. Installation of one switch above the fire door and another above the smoke pipe is recommended for maximum protection.

Ultrasound Inspects Tires

Inspection of used tires by ultrasonic vibrations spots invisible internal defects that make the tires useless for recapping. By assuring that only good tires are recapped, the inspection system makes recapped tires last longer. The tire is rotated in a liquid and the ultrasonic vibration transmitted through the sidewalls and tread to a microphone inside the tire. Breaks and defects are quickly spotted.

They're Off!

NO HORSE gets a head start when the timer goes off on a 60-foot portable starting gate. The seven-ton steel rig, which, at present, is used on more than 20 race tracks, is divided into 14 stalls. The apparatus is mounted on casted truck wheels so it can be hauled around by tractor to any location. Two units can be worked end to end, when the field is larger, to accommodate up to 28 starters. Two sets of truck batteries and a solenoid about the size of a quart Thermos jug, whip open all 14 gates of each unit at the same instant by simultaneous release of a magnetic bolt bar securing each stall door. Another set of batteries and a solenoid hold rear gates shut tightly. Bars making up each stall are padded with sponge rubber to prevent possible injury to either the horses or the jockeys.



Starting gate is set into position five feet from rail and doors are being closed before horses reach post. Man at right sets control switch

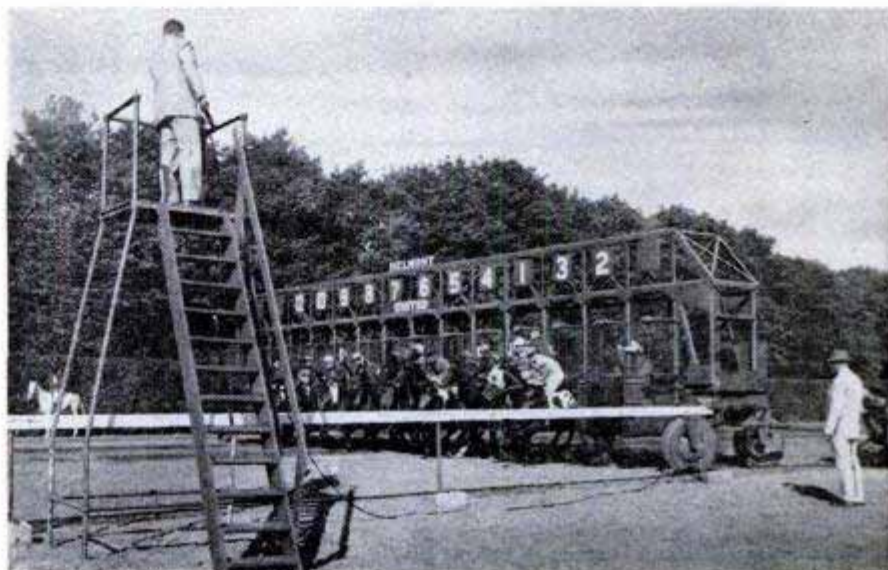

Starter on control stand with complete view of horses presses button connected by cable to main switch to open doors of gate. They're off!

Old-style gate, below left, could injure head of rearing horse. The new gate at right is completely padded



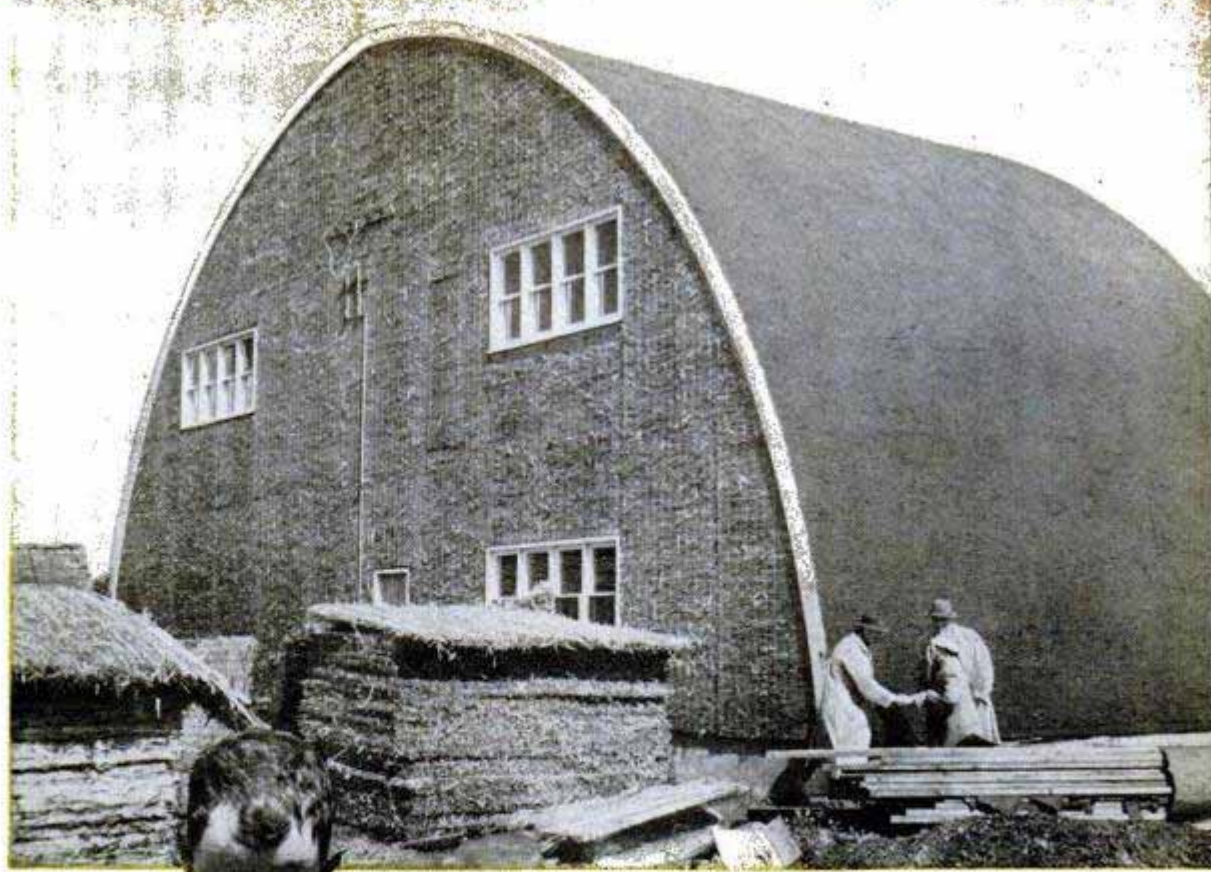

Reed-panel factory is made of its product. Tar covers roof

Houses

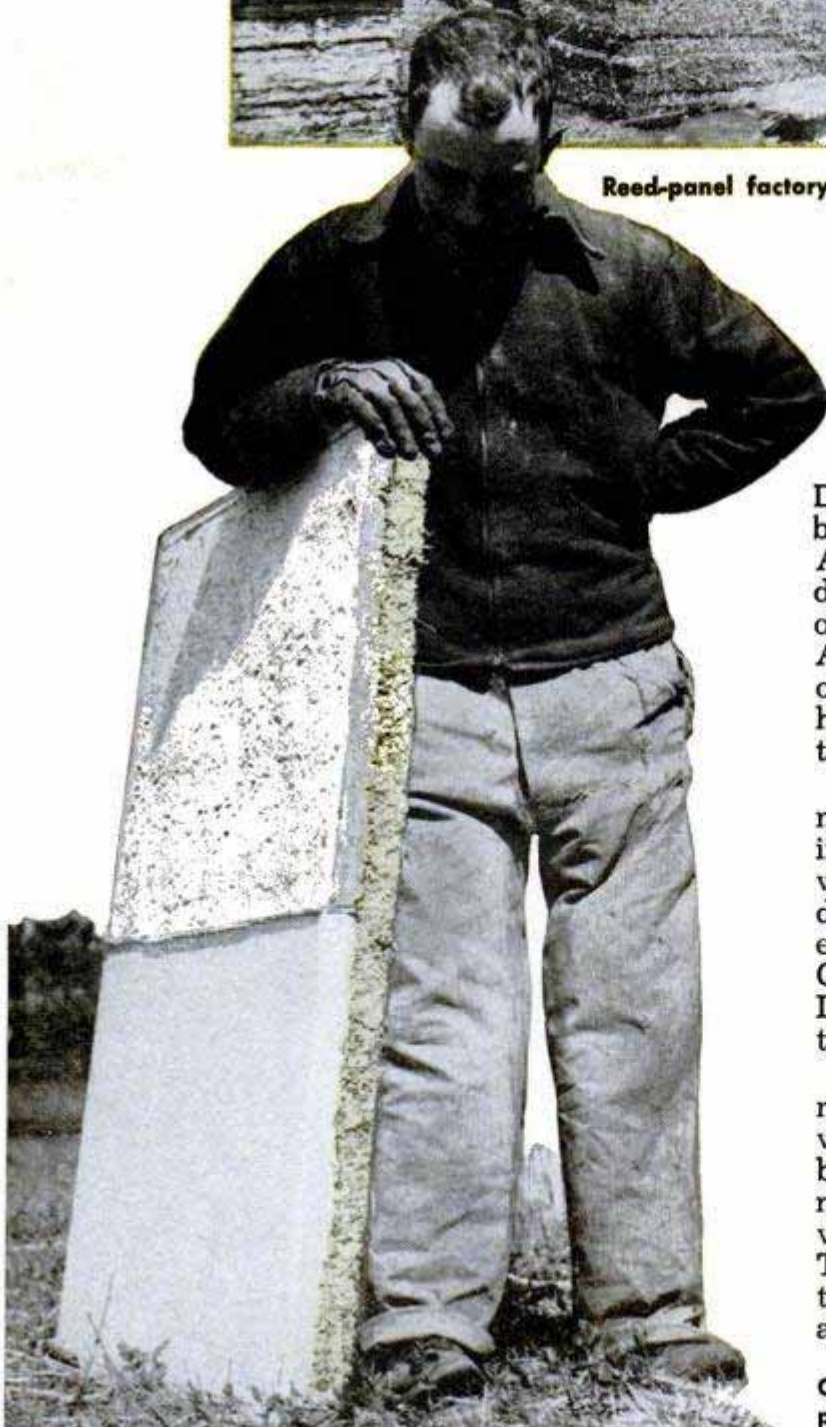

SIXTY MILES northwest of Winnipeg, Can., lies the vast Delta Marsh—36,000 acres of reeds, bulrushes and twisting water lanes. A favorite nesting place for wild ducks and geese, it's also the source of a building material new to North America, but used for centuries in other parts of the world. Reeds have long been a popular reed thatching in Europe and Asia.

In 1925, a Dutch firm invented a machine for pressing dried reeds into a thick board that resists winter winds and summer heat, deadens sound, is economical and easy to handle. Two years ago, a Canadian plant using imported Dutch machinery started operations at Portage la Prairie.

Each December, as soon as the marsh is frozen enough to bear the weight of machinery, tractors and binders hired from local farmers move in to cut the dried reeds which stand six to nine feet tall. The frost has stripped them of their narrow leaves until only pith and stalk remain. Workmen toss

Concrete, plaster or stucco adhere to rough panel surface without need of wire base



Two men feed reeds into machine, placing stalk butts in opposite positions to make boards of even thickness

Built of Reeds

By Lyn Harrington

Photographs by
Richard Harrington

the sheaves of reeds onto large trailers and haul them to the big storage yard at Portage la Prairie. Last year, approximately 800 tons were harvested from as many acres.

In the factory, two men feed the reeds into the large compressing machine, which stamps them into firm board under a pressure of 300 tons per square inch, and trims the board to a width of 64 inches.

Twelve reels of wire on either side feed into the machine, while staples at frequent and regular intervals lock the strands together, so that the reeds are imprisoned

Reeds are imprisoned between wires running the length of panel and staples which connect them with wires on opposite side. Crosswise strength equals inch plank





Paneling can be of any desired length. This 64-foot section forms the entire wall of a field granary

between the wires. This makes a board which is inflexible crosswise but which can be curved to almost any extent lengthwise—suiting it for use in curved barn roofs and Quonset-type buildings. The board slides down through the machine on the mezzanine floor to the ground floor under inspectors' watchful eyes.

The finished product may go into a barn, a home or a granary. It may be used for interior or exterior walls, for ceilings, and for underflooring. It can be cut easily into window spaces, curves or arches with nippers and hand or power saws. Application does not require skilled labor, making it easy for amateur craftsmen to use.

Workman feeds fresh wire into the machine. There are 12 strands on each side of standard 64-inch panel

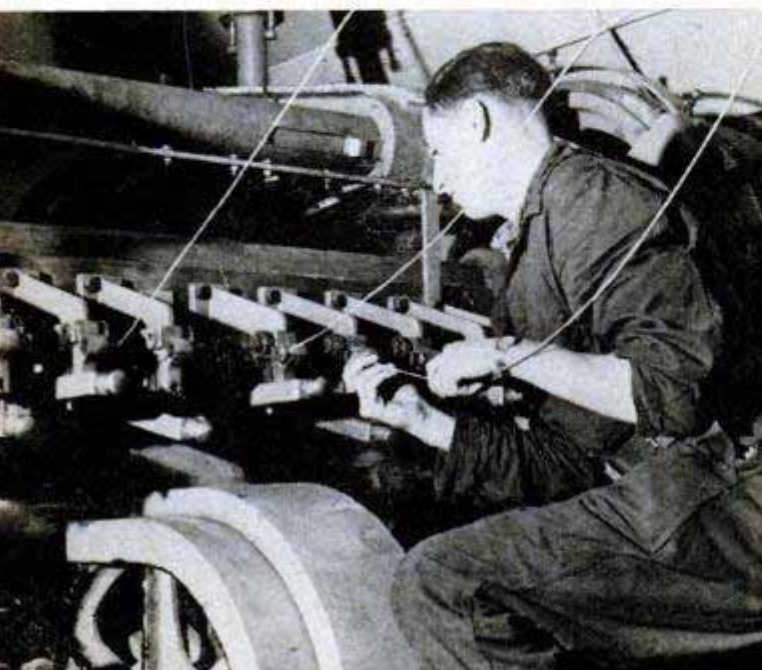

Eight-foot length is standard size, though the paneling may be cut to 12 feet, 18 feet, or any desired length.

The panels are made in two weights. The 2-inch thickness weighs $3\frac{1}{2}$ pounds per square foot and is used mostly for exterior walls. The $1\frac{1}{4}$ -inch thickness is $2\frac{1}{2}$ pounds per square foot and is generally used for interior construction. Both take plaster or stucco readily, and the rough surface forms a good bonding agent. A narrow strip of chicken wire and long nails with curled heads are needed at the seams. Siding may be nailed directly against the panels.

Two-inch paneling costs about 12 cents per square foot. It's light, and therefore needs minimum foundation. An additional saving of materials and labor is possible because the distance between studding can be lengthened from 16 to 32 inches.

Tests made in England and Canada speak well for the reed panels. The British Department of Scientific and Industrial Research reported a fuel saving of 35 percent when the reed house was compared to a standard brick house. The two-inch building panel is said to have the same insulating value as a 22-inch brick wall.

There's no danger of insect or rodent damage. Furthermore, the dry, moisture-resistant reeds which burn easily when loose do not burn at all when compressed. After research figures were released, the government housing bureau authorized its use in construction, and now city homes as well as rural buildings are being built from the marshland product. ★ ★ ★

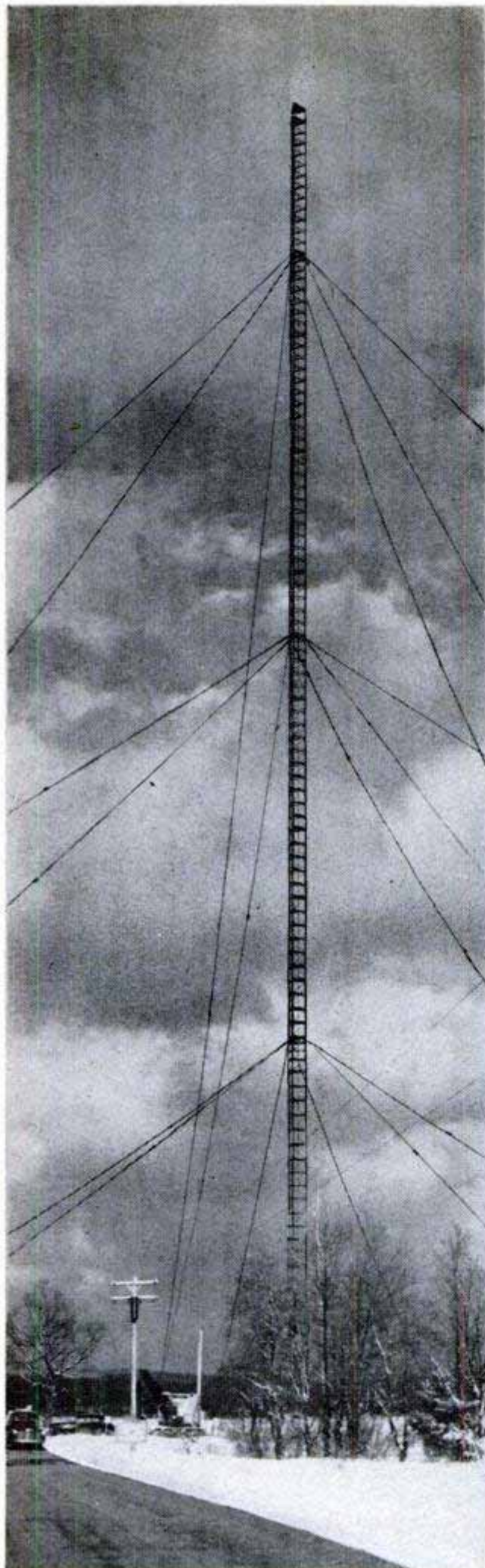

1218-Foot Radio Tower for Air Force Radio-Wave Tests

Experimental radio waves will be beamed over a large part of the universe from the Air Force's new 1218-foot tower at Rome, N. Y. Triangular in cross section, the tower's 772 tons of fabricated steel are held steady by about four miles of guy wires. Some are anchored nearly a quarter of a mile from the shaft's base. During 120-mile-per-hour winds, which have already lashed the tower, it has swayed less than the seven feet calculated for a 150-mile-per-hour gale. There is a maintenance platform at each elevation of the obstruction lights, 238 feet above the base insulators, and at 120-foot intervals to the top of the antenna. The inspectors use an elevator and there is a telephone at the elevator entrance at each platform level. The central pier, upon which the main tower rests, is a pyramid-shaped reinforced mass of concrete, measuring at its base 30 feet 6 inches in length, 28 feet in width and 7 feet in height. The tower's top is only 232 feet lower than the world's highest antenna, perched atop the Empire State Building.

Automobile Snack Bar Holds Food and Beverages

Slung over the back of the front seat or easily carried to a picnic site, an automobile snack bar provides a center compartment for food as well as two quart-size vacuum bottles. The curved handles pivot together to provide a comfortable grip for carrying the unit. Lithographed with a plaid design, the case is made of sturdy metal.



U. S. Air Force photo

Mobile Hydraulic Jack Gives Workmen Big Lift

Hoisting a crew of workmen or three tons of building material 38 feet into the air, a mobile hydraulic lift proves valuable on construction and maintenance jobs. Dual controls permit operation from the ground, or allow a workman on top to raise, lower or rotate the eight-foot platform. A 7½-horsepower engine, resting on the heavy, pneumatic-tired trailer, drives the hydraulic columns. Fully retracted, with platform guard rails collapsed, the lift requires a clearance of only 13½ feet. Safety devices provide a gradual descent in case of hydraulic or control failure.

Electric Starter For Outboard Motor

Starting an outboard motor was once a big chore, but today all the work has been eliminated by an electric starter that works with the push of a button. Made only for the 25-horsepower Johnson and Evinrude motors, the starter consists of a small electric motor that fits inside the cowling. A regular six-volt storage battery provides the power. When the button is pushed, the flywheel is whirled around at about 400 revolutions per minute, about three times as fast as it can be spun by hand. This assures fast starts and cuts battery drain to a minimum. Once the motor has started, the mechanism is disengaged.

Taillights That "Talk"

When German movie star Joachim Brennecke drives around, he can "talk" to other drivers with the help of twin taillights. If he feels that the motorist he has just passed has been courteous, he turns on the left-hand light which says in large letters "danke" (thanks). However, should he feel that the driver of the other car was uncooperative or discourteous, he flashes the other light which has on it the head of an ox. No German fails to understand that it means "You are a stubborn ox."

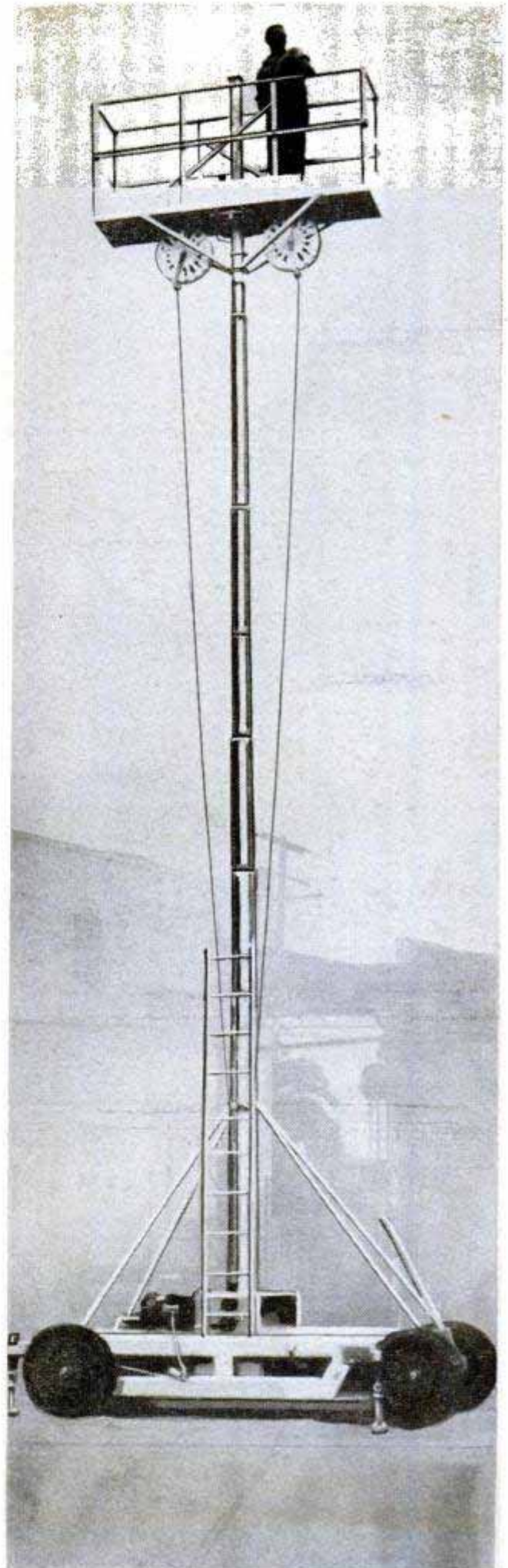

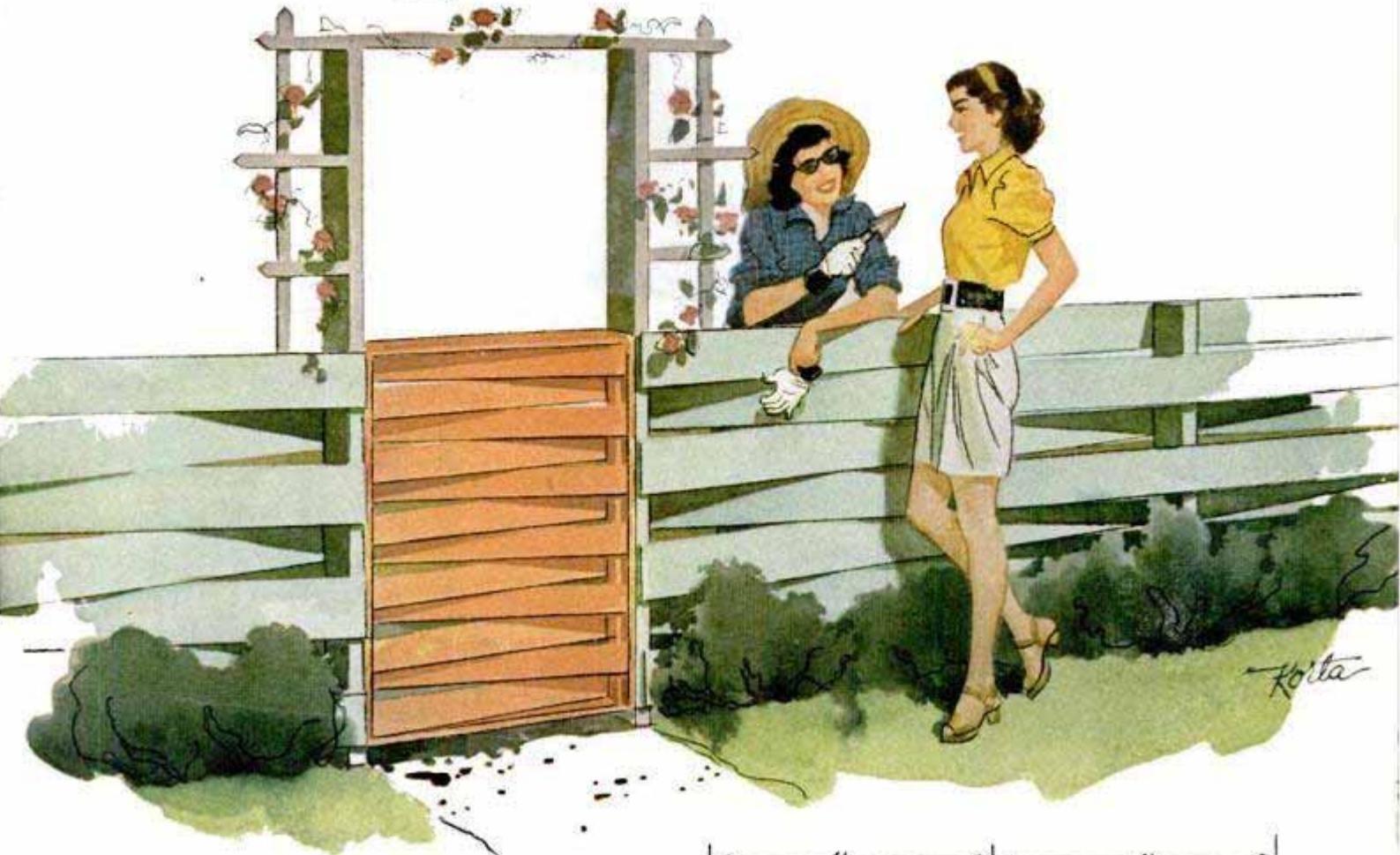

Basket-Weave FENCE and GATE

By Hi Sibley

THE IDEAL FENCE treatment for the modern house, this basket-weave pattern is easy to build and affords privacy without keeping out cooling summer breezes. The fence is made as in the lower detail, nailing 12-ft. lengths of 1 x 6 to 4 x 4 posts. The latter are spaced slightly less than 6 ft. apart so that the ends of the 1 x 6s will butt at the centers of the posts. A matching gate is made by weaving 1 x 3s in a frame of 2 x 6s. A length of 1 x 4 is nailed vertically to the inside of each side-frame member to form a nailing surface for the ends of the 1 x 3s. The gate may be hinged directly to 4 x 4 posts or it can be framed with 2 x 4s or 2 x 6s to simulate a doorway as in the illustration above. Use creosoted lumber or apply a wood preservative before painting. Stock sizes, of course, may be varied.

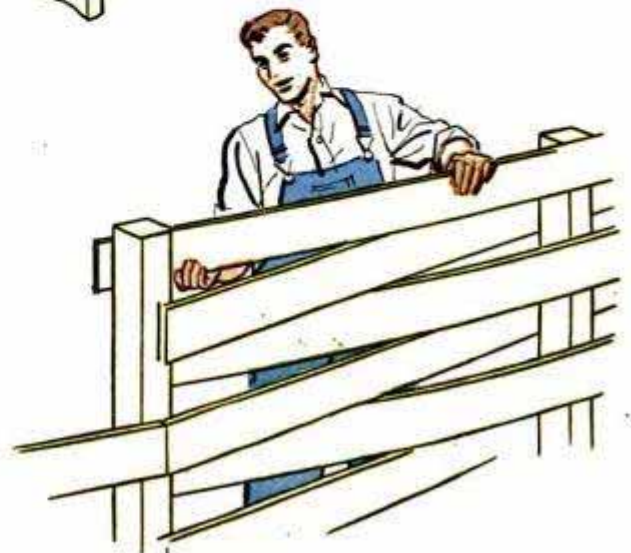
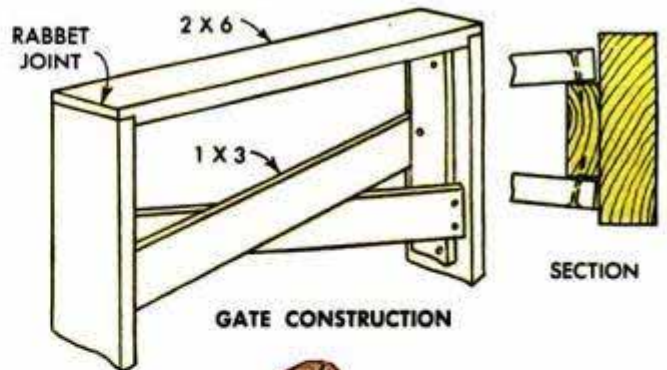

Contemporary



FOSTER

BAMBOO FURNITURE

By Walter E. Burton

LIGHTWEIGHT and sturdy, this simple-to-build bamboo furniture lends itself to many applications around the home. The slender bamboo poles conform nicely with present trends in modern furniture, so that the coffee table and chair pictured on the opposite page are right at home in the living room. And all three pieces, including the folding table on the next page, are ideal for use as porch or yard furniture.

Folding table: Weighing less than 2 lb., the little folding bamboo table is intended for chair-side use but doubles neatly as a luggage rack or serving-tray stand. Use bamboo stems or sections of a fishing pole for the table members, $\frac{3}{4}$ -in. bamboo being about the right diameter for the side rails, $\frac{5}{8}$ to $\frac{7}{16}$ -in. for the legs and $\frac{1}{2}$ -in. for the stretchers. The top is a piece of plastic-coated awning material.

The details on the next page show how to join the table members. Note that in joining the legs to the side rails, the ends of the legs are shaped to fit the curvature of the rails. This is done by using a rotary file or a sanding drum which approximates the diameter of the rail. If you do not have a drill press, the ends of the stems can be concaved with a half-round rasp or a sandpaper-covered dowel.

Fit a $1\frac{1}{2}$ -in. length of hardwood dowel in the end of the leg and drill the rail to receive the projecting end of the dowel, as shown. The dowel is glued in the leg, while the joint between the rail and leg is glued and reinforced with an oval-headed screw. To prevent splitting, drill and countersink the rail to take the screw. The legs and stretchers may be joined similarly or, if desired, without the wood screws. The two leg sections are joined with bolts and washers to pivot freely.

The awning-material table top is hemmed and slipped over the bamboo rails before the legs are attached. Two bamboo spreaders, notched to fit, are inserted between the rails at both ends of the table to hold the table in the open position when books or other heavy items are set on it.

All exposed ends and edges of the bamboo are rounded with sandpaper, and the ends of the legs may be plugged with dowels. If the bamboo shows signs of splitting at any point, wrap the damaged area with nonrusting wire, cord or raffia. Before

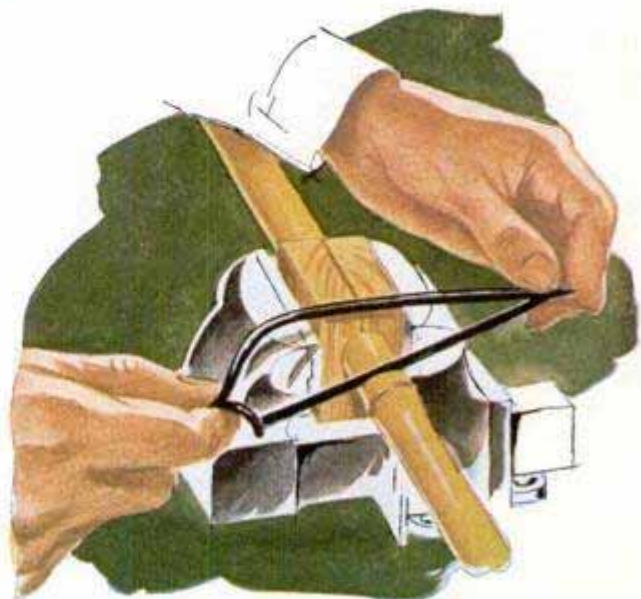

To cut bamboo stem, clamp in vise with protective block, score all around and cut with hacksaw blade



Coffee-table legs, above, and chair legs, below, are joined with brackets made of scrap sheet metal



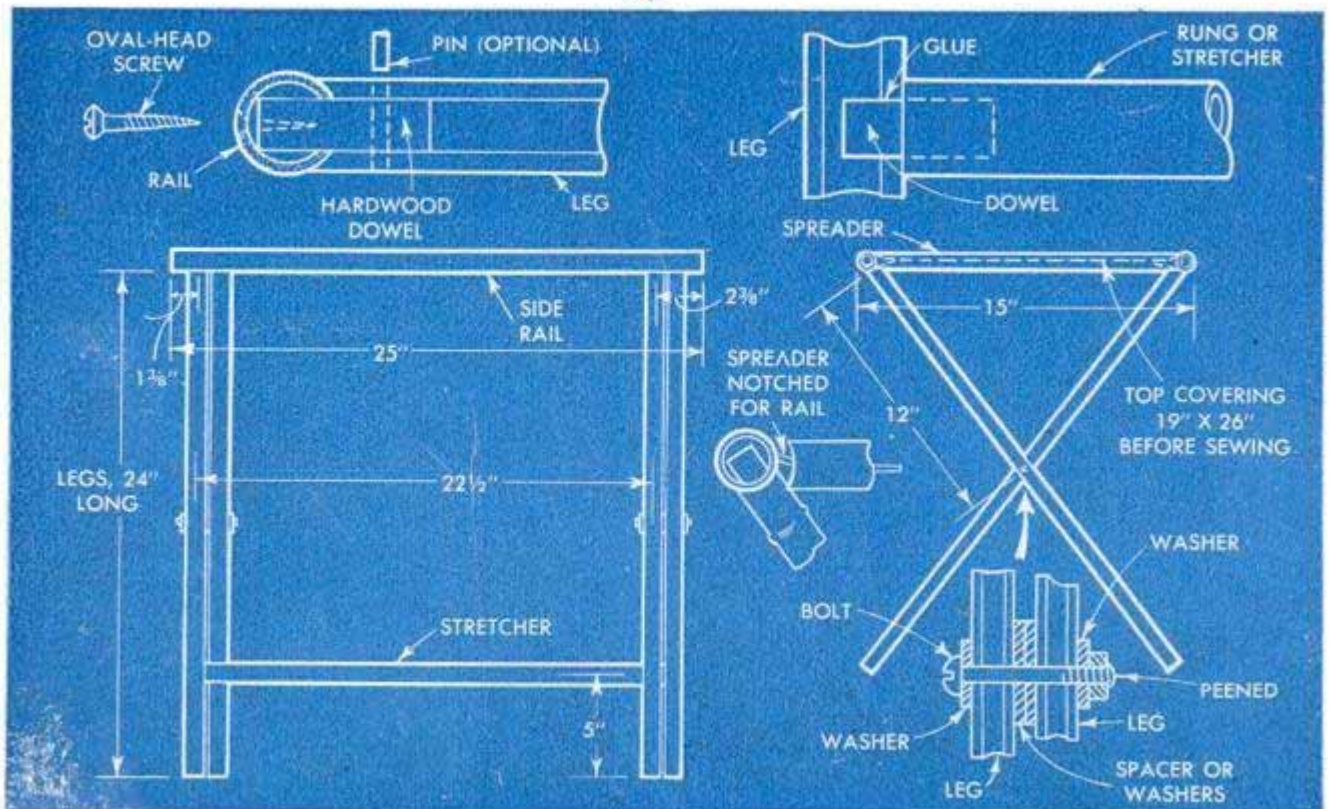

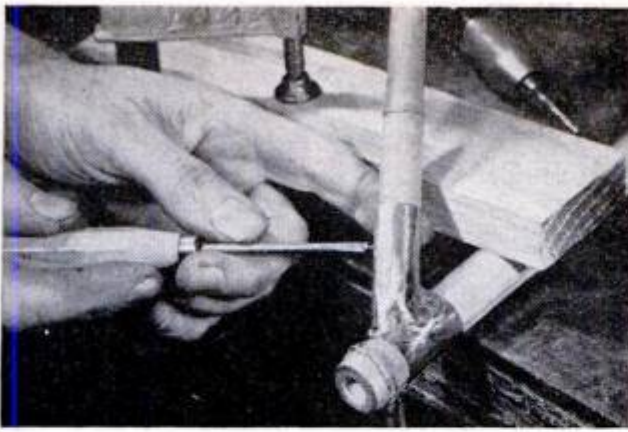

Diagonal brace is inserted in sheet-metal bracket fitted to chair leg. Wood screw prevents slipping

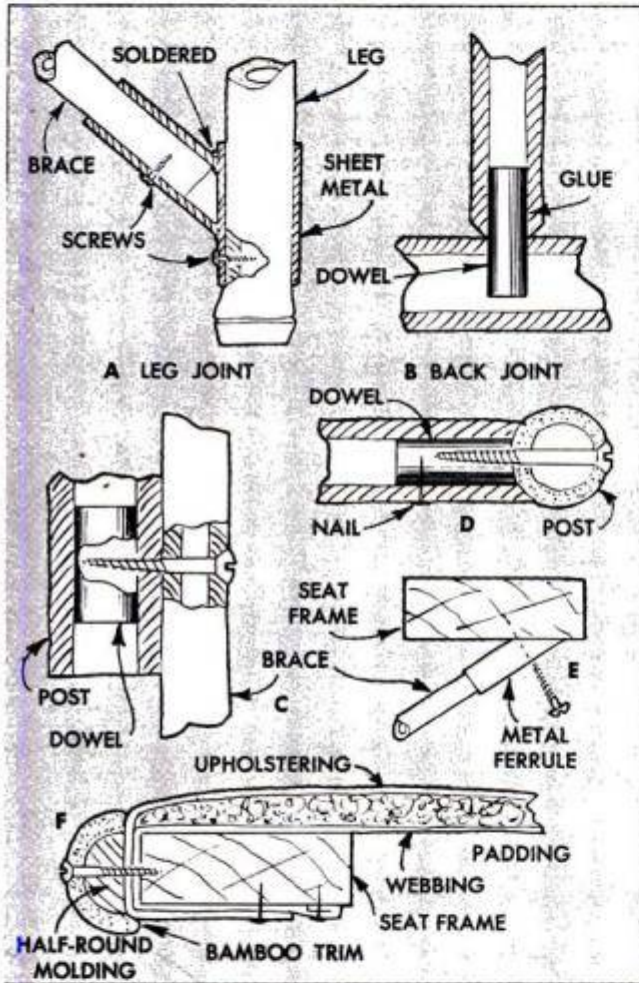

Chair-back posts are passed through seat frame and fastened to leg braces. Screw anchors post to frame

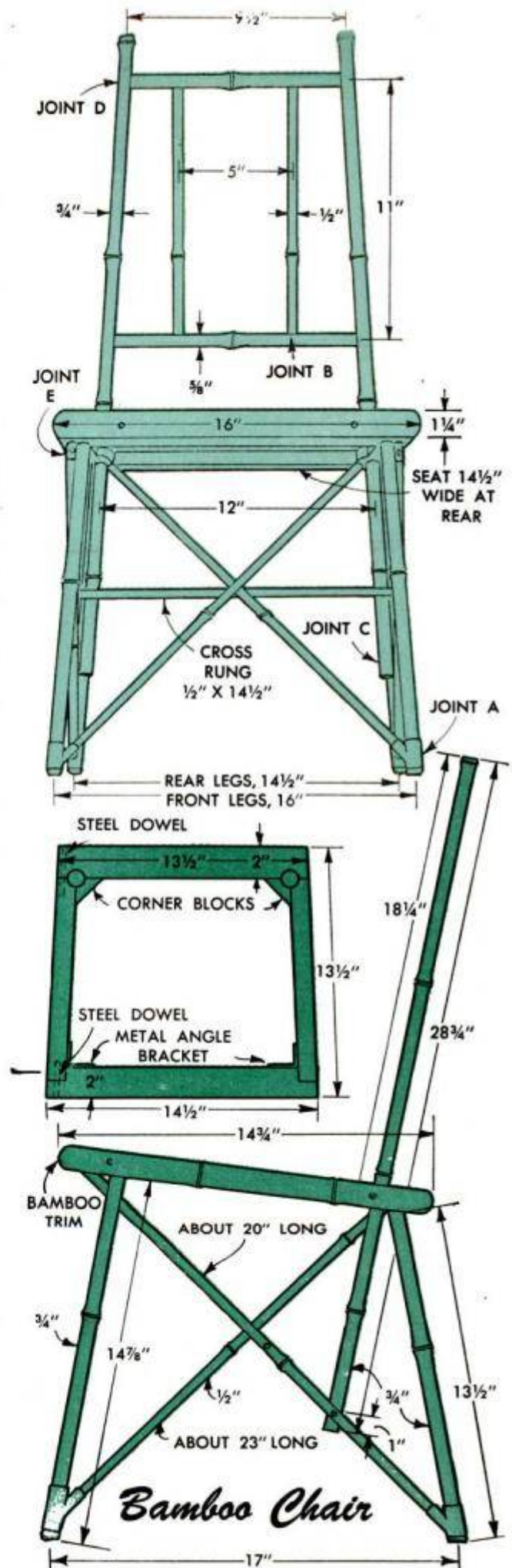
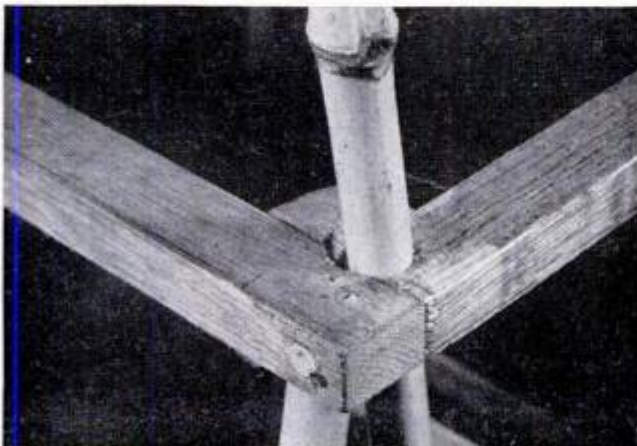

Bamboo Chair



After fabric is tacked to chair frame, bamboo edging is fitted around seat, photos above. The mitered bamboo edging is backed with half-round molding



Use spur bit, above, for drilling large holes. If screw-tipped bit is used, first drill pilot hole. Preheat stems over low flame, below, before bending them

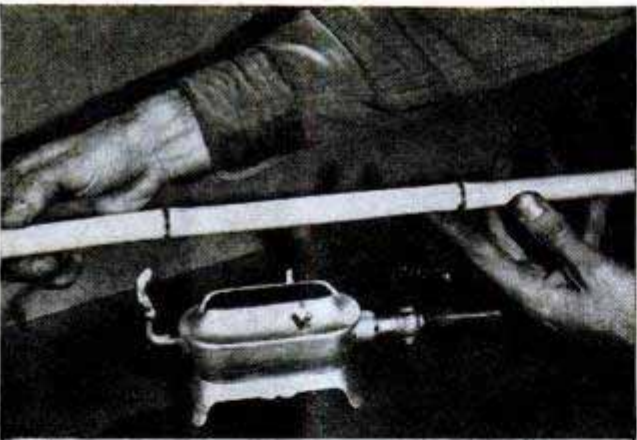

gluing the bamboo joints, be sure the surface of the stock has been scraped to clean the hard "skin" from contacting surfaces.

Bamboo chair: Including a seat frame of oak, this comfortable chair weighs a mere 4½ lb. The cross bracing and careful joinery, detailed on page 153, give the chair its rigidity. Each chair leg is set in a blind hole bored in the seat frame. Note that the holes must be bored at an angle to splay the legs.

The diagonal braces are fastened to the legs with sheet-metal brackets. The metal, which may be cut from empty tin cans, is bent around the leg, as in detail A. Then the ends are soldered together or fastened with the small wood screw which anchors the bracket sleeve to the leg. A second piece of sheet metal is bent to form a ferrule for the end of the brace. The ferrules are joined to the leg sleeves by soldering or fitting with interlocking tabs. Before soldering, the end of the ferrule should be trimmed to fit snugly against the side of the leg sec-

Below, left, rotary file being used to concave end of bamboo stem for neat butt joint. Raffia binding is coated with shellac or clear lacquer, as below

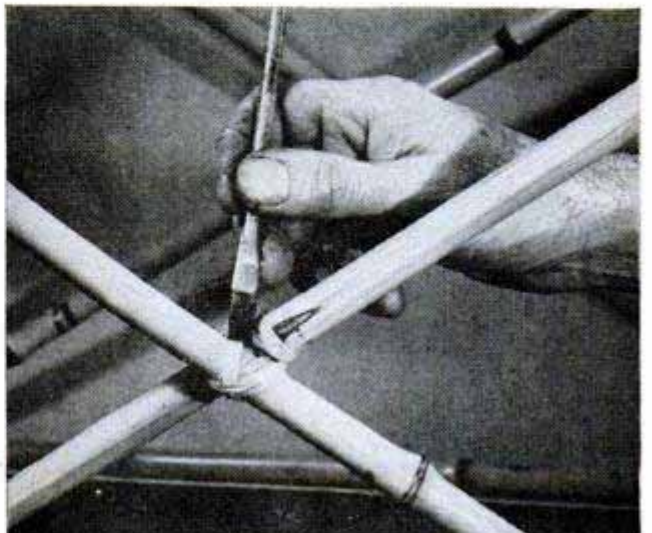

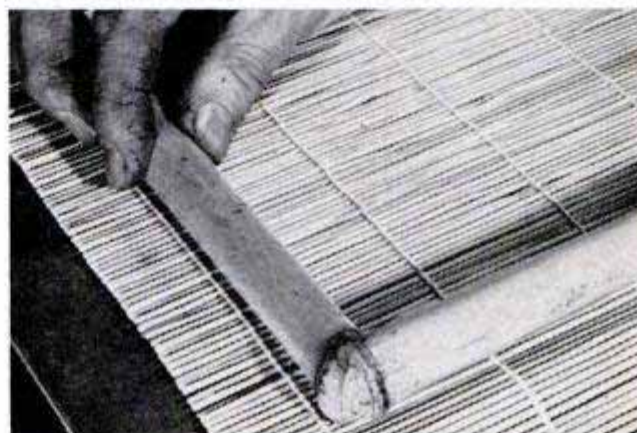
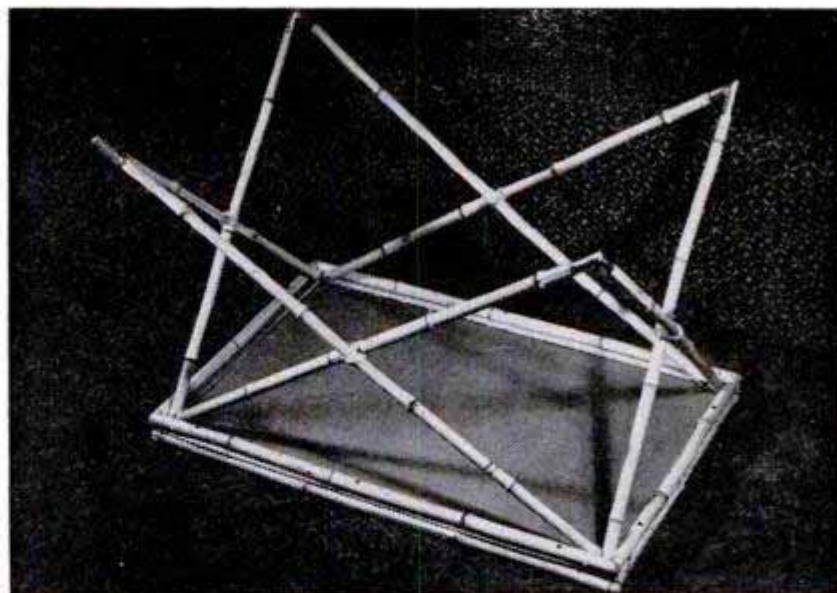
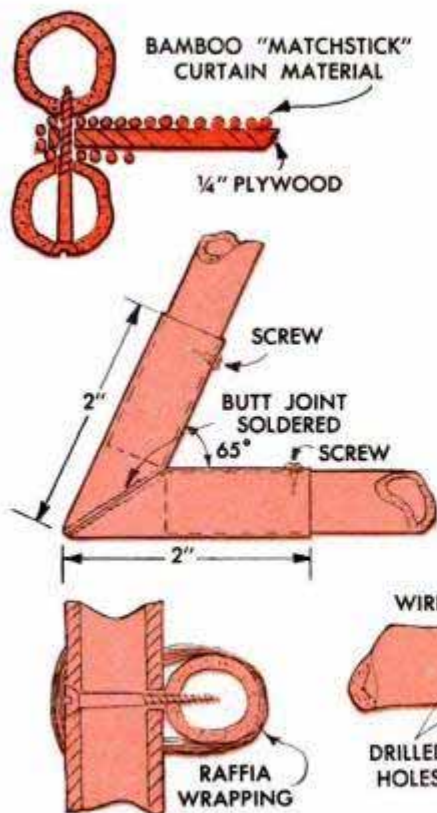

Corners of bamboo table-top frame, above, are mitered and joined with splines, below, or loops of wire



Ends of coffee-table legs are bolted to the lower sections of the table-top frame, as pictured below

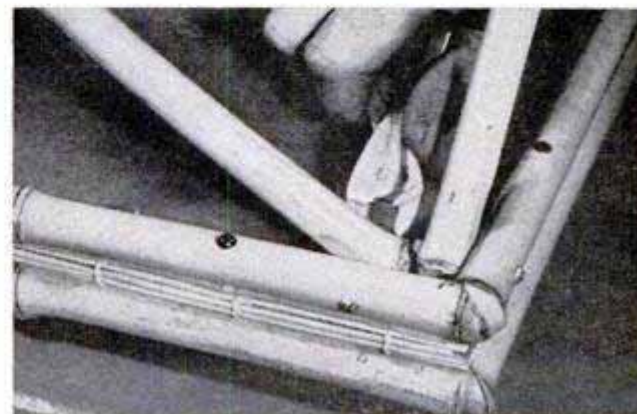

tion. The metal may be painted or wrapped with rattan, raffia or suitable cord. If rattan is used, it is softened by soaking in water for a few hours. Then it is applied wet and, when dry, is given two or more coats of white shellac or clear lacquer. The upper end of the brace is fastened to the chair frame as in detail E.

The back posts are passed through the seat frame and joined to the diagonal braces, C, with dowel sections and wood screws. The vertical and horizontal sections of the back are joined with dowels and glue, as in detail B. The seat, F, is padded, covered and then finished with an edging of split bamboo.

Coffee table: Featuring a plywood top covered with bamboo-curtain material, this interesting coffee table has diagonally braced legs. The $\frac{1}{4}$ -in.-plywood table top measures $17\frac{3}{4} \times 29\frac{3}{4}$ in., and after it has been covered with the curtain material, it is framed with a double row of bamboo stems. The latter are approximately $\frac{3}{4}$ in. in diameter and are fastened to the plywood with screws driven up through the bottom row of stems.

On the original coffee table, each leg was made of two lengths of bamboo; one $24\frac{1}{2}$ in. long and the other $32\frac{1}{2}$ in. long. These support the table at a height of about 20 in., so if you wish to lower the table use somewhat shorter leg sections. Note that the two sections of each leg are joined by a sheet-metal foot as in the center detail. When cutting and bending the sleeves to form the foot, be sure to round the metal where the foot will rest on the floor. ★★★

Bluebirds Attracted to "Apartment" House Rid Garden of Cutworms

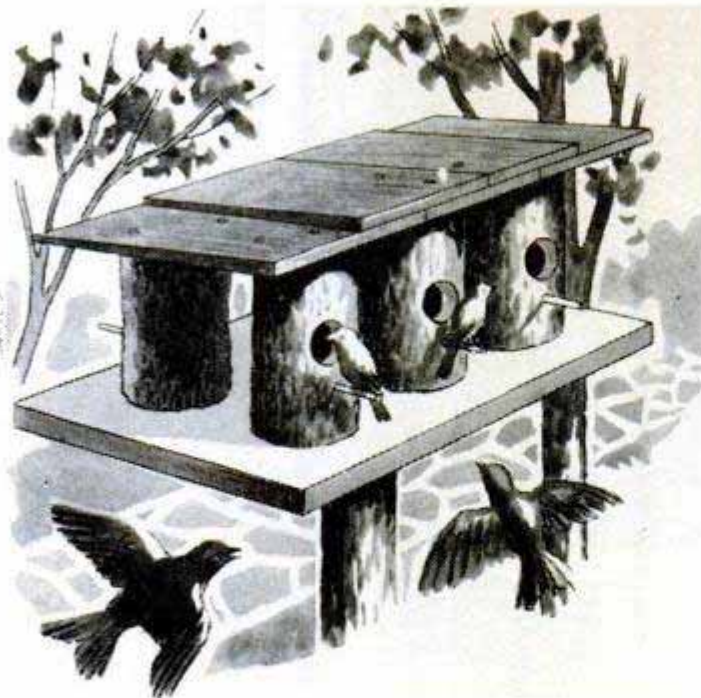

Bluebirds attracted to this unique "apartment" house will help considerably in reducing the cutworm population in a garden. The apartments are 10-in. sections cut from a small log, each of which is hollowed out and drilled to provide a 1½-in. "door" in the side. The sections can be hollowed out by drilling a series of holes close together in a circle and then completing the job with a chisel. The sections then are nailed to a base, preferably ¾-in. waterproof plywood, that is large enough to allow ample shelf space on all sides. If a pitched roof is desired, tops of the sections are sawed at an angle, after which shingles are applied as shown. The house is then mounted on a tall pole.

Fred Cornelius, El Paso, Tex.

Wallpaper Removed Easily When Soaked Thoroughly

Wallpaper removal can be made easier if the paper is soaked thoroughly with warm water before beginning. Use a large sponge, paintbrush, mop or hand sprayer to wet the paper, going over the surface as many times as necessary to soak it. To avoid marring the wall, pull off as much of the paper as you can, using a wide putty

knife to get under it when necessary, and being careful not to dig the blade into the plaster. After the paper is off, all traces of paste must be removed by washing the wall with a paint cleaner dissolved in warm water. Rinse with clear warm water and let dry. Before applying the new paper, patch all cracks and holes.

Simple Paintbrush Holder

A spring-type clothespin screwed to a wooden crossbar will be found handy for suspending a paintbrush in a can of thinner. By fitting several clothespins to a crossbar, a number of brushes can be supported individually in a row of cans. This provides an excellent means of storing brushes so that they retain their original shape.—Ken Murray, Colon, Mich.

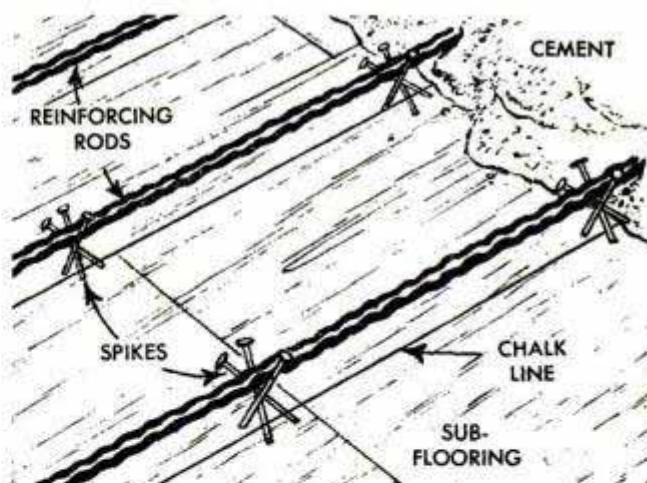
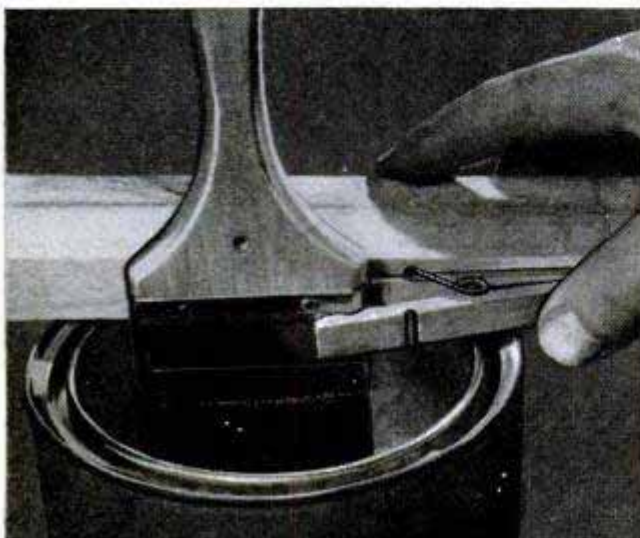

Spikes Support Reinforcing Rods

Reinforcing rods for a concrete floor that is poured over a wooden subfloor can be supported at the proper height by spikes. First, chalk lines are run on the subfloor to indicate positions of the rods, and then the spikes are cross-driven over them at intervals as indicated.

☐ An old toothbrush, with all except the first three rows of bristles trimmed off, makes an excellent comb cleaner.

Signal Automatically Indicates Mail Delivery

Set manually each time you remove mail from a rural-type mailbox, this signal automatically drops when the postman opens the box. In the closed position, the arm is raised out of sight behind the box. The simple operating mechanism consists of a small rod, 1 in. longer than the box, supported by two eyebolts in the top of the box. When the door of the box is closed, it pushes the rod through the back of the box to support the arm in the upright position. When the door is opened, an expansion spring pushes on a washer held in place on

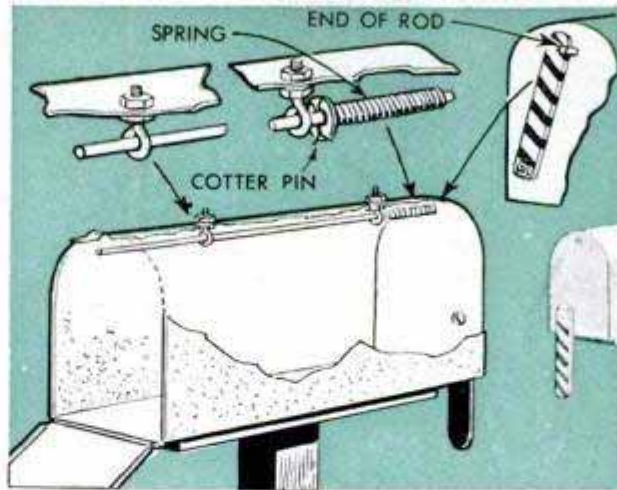

the rod by means of a cotter pin, moving the rod forward and allowing the arm to drop.—W. S. Head, El Cajon, Calif.

Success With New Nursery Stock Depends on Proper Care

When young trees or plants arrive from the nursery, there are several important factors to be understood if they are to flourish. Should the trees or plants arrive frozen in their package, do not open. Place the package in the cellar or other cool, protected place, or cover heavily with earth until they have thawed, after which they may be planted safely. Do not plant if the surface of the ground is thawed, but still frozen at root level. Do not pamper young stock planted in the fall with any kind of protective covering. Many make the mistake of wrapping burlap, straw or corn stalks around the young trees, and are surprised in the spring to find the trees dead.

Young trees, even the peach, generally can withstand temperatures as low as 30 deg. below zero when dormant, but will freeze in much higher temperatures if not entirely dormant. Where a protective covering is used, the trees take longer to enter the period of dormancy than do unprotected trees. Thus a sudden freeze may catch protected trees before dormancy and kill them. Avoid late cultivation and fertilization that may stimulate the young stock to put out new growth which will retard dormancy. Should frosts be sharp and frequent in early spring, hold off fertilizing or cultivating, for a sudden cold snap may destroy or damage the stimulated trees.

Rubber Shield Prevents Door From Locking Unexpectedly

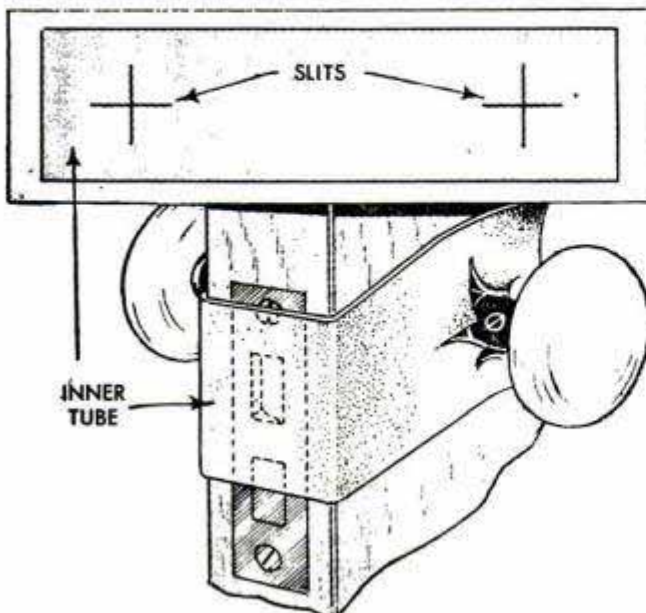

Used in some hospitals to prevent bed-ridden patients from being locked in their rooms accidentally, this shield, which is cut from an inner tube, also can be used around the home. It will keep children from locking themselves in the bathroom, and prevent doors from being locked when slammed by a gust of wind.

Jeanne Stasack, Chicago.

Nail Substitutes for Drill

If a twist drill of the correct size is not at hand for making pilot nail holes in hardwood, a substitute can be improvised from one of the nails. Clip the head from the nail and file the burrs from the clipped end to keep it from wobbling in the chuck. Use this as you would any standard drill.

Martin Mantell, Hazleton, Pa.

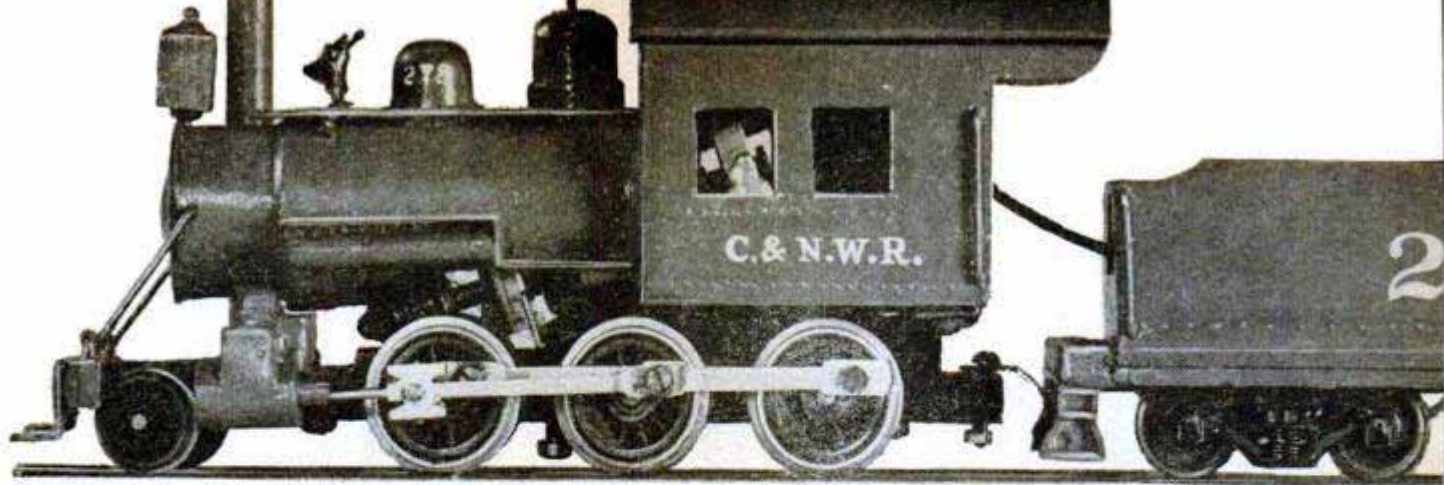

THE GHOST OF OLD

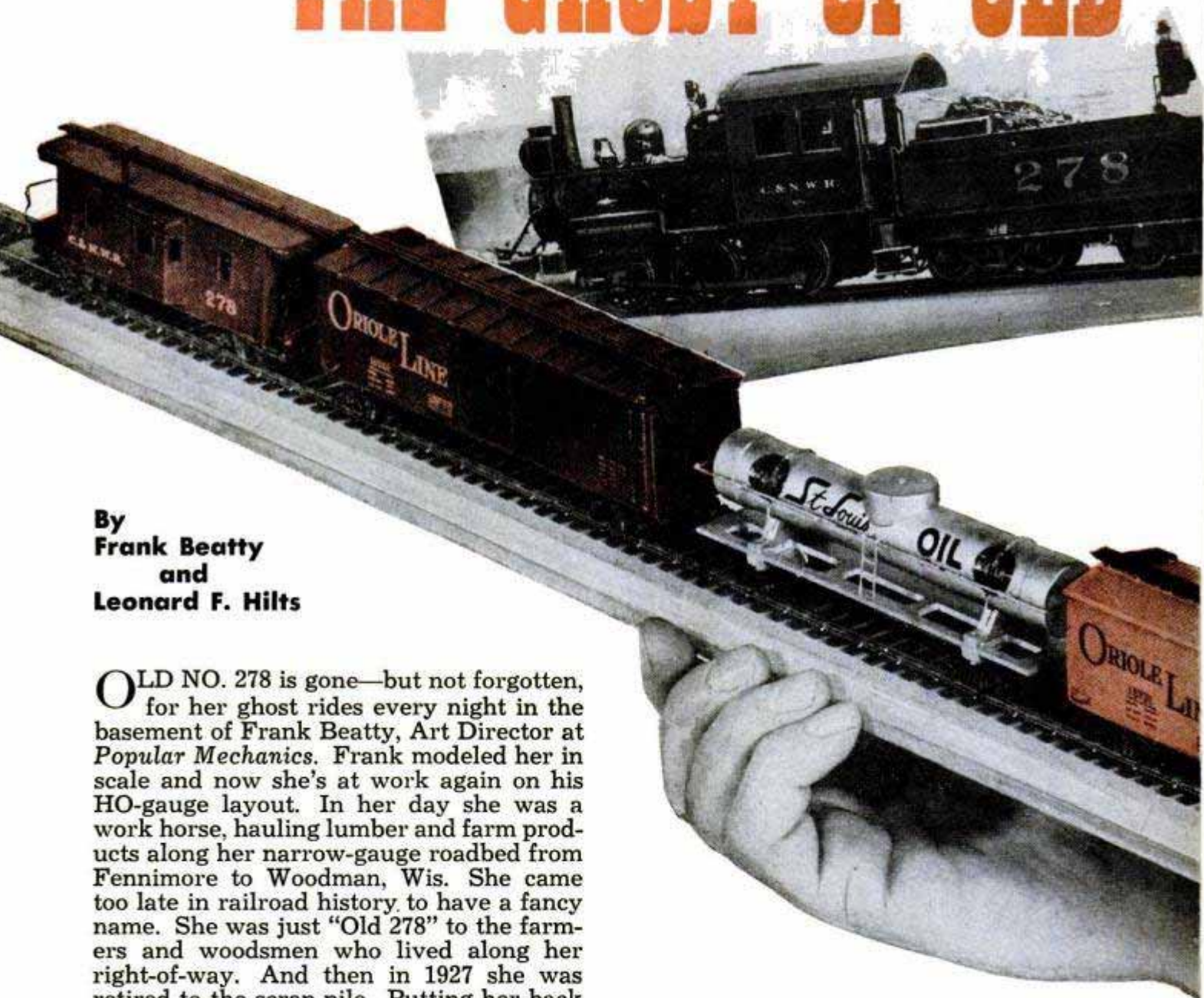

By
Frank Beatty
 and
Leonard F. Hilts

OLD NO. 278 is gone—but not forgotten, for her ghost rides every night in the basement of Frank Beatty, Art Director at *Popular Mechanics*. Frank modeled her in scale and now she's at work again on his HO-gauge layout. In her day she was a work horse, hauling lumber and farm products along her narrow-gauge roadbed from Fennimore to Woodman, Wis. She came too late in railroad history to have a fancy name. She was just "Old 278" to the farmers and woodsmen who lived along her right-of-way. And then in 1927 she was retired to the scrap pile. Putting her back on the "high iron" cost about \$16 and three weeks of spare-time work.

Main frame: To model Old 278, start with the main frame cut according to the full-size, side-view pattern from $\frac{7}{16} \times \frac{7}{16} \times 3\frac{1}{16}$ -in. channel brass. A wedge-shaped

Built in 1915, No. 278 was a narrow-gauge coal-burning locomotive modeled after a similar type of engine which had been operating for some years on Eastern railroads. The line from Fennimore to Woodman, Wis., over which she operated, was abandoned by the C. & N. W. No. 278 was scrapped in 1927

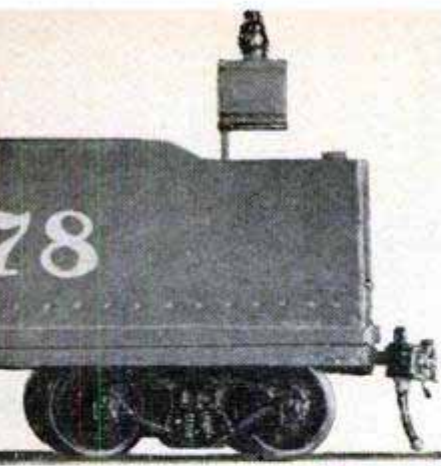

WIM
Book for
Boys

Build this HO-gauge scale model of an historic Chicago and Northwestern R.R. locomotive for your layout. Full-size engine and tender plans are in this issue. Scale drawings for the cars will appear next month

No. 278

wooden block, which is included in the side-view pattern, is fitted into the channel brass to complete the motor mount. Including this block, the main frame is $\frac{3}{4}$ in. high. The axles float in grooves cut across the bottom of the main frame, and one half of a $\frac{5}{16}$ -in. washer is soldered over each axle opening. A $\frac{3}{16} \times \frac{9}{16}$ -in. opening is cut into the frame over the front axle to clear the gear wheel. As shown, a $\frac{1}{4} \times 1\frac{1}{16}$ -in. sheet-brass cab-mounting plate is cut at the back of the main frame. (All sheet brass used is 24 or 26 ga., half-hard.) A $\frac{7}{16} \times 2\frac{7}{8}$ -in. bottom plate is cut from sheet brass and drilled for screws as shown. The motor-mounting screw passes through the frame and threads into the motor. The hole at the back of the bottom plate takes an 0-80 nut and bolt which joins the engine to the pulling bar. The three remaining holes take 2-56 screws which are tapped into the main frame. The drive wheels are mounted in their slots with the insulated wheels on the left side and are held in place by the bottom plate.

Front-end assembly: The cylinder block is machined from solid brass, $\frac{7}{16} \times \frac{1}{2} \times 1\frac{3}{8}$ in., following the layout in the plans. The cylinder heads, of $\frac{1}{4}$ -in. brass rod, $\frac{3}{8}$ in. long,

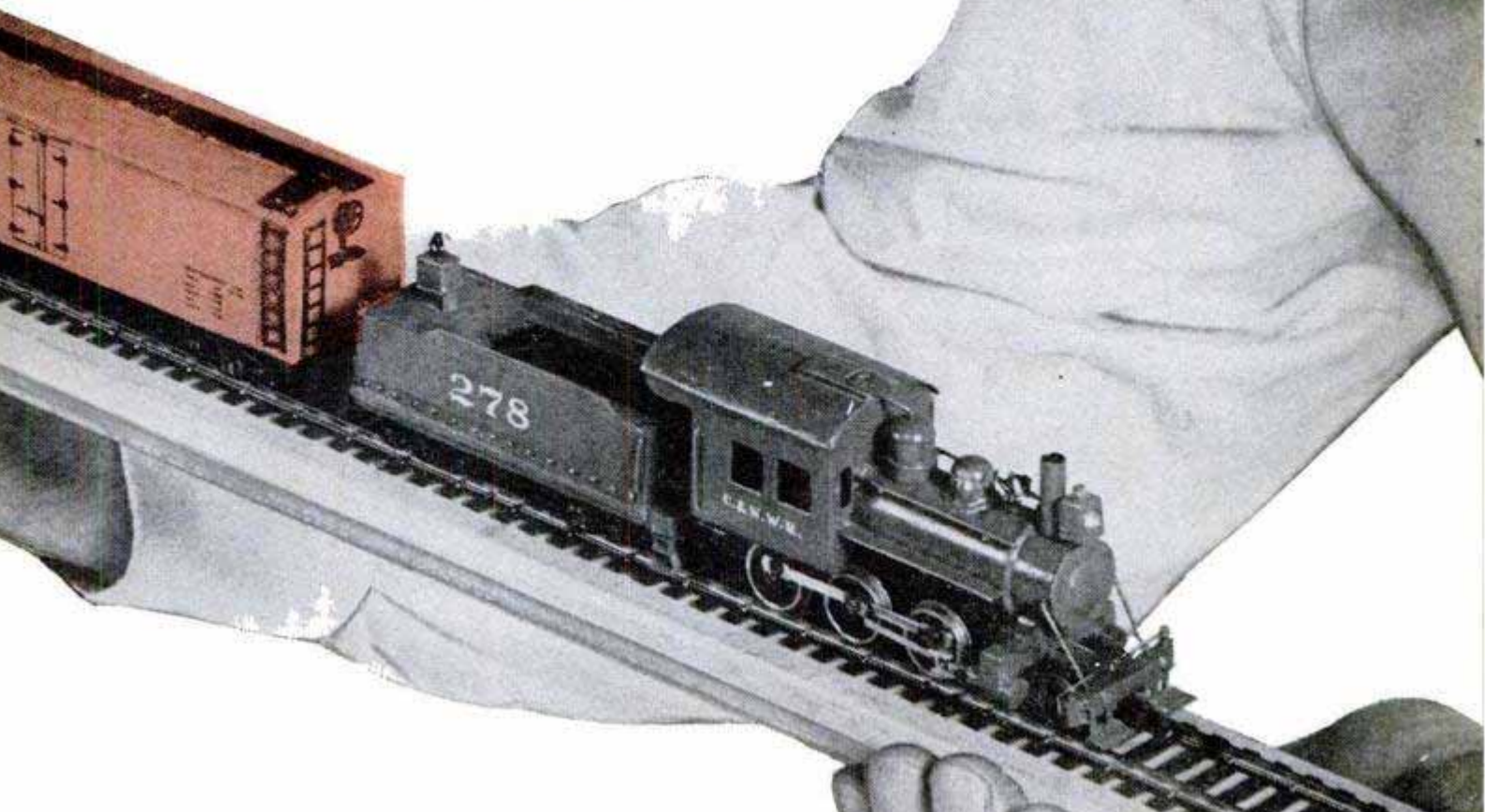

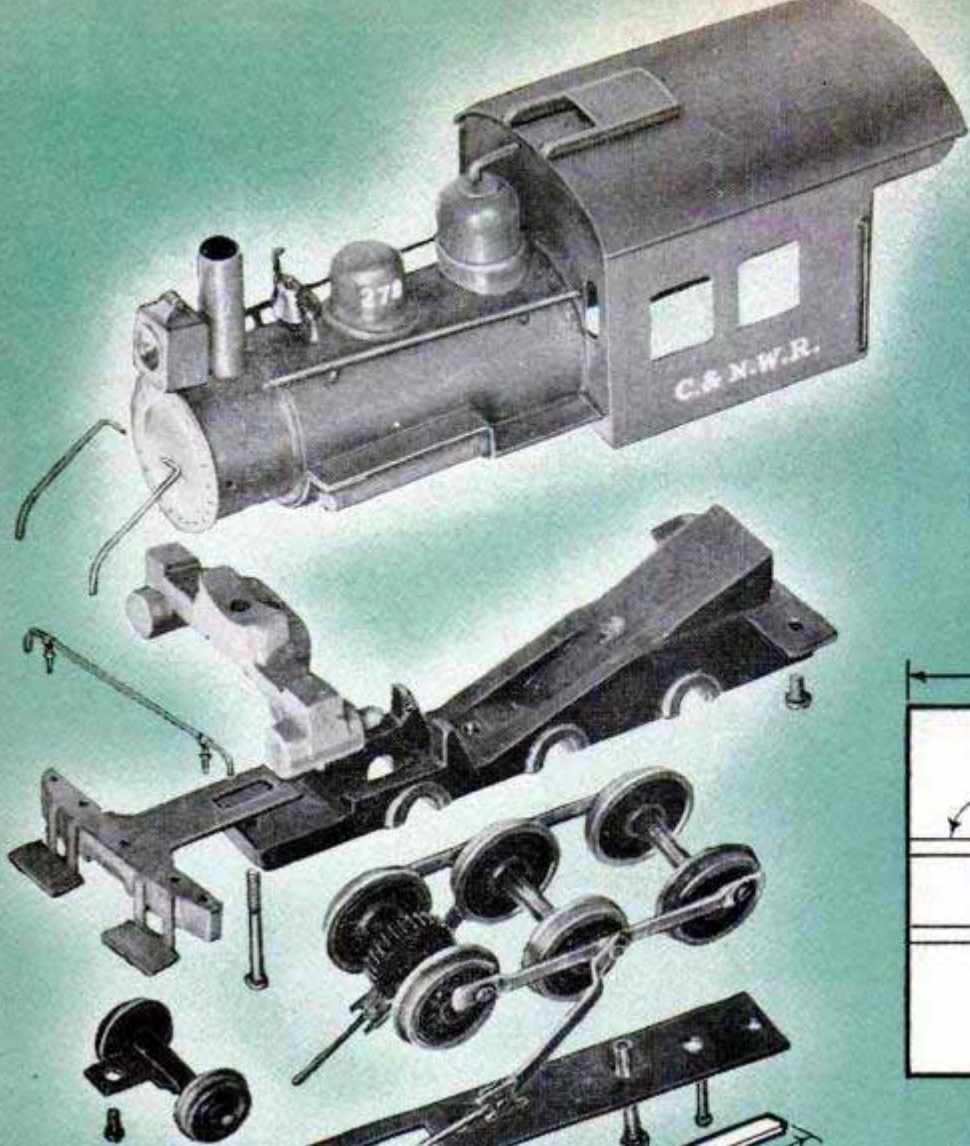

CAB BACK

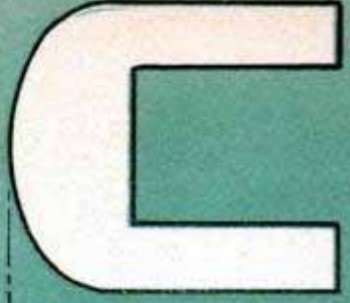

CAB FRONT

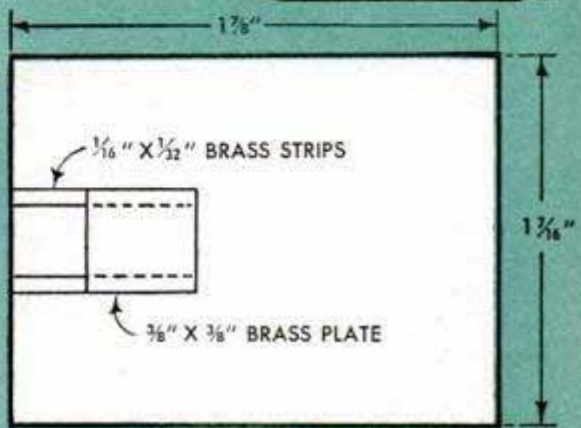
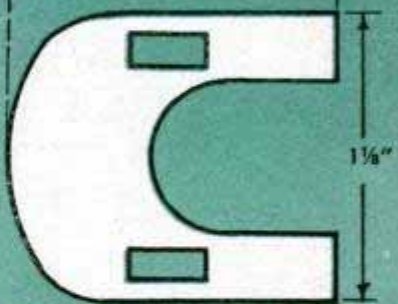

CAB ROOF

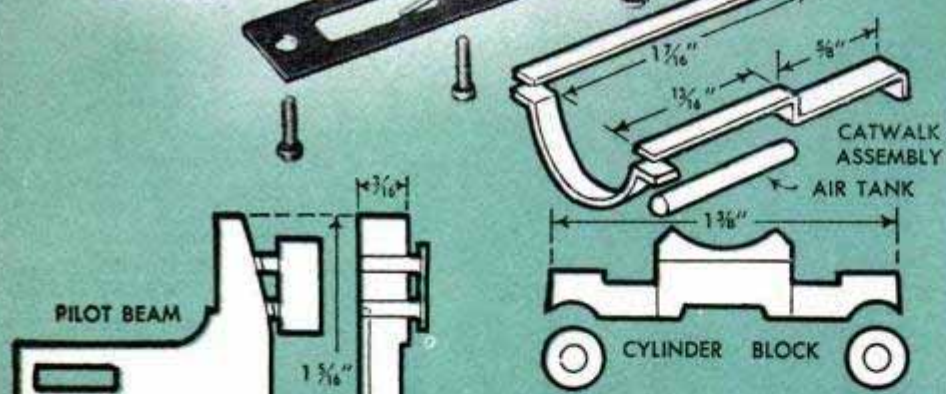

CATWALK ASSEMBLY

CYLINDER BLOCK

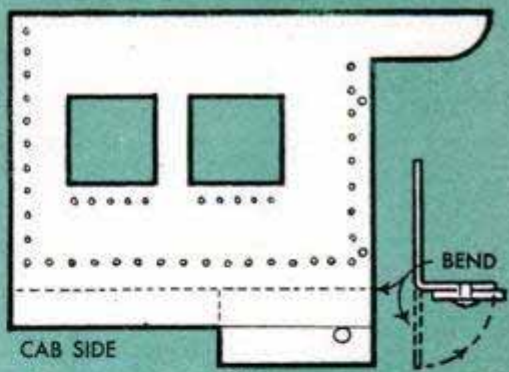

CAB SIDE

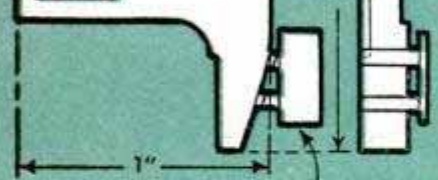

PILOT BEAM



WOODEN BLOCK

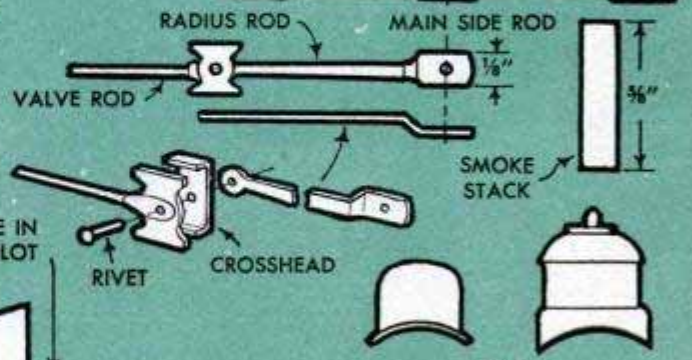

RADIUS ROD

MAIN SIDE ROD

VALVE ROD

SMOKE STACK

RIVET

CROSSHEAD

DOMES

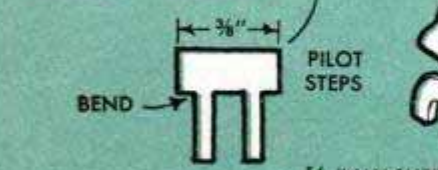

PILOT STEPS

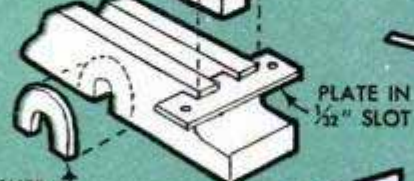
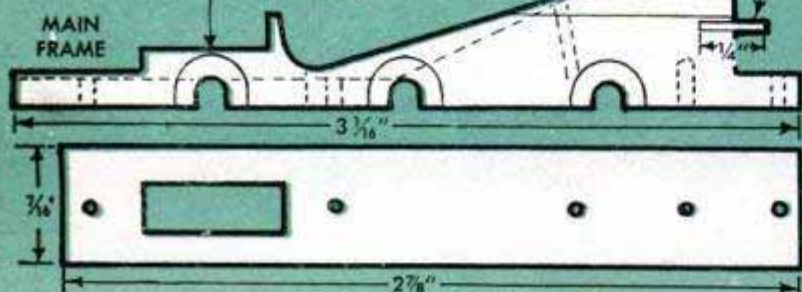
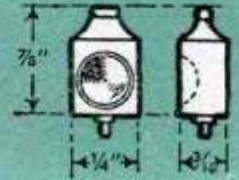

PLATE IN 1/32" SLOT

3/16" WASHER SOLDERED



MAIN FRAME



HEADLIGHT

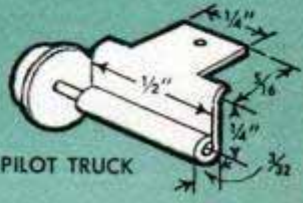

PILOT TRUCK

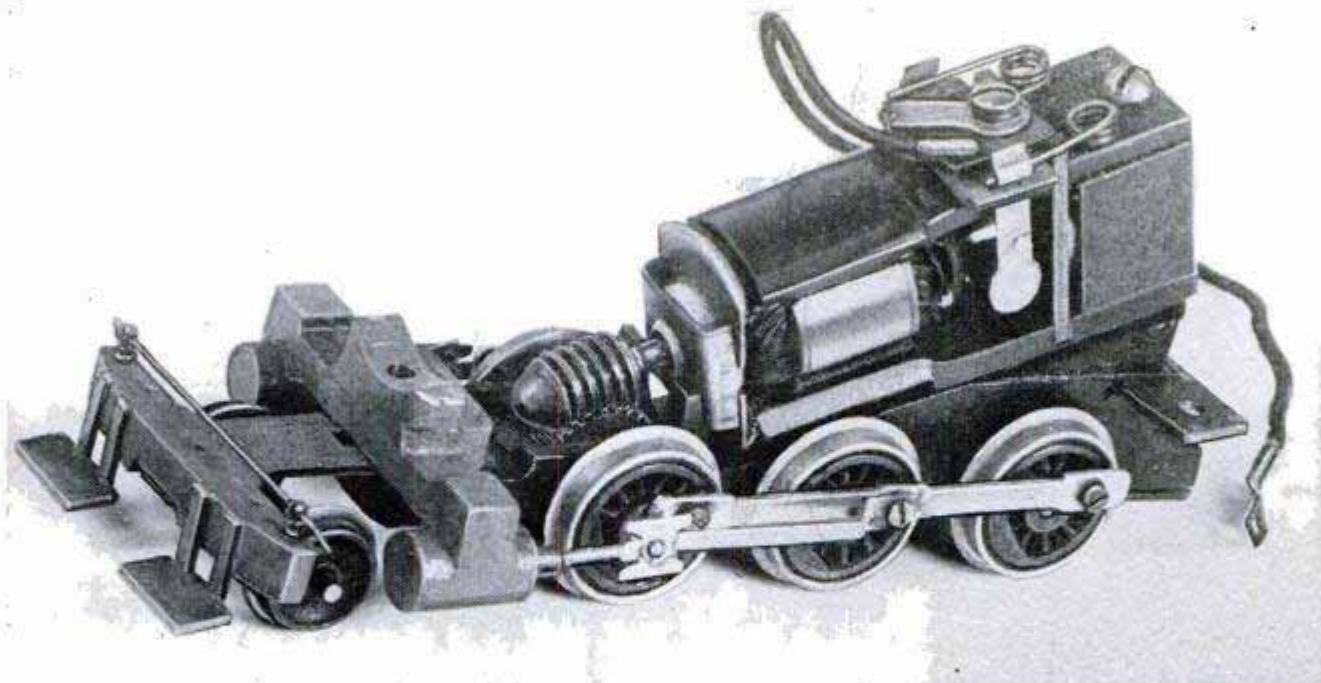

are drilled to receive $\frac{1}{16}$ -in. i.d. tubing, which projects from the head about $\frac{1}{8}$ in. The cylinder heads are then soldered to the cylinder block. Next the pilot beam is shaped from $\frac{3}{16} \times \frac{3}{16} \times 1\frac{5}{16}$ -in. brass, with a notch in the top for the sheet-brass pilot-beam bracket and one in the bottom for the pilot-truck mount. The pilot steps are cut from sheet brass, bent and soldered to the beam. The pilot truck is held in place with an 0-80 screw. The pilot beam is drilled at this time, photo detail on opposite page, for the handrail and the two braces which run to the boiler. To assemble the front end, a long 2-56 screw is put through the front of the main frame, the pilot-beam bracket, the cylinder block and tapped into a hole in the boiler. For rigidity, an 0-80 screw can be tapped down through the back of the cylinder block into the main frame.

Mounting the motor: The motor is laid on the main frame so that its gear meshes with the drive-wheel gear. It is secured in place by the screw through the frame ahead of the rear axle. Now the engine should be test run. If the worm gear is too tight, the

screw under the front of the motor should be turned in. This will raise the motor and relieve the friction.

Boiler: The large section of the boiler is $\frac{3}{4}$ -in. brass tubing, $1\frac{1}{2}$ in. long. The small section is the same tubing, $\frac{5}{8}$ in. long, slit lengthwise to permit it to be fitted inside the larger section with a $\frac{1}{16}$ -in. overlap. The joining surfaces are tinned and sweat soldered. The boiler front is a circle of sheet brass $\frac{3}{4}$ in. in diameter. To make it convex, place over a $\frac{7}{16}$ -in. bolt hole and tap with a ball-peen hammer. The rivets in it are simulated by denting it from the inside with a center punch. The boiler fittings are put on after cab is joined to the boiler.

Engine cab: Using the full-size templates, cut the sides and roof from sheet brass. Bend the lower edges of the side panels as shown and solder a piece of brass to the bent section to increase its thickness so that it can be tapped for a 1-72 screw. Place the "rivets" in the cab sides and then solder the four side panels together and curve the roof over them. Block up the boiler and cab and solder them together.

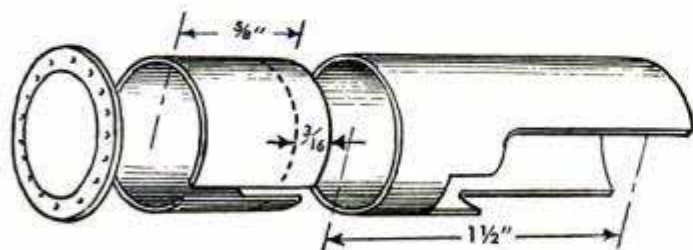

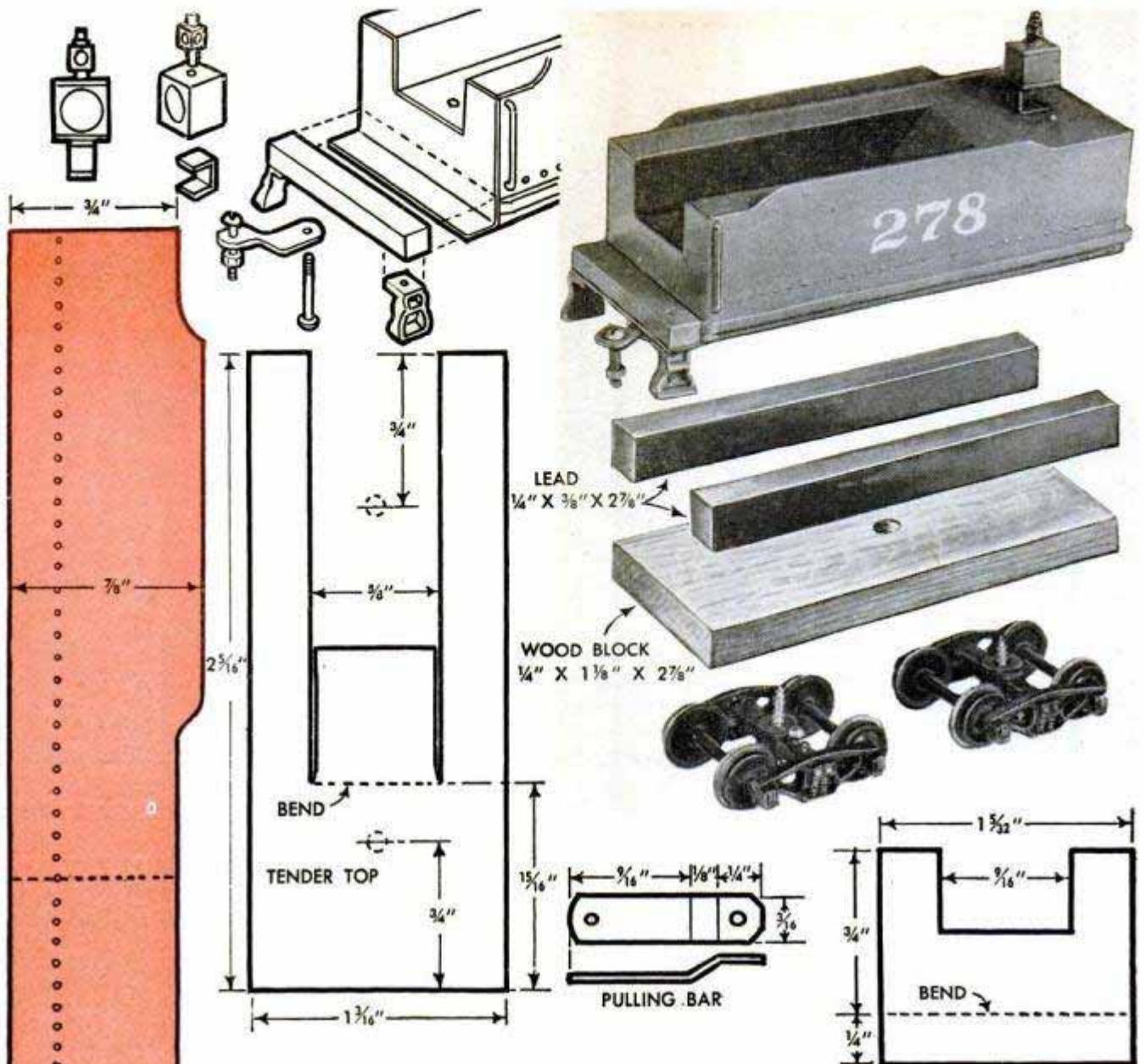

Boiler fittings: The domes may be purchased from any model-supply house, and are held in place by small screws from the inside of the boiler. The bell-and-hanger assembly is purchased and screwed into a tapped hole. The stack is $\frac{1}{8}$ -in. i.d. brass tubing, $\frac{5}{8}$ in. long, soldered in place. The head lamp may be purchased or made as shown. Weight should be added to the engine now by pouring molten solder or type lead into the front of the boiler and under the front of the cab roof. The motor must not contact this lead or a short will result. Now the catwalks are made from sheet brass and soldered to a brass strap which runs under the boiler. This assembly is soldered to the boiler, and the air tank, a $1\frac{3}{16}$ -in. length of $\frac{1}{8}$ -in. brass rod, is attached under the left walk. The piano-wire handrails and braces are added after the superstructure is mounted on the frame.

Drive-wheel linkage: Parts should be of German silver or aluminum. The radius rod, valve rod and crosshead link are purchased already assembled. The main side rods are $1\frac{13}{16}$ in. long and are screwed to the drive wheels at a point opposite the balance weights. The radius rods are attached to the drive wheels by the same screw. Care must be taken to see that the linkage works smoothly.

The tender: Exploded details show construction of tender. Type-lead strips are screwed to a wooden floor, after which the sides are cut from sheet brass, using the full-size template, and wrapped around the under assembly. Small pins driven through the brass sides into the wooden floor secure the sides and also show as rivets. The tender top is soldered in position with the center bent down to the floor. The

Material List

Locomotive

- 1 d.c.-60 motor
- 1 pr. 48" drive wheels, geared
- 2 pr. 48" drive wheels, ungeared
- 1 pr. standard car wheels
- 1 pc. channel brass, 7/16" x 7/16" x 3-1/16"
- 6 5/16" washers
- 1 wooden block, 1/2" x 1/2" x 1-5/16"
- 3/4" i.d. brass tubing, 2" long
- 1/8" i.d. brass tubing, 5/8" long
- 1/16" i.d. brass tubing, 1/2" long
- 6" piano wire
- 1 pc. solid brass, 3/16" x 3/16" x 1-5/16"
- 1 pc. solid brass, 3/16" x 1/2" x 1 3/8"
- 7 2-56 screws
- 2 1-72 screws
- 3 0-80 screws
- 1 0-80 nut and bolt
- 1 bell-and-frame assembly
- 2 engine domes
- 1 headlight
- 2 handrail posts
- 1/4" brass rod, 3/4" long

Sheet brass for engine and tender, 24 or 26 ga.

Tender

- 2 lead blocks, 1/4" x 3/8" x 2 7/8"
- 1 wooden block, 1/2" x 1 1/8" x 2 7/8"
- 1 wooden block, 1/8" x 3/8" x 1-5/32"
- 2 4-wheel trucks
- 2 brass blocks, 3/16" x 3/16" x 1"
- 1 light
- 1 pr. steps
- 1 HO-gauge coupler

tender front, shown in the lower-right-hand corner of the detail, is cut and bent, and the wooden platform is glued into the bend. The tender steps, which are bought, are attached, and the front assembly is then soldered in place. A small strip of brass is soldered around the body of the tender below the rivets to add more detail. Two truck bolsters, which are brass pieces 1/8 x 3/16 x 1 in. tapered at the ends, are now located across the bottom of the tender, 3/4 in. on center from either end. The trucks are screwed to these. The rear coupler is purchased, while the pulling bar is cut from sheet brass. The motor lead wire passes through the tender floor and is screwed to the front truck. Note that the insulated wheels of the tender are on the right side. Handrails, a ladder and the back-up lamp are now put on and the engine and tender painted a standard black.

Next Month: Full-size plans for four cars, No. 278's rolling stock, will be shown. ★★

Plans—SS United States

Complete plans, consisting of three large sheets, and a kit containing all tiny fittings for the 36-in. model of the SS *United States* now are available. These may be obtained by sending \$1.50 for the plans and \$15.50 for the kit to the Popular Mechanics Book Dept., 200 E. Ontario St., Chicago 11.

Burnishing Wheel for Hand Grinder

By placing a typewriter eraser on a mandrel as indicated, one metalworking craftsman makes a burnishing wheel for use in his portable electric grinder. The erasers come in four grades and may be used over and over again without appreciable wear.

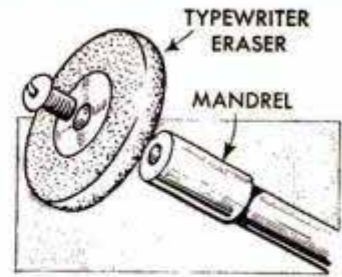

John A. Comstock, Wellsboro, Pa.

Nail in Groove Anchors Shelves

To anchor a shelf securely in a grooved side panel, drive a finishing nail between the shelf and the side of the groove, as indicated in the photo. The nail is driven straight into the groove and grips both pieces of wood, thus bracing them against side stresses.

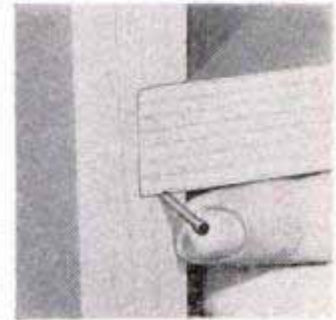

R. F. Donovan, Guttenberg, N. J.

Oil Barrier Stops Slugs and Snails

While tin cans and waxed cartons pressed into the soft earth around small plants have proven effective in keeping out most crawling insects, they present no barrier to slugs and snails. However, if a 1/2-in. band of heavy oil or grease is spread around the rim of the can or carton, neither snails nor worms will cross it.

Clinton Hull, Costa Mesa, Calif.

Cans Protect Campfire Stakes From Spreading Flames

To prevent a campfire from burning stakes that support cooking utensils, use cans to shield the lower ends as shown. After punching holes in the bottoms of the cans, invert them and force stakes through the holes and into the ground. However,



if the ground is rocky or partly frozen, set the stakes inside large cans which are filled with rocks to hold them upright.

Solving HOME PROBLEMS



CROQUET STAKES that must be taken up after each game can be reset quickly if they are drilled to receive a $\frac{3}{8}$ -in. pointed dowel. With this sharp end, they may be quickly pushed into the ground

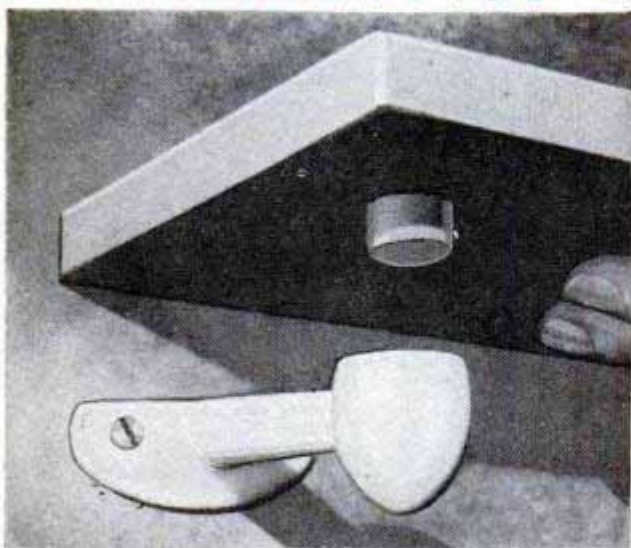

NEAT, BATHROOM-SHELF brackets can be made from plastic towel-rod holders. Trim the inside of the base flat and attach the shelf with dowel stubs

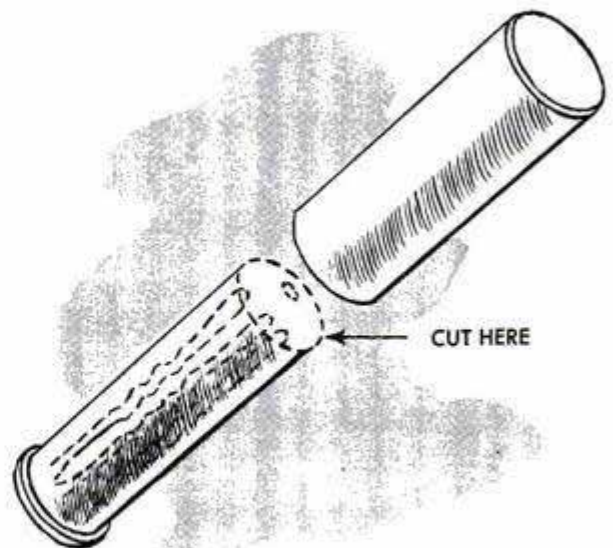

A WORN-OUT POCKET inhaler can be converted to a bobby-pin case by cutting off the rounded top, as indicated above, and dressing the edges with a file

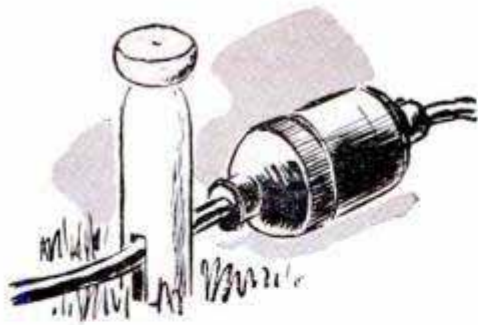

CLOTHESPIN driven across an electric cord near the socket will prevent disconnections while using an electric lawn mower or when vacuuming the car



SHAVING BRUSHES dry best when hung with bristles down. Suction cup screwed to handle allows brush to be hung out of the way under shelf when drying

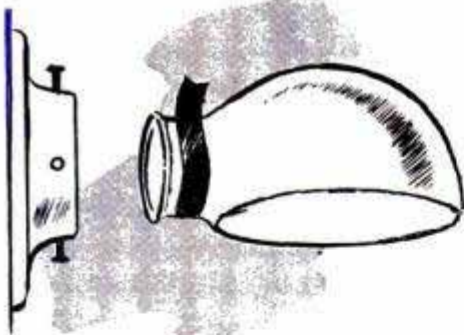

WHEN VIBRATION tends to loosen set-screws on heavy glass shades, a piece of rubber tape will hold them secure



ALUMINUM AND OTHER metal trim on kitchen cabinets won't stain clothes brushed against it if given two coats of thinned white shellac

SCREEN-DOOR PULL hangs broom from wall to keep bristles straight in storage. Mounted at angle, pull bears against opposite sides of handle to support weight of broom

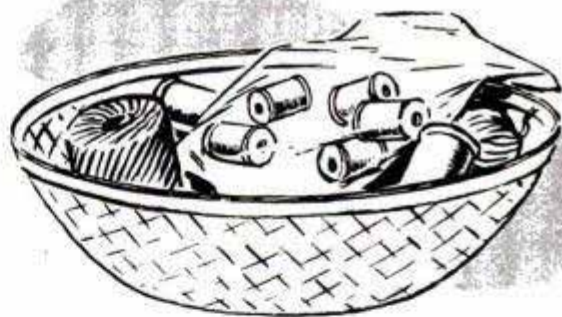

SMALL, TRANSPARENT plastic bags are fine containers for spools of thread in a sewing basket. Thread colors are visible for easy selection and spools have no space in which to unwind

WHEN WINDING newly purchased yarn into a ball, use wrapper in which it comes as a core. When it is necessary to reorder, you will have all of the color and weight specifications right at hand



Shingle Anchors Boat-Seat Pad

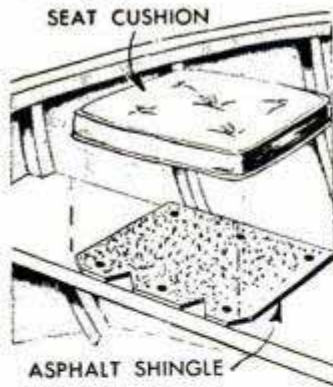

To prevent a rowboat seat cushion from sliding about or falling to the bottom, tack an asphalt shingle to the wooden boat seat with the rough surface up. If the seat is made of metal, so that the shingle cannot be tacked in place,

the cushion may be secured by attaching to it cloth ties or leather straps with buckles to be fastened under the seat.

Lawn-Party Ash Trays From Coffee Cans

To protect your neatly trimmed lawn from being littered with cigarette butts at your next lawn party, provide the guests with sand-filled ash trays. Collect a number of 1-lb. coffee cans, give them a coat of bright enamel to blend in with the colors of your other trimmings and decorate them with decals. Then fill them with fine sand. They will be eye-catching enough to remind your guests to use them.

Jack Ferrari, Milwaukee, Wis.

Tab Formed Out of Page Margin Serves as Bookmark

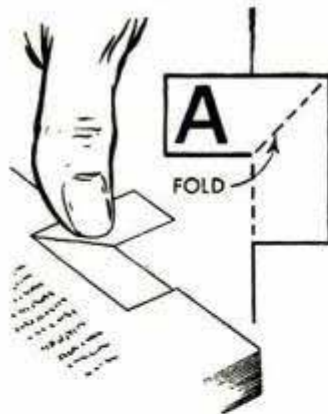

To mark a page of a book or magazine for future reference, simply tear or cut the margin, fold and press flat as indicated to form a projecting tab. If the tab is to be used quite often, it should be pasted flat. Similar tabs marked with letters of the alphabet

or numbers can be provided in the same way for catalogues and directories.

Carl S. Bates, Chicago.

Inch Scale on Bench Saves Time

A scale in inches marked on your workbench top near one edge provides a "ruler" that is always at hand. Use India ink and lay out the scale in the desired divisions of an inch. Two coats of shellac will protect the markings. If the wood of the bench is dark, paint a white strip on which to draw the scale, and then coat with shellac.

★ FLOOR FAN

Want to do something about the hot weather that is coming? It's easy. Relax and serve cold drinks around this end table with the built-in breeze



By Bertram Brownold

WITH ALL ITS advantages of good air movement, the circulating floor fan is still an extra piece of furniture in a sometimes overcrowded living room. If this is the case in your home, let the fan do double duty by building it into an occasional table. The fan motor is mounted on a standard 14-in. bracket, detail A, that can be purchased at most electrical-supply stores. The table, exclusive of a pyramid-shaped air deflector, is made of 25 parts; 4 legs, 4 side pieces, 16 louver slats and the top. The dimensions for these parts are shown in the pull-apart diagram, and they are assembled with glue. After legs have been grooved and slats and side pieces cut to size, two sides are assembled, detail B. The motor-support blocks, in addition to being glued, are screwed to the side pieces. The two assembled sides are now joined together with the remaining side pieces and slats. The motor bracket is then installed, motor down and fan blades up. Holes are drilled in the frame of the motor bracket so that it may be screwed to these support blocks. The last items to be assembled are the table top and the deflecting pyramid. The latter consists of four plywood triangles, each having a base of 14 in. and a height of 9 in. The sides are beveled so they fit together smoothly when assembled and wire nails

DOUBLES AS END TABLE

are used to join them. The table top is a square of $\frac{1}{4}$ -in. plywood, the edges of which are glued in grooves cut in four edging strips that are mitered at the corners. A frame that fits inside the edging to support the pyramid, as shown in the pull-apart detail, is glued to the underside of the table top along with the pyramid, detail E. The assembled top section is doweled and glued to the legs, as shown in detail F. A switch for the fan is attached to the outside of the cabinet. Much of the final appearance of the table depends on the type of wood used and the way in which it is finished. If you want it as a piece of living room furniture, the top should be made of plywood faced with one of the hardwoods such as mahogany or walnut. The side panels can be made of the same material, but the louver slats should be of solid wood, because the edge grain is visible. In this case, the louvers and the legs should be stained to match the top as closely as possible. Another method of finishing the table is to use one of the new plastic laminates to cover all surfaces. In this way, the table could be made of the most common woods and yet be given an "expensive" look, since the laminates are available in many rare and unusual wood grains. ★ ★ ★

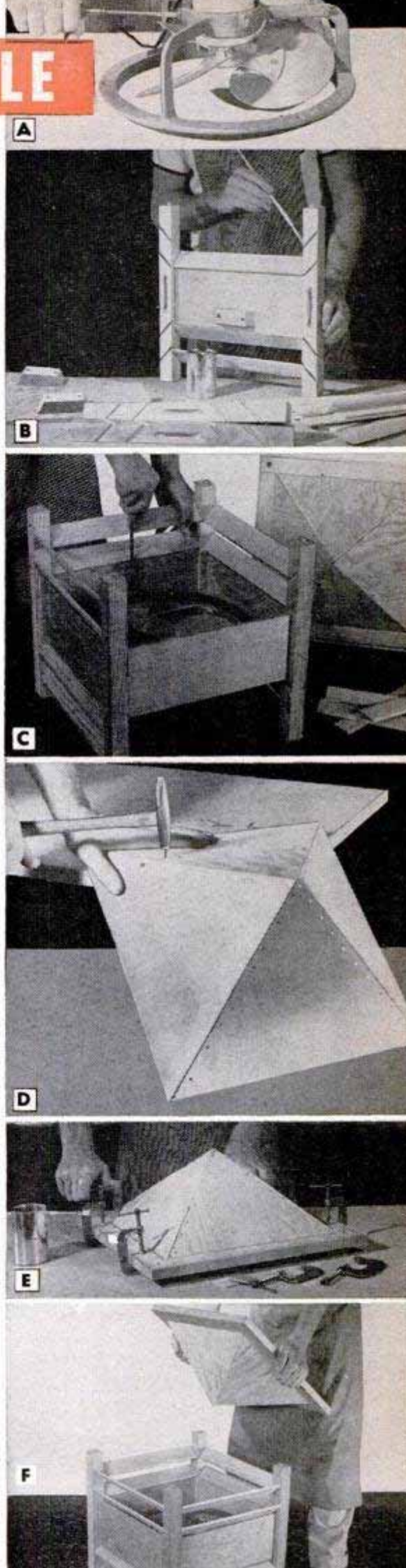
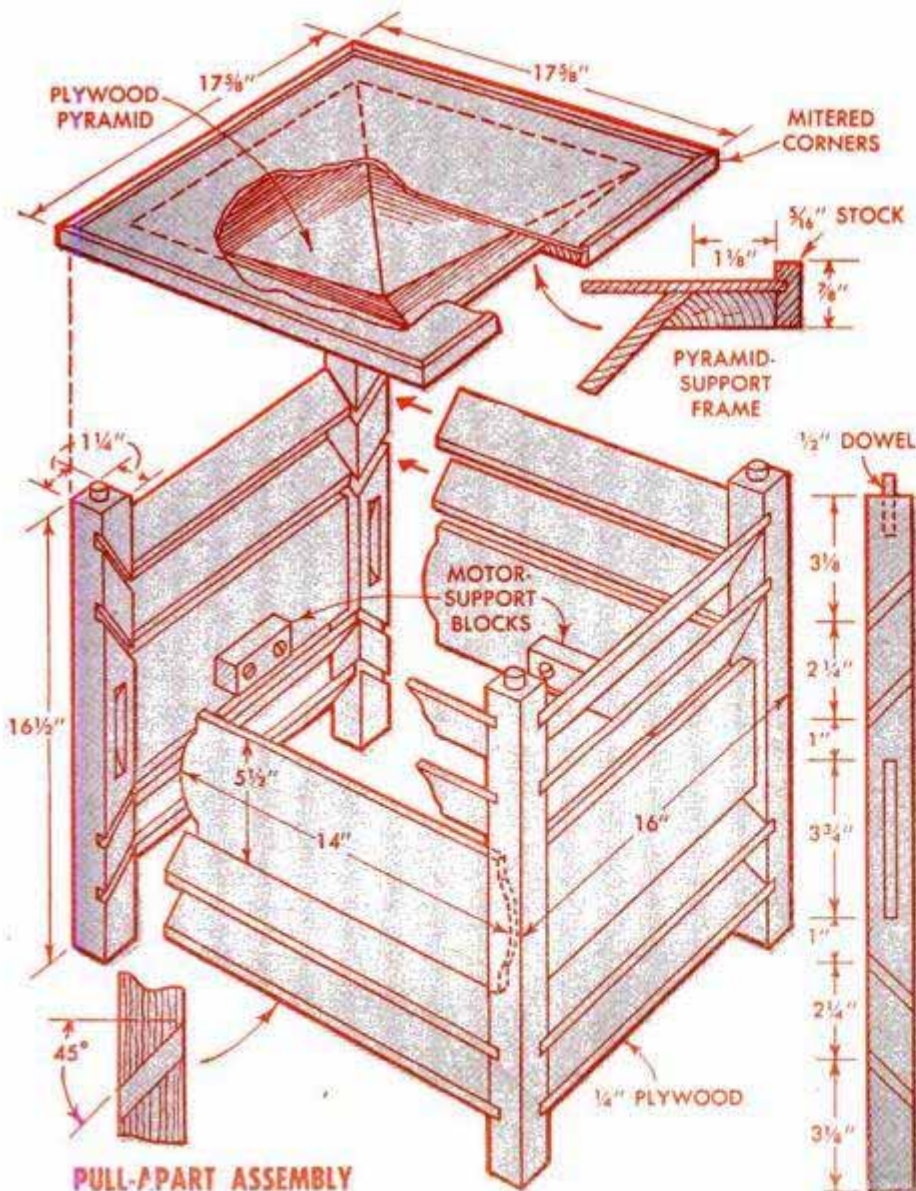

PLAN of the MONTH...

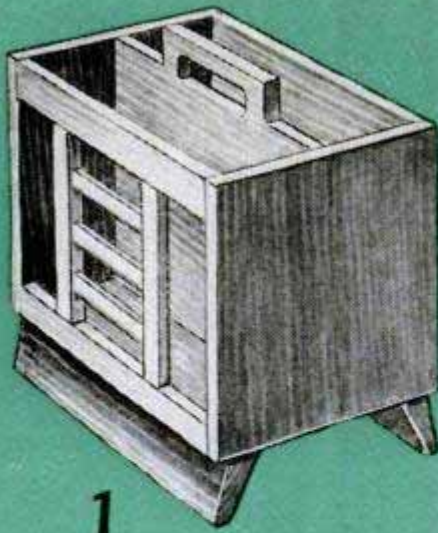

1

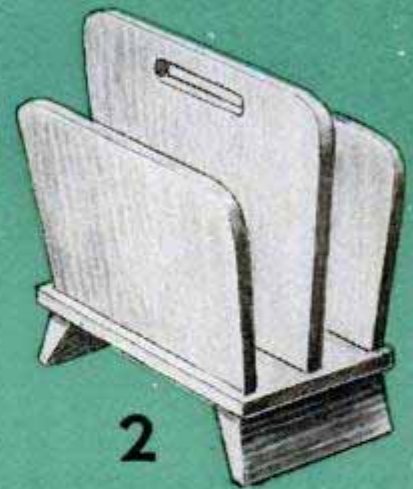
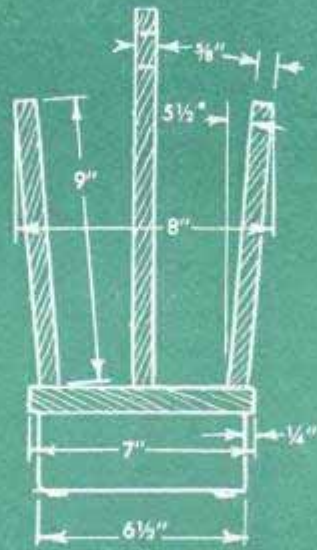

2

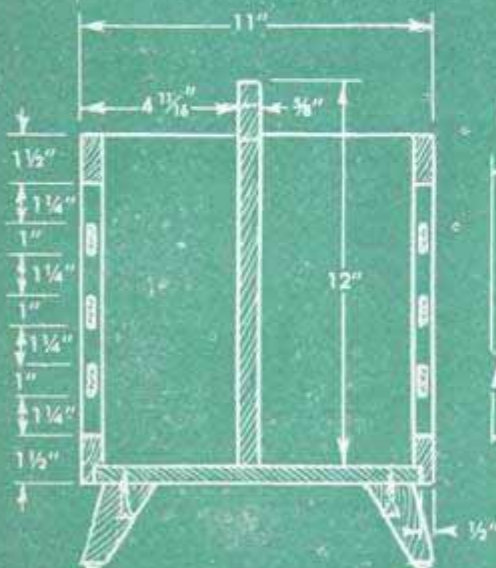
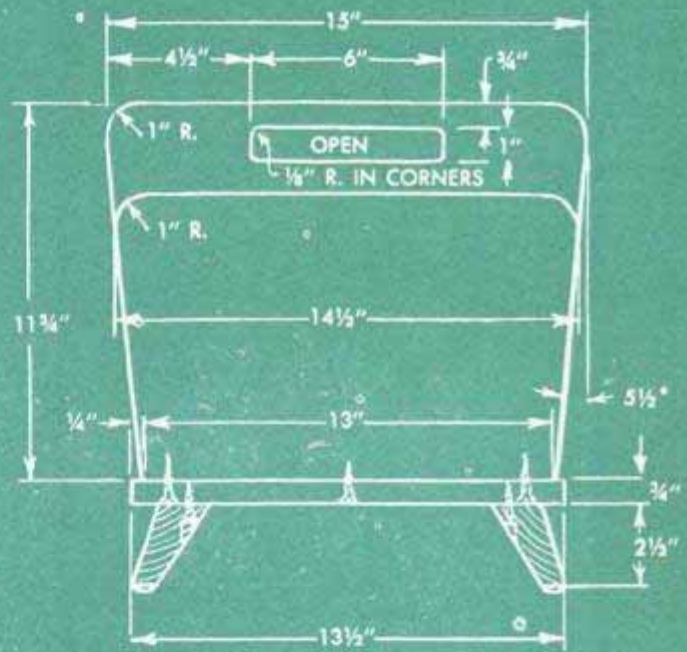
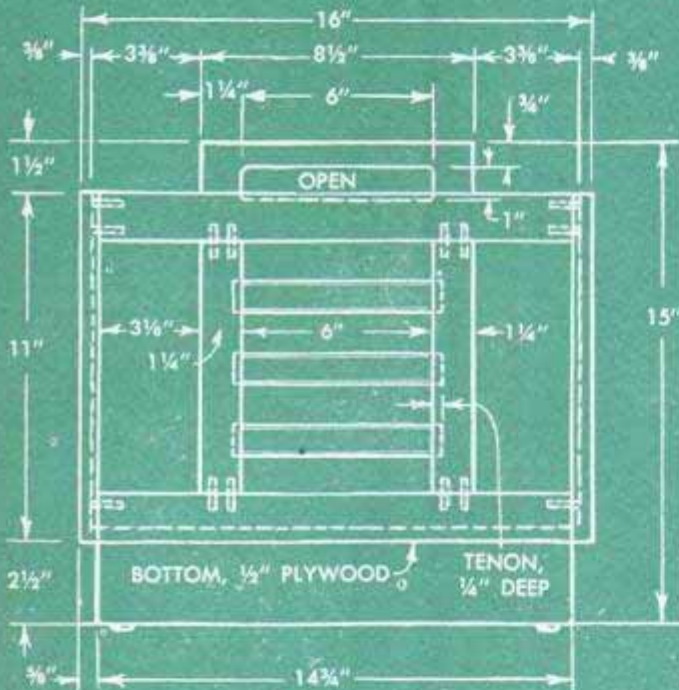

DETAIL OF LEG



POSTS ARE MORTISED $\frac{1}{4}$ " DEEP TO RECEIVE ENDS OF SLATS. POSTS, RAILS AND ENDS ARE JOINED WITH $\frac{3}{16}$ " DOWELS. ENDS ARE GROOVED FOR CENTER DIVIDER. ALL JOINTS ARE GLUED.

To fill the need in practically any modern interior, furniture designer John Bergen this month presents these attractive magazine stands, one of which is combined with a small table mounted on angled supports. Stand No. 1 has plywood ends and center partition, with one or both sides slatted as shown. The simplest of the stands, No. 2, features finlike sides and a center partition secured with glue and screws to a plywood base. Upright supports for the combination stand-table, No. 3, are attached to the base and top frame with half-lap joints. Mitered joints of the top frame are reinforced with wooden splines, while crossrails are joined to uprights with $\frac{1}{4}$ -in. dowels. Note that the edges of the plywood top are rabbeted to fit rabbeted edges of the frame. The bottom fits a groove cut in the lower front crossrail of the base and also a rabbeted edge cut in the bottom crossrail at the base of the uprights. Lacing is done with cotton twine

Magazine Stands *Modern Furniture*

MATERIAL LISTS

Plywood

- 2 pcs.— $\frac{5}{8}$ " x 11" x 11"—Ends
 1 pc.— $\frac{5}{8}$ " x 12" x 15 $\frac{1}{4}$ "—Center partition
 1 pc.— $\frac{1}{2}$ " x 10 $\frac{1}{4}$ " x 14 $\frac{3}{4}$ "—Bottom

Lumber

- 4 pcs.— $\frac{5}{8}$ " x 11 $\frac{1}{2}$ " x 14 $\frac{3}{4}$ "—Top and bottom rails
 4 pcs.— $\frac{5}{8}$ " x 11 $\frac{1}{4}$ " x 8"—Uprights
 6 pcs.— $\frac{1}{4}$ " x 1" x 6 $\frac{1}{2}$ "—Slats
 2 pcs.—1 $\frac{1}{2}$ " x 3" x 14 $\frac{3}{4}$ "—Feet

Miscellaneous

- 3 $\frac{1}{16}$ "-dia. dowel
 4 $\frac{5}{8}$ "-dia. glides

Plywood

- 2 pcs.— $\frac{5}{8}$ " x 14 $\frac{1}{2}$ " x 9"—Sides
 1 pc.— $\frac{5}{8}$ " x 15" x 11 $\frac{3}{4}$ "—Center partition
 1 pc.— $\frac{3}{4}$ " x 7" x 13 $\frac{1}{2}$ "—Bottom

Lumber

- 2 pcs.—1 $\frac{1}{2}$ " x 3" x 6 $\frac{1}{2}$ "—Feet

Miscellaneous

- 4 $\frac{5}{8}$ "-dia. glides
 13—# 10-1 $\frac{1}{4}$ " flat-head wood screws

Plywood

- 1 pc.— $\frac{1}{4}$ " x 18 $\frac{1}{8}$ " x 18 $\frac{1}{8}$ "—Top
 1 pc.— $\frac{1}{2}$ " x 4 $\frac{5}{8}$ " x 16 $\frac{1}{2}$ "—Bottom

Lumber

- 4 pcs.— $\frac{3}{4}$ " x 2- $\frac{3}{16}$ " x 18"—Top rail
 2 pcs.— $\frac{3}{4}$ " x 3 $\frac{1}{8}$ " x 24 $\frac{1}{2}$ "—Center uprights
 2 pcs.— $\frac{3}{4}$ " x 3 $\frac{1}{8}$ " x 9 $\frac{7}{8}$ "—Front uprights
 1 pc.— $\frac{3}{4}$ " x 2 $\frac{5}{8}$ " x 16 $\frac{1}{2}$ "—Top crossrail
 1 pc.— $\frac{3}{4}$ " x 1 $\frac{3}{4}$ " x 16 $\frac{1}{2}$ "—Bottom crossrail
 1 pc.— $\frac{3}{4}$ " x 3 $\frac{1}{4}$ " x 16 $\frac{1}{2}$ "—Bottom front crossrail
 2 pcs.— $\frac{3}{4}$ " x 3" x 16 $\frac{1}{8}$ "—Side bases
 1 pc.— $\frac{3}{4}$ " x 1-11 $\frac{1}{16}$ " x 16 $\frac{1}{2}$ "—Top front crossrail
 2 pcs.— $\frac{3}{4}$ " x 1 $\frac{1}{4}$ " x 5 $\frac{1}{2}$ "—Bottom cleats

Miscellaneous

- $\frac{1}{4}$ "-dia. dowel
 4 $\frac{5}{8}$ "-dia. glides
 10 ft.— $\frac{3}{16}$ "-dia. cotton twine
 18 brass screw eyes

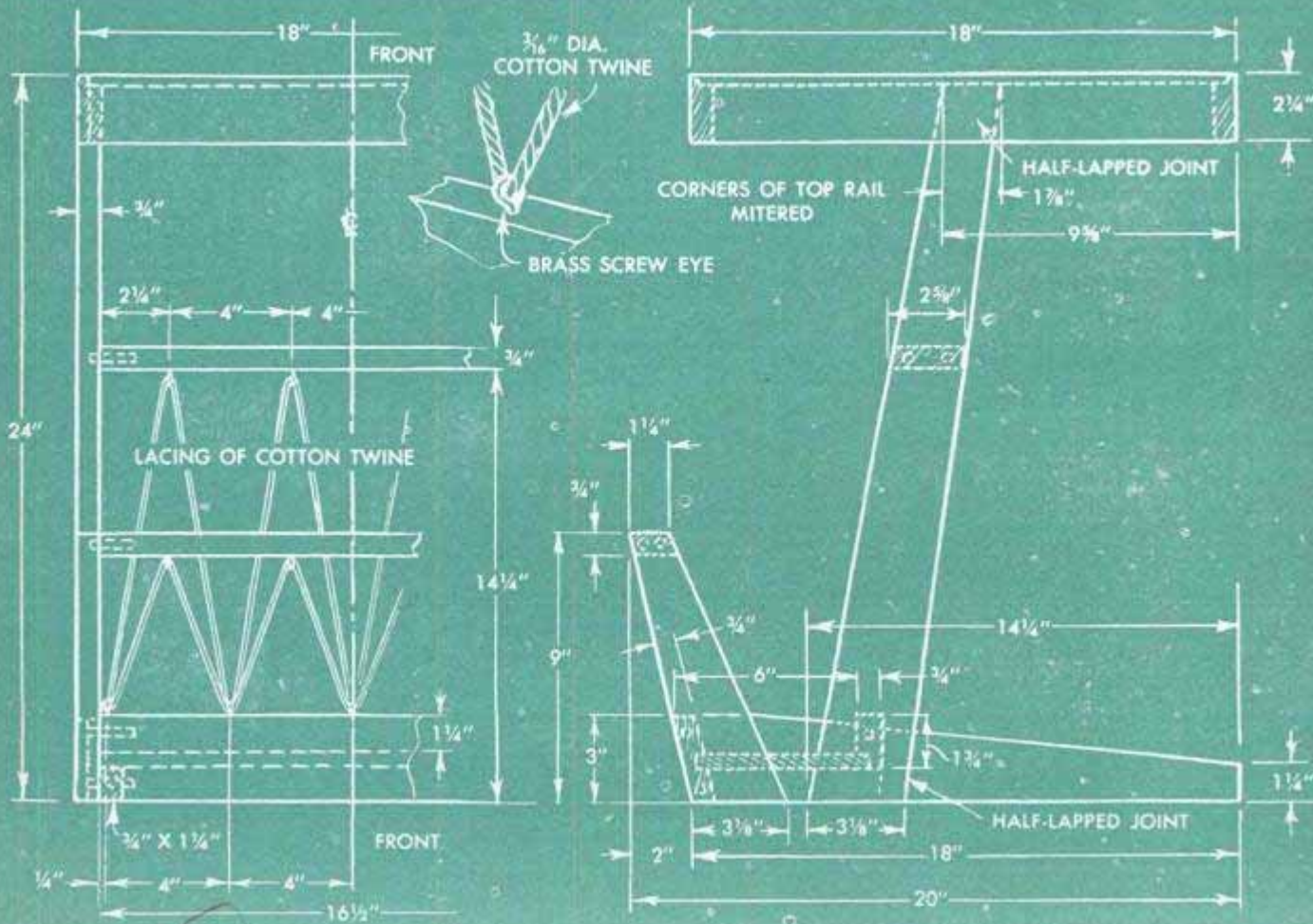
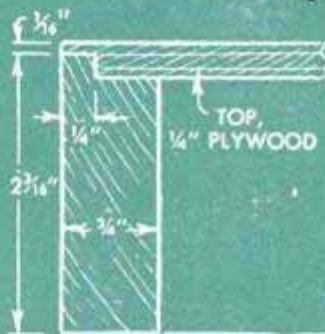
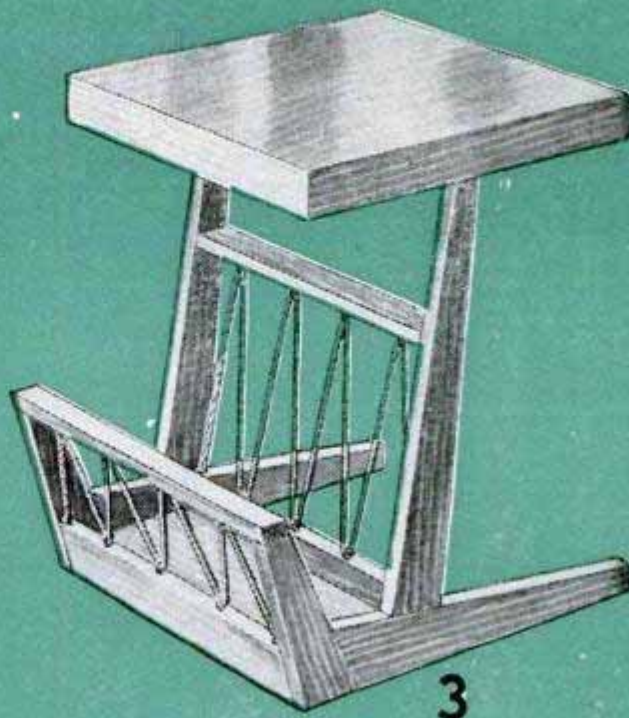

Clothes Held Over Radiator By Wooden Drying Rack

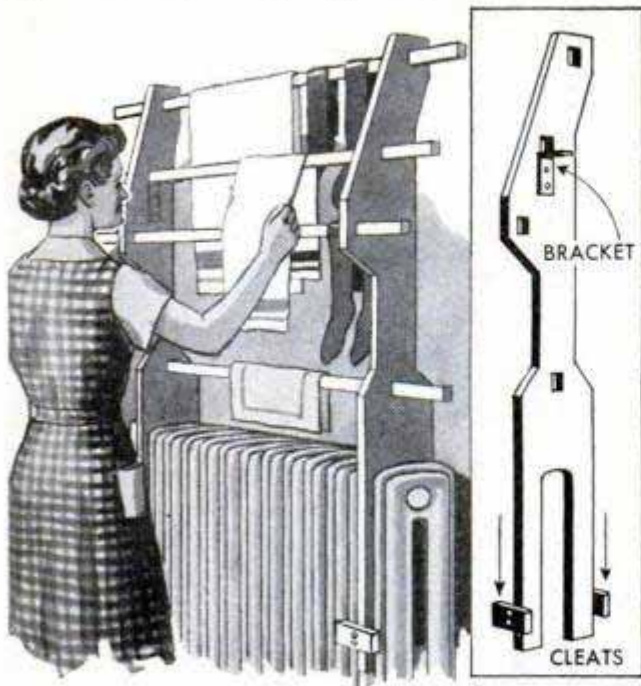

This rack utilizes the rising heat from a radiator to speed the drying of small articles. The side panels are cut and fitted as shown in the illustration, with the dimensions determined by the size of the radiator. The crossbars can be made from either $\frac{3}{4}$ -in. dowels or square stock.

Dr. J. Roberts, Bangor, North Wales.

Infrared Lamp Heats Asphalt Tile

Asphalt tiles usually are heated with a blowtorch to make them pliable for installing over a concrete floor and for cutting to fit corners and around pipes. An easier method of heating which also eliminates any danger of fire is to use an ordinary infrared bulb in a large reflector. The lamp is used to heat the tiles until they are sufficiently pliable to assume the contour of the floor when laid in the mastic.—Glen F. Stillwell, Manhattan Beach, Calif.

Ice-Filled Jar in Basket Chills Food for Picnic

If you have been disappointed on a picnic in discovering that some foods had become unpalatably warm and, in some cases, spoiled, you'll appreciate this stunt for chilling foods in the basket while en route. A basket with solid-metal sides is best for the purpose, although an open-weave basket will be suitable if lined with several layers of newspapers for insulation. Take a $\frac{1}{2}$ -gal. fruit jar and fill it with ice cubes or crushed ice. Next, partly fill the jar with a concentrated fruit juice or tea made double strength to offset dilution by

water from the ice. If carrying tea, be sure to cool it before pouring over the ice. Then place the jar in the center of the basket and pack all the perishable foods around it. In this way, the ice not only helps preserve the foods but also makes possible the addition of a cool, refreshing drink.

Blanche Campbell, Las Vegas, Nev.

Staple Anchors Flowerpot on Sill

If you wish to place potted plants on a window sill for an occasional airing and sunning, they may be prevented from sliding off by anchoring them with staples driven into the sill. The staples should be small enough to engage the drain openings on the bottoms of the pots in the manner indicated.

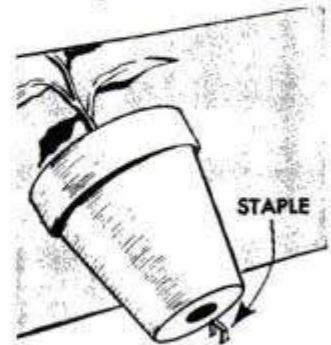

Camp Water Supply Strained Through Punctured Pail

Sportsmen and campers, who are often obliged to obtain drinking water from a brook or a spring, will find it a simple matter to eliminate any floating sticks or leaves by punching a row of holes near the rim of the dipper or pail that is used for the purpose. The pail is lowered into the water until the holes are covered, and allowed to fill through the holes.



Window-Cleaner Spray Used To Apply Insecticide

When applying insecticide solutions to house plants or to single plants in the garden, it is economical to use a small window-cleaner spray. In addition to being easier to direct in a small area, it will spray the solution as fine droplets which spread quickly, while a regular sprayer atomizes much of the liquid into the air where it is wasted.



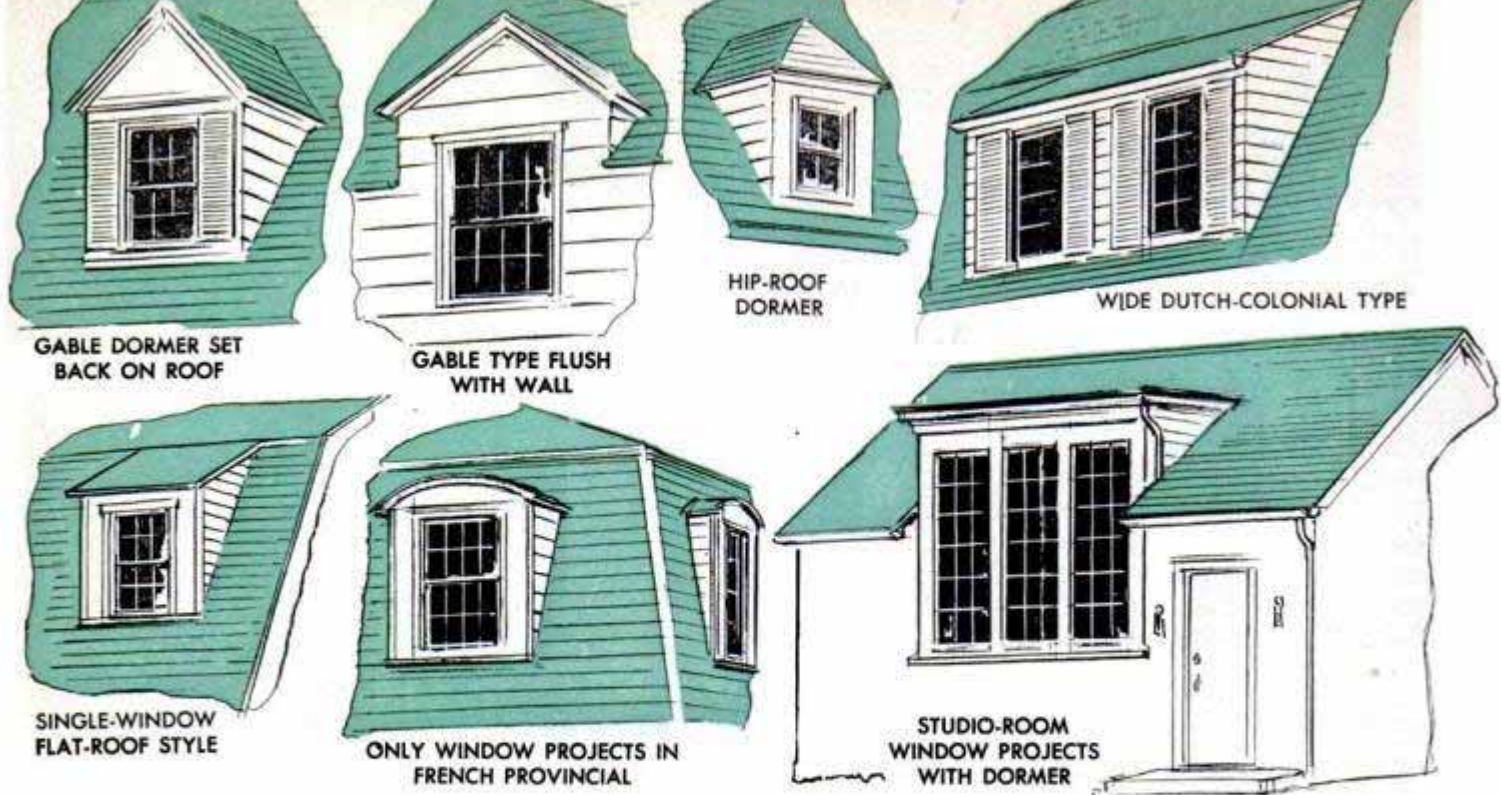

How to Install DORMERS

IN ADDITION to the obvious advantages of increasing usable floor space and providing adequate ventilation for upstairs rooms, dormers also improve the appearance of a house when properly designed and installed. However, location or styling of the dormers can detract from the lines of the house and, therefore, should be given careful consideration. One effective way to plan your dormers is to sketch various types and sizes of dormers on tracing paper taped over a photograph of the house. Then judge for yourself which dormer lends itself best to your installation.

Precautions when starting: It's wise to have a large waterproof tarpaulin on hand before starting to install a dormer, so you can cover the roof opening or unfinished dormer overnight or when rain is probable. The tarpaulin should extend over shingles on either side of the opening and over the roof ridge. The opening is bridged with

boards and the tarpaulin held down by sandbags and narrow boards, as in Fig. 1.

Remove shingles first: After measuring the location of the dormer from the roof edges, remove the shingles where the opening is to be made. You can start loosening shingles from a ladder set against the eave, a ladder hooked over the ridge, Fig. 2, or from an improvised roof scaffold, as in Fig. 3. When using a ladder set against the eave, provide footrests by nailing 2 x 4 cleats to the roof as the shingles are removed.

Strips of asphalt shingle are easy to remove after prying up the nails as in Fig. 4. Use a wooden block as a fulcrum to avoid damaging the shingles. Nails in wooden shingles are cut with a flat tool having a sharp V-notch at one end. It is pushed up under shingles and struck with a hammer to sever the nails. Remove shingles a foot or so beyond the limits of the opening to be made and cut the roofing paper a few

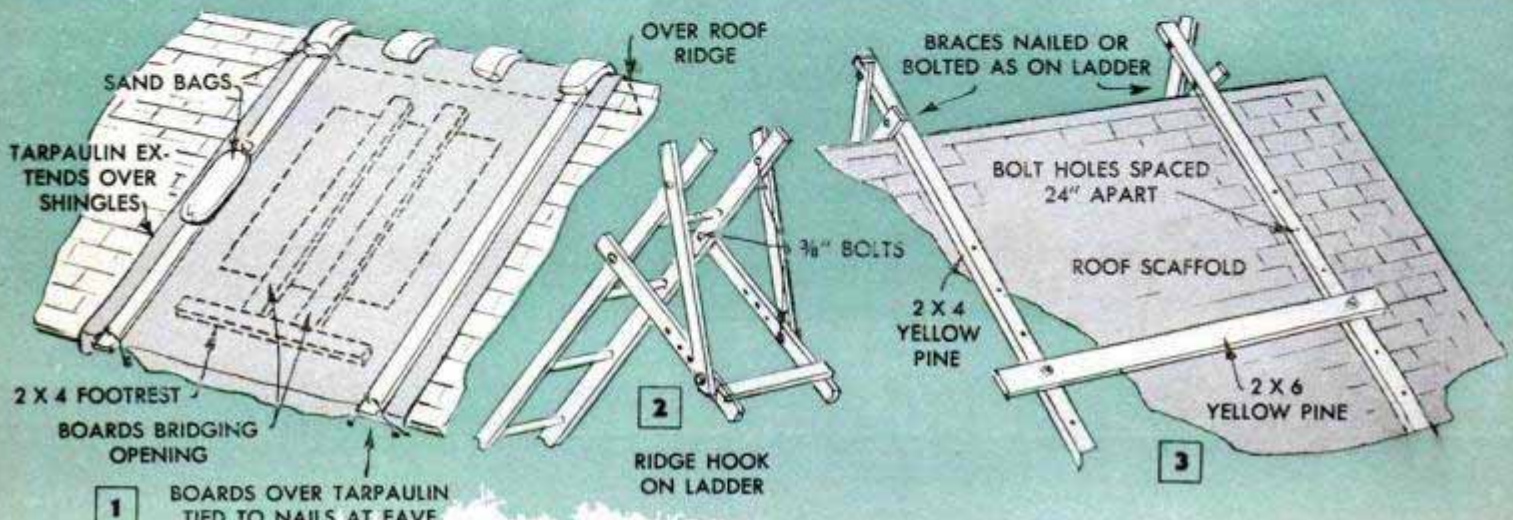

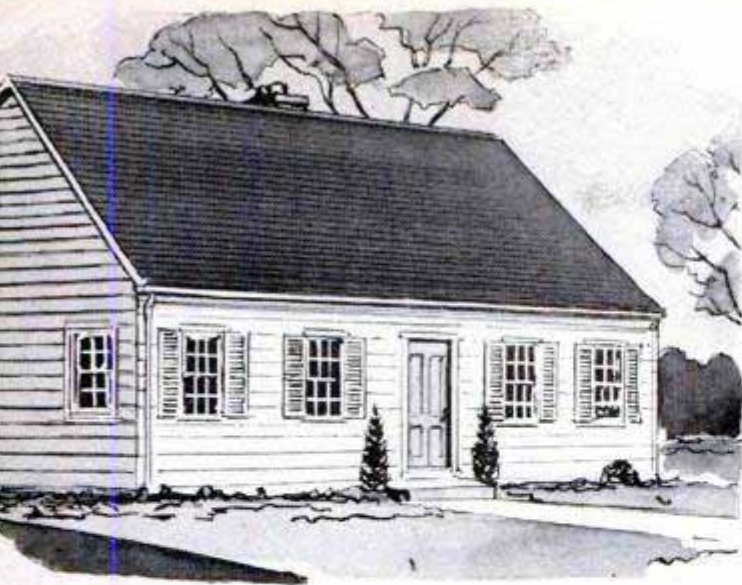

For house expansion and for appearance, dormers are important. Here is the step-by-step procedure for opening the roof, framing, sheathing, roofing and finishing

An example of what dormers can do for the appearance of a home having a large, unbroken expanse of roof. They also give light and air to attic rooms

By E. R. Haan

Below, when opening up roof, shingles can be saved for use on dormer roof. Nails are lifted from roof without damaging shingles by using block as fulcrum

inches from the edges of the shingles, Fig. 5.

Cutting the opening: Start cutting the roof boards with a keyhole saw after boring holes to start. As soon as the kerf is long enough, use a crosscut saw. Cut closely along the rafters at each side of the opening, sawing on the side toward the opening, and remove the cut boards with a pry bar. The opening should extend the width of a roof board past the point where double headers are to be located top and bottom.

Next, cut the rafters that bridge the opening, as indicated by the dotted lines in Fig. 5. The lower edge of the upper double header should come at ceiling height as in Fig. 6. It's best to install headers on edge, marking the rafters with the aid of a level. Cut the header piece from the same size stock as rafters. Nail the rafters at the sides of the opening to one header first, then nail the header to the cutoff ends of the rafters. Install the second header piece the same

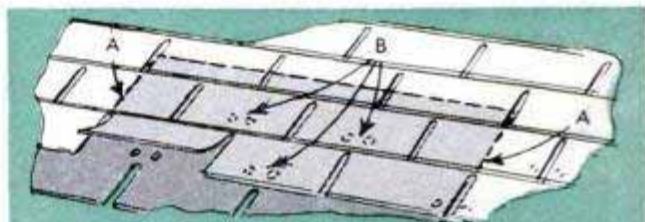

SHINGLE STRIP TO BE REMOVED. LOCATE EDGES "A," THEN PRY UP NAILS OR TWO ROWS AS AT "B"

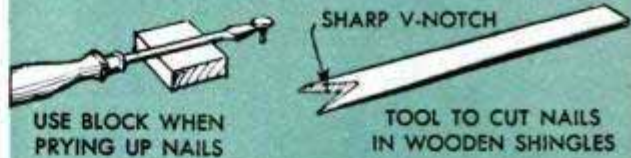

USE BLOCK WHEN PRYING UP NAILS

TOOL TO CUT NAILS IN WOODEN SHINGLES

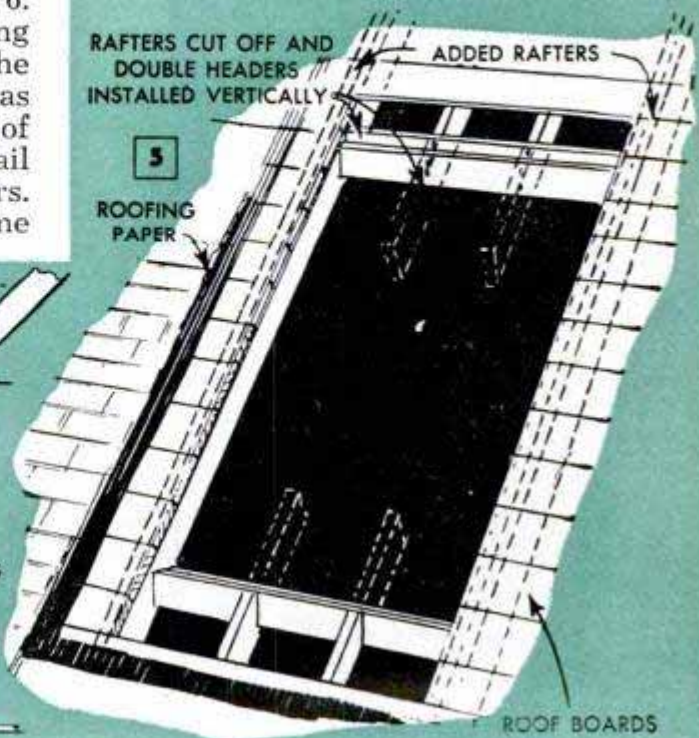

RAFTERS CUT OFF AND DOUBLE HEADERS INSTALLED VERTICALLY

ADDED RAFTERS

5

ROOFING PAPER

ROOF BOARDS

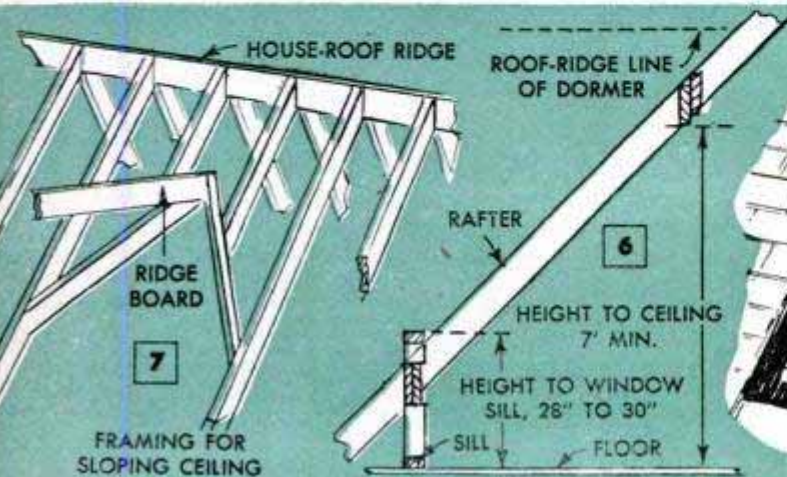

6

7

FRAMING FOR SLOPING CEILING

STUDS AND
RAFTERS
SPACED
16" ON
CENTERS

DOUBLE
HEADER

8

FRAMING DETAILS OF
GABLE-TYPE DORMER

1 X 4
RIDGE BOARD

2 X 4
PLATES ON
ROOF
BOARDS

2 X 4
RAFTER
PLATE

2 X 4
FOOTRESTS

9

GAMBREL OR
DUTCH-COLONIAL
TYPE DORMER

10

WINDOW IN
WALL TOP
PROJECTS
ABOVE EAVE

11

HIP-ROOF
DORMER

way, dropping it as necessary. The two pieces comprising the lower header should have their top edges flush, at a location where the window will come about 30 in. above the floor. If the ceiling of a dormer is to be sloping, the top header is arranged as in Fig. 7.

Wall framing: Framing of a gable-type dormer is shown in Fig. 8, and the same procedure, with only slight differences, is followed on other types shown as in Figs. 9, 10 and 11. Use 2 x 4 stock for both the wall framing and rafters, although large roof spans may require 2 x 6 rafters. First add a reinforcing rafter to each of the rafters at the sides of the opening as indicated by dotted lines, Fig. 5. These project 3 or 4 ft. beyond the double headers. Next, nail plates on the roof boards along the sides of the opening, nailing into the rafters underneath, Fig. 8. Also nail temporary footrests on the roof, which can extend over the shingles but should not be nailed through them.

Start the wall framing by installing the double corner posts with a double header above them. Toenail the lower ends of the posts to the roof plates and temporarily brace this framework with a board from the top of the window header across to the upper roof header. The rafter plates are next. On the gable-type dormer their top edges should be at the same level as the underside of the upper header in the roof, which is ceiling height. The rafter plates are cut at an angle at one end to fit roof plates to which they are nailed. Nail the plates to the front framing while the corner posts are checked with a level to assure getting them plumb. Now, with skeleton framing in place, mark the plates for the

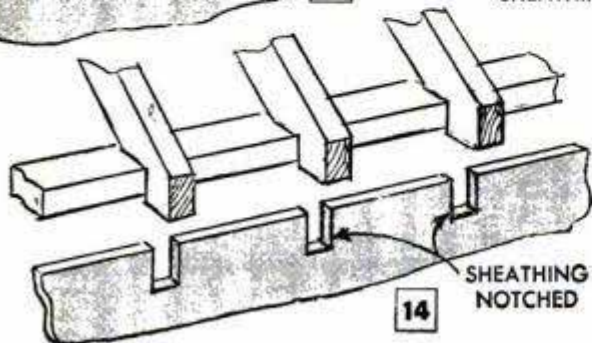
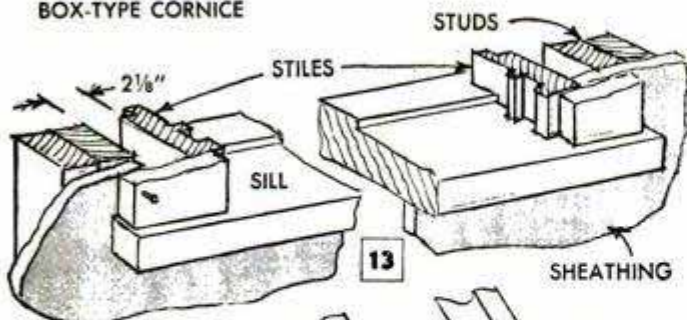
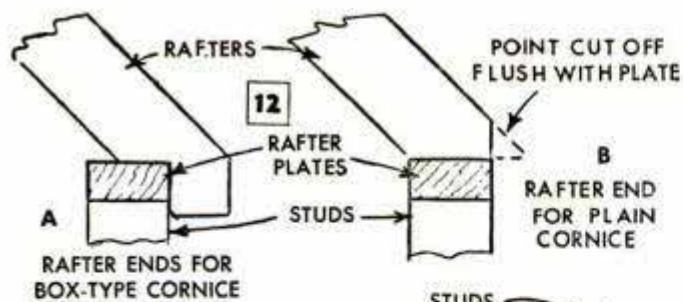

studs which are spaced 16 in. on centers. Drive nails through the top plate into the studs and toenail the studs to the roof plate.

Roof framing: Next proceed with the roof framing, starting with the 1 x 6 ridge board nailed between the roof plates at the point where they meet, in line with the center of the dormer. Support the front of the ridge board temporarily so it is level and above the exact center of the dormer. Then take careful measurements of the rafters so they can all be precut. Nail them in place after marking the ridge board and the rafter plates to locate them 16 in. on centers. If you are making a box-type cornice, the rafters are notched and extended beyond the walls, Fig. 12-A, but for plain cornices the rafters are cut off flush with the plate as in detail B. Framing the gambrel-dormer roof as in Fig. 9 is the simplest and most rigid type of construction, but requires the installation of a false ceiling. To save this extra work, the center rafters may be butted against the header and the outer rafters mounted flush with the lower edge of the header.

Window framing: After the sides and roof are framed, nail the ceiling joists, spacing them 16 in. on centers, and install the window framing. The window opening is centered and should be 4 1/4 in. wider than the window frame at the stiles, thus providing a 2 1/8-in. space from each stile to the frame as in Fig. 13. Usually the rough framing consists of double studs at the sides and a double header at the top. In Fig. 8 only

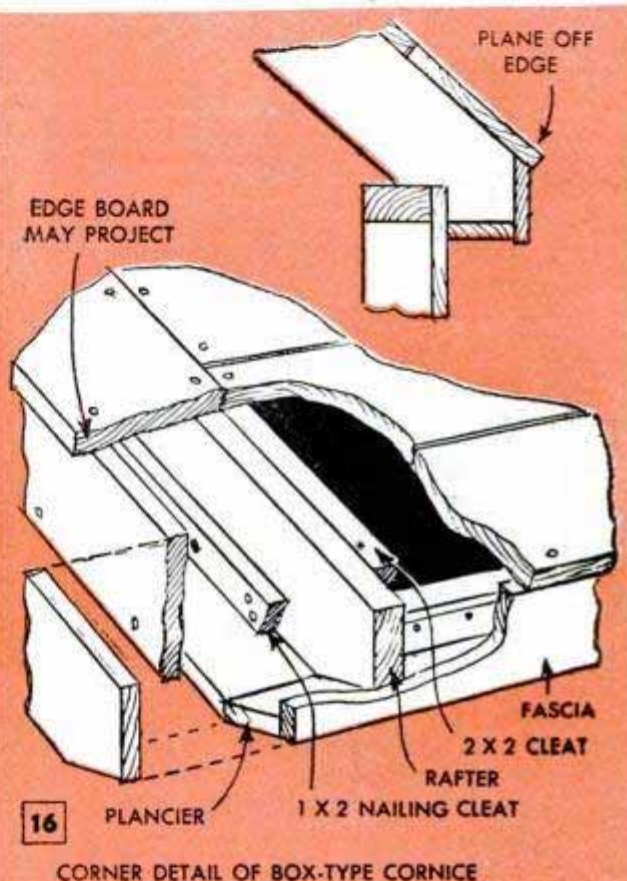
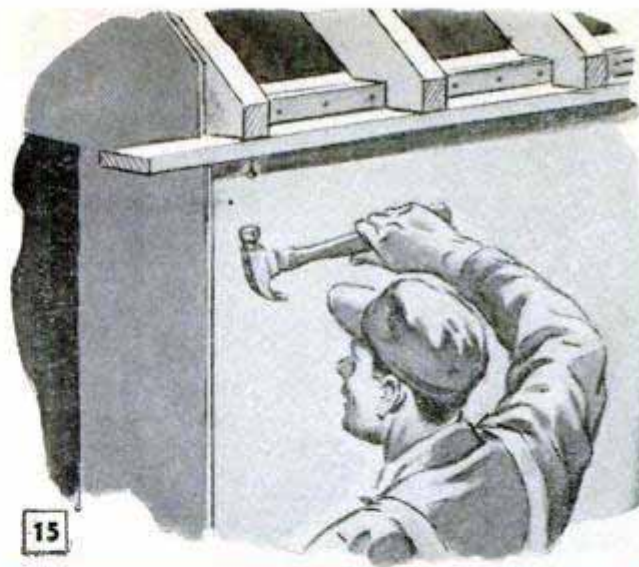

CORNER DETAIL OF BOX-TYPE CORNICE

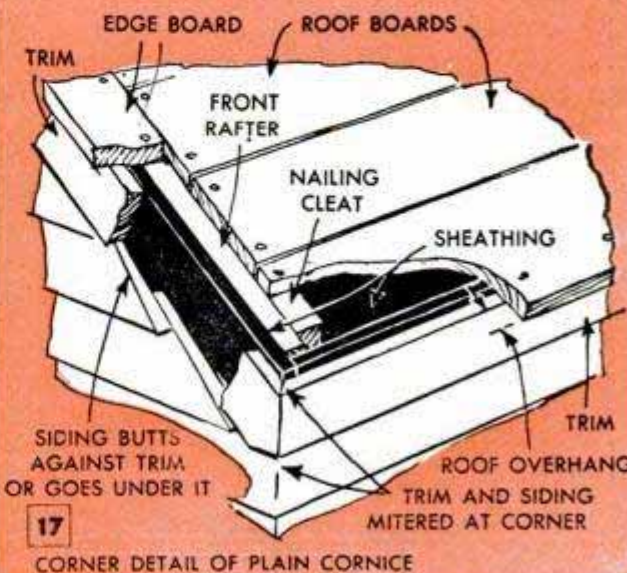

CORNER DETAIL OF PLAIN CORNICE

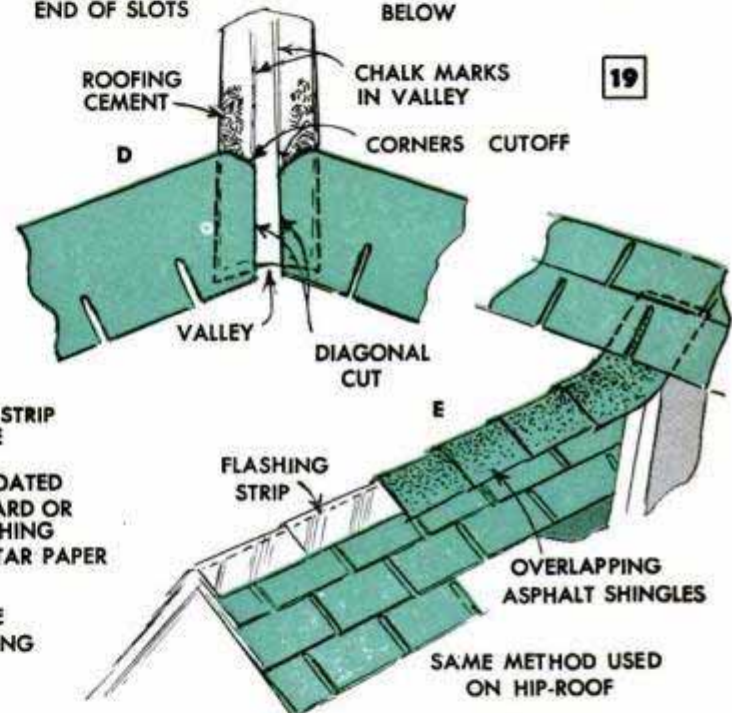
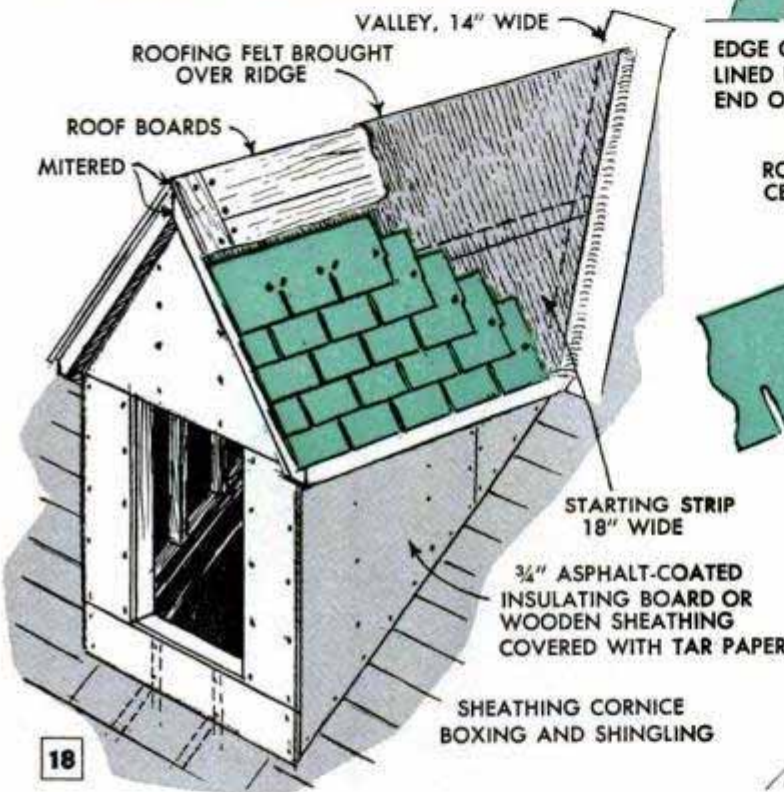
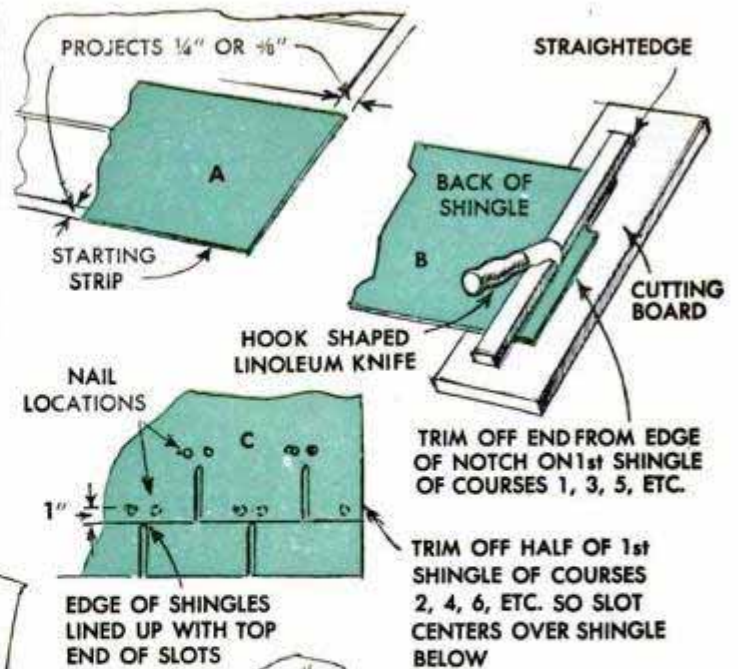
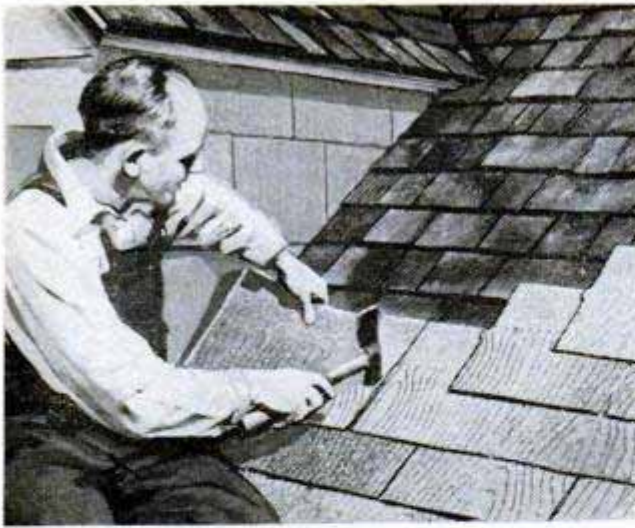

single studs are shown because of their proximity to the corner posts to which they are nailed with short blocks at the center.

Sheathing: The roof is sheathed and shingled before sheathing the walls, the roof boards projecting over the edges of the siding and trim. On roofs with box cornices, apply the wall sheathing first, then add the cornice and lastly the roof. You can use wooden sheathing or composition sheathing board for the walls. The top edge of side-wall sheathing is notched, Fig. 14, to fit over the rafters, or the rafter notches may extend $\frac{3}{4}$ in. over the plate so that the sheathing can be inserted.

Cornice construction: Rafter ends for box-type cornices must be identical. Mark the rafters along their top edges using a straightedge. Mark for vertical cuts by using a level or miter gauge, and for the bottom horizontal cuts by using a square. The

bottom board, or plancier, of the side cornice, Figs. 15 and 16, should extend at the front a distance equal to the width of the board. The side of the cornice (fascia) has its top edge beveled at an angle to fit snugly under the roof sheathing, which may project beyond it an inch or so. The side and front cornices are joined, as in Fig. 16. The edge board—also called drip edge—is nailed to the end rafter while the other roof boards butting against it are nailed to a 2 x 2 cleat nailed along the inside edge of the rafter. Dormer roof boards will fit snugly against the house roof boards if sawed at the correct angle and bevel. Construction of a plain cornice is shown in Fig. 17.

Shingling: First lay a 14-in. sheet-metal valley where dormer and house roof meet, Fig. 18, bending it with a straightedge so it lies flat on both roofs. Lay roofing felt on the roof in overlapping strips, the higher

one covering 4 or 5 in. of the lower one. Then space a "starting" strip along the roof, as in Fig. 19-A, letting it project $\frac{1}{4}$ or $\frac{3}{8}$ in. Sometimes regular strip shingles are used instead of a starter strip, the shingles being placed upside down so that the slots are on top. The first shingle of the bottom course and other alternate courses is trimmed, detail B, to eliminate the half slot, or notch, at the end. Cut shingles from the back side with a linoleum knife or heavy pocketknife. Cutting is easier, especially on hot days, if you keep the knife blade moistened with kerosene. You can use the edge of a shingling hatchet or a pair of tin snips instead of a knife. Use a straightedge and cut the shingles on a board to prevent damaging them. The first shingle of the second and alternate courses is trimmed so the slot comes halfway over the shingle below, detail C. Two nails are driven about an inch above and on either side of each slot. Mark the valley by snapping a chalk line to indicate where the shingles must be cut diagonally, detail D. This detail also shows how the top corners of shingles at the valley are cut at an angle to shed water. Nails should not be driven through the sheet metal, the ends of the shingles being cemented to the valley. Shingle courses are continued to the ridge, the nails of the last course being covered with the capping, which consists of a flashing strip and individual shingles overlapped, as in detail E. The last capping shingle is brought upward and under a shingle course of the house roof. When wooden shingles are used, courses overlap to expose about 5 in. to the weather. The shingles are spaced $\frac{1}{4}$ to $\frac{3}{8}$ in. apart. Keep the side edges of the shingles at least $1\frac{1}{4}$ in. from the edges of shingles in the course below. Drive the shingle nails



20

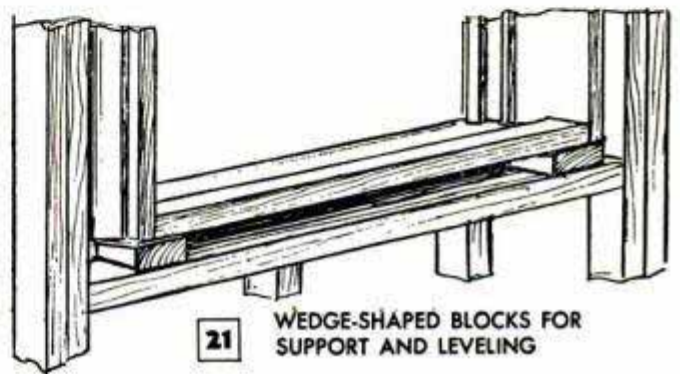

21 WEDGE-SHAPED BLOCKS FOR SUPPORT AND LEVELING

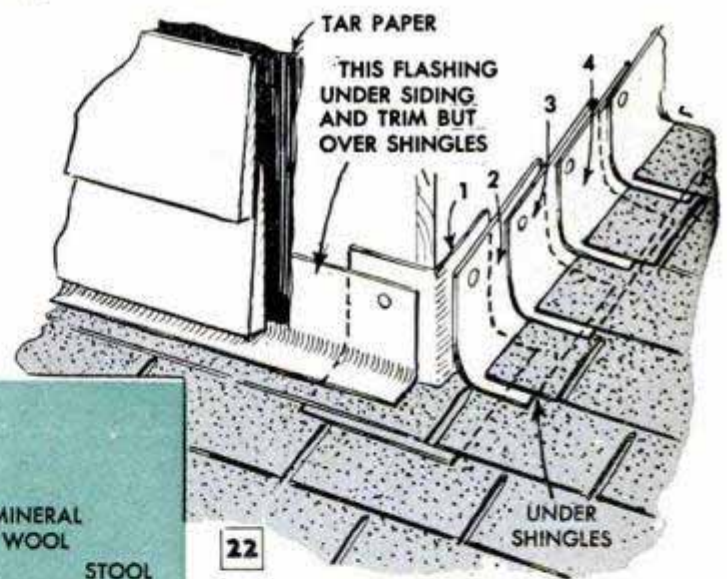

22 FLASHING AT JOINTS OF DORMER AND HOUSE ROOF

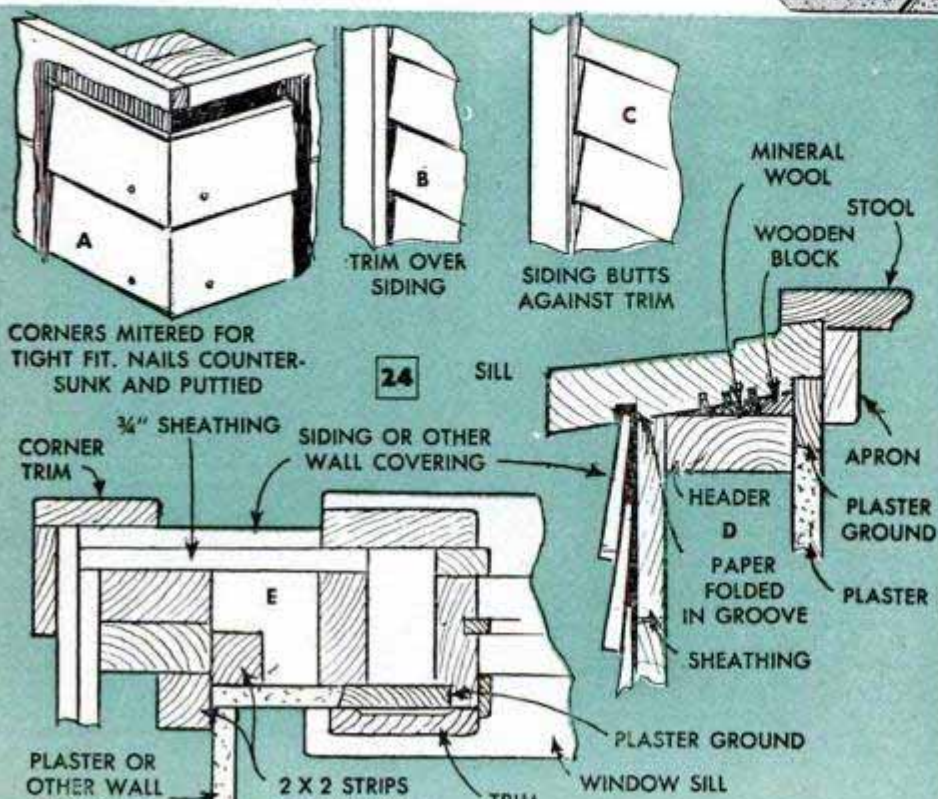

24

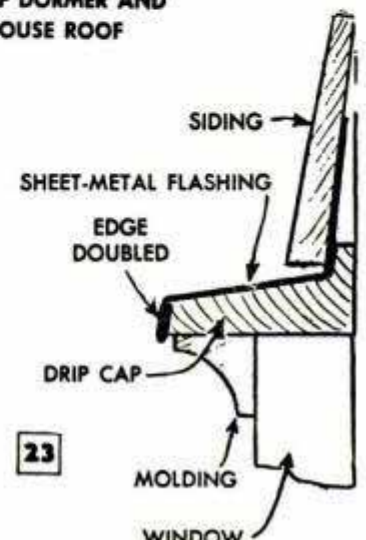

23

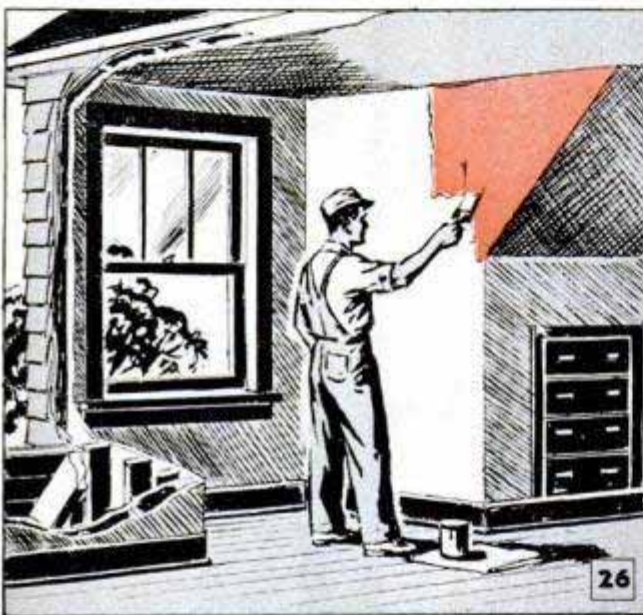

about 6 in. above butt ends of the shingles and not closer than $\frac{3}{4}$ in. from the edges.

Installing window frames: Set the window frame in the opening so that the stiles are $2\frac{1}{8}$ in. from studs, Fig. 13. Drive wooden wedges between the sill and the header as shown in Figs. 21 and 24-D to get the frame plumb and hold it securely in position while nailing the outer trim. Before nailing, check the window frame with a level, as in Fig. 20.

Flashing to prevent leaks: After reshingling the house roof to the front of the dormer, add a sheet-metal flashing strip along the dormer. The strip should be at least 8 in. wide and bent centrally to come over the shingle nails, as in Fig. 22. Fasten the upper edge to wooden sheathing or to studs under insulating-type sheathing. Also apply a flashing strip over the drip cap at the top of the window, as in Fig. 23. Use "metal shingles" where the dormer sides join the house roof, Fig. 22, starting at the front corners. Note that flashing piece No. 1 is applied before the front flashing strip and

NAILS TO USE

- 20d COMMON NAILS: Rafters to double headers and vice versa; roof plates to rafters underneath
- 16d COMMON NAILS: Rafter plates to ends of studs
- 10d COMMON NAILS: Reinforcing rafters or any double studs fastened together; toenailing studs, rafters, joists, etc.
- 8d COMMON NAILS: Wooden wall and roof sheathing, outside trim (countersunk and puttied)
- 8d ALUMINUM NAILS: Siding and exterior trim
- 8d FINISHING NAILS: For interior trim
- $1\frac{3}{4}$ " LARGE, FLAT-HEAD, GALV. NAILS: For insulation-type sheathing
- $\frac{7}{8}$ " or 1" WIDE, FLAT-HEAD, GALV. NAILS: Asphalt shingles on roofing boards
- 3d GALV. SHINGLE NAILS: For wood shingles

is bent around the corner. Bring the roof shingling over flashing piece No. 1, which should lie flat on the roof about 4 in. beyond the dormer. Flashing piece No. 2 overlaps No. 1 and is similarly covered with the next shingle course. The same procedure is followed for pieces 3 and 4.

Application of siding: Outside wall covering should match that of the house or harmonize with its styling. If wooden sheathing is used, it is covered with tar paper before applying siding, clapboard or shingles. Siding at outside corners can be neatly mitered, Fig. 24-A, with the joining edges embedded in calking compound. Siding may be covered with trim, detail B, and spaces between the siding and trim tamped with mineral wool and calked. Another method is to butt the siding against the trim, detail C, the lower edge of the siding being kept about $\frac{1}{2}$ in. above the roof to prevent absorption of water. It's best to use aluminum nails as they need not be countersunk and puttied to prevent rust spots. Siding under a window fits into the groove on the underside of the sill, detail D, and is pushed up tightly against a folded edge of the sheathing paper.

Finishing the inside: It's advisable to insulate walls and ceiling of a dormer, using a vapor-barrier insulation. Fig. 25 shows batt-type insulation being installed. When insulating, stuff mineral wool between the window sill and the header, Fig. 24-D. The inside wall may be finished with wallboard or plasterboard. If the wall is to be plastered, apply plaster grounds along all edges of the window, details D and E of Fig. 24, and along the floor edge of walls. These grounds come flush with the plaster. Apply perforated-metal corner beads at outside corners before plastering, and strips of metal lath along inside corners.

After plastering, install trim around the windows. A plywood subfloor is installed, over which any type of finish floor may be laid. Baseboards are applied after laying the finish floor. Fig. 26 shows an inside view of the finished dormer. ★ ★ ★

Built-in Bins Utilize Waste Space in Rooms

Installed as built-in units under shelves and counters, tilt-out bins similar to the one shown will convert waste space into extra storage facilities in the kitchen, bathroom, halls and other passageways of a home. Built to dimensions required by a particular installation, each bin is made from $\frac{3}{8}$ -in. plywood reinforced in the corners with three-cornered wooden cleats. The back, sides and bottom of the unit are assembled with glue, nails and screws driven in from the outside, while the front panel is attached with glue and finishing nails. The bin thus formed is then hinged at the lower end to

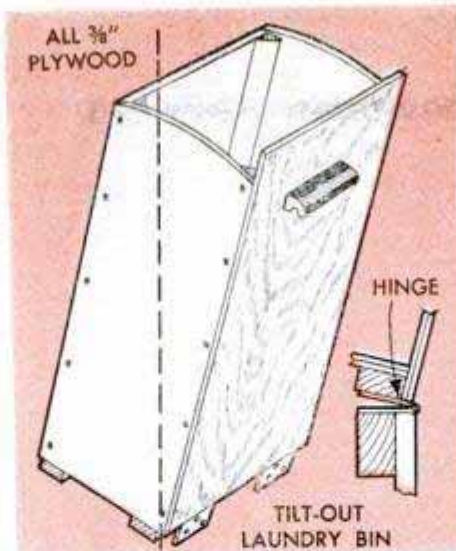

the bottom framing member. The front panel may be finished with varnish or painted to match the surrounding walls as desired.—Hi Sibley, Nuevo, Calif.

Calcimine Removed From Wall With Paint Cleaner

Before a calcimined wall or ceiling is painted, the calcimine must be completely removed. Dip a large sponge into a pail of warm water in which paint cleaner has been dissolved. Keep the sponge well filled with water. Begin on the ceiling, then do the top of the walls and finally work down

the walls. Calcimine comes off smooth plaster easily. Bits of calcimine remaining in rough-textured surfaces, even after careful washing, usually will not harm subsequent paint coats. After washing, let the surface dry thoroughly, and before painting, fill all cracks.

C-Clamps and Scrap Wood Form Jig to Simplify Picture Framing

Assembling a picture frame becomes an easy job when this simple jig is used. It consists of two C-clamps and a short length of 2 x 4 squared at one end, in which a depression similar to a screw pocket is cut near the same end to take one jaw of a clamp. The first step in setting up the jig is to nail a short board to a table or bench top, allowing one side to overhang at least

1 in. This will provide a grip for the other clamp. Next, the 2 x 4 is placed edgewise on the overhanging edge of the board so the squared end is flush with the end of the board, and nailed in place. Then two pieces of molding are joined over the end of the 2 x 4, blocks used to prevent marring and the clamps adjusted as shown.

Perry W. Trout, Kansas City, Mo.

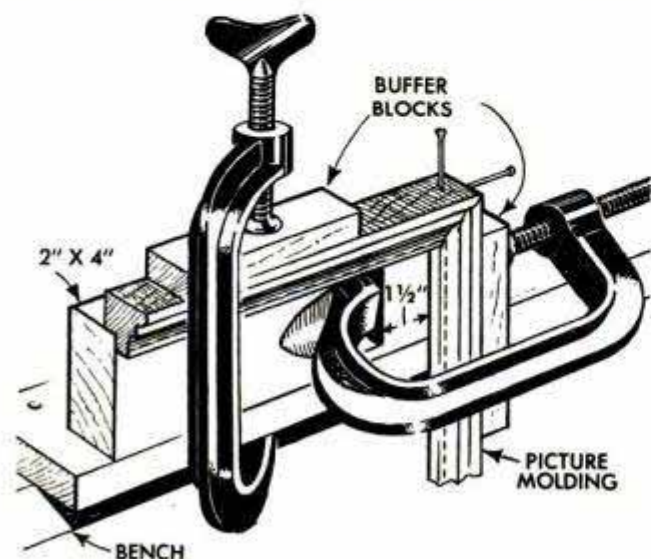

Method for Increasing Capacity Of Electrical Outlet

To rewire an electrical outlet for a home freezer or cooling unit that is to be plugged into a circuit having wires that are too small, connect the old wires together and pull in a new heavier wire to serve as the other side of the line. This will eliminate pulling out the old wire, which usually is difficult in old houses, and replacing it with heavier wire. The new wire, which may be a twin-conductor cable with its wires connected at the ends to provide a single conductor, can be run through a different path if necessary.

Hugh Lineback, Stillwater, Okla.

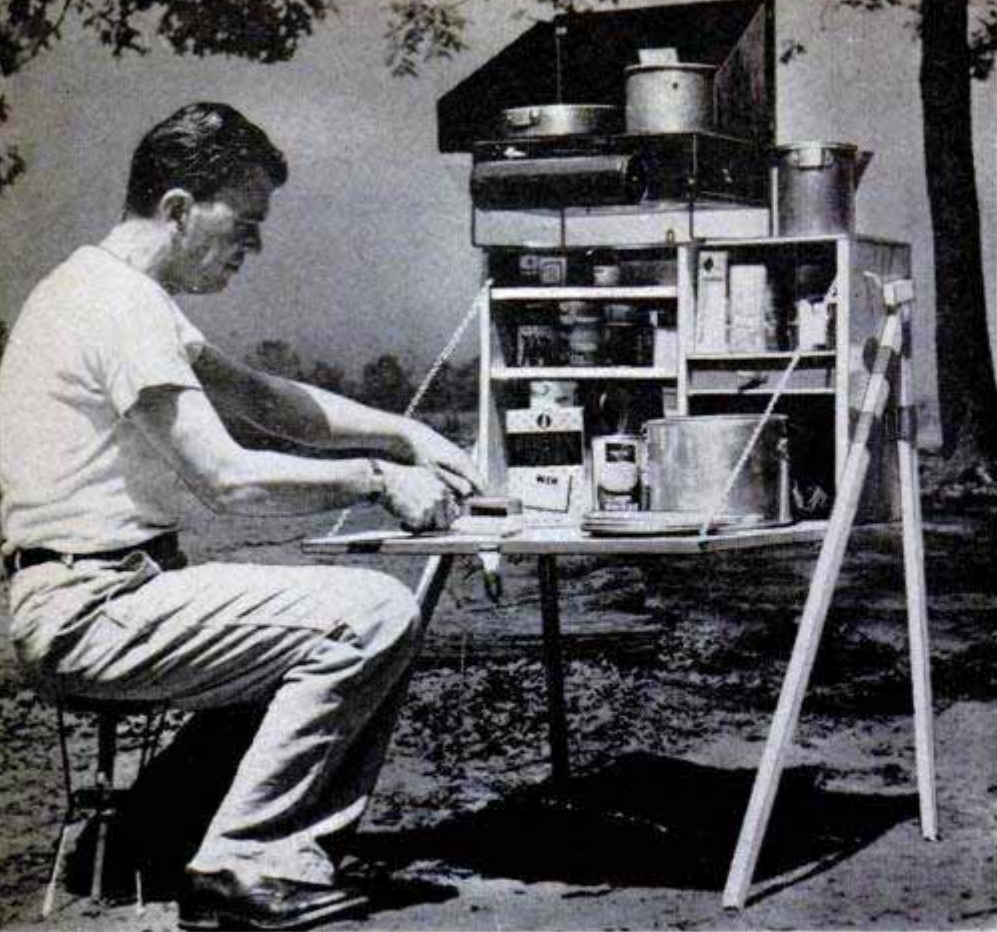

CAMPER'S CABINET KITCHEN

By Paul F. Runge

Being the camp cook is a real pleasure when everything you need is right at your finger tips. Note how the hinged front of the portable cabinet opens to provide a worktable at a convenient height

THERE WAS A TIME when camping out meant roughing it, and eating camp food was a test of endurance. That picture has changed considerably and camping has become the art of living as comfortably as possible under all kinds of conditions. For family camping, this compact portable kitchen will provide the answer to the problem of a place for everything. It also can be used by hunters and fishermen who are going to spots that are accessible by car. The cabinet is designed to hold a cooking kit, eating utensils, and enough canned and dehydrated foods to feed six people for a week. Removable legs make it easy to stow the cabinet in the trunk of your car.

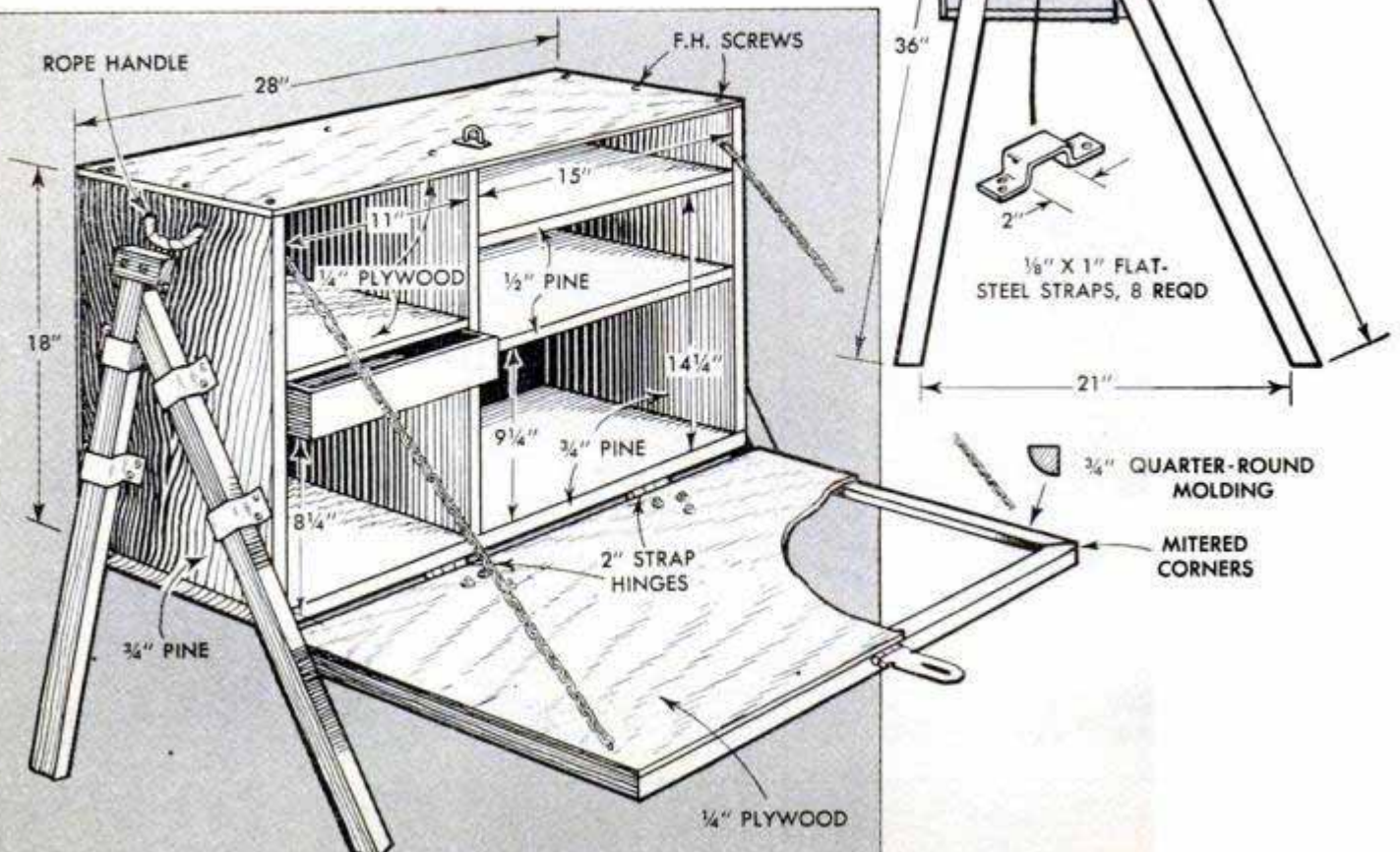

Repairing Broken Heater Element

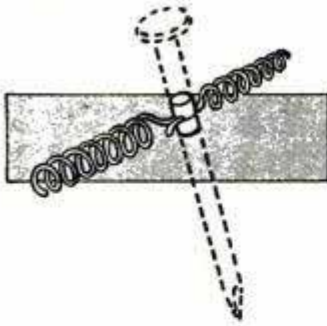

Broken electric-heater elements can be repaired with a slotted section cut from a shingle nail. The slot is filed three quarters of the way through the nail, and the slotted segment is then cut from the body of the nail. The ends of the broken heating element are cleaned and then inserted in the slot, which is hammered close around them. This makes a solid repair job which will last indefinitely.

A. S. Kallenborn, San Carlos, Calif.

Worn Force Cup Nailed to Handle

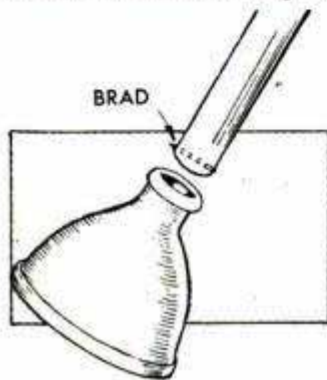

If you have difficulty in keeping a rubber force cup on the handle once the socket has become stretched and deteriorated, drive a brad or thin nail through the handle near the end. Cut the ends of the nail so that they project about $\frac{1}{8}$

in. and file them to sharp points. Then, using a twisting motion, force the end of the handle into the socket.

Cool Water Provided for Invalid By Altering Vacuum Bottle

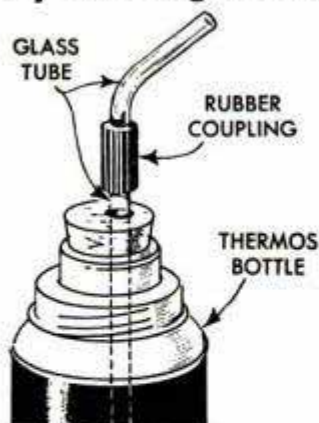

By altering a vacuum bottle to provide a ready source of cold drinking water for an invalid, the comfort of the patient can be increased and some of the time spent caring for him can be saved. Drill the bottle cork so that a glass drinking

tube can be inserted loosely through it. With a short length of rubber tubing couple a curved and a straight glass drinking tube. Insert the straight tube in the bottle so that it reaches almost to the bottom. The patient drinks from the curved tube.

☛ Moles can be discouraged by putting moth balls or crystals in their runways.



Shelves Installed on Bassinet Keep Baby Supplies Handy

Fitted to the underside of a bassinet of the type shown, one or two shelves will provide a handy storage place for diapers and blankets as well as other frequently used baby supplies. After the outside length and width of the carriage are measured, a piece of $\frac{1}{2}$ or $\frac{3}{8}$ -in. plywood is cut to the same measurements and then notched at both ends to fit over the legs. A single shelf may be rested upon the main leg braces. However, if there are, as in most cases, additional braces located higher up, a second shelf may be added in the same way.

Kathryn M. Wilson, Pontiac, Mich.

Disposal of Staples Made Easy When Remover Is Magnetized

If you use a staple remover frequently, you'll appreciate this kink for magnetizing the tool so it will collect the staples as they are removed, instead of letting them scatter over the desk and floor. This is done by rubbing the tool with a permanent magnet. After a cluster of staples has formed, it can be removed easily and disposed of. Repeat the action as often as is necessary.

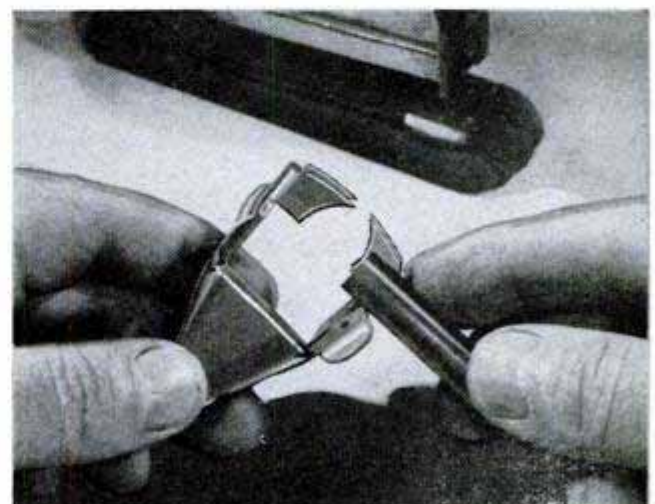



CAR-TOP SLEEPER

By Joe Ott



After car has been parked, remove cover and raise folding frames, or bows. Insert the lugs at the ends of the expansion bar in the elongated holes in frame

Front awning over screened window is held firmly in place by cords which are tensioned by springs attached to free ends. Springs hook into screw eyes



WITH THIS weather-tight sleeper installed on your car top you can take to the back roads on fishing and hunting trips or vacation without any worry about where to put up overnight. As pictured, the unit accommodates a three-quarter (48-in.) mattress of the innerspring type, but by increasing the over-all width about 6½ in. it takes a full-size mattress. The bedframe, detailed on the opposite page, is a simple, shallow box having a plywood bottom reinforced with three equally spaced slats. The latter rest on five cross cleats spaced to provide channels for the tubular supports. Before cutting material

Lower end of canvas fly is supported by wooden arms. Protruding heads of nails driven into ends of arms enter holes in frame and wooden bar in fly

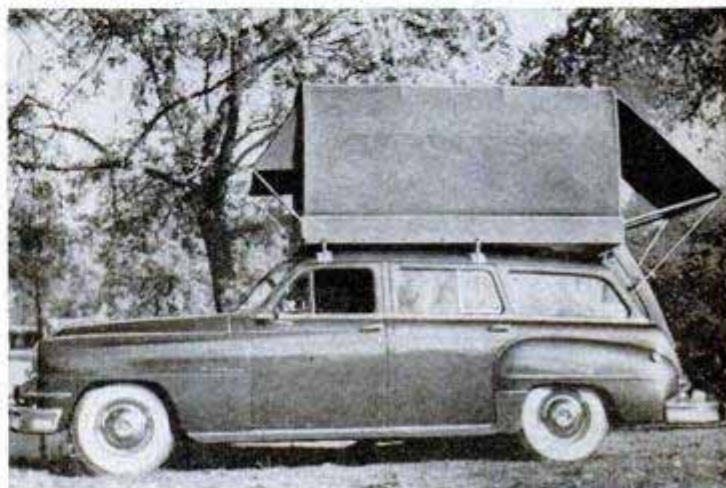

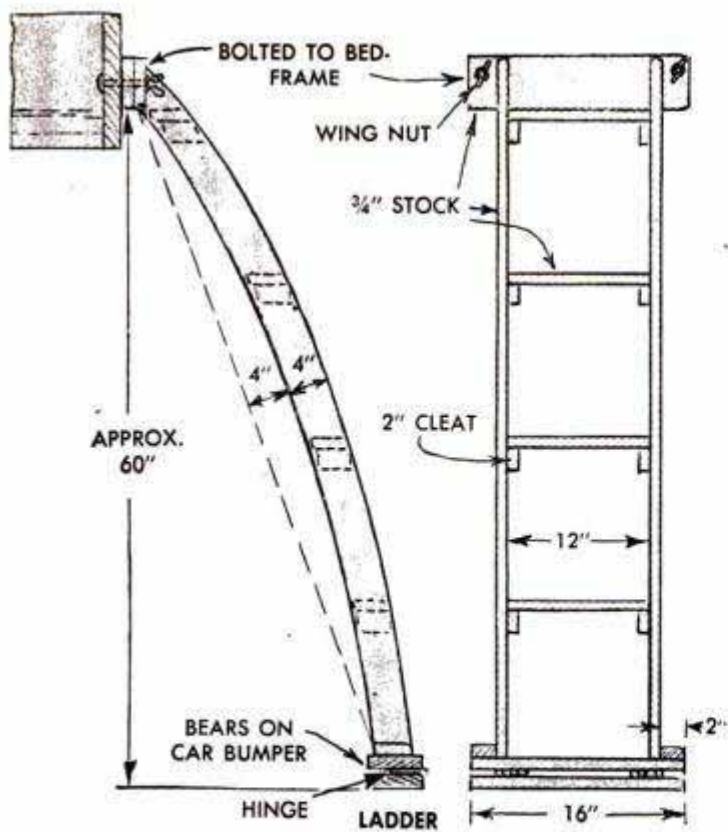

Ladder leading to entrance has curved stiles to fit over car trunk. Ladder is hinged to car bumper

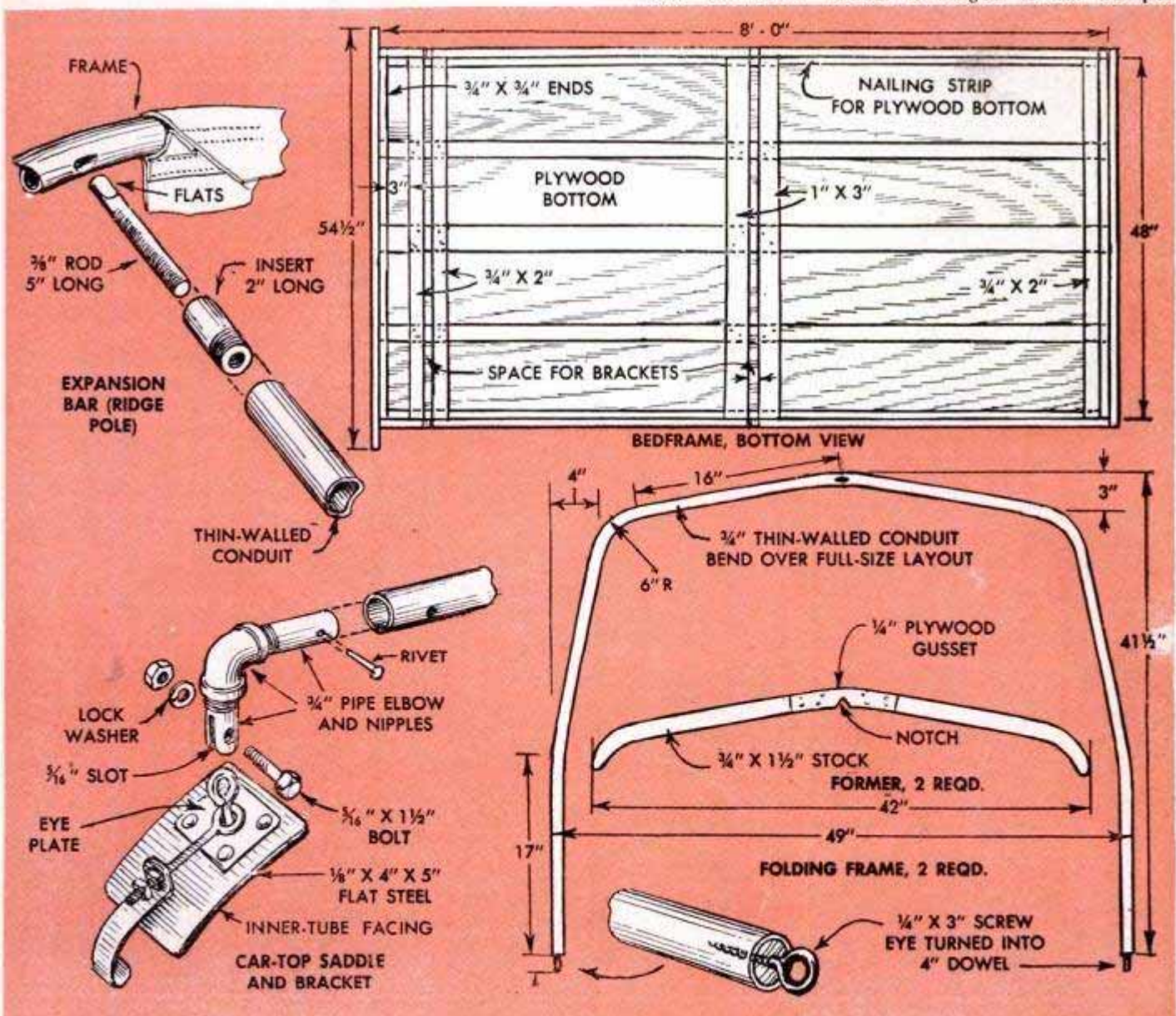

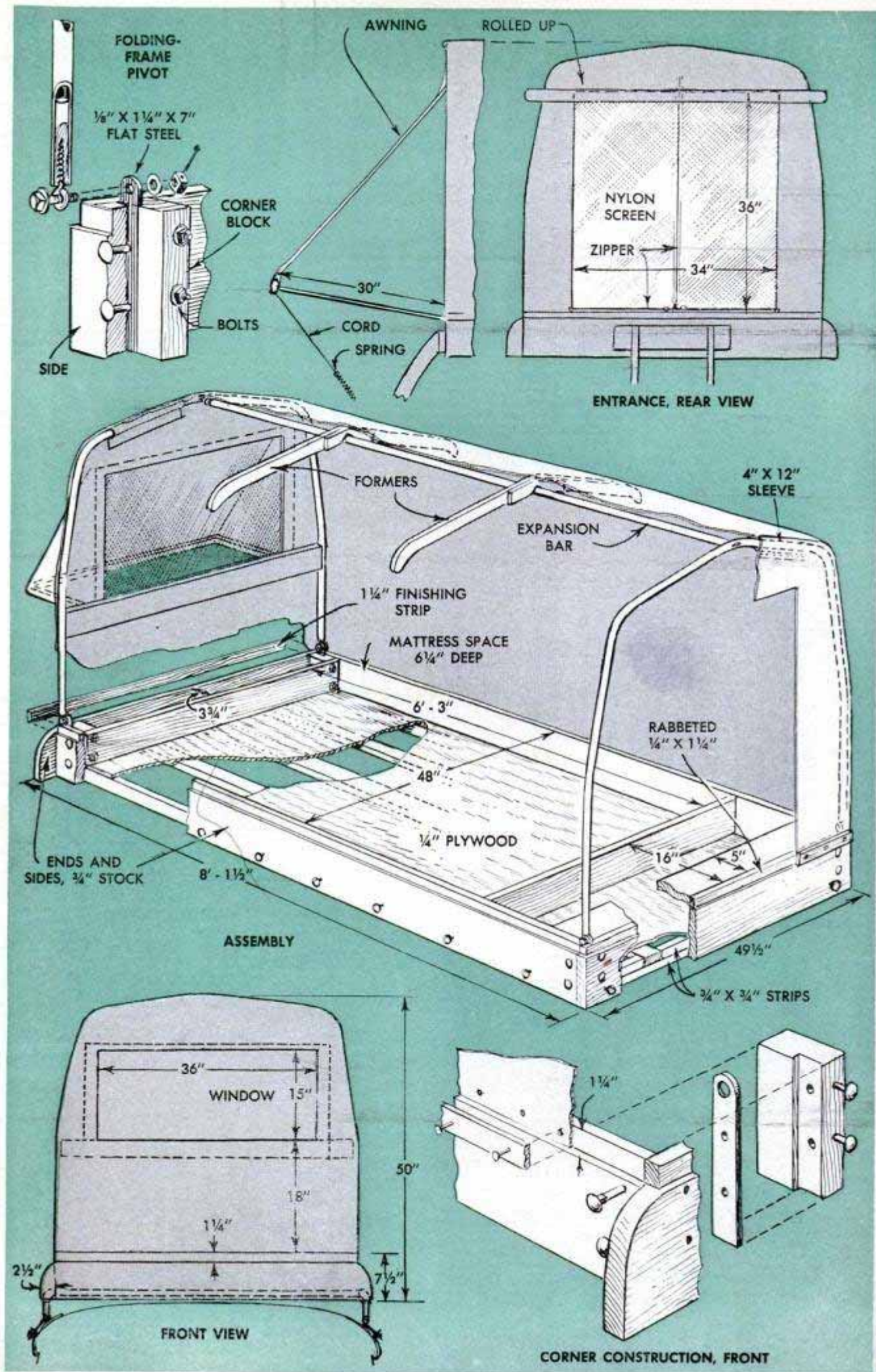

note especially the construction at the front and rear corners detailed on page 184. Flat steel lugs that fit between the rabbeted corner blocks and the sides of the box are held rigidly in place by two bolts which pass through the side of the box, the lug and the block. Two additional bolts are used to draw the block tightly into the corner. In the assembly, waterproof glue is used on all meeting faces of the parts. Note also that the ends of the plywood bottom are supported on filler blocks fitted between the slats as in the center detail on the opposite page. The slats are clinch-nailed to the cross cleats and the latter are butt-joined to the sides with screws and glue. Be sure that they are correctly spaced.

Before cutting parts for the car-top saddles, brackets and tubular supports, lift the bedframe onto the car and block it up to the correct height so that you can determine the varying lengths of the slotted pipe nipples which slip over the eyebolts on the saddles. The metal saddles are bent to the contour of the car top and faced with sponge rubber or pile fabric to prevent marring. The $\frac{3}{4}$ -in. pipe nipples which serve as studs are inserted in the ends of the tubular supports as in the lower left-hand detail on page 183. They should be shouldered in a lathe to a snug, press fit. After fitting, the parts are riveted or welded. The conduit supports are held tightly in the channels by $\frac{1}{4}$ -in. bolts which pass through both cleats and the metal tube.

The folding frames, or bows, are lengths of thin-wall conduit bent over a full-size layout to insure duplication. The formers, or half bows, are of $\frac{1}{2}$ -in. plywood with curved ends. Note that each unit is notched on its lower edge to fit over the expansion bar, or ridge pole. The hardwood plugs at the lower ends of the frames should be turned to a tight fit. Screw eyes turned into the plugs provide a means of pivoting the frames so that they fold easily. Construction of the expansion bar, or ridgepole, is shown in the center left-hand detail on page 183. As dimensioned, the ladder fits the station wagon pictured. Be sure to take measurements on your own car before cutting parts. Note that the lower end of the ladder is hinged to a separate piece of stock bolted to the car bumper, and that it is attached at the top with bolts and wing nuts so that it can be swung down when opening the car trunk. Have the canvas top, fly, awning and waterproof canvas cover made to fit the frame by a professional upholsterer. The cover is attached, as in the upper photo on page 182, by means of a cord passing through grommets in the corner and a row of screw eyes on each side and across the ends of the bedframe. ★ ★ ★

Rewinding Dried Fishline

A wet fishline can be dried quickly and uniformly if wrapped around a bottle and placed in the sun. To rewind the fishline, simply slip the bottle over a branch or a stick that has been stuck in the ground so it will permit the bottle to rotate easily as the line is rewound on a reel. A tall, slender jar or can may be used in place of the bottle if necessary.

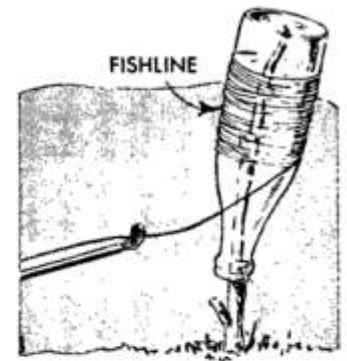

Pocket Minnow "Bucket"

Stream fishermen using live baits find that a flat or oval-shaped half-pint bottle is just the thing for carrying live minnows. The bottle is filled about half full of water and carried in a hip pocket. Four to six small minnows can be carried for several hours in this manner as the uncorked bottle permits free entrance of air and movement aerates the water.

Rabbit Brooder Made From Keg

Raising baby rabbits in the winter is no problem if you use an inexpensive brooder like the one shown. It is made from a nail keg and is heated by an electric-light bulb. The keg is supported horizontally by two feet cut as indicated and screwed in place. A lamp housing constructed of $\frac{1}{2}$ -in. plywood is mounted over a 7 x 7-in. opening in the upper side of the keg. Size of the bulb, which should be shielded with sheet metal, is determined by the amount of heat required. The open end of the keg is closed with a plywood disk screwed in place for easy removal when the straw nesting has to be replaced. A 5 x 5-in. entrance is cut in the disk as shown.

Arthur A. Stevens, Canby, Ore.

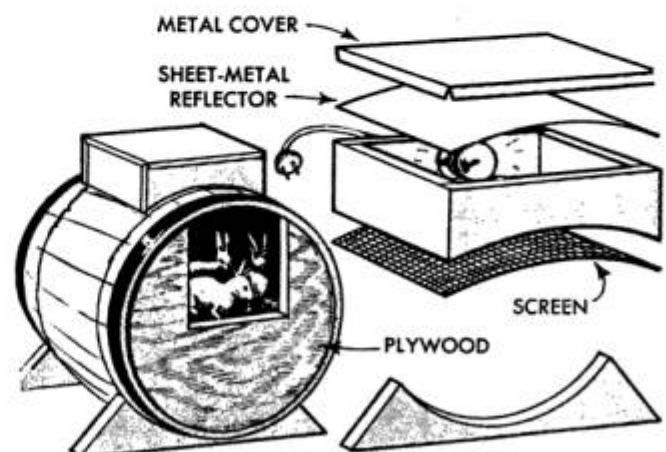



The first thing to do after floodwaters recede is to have the car towed to parking space for reconditioning

REDUCING FLOOD DAMAGE

By Ed Packer

SHOULD YOU ever be forced to abandon your car to a sudden, swirling flood, the receding waters may leave it looking something like the cars in the photos above and on the opposite page. Often the prospects for salvage and repair appear pretty discouraging, especially if the windows have been broken and the interior of the car half filled with water-borne sand, silt and other debris left in the wake of floodwaters. But while you're viewing the "wreck," keep in mind the chances are good that damage to the vital mechanical parts is comparatively slight and, that by follow-

ing a step-by-step procedure you can put the old bus back on the road as sound and good as ever.

The first thing to do is have the car towed to a garage or parking space where facilities for cleaning are available. When possible to reach the plug, drain the differential before permitting the car to be moved. This will get rid of all the silt-laden water that may have found its way into the differential housing. Remove the battery immediately and take it to a service station for reconditioning, as the electrolyte may have been contaminated by impure water. If so,

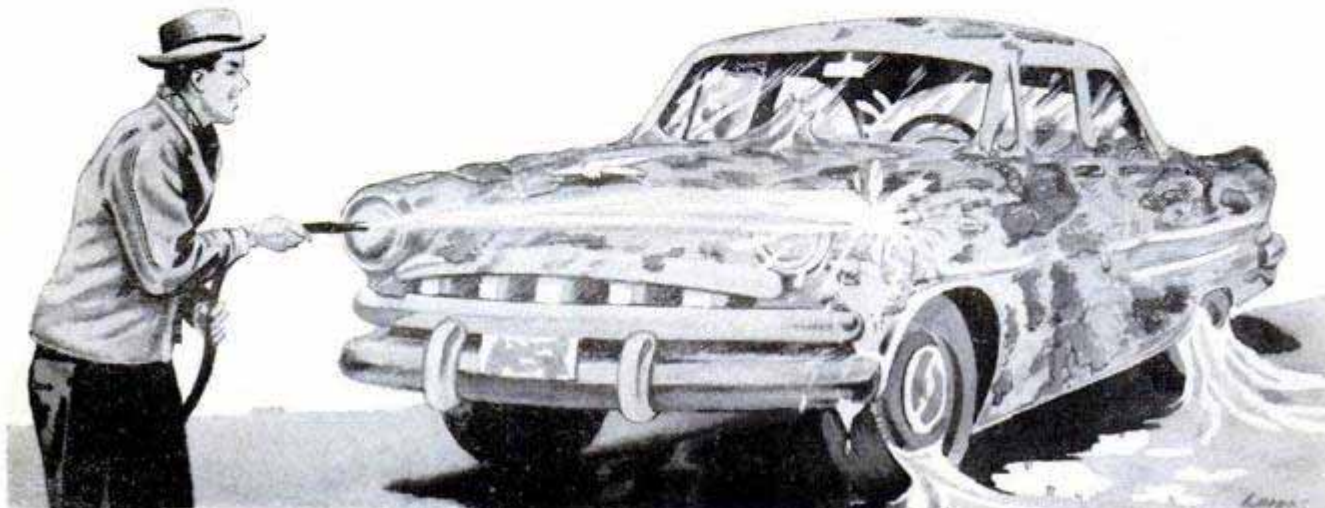



Montgomery photos

Cleaning up a convertible can appear discouraging, but chances are that car still is mechanically sound

TO YOUR CAR

it will have to be replaced and the battery recharged. If possible avoid moving any part of any mechanism, including the windows and steering wheel, until the car has been parked where the cooling system, crankcase, transmission (conventional type) and the fuel pump and fuel tank can be drained. In addition, it's a good idea to drain the hydraulic-brake system, including the master cylinder and also the steering gear.

The best way to flush away mud and other debris is to connect a hose, without

a nozzle, and adjust the water pressure to give a full curving stream. Open the doors and trunk and take out the seat cushions. Wash the cushions and then invert them on sawhorses so they will drain and dry quickly. Then hose the car inside and out, leaving the doors open until fabric is dry.

At this point, if it is at all possible, have the car towed to a service station or garage where facilities will be available for reconditioning the mechanical parts. If any quantity of water ran out of the crankcase when it was drained, it can be safely assumed that, even though the water displaced the oil in the pan, the oil pump still contains a quantity of gritty silt carried in

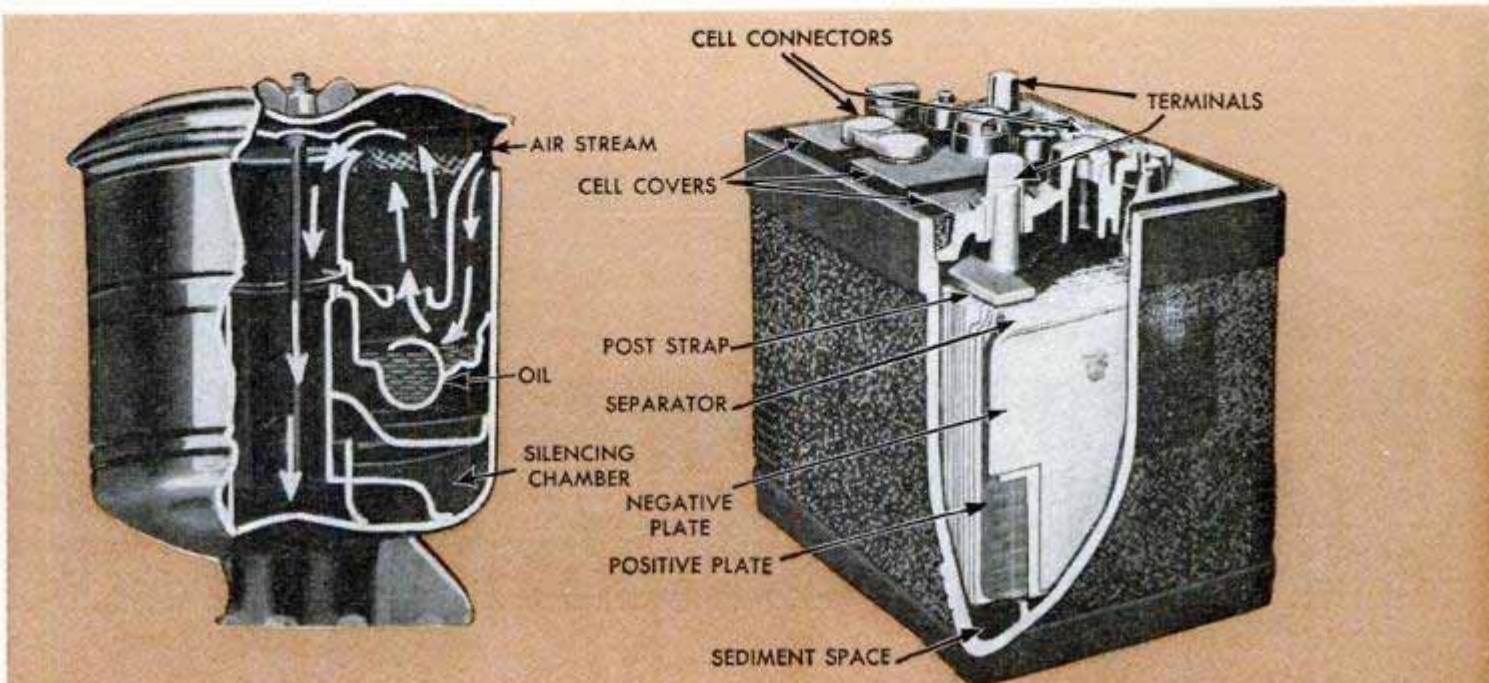

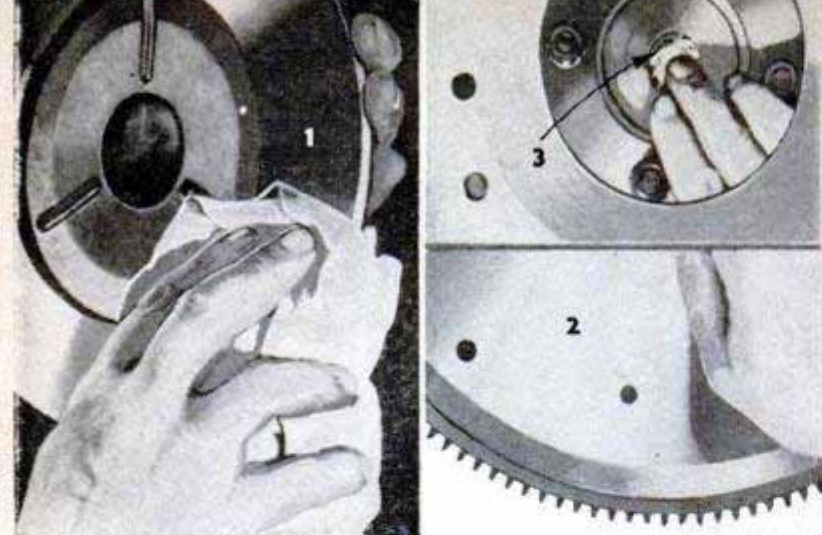

Do a careful job on the clutch, especially on the pressure plate, flywheel and pilot bearing, parts 1, 2 and 3

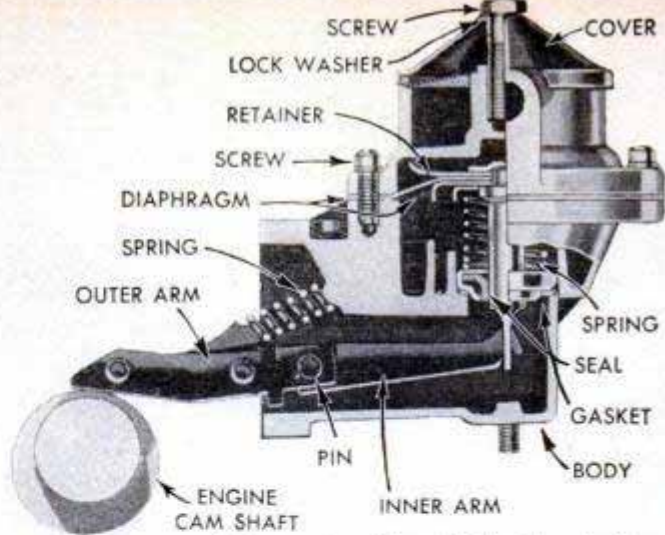

Photos courtesy Plymouth Div. Chrysler Corp.

It isn't likely that fuel pump will be affected even though submerged. It is cleaned easily if necessary

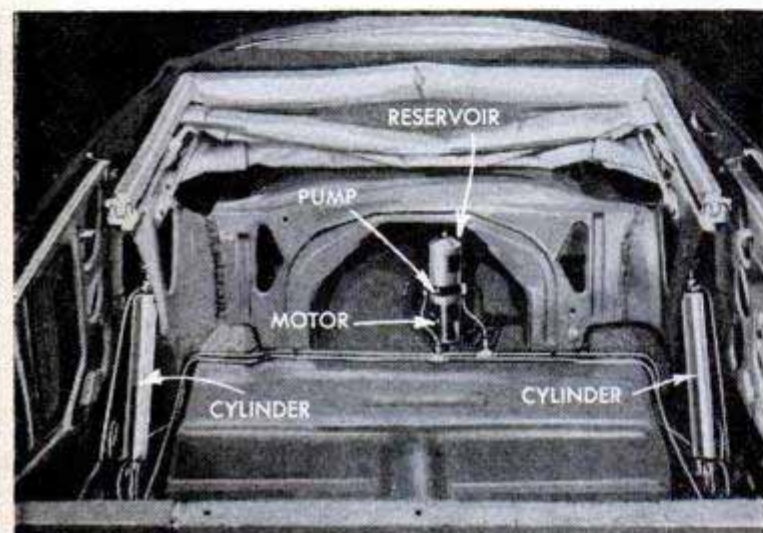

Hydraulic lifts for convertible tops may not need servicing. Check after car has been reconditioned

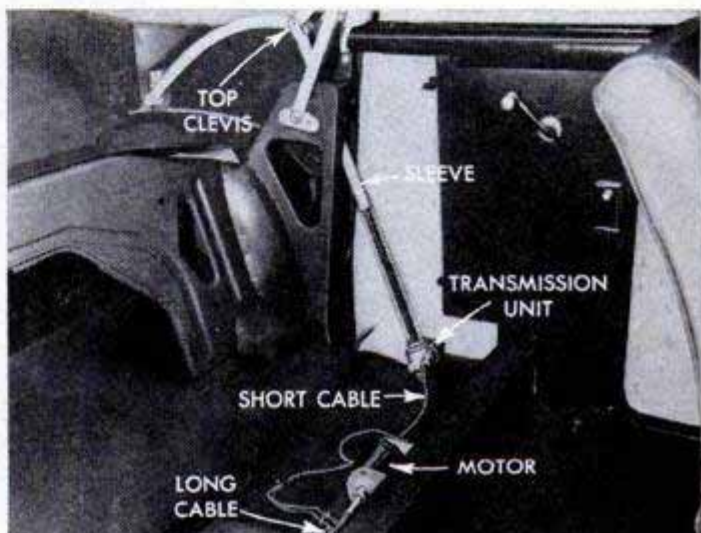

Dismantle the electrical lift for convertible top and clean and dry all the parts. Then relubricate the transmission unit

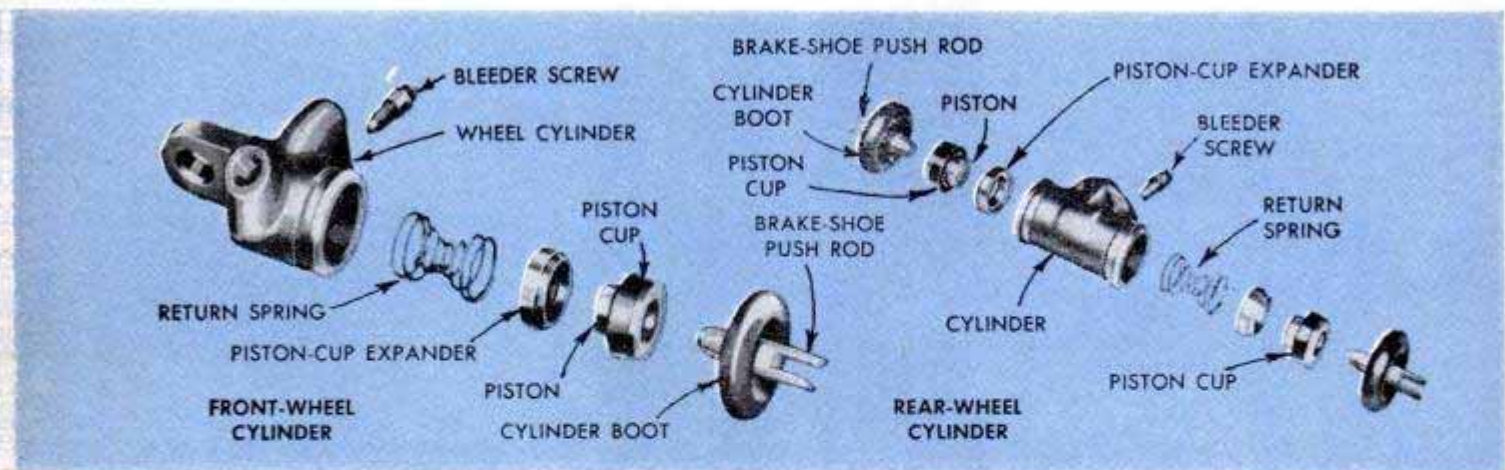

Leave reconditioning and servicing of hydraulic brakes to your serviceman as he will have special equipment required. Dismantled master and wheel cylinders are shown above. Below, bleeding air out of brake lines

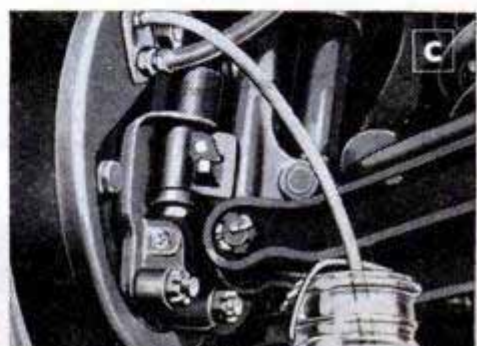

by the floodwaters. There is always the possibility that this may have found its way to wear surfaces of the crankshaft and possibly the camshaft by incorporation with the displaced oil. In this case it will be necessary to drop the oil pan and remove the valve cover so that the interior of the engine can be washed thoroughly and the oil passages blown out with compressed air. Lacking other equipment, an ordinary paint-spray gun filled with kerosene does a good job of washing the crankcase and valve chamber. While carrying out this procedure don't forget to remove the oil filter, blow out the oil lines leading to it and renew the filter cartridge. Blow out the fuel and hydraulic-brake lines. Clean the oil pump and inlet screen thoroughly to assure removal of all gritty substances. If the engine was submerged, even for a short time, there's reason to suspect that water may have entered the cylinders through the air cleaner. Because of this possibility it's a wise precaution to open the engine, remove any water present and dry the upper cylinder walls and tops of the pistons. Coat the cylinder walls and pistons with light oil. Pour a small quantity of light oil on top of each piston. It will creep past the rings and coat the lower cylinder walls to prevent rust and provide initial lubrication when starting the engine for the first time after reconditioning. Be sure to use a new gasket when replacing the cylinder head. Dismantle the carburetor and blow it out with compressed air. Clean the air cleaner thoroughly before replacing it. Replace the oil pump and oil pan and fill the crankcase to the recommended level with special break-in oil, such as that used in new cars. Fill the transmission and differential with a half-and-half mixture of kerosene and No. 20 crankcase oil. All parts of the ignition system and also the generator and starter should be dismantled and thoroughly cleaned and dried out. Some parts, such as the armatures and field coils of the starter and generator, parts of the distributor, also the condenser, spark coil and voltage regulator can be dried quickly in an oven at 160 deg. When reassembling the generator and starter be sure that the brushes are correctly installed and don't forget to lubricate the bearings of both units. Be sure to place a few drops of light oil on all moving parts of the starter gear. To prevent rust, all parts of the distributor assembly subject to wear should be coated with light oil. Clean the breaker points and wipe light oil on the breaker-arm and governor-weight springs. Clean and dry the vacuum chamber before reassembling the distributor. When assembling, make sure that the wick in the oiler, located just beneath the distributor body, is clean and

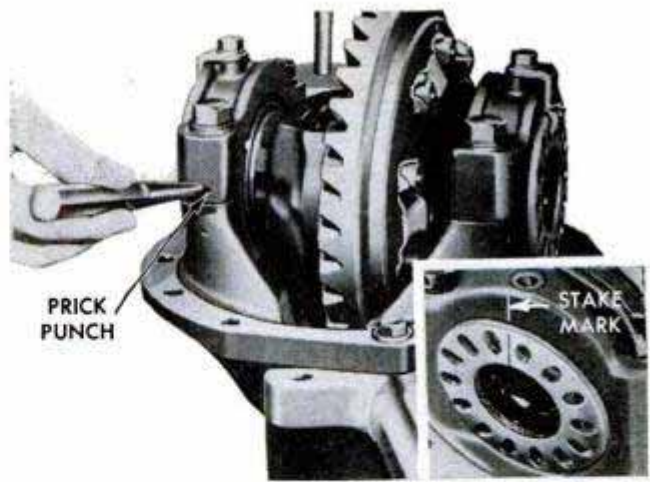

When removing differential gear make prick-punch marks to insure returning parts to proper position

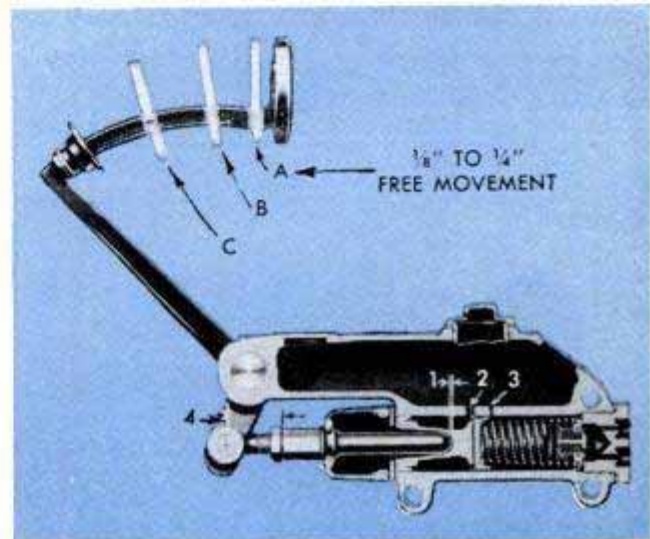

Adjust free movement of the brake pedal after servicing brakes. Recommendations vary from $\frac{1}{8}$ to $\frac{1}{2}$ in.

well saturated with light oil. Also, it's a good idea to coat such parts as the governor weights and the upper end of the spindle with light oil while assembling. Remove all the spark plugs, clean them and readjust the points. Pull the wires from the distributor cap and blow out each terminal socket. Examine the voltage regulator carefully for embedded sand and other foreign particles that might interfere with its operation. Brighten the contact points with a fine abrasive strip which is made especially for this purpose. If the unit has been damaged in any way, by water or otherwise, it is best to replace it. As the final step on the electrical system, dismantle the horn, clean the parts thoroughly and brighten the contact points. After the battery has been installed it may be necessary to adjust the tone of the horn by releasing the lock-nut, No. 3, and turning the adjusting screw, No. 2, as in the lower left-hand photo on page 191.

The clutch (conventional disk type) is one of the most vulnerable parts of the car to flood damage. In some instances it is possible to recondition it satisfactorily fix



When generator and starter are removed it may be necessary to clean commutators. Use fine sandpaper

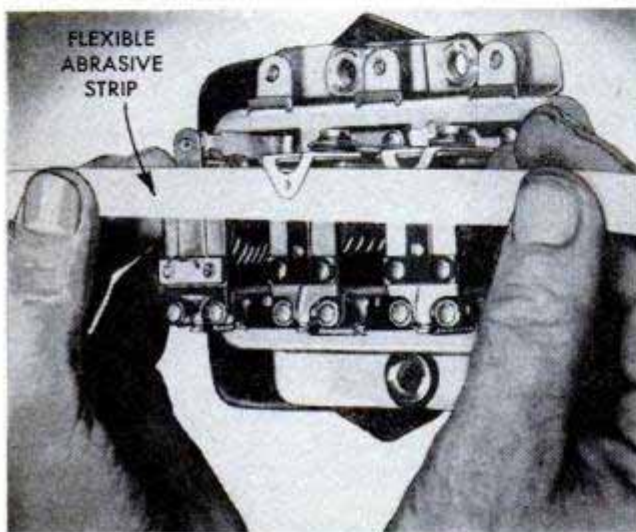

All parts of electrical system, including voltage regulator, above, and distributor, below, must be thoroughly reconditioned. Relubricate all the wear parts

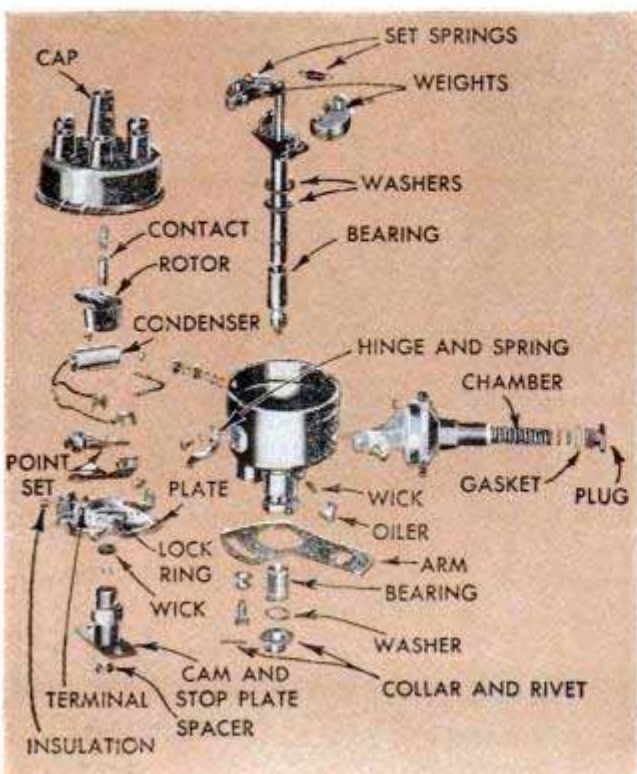

simply by slipping it lightly after the engine is started. Often this procedure will generate sufficient heat to dry the disk and clear rust from the machined surface of the flywheel. However, careful auto mechanics will not be entirely satisfied with this rather slipshod method. They will prefer to dismantle the clutch and go over it piece by piece. Special attention should be given to the condition of the disk, as water absorption may cause swelling and distortion which in turn will result in unsatisfactory operation. If the disk shows water damage in any appreciable degree it is advisable to replace it. Clutch parts operate dry, without oil, and rust will attack the machined surfaces of the flywheel, the splined shaft and pressure-plate springs if not checked immediately. Remove rust that may have formed, rub a film of oil on the pressure-plate springs and clean and lubricate the pilot bearing before reassembling the clutch.

Before starting the engine, flush the cooling system thoroughly and direct a hard, thin stream of water through the radiator core from the back to remove any mud or sand that may have lodged in the core. Fill the system with soft water or antifreeze if required.

Next, install the battery and then jack up the car, blocking under the axles so the wheels can turn freely. Before switching on the ignition, turn the engine over several times with the starter to assure that oil from the pump reaches the bearings. Then start the engine, shift to high gear and allow it to run slightly above idling speed (about 25 m.p.h.) for 20 to 30 minutes. Immediately after starting the engine note whether the speedometer is operating and also keep a close check on the oil-pressure gauge and the ammeter. If neither of the latter instruments registers, then it is best to stop the engine and investigate the cause. If the fault is in the instruments, they should be replaced. After running the engine with the transmission in high gear for the specified time, stop it and immediately drain the transmission and differential. After draining thoroughly, refill with regular oil of the specified viscosity. Usually this flushing procedure can be considered adequate. However, if there is any reason to suspect that this treatment may be insufficient, then it's good insurance to dismantle both the transmission and differential and do a more thorough job of reconditioning. If this is done, it's a good idea to prick-punch the parts of the differential gear as in the upper photo on page 189. This precaution will assure that the parts are reassembled in their proper relationship. Always install new gaskets on any units that are disassembled.

If your car is a convertible having a cloth top which is raised and lowered electrically or hydraulically, then the power unit will, of course, require attention along with the other mechanical parts. In the electrical unit, the motor should be removed, cleaned and dried out. All other parts must be inspected and cleaned and, where necessary, relubricated. The hydraulic unit is less susceptible to flood damage. Unless it has been damaged mechanically by floating debris, then it probably will be safe to leave it for trial later on when you have the car ready for service. If service is required to recondition the unit, it will pay to have the job done by a serviceman, who will have equipment required for complete overhaul. This also is true of the wheel brakes which will require special equipment for filling the master cylinder and lines and bleeding the system to assure proper operation. The brakes may require relining. Have the serviceman adjust the brake-pedal travel to the correct amount recommended by the manufacturer of the car, as this distance varies.

By this time the felt channels in the

doors and windows should be sufficiently dried out to permit the glass to roll up and down easily. If the channels have not been subjected to a prolonged soaking they still should be serviceable. However, the door panels should be removed so the lifting mechanism can be cleaned and lubricated. Run water from the hose inside the glass compartment to wash out any sediment that may have collected. Flush the door locks with a lock-cleaning fluid and blow dry with compressed air. Lubricate the locks, strikers and hinges. If the fabric in the seat cushions is torn, have the damaged section renewed by a professional upholsterer. Discoloration of the fabric usually can be removed by steam cleaning, but care must be taken not to damage sponge-rubber padding. Unless the car is nearly new, do not permit the engine to run more than three to five hours with break-in oil in the crankcase, and then only at slow speeds. It generally is best in an older car to drain the break-in oil after two to three hours of operation. Drain the oil only when the engine is hot, then fill the crankcase with regular oil. ★ ★ ★

Photos courtesy Plymouth Div. Chrysler Corp.

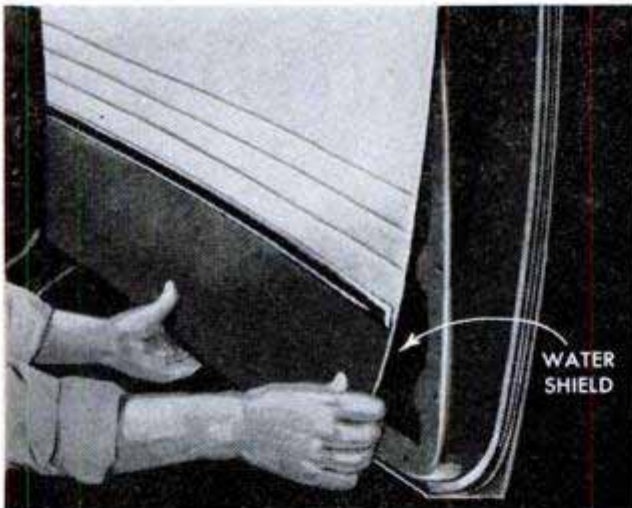

Above, door panels should be removed so that glass-lifting mechanism can be cleaned and serviced. Below, it may be necessary to readjust the horn by removing cover and adjusting the screws, parts 1, 2 and 3

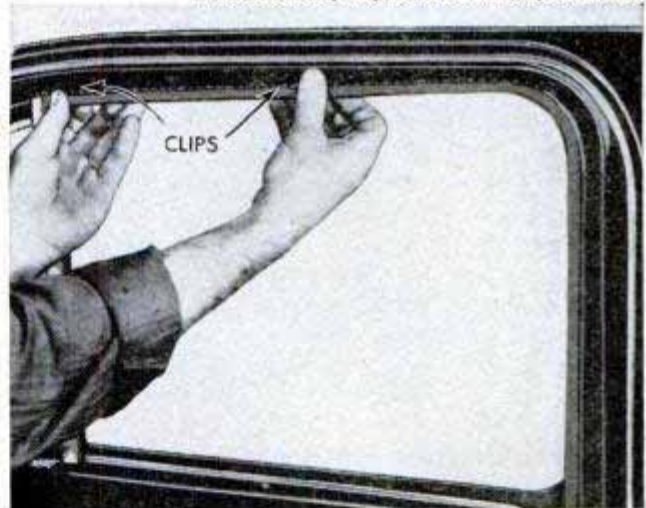

Above, glass channels may still be serviceable even though immersed. If not they are easily replaced. Below, usually a thorough washing and drying will recondition seat cushions. Then vacuum-clean the fabric

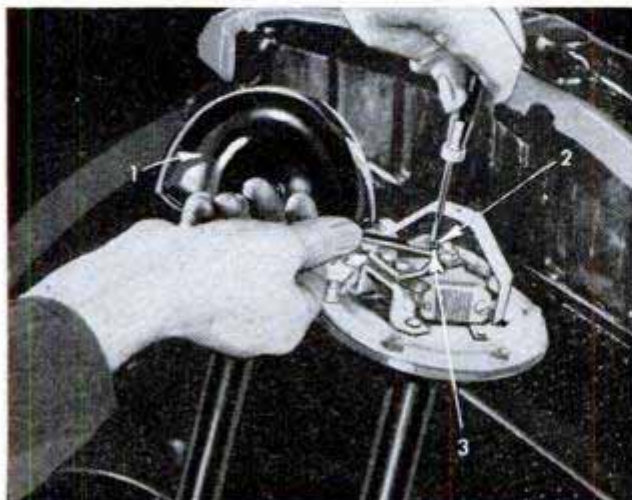



Camera Fitted With Extension To Eliminate Reflections

To eliminate surface reflections on the ground-glass of a twin-lens reflex camera, make yourself an extension for the focusing hood. Use a black paper envelope of the kind in which photographic paper is packaged. Cut the bottom from a 5 x 7 envelope and crease it lengthwise in the center of both sides to fit over the top of the hood as shown.

Virginia Hanson, Los Angeles, Calif.

Clipped Corner of Transparency Aids Positioning in Projector

The problem of keeping transparencies right side up when showing them in a darkened room can be eliminated simply by cutting off an upper corner of the mount. This will make it possible to feel whether or not the transparency is right side up as well as prevent it from being placed in the projector backwards. The job can be done with either a scissors or nail clippers.

R. L. Taylor, Cuyahoga Falls, Ohio.

Zing - - -

Another one hooked, but what! That's the intriguing part of surf fishing—you never know what's on the line until you land it, and it takes a costly rod to do the job. Cost will be no problem if you make a husky rod as described next month. Read this story and get in on the fun of fishing the surf

Rectangular Paint Can Converted Into Inexpensive Print Box

An inexpensive photographic print box can be made from a rectangular 1-gal. paint can by cutting out a section of the top of the can to fit a standard metal print frame. The frame is bolted over the opening and a switch is mounted in the top as shown.

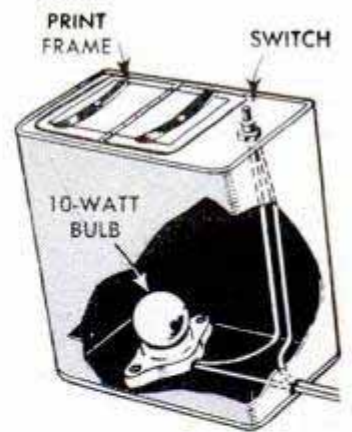

On the bottom of the can under the center of the frame mount a porcelain light socket. If the interior of the can is clean, so that it will reflect light, a 10-watt bulb should be used.—Thornton J. Parker III, Chevy Chase, Md.

Rubber Tips for Tripod Legs From Medicine-Dropper Bulbs

Replacements for rubber tips on the legs of some camera tripods can be made by cutting the tops from large medicine-dropper bulbs. Pack cotton into each bulb to act as a pad and slip it over the end of the leg, holding it in place with masking tape if necessary. Rubber tips that are not worn may be preserved indefinitely by placing the bulbs over them as "shoes."—John J. Rea, Urbana, Ill.

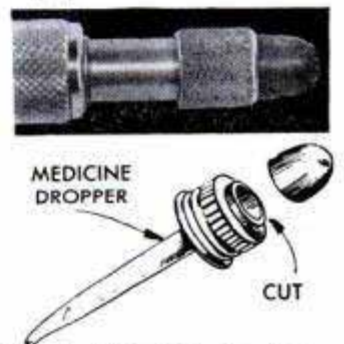

"Pincushion" on Bottle Cap Holds Retouching Materials

To assure having cotton and applicator sticks stored close at hand when using a retouching medium, one photographer made a holder from part of a toy balloon to fit over the cap of the retoucher bottle. Cutting the neck from the balloon, he filled it with a small quantity of cotton and then stretched the mouthpiece of the neck over the cap. The applicator sticks are pushed down into the cotton as shown.

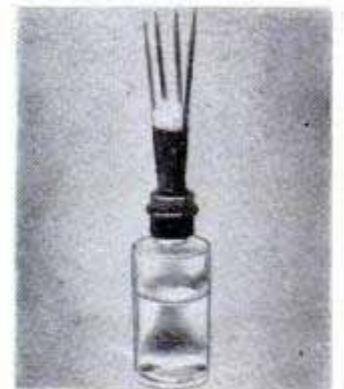

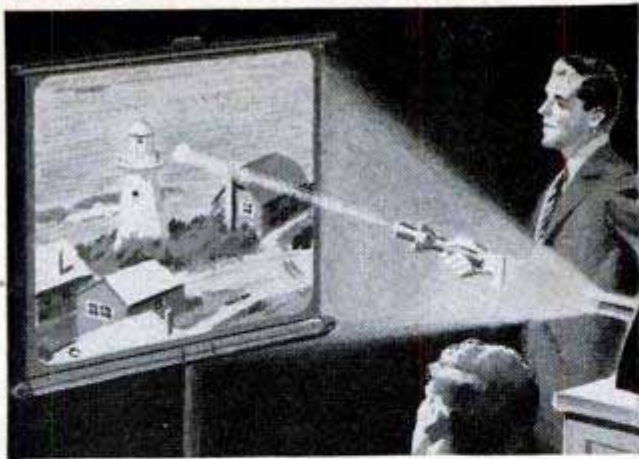

LIGHT- SPOT POINTER

HAVE THIS spot pointer handy the next time you show those vacation pictures. With it you can indicate interesting details without distracting the attention of your audience with a yardstick or some other improvised pointer. It consists of an ordinary flashlight fitted with a projecting lens from a 16-mm. projector. The projecting lens is fitted in a flanged mounting, or housing, made by soldering a sheet-brass flange to a length of thin-walled brass tubing which is a sliding fit over the lens barrel. In the assembly the flanged tube is inserted through the lens-retaining ring of the flashlight as shown in the detail at the right. When the ring is screwed tightly in place, the projector-lens tube and the flashlight lens are held securely in position. The projector lens is focused by sliding it in the tubular housing. Note that the flashlight reflector is covered with black paper so that only the light from the filament reaches the projecting lens. In flashlights having large reflector heads it may be necessary to assemble the parts without the flashlight lens. In this case, replace the lens with a cardboard washer of approximately the same thickness as the lens at the rim. In use, adjust the projecting lens until it throws a round, sharp-edged spot on the picture screen. For maximum brilliance of the spot, equip the flashlight with a new bulb and fresh batteries. Be sure that the lens slides smoothly in the tubing, yet is sufficiently tight to prevent it from falling out when the pointer is in use.



Safelight on Enlarger Lens Saves Darkroom Time

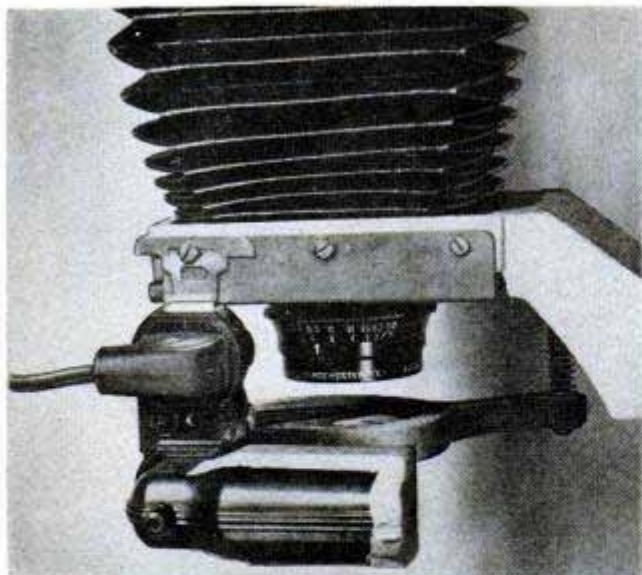

Lost time and motion can be saved in the darkroom by fitting your enlarger with a small safelight to illuminate the calibrations on the lens. Thus, in making a print, you merely focus the enlarger, stop down the lens, load the easel and make the exposure—no reaching for the room light switch to see the lens setting and no temporary blindness when the room light is turned off. The lamp is improvised from a dime-store sewing-machine lamp which is fitted with a cardboard shade resembling the lid of a box. A window is cut in the top

and covered with a piece of safelight filter. The shade is attached to the lamp with adhesive tape to seal against any light leakage. A duplex receptacle, in which the lamp is plugged, is mounted to the enlarger by one of the screws holding the lensboard retainer as shown in the photo. If you are unable to make use of an existing screw, an extra mounting hole can be drilled in the bellows bracket. Current is supplied to the lamp by an extension cord which is plugged into one side of the receptacle.

Robert C. Wilson, Akron, Ohio.

Strengthening Photo Developer

If you discover the developer getting weak when finishing the last of a batch of photographic prints, add a little sodium carbonate to the solution to make it last longer. This will enable you to develop a few more prints without having to mix fresh developer, eliminating also the need for forcing the prints in a weak, slow developer.—Robert C. Florian, Chicago.

☐ A handy, pocket-size exposure guide can be made by pasting tables and other data included with film on a piece of stiff cardboard. Use both sides of the card for the two kinds of film used most often and shellac to protect the tables from moisture.

Popular Mechanics Bookshop

Question:

How can I seal the basement floor—and I mean really seal it? Answer: See complete details starting on page 72 of *How to Paint With Brush and Spray*. Question: How can I apply those popular blond and pickled finishes to my own furniture? Answer: In the same book you'll find six full pages of "furniture schedules" telling step by step how to develop modern as well as traditional finishes. Question: Any ideas on touching-up the paint on my car? Answer: You bet! See page 142, same book. You'll find a thousand and one other answers to your painting problems, too. Question: Where can I get the book? Answer: Order *How to Paint With Brush and Spray* from Popular Mechanics Press, 208 E. Ontario St., Chicago, Ill. The price is only \$2.50.

For the Kids . . .

. . . we offer that all-time favorite, *The Boy Mechanic*. Here, in a brand-new edition, is the standard handbook for young craftsmen, completely revised and packed with more than 500 projects for any boy.

Each step is clearly illustrated with photos and drawings. It's a treasure chest of things to make from birdhouses to box kites, with special sections on outdoor projects, models, scientific experiments and indoor crafts. There's information for Dad, too, on how to get more fun out of his lad's electric train. The price is only \$2.95 from Popular Mechanics Press, 208 E. Ontario St., Chicago 11.

Plumb Tired . . .

. . . of leaking faucets and slow drains? The *Home Plumbing Guide* offers complete information on the design, installation, operation and repair of home-plumbing systems. It's written by E. R. Haan, former Shop Notes Editor of *Popular Mechanics*. There are chapters devoted to materials and tools, drainage systems, private disposal of sewage, installing house water lines, valves, faucets and fixtures. Here's an authoritative book that belongs in every home library—it can save the homeowner many times its price. Order the *Home Plumbing Guide* for \$3.50 from Popular Mechanics Press, 208 East Ontario St., Chicago 11.

All books available from Popular Mechanics Book Department, 208 E. Ontario St., Chicago 11



SHOP NOTES

Farm Manual (1955 ed.)

JEEP DOZER

By E. V. Reyner

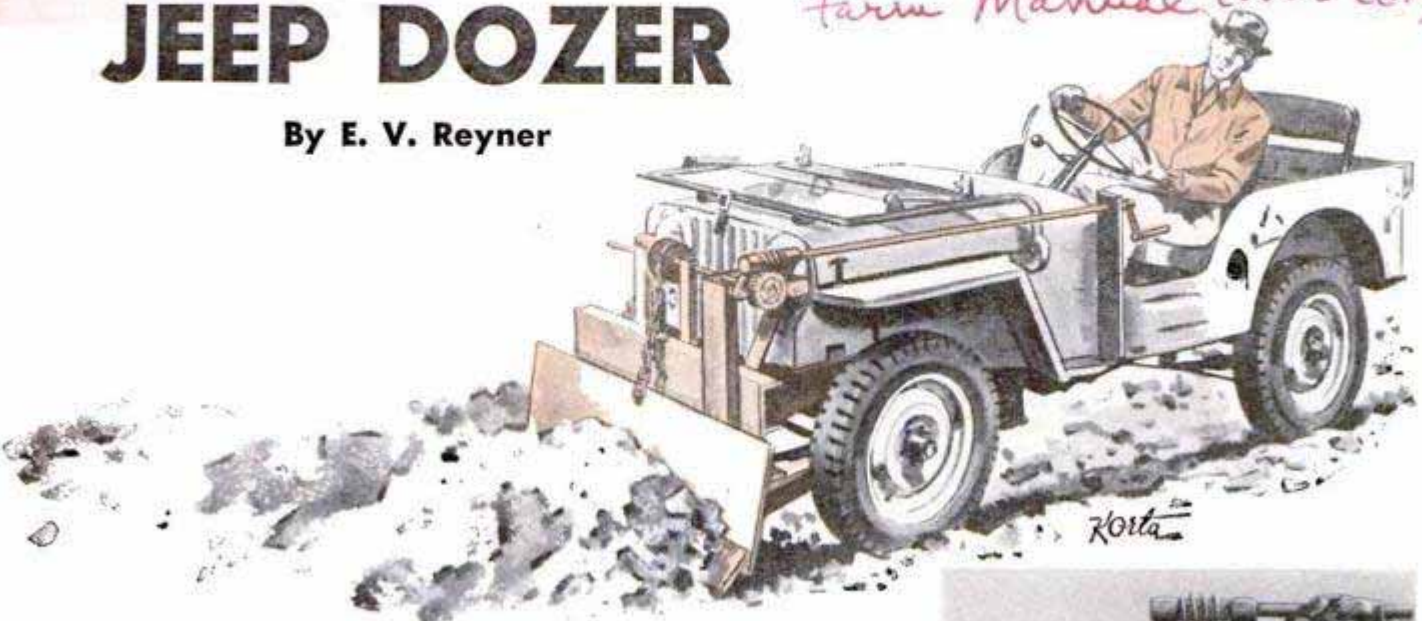

THIS LIGHT DOZER utilizes the agility, maneuverability and power of the Jeep to move snow, fill ditches, level fields and grade homesites. These jobs require a small, short-coupled unit that can move fast where the going is rough. The X-braced frame of the dozer detailed below is dimensioned for the regular Jeep with four-wheel drive and is operated by a simple hand lift improvised from a binder-wheel lifting gear mounted on two pieces of steel channel as in the photo at the right. The gear, which is a self-contained unit, is bolted to a bracket supported by the channels. These, in turn, are bolted to a special bumper made by welding two lengths of channel web to web. The gear operates a drum-type hoist, the free end of the chain being attached to the scraper blade. The dozer pivots on thrust plates welded to the Jeep frame.

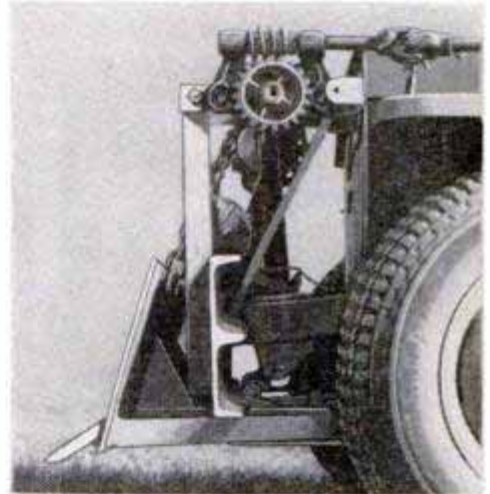

Raising gear is operated by a crank attached to extended shaft supported by a bracket welded to the Jeep body

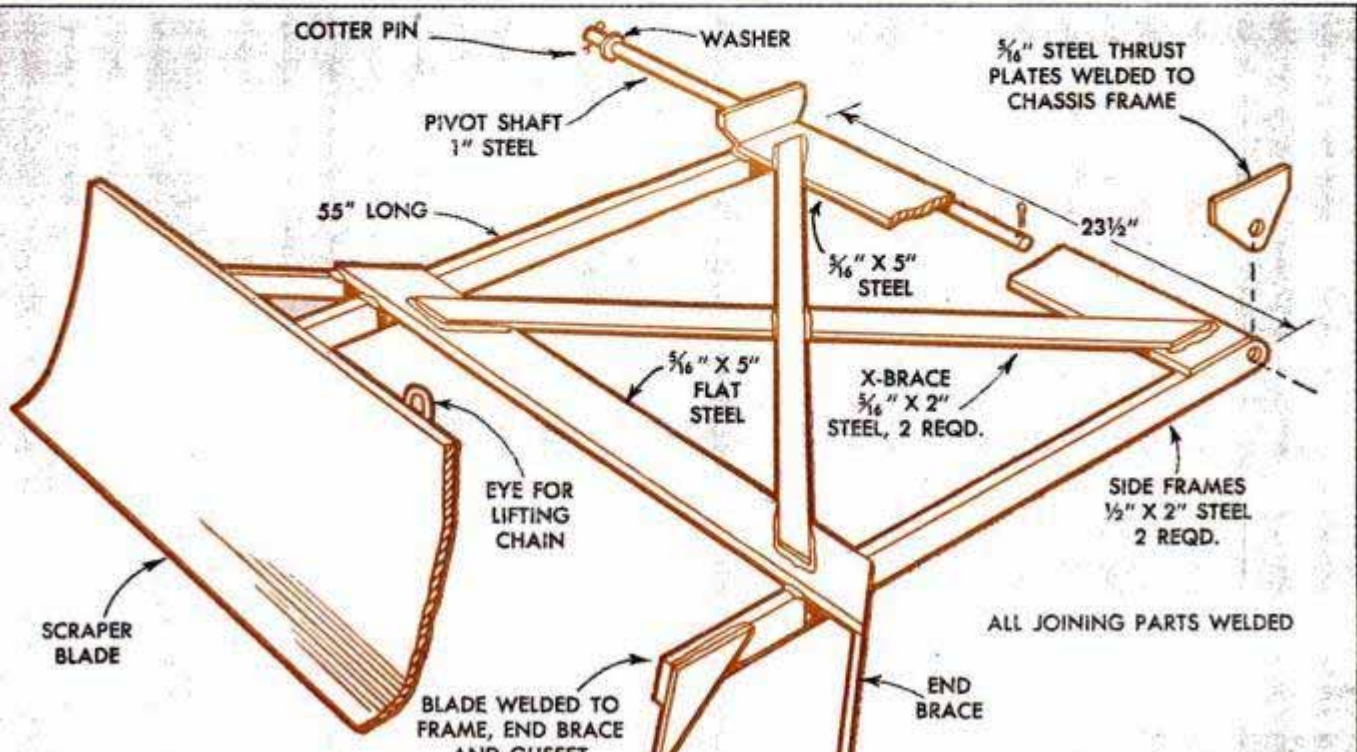

Sturdy Rack for Holding Tank From Farm-Implement Wheels

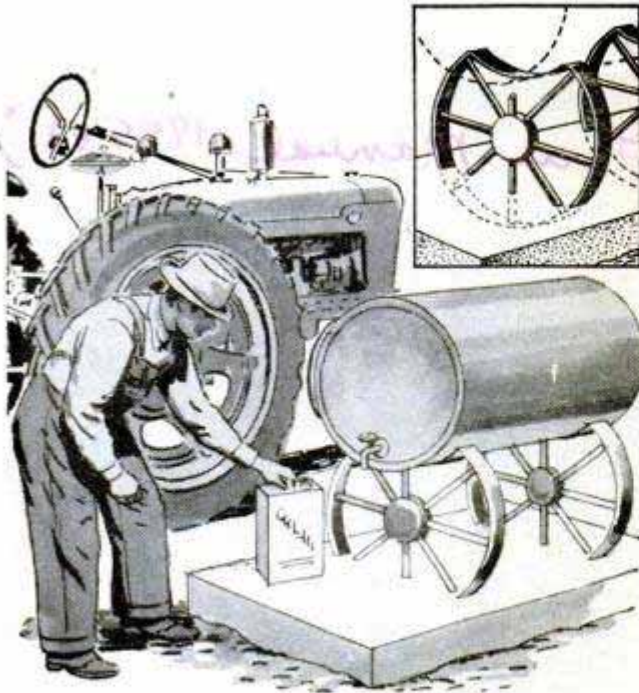

One farmer found that a pair of altered farm-implement wheels set in a concrete base provided a sturdy, durable rack for holding a fuel storage tank. A single spoke was cut from each wheel and the rim bent in at that point to fit the curving side of the tank. After pouring the concrete base, which was made long enough to provide a rest at one end for cans being filled, the wheels were set in the concrete with the bent portion uppermost. When the concrete had hardened sufficiently, the tank was installed on the top of the wheels.

G. E. Hendrickson, Argyle, Wis.

Paper-Tape Adhesive Renewed By Moisture in Kitchen

If you have a roll of gummed paper tape that has dried to the extent where the adhesive is no longer effective, store it on a high shelf in the kitchen for a few days. The high humidity of the room will soon restore the tape to its original usefulness.

H. G. Frommer, Milwaukee, Wis.

Novel Cap Warns of Overflow When Refueling Tractor

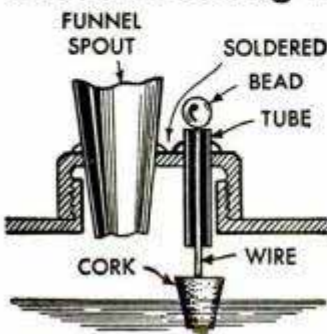

By using an extra gas-tank cap fitted with a funnel and a floating level gauge, one farmer is able to fill his tractor gas tank without danger of the fuel overflowing. The

spout of the funnel is soldered into one of two holes drilled through the cap. A short length of copper tubing soldered in the second hole serves as an air vent and as a sleeve for the level indicator. The latter is simply a length of wire having a cork impaled on the lower end and a wooden bead mounted on the top. Thus, when the tank is almost filled, the cork will float and raise the bead. The wire should be short enough so the bead will not rise until the level of the gasoline has reached nearly to the top of the tank.

John Kretschmar, Monsey, N. Y.

Improvised Pouring Spout

Thinner or cleaning fluid poured from a gallon can will not be wasted by spilling if the can is fitted with a pouring spout. The rubber shell of an extension-cord plug provides a ready-made spout when pressed tightly over the threaded neck of the can. If the shell fits too loosely to stay in place while pouring, the can neck may be shimmed by wrapping the threads with friction tape.

Outdoor "Broody Coop" on Farm Given Legs to Speed Function

Elevated off the ground and located in the chicken yard where air can circulate about it, this "broody coop" has proven a valuable timesaver for one farmer. The coop, which is supported almost 2 ft. above the ground on 4 x 4 legs, simplifies both caring for and feeding the birds as well as cleaning underneath. The sides and flooring consist of 1 x 2 strips spaced approximately 1 in. apart, whereas slightly heavier stock is used for cross members that support the flooring. Uprights are centered in both ends of the coop to permit installation of small doors. The roof and gable ends are constructed from beveled drop siding. The coop, which is 6 ft. wide and 8 ft. long, is 2 ft. high at the sides and 4 ft. high at the ridge.

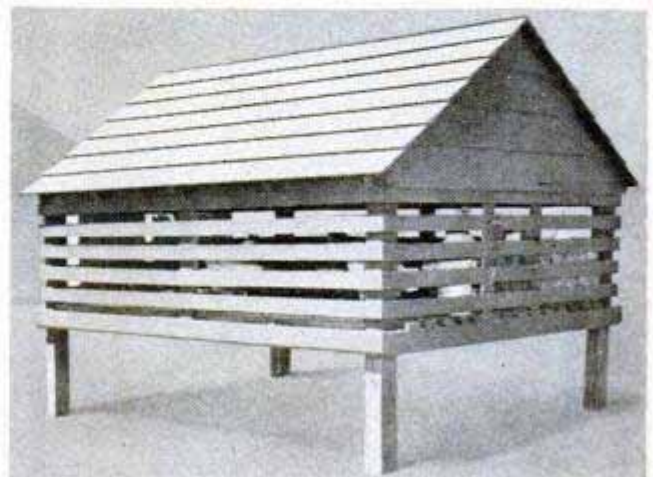

POPULAR MECHANICS



Serviceing VIBRATOR CHARGER

By Max Alth

KEEPING AN older-type vibrator charger in working order is a simple procedure that can pay off on a zero-cold night when your car battery needs a boost. For a complete check-over it's best to remove the unit from the metal box, or case. Be careful not to damage the wiring or the ammeter when this is done. Brush the accumulation of dust from all parts, especially the reed and the a.c. and d.c. coils. Be sure that the screw or bolt anchoring the reed is tight. Check the entire unit for frayed or cracked insulation and broken wires. Replace defective wiring and coat any frayed insulation with model-airplane cement and press back into place. Open the vibrator contact points by backing off the adjusting knob. Note the size of the fuse. It should have the same ampere rating as the high reading on the ammeter, usually 10 amp. When you plug the unit into an a.c. outlet, the reed should vibrate even though the points are quite widely separated. Badly pitted points may cause some irregularity and it is advisable to reface them so that they meet in as nearly a flat, over-all contact as possible.

To check the d.c. coil, clip the low-voltage leads to the battery posts and disconnect the a.c. plug. Adjust the reed

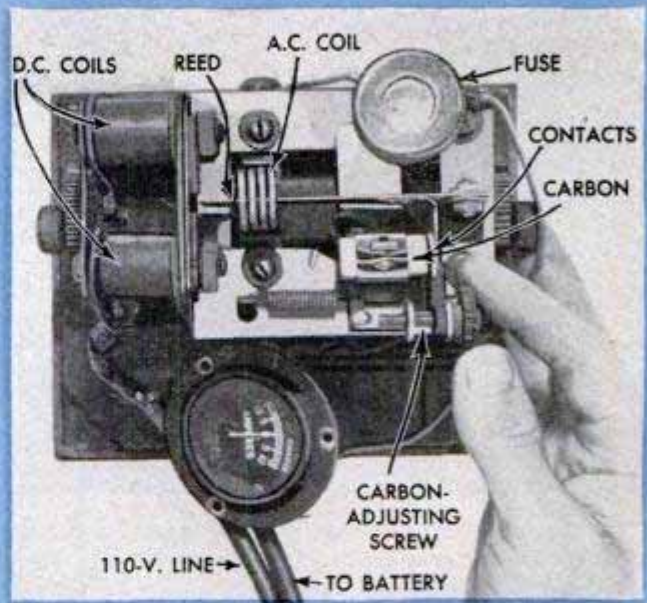

Before servicing the charger unit it's a good idea to remove it from the case. Be careful not to damage either the ammeter or wiring in this procedure

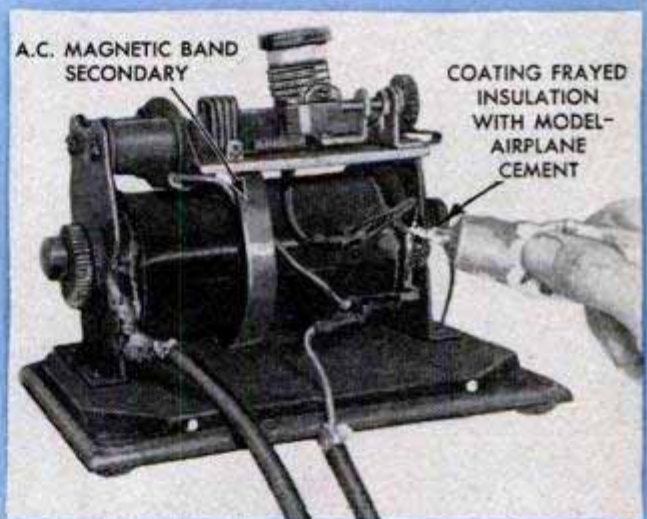

Above, give unit a thorough check-over for defective wiring. Recement frayed insulation. Below, be sure the carbon is tight in its holder before using

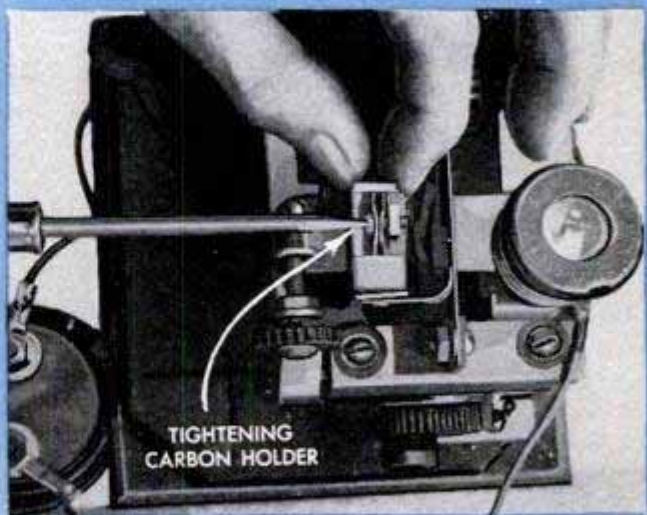



After servicing the charger, check it over for loose connections. Some adjustment of the reed and other parts will be necessary after unit is in operation

until it vibrates in a manner similar to a buzzer and sparks appear between contact points. A 1 to 3-amp. rate usually will show on the ammeter. Then connect to the a.c. and adjust the reed to give the highest possible charging rate with reasonably quiet operation. If the battery is low, at half charge or less, and the charging rate will not rise above 2 to 3 amp., check for poor contact between the battery clips and the posts, also loose connections at the ammeter and fuse. When putting the unit in service after reconditioning, note carefully the performance of the ammeter. If the pointer swings widely, close the points slightly or until it steadies. If the points are too far apart, excessive sparking and a lowered charging rate will result. If, on the other hand, adjustment fails to quiet the vibrating reed and the ammeter pointer still wavers, adjust the spacing between the free end of the reed and the d.c. coils. It is probable that a slight adjustment of the reed while the unit is in operation, will quiet the reed and may even increase the charging rate slightly. In normal operation this should range from 4 to 6 amp., with 5 amp. a good average unless, of course, the battery is bearing full charge. ★ ★ ★

Loose Screw Is Tightened By Notching Thread

When a small machine screw is made to serve as a stripper bolt by permitting a slight movement of the part it is holding, the problem of preventing the screw from turning is solved by notching the threads diagonally with side-cutting pliers. The notches have much the same holding power as knurled threads on certain types of self-locking screws.

Barbed Wire Unwound Safely From Harrow-Disk Reel

To hold a spool of barbed wire so that it can be unwound safely as needed for farm fencing jobs, improvise this useful reel from a steel fence post and a harrow disk. The post is driven partially into the ground and the disk is dropped over the end of the post so that it rests on the metal plate near the bottom. Then the spool of barbed wire is placed over the post and set on the disk. Pulling on the wire rotates both the spool and disk to pay out the wire.

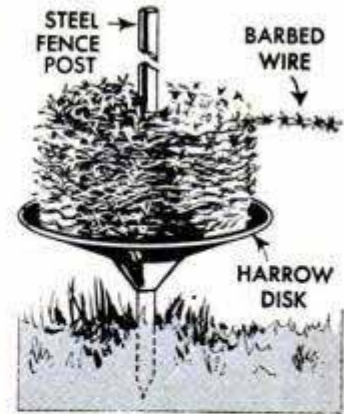

Increasing Life of Dry Cells

The life of flashlight dry cells can be prolonged by polishing the contacting surfaces at both ends of each cell with fine sandpaper. All traces of corrosion are removed by this treatment and contact is improved. I. M. Fenn, Chicago.

Paint-Can Rims Cleaned Easily With Small Contour Scraper

To simplify cleaning the rims of paint cans so they can be sealed tightly, one painter made a small contour scraper from a piece of sheet metal. Working by trial and error, he transferred the contour of the rim onto cardboard which then was used as a pattern for tracing the outline on a piece of sheet metal. Allowing enough extra metal for a handle, the piece was cut out and then filed to the exact shape required.

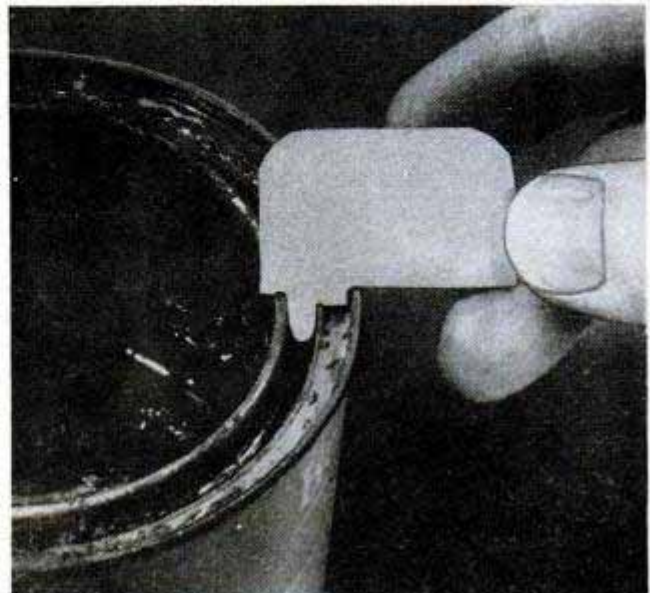

Depth-Stop Nuts on Drill Press Kept Tight by Lock Washer

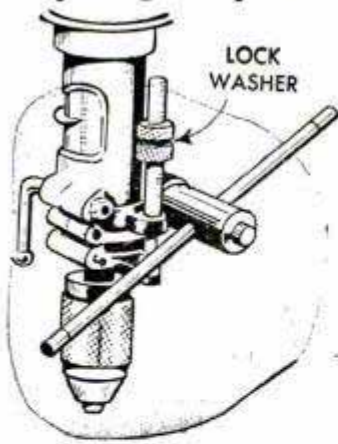

If the knurled nuts on the depth stop of your drill press have a tendency to work loose as a result of vibration when the press is operating, a lock washer inserted between them will provide an effective remedy. Thus, when tightened by finger pressure only, the nuts will stay securely in place during work and yet be easy to adjust whenever a change in setting is necessary.

finger pressure only, the nuts will stay securely in place during work and yet be easy to adjust whenever a change in setting is necessary.

Handy Brake-Fluid Dispenser

By attaching a short length of rubber tubing near the bottom of a container used to pour brake fluid, one service-station attendant is better able to control the flow of the fluid when locating the cylinder-chamber opening. After punching a hole in the container, a nipple is soldered in place to take one end of the tubing. In use, the tubing is held upright along the side of the container while it is being filled, after which the free end is pinched until the opening is located.

Wire Holder for Hammer Hooked Over Belt

To carry a hammer when working on a ladder, scaffold or roof, one carpenter formed this novel holder from a piece of heavy wire, 1 ft. long. Slipped over the belt as shown, it can be worn either in front or back.—Grover Brinkman, Okawville, Ill.

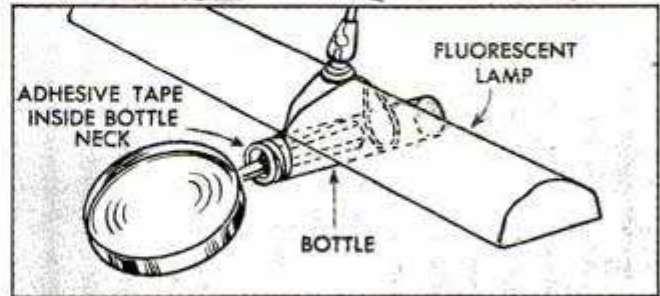

Holder for Magnifying Glass Attaches to Artist's Lamp

To free both hands for work while using a magnifying glass, wire or tie a vial-type bottle large enough to contain the handle to an adjustable fluorescent lamp. As shown in the sketch, it will act as a holder for the magnifying glass. Adhesive tape applied around the inside neck of the bottle will provide a collar to keep the glass from slipping out while in use.

Walter White, Chicago.

Measuring Old Drill Shanks

As drills become old, the figures on their shanks which indicate their size sometimes become indiscernible. Where a caliper is not available, a fairly accurate reading may be taken with your shop vise. Close the vise carefully on the drill and measure the open span between the jaws with a ruler. Stove-bolt and machine-screw sizes also may be determined by this method.

Bob Funk, Sacramento, Calif.

Boxed-in Studs of Poultry House Provide Simple Feed Hopper

Hoppers for grit, oyster shell or laying mash can be improvised easily in a poultry house simply by boxing in pairs of studs and fitting them with shallow boxes at the bottom as shown. If held in place with screen-door hooks, the boxes may be removed easily for cleaning.



Sickle From Mowing Machine Makes Handy Weed Cutter



With all but three or four blade sections removed and the bar bent as shown, a discarded sickle from a mowing machine will provide an efficient weed cutter that is lighter and easier to handle than a scythe. The end of the bar serving as a handle may be smoothed and the edges rounded either on an emery wheel or with a file. Better still, rounded wooden pieces could be riveted to both sides of the bar and then taped if desired.

Extra Gasket Stops Plug Fouling

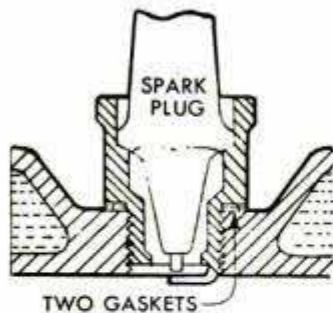

An extra gasket installed under each spark plug of your car will in many cases prevent plug fouling. The additional gasket raises the plug slightly so that it receives less oil. It also interrupts heat flow from the plug to the water jacket, thus causing the plug to run hotter and burn away deposits which might otherwise cause fouling.

Oil Cup on Car Air-Filter Cover Aids Gas Priming of Carburetor

Priming the carburetor with a little gasoline poured into the air-filter intake is one of the best ways to start a car in cold weather. But on most modern cars this

cannot be done without first removing the air-filter cover. One way of eliminating this step is to install on the cover a spring-lid oil cup of the type generally used on generator bearings. To do this, remove the cover and carefully punch a hole with a taper punch somewhere near the center so it will be positioned over the intake when the cover is replaced. Then force the cup into the hole and replace the cover. If desired, the cup may be brazed or soldered in place.

Handy Paddle for Shop Figuring

To provide a handy surface for recording measurements and figuring around his shop, one carpenter made this blackboard paddle. Cut from plywood, and drilled at the top so that it can be hung on the shop wall, the paddle is painted with standard blackboard paint. In use, the paddle saves the trouble of hunting for paper or scribbling on good pieces of lumber when figures are to be jotted down.



Poultry Waterer Refills When Water Level Lowers

Using a float valve from a toilet flush tank, this large-capacity poultry waterer refills automatically whenever the water level in the tank is lowered. The tank, which is made of welded angle steel and heavy galvanized iron, rests on a concrete base and is connected into the home water-supply system. A sliding door at one side of the base allows a kerosene heater to be placed under the tank for cold-weather operation. An outlet pipe with a stopper is located in one corner of the tank for easy draining, while a railing for birds to perch on is bolted around the waterer.

Gerald Rosenbloom, Wright, Iowa.

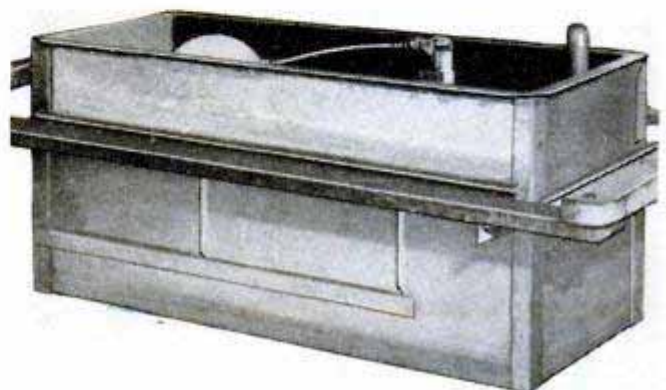

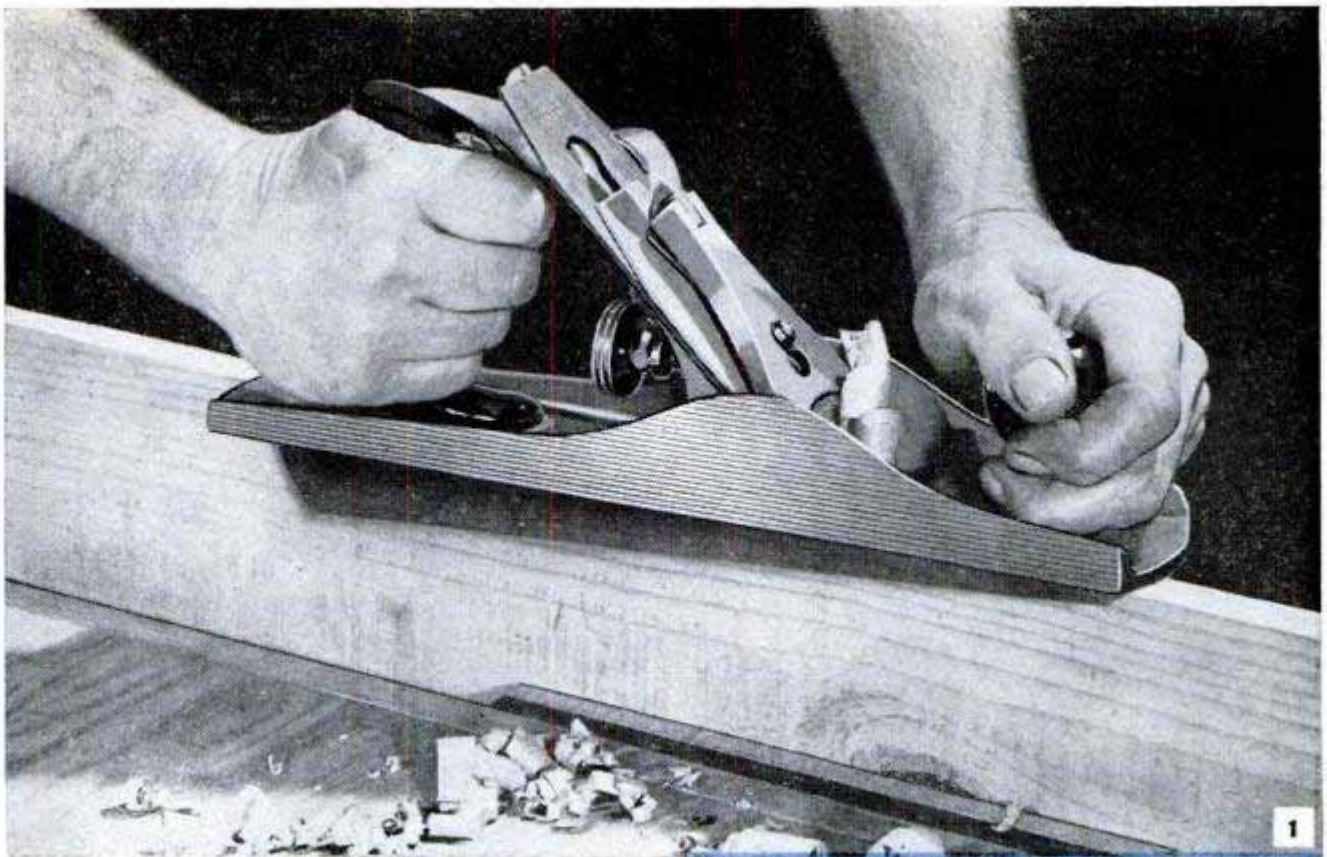

Planes Know-How

USED TO DRESS WOOD to exact size and produce smooth surfaces, a plane, basically, is nothing more than a chisel held at an angle in a block. The edge of the blade projects through a slot in the bottom, or sole, of the tool, the distance that the edge of the blade projects determining the thickness of the shavings removed from the work. Many jobs in the average home can be done with a block plane and, being the smallest of the common planes, it is especially suited for fine, exacting work. Often, however, you will find need for the larger, general-purpose jack plane for dressing rough wood to size; for example, when fitting new screens or storm sash in window frames. In addition to the block and jack planes, there are many other types designed for specific purposes.

Block planes: Made as shown in Fig. 2, block planes vary in size from 2-in. midgets to the more popular 5 to 7-in. lengths. They come in many varieties, including small curved-bottom planes used in specialized work. The blade, or plane iron, of a block plane is set at a lower angle than that of larger planes. This low angle—usually 20

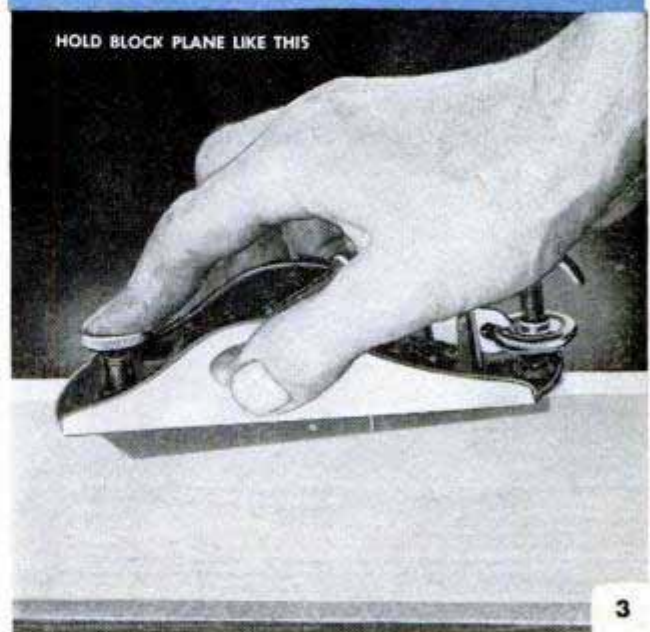
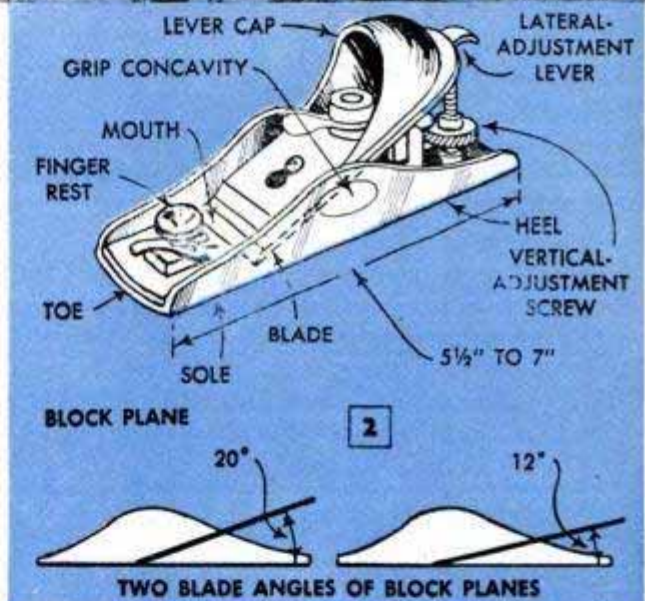

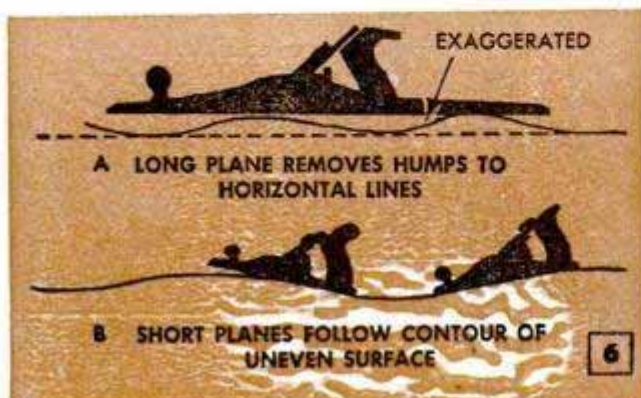
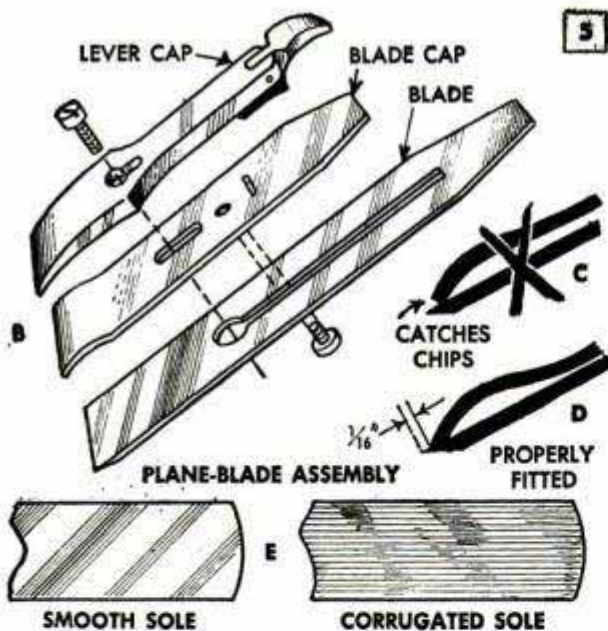
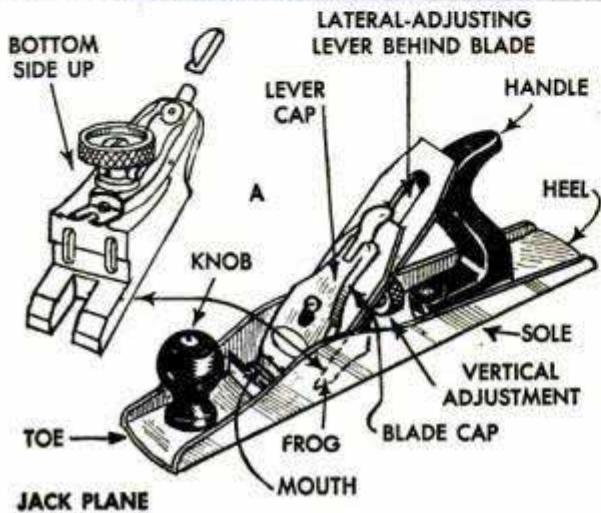

deg. and sometimes 12 deg.—permits cutting end grain and oblique hardwood grain more readily. The beveled edge of a block-plane blade, or iron, should always face upward instead of downward as on the larger planes. The blade is locked in position by means of a lever cap tightened with a small lever or thumbscrew and the upper end of the cap is usually rounded to fit the palm of the hand comfortably.

Block planes are held in one hand, as pictured in Fig. 3, with the index finger resting on the concave finger rest at the toe and the thumb and other fingers gripping both sides. The slot in the sole through which the blade projects is called the mouth, or throat. In some cases, its width is adjustable for fine or coarse work. A knurled nut at the heel provides for vertical adjustment, the movement that advances or retracts the blade through the mouth. On many block planes, lateral adjustment is obtained by means of a lever located at the heel of the plane. The lever tilts the blade toward either side and permits aligning the cutting edge parallel with the sole, so the shavings will be of equal thickness across the full width of the cut.

When making blade adjustments, a block plane, like other planes, is held as in Fig. 4. Sight across the sole to see how far the cutting edge projects and whether it is parallel to the sole. The usual error is to have the blade projecting too far. It should project only the thickness of a hair to produce thin shavings. Lateral blade adjustment on planes not equipped with a lever is made by loosening the lever cap and then pushing the blade toward one side or the other.

Jack planes: Made in lengths from 11½ to 15 in., jack planes are used for rough, heavy work in dressing stock to size. The parts and assembly are shown in Fig. 5, detail A. The frog is a steel block at the rear of the mouth to support the blade and, in some cases, it is adjustable to control the width of the mouth in proportion to the thickness of the shavings. The blade is fitted with a blade cap that prevents the blade from chattering and also acts as a chip breaker which diverts shavings so they will not break off ahead of the cutting edge. The blade and blade cap are held against the frog by means of a lever cap. Detail B shows the three parts separated. When the blade cap does not fit properly, as in detail C, wood shavings are likely to wedge under it, piling up and choking the plane. Detail D shows how the blade cap should fit, 1/16 in. behind the edge of the blade.

The thumb nut at the rear of the frog permits vertical adjustment of the blade to control shaving thickness. The lateral-adjustment lever is located between the blade and handle. As in detail E, the sole of the

plane may be either smooth or corrugated, many users preferring the latter as there is less surface friction between the plane and the work. In use, a jack plane is held with both hands, as in Fig. 1, which gives control of pressure at both toe and heel.

Fore and jointer planes: Assembled in the same manner as a jack plane, jointer planes differ only in length, ranging from 18 to 24 in. long. A short jointer plane is called a fore plane. The length of a jointer plane allows it to dress the edges of long boards perfectly straight, as the plane bridges the concavities and dresses down the humps, Fig. 6, detail A. Shorter planes follow the surface contours as in detail B.

Smoothing planes: Ranging from 7 to 10 in. long, smoothing planes are used for fine finishing of surfaces that have been dressed down uniformly with a jack plane. The cutting edge of a smoothing plane must be kept razor sharp and the blade adjusted for extremely thin shavings. Equal pressure must be exerted at both ends to prevent forming hollows.

Work support: Work to be planed must be supported rigidly, which usually is done by holding it in a woodworking vise, Fig. 7 and Fig. 8, detail A. Other types of vises generally will mar the surface of the work unless wooden or hardboard pads are inserted between the jaws and the work. The best location for a vise is on the left end of a workbench, allowing plenty of clearance for long stock. To support long boards, two vises may be used or tapered dowels pressed into holes bored in the bench apron as in Fig. 8, A.

A bench stop, detail B, fitted near the left end of a bench also is convenient for holding stock being planed. When not in use, the stop is dropped below the surface of the bench top. Another type of bench stop, detail C, consists of a slotted wooden block which is screwed to the bench top. Short work also can be held by means of a bench hook, Fig. 9, detail J. Wide work, such as doors, screen frames and storm sash, is supported vertically on the floor by an improvised brace clamped to the work, or with an L-vise mounted on a sawhorse, as in detail E. Dressing the top edge of a door can be done without removing it from the hinges simply by inserting a wedge between the door and the floor to hold the door in position.

Consider the wood grain: Always examine stock to see which way the grain runs and then arrange the setup so you can plane with the grain instead of against it, Fig. 9, details A and B. Ordinarily, opposite edges of a board must be planed from opposite directions. When planing against the grain, the wood fibers are broken off, producing a rough surface. When the direction

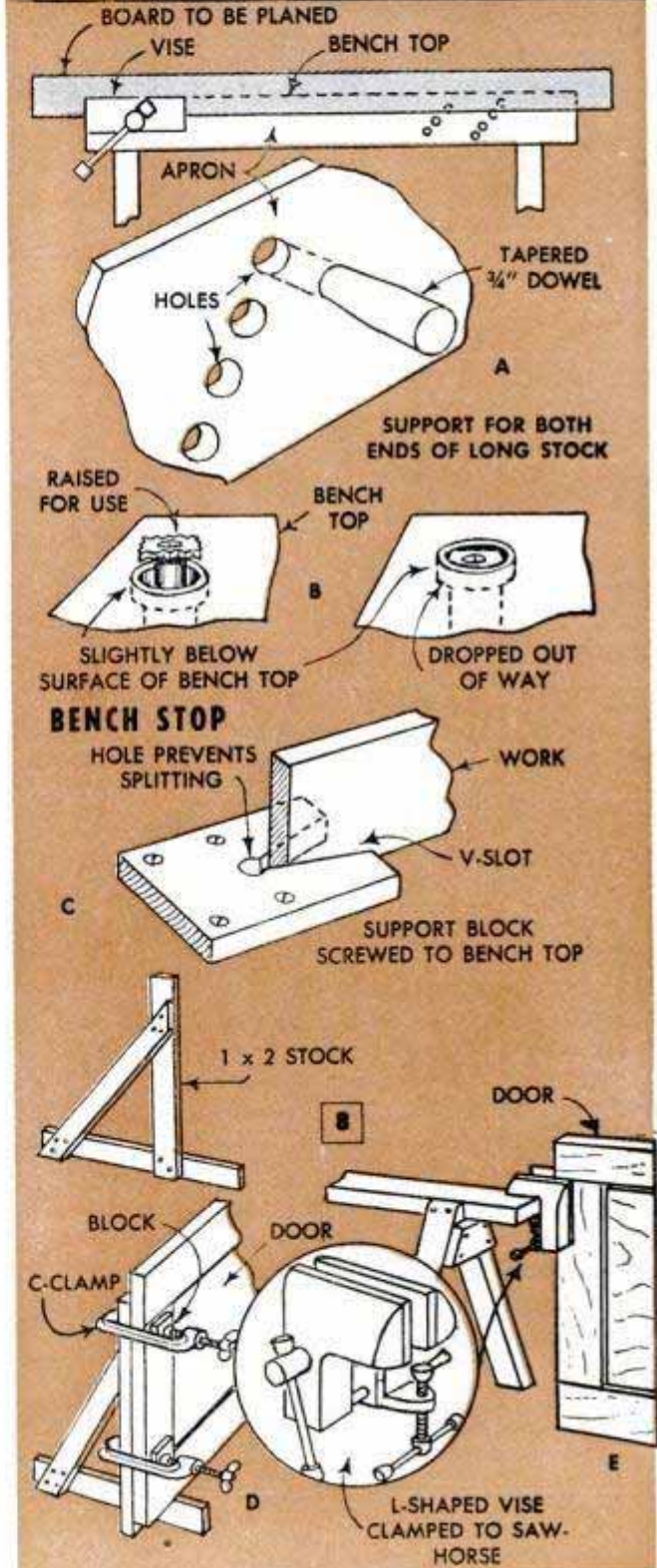
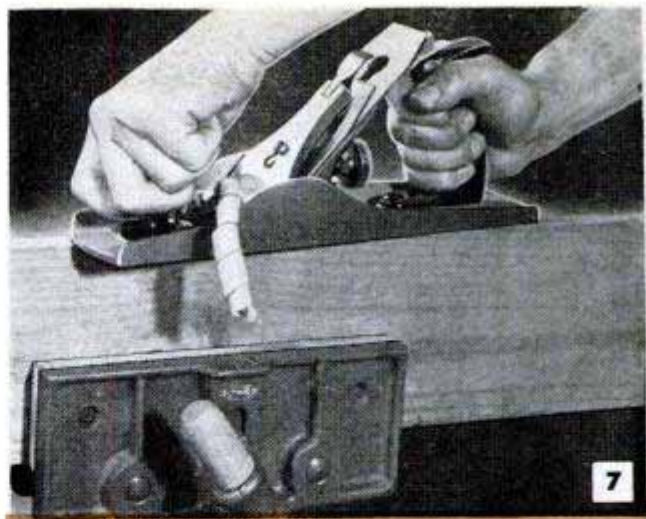

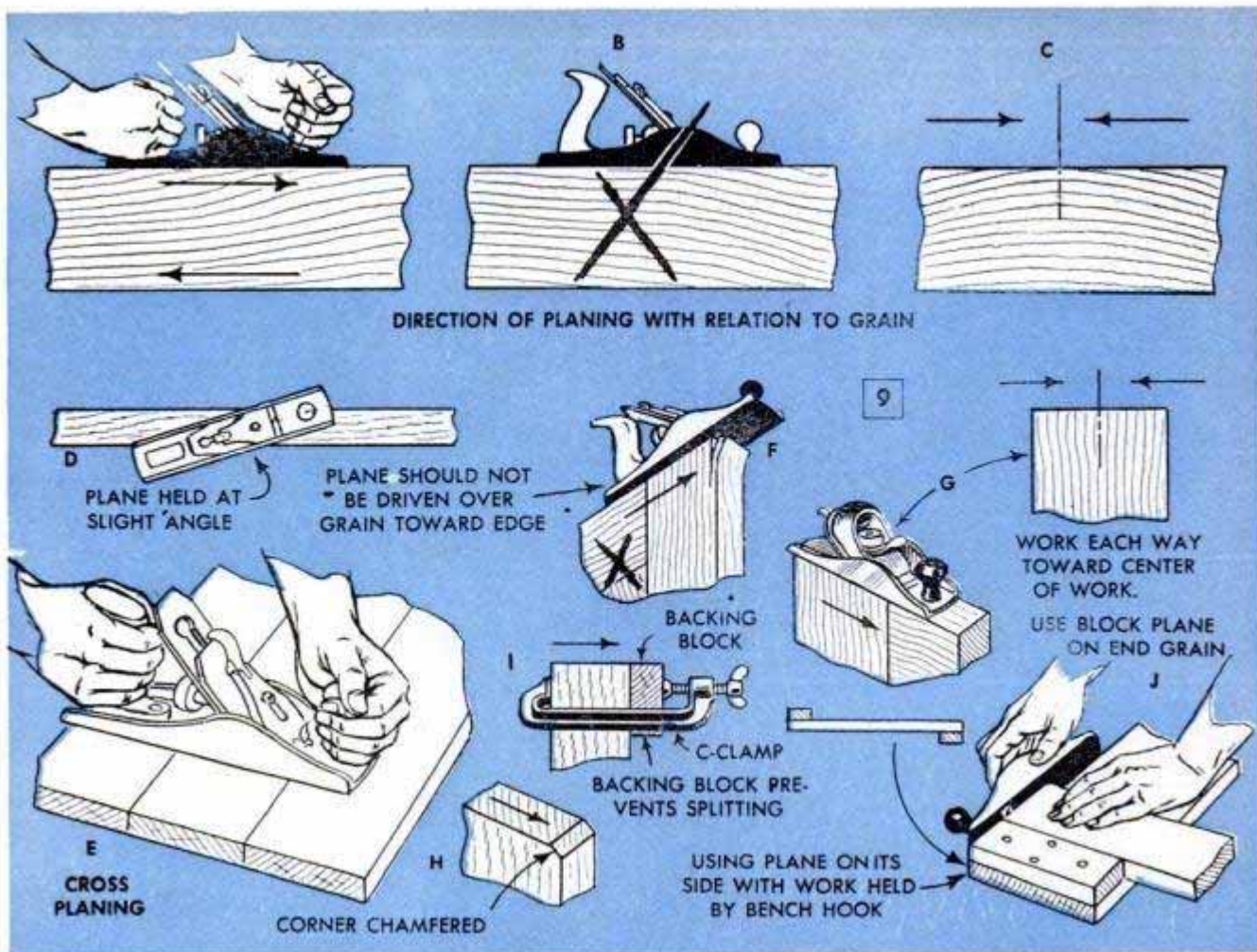

of grain changes somewhat along the edge, as in detail C, plane from both ends to the point where the grain direction changes.

Planing is easier if the plane is held at a slight angle, as in detail D, to produce a shearing action. Used in this way the blade will retain its cutting edge longer. Wide surfaces, consisting of several pieces of stock glued together, often are cross-planed as in detail E. A plane used for this purpose must be razor sharp and set to take a very shallow cut. When planing end grain, which is usually done with a block plane, the wood at the corner of the work is likely to break off, detail F, if the cutting edge of the plane is run off a corner. To prevent this, plane from the corners to the center as in detail G. Another method of avoiding chipping the corners is to chamfer the corner, as in detail H, or support the wood with a backing piece where it is likely to break off, details I and J.

Pointers on handling planes: An easy, coordinated swing of arms and body is used in planing. Plane toward the left, standing at one end of the work, with your left foot forward, as in Fig. 10, detail A. As you move the plane forward, keep your head approximately over the plane handle and rock your body forward, transferring the weight to the left foot toward the end of the stroke. When drawing the plane back on the return

stroke, lift the blade above the work surface, as dragging the blade over the work will quickly dull the cutting edge.

Beginners often experience two troubles when planing: the planed edges of a board are not square with the sides, and more stock is removed from one or both ends of the work than at the center. To plane an edge square with the surfaces of a board, hold a wooden guide block under the plane and against the side of the board, as in detail B, hooking the thumb over the knob and grasping the front side of the plane and block at the same time. Still more accuracy in edge planing is assured by using an edge-trimming block plane, detail C, or by using a jointer gauge, D. The latter consists of an adjustable fence which is clamped on a plane and bears against the side of the work. Attached to either side of the plane, the fence can be adjusted for planing bevels and also fitted with a larger auxiliary fence for greater bearing surface. You can improvise a gauge by making interchangeable 45 and 90-deg. guides from hardwood, as in the lower detail. The bearing surfaces of the guides are sanded smooth and waxed to minimize friction and are screwed to tapped holes in the side of the plane.

The common tendency to remove more stock from the ends of a board than at the center results from incorrectly applying

downward pressure on the plane. The right way to start a cut, Fig. 11, detail A, is to hold the sole of the plane on the work horizontally, in line with the edge, and to bear down only on the knob at the toe before the entire plane rides on the wood. Then pressure is exerted equally on both toe and heel of the plane. When the toe of the plane leaves the work, remove pressure from it but keep bearing down on the handle. Don't start a cut with the toe up, detail B, or allow the toe to drop down at the end of a stroke, as both of these errors will cause rounded corners.

Plane care: When not using a plane, place it on its side, as in Fig. 11, detail C. Before storing a plane, retract the blade inside the mouth to protect it from possible damage. Never use a screwdriver or other metal tool to remove shavings which clog the mouth of the plane as this may dull the cutting edge. Instead, remove the shavings with a pointed dowel.

Sharpening: Every plane user should know how to keep the cutting edges sharp. The cutting edge of a properly ground blade can be renewed a number of times without regrinding by whetting the blade on an oilstone. A special holder, Fig. 12, overcomes inaccuracies. The whetting angle of 30 to 35 deg., Fig. 13, detail A, is about 5 deg. greater than the grinding angle. After whetting, the fine burr or featheredge is removed by a few very light strokes on the other side of the blade while it is held flat on the stone, detail B. To avoid plane marks on the work, the corners of the blade should be rounded slightly. When reassembling the blade, attach the cap with its edge well away from the cutting edge of the blade, and then advance the cap to $\frac{1}{16}$ in. from the edge as in Fig. 5, D.

Grinding is necessary when the cutting edge is nicked or worn by repeated whettings. In grinding, a plane blade must be passed squarely across the face of the grinding wheel, Fig. 13, detail C—not held against the side of the wheel. When grinding, don't

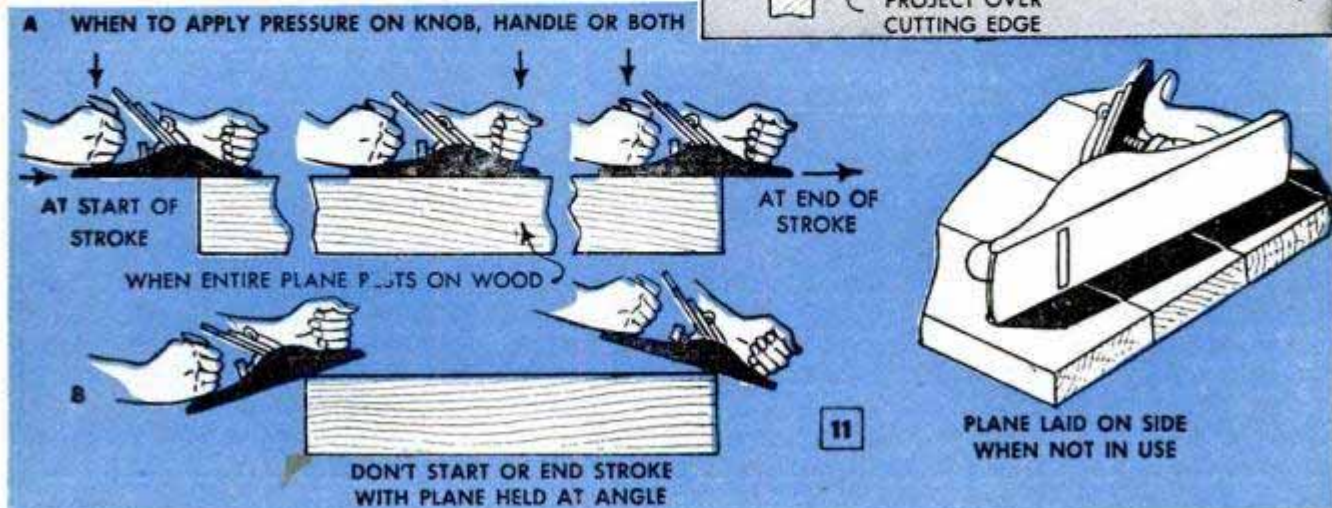
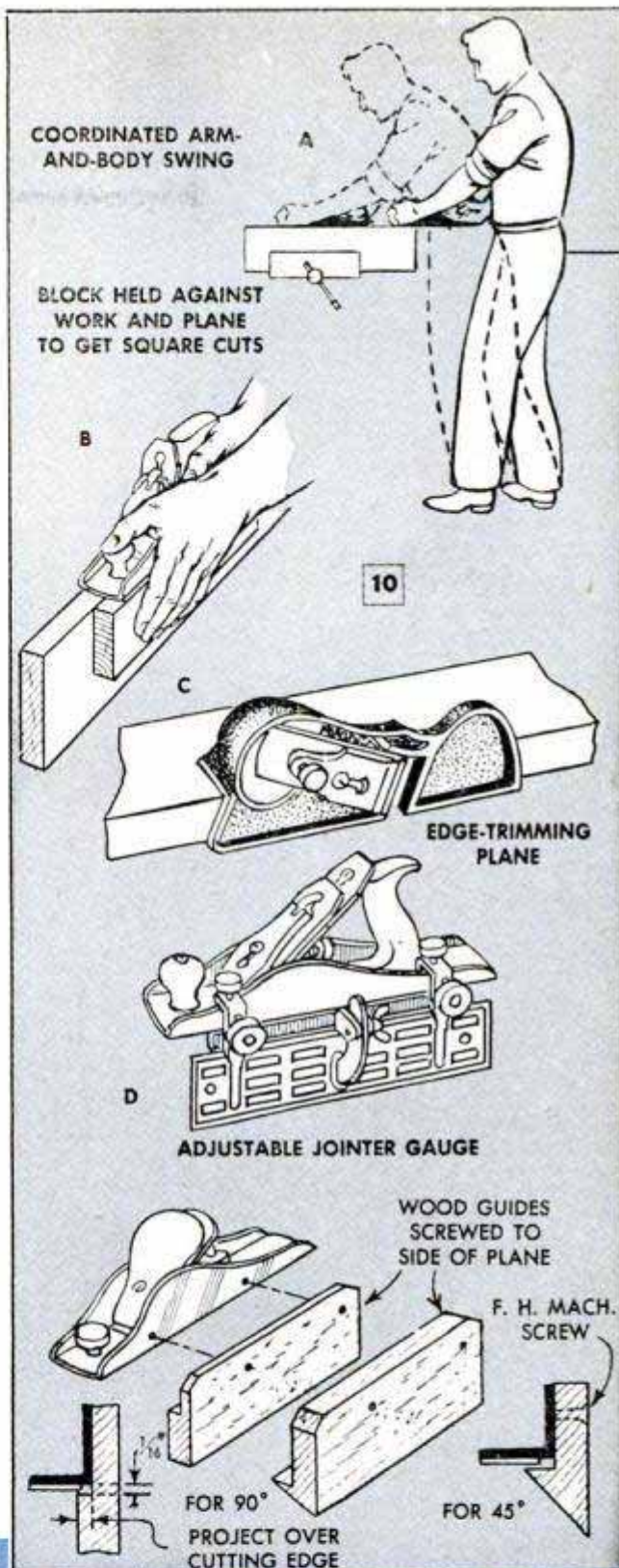

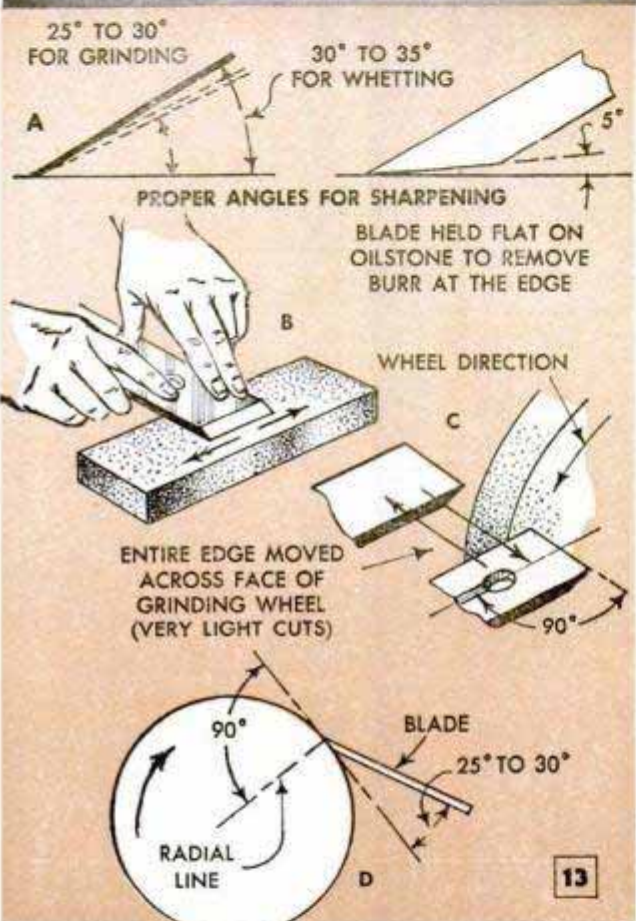
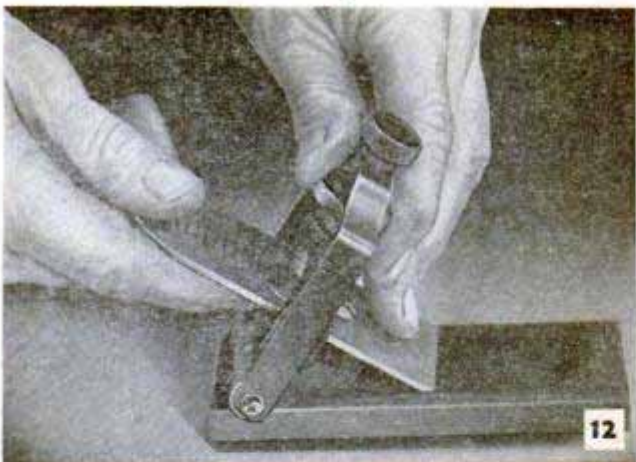

attempt to square the sides of the blade above the cutting edge, as many blades have slight clearance bevels on the sides. For grinding the bevel, hold the blade as in detail D, at a 25 to 30-deg. angle to a line running at right angles to the radial line of the wheel. The tool rest should be set to just clear the wheel in order to provide maximum support for the blade.

When properly aligned, the blade is advanced just far enough to barely touch the edge of the wheel when passed across it. Each advance feed should not be greater than the thickness of a piece of writing paper—sometimes less. The edge of the blade must be kept cool by dipping it in water after each pass, unless a grinding coolant can be used while the grinding proceeds. Overheating the blade to the point of color change removes the temper so that it will no longer hold a cutting edge. The blade is ground down until a fine burr or featheredge is visible. This is then removed on an oilstone.

Grinding plane blades is simplified considerably by using an adjustable tool rest similar to the one shown in Fig. 14. This gives accurate results that are hardly possible by hand grinding, due to the difficulty of grinding an edge straight and at 90 deg. to the blade axis. The features of the grinding fixture are a cross slide that gives straight-line accuracy and a threaded feed control for advancing the blade to the wheel. Although a satisfactory fixture can be made from hardwood, a better and more accurate job, of course, will result from using metal. ★★★

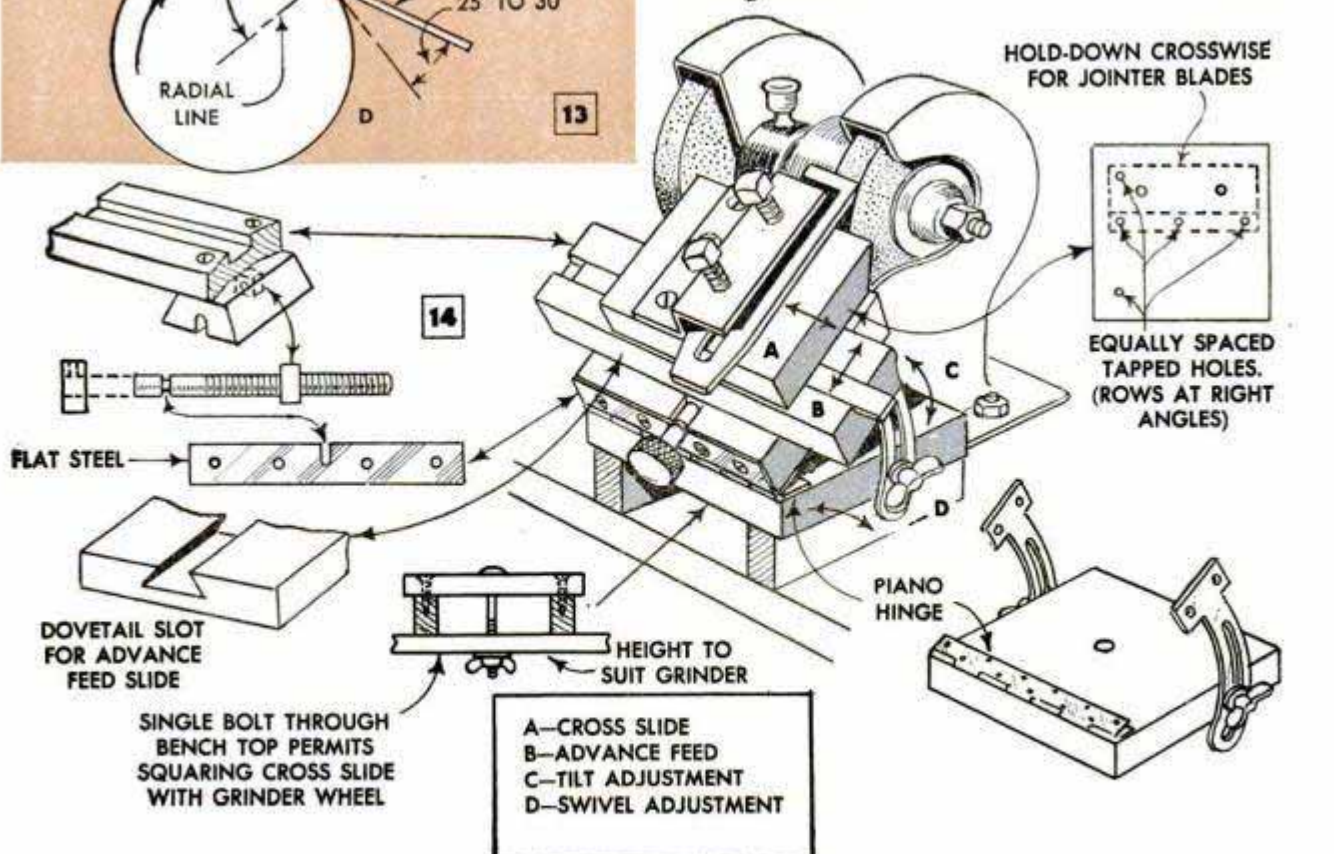

Lifting and Carrying Hoist Mounted on Small Tractor

By installing a hardwood boom on the regular hydraulic lift of his tractor in the manner shown, one farmer was able to speed up the job of loading or transporting oil drums and other heavy objects around the farm. The improvised assembly consists of a boom which is A-braced to the tractor drawbar. The braces pivot at both ends to permit movement of the boom. One end of the latter is pivoted on the tension-bar yoke which is mounted on the top of the transmission housing. A clevis fitted to the outer end of the boom provides for attachment of a chain sling or a hook.

A. M. Wettach, Mt. Pleasant, Iowa.

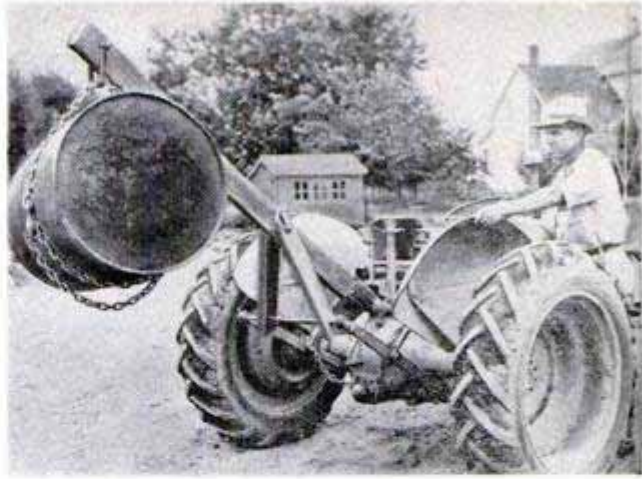

Outer Edge of Washer Machined by Mounting in Lathe Chuck

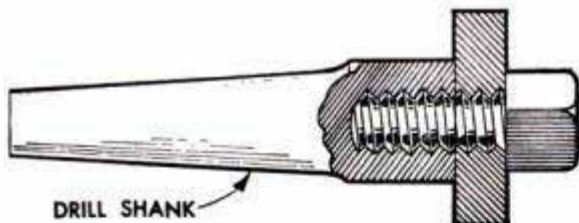
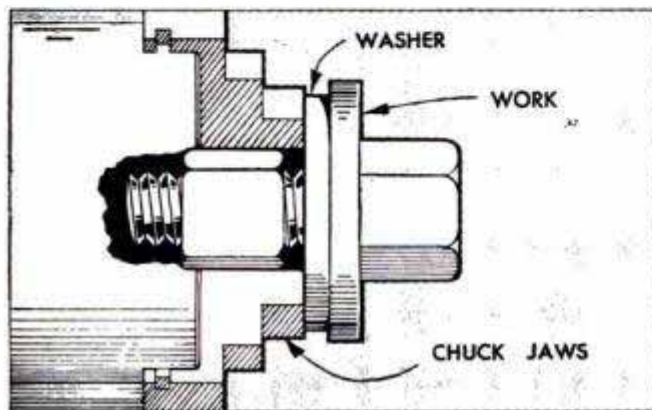

For machining the outer edges of washers, mount them by chucking a hexagon nut in the three-jaw chuck, as shown in the upper diagram. The work is centered and screwed tightly against the chuck jaws with a cap screw. If the washer to be machined does not project beyond the chuck jaws, insert a smaller washer in back of the work so the lathe tool will not strike the chuck. In machining collars or work with small center holes, a simple mandrel as shown in the lower diagram can be used. This is made from the tapered shank of a discarded twist drill with the large end faced smooth and a hole drilled and tapped for a cap screw to hold the work in place.

Electric Heater Warms Engine For Easy Winter Starting

Easy starting of a car on a sub-zero morning is possible in most instances if the engine block or manifold is preheated during the night. In modern automobiles, however, these parts usually are difficult to get at. Although small enough in some cases for this purpose, certain single-coil electric heaters nevertheless present a fire hazard, in that the coil usually is exposed. To overcome these obstacles, one car owner places an electric blower-type heater on a box inside the car so its heat is directed against the car heater. Plugged into an outlet in his unheated garage, the heater eventually heats the water in the car heater sufficiently to start it circulating through the engine block. Under extreme weather conditions, a blanket placed over the block is useful in helping to cut down the amount of heat lost by radiation.

Removing Worn Bushings

If you find it difficult to remove a worn bearing or bushing, try forcing it out as I did with pressure applied by turning a long bolt through a new bushing, a nut, two washers and a short length of pipe as shown. The pipe should be longer as well as slightly larger in diameter than the bushing that is to be removed. In use, pressure on the new bushing as the bolt is turned forces the old bushing into the pipe.

Arthur R. Spelbring, Rochester, Mich.

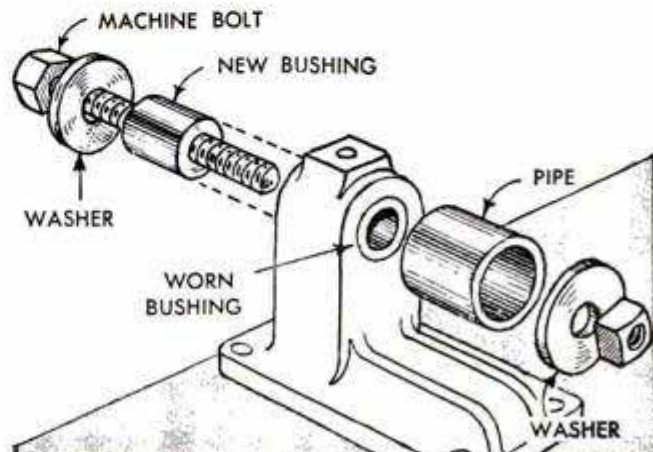

SHOPPING FOR TOOLS

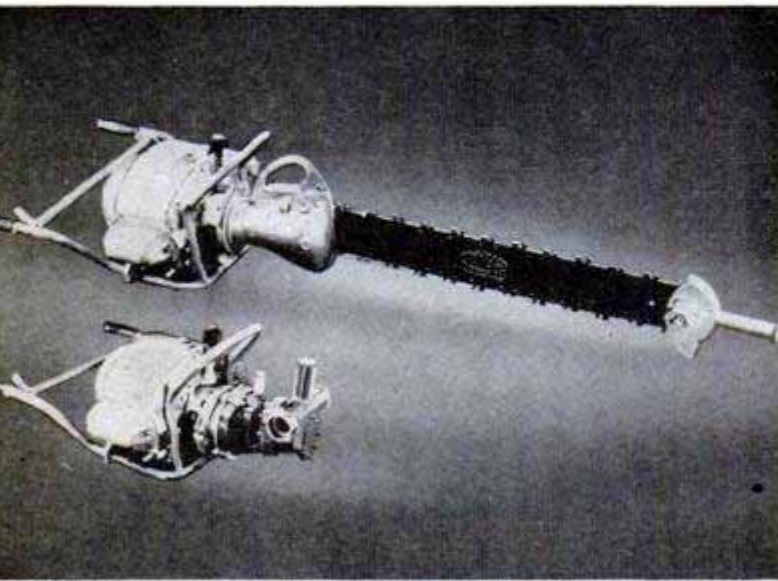

↑ **PUMP ATTACHMENT** for chain saw has a capacity of 50 gal. per min. and can be attached ready for operation in a few seconds. Farmers, estate managers and forest-fire fighters will appreciate its advantages

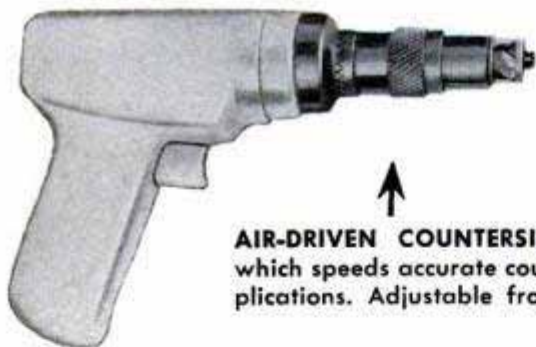

↑ **AIR-DRIVEN COUNTERSINK** has nonrotating head which speeds accurate countersinking in nearly all applications. Adjustable from zero to maximum depth

↓ **"ENDLESS" HACKSAW** is actuated by a spring-loaded plunger which permits unrestricted depth of cut. Takes regular 10 or 12-in. blade, which is supported by a guide tube. The back of the blade rides on hardened steel balls. Locking screw is loosened for deep cuts

LOCKING SCREW TIGHT

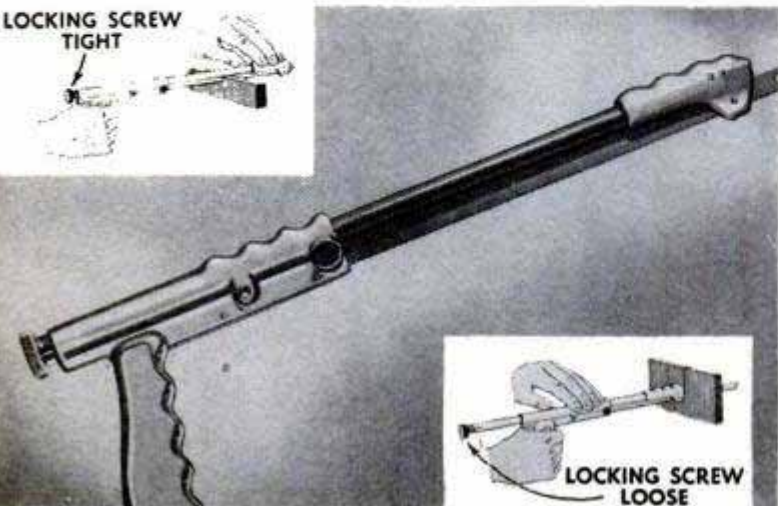

LOCKING SCREW LOOSE

↓ **WHEEL-MOUNTING TOOL** simplifies the disagreeable job of lifting and guiding an auto wheel into position on the brake-drum studs. Simply insert the hollow end of the tool through the lower hole in the wheel, slip the end over the stud and raise to proper level



↓ **WOOD WELDER** for small shop speeds bonding of wood to wood, and plastic to metal or wood. Penetration ranges from 1/8 to 2 in. A three-position switch controls the energy required for shallow or deep bonding. Unit is designed to operate on 115-volt a.c.

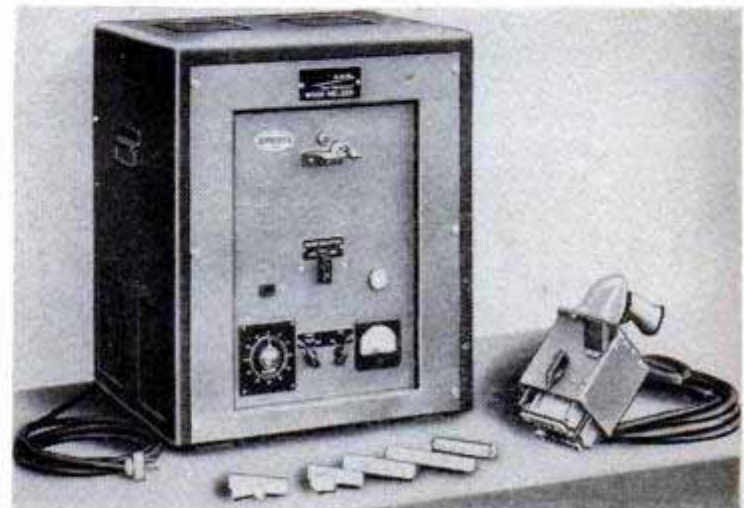

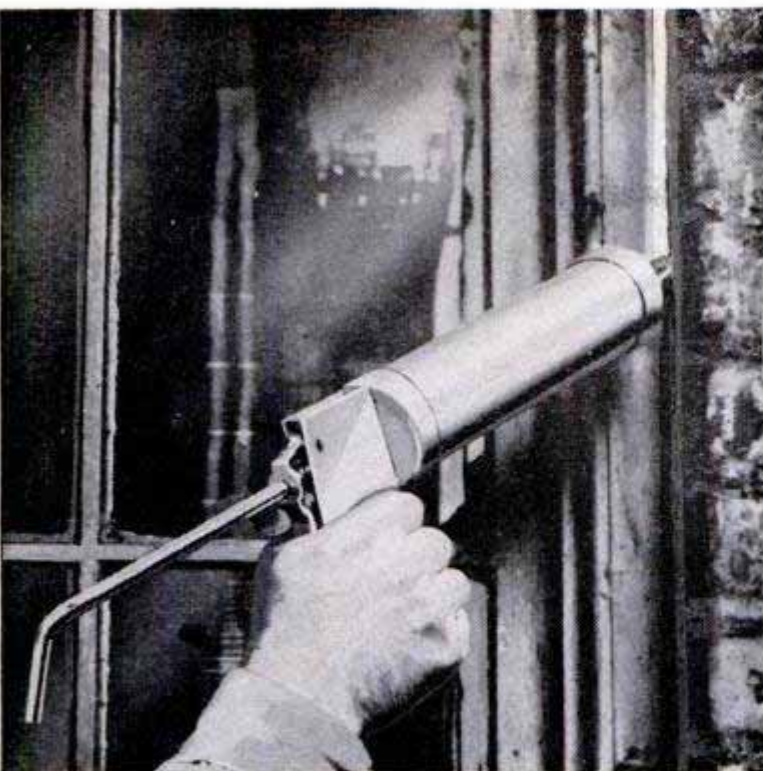

↑ **CALKING COMPOUND** in a cartridge-type container is available in 26 different colors to get matching or contrasting effects on brick, asbestos-cement siding, shingles and wood. Cartridge container can be used in regular calking guns by removing plastic nozzle

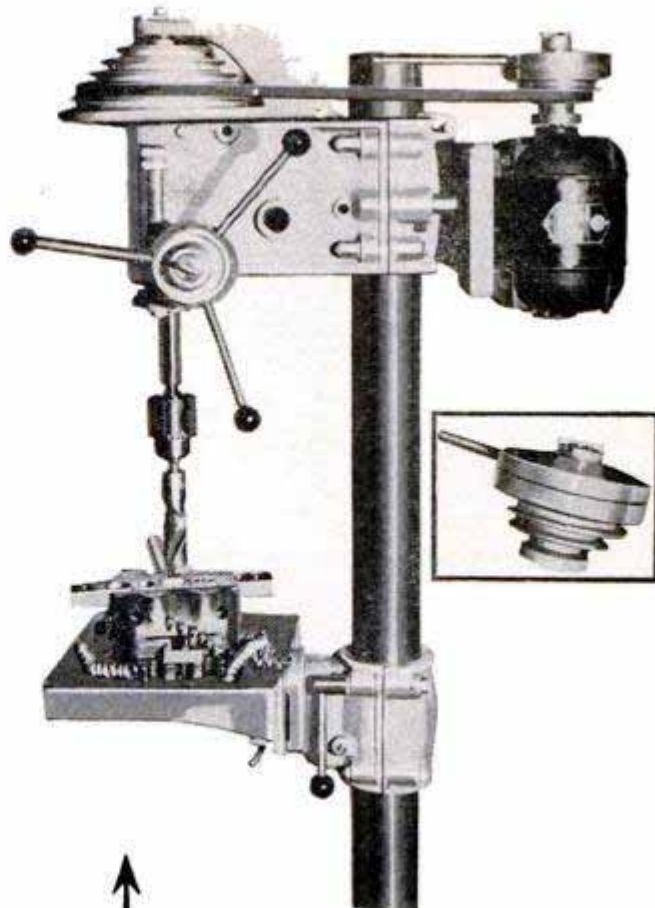

↑ **SPEED-REDUCING PULLEY** has been designed to increase the use range of a small drill press. Reducer is gear driven and models are available with 4½:1 and 7:1 reductions, the speeds ranging from 75 to 2000 r.p.m. through six variations on a three-step pulley

→ **PORTABLE POWER-TOOL STAND** comes knocked down and consists of four steel legs with bolt holes drilled, brackets, four rubber feet for legs and ball-bearing rollers. The top and shelf can be made by the purchaser



↑ **HEAVY-DUTY SOLDER POT** takes large units for soldering by immersion and is available in varying sizes and temperature ranges. Has long-life ceramic-embedded element and thermostatic control for fast recovery. The unit is fitted with adjustable legs and dross tray

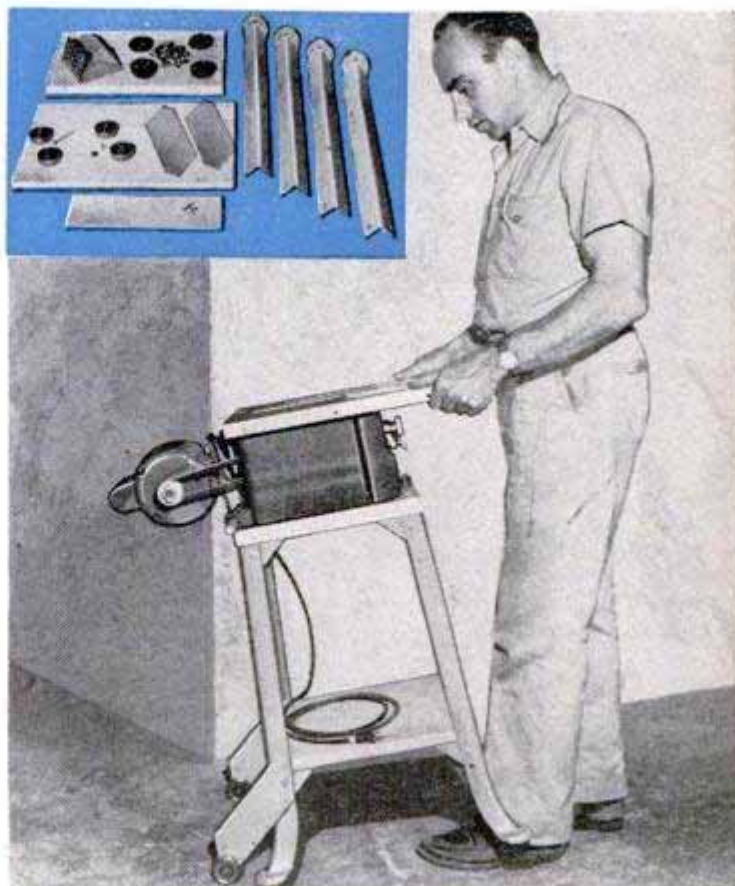

Low-Bed Farm Trailer Has Loading Winch

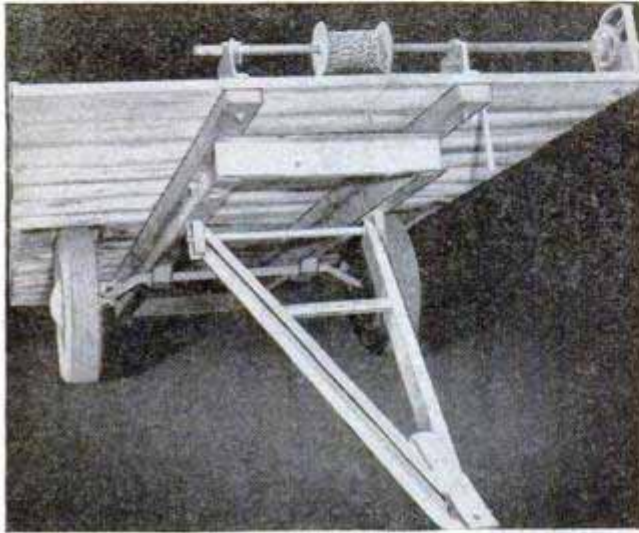
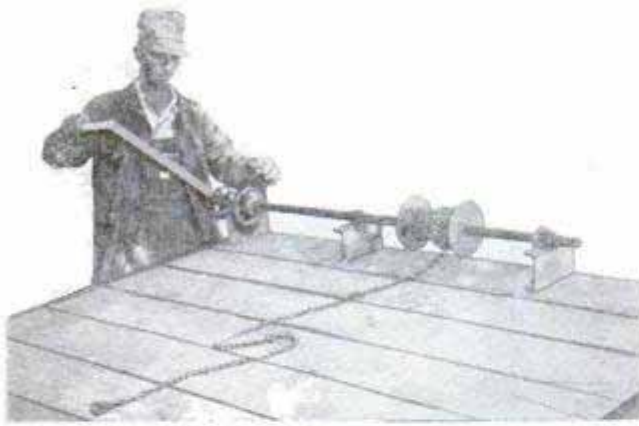

Especially designed for transporting heavy machinery and implements, this farm trailer has a bed, or platform, 6 ft. wide and 10 ft. long. The top of the bed is about 30 in. from the ground when in the horizontal position. An exceptionally long A-type drawbar allows ample clearance for short turns when drawn by a tractor. Both the drawbar and the trailer subframe are made from heavy steel channels, all joints being welded. The drawbar is pivoted to the subframe in front of the axle, permitting the bed to tilt readily. A geared winch, crank-driven, has a drum carrying a length of welded steel chain. The drum is mounted on a long shaft having bearing brackets placed so that the drum is at the center of the platform. With this arrangement, heavy implements are drawn easily onto the trailer bed for transport.

Fuel Pump May Cause Slow Starts

The fuel pump, usually one of the last items to be considered by the automobile owner, may be the cause of hard starting in cold weather. When the pump is more than a year old, its shaft may be worn as much as .010 to .020, enough to permit moisture to enter the bearing. If this moisture

freezes on the bearing surfaces, it prevents the arm from returning when it stops on the high side of the cam, thus putting the pump out of operation. Therefore, a new pump should be considered when troubled by continual hard starting in cold weather.

E. K. Schooley, Waukegan, Ill.

Garage Car-Washing Kink

Observing that the hoses in the car-washing section of his garage were wearing rapidly because of constant kinking near the sill-cock connection, one garage owner slipped a length of radiator hose over the water hose and taped it in place just below the sill cock. By thus preventing further kinking, the life of the hose is prolonged considerably.

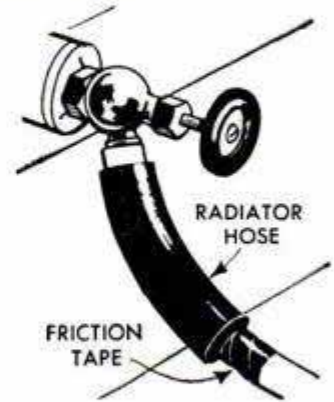

Chain End Held Extended by Hose To Hook in Out-of-Reach Eyebolt

To attach the hook on a hoist chain to an eyebolt just out of reach, one mechanic slipped a length of radiator hose over the end near the hook. This made it possible to engage the hook while standing on the floor.

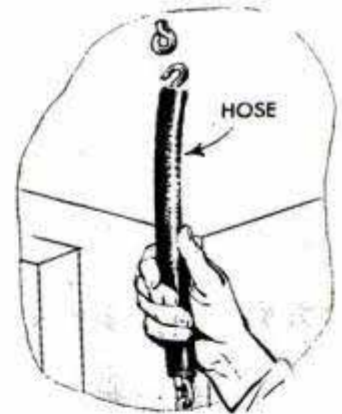

Auger Shank Squares Round Hole

One sheet-metal worker, who had none of the essential tools ordinarily needed for punching square holes to receive square-shanked bolts in sheet metal, cut the shank from a discarded auger bit and used it as a punch to square previously drilled round holes. Since the auger shank is tapered at one end, the final size of the square hole will be determined by the depth to which the tool is driven.

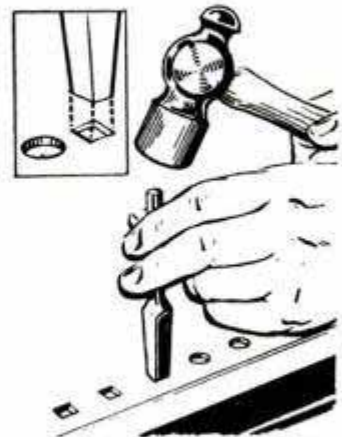

WIRESPONDENTS USE "TALKING LETTERS"

By Tom Riley

WIRE RECORDERS have created a new hobby for many people who now "mail their voices" on a coil of wire instead of writing letters to distant friends and relatives. The message goes to their friends on a 15, 30 or 60-minute spool of fine wire, instead of a disk recording. Friends in Chicago, photo A, gather to hear a spool from a wiresponsendent across the nation. After hearing a message it can be erased by simply recording the reply on the same spool, as the couple are doing in photo C.

A wiresponsendence club, sponsored by a Chicago manufacturer of wire recorders, now has 1987 members in the United States and foreign countries; mailing cartons are supplied to members using his spools.

An international wiresponsendent is Tahia Karioka, the glamorous Egyptian film star shown in photo B. She uses the wire recorder to keep in touch with distant friends and also employs it to rehearse her roles. To men on the battle front in Korea, to hospital patients and friends in distant countries, these spools of "talking wire" provide an especially precious tie.

Wiresponsendence is frequently combined with other hobbies, carrying on exchanges between fans in various parts of the world. Photo D shows members of the Mango Lines Model Railroad Club of Chicago recording a meeting to send to another railroad club in England. Radio "hams" often exchange wire recordings for checking speech quality.



HOW TO BUILD AN

By Edward J. Bukstein

IMPARTIAL JUDGMENT as registered by the electronic circuit of an applause meter removes all questions of fairness and suggestions of favoritism. This simplified version justifies its construction with the increased pleasure and interest it adds to amateur shows, parties, school affairs, contests and similar group activities.

The circuit consists of two tubes (plus rectifier). All parts are standard and easily available from radio-parts houses. The cab-

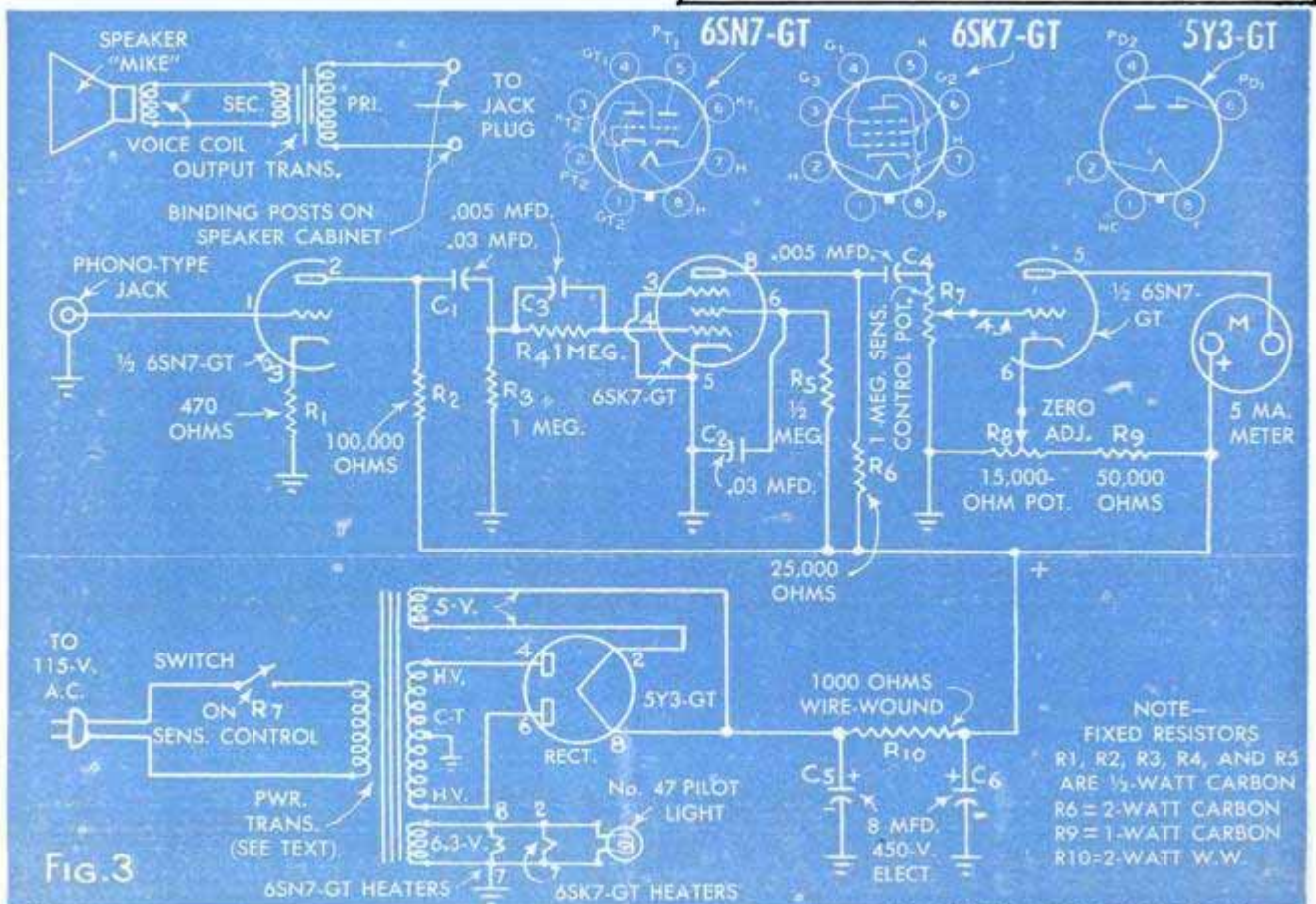
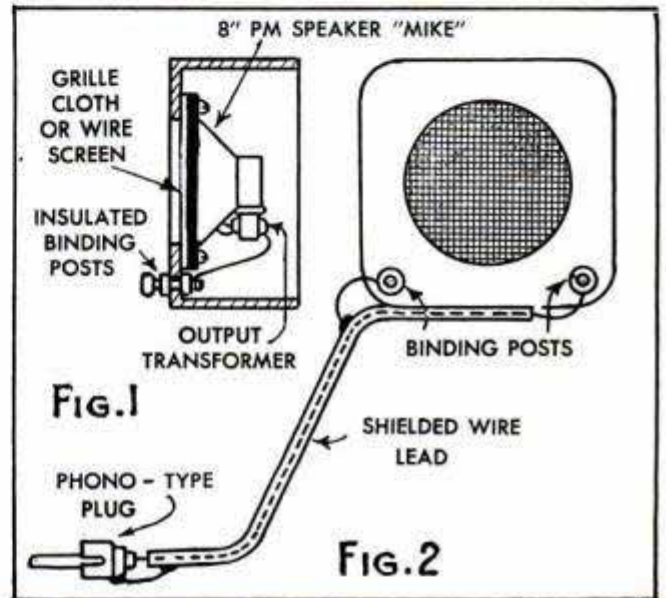
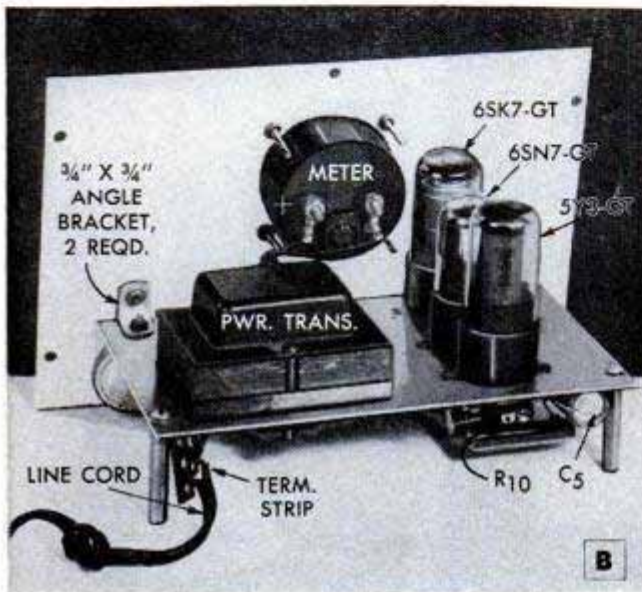
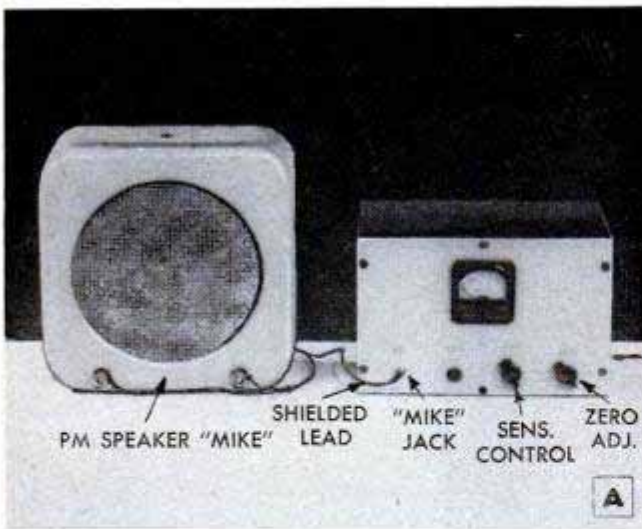

APPLAUSE METER

inet is a steel type measuring 6 x 9 x 5 in. It comes in a black ripple finish and is available also in aluminum with a gray finish. The loudspeaker is an 8-in. PM type which, in this case, serves as a microphone. A universal-type output transformer (usually mounted on loudspeakers) was left on the speaker so that it acts as a step-up transformer to increase the sensitivity of the instrument. It can be any inexpensive single 8000-ohm, 20 ma., 3-watt type. The meter used in the model was a rectangular flush-mounting type. The diameter of the mounting hole in the panel will depend upon the particular meter used. A 0-5 d.c. milliammeter can be used as shown in the schematic diagram Fig. 3, or if the builder wishes greater sensitivity he can use a 1 ma. meter without any circuit changes.

Photo A shows the complete applause-meter assembly; photos B, C, D and E are various views of the chassis base and panel. All details for the base and front panel are given in Fig. 5. A pictorial wiring diagram showing all connections under the base panel, appears in Fig. 4.

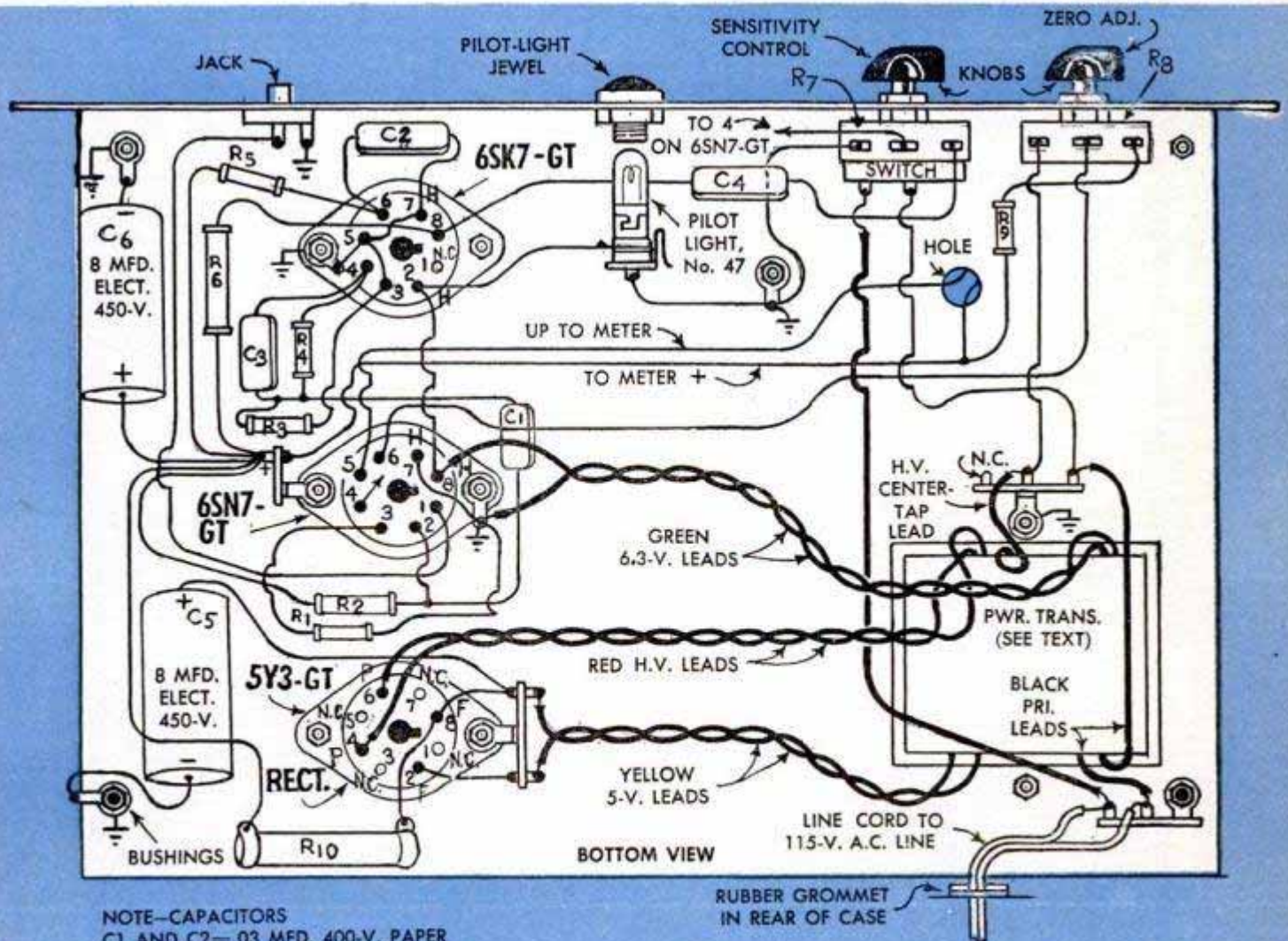
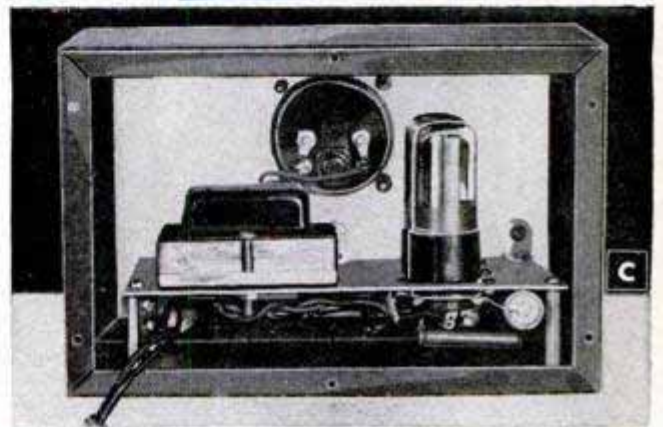
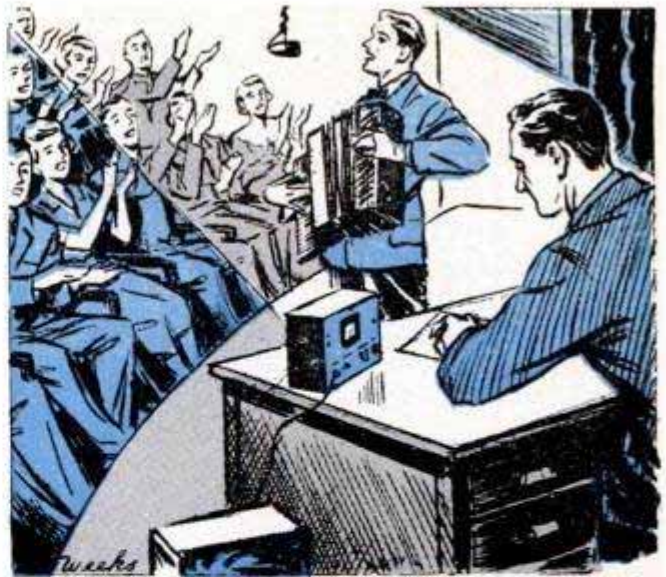

NOTE—CAPACITORS
 C1 AND C2—.03 MFD. 400-V. PAPER
 C3 AND C4—.005 MFD. 400-V. PAPER
 N.C.—NO CONNECTION
 ⊥ =GROUND ON CHASSIS BASE

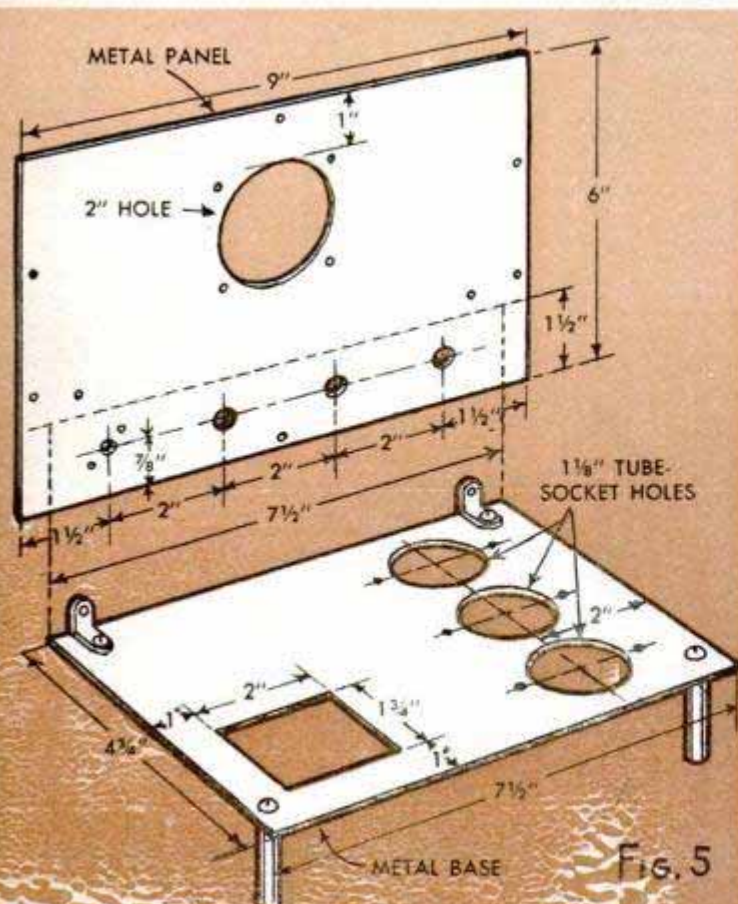
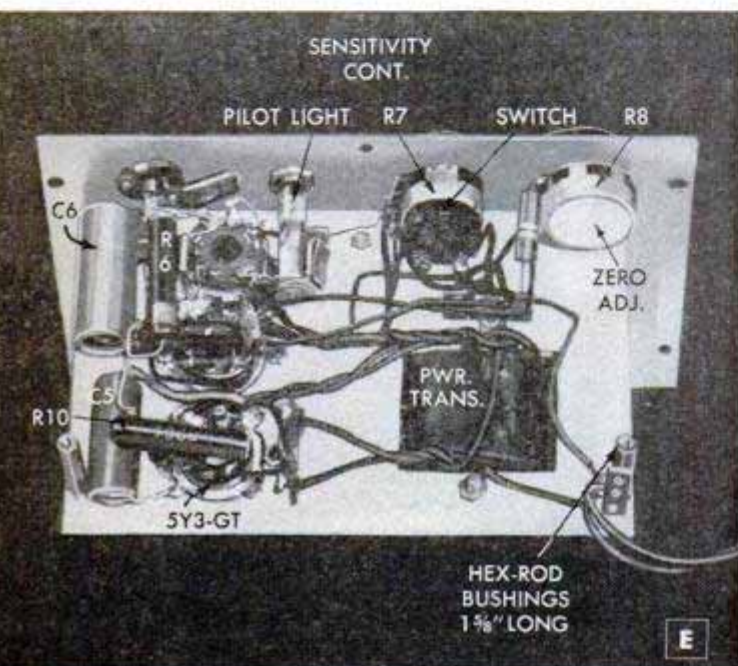
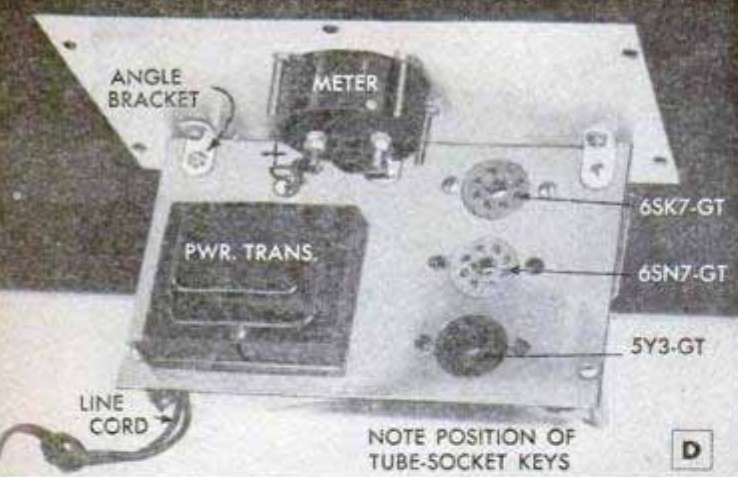

The power transformer can be any good make, either fully shielded or the half-shell type. The size of the mounting hole in the metal base will depend upon the type used. The one employed in the model has a 650-volt, center-tapped 40-ma. high-voltage plate winding; 6.3-volt, 2-amp. filament winding, and a 5-volt, 2-amp. winding for the 5Y3-GT rectifier tube, R7, the sensitivity control, is a 1-megohm, audio-taper type with switch. The zero adjustment potentiometer, R8, is a 15,000-ohm, linear type.

The sensitivity control is for adjusting the amount of sound required to produce a full-scale deflection of the meter; the zero control is for adjusting the meter to zero in a quiet room. A length of single-conductor shielded wire cable terminating in a phono plug is used to connect the speaker microphone to the applause meter. The microphone is mounted in a separate cabinet as shown in photo A and Fig. 2 so that the judges watching the meter will not obstruct the sound.

The electronic circuit employs a 6SN7-GT double-triode tube; one half of this tube is used for the first amplifier stage. The second stage is a 6SK7-GT tube operating with grid-leak bias. With this arrangement, the gain of the tube becomes dependent upon the level of sound energy entering the microphone. The gain of the amplifier therefore decreases with the increase of sound level. This feature gives the instrument a response which is approximately logarithmic and which simulates the response of the human ear. The remaining half of the 6SN7-GT tube is used as the final amplifier and the meter is connected in its plate circuit. This stage is biased at cutoff so that the meter will read zero when no sound enters the microphone. The zero control makes this adjustment as previously stated. The amplitude of the signal applied to the final stage is adjusted by the sensitivity control. The setting of this sensitivity control is necessarily rather critical as it determines the amount of applause or other sound which will produce a full-scale reading of the meter.

This instrument also can be used for noise studies in factories, offices, traffic, etc. Many industrial firms conduct surveys of this type as it has been found that the efficiency of factory workers is impaired by excessive noise.

When wiring the circuit, use the insulated tie-point strips shown in Fig. 4. Solder all connections carefully with rosin-core wire solder; No. 20 hookup wire with push-back insulation is used for circuit wiring. Detailed student material list R-419 is available from Popular Mechanics Radio and Electronics department upon receipt of ordinary letter postage. ★ ★ ★

TELEVISION TODAY

TELEVISION-TELEPHONE recently demonstrated in England enables the caller to view the person answering the call on a TV screen. The **PYE TV-telephone** engineer in photo A has just called the young lady whose image appears on the screen in front of the instrument. A specially designed TV light, claimed to relieve eyestrain, appears in photo B. Unlike similar TV lights in clocks and other devices, this one is in a highly decorative planter.

An easily installed TV interference filter is shown in photo C. This compact television filter is claimed to clear or minimize TV interference picked up through the antenna system, such as auto and airplane ignition, high-frequency flutters, motor sparks, etc. No adjustments or technical skills are required to connect it to any TV receiver.

The mirror arrangement on the CBS television camera that appears in photo D enables the operator to capture shots that ordinary TV cameras could not reach. The two mirrors are hinged to the front of the camera so that one picks up the picture at the difficult location and the other reflects it to the lens.

Those who live in areas frequently visited by hurricanes and high winds often wish they could lower their TV-antenna array quickly to protect it from damage. The one-man telescoping tower shown in photo E solves the problem by means of a crank at ground level. It telescopes from a height of 40 ft. to 20 ft. and weighs 60 lb.

The tap-off device shown in photo F provides the necessary isolation between television receivers in master TV-antenna systems along the transmission lines housed in conduits. At the same time it provides the proper attenuation to maintain a constant level of signal strength throughout the system. It will fit a standard outlet box.

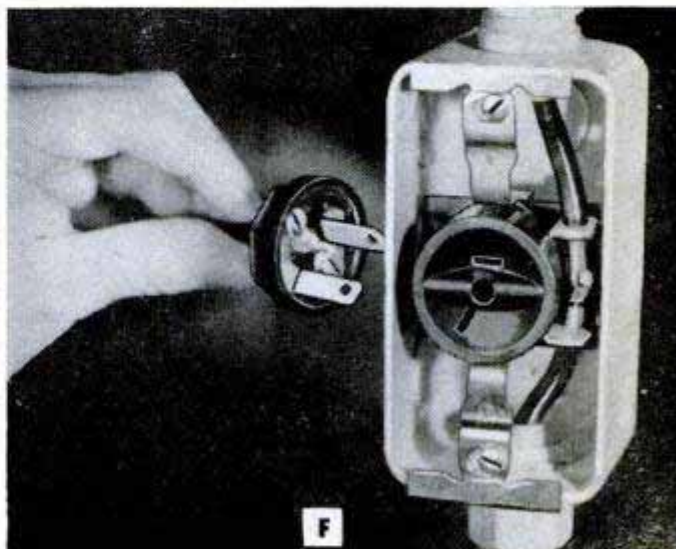
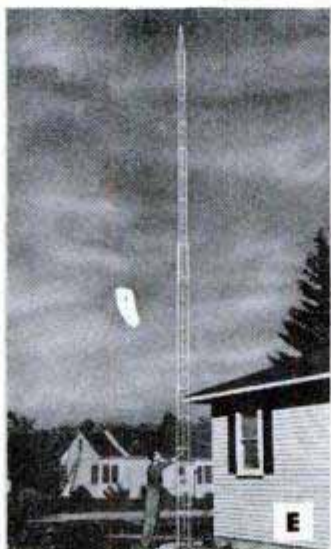
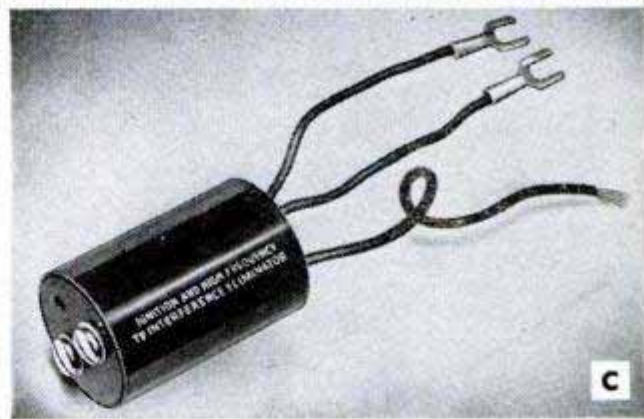

Hints for Radio and Electronics Experimenters

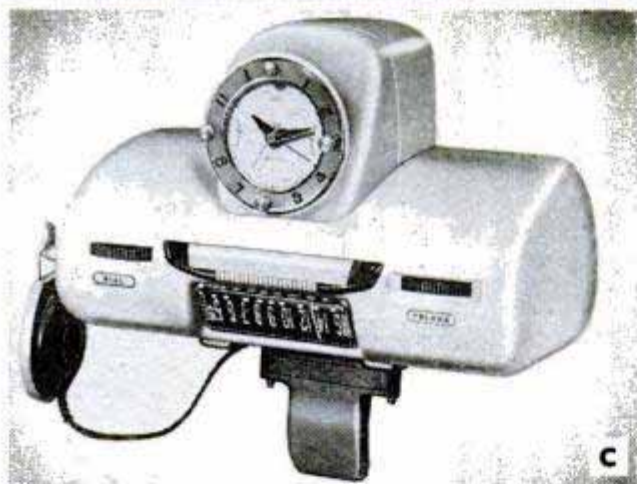
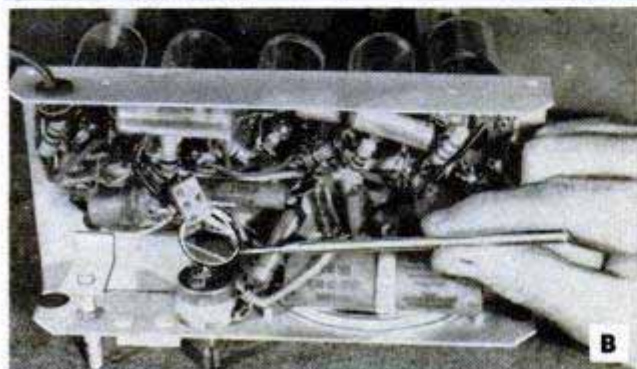

A LOST WORLD of priceless entertainment has been opened to exploration by General Electric audio engineers with a newly developed record compensator shown in photo A. The great performances of Enrico Caruso, Amelita Galli-Curci, John Phillip Sousa and other noted artists, whose legacies have been buried under the scratched and worn surfaces of thousands of old phonograph records, can now be freed of surface noises which in most cases bar any possible enjoyment in listening to early recordings. It can also be used with modern recordings of any of the three popular speeds.

Radio and TV servicemen often use a dentist's mirror, in the manner illustrated in photo B, to detect broken wires and bad connections in difficult chassis locations.

The bedroom radio receiver shown in photo C employs an under-pillow speaker designed to meet hospital specifications for quiet operation. It has an upside-down dial and combines radio, clock, alarm and night light.

A sediment-free solution that does not clog contacts in radio and TV-set controls is now available for eliminating noise and preserving moving contacts in controls. It is applied with a dropper as illustrated in photo D, to clean the contacts without harm to insulation or soldered joints.

Modern radio experimenting recently reached a new high when George M. Rose, who operates amateur radio station K2AH from his home in Mountain Lakes, N. J., demonstrated his tiny transistor transmitter shown in photo E. It is built around a single RCA transistor.

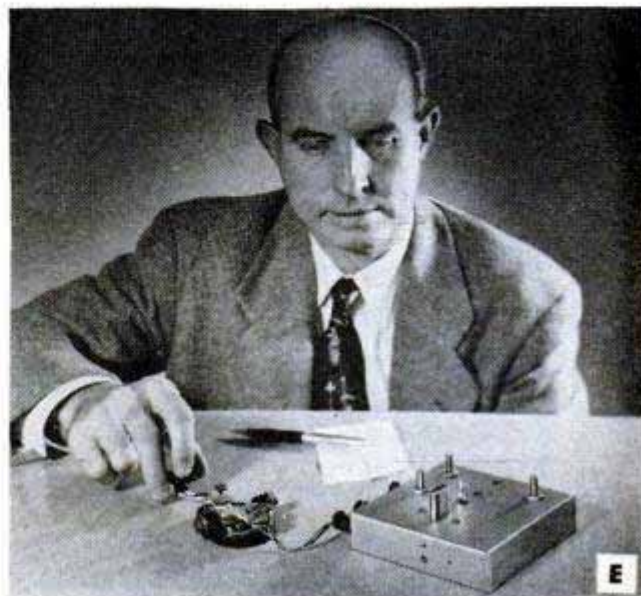

It's the sportsman's movie camera



30-shot loading

Uses economical 8mm. roll film with easy, no-thread loading.

Enough film in each roll to shoot 30-40 average-length movie scenes!



Movies rain or shine

Your choice of an f/2.7 lens . . . plenty fast for cloudy-day shooting . . . or a super-speedy f/1.9 job that can see in the rain.

Both Lumenized (hard-coated), of course.



Tough... rugged

Die-cast aluminum body is built to take it. Your "Reliant" thrives on rough going — yet it's sweet-running as a custom-made reel.

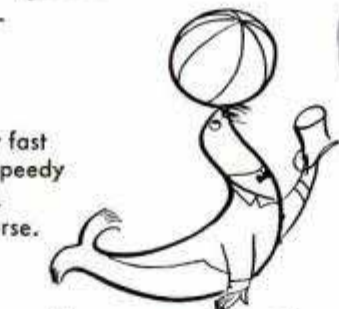

Exposures on the nose

Built-in exposure guide takes out all the figuring, leaves only the fun . . . makes sure exposure's right every time!

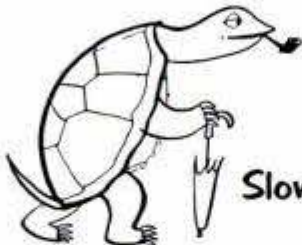

Slow motion, too

Really cuts fast action down to size. Use it with any film, either lens, for those extra-detailed effects.

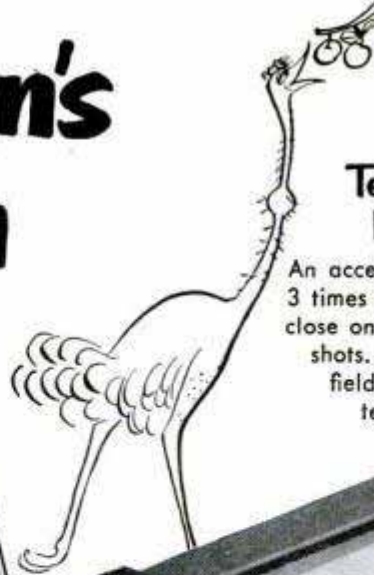

Telephoto for long reach

An accessory lens magnifies 3 times to let you come up close on those hard-to-reach shots. View finder shows fields for standard or telephoto lens.

CINE-KODAK RELIANT CAMERA
 With f/2.7 lens, \$89.50
 With super-speedy f/1.9 lens, \$110
 Other Kodak movie cameras, from \$39.75 . . . at your Kodak dealer's. Prices include Federal Tax and are subject to change without notice.



Slips in a pocket



Light and compact enough to slip in a jacket pocket where it's always ready when action starts popping. Swings and points as easily as your own 12-gauge.

Color movies, of course

They're easy — inexpensive, too. Kodachrome movie film costs but \$3.95 a roll (8mm.) — including processing! (Only \$3.25 for black-and-white.)



Eastman Kodak Company, Rochester 4, N. Y.



See "Photographic Equipment and Supplies"



"LET'S MAKE MOVIES"

A free and fascinating booklet that tells you how to make color movies . . . how to make movies indoors as well as out . . . how to choose the right camera for your needs. Just fill out coupon and send to Kodak.

Please send free copy of "Let's Make Movies" to:

Name _____

Address _____

City _____

State _____

Kodak
TRADE-MARK

How to Get Smoother, Slicker Paint Jobs

Step 1. Prepare surface. Remove all chipped and peeling paint or varnish down to bare wood. You can do this easily and quickly with Strypeeze . . . the guaranteed paint remover that stays wet longer, clings to upright surfaces, doesn't harm hands.

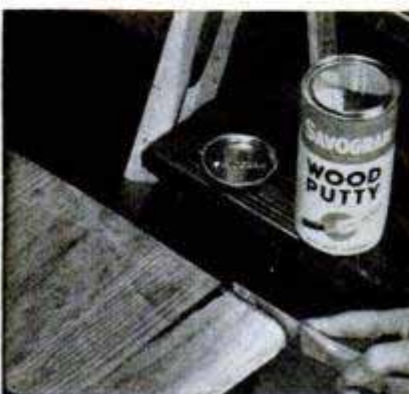
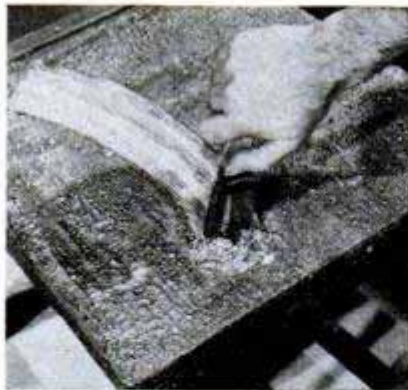

Step 2. Rebuild broken corners, fill nicks and holes. A powder-form plastic putty, Savogran Wood Putty, is ideal for this. You can form it, tool it . . . and it doesn't shrink. For cracks in plaster, use Savogran Crack Filler. It's the original patented quick-hardening water putty.

Step 3. Start job with clean brushes. If it's an old brush, clean it before you begin painting. Clean all brushes after painting and whenever you change colors. Kwikkeeze, the Liquid Brush Cleaner, softens hard brushes in minutes . . . cleans out fresh paint instantly! May be re-used.



Whenever you're painting, you need

SAVOGRAN

REG. U. S. PAT. OFF.

PRODUCTS . . . at better paint & hardware stores

Write for free helpful literature

SAVOGRAN CO., Dept. 34, 25 Huntington Ave., Boston 16, Mass.

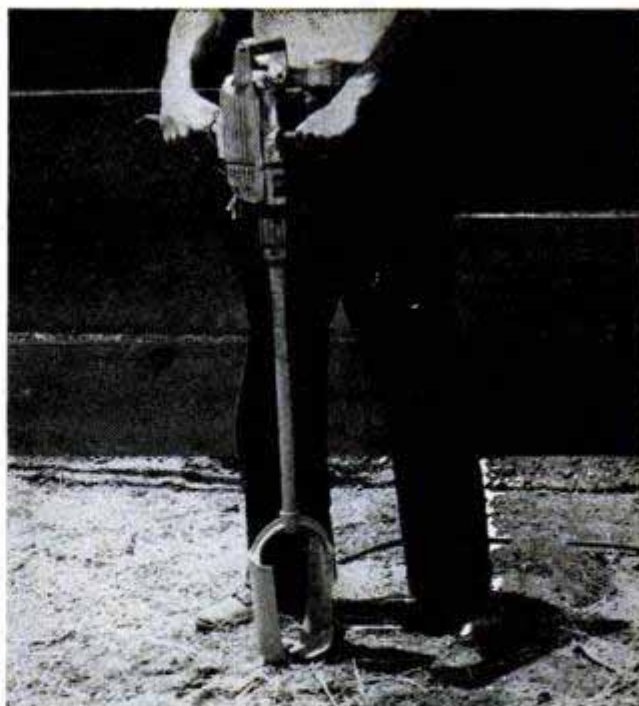

Drill Digs Postholes

Postholes are dug quickly and neatly by an earth bit that fits power drills $\frac{1}{2}$ inch or larger. The special digger, made of hardened alloy steel, slips into the regular drill chuck. It works in hard or soft soil and can also be used to dig trenches.

Cover Protects Scooters

Only a minute is required to install an Italian rain-and-wind deflector for motor scooters. A watertight canvas top and unbreakable windshield comprise the unit. It is manufactured in several different colors.



Why pay more?

You can install
a guaranteed

KENTILE FLOOR

like this for only \$27⁵⁰*



**A KENTILE FLOOR LIKE THIS COSTS
\$9 to \$22 LESS THAN TILE FLOORS
OF MANY OTHER MATERIALS...
YET KENTILE IS GUARANTEED!**

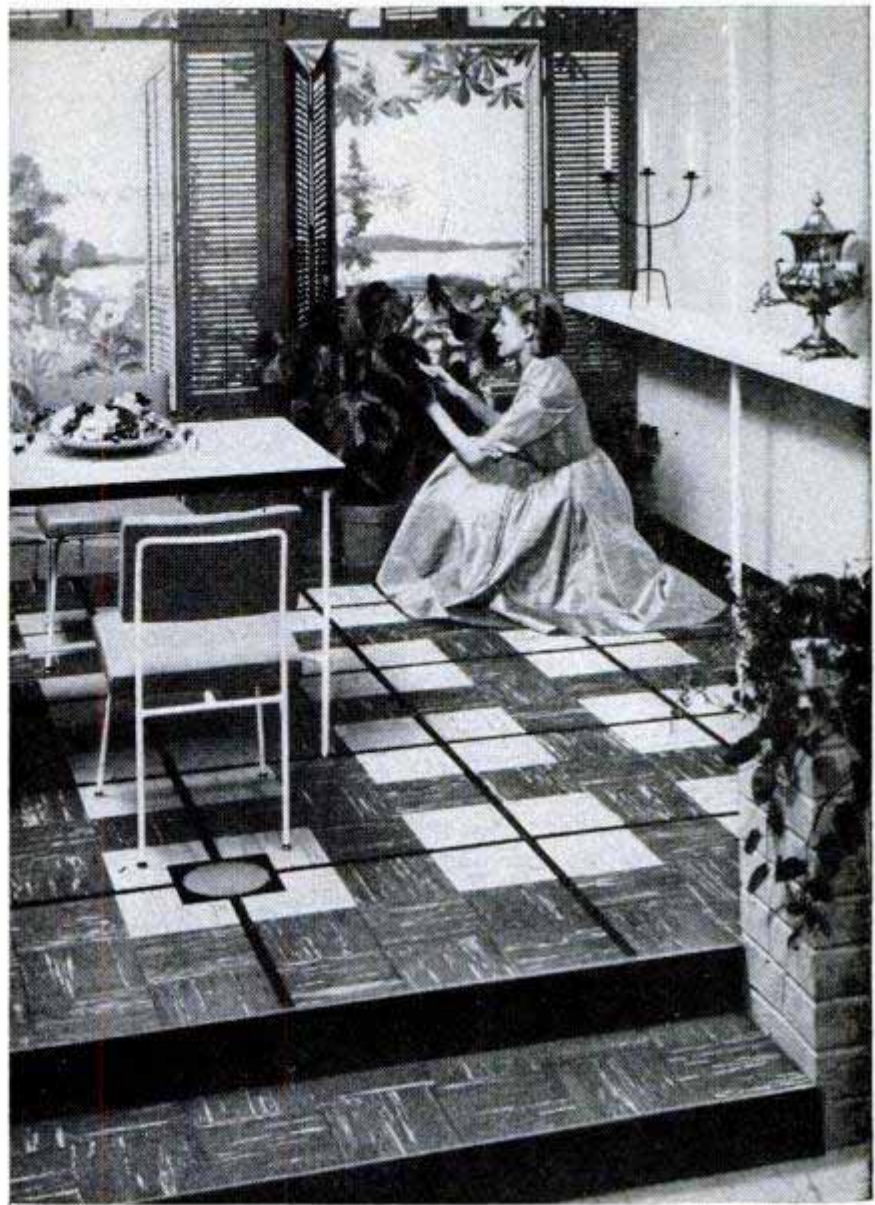

You can't imagine how easy it is to install your own Kentile Floor until you've actually done it. Mix or match your choice of the 25 "lovely-to-live-with" colors. Kentile resists soil and stains. And, after parties or just family-fun, Kentile is easy to mop clean.

It's easy to keep glistening like new with an occasional no-rub waxing, too. These modern colors can't get dull or wear off . . . they go clear through the rugged, durable tile. That's why more people buy Kentile . . . because Kentile gives more value.

Only KENTILE DEALERS have these money-saving buys in GUARANTEED FLOORS

* Price quoted is for a floor approximately 11'6" x 9'3" installed by you. Your floor may cost less or slightly more depending on size, colors and freight rates. See your local Kentile, Inc. Dealer for FREE estimate. His name is listed under FLOORS in your Classified Telephone Directory. In Canada, T. Eaton Co., Ltd.

KENTILE, INC., 58 2nd Avenue, Brooklyn 15, N. Y.

KENTILE
GUARANTEE

Kentile, Inc., will furnish new tile without charge for any Kentile that wears out . . . and on which colors wear off . . . during your own occupancy of your own home wherein you have installed Kentile or have had it installed by an authorized Kentile Dealer. This guarantee does not apply to damage caused by your improper handling or your failure to follow the instructions for installation and/or maintenance available at your Kentile dealer's. This guarantee must be presented if  is made for new tile.

KENTILE 

**The Asphalt Tile of
Enduring Beauty**

Copyright 1953
Kentile, Inc.

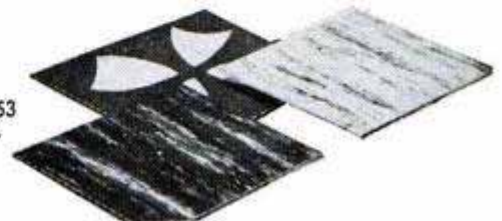



YOU, TOO,
CAN ENJOY
**LIGHT-HEARTED
LIVING**

*in a
MOBILE
APARTMENT
HOME*

WE FOUND NEW LIVING FREEDOM AT NEW LOW COST, IN OUR **NEW MOON**, AND, TOO, THE WHOLE FAMILY LOVES IT.



NOW I MOVE TO TOP PAYING JOBS AND TAKE MY FAMILY WITH ME. WE ENJOY TRAVEL AND VACATION FUN - ALL IN OUR **NEW MOON** HOME THAT WE TAKE WITH US WHEREVER WE GO. WE TURNED WORTHLESS RENT RECEIPTS INTO REAL HOME OWNERSHIP.

COMPLETELY FURNISHED — READY TO LIVE IN — AT NEW LOW COST



Write FOR YOUR COPY OF "ADVENTURES IN LIVING" → *free*

Gleaming streamlined exteriors sheath a world of living comfort that is completely furnished and ready to set-up housekeeping. Modern all-steel kitchens feature built-in cabinets, sink refrigerator and range. Automatic heating system, with scientific insulation, assures warmer winters and cooler summers. America's finest mobile home, every New Moon includes everything for **BETTER LIVING** — for housing, travel and vacation fun.

Learn all about the advantages of New Moon mobile living — how you can enjoy complete living comfort and convenience in a New Moon on our "like-rent" payment plan. Write for "Adventures in Living" — it tells all about Lighthearted Living in a New Moon. It's **FREE!**

REDMAN TRAILER CO., ALMA 40, MICH.



LATEST NEWS ABOUT **SAVAGE** POWER MOWERS

★ Companion products of world-famous Savage firearms ★

Gunmaker Builds Super Mowers

The "gunsmith" precision and quality materials that go into Savage power mowers give you extra years of dependable, trouble-free operation with a minimum of servicing.

Savage gives you the features that mean the most in convenience, efficiency and economy:

PROTECTED CHAIN DRIVE for safety, long service. **GRASS GUARDS** stop annoyance of grass winding around shaft.

EASY, POSITIVE ADJUSTMENT of cutting height. **FINGER-TIP CLUTCH AND SPEED CONTROLS** on the handle.

FREE-FLOATING HANDLE cuts vibration, adjusts to person of any height, permits small space parking. **EXCLUSIVE "STA-TEMP" PROCESS** keeps blades sharp and true.

SMOOTH-ROLLING TIMKEN BEARINGS. **QUICK STARTING 4-CYCLE BRIGGS & STRATTON ENGINE.**

Ask your dealer to demonstrate these features. You'll be convinced that Savage is the mower for you.

Tips on how to have a perfect lawn, plus details on Savage mowers are yours in an interesting, illustrated, free booklet. Write to Savage Arms Corporation, Lawn Mower Div., 99 Broadway, Chicopee Falls, Mass.



The 21" Savage **YARD CHIEF***, Model 90. Also made in 18" Model 75, the Savage **POWER CHIEF***.

Other Savage mowers include the 20" rotary, Savage **ROTOR CHIEF***, Model 81; Savage **DYNA CHIEF** reel-type, electric mower, Model 70; and 4 fine hand mowers.

*Reg. U. S. Pat. Off.

These "Unseen Differences" Help **AUTO-LITE** SERVICE PARTS

Give BEST PERFORMANCE!

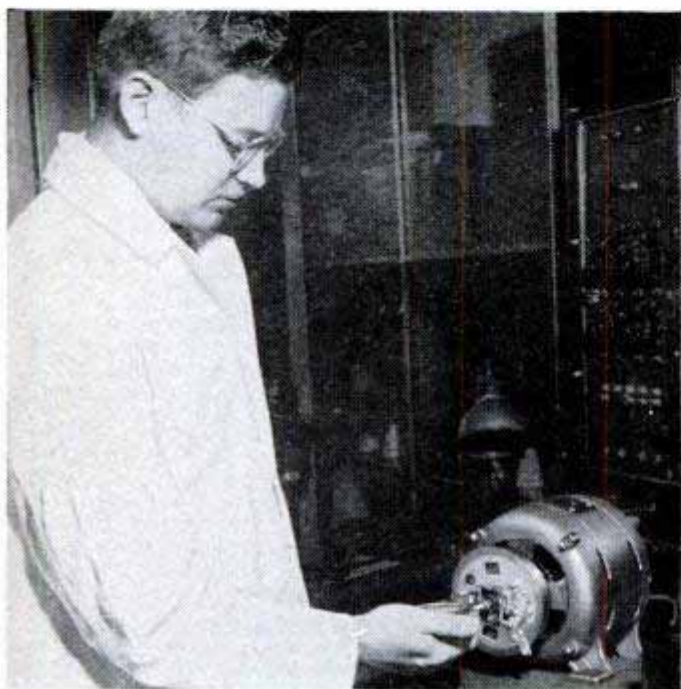

The Breaker Arm Test—typical of the tests conducted by Auto-Lite engineers to assure "Tested Quality". Here test conditions for the breaker arm, a vital part of the contact set, are sharply accelerated so that a few hours are equivalent to 25,000 to 30,000 miles of actual operation. In these tests most "look-alike" parts fall far below the average performance for Auto-Lite breaker arms.



RIBBED ARM

ribbed breaker arm provides extra strength with less weight . . . assures smooth, efficient performance even at highest speeds.



TUNGSTEN POINTS

of pure end-grained tungsten, points withstand greater "pounding" and terrific arc heat of 3500° F. for long life.



SERRATED SLEEVE

special design serrated bushing makes it impossible for bushing to slip or come loose . . . keeps close tolerance.

RUBBING BLOCKS

of special material that withstands tests equivalent to 50,000 engine miles assuring accurate contact needed for best performance.



INSIST ON AUTO-LITE SERVICE PARTS FOR YOUR AUTO-LITE EQUIPPED CAR

These typical "unseen differences" engineered into all Auto-Lite electrical equipment show why the "Tested Quality" of Auto-Lite Original Service Parts is your best guarantee of trouble-free motoring. Auto-Lite is specified as original factory equipment on many of America's finest cars, trucks and tractors. So be safe! Always insist on Auto-Lite Original Service Parts . . . because you're always right with Auto-Lite.



**SEE THE DEALER WHO SELLS
YOUR MAKE OF CAR OR
LOOK FOR THESE SIGNS!**



Tune in "SUSPENSE!"... CBS Radio Mondays... CBS Television Tuesdays

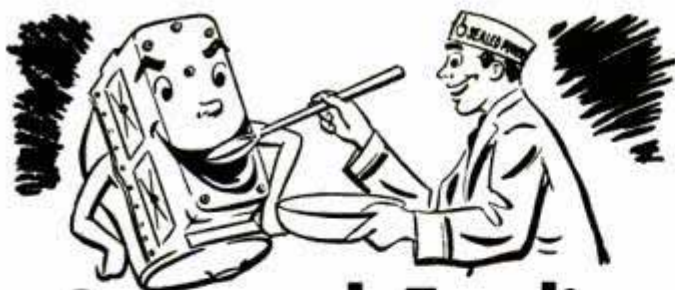

Care and Feeding of Engines

BY S. P. CORP

HOW TO TUNE UP YOUR ENGINE

Every engine needs a periodic tune-up. Here is a list of operations to check:

BATTERY: Tune-up starts with the battery which should test from half to full charge. See that cables are tight and connections clean.

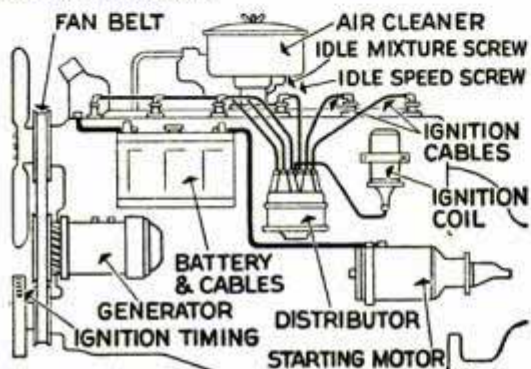

SPARK PLUGS should be removed, cleaned, and inspected. Replace any which are defective. Check gaps to car manufacturer's specifications. Use new gaskets.

COMPRESSION: While plugs are out, use a pressure gauge to check compression of each cylinder. Sticky valves and defective piston rings will be revealed by this test. Such conditions must be corrected if your engine is to perform satisfactorily. If compression is up to standard, make these other tune-up checks:

DISTRIBUTOR: Check ignition points to see that they are clean and offer no resistance to current flow. Check distributor cap, rotor, and wires for cracks, corrosion, or damage. For peak economy time the engine for the gasoline used.

CARBURETOR: There is an idle mixture adjusting screw on the lower side of the carburetor—two screws if it is a dual-throat carburetor. Connect a vacuum gauge to the intake manifold and adjust the mixture to obtain a reading of 18-20 in. Set throttle stop screw so car will travel not less than 8 to 10 miles per hour.

AIR CLEANER: Clean the air cleaner on top of the carburetor and refill to indicated oil level with same grade of oil used in your engine. While cleaner is off, inspect choke valve to be sure it is free. Also make sure manifold heat control valve is free, as required for smooth and economical operation.

All this may sound like a lot of work, but it's mighty important if you want peak performance!



IT'S TIME TO RE-RING

When you need new rings, install Sealed Power KromeX Ring Sets for maximum power, long wear, and oil economy. Sealed Power chrome rings are used by 23 leading engine builders. Write for free manual on car care, "MORE POWER, Less Oil, Less Gas." Address Sealed Power, Dept. G-5, Muskegon, Michigan.

Clinic for Homemakers

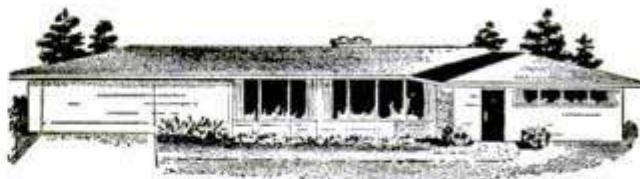

As a service to our readers in solving the hundreds of problems pertaining to a home—inside or out—the editors of *Popular Mechanics* invite you to present your problems to The Clinic Editor for help and advice. Address your questions to The Clinic Editor, *Popular Mechanics Magazine*, 200 East Ontario Street, Chicago 11, Ill.



Snow Mold

Q—When grass started on my lawn a year ago, I noticed several areas where there was no new growth. Apparently the plants had been killed, as only weeds took over later on. The grass adjacent to these spots seemed unaffected and I raked the soil and reseeded. The new seeding made a good growth. What happened?—W.A., Ind.

A—There are several possibilities, but your description makes it sound like what is known as snow mold. Of course, oil, dry-cleaning fluids and certain root destroying chemicals produce similar phenomena but, the fact that new seeding germinated and rooted freely makes snow mold the more probable cause. It is fairly common in northern states yet does not seem to occur in any given locality with any degree of regularity. It is caused by a fungus, and to prevent recurrence, the soil can be treated with mercuric chloride at the rate of about 3 oz. per 1000 sq. ft. In your own experience this would appear to be unnecessary.

Layering

Q—What is the meaning of the term layering as applied to plants? Is it a natural or artificial method of propagation?—R. U., Pa.

A—Well-known examples in nature of what is known as layering as a means of propagation, are strawberries, dewberries and black raspberries. Strawberry plants send out runners each season which root in the soil adjacent to the parent plant and thereby establish a new plant, or plants, depending on the number of runners. Dewberries and raspberries root at the tips of the canes, which bend naturally until the tips contact the surface of the soil. Gardeners practice simple layering by bending the canes in the spring and covering them near the ends with soil to a depth of 2 to 5 in. In this procedure the tip must be left exposed. Air layering is sometimes utilized on certain house plants that have developed long, unsightly stems. In this process, the stem is notched and the wound covered, or "bandaged," with loose soil and sphagnum moss held in place with raffia or burlap. The bandage is kept damp by frequent application of water until roots have formed. Then the stem is severed below the bandage and the altered plant repotted. When repotting, don't remove the bandage, as the materials will not restrict root development.

(Continued to page 224)

Here's how for home painters



Wipe out ladder accidents! Take sensible precautions. One good trick to prevent foot slipping while painting outside your house: wrap a piece of burlap around low rung, use it as foot-wiper. Remember, for repainting, Devoe Wonder-1-Coat is the most economical house paint you can use.



Masking tape hints! Masking tape is indispensable for painting stripes on furniture, masking off walls when painting baseboards, keeping glass clean while painting window frames. Big point to remember is remove tape as soon as paint has set. If paint dries, you may pull off some paint. Have you tried Devoe Velour Gloss or Semi-Gloss for baseboards and indoor trim? Highly washable.



Neatest trick of the week! When cleaning your brush in thinner—to shake it out without splattering the room, put it in a paper bag and grasp the mouth of the bag around handle. The splatter is literally “in the bag.” For the neatest paint job on walls and woodwork you ever saw, try new Devoe flat wall enamel—odorless, one-coat coverage, completely scrubbable.



How to keep outdoor furniture from chalking! Always use an “alkyd” paint because it prevents chalking and protects your clothes. Devoe Mirrolac Enamel is what you need. Easy to apply; will not fade. Incidentally, on metal furniture, be sure to sand off loose rust before refinishing.

For repainting your home, use Devoe Wonder-1-Coat House Paint . . . gives 2-coat beauty and protection in just one coat, cuts repainting time and costs practically in half. Your Devoe dealer (in Classified Phone Book) will be glad to help you with all your painting needs.



(Continued from page 222)



Polishing Pewter

Q—I have some old pewter, a platter and several bowls and a part of what I suppose was a tea service. How does one polish pewter without producing scratches on the surface? I've tried several methods and preparations, none of which have been satisfactory as small scratches are still visible on the surface of the metal, giving it a

dull appearance. I want to produce a bright surface, like silverware.—B. W., Colo.

A—You might try one of the older methods which is a two-step procedure. Mix flour and salt in approximately equal parts and then add sufficient vinegar to make a medium-heavy paste that will adhere to the surface of the metal. Apply immediately and allow to dry. Then rub off the coating with a soft cloth and wash the pieces in warm water. This first step will remove the discoloration. Dry the pieces before polishing. Dry-polish with a piece of soft leather (a small square cut from an old kid glove is just the thing) which is sprinkled occasionally with ordinary whiting.

Clearing Gutter Drain

Q—I have tile drains from the downspouts to the storm sewer and one of these is plugged so tightly that water no longer passes through it. The house is quite old so the system must have been working normally for some years. The concrete cap over the bell end of the tile seems to be intact and there are no trees near the tile line. What could cause the complete stoppage and how can I remove the obstruction?—V. T., N. J.



A—Offhand, of course, we don't know but there are several possibilities. We'd guess that a partial stoppage has existed for some time and, proceeding on this as an assumption, it's probably safe to rule out leaves as these usually decompose and eventually wash away, especially if the stoppage is in the tile and not in the downspout. It's more likely that a twig, a piece of concrete or some other hard object has found its way into the tile and lodged in the horizontal run of tile below the elbow. Particles of slate from the roof coating and possibly a small piece of roofing or shingle can build up behind such an obstruction and cause the complete stoppage you describe. The surest remedy is to remove the concrete cap from the end of the tile and also the lower section of downspout so that a sewer rod, or “snake,” can be inserted to dislodge the obstruction. After the tile has been cleared, flush it with a strong stream from a hose.

Preventing Corrosion of Car-Battery Terminals

Q—How does one remove the white powdery substance that collects on car-battery terminals? How can I prevent its recurrence?—T. S., La.

A—Several methods are recommended, none of which can be considered permanent. However, one of the simplest ways of minimizing corrosion at the terminals is to remove the cables and clean the top of the battery thoroughly, using a dampened cloth and a soft bristle brush. You may have to remove the top of the battery carrier in order to do a thorough job. Then coat the posts, the cable clamps and the area around the posts with petroleum jelly, applying a fairly heavy coating to all parts. When replacing the carrier top, don't draw the hold-down bolts too tightly.

We're set for
summer driving!



*"You can't have good engine performance without good spark plugs. So, get the best—**GET CHAMPIONS**—and you, too, will be set **FOR SUMMER DRIVING**"*

—says **WILBUR SHAW**, President, Indianapolis Motor Speedway and
3-Time Winner of the Indianapolis 500-Mile Race

WANT BETTER PAINT JOBS?

Use *Pol-mer-ik*
LINSEED OIL



● For years Archer Pol-mer-ik has been the linseed oil chosen by more professional painters than any other for paint reducing and brush conditioning. Pol-mer-ik has been *super-treated* by a special polymerization process which reshuffles the oil molecules so they are interlocked. This gives you a tougher, more durable paint film than ordinary linseed oil. When you reduce your paints with Pol-mer-ik, they brush out easier, level out better, have a smoother, more dirt-resistant surface, and give you a longer-lasting job! Next time you paint, use Archer Pol-mer-ik Linseed Oil. You'll get better results!

BRUSHES OUT
BETTER

TOUGHER
SURFACE

BETTER GLOSS

ARCHER *Pol-mer-ik* LINSEED OIL

PROTECTS MOST ANYTHING



A few of the
101
HANDY USES:

- Preserves tools and handles.
- Refinishes antiques.
- For natural wood finishes.
- Softens stiff putty.

Yes, Archer Pol-mer-ik is a real Handy-Andy helper that saves you time and money by doing the job of a dozen specialized products. The handiest single product in your home!

FREE! 101 Money-Saving Ideas!



Get your copy today. Shortcuts and pointers from the "pro's" based on practical experience. Free! No obligation—just drop us a card today.
ARCHER-DANIELS-MIDLAND Co.,
603 Roanoke Building, Minneapolis, Minnesota

TRY

MONTA MOWER

on YOUR OWN LAWN

on *Approval!*

8 1/4 LBS.



TRIMS AS IT MOWS!
VASTLY
IMPROVED,
NEW 1953 MODEL

Amazing new-type cutting discs save time and labor! Actually "Two-Tools-In-One", the versatile MontaMower is an amazing work saver! Try it on your own lawn, on approval, for an extended trial period. Its live, precision mechanism first gathers, then smoothly cuts a clean 16" swath through grass, dandelions, tall lawn weeds. Cuts right up to walls, fences, trees and under over-hanging shrubs... practically eliminates hand trimming! Cuts steep banks easily! Cutting discs are now both Self-Cleaning and Self-Sharpening. Drive shaft mounted on permanently lubricated, sealed bearings. Hundreds of thousands in use. Buy direct from factory and save. Owners Cooperation Plan can repay cost. Write today for full details on limited "Special Price... Extended Trial Offer". Sold Direct Only.

MONTAMOWER DISTRIBUTING CO.

P.M. 35 KEELER BLDG., GRAND RAPIDS 2, MICH.



The Modern PLASTIC
for lasting Home Repairs

PERMANENTLY mends cracks or holes in wood, tile, stone or plaster. Sticks and stays put—Does not chip, shrink or fall out. Easy to use. Economical. Mold it, chisel it, polish or paint it. If unobtainable from your lumber, paint or hardware dealer, the big 4-lb. can will be sent you postpaid (in U.S.) for only \$1.25. Full money-back guarantee, order now.

DONALD DURHAM CO.

253 School St., Des Moines, Iowa

PICTURED PERFECTION— BULLDOG TRAILER PARKING JACKS!

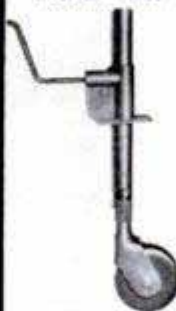

MODEL 50-P makes hitching or parking trailers an easy, one-man job. Rides flush. Easily installed. \$15.37 complete, postpaid (when paid in advance).

Manufacturers of a complete line of Safety-Engineered trailer parts. Write for Brochure 13-E

HAMMER BLOW TOOL COMPANY

"As old as the Industry"
WAUSAU, WISCONSIN

FOR BETTER TOOLS LOOK FOR THIS CRESCENT REVOLVING TOOL DISPLAY



Crescent hand tools are world famous for their excellent design, fine workmanship and superior construction from materials best suited to the type of work for which the tool is intended.

CRESCENT...CRESTOLOY
WRENCHES • PLIERS • PUNCHES
SCREWDRIVERS • HACKSAWS
TIN SNIPS • CHISELS • NAIL
PULLERS • SLEEVE WRENCHES
WIRE GRIPS • SCRATCH AWLS

*Write for the
Crescent Catalog*



CRESCENT TOOLS

Give Wings to Work

*Sign of the Artisan
Symbol of Excellence*

®

Crescent is our trade-mark, registered in the United States and abroad, for wrenches and other tools. Sold by leading distributors and retailers everywhere and made only by
CRESCENT TOOL COMPANY, JAMESTOWN, NEW YORK

BIG NEWS IN THE BIG SWEEP TO SPIN-FISHING THE NEW AIREX VAGABOND

Featuring New FULL
BAIL with ROLLER PICKUP
\$16.50



Airex, who made spin-fishing sweep America, brings you another great new reel...the "Vagabond." Amazingly light in weight (only 8 oz.), this rugged yet streamlined beauty has every great Airex feature plus entirely new bail pickup. Let it be *your* introduction to the thrill of long, smooth, accurate casting with never a backlash...to the excitement of playing big fish with lightweight tackle. Chances are 9 out of 10 American spin-fishermen use Airex. Follow their lead. See the "Vagabond" and all the famous Airex reels, rods and lines at your dealer's.

THE NEW AIREX
"BEACHCOMBER"
SALT WATER SPINNING REEL
weighs only 14 oz. yet holds 270 yds. 12 lb. test line. For surfcasting, boat or squidding and heavy fresh water fishing.



Now 4 Great Reels \$13.50 to \$28.50. Famous "Master-reel," \$22.75. Popular "Spinster," \$13.50. New "Vagabond," \$16.50. New salt water "Beachcomber," \$28.50.

FREE AIREX Corporation, Division of the Lionel Corporation, 411 4th Ave., New York 16

Please send me free illustrated booklet on all Airex products... with questions and answers on spinning... plus spin-casting instructions.

Name _____

Address _____

City _____ State _____

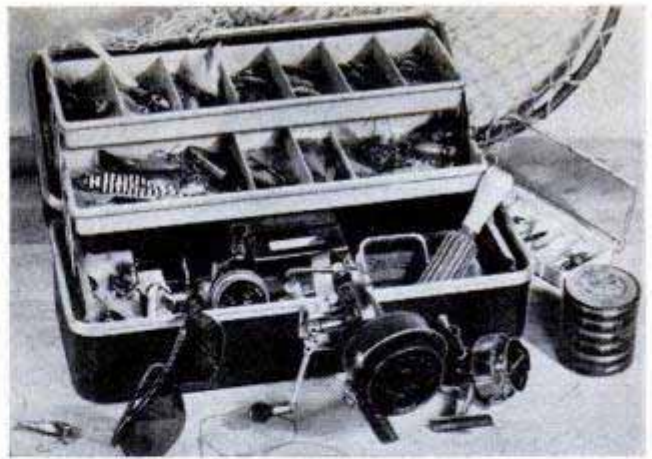

Spin-fishing equipment includes a tackle box, reels, selection of lures, extra line, floating net and Polaroid glasses so angler can see fish beneath surface

They Call It Spin Fishing

(Continued from page 88)

of three o'clock. You will hear a clicking as you overpower the drag. Now reverse the direction until the crank snaps into the casting position at about five o'clock, and make your cast as with an open-face reel.

Most spin fishermen will recognize only one drawback to spinning, but it's important that you know about line twist and how to overcome it. Each time the pickup revolves around the reel it puts a twist in the line, but this straightens out when you cast. A great many lures such as devons and spinners will twist the line as they move through the water. Eventually the line may twist to such a point that it may shrivel into tight loops. Then there are those times when the fish is running out line and you carelessly reel in. More twist.

To overcome line twist, it is better to wind new line on a spool by hand or with a lathe than with the reel itself. There are many good spin fishermen who don't completely agree with this; they put line on their reel by twisting it on with the pickup, figuring they can straighten the line when they cast out.

Many of the spinning lures are loaded so the weight is off center to combat line twist. Some are made in pairs: Twin lures that look exactly alike, yet one revolves to the left and the other to the right. You fish with one for a while, then switch to the other and work the twist out of the line. Other lures have keels which keep them from revolving but permit a blade to spin. Bead-chain swivels are very effective in preventing line twist and even more effective when used with keel-type lures. Some use the ball-bearing swivels. When you complete a retrieve, keep the rod tip as high as possible to untwist the line.

(Continued to page 230)

A SPARTAN HOME

*will take your Castle
out of the air...*



and Put it Behind
YOUR CAR

Today is the day to begin planning your investment in the finest mobile home—a **Spartan Home**. Go where the Climate is for you — where you live the carefree Spartan way. Today is the day to visit your nearest friendly Spartan Homes Dealer and let him amaze you—see luxurious living in the most modern manner. The modern home goes with you wherever you go—if it's a **Spartan Home**.

Terms: ¼ down — 5 years to pay balance
5% yearly finance charge.



SPARTAN AIRCRAFT COMPANY

2011 North Sheridan Road
TULSA, OKLAHOMA



It's all there — ready to move into — completely equipped — no furniture or appliances to buy — your own Home - On - Wheels — a Spartan Home!

Write TODAY for FREE full-color literature!

Spartan Aircraft Company
2011 North Sheridan Road
Tulsa, Oklahoma

Name.....

Address.....

City.....

GET OUT OF THE "SNAPSHOT CLASS"!



Graflex Prize-winning Photo by Don Downie

**GRADUATE
TO A**

Graphic

FOR SHOTS THAT "SIZZLE"!

● Nothing complicated about a Pace-maker Graphic. That's one of the reasons why it's first choice of press photographers who live by the lens. Another is its amazing versatility that enables it to handle everything from action to portraits. Examine both the Speed and Crown Graphics—each in three sizes. And see the popular Century Graphic too, now only \$108 with f4.5 lens. Your Graflex dealer will show you how easy and economical your Graphic graduation can be. Many dealers offer budget terms as low as \$2.00 weekly.

Graflex Inc., Dept. 156A
Rochester 8, New York

Please send me the new FREE GRAFLEX
48-page booklet.

Name _____

Street _____

City _____

County or Zone _____ State _____

GRAFLEX[®]
Prize-Winning Cameras

After each hour of spin fishing you'll be wise if you remove the lure and let out the line in a current or trail it over the stern of a moving boat until all the line twist comes out. Most fishermen carry extra spools of line for changing during a day of fishing, especially if they are going after fish of different sizes, in which case they change the weight of the line to fit the circumstance.

Among the spin-fishing reels which have contributed to this new sport in America are the Mitchell, Salt Water Mitchell, C.A.P., Thommen Record, Booth Centaure, Orvis 100 and 101 (Pelican), Ambidex, Rockland Ru-Lac, Ru-Sport, Ru-Mer, Ru-Atlantic, Airex Bache-Brown Mastereel, Spinster, Vic, Beachcomber, Vagabond, Luxor-Luxe No. 1 and 1-S Special, Luxor No. 2 Supreme, Luxor No. 3 Mer Salmon, South Bend Spincast, Shakespeare Spinning Reel, Wright & McGill Fre-Line, H-I Triplex, H-I Bradco, Heddon Spinpal, Benora, Zebco, Waltco Ny-O-Lite, Ocean City No. 300, Fix Manual, Fix Automatic, Silent Spin-Flyte, Pecos-Luxe, Swiss Whiz, Quick, Staro, Alcedo, Oredon, Capta, Louis Johnson Sure-Spin, Tradewinds Spin-in Champ, Langley Spinlite, International No. 100, Bretton Spinning Reel, Good-All Star Deluxe, Bristol No. 69, Monti-Super, Rado, Johnson Reel, Telecast, Whirlaway, Humphreys, Worden Belly-Winder, Agal, Olympic De Luxe and the Magic. Many others are expected soon.

Spin fishing has really taken hold on the Pacific Coast. Don Harger, a widely known fishing authority of Salem, Ore., says that spinning on the West Coast has grown from the novelty stage to a point where it now leads all other angling methods by a wide margin. Down Florida way, Homer Rhode, an all-around angler of Miami, reports that fishermen of the southeastern part of the nation have gone overboard for spinning, and are taking pompano from the bridges, bonefish and permit on the Keys flats, snook along the canals, tarpon up the rivers, and sailfish, white marlin, wahoo and dolphin in the Gulf Stream, all on monofilament line of less than 12-pound test.

Ted Williams, the Boston slugger-Marine Corps pilot, who also specializes in catching anything that swims, told me "It's even more fun than fishing with my fly rod." Joe Bates, Jr., of Longmeadow, Mass., one of America's leading authorities on spin fishing, says "Any fisherman not equipped with spinning gear is a bit old-fashioned." Clare Bryan of Chicago, who caught a 34-pound 10-ounce white marlin on an 11-pound test monofilament line, says, "Soon spin fishermen will be catching 100-pound

(Continued to page 252)

Protect your cooling system now
to guard against summer overheating



Cooling system failure—on the New York Southern State Parkway last summer—stranded these motorists.

NEW DU PONT ANTI-RUST

and Water Pump Lubricant

RETARDS RUST FORMATION, NEUTRALIZES CORROSIVE ACIDS



Just pour it in the radiator, leave it in!

Now, you can easily eliminate one hot-weather worry—failure of your car's cooling system. Most overheating is caused by clogging due to rust, and corrosive attack. New Du Pont Anti-Rust not only inhibits rust, but neutralizes acids and lubricates the water pump as well.

Best of all, liquid Du Pont Anti-Rust is simple to use. Just pour it in your radiator and forget it. It starts immediately to protect you against troublesome breakdowns and costly repairs. And Anti-Rust can't clog . . . is harmless to hose or metal parts. Get it at your service station or auto supply store—\$1.00 at most dealers.



Better Things for Better Living
... through Chemistry

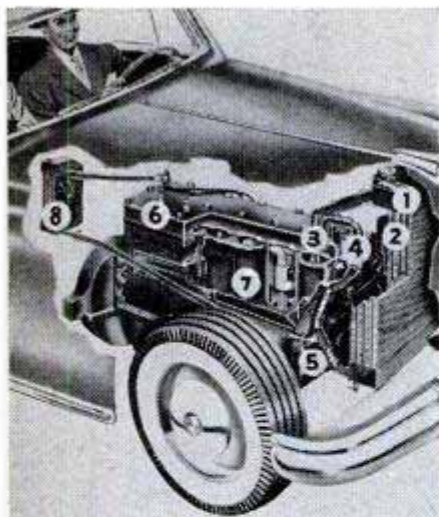

HERE'S WHERE Du Pont Anti-Rust works in your car's cooling system to neutralize acid, retard rust and corrosion, lubricate moving parts. 1. Radiator tanks. 2. Water tubes. 3. Thermostat. 4. Water pump. 5. Hose connections. 6. Cylinder head. 7. Cylinder wall. 8. Heater.

DU PONT SPRING DRAIN-OUT:



Ask at your garage or service station about this complete summer protection. The service includes 1. Draining out winter-worn anti-freeze. 2. Thoroughly cleaning out rust and scale with Du Pont Cooling System Cleanser. 3. Adding Du Pont Anti-Rust and Water Pump Lubricant. 4. Checking all cooling system parts.

DU PONT COOLING SYSTEM CLEANSER

**Top-Quality
Individual
Power Tools**

are actually

**The Same 4 Basic
Parts Arranged in
Different Ways**

plus a

Principal Feature

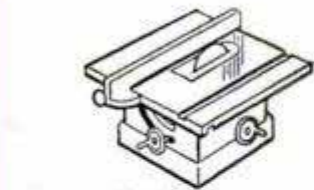

**8-INCH
CIRCULAR SAW**



**12-INCH
DISC SANDER**



**15-INCH
DRILL PRESS**



**33-INCH
WOOD LATHE**

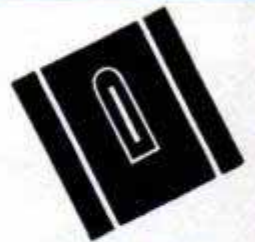
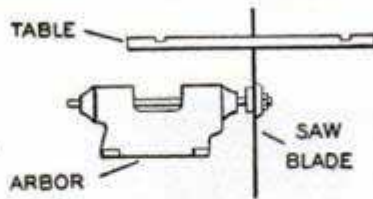

LARGE TABLE

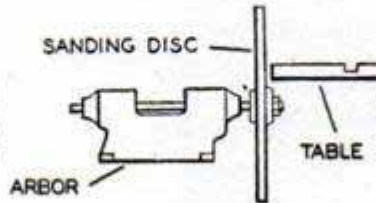

EXTRA POWER

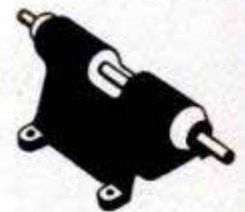
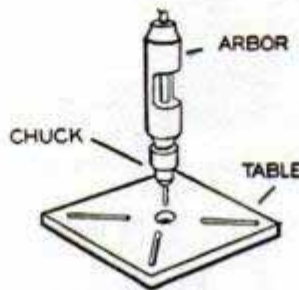

**BALL-BEARING
SPINDLE**

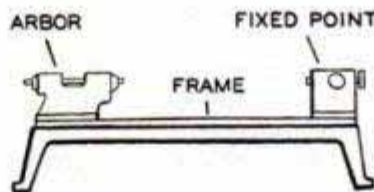

RIGID FRAME

How to compare today's

NOW LET'S LOOK AT THE "GENERAL ASSEMBLY"



3 OR 4 TABLES



4 SEPARATE FRAMES



4 SPINDLES OR ARBORS



1 MOTOR, 4 V-BELTS

SINGLE, MULTI-TOOL UNIT COMBINES THE BEST FEATURES OF BIG INDIVIDUAL POWER TOOLS



In each of its basic operations, the multi-purpose tool does the job of a big individual tool, does it as well (because it has the same basic features) or does it better (because it has features which though standard in one operation are useful and unique in another). For example:

CIRCULAR SAW—has added feature of large working area, saw blade that can be shifted from side to side for hairline adjustments or dadoing. Ball-bearing spindle means extra-smooth, quiet operation.

DISC SANDER — outperforms all but the largest industrial types. Has unique feature: Disc can be fed into work for maximum accuracy and for precise finishing of duplicate pieces.

DRILL PRESS — works horizontally as well as vertically. This makes the handling of long or awkward pieces an easy job. Horizontal drill is an ideal tool for making doweled joints.

WOOD LATHE — has movable headstock instead of movable tailstock. Means operator can slide headstock to end of ways for faceplate turning, enabling him to face the work instead of working from one side.

multi-use power tools

ASSEMBLED COMBINATION TOOL
(duplication of parts cuts down on quality, capacity)

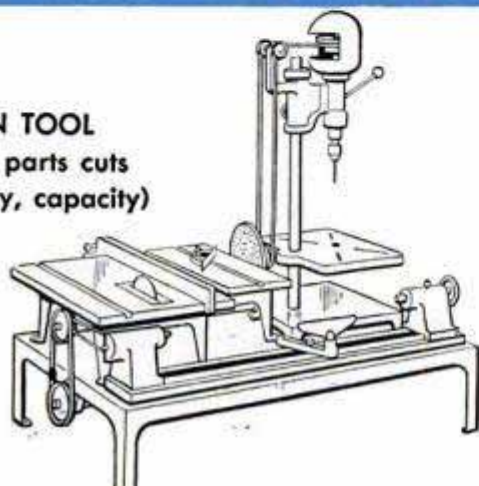

The new multi-use power tools do more than saw, sand, drill and turn. They've broken down forever the old saw that "the biggest and best projects require individual tools." And they're kicking up a furor all their own. Which is better: the "all-in-one" combination tool or the "one-for-all" multi-purpose tool? A basic concept is involved. So that the important differences won't be overlooked in the battle of advertising claims, we diagram them here and discuss them in the two pages following.

**LEADING
MULTI-
PURPOSE
TOOL**

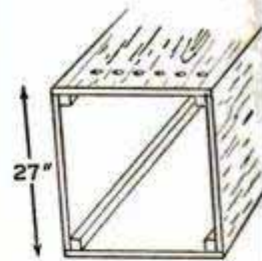
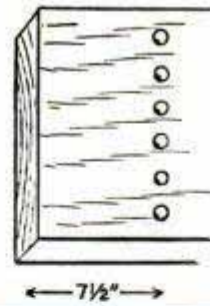
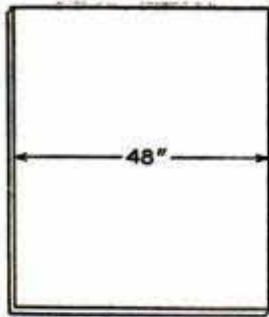

**LEADING
COMBINATION
TOOL**

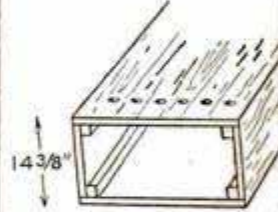
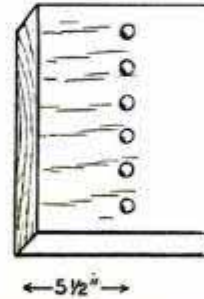
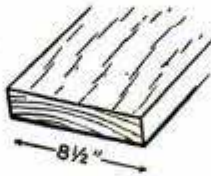
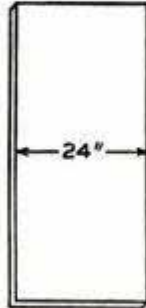

Sawing big panels - maximum blade to fence capacity

Sanding ends of boards - maximum width of work

Drilling - maximum distance in from edge of work

Drilling - maximum thickness or height of work

Americans have suddenly discovered that there's fun, relaxation and substantial savings in the age-old art of woodworking. One reason for this new "do-it-yourself" enthusiasm is the advent of some exciting, new multi-purpose and combination power tools. They make it possible to have a complete, versatile power shop in limited space, on a limited budget.

The three principal new-type tools are: (1) Radial-arm saws—standard cut-off saws with provision for other attachments; (2) Combination tools—assemblies of single-purpose tools on single benches with one or two motors; (3) Multi-purpose tools—single units designed specifically for multiple operations.

A look at the facts

The radial-arm saw does an excellent, though specialized, job. It is unsurpassed

for cross-cut sawing, outperforming both tilting table and tilting arbor saws. But it is somewhat limited in other sawing operations and in drilling, sanding or turning. It cannot, for example, be used conveniently to cut large plywood panels or to rip wide boards.

The combination tool, with its neat arrangement of single tools, is similar in principle to the old shops where all the tools were driven by belts from a jack shaft. The latest model, for example, requires more than 15 feet of V-beltting to operate four tools.

Usually built around a good saw, the combination tool is likely to fall short in its other operations. Its basic weakness is its duplication of parts, duplication at the expense of quality and tool capacity. Furthermore, the combining of individual tools reduces the ease of operation and

**Bonus features
of
multi-purpose
tool**

QUICK-CHANGE SPINDLE TIP
— all changes made with Allen wrench *in seconds*. Hardened tip has a self-locking safety flat.

EXTENDIBLE QUILL
— feature of vertical and horizontal drill gives accurate saw blade settings.

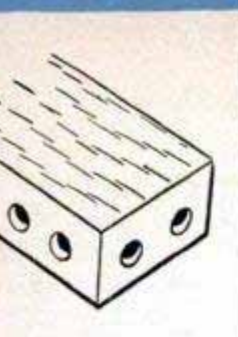
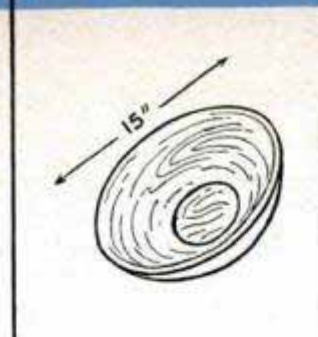
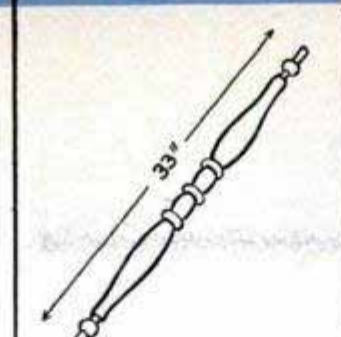

		
NOT PRACTICAL* <small>*even with extra attachment</small>	NOT POSSIBLE	NOT POSSIBLE
Horizontal drilling — for drilling board ends and edges	Faceplate turning — maximum diameter of work	Lathe turning — maximum length of work

flexibility of each, may even cause interference between tools.

An entirely new concept

Most revolutionary of the multi-purpose tools is the SHOPS MITH, manufactured by Magna Engineering Corporation, Menlo Park, California. The main difference between this and the other tools is *design*. SHOPS MITH is a completely new design and not just another assembly. It is first and foremost a *single, multi-tool unit*.

SHOPS MITH takes the basic elements of the very finest individual tools — large, machined table; ball-bearing spindle or arbor; heavy-duty castings and frames — and works them into an 8" saw, a 12" disc sander, a 33" lathe and a vertical and horizontal drill press. In each of its operations, this versatile tool equals or outperforms the single-purpose tool it replaces.

AUTOMATIC JIGGING — miter gauge and rip fence for all operations. Speeds drilling and sanding jobs.



HORIZONTAL DRILLING—unique, time-saving operation. Does 50% of all drilling jobs, does them faster, more accurately.

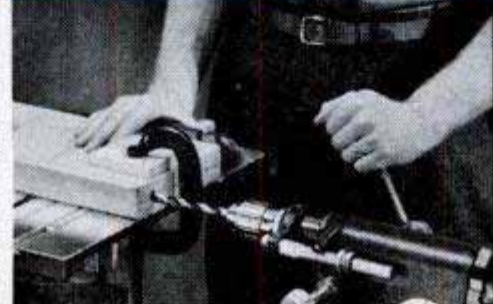

POINTS TO CHECK WHEN COMPARING POWER TOOLS

	Power Tool A	Power Tool B	Power Tool C
Circular Saw			
Capacity—ability to handle big work	<input type="checkbox"/>	<input type="checkbox"/>	<input type="checkbox"/>
No interference from other tools	<input type="checkbox"/>	<input type="checkbox"/>	<input type="checkbox"/>
Automatic stops in miter gauge and tilting table	<input type="checkbox"/>	<input type="checkbox"/>	<input type="checkbox"/>
Micro adjustments (table raising, blade-to-fence)	<input type="checkbox"/>	<input type="checkbox"/>	<input type="checkbox"/>
Drill Press			
Capacity—chuck-to-table, chuck-to-column	<input type="checkbox"/>	<input type="checkbox"/>	<input type="checkbox"/>
Full 4-inch quill feed; adjustable indicator	<input type="checkbox"/>	<input type="checkbox"/>	<input type="checkbox"/>
Tilting drill table	<input type="checkbox"/>	<input type="checkbox"/>	<input type="checkbox"/>
Horizontal drilling	<input type="checkbox"/>	<input type="checkbox"/>	<input type="checkbox"/>
Disc Sander			
Large sanding disc	<input type="checkbox"/>	<input type="checkbox"/>	<input type="checkbox"/>
Sanding disc can be fed into workpiece	<input type="checkbox"/>	<input type="checkbox"/>	<input type="checkbox"/>
Miter gauge and fence for accuracy	<input type="checkbox"/>	<input type="checkbox"/>	<input type="checkbox"/>
Wood Lathe			
Ball-bearing spindle	<input type="checkbox"/>	<input type="checkbox"/>	<input type="checkbox"/>
Full 15-inch swing, 33 inches between centers	<input type="checkbox"/>	<input type="checkbox"/>	<input type="checkbox"/>
Tool rest slides parallel with work	<input type="checkbox"/>	<input type="checkbox"/>	<input type="checkbox"/>
General			
All ball-bearing construction throughout	<input type="checkbox"/>	<input type="checkbox"/>	<input type="checkbox"/>
Ready-made jigs for difficult operations	<input type="checkbox"/>	<input type="checkbox"/>	<input type="checkbox"/>
Full line of low-cost accessories	<input type="checkbox"/>	<input type="checkbox"/>	<input type="checkbox"/>

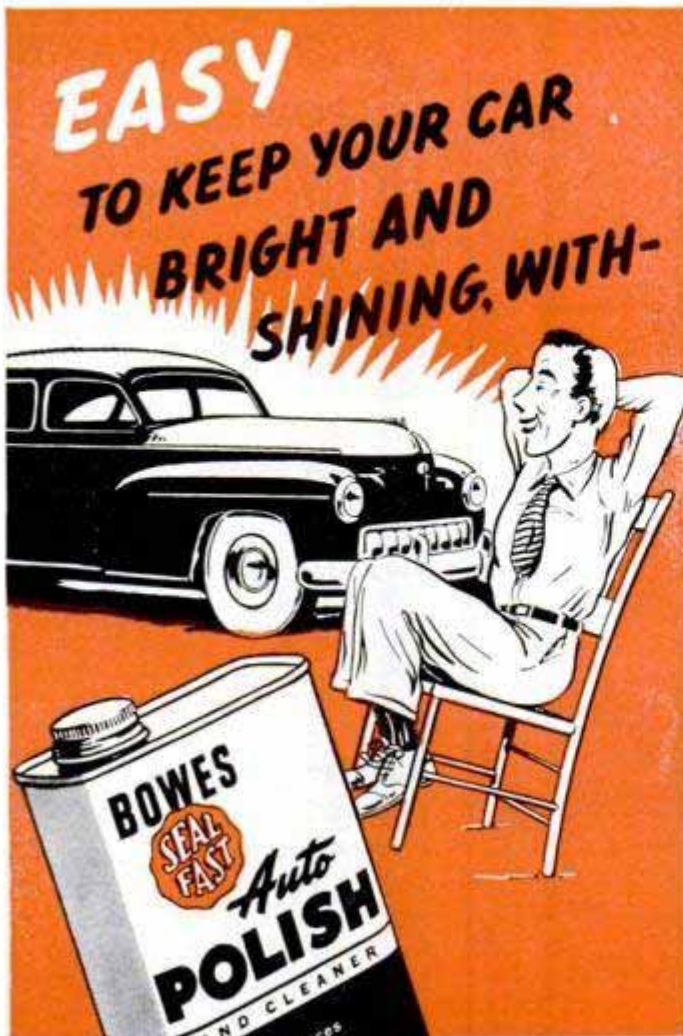

EASY
TO KEEP YOUR CAR
BRIGHT AND
SHINING, WITH-

★ Because it cleans and polishes in the

same operation, it is easy to keep your car clean and shining with BOWES Auto Polish and Cleaner.

In one quick operation you remove dirt and dulling road film and restore original beauty . . . without back-breaking fatigue.

Keep your car clean and shining the easy way, with BOWES Auto Polish and Cleaner . . . gives you more shine with less work and will make you proud of your car.

BOWES SHINE CLOTH

Chemically treated, this unusually efficient shine cloth absorbs dust, leaves no oily film to catch more dust . . . and . . . makes your polish and cleaning job last over a long period of time.



BOWES Save time and labor with this unusually effective shine cloth.



BOWES "SEAL FAST" CORPORATION
INDIANAPOLIS 7, INDIANA

Sports Cars Have a Field Day

(Continued from page 137)

up with a gymkhana involving some tests of driving skill. Courses are varied to suit the occasion, place and expertness of the group. Most sports-car gymkhanas start with simple speed tests for tire or spark-plug removal, in which cars are lined up and the awkward driver pinches his fingers in the jack or wrench in the rush to remove the part and race with it to the finish line.

While one group of cars is busy at this, others snake, with engines roaring, in and out between barrels on an obstacle course in a race against time. The driver must end up cleanly between a set of flags, ram his gears quickly but quietly into reverse and swing around into an adjacent set of flags without knocking down any barrels, flags or judges.

On another course, blindfolded drivers back their cars down the field under the direction of their navigators. They may have to weave around a couple of barrels, then straighten out and knock over a target of tin cans. Colorful talk frequently goes on between team mates in this event when "rights" and "lefts" are balled up by the reverse motion of the car. Few drivers hit the target on the first run. One of the cars in our rally ended up facing the wrong way.

An exciting contest is the balloon-popping race—a West Coast favorite. While the driver guides his car down the course, his passenger leans out and pricks a series of balloons laid out on the ground along the way. He'll be scored not only for speed, but also for unpoped balloons left on the course when he hits the finish line. The trick is to keep from falling out of the car while popping a balloon. And the driver can't come up too close or too fast to a balloon or the car will waft it out of reach.

Along a straightaway near by, or around the contest area, teams of cars may run a spark-plug relay race. Each contestant tears down a given distance, slithers to a halt, climbs out, throws up the hood, removes a spark plug and passes it to the waiting driver of the next car in his team. The second man grabs the plug, leaps into his car, starts it and roars off to the squeal of tires and smell of rubber. This process is repeated at relay point after relay point—for as many cars as there are on each team. Shortest time around the course wins the race. After the competition is over and the winners applauded, the drivers pile into their sports cars and drive home—once more using their vehicles, like ordinary folks, just for transportation purposes only. ★ ★ ★

Proof!

VIGORO* CAN GROW FINE VEGETABLES

even in Sahara Desert sand!

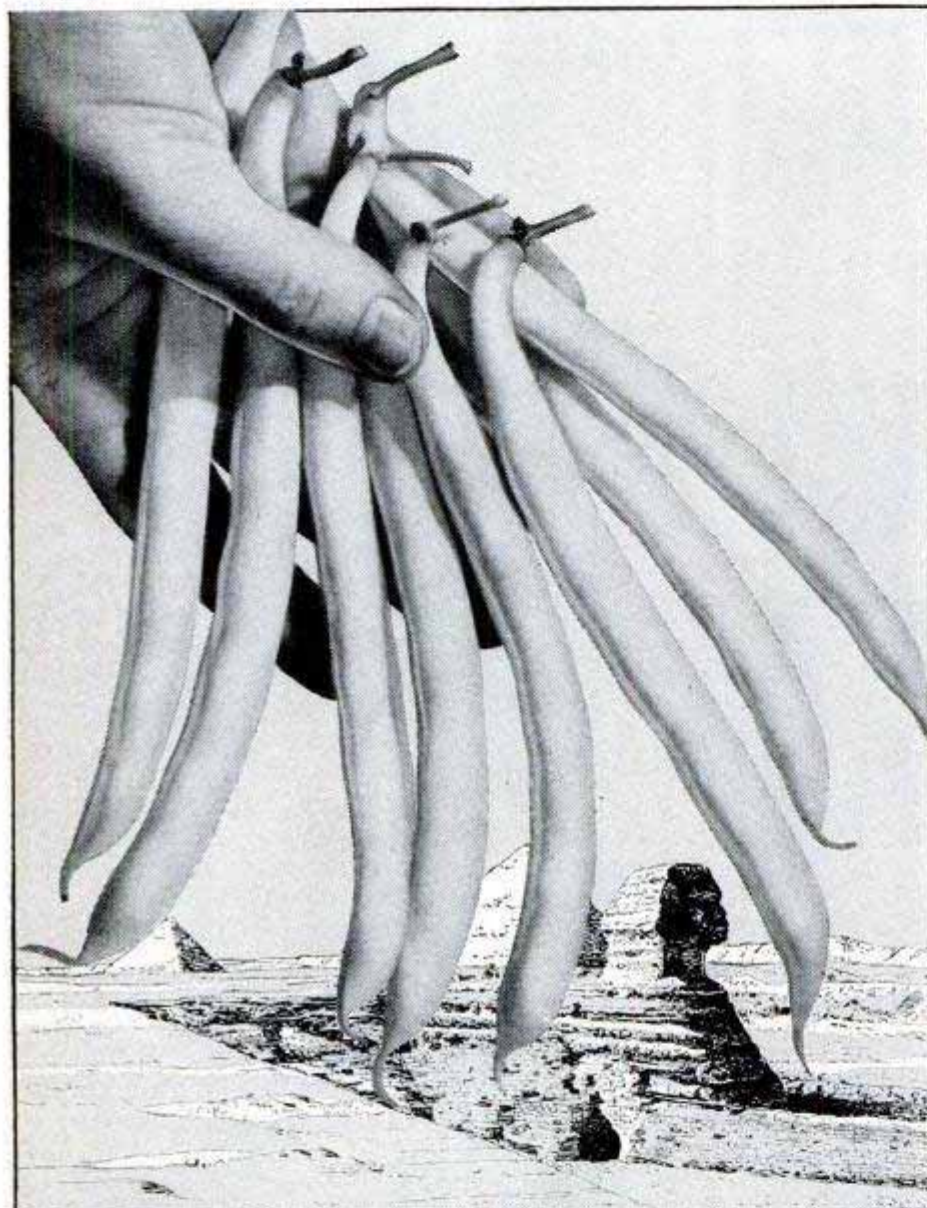

New feeding test reveals basic secret of gardening success

You couldn't find *any* soil as utterly lacking in nourishment as barren Sahara Desert sand!

Beans . . . from sand

And yet, we managed to grow these fine, plump, wax beans in that sand—thanks to regular Vigoro feedings. Imagine—then—what Vigoro can do for the vegetables you grow in *real* soil . . . in *your* garden.

Poor soil no problem

Your garden soil may be below par. It may lack some of the nutrients which help produce fine vegetables. But no matter how poor your soil is, Vigoro can give it *all* the food elements vegetables need to be big, mineral-rich, full of flavor. Remember—vegetables are the richest single source of minerals. Regular Vigoro feedings assure your family every last possible ounce of goodness in the vegetables you grow.

So, for a bumper crop of fine vegetables, work Vigoro into your soil before planting. Apply at the rate of 4 lbs. per 100 sq. ft.

**Vigoro is the trade-mark for Swift & Company's complete, balanced plant food.*

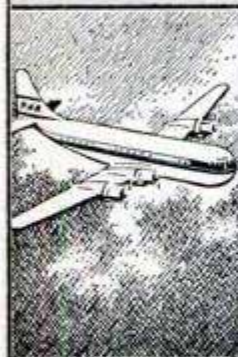

Sand from the Sahara Desert was flown in for this test by Pan American World Airways.



We planted bean seeds in that sand—and gave them no other form of nourishment but Vigoro.



Vigoro goes to work—within a few days, bean sprouts appear...the plant matures.



And the result! A bean plant as fine and healthy as any grown in rich, black soil.



The **VIGORO** Family of Gardening Aids!

- VIGORO
- Instant VIGORO
- End-o-Pest
- End-o-Weed
- End-o-Weed Crab Grass Killer
- End-o-Pest ARC (Anti-Reach-Chigger Killer)

Vigoro comes in 2 forms—regular and new, water-soluble Instant VIGORO

DRAWFILING...

for a smoother surface

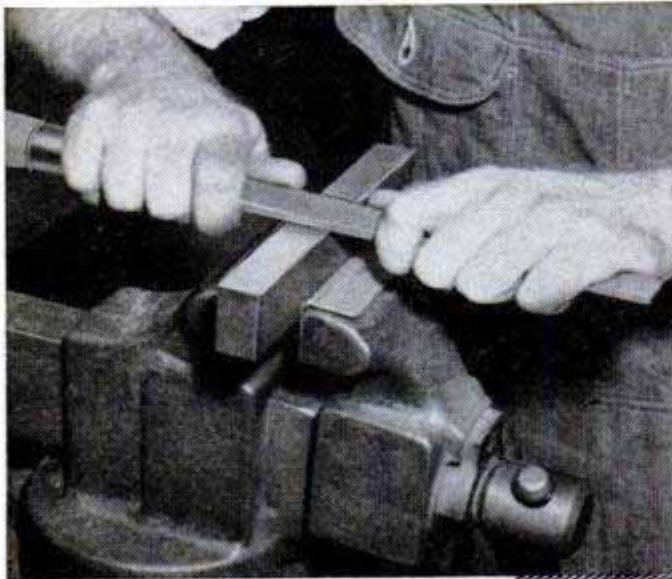

Drawfiling with a Nicholson or Black Diamond file (which is perfectly straight, accurately cut and of highest quality) produces a truly smooth, level surface, considerably finer in finish than does "straight" filing. Clamp the work in a vise, using zinc, copper or other soft metal "protectors" to prevent vise pressure from damaging work. Grasp the file firmly at each end and, without "rocking" it, alternately push and pull it sidewise across the work.

• **THE FILE TO USE:** Ordinarily, a Nicholson or Black Diamond Mill Bastard File (illustrated) is best for drawfiling. But where a greater amount of stock is to be removed—as on the edge of a metal sheet or plate—a Flat or Hand file (double-cut) will work faster. The resulting surface is not as smooth, so it may be necessary to follow up with the single-cut (Mill) file. *Your hardware dealer has both types.*



NICHOLSON FILE CO.

23 Acorn Street
Providence 1, R. I.

(In Canada, Port Hope, Ont.)



NICHOLSON

FILES

FOR EVERY PURPOSE

What Became of the Shelter Belt?

(Continued from page 106)

he's a farmer. The smell of the Russian olives is sweeter than that of clover. Going to plant more trees soon—all along the rest of my farm."

Probably the greatest limiting factor on the planting of windbreaks today is the availability of seedlings. Clarke-McNary Act nurseries throughout the country annually supply millions of seedlings to farmers and ranchers at low cost through the extension services, but more are needed. D. H. Cogdill, an old-time cattleman near Crowheart, Wyo., points out another factor:

"When the early settlers came west," he says, "one of their first moves was to set out trees. Many carried seeds and seedlings in the boxes of their covered wagons. The ranchers who live on their own land are generally still planting trees. But we have a lot of ranches in these parts today which are owned by folk living on the other side of the United States. Of course, there are many outstanding exceptions, but for the most part the remote-control ranchers are interested in profits from the land now—not later. And not trees. Especially if the foreman's main interest is Saturday night in town, a tree just doesn't have a chance."

But the tree-planting future for the West generally looks bright—particularly when viewed through the eyes of the generation coming up. Conservation is being taught extensively in grade and high schools. Essay contests with cash awards are sponsored by SCS districts.

Demand for shelter belts and farmstead windbreaks is greatest today in the Dakotas. North Dakota led last year with 373 miles of shelter belts planted, and 4092 acres of farmstead windbreaks. South Dakota was next with 111 miles of shelter belts, 4067 acres of farmstead windbreaks.

But, for an all-around tree-planting program throughout the years it's hard to beat the State of Nebraska. Comments Earl G. Maxwell, extension forester at the University of Nebraska: "Tree planting for Nebraskans is both a heritage of the past and a mission for the future."

Early settlers planted so many trees to provide shelter from the wind and for fuel that the state became known as the "Tree Planters' State." In 1861 a law was passed providing for a \$50 tax exemption for the planting of a specified number of trees. Later this exemption was increased to \$100.

In 1872 Nebraska started Arbor Day, which was later adopted by all other states and many foreign countries. On that first Arbor Day in Nebraska more than 3,000,000

(Continued to page 240)

The plier design that **OBSOLETE**s all others

THE NEW No. 420

CHAN NEL LOCK

PLIER

TRADE MARK REG.

U. S. PATENT OFFICE

New type wide base lugs provide maximum cross section strength . . . cannot shear.

Precision machined interlocking surfaces provide perfect fit, thus distributing pressure evenly.

Interlocking principle positively prevents slipping under any load . . . the heavier the job the greater the interlocking action.

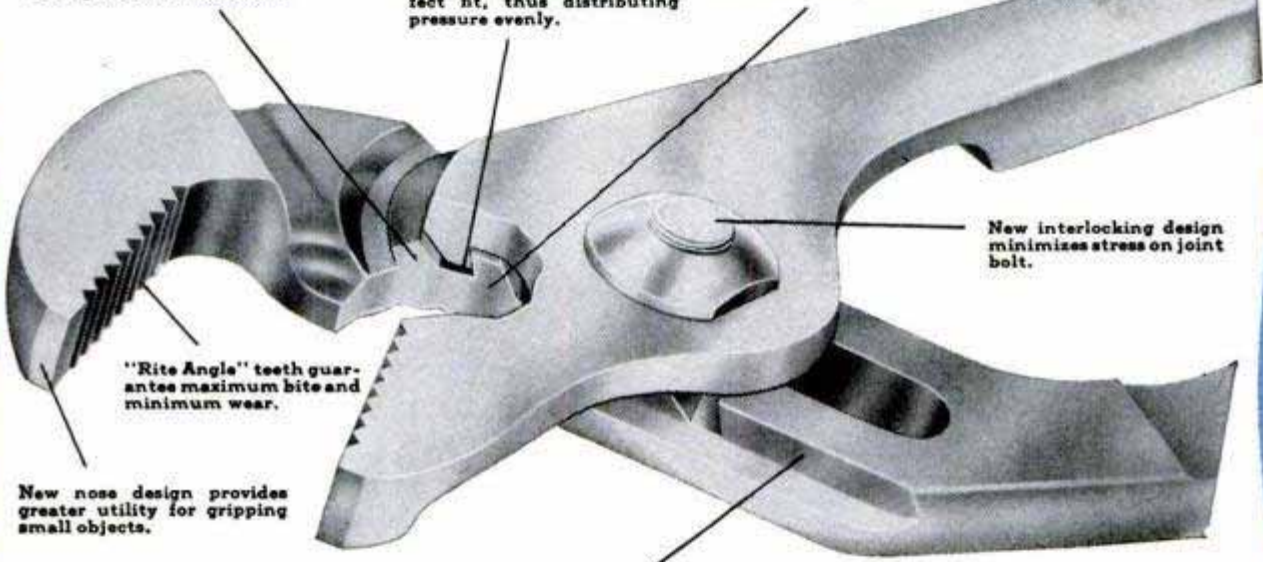

"Rite Angle" teeth guarantee maximum bite and minimum wear.

New nose design provides greater utility for gripping small objects.

New interlocking design minimizes stress on joint bolt.

Patented design of tension edge provides more strength and eliminates stress concentration at channels.

Channellock pliers are listed in the Yellow Pages of most Telephone Directories under "Tools".

Here's the new, improved Channellock Plier—bringing to you new features which offer more positive gripping, greater strength and longer wear. The undercut interlocking channel is the first really new idea in plier design in years. Engineering skill has developed a plier with new patented features which give you the newest, strongest, most practical plier you can buy. Here is a plier that will last for years! Channellock Pliers—made only by Champion DeArment Tool Company, Meadville, Pa.

Send for your Catalog today.



THE PLIER DESIGN THAT OBSOLETE

Only **CHAMPION DeARMENT** makes

CHAN NEL LOCK



CHAMPION DeARMENT TOOL CO.

MEADVILLE, PA.

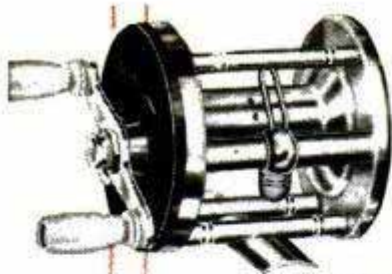

BRONSON

J. A. Coxe Coronet
(No. 25-C) \$33.00
Only casting reel with automatic
free spool—handle disengages
on cast. One-piece machined
aluminum spool revolves on stationary shaft. Wt. 5 oz. Finest
reel money can buy.



BRONSON

Royal-Matic (No. 390) \$10.95
Only free-stripping automatic fly
reel with governor-controlled re-
trieve to help prevent rod tip
breakage. 50% greater capacity.

You'll find a Bronson-made reel just right for you at your nearest sporting goods counter. You'll get lightweight ruggedness . . . precision gears for speed and accuracy . . . advanced design for good looks and long life. Ask for a Bronson or a Bronson-made J. A. Coxe reel—from \$2.95 to \$33.00.

Free Catalog—Write Dept. HF, Bronson Reel Co., Bronson, Mich., (Division of Higbie Co.)



BRONSON

Multi-Royal (No. 380) \$7.95
Only fly reel with 2½-to-1
gear ratio for fast line pick-
up. Adjustable drag. Re-
versible handle for left hand
use. Maroon aluminum for
looks, lightness and life.
Weighs in at 6 ounces.

Free Catalog—Write Dept. PM, Bronson Reel Co., Bronson, Mich. (Division of Higbie Mfg. Co.)

trees were planted in a state-wide program.

The first Soil Conservation District was organized in 1938. Within the next 10 years, 84 districts had been established, comprising 93 percent of the state's land area. Under the SCS program, more than a million trees are now being planted a year.

Since 1941, the State Game, Forestation and Parks commission has planted trees and shrubs on farms in eastern Nebraska in a wildlife-habitat dam project. In one year alone, 428,236 trees and shrubs were planted on 150 farms. From 1934 to 1941, the State Highway Department planted approximately 185,000 trees and shrubs beside main highways. Since 1936, 4-H clubs in the state have planted about 500,000 trees.

But the backbone of Nebraska's tree-planting program has been such men as W. L. Merz, a cattleman in the sand-hills country near Mullan. Merz has five acres of thriving windbreaks surrounding his farmyard and pastures—and every tree came the hard way over a 50-year period.

When Merz first started raising cattle in the area about a half century ago, folk told him trees wouldn't grow there. They were almost right, for most of the first trees he planted never lived the year out. He kept replacing and adding a few more each year.

"Used to be that you could take a rack of hay out in the winter and most of it would blow away before the hunched-up cattle got to it," says Merz. "Now, in the protection of the groves, one man can feed a thousand head of cattle in the winter winds—and be done by noon. Cattle eat in comfort, too."

A major accomplishment of the original Prairie States Forestry Project, which had such rough going in the first years, was the determination of what types of trees were best suited to different types of soil and climatic conditions. Many early settlers just planted cottonwoods—even though they were on the messy side—because they grew wild along creek beds and cuttings were easy to get. Today some 40 different varieties of trees are being utilized in the shelter-belt project.

Some farmers are now tearing out their old cottonwood stands and planting new windbreaks. Others feel the cottonwoods have been so kind to them throughout the years they can't destroy them.

"The wind will have to knock mine down," says Homer Jensen, who raises cattle and cottonwoods on Poverty Flats in Montana. "When my father and his brother came here from Denmark in '92 they were dismayed by the barrenness of the land. They plowed furrows, then went down to Clark's Fork River and got cottonwood branches, dragged them back and laid them

(Continued to page 242)

MAKE ELECTRONICS WORK FOR YOU!

DON'T MISS
THIS
AMAZING OFFER

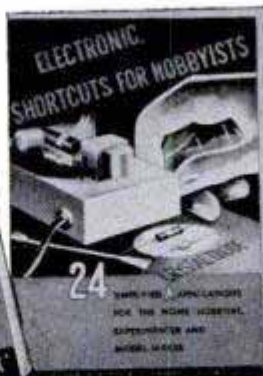

104 fascinating circuits...
Easy-to-follow diagrams and
instructions.

Three books
now only

50¢

Send your half-dollar now to:
Sylvania Electric Products Inc.,
Dept. 3E-3705, 1100 Main Street,
Buffalo, N. Y.



Here's the most comprehensive information ever published concerning the things you can do with crystal diodes. Complete instructions for building electronic door locks, charger for dry batteries, pocket stroboscope, door bell booster, remote control for electric trains . . . and scores of other devices. Don't delay, supply of these books is limited!

RADIO TUBES; TELEVISION PICTURE TUBES; ELECTRONIC PRODUCTS; ELECTRONIC TEST EQUIPMENT; FLUORESCENT TUBES, FIXTURES, SIGN TUBING, WIRING DEVICES; LIGHT BULBS; PHOTOLAMPS; TELEVISION SETS



SYLVANIA

Holds the Screw!
Drives it too!



Unconditionally
Guaranteed

**Quick-Wedge
SCREW-HOLDING
SCREWDRIVER**

Ask for it at your Dealer

Kedman Co., 233 S. 5 W., Salt Lake City, Utah

Aim HIGH-Aim LOW!

You don't need a third hand with a Delta Reddy-lite. Hang it up. Set it down. Aim the 800-ft. beam anywhere! Uses 6-volt battery. See your dealer. Yours, less battery, for **\$3.50** only



Delta ELECTRIC CO.
Marion, Ind.

REDDYlite

360° Swivel
ELECTRIC
LANTERN

MAY 1953

**WHY PAY MORE
for an
ELECTRIC SHAVER?**



WHISK AWAY EVEN A 7 DAY BEARD
WITH THE WHISKER ELECTRIC SHAVER

Precision-built,
with .002"
thin blade that
shaves all
beards
smoothly,
closely.



Whether you shave once a day, or once a week you'll like WhiskER Electric Shaver. Its clipper-like blade is designed for all beards, is definitely less irritating. 110v AC model; no TV or radio interference. See your barber or dealer. If he cannot supply you, send \$15.95—we pay postage; or send \$2, you pay balance plus postage and COD. 10-day money-back guarantee.

GADET ELECTRIC HAIR CLIPPER
Cuts hair, removes superfluous hair from legs and under arms. The same fine quality clipper used and sold in many beauty shops. See your shop, or dealer. If you prefer, send \$10.95—we pay postage; or \$2, you pay post-man balance, postage and C.O.D.



ELECTRO TOOL CORP., Dept. W523-E, Racine, Wis.

241

in the furrows and plowed dirt back over the furrows. You can't imagine the comfort those cottonwoods have given to our family and our cattle."

Tree planting today is more scientific. First the soil is carefully worked. In many areas it is advisable to summer-fallow the land for a year to store up additional moisture before planting. The land must be cultivated until the trees become large enough to shade the ground, and to outgain the weeds and other growth competing for moisture.

Under the SCS program the farmer can rent cheaply from the Service one of several hundred tree-planting machines located strategically throughout the country. This machine not only digs a trench in which the trees are planted but packs the earth around the trees with special wheels as it moves. Two-man crews are supplied with the planter, and the farmer usually furnishes and drives the tractor pulling it.

Typical shelter belts planted today have 10 rows of trees about 10 feet apart. The belts are usually at right angles to the prevailing winds, but some are also made on the contour to fit the field pattern. Low shrubs are planted in the first row on the wind side, followed by a stair-stepping variety of trees. Row number nine is the key one, containing a tall and fast-growing type

of tree to break the wind in the fewest number of years. The tenth row tapers down again with shrubs. Winds blowing across the plains thus get a sort of roller-coaster ride over the farm lands.

If you travel far across the country, you will see thousands of miles of such protective belts. Don't expect, though, to see that continuous cross-country belt proposed in the headlines of 1934. ★ ★ ★

Jet Noise Is Loud Enough to Break Down Tissues of Body

Jet-engine noise of 120 to 140 decibels, loud enough to break down body tissues, is posing a serious problem for the military services. The roar was termed the loudest manmade industrial noise by Lt. Col. James E. Lett of the United States Air Force School of Aviation Medicine. Ninety-five decibels is a safe level and the loudest sound from piston-engine airplanes was 110 decibels from the B36. Ground-crew workers are those most affected, since the flyers sit forward of the noise area. In addition to making those exposed for long periods jittery and tired, high-frequency sound adversely affects lung tissue. The noise from jet planes in flight cannot have a serious physical effect on those on the ground.



"All I got was a letter from my girl,
He got a tube of non-alcoholic
Wildroot Cream-Oil!"

CAN YOUR SCALP PASS THE FINGERNAIL TEST?

Don't give dandruff and dryness a chance to ruin the looks of your hair. Keep it neat and natural all day with Wildroot Cream-Oil. Made with the heart of Lanolin, so much like the natural oil of your skin! 29¢ 60¢ \$1



Get that successful look with America's largest selling Hair Tonic!



Build Your Own Outdoor Furniture!

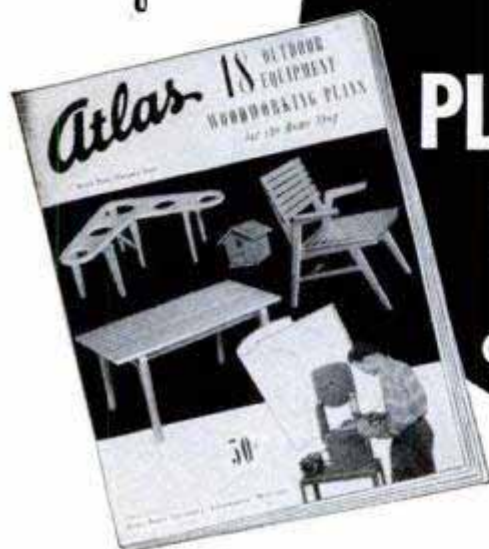

NEW!
Atlas
PLAN BOOK No. 2
NOW READY
ONLY 50¢



Makes An
***Atlas* 8" SAW**
More Valuable Than Ever



Beautify your yard and enjoy it in comfort this summer. Get this all-new, easy-to-build plan book — and an Atlas 8" saw to help you make your furniture quickly, and save hundreds of dollars. The Atlas does so much more than other types of power saws — rips, crosscuts, shapes, bevels, dados, cuts tapers and tenons. It's more efficient and more accurate, too, because of its big grey-iron *ground* table, tilt arbor, exclusive quick-positioning double-locking fence with vernier control, and large sealed ball bearings. See its extra values, and get your plan book, at your Atlas dealers.

RUSH THIS COUPON ➔

ATLAS PRESS COMPANY
 524 N. PITCHER STREET, KALAMAZOO, MICH.

Atlas

DEPENDABLE QUALITY TOOLS SINCE 1911

ATLAS PRESS CO., 524 N. Pitcher St., Kalamazoo, Mich.

- Please send catalog of woodworking tools
 Inclosed is 50c for 18 Plan Book No. 2

Name _____

Address _____

City, State _____

Instant

HEAT

that's "QUICK-ON-THE-TRIGGER"

and "RIGHT-ON-THE-TARGET"

USE THE

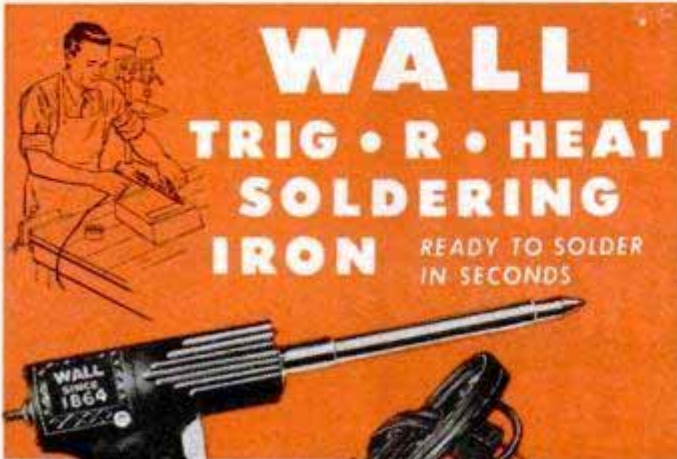

HEAT-CONTROL
Thermostatic Action
guaranteed for the
life of the iron, or
double your money
back!

\$11.95

Heat is QUICK! Just touch the trigger, and in seconds TRIG-R-HEAT is ready to solder. Heat is RIGHT! Exclusive thermostatic action, (without transformers or fragile thermostats) quickly brings TRIG-R-HEAT to "on-the-target" soldering temperature and keeps it there. Iron is never too hot. The result — tips last two to three times as long. Complete with built-in spotlight. Wattage starts at 400, idles at 100. Operates on 115-120 volts, AC or DC. Get Wall TRIG-R-HEAT today!

OVER 20,000,000 SOLDERING
PRODUCTS SINCE 1864



WALL
MANUFACTURING CO.
GROVE CITY • PENNSYLVANIA

Industry's Private Detectives

(Continued from page 123)

husband was picked up with a .38-caliber pistol and ammunition in his possession. A day later another man was arrested with his .41-caliber revolver and ammunition. By shooting both guns into a large block of wood and running spectrographs of the lead from the two pistols in contrast with the lead recovered from the victim's body, it was proved that the .41-caliber gun was the murder weapon.

The laboratories do considerable work for insurance companies. Before they settle doubtful claims, the firms often seek the help of the laboratories to find just what the facts are. When some insured cattle of an Oklahoma farmer died, the farmer suspected paint which was left in open cans by a contractor who had been painting tanks on the premises. The paint was analyzed and found to contain lead compounds which, of course, poisoned the cattle. The responsibility was established.

In another instance, the Oklahoma Testing Laboratories of Oklahoma City showed that someone had poured salt into a car's gasoline tank with the intention of ruining the engine. The interior of the engine was covered with a shiny salt glaze similar to that formed on clay pipe or tile during its manufacture.

There are close to 400 commercial research and testing laboratories in the country. They range in size from some with four employees to a few with staffs of 500 or more. Laboratories will work for anyone, not only industrial firms. If you have a problem which scientific investigation and testing can solve, they'll uncover the facts and evidence. The fees range from \$5 for a routine report on a bottle of liquid to over \$100,000 for extensive testing. ★ ★ ★

Synthetic-Rubber Tires May Outwear the Car

Still in the development stage is a new type of synthetic rubber which engineers predict will make the tire of the future outwear the car itself. Secret work on the material has been underway for several years at the Goodyear Tire and Rubber Company. Tests show that tire treads of this material have from two to five times greater wear resistance than the best cold rubber produced and resistance to oxidation is far superior to any other rubber, natural or synthetic. It is equivalent to butyl rubber in air-diffusion resistance and vulcanization time for tires made of it can be cut more than half.

Best SHAVE News in 50 Years!
"CANNED-LATHER" READY TO USE



Just Push Valve



No Brush Needed



Faster Shaves

- Richer, Creamier Lather
- No Brush Needed
- No Greasy Cream
- 3 Beard Softeners
- Built-in Lano-Lotion Soothes, Smooths Your Skin

JUST PUSH VALVE...
 OUT COMES LATHER



59¢

AERO SHAVE Lather Bomb



MAGNETS 225 lb. PULL
 GENUINE ALNICO—NEVER WEAKENS

AMAZING, PERMANENT MAGNETS—WILL NOT WEAKEN! NON-ELECTRIC
 Retrieve guns, tackle, tools and other steel items from lake, river, plating tanks, drains or other hard-to-reach spots. Recover drills, taps, etc. from sweeping. Clear alley of harmful tacks, nails. Many other uses. Pays for itself quickly. **GUARANTEED.** Try any magnet one week. Money refunded if you are not well pleased.
 No. M-725 (Weighs 54 oz.) Has pull of 225 lbs. on steel block. \$15.00
 No. M-675 (Weighs 49 oz.) Has pull of 175 lbs. on steel block. \$10.50
 No. M-650 (Weighs 41 oz.) Has pull of 150 lbs. on steel block. \$ 8.50
 No. M-500 (Weighs 15 oz.) Has pull of 50 lbs. on steel block. \$ 4.00
 No. M-30 Hobbyist assortment of six small magnets. \$ 1.50
 Send Money Order or Check. We pay postage. No C.O.D.'s.
MIAMI MAGNET COMPANY, 3240 N. W. 27th Ave., Miami 42, Fla.



1/2 SIZE

\$2.50 VALUE 2 LURES \$1.00

GUARANTEED TO CATCH MORE FISH

All Plastic lures 2 1/4" long...5 sure fish getting colors...Frog, Perch, Black with white, White with black or red. Choice of 1/4 oz. Spinning or 1/2 oz. Casting and Trolling Wts. No COD's.

CATCH-EM BAIT CO.

Dept. 55 • Box 273 • Main P. O. ST. LOUIS 3, MISSOURI

Special Offer 5 for \$2.00

5 BIG POWER TOOLS in ONE

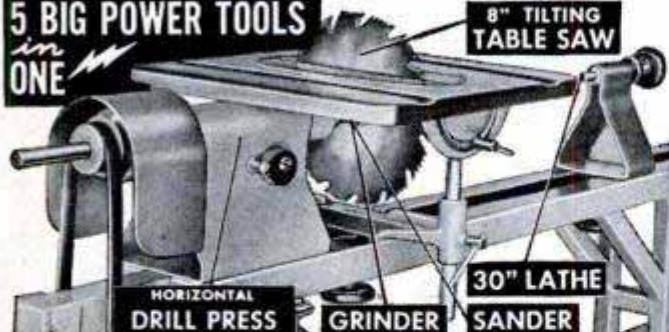

8" TILTING TABLE SAW

HORIZONTAL DRILL PRESS

GRINDER

30" LATHE

SANDER

RETAIL PRICE \$125.00

FACTORY TO YOU \$79.95

SUPERSHOP is a PRECISION-BUILT WORKSHOP. 100% ball bearing. All running parts precision ground. Big capacity. Extra rugged. Amazing value. Write for FREE catalog.

BUY ON EASY PAYMENTS

POWER TOOLS, INC.

147 YATES AVENUE
 BELOIT, WISCONSIN



VERTICAL DRILL PRESS

Do it Yourself and Save!

Assemble Your Own
BILT-WELL
 Nu-Style Wood Cabinets



Your local Lumber Dealer will assist you in the purchase of Bilt-Well Cabinets.



Anyone can assemble Bilt-Well Cabinets as all parts are prefitted. Cabinets fit directly to wall surface.



You can decorate Nu-Style Cabinets any color. Re-decorate them anytime.

Why wait to buy what you can have now by doing the assembling, the installing and the decorating yourself? Bilt-Well Nu-Style Cabinets are completely machined, pre-fitted, and ready to put together. Don't wait until you "save up" for a new kitchen, do it yourself and save. Sold by leading Lumber Dealers.

CARR, ADAMS & COLLIER CO.

Dubuque, Iowa

CARR, ADAMS & COLLIER CO.
 Dept. M/3
 Dubuque, Iowa

Please send me BILT-WELL cabinet booklet. Enclosed 25c to cover cost of mailing.

Name.....
 Address.....
 City.....
 My Lumber Dealer is.....
 State.....
 State.....

Build Well with

BILT-WELL WOOD WORK



Now **3** **Coleman**



"OUTING PALS"
for More Fun
Wherever You Go!
Easy Meals—The Coleman Camp Stove cooks like a city gas range. Instant lighting. Two and three-burner models. Safe; help prevent forest fires. Fold up like a suitcase.

More Fun with the powerful Coleman Lantern. Floodlights 100-ft. area. Lights instantly. 8 to 10 hours lighting service from one filling. Safe; stormproof. Coleman reflector makes powerful spotlight.

NEW Coleman Folding Picnic Table and Carrying Case sets up in a jiffy on strong steel legs. Big 28-in. top. Folds into carrying case (28-in. x 14-in. x 6-in.) with legs and folding stools inside; extra space for other equipment. See these three "Outing Pals" at your dealers.



(Stools Extra)

Mail
Coupon
for Free
Outdoor
Book



MAIL COUPON TO The Coleman Co., Inc.
Dept. 203-PM2 Wichita, Kans.

Please send me my free copy of the new Coleman Outdoor Book.

Name _____

Address _____

City _____ State _____

The Owners Report on the '53 Plymouth

(Continued from page 115)

And now for my own test — The model tested was the Cranbrook four-door sedan, which I drove for 830 miles from Los Angeles over the winding Angeles Crest mountain road and across the Mojave Desert to Lone Pine, Calif., then through Death Valley heat to Las Vegas, Nev., and return to Los Angeles. Included were some tests on roads that were little more than trails.

This new 1953 model with shortened

1953 PLYMOUTH SPECIFICATIONS

ENGINE

Type 6-cyl. in-line L-head
Bore and stroke 3¼ in. x 4¾ in.
Piston displacement 217.8 cu. in.
Brake horsepower 100 @ 3600 r.p.m.
Compression ratio 7.1:1
Transmission 3-speed conventional.
Conventional with over-drive optional. HyDrive Fluid torque converter is optional

GENERAL

Steering ratio (over-all) 21.1:1
Steering wheel, lock to lock 4 turns
Turning radius 19 ft. 6 in.
Brakes Hydraulic with bonded linings
Tire size 6.70 x 15
Recommended tire pressure 24 lb. front and rear
Shipping weight (4-dr. sedan, unladen) 3007 lb. Cranbrook; 2970 lb. Cambridge
Wheelbase 114 in.
Tread, front 55⅞ in.
Tread, rear 58½ in.
Height over-all (4-dr. sedan, unladen) 63⅝ in.
Width over-all (4-dr. sedan, unladen) 73⅜ in.
Length over-all (4-dr. sedan, unladen) 189⅞ in.
Minimum road clearance 8 in.

INTERIOR DIMENSIONS

(4-door sedan models)

Front-seat width 59¾ in.
Rear-seat width 58¾ in.
Headroom, front 36⅝ in.
Headroom, rear 35⅞ in.
Legroom, front 43¼ in.
Legroom, rear 42 in.

CAPACITIES

Oil 5 qt.
Water 13 qt. (14 qt. with heater)
Gasoline 17 gal.

wheelbase (from 118½ inches in 1952 to 114 inches in 1953) is much more maneuverable and easier to park than last year's model. Cranbrook over-all length is 1 inch less than the 1952 model and it weighs 81 pounds less. I detected little difference in the ride of the new, shorter car. The Oriflow shock absorbers do an excellent job in controlling the ride over rough roads and severe bumps. Through improved suspension

(Continued to page 248)

TOPS IN TOOLS

TRUE TEMPER TOMMY AXE

Hundreds of uses! Does the work of a heavy hatchet or light axe. Dynamically balanced power for chopping, driving, nail pulling. Highest grade steel coated with rust-resisting black. 15 3/4" hickory handle, fire hardened to resist weather and wear. At your favorite hometown hardware store. True Temper Corporation, Cleveland 15, Ohio.



For over 100 years makers of fine tools, fishing rods, golf shafts

UNMATCHED SPEED FOR OUTBOARDS



of all makes from 7 1/2 to 50 HP on racing boats and fast runabouts is provided with the famous Michigan AQUA-JET propellers. No rebuilding of lower unit is necessary. Each propeller is specifically engineered for the motor on which it is to be used. Other propellers for superior performance for practically every motor ever built, and a complete line of fine boat fittings are described in our 1953 catalog — the Outboarder's Bible. Its FREE. Write Michigan Wheel Company, Dept. P-45, Grand Rapids, Mich.

BUILD YOUR OWN ARC-WELDER



We show you how to build NEW powerful welder. No rewinding. Uses most any surplus aircraft generator. Easy to build. 75-300 amps. Complete PLANS 25c. Send today and we'll include FREE our Big War Surplus & Electrical Catalog.

LEJAY MFG. CO., 1247 LEJAY BLDG., MINNEAPOLIS 8, MINN. or, LEJAY CO., 928-1st AVE. SO. E 47, SEATTLE 4, WASH.



STOP DRIP

caused from condensation on cold water pipes. Turn idle basement space into play or work rooms. Keep store rooms dry. Just wrap cork-filled



NoDrip pipes and joints. Do it yourself. Clean and easy to apply. Roll covers about 10 feet of 1/2" pipe, \$1.69. Higher west of Rockies and Canada. Get at Hardware, Department Stores.

or sent postpaid. Write for free circular. J. W. Mortell Co., 522 Burch St., Kankakee, Ill.



IF A LAWN IS WORTH CUTTING...



IT'S WORTH TRIMMING WITH Trim Master Jr.
Pat. Pending

Here's the easy way to trim your lawn and keep it the best looking lawn in the neighborhood. Use Trim Master Jr. . . . the new AC-DC electrical appliance that does a neater, faster job than you could ever do by old-fashioned hand-trimming methods. It's bargain-priced and guaranteed. See it today at your nearest garden supply store or hardware dealer.

SAY GOODBYE TO BACK-BREAKING WORK



FINISH THE JOB WITH TRIM MASTER JR.



Write for detailed literature. **E. F. BRITTEN & CO., INC.** 27 South Avenue W., Cranford, New Jersey

there is less roll, but the springing of the front end (as in most modern American cars) is still too soft and flexible to suit me. Even so, it seemed almost impossible to "bottom" the front end regardless of the roughness of the road.

Apparently Plymouth isn't in the horsepower race, although an increase in the compression ratio from 7.0 to 7.1 gives a moderate horsepower rating of 100 at 3600 revolutions per minute. Many makers now are going to the "square" engine (near-equal bore and stroke), but the Plymouth engine definitely is in the long-stroke category (3½-inch bore and 4¾-inch stroke). This long stroke does give Plymouth a favorable tendency to "hang on" with excellent power at low engine speed. This doesn't mean that power at higher engine speeds is not good, for it is. With less weight and slightly higher compression, the 1953 car is snappier than the '52 model.

In my previous Plymouth article (1951) I remarked I would like to see overdrive as optional equipment. I am happy that overdrive equipment now is available and was included on my test car. Rear-axle ratio in the overdrive model is 4.1:1 and with conventional three-speed transmission the ratio is 3.73:1. Other optional ratios are 3.54:1, 3.90:1 and 4.30:1.

The car cruised nicely at 75 to 80 miles per hour and would easily do 85 by speedometer. The top speed was 94-96 speedometer miles per hour on long stretches.

The overdrive definitely has improved Plymouth gas economy which always has been good, as shown in the economy test.

On mountainous roads I found the Plymouth brakes to be up to par. There was little tendency to fade and brake pedal action was easy. When it comes to a comfortable riding position, Plymouth's chair-height seats are excellent. There is ample legroom and 1953 models offer more head and hip room and shoulder space than previous models, despite a slight lowering of the car itself.

Front vision through the curved one-piece windshield and directly in front of the hood is excellent because the hood is short, permitting good visibility only a few feet ahead of the bumper. This is an excellent safety feature and is valuable when parking. The wrap-around one-piece rear window also affords excellent vision. The ventilating system is excellent, but control levers could operate easier. Plymouth retains the cowl ventilator to permit direct entry of fresh air into the interior. I am in favor of this design, because less engine fumes from city traffic and dirt and dust enter through

(Continued to page 250)

CLEAN YOUR CARBURETOR better, quicker, cheaper with GUMOUT

Why pay a lot of money to have your carburetor taken apart and cleaned? Clean it yourself with GUMOUT—right on the engine. Or, your favorite garage or service station can do the job for you with GUMOUT in only 20 minutes.

GUMOUT removes all the dirt, muck, moisture, gum and varnish that clog your carburetor. Your engine will run smoother and more economically.

A single pint of GUMOUT costing only \$1.50 will thoroughly clean any carburetor. The easy-to-use applicator called the GUMOUTER lasts indefinitely and sells for \$4.75. Get GUMOUT and the GUMOUTER from your auto supply store, service station, garage, speed shop, or implement dealer. If not available locally, order direct. And be sure to write for a free copy of our helpful Carburetor Handbook.

GUMOUT DIVISION

Pennsylvania Refining Company
2688 Lisbon Road
Cleveland 4, Ohio
Butler, Penna. Edgewater, N. J.
Refiners of Penn Drake Petroleum
Products since 1878

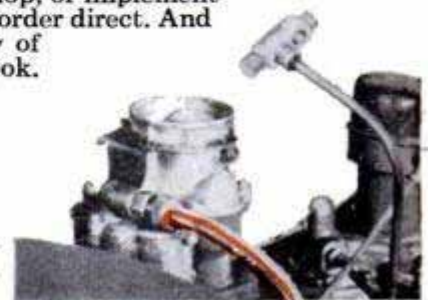

Make it Yourself with Professional Precision!

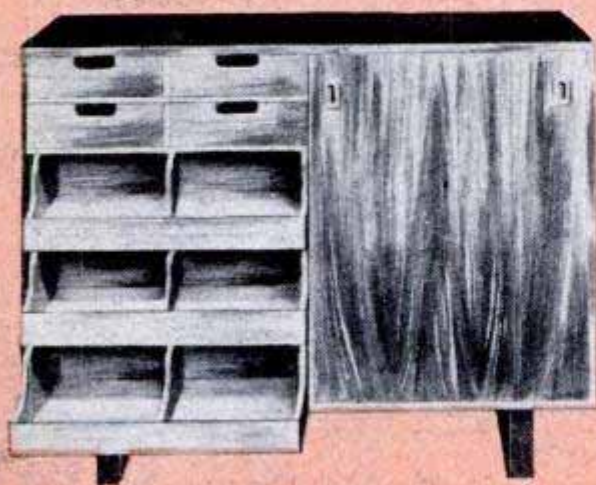

Buy this Gentleman's Wardrobe Cabinet—pay over \$200. Make it yourself with DeWalt® for less than \$45!

DeWalt "Power Shop" makes it easy to make fine furniture yourself. And the home improvements you can make can save you hundreds of dollars.

The DeWalt "Power Shop" is the new, completely modern home workshop version of the same precision machine that's been the leader among professional builders and cabinet makers for over 25 years!

FAST—Adjusts in seconds to make any desired cut! Material *always* remains flat on table.

VERSATILE—Cross-cuts, rips, miters.

ACCURATE—To professional tolerances!

SAFE—Thanks to DeWalt Safety Guard!

COMPACT—Fits in 3 ft. by 3 ft.

Now being demonstrated and sold at the nation's leading department stores, hardware stores and mill supply houses.



DE WALT
"Power Shop"

PRICE \$229.00 (Custom-built motor included)

Makes all these cuts quickly...easily...expertly



IT'S A SAW
Cross-cuts, miters and rips.



IT'S A DADO
Measure-marks always visible.



IT'S A SHAPER
Straight, irregular or bevel shaping.



IT'S A LATHE
Makes wood turnings up to 34" long.



IT'S A JIG SAW
Cuts out any shape—quickly, easily.



IT'S A DISC SANDER
For vertical and horizontal sanding.

and it drills, grinds, routs, joints... does everything in woodworking!

Send coupon for "Make it Yourself" booklets!

28 fascinating pages cram-filled with facts on 20 separate pieces of furniture! How they fit into your home... cost at retail... cost to make yourself... "do's and don'ts" of finishing. See how easy the amazing DeWalt "Power Shop" makes expert woodworking!



(Modern and Outdoor Furniture)

Send 25¢ — Save Hundreds of Dollars!
DeWalt Inc., Dept. PM-5, Lancaster, Pa.

Please send "Make It Yourself" booklet(s) checked below. Enclosed find _____¢ in coin @ 25¢ for each booklet checked.

- Early American and Juvenile furniture. [25¢]
 Modern and Outdoor furniture (25¢)

Name _____

Address _____

City _____ Zone _____ State _____

Pointers for Home Painters



Choose the right brush for the job!

A 4" flat brush is an easy-to-work-with size for painting walls, floors, ceilings and other large, flat areas. And you'll find a brush with Du Pont nylon bristles picks up more paint per brushful . . . flows it on faster and easier.

Paint floors in areas about four feet square. Start in far corner and work toward door. For best results use wide, flat, nylon-bristled brush — one designed for the job.



With the tip of brush, work paint up to ceiling moldings and down to baseboards. Cover space two feet wide. Paint last strokes into area just painted to avoid overlap.



When painting ceilings, dip brush to one inch only. Raise quickly and use short, light strokes. Paint areas about four feet square. Don't poke or jab a large brush into corners.



For storage, clean brush with thinner, then scrub bristles on a board with warm water and cleanser. Rinse and comb bristles. Wrap in heavy paper to store.

For best results use NYLON PAINT BRUSHES

JOB AFTER JOB, you'll get best results with a well-tipped nylon paint brush. Durable Du Pont nylon bristles paint smoother . . . are clean and sanitary . . . never get brittle . . . don't break off even under the roughest treatment. And nylon bristles last from 3 to 5 times longer than ordinary bristles. Leading manufacturers make nylon paint brushes in all types and sizes. Look for the name NYLON on the handle. Be sure to pick the size brush designed for the job.



Better Things for Better Living
...through Chemistry

The best brushes have
**DU PONT NYLON
BRISTLES**

a cowl ventilator than through the low front ducts beside the engine as on many makes.

While no modern car has completely eliminated sun glare on top of the instrument panel, Plymouth has reduced it to a minimum by avoiding a lot of reflecting chrome. The seat cushions are soft and comfortable. The back cushion is quite hard and there were some spring squeaks. The upholstery is not in keeping with Plymouth standards. One feature I like is the small number of turns required to open and close the windows. Styling engineers, however, pulled a boner by running a metal strip alongside the front-window crank handle. It is so close that the crank lever sometimes hits the strip and it's easy to pinch a finger between the crank and metal strip.

The doors are easy to operate. Plymouth eliminated the twist-type door handle (which I like) in favor of the pull type. The upper half of the horn ring should be removed, as it somewhat obstructs speedometer and instrument vision. The electrically operated two-speed windshield wipers are effective, though noisy.

The Plymouth engine is mounted in rubber. Plymouth pioneered the "Floating Power" principle in 1932. The engine is balanced on its center of gravity and rests on live-rubber cushions, which undoubtedly serve to cut vibration and prolong the life of chassis and body. A new six-bladed fan with a surrounding metal shroud around it is mounted quite high and the radiator is unusually close to the engine. This provides better engine cooling, though Plymouth never has been noted for overheating.

The body is well built and very solid, as no squeaks, rattles or dust or water leaks developed during the entire test. Plymouth has dropped the separate rear-fender panels; they are now integral with the body rear-quarter panels. Trunk space is larger. The gas filler pipe is now on the left corner of the rear body sill instead of on the side. This location certainly is more convenient, but I, like many owners discovered that with a nearly full tank, gas leaks out when cornering to the right or climbing steep hills. A sharper incline on the filler pipe would eliminate this complaint.

Plymouth has a long-standing reputation of building dependable and economical automobiles. If there is any doubt as to this statement, ask any taxi driver. More Plymouth cars are in taxi service in this country than any other make of car and a large percentage of taxi drivers are enthusiastic Plymouth boosters. When riding in a taxi cab I always ask the driver what make of car he likes best. Usually the answer is "Plymouth," which is a real tribute, as probably no service is tougher. ★ ★ ★

CRAFTSMAN Arc-Joint
REG. U.S. PAT. OFF.
Mechanics' Plier . . .



**GRIPS LIKE
 FIVE BULLDOGS**

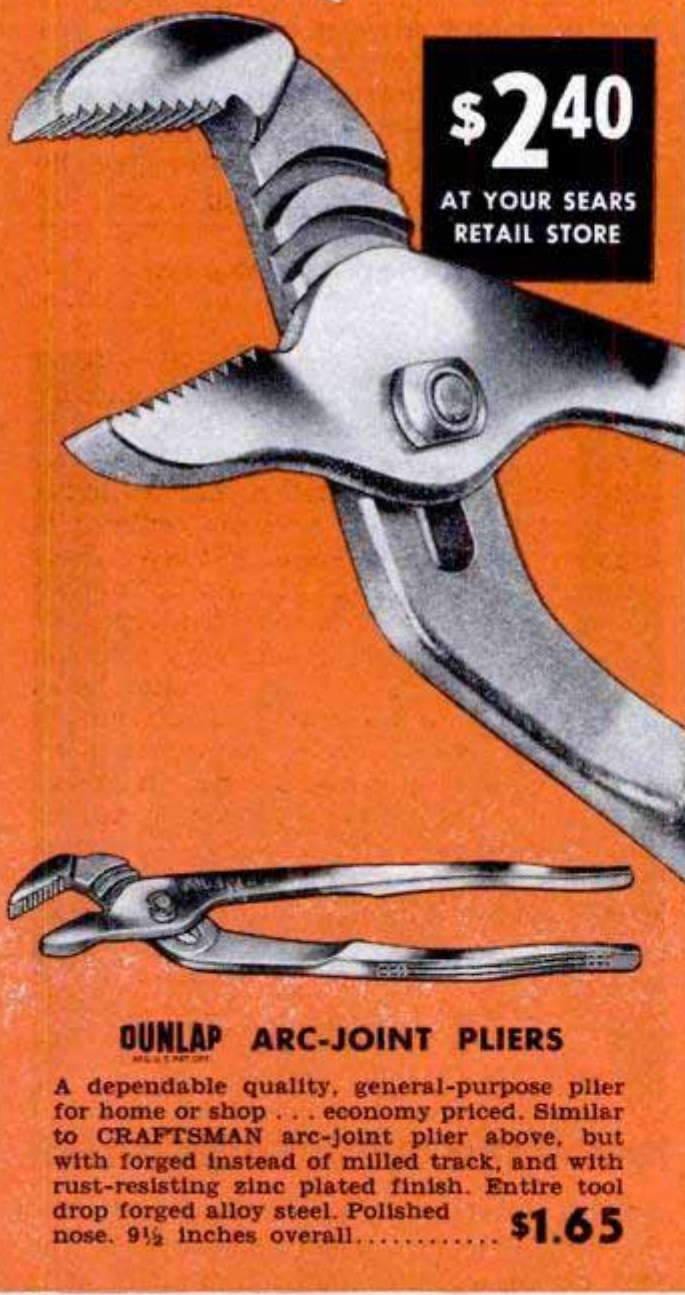

\$2.40

AT YOUR SEARS
 RETAIL STORE



**FIVE Positive Adjustments . . .
 won't slip under any load**

New improved design! FIVE different positions that positively will not slip under any load. Precision milled channels guide a raised arc on the lower arm into position, and the heavier the load the tighter it holds. Close-fitting arc joint carries load evenly . . . practically eliminates strain on plier bolt . . . defies breakage.

Both arms forged from "Super-Tuff" steel, with arc and channels milled for close fit. Milled jaw teeth assure positive grip and minimum wear. Knurled handles fit your hand comfortably. Chrome plated to resist rust. 9½ inches overall.

Will outlast several ordinary pliers. It's a must for almost any kind of repair and maintenance work . . . for professional and home users. Buy it at your Sears Retail Store.



DUNLAP ARC-JOINT PLIERS

A dependable quality, general-purpose plier for home or shop . . . economy priced. Similar to CRAFTSMAN arc-joint plier above, but with forged instead of milled track, and with rust-resisting zinc plated finish. Entire tool drop forged alloy steel. Polished nose. 9½ inches overall. **\$1.65**

CRAFTSMAN and **DUNLAP** Tools by **SEARS, ROEBUCK and CO.**
REG. U.S. PAT. OFF.
Famous for fine quality . . . precision performance . . . low price!

LUMITE*

WINDOW
Screening
Won't Rust,
Corrode or Stain



Costs **ONLY** 12¢-13¢ per sq. ft.
(Slightly higher west of the Rockies)

WRITE FOR FREE sample and descriptive folder
... or visit your hardware or
building supply store today.

REPLACEMENT OR A RETURN OF MONEY
Guaranteed by
Good Housekeeping
IF NOT AS ADVERTISED THEREIN

LUMITE*

SARAN SCREENING

*Registered Trade-mark

LUMITE
DIVISION

Chicopee Mills, Inc., Dept. PM-32
47 Worth Street, N. Y. 13, N. Y.

salt-water fish on 11-pound test line." Ross D. Siragusa, whose art and skill at big-game fishing for tuna won him the distinction of top honors in the Cat Cay Tuna Tournament and whose real hobby is taking bonefish on spin-fishing tackle in Bimini Bay waters, says, "Using six-pound test monofilament and a four-ounce split bamboo spinning rod makes bonefishing look easy." And M. Ray Applegate of Muncie, Ind., who spins for bonefish at Bimini, Walker Cay, Florida Keys and in Hawaii, says, "Sixteen bonefish in one day is easy with a spin-fishing outfit, but would be difficult with any other tackle. It's lucky for fishing that spin fishermen return their fish to the waters."

Spinning can't guarantee that you'll take more fish or bigger ones; fortunately the lure of fishing always has been the fact that the angler is pitting his wits and ability against an untamed opponent. But spinning will guarantee one thing—you'll have a lot more fun playing this age-old game of fishing. ★★★

Monstrous Molar Made of Plastic

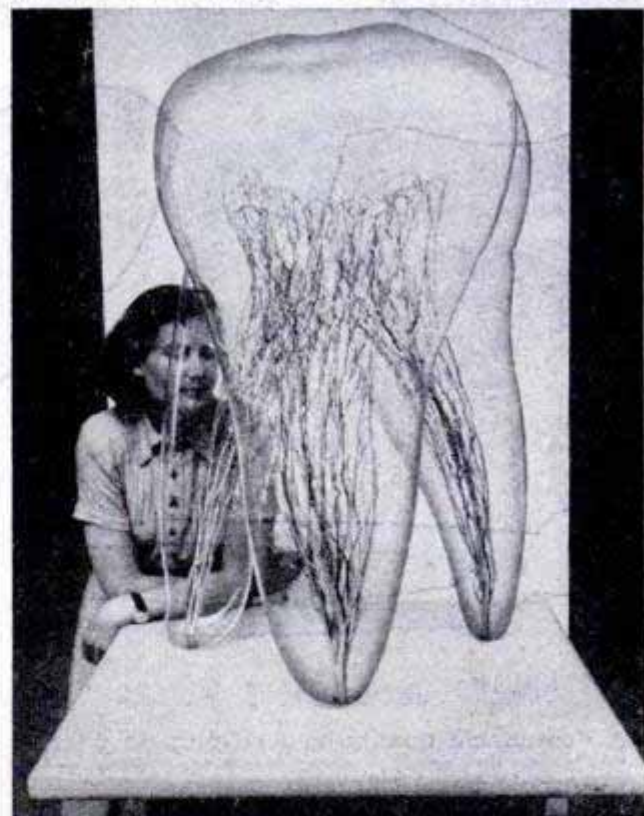

Made of clear plastic, a huge model of the human molar clearly shows the veins and nerves of the tooth. Exhibited at a health show in Berlin, it was carefully molded to the exact proportions of the real article. Even the convolutions of the rugged grinding surface were painstakingly duplicated.

Prize Catch!



...it's **LIGHTWIN... by EVINRUDE**
3 h.p.*—only 32 lbs.—only \$145†

PRIZE CATCH is right—here's the handiest, lightest, *full-powered* motor that ever streaked the miles past the stern of a boat! Packed in its 32 trim pounds is a brimming measure of Evinrude features, Evinrude *performance*. Not a "single," but a beautifully balanced twin—smooth, fast-starting, quiet—*the quietest of outboard motors*. And Lightwin gives you the most important of light motor advancements—Evinrude's famed Fisherman Drive! With it you can power through thick weeds and reeds—over rocks, deadheads, shallows... go "wherever there's water to float your boat!" SEE YOUR EVINRUDE DEALER! Look for his name under "Outboard Motors" in the yellow pages of your phone book. *Catalog free!* Write today for full-color catalog of the complete Evinrude line. EVINRUDE MOTORS, 4185 N. 27th Street, Milwaukee 16, Wisconsin.

In Canada: Manufactured by Evinrude Motors, Peterborough, Ontario



*3 O.B.C. certified
brake H.P. at
4000 R.P.M. †Price
F.O.B. Factory,
subject to change
without notice.

EVINRUDE

quiet OUTBOARD MOTORS

Speed Up Home Repairs

with fast, easy-handling
B&D UTILITY TOOLS



Speed Up Drilling with a B&D
UTILITY 1/4" DRILL (only \$22.95)
Drives holes to 1/4" in steel, 1/2" in hardwood. Also drives accessories for sanding, polishing, grinding, sharpening, etc. Geared chuck model available, \$24.95.



Speed Up Finishing with a B&D
UTILITY No. 44 SANDER (only \$46.95)
Gives satin-like finish to furniture, woodwork, wallboard joints, pleasure boats, workshop projects... 10 times faster than hand sanding! Light, easy to use, priced below tools of comparable quality!



Speed Up 1001 Jobs with a B&D
UTILITY 5" SANDER-POLISHER (only \$32.95)
A home workshop in itself! Drills, polishes, sands, grinds, sharpens, cleans, buffs, burnishes, etc. Comes complete with 1/4" hex-key chuck, lambswool bonnet, sanding discs, backing pad and can of wax.



Bob Davis says:

"When you're buying a tool for home repairs or the basement workshop, pick the brand the experts choose... BLACK & DECKER! You'll get real tools, not mere toys. You'll find they quickly pay for themselves in money saved by doing the work yourself. They'll give you lots of pleasure, year after year!"

Black & Decker



PORTABLE
ELECTRIC
TOOLS



WRITE TODAY for free book giving you helpful, money-saving hints on home jobs. Address: Home Service Dept. H5M, The Black & Decker Mfg. Co., Towson 4, Maryland.

The 500 as the Experts See It

(Continued from page 99)

If you start for Florida with seven persons and a load of baggage, you can easily and quickly get a different rate.

Q: It wouldn't add as much as some of the items being added today, would it?

VANRANST: No, but it is something that you can't see. The average buyer isn't able to evaluate it. He wouldn't know the difference. He wouldn't know whether he was on torsion bar and if it added to the cost it wouldn't appeal to him.

MILTON: I think it is probably somewhat doubtful how much better it is than the helical springs and independent suspension we now have on the family car, that is.

VANRANST: I doubt if anyone could tell the difference in ride between coil springs and torsion bar simply by riding in the car.

MILTON: However, in a racing car, they do more tricks with the torsion bar than a monkey on a vine. I am told that one reason the cars handle so well at Indianapolis, as compared with cars of my time, is this torsion-bar system. They adjust them in such a way that the cars stick to the track like glue.

Q: What would be an ideal car weight?

VANRANST: I would say the lowest you can get is probably the optimum.

Q: Wouldn't that tend to create a handling problem?

VANRANST: The big problem is traction. When you reduce weight and keep the same horsepower, your traction is less. If you keep cutting weight you will have to go to four-wheel drive.

MILTON: Here's what we think a car ought to be: Four-wheel drive with manual control to release the rear wheels so that going through the corner you would be using front-wheel drive only. Then when you hit the straightaway and are tromping on it, you have four-wheel drive again. There would have to be a quick manual release.

Q: What, in your judgment, makes a good race driver?

MILTON: The answer I shall give is anything but complimentary to drivers, but it is essentially true. In the first place, you are a guy with a colossal ego. You have read the papers and you know that Joe Doakes and Charlie Potatoes were killed, but you say to yourself, well, they were stupid or they wouldn't have been killed. I would like to get hold of one of those cars and show the boys how to do it.

So you start on that basis. Maybe it is a year or two before you start winning, but you laugh that off some way or other. Then

(Continued to page 256)

MARVEL keeps

NEW CARS NEW LONGER...

USED CARS IN USE LONGER...



Drivers in the know . . . know Marvel is the finest lubricant you can put into your crankcase and gas tank.

And that goes for both new cars and used cars. Age doesn't matter. What does matter is the way Marvel registers — in the lower service charges you shell out at inspection intervals.

Try a can of Marvel in your engine today. See if your car doesn't run better, longer . . . right from the start!

**MARVEL MYSTERY OIL—
THE MECHANIC'S CHOICE
FOR THIRTY YEARS**

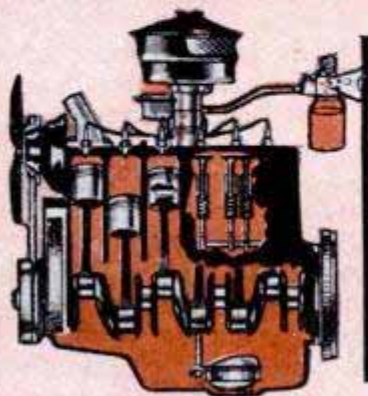

Marvel in the crankcase lays a strong, heat-resistant film of oil on all moving parts . . . eliminates hydraulic valve clatter . . . provides ring seal . . . cleans, cools and protects bearings and vital upper cylinder regions. The car runs for many more engine miles per dollar.

Install a Marvel Inverse Oiler for direct lubrication to the heart of the engine. Feeds in direct proportion to horsepower curve through inverse ratio to manifold vacuum. No other oiler works on this principle! Fully adjustable. Easy to install. Fully guaranteed.

For more information, write:
EMEROL MANUFACTURING CO., INC.
Dept. 117, 242 W. 69th St., New York 23, N. Y.



Buy *this*
PENTA
Wood Preservative



Life Insurance for Wood

DO IT YOURSELF—Brush, spray or dip-on Seal-Treat before painting wood. Clear, non-staining, water-repellent. Acts like a prime-coat . . . just paint over it. For wood *not* to be painted use general-purpose Deep-Treat.

Ready-to-use in handy 1 and 5 gallon cans, or 55 gallon drums. At your Lumber, Hardware or Paint Dealer.

Send for **FREE BOOK**

CHAPMAN CHEMICAL COMPANY
 DERMON BUILDING
 MEMPHIS, TENNESSEE



Name _____

Address _____

City _____ Zone _____ State _____

you win a race. All your faith is confirmed. You are the best and from there on out nobody else is going to win.

Then Joe Blow comes along and beats you. Well, that was just an accident. But then he beats you again and perhaps a third time. So you cut him in—he's not as good as you are, but he's a good driver, too. Then some other drivers beat you and you cut them in. You are still the best, but you have had to cut in two or three guys with you. Then those drivers start getting bumped off. It now begins to penetrate your brains that the thing is hazardous and when that happens, you are all washed up as a race driver. And that is why I say that the popular conception of guts is strictly malarkey. I drove for 16 years and in only one race was I called upon to, and did, exhibit just a bit of that "steel nerve" you read about. Once it penetrates your consciousness that it is dangerous, and that you are apt to get torn to bits, you are all through as a race driver. That is my opinion.

Q: What are the important decisions a driver makes in the first few miles?

MILTON: He must give great attention to staying out of traffic, as much as possible. My heart goes right up in my mouth watching the first few laps of the 500. It isn't so bad when you're in it, but just stand on the side and watch those 33 cars bust into that first turn! There is a terrific cloud of dust and a lot of vacuum which is progressively higher toward the rear of the pack. First-year drivers, especially, are shocked when they discover that closing the throttle is not accompanied by normal deceleration. It's a terrific sensation—a situation that requires good headwork. I would say a primary rule is to stay out of traffic as much as possible because that is where the hazards are greatest.

Q: Are drivers any better today than when you were one?

MILTON: I don't know of any reason why drivers shouldn't be better today. The species seems to improve in all lines of endeavor.

Q. How is the best way to drive a racing car at Indianapolis?

MILTON: There is at Indianapolis, or any track, what is called the groove. That is simply that part of the track which is best to take to get around the quickest and safest. At Indianapolis, if you were qualifying and no traffic were involved, you would be as close to the outside fence as you consider comfortable. I always liked to be very close—a couple of feet away. Then as you reach the end of the straightaway at a predetermined point you get off the throttle and you kind of kick the tail end up a little, just cut

(Continued to page 258)

THIS PENTA TREATED BOAT WILL LAST YEARS LONGER

Famous DOW wood preservative guards
against rot, decay and termites

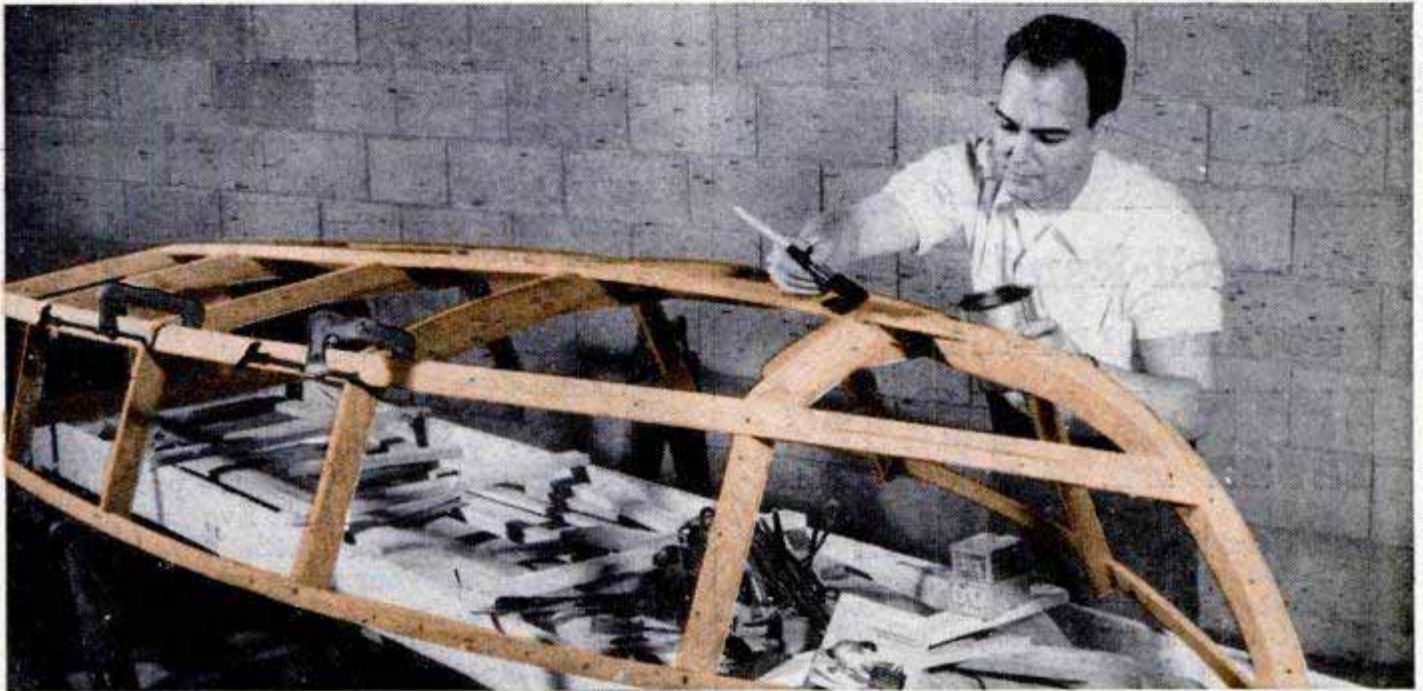

SEND FOR THIS FREE BOOKLET

The Dow Chemical Company
Dept. PE 3-6B
Midland, Michigan

Please send me without cost:

___ "Handyman's Guide to Home Wood Preservation."

___ Location of my nearest PENTA dealer.

Name _____

Address _____

City _____ State _____



Here is a simple, easy way to protect wood against the damaging effects of rot, decay and termites—*treat it with a clean PENTA* solution*, and make sure that it will last years longer.

Now, you can treat wood yourself with water-repellent PENTA solutions to prevent decay, improve dimensional stability, reduce checking and cracking caused by rain, moisture, sun and changing weather.

Learn how you can protect your investment in wood. Write today for a free copy of Dow's new booklet, *Handyman's Guide to Home Wood Preservation*. It tells how to apply PENTA solutions to storm windows and screens, porches, fence posts, picnic tables and many other house and yard items.

Your lumber dealer or paint store stocks brand name wood preservatives in both paintable and unpaintable grades. Look for the name *PENTACHLOROPHENOL on the label. THE DOW CHEMICAL COMPANY, Midland, Michigan.

you can depend on DOW CHEMICALS

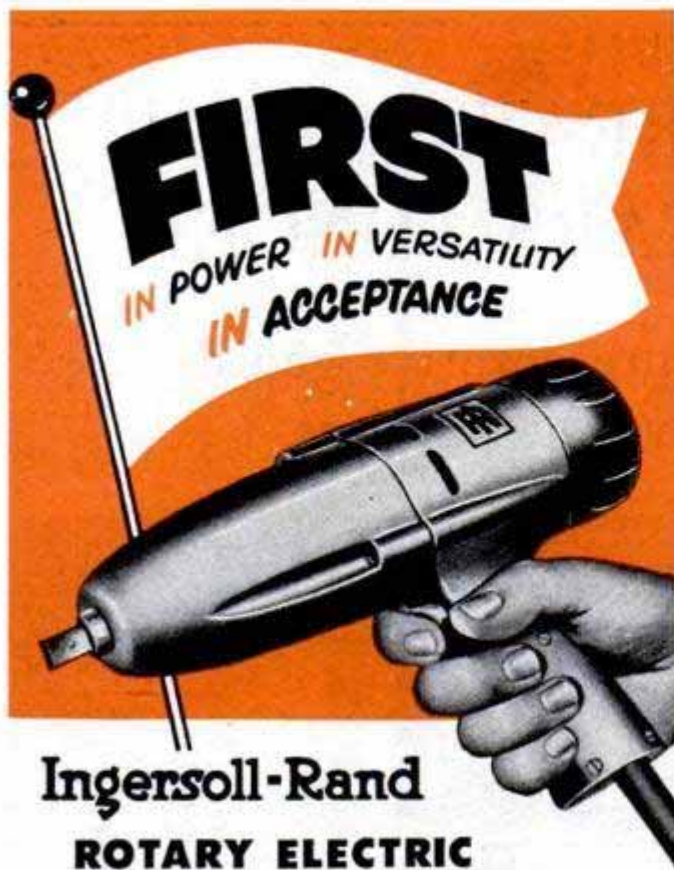

Ingersoll-Rand

ROTARY ELECTRIC

IMPACTOOL

Ingersoll-Rand IMPACTTOOLS stand alone . . . in power delivered without kick or twist . . . in acceptance, through more use by mechanics every day than any other power tool . . . in versatility that enables you to do all these things better, faster.

LOOK! **RUNS AND REMOVES NUTS**

—even frozen nuts no wrench could budge—in one-tenth the time! Also Drills • Reams • Taps • Drives Screws • Drives and Removes Studs • Wire Brushes • Saws Holes • Drills Masonry • Drives Wood Augers.

Standard Attachments handle all operations. 1900 rotary impacts per minute—forward or reverse—do all the work. Motor never stalls . . . can't burn out.



3 SIZES fit every need . . . 4U, 8U and 34U (extra heavy duty). Size 4U Impactool only \$120.00, also available in metal kit with multi-purpose attachments. Sold by all leading automotive jobbers and industrial distributors. Ask for a demonstration or write for catalog.

RR-10

RR Ingersoll-Rand
Dept. M-5, 11 Broadway, New York 4, N.Y.

ORIGINATORS OF IMPACTTOOLS—AIR AND ELECTRIC

your front wheels and set yourself for the corner a bit. You get it headed in there and start feathering the throttle and you come down low. Your front wheels are a little to the right to offset your skid and you kind of float and drift. About the middle of the turn you get progressively on the throttle and you drift out. By the end of the corner you are on it (wide open) and you come off the corner good and fast. Making high speed on a track is not all a matter of how fast you are willing to go into the corner. That is a mistake many drivers make. The trick is to get into the corner at such a speed that you can come off the turn fast. When you go in too fast, you flounder around in there and lose your speed and just creep out of it.

Q: Are there factors that make Indianapolis driving different from any other style of driving?

MILTON: The track is unlike any other track so there is a difference. Indianapolis has four curves and four straightaways—two long straightaways and two short ones. The bank is not steep so it is more like dirt-track racing than any other.

Q: What does a driver think about as he rolls around those 500 miles?

MILTON: You know pretty well who your competitors are. You have probably narrowed it down to about five cars that you are to be concerned with. You watch them, making up your mind whether they are running too fast or, if you are leading, whether you are. There is always lap money—\$100 a lap—which you want to get and just how fast dare you go to get it in relation to your over-all chances for the race itself. You keep watching your tires and listening to your engine and keep hoping you're lucky. Unequivocally, the element of luck is enormous. Your safety factor is a minus quantity when you start. There is no reason to expect the machine to stand up to the punishment you are going to subject it to. If you pull it through, then you just have to say you are a lucky guy.

Q: Does it seem like a never-ending grind?

MILTON: When you are running up in front, 500 miles is not a long race. If you are up in the contention and have a chance to win, it goes by mighty fast. But suppose early in the race you had trouble with your car and from then on it was a matter of running for what the boys call ham-and-egg money—then the "ting" is interminable and it is just all you can do to keep going.

Q: What is the greatest single improvement in racing cars since you raced?

MILTON: I would say the suspension system and everything else that goes to make up good handling. ★ ★ ★

HYDRAULIC SPEED REDUCER

(ITEM #115) WITH FINGERTIP CONTROL

USE FOR: Reamer Drives • Midget Cars • Feed Mills • Canning Machines • Conveyors • Lathes • Milling Machines • Motor Boats • Cream Separators • Garden Tractors • Pumps



Variable output speeds from 0 to input speed available by moving control handle. Locking handle maintains setting. Use input power of 1/4 to 1 1/2 H.P. This Westinghouse-Oil Gear Unit consists of a variable displacement hydraulic pump feeding a fixed displacement hydraulic motor. Adjustable relief valves set at factory for 100 inch pounds of torque may be reset up to 180 inch pounds. Independent reverse control allows full output power and speed selection in either direction of rotation. Shafts measure 3/8" diam., include keyway. Input rotation is counter-clockwise facing shaft. Recommended input speed not to exceed 750 R.P.M. Overall dimensions, 7 1/2" x 7 1/2" x 1 1/2". Gov't acquisition cost, \$428.00. Ship. wt. 31 lbs. Complete with 2 gals. of oil and full instructions. F.O.B. Chicago.

54.50

SHOP by MAIL
and **SAVE**
at **GROBAN'S**



TINY TIM BATTERY CHARGER

Item #301 Model 125 to charge 6 and 12 volt batteries — 12 volts — 300 Watts; Heavy Duty Generator; Push button self-starter; Sturdy single cylinder air cooled Continental 1.3 H.P. engine; 2 qt. gasoline tank in base; Ammeter; Generator cut-out; Concealed coil, etc.; Speed and charging rate control; Attractive orange finish; Weight 93 lbs.; Length 15 1/2", width 11 3/4", Height 14 3/4". F.O.B. Chicago.

89.00

CENTRIFUGAL PUMP

General Motors — Allison
200 GALLONS PER MINUTE

For Draining Basements
Fire Fighting • Irrigation
Fuel Transfer
Swimming Pools
Home Water Systems
Dewatering



Converted for high volume commercial, home, and industrial use. Standard 2 1/2" pipe thread inlet, twin 1 1/4" pipe thread outlets. Ball bearing supported 3/4" shaft. Easy priming. Rotation, counter-clockwise facing shaft. Gov't. acq. cost \$145.00. Complete with full instructions. Ship. wt. 35 lbs. F.O.B. Chicago.

39.50

Suction Lift	Head Pressure	Gal. Per Min.	H.P.	R.P.M.
10'	75'	260	6.0	3500
10'	65'	200	5.2	3500
10'	80'	40	1.5	2500
10'	50'	140	5.0	3500
10'	30'	100	3.0	2500

FREE 1953 CATALOG 48 pages, chock-full of unsurpassed War Surplus Equipment Bargains for farm, home, factory and workshop. Every item is unconditionally guaranteed. You save on everything! Write today.



LUGAN 4-Way, Foot Operated AIR VALVE. Item #59, Model 6520—Ideal for operating air vices, presses, air machinery, and other double acting pneumatic devices. Heavy cast construction. Standard 1/2" pipe thread ports. Overall dimensions 8 1/2" x 5 3/4" x 7 1/2". Gov't. Acquisition cost \$42.00. Shipping weight 28 lbs. An outstanding

15.00

Item #126 — Four-way, open center control valve with built in adjustable relief valve. Factory set at 1000 P.S.I., spring loaded neutral position, for use with one double acting cylinder. In neutral position cylinder is locked and pump unloaded. Fully balanced plunger type, smooth, positive, easy operation. Can be used as single unit or mounted in series of any combinations desired. Has 3/4" pipe thread inlet and outlet, 1/2" pipe thread cylinder ports. Newly manufactured to our specifications. Shipping weight 8 1/4 lbs. An outstanding buy! F.O.B. Chicago.

21.50

HEAVY DUTY HYDRAULIC and AIR EQUIPMENT

Large supply of new labor-saving, economical hydraulic equipment in many types and sizes. Use these positive, highly efficient smooth pressure hydraulics on presses, arbors, lifts, loaders, power control, positioning, brakes, plastic dies, auto frame alignment, etc.

ALL ITEMS UNCONDITIONALLY GUARANTEED



ITEM #1036

Item #1036—Double acting hydraulic cylinder, 3" bore, 36" stroke, 1/2" pipe thread ports, 1 1/4" solid steel shaft. Overall length closed 49", clevis mounting at base and shaft. FEATURES: • Cup & Chevron Packing • All Welded Construction • Precision Ground and Honed Construction • Will lift 7000 lbs. using 1000 P.S.I. line pressure. Weight (net) 57 1/2 lbs. F.O.B. Chicago.

50.00

Item #150—Double acting hydraulic cylinder, 2 3/8" bore, 12" stroke. Use either foot or clevis mounting. Will lift 4400 lbs. using 1000 P.S.I. Overall length 19 1/2". Shipping weight 8 lbs. Postpaid.

18.00

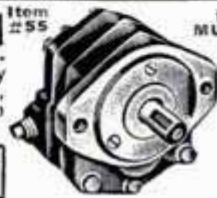

BRAND-NEW MULTI PURPOSE Hydraulic Pump or Motor

Silent, High Efficiency, Helical Gear Type Ball Bearing, Hydraulic Pump or Motor.

Rated 8 Gal. Per Min. At 1500 R.P.M.—Delivers — 1000 P.S.I. Using 6 H.P. — Reversible Rotation—3/4" Pipe Thread Inlet and Outlet Ports—1/4" Drain Port—3/4" shaft with keyway and flat for either direct or pulley drive. Dimensions—5 3/8" high, 7 1/4" long, 5 1/8" wide. Shipping weight 18 lbs. F.O.B. Chicago.

45.50

Item #42—Double action hydraulic cylinder, 4" bore, 18" stroke. Rated lift capacity with 1000 PSI line pressure is 12,500 lbs. Ship. wt. 30 lbs. F.O.B. Chicago. An Excellent Buy for.

32.50

Item #16C—Double acting hydraulic cylinder, 1 1/2" bore, 26" stroke. Will lift 1700 lbs. with 1000 PSI line pressure. Weight 8 lbs. A \$55.00 value. Now only.

16.95

GENERATORS Many Sizes From 350 Watts to 25 KVA



Item #183 — 3000 to 4000 WATT GENERATOR SET — FEATURES — Power for your home or business. Simply connect to power panel or house circuit. • Constant voltage regardless of load. • Push button start or stop. • Easily made full automatic start or stop. SPECIFICATIONS — Sizes 19" x 30" x 48". Steel skids, weatherproof housing, requires no building. Wt. 725 lbs. • Hercules 4-cyl. 10 HP gasoline engine. Load governor. Oil filter. Quiet muffler, 6-volt starter, generator. • Hobart 115 volt, 60 cycle, 3000 to 4000-watt generator. Furnishes either single or three-phase power, 2 or 3 wire. • Panel contains oil gauge, voltmeter, ammeter, circuit breaker, voltage regulator, start button. Today's cost over \$1200.00. SALE PRICE.

465.00

Item #300—Model C1B—3 KW—110 Volts D.C. This mighty mite develops 3 KW—28.5 amps. D.C. Standard Delco generator direct coupled to a Model ZEP Briggs and Stratton 1 cylinder, 5-7 HP, air cooled, rope starting gas engine. Instruments include voltage control rheostat & voltmeter. Ideal for Power Tools. Wt. 275 lbs. F.O.B. Chicago.

295.00

NEW GROBAN MANUFACTURE MODEL 251

2500 watts, 115 volts, 60 cycles, single phase, A.C. electric generating plant, powered by dependable 6.5 H.P. Wisconsin engine. Two pole ball bearing belt driven high efficiency generator with heavy duty windings for high torque motor starting loads. Rated 3000 watts for intermittent service. Light weight portable rugged unit, easily transported to job site. Consumes 3 quarts of gas per hour at rated load. Dimensions: 24"x20"x24", ship. wt. 220 lbs. Complete with fused outlet box and voltmeter. F.O.B. Chicago.

349.00



CONTINENTAL "RED SEAL" 1 1/2 H.P. ENGINE

Item #97—Power for lawn mowers, garden tractors, pumps, generators, compressors, tillers, rakes, plows, feed mills, milking machines, and motor scooters. Brand new Continental "Red Seal" 1 1/2 H.P. gasoline engine, Model AA-7, single cylinder, 4 cycle, with 6:1 gear reducer. At 1800 RPM engine speed, shaft turns at 300 RPM. Complete with muffler, starter rope, oil bath air cleaner, killer button and governor. Economical to operate—runs 5 hours on one gallon of gas. Shipping weight 60 lbs. SATISFACTION GUARANTEED. A \$74.00 value. Offer now. Limited quantities. F.O.B. Chicago.

47.50



SELF-PRIMING ELECTRIC PUMP

Compact — Brand New. Applications: oil burners, aquariums, fluid metering, fuel pump, tool post grinding lubricating pump, general industrial, etc. Motor mfd. by Black & Decker, double ball bearing series wound, continuous duty, 1/30 H.P. electric motor, rated 12,000 RPM. Transformer included for use on 110 VAC current. Also applicable for 24-32 VDC. Pump mfd. by Weldon Tool Co. with standard 1/4" tubing ports; Rated 2 G.P.H. Remove pump and use motor as high speed grinder. Overall dimensions 7 3/4" long x 3 3/4" wide x 3 1/4" high. Approx. wt. 5 lbs. \$51.00 Value. Postpaid.

12.95

D.C. ARC WELDER

NEW MODEL 353—DUAL RANGE

For Stationary or Portable Use
HEAVY DUTY RANGE TO 250 AMPS.
New "Magic Terminal" for Low Current 30 to 100 AMPS.

Ideal for
• FARM
• GARAGE
• FACTORY
• WORKSHOP



- Dial Type Rheostat Control
- Use 1/16" to 1/4" Rod
- Generator-type Welder
- Reactor Coil for Smooth Even Arc
- Use 7 1/2 H.P. Electric Motor or 10 H.P. Gasoline Engine
- Run at 2500 R.P.M.
- Available with Either Flat Belt or Double V Pulley
- Complete Operating Instructions

Shipping weight 107 lbs. \$350.00 Value. Item #65. F.O.B. Chicago.

119.50

ORDER DIRECT FROM AD — SEND PAYMENT OR PURCHASE ORDER TODAY — SATISFACTION GUARANTEED

GROBAN SUPPLY CO. 1139 SO. WABASH AVE., CHICAGO 5, ILL. DEPT. PM-5



Treat yourself to the tip action that gives spot accuracy, new distance, perfect bait control. Try Actionrod's *live* action for spinning, for fly-fishing, for bait-casting. Tubular or solid glass models, at the price you want to pay, \$4.87 to \$75.00.



Actionrod 4500—The world's only hexagonal tubular glass flyrod, \$75.00.



Actionrod 4400—Custom-made tubular glass flyrod, \$35.00. Other models as low as \$11.95.



Actionrod 4266—Tubular glass spinning rod, \$35.00. Other models as low as \$11.95.



Actionrod 4160-D—Tubular glass custom casting rod, \$40.00. Other models as low as \$9.45.



Actionrod 100—Finest solid glass casting rod, \$25.00. Other models as low as \$4.87.



ORCHARD INDUSTRIES, INC.
HASTINGS, MICH.

GUARANTEED BITE-PROOF! NEW NYLON BIT

TASTELESS!
CUSHION BITE

MEDICO V.F.Q. FILTER PIPE



\$2

ASSORTED STYLES

Throw Away Nicotine
TRAPPED IN MEDICO'S FILTER

ACCURATE, gas powered

WRITE FOR CATALOG



Crosman

Single shot or 10 shot repeater, precision rifled barrel, push type safety, adjustable sight, power adjustment. .177 or .22 cal.

AT DEALERS EVERYWHERE

CROSMAN ARMS CO., ROCHESTER 20, N.Y., Dept. 45

Get the FACTS!



Write for complete information. Dept. 3205
SCHULT CORP., ELKHART, IND.

SCHULT
TRAILERS



Freeland METAL BOATS

NEW LUMA TOP for '53
Aluminum—12 ft., 46" beam.
Carry atop car. \$179.

GALVANNEALED 12'-14' \$78-\$130
Rugged, all-welded construction.
Fast, safe. Take motors to 10 H. P.
Write Dept. 85 for folder.



FLA. BRANCH

FREELAND SONS CO., STURGIS, MICH. 302 S. WATER ST., TAMPA



FOR FASTER WORK IN HOME OR SHOP...

HOLD-E-ZEE

The Original AUTOMATIC GRIP SCREWDRIVERS



See these popular, high-quality drivers with the exclusive Grippe that holds, starts and sets up screws in unhandy places!

New Models FOR RECESSED HEAD SCREWS

At Leading Dealers Everywhere
UPSON BROS., INC., ROCHESTER 4, N. Y.

POPULAR MECHANICS

**COMPARE SHOPSMITH
CAPACITY
WITH ANY OTHER
POWER TOOL!**

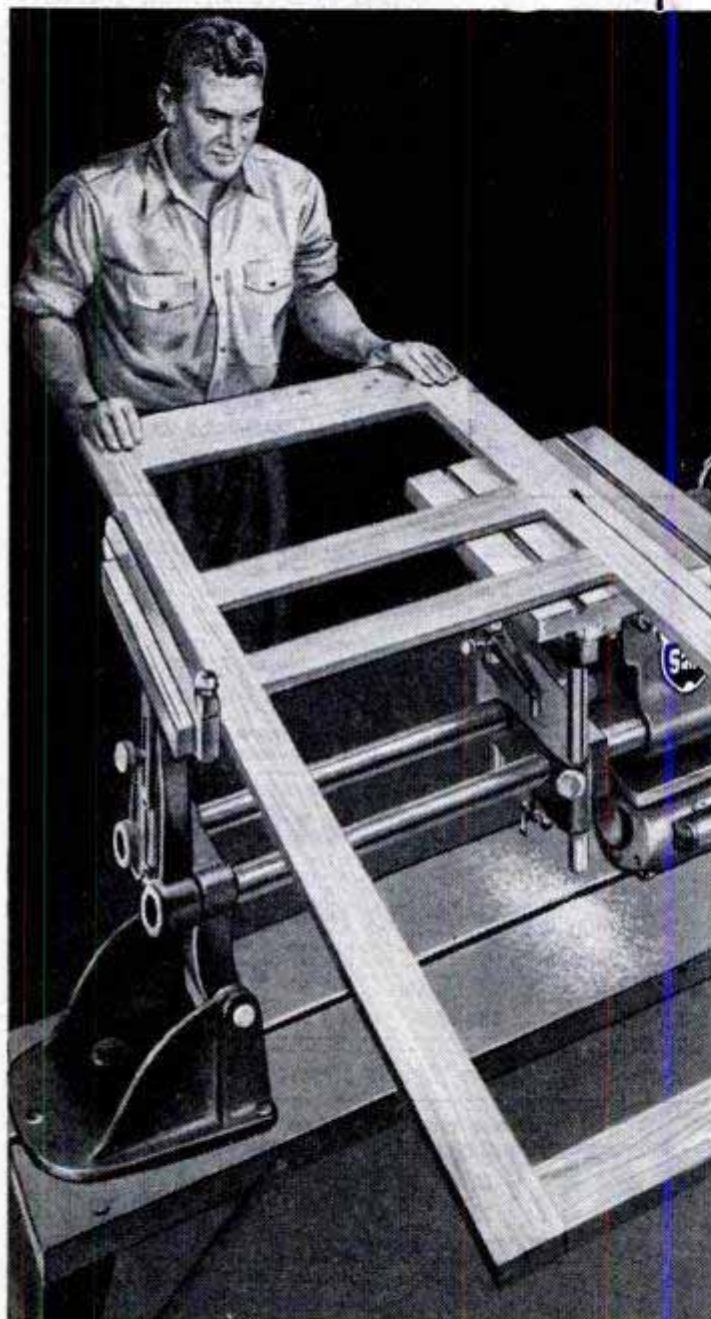

AS A CIRCULAR SAW it can cut 8' panels in half and trim doors, big screens, storm sash. Effective table area, 54" x 17", is *twice* that of most circular saws. Maximum depth of cut, 2 1/4". Extra-fine depth and blade-to-fence adjustment for greater accuracy.

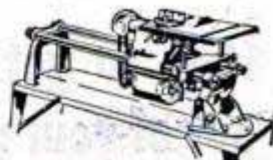

AS A DISC SANDER, the SHOPSMITH handles room-length boards. Quick-change 12" discs can be fed into work for greater accuracy, speed and safety . . . and precision finishing of duplicate parts. Miter gauge and tilting table simplify compound angle and bevel sanding.

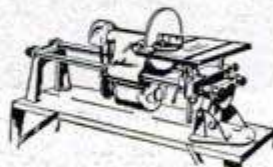

AS A HORIZONTAL DRILL PRESS, size of work limited only by size of room! Making a perfect doweled joint, so difficult with most home power tools, is easy because of horizontal feed. Drilling, mortising oversize furniture or cabinet frames is simple, too.

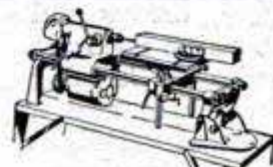

AS A LATHE, it turns work up to 33" long, 15" in diameter—4" more than most lathes. Other SHOPSMITH exclusive features: a sliding headstock that puts work within easy reach; a swiveling tool rest that slides parallel to work—no need to reset constantly.

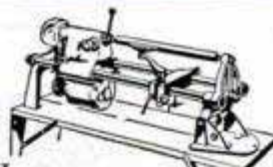

AS A VERTICAL DRILL PRESS, the SHOPSMITH drills to center of 15" circle. Both table model (table to chuck, 27") and floor model (floor to chuck, 55"). Jacobs key chuck takes drills from 5/64" to 1/2" dia. Spindle floats on *four* grease-sealed ball bearings.



See SHOPSMITH demonstrated at leading hardware or department stores, or at any Montgomery Ward store.

COMPLETE 5-TOOL UNIT \$199.50 Motor* and bench extra

FREE! Fact-packed 16-page illustrated booklet!

*Special SHOPSMITH heavy-duty, ball-bearing motors: 1/2 hp., \$34.50; 3/4 hp., \$44.50.

MAGNA ENGINEERING CORPORATION
Dept. 231-B at factory nearest you:
12819 Coit Road, Cleveland 8, Ohio, OR
Menlo Park, California

Please send me a free copy of the SHOPSMITH catalog, and the name of my nearest dealer.

Name _____
Address _____
City _____ State _____

How to get more mileage out of your motoring dollar



"LIFE BLOOD" FOR YOUR BATTERY

Check battery water frequently—especially in hot weather. Batteries and conditions may vary a good deal; but to play safe, check regularly. Many modern batteries will give remarkably long, dependable service. To get the most out of yours, keep distilled water level above top of plates.

Guard against light failure, delays and expensive roadside service by keeping spare fuses and a powerful flashlight in your glove compartment. A new fuse may make it possible to drive to the nearest garage for a check on possible shorts. The flashlight will help you locate fuse clips; may serve as emergency "headlight" if car lamps won't function.



NIGHT-DRIVING SAFEGUARDS



FINEST OIL FILTER

Keep a clean oil filter on the job. Your oil filter traps engine-wrecking abrasives and sludge out of engine oil. In time, however, any filter loads up—gets so clogged it can't filter any more. Before that happens, put in a new Purolator* Refill. Accordion-pleated, plastic-

impregnated element has up to 10 times more filtering area than ordinary filters . . . stops dirt you can't even see. Purolator Micronic* Refills come in a full range of sizes . . . cost as little as \$1.60. Take just a few minutes to install.

*Reg. U.S. Pat. Off.

Check your oil filter every time you change your oil

PurOlator
World's finest OIL FILTER



PRECISION CALIPER



This Trade Mark guarantees highest quality

MODEL #30-78 With set screw accurately fixing position of the slide



M-Z-B PRECISION CALIPERS made by the leading European precision tool craftsmen. Guaranteed highest accuracy for any kind of precision work. Chrome steel, spring-tempered, glass hard on all measuring surfaces. For measuring inside, outside, thread and depth. To read .001" and 1/128", 8" overall, 6" graduation.

The following models have the famous M-Z-B cam lock which guarantees fixed and never shifting setting when pressure lock is released.

#30-61	Chrome Steel	.001" & 1/128"	\$14.00
#30-64	Chrome Steel	.001" & 1/20mm	\$14.00
#30-62	Stainless Steel	.001" & 1/128"	\$16.50
#30-65	Stainless Steel	.001" & 1/20mm	\$16.50

Leather cases supplied free of charge with each caliper. You pay postage on C.O.D. Money back guarantee. Other models up to 12" available. Send for our catalog of fine imported bliers.

\$9.75
POST PAID

INTER-CONTINENTAL TRADING CORP.

90 WEST STREET • NEW YORK 6, N. Y.



CUT BUILDING COSTS 2/3! Make Your Own Concrete BLOCKS and BRICKS To Use or Sell

New superior moulds make absolutely square, true, easy-to-lay blocks which will pass any building code. Production is fast . . . easy. One durable \$30 machine will make four 5"x8"x12" blocks per minute—1,000 a day. Pays for itself in one day! Sell blocks for big profit . . . or save 2/3 building cost for yourself. POST CARD BRINGS FREE FOLDER.

ECONOMY MFG. CO.

DEPT. P STONE MOUNTAIN, GA.



Only \$24.75 Complete

\$ Free Course! Big Profits! \$ Flocks & Sandblasts

Dual Purpose Spray Gun! Uses only 25 lbs. Air Pressure • Thousands of uses in Home, Shop, Industry. Makes Auto Interiors Clean & New, Lines drawers, Marproofs lamp bases, Refinishes any object. All in colorful Flock, Etch & Frost windows, glassware, etc. Removes Paint & Rust from Autos, Tools. Guaranteed! Send \$24.75 or write for free information. Flocking supplies!

BLASTO SPRAY GUN MFG.

Dept. PM-5, 7007 Haas Avenue, Los Angeles 47, Calif.

VARIABLE SPEED

HYDRAULIC POWER TRANSMISSION



It has Infinite Speeds 0 to 550, Reverse, Automatic Overload Protection; Adjustable Torque up to 180 inch pounds, 3/4" Input and Output Shafts. It will handle 1/2 to 1 1/2 H.P. Motor. Case measures 7 1/2" long, 7" high 6 1/2" wide. VALUE OVER \$300. Shipping Wt. \$54.50
25¢. On C.O.D. Orders we require a 10% only Feb. Chicago Deposit.

DIRZIUS MACHINE SHOP "B" 1423-25 So. 52nd Ave., Cicero 50, Ill.

Say You Saw It in Popular Mechanics

boost your income with the

IDEAL LAWNMOWER SHARPENER

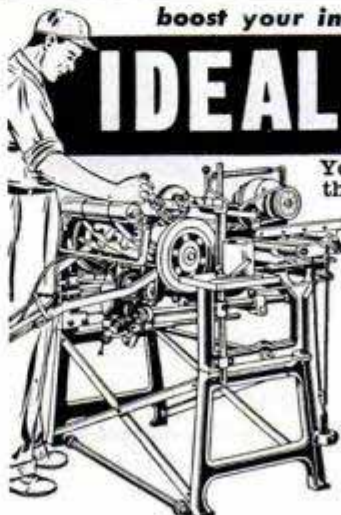

You can earn extra cash with the Model 300 Ideal Lawnmower Sharpener. Used and recommended by leading manufacturers and service shops, the Ideal has everything you need, nothing else to buy. Grinds reel and bed knife, also reconditions. Get started now in this highly profitable business. Write for catalog today.

The Fate-Root-Heath Co.
Dept. PM-5, Plymouth, Ohio



Developed by RCA Victor, the new "45 Extended Play" record gives music lovers more music for less money.

Twice as much music on the same size record

Another RCA achievement in electronics:

A challenging question was asked RCA engineers and scientists in 1951. How can we increase the playing time of a 7-inch record, *without using a larger disc?*

Sixteen months of research gave the answer, "45 EP"—Extended Play. Public response confirmed this as *the most important achievement in the new recording speeds.* More than 2 million RCA

Victor "45 EP" records were bought the first four months!

Research leadership—your guide to better value: RCA Victor's "45 EP" record accents the importance of research *to you.* Research adds greater value to all products and services trademarked RCA and RCA Victor.

Secret of "45 Extended Play" record is a new way to cut a master disc—with an electrically heated stylus.



**RADIO CORPORATION
OF AMERICA**

World leader in radio—first in television



Add New
Living Space
to Your Home
with **TORIDHEET**
Automatic Heating!



Your old coal bin becomes a workshop, photo dark room or playroom for the children when you switch from the dirt and inconvenience of coal firing to TORIDHEET—the modern, economical way to heat your home.

Cuts Fuel Bills up to 40%

TORIDHEET's direct heating action means you get the maximum efficiency out of your fuel. Think what these efficiency figures mean to you—in dollars and cents.



You can enjoy all the automatic comfort of TORIDHEET and pay for that new living space out of your fuel savings! Complete furnaces or Conversion Burners—oil or gas.

For Fuel Savings up to 40%... Mail this Coupon Today!

TORIDHEET DIVISION
CLEVELAND STEEL PRODUCTS CORP.
7312 Madison Avenue • Cleveland 2, Ohio

Please send me complete facts on the TORIDHEET Wall Flame burner with direct heating action.

NAME _____
ADDRESS _____
CITY _____ ZONE _____ STATE _____

DRILL SAW REAM CUT
INTERNATIONAL
HIGH SPEED COPE SAW DRILL BIT



DRILL, SAW, REAM . . . metal, pipe, wood, plastic, Transite, etc. Use with any electric drill, slow drill press, lathe or milling machine. Drills own starting hole—upper part of bit is used to cut, saw or ream circles, ovals, squares or scrolls. Easy to operate. Ideal for carpenters, mechanics, electricians, plumbers, hobbyists, many others. Abrasive resistant, high speed steel. Flutes ground from solid. Will withstand severe continuous use without breaking. Resharp-ened at no charge. Takes place of up to \$50 in tools. 1/4" diameter, 2" cutting sections, total length 3 1/2". Available in three types—All Purpose, Wood, Heavy Metal. Specify type needed. Set of 3, \$11.50. Details on request. Shipped same day. Money-back guarantee. Dealer inquiries invited. **ORDER NOW! SEND CASH, CHECK OR MONEY ORDER.**

Manufactured and distributed by
INTERNATIONAL TWIST DRILL CORP.
618 Wyandotte, Rm. 633, Kansas City 5, Mo.

only
\$3.95
POST PAID

TREASURE! URANIUM!

GEIGER COUNTERS—METAL DETECTORS
GEIGER COUNTERS for Uranium. METAL DETECTORS for gold, silver and buried treasure. 5 models from which to choose. We have one in your price range. No finer instruments available anywhere. **FREE ILLUSTRATED FOLDERS.**



THE Detectron CO. Model DG-7
5631 CAHUENGA, NO. HOLLYWOOD, CALIF.

PUMP WATER FAST!



DRAIN WASH TUBS, CELLARS, CISTERNS
IRRIGATE—FILL TANKS—DRAW WELL WATER

Pumps 2800 GPH. 420 GPH at 75' High or 1600 GPH from 25' well. Sturdy, Rustproof Alloy Metal. Six Blade Impeller. Uses any 1/8 to 1/2 H.P. Motor. Will not leak or clog. Fits any garden hose. Immediate Money Back Guarantee. Send Check, M.O., or C.O.D. **895** IN U.S.

MOORE MANUFACTURING CO.
SWEDSBORO 1 NEW JERSEY

AIR COMPRESSORS

Portable 2-Cyl. Piston Type
WESTINGHOUSE

Reg. \$60.50 **25.95**
Model T-1 Complete

Brand new surplus special at an amazing low price. Westinghouse double-piston type 6.54 CFM volume, 2" bore, 1 1/2" stroke. Runs off power take-off or 1/2-hp motor equipped with the V-type direct-drive pulley and belt. For farm, home, industry, painters. Instructions and parts manual included. Send check or money order (parcel post weight 23 lbs.). A complete line of genuine Westinghouse spare parts.

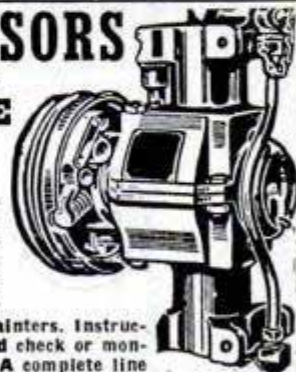

AIR HOSE—to fit, 25-ft. length with fittings & chuck \$4

AIR PRESSURE TANK ASSEMBLY, complete \$10.95
Includes 6" x 24" tank, 160-lb. gauge, relief valve, tubing, all necessary fittings & hose. Weight 15 lbs.

NATIONAL EQUIPMENT CO. 2669 MONROEVILLE ROAD
TURTLE CREEK, PA.

IF YOU OWN ONE OF THESE...



ask for **MOPAR**...

genuine Chrysler Corporation Parts and Accessories



1. The name MOPAR means parts and accessories made specially for your Plymouth, Dodge, De Soto or Chrysler car or your Dodge "Job-Rated" Truck.



2. Engineered and inspected by the engineers of Chrysler Corporation who designed your car or truck . . . and who maintain the original high standards.



3. They fit right and work right because they are made right. You enjoy lasting satisfaction with the better performance and long life of MoPar parts.



4. Whatever you may need is readily available. MoPar offers a complete line of parts and accessories for cars and trucks built by Chrysler Corporation.

Look for the **MOPAR** sign

You can get MoPar parts and accessories from the thousands of Plymouth, Dodge, DeSoto and Chrysler dealers, also many general service and repair shops.



CHRYSLER CORPORATION, PARTS DIVISION • DETROIT 31, MICHIGAN

SOMETHING **NEW** IN PAINT COLOR CARDS

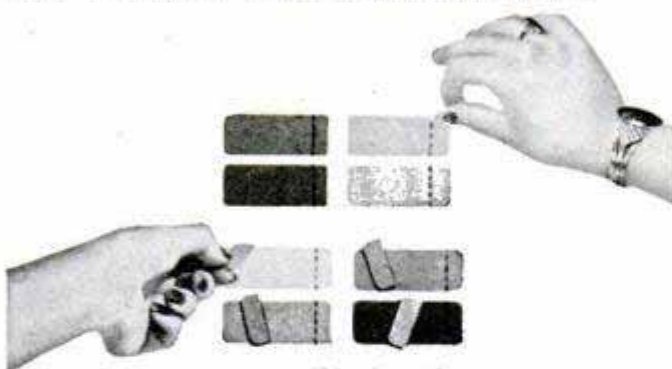

THE EXCITING 'MATCH-A-CHIP' COLOR CHART FOR



SATIN LUMINALL

THE LATEX PAINT WITH EVERYTHING BUILT IN!

Here's a thrilling new way to create hundreds of wonderful color schemes for every room. All the exquisite shades you've yearned for—at your fingertips! The 'Match-a-Chip' Color Chart is an ideal companion to Satin Luminall, the Concentrated Latex paint that primes, seals, undercoats and finishes in one easy, lovable, scrubbable coat!



FREE

'MATCH-A-CHIP' COLOR
CHART FOR ALL INTERIORS

LUMINALL PAINTS
Dept. 25
3617 S. May St.
Chicago 9, Ill.

Please send free 'Match-a-Chip' Color Chart and facts about Satin Luminall Latex Paint.

Name _____

Address _____

City _____ Zone _____ State _____

LUMINALL PAINTS

Chicago 9 Newark 5
Los Angeles 1

Dealers throughout the U.S.A. See Classified Pages, phone book

BURKS SUPER TURBINE PUMPS LAST LONGER

ONLY PUMP
WITH LIFE-LOK
FEATURE

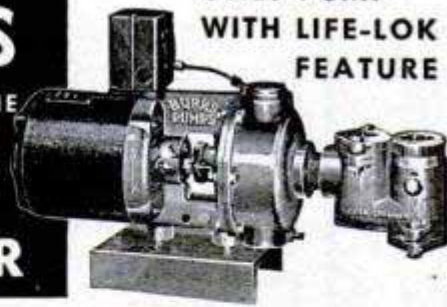

Thanks to the LIFE-LOK feature, the BURKS Super Turbine Water System lasts up to 40% longer than any other kind, delivers more gallons per minute and provides "like-new" performance and efficiency when other types would be worn out. It's completely automatic—self-priming.

FREE BOOK PICTURES PUMP DETAILS

Send today for "The Story of Burks"—a 32-page book giving detail drawings, graphs, etc. See why BURKS is finest engineered system . . . why it delivers more water per hour . . . why it's the finest water system you can buy. Write to—**DECATUR PUMP CO., 61 Elk St., Decatur 70, Ill.**

KING MIDGET

WORLD'S LOWEST PRICED
2 PASSENGER AUTO



JUST OUT — NEW CONVERTIBLE!

Operate it for 75c per week. Amazing performance. Surprising comfort. All steel construction. Ready to run or assemble it yourself with our bolt-together parts. Rider Agents wanted, earn your car free. Send 25c for detailed literature or \$1 (refunded first order) for actual assembly book and service manual filled with photos, drawings, specifications, etc.

MIDGET MOTORS MFG. CO., ATHENS, OHIO



BUILD FINE GRANDFATHER CLOCK NOW

The simple sensible Red-i-Kut way as thousands have — **SAVE HALF. SHOP TESTED PLANS "SPIRIT OF THE CENTURY"** Narrow waist 83" tall or stately straight "SPIRIT OF AMERICA." **EASY-TO-FOLLOW photopack PLANS** tell all—plus **BROCHURE** of heavy brass weight Westminster, tube chime, movements, gorgeous dials, 3/4" solid mahogany case kits. Send \$1.00 today — Both plans \$1.50 NOW.

KUEMPEL CHIME CLOCK CO., #6 Kuempel Bldg., Minneapolis 16, Minn.

Make Money
SELLING
Eshelman
Tractors
and doing
GARDEN
WORK

MAKES
PLOWS
CULTIVATES
HARROWS
HAULS
SPRAYS
SAWS
DOZER
MOWS
CUTS
ROLLS
TILLS
SNOW PLOW

ESHELMAN

FOR BETTER
LAWNS
and GARDENS

From
\$95
Plus
Tools

1 1/2-3 1/2
H.P.

Also Power Reverse. Women can operate it. Free Catalog. Write nearest branch:—**Eshelman Co., Dept. 55** 119 Light St. Balto. 2, Md. 333 N. Michigan Ave. Chicago-1, Ill. 7070 Hollywood Blvd. Los Angeles 28, Calif.

NOW—40 different CUTS with AMAZING, NEW



Warren

DADO SAWING WASHERS On Your Saw Blade

Just dial widths to cut parallel grooves perfectly smooth. No warp, vibration

or trick screws. Strengthens blade, perfect balance. **GUARANTEED!** At your dealer's or order direct. Give arbor size—1/2", 3/8", 3/4", 1".

Send for free booklet

WARREN WASHERS COMPANY

Dept. 25, Box 98 North End Station, Detroit, Mich.

ONLY
\$4.95
PER
SET

Do It Yourself Better... These Tools Give You EXTRA WORK-SAVING FEATURES

WIZARD ADJUSTABLE END WRENCH

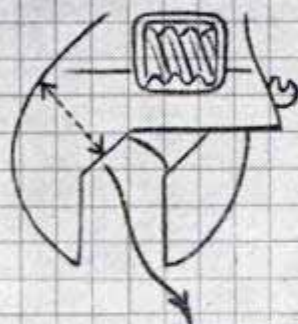

DEEP-THROAT JAW IS CONTOUR-SHAPED FOR FULL, FIRM GRIP ON HEX BOLTS... EXTRA STRONG AT GREATEST POINT OF STRAIN

(HR2402)

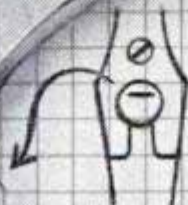

PRECISION-FITTED, ROUNDED GEAR BAR RIDES SMOOTHLY, YET FIRMLY IN SLOT FOR EASY POSITIVE ADJUSTMENT



EXTRA-THIN, SLENDER HEAD GETS INTO TIGHTEST SPOTS

A flick of the thumb is all you need to make this one wrench fit a wide range of nut and bolt sizes. Every feature—each angle and rounded corner—is job-designed by tool experts for easier, better performance in *your* hands. Made of stronger, yet lighter alloy steel... heat-treated, tempered, hardened for extra strength and durability. Polished chrome-plated head, satin finished handle. Your choice of 5 sizes... (8-inch size) **\$1.98**

WESTCRAFT 6 IN. "POWER-GRIP" PLIER

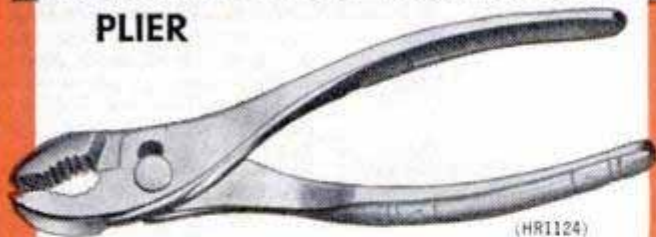

(HR1124)

50% more gripping power plus 38% more leverage from patented "reverse V" jaw design! Deep-cut, perfect-matched teeth. Precision tooled from alloy steel... so accurate you can pluck a hair! **95c**

WESTCRAFT 8 FT. PULL-PUSH RULE

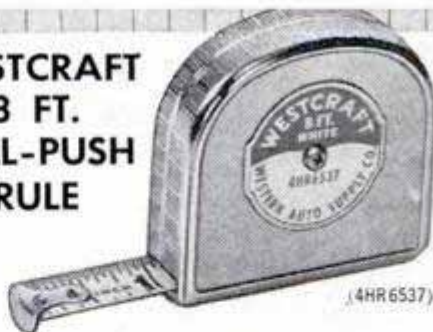

(4HR6537)

Flexible-rigid steel blade allows quick, accurate measuring of straight, curved, angular or irregular surfaces. Flat 2" base. Baked-on white enameled blade with big, easy-to-read 1/16 inch graduations **96c**

Choose from over 1,100

Wizard-Westcraft Tools...Western Auto

SOLD ONLY BY

STORES AND ASSOCIATE STORES

NOTE: Western Auto Associate dealers own their stores and set their own prices, terms and conditions. Prices may vary due to differences in local conditions. If you do not know the location of your nearest Western Auto Store, write Western Auto Supply Co., 2107 Grand, Kansas City, Mo. (PMS3)

CRAFTSMAN'S GIFTS for FATHER'S DAY!

DREMEL Electric MOTO-TOOL

1001 USES AROUND THE HOME AND SHOP

Here is the fastest (27,000 r.p.m.) most powerful tool in its class—**THE ORIGINAL POCKET-SIZE MACHINE SHOP.** A jack of all trades around the workshop, it is indispensable for carving, drilling, grinding, and for sharpening tools, scissors, kitchen knives, garden tools, lawn mower blades, etc. More versatile than a 1/4" electric drill as it is so light weight (13 oz.) and handy for so many small jobs. Perfect for drilling small holes to hang pictures, installing cabinet hardware, hardwood trim. Powerful, 110 V. A.C.-D.C. motor. A tool built for years of lasting service.



MOTO-TOOL NO. 2 Offers more convenience and long life features for the money than any other hand grinder. Thousands of satisfied users.

Moto-Tool No. 2 (with 1 emery wheel point).....

\$16.50

KIT NO. 2 Includes Model 2 Moto-Tool and 23 Accessories (High-Speed Steel Cutters, Grinding Wheels, Polishers). Packed in sturdy hardwood case....

\$23.50



A PRECISION TOOL WIDELY USED IN INDUSTRY



For Sharpening Tools



Speeds Up Repair Jobs



Great for Hobbyists



AMAZING FOOT-A-MINUTE
(7,200 Strokes Per Min.)
CUTTING SPEED!



Only **\$5.85**

with 3 saw blades

FREE PLANS!



Make your own Jig Saw Table. Complete plans and six project patterns included FREE.

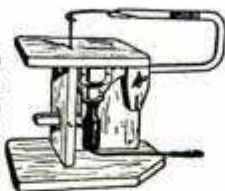

FAMOUS DREMEL ELECTRIC MOTO-SAW

Here is a genuine craftsman's tool with dozens of household and workshop uses. It is perfect for all sorts of coping and jig saw work making window valances, knickknacks, hobby projects, etc. High-speed, reciprocating-type motor easily cuts asphalt and rubber tile, also masonry and formica—wood up to 3/4". Perfectly safe for children—so easy to handle that women love to use it. Has only two moving parts, never needs oiling. A high quality tool used by craftsmen, tile layers, and carpenters.

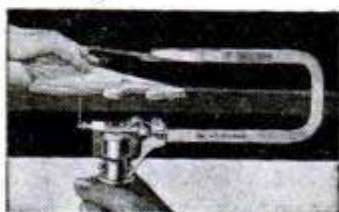

Cuts scrolls like magic!

SEE YOUR DEALER! If he can't supply, order direct on five-day trial, money-back guarantee. Remit in full for postpd. shipment; or, send \$2 now, pay postman balance plus postage and C.O.D.

DREMEL MFG. CO. DEPT. 113-E

RACINE, WIS.

BRIKCRETE



Local Manufacturers Have Broad Opportunities

Brikcrete manufacturers operate compact, self-contained plants under franchise privileges in protected territories. Each is an independently owned unit in a country-wide chain, using local materials and local labor to supply the world's most modern masonry for local building needs.

Brikcrete is rich in sales appeal because it is ahead in design, style, size, color, economy. Easily the preferred masonry. But because local production eliminates economic wastefulness, Brikcrete can be sold at a lower-than-lumber price. Yet still allow a generous profit margin.

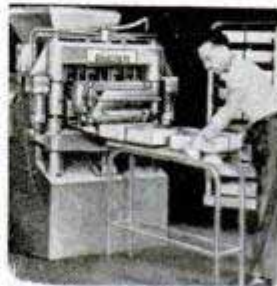

Brikcrete offers much to men looking for a community enterprise on a nominal investment. We supply complete equipment; easy terms when desired. Liberal cooperation. Write today for Brikcrete Book No. 2—while territory is still open.

BRIKCRETE ASSOCIATES, INC.

4679 Division Avenue, S.
Grand Rapids 8, Mich. 82

**TRANSFORMER \$18.95 FOB
WELDER QUINCY**



Complete with everything. Ready to plug in. 110 volts AC. 15-30 amps. 3 heats. Welds metal from 1/16" to 1/4" using 1/16" to 3/32" standard rods. Guaranteed unconditionally. 10-day trial. No C.O.D. Does everything welders costing up to \$75.00 do. Buy direct and save.

ESSAY MFG. CO., INC., Dept. 51, Quincy 69, Mass.

MAGNETS OF ALL TYPES — 10c UP
AMAZINGLY POWERFUL!!
#6 ounce horseshoe magnet—\$1.50.
Our Leader, 1 lb. magnet lifts 40 lbs. \$2.95. New alloy—will not weaken! Useful for lifting valuables from tanks, lakes, or rivers easily! 7 small magnets \$1.25 with list of many shop and home uses. Satisfaction guaranteed.
R. EYRICH, 1091 N. 48 STREET, MILWAUKEE-8, WISC.

Say You Saw It in Popular Mechanics

WORLD'S BEST SMALL TRENCHERS

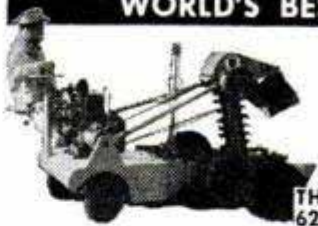

Portable DITCH-WITCH digs 2" to 6" clean, even ditches to 36" depth in all types of soil. Complete unit—self propelled—outdigs 8 men. Four rugged models.

Write for illustrated literature.
THE CHARLES MACHINE WORKS
620 B Street Perry, Oklahoma

MODERN LAWN MOWER SHARPENER

Service departments of leading Lawn Mower manufacturers use the Modern Lawn Mower Sharpener. One lever moves lawn mower into grinding position. Gasoline and oil remain in engine while sharpening, no dismantling of wheels, roller or handle. The Modern is a precision bed knife grinder—no extra grinder to buy. Imitated but never equalled—Compare before you buy. If it isn't a Modern it can't be Modern

(Prices subject to change without notice)

MODERN MFG. CO.
160 N. Fair Oaks - Pasadena 1, Calif.



WRITE FOR
FREE BOOKLET
10P

\$263.00
with motor
F.O.B.
PASADENA

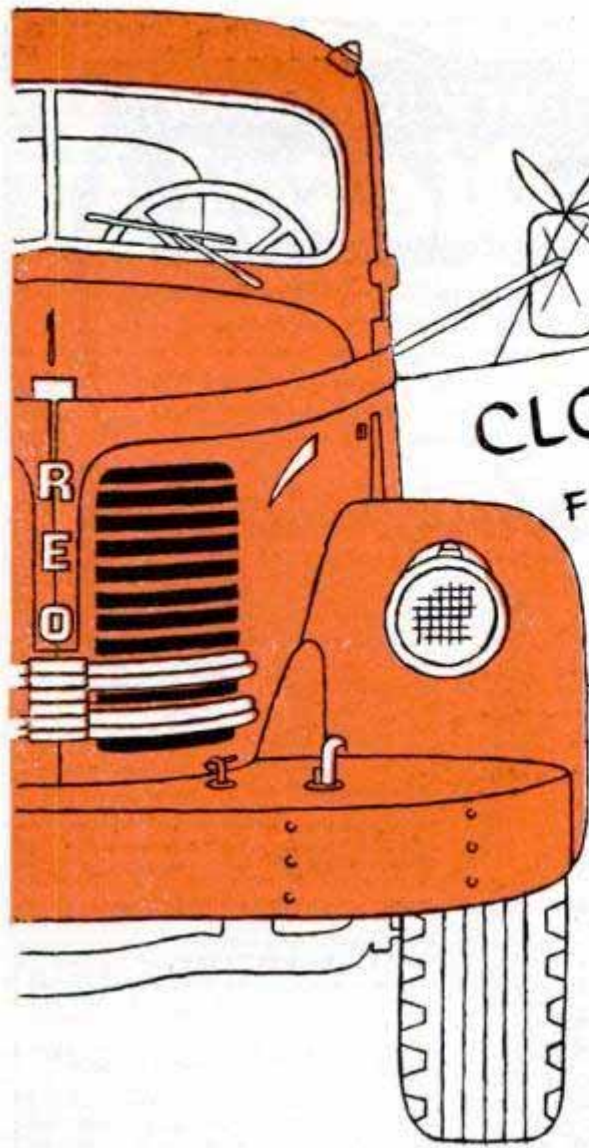

BANKERS HOURS???

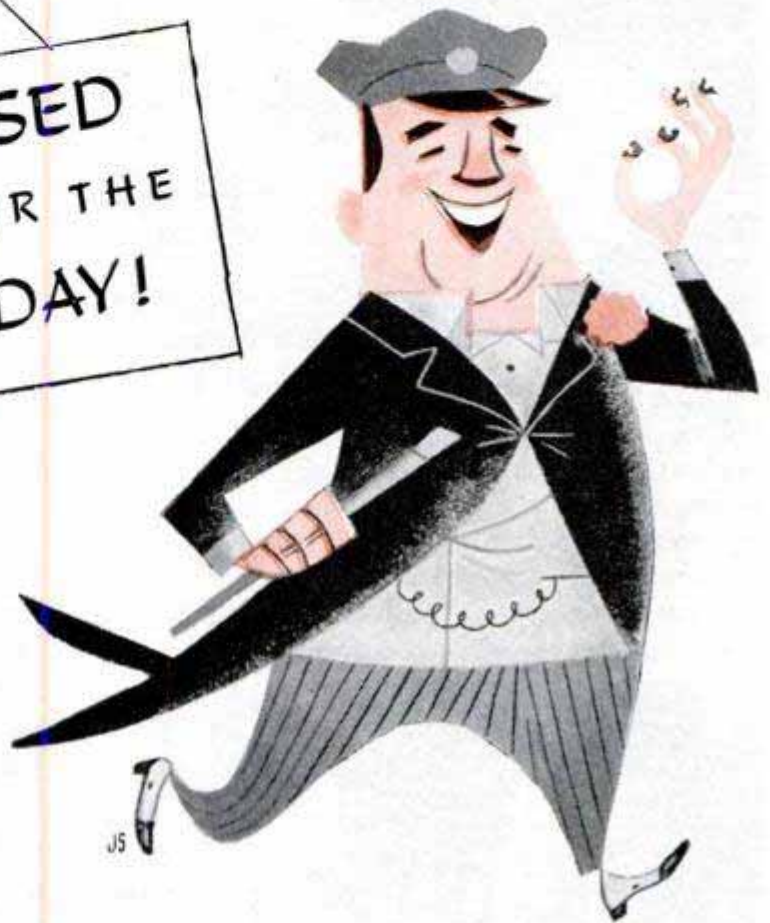

SURE, REO GETS YOU THERE AND BACK QUICKER!

It's a fact. A Reo zips you over hills 15 to 20% faster than similarly rated trucks carrying the same payload. On the straightaway, that eager *Gold Comet* engine is just champing at the bit. A "high-balling" clip for ordinary trucks is just comfortable cruising speed for Reo. Remember, Reo's *Gold Comet* engines give you more horsepower per pound than any other 7-bearing truck engine.

What's more, that comfortable new Reo cab makes trips seem even shorter. No wonder Reo drivers finish each day's run

"fresh as a daisy." They enjoy increased head and leg room...executive driver's seat...a new comfortable steering wheel angle that gives unobstructed viewing...big, full door openings...factory applied undercoating for quiet, fatigue-free driving and a cab-full of additional comfort features.

But take a tip...don't rave about cab comfort to the boss man. Tell him to check on the unbelievable economy of Reo trucks.

REO MOTORS, INC. LANSING 20, MICHIGAN

JOIN THE



Haul of Fame!

COOL YOUR HOME THIS LOW-COST WAY

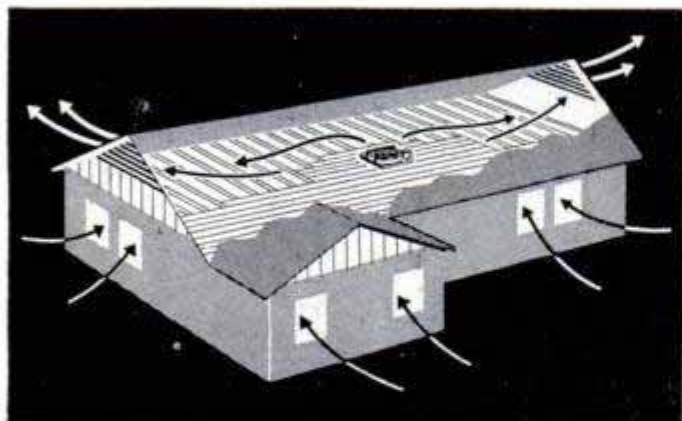

Hunter Attic Fan cools the whole house

This modern ventilating fan pulls in cool air through windows, exhausting hot stuffy air through attic louvers. In hottest summer months it circulates cooling breezes through every room in your home. The quiet, powerful Hunter Attic Fan requires little or no maintenance, costs only a few cents a night. It is backed by Hunter's 65 years of fan experience.



You can easily install a Hunter Attic Fan in your home. This compact unit is complete with automatic shutter and modern metal trim to cover the ceiling opening. No suction box to build: no accessories needed. Fan requires only 17 in. attic clearance. Look in your classified directory and phone the Hunter dealer. You can have cool comfort at low cost.

MAIL FOR FREE BOOKLET

Hunter Fan and Ventilating Company
Box 2858-AJ, Memphis 2, Tennessee
Send a copy of "Change Your Home
from Hot to Cool" to:

Name _____
Address _____
City & State _____



HUNTER ATTIC FANS

NEW LOW PRICED Diesel

Puts Diesel Economy Within Reach of All
A real diesel with simplified Sheppard fuel injection. Extremely low weight-to-horsepower ratio. 100% diesel construction. Fuel consumption, 1 gallon fuel oil per hour. Write for literature and prices.

Sheppard MODEL 17
DIESELS HANOVER, PA. **20 hp**

Compact

30"
High
27"
Long
21"
Wide

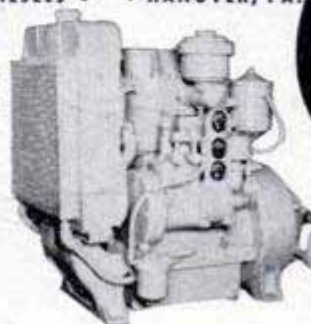

Delivered complete for original equipment or replacement power.

DIESEL'S THE POWER . . . SHEPPARD'S THE DIESEL

Send FOR this Giant AUTOMOTIVE Catalog

& Save to 50% on All Parts & Accessories

1953 EDITION JUST OUT

World's largest Auto Accessory & Parts Catalog. Over 50,000 items:—Hollywood Accessories, Hi-Speed Equipment, Rebuilt Engines. Everything for all cars & trucks. We have that Hard-To-Get part. Jam packed with bargains. Completely illustrated (134 pages). Send 25c (refundable).

J. C. WHITNEY & CO. 1917xp Archer, Chicago 16



STARRETT "Tools and Rules" BOOK

Describes and illustrates the precision methods skilled mechanics use. Only one dime. Write Dept. AP.

THE L. S. STARRETT CO., Athol, Mass., U. S. A.

Help STOP PAINT PEELING!

Seal out moisture . . . prevent paint peeling, blistering . . . wood rot . . . costly repair bills. Do it yourself with Handicalk!

Write for Leaflet

Handicalk

2366 Woodhill Rd., Cleveland 5, Ohio

BUY IT IN HANDY CARTRIDGES OR CANS
AT HARDWARE, PAINT OR LUMBER DEALERS

AMERICA'S BIGGEST
RADIO VALUE!

THE MIGHTY MIDGET



\$49.95

MODEL SW-54

**4-BAND RECEPTION
AT A 2-BAND PRICE!**

With the "Mighty Midget", National's SW-54, you hear not only the broadcast band, but 3 shortwave bands beside! Voice, music and code reception guaranteed from 540 kcs. to 30 mcs.! Listen to Berlin, Paris, Moscow, London, Argentina — every country on the globe — PLUS police, ships, aircraft, radio amateurs! Yet the SW-54 costs less than many two-band table radios!



for radio's crowning achievements...

National radio receivers are used by the U. S. Navy, Scotland Yard, Idlewild Airport, movie makers, steamship lines, scientists and radio amateurs the world over!

National



FREE!

See and hear the Mighty Midget and get your free copy of "The Shortwave Listeners' Guide" (tells what you can hear, when and where, in shortwave radio).



AT ANY
OF THESE DEALERS

ALABAMA

Greenwald Spec., 58 S. Roy. St. Mobile

ALASKA

Yukon Rad., P. O. Box 406, Anchorage
Yukon Rad., 655 6th Ave., Fairbanks

CALIFORNIA

Henry Rad., 11240 W. Olympic Blvd., Los Angeles
Rad. Prod. Sales, 1501 So. Hill St., L. A.
Elmar Electron., 140 11th St., Oakland
Montgomery Ward & Co., Oakland
Zack Rad., 225 Hamilton Ave., Palo Alto
Zack Rad., 1426 Market St., S. F.
T. V. Rad. Sup., 408 Market St., S. F.
S. F. Rad. & Sup., 1282-84 Market St., San Francisco

COLORADO

Montgomery Ward & Co., Denver
Rad. Products Sales, 1237 16th St., Denver

DELAWARE

Almo Rad., 6th & Orange St., Wilmington

DISTRICT OF COLUMBIA

Sun Rad., 938 "F" St., N. W., Wash.
Kenyon Rad. Sup., 2214, 14th St., N. W., Washington

FLORIDA

Herman Rad. Sup. Co., 1365 N. W. 23rd St., Miami

ILLINOIS

J. G. Bowman, 515 E. 75th St., Chicago
Allied Rad., 833 W. Jackson Blvd., Chi.
Newark Elec., 223 W. Madison St., Chi.
Montgomery Ward, 618 W. Chicago Ave., Chicago

Hudson-Ross, Inc., 111 W. Jackson Blvd., Chicago

IOWA

World Rad. Lab., Inc., 740 West Broadway, Council Bluffs

LOUISIANA

Southern Rad. Sup. Co., 1900 Tulane Ave., New Orleans

MARYLAND

Montgomery Ward, Baltimore

MASSACHUSETTS
Hatry & Young, 811 Boylston St., Boston
Jordan Marsh Company, Boston

Rad. Wire Television, 110 Federal St., Boston

Boston Ship Serv., 230 State St., Boston

MICHIGAN

M. N. Duffy & Co., 2040 Grand River Ave., W., Detroit

Reno Rad. St., Inc., 1314 Broadway, Det.

MINNESOTA

Lew Bonn Co., 1211 LaSalle Ave., Minn.
Montgomery Ward & Co., St. Paul

MISSOURI

Radiolab, 1612 Grand Ave., Kansas City

Burstein-Applebee Co., 1012-14 McGee St., Kansas City

Walter Ashe Rad. Co., 1125 Pine St., St. Louis

NEW JERSEY

Almo Rad. Co., 4401 Ventnor Ave., Atlantic City

Almo Rad. Co., 1133 Haddon Ave., Camden

Davega Stores, Inc.:

325 Main St., Hackensack

2839 Hudson Blvd., Jersey City

110 Market St., Newark

373 George St., New Brunswick

185 Main St., Patterson

Rad. Wire Television, 24 Central Ave., Newark

Rad. Wire Television, 139 W. 2nd St., Plainfield

NEW YORK

Ft. Orange Dist. Co., 904 Bdwy., Albany

Montgomery Ward, Albany

Rad. Equip. Corp., 147-151 Genesee St., Buffalo

Davega Stores, Inc.:

31-55 Steinway St., Astoria 3, L. I.

924 Flatbush Ave., Brooklyn

39-11 Main St., Flushing, L. I.

45 Main St., Hempstead, L. I.

163-24 Jamaica Ave., Jamaica

96-70 Queens Blvd., Rego Park, L. I.

175 Main St., White Plains, L. I.

27 Main St., Yonkers

Rad. Wire Television, 542 E. Fordham Rd., Bronx

NEW YORK CITY

Harvey Rad., Inc., 103 W. 43rd St.

Federated Electron. Sales, 66 Dcy St.

Terminal Rad. Corp., 85 Cortlandt St.

Rad. Wire Television, 100 Sixth Ave.

Davega Stores, Inc., 63 Cortlandt St.

Nat Unger, Inc., 174 Greenwich St.

Harrison Rad., 10 W. Broadway

Maritime Rad., 24 Whitehall St.

OHIO

Selectronic Sup., 1013 Jefferson Ave., Toledo

OKLAHOMA

Radio, Inc., 1000 So. Main, Tulsa

OREGON

Un. Rad. Sup., Inc., 179 W. 8th, Eugene

PORTLAND

Pacific Stationery, 414 S. W. 2nd Ave

Un. Rad. Sup., Inc., 22 N. W. 9th

Montgomery Ward & Co.

PENNSYLVANIA

Almo Rad. Co., 412 No. 6th St., Phila.

Almo Rad. Co., 509 Arch St., Phila.

Eugene G. Wile, 218 So. 11th St., Phila.

TEXAS

Hargis Co., 410 Baylor St., Austin

Montgomery Ward & Co., Fort Worth

VIRGINIA

Rad. Sup. Co., Inc., 711 Granby St., Norfolk

WASHINGTON

Seattle Rad. Sup., Inc., 2117 Second Ave., Seattle

WISCONSIN

Radio Parts Co., Inc., 536-38 W. State St., Milwaukee

Samson's:

222 E. Erie St., Milwaukee

2nd and Wells, Milwaukee

3rd and Lloyd, Milwaukee

8th and Mitchell, Milwaukee

Power-Full helps for you from Millers Falls



Shown above
as No. 1814
with Jacobs
Geared Key
Chuck—\$22.35

No. 814
\$19.85
with Millers Falls
Precision Chuck

New 1/4-Inch Pistol-Grip Drill

The biggest 1/4" drill
value ever offered.
Power-packed, rugged,
dependable. Wide line
of accessories for pol-
ishing, grinding, clean-
ing and many other
uses.

Most Powerful 1/2" Utility Drill Made

The last word in de-
sign for men who
want full 1/2" drilling
capacity in steel. A
real husky — yet
weighs only 8 lbs.
Ideal for farmers,
home craftsmen, re-
pair and service men.



No. 912
\$40.95
with Jacobs
Geared Key Chuck



No. 700 **\$67.95** complete with
depth and angle
attachment

The Biggest Buy in Saws Today

Compact, easy-to-use,
safe — this 7" beauty
will handle 90% of all
sawing jobs. 2 3/8" ca-
pacity — cuts finished
2x4's at 45° mitre. Full
1/2 h.p. Weighs only 11
lbs.

Most Versatile Tool You Can Own

It buffs, sands, grinds, pol-
ishes, waxes, wire brushes,
drills, mixes paints. And,
it's the only disc sander-
polisher with an orbital
attachment for fine-finish
sanding.



No. 966
Sander-
Polisher
with 6"
rubber
pad, 6"
lamb's
wool
bonnet,
three 6" sanding discs.
\$37.50



The Mark of Superiority

Send for free
Electric Tool Folder
MILLERS FALLS CO.
Greenfield, Mass.



BUILD your own SMITH AIR COMPRESSOR

Operates spray guns, rock drills, tampers, paving breakers, sandblasting . . . Uses only 1 gallon of gas an hour! Famous the world over! Capacity 60 cu. ft.; pressure up to 100 lbs. per sq. inch. Just order the Smith Compressor Head and Accessories with complete instructions for assembling. All you need is a Ford Motor and shop facilities. Head equipped with high speed compressor valves; automatic unloading and idling.

Write for complete information!
GORDON SMITH & COMPANY, Inc.
410 College Street • Bowling Green, Ky.

MONEY FOR MEN ALL FREE

THE PLASTEX Industry needs manufacturers on small scale and for big production of Lamp and Clock Stands, Art Goods and Novelties in Plastex and Marble imitation. Experience unnecessary. 1/2¢ material makes regular 10¢ store sellers. Rubber moulds furnished for speed production. Small investment brings good returns. We are now placing big Chain Store Orders with manufacturers. Ambitious men have chance for real prosperity. Our Free booklet will interest and benefit you.

PLASTEX INDUSTRIES, Dept. A
3400 Third Ave. New York 56, N. Y.

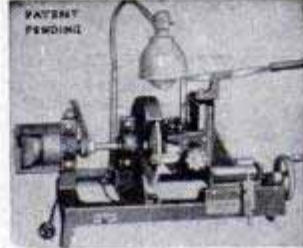

Start a NEW BUSINESS! or Add to your present Repair Business

SHARPEN DULL PIPE WRENCHES
PIPE TAPS & DIES
"GUM" CIRCULAR SAWS
Write for Information
J. C. MOORE INDUSTRIES
BOX M 276 FREDONIA, PA.

DEPENDABLE  You can count on the performance of a genuine Gerstner Chest. Free Catalog.

GERSTNER TOOL CHESTS
453 Columbia St.
Dayton 7, Ohio

ONE-MAN SAWMILL LOW \$50.00 DOWN

Take BELSAW Portable Sawmill right to the trees—turn out valuable lumber for home and farm—sell to local yards—make up to \$50 a day custom sawing for neighbors. BELSAW lasts a lifetime. No crew needed. Power with tractor or auto engine. Beginners get excellent results. Send today for FREE BOOK, "HOW TO MAKE LUMBER".

BELSAW MACHINERY CO.
8118 Field Bldg. Kansas City 11, Missouri



EARN \$6.00 PER HOUR

At a cost of 20¢ with the NEW JENZ SUPER CHIEF STEAM CLEANER. Portable—No moving parts—Cleans anything—Any place—Motors—Chassis—Machinery—Floors—Buildings—Oil Rigs, etc.—Oil fired—Economical—Fully tested and warranted. 75 lbs. steam in ten min.—Model 90. Complete as illustrated. **\$388.50**

F.O.B. shipping point
HI-PURE LABORATORIES, Evansville, Ind.

Never before...air conditioning like this

new Coleman Blend-Air Conditioning!

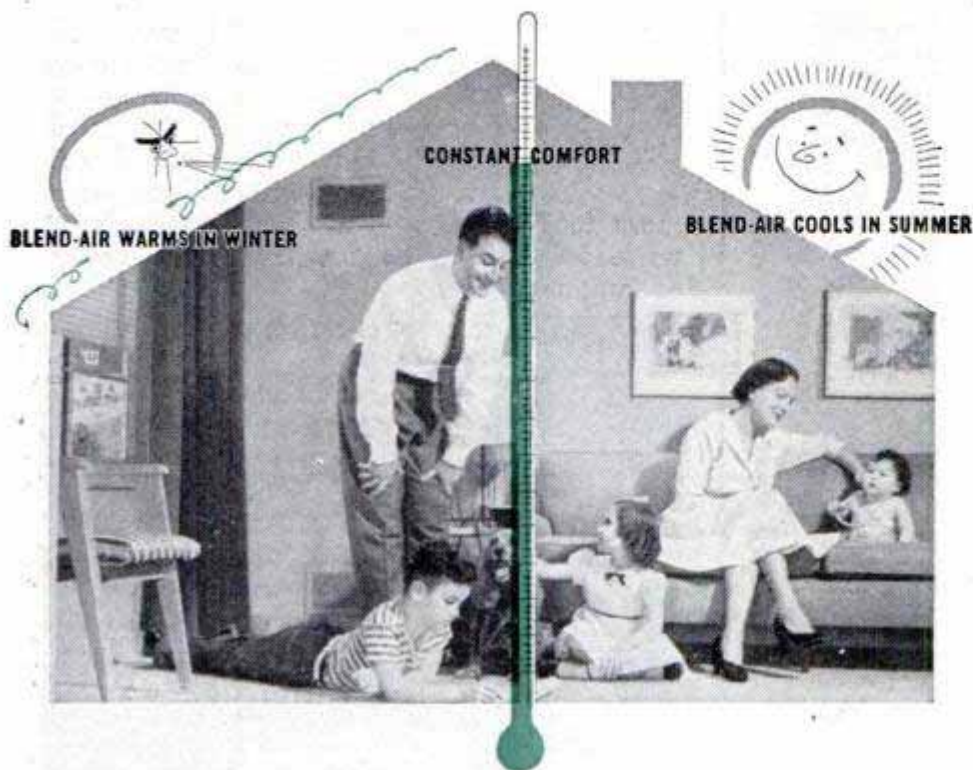

YEAR-ROUND BLEND-AIR CONDITIONING KEEPS YOUR HOME COOL ALL SUMMER, WARM ALL WINTER

To make every room in your home more comfortable all year long, Coleman now adds a cooling and dehumidifying unit to its famous Blend-Air Heating System.

This new combination system — Blend-Air Conditioning — uses the same revolutionary air-blending principles as Blend-Air Heating. It keeps you more comfortable than ordinary air conditioners because it squeezes twice as much moisture from the air. This makes the air cool and crisp—not cold and damp. Continuous circulation, perfect “perimeter” heating and cooling.

In winter, this new system floods your home with constantly circulating warm air that eliminates cold floors and provides uniform comfort. Mail the coupon for details. The Coleman Co., Inc., Wichita, Kansas.

Keeps comfort constant

Exclusive Magic Blenders increase air circulation, improve comfort, reduce floor-to-ceiling temperature difference.

Squeezes twice as much

moisture from summer air, reducing humidity that much more. Air is cool, crisp, dry — not cold and clammy.

Cuts water costs 97%

Exclusive Water Saver uses cooling water again and again, not just once. You save 97% on water costs. No cooling towers are needed.

Spreads total cost

Get heating now, cooling later. Both systems use same small air tubes, same Blenders. A big money-saver in any home.

Saves space

Put it in closet, utility room, basement. Or split up components, with compressor outside if desired.

Installs easily

in new and old homes. Small (3½”) air tubes, prefabricated and delivered ready to install, fit in standard walls.

THE MAGIC BLENDER DOES IT!

In winter, the Magic Blender blends room air with freshly heated air to maintain constant comfort. In summer, the Magic Blender blends room air with cool air from the cooling unit for refreshing coolness. The Blender keeps air circulating for year-round health and comfort.

ALL MODELS AGA APPROVED OR LISTED WITH UNDERWRITERS' LABORATORIES

HEATERS · WALL FURNACES · FLOOR FURNACES · WATER HEATERS

“If it isn't

Coleman it isn't Blend-Air”

THE COLEMAN CO., INC.
Dept. P-708, Wichita 1, Kans.

Please send me free literature on Coleman Blend-Air Conditioning

Oil Gas LP-Gas

Name _____

Address _____

City _____ State _____

COMFORT COSTS SO LITTLE WITH A COLEMAN

FIRE PUMPS

Get Curb Service



Old time fire fighting depended on water from nearby ponds, wells or cisterns. Improved efficiency came (early 1800s) with water mains and curbside hydrants.

AC FUEL PUMPS

... America's First and Finest

Fire pumps put fires out, but AC Fuel Pumps keep the "fires burning" in automotive engines . . . with a steady, dependable metered flow of just the right amount of fuel.

That's why AC Fuel Pumps introduced in 1927, soon made old-time fuel systems obsolete . . . why 9 out of 10 cars on the road rely on AC Fuel Pumps for smooth, reliable performance.

After thousands of miles of faithful service, fuel pumps can wear out—causing unnecessary roadside delay and expense. If your car has seen many miles of service—renew its reliability—install a new AC Fuel Pump—now serving more than 40 million motorists.

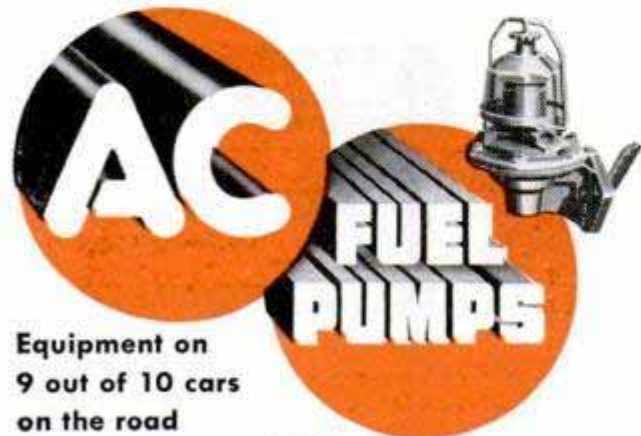

Equipment on
9 out of 10 cars
on the road

AC SPARK PLUG DIVISION



GENERAL MOTORS CORPORATION

WORLD'S LARGEST SELLING PLUG

The Flatfish!

OVER
ELEVEN MILLION
SOLD

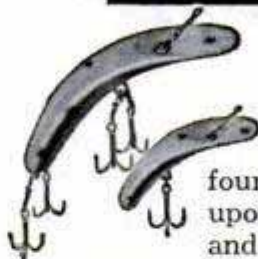

There is only one reason why the Flatfish outsells all other plugs year after year. It's because fishermen have found that it can be depended upon to deliver the goods. Try it and see how it will help you catch more fish. Get it at your tackle dealer's or write for 48-page book with fishing secrets of famous anglers.

Free
CATALOG

HELIN TACKLE CO.

3669 Meldrum

Detroit 7, Mich.

Our 603rd Advertisement

REAL DIESEL ENGINE

\$3.95

- for planes, boats, midget cars
- 7500 RPM; 1/7 HP; ht. 3 1/2"; wt. 5 oz.
- precision machined for smooth operation

You just can't beat this price for a precision diesel engine! Streamlined, compact, easy to install. Thousands of satisfied users all over the world. Fast delivery if you ORDER TODAY! Send \$3.95 plus 25¢ postage.

GOTHAM HOBBY CORP. Dept. P, 107 E. 126th St. New York 35, N. Y.

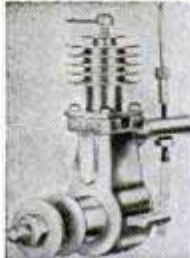

Treasure - Minerals - COINS

Easily located with new Light-weight M-Scope Detector. Superior performance, lowest price, monthly payment plan.

FREE LITERATURE

FISHER RESEARCH LAB., INC.
PALO ALTO CALIF.



SILVER SOLDER TORCH & KITS \$7.95

JOINS ALL METALS PERMANENTLY

Do your own repairing. KIT includes one tube silver solder paste and 10 5-in. lengths silver solder alloy. Hottest ALCOHOL TORCH known. 2700° F. flame. Operates in any position, indoors or out. Pint of special fuel included. Complete outfit ready for use \$7.95 postpaid. TORCH alone with pint of special fuel \$6.85. KIT alone \$1.65. Instructions included. AMERICAN PRODUCTS CORP., 422 S. Dearborn, Dept. 3-E, Chicago

Make Money

Selling

Eshelman

Power

Mowers

Riding

Tractors

& Rotary

Tillers

For
BETTER
GARDENS

ESHELMAN

ROTARY
TILLER

ONLY
\$119.50

Turns virgin ground into a garden bed in one operation. Replaces plowing, discing, and cultivating. Women can operate it. Also POWER MOWERS & RIDING TRACTORS from \$69. Free Catalog. Write nearest branch:—

ESHELMAN CO., Dept. R-25
119 Light St., Balto. 2, Md.
333 N. Michigan Ave., Chicago 1, Ill.
7070 Hollywood Blvd.,
Los Angeles 2, Calif.

FILE SAWS THE RIGHT WAY



SO EASY with this new filing jig and jointer anyone can now sharpen any handsaw like new! When file hits hardened steel rollers teeth are finished and EXACTLY THE SAME HEIGHT. All teeth cut and saw runs true and smooth. Jig and instructions \$2.95 postpaid. FREE FOLDER.

SHARPEN YOUR CIRCULAR SAWS

The RIGHT WAY on your own saw table. Sharpens rip, cutoff, hollow ground and combination blades—6" to 10". Saws stay round with correct bevel. Precision made easy to use. GUARANTEED. Only \$8.95. Includes \$3.00 Grinding wheel.

"TRU-CIRCLE" saw set automatically sets teeth at 10° or more. \$2.95

AT DEALERS OR POSTPAID



A. D. McBURNEY, 317 E. 4th St., Los Angeles 13, Calif., Dept. A-29

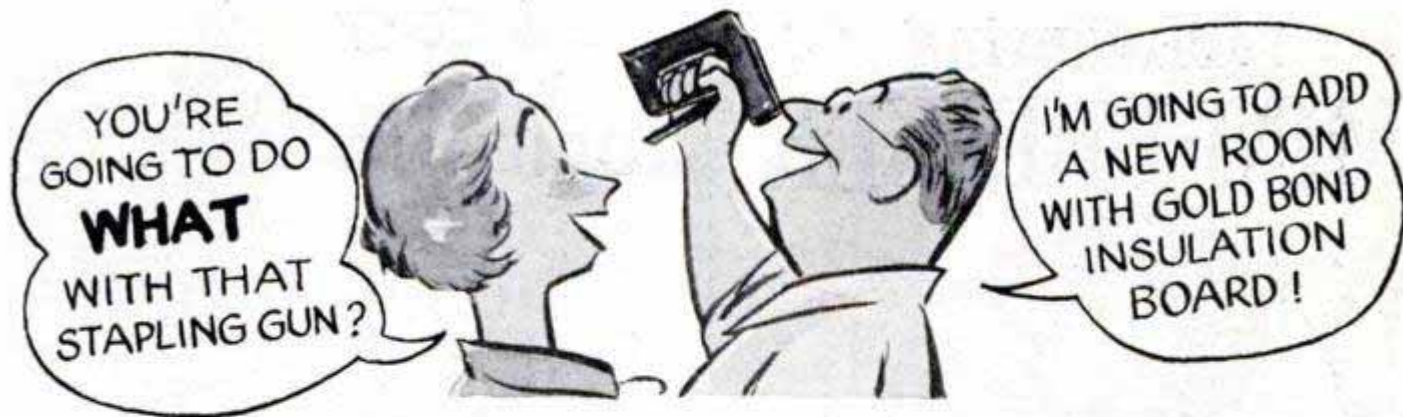

Our sunporch was no fun. It was a chilly place to sit even in May and June. Here was a considerable part of our house going to waste!



Then our dealer showed us Gold Bond Insulation Board Products, explained how we could use them to insulate...and decorate as well.



Gold Bond Insulation Planks are lightweight, easy to handle. They come in four widths and in a variegated blend of four colors.

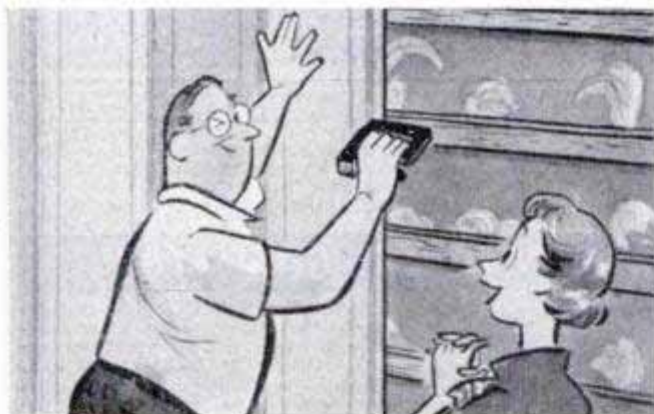

First step was to nail furring strips to the old wall. Then we stapled on Gold Bond Insulation Board Planks. Snug, interlocking edges hid the staples.



For the ceiling we selected another Gold Bond Insulation Board Product—Acoustamatic* Tile. This gave us a smart, good-looking ceiling...with built-in sound-conditioning.

*TRADE MARK

See Gold Bond Insulation Plank...and new Gold Bond Acoustamatic Tile...at your Gold Bond lumber and building materials dealer.



Now...here's the quietest, most comfortable room in the house. And there was no painting or papering at all. Gold Bond Insulation Board Products come already decorated.

ADD-A-ROOM NOW!
with **Gold Bond®**

NATIONAL GYPSUM COMPANY
BUFFALO 2, NEW YORK

Fireproof Wallboards, Decorative Insulation Boards, Lath, Plaster, Lime, Sheathing, Roofings, Siding, Masonry Paints, Wall Paints, Textures, Rock Wool Insulation, Metal Lath and Sound Control Products.

Introducing MINI-BREAKER®



... the amazing new permanent "Circuit Protector" that fits like a fuse in any standard Edison base fuse socket!

**No additional equipment to buy!
No special wiring required!**

No more fussin' with "blown out" fuses! Now you can enjoy modern permanent protection against electrical fire hazards at a new low cost simply by installing MINI-BREAKERS in your present fuse box!

SAFE, CONVENIENT, ECONOMICAL! Yes, you save many times the price of the device by being able to install them yourself. Yet, MINI-BREAKERS give you positive, pre-tested circuit protection at all times. They trip instantly on "shorts," but have a built-in time lag to handle temporary starting loads and line surges. Then, once the circuit is safe again, all you have to do to restore electrical service is press in and release the shock-proof reset button! Never need be replaced!

LISTED BY U. L. I MINI-BREAKER is a precision-built, tested and inspected "Circuit Protector" . . . the only device of its kind ever to be listed by Underwriters' Laboratories, Inc.!

• AVAILABLE IN 3 RATINGS!
15, 20, and 30 ampere for A.C.
service to 125 volts maximum.

\$1.50

SEE YOUR LOCAL DEALER
or send for complete information today!



MECHANICAL PRODUCTS, INC.
1824 River Street • Jackson, Michigan

Please rush me full details on new MINI-BREAKER today!

NAME _____

ADDRESS _____

CITY _____ ZONE _____ STATE _____

LOW COST WELL DRILLING



Save well drilling costs . . . have all the wells you need . . . in cellar, barn or outdoors . . . shallow or deep wells. CON-SOL's low cost well driller is easily moved, set up and operated. Sturdy and reliable, its extra-hard, quickly installed, drill insert drills through many feet of solid rock before replacement is needed. Used by U. S. Depts. of Agriculture and Forestry, by the U. S. Navy, and by many well drillers. Fully guaranteed.

For 4" casings, price \$385 F.O.B. factory, includes drill, bailer and 100' cable. Additional cable, up to 300', 3/4 H.P. motor or 1 1/2 H.P. gasoline engine, available at extra cost.

HEAVY DUTY MODEL, for 6" casings, also available at \$1295 F.O.B. factory, equipped with gasoline engine.

Write for literature to Dept. PM-5.

CONSOLIDATED INDUSTRIES
WEST CHESHIRE, CONNECTICUT, U. S. A.

SET-UP - KNOCKDOWN SAWHORSE with *Jiffy* BRACKETS



No nails or bolts . . . use 2x4's for legs. 2x4 or wider for crossbar. Rugged, sturdy, easy to move, saves storage space. Sold by hardware and building material dealers, or order direct.

GRAND HAVEN STAMPED PRODUCTS CO., Grand Haven, Mich.



LAWN ORNAMENT-NOVELTY PATTERNS

28 Lawn Ornament Patterns, 25c. Other Patterns: 15-20" high; Dutch Girl, Dutch Boy, Pirate, Bull Terrier, Mexican Girl, Mexican Boy, Dwarf, Penguin, Flower Girl, 15¢ each. 25 Novelty Patterns, 30¢. All 62 Full Size Patterns, \$1.00. Strother Pattern Service, Dept. DH-8, Box 128, Belington, W. Va.

"SNOOPER" GEIGER COUNTER



Super-sensitive! Only 1 1/4 lbs.! Fits pocket—uses flashlight battery. Find a fortune in uranium. Order Now! Send \$5.00, balance C.O.D. MONEY BACK GUARANTEE. FREE CATALOG—scintillator and larger uranium and metal detectors. DEALERS WANTED.

2495
COMPLETE

PRECISION RADIATION INSTRUMENTS
2235 PM S. LA BREA, LOS ANGELES 16, CALIF.

Say You Saw It in Popular Mechanics

FEL-PRO SPECIAL HOT ROD GASKETS for FORD-CHEVROLET-MERCURY engines

Especially designed Hot Rod Gaskets having enlarged cylinder openings to provide piston clearance on popular hot rod engines.

AVAILABLE NOW!!

Get them at your nearest automotive wholesaler . . . and while you are there—ask for a copy of the FREE Fel-Pro GASKETING MANUAL . . . the booklet that contains more than 30 helpful gasketing tips learned from Fel-Pro's many years' experience in manufacturing gaskets by the millions for car factories and the replacement field.

FREE MANUAL may also be had by writing direct to

FEL PRODUCTS MFG. COMPANY,
1527 Carroll Ave., Chicago 7, Ill.



MASTER GARDENER

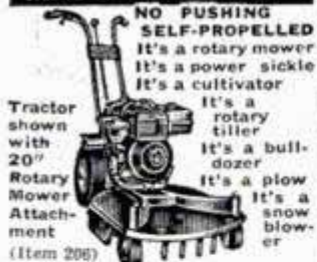

NO PUSHING SELF-PROPELLED
It's a rotary mower
It's a power sickle
It's a cultivator
It's a rotary tiller
It's a bulldozer
It's a plow
It's a snow blower

Tractor shown with 20" Rotary Mower Attachment (Item 206)

Where else can you get a power tool that does so many jobs? Works for you year 'round. Does terrific job cutting grass or weeds. Or, prepares mellowed deep seed bed without labor. Built-in power take-off to drive pumps, saws, generators, etc. Safety clutch—can't burn out. More versatile and efficient than tractors costing twice as much. Converts in minutes to Tiller, Power Sickle, etc. Basic self-propelled 2 hp tractor with Briggs or Clinton famous engine. Only **\$119.50**
Rotary Lawn Mower \$42.50; Sickle Bar-Mower \$42.50; Lawn Mower Hitch \$4.50; Cultivator \$8.75; Rotary Tiller \$12.50; Furrowing Tool \$8.75; Disc Harrow \$15.75; Plow \$8.75; Snow Blow \$39.50. Freight prepaid to most areas. Easy payment plan available.

VENTILATING FAN

(Item 10) Mount in wall or ceiling to ventilate any area. Over range, removes kitchen smoke and odors. Easily installed in furnace pipes. Forces even heat to all rooms. Powerful continuous duty motor. 110-120 v. A.C. Quiet, super efficient fan moves huge volume of air (400 to 600 c.f.m.) 8" Fan, wt. 5 lbs., \$6.85; 9" Fan, wt. 6 lbs., \$7.85; 10" Fan, wt. 7 lbs., \$8.85; 12" Fan, wt. 8 lbs., \$9.85.



HEAVY DUTY FAN. Semi-enclosed motor, suitable for spray booths, restaurant exhausts, poultry houses, etc. 10" Fan, wt. 8 lbs., Item 10E \$11.95. 12" Fan, wt. 10 lbs., Item 10D \$12.95

NEW MOTOR BIKE

Our Commando Motor Bike is trouble-free—carries amazing 5 yr. guarantee. Goes to 150 miles per gal. on all roads. Speed to 40 mph. No oil or gas fumes. Easy automatic pedal or pull starting. Has new principle of automatic transmission. No belts or chains—power transmitted directly to rear wheel. Accelerates quickly. Complete motor and kit ready to attach to your bike in 1 hour. Get free **\$125.00** Complete Motor and Chassis **\$199.50**

Variable Speed Selector

Heavy duty, made by B. F. GOODRICH for industrial use. Provides instant speed changes for any drive. For machine tools, dryers, printing, conveyors, production lines, hoists—any operation requiring variable speed. Ideal for midget autos. Employs reliable "trouble free" planetary system. No hydraulic power losses or creeping. Infinite range, smooth operation, easy installation (data included). 3 sizes: 1/2-1 hp., wt. 54 lbs., 1-2 hp., wt. 95 lbs., 2-3 hp., wt. 105 lbs. Reg. List \$228, \$252 and \$352. Our prices... **\$79.50, \$89.50 and \$114.50.**

HYDRAULIC JACKS

Heavy duty, precision built, smooth, positive acting with built-in relief valve. Hi-Lift with screw extensions. Govt. surplus at a fraction of orig. cost. (Handle included.) 3 ton (Item 208A) **\$9.45**
5 ton (Item 208B) **\$11.45**
17 lbs. **\$11.45**



DIRECT FACTORY SALES GIVES YOU BEDROCK SAVINGS

WORLD'S FINEST GUARANTEED LIGHT PLANTS

PORTABLE LIGHT PLANTS
PUSH BUTTON START A.C. PLANT 500-700 watts—115 v. —60 cyc. A.C. Powered by a rugged 2 hp. easy-starting Briggs gas engine. No wiring necessary, just plug in and operate. Plenty of current for any oil burner, freezer, brooder, emergency lights, etc. which require up to 700 watts. Ideal for Civil Defense, Fire Depts., trailers and camps. Complete with Voltmeter and built-in winding to charge 6 v. auto batteries. Item 24. Wt. 85 lbs. Be prepared if war or storm knocks out power lines. **\$143.50**
\$242 value.

700-800 Watt Plant (Item 24) same as Item 24 but larger engine. **\$169.95**
1000-2000 Watt Plant (Item 45) same as Item 24 but larger generator & engine. **\$199.50**

1500-1700 Watt Plant (Item 20)—Similar to Item 24, but has three times more capacity. Wt. 173 lbs. Factory price **\$279.50**

GIANT 2000-2500 WATT PLANT
110-120 V. 60 cyc. A.C. Absolutely the best made—exclusive dynamically balanced armature; heavy windings develop up to 5000 watt overload for motor starting. Skid-mounted—portable. Powered by easy starting Briggs or 6 hp. Wisconsin engine—complete with all accessories; engine easily disconnected for other uses. Big outlet box, voltmeter, no wiring necessary. Ample current for all purposes. Factory warranty and complete instructions included. (Item 31) Wt. 220 lbs. Reg. price \$585.00, Special at **\$299.50**
Generator only and control box **\$169.50**
2500 Watt Plant (Item 21) Push Button Start. A big plant at a low price. Wt. 238 lbs. **\$329.50**
3000-3500 WATT PLANT (Item 198) 110-220 v. 60 cyc. A.C. Belt drive with Wis. Engine. Push button start. Wt. 350 lbs. Heavy duty **\$399.50**
Generator only for belt drive, Wt. 116 lbs. (Item 198A) **\$239.50**
3000-3500 Watt Plant (Item 29) 115 v. 60 cyc. A.C. Push Button Start. Direct Drive. Wt. 270 lbs. Factory Price **\$379.50**

HI-LINE 6000 WATT PLANT
(Item 162) Push Button Start, 115-230 v. 60 cycle A.C. A brute of a power plant with a rugged 18 hp. Wisconsin engine. Plenty of electricity for ranges, water heaters, freezers, pumps, machinery, etc. Affords both 110 and 220 volts. Ideal where heavy current is needed. Wt. 590 lbs. Easily worth \$995.00. With self starter. **\$645.00**
Factory price **\$885.00**
Same plant but with Crank Start. (Item 166) **\$585.00**
Generator and control box only, belt driven. Use your own engine or tractor. Wt. 240 lbs. (Item 163) Factory price **\$345.00**
We make fully automatic controls to operate any of above light plants. Write for details.

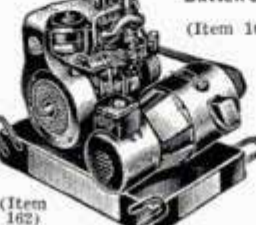

(Item 162)

DIESEL ENGINE

GET QUICK DELIVERY SAVE BIG MONEY
Powerful, smooth running for industry, farm, irrigation, saw mills, pumping, etc. Economical operation, cutting costs to the bone. Electric starting. Complete with clutch. Power take off. Ready to run. Best made. Easy electric starting. Factory priced to save our customers big money. Order from these four rugged units or write for complete details:
27 Horse Power Engine... **\$895.**
42 Horse Power Engine... **\$1,515.**
50 Horse Power Engine... **\$1,690.**
72 Horse Power Engine... **\$2,115.**

MASTER AIR COMPRESSOR

(Item 209) High pressure type for large volume of air for heavy duty service. For paint spraying, inflating truck and auto tires, greasing, and the hundreds of other jobs done by compressed air. Piston type. 2" bore compressor with built-in air filter. Master built with hi-strength alloys and precision bearings. Stainless steel tank, 12"x24", 2100 cu. in. cap. Safe up to 500 lbs. Equipped with automatic switch that starts and stops motor to maintain desired pressure (up to 150 lbs.) and check valve, safety valve, gauge, shut-off valve, 20 ft. air hose and tire chuck. Beautifully balanced on ball bearing wheels and rubber tires. Low factory prices. With 1/2 hp. 110 v. A.C. motor (Reg. \$175.00) **\$98.50**
(Item 209) With 3/4 hp. motor, Reg. **\$119.50** (\$109.50) (Item 209A) **\$119.50**
With 2 hp Briggs Gas Engine (Reg. \$199.50) **\$109.50**
(Item 209B) **\$109.50**
Write for prices of compressors only. A complete line of spray guns and air tanks available.

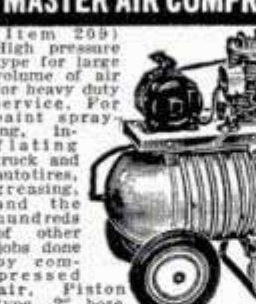

(Item 209)

DIESEL LIGHT PLANT

(Item 1660) Diesel Master—11-12 kw. 115/230 V. A.C. single or 3 phase. 1800 rpm, direct connected. Designed and engineered for permanent power installations. Assures efficient, dependable low cost operation where heavy current is important. Wt. 1350 lbs. Regular list **\$1895.00**
\$3,650.00. Factory price **\$1895.00**

10-11 kw. GAS DRIVEN PLANT. 115-230 V. 60 cycle A.C. powered by 4 cylinder Wisconsin air cooled engine. Belt driven. With self starter. Constructed similarly to Item 162 but much larger. Item 217 wt. **\$1245.00**
900 lbs. Factory price **\$1245.00**



(Item 1660)

HEAVY DUTY D-C ARC WELDER

Use as portable or shop welder. Up to 300 amps. Senior model. Made for years of trouble-free, continuous service. Will handle light or heavy jobs. Easily welds up to 3/4" plate using 1/4" rods. Built-in air cooling system. Arc is easy to strike and hold, because of specially designed arc stabilizer. Hi-to switch and dial control gives wide range of welding heats. Run welder at 2800 rpm. with tractor, jeep or 15 hp. gas engine, or 7 hp. elec. motor. Complete with instructions, gear, and double V belt or flat pulley. You can pay more, but you can't buy a better welder. (Item 58) Wt. 110 lbs. \$400 value at **\$99.75**
DUAL CONTROL MODEL same as above but with built-in dual rheostat for low heat soldering, brazing, welding. Spec. **\$119.50**
WELDING KIT. Two 10 ft. leads, welding helmet, electrode holder, ground clamp. Sold only with welder at **\$10.50**
Write for prices on A.C. Arc Welders.



with mounting flange

Factory Prices on Catalog Items

Send 10c for BIG 1953 catalog. Hundreds of bargains

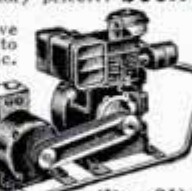

(Item 31)

EXTENSION CORD



(Item 16) Heavy duty. Made of Neoprene, insulated. No. 16 2 conductor wire. So tough that you can drive over it. Yet, flexible for easy handling. Resists oil, grease, or water. Perfect for hedge trimmers, lawn mowers, power tools, lights, etc. Complete with heavy rubber plug and outlet. 40 ft. Reg. \$4.95. Wt. 2 1/2 lbs. **\$2.45**
Special. **\$2.45**
100 ft. length (1 pc.) **\$5.85**
Wire only (Item 50) No fittings. **\$5.00**
NEOPRENE CABLE No. 14-2 (Item 185) Wt. 9 lbs. \$9.95

Heavy Duty Power Cable

12-2 Cond.—stranded, very flexible, rubber covered, special outside conductor for grounding power tools, etc. Finest heavy duty power cable made. 50 ft. (Wt. 8 lbs.) Item 199. **\$6.95**
100 ft. (Wt. 16 lbs.) **\$12.95**
Item 200. **\$12.95**

32 Pc. SOCKET SET



Highest quality guar. non-breakable sockets made by Husky. Beautiful, matched chrome alloy, absolutely the best. Complete range of 21 sockets from 1/4" thru 7/16" in 1/4" drive and 7/16" thru 1-1/8" in 1/2" drive; 2 extensions, reversible 1/2" ratchet, adaptor bit, slide head, all angle coupling, 2 end wrenches, 1/2" speeder handle and sturdy metal tool box. For prof. mechanics who want the best. Wt. 14 lbs. (Item 59) Easily worth **\$16.95**
\$41.50 **\$16.95**

45 Pc. SOCKET SET

(Item 205) Contains a complete set of sockets in 1/2" drive, 3/4" drive and 1/4" drive, plus all necessary extensions, handles, speeders, reversible ratchets, etc.; all uncond. guaranteed against breakage. Beautiful matched chrome thin wall alloy sockets in a sturdy handsome steel tool box. Wt. 17 lbs. List price \$62.00. **\$26.95**
Factory Special. **\$26.95**

6-Pc. MAGNETIZED Screw Driver Set!

Permanently magnetized tempered and hardened tool steel blades. Plastic handles—unbreakable and shock-proof. Picks up and holds screw in tight spots. Makes impossible jobs easy. You get following types: Midget, stubby, close quarter, cabinet, thin blade, machinist, heavy duty, extra heavy duty. Fully guaranteed. Easily worth \$4.95. Item 106: **\$1.95**
wt. 3 lbs. Special. **\$1.95**



3-Pc. ADJUSTABLE WRENCH SET

Made of finest steel alloy, chrome plated. Prices are exactly half actual value. Take the place of a whole set of tools. Packed in leatherette pouch.
Set A—4-inch, 6-inch, and 8-inch wrenches. (Item 107). Wt. 2 lbs. only **\$2.95**
Set B—8-inch, 10-inch, and 12-inch wrenches. (Item 108). Wt. 4 lbs. only **\$6.45**



3-Pc. PIPE WRENCH SET

Made of finest German Tool Steel. Completely drop forged. Pipe sizes clearly marked for easy one-hand setting. Heavy sharp jaws will never slip. Ideal for master craftsmen. Set includes 8"-10" and 14" wrenches. Covers most pipe sizes. A combination of brute strength and precision workmanship. Will pay for themselves on one job. Item 12. Wt. 6 lbs. Easily worth \$11.95. **\$6.55**
While they last. **\$6.55**



Prices f.o.b. Factory. 10 day Money back guarantee. Send check or Money Order
MASTER MECHANIC MFG. CO., DEPT. 48-C Burlington, Wis.



● You'd soon realize how much an oil-pumping engine costs, if you bought all that wasted oil at one time.

Every extra quart is a danger signal—and so are loss of power and smoke from the exhaust. They're symptoms of worn-out piston rings. And the sooner you replace those rings, the more money you'll save.

As your engine gets older, the cylinders wear tapered and out-of-round. The engine runs hotter because of accumulations in the cooling system. It needs more oil on the cylinder walls.

The problem is to deliver this needed oil, under full control. This requires a special type of piston rings . . . *replacement rings.*

Hastings makes replacement rings exclusively . . . devotes all its research to the particular replacement problems of each make and type of engine—for re-ring, re-bore and re-sleeve.

Hastings rings are nationally known for their ability to stop oil-pumping, check cylinder wear, restore engine performance.

So go to your motor specialist at the first sign of oil-pumping. He'll gladly install a Hastings Steel-Vent replacement set. Truly the best money you can spend on your car. Hastings Manufacturing Co., Hastings, Mich.; Hastings Ltd., Toronto (Piston Rings, Spark Plugs, Oil Filters, Casite, Drout)

TOUGH but oh so **GENTLE**
TOUGH ON OIL-PUMPING
GENTLE ON CYLINDER WALLS



HASTINGS
STEEL-VENT PISTON RINGS
Regular or Chrome-Faced

BUILD YOUR OWN POWER TOOLS—TILT/ARBOR SAW

Exclusive GIL-BILT Build-It-Yourself Features

- No machining—build easily with hand tools only
- No blueprint reading—step-by-step pictorial plans, full scale patterns, actual photographs
- Sturdy wood, aluminum and steel construction
- Capacity and performance of commercial saws selling for \$60 and up

BANDSAW
BELT SANDER
SAVE \$50.
OR MORE

GIL-BILT 10-INCH TILTING ARBOR SAW



- 27x28 in. table, 13½ in. capacity in front of blade
- 10 in. blade cuts 3¼ in. deep, tilts full 45 degrees
- Floor model 34" high, table always stays level

- New Departure ball bearing arbor, ¾" precision shaft turned down for 5/8" bore blades, alum. housing, shipped ready to run
- Jackscrew and 4½ in. dia. handwheel lowers and raises blade
- Cast aluminum miter gauge and self-aligning rip fence guide

GIL-BILT Metal Parts Kit includes Plans, ball bearing arbor, miter gauge and bar, rip fence guide, dado insert, lock knobs, jackscrew mechanism and handwheel, and all other metal parts (less blade) \$21.95
Same Kit with 10" Combination Blade \$24.90
Same Kit with 8" Combination Blade \$23.90

GIL-BILT 12-INCH BAND SAW

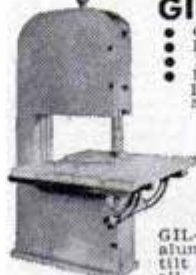

- Cuts to center of 24 inch circle
- Handies stock up to 6 inches thick
- 18x18 inch table tilts 45 degrees
- Lower wheel and drive pulley runs on sealed New Departure Ball Bearings; Upper wheel runs on two 5/8" bore Ollite Bronze bearings.

- Upper wheel tension and tilt mechanism of cast aluminum, completely assembled.
- Upper and lower blade guides. Each has ball thrust bearing, self-lub bronze jaws.
- Rigid cast aluminum wheels fully machined ready-to-install. Heavy rubber tires.
- Uses standard 78 inch blades up to ¾ in. wide.
- Fully enclosed mechanism for utmost safety.

GIL-BILT Metal Parts Kit includes Plans, rubber tires, aluminum wheels, ¼ in. blade, ball bearing spindle, tilt mechanism, blade guides, table tilt segments, and all other metal parts \$21.95

Return Kits in 10 days for refund if not satisfied. (Prices include postage within 300 miles. Over 300 add 5%)
Also available—Plans and Parts Kit for 18" Band Saw, Belt Sander and 8" Tilt/Arbor Saw. Order Plans at \$1.00 each—Sent postpaid anywhere in the world or write for FREE descriptive catalog.

GILLIOM POWER TOOLS P. O. Box 1-PE, Lambert Field St. Louis 21, Missouri

STOP JERKY STARTS! with an **AUTOMATIC CLUTCH**

END BELT SLIPPAGE—Get smooth pickup for your power mower, scooter or garden tractor with only throttle control.



only \$7.95 AND UP

PREVENT STALLING engine, cut belt wear, gain no-load idling. Quickly and easily installed on ½, ¾, 1" shafts. Every clutch factory tested.

See dealer or write for Folder PM5

V-PLEX CLUTCH DIVISION • Hagerstown, Indiana

FREE CRAFT CATALOG



120 PAGES . . . Craft Supplies, Tools, Designs, Instruction Books from America's Largest, Most Complete Handcraft Stock.

Send for your free copy NOW!
GRIFFIN CRAFT SUPPLIES
5626-A Telegraph Ave • Oakland 9, Calif.



BE READY FOR ANY FISHING OPPORTUNITY!

CARRY A
Handle-Rod

ALONG AT ALL TIMES IN YOUR POCKET - IN YOUR TACKLE BOX GLOVE COMPARTMENT BRIEF CASE - SUITCASE PICNIC BASKET

A 5 foot precision made Casting Rod — Telescopes within its handle to just 11 inches. Will not rust. Weighs only 6 oz.

\$13.50

CHAMPION PRODUCTS CO.
Muskegon, Michigan

**RELIEVES
HEADACHE
NEURALGIA
NEURITIS PAIN**

FAST



Here's Why...

Anacin® is like a doctor's prescription. That is, Anacin contains not one but a combination of medically proved active ingredients. Anacin is specially compounded to give FAST, LONG LASTING relief. Don't wait. Buy Anacin today.

VIKING

Garden Tractors and Power Mowers

**CHORES NOW
A PLEASURE**

Mowing at its best—Lawns, Weeds and Brush.

WALK or RIDE

Also handles wide range of garden and ground maintenance jobs. Three Models.

LOW PRICES

Write Today Free Catalog Easy Terms

AMERICAN FARM MACHINERY CO.

1059 33rd Ave. S. E. Minneapolis, Minn.



See You Saw It in Popular Mechanics



CI

COLORCRETE

Drab or dirty masonry—concrete, stucco, etc., becomes gleaming white. Or there's a range of sparkling colors—ivory, cream, pink, blue, green, and 25 more. Colorcrete is fused to masonry surfaces under pneumatic pressure. Stays put and stays beautiful. Highly water resistant. Used for more than a quarter century.

**There's Profit-Appeal
in Stucco Spraying**

The business of applying Colorcrete is a community enterprise, with special appeal to men of limited capital. Equipment is compact, simple to operate, practically wear-proof. Work is easy, interesting and rich in profit potentials. Broad opportunities for development. We supply all equipment and full instructions.

No experience or special ability needed. Write or wire today for the Opportunity Book.

**COLORCRETE
INDUSTRIES, INC.**
570 Ottawa Ave.
Holland, Mich.



BEAUTIFUL, MODERN

**Bruce PREFINISHED
Oak Floors**



Your choice of Block,
Strip, or Ranch Plank

**Easy to lay right over
your old floors
...no sanding or finishing**

Now it's easy and economical to give your home the new beauty of modern oak floors... with all the glamour of nationally-famous Bruce Prefinished Hardwood! In only a few hours, your living room, bedroom, dining room—or that unfinished room upstairs—will glow with a style as modern as tomorrow. You can choose Block, Strip, or Ranch Plank design.

It's EASY! These floors are completely finished—even waxed—at the factory. Just cover old floor or smooth subflooring with felt paper and nail down this highest quality oak. No sanding or finishing... no mess or smell. Ready for use as soon as it's laid... and your home will have the rich style and lasting beauty chosen by leading interior decorators.

It's ECONOMICAL! A new Bruce Hardwood Floor will cost you less than a good rug or carpet... and will last the life of your home. The famed Bruce "Scratch Test" proves this durable finish doesn't scratch, chip or mar. Ask your lumber dealer for an estimate. Mail coupon below for colorful literature.

MAIL FOR FREE LITERATURE

E. L. Bruce Co., Box 397-G, Memphis 1, Tenn.

Send me complete, free information on prefinished Bruce Hardwood Floors.

Name.....

Address.....

City..... State.....



Bruce Hardwood Floors

Product world's largest hardwood flooring maker

B.F. Goodrich RUBBER FLOOR TILE

MAKE THE TOUCH TEST

Feel what
"SUPER-DENSITY"

means...



Smooth!

NO DIRT-CATCHING SURFACE PORES!



... in a floor with a surfacelike this. Cleaning is difficult, ineffective, costly.



... in B. F. Goodrich Rubber Floor Tile ... a smooth surface with no dirt-catching pores.

Enjoy the many advantages of this beautiful, easy to clean floor tile; enjoy its natural resiliency for quiet comfort underfoot.

INSTALL IT Yourself...

IT'S Easy

B. F. Goodrich Rubber Floor Tile is now available in a special thickness for economical home installation.



Send today for a free, full color booklet. Write Dept. M5, B. F. Goodrich Co., Flooring Division, Watertown 72, Mass.

Make Ur-Own ROTARY TYPE POWER MOWER

THIS IS NOT A KIT

A Complete Mower
Assembled As Illustrated

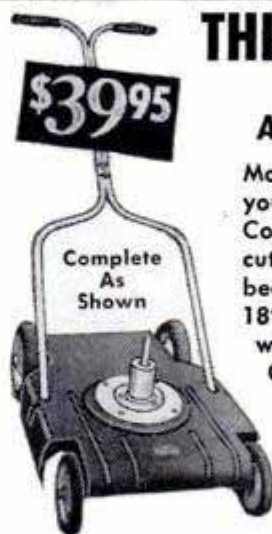

Model 53M Keen Mower. Add your electric motor or gas engine. Concealed blade for safety, 3 cutting heights, 1½" to 3½". Ball bearing semi-pneumatic wheels. 18" cut. Cuts to within ½" of sidewalk. Weight 48 lbs. America's Greatest Power Mower Value.

Order Now. Shipped **\$39.95**
F.O.B., K.C.

Send check or money order

229 S.W. BLVD.

Dept. PMS

ATLAS KEEN MOWER
KANSAS CITY, MO



BRONZE FOUNDRY

Schools and Home Workshops

Make your own castings of aluminum, copper, bronze, silver. Foundry sets are available in three sizes including 2400 Deg. F. blast Furnaces. \$22.50; \$29.50; and \$42.00. f.o.b. Kansas City. Free Circular.

KANSAS CITY SPECIALTIES CO. P. O. Box 6022, Dept. P-5
KANSAS CITY, MO.

PROTECT TOOLS AND PARTS WITH

an easily applied plastic hot-melt coating that protects tools and metal parts against rust, corrosion, abrasion and shock. 1-lb. can with instructions, \$1 plus 20c p.p. L. FRADER, 8318 Roberts Road, Elkins Park 17, Penna.

PLASTIC STRIPPABLE COATING

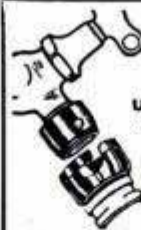

SPEE-DEE HOSE COUPLING

Easy on or off, Fits any Standard Garden Hose

Used at faucet
or extension
NON-RUST
METAL

\$1.00 ea. ★ 6 for \$5.00
with Extra Washer
POSTPAID

WHITE SPECIALTY MFG. CO.

2611 N. 85th St., Milwaukee 10, Wis., Dept. M

BABY YOUR HANDS!

WATERLESS DL HANDI-CLEANER



just apply and wipe dry

NO WATER NEEDED!

Dissolves dirt instantly . . . Prevents soreness due to chapping . . . Fortified with Lanolin . . . Guards against skin infection . . . Contains no harsh grit or abrasives . . . Ideal for home workshop, home, car and office.

SOLD AT SERVICE STATIONS, AUTO PARTS, AND HARDWARE STORES,

In 14 oz., 3 lb., 5 lb., and 5 gal. containers

BANITE CO. BANITE BLDG., BUFFALO 4, N. Y.

General Salvage Co. SURPLUS Bargain-SALE!

BUY DIRECT FROM THIS AD!

BUILD YOUR OWN ARC WELDER OR LIGHT PLANT

NEW D-C GENERATOR

Save \$250 to \$500

\$21.50 Instructions incl. for combination welder & Light Plant. 200 Amps. 28 Volts. 2500 R.P.M. Wt. 30 lbs. No. 700.

PRICE F.O.B. K.C. MO.

CONVERTS TO ARC WELDER 200-250 AMP. OR LIGHT PLANT CAP. LOAD 5000 WATTS

Stock No. 711 D. C. Generator N-1 Jack & Heintz, rated 300 Amp. 30 Volts. Gov't. cost \$300.00. Instruction for converting to welder or light plant incl. **\$27.50**

RHEOSTAT #R-21 heavy duty recommended for regulating the voltage on post-converted electric welder. **\$6.95** paid

Carbon Pile GENERATOR VOLTAGE REGULATOR For use with 24 or 32 Volt D.C. Generators. Also recommended for the P-1 and R-1 type generators in "build your own" **\$6.95** Light Plant. Only. postpaid

RHEOSTAT #R-71 For regulating voltage on model trains, lights, Photo flood lamps, etc. Rated 2 ohms, 100 watts, size 7"x5 1/2"x3 1/4". Wt. 2 1/2 lbs. \$15.00. **\$4.95** post-value. New. **\$4.95** paid

WEAVER HYDRAULIC HAND PUMP New With Built in Check & relief valve. For oil or Hydraulic Fluid. Rated 1000 P.S.I. \$75.00 Value **\$12.95** post-paid

VALVE GEARS BARGAIN SPEED REDUCER. 5-1 or 10-1 ratio 90 degree angle 1 1/2" splined shaft with 3 mount- (Add 50c ing holes rated 2 H.P.) **\$5.95** Postpaid

SENSATIONAL SELSYNS - Two or more connected together work on 110V A.C. For controlling distance operations, etc. Instr. incl. Post-positions incl. Per Pair **\$7.95** paid

D. C. GENERATOR. Brand new. Navy Type for Farm-House-Ranch. Delivers 450 Volts D.C. at 3450 R.P.M. Ball bearing supported. Fan cooled armature. Self lubricating bearing. #211220-A. Wt. **\$7.50** 21-lbs. Now only.

ROMEC WOBBLE PUMP. Hand lever operated. Ideal for Camp, Farm, Ranch, for fuel transfer to boats, etc. Self priming, including built in relief valve. Ideal for water, oil, insecticides, liquids. **\$8.95** post-incl. paid

VOLTMETER, DC. The Basic Element of this meter is 30 volts DC Voltmeter with zero center. Internal resistance is 300 Ohms. Dial may be easily calibrated to read DC Volts. Brand New. **\$3.95** post-\$25.00 value

SOLENOID #804 Equipped with lever arm which gives a 1/2" or 1 1/4" travel. Compact, powerful as actuator & to operate locks, switches, toy applications, etc. For 24V D.C. & applicable for 110V A.C. Instructions **\$4.95** post-incl. \$2.95 ea. Per pair.

Hydraulic Solenoid Control Valve
BENDIX, No. 81560. For remote control operation and to operate one single action or double action hydraulic cylinders with 24 V. D.C. Connections are P.S.I. connections are .550"-18thd. Armature cable for 115 V. A.C. Instructions & Data included. **\$3.50** ea. **\$6.50** pair \$35.00 value.

RIGHT ANGLE DRIVE with 1 to 1 ratio through 90 degree bevel gears. Drive and take off shaft are 3/8" dia., Self lubricating. Size 3 1/2" x 2 1/2" x 1 1/2". Rated 1/2 H.P. at 1750 R.P.M. Ideal for use with power tools, etc. Has three 3/16" mntg. holes on 1-5/16" **\$3.50** post-center. Price

BOMB INTERVALOMETER Type B2. Applicable to operate electric equipment lights, displays, signals, photography, etc. Can be set to release current supply at fixed time interval or split second timing. Size 5"x9"x3 1/2". \$50.00 value. For 24V. D.C. & applicable for 110V. A.C. Instructions incl. **\$8.95**

INSECTICIDE PUMP SPRAYER AND FIRE EXTINGUISHER. Four gallon size includes approx. 3 ft. of high pressure hose with fine mist nozzle. Used, good condition built to give years of heavy duty service. Wt. 15 **\$2.50** ea., add lbs. Price. **\$2.50** postage

CUNO OIL FILTER-Brand New Aircraft type. Filters oil without cartridge replacements. Just turn handle and cartridge is clean. Standard 3/8" inlet and outlet ports to accommodate 14 gallons per minute. STOP CHANGING OIL. Instructions **\$4.95** post-incl. paid

Send CHECK OR M. ORDER. PRICES F.O.B. KCMO EXCEPT when marked POSTPAID U.S.A.

ELECTRIC MOTORS
GEAR HEAD MOTOR Heavy duty 1/4 H.P. 3400 R.P.M. Series wound, Reversible, including built in reduction gear with 14:1 ratio Gear shafts runs 600 R.P.M. For 24VDC & applicable for 110VAC. Ideal for rotating antenna, window display & other low speed drives. #291 **\$8.95**

Stock No. 2832 is 1/4 H.P. 28V. D.C. 4000 R.P.M. With simple instructions to convert to 28-32V. A.C. Gov't. cost **\$4.95** \$82.84. New.

Stock No. 4949 is 1/8 H.P. 24 V. D.C. 2000 R.P.M. Mfg. by Pesco, applicable for 115 V. A.C. Instructions incl. Base mounted **\$3.95**

DELCO MOTOR 6 Volt DC. Shaft is 1/4" in dia., 1 1/4" long. Size 5"x3" two mount- \$2.95 post-incl. \$1200-2000 RPM. Price

AIRCRAFT STARTING MOTOR. Operates on 12 to 32 volts. Gives high torque, slow speed and tremendous power. Applicable for pulling or moving heavy loads. Makes ideal winch or heavy duty hoist. For belt or direct drive. Mfg. by Jack & Heintz. O. Cost over \$300.00. Ship. Wt. 55 lbs. **\$9.95** f.o.b. Stock #JHG4. **\$9.95** KCMO.

ECLIPSE MOTOR & GEAR UNIT. Brand New including 24V. D.C. Motor. Gear ratio 4:1. can be adapted for 2:1, 3:1, 4:1, 20:1. Ideal for GARAGE DOOR OPENER, HOIST, PUMP JACK, HAY-LIFT, LAWN MOWER DRIVE, DRIVE FOR POST DRILL, etc. Gear unit applicable for 110 A.C. Diagrams & instructions incl. Gov't cost \$221.00. Wt. 23 lbs. **\$9.95** f.o.b. only. **\$9.95** KCMO.

BEAM ROTATOR MOTOR New Powerful geared motor for TV aerials. Ham, FM, etc. Light weight, rugged. Shaft Speed is 9 R.P.M. Torque 75" lbs. & built in mounting bracket. For 24V.D.C. & applicable for 110V.A.C. Instructions incl. Stock #AJ31 **\$8.95** \$50.00 value

VICKERS CONSTANT DIS-PLACEMENT HYDRAULIC PUMPS. Brand New Stock No. PF-713-20. For any type liquid pumping job. 375 gal. per hr. at 3750 R.P.M. 1000 P.S.I. 410 cu. in. per rev. Gov. cost over \$150.00. **\$17.50** post-Data and instr. incl.

VICKERS PRESSURE & RELIEF VALVE. Adjustable 1/2" AC tube ports. **\$5.50** New. #501

PESCO POSITIVE DISPLACEMENT HYDRAULIC PUMP Gear type De ivers 198 G.P.H. at 1500 P.S.I. Rated 1500 to 4300 R.P.M., 1500 to 1750 P.S.I. Pump will operate in either direction & any position. 3/4" pipe ports and flange mounting. O. Gov't cost over \$150.00. Data incl. **\$15.50** #349

PESCO Centrifugal HEAVY DUTY PUMP Including built in motor. 1/4 H.P. Applicable for 24V. D.C. /A.C. or 110V. A.C. The motor is explosion proof constructed for gasoline fuel, oils, water, fuel booster, etc. 3/4" hose connection. Rated capacity, pressure instructions incl. Gov't cost \$172.00 Stock #659 **\$9.95**

PESCO LARGE VOLUME UTILITY PUMP For Water, Oil, Insecticides, etc. Including built in relief and pass valve. Capacity 400 G.P.H. 1/2" drive spline shaft. 3/4" pipe inlet and outlets. Engineering data incl. **\$7.95** post-Stock #6001 only

Adel Self-Priming ELECTRIC PUMP For pumping light oils, oil burners, fluid heaters, fuel pump, tool post grinder coolant, pressure lubricating pump, etc. 1/30 H.P. rated 1200 R.P.M. Applicable for 24 V. D.C./A.C. or use on 110 Volt A.C. Size 6 3/4"x3 1/2"x3 1/4". rated 3 G.P.H. Diagram and instr. **\$9.95** post-incl. \$50.00 val.

ROTARY PUMP for pumping WATER FROM POOLS, OR BASEMENTS, SUMP, pumping lubricants. For Garden & lawn sprayers. For use with hydraulic cylinders, vacuum, in dental lab, etc. Capacity 180 G.P.H., 200 lb. pressure, 29 in. vacuum. 500 to 3000 R.P.M. Steel shaft Std. 1/2 in. Stock #101. Instr. incl. **\$7.50**

ELECTRIC HYDRAULIC PRESSURE SWITCH For use with accumulator type hydraulic system. Shuts off motor when pump pressure reaches desired point & starts motor when pressure drops. 1/4" pipe ports \$35.00 value #401 **\$9.95** post-instructions incl.

HYDRAULIC HOSE 2000 P.S.I. Pressure For Oil Fuel & Air. Highest Quality

Length	Fittings	Tube size	Price
27"	F & F	1/4"	\$1.10
27"	F & F	3/8"	1.15
40"	F & F	3/8"	1.35
28"	F & F	1/2"	1.45

Add 20% for postage. Free Hose Listing on request.

HYDRAULIC OIL In Gallon Sealed cans Made to Exact U.S. Gov. Spec. **\$3.95** \$1.49 per gal. 3 gal. **\$3.95** Wt. 10 lbs. per gal. (ADD POSTAGE)

BENDIX VACUUM AIR GENERAL PURPOSE PUMP for water, oil, insecticides, Air, fluid pressure or vacuum or as auto drain case pump. 150 G.P.H. Instructions Incl. 3/4" pipe ports. Stock #75 **\$9.95**

Stratopower Constant Displacement HEAVY DUTY PUMP For operating Hydraulic cylinders, hydraulic motors on tractors, Bulldozers, Construction machinery, Lift trucks. For fuel or oil transfer. Industrial applications, etc. Delivers up to 400 G.P.H. at 3750 R.P.M. Rated 1250 to 1400 P.S.I. 3750 to 4500 R.P.M. HAS BUILT IN RELIEF AT HEAD. Rotation either direction without adjustment. \$100.00 value. Engineering data and instr. **\$17.50** incl. Stock #37. Wt. 8 lbs.

AIR OR OIL HYDRAULIC CYLINDERS

Stock #10 This is a double action 1" bore, 4" stroke 3/8" shaft, clevis mounting, overall length 9". Capacity 700 lbs. with 1000 P.S.I. or 9800 lbs. with our stratopower **\$4.95** post-pump 1400 P.S.I. **\$4.95** paid

Stock #27-Single Action for Air or Hydraulic 2 1/2" Bore, 2 1/2" dia. shaft, 5 1/4" stroke, use as snubber or Hyd. Cylinder. \$35.00 value. **\$6.95**

Stock #11-Double action 1 1/2" Bore, 6" Stroke, 3/4" Dia. shaft, Clevis mounting base and shaft end. Capacity 1160 lbs. with 1000 P.S.I. input. **\$9.95** post-\$50.00 value

Stock #303-Double Action 2" Bore, Stroke 1 1/4", 1 1/4" Dia. shaft. Overall length shaft retracted 23". 2000 lbs. capacity with 1000 PSI gives 2800 lbs. with **\$14.95** f.o.b. our stratopower. Wt. 14 lbs. **\$14.95** KCMO.

Stock No. 22 Hydraulic Cylinder Double Action output 1250 lbs. with 1000 P.S.I. input. Gives 1758 lbs. with our STRATOPOWER PUMP 1400 P.S.I. or will produce 34168 lbs. with 3000 line pressure. Can also be operated on low pressure system. 4" Bore. 10 1/2" Stroke 1-5/16" Dia. Shaft, clevis mounting. O. Gov't. cost **\$25.50** f.o.b. \$300.00. **\$25.50** KCMO.

PESCO HYDRAULIC FLOW EQUALIZER & PRESSURE BALANCER VALVE. Brand New. Guarantees equal flow and equal pressure for Two cylinders or Two systems. Capacity 340 G.P.H. 1500 P.S.I. Data & instructions incl. A \$75.00 value. Stock 1-D-397 **\$14.50** post-only.

Vickers Valve #130 Has two operating levers for controlling 2 single action cylinders independently of each other, or simultaneously. Or each lever operates double action cylinder. 3/4" connection, female ports. **\$8.95** \$50.00 value.

VICKERS Four Way Hyd. Control Valve #137 For two double action cylinders allowing operator to raise or lower the both cylinders simultaneously or raise one and lower the other at predetermined rate **\$14.50** post-paid speed.

FOUR WAY HYDRAULIC CONTROL VALVE Poppet type Valve shuts off on neutral position. Has 3/4" A.C. Tube ports -9/16- 20 thread, capacity 1500 P.S.I. Brand **\$5.95** post-new. Stock #1032

ADEL PRECISION VALVE #10335. Brand New. This is for a double end cylinder control or for two cylinders that are to work in opposition to each other. **\$5.95** post-\$35.00 value.

FOUR WAY BANK VALVES In one unit with common inlet and outlet. Built in relief valve and built in metering valve. 4 way valve independently controlled; poppet type. pressure balance with neutral **\$17.50** post-position. 3/4" A.C. tube size

MULTIPLE FOUR WAY SOLENOID VALVE UNIT Consisting of 5 four way valves in one unit connected to common pressure & return connection with individual connection to each valve. It will operate 5 double action valves separately or in any combination of 5 For 24V. D.C. & applicable for 110V. A.C. Instructions incl. O. cost over \$200.00 #44R122 **\$22.50**

VICKERS UNLOADING VALVE Brand New-By passes full amount output of the pump while the cylinder is not in operation. Takes starting load off of electric motor driving the pump. 1/2" AC TUBE PORTS **\$8.50** post-Price

ALTERNATING SHUT-OFF VALVE Brand New. High pressure. Operates by worm-gear cam operating poppets to alternately close & open either pair of four ports. Standard 3/8" pipe **\$5.50** post-ports. \$50.00 value only

Hydraulic Accumulators - Bendix Ball Type Dia. 5 1/2". Built to stand 2000 P.S.I. Stock #A-65. Wt. 4 lbs. only **\$5.95**

BENDIX ACCUMULATOR Ball Type. Dia. 10 1/2". Built to stand 2000 P.S.I. Wt. 15 lbs. Stock #A-85. Only **\$15.50**

GENERAL SALVAGE CO., 2922 E. 27 St., Dept. 735, Kansas City, Mo.

A New Kind of Tool for Your Kit

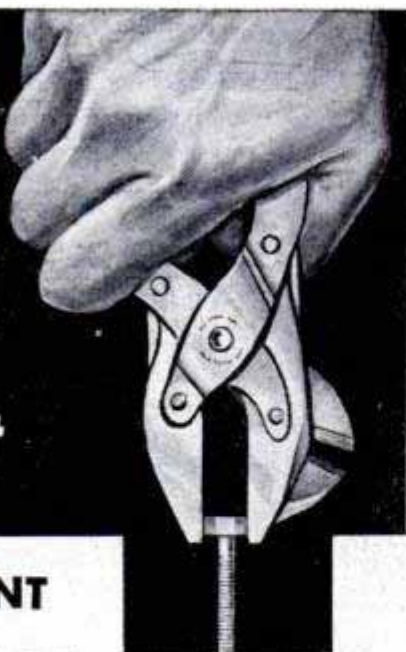

THE SARGENT

Grip-Snip... you need it

for 5 KINDS of JOBS

1. **Grips like a vise**...a wrench-like grip that doesn't slip. Compound leverage multiplies power along entire length of jaws.
2. **Cuts wire easily**...outside cutters cut wire even when it tightly hugs a flat surface.
3. **Holds nuts like a wrench**...powerful parallel jaws and extra leverage prevent rounding corners.
4. **Gets into tight spots**...small nose of jaws permits working in close quarters.
5. **Unkinks wire**...run wire between jaws, from either end, to straighten or pull it.

• Get hold of a Sargent "Grip-Snip"* at your hardware dealer and see for yourself why mechanics, hobbyists, sportsmen, farmers—even women—call it their favorite. Comes in 4½, 5½, 6½ and 8-inch lengths. For further details, write Dept. 20E.

* Trade Mark



SARGENT and COMPANY

New York • NEW HAVEN, CONN. • Chicago

Builders Hardware and Fine Tools since 1864

\$40 A DAY BUSINESS

IN YOUR SPARE TIME



ANDY PHILLIPS SAYS:

"My Belsaw Sharp Smith gives me big profits at low expense — I can run 35 to 40 Circular Saws in an 8-hour day — that makes me \$40 cash."

"I also get BIG EXTRA PROFITS... up to \$4 an hour... by grinding planer and jointer knives — there's always a demand for this kind of work."

You can start this REPEAT CASH business in your own home or garage while you are working at your regular job. Easy to operate, no experience needed. "My BELSAW paid for itself the first month." — H. J. Opie

For as little as \$15 down payment, you can get your BELSAW SHARP SMITH rushed to you.

FREE book tells how

YOU can start making money the very day your BELSAW SHARP SMITH arrives. Hundreds of jobs in your own neighborhood. Send for Free book "Life-Time Security."

BELSAW MACHINERY CO

3705 Field Building

Kansas City 11, Mo.



25c

DeLong Lures

4026 Princeton Blvd.
Cleveland 21, Ohio

See Your Dealer

FEEL ALIVE — LOOK ALIVE
SOFT PLASTIC

RED WORM

Inch Worm, Wood Worm, Ant, Cricket, Black Head, Grub, Corn Borer, Angle Worm, Night Crawler, in same Feel Alive soft plastic. So LIFE-LIKE they seem to CRAWL. Colors that last. Won't crack or harden in heat or cold. Iowa '62 Catfish, same Night Crawler. New Jersey '21 Stripers on one Night Crawler."

See Our NIGHT CRAWLER page 84.

DOES A BETTER JOB
CULTILLER ROTARY TRACTOR
BUY DIRECT FROM MFR. and SAVE!

• PLOWS • HAULS
• ROLLS • MOWS
• CULTIVATES
• SICKLE-BARS, ETC.

Fully Guaranteed! Smooth, Powerful Operation. Women and Children Can Handle It!

SEND TODAY FOR VALUABLE FREE BOOKLET WITH BIG SPECIAL DISCOUNT OFFERS!

CULTILLER CO. 162 Church Street, Dept. 76 New Brunswick, N. J.

Kar-Lite
lights your way
when you
park in the dark!

Time Switch turns headlights off automatically after you leave your car. Easy to install. At automotive supply stores, or write for nearest dealer.

\$595

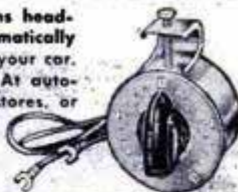

M. H. RHODES, INC.
HARTFORD 6, CONNECTICUT

Say You Saw It in Popular Mechanics

High output! Compact! Low cost!

NEW ONAN "CW"
ELECTRIC PLANTS
5,000 or 10,000 watts A.C.

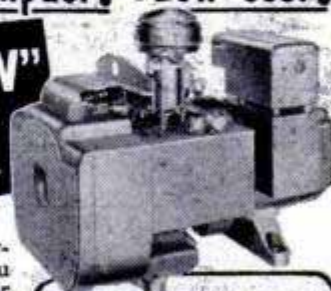

YEARS AHEAD in design, performance, value! Give you regular 110-volt current for trailers, homes, farms, cabins, resorts. Air-cooled, heavy-duty engine. Costs less than any other complete electric plant.

WRITE FOR FOLDER.

D. W. ONAN & SONS INC.
9565 Univ. S. E. • Minneapolis 14, Minn.

- Quiet-running • Fits in small space • Vacuum air-cooled engine and generator • Lightweight
- Completely equipped

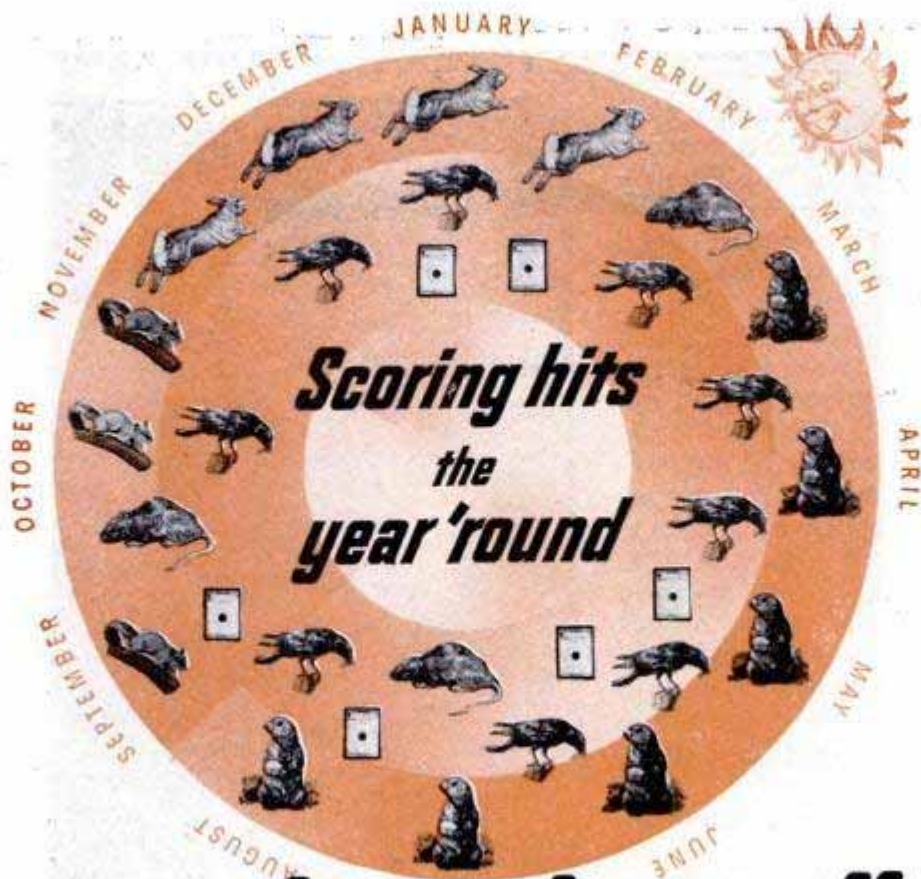

Savage . . . Stevens . . . 22 Rifles



Sturdy, simple action—quickly disassembled, without tools, for cleaning.

Shoot . . . Spring, Summer, Fall, Winter—year 'round—with a Savage or Stevens "22" rifle. They're built to give you top dependability—more exclusive features—more value and more shooting fun in any season!

You'll find just the "22" you want in the complete Savage-Stevens line of lightning fast auto-loaders—smooth operating slide and bolt action repeaters and handy, reliable single shot rifles. Stop in and look 'em over at your dealer's today. Send for free catalog. Savage Arms Corporation, Firearms Division, Chicopee Falls, Mass.

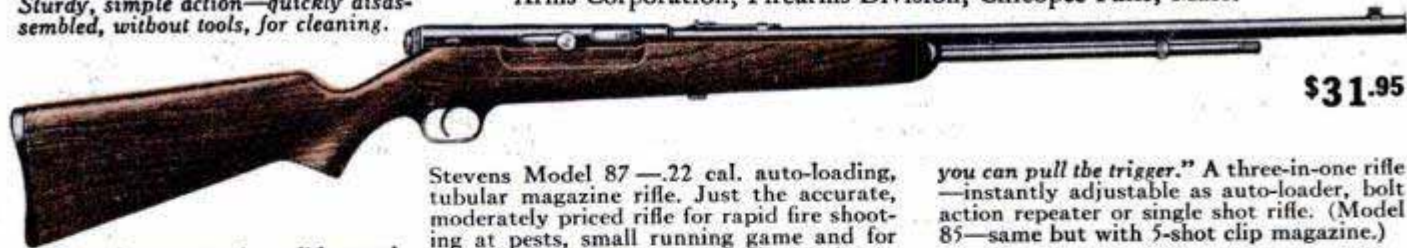

\$31.95

Short forearm stroke—slide travels only 1½" in loading and ejecting.

Stevens Model 87—.22 cal. auto-loading, tubular magazine rifle. Just the accurate, moderately priced rifle for rapid fire shooting at pests, small running game and for year 'round plinking fun. "15 shots as fast as

you can pull the trigger." A three-in-one rifle—instantly adjustable as auto-loader, bolt action repeater or single shot rifle. (Model 85—same but with 5-shot clip magazine.)

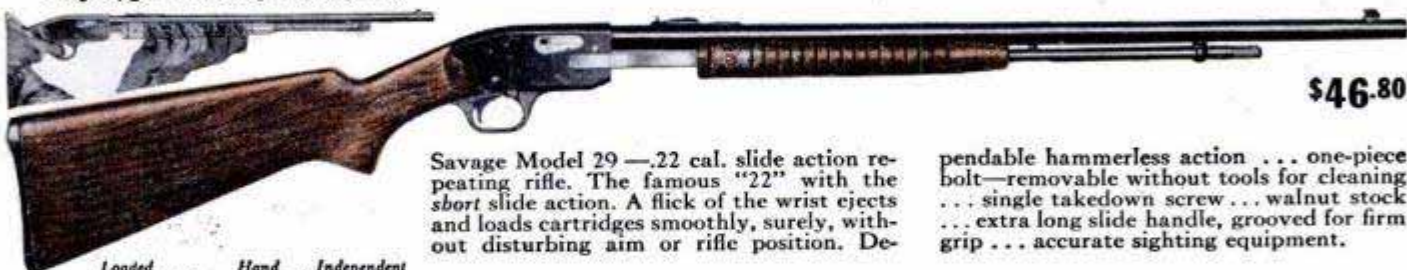

\$46.80

Savage Model 29—.22 cal. slide action repeating rifle. The famous "22" with the short slide action. A flick of the wrist ejects and loads cartridges smoothly, surely, without disturbing aim or rifle position. Dependable hammerless action . . . one-piece bolt—removable without tools for cleaning . . . single takedown screw . . . walnut stock . . . extra long slide handle, grooved for firm grip . . . accurate sighting equipment.

pendable hammerless action . . . one-piece bolt—removable without tools for cleaning . . . single takedown screw . . . walnut stock . . . extra long slide handle, grooved for firm grip . . . accurate sighting equipment.

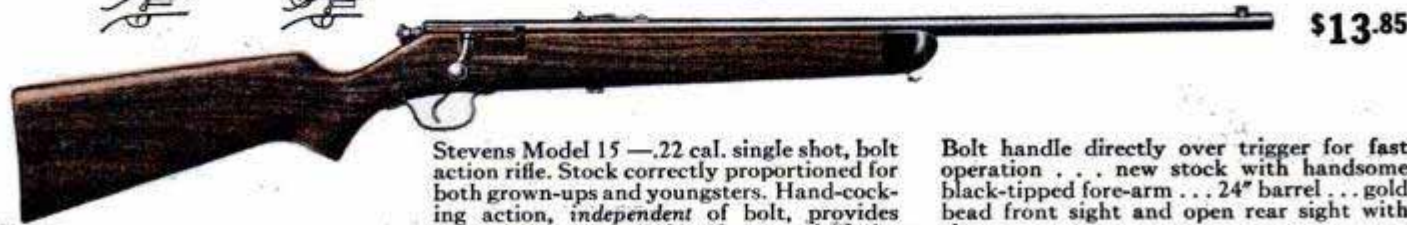

\$13.85

Stevens Model 15—.22 cal. single shot, bolt action rifle. Stock correctly proportioned for both grown-ups and youngsters. Hand-cocking action, independent of bolt, provides maximum safety. Other features include:

Bolt handle directly over trigger for fast operation . . . new stock with handsome black-tipped fore-arm . . . 24" barrel . . . gold bead front sight and open rear sight with elevator.

Farmer Couples or Releases Hitch From Tractor

Without leaving his tractor seat the farmer can operate a new hitch to pick up or drop his implements. One advantage of the new hitch is that the coupling mechanism need not approach the tongue of the implement at a definite, critical height. The hitch consists of two parts—the hitch proper which is bolted to the drawbar of the tractor, and a triangular bar which is fastened to the tongue of any implement. The tongue bar slopes upward at a 45-degree angle. Thus the jaws of the hitch can grab the bar anywhere along its slanting surface. Then as the tractor moves forward the tongue slides upward until the hitch makes a strong, positive coupling at the base of the bar. To unhitch the implement the operator simply pulls a cord which releases the coupling pin.

Jaws of hitch are opened by tug of cord which releases coupling pin in the hitch. When jaws hit sloping side of triangle, they snap partially shut, lock positively when they reach narrower portion at front



Packed with **POWER...** ...Rarin' to **GO!**

THIS great Hydra-Glide is the undisputed ruler of the highways and byways! Its 55 HP, 74 OHV motor provides thrilling, dynamic action . . . the result of hemispherical combustion chambers, hydraulic valve lifters and rotating valves. Its shock absorbing construction gives sensational riding com-

fort for miles and miles of tireless travel.

See this Hydra-Glide at your Harley-Davidson Dealer today, or send for free illustrated literature. Enclose 25¢ and you'll receive a copy of the action-packed, picture-filled **ENTHUSIAST** Magazine. Harley-Davidson Motor Co., Dept. P, Milwaukee 1, Wisconsin.

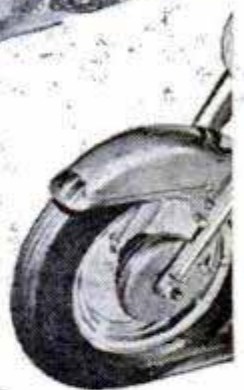

HARLEY-DAVIDSON

HYDRA-GLIDE®

best
white tape
made

ONLY
98¢*

The new "Evans White-Tape" has everything you'll find in tapes costing over \$1.50—plus.

- snow-white blade with bold, legible, jet-black numerals and graduations. Graduated in 32nds for first 6 inches.
- sturdy die-cast case heavily chrome-plated, calibrated for quick reading inside and outside measurements.
- blade 1/2" wide made of finest high carbon steel—tempered—Bonderized—enamelled—baked.
- blade replaceable in seconds—without tools—without even opening case. And Evans replacement blades cost far less.
- every "Evans White-Tape" is unconditionally guaranteed.
- exclusive Evans' automatic brake gives smoother push-pull action with absolutely no "creeping" of tape into case.
- underside is white, too. Mark with ordinary pencil, remove mark with flick of thumb.
- unheard-of low price*: 10-ft. \$1.49; 8-ft. \$1.19; 6-ft. 98¢. Prices higher in far west and Canada.

Evans & CO. • Elizabeth, N.J. • Montreal, Que. © 749
Makers of Evans 6-ft. Folding Rule and Folding Yardstick

Sold only through retailers.

Alumatic
ROYAL
aluminum
combination
door

A PERMANENT improvement
— now at surprisingly low cost!
Storm door in winter — screen door in summer
You save with an Alumatic ROYAL — on first cost, on upkeep, on repairs! No painting needed. Adds charm to old and new homes. See the ROYAL at your dealer — he'll make it easy for you to own the door you've always wanted!

Ask him about ALUMATIC or ARALUM aluminum combination windows!

ATTACHMENT OR A REFUND OF MONEY
Guaranteed by
Good Housekeeping
IF NOT AS ADVERTISED THEREIN

Alumatic CORPORATION OF AMERICA
Dept. C95G, Milwaukee 14, Wisconsin
IN CANADA: ALUMINUM BLDG. PRODUCTS CO., LTD., WINDSOR, ONTARIO

Get the Best
BUY AMERICAN

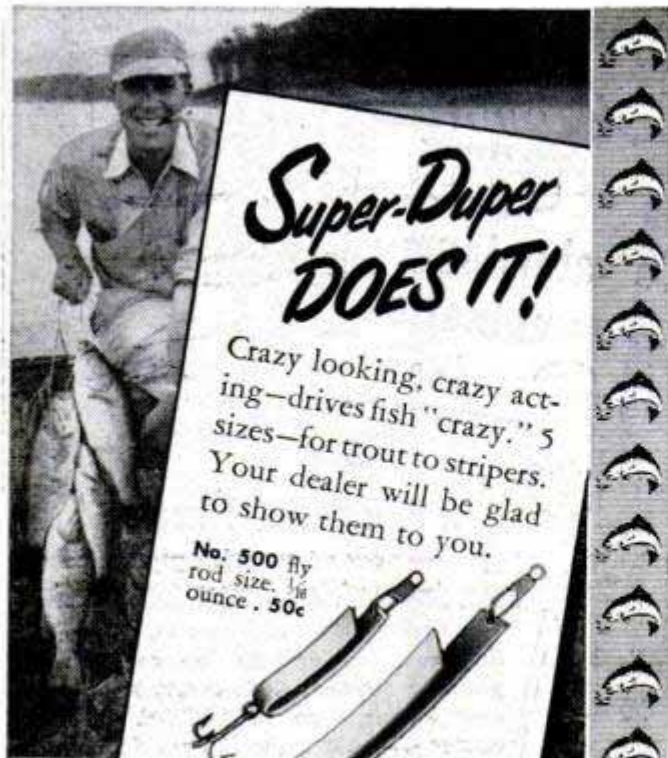

Super-Duper DOES IT!

Crazy looking, crazy acting—drives fish "crazy." 5 sizes—for trout to stripers. Your dealer will be glad to show them to you.

No. 500 fly rod size. $\frac{1}{16}$ ounce. 50c



No. 516 salt water, bait casting and trolling. $\frac{3}{8}$ ounce \$1.25

FREE BOOK—New! Fishing tips—how to bait, fly, spin cast—pictures—records—tackle. Write! SOUTH BEND BAIT COMPANY 891 High St., South Bend 23, Ind.



SOUTH BEND

A Name Famous in Fishing

Say You Saw It in Popular Mechanics

WELD IT YOURSELF! IN A JIFFY!

Weld, Cut, Braze, Solder IRON, STEEL, BRONZE, BRASS, ALUMINUM & OTHER METALS

Tool and Equipment breakdowns are always annoying and costly. Don't let them bother you. Get a Dynamic Arc Welder. You can do expert work on your very first job. Welders operate from any properly wired 110 V. AC line. The handiest "tool" in your workshop. A Dynamic Welder will save its low cost of only \$38.50 F.O.B. in both time and money.

DYNAMIC INDUSTRIAL type transformer Arc Welder 75 amp. output for Industrial or Workshop use.

DYNAMIC WELDER CO.

Dept. D2-E, 15 E. 23rd St. Chicago 16, Ill.



Free Details and "How to Weld"

Everything YOU NEED

One low price gives you a complete welding outfit ready to use. Save Money! Buy direct! Sold on 10 day money back guarantee. Send today for FREE details.

2 DRILLS in 1

\$11.95 post paid

Send check or Money Order • Satisfaction guaranteed • Order yours now

This attachment gives you two drills in one. It converts any $\frac{1}{4}$ inch electric drill to $\frac{1}{2}$ inch capacity. Reduction gears reduce the drill speed 5 to 1, the average speed of a $\frac{1}{2}$ inch drill, and thereby increases the power. Absolutely indispensable for all shop work and home craftsmen.

G. M. CO. MANUFACTURING, INC.
1308 43rd AVE.
LONG ISLAND CITY 1, NEW YORK

ROADSIGNS CAN FAIL YOU BUT NOT YOUR HULL AUTO COMPASS

• Frequently damaged highway signs are one of countless reasons motorists easily lose directions, drive worthless, angry miles the wrong way. The one sure guide, every mile, is a Hull Auto Compass. Write for local dealer's name, free literature.

MORE HULLS IN USE THAN ALL OTHERS COMBINED

Beaconlite \$6.95
Illuminated
STREAMLINE \$4.95
non-illuminated

HULL MFG. CO. P.O. BOX 246-D5
WARREN, OHIO

Print Your Own

Cards, stationery, circulars, tags, labels, photo and movie titles, advertising, etc. Save money. **Print for Others, Good Profit!** easy rules sent. Raised Printing like Engraving, too. Sold direct from factory only. Write for free catalog of outfits and all details. **KELSEY PRESSES, M-37, Meriden, Conn.**

TOOLS AT WHOLESALE

PROFESSIONAL MECHANICS HAND TOOLS
Farm, Household and Special Tools
TOP QUALITY, FACTORY GUARANTEED

Write Today for **FREE CATALOG** **MECHANICS CO-OP**
Dept. X Oakland 8, Calif.

RUN YOUR CAR WITH BUTANE

- Normal oil change eliminated
- Running cost cut one-third
- Equiv. to 120 Octane Gasoline
- Easy to install
- Engine Life extended 3 times

Write for Free brochure to: Dept. PM5

CYCLONE EQUIPMENT CO.
10600 PRAIRIE AVE., INGLEWOOD 2, CALIF.

The QUICK-WAY to SHARPEN CIRCULAR SAWS

Now you can do it yourself—save time and money. The new QUICK-WAY Index Plate Circular Saw Sharpener makes your own power table a precision saw sharpener. Guarantees accurate grinding and spacing of every tooth. Complete unit only \$16.50 postpaid, including patented Index Plate block for mitre and \$3.00 grinding wheel... Nothing else to buy!

Send check, cash or money order. We pay postage.

Model 6-12P **QUICK-WAY Saw Company**
\$16.50 Postpaid 11 Riverside Corning, N.Y.

The Boat Sensation of the Nation!

Get YOUR greatest enjoyment in the natural setting of the outdoor world . . . among the best of companions . . . gliding along in easy-chair comfort for luxurious relaxation or glorious action, once you own

YOUR SMART
and USEFUL

FOLBOT

FOLDING
BOAT

SAIL
RIGS
from \$29

BIG
CRAFT
NOW ONLY
\$119 up

SAFEST
and SEAWORTHY

Wide protective decks, low gravity center, balanced seating, high or low. Very substantial framework. Leakproof, rock-resistant heavy duty hull, of extra tough multi-ply canvas, compressed rubber—strong, tenacious, tire-like construction. CAN'T SINK with INVISIBLE airtanks for maximum space & loads to 2000 lbs. Steadier, sturdier, GUARANTEED widest WATERLINE STABILITY — acclaimed since 1933 by thousands of happy Folboters, Champions, Guides, Scouts, Explorers & Navy.

Newest Style,

YACHT-SMART

FOLBOT SAILS . . .

another Folbot advantage

EASIER FISHING

BETTER HUNTING

NEW Largest Folding RUNABOUT

another Folbot exclusive with rigidly INTERLOCKING frames. Provides the ULTIMATE COMFORT for You and YOUR entire FAMILY. Faster, smoother with any outboard up to 16 H.P. Speeds 25 m.p.h. with ideal 5 to 7½ H.P.

Many models, styles, colors. 1 to 4 seaters with swivel backrests. Each takes motor, sails, or paddles. No upkeep!

LASTS LONGER
THAN A
CAR

FOLDS

in 2 light bags
—erects in a jiffy!
Fits INSIDE car trunk
or rides erected on top.

TO: FOLBOT CORPORATION

Stark Industrial Park, PM, Charleston, S. C.

NAME.....

ADDRESS.....

CITY..... STATE.....

FREE
ACTION CATALOGUE
MAIL COUPON TODAY!

GOIN' FISHING!

You Bet!



And you can depend on this powerful four-battery flashlight for hundreds of handy uses in camp, farm, home, travel. Only JUSTRITE combines 6-volt power spot-beam, exclusive adjustable head, handy square shape.



Most light for the money! \$2.95 (less batt.)



JUSTRITE Red Four-Battery Warning Flasher prevents road accidents. Visible half-a-mile. Converts to steady, white light.

Rugged, dependable, rustproof.

Only \$4.95 (less batt.)

At hardware, sporting goods, department, auto stores—everywhere.

JUSTRITE MANUFACTURING CO.

2061 N. Southport Ave. • Chicago 14, Ill.

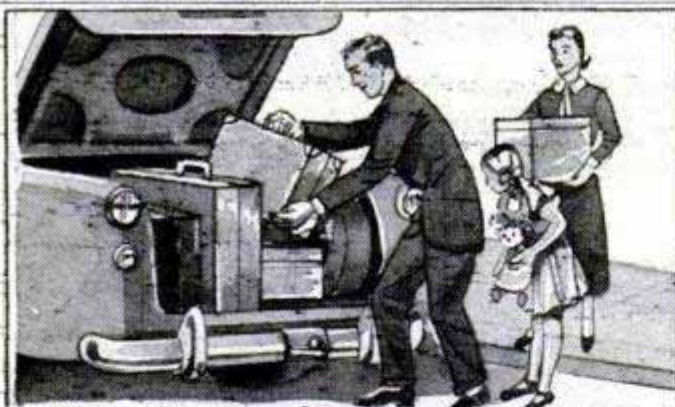

Vacation Loads . . . and Rough Roads . . . need AIR LIFTS

Air Lifts, the sensational Pneumatic Spring Boosters, are perfect to equip your car for safe and comfortable driving with vacation loads.

Whether you haul a trailer or load your vacation needs in your car, you'll always enjoy a level, safely balanced ride with Air Lifts in the rear to assist your regular springs. They adjust with air to suit your exact loading requirements.

Air Lifts are also available to install in your front springs for improved dependable steering.



See your dealer today or write to:

AIR LIFT CO.

2330 West Main Street
LANSING, MICHIGAN

YOU'LL BE SO

HANDY

With The **WORLD'S MOST USEFUL HAND TOOL**

No. 10-W
\$2.60



VISE-GRIP WRENCH

The "USINGest" tool you can own! Just a squeeze of the hand locks jaws with **Ton-Grip**. Won't slip. It turns, twists, holds, bends, cuts, ratchets. For hundreds of different jobs! Really a super-pliers, adjustable wrench, hand vise, and many more—all in one! Really handy! 7" and 10", only \$1.85 to \$2.60, at your hardware dealer.

Mfg. Only By Petersen Mfg. Co., Dept. M-5, DeWitt, Nebr.

DRIVING COMFORT at its best!
The New Electric Throttle

With Foot Control

The Electric Throttle ("Speed-selector") sets whatever speed you choose electrically — releases instantly at a touch on the toe-button, or by applying foot-brake. Banish foot and back strain for good! Install it yourself. Price, \$17.50 F.O.B. Check or C.O.D. Several State franchises open. Dealer inquiries invited. Give car, make, and year. Pays for itself in gasoline savings.

WRITE FOR DETAILS



D & M MFG. CORP., Anderson, Ind.

NEW SAW SHARPENER

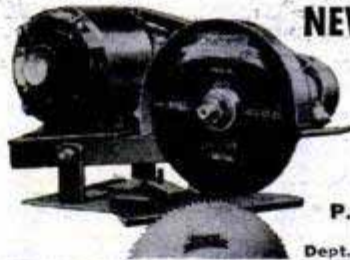

Improved #64 Hand Gummer sharpens all types circular saws 4" to 20" diam. Ideal for saw shops. Self-Centering adjustment for quick, easy set-ups. Complete with 1/4 HP motor, 1 grinding wheel & cord. \$79.50 FOB Portland. Wt. 70#. SEND FOR FREE LITERATURE.

P. T. HOBBS MACHINERY

8375 N. INTERSTATE AVE.

Dept. P.M.-61, PORTLAND 17, OREGON



x-acto®

HOBBY KNIVES and TOOLS

SEND 15¢ TO COVER POSTAGE FOR NEW ILLUSTRATED 28-pg. CATALOG
X-ACTO CRESCENT PRODUCTS CO. INC., 440 FOURTH AVE., N. Y. 16, N. Y.

ROTO-HOE
America's Most Usable Garden Tool
Now You Can ENJOY Gardening!

2 h. p. (as shown) only \$134.



Useful All Year Around Complete Interchangeability

You'll find fun and healthful relaxation in gardening with **ROTO-HOE**. It was first and it still leads with a quality front-tiller power garden tool at a reasonable price. You can still buy this tested, proven tool at the low, low 1947 price!

Inexpensive attachments give you year 'round usefulness—extra dividends on your **ROTO-HOE** investment. Thousands of satisfied customers swear by **ROTO-HOE** quality and satisfaction. Write today for free illustrated color folder and name of nearby dealer.

ROTO-HOE & Sprayer Co., Box 19, Newbury, Ohio

Be safe...

**buy the lamp that
won't black out!**

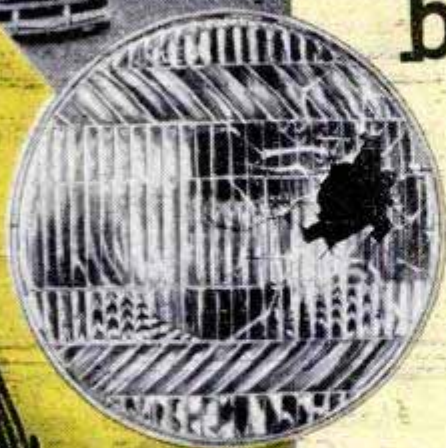

Ordinary lamp blacks out when
the lens is cracked or broken



Auto-Lite Bull's Eye keeps burning
even when the lens is cracked or broken

AT MODERN car speeds, a small pebble can shatter a headlight lens... and black out the ordinary lamp. Why buy lights that "black out" and endanger you and your family? Insist on Auto-Lite Bull's Eye headlights that are guaranteed to burn even when the lens is cracked or broken.

In addition the Bull's Eye concentrates more light into the Main Driving Beam for clearer, brighter night driving.

Tune in "Suspense!"... CBS Radio Mondays... CBS Television Tuesdays

THE
Bull's-Eye
MAKES THE
DIFFERENCE



Concentrates MORE Light into the Main Driving Beam

Ask for

AUTO-LITE

Bull's-Eye

METAL BACK SEALED BEAM LAMP

SEALED TIGHT—STAYS BRIGHT ... Guaranteed to burn even when lens is cracked or broken

KNOWN FOR THEIR FINER QUALITY



IMPORTED

SWEDISH TOOLS



WOOD CHISELS

Finest Swedish steel blades with unbreakable, machined plastic handles. Take and hold a better cutting edge. Sizes from 1/4" to 2" widths.

MORA HUNTING KNIVES

Seven models, all with leather sheaths. Hand forged, hand honed Swedish steel blades. Polished curly birch handles.



BUSHMAN BOW SAWS

Fastest cutting saw you can own for firewood and rough work. For campers, home owners, farmers, ranchers. 24", 30", 36", 42" sizes.

AT BETTER HARDWARE STORES EVERYWHERE

GENSCO TOOL DIVISION

GENERAL STEEL WAREHOUSE CO., INC.

1832 North Kostner Ave. • Chicago 39, Ill.

SAY YOU SAW IT IN POPULAR MECHANICS

LUTHY AERO TYPE SPARK PLUGS

Aluminum Oxide Insulators

Material developed during World War II for high speed combat aircraft. Aluminum Oxide insulator cools very rapidly, is stronger, has greater resistance to moisture and reduces breakage to a minimum. Correct Gap setting and proper heat range for your automobile, truck, tractor, hot-rod and stock car.

Packed In Engineered Sets

PACKED IN SETS OF 6 OR 8 - CORRECTLY GAPPED FOR THE MODEL AND YEAR OF ALL CARS

ORDER YOUR SETS NOW

8 cyl. set

7-12

6 cyl. set

5-34

More R.P.M.

More Miles Per Gal.



Satisfaction Guaranteed

Longer Life More Economy High Speed Performance

Luthy Aeronautical Sales Company

JACKSON, MICHIGAN (Canadian address, Box 394, Hamilton, Ontario)

Send me a set of _____ plugs. Enclosed is \$_____ Check here if you want us to ship COD.

Name _____ Address _____

Year of Car _____ Make and Model _____

3 POINT ELECTRONS

PARTS FOR MILITARY TRUCKS

FOR JEEP, DODGE, CHEV., GMC, STUDEBAKER, 4 WHEEL DRIVE AND 6 WHEEL DRIVE. ALSO PARTS CATALOG. WRITE

JEEP TOPS and CURTAINS

All Brand New . . . Not Surplus
Made of Heavy Canvas Duck . . . Waterproof
MILITARY TYPE models, Top and Curtains, complete, **\$59.50**
less bows

TOP and CURTAINS, HALF CAB . . . MODELS CJ2A and CJ3A, complete with hardware, **\$65.00**
less bows

TOP and CURTAINS Complete, MODELS CJ2A and CJ3A, with hardware for entire Jeep **\$88.80**
less bows

When ordering please state exact model
All prices F.O.B. K.C. 25% dep. on COD's

American AUTO PARTS CO. INC.
1830 LOCUST - DEPT. PM
KANSAS CITY, MISSOURI

B-M POWER MOWERS

CUT HOURS OF WORK into MINUTES of PLEASURE!

Prompt Shipment
★
Low Factory Prices
★
Fully Guaranteed
★
Model D-3

For a quick, slick job and a smooth-as-velvet lawn, you can't beat a B-M Power Mower. Three Models of fine rotary mowers available for your special cutting needs. The D-3 (pictured here), the self-propelled P.D. models, or our light VD-1 Mower with vertical shaft engine and direct blade drive. Quick starting, dependable 1 1/2 h.p. Clinton engines. Safety features. Easy adjustments. Low factory-to-you Price. Write for **FREE LITERATURE.**

B-M MOWER CO., Box 66-PM, Blue Mound, Kansas

Get This TOMLEE SHOP BOOK

28 picture pages of how-to-make-it with power tools. Illustrates 50 handicraft patterns. Send 25c, stamps or coin, to TOMLEE TOOLS, 723 N. Washington, Minneapolis 1, Minn. **25¢**

**CAPE COD CHAIRS
TRELLISES • ARBORS
DUTCH WINDMILLS**

Chairs style B-C-A PLANS 50c Ea., all 3 only \$1.00. 12 different trellis designs PLAN of all 12 only 50c. Authentic 40" high Dutch Windmill Detailed PLAN only 75c. Unique 40" high Lighthouse having copper lantern, ideal for garden or on lake shore of summer home. Large detailed PLAN 75c. **SPECIAL all plans above \$3.00 val. Only \$2.50. Send 10c for catalog.**
Craftsman's Model Co. Dept. P-52 DELAFIELD, Wis.

DO MORE PLANING JOBS WITH LOW COST BELSAW

Exclusive MONEY-MAKING Features: • Full 12 1/2" x 6" capacity • Power feeds at 24" a minute • Provides for Grinding Knives in the Cutterhead • Attachments for Jointing, Rabbeting, Tongue, Groove, Matching. Convert low cost rough lumber into high priced cabinet finished stock . . . Easy to make flooring and popular patterns. Send today for free literature and prices.
Belsaw Machinery Co., 1010 Field Bldg., Kansas City II, Mo.

MAKE UP TO \$5 AN HOUR WITH EASISHARP

Big profits in your spare time sharpening scissors. We show you how to start making money immediately. This is your chance now to have your own business with Easisharp. Sharpen a pair of scissors in less than two minutes! A child can operate it. Weighs only 10 lbs. Every home, barber, tailor, dressmaker — everybody uses scissors and all need sharpening two to four times a year. Don't let some one else get ahead of you. Write immediately to
SERR-EDGE MACHINE CO., 9731 Lorain Ave., Cleveland, Ohio

U. S. Patents
No. 2,351,906
No. 2,461,872

Save Fingers



Steel-Grip Finger Guards Lower Your Hand Protection Cost
Hundreds of factories save time and injuries by protecting workers with Steel-Grip Open End Finger Guards. For handling rough, sharp articles, buffing, grinding, sanding, punch press work, and hundreds of other jobs. Protect fingers or thumbs, front or back, from cuts, abrasions or blisters. Various designs in leathers and other materials; elastic web back for snug, cool, comfortable fit. Sizes for men and women. Send 10¢ for sample. Catalog of Safety Apparel Free.

INDUSTRIAL GLOVES COMPANY
A Corporation
1400 Garfield St., Danville, Ill.
(In Canada, Safety Supply Co., Toronto)

FAMOUS INDUSTRIAL SAFEGUARDS SINCE 1910

Be sure with **WIL-DU**
HEDGE CLIPPER

At last, a low-cost hedge clipper, light weight, portable, efficient, easy to attach.
- SIMPLE TO OPERATE - EASY TO ASSEMBLE
- FITS ALL POPULAR 1/4" ELECTRIC DRILLS



\$14.95

UNIVERSAL MACHINE COMPANY

537 N. Braddock Ave., PITTSBURGH 21, PA.

DRAINS Cellars, Laundry Tubs; CIRCULATES Oil; IRRIGATES Gardens

Original "Type P" Pump has 2400 GPH capacity. 360 GPH 75' high, or 1500 GPH from 25' well. Use any 1/8 to 1/2 HP motor. DOES NOT CLOG. 1" intake; 3/4" outlet.

Postpaid if cash with order. (West of Miss. add 50c.) Motor coupling included.
MONEY BACK GUARANTEE
Also Gear Pumps in all sizes.

\$6.95



LABAWCO PUMPS, BELLE MEAD 7, N. J.

HOBBYISTS! SHOPMEN! Special ONLY \$54.50

PALMGREN "HOBB-E" Rotary, Index, Milling Table
Ideal for Model Parts or Shop Work

Mill-Grind-Drill-Index-Rout curved or straight-Rabbit and Mortise on drill press or lathe. 8" Table, 4" Cross Feed, 360° Rotation, Accurately Graduated. Bolts to table. Order NOW! SAVE \$100. Only \$54.50. Less Rotary Feed \$39.75. Write for "HOBB-E" Tool Circular.

CHICAGO TOOL AND ENGINEERING CO.
8365 South Chicago Ave. Chicago 17, Ill.



WATERLOO METAL BOXES AND CHESTS

BUY THE FINEST Metal Boxes
.. FOR EVERY SHOP USE

• Designed to meet exacting requirements of tool experts in every phase of automotive, radio, electrical, and industrial work. Unmatched for lightness, strength, beauty, durability. See them at your hardware dealer now or write for free catalog.

WATERLOO VALVE SPRING COMPRESSOR CO., WATERLOO, IOWA

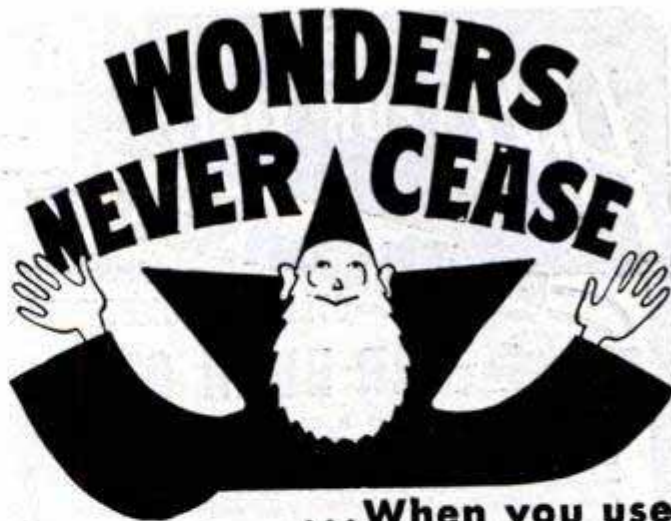

...When you use these WIZARDS with WOOD!

When you join two pieces of wood with Weldwood Glue, brother—they stay joined! When you use Firzite and Satinlac for finishing, brother—they look great! Mail coupon below for free leaflets.

The Wood Glue you can rely on

To make things or fix things, use Weldwood Glue for all wood-to-wood bonds. Makes joints stronger than the wood itself. Mixes easily with water. Stain-free, rot-proof... highly water-resistant!

WELDWOOD®
PLASTIC RESIN GLUE

For blond or pickled effects—

White Firzite produces those magical "woody" effects—on hard wood or soft, plywood or solid lumber. For light pastel tones, tint White Firzite with Colors-in-Oil. (On fir plywood stain jobs, tame that wild grain with Clear Firzite.)

White FIRZITE®

Gets that Natural-Wood Finish

On furniture, panelling or woodwork, there's nothing like Satinlac. Brings out natural grain and color beauty of any plywood or solid wood. Avoids that "built-up" look; will not turn yellow or darken with age. "Water-clear," easy to brush or spray, dries ready for next coat in 2 or 3 hours.

Pints, Quarts, Gallons **SATINLAC®**

United States Plywood Corporation
Dept. 218, 55 West 44th St., New York 36, N.Y.

Send me free leaflets on Weldwood Glue, Firzite and Satinlac.

NAME _____

ADDRESS _____

Holt's DOES THE JOB FOR YOU!

Piston Seal

CYLINDER COMPOUND



CAR BURN OIL?

Nothing's as good as a complete engine overhaul — but Holt's genuine Piston Seal cylinder compound does restore power and compression — does cut oil consumption — up to 10,000 miles! Only Holt's has been tested and proved throughout the world more than 15 years. Your car needs it! Only \$4.95. Canada \$5.95.

MUFFLER TROUBLE?

No muffler is installed right, no muffler is repaired right, unless the job is done with Holt's "Gun Gum" Muffler Seal. Use straight from the can, no mixing. \$1.69 per can. Canada \$2.00.

HOLT'S Gun Gum MUFFLER SEAL

ONLY HOLT'S LOY Metal Mender

IS REAL METAL IN-A-TUBE!

Holt's Loy repairs everything from auto body dents to loose tool handles! Rust-proof, flameproof, waterproof, holds 150 lbs. pressure! Handles like putty — sets harder than lead in metal, plaster, wood — even on aluminum! Loy is new — nothing else is "like" it. Only \$1.00 for large tube. Canada \$1.25.

If your dealer cannot supply Holt products, send to:

TREGLOWN CO., INC., FANWOOD 23, N. J.

CANADA: Treglown, Ltd., 1366 Greene Ave., Montreal 6

WHOLESALE RADIO PARTS CO. INC.

FREE!

NEW, 1953
TV & RADIO
VALUE
BOOKLET

Send for booklet thousands of dealers and servicemen buy from.

Packed with values in TV and Radio accessories, parts, antennas, Amateur supplies, high fidelity sound, P.A. Systems, test instruments, kits, tubes and tools. Up-to-the-minute items at lowest prices.

Send name & address. Ask for "For Your Information" value booklet #30.

WHOLESALE RADIO PARTS CO., INC.
311 W. BALTIMORE ST. BALTO. 1, MD.

NO TANKS USED
NEW SIMPLIFIED METHOD
SUCCESS IN THE
ELECTROPLATING
BUSINESS

ELECTROPLATE

ANY OBJECT IN HOME, SHOP, GARAGE OR START YOUR OWN WELL PAYING ELECTROPLATING BUSINESS



NOW, using NEW plating kit.

It's easy to electroplate any object. Complete kit and instructions on plating metal and non-metal objects, with nickel, copper, chrome, silver, gold, etc., plus full data on obtaining all the business you desire and make BIG MONEY full or spare time. ONLY \$4.95. SEND NO MONEY — everything sent COD plus postage.

OR send \$4.95 now and receive it postpaid. Mon. y back in 7 days f. oc. a. isfied. M. Z. NATIONAL SALES CO., 113-U West 42 St., N. Y. 18, N. Y.

make your own Gems 29.50 F.O.B.

The Gem Maker comes complete with all necessary equipment, including a super-charged diamond blade for sawing, and all wheels for grinding, shaping and polishing; also complete instructions. The complete equipment as shown, less motor and belt, for only \$29.50, f.o.b., Burlington, Wisconsin. Write today for information and literature.

B & I MANUFACTURING CO.

Dept. 5 Burlington, Wis.



5 pc. basic CONWAY group \$2.00
Includes settee and adult's chair with removable backs, end table, low benchtable and child's chair. Plans 50c ea. All 5 \$2.00 with FREE decal.

SUMMERCRAFT STUDIO
DEPT. D. HAMPTON, N. H.

Build your own JET ENGINE!

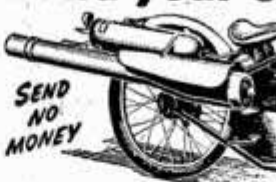

SEND NO MONEY

Order these plans today

1. JET PROPELLED BICYCLE. Assemble your own. Photo and instructions, \$1.00.
2. HOW TO MAKE EXPERIMENTAL JET ENGINES. Seven sheets drawings with information and instructions \$2.95.
3. BOTH OF ABOVE in one order \$3.75. SEND NO MONEY. Order both at once \$3.75 C.O.D. in USA plus e.o.d. postage. Send check or Money Order and we pay postage. Get other information too. Rush Order.

J. HOUSTON MAUPIN, Dept. 55, Tipp City, Ohio

NEW READY-BUILT FIRE-SAFE CHIMNEY

INSTALLS EASILY • COSTS LESS

One man can install in 3 hours or less. No foundation needed. Costs up to 1/2 less than brick.

EVERYTHING FURNISHED

Shipped complete. Immediate delivery. Approved for all fuels. Underwriters' listed. F. H. A. accepted. Bldg. code approved.

WRITE FOR FREE BOOKLET

describing fully The Van-Packer Packaged Masonry Chimney.

VAN-PACKER CORPORATION

Dept. 15 • 209 S. LaSalle St. • Chicago 4, Illinois

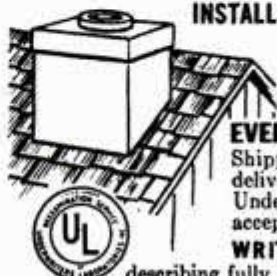

U.S. GOV'T CLOSEOUT

THIS WIRE HAS NOT BEEN OVERSEAS

This high quality two conductor communication wire offered in No. 18 and No. 22 gauge is ideal for intercoms, lead-ins, telephones, indoor and outdoor speaker extensions, doorbells, signal and burglar alarm systems, shot firing, etc., etc. SAMPLES ON REQUEST.

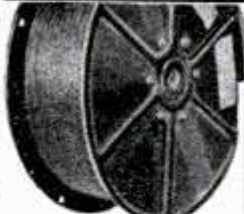

NEW WAR SURPLUS
Mfgd. to rigid Signal Corps specifications

Wire

U. S. Signal Corps
Communication Wire
TWISTED TWO CONDUCTOR \$5.00
No. 18 STRANDED per 1000 ft.
\$7.50 per 1300 ft. TWISTED TWO CONDUCTOR No. 22 STRANDED

Won't Last Very Long at These Prices

Stock Up Now — Subject to Prior Sale — Order Today

W-110-B — TWO CONDUCTOR #18 STRANDED (four steel and three copper strands) rubber covered plus weatherproof cotton braid and twisted, 5,280 feet per steel reel. Only \$3.50 per thousand feet on 5,280 foot reels or \$18.25 per reel.

W-130 — TWO CONDUCTOR #22 STRANDED and twisted (one copper and six steel strands) in your choice of rubber or plastic insulation, 10,000 feet per steel reel. Only \$3.50 per thousand feet on 10,000 foot steel reel or \$35.00 per reel.

(Note: Steel strands are incorporated for extra tensile strength and are tinned and treated for efficient conductivity.)

Wt. per 100 ft. #18 wire, 23 lbs. Wt. per 1300 ft. #22 wire, 11 lbs. All these way below market prices, our stock will not last long.

Take advantage of this exceptional closeout and STOCK UP NOW!

Prices F.O.B. Chicago. Include approx. postage on orders paid for in advance. C.O.D. orders enclose 25%, balance sent C.O.D.

U. A. S. Corp. Dept. PM5 5637 W. 63rd Pl. Chicago 38, Illinois

Take The "PAIN" Out of PAINTING!



Basements . . . Fences . . . Furniture . . .

USE A BECKER CO₂ SPRAY GUN

Completely self-contained—No "Extras" to Buy! Sprays: Paints, Oils, Varnishes, Insecticides, etc.

Men! Women! Here's the easy way to lick those tough, tedious, tiresome paint jobs: Becker Spray Gun is fun to use, requires no electricity or compressors—pressurized by low-cost CO₂ cartridges each sprays up to 21 oz. containerful. Used 5 years successfully in industry.

SEE YOUR DEALER! If he cannot supply, order direct for postpd. a/spt. Extra cartridges 10 for \$1.

SULLIVAN-BECKER CO.
Dept. 113-E • Kenosha, Wis.



ONLY
\$15⁹⁵

with 3
cartridges

LOCK THAT DOOR! Install this KNOB-LOK in 2 minutes!

BRASS \$3.50
Chrome \$3.95

with
2 keys
ppd.

NO CUTTING! NO DRILLING!

Only screwdriver needed to convert old latch-type knobs into foolproof lock. Fits all doors equipped with one-piece shaft.

FREE GIFT 'N GADGET CATALOG No COD's

MASTERCRAFT 214 SUMMER ST., DEPT. P5
BOSTON 10, MASS.

SAVE OVER \$100! BUILD YOUR OWN ORGANIC SHREDDER! A sturdy, practical, power driven machine that compares in performance and capability with manufactured shredders costing \$125. Costs about \$20 to build. Converts autumn leaves, garden wastes, compost piles, into an ideal material for quick composting or mulching. WATCH YOUR GARDEN GROW! Complete Plans & Instructions . \$2.00.

ORGANIC SHREDDER, PM-553, Box 34, Valley Stream, N. Y.

MAKE BIG MONEY

Sharpening Lawn Mowers

SPARE
OR FULL
TIME

Mr. G. E. of Ark. writes, "I have had my Universal Grinder 2 mos. and made a net profit of \$227." Be your own boss in a business of your own in your garage or basement with the Universal Lawn Mower Grinder. No experience necessary. Send today for proven success plan FREE.

ROGERS MFG. CO. Dept. M-53 LINDSEY, OHIO

Say You Saw It in Popular Mechanics

AMERICA'S BIGGEST FAN VALUE!!

WESTAIR 24" BELT DRIVE

Precision built belt drive Fan— for Homes, Stores, Factories, Barns, etc. Fan frame, welded steel Blade Dia. 24". R. P. M. 550. CFM 5400

Attic FAN

\$39⁹⁵
Less
Mtr.

Reconditioned 1/4 GE Mtr. \$8.95
New Delco Motor \$15.95
Aluminum Side-Wall Shutter \$12.95
Aluminum Counterbalanced Ceiling Shutter \$14.95

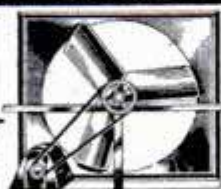

5 YEAR GUARANTEE

Kitchen Ventilators, Exhaust Fans, Attic Fans, Blowers, Heat Boosters, Desk Fans, Window Fans, Blades Guards, Shutters, Motors, etc.
Free illustrated catalogue, dealers inquiries invited.



EDWARDS BROS.
ESTABLISHED 21 YRS. **WESTAIR FAN & BLOWER CO.**
5650 Grand River, Dept. M Detroit 8, Mich.

Do it better with

STANLEY TOOLS

100th
YEAR
1853
1953

Add these top quality STANLEY and "YANKEE" tools to your workshop— to make the most of your time and talent. They are designed for professionals, yet priced for the occasional user. See them at your dealer's.



Stanley No. 126 Folding Rule— Every joint opens on an even number. Square ends, with big black numbers— plastic coated for longer wear. Use as a marking gauge, for hook and end-to-end measurements.

Stanley No. 1206W Pull-Push Rule— White blade with large, easy-to-read black numbers, graduated in 16ths the entire length. Blade is rigid for straight measuring— flexible for circular and angular surfaces. "D" shaped case for inside measurements.

New Stanley No. 47 Bit Gauge— Spring easily adjust to exact hole depth wanted. Spring bends if boring continues beyond desired depth. Will not mar surface. Fits any auger bit from 3/16" to 1 1/16".



"YANKEE" TOOLS



"Yankee-Handyman" No. 233H Handyman Spiral Ratchet Screw Driver— The complete tool— drives, draws screws, bores holes. Transparent magazine handle holds extra bit and drill points. Positive, adjustable ratchet.



"Yankee" No. 1993 Vise— Accurate and convenient. Used with swivel base on bench for hand work, quickly removed from base for machine work. Two-in-one use makes it popular in home shops. Four jaw widths: 1 1/2", 2", 2 3/4", and 4".

STANLEY TOOLS
New Britain, Connecticut
THE TOOL BOX OF THE WORLD



Reg. U.S. Pat. Off.

STANLEY TOOLS, 353 ELM ST., NEW BRITAIN, CONN.
(In Canada: Send to Stanley Tool Co. of Canada, Ltd., 353 Stanley St., Roxton Pond, Quebec)

Please Send Me:
 Stanley Tool Guide FREE "Yankee" Tool Book FREE — No. 126 Rule Folder

Name.....
Street.....
City..... State.....

HARDWARE • TOOLS • ELECTRIC TOOLS • STEEL STRAPPING • STEEL



TEENUTS®

STEEL THREADS IN WOOD!

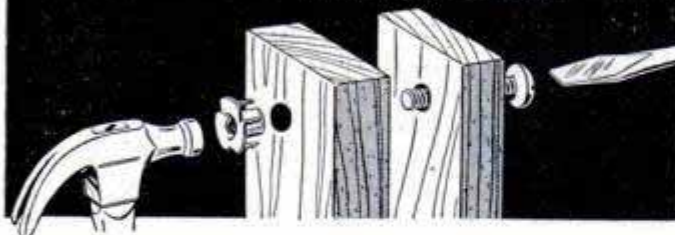

Industry proven TEENUTS, now available for home craftsmen . . . provide flush mounting without counter-boring. Excellent for new work or repairs. Ideal for metal-to-wood applications and where old screw holes have become useless. You simply drill hole size of TEENUT barrel, hammer home TEENUT and its steel prongs provide rigid, permanent anchorage. Same size hole for bolt. Complete line to fit standard bolt sizes. Show your hardware dealer this ad. No mail orders please.

15¢

AT HARDWARE
COUNTERS EVERYWHERE

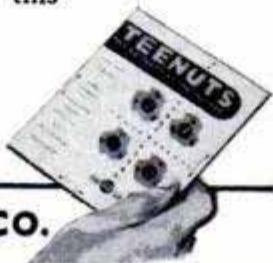

COLUMBIA FASTENER CO.
Chicago 8, Illinois

Scores of Chores

with the multi-purpose

CHOREMASTER

ONE-WHEEL GARDEN TRACTOR

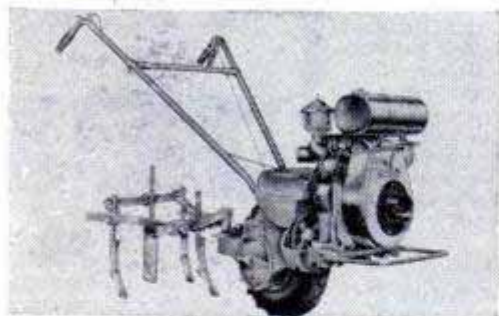

The CHOREMASTER Tractor takes work out of lawn and garden chores year 'round. Anyone can operate this compact, powerful tractor. One multi-purpose CHOREMASTER quickly becomes a low-cost power mower, cultivator, snowplow or sickle bar.

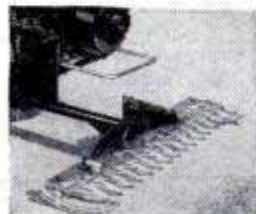

1½ to 3 H.P. Low as \$154.75 Freight Extra
35 Low-cost Attachments

Write TODAY for dealer name
and literature.

Dealers throughout U.S. and Canada

CHOREMASTER DIVISION
Weber Engineered Products, Inc.
878 Evans St., Cincinnati 4, Ohio

← CHOREMASTER Tractor with Sickle Bar.

**36½" HIGH 30 DRAWER ALL-PURPOSE
STEEL SMALL PARTS STORAGE CABINET**
SOLVES ALL STORAGE PROBLEMS! Ideal for office, home, factory, toolroom, den, workshop! 1001 uses. Sturdy welded construction, Fire-Resistant. Protects, organizes small articles, papers, machine parts, tools, etc. 36½" high, 29¾" wide, 12" deep. Drawer Dim. 3" high, 9¼" wide, 11¼" deep. Grey or Green.

\$35.95



ALL-IN-ONE STEEL OFFICE UNIT HAS SECRET COMBINATION VAULT FOR VALUABLES!

Welded steel cabinet files all important papers for home and business. Protects: correspondence, insurance policies, bills, documents, etc. Features: 2 letter file drawers, index card compartment, storage space for stationery, accessories, secret safety vault with large combination lock. Door has outside lock and key. 27" wide, 16" deep, 34" high. Grey or Green.



Send Check or M.O. No C.O.D.'s. FOB. NYC. Indicate Color Desired. Money-Back If Not Completely Satisfied.

\$45.95

NEW YORK STEEL CO., Dept. PM, 35 Maiden Lane, N. Y. 38, N. Y.



New! Miracle Wood Drill "Screw-Mate" DOES 3-JOBS AT ONCE!

- 1 SET**
5 SIZES
¾" x #7
1" x #8
1¼" x #8
1¼" x #10
1½" x #12.

Drills shank hole, pilot hole and countersinks in one operation on wood or plastic. Automatic stop at right depth . . . insures 100% holding power. Drill up to 40-holes p.m., easily, accurately! High-tungsten steel outlives ordinary drills. Fits all ¼"-chucks. Utility kit 5-popular sizes with stand . . . the mechanic's friend, complete postpaid

for only **\$3.95**

FREE FOLDER describing other "do-it-better-easier" tools.

Eagle Products

BOX
84A **MERIDEN, CONN.**

WAR SURPLUS

FREE CATALOG

Bargains Galore. Welders, Generators, Motors, Hydraulics, Wire, Instruments, Meters, Gauges, Pumps, Drills, Winches, Books, Assembly Kits. Many other NEW and SURPLUS items. All merchandise guaranteed. Send for FREE LeJay Bargain Catalog today.

LEJAY CO., 247 LeJay Bldg., Minneapolis 8, Minnesota
Or, **LEJAY CO., 928-1st Ave., So., B47, Seattle 4, Washington.**

HELPFUL BOOKS

Send post card asking for FREE catalog

Popular Mechanics Press, 200 E. Ontario, Dept. 601, Chicago 11

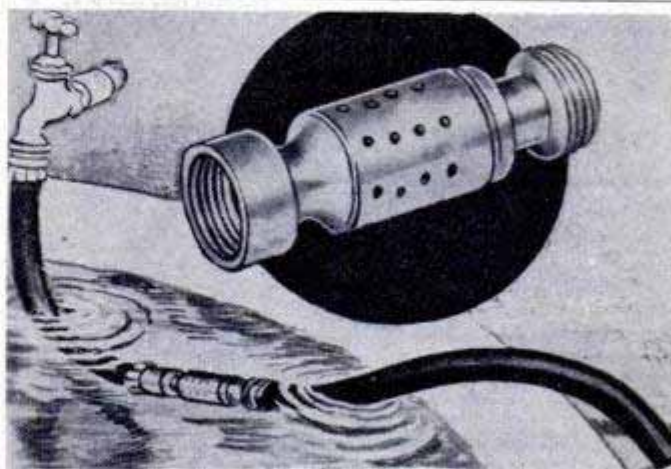

DRAINMASTER. Without electricity or suction drainer pumps 300 gallons of water per minute from flooded cellars, pools, trenches, etc. Just attach with a garden hose to any screw-type faucet, attach another section of hose to the discharge end, turn on the water and it goes to work. Solid brass, non-rusting.

Only 3.95

Write for free Novelty Catalog.

Postpaid

NOVELTY MART, NEW YORK 3, N. Y., DEPT. 125

POPULAR MECHANICS

STOP CHANGING MOTOR OIL!

End this needless expense forever with

RECLAIMO Today's most advanced OIL RE-REFINING filter FOR CARS, TRUCKS, TRACTORS.

Continuously cleans and RE-REFINES motor oil as you drive by utilizing motor heat — keeps oil in high grade lubricating condition at all times.

"RECLAIMO"

- REMOVES SOLIDS (by filtration)
- REMOVES WATER (by distillation)
- PREVENTS Excess fuel dilution
- PREVENTS Acid and Sludge Formation
- ADDS Thousands of Miles to Engine Life

MAINTAINS Stable Viscosity **ELIMINATES** All Oil Changes
 FREE 32-page book "OIL FACTS" with bonafide \$1,000.00 offer on page 30. Gives you the complete "Reclamo" story and details of our extraordinary 90-DAY NO-RISK TRIAL OFFER. Write for your copy today!

RECLAIMO MFG. CO., INC.

5083 Elston Ave., Dept. M-5, Chicago 30, Ill.
 Wm. Schwalge, U.S. Pat. 1757223, 1834654, 2068473.

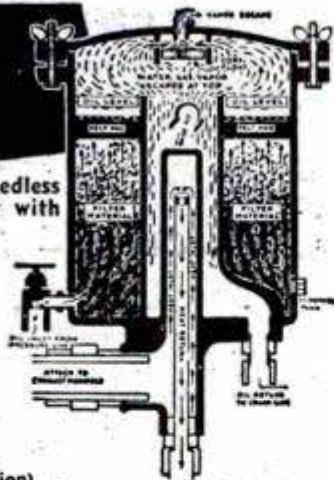

DEALERS WANTED

U. S. BUREAU OF STANDARDS, Bul. 86 States, "Oil does not wear out mechanically."

Be sure with **WIL-DU**

SANDING ATTACHMENT

Fits all 1/4" Electric Drills. Uses 2"x21" Standard Belts. A real piece of equipment with your drill. Will do most all your sanding and grinding.



\$14.95

UNIVERSAL MACHINE COMPANY

537 N. Braddock Ave., PITTSBURGH 21, PA.

WE HAVE MOVED! As of April 15th to 5100 Grandriver, Detroit, Michigan. A bigger and better supply of new, used and surplus cutting tools. Write us your needs today! **T & T TOOL** 221 W. 2nd Tulsa, Okla.

SUPER DRILL GRINDER



Sharpens round shank drills from 3/32" to 1/2" in diameter, up to 6" long. Grinds old drills like new in 4 different point grinding angles, using hand or power grinding wheels. Money-back guarantee. only \$2.95

At Dealers or Postpaid
A. D. McBURNEY 317 E. 4th St., Dept. A-29
 Los Angeles 13, Calif.

Say You Saw It in Popular Mechanics

SAVE MONEY! Prevent Costly Repairs!



Detek-Tro-Lex

Gives You Immediate Warning of Dangerous Electrical Faults

Dial shows battery state of charge, faulty cells, hot generator, defects in voltage regulator; loose connections, short circuits. Gives advance warning, preventing costly repairs. Easily installed. Fully guaranteed. At your dealer's or order direct . . . \$13.75 postpaid (cash with order); specify 12-volt or 6-volt.

IMPORTED MOTOR CAR CO.

236 E. PENN ST. • HOOPESTOWN, ILLINOIS

Be Safe from

RUST

With an A. O. Smith

Permaglas®

Automatic Water Heater

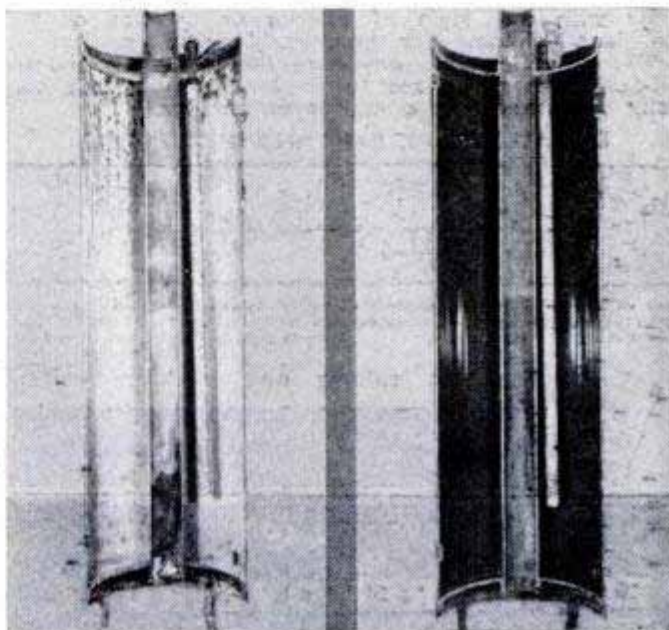

ORDINARY WATER HEATER INTERIOR

Unretouched photo shows how rust eats away unprotected metal in just one year of use. Note deep rust pits!

PERMAGLAS WATER HEATER INTERIOR

Unretouched photo shows that Permaglas glass-surfaced steel tank does not rust . . . because glass can't rust.

More than 2,000,000 ordinary water heaters have to be replaced every year! Every minute, without warning, rust kills another!

Be safe from rust. Buy an A. O. Smith Permaglas automatic water heater and enjoy abundant, clean hot water. Permaglas water heaters cost no more than ordinary water heaters, are completely protected from rust and fit any home, anywhere.

Write for "MURDER IN THE TANK" booklet of pictured facts. Address: A. O. Smith Corporation, Dept. PM-553, Kankakee, Ill. Licensee in Canada: John Inglis Co., Ltd.



A. O. Smith also manufactures Gas Conversion Burners, Home-heating Boilers, Warm Air Furnaces and Commercial Water Heaters.



A.O. Smith

PERMAGLAS-HEATING PRODUCTS

NOW . . . a louvered window you can easily install yourself!



SUN-SASH . . . America's Largest Selling Lowest Cost Louvered Window!

Your neighbors will envy you when you install Sun-Sash louvered windows in your home. Sun-Sash blends perfectly with any style of interior or exterior design. The ideal window for porches, breezeways, interior partitions, patios, and anywhere throughout the home. Sun-Sash comes in sizes to fit any opening and can easily be installed in a matter of minutes.

INSTALLATION IS EASY AND INEXPENSIVE



Screw on SUN-SASH fittings to side of window frame. Slide glass louvres to rattle-proof clip holders. Close end of clips over firmly in position. Install 3/4" stop top and bottom. (Window stool may be used for bottom stop).

For free catalog and literature write:

**SUN-SASH Company, Dept. PM-1
38 PARK ROW, NEW YORK 38, N. Y.**

Now you can EASILY REMOVE RUST from chrome and other metals



METAL TREAT is also an excellent rust preventive and metal pre-primer

Just rub on concentrated Metal Treat and unsightly, damaging rust comes right off automobile chrome, tools, outdoor furniture, machinery and other metal surfaces. And, before you paint any metal surface, prime it with diluted Metal Treat to prevent rust and make paint stick (12 oz. bottle makes full gallon). If your paint or hardware dealer doesn't have Metal Treat yet, send \$1.00 (check or cash) to THE KLEAN-STRIP CO., 2376 S. Lauderdale, Memphis 6, Tenn.



METAL TREAT

A quality remover by the makers of KLEAN-STRIP

NEW and DIFFERENT TOOL SHARPENER!

Keep your good tools sharp! Use this sensational New Electric Hone for all types of Working Tools because: (1) Honing is easier, better, (2) many times faster than hand honing, (3) Syncro motion keeps stone clean, (4) you direct the tool — the machine does the work! This amazing tool is entirely different — nothing else like it. Sharp, efficient tools will many times pay for its low cost! Sharpener comes complete with extra stones (convex for curved blades) coarse for 1st operation — medium for knives, chisels, etc. — fine abrasive type for razor blade sharpness. Send for FREE DETAILS to:



ELECTRIC M-O-V-I-N-G HONE

**SYNCRON CORPORATION, Dept. HS-53
Oxford, Michigan, U.S.A.**

BOAT TRAILERS—\$65 F.O.B. PHILADELPHIA Tax Included



Up to 500 lbs. cap. Transverse type spring; tubular boom construction. Full length boat support. Self adjust. cradles—sponge rubber pads. 16" auto wheels, less tires. Ship wt.—160 lbs. Send check or money order; we'll bill you shipping charges. No C.O.D.'s, please.

Keystone Division

Also Utility Trailers Rented—Local or 1-Way Coast-to-Coast.

**Bennett's 5515 LANCASTER AVENUE
TRAILER RENTAL SYSTEM PHILADELPHIA 31, PA.**

Say You Saw It in POPULAR MECHANICS

Handy Mail Order List

Little Library of Useful INFORMATION

5¢ for \$1.00
12 for \$2.00
25¢ Each

Here at amazingly low cost is the practical help and information you have always wanted. Articles in previous issues of Popular Mechanics have been classified according to subject and are now available in these handy reprint booklets.

- How to Use Measuring Tools—Micrometers, Calipers, etc.—106.
- Power Driven Saws—74.
- Drill Presses, Grinders, Etc.—79.
- Wood, Metal Turning Lathes—81.
- Filing Machine, Hack Saw, Cut-off Wheel, Shaper—82.
- Lathe Tools You Can Make—101.
- Workbenches—Tool Cabinets—47.
- Spray Painting—94.
- From Pattern to Casting—91.
- Tool and Saw Sharpening—92.
- Sharpening Drills, Wood Bits—90.
- Successful Wood Turning—32.
- How to Read Blueprint—71.
- Metal Turning Lathe Kinks—99.
- Operating a Metal Lathe—100.
- Heat Treating, Hardening—102.
- Working With Glass—103.
- Servicing Elec. Motors—75.
- Electromagnets & Solenoids—44.
- Transformer Construction—41.
- The Boy Electrician—43.
- Soldering and Brazing—17.
- Arc and Spot Welders—5.
- Electroplating With Nickel, Chromium, Cadmium, Etc.—86.
- Plating Leather, Wood, etc.—87.
- Lower Your Fuel Costs—31.
- Curing Leaky Basements—45.
- Fitting Home Game Room—55.
- Indoor & Outdoor Fireplaces—88.
- Backyard Gardening—39.
- Lawn and Garden Novelties—72.
- Trellises, Pergolas, Fences—76.
- Lawn and Garden Furniture—77.
- Playground Equipment—73.
- How to Use Your Drill Press—125.
- Making Serving Trays—53.
- Knots and Ropework—105.

- Working With Plastics—61
- Simple Home Improvements—104
- Ridding Home of Insect Pests—107
- Children's Room Furniture—51.
- Jigsawed Novelties—57.
- Doll House & Doll Furniture—60.
- 25 Shelves You Can Make—64.
- Novelties Turned on Lathe—62.
- Inlay Pictures—Veneering—63.
- Wood, Soap Carving—65.
- Windmills & Weather-vanes—68.
- Lamps from Wood, Metal—69.
- Rustic Furniture—18.
- Wood Finishing—40.
- How to Fix Electrical Appliances—111
- Painting Your House—117
- Build Your Own Relays—123
- Rowboats, Small Dinghy—83.
- Small Sail Boats—84.
- Two Outdoor Runabouts—85.
- Build Own Canoe, Kayak—30.
- Build Class-E Ice Yacht—22.
- Auto Kinks, Shortcuts—10.
- Lawn and Garden Equipment—124
- Motor-Driven Midnet Cars—34.
- Stop Auto Elect. Troubles—95.
- Photo Printers and Drivers—25.
- Photo Darkroom Equipment—96.
- Trick and Table Top Photos—97.
- Home Movie Equipment—118
- Poultry Houses—108.
- Guns and Decoys—109.
- Re-Silvering Mirrors—70.
- Chemical Experiments—93.
- Log Cabins, Tourist Houses—14.
- Using Basic Tools—120
- Farm and Garden Tractors—8.
- Building Extra Attic Rooms—23.
- Attractive Basement Rooms—24.

- Sanders—80.
- House Wiring—89.
- Hanging Wallpaper—38.
- Built-in Fixtures—78.
- Bird Houses—7.
- Magazine Racks—49.
- Clock Cases—50.
- Book Ends—52.
- Small Tables—54.
- Smoking Stands—56.
- Desks—58.
- Book Cases—59.
- Action Toys—66.
- High Flying Kites—67.
- Telescopes—20.
- Metal Craft—28.
- Small Looms—37.
- Gem Cutting—42.
- Photo Enlargers—1.
- Photo Kinks—98.
- Cleaning Formulas—11.
- Taxidermy—9.
- Photo Lighting—119
- Training Dogs—35.
- Small Furnaces—36.

Check Titles Wanted. Clip, Mail with Remittance to

POPULAR MECHANICS PRESS, Dept. 23, 200 E. Ontario, Chicago 11

MATTE BLACK IRON LEGS

transform a
plywood sheet or
Flush door into
a handsomely
modern desk, sofa,
dining-table,
cocktail table
or coffee table.



SET of FOUR LEGS

Couch or Sofa
height: 6"

\$495

NEW LOW PRICES on wrought iron legs make it easy to GO CASUAL MODERN. Make sleek and practical furniture with these WELDED wrought iron legs; solid 1/2" thick. Screws included at prices shown:

CHOOSE FROM 4 SIZES:

28" Desk or Dining Table \$13.95
Size; four for

16" Cocktail Table or \$7.95
Bench Size; four for

12" Coffee Table
Size (see \$6.95
photo above) 4 for

6" Couch or Sofa \$4.95
Size; four for

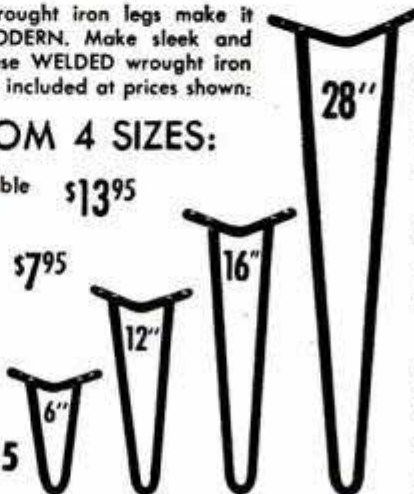

SENT POSTPAID

Please send check,
cash or money order.
We pay postage.

C.O.D.'s accepted
with 25% deposit,
and you pay
postage.

YOUNG PRODUCTS, Dept. 1377, 2605 Elmhurst, Detroit 6, Mich.

Buy the Mechanic's FIRST Choice

...EMPIRE LEVELS

For Home, Farm, all Trades



See Empire Levels at your
dealer.

Empire No. 151 Aluminum
Level; Adjustable vial cases,
twin levels, plumbs, 45° vials
— 24" — \$7.50.



EMPIRE LEVEL
MFG. COMPANY

10930 West Potter Rd., Dept. PM., Milwaukee 13, Wis.

SAY YOU SAW IT IN
POPULAR MECHANICS

SALE-SAVE \$40.00!!

PRICE REDUCTION ON FAMOUS
NATIONAL POWER MOWERS

18 in. cut—4 cycle 1.1 HP.
Engine, Chain Drive, Self-
propelled, Saber Steel
Blades, Ball Bearing Reel.
Reg. \$119.50. Reduced to

\$79.50

National 21 in. cut Power Mower—
Powerful 1 1/2 H.P., 4 cycle Engine.
Positive Chain Drive—
Self-Pneumatic tires. Reg. 139.50.
Reduced to

\$99.50



MAIL ORDERS ACCEPTED. NO C.O.D.'s
BUY NOW WHILE SUPPLY LASTS.
THIS SALE IS FOR LIMITED TIME ONLY.

NATIONAL FARM EQUIPMENT CO., Inc.
142 GREENE STREET NEW YORK 12, N. Y.

Compare... and you'll decide



RUDGE Sports
Light Roadster with
Sturmev-Archer
3 speed gears
Dynamohub Lighting
Set optional at
extra cost. \$68.50

Here is the bicycle that has no equal... Since 1869,
RUDGE's engineering staff has sought ways to produce
the perfect bicycle—the true "thoroughbred" in looks
and performance!

RUDGE



"BRITAIN'S BEST BICYCLE" SINCE 1869

For free catalogue
and dealers' names,
write to:

Raleigh Industries of America, Inc., Dept. P
669 Boylston Street, Boston, Mass.



Make Your Own!

The Only Tool
You Need
Is A Screwdriver!

DOOR CANOPY—SPECIAL
47½" WIDE
18" DROP
GRADUATED SIDES
43" PROJECTION
\$21.50—F.O.B. ST. LOUIS

ASSEMBLE AMERICA'S

Most Beautiful
ALL-ALUMINUM
DOOR CANOPIES
AND WINDOW
AWNINGS



They're pretreated, ready for paint. It's easy! Just do the top — the sides are assembled.

Designed and engineered by Herbert's — with experience and machinery to sell you a better awning.

Also Available Completely Assembled
With Baked Enamel Finish!

WRITE FOR FREE MEASURING CHART AND LITERATURE

8974 St. Charles Rd. *Herbert's* St. Louis 14, Mo.
ALUMINUM AWNING

DIRECT FROM FACTORY
Save 50%

New LUFKIN MITI-MITE

MAGNETIC PRODUCTS HAVE
HUNDREDS OF USES IN
HOME AND SHOP!



Attach Instantly to Curved or Flat Surfaces to Give You —

- **LIGHT**
in more hard-to-see places.
- **MAGNIFICATION**
4x magnifier can be put in almost any position.
- **INDICATOR HOLDER**
sensitive positioning without cumbersome clamps.

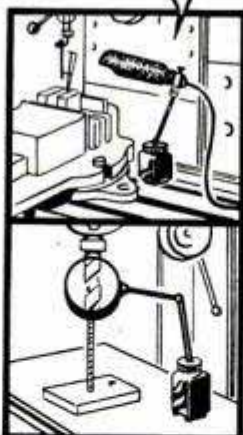

— 200
HANDI-LITE
\$8.50



Buy LUFKIN TOOLS
AT YOUR HARDWARE
OR TOOL STORE.

FREE
MITE-MITE
BOOK

LUFKIN RULE CO., Saginaw, Mich. DEPT. PM
RUSH ME YOUR FREE BOOKLET DESCRIBING
LUFKIN MITI-MITE MAGNETIC PRODUCTS.

Name _____

Street _____

Ad 239 City _____ State _____



Drive Screws, Nuts, Bolts
10 TIMES FASTER
with DRIL-O-DRIVER

NOW
ONLY
\$9.95

P. P.

Picture shows greatest little invention ever designed to save time and work for carpenters, cabinet makers, home craftsmen, hobbyists, electricians, plumbers, farmers — everybody who uses tools. The new DRIL-O-DRIVER is an Electric Drill Attachment that can be used with any quarter inch electric drill. It drives slotted and Phillips screws, nuts and bolts. Operator controls speed and force of drive. Designed to give durable, useful long years of service. Small enough to fit any kit. Unconditionally guaranteed. If your dealer does not stock Dril-O-Driver, send \$9.95 today for your DRIL-O-DRIVER, Screw Driver Bit and Drilo "Magic Connector" — an adapter enabling you to use 54 standard tools available to electric drill owners. We pay postage.

THE DRILO CORPORATION

201 E. Carson St.

Pittsburgh 19, Pa.

Midget Monitor S. W.

AMAZING PERFORMANCE!

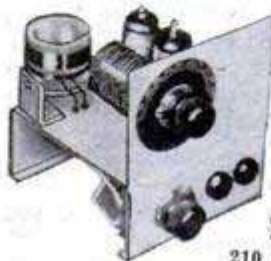

This short wave set receives "Ham," Aircraft, and Foreign broadcast. Uses only two tubes. Simple pictorial diagram. Kit with tubes and all parts less phone and batteries..... ONLY **\$7.99**

Foreign orders \$8.99. Batteries \$2.10. Phone \$2.00. Deposit \$1.00 on C.O.D. orders.

Dura-Mite Products Co.

210 Fifth Ave.

New York 10, N. Y.



\$39.95
POSTPAID

For FASTER FINISHING Use

MODEL "200" SANDER on Wood, Metal, Stone, Plastics, etc. For Factories, Builders, Schools, Homeshops, Autos & Boats, DRY or WET. Big 4½" x 7½" rubber pad takes ½ std. sandpaper sheet. Quiet, smooth running, stall free, 3450 rpm, ball bearing elec. MOTOR. NOT a vibrator. \$39.95 postpaid. Sent C.O.D. plus C.O.D. fee, 1 yr. guarantee.

GLASS CITY SALES

Sta. C Box 241 Toledo 7, Ohio

PAGE Tractors

Do The Job Faster—Easier—At Less Cost!

DOES
TILLING,
PLOWING,
DISKING,
Dozens of
other jobs



Rugged 1953 riding, walking, models 2 to 6 HP. All gear drive with reverse. Over 60 attachments! No belts, no chains. Fully Guaranteed!

Over 25 years' experience

Free Catalog—

PAGE 1804 S. 81st St.
Milwaukee, Wis.

ARMSTRONG BROS.

PIPE THREADING SET

Do your own pipe work with this Drop Head Ratchet Die Stock. Threads 90% of the pipe work around the home. OD-4A Die

\$29.95



Stock Set comes complete with four instantly changeable die heads for threading ¾, ½, ¼ and 1" pipe, all in a fitted steel case with handle and hasp.

ARMSTRONG BROS. TOOL CO.

"The Tool Holder People"

5268 Armstrong Ave., Chicago 30, U. S. A.

Another in the series of Monsanto Rez "Modern" functional selections developed by Kim Obata—one of the country's leading contemporary designers.

Distinctive 4-in-1 coffee table is easy to build and finish

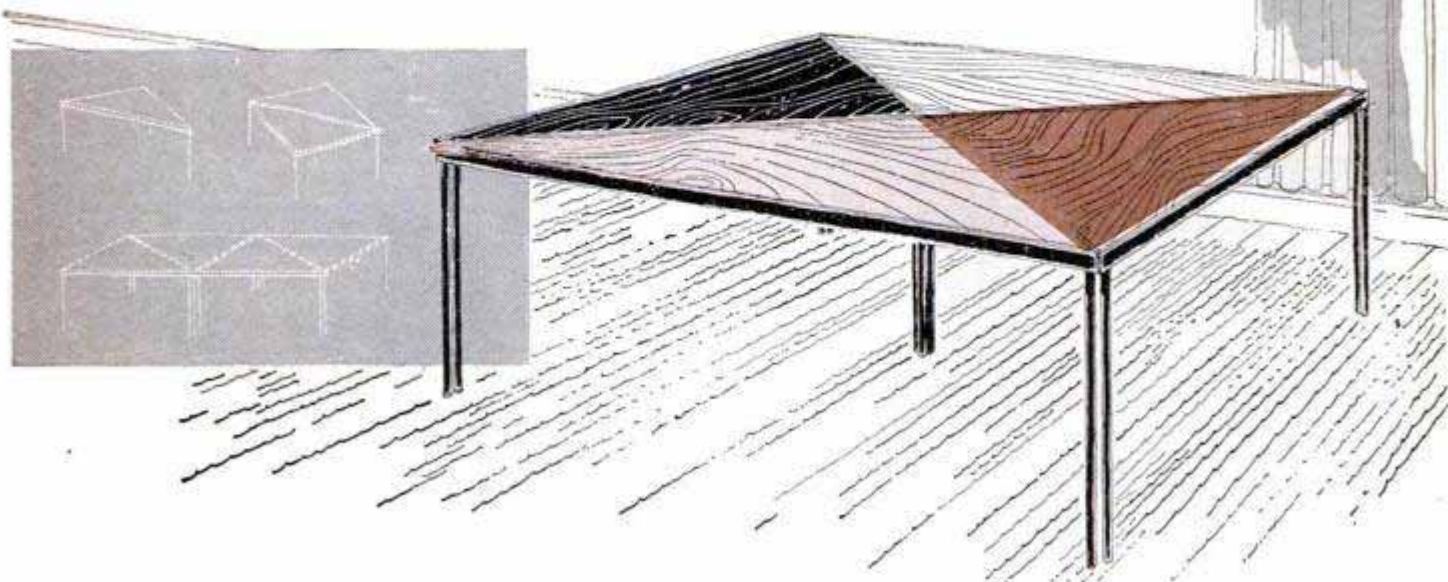

Designed so that it can be handily built of available materials, this modern functional table requires the use of only simple tools. A high-quality, professional finish can be achieved easily with Rez products.

As the illustration shows, this 4-section table can be grouped as a large coffee table of square proportions—or each of the triangular-topped sections can be used as an individual chair-side table. In fact, the 4 sections can be arranged in a number of convenient shapes—making this a very adaptable piece of contemporary furniture.

Individual table tops are cut of 1-inch solid stock or of plywood—depending on size. If plywood is used, the exposed edges can be faced with contrasting hardwood, 1/8 inch thick. Legs are of wrought iron, attached as described in detailed plans and specifications. Mail the coupon for your copy.

Rez is recommended for the finish coat. Use clear Rez, or any of the 5 beautiful Rez color tones—Redwood, Driftwood, Sage, Cedar, Mahogany or White (for one-coat bleached effects) . . . Rez is easy to apply with brush, spray or wipe-on cloth . . . All Rez products

seal and prime the surface to which they are applied. Their penetrating action equalizes the surface density of the wood—preserves beauty of grain by preventing streaks and blotches. Sealing action checks grain raise—minimizes warping, swelling and twisting by keeping out moisture.

At your paint, hardware or lumber dealer—ask for color samples. Or, write MONSANTO CHEMICAL COMPANY, Merchandising Division, 1700 So. Second St., St. Louis 4, Mo. In Canada, Monsanto Canada Limited, Montreal, Toronto, Vancouver.

*Laux Rez: Reg. U. S. Pat. Off.
Copyright 1953, M. C. C.*

COMPLETE PLANS AND SPECIFICATIONS AVAILABLE

This specially designed set of tables can be easily constructed from solid stock or standard plywood panels. Ideal for chair-side guest tables, or larger coffee table. Send 25¢ for plans and specifications. Use coupon.

.....

• Merchandising Division
• MONSANTO CHEMICAL COMPANY
• 1700 South Second Street
• St. Louis 4, Missouri

• Enclosed find 25 cents (25¢) for which please send 4-in-1 plans and specifications to:

• Name

• Street

• City..... Zone..... State.....

•.....

Do a
better job
EASIER...
FASTER



• S52 reversible "Super-ratchet" (82 tooth action) for faster rotation in close quarters.

• "Super-adjustable" wrenches for fast sure fit... durable service.

• Streamlined "Super-rentch" has weight distributed for perfect balance. Slim, extra-strong.

Be Wise... Buy
WILLIAMS
TOOLS

Correctly Designed and Drop-Forged
of Finest Selected Alloy Steels

• The feel, fit and finish of Williams Tools tells you there are none finer at any price. Designed and made by specialists, "tested" and preferred by leading industrial and automotive mechanics for over 70 years... they have extra strength and durability.



WRITE FOR FREE CATALOG A-50 describing the complete line of WILLIAMS alloy tools sold through Industrial Distributors, Automotive Jobbers and leading Hardware Stores.

J. H. WILLIAMS & CO. 559 Vulcan St., Buffalo 7, N. Y.

SAY YOU SAW IT IN
POPULAR MECHANICS

EVER GLASTING
(FIBERGLAS BOAT ARMOR)
FOR
ALL
BOATS



Keeps new boats new longer. Keeps used boats in use longer. Ideal for Hulls, Cabin Roofs, Decks and Canoes. New simplified method, No mixing, No curing. Applied in the morning, ready for use the same day. Easy as A-B-C. SEND 10¢ postage for interesting, illustrated booklet and detailed instructions.

EVER GLASTING 703P WHITTIER ST.
(U-Mak-It Products) BRONX 59, N. Y. CITY

BEAT SUDDEN DEATH



Don't risk death or serious injury at night because you can't be seen. Light up your Car, Truck, Bicycle, etc., with the famous "SCOTCH-LITE" brand reflective tapes. Tests have proven that the glowing "SCOTCH-LITE" brand tapes on automobile bumpers can be seen 70% faster than tail lights!

This amazing material reacts to the faintest light under all weather conditions and has long been used by our armed forces to mark landing strips, channel markers, and obstructions. Now for the first time it is available to you in complete easy to use kits.

STOP TAKING CHANCES AND ORDER NOW!

Kit #2 Protects (1) car or truck, front & rear, now only... \$1.00 ppd.
Kit #3 This is a necessity for all bicyclists! lights up front and rear fenders... \$0.50 ppd.
Kit #4 Now you can make your own roadside signs, light up your mailbox, etc. Kit contains the large, die cut, letters & numbers that you ask for. Each 2 inch letter or number... \$0.10 ppd; 4 inch... \$0.25 ppd; 6 inch... \$0.50 ppd.
Kit #5 Obstruction Kit, Sailors... light up those piling, docks, anchor can, etc... Farmers mark that barn entrance, garage door, gates, etc. This kit has a million uses... \$1.00 ppd.
Kit of (2) large 3"x8" pieces of reflective material... \$1.00 ppd.

SAFE - T - GLOW PRODUCTS

BOX 2467

DEPT. PM-4

GARY 5, IND.

SHEET METAL BRAKES

Angles, flanges, Pittsburgh locks, 24 G. steel, heavier aluminum. Cam locking, mount on bench, truck or floor stand. Truss braced-steel. Express collect, 30", 65 lbs., \$28.50, 36", 75 lbs., \$33.00, 48", 100 lbs., \$48.00. Portable stands, 32" hi., 30 lbs., \$7.00.



IRON BENDER forms hooks, angles, eyelets, etc. Capacity 1 1/2" x 2", 5/16" x 1 1/2". 10 parts, all steel, express collect... \$9.50
30" CURVE FORMER. Forms straight and tapering pipes 2" to 2 ft. in diameter, 20 gauge, express collect. \$10.50 (Immediate delivery. Order cash or C.O.D., or send for folder)

VYKE BRAKE CO., P-3016 Leavenworth, Omaha 5, Nebr.

New LOW COST WINDSHIELD WASHER



Ready for immediate use... Just press flask and two streams of water cover windshield, then turn on Wiper Blades. Wash away Bugs, Insects, etc. Enjoy perfect vision instantly. Easily installed; drill one small hole. **SOLD ON MONEY BACK GUARANTEE.** Fits All Cars. SEND NO MONEY! Simply pay postman plus postage of remit with order.

and we prepay postage. MAIL YOUR ORDER TODAY. **\$3.98** Postpaid
GERALD PRODUCTS CO., 309 No. Wille St., MOUNT PROSPECT, ILL.

PLYWOOD BARGAIN PRICES

Over 3,100 Ready Cut Selections in Plywood & Lumber
Fir • Birch • Mahogany • Walnut • Oak
For Cabinets—Furniture—Wall Panels—Repairing

Thicknesses... 1/4", 3/8", 1/2", 3/4"

AVAILABLE SIZES
Widths... 12" 16" 18" 20" 24" 36" 48"

Lengths... 24" 30" 36" 48" 60" 72" 96"

WROUGHT IRON TABLE LEGS AND CHAIR FRAMES

AT BARGAIN INTRODUCTORY PRICES

Money-Back Guarantee of Satisfaction

PLYWOOD CENTER, 215 N. ABERDEEN ST., CHICAGO 7, ILL.

OIL FILTER REFILLS... 10c



Filters Oil the full length of the Pack

10,000 Sq. In. of Filtering Surface

Plates Last Indefinitely

Here's News! Ordinary toilet paper makes an ideal oil filter. Laboratory tests prove it cleans oil faster and better than popular makes of filter elements. All you need is a simple set of **RETLIF ADAPTER PLATES**... and you can start using ordinary toilet paper rolls in your present oil filter. For proof and descriptive literature, send name and address to:

RETLIF CORPORATION, Dept. 118
1239 No. Highland Ave., Los Angeles 38, Calif.

OWN a **Cushman** for as little as

CUSHMAN
gets you there
**FASTER—
CHEAPER**

\$ **44**⁵⁰ Down Payment



Up to 50
miles per hour 3/4c per mile—
75 miles per gal. Total Operating Cost!

Get your Cushman NOW! Use it to go to work or school or get new jobs—plenty of opportunity! Own it and ride it now. Pay for it as you earn—dependable, over 50 years of engineering experience. Go everywhere on a Cushman, America's best buy in low cost transportation.

Send for new FREE illustrated literature.
Ask your nearest Cushman dealer for
FREE demonstration.

CUSHMAN MOTOR WORKS, INC.

Dept. PM-5, 900 No. 21st St., Lincoln, Nebraska

THE NU-WAY WEED CLIPPER

Eliminates hand cutting of dandelion stems and other weeds too high for your mower to cut. Attach a Nu-Way Clipper to your hand operated or power mower and do a clean job of mowing in one operation. Save time and work. Easy to put on and remove as needed. Order one today. Give make of mower, length of blades and inside distance between drive wheels. \$5.29 for 16 and 18 inch mowers. \$5.95 for 20 inch mowers. Ohio residents include 3% sales tax.

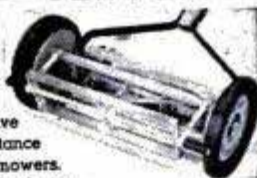

NU-WAY CLIPPER 658 South Washington Street TIFFIN, OHIO

K-D TOOLS for YOU!

Free Catalog
Over 100 tools described, illus. Special time savers for general workshop; auto valve, ring, ignition service. Tool chart for servicing Ford valves. Ask any mechanic about K-D Tools—oldest line of valve service tools in U.S. At Auto Jobbers everywhere.



TOOLS LIKE THIS

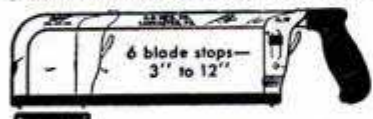

K-D Convertible Hacksaw Frame "CUTS AROUND CORNERS"

Finely balanced solid steel frame spans obstructions with 3" or 4 1/2" blade. Heavy duty. Stops for 3", 4 1/2", 6", 8", 10", 12" blades, quick change. Frame & handle integral, no loose parts. One 3", 12" blade furn. Auto

K-D No. 99
\$2.03

Paid U.S. No stamps, No COD

Jobbers or direct. **Order Today**

K-D MFG. CO., DEPT. 66, LANCASTER, PA.

**Need
extra
money
?**

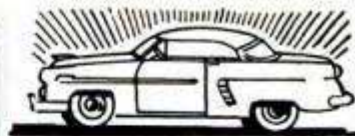

NEW CAR?



BUYING A HOME?



EDUCATING YOUR CHILDREN?

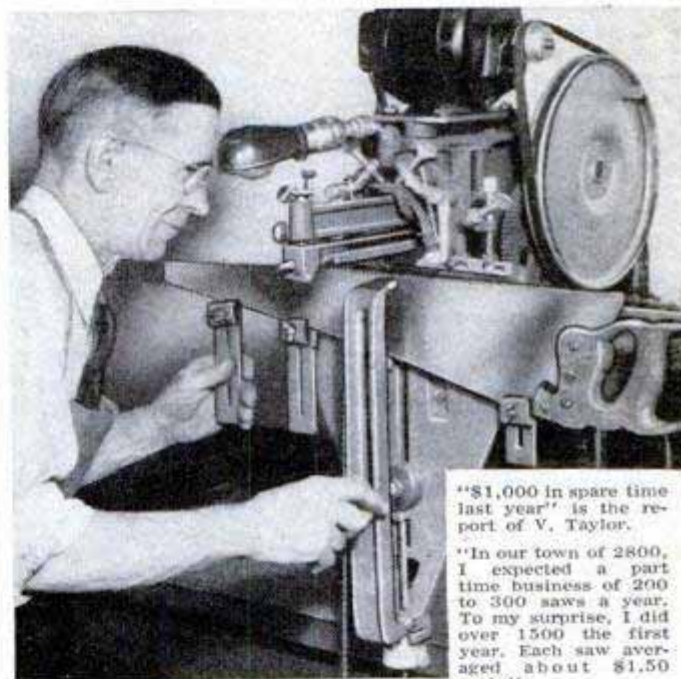

"\$1,000 in spare time last year" is the report of V. Taylor.

"In our town of 2800, I expected a part time business of 200 to 300 saws a year. To my surprise, I did over 1500 the first year. Each saw averaged about \$1.50 each."

Frank P. Layne

"I am 70 years old and still working at the filer."

C. D. Ronerts

"I have about 600 satisfied customers—all the business I can handle. \$400.00 monthly is a good salary for anyone."

Woody Miller

**Turn Spare Time
Into Cash for
Things You Need**

Here is a proven, practical way to start a business of your own, and earn up to \$3 or \$4 an hour. The Foley Saw Filer sharpens hand, band and circular saws with machine accuracy—no experience needed. Time payments if desired. Investigate—Free Plan shows how to start—no salesman will call.

"Start a Business" Plan

FOLEY MFG. CO.

516-3 Foley Bldg., Minneapolis 18, Minn.

Send "Money Making Facts" and Free Plan on how to start a saw filing business.

NAME _____

ADDRESS _____



How To BY MASTER

MARK STUDS FASTER

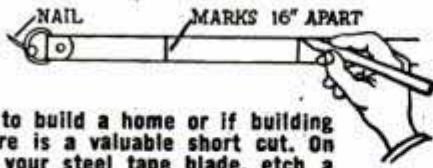

If you are planning to build a home or if building is your business here is a valuable short cut. On the reverse side of your steel tape blade, etch a mark every 16 inches, the length of the blade. Then when you are placing rafters, joints or studs you have only to hook as indicated, roll out and mark.

TUFBOY

For an inside measurement add 2 inches for Case and Tip.



WHEN YOU BUY YOUR NEXT STEEL TAPE: Ask the dealer to show you the new Master Tufboy rule. You get a rugged die-cast case, plus the world's most accurate and durable tape . . . and the blade is replaceable too.

AS A SERVICE TO YOU: Each month we will print the best in home workshop shortcuts. Why not make a card index of them for handy reference?

If you have a "Short Cut" which you feel should be printed in "HOW TO" send it along. If we use it we will give you a bonus, your choice of any wood rule or steel tape in the Master line. All entries become the property of the Master Rule Co., and will not be returned.

MASTER

MASTER RULE MFG. CO. INC. Middletown, New York
WOOD AND STEEL TAPE RULES

Send for this
BIG NEW
Hunt's
WOODWORKERS
CATALOG NO. 19

NEW LOW PRICES

ONLY
15c

Offers greatest selection of fine domestic and imported woods--and hundreds of woodworkers items at bargain prices!

You'll save time and money with this big, new catalog. Contains everything wood craftsman needs. Shows 32 rare and fancy woods in color...43 veneer designs...275 scroll patterns...multicolor inlays, overlays, bandings...all kinds of tools, machinery, cabinet hardware, ornaments, mouldings...and pages of valuable tips, ideas, information, instruction. Send for your copy NOW. Only 15c--refundable on your first order.



144 PAGES
QUICK
DELIVERY

- on maple, poplar, oak, mahogany, red cedar, cherry, walnut, and many others--
- all properly seasoned and kiln dried.

MAIL THIS COUPON--TODAY!

CRAFTSMAN WOOD SERVICE CO.
2729 S. Mary St., Dept. A5
Chicago 8, Illinois

Send me the big, new, money-saving Catalog No. 19. Enclosed is 15c--refundable on my first order.

Name _____
Address _____
City _____ Zone _____ State _____

MAKE YOUR OWN POWER LAWN MOWER \$13.95

with this DRIVE CUTTER ASSEMBLY

Constructed for those who desire to build their own mower or to replace your old cutter assembly. Complete with 18" blade and double ball bearing drive . . .

Add 50c to cover handling & shipping anywhere in U.S.A.
Send Check or M. O.

ATLAS KEEN MOWER

229 S. W. BLVD.

Dept. PM 5

KANSAS CITY, MO

NEW TV CATALOG FREE

Just off the press. Loaded with a host of new bargains for the TV serviceman, technician, installer who wants the finest in TV antennas and equipment at the country's lowest prices. Shows new Motorless Directronics, Multi-Channel Yagis, UHF Antennas, UHF Converters, Motors, Boosters, Parts, Test Equipment and hundreds of other standard television antennas and accessories at prices that can't be beat. Send for this complete FREE catalog now as quantities are limited.

NATIONAL ELECTRONICS OF CLEVELAND
305 DELCO BLDG., CLEVELAND 3, OHIO



6-IN-1 NEST of SAWS

A complete set of saws for every purpose. 5 changeable blades, 6 cutting edges. Here's what you get:

- 16" regular saw for general use
- 12" mitre and meat saw blade
- 15" double edge pruning saw
- 12" blade for cutting metal
- 10" keyhole blade for cutting circles

Sturdy carved handle, natural finished hardwood.

High quality blades of high carbon, tempered spring steel. Complete set, postpaid, only \$3.95. Satisfaction guaranteed.

LEE MORRIS CO., Dept. M4
2700 W. Gregory St., Chicago 25, Illinois

HELPFUL BOOKS

Send post card asking for FREE catalog

Popular Mechanics Press, 200 E. Ontario, Dept. 601, Chicago 11

OWN A . . . PLYMOUTH?

FIX IT YOURSELF!

Popular Mechanics Magazine has just published a new Owners Manual covering all 1941 to 1952 models of Plymouth cars. So accurate mechanics use it . . . so simple a woman can understand it.

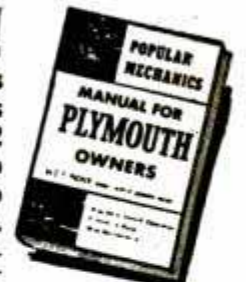

Save money on your Plymouth repairs. Prevent trouble. Enjoy care-free driving. Increase trade-in value. Avoid major repairs by fixing minor troubles before they get serious. Get sparkling performance at all times. Has 272 pages, more than 350 photos, diagrams, tables, charts, breakdown drawings, plus clear, non-technical directions that make all repairs simple as ABC. Written by Ed Packer with assistance of Chrysler Corporation. Shows you how to diagnose Plymouth troubles by feel, sound, sight, smell and performance. Simple trouble shooting. Permanent repairs. Emergency repairs. Plus, "How to get value from garages."

MONEY BACK IF IT DOESN'T SAVE MORE THAN IT COSTS!

One minor repair will save the cost ten times over. Read it. Then you decide. If you don't see that you'll save more than the cost, send it back for refund. SEND NO MONEY. Send postcard. Ask for PLYMOUTH Manual. Postman will deliver C.O.D. for \$3.50 plus postage. Or, save postage by sending \$3.50 with order. Send today. Save its cost on your next repair.

POPULAR MECHANICS PRESS

200 E. ONTARIO

DEPT. 18

CHICAGO 11, ILLINOIS

POPULAR MECHANICS



Preferred at Famous Fishing Spots

Fontana Lake, North Carolina
for leaping lunkers

POWER GLASS RODS

...lithe, live, lifetime action...

lighter...stronger...set proof

GREEN DRAGON, No. 1880—all metal—chrome plated parts—adjustable spool bearings—spiral gears—cork arbor. Green anodized side plates—chartreuse handle knobs. Price \$6.66.



Old Hi Says:

"Look for
on the tackle you buy"



H-I Power Glass Casting Rods \$6.00 — \$14.00

HIGLASS — GLASSLAKE — BANSHEE . . . Three great series to choose from—both solid and tubular—in a wide range of prices, lengths, weights and actions . . . for plugging, trolling, still fishing. Take your pick, but pick an H-I Power Glass Casting Rod. And . . . remember . . . all is not glass that glitters . . . there's only one line of Power Glass Rods and it's built by H-I.

FREE—Old Hi's Famous Fishing Book. Write today for your copy. H-I Co., Utica, N.Y. Dept. 23.

HORROCKS-IBBOTSON COMPANY, UTICA, N.Y.

Manufacturers of the Largest Line of Fishing Tackle in the World

this **ONE**
GOVERNOR

fits ALL popular
farm & industrial
gasoline engines



PIERCE LONG RANGE
Universal Governor

ONLY
\$39.50

● Instant variable speed selection and accurate engine control at any speed setting within 1200 to 2600 RPM. Higher and lower ranges obtainable by simple change of pulley. Also "constant speed" operation.

● Accurate, dependable speed control for engines operating corn shellers, drag lines, hoists, arc welders, trucks and tractors with power take-offs, etc.

Write for Complete Information

DEALERSHIPS
AVAILABLE

"World's Most
Experienced Governor
Manufacturer"

**THE PIERCE
GOVERNOR CO., Inc.**
1652 Ohio Avenue, Box 1000
Anderson, Indiana, U. S. A.

Pulley extra:
4"—\$1.70
5"—\$1.75

Send Check or
Money Order.
State Make,
Model of engine.

JOIN THE FUN—SAVE 50%

PACKAGED BOAT KITS



EASY TO
ASSEMBLE

OUTBOARD
CRUISERS
from \$349.50

SEND 25c
FOR BIG 1953
CATALOG

See our complete line before you buy! World's most complete line of real Performance Boats: Dinghies, Skiffs, Pontoon Racers, Runabouts, Outboards, Cruisers. Exclusive features, mahogany parts plus brass screws. Also marine hardware, fittings, accessories and quality paints.

Catalog plus booklet "Boat Selection, Operation & Maintenance" \$1.00
SEND 35c for World's most complete Catalog of Full Racing and Speedboat Accessories, general boat hardware, fittings, paints, conversions and conv. kits. Also new "ARMOR-GLASS" covering material for boats. Catalog plus booklet "How to Paint, Outfit and Care For your Boat" send \$1.00

BOAT PAINT,
ACCESSORIES
and FITTINGS

BOAT PLANS
AND FULL-SIZE:
PATTERNS

Over 100 Modern plans and full size patterns. Racing classes, cruisers, inboards, outboards, sail boats. By famous designers, 6' to 30'. DESIGN CATALOG only 35¢. For Design Catalog plus boat building handbook send \$1.00.

CUSTOM-CRAFT (DEPT. A) BUFFALO 7, N. Y.

FACTORY-TO-YOU
New Improved 1953
MIDWEST
21" and 27" TELEVISION



**30 DAYS
TRIAL
EASY
TERMS**

Adaptable
for UHF
Reception

Magnificent new consoles and table models in your choice of walnut, mahogany, or blond finishes. Also UHF converters for operation on all channels and all sets. 1 minute installation. Finest Midwest line in 33 years.

SEND THIS
COUPON
For FREE
MIDWEST
1953 literature

MIDWEST RADIO & TELEVISION CORP.

Dept. 25H, 909 Broadway, Cincinnati 2, Ohio

NAME _____

ADDRESS _____

CITY _____ ZONE _____ STATE _____

**SPARE TIME PROFITS
EARN MONEY AT HOME**

Cash in on this pleasant and profitable business. Re-string Rackets full or spare time. No experience or skill required. Easy to learn. Full line of finest quality, guaranteed Stringing Tools. Frames. Gut and Nylon Strings.



FREE CATALOG
INSTRUCTIONS
WRITE TODAY

W. A. BICKEL & CO., 803 South Blvd., Dept. PM-5, Oak Park, Ill.

**WELD-BRAZE
CUT-SOLDER**



**4 Ways to Handle 1001 Repairs
Around Home-Garage-Garden**

Complete welder with Twin Carbon Arc Torch and all operating accessories to do all types of metalcraft work. Easy instructions for work on iron, steel, bronze, brass and aluminum. Plugs into any properly wired AC or DC line. Low cost pays for itself in money saved and earned. A wonderful practical Gift of a lifetime. Order now!

only **\$14.75**

f.o.b. factory

Larger Models Available on request.

FOUR WAY WELDER CO.
2326 S. Michigan Ave.
Chicago 16, Ill., Dept. F2-E

4 way welder

Yours on a money back
10 DAY TRIAL



**BUILD YOUR OWN
POWER MOWER**

With Parts We Furnish

Why break your back mowing field or lawn? Now anyone can save time, money and effort by building their own Power Mower. Build it to fit your needs, in a short time without special tools.

**PULLS
ITSELF,
STEERS
ITSELF**

WRITE FOR FREE BUILDING
INSTRUCTIONS—NO OBLIGATION!

T & H Mfg. Co., 811 E. 31 St., Dept. M-45, Kansas City, Mo.



**DEVCO 10-in-1 Vest-Pocket
Writing SLIDE RULE**

Sturdy metal & plastic TWO Color pencil with A, B, C, D, L, S, & T scales. Detachable straight-edge & depth gage in Ins. & Cms., magnifier, eraser, leads, and clip-indicator. Durable, light & small. With Instructions. Fully guaranteed. Write for Slide-Pen-Cyl Folder, or send M.O. or check.....ppd. **\$4.98**

DEVICE DEVELOPMENT CO. Dept. D, 226 W. 4th St. N. Y. 14, N. Y.

Say You Saw It in Popular Mechanics



I want power tools at wholesale prices
I want nationally advertised brands of power tools
I want to pay wholesale prices for nationally advertised brands of power tools
I want your power tool catalog and price list FREE

**JACKSON
SUPPLY CO., INC.**
43 Exchange Place
New York 5, N.Y.
Dept. A1

OUR MOTTO:
"Buy Wholesale"

MOST POWERFUL MINIATURE MOTOR BUILT!

50% more performance than any other its size

This brand new precision motor built by RAY-O-VAC weighs less than 2 ounces and measures a scant 1 1/2 x 1 1/2 x 1 1/8 inches yet has the smooth performance and operation of motors more than four times its size.

Operates on flashlight batteries from one and a half to six volts at speeds from 2000 to 10,000 revolutions per minute. Can also be geared down to as little as 200 revs per m. This Hi-Power unit will run in any position and can reverse instantly. Has genuine PHOSPHOR BRUSHES and a Permanent Alnico magnet. Open end construction for commutator cleaning and brush adjustment. FACTORY TESTED to run up to 2000 hours w. l. at high speeds.

This Hi-Power Motor takes little space, is practically noiseless and can be adapted for use in MOVING or ANIMATED TOYS, MODELS, DISPLAYS INSTRUMENTS, for SOUND REPRODUCTION, for CONSTRUCTION KITS, for FINE GRINDING, BUFFING and DRILLING. Has low battery drain. ORDER NOW at our low price of \$3.98 and get at no extra cost this 3 volt battery clip. RUSH YOUR ORDER for this practical, useful in 101 ways precision motor. Enclose check, money order or cash or sent C.O.D. PLUS POSTAGE.



\$3.98

IMPERIAL SALES, 480 Lexington Ave., Dept. RM-105, New York 17, N. Y.

HOUSEHOLD SHARPENING IS EASY...



with a CRYSTOLON STONE

The right stone is a NORTON Abrasives JB-8 CRYSTOLON® with coarse and fine sides, oil-filled at the factory for your convenience without added cost. \$2.45 at hardware stores. The "know-how" on all kitchen, household, garden and shop tools is in the "HOW TO SHARPEN" Book—32 illustrated pages that take all the mystery out of sharpening. For your copy, send 10c to Behr-Manning, Troy, N. Y., Dept. PM-5.



▲ COATED ABRASIVES ▲ SHARPENING STONES ▲ PRESSURE SENSITIVE TAPES

JACKNIFE SMITTY



CARRY IN YOUR POCKET

Everyone who works with socket heads and screws needs a Smitty. Pocket size driver fits all standard Allen type or socket type bolts and screws. Five sizes of shafts to fit #10 to 7/16" inclusive, cap screws #5 to 5/16" inclusive. Actual sizes illustrated. Smitty Jr.—sizes .050"-5/32" inclusive. \$1.44 ppd. SATISFACTION \$1.50 ppd. OR REFUND. SEND TODAY. DEALER INQUIRIES ARE INVITED.

for
ALLEN HEADS



HUNTER TOOLS

BOX 7395 LUGO STATION • LOS ANGELES 23, CALIF.

Compare this Sensational SAVING!



FLARED FENDER SKIRTS

Custom built, heavy gauge steel. Concealed heading. Models for most popular cars. Easy to install. **\$9.25** Plus 3% sales tax in Calif. Pair.....

SPECIFY MAKE, YEAR, MODEL 25% deposit on all orders

Thousands of other savings direct from jobber!

100 PAGE CATALOG

Send 25c today for fully illustrated Catalog. Bonus, we include \$1 voucher on \$10 order.

NAME _____

ADDRESS _____

CITY _____ STATE _____

CUSTOM AUTOMOTIVE
Products Company DEPT. PM-2 **EAPCO**
POST OFFICE BOX NUMBER 7724 • LOS ANGELES 15, CALIF.



TRAP these
WEARMITES
that poison your motor oil!



* WEARMITES are "engine termites"—the Grit, Dirt and Tarry Sludge that multiply in dirty oil and combine to destroy car, truck and tractor engines.

What you can't see in your motor oil CAN hurt your car engine. A WIX HEVI-DUTY Cartridge in your oil filter traps the Grit, Dirt and Tarry Sludge your oil picks up and eliminates these "engine termites" that eat holes in your pocketbook with costly repair bills. WIX means continuously clean oil...safer lubrication...longer engine life.

wix
Trademark Reg.

ENGINEERED FILTRATION

WIX HEVI-DUTY Cartridges far exceed engine manufacturers' specifications and are specifically designed for individual engine requirements. They remove more contaminants yet fully protect the detergency of today's heavy duty oils. Demand WIX and get the utmost in oil filtration.



LOOK FOR THESE TWO THINGS WHEN YOU BUY YOUR OIL FILTER CARTRIDGE

CHECK YOUR FILTER WHEN YOU CHECK YOUR OIL!

WIX CORPORATION
GASTONIA, N. C.

IN CANADA: WIX ACCESSORIES CORP. LTD., TORONTO

CASH IN ON THE BUILDING BOOM! MAKE CONCRETE BLOCKS

WITH THE AMAZING, NEW, LOW-PRICED
GENERAL BLOCK MACHINE!

EARN UP TO \$75 A DAY CLEAR PROFIT
IN YOUR BACK YARD OR BASEMENT!

NOW! Big Building Boom Profits Within Your Reach

You don't need much cash to cash in on the building boom! New high speed, low cost General Block Machine produces up to 1,000 concrete blocks a day for homes, factories, buildings, garages. Your profit mark-up is 100% to 150%! Fool-proof, easily operated, sturdy steel machine can make any size from 4" to 12". These superior 3-core blocks meet all building code requirements for foundation, chimney, corner, sash and many other types of blocks. Works indoors or out. Sand, cement and water available anywhere! Simple operating instructions and mixing formulae for cement and cinder blocks supplied FREE. Get full details, no obligation!



"GENERAL"
BLOCK
MACHINE

Thousands
Now In Use The
World Over!
Only \$218 less motor T.o.b.
plant. Ship. wt. 400 lbs.

PAY AS YOU EARN!
small down payment

HOW TO
BUILD
YOUR OWN
CONCRETE
BLOCK
HOME

MONTHLY
PAYMENTS **28³³**
as low as

Write Now for FREE Details
SEND \$1 — Refunded
if you buy machine!

EXTRA!

Amazing illustrated book gives floor plans for 6 sensational concrete block bungalows. Tells how to lay blocks, lay out building lines, mix concrete, build steps, porch and concrete floors all at great savings. Written by experts. Can save many times the cost of the machine! Get it now! No strings attached.

GENERAL ENGINES COMPANY

Dept. M-53B, 307 HUNTER STREET, GLOUCESTER, N. J.

STEP UP GAS MILEAGE, CUT COSTLY REPAIRS

NEW!

STEWART-WARNER MOTOR MINDER®

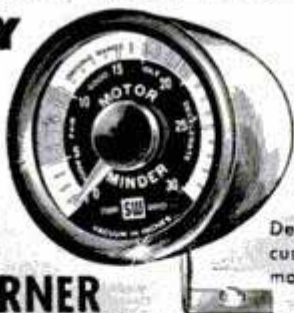

De luxe
custom
model

The new Stewart-Warner Motor Minder lets you see as you drive how to get more miles per gallon. Gives early warning of engine trouble, of faulty valves, rings, spark plugs, carburetor or timing.

The simple illuminated dial can be read at a glance. New Motor Minder is installed easily, quickly. Operates accurately on even latest high compression cars. Swivel mounting gives all-angle vision. Complete instructions are included.

Get it at your dealer's. If he cannot supply you, send his name and address, and your check or money order for \$10.95 to Stewart-Warner. Your Motor Minder will be sent direct to you prepaid!

STEWART-WARNER

Instrument Division, Department N-53
1840 Diversey Parkway, Chicago 14, Illinois

The Most Fascinating Book About the Automobile Ever Printed!

Popular
Mechanics



AUTO ALBUM

The Motor Car in Picture
and Story from
1769 to 1952

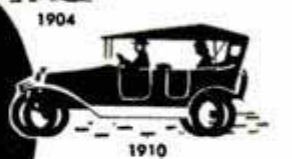

You'll Find...
the Answers... the Fascinating Stories...
in the AUTO ALBUM

Who built the first horseless carriage?

Who obtained the first U.S. patent on an automobile?

Where did the name "automobile" come from?

Are you familiar with the workings of the Stanley Steamer... the "electrics"... the famous Ford Model T?

Do you know when the first Indianapolis race was won... by whom... at what speed?

Do you know the story of Henry Ford, Barney Oldfield, Ransom Olds, Walter Chrysler, W. C. Durant and other automotive giants?

166 Illustrations Including
94 Old-Time Cars — 22 Auto
Ads of By-Gone Days!

Here is a book you can't help enjoying and wanting, whether or not you have, or ever will own an automobile. It is the fascinating, thrilling and informative story of the horseless carriage from the first gasoline-propelled buggy to a forecast of the atomic car of the future.

Popular Mechanics AUTO ALBUM by Throm and Crenshaw presents America's first cars and the pioneering men who made them; the scrambled start and the development of the fabulous auto industry; the story of automobile racing; the growth of the Nation's highways. It is a book that just had to be published.

To Read... to Enjoy...
to Remember!

More than one-half of the book is pictures, most of them action pictures, from photos of old-time cars in operation. Other pictures show race cars from 1911 to 1951; early auto advertising, picturing 32 cars priced from \$375 to \$6000; tri-cycle autos, wind wagons, auto cyclist and other automotive oddities. A roll call of horseless carriages is included — the names of more than 2000 cars made in the United States.

Gift Book of the Year

Get the fascinating AUTO ALBUM for yourself today. Send it as a gift to friends and business associates. Order on coupon below. Money refunded if you are not entirely pleased.



Cloth
Binding

Use Coupon to Get AUTO ALBUM

POPULAR MECHANICS PRESS, 200 E. Ontario, Chicago 11

Send at once postpaid — copies of Popular Mechanics AUTO ALBUM at \$3.00 each. Remittance enclosed. Send COD. I will pay postman plus charges. I understand books are returnable in 7 days for full refund if I am not pleased.

Name _____

Address _____

City _____ Zone _____ State _____

STOP THAT GAS HOG!

REDUCE:

- Power Loss
- Fuel Waste
- Flooding
- Stalling

**NEW FUEL REGULATOR
CUTS GAS COSTS UP TO 25%**

with a PRESSURE REGULATOR

Users claim up to 25% better mileage with this revolutionary new attachment that eliminates hidden gas waste caused by excessive fuel pressure. Prevents carburetor flooding and "surge" due to erratic pulsation inherent in all fuel pumps. "Gane-Master" s-m-o-o-t-h-s fuel flow, prevents vapor lock, stalling, flooding, and fire danger. Made of highly polished aluminum with bronze valve and copper fittings. Features a sensitive, large diameter diaphragm, pressure-spring balanced for extreme accuracy. "GaneMaster" pays for itself many times over by saving gas and eliminating frequent carburetor adjustments! Easily installed in line between fuel pump and carburetor. Fits all cars and trucks. 15 day money-back guarantee.

DEALERS: Valuable territories now being awarded for our complete line. Inquire on your letterhead today!

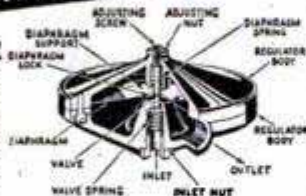

Gane-Master Fuel Pressure Regulator

COMPLETE UNIT **\$7.95** Postpaid

(Or send \$1.00 deposit, balance C.O.D.)

Dept. 2
5801 E. Beverly Blvd.
Los Angeles 22, Calif.

ENGINE PRODUCTS CO.

HELPFUL BOOKS

Send post card asking for **FREE** catalog

Popular Mechanics Press, 200 E. Ontario, Dept. 601, Chicago 11

War Surplus SAVE UP TO 85%



ALTIMETERS Pioneer sensitive altimeters . . . range 0-35,000 feet. Calibrated in 20 ft. increments. Barometric pressure setting adjustment. No hook-up required . . . ready for installation in auto or aircraft.

Used, Good, **\$12.95**



GENERATORS 115 VAC

FOR AUXILIARY LIGHT PLANTS

Here's the buy of the year . . . brand new Eclipse generators in the original box. These generators have an AC output of 115 volts, 9.4 amp, 1000 watts, single phase, 800 cycles, 2400-4200 rpm. DC output is 30 volts at 25 amp. The unit has a spline drive shaft and is self-excited. It will serve as a dependable 115V-AC auxiliary light plant when driven by a gasoline engine for farms, cottages, trailers, boats, flood lighting, or wherever power is not readily accessible. Shipping Wt. 50 lbs. Gov't cost more than ten times selling price.

BRAND NEW . . . **\$29.95**

All Equipment F.O.B. Pasadena • Enclose Full Amount with Order

C & H SALES CO.

BOX 356-MM EAST PASADENA STA. • PASADENA 8, CALIF.

HOW TO CHOOSE a DRILL

Before you buy, make sure you get all these up-to-date features . . .

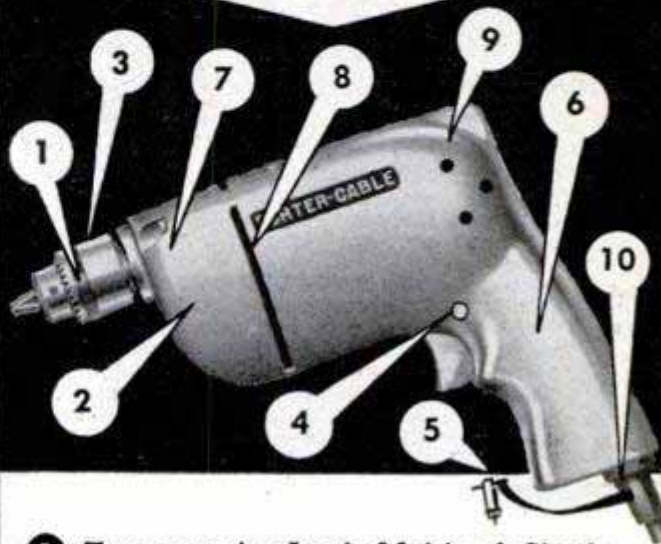

- 1 True-centering Jacobs Multicraft Chuck.
- 2 Compound reduction gears assure smooth operation, longer life.
- 3 Drills within $\frac{7}{8}$ " of vertical surface.
- 4 Trigger lock under right thumb for instant control.
- 5 Convenient chuck key strap included.
- 6 Longer, more comfortable full-hand pistol grip.
- 7 Spindle ball bearing absorbs radial and thrust loads.
- 8 Air vents never blocked by left hand.
- 9 Brushes easily accessible for quick change.
- 10 Strain reliever prevents cord pulling out.

PLUS speed and power to drill 1" bar stock in 2 min.—1" hardwood board in 1 $\frac{1}{4}$ min.

Everything you want in this
new $\frac{1}{4}$ " DRILL by

ONLY
28.50
MODEL 107

Porter-Cable
Quality Electric Tools

See it at your Porter-Cable dealer's or mail coupon for new folder "How To Choose A Drill".

Porter-Cable Machine Co.
1445 No. Salina St., Syracuse, N. Y.

Name _____
Street _____
City _____ State _____

In Canada: STRONGRIDGE, LTD., London, Ont.

STOP BURNING OIL!

K. O. ENGINE WEAR!

With This Terrific 1-2 Combination

Ring-Re-Nu

TRADE-MARK
and P.V.R. Compound

Get new get-away power in your car this simple, easy way:

- 1 Clean your engine with hard-hitting P.V.R. compound. Simply pour into carburetor. Idle engine and see how P.V.R. knocks out sludgy carbons, sticky gums from rings, valves and pistons!
- 2 Squeeze amazing RING-RE-NU compound in cylinders. Forms a heavy-duty, self-expanding lubricating seal around worn rings and pistons. RING-RE-NU restores compression, gives your car new zip and power! Guaranteed harmless to the finest engine. 1 tube carton—good for all makes of cars, only \$4.95 Special 2 tube carton for larger engines — Buick Roadmaster, Cadillac, Chrysler 8, La Salles, Lincoln, Packard 8, Olds 88 and 98 — \$8.95 postpaid.

only \$4.95

10 day money back guarantee

Write for Free Folder!

(C.O.D.'s — \$1.00 deposit required, balance and postage on arrival.)
Get all the facts and you'll get RING-RE-NU, the finest product of its kind on the market!

RICHE DISTRIBUTING, INC.
11916 MADISON AVE., Dept. A5 CLEVELAND 7, OHIO



you CAN PAINT THE THOMAS WAY...AND SAVE!

"I help my husband with all the painting. It's easy with a Thomas Paint Roller! You can save time and money, too, by painting your walls, ceilings, floors, fences, boats, farm buildings—with a THOMAS roller."



... BE SURE YOU GET THOMAS... at your paint, hardware, lumber dealer.

THOMAS PRODUCTS COMPANY
8490 Lyndon Ave. • Detroit 21, Michigan

SALE

2" DEEPER-DRAWER PLASTIC PARTS CABINET



Special 995
Equal space to average 24 drawers @ \$24.95

We specialize in this one most-popular size—at this special price. It's everything you could want in a small-parts storage cabinet—America's newest, handiest, sturdiest. Lightweight yet strong enough to hold 250# lead. 15 clear plastic see-thru drawers with larger 2-inch depth, each with name slot on front, safety catch to prevent spilling, each with 2 movable inside dividers. Electric-weld 20-gauge steel gray cabinets. Can be stacked to a complete storage room. Send check or money order for \$9.95—or C.O.D.'s require \$2.00 deposit. Order now!

FRANKLIN CO., 4723 Liberty Ave., Pittsburgh 24, Pa.

BUILD YOUR OWN DEHUMIDIFIER! — SAVE \$65 or more



End moisture damage in workshop, basement, darkroom, etc. Build your own Dehumidifier with this Refrigeration unit. Complete. No parts to assemble. Just add a wooden or metal cabinet around the device and you have a Dehumidifier equal to a \$139 job. Compact. Portable. Plugs in 110/115V AC outlet. Removes up to 3 gals. per day. Size 16"x11"x10". Wt. 47 lbs. Unit, plans for cabinet & 1 yr. Guar. \$69.50 Same with 5 yr. Guarantee. \$74.50

Prices F.O.B. St. Louis. Send check or M.O., or 25% deposit, bal. C.O.D.

ACME ELEC. CO., 922 N. Broadway, St. Louis 2, Mo.

Say You Saw It in Popular Mechanics

PLEASE SEND ME

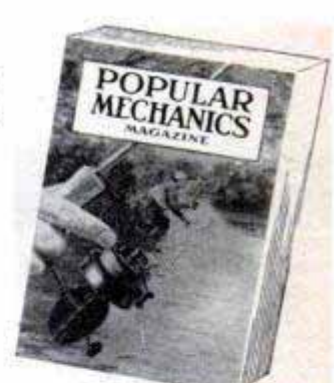

for the time checked.
I am enclosing . . .

1 year \$3.50
2 years \$6.00

name _____
address _____
city _____ zone _____ state _____ C-53

Hand this order to your newsdealer or send it to
POPULAR MECHANICS
200 East Ontario St. Chicago 11, Ill.



**WINTER OR SUMMER
DO EVERY OUTDOOR JOB
FASTER—EASIER—BETTER**

WITH A **GEORGE** GARDEN TRACTOR

\$119.50
F.O.B. Sullivan, Ill.

Illustrated:
2 wheel, 2 HP GEORGE Garden Tractor, Briggs or Clinton Engine

Your George garden tractor is a multi-purpose, year-round work saver. In price, it compares with a power mower. In use, the George garden tractor is incomparable. Complete range of attachments for tilling gardens... mowing lawns... cutting weeds... removing snow. A George tractor is ideal for every purse and purpose.

SEND TODAY
Write for free copy of illustrated George garden tool folder. See how a George garden tractor can do every outdoor chore.
George Garden Tool Div.
PM-5
Sullivan, Illinois

GEORGE GARDEN TOOL
Div. of Community Industries Ass'n

Say You Saw It in
POPULAR MECHANICS

ELECTRIC MOTOR BARGAINS!



Prices Complete! We PAY SHIPPING
FAMOUS MAKES... FULLY GUARANTEED

1/2 HP 3450 or 1750 RPM **19.75** 1 HP 1750 RPM **52.00**
2 HP 3450 RPM **67.50** 3 HP 3450 RPM **79.50**

Immediate Delivery
Tremendous savings! Heavy Duty, Repulsion Induction and Capacitor types, 110-220 volts, 60 cycle, Single phase, G.E., Wagner, Leland, Westinghouse, etc. Powerful motors for home, shop and farm. Limited Supply. Order NOW!

Send for **FREE CATALOG**
ROBERTS ELECTRIC CO., Dept. 63, 849 W. Grand, Chicago, Ill.

SCORES OF PROJECT PLANS
for approximately 1¢ each!

Attached is \$1—please send me the next 6 issues of the DELTAGRAM, the finest woodworking publication in the world—12 to 15 practical projects, all shop-tested, in every issue.

Delta Power Tool Division
Rockwell Manufacturing Company
502E N. Lexington Ave., Pittsburgh 8, Pa.

Name _____
Address _____
City _____ Zone _____ State _____



**PLUS
POWER
PER
POUND**

*...and the price
is right!*



\$29.95

SANDER-POLISHER KIT

For furniture, the car, every waxing, polishing, sanding job. Powerful motor, trigger switch, instant release lock. Lamb's wool polisher, complete set of sanding discs, rubber backing pad and adapter, and drill chuck. Two packages of world-famous Johnson's Wax—liquid and paste.
Model 1540K.....**\$29.95**

Maximum power per pound of weight is a plus you get with PET Power Tools. That's why they're so easy to work with, so fast on every "do-it-yourself" job. Another PET Power Tool extra is low price. Compare. Convince yourself that your one best buy in power tools is PET.



Portable Electric Tools, Inc., 320 W. 83rd St., Dept. PM-53, Chicago.
In Canada: Portable Electric Tools, Ltd., 452 Birchmount Rd., Toronto.



When Screws Won't Stay TIGHT, Use SMOOTH-ON

Apply Smooth-On No. 1 Iron Cement to screw threads and into the screw hole. Insert and tighten up the screw. It will take hold and, when set, will **STAY TIGHT**, for Smooth-On expands slightly as it hardens, wedging the screw in place. This is only one small use for this general-purpose iron cement. With it you can stop leaks and seal cracks in cast metal parts, tighten loose knobs, casters, tool and utensil handles, make many auto repairs. Buy it in 1 $\frac{3}{4}$ -oz., 7-oz., 1-lb. or larger size at your hardware store. If they haven't Smooth-On, write us.

FREE 40-page Repair Handbook

Many original uses for Smooth-On around the house, on the car, etc. Simple directions. 140 illustrations. Send postcard for YOUR free copy.

SMOOTH-ON MFG. CO., Dept. 37E
570 Communipaw Ave., Jersey City 4, N. J.

Do it with

SMOOTH-ON

THE IRON CEMENT OF MANY USES



Say You Saw It in Popular Mechanics

LEVELALL

FASTER THAN \$100 ENGINEER INSTRUMENTS



Regular
50 Feet
\$8.95

The New Improved
Water Level
For Simplest
One Man Operation
Anything you need level
Levelall does it.
Dealer inquiries invited

DeLuxe
75 Feet
\$12.95

A sturdy instrument that can be left on the job for any workman to use. Cannot be put out of adjustment and even with the most casual handling its principle is so simple anyone can level points quickly and accurately.

For footings, forms, batter boards, sills, lintels, floors, ceilings, roads, driveways, lawns, piping, farm contouring and all general construction work normally needing an expensive instrument.

1 qt. extra Level-Flo Liquid shipped with Deluxe Model only.

Complete with instructions, high quality vinyl polychloride tubing filled with Level-Flo Liquid, mounting brackets, and metal case.

LEVELALL, 87F Webster St., Rockland, Mass.
Mail me 75' DeLuxe Levelall @ \$12.95
Mail me 50' Levelall Instruments @ \$8.95
you guarantee satisfaction or money back upon return of Levelall within ten days.

Name _____
Address _____
City _____ Zone _____ State _____
 Send C.O.D. I will pay postmas full purchase price plus delivery charge on arrival.
 Full purchase price is enclosed. Send postpaid. (Postage prepaid on orders in U.S.A. only).

All the Facts You Need About Portable ELECTRIC TOOLS



NEW CATALOG!

Hundreds of time and money-saving ideas for hobbyists, builders, professional woodworkers! New 28-page catalog describes latest portable electric tools—how they work—what they do—where they save. Explains features and uses of electric saws, belt

sanders, orbital sanders, disc grinder-sander-polisher, routers, planes, shapers, drills, bench grinders, chain saws, hedge trimmers—tool accessories. Invaluable for reference. Shows what to look for when buying electric tools—how to get most value. Write today. Send 10c to cover postage and handling.



ONLY
10c

Send for your copy NOW!

Porter-Cable Machine Co., 1445 N. Salina St.,
Syracuse 8, N. Y.

GENUINE GERMAN SABRE
Genuine sabres with 21 $\frac{1}{2}$ in. high quality steel blades, 4 $\frac{1}{2}$ in. handle grip. Comes with protective sheath, can be worn on belt. Decorative for den, and dependable tool for many uses such as cutting underbrush, pruning, etc. Fine for hunters, campers. Used but in perfect condition. Ship wt. 5 lbs. No. 309. Complete, Sabre and Sheath, only... **\$2.95**

SILVERED OPTICAL PRISMS

Solid glass with 1 silvered facet precision ground and polished—3 $\frac{3}{4}$ " long, base 2 $\frac{1}{2}$ in. wide, sides 1 $\frac{1}{2}$ inches. Free from scratches, abrasions and imperfections. Use in any type optical system—photography, telescopes, etc. Weight each $\frac{3}{4}$ lb. A \$25.00 value. Stock No. **\$2.00** Four for **\$5.00** Each.

WAR SURPLUS BARGAINS

Page After Page of Values

This big catalog shows page after page of amazing money saving values. Write for your copy today. Send 10c to cover postage, mailing, etc. Write today!

SEND
TODAY
FOR YOUR
COPY **10c**

STARK'S Dept. PM 553 509 So. STATE STREET
CHICAGO 5, ILLINOIS

Build this Beautiful LAWN FURNITURE YOURSELF

NO EXPERIENCE NEEDED

Smart Exclusive Styles By John Bergen
... Four Big Plans Drawn to Scale ...
Complete Material List

Now with just a few spare time hours and some inexpensive materials you can build gay comfortable lawn furniture that will make your garden more attractive ... more comfortable and more fun this summer.

No need to pay a small fortune for lawn furniture when you can build your own and save over 50% of what it would cost you already built!

Popular Mechanics four big drawn-to-scale plans show every step to follow. Complete material list tells you just what sizes of wood to buy so there will be no waste.

Make your lawn and garden the finest and most attractive on your block by building this smartly styled furniture. Enjoy real comfort during those hot summer months by making your garden your outdoor living room. Send today for your plans and material list. Complete set of four plans only \$2.00. Complete satisfaction guaranteed or your money refunded.



PORCH CHAIR



SERVING CART



GARDEN LOUNGE



PICNIC TABLE



PORCH GLIDER



ADIRONDACK CHAIR

POPULAR MECHANICS PRESS
200 E. Ontario St.
Chicago 11

SAKRETE

READY-MIXED
CONCRETE
& MORTAR

in a bag!

- CONCRETE MIX
- SAND MIX
- MORTAR MIX



© 1953 Sakrete, Inc.

**BUILD IT! REPAIR IT!
YOURSELF!**

**IT'S EASY-
JUST ADD WATER**

NEW TOOL CATALOG

for DEALERS and WAGON JOBBERS!

We are direct factory warehouse distributors for nationally advertised Standard Brands Mechanics tools. Complete line of latest Automotive, Industrial, Aircraft, and Maintenance tools and equipment.

Send \$1 (refundable on first order) for our 160 page illustrated wholesale Catalog.

INDUSTRIAL TOOL & SUPPLY CO.

DEPT. PM, 144 CHAMBERS ST., NEW YORK 7, N. Y.

**8 Tools in 1
HUSKY HE-MAN
KNIFE***

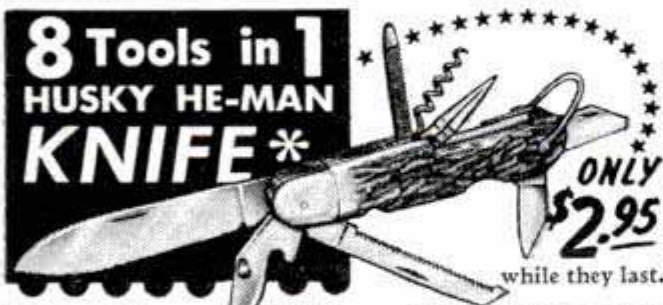

ONLY \$2.95
while they last.

*A Tool Chest in your pocket!

1. 3 1/4" Knife Blade
2. 3 1/4" Saw
3. Screw Driver
4. 1 1/2" Curved Blade
5. Awl Piercer
6. 1 1/2" File
7. Corkscrew
8. Bottle & Can Opener

This is a real HE-MAN'S KNIFE!! Ruggedly constructed of finest quality, TEMPERED STEEL. Handle of GENUINE STAG HORN. This is the knife of a hundred uses for Outdoorsmen, Gardeners, and Hobbyists. This imported multi-purpose knife weighs 9 oz., and measures 6 inches when closed. Order NOW...

★ HOLLYWOOD SALES CO.

3414 W. MAGNOLIA BLVD., BURBANK 2, CALIF.

In a jiffy—install the beautiful **ADJUSTO** shower AND tub filler **MODERN SWING-DOWN FIXTURE**

A TURN OF THE HEAD GIVES SHOWER OR STREAM



Please all the family with today's smartest bath fixture. **LOW COST.** Easily and quickly installed on the outside of the wall. One fixture for both tub filler and shower—mixes hot and cold water, swings up and down. Direct water where needed. Ideal for treating aching bodies. Offers many conveniences.

FOR MODERNIZATION

If you have no shower, an Adjusto can replace your tub spout to give you a combined tub filler and shower. Model K-1472 is designed for those who prefer the control valve installed at a lower level. Your plumber can supply the Adjusto.

MODEL K-1442

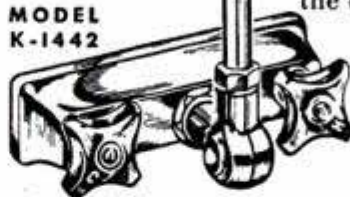

MODEL K-1472

Adjusto is a product of the Manufacturers of the famous Milwaukee Plumbing Fixtures.

SEND COUPON FOR FREE ILLUSTRATED FOLDER

MILWAUKEE FLUSH VALVE CO.

345 E. Reservoir Ave., Milwaukee 12, Wis.

Please send Adjusto Folder

Model K-1472 Bulletin No. 131

NAME _____

ADDRESS _____

CITY _____

STATE _____

HOW TO... SET UP and KNOCK DOWN SAWHORSES FAST!

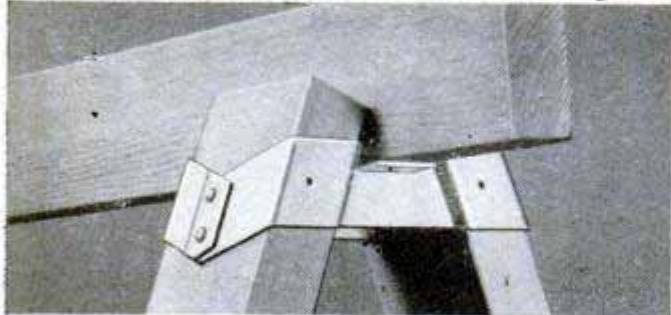

USE STRONG, PRECISION-ENGINEERED **NU-WAY SAWHORSE BRACKETS**

Set up or knock down sawhorses in jig time! Carry them in your car—or store them easily—the modern way . . . the NU-WAY! ONLY **\$1.50** Pair (\$1.60 West of Rockies)

SEE Your Hardware, Lumber or Paint dealer NOW!

THOMAS PRODUCTS CO., 8490 Lyndon Ave., Detroit 21, Mich.

WOODS

Get This BIG Manual And Bargain Book

Loaded with how-to-do it articles on wood-finishing, veneering, making inlay pictures and cabinets. Contains 83 distinct inlay designs and borders, plus a wood identification panel of 60 different varieties. All shown in full natural color suitable for framing.



A MULTITUDE OF MATERIALS

- Lowest Prices On**
- Veneers
 - Inlays
 - Lumber
 - Plywood
 - Plans
 - Supplies
 - Plastics
 - Period Furniture Hardware
 - Modern Picture Frame Molding
 - Upholstery
 - Hand and Electric Tools
 - Finishing Materials
 - Decorative Metals
 - Leather

Albert Constantine & Son, Inc. Dept. PM-12, 797 E. 135th St., N.Y. 54

● VISIT US at our N.Y. Plant. Demonstrations every Saturday on making inlaid pictures, wood finishing and other crafts. Everyone invited.

SEND THIS COUPON!

Albert Constantine & Son., Inc., Dept. PM-12 797 E. 135th St., New York 54, N.Y.

Enclosed find 50c (refunded on 1st order) for your copy of "Manual For Craftsmen" No. 52.

Name _____
 Address _____
 City _____ State _____

Explore the MICRO-JUNGLE!



Triple-turret microscopes as low as . . . \$9.95

New Quadruple-turret models (as shown) \$16.95

All slide materials. Other optics from \$1. Send postcard. **FREE 44-PAGE**

CATALOG!

World's greatest values in quality microscopes, telescopes, binoculars. All hobby and professional models.



the AKRON 24 Akron Bldg., 4400 Sunset Blvd. Los Angeles 27, California

BUILD YOUR OWN FAN



One-piece cast aluminum propellers for cooling and ventilating.

Size Inches	Polished 2 Blade	Polished 3 Blade	Unpolished 2 Blade	Unpolished 3 Blade	Bore Inches
15	\$3.00	\$4.00	\$2.50	\$3.00	1/2, 5/8, 3/4
18	3.75	5.00	3.00	4.00	1/2, 5/8, 3/4
20	4.00	5.50	3.25	4.50	1/2, 5/8, 3/4
24	4.50	6.50	4.00	5.50	1/2, 5/8, 3/4

Write for pamphlet on larger fan blades, wire guards, fan bases, shutters, pillow blocks, exhaust fan frames, etc. Dealers write for discount. Shipped prepaid if money accompanies order. KLOPPENBORG ALUMINUM FDY., Dept. PM-53, Davenport, Iowa

MAKE YOUR OWN TRAILER

or shop wagon with this sturdy aero. tire, tube and wheel with bearings for \$8.50 complete. Tires OD 10 1/2" high, 3 1/2" wide. Bore for axle 5/8".



WRITE FOR FREE CATALOG

on other sizes with stub axles and other farm tires. Wheel barrow and Trailer manufacturing inquiries invited.

HARMO TIRE & RUBBER CO. Part #218 804 HAMMOND BLDG., Dept. PM DETROIT 26, MICH.

You Can Become an Expert User of POWER TOOLS

Brand New Book Shows You How to Select and Operate Home Workshop Machines—How to Use All Popular Power Tools Efficiently in Your Home Workshop

Here's the book that tells and shows you how you can become an expert in the use of all power tools. It covers selection, use and operation of sanders, drill presses, bandsaws, scrollsaws, lathes, shapers, jointers, metal working tools, accessories, etc. Tells how to use tools to make cabinet joints, moldings, compound angles; contains actual plans and instructions for a variety of fascinating projects. A special directory in the back of the book lists names and addresses of various manufacturers and sources of supply.



7 Day Money Back Guarantee

Send only \$2.50 today for this big 144 page book with its more than 375 photos, drawings and diagrams. Return it within 7 days for a full refund if it is not entirely satisfactory.

POPULAR MECHANICS PRESS, Dept. 93 200 E. Ontario St., Chicago 11, Ill.

Send at once my copy of POWER TOOLS AND HOW TO USE THEM. I may return it for a full refund in 7 days if it is not satisfactory.

NAME _____
 ADDRESS _____
 CITY _____ ZONE _____ STATE _____
 \$2.50 enclosed Send C.O.D. (Postage Extra)

Buy the Best...WISS!



for all sheet
metal cutting

WISS Metal Master Compound Action Snips

#M-3. Easily cuts 18 gauge sheet metal. Cuts curves and circles as well as straight. Ideal for the home workshop. \$4.25. Rubber grips recommended, 60¢ extra.

WISS Straight Cut Snips

#9. Crucible steel inlaid blades. The basic snips for straight metal cutting. Gun metal handles. Overall length 12½". \$5.25.

WISS Combination Snips

#V-13. Solid steel, with gray japanned handles. Cuts curves and irregular shapes with ease. Handy pocket size. 7" long. Accurately tempered jaws and strong bolts. \$1.85.



Prices slightly higher
Denver and West



Quality for more than a Century

J. WISS & SONS CO. • NEWARK 7, N. J.

Build Your OWN Hi-Fi Radio-Phono Cabinet

KITS

by **Cabinart**

Now available in select 3/4" white pine wood cut to size. Takes beautiful blond or mahogany finish.

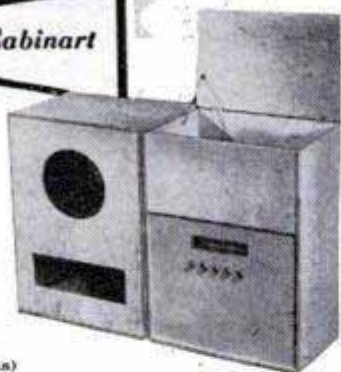

Bass Reflex and Equipment Cabinets

Ideal housing for hi-fi components...removable panels make future changes easier. Loudspeaker cabinet acoustically-designed for either 12" or 15" speaker.

Overall dimensions:
33½", 23", 16"
Tuner Compartment: 20"H,
21¾"W, (inside dimensions)
Baffle volume: 6 cubic feet

#80 (equipment kit).....\$27.00
#8112 (12" speaker).....\$18.00
#8115 (15" speaker).....\$18.00

CORNER FOLDED HORN ENCLOSURES

Reproduces a quality of bass heretofore only possible through the use of far more expensive designs.
#61 (12" speaker).....\$19.95
#63 (15" speaker).....\$23.95
All kits include baffle, pre-cut for 12" or 15" speaker, Saran Plastic, AcoustiCloth, Kimsul Acoustic Insulation, Assembly and finishing instructions, hardware, plastic wood, sandpaper and glue.

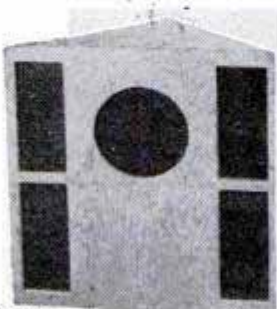

CHECK OR MONEY ORDER—NO C.O.D.'s
SHIPPED EXPRESS COLLECT

ELECTRONIC WORKSHOP

26 W. 8th STREET • NEW YORK 11, N. Y.

You'll be money ahead when you discover **THERE IS A DIFFERENCE IN HOUSE PAINTS!**

In this age of scientific progress you are entitled to house paint on your home that provides the *maximum* in lasting beauty and protection. Sherwin-Williams makes SWP House Paint in only *one* grade . . . the best we know how to make. You benefit four ways when your home is painted with SWP . . .

 **1. LASTING BEAUTY**—When you paint with SWP House Paint in 1953, you can expect longer lasting beauty than ever before.

 **2. MAXIMUM PROTECTION**—Building and repair costs today are the highest in history. You want to protect the investment you have in your home. SWP House Paint will give it greater protection than ever before.

 **3. LOW COST - PER - YEAR**—The real cost of painting your house is determined by how often you must repaint it. You will find that you have to paint *less* frequently when SWP House Paint is used.

 **4. ASSURANCE OF QUALITY**—More homes have been painted with SWP since 1880 than any other brand of house paint. Constant research has kept SWP the world's standard of house paint quality.

Why risk disappointment when you are sure of satisfaction if SWP House Paint is used? There are substitute house paints that sell for less than SWP, but don't let that fool you! *Insist upon SWP, and be sure!*

Write for the free booklet, "The Truth About House Paint" . . . The Sherwin-Williams Co.,
1205 Midland Building,
Cleveland 1, Ohio.



Go to the store
that displays
this famous
trademark

SHERWIN-WILLIAMS HOUSE PAINT

© The Sherwin-Williams Co., Cleveland, Ohio

SHERWIN-WILLIAMS LEADS THE WORLD IN PAINT RESEARCH

SW 5310



BUY from C&H
you'll save and be sure

HUNDREDS
 of SENSATIONAL BARGAINS!



HOT ROD SUPERCHARGER

Extra soup and go at a price you can't afford to miss! Mfr'd by Borg - Warner.

Specifications:
 7 1/2" deep, 7" high. Wgt. 17 lbs. Compact and sturdy. 4 base mounting holes. 3/4" outlet. 3/4" shaft with female Lovejoy coupling. Priced today at \$85. Our Special SALE PRICE, NEW \$31.00. Used \$18.95

80-1 ratio Gear Reducer



Double reduction, reduces 1/8 to 1/2 HP electric motors 1750 rpm to 22 rpm. Reg. \$45. NOW \$26.00

CENTRIFUGAL CLUTCH - Ball Throw-out type. A or B belt pulley. 3/4" bore \$9., 1" bore \$11.

WATER PUMPS

7500 gal. per hr. self-priming Marlow centrifugal pumps. Driven by 2 HP B & S gas engine. 2" dia. discharge & suction. \$175. value. Now \$130.

LIGHT PLANTS

300 Watt 110-220 volt AC. Wgt. 40 lbs.—portable \$99
 750-1000 Watt 110v. AC Briggs & Str'n. eng. \$169
 1000-1200 Watt 110v. AC only \$194.00
 2500-3000 Watt 110v. AC Slow speed (1800 rpm) Leland generator for longer life. Record'nd and fully guaranteed \$295. NEW \$345
 5 KW Plant, 120 v. 60 cycle AC. Lists at \$1300. Our Price \$795. Extra parts & tools \$25. 2 reels of cable & switch \$115. Plant, cable & parts complete \$899. UP TO 100 KW carried in stock - write for complete information.

ELEVATORS

Build your own dumb waiter for store, shop, home, restaurant, or incline elevator for hills, and steep shores at factory prices. We furnish Steel Car - Guide Rails - Worm Gear - Electrical Controls - Steel Cable. SEND 25c for completely diagrammed instructions with price list.



ALARM HORNS SIRENS

Heavy duty motor driven; high, med. or low tone, 110v. AC Weatherproof. For alarm or signal horn for boats, school yards, factories, air raids, etc. Lists at \$47. NEW \$24.95



POWER & HAND WINCHES AT FACTORY PRICES!

For—BOATS, TRUCKS, FARMERS, LOGGERS, CONTRACTORS, ETC. Hand Winch, 3-1 ratio, 600 lb. pull, drum has 1 1/2" spool, 6" flange, takes 75' of 3/16" cable, stop locking pawl, wgt. 26 lbs. \$16.95
 Ball Bearing Hand Winch, low ratio 1-1, high ratio 3-1, 600 lb. pull. \$29.50
 Same as above with bronze worm gear, 12-1 ratio and hand-brake \$39.50
 1/2 HP electric ball bearing model; compact gear box, 12 rpm drum speed. \$145.00
 3/4 HP, same as above, 3" drum \$165.00
 Heavy duty, 10-1 ratio, double drum model with jaw type clutch, wgt. 280 lbs. \$49.95
CABLE, 1/4" preformed stainless steel aircraft, 100 ft. or less 17c/ft. Over 100 ft. 15c/ft.

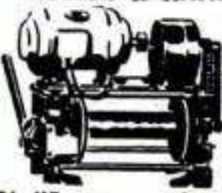

SEND TODAY FOR FREE CATALOG

Hundreds of \$5 saving buys. These are a few of the many items at sensationally low prices!

- Pumps
- Grinders
- Drop Cords
- Generators
- Fire Pumps
- Saws
- Clutches
- Air Tanks

C&H ELECTRIC MACHINE CO. Inc.

4348 W. Juneau Ave., Milwaukee 3, Wisconsin

HELPFUL BOOKS

Send post card asking for FREE catalog

Popular Mechanics Press, 200 E. Ontario, Dept. 601, Chicago 11

GREATEST SAVING EVER OFFERED!

U. S. GOV'T SURPLUS

"BARGAIN BOOK"

SAVE ON WINTER NEEDS!

It's loaded with bargains in genuine Gov't Surplus for farm-home-industry. Save up to 85% on clothing, hardware, sporting goods, etc. The "Book of the Year". Send 10c for yours today.



500 BARGAINS
 • FARMS • SPORTS
 • HOME • SHOP

MAIL TODAY Only 10c

FISLER SALES CO.

1329 MAIN ST., DESK SF, KANSAS CITY, MO.

LAST CHANCE TO ENTER \$1,000⁰⁰ CASH
SYNCR O SANDER CONTEST
 NOTHING TO BUY—FUN—EASY!



Write for FREE DETAILS!

Last chance to enter this different Contest—nothing to buy! WIN one of 43 cash prizes. No special mechanical-craft skill or knowledge needed. Just find Missing Words for Jingle, finish the Sentence, "I LIKE SYNCR O SANDER BECAUSE" in 15 additional words or less. Contest starts March 1—ends May 31, 1953. Enter—you may win first prize of \$500 cash! Write for FREE CONTEST FOLDER, Entry Blank. Rules—or get Folder at hardware stores handling SYNCR O SANDERS! Hurry!

\$1,000 Contest Folder FREE At Store Or Write!

SYNCR O ELECTRIC SANDERS

SYNCR O CORPORATION
 Contest Dept. D-53
 Oxford, Mich., USA

SYNCR O POWER UNITS
GUARANTEED
 AGAINST BURN-OUT DURING
 YOUR OWNERSHIP OR
 REPLACED FREE!



PRACTICAL BOOKS ON HOME PLANNING BUILDING • REPAIRS

MAIL ORDER TODAY

Plan Now—Build When You Can
 Books Sent C.O.D. Anywhere in U.S.A.

Select from this list of helpful books. In U. S. books sent postpaid if remittance accompanies order. Outside U. S. include 15% extra for shipping charges.

- How to Plan a House. \$5.00
- Your Home and How to Build It Yourself. \$3.00
- Painting, Decorating. \$1.75
- Carpentry \$2.50
- Painting, Furniture Finishing and Repairing
 Includes floor renewal \$1.50
- How to Remodel a House Complete, practical. \$5.00
- Building Insulation .. \$4.50
- Concrete Handbook Do work for yourself, others \$2.00
- Blueprint Reading for Building Trades \$1.50
- Practical Bricklaying. \$2.00
- Primer for Home Builders \$2.50

FAMOUS PLAN BOOKS

Books contain floor plans, photos, descriptions of homes.
AMERICA'S BEST LOW COST HOMES. 125 designs \$1.00
DE LUXE SMALL HOMES. 210 designs. \$1.00
OUR FUTURE HOME. Wide selection of residences, summer homes, garage apartments. \$1.00
MODERN HOME & GARDENING. 42 popular designs. Improvements, garden short-cuts, etc. \$1.50

Set of Four Books \$3.50

Stair Building \$2.50



POPULAR MECHANICS PRESS

DEPT. 24 • 200 E. ONTARIO STREET, CHICAGO 11

The easy way to paint!



Speedy Sprayer



ONLY \$36.50
LESS MOTOR

Favorite of home owners and craftsmen for 20 years! SPEEDY SPRAYER gives your work that professional paint finish everyone admires. Sprays paint, enamel, varnish, lacquer, etc. . . . 4 to 7 times faster than hand brushing! Lightweight, portable, uses any 1/4 H.P. motor. Improved diaphragm principle assures clean, oil-free air. You'll find dozens of time and money saving uses for SPEEDY SPRAYER, including spraying insecticides 2-4-D and DDT. Complete outfit, without motor, only \$36.50.

At leading hardware, lumber, and auto supply dealers.
FREE—write for handy booklet "How to Spray."

W. R. BROWN CORPORATION
2635 N. Normandy • Chicago 35, Ill.

FURNITURE FOR YOUR BEDROOM

YOU'LL BE THE ENVY of your neighbors with this beautiful bedroom suite in honey maple, oak or walnut! Here's a bed with storage space . . . a three-piece vanity with cosmetic compartment and makeup mirror . . . a Mr. and Mrs. dresser . . . twin night stands with drawers!



Send for Complete PLANS Only \$2.00

YOU MAKE IT YOURSELF! Only two power tools, a saw and a jointer, are needed to turn out this modern bedroom furniture. No other project of Popular Mechanics Magazine in recent years has captured the fancy of home craftsmen as has this easy-to-build suite. Letters demanding detailed plans poured in after the suite was pictured in Popular Mechanics. And now the plans are ready! They're detailed scaled drawings—a complete set of 4. Send for them today!

POPULAR MECHANICS PRESS, Dept. 26
200 East Ontario Street, Chicago 11, Illinois

I enclose _____ for a complete set of plans for making the modern bedroom suite illustrated above.

Name _____

Address _____

City _____ Zone _____ State _____



With FEDERAL-MOGUL bearings in the engine you get

NEW, SMOOTH POWER, ECONOMY

on the Road!



The Best Known Engine Bearings for all Replacement Service!

Is oil-pumping stealing from your car or truck performance? Oil pumping starts with worn engine bearings. Replace 'em! Restore oil-control and fine performance with Federal-Mogul bearings, engineered for the job of oil-control!

FEDERAL-MOGUL SERVICE
(Division of Federal-Mogul Corporation)
DETROIT 13, MICHIGAN

You replace **RIGHT** with Federal-Mogul Bearings

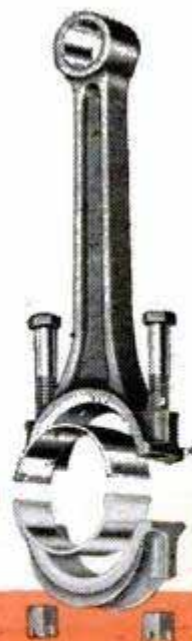

insist on . . .

FEDERAL-MOGUL

Oil-Control Bearings



Ask Your Mechanic!

The **NEW Model 50 UTILITY TESTER**
FOR REPAIRING ALL ELECTRICAL APPLIANCES-MOTORS
an all-around electrical trouble shooter



- Measures A.C. and D.C. Voltages, A.C. and D.C. Current, Resistances, etc.
- Will measure the current consumption while the appliance under test is in operation. The appliance or utility may be plugged directly into the front panel receptacle. A special pair of insulated clip-end leads is included for motors, etc.
- Incorporates a sensitive direct-reading resistance range which will accurately measure all resistances commonly used in electrical appliances, motors, etc. This range will enable continuity checks and tests for shorts and opens.
- Will test thermostats, radio tube filaments, bulbs, fuses, fluorescents, condensers, switches, field coils, circuit breakers, lighting systems, etc.

Handsome round cornered molded bakelite case 3 1/8" x 5 7/8" x 2 1/4". Complete with all test leads and instructions.

\$13.90

SHIPPED ON APPROVAL
No Money With Order - No C.O.D.

Try it for 10 days before you buy. If completely satisfied send \$3.90 and pay balance at rate of \$2.00 per month for 5 months — No Interest or Carrying Charges Added. If not completely satisfied, return to us, no explanation necessary.

SUPERIOR ELECTRONIC CO., INC.
 Dept. D-59, 227 Fulton Street, New York 7, N. Y.

Please rush 1 Model 50. I agree to pay \$3.90 within 10 days after receipt and \$2.00 per month thereafter.

Name _____

Address _____

City _____ Zone _____ State _____

HANDIEST CABINET EVER MADE
FOR STORING SMALL PARTS

What a relief! No more frantic searching for misplaced items. No other cabinet has so many desirable features. Maximum strength, crystal-clear plastic drawers can't spill accidentally. Strong, all-steel welded cabinet with baked-on gray finish. 32 drawers subdivide into 96 compartments — lengthwise or crosswise. Drawers 5 7/8" long, 2 3/4" wide, 1-7/16" deep. Semi complete, postpaid. Money back if not satisfied within 10 days. Free catalog on other 8 sizes.

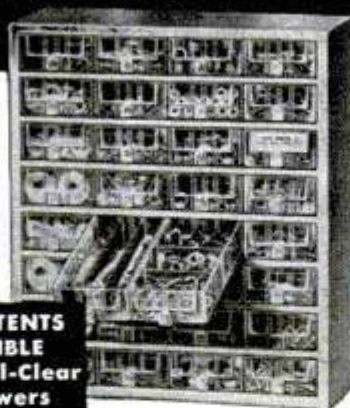

CONTENTS VISIBLE
Crystal-Clear Drawers

15 1/4" high, 12 1/2" wide, 6" deep
 Model J-32 Illustrated **\$12.95**

Mfd. by

AKRO-MILS, INC.

818 E. MARKET ST. AKRON 5, OHIO

Here's the *All-purpose*
"1001" RE-BLADE KNIFE
... with the 1001 uses!

- KEEN
- EVER-READY
- PERFECT BALANCE
- LIGHT-WEIGHT
- YOU'LL LOVE THE FEEL OF IT

Regular \$1.59 value
NOW! \$1.00

EXCLUSIVE PATENTED CHUCK MAKES BLADES SIMPLE TO CHANGE — KEEPS BLADES FIRMLY LOCKED!



COMPLETE WITH THREE BLADES AND UNBREAKABLE HONER!

If not satisfied in 5 days, your **MONEY BACK!** Mail your dollar today for the "1001" Kit complete with 3 blades and unbreakable honer to Dept. P. M.

Please, No C.O.D.'s.

MARSTAN SALES CO.
 DANVERS, MASS., U.S.A.

SAY YOU SAW IT IN
POPULAR MECHANICS

BIG 20" ROTARY LAWN MOWER

Powerful 2 H.P. world famous Lauson or Clinton Engine. Remote throttle control. Strong steel base and handle. Hardened steel cutting knives. Direct drive. Well guarded for safe operation. Cutting height adjustable 1" to 3". A top quality all purpose mower—outvalues them all. Satisfaction guaranteed or money back. *With recoil starter—\$4.50 extra. Dealer inquiries invited. Write or order now!

ONLY **\$89.50***
 F.O.B. LANSING



KROY MANUFACTURING CO. So. Lansing Box 53 Lansing, Michigan

SHOPMASTER'S

NEWEST SENSATION

COMBINATION POWER TOOL



It's... Circle Saw, Drill Press, Sander, Router, Chopper, Lathe All in One

For Complete Information Write Dept. PM5 1214 S. 3rd St., Minneapolis, Minn.

SHOPMASTER, INC.

Start Your Own Welding Business
 with a **HOBART**
"Simplified" arc welder



Go after WELDING jobs that Pay Big Money!

Write today for complete details on this **PROFIT MAKING EQUIPMENT!** No Obligation.

Never before has the demand for welding been so great—the profits so large. That's why smart operators everywhere are setting up their own welding business... and you can do the same.

SIMPLY CHOOSE from our complete line, the welder that best suits your needs—gas or electric drive—portable or stationary. The big pay jobs are waiting, so don't miss this opportunity. Write today.

"One of the world's largest builders of arc welders"

HOBART BROTHERS CO., Box M-53, Troy, Ohio



1903—GOLDEN ANNIVERSARY—1953

SHAW "DU-ALL"

GARDEN AND SMALL FARM TRACTORS

Low Cost 1½ to 5 H.P. Walking Models Do All Garden and Yard Work ..Fast, Easy

5 H.P. Walking Model with 10-inch Plow



Plow with a 6-7-10 inch plow ... plant, cultivate ... mow, bulldoze, saw wood ... do many other jobs with the Shaw Du-All. 1½, 2½, 3, 5

H.P. machines. Variable speeds, adjustable wheel widths, individual gang tool controls. Power take-off pulley and attachments. Power turn models available.

Powerful 5-8-12 H.P. Riding Tractors, Ideal for Larger Acreage

Famous Shaw design provides lowest cost power for small farms. Handle 10, 12, 14-inch plows. Work 4 to 8 acres daily. Handle all ground preparation and cultivation ... mow, rake, cut

12 H.P. Riding Tractor with 12-in. Plow

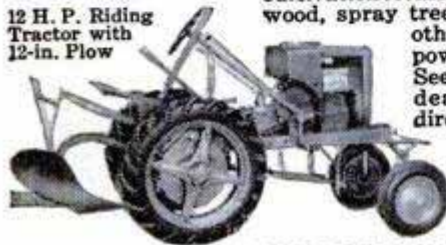

wood, spray trees, do many other jobs with power take-off. See the Shaw dealer. Write direct for

FREE CATALOGS
low prices
complete
Shaw line.

SHAW MANUFACTURING CO.

4505 Front St., Galesburg, Kansas
668-G N. 4th St., Columbus, Ohio

ATR

for A.C. current ANYWHERE!



STANDARD and
HEAVY DUTY

INVERTERS

For Inverting D. C. to A. C. ... Specially Designed for operating A. C. Radios, Television Sets, Amplifiers, Address Systems, and Radio Test Equipment from D. C. Voltages in Vehicles, Ships, Trains, Planes and in D. C. Districts.

See your jobber
or write factory

ATR

NEW MODELS
NEW DESIGNS
NEW LITERATURE

"A" Battery Chargers, DC-AC Inverters, Auto Radio Vibrators
AMERICAN TELEVISION & RADIO CO.
Quality Products Since 1931
SAINT PAUL 1, MINNESOTA—U. S. A.

PLUMB

BALL PEIN HAMMERS

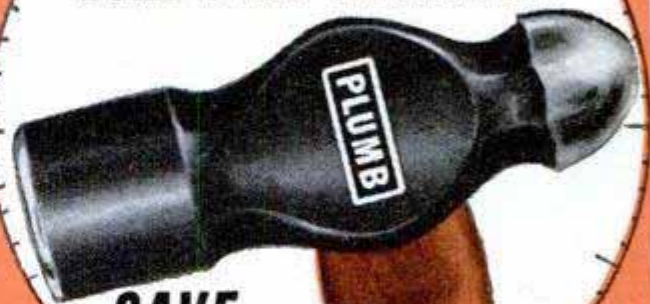

SAVE TIME

You'll speed through the job with this hand tool. It packs more power—hits faster, more accurate blows.

Balance is the reason

for this time-saving speed. Weight is directly behind the striking face so that the blow lands true.

For *Safety*, the flared-end handle prevents slipping

—the take-up screw keeps the head tight.

The *cone-shaped pein* spreads rivets evenly without mashing them. Do your next job with a Plumb—you'll finish faster.



Quality Comes **FIRST**

PLUMB

Is **FIRST** In Quality

PLUMB®

HAMMERS • HATCHETS • AXES • FILES

send for **FREE CATALOG**



America's Foremost
money-making
MECHANICS'
TOOLS

It's easy to own the same "pay-off" tools used and endorsed by America's top-earning mechanics throughout the automotive, aviation and industrial fields! Snap-on tools help you handle every repair job faster, easier, better. And they LAST... pay for themselves over and over again! Start building your own tool set now with basic Snap-on units—add others any time. Genuine Snap-on tools are never sold in stores—direct to users only. Mail coupon for free catalog.



SNAP-ON TOOLS CORPORATION
8062-E 28th Ave., Kenosha, Wisconsin
Send me free catalog of Snap-on tools.

Name _____
Address _____
City _____ Zone _____ State _____

**SOME MORE
GOOD SHORT CUTS**
from "Handy" SANDY



90-second cure for a "sticky" drawer. 1. Remove the drawer and rub white chalk on all parts that might be sticking. 2. Now put the drawer back and run it in and out a few times. 3. Pull it out again—where chalk is gone is where you have to sand. 4. Wrap a sheet of Medium Flint Paper around a small block of wood and sand 'er down. (You should have an assortment of Flint Paper Sheets by CARBORUNDUM on hand for such jobs—five handy grades: Extra Fine, Fine, Medium, Coarse, and Extra Coarse.) For the final touch on that drawer, wipe the rest of the chalk off and rub all the "sliding" parts with a piece of yellow laundry soap.

Next time you cut a piece of glass, whether for a window, a picture, or for the top of your desk—remember this: You can remove the sharp edges, square the corners, or make round edges with CARBORUNDUM's No. 109 Combination Sharpening Stone. Just file the glass to the shape you want. This No. 109 stone is the same one I recommend for putting sharp edges on your tools.

Send me YOUR favorite short-cuts on home repair, one to a postcard. I'll send you \$5.00 right away for each one I can use in this column. Even if I can't use it (due to duplicates, etc.) I'll send you a worthwhile little gift, anyhow.

Send for a new free pamphlet: "How to Sand," by CARBORUNDUM. A separate postcard from you will bring it by return mail. Just address your card to me.

"Handy" SANDY
CARBORUNDUM
Niagara Falls, New York

"CARBORUNDUM" IS A REGISTERED TRADEMARK OF
THE CARBORUNDUM COMPANY, NIAGARA FALLS, NEW YORK

90-312

**MAKE
Big Money
SANDING
FLOORS!**



BE YOUR OWN BOSS

It's easy to turn your own labor into money—BIG MONEY—in floor surfacing work. You keep *all the profits* from your labor! Thousands of prospects—sand floors in maintenance or remodeling of old homes... also new homes! Earn \$50 a day and more... pleasant indoor work... and you are boss! Send for "tell-all" booklet entitled "Opportunities in Floor Surfacing" enclosing 25 cents in coin or stamps to cover handling. The American Floor Surfacing Machine Co., 535 So. St. Clair St., Toledo 3, Ohio.



AMERICAN

FLOOR MACHINES • PORTABLE TOOLS

Direct from Manufacturer

MEN'S HANDKERCHIEFS

Sof-White, large size, 18" square, first quality, deluxe, hemstitched hems. Satisfaction Guaranteed.

10 for \$1

POSTPAID

WINDSOR-CRAFT CO. DEPT. 1, 623 NORTH BLEAKWOOD LOS ANGELES 22, CALIF.

TOOLS WHOLESALE

MAKE EXTRA MONEY

Start Your Own Business. Sell tools to your friends, neighbors, etc., in your spare time. A MILLION DOLLAR INVENTORY AT YOUR FINGERTIPS. Send \$1.00 for Dealer's Card and Wholesale Catalog

Stanley, Millers Falls, Plumb, Disston, Wiss, Skil and others at 30% to 50% off.

SILVO HARDWARE CO., Dept. M, 108 Market St., Phila. 6, Pa.

UPHOLSTER IT YOURSELF

With this brand new book you can upholster your own furniture at great savings. It contains the very latest information on new upholstering methods including the use of foam rubber. There are hundreds of illustrations so clear and to the point that you cannot go wrong. First you read how to do it and then you actually see how it is done. Order from your newsstand today, or if you prefer, send your order to address below.. **\$1.00**



POPULAR MECHANICS PRESS
200 EAST ONTARIO ST., CHICAGO 11, ILLINOIS



"I decorated these damp walls for less than 2¢ a square foot!"

Novaproof your basement walls yourself and save money! Just mix "micro-milled" Novacrete with water and brush on—while wall is wet. Unlike ordinary masonry paint, Novacrete contains Novamix, the magic "backbone" ingredient that prevents flaking, blistering and peeling—on either exteriors or interiors . . . Makes paint go further. Completes the seal against dampness and moisture.

Alkali-proof. Gives you a clean, dry, colorful room for work and play . . . Used in carloads by leading contractors. Gives professional results on your walls. Write for name of dealer, prices, colors, etc. Dept. 70C, NOVA SALES CO., Trenton 3, N. J.



NOVACRETE THE MASONRY PAINT WITH "BACKBONE"



Standard equipment on Bendix, Frigidaire, Hamilton, General Electric and many other appliances

YOU PAY NO MORE for CONGRESS QUALITY

Congress quality costs no more! Insist on the drive preferred by most original equipment manufacturers. There is a difference! Congress Drives are electrolytically plated, diamond-bored and tested for trueness.

Buy Congress V-Belts and Pulleys from your local supplier.



LOOK FOR THIS DISPLAY

You'll see it at leading suppliers throughout the United States.

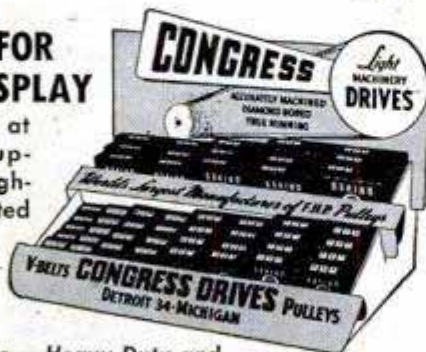

Q-D Sheaves — Heavy Duty and Steel Cable V-Belts—FHP Drives

CONGRESS DRIVES DIVISION

TANN CORPORATION
World's Largest Manufacturer of FHP Pulleys
DETROIT 34, MICHIGAN

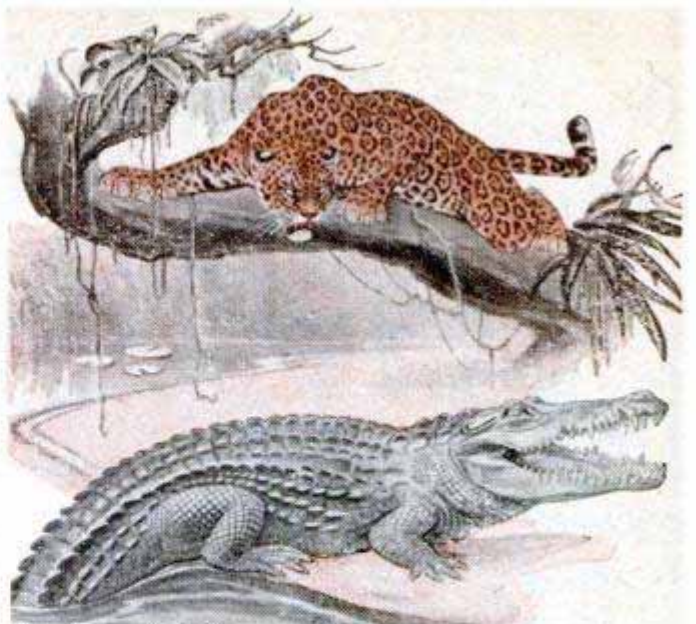

A tough, horny hide, along with powerful jaws and teeth, provide this South American crocodile with such complete protection that even a vicious and hungry jaguar hesitates to attack him.

Complete Protection

Every vital part of the crocodile is protected—and every vital moving part of your engine can be protected with an AC Aluvac Oil Filter Element.

- **Microscopic filtration**—AC Aluvac removes sludge and particles as small as 1/100,000 of an inch.
 - **Maximum filtering area per cubic inch**—AC Aluvac has 10 times the area of ordinary elements.
 - **No harmful chemicals**—AC Aluvac won't remove detergents from heavy duty motor oil.
 - **Acidproof**—secret process renders AC Aluvac material resistant to acid, gasoline and water.
- There's an AC Aluvac Element designed to fit most any type of oil filter on any make of car.



WITH **ALUVAC** ELEMENTS

Standard or original factory equipment on Oldsmobile, Buick, Cadillac and Chevrolet cars—Chevrolet and GMC Trucks

AC SPARK PLUG DIVISION



GENERAL MOTORS CORPORATION

BUY DIRECT MANUFACTURER TO YOU!

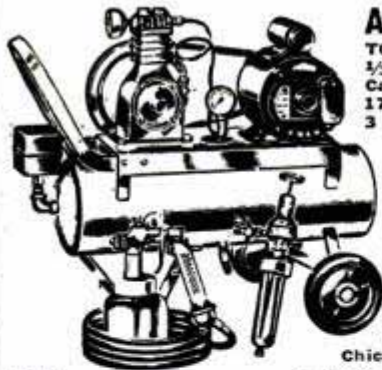

AUTOMATIC AIR COMPRESSOR

TOP QUALITY NAME BRAND COMPONENTS
 1/3 H.P. Extra Heavy Duty Westinghouse Capacitor Motor, 115/230-V, 60 cy., 1 ph., 1725 RPM, overload protected. Quincy X2—3 CFM—100-150 lbs. Compressor—2 in. x 1 3/4 bore & stroke. Furnas Automatic Adjustable Pressure Switch. Tank 8" x 26". Rubber Tired Wheels and Handle. Speedy External Atomizing Quart Spray Gun, Pressure Regulator, Filter, Gauge, Hose & Tire Chuck, Check Valve, Safety Valve, V-Belt Drive. Completely Assembled into a Compact Balanced Unit. Ready To Use, 1/2 H.P. #A-33 Fob. Chicago. Only \$89.00
 SAVE \$10.00 . . . 1/2 H.P. Outfit, knocked down, you assemble, #K-33 . . . Fob. Chicago. Only \$79.00



BIGGER, EXTRA HEAVY DUTY, AUTOMATIC AIR COMPRESSOR UNIT. BIG 1/2 H.P. HEAVY DUTY Capacitor A.C. 110/220-V Motor, Giant Stainless Steel Tank, 12 x 24 inches, 500 lb. test. Bigger Precision Air Compressor, 2 in. bore x 2 in. stroke, 3.5 CFM. pressures to 150 lbs. Big 10 x 175 Rubber Tired Ball Bearing Wheels, plus all accessories and parts listed above. Completely assembled into a Compact Balanced Unit. Ready to use, 1/2 H.P. #A-55 Fob. Chicago. Only \$117.00
 SAVE \$10.00 . . . 1/2 H.P. Outfit, knocked down, you assemble, #K-55 . . . Fob. Chicago. Only \$107.00

VERTICAL STATIONARY COMPRESSOR UNIT

Air for Dentists, Laboratories, Gas Stations, Garages, Farms & Factories. Neat, Compact, takes minimum of space. 1/2 H.P. 110/220-V-AC Westinghouse Capacitor Motor. 3 CFM-100 lbs. Quincy X2 Compressor. Furnas Automatic Pressure Switch. 12 x 24 in. Stainless Steel Tank. Complete Vertical Stationary Automatic Compressor Unit #VSA-55 . . . Fob. Chicago. Only \$97.00

C. MARSHALL SALES

3546 W. Fullerton Ave., Dept. P-5 Chicago 47

New MOTOR BARGAINS for Home, Farm & Industry



1/2 H.P. } Dayton, 3450 RPM IND type \$18.50
 Westinghouse, DBL shafts, 1725 RPM \$22.50
 Westinghouse, dbl. shafts, 3450 RPM \$23.50

3/4 H.P. } Ecor, capacitor type ball brg., 1725 RPM \$32.50
 General Electric, cap. ball brg. dbl. shafts, 1725 RPM \$34.50
 General Electric, cap. type, 3450 RPM \$34.50

Above are 110 V. or 110/220 V. 60 cy. 1 ph. A.C. Motors. All Motor Prices are F.O.B.



SPECIAL BARGAIN OFFER . . .
 Brand New! 2 H.P. Repulsion Induction Single Phase Late Style—Name Brand—220 V 60 Cy 3450 Rpm 3/4 Shaft . . . Only \$65.00. Weight approx. 100 lbs.

Write for FAN CIRCULAR: Listing Blades, Guards, Motors, ALL SIZES: Attic, Window or Room Cooler.

16 TO 1 SPEED REDUCERS
 For Display Table—Barbecue Spits—Toy Auto Gear Box—Experimental Uses, Etc. Gears Enclosed in Aluminum Housing. Bronze Gear, Hardened Worm. Input Shaft 3/4 in. Output Shaft 3/8 in. Speed Reducer Post #R 161. \$5.95 Paid

VOLUME BLOWERS FOR HEATING, VENTILATING, EXHAUSTING

Blowers for forced drafts, heating boosters, exhausters, coolers, dryers and dust collectors, 110 volt A.C., 50/60 cycle motors.
 75 cu. ft. per min. Blower and Motor, Postpaid, Only \$9.75
 150 cu. ft. per min. Dust Collector Blower with hi-speed Motor, Postpaid Only \$12.50
 250 cu. ft. per min. Blower, 5 in. Wheel, Only . . . \$22.50
 Giant Dust Collector, 2000 cu. ft. per min.—14"x14"x12" overall, 1/2 H.P., 110 V-AC Motor. Hi-speed 3450 RPM, 6 in. non-clogging Aluminum Impeller. Shipping wgt. 60 lbs. FOB Chicago. Only \$55.00

SAY YOU SAW IT IN POPULAR MECHANICS

New! AMAZING FOTO-GLO
TRANSPARENT COLOR PICTURES

Take Old Favorite Negatives and Convert Them Into Dimensional - True - To - Life - Glowing Photographs
 Frame Them In Reflecto-Easel With Back-Lighting

EVERYONE HAS FAVORITE PHOTOS—HAVE FUN—MAKE EXTRA MONEY—NO SPECIAL SKILL—NOTHING ELSE TO BUY

Get this big outfit today! Print any negative . . . old favorites, handsome pictures in wood frame with special BACK-LIGHTING are delightfully received by friends and neighbors.
 Commercially, they would cost \$15 to \$40 each . . . printed, colored, framed, rear-illuminated. Sell yours for \$5 to \$10 . . . or more. Here's a market with demand ready-made. You learn . . . have FUN . . . make EXTRA MONEY.
 Everyone has favorite photos. Perhaps of Mother or Grandmother taken years ago . . . or a loved one gone far away. A shot of the children is often outstanding. Remember, just take a simple "black and white." From the negative make an extra print . . . color it . . . frame it . . . and arrange back-illumination. It's ready for the living-room table! You've made someone very happy and they'll pay handsomely. Foto-Glo Outfit includes everything you need plus easy to follow lesson.

life-like TRANSPARENT PHOTOS from COLOR them in striking brilliancy! These

OUTFIT INCLUDES:
 Plates
 Print Glass
 Picture Frame
 Ruby Electric
 Bulb
 Reflector Easel
 Solution Trays
 Tinting Sticks
 Tongs
 Pkg. Lintless Paper

Angle Masks
 Corner Clips
 Pkgs. of Powder "A", "B" and "C"
 Color Pigments in Red, Green, Yellow, Blue, Brown, Flesh, Tinting Cotton

only \$4.95 POST PAID COMPLETE

FULLY GUARANTEED
 We know you'll like it. Send today. Make your first picture. If not completely satisfied with this set . . . that you can make transparent color pictures that are outstanding then send back the remaining supplies and equipment and your money will be refunded in full, airmail. This is our guarantee.

EASIER QUICKER BETTER

ROOF FRAMING

Rafter Length and Cuts Without Use of Square!

Lay out any type of roof more accurately and in only one-fifth of the time required by other methods. Get the **POULSEN METHOD OF ROOF FRAMING**. It will save your time and make money for you. Valuable tables—54 of them—starting with one-quarter inch rise per foot of run—simplify all roof framing problems. Tables give common, hip, valley and jack rafter length and necessary cuts in a jiffy without calculation. Learn also how to measure rafters from top and edge—definitely and accurately. No need to bother with centers and making adjustments for cuts.

For Amateur and Professional
 Every handyman, repairman, amateur carpenter and professional builder needs this **POULSEN METHOD** book. It saves four-fifths of all roof layout time and labor. Everything is already worked out for you in simple, easy-to-use tables. Cloth bound. Book has 90 pages and many illustrations. Besides the tables it contains every other bit of roof information a carpenter, whether amateur or journeyman, should have.

Money Back Guarantee
 Send your name and address and \$3.00 for your copy postpaid today, or order C.O.D. if you prefer. Money back if not fully satisfied.

MAIL COUPON

ALLANRAFT PRODUCTS, Dept. PM
 6340 N. Western Ave., Chicago 45, Ill.
 I want my **PHOTOCOLOR** OUTFIT immediately, at \$4.95.
 Please send C.O.D. (I pay postage and C.O.D. charges).
 Enclosed is \$4.95. Rush it **POSTPAID**.

Name _____
 Address _____
 City _____ State _____

FULLY GUARANTEED. Try at our risk. Return for refund if you choose.

POPULAR MECHANICS PRESS
 DEPT. RF 200 E. ONTARIO ST. CHICAGO

Wonder Compound #57

MONEY BACK GUARANTEE

Power Tools, Tractors, Automobiles.
Save repairs and regain lost efficiency.

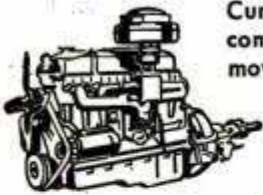

Cures common ailments, restores lost compression. Stops piston slap, removes carbon, frees rings and sticky valves. Puts motor in perfect condition. Frees sticking storm windows. Ideal for farm and garden equipment, etc.

Wonder Lubricant #58

Highly recommended for breaking in automobile engines, all fast running motors, all delicate machinery.

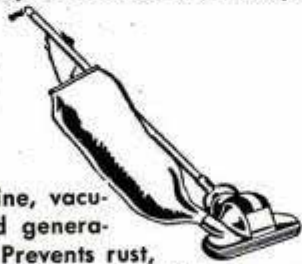

Ideal for your sewing machine, vacuum cleaner, electric fan and generators. All refrigeration units. Prevents rust, cleans and polishes. Indispensable around the home.

KIT CONTAINS:

Wonder Compound #57

Wonder Lubricant #58

Full year's supply

Easy-to-follow instructions

\$4.95

Check or
Money Order
—Shipped
Prepaid.

100% Satisfaction or 100% Refund

WONDER COMPOUND

Dept. 6103 So. Halsted St.
PM-5 Chicago 21, Ill.

Increase "gas" mileage!

10 DAY
FREE TRIAL
IN YOUR CAR

TEST FOR

- ✓ BETTER MILEAGE
- ✓ BETTER IDLING
- ✓ FASTER PICKUP

**PAY ONLY IF
SATISFIED!**



Did you know that your engine actually uses a richer gasoline mixture when you take your foot off the gas pedal than when you step on it? When your engine slows down or idles, higher manifold vacuum sucks a far richer mixture through the carburetor than needed even for fast driving. At last, engineers designed the Gane Air-Flow needle to bleed air during high manifold vacuum periods and thus try to increase gas mileage. Does it work? Of the more than 1/2 million users, some report up to 25% more mileage, faster pickup, smoother idling. But some swear at them, say: "no improvement" and fire the "little stinkers" back to us—proving Ganes sometimes fail. That's why we invite you to TRY BEFORE YOU BUY.

**SEND NO MONEY! MAKE NO DEPOSIT!
PAY POSTMAN NOTHING!**

Just send us your name and address plus make, year and number of cylinders of your car and carburetor make (if you happen to know). Install easily in a few minutes, then check your mileage for 10 days. If you average 2 or more extra miles per gallon, send us \$1.50 per needle. If you don't, send them back and owe nothing. Write:

**MEHREN INDUSTRIES, Dept. GP-5
9909 Santa Monica Blvd. Beverly Hills, Calif.**



for fast, clean boring

Greenlee 22
SOLID-CENTER AUGER BITS

Here's the auger bit that makes good workmanship come easy! Smooth, accurate holes are bored swiftly because solid-center design gives extra strength and provides fast, positive chip clearance. Every GREENLEE 22 Solid-Center Auger Bit has accurately sized, perfect cutting edges that last through long use. "Induction Heat Treated" for uniformity, long life . . . "Plastic Sealed" to reach you factory-sharp. Available in 18 sizes: from 4/16" diameter through 24/16". Buy singly or in sets attractively packaged in handy plastic rolls, steel boxes or metal holding panels. Stocked by leading hardware and building supply dealers.

**SPECIAL OFFER — GREENLEE
WOODWORKING CALCULATOR — ONLY 25c**

Converts linear to board feet, gives nail specifications, tool sharpening tips. Compares woods, gives bit sizes for screws, concrete mixes, painting information, etc. Convenient . . . simple to read. 6" diameter circular shape . . . heavily varnished cardboard. Send 25c (no stamps please).



**GREENLEE TOOL CO.
2105 Columbia Ave., Rockford, Ill.**

**GIGANTIC
SAVE-TO-70%**

MAIL SALE

**WAR SURPLUS
EXCESS INVENTORY
BANKRUPT STOCK**

AIR COMPRESSOR UNITS

Build your own air unit. • DeLuxe Air Kit. Compressor, tank, valves, gauges, etc. \$45.49. • Air Items, 1-cyl. compressor, \$20.50, motor pressure switch, \$4.95. Adj. pressure regulator \$2.65. Pop off valve \$1.95. 160-lb. gauge, \$1.89.



WATER PUMPS and SYSTEMS

Small pumps for every use. Free advice. • Centrifugals, 25 g.p.m., \$18.90. • Rotary bronze self priming 6 g.p.m., \$14.75. • Hi Pressure (400 lb.) for cattle, orchards, \$54.50.



POWER PLANTS and GENERATORS

Save to 70% on 115-v, 60-c plants. • 5 KW, \$531; 2 KW, \$289; 1 KW, \$179. • Generators, 5 KW, \$259; 3 KW, \$189; 2 KW, \$139; 1 KW, \$121. Many other values.



HYDRAULIC BARGAINS

Build loaders, diggers, presses. Save to 50%. Brand new units. • Tractor Pump (1000 PSI), \$45.50. • Hand Pump, \$10.50. • Cylinders, 3" bore by 8" stroke, one-way, \$11.95. • 3"x24", \$39.90. (two way). • 2 1/2"x36", \$34.95. (one way). • Control Valves, \$18. (one way or two way).



HAND WINCHES—HOISTS

• 1000 lb. winch.....\$19.95
• 2000 lb. winch.....\$29.95
• Chain Hoist (lever type) 3000 lb. \$19.48. • Aviation Winch, requires gears, \$17.44.

CORRESPONDENCE SCHOOL BARGAIN

• Engineering school closes due to high costs. Limited quantity their fine courses. Radio, \$5.95. Electrical-Radio, \$9.95.



SPECIAL for the month!



Portable AIR TANK

• 400-lb. light weight tank for compressed air. Fill at station. Holds enough air for several low tires. Use on farm. Carry in car. List \$21.50. SALE.....\$7.49

SUPER CLOSEOUT BARGAINS

• City Phones \$4.99; Rural Phones \$13.90
• Air Power Grease Guns (\$60).....\$23.85
• Gas Chain Saw (24 in.).....\$259.50
• Electric Drill, 1/2", Jacobs Chuck.....\$5.95
• Precision Hand Level.....\$79.50
• Tractor 5-Row Weed Spray.....\$79.50

We pay shipping charges. Send for catalog.

BURDEN SALES COMPANY

807 "O" ST.

LINCOLN, NEBR.



\$\$\$ PROFITS with "all 'round" HOBART WELDING

Goes anywhere!

Trailer type gas drive welder.



HOBART welders

The demand for welding has never been so great—and is only just beginning. Profit opportunities are unlimited. You, too, can cash in on it! Set up your own welding shop—the smart way—with a

Hobart welder. Only a performance-proven, long lived, all round welder can assure maximum jobs, bigger profits. Write for FREE booklet "How to Get Better Welds"

HOBART BROS. CO., Box M-534, TROY, O.



HELPFUL BOOKS

Send post card asking for FREE catalog

Popular Mechanics Press, 200 E. Ontario, Dept. 601, Chicago 11

START A HOME WORKSHOP FOR AS LITTLE AS \$20⁵⁰



"Best of All" MALL POWER TOOLS

MALL 1/4" Drill

Here's the basic shop tool. A streamlined bundle of power with free spindle speed of 2000 rpm. for real speed drilling. Start with the drill—then add attachments for polishing, sanding, grinding, sawing, buffing, and many other shop jobs.

Model 149B, geared chuck, key & holder.....\$20.50

MALL 1/4" Drill Kit

If you'd rather get a complete assortment of attachments when you buy your drill—this value-packed kit is for you. It contains the Model 149B Drill plus many practical attachments to handle a hundred different kinds of workshop jobs. The complete kit comes in a handy metal carrying case.

No. 37000A.....\$29.95

MALL 7" Circular Saw

You can cut 2 x 4's at 45° with this precision-built MALLSAW... a wonderful asset to any workshop. Features include: automatic telescoping blade guard, built-in trigger switch, depth and bevel adjustments, and rip guide. You can't beat MALL tools for performance and dependability.

Model 71.....\$49.50

40 Factory-Owned Service Warehouses, Coast to Coast To Serve Our Customers and Thousands of Dealers



Model 149B



MAIL THIS COUPON TODAY

FREE! Send me more information about
 Drills Drill Kits Saws

Name _____

Address _____

HU-3

MALL TOOL COMPANY 7805 S. Chicago Ave. Chicago 19, Illinois

FIX YOUR OWN...

PLYMOUTH or CHEVROLET

IT'S EASY!

Popular Mechanics Magazine has just published two new Owners Manuals covering all 1941 to 1952 models of Plymouth and Chevrolet cars. So accurate mechanics use them...so simple a woman can understand them.

Save money on your repairs. Prevent trouble. Enjoy care-free driving. Increase trade-in value. Avoid major repairs by fixing minor troubles before they get serious. Get sparkling performance at all times. Each manual has 272 pages, more than 350 photos, diagrams, tables, charts, breakdown drawings, plus clear, non-technical directions that make all repairs simple as A B C. Each Manual written by Ed Packer, one with assistance of Chrysler Corporation, the other with assistance from General Motors Corp. Shows you how to diagnose troubles by feel, sound, sight, smell and performance. Simple trouble shooting. Permanent repairs. Emergency repairs. Plus "How to get value from garages."



MONEY BACK IF IT DOESN'T SAVE MORE THAN THE COST!

One minor repair will save the cost ten times over. Read it. Then you decide. If you don't see that you'll save more than the cost, send it back for refund. SEND NO MONEY. Just send postcard. Be sure to specify whether you want PLYMOUTH or CHEVROLET Manual. Postman will deliver c.o.d. for \$3.50 plus postage. Or, to save postage cost, send \$3.50 with your order. Send today. Save its cost on your next repair.

POPULAR MECHANICS PRESS
200 E. Ontario, Dept. 1810, Chicago 11, Illinois

POPULAR MECHANICS

There's a **CORBIN** PADLOCK

for every purpose

TOOL
CHESTS

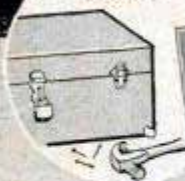

LOCK SHOP



They're the locks you see
ADVERTISED in
POPULAR SOURCE
MAGAZINE ILLUSTRATED

CHOOSE THE ONE
YOU NEED!



CORBIN LOCK SHOP

SUMMER
CAMPS



TACKLE
BOXES



Just name your padlock need! Corbin offers sizes and models for every purpose — from the big, rugged "All-Weather" models for outdoor or indoor use, right down to midget models for golf bags or tackle boxes. **TOP VALUE** in **EVERY** price range, too!

LOOK FOR THE CORBIN "LOCK SHOP" at leading hardware stores everywhere

Be sure . . . with



BIKES



GOLF
BAGS



BOATS

CORBIN CABINET LOCK DIVISION

The American Hardware Corporation
New Britain, Connecticut, U.S.A.

Say You Saw It in Popular Mechanics

NOW! SAW 2x4's IN ONE EASY CUT WITH NEW LARGER 'ARCO-SAWS'

AT
BETTER
HARDWARE
STORES
EVERY-
WHERE

**ARCO
SAW**

No. 455
"ARCO-SAW"
For Depth &
Bevel Cuts.
\$12.50

with ALL GAGES & 5"
"ARCO SAFECUT" Blade.
No. 454 "ARCO-SAW"
For Straight Cutting.
Same as above, less gages.
Has accurate
Visual Guide. . . . **\$10.95**



Amazing New Safecut
Blade Allows Any 1/4"
Drill To Whiz Thru
Heavy Lumber, Wall-
board, Plywood, etc.

At last, here are the first—the only—gear driven saw attachments to whiz thru 2x4's in one cut! Imagine, now you can build anything from bookcases to a bungalow with these sensational new saws. A moderately priced drill will do the job because of new "ARCO SAFECUT" Blade.

ONLY "ARCO" GIVES YOU THESE FEATURES:

5-inch Safecut Blade—cuts faster—uses 30% less power, Graduated Depth & Bevel Gages for cuts to 1 3/4"—berels from 0 to 45°. Adjustable Rip Gage & Visual Guide. Sturdiest and Easily Adjusted Safety-Yoke keeps drill steady. Worm Drive Clamp releases drill in seconds. Precision Gear Box with Steel Gears.

90-DAY FACTORY GUARANTEE.

REPLACEMENT BLADES: Specify 5" Safecut, or Combination, or Rip, or Crosscut Style. . . . **\$1.75**

UNCONDITIONAL 10-DAY MONEY-BACK GUARANTEE.

BUY THE BEST—see your hardware dealer now! Don't accept inferior substitutes—if not available send us check or M.O. (Postpaid). C.O.D.'s—postage extra.

DEALERS:
Write for
nearest jobber

ARROW METAL PRODUCTS CO.

Dept. PM-5, 140 WEST BROADWAY, NEW YORK 13, N. Y.

WAR SURPLUS AND OTHER BARGAINS SAVE UP TO 90%

"HELIOS" ORIGINAL TOOLMAKERS VERNIER CALIPERS

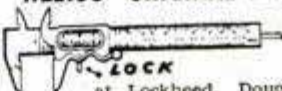

ULTRA PRECISION—Imported for the really critical mechanic who must have the best. Recommended and used by experimental and research machinists at Lockheed, Douglas, Bendix, GM, RCA, GE, A.I.L. NEW and at low, low prices . . . but quantity is limited! Model 51—Genuine Helios. Hardened lapped precision surfaces. 1/1000" and 1/128" graduations. Has handy slide roll and thumb lock. Quick, accurate depth. A \$35 value, it's yours complete with leather carrying case for just \$6.95.

LOW VOLTAGE CIRCUIT TESTER

Made for U. S. Ordnance Dept. to rigid specification. Portable steel hand-carrying unit is a self-contained trouble shooting device for making a complete and rapid check of the generator battery circuit, incl. any circuit & voltage regulators. Battery voltage, regulators, cut-out settings & generator performance easily determined. It's great for garages, mechanics, truck fleet owners, boat and marine mechanics. Can be used on any 6 or 12 volt system. Approx. Govt. cost \$175. NEW. Complete with instruction book, only \$32.50. Shpg. Wt. 20 lbs.



MICROMETERS

Chrome plated, precision engineered, carefully tooled to give long life. All new 0-1" capacity—\$2.25 ea., 1-2" capacity—\$3.50.



RIGHT ANGLE ACTUATOR

Has worm gear drive in 6 to 1 ratio. Thrust shaft and 9/16" dia. and travels 12", forward or reverse on Acme Worm Thread. Drive shafts on either side of housing are 3/8" dia. with 16 splines. Overall length 25", width 4". Ideal for pushing, pulling or lifting. Sealed, self-lubricating chamber. Shpg. Wt. 5 lbs. Govt. Cost \$150. NEW. . . . \$4.95 ea.

SEND 25c for BIG • NEW • 1953 CATALOG

Bargains for everyone. Check. Money Order or Cash. 25% deposit on C.O.D. orders. Prices F.O.B. Culver City, Calif., unless otherwise stated.

AIRBORNE SALES CO., INC., Dept. PM 553
8501 Stellar Dr. Culver City, Cal.

CONTOUR COPY

Carpenters, Bricklayers, Welders, Mechanics, Linoleum Layers, many, many others—USES UNLIMITED—Every worker needs this NEW Contour Copy. The workman simply releases the easy acting lock, places it against the contour to be copied, then presses each blade forward so they fit snugly. Once locked, the contour outline can be copied onto any desired surface. SIMPLE AND FAST. Made of life-lasting ALUMINUM.

SIZE	PRICE
4 1/4" x 4 1/4" ...	\$4.00
6 1/4" x 4 1/4" ...	5.80
8 1/4" x 4 1/4" ...	7.60
9 1/4" x 4 1/4" ...	8.50
10 1/4" x 4 1/4" ...	9.40

Special lengths made to order \$1.00 per in.

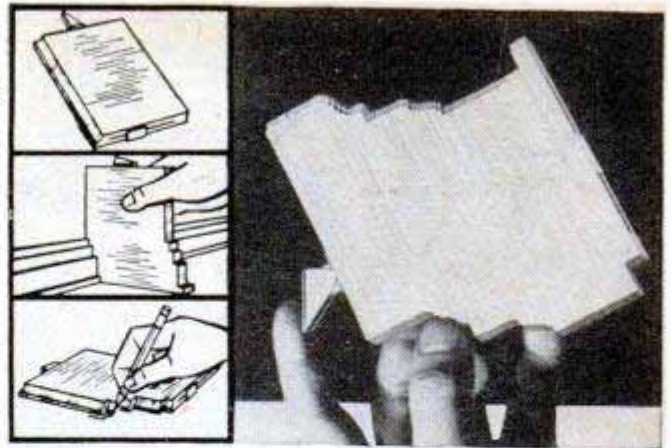

W. L. BUSH & COMPANY 1570 NORTHWESTERN BANK BUILDING MINNEAPOLIS 2, MINNESOTA

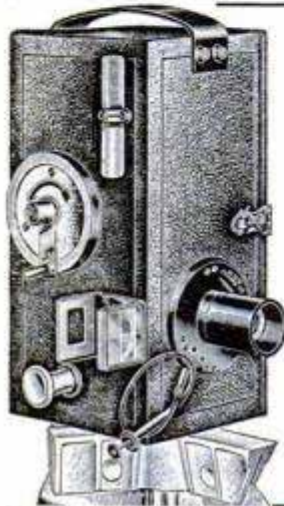

Finished Photos in 2 Minutes! Great Quick Photo Invention P D Q CHAMPION PHOTOMASTER

Takes and finishes 30 to 40 everlasting, black and white or sepia photos an hour. No dark room. Guaranteed not to fade. Photos taken on "SUPER-SPEED" direct positive paper. Picture size 2 1/2 x 3 1/2 in. Complete, easy to operate portable photo studio. 700% PROFIT. Write quick, get details about the great PHOTOMASTER.

P D Q CAMERA CO.
1161 N. Cleveland Ave., Dept. PM-5
Chicago 10, Ill.

FAST, EASY WAY TO DRILL MASONRY



Get new **CARBOLOY** "LIVE-SPIRAL" Masonry Drill

ZIPS THROUGH CONCRETE LIKE WOOD!

No more slow, tedious hammering on a thumb-smashing star drill. New Carboloy "Live-Spiral" drill with its diamond-hard cemented carbide tip rotary drills toughest masonry with ease... won't stall, stick or bind in brick, slate, concrete, tile, cast stone... any masonry around your home.

Makes it easy for you to drill holes to bolt down a washer, dryer... put in hooks, furring strips or partitions... attach awnings, trellises, screens, etc.

Get "Handy-Man" Kit today. Contains 3 "Live-Spiral" Drills; 1/4", 3/8", 1/2". Fit 1/4" chucks. \$6.65 per kit. Send coupon, or see your hardware dealer.

"Carboloy" and "Live-Spiral" are registered trademarks of Carboloy Department of General Electric Company



MAIL THIS COUPON TODAY

CARBOLOY

DEPARTMENT OF GENERAL ELECTRIC COMPANY
11185 E. 8 Mile Blvd., Detroit 32, Michigan

Send me _____ Handy-Man Kits at \$6.65 per kit, postpaid.

Enclosed is check or money order for _____

Send C.O.D.

Send me free folder.

Name _____

Address _____

City _____ Zone _____ State _____

POWER WOOD BITS

UP TO 1" WITH 1/4" ROUND SHANK
TO FIT ALL ELECTRIC DRILLS. Set of six, consisting of, 3/8"-1/2"-5/8"-3/4"-7/8"-1". Bits approx. 6" long. Packed in \$3.50 per set • FREE DELIVERY plastic roll.
Send Check or M.O. — No C.O.D.'s
TROJAN TOOL CO. 1184 Walton Ave., New York 52, N.Y.



- MADE OF HEAVY PLATE STEEL
 - UNIVERSAL—FITS ALL EXHAUSTS
- Send \$1.95 check, cash, money order (postpaid) or C.O.D. plus postage to:
FUR SALES, 1031 E. 63rd St., Chicago 37, Ill. Dept. PM
Dealer Inquiries Invited

NEW! EXCITING! JET EXHAUST CUT-OUT

Now your car can sound off those exciting, dynamic tones — easily controlled mechanically from your dashboard. Channel your exhaust through special pipes or muffler without removing your original muffler. Easily installed. MONEY BACK GUARANTEE.

HEADQUARTERS for CARBIDE!

Write for Free Catalogue of Tools and Conversion Kits
TIME SAVER TOOLS, INC., Dept. 25, MUNDELEIN, ILLINOIS



So Easy - You Can't Miss!

Simply select 3 easily identified objects as points of reference. Note objects and degree readings for future use.

1001 USES ON LAND OR WATER

NO GUESSWORK... you can quickly return to good spot where you found big ones—next day—next year—anytime. Recover rods, motors, guns etc. lost overboard. Just the thing for hunters to find fallen game, trappers to locate traps in deep snow, campers to find camp. Don't be without one! As a gift item — it's a natural.

Put up in attractive, Sturdy Metal Case. For sale in Sporting Goods Stores. If dealer can't supply - Order direct. (Dept. P) **ONLY \$2.00** Makes an Ideal Gift

Makers of famous GUNSLICK and REELSICK LINES
Sold the world over.

OUTERS LABORATORIES, INC. ONALASKA, WISC.

BUY WELLWORTH PRODUCTS

AT SAVINGS UP TO 75%



RED SEAL CONTINENTAL GAS ENGINE
Red Seal, 2 HP with 6 to 1 reduction gear. Operates at 450 R.P.M. For lawn mowers, scooters, garden tractors, pumps, compressors, generators, etc. List Price \$79.50. Shipping wt. 54 lbs. **\$47.50**
SPECIAL PRICE.....
Same engine, 3600 r.p.m. **\$47.50**
SAME, 2 1/2 H.P. **\$62.50**

WELLWORTH AIR COMPRESSORS

Aluminum piston, stainless steel valves, 3 piston rings, bronze bearings, splash lubrication. Intake muffler. V-belt, cast iron fan cooling flywheel.

Model W800 COMPRESSOR 2"x1 3/4". 2.8 c.f.m. Operates with 1/4 HP or 1/2 HP motor up to 150 lbs. Weight 20 lbs. Special price..... **\$20.50**



MODEL W200 COMPRESSOR
2 1/2" x 2". 2.55 to 4.80 c.f.m. up to 150 lb. pressure. Operates with 1/8-1/2-3/4 HP motor. Special Price..... **\$27.95**
Shipping wt. 24 lbs.

MODEL W7 COMPRESSOR
2 cylinder 2 1/2" x 2". 5.10 to 8.50 c.f.m. up to 150 lb. pressure. Operates with 3/4-1-1 1/2 HP motor. Special Price..... **\$54.50**
Reg. Price \$67.50. Shipping wt. 45 lbs.

Wellworth V-BELT CLUTCH



Takes starting load off engine or motor. "A" belt, 2.35 pitch diameter, 3/8" bore, ball bearing. Positive action. Price \$7.50. 3/4" bore, \$8.50. Bushing for 1/2" shaft, 15c.

MERCURY CLUTCH



3" A-belt pulley. Centrifugal action for heavy loads. 5/8" bore. \$22.50 list. Special Price..... **\$9.95**
3/4" bore..... **\$10.95**

AUTOMATIC COMPRESSOR UNIT WITH 22 GALLON TANK

1/4 H.P. heavy duty capacitor motor, 110 volt A.C., compressor 2" bore, 1 3/4" stroke, piston type, splash feed lubrication, 14"x32" tank, automatic pressure switch. CFM 2.8 at 100 lb. pressure. Check valve, safety valve, air regulator with gauge and filter, 20 ft. air hose with air chuck for inflating tires. V. belt drive. Ball bearing wheels, with 2"x8" rubber tires. Portable with handle. Ship. wt. 150 lbs.

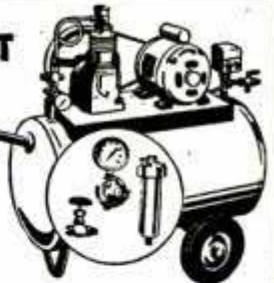

With 1/8 h.p. motor Reg. price \$175

\$98.50

Same unit with 2 1/2"x2" compressor, 1/2 h.p. motor, 3.25 c.f.m..... **\$136.50**

With 1 1/2 h.p. gas engine Reg. price \$200

\$124.50

Same unit with 2 1/2"x2" duplex compressor, 1 h.p. motor, 7.35 c.f.m..... **\$195.00**

Regulator, gauge and filter sold separately. Price for the 3 items... **\$8.95**

LIGHT PLANTS

New Hobart Signal Corps Power unit PE197. 110-220 volt 60 cycle A.C. single phase 5 K.W. 4 cylinder Hercules 20 H.P. water cooled engine. Remote control push button start. Complete panel board with instruments. Housed in metal case. Price complete..... **\$745**

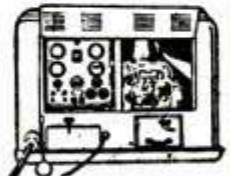

GEAR HEAD MOTORS Right Angles, 110 V., AC

1/40 h.p. 135 RPM (no housing) **\$8.95**
1/30 h.p. 1250 RPM **\$10.25**
1/20 h.p. 24 v. 75 RPM. **\$13.50**



PRICES F.O.B. CHICAGO. MONEY BACK GUARANTEE. SEND CHECK OR MONEY ORDER TODAY. WRITE FOR FREE CATALOG OF LIGHT PLANTS, GENERATORS AND HOME WORK SHOP EQUIPMENT. SEND 10c FOR MAILING AND HANDLING.

WELLWORTH TRADING CO. 1832 S. Wabash Ave. Dept. D-553 Chicago 16, Ill.

RED HOT ELECTRIFYING BARGAIN!

LOOK AT ALL THE PARTS YOU GET



You get the complete set including cabinet and wiring diagram for only

2.98

Delivered FREE to your door! no COD's please!

Can easily and quickly be modified for Electronic Remote Control of: Transmitters; Turn Radio and TV on and off; Open and Close garage Doors from your car, etc. Schematic Diagram included at No Extra Cost.

THYATRON REMOTE CONTROL

SERVICEMEN—HOBBYISTS—HAMS—EXPERIMENTERS—RADIO SCHOOLS

Here's the chance of a lifetime to own a genuine Thyatron Electronic Remote Control of your own at a fraction of its regular price! This mighty handful (only 5 3/4 x 5 x 3 1/4) of miracle control can be made to perform hundreds of practical, fascinating feats of remote control. A complete schematic showing the circuit is included with each unit.

IT'S A STEAL! Buy it for the parts alone. Take it apart! Look what you get: Valuable parts galore that you can so easily use in any other radio, amplifier, etc.—or for experimenting.

The New Wonder Unit Yours for Practically Nothing

HOW CAN YOU LOSE? These parts are certainly worth THREE TIMES this amazing low cost. The extra sensitive Plate Trigger Relay costs more than what we're asking for the entire set. Besides, consider the Filament Transformer, condensers, Resistors (many of them 1% precision). No matter how you use it, here's a red hot Bargain. Operates on 115 V AC.

MANUEL KLEIN CO., 94 Chambers Street, New York 7, N. Y., REctor 2-6460

- Filament Transformer
- Control Relay
- Switch—SPST
- 16 Mfd @ 150 Volts
- 1 Mfd @ 200 Volts
- .02 Mfd @ 200 Volts
- .25 Mfd @ 600 Volts
- .25 Mfd @ 600 Volts
- 125 Ohm Variable Control
- 600 Ohm Calibration Control
- 1 Megohm—1/2 Watt
- 3 K-Ohm—1 Watt Wirewound
- 925 Ohm—1 Watt Wirewound
- 8 K-Ohm—10 Watt Wirewound
- 2600 Ohm—1 Watt Wirewound
- 75 K-Ohm—1/2 Watt
- 1 Megohm—1/2 Watt Carbon
- 150 K-Ohm—1/2 Watt
- 1 Megohm—1/2 Watt Carbon
- 47 K-Ohm—1/2 Watt Carbon
- 2 Megohm—1/2 Watt Carbon
- 1 Megohm—1/2 Watt Carbon
- 1 Megohm—1/2 Watt Carbon
- .24 Ohm—2 Watt Wirewound
- Pilot Lamp, Type 44
- Neon Bulb—NE-2
- Control Housing
- Bottom Plate
- Escutcheon

SAY YOU SAW IT IN POPULAR MECHANICS

NEEDS NO TANK!

Cost LESS to buy —LESS to install



—Yet this amazing pump outperforms many larger, costlier water systems!

GOULDS Balanced-Flow Jet is a full-capacity, shallow-well water system —yet small enough to install anywhere—with no costly tank, fewer fittings to buy. Self-adjusting flow delivers exact amount of water wanted at all outlets at the same time, within capacity! Self-priming, trouble-free, quiet—only one moving part. Send coupon today!

GOULDS water systems

Goulds Pumps Inc., Dept. PM-2, Seneca Falls, New York.

Send free, 20-page booklet on Balanced-Flow and other Goulds Pumps. Also distributor's name.

Name.....

Address.....

NEW POND GARDEN TRACTOR

\$119⁶⁰

LIMITED TIME ONLY
FULL 2 1/2 H.P.



ALL IMPLEMENTS
AVAILABLE: WRITE
TODAY FOR FREE
12-PAGE CATALOG!

DEALERS
WANTED—
MAKE EXTRA MONEY
17" ROTARY
POWER MOWER.
\$66⁰⁰
LIMITED TIME ONLY
MAIL THIS
COUPON NOW

THE POND COMPANY
Box 216D5, Ravenna, Ohio

- Send 12-page tractor catalog.
 Send data on power mower.

NAME _____

ADDRESS _____

CITY & STATE _____

Bargain Buy! G.I. COVER CLOTH



1001 USES in Home, Shop, Office, Farm
Extra Large! Ideal for spring cleaning. Light-weight, Government Surplus cover made of unused O.D. pieces of plastic film on cotton gauze. Inexpensive Dust covers, Drop cloths—Furniture, Equipment and Storage covers. Oil & paint repellent. Satisfaction Guaranteed. Order NOW!
8x8 ft. only \$1.49 each SAVE! \$14.28 Doz.
8x14 ft. only \$2.98 each SAVE! \$27.00 Doz.
Send for FREE CATALOG

SAX-ON, Dept. PM-75, 3840 Fullerton, Chicago 47, Ill.

AMAZING TOOL BARGAINS!

ALL BRAND NEW MERCHANDISE

50 Pieces \$4⁵⁰
26 Mounted Wheels and Points Post-paid
and 24 miniature cutters on 3/32" Mandrels. For grinding and cutting on metal, Plastic or wood. Will fit all electric drills and hand grinders. Regular \$9.00 value.



7 HIGH SPEED TWIST DRILLS \$1⁰⁰

15 DRILLS FOR ONLY \$2.00! Order Today! Post-paid
7 Popular Sizes — up to 3/4". Brand new, ideal for home or shop use. Fits all standard chucks.
5 DRILLS FROM 1/4" TO 1/2" DIAMETER.....\$1.95
4 WOODWORKER'S DRILLS, 5/16" to 1/2" on 1/4" shank—\$2.00



2 DRUM SANDERS \$1⁵⁰

With 12 Bands in Assorted Grits. 1 1/2" dia. x 1" long on 1/8" arbor with 12 bands
ONE DRUM, 1" DIA. x 1" LONG ON 1/4" ARBOR WITH 6 EXTRA SLEEVES \$1⁰⁰ Post-paid

12 MINIATURE CUTTERS \$1⁰⁰

For Cutting Wood, Plastic, or Metal. Actual size. Assorted shapes on 3/32" shanks. For die makers, home workshops, etc.

36 SHORT SHANK MINIATURE CUTTERS, 7/8" LONG...\$1.00

SCHUPACK SUPPLY CO., 7331 Cottage Grove, Dept. M-42
Chicago 19, Ill.
NEW 1953 Illustrated Catalog 10c

LOOK FOR THIS SELF-SERVICE DISPLAY



Every fine Fuller steel screw driver and wood chisel has our famous unbreakable amber handle. Fully guaranteed. At hardware stores everywhere. Wholesale Distributors! Write for Catalog Pages & Prices.
FULLER TOOL COMPANY, INC., 3522 Webster Ave., Bronx 67
World's largest makers of Amber-Handle Tools
EXPORT SALES DEPT., JOHN H. GRAHAM CO., 105 Duane Street New York, U. S. A.

CARBURETOR TOO RICH MAKES MOTORIST TOO POOR



Car owners who are wasting money, getting poor mileage due to over-rich mixtures, will be pleased to learn how to save gasoline by **VACU-MATING OVER-RICH MIXTURES.** Vacu-Matic fits all cars, trucks and tractors. Automatic and operates on the supercharge principle. Easily installed in a few minutes.
SALESMEN WANTED! Big Profits

For FREE particulars, how you can install one on your own car for introducing, just send your name and address on a postcard to **VACU-MATIC, 7817-2013 W. State St., WAUWATOSA, WIS.**

Syco brings to the mechanical world an engineering marvel that has been the desire of every mechanic. This unique wrench takes the place of conventional types of speed wrenches.

8" Capacity, 7/16" to 3/4" 4.95
12" Capacity, 3/4" to 1 1/8" ... 9.95

Other sizes available soon. Tested and approved by mechanics, electricians, plumbers, refrigeration men, etc. Unconditionally guaranteed for normal wear

SYCO MFG. CO.
Box 9673
Norfolk 5, Virginia

AT LAST...an ADJUSTABLE OPEN END RATCHET WRENCH

ARROW POINTS TO AMAZING RATCHET JAW!



8" Syco Mfg. Co. MADE IN U.S.A. NORFOLK, VA.

NAVY PHONE SET



Used by the NAVY for Flight Deck and Gun Control. An ideal emergency communication system because each set is "sound-powered"—no power supply needed. Perfect for office-to-shop, house-to-garage or barn, or any point-to-point within the radius of 1/2 mile. Each set includes 2 phones on chestplates, 2 headsets, button switches and approx. 35 ft. of cable. **995 SET**

One Phone and headset **595 EACH**

2-WAY TELEPHONES



Install this set of desk phones for perfect two-way communication from any two points up to 100 ft. apart. This handsome set is finished in a blue baked enamel. Has 2 phones, wire and simple hook-up instructions. Operates on ordinary flashlight batteries. Here is an ideal set for use room-to-room, garage-to-house, barn-to-house, darkroom-to-outside, office-to-office, office-to-shop, etc. Order Today—ONLY. . . **750**

SWIMMING EQUIPMENT

SWIM FINS



Made of top quality rubber with pebble tread bottoms. Reinforced, adjustable heel strap. Vented for air & drainage. Ideal for diving & swimming. Available in men's, women's and children's sizes. **595**

DIVING MASKS



A fine quality mask. Ideal for shallow water skin diving or swimming. Soft gum rubber with sturdy glass lens and adjustable head band. Lightweight & water-tight. Comes in 3 sizes.

JR. **259** MISS **269** MR **395**
4 1/2" 5" 5 1/2"

We carry a complete line of Swimming, Diving and Fishing equipment. Write us your requirements.

NEW ARMY D-12 MAGNETIC COMPASS



A real WAR SURPLUS BARGAIN! Was standard navigational equipment on all Army Aircraft. Has a rotating verge range ring, calibrated in 1 degree increments from 0 to 360°. Two parallel grid wires for N-S alignment. Ideal for airplane, boat, etc.

1750

LIGHT BARGAINS

NAVY SEALED BEAM



A portable search-spot light. Has a pistol grip and aiming sight. Makes an ideal spot, search or emergency light for Home, Camp, Car or Boat.

12 Volt light . . . 4" lens **439**
24 Volt light . . . 5" lens **479**

Set of 3 Filters (Red, Green, Amber). Specify Lamp size when ordering. . . Per set **995**

FOUR WAY SWIVEL LAMP



A handy lamp for desk, work bench, chart table, engine room, etc. May be used on 6-12-24-110 volt current by simply changing the bulb. 3 ft. shaft has four movable joints to adjust light position. **395**

FAMOUS PALLEY MIXES



WAR SURPLUS MIX. Four hand tools plus an Army Scoop for fireplace or barbecue. Tools alone are worth for more than our price but we throw in the Scoop FREE!

Tools include a Hammer Punch, Chisel-Hammer, Stake-Driver and 17" Stanley Screwdriver. All have crucible cast steel heads and hardwood handles. For home, farm, ranch, machine shop, garage, etc. **289**

FILE MIX

10 assorted Files. 4 inch to 12 inch. This includes Vixens, Half Rounds, Mills, Bastards, etc. In seconds and used but good condition. One Vixen alone is worth our price for entire mix. **995**

GADGET MIX

Another SURPLUS BARGAIN! Includes Rivets, Spacers, Bolts, Screws, Wheel Bearings, Springs and Clamps. 5 pounds for ONLY **119**

Palley's

SAVE UP TO 85% IN WAR SURPLUS

ORDER BY MAIL!

TERMS
ORDER FROM THIS AD. Pay by M.O. or Check. P.O.'s accepted from well rated D & B firms. 50% deposit required with all C.O.D.'s. All prices are F.O.B. our warehouse, Los Angeles, Calif.

KAPOK FILLED MUMMY BAG



Another BARGAIN from Palley's! Filled with 2 1/2 pounds of 100% KAPOK. Has water-repellent, Balloon cloth cover and lining. Easy to pack. Weighs only 4 1/2 lbs. Cut size is 35" by 90". Has 3/4 length zipper closure. You'll want one of these! **995**

NYLON SLEEPING BAG



Guaranteed top quality! Has a bright forest green, water repellent, NYLON outer cover. Filled with 3 lbs. of 100% WOOL. Full double-pull zipper down one side and across the bottom to form one double-up bag when two are zipped together. Has two air mattress pockets. Large headflap with two built-in pockets. Finished size is 34" x 78". Weighs 7-1/2 pounds. Easy to roll and pack. **1950**

AIR MATTRESS



Made of heavy Vinylite plastic. Ideal for sleeping bags, cots or as a swimming float. Inflated size: 25" x 72". A \$7.00 value. **ONLY 595**

NAVY WADING SUIT



Will make Surf and Deep Stream fishing a pleasure. Also ideal wherever it is necessary to protect the body or clothes from moisture, silt, muck, etc. Made of rubberized canvas with vulcanized seams and boots. Sizes: Small, Med., Lg. **795**

CONVERTED MODEL - Waist length, bib front and suspenders. **995**

BRITISH ARMY PACK RACK



The famous Everest Pack Carrier. Has an all steel frame with a canvas covered, fold-up bottom pack shelf. All straps are genuine leather. Designed so there is a minimum of rubbing and weight is evenly distributed. Strap across lower section acts to absorb shock and sway. Folds flat when not in use. Weight only 3-1/2 pounds **795**

WESTINGHOUSE COMPRESSOR



A 2 cylinder, piston type Air Compressor. Ideal for spraying, inflating, air tools. Used in garages, shops, laboratories—on trucks, tractors, jeeps, etc. Will run off fan belt or power take-off. Operates on 1/2 HP. Gas or Electric motor. Runs in either direction. Delivers approx. 3.27 CFM at 600 RPM or 6.54 CFM at 1200 RPM. Has 2" bore, 1-1/2" stroke. Automatic clutch. Size: Width 9", height 11-7/8", depth 5-3/4". Approx. weight 23 lbs. We have motors, tanks and fittings to adapt this unit. **ONLY 2395**

230 PAGE CATALOG

1000's of ITEMS! Fully ILLUSTRATED! For the MECHANIC, SPORTSMAN, HOBBYIST, HOME OWNER, etc.

War Surplus - Factory Closeouts and General Merchandise Values! Save on Hardware, Hand and Power Tools, Gadgets, Sports Equipment, Hydraulics etc. SEND 25c for HANDLING & MAILING.

SAVE ON SURPLUS MOTORS

606 DELCO MOTOR



1/50 HP, 24V, DC, 1.6 amp. turns 3000 RPM. Has adjustable speed controller to stabilize and control speed— **495**
Length 5 1/2"

SURPLUS 1/2 HP MOTOR



No. 500 - Used - 1/2 HP - 27v, DC-AC. This motor can be readily adapted to deliver up to 1/2 HP on 110 volts AC, by the simple method of rearranging armature brush-leads. Free diagram with each order. Supply is limited so order today. A SENSATIONAL VALUE. **595**

1/5 HP SAMSELL MOTOR



27 volts, 16 amps., 1/5 HP, reversible, series wound motor. 3800 RPM, shaft 9/32" diam. 12" soline. 4-1/8" x 2-3/8". **395**
NEW - ONLY . . .

6 TAKE-OFF DRIVE UNIT



All six drives turn in unison at a ratio of 1 to 1. This unit is adaptable to use with standard 9/32" flex drive shafts & accessories. Many uses where one to five take-offs are desired. This item is worth at least twice our price. **475**

RADIO BARGAINS



Popular Telephone Type. Highly sensitive. Has excellent, clear tone. Was the Signal Corps favorite. An ideal instrument for the Radio "Ham" and the professional recording studio, for broadcasting, home recording, public address systems, etc. Unit comes complete with cord & plug. **329**

USAF THROAT MICROPHONE



Genuine USAF type T-30-0. Gives clear, distinct voice reproduction for aircraft or the amateur broadcaster. Set consists of two microphones, mounted on rubber neckpiece which is fastened to elastic neck band. Operates between 100 and 300 ohms. **139**

NEW RADIO SPEAKERS



Ideal for small radios, inter-com systems, test equipment, etc.

ALNICO - Permanent magnet type. 4" diam. 2 wire hook-up. **NEW 249**

DYNAMIC SPEAKER - 10" with plug-in and transformer. A popular model for use in radio sets, TV receivers and portable Public Address systems. Has full tone range. Standard rim mounting. A Bargain. **295**

16MM SURPLUS MOVIE CAMERA



The "Gun Camera" used by the Navy & U.S.A.F. Electrically operated. Ideal for the amateur or professional movie maker. Lens is a 1-3/8" (35mm) with a built-in exposure guide and shade. Adjustable for THREE SHUTTER SPEEDS 16, 32 and 64 frames per sec. Uses regular Eastman (50 ft.) magazines. Comes complete with ZOOM viewfinder and battery box. Requires no winding—operates on 24 volt current supplied by ordinary dry cell batteries carried in box that clips on belt. Takes excellent Black & White or Full Color films. **4495**
Cost Gov't approximately \$300.00.

CONVERTED MODEL—Rebuilt with a special "C" mount adapter for any standard 16mm Movie Lens. **5995**
FILM (50 ft.) B&W—\$3.00 Set of Batteries—\$1.79

NEW PIANO HINGE



1 1/2" x 5 3/4" Cad. Plated Steel . . **89c**
1 1/4" x 7 1/2" Aluminum **1.29**
3/2" x 5 1/4" Stainless Steel **1.95**

PALLEY SUPPLY CO. Dept. PMS, 2263 E. Vernon Ave., Los Angeles 58, California

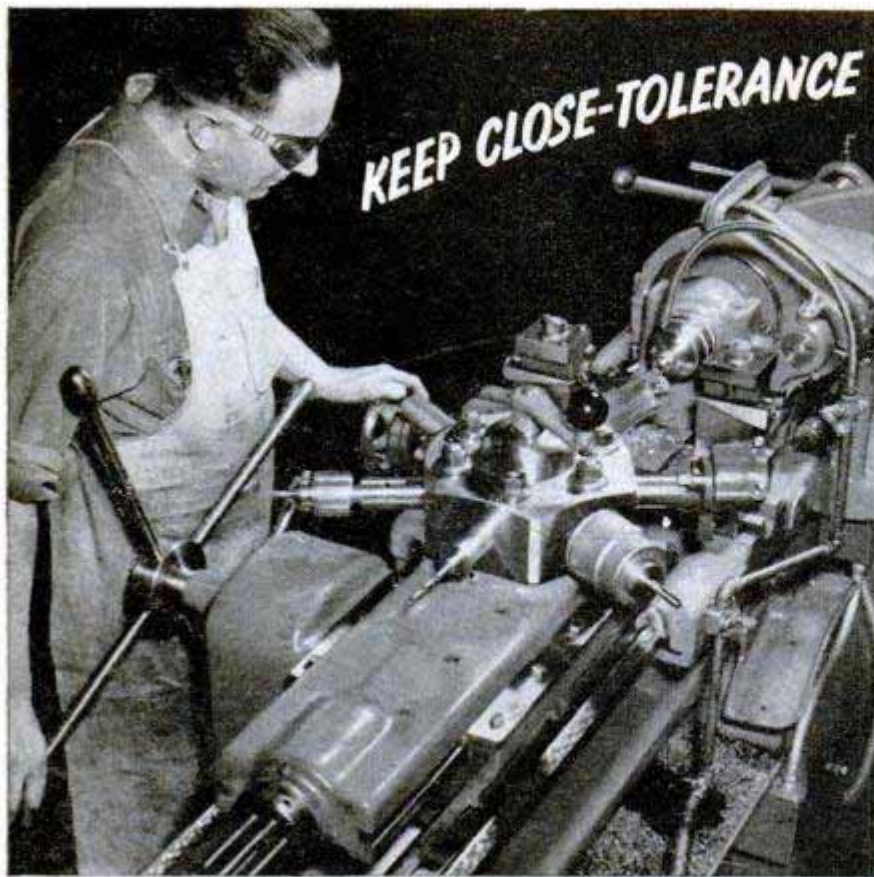

KEEP CLOSE-TOLERANCE MACHINING EFFICIENT!

South Bend PRECISION TURRET LATHES

South Bend 2-H Precision Turret Lathe—1" collet capacity, 16 1/4" swing, 96 power turret feeds, 48 cross slide feeds, 48 carriage feeds, 48 thread cutting feeds.

South Bend Precision Turret Lathes keep efficient the machining of small duplicate parts. Their remarkable accuracy and positive controls simplify the holding of close tolerances with only normal machine handling care. Finishes are commonly produced that otherwise would require additional operations. Simplicity of tooling makes job changes quick and economical. Wide ranges of power feeds and thread cutting feeds assure maximum efficiency on every job. They are particularly suited for second operations. Available in 3 sizes: 1" collet—16" swing; 1" collet—10" swing; 1/2" collet—9" swing.

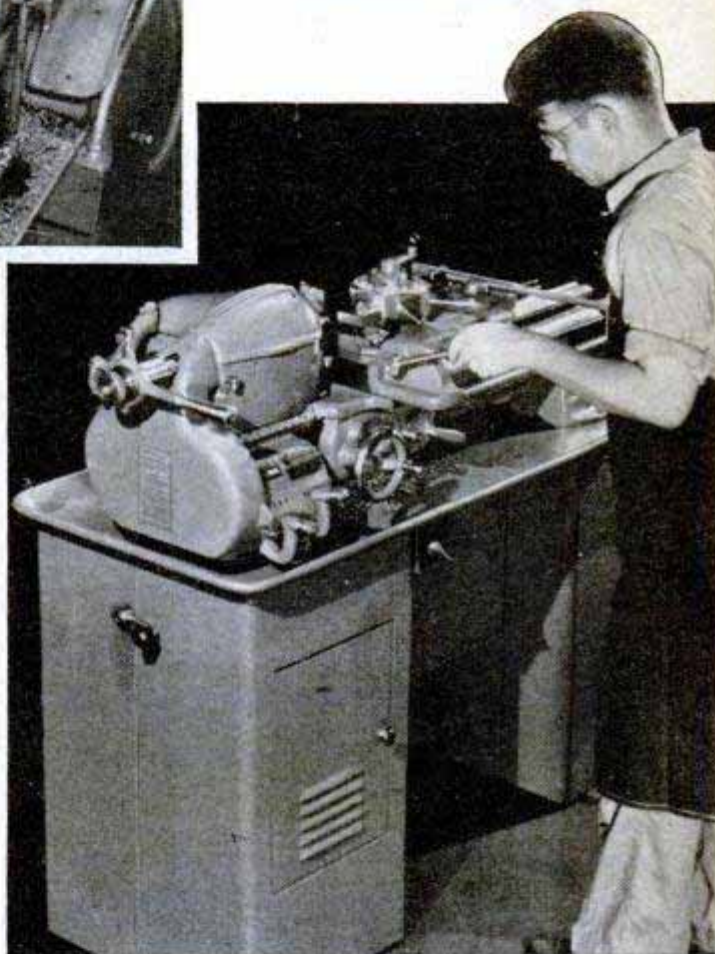

South Bend CL930-Z Precision Turret Lathe—1/2" collet capacity, 9 1/4" swing, 48 carriage feeds, 48 thread cutting feeds, handlever cross slide, handlever turret.



SOUTH BEND LATHE

South Bend 22, Indiana
Building Better Tools Since 1906

Send Information Checked:



9" and 10" BENCH LATHES



10" to 16-24" FLOOR LATHES

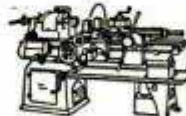

1/2" and 1" Collet TURRET LATHES



14" DRILL PRESSES



7" BENCH SHAPERS

Name _____ Company _____

Street _____ City & State _____



This IS
**AMERICA'S LARGEST
 SELLING OUTBOARD**

More people drive the Johnson Sea-Horse 5 than any other outboard motor!

Its day-in, day-out **DEPENDABILITY** makes it a favorite of *everyone*. It delivers a quiet, silken surge of power—at a crawl or wide open. It is noted for one-pull starting. It has Shock Absorber Drive — no shear pin! Neutral Clutch adds the final touch of modern convenience.

For all-around use on average fishing and family boats, the Sea-Horse 5 is your motor. All the power you need—*every time you need it!*

See your Johnson Dealer. Look for his name under "Outboard Motors" in your classified phone book.

Johnson
SEA-HORSE 5

FOR 1953

4 GREAT ALTERNATE FIRING TWINS

SEA-HORSE 3—3 hp. 32 lbs. Angle-matic Drive..... **\$145.00***

SEA-HORSE 5—5 hp. 44 lbs. Outboard-ing's happiest combination of power, weight, features!..... **\$187.50***

SEA-HORSE 10—10 hp. 60 lbs. Gear Shift. Mile-Master Fuel Supply System. Twist-Grip. Dazzling performance. Only..... **\$275.00***

SEA-HORSE 25—25 hp. Only 98 lbs! Gear Shift. Mile-Master. Twist-Grip. Speeds over 30 mph!..... **\$390.00***

SHIP-MASTER REMOTE CONTROL—Shift-and-throttle. Instant hook-up on Sea-Horses 10 and 25..... **\$29.50***

 *Prices f. o. b. factory, subject to change. Weights approx. OBC Certified brake hp at 4000 rpm.



FREE! Write for new, fully-detailed Sea-Horse Catalog that describes the 4 great Johnsons for 1953.

JOHNSON MOTORS, 400 Pershing Road, Waukegan, Illinois
 In Canada: Mfd. by Johnson Motors, Peterborough

THE ONLY MANUFACTURER WHO HAS BUILT A MILLION OUTBOARD MOTORS

CAMEL



...big league choice for
MILDNESS and FLAVOR



BOB LEMON, Cleveland pitcher, says, "My own 30-Day Test gave me the pitch on Camels!"



BILL COX tried different brands and said, "My choice for steady smoking is mild Camels!"



HANK SAUER, M. V. P. in 1952, says, "No other cigarette gave me as much pleasure as I get from Camels."



MICKEY MANTLE, Yankee slugger, states, "For mildness and flavor, you can't beat Camels!"



Throughout America, more people — including many Big League stars — smoke Camels than any other cigarette! *Why* is this fact important to you? Because it's real *reassurance* that Camels have the full, rich flavor and easy mildness *you* want for steady smoking enjoyment! Prove it! Make the Camel 30-day test. Smoke only Camels for 30 days and discover the wonderful reason *why*...



EARLY WYNN, Cleveland, says, "Smoking Camels pack after pack proved how mild Camels are!"



EDDIE ROBINSON, slugging first sacker, says, "Camel flavor keeps tasting good, pack after pack."

**More People
Smoke Camels
than any other cigarette!**

L. J. Reynolds Tob. Co., Winston-Salem, N. C.



JERRY STALEY, St. Louis Cardinal pitcher, states, "Camels give me real smoking pleasure!"



VIC RASCHI, New York Yankees, says, "Camels are my choice for mildness and rich flavor!"



WARREN SPAHN says, "I picked Camels for steady smoking. They've got the flavor I want!"



DICK SISLER, Card's infielder, states, "Camel mildness and flavor made a hit with me from the start!"



BILLY MARTIN, New York Yankee infielder, says, "Camels have everything I want in a cigarette!"