

ANC



POPULAR MECHANICS

MAGAZINE

WRITTEN SO YOU CAN UNDERSTAND

REG. U.S. PAT. OFF.



*Ski Wing—
page 155*

WANTED: 50,000 ENGINEERS—page 133

Build Glamour Into Your Basement Playroom—page 165

RACING'S TOP POWER PLANT!

THE 270 OFFENHAUSER

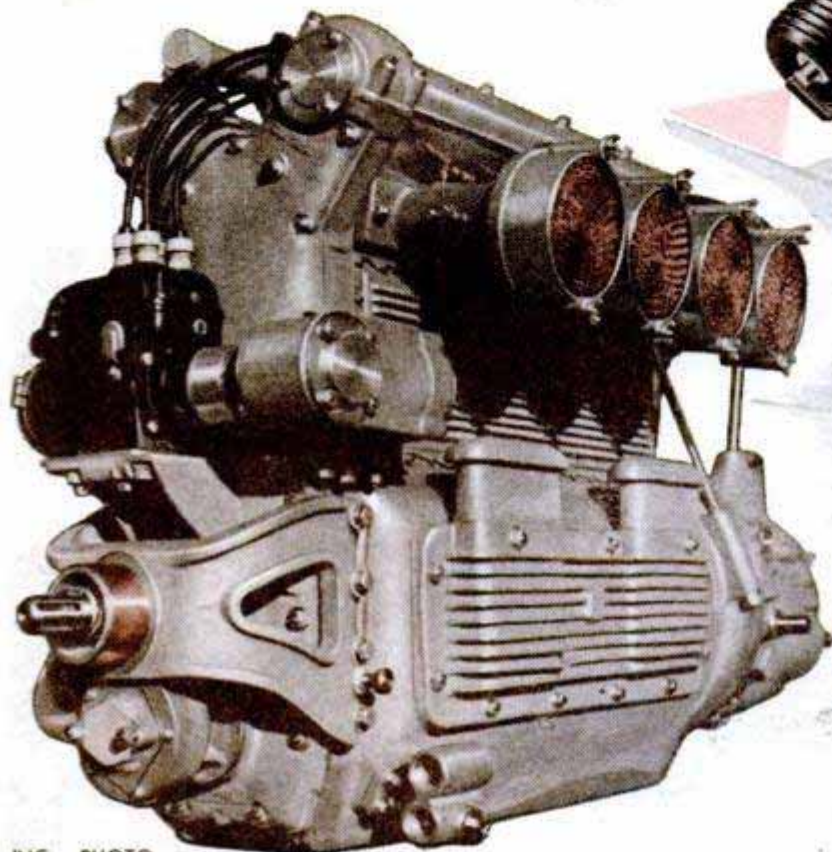

TREND, INC.—PHOTO

*"I build racing's top engine. Here's why I recommend
Champion spark plugs for your car." Louis Meyer*



Louis Meyer, three-time winner of the Indianapolis 500, three-time national AAA racing champion, today builds America's foremost racing engine—the Offenhauser, product of the Meyer-Drake Engineering Company. Its success in competition is without parallel in automobile racing.

Says Meyer, "We specify Champion Spark Plugs as standard equipment for the Offenhauser because we've never found any spark plug that can equal Champion in that extra notch of power and speed and extra dependability which you must have for

championship performance. Speaking from broad experience in this field, we know that all Champion Spark Plugs are built to *one, single* exacting standard—the best that top research, engineering and manufacturing can produce.

"Therefore, I say to every motorist, 'If you value the very best performance of which your car is capable, you'd better specify Champions for your car. In my book they're tops for every engine, and the record books prove it.'"

CHAMPION SPARK PLUG COMPANY, TOLEDO 1, OHIO

FOLLOW THE EXPERTS

Demand

CHAMPIONS

FOR YOUR CAR!

YOU CAN INSTALL IT YOURSELF

"World's Most Beautiful Flooring"



Beautiful in den or living room. Never slippery, cleans with a damp mop—and it never needs waxing.



Perfect for the kitchen. Not affected by water, will not rot or mildew, ideal for counter tops and wainscoting — and it never needs waxing.



Practical for children's rooms or play rooms. Resists scuffing —recovers quickly from denting—and it never needs waxing.

Send for free—"How To Install" booklet — Goodyear Flooring Dept., Akron 16, Ohio

**PRE-POLISHED
VINYL-TILE
NEVER NEEDS WAXING**

Amateurs can install Vinyl-Tile and get a neat, professional-looking job. Handy kit is available, along with full illustrative instructions.

Pre-polished Vinyl-Tile is the All-Vinyl flooring decorators have proclaimed "The World's Most Beautiful Flooring." You can depend on it for years and years of long wear and lasting beauty.

Vinyl-Tile comes to you in 12 marbled colors and 12 solid colors — colors that add warmth and beauty to any room. Economical, too. Available at better flooring dealers and department stores everywhere.

Vinyl-Tile BY
GOODYEAR
Makers of Wingfoot Rubber Flooring

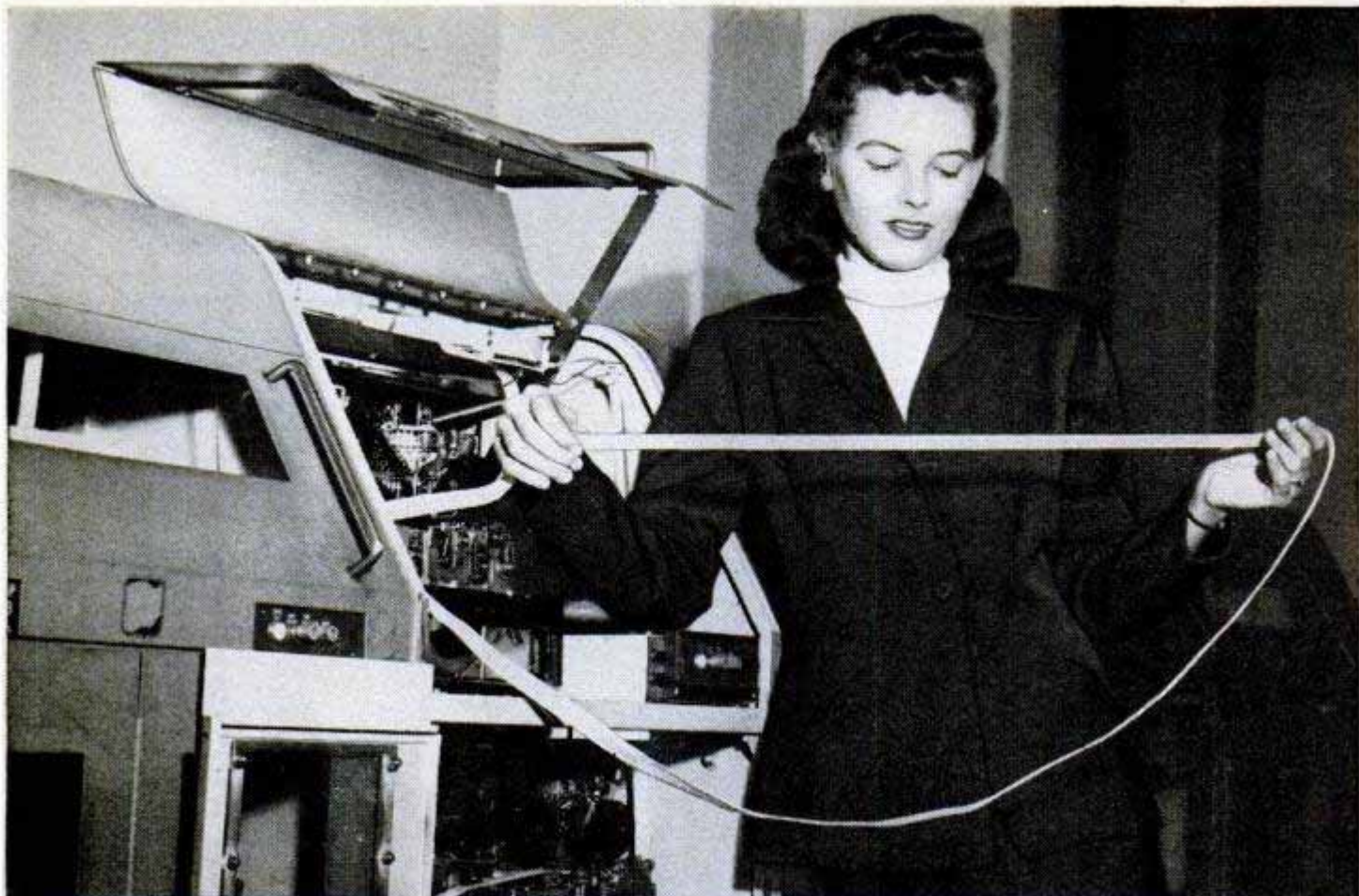

These signals find the way



SENDING

When you dial a telephone number, high-speed switching mechanisms select your party and connect you. Through a new development of Bell Telephone Laboratories, similar mechanisms do a similar job in private wire teletypewriter systems which America's businesses lease from the telephone company.

Company X, for example, operates an air transportation business with offices all over America. At one office, an operator wishes to send a message, let us say, to Kansas City. Ahead of the message, she types the code letters "KC". The letters become electric signals which guide the message to its destination.

Any or all stations in a network, or any combination of stations, can be selected. Switching centers may handle 50 or more messages a minute... some users send 30,000 messages a day. Delivery time is a few minutes.

Defense manufacturers, automobile makers, airlines and many other American businesses are benefiting by the speed and accuracy of the new equipment—another example of how techniques developed by the Laboratories for telephone use contribute to other Bell System services as well.



RECEIVING



BELL TELEPHONE LABORATORIES

Improving telephone service for America provides careers for creative men in scientific and technical fields.

Popular Mechanics Magazine

Registered in U. S. Patent Office and Canada

H. H. WINDSOR, Founder

H. H. WINDSOR, JR., Editor and Publisher



this month's cover

SAILING high, wide and handsome across our cover is a skier equipped with a new sail that permits effortless gliding above the ground. The sail-rigged skier can make leaps as long as 50 feet on slight inclines. You'll find more information on this high-flying subject on page 155 so we'd like to pay our compliments here to the artist, Robert Korta, the 32-year-old Chicagoan who painted the cover. Bob's apprenticeship in the field of commercial art consisted of running errands for a studio. Now he's become one of the most accomplished young artists in the field. Career girls in our own office went into raptures over the face of that skier on the cover. When asked who served as a model, Bob diffidently mumbled that he had no model—he used a mirror. Three of Bob's paintings recently were selected for exhibit at the Annual Exhibition of the Art Directors Club of Chicago—a high honor for a former errand boy

Published monthly by Popular Mechanics Company, 200 E. Ontario St., Chicago 11, Ill. H. H. Windsor, Jr., president; William Harrison Petridge, vice-president; D. P. Windsor, vice-president and secretary-treasurer; H. H. Windsor III, vice-president; Clover L. Perkins, advertising manager; Alan M. Deyoe, circulation manager. Single copy in the United States and Canada, 35 cents; subscription rates in the United States and possessions, Canada, Philippines and countries of the Pan-American Postal Union, 1 year \$3.50; 2 years, \$6.00; 3 years \$8.00. To all other countries add \$1.00 a year over United States prices for overseas postage. If you plan to move, notify us at least 30 days in advance so you will not miss an issue. Give both your old and new addresses. Entered as Second Class Matter, September 15, 1903, at the Post Office at Chicago, Illinois, under Act of March 3, 1879. Entered as Second Class Matter at Post Office Dept., Canada. Registered as Second Class Matter at the Post Office at Mexico, D. F., Mexico, June 20, 1950. Copyright 1953 by Popular Mechanics Company. Copyright under International Copyright Union. Copyright in France. All rights reserved under Pan-American Copyright Union. Printed in the United States of America.

Volume 99

JANUARY 1953

Number 1

Address all communications to:
200 East Ontario Street, Chicago 11, Illinois

Managing Editor.....Roderick M. Grant
Assistant Managing Editor.....Wayne Whittaker
Shop Notes and Crafts Editor.....James R. Ward
Radio-Television, Electronics Editor.....Frank L. Brittin
Associate Editor, Aviation.....Aubrey O. Cookman, Jr.
Associate Editor.....Clifford B. Hicks
Associate Editor, Automotive.....Arthur R. Railton
Assistant Shop Notes and Crafts Editor.....Wayne C. Leckey
Assistant Editor, Makeup.....John C. Dalen
Automotive Correspondent.....Siler Freeman
Art Director.....Frank Beatty

Assistant Editors
W. Clyde Lammy Leonard F. Hiltz Frank N. Stephany
Theodore A. Daum Elsie L. Domin Elliott H. McCleary
Eastern Editor.....Richard F. Dempewolf
Empire State Bldg., Room 2906, New York City 1
Western Editor.....Thomas E. Stimson, Jr.
302 23rd St., Santa Monica, Calif.
London Manager.....Douglas W. Wedderspoon
Eagle House, Jermyn St., London S. W. 1, England
Director, Bureau of Information.....Allan Carpenter
200 E. Ontario St., Chicago 11

IN THIS ISSUE

Headaches of a Jet Designer	- - - - -	81
Bonanza in Bark	- - - - -	88
Darkroom in a Desert	- - - - -	92
Life Six Miles Under the Sea	- - - - -	97
Owners Report on the Hillman Minx	- - - - -	112
Here Comes the Ski Patrol	- - - - -	122
The House That Will Never Burn Down	- - - - -	128
Wanted: 50,000 Engineers	- - - - -	133
Water Lift Fights Australia Drought	- - - - -	146
Boat That Inhales Fish	- - - - -	150
Florida Builds a Great Wall	- - - - -	160

For the Craftsman

Here's Glamour for Your Basement	- - - - -	165
SS United States—Part II	- - - - -	181
How to UNpaint	- - - - -	188
Chip Carving	- - - - -	198
More Miles for Your Tires	- - - - -	204
Collets for Precision Chucking	- - - - -	211
Wheels for Your Power Tools	- - - - -	216
Shopping for Tools	- - - - -	222
Radio, TV and Electronics	- - - - -	227
Clinic for Homemakers	- - - - -	236

Other items, and manufacturers of available products described, are listed on pages 12, 14 and 16

"OWN a Business" Coupon

DURACLEAN CO., 3-161 Duraclean Bldg., Deerfield, Illinois

Without obligation to me, send booklet and letter giving full details. Tell me how I may OWN a growing business of my own built upon satisfied customers.

Name _____

Address _____

City _____ State _____



Are You The Man?

If you are dependable, honest and willing to work to own a large-profit, lifetime business and become financially independent, we invite you to mail the above coupon for full details. We are now enlarging this 23-year-old, world-wide chain of **individually-owned** service businesses. We'll establish you in YOUR OWN business and help

finance you. You use successful methods of established Duraclean dealers. This is a nationally advertised, lifetime business. You can average \$5.00 hourly gross profit on service you render and \$3.00 on **EACH** of your servicemen at National Price Guide charges. **Easy to learn . . . quickly established.**

Revive, Clean and Protect Rugs and Upholstery!

The remarkable Duraclean Service (illustrated below) restores the natural fibre lubrication of wool and other animal fibers. Resiliency returns to the pile. It rises again. Brilliant colors revive. Results in many instances are almost unbelievable.

Duraclean Service banishes the need of cleaning upholstery, rugs and carpeting by harsh machine scrubbing and soaking. It eliminates harmful solvents and strong soaps.

The aerated foam, created by the **patented** electric Foamovator, cleans by **ABSORPTION**—not by scrubbing. Dirt, grease and many unsightly spots vanish like magic. Furnishings become clean, fresh, enlivened.

Forefall Damage by Moths & Carpet Beetles

The Duraproof Service (illustrated above) not only kills moths and carpet-beetles but is also **WARRANTED** to make fabrics **repellent** to both. The U. S. Government says, "**Moths are present in practically every household. . . . No section of the country seems free from such infestations.**" Damage to household goods and wearing apparel is greater from moths than from fire. This modern treatment **DEFINITELY PROTECTS** rugs, carpets, upholstery, furs, clothing, blankets, piano-felts, auto interiors, etc.

What Dealers Say

W. Lookiebill: "We've had 20 years of pleasant dealings. I'm 65 but am setting my sights for 20 more years."

G. Merriman: "This made me \$700 cleaning with only 13 working days."

P. Freidinger: "We had a big moth-proof business last year; one job alone was \$322.25."

Margaret Turner: "Took in \$106 and worked 15 or 18 hours."

R. Kimbrough: "Finished First White House of Confederacy and am to Duraclean the Governor's Mansion."

Q. Corbett (Canada): "Several hundred dollars in jobs lined up from canvassing."

H. Satterfield: Duracleaned chair for largest department store and got order for 60-75 chairs, couches & davenports."

E. Schenk: "The customers I had on **House and Garden** ads were very pleased. Their furnishings came out beautiful."

A. Ullman: "It is very encouraging that every demonstration has been a sale."

L. Johnson: "Each customer leads to 3 or 4 more."

No Shop Needed—EASY to Learn

No overhead expense. Service may be rendered in homes, offices, hotels, theaters, institutions, etc., by your servicemen. Auto dealers have upholstery revived in used cars. Some Duracleaners establish shops or an office—others operate from their homes.

Start Part or Full Time

No experience needed. We show you 27 ways to get customers. Almost every building houses a potential customer. A waiting market is in small and large towns alike. These year-round services are in constant need.

Nationally Advertised

Your services are advertised in magazines such as Life, McCall's, House & Garden, Ladies Home Journal, Better Homes & Gardens, etc. See the column ad in House Beautiful this month. These ads give your services national prestige.

Easy Terms!

A moderate payment establishes your own business—pay balance from profits. We furnish electric machines, folders, store-cards, introduction slips, sales book, demonstrators and enough materials to return your **TOTAL** investment. You can have your business operating in a **very few days.** Mail above coupon. No obligation.

Repeat & Voluntary Orders

Demonstrations win customers. Duracleaners find **REPEAT** and **VOLUNTARY** orders a main income. Customers, enthused at results, tell friends and neighbors. Your service is recommended nationally by America's foremost furniture and department stores.

Double Profits

You enjoy large profits on both materials and labor. To start, you may want to render service yourself. You have co-operation of a world-wide organization interested in YOUR success.

FREE Booklet

Our first letter and 16 page illustrated booklet will explain everything—these modern urgently needed services, the waiting market, how business grows, your large profits, easy terms and protected territory. Mail the coupon **TODAY.** No obligation.

OWN
a Growing
BUSINESS



Patented Machine converts to carrying case

World-wide Services

DURACLEAN CO., 3-161 Duraclean Bldg., Deerfield, Ill.

Mail Coupon TODAY—While Territory Is Open

HOW TO MAKE YOUR OWN

3 DIMENSION COLOR PICTURES



AT LESS THAN SNAPSHOT COST!

Three dimension photography is different because it affords an opportunity for depth planning. Subjects appear to "come to life" in stereo pictures.



STEP NO. 1

All you need to know is sky condition and subject color. The patented View-Master Expo-Sure guide makes all other adjustments. No focusing necessary. Have film processed in the usual manner.



STEP NO. 2

Semi-automatic View-Master film cutter works quickly and easily. Film is registered perfectly to produce stereo pairs accurately die-cut to 1/1000 of an inch. You get 37 pairs on a 20-exposure film; 69 on a 36-exposure roll.

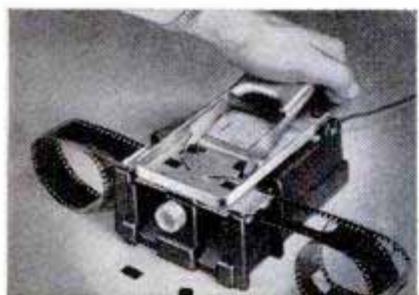

STEP NO. 3

Die-cut film slips into die-formed pockets. Photographically exposed marks on right and left pictures, which correspond with similar marks on film pockets, positively identify pictures and facilitate mounting.



STEP NO. 4

The completed picture is viewed in three dimensions with a View-Master Stereoscope or in two dimensions with a View-Master Projector. An additional advantage is the huge View-Master library of scenic Reels with which to supplement your personal library.



Now, with the new View-Master Personal Stereo Camera, you can take brilliant, full color stereo pictures in thrilling "come to life" realism, for less than the cost of ordinary black and white snapshots. Persons with little or no photographic experience find it easy and fun to make breath-taking three dimension pictures of family scenes, children, friends, vacation travels. The illustrations show the simple steps of View-Master stereo picture-making. Adjust the camera and snap the picture. Have the color film processed. Use the View-Master film cutter to quickly and accurately die-cut stereo pairs. Then insert stereo pairs into blank Personal Reel for exciting viewing.

Integrated Units of the View-Master Stereo System

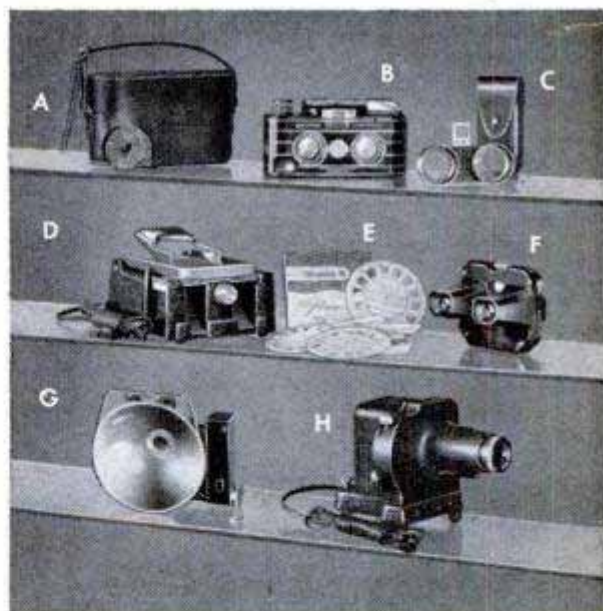

(A) Carrying Case (B) View-Master Personal Stereo Camera (C) Close-up attachment (D) Film Cutter (E) Personal Reels (F) View-Master Stereoscope (G) Flash attachment (H) View-Master S-1 Projector.

© Sawyer's Inc., Portland 7, Ore.

VIEW-MASTER

STEREOSCOPIC PRODUCTS ARE
AVAILABLE AT YOUR PHOTO DEALER

BE SAFE

add PYROIL to your winter oil

NOW!

● You need Pyroil more than ever when you change to winter oil. Low viscosity oil quickly drains off cylinder walls and piston rings, exposing them to excessive corrosion, caused by dampness and cold. Not so, if you use Pyroil. Pyroil causes oil—any oil—to adhere to all exposed motor surfaces. Perfect insulation against the ravages of winter driving!

Yes, you need winter oil for "easy starts"—but you need Pyroil for the extra protection, improved lubrication, reduced maintenance cost—and more comfortable driving.

Be sure your gas station attendant adds Pyroil and you will add trouble-free miles of winter driving to your car.

Pyroil for Aircraft Engines

Use Aircraft Pyroil B for lubricating oil, Aircraft Pyroil A for gasoline.

GIVEN! An attractive Pyroil metal savings bank—takes coins up to 50¢ pieces. **MOTORISTS**, it's yours for the asking—sent postage paid.

Manufactured and Guaranteed by Pyroil Company, 184 Pyroil Bldg., La Crosse, Wisconsin

Canadian Distributors: Central Purchasing Agencies, Ltd., Toronto, Ontario



PYROIL COMPANY
184 Pyroil Bldg., La Crosse, Wisconsin

I want my car to last and run properly. Please tell me more about Pyroil and how it can accomplish this for me.

Name _____

Address _____

City or Town _____ State _____



in this corner.....

THE EDITORS



Letter to the Editor:

In regard to your article on the '52 Lincoln in this month's (Oct.) issue of your fine magazine, 'twas noted . . . a gentleman from St. Louis said "the difference between 15 m.p.g. and 19 m.p.g. amounts to only a few bucks by the end of the year." Now this may be true depending on what people consider a "few bucks."

Referring to my slide rule, comes out the figures of sumpin like a difference of about

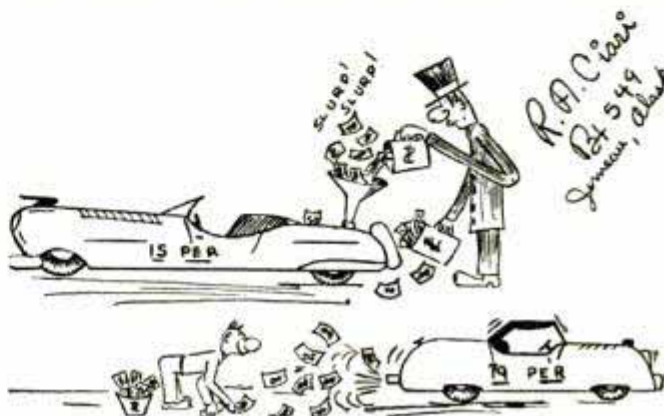

65 bucks each year, depending on the amount of mileage at the end of the year. For instance, take an auto making 19 m.p.g.; it will burn up about 789 gallons in 15,000 miles while at 15 m.p.g. it will burn up about 1000. Figuring at 30 cents a gallon, it would be \$300 for the 15 m.p.g. and about \$235 for the 19 m.p.g., on the basis of both being driven 15,000 miles a year which, I believe, is pretty near average. Like I say, this may just be a few bucks to some, but to some of us peasants—well!!

R. A. Ciari,
Juneau, Alaska.

Letters to the Editor:

Just a line from an habitual reader of *Popular Mechanics*. A most enjoyable habit it is, too.

On page 164 of the October issue, the mysterious shotgun seems to be a "Hagen" tear-gas gun, or a copy of it. I wouldn't know how it got to Germany, but I sell 'em in Houston.

P. E. Preston,
Houston 22, Tex.

* * *

The gun in question is the type used by German farmers and foresters to kill wild pigs that destroy crops and gardens. They

(Continued to page 8)

This **FREE SAMPLE LESSON** will prove you can become an expert **BOOKKEEPER... ACCOUNTANT** OR **C.P.A.**

FREE SAMPLE LESSON

We offer you this free sample lesson so that you can *prove to yourself* that you CAN master Accountancy—quickly, thoroughly—in spare time at home.

You will see exactly how LaSalle's famous "Problem Method" works... how you are led step-by-step through actual accounting work—*learning by doing* and not by study of theory alone. First you tackle easy problems, then more difficult ones—until soon you master them all. And at every step you have the close personal guidance of LaSalle's large staff of C.P.A. instructors.

**Nearly 10%
of all C.P.A.'s
in the U.S. have
been trained by the
LaSalle Problem
Method**

GOOD-PAY JOBS IN 5 BIG FIELDS

If you were an expert accountant right now, chances are you would find yourself among the highest-paid of all professional men and women. Surveys show that accountants earn more than those in other major professions.

There are five big fields of opportunity open to Accountancy-trained men and women... opportunities that are wide open and highly inviting, offering maximum income and job security in good times or bad. And under LaSalle's "Problem Method" you can start earning while still learning—either in spare-time or full-time employment... or in business for yourself with no capital required.

Get the latest information by sending for our 48-page book, "Accountancy, the Profession That Pays"... plus free sample lesson. The coupon at right will bring both to you without cost or obligation. LaSalle Extension, 417 S. Dearborn St., Chicago 5, Ill.

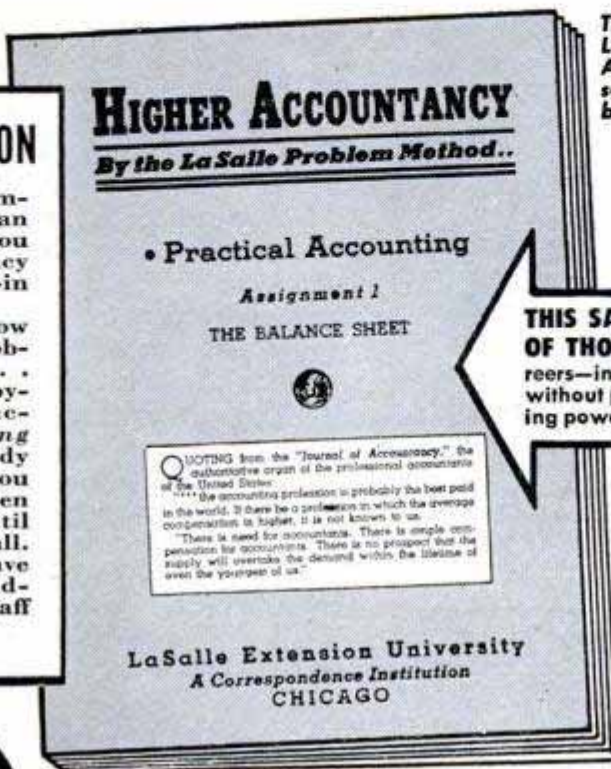

This well-paid LaSalle-trained Accountant's success could be yours.



THIS SAME LESSON HAS STARTED HUNDREDS OF THOUSANDS toward well-paid accounting careers—in business, government, and as C.P.A.'s. Even without previous knowledge, progress is rapid—earning power climbs fast. This sample lesson shows why.

If you have been envying the high incomes and good jobs enjoyed by thousands of men and women Accountants today... incomes ranging from \$4,000 to \$10,000 and more per year... why not launch such a career for yourself?

Do you doubt that you can?

Then let us send you—without cost or obligation—the same Lesson Number One with which LaSalle has started several hundred thousand

men and women toward successful accounting careers. We want you to see for yourself how this remarkable method, originated by LaSalle, makes Accountancy simple, interesting, practical, and certain... how it leads you step-by-step to a complete mastery of Accounting—and on up to the coveted degree of Certified Public Accountant if you so aspire.

It doesn't matter whether you've had previous bookkeeping experience, or whether you don't know a debit from a credit. Whether you wish to qualify as an expert bookkeeper, advanced accountant, cost accountant, auditor, government accountant, income tax specialist, or public accountant... you'll find in LaSalle's Problem Method the exact plan to prepare you rapidly and inexpensively—in spare hours at home—without losing a day from your present job.

So right now, today... if you are an adult, employed, and earnestly ambitious for rapid advancement in this highest-paying of all professions... send your name and address on the coupon below. We'll send the free sample lesson—plus our 48-page book outlining today's career opportunities and how you can qualify for them. A coupon like this has started many thousands toward greater success. It can do the same for you. Mail it today!

Clip Coupon... Mail TODAY!

LaSalle Extension University... A Correspondence Institution
Dept. 164 H, 417 S. Dearborn Street, Chicago 5, Illinois

YES, I want to see how LaSalle's "Problem Method" works.. how I can qualify for high-pay Accountancy positions. Send Free Sample Lesson—also your 48-page book, "Accountancy, the Profession That Pays"
...all without cost or obligation.

Name.....
Street Address.....
City, Zone & State.....
Present Position.....

This One



BYE8-RBT-OWJN

NOW YOU CAN BUILD IT WITH CONCRETE BLOCKS



This practical guide shows every step from how-to-plan to how-to-build with one of the most abundant and economical building materials known to man. Over a hundred pictures and cut-away diagrams show exactly what to do and what not to do. Tells how to plan, place corner block, make foundations easily, how to paint for special purposes. A picture story of everything in building any type of structure with concrete blocks, easily and inexpensively.

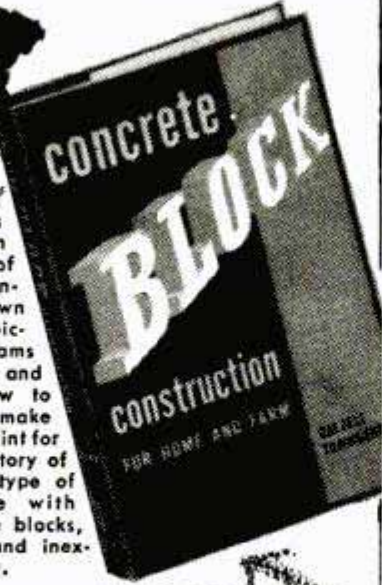

Here's how to apply mortar

Here's how little this book costs you . . . or if you don't keep it after 10 days trial, return it and you owe nothing. **\$2.75**

CARPENTRY FOR EVERYONE



A clear explanation of modern carpentry construction including framing, roof constructions, general carpentry work, exterior and interior finish of buildings, building forms and working drawings, and farm buildings. Covers everything you need to know about lumber, tools, joints and splices, floors, stairs, partitions, rafters, etc. Gives short cuts and tricks used by the master carpenter. Easy to understand. 504 pages, 580 illustrations. **\$2.50.** Use 10 day no-cost trial coupon below.

BRICKLAYING — WIRING — PLUMBING

Bricklaying Skill and Practice shows by clear explanations and actual on-the-job illustrations, simplifies the construction of everything from fireplaces to complete buildings. **\$3.00**
Electric Wiring—New book covers job-tested methods of residential and farm wiring, code changes. Show-how for amateur, valuable reference for tradesman, estimator, contractor. **\$3.95**
How to Design and Install Plumbing—Hundreds of how-to-do-it pictures, full-sized blueprints for most every plumbing job. 349 illustrations, 422 pages. **\$3.95**

OTHER YOU-CAN-DO-IT BOOKS IN COUPON BELOW

Mail this coupon today—10 days trial at no cost to you
American Technical Society, Dept. C-119
 848 East 58th Street, Chicago 37, Illinois

Please rush me the following books I'm checking below to examine at home. If I'm not convinced these books will help me save thousands of dollars by doing my own building and planning, I may return the books and owe nothing.

Examine	<input type="checkbox"/>	CONCRETE BLOCK CONSTRUCTION FOR HOME AND FARM.....	\$2.75
at home	<input type="checkbox"/>	CARPENTRY.....	\$2.50
or no	<input type="checkbox"/>	BRICKLAYING...Skill and Practice...	\$3.00
cost.	<input type="checkbox"/>	HOW TO DESIGN AND INSTALL PLUMBING.....	\$3.95
	<input type="checkbox"/>	ELECTRIC WIRING—Residential and Farm.....	\$3.95
	<input type="checkbox"/>	How to Insulate Home & Farm Bldgs...	\$3.00
	<input type="checkbox"/>	Steel Square.....	\$2.25

Name _____
 Address _____
 City _____ State _____

Ten day no-cost-trial. If I keep books, will remit by check or money order.
 Send C.O.D. Same return privilege—money refunded.
 I'm enclosing \$_____ now to save postage—same return privilege—money refunded.

(Continued from page 6)

are attached either to a tree or a stable support of sorts and are fired when the game trips a trigger wire.

M/Sgt. Fred E. Lepo, Jr.,
 85th Fighter-Interceptor Sqdn.,
 Scott Air Force Base, Ill.

Letter to the Editor:

Enclosed is a personal check for eight dollars for which I would like you to send a two years' subscription of *Popular Mechanics* to Mr. Antoine Jung, 78/a Grey Avenue, Vereeniging, South Africa.

Mr. Jung was a former subscriber of yours when he lived in Cyprus, but on occasions failed to get his issue. When this happened he'd ask me to buy it for him in Beirut, Lebanon, since I was flying over there often. Now that both he and I have left Cyprus I'd like to see that he gets the *Popular Mechanics* regularly. Mr. Jung has probably utilized your magazine to obtain ideas for more varied fields than any other reader. He is an accomplished musician, playing and repairing most every instrument; he is a well-qualified engine mechanic; a sculptor; a painter; a writer of fiction and technical books (in Hungarian); he molds and carves plastics (for which he designed and built his own tools—drills, lathe, saw, etc.). The man is as close to being a genius as I can imagine.

Mr. Jung is a middle-aged Hungarian who moved to Cyprus a few years before the war; was interned in West Africa during the war; returned to Cyprus; and recently immigrated to South Africa where he will again "start from scratch."

When he left, I asked if there was anything I could send him from the States—his only answer was "*Popular Mechanics*."

That, gentlemen, is a tribute.

W. G. Ghormley,
 Westover AFB, Mass.

This Bright-Green Chlorophyll World

We asked our Eastern Editor to bird-dog the chlorophyll business. Here is his report:
 Dear Boss:

When you told me that dogs who eat chlorophyll-treated food are supposed to lose their doggy smell, I decided to investigate this new bonanza of green gold our chemists have struck. I want to report that, if the discoverers of this fabulous deodorizer have their way, we soon may be living in a world devoid of every unpleasant whiff.

Already, manufacturers are chlorophylling more than 100 products, to make people, animals and things smell like fresh air. One manufacturer recently marketed

(Continued to page 10)



Picture yourself going places

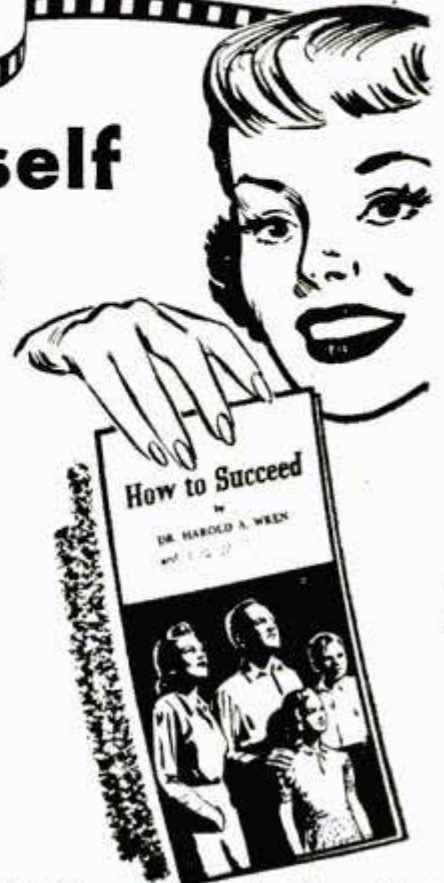

You've done it often. Call it day-dreaming if you like, but you've seen yourself in a bigger job — giving orders and making decisions — driving off in a smart new car — buying your family a fine home.

There's nothing wrong with dreams. But how about making them come true? *You can do it*, if you're willing to try!

Look around you. The men who are going places are the *trained* men. They've learned

special skills that bring them better jobs and higher pay. It's the men *without* training whose dreams never come true.

What are you going to do about it? Just wait and wish? If you really *want to succeed*, you can get the training you need by studying at home in your spare time. International Correspondence Schools offer you a course in just about any field you choose, giving you the practical plus the bedrock facts and theory. No skimming or skimping! And you'll be earning while you learn. Students report better jobs and more pay within a few months.

Look over the list of subjects in the coupon below. Pick out the one that interests you most — the one that holds the greatest future for you. Then mark the coupon, and mail it today. *Find out* what I. C. S. can do for you. It costs only a stamp or postcard, but it's the first step if you want to go places!

SMARTEST THING HE EVER DID

"I noticed that the trained men held the better jobs. That's when I decided to take an I. C. S. course. Enrolling with I. C. S. was one of the smartest things I ever did. The position as Plant Engineer I hold today is largely due to the 'know-how' derived from my I. C. S. texts. I. C. S. can help any man who will study."

L. P. S., Elkhart, Ind.

FREE BOOK

"How to Succeed." 36 pages packed with worthwhile success tips. Step-by-step plan of action. Pocket size edition. Absolutely free. Send coupon below.

INTERNATIONAL CORRESPONDENCE SCHOOLS



BOX 5555-L, SCRANTON 9, PENNA.

Without cost or obligation, send me "HOW TO SUCCEED" and the booklet about the course BEFORE which I have marked X:

- | | | | | |
|---|---|---|---|---|
| <ul style="list-style-type: none"> <input type="checkbox"/> ART <input type="checkbox"/> Commercial Art <input type="checkbox"/> Magazine and Book Illustrating <input type="checkbox"/> Cartooning <input type="checkbox"/> Show Card and Sign Lettering <input type="checkbox"/> Fashion Illustrating <input type="checkbox"/> AUTOMOTIVE <input type="checkbox"/> Automobile, Mechanic <input type="checkbox"/> Auto-Elec. Technician <input type="checkbox"/> Auto Body Rebuilding and Refinishing <input type="checkbox"/> Diesel—Gas Engines <input type="checkbox"/> AVIATION <input type="checkbox"/> Aeronautical Engineering Jr. <input type="checkbox"/> Aircraft Engine Mechanic <input type="checkbox"/> Airplane Drafting <input type="checkbox"/> BUILDING <input type="checkbox"/> Architecture <input type="checkbox"/> Arch. Drafting <input type="checkbox"/> Building Contractor <input type="checkbox"/> Estimating <input type="checkbox"/> Carpenter and Mill Work <input type="checkbox"/> Carpenter Foreman <input type="checkbox"/> Reading Blueprints <input type="checkbox"/> House Planning <input type="checkbox"/> Plumbing | <ul style="list-style-type: none"> <input type="checkbox"/> Heating <input type="checkbox"/> Steam Fitting <input type="checkbox"/> Air Conditioning <input type="checkbox"/> Electrician <input type="checkbox"/> BUSINESS <input type="checkbox"/> Business Administration <input type="checkbox"/> Certified Public Accountant <input type="checkbox"/> Accounting <input type="checkbox"/> Bookkeeping <input type="checkbox"/> Stenography and Typing <input type="checkbox"/> Secretarial <input type="checkbox"/> Federal Tax <input type="checkbox"/> Business Correspondence <input type="checkbox"/> Personnel and Labor Relations <input type="checkbox"/> Advertising <input type="checkbox"/> Retail Business Management <input type="checkbox"/> Managing Small Business <input type="checkbox"/> Sales Management <input type="checkbox"/> Salesmanship <input type="checkbox"/> Traffic Management <input type="checkbox"/> CHEMISTRY <input type="checkbox"/> Chemical Engineering <input type="checkbox"/> Chemistry <input type="checkbox"/> Analytical Chemistry <input type="checkbox"/> Petroleum—Nat'l Gas <input type="checkbox"/> Pulp and Paper Making <input type="checkbox"/> Plastics | <ul style="list-style-type: none"> <input type="checkbox"/> CIVIL, STRUCTURAL ENGINEERING <input type="checkbox"/> Civil Engineering <input type="checkbox"/> Structural Engineering <input type="checkbox"/> Surveying and Mapping <input type="checkbox"/> Structural Drafting <input type="checkbox"/> Highway Engineering <input type="checkbox"/> Reading Blueprints <input type="checkbox"/> Concrete Construction <input type="checkbox"/> Sanitary Engineering <input type="checkbox"/> DRAFTING <input type="checkbox"/> Aircraft Drafting <input type="checkbox"/> Architectural Drafting <input type="checkbox"/> Electrical Drafting <input type="checkbox"/> Mechanical Drafting <input type="checkbox"/> Structural Drafting <input type="checkbox"/> Sheet Metal Drafting <input type="checkbox"/> Mine Surveying and Drafting <input type="checkbox"/> ELECTRICAL <input type="checkbox"/> Electrical Engineering <input type="checkbox"/> Electrician <input type="checkbox"/> Electrical Maintenance <input type="checkbox"/> Electrical Drafting <input type="checkbox"/> Electric Power and Light <input type="checkbox"/> Lineman <input type="checkbox"/> HIGH SCHOOL <input type="checkbox"/> High School Subjects | <ul style="list-style-type: none"> <input type="checkbox"/> College Preparatory <input type="checkbox"/> Mathematics <input type="checkbox"/> Commercial <input type="checkbox"/> Good English <input type="checkbox"/> MECHANICAL AND SHOP <input type="checkbox"/> Mechanical Engineering <input type="checkbox"/> Industrial Engineering <input type="checkbox"/> Industrial Supervision <input type="checkbox"/> Foremanship <input type="checkbox"/> Mechanical Drafting <input type="checkbox"/> Machine Design-Drafting <input type="checkbox"/> Machine Shop Practice <input type="checkbox"/> Tool Design <input type="checkbox"/> Industrial Instrumentation <input type="checkbox"/> Machine Shop Inspection <input type="checkbox"/> Reading Blueprints <input type="checkbox"/> Toolmaking <input type="checkbox"/> Gas—Electric Welding <input type="checkbox"/> Heat Treatment—Metallurgy <input type="checkbox"/> Sheet Metal Work <input type="checkbox"/> Sheet Metal Pattern Drafting <input type="checkbox"/> Refrigeration <input type="checkbox"/> POWER <input type="checkbox"/> Combustion Engineering <input type="checkbox"/> Diesel—Electric <input type="checkbox"/> Electric Light and Power | <ul style="list-style-type: none"> <input type="checkbox"/> Stationary Steam Engineering <input type="checkbox"/> Stationary Fireman <input type="checkbox"/> RADIO, TELEVISION, COMMUNICATIONS <input type="checkbox"/> General Radio <input type="checkbox"/> Radio Operation <input type="checkbox"/> Radio Servicing—FM <input type="checkbox"/> Television <input type="checkbox"/> Electronics <input type="checkbox"/> Telephone Work <input type="checkbox"/> RAILROAD <input type="checkbox"/> Locomotive Engineer <input type="checkbox"/> Diesel Locomotive <input type="checkbox"/> Air Brakes <input type="checkbox"/> Car Inspector <input type="checkbox"/> Railroad Administration <input type="checkbox"/> TEXTILE <input type="checkbox"/> Textile Engineering <input type="checkbox"/> Cotton Manufacture <input type="checkbox"/> Rayon Manufacture <input type="checkbox"/> Woolen Manufacture <input type="checkbox"/> Loom Fixing <input type="checkbox"/> Finishing and Dyeing <input type="checkbox"/> Textile Designing <input type="checkbox"/> HOME ARTS <input type="checkbox"/> Dressmaking and Designing <input type="checkbox"/> Cookery <input type="checkbox"/> Tea Room Management |
|---|---|---|---|---|

Name _____ Age _____ Home Address _____

City _____ State _____ Working Hours _____ A.M. to _____ P.M.

Occupation _____

Special tuition rates to members of the Armed Forces, Canadian residents send coupon to International Correspondence Schools Canadian, Ltd., Montreal, Canada

GET THE WORLD'S LEADING TV & RADIO CATALOG

FREE

236
VALUE-
PACKED
PAGES

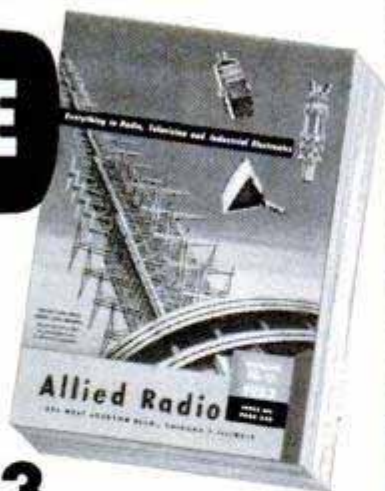

1953 ALLIED BUYING GUIDE

Save on Everything
in TV & Radio!

Everything for Experimenters, Builders, Amateurs, Service- men, Engineers and Soundmen

Get ALLIED's big 236-page Catalog featuring the world's largest selections of latest top-quality electronic equipment at lowest, money-saving prices. See the newest in custom TV chassis, TV accessories, FM and AM radios, Amateur Equipment, High-Fidelity sound, P.A. systems, recorders, test instruments, builders' kits—plus thousands of parts, tubes, tools and books. Get more for your money—send today for your FREE 1953 ALLIED Catalog!



FREE
CATALOG

SEND FOR IT TODAY

ALLIED RADIO

ALLIED RADIO CORP., Dept. 5-A-3

833 W. Jackson Blvd., Chicago 7, Illinois

Rush FREE 1953 ALLIED 236-Page Catalog

Name _____

Address _____

City _____ Zone _____ State _____

(Continued from page 8)

chlorophyll-impregnated socks for men. There's a new shoe lining with green stuff in it. There's chlorophyll in a new brand of pipe tobacco, to keep your pipe fresh as an alfalfa leaf, the makers claim. There's a cigarette, too, that's supposed to exude odorless smoke that won't make the draperies smelly. They've chlorophylled mothballs so your winter clothes won't make your eyes water when you take the clothes out of storage in the fall. There's a chlorophyll bubble bath for the ladies. Shampoo, foot powder, talcum powder, soap, skin lotion, air purifiers, candles, cleansing cream—all come loaded with the green stuff that's supposed to chase odors. Just about everything for the bathroom from cologne to toilet tissue—and even the roller it goes on—is impregnated with the substance. And one adventurous company has just marketed chlorophylled baby diapers. Besides these there are droves of products everyone knows about—odor-chasing tablets, chewing gum, toothpaste, mouthwash and green stick deodorants.

This deluge of green extract from alfalfa leaves is just one more answer to the pessimists who claim everything has been invented and you can't make a million dollars anymore. Economists estimate that \$50,000,000 to \$120,000,000 worth of chlorophyll products will be sold this year.

Chlorophyll is the stuff that makes plants green. An Englishman named Priestley, who discovered oxygen, examined it in the 1800s, and learned that it played a part in photosynthesis—the process by which plants turn sunlight to their own use. No one paid much attention. Then, about 1930, Dr. Benjamin Gruskin at Temple University pulled chlorophyll apart in the lab and worked it over for 10 years. By removing cellulose and other products, he found the material could be produced in water-soluble form. In a paper published in 1940 he told how the amazing substance did something to burns, open sores and wounds, helped to heal them and, incidentally, robbed them of their odor. He used it in hundreds of cases ranging from trench mouth to brain abscesses with remarkable success—but the emphasis was on curing.

About this time, O'Neill Ryan, an advertising man looking for a new drug to market, heard of Gruskin's discovery, bought out his patent and started work on a healing ointment. Others were working on a chlorophyll preparation for treating anemia. Although it didn't work, the scientists were struck by the deodorizing effect produced on animals and people to whom the preparation was administered.

(Continued to page 30)

OIL BURNER

INFORMATION IN A HANDY FORM

AUDELS OIL BURNER GUIDE

- A new practical, concise treatise, 384 pages-31 Chapters - 321 Diagrams and Illustrations - covering Domestic and Industrial Oil Burners.

New from Cover to Cover, for mechanics interested in Oil Burners. Gives practical inside working knowledge of theory, construction, installation, operation, testing, servicing and repair of all types of oil burners. Includes electrical hook-ups and wiring diagrams of automatic control systems.

PRICE \$1 POSTPAID

Get this information for yourself. Mail coupon today. No obligation unless satisfied.

ASK TO SEE IT

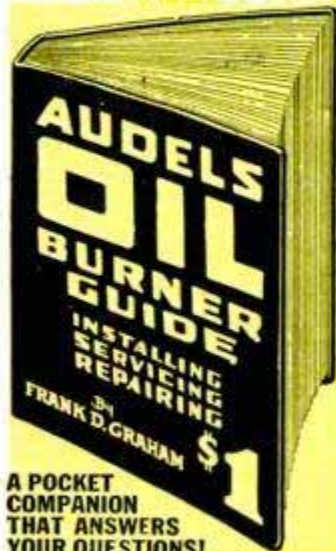

A POCKET COMPANION THAT ANSWERS YOUR QUESTIONS!

AUDEL, Publishers, 49 W. 23rd St., New York 10, N.Y.

Please mail AUDELS OIL BURNER GUIDE (Price \$1). If satisfactory, I will remit \$1 on its safe arrival, otherwise I will return the book.

Name _____
 Address _____
 Occupation _____
 Employed by _____ P1

AUDELS Carpenters and Builders Guides 4 vols. \$6



Inside Trade Information for Carpenters, Builders, Joiners, Building Mechanics and all Woodworkers. These Guides give you the short-cut instructions that you want—including new methods, ideas, solutions, plans, systems and money saving suggestions. An easy progressive course for the apprentice and student. A practical daily helper and Quick Reference for the master worker. Carpenters everywhere are using these Guides as a Helping Hand to Easier Work, Better Work and Better Pay. To get this assistance for yourself, simply fill in and mail FREE COUPON below.

Inside Trade Information On:

How to use the steel square—How to file and set saws—How to build furniture—How to use a mitre box—How to use the chalk line—How to use rules and scales—How to make joints—Carpenters arithmetic—Solving mensuration problems—Estimating strength of timbers—How to set girders and sills—How to frame houses and roofs—How to estimate costs—How to build houses, barns, garages, bungalows, etc.—How to read and draw plans—Drawing up specifications—How to excavate—How to use settings 12, 13 and 17 on the steel square—How to build hoists and scaffolds—skylights—How to build stairs—How to put on interior trim—How to hang doors—How to lath—lay floors—How to paint.



AUDEL, Publishers, 49 W. 23rd St., New York 10, N.Y.

Mail Audels Carpenters and Builders Guides, 4 vols., on 7 days' free trial. If OK I will remit \$1 in 7 days and \$1 monthly until \$6 is paid. -Otherwise I will return them. No obligation unless I am satisfied.

Name _____
 Address _____
 Occupation _____
 Employed by _____ P1

WHAT ALL AUTO MECHANICS WANT TO KNOW

1800 PAGES

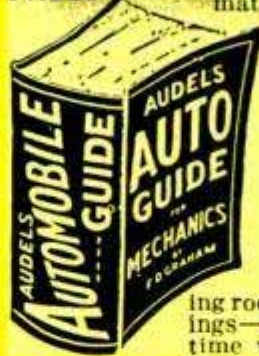

This Big Practical Book gives full information with working diagrams covering the principles, construction, ignition, service and repair of modern cars, trucks and buses.

Diesel Engines, Hydrumatic & Fluid Drives Fully Explained.

A complete Guide of 1800 pages, with over 1500 illustrations showing inside views of working parts, with instructions for service jobs.

IT PAYS TO KNOW

How to fit pistons—How to locate engine knocks, How to fit connecting rod bearings—How to service main bearings—How to recondition valves—How to time valves—How to adjust fan belts—How to adjust carburetors and chokes, How to rebuild a clutch—How to service automatic transmissions—How to service brakes—How to adjust steering gear—How to cope with ignition troubles—How to service distributors—How to time ignition—How to "tune up" an engine.



\$4 COMPLETE • PAY \$1 A MO. TO GET THIS ASSISTANCE FOR YOURSELF SIMPLY FILL IN AND MAIL COUPON TODAY.

Step up your own skill with the facts and figures of your trade. Audels Mechanics Guides contain Practical Inside Trade Information in a Handy Form. Fully illustrated and Easy to Understand. Highly Endorsed. Check the book you want for 7 DAYS FREE EXAMINATION. Send No Money. Nothing to pay postman.

MAIL ORDER

AUDEL, Publishers, 49 W. 23 St., NEW YORK 10, N.Y.



Check NOW!

You Can Look Over Any Guide In Your Own Home

Start the Easy Payments If Satisfied

MAIL THIS TODAY

Name _____
 Address _____
 Occupation _____
 Employed by _____ P1

Please send me postpaid for FREE EXAMINATION books marked (X) below. If I decide to keep them I agree to mail \$1 in 7 Days on each book or set ordered and further mail \$1 monthly on each book or set until I have paid price, otherwise I will return them.

- AUTOMOBILE MECHANICS GUIDE, 1800 Pages \$ 4
- TRUCK & TRACTOR GUIDE, 1299 Pages . . . 4
- DIESEL ENGINE MANUAL, 575 Pages . . . 2
- MACHINISTS HANDY BOOK, 1650 Pages . . . 4
- WELDERS GUIDE, 400 Pages . . . 1
- BLUE PRINT READING, 416 Pages . . . 2
- MATHEMATICS & CALCULATIONS, 700 Pages. . . 2
- SHEET METAL PATTERN LAYOUTS, 1100 Pages. . . 4
- SHEET METAL WORKERS HANDY BOOK, 388 Pgs. . . 1
- MECHANICAL DRAWING GUIDE, 160 Pages . . . 1
- MECHANICAL DRAWING & DESIGN, 480 Pages . . . 2
- AIRCRAFT WORKER, 240 Pages . . . 1
- TELEVISION SERVICE MANUAL, 384 Pages . . . 2
- RADIOMANS GUIDE, 914 Pages . . . 4
- ELECTRONIC DEVICES, 216 Pages . . . 2
- ELECTRIC MOTOR GUIDE, 1000 Pages . . . 4
- ELECTRIC WIRING DIAGRAMS, 272 Pages . . . 1
- ELECTRICIANS EXAMINATIONS, 250 Pages . . . 1
- ELECTRIC POWER CALCULATIONS, 425 Pages. . . 2
- HANDY BOOK OF ELECTRICITY, 1440 Pages. . . 4
- ELECTRIC DICTIONARY, 9000 Terms . . . 2
- ELECTRIC LIBRARY, 7000 Pages (12 Book Set) 18
- MARINE ENGINEERS HANDY BOOK, 1258 Pgs. . . 4
- SHIPFITTERS HANDY BOOK, 250 Pages . . . 1
- REFRIGERATION & Air Conditioning, 1280 Pgs. . . 4
- MILLWRIGHTS & MECHANICS GUIDE, 1200 Pgs. . . 4
- POWER PLANT ENGINEERS GUIDE, 1500 Pages . . . 4
- ENGINEERS & FIREMANS EXAMS, 525 Pages . . . 1
- PUMPS, Hydraulics & Air Compressors, 1658 Pgs. . . 4
- ENGINEERS LIBRARY (3 Book Set) . . . 9
- MECHANICAL DICTIONARY, 950 Pages . . . 4
- GARDENERS & GROWERS GUIDES (4 Book Set) . . . 6
- CARPENTERS & BUILDERS GUIDES (4 Book Set) . . . 6
- PLUMBERS & Steamfitters Guides (4 Book Set) . . . 6
- MASONS AND BUILDERS GUIDES (4 Book Set) . . . 6
- PAINTERS & DECORATORS MANUAL, 450 Pgs. . . 2
- HOUSE HEATING GUIDE, 1000 Pages . . . 4
- OIL BURNER GUIDE, 384 Pages . . . 1

Fastest

Torquer in the World!!



**The Amazing New PROTO
Torque-Limiting Wrench
with Automatic Release!**

Use it in the dark, in noisy locations, in "blind" spots, in water or oil, with gloved hands! Automatic release tells you "when", without looking or listening—prevents over- or under-torquing.

**Super-Fast
Easy To Use
Low-Priced
Versatile
Accurate
Rugged
Safe**



**SIX MODELS—5-75 & 10-150
FT.-LB. CAPACITIES COVER
MAJORITY OF REQUIREMENTS**



Vastly superior to old-fashioned indicating types, the new PROTO torque-limiting wrench quickly pays for itself

by doing work better and faster! See and buy it at your nearest PROTO dealer. Send for free details (enclose 10¢ for 68-page catalog of complete PROTO line) to:

PLUMB TOOL COMPANY
2255X Santa Fe Ave., Los Angeles 54, Calif.



Eastern Factory—Jamestown, N.Y.
Canadian Factory—London, Ont.

WHERE-TO-BUY-IT INDEX

Source of supply appears after items commercially available

AUTOMOTIVE

Clamp-on tow chains grip bumpers firmly (Master Specialty Co., Inc., 3016 E. Lake St., Minneapolis, Minn.)	91
Lift truck on crawler tracks operates almost anywhere (American Tractor Corp., Churubusco, Ind.)	91
Door-locking button protects children (Semco Research Inc., 212 W. Florence Ave., Inglewood, Calif.)	95
Bumper jack operated by handle on top (Walker Mfg. Co., Racine, Wis.)	96
Parking device eliminates need for attendants	106
'53 Pontiac, Ford, Mercury and Packard	108
Detroit Listening Post	111
Miniature French auto solves space problems	116
Five-passenger housecar (Vita Automatic Windows, Inc., 65-30 Queens Blvd., Woodside, Long Island, N. Y.)	117
Woven-wire carpet gives better traction for auto tires (The Pecks, Box 3513, Merchandise Mart Station, Chicago 54)	148
Gasifier aids motor starting under arctic conditions	149
Junior-size Jaguar	159
Warning light on dash signals wasteful driving (Magnex, Box 8878, University Park Station, Denver 10, Colo.)	164
Time switch for car headlights (M. H. Rhodes, Inc., Hartford, Conn.)	244
Flexible radiator hose fits many models (Miller Rubber Co., Div. of B. F. Goodrich Co., Akron, Ohio)	278

FARM AND GARDEN

Electronic guide pilots lawn mower through tall grass	90
Automatic pilot for tractors holds steering wheel in position (E-Z Drive Co., Dundee, Ill.)	95
Flexible swinging gate adjusts to any grade level	118
Ford tractor—'53 model (Dearborn Motors Corp., Birmingham, Mich.)	120
Chemical eggs disinfect and protect poultry	280

HOBBIES AND NOVELTIES

Old-time bicycle built for steam is still operating	86
Miniature railroads new man toy switchyard (Lionel Corp., 15 E. 26th St., New York City)	118
Solar stove	158

HOUSE AND HOME

Humidifier uses asbestos wick to double moistening capacity (Milliken's Air Moistener, Box 114, Dixon, Ill.)	106
Pastry board (Wooster Rubber Co., Wooster, Ohio)	142
Electric broiler (Telfoam Corp., 411 N. 7th St., St. Louis, Mo.)	142
Bathtub cleaner (V. F. Garrett Co., Box 1143, Dallas, Tex.)	142
Sign kit (Lumo-Name Markers, Box 1197, Texarkana, Tex.)	142
Table tray (Du-All Products, Inc., 882A Commonwealth Ave., Boston, Mass.)	142
Knitting set (Yarn-Apart Co., Inc., 46 Cottage St., Manchester, Conn.)	143
Shutter kit (Shop Craft Shutters, Box 110, Beverly Hills, Calif.)	143
Luminous pendant (Radium Arts, 411 Lincoln Bldg., New York City 17)	143
Clothesline reel (Glasscraft, 920 Chicago Ave., Evanston, Ill.)	143
Hobby house 200 feet long	158
German iron rest	248
Loaded toothbrush (Twisto Container Corp., 7960 Santa Monica Blvd., Hollywood, Calif.)	252
Chimney blocks with flue liners (Molin Concrete Products Co., 885 W. Minnehaha, St. Paul, Minn.)	270
Spring-action weather strip (U. S. Weatherstrip, Inc., 24 W. Broadway, Salt Lake City, Utah)	274

MILITARY AND NAVAL

Army ration heater is smokeless	104
Oil fuel drums reclaimed by speedy Navy process	104
Hydro-skis on seaplanes speed take-off	119
Light beams gauge carrier planes' rate of descent	121
Radio-guided model blimp used in Navy recruiting program	144
Hospital ship has helicopter landing platforms	148
Supersonic-propeller planes	258

OFFICE, SHOP AND STORE

Convertible brush is adaptable to three widths (Baker Brush Co., Inc., 83 Grand St., New York City 13)	87
Book-size dictating machine is portable and lightweight (Thomas A. Edison, Inc., W. Orange, N. J.)	95
Plastic rotating tray places artists' tools within reach (E. G. Henrikson, Dept. J., Box 2428, Main Post Office, Los Angeles 53, Calif.)	127
Window sheeting removes glare from sun's rays (Transeal, Ltd., 821 N. Ave., Plainfield, N. J.)	148
Plastic pencil case snaps into binders (Renick Boggs & Co., 412 N. Orleans St., Chicago 10)	272

PHOTOGRAPHY

High-speed film permits movie-making in the dark (Eastman Kodak Co., Rochester 4, N. Y.)	87
Photo-retouching machine duplicates skin textures (Adams Retouching Machine Co., 737 Lincoln, Denver 3, Colo.)	91
Deep-sea photographs	105

SCIENCE AND INDUSTRY

V-type blender speeds mixing of dry materials (Patterson-Kelley Co., Inc., East Stroudsburg, Penna.)	86
Steel or iron coated with aluminum in low-cost process	87
More eggs?	87
Discover natural neptunium	87
Sandy rubber bounces at low temperatures	106

(Continued to page 14)

INVENTORS

Learn how to protect your invention. The U. S. Patent Laws provide that any new and useful art, machine, article of manufacture, or composition of matter, or any new and useful improvement thereof, may be patented if the act of invention is involved. Therefore, every inventor with a valuable invention should take advantage of the Patent Laws and proceed for patent protection in order to safeguard his rights.

A patent gives the inventor the exclusive right to prevent others from making, using, or selling the invention claimed in the patent for a period of seventeen years.

The Patent Laws were enacted for the benefit of the inventor to give him protection for the features of his invention which are patentable. These features must be properly and concisely set forth and claimed in a formal application for patent, in order to comply with the requirements of the Patent Laws. For that reason, unless the inventor is familiar with patent matters, he should engage a competent registered patent attorney or agent to represent him. We are registered to practice before the U. S. Patent Office and are prepared to serve you in the handling of your patent matters.

A specially prepared booklet entitled "Patent Guide for the Inventor", containing detailed information with respect to patent protection and procedure, together with a "Record of Invention" form will be promptly forwarded to you without obligation upon request.

CLARENCE A. O'BRIEN & HARVEY JACOBSON

Registered Patent Attorneys

31-A DISTRICT NATIONAL BUILDING

WASHINGTON 5, D. C.

FREE!

10 HITLER STAMPS!



10 SCARCE STAMPS
ALL DIFFERENT
SENT FREE
TO SECURE NAMES FOR OUR
MAILING LIST

MAIL coupon at once. We'll send you this fascinating set of 10 Hitler stamps. Different sizes, colors, values. **NO COST TO YOU.** Stamps were issued by short-lived nation of Bohemia-Moravia. Much sought after. Now becoming **SCARCE.** Our supply is limited. Don't ask for more than one set. We'll also include other interesting offers for your inspection—**PLUS a FREE** copy of our helpful, informative book, "How to Collect Stamps." This special offer may have to be withdrawn soon—so rush coupon with 10c to help cover postage and handling **NOW to: Littleton Stamp Co., Dept. 1-PM, Littleton, N. H.**

LITTLETON STAMP CO.
Dept. 1-PM, Littleton, N. H.

Send — **FREE** — the ten Hitler stamps and informative booklet, "How to Collect Stamps." I enclose 10c to help cover postage and handling.

Name _____

Address _____

City _____ State _____

(Continued from page 12)

Death-ray chamber tests atom effects.....	141
Synthetic asbestos substitute (Carborundum Co., Niagara Falls, N. Y.).....	144
Rocket-fuel chemical produced by electric method.....	148
Chemical technique produces metals from low-grade ores.....	155
Some scientists believe H-bomb harnessed for power.....	280
Construction takes most steel.....	284

SPORTS AND RECREATION

Swiveling outboard motor for low-cost "yachting" enthusiasts (Martin Motors, Eau Claire, Wis.).....	121
"Snakes" in the snow.....	145
Cap protects rifle sights against rain and snow (Anderson Gun Shop, 1203 Broadway, Yakima, Wash.).....	149
Austrian's ski-sail permits long leaps.....	155

MISCELLANEOUS

Thunderstorm energy equals 50 atom bombs.....	86
Plastic louvers provide sleek illuminated ceilings (J. A. Wilson Lighting & Display, Ltd., 995 Main St., Buffalo 3, N. Y.).....	90
Concrete and glass university building.....	96
Ancient cedars form memorial for logging industry.....	104
Super Dome car.....	110
Railroad "snow eater" plows and melts.....	116
Pocket calendar can be used for 307 years.....	126
Germans develop fast monorail train for high-speed travel.....	127
Whistle aids anesthesia (Globe Tapping Machine Co., 751 Central Ave., Bridgeport, Conn.).....	127
"Tilt up" method hurries building.....	153
Rolling hoosegow serves Capital police.....	154
\$100,000 "brain" keeps Denver traffic rolling.....	156
Vacuum cast (Dewey & Almy, 62 Whittemore Ave., Cambridge 40, Mass.).....	158
Rubber valve cap shields pipe-line workers from chemical leaks (Industrial Products Co., 2820 N. 4th St., Philadelphia 33, Penna.).....	164
Kansas City weather beacon provides latest forecasts.....	164
Binding kit makes album.....	282
Jet power pod is third engine for air freighters.....	282
Mechanical heart-lung.....	284

Craftsman and Shop Notes Index

AUTOMOTIVE

Tire-chain life prolonged by waterproofing straps.....	185
Portable transmission stand reduces overhaul time.....	187
Seat-cover shock eliminated.....	210
Leaky fuel tank repaired while still on car.....	226
Shorted auto horn disconnected.....	226

FARMING

Door brace made easily from pipe strap.....	203
Farm-machine parts assembled to provide small concrete mixer.....	213
Double-swing farm gate closed by coil spring.....	225
Grinder mounted on feeder skids saves handling of materials.....	225

HOBBIES AND NOVELTIES

Tracing wheel perforates plastic lacing for decorative effect.....	186
Treatment for violin keys that stick or slip.....	193
Candle hints.....	194
"Candles" on cardboard cake formed with dollar bills.....	196
Leather squares prevent rolling of punch on smooth surface.....	210

HOUSE AND HOME

Cookbook shelf slides underneath cabinet.....	173
Plastic webbing brings 'em back to life.....	174
Coasters improvised from salt box.....	177
Terrarium lamp.....	177
Solving home problems.....	178
Piece of chain in clothesline improves airing of garments.....	180
Caster cups hold sewing supplies.....	180
Brackets on basement joists aid stretching of clothesline.....	185
Linoleum held flat against floor by friction tape on underside.....	186
Repairing damaged linoleum.....	192
Tape prevents suction loss through vacuum-cleaner units.....	196

JIGS AND FIXTURES

Bracket serves as doorstop.....	192
Improvised plumber's snake fits small traps.....	213
Predrilled nut protects threads when drilling hole in bolts.....	214
Fitting nipples into an air hose.....	214
Drill-press tapping jig.....	220
Jig simplifies right-angle welds.....	221
Rigid stand for power grinder made from scrap pipe.....	226

OFFICE, SHOP AND STORE

Improvised mailing labels.....	176
Wrapping paper cut to length with plywood template.....	180
Clipped magazine articles stored in box-type letter file.....	187
Wire screen perforates paper.....	192
Wrapper cut from leftover rolls helps identify wallpaper quickly.....	196
Cup stores nails under shop shelf.....	210
Emergency "stamp pad" provided by typewriter ribbon.....	210
Adjustable stool for mechanic from jack and brake drum.....	213
Board aids cutting of card stock.....	213
Sliding shield protects glass in carpenter's level.....	213
Pigeonhole bolt rack.....	221
Tack pocket from old rubber toe.....	221

PAINT AND PAINTING

Durable varnish finish for wooden counter tops.....	173
Method for creating vacuum in can to retard thickening of paint.....	173
Supply kit for lettering artist mounted on tripod near work.....	192
Touch-up brush from feather.....	210

(Continued to page 16)

INVENTORS

If you believe that you have an invention, you should find out how to protect it. The first step is to have a search made of the prior pertinent U. S. patents. If a report on this search indicates that the invention appears patentable you can apply for a patent, and the specifications and claims should be prepared.

The firm of McMorrow, Berman & Davidson, with offices in Washington, D. C., is qualified to take the necessary steps for you. We can make a preliminary search on your invention, advise you whether we think it can be patented, and prepare your application for patent.

Unless you are fully familiar with the U. S. Patent Laws, we recommend that you engage the services of a Registered Patent Attorney to protect your interests. The patent laws are *your* laws. A patent gives you the right to prevent others from making, using or selling the invention claimed in your patent for a period of 17 years.

Use these patent laws for your protection. Investigate whether your invention can be patented. If you have what you believe to be an invention, we suggest that you have this firm make a search for you.

Send for a copy of our Patent Booklet entitled "How To Protect Your Invention," containing information about patent protection and patent procedure. Along with this we will also send you an "Invention Record" form, for your use in writing down and sketching details of your invention. We will mail them promptly. No obligation. They are yours for the asking.

McMORROW, BERMAN & DAVIDSON

Registered Patent Attorneys

PATENTS • COPYRIGHTS • PATENTS

135-F VICTOR BUILDING, WASHINGTON 1, D. C.

GOLLY--YOU SURE FOUND OUT FAST THE TROUBLE WITH THAT CARBURETOR!

IT'S A CINCH WHEN YOU USE MOTOR'S TROUBLE-SHOOTER!



"Put Your Finger" ON Any Car Trouble IN A JIFFY!

Handy New Guide Lists 2,000 Causes of Faulty Operation, Noises, Break-downs

SAVE TIME AND WORK on any auto repair job by being able to "put your finger" on exactly what's causing the trouble—right from the start! New, indexed TROUBLE-SHOOTER GUIDE—prepared by the Editors of the world-famous MOTOR'S Repair Manuals—lists 2,000 specific causes of car and truck troubles; helps you find the one you're after FAST. Book fits right in your pocket for instant reference. Spiral binding lets book stay open while you work. Cross-section PICTURES also included.

If car has Fan Belt noise—turn to Fan Belt Section for 8 specific things that can be wrong. MOTOR'S TROUBLE-SHOOTER helps you track down noises, knocks, misses, breakdowns—faulty operation from radiator to rear end. Covers engines, clutches, brakes, ignition, new automatic transmissions, etc. Gives quick help to beginners as well as experienced repair men!

Try Book for 7 Days — without obligation!

SEND NO MONEY—Mail Coupon—When postman delivers book, pay him \$1, plus postage and C.O.D. charges. (Or send \$1 with coupon, and we pay shipping charges.) If not delighted, return book in 7 days for full refund. MOTOR Book Dept., Desk EY, 250 W. 55th St., New York 19, N. Y.

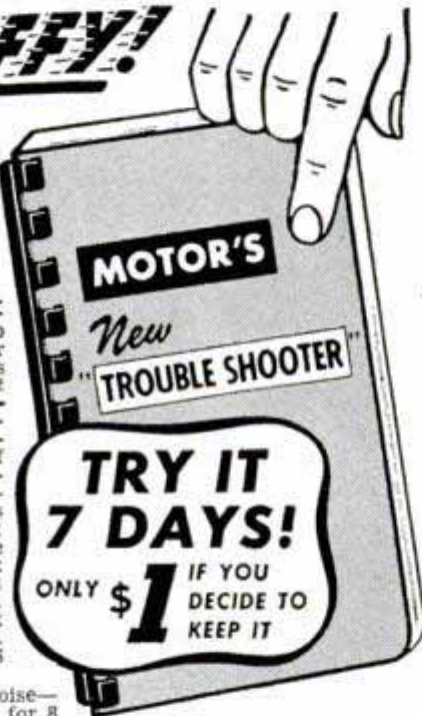

HOW TO SPOT —

87 Automatic Transmission Troubles. 8 Causes of Connecting Rod Noise. 87 Checks for Poor High-Speed Performance. Lack of Power. 82 Causes for Engine "Misses." 17 Checks for Pre-Ignition or Spark Knock. 45 Causes of Excessive Oil Consumption. 14 Causes of Crankshaft Noise. 73 Checks for Clutch Troubles. 66 Causes of Rear-Axle Trouble. 150 Checks for Front Suspension and Steering Troubles. 81 Causes of Brake Trouble. 27 Checks for Faulty Springs and Shock Absorbers. 84 Different Types of Wheel Troubles AND MUCH, MUCH MORE!

MOTOR Book Dept., Desk EY, 250 West 55th St., New York 19, N. Y.
Rush me MOTOR'S work-saving TROUBLE-SHOOTER. I will pay postman \$1 on delivery, plus 43c postage and actual Gov't. C.O.D. charges for each copy ordered. Unless completely satisfied, I may return book in 7 days and my money will be promptly refunded.

Name.....
Address.....
City..... Zone..... State.....

SAVE 43c POSTAGE, C.O.D. CHARGES.
Check if you send \$1 with coupon, then we pay shipping costs. Same refund guarantee.

New "Dope" On Automatic Transmissions Covers:

- HYDRAMATIC
- BUICK DYNAFLOW
- CHEVROLET POWERGLIDE
- PACKARD ULTRAMATIC
- STUDEBAKER AUTOMATIC

(Continued from page 14)

Easy method of cross hatching.....	214
Preventing clogged spray gun.....	219
Sprinkler heads in spraying booth protected by paper bags.....	226

PHOTOGRAPHY

Vent holes in reflector help cool floodlights.....	208
Positive connection for flash gun.....	208
Useful kinks for the camera gadget bag.....	209

ROOFING SHORT CUTS

Ladder secured to slanting roof without use of nailed brace.....	176
Dividers hold toolbox on roof.....	187
Roof cement secures shingles against strong winds.....	197
Loop anchors chalk line.....	219

TOOLS

Lathe tool for internal slotting is used as boring bar.....	214
Add a shaper to your lathe.....	215
Water-cooled diamond drill (Wheel Trueing Tool Co., 3200 W. Davison Ave., Detroit 6, Mich.).....	222
Magnetic holder (Cullen Mfg. Co., 1318 Clark St., Racine, Wis.).....	222
Adjustable clamp (Centinela Industrial Supply Co., 11930 Inglewood Ave., Hawthorne, Calif.).....	222
Easily handled level (Mayes Brothers Tool Mfg. Co., Port Austin, Mich.).....	222
Paintbrush handle (Wells Products, 14719 Armin Ave., Cleveland, Ohio).....	223
Wobble dado saw (Magna Engineering Corp., Menlo Park, Calif.).....	223
Preset timing control (Ampower Products Co., 5737 W. 87th St., Oak Lawn, Ill.).....	223
Ceiling-tile staple gun (Fastener Corp., 860 Fletcher St., Chicago 14).....	223
Portable electric sander (Black & Decker Mfg. Co., Towson 4, Md.).....	223
Wood-boring set (Time Saver Tools, Inc., Mundelein, Ill.).....	224
Electric paint remover (General Electric Co., Industrial Heating Dept., Schenectady 5, N. Y.).....	224
Hand-tapping guide (Forest City Bit & Tool Co., Rockford, Ill.).....	224
Swivel vise (Bellows Mfg. Co., 1017 N. Central Expressway, Dallas, Tex.).....	224

WOODWORKING

Folding table transported or stored easily.....	186
Rubber strips tighten shelves wedged between studs.....	187
Tape protects floor outlet when remodeling room.....	192
Modern coffee table to brighten living room.....	193
Attractive writing desk for child's room.....	197
Repairing loose furniture casters.....	210

WORKSHOP HINTS

Ax handle shock absorber.....	176
Abrasive mounted on sanding disk with photographic tissue.....	177
Ratchet wrench turns square bit.....	180
Container for small drills from old fountain pen.....	187
Leveling power-tool stands.....	196
Steel wool in blowtorch cup prevents spilling of gas.....	196
Graphite mixed with lighter fluid for out-of-the-way crevices.....	203
Angle irons lengthen vise jaws.....	214
Drill rack supports round work for boring lengthwise.....	219
Wire splices soldered quickly by altering tip of iron.....	219
Mark steel to avoid errors when shaping or planing.....	221
Thumbscrew on tap wrench locks handle in position.....	221
Loose-pin hinges lock workbench securely against shop wall.....	226

MISCELLANEOUS

Blanket-roll knot is slip-proof.....	176
Soles of child's shoes taped for play on waxed floors.....	176
Wooden doorstep tips flagstaff.....	176
Shield guards hunter's bootlaces.....	180
Fruit-box boards salvaged intact by sawing off ends of boxes.....	192
Alarm-clock spring used in scale for chemicals.....	203
Sealed refrigerator-wall duct.....	219
Steel balls drawn through tubing to true diameter after bending.....	225

Radio-Television, Electronics

TV system eliminates roof-top antennas (RCA Manufacturing Corp., Camden 2, N. J.).....	227
How to make your TV picture tube last longer.....	228
Wide-vision screen for movie theaters (RCA Manufacturing Corp., Camden 2, N. J.).....	231
New RCA tricolor TV tube (RCA Laboratories Div., Princeton, N. J.).....	232
Hearing aid for deaf radio-TV listeners (Masteradio Ltd., 10 Fitzroy Place, London N.W. 1, England).....	232
Standard TV receiver installed in artificial mantel and fireplace (Artcraft Mantel Co., 1811 W. Liberty Ave., Pittsburgh 26, Penna.).....	232
Combination UHF and VHF television antenna (LaPointe-Plascomold Corp., Rockville, Conn.).....	232
TV plug-in line voltage ballast (Clarostat Mfg. Co., Inc., Dover, N. H.).....	232
Device reactivates TV picture tubes (Transvision Inc., 460 North Ave., New Rochelle, N.Y.).....	232

IMPORTANT NOTICE—It is the intention of this magazine to provide its readers with information regarding the latest developments in the mechanical arts. We take no responsibility as to whether the disclosures contained in our articles are covered by patents and advise readers to investigate this subject before making, using, or selling any of the products, machines, or processes described in order to avoid possible liability for patent infringements.

BOOST YOUR EARNING POWER DURING THE HOURS THAT COUNT



"Every hour I spent on my I. C. S. Course has been worth \$95.00 to me! My position, my \$7,000 a year income, my home, my family's happiness - I owe it to spare-time training with I. C. S."

EVERY MAIL brings letters like this from men and women who studied I. C. S. courses in their spare time.

What are you doing with the hours after supper? Can you afford to let them slip by unimproved when you can easily make them mean so much?

No matter where you live, I. C. S. will come to you. No matter what your handicaps or achievements, whether you make \$2,000 or \$20,000 a year, I. C. S. has a plan to fit your needs exactly. No matter how limited your previous education, the simply written, fully illustrated I. C. S. textbooks make it easy to learn. No matter what career you may choose, some one of the 391 I. C. S. courses can be your springboard to success.

An hour or two a day spent with I. C. S. will prepare you for the position you want in the work you like best. Doubt it? Then put it up to us to prove it! Mark and mail this coupon - now! We'll send you full information plus free book, "How to Succeed."

INTERNATIONAL CORRESPONDENCE SCHOOLS



BOX 5556-L, SCRANTON 9, PENNA.

Without cost or obligation, send me "HOW to SUCCEED" and the booklet about the course BEFORE which I have marked X:

- | | | | | |
|---|---|---|---|--|
| <p>ART</p> <ul style="list-style-type: none"> <input type="checkbox"/> Commercial Art <input type="checkbox"/> Magazine and Book Illustrating <input type="checkbox"/> Cartooning <input type="checkbox"/> Show Card and Sign Lettering <input type="checkbox"/> Fashion Illustrating AUTOMOTIVE <input type="checkbox"/> Automobile, Mechanic <input type="checkbox"/> Auto-Elec. Technician <input type="checkbox"/> Auto Body Rebuilding and Refinishing <input type="checkbox"/> Diesel-Gas Engines AVIATION <input type="checkbox"/> Aeronautical Engineering Jr. <input type="checkbox"/> Aircraft Engine Mechanic <input type="checkbox"/> Airplane Drafting BUILDING <input type="checkbox"/> Architecture <input type="checkbox"/> Arch. Drafting <input type="checkbox"/> Building Contractor <input type="checkbox"/> Estimating <input type="checkbox"/> Carpenter and Mill Work <input type="checkbox"/> Carpenter Foreman <input type="checkbox"/> Reading Blueprints <input type="checkbox"/> House Planning <input type="checkbox"/> Plumbing | <ul style="list-style-type: none"> <input type="checkbox"/> Heating <input type="checkbox"/> Steam Fitting <input type="checkbox"/> Air Conditioning <input type="checkbox"/> Electrician BUSINESS <input type="checkbox"/> Business Administration <input type="checkbox"/> Certified Public Accountant <input type="checkbox"/> Accounting <input type="checkbox"/> Bookkeeping <input type="checkbox"/> Stenography and Typing <input type="checkbox"/> Secretarial <input type="checkbox"/> Federal Tax <input type="checkbox"/> Business Correspondence <input type="checkbox"/> Personnel and Labor Relations <input type="checkbox"/> Advertising <input type="checkbox"/> Retail Business Management <input type="checkbox"/> Managing Small Business <input type="checkbox"/> Sales Management <input type="checkbox"/> Salesmanship <input type="checkbox"/> Traffic Management CHEMISTRY <input type="checkbox"/> Chemical Engineering <input type="checkbox"/> Chemistry <input type="checkbox"/> Analytical Chemistry <input type="checkbox"/> Petroleum-Nat'l Gas <input type="checkbox"/> Pulp and Paper Making <input type="checkbox"/> Plastics | <p>CIVIL, STRUCTURAL ENGINEERING</p> <ul style="list-style-type: none"> <input type="checkbox"/> Civil Engineering <input type="checkbox"/> Structural Engineering <input type="checkbox"/> Surveying and Mapping <input type="checkbox"/> Structural Drafting <input type="checkbox"/> Highway Engineering <input type="checkbox"/> Reading Blueprints <input type="checkbox"/> Concrete Construction <input type="checkbox"/> Sanitary Engineering DRAFTING <input type="checkbox"/> Aircraft Drafting <input type="checkbox"/> Architectural Drafting <input type="checkbox"/> Electrical Drafting <input type="checkbox"/> Mechanical Drafting <input type="checkbox"/> Structural Drafting <input type="checkbox"/> Sheet Metal Drafting <input type="checkbox"/> Mine Surveying and Drafting ELECTRICAL <input type="checkbox"/> Electrical Engineering <input type="checkbox"/> Electrician <input type="checkbox"/> Electrical Maintenance <input type="checkbox"/> Electrical Drafting <input type="checkbox"/> Electric Power and Light <input type="checkbox"/> Lineman HIGH SCHOOL <input type="checkbox"/> High School Subjects | <ul style="list-style-type: none"> <input type="checkbox"/> College Preparatory <input type="checkbox"/> Mathematics <input type="checkbox"/> Commercial <input type="checkbox"/> Good English MECHANICAL AND SHOP <input type="checkbox"/> Mechanical Engineering <input type="checkbox"/> Industrial Engineering <input type="checkbox"/> Industrial Supervision <input type="checkbox"/> Foremanship <input type="checkbox"/> Mechanical Drafting <input type="checkbox"/> Machine Design-Drafting <input type="checkbox"/> Machine Shop Practice <input type="checkbox"/> Tool Design <input type="checkbox"/> Industrial Instrumentation <input type="checkbox"/> Machine Shop Inspection <input type="checkbox"/> Reading Blueprints <input type="checkbox"/> Toolmaking <input type="checkbox"/> Gas-Electric Welding <input type="checkbox"/> Heat Treatment-Metallurgy <input type="checkbox"/> Sheet Metal Work <input type="checkbox"/> Sheet Metal Pattern Drafting <input type="checkbox"/> Refrigeration POWER <input type="checkbox"/> Combustion Engineering <input type="checkbox"/> Diesel-Electric <input type="checkbox"/> Electric Light and Power | <ul style="list-style-type: none"> <input type="checkbox"/> Stationary Steam Engineering <input type="checkbox"/> Stationary Fireman RADIO, TELEVISION, COMMUNICATIONS <input type="checkbox"/> General Radio <input type="checkbox"/> Radio Operation <input type="checkbox"/> Radio Servicing-FM <input type="checkbox"/> Television <input type="checkbox"/> Electronics <input type="checkbox"/> Telephone Work RAILROAD <input type="checkbox"/> Locomotive Engineer <input type="checkbox"/> Diesel Locomotive <input type="checkbox"/> Air Brakes <input type="checkbox"/> Car Inspector <input type="checkbox"/> Railroad Administration TEXTILE <input type="checkbox"/> Textile Engineering <input type="checkbox"/> Cotton Manufacture <input type="checkbox"/> Rayon Manufacture <input type="checkbox"/> Woolen Manufacture <input type="checkbox"/> Loom Fixing <input type="checkbox"/> Finishing and Dyeing <input type="checkbox"/> Textile Designing HOME ARTS <input type="checkbox"/> Dressmaking and Designing <input type="checkbox"/> Cookery <input type="checkbox"/> Tea Room Management |
|---|---|---|---|--|

Name _____ Age _____ Home Address _____
 City _____ State _____ Working Hours _____ A.M. to _____ P.M.
 Occupation _____

Special tuition rates to members of the Armed Forces. Canadian residents send coupon to International Correspondence Schools Canadian, Ltd., Montreal, Canada

In your Mind's Eye

The Secret of MENTAL CREATING

IF you just like to dream, read no further. There comes a time when your fancies *must be* brought into light—and stand the test of every-day, hard realities. Are you one of the thousands—perhaps millions—whose thoughts never get beyond the stage of *wistful wishing*? Do you often come to from a daydream with the sigh, "If only I could bring it about—*make it real*?"

All things begin with thought—it is what follows that may take your life out of the class of those who hope and dream. Thought energy, like anything else, can be dissipated—or it can be made to produce actual effects. *If you know how to place your thoughts* you can stimulate the creative processes within your mind—through them you can assemble things and conditions of your world into a happy life of accomplishment. *Mental creating* does not depend upon a magical process. It consists of *knowing how* to marshal your thoughts into a power that draws, compels and organizes your experiences into a worth-while design of living.

ACCEPT THIS *Free* BOOK

Let the Rosicrucians tell you how you may accomplish these things. The Rosicrucians (not a religious organization), a world-wide philosophical fraternity, have preserved for centuries the ancients' masterful knowledge of the functioning of the inner mind of man. They have taught men and women how to use this knowledge to *recreate their lives*. They offer you a free copy of the fascinating book, "The Mastery of Life." It tells how you may receive this information for study and use. Use coupon opposite.

The ROSICRUCIANS
(AMORC)

SAN JOSE

CALIFORNIA

SCRIBE: O. J. H.
The Rosicrucians (AMORC),
San Jose, California.

Please send free copy of "The Mastery of Life,"
and I shall read it as directed.

Name.....

Address.....

City.....

**Train QUICK
in Big Coyne
Shops**

GREAT OPPORTUNITY FIELDS!

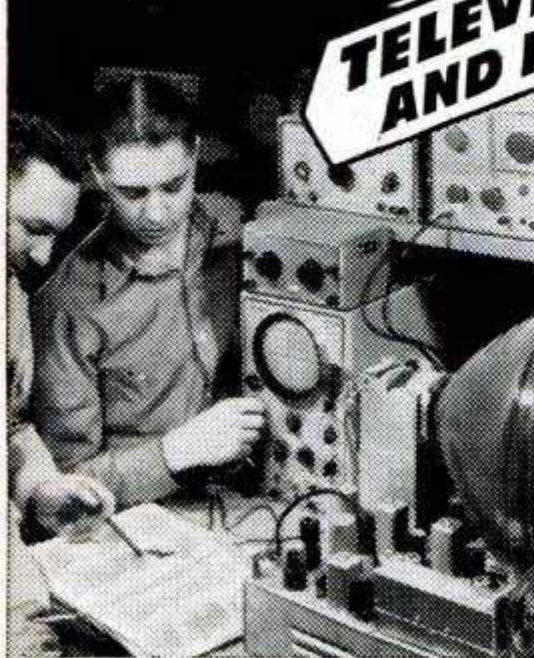

Instructor helping students check the wiring and trace the circuits of television receivers.



This big fire-proof building is occupied entirely by Coyne.



Instructor explaining operation and testing of a large Motor Generator.

TRAINED YOUNG AND OLDER MEN— URGENTLY NEEDED IN VITAL FIELDS!

ELECTRICITY—RADIO—TELEVISION—ELECTRONICS—VITAL in defense program. Trained men whether 16 or up to 50 needed. **TRAIN QUICKLY** for better rating if drafted—Vital job in industry if not.

TELEVISION-RADIO ELECTRICITY

Here at **COYNE** you're retrained for Television, Testing, Trouble-Shooting on Radio, Public Address, F. M. Sound Units, etc. Many Coyne trained men in good jobs or own well paying Television-Radio businesses of their own.

Big future in Power Plant Work, Motors, Industrial Electronics, Armature Winding, Home and Factory Wiring, Appliances, Refrigeration, Maintenance, Illumination, etc. Lifetime job service to Coyne graduates.

WE TRAIN YOU IN CHICAGO

Our famous Practical-Technical method gives you practical experience on a massive outlay of equipment. Actual shop work plus necessary technical training. You are trained right here in the great Coyne shops. Send for **BIG FREE BOOK**.

LARGEST, OLDEST, BEST EQUIPPED SCHOOL OF ITS KIND IN THE U.S.

Mail Coupon for Big FREE Book!



Whether you prefer Television-Radio or Electricity, train on actual equipment at Coyne. We will send you a Big, fully Illustrated Book. Indicate below which course interests you most. No salesman will call. Mail coupon TODAY.

**APPROVED
FOR
VETERANS**

START NOW—PAY LATER

Enroll now, pay most of tuition after graduation. Special plan for men of draft age. We'll help you get part-time work, if you need it to help pay living costs while at Coyne.

B. W. COOKE, President

COYNE
SCHOOL

A TECHNICAL TRADE INSTITUTE
CHARTERED NOT FOR PROFIT
Established 1899
500 S. Paulina Dept. 13-72H
Chicago 12, Illinois

ELECTRICITY ★ TELEVISION ★ RADIO ★ REFRIGERATION ★ ELECTRONICS

B. W. Cooke, President
COYNE SCHOOL, 500 S. Paulina St.
Dept. 13-72H, Chicago 12, Ill.

Send me your Big Free book. I am interested in field checked below. This does not obligate me.

TELEVISION-RADIO ELECTRICITY

NAME.....

ADDRESS.....

CITY.....STATE.....



SEND NO MONEY
MORE THAN 4000 PAGES
2750 PICTURES

9 BIG COMPLETE BOOKS
BUILDING, ESTIMATING, CONTRACTING

Examine this Up-to-Date Edition for 10 days. See how these nine books supply easily understood training that will help you to get a better job and make more money, or start a profitable business for yourself. Think what a BIG help it will be to have them handy for use in solving all sorts of building problems.

Learn to draw plans, estimate, do all-new construction and modern remodeling to meet fast growing demand. More than 4000 pages of practical, pay-raising information with 2750 helpful illustrations, on such subjects as blueprint reading, concrete forms, masonry, carpentry, steel square, electrical wiring, plumbing, heating, painting, and hundreds more.

In our more than 50 years we have never offered more complete building information. Send the coupon TODAY.

(A year's consulting privileges with our engineers now given with these books without extra cost.)

AMERICAN TECHNICAL SOCIETY—Publishers Since 1898
 Dept. G119, Drexel Ave., at 58th St., Chicago 37, Ill.

I would like to examine your 9-Volume Set of Building, Estimating, Contracting Books. I will pay the delivery charges only, but if I choose I may return them express collect. If after 10 days' use I prefer to keep them, I will send you \$3 plus postage and pay the balance at the rate of only \$4 a month until \$34.80 has been paid.

Name _____

Address _____

City _____ State _____

Please attach letter giving employer's name and address (if self-employed give business man reference). Men in service please give home address.

Rapid Promotion for NORTHROP Engineering Grad

It's another promotion—the second in two years—for Howard Sherman! Since graduation from Northrop Aeronautical Institute, Howard has held an interesting and exciting job solving assembly, ducting, motor-mounting, and other engineering problems on advanced design and experimental aircraft. His Northrop training has helped speed his progress toward success!



Northrop Graduates Have Vast Opportunity! Hundreds of NORTHROP graduates are building successful careers in every phase of aviation. The enviable records of achievement they have established have created an increasing demand for NORTHROP graduates. This demand is so great that NORTHROP graduates are offered their choice of interesting, exciting, profitable jobs PRIOR TO GRADUATION!

Begin Your Aviation Career at Northrop! NORTHROP AERONAUTICAL INSTITUTE is an accredited technical institute open to public enrollment. NAI offers courses in AERONAUTICAL ENGINEERING and AIRCRAFT & ENGINE MECHANICS that are thorough, practical, and complete! A NORTHROP Catalog outlining courses and picturing the advanced training facilities will be mailed on request. Fill in the coupon below.

KOREA VETERANS... NAI training is fully approved for all veterans.

Northrop Aeronautical Institute

1527 E. Broadway, Hawthorne, Los Angeles County, Calif.

NORTHROP AERONAUTICAL INSTITUTE
 1527 E. Broadway, Hawthorne, Los Angeles County, Calif.

Please send me immediately the Northrop catalog, employment data, and schedule of starting dates of classes. I am interested in:

Aeronautical Engineering * Aircraft & Engine Mechanics

Name _____ Age _____

Address _____

City _____ Zone _____ State _____

VETERANS: Check here for Special Veteran Training Information

SNIS-A



MAKE EXTRA MONEY **PLASTICS** **LEARN AT HOME**

LEARN HOW TO MAKE fast-selling PLASTIC NOVELTIES FURNITURE JEWELRY SIGNS TOYS LAMPS WRITE TODAY!

There are RICH OPPORTUNITIES for MEN and WOMEN with "know-how" in Plastics. Interstate's new Plastics course tells and shows how to make hundreds of fast selling items out of Plastics. Gives complete training in fabrication, casting, lamination, molding, internal carving, etc., in simple, easy, step-by-step language and pictures. Plastics and Fabricating Kits for 23 valuable Plastic items come with training at no extra cost. **START A PLASTICS BUSINESS OF YOUR OWN.** No other industry holds such promise for the future. You can make big money manufacturing novelties, toys, signs, etc., in your own home in spare or full time. Don't wait! Learn NOW how Interstate's Plastics Training qualifies you for success in the Plastics field.

PLASTICS AND SUPPLIES FURNISHED FOR 23 VALUABLE PROJECTS

INTERSTATE TRAINING SERVICE
 Dept. C3A Portland 13, Oregon

Bar Bells

Buy Direct From Factory \$8.95 up

Write for free booklet and price list

INDEPENDENT IRON WORKS
 2416 East 23rd Street, Dept. B
 Los Angeles 58, Calif.

REAL ESTATE **BE A BROKER**

PAYS BIG! SEND FOR FREE, BIG, ILLUSTRATED CATALOG NOW! Graduates report making substantial incomes. Start and run your own business quickly. Men, women of all ages, learn easily. Course covers Sales, Property Management, Appraising, Loans, Mortgages, and related subjects. **STUDY AT HOME** or in classrooms in leading cities. Diploma awarded. **WRITE TODAY** for free book! No obligation.

WEAVER SCHOOL OF REAL ESTATE (Est. 1936)
 Suite 300 Law Bldg. Dept. PM Kansas City, Mo.

FREE BOOK TELLS HOW

LEARN WATCH REPAIRING

AT HOME. By our modern and original system of instruction you can learn every part of the **WATCH REPAIRING TRADE AT HOME.** Prepare yourself for a well-paying position or start in business after completing our course of instruction. Good watch repairers are in demand and generally earn very good salaries. For particulars apply to the **WISCONSIN SCHOOL OF WATCH REPAIRING**
 759 N. Milwaukee, Dept. 1, Milwaukee 2, Wis.

RUPTURE!

An amazing Air-Cushion Invention allows body freedom at work or play. Light, neat, cool, sanitary. Durable, cheap. Day and night protection helps Nature support weakened muscles gently but surely. No risk. **Sent on Trial!** Write NOW for free Booklet and **Proof of Results.** All correspondence confidential.

Brooks Co., 373-B, State St., Marshall, Mich.

STUDY LAW FREE AT HOME **LAW BOOK!**

Prepare for the Bar!

Write today for a copy of our FREE book, "The Law-Trained Man," which gives the bar rules in your state and tells how ambitious men and women since 1890 have been preparing at home in spare time for the practice of law by studying the famous Blackstone bar-training course. All needed instruction material is furnished including big 16-volume law library. Law diploma awarded. Moderate tuition; easy monthly terms. Write for FREE book today!

BLACKSTONE SCHOOL OF LAW
 225 N. Michigan Ave., Dept. 51, Chicago 1, Illinois



Get Shop-Method Training at Home for success in **RADIO TELEVISION ELECTRONICS**

One Master Course - One Low Tuition
LEARN ALL PHASES - EARN WHILE YOU LEARN

AS A NATIONAL SCHOOLS GRADUATE THERE'S A PLACE FOR YOU IN THIS EXPANDING INDUSTRY...Never before such a demand for you! For never before such a growing industry as today's Television, Radio and other Electronic fields. This industry needs you... TODAY... and it needs you as a trained man... the kind of man you will be as a National Schools graduate. So don't wait. Start your National Schools training NOW...and enjoy big money, job security, SUCCESS!

LEARN from EXPERTS! BE A SUCCESSFUL MAN YOURSELF! You learn from men who are themselves successful Radio, Television and Electronics technicians. You learn the practical way... by doing... with equipment we send you. And you advance quickly, step by step. Get ALL the facts from FREE book and sample lesson. Mail coupon below NOW. Absolutely no obligation.

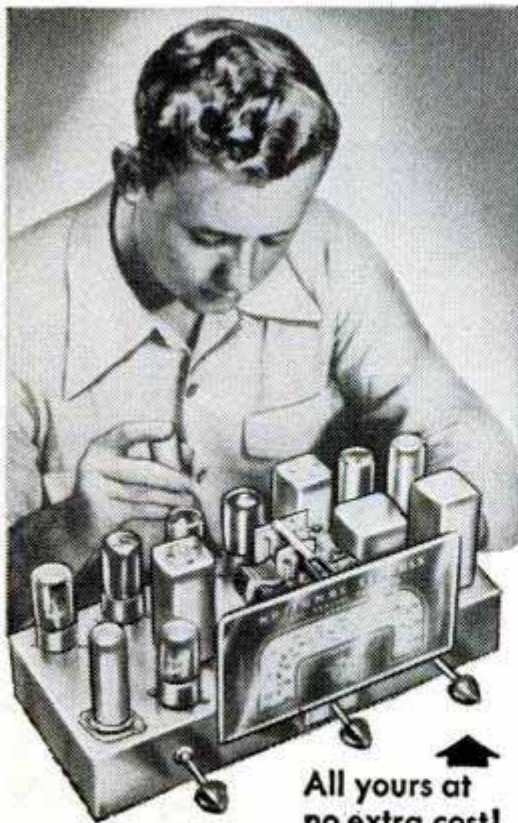

All yours at no extra cost!

You can qualify FAST for these big-pay jobs...plus many more

Radio Station Technician • Your own Sales and Service Shop • District Service Manager • Inspector Technician • Aircraft Radio Inspector • Special Govt. Positions • Service Specialist • Sound Truck Operator • and many others!

ONLY NATIONAL SCHOOLS GIVES YOU THIS PROFESSIONAL



MULTI-TESTER
Ready to use. Easy to operate. Light enough to carry on service calls.

DRAFT AGE? National Schools training helps you get into special service classifications—get higher grades, better pay!

GET YOUR TRAINING FROM THE RADIO-TV CAPITAL OF THE WORLD

Let National Schools



—a resident technical trade school for nearly 50 years—train you at home for today's unlimited opportunities in Radio-TV.



FREE!

Radio-TV Book & Sample Lesson JUST MAIL COUPON!

NATIONAL SCHOOLS GRADUATES IN BIG DEMAND. You'll find National Schools graduates in good jobs everywhere. For these are the jobs National Schools trains you for. Such complete, shop-method home training can be your ticket to success...your key to the job happiness you've always wanted. It's up to you. Mail coupon NOW!

FRIENDLY GUIDANCE AS STUDENT AND GRADUATE. Our special Welfare Department is constantly at your service. Helps you with your technical and personal problems. Gives you the benefit of its wide industry contacts and experience in helping you after graduation. **GET THE FACTS—ALL OF THEM—NOW!**

NATIONAL SCHOOLS APPROVED FOR G. I. TRAINING

Los Angeles, Calif. • Est. 1905 • In Canada: 193 Hastings St., Vancouver, B.C.

YOU GET ALL THE PARTS INCLUDING TUBES for this superheterodyne receiver... and lots of other equipment...to keep!

NATIONAL SCHOOLS, Dept. RB-13
4000 South Figueroa Street
Los Angeles 37, California

Mail in envelope or paste on postal card

Mail me FREE the book mentioned in this ad. Also a FREE sample lesson. I understand no salesman will call on me and that there is no obligation.

NAME _____ AGE _____

ADDRESS _____

CITY _____ ZONE _____ STATE _____

VETS! Check here if you are a veteran.

Don't put it off! Mail coupon NOW!

EXTRA CASH



for YOU!
TAKING ORDERS
 Full Time—Spare Time for
STARK FRUIT
TREES

Send No Money—You don't need experience to Make Money this EASY WAY! Show friends, neighbors, others how to make small back yards, vacant lots, and tiny plots produce bushels of luscious, taste-tempting fruit—Apples, Pears, Plums, Peaches, Cherries, Berries, etc.—and cut food costs to the bone. Take orders for hardy, new, Quick-Bearing Stark Fruit Trees. Sensational U.S. Patent Leaders bring easy orders, pay you rich rewards in extra cash profits. Added income with beautiful Stark Ornamentals, Roses, Shrubs to home owners. Enormous demand for attractive landscaping. Stark Bro's is largest and oldest nursery in the world. Join the leader.

SENSATIONAL DWARF FRUIT TREES
 Ideal for backyard and vacant lot orchards. Yield fruit years earlier! One bushel or more of full size fruit from each tree. Plant up to 9 trees in only 20 ft. sq. plot. Sell everywhere—make money!



FREE SALES OUTFIT AND BEAUTIFUL PLATE BOOK—Everything you need to make money—given you FREE. Just send name, address on Coupon below. No experience is needed. Giant demonstration Sales Outfit includes beautiful color Photo Plate Book. Write

STARK BRO'S
 Desk 5513, Louisiana, Missouri

Rush FREE Demonstration Sales Outfit. Include your new 1953 Stark Colorphoto Catalog—showing Stark Fruit, Berries, Ornamentals.

NAME _____ PM 1-53
 ADDRESS _____ COUNTY _____
 TOWN _____ STATE _____

Learn this Profitable Profession



IN 90 DAYS AT HOME

Money-Making Career Open to Men and Women, 18 to 60

Hundreds of men and women between 18 and 60 make \$10 to \$20 in a single day giving scientific Swedish Massage and Hydro-Therapy treatments. There is big demand from doctors, hospitals, sanatoriums and clubs. Graduates earn large full time income from these or in private practice in their own offices. Others make good money from home treatments given in spare time. Learn this interesting money-making profession in your own home, through our home study course. Same instructors as in our nationally known resident school. You can win independence and prepare for future security by qualifying for your Graduation Certificate. Course can be completed in 3 to 4 months. Many earn while they learn. Begin your training at once.



NEW 32-PAGE BOOKLET FREE

Fill in the coupon below (please print name and address) and mail it for your FREE copy of 32-page Information Booklet. If you act at once we will include Anatomy Charts and Success Booklet which supply additional information you should have. All will be sent postage paid.

THE COLLEGE OF SWEDISH MASSAGE
 Dept. 364A, 41 E. Pearson St., Chicago 11, Illinois
 Please send me FREE and postpaid New 32-Page Illustrated Booklet, Anatomy Charts and Success Booklet at once.

Name _____ Age _____
 Address _____
 City _____ State _____

EASE COLD MISERY



Take Tabacin

AT ALL DRUG STORES • 45c and 75c SIZES

Macmillan Ring-Free Motor Oil

will increase gasoline mileage an average of 8%. For further information write R. S. Macmillan, President, **MACMILLAN PETROLEUM CORPORATION**, 530 West Sixth Street, Los Angeles

\$750 BUILDS 4 ROOMS & BATH!

WHY PAY RENT?

For Seven Hundred Fifty Dollars and 30 days of your spare time, you can build yourself this Beautiful Home. Living Room 11x15, Front bedroom 9x11, Back bedroom 10x12, Kitchen 9x11, Bath 5x8, Hall 3x4. Wind out steel casement windows, Concrete block, stuccoed. Illustrated pictures, step by step instructions, blueprint and material list, \$1.00. Money back guarantee. L. H. FARROW, Dept. C, Box 645, Columbus 16, Ohio



PINS 35¢ up RINGS \$1.65 up
 52 For your class or club. Over 300 designs. Finest quality. Write Dept. K, Metal Arts Co. Rochester, N. Y. Send 5¢ for Catalog

Learn ACCOUNTING Business Administration

Bookkeeping, secretarial and allied subjects at home in your spare time or attend nationally approved resident school. Write for FREE Success Book giving complete information about courses, plans, rates and employment opportunities.

Hills BUSINESS UNIVERSITY AND EXTENSION SCHOOL
 619 W. MAIN ST. OKLAHOMA CITY 2, OKLAHOMA

ESSENTIAL IN PEACE OR WAR AVIATION

- MASTER A & E MECHANIC
- PILOT AND SPECIALIST
- DRAFTING AND DESIGN

The aviation industry urgently needs properly trained young men for essential civilian aviation positions. Embry-Riddle offers maximum training in minimum time. Fully accredited 6-month to 2-year courses in all aeronautical phases also aid rapid military advancement if called to armed forces. Thorough, practical instruction backed by 25 years' experience training today's aviation leaders. Complete school campus. Training authorized under G.I. Bill. Enroll today!

Illustrated catalog, address: Registrar, Dept. 99, Miami 30, Fla.
Embry Riddle International SCHOOL OF AVIATION
TRAIN IN MIAMI -- AIR CAPITAL OF THE WORLD

NOW...from D.T.I.'s MILLION DOLLAR TRAINING CENTER

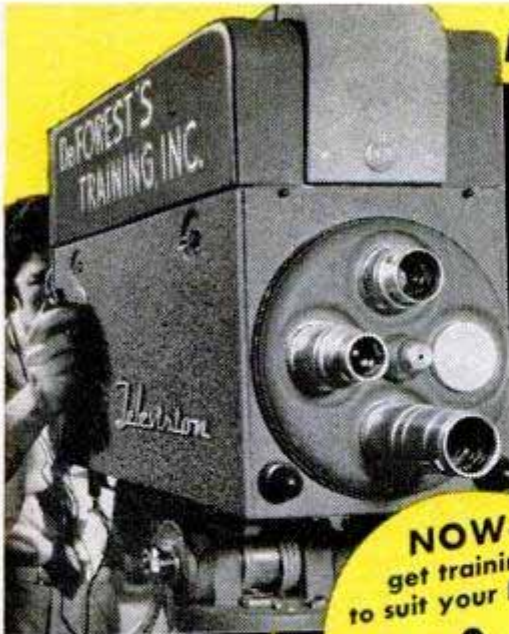

Learn to master TELEVISION

RADIO - ELECTRONICS

by getting **EVERYTHING YOU NEED!**

NOW—
get training
to suit your NEEDS

TAKE YOUR
CHOICE

Come to
D.T.I.'s
great **CHICAGO
LABORATORIES**

...one of the Nation's **FINEST!**

Now, in the heart of the nation's TV Center, you can get all of your preparation in D.T.I.'s big, modern, wonderfully equipped training laboratories. Loads of commercial equipment and ample, well qualified instructors help you get a thorough, practical preparation in the **SHORTEST POSSIBLE TIME**. Part time student Employment Service can help you pay your way while in training.

EMPLOYMENT SERVICE

As soon as you complete either the Chicago Laboratory or Home Training, you'll find D.T.I.'s grand Employment Service ready to help you start earning real money. Get full facts. Mail coupon today.

MILITARY SERVICE! If you're subject to military service, the information we have for you should prove very helpful. Mail coupon today.

89 WAYS TO EARN MONEY
IN TELEVISION
RADIO ELECTRONICS

ACT NOW! MAIL COUPON TODAY
Get this publication **FREE!**

DeFOREST'S TRAINING, INC. DEPT. PM-1-J
2533 N. ASHLAND AVE., CHICAGO 14, ILLINOIS

I would like your Opportunity News Bulletin showing "89 Ways to Earn Money in Television-Radio-Electronics"; also, complete facts about the training opportunity made possible by your organization.

Name _____ Age _____

Address _____ Apt. _____

City _____ Zone _____ State _____

America's amazing multi-billion dollar Television field now offers you a chance of a lifetime to get started toward a grand job or your own business. With TV station limit now raised from 108 to 2053, Television is headed for almost every community. Mail coupon today. See how you may prepare to cash in on the coming TV 800M.

Get **ALL** of your training
AT HOME!...including setting
up your own **HOME LABORATORY**

If unable to come to D.T.I.'s big Chicago laboratories, we'll provide you with one of today's most complete and effective combinations of major home training aids. Not only will you get (1) well illustrated lessons and (2) the unique and wonderful aid of instructive **HOME MOVIES**, but you'll also (3) set up your own **HOME LABORATORY**

You'll get and keep 16 big shipments of electronic parts—the same type of basic equipment used by students in our wonderfully equipped Chicago laboratories. You'll work over 300 interest-gripping experiments for the practical experience you need. This even includes building and keeping the valuable commercial test equipment and Super Radio Set shown at left. Mail coupon today for the whole exciting story.



Build a 17 inch TV set

After completing foregoing training, and for a moderate added cost, you may build and keep this top quality, 17 inch TV Receiver—an optional feature for valuable added experience.

Use 16 mm. **MOVIES** Only D.T.I. provides you with the loan of visual training movies of home to help you master important basic points faster... easier... better!

"ONE OF AMERICA'S FOREMOST
TELEVISION TRAINING CENTERS"

Established 1931



De FOREST'S TRAINING, INC.
AFFILIATED WITH
De VRY Technical INSTITUTE
CHICAGO 14, ILLINOIS

No Waiting to LEARN
START NOW TO EARN!
 This BIG BOOK SHOWS HOW



THIS IS YOUR BIG OPPORTUNITY!

Never before has a more helpful book been printed for those planning a business of their own. Gathered in this large illustrated volume are the formulas, recipes, facts and secrets that have contributed so largely to America's great industrial progress. Capitalize on this information for making most any conceivable product without experience, special equipment or previous knowledge of chemistry or manufacturing.

The experts who compiled this book are authorities, and present this information in simple, understandable language. They also give you wholesale supply sources for needed materials, short cuts and methods for the most profitable results.

FORTUNES FROM A SINGLE IDEA

Hundreds of good paying businesses have been built on a product made from a simple recipe. Choose from any of the 162,000 facts and 10,000 formulas of which the following are only a very few: Adhesives, Alloys, Anti-Freeze Solutions, Cosmetics, Beverages and Liquors, Candy, Gum, Casein, Celluloid, Ceramics, Cheese, Cleaning Preparations, Concrete, Copper, Cotton, Dentifrices, Depilatories, Dyes, Embalming Fluids, Enameling, Glass, Glazes, Gold, Household Formulas, Inks, Insecticides, Iron, Jewelers' Formulas, Lacquers, Laundry Preparations, Leather, Linoleum, Lubricants, Manicure Preparations, Marble (artificial), Metals, Mirrors,

ALSO

We include Free —our new book of helpful money-making information: —“The More You Know the More You Can Earn—Easier and Quicker.”

Oils and Ointments, Paints, Paper, Perfumes, Photographs, Polishes, Powders, Remedies for Man, Beast or Fowl, Rubber Products, Refrigerants, Soaps, Solder and Soldering, Tooth Cements, Transfers, Varnishes and Thousands of others for making all sorts of profitable and practical things.

BEAT THE HIGH COST OF LIVING

Homemakers and business men make substantial savings with this comprehensive book. It is an accepted authority by chemists, schools, industry, etc. and is the largest and most comprehensive book of its kind ever issued. Nothing else like it in existence. A single formula has been worth a thousand times this book's small cost to countless owners. Crammed with money-making ideas, invaluable for reference. Ideal for Factory, Home, Farm, Office or Workshop. As necessary as the dictionary and more useful for manufacturers, chemists and salesmen who put up products for profit.



\$3.98 postpaid anywhere. (Send \$1., pay balance C.O.D., U. S. only). Immediate same-day shipment. Safe Delivery Guaranteed.
ADAMS BROWN COMPANY BOOKS OF APPLIED SCIENCE
 Dept. 102, Chestnut Hill 67, Massachusetts, U. S. A.



Garlinghouse HOME PLANS

America's Pioneer Home Plan Service for Better Living

5 LATEST PLAN BOOKS — 1 TO 4 BEDROOM SIZES

- **“PLANS FOR 100 NEW HOMES”**
100 Sparkling new designs, 16 pages in full color.....50c
- **“CHOICE SELECTED HOMES”**
Over 75 homes pictured — 32 in full color.....50c
- **“PLANS FOR NEW HOMES”**
108 varied styles — 16 pages in full color.....50c
- **“RANCH AND SUBURBAN”**
125 plans most practical for town and country. Ranch styles and many others.....50c
- **“AMERICA'S BEST HOME PLANS”**
Over 125 designs, many in colors. A wonderful selection...50c

Select your new home from the hundreds of photographs and colored drawings in these five books. All sizes and styles are shown along with accurate description and floor plan of each. Complete working plans, specifications, lumber and mill lists are available for every design at low cost which is listed with each design. The moderate price of these plan sets is your best investment when building, since you know in advance what you are getting, thus avoiding misunderstandings. Complete plan sets when ordered will be sent by return mail on a money-back guarantee basis if unused plans are returned in five days.

Our Complete Home Plan Library—22 Books and over 1,250 Home Designs—A \$12.50 value—Only \$10.00
ORDER YOUR BOOKS TODAY
 All Books POSTPAID. No C.O.D.'s Please

L. F. GARLINGHOUSE CO., INC., Box PM-18 TOPEKA, KANSAS

INSURED TIRE SERVICE
POPULAR BRANDS
FREE INSURANCE POLICY given with each used tire sold. We guarantee the amount of service you pay for.
 Tube Given Free with Each Used Passenger Tire Upon Request

Super Quality — Rugged Performance — 15 Months Insured Service		Supreme Quality. Nothing Finer — 30 Months Insured Service	
600x16 \$4.55	670x15 \$5.25	700x16 10.45	750x16 8) 15.95
650x15 4.95	670x16 5.35	710x15 10.95	900x20 19.95
650x16 5.45	700x15 5.40	760x15 5.95	1000x20 20.45
		700x20 12.50	1100x20 26.75
		750x16 12.50	710x15 11.95
		32x6(8) 12.75	1100x22 19.50
		760x15 6.95	32x6(10) 12.75
		750x20 14.50	1200x20 23.50
		825x18 5.75	475x19 5.75
		600x16 10.95	670x16 11.75
		640x15 11.45	700x15 13.95
		650x15 11.95	710x15 13.95
		680x16 11.95	760x15 14.95
		670x15 11.95	820x15 15.95

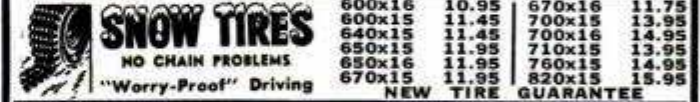

MIDLAND TIRE SALES
 1141 W. Randolph St., Dept. PM-6, Chicago 7, Ill.
 Speedy shipments on Mail Orders. F.O.B. Chicago. Insurance policy sent with each order. Deduct 10% on orders for 2 or more used tires. Send CHECK or MONEY ORDER.—No COD's.

NEW SEED CATALOG



Write today for Will's big New 70th Anniversary 1953 CATALOG. 80 pages packed with the finest hardy northern grown flowers, vegetables, fruits, berries, trees, evergreens, farm seed and Pioneer Hybrid Corn. Early, hardy varieties. Special low mail order prices for early orders. Send card or letter today for FREE COPY.

OSCAR H. WILL & CO.
 BOX 600-4G BISMARCK, NO. DAKOTA

BECOME AN EXPERT IN TRAFFIC

Traffic men earn \$4,000 to \$10,000 and up. Thousands of firms need experts on rates, tariffs, regulations. We train you thoroughly in spare time at home for executive traffic jobs. Personal training under traffic authorities. Placement counsel and help. Write for free 48-page book "Traffic Management—the Fast Growing Profession."

LASALLE Extension University, 417 So. Dearborn St.
 A Correspondence Institution Dept. 1647 Chicago 5, Ill.

FALSE TEETH
KLUTCH holds them tighter

KLUTCH forms a comfort cushion; holds dental plates so much firmer and snugger that one can eat and talk with greater comfort and security; in many cases almost as well as with natural teeth. Klutch lessens the constant fear of a dropping, rocking, chafing plate. 25c and 50c at druggists. . . If your druggist hasn't it, don't waste money on substitutes, but send us 10c and we will mail you a generous trial box.

KLUTCH CO. Box 5393-A ELMIRA, N. Y.

Tool and Die Design Training

\$8,000 to \$15,000 YEARLY INCOME!
 ACME training has been fully proved in practice through its fine resident schools. Acme graduates report outstanding promotions, resulting in higher salaries. Progress is sure and easy through Acme's famous "COPE" System. Prepare yourself IN YOUR SPARE TIME for a secure position of responsibility and high earnings, and qualify at a time when you will have every opportunity to rise to a position in the \$8-15,000 per year salary bracket. Be successful—Go Farther Faster!
 Detailed information upon request.

ACME SCHOOL OF DIE DESIGN
 (Correspondence Division, Dept. M)
 8 N. JEFFERSON STREET DAYTON 2, OHIO

Now Any AUTO REPAIR JOB Can Be a "Push-Over" for You!

**IN LESS TIME—WITH LESS
WORK—AND MORE PROFITS!**



NOW, tackle anything from carburetor to rear end on ANY car built from 1935 thru 1952. And fix it quick, easy, right the **FIRST** time! Just look up make, model, and job in quick index of **MOTOR's giant-new AUTO REPAIR MANUAL**. Clear, illustrated instructions lead you step by step all the way. Covers all automatic and semi-automatic transmissions including the new Dual-Range Hydra-Matic, the new Power Steering.

ONLY Manual of Its Kind!

The engineer-editors of **MOTOR** Magazine condensed all the meat of over 170 official factory manuals for you. They dug out all the information you need—made sure every word and picture is crystal clear—and put the whole "works" into this one big 780-page book. Contains 225,000 service, repair, tune-up facts. 38,000 essential dimensions! More than 2400 cut-away photographs, diagrams, charts show what the clear text tells.

Win Prestige! Earn More Money!

MOTOR's Manual makes every operation so easy that you'll find yourself tackling jobs you wouldn't think of doing before. And you'll win added prestige and more money in the bargain.

Beginners will find usable helpful guidance on every kind of repair and service job imaginable. Experts will be amazed by the time and labor-saving short cuts.

This **GIANT** Manual is used by Army, Navy, Technical Schools, and thousands of successful auto-repairmen. Now **YOU** can try it **FREE** for 7 days. Learn firsthand how it can pay for itself the first few times you use it!

SEND NO MONEY

Mail coupon below — *without money!* When your book arrives — *make it show you what it's got!* Unless you agree it's the greatest time and work saver you've ever seen—return book in 7 days and pay nothing. Mail coupon **NOW!** **MOTOR** Book Department, Desk 11, 250 West 55th St., New York 19, N. Y.



**Just 2 of the Many
Letters of Praise**

"**MOTOR's** Manual paid for itself on the first 2 jobs, and saved me valuable time by eliminating guesswork." — **W. SCHROP**, Ohio

"Instructions so clear have no trouble learning anything about any car. Now working as mechanic in big plant." — **SAM ORDONEZ**, California



**COVERS 851 MODELS—
ALL THESE MAKES**

- Buick Henry J
- Cadillac Hudson
- Chevrolet Kaiser
- Chrysler Lafayette
- Crosley La Salle
- De Soto Lincoln
- Dodge Mercury
- Ford Nash
- Frazer Nash
- Rambler
- Oldsmobile
- Packard
- Plymouth
- Pontiac
- Studebaker
- Terraplane
- Willys



ABOVE: Showing operation of Buick Dyna-Flow — and, **BELOW:** How to adjust Ford Clutch. Every moving part is covered in simple words and **BIG, CLEAR** Pictures.

**Same FREE Offer on
MOTOR's New TRUCK
& TRACTOR MANUAL**

A "must" for mechanics, truck specialists, service stations, fleet owners. Covers **EVERY** job on 3058 truck and 157 farm tractor models made from 1935 thru 1952! Over 2200 pictures, 930 pages, 300,000 facts. Used by Armed Forces.

All types of Gasoline Engines, Fuel Systems, Governors, Lubrication Systems, Starters, Generators, Clutches, Transmissions, Axles, Brakes, Steering, etc.

For **FREE 7-DAY TRIAL** check box in coupon.



Published by **MOTOR**, The Leading Automotive Business Magazine.

MAIL COUPON NOW FOR 7-DAY FREE TRIAL

MOTOR BOOK DEPT.
Desk 11, 250 West 55th St., N. Y. 19, N. Y.

Rush to me at once (check box opposite book you want):
 MOTOR's New **AUTO REPAIR MANUAL**. If O.K., I will remit \$1 in 7 days (plus 35c delivery charges), \$2 monthly for 2 months and a final payment of 95c one month after that. Otherwise I will return the book postpaid in 7 days. (Foreign price, \$8 cash with order.)
 MOTOR's New **TRUCK & TRACTOR REPAIR MANUAL**. (Described at left.) If O.K., I will remit \$2 in 7 days, and \$2 monthly for 3 months, plus 35c delivery charges with final payment. Otherwise I will return book postpaid in 7 days. (Foreign price, remit \$10 cash with order.)

Print Name.....Age.....
 Address.....
 City.....State.....

Check box and save 35c delivery charge by enclosing **WITH** coupon entire payment of \$5.95 for Auto Repair Manual (or \$8 for Truck & Tractor Repair Manual). Same 7-day return-refund privilege applies.

MIRACLE TOMATO Yields 2 BUSHELS To a Vine



Now—You can grow the world's most amazing Tomato right in your own garden and get from 2 to 3 bushels of delicious, ripe tomatoes from every vine.

BURGESS CLIMBING TRIP-L-CROP

TOMATO grows 16 to 20 feet high. Huge, meaty, solid fruit, wonderful flavor. Some weigh as much as 2 pounds each. Unsurpassed for canning and slicing. Blight free—drought and disease-resistant. Grows in any garden. Outyields all other varieties.

TRIAL PACKET 10c
Postpaid. Order Today

3 Packets for 25c

Write for **FREE** complete Catalog listing many unusual Seeds, Plants and Bulbs.

BURGESS SEED & PLANT CO.
117 B. Galesburg, Mich.



Drafting OFFERS YOU TOP PAY NOW!

Trained Draftsmen command big wages, do interesting work . . . help create new products . . . aid America when All Out Production is needed.

DRAFTING EQUIPMENT SENT including portable drafting table, drafting instruments, instruction manuals, etc., so you can learn the fascinating profession of Drafting in your spare time at home.

FREE ILLUSTRATED BOOK

with special pay later form sent to all who write

Christy Trades School, 4432 N. Kedzie Avenue, Dept. DB-2402, Chicago 25

'How to Make Money with Simple Cartoons'



A book everyone who likes to draw should have. It is free; no obligation. Simply address

FREE BOOK

CARTOONISTS' EXCHANGE
Dept. 91D Pleasant Hill, Ohio



MECHANICAL DENTISTRY AT HOME!

A profession offering unlimited opportunities. Most modern and complete course embracing every branch from Plate to Porcelain Work, which prepares you to work for Dentists or start your own business. Individual instruction—practical training in day or night school. No books—no classes. Catalog upon request.
MCCARRIE SCHOOL OF MECHANICAL DENTISTRY
207 N. Broad Street Dept. 11 Philadelphia 7, Penna.



MEN! TRAIN NOW FOR A BIG PAY FUTURE IN DIESEL & SCIENTIFIC MOTOR TUNE-UP



- Diesel Construction
- Diesel Engine Repairman
- Diesel Operator
- Industrial Maintenance
- Auto Engine Rebuilding
- Bus & Truck Maintenance



Be a Trained Diesel Man

Go places with **DIESEL!** Farms, factories and power plants, trains, ships, trucks, buses all use **DIESEL POWER** . . . all need **DIESEL-trained** men! You can start your **DIESEL** training at home, in spare time, with tested, proved **U E I** training. Course includes practical work on Diesel engines under skilled instructors. You learn the operation, maintenance, servicing of all types of Diesel engines, **PLUS Scientific Motor Tune-up.**



ACT NOW! If you have mechanical ability, you'll like **Diesel!** High School diploma not necessary. Write now for **FREE** book, "EARNING POWER IN DIESEL." Act Today!

MAIL NOW FOR FREE BOOK!

UTILITIES ENGINEERING INSTITUTE, Dept. DC-24,
2521 Sheffield Ave., Chicago 14, Ill. (Founded 1927)
O. K.! Rush, without obligation, **FREE** Book on **DIESEL.**

NAME _____
ADDRESS _____
CITY _____ ZONE _____ STATE _____
 Check here for information if under 17.

RUPTURE



RELIEF...OR YOUR MONEY BACK
Original, patented Web, copied but never matched. Users say it's best ever. Relief or no cost to you. Write:

WEB TRUSS CO., Dept. M-1, Hagerstown, Md.



A "GOOD HAND" HELPS YOU SUCCEED! LEARN TO WRITE WELL

Handwriting quickly improves with our easy-to-understand picture lessons! Put your spare time to good use; send today for **FREE BOOKLET**, "How to Become a Good Penman," or check volumes wanted below at \$1 each: Business Writing Artistic Writing Card Writing Bird & Design Flourishing Engraving Alphabets. **COMPLETE SET \$4.50.** Ask for price list of penman's supplies.

Only 10c

TAMBLYN SCHOOL of PENMANSHIP
S.A. Ziller, Pres., 442 Ridge Bldg., Kansas City, Mo., USA



Trains & Travel Magazine

Get this interesting and exciting picture-packed, magazine. Read about fascinating places and railroads that reach them! 50c at larger stands. **Special Offer!** Send \$1 for 3-month subscription. Act now!

Trains & Travel Magazine Dept. 1573A, Milwaukee 3, Wis.

EASY TO LEARN CODE

Learn to increase speed with an Instructograph—the Radio-Telegraph Code Teacher that takes the place of an operator-instructor and enables anyone to master code without further assistance. Available tapes from beginners alphabet to typical messages on all subjects. Speed range 5 to 40 WPM. Always ready—no QRM. Thousands have "acquired the code" with the Instructograph System. Write today for convenient rental and purchase plans.



INSTRUCTOGRAPH COMPANY
4701-V Sheridan Road, Chicago 40, Illinois

Learn BAKING At Home

Baking is one of America's high industries in wages. Nearly depression-proof. Thorough basic home course lays sound foundation. If you have aptitude, write for **FREE BOOKLET**, "Opportunities in Commercial Baking." **NATIONAL BAKING SCHOOL**
835 Diversey Parkway Dept. 1351 Chicago 14, Ill.



TURN RIGHT

Get on the Road to a

Better Job-Brighter Future with RIGHT Training —then You Can Really GO!

AMERICAN SCHOOL, Dept. G145, Drexel at 58th, Chicago 37, Ill.

Without obligation, please send FREE and postpaid, full particulars about the subject checked below.

- | | | |
|--|---|---|
| <input type="checkbox"/> Accounting | <input type="checkbox"/> Drafting—Building Trades | <input type="checkbox"/> Plastics Engineering |
| <input type="checkbox"/> Air Conditioning | <input type="checkbox"/> Drafting—Machine Trades | <input type="checkbox"/> Plumbing—Practical |
| <input type="checkbox"/> Architecture & Building | <input type="checkbox"/> Electrical Engineering | <input type="checkbox"/> Private Secretary |
| <input type="checkbox"/> Automotive Technician | <input type="checkbox"/> Electricity—Practical | <input type="checkbox"/> Refrigeration |
| <input type="checkbox"/> Better Foremanship | <input type="checkbox"/> Electronics—Industrial | <input type="checkbox"/> Retail Merchandising |
| <input type="checkbox"/> Bookkeeping | <input type="checkbox"/> High School Courses | <input type="checkbox"/> Salesmanship—Outside |
| <input type="checkbox"/> Business Management | <input type="checkbox"/> Machine Shop Operations | <input type="checkbox"/> Sheet Metal Work |
| <input type="checkbox"/> Contracting | <input type="checkbox"/> Mathematics & Slide Rule | <input type="checkbox"/> Tool Making |
| <input type="checkbox"/> Diesel Technician | <input type="checkbox"/> Mechanical Engineering | |

NAME OCCUPATION

HOME ADDRESS AGE

CITY STATE

START NOW by checking, filling in and mailing this coupon. You'll get full information — No cost, No obligation!

• Today, make the BIG decision of your life. Choose the career you want and take the first easy step toward your goal. Learn how you can get the training that can put you in the bigger pay class and give you security in the years ahead. Find out how, in spare time at home, you can qualify for work you prefer, and higher pay. Or if you are already in the work you like, find out how you can win quicker promotion and a larger income.

Backed by 55 Years of Training Know-How

Since 1897 American School has helped many thousands of ambitious people toward success by providing specialized training for

commercial and technical advancement. Its study program for *you* has been prepared by experts in the subject you select and the school will give you guidance every step of the way. In time you might otherwise waste and at a cost you can afford you can prepare at home and really GO on the *right* road.

Don't Delay YOUR Start

Give serious thought to the list of training courses listed above. Pick the opportunity that interests you, check it and add your name and address. (Check more than one if you are undecided which appeals most.) Then clip and mail the coupon. Full information will be supplied without cost or obligation.

PRACTICAL, EFFECTIVE HOME STUDY TRAINING SINCE 1897

AMERICAN SCHOOL, Dept. G145, Drexel at 58th, Chicago 37, Ill.

THE SOONER YOU START, THE SOONER YOUR GOAL CAN BE REACHED

TRAIN **FASTER**— IN ONLY 10 **RADIO.**

I SEND YOU 18 BIG KITS

of Radio Television parts and equipment. Much of your training will be actual construction and experimentation . . . the kind of truly PRACTICAL instruction that prepares you for your Radio-Television career.



Frank L. Sprayberry, President
Sprayberry Academy of Radio

YOU BUILD the Television set and the powerful superhet radio receiver shown above. IN ADDITION to the other test units shown here (many are not shown because of lack of space). All equipment I send you is **YOURS TO KEEP.**



Training Men for Greater Incomes and Security in Radio-Television

TRAIN **BETTER**—TRAIN **EASIER** MONTHS—OR LESS—FOR **TELEVISION**

NEW! NO OBLIGATION PLAN

**You Have No Monthly Payment Contract to Sign
—Pay For Your Training as You Earn and Learn**

You can get into Radio-Television, today's fastest growing big money opportunity field, in *months* instead of years! My completely new "package unit" training plan prepares you in as little as 10 months or even less! No monthly payment contract to sign—thus **NO RISK** to you! This is America's finest, most complete, practical training—gets you ready to handle any practical job

Valuable Equipment Included With Training

The new Sprayberry "package" plan includes many big kits of genuine, professional Radio-Television equipment. You perform over 300 demonstrations, experiments and construction projects. You build a powerful 6-tube 2-band radio set, multi-range test meter, signal generator, signal tracer, many other projects. I also include many useful books and service manuals. All equipment and lessons are yours to keep . . . you have practically everything to set up your own profitable Radio-Television service shop.

in the booming Radio-Television industry, where trained service technicians are needed—urgently! Start your own profitable Radio-Television shop . . . or accept a good paying job. I have trained hundreds of successful Radio-Television technicians during the past 21 years—and stand ready to train you, even if you have no previous experience! Mail coupon and get all the facts—FREE.

Earn Extra Money While You Learn!

Train **IN YOUR HOME** in spare hours. Keep on with your present job and income while learning. With each training "package" unit, you receive extra plans and "Business Builder" ideas for spare time Radio-Television jobs. New television stations everywhere open vast new opportunities for trained men—and those in training. If you expect to be in the armed forces later, there is no better preparation than practical Sprayberry Radio-Television Training.

SPRAYBERRY ACADEMY OF RADIO

111 NORTH CANAL ST., Dept. 10-S, Chicago 6, Ill.

I invite you to get all the facts—



FREE
TO YOU
3 BIG
RADIO-TELEVISION
BOOKS

I want you to have ALL the facts about my new 10-MONTH Radio-Television Training—without cost! Rush coupon for my three big Radio-Television books: "How to Make Money in Radio-Television" PLUS my new illustrated Television Bulletin PLUS an actual sample Sprayberry Lesson—ALL FREE. No obligation and no salesman will call. Mail coupon NOW!

MAIL COUPON TODAY—NO OBLIGATION—

SPRAYBERRY ACADEMY OF RADIO, Dept. 10-S
111 North Canal St., Chicago 6, Ill.

Please rush to me all information on your 10-MONTH Radio-Television Training Plan. I understand this does not obligate me and that no salesman will call upon me. Be sure to include 3 books FREE.

Name..... Age.....

Address.....

City..... Zone..... State.....

Approved for Veterans under the G. I. Bill

AUTO BODY MEN Expd. comb. paint and metal; excel. cond., high earnings; Ogd. dir. Norman Melors, 1012 Chicago, Evanston, University 4-4100.	AUTO BODY-FENDER MAN Ideal working conditions; to Woodbury, 492 W. 11th St., Chicago, Ill.
---	--

Auto Body Craftsmen WANTED!

Learn This Craft—Earn Big Money

Look at the Help Wanted ads in your paper. The billion-dollar auto repair trade needs trained men NOW! The demand is big . . . pay is big . . . opportunities are great. You have a chance to grow with this growing trade, perhaps set up your own profitable shop.

CASH IN ON YOUR SPARE TIME!

You can begin your Auto Body & Fender Training at home in spare time with the proven UEI plan. You learn about appearance reconditioning, metalwork, painting, welding, other practical phases without leaving your present job. Then get actual practice in our large, well-equipped shops, repairing wrecked cars under the guidance of skilled instructors. Get FREE book and all the facts by sending coupon NOW!

UTILITIES ENGINEERING INSTITUTE 2523 Sheffield Ave., Dept. XC-17, Auto-Crafts Div., Chicago 14, Ill.

MAIL TODAY FOR FREE FACTS

UEI has been training men for industry since 1927.	Auto-Crafts Div. UTILITIES ENGINEERING INSTITUTE 2523 Sheffield Ave., Dept. XC-17, Chicago 14, Ill. YES! Rush FREE Book and full facts on Auto Body & Fender Repair Training.
	Name..... Age.....
	Address.....
	City..... Zone or County..... State.....
	() Check for special information if under 17.

SHORTHAND IN 6 WEEKS AT HOME

WRITE 120 WORDS PER MINUTE

Age No Obstacle

Famous Speedwriting Shorthand. No symbols, no machines. Uses ABC's. Easiest to learn and use. Qualify at home in spare time. Fast preparation for a better position and a sound, substantial future. Nationally used in leading offices and Civil Service; also by executives, students, etc. 120 words per minute. 50% FASTER than Civil Service requirements. Over 150,000 taught by mail. Also typing.

The very low cost will surprise you
30th YEAR
 Schools in over 300 cities in U. S., Canada, Cuba and Hawaii.
 Write for FREE Booklet to:



MASTERS SPEEDWRITING IN FEW SHORT WEEKS
 "In my work as a writer I had long felt the need for a knowledge of shorthand, but had no time to learn it. One day I read a Speedwriting advertisement and decided to enroll. Within just a few short weeks I mastered Speedwriting and now its speed and accuracy are proving invaluable."—Joseph J. Kudlac, Clifton, N. J.

Speedwriting
 Dept. 1501-3, 55 West 42 St., N. Y. 36

(Continued from page 10)

Since chlorophyll is in all of nature's greenery, free for the chewing, you may wonder as I did, how come goats—who eat a steady green diet—can smell so awful. And camels are even worse. The men at Rystan explain it this way: "In nature, the substance does not have the properties that the derivatives do after impurities like waxes and cellulose are removed. Before it goes in your pills or toothpaste chlorophyll has been transformed by sodium or potassium hydroxide to water-soluble salts." This, it seems, is the big difference.

Another thing they point out is that chlorophyll is a contact deodorant, which means that it does the job by touching the thing it deodorizes. Some people think it gets in the blood stream and removes perspiration odors and the like there. "It has never been proved to have a systemic effect," the Rystan men point out. "We're not sure." They're more inclined to the theory that distinctive odors—like those in dogs—are removed by chlorophyll acting on food in the alimentary canal before it even gets to the blood stream.

"And don't be misled by a lot of impossible claims," they say. "Some products can't possibly do what they are claimed to do. First, if it's very cheap, beware. Chlorophyll costs \$90 a pound. And remember that it must touch something to deodorize it. It doesn't vaporize. Evaluate each product on its own and you won't go wrong."

No matter what you think, I can guarantee one thing: Chlorophyll is absolutely great for coloring things green. They gave me a sample of that toothpaste and my toothbrush has looked like something out of *Finian's Rainbow* ever since.

Dick Dempewolff.

Letter to the Editor:

If it is true that someone in good old England is really building the giant radioscope depicted on page 18 of your November issue, then who . . . is going to live to receive the echoes which will return to earth in about 1,500,000 years from now?

R. C. Olds,
 Westmont, Ill.

Sorry, we won't be around. We regret, also, a misleading report from the English project. The radar echo is not used to detect distant stars, but to track down meteors and other bodies closer to the earth. The radio-telescope is, however, intended to give the astronomers data on stars as far as 750,000 light-years away by picking up signals sent out by the stars themselves in the astronomical past, then measuring the angles and pin-pointing their origin.—The Editor

**Yours for the asking—
No charge—no obligation**

"How to Become a Mail Order Millionaire"

Read how Gilbert on a "peanut" investment built up to \$350.00 **A DAY**. Learn how Zimmerman started a mail order business on a buck private's pay and spiraled \$16.80 into a big yearly income. See how a Chicago clerk quit a \$75.00 job and now makes \$22,000 a year in his own Mail Order business. Read how a southern boy made a fortune selling war-surplus parachutes which he bought as he went along. All Free! Send name on coupon for a copy of this fascinating reprint of "How to Become a Mail Order Millionaire" from *Mechanix Illustrated* plus details on the L.W. Mail Order Survey.

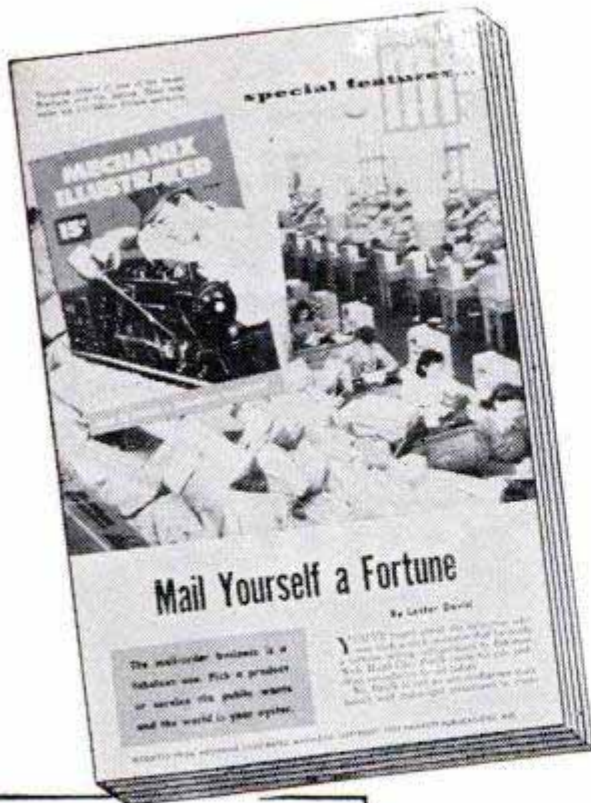

Start on a SHOESTRING!

The real-life stories of success in Mail Order read like fairy tales. If I had not personally known these people their stories would be hard to believe. Yet they are not only true, but they represent just a few of the hundreds of "little operators" who have been swept into big money by Mail Order.

GAINES. I personally guided his start when he invented an automatic pants presser. He started with one little ad in one magazine. Four years later he retired — with enough real estate to keep him in cash income the rest of his life.

VAN MARK. I worked with him for six years. I met him when he was a wagon man for a tea and coffee house, knocking on doors. He went into Mail Order on nothing—made money from the start—ended up six years later with savings of \$50,000 and an income of \$5000.00 a year for life without further work.

DUGGAN. A few years ago he was a truck driver. Started fooling with Mail Order in a spare room in his spare time. Last year he said, "I don't know how much I'm worth—after you get the first million you quit keeping track."

MRS. NIXON. Started a small Mail Order business at home—just to keep occupied. It looked good and she came to me for advice. I showed her how to expand. In two years the business got so big her husband resigned his job to help manage it.

FOXMAN. Foxman worked as a hack writer at \$70 a week. He had idle time in the evenings—ran an ad offering something he didn't have—got so many orders he had to find a source of supply. He made \$18,000 the first year. He gives me credit for "showing the way."

JORGENSEN. Consulted me about a specialty product. On my advice he ran one ad to "test" its saleability. That ad brought sales of \$50,000. In his first year he did a business of nearly a half million dollars. His original investment was less than a thousand.

These things I have seen. These people I have helped to the realization of their dreams — these and hundreds of others. My own fortune was made in Mail Order. And now my secrets can be yours.

L. W.

Have you ever thought of running a profitable little sideline right from your home? Has it occurred to you that *you are just as capable as anyone else* of making money on a product or service that can be sold by mail? Have you ever looked into the Mail Order business as it's run (on tiny investments) by innumerable small operators?

Forget about Sears and Ward's! Read about the "little fellows" . . . clerks, teachers, vets, mechanics, salesmen and others . . . who are packing Mail Order items in bedrooms, spare rooms, attics, garages, cellars . . . dumping them in the Post Office . . . and quietly banking the fistful of Money Orders, cash and checks delivered to them daily by the mailman.

An annual business of almost a billion dollars is done by "little fellows" who advertise and sell just one item! The Department of Commerce of the United States says, "A number of the most successful obtain incomes as high as \$40,000 to \$50,000.00."

It's an incredible story . . . a story of a business that's wide-open for newcomers . . . with opportunities for income far-and-away greater than you can ordinarily hope to attain by holding down a job. And in Mail Order you can stay as small as you wish—run your deal as a \$50 or \$75 weekly sideline—or consider jacking it up into really big figures as a full time operation.

Glance at the examples at left. *These true stories are far from unusual.* Multiply them by the hundreds and you begin to get an idea of what can be done . . . what is being done . . . in the phenomenal Mail Order field.

Yet, if you were to jump blindly into Mail Order your chances would be slim. A peculiar brand of "know-how" is vital in this little-known, little-understood business. *This is fortunate for you.* If any Tom, Dick, or Harry would "click" in Mail Order, the field would have been overloaded years ago.

But now you have the opportunity to learn the authentic secrets of successful Mail Order operation. They are revealed for the first time, step by step, in an extraordinary new Survey . . . the L.W. Confidential Mail Order Letters.

This Survey is not a course—not a book—not a group of lessons. It is a simple guide that anyone can follow. It shows you how to pick the right product for Mail Order. It shows you exactly how to start a profitable business *fast*, with cash or Money Orders in the envelopes you receive. It shows how to buy your product out of the very money you get in the mail, so you don't have to tie up cash in large supplies of your product. It gives you actual examples of ads and letters, analyzed to show how and why they make money. It demonstrates the months to start, the time to expand, the best way to get prospects' names. It reveals from A to Z the confidential facts that have made fortunes for Mail Order operators who use them.

Mail the coupon today, or simply send your name and address on a postcard. No salesman will call. We will mail, postage prepaid, a Free copy of "How to Become a Mail Order Millionaire" and along with it will give you complete facts about the L.W. Mail Order Survey. Read the facts. Then decide whether you would like to spend spare time or full time in a profitable, fascinating Mail Order enterprise. If you think you would like to follow the footsteps of hundreds of others who are now making good money in this way, you can get your L.W. Survey and begin at once.

Please don't decide to write us "a little later." Send your name *now*, before you forget. This one little act might be the first step to a future of independence and wealth.

**The L. W. MAIL ORDER SURVEY, Dept. 11
7070 N. CLARK ST., CHICAGO 26, ILL.**

The L. W. MAIL ORDER SURVEY, Dept. 11
7070 N. CLARK ST., CHICAGO 26, ILL.

Mail me a free copy of "How to Become a Mail Order Millionaire" and details about the L. W. SURVEY. It is understood there is no charge at any time, and that I am not under the slightest obligation. After reading, I will decide whether I want to use the L. W. Confidential Letters to help me start a Mail Order business at home.

NAME.....
ADDRESS.....
CITY.....ZONE.....STATE.....

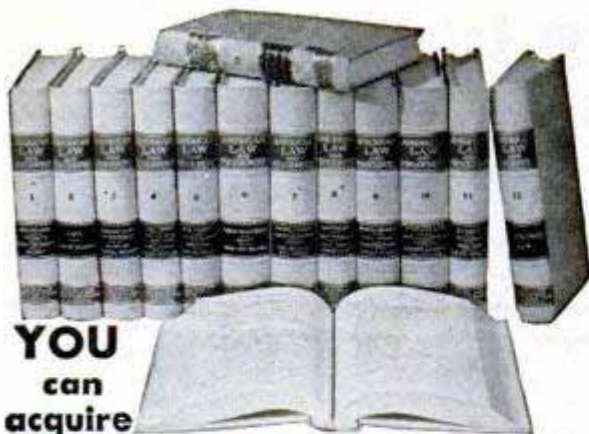

**YOU
can
acquire**

**LAW NIGHTS AT HOME!
L. B. DEGREE**

LaSalle's famous Law Library—used as reference in many Law libraries and Law offices—has enabled thousands to master Law surprisingly fast, in spare hours at home, for business and professional advancement.

These 14 remarkable volumes, compiled by leading professors and lawyers, cover the whole basic field of Law in condensed, orderly, simplified manner.

You advance rapidly with this great library, plus special lectures furnished. We guide you step-by-step with personalized Problem Method of instruction . . . you *learn by doing*—handling legal problems—not by memorizing rules.

Send for two FREE 48-page booklets, "Law Training for Leadership," and "Evidence," answering questions about Law and its value to you, and telling how LaSalle Law graduates are winning rapid advancement in business and public life. Mail coupon below. No obligation.

**LA SALLE EXTENSION UNIVERSITY
A Correspondence Institution**

417 S. Dearborn St. Dept. 164 L Chicago 5, Ill.

Send me your two FREE booklets described above, without obligation.

Name..... Age.....

Street.....

City, Zone & State.....

**MAKE MONEY 90 WAYS IN
PHOTOGRAPHY**



Famous low-cost LEARN-BY-DOING method and INDIVIDUAL attention trains you quickly at home—for profitable, action-packed career, or steady, spare-time income.

Big FREE book gives full facts on more than 90 money-making opportunities in photography.

Our 43rd year. Write TODAY! Also Resident Courses. Approved for Veterans.

New York Institute of Photography

DEPT. 49, 10 WEST 33 ST. NEW YORK 1, N. Y.

**SEND FOR
FREE
BOOK**

RUPTURED?

Get Relief This Proven Way

Why try to worry along with trusses that gouge your flesh—press heavily on hips and spine—enlarge opening—fail to hold rupture? You need the Cluthe. No leg-straps or cutting belts. Automatic adjustable pad holds at real opening—follows every body movement with instant increased support in case of strain. Cannot slip whether at work or play. Light. Waterproof. Can be worn in bath. Send for amazing FREE book, "Advice To Ruptured" and details of liberal truthful 60-day trial offer. Also endorsements from grateful users in your neighborhood. Write:

CLUTHE SONS, Dept. 31, Bloomfield, New Jersey.

KOREAN VETS!

Now you can attend one of the world's most famous aeronautical colleges under Public Law 550.

B.S. degree in 3 yrs. from Saint Louis University—Aero. Eng., Maint. Eng., Aero. Adm.

Write today for full details

PARKS COLLEGE DEPT. M-13
EAST ST. LOUIS, ILL.

**STUDY TO BE A DOCTOR
of Psychology or Metaphysics**

Obtain a Ps.D., Ms.D., or Ph.D. degree. Be a Teacher, Lecturer, or Accredited Practitioner. Teach others how to achieve Health, Happiness and Contentment. Chartered by State. Write for FREE book telling how.

THE NEOTARIAN COLLEGE OF PHILOSOPHY

Desk B, Pickwick Building Kansas City 6, Missouri

Regular Price of a
Slide Rule \$4 and up

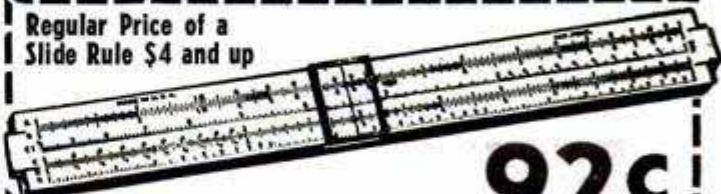

Slide Rule

92c

and this coupon
Add 8c Postage

If you know how to use a pencil you can use a slide rule. For bookkeepers, accountants, salesmen (figuring commissions, cost, etc.), farmers, housewives, etc. For Armed Forces highly important. Men's most useful tool. Easy to calculate instantly. Multiplying, proportions, division, roots, etc. "High Vision" Clear View Slide. Full 10" Rule. A, B, C, D, C1 and K scales.

FREE 28-page instruction book on how to get correct answers instantly without pencil or paper.

Gene Loewy, 545 5th Ave., Dept. 43-A, N.Y. 17

Limit three rules to each coupon

**ENGINEERING DEGREE IN
27 MONTHS**

Big Demand for Graduates

Aeronautical, Chemical, Civil, Electrical, Mechanical and Radio Engineering (inc. TV and Electronics)

Hundreds of young men are earning B. S. ENGINEERING DEGREES annually in this recognized institution—year around operation. New terms start quarterly. Many students earn a major part of their college expenses in this large industrial center.

Low tuition. Competent instruction. Thorough, intense, practical program. Modern, well-equipped laboratories including new physics laboratory and modern wind tunnel. Individualized instruction emphasized.

Government approved for G.I.'s. Engineering preparatory courses. Students from 48 states and 21 foreign countries. Enter March, June, September, December. Send coupon for free catalog and full information. Enroll now.

SEND COUPON TODAY

INDIANA TECHNICAL COLLEGE

513 E. Washington Boulevard
Fort Wayne 2, Indiana

Please send me free information on B.S. Engineering Degree in 27 months as checked.

Aeronautical, Chemical, Civil, Electrical,

Mechanical, Radio-Television

Name.....

Address.....

Check the Kind of Body YOU Want! RIGHT IN THE COUPON BELOW

...and I'll Prove How EASILY You Can Have It!



SILVER CUP GIVEN AWAY
This handsome cup, over a foot high, will be given to the pupil who makes the greatest physical improvement in the next 3 mos.

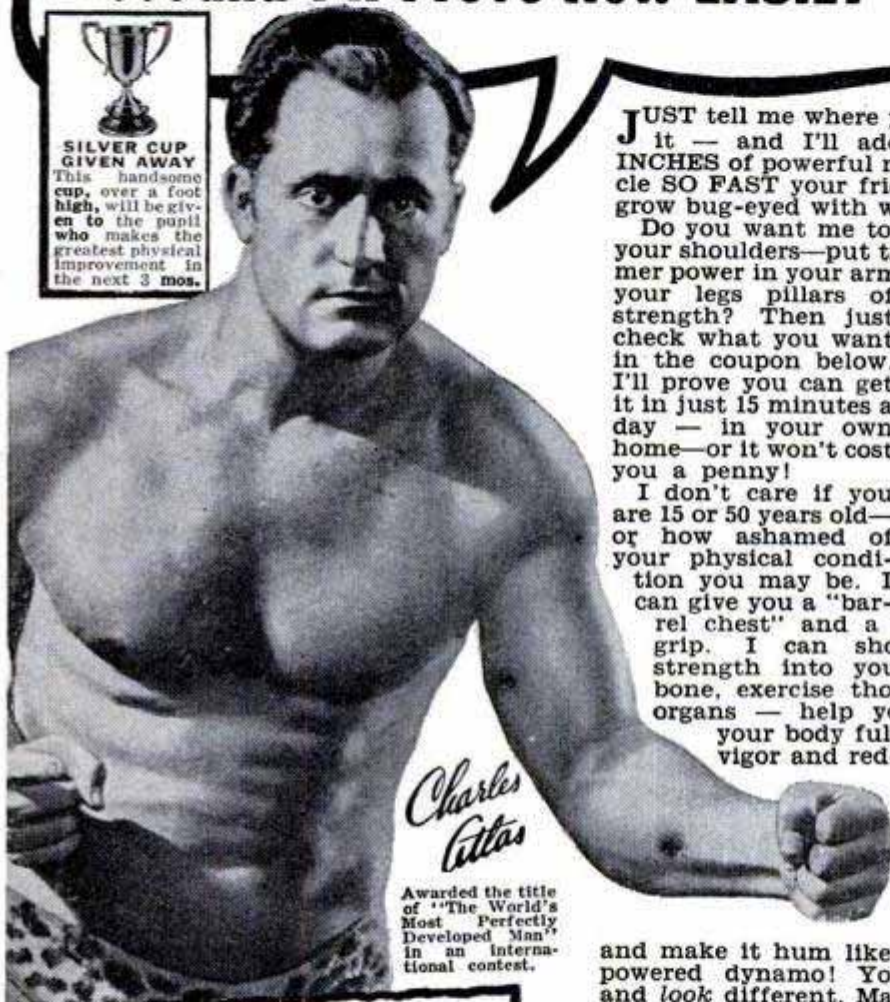

Charles Atlas

Awarded the title of "The World's Most Perfectly Developed Man" in an international contest.

JUST tell me where you want it — and I'll add **SOLID INCHES** of powerful new muscle **SO FAST** your friends will grow bug-eyed with wonder!

Do you want me to broaden your shoulders—put trip-hammer power in your arms—make your legs pillars of strength? Then just check what you want in the coupon below. I'll prove you can get it in just 15 minutes a day — in your own home—or it won't cost you a penny!

I don't care if you are 15 or 50 years old—or how ashamed of your physical condition you may be. I can give you a "barrel chest" and a vise-like grip. I can shoot new strength into your backbone, exercise those inner organs — help you cram your body full of pep, vigor and red-blooded vitality! I'll wake up that sleeping energy of yours

and make it hum like a high-powered dynamo! You'll feel and look different. Man, you'll begin to LIVE!

ling I was at 17 to my present superman physique! Thousands of fellows are becoming marvelous physical specimens — my way. I give you no gadgets or contraptions to fool with. When you develop your strength through "Dynamic Tension"

you can laugh at artificial muscle-makers. You simply utilize the dormant muscle-power in your own God-given body—watch it increase and multiply double-quick into real solid LIVE MUSCLE.

My method — "Dynamic Tension" is so easy! Spend only 15 minutes a day in your own home. From the very start you'll be using my method of "Dynamic Tension" almost unconsciously every minute of the day—walking, bending over, etc.—to BUILD THE MUSCLE and VITALITY you want. And you'll be using the method which many great athletes use for keeping in condition — prize fighters, wrestlers, baseball and football players, etc.

ARE YOU

Skinny, Weak and run down?
Always tired?
Nervous?
Lacking in confidence?
Constipated?
Suffering from bad breath?
Fat and flabby?
Do you want to lose or gain weight?
WHAT TO DO ABOUT IT is told in my **FREE BOOK**

FREE Illustrated 32-Page Book. Just Mail the Coupon.

SEND NOW for my famous book, "Everlasting Health and Strength." (Over 3½

MILLION fellows have sent for it already.) 32 pages, packed with photographs and valuable advice. Shows what "Dynamic Tension" has done for others, answers many vital questions.

This book is a real prize for any fellow who wants a better build. Yet I'll send you a copy absolutely FREE. Rush coupon to me personally: Charles Atlas, Dept. 81, 115 East 23rd St., New York 10, N. Y.



Here's The Kind of Results I Give:

"I gained 11 lbs. and 4¼ inches on my chest. 3 inches on my arms. I am never constipated."
—Henry Neven, Canada

course I weighed only 141. Now I weigh 170."
—T. K., New York

"I gained 34 lbs. and increased my chest 6 inches."
—Stanley Lynn, Calif.

"The benefits are wonderful. The first week my arm increased one inch, my chest two inches."
—E. M., Conn.

"What a difference! Have put 3½ inches on my chest (normal) and 2½ inches expanded."
—F. S., New York

"You changed me from a weakling to a real he-man. My chest has gone up 6 inches. I am a solid mass of muscle. Friends and doctors have noticed a great change in me."
—J. W., Montana

"Gained 29 pounds. When I started your

WHAT'S MY SECRET?

"DYNAMIC TENSION"! That's the ticket! The identical natural method that I myself developed to change my body from the scrawny skinny chested weak-

CHARLES ATLAS, DEPT. 81
115 East 23rd St., New York 10, N. Y.

Dear Charles Atlas: Here's the kind of Body I Want:

(Check as many as you like)

- More Weight—Solid—In The Right Places
- Broader Chest and Shoulders
- More Powerful Arms and Grip
- Slimmer Waist and Hips
- Better Regularity, Digestion, Clearer Skin
- More Powerful Leg Muscles
- Better Sleep, More Energy

Send me absolutely FREE a copy of your famous book "Everlasting Health and Strength"—32 pages, crammed with photographs, answers to vital health questions and valuable advice. I understand this book is mine to keep and sending for it does not obligate me in any way.

NAME.....AGE.....
(please print or write plainly)

ADDRESS.....

CITY.....STATE.....

RUSH COUPON FOR FREE BOOK

CORTINA makes it FUN to Learn
French · Spanish
RUSSIAN · GERMAN
Italian, Brazilian, Japanese
-in your own home!

BIG OPPORTUNITIES and JOBS await Americans who can speak a foreign language. Millions of dollars being spent each year by government and industry in Europe, Latin America, Asia create fascinating, well-paying jobs here and abroad. Travel booming. World conditions now make a second language more valuable than ever.

Only 15 Minutes a Day

The **CORTINA METHOD** teaches you to speak languages LIKE A NATIVE. Right at home, relaxed, at ease, you learn as easily as a child learns — **BY LISTENING** to these new, easy-to-understand **CORTINA** recordings.

Send for FREE BOOK!

THOUSANDS have learned a second language this easy way for **PLEASURE, BUSINESS, TRAVEL, CULTURE**. Why not you? Send for **FREE** book, "Cortina Short-Cut." Describes method fully—tells why it works so amazingly fast — and about **FREE TRIAL** offer. No obligation.

ALL NEW RECORDINGS ON UNBREAKABLE RECORDS Mail Coupon Today!

CORTINA ACADEMY (Established in 1882)
 Dept. 641, 105 West 40 St., New York 18, N. Y.

Please send me—without obligation—your free book. I am interested in (check)

- French Spanish German Italian
 Russian Brazilian Japanese

Name _____

Address _____

City _____ State _____

VETS! Check if NOW eligible under G. I. Bill

Photography
for



PLEASURE or PROFIT

Learn at home. Spare time. Practical basic training. Long-established school. Many have earned while learning. Send coupon below for free booklet, "Opportunities in Modern Photography" and full particulars.

AMERICAN SCHOOL OF PHOTOGRAPHY
 835 Diversey Parkway Dept. 1351 Chicago 14, Illinois
 Send booklet, "Opportunities in Modern Photography," full particulars and requirements.

Name _____ Age _____
 Address _____
 City _____ Zone _____ State _____

EAR NOISES?



If you suffer from those miserable ear noises and are **Hard-of-Hearing** due to catarrh of the head, write us **NOW** for proof of the wonderful, palliative relief many people have reported after using our simple home treatment. **NOTHING TO WEAR**. Many past 70 reported such relief in hearing and ear noises. **SEND NOW FOR PROOF AND 30 DAYS TRIAL OFFER.**

THE ELMO COMPANY
 DEPT. 3PM1 DAVENPORT, IOWA

LEARN CARTOONING at home in spare time

Simplified Landon Picture Chart Method makes progress quick, exciting, easy. Former Landon students include creators of "Steve Canyon," "Freckles," "Out Our Way," "Winnie Winkle," "Regular Fellers," "The Neighbors," "Strange as it Seems," and many others. Earn while learning. Rush 10c for Picture Chart (to test your ability) and full details. Please state age.

Landon School of Cartooning, 5301 CTS Bldg., Cleveland, O.



Is Your Life Crowned With Success?

LEXIPOWER



WE THINK IN WORDS. THOUGHT IS POWER. Let this New Science show you how to **WIN WITH WORDS** — financially, socially, culturally. Develop a **MASTERFUL VOCABULARY**. Influence others, improve your personality, manifest your latent ability. You are judged and rated by every sentence you utter. Start using the **POWER of LEXIPOWER** after the first Lesson. Write **NOW** for **FREE** details about **LEXIPOWER**. **Dime-a-Day LESSON CLUB.**

LEXIPOWER LESSON CLUB
 517-G W. Deming Place Chicago 14, Illinois

ROLL-O-KITE

\$1
POST PAID

Amazing new spool-type kite spins as it flies. Unusual performance. Quick, easy to assemble. Fun to fly. Requires no tail or other complicated adjustments. Flies up to 1/4 mile high. **COMPLETE** kit in colorful package includes all ready-cut parts, flying string, instructions plus hours of inspiring fun. Size 18 x 7 in. Choice — red, blue, or yellow.



ROLL-O-KITE CO.
 LOMITA, CALIFORNIA
 P.O. BOX 182 * DEPT. 22

BE YOUR OWN BOSS!

EARN UP TO \$200 WEEKLY
 Work home! Start in your spare time. Only small capital needed. Book "301 Unique, Successful Businesses" gives all details. Send postcard for your **FREE** copy today.
DEUMANT PUBLICATIONS, 81-PP Deumant, Kenmore, N.Y.
START YOUR OWN BUSINESS

MANAGEMENT PRODUCTION

Production experts earn big money. Thousands of firms need them. We train you thoroughly at home in spare time for management positions. Previous experience unnecessary. Personal training under supervision of production management authorities. Placement counsel and help. Write for **FREE** book "Industrial Management."
LASALLE Extension University, 417 So. Dearborn St.
A Correspondence Institution, Dept. 164 IM, Chicago 5, Ill.

HERE'S A READY-MADE FUTURE FOR YOU

MILLIONS OF HOMES IN U.S. HAVE 6-12 SMALL APPLIANCES MORE SOLD EVERY YEAR - MILLIONS NEED REPAIR NOW WITH THE NEED INCREASING DAILY!

Start Your own Business IN

ELECTRICAL APPLIANCE REPAIRING

EARN WHILE YOU LEARN

Only had your course a few short weeks and have already made \$800.00. Going to quit my job paying \$250.00 straight salary to operate my own business. — J. D. S., St. Louis, Mo.

Make \$15.00 Saturdays and more. Am only able to operate in my spare time. It is just what a mechanical minded man needs. — G.O.F., Thomasville, Ga.



IN YOUR OWN KITCHEN, BASEMENT OR GARAGE

Learn at home in your spare time this fascinating big paying profession.

If you are mechanically inclined, can hold and use tools, we can give you the training and time saving kits that will enable you to . . . Command More Money At Work . . . A Better Paying Job Elsewhere . . . Or A Business Of Your Own!



3 EASY STEPS

- 1 We Send You An ELECTRONIC KIT
- 2 We Teach You Electrical Appliance Repairing.
- 3 We Show You How To Get Business.

New Shop Method Home Training teaches you both the technical and practical side of Electricity by having you work with your hands, Building, Testing, Repairing. All instruction manuals are written in easy-to-understand language chock full of hundreds of detailed photos and drawings.

We show you how to quickly locate the trouble, how to fix it and what to charge. ALSO, how to solicit business and keep business coming to you!

\$5.00 TO \$6.00 AN HOUR

Often charged for making ordinary repairs. We show you how to repair refrigerators, vacuum cleaners, washing machines, motors, etc.



WE GIVE YOU THIS ELECTRONIC KIT TROUBLE FINDER



SEND FOR FREE BOOK!

CHRISTY TRADES SCHOOL, Dept. D-1403
4432 N. Kedzie Ave., Chicago 25, Ill.

Please send me FREE Illustrated Book on Electrical Appliance Repairing and special form for paying later from earnings.

NAME _____ Age _____

ADDRESS _____

CITY _____ Zone _____ State _____

INVENTORS

Your first step—if you consider your invention to be something of importance—is to have a search made of pertinent, prior U. S. patents. If our search report indicates probable patentability of your invention, you may apply for a patent which gives you the right to exclude others from making, using or selling your invention as claimed for a term of 17 years.

This firm is registered to practice before the U. S. Patent Office and is available to assist in the preparation of the necessary drawings, specification and claims.

Ask for a copy of our instructive booklet "Patent Protection for Inventors" and our convenient "Evidence of Invention" form. No obligation.

VICTOR J.
EVANS & Co. *Merlin M. Evans*
REGISTERED PATENT ATTORNEY
830-A MERLIN BUILDING, WASHINGTON 6, D. C.

SAY YOU SAW IT IN POPULAR MECHANICS

C. T. C. TRAINING IN DRAFTING

PREPARES FOR
PROMOTION
MORE MONEY
SUCCESS

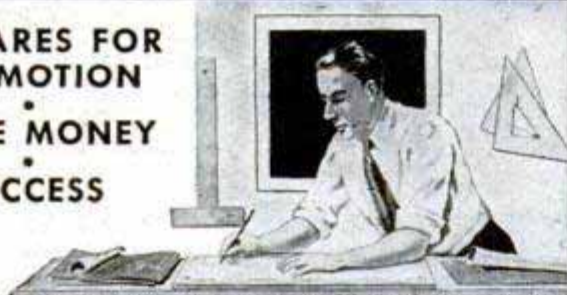

"Here I am at work making good money as a draftsman. I'm glad I sent the coupon to Chicago Tech for that Free Trial Lesson and found out how easy it is to learn Drafting in spare time at home. Today, I feel secure in my job. What's more, I feel I'm slated for promotion and more pay."

LEARN IN SPARE TIME—AT HOME!
(or at the College in Chicago)

A few hours of pleasant home study every week—that's all. All the tools you need; drawing outfit included. This tested method—developed over 48 years of C.T.C. progress—prepares men quickly for good positions in industry.



FREE INFORMATION—SEND COUPON

To prove to you how easy it is to learn Drafting at home, we will send you this FREE TRIAL LESSON. Mail coupon or send post card today.

CHICAGO TECHNICAL COLLEGE

A-251 Tech Bldg., 2000 So. Michigan Ave.
Chicago 16, Illinois

Mail me FREE Lesson with information about big opportunities in DRAFTING.

Name _____ Age _____

Address _____

City _____ Zone _____ State _____

INVENTORS

IF YOU WISH TO PROTECT YOUR INVENTION, You should take steps to protect it by a U. S. Patent. Write me for "INVENTION RECORD" form

CARL MILLER
REGISTERED PATENT ATTORNEY

WOOLWORTH BLDG., 35th FLOOR, 13A
NEW YORK CITY



PATENTS
C. A. SNOW & CO.
REGISTERED PATENT ATTORNEYS
WRITE FOR INFORMATION TO
428 SNOW BUILDING, WASHINGTON 1, D. C.

INVENTORS

Send for **PATENT INFORMATION** Book and **INVENTOR'S RECORD** without obligation
GUSTAVE MILLER
13-PM WARNER BUILDING
WASHINGTON 4, D.C.

REGISTERED PATENT ATTORNEY
Patent Attorney & Advisor
U. S. NAVY DEPT. 1930-1947
ASSOCIATE EXAMINER
U.S. PAT. OFF. 1922-1929
PATENT LAWYER

INVENTORS

Whether an invention is patentable can be substantially determined by a search of the U. S. Patent records. Without obligation, write for information explaining the steps you should take to secure a patent.

JOHN N. RANDOLPH
Registered Patent Attorney
201 Columbian Building, Washington 1, D. C.

INVENTIONS WANTED AT ONCE

If you want to market, or sell, your invention for cash or royalties. Write for our Free Booklet. Send no drawings. We also welcome hearing from firms, or private capital, wishing to review inventions in any field. We will be glad to send notice of our clients' inventions.

GLOBAL MARKETING SERVICE
1404 Mitchell Street Dept. MD Oakland 1, Calif.

INVENTORS

If you have working models, blue prints, or patents, covering "special use" parts or assemblies for Chevrolet, Ford, or Plymouth Cars, it will be to your advantage to get in touch with us. Write us at the factory. Dept. PM

 **NATIONAL MACHINE WORKS, INC.**
P. O. BOX 4305 AUTOMOTIVE PARTS MANUFACTURERS OKLAHOMA CITY 9, OKLA.

INVENTORS

I shall be pleased to furnish you, upon request, with full information relative to patent procedure—without any obligation on your part.

PATRICK D. BEAVERS
Registered Patent Attorney
934 Columbian Building Washington 1, D. C.

GET INTO

AUTO-DIESEL

& ALLIED MECHANICS *Master All Phases*

JOBS LIKE THESE ARE AVAILABLE TO TRAINED MECHANICS. CHOOSE THE FIELD YOU LIKE BEST

GET COMPLETE TRAINING FOR:

Automotive Motor Tune-Up • General Garage Mechanic • Agricultural Implements Mechanic • Diesel Engine Rebuilding • Diesel Fuel Injection • Auto Engine Rebuilding • Auto Electrical Service • Parts Dealers • Bus & Truck Lines • Industrial Maintenance • Contracting and Excavating • Business of Your Own • AND MANY OTHERS!

SHOP-METHOD HOME TRAINING BY AN ESTABLISHED RESIDENT SCHOOL TRAINS YOU FOR ALL OPPORTUNITIES IN AUTO & DIESEL INDUSTRIES!

Opportunity is everywhere for the trained Auto-Diesel Mechanic. Highways throng with cars, buses, trucks, tractors. Garages and service stations are busy. Farm machinery is "going Diesel." Factories, ships, farms, railroads, general industry, are dependent on engine power. Here's a dynamic, fast-growing field that needs trained men who know all phases: installation, operation, maintenance and repair. Now—National Schools offers you a practical, all embracing Auto-Diesel Mechanic's Course, including all these advantages:

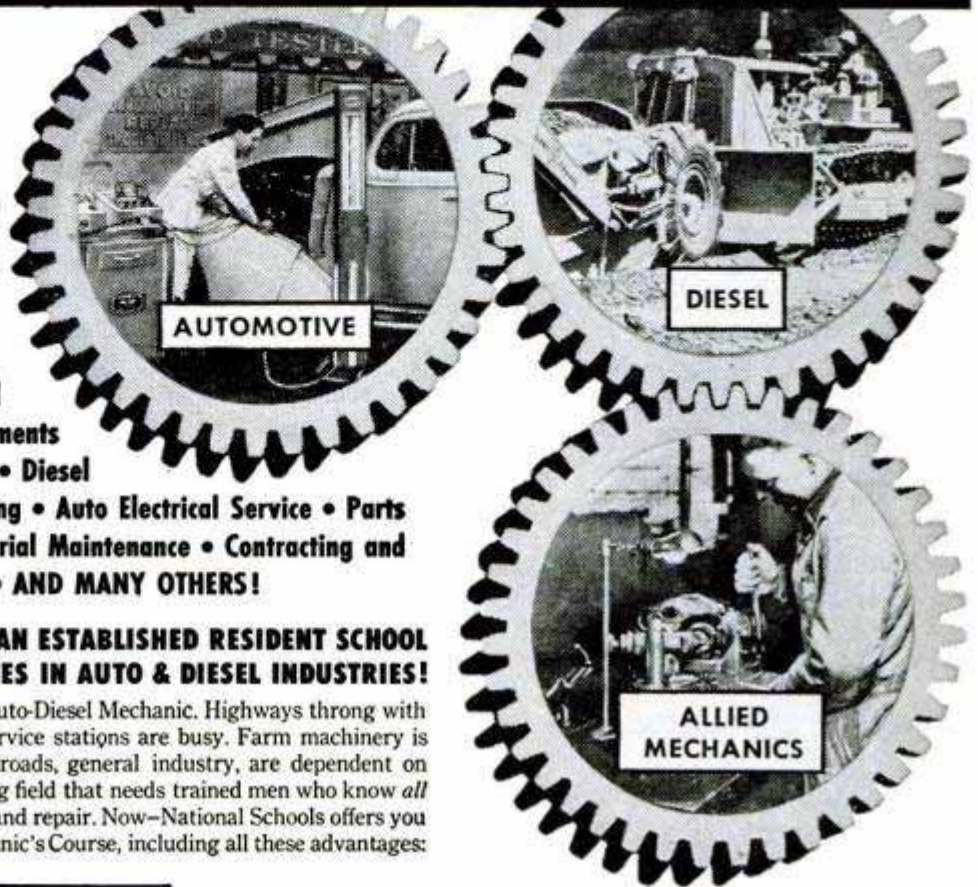

COMPLETE SHOP-METHOD HOME TRAINING COVERS DIESELS—High Speed and Heavy Duty SEMI-DIESELS—Gasoline and Special Fuel Engines AND ALLIED MECHANICS!

- | | |
|-----------------------|------------------------|
| Basic Lesson Texts | Engine Service Manuals |
| Diesel Installations | Engine Repair |
| Operation—Maintenance | Drive Systems |
| Diesel Chart Manual | Diesel Electric Power |
| Spare Time Lessons | Thermodynamics |

AND YOU CAN EARN WHILE YOU LEARN!

With our practical Master Shop-Method Home Training, you study at home in your spare time. You get Spare Time Work Lessons showing you how to earn while you learn, for extra money and experience. You learn by DOING.

DRAFT AGE? Services offer better ratings, more pay to men with training. Start now—if called while training, we'll make satisfactory adjustment for you.



FREE BOOK and SAMPLE LESSON show how we train you! SEND FOR THEM TODAY!

WE GIVE YOU TOOLS OF YOUR TRADE

TO MAKE YOUR TRAINING COMPLETE, WE GIVE YOU PROFESSIONAL QUALITY TOOLS AND EQUIPMENT, INCLUDING ALL-METAL TOOL BOX! THEY ARE PART OF YOUR INSTRUCTION, YOURS TO KEEP! DON'T MISS THIS OPPORTUNITY OF A LIFETIME! GET THE FACTS—MAIL THE COUPON NOW!

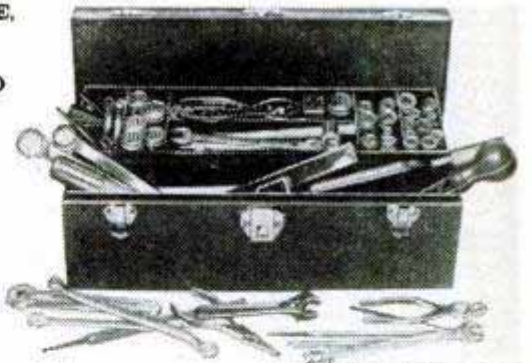

APPROVED FOR G.I. TRAINING

NATIONAL SCHOOLS

LOS ANGELES 37, CALIFORNIA • ESTABLISHED 1905
In Canada: 192 E. Hastings St., Vancouver, B.C.



FIND OUT NOW...MAIL COUPON TODAY

NATIONAL SCHOOLS, Dept. DB-13
4000 South Figueroa Street
Los Angeles 37, California

Mail in envelope or paste on postal card

Mail me FREE the book "My Future in Automotive-Diesel & Allied Mechanics" and the Sample Lesson. I understand no salesman will call on me.

NAME _____ AGE _____

ADDRESS _____

CITY _____ ZONE _____ STATE _____

VETS! Check here if you were released from service less than 4 years ago.

FOR YOUR TECHNICAL AND VOCATIONAL TRAINING

Come to the
UNIVERSITY OF HOUSTON

One of America's large and most modern universities. Select from these fascinating fields: aeronautics air conditioning & refrigeration auto body and paint auto mechanics auto upholstery & trim diesel drafting electricity electronics machine shop photography radio stationary engineering television welding woodworking furniture upholstery.

PREPARE FOR YOUR FUTURE NOW . . . with very latest methods and equipment, at modern U. of Houston College of Technology. Entrance: high school diploma, or over 18 and ability to profit from instruction. Beautiful campus—250 wooded acres in Houston, Texas—city of tomorrow. Full college activities, sports, social life. Day or night, short or longer courses. Co-op work-study programs . . . earn part of tuition and expenses with part-time job in your own career field, while you learn. Personal vocational counselling. Diploma on completion and all credits apply towards Bachelor of Applied Science Degree. Job placement assistance. Feb., June, Sept. semesters. Mail ad now for Free fully-illustrated brochure. No obligation. Mark X before choice of subject. **Do it today!**



ADMINISTRATION BUILDING

University of Houston, College of Technology
Dept. 113 — HOUSTON 4, TEXAS

**FIND OUT
FREE!**

**HAVE YOU
GOT WHAT
IT TAKES?**

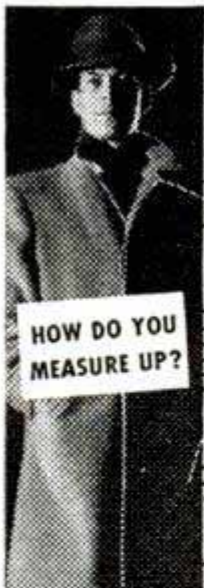

SUCCESS
HOME STUDY
WILL TO WIN
CHARACTER
HEALTH

HOW DO YOU
MEASURE UP?

...to become a
**CRIMINAL INVESTIGATOR
FINGER PRINT EXPERT?**

FREE BOOKLET OFFER

Everything to gain...nothing to lose. The famous, fascinating **BLUE BOOK OF CRIME** will give you examples of "what it takes" to track down outlaws and thieves. Read this exciting story of the triumph and battle of law and order against crime. THEN, decide for yourself if YOU have what it takes for exciting, steady, "good pay" work. **OUR GRADUATES ARE KEY MEN** in more than 800 Identification Bureaus. Institute of Applied Science has been teaching finger print and firearms identification, police photography and criminal investigation for more than 30 years. No obligation. No salesman will call.

GET THE FACTS . . . FREE! Mail Coupon Today!

INSTITUTE OF APPLIED SCIENCE, Dept. 1351
1920 Sunnyside Ave., Chicago 40, Ill.
(A Correspondence School Since 1916)

Gentlemen: Without obligation or expense to me, send me the famous "Blue Book of Crime" absolutely free.

Name _____

Address _____ RFD or Zone _____

City _____ State _____ Age _____
You must state your age.

5 Year Written Guarantee NEW \$13⁹⁵
17 JEWEL INCABLOC WATCH
WAS \$50 NOW ONLY

DROP IT! WET IT! BANG IT!

Incabloc shock proof. Waterproof. Dust-proof. Tested best in Army and Navy Service. Anti-magnetic. Imported accurate Swiss lever movement. Sweep second hand. Radium dial.

TO DAY FREE TRIAL SAVE \$36 IN **BANKRUPT FACTORY STOCK SELLOUT**

Wear at our risk. Money back if not pleased. SEND NO MONEY. Pay post-man plus tax and postage. Or en-close \$13.95 plus \$1.40 tax for men's watch, and we ship prepaid. (Ladies' model) \$18.95 plus \$1.70 tax. Order now. Receive \$2 expansion band free with prepaid order.



SAVE \$36

STANLEY SALES CO., Dept. P-1, Long Island City 4, New York

NEW! CHEAP! **OIL BURNER**
SWEEPING THE COUNTRY!

SALESMEN BIG MONEY! SLIPS INTO ANY COAL RANGE, STOVE OR FURNACE

Amazing quick, intense heat. By finger-tip control. Cheaper than coal. No more shoveling coal or ashes. **SENT ON TRIAL.** Prove it pays for itself quickly by what it saves. \$1 bonus for testing. We'll let you try one in your own home for one month. Write for details today. **NORTHWEST MFG. CO., 360-A Main, Mitchell, S. Dak.**

WHY DON'T YOU WRITE?

Writing short stories, articles on business, sports, hobbies, travel, shop crafts, local, club and church activities, etc., will enable you to earn extra money. In your own home, on your own time, the New York Copy Desk Method teaches you how to write the way newspaper men learn—by writing. Our unique "Writing Aptitude Test" tells whether you possess the fundamental qualities essential to successful writing. You'll enjoy this test. Write for it, without cost or obligation.

NEWSPAPER INSTITUTE OF AMERICA
SUITE 5593-A, ONE PARK AVENUE, NEW YORK 16, N. Y.

WARN HUB CAP MAKES 2 JEEPS OUT OF 1

Ends front wheel drag on all 4-wheel drive Willys and Dodge vehicles

Saves gas up to 5 miles per gallon, tire wear, front axles, increases speed and power. Stops shimmy—front wheels coast out of gear! 4-wheel drive handles, performs, climbs like 2-wheel. Install or remove **WARN HUB CAPS** in 10 minutes. Polished aluminum, guaranteed. Rush check, M.O., or C.O.D. Write for circular.

WARN MFG CO., Riverton Box 6064A, Seattle 88, Wash.

TOOTHACHE? **TOOTH GUM TOOTH DROPS DENT'S POULTICE**

Ask your Druggist for

Watch Repairing Pays Big Money Learn at home



Watch repairers in great demand. Train step-by-step in 10 easy lessons. We furnish all tools and 15 jewel watch and practice movement. Turn spare time into cash. A licensed school. Low cost. Send for **FREE** book today.

ILLINOIS SCHOOL OF WATCH REPAIRING
2870 Elston Ave., Dept. PM13 Chicago 18, Ill.

Make BIG MONEY! RAISE CHINCHILLA RABBITS!

Cash Markets Supplied for Your Production
FREE - Illustrated Booklet - WRITE TODAY!
ROCK HILL RANCH, SELLERSVILLE 36, PA.
World's Largest Breeder of Chinchilla Rabbits



Plays Pieces



"Was able to play many pieces in a short time. Family and friends surprised! Play for social functions, dances." — Peter H. Koryra, Manitoba, Canada.

Excels Friend Who Has Teacher



"I didn't know a note. Now I play for parties. A friend (taking lessons from private teacher same length of time) is still doing simple exercises." — Marie Van Hulle, Manitoba, Canada.

Now Invited Out Lots



"It's been fun. Hasn't cost anywhere near as much as private teacher. Now invited to affairs, dances." — Howard Hopkins, E. Syracuse, N.Y.

"Didn't Know A Note"



"I didn't know a note. Now I play many selections, to the delight of friends and relatives." — Lawrence M. Deno, West Chazy, N. Y.

Progresses Rapidly



"How rapidly I am progressing! Lessons so simple, anyone can understand them." — Andrew Schneider, Hanna, Wyoming.

Family and Friends Surprised



"I, my family and friends are surprised at my rapid progress!" — Pearl May Clay, Center, Tex.

Learns Foster Without Teacher



"Have no special talent—but now I play guitar better than many who have had teachers for longer time." — Myrella-Muquette Saint-Andre, Montreal.

"Friends Were Amazed"



"Didn't know a note on piano. In a short time I could play simple hymns. Friends were amazed. Now entertain at parties, play at church." — Samuel Moses, Mt. Vernon, Tenn.

"How Happy I Am"



"How happy I am. I play for parties, entertainments. Never once thought I would be able to play the piano. Thanks a million!" — Cora Franklin Duke, Bumpass, Va.

13-Year-Old Learns



"Never took lessons before. Now play better than friends (with private teachers) who began same time I did." — Joan Lueck, Big Stone, S. Dak.

"Easy as Falling Off Log"



"Easy as falling off log. Have always wanted to play. Now my dream is being fulfilled." — Mrs. Phyllis B. Jones, Blanding, Utah.

He Makes Many New Friends

Thousands Now Play Who Never Thought They Could!

EASY LOW-COST METHOD SHOWS YOU HOW TO Play Right Away...EVEN IF YOU DON'T KNOW A NOTE NOW

Wins Bet With Friends



"Bet friends I could learn piano quickly. Last night, one said, 'Why, sounds like you've been playing for years!'" — Louise Gomez, Oakland, Cal.

"Now Play Any Piece I Like"



"Never studied music before. Your method is easy! Now play any piece I like." — Ross Boyer, Blackwell, Mo.

"Never Dreamed I Would Play"



"Wouldn't have believed it possible — learning to play in such a short time. Friends can't get over it — think it's me, but it's your wonderful lessons!" — Eileen Turner, St. Victor, Canada.

Plays for Church



"I'm 12 years old. I have played for our church. My sister also uses the course. She can play anything — and had never taken lessons before." — Patsy Jeffrey, Sweetwater, Tex.

Gave Famous Band Leader His Start



"Got my start with a U. S. School Course. It's easy to learn to read notes and play this 'teach-yourself' way!" — Lawrence Welk, well-known orchestra leader.

"Enjoyed Every Step"



"Enjoyed every step of the way. Friends can't get over the improvement made in such a short time." — Helen Prevas, New Castle, Del.

Never Believed It Possible



"Never dreamed I would ever play. I didn't know one note. Today I play delightful pieces." — Mrs. Dallas B. Kerk, Lodgepole, Nebr.



FREE BOOK AND LESSON-SAMPLE

The School will gladly send you, FREE, its interesting 36-page book and a Free copy of its simple "print-and-picture" Lesson-Sample. Merely mail the coupon below for them. There is no obligation, and no salesman will call on you.

NOW IT'S EASY to put this wonderful "new friends and more fun" accomplishment into YOUR life! Mail coupon NOW for FREE BOOK telling all about it. U. S. School of Music, Studio C301, Port Washington, N. Y. (Special Reduced Prices on instruments to our students.) We are now in our 55th successful year!



Mail this for FREE BOOK

U. S. School of Music, Studio C301, Port Washington, N. Y. Send me FREE BOOK and FREE Lesson-Sample. No obligation—and no salesman is to call upon me. I'm interested in playing (name instrument).....

I do I do not—have instrument now.

Name..... (Please Print)

Address.....

City..... State..... (Please state Zone No. (if any))

Note: You will find our ad below particularly interesting. Read about this new and profitable hobby.

Northwestern School of Taxidermy
2501 Elwood Bldg., Omaha, Neb.

World's Greatest Hobby For Men and Boys!



L
A
T
E
R

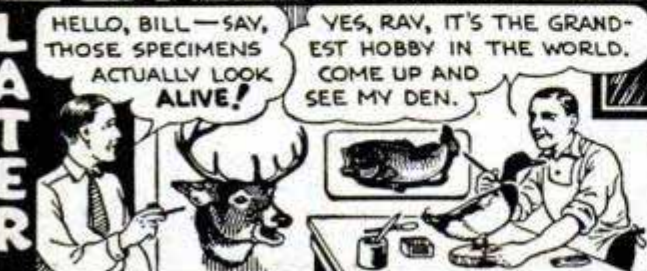

WE CAN TEACH YOU TO MOUNT BIRDS

Great Fun and Profit. Send Coupon for marvelous **Free Book.** It tells **All** about taxidermy—how you can **Make Money** and have great **fun** and fascination mounting **Birds and Animals.** Save your wild-game trophies—mount for others. Also **Mount** common specimens, pigeons, squirrels, rabbits, even frogs, into humorous and useful groups—highly interesting and sell at sight. Wild-game **Not necessary.** Men, Women, Boys learn quickly **by Mail.** Marvelous business, **send coupon TODAY.**

BIG PROFITS! Turn your spare time to **Cash.** Besides Taxidermy learn also to **Tan Leather, Tan Fine Furs** and make them into scarfs, etc. We teach you **Genuine Chrome** method—never before revealed. 400,000 students endorse this old reliable school. We offer **You** our marvelous **Free Book.** Send for **Your copy Today.** In a few weeks we can teach you a **New Trade** that earns **Cash** in depression and good times, too. Then Taxidermy brings fun, fascination. **Investigate!** Get **Free Book.** Sign your name, state **AGE,** and the **FREE BOOK** is yours. Send coupon Today. Or a postal card will do.

FREE BOOK

Northwestern School of Taxidermy,
2501 Elwood Bldg., Omaha, Neb.

Gentlemen:—Please send me your free 48 page booklet explaining Taxidermy. Please print plainly, and please state your **AGE.**

Name _____ Age _____

Address _____
Print plainly. Use margin, if necessary, or send postal.



UNLIMITED OPPORTUNITIES IN ENGINEERING

DEGREE
IN 27 MONTHS

Study Engineering in this world-famed school, established 1884. Demand for our graduates exceeds supply. Growing shortage of engineers. No field offers greater opportunities for responsible, lucrative positions. Approved for Korean vets.

Bachelor of Science Degree in Mechanical, Civil, Electrical, Chemical, Aeronautical, Radio (Television) Engineering; Business Administration and Accounting. Also 36-weeks certificate course in Surveying and Drafting.

Personalized Instruction. Accelerated courses. Non-essentials eliminated. For ambitious, earnest students. Earn your degree in the shortest possible time. Preparatory courses. Placement service.

Extensive Campus. Well equipped, new and modernized buildings; up-to-date labs. Low cost. New terms start quarterly. Enter September, January, March, June.

Write today for free catalog and special information.



TRI-STATE COLLEGE

413 College Avenue, ANGOLA, INDIANA

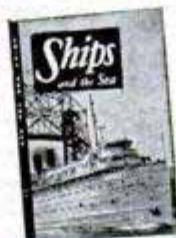

Ships & the Sea Magazine

You'll enjoy this big popular magazine. It's packed with sea-going pictures, salty yarns, charts, articles & model ship department. 50c at larger stands. **Special Offer!** Send \$1 for 3-month trial. Act now!

Ships and the Sea Magazine Dept. 1573B, Milwaukee 3, Wis.



GROW MINIATURE TREES

Grow authentic, LIVE dwarf trees!
Fascinating hobby! Fabulous profit!

SEND FOR FREE SEED & INSTRUCTIONS!

MINIATURE NURSERY CLUB

Dept. 5-E, P. O. Box 18696, Rimpau Sta.
Los Angeles 19, California



ITALIAN ACCORDIONS

Hand Made. Very Best. Buy Direct from Factory Representative at lowest wholesale prices and Save Money. Send Name and Address for FREE catalog.

ITALIAN ACCORDION MFG. CO.

7600 Cottage Grove Ave., Dept. PM-1, Chicago 19, Ill.

Make More Money

- Architecture & Building
- Drafting & Design
- Contracting & Building

Advance Faster

• Don't envy the man who has a big-pay job in the building field or who is starting a business of his own. In spare time at home get the practical training that can enable you to reach high income brackets, independence, security. Don't gamble with your future. Write **BUILDING** on a post card, with your name and address, and mail it to this 55-year-old home study school **AT ONCE.** Full information will be supplied. No obligation.

AMERICAN SCHOOL, Dept. B145, Drexel Ave. at 58th St., Chicago 37, Ill.

I have a good proposition for men or women who would like to make an extra \$125.00 a month for spare time.



By F. A. Strong



These 15 Utensils and covers are all interchangeable. They fit into each other so as to make up 21 different cooking combinations for "Waterless Cooking." The four extra egg cups and the Spoon and Cake Turner make a 19-piece set that covers 99% of all cooking needs.

I won't make any fancy promises of \$50.00 a day. And I'm not after any of your money. What I can do is show you a simple plan by which you can pick up enough extra money every week to help make up for the money you're losing in higher taxes and higher costs of living. And I supply your working outfit free—no charge and no deposit. Just your name is all I need. Read my proposition. It is honest and down to earth. And it won't cost you anything to try it.

TODAY almost everyone needs extra money. Increased taxes and increased living costs are making your dollar worth less and less, so you have to have more and more dollars just to keep even. There are lots of good ways to make extra money. I don't say my way is the best. I do say it's one of the easiest and most pleasant. It even leads to making new friends in sort of an endless chain. It doesn't call for house-to-house canvassing, either. Let me explain:

I am Sales Manager for a very big company. We make Stainless Steel Cooking Utensils. We do an enormous business with hotels, restaurants, hospitals, and institutions. We also make utensils for the Army, Navy, and Air Force.

As a result, we have very low manufacturing costs. We can sell a set of Stainless Steel Cookware for home use for about what it costs some companies to make it! In fact, for years we did sell to one Sales Organization who resold our cookware house to house under their own name. They got \$120.00 for the same set that our people sell for less than half of that.

You've probably heard of salesmen who give dinner parties in homes and then take orders from the ladies who attend. These salesmen have to get a high price because it costs money to give parties — he has to make his share — and his supervisor has to make his. The sales organization comes in for a share, and the manufacturer who sells to them has to make his. So there are about five profits added to the actual manufacturing cost.

About two years ago I got to figuring. There are five good reasons why Stainless Steel is the kind of cookware that should be in every home. 1. It washes as easy as a drinking glass. No scouring, scraping or scrubbing. 2. It doesn't rust or corrode—and it doesn't stain. 3. It doesn't affect the taste of food. 4. Buy it once and you're all through buying for life. You can't wear it out.

You see, Stainless Steel is not a coated or plated metal, like chromium plate on the bumper of your car. That chromium plate can chip or wear off and exposes the raw steel underneath. Then the steel rusts. But our kind of Stainless Steel is stainless all the way through. It can't chip, crack, peel, or wear off. You could use a set the rest of your lifetime and then give it to your children and it would still be good for their children. 5. Carlton Ware enables you to prepare food by the method called "waterless cooking" which keeps more of the natural minerals and vitamins in your food and makes the food taste better.

Well, I figured that if the price was low enough every family could afford Stainless Steel Carlton Ware. So I worked out this plan! We would sell a complete set of 19 pieces at a figure that would include our profit. Then you add your profit and re-sell this set to your friends and neighbors for less than half of the usual price charged on the "party plan." You actually save them more than half. They are glad to get such a bargain and they feel that you've done them a real favor. That's because the set they buy has in it only two profits, ours and yours. Both our profit and your profit is small and fair.

The plan becomes like an endless chain. When a woman gets her first piece of Carlton Ware she gets so thrilled with its better cooking and easy cleaning that she talks and talks. She can't wait to demonstrate it to her friends and tell them all about it. She's so proud of its silvery sheen and so happy about how easily it washes that she just "bubbles over." So just by letting your own friends in on a good thing, before you know it their friends call you up and ask if you can get the

same low prices for them. Then their friends call you and their friends' friends. It goes on and on!

To make an extra \$125.00 a month, you only have to deliver ten sets and that's easy. Mrs. Montell in Pennsylvania took orders for \$1400.00 worth in her first month. And Mrs. William Hanchow wrote, "Got my set Saturday—I already have 17 customers."

Now, I'll let you in on another part of my plan. If you take only ten set orders a month for six months, my company pays your expenses for a winter vacation in Florida. You and one other member of your family can spend a whole week at our expense. My company maintains a beautiful resort in the Florida Keys, just so our sales representatives can enjoy a Florida vacation at company expense.

Get all the information right now. I'll not only be glad to send Free Information. I'll also send you a complete demonstrating outfit that you can show to your friends and neighbors. And I'll give you exact instructions by which you can write up orders without ever trying to "sell" and without making any house-to-house calls.

Everything I send you is free. When you qualify, I'll even furnish you with a complete 19-piece set of Carlton Ware to use in your own kitchen and show to your friends. It's an extra bonus I give to encourage good earnings on your part.

Send your name today in confidence. You'll be glad you wrote. This ad may not appear in this magazine again, so don't take any chances on losing out. Send the coupon or just send your name on a postcard. I won't send any salesmen to call on you and you won't be under the slightest obligation.

F. A. STRONG

Carlton of Carrollton—Carrollton, Ohio

**F. A. Strong, Carlton of Carrollton
Carrollton, Ohio**

Dear Mr. Strong: Please send me free and without any obligation whatever a complete selling and demonstrating outfit with exact instructions for making an extra \$125 a month. I don't want to do any house-to-house selling, but I will show your products to my friends and give them the advantage of the low prices.

Name.....

Address.....

City.....Zone.....State.....

I am already selling Cookware and am interested in getting a line that can be sold at a lower price. Please send me your Distributor's proposition.

ONE THOUSAND GOLDEN OPPORTUNITIES

MOST GENEROUS OFFER!

We offer men and women everywhere what we believe is the greatest and most generous offer ever made to ambitious people in the U.S.A. It's like receiving an inheritance or being remembered in your rich Uncle's will! We show you how to make an endless variety of beautiful things. We supply all the materials and instructions and show you how to dispose of your products at tremendous profits! **NO TOOLS OR MACHINERY REQUIRED!** The casting process is as easy as pouring water out of a glass! Work at home or in your garage!

FASCINATING BUSINESS OR HOBBY!

Make extremely beautiful imbedded jewelry, bookends, figurines, planters, ceramics, statues, ash trays, lighters, banks, lamps, exquisite gems, fishing lures, keychains, novelties, curios, gadgets, souvenirs, pensets and an unlimited variety of useful and wonderful products! This work is so pleasant and fascinating that many take it up as a grand and profitable hobby!

UNLIMITED POSSIBILITIES!

The ONLY limitation is your imagination! No special talent, no previous experience, no special tools or machinery required! We will supply you with raw materials or finished products, start you in business and **GUARANTEE** your sales or money refunded!

HOW TO START

We can't hand you cash . . . but we offer you something that ordinarily takes thousands of dollars and many years to establish; yet it's all yours for the asking! We urge you to investigate this unusual offer today. You'll be excited and thrilled over the many wonderful opportunities we hand you **ABSOLUTELY FREE!** Send only 25c for our big 56 page Catalog describing the fascinating process of creating and manufacturing mentioned above. Do it today . . . don't delay anything that could be so important to your future!

PLASTICAST CO. (DEPT. C)

P. O. Box 6737
Chicago 80, Ill.

(WRITE TO
NEAREST
ADDRESS)

P. O. Box 987
Palo Alto, Calif.

CANADIAN CUSTOMERS: Send 35c for catalog to Canadian Ind. PLASTICS, 1056 1/2 W. Pender St., Vancouver, B. C.

WATCHMAKING FREE Sample Lesson

Shows how to clean watches by hand or machine. It's fun . . . profitable too! An exciting hobby or fascinating career. Chicago School of Watchmaking will train you in professional watch repairing at home or in resident school. Learn modern methods. No experience needed. Send coupon today! No obligation.

CHICAGO SCHOOL OF WATCHMAKING

2320 N. MILWAUKEE AVE., DEPT. 113, CHICAGO 47, ILL.

SEND FREE SAMPLE LESSON

Veteran

Name _____

Address _____

City _____ Zone _____ State _____

40 QUARTS OF STRAWBERRIES

Raise 40 to 60 quarts of delicious berries in only 6 ft. of space. Full details about our new type strawberry pyramid in our information packed 1953 nursery catalog. A complete selection of flowers, bulbs, fruit, berries, trees, etc. Money-saving collections. Finest varieties. Low cost 104th anniversary specials.



WRITE FOR
FREE CATALOG

Spring Hill Nurseries, Dept. 0-26, Tipp City, O.



QUALITY TRUCK & PASSENGER TIRES
LOW PRICES - GUARANTEED
FREE TUBE WITH EACH PASSENGER TIRE

Buy first quality used tires direct from wholesaler and save money. Each tire triple inspected and guaranteed. Free tube with each passenger tire. Order today.

QUALITY PASSENGER TIRES 1 YEAR WRITTEN GUARANTEE

600x16 \$5.59 | 670x15 \$5.95
650x16 5.79 | 700x15 5.59

EXTRA VALUE TRUCK TIRES | **MUD & SNOW TRUCK TIRES**
1 YEAR WRITTEN GUARANTEE | **2 YEAR WRITTEN GUARANTEE**
700x20 \$12.50 | 750x20(10) \$18 | 600x16 \$6.95 | 650x16 \$7.50
750x20(8) 14.50 | 825x20 21.50 | 900x16 12.95 | 750x20 15.95
Complete line of High Mileage Tires in stock. Write for price list for sizes not listed. Take off 10% on orders for two or more tires. All prices F.O.B. Richmond, Virginia.

THE SAFTYRE CO., INC.

MAIL ORDERS PROMPTLY FILLED. Send check or money order with this ad.

"FOR THAT SAFE TIRE"
Dept. PM, 1801 E. Broad Street
P.O. Box 2254, RICHMOND, VA.

ENGINEERING DEGREE IN 27 MONTHS

INDIANA TECHNICAL COLLEGE

B. S. DEGREE, Aeronautical, Chemical, Civil, Electrical, Mechanical, and Radio Engineering (inc. TV and Electronics), Drafting, 1-yr. G.I. Gov't approved. Low rate. Earn board. Large industrial center. Students from 48 states, 21 countries. Demand for graduates. Enter March, June, September, December. Write for catalog, 1613 E. Washington Boulevard, Fort Wayne 2, Indiana.

TASCOPE PHOTO-ENGRAVING PLANTS



Establish your own profitable **PHOTO-ENGRAVING** business. Make cuts for newspapers, printers, and advertisers. Make etched name plates, plaques etc. Instructions furnished, no experience necessary. Sold direct from factory since 1931. First five hundred cuts sold locally or by mail will pay for plant and pay you well for your time. Write for **FREE** catalog. **TASCOPE DEPT PM1, AURORA, MO.**

Material Cost of This Cut 34c
Selling Price \$1.00 And Up

Learn TATTOOING At Home

Earn extra **MONEY**—Tattoo blood types and designs in your community. Splendid opportunity in every town. Prepare in spare time. Practical instructions. Send 25c for details and list of Tattoo Supplies. No obligations. **ZEIS SCHOOL OF TATTOOING • 728 Leslie, Rockford, Ill.**



FALSE TEETH BROKEN?

A new sensational plastic liquid enables you to weld broken plastic dentures at home.

! U-WELD !

Saves you both money and time. Have U-Weld handy for emergencies.

INTRODUCTORY OFFER \$2.00

Send check or money order to:

SABCO SALES CO. 47 SO. DR. VALLEY STREAM, N. Y.



Thrilling Work COLORING PHOTOS



Fascinating vocation learned at home by those with aptitude. Thrilling pastime. National method brings out life-like colors. Free booklet.

NATIONAL PHOTO COLORING SCHOOL
835 Diversey Pkwy., Dept. 1351, Chicago 14

EASY TO LEARN

TRAIN FOR GOOD PAY IN A FIELD THAT ISN'T CROWDED!



NOW! you can LEARN ELECTRIC MOTOR REPAIR

... A good-paying, modern profession



OPPORTUNITIES EVERYWHERE!

Don't drift into a rut! Don't train for something that everybody and his brother are studying! Consider the facts. . . . The average small home has at least 11 electric motors! Big homes have many more—in phonographs, recorders, oil burners, refrigerators, washers, fans, clocks, mixers, cleaners, air conditioners, etc., etc. Millions more in office, industrial, mining, and transit equipment. Be the well-paid expert who can keep them working!

FREE STUDY GUIDE

A unique Study Guide booklet of 500 practical motor study questions—priced and sold separately at 25¢—is yours FREE with your request to examine ELECTRIC MOTOR REPAIR book. Makes learning easier—speeds up the work! See coupon.



... for only \$6 FOR THE COMPLETE TRAINING

Every day, more and more electric motors and motor control systems are being used BOTH in industry and in home appliances. The expert who can install and keep them working properly is a valuable man in this Electrical Age. The pay is surprisingly good. The field is tremendous—and growing rapidly. Trained men find opportunities everywhere for full or part time work. ELECTRIC MOTOR REPAIR, the big 560-page training course book teaches you the work step by step—quickly and easily—at home in spare time. There is no other book like it. Ideal for beginners or for actual bench use in busy shops. Thousands already in use in leading vocational schools, shops, and for home study.

SHOWS YOU HOW . . . Every Step of the Way!

Based on what you can learn quickly at home from ELECTRIC MOTOR REPAIR you can train for prompt, profitable installation, servicing, repairing and complete rewinding of practically any motor in use today. You learn fast! You learn right! Every subject is clearly explained by text AND ALSO by more than 900 illustrations and diagrams. You not only read what to do—you SEE how it is done. Quick reference guides tell you how to handle specific jobs. When a certain motor comes in for repairs, just look it up. ELECTRIC MOTOR REPAIR tells you what to do—and exactly how to do it.

ELECTRIC MOTOR REPAIR is designed for use right at the service bench. Unique Duo-Spiral Binding divides the book into two sections so that both text and related diagrams can be viewed together. An instructor standing by your side could hardly do better! ELECTRIC MOTOR REPAIR covers the entire field—from alternating- and direct-current motors and generators, etc., to mechanical and electrical and electronic control systems. Right down the line, it explains trouble diagnosing, repair, rewinding and maintenance in a way you can easily understand.

PRACTICE FROM IT 10 DAYS AT OUR RISK!

You don't risk a cent! Use coupon for 10-day examination of this famous home training book.



LEARN FAST . . . No Lessons to Wait for!

If sold as a course and sent to you in lesson form, ELECTRIC MOTOR REPAIR would be a bargain at 10 times the price. You get it all at once. You learn rapidly. Here are just a few of the subjects covered:

- Split-Phase Motors
- Capacitor Motors
- Repulsion-type Motors
- Polyphase Motors
- Alternating-Current Motor Control
- Direct-Current Armature Winding
- Direct-Current Motors
- Direct-Current Motor Control
- Universal, Shaded-pole, and Fan Motors
- D-C Generators, Synchronous Motors and Generators
- Electronic Motor Control
- ... and essential motor data

10-DAY EXAMINATION COUPON

Dept. PM-13, RINEHART BOOKS, Inc., Technical Division, 232 Madison Ave., New York 16, N. Y.

Send me the 560-page ELECTRIC MOTOR REPAIR home-training book for 10-day FREE EXAMINATION. At the end of 10 days, I will either return book to you postpaid in good condition or send you the sum of \$6.00 in full payment. Include FREE Study Guide which is mine to keep whether I buy the book or not.

Name _____
 Address _____
 City, Zone, State _____
 Your Employer's name & address _____

(Outside U.S.A. \$6.50 cash only—same return privilege)



SCRAM! You SKINNY SCARECROW!

The boys Shouted at me—
ONLY A FEW WEEKS AGO!

"I was a SKINNY, scared, girl-shy skeleton. Now I feel and look great. Pal, do as I did, right NOW! Mail the Coupon below.

I gained 53 lbs. of MIGHTY MUSCLE

6 1/2 inches on my CHEST;
3 inches on each ARM

You can do it in 10 minutes a day and WIN This 15" Tall SILVER TROPHY"



Roger D. Hirsch
New York



ROGER HIRSCH was on 112 lb. & ft. weekling LOOK AT HIM NOW!

MAN! aren't YOU as SICK and TIRED as I and thousands of MIGHTY JOWETT HE-MEN were of being SKINNY?

Come on, Pal, Give me 10 pleasant minutes of fun a day and I'll give YOU a NEW HE-MAN BODY for your Old Skeleton Frame.

NO! I don't care how skinny or flabby or how young or old you are I want to MAKE YOU OVER by the SAME METHOD I turned myself from a wreck to a Champion of Champions.

YES! You'll see INCH upon INCH of MIGHTY MUSCLE added to YOUR ARMS. Your CHEST deepened. Your BACK AND SHOULDERS broadened. You'll gain SOLIDITY, SIZE, POWER, SPEED! You'll become an ALL-American HE-MAN, a WINNER in everything you tackle—or my Training won't cost you one cent!

Develop YOUR 520 MUSCLES! Gain Lbs., INCHES, FAST!

Friend, I've made a LIFETIME STUDY of every way known to develop your body. Then I devised my "5-WAY PROGRESSIVE POWER" the only method that builds you 5-ways fast. You save YEARS and DOLLARS by Mailing Coupon NOW.

"IN 90 DAYS
You changed me from a SKINNY wreck to a MIGHTY HE-MAN. With ONE hand I can NOW lift overhead a boy weighing 115 lbs."

John Jacobson ARK.

"10 Minutes a day and I am a NEW STRONG MAN! I have a big 49 in. CHEST, powerful 17 inch ARMS a 32 inch WAIST."

Felipe Montoya -Cal.

GEORGE F. JOWETT
Champion of Champions

FREE if you mail COUPON NOW
1. MUSCLE METER
2. JOWETT'S Photo Book of Famous Strong Men—
"Nerves of Steel, Muscles of Iron," packed with photos of miracle he-men whom Jowett guided from weaklings to muscular power. Read thrilling adventures of Jowett, himself. Mail Coupon NOW!



AMAZING ALL 5 Picture-packed courses while the supply lasts—only

10¢

MILLIONS SOLD at \$1 and more

FREE PHOTO BOOK of Famous Strong Men and a MUSCLE METER

Dept. PM-31

"Jowett Courses greatest in World for Building All-Around HE-MEN."
—R. F. Kelley
Physical Director

JOWETT INSTITUTE OF PHYSICAL TRAINING
220 FIFTH AVENUE, NEW YORK 1, N. Y.
George: Send me FREE Photo Book of Strong Men, a Muscle Meter, plus all 5 HE-MAN Building Courses: 1. How to Build a Mighty Chest; 2. Mighty Arm; 3. Mighty Grip; 4. Mighty Back; 5. Mighty Legs—all in One Volume "How to Become a Mighty He-Man." I enclose 10c. (No C.Q.D.'s)

Name Age.....
(Please print plainly)
Address.....
City..... Zone..... State.....

321 DIFFERENT STAMPS

FROM ALL OVER THE WORLD—only 25¢

FREE! "Midget Encyclopedia of Stamp Collecting"

Big valuable imported collection of 321 different stamps from dozens of hard-to-get countries! Includes UNITED NATIONS—the 3 first stamps issued; FRANCE—thrilling anti-Communist set complete; MONACO—Pope Pius triangles; SO. MOLUCCAS—General MacArthur—plus hundreds of other fascinating stamps and sets from all over the world! It's a regular \$3.50 value—all yours for only 25¢ to introduce our Bargain Approvals. Included, FREE, a helpful 32-page booklet, on Stamp Collecting. Money Back if not delighted. Send 25¢ today. ASK FOR LOT F0-3



ZENITH CO., 81 Willoughby St., Brooklyn 1, N.Y.

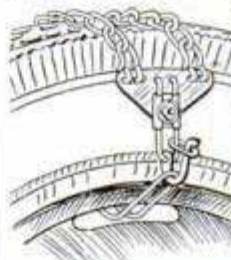

Kon-veen-yunt EMERGENCY TIRE CHAINS

Put On Your Tire in 10 Seconds
Gets You Out of Trouble "Quik"

Wonderful new emergency tire chains widely used throughout the United States. Designed for simplicity of adjustment. No buckles or swollen straps to fuss with or break—ALL SWEEEL and twice as strong as strap type. Fits all passenger cars except Buick. All prices F.O.B. Richmond, Va. ORDER TODAY—SATISFACTION GUARANTEED. Mail orders promptly filled. Send check or money order with this ad. PLEASE indicate tire size.

SATISFACTION GUARANTEED

only \$5.98
Set of 4 Chains
KON-VEEN-YUNT TIRE CHAINS
P. O. Box 283-B Richmond, Va.



SEND FOR THIS **FREE!**

Make money. Know how to break and train horses. Write today for this book FREE, together with special offer of a course in Animal Breeding. If you are interested in Galting and Riding the saddle horse, check here () Do it today—now.

BEERY SCHOOL OF HORSEMANSHIP
Dept. 1101 Pleasant Hill, Ohio



STROMBERG POULTRY BOOK FREE

TELLS how to raise pullets at LESS COST on Stromberg more-profit breeding plan. ILLUSTRATES Pedigreed Sired profit strains, all varieties. Large Type DANISH BROWN LEGHORNS, Anconas, Rhode Island Reds, No. 171's, etc. Backed by Golden Rule Guarantee. FREE beautiful Stromberg 1953 Colored Catalog. STROMBERG HATCHERY, Fort Dodge 25, Iowa

Develop Hidden Earning Power

STUDY LAW

at home! LL.B. Degree

Qualify yourself in spare time for advancement, greater earnings, business success. Now, more than ever, legal ability is in demand! Easy-to-understand step-by-step lessons and text material furnished— invaluable for permanent reference. Over 40 years expert instruction. 114,000 students enrolled. Easy payments. Find out now, at no cost, how study of law can help you. Write today for FREE Book "Law and Executive Guidance."

AMERICAN EXTENSION SCHOOL OF LAW
Dept. PM-58, 664 N. Michigan Ave., Chicago, Ill.

DOES YOUR TV SET HAVE TO COST YOU FROM \$25-\$90 A YEAR FOR REPAIRS?

Not if you know a few simple things about your television set . . . not if you know when you really need a serviceman . . .

and when your trouble can be corrected with a minor, simple, safe adjustment you can make yourself . . .

You've seen a serviceman come in to work on your set. He taps this and twists that. Then he either replaces a tube, or makes an adjustment on a part. All he has to do is recognize and locate the trouble, and then make the correction.

You don't have to be a mechanical genius to be able to make many of these same adjustments on your set yourself. If you have ever put a new washer on your water faucet, or changed a tire on your automobile, or attached a new plug to an electric cord—you have enough "mechanical background" to be able to take care of all "nuisance repairs" yourself, and probably of most other things that go wrong with a set.

Amazing New TV Owner's Self Repair Book Takes the Mystery Out of TV Repairs

With the amazing new TV Owner's Self Repair Book, you can have a television expert at your side whenever you need it. Now, every time your set begins to flicker or jump, or becomes distorted or dissolved into lines or zags—a flick of the finger to the right page **SHOWS YOU EXACTLY WHAT CONTROL** knob to turn to correct the trouble in less than a minute! From now on, every time you're annoyed by "ghosts," snow or weak channel reception—the TV Owner's Self Repair Book shows you how to effect a quick 15-minute repair job that eliminates these faults and restores the set to perfect, movie-clear reception.

IT HAS BEEN PROVEN THAT 1 OUT OF EVERY 3 TV FAULTS IS CAUSED BY A WEAK OR BURNT OUT TUBE. Just by replacing a tube you can correct fully 33 1/3% of the troubles that may develop in a set. The TV Owner's Self Repair Book shows you how to safely locate and change the bad tube in less than 5 minutes.

Contains special tube diagrams that spot faulty tubes immediately . . . a complete section on antennas . . . interference . . . covers T.V. set models from 1947-1952 . . . all makes . . . all sizes.

When you check your trouble and find that it is due to a faulty tube, you are led right to it. You simply find the diagram for your set and the one (or more) tubes you are to check—and **THE ONE TO REPLACE** are pinpointed for you! You are directed right to it. No blind guessing or hunting for the bad tube. **ONLY IN THIS BOOK**, has there been developed a special identification method to make it a cinch to locate the bad tube. Each tube in each diagram not only carries its usual trade identification number, but also a special letter to identify its function and location as well. It's (1) find the trouble, (2) find the tube, bingo, (3) replace the tube—and that's all there is to it!

Which Type of Antenna Is Best for Your Set

The special chapter on antennas explains what an antenna is supposed to do; the reason for the different shapes and arrangements; the reason for "stacking" and multiple antennas; how to "orient" an antenna for best reception; the need and use of a "rotator"; the special antennas for "fringe" areas; how to install, change or add antennas and parts; information on complete antenna installation kits which are available. Just about everything practical that you need to know about antennas.



Do This Right Now and Prove You Can FIX TV TROUBLES YOURSELF

Turn your set around. You will find in the back of it an arrangement of "rear controls" looking like this:

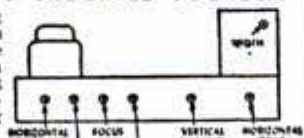

Zags on Your Screen

Now, if you are troubled with these zags on your screen, locate Hor. Syn. on the above rear panel. Turn control slowly to right. Zags will appear even stronger. Turn control slowly back to left. Zags will disappear and you will have a perfect picture on your screen. That's all there is to it. You have made a \$5 repair in less than 5 minutes. A few other repairs that you can make yourself without tools, without any special knowledge, just with the help of this new TV Owner's Self Repair Book.

made a \$5 repair in less than 5 minutes. A few other repairs that you can make yourself without tools, without any special knowledge, just with the help of this new TV Owner's Self Repair Book.



Picture Not High Enough to Fill Screen Top to Bottom. Sound and Picture Not in Step, Sound Not Good When Picture Is Best. Picture Weak, Gray, Lacking in Contrast.



Jumpy Picture Dark Fuzzy Picture No Picture, Sound Okay

6 Easy Ways to Eliminate Interference

In the TV Owner's Self Repair Book there is a unique chapter devoted just to elimination of interference. This chapter tells you just what "interference" actually is. It describes and illustrates the interference symptoms or patterns which appear on your screen in the form of diagonal lines, vertical lines, herringbone or hypens all over the screen, etc. This chapter gives you the easy ways to eliminate interference, doing it yourself in a few minutes.

Complete Price Lists of All Tubes

The TV Owner's Self Repair Book contains a full listing of every tube used in TV sets, fully identified with number, and also listing of picture tubes and with the fair retail prices (by the way, prices range from \$1.10 for a 5YEGT tube to \$6.60 for a 6CDG tube and up to \$101.00 for a 24 inch picture tube, 24BF4). A full listing, also, of standard and reasonable charges for every type of television service and repair job. No longer need you be in the dark when it comes to knowing what a job should cost. Now you can make your own minor repairs and in addition know just how expensive "Expensive" repairs should really be.



A Practical Reference Book & Reading Course Combined in One Big Volume . . . for Only \$1.98

An Amazing Bargain Actual Size 6x9 inches, 160 Pages, Over 300 Illustrations And How To Do It Pictures

- How To Install Your Own Television Set
- How To Adjust Your Set Controls
- Special Answers To Common Questions
- Troubled With No Sound?
- How To Locate Tubes
- Tube Identification
- How To Eliminate Interference
- Antenna Plans and other tips

Never Before Such a Complete, Authoritative Book for So Little Money!

It contains chapters devoted to GETTING ACQUAINTED WITH YOUR TV SET, telling you how the set is put together, how to understand the controls, how to operate the set, why a "test" pattern is needed—and HOW A TV SET WORKS, telling you how pictures and sound are broadcast and received. Included in the broad scope of this book, is complete information on HOW TO DIAGNOSE TROUBLES IN YOUR TV SET, telling you how to spot faults due to poor adjustment, faults due to wear and breakdown of tubes and parts, faults due to outside causes including extreme distance from telecasting center; also HOW TO CURE YOUR TROUBLES IN THE SET, telling you with pictures and descriptions just how to go about replacing tubes, parts, HOW TO MAKE VARIOUS ADJUSTMENTS and how to do all this without the slightest danger to yourself or to your set! There is also a special chapter devoted to television accessories, such as boosters, what they do, Interference, Traps, Glare Filters, Antenna Couplers, which means a master antenna system which permits the operation of two sets from a single antenna, and much, much more.

Unconditional Money Back Guarantee!

Let us send you a copy of this TV Owner's Self Repair Book. Look at it, go through it, read the general information it offers on how a TV set works. Use it to adjust the controls on your set to 100% perfection. Use it, above all, in making your next "fix-it" job on your set. Then—if you don't think that it is the best book of its kind on the market, that it will save you up to a possible \$300 on repairs and adjustments on your set during its life, return it to us. We'll promptly send your money back. You must be satisfied 100% or it costs you nothing to examine and try the book—in your home on your set. What could be fairer? But send for the book now and enjoy the best television reception from your set right away!

SEND NO MONEY unless you wish

MECRAFTS, DEPT. 753
799 Broadway, New York 3, N. Y.

Please send me the TV OWNER'S SELF REPAIR BOOK immediately. I agree to pay postman on arrival \$1.98 plus C.O.D. postage. If the book does not help me get a clearer, sharper, better defined picture than I am now getting—if the book doesn't make it possible for me to fix or repair my own set, if I am not 100% satisfied, I may return the book for my full money back!

NAME _____ (Please print plainly)
ADDRESS _____
CITY & ZONE _____ STATE _____

SAVE MORE! If you enclose \$2 cash, check, or money order with this coupon, we pay all postage charges. Same unconditional money back guarantee!

not everyone does as well, but E. O. Lockin, who started a business of his own, reports...

for 12 months I've averaged

\$800 PER MONTH INCOME

—most of it clear profit for me!

● Mr. Lockin expresses his grateful thanks for the opportunity to make a decent living on his own. Many men have discovered how to be independent, to be free of bosses and layoffs. L. A. Eagles grossed more than \$200 his first week. R. E. Traynor says, "I made \$62 gross in one day." Others report gross up to \$12,000 per year.

How much you make depends largely on you. You need no special skill, no large investment.

No shop necessary.

Our **ELECTRIC RUG WASHER** cleans rugs, carpets right on floor... helps to show their natural color and beauty. So efficient and safe, used by largest hotels and railroads.

You take no risk. Machines fully guaranteed. Mail coupon today for complete information including how to start making big profits in **YOUR OWN BUSINESS.**

VON SCHRADER MFG. CO., RACINE, WIS.

You, too, can start your own business. No special skill, no large investment required. Mail coupon today for interesting **FREE book.**

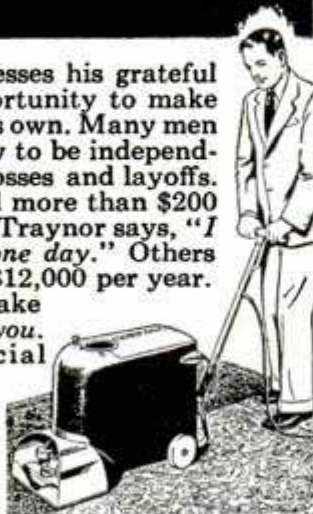

VON SCHRADER MFG. CO.,
5011 "R" PL Racine, Wisconsin

Send at once (no obligation) your **FREE** booklet containing information about your **ELECTRIC RUG WASHER** and how I can start my own permanent, profitable business.

Name _____

Address _____

City _____ Zone _____ State _____

Say You Saw It in Popular Mechanics

High School at Home

Many Finish in 2 Years

No classes. No time wasted going to and from school. Progress as fast as your time and abilities permit. Standard H. S. texts supplied. Thousands enroll each year in this 55-year-old school. Send for **FREE** descriptive booklet.

AMERICAN SCHOOL, Dept. H145
Drexel at 58th St., Chicago 37, Ill.

Without obligation, please send **FREE** descriptive booklet.

Name _____

Address _____

Pocket-Size ADDING MACHINE

ONLY **\$1.49**



Adds-Subtracts Multiplies-Divides
EASY - QUICK - ACCURATE

Calculates 9,999,999

Simple to use! Operates with a flick of the finger. As accurate as machines costing many times this amazing low price. A practical machine—**NOT A TOY.** Sturdily constructed, fully guaranteed. Saves money and time in avoiding calculating errors. Ideal for offices, clerks, farmers, schools, and other personal uses such as keeping scores; canasta, golf, etc.

SEND NO MONEY—Just Mail Order. Pay post-man only \$1.49 plus postage and COD fee on delivery. Or send \$1.50 with order and we pay postage. Use 10 days. If not delighted, return for money back. **ORDER NOW!**

RAY CALCULATOR CO. 259 STRADER AVE., DEPT. R-212, CINCINNATI 26, OHIO

LEARN LOCKSMITHING

Learn Locksmithing and Keymaking from Experts in Your Spare Time at Home!

Locksmiths in big demand! No layoffs, no slow seasons! No no disadvantage. Year-round, steady income in this permanent, respected field. Full or part time. Practical, illustrated lessons show how to make money even while learning! All materials, special tools supplied.

(Send for **FREE BOOKLET.**)

INSTITUTE OF LOCKSMITHING, Dept. P38
15 PARK AVE. RUTHERFORD, N. J.
Lic. & Approved State of N.J. VA Approved

'How to MAKE MONEY with Simple CARTOONS'

A book everyone who likes to draw should have. It is free; no obligation. Simply address **FREE BOOK**

CARTOONISTS' EXCHANGE
Dept. 91A, Pleasant Hill, Ohio

500 TRICKS MAGIC TRICKS

IT'S FUN TO DO MAGIC

Be popular! Amaze—mystify—entertain! For 30 years Douglas has satisfied customers all over the world. Now, you can enjoy this fascinating hobby. Only 10¢ brings our Catalog 500 Tricks, containing brand new tricks for pocket, parlor, stage. Join in the fun—send 10¢ today!

Douglas Magicland, Dept. A, Dallas, Texas

508 DIFFERENT STAMPS 25¢

WHAT A BUY!

YOU receive the complete airmail set of 4 beautiful bicolored stamps from Albania depicting Roosevelt and Churchill plus the new country of South Molucca's issues of the United Nations; Universal Postal Union; MacArthur and map; Indonesia beauty plus hundreds and hundreds of unusual stamps from the four corners of the world. All in all you get **508 DIFFERENT STAMPS** for only 25¢ to introduce our bargain approvals.

BONUS! POCKET STAMP DICTIONARY AND GUIDE!

STAMPEX CO. 116-M NASSAU ST. NEW YORK, N. Y.



Leonard C. Lane, B.S., M.A.
 President of Radio-Television
 Training Association, Exec. Dir.
 of Pierce School of Radio and
 Television.



I GIVE YOU
MORE EQUIPMENT
 TO TRAIN YOU BETTER

Set up your own home laboratory with the 15 BIG TV-Radio kits we send you. You build AND KEEP your own complete BIG SCREEN TV RECEIVER, Super-Het Radio Receiver, R.F. Signal Generator, Combination Voltmeter-Ammeter-Ohmmeter, C-W Telephone Receiver, AC-DC Power Supply. Everything is furnished complete, including all tubes, plus big TV picture tube.

GET MORE!
 LEARN MORE!
 EARN MORE!

THOUSANDS OF NEW JOBS IN
TELEVISION
 I PREPARE YOU AT HOME IN YOUR SPARE TIME

TRAINING TO FIT YOU
 FOR THE BETTER PAY JOBS

Thousands of new jobs will open up right in your own state, now that the government has lifted restrictions on new TV stations. My simple, successful methods have helped hundreds of men — most of them with NO PREVIOUS TRAINING — find places in America's booming TELEVISION and Electronics industries. You too can get the success and happiness you always wanted out of life within months... studying at home... as I train you to become a full-fledged TV TECHNICIAN. Many of my students make as much as \$25.00 a week repairing Radio-TV sets in their spare time while learning... pay their entire training almost from the very beginning from spare time earnings... start their own profitable service business.

But I don't stop after I qualify you as a TV Technician... although right there you can choose from among dozens of fascinating careers! I continue to train you — AT NO EXTRA COST — to qualify for even better pay in the BETTER JOBS that demand FCC licenses, with my...

FREE FCC COACHING COURSE
 PREPARES YOU AT HOME FOR YOUR FCC LICENSE.
 THE BEST JOBS IN TV AND RADIO REQUIRE AN FCC LICENSE.
 Given at NO EXTRA COST after TV Theory and Practice is completed.

NOW! ADVANCED FM-TV TRAINING
 If you have previous Armed Forces or civilian radio experience—my ADVANCED COURSE can save you months of training. Full theory and practical training... complete with kits, including BIG SCREEN TV RECEIVER and FREE FCC License Coaching Course.

FREE EMPLOYMENT ASSISTANCE
 My vocational adviser will help you obtain a good-paying job in the locality of your choice.

RADIO-TELEVISION TRAINING ASSOCIATION
 1629 Broadway, Radio City Station, New York City 19, N. Y.
 LICENSED BY THE STATE OF NEW YORK

MORE VALUE!
 YOU GET A ROUND TRIP TO
 NEW YORK CITY
 AT NO EXTRA COST

FROM ANYWHERE IN THE U.S. OR CANADA — I pay your way to New York and return, PLUS 2 FREE weeks, 50 hours of advanced instruction and shop training at the PIERCE SCHOOL OF RADIO & TELEVISION. You use modern electronics equipment, including student-operated TV and Radio stations. You go behind the scenes of New York's big Radio-TV centers, to study first hand. And I give you all this AT NO EXTRA COST! (Applies to complete Radio-TV course only.)

Only RTTA makes this amazing offer.

I GET MY
GRADUATES GOOD PAYING JOBS

"Thanks to your training, I qualified for a good job as a Receiver Tester at Federal Telephone and Radio."
 — Paul Frank Seier



"I'm making good money in my own business, repairing and installing radio and TV sets — thanks to your training."
 — Irwin Polansky



"Your excellent instruction helped me get my present job as an airport radio mechanic for American Airlines."
 — Eugene E. Basko



"I'll always be grateful to your training which helped me get my present fine position as Assistant Parts Manager."
 — Norman Weston



Many others working at NBC, RCA, CBS, DuMont, Philco, Emerson, Admiral and other leading firms.

VETERANS!

MY SCHOOLS FULLY APPROVED TO TRAIN VETERANS UNDER NEW G.I. BILL! If discharged after June 27, 1950 — CHECK COUPON BELOW!

Also approved for RESIDENT TRAINING in New York City... qualifies you for full subsistence allowance up to \$160 per month.

MAIL COUPON TODAY!
 BOTH FREE! New Illustrated Book and Sample Lesson. Learn How My Simple Methods Make Success Easy!

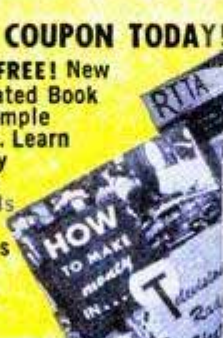

NO SALESMAN WILL CALL!

Mr. Leonard C. Lane, President
 RADIO-TELEVISION TRAINING ASSOCIATION
 1629 Broadway, Radio City Station
 New York 19, N. Y. Dept. M-1

Dear Mr. Lane: Mail me your NEW FREE BOOK and SAMPLE LESSON that will show me how I can make BIG MONEY in TELEVISION. I understand I am under no obligation and no salesman will call.

(PLEASE PRINT PLAINLY)

Name _____ Age _____
 Address _____
 City _____ Zone _____ State _____

I am interested in: Radio-TV Advanced FM-TV.
 VETERANS: If qualified under new G.I. Bill, check your choice: Home Study Resident Study.

"I'M MAKING MORE THAN \$1000 a Month Haven't Touched Bottom Yet!"



—reports Charles Kama, Texas, one of many who are "cleaning up" with orders for PRESTO, Science's New Midget Miracle Fire Extinguisher. So can YOU! Over a Million Already Sold!



Science's New Midget Miracle "PRESTO"

A MAZING new kind of fire extinguisher. Tiny "Presto" (about size of a flashlight!) does job of bulky extinguishers that cost 4 times as much, are 8 times as heavy. Ends fires fast as 2 seconds. Fits in palm of hand. Never corrodes. **Guaranteed for 20 years!**

Show it to civil defense workers, owners of homes, cars, boats, farms, etc. and to stores for re-sale—make good income. H. J. Kerr reports \$20 a day. Wm. Wydal-lis, \$15.20 an hour. Write for FREE Sales Kit. No obligation. MERLITE INDUSTRIES, Inc., Dept. 51, 201 East 16th St., New York 3, N.Y. **IN CANADA: Mopa Co., Ltd., 371 Dowd St., Montreal 1, P.Q.**

(If you want a regular Presto to use as a demonstrator, send \$2.50. Money Back if you wish.)

NOW! BECOME EXPERT AT

RADIO-TELEVISION

IN 4 EASY STEPS

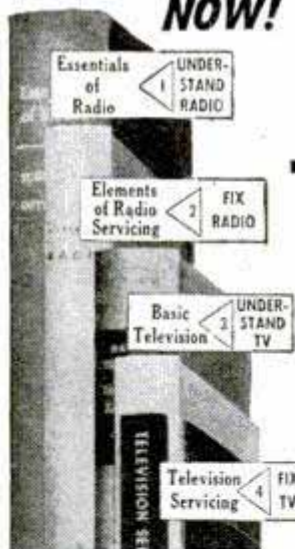

The McGraw-Hill Radio and TV Servicing Library gives you all you need to know for FM and TV in FCC's 1st-Class license exam.

Complete self-training library in RADIO and TELEVISION prepared by famous experts. Takes you by simple, practical steps from basic theory to advanced problems of repair, installation, color TV, etc. Do any repair job like an expert. Step into a good-paying job—or start your own business. Train AT HOME . . . in SPARE TIME.

2296 pages — 1541 illustrations
Every detail clearly explained with step-by-step instructions, "how-to-do-it" illustrations, cross-section diagrams, etc. Review questions and answers "nail down" everything you learn. At-a-glance "trouble-shooting" charts show how to diagnose instantly any radio or TV breakdown . . . and how to repair it expertly and quickly.

10 DAYS' FREE TRIAL

McGraw Hill Book Co., Inc., Dept. PM-1
327 W. 41st St., N. Y. C. 36

Send me McGraw-Hill's Radio and TV Servicing Library, 4 volumes, for 10 days' examination on approval. If the books prove satisfactory, I will remit \$1.95 in 10 days, and \$4.00 monthly until \$21.95 is paid. Otherwise I will return books postpaid.

PRINT Name
Address
City Zone State
Company
Position PM-1

Embed Real Flowers In New MAGIC PLASTIC

Create lovely things like the pansy coaster shown—made by embedding real pansies in Castolite liquid casting plastic. Comes crystal clear or may be colored. Also make jewelry, book ends, candle holders, picture frames, figurines. Embed real flowers, butterflies, coins, photos, for plaques, paper weights, tiles, other objects. Use only home tools.



• New Book SHOWS HOW

Big, new book explains how to get started. Have fun—make extra money! Send 25c today for our "Castolite Creations" Manual and our proved "Home Success Plan." Or write for free folder.

The Castolite Co., Dept. A-1, Woodstock, Ill.

AMAZING NEW "TUBELESS" RADIO



Money Back Guarantee **COMPLETE KIT \$8.95**

Plays anywhere. Needs no batteries. Gets distant stations clearly. Germanium Crystal Diode eliminates costly radio tubes. Special selector switch for best reception. Head phones, aerial kit included. Nothing else to buy. Assembled in minutes. Table model size. Send \$1.00 deposit now, we'll mail C.O.D. for balance.

JAEGER & CO.

P. O. BOX 246M SKOKIE, ILL.

New Way to Improve YOUR ENGLISH



A command of effective English gives you added advantages and better opportunities. Poor English handicaps you more than you will ever realize. You can improve your English through Sherwin Cody's 100% self-correcting invention. If you are embarrassed by mistakes in grammar, spelling, punctuation, or pronunciation, this free book "How You Can Master Good English in 15 Minutes a Day" will prove a revelation to you. Send for it now. It is free. No obligation. No agent will call. Address **SHERWIN CODY COURSE IN ENGLISH, 51 B&O Building, Rochester 14, N. Y.**

GET UP TO 40% OFF!

BUY IT WHOLESALE!

START A BUYING SERVICE

Get big-name merchandise for clients (and yourself) at up to 40% and more below the regular list price. Make fat commissions. Poiks eagerly buy through you to get sizeable discounts. Send postcard for details.

AMERICAN BUYERS' SERVICE, 631-PM Linden Ave., Buffalo 16, N. Y.

LEARN Modern Appliance and Electrical Servicing

Revolutionary New Method shows you how—at home—in YOUR SPARE TIME! We send you complete Home Training Kits and Latest Engineered Test Equipment. You can actually earn BIG MONEY WHILE LEARNING! Many men are making \$2.50—\$3.00 and more PER HOUR! RUSH name and address for big FREE book and full details—WRITE TODAY!

ADVANCE TRADES INSTITUTE, Dept. 501
5944 NO. NEWARK AVE. CHICAGO 31, ILL.

CIGARS FACTORY FRESH

Mild. Flavorful. Fine Smoking.
10¢ size. Box of 50 \$3.00. Two boxes \$5.50. Postpaid. Check or currency. Get fresh Cigars and save. Money back guarantee. Or send 25¢ for four trial cigars.

ESQUIRE CIGAR FACTORY, 5514J Easton, St. Louis 12, Mo.

Now Many Wear FALSE TEETH With More Comfort

FASTEETH, a pleasant alkaline (non-acid) powder, holds false teeth more firmly. To eat and talk in more comfort, just sprinkle a little FASTEETH on your plates. No gummy, gooey, pasty taste or feeling. Checks "plate odor" (denture breath). Get FASTEETH at any drug store.

Now YOU can PICK your JOB with a BIG PAY Future in INDUSTRY

TOOL ENGINEER
 •
 TOOL & DIE DESIGNER
 •
 MACHINE DESIGNER
 •
 INDUSTRIAL ENGINEER
 •
 INDUSTRIAL DRAFTSMAN
 •
 MASTER MACHINIST
 •
 TOOL & DIE MAKER

Yes, you can pick your job now! Industry is expanding so rapidly there are more good paying jobs than there are trained men to fill them. Shortages of Draftsmen, Designers, Tool Engineers, Machinists, Tool & Die Makers are so widespread that you can pick one of these highly paid key jobs—and then look forward to a lifetime of Achievement and Security!

Due to the enormous present-day expansion in the field of Tool Engineering, Industry has been clamoring for Allied-trained men to fill important jobs in the industrial fields.

Allied courses are integrated so that you can either study at your home or at the Allied Institute. You may enroll in our short term courses — or you may continue with training that will lead you progressively to a degree of Bachelor of Tool Engineering in twenty-six months.

ALLIED is approved by Industry, the American Society of Tool Engineers, Department of Education and Registration, the Department of Public Instruction — State of Illinois and the Veterans Administration.

Accredited by the Central Schools Association.

Free employment service and housing assistance all through your training period and after your graduation. Our industrial contacts cover the U.S.A.

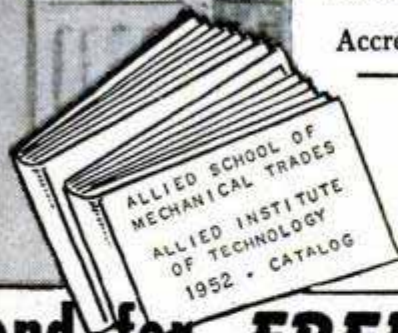

send for **FREE BOOKS**

ALLIED SCHOOL
 of Mechanical Trades
 1338-42 S. Michigan Ave.
 Chicago 5, Illinois



GRADUATE IN DEMAND
 "Believe me, it really gives you a feeling of satisfaction to be able to pick your employer instead of having to go wherever you can to get a job..."
 Dave Nickels, Dundee, Ill.

PRACTICAL TRAINING
 "I am employed as an aircraft draftsman and junior engineer. Thanks to Allied and the excellent instruction I received there..."
 R. Clugston, Joliet, Ill.

EMPLOYER IMPRESSED
 "My employer was impressed with my practical knowledge and drafting skill. Both of these I learned at Allied having never worked in the die design field..."
 Frank E. Myers
 Maywood, Ill.

ALLIED SCHOOL of MECHANICAL TRADES
ALLIED INSTITUTE of TECHNOLOGY
 1338-42 S. MICHIGAN AVE., Dept. PM-1
 CHICAGO 5, ILL.

GENTLEMEN,

I WANT TO GET INTO IMPORTANT INDUSTRIAL TRADES AND PROFESSIONS.

SEND ME WITHOUT OBLIGATION YOUR FREE BOOKS EXPLAINING ALLIED'S COURSE OF INSTRUCTION.

I AM INTERESTED IN RESIDENT TRAINING.

I AM INTERESTED IN HOME STUDY TRAINING.

I AM ELIGIBLE I AM NOT ELIGIBLE FOR TRAINING UNDER G. I. BILL.

Name _____ Age _____

Address _____

City _____ State _____

DYNA-MITE POCKET RADIO

POWERFUL! PERSONAL! PORTABLE!

- Covers Full Broadcast Band 550-1600 K.C.
- Selective Dyna-Coil Tuning
- Batteries and All Parts Fit Within Case
- Hearing-Aid Battery-Powered, Long Life
- Tiny Acorn Low Drain Tube
- Loud Clear Tone
- Over 1,000 Mile Range
- No Antenna Used for Local Reception
- No Ground Connections Ever Needed
- Picture Diagram for Radio Beginners



\$4.95 Postpaid

This neatly engineered little KIT was designed to give you a real personal, portable radio that you can enjoy anywhere without disturbing others. Use it on camping trips, in bed, in your office or just anywhere. Remember this is not a weak crystal set but a powerful "VACUUM TUBE" receiver that will give you good local and long distance reception. Set, with tube less batteries ONLY \$4.95 postpaid. A deposit of \$1.00 is acceptable in U.S. and possessions on COD orders. If batteries are desired we will supply at only \$1.50 per set includes TWO "A" and ONE "B". These are obtainable at local hearing aid concerns.

1,500 ohm Alnico magnet receiver \$1.50 only, when purchased with KIT. All parts guaranteed.

Order Today at This Unbelievable Low Price!

PRECISION ELECTRONICS LABORATORY
DEPT. A PLACERVILLE, CALIF.



How YOU can make BIG MONEY operating this franchised Roadside Stand

You can start a business of your own with an amazingly small investment . . . and make thousands of dollars like others who follow our *proved* methods of stand building and operating. Our free folder gives you the facts—tells you how hundreds of men like you have built successful, profitable businesses of their own—tells you just how to proceed. Send for your free copy.

GO IN BUSINESS FOR YOURSELF!
FREE FOLDER TELLS HOW



RICHARDSON Corp.
Dept. PM-1, Rochester 3, N. Y.

Please send me FREE folder on the franchised RICHARDSON refreshment stand.

Name.....
Address.....
Place.....

\$199 STARTS YOUR OWN BUSINESS WITH A Jetspray VENETIAN BLIND LAUNDRY



1,000 LBS. FREE DETERGENT!!
MAKE UP TO \$75.00 A DAY
In This New Fast Growing Industry

Use latest lowest priced professional unit engineered by inventor, world's largest manufacturer of venetian blind cleaning equipment. Beware of imitations.

JETSpray is incomparable—re-uses detergent. Cleans quickly without rubbing or taking blind apart. Homes, factories, etc., want this fast low cost service. Start in basement or garage—expand as business grows.

BIG PROFITS - - - UNLIMITED OPPORTUNITIES
NO EXPERIENCE NECESSARY - WE SHOW YOU

Write today—learn how you can be independent in your own business.

L. C. ROBINSON MFG. CO.

522 N. Rural St. Dept. M-1 Indianapolis 1, Indiana

Broken or Loose FALSE PLATE?



Fix it Yourself EASILY in a Few Minutes

Your plates may become broken or loose just when you need them most. With FIX-IT-KIT you can repair your own broken plates. Also tightens loose fitting plates, easily. Get permanent comfort with professional material. Complete instructions. Satisfaction guaranteed or your money refunded. Order Now at a new low price only **\$2.98** postpaid—or sent C.O.D.

Make Plates Like New
DENT-FIX DENTAL PRODUCTS, Dept. PM-1,
P.O. Box 674 Kansas City 8, Missouri

ORLON Work Uniforms

Coining Money for Salesmen!

The billion-dollar work uniform business is up for grabs! Miracle ORLON UNIFORMS make wool and cotton obsolete! Outwears wool 3-to-1; outwears cotton 5-to-1. What's more, ORLON is acid-proof, water-repellent, grease-resistant. Looks like wool, tailors like wool—but washes clean in soap and water. Dries out with original factory press! Everybody buys—service stations, garages, factories, etc. Huge demand and huge profits! Custom embroidery clinches sales.

TOPPS Write for Free selling outfit, actual samples.
Dept. 611, ROCHESTER, INDIANA



FREE BERRY'S NEW POULTRY BOOK



Gorgeously illustrated, describing DAY-OLD and 4-WEEK CHICKS, 50 varieties, named or unnamed. AMERICA'S FINEST, also Ducks, Geese, Guinea. ORIGINAL BERRY'S FARM, for over 50 years. Beautiful book and LOW PRICE LIST FREE, stamps appreciated. BERRY'S POULTRY FARM, Box 29, Clarinda, Iowa

CARD TRICKS ARE EASY



Everyone loves card tricks and here's your chance to become the Life of the Party. You'll have everyone gasping with amazement and applauding every trick. Card tricks are a cinch once you know how and you can learn quickly from two master magicians—Howard Thurston and Rob Roy. They will show you 100 tricks, with diagrams and easy to follow step-by-step descriptions of each one. Just pin \$1 to this ad and "Card Tricks" and "Easy Card Magic" will be sent to you postpaid by return mail.

BOOKS PUB. CO., 56 W. 24th St., New York 10

FREE OUTFIT STARTS YOU IN BIG MONEY SHOE BUSINESS!

We furnish everything FREE to set you up in your own profitable full or spare-time shoe business. Just 3 easy sales a day brings up to \$84 a week EXTRA! Repeat orders mean big, steady profits. No experience or investment needed. You feature over 150 fast-selling styles in dress, sport, work shoes for men, women, including beautiful Nylon mesh shoes with Air Cushion innersoles. Also special kinds of shoes for different occupations. Amazing range of sizes, widths. Fit customers stores are unable to take care of. Start now by selling to friends, neighbors and relatives. EVERYONE is your prospect. Just send your name on postcard TODAY for FREE SELLING OUTFIT!



Write TODAY!

Consolidated Shoe System, Dept. CD-135, Chippewa Falls, Wis.

Now! Earn \$5..\$8..\$10..up to \$12⁵⁰ per Hr.

SPARE TIME!

Sensational New HOME-BUSINESS!

AMAZING NEW PRINTING SECRETS CAN BE YOURS

For Pleasure & Profit. Once you learn the closely guarded printing secrets of Screen-Print there's virtually no limit to how much "extra money" you can earn. SPARE-TIME WORK—For FULL-TIME PROFITS. Screen-Printing is the most fascinating Home-Business ever! Learn in a few days and start making money immediately. Even earn while you learn—it's amazing!

LEARN AN "EXTRA TRADE!"

MEN! WOMEN! Learn Screen-Printing and make up to \$200 per week—even working for someone else. Learn Screen-Printing and you learn an "extra trade."

PRINT WITHOUT A PRINTING PRESS!

OR ANY SPECIAL EQUIPMENT

SCREEN PRINT
TRADE MARK REG.

WHAT IS SCREEN PRINTING?

It's a revolutionary new method of printing—WITHOUT an expensive printing press. This amazing new development lets you print quantities of 25, 50, 100, 500 or even 1,000 in many cases, FOR LESS THAN YOU CAN PRINT ON A \$5,000 PRINTING PRESS. Just put anything under a screen and take out beautiful products of printing—no expensive plates or "cuts" needed. No big overhead. Never has such an opportunity been offered the spare-time person who wants to make "Extra Income" in his home. This amazing NEW INDUSTRY can mean huge spare time profits for you.

PRINT IN COLORS—EVEN NEW FLUORESCENT COLORS

There's no limit to the number of colors you can use. It's easy to print in luminescent, "glowing" fluorescent colors, too. (These "brilliant" new inks can ONLY be printed satisfactorily by the Screen-Print method.) Screen-Print lets you print on paper, cardboard, leather, glass, wood, plaster, fabrics—anything!

NO ART NECESSARY—EASY TO LEARN

Anyone (young or old) can be a Screen-Printing expert—he doesn't have to be a "Rembrandt" either. Beautiful printing can be produced WITHOUT doing any art work whatsoever—simple tracing is all that's necessary in most cases. Simplified photo method ELIMINATES ALL HAND WORK. No camera needed.

One of America's FASTEST GROWING BUSINESSES! Hundreds are already profiting handsomely with Screen-Print. This New method may revolutionize the printing business, as we know it today! Get the facts NOW!

A BUSINESS OF YOUR OWN

Be your own boss. Operate from the corner of your kitchen or garage. Build a successful future with a few cents worth of materials. Screen-Printing is the opportunity to establish a spare-time business without sacri-

ficing job or pay check—have 2 INCOMES INSTEAD OF ONE.

"I already make 75% of my expenses doing Screen-Printing only spare-time" says Mr. E. L., Ontario.

THERE'S \$\$\$ IN ADVERTISING!

Here's your chance to GET INTO ADVERTISING—one of the largest paying businesses in America. Most Screen-Printing is used for advertising purposes. Materials cost you 10%—you can earn 90%—few businesses offer this high profit.

HUGE DEMAND! ENORMOUS PROFITS!

Millions of shops, stores, theaters, markets—almost any business needs Screen-Printing done for them. It's possible to even do your business by mail. No house-to-house selling either. You can make \$10 to \$20 profit on each dollar of cost on some jobs. Here's

YOUR "Chance of a Lifetime" OPPORTUNITY to "cash-in" on a new printing method not generally known. We supply everything you need! From easy step-by-step instructions—secrets plus materials enough to make money immediately. A complete ready-made BUSINESS PLAN guides you every step of the way. This all can be yours—at our risk. Space here does not permit telling you all the terrific opportunities of Screen-Print. Don't waste a minute—mail coupon NOW! TODAY!—and get all the FREE FACTS and ACTUAL SAMPLE.

FREE

MY BOOKLET AND ACTUAL SAMPLE OF SCREEN-PRINTING. TELLS ALL THE FACTS ABOUT MY HOME-BUSINESS OPPORTUNITY PLAN.



Mr. C. J. Nowak
GENERAL MANAGER



SCREEN PRINT COMPANY Dept. 21
1010 SO. LOS ANGELES ST.,
LOS ANGELES 15,
CALIFORNIA

FREE BOOKLET AND REAL SAMPLE
MAIL TODAY!

Screen-Print Co., Dept. 21
1010 So. Los Angeles Street
Los Angeles 15, California

Dear Mr. Nowak: Please rush me booklet, facts, sample and entire Home-Business Plan. All this is Free. No salesman will call. I am under no obligation now or ever.

Name _____
Address _____
City _____ Zone _____ State _____

PRINT colorful ADVERTISING DISPLAYS at home!



You've seen thousands of them in stores, gas stations, theaters, markets — everywhere! Many of these displays are printed by Screen-Printing in brilliant "eye-catching" colors.



PRINT expensive SIGNS, BANNERS, POSTERS, LABELS, etc. at home!



EVERY BUSINESS, large or small, needs these items—they order them almost daily. It's possible to specialize in Screen-Printing banners alone and get all the orders you can take care of.



PRINT beautiful CLOTH, FABRICS, GLASSES, NOVELTIES etc. at home!

Because you can Screen-Print on any kind of materials, there are thousands of uses. Print lamps, glassware, ties, calendars, draperies, wall paper, flags, dress materials, balloons, bows, etc. Orders come from gift shops, manufacturers, markets, department stores, etc.

NEW "PAINT PEN"

PAINT STRIPING TOOL

Works like a Fountain Pen
Stripes with Paint instead of Ink!

This amazing new "PAINT PEN" is a Paint Striping Tool that makes it easy to do expert striping on furniture, bikes, model planes, autos, signs, toys, linoleum, wall board, etc. Makes plain, painted walls look like tile. Paint straight, curved, circular or evenly spaced parallel lines the same way a professional painter does. Simply fill Tubular Glass Paint Fountain with any color paint and wheel tip feeds paint evenly. Tips interchangeable — jaws split apart for easy cleaning. Tool complete with tip for 1-16 inch stripe only \$1.00 postpaid. Other complete tools with 1-64, 1-32, 3-64, 1-16, 5-64, 3-32, 1-8 inch tips. \$1.50 ea. Extra tips, 75c each. Complete KIT with 7 tips, \$5.00. C.O.D.'s postage collect. Here's the handiest tool in your whole painter's kit. Get yours today.



Paint
STRAIGHT,
CURVED OR
PARALLEL LINES

Home Craftsmen

Just the tool you've been waiting for! New Paint Striping Tool gives "professional" results every time, yet simple and easy to use as a fountain pen. Adjustable guide keeps lines straight as an arrow. Just as easy to make curves or free hand designs. Adds new beauty and finished look to everything you paint. Send \$1 now!

Only \$1.00
WENDELL MFG. CO., Dept. 31,
4234 LINCOLN AVENUE, CHICAGO 18, ILL.

DEALERS
PAINT STRIPING TOOL
packed in display cartons
of 1 doz. Fast, profitable
seller. Write for illustrated
circular, discounts

FREE 100 BRITISH EMPIRE STAMPS



Sent to Acquaint You with the
Exceptional Values of Our Special Offers

Get these valuable exciting stamps from the far corners of the British Empire: Pitcairn Islands (settled by mutineers), Falkland Islands (only post-office in Antarctic Circle), Tanganyika (land of pygmies and head-hunters), Ceylon, South Africa, many others! Price in Standard Stamp Catalog at least \$2.00! Supply limited — so rush coupon today enclosing 10c to help pay postage and handling charges. (We'll also include other exceptional offers for your inspection.)

Also FREE —
—our valuable illustrated booklet "How to Recognize Rare Stamps" Tells where and how to hunt for rare stamps, how to identify and sell them. May guide you to stamps worth hundreds of dollars!



KENMORE STAMP CO., Dept. PM-1
Milford, New Hampshire

Rush me **FREE** 100 British Empire Stamps and Booklet "How to Recognize Rare Stamps." I enclose 10c to help pay postage and handling.

Name _____
Street _____
City _____ State _____

Amazing Attachment for Thermostat AUTOMATICALLY TURNS HEAT UP 10° EVERY MORNING! —and down every night!



- No Installation — Mounts Anywhere!
- Saves Double its Cost in Fuel Every Year!

Now you can sleep in refreshing coolness, save fuel, and wake up to a comfortably warm house. New Magic Brain turns heat up to normal at 6 a.m. every morning—turns it down 10° every night. Works automatically—set it once and forget it. Operates on 110-120 volt standard household a.c. outlet. Safe—UL approved. Money back in 10 days if not delighted. Order NOW!

COLLOID EQUIPMENT CO. Dept. PM-1, 50 Church St.
New York 7, N. Y.

• GROW WITHOUT SOIL •



YOU can grow vegetables, flowers or rare plants without soil (HYDROPONICS) every day of the year. Start this fast, clean EASY way to grow any plant for fun or PROFIT now. Big returns from small space. Send postcard today for FREE picture book showing how others from every state are succeeding in this new wide open field.

GILBERT CO., Box 22-M, San Diego 6, Calif.

Hand Guide!

OZMENT (INVENTOR), 34-P, ST. LOUIS, MO. (BX665)

STOPS FOGGY WINDSHIELDS NEW Chemical Mitt



Amazing Discovery! Autoists wild over new FOG-STOP Windshield Cleaner. Simply glide over windshield chemically-treated Mitt—at once glass sparkles crystal clear. Blurry mist, frost, snow disappear like magic. Stops fogging. *Sells like wild!*

SAMPLES FOR AGENTS Sample offer sent immediately to all who send name at once. Hurry. Postcard will do. **SEND NO MONEY—just your name.** KRISTEE CO., Dept. 695, AKRON 8, OHIO



SOMETHING DIFFERENT

Handy Auto Snack Table (9 1/2" x 11"). Comes equipped with two screw on plated brackets with slide. Easily attached under moulding on any window of car or instrument panel. Also has leveling feature. Choice of colors: blue, green, red. When not in use easily stored under cowl on hook provided. Eat that snack in comfort. \$2.95 postpaid. Money back guarantee. Send check or money order now. Pat. #2189607 U.S.A.

FAYKRIS AUTO TABLES
#22 Peck St. Rochester 9, N. Y.

FREE!

GIANT CATALOG OF Amazing Bargains!

• SPORTSMEN • HUNTERS
• FISHERMEN • CAMPERS

Famous Gateway Catalog
Most interesting catalog in the world! Nearly 100 pages—thousands of items—breath-taking bargains! Before you buy any sports equipment anywhere —check your Gateway catalog!

NEW 1953 EDITION
Ready for Mailing
About Feb. 10

GATEWAY SPORTING GOODS CO.
Dept. F 2 1321 Main St. Kansas City 6, Mo.

If YOU have hidden talent, your future is secure!

Now: America's 12 Most Famous Artists

TEST YOUR ART TALENT!



Yours FREE if you act today! Thousands paid \$1.00 to take this revealing test. Now, to meet the ever-increasing demand for artists needed for higher-paying jobs, this same Talent Test is yours without charge or obligation. Here's your chance-of-a-lifetime to find out if you have that real, hidden talent which can open up an exciting, glamorous, well-paying career in magazine illustration and advertising art. This is one field with no age limits, seniority, or prejudices, nothing to hold you back, *when you are a talented artist*. If you like to draw, you owe it to your future to take this Talent Test now.

Quantity limited. Write today!



FREE!

This exciting test, printed on 8 large pages of drawing paper, has over 50 illustrations. It tests you seven ways to show your sense of design, composition, form, observation, imagination, originality and picture sense. Yours if you act today!

FAMOUS ARTISTS COURSE

Studio PM-1, Westport, Connecticut

Send me with no obligation the Famous Artists Talent Test

Mr. _____ Age _____
 Mrs. _____
 Miss _____ (please print)
 Address _____
 City _____ Zone _____ State _____

- Norman Rockwell
- Jon Whitcomb
- Stevan Dohanos
- Harold Von Schmidt
- Peter Helck
- Fred Ludakens
- Al Parker
- Ben Stahl
- Robert Fawcett
- Austin Briggs
- John Atherton
- Albert Dorne

Can A Man My Age Become A Hotel Executive

Even Though He Has No Previous Hotel Experience?

W. BRADLEY HALL, FORMER RAILROAD CONDUCTOR, BECOMES CAFE OWNER



"When I enrolled in the Lewis School, I was a Railroad Conductor. Afterwards I worked in a Chicago hotel. Later I became Manager of an Iowa hotel, and recently took over the 'X' cafe. I have made good, thanks to Lewis Training."

"How I Stepped Into A BIG PAY Hotel Job"

GEORGE WEBER, STOCK CLERK WITHOUT PREVIOUS HOTEL EXPERIENCE, BECOMES HOTEL MANAGER



"From stockman for an industrial company to Manager of this Indiana hotel is a big jump. My regret is that I did not enroll for Lewis Training sooner. I have found the hotel profession the most interesting work in the world, and well-paid. I am grateful to the Lewis School."

STEP INTO A WELL-PAID HOTEL POSITION

Well-paid important positions, ever-increasing opportunities and a sound future await trained men and women in essential hotels, clubs, defense housing, officers' and service clubs. Lewis graduates are "making good" as managers, assistant managers, stewards, executive house-keepers, hostesses and in 55 other types of well-paid positions. Record breaking travel and defense needs mean greater opportunities. Previous experience proved unnecessary in this business, where you're not dropped because you are over 40. Lewis Training qualifies you at home, in spare time.

FREE book describes this fascinating field. It tells how you are registered FREE of extra cost in Lewis National-Placement Service. Mail coupon today! Lewis Hotel Training School, WA-317, Wash. 7, D. C.

COURSE APPROVED FOR ALL VETERAN TRAINING

LEWIS HOTEL TRAINING SCHOOL, Room WA-317, Washington 7, D. C.

37 ^{1/2} **SUCCESSFUL YEAR**

Send me, without obligation, your Free Book. I want to know how to qualify for a well-paid position at home in spare time.

Name _____
 (Print Name & Address)

Address _____

City _____ Zone No. _____ State _____

Check here if eligible for Veterans' Training

Free Booklet Shows how to MAKE MONEY IN ART

Book explains: Art principles; artists' earnings; age no obstacle, youth no handicap; advantages of home study; figure drawing from life; examples of successful cartoonists, illustrators; layout, lettering, fashion art; design, color, composition; reproduction processes; outline of WSA home study course; how to sell your work.

Booklet is free so you can learn of WSA's place in the art-teaching picture. We teach you from the beginning with famous Step-by-Step method; 39 years' experience; 2 art outfits included without extra cost. Enjoy a relaxing hobby—extra income—or a new and profitable career. Use coupon to get this illustrated, helpful book. No salesman will call. GI approved for eligible veterans.



**\$300 for
single
illustration**

"My work has been published in magazines; least I've received is \$40, most is \$300. Your great course gave me the 'know-how'." Floyd M. Green, Seattle, Washington.



**Now
Commercial
Art Partner**

"Was artist for engraving firm; now I'm in a commercial art partnership; I teach art in my spare time. Your course worth more to me every year." Thomas D. Dudley, Roanoke, Va.

DRAW FOR FUN & MONEY . . . DETAILS FREE

WASHINGTON SCHOOL OF ART
Studio 121K, Washington 5, D. C.
Rush "Art for Pleasure & Profit" to

Name _____ Age _____

Street _____

City _____ Zone _____ State _____

Tell Me about Trial Plan

Say You Saw It in Popular Mechanics



**MEN! send for this
MONEY-
MAKING
OUTFIT FREE!**

**MAKE \$15⁰⁰ IN A
UP TO DAY**

Do you want to make more money in full or spare time . . . as much as \$15.00 in a day? Then write for this BIG OUTFIT, sent you FREE, containing more than 150 fine quality

fabrics, sensational values in made-to-measure suits and overcoats. Take orders from friends, neighbors, yellow-workers. No experience needed. You'll say it's the greatest way to make money you ever saw.

PERSONAL SUITS TO WEAR

Pay No Money! Send No Money!

Our plan makes it easy for you to get your own personal suits and overcoats without paying 1c, in addition to your big cash earnings. This offer is limited. Rush your name and address for big FREE OUTFIT—today!

**STONE-FIELD CORP., Dept. R-816
532 S. Throop St., Chicago 7, Ill.**

"WOVEN-Gards"

**BETTER HAND PROTECTION
at Amazing Low Cost**

"Woven-Gards" are hand protectors, mitts, pads, sleeves and aprons made of a new long-wearing safety material. Provide flexibility, comfort, resistance to abrasion and cutting far beyond anything used before. Extremely oil-absorbent, excellent for handling oily, slippery sheets. Porous weave makes them one of the finest protectors for handling lower temperatures. Enthusiastic users say they have never seen values like "Woven-Gards." Excellent protection at lowest cost. Send now for descriptive folder and prices.

INDUSTRIAL GLOVES COMPANY
A Corporation

1401 Garfield St., Danville, Ill.
In Canada: Safety Supply Co., Toronto, J.



To be Sure of the Genuine
Demand This Trade Mark

FREE FLOWER BOOK

Seed catalog - 3000 varieties - old and new.
Yours for the asking. Send postcard today!
GEORGE W. PARK SEED CO., GREENWOOD 36, S. C.

FOR BIG MEN ONLY!

SIZES 10 to 16 **WIDTHS AAA to EEE**

We SPECIALIZE in large sizes only—sizes 10 to 16; widths AAA to EEE. Loungers, Wing Tips, Moccasins, Dress Oxfords, High and Low Work Shoes, House Slippers, Rubbers, Overshoes, Sox. Extra quality at popular prices. Satisfaction guaranteed. Sold by mail only. Write for FREE Catalog.

SEND FOR FREE CATALOG

KING-SIZE, Inc., 170, Brockton, Mass.

RADIO

Engineering. All phases radio & electronics theory & practice; television; FM; broadcasting; servicing; aviation, marine & police radio. Prepare for high pay; 18-month course. Graduates in demand by major companies. Enter Jan., March, June, Sept. Regular campus life. Write for catalog.
VALPARAISO TECHNICAL INSTITUTE, Dept. D, Valparaiso, Ind.

Become a MENTAL SUPERMAN OVERNIGHT!

Floor everybody! No studying! Revolutionary MEMO-PROP does all your thinking! It's uncanny! Unprecedented! FULL MONEY-BACK GUARANTEE! For FREE LITERATURE write: **BIJOU HOLLYWOOD STUDIO, BOX 1727-M2, HOLLYWOOD 28, CALIFORNIA.**

RING & VALVE JOB \$6

MOTALOY TABS

No Work
or Equipment

Guaranteed 200,000 Miles

- Stops Oil Burning
- Increases Gas Mileage
- Raises Compression

Drop Motaloy Tabs in fuel tanks of cars, trucks, tractors (any internal combustion engine). Eliminate replacing worn pistons, rings, valves. Send check or M. O.

R. E. OLSON Sales Company
416 SOUTH TEXAS BLDG.
SAN ANTONIO 5, TEXAS
PM-1

BUILD MODERN FURNITURE



EASI-BILD®
Pat. No. 129-50c

Build this handsome, modern cabinet *yourself* with an Easi-Bild full-size pattern . . . and finish with amazing Plastic Wood! Handles like putty, hardens into wood! Can be molded, sanded . . . takes *any* finish!



Get Pattern #129 at any hardware counter. Or send 50¢ to: Plastic Wood, Box 215, Pleasantville, N.Y.

P.S. Pulleys, hinges, locks and latches work better with 3-IN-ONE Oil

Reduce RADIO NOISES

NEW CLEAR-TONE LINE-NOISE ELIMINATOR

SIMPLY PLUG Radio or Appliance cord into Noise Eliminator and plug into wall socket. Enjoy reception **FREE** from many distracting noises. Send No Money, pay postman \$1.25 each (2 for \$2.00) plus postage or send cash and we'll mail postpaid. Try 5 days, money back if not delighted. Many hundreds of satisfied users. Send for yours today. 2 for Merit Sales, Dept. N-30, 800 Edmondson Ave., Baltimore 28, Md. **\$2.00**

FISHERMEN SEND FOR FREE CATALOGUE TODAY!

Make Your Own SINKERS! JIGS! SQUIDS! CASTING AND SPINNING LURES!

It's fun, it's easy with Sweet's **ALUMINUM MOLDS**

Molds for fresh and salt water fishermen. Handled and hinged for easy, fast operation. Over 100 types, 500 sizes. Write for free catalogue.

AS LOW AS **\$2.95** PER MOLD

SWEET'S MOLDS
Tonawanda 16, N. Y.

FULLY ILLUSTRATED
FULLY DESCRIPTIVE
ALL PRICES LISTED

SENSATIONAL OPTICAL BARGAINS

IMPORTED 20X TELESCOPE AND TRIPOD
Machined threaded fittings throughout. Weighs 7 ounces. 6 3/4" closed length, 13 1/2" open length. Achromatic objective lens low reflection coated on inside. Makes excellent spotting scope. Swivel-head tripod is collapsible. 9" high.
Stock #50,007-H (with tripod) **\$12.95** Postpd.
Stock #50,006-H (without tripod) **\$8.95** Postpd.

SLIDE PROJECTOR SETS Consists of all unmounted lenses you need to make the following size projectors:
Stock #4029-H-35 mm. **\$2.85** Postpaid
Stock #4038-H-2 1/4"x2 1/4" **\$3.35** Postpaid
Stock #4039-H-2 1/2"x3 1/2" **\$3.35** Postpaid

SIMPLE LENS KITS —Include plainly written, illustrated booklet showing how you can build lots of optical items. Use these lenses in photography and for dozens of other uses in experimental optics, building **TELESCOPES**, low power **Microscopes**, etc.
Stock #2-H-10 lenses **\$ 1.00** postpaid
Stock #5-H-45 lenses **5.00** postpaid
Stock #10-H-80 lenses **10.00** postpaid

Order by Stock No. Send Check or M. O.

We Have Literally Millions of War Surplus Lenses and Prisms for Sale at Bargain Prices. Numerous Types of Instruments. Tool Write for **FREE CATALOG-H.**

EDMUND SCIENTIFIC CORP., Barrington, N. J.

"GET ON," Uncle Sam's PAYROLL

START as high as \$3,795.00 a Year
(Veterans Get Special Preference)

Get Ready Now for 1953 Examinations

GOVERNMENT CLERK

CITY MAIL CARRIERS, POST OFFICE CLERKS

Clerks and Carriers now get \$3,270.00 the first year of regular employment and automatically increase \$100 a year to \$4,070.00. Open to Men—Women 18 to 50. Clerks and Carriers can be promoted to other postal positions paying as high as \$8,437.00.

Railway Postal Clerks

Railway Postal Clerks get \$3,470.00 the first year of regular employment, being paid on the first and fifteenth of each month. (\$144.58 each pay day.) Their pay is automatically increased yearly to \$4,270.00. Advance may be had to Chief Clerk at \$6,565.00 a year. Men only.

RAILWAY POSTAL CLERKS

3 DAYS ON—3 DAYS OFF—FULL PAY

Railway Postal Clerks on long runs usually work 3 days and have 3 days off duty or in the same proportion. During this off duty their pay continues just as though they were working. They travel on a pass when on business. When they grow old, they are retired with a pension.

MANY OTHER POSITIONS

Many other positions are obtainable. Rural Carriers—Stenographers—Typists—Patrol Inspectors—Meat Inspectors—etc. Those wishing these positions should qualify at once.

GET FREE LIST OF POSITIONS

Fill out the following coupon. Tear it off and mail it today—NOW, at once. Although not government controlled, this can result in your getting a big paid government job.

FRANKLIN INSTITUTE, Dept. S83, Rochester 4, N. Y.

Rush to me, entirely free of charge (1) a full description of U. S. Government Jobs; (2) Free copy of illustrated 32-page book, "How to Get a U. S. Government Job" with (3) List of U. S. Government Jobs; (4) Tell me how to qualify for one of these jobs.

Name _____

Street _____

City _____ Age _____

Use This Coupon Before You Mislay It. Write or Print Plainly.

BECOME AN Electrical Engineer

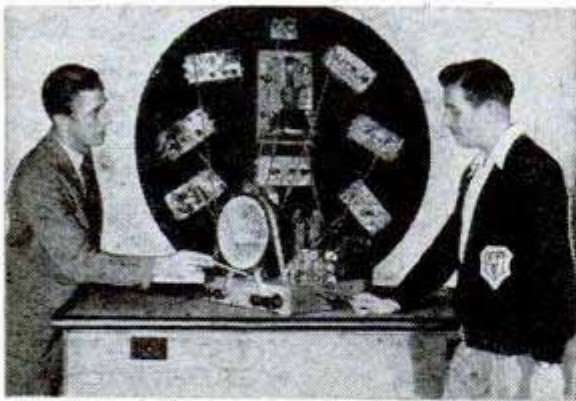

- Major in Electronics or Power B. S. Degree in 36 months
- Television Technician Certificate in 18 months

FOLLOW THIS PLAN

By 1954 there will be at least two positions for every engineering and technician graduate. Enter these opportunities early... earn your B. S. Degree in 36 months through optional year 'round study.

TELEVISION

TECHNICIANS are needed throughout America's fastest growing industry.

You become a Radio Technician in 12 months. In 6 additional months become a Radio-Television Technician. These Technician Courses are complete in themselves and can be applied as one-third of the B. S. Degree program. Recent developments forecast unlimited opportunities for TV technicians and engineers.

TERMS OPEN APRIL, JULY, OCTOBER, JANUARY

Military, Practical, or Academic training evaluated for advanced credit. Faculty of specialists. Over 48,000 former students from all states and 23 overseas countries. Nonprofit. Founded in 1903.

MILWAUKEE

SCHOOL OF ENGINEERING

MILWAUKEE SCHOOL OF ENGINEERING
Dept. PM-153, 1025 N. Milwaukee
Milwaukee 1, Wisconsin

Without obligation send Catalog for Electrical Engineering, B. S. Degree, major in Electronics; Power; "Your Career"; Occupational Guidance Bulletin on: Radio-TV Electrical Power Mechanical Engineering Welding Heating, Refrigeration, Air Conditioning Preparatory.

Name.....Age.....

Address.....

City.....Zone.....State.....

If veteran, indicate date of discharge.....



Now! Amazing New Relief from RUPTURE



Guarantees You Perfect Fit Always

Definitely NEW! Definitely better than anything you've ever used. For real relief from pain caused by rupture get LOCK-O-MATIC. Fits everybody, and is adjustable to keep perfect fit always.

Write for FREE booklet: "RUPTURE FACTS"

LOCK-O-MATIC SALES CO.

21 So. Third St. Dept. P-1 Minneapolis, Minn.

DAN LURIE
"America's Most Muscular Man"
—on television's "Big Top."

FAMOUS DAN LURIE

BARBELLS

with 4 courses—low factory prices

50 lb. set... \$ 8.48 | 150 lb. set... \$20.48
100 lb. set... 13.98 | 200 lb. set... 25.98

Write for Free Catalog Extra wts. 13c per lb., F.O.B. plant

DAN LURIE BARBELL CO.

1701-M-1 Pitkin Ave., Dept. 359-A, Brooklyn, N. Y.

STUDY AT HOME

WITH AN EDUCATIONAL INSTITUTION

Courses in ARTS AND SCIENCES: Philosophy; Education; Letters; Public Health; Medical Jurisprudence; Psychology; Sociology; Physics; Chemistry; Geology; Pol. Science; Theology; Law; Business and Commerce; Accounting; Mathematics; Statistics; Agriculture. **ENGINEERING:** Electrical, Civil, Mechanical, Drafting, Architectural, Steam, Diesel, Aeronautical, Radio, Structural, Mining, Industrial, Petroleum, Refrigeration, Air Conditioning, Chemical. Send for free catalog.

McKinley-Roosevelt Incorporated, 4610-K32, Sheridan Rd., Chicago 40, Illinois



SPORTONE MUFFLERS

Ford & Chevrolet.....\$ 4.45

All other popular cars..... 5.45

V-8 Dual Sets..... 15.95

Chromed Silentips..... 2.95

(Please state make & year of car on all orders.)

SANDEE MUFFLER CO.

5643 Corryno Place • Culver City, California

For your NARROW FOOT!



Sizes 6 to 16

Men with narrow feet! Enjoy a perfect fit at no extra cost. We specialize in narrow widths only. AAA to B, sizes 6 to 16. Write TODAY for FREE information about wide style variety.

Write for FREE Catalog

NARROWS Inc. N-7, BROCKTON, MASS.

MEAT CUTTING OFFERS YOU SUCCESS And SECURITY

In The Best Established Business In The World • **PEOPLE MUST EAT!**

TRAIN QUICKLY in 8 short weeks for a job with a bright and secure future in the vital meat business. Trained meat men needed. Good pay, full-time jobs, year-round income, no lay-offs—HAVE A PROFITABLE MARKET OF YOUR OWN!

LEARN BY DOING

Get your training under actual meat market conditions in our big modern cutting and processing rooms and retail meat market. Expert instructors show you how—then you do each job yourself. Nearly a million dollars worth of meat is cut, processed, displayed and merchandised by National students yearly!

PAY AFTER GRADUATION

Come to National for complete 8-weeks course and pay your tuition in easy installments after you graduate. G.I. APPROVED. Diploma awarded: Free employment help. Thousands of successful graduates. OUR 28th YEAR!

FREE CATALOG—MAIL COUPON

Send now for big new illustrated National School catalog. See students in training. Read what graduates are doing and earning. See meat you cut and equipment you work with. No obligation. No salesman will call. Send coupon in envelope or paste on postal card. Get all the facts NOW!

NATIONAL SCHOOL OF MEAT CUTTING, INC.
Dept. 50-N Toledo 4, Ohio



NATIONAL SCHOOL OF MEAT CUTTING, INC., Dept. 50-N, Toledo 4, Ohio

Send me FREE 52-page school catalog on LEARN-BY-DOING training in PROFITABLE MEAT CUTTING, SUCCESSFUL MEAT MERCHANDISING and SELF-SERVICE MEATS at Toledo. No obligation. No salesman will call. (Approved for Training Korean Veterans)

Name Age.....

Address

City Zone..... State.....

Draw This Car

FREE \$295 ART COURSE

6 PRIZES! 1st: Complete \$295 Art Course—
2nd to 6th: Complete Artist's Drawing Sets.

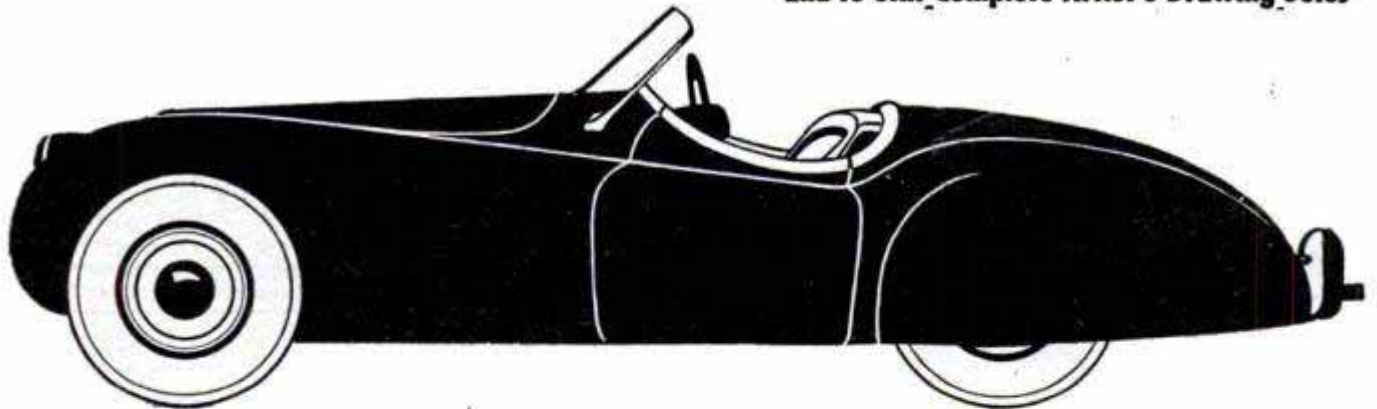

Here's your big chance, if you want to become a commercial artist, designer, or illustrator! An easy-to-try way to win FREE art training!

If your drawing shows promise we give you professional comments on it free! Trained illustrators, artists and cartoonists now making big money. Find out now if YOU have profitable art talent. You've nothing to lose—*everything to gain*. Mail your drawing today.

Amateurs Only! Our students not eligible. Make copy of car 8 ins. long. Pencil or pen only. Omit the lettering. All drawings must be received by March 31, 1953. None returned. Winners notified.

ART INSTRUCTION, INC., Dept. 1133

500 S. 4th St., Minneapolis 15, Minn.

Please enter my attached drawing in your
Draw a Car contest. (PLEASE PRINT)

Name Age.....

Address Phone.....

City Zone..... County.....

State Occupation.....

Only **OLD TIMERS** Offer

Nostalgic Realism



1903
CADILLAC

Length 7" Kit with instructions \$2.50

The original "Old Timers" Antique Automobiles reveal the true-to-life qualities so demanded by discriminating collectors of Americana.

The ultimate in nostalgic realism is captured by the builder with these authentic prefabricated kits.

"Old Timers" Antique Auto kits are sold at leading Hobby, Toy and Department stores, or order direct—add 25c for postage and handling. Write for free color catalog containing fifteen additional models.

OLD TIMERS

SCRANTON HOBBY CENTER

Dept. A14, 315 Adams Ave., Scranton 10, Pa.



1914 STUTZ BEARCAT

Kit with instructions \$3.95
Length 10 1/2"



1911 MAXWELL

Kit with instructions \$2.50
Length 7 1/2"



HURRICANE EXHAUST CUT-OUT

Now control your exhaust tone from a dash control button. Cut back into your original muffler in restricted areas at will. This especially engineered Cut-Out enables you to install special pipes and mufflers without removing the original muffler. We originated this top quality performer, with exclusive deep seat below pipe line to assure tight exhaust seal. The angled outlet permits freer flow to auxiliary pipe. Made of heavy plate steel, designed for easy installation. Thousands in use. Sent post paid for only \$4.95 check or money order. Satisfaction guaranteed or your money back.

ST. LOUIS PRODUCTS CO. Box 24-AA Normandy 21, Mo.

CARBURETOR TOO RICH MAKES MOTORIST TOO POOR



Car owners who are wasting money, getting poor gas mileage due to over-rich mixtures, will be pleased to learn how to save gasoline by **VACU-MATING OVER-RICH MIXTURES**. Vacu-Matic fits all cars, trucks and tractors. Automatic and operates on the supercharge principle. Easily installed in a few minutes.

SALESMEN WANTED! Big Profits

For FREE particulars, how you can install one on your own car for introducing, just send your name and address on a postcard to **VACU-MATIC, 7617-1980 W. State St., WAUWATOSA, WIS.**



Model Railroading is Fun!

Read about it in picture-packed Model Railroader magazine. **Special Offer!** Send \$1 (\$1.75 value) for special 3-month subscription plus new 64-page "Introduction to Scale Model Railroading." Limited. Act today!

Model Railroader Magazine Dept. 1573C, Milwaukee 3, Wis.

THE "NEW" POCKET KNIFE of 1001 uses! only 50c p.p.



Can't open in your pocket! Craftsmen, clerks, secretaries, outdoorsmen, etc. "A Must!" Taylor-Made Pocket Knife is made of

the finest surgical steel—10 for \$4.50—Sent postpaid. **BROWN'S, Dept. P.M., 200 W. 48th Street, N. Y. 36, N. Y.**

BEING PUSHED AROUND??



Why take any more nonsense from bullies, wise guys and other pests? The next time they try to act smart—give them the surprise of their lives! It's easy when you know **POLICE JIU JITSU**. This complete, fully illustrated course comes to you in one volume. The same as taught to police, marines, "G" men, soldiers, sailors and members of the U. S. Coast Guard. By all means, just pin \$1 to this ad and we will send **POLICE JIU JITSU** to you postpaid by return mail. Satisfaction guaranteed or your money back.

BOOKS PUBLISHING CO., 56 W. 24th St., N.Y. 10

Say You Saw It in Popular Mechanics



The Modern PLASTIC for lasting Home Repairs

PERMANENTLY mends cracks or holes in wood, tile, stone or plaster. Sticks and stays put—Does not chip, shrink or fall out. Easy to use. Economical. Mold it, chisel it, polish or paint it. If unobtainable from your lumber, paint or hardware dealer, the big 4-lb. can will be sent you postpaid (in U.S.) for only \$1.25. Full money-back guarantee, order now.

DONALD DURHAM CO.
213 School St., Des Moines, Iowa



YOUR HIGH-PAYING
interesting career in
TELEVISION
starts here!

HOME STUDY COURSE

with one of America's largest schools There's a place for YOU in the tremendous, billion-dollar Television, Radio & Electronics industry! It's so easy to get started with the famous **CRESCENT SCHOOL** course. Learn in your spare time... illustrated, simplified lessons and kits to practice on. No previous training needed. Send for **FREE** sample lesson... make this day the day you started on your way to a brilliant career!



Complete parts kits included. Build your own TV SET!

APPROVED FOR KOREAN VETS
Also Day & Eve. Classes
Trained at Our School

SEND COUPON TODAY!

CRESCENT SCHOOL Dept. B1
500 Pacific Street, Bklyn. 17, N. Y.

Sirs: Rush your **FREE** sample lesson and full details about the **CRESCENT SCHOOL** Course—at no obligation to me!

HOME STUDY COURSE **RESIDENTIAL COURSE**

NAME _____

ADDRESS _____

CITY _____ ZONE _____ STATE _____

11 Million Watches Sold Last Year

Over 60% of the People Now Own 2 or More Watches
UNLIMITED OPPORTUNITIES FOR SKILLED MEN

Know WATCHMAKING

and You KNOW a Profitable, Lifetime Trade
Learn by KCSW's HOME STUDY METHOD
and You KNOW Watchmaking



STUDENT STAKING IN BALANCE STAFF.
At this stage in the course many students are earning money to apply on the cost of their training — repairing clocks and watches for neighbors, friends and local shops. You can **REALLY EARN AS YOU LEARN WATCH REPAIRING.**



Student learning use of Watchmaker's Lathe.

THINK OF THIS: 11 Million Watches sold a year; Fashion demands at least two watches per person. **THESE MUST ALL BE SERVICED REGULARLY.**

You can now learn this valuable trade in your **SPARE TIME** by KCSW's **PRACTICAL HOME STUDY METHOD.** Course carefully planned by KCSW's regular staff of experienced watchmakers. Instructor's personal comments and correction on each lesson and project.
BEFORE You enroll for any Home Study Course, it will pay you to write to KCSW, where the best is yours for the writing. *Ours is not a short-cut course.* Get the facts. Write today.

WATCHMAKERS ARE URGENTLY NEEDED.

• When You Learn Watchmaking the KCSW Way—You KNOW Watchmaking •

Old Established
Resident
School

KANSAS CITY SCHOOL OF WATCHMAKING

WATCHMAKING • JEWELRY REPAIRING • ENGRAVING
1218 Admiral Blvd., Dept. PM Kansas City 6, Missouri

Practical
Home Study
Courses

MEN! Earn \$15 to \$20 in Just a Few Spare Hours

UP TO \$210⁰⁰ A WEEK Full Time...

with Amazing D-FROST-O-MATIC!



SELLY OF CALIFORNIA

started in his **SPARE TIME** and now sells 1,500 D-FROST-O-MATICS a month!

Just say "Never defrost your refrigerator"—four magic words that can pay you **BIG MONEY**... spare or full time! Show housewives how amazing **D-Frost-O-Matic** ends forever the messy, sloppy, time-wasting task of defrosting by hand! **D-Frost-O-Matic** makes any electric refrigerator **automatically self-defrosting!** And talk about easy sales! Just plug in **D-Frost-O-Matic** and leave a few days. When housewife sees how **D-Frost-O-Matic** saves time, work, food, and money—she won't let you take it out! That's why 9 out of ten **FREE TRIAL** installations are almost certain sales with big cash profit to you! Many **D-FROST-O-MATIC** men sell 5, 7, 10 and more units **IN A DAY** on this sure-fire **Free Trial Plan!**

Rush Name Today for Profit Details and Free Trial Plan!

More than 29,000,000 prospects waiting! Rush name, address today. We'll airmail exciting facts, proof and sure-profit **Free Trial Plan.** No obligation. Mail coupon now!
D-FROST-O-MATIC, 173 W. Madison St., Dept. S-6, Chicago 2, Ill.



I MADE
\$14 PER DAY
While still learning!

T. E. H.—WEST VIRGINIA



I MADE
\$800 IN 3 MONTHS
While taking your course!

F. V.—NEW YORK

Get into the

ELECTRIC APPLIANCE REPAIR & SERVICE BUSINESS



OPEN YOUR OWN SHOP

As soon as you enroll, I send you my New Book "How to Open Your Own Business" at no extra cost. **PTS** training is more than a home study course in electric appliance repair and service. It gives you the "know how" on the operation of your shop from a business standpoint: What to charge, how to get customers. Everything possible is done to start you on the road to success.

WE TEACH YOU:

Electric motors, house wiring, refrigerator, auto ignition, automatic washers, garbage disposals, fluorescent lights, irons, cleaners, etc., at home.

FULL OR SPARE TIME

SEND FOR THIS FREE BOOK



SPARE OR FULL TIME

You can actually increase your income while still learning—spare or full time

ACT NOW

Want a good-paying business—a job in a fast-growing industry? Send now for your **BIG FREE BOOK—"My Plan for your Success."** Get started **NOW**

EASY TO LEARN

Men of all ages, yes, even the man of 69 can get into this expanding field. A **REAL OPPORTUNITY** for the practical man who wants the **BETTER THINGS IN LIFE.** The easy **PTS Home Study Plan** prepares you for greater earnings **NOW!**

I SEND YOU A

BIG KIT of TOOLS at No Extra Cost



MAIL THIS COUPON TODAY

PACIFIC TRAINING SCHOOL H. T. ARMSTRONG
7219 So. Broadway, Dept. P-531 Los Angeles 3, Calif.
Please send me, without obligation, your free booklet and details.

Name _____
Address _____
City _____ Zone _____ State _____

FREE 5-Day Trial

How to Make Your Own CABINETS, BOOKCASES and WALL SHELVES

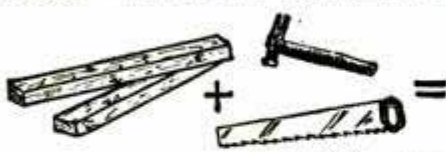

NOW — You Can Build the Things You Want at Big Cash Savings — Without Expensive Tools

YOU don't have to be an experienced craftsman—you don't even have to understand blue prints. The amazing new **GIANT-SIZE BIG HOME-PROJECT CRAFTSMAN MANUAL** shows you step-by-step, with easy-to-understand illustrations how to make your own useful things for your home and earn or save hundreds of dollars. Here are detailed drawings so simple, that even a child can understand and follow. This **HUGE** new atlas-book guides you every step of the way on any of the 77 up-to-date projects you decide to make.

Big Money-Market for Every Project Made

These hand built pieces of furniture whether they are a Chest, Cupboard, or Night Table bring many, many dollars in the market. Yes, you too, can share in the profits to be made in this lucrative field. Cash in on this golden opportunity of getting into a hobby that really pays off in gold dust.

Enrich Your Own Home

The 27 styles of cabinets alone, shown in this wonder-book can produce outstanding results for your home—watch your friends gasp when they see the practical bookcases (19 styles) and magazine racks you can make. You'll find yourself turning out modern cabinets, book shelves, hanging racks, chests and dozens of other things you need, "just like magic."

Follow Expert Advice

Scores of experts including furniture designers, woodworking instructors, master craftsmen and cabinet makers put their heads together to give you a book that will enable you to make the things you always dreamed of having.

Clear-cut photos guide you as you work. The complete drawings and dimensions shown make every job so easy you will marvel at how quickly you can turn out these fine pieces.

SEND NO MONEY Risk Nothing—**READ ON 5-Day FREE TRIAL**

Just fill in coupon and mail. Use **CABINETS, BOOKCASES AND WALL SHELVES** for 5 days FREE. If not delighted, return the book within 5 days and owe nothing or keep it and send only the low price of \$3.95 (plus postage). **Order NOW!**

CRAFTSMAN PUBLISHING, Dept. PM3, 115 Worth St., New York 13, N. Y.

5-Day FREE TRIAL COUPON

CRAFTSMAN PUBLISHING, Dept. PM3, 115 Worth Street, New York 13, N. Y. **Mail NOW**

Please send me **CABINETS, BOOKCASES AND WALL SHELVES**. If not delighted, I will return the book within 5 days and owe nothing, otherwise I will keep it and send you only \$3.95 (plus postage).

Name.....

Address.....

City & Zone..... State.....

SAVE. Send payment (check or money order) NOW and We pay postage. Money back if not delighted.

MAKE THESE THINGS

Wardrobe Chests, Dresser, Night Table, Breakfast Cupboard, Phonograph Record Cabinet, Modern Chest Units, Sewing Cabinet, Book Shelves, Wall Shelves and dozens of other pieces.



630 PHOTOS & DRAWINGS BIG BOOK
9" x 12"



CUSSIN'

WON'T START YOUR COLD OR WET MOTOR...

KAR-START WILL!

Amazing device helps start cold or wet car engines instantly! 5 times more spark from plugs for sure-fire starts. Will not damage points. Simply installed—3 quick connections. Long lasting. If your dealer can't supply, order direct. Only \$5.95 postpaid. Buy Kar-Start today. Money back if not delighted. Write for free bulletin.

Get Kar-Start and GO!

SCHAUER MANUFACTURING CORP., 4532 ALPINE AVE. CINCINNATI 36, OHIO

You can earn a HIGH SCHOOL DIPLOMA

No classes—all materials furnished. Certified teachers. Diploma awarded. Write today for complete information.

SOUTHERN STATES ACADEMY
BOX 144-M, STA. E ATLANTA, GA.

IN YOUR SPARE TIME, IN YOUR OWN HOME!

NEW HAMPSHIRE MIDGET WATERMELON

PACKET 15c

1951 All-America Gold Medal Winner. Delicious flavor, size of a grapefruit for simple refrigerator storage. Deep red, very early, hardy. Makes two good servings. Another of Prof. Yeager's fine products. Packet only 15c. **WRITE FOR WILL'S BIG 80 PAGE 1953 CATALOG FREE.**

OSCAR H. WILL & CO.
Box 600-2G Bismarck, No. Dakota

STUDY INDUSTRIAL DESIGN

You can train at Art Center School in California with practicing-professionals for upper-level jobs in **INDUSTRIAL DESIGN**. Recent graduates have been added to the staff at General Motors, Chrysler, Raymond Loewy, Henry Dreyfuss, etc. Majors in transportation, general product design, structures, community development, furniture design, packaging, display, 4-year degree courses. Learn to combine imaginative design with technical proficiency, coordinate utility and beauty. Stimulating environment. Field trips. Advantages of mild Southern California climate and nearby holiday spots. Coed. Placement service. Write for catalog.

ART CENTER SCHOOL, Edward M. Adams, Director
5353 WEST THIRD STREET, LOS ANGELES 5, CALIFORNIA

BOYS! MAKE YOUR OWN RADIO

Make your own simple, tubeless, batteryless Crystal Radio. **SEND 25c for a GENUINE MELOMITE CRYSTAL** with complete illustrated instructions for making your own set. Crystal sent postpaid with instructions and our own publication, "THE MAGIC CRYSTAL" which is full of news, diagrams, questions and answers of interest.

SEND 25c FOR YOUR CRYSTAL TODAY!
ALVA ALLEN RADIO Dept. PM-1 Clinton, Mo.

METAL REPAIRS?

Real metal-in-a-tube for 1001 shop and household repairs... everything from auto body dents to pipe joints! Use right out of tube, no heat needed. Only \$1. Ask your dealer.

HOLT'S LOY All-Purpose Metal Mender

MUFFLER TROUBLE?

No muffler is installed right, no muffler is repaired right, unless the job is done with Holt's "Gun Gum" Muffler Seal. Use straight from the can, no mixing. Ask your dealer!

HOLT'S GunGum MUFFLER SEAL
TREGLOWN CO., INC., FANWOOD, N. J.
IN CANADA: Treglown, Ltd., 1366 Greene Ave., Montreal 6

MEN - WOMEN!

Paint it with Suede!

SPRAY ON RAINBOW COLORS

for PROFIT and Pleasure...

A SENSATIONAL NEW HOME BUSINESS!!

A NEW INDUSTRY... A NEW MIRACLE FINISH!!
MAKE \$500 to \$1000 PER HOUR and more!

Flok-Kraft Covers:
Fabric, Metal, Glass, Plaster,
Wood, Plastic or -any surface!

PROFESSIONAL SECRETS CAN BE YOURS

At last the carefully guarded secrets of this amazing miracle finish can be yours. Huge profits are waiting to be tapped in this tremendous new field. Flok-Kraft gives a velvety, luxurious surface to radios, lamps, toys, signs, store displays, figurines, auto dash boards—actually a thousand and one items to be seen on every hand can easily and quickly be beautified, enriched, increased in value with Flok-Kraft. Make old objects beautiful and saleable. Make new things worth more with this soft, rich covering that can be applied to any surface, even if old and worn.

YOU CAN LEARN IN A FEW DAYS

Yes, you can learn in a few days to start making money—big money! Make to \$5.00—yes! even \$10.00 and more per hour. Everything you need is furnished, including fully detailed instructions that are complete and easy to understand. Every point is explained to show you how to start on the road to big money, full or spare time.

WE FURNISH EVERYTHING YOU NEED TO START

In addition to the full step-by-step instructions you get a complete set of materials and equipment that enables you to start at once. A few cents worth of materials can mean many dollars in returns to you. You can make big profits, spare or full time—add to your income from your regular job or begin to build your own successful future with a full time business of your own and do it all right in your own home! A corner of your basement, garage, service porch, kitchen or living-room is all the space you need to start.

GRASP THIS LIFETIME OPPORTUNITY TODAY

This is one too good to miss. Fill out the coupon below and mail it today for full free details. I'll arrange to send you the complete outfit—everything you need to start—for leisurely, no-risk examination right in your own home. You owe it to yourself to investigate. Write now for full, free details, samples, etc. Fill out and mail the coupon below. Do it today! Everything I send you is FREE.

SEND NO MONEY—MAIL COUPON NOW!

COAST INDUSTRIES, Dept. 21
1004 S. Los Angeles St., Los Angeles 15, California

Gentlemen
Please rush me FREE details, sample, etc., I understand that everything you send is free and that I'll be under no obligation now or ever

NAME _____
STREET _____
CITY _____ STATE _____



Read What Others Say About Flok-Kraft

"Received the flok-kraft outfit and everyone that saw it is very enthused. I only had it about thirty minutes and got an order for a hundred dollar job." Mr. C. H. Maryland.



"... I have received my order of Flok and Adhesives and believe me, I'm very pleased and happy as I've made myself MORE than the cost of my supplies already, and I've still got more jobs to do." Cpl. G. W., S. Carolina



"Got \$52.50 for those 7 trunk interiors for about 4 hours work. \$7.50 per trunk." J. O., Mo.



"... pleased with your course and I'm being swamped with work to do." W. F.,



YOURS TO EXAMINE WITHOUT RISK!!

Examine in your own home—then decide. The complete instructions, the full starting kit of materials and equipment and full details on how you can open your own business, spare or full time—EVERYTHING will be sent you to EXAMINE AT OUR RISK!

FLOK-KRAFT and DEFENSE

This amazing miracle finish is of inestimable value for use on hundreds of defense products. Flok-Kraft offers you a way to big, extra money, assisting manufacturers in many lines as well as filling a big demand on the home front.

Coast Industries, Dept. 21
1004 Los Angeles St., Los Angeles 15, Calif.



FREE!
Booklet,
Sample,
Plan!



BUILD A \$15,000 A YEAR FUTURE!

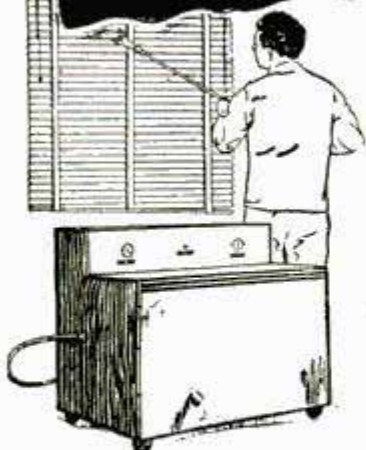

IN THE EXCITING NEW BUSINESS OF LAUNDERING VENETIAN BLINDS

There is big money to be made cleaning Venetian Blinds and a permanent, fast growing, Lifetime Business, besides.

An amazing new kind of business of your own in a field that is growing like mad. Millions of Venetian Blinds need laundering at regular intervals.

With our new patented machine, you can start small—using your basement, garage or utility room to begin with. You can expand as your business increases by leaps and bounds. Income up to \$200.00 daily already being made by others. Small investment for equipment starts your own lifetime business—and monthly payment plan permits you to pay for it as you grow.

FREE Get all the facts about this sensational new kind of machine that launders blinds so fast that your charges are unbelievably low. People would rather send blinds to you than do the work themselves. Yet, you make 700% profit on every blind you clean. Get names of successful owners near you. Get details of the full amazing plan without obligation. Be first in your territory to start a business that has brought \$15,000 PROFITS the first year to others. Wire today or send name on postcard.

VENETIAN BLIND LAUNDRY EQUIPMENT CO. INC.
442 SENECA ST. DEPT. 10-A WICHITA 12, KANSAS

LOCATE TELEVISION TROUBLES AT A GLANCE . . . REPAIR THEM IN HALF THE USUAL TIME!



Ghirardi's PIX-O-FIX TV TROUBLE FINDING GUIDE

The short cut way to handle up to 90% of TV troubleshooting and repair by easy PICTURE ANALYSIS METHOD

The new Ghirardi PIX-O-FIX covers ALL television receivers. Operation is simplicity itself! Just turn PIX-O-FIX dial until actual TV screen photo in its "window" matches the distorted screen picture on the defective set. PIX-O-FIX then gives you possible causes of this particular trouble and where to locate them in the receiver. Step-by-step repair instructions follow.

PIX-O-FIX is NOT a gadget — but is a professional how-to-do-it TV repair guide by America's best-known service authority. Only \$1. Order yours today!

MONEY-BACK GUARANTEE! Pin \$1 bill to this ad, and mail with your name and address. If PIX-O-FIX is not satisfactory, return in 10 days and your \$1 will be refunded promptly. Outside U.S.A. \$1.25, same guarantee.

Dept. PM-13A, RINEHART BOOKS, Inc., Technical Div.
232 MADISON AVE. NEW YORK 16, N. Y.



MONEY in HAMSTERS

The new wonder animals from Syria. Often called Toy Bears. Delightful pets. Everyone desires them. Wanted by laboratories and pet shops. Clean, odorless. Raise anywhere. A profitable hobby or business. Write today for free book of details.

GULF HAMSTERY, 13 Jay St. Gulf Shores, Ala.

Quick, EASY Way to REPRODUCE any Object



Make exact duplicates of trays, lamp bases, medals, figurines, vases, etc., right at home over night! New RUBBER MOLD method needs no heat curing. No special skill or tools required. Make perfect reproductions of objects of clay, plastiline, wood, metal, glass, in any quantity! Cost will be only few cents. Send for Brochure 42 which gives exact step-by-step instructions anyone can understand and follow. Send 10c for it today to SCULPTURE HOUSE, 304 West 42nd Street, New York 36, N. Y.

ANY BOOK IN PRINT

Delivered at your door. We pay postage. Standard authors, new books, popular editions, fiction, reference, medical, mechanical, children's books, etc. Guaranteed savings. Send card for Clarkson's 1953 Catalog.

FREE Write for our great illustrated book catalog. A short course in literature. Buying guide of 300,000 book lovers. Free if you write Now—Today!

CLARKSON PUBLISHING COMPANY
Dept. PM-531, 1253 South Wabash Ave., Chicago, Ill.

Learn CARTOONING

HAVE FUN! MAKE MONEY! Cash in on your sense of humor at HOME! BY MAIL. No experience needed to start. Write today for FREE TRIAL LESSON and full particulars.



MooN Gag Cartoon School, Dept. G, Fall Creek, Wis.

Say You Saw It in Popular Mechanics

INCREASE COMPRESSION AS MUCH AS 126%

with Fisher's Compression SEAL
• Stop Burning Oil & Check Piston Slap!



\$3.95 PPD.

ADVANCED ENGINEERING Box 7013, Dept. PM-1
Los Angeles 37, Calif.

Amazing new discovery, Fisher's Compression SEAL, has been tested and approved by a leading independent laboratory. Guaranteed to increase your car's compression, reduce oil consumption and check piston slap or your money back! Easy to apply. Simply squeeze a small amount into each cylinder bore. This self-expanding compound then seals the excessive clearance between piston and cylinder wall, thus allowing you to enjoy former operating efficiency. Lasts 10,000 miles. \$25,000 insurance policy assures you it cannot harm the finest engine. Only \$3.95 postpaid. Acts while you drive, costly ring or rebore jobs may not be necessary. Free folder. Send cash, check or M.O. Dealers, a postcard will send our representative to your door.

HUNDREDS OF NEW PROFIT SOURCES



Yours today in the New
1953 treasury of

"NEW PRODUCTS AND SERVICES"

This exciting new Journal of Commerce 80-page handbook lists and describes 1,000 new money-making lines by 750 manufacturers. Yours to use, sell, produce or compete with. Get your copy now—then follow the daily "New Products" column in The Journal of Commerce. Your copy sent free with trial subscription of J-of-C—10 weeks for only \$5, a saving of \$2.50. Mail coupon now—keep track of new profit sources.

THE NEW YORK Journal of Commerce

53 Park Row, New York 15, N. Y.

Send me the J. of C. for the next 10 weeks plus my copy of "New Products and Services." Check for \$5 is enclosed.

Name _____

Address _____

City _____ Zone _____ State _____

An Amazing Invention—"Magic Art Reproducer"

DRAW

The First Day NO LESSONS! NO TALENT!

Anyone can Draw With This Amazing New Invention—Instantly!



You Can Draw Your Family, Friends, Anything From REAL LIFE—Like An Artist... Even if You CAN'T DRAW A Straight Line!

De Luxe Model Complete for only

\$1.98

—With extra high power, extra clear and sharp "reproducer" unit.

A New Hobby Gives You A Brand New Interest!

Yes, anyone from 5 to 80 can draw or sketch or paint anything now... the very first time you use the "Magic Art Reproducer" like a professional artist—no matter how "hopeless" you think you are! An unlimited variety and amount of drawings can be made. Art is admired and respected by everyone. Most hobbies are expensive, but drawing costs very little, just some inexpensive paper, pencils, crayons, or paint. No costly upkeep, nothing to wear out, no parts to replace. It automatically reproduces anything you want to draw on any sheet of paper. Then easily and quickly follow the lines of the "picture image" with your pencil... and you have an accurate original drawing that anyone would think an artist had done. No guesswork, no judging sizes and shapes! Reproduces black and white and actual colors for paintings.

Also makes drawing larger or smaller as you wish.

Anyone can use it on any desk, table, board, etc.—indoors or outdoors! Light and compact to be taken wherever you wish. No other lessons or practice or talent needed! You'll be proud to frame your original drawings for a more distinctive touch to your home. Give them to friends as gifts that are "different," appreciated.

Have fun! Be popular! Everyone will ask you to draw them. You'll be in demand! After a short time, you may find you can draw well without the "Magic Art Reproducer" because you have developed a "knack" and feeling artists have—which may lead to a good paying art career.

FREE!

A. B. C. Guidance of Figure Drawing
This valuable illustrated guide is yours free with order of "Magic Art Reproducer." Contains simple guidance on drawing human figures. Includes techniques, shading, proportions, etc., to use with your "Magic Art Reproducer" for added touches to your drawings.

**SEND NO MONEY!
Free 10-Day Trial!**

Just send name and address. Pay postman on delivery \$1.98 plus postage. Or send only \$1.98 with order and we pay postage. You must be convinced that you can draw anything like an artist, or return merchandise after 10-day trial and your money will be refunded.

NORTON PRODUCTS

Dept. 5801C, 296 Broadway
New York 7, N.Y.

ALSO EXCELLENT FOR EVERY OTHER TYPE OF DRAWING AND HOBBY!

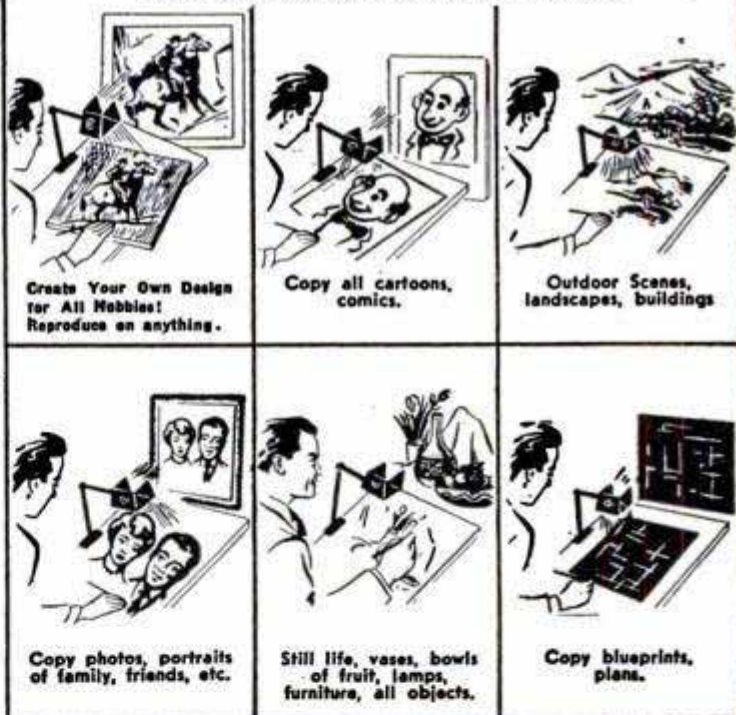

Create Your Own Design for All Hobbies! Reproduce on anything.

Copy all cartoons, comics.

Outdoor Scenes, landscapes, buildings

Copy photos, portraits of family, friends, etc.

Still life, vases, bowls of fruit, lamps, furniture, all objects.

Copy blueprints, plans.

FREE 10-DAY TRIAL COUPON

**NORTON PRODUCTS, Dept. 5801C
296 Broadway, New York 7, N. Y.**

Rush my "Magic Art Reproducer" plus FREE illustrated guide "A. B. C. Guidance of Figure Drawing." I will pay postman on delivery only \$1.98 plus postage. I must be convinced that I can draw anything like an artist, or I can return merchandise after 10-day trial and get my money back.

Name.....

Address.....

City & Zone..... State.....

Check here if you wish to save postage by sending only \$1.98 with coupon. Same Money Back Guarantee!

Get into...

PLASTIC LAMINATING AT HOME!

Sensational New
**"ONE MAN
BUSINESS"**
...pays \$10 to \$20 profit
for each dollar of cost.

Make \$20 to \$30 a day by our
MAGIC MAIL PLAN... get
orders and cash from your mailman!

Here's the newest and most fascinating of all home-operated businesses. For the first time, a simplified machine brings the fabulous profits of Plastic Sealing and Plastic Laminating within the reach of the small operator. Can be

operated in a corner of the kitchen, basement, or garage. And any man or woman, regardless of age, education, or experience—can learn this interesting work in a few minutes of reading—can turn out professional jobs after one hour's practice.



TWO EXCITING FIELDS FOR BIG PROFITS!

No house-to-house canvassing. No face-to-face selling. We not only supply the equipment you need for the work, but also show you exactly how to cash in big daily profits from two big demand fields.

A FORTUNE IN PLASTIC SEALING

Millions of people want to protect valuable cards, photographs, documents and papers against wear, soil, and damage. By our MAGIC MAIL Plan you get this business through the mails. Open envelopes and take out money and orders. Details of this plan will amaze you. It will be sent free. Just mail coupon.

ENORMOUS PROFITS IN LAMINATING

A creative, artistic business. Gift shops sell your entire output. Just a few of thousands of giftwares illustrated on this page. Beautiful colors. Endless designs. Exclusive "one of a kind" appeal brings sales at ten to twenty times the cost of materials. Beautiful illustrations and instructions for making these artistic novelties sent free.

The opportunities in Plastic Laminating are so big that space here does not permit even skimming the surface. To get any idea

FREE at all of the size of these markets and your place in this sensational business you must read the details. See for yourself how easy it is to do the work—how you can put plastic sheets into your machine and take out a fortune—how money and orders come to you in the mail—how gift shops clamor to get more and more of your creations—how you can start with one machine and build up a big production plant with others doing the work—how you can get money and business from every State in the Union—how you can achieve independence without study or experience.

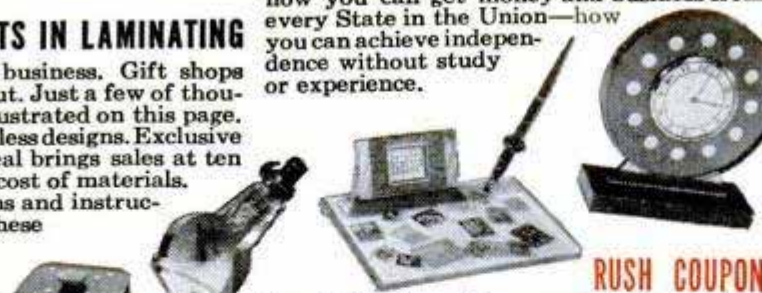

RUSH COUPON

Never before has such an opportunity been offered the small, home-operator—an opportunity to gain complete personal independence in a big money business of your own. Don't lose a minute. Get the facts at once. All information, fully illustrated with pictures, is free. Send the coupon—or send your name on a penny postcard. There is no charge now, or at any other time. We may be limited in the number of Warner Laminators that can be made up, so don't put this off. Send for the information on this exciting opportunity today.

WARNER ELECTRIC CO.,

1512 Jarvis, Dept. L-101, Chicago 26, Illinois

WARNER ELECTRIC CO. Dept. L-101

1512 Jarvis, Chicago 26, Illinois

Rush complete information with illustrations showing the things I can make and the money possibilities in Plastic Laminating. All this is free. I do not pay a penny now or at any other time. No salesman is to call. Send all facts by prepaid mail. Be sure to tell me how I get orders and money from my Postman by your MAGIC MAIL Plan.

NAME _____
ADDRESS _____
CITY _____ ZONE _____ STATE _____

\$5-\$10-and \$20 BILLS

COME TO YOU IN THE MAIL

By our MAGIC MAIL Plan you sit at home, send out mail, and get back money and orders. Additional profits in supplying local people with lifetime protection for

SNAPSHOTS—IDENTIFICATION CARDS—DISCHARGE PAPERS—DRIVERS' LICENSES—SOCIAL SECURITY CARDS—VOTERS REG. CARDS—MENUS—BIRTH CERTIFICATES—CREDIT CARDS—BIRTH AND WEDDING ANNOUNCEMENTS—RAILROAD PASSES—IMPORTANT DOCUMENTS OF ALL KINDS.

Lifetime protection. See how laminating protects against wear, soiling, and moisture damage with its smooth, flexible, plastic covering on each side. **LIFETIME PROTECTION** needed for valuable or sentimental objects of all kinds—even a priceless whisp of hair can be laminated. Think of the countless thousands of profit items for your Laminating Press.



Thousands of Beautiful Art Creations

No one yet has been able to list the thousands of gorgeous articles that can be made by Laminating as explained in our Free Information. Just a few are **COSTUME JEWELRY—CIGARETTE BOXES—JEWEL CASES—GLOVE AND HANDKERCHIEF BOXES—CUFF LINKS—NOVELTY BUTTONS—TRAY—CANDLESTICKS—COASTERS—CLOCK CASES—LAMP BASES—PICTURE FRAMES—BOOK ENDS—PAPER KNIVES—KEY CHAIN CHARMS—CHECKERS—CHESSMEN—ADVERTISING SIGNS—NAME PLATES—BOOKMARKS—BELT BUCKLES—TIE RACKS—KEEP-SAKES OF ALL KINDS.**

**WORLD'S
BEST
WANT AD
MEDIUM**

CLASSIFIED Advertisements



Advertisements in this section 85 cents per word, each insertion, minimum 10 words, payable in advance. To be inserted under proper classification, copy must be in our office the 20th of the second month preceding date of issue
F. W. Johnson, Manager, Classified Advertising
Popular Mechanics Magazine, 200 East Ontario Street, Chicago 11, Illinois

1034 CLASSIFIED 1034 OPPORTUNITIES ADVERTISEMENTS FOR YOU

AUTOMOBILES. MIDGET CARS

SAVE—California custom accessories headquarters. Buy direct from original designers. Chrome dash panels, electric push button door-trunk conversions, fender skirts, dual mufflers, lowering kits, speed-dress up equipment. 40 page catalog, hundreds of photos—25c. Eastern Auto, 3319A South Grand, Los Angeles 7, Calif.

3/4 MIDGETS—Prints for home construction. Magnesium wheels, rear ends, etc. Wrrf Mfg., 2344 Dudley St., Pasadena, California.

BUILD Midget auto. Complete drawings, pictures and list of parts \$1.00. Lee's Midget Autos, 3301 Dupont Ave., So., Minneapolis, Minnesota.

INCREASE Gasoline mileage. 120 ways. \$1.00. Holloway Publications, Bijou, Calif.

FREE Motor magazines; automobile literature, old, new and foreign; glossy photos, dealer books, shop manuals offered with non-profit organization. Write today; get on free mailing list. Auto Maniacs, Inc., Stockbridge, Mich.

PARIS And London special automobile show issue of Automobile Topics now ready. Most complete magazine ever published covering all cars at foreign shows. Sample copy 50c, postpaid. Floyd Clymer, 1268A South Alvarado Street, Los Angeles 6, California.

MAKE, Repair your own auto body. Polyester-Fiberglas. Catalog 10c. Air-mailed, 35c. Gem-O-Lite, Box 6861V, North Hollywood, California.

HOW To buy speed equipment without money. No selling. Information free. Newhouse Industries, Los Angeles 22.

FACTORY Tuneup specifications for best performance, economy, all makes (Buick to Willys) 1940-1952. Complete data 25c. Goodheart-Willcox, 1321A So. Michigan, Chicago 5.

AUTO SUPPLIES AND EQUIPMENT

ELECTROPLATE Auto parts, novelties, mirrors. Easy, inexpensive home processes. Free booklet. Tyco Metals, Box 13231-BG, Houston 19, Texas.

AUTO Parts 1920 up. No catalog. Bill's Auto Parts, Valley Falls, Rhode Island. We buy parts from old cars.

OIL-Vuer, vital link between oil filter and motor. Annealed glass dome cuts oil inspection to seconds. Easily attached to all filters with external lines. Thousands in use. \$4.95 postpaid or send \$1.00, balance c.o.d. Guaranteed. Rogers Automotive Supply Company, Box 23, Station C., Pasadena, California.

GM71 Discarded injector parts wanted. Bares, 7120 Carnegie, Cleveland, Ohio.

SPEED Equipment. Edelbrock, Offenhauser, Navarro heads, manifolds, Winfield cams, dual ignition points. Chev. 37-51, Ford 49-51. Deetone mufflers, headers, dual muffler sets, Mallory coils, distributors. Speed catalogue 25c. Urz's Auto Supply, San Jose, California.

NEW And used guaranteed parts for civilian and army cars and trucks. Largest stock in America. Mail orders. Pioneer Auto Wrecking Co., 734 W. 13th Ave., Denver, Colorado.

AUTO Parts and accessories. Briggs Automotive Engineering of Chicago, P.O.B. 3454 Merchandise Mart, Chicago 54, Ill.

BRUSH Plating outfits connect to a battery. No tanks or shop required. Free particulars. Gunmetal Co., Ave. J., Decatur, Ill.

BE Independent, save money. Grind crankshafts without disassembling engine. New hand operated tool \$3.75. Literature. D. McGee, 719 Cascade, Wenatchee, Wash.

"WATER Injection." Airflow needles. Economy methods. Free illustrated information. Neher Industries, La Verne, Calif.

NEW Auto accessory. Holds parking coins, maps, etc. Details. Wennerstrom, Box 69-B, Auburn, Mass.

"HELL'S Bells" for automobiles. Provoke amazement, attention, laughter. Free literature. "Winco," Box 9525, Dallas, Texas.

CLEANS And keeps cooling systems on autos, trucks and busses at top efficiency. \$24 invested returns \$47 to \$120 selling wholesale or retail. Send 50c for samples, year supply, and information. Tre-Cor, 4012 Truman Road, Kansas City, Mo.

START Your car instantly in zero weather with Quik-Start carburetor preheater. Easily installed. Unconditionally guaranteed. Free information. White's, Catawissa, Penna.

SPEED Equipment from the world's largest distributor. Huge catalogue 25 cents. Illustrated literature free. Dealers, wholesale. Newhouse Automotive Industries, Los Angeles 22.

WHITE Metal welding pays. Instructions \$1.00. New automatic refrigerator defrosters \$7.95. Never change oil auto filters. Details 25c. Lewis Spicer, Bath, Maine.

INCREASED Mileage proven! America's latest guaranteed odd gas saver! Everything for 25c. Ganus Enterprises, 1815-B Fairview Avenue, Augusta, Georgia.

MOTORIST Save gasoline by Vacu-mating overrich mixtures. Fits all cars. For free particulars write Vacuumatic, Dept. 1981, Wauwatosa, Wis.

LACHAPELLE'S Treatment. (Patented.) For a better motor for \$3.00. Write, Ferns Products, 8120-B Walnut Dr., Los Angeles 1, Calif., for free information.

REMANUFACTURED Motors \$75.00 up. Exchange or outright. Auto Parts Service, West Salem, Ohio.

LACHAPELLE'S Treatment. Canadian distribution. Master, Box 3, Station C, Hamilton, Ontario.

HELP Make and market new carburetor. Zip plus mileage. 17 parts. 3 move. No choke, jets, idling system or accelerating pump. J. R. Fish, Daytona Beach 11, Florida.

VACUMITE Car vacuum cleaner, \$3.98. Request details. Wern, 333 N. Michigan, Chicago 1, Illinois.

LACHAPELLE'S Treatment. Cuban distribution. Luis Izaguirre, San Carlos 178, Cienfuegos.

"SAVE 50%"—Speed equipment, Hollywood mufflers, duals, manifolds, cams, chrome accessories! "Souping Manual—Catalog" 25c (Circular free.) Almuist Engineering, Milford 1P, Pennsylvania.

FIBERGLAS—Plastics for bodies and hardtops. Complete building instructions. New low prices. Nationally known suppliers. Industrial Plastics, 4425 Linden, Oakland 8, Calif.

LACHAPELLE'S Treatment. Agent's distribution, warehouse. Dillon, Box 323, Bridgeport, Ohio.

CAR Owners. New Micro Nut free thirty day trial. Add 5,000 more miles per tire. Stop road wander, brake squeak-repair bills. Satisfaction guaranteed or money back \$3.00 prepaid. Send make and model. Auto Industries, Box 12055, Los Angeles 26, Calif.

GENUINE Chamois. Special offer 18x24" \$2.00 postpaid. Victor Calamia, 334 Manhattan Ave., Brooklyn 11, N. Y.

CHEVROLET Owners: Stop tappet noise with Kaye Tappet Silencers. Quality product. Easy to install. Complete set \$5.95. Kaye Products, 1321B So. Layton Blvd., Milwaukee 15, Wis.

AUTO TRAILERS

BUILD Your own trailer! Plans for all kinds. Illustrated catalog 10c. Jim Dandy, 125-M, Wausau, Wisconsin.

TRAILERS. Build-it-yourself. Telescoping and conventional models. Slip-on coach for pickup trucks. Information, pictures 10c. Comstock Trailers, 585, Parsons, Kansas.

UTILITY Boat trailers. Hitches, axle assemblies. Box 141, Watertown, Conn.

MOTORCYCLES, BICYCLES, MOTORSCOOTERS AND SUPPLIES

40 RECONDITIONED Harley-Davidson motorcycles. Large stock of parts and accessories, good chromium parts. Complete motor rebuilding by H-D factory trained men. Bill Thede, The Motorcycle Man, 7577 West Lake Street, River Forest, Ill.

HARLEY-Davidsons—All models and prices. Genuine late and old model supplies. Expert service. Send 25c for bulletin. Knuth's, 1753 Muskego, Milwaukee, Wis.

U. S. Govt. surplus "45" Harley Davidson motors, complete with carburetor and generator, in running condition—\$69.50 f.o.b. Chicago. 25% deposit with order. Parts and accessory catalog 25c. Triangle, 2157 Harrison, Chicago.

BUZZZZ Magazine. Describes, illustrates worldwide motorcycling. \$2.00 year. Sample 20c. 5424-A Sawyer, Chicago 25.

RECONDITIONED Motorcycles and motors. Chromium accessories. Complete stock Indian parts. Expert rebuilding. Fast service. Indian Motorcycle Sales, Kansas City 27, Mo.

WHIZZERS \$20; Midget car \$15; motor-scooter belt drive \$6; 3-wheel scooter car \$39.50. Send 25c (35c first class mail) for special circular #22 jammed with sensational bargains in wheels, motors, clutches, motorscooters, midget cars, motorbikes, etc. Gail, 538 Erie, Toledo, Ohio.

SERVICYCLE \$10; Indian Scout \$45; Comet motor-scooter \$20; Whizzer motor \$15; midget car \$75. Four airplane tires \$3. (Mailorder only.) Send 25c for catalogue Number 51 just out, listing the above and hundreds of other bargains in new and used motorscooters, midget cars, homebuilders parts, plans, etc. (35c by first class mail.) Midget Motors Directory, Athens, Ohio.

LEATHER Jackets—repaired, "free circular." Zip-Jack, 708 East Tremont Avenue, Bronx, New York.

WHIZZER \$20; Servicycle (good tires) \$20; motorbike conversion kit \$25; Cushman motorscooter \$25; Harley twin \$25. Rush 25c (35c first class mail) for special circular #953 listing many other amazing bargains in motors, midget cars, motor-scooters, motorbikes, etc. Associated, Box 1764-CS, Toledo, Ohio.

AVIATION

PROPELLERS, Plans for snow sleighs, air boats. Lowest prices, fastest service. Literature. Gano Propeller, Box 3284A, Ft. Worth, Texas.

PROPELLERS: For snowsleds, boats. Literature. Standard Aircraft, Box 387, Ft. Worth, Texas.

PROPELLERS, Plans, supplies for snow sleighs, air boats. New catalog 25c. Banks-Maxwell, Box 3301E, Ft. Worth, Texas.

BATTERIES, GENERATORS

EDISON Nickel odorless storage batteries. 12 to 600 ampere hour. Any voltage. Long guarantee. Literature. Hawley Smith Co., Croton Falls 1, N. Y.

ELECTRICAL SUPPLIES

LAMPS—25c Brings bargain parts catalog containing instructions for electrifying oil lamps, vases, etc. Gyro Lamps, 5402P Clark, Chicago 40.

LAMP Supplies—Wholesale. Any amounts. Prompt shipment on all parts for repairing and building lamps. Illustrated catalog 15c. Brown Lamp Co., Box 501, Wellston Sta., St. Louis 12, Missouri.

ELECTRIC Pencil: Engraves all metals \$1.50. Beyer Mfg., 10511-H Springfield, Chicago 43.

FREE—War surplus catalog. Bargains galore. Welders, motors, generators, hydraulics, pumps, kits for assembling your own, other items. Save. LeJay Company, Minneapolis, Minnesota.

ELECTRIC Pencil—Writes, engraves all metals. \$2.95. Reb Industries, 265-DAJ, Elmhurst, Illinois.

TELEPHONES—Telephone wire. Solve communication problems with army field telephones. Anyone can install, operate. Free folder. See our advertisement on page 277. Loris Sales, Box 1896-B Sacramento, Calif.

WELDING, SOLDERING, PLATING

A.C. Welders, four sizes, lowest prices. Free literature. Holgeron's Service, Canton 1, Kans.

WELDER Sale. 300 amp. d.c. aircraft type. Reg. \$99.50, special \$89.50. Harris Machinery Co., Minneapolis, Minn.

ACETYLENE Welding outfits—New \$49.00; used \$29.00. Arcwelders \$49.50. Eagle Welding, Dept. PM, 5085 Broadway, Chicago 40, Illinois.

ELECTRO Plating equipment—New and used. Complete assemblies. All sizes for all types of plating. Baby shoe metallizing sets. Mounts, supplies, instructions. Free catalog. We buy used plating equipment. Send description. Hollywood Bronze Supply, Dept. 2, 1624 E. First Street, Los Angeles 33, Calif.

50% SILVER Solder wire, 1/8-3/32, 60c. Beacon Smelting Co., 93 Federal St., Boston, Mass.

MACHINERY, TOOLS, SUPPLIES

FREE! Complete catalogs of precision tools for any job. Big stocks—famous brands: Lufkin, Starrett, Brown & Sharpe. Immediate delivery. Wide selection. Write for your copy today! Mid-City Hardware & Supply Company, 318 South Halsted Street, Chicago 6, Illinois.

DUNCAN Dozer blades, Caterpillar D2, D4, Cletrac A, B, International TD-6, TD-9. \$915.00 to \$1355.00. Wayne Wyant, 122 Sheridan Square, Pittsburgh 6, Penna.

INDISPENSABLE Screw gage 3/32" x 2" x 5". Steel enameled finish. 20 accurate threaded holes. 1-64 to 1/4-28. Also measures wood screws from #0 to #24. Useful tool for apprentices, machinists, toolmakers, and home craftsmen. Free details—Faas Research Laboratory, 13 Dogwood Road, West Orange, New Jersey.

BARGAINS Tools, pumps, motors. Free list. Ramapo Engineering, Riverdale, New Jersey.

SOFT Face hammer, machinists, welders, maintenance, sheet metal, auto mechanics, plumbers—Protect parts, machines, safety, with new, non-ferrous, no-spark metal work hammer. Softer than steel, bronze, aluminum. Won't dent, chip, parts, machines, under heaviest blows! Handy tapered mallet head. Chuck, true work in lathes, mills, straighten after welding, form sheet metal, drive bushings, gears, work around fire hazard areas. Amazingly small, heavy 3 1/2" head. Electrolytically alloyed, hardened lead. No tool kit complete without! Order today! \$3.50 postage prepaid. Details free! Satisfaction guaranteed. Metal Work Hammer Company, 812 Pine Avenue, Long Beach 13, California.

ONLY \$3.95. Precision 2" universal lathe chuck, \$14 value. Har Mur, 2349 Devon, Chicago 45, Ill.

FOOTSWITCH—Controls all power tools. Speeds production, increases safety. \$3.95. Reb Industries, 265-DAK, Elmhurst, Ill.

BOATS, OUTBOARD MOTORS

PLANS: Inboard-outboard runabouts, cruisers, sail. Wood, plywood, welded steel. Advise requirements. John B. Clark, N.A., 329 Kenmore, Bay Village, Ohio.

OUTBOARD Motor parts—New, used for all makes. Send stamp for price quotation, listing parts needed. Outboard Motor Mart, Inc., 229A State Street, Boston, Mass.

FULL Size, cut to shape boat patterns, blueprints, 7 1/2-38 feet. Illustrated "Build a Boat" catalog, 25c (coin). "How to Build Boats" book, \$1.00. PolyWog houseboat plans \$10. Marine catalog \$1.00. Cleveland Boat Blueprint Co., 3107 Detroit Ave., Cleveland 13, Ohio.

SAVE Money, have fun—Build your own boat. Popular Mechanics "23 Boats You Can Build" tells and shows how. 192 pages, 500 illus., detailed diagrams and material lists. Everything from 10 ft. dinghy to 25 ft. cabin cruiser. Only \$2.00. Order today from Popular Mechanics Press, Dept. 107, 200 E. Ontario, Chicago 11, Ill.

MARINE Conversions for Ford and Jeep engines. Catalog 10c. Lehman Manufacturing Company, 972D Broad Street, Newark 2, New Jersey.

NEW, Used, rebuilt marine motors. Marine conversions, fittings. Free catalog. Stokes Marine Supply, Dept. 24, Coldwater, Michigan.

CONVERT Fords and Jeeps to 100% marine engines with Osco's world famous Convo-Kits. Deluxe catalogue 25c (coin). Oscomotors, 3627B Lawrence, Philadelphia 40, Penna.

P38 BELLY Tanks, steel, \$9.95. Free picture. Bucks Auto Wrecking, Box 89, Merced, Calif.

PLYWOOD Boat plans, twenty for \$1.00. Catalog boat building plans 25c. The Rudder, 15 Murray Street, New York 7.

GET Our big 224 page 1953 marine hardware, boat kit and equipment catalog. Send \$1.00 for handling costs, refunded with first order. Garland Frasher Marine Sales, 540-J 31st Street, Huntington, W. Va.

CURE That leaking boat with Fiberglass-plastic covering. Ends caulking and painting. Nationally approved process. Complete instructions. New low prices. Industrial Plastics, 3807 Harrison, Oakland 11, California.

FASTEST Boats in the world! Build your own Champion boat or let us build you a custom-made racer or family runabout. Send 25c today for catalogue of easy-to-follow plans for 3 point hydroplanes, runabouts and others. Dealer inquiries invited. Champion Boats, 1524 W. 15th St., Dept. 22-A, Long Beach 13, Calif.

PERFECT Boat coating. Polyester-Fiberglass. Permanent protection. Catalog 10c. Airmalled, 35c. Gem-O'-Lite, Box 6861U, North Hollywood, California.

SAVE 3/5 Cost. Assemble your own boat. We furnish parts. No experience necessary. Rowboats, cruisers. Illustrated catalog 25c. Midwest Boat Company, Menomonee Falls, Wis.

LARGEST Line of racing and pleasure inboard speedboat fittings and speed equipment. Hundreds of special items. Big illustrated catalog 25c. Debbold's Marine Supply, Lynwood 2, California.

NOW Faster than ever! Champion Boats—the choice of champions now available to you! Easy-to-read plans; easy-to-assemble kits; or easy-to-afford custom built speed boats. (18 models, outboard and inboard). Send 25c today for multicolored, illustrated catalogue. Champion Boats, 1524 W. 15th St., Long Beach, Calif. Dept. 22-A.

ENGINES, MOTORS, DYNAMOS

WINDING Data, listing 225 motors, single and three phase, \$1.00. Motor Data Co., Box 7631, Kansas City 3, Mo.

ALTERNATING Current generators, 3000 watt \$95. 5000 \$135. Motors 1/2 horse \$15. 3/4, \$22. 1, \$35. Butler, 1885 Milwaukee, Chicago 47.

ATHLETIC EQUIPMENT, BODY BUILDING COURSES

100 TRICK Knockouts for self defense. \$1. 1c each. Lincoln, 529 Main, Evanston 1, Illinois.

GAIN Weight, muscle fast! Proven method. Details. Cambria, Box 26-M, Cambria Heights 11, N. Y.

PERSONAL Home recorded barbell instruction. New modern approach, free information. Staggs, 1412 Flagler, Jacksonville, Florida.

SPORTING GOODS, GUNS, FISHING TACKLE, ARCHERY, TRAPPING

CAST Iron molds—For casting fishermen's sinkers. Free illustrated booklet. Reading Instrument Co., Box 78, Reading, Penna.

120 PROFUSELY Illustrated pages antique pistols, swords, daggers, armor, etc. 50c. Robert Abels, M860 Lexington Ave., New York 21.

SHOTGUNS, Rifles, Revolvers, 500 modern, obsolete. Also cartridges. Each list 10c coin. Ed Howe, 52 Main, Coopers Mills, Maine.

5000 BARGAINS, Firearms, binoculars, war relics. Catalog 50c. Smith Firearms, Runnemed, N. J.

FASCINATING, Practical book for the hunter and trapper. Guide to Good Hunting and Trapping lists all popular game animals, tells how to hunt and trap them. Many articles written by famous guides and well-known sportsmen. Author Joe Godfrey is famous sportsman, founder of Sportsman's Club of America. 160 pages, \$3.00. Popular Mechanics Press, Dept. 90, 200 E. Ontario, Chicago 11, Ill.

BOWS And arrows! Raw materials. Send 5c for catalog. Illustrated handbook—"How to Make and Shoot Archery Tackle." 75c. Stemmler Co., Dept. 3, Manorville, Lond Island, N. Y.

SNAGFREE Sinkers, save tackle, time and broken lines. Sinker pulls off line when snagged. Assortment of six (Dipse type) for \$1.00 postpaid. Money back guarantee. Stark Co., Dept. PC-1, Grafton, Wisconsin.

"CROW Hunting," complete book and guaranteed crow call, \$1.00. Toad Woodward, Lamar, Missouri.

FISHWORM Culture—This booklet "Raising Worms for Pleasure or Profit" tells how to fix beds indoors, outdoors; small or commercial scale; what, when, how to feed, water, harvest, package, sell. \$1.00 postpaid. Tennessee Worm Hatchery, Section 4A, Box 265, Nashville 2, Tenn.

AGRAMONTE Offers 2000 guns, antiques, sporting guns. New. Used. Trade. Bargain list 25c. Ed Agramonte, 201 Warburton, Yonkers 2G, N. Y.

TAXIDERMY

TAXIDERMY Supplies, books, instructions. Everything! Catalog 10c. Vandyke's, Wessington Springs 12, S. Dak.

BINOCULARS, TELESCOPES, MICROSCOPES, MAGNIFIERS

GIANT Astronomical telescope complete with 6 ft. tripod, 45X and 100X (10,000 area magnification) eyepieces and sun projector lens. Full power, clear vision guaranteed. \$15.00 f.o.b. factory. Suffolk Science Service, Dept. BT, Riverhead, New York.

AMAZING Prices, binoculars, telescopes, microscopes. Free trial. Folder, "Binocular Selecting," optical catalog free. Prentiss Importers, Mercury Bldg., West Los Angeles 25, Calif.

TELESCOPES, Microscopes, binoculars, books. Buy, sell, repair. Rasmussen-Reece, Amsterdam, N. Y.

REFLECTING Telescopes, 60X, completely assembled \$29.75. Guaranteed observatory clearness. Free information. Skyscope, 475 Fifth Avenue, New York 17.

BINOCULARS, Telescopes, microscopes. Our 20th year of leadership in optical values. Bargain catalog free. Brownscope Co., 24 West 45th Street, New York.

BUILD Your own microscope. 200 power. Complete castings, mounts, lenses, screws, instructions. Kit \$14.75. Free illustrations. Esco, 911 Willow Ave., Hoboken, N. J.

FREE 1953 40-Page, 3 color catalog! 67 different models! United Binoculars, 9043 S. Western, Dept. A-5608, Chicago 20.

SAVE! Save! New binoculars! Free catalog. Free book, "How to Select Binoculars." Write today! Bushnell's, 43-M61 Green, Pasadena 1, Calif.

POWERFUL Telescopes easily made. Lenses, erector, focusing tube, instructions for making 40X, 100X, 200X and 400X telescope \$6.00. Telescopic Cameras, Manorville, N. Y.

BARGAINS! Telescopes for sky hobbies, view homes. Binoculars. Microscopes. Gift-wise, Box 704-A, Santa Barbara, Calif.

MAKE Your 6" telescope reflector. Glass, abrasives, instructions—\$8.50. F. Cameron, Box 65, Inwood 96, N. Y.

GIANT 100 Power telescope easily made for pleasure or profit. Instructions, 5 lenses, wholesale list, profit suggestions all for \$3.00. Carl James, Manorville, N. Y.

POWERFUL Astronomical telescopes easily made. Perfect lenses and instructions; 45X and 100X, \$3.50; 45X, 100X, 200X and 400X, \$6.00. Full power clear vision guaranteed. Instructions alone 10c. Suffolk Science Service, Riverhead, N. Y.

GIANT 100 Power complete telescope and tripod. (10,000 area magnification). No upside down images. Completely assembled. \$10 f.o.b. factory. Carl James, Manorville, N. Y.

WAR Surplus bargains, binoculars, telescopes, sextants, millions of lenses, prisms, reticles, eyepieces, objectives, etc. Mail 10c for big "Catalog CH." Send \$1.00 for Stock CH—10-piece lens kit and big instruction booklet. Edmund Scientific Corp., Barrington, N. J.

PARADISE For hobbyists. Microscopes, telescopes, supplies. Unusual cameras. Many other items. Free lists. Nassau Optical Co., 9 W. Greenwich Ave., Roosevelt, L. I.

PETS—DOGS, BIRDS, RABBITS, HAMSTERS, ETC.

HAMSTERS—Virgin stock; young, \$3.00 pair; fully developed, \$4.00 pair. Adiron-dack Hamstery, Prospect 2, New York.

BEAUTIFUL Pure white pedigreed police puppies. Ansonia Kennels, Mose, N. Dak.

BIG Profits raising pet hamsters in garage or basement. Write for free information. Southern Hamstery, Box M685, Gaffney, S. C.

GOLDEN Hamsters, Bear strain. Pedigree stock. Breeders, laboratory or pet stock. Shipped express anywhere. Price list free. Charles E. Bowser, Smoke Run, Pennsylvania.

700 BRED Mink—booklet, pen plans 20c. Lake Ontario Mink Ranch, Gravel Road, Webster 4, N. Y.

SPORTSMEN: 200 Pointers, Setters, Straight Cooners, combination hunters, rabbit and fox hounds. Reasonable. List free. Ramsey Creek Kennels, Ramsey, Ill.

STANDARD Rabbit Journal, B-241-M, Milton, Penna. Year \$1.00, sample dime, beginner's manual 25c.

HAMSTERS—Golden or spotted. Cages and equipment. Free illustrated details. Lakeview Hamster Colony, Newfield, New Jersey.

BOOKLET "Treatise on Breeding and Raising Canaries"—\$1.00. Audubon Publishing Co., 3449-PM N. Western, Chicago 18, Illinois.

MAKE Big money! Raise Chinchilla rabbits. Cash markets supplied. Write today! Rockhill Ranch, Sellersville 15, Penna.

A Practical beginning to successful rabbit raising. 48 page illustrated booklet. Dime. American Rabbit Breeders Association. 36 AR & CBA Bldg., Pittsburgh, Penna.

MINK Raising information free. Complete. Lake Superior Mink Farm, Superior, Wis., Wisconsin.

RAISE Mink: Free booklet, pen plans, inside "secrets," feed, care. Mink are money makers. Investigate today. Lawrence Molgard, Brigham City 12, Utah.

RAISE Highly-profitable Angora and New Zealand rabbits. Particulars free. White's Rabbitry, Newark, Ohio.

RAISE Rabbits. Markets plentiful. Booklet free. Tayco Rabbitry, Hapeville, Georgia.

TALKING Dog! Lucy Mee speaks. Record \$1.25. Check or money order. No c.o.d. Novelty Record Co., Box 5124, Los Angeles 55, California.

RACCOONS, Minks—Bred females. Baby skunks. Catalog, 25c. Shady Fur Farm, Springfield, Minnesota.

RAISING Guinea pigs, profitable. Free booklet. Taylors, B426A, Hapeville, Ga.

YOUNG Parrots—Make fine talkers. Herb Miller, 1911-N, Lubbock, Texas.

EARTHWORM Raising pays worthwhile profits! Illustrated 24-page booklet explains raising, feeding, packing, marketing. 25c. Ozark Worm Farm-J, Willow Springs, Missouri.

MONKEYS Are the bestest pets—Intelligent, easily trained, inexpensive. Send 10c for catalog. Tropical Hobbyland, 1525-R Northwest 27th Avenue, Miami, Florida.

PLANTS, SEEDS, NURSERY AND GARDEN SUPPLIES

WE Sell on the installment plan. Best varieties peach and apple trees, low as 12c; grapevines 5c; shrubs 13c; evergreens 15c. Berries and plants. Catalog free. Benton County Nursery, Box 542, Rogers, Arkansas.

FRUIT Trees! Stark Bro's sensational new "Dwarfs." All standard size, exclusive patented, trade-marked varieties produce abundant, larger, better apples, peaches, pears. All fruit faster growing, quicker bearing. Also beautiful ornamental trees and shrubs. Get giant new colorphoto catalog free. Stark Bro's., Dept. 30013, Louisiana, Missouri.

MULTIFLORA Rose, the living self-repairing fence, ornament, erosion control, windbreak, snow fence. Rapid grower. Raise from seed. Free planting guide. Woodlot Seed Company, Norway 4, Mich.

FARMS, FARM LANDS, REAL ESTATE

FLORIDA—Beautiful lake front camp and homesites across from Ocala National Forest, Lake County. Good fishing and hunting. Ideal for the sportsman. Price \$295 up, easy monthly payments. Write for free literature. Grace and Euclid Parker, Box 5, Paisley, Florida.

FLORIDA—New Lake County development adjoining Ocala National Forest. Best fishing, hunting. Safe from bombs. Nice homesites \$245 at \$10 monthly. Folder free. Howard Vernor, DeLand, Florida.

\$5.00 MONTHLY Buys 40 acres near town; price \$200.00. Free list. Box 425-P, Carthage, Missouri.

HOMESITES \$300—Convenient payments. California's finest garden section. On Morro Bay's scenic shores. Wonderful fishing, boating, bathing. Fertile soil, softest water, temperate climate, congenial community. Free literature. Richard Otto, Department M, San Luis Obispo, Calif.

STROUT Catalog mailed free! Farms, homes, businesses, 31 states. Coast-to-coast. Over 3400 bargains. World's largest. Our 52nd year. Strout Realty, 7-M So. Dearborn St., Chicago 3, Ill.

FARM And business catalog free! Big new edition. Hundreds of bargains from \$1000 up. Maine to Florida. West's, M-1, Pittsburgh 17, Penna.

FARM-Ranch opportunities. Favorable conditions. Washington, Minnesota, Montana, Idaho, Oregon, North Dakota. Literature, farm descriptions. Specify which state. J. W. Haw, 119 Northern Pacific Ry., St. Paul 1, Minn.

FLORIDA \$495. Terms. Beautiful 100 foot homesites overlooking lakes, orange groves. Fine fishing, hunting, bathing. Free literature. Edward Mathews, owner. Box 1406, Asheville, N. C.

ARMSTRONG'S Best specialty farming; timbered; retirement and mineral lands, \$10 per acre. Lowest terms. Biggest listings. Write, Mr. Armstrong, Schook, Mo.

FLORIDA Highway ranches—\$345. Payable \$15 monthly. Beautiful country estates on U. S. highway 231. High and dry. In famous Panama City pleasure resort area. World's finest beaches. Many lovely lakes. Wonderful fishing, hunting. Grow fruits, berries, vegetables, flowers, poultry. Cheap electricity. Desirable community. Fine investment. Free booklet. Wendell Wood, Box 873, Houston, Tex.

UNITED Farm Agency's big free winter catalog of farm and country real estate bargains can help you plan soundly for your future security in the country. Good pictures, many states, easy terms, many equipped, hay and feed included. For special service, state requirements, desired location. Write for your catalog today—It's free! United Farm Agency, 1408-PM Consumers Bldg., Chicago 4, Ill.

POULTRY, FARM SUPPLIES

KNOW How to raise poultry for profit. Read Poultry Industry. Every issue packed with helpful hints and practical suggestions. Latest articles on breeding, feeding and management. Subscribe now, 1 year 50c, 3 years \$1.00. U. S. funds or checks payable at a New York or Boston bank. Poultry Industry, Dept. PM, 376 Boylston St., Boston 16, Mass.

RAISE Turkeys the new way. Write for free information explaining how to make up to \$3000 in your own backyard. Address—National Turkey Institute, Dept. 3, Columbus, Kansas.

POULTRY Farmers—Broiler growers—Turkey raisers read the new American Poultry Journal for latest ideas and greater profits. 12 months, 50c. Special offer, 4 years, \$1.00. American Poultry Journal, 182 North Wabash, Chicago.

EARN \$4 To \$12 hourly. Terrific profits in chick and turkey sexing, culling, caponizing. School G.I. approved. Write Pilch's School, Box SSC-10, Thompsonville, Conn.

PROFITABLE OCCUPATIONS

SECRET Investigation. Experience unnecessary. Investigators' particulars free. Write Wagoner, 125-M West 86th, New York 24.

MUSHROOMS Grown boxes, barrels. Manureless process 50c. Spawn \$1.00. Gordons, 553 William, Winnipeg, Manitoba.

FOREIGN And Latin American employment. 1953 "Foreign Service Directory" gives up-to-minute facts on military and civilian construction, government jobs, major oil listings, aviation, transportation, steamship lines, mining, importers, exporters, how-when-where to apply, application forms, hot list firms hiring. \$1.00 postpaid. Global Reports, Box 883-P, Hollywood 28, Calif.

ALASKA! Last American frontier. \$1.00 brings 1953 business directory and government map. Military and civilian construction; homestead and highway facts; mining, aviation, fur farming, grazing, timber, travel directions. List of firms hiring. How to apply. Alaska Opportunist, Box 883-P, Hollywood 28, Calif.

ALASKAN Jobs! Over 100 new construction contracts with names, addresses companies hiring. Thousands needed. Highest wages. Military, private construction, mining, fishing, lumbering, aviation, railroads, homesteading. Skilled, unskilled workers. Write today. Our information accurate. \$1.00 complete. Alaskan Opportunities (PM), Box 362, Kenmore, Washington.

MEN—Women—"Everybody likes candy." Learn to make professionally. Tools and supplies. (Our 42nd year.) Ragsdale Candies, D6, East Orange, New Jersey.

GROW Mushrooms. Cellar, shed, and outdoors. Spare, full time, year round. We pay \$3.50 lb. We paid Babbitt \$4.165 in few weeks. Free book. Washington Mushroom Ind., Dept. 99, 2954 Admiral Way, Seattle, Wash.

MAKE Flexible molds! Cast plaques, bookends, figurines! Free sample! H. Tooker, 630-M Chestnut, Hamilton, Ohio.

RAISE Pheasants on the \$100 week plan. Little capital and space can make you independent. Free details. Great Central Game Management System, Columbus 1, Kansas.

BE The Popular Mechanics representative in your neighborhood and earn big profits in your spare time. Write Popular Mechanics Magazine, Room 408M, 200 E. Ontario St., Chicago, Ill.

SOILLESS Gardening (Hydroponics) easy, profitable. Free literature. Earl Riley, Red Bluff, Calif.

FREE Book "505 Odd, Successful Businesses." Work home. Expect something odd! Pacific, Oceanside, Calif.

FOREIGN Jobs. Contracts underway and soon starting in Africa, South America, Canada, England, Europe, South Pacific, Middle East, Mexico and Alaska. Send \$1.00 for foreign job news, information, application forms, etc. DCS Foreign Job News, Dept. 268-JU, Bridgeport, Ill.

SEND For big, new 1953 illustrated catalog that will show you how to turn your spare time into cash—making quick-selling, highly profitable lamps. Every home a prospect. Hundreds doing it, you can, too. No experience or special tools required. Catalog No. 7 contains 56 pages filled with shades, shade frames, figurines and bases, oil lamp converters, boring compound, and dozens of similar items. Also all kinds of sockets, cords, pipes, harps, finials, bases, and hundreds of other parts—everything you need. Special 8-page section shows 6 beautiful lamps in kit form, ready to assemble. You buy wholesale, sell at retail. Make big profits. Send 25c today for new 1953 catalog and wholesale price list, you'll be glad you did. The 25c will be refunded on your first order. Gearon Co., Dept. 500-B-1, 27 S. Desplaines, Chicago 6, Ill.

GROW Living miniature trees from seed. 12" tall. Flower, bear fruit. Terrifically profitable hobby. Free details. Miniatures, 1020 N. Richman, Fullerton 9, Calif.

CONSTRUCTION Job list. Published monthly. \$1.00. Dempster's Construction Scout News, Dept. 268-JT, Bridgeport, Ill.

"HOW To Make Money With Simple Cartoons"—A book everyone who likes to draw should have. It is free; no obligation. Simply address Cartoonists' Exchange, Dept. 91-CP, Pleasant Hill, Ohio.

WANT A diesel job? New opportunities to increase income. Higher pay. More money. We can help you qualify. Tools. Shop method home training. Write today! Diesel Tractor, Heavy Equipment Division, Interstate Training Service, Dept. 3A, Portland 13, Oregon.

\$10,800 PROFITS! Your own mailorder business! No capital risk! "Success plan" (worth \$2) free! Write today! Treasury, 149 Storer, New Rochelle L-7, New York.

FOREIGN Employment construction men, building trades, helpers, office men, others interested in foreign projects. High wages, quarters, transportation. Send \$1 for foreign construction compendium and application forms. Foreign Service Bureau, Dept. PM-1, Metuchen, New Jersey. (Not an employment agency—no fees.)

BUY Wholesale thousands nationally advertised products at big discount. Free "wholesale plan." American Buyers, 628-PM Linden, Buffalo, N. Y.

OVERSEAS Jobs. Big pay, transportation, expenses. Clerical, professional, mechanical workers. Most all trades. Latest listings airline, construction, manufacturing, oil, steamship companies, government agencies, many other opportunities. Up to date information on securing employment, contracts, income tax, application forms. \$1.00. Overseas Jobs, Box 335-A5, Baton Rouge, La.

"FROG Raising!" New book tells how! Illustrated literature free. Broel-A., 1035 Marlborough, Detroit 15, Michigan.

GOLD Mine in your cellar. New book shows workshop owners how to make money selling workshop projects. Free details. Craftsman, 115-M Worth, New York 13.

\$40.00 WEEKLY. Made growing mushrooms. Dominion patent 331,583. Free spawn with order. North American, 169P Yonge, Toronto, Canada.

\$25.00 A Day profit plan—Sound, sane and foolproof. Complete plan and working samples 50c. Money back if you disagree. Mann-Sales, Dept. PM, 17 William, Hillsdale, N. J.

PLASTIC Engraving, carving machine "Dupliscaer." Profits to \$5 hour engraving plastics. Details, sample 25c. Desco Distributors, 6334-B Sepulveda, Van Nuys, Calif.

DRESDEN CRAFT Business on \$19.95. Information free. Osgoods, 1320-A Prospect, New York 59.

MAGAZINE Subscription agents. Bonus arrangements. Qualified Publications, 451 Kingston, Brooklyn 25, N. Y.

OVER \$1400 A month are the wages of truck drivers on some construction jobs. For complete foreign job listings send \$1.00. Construction Workers Service Co., 1111 Commerce Bldg., St. Paul, Minn.

CANADA—Boom country. Wanted—Carpenters, welders, heavy duty mechanics, miners, plumbers, equipment operators, steelworkers, —oil contractors drilling. Send \$1.00 for "Construction & Oil Workers Monthly Bulletin." National Surveys, Box 402, Vancouver, B. C., Canada.

UP To \$200 weekly! Work home, start spare time, small capital. Free booklet "301 Unique, Successful Businesses" tells how. Deumant Publications, 85-PM Deumant, Kenmore 23, N. Y.

REDY-To-build power mowers —\$19.95. Parts list free. Smith Agency-51, Excelsior Springs, Mo.

TYPISTS —Profitable home business. Complete copyrighted information, 50c. Gaunt, 827-A Irving Park, Chicago, Ill.

PROFITABLE Year-round income upholstering automobiles. Diagrammed instruction manual shows easy way to make and install seat covers, door panels, headlinings, tops, etc. Only \$2. Free literature. Purifoy Upholstery Service, P. O. Box 3042, Dept. C, Jackson, Mississippi.

BOOKS, PERIODICALS, PICTURES, POSTCARDS

BOOKHUNTERS! All subjects. Send wants! Jaher Book Service, 620-P East 178 Street, New York 57.

MAGAZINES (Back dated)—Foreign, domestic — Arts, books, booklets, subscriptions, etc. Catalog 10c (refunded). Cicero's, 86-23 Northern Blvd., Jackson Heights, N. Y.

BOOK "Breeding of Parakeets" and cage-bird magazine—\$1.00. Audubon Publishing Co., 3449-PM N. Western, Chicago 18, Illinois.

BOOKHUNTERS! Scarce, unusual, miscellaneous books supplied. Atlantic Book Service, Lawrence Avenue, Charlestown 29, Massachusetts.

FREE Giant Popular Mechanics 40 page Golden Anniversary Book Catalog! Over 400 books. Workshop planning. Home building. Household repairs. Projects. Motoring. Sports. Photography. Money-making opportunities. Machinery, inventions. Crafts. Hundreds more. Many not available in stores. Send postcard today. Popular Mechanics Press, Dept. 110, 200 E. Ontario, Chicago 11, Ill.

SPARETIME Profits taking subscriptions, all magazines. Wholesale catalog free. Cassell Agency, Westfield 2, New Jersey.

OZARK Guide, Eureka Springs, Arkansas. Magazine of the Ozarks. Year. \$1.50.

BACK Number magazine specialist—Specific requests. Ellis Chalfin, 410 East 17th Street, Brooklyn, New York.

BOOKS Found, early Americana, any subjects. Huge search service. John Williams, 165-3rd St., Hoboken, N. J.

SEND 10c For list 3000 book bargains. (Refundable.) Joseph Chobot, 2921 W. Vine, Milwaukee 8, Wis.

FREE! 100 "Self-help" books. Information, book titles: 5c. Amorose's, Route Four, Richmond, Virginia.

POPULAR Novels, 3 for \$1.00. Pocket books, 8 for \$1.00. Catalog 10c. Miller, 5255-M Page, St. Louis, Mo.

BIG Catalog, 1500 popular books. Bargain prices. Send 10c. Books Publishing Co., 56P West 24th, New York 10.

BOOKS, Self help, instructional. Many mint editions, collectors items. Free list. Mutual, Section 2, Witholt Building, Springfield, Missouri.

NATIONAL Geographic Magazines, 1888-1952. Periodical Service, Box 465-PM, Wilmington, Delaware.

MAGIC TRICKS, PUZZLES, JOKER NOVELTIES

200 ELECTRIC Stunts, 110 volts, \$1.00. Kutting Sons, Los Altos, Calif.

WE Supply every noted magician. Large professional catalog \$1.25. Holdens, P220 West 42nd Street, New York.

PROFESSIONAL Catalog, 180 pages, 25c. Williams, 906 Plymouth, Ellwood City, Penna.

512-PAGE Catalogue of 2500 tricks, pocket, parlor, stage. World's finest magic. Send \$2.00 for catalogue (refunded first \$8.00 order). Kanter's, M-1311 Walnut, Philadelphia 7.

FREE Trick and large illustrated catalog 35c. Lerro Magic, 8111 Fifth Avenue, Brooklyn 9, N. Y.

BIG Fun kit! Tricks, jokes, novelties, books. Real gay stuff. Howls galore. \$1.00. Johnson, 414 McRae, Wilmington, N. C.

NO. 29 Edition catalog, 500 tricks now ready. Send 10c for your copy, containing latest in good magic for pocket, parlor, stage. Douglas Magicland, Dept. 1, Dallas, Texas.

MAGIC-Jokes. Big magician's catalog 10c. Top Hat, 521-A Main, Evanston, Ill.

WOODEN Nickels, magic catalog, free trick, 35c. Fun 'N Magic, 511 North St. Marys, San Antonio 5, Texas.

PROFESSIONAL Catalog and free trick 35c. Terry's Magic Studio, 1921 66th Street, Brooklyn 4, New York.

FREE Magic vanisher with illustrated catalog 25c. Maj Magic, 23 Friends Lane, Westbury, N. Y.

COMPLETE Magic show ready to perform. All equipment necessary. Detailed instructions on performing—booking shows. Present magic at parties, banquets and clubs. Earn money—have interesting hobby. Free details. Marsh's, 237 W. 11th Ave., Columbus, Ohio.

LEARN Ventriloquism. 3c stamp brings particulars. Smith, 801 Bigelow, Peoria 5, Ill.

VENTRILOQUISM Selftaught. My quick, easy instructions, 25c. "Ventriloquist," Calallen, Texas.

BE A magician. Large professional magic catalog of latest tricks, 35c. Ireland, C-109 North Dearborn, Chicago 2.

FREE List of magical and joker novelties. Ask Carlson & Son, P.O. Box 3541, Miami 22, Florida.

TRICK Of the year! "Magic money-maker." Fool everybody. Only \$1.25. Literature, free gift 35c. Rothleder, 102PMT Cathedral Station, New York 25.

VANISHING Key trick and catalog, 35c. Stirling Magic, Royal Oak, Mich.

COINS, TOKENS, CURRENCY

BARGAINS At auctions, \$50,000 sold monthly. Free catalog. Hollinbeck Coin, Des Moines, Iowa.

COIN Collector's Magazine. Largest independent, over 1000 pages per year. Sample copy 30c; \$3.00 per year. Hewitt, 7320-J Milwaukee Ave., Chicago 31.

FREE! Foreign coin, banknote and coin collectors illustrated catalog to approval service applicants. Send 3c postage. Tatham Coinco, Springfield 30, Mass.

5-IN-1 Special, \$1.00, 1893 Columbian half dollar; coin album; wooden nickel; check list and coin catalog. Ben's, PM Dept., 31 North Clark, Chicago 2.

SET Japanese invasion notes for United States, \$2.00. Burma note and coin catalogue, 25c. Shultz, Salt Lake 10, Utah.

GET Profit and pleasure in collecting old coins. Send 10c for 56 page illustrated coin catalog. You'll be delighted with it. Send for it now. B. Max Mehl, 370 Mehl Bldg., Fort Worth, Texas. Largest rare coin establishment in U. S. Established 53 years.

\$10.00 EACH For certain Lincoln pennies, Indianheads \$50.00. Send dime for booklet listing prices paid. Lincoln Coin Company, D-29, Glendale, Arizona.

WHAT Are your coins worth? Amazing Fell's new 1952 United States coin book. Everything on every single coin minted—Worth, value, how to sell, speculating, investment; other valuable facts. Cloth-bound. 150 illustrations. Send no money. Pay postman only \$1.50 (plus postage) or \$1.50 postpaid (refundable). Order now! Fell Publishers, 386-M8 4th Ave., New York City 16.

OLD Money wanted. Will pay fifty dollars for nickel of 1913 with Liberty head (not buffalo). We pay cash premiums for all rare coins. Send 4c for large coin folder. Many mean much profit to you. Numismatic Co., Dept. 20, Fort Worth, Texas.

40 DIFFERENT Selected coins \$1.00. Oddehon, Box 482, St. Louis, Mo.

COIN Collector's biggest bargain—Huge monthly magazine and wooden nickel 10c. Lawrence Brothers, Anamosa, Iowa.

FORTY Different liberty head quarters, \$21.00. Complete list U.S. coins for stamp. Johnson's, 644 E. Valerio, Santa Barbara 3, Calif.

NEW Catalog with Indian penny, 10c. Brunk, 3530-B Osceola, Chicago 34.

THREE U. S. large cents, different dates, \$1. Six Indianhead cents 25c. Del-maco, Box 1123, Wilmington, Del.

COOK'S Coin chart. Guaranteed fastest, easiest. Most spectacular U.S. selling guide available. Send 25c. V. Cook, 32 Colt, East Hartford, Conn.

WANTED—1894-S Dime pay \$500.00. Certain 1913 nickel \$1,000.00. 1901-S quarter \$20.00 to \$150.00. Hundreds of others. Know their true value. Complete illustrated catalogue 25c. Worthycoin Corporation (D-325) Boston 8, Massachusetts.

CONFEDERATE Money, coins, wanted. List free. Stecher, Box 338, Washington 4, D. C.

STAMP COLLECTING

OUTSTANDING Booklet! Easy way stamp collecting! Send dime today! "Stamps By Mail," 2133 Lunt, Chicago 45.

AMAZING Offer! 200 United States stamps—including commemoratives, airmails, high denominations to \$5.00, only 10c to approval applicants! Illustrated bargain lists free. Mystic Stamp Co., Dept. 80, Camden, New York.

UNITED States mint specials! Tipex, Cipek souvenir sheets, 778-81, 948-50c; flags complete—\$1.00. Want lists filled. Brooks, 2352F East 23rd Street, Brooklyn 29, New York.

FIFTY Different United States; commemoratives, airmails, etc. All for 10c. Ed. Keller, Library 1, Penna.

200 DIFFERENT, Triangle, airmail, pictorials, etc.; 10c. Carlton's, Tujunga, Calif.

OLD U. S. on approval. Low prices. MacG., 2905 Observatory, Cincinnati 8, Ohio.

U.S. Illustrator catalog free. Ernest Lush, 9627 Martindale, Detroit 4, Mich.

STAMPS On approval. One cent each. Packets: 500 different \$1.00; 1,000, \$2.00; 2,000, \$5.00; 5,000, \$15.00 C. Wessbecher, Kirkwood, Missouri.

VALUABLE Airmail book plus gorgeous world-wide airmail collection 10c. Includes \$10,000 stamp, zeppelin, scarce triangle, many others with beautifully illustrated book, only 10c with choice approvals and bargain lists. Jamestown Stamp Co., Jamestown 708, New York.

FREE! Abyssinia to Zanzibar packet plus 2 Monaco triangles, to new approval applicants. Moublow, Box 278A, East Northport, N. Y.

250 STAMP Hinges and 15 different Switzerland free with approvals. Jaydee, 218 Dickinson S.W., Grand Rapids 7, Mich.

1000 LUXOR Hinges, five cents. With approvals. Lush, 9627 Martindale, Detroit 4, Mich.

U. S. Army and Navy heroes on stamps: 10c with United States approvals. Locust, Box 205-T, Harmon-on-Hudson, New York.

200 EXOTIC Japan stamp—10c. Kenmore, Milford K57, N. H.

COMMEMORATIVES, 100 Mixed U. S., 25c. Ray Worth, 321 S. Cicero, Chicago 44.

312 MIXED U. S. only 10c to "Gold Nugget" approval applicants! Nothing like them. Kessel's, Folsom, California.

FREE! Powerful magnifying glass for 5c post. Bargain lists and approvals. Jamestown Stamp Co., Dept. 207, Jamestown, New York.

NUDES Set; colorful approvals—10c! Atlas, 2830-M Eisenhower, Racine, Wis.

GREAT Free offer—Weird mosquito stamp, thrilling bicycle race, gorgeous orchid, colorful native drummer, gigantic diamond airmail, stamp albums, all to our approval buyers. Bell Stamp Service, Dept. S-4, Bell, California.

FREE, 25 British Colonies, illustrated lists, real stamp bargains, more free packets, sets. Stoll Stamp Service, 2632 Burnett, Louisville 10, Kentucky.

ALBUM! Capacity over 1000 stamps! Only 10c! Stampmart, Hartford 1, Conn.

850 MIXED U. S. Old-New, 25c. Lists. Weatherby, Medina, Ohio.

500 MIXED Stamps and surprise packet for 10c with approvals. Fahsing, Dept. PM, Atascadero, California.

AN Extra bonus—Your choice latest Scotts Albums; catalogue and available philatelic accessories. Realize—you get these extra bonuses when you buy from our better foreign approvals. Write today for full particulars sent with trial approval selection. Americas' Stamp Service, Riverside 9, Calif.

TEN Dandy sets, 10c to approval applicants. Faszold, 423c Cameron, St. Louis Co. 15, Mo.

1,000 UNIQUE Colorful attractive mounted stamps 1c-2c each. Rushed. Niagara Stamp Co., Niagara-on-the-Lake 71, Can.

100 DIFFERENT France 10c. Approvals. Aronson, 91 Marion, Brookline 46, Mass.

300 STAMPS For only 10c.—This mammoth value includes airmails, pictorials; stamps from strange countries cataloguing up to 25c each! Also approvals. Mystic Stamp Company, Camden 80, New York.

FLAG Stamp—Free with hygrade U. S. approvals. Wenigman, 1933 Patterson, Chicago 13.

200 DIFFERENT Including Roosevelt triangle, 5c to approval applicants. M. Avalon Stamp Company, Springfield, Mass.

STAMPS Wanted. Collections, duplicates, surplus stock, mint and used. Good grades only. Buy outright if bargain. What have you? Write us details. Vanroy Shirk, Lebanon, Penna.

1/2-1-2c APPROVALS. Bargains galore! Cole, 43A Rinewalt, Buffalo 21, N. Y.

FREE Sample—Interesting, informative, illustrated! National Stamp News, Anderson, South Carolina.

POLAR Bear triangle, giant George Washington, six colored Ecuador, Arctic triangle, first American commemorative, Corsica, Devils Island, others. Everything free with approvals. Capital Stamps, Little Rock 2, Ark.

FREE—Illustrated catalog! Kenmore, Milford C-57, N. H.

FREE, Scott's International Album. Other big premiums. Full particulars with approvals. Raymax, 68-Z Nassau St., New York 38.

DIFFERENT 500, 35c; 1000, \$1.00; 2000, \$2.00; 5000, \$10.00 with approvals at wholesale to clear. K. S. Holmes, London, Can.

U. S. Price list free. P. Wetterquist, 1635-13th Avenue, Rockford, Illinois.

100 DIFFERENT Spain 25c. Penny approvals included. Reed, Box 980, Chicago 90, Ill.

50%-75% DISCOUNTS! Approvals from 33,000 collection—1/2c up! Schur, Box 235, Buffalo 12, N. Y.

WOW! 203 All different Germany 10c! Zeppelins, semipostals, airmails, high values, etc. to new customers. Jamestown Stamp, Jamestown 512, New York.

WORLD'S Largest stamp (7 1/2 x 14 inches). A real curiosity! Retail for 50c, only 3c to approval applicants. Tatham Stamp Co., Springfield 30, Mass.

77 DIFFERENT United States—25c. Approvals. Utechts, 1143-D North Keeler, Chicago 51.

WE Give you—Mammoth International albums, Scott's catalogues, hinges, complete accessories, when you buy our wonderful foreign approvals. Don't write unless you intend to buy. But don't buy elsewhere without comparing our more generous offers. Bargain Stamps, Santa Ana, California.

OLD Scarce U.S. seconds on approvals. Slight imperfections, lowest prices. Herfield, Clintonhill Sta., Newark 8, N. J.

81 MULTI-Colored flags of the world; only 15c. Kenmore, Milford F-57, N. H.

100 DIFFERENT U.S. 25c. approvals. Buckeye, Box 53, Mansfield 2, Ohio.

ITALIAN Social Republic complete set with approvals. Pomykala, 3110 W. 40, Chicago 32, Ill.

FREE Bahawalpur jubilee set with approvals. Lighthouse, Box 1516B, Colorado Springs, Colorado.

SHEPARD Stamp news. One year 20c. Sample free. Box 1147, Chicago.

FREE! Big illustrated catalog listing everything for the stamp collector. Approvals. Harrisco, 202 Transit Bldg., Boston 17, Mass.

1000 MIXED U.S. coils, airs, etc. 25c. Sibley, Mendon, Mass.

START Your own stamp business. Send for free circular. Donald Shepard, Box 1147, Chicago.

14,000 STAMPS, 50c Weekly. Details free. Sjoquist, 985 Fenwood, Valley Stream 17, New York.

GIVEN Free—U. S. \$1.00 Presidential plus German peace issues. Write Bala Stamps, Bala Cynwyd, Penna.

TWO Mint pictorial sets: San Marino, Vatican, 5c. Request approvals. Silas Stamps, Box 55-X, Triborough Station, New York 35, N. Y.

COLLECTION At a standstill? Let us show you our top quality 1c to 5c approvals. Many satisfied customers. Write today. References appreciated. Roseland Stamp Co., Dept. 10-D, Spring Lake, Michigan.

BIG Bag mixed stamps. Enormous quantity, \$1.00. Longacre Shop, 583y Sixth Avenue, New York City 11.

CANADIAN Collection free—Includes early Victorian issues, jubilees, high values, commemoratives, special issues. Newfoundland, pictorials, etc., etc., together with Philatopic Magazine all free. Send 5c postage. Empire Stamp Company, Dept. PM, Toronto, Canada.

PAYING High prices for approvals? If your collection numbers under 15,000 try our 1c and 2c approvals. In books of 1,000 different. Lots to choose from at lowest prices. Also special offer to customers. Clark Stamp Co., Dept. P-1, Muskegon Heights, Mich.

FREE Complete set of famous Americans, flags, parks and presidentials to approval buyers. Send 3c for 15 of the above stamps plus full particulars. Triboro Stamp Company, 145 Nassau Street, Dept. 101, New York 38, N. Y.

FREE—Italy pictorial set of 15 stamps to approval applicants. (We pay return postage). Frank Newman, 3539 Hartford St., St. Louis 18, Mo.

DEALERS—Wholesale list. Postage 3c. Frank, 5031 Queensberry, Baltimore 15, Maryland.

200 FOREIGN, 20 U. S. commemoratives, 10c with approvals. Weckerling, 608-J South 8th, Raton, New Mexico.

UNITED States stamps! Bargains! Sullivan, 127-F East 4th, St. Paul 1, Minn.

TRIANGLES, Airmails, bicolors, U.S.A. stamp centenary, fascism downfall, Columbus, Trieste fair, Garibaldi's escape, palace, fortresses. Only 3c to approval buyers. Fortune Stamp Company, Dept. 1, Washington 10, D. C.

100 DIFFERENT Beautiful pictorials 50c. Scott, 2653 Midwood, Toledo, Ohio.

FINE Approvals. Fast, personal service. What countries do you prefer? I'll send their stamps. Skinner, 438 Locust, Long Beach 12, California.

1500 MIXED United States 30c. 2 pounds \$1. Peterson, 284, Ponca, Neb.

USED War and postwar issues, \$4.00 catalogue value for \$2.00. McDonald, 807 LeBlanc, Lincoln Park 25, Mich.

MINT King George Coronations from 5 different British Colonies only 10c with approvals. Walter Welles, Box 1246-R, Church St. Station, New York City 8.

HAWAII 2 Values 10c. Approvals. Kem, 670 W. Florence, Los Angeles 44, Calif.

FREE! Mint British Colonies from Tonga, Seychelles, Brunel, Transjordan, Sarawak, Solomon Islands, Caymans, Gilbert Ellice—Free with approvals. Viking, 130-Z Clinton St., Brooklyn, N. Y.

1000 FOREIGN Stamps \$1.00 off paper. 5000, \$4.00. Anderson, Box 855, Mountain Home, Tenn.

50 NETHERLANDS Free to approval applicants. Collier, Box 4243, Atlanta 2, Ga.

FREE! Obsolete U.S. occupation set with most attractive approvals ever offered. Riedell, Greensburg, Penna.

50 DIFFERENT U.S. 5c. Price lists included. Bookman, Maplewood 2, N. J.

10 COMPLETE Sets, 25c. Free lists. Pinkerton, Box 81-B, Bethlehem, Penna.

UNITED States—40 different 10c; 40 different commemoratives 25c. No approvals. Seidenberg, Appleton 944, Wis.

50 DIFFERENT Worldwide 3c! Approvals. Vinny Jo, Box 3062, Seattle 14, Wash.

111 STAMPS From 111 countries \$1.11. U.S. presidentials 1/2c to \$5. 32 values complete \$2.00. No approvals. John Bosse, 536 Rush St., Chicago 11, Ill.

FREE, 30 Different U.S., to applicants for our unexcelled U.S. approval service. Sparta, Box 1082, Rochester 3, N. Y.

100 DIFFERENT Worldwide free with approvals. Popular sets priced right. W. Langford, 53 Durham Road, San Anselmo, Calif.

ITALY—100 Different 5c with approvals. DeRespinis, G.P.O. Box 771-R, New York City.

COMMEMORATIVE Sheet, 40c value, 3c with approvals. Enterprises, Box 371A, Kennebunkport, Maine.

LOOKING For better U. S. on approval? Write New-Way Stamp, Lawrence, Mass.

1c BARGAINS. 75,000 Different stamps in books of 1000—Only 1c each sent on approval. References please. B. Sir, 228 Woodstock, Crystal Lake, Illinois.

111 SCANDINAVIA 25c. 105 Netherlands 25c. Free lists U.S. or foreign. Olson, 801-Chester Ninth, Cleveland 14, Ohio.

MONACO Nudes, 10c with approvals. Royal Stamp Company, Tamaqua, Penna.

25 DIFFERENT Sport stamps 25c. M. Voker, 232b East 77th, New York 21.

50 MINT, Including Monaco bicolors, given approval applicants. Broadmoor Company, Pittsburgh 34, Penna.

TWO Boxes distributing hinges, 10c with approvals. Buckley, 208 Ludlow Bldg., Dayton 2, Ohio.

ZOUNDS! Exciting "strange countries," savage and exotic lands packet—Free with approvals! Saxon, Vista, California.

BIRD Collection features Angola multicolors; bicolors, triangles. Free to approval buyers. Pleasure Stamps, 1865P 52nd, Brooklyn 4, N. Y.

25 DIFFERENT U.S. mint commemoratives \$1.00, 12 for 50c. We supply all new U.S. issues. Commo Stamps, Box 56, Homecrest Sta., Brooklyn 29, N. Y.

UNITED States approvals? Select copies, used and mint. Kingsbury, Woodbury 2, Vermont.

FASTEST Approval service, surprise packet 5c. Potomac Stamps, Washington 15, D. C.

UNITED States! 58 different including commemoratives, airmails, 10c Approval applicants. Sunset, Box 47, South Gate, Calif.

1000 MIXED U.S. and foreign 25c. Monjar, Cincinnati 14, Ohio.

FREE! 25 Different Switzerland with swell approvals. Kardell, 209 Bower, Santa Fe, New Mexico.

SCOTT'S Popular Stamp Catalog makes collecting more fun! Covers world, 680 pages, thousands of illustrations. Simplified edition of Standard Catalog. Only \$3. If your dealer cannot supply, write Scott Publications, 1 West 47th, New York 36.

SENSATIONAL—Bahawalpur UPU complete mint issue (8 values), plus five other complete mint pictorial sets only 10c with bargain approvals. Dresel, Box 270-K, Cathedral Station, New York 25, N. Y.

EXCHANGE Your duplicate stamps. Send 100-200 different foreign and dime. Receive all different. Patterson, 5622 Broadway, Lancaster 20, New York.

AFRICAN Stamps. 25 mint 25c. Melrose Distributors, 6 Rockland, Melrose, Mass.

SENSATIONAL! Set each Honduras, Martinique, Guadeloupe, Guiana, also \$2.-000,000 stamp. Brunel, over 100 different others. Everything 10c with approvals. Whitehead, 315P South 5th Ave., Canton, Illinois.

ILLUSTRATED U. S. and Confederate states catalogue free. Stone, 45 Bromfield, Boston 8, Mass.

FREE "Stamp Finder." Tells instantly country to which any stamp belongs. 32 pages profusely illustrated. Garcelon, Calais 17, Maine.

FANTASTIC—Zanzibar, Borneo, Liberia, Sarawak, Fezzan and over 100 different others. Everything 10c with approvals. Thompson, 5708 Osseo Road, Minneapolis, Minn.

100 LARGE Pictorials, \$1.00 postpaid. Kreisher, 710 Walnut, Reading, Penna.

COLOSSAL Offer. 108 different beauties. Abyssinia to Zanzibar 10c. Approvals. Charles Streff, 1419 N. American St., Philadelphia 22, Penna.

PACKETS, World different 1,000, \$1.00; 2,000, \$2.25; 3,000, \$5.00; 5,000, \$13.00; 10,000, \$45.00. Russell, 2011D, Natural Bridge, St. Louis 15, Mo.

TRIANGLES! Diamonds! Eleven scarce, beautiful, bi-colors only 10c with approvals! Thrifty Company, Silver Spring, Md.

FREE Packet with United States, Canada approvals. Hoyt, Lowell Road, Hudson, N. H.

SPANISH Colonies. 3 animal sets 10c with approvals. Seminole Stamps, Box 1138-P, Coral Gables 34, Florida.

POSTMARK Collectors Guide and 10 Postmarks. Send 35c. Kazaks, 234 E. 58th St., New York 22.

MINT, (Unused) United States approvals. Russell Patrick, 3650 Central, Indianapolis 5, Ind.

MINT Sets—Pick your own premiums from new triangles, colorful British Colonies sets. Any two sets at half price. Universal Stamp Co., Box 145, Boston 1, Mass.

ALBUMS, Accessories, Leading brands. Gifts. Coupons. Harry Smolin, Box P-288, Flushing, N. Y.

MINT Army Navy set 50c. Twelve mint commemoratives 50c. Fine approvals sent to serious collectors. Charles Mekeel, 2101 East Market, York, Penna.

SCANDINAVIA 400 Diff. \$2.00 list 10c, refundable. August, Box 349, Altoona, Penna.

WONDERFUL Offer 7 complete mint sets, Manchukuo, etc. only 10c with approvals. Reich (M25), 1033 Lawrence, Chicago 40.

SAMPLE American Stamp News, plus 200 mixed foreign stamps, 10c. C. Ritchie, Watertown, South Dakota.

CIPEX Souvenir sheet plus 25 different U.S., 10c. Approvals accompany. Village Stamps, 90-39P 214 St., Queens Village 28, N. Y.

150 UNITED States commemoratives, etc. 10c. Approvals. Hart, 3612 Darwin, Cincinnati 11, Ohio.

COLBURN-Stamps, Twentynine Palms, Calif., Box 672. Fine foreign on approval. 2 cents and up. Premium plan.

327 DIFFERENT Stamps 25c! Including early Canada, Newfoundland, British Colonies, Vatican, Red Russia, Hitler heads, Indian states, animals, airmails, French Colonies, rarities, unusualls. Every stamp different. Rare bargain only 25c with our bargain approvals. Money back guarantee. Niagara Stamp Co., Niagara-on-the-Lake 61, Canada.

50 DIFF. Finland 10c with approvals. Carroll's, E. 1817-A Sprague, Spokane, Wash.

FREE Illustrated price list. Philatelic House, Rockville Centre, N. Y.

ONE Kilo Italian large pictorials \$10.00. Beverini, Caselpostale, Ge-Pegli, Italy.

15 DIFFERENT Norway 5c. Approvals. Lincoln Stampco, 8820 Aberdeen, Chicago 20.

65 ALL Different U. S. stamps includes 19 Century, commemoratives, airmails and \$5.00 stamp. Only 10c. Approvals. Willett Co., Box 507 L, Port Chester, N. Y.

FREE! Big United States stamp catalog—including value guide and identifier, plus check list. Hundreds of illustrations. Harris & Co., Boston 17-W, Mass.

KOREAN Set free. Approvals. Wbm, P.O. Box 758, Wilkes-Barre, Penna.

300 DIFFERENT Given free with approvals. Write for details. Windsor Stamps, 1435 East 67th Place, Chicago 37.

10,000 PENNY Approvals waiting for you. Many from exotic countries, pictorials, airmails, new issues. Tilbury, Box 862, Newark 1, N. J.

FREE Stamp zoo! Rhinoceros, snake, giant, pygmy, emu, kangaroos, koalabear, kookaburra and other wild animals. Free with exciting approvals. Niagara Stamp Co., Niagara-on-the-Lake 51, Canada.

50,000 STAMP Grabbags 25c each. Anderson, 630B Bingaman, Reading, Penna.

OLD STAMPS WANTED

I Will pay \$100.00 each for 1924 1c green Franklin stamps, rotary perforated eleven (up to \$1,000 each unused). Send 10c for large illustrated folders showing amazing prices paid for old stamps, coins and collections. Vernon Baker, PM-31, Elyria, Ohio.

ANTIQUES, RELICS, INDIAN GOODS, CURIOS

4 PERFECT Arrowheads \$1.00; perfect pipe \$2.50, \$5.00; tomahawk \$3.00; knife 50c. Catalog 10c. H. Daniel, Lamar, Ark.

ANTIQUÉ, Pistols, flintlocks, muskets, swords, list 25c coin or stamps. Westbrook, 5637 Lafaye Street, New Orleans, Louisiana.

4 PERFECT Ancient arrowheads \$1.00. Fine grooved tomahawk \$3.00. List free. Lear's, Glenwood, Arkansas.

PRECIOUS STONES, MINERALS

GEMOLOGY Books, catalog 10c. Atlantic Books, Lawrence Avenue, Charlestown 29, Massachusetts.

GEMSTONES, Mineral specimens. Every variety. Lowest prices. Postcard brings free booklet. Plummer's, 4720 Point Loma Ave., San Diego 7, Calif.

FIND Tungsten, mercury, uranium with Mineralight. Free brochure. Write Dept. PM8 Ultra-Violet Products, South Pasadena, California.

GEMS, Precious and semi-precious, genuine, from world-wide sources. Deal direct, no overhead, save money. Catalog 10c. Hill Co., 5450-G Portland Rd., Salem, Oregon.

GEMS And minerals, beautiful magazine tells how to cut and collect. Brochure and book list free. Gembook Co., Palmdale, Calif.

GEMOLOGIST, Mineralogist, prospector kits. Beautifully packaged. Immediate delivery. Contain equipment (ultraviolet ray lamp, etc.) specimens (atomic blast material, uranium, etc.) instructions. Also, book of stones and minerals. 200 illustrations. \$2.00 postpaid. Send for free catalog. Royal Gem Sales, 6671 Sunset Blvd., Hollywood 28, Calif.

JADE, Agates, gems, gem cutting machines, supplies. Free list. North West Gems, 2819 North Warner, Tacoma 7, Wash.

JASPER, Agate, quartz and catalog 25c. Gemco, Elkhart Lake 2, Wisconsin.

HOBBIES AND COLLECTIONS

WANTED Cigarette, tobacco, cards. Write Charles Bray, East Bangor, Penna.

BIG Packet foreign campaign ribbons. Colored catalogues. \$1.00. Medcrafts, 421 6A St. N.E., Calgary 2, Canada.

UNUSED Matchbook covers—100 different \$1.00 36-page catalog 25c. Charles Edelman, 13110 East 84, Cleveland 3, Ohio.

INVENTING Can be an interesting and profitable hobby. Write for complete particulars. Institute of American Inventors, Dept. 40-E 631-E St. N.W., Washington 4, D. C.

GET Acquainted offer. 50 different matchbook covers 25c. Free lists. Yeingst, 502 Parkway, Harrisburg, Penna.

57 ASSORTED Collector's items only \$1. Amazing hobby. Embroidered patches, authentic armed forces insignia, ribbon bars, naval insignia. Gift free with order. Pritt Co., Dept. M-1, 16 West 27th Street, New York City.

CAMERAS, PHOTO SUPPLIES

WHOLESALE Photographic supplies. Cameras, films, projectors, enlargers. Write for free catalog. Capitol Photo Supplies, 2428 Guadalupe, Austin, Texas.

PHOTOMURALS. Your negative or ours. Catalogue 25c. Photomammoth Murals, Dept. M, 12048 Vanowen Street, North Hollywood, California.

BASS Says: Trading since 1910. Used but good as new buys: 8mm. B.&H. Sportster \$52.50; 16mm. Keystone A-7, F:2.5 lens \$37.50; Voigt. 35mm. Vito II, flash shutter, Skopar F:3.5, like new \$38.50; Kodak Reflex F:3.5 lens, like new \$88.50; Contax I, F:2 Sonnar \$87.50; 3 1/4x4 1/4 Speed Graphic, Skopar F:4.5, Ibsor shutter, \$52.50. Satisfaction guaranteed. Bass Camera Co., Dept. AG, 179 W. Madison St., Chicago 2.

PHOTOGRAPHY For pleasure or profit. Learn at home. Practical basic training. Long established school. Free booklet. American School of Photography, 835 Diversey Parkway, Dept. 3431, Chicago 14.

20% TO 40% Discount on factory sealed cameras, projectors, recorders. Send us your needs. Dart Sales, 3812 Atlantic Ave., Dept. MP1, Brooklyn 24, N. Y.

HUMOROUS—Old time color slides for home projection. Illustrated catalog free. Universal, Box 629A, Beverly Hills, Calif.

FILM Sale. Three 35mm. 20 exposure cartridges \$1.00. Quality film. Postpaid. Calif. Art-Crafts, Box G-928, Pasadena, California.

FREE Photographic bargain book packed with hundreds of sensational values in still and movie cameras, lenses and latest accessories. Super savings for you in new and used equipment. No money down. Up to 15 months to pay. Liberal trade-in allowances, too, on your own equipment. Write now for your free copy to Central Camera Co., Dept. 9A, 230 S. Wabash Ave., Chicago 4, Ill. (Photographic headquarters since 1890.)

PHOTO FINISHING

OVERSIZE Prints no extra charge. 8-exposure roll, 30c. 12-exposure, 45c. 16-exposure, 55c. Reprints oversize 4c. Finest quality. Mail Order Photo Service, Box 297, Watertown, Wisconsin.

SATISFACTION Guaranteed! Eight jumbo size prints mounted in album, 35c—12 to 16 exposure rolls, 50c. Free mailers, quick service, finest developing, finishing. Photo Christmas cards our specialty. Crown Studios, Box 1223-PM, Dallas, Texas.

GIANT Glossy prints (3 1/2" x 5"); fast service. Mail us your holiday films, 8 exposures, 30c; 12 exposures, 45c; 16 exposures, 60c. Trimman, 335 East Utica, Buffalo 8, N. Y.

12 JUMBOS 25c, 16 Jumbos 35c, from any size roll or negatives, with this ad. Skrudland S. Lake Geneva, Wis.

GIANT Size deckle album prints. 8 exposure roll, 35c, 12 exposure 50c. Send money. Free mailers. Dowl Photo Co., P.O. Box 2077, Ft. Worth, Texas.

ENLARGEMENTS! Eight 5 x 7's or five 8 x 10's, \$1.00. Wilart Enlargers, Box 967, Little Rock, Ark.

CUSTOM Photo finishing guaranteed. 8 exposures 35c; 12, 50c. Bound in beautiful plastic ringed album. Special! 35mm., 36 exposure \$1.00. Free mailer. Flash Foto, Box 36M, Brooklyn 4, N. Y.

FAST—Same day service! 8 oversized prints in attractive plastic-bound book only 35c; 12-50c; 16-60c. Satisfaction guaranteed. Free exposure guide with first order. Pic-Sure, Box 899-B, Philadelphia 5, Penna.

6 OR 8 Picture roll 35c, 12 or 16 picture roll 55c. Each roll printed and developed. Handy album pack. If you fail to get pictures on your film a new roll will be sent you without extra cost. Send coin with roll. No c.o.d.'s. Mailing containers sent free. DeLuxe Film Service, Box 1288-A, Shreveport, Louisiana.

BEAUTIFUL Enlargement from each picture on 8 exposure roll 35c. Cut Rate Photos, Dept. B-4, Janesville, Wis.

TWO Beautiful prints from each picture on 8 exposure roll 35c. Thirty-one years of satisfied customers. Quick service. Lens Photos, Dept. J-4, Janesville, Wis.

GREAT News! Our famous Century Jumbo oversize finishing at contact prices. Our Chicago plant, with new improved equipment, exclusive with Century, produces sensationally magnificent quality work. Any 8-exposure roll finished deluxe style only 40c. 12-exp., 55c. 16-exp., 70c. 36-exp., \$1.50. Oversize reprints 5c each. Free mailers. Send us your next order, you will be delighted with results. Century Photo Service, Box 5208, Chicago 80, Ill.

UNBEATABLE For quality and price. You will be surprised and pleased with the beautiful results from our celebrated jumbo oversize finishing. Low prices, same as contact. 8-exp. roll superfine finish only 40c. 12-exp., 55c. 16-exp., 70c. 36-exp., \$1.50. Oversize reprints 5c each. Send us your order, you will be delighted. Free mailers. Mailbag Film Service, Box 5440A, Chicago 80, Ill.

TWO Prints each good negative. 8-exp., 45c; 12-exp., 65c; 16-exp., 85c; reprints 4c. Mayfair Photo Service, Box 617-K, Toledo, Ohio.

8 CONTACTS 30c, Jumbos 40c, 12, 45c; jumbos 55c. Reprints 4c; jumbos 5c. Western Photo, Dept. PM-13, Box 298, San Francisco 1, Calif.

PHOTOSTAMPS. Finest quality. Free samples. Photostamps, Box 4216-M, Jacksonville, Florida.

MOTION PICTURES AND SOUND EQUIPMENT

WILD Life films. Exciting, dramatic action in the natural habitat of animals of forest and plain. 8mm. or 16mm. in beautiful color or B & W. Also 2" x 2" color slides. Write for free illustrated literature. Wild Life Films, 5151A Strohm Ave., North Hollywood, California.

5000 NEW-Used 8-16mm. silent-sound films. International-B, 2120 Strauss, Brooklyn 12.

BARGAINS 16MM. sound films. Also for exchange. Bedner, 5300 So. Talman, Chicago.

8-16MM. Silent-sound films. Complete rental library. All latest subjects. Free catalogue, sample film 10c. Garden Film, 317 West 50th, New York 19.

RENT 16MM. sound films, 50c reel. Large selection; free catalog. Film Service, 128 Chestnut St., Roselle Park, N. J.

GUARANTEED Fresh 8mm. roll, magazine; 16mm. roll, magazine movie films. Color, b&w. Free catalog. ESC-S, 47th Holly, Kansas City 2, Missouri.

MOVIE Camera film: 8mm. roll \$1.50, 16mm. 100' \$3.00. Free processing. Better Films, 742 New Lots, Brooklyn, N. Y.

TAPE Recorders, tapes, accessories. Unusual values. Dressner, 624-M East 20th Street, New York City 9.

SYNCHRONOUS Magnetic recorder professional quality. Magnetic Recorders Co., 7120-A Melrose Ave., Los Angeles 46, Calif.

NEW And used sound film for sale at less than cost. Soundies, shorts, features. Write for listing. Lawrence Camera Shop, Box 1597, Wichita, Kansas.

RECORDING Tape; plastic. Write for discounts. Fidelity Sound, 1412 Flagler, Jacksonville, Florida.

"ENTIRE Life Story of Christ" 8 mm., 16mm., sound and silent, purchase or rent. Hemenway Film, 31F Church St., Boston 16, Mass.

MAKE Your 8 or 16mm. silent movies talk "in-sync" automatically. Free literature. Movievox Co., Dept. 4, 1113 Pleasanton Road, San Antonio 4, Texas.

BIGGEST Bargains at Blackhawk! Headquarters for used films—16mm. sound prints often available at \$3.98 a reel; 16mm. silent, \$2.98; 8mm., \$1.98. Tremendous stock of used features, comedies, cartoons, sports, travels, musicals, 100' 16mm. used Panoram musicals, six for \$4.99. Big savings on new 16mm.-8mm. subjects. Lowest prices on reels, cans, editors, splicers, supplies. Good used 16mm. sound projectors—Ampros, Bell & Howells, Victors—often available at \$129.95. Whatever it is, Blackhawk almost always has the biggest selection at the lowest price. Get Blackhawk's big free monthly catalog. Blackhawk Films Inc., 1218 Eastin Bldg., Davenport, Iowa.

RARE Old time movies, 16mm., 8mm. Send for list. Film Classics, 1645 N. LaBrea Ave., Hollywood 28, Calif.

MUSIC AND MUSICAL INSTRUMENTS

SONGWRITERS! Outstanding, convincing offer. Hibbler, C-5, 2157 N. Avers, Chicago 47.

MUSIC Arranged. Songs printed. Frank Wildt, Music Publisher, Lancaster, Penna.

1952 ACCORDIONS—Wholesale. Free catalog. American Accordion Center, 5329 Belmont, Chicago.

ELECTRIC Guitars, accordions, amplifiers, wholesale, free catalog. Carvin, Baldwin Park, Calif.

ACCORDIONS—Save 50% and up. Cash or terms. New and used. All brands. Wholesale to everyone. Free catalogue. Del Principe, 29 South Cicero, Chicago 44, Ill.

POPULAR Songs. How to write and sell them. Write for free booklet Successful Songwriting. Gateway Songs, Box 2470, Hollywood 28, Calif.

SONGWRITERS! Protect your ideas! Hold all songs; poems! Write for Safe Correct Procedure first! Song Service, Dept. P, 333 W. 56th St., New York 19, N. Y.

SONGWRITERS! Send poems, songs. Music Service, 243 West 72nd St., PM, New York 23.

WANTED! Poems for musical settings. Write Songwriters' Service, Clifton, N. J.

POEMS wanted to be set to music. Free examination. Send poems. McNeil, Master of Music, 510-PM S. Alexandria, Los Angeles, California.

WRITE Songs. Big money and reputation. Write for information. J. Gordon Pub. Co., 4700 South California Avenue, Chicago.

SENSATIONAL Free booklet, "How To Write And Sell Songs." Get the facts first. Poems examined free. Reliable Music Service, Box 430-P, Hollywood 28, Calif.

525 Tested Music publishers' addresses—\$2.00, postpaid. Nick Pollino, 507 W. 6th Street, Wilmington, Delaware.

POEMS Wanted for musical setting. Send poems for free examination. Five Star Music Masters, 630 Beacon Bldg., Boston, Mass.

LEARN Piano, singing, songwriting, professionally. For pleasure or profit with our amazingly easy self-taught courses. Music Teachers' Associates, 26 Potters Lane, Great Neck, N. Y.

POWERFUL, Dynamic voice quickly developed with diaphragm exerciser. Write, Voice Developer, Box 665-(34V) St. Louis, Mo.

POEMS Wanted for musical setting on percentage basis. Free broadcasts. Sooner Song Co., 22-PM North West 8th, Oklahoma City 2.

SONGPOEMS Wanted. Mail to: Tin Pan Alley, Inc., 1650 Broadway, New York 19, N. Y.

SWISS music movements, finest make, lowest price. Ask for leaflet. Helax Company, 218 West 72nd Street, New York.

SONGWRITERS: Your song expertly arranged for piano. Send lead and \$12.00 to Zarlengo Music, 1454 Welton, Denver, Colorado.

POEMS Wanted! Immediate consideration! Song Promotion Guild, 350-M Broadway, New York 13.

YOUR Songs professionally recorded! Recording Society, New Boston, Ohio.

RADIO AND TELEVISION

BUILDER'S "Pictorial Construction Plans." Free list. Alena, Box 24, Astoria 6, New York.

CLEARCO Crystal radio kit \$1.50; pre-assembled \$1.75. Free catalogue. Clearco Crystal Co., Box 1857, Milwaukee, Wis.

BUILD 15 Radios—Only \$1.30 each. Experience unnecessary. Home radio and TV course includes trouble shooting and servicing lessons, radio principles, code instructions, practical radio building and repairs. You build and keep receivers, transmitters, amplifiers, test equipment and code oscillator. All parts, tools, instructions supplied, including radio tester and electric soldering iron. Send for big, new time and money saving catalog and radio TV repair guides. Enclose 25c. Progressive Electronics Co., 497 Union Ave., Dept. PM-26, Brooklyn 11, N. Y.

FREE 236 Page 1953 television-radio-electronic catalog! World's largest stocks, lowest prices. Complete supplies for builders, experimenters, amateurs, servicemen. Latest television, radios, phonos, recorders, sound equipment. Thousands of parts, tubes, test instruments, books, diagrams. Top quality money saving values. Get yours now! Allied Radio Corp., 833 W. Jackson Blvd., Dept. 34-A-3, Chicago 7, Ill.

MAKE Simple, tubeless, batteryless distance-getting crystal radios. Crystal and illustrated instructions 25c postpaid. Allen, 427-P, Clinton, Missouri.

REPAIR Your own radios. Complete simplified instructions only \$1.00. Details free. Slate's Radio Service, Corsicana, Texas.

NO Crystal. No tubes. No batteries. Amazing radio reception from razor blade. Guaranteed plans 25c. Philippi, 48 East Chicago Avenue, Chicago 11, Illinois.

THREE Used workable television tubes \$1.00. Regen, 801 W. Erie, Philadelphia.

EXTRA Loud crystal, catwhisker, latest radio plans, catalogue: 25c. Amorose, Route Four, Richmond, Virginia.

TELEVISION Antenna, attic installations. Equals 20' roof mast. Instructions \$1. Cywar Television, West Point Pleasant, N. J.

CUSTOM Radios for 1952 Fords \$44.50. Nordic Radio Co., Box 582, Evanston, Ill.

AMAZING Television antenna eliminator. Small device attached to rear of set where it's out of sight. Outperforms outdoor aeriels. No snow, no ghosts. Send only \$2.95 or write for free details. Arrow Sales, 2306 S. Howell, Milwaukee 7, Wis.

RADIO Control model booklet with illustrated diagrams and list 18 builder's plans, 25c coin. Dittofax, 5208-A Onacrest, Los Angeles 43.

ENJOY 3 Color television now. Seconds to attach. Send \$1.50 for 16" or under, \$2.00 size 17". \$2.50 size 20". \$3.00 for 21" screen. Zingo Products, Johnston 7, N. Y.

TV-FM Antennas. All types including UHF. Mounts, accessories. Lowest prices. Wholesale Supply Co., Lunenburg 1, Mass.

BUSINESS OPPORTUNITIES

CONVERT Hand mowers to power mowers. Do it now, this winter. Sell the Handy-Dandy conversion kits. Easily installed on 16 to 20" mower. Use any small gasoline or electric motor. Quick delivery. Kits purchased with or without engines. Also new garden cultivator. Cultivates 3" deep. Attachments available: weed cutter, lawn mower, snow plow, and rotary snow brush. Discount to dealers. LeClaire Manufacturing Company, LeClaire, Dept. PM, Iowa.

FREE Valuable catalog. Over 2000 select businesses, farms, ranches and income properties for sale throughout West. Contains prices, addresses, etc. Write us what and where you want to buy and we'll advise sellers of your requirements. No salesmen, no commission to pay. Write for free catalog No. 76. National Business & Property Exchange, 4101 West 3rd St., Los Angeles 5, Calif.

LEARN Silk screen printing; invisible reweaving; repair dolls; make rubber stamps. Rubber for molds, new low prices. Large catalogue free. Universal, Box 1076-A, Peoria, Ill.

ABC Shorthand in one week \$2. Returnable, 215P West 91, New York 24, N. Y.

SELL Printing by mail! We fill orders. Free plans, samples. Sutton Printing, Box 853-G, Waycross, Georgia.

PROFITABLE Home business, electroplating novelties, giftwares, auto parts, mirrors. Easy, inexpensive home processes. Free booklet. Tyco Metals, Box 13231-MJ, Houston 19, Texas.

RAISE Chinchillas for profit. New "Easy-Pay" plan helps you start at low cost. Registered N.C.B.A. breeding stock. Write Kryders Chinchillas, Sturgis 1, Michigan.

START Home perfume business. No equipment. Everything furnished. Emly Enterprises, Box 319-P12, North Hollywood, Calif.

COLOR Concrete with chemicals. Marble-glaze cement benches, pottery, garden ornaments. Home — shop. 10c brings sample, pictures. Hollywood Cementcraft, 8527-R Wonderland, Hollywood 46, Calif.

MONEYMAKING Mailorder plan, 25c. George Lenhoff, Box 201-M, Lincoln 1, Nebraska.

HAND Tools — Nationally advertised. Jobber prices. 2000 item catalog 25c. Midwest Sales, 3219 W. 117th, Cleveland, Ohio.

BITS Of plywood; jigsaw. Exceptional income. Literature free. Woodarts, PM-153, Bridgewater, Mass.

CO-Partners wanted—Share in big time profits publishing-selling new book with terrific possibilities. Foreman, 351-H, Fairmount, Jamestown, N. Y.

MAKE Gifts, novelties, jewelry, from sea shells, fish scales, plastics! Wholesale, illustrated catalog 10c. Giftcrafts, Box 4550-PM, Coral Gables, Florida.

YOUR Own business without investment. Be an authorized agent for magazines and take care of new and renewal orders in your territory. Experience not necessary. We furnish all supplies free. Write for our catalog. Subscription Service Company, P. O. Box 2070, Birmingham, Alabama.

PROFITABLE Home business. Make fast-seller chenille monkey trees, dolls, flowers. Terrific holiday demand. Information free. Velva, Bohemia 16, N. Y.

LIQUID Rubber, make flexible molds. Free sample. Chaney, 1130 E. 16th St., Jacksonville 6, Fla.

YOU Can have a steady lasting income with my copyrighted system in the mail-order business, right at your own home. Write me, I'll tell you how. F. Little, R.D. 1, Glenshaw, Penna.

NATURAL Molding latex. Extra thick. Free sample. W. Wooley, 115-A Donald, Peoria, Ill.

TO \$35.00 Weekly. Spare time, home operated, mailorder business. Successful "beginner's" plan. Everything supplied. Lynn, 10420-M National, Los Angeles 34, Calif.

RAISE Fishworms. Easy, profitable. Complete instructions 25c. Huffmans Worm Ranch, Rives Junction, Mich.

FIX Typewriters. Free booklet describes our modern, inexpensive home-study course. Factory methods taught. Write: Typewriter, Building 1, Tarentum, Penna.

\$25 WEEKLY Working two hours daily. No canvassing. No manufacturing. Lycke, Box 2471-A, Cleveland 12, Ohio.

RESILVERING Mirrors, formula 50c; two-way lookout mirrors, (No one sees you), 50c; coppered mirrors, 50c. All \$1.00. Neiko-Mir, Box 3462-J, Chicago 54.

FIGURINE Molds and many others, liquid rubber, statuary plasters, flock finishes, Glo-candle wax, etc. Illustrated catalog and "Plastercraft" manual free. Blue Rapids Supply, Blue Rapids, Kansas.

START Home manufacturing business. Make cleaners, soaps, polishes, cosmetics. Free literature. Kemix, Park Ridge, Ill.

HOW And where to obtain capital? Free details. Star Service, Wapakoneta, Ohio.

BIG Profits making new greaseless doughnuts. Start in kitchen. Wholesale to grocers and cafes. Free plans. M. Ray Company, 3605 South 15th Ave., Minneapolis 7, Minnesota.

BIG Money and fun growing live miniature Ming trees on your window sill. Write for free rare tree seed and plan. National Nursery Gardens, 8463 South Van Ness, Inglewood 4, California.

MAKE Money spare or full time, casting metal toys and novelties. Big wholesale and chain store demand for autos, soldiers, ashtrays, banks, etc., keeps manufacturers busy. Production moulds furnished for up to 100 and more castings per hour. No experience or special place necessary. Write for information and illustrations of patterns needed. Metal Cast Products Co., Dept. A, 1696 Boston Road, New York 60, N. Y.

WHY Not make extra dollars repairing zippers? Excellent profits uncrowded field. Details free. Texas Specialty Company, 204-B Texas, Texarkana, Texas.

NEW Exceptionally profitable plans, ideas for home operated mail business. Rush name. Miller, 1772-P Carlyon Road, East Cleveland 12, Ohio.

MAKE Flexible molds! Cast plaques, bookends, figurines! Free sample! H. Tooker, 630-R Chestnut, Hamilton, Ohio.

21 POPCORN, Candy apple formulas, proven money-makers. Send \$1 today for formulas, catalog of money-making ideas. Concession Supply, 3916 Secor, Toledo, Ohio.

RECAST Old batteries into new. Latest achievements. Battery Laboratories, Minneapolis.

READ "Advance"—The voice of mail order. Offers money-making opportunities, sources of supply, personal guidance, etc. Issued monthly. Sample copy 35c. Yearly subscription \$2.00. Advance Publishing Company, 313 East 21st Street, Suite 450, New York 10, N. Y.

GOOD Paying business silvering mirrors, plating autoparts, reflectors, bicycles, bathroom fixtures, etc., by late method. No tanks or shop required. Outfit furnished. Free booklet. Gunmetal Co., Ave. H, Decatur, Illinois.

BUY Wholesale. Thousands articles. Supply directory, 10c. Idealco, Park Ridge, Illinois.

EARN Extra money! "Homeworker Magazine" tells how. Sample 25c. Sizemore, Box 7, 4917 Kostner, Chicago 30.

BOOKKEEPERS, Keep books, small firms spare time. Manual latest technique by C.P.A., \$3.00. Modern Business, Box 406, Youngstown 1, Ohio.

EXTRA Money—No selling, operate vendors. Amazing profits, details free. Silver King, Suite 220, 622 Diversey, Chicago 14.

BUY It wholesale! Manufacturers, distributors offer 850,000 items. Literature free. Olsen, 1231-A East Third St., Duluth 5, Minn.

OPERATE Profitable mail order business. Write Walter Service, 4159-A East 112th, Cleveland 5, Ohio.

EARTHWORM Breeding? First, get unusual story. "An Earthworm Turned His Life." Free. Earthmaster, Dept. 14, El Monte, Calif.

DOLLARS In personalized baby record books. Sell by mail. Use same literature we do. No-Co-Ro, Oakland 6, Calif.

MADE \$24,500 Using money making plans from Schemer Magazine, world's oldest mailorder publication. Box 275M, Canfield, Ohio. Year \$2.00. Sample 20c.

MINK Raising information free. Complete. Lake Superior Mink Farm. Superior, EEL, Wisconsin.

COPUBLISH Leading m.o. paper. Latest copy Mail Sale Advertiser, details, dime. Vanroy Shirk, Lebanon, Penna.

GET Dollar orders in your mail. Keep 90c. Everything supplied. Genmerco, Box 142-D, Dorchester 24, Mass.

COLORGLAZED Concrete pottery made without molds. Patented method. Cemetery products, novelties, tiles. Basement leak-sealing. Money-making projects. Booklet, details free. Men only. National Pottery Company, Grand Rapids, Minnesota.

HOME Mail business! We supply exclusive product, advertising, everything. Experience unnecessary. Start low as \$150. Terrific potentialities. Write: NMD Agency, Box 88-D, Dorchester 22, Mass.

FREE Book "505 Odd, Successful Businesses." Work home. Expect something odd! Pacific, Oceanside, Calif.

CHINESE Raised art. Fantastic profits. Easy enjoyable hobby. Details free. Modern Aids, 248 South Main, Jamestown, N. Y.

MILLER'S Modern manufacturing formulas make fast-selling products that get the business and pay. Fifty years supplying the best. Literature free! Miller, Research Chemist, Tampa, Florida.

MAKE Fast-selling repeat order products at home. No machinery. Everything furnished. Write, Shepard, 455-D West 34th, New York 1, N. Y.

MOLD Making liquid rubber; sample pint, with instructions, \$2.00 postpaid. Plastercraft Supply Company, 3051 St. Clair Avenue, Cleveland 14, Ohio.

\$50.00 AN Hour, spare time. Johnson, Box 351-B, Ithaca, New York.

START Mail order business at home. Expert will show you how. Now owns \$100,000 business built in 4 years. Dime brings amazing proof and valuable information. No postals. Northmore, Highland Park, Illinois.

TAKE Your choice of a big profit business of your own, a better job or high sparetime earnings in uncrowded, million-dollar field of custom furniture upholstery. Earn-while-you-learn training turns your hobby skill into a career, easily, quickly, right at home! Course includes free of extra charge all tools, frames, materials needed to build \$200 worth of furniture! You can actually be making and repairing furniture soon after starting—Earning sparetime money, getting "set" for a highly-paid craftsmen's job or your own shop where you can be independent of hours, bosses. Nationwide shortage of trained upholsterers—Because of record-breaking building, home-buying, refurbishing. Course includes two big, money-making extras—Slip covers and draperies! Our free book tells all about this ever-growing lifetime business, explains how you train at home under personal supervision of experienced craftsmen. You don't leave your job until you're ready for a big pay, big profit opportunity. Write today to Upholstery Trades School, Dept. BA-1402, 721 Broadway, New York 3.

MAKE \$300 And up weekly in a business of your own! Full or part time, take orders for the sensational, new "20-Hand Rubdown" roller vibrator. Over 300 sold at Pomona fair in 7 days. Write for complete details today. Roller Vibrator Co., Dept. PM, 6622 Sunset Blvd., Hollywood 28, Calif.

IMPORT-Export! Opportunity, profitable, world-wide, mail-order business from home, without capital; or travel abroad. Established World Trader ships instructions for no-risk examination. Experience unnecessary. Free details, Mellinger 21, Los Angeles 24.

POPCORN And potato chip equipment. Long Eakins Company, 5360 High, Springfield 99, Ohio.

A Big-paying business for a man in his 50's. One of our men makes \$11,000 in a year, other top men in their 50's earn up to \$5,000 to \$8,000 right from the start. We pay earnings in advance. Require no investment. Write confidential letter to Vice President, Dept. PM, Box 676, Dayton 1, Ohio.

FABULOUS Florida — Cool in summer, warm in winter. Industrial opportunities await you in Florida. If you are interested in going into business in fast-growing Florida, write State of Florida, indicating type of business you are interested in and stating your specific requirements. You will be put in touch with communities where opportunities exist. Get complete information, without cost or obligation. Write today. State of Florida, 4217E Commission Building, Tallahassee, Florida.

1001 OPPORTUNITIES, Dept. P., Box 209, New York 28, offers real business-building aids and ideas. Free information.

START Venetian blind laundry. Profitable lifetime business. New machine. Free booklet. F. C. Co., 442 N. Seneca, Wichita 12, Kansas.

START Your own business on credit. Your own boss. 1586 of our dealers sold \$5000 to \$27,500 in 1951. We supply stocks, equipment on credit. 200 home necessities. Sales experience unnecessary. Pleasant, profitable business backed by world-wide industry. Write Rawleigh's, Dept. A-U-PPM, Freeport, Ill.

ADVERTISING Book matches—Cash in on big demand! sell union label matches. Cuts for all businesses and political parties. Free powerhouse selling kit, low prices, protection guaranteed on repeat orders. Cash commissions. Superior Match Co., Dept. MX-153, 7530 Greenwood, Chicago.

LEARN Sewing machine repair. Electrify, rent, trade, sell. Make up to \$125 week spare time. New machines, motors, etc. wholesale. Details free. Taylor Service, Hamilton PM-1, Ohio.

\$200 WEEKLY Reported! No selling. Free booklet. T. J. Surface, Roanoke 4, Virginia.

25%-50% COMMISSIONS Taking magazine subscriptions. Details. Courier, 40-69G 97th Street, Corona 68, New York.

WANTED! Home producers, by manufacturers in our clearing house service. Become a sub-contractor, casting plastic products for these companies. You don't have to look for markets; we do the missionary work. Thousands of easy to make items required for consumer and industrial use. Cash in at home. No previous experience required. Write for free details. Plastic Service Associates, Dept. PM2, East Boston 28, Mass.

INVENTORS: We can handle manufacturing and sales of good inventions. Cash your ideas. Write, Iroquois Farm Supply, Cissna Park, Illinois.

START A buying service, buy wholesale thousands nationally advertised products. Make big profits selling at sizable discounts. Postcard brings details. American Buyers, 627-PM Linden, Buffalo, N. Y.

RADIO Advertising without risk! Pay "per order"! 400 broadcasters! Details free! Simon—P12, 48 Fifth Avenue, Pelham 65, New York.

MAKE Money at home as renewal headquarters for all magazines. Liberal commissions. No experience, no capital needed. Supplies furnished. Write for free catalog. McGregor Magazine Agency, Dept. 500B, Mount Morris, Ill.

\$40.00 DAILY With inexpensive sawshop equipment. Zapart, 586-P Manhattan Ave., Brooklyn 22, N. Y.

CO-Publish leading mail order paper. Latest copy. Details, dime. Hugh Zentz, Elkhart, Indiana.

BOOKKEEPERS, increase earnings operating sensational bookkeeping service. C.P.A. system. Kern, 4942 Vineland, N. Hollywood, Calif.

NEW Fabulous home-business, "Jewelry" finish. Free money-making plan. Pearl-Art, 7216C Bear, Bell, Calif.

SELL Books by mail! Wholesale catalog, 25c. Monarch, Auburn, New York.

"BARGAINS" Big tabloid paper lists hundreds of bankrupt, closeouts, wholesale bargains every month! Many buys 15c-20c on the dollar! Also lists sources 100,000 items wholesale. 6 months, \$1.00, 1 year, \$2.00 (reg. \$3.00). Box 591-SA, Lynn, Mass.

FORTUNE in "Floating Henryburger" county franchise. No canvassing. Small investment. Floating Henryburger System, Box 936, Wichita, Kansas.

FLEXIBLE Rubber moulds for plaster and Marblite figurines. Sample and large illustrated catalog 25c, refunded on first order. K-C Novelties, Dept. 29, Easthampton, Mass.

500% PROFIT! Make beautiful fast selling costume jewelry. From natural marine and botanical life; transformed into exquisite "ceramic's" gems. Orange blossoms, seahorse, starfish, etc. Free instructions. Jewelry by Julium, Box 460, Ft. Lauderdale, Florida.

MAKE This your business—Fire protection equipment vital for every home, garage, office, store, farm, etc. Invest approximately \$200 in fast-selling items and enjoy profit of \$96. S.O.S. glass ball automatic fire extinguishers and S.O.S. brass pump type C.T.C. 1 qt. extinguishers meet every need. Guaranteed. Write today for details. Schwartz Bros., Inc., Dept. PM, 827 Arch St., Philadelphia 7, Penna.

EXCELLENT Earnings, repairing sewing machines as a business. Details free. Joseph Alexander, 313-8th Ave., New York 1.

EARN Income at home. Circular 10 cents. Reho, Box 21A, Whitsett, Penna.

NEW Sandwich. Fast seller, big profits for sandwich shops, soda fountains, etc. Make it yourself. No franchise or equipment to buy. Write today for descriptive folder. Haskell D. Boyer, Box 1486, Fort Worth 1, Texas.

MAKE Perfumes at home. Write, Carey Laboratories, 1914 Chouteau PM-1, St. Louis 3, Missouri.

HOME Business. Make perfumed stationery. Powerful smell wins steady customers everywhere. Sell by mail, stores, women. Particulars free. Rlenze Press, 24 North Seventh, Newark 7, New Jersey.

BE First. Sensational new business. No competition. Details free. A-J Products, 6166A Parkway Drive, Baltimore 12, Md.

START Home mailorder business. Details. Gedgard, Box 798-X, New York 1, N. Y.

LIFETIME Income. Free mailorder opportunities. Specialco, Box 345, Wilkes-Barre, Penna.

SPECIALIZED Magazines covering your field of interest help you to greater success. Get latest copies through our easy-to-get-acquainted service. Hundreds of business, trade, professional, educational, sport, hobby, advertising, amusement, architecture, art, athletic, automotive, aviation, banking, barber, beverage and others covering all interests. Send for list today. It's free. Commercial Engraving Publishing Company, 34C North Ritter, Indianapolis 19, Indiana.

LARGE Wholesaler of nationally advertised appliances, cameras, watches, etc., will help you start your own business with investment of under \$20.00. No selling involved. Free details. Cam Company, 1717-58th Street, Brooklyn 4, New York.

MAKE Money from newspaper clippings. Siegel, Box 183 PM, New York 2.

LEARN Professional candy making, profitable home business. Details free. Pate, Kissimmee, Florida.

SILK Screen printing. Inexpensive course teaches everything. Typcrafters, 510-H West Susquehanna, Philadelphia 22, Penna.

BOOKKEEPERS—Earn up to \$520 month serving small firms part or full time. Proved plan; simplified system. Particulars free. Tax Saver System, Dept. 2, Fort Worth 2, Texas.

OWN A mail-order paper products business. Sell envelopes, tags, bags, boxes, wholesale. Tremendous demand. Steady profits. No capital necessary. Write Omaha Envelope Service, Dept. 10, 4721 California, Omaha 3, Neb.

ALL Profit—Making, selling, installing important heating specialties. Details free. Harrington, Box 103MI, St. Matthews, Ky.

MOLDEX—Best moulding rubber, sample 10c. Pentucket Arts, Seabrook, N. H.

GET Started in your own profitable mailorder business! We supply everything! Write today! Studio Products, Box 564-AB, Glendale 5, Calif.

OPERATE "Escalator" mailorder system, selling our products or any products. Fastest, most revolutionary mailorder system known. Write: Selbyco, Decatur 152, Ill.

TIN-CANS. Turn them into cash. Nine methods. Instructions 50c. Charles Company, 12-DAT, Norwood, Ohio.

LIFETIME Business! Manufacture extremely profitable chemical products! Descriptive information free! Thermolab, Peoria 4, Ill.

137 PLANS For starting home business. Details: Elite Co., 220 Grand St., New York 13.

FRANCHISES Make profits. Become an exclusive distributor or agency operator in your area. Get the facts on franchise opportunities nationwide. Write for details. National Franchise Reports, 452 Pure Oil Building, Chicago 1, Illinois.

BUILD Good home \$150.00 room. Make durable, attractive building plastic for floors, walls, stucco, built-ins. Fire, water, termite resistant. Bays Laboratory, Oklahoma City 9.

MAKE Perfume. Catalogue free. International, 6347 Parnell-PM-1, Chicago 21, Illinois.

PROFITABLE Mail selling, twelve tested plans. Write: Edwards, Box 1067-P, Allen Park, Michigan.

"SIX Secrets for Success," plus five formulas, all for a dime. Lexington Mail Service, 5538 Lexington, Chicago 44.

OWN A Stonetex precast mantel business. We send dies, colors, frames, lumber, complete instructions. Dies give positive stone texture. They are cast from real stone. Makes all types of mantels from concrete. One day installation. Protected territory. \$125.00. Stonetex, 533 Manhasset Rd., Pittsburgh 27, Penna.

METALIZE, Permalize, ceramic, porcelainize, baby shoes, dolls, pottery, hundreds of items. No firing, no baking. Tremendous profits without costly equipment! Send 25 cents for complete business plan and illustrated instruction book. Professional Art Products, Dept. P.M.25, 845 S. Wabash, Chicago 5, Ill.

FREE Information—Home business opportunity mailing to automobile owners. Everything furnished. Big Earnings, Wood, 2-B, Intervale Road, Worcester 2, Mass.

LEARN Invisible reweaving! Details free. Harris, P.O. Box 7112, New Orleans 19, Louisiana.

ELEVEN Master keys to fame, fortune and power. Wonderful book, illustrated. \$1. or c.o.d. Brooks, B120M, Arkansas, Wisconsin.

NEWEST Spare, full-time home business. \$5 to \$10 hour possible. Paint with suede—The finish with touch and eye-appeal. Beautify auto dashboards, signs, radios, toys, figurines, lamps—1001 others. Complete, step-by-step instructions sent for no-risk examination. Free details. Coast, 1004-AX So. Los Angeles St., Los Angeles 15.

EARN Money with typewriter, sewing machine! Spare time! Details free. Edwards, 3915-PM, 12th, Des Moines 13, Iowa.

PLANS, Tips, money making information. "Inside Secrets" free. Edkar, Johnstown, Penna.

MAKE Money at home mailing cards, circulars. Everything furnished. Start at once with almost no investment. Paton, Box 55-E, New York 23, N. Y.

SELL! Buy! Trade! anything. In "Trading Post Magazine" — Details 3c. Thorner's 525 Dewey, Jackson 15, Mich.

VENDING Machines—No selling. Operate a route of coin machines and earn amazing profits. 32-page catalog free. Parkway Machine Corporation, Dept. 72, 715 Ensor St., Baltimore 2, Md.

START Business without capital! Reliance, 15-A Park Row, New York 38, N. Y.

QUICK Money! Repairing car batteries! At home! Amazing profits! "The Batteryman's Secrets," tell how! Complete instructions \$5.00. 5 day moneyback guarantee! Batteryman, Grand Junction, Colo.

UP To \$200 weekly! Work home, start spare time, small capital. Free booklet "301 Unique, Successful Businesses" tells how. Deaumont Publications, 79-PM Deaumont, Kenmore 23, N. Y.

MAKE \$6.73 Every time you sell one—And they're amazingly easy to sell! We have new adding machines in original factory cartons you can sell for only \$14.95 and you make 45%. They're executive model portables, precision built with automatic clearance, direct subtraction, fully guaranteed. Send for life size color photo with full details. Write today to Lightning Adding Machine Co., Inc., Dept. P-25, 1260 West Second Street, Los Angeles 26, Calif.

MONEYMAKING OPPORTUNITIES

SELL Titania gems; \$9.75 carat wholesale. More brilliant than diamonds. Free catalogue. Diamonite, 1404-M Mitchell, Oakland 1, California.

"NEWSPAPER Clipping Bureau" Instructions 25c. Shroder, 803 Wisconsin, Peoria 4, Illinois.

SERVICEMEN, Agents, dealers wanted. Sell television wavetraps \$2.75. Sample \$2.00. Steils Co., Box 1104, Sioux City, Iowa.

TIE-Breaker picture puzzles exposed, \$2.00. Wenograd, Box 1495, Philadelphia 5, Penna.

SCHUHMACHER Matmakers. Convert old tires into dollars. Devote full or spare time. S and S Patents, Inc., 1307 North Clark St., Chicago 10, Ill.

EARN Money evenings, copying and duplicating comic cartoons for advertisers. Adservice, Argyle 1, Wisconsin.

MAKE Money—Sewing and assembling at home. Liebig Industries, Beaver Dam 10, Wisconsin.

50,000 ARTICLES Wholesale. Source directory dime. Nelko, Box 3462-DR, Chicago 54.

PUBLISH Your own magazine. Handsome 52 page format, well edited, illustrated. Cost low as \$1.00 month. Brings you prestige, profits. 25c brings sample, details. National, Ord, Nebr.

BE Appointed State Notary Public now! Details: Stationers, Helotes, Texas.

READ Progressive Mailtrade, the magazine that tells how to make money by mail. Dime brings sample and special offer. Progressive Mailtrade, Box 357, Sheboygan, Wisconsin.

FREE Book "505 Odd, Successful Businesses." Work home. Expect something odd! Pacific, Oceanside, Calif.

SPARETIME Profits taking subscriptions, all magazines. Wholesale catalog free. Cassell Agency, Westfield 2, New Jersey.

LEARN Watch-clock repairing at home. While learning we fix your watches-clocks. Special bonus offer. Inquire Modern Technical Supply, 55-PM West 42nd Street, New York 36.

"HOW To Make Money With Simple Cartoons." A book everyone who likes to draw should have. It is free; no obligation. Simply address Cartoonists' Exchange, Dept. 91-CM, Pleasant Hill, Ohio.

BE Independent, be secure, have your own profitable business—Earn \$20.00 and more a day making beautiful, fast-selling lamps at home. No equipment needed. Illustrated course teaches you quickly. Course, parts catalog, wholesale price list—only \$2. Gearon Co., Dept. 200-B-1, 27 S. Desplaines, Chicago 6, Ill.

\$10,800 PROFITS! Your own mailorder business! No capital risk! "Success plan" (worth \$2) free! Write today! Treasury, 149 Storer, New Rochelle PM-7, New York.

START A buying service, buy wholesale thousands nationally advertised products. Make big profits selling at sizable discounts. Postcard brings details. American Buyers, 630-PM Linden, Buffalo, N. Y.

DECAL Signs—25c retail, 400% profit. Send 25c for assorted samples. Box 58M, Morris Heights Station, New York City 53.

MAKE To \$4.50 hour doing common pen lettering. National Artists, 801 North Mar-salis, A-5, Dallas 3, Texas.

MAILORDER Business. Profitable, successful free advertising method. Experience unnecessary. Write H. F. Seidel, 7070 Hollywood Blvd., Hollywood 28, Calif.

HUGE Profits, home business. Assemble rhinestone jewelry. Catalog 20c. Start today. Order gorgeous sample kit \$1.98. Completed sells \$6.50. House of Hobbies, Dept. C-8, Evanston, Ill.

MAN Or woman with spare time to try our food and household products, without cost, at home and supply neighbors. Make good money. Big box of full-size products free. Blair, Dept. 31LA2, Lynchburg, Va.

DON'T Envy the mail order millionaire—Be one. Write now. Payne's, 162-P McKitt-ric, Kentville, N.S., Canada.

BOOKKEEPERS! Big earnings. Operate bookkeeping-income tax service. Latest amazingly simplified plans, \$2.00. Tack-ett's, North High, Salem 2, Indiana.

137 PLANS To make money, local mail-order. Details: Elite Co., 220 Grand St., New York 13.

BUY Thousands articles wholesale. Best, lowest-priced book tells how and where. \$1.00 postpaid. Guaranteed. United, Box 87-M, Detroit 2.

FREE! Your own mailorder business! No investment! Terrific profits! Everything furnished free. Write today. California Vitamins, 2910PM Beverly Boulevard, Los Angeles 4, California.

BE Your own boss! Free booklet "301 Unique, Successful Businesses" tells how. Start spare time, small capital, work home. Deumant Publications, 83-PM Deumant, Kenmore 23, N. Y.

FORMULAS, PLANS, ETC.

MILLERS Modern manufacturing formulas make fast-selling products that get the business and pay. Fifty years supplying the best. Literature free! Miller, Manufacturer's Chemist, Tampa, Florida.

REAL Manufacturing formulas. Lists free. Cummings, Chemist, Gordon Ave., Syracuse 4, N. Y.

FORMULAS; All kinds. Latest, best. Literature free. Kemixal, Park Ridge, Ill.

TESTED Formulas. Interesting descriptive booklet free. Pont, Box 635-PM, Terre Haute, Indiana.

ANY Formula. Jack, Consulting Chemist, 5138 Gainer Road, Philadelphia 31, Penna.

GENUINE Manufacturing formulas. Lat-est. Literature free. Nelko, 3462-P Mer-chandise Mart, Chicago 54.

SECOND Printing, improved version, spectacular chemical fireworks experiments manual. Complete setups, formulas, instructions, still \$1.00 postpaid. Chemi-Technix Laboratories, 568K Riley, Buffalo 8, N. Y.

LUMINOUS Paint. Formula, selling plans \$1.00. Krysto Products, Felton, Calif.

AMAZING Books! 10,000 formulas, trade secrets, \$3.98. Chemical formulary, authori-tative, 9 volumes, \$7.50 any volume. Chemical Engineers Handbook; world's standard reference! \$17.00. Guaranteed. Free literature. Paulin, 109P, Loudonville, Ohio.

PLASTICS

LEARN Plastics at home. Small cost—Spare time. Dime brings sample plastic, three experiments, full details. Plastic Projects, Box 5151, Detroit 35, Mich.

INTERNAL Carvers increase profits, make television or night lights. Now avail-able, plastic lamp base completely wired, with slot in top to illuminate your carved plaque. Available in opaque black, trans-lucent ivory or pink. Send for sample and prices, \$1.25 postpaid. Arata, Roberts and Browne, Inc., Towaco, N. J.

WILDLIFE Internally carved plastics. Wholesale literature 10c. Cosmopolitan Plasticrafters, Box 176, New York 8.

PLASTIC, Sheets, rods, tubes, etc. Free list. Plastic Supply Co., 2901 N. Grand Blvd., St. Louis 7, Mo.

LUCITE, Plexiglas. Any size sheets, masked. Square foot (12 x 12) cost, 1/16", \$1.20; 1/8", \$1.40; 3/16", \$1.75; 1/4", \$2.08. Include 10% postage. Almac Plastics, 230 Fifth Ave., New York 1, N. Y.

NEW Liquid casting plastic. Clear, col-ors. Embed flowers, insects, coins. Saw, drill, carve. Free folder shows fine things you can make at home; sell at big profit. Write today. Castolite, Dept. A-101, Woodstock, Illinois.

PLASTICS, Lucite, plexiglas, acetates, complete supplies. Retail-wholesale prices. Catalog 10c. Airmailed 35c. Gem-O'-Lite, Box 6861T, North Hollywood, California.

CHEMISTRY

AMAZING New book of science. Experi-ments, formulas and catalogue of labora-tory supplies. Only 25c. National Scien-tific Co., Dept. 16, 2204 W. North Ave., Chicago 47, Illinois.

LABORATORY Apparatus, chemicals, microscopes, complete chemistry sets, min-erals, uranium ore. 10c brings catalog. Porter Chemical Company, Hagerstown 1, Maryland.

NEW Idea chemical and apparatus out-fits for home experimenting. Photo-scales, microscopes, chemicals, biological and laboratory supplies in small quantities. Cata-log 25c. Established 1931. John H. Winn, 124A West 23rd Street, New York, N. Y.

CHEMICALS And apparatus for indus-trial, analytical, and private laboratories. Catalog 20c. Dept. M-50, Biological Sup-ply Co., 1176 Mt. Hope Ave., Rochester 20, N. Y.

ILLUSTRATED Catalog: Chemistry, mineralogy, biology. 10c. Tracey Labo-ratories, Evanston, Illinois.

SPECTROSCOPE For quick chemical analysis \$3.00. Kutting Sons, Los Altos, Calif.

SECOND Printing, improved version, spectacular chemical fireworks experiments manual. Complete setups, formulas, in-structions, still \$1.00 postpaid. Chemi-Technix Laboratories, 568K Riley, Buffalo 8, New York.

CHEMICAL Supply catalog, 20c, refund-able. Laboratory Sales, Box 161-E, Brighton, Mass.

AGENTS WANTED

1 CENT Each in quantity. Beautiful miniature toys. Terrific profits. Sell stores, mail order, homes. Send \$1.00 for 50 assorted samples. Money back guaran-tee. Morael Manufacturing Co., Box 115-M, Rockaway Park 94, New York.

SELL Harmar's French fried popcorn to stores and taverns. Fast repeater. Harmar Products Co., Hammondsport, N. Y.

ABSOLUTELY Free—Sales kit. Sell personal initialed buckles with belts, cap badges, tie clasps, etc. Choose from 3000 emblems. Hook-Fast, Box 1425PM, Provi-dence, R. I.

SPARE-Time earnings as representative. No selling. Knight, 19217 Schoolcraft, De-troit, Mich.

RES'ORE TV picture tubes. Big "de-mand" profits. TV, 484 Massachusetts Ave., Buffalo, New York.

\$200 WEEKLY. New invention. Amazing 4-second Presto emergency tire chains, fit all modern auto wheels. National adver-tising building big demand. 3 sales daily to oil stations, dealers, etc., make \$200 or more weekly. Territory going fast. Write Presto Chain Co., Dept. P-16, Des Moines 2, Iowa.

YOUR Own business—Used suits \$1.50, overcoats 65c, mackinaws 35c, shoes 12 1/2c, ladies coats 30c, dresses 15c. Enormous profits. Catalog free. Moro, 558-AA Roose-velt, Chicago 7.

SCHOOL Seniors—Earn sensational prof-its selling classmates America's most beau-tiful graduation name cards. Largest sel-lection. Outsells all others. Free sample kit. Printercraft, Dept. M, 1509 Maple St., Scranton 5, Penna.

AGENTS — 300% Profit selling genuine gold window letters; stores and offices. Free samples. Metallic Sign Letter Co., 431-D North Clark, Chicago.

GOLD Lacquered and silver sign letters. Windows, doors, trucks. Standard sizes. Penny and up samples. Atlas-P, 544 West 79th, Chicago 20.

MEXICAN Feather pictures. High prof-it! Fast sellers! Adelphi, Box 57-B, Belle-rose 6, N. Y.

\$50 WEEKLY Selling finest razor blades, other items. Free details. Edisons, Box 274, Far Rockaway, N. Y.

EXCELLENT Sideline for printing and advertising salesmen. Decalcomania name plates in small quantities. Great demand. Also, make money with our line of auto-mobile initials and sign letters. Free samples. "Ralco" XL-Roxbury, Boston 19, Mass.

AGENTS: Stamping names on key pro-ectors. Sample 25c. Stamping outfits, checks, social security and name plates. Hart Mfg. Co., 303 Degraw St., Brooklyn, N. Y.

SALESMEN, Distributors, fast selling costume jewelry direct from factory. Big picture catalog, free. Pickcraft, M19 Bank, Attleboro, Massachusetts.

MEXICAN Feather pictures. Sell on sight; 200% profit! Free details. Sample 20c stamps. (No coins.) Sylviap, Apartado 9036, Mexico City.

PRINTING, Salesbooks, envelopes. Free illustrated catalog. Erscow, Dept. PM, Bronx 72, New York.

PHOTO-Salesmen, agents. Sell beautiful hand colored plastic enlargements and sensational new photo compacts, rings, bracelets, lockets, etc. Collect deposit, we deliver. Profitable sideline. Send card for free sample kit. Novel Portrait Co., 3343 North Ave., Chicago, Ill.

MAKE \$50 Or more fast with sensational greeting card line. Big value all-occasion box assortments, birthday, Easter, secret pal, religious cards. Wrappings, stationery. Unusual gifts and gadgets. Amazing prof-its. Bonus. Experience unnecessary. Write now without risk for samples on approval and selling plans. Hedenkamp, 361 Broad-way, Dept. PM-26, New York.

BE A money make. Use your home as magazine headquarters. Liberal commis-sions. No experience. No capital needed. Everything furnished. Write for free cata-log. McGregor Magazine Agency, Dept. 500A, Mount Morris, Ill.

BUY Wholesale. 25,000 items. Cata-logue 25c. Matthews, 1472-B-3 Broadway, New York City 36.

STRANGE "Dry" window cleaner. Sells like wild. Replaces messy rags, liquids. Simply glide over glass. Samples sent on trial. Kristee 156, Akron, Ohio.

NEED Extra money? Show your friends wonderful Regal line of all-occasion greet-ing cards. Over 100 beautiful assortments to choose from. Also exclusive stationery unobtainable elsewhere. No experience necessary. Your profit up to 100% plus bonus. Write for free samples. Sales kit on approval. Regal Greeting Card Co., Dept. 33, Ferndale, Michigan.

BOYS Or girls, men or women: Earn large cash commissions, or valuable merchandise selling Garden Spot seeds. Send no money, just name and address, receive 50 packets of seed to sell at 10c packet, and free 24 page catalog. Lancaster County Seed Company, Dept. 412, Paradise, Penna.

MAKE Extra cash every day. Free illustrated catalog shows how. Stephen Products, 1947 Broadway, Dept. M, New York 23.

EXTRA Money! Make up to 100% profit selling amazing value all occasion greeting cards, gift wrappings, gifts. Bonus. Surprise offers. Experience unnecessary. Write for feature samples on approval, free samples exclusive name imprinted stationery, napkins, free catalog and selling guide. New England Art Publishers, North Abington 801-B, Mass.

EASY Money! Sell new kind nylons. Guaranteed 3 months. Perfect fit, like made-to-order, for every leg-shape. Demonstration kit with actual stockings free. American Mills, Dept. 409, Indianapolis.

MAKE Money introducing world's cutest children's dresses. Big selection adorable styles. Low prices. Complete display free. Rush name. Harford, Dept. J-2341, Cincinnati 25, Ohio.

BIG Profits on brand names! Appliances, giftwares, etc., like Wearever, Bulova, Eversharp, Hickok, Silex, Detecto, sell themselves. New! Illustrated catalog free! Over 280 items. Winderman (Dept. A-13), 527 Hendrix Street, Brooklyn 7, New York.

JUST Out! New thrilling sensation in everyday cards. Rich foils, satins, velours sell on sight, 21 for \$1. Make up to 100% profit. 50 assortments, imprint stationery and book matches, gift items. Three \$1 assortments on approval, imprints free! Joy Greetings, 507 N. Cardinal, Dept. 60-E, St. Louis, Mo.

ABSOLUTELY Free, yours for the asking. Send postcard today requesting free sales kit showing complete new line, belt buckles with your name or personal initials, cap badges, 3000 different emblems also uniforms, caps, shirts, ties, wallets, etc. Write Hook-Fast Company, Box 480PM, Roanoke, Virginia.

AGENTS, Big profits on name brand appliances. Wearever, Detecto, Dormeyer, Bulova, etc. Send for free illustrated catalog. Continental Company, P. O. Box 145, Dyker Station, Brooklyn, N. Y.

BUY Wholesale thousands nationally advertised products at big discount. Free "wholesale plan". American Buyers, 629-PM Linden, Buffalo, N. Y.

AT Last! Something new and sensational in everyday cards, 21 for \$1. Make extra money fast! Show satin, velour, metallic cards. Get orders easy. Big line \$1 assortments, scented stationery, personal matches, kiddie books. Imprints free. Three \$1 boxes on approval. Puro Co., 2801 Locust, Dept. 340-A, St. Louis 3, Mo.

VITAMINS! Sell via mail order. 50% commission. Sales circulars free. Send for free details. Vimvite, 2910PM Beverly Boulevard, Los Angeles 4, Calif.

"FOG-Stop" windshield cloth. Instantly removes blurry mist, frost, sleet, snow. Stops windshield fogging. Samples sent on trial. Kristee 155, Akron, Ohio.

\$75.00 FOR YOU! Sell only 100 lovely everyday greeting card assortments. Also new 21 card \$1 assortment, gold name stationery, 100 fast-sellers. Extra gift bonuses. Experience unnecessary. Assortments on approval. Stationery samples free! Creative, 2505 Cermak, Dept. 183-D, Chicago 8.

HOTTEST Seller ever! Get in on the ground floor! Huge profits await you as our agent selling full or part time new nationally advertised top quality Pennsylvania saw sets. Tempered steel saws for every use, all on one handle. Hack saw, crosscut, frozen meat and bone saw, pruning saw, keyhole saw, dovetail saw. Tremendous value everyone can use, everyone wants! Sell on sight! Send for free illustrated catalogue. James R. Barnett Co., Dept. M, Box 188, Wellesley Hills, Mass.

BIG Profits selling ties (\$2.00 values), \$6.50 dozen. Free catalog. Empire Cravats, 648 Broadway, New York 12.

BONUS Suit plus big profits! Sell made-to-measure men's clothes. Fit, satisfaction guaranteed. Big values sell fast. Profits to \$11.50 per suit. Sample outfit free! O. K. Tailoring, 325 S. Market, Dept. 166, Chicago, Ill.

MORE Money in closeouts. List free. Metro, 60 South Street, Boston 11, Mass.

LADIES! Need clothes and money? Easy to take dress orders. Big commissions in advance. Beautiful style presentation absolutely free! Send no money. Melville Co., Dept. 7897, Cincinnati 25, Ohio.

SCHOOL Seniors! Postal brings you our Kwick-Sell cardalog of popular graduation name cards. Biggest profits! Only firm giving free golden memory book and souvenir chest. Don't miss out. Write immediately for free kit. Craftcards, Box 235L, Pittsburgh 30, Penna.

NEW Plastic ties. Ready tied 4-in-hand. Unique, attractive, long lasting. Fast sellers anywhere. Send \$1.00 for sample or \$7.20 dozen. Leader Plastic Products, Capac 1, Michigan.

EXTRA Money every week. I'll send you full-size Blair household products. Show them to friends and neighbors. You can make big extra profits. Write Blair, Dept. 31LA1, Lynchburg, Va.

PITCHMEN! Salesmen! Sensational magic trick! A sale every time. Beats army shell game. Sample, price list, \$1.00. P.O. Box 8132-P, Ocean View Station, Norfolk, Virginia.

PLEASANT, Spare time work. No canvassing. Details free. RTK Sales, 1402 East 49th St., Cleveland 1, Ohio.

COUNTY Agency. Power mowers—\$19.95 up. '53 models. Prepaid. Rotacut-RM, Excelsior Springs, Mo.

SELL Sunshine exclusive everyday cards and make big money the easy friendly Sunshine way. Complete selection greeting cards, imprinted stationery, gift wraps, novelties, handy home wrapping kit, etc. 21 deluxe miniature everyday cards—75c. Many others. Send postcard today for your Sunshine sample kit on approval. Sunshine Art Studios, Dept. PM-1, Springfield 1, Mass.

3 CHANCES To make money—Three repeat-profit items needed by every housewife. Write for money-making details. R. G. Dispenza Manufacturing Company, 2020 Harbor Ave., Ashtabula 1, Ohio.

BE Your own boss! Free booklet "301 Unique, Successful Businesses" tells how. Start spare time, small capital, work home. Deumant Publications, 81-PM Deumant, Kenmore 23, N. Y.

MAKE Big earnings—100% profit selling beautifully packaged fine quality perfumes direct—through stores. Write: Perfume Industries, Bantam 4, Conn.

TERRIFIC Bargains—Profits! Suits \$1.75, pants 35c, dresses 20c, shoes 20c. Operate from store, home, car. Free catalog. Superior, 1250-A Jefferson, Chicago 7.

EXTRA Money showing home decal decorations. Exciting beauty, color, new personality for every room. Free samples plus two complete assortments on approval. Write Decal-Art, 344 Lorel Ave., Dept. A-106, Chicago 44.

DO You need \$100? It's yours quickly with Fannour's nationally advertised line of greeting cards, imprinted stationery, gifts, children's items, guaranteed nylons. Folks with no experience easily earn \$100 in spare time with the tested "Fannour 100% Profit Plan." Write today for free samples. Selling outfit on approval. Fannour, Dept. PM-1, 200 Fifth Ave., New York City.

SALESMEN—DISTRIBUTORS

NEW Jobs open in selling! Send name, address for five free issues of Opportunity Magazine's money-making guide, listing hundreds of companies who'll pay you well, full or part-time. No experience needed. Opportunity, 28 E. Jackson, Dept. 17, Chicago 4, Ill.

SEE Miracle orlon embroidered work uniforms! Looks, feels, tailors like wool; wears 3 times longer. Outwears cotton 5 to 1. Acid-proof, grease-resistant. Washes perfectly pressed. Amazing profits! Outfit free. Topps, Dept. 531, Rochester, Ind.

MONEY Making opportunity! Take big profit orders for world famous patented varieties fruit trees. Also flowering shrubs, roses, vines. Big sales outfit free. Stark Bro's., Desk 30113, Louisiana, Missouri.

RICH Opportunity for men in their 50's. Healthful, pleasant occupation. No investment needed. 150 of our men made \$500 to \$3,000 in one month; many just beginners. Heckman made \$104 first 2 hours; Crowley made \$224 first day; exceptional earnings. Openings available. Write President, Dept. P.M., Box 711, Fort Worth 1, Texas. If you live in Canada, write President, Dept. P.M., 25 Industrial Street, Leaside, Ontario.

ADVERTISING Specialty salesmen. Experienced men can add \$50.00 to \$200.00 per week to their income. If you are now selling to businessmen or clubs, organizations or schools, resorts, roller rinks, or any similar prospects, our Auto Ad Plates, Scotchlite signs, glass ash trays and a full line of advertising specialties is a money-maker for you. A new plan for starting. It costs money to reply to shoppers and curiosity seekers so please answer only if you mean business. License Equipment Company, 3530-P E. 88th St., Cleveland 5, Ohio.

ADVERTISING Book matches—Cash in on big demand; sell union label matches. Cuts for all businesses and political parties. Free powerhouse selling kit, low prices, protection guaranteed on repeat orders. Cash commissions. Superior Match Co., Dept. M-153, 7530 Greenwood, Chicago.

CALENDARS, Advertising novelties, matches. All styles, including religious, varnished, 12 sheet, girls. Hundreds of advertising novelties, book matches, etc. Fleming Calendar Co., Sales Division, 6539 Cottage Grove, Chicago 37, Ill.

\$12,000 EARNINGS Or more each year. Sell for a company successfully manufacturing a molybdenum disulfide grease and other top quality "specialized lubricants." Call on owners and users of heavy duty equipment in industry and in the field. An advance on earnings with no collection or delivery worries. Write experience and qualifications to E. J. Baker, P.O. Box 676, Dayton, Ohio.

ANYONE Can sell Hoover, DuPont nylon uniforms for beauty shops, waitresses, doctors, nurses, others. In white and colors. Exclusive styles. Top quality. Low priced. Exceptional income. Real future. Equipment free. Write fully. Hoover, Dept. H-100, New York 11, N. Y.

MAKE Money with fast-selling Bostonian shirts. Blouses too. Spare time, full time. Sales kit free. Bostonian, 89 Bickford, Dept. U-10, Boston 30, Mass.

REDUCING—Relaxing home massage unit. Distributors wanted everywhere. Big seller. Gyro-Belt, 6920 Market Street, Upper Darby 7, Pennsylvania.

AD Matches! Sell amazing designs—20, 30, 40 and 240-light book matches. Bigger spot cash commissions; every business a prospect. Low prices for high quality. Repeats. Start without experience; men, women; full, part time. Buy nothing! Sales kit furnished. Match Corp., Dept. PM-37, Chicago 22, Illinois.

ESSENTIALLUBE—The scientific modern motor lubricant; that lubricates as it cleans; as it powerizes. Needs mechanically inclined men above thirty to tell its astounding story to farmers and machine owners from coast-to-coast. Must have car and ambition. Full field training by Division Manager. Liberal drawing account, quarterly and yearly bonuses, high commissions. Rapid advancement for good men. Write at once, giving full qualifications to Petroleum Division, Box 392, Dallas, Tex.

DISHWASHER, Bessen automatic. Portable. Nationally advertised. Low \$69.50 retail price. For literature or dealer-distributor propositions, write B & D Company, Box 51, Oconomowoc, Wisconsin.

NEW Ideas and items, 25c brings samples to retail for \$1.00. Specialties, Box 475-E, Park Ridge, Ill.

YOU Can make big money! We train you in America's No. 1 industry, regardless of your education, experience, or occupation. Over 100,000 qualified automobile salesmen are needed now! If you are looking for a profession which offers you security, a respected position in your community, and a high standard of living, learn to be a highly successful automobile salesman with our exciting correspondence course. We can help you to succeed! For free information send name and address to Worldwide Automotive Sales, Dept. C-A, Box 4485, Jackson, Mississippi.

AMAZING Discovery, Master Glaze, puts brilliant glass-like surface on cars. Free sample, information. Big commissions. Master Glaze, Dept. 753, 7720 Harwood, Milwaukee, Wis.

PATENT Just issued. Sell to stores. Sign-Riter, Inc., 261 Great Arrow, Buffalo 7, New York.

MAN To earn \$500 month up. National company. Exclusive territory. Full or part time. Prospects everywhere. \$11 sale earns you \$7.00. Write Superior Products, Inc., Dept. 116, 3410 Main St., Kansas City, Mo.

RUN Your own repeat-order shoe business! 3 sales a day brings up to \$63 or more a week extra with fast-selling Consolidated shoes! No experience or investment needed. Fit customers stores are unable to take care of. Special kinds of shoes for different occupations. Send postcard now for free selling outfit! Consolidated Shoe System, Dept. CC-17, Chippewa Falls, Wis.

POSITIVELY Make \$50.00 a day and up selling brand new item going to every type of food and beverage store, factories, laboratories, hospitals, etc. Samples furnished. Utility Durawear, 53 West Jackson Blvd., Dept. PM-1, Chicago, Illinois.

BIG Money. Sell revolutionary new pendulum putter to golfers, golf clubs, stores. Player stands astride ball, faces hole, strokes between legs. Users report lower scores. Legal. Tremendous market. West Michigan territory reserved. Midwest, 1991 Lakeshore, Muskegon, Mich.

HELP WANTED

WANT To make more money? Have a real career with a lifetime of high salaries? I'll show you how to succeed in the growing automotive-diesel field. Write Ed Howes, Chief, Dept. 213, 4000 S. Figueroa St., Los Angeles 37. No obligation.

SELL Dresses from New York. Fifth Avenue New York firm desires women to sell dresses, suits, lingerie. Seen "Vogue," "Mademoiselle." Good commissions. Modern Manner, 260PA Fifth Avenue, New York.

NEW Plastic mending tape. Just press on! Repairs clothing instantly. Lightning seller. Samples sent on trial. Kristee 177, Akron, Ohio.

EDUCATIONAL AND INSTRUCTION

PIANO Tuning pays. Learn this profitable profession at home. Our Tonometer and mechanical aids make learning easy. No knowledge music necessary. Diploma granted. Largest and oldest school—55th year. G.I. approved. Write for booklet, Niles Bryant School, 78 Bryant Bldg., Washington 16, D. C.

NEW Analytic, guaranteed method teaches algebra instantly. Send \$1. Ziembeck, 6123 Orchard, Dearborn, Mich.

ESTIMATING Building construction. Home study course. For full particulars write, Quantity-surveyor, 1016 Coolidge Drive, San Gabriel, California.

HOME Study course, drugless therapy. Free literature. Institute of Drugless Therapy, Tama, Iowa.

MEDICAL Laboratory technicians in great demand. We train you in your own home. Catalogue free. Imperial Technical Institute, Box 973-J, Austin, Texas.

SECRET Investigation. Experience unnecessary. Investigators particulars free. George Wagner, M125 West 86th, New York 24.

INVESTIGATOR Training. Phillips Secret Service System, 1917-B North Kenneth, Chicago 39.

MIDLAND Linotype School, Charles City, Iowa. Civilian and Veteran Courses. Free placement. Established 1909.

BE A real estate broker. Study at home or in classrooms in leading cities. Write for free book today. Weaver School of Real Estate, 304 Law Bldg., Kansas City, Mo.

USED Correspondence courses and educational books bought, sold, rented, catalogue free. Educational Exchange, Summerville, Ga.

COMPLETE Your high school at home in spare time with 55-year-old school. Texts furnished. No classes. Diploma. Information booklet free. American School, Dept. X145, Drexel at 58th, Chicago 37, Ill.

WANT To make more money? Have a real career with a lifetime of high salaries? I'll show you how to succeed in the growing radio-television field that needs men. Write Ed Howes, Chief, Dept. 413, 4000 S. Figueroa St., Los Angeles 37. No obligation.

PRACTICAL Nursing—Learn easily at home, spare time. Big demand, good earnings. High school not necessary. Write for free facts. Wayne School, Dept. FG-13, 2525 Sheffield, Chicago 14, Ill.

\$4 TO \$10 Hour spare-time in billion- dollar adjustment field. Qualify now! Write today. Universal Schools, M-64, Box 8202, Dallas 5, Texas.

ELECTRONIC Draftsmen—Many need- ed immediately by defense agencies and contractors. Excellent pay. Pioneer radio engineer offers an original and exceptionally high class correspondence course to qualified ambitious young men and women. Details free. Charles Leutz, P.O. Box 368, Silver Spring, Maryland.

BOOKKEEPERS! Increase your earn- ings! Operate your own simplified "Dollar-A-Week" bookkeeping and tax service. Full or spare time. Details free. No obligation. Ellis, Box 200, Cedar Grove, North Carolina.

WANT A diesel job? New opportunities to increase income. Higher pay. More money. We can help you qualify. Tools. Shop method home training. Write today! Diesel, Tractor, Heavy Equipment Division, Interstate Training Service, Dept. 3A, Portland 13, Oregon.

MAKE Up to \$45-\$55 week as a trained practical nurse! Learn quickly at home. Booklet free. Chicago School of Nursing, Dept. M-1, Chicago.

USED Correspondence courses and books sold and rented. Money back guarantee. Catalog free. (Courses bought.) Lee Mountain, Pisgah, Alabama.

FOR An extremely profitable lifetime business, operate a collection agency. Quickly learned. Write Cole Associates, Syracuse 2, N. Y.

WELDING Training pays at Hobart Welding School, Box M-132, Troy, Ohio. VA contract. Best equipment. Catalog free.

BECOME A doctor of psychology or meta- physics. Learn secret of contentment, happiness. Win degree of PsD. or MsD. Solve mental worries. Free book. College of Universal Truth, 5038-C N. Clark, Chicago.

HIGH School—No classes. Study at home. Spare time. Diploma awarded. Write for free catalog HF-28, Wayne School, 2527 N. Sheffield, Chicago 14, Ill.

HOBBYIST, Homeowner, sportsman. How-to-do-it books. Borrow or buy. Catalog free. Renta Book, 445-D West 34th Street, New York 1.

OIL Coloring photographs a fascinating hobby or profitable sideline for those with artistic talent. Learn at home. Easy simplified method. Free booklet. National Photo Coloring School, 835 Diversey Parkway, Dept. 3441, Chicago 14.

OPPORTUNITY Without end! Industry is constantly absorbing more trained electronic and instrument technicians than we can graduate. Start studying for a future in electronics now. For information, write the Ward School of Electronics, 44 Niles Street, Hartford 5, Connecticut.

WANTED—American (Schenectady) collection course. Young, 533-S Harrison, Kankakee, Ill.

WANT A 1953 gov't job? Start high as \$73.00 week. Men-women. 720,000 jobs! Qualify now! Experience usually unnecessary. Free 32-page civil service book showing jobs, salaries, requirements, sample tests. Write: Franklin Institute, Dept. T-24, Rochester, N. Y.

TELEGRAPHERS in big demand. Full information. Chicago Telegraph Institute, 7626 Normal, Chicago 20, Ill.

GO Higher, learn drafting. Write Monroe Institute, PM-1, Alton, Illinois.

MASTER Those worries, fears, and problems with our amazing home-study "Human Behavior Control" plan. Many helped. Write for unusual free lecture without obligation. Personal Psychology, Inc., Box 1924-E, Louisville 1, Ky.

PHOTOGRAPHY For pleasure or profit. Learn at home. Practical basic training. Long established school. Free booklet. American School of Photography, 835 Diversey Parkway, Dept. 3451, Chicago 14.

START Your own bookkeeping business by mail; large earnings; full instructions and books \$1. Mixon, Postoffice Box 2048, Los Angeles 53, California.

IT'S Fun learning a language by Lin- guaphone. At home, in leisure time, quickly, easily master Spanish, French, German, Russian, Japanese—29 languages by Linguaphone world's-standard conversational method. You listen, you hear men and women speak, you understand, you speak. Save time, work, money. Gain job, school, travel, cultural opportunities. Write today for free book. Linguaphone Institute, 8301 Mezz., Rockefeller Plaza, New York.

PROFITABLE—Mailing service easily started. Complete information, copyrighted booklet \$2. Gaunt Ind., 827 Irving Park, Chicago 13, Ill.

ANALYZE Your I.Q.! Comprehensive self-grading test, instructions \$1. Union Institute, Lakewood 1, New Jersey.

INCREDIBLE! Unprecedented! Look under "Miscellaneous"! Bijou, Box 1727-M, Hollywood 28, California.

SCHOLARSHIPS Worth millions award- ed yearly. For information on scholarships and fellowships in colleges and universities in United States and abroad send \$2.00. Key Publications, Box 6751, Fort Davis Station, Washington 20, D. C.

PLAYS, STORIES, MANUSCRIPTS

I Want new writers to cash checks of \$1 to \$100 offered daily. The easiest way to write for pay. No previous experience necessary. Free details. Saunders M. Cummings, 6840 Odin St., Studio 11, Hollywood 28, Calif.

NO Luck finding a book publisher? Write for free Booklet PM. Vantage Press, 120 W. 31, New York.

BEGINNING Writers: Get \$1 to \$20 checks daily writing simple children's stories, articles, poetry in your sparetime. Experience unnecessary. Our instructions reveal how. Details free. W. Herman, 7016 Euclid, Cleveland 3, Ohio.

SPECIAL SERVICES

LETTERS Retailed 25c. Hobkirk, Box 1637, Wichita, Kansas.

MIMEOGRAPHING—Manuscript typing—Samples. L. Sartin, Box 185, Galax, Va.

LOS Angeles letters retailed 25c each; 6, \$1.00, month \$2.00. Los Angeles classified columns airmailed 75c. Sunland Studios, 1624½ Magnolia, Los Angeles.

NECKTIE Exchange. Your new tie you don't like and dollar for another new tie. St. Louis Tie Exchange, Box 510-M, St. Louis 3, Mo.

FLORIDA Remails 20c. Bowers, Rte. 2, Box 210, Ft. Pierce, Florida.

EXTRA Income! Sell Mexican curios! No stock investment! Drop shipment deal! Details 10c. Filmer, 910-R Marion, Pharr, Texas.

HAVE Exclusive postcard beautifully foreign stamped sent airmail from abroad to your friends. Cairo, Paris, Rome amongst interesting list. Send text for four with \$1.00. Correspondents Association, care of Boite Postale 112-08, Paris, France.

ENVELOPES Addressed—\$6.00 per thou- sand using your list. E. Barnes, Franklin Street, Newton Falls, Ohio.

CHICAGO, Letters retailed 25c. Sutter, 2725 77th Ave., Elmwood Park, Ill.

INFORMATION On any matter. Ferguson Research Specialists, 116-14 141 St., South Ozone Park 36, N. Y.

CHICAGO Postmark 25c, also confiden- tial service. Ingills, 1946 Foster Ave., Chicago, Ill.

BOSTON Letters retailed 25 cents. Also private receiving address. Replies forwarded. Monthly rates. Employment columns and business opportunities airmailed \$1.00. International Mailings, Box 144, Boston, Mass.

CARTOONING, COMMERCIAL ART, SHOWCARD WRITING, SIGN PAINTING

LEARN Sign painting at home. Test lesson free. Ben Kerns, Box 812-P.M., Greenville, S. C.

CHALK Talks. Laugh producing program, \$1.00. Catalog 10c. Balda The Cartoonist, Oshkosh, Wisconsin.

9 ALPHABET, 3 Numeral pattern sets and raised wood letter catalog, \$1.00. Sign Letter Distributors, P.O. Box 101, Mineola, N. Y.

"HOW To Make Money With Simple Car- toons." A book everyone who likes to draw should have. It is free; no obligation. Simply address Cartoonists' Exchange, Dept. 91-C, Pleasant Hill, Ohio.

WINDOW Display, low cost instructional kit. Larry Vandeman, Box 104, Hinsdale, Illinois.

FREE Sample copy, "Cartoonists' Mar- ket Letter," Box 187PM, LaHabra, Calif.

PAINT Signs for profit. Biggest complete course, with 324 illustrations, \$5 postpaid. Illustrated circular free. Matthews, 2325 Cass, St. Louis 6, Mo.

LEARN How to write showcards quickly, easily. No special skill needed. Profitable lifetime business of your own. Details free. Sherwood Publishing Co., Irvington 13, N. J.

ADVERTISING AGENCIES, LETTER WRITERS, FOR ADVERTISERS

WANT Ads placed. Southern dailies list free. National Advertising Agency, 516 N. 21 St., Birmingham 3, Ala.

ADVERTISE: 24 Words, 100 Canadian newspapers \$5.50. Lists free. Advertising Bureau, 10511-C Springfield, Chicago 43.

ADS Placed in out of town newspapers and magazines. Low rates. Catalogue free. Ideas that pay. Baker Advertising Agency, Successors Ankrum Agency, 169 W. Madison, Chicago 2.

ADVERTISERS! Reach nearly 18,000,000 readers. 25 Sunday national key newspapers. 18 words, \$59.00. "Terrific pullers." 20 popular newspapers, \$11.50. Free booklet. Special—One inch display 2,-821,198 circulation. \$51.10. Newmark's Advertising Agency, (Established 1893), 217-7th Ave., New York 11.

MAILING Lists; \$5.00-1000 up. Write Dixie Service, King, N. C.

FREE Copy, layout service. Mailorder ad, 1,700,000 nationwide circulation, \$27.30 inch. 24-word classified, 20 big Sunday newspapers, \$30.00. Advertising ratebook free. Chicago Advertising Agency (established 1900), Chicago 4.

FREE—"Amazing new book"—"Profits From Classified Advertising." Tells how and what to advertise. Be sure to read this book before you invest one cent in advertising. Remember—it's free. Write for your copy now. F. W. Johnson, Classified Adv. Manager, Popular Mechanics Magazine, Room 602, 200 East Ontario Street, Chicago 11, Illinois.

FREE! 1953 Advertisers Rate and Data Directory. 52 pages! E. H. Brown Advertising Agency, 20 N. Wacker, Chicago 6.

LAST Chance! \$1.00 for trial 1000 names mail buyers (\$5.00 value). States Company, Dundee, Michigan.

OVER 10,000 Names of merchants in Western Canada, including general stores, hardware, radio shops, furniture, appliances, implements, etc. Humen Sewing Machine Co., 12405—87 St., Edmonton, Alberta, Canada.

RUBBER STAMPS AND OFFICE SUPPLIES

RUBBER Stamps made. Free style list. Criterion, Box 2326, Denver 25, Colo.

LINE 25c; 2-45c; 3-65c. Stamp Works, Auburn, Nebraska.

RUBBER Stamps. Fast service, low prices. Catalog free. Weymouth Rubber Stamp Co., North Weymouth 91, Mass.

3 LINES 65c; Pad 40c; signature \$2.35. Stamp-right, Wauwatosa, Wis.

RUBBER Stamps, any kind, style, size or quantity. Real money saving prices. Postal brings catalog. Postage refunded. Esco 13 Print, 2 Holt, Dayton-7, Ohio.

RUBBER Stamps. Send for catalog. Excello, Box 500, Shreveport, Louisiana.

RUBBER Stamps — Stationery, reasonable. Free list. Johnson Press, Box 6-A, New York City 26.

TYPEWRITERS, DUPLICATORS, OFFICE DEVICES

RECONDITIONED Typewriters, printing devices, office machines, equipment. DixieGraph, King, N. Car.

TYPEWRITERS, \$20.00 Up; mimeograph ink, \$1 pound; stencils, 12, \$1.35. Natmerch, 1975-AA, Little Rock, Ark.

PRINTING, MULTIGRAPHING, MIMEOGRAPHING GUMMED LABELS

1000 BUSINESS Cards \$2.50 prepaid. Samples free. Reliable Print Shop, 905 E. Jefferson, Louisville 6, Ky.

MIMEOGRAPHING — Letters, pricelists, formulas, instructions. Lowest prices. Lem's Letter Shop, 5710 Stanton, Detroit 8.

125 8½x11 LETTERHEADS And 125 6¼ envelopes \$2.00, postpaid. 250 of each \$3.50. Going Print Shop, Box 1544A, Muskogee, Oklahoma.

500 ¾x2¼ FOUR Line gummed stickers 50c. Red border \$1.00. Moritz Printery, Saginaw, Mich.

500 EACH Letterheads, envelopes—\$7.75. Wainright Printers, Toms River, N. J.

100 PRINTED Business envelopes or letterheads \$1.00. Salesbooks \$3.00. Broadbrook, Botsford, Conn.

PRINTING That pleases. Send copy for estimate. Samples, prices. Mercury Press, Box 69M, Marengo, Iowa.

DISTINCTIVE Printing, free samples, prices. McDonald, 545 North Oakland, Pasadena 4, California.

BUSINESS Printing. Samples, prices free. Howprint, 723-M Eunice, Webster Groves 19, Missouri.

PRINTED Personal postcards, 250, \$2.00; 500, \$3.00; samples. Don Yusko, R. #3, Streator 4, Illinois.

1000 TU-Tone stickers \$1.00. Specialty Products Co., Murrysville 3, Penna.

YOU Must have printed stationery in any business. Try ours. 100 8½x11 letterheads, 100 6¼ envelopes, \$2 postpaid. Edwin Dornbush, Box 343, Woodstock, Ill.

1000 TU-Tone gummed stickers \$1.00 three lines. Orwat, 1243 South 54th Street, Philadelphia 43.

100 LETTERHEADS, 100 Envelopes \$2.00. Paul Stearns, 74 Williams, Brooklyn 7, N. Y.

START Home-print shop on small investment. Hamilton, 2301 Hill, Alexandria, Louisiana.

125 8½x11 LETTERHEADS And 125 envelopes \$2.00 postpaid. 24 hours service. Samples free. Catalpa Press, 5519 N. Clark, Chicago 40, Ill.

FINE Printing, reasonable. Free samples, prices. Gay Printing, Homer, N. Y.

1000 BUSINESS Cards \$2.50. Case included. Gooch, 202PM, Hernando, Miss.

ENVELOPES Printed wholesale; Kraft, air, drug catalogue, clasp, glassine. Ideal Printing, Hudson, New York.

1000 8½x11 HAMMERMILL Letterheads \$4.00; cards \$1.60. Woodprint, Romeo, Michigan.

100 8½x11 LETTERHEADS \$1.00 Postpaid. Envelopes same. Race Printers, Hudson, New York.

OFFSET Plates. Send original copy. Lewis Graphic, N. Tonawanda, N. Y.

PRINTING OUTFITS AND SUPPLIES

DO Your own printing. Save money. Simple rules. We supply everything. Print for others; good profit. Raised printing like engraving too. Have home shop. Details free. Kelsey Presses, V-11, Meriden, Connecticut.

PRESSES, Supplies, paper. Catalog 10c. Custom, Box 211-P, Springfield, Missouri.

MAKE Your own self-molding rubber printing cuts. Plexirubber, Argyle 1, Wis.

PRINTING Presses, type, supplies. Lists 3c. Turnbaugh Service, Loysville, Penna.

PRESSES, Type, cabinets, supplies. List for stamp. Lincoln Press Company, 220-P Hartwell, Fall River, Mass.

PATENT ATTORNEYS

C. A. Snow & Co.—M427, Snow Building, Washington 1, D. C. Registered Patent Attorneys. Write for information.

PATENTS. "Proof of Invention" free. E. E. Vrooman, Registered Patent Attorney, 507 McKim Building, Washington 5, D. C.

"INVENTOR'S Guide" free. Frank P. Ledermann, Registered Patent Attorney, 154 Nassau Street, New York.

REGISTERED Patent attorney offers services. Sanders, 6430 Evans, Chicago 37, Ill.

INVENTORS — For "Invention Record" form, contact Carl Miller, Registered Patent Attorney, Woolworth Building, New York.

INVENTORS: When you are satisfied that you have invented something of value write me, without obligation, for information as to what steps you should take to secure a patent. Write Patrick D. Beavers, Registered Patent Atty., 935 Columbian Bldg., Washington 1, D. C.

INVENTORS—If you believe you have an invention, you should find out how to protect it. The firm of McMorro, Berman & Davidson with offices in Washington, D. C., is qualified to take the necessary steps for you. Send for copy of our patent booklet "How to Protect Your Invention." We will also send you an "Invention Record" form. No obligation. They are yours for the asking. McMorro, Berman & Davidson, Registered Patent Attorneys, 1348 Victor Building, Washington 1, D. C.

INVENTORS: Without obligation, write for information explaining the steps you should take to secure a patent. John N. Randolph, Registered Patent Attorney, 203 Columbian Bldg., Washington 1, D. C.

CANADA—Ramsay Company Registered, 273 Bank Street, Ottawa, Canada.

INVENTORS—If you consider your invention to be something of importance, take steps to protect it with a United States Patent which gives you the right to exclude others from making, using and selling your invention as claimed. "Patent Protection for Inventors" outlines steps to take to secure patent protection. Mailed promptly without obligation. Victor J. Evans & Co., Merlin M. Evans, Registered Patent Attorney, 831-A Merlin Building, Washington 6, D. C.

INVENTORS: Learn how to protect your invention. Unless the inventor is familiar with patent matters, he should engage a competent registered patent attorney or agent to represent him. We are registered to practice before the U. S. Patent Office and prepared to serve you in handling your patent matters. "Patent Guide for the Inventor" containing detailed information concerning patent protection and procedure with "Record of Invention" form will be forwarded to you upon request—without obligation. Clarence A. O'Brien & Harvey Jacobson, Registered Patent Attorneys, 31B-A District National Building, Washington, D. C.

FOR INVENTORS

CASH For your idea, 280 manufacturers need inventions, patented or unpatented. List free. Invention Bureau, 208M Clinton, Oak Park, Ill.

PATENT Searches \$5.00, including patent copies. Same careful, reliable searches conducted for patent attorneys. 48 hour airmail service. "Record of Invention" free. Competent experienced investigators. Capitol Patent Service, Box 664-P, Washington 4, D. C.

"INVENTOR'S Guide" free. Frank P. Ledermann, Registered Patent Attorney, 154 Nassau Street, New York.

INVENTORS: Without obligation, write for information explaining the steps you should take to secure a patent on your invention. John N. Randolph, Registered Patent Attorney, 202 Columbian Bldg., Washington 1, D. C.

SEARCHES—Put your patent searches in the hands of a registered patent attorney or agent, as he qualifies to give a worthwhile patentability report. Record of invention form upon request and information on patent protection. Patrick D. Beavers, Registered Patent Attorney, 936 Columbian Bldg., Washington 1, D. C.

INVENTORS — For "Invention Record" form, contact Carl Miller, Registered Patent Attorney, Woolworth Building, New York.

INVENTORS: If you have an invention for sale, patented or unpatented, write Institute of American Inventors, Dept. 40A, 631-E St. N.W., Washington 4, D. C.

INVENTORS: Learn how to protect your invention. Unless the inventor is familiar with patent matters, he should engage a competent registered patent attorney or agent to represent him. We are registered to practice before the U. S. Patent Office and prepared to serve you in handling your patent matters. "Patent Guide for the Inventor" containing detailed information concerning patent protection and procedure with "Record of Invention" form will be forwarded to you upon request—without obligation. Clarence A. O'Brien & Harvey Jacobson, Registered Patent Attorneys, 31A-A District National Building, Washington, D. C.

INVENTORS—If you have a valuable invention, you are advised to authorize a preliminary search through appropriate classes of United States patents. This firm is registered to practice before the Patent Office and is available to make such search and report to you concerning the probable patentability of your invention. Instructive booklet with "Evidence of Invention" form sent upon request. Victor J. Evans & Co., 832-A Merlin Building, Washington 6, D. C.

INVENTORS! For "Copyright, Design and Patent Guide" contact Mr. Metzler, 11 West 42nd, New York 18.

PATENT Searches \$5.00. Reports airmail within 48 hours. Free protection forms. Write Miss Ann Hastings, P.O. Box 176, Washington 4, D. C.

INVENTORS—If you believe you have an invention, you should find out how to protect it. The firm of McMorrow, Berman & Davidson with offices in Washington, D. C., is qualified to take the necessary steps for you. Send for copy of our patent booklet "How to Protect Your Invention." We will also send you an "Invention Record" form. No obligation. They are yours for the asking. McMorrow, Berman & Davidson, Registered Patent Attorneys, 1347 Victor Building, Washington 1, D. C.

INVENTORS—Send for free patent information book and inventor's record. Registered Patent Attorney. Associate Examiner, Patent Office 1922-29; Patent Attorney & Advisor, Navy Department 1930-47. Gustave Miller, 13A Warner Building, Washington 4, D. C.

PATENT Searches \$5.00. 48-hour airmail service. Protection forms free. Patent drawings prepared. Write Patent Engineering Service, 711 14th Street N. W., Washington 5, D. C.

PATENT Searches, \$5.00, including patent copies. Same reliable searches as conducted for patent attorneys. Promotion and marketing services also offered. Free protection forms, 48 hour service. Patent Service Institute, 945A Pennsylvania Avenue, Washington 4, D. C.

HOW To sell ideas. Literature free. Grayland, 5312PML Grace, Chicago 41.

PATENT Searches \$5.00, 48-hour service. Free record of invention. Write Raymond L. Smith, Patent Searcher, 622 Sheraton Building, Washington 5, D. C.

INVENTIONS, Sold, leased, complete services. M. Joyce Humphries, 1425 Landtitle, Philadelphia 10.

INVENTIONS WANTED

INVENTORS—If you have a patent application pending in the patent office or if your patent has already been granted, we can help you market your invention through our nationwide contacts. Write today for complete information, free. Patent Promotion Company, Box 1225, Washington, D. C.

INVENTIONS Wanted, Patented; unpatented. Tremendous manufacturers lists. Global Marketing Service, 1404 Mitchell, Oakland 1, California.

MARKETING Aid—Nation wide. Patented, patent pending. Booklet free. Market Contacts, 719-A2 Magnolia, Tupelo, Miss.

INVENTIONS Wanted, Patented or patent pending. 21 years experience promoting inventions. National Service Bureau, 3120 Meramec, St. Louis 18, Mo.

INVENTORS: Hundreds of manufacturers have requested our assistance in locating marketable new products. Complete information free. Institute of American Inventors, Dept. 40-D, 631-E St. N.W., Washington 4, D. C.

INVENTIONS Promoted, Patented or unpatented. Established 1911. Write Adam Fisher Company, 61 Enright, St. Louis, Mo.

CASH Buyers for ideas and inventions. Write National Inventors Institute, 4097 East 131st St., Cleveland 5, Ohio.

INVENTORS! We have buyers. What have you patent pending, patents? Free details. Inventors Creative Service, 354 South Spring St., Los Angeles 13, Calif.

PATENTS FOR SALE

INVENTORS: Test the commercial value of your patented or unpatented inventions, quickly and inexpensively. Write for free information. Institute of American Inventors, Dept. 40-B, 631-E St. N.W., Washington 4, D. C.

WINDOW Washer and wiper, patent #2,587,382. New, plastic, carries fluid in handle, handy for automobiles, showcases, home use, sale or royalty, will consider partner, half interest, to finance manufacture and sales. Stafford Pyne, 106 E. Alexandrine, Detroit 1, Mich.

MANUFACTURING

MODELS—Small lot manufacturing. Metals, plastics, etc. Milburn, Burlington, Kentucky.

MODELS, MODEL SUPPLIES

STEAM Locomotives, 1 1/2", 1", 3/4", 1/2" 1/4" scales. Castings, rail, steam fittings! Thorough drawings with instructions. Catalog 50c. Little Engines, Wilmington, California.

WORLD'S Finest illustrated catalog-handbooks. Railroads 92 pages 35c. Airplanes, boats, crafts, hobbies, tools 60 pages 25c. No stamps. Print name, E and H Model Hobbies, Room 70, 130 W. Cheltenham Avenue, Philadelphia 44.

MINIATURE Gasoline, steam and locomotive engines; finished or rough castings. Catalogue 25c (50c if airmail). Far East Patternmakers Guild, Shinjuku Post Office Box 36, Tokyo, Japan.

SHIP Models—Most complete line in New England. Kits, fittings, plans, books, tools, engines, motors. Illustrated catalog 25c. James Bliss & Co., Inc., Dept. SM, 342 Atlantic Ave., Boston 10, Mass.

SHIP And yacht model fittings; blueprints. Send 25c for illustrated catalog No. 27—listing hundreds of items. A. J. Fisher, 1002-1 Etowah Ave., Royal Oak, Mich.

SHIP Models and yacht supplies complete. Large 64 page catalogue 30c. Bill Wild's, 510 East 11 St., New York City 9.

ILLUSTRATED Lionel catalog, 10c; American Flyer, 10c; H. O. gauge, 10c. Ben's PM Dept., 134 North Dearborn, Chicago 2.

FAMOUS Model catalogs: Ships, fittings, hints, 169 pgs. 50c; World's Tinplate Trains, 148 pgs. 50c; HO Trains—Manual, 140 pgs. 50c. Each includes 50c refund coupon. Also Collectors Soldiers 25c; Old Time Autos, 15c; 100 model projects, 10c. Folk's, Dept. M-23, 314 5th Ave., New York City 1.

BRASS Gears and model supplies for the inventors. Send 10c for catalog. Pierce Model Works, Tinley Park, Ill.

"FIRST-Name" decals—6 for 25c. Box 58M, Morris Heights Station, New York City 53.

BALSA Wood, Grade AAA. Free sample, price list. Sig Mfg. Co., Montezuma, Iowa.

IT'S Terrific! It's different! Reference Guide to Electric Trains. Just published. Packed full of valuable information, track layouts, ideas, wiring diagrams. Hundreds of illustrations showing trains and all available accessories. Rush only 50c. Hobby House Inc., Dept. B1, 800 Huron Rd., Cleveland 15, Ohio.

HOBBY, Model, toy catalog 10c. Year 'round stock—airplanes, American Flyer, Lionel trains, cars, crafts, etc. Cleveland, 4509T907 Lorain, Cleveland 2, Ohio.

BUILD Miniature homes with our accurately scaled materials. Send 25c for booklet and samples. Architectural Model Materials, Inc., Dept. M-13, 4208 Armitage Avenue, Chicago 39.

HOME CRAFTSMEN

KNOCKDOWN Cedar chests. Lumber and veneers. Free price list. Giles & Kendall Company, Huntsville, Ala.

100 FULL Size jig saw patterns up to 20" high, only \$1.00. Pattern Service, Medway 9, Mass.

LEATHERCRAFT, Copper tooling, textile painting, beadcraft, shellcraft. Many other crafts. Big free catalog shows everything you need. Kit Kraft, 7373 Melrose, Hollywood 46, California.

TOOLING Copper, flock, finishes, free instructions. Bestcraft, Dept. M, 949 Kenwood Ave., Inglewood, Calif.

FREE Seashell catalog. Shellcraft instruction book 35c. "Secors," Bradenton Beach, Fla.

FREE Blueprint Catalog! Hundreds of projects—Motor scooter, furniture, toys, birdhouses, radios, garden furniture, power tools, boats, work benches, home freezer, many more! Send postcard to Popular Mechanics Press, Dept. 103, 200 E. Ontario, Chicago 11, Ill.

VIOLIN Makers, amateurs, professionals. Fine tone European wood. Supplies, Tools, Patterns. Instructions. Illustrated catalogue 10c. Refunded. Premier Violin Supplies, Dept. VZ, 430 South Broadway, Los Angeles 13, California.

LEATHERCRAFT—New stylecraft folder free. New kits illustrated. Filigree belts, billfolds, purses, etc. Send 25c new catalogue. Refunded first order. Apache Leather Co., 2804 East Washington St., Phoenix, Arizona.

STENCILS, 15 Assorted for textiles, furniture, etc., \$1.00. Catalog 300 designs 25c, refundable first order. Marion Specialties, Box 141, Halesite, N. Y.

MINIATURE Furniture kits. Colonial reproductions. Solid cherry. Catalog 20c. Culver Miniatures, 194 61st St., Dept. A, Niagara Falls, N. Y.

30 LAWN Ornament patterns. Ready cut. Full size. Color indicated. \$1.00 postpaid. Lincoln Craft Studio, Columbia, Conn.

LEATHERCRAFT. Tremendous stock of leather, tools, supplies, and kits. In leather business over forty years. Send 10c for big catalog. Sax Bros., 1111 No. 3rd, Dept. PM, Milwaukee 3, Wisconsin.

FREE Information. How to make money with jig saw. Write Jigsaws, 117-M Worth, New York 13.

"TOPS" In everything for leathercraft. Low priced kits, leathers, tools, lacing. Catalog 10c. Crown Leathers, 22 Spruce Street, New York 38.

NEW! "100 Best Woodworking Projects"—144 page Popular Mechanics book with 100 special projects for every member of the family. Furniture, toys, novelties, many more. Send \$2.00 to Popular Mechanics Press, Dept. 105, 200 E. Ontario, Chicago 11, Ill.

PERSONALIZE—Decorate glassware. Etch designs and monograms easily and safely in three minutes with Etchall. Send \$1.00 for trial kit. Etchall, Inc., Columbia 4, Missouri.

SAVE Thousands of dollars. Build your own home. Book and plans for Popular Mechanics Ranch-Type House ready now! Six rooms and carport for \$5000; add breezeway, garage, extra bedroom \$2500. No experience needed. Book shows you how. Get copy today. Step-by-step instructions, hundreds of photos, drawings. Mail \$3.50 to Popular Mechanics Press, Dept. 101, 200 E. Ontario, Chicago 11, Ill.

PLYWOOD—Masonite, new large factory cutoffs one third original cost. Free stock list. Interstate Metals, 119 W. Garfield Ave., Elkhart, Indiana.

JIGSAW Owners attention! Start earning money at home cutting out wooden novelties and souvenirs. Write H. Cook, Dept. A, 4407 S. Normal Ave., Chicago 9, Illinois.

SWISS Music movements—Make musical toys, boxes, novelties. Send \$2.50 for Christmas or nursery unit and free pattern. It's a profitable hobby. Free tune list. Maritime, 13 E. 60, New York 22.

LEATHERCRAFT For pleasure or profit. Make easy-to-assemble purses, belts, gloves, woollin toys, 100 other items for gifts or to sell. Send 10c today for big catalog. Largest leathercraft stock in U.S. J. C. Larson Co., 820 S. Tripp, Dept. 2850, Chicago 24.

LAMP Size cypress knee \$1.00. Cy Products, Ella Street, Lafayette, La.

REPLACES Sandpaper: Make your own sanding disks, or cover any wood or metal shape with abrasives. Complete kit \$2.00. San-Dit, Box 96PM, Oconomowoc, Wis.

90 ALL New, full size lawn ornament and novelty patterns, up to 20" high. Only \$1.00. Mastercraft 12M, 7041 Olcott, Chicago 31, Illinois.

MAKE Woodenware to decorate. Tested, proven money makers. 25 plans \$1.50. Continental, 907 Birch, Eau Claire 1, Wis.

89 FULL Size jig saw patterns of beautiful shelves, ornaments, toys, novelties. Plus "How, Where to Sell." Only \$1.00. Mastercraft 14M, 7041 Olcott, Chicago 31, Illinois.

ANIMALS! Locomotives! Six-foot train! 34 jig saw wall patterns, 50c! Pauls Plans, 2233A North 35th, Milwaukee 8, Wisconsin.

BASSWOOD Surfaced random widths 6", lengths 30", mixed 13c square foot. Crafts-Mart, White Lake, Wis.

WOODCRAFTERS—Big, thrilling, colorful war game. (Patented.) Rules, plans, license \$1. Hobby King, Box 861, Baltimore 3, Md.

OUR Biggest leather and craft catalog yet! 1000's of items. Send 25c (refunded with first order). Russo Handicraft Supplies, Dept. 13C, 245 S. Spring, Los Angeles, California.

35 TOY Patterns \$1.00. Continental Products, 907 Birch, Eau Claire 1, Wis.

LEATHER Secrets, complete encyclopedia of leather craftsmanship. More than 1,000 actual-size photos, drawings show how to cut, carve, emboss, tool, etc. Send for free information. Baird School of Leather Carving, Dept. 11, Manitou Springs, Colo.

16 NEW lawn chairs, 22 picnic tables, benches, trellises, etc. All 38 plans with necessary full size patterns, \$1.00. Mastercraft 13M, 7041 Olcott, Chicago 31, Ill.

LEATHERCRAFTERS: Big illustrated catalog of materials, tools, kits, 10c. Art Leather, 411 Joseph Ave., Rochester 5, N. Y.

93 "ORIGINAL Idea" jig saw patterns \$1.00. Professional drawing, quality printing. Full size shelves, toys, lawn ornaments, novelties. Walker Studio PM-1, 4343 Lindell, St. Louis 8, Mo.

FIRST Quality tool steel screwdrivers. Unbreakable handles. Guaranteed. Set of six \$2.00. Craft-Mart, 316-B West Oakwood, Bucyrus, Ohio.

"ANTIQUES"—Best selling, easily built shelves, spice cupboards, what-nots, etc. 32 full size patterns, plus "Fast Finishing," \$1.00. Vosbury's, Mounted Route 95, Binghamton, N. Y.

WOOD, Plastic plans; jewelry making ideas 25c. Leisure Products, 416 Rose, West Hazleton, Penna.

BLEACHING Kit for furniture, panels, woodwork, etc. Full instructions. Daly's, 1115 N. 36th, Seattle, Wash.

LEATHERCRAFT: Genuine suede (deer-skin) leather. Finest imported full length skins. Fawns \$2.95. Does \$3.95. Bucks \$4.95. Money back guarantee. Swatch 25c. A. Frank, 45 Vesey, New York City 7.

SHELF Plans—13 full size, plus 88 page hobby book. Send \$1.00. Crafters, Oostburg 12, Wisconsin.

WHITTLE And carve white pine with Ben Hunt crooked knife. Send \$2.00 for preblanked kit, crooked knife and 88 page craft catalogue. Crafters, Oostburg 12, Wis.

\$46 FROM Square foot plywood; jigsaw necessary. Write: Woodarts, PM-252, Bridgewater, Mass.

MAKE IT YOURSELF

BUILD With concrete, fieldstone, earth. Movable form system cuts costs. Construction simplified. Free literature. Smith, PM, Box 36, Eagle Creek, Oregon.

BUILD Inexpensive concrete blockmaker. Motor, hand. Write: C. Lee, Mountain View, Oklahoma.

MAKE Your own "Stone-Veneer." Economical. Easily made, quickly applied. Looks like genuine stone. Transforms any home into one of excellent beauty. Formulas, illustrations, patterns. Alburg, Box 17, Carrollton, Mich.

SEND 25c Today for new large catalogue of supplies for 21 popular crafts. Dept. D-11. Dearborn Leather Company, 8625 Lincoln Avenue, Detroit 6, Michigan.

BUILD Your own "tractor." Free information. Eltraco, D-1, Camptonville, California.

100% IMPROVED Floor furnace performance. Plans \$1.00. Ostrom, 608 30th, Richmond 2, Calif.

300 PROJECTS You can make—In Popular Mechanics 32-page Blueprint catalog. Send 3c stamp for copy. Popular Mechanics Press, Dept. 106, 200 East Ontario St., Chicago 11, Ill.

HOMES You can build for \$4500 to \$7046. Books that take you through every step. Popular Mechanics Famous Concrete Block House, \$2.00. Your Home and How to Build It Yourself, \$3.00. Ranch Type House You Can Build, \$3.50. Also full-sized builder's plans for each home at nominal price. Popular Mechanics Press, Dept. 102, 200 E. Ontario, Chicago 11, Ill.

BUILD-It-yourself projectograph, own use, sell, thousands needed. Lens and instructions \$10.00. Photo 25 cents. Projectograph Co., Box 276B, Kawkawlin, Mich.

BUILD Luggage and cases. Complete illustrated instruction enabling home craftsman to make cases for tools, instruments, photography equipment, jewelry, portables, salesman's samples, etc. No special tools. Write for free information. Abarsi Casecraft, 805 Sunset Blvd., Los Angeles 12, Calif.

BEAUTIFUL Knockdown solid cedar chests. Free literature. Cedarcraft, Fayetteville, Tennessee.

"CONCRETE Block Homes." 32-page booklet, on how to build. \$1.00. H. C. Lightfoot, Civil Engineer, Richboro 1, Penna.

UNUSUAL Illustrated booklet. How to build electric work-savers. \$1.00. Hill, Box 358, Lee, Mass.

FLUORESCENT Work shop lite. Assemble yourself, save dollars, year guarantee. Literature free. Box 5907, Chicago 80, Ill.

BOOKLET Gives workshop "tips" galore. Describes 100 machines you build! 25c (refundable). Kimo, RCS-P, New York 19.

GRANDFATHER Clock easily built. Big savings. See ad on page 253.

SAVE With Monarch mower kits. Write for prices. Monarch, P.O. Box 62-M, Ft. Scott, Kansas.

WATCHES, OLD GOLD, JEWELRY

WATCHMAKERS—Jewelers' complete informative catalogue 20c. Bengale Company, Culver City, California.

JEWELRY Making can be a profitable hobby—Send 20c for our latest illustrated catalog. Milady-Fair Co., G.P.O. Box 1328, New York City.

HIGHEST Cash paid for old, broken jewelry, gold teeth, watches, silverware, diamonds, spectacles, platinum. Free information. Satisfaction guaranteed. Rose Smelting Company, 29-A East Madison, Chicago.

OLD Gold wanted. Highest prices paid on old or broken watches, diamonds, spectacle frames, dental gold and platinum. Cash by return mail. Information free on request. Alamo Watch Company, Second Floor, Melrose Building, Houston 2, Texas.

UNREDEEMED Diamond, 1-carat, \$295. 30-day refund. Free catalog. Broff's Diamond Loan Association, 411 Smithfield, Pittsburgh, Penna.

5000 **JEWELRY** Styles, you can easily make yourself—Pins, earrings, bracelets, rings, matched ensembles. Instructions and catalog 10c. Barry's, 124 Ardsley Court, Newark, N. J.

WATCHMAKERS' Tools, materials, supplies, watches. Catalog. Gales, Box 1000, Chicago 90, Ill.

HIGHEST Prices paid for old gold, silver, platinum, diamonds, watches, gold teeth, spectacles. Cash immediately. Goods returned if offer unsatisfactory. United Smelting Works, (The Old Reliable), 39-B South State, Chicago 3.

INFORMATION Free. Watches repaired at little cost. Watchmaker, 1200 East Cotton, Longview, Texas.

RHINESTONES. Jewelry settings, cameos, sequins, beads. Send 10c for illustrated catalog. J & M Novelities, Dept. CA-3, Griffith, Ind.

SWISS Watches from importer. For resale only. \$3.30 up. Catalog. Transworld, 565 5th Ave., New York City.

5 **ELGIN,** Waltham, Illinois, Hampden gents' wristwatches needing minor repairs, \$18.00. Write for prices. B. Lowe, Holland Bldg., St. Louis 1, Mo.

WATCH And clock repairing books for hobbyists. Free information. North American, Dept. 13-A, 2320 Milwaukee, Chicago 47, Illinois.

TOBACCO, SMOKERS' SUPPLIES

100 **CIGARS,** \$4.75 Postpaid. Packed 25 in vacuum tin. All Havana filler. Money-back guarantee. Others. Ace Mail Order Co., East Orange 1, N. J.

CIGARETTES—Roll 200 guaranteed to please for 75c. Particulars free. Pete Moberly, Box 864, Owensboro, Kentucky.

RAZORS, BLADES, SHARPENING

RAZOR Blades, single or double edge. Five 10c packages 25c postpaid U.S.A. Guaranteed. Spedding Better Products, Coldwater 3, Mich.

OF INTEREST TO WOMEN

GOOD Money in weaving. Weave rugs at home for neighbors on \$59.50 Union loom. Thousands doing it. Booklet free. Union Looms, 153 Post St., Boonville, N. Y.

MAKE. Sell artificial flowers, corsages, chenille dolls, jewelry. Starting kits, fibre, leaves, shellcraft, rhinestones, sequins, findings. Wholesale catalog 10c. Profit-krafts, 4509T242 Lorain Ave., Cleveland 2, Ohio.

INVISIBLE Reweaving in big demand! Cash in supplying laundries, cleaners, stores, homes. Make tears, holes, cuts disappear from all fabrics. Earn up to \$10.00 an hour. Get full details free. Fabricon, Dept. C-1, 8342 S. Prairie, Chicago 19, Ill.

NEEDLECRAFT, Mothercraft, decorating. How-to-do-it books. Borrow or buy. Catalog free. Renta Book, 445-E West 34th St., New York 1.

QUILT Pieces, doll remnants, patterns, samples, postpaid. Rainbow 13, Estill Springs, Tennessee.

TOE—And fingernail nippers, chromed, 5 inches, (the one you've always wanted) \$2.00. National Traders, Box 1542, Hollywood 28, Calif.

FOR SALE—MISCELLANEOUS

FREE Catalog on government surplus bargains from country's largest surplus organization specializing in outdoor, sporting goods, clothing, camping equipment. Tents, rubber boats, tarpaulins, hundreds of other items. Rockaway Sales Co., Route 6, Rockaway 7, New Jersey.

SAVE Money on army, navy and factory surplus. Write today for new 60-page illustrated catalog. Tennusa Sales Co., Dept. C, 1451 Market, Chittanooga, Tenn.

BUY Direct, save! Coveralls, uniforms, shirt-pant sets. Lowest prices U.S. New England's largest industrial uniform company. Lettering, emblems supplied free. Free circular. Eastern Sales, Chelsea Street, Everett 49, Mass.

ORANGES, Florida's tree-ripened, picked to your order by private home and grove owners. \$4.50 per bushel express prepaid east of Mississippi. J. D. Rapalje, Box 792B, Tavares, Fla.

WANTED—MISCELLANEOUS

SCRAP Mercury (quicksilver) containers supplied—Tantalum, bismuth, tungsten. Metallurgical Products Company, Established 1909, 35th and Moore Sts., Philadelphia 45, Penna.

WE Buy used plating equipment. Send description. Hollywood Bronze Supply, Dept. 22, 1624 East First Street, Los Angeles 33.

PERSONAL

LETTERS Remailed 25c. Private mailing and receiving address at monthly rates. McLaughlin, 369 Welch, Columbus 7, Ohio.

BIBLE Reveals the time of the end. Free. Write: Harvest, Jefferson City, Mo.

LETTERS Remailed 25c. "Mail Me From St. Louis," Box 510-M, St. Louis 3, Mo.

FUN Traveling in New York City. Letters remailed 25 cents each. Greenberg, Box M59, Whitestone 57, New York.

BORROW By mail. Loans \$50 to \$600 to employed men and women. Easy, quick. Completely confidential. No endorsers. Repay in convenient monthly payments. Details free in plain envelope. Give occupation. State Finance Co., 323 Securities Bldg., Dept. W-14, Omaha 2, Nebraska.

WRITE Your friends from glamorous Miami; letters remailed 25c; scenic postcards, 3 for 25c; remailed free; coin please. Fred's Service, Box 3501, Miami 22, Fla.

LETTERS Remailed 25c, \$3.50 per month. Particulars. Hbl, 2029½ Main, Dallas 1, Texas.

LETTERS Remailed San Francisco postmark 25c. Private receiving-forwarding address available. Shanks, Box 3110-D, San Francisco 19, California.

BE The Popular Mechanics representative in your neighborhood and earn big profits in your spare time. Write Popular Mechanics Magazine, Room 408M, 200 E. Ontario St., Chicago, Ill.

HERE'S How and where to borrow \$50.00 to \$300.00 by mail. Confidential. Free particulars. Postal Finance Company, Dept. 45, Sioux City, Iowa.

ENDLESS Energy. "Secrets of Tiredness." \$1.00. Eldetic Foundation, Fairhope, Alabama.

SKINNY? Amazing bodyweight gains possible! Proven method. Write Cambria, Box 26-N, Cambria Heights 11, N. Y.

CACTUS Candy, delicious, healthy, fresh, \$1 lb. National Traders, Box 1542, Hollywood 28, Calif.

"**HOW** Can I find out?" You can! Information confidentially developed. Any matter, person, problem. Worldwide. Officially licensed. Established 1922. William Herman, 170 Broadway, New York City.

MISCELLANEOUS

I Buy, sell or trade anything of value. Over 10,000 items in stock. If not in stock, I can get it for you new or used. Joe's Trading Post, P.O. Box 378, Wooddale, Ill.

LET'S Trade ties. Send yours with \$1.00. Receive others. Ernest Winings, Box 886-B, Trenton, N. J.

300 BIG Mails guaranteed. Samples, plans, offers, propositions, 12 months listing, \$1.00 (refundable). Wright Publications, 2270 Hubbard, Memphis 8, Tenn.

RECEIVE Mammoth mails, magazines, catalogs! Three months 25c, two years \$1.00. Waddell's Directory, 341-B East 76th, New York 21.

FREE Blueprint Catalog! Hundreds of projects—motor scooter, furniture, toys, birdhouses, radios, garden furniture, power tools, boats, workbenches, home freezer, many more! Send postcard to Popular Mechanics Press, Dept. 103, 200 E. On-

STUDY Wildlife, game warden, fish, park, forestry and patrol service. Details free. Write Delmar Institute, D11, Whittier, Calif.

YOUR Leather jacket renovated expertly. Free circular. Berlew Mfg. Co., Dept. 8, Freeport, N. Y.

GOLD, Silver, metal detectors. Geiger counters for uranium. Mineralights. Sensational new fully guaranteed models. None finer. Information free. Detector Co., 5631 Cahuenga Blvd., North Hollywood, California.

TREASURE—M-Scope Geiger counters, mineral locators. Why buy something inferior when you can buy the best at a lower price? Backed by years of experience. Fully guaranteed by factory. Detects minerals, metals, gold, silver, coins. Payment plan available. Proven superior performance. Free 16 page illustrated booklet. Fisher Research Lab., Inc., Palo Alto, California.

GENUINE Buckskin jackets, gloves, moccasins. Send 50c for buckskin pouch and illustrated catalogue. Berman Buckskin Co., Dept. 55, Minneapolis, Minn.

BOOKS Found! Any author, old or new. Rush titles wanted; no obligation. International Bookfinders, Box 3003-PM, Beverly Hills, California.

PANNING Gold lesson and catalogue. Beginners supplies, books, "maps where to go" free. Old Prospector, Box 729D1, Lodi, Calif.

TREASURE Finders for gold, silver and minerals. Money back guarantee, best available. Also Geiger counters for uranium prospectors, free information. Write Goldak Company, 1541 West Glenoaks, Glendale 1, Calif.

SELECTIVE Metal and mineral detector. Revolutionary design. Distinguishes metals from black magnetic sands. Readily detects metals under salt water. Also Geiger counters and mineralights. Free literature. Gardiner Electronics Company, 2018 N. Dayton, Phoenix, Arizona.

ATTRACTIVE, Novel, treasure map, in colors. One dollar. Treasure, Elmwood, Box 161, Providence 7, R. I.

HEARING Aid batteries, wholesale. Free list. HABS, Box 51, York, Penna.

LEATHERCRAFT For pleasure or profit. Make easy-to-assemble purses, belts, gloves, woollens, toys, 100 other items for gifts or to sell. Send 10c today for big catalog. Largest leathercraft stock in U.S. J. C. Larson Co., 820 S. Tripp, Dept. 2851, Chicago 24.

SQUARE Dance instructions, calls, 25 sets, \$1.00. Rayburn, Eureka Springs, Arkansas.

FALSE Teeth loose or slipping? Try Nu Liner for a real fit. Permanent reliner, fully guaranteed \$1. Nu Liner, Box 303, Department C, Latrobe, Penna.

ASTOUND Everybody with your "X-ray mind." For this great power over others, send for Maravedi el Krishnar's amazing course, "Analyze People at Sight." Only \$2.95 postpaid, Krishnar Institute of Universal Knowledge, 1912 Lincoln-Park-West, 4PM-1, Chicago 14.

DO You need a change? Investigate the amazing State of California. Our descriptive brochure is not high pressure nor promotional but solid factual data giving sources of employment opportunities, wages paid, farming information, climate, housing availability, etc. Satisfaction or purchase price refunded. Send \$1.00. West-erner Sales Company, Box 865, Menlo Park, California.

ATEMIWAZA Judo—Helps you protect yourself. Be safe, confident in life with book of secret oriental blows. U. S. \$1.00. Sato Doido, 38 Robinson Road, Ground Floor, Hongkong.

OUTDOOR Toilets, cesspools, septic tanks cleaned, deodorized with amazing new product. Safe, easy, economical to use. Double waste digesting action. Saves digging, pumping. Satisfaction guaranteed by 150,000 customers. Postcard brings free sample. Burson Laboratories, Dept. C-36, Chicago 22, Illinois.

NYLONS, Merchandise wholesale. Catalog 50c. Economy, 28 Trinity, Lynn Mass.

JOIN With nationwide traders. Send list of your trade items. We print them in our swap bulletin. For 25 cents you receive this money saving bulletin containing many valuable trades. Traders Exchange, 714 American Bldg., Seattle 4, Wash.

RECEIVE Big mails; samples, magazines, fireside money opportunities, discount catalogs, 10c. States Company, Dundee, Michigan.

LABELS, Small cartons, price list 10c. Smith's, 1040 South Westlake, Los Angeles 6.

TINY Mirror attachment for glasses enabling you to see who is behind you. Send \$1.00 to Starling Co., 2206-M Starling Avenue, New York 61, N. Y.

CESSPOOL Trouble? Start leaching process with Sursolvent, the miracle cesspool cleaner. Saves pumping. Reduces odors. Unclogs drains. Reclaims old systems to a condition approaching newness. Simple to use. Write for information. Electric Sewer Cleaning Co., Boston 34, Mass.

DANDY Bird house. New, different. Details. The Yankee Doodle, Box 75-B, West Thornton, New Hampshire.

"COMMODORE'S Commission Confederate navy." Your name inserted \$1. Southern Documents, Box 4607, Jacksonville, Fla.

RECEIVE Magazines, samples, catalogues. Mails from everywhere. Offers, hundreds. Get listed 25c. Rorick, Box 86, Cincinnati 26, Ohio.

"BILLFOLD Photos" 20 for \$1.00. Ideal for applications or student exchange. Send any size photo or negative. Federal Wallet, P.O. Box 2448, Dept. P, Kansas City 6, Mo.

INSTRUCTIONS For building Radio Treasure Finder, \$1.00. Wyss, 104 1/2 Francis, St. Joseph, Mo.

AUCTION: Real bargains. List mailed. Auctioneers, 5976 Cote Brilliant, St. Louis, Missouri.

GIANT "Grab bag." Over 30 items, nearly 1100 pieces, \$1.00. List free. Dougherty, BX-12, Phillipsburg, N. J.

HAVE Billion tons limestone above ground. Need development. Clyde Lee, Mountain View, Okla.

CONQUER That old worry habit. Wake up your mind with our amazing home-study "Human Behavior Control" plan. Many helped. Write for unusual free lecture without obligation. Personal Psychology, Inc., Box 1924-M, Louisville 1, Ky.

SECRET "X-ray" mirror, transparent from back. Formula, instructions, \$1.00. Kem Industries, Box 1032, Stockton, Calif.

EXCHANGE Your disliked ties, 15c each, plus postage. DeHart, 444 Fullerton, Chicago.

70 BIBLE Lessons, 25c. Bulletin, Box 87, Cathedral Station, New York 25.

SEPTIC Tank cleaner. No digging. Guaranteed. Miller Plumbing, Willard, Ohio.

GROW Living miniature trees at home. Fascinating, profitable. Complete instructions plus chemicals, \$2.00. Details free. "Revealer," Box 37, New York 53, N. Y.

INCREDIBLE! Unprecedented! Become a mental superman overnight! Floor everybody! No studying! "Memoprop" does all your thinking! It's uncanny! Revolutionary! Write: Bijou, Box 1727-M, Hollywood 28, California.

100 TRICK Knockouts For Self Defense, \$1. 1c each. Lincoln, 529 Main, Evans-ton, Ill.

EXPERIENCED Roof repairer. Franchise protection. Luster-Kote, 19417 Derby, Detroit, Mich.

MINIATURE Bible with magnifying glass on key chain. Ideal gift set. Guaranteed. 50c postpaid. Send to: Jay Sales Company, Dept. P, 5621 N. Clark St., Chicago 40, Ill.

INDIAN Buckskin beaded bag, beautiful gift. \$4.00. Satisfaction guaranteed. Dysart's Gifts, Harlowton, Montana.

FAMOUS German pink alum crystal-block available again. Indispensable after-shaving-antiseptic. Allays smarting sensation. Checks bleeding. Prevents barber's itch. Makes skin firm, smooth and healthy looking. Users never do without it. \$1.00 postpaid. National Traders, Box 1542, Hollywood 28, Calif.

EVEREST & JENNINGS
Folding WHEEL CHAIRS

- Easy-handling
- Comfortable
- Made stronger to last longer!
- Accessories and modifications available.

FOLDS TO 10 INCHES

See your dealer or write for catalog

EVEREST & JENNINGS
761 No. Highland Ave., Los Angeles 38, Calif.

Saves Digging, Pumping, Moving!

OUTDOOR TOILETS
CESS POOLS • SEPTIC TANKS
Cleaned—Deodorized

Banish offensive odor of disposal units with amazing new product! Just mix dry powder with water and pour into outside toilet, cesspool or septic tank. That's all! Absolutely safe—non-toxic, no poisons. Will not harm livestock, poultry, trees, grass. Works like magic to reduce mass, to eliminate odors, to unclog walls and pipes... to facilitate free and easy drainage. One treatment lasts months and months.

FREE SAMPLE

Just send your name and address on a postcard for actual "convince yourself" sample and complete details. Discover this new, easy way to clean, deodorize and sanitize disposal units... at amazing low cost. Learn how to avoid excessive, costly digging, pumping and moving. Write today for Free Sample & full details.

BURSON LABORATORIES, 951 Willard Ct., Dept. 192, Chicago 22, Ill.





This new manual shows you how to get HIGH SPEED & EXTRA POWER QUICK EASY with any car

0 to 60 miles in 12 seconds

Increase top speed of your car up to 30 miles

Secrets of Indianapolis Speedway revealed!

You have heard of drivers getting 30, 40, 50 miles on a single gallon of gas . . . you've been rattled to see "tin can jalopies" beat you at the light every time . . . leave you in the dust on the highway! Now you can give your car greater pep, add 30 miles per hour to its top speed, surge ahead from 0 to 60 M.P.H. in 12 seconds flat! You can save hundreds of dollars annually, burn water with gas, extend car life by simple, easy tricks, quickly recondition cylinder walls without removing the motor! It seems incredible—but it's true! Many of these methods have been tested by huge industrial and oil firms, special laboratories, government bureaus and used by famous Indianapolis Speedway champions. Now this information is yours in the new amazing book: "High Speed & Extra Power"—hot off the presses!



**EASY PICTURES
SHOW YOU HOW!**



No need to be a mechanic! Easy directions & clear pictures show you how to get more speed, power & economy with only a Screwdriver! Tells of cheap gadgets that work miracles with any motor, a 1953 model or a junkyard derelict! Shows you how to **SAVE** up to \$500.00 a year, increase resale value of your car, reduce repair costs.

Drive 45 miles or more with one gallon of gas!



READ 7 DAYS AT OUR RISK!

This great book is yours to try 7 days without obligation! Only **ONE** of its 1000 secrets may begin to save money the day received. Read how a simple trick gives added power and speed in minutes, with a screwdriver, how to start a weak battery with a bumper jack. Look over plans for converting \$75 jalopies into streamlined, low-sprung models with terrific horsepower, speed & European styling. Use old parts, ordinary tools. Learn how to repair dents, "fill in" with plastic paste, refinish all cars, remove dust, restore chrome appearance, enjoy amazing new gas economy with any car, any year! Only **ONE** idea can save 100 times the price of this book! And you can try it the very hour you get it.

SEND NO MONEY. Pay only 1.98 plus post on arrival. Read it 7 days at **OUR RISK.** Try as many of the amazing methods as you wish. Let **RESULTS** talk for themselves. Note how you **ZOOM** ahead every time! Thrill to greater speed & power. Try economy hints. Check for greater mileage per gallon. You must be delightfully surprised or your money back! Act **NOW!** Mail coupon today for new thrills, new economy!

▶ **SPEEDWAY BOOKS, Dept. 6-SA** ◀
127 West 33rd Street, New York 1, N. Y.

**U.S. Gov't Scientist
reveals how to
BURN
WATER
& SAVE
GAS!**

make your own "Super-Charger" with cheap mason jar & 15c rubber hose! Simple! Easy! Saves up to 15% more gas! Gives more power!
**DRIVE 8000 MILES
WITHOUT OIL CHANGE!**
Yes! Drive up to 8000 miles without oil change. Thousands now using this new, simple method for smoother running motor, less friction, longer engine life! Read how few cents worth of graphite works wonders for your car! Over 1000 secrets show you how to get greater **ECONOMY, SPEED, POWER & SAFETY** from your car! Read it at **OUR** expense for a whole week!

FREE!

even if you return manual!

1. "Pocket Trouble Shooter" gives advice on motor defects.
2. "Save on Accessories" tells how to save on tires, accessories, etc.
3. "Economy Driving Technique" shows how they got up to 168 ml. per gallon this year!
4. "33 Ways to Increase Trade-In-Value."



All 4 booklets yours free with manual!

EARN BIG MONEY... RAISE RARE Tropical Fish

**NEW SPARE TIME HOME-BUSINESS
FOR PLEASURE AND \$\$\$ PROFITS**

Wonderful opportunity! No experience needed—no expensive equipment to buy. It's easy and fascinating to breed "Tetras" that **LIGHT-UP** like neon signs; "Gourami" that are 12 **DIFFERENT COLORS**; "Fighting Fish" that **FIGHT UNTIL DEATH**; "Rosy Tetras" that are **TRANSPARENT**; "Danio" that are **STRIPED LIKE A ZEBRA**—hundreds of fascinating rare varieties. **SOME SELL FOR \$50 EACH & MORE!** Takes only minutes per day. **WE SUPPLY EVERYTHING YOU NEED.** **HELP US FILL HUGE DEMAND** from homes, interior decorators, clubs, hotels, pet stores, flower shops, schools, etc. **Fabulous Profits!** **FREE** Illustrated Plan & Details. **RUSH** name and address to:
TROPICAL FISH BREEDERS OF AMERICA DEPT. D-1, LOS ANGELES 15, CALIF.

**Free
HOME-BUSINESS
PLAN**

Jet Racers Build and Have Fun With Monogram Models



**Complete Kit of
Parts—Each Only 85c**

Send 3c Stamp for Big
Catalog of Planes-Ships-Racers

They Go! Power With Jet Cartridge
For the thrill of your life build the Midget (Midget type) and Monojet (Indianapolis type) jet power race cars. Power with inexpensive CO2 cartridge for sale everywhere. Speeds up to 50-60 mph. Kits include shaped and bored balsa bodies, rubber wheels, metal axles, plastic shields, instructions and other parts. Easy to build in one evening.

If no hobby shop near you order from address below. Either racer sent postpaid for \$1.10 — two racers for \$1.95. Delivery guaranteed. If you want catalog in colors showing airplanes, ships and race cars send 3 cent stamp.

MONOGRAM MODELS, Dept. 11, 3421 W. 48th Place, Chicago 32

I'LL GIVE YOU THESE **AUTO SEAT COVERS**



AS A BONUS

**And Pay You Well
Besides If You Will
Show Them And Take
Orders From
Car Owners
In Spare Time
Only!**

**JUST 1 SALE
A DAY CAN
PAY YOU UP TO
\$16.50 DAILY
IN PROFITS!**

Want extra money—plenty of it day after day? Then rush your name and address at once for **Free Sample Outfit** that will start you taking orders from car owners everywhere for **Key** expertly tailored **Auto Seat Covers**. **EXCLUSIVE NEW PATTERNS** to fit every make and model car. No one can compete with you, in wide choice, in quality—and

in expert tailoring that makes covers fit like a pair of gloves—and when you quote prices that are only a fraction of what the customer expects to pay, brother! You make money hand over fist writing up the fast orders! Line includes nationally advertised sensations like **BLACK EBONY** Saran, beautiful **BAMBOO**, brilliant **PIESTA**, colorful **BULL FIGHTER PLAIDS**, plus many other exclusive patterns to choose from, all at unbelievably low prices.

RUSH NAME for FREE OUTFIT

Give MAKE, YEAR and MODEL of YOUR CAR

No experience needed. Make all the extra money you need easily just by showing! Every car owner a "hot" prospect. **YEAR AROUND STEADY PROFITS.** No investment to make. Actual seat covers given to producers as a bonus for **OWN USE!** Write for **Free Selling Kit** valued at \$2.00 and actual samples **TODAY!**

KEY PRODUCTS CORP., 800 N. Clark St., Dept. 4-A, Chicago 10, Ill.

HOW TO TURN YOUR BASEMENT or ATTIC INTO A "RECREATION ROOM"!



Need More Room At Home For Carefree Social Times . . . More Play Space For Your Youngsters—This Complete New "How-To-Make-It" Book, HOW TO BUILD A RECREATION ROOM IN YOUR HOME or ATTIC, Will Show You How To Plan and Build "The Room of Your Dreams."



Never before has there ever been a book like this! Every step of the way in building your recreation room is given to you in easy-to-understand diagrams, illustrations and explanations. You are given scores of suggestions for every need, covering every size room or space available. Just think of it, you can easily turn your plain looking basement into a room for entertainment made to resemble a Night Club of your own choice; Down to the Sea; On a Rustic Theme; Under The Big Top; Below the Border. Or you can build an All Purpose Room, Teen Age Room, Music Room, A Man's Den, Home Craftsman's Work Room, Laundry Room With Glamour. No matter what you make, your friends will marvel at this new added beauty and luxury to your home.

Complete Information On Planning and Building Makes Everything So Easy

Everything from putting the plan on paper to finishing off your recreation room is covered. You are shown how to overcome Dampness—Enclosing Basement Rooms—Framing for the walls—Wall Covering materials—A New Ceiling For Your Recreation Room—A Good Floor—Novel Wall Treatment and Partitions—Increasing Light and Ventilation, etc. . . . just about everything you need to know, NOTHING IS LEFT OUT!

Give Your Attic That "Magic Touch"

Turn your attic into a Playroom for Children, Study, Den, Sewing Room or even a Colorful Guest Room. Just follow the step-by-step explanation and illustrations on Structural Alteration, Windows, Skylights, Insulating, Framing and Panelling, etc.

You Don't Have To Be A Carpenter

Remember, this book was written so that you, the average home owner, even if you never picked up a hammer before, can build everything that this book contains. Not only will you save money on doing your own building . . . and have hours of fun—but after you're all finished, you will have a room that will bring joy to every member of your family. Send for this amazing new book "How To Build A Recreation Room In Your Basement or Attic" by Bob Baer, NOW! Big Book, 8 1/2 x 11—Over 200 Illustrations, 96 pages, Only **\$1.50**

7-Day Free Trial

Send \$1.50 now (we pay postage). C.O.D.'s accepted (plus postage). If not delighted, return book within 7 days for full refund. Order NOW!

MECRAFTS DEPT. BA3, NEW YORK 3, N.Y. 799 BROADWAY

"HOW TO PICK UP A FORTUNE IN GEMS!"

(Reprinted from Mechanix Illustrated)

AMAZING NEW BIG \$\$\$ HOME-BUSINESS

Now, at last you can start a big-profit gem business at home. The secrets are out. Make valuable gem settings, bookends, novelties, jewelry and other big demand articles from materials you find. Amazing ground floor profit opportunities with unlimited future. No previous experience needed. Learn at home. Start at once, spare or full time. Good profit orders come from stores, friends, exhibits—even by mail order. Profits of \$6 an hour and over, possible at home. Certificate awarded upon satisfactory completion of course. Complete instructions show you where to find FREE valuable gems, how to identify them, how to cut and polish, how to make your gems into jewelry, and how to sell at big profits! All details and your copy of "How to Pick Up A Fortune In Gems" sent FREE. Write NOW. Air-mail reaches us overnight.

GEM KRAFTERS, Dept. 51, 1717 Westwood, Los Angeles 24, Calif.

LOOK! A MILLION THRILLS!



High Power
BINOCULARS
30 DAY FREE TRIAL

Finest Precision Optics
Featherlight
Guaranteed Savings
Money Back Guarantee
Easy Pay Plan

Compare Before You Buy!
Dealer Name on Request.

33 Models
\$9.95
UP

FREE BOOK & COLOR CATALOG

BUSHNELL Binoculars Bushnell Bldg., Dept. M61
Pasadena 1, Calif.

FREE BOOK AND COLOR CATALOG

NAME _____ CITY _____

ADDRESS _____ STATE _____

The Most Fascinating Book About the Automobile Ever Printed!

Popular
Mechanics



AUTO ALBUM

The Motor Car in Picture
and Story from
1769 to 1952



You'll Find...
the Answers... the Fascinating Stories . . .
in the AUTO ALBUM

Who built the first horseless carriage?

Who obtained the first U.S. patent on an automobile?

Where did the name "automobile" come from?

Are you familiar with the workings of the Stanley Steamer . . . the "electrics" . . . the famous Ford Model T?

Do you know when the first Indianapolis race was won . . . by whom . . . at what speed?

Do you know the story of Henry Ford, Barney Oldfield, Ransom Olds, Walter Chrysler, W. C. Durant and other automotive giants?

166 Illustrations Including
94 Old-Time Cars — 22 Auto
Ads of By-Gone Days!

Here is a book you can't help enjoying and wanting, whether or not you have, or ever will own an automobile. It is the fascinating, thrilling and informative story of the horseless carriage from the first gasoline-propelled buggy to a forecast of the atomic car of the future.

Popular Mechanics AUTO ALBUM by Throm and Crenshaw presents America's first cars and the pioneering men who made them; the scrambled start and the development of the fabulous auto industry; the story of automobile racing; the growth of the Nation's highways. It is a book that just had to be published.

To Read . . . to Enjoy . . .
to Remember!

More than one-half of the book is pictures, most of them action pictures, from photos of old-time cars in operation. Other pictures show race cars from 1911 to 1951; early auto advertising, picturing 32 cars priced from \$375 to \$6000; tri-cycle autos, wind wagons, auto cycles and other automotive oddities. A roll call of horseless carriages is included — the names of more than 2000 cars made in the United States.

Gift Book of the Year

Get the fascinating AUTO ALBUM for yourself today. Send it as a gift to friends and business associates. Order on coupon below. Money refunded if you are not entirely pleased.



Cloth
Binding

Use Coupon to Get AUTO ALBUM

POPULAR MECHANICS PRESS, 200 E. Ontario, Chicago 11

Send at once postpaid — copies of Popular Mechanics AUTO ALBUM at \$3.00 each. Remittance enclosed. Send COD. I will pay postman plus charges. I understand books are returnable in 7 days for full refund if I am not pleased.

Name _____

Address _____

City _____ Zone _____ State _____

Announcing the NEW...POPULAR MECHANICS MAGAZINE LIBRARY FILE



Check these Outstanding Features

1 Convenient size; measures 6 $\frac{3}{4}$ " wide, 3 $\frac{3}{4}$ " thick x 10" high. Ideal for tabletop, shelf or bookcase storage.

2 Special Reference Index Form, printed on back, records exact location of selected articles, diagrams and other information.

3 Date Label Stickers—enough to index ten years issues, furnished FREE.

NEW! NOVEL! INEXPENSIVE!

Never before so much convenience and utility at such a low price. So act now. Place your order today!

INGENIOUS CUSTOM-BUILT STORAGE FILE

A Sensational Popular Mechanics Value Scoop!

Now you can preserve every issue of Popular Mechanics Magazine in orderly, chronological sequence... indexed and ready for instant reference! Made of high quality kraft fibre board, printed in rich colors and constructed to look like an attractively bound book, Popular Mechanics Magazine Library Files enhance the reference value and double the usefulness of your collection of Popular Mechanics Magazines.

Serviceable, convenient, handsome in appearance, Popular Mechanics Magazine Library Files make every volume and article instantly accessible. No more hunting for the issue or special data you want. No misplaced copies. A "must" for every reader of Popular Mechanics. Order now for immediate delivery. Use the handy coupon below.

PER SET OF 2
(Set holds 12 issues)

Only

70¢

POSTAGE PAID

5 SETS \$3.10
ONLY

10 SETS \$6.00
ONLY

POSTPAID

Best of all, production economies by the distributor service organization appointed by us to serve your needs—plus our large volume purchases—makes the phenomenally low cost of the Libraries possible.

USE THIS COUPON...Mail Today

POPULAR MECHANICS MAGAZINE, Dept. PL
200 East Ontario Street, Chicago 11, Illinois

P 1-53

Please rush PREPAID _____ sets Popular Mechanics Magazine Library Files.

Remittance for \$ _____ is enclosed.
(AMOUNT)

PRICES — 1 set (2 files) Holds 1 yr's. issues only \$.70
5 sets (10 files) Holds 5 yr's issues only \$3.10
10 sets (20 files) Holds 10 yr's issues only \$6.00

Includes Prepaid Parcel Post anywhere in U.S. and Possessions

Name _____

Address _____

City _____ Zone _____ State _____

UNITED

SEAL OF QUALITY

Precision ground. Featherweight. Achromatic. UNI-COATED* Moisture-Dust proofed. Compare Price-Quality then BUY UNITED.

- 6x 4 1/2 oz. Pkt. \$16.95
- 6x30 15 oz. 27.95
- 7x Chrome Pkt. 19.95
- 7x35 5"x6 1/4" 45.50
- 7x35 CENTER FOCUS 49.50
- 7x40 CENTER FOCUS 52.50
- 7x50 31 oz. Barg.!! 36.00
- 7x50 CENTER FOCUS 39.50
- 8x30 18 oz.!! 32.50
- 8x40 More Power 54.50
- 8x40 CENTER FOCUS 62.50
- 10x Pkt. 7 1/2 oz. 24.95
- 10x30 Compact Power 39.50
- 10x50 CENTER FOCUS 59.50
- 12x50 CENTER FOCUS 67.50
- 16x50 27 oz.!! 69.50

This seal etched in your binocular certifies it is a UNITED "Best-By-Test" UNI-COATED* binocular. Your guarantee of satisfaction.



BUY UNITED and BE SURE!

GERMAN WORLD'S LIGHTEST

- 8x30 4"x5 1/4" 11 oz. \$39.50
 - 7x35 5"x6" 14 oz. 57.50
 - 20x56 8 1/2"x6 3/4" 27 oz. 99.50
- Made in Germany, optical center of the world! UNI-COATED* "Whisper Weight" CENTER FOCUS prismatic binoculars with individually focusing right eye piece. Follow moving objects faster, easier. Enjoy clearer, sharper, brighter images.



15x to 40x 6 TELESCOPES IN ONE! \$30.75

American made Wollensak telescope. Instant focusing at 15x, 20x, 30x and 40x, etc. Turn power tube to click—no guesswork. Telescope measures 9" closed, 27" when extended. Weighs 18 oz. Rustproof chrome tubes. All 12 optic surfaces are COATED. See .22 bullet holes clearly at 300 feet. Use also for astronomical observation. \$30.75 price includes fine leather case. Federal Tax Free!

20x TELESCOPE 7 1/2 Oz.!! \$36 closed. 13 1/2" extended. UNI-COATED*. Federal Tax Free. \$8.95
UNI-COATED* Assuring buyers that applications of magnesium fluoride have been applied to the interior sides of the VITAL front and rear ACHROMATICS assuring users brighter, clearer, sharper images than ever before.

FROM 3 CONTINENTS come UNITED'S "BEST-BY-TEST" binoculars. Above are from America, Germany, and where not indicated, from American influenced Japan where skilled German optical craftsmen tutored local optical workmen in advanced techniques. It explains why the quality is so HIGH and the price so LOW.

FREE 3 color 40 page catalog listing over 60 different models. UNITED, Zeiss, Hensoldt, etc. from \$14.95

30 DAY FREE TRIAL—If not fully satisfied, return for full refund. Cash orders postpaid. C.O.D.'s require \$2.00 deposit. Add Federal Tax. Prices all include handsome genuine leather case and straps!

UNITED BINOCULAR CO., United Bldg., 9043 S. Western Ave. DEPT. ARF-5808 CHICAGO 20 DEALERS WANTED Display Sales Rooms open Mon.-Fri. 9:00-3:30



AMAZING NEW POCKET SIZE RADIO!

NO TUBES, BATTERIES OR ELECTRIC "PLUG-INS" NEEDED. "TUNES IN" MOST LOCAL RADIO STATIONS with STATIC-FREE CLEAR TONE. Has new perma-crystal diode and TINY SELF-CONTAINED SPEAKER PHONE—A marvelous real tiny pocket size radio to take with you anywhere you go — FOR REAL FUN AND ENJOYMENT. GUARANTEED TO WORK and should last for years! **SEND \$1.00** (Cash, M.O., Ck.) and pay postage or send \$3.99 for p.p. delivery. COMPLETE ready to play. By mail only from: Midway Company, Dept. PPM-1, Kearney, Nebr.

Taking Vitamins?

Cut Your Costs up to 50%

A Postcard Will Bring You FREE CATALOG

that lists practically every known combination of vitamins and vitamins and minerals.

Also FREE Vitamin Guide Book that shows you how to read a vitamin label and compare values.

No longer need you pay \$4, \$5, \$6, up to \$15, per 100 capsules for the same vitamins your Doctor advises. After 20 minutes' reading of this Guide Book you will understand vitamins as you never have before. You will not be fooled again by confusing, mysterious labels; you will be able to pick up any vitamin product and know if you are getting your money's worth. In this free catalog you are sure to find the combination of vitamins or vitamins and minerals you are now using. Compare the potencies and the prices and you'll be amazed at the savings of up to 50%. Stop buying vitamins blindly. Send postcard today for free guide book and catalog to VITAMIN-QUOTA, Dept. 12T, 880 Bway, New York 3, N. Y., or Dept. 12T, 1125 Crenshaw Blvd., Los Angeles 19, California.

FOR ALL TRUSS WEARERS FREE TRUSS PAD EASERS!

Here's wonderful news for all truss wearers. In order to introduce the new Active Man Truss Pad Easer—we will send every truss wearer who answers this advertisement a sample pad easer *absolutely free*. There are no strings to this offer, no obligation on your part—not a single penny to pay either now or later. These remarkable new pad easers provide a soft buoyant air cushion that fits under any truss pad—gives you increased comfort, reduces irritation and greatly improves the holding power and safety of your truss. Prove this to yourself—by writing today for your FREE Active Man Truss Pad Easer. Only one to a person.



Active Man Truss Company Dept. PM-1

549 W. Randolph St., Chicago, Ill.

1/2" x 3 3/8" x 5 3/4"

30 DAYS AT OUR RISK!

New Advertising Machine Prints and Illustrates Gov't Post Cards

FREE Send name—learn how all types of business are boosting sales with Postcard Advertising. We'll also send FREE illustrated book of money-making ideas for your business—complete, unique advertising plans—and 30-day Trial Offer.

CARDMASTER CO., 1920 Sunnyside Ave. Dept. 131 CHICAGO 40, ILLINOIS



Low In Cost

5 year Guarantee

HIGH SCHOOL Taken at Home

EARN A DIPLOMA

High school graduates get better jobs, earn more. Earn your diploma at home in spare time in 18 to 24 months. Equals resident school. College prep. Credit for attendance elsewhere. Books supplied. Write for free booklet!

COMMERCIAL TRADES INSTITUTE, Dept. H2-1 1400 Greenleaf Avenue • Chicago 26, Illinois

NEW AUTOMATIC DEFROSTER

ONLY \$7.95—YOU MAKE UP TO \$4.00 ON EVERY FAST SALE.

New low cost attachment converts any old style refrigerator into automatic defroster in 10 seconds! Just plug in. New guaranteed HOLWIN at \$7.95 breaking all records. Men selling up to 10 and 12 a day and more—pocketing as much as \$4.00 cash on every sale! Sells 4 out of 5 calls. FREE—Rush name for free sales kit and offer of Demonstrator Sample. DEFROSTER SALES CO., 415 N. LaSalle St., DEPT. H-81 - CHICAGO 10, ILLINOIS



OVERHAUL YOUR MOTOR in 10 minutes

STOP BURNING OIL, STOP PISTON SLAP

15,000 Mile Performance Guarantee!

1st Step — CLEANSE WITH "MOTOR PURGE"—In the FIRST step of the famous and power robbing carbon, gums and varnish. Pour this miracle solvent into the cylinders, run your motor and watch the combustion residue billow out of your exhaust pipe.
2nd Step—RENEW WITH "COMPRESSION SEAL"—RESTORE COMPRESSION . . . GET NEW POWER, SPEED AND ECONOMY with "Compression Seal"! As the SECOND step of the Renew treatment, squeeze this self expanding mineral compound into your cylinder where it can fill worn spots (which cause compression leaks) between cylinder walls and pistons. Thus it restores compression . . . cuts oil-gas waste and eliminates costly engine overhaul and ring jobs. **100% MONEY BACK GUARANTEE!**
Free Auto Manual with each order. Kit treats all cars and trucks. \$6.95 Postpaid (or send \$1 deposit, bal. C.O.D.) CONSOLIDATED ENGINEERING, Dept. PMK-1 10407 W. Washington Blvd., Culver City, Calif.



MONTH AFTER MONTH, YEAR AFTER YEAR, YOU SEE OUR AD.

CHECK AND DOUBLECHECK BEFORE YOU BUY ANYWHERE!

- 1 Are These Tires "Family-Safe?" Our Families Use Them.
- 2 Are They Recaps? Ours Are Not (Except Passenger Snow-Tires)
- 3 Will I Get Goodyear, U. S. & Famous Brands? From Us, You Must!
- 4 Is The Guarantee Unconditional? See Our Fine Offers Below.
- 5 Can Good Tires Be Bought Cheaper? It's Dangerous To Pay Less.
- 6 Is A Tube Included Free? Yes, We Do. See OUR Free Tube Offer.

GOOD YEAR Firestone

GOODRICH, U.S. & OTHERS, SLIGHTLY USED (NO, NOT RECAPS) DOUBLE WARRANTY & UNCONDITIONAL GUAR. ON PASS. TIRES

Our Policy is to select your tires so carefully, as if our very future depended on the service given by that particular tire.

FREE TUBE		WITH EVERY GOOD GRADE & FINEST GRADE PASSENGER AND TRUCK TIRE			
GOOD GRADE	20 MONTHS	GUARANTEE	BOND		
600-16	\$4.02	820-15	\$5.30	600-20	\$ 6.92
650-16	4.40	700-15	4.22	650-20	7.52
700-16	5.00	670-15	4.40	700-20	8.40
650-15	4.00	710-15	4.60	750-20	8.40
760-15	4.90	550-19	6.54	825-20	13.92
				1100-20	13.94

FINEST GRADE, 30 MONTHS GOLDEN RULE GUARANTEE BOND

THIS GRADE MADE THE "BLATT" NAME WORLD FAMOUS.		30 MONTH GUAR. TRUCK TIRES	
600-16	\$5.12	700-15	\$5.82
600-16(6)	5.92	700-15(6)	5.92
650-16	5.92	700-17	10.62
650-16(6)	6.92	750-16	9.62
700-16	6.52	750-15	13.22
700-16(6)	8.72	750-17	11.52
750-16	7.02	800-15	6.62
525-18	4.92	820-15	6.72
550-17	4.52	760-16	6.62
650-15	5.12	450-21	5.08
WHITEWALLS	\$1 ea.	EXTRA	32x6(10)
			13.42
			1100-22
			20.42

Buy the "Right" Truck Tires for "Your" Job.

750-16Std	\$13.52	750-20Std	\$10.08	750-20Rg.	\$14.52
750-16Rg.	17.64	900-16Std	10.58	900-16Rg.	15.08
		600-16Std	6.48	600-16Rg.	9.95

FACTORY RETREAD SNOW-TIRES, 30 MONTH GUARANTEE. "New Tire Traction"

GOOD YEAR, FIRESTONE & OTHERS	670-15	600-16	710-15	650-15	650-16
	\$8.50	\$8.50	760-15	700-15	800-15
					\$11

BLATT BLATT BLDG., GIRARD & LANCASTER AVES. DEPT. PM, PHILADELPHIA 31, PA. SEND CHECK OR MONEY ORDER & THIS AD. Shipments RUSHED Down South, Far-West & Up North

Wheels Wheels



Wheels Wheels

5" Disc Wheel	5/8" Tire	5/16" or 3/8" sleeve	30c ea.
6" Disc Wheel	5/8" Tire	5/16" or 3/8" sleeve	35c ea.
7" Disc Wheel	3/4" Tire	3/8" sleeve	45c ea.
8" Disc Wheel	1 1/4" Tire	1/2" sleeve	70c ea.
7" Disc Wheel	1" Tire	1/2" ball bearing	80c ea.
8" Disc Wheel	1 1/4" Tire	1/2" ball bearing	\$1.00 ea.
8" Disc Wheel	2" semi-pneum.	T. 1/2" B.B.	\$1.50 ea.
10" Disc Wheel	1.75 semi-pneum.	T. 1/2" B.B.	\$1.50 ea.
12" Disc Wheel	1.75 semi-pneum.	T. 1/2" B.B.	\$1.85 ea.

Above wheel prices includes hub cap. Plus Postage. C.O.D.'s accepted. AXLES—Sizes 5/16 in., 3/8 in., 1/2 in.—Cut to size—End holes drilled.

UNITED WHEEL STAMPING CO.
12131 S. PEORIA STREET PM-1 CHICAGO 43, ILLINOIS

WHAM-O SPORTSMAN * \$1.50 35-LB. PULL!



HITS LIKE A RIFLE—KILLS RABBITS, SQUIRRELS. Powerful, silent, accurate. For hunting, target, routing pests.

HUNTING SLINGSHOT

Heavy duty 7" ash stock. 40 steel balls, extra rubber, target. GUARANTEED. At dealers, or send \$1.50 to Wham-O Mfg. Co. Box 8T, South Pasadena, Calif. * Professional model of Nat'l Slingshot Assn.

NOW! Get Amazing New Comfort And Relief With Patented RUPTURE-EASER

NO FITTING REQUIRED



Right or left side \$3.95
Double....\$4.95

A strong, form fitting, washable support. Back lacing adjustable. Snaps up in front. Adjustable leg strap. Soft, flat groin pad. No steel or leather bands. Unexcelled for comfort. Also used as after operation support. For MEN, WOMEN and CHILDREN. Mail orders give measure around the lowest part of the abdomen and state right or left side or double. (Note: Be sure to give both size and side when ordering.) We prepay postage except on C.O.D.'s.

Over 400,000 Satisfied Users!

10 Day Trial Offer—Money back guarantee if you don't get blessed relief.

Piper Brace Company — Dept. PM-13 — 811 Wyandotte — Kansas City 5, Mo.

FREE 10-DAY TRIAL

DO YOUR OWN HOUSE CARPENTRY

SAVE TIME AND MONEY This Easy Way

Every step of carpentry in and around a house is clearly explained and illustrated in this big, useful book. Shows you how to build forms for foundations, footings, walls, steps, walks — How to build sills, girder supporting posts and girders — How to figure loads for house framing — How to lay out, cut and erect floor joists — How to lay flooring — How to frame outside and inside walls, allowing for openings — How to check the plumb of studs — How to brace and sheathe up outside walls — How to erect ceiling joists — How to frame around a chimney and stair well — How to lay out rafters for a gable roof, dormer roof, porch roof — How to sheathe gable ends and rafters — How to build cornices — How to lay shingles — How to build porches and bays — How to apply siding — How to frame up inside walls — How to construct stairs — How to place trim around windows and doors — How to fit and hang sash — How to hang doors — How to make closets, shelving and built-in equipment — How to lay finished wood flooring, linoleum flooring — How to hang a set of garage doors—How to insulate.



Over 600 Illustrations Show You Just What To Do and How To Do It

If you have a hammer, saw and plans, just follow the step-by-step directions and do any house carpentry job from foundation forms to interior trim. Here, in one remarkable volume, is the practical know-how that saves you time and money on house carpentry jobs of every description.

"I built my entire 5-room house myself with no other instruction except your book."—James Sidwell, Twin Falls, Idaho.

USE IT FOR TEN DAYS FREE

Don't send us a penny. Just mail coupon and get "HOUSE CARPENTRY" for 10 days FREE trial. If not delighted, send book back to us and owe nothing. If you keep it, entire cost is only \$4.75 plus few cents postage. Mail coupon below for your free-trial copy.

Send No MONEY

MAIL THIS COUPON

SIMMONS-BOARDMAN PUBLISHING CORP., PM-153
30 Church Street, New York 7, N. Y.

Send me for 10 DAYS' FREE TRIAL, "House Carpentry and Joinery" I will either return it in 10 days and owe nothing, or send only \$4.75 (plus shipping charges) in full payment.

Name _____
Address _____
City _____ State _____

SAVE! Send \$4.75 with this coupon and we pay postage. Same return and refund privilege.



BRAND NEW Firestone TIRES

BRAND NEW FIRST LINE
HEAVY DUTY

TRUCK TIRES

FIRST QUALITY

NEW FIRESTONE WINTER TREAD TIRES

With special, tough, rugged tread to provide maximum traction. The BEST Tire for the WORST Going!

SNOW TIRES	Brand New Heavy Duty	Full Price	Brand New Heavy Duty Butyl Tubes
4 Ply			
640x15	14.16	1.79	
650x15	14.96	1.97	
670x15	14.96	1.97	
710x15	16.56	2.04	
700x15	18.14	2.21	
760x15	18.14	2.21	
800x15	20.66	2.68	
820x15	20.66	2.68	
600x16	14.20	1.77	
650x16	15.19	2.02	
700x16	18.41	2.33	
550x17	14.37	1.87	
550x18	14.04	1.87	
475x19	12.73	1.78	

Brand New White Wall Tires 4 Ply

First Line	First Quality	Brand New Heavy Duty Full Price	Brand New Heavy Duty Butyl Tubes
640x15	17.15	1.79	
670x15	18.14	1.97	
710x15	20.08	2.04	
760x15	21.97	2.22	
800x15	24.19	2.68	
820x15	25.12	2.76	

Special! Brand New—First Line—
4 Ply WHITE SIDE WALL TIRES

(Seconds)	First Quality	Brand New Heavy Duty Full Price	Brand New Heavy Duty Butyl Tubes
670x15	15.65	1.97	
760x15	18.95	2.22	
800x15	20.92	2.68	

Tires	Price	Tubes	Price
700x15 6 ply	25.84		2.75
600x16 6 ply	16.91		2.00
650x16 6 ply	20.67		2.36
700x17 6 ply	29.21		3.21
700x17 8 ply	32.36		3.21
700x18 8 ply	33.65		3.64
600x20 6 ply	23.23		2.88
600x20 8 ply	29.44		3.88
650x20 6 ply	25.94		3.13
650x20 8 ply	31.47		3.13
700x20 8 ply	34.30		3.90
700x20 10 ply	39.71		3.90
750x20 8 ply	43.14		4.58
750x20 10 ply	47.12		4.58
825x20 10 ply	55.92		5.35
825x20 12 ply	66.34		5.35
900x20 10 ply	67.39		6.26
900x20 12 ply	78.35		6.26
1000x20 12 ply	85.31		7.25
1100x20 12 ply	100.06		8.58
1000x22 12 ply	89.85		7.88
1100x22 12 ply	105.79		9.23
1100x24 12 ply	109.99		10.01

BRAND NEW ARMSTRONGS	Full Price	Brand New Heavy Duty Butyl Tubes
640x15	12.01	1.79
650x15	13.94	1.97
670x15	12.52	1.97
710x15	13.90	2.04
600x16	10.89	1.77
650x16	14.38	2.02

(All prices F.O.B. plant.)
Order by mail—Send check or M.O.
All tires unconditionally guaranteed.

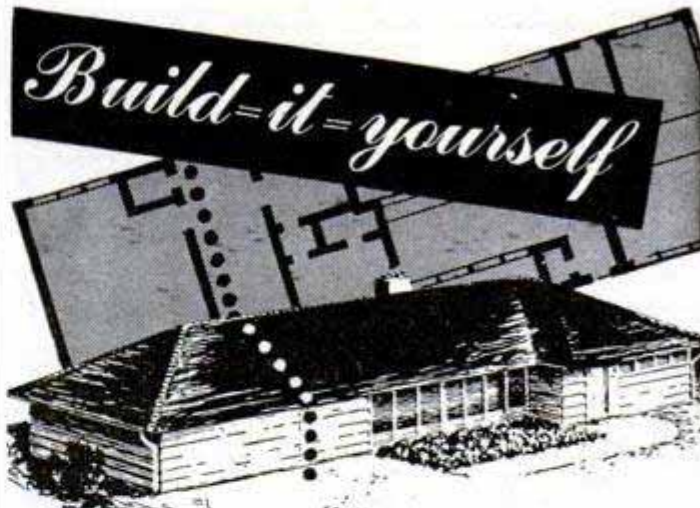

Popular Mechanics Famous

RANCH-TYPE HOUSE

Save Thousands of Dollars by Building This
Beautiful Home Yourself

Join the more than 100,000 families who have built their own homes in the past few years doing all or most of the work themselves and you can save more than 50% of usual building costs! Here is a dream home designed by the noted architect John J. Whelan, designer of the Drew Pearson home, especially for amateur home builders. You can build the basic five room unit for approximately \$5000. Carport may be converted into third bedroom and breezeway and garage added at your leisure. Basic house is to the right of the dotted line in the picture above; expansion is to the left. House fully expanded is 81 feet long and 29 feet wide.

Order Book and Plans — Save \$7000 to \$10,000

Book gives complete step by step instruction. Hundreds of pictures, photos and diagrams, showing every phase of construction, guide you from start to finish. Ten working size blueprints give floor plans, elevations, notes on construction, framing, lumber list, specifications, plumbing and wiring diagrams.

than he spends for material.

Order Book, Plans Now

Use the handy coupon below to order RANCH-TYPE HOUSE BOOK AND PLANS. Read the book; study the plans and then be prepared to go right ahead when you are ready to build. Even if you have the house mainly built by others you can enjoy a tremendous saving by using the instructions and blueprints.

Read How and See How — Simplified Instruction

You read "how-to-do-it" in the book and see how it looks in actual pictures. You follow the plans for dimensions. You make use of labor-saving kinks, special methods.

No Previous Building Experience Required

Any ordinary handy man, using simple tools, can build this house with little or no assistance. And at the same time, save more



Order on this Handy Coupon

POPULAR MECHANICS PRESS, Dept. RH
200 East Ontario St., Chicago 11, Ill.

Send at once my copy of the Ranch-Type House Book and Plans as checked below:

- Remittance enclosed Send C.O.D. (postage extra)
- Ranch-Type House Book \$ 3.50
 - Set of 10 Blueprints 13.50
 - Book and Blueprints 15.00
 - Duplicate Set of Blueprints 5.00

Name _____

Address _____

City _____ Zone _____ State _____

S&S TIRE CO. 1400 HADDON AVE. CAMDEN 3, N. J.

THIS HANDBOOK FOR AMBITIOUS MEN FREE!



Have you had your copy?

150 pages of guidance to best-paid positions. Up-to-the-minute information for men who want to climb to the top. Tells how to get promotion, security and better pay through home study courses. This handbook "Engineering Opportunities" is free and entirely without obligation. Send the coupon. Make this your big year! Describes over ninety courses including:

- | | | |
|-----------------|---------------|---------------------|
| Mechanical Eng. | Electrical | A.F.R.Ae.S. |
| Aeronautical | Radio | A.M.I.C.E. |
| Television | Automobile | B.S. (Pure Science) |
| Building | A.M.I.Mech.E. | |

SEND COUPON TODAY

Canadian Institute of Science & Technology Limited, 557 Century Building, 412, 5th Street, N.W., Washington, D.C.

Please forward free of cost or obligation your handbook, "ENGINEERING OPPORTUNITIES".

Name _____

Address _____

Course interested in _____ Age _____

Canadian Address: Canadian Institute of Science
557 Garden Building, 263 Adelaide St. W., Toronto, Ont.

POWERFUL!
 IMPORTED FROM
GERMANY with **\$3.**



Waterproof CARRYING CASE

Don't pay \$10.00 for crudely made binoculars claiming 18 mile ranges! Forget the 'o'v price . . . Just look thru them O.N.C. . . You'll be convinced of their terrific quality! Kleeer-Power lenses made by German artisans. Bring in distant people and objects with amazing clarity! Center focusing!

Light weight, easy to carry, yet **STRONGLY** made! Ideal gift for father or son! Gives him a ringside seat at games, theater, nature study. Order by

No. 134—only 3.00. SPECIAL! De Luxe Hi Power model (No. 134-B) with waterproof carrying case and COMPASS, now only 3.95. Why pay more? Buy DIRECT from importer and SAVE! Order now—mentioning model number. Pay price plus post on delivery. SAVE postage by sending check or m.o. now. Absolute satisfaction or your money back. THORESEN'S, Dept. 6-A-134, 140 Fifth Ave., New York 11, N. Y.

GROW Living MIDGET TREES!

EARN \$10.00 PER HOUR!

- AT HOME
- IN SPARE TIME
- NO EXPERIENCE NEEDED



It's new! Amazing! At last, the secret of growing miniature (MING) trees can be yours. FULL GROWN, dwarf trees—only a few inches high. Beautiful miniature fir, orange, oak, Chinese elm, peach, pine, cypress—any kind! ALL BLOOM and even BEAR FRUIT. All perfect healthy specimens—but miniature in size! Make costly home decorations and expensive centerpieces. (SOLD FOR OVER \$1,500 EACH) Big demand. Costs only pennies—takes only minutes per week. IT'S EASY! Fun! A new fascinating hobby—a new fabulous \$\$\$\$ business. Send for free secret plan details and real seed.

HELP US FILL HUGE DEMAND!

These trees are being demanded by STORES CLUBS • HOTELS • FLORISTS • HOUSEWIVES • INTERIOR DECORATORS • COLLECTORS • HOBBYISTS—A Big Money Opportunity FOR YOU.

FREE! GENUINE SEED AND PLAN!



NATIONAL NURSERY GARDENS, Dept. M-1
 8463 South Van Ness
 Inglewood 4, Calif.
 Rush me FREE plan and seed IMMEDIATELY!
 Name _____
 Address _____ Zone _____
 City _____ State _____

WALKIE TALKIES! — \$4.99 COMPLETE SET OF 2
 POCKET SIZE — ELECTRONIC VOICE POWERED



No tubes, batteries, adjustments. Guaranteed to work anywhere up to 1/4 mile with extra wire. Swell for room to room—garage to house, etc. Your own private, talk-listen phone. Not war surplus. Brand new. Guaranteed. Two complete units with interconnecting wire — READY TO USE!

SEND \$1.00 deposit and pay postman \$3.99 plus postage charges or send \$4.99 for postpaid delivery. Available only by mail from MIDWAY COMPANY, Dept. WPM-1, Kearney, Nebraska

DEVELOP A STRONG HE-MAN VOICE

STRENGTHEN your voice this tested scientific way. Yes—you may now be able to improve the POWER of your speaking and singing voice—and in the privacy of your own room! Self-training lessons, mostly silent. No music required.

WRITE TODAY FOR FREE BOOK
 Eugene Feuchtinger's great booklet "How to Develop a Successful Voice." It's absolutely FREE! You must state your age. Booklet mailed postpaid in plain wrapper. No salesman will call. Send your name, age now!

PREFECT VOICE INSTITUTE
 210 S. Clinton St., Studio AX-2 Chicago 6, Ill.

Say You Saw It in Popular Mechanics

\$10,000 - \$20,000?
 I Can Show You How to **DOUBLE YOUR INCOME**

Let me show you a new life . . . a successful life of selling. Learn how easy it is to make more money by following my simple technique. In the past 19 years I have developed 105,000 selling word combinations which have been used by hundreds of famous corporations; Sears, Parker Pen, Cadillac, Remington Rand and many others.

You, too, can learn the Wheeler Way to success. My Home Study Sales Training Course will teach you how to sell, how to make more money, easy money. Write TODAY for details.

ELMER WHEELER SALES TRAINING INSTITUTE
 Home Study Division Dept. PM-58
 664 N. Michigan Ave. Chicago 11, Ill.

MANUFACTURE THIS BEAUTIFUL CONCRETE OUTDOOR FIREPLACE
 Right In Your Own Back Yard

\$4.00 Worth of Sand & Cement produces this Attractive Fireplace.

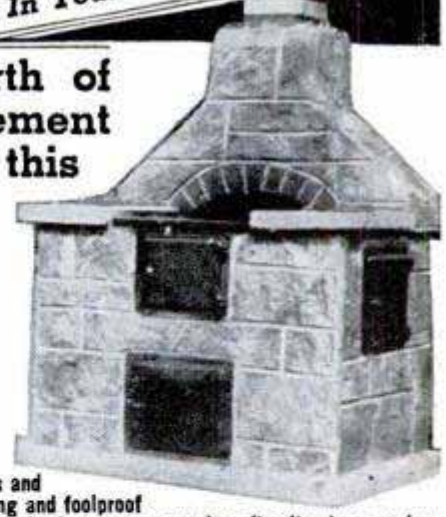

Sells on Sight from \$60. to \$80. Easy to start your own Profitable Business.

The General Fireplace Molds and Process are the most amazing and foolproof ever invented. Simple to operate, two men can produce five fireplaces a day.

BIG DEMAND!!

Sell all you produce to Department Stores, Homeowners, Parks, Nurseries and Picnic Groves. Fireplaces sell on sight. No experience necessary, we supply full operating instructions and equipment plus the know how that spells BIG PROFITS. This is an outstanding opportunity for men of vision and small capital to get into a busy rich paying field. Don't delay, be the only exclusive manufacturer in your own home town. Mail coupon at once for full details as to how you can reserve your territory.

Molds sold only on exclusive franchise.

GENERAL ENGINES CO., Inc., Dept. MF-13
 307 HUNTER ST. • GLOUCESTER CITY, N. J.

Mr. Tor of Phila. writes: Sold 250 in first 4 months. Selling to Sears Roebuck, John Wanamaker & Gimbel Bros. in Phila. area.

Name _____
 Address _____
 City _____ Zone _____ State _____

EAVESDROP...

behind the "IRON CURTAIN"!
hear Aircraft! Ships! Amateurs!

Sensational

**TABLE
RADIO
SW-54
\$49.95**



**GUARANTEED RECEPTION
ON 3 SHORTWAVE BANDS
PLUS STANDARD BROADCAST**

Turn the knob and—presto!—Radio Moscow is pouring propaganda into your ears! Turn it again and hear music from Paris, or amateurs chatting, or an aircraft control operator! Thousands have discovered a whole new world of listening pleasure with the "Mighty Midget," by the makers of radio equipment for the famed Kon-Tiki Expedition. Write for details and name of nearest supplier.

NATIONAL COMPANY, INC.
61 Sherman St., Malden, Mass.

**GENUINE U. S. ARMY HAND GRENADE
CONVERTED INTO TABLE
LIGHTER**

Need a real man-sized desk or table lighter? One that's new and unusual! Lights cigarettes, cigars, or pipes with ease. Makes an excellent paper weight. Amazes everyone! You'll like its extra large fuel capacity. Limited quantity—act fast—send check, money order, or \$2 today!

\$2.00
Post-paid



KAUFMANN ARMY-NAVY
318 W. 42 St., New York 36, N. Y. in U.S. only

**PRESTO! ANYONE CAN
MASTER GLAZE**

KEAVES HARD
GLASS-LIKE
FINISH
SEALS THE PORES
OF THE SURFACE
EASY TO APPLY
WILL NOT
FINGER-MARK
NO
OILY FILM
AS WITH POLISH
PROTECTS
THE SURFACE
EASY TO
KEEP CLEAN
SMEAR OR STREAKS
AS WITH WAX
LASTS SIX MONTHS
TO A YEAR



SAVES
YOU MONEY

Car Owners! Meet Master Glaze—the sensationally different luster for new and used cars! Not a wax—not an oil polish—not a paint!—nothing that "smears" over the surface.

MASTER GLAZE is a unique discovery—a creamy liquid—quick and easy to apply! Gives a hard, glass-like surface. Even gasoline cannot dull it! Lasts six months to a year! Amazing luster—beautiful, sparkling clean and brilliant! Doesn't finger-mark—doesn't smear! A match box full glazes an entire car. Seals the pores—protects! **NOTHING LIKE IT!**

AGENTS
An unusual opportunity!
Quick, flashy demonstrator.
Big profits.
Good territory.
Write today!

FREE SAMPLE

Just send your name and address to
MASTER GLAZE CO., 7720-756 W. Harwood Ave., Milwaukee, Wis.

Powerful Motor



One of the smallest precision motors ever built yet does **GIANT-SIZED JOBS**. Drives Model Planes, Boats, Construction Sets, Working Models, Trains and Cars, etc., with amazing speed up to 6800 R.P.M. (or as little as 50 R.P.M.), using the reduction gears that come with this exciting set. The **MIGHTY MIDGET** does hundreds of jobs. It's a Honey. Looks exactly like a Big Motor, yet measures 1"x1 1/4" and weighs one ounce. For only \$2.98, YOU GET LOTS MORE with this Mighty Midget. You get a complete set of gears and pulleys and a transparent multi-ratio gear box as well as a battery clip with two batteries and instructions. **NO SHOCKS, SPARKS, NO SHORTS, NO TRANSFORMER NEEDED.** Reverses immediately, too! Endless hours of fun. Enclose check or money order for \$2.98 for this entire set and we will pay postage. C.O.D. orders plus postage.

IMPERIAL SALES CO.

480 LEXINGTON AVE. DEPT. M-978 NEW YORK 17, N.Y.

NYLON Stockings

All over the world in 2 pound AIR MAIL packages by
RICH SUPPLY CO.

215A W. 98 ST.

NEW YORK 25

GREAT PROFITS
MAKE YOUR OWN
RUBBER
MOLDS

X.L. RUBBER MOLDS

will realize your great profits quickly!
WRITE FOR NEW FREE CATALOG

YOU can EASILY learn to cast thousands of perfect plaques, book ends, figurines, ash trays, etc. IT'S EASY, FUN, PROFITABLE! X.L. Rubber, Pts. \$2.50; Qts., \$4.00 (postage extra). Models and enough for 3 molds \$1.50 prepaid.



SEND FOR FREE FACTS

PLASTIC ARTS STUDIO

Address Dept. 2
3403 S. Madison St.

Muncie, Ind.

What Every Farmer Should Know About
Taking Care of **Farm Animals**



The Most Popular Veterinary Guide Ever Printed

This practical and helpful **VETERINARY GUIDE FOR FARMERS** prepares the farmer to perform many routine veterinary tasks—provides quick information that can often save the life of an animal—prevents disease in herds—saves money on the farm in a hundred different ways.

Written in plain understandable language. It covers symptoms, causes of disease and prevention, and treatment of cattle, swine, sheep, horses and poultry and warns when to call in the professional veterinarian. Names, terms and phrases made clear in a separate section. Over 100,000 copies of this book are in use on American farms. 275 pages. Fully illustrated. Only \$3.95. Order today under money-back guarantee.

POPULAR MECHANICS PRESS, Dept. PM13
200 E. Ontario St. Chicago 11, Ill.



Introductory Offer
\$1.69

New WINDSHIELD WASHER

- LOWER IN COST
- EASIER TO INSTALL
- SIMPLER TO OPERATE

SEND NO MONEY

Guaranteed trouble free operation . . . outperforms \$8.95 custom models. Can't clog . . . easy to refill. Visible fluid supply. One filling cleans windshield 35 times. **TRY 10 DAYS ON YOUR CAR AT OUR RISK.** Money back if not delighted. Pay postman plus postage or enclose payment, we pay postage. Act now . . . this low price can't last.

YOUNG PRODUCTS
Dept. 1045
2605 ELMHURST AVENUE
DETROIT 6, MICHIGAN

I'm going to name him Champ, Dad!

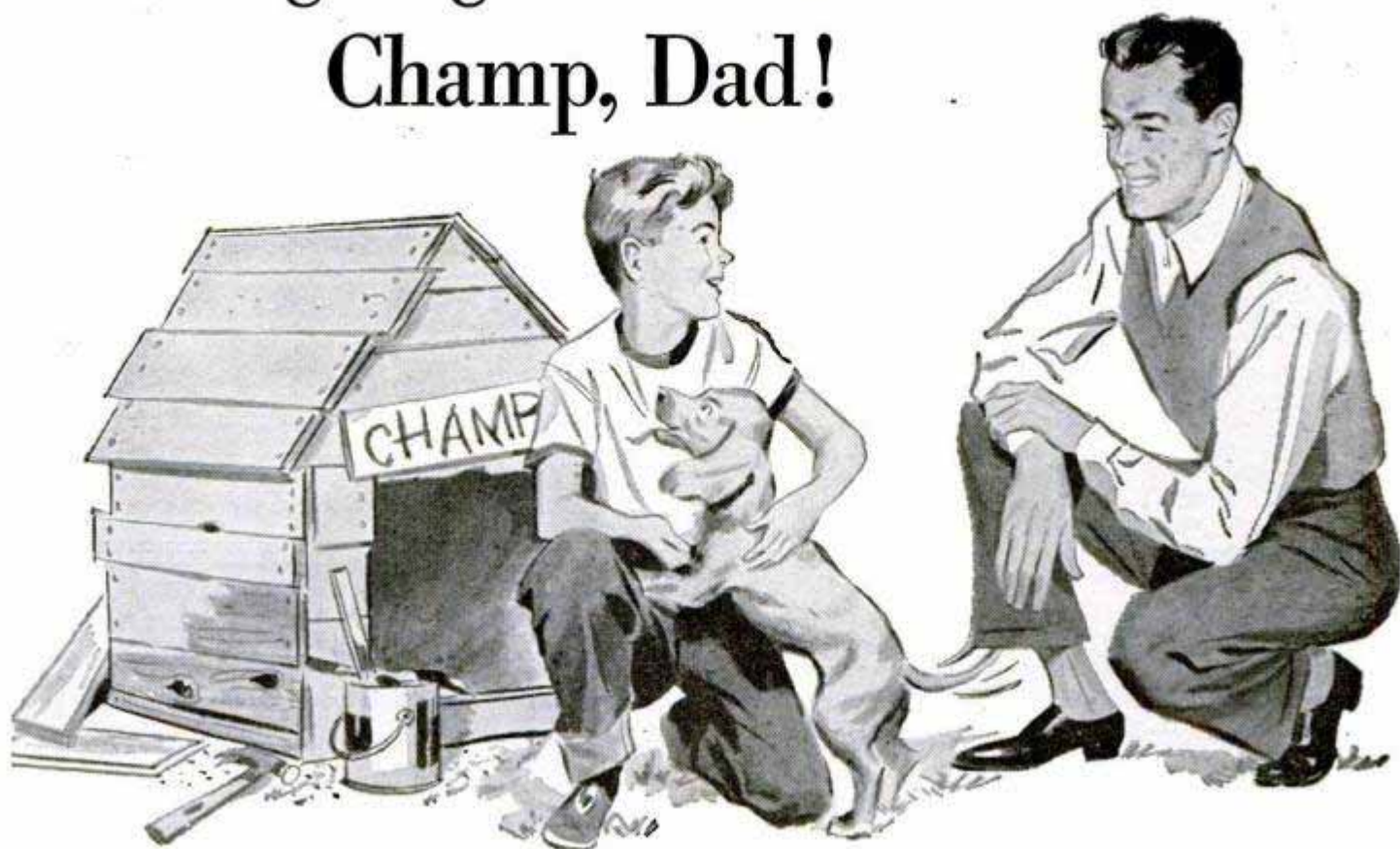

Yes — pups, people or products — names play a very important part in our everyday lives.

Today, our standard of living is greatly enriched by our system of competing brand names.

What do these names mean to you? A great deal, because they really make you — and every consumer — the *boss*.

When a manufacturer proudly signs his name to his product, he knows that he has to win your faith in that name.

Only through satisfying you, can he be sure that you will buy again — *and again!*

That's the main reason why manufacturers of branded and advertised products carry on continuous programs of research and product improvement. That's why winning your favor is the full time job of thousands of scientists and testing engineers, and the sole purpose of laboratories and experimental plants in every division of industry where trade-marking is practiced.

Yes, in the factories of the brand-makers, yours is the final word. Your free choice of branded products makes you the boss of the greatest manufacturing system in the world.

Brand Names Foundation
INCORPORATED

A NON-PROFIT EDUCATIONAL FOUNDATION • 37 WEST 57TH STREET, NEW YORK 19, N. Y.

JOIN THE FUN—SAVE 50%

PACKAGED BOAT KITS



OUTBOARD CRUISERS from \$349.50

EASY TO ASSEMBLE



SEA-GOING SERIES from \$168.50



OUTBOARD RACERS from \$119.95

► World's finest, most complete line of real performance boat kits! 27 exciting new models: Dinghies, Skiffs, Pontoon Racers, sleek Runabouts, roomy Outboards, Cruisers. Tops in design, styling, construction. Exclusive features for easier, more rapid assembly. Philippine Mahogany pre-assembled frames, brass screws. Easy to follow instructions.

► SEND 25¢ FOR 28 PAGE CATALOG. All 27 models fully illustrated including specifications, performance data plus complete line of marine hardware and paints.

BOAT PLANS AND FULL-SIZE PATTERNS

Over 100 Modern plans and full size patterns. Racing classes, cruisers, inboards, outboards, sail boats. By famous designers. 6' to 30'. DESIGN CATALOG only 35¢. For Design Catalog plus boat building handbook send \$1.00.

CUSTOM-CRAFT (DEPT. A) BUFFALO 7, N. Y.

PLEASE SEND ME

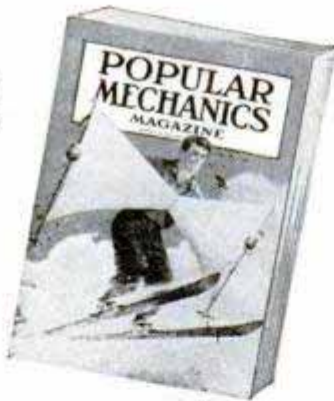

for the time checked.
I am enclosing . . .

1 year \$3.50
2 years \$6.00

name _____
address _____
city _____ zone _____ state _____ C-13

Hand this order to your newsdealer or send it to
POPULAR MECHANICS
200 East Ontario St. Chicago 11, Ill.

Amazing NEW MOTORLESS TV Antenna

Super Powerful All Channel TV RECEPTION IN ALL DIRECTIONS

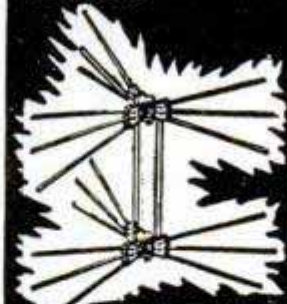

Rocket DIRECTRONIC MOTORLESS TV ANTENNA

360° Electronically Switched Beam

- No Motors
- No Roof
- Orientation
- No Electric Power
- No Ghosts
- Flick of Switch Clears Picture Instantly

In the city or in an ultra-fringe area, the Directronic will out-perform ordinary antennas. Only the Motorless 360° Directronic TV Antenna offers "around the compass" reception WITHOUT Rotors. Clarity of picture will amaze, it's so bright, so sharply defined. AX-599 "Serviceman's Array" contains Hi-Pac molded insulator of extremely high tensile strength, 18 hi-tensile aluminum alloy elements, 1 set of connecting stubs (3), Universal U-Clamps for masts to 1 1/2", Directronic Beam Selector, 75 feet of Tri-X Cable.

AX-599 Directronic \$16.95 You pay postage

Do not remit more than complete purchase price. 25% deposit on C.O.D. orders, please. Money-back guarantee.

NATIONAL ELECTRONICS OF CLEVELAND
301 DELCO BLDG. CLEVELAND 3, OHIO

PROFITABLE HOME BUSINESS SPARE OR FULL TIME

LEARN FROM EXPERIENCED INVISIBLE REWEAVER HAVE YOUR OWN REWEAVING STUDIO AT HOME. Reweaving Burns, Tears, Moth Holes, Etc. — LIKE NEW. Big profit orders come from Homes, Cleaners, Dept. Stores—also mail orders. Up to \$5 an hour possible, spare time. No previous experience or expense for materials. Examine complete instructions at home, without risk. FREE details—write NOW. SKIL-WEAVE, Suite 501, 1717 Westwood, Los Angeles 24

THIS HOME CRAFT PAID ME \$1,500 FOR A SINGLE ORDER



"SURE SHOT GUN CASE TREATMENT"

A new proven chemical process that prevents RUST ON GUNS

It's radically different. The case is treated instead of the gun. This odorless chemical vaporizes slowly. The vapor seeks out and attaches itself as an invisible rust preventing film, to all metal gun parts, including the action and bore. Protection is complete. A \$1.00 2 fl. oz. bottle treats one gun case for one year. Money back guarantee. At your dealer or direct from—
BAYPORT CHEMICAL COMPANY, DEPT. 26
LINDEN HILLS STATION, MINNEAPOLIS 10, MINN.



Treasure and Minerals

Easily located with new Lightweight M-Scope Detector. Superior performance, lowest price, monthly payment plan.

FREE LITERATURE
FISHER RESEARCH LAB., INC.
PALO ALTO CALIF.

SAY YOU SAW IT IN POPULAR MECHANICS

French STYLE DUELING SWORDS

Once used in deadly combat—now an exciting sport! Learn right at home. Fun—safe—educational. These swords are made of fine blue spring steel, polished metal guards, turned handles, rubber safety tips. Fencing teaches quick thinking, develops coordination, posture. Since the Middle Ages, Europeans have enjoyed the sport of dueling. *Now advocated by U.S. colleges. Set includes two swords and the booklet, "The Art of Fencing". Special price. MONEY BACK IF NOT COMPLETELY SATISFIED

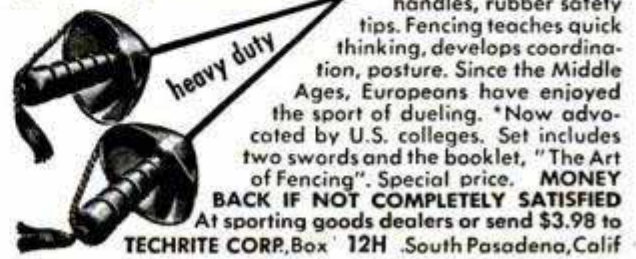

At sporting goods dealers or send \$3.98 to
TECHRITE CORP., Box 12H, South Pasadena, Calif

BLUE-WHITE & HARD



It Doesn't SCRATCH, CHIP or BREAK!

SENSATIONAL New Ultra-Brilliant GERMAN Synthetic Gem

HERE IT IS!! BLUE WHITE and HARD MAGA-LU-X, the marvelous new German product rumored late in 1952. Laymen and tradespeople alike when shown MAGA-LU-X and diamonds in their selections. The spectrograph test is a positive identification. MAGA-LU-X completes the search for BLUE-WHITE and HARDNESS as well as Brilliance. Here are some facts about MAGA-LU-X . . . BLUE-WHITE and HARD . . . Some specific gravity as diamonds. Same dia. MAGA-LU-X weighs 1 carat . . . Like diamonds and unlike a previous synthetic, MAGA-LU-X works equally well in Triangle, Square, Marquise, Emerald and Baguette shapes as well as 58 facet Brilliant . . . Laboratory made MAGA-LU-X is flawless . . . Standard 58 facet American cutting system used by painstaking German craftsmen . . . Hand worked throughout . . . Guaranteed not to Scratch, Chip or Break MAGA-LU-X may be worn continuously at work or play . . . BLUE-WHITE and HARD MAGA-LU-X is not detracted from by DAYLIGHT, a significant test failed by an earlier synthetic; the natural sparkle of MAGA-LU-X needs no artificial light beams to force-feed its facets . . . HARD MAGA-LU-X can be set anywhere by almost anyone having a setting; MAGA-LU-X doesn't fracture when the prongs are positioned; a wide field is opened for the amateur . . . Ideal for jewelers equipped only for diamond setting in gold and platinum settings. The sharp point or cleft of a MAGA-LU-X 58 facet Brilliant will scratch glass repeatedly without itself being affected. In sizes 1 through 4 carats and intermediate fractions. Triangle, Square, Marquise, Emerald, Baguette and 58 facet Brilliant cuts, \$15.00 per carat. Add 20% federal diamond tax. Smaller than 1 carat sizes for side stones 50% additional. Replacement stones for your present settings, to exact millimeter specifications, 15% extra. Do NOT send settings. Use paper diagrams. 35¢ shipping charge per order. Sent insured mail, plain package. Literature not available since above information is maximum permissible without disclosing confidential manufacturing processes. MAGA-LU-X can be ordered or purchased only from STARFIRE Corporation. On display and sale at our office. Guaranteed not to Scratch, Chip or Break. STARFIRE CORP., Suite 704, Dept. B, 570 7th Ave., New York 18, N. Y.

GO IN BUSINESS—FULL OR SPARE TIME Learn UPHOLSTERING

Earn Money as You Train

Our exclusive Home Training Plan teaches you to upholster every type of chair, sofa, ottoman. Easy, picture lessons make every step simple. You get experience as you train because we send complete tool set and materials to build ottoman. Make money as you learn, get a business started by time you graduate. Write today for valuable, free booklet.



COMMERCIAL TRADES INSTITUTE

1400 Greenleaf Avenue • Chicago 26, Ill. • Dept. U2-1

A REAL MINIATURE OUTBOARD MOTOR



Here's something for loads of fun at a low price! A genuine, precision-made "IMP" OUTBOARD MOTOR only 4 3/4" high. It's SAFE! It's not a TOY! It's PRE-TESTED! It runs on regular flashlight batteries! It attaches to boat models! Replacement parts are always available. **\$3.50** POSTPAID ONLY

Send check or money order to

HOBBYSPTS Box 104, Flushing, N.Y.

Increase gas mileage!

FREE TRIAL IN YOUR CAR

ABOUT 1/2 MILLION NOW IN USE. Most users who write us swear by them and some report up to 25% more mileage. Many comment on Smoother Motor, Easier Starting, Faster Pick-Up, Better Idling. But some swear at them with "No Improvement" and fire "the little stinkers" back—proving Ganes can and do sometimes fail completely. So we invite you to try "the little stinkers" at "no cost," to see what they will do for you. Make NO deposit. Send NO money. Pay postman NOTHING. TRY BEFORE YOU BUY—10 DAY FREE TRIAL OFFER. You, or your service station, can quickly install them.

USE GANES 10 DAYS—Check for increased gas mileage which must average 2 or more extra miles per gallon. At the end of ten days send us only \$1.50 per Gane Needle or else send them back and owe nothing! Just send your name, address and the year and make of your car to:



OCTA-GANE, Inc. Dept. GP-1, 6051 1/2 W. Las Tunas San Gabriel, Calif.

GREER SHOP TRAINING

2230 So. Michigan Blvd. Chicago 16, Illinois

Leader in Practical Training for 50 Years

Gain success by learning a trade offering security and high pay—go into business for yourself.

Get the "Know-how" at Greer

You learn in our new, large, modern shops by working with latest tools and equipment of the trade — tear down, inspect, repair and rebuild . . . under supervision of experts. Greer founded 1902. Over 51,000 successful grads. Part time, full time, day and evening. E-Z terms. Mail coupon today.

CLIP COUPON . . . MAIL TODAY
Greer Shop Training—2230 South Michigan Chicago 16, Illinois Desk 213

Please send information about trade checked:

- In our Chicago Shops: Auto Mechanics
 Body, fender Repair Diesel Mechanics
 Welding—Arc, gas Tool & Die
 Refrigeration & Air-conditioning
 Machine Shop Piano tuning
G.I. appr. for Vets dischgd. after 7-25-47

Or learn at home—extension courses:

- Diesel Refrigeration Plastics
 Check if Veteran

Name _____
Address _____
City _____
State _____ Age _____



SAVE MONEY · SAVE FUEL · BE WARMER

STORM WINDOWS

OF GENUINE **DUPONT** CELLULOSE ACETATE

● CLEAR AS GLASS
No cloudy vinyl plastic effect—but as transparent as the windows it covers.

● INSTALL IN MINUTES . . . FROM INSIDE
Scissors and Scotch tape are all you need. No climbing ladders for outside installation! No marring of window sills with tacks. Simply tape on . . . as easy as mending a page!

● PERMITS AIRING OF ROOMS
Just lift off tape when open window is desired . . . Replace when window is closed.

100% AIRTIGHT — Used by the U.S. Gov't. Fit any window. Roll size 36" x 288". Sheets easily taped together to cover wider windows. Completely waterproof . . . Instructions furnished. They'll pay for themselves many times over in fuel savings alone. Fill in and mail the coupon TODAY.

5 WINDOWS for \$6 POSTPAID



SEND NO MONEY!

Pay Postman YOUR MONEY BACK IN FULL IF RETURNED IN 10 DAYS

T. C. TOR, 2113 Bellevue St. Phila. 40, Pa., Dept. PM 4
GENTLEMEN: Please ship immediately () rolls (ea. roll 36" x 288") — at \$6. per roll of TOR Plastic Storm Windows . . . ea. roll enough for five average size storm windows — with instructions.
() I will pay postman \$. . . plus few cents postal collection fee.
() Am enclosing payment here-with (saving collection cost)
Name _____
Address _____
City _____

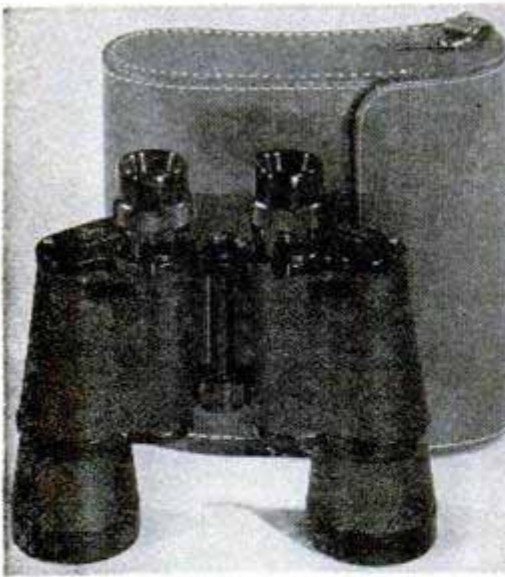

Precision Binoculars at CUT Prices!

COATED • PRISMATIC • COLOR BALANCED

Absolute MONEY BACK Guarantee!

Look to old reliable Thoresen's for fine Binoculars at deep-cut prices. Every binocular listed is COATED, ACHROMATIC and PRISMATIC! Best of all, they are FOCUS BALANCED, a Thoresen feature that gives enjoyable viewing without annoying aberrations. All have pigskin or fine calf carrying cases & 2 straps. We defy ANY competitor to match this quality or prices!

NOTE — ALL PRICES FULLY TAX PAID — NOTE

- 7 x 50 mm Individual Focus (No. 157) **33.95**
- Tax PAID
- 7 x 50 mm Center Focus (No. 153) **39.85**
- Tax PAID
- 6 x 15 mm Tiny Pocket Size (No. 154) **16.75**
- Tax PAID
- 8 x 30 mm Center Focus (No. 146) **38.50**
- Tax PAID
- 20 X Telescope, Light Pocket Size. **8.65**
- POWERFUL!

Send check or money order for quick prepaid delivery. COD's plus post. 5 Day Money Back Guarantee! Why pay more? Buy the Thoresen's way and SAVE!

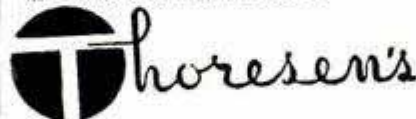

140 Fifth Ave.
Dept. 7-A-500
New York 11, N. Y.

SPECIAL!
16x50 mm
COATED
CENTER
FOCUS **66⁵⁰**
Tax Paid

LOOK!
10x50 mm
COATED
I. F. **49⁹⁵**
Tax Paid



TALK-SING-PLAY OVER YOUR RADIO

with the real Radio Mike! Attaches in a jiffy — full instructions given! Swell for "parties"—"cut in" on or "kid" regular network programs or put on your own broadcasts! Amaze your friends—real fun. Beautiful Metallic Plastic 6 in. high!

12 RADIO BROADCAST LESSONS GIVEN with each mike
SEND NO MONEY Just pay postman \$3.99 COD plus postage or send \$3.99 and we pay postage! Radio Mike is available only from us by mail—guaranteed.
Midway Co., Dept. MPM-1, Kearney, Nebr.



NEW! EXCITING! JET EXHAUST CUT-OUT

Now your car can sound off those exciting, dynamic tones — easily controlled mechanically from your dashboard. Channel your exhaust through special pipes or muffler without removing your original muffler. Easily installed. **MONEY BACK GUARANTEE.**

- MADE OF HEAVY PLATE STEEL
- UNIVERSAL—FITS ALL EXHAUSTS

Send \$3.95 check, cash, money order (postpaid) or C.O.D. plus postage to:
FUR SALES, 1031 E. 63rd St., Chicago 37, Ill. Dept. PM
Dealer Inquiries Invited

Secrets of VENTRILOQUISM Now Revealed!



Easy to learn in 60 to 90 days with our Home Study Course. **RESULTS GUARANTEED.** Make Money! Be Popular! Have Fun! Big Opportunity! Radio, Television, Stage Appearances! For FREE Information regarding price and terms, WRITE. You must state your age. Dummy Catalog 25c.
FRED MAHER SCHOOL OF VENTRILOQUISM
Box 36, Studio A Kensington Station
Detroit 24, Michigan

LOCKSMITHING & Key Making

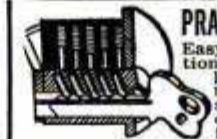

PRACTICAL UP-TO-DATE COURSE—ONLY \$4.95

Easy-to-learn modern information for self-instruction. How to work on locks, de-code, make master-keys, repair, install, service, etc. For every handyman, home owner, carpenter, mechanic, service station operator, fix-it shop, hardware dealer, gunsmith. 53 plain illustrated lessons. **FULL PRICE ONLY \$4.95. SEND NO MONEY.** Just pay postman plus C.O.D. postage. Or send \$4.95 with order, we'll ship postpaid. Satisfaction guaranteed or refund.
NELSON-HALL CO., 210 S. Clinton Ct., Dept. AX-2, Chicago 5, Ill.

Say You Saw It in Popular Mechanics

PORTABLE GARAGE

\$6.75 Plastic Vinyl
USE IT ANYWHERE

- Folds compactly • Keeps rain, snow, dust, salt air, sun or sleet away
- Protects your car's finish • Durable construction of vinyl plastic
- Springtite elasticized bottom, holds securely in all kinds of weather • Fits all makes • Direct from manufacturer
- Enclose check or money order for 6.75, or sent C.O.D. 10-Day Money Back Guarantee.



MARDO SALES CORP.

480 LEXINGTON AVE., Dept. G-979 NEW YORK 17, N. Y.

REVERSIBLE AUTO SEAT COVERS

Made of FLEXTON plastic.
Choice of: SNAKE-ZEBRA DESIGN
or LEOPARD-COWHIDE DESIGN

ORDER FROM MFR. AND SAVE
Colorful SNAKE AND ZEBRA DESIGN And LEOPARD-COWHIDE DESIGN. Can Be Used On Either Side. Water And Stainproof. Tailored With Side Grip Panels For Tight Fit. Sewn With NYLON Thread For Long Wear. Simple To Install. Dress Up Your Car With A Set Of Either Of These Colorful Expensive Looking Covers!

10 DAY MONEY BACK GUARANTEE

Choice Of SPLIT Or SOLID Front Seat Only \$2.98.
Complete Set For Both Front & REAR ONLY \$5.00.
When Ordering Specify Choice Of Design Wanted, Make of Car And Seat Style. Enclose Payment And Save Postage Or Sent COD.

MARDO SALES CORP. Dept. DS-979
480 Lexington Ave., New York 17, N. Y.



Each Only
\$2⁹⁸

GET THIS SUIT AS A BONUS!

Make up to \$10-\$15 daily

Sell popular Smith tailored-to-measure suits. Make up to \$10-\$15 daily, plus extra CASH bonuses, plus your own suit as added bonus. No experience needed. Send for FREE selling kit and sample line. Send no money. Write fully, state age, etc.

W. D. SMITH & CO.

Dept. D, 833 W. Jackson Blvd., Chicago 7, Ill.



TRAILER COACHES

Here's everything you want to know about trailers, with plenty of pictures and plans and instructions for building three different types. Covers also, history of trailers, trailer parks, camps and overnight-stops information, furniture, furnishings, materials and engineering data. If you want to build a trailer, live in a trailer, or just want to know more about trailers, get this book. Only \$1.50 postpaid. Rush order to:

Build it Yourself!

Complete Trailer Book and Construction Data for 10, 16 and 22 Foot Trailers — Only \$1.50

Partial Contents

Trailer Parks—Living in a Trailer—Towing a Trailer—Floor Plans—Service—Classifications—Balance—Dollies—Jacks—Weight Distribution—Construction—Working Drawings for a Two-Place, Standard Travel and Standard Dwelling Trailers. Size 8 1/2 x 11 1/4 inches.

POPULAR MECHANICS PRESS • Dept. 350, 200 E. Ontario St., Chicago

Now you've GOT to make more money!



Your first-born son!
How does it feel to hold that wee bundle of life in your arms and plan for his future?

You want to give that boy of yours a break. You want him to have every advantage you can give him. But to do that you'll have to have more money. You'll have to snap out of the rut—and quick!

How does a young father get bigger pay? Promotion to a new and better job takes special training. Fortunately for you there's a way

to get that training *right in your own home*. International Correspondence Schools offers 391 different courses, and one of them is the course you need. This famous school has helped 5,918,632 men and women train for success!

Studying an I. C. S. course at home lets you earn while you learn. You can move ahead as fast as you like, with no slow classmates to hold you back. Lessons are clear, understandable and thorough, and able instructors answer your questions personally. Many of the courses are listed below. Check the one that will help you most, sign the coupon and mail it *today*. We'll send you full information plus free book, "How to Succeed."

INTERNATIONAL CORRESPONDENCE SCHOOLS



BOX 5558-L, SCRANTON 9, PENNA.

Without cost or obligation, send me "HOW to SUCCEED" and the booklet about the course BEFORE which I have marked X:

- | | | | | |
|--|---|--|---|--|
| <p>ART</p> <ul style="list-style-type: none"> <input type="checkbox"/> Commercial Art <input type="checkbox"/> Magazine and Book Illustrating <input type="checkbox"/> Cartooning <input type="checkbox"/> Show Card and Sign Lettering <input type="checkbox"/> Fashion Illustrating <p>AUTOMOTIVE</p> <ul style="list-style-type: none"> <input type="checkbox"/> Automobile, Mechanic <input type="checkbox"/> Auto-Elec. Technician <input type="checkbox"/> Auto Body Rebuilding and Refinishing <input type="checkbox"/> Diesel—Gas Engines <p>AVIATION</p> <ul style="list-style-type: none"> <input type="checkbox"/> Aeronautical Engineering Jr. <input type="checkbox"/> Aircraft Engine Mechanic <input type="checkbox"/> Airplane Drafting <p>BUILDING</p> <ul style="list-style-type: none"> <input type="checkbox"/> Architecture <input type="checkbox"/> Arch. Drafting <input type="checkbox"/> Building Contractor <input type="checkbox"/> Estimating <input type="checkbox"/> Carpenter and Mill Work <input type="checkbox"/> Carpenter Foreman <input type="checkbox"/> Reading Blueprints <input type="checkbox"/> House Planning <input type="checkbox"/> Plumbing | <ul style="list-style-type: none"> <input type="checkbox"/> Heating <input type="checkbox"/> Steam Fitting <input type="checkbox"/> Air Conditioning <input type="checkbox"/> Electrician <p>BUSINESS</p> <ul style="list-style-type: none"> <input type="checkbox"/> Business Administration <input type="checkbox"/> Certified Public Accountant <input type="checkbox"/> Accounting <input type="checkbox"/> Bookkeeping <input type="checkbox"/> Stenography and Typing <input type="checkbox"/> Secretarial <input type="checkbox"/> Federal Tax <input type="checkbox"/> Business Correspondence <input type="checkbox"/> Personnel and Labor Relations <input type="checkbox"/> Advertising <input type="checkbox"/> Retail Business Management <input type="checkbox"/> Managing Small Business <input type="checkbox"/> Sales Management <input type="checkbox"/> Salesmanship <input type="checkbox"/> Traffic Management <p>CHEMISTRY</p> <ul style="list-style-type: none"> <input type="checkbox"/> Chemical Engineering <input type="checkbox"/> Chemistry <input type="checkbox"/> Analytical Chemistry <input type="checkbox"/> Petroleum—Nat'l Gas <input type="checkbox"/> Pulp and Paper Making <input type="checkbox"/> Plastics | <p>CIVIL, STRUCTURAL ENGINEERING</p> <ul style="list-style-type: none"> <input type="checkbox"/> Civil Engineering <input type="checkbox"/> Structural Engineering <input type="checkbox"/> Surveying and Mapping <input type="checkbox"/> Structural Drafting <input type="checkbox"/> Highway Engineering <input type="checkbox"/> Reading Blueprints <input type="checkbox"/> Concrete Construction <input type="checkbox"/> Sanitary Engineering <p>DRAFTING</p> <ul style="list-style-type: none"> <input type="checkbox"/> Aircraft Drafting <input type="checkbox"/> Architectural Drafting <input type="checkbox"/> Electrical Drafting <input type="checkbox"/> Mechanical Drafting <input type="checkbox"/> Structural Drafting <input type="checkbox"/> Sheet Metal Drafting <input type="checkbox"/> Mine Surveying and Drafting <p>ELECTRICAL</p> <ul style="list-style-type: none"> <input type="checkbox"/> Electrical Engineering <input type="checkbox"/> Electrician <input type="checkbox"/> Electrical Maintenance <input type="checkbox"/> Electrical Drafting <input type="checkbox"/> Electric Power and Light <input type="checkbox"/> Lineman <p>HIGH SCHOOL</p> <ul style="list-style-type: none"> <input type="checkbox"/> High School Subjects | <ul style="list-style-type: none"> <input type="checkbox"/> College Preparatory <input type="checkbox"/> Mathematics <input type="checkbox"/> Commercial <input type="checkbox"/> Good English <p>MECHANICAL AND SHOP</p> <ul style="list-style-type: none"> <input type="checkbox"/> Mechanical Engineering <input type="checkbox"/> Industrial Engineering <input type="checkbox"/> Industrial Supervision <input type="checkbox"/> Foremanship <input type="checkbox"/> Mechanical Drafting <input type="checkbox"/> Machine Design-Drafting <input type="checkbox"/> Machine Shop Practice <input type="checkbox"/> Tool Design <input type="checkbox"/> Industrial Instrumentation <input type="checkbox"/> Machine Shop Inspection <input type="checkbox"/> Reading Blueprints <input type="checkbox"/> Toolmaking <input type="checkbox"/> Gas—Electric Welding <input type="checkbox"/> Heat Treatment—Metallurgy <input type="checkbox"/> Sheet Metal Work <input type="checkbox"/> Sheet Metal Pattern Drafting <input type="checkbox"/> Refrigeration <p>POWER</p> <ul style="list-style-type: none"> <input type="checkbox"/> Combustion Engineering <input type="checkbox"/> Diesel—Electric <input type="checkbox"/> Electric Light and Power | <ul style="list-style-type: none"> <input type="checkbox"/> Stationary Steam Engineering <input type="checkbox"/> Stationary Fireman <p>RADIO, TELEVISION, COMMUNICATIONS</p> <ul style="list-style-type: none"> <input type="checkbox"/> General Radio <input type="checkbox"/> Radio Operation <input type="checkbox"/> Radio Servicing—FM <input type="checkbox"/> Television <input type="checkbox"/> Electronics <input type="checkbox"/> Telephone Work <p>RAILROAD</p> <ul style="list-style-type: none"> <input type="checkbox"/> Locomotive Engineer <input type="checkbox"/> Diesel Locomotive <input type="checkbox"/> Air Brakes <input type="checkbox"/> Car Inspector <input type="checkbox"/> Railroad Administration <p>TEXTILE</p> <ul style="list-style-type: none"> <input type="checkbox"/> Textile Engineering <input type="checkbox"/> Cotton Manufacture <input type="checkbox"/> Rayon Manufacture <input type="checkbox"/> Woolen Manufacture <input type="checkbox"/> Loom Fixing <input type="checkbox"/> Finishing and Dyeing <input type="checkbox"/> Textile Designing <p>HOME ARTS</p> <ul style="list-style-type: none"> <input type="checkbox"/> Dressmaking and Designing <input type="checkbox"/> Cookery <input type="checkbox"/> Tea Room Management |
|--|---|--|---|--|

Name _____ Age _____ Home Address _____
 City _____ State _____ Working Hours _____ A.M. to _____ P.M.
 Occupation _____

Special tuition rates to members of the Armed Forces. Canadian residents send coupon to International Correspondence Schools Canadian, Ltd., Montreal, Canada



WHY PAY MORE for an ELECTRIC SHAVER?

WHISK AWAY EVEN A 7 DAY BEARD
WITH THE WHISKER ELECTRIC SHAVER

Precision-built,
with .002"
thin blade that
shaves all
beards
smoothly,
closely.



Whether you shave once a day,
or once a week you'll like Whisker Electric Shaver.
Its clipper-like blade is designed for all beards,
is definitely less irritating. 110v AC model; no TV
or radio interference. See your barber or dealer.
If he cannot supply you, send \$15.95—we pay
postage; or send \$2, you pay balance plus postage
and COD. 10-day money-back guarantee.



CADET ELECTRIC HAIR CLIPPER
Cuts hair, removes superfluous
hair from legs and under arms.
The same fine quality clipper
used and sold in many beauty
shops. See your shop, or dealer.
If you prefer, send \$10.95—we
pay postage; or \$2, you pay post-
man balance, postage and C.O.D.

ELECTRO TOOL CORP., Dept. W523-A, Racine, Wis.

SEND ME

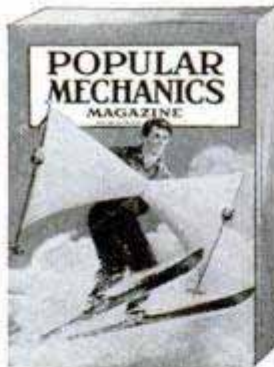

every month so I am sure to
see each new issue. Here's

- \$3.50 for 1 year
- \$8.00 for 3 years

name _____

address _____

city _____ zone _____ state _____ B-13

Hand this order to your newsdealer or send it to

POPULAR MECHANICS
200 East Ontario St. Chicago 11, Ill.

WHAT GOOD IS A TIRE WITHOUT A TUBE?
TUBE GIVEN WITH EVERY TIRE AT NO EXTRA COST



Why Pay More!

WINTER SPECIALS—AT LOW PRICES
SAVE TIME — SAVE MONEY — SEND THIS AD
GOOD USED TIRES — NOT RECAPS
20 YEARS AT THIS ADDRESS
Be Wise—A TRIAL OF ONE TIRE WILL
CONVINCE YOU.



EVERYBODY 10% off ON EVERY TIRE
MAY TAKE 20 MONTHS WRITTEN GUARANTEE

600-16 \$4.12	820-15 \$5.32	600-20 \$7.02	32x8(8) \$8.52
650-16 5.52	700-15 4.52	650-20 7.82	32x8(10) 9.82
700-16 5.02	670-15 4.42	700-20 8.42	900-20 13.12
650-15 4.32	710-15 4.62	750-20 8.52	1000-20 13.72
760-15 4.92	550-17 4.42	825-20 14.62	1100-20 13.62

EXTRA SPECIAL — 30 MONTH WRITTEN GUARANTEE

600-16 \$5.32	475-19 \$4.82	700-15(6) \$8.92	700-20 \$11.02
600-16(6) 6.42	640-15 5.02	750-16(8) 10.72	750-20(10) 15.42
650-16 5.82	670-15 5.52	700-17 9.92	750-20(8) 15.02
650-16(6) 7.32	710-15 5.72	750-17 11.72	825-20 18.32
700-16 6.42	760-15 6.02	750-15 13.92	900-20 17.22
750-16 9.22	800-15 6.52	825-15 12.92	1000-20 17.72
525-18 4.72	820-15 6.62	600-20 8.72	1100-20 19.52
550-17 4.72	670-16 6.32	650-20 10.22	1000-22 19.42
650-15 5.32	760-16 7.12	32x6(8) 11.12	1100-22 20.42
700-15 5.42	700-16(6) 7.62	32x6(10) 11.72	1100-22 20.42
White Walls \$1.00 extra		Military treads	750-20 16.12

Thousands of tires shipped all over U.S.A. All tires shipped
F.O.B. Phila. Send Check or M.O. with this ad. Dept. 2.

STANDARD 834 N. Broad St., Philadelphia 30, Pa.

RAISE GIANT FROGS BIG DEMAND

Nufend
Giant



MILLIONS USED YEARLY!

Frogs sell \$5 dozen. Breeder lays
up to 20,000 eggs yearly. Season just
starting! Men & Women get ready now
for this year's eggs. Small pond starts
you. New book tells how! Send for il-
lustrated FREE folder today. Write to
MARLBORO HOUSE-7
1035 Marlborough Detroit 15, Mich.

**REPAIR YOUR TELEVISION SET WITH EASE
AND MAKE MONEY IN YOUR LOCALITY**
We Guarantee To Show You in Minutes
Without Experience . . . We Show You How
to quickly locate and change all defective tubes
with complete safety in your set and other
sets. How to repair 90%
of troubles . . . SEND ONLY \$1.00 ANTEE

ANDERSON TV SHOP, 5146 No. Broadway, Dept. P-1, CHICAGO 40

STOP FORGETTING

STOP FORGETTING names,
faces, dates, appointments!
Scientific SUPER-MEMORY
can be YOURS! Enjoy great-
er popularity and success! Don't delay . . .
start on the road to super memory im-
mediately! Quick, complete course only
\$3.00! Send for it today!



MEMORY INSTITUTE — BOX 261 B
Staten Island 1, N.Y.

Play GUITAR in 7 DAYS

OR GET YOUR MONEY BACK! Let Ed Sale
teach you to play with his famous 66 page
diagram photo system. Contains 52 photos,
87 diagrams, showing exactly how to place
your fingers. Over 100 Hillbilly, Popular, and
Western songs, words and music—along with com-
plete, easy to learn instructions. Imagine your joy
when you find after 7 days you are playing beautiful
music! Amaze your friends! Be the life of the party! SEND
NO MONEY. Pay Postman \$1.98 Plus Postage or send \$2 and I pay
postage. (Same guarantee.) ED SALE, Studio 1904, Bradley Beach, N.J.

You Are Invited to Join the INTERNATIONAL TRADERS GUILD

Free to new members of the International
Traders Guild - many unusual, useful prod-
ucts from France, Japan, Germany and other
foreign lands, and trade bulletins listing
hundreds of import bargains to sell at high
U. S. prices. Also requests from overseas
buyers for U. S. exports. Opportunity, men-
-women, profitable, world-wide, mail order
business at home; or travel abroad; no cap-
ital needed. 2,000 members in 42 countries.
7th successful year. FREE details. Mellinger Co.,
Suite 251, 1717 Westwood, Los Angeles 24, Calif.



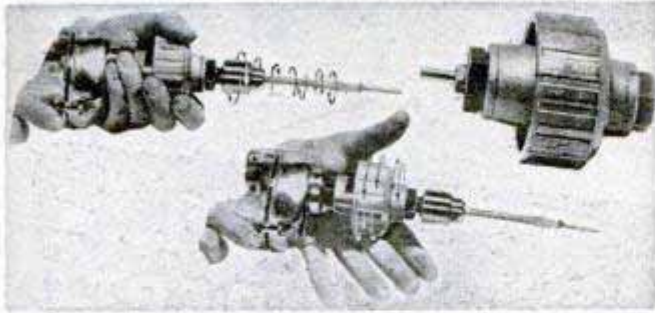

Babco 5-to-1 Speed Reducer Fits 1/4" Drills
Convert your 1/4" electric drill to electric screw-driver—drill holes to 1 1/4" in wood, to 1/2" in masonry. Planetary gear system provides tremendous torque increase. Instant starting, stopping with hand clutch control. To operate tool, simply grip reducer; release to stop. \$9.95 ppd. Babcock Mfg. Co., 6251 Claremont Ave., Oakland 18, Calif.



Stamps for collectors—We are giving away FREE the above album, unique because of its historical and geographical data. We will also send 50 different U. S. stamps plus 100 foreign stamps from all over the world for only 25c, and will also include our unexcelled approval selection. Send your 25c today. Globus Stamp Co., Dept. 217, 268-4th Ave., New York 10, N. Y.

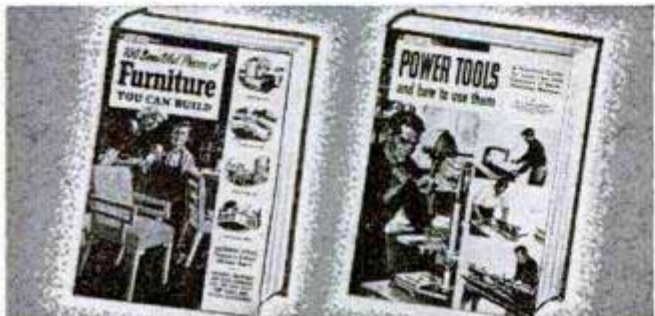

Books for the Craftsman—With designs by furniture stylist John Bergen, 100 Beautiful Pieces of Furniture You Can Build tells how to build furniture for the home at big savings. Price \$3.00. Power Tools and How to Use Them, a guide to selection and operation of homeshop tools. Price \$2.50. Popular Mechanics Press, 200 E. Ontario St., Chicago 11, Ill.



You Save \$\$\$ With These Plan Books
—Get new, exciting ideas from these books. **Harmonious Homes**—mostly homes, some income property; all styles, \$1. **Small Homes (Vol. I, II, III)** \$1 ea. **New! Ranch & Country Homes**, \$2. All 5—\$4.50. No COD's. Complete Home Plan Service, 17261-79 Osborne St., Northridge 1, Calif.



Corkeroo Pipe—Lighter, sweeter smoking than a corn cob! Big genuine cork bowl is lined with "Meeracle," a material like costly meerschaum. Bamboo stem, with hard-rubber mouthpiece. Never burns out—lasts a lifetime. Weighs less than an ounce. Send check or money order, no C.O.D.'s. 3 for \$1.15 ppd. Bell Industries, Dept. M-12, 21 East 22nd St., New York 10, New York.



Flea-No-Mat Protects Children by keeping pets clean. Flea-no-mat rids pets of fleas and ticks; counteracts dog odor. A chemically treated mat for use on the pet's regular bed or separately. No messy powdering—pleasant clean odor. Only \$2.95 for 15"x28" mat—\$4.95 for 28"x36" mat. Kennel-tested by Vets. Money back guar. Send chk. or m.o. to V. F. Garrett Co., Box 1143-90, Dallas, Tex.

Take it EASY...

SMOKE P.A.
-MILD, TASTY
all the way

EASY
on your
TONGUE!

Prince Albert is specially treated by the patented* "No-Bite" process to insure against tongue bite!

EASY
to
DRAW!

Crimp cut Prince Albert packs just right in your pipe. Smokes cool, mild and mellow!

EASY
on your
POCKET-BOOK!

Prince Albert gives you more choice tobacco in every pocket tin. More smoking pleasure for your money!

EASY
TO ROLL!

You can't beat Prince Albert for a "makin's" cigarette! Rolls easy . . . stays put . . . doesn't dribble out the ends!

*Process Patented July 30, 1907

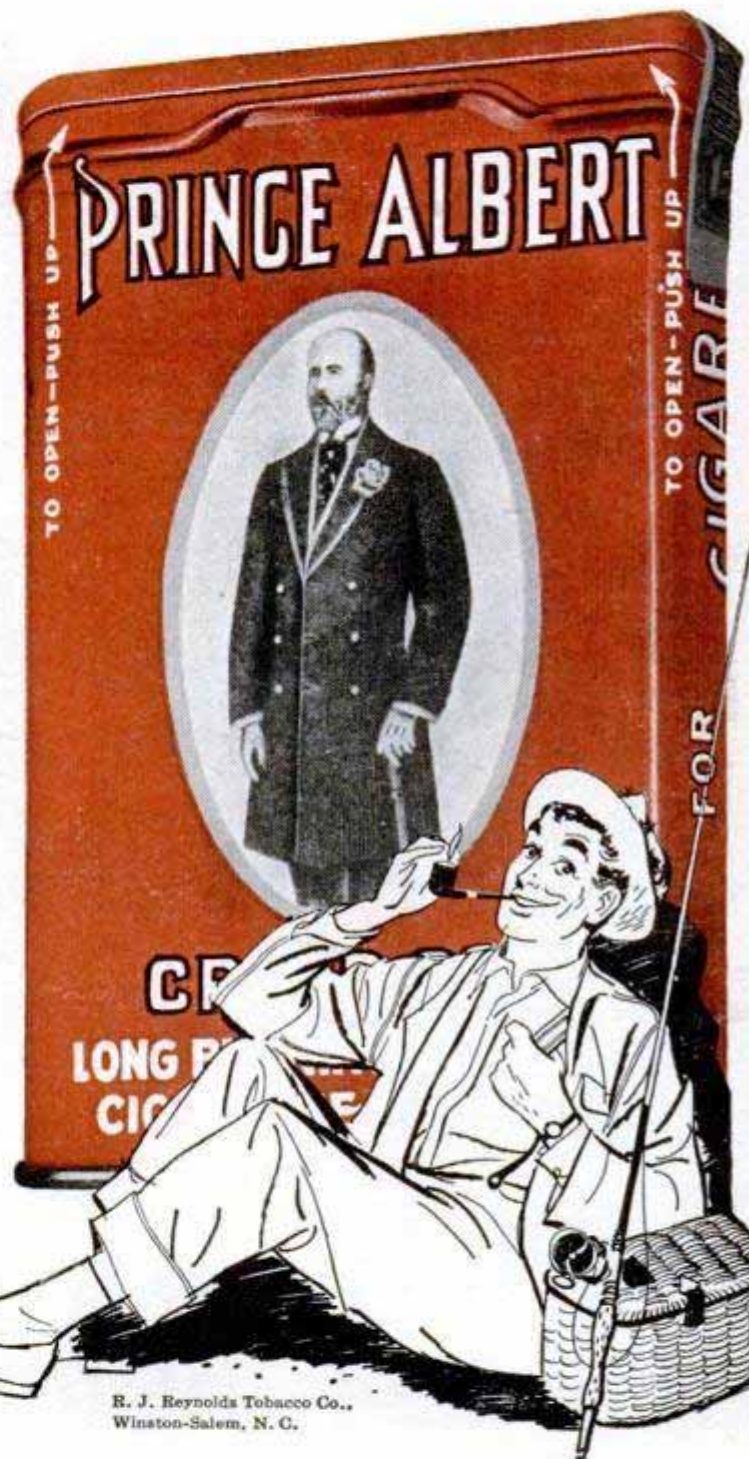

R. J. Reynolds Tobacco Co.,
Winston-Salem, N. C.

PRINCE ALBERT

America's largest-selling smoking tobacco!



Jets, the author points out, are rapidly overtaking speed of the gun projectile

HEADACHES OF A *JET* DESIGNER

By Edward H. Heinemann

(Chief Designer, El Segundo Division, Douglas Aircraft Company)
As told to Andrew Hamilton

EVER SINCE ORVILLE and Wilbur Wright dreamed up the first airplane a half century ago, aircraft speed has increased at the rate of 14 miles per hour per year. This is what makes aviation designing totally different—and compels jet designers to keep a big bottle of aspirin handy at all times.

When you're designing an automobile, a ship or a piece of furniture, a good bit of your work goes into "fashion design." You make it better than previous models, but a good many of the improvements come under the heading of styling. But when you're designing a military airplane, you start from scratch and redesign the whole works from nose to tail wheel on a functional basis.

That's why airplane designing is so complicated. It's why our newest planes were designed five years ago and those on the drawing boards now won't be in production

until 1958. It's why a modern plane requires 1,250,000 man-hours, 10,000 drawings and 25,000 new tools—ranging from \$5 patterns to \$20,000 main-wing jets.

When I started designing airplanes 25 years ago, a new experimental-model military aircraft cost \$20 a pound to build. Today such costs have zoomed to as much as \$1000 a pound. As a matter of fact, the electronic gadgets alone in some of today's planes cost as much as a whole airplane did in 1939.

Therein lie the headaches of modern jet-airplane designers: How to keep from adding weight, cost and complexity to tomorrow's fighting planes.

I often think of the problem as trying to roll a snowball downhill without its getting bigger by the time it reaches the bottom. The solution may be possible—but as yet no designer has been able to find it.

This is why the engineering staffs of most

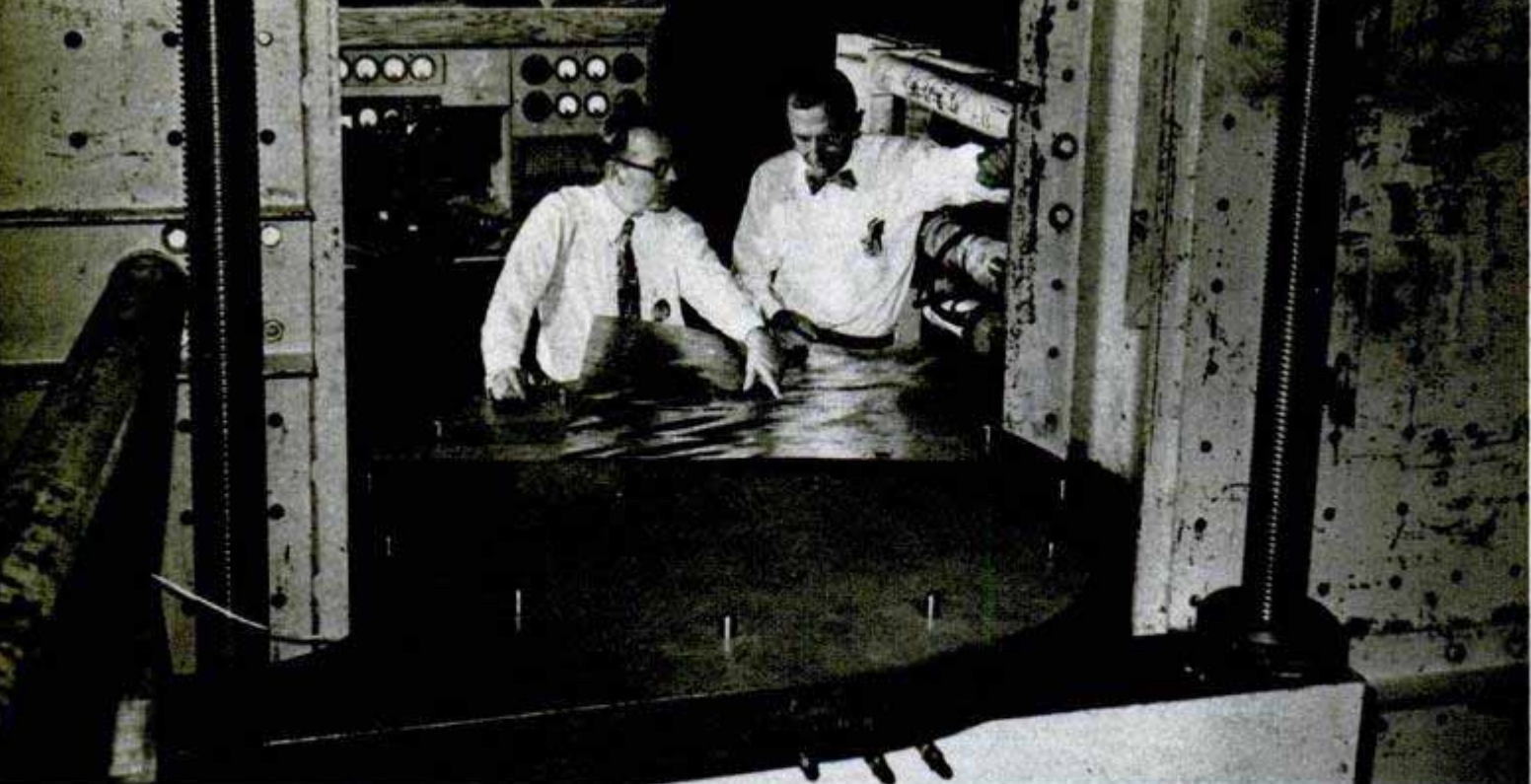

Testing strength of one of the new metals, a titanium panel on a 2,500,000-pound compression-torsion machine

aircraft companies have grown until today aviation employs more professional engineers than any other industry. Twenty-five years ago, the average major aircraft-engineering department employed 15 to 20 engineers and draftsmen. Today the number ranges from 1000 to 3000. The ratio is about one engineer for every 10 other persons employed—or a total of between 350,000 and 450,000. Even so, a shortage of around 30,000 currently exists.

Just why should one industry require so many professional engineers?

As an industry, aviation is one of the most complex because of the many conflicting requirements of aircraft design. A designer, for example, is constantly plagued with the necessity of designing each part lighter—but at the same time stronger. He must build planes more reliable and able to accomplish more functions—but at the same time more simple.

Each new model must have greater high speed, but no greater low speed. It must function perfectly under all extremes, from 165 degrees Fahrenheit, when operating

from a desert base, to minus 65 degrees when flying in the stratosphere. It must carry a higher percentage of its weight in pay load—at the same time it must carry a higher percentage of its weight in fuel.

When the Wright brothers made their historic initial flight at Kittyhawk, Dec. 17, 1903, they reached an altitude of less than 20 feet, a speed of 20-odd miles per hour, and flew for a distance of approximately 100 feet. Today the Douglas Skyrocket has been clocked at 1238 miles per hour and recently reached an altitude of 79,494 feet, both world's records.

In response to constant pressure for superior planes, the aircraft engineer is confronted with a fundamental requirement for better performance. This can be broken down into two basic problems: (1) improved aerodynamics and (2) increased thrust or horsepower. These are the same two headaches that plagued the Wrights in their original design.

Recent aerodynamic developments—such as the swept wing, the delta wing and the thinner wing—have cut down “drag” in the

Designers are constantly hunting ways to cut down weight in new airplanes. Tube fitting at top was replaced by one below, weighing one sixth as much

Among the many planes author Heinemann has helped develop during 14 years as Douglas' chief designer are those displayed in model form below and at right

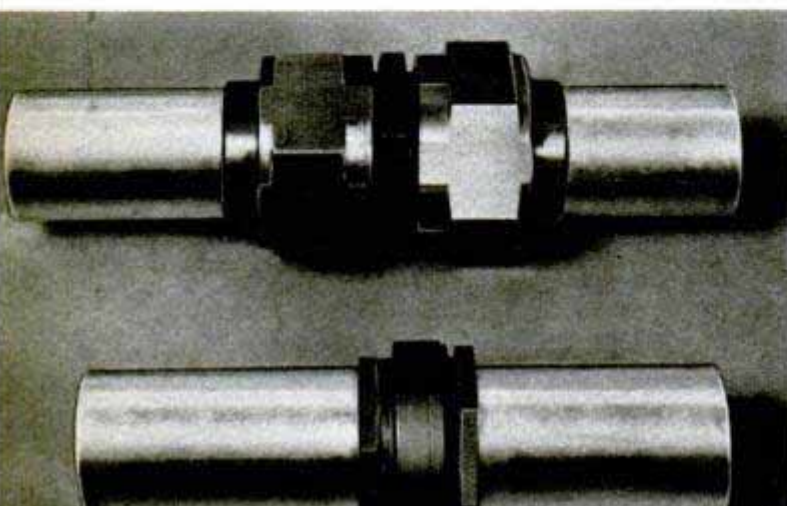

SKYROCKET

transsonic and supersonic speed ranges and will no doubt have a great influence on the trend of future developments. All, however, raise additional structural-design problems to be solved.

In addition to "drag," an entirely new factor has recently arisen in the transsonic and supersonic speed ranges. This is the problem of obtaining the necessary stability and control to make increased performance useful.

It took the first half century of aviation to perfect the means by which we take off, guide the plane in flight and land it. Now that we are operating in the supersonic range, we must perfect stability and control at supersonic speeds without sacrificing them at low speed.

In power plants, great gains have been made with turboprop and turbojet engines. For example, some jets today can deliver 8000 to 9000 pounds of static thrust. (The term "thrust" is used rather than "horsepower" in the jet business, a pound of thrust equals one horsepower at 375 miles per hour—at higher speeds more, at lower speeds less.) Such an engine weighs only about 4000 pounds and with afterburner develops as many horsepower as do three 3-unit diesel passenger locomotives. Compare this to the 12 horsepower of the Wright brothers' plane.

A fighter airplane of 20 years ago consumed, with maximum power at sea level, only 60 gallons of fuel hourly. The modern jet fighter without afterburner will burn approximately 1800 gallons per hour. With the afterburner turned on, it will use 7000 gallons of fuel per hour. At a Mach number of 1, or the speed of sound, this is equivalent to approximately 38,000 horsepower. This 7000-gallon-per-hour consumption explains why operation of the afterburner must be limited to a matter of a few minutes, as this much fuel is approximately five times as much as the average fighter carries.

The relatively new problem of aerodynamic heating may soon slow down the

Oxygen system of the Douglas Skystreak is checked thoroughly by veteran test pilot Gene May and medical consultant

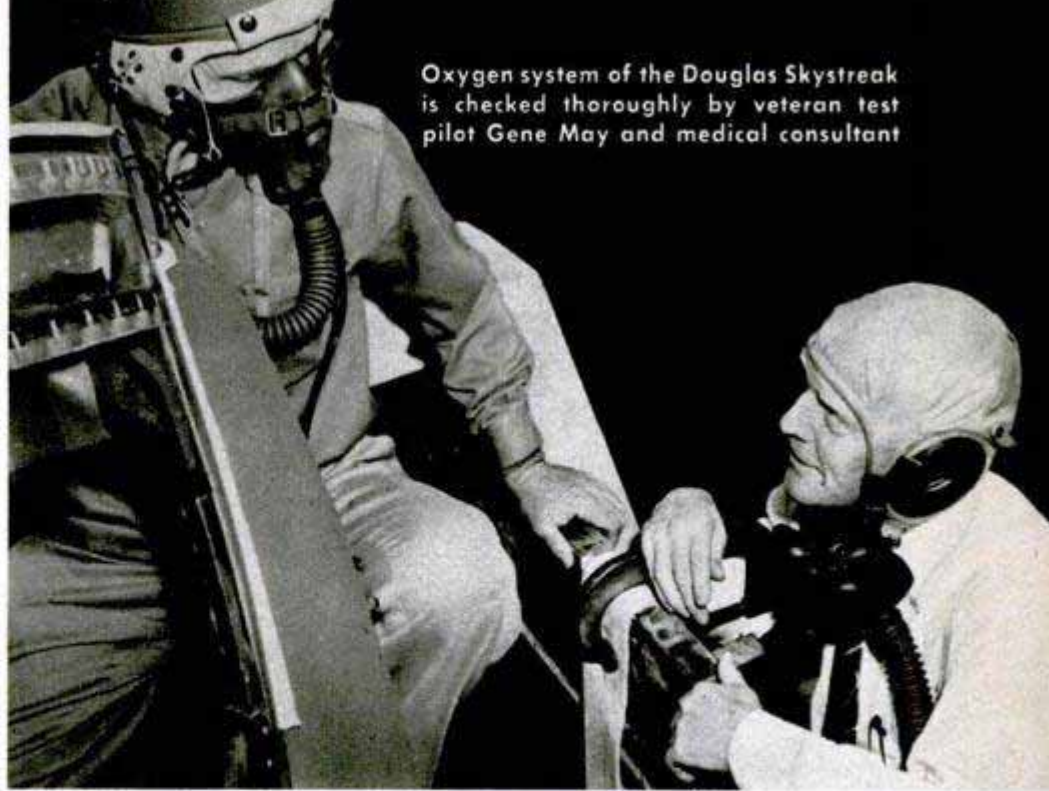

progress of aviation, especially at low altitudes. This phenomenon causes the entire airplane, its equipment and occupants to become heated with speed, and has every indication of limiting speeds at sea level to 900 to 1000 miles per hour. At 35,000 feet, where standard air temperature is 65 degrees below zero (Fahrenheit), this limit can be expected to be approximately 1200 to 1300 miles per hour.

These limitations are based upon a 200-degree-Fahrenheit structural limit that applies to all lightweight airplane materials now in use. Titanium and stainless steels will permit operating at higher structural temperatures, but there is still the serious problem of cooling airplane occupants and equipment when operating at such temperatures.



DAUNTLESS



SKYRAIDER



SKY SHARK



SKYKNIGHT



SKYSTREAK



Engineers test pilot's means of leaving demountable nose of the Skyrocket in a simulated emergency escape

Miles of wire are needed for the complex electronic gadgets that are essential to modern fighter planes



The main increase in airplane costs is due to growth in size and complexity. For example, in the past 20 years the average fighter has grown from a gross weight of approximately 5000 pounds to the neighborhood of 30,000 pounds. Some fighters soon to go into production will run over 50,000 pounds. Twenty years ago the average bomber's gross weight was about 15,000 pounds; today it averages about 200,000 pounds.

Another way of expressing the recent trend in airplane costs is to consider that 20 years ago \$100,000,000 would purchase approximately 1000 fighters. Today it purchases only about 100. In the bomber category, 20 years ago \$100,000,000 purchased approximately 350 bombers. Today, approximately 20.

In the design of a current new model, if a 100-pound item of equipment is added and the performance and strength are maintained, the gross weight will increase—not by the 100 pounds—but by a factor of 10—or a total of 1000 pounds.

The reason for this is that as equipment weight is added, it is necessary to increase the wing area to maintain stalling speed, to increase horsepower to maintain high speed, to add material to the airframe to maintain strength and to add fuel to maintain combat radius.

To cool a 600-mile-per-hour interceptor cockpit and its electronic equipment at high speed and low altitude, the air-conditioning systems must handle five tons of air per hour. This however, won't even do the complete job. In addition, a refrigeration system is installed with a capacity equivalent to that required to freeze 176,000 one-inch ice cubes from 70-degree water in one day.

On the other hand, the system to heat the pilot and equipment in this airplane at high altitudes is capable of heating three 6-room average dwellings on a zero-degree-Fahrenheit day.

The aerodynamic forces on such an airplane are so great at high speed that the required power-control system is approximately 100 times greater than the normal pilot's effort. In other words, the control system requires approximately 22 horsepower or almost twice as much power as was used to propel the Wright brothers' first airplane.

In night-fighter planes the radar equipment alone weighs over 1100 pounds and contains approximately 400 vacuum tubes. This equipment alone is about 1½ times as heavy as the Wright brothers' airplane, including the engine and pilot. This radar equipment is extremely complicated, but without it the airplane could not operate under all conditions of weather and darkness effectively.

There is no question about it. American military airplanes are in general the most complete and best built in the world. Still, in many cases, they contain so much equipment that their performance and cost have been reduced to a point where their primary purpose and tactical usefulness have suffered.

Another way of expressing it might be to say that we are fighting a war with Cadillacs, whereas both World War II and the present Korean incident have shown that our enemies employ stripped down "hot rods."

Perhaps we are selling the pilot short. And it may well be that if we put our efforts into supplying aircraft with higher performance and less automatic or convenience features, the pilot-airplane team would be more effective.

We had something like this in mind when we set about to design the Douglas AD. The Navy wanted a plane whose maximum weight would be under 18,500 pounds. We scrimped and saved on weight—a few pounds here, a few more there. A bulletin went to all designers showing that for every 100 pounds of weight saved, take-off would be reduced by 8 feet, combat radius would be increased by 22 miles and rate of climb would be increased by 18 feet per minute.

We saved 270 pounds by simpli-

fying the fuel system. More than 200 pounds were shaved off by eliminating the bomb bay and hanging bombs, torpedoes and rockets outside. The use of fuselage dive brakes saved another 70 pounds. We even "lost" 100 pounds by using the old-fashioned tail wheel.

Result: A reduction of more than 1800 pounds in the weight of the airplane, which enables the AD to carry 8000 pounds of bombs, torpedoes and rockets and gives it the striking power of a heavy cruiser. Many authorities consider it the best possible

(Continued to page 248)

Heinemann and A. M. Mayo, right, chief of equipment design, inspect arrangements in a mockup. During vibration tests, plane below rests on inflated bags to simulate free flight



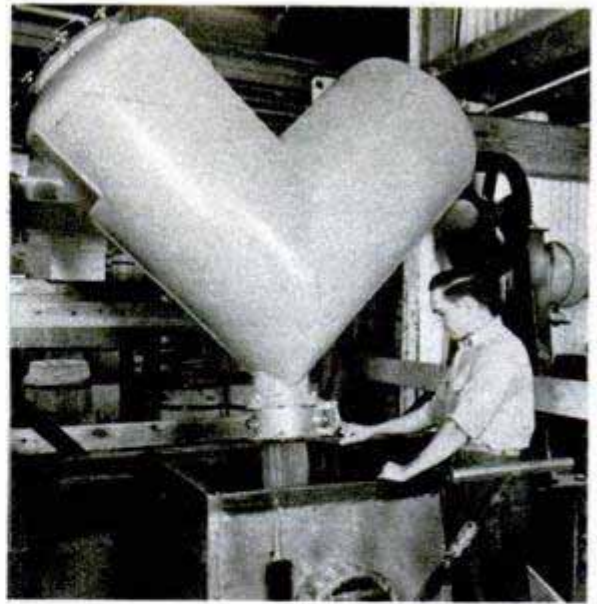

V-Type Blender Speeds Mixing of Dry Materials

Development of a V-type blender has speeded and improved the mixing of dry materials, such as are used in the manufacture of aspirin or other powder-base products. The blender, basically two metal or transparent-plastic cylinders joined at a right angle, is set in a U-shaped frame and revolves slowly on ball-bearing mounts. The mixing motion is supplemented by a

folding action as the blender alternately divides and combines the contents. A motor-driven bar studded with pins, placed across the interior of the blender at the axis of rotation, aids the mixing and can be used to disperse small amounts of liquid through dry material. Independently powered, it turns at speeds as high as 3200 r.p.m., compared with the 2 to 32 r.p.m. of the blender.

Old-Time Bicycle Built for Steam Is Still Operating

Powered by a steam engine, a 1910-model bicycle uncovered by a Waynesburg, Pa., mechanic, has potential speed in excess of 1952 speed limits. Finder Russell Gay duplicated missing parts and now has the machine puffing along as merrily as the day it was built. The two-horsepower engine has a bore of 2½ inches and a stroke of 3½ inches. It is mounted on the frame and receives steam from a flash-type steam boiler.

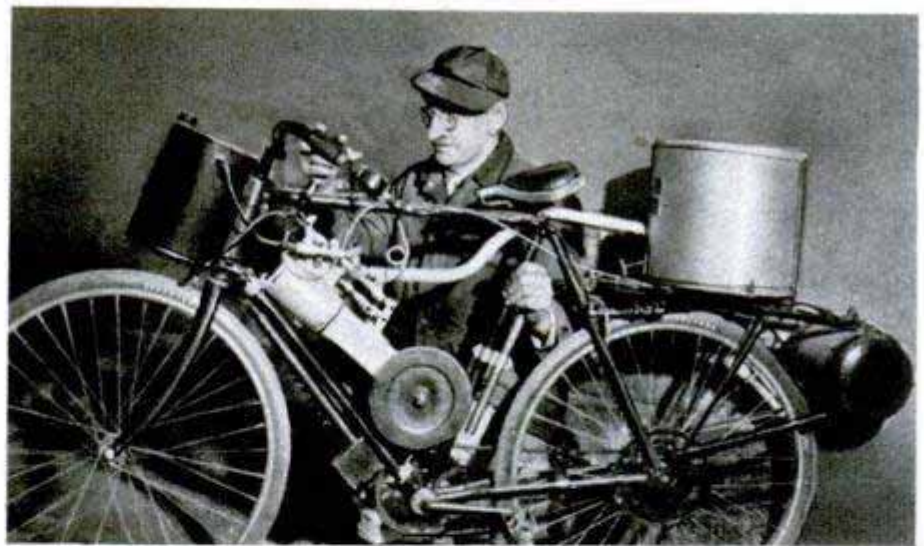

Thunderstorm Energy Equals 50 Atom Bombs

It would take at least 50 Hiroshima-type atomic bombs to equal the energy required to make one thunderstorm, says Dr. Roscoe R. Braham, University of Chicago meteorologist. In the average thunderstorm, 1 to 1½ quadrillion calories of heat are required to accumulate moisture from the atmosphere and carry it in an updraft inside the storm. The Hiroshima bomb generated 20 trillion calories, a puny figure by comparison. But even if 50 atomic bombs were ex-

ploded all at once, the effect on the atmosphere wouldn't be the same. The normal thunderstorm builds up over a period of several hours. Hot, moisture-laden air soars up, building towering thunderheads. Finally, the vapor forms into snow or ice crystals which start falling and accumulate moisture on the way down. Only 10 percent of the moisture a thunderstorm gathers in usually falls to the ground as rain, but that is more than formed by atomic bombs.

Steel or Iron Coated With Aluminum in Low-Cost Process

Steel or iron can be coated with aluminum in a simple and inexpensive process recently developed by General Motors researchers. Heated to a temperature of about 1300 degrees in a bath of preheating salt, the metal to be coated is placed in an aluminum bath for 30 to 60 seconds. It is redipped in the first bath and finished by air-blasting. "Aldip" metals are corrosion and rust-resistant, and they are heat-resistant when specially treated. They are expected to replace certain scarce heat-resistant materials now vital to the national defense.

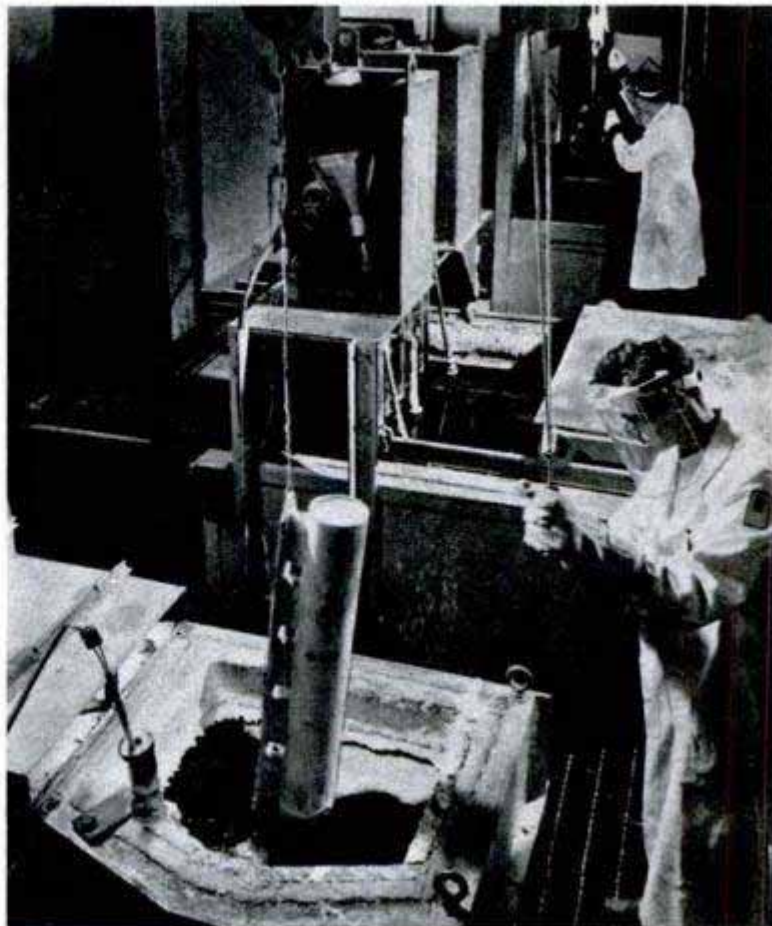

More Eggs?

Aureomycin, the wonder drug, now shows promise of increasing egg production during the summer slack period. In one experiment, low-producing hens were given a feed supplement containing aureomycin. It apparently raised egg production from 26 to 57 percent over former levels.

Discover Natural Neptunium

Neptunium 237, originally obtained by cyclotron bombardment of uranium, has been isolated for the first time in its natural state in the Belgian Congo. Synthesized in 1942, the isotope is the long-lived parent of an important radioactive series valuable in radiation studies. It is the fourth such parent of a radioactive series to be found in nature and was discovered in microscopic quantities in pitchblende ore.

High-Speed Film Permits Movie-Making in the Dark

Moving pictures made in the dark are possible with a new infrared film possessing ultrahigh "red speed." For use in total darkness with invisible infrared rays or in extremely dim natural light, the film takes successful pictures in a room dimmed to $\frac{1}{70}$ of normal. Originally designed for industry, the film is now available to all owners of 16-mm. and 35-mm. movie cameras.

Convertible Brush is Adaptable to Three Widths



Three paint brushes of different sizes can be made out of a new convertible brush. The paint applicator consists of a screw-on handle, two brush heads and a socket for holding the two heads together. The complete assembly forms a four-inch wall brush. The handle also may be screwed into either of the two heads to make a 2½-inch varnish brush or a 1½-inch sash brush.

⌚ Clocked at 152.691 miles per hour in Belgian speed tests, an experimental gas-turbine British Rover automobile runs on kerosene or other fuels, has no clutch, gearbox, carburetor or ignition.

BONANZA IN BARK

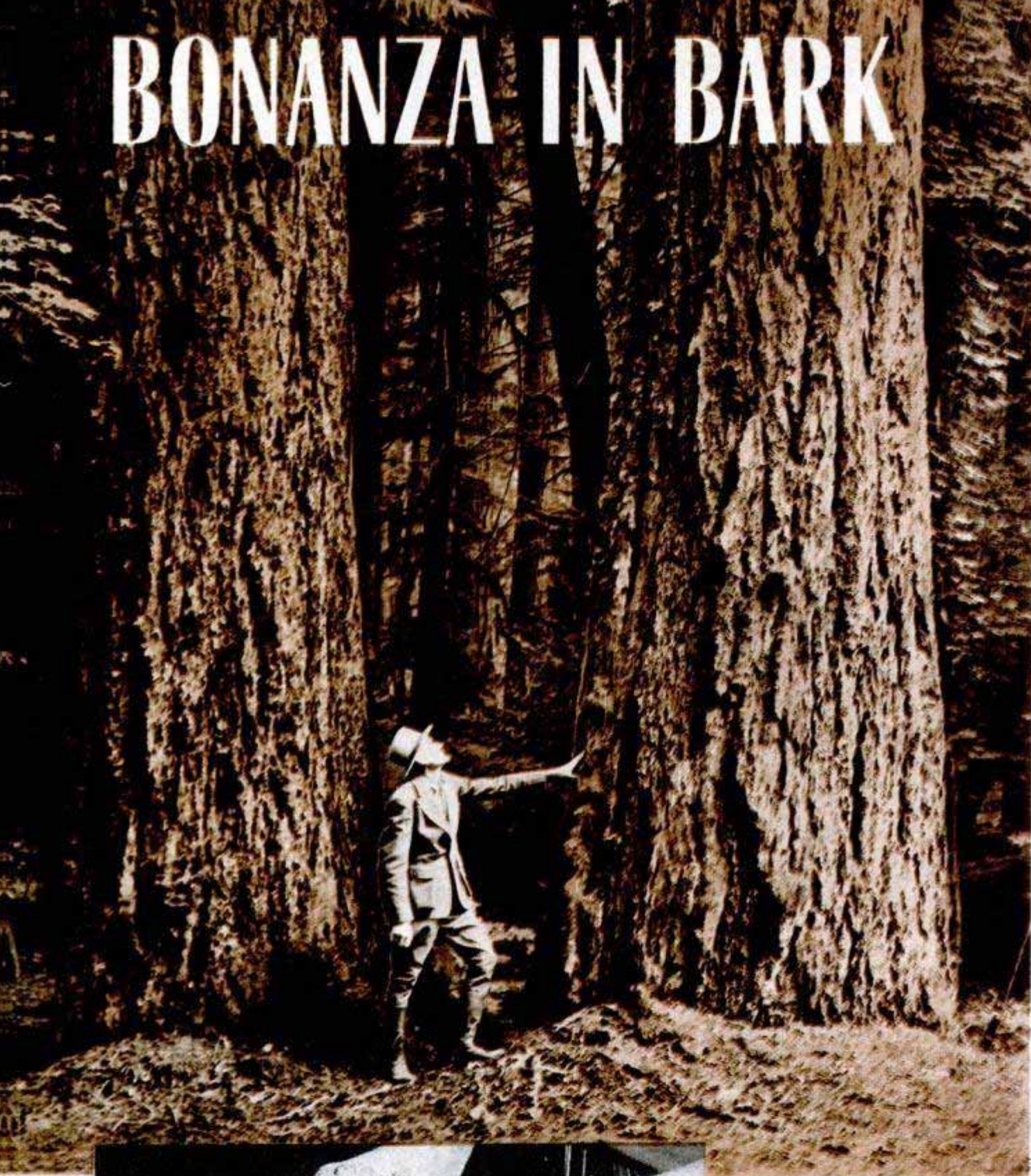

Bark on old-growth Douglas firs like those above may be from six inches to two feet thick. There are plenty of these big veterans standing in Washington and Oregon

By
Robert H. Forbes

Bark in its fine-powder state. At Longview, Wash., after the grinding and screening processes, some is sold for plastic-molding compound and for use in cements and glues

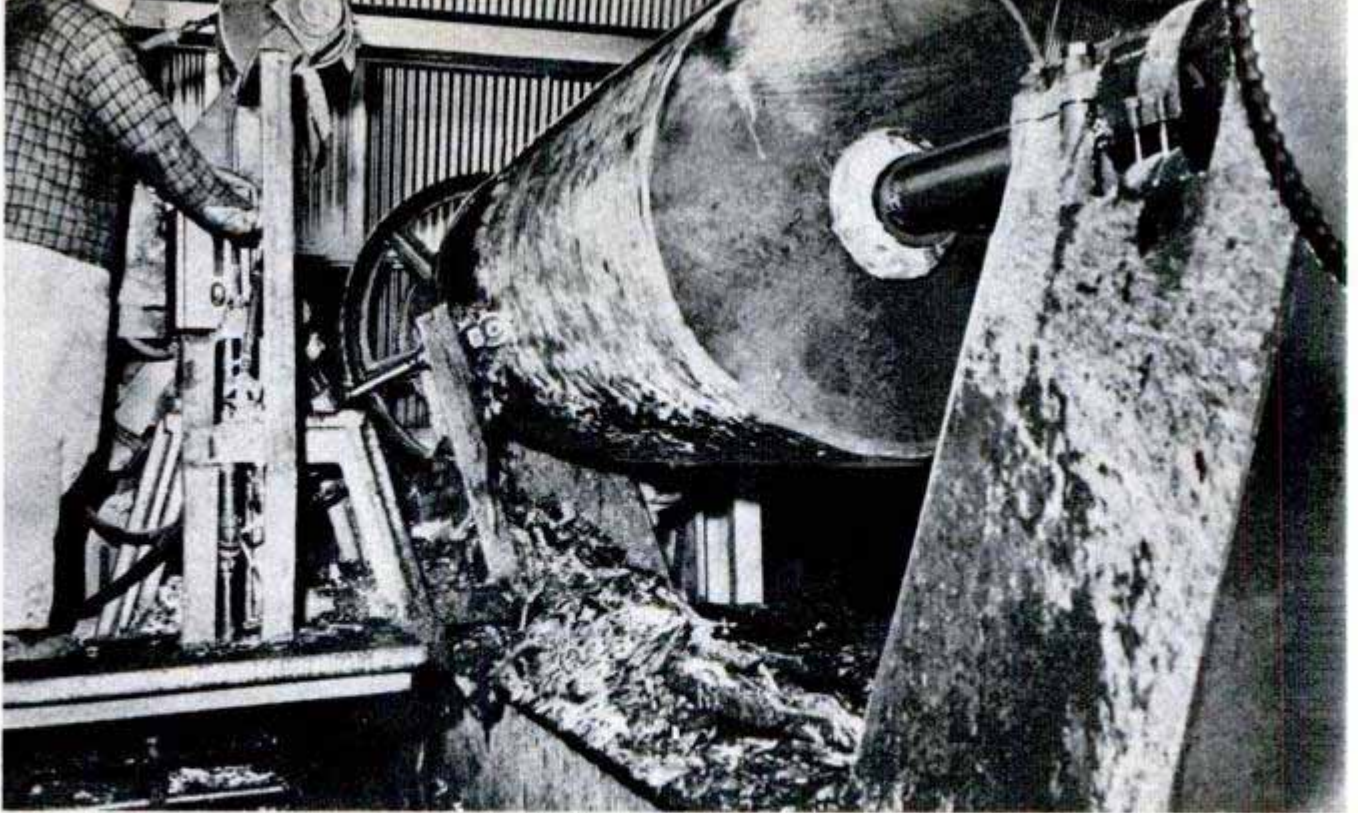

As the log is rotated, a roller head is pressed against it with sufficient force to peel off the bark

CHANCES ARE that there is a liberal lacing of refined bark from Douglas fir trees in the shoes you're wearing. Soon, too, you may be polishing your floors with wax derived from the bark.

Uses for Douglas-fir bark, other than wrapping for trees, are now booming in the "big timber" country of Washington and Oregon. Well they might! The region's sawmills for some years have destroyed as waste almost 2,000,000 tons of this bark.

The hope of making dollars from their plentiful waste products has always interested lumbermen. The sawmill, wood-pulp mill and veneer plant of one company at Longview, Wash., alone pile up 200 tons daily of thick bark from fir logs, only part of which has been converted into market-

able products. Five mixtures of bark elements are now in regular production. Separated by grinding and screening, they contain various amounts of the three bark constituents—cork, needlelike fibers and a fine powder.

They are used for plastic-molding compound (your plastic ash tray may contain a good-sized portion of bark); as extender for plywood glues and in oxychloride and magnesite cements. They are also used in fertilizers and insecticides; in rubber; as a stabilizer in asphalt roof coatings; in hard-board (construction-board) manufacture, and explosives. Bark products also serve a unique purpose as a part of the "mud" and "completion fluid" that act as lubricants for oil-well bits as they bore into the earth.

(Continued to page 258)

Left, a six-inch ruler indicates percentage of bark on a small fir. Thick cork layers in chunks of Douglas-fir bark, right, are evident as light-colored bands. Needlelike fibers and fine bark powder are being poured

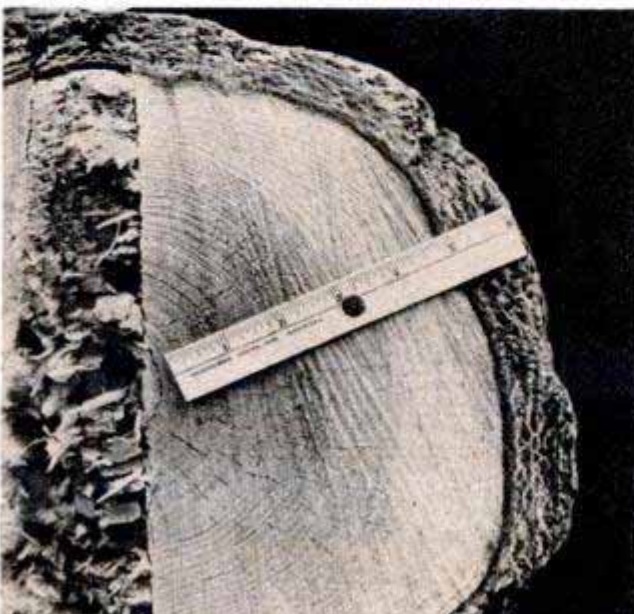



Clamping the plastic squares together is easily accomplished with a slight press on the small clips

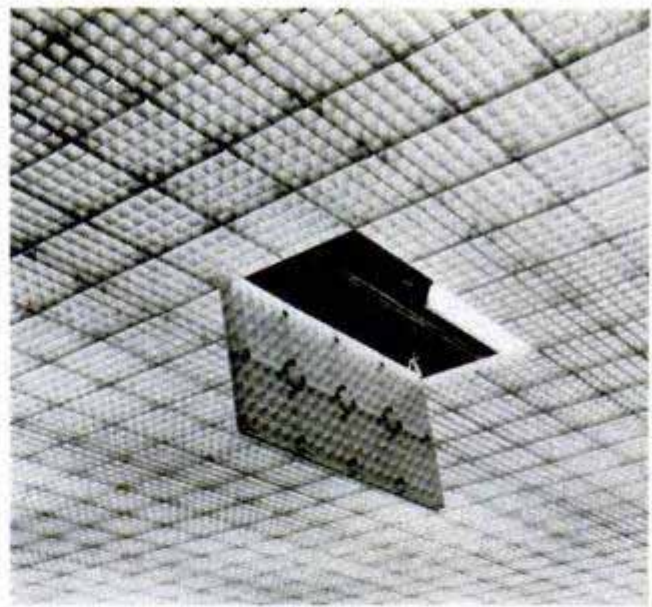

Doors for servicing are quickly made. Special hanger hooks allow the sections to hang at right angles

Plastic Louvers Provide Sleek Illuminated Ceilings

Illuminated ceilings assembled from light-diffusing, fixture-hiding plastic louvers are now possible. Made of polystyrene plastic, the one-foot-square sections are clamped together side by side, hiding all light fixtures, plumbing, fire sprinklers and air ducts. The glareless, even light produced

is suited to theater lobbies, restaurants, stores and certain factories where goods are to be inspected or glass-covered gauges read. Hangers allow the units to swing out of the way for quick access to lighting or other fixtures. Removal for cleaning is also speedily accomplished.

Electronic Guide Pilots Lawn Mower Through Tall Grass

Guided by an electronic "feeler" that ferrets out tall grass, a robot lawn mower does its job without human help. The machine is thrown into gear by raising the handle to an upright position. Once an initial swath is made in the lawn, the mower follows the uncut-grass line in decreasing circles until the last thin line is cut. The

electronic feeler, "brain" of the mower designed and built by Raymond P. Meyer of Omaha, is located just ahead of the front wheel. Only three inches long and two inches wide, it operates on two dry-cell batteries. The mower's one-horsepower engine weighs only 14 pounds and the complete unit totals 50 pounds.

Designer Meyer makes adjustments (left) and then relaxes as automatic attachment guides mower around lawn



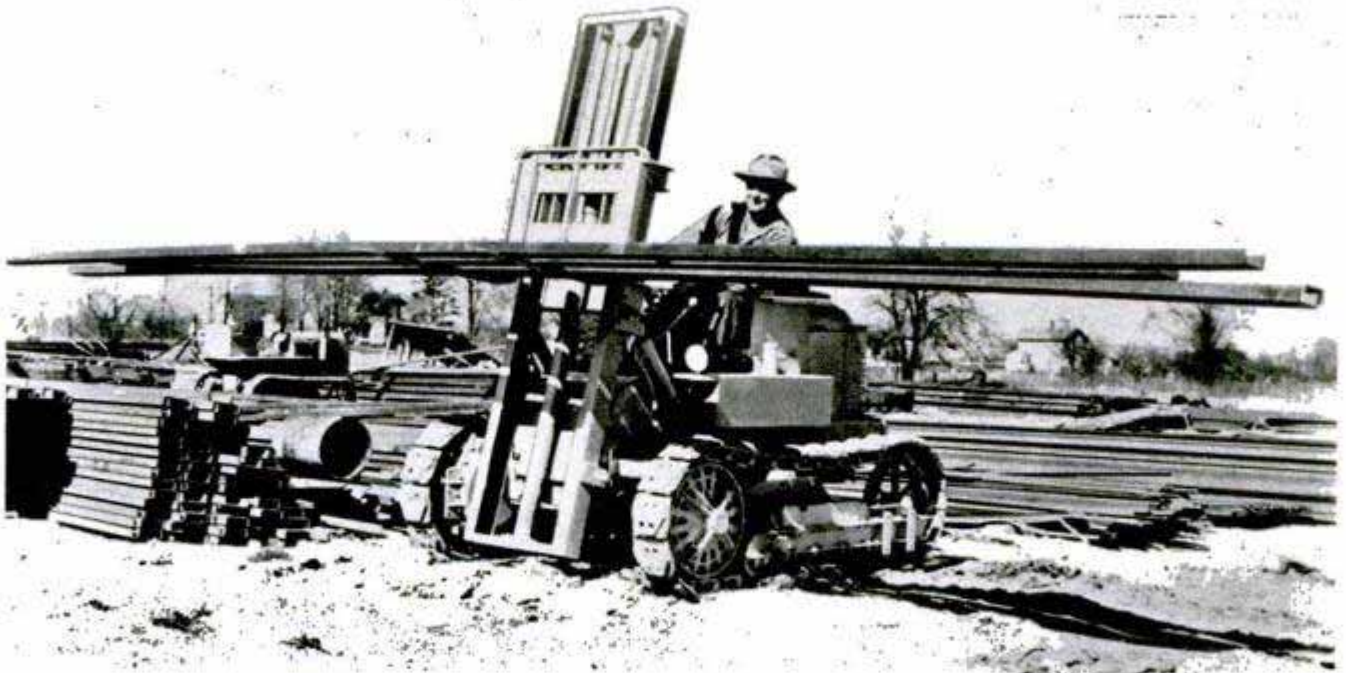

Lift Truck on Crawler Tracks Operates Almost Anywhere

Thick mud, up to six inches deep, cannot stop a fork-lift truck mounted on crawler tracks. Maneuverable in terrain that would bog down other lift trucks, it is designed to handle heavy loads outdoors as well as

indoors. One model handles 2000 pounds with a maximum lift of 8½ feet; the other lifts 4000 pounds to a height of six feet. Attachments convert the machine into a bulldozer, angle dozer, loader or snowplow.

Photo-Retouching Machine Duplicates Skin Textures



Doubling photographic-retouching output, an electric machine renders more natural skin textures. The negative carrier, oscillating 3600 times a minute, converts strokes made by the retoucher's pencil into a diffused pattern resembling skin texture. If desired, an etching tool—available as an attachment—can be used in place of a pencil. The unit accommodates all negatives up to 8 by 10 inches, operates on standard current and has fluorescent lighting that will not cause the negative to buckle. Portable, it weighs only 25 pounds, measures 18 by 11 by 12 inches. The unit is available in three models for right-hand, left-hand or dual use.

Clamp-On Tow Chains Grip Bumpers Firmly

Automobile tow chains which clamp onto instead of encircling bumpers end the nuisance caused by obstructing ledges. At each end of an eight-foot chain are twin clamps joined by steel springs which hold them firmly to the bumpers. A self-equalizing section of chain on each end connects the clamps to the main chain. The chain weighs 5½ pounds.



☐ Clothes are protected by a ball-point pen which features a retractable point.



Ideal for operating in the wilderness, this Jeep was equipped by a wildlife photographer. Left, a crested lizard snapped in Arizona



DARKROOM in the DESERT

By E. P. Haddon

FOR A NUMBER of years I was content with my hobby of wildlife, travel and nature photography. Then the hobby developed into a profession that brought me a great deal of satisfaction as wildlife photographer for the State of Texas; later I became chief of the photo section of the United States Fish and Wildlife Service.

But always in the back of my mind was the desire to photograph our great Southwest entirely on my own. Recently I took the step.

With the knowledge of the ruggedness of this section of the country always before me, I decided that a Jeep with its four-wheel drive was a natural—aside from the fact that I was able to find a '49 model with insulated metal top (all in excellent condition) for \$500.

The Jeep's somewhat limited storage space did not stop me, but proved to be a

real test in planning. It was necessary to devise a means whereby I could carry food, water and equipment for extended stays away from any source of supply. My success with the Jeep should prove of interest to prospectors, hunters, fishermen, or anyone operating in wilderness or desert.

In order to organize my equipment, a box was made using $\frac{3}{4}$ -inch plywood joined with aluminum angles. This box exactly fitted the bed of the Jeep. Rear of the box, supported by a piano hinge, opens to form a sturdy table, which has proved to be almost indispensable. It is used for cooking and serving food, or as a desk when typing manuscripts and supports the backdrops I use when photographing small subjects.

This box, with its partitions, enables me to carry a large amount of equipment. Aside from its storage capacity, the box also acts as a divider, making it possible to utilize the

areas above each rear wheel. With such an arrangement, any item is available without having to disrupt the entire layout.

Two five-gallon Jeep cans fit the space over the right wheel. This takes care of water and gasoline for travel to remote areas. Over the left wheel rides a nine-foot-square umbrella tent, complete with sewed-in ground cloth, netting doors and windows, plus the stakes. It fits perfectly.

Four strong web straps with buckles were double-screwed topside of the box—two at the front and two at the rear. The front one holds a camp cot in place (could hold two), and at the rear, the collapsible tent poles are lashed down. Between them a bedroll is carried. The web straps are long enough to hold an extra bedroll. Inside the box is a shelf that holds a two-burner Coleman gasoline stove, cooking utensils and a large supply of canned goods.

In a government surplus store I found an oxygen maintenance chest, sturdily constructed of metal, fiber and plywood. With a few slight changes it gives me the equivalent, in smaller size, of the old-time Western chuck box. This chest stands 20 inches high, is hinged on the back side and has numerous Plexiglas drawers inside. Many food items are kept in this chest, along with a complete set of plastic dishes, silverware, paper napkins and other small items.

This little chest has proved a versatile piece. When meals are being prepared, it is opened and placed under the shelf, just back of the table space. This makes every item available. At night, if insects become bothersome, the chuck box becomes a typewriter stand inside my tent. Or, if an unexpected guest should arrive, it provides an extra seat.

Also at government surplus, I found three heavy canvas pads that are almost the exact dimensions of the box. One pad was used on the shelf and one on the bottom of the box inside to act as cushioning and to minimize noise. The other was fastened to the outside of the box, coming down far enough for the two Jeep cans to rest on, preventing the metal-to-metal clatter.

Aside from the chuck box with food and the canned goods on the shelf, there

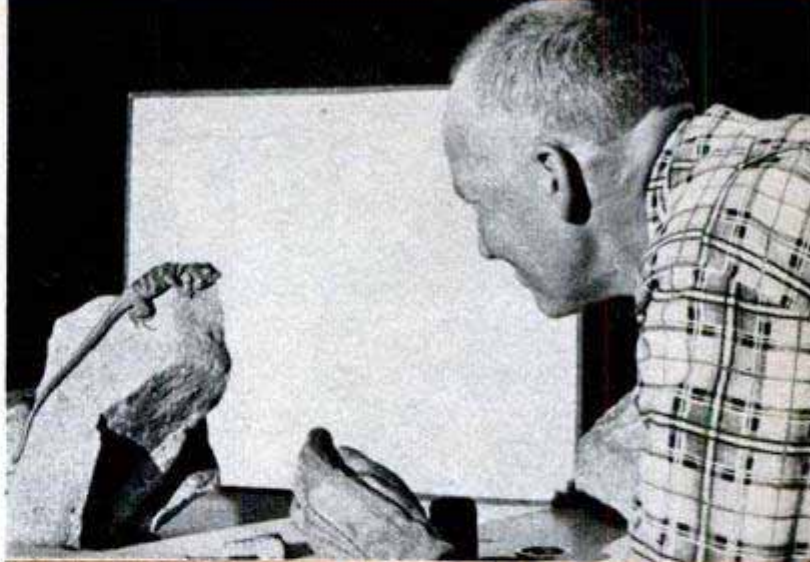

The author poses a collared lizard with the aid of background board he carries as prop for close-ups

A wildlife photographer adapted his Jeep as a rolling home and camera mount for the wilderness

Chuck box serves as table for typing and five-gallon gasoline can as a chair

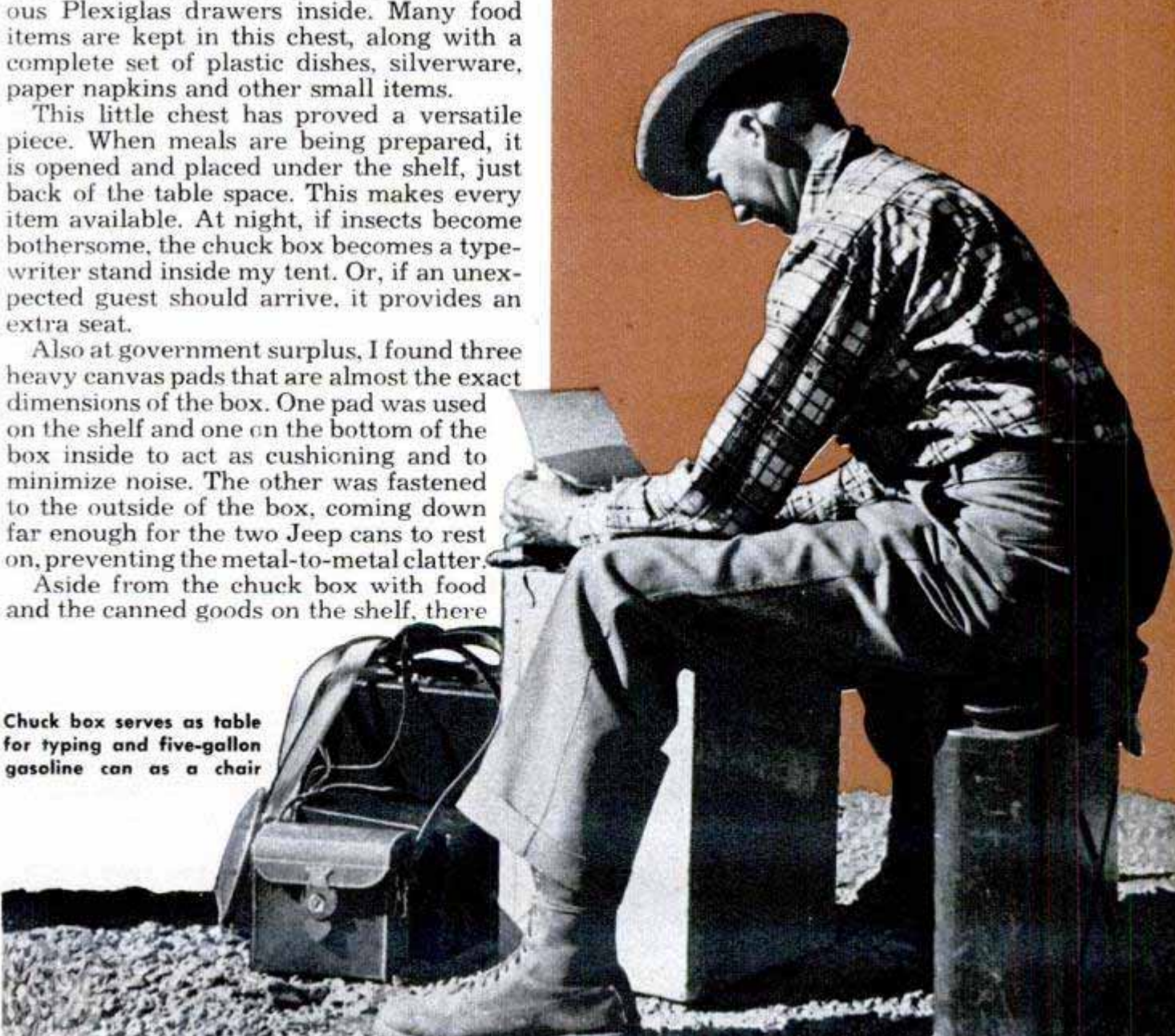

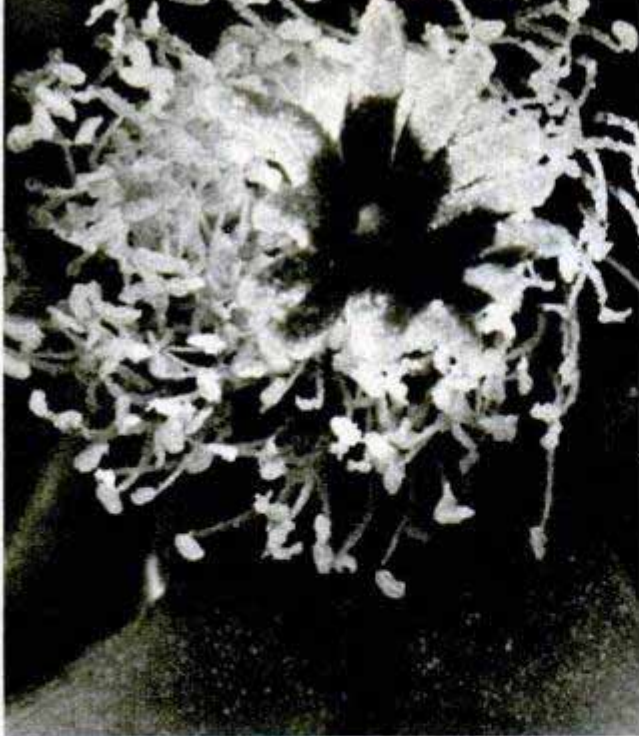

Enlarged shot of the heart of a cactus bloom was made by author "on location" with a 35-mm. camera



Author Haddon removed metal doors from his Jeep to photograph wild game that stands to look at the car

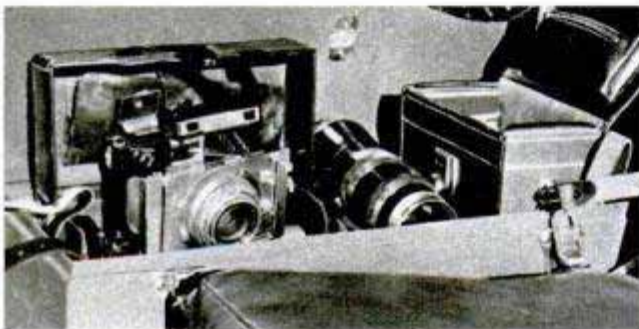

The Jeep camera case consists of a metal toolbox screwed to the floor and lined with sponge rubber on ends, sides and bottom. The case has a sturdy lock

Cooking is easy when the chuck box is opened and slid back under the shelf of big Jeep box. There is not only room for stove but a place to eat, too



is another box containing foodstuffs. Canned fruits and juices are particularly desirable in the desert areas.

Stowed in one corner behind the chuck box are two cases which contain my portable darkroom, including a 35-mm. enlarger, stainless-steel trays, squeegee plates, dark-room lamps, developing tanks, chemicals and other necessary accessories.

A portable typewriter, stationery and a small ammunition box filled with field reference books find a place—along with a package containing a two-by-three-foot collapsible background to be used in photographing small objects. There is also room for a large two-suiter for my clothing.

Since driving over rough back country presents an extreme hazard to delicate photographic equipment, I placed it in a box, 20 by 9 by 10 inches, screwed to the floor with metal screws. This box is lined with sponge rubber, an inch thickness on the bottom and a quarter-inch on the sides. With additional cushioning of their specific cases, my cameras and lenses survived much rough travel without appreciable damage or loosening of screws. A Yale lock added to the box discourages any would-be prowlers.

The cab of the Jeep could be unbearably hot while working in the desert country, but removing the doors makes riding inside comfortably cool. Also, it helps give freedom of movement, for a camera can be handled easily without having to leave the driver's seat. Often, startled game will permit numerous snaps from a stopped vehicle, but will take off should the photographer step outside.

(Continued to page 252)

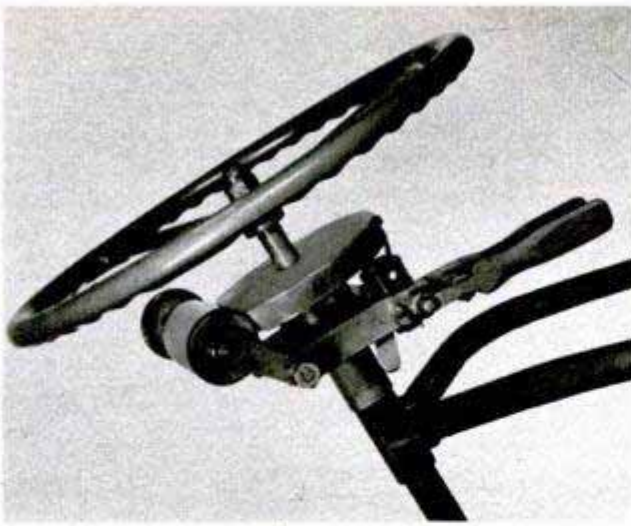

Left, close-up view of tractor pilot. Right, making "vernier adjustment" to lock the wheel securely

Automatic Pilot for Tractors Holds Steering Wheel in Position

Mounted on the steering-wheel shaft of a farm tractor, a locking device fixes the position of the wheel when the operator moves a small lever. Useful when the driver wishes to manipulate control levers, it also prevents constant "fighting" with the wheel during plowing or when working on rough ground. The device consists essentially of a matched worm gear and wheel, the latter

rigidly mounted on the steering-wheel shaft while the worm is hinge-mounted on the shaft tube or bracket. A light touch on the lever instantly meshes the two parts, locking the steering system in the desired direction. A small handwheel on the end of the worm shaft permits easy corrections or compensations in steering. The device is easily installed.

Book-Size Dictating Machine Is Portable and Lightweight



Shaped like a book, an 11-pound dictating machine is only 2½ inches thick and can be carried in a brief case. It records 30 minutes of dictation on a seven-inch reusable disk. One knob with four-way controls permits recording, complete playback, back-spacing to play back the last few words or any section of the complete recording. Lights indicate when the machine is turned on and ready to operate; an audible signal warns when the recording is near the end of the disk. The microphone serves as a loudspeaker for playbacks. A lock-switch holds the diamond stylus in place as well as anchoring other internal parts while the machine is carried.

Door-Locking Button Protects Children

Rear doors of four-door sedans are made accident-proof by a small lock that replaces the conventional locking button in the window frame. Installation is simple: Merely unscrew the standard button and replace it with the new lock. For normal use, the lock acts in the conventional fashion. However, if you depress the safety button on the side of the lock, the door cannot be opened accidentally from the inside or outside by children. Positive in action, the device is unlocked with the car's ignition key.

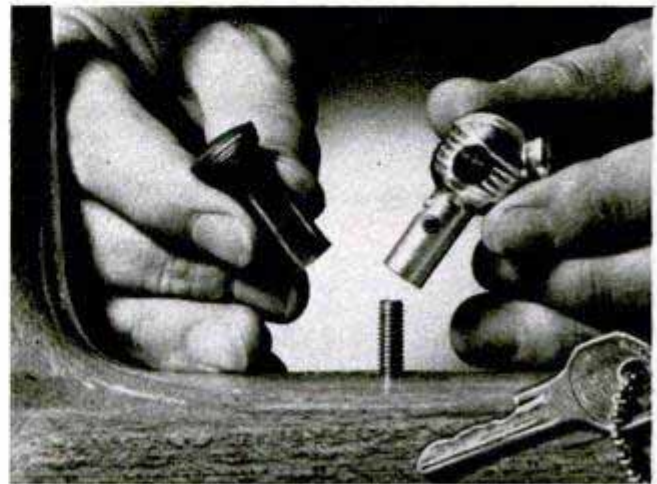

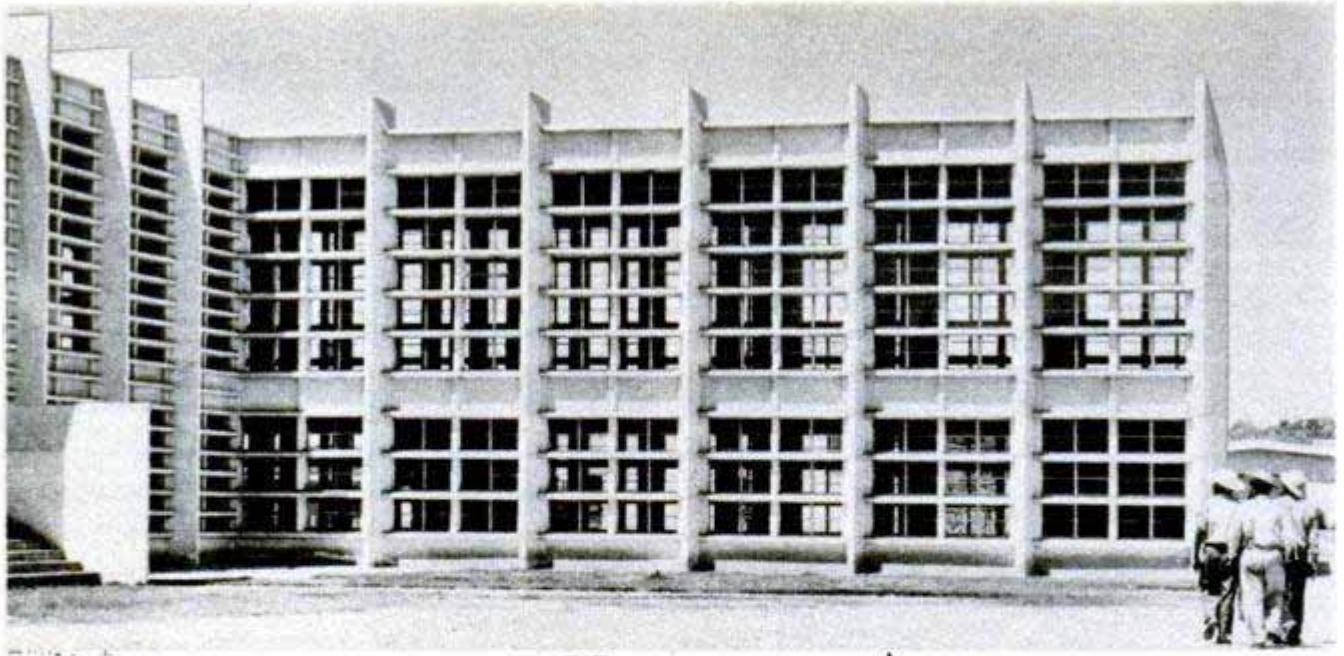

Concrete and Glass University Building

Reinforced concrete and glass form the entire structure of a striking building on the campus of the University of Sonora in Mexico. It was designed by Mexican engineers and architects. Engineering principles resembling those developed in the aircraft industry make for lightweight rigidity. Economy, too, is a feature of the construction which uses the concrete slab as a structural member to cut down the amount of metal needed. A unique interlocking grid system permits the utilization of unusually thin concrete members.

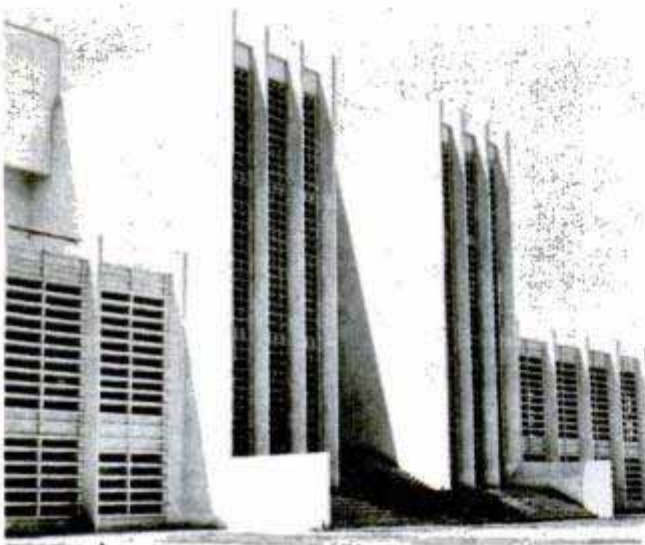

Bumper Jack Operated By Handle on Top

You don't need to stoop down to operate a new automobile bumper jack; you simply turn a swivel handle on top. An adjusting lift hook supplied with the jack fits bumpers that have odd contours or deep skirts. Designed to prevent sudden drops or "handle whips," the screw-lifting action assures positive load control at all times. Easy and safe to operate, the jack has counteracting rollers which travel against the inner and outer surface of the U-channel supporting column and eliminate unnecessary frictional drag. The new jack is sturdy enough to support the heaviest passenger cars.

Sources of available products described in this issue are listed on page 12, 14 and 16. Sources of further information on other articles are listed in the WHERE-TO-FIND-IT LIST, which is available without charge to readers upon request to the Bureau of Information, *Popular Mechanics Magazine*, 200 East Ontario Street, Chicago 11, Illinois



Back from a world-girdling voyage, Danish scientists have brought home exciting evidence of

By Kai Norredam

ONE FINE JUNE DAY last summer, a beautiful white ship ran into the harbor of Copenhagen and was greeted by jubilant cries of welcome. From keel to deck the big vessel was loaded with weird things from all over the world. Upon its slender bow was painted the name *Galathea*. From a previous article, (March 1951) readers of *PM* will know this was the Danish deep-sea expedition which had come home after an adventurous voyage around the globe.

For two years the *Galathea* had been on the move. The expedition had passed over the deepest holes in the oceans, where the animal life had been completely unknown—nothing but one big question mark in our zoological knowledge.

What main results can be squeezed out of the voluminous reports from the *Galathea*? I put the question to the leader of the deep-sea expedition, Dr. Anton Fr. Bruun.

"The main purpose of the expedition was the exploration of depths greater than 18,000 feet," Doctor Bruun relates. "This was an almost-closed area to scientific research. The deep-sea scientist was in

Drawn up from a depth of several miles, fish net fastened to an iron frame is pulled aboard the *Galathea* with a load of queer luminous fish

LIFE SIX MILES UNDER THE SEA





Professor ZoBell, American scientist on the Danish expedition, looks over his valuable collection of deep-sea bacteria which he keeps in vessels under 800 atmospheres of pressure and temperature of 36 to 38 deg. F.

Below, the Danish exploration ship *Galathea* at anchor off a tropic island. Inset at left is of a tiny sea monster with numerous legs like sticks. The other inset shows a weird fish that was brought up from the sea's depths

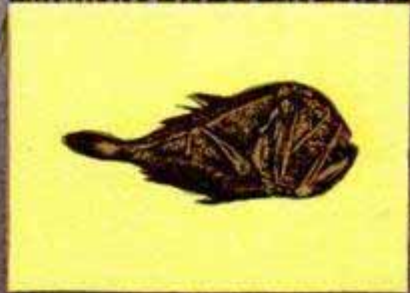

possession of very meager facts: A few sea cucumbers found 23,400 feet under the surface and some sponges from 22,800 feet. From more than 30,000 feet he had only a small sample of clay and one of water. Before the *Galathea* put to sea, nothing beyond this had been brought up from depths of more than 18,000 feet. Many biologists refused to believe in the existence of animal life beneath 24,000 feet. They claimed that life was impossible at this fantastic depth because of the tremendous pressure—about 800 atmospheres. Further, they pointed out that there could be no sun energy, basis of any form of life, at the greatest depths. The light of the sun penetrates at most to a depth of only 1200 feet. From here downward reigns an impenetrable darkness. The results of the *Galathea* expedition, however, prove these claims to be false.”

Although far from having mapped out in detail the fauna of the deep sea, the expedition has, nevertheless, revealed many of its secrets. Where before we had only vague hypotheses we are now in possession of facts, namely, many samples of various deep-sea animals.

Among the expedition discoveries is the finding that there are no “deserts” in the oceans as is the case on land. A Sahara of the sea will be searched for in vain. Everywhere there is life, even at depths that surpass the height of Mount Everest. Sea anemones, bivalves, sea cucumbers and other species have been found in these places. Rather primitive forms of life, but just consider how tough they must be to be able to live under the almost incomprehensible pressure of a thousand atmospheres—corresponding to the weight of a seven-mile water column.

Beneath 30,000 feet the *Galathea* scientists found only nine species of life, but as they came nearer the surface the conditions of life grow better in regard to pressure as well as food. Here they met various forms of life such as a crowd of weirdly formed, sometimes luminous, fish. The deepest catch of a fish was in the Java Trench at 23,400 feet beneath the surface.

The *Galathea* made deep-sea explorations at several places along the route, but trawling in the trench along the islands of the Philippines was anticipated with great



Here are some of the assorted eellike, shrimplike, fishlike creatures brought up from great depths at sea. Many are unknown to scientists

excitement. As Doctor Bruun tells about it:

“The Philippine Trench is next to the deepest hole in the earth. It is almost 35,000 feet deep, measuring 100 miles in length. It is from one to two miles broad, the sides being limited by rather steep slopes. We fished with a so-called sledge-trawl. This is a sack-shaped net, nine feet broad and fastened to an iron frame, to which are fixed two bottom dredges. The sledge-trawl is fastened to the long steel wire.”

The wire has a chapter of its own. The constructors had to consider that not only must the wire carry the sledge-trawl and the friction of the water, but also its own weight. Consequently the wire was tapered. The result was an 8-mile-long steel wire, one of its ends measuring 22 millimeters with a breaking strength of 33 tons, while the other end was only 9 millimeters in thickness and had a breaking strength of approximately 4½ tons.

“There were exciting hours when for the first time we were to scrape the bottom,” Doctor Bruun relates. “With a speed of only 2½ miles per hour, the sledge-trawl sinks downward into the unknown water until all eight miles of wire are out. We know the configuration of the area from previous investigations with an echo sounder. And then—forward goes our ship, navigated according to the echo sounder. The most difficult of all is to keep the trawl at the right depth. It must not



Eighteen-foot trawl is swung overboard far at sea; right, steel dredge brings up a chunk of the sea bottom

take too much of the bottom; but if, on the other hand, it floats just a few feet over the bottom, everything has been done in vain. So that you may understand, deep-sea fishing is just about as difficult as exploring the behavior of birds in a woods from a plane at a height of 30,000 feet—and in absolutely impenetrable darkness!

“But the catch of this trawl was sensational: Our net contained sea anemones, sea cucumbers, an amphipod and some bivalves, representing four main groups of animals.”

In all, the *Galathea* brought up 140 species from depths of more than 18,000 feet. The animals inevitably died when they came up to the surface because of the steep reduction of pressure and the great difference in temperature which exists between surface and bottom with the latter's mere 36 to 38 deg. Fahrenheit.

Among the most interesting happenings on board the *Galathea* were the bacteriological experiments of Professor ZoBell. Reports that ZoBell, aboard the *Galathea*, had brought up bacteria from a depth of

Professor ZoBell examines copper vessel dented by pressure at great depth; glass balls fit in containers





Prof. Grace Pickford of Harvard University visited aboard the *Galathea* to inspect deep-sea specimens

18,000 feet were sensational news to scientists all over the world. There was not the slightest suspicion as to the existence of these high-pressure bacteria. By means of a specially constructed, ingenious little high-pressure apparatus, Professor ZoBell put his bacteria under a pressure of 800 atmospheres at a temperature of 36 to 38 deg. Fahrenheit. The professor was overwhelmed with joy when he discovered that these microorganisms were actually living and breeding. This meant they were accessible for various experiments.

Professor ZoBell's bacteriological experiments will teach us under what conditions oil is produced, thereby helping the oil geologists find new sources. Professor ZoBell has taken his rare organisms home with him to the University of California.

"Those bacteria have given me plenty of work for the rest of my lifetime," he says.

As a proof of the enormous significance that various societies ascribe to his work, the professor has been granted \$83,000 for continued research. No doubt, the near future is going to hear a lot of grand news from ZoBell's laboratory at Scripps Institution of Oceanography in LaJolla.

Though deep-sea exploration was the main purpose of the *Galathea* expedition, many other subjects were studied, such as various zoological fields, ethnology and measurements of the magnetism of the earth.

Since ancient times man has been aware of the curious fact that the earth is loaded with magnetism. And just as long have the



Octopus and flying fish were caught near surface at night fishing by floodlight from side of ship

sources of this natural force been a puzzle to the wise men. Where did the mysterious force originate that makes the needle of the sailor's compass turn north, no matter where he is?

During the centuries, theories of various sorts have been put forward in order to solve this problem.

According to older theories the magnetism is due to certain qualities of the interior of our globe, which consists of floating iron and nickel. In 1948, however, the Nobel prize winner, Professor Blackett from the University of Manchester, advanced a new epoch-making theory. He said that all bodies with a mass—and so, of course, the earth—are surrounded by a magnetic field, *when they move*. In this way he explained the magnetic field of the earth as a result of its rotation around its own axis. If an old theory is correct, the strength of the magnetic field must increase toward the interior. If Blackett is right, it will decrease. So the job would be to find out whether the magnetism actually grows more or less intense towards the center of the earth.

This was an ideal job for the *Galathea*, partly because at sea greater depth may be reached than on the ground, partly because the injurious influence on the measurements from certain magnetic rocks would be insignificant in the ocean.

The measurements that were carried out on board the *Galathea* did not concern the exact direction of the magnetic field. This varies all over the world, being vertical at

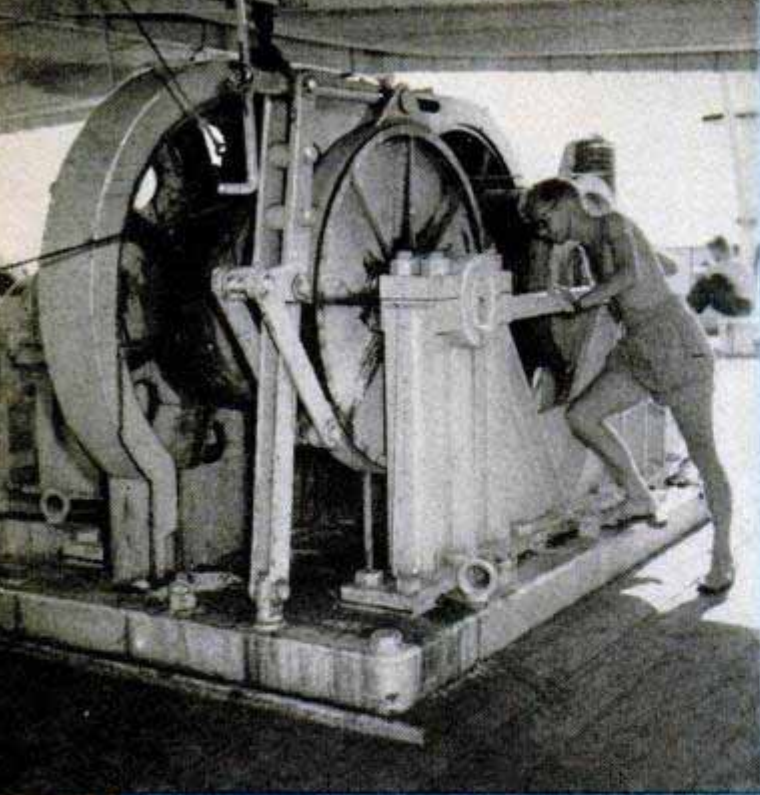

Giant winch holds eight miles of wire used for lowering sledge-trawl in deep Philippine Trench

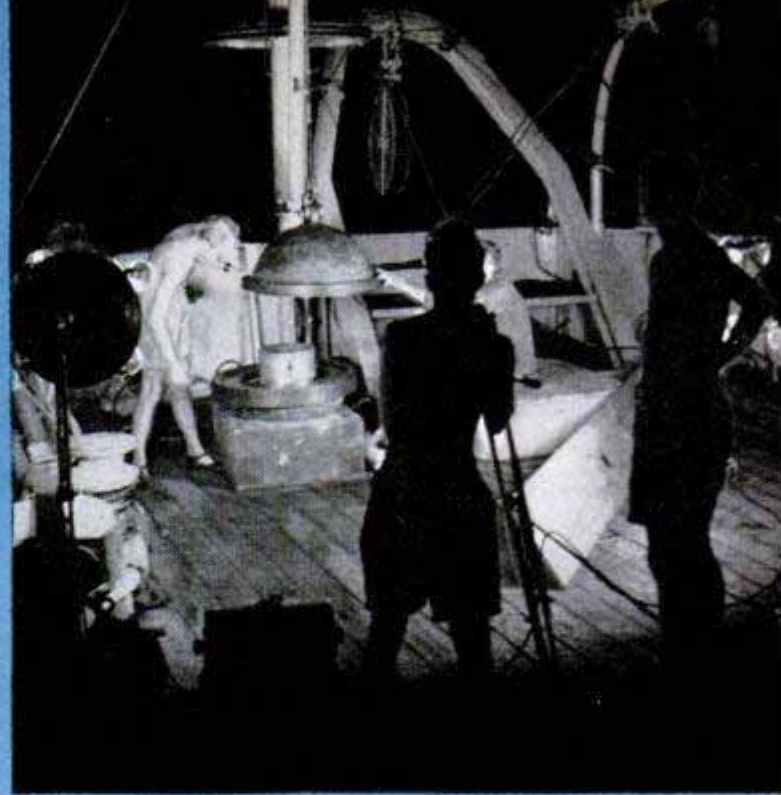

Sphere for testing magnetism is readied for drop overboard. Test unit is in lower half of sphere

Below, sketch shows depth of ocean probed by expedition scientists in search of deep-sea fish. Forms of plant life and bacteria were found farther down

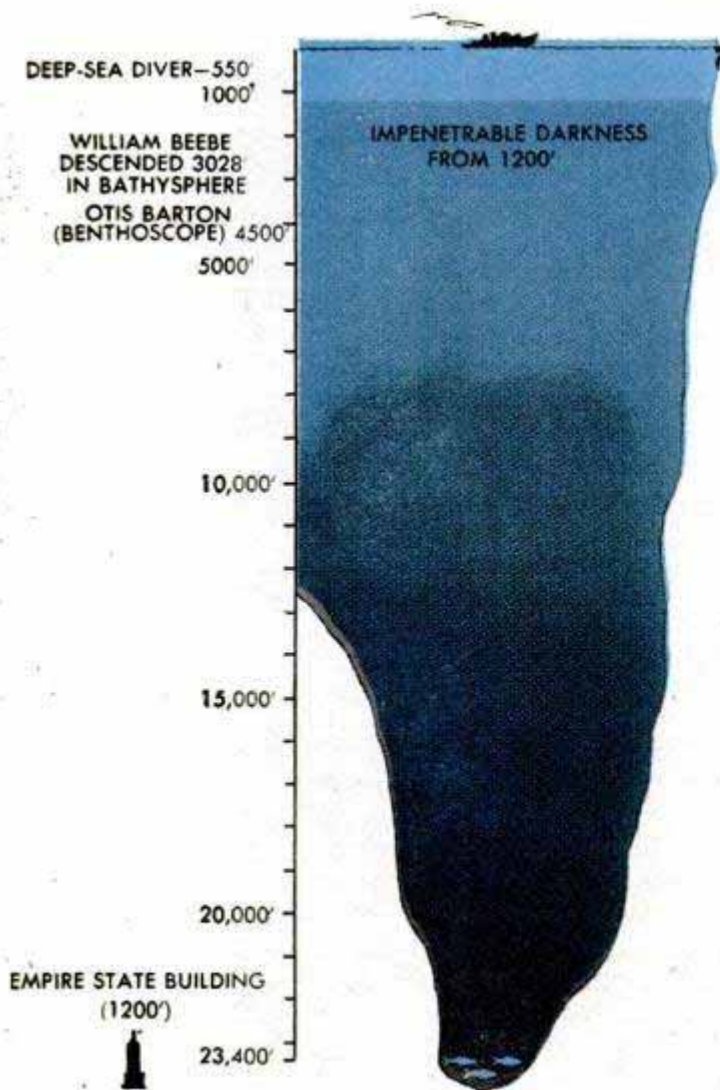

the poles and horizontal at the equator. Besides, the actual strength of the field is of minor importance. The point is whether it increases or decreases with depth.

In order that the delicate, immensely accurate apparatus might stand the enormous pressure of almost 1000 atmospheres, it had to be protected by hollow spheres. For this purpose two spheres were constructed, a single sphere weighing 2400 pounds and a double sphere weighing 3600 pounds. The walls are four inches thick, the inner diameter 20 inches. It proved very difficult to find an alloy that was completely nonmagnetic. After many vain attempts, a Danish firm finally succeeded in making a special bronze alloy—the so-called "Galathea bronze"—which suited the purpose well.

The *Galathea* scientists used two instruments for measuring the vertical and horizontal parts of the magnetic field. The apparatus for measuring the vertical force principally consists of a magnetic needle (as in a compass) turning around a horizontal axis with its center of gravity beneath the point of rotation. At the same time, the needle is influenced by an artificial magnetic field, the strength of which equals that of the earth at the surface but is opposite in direction. Consequently, at the surface of the ocean, the needle will be horizontal. When the instrument is sunk into the sea, the needle will turn one way if the field grows stronger (thus confirming the old theory) and turn in the other direction if the field decreases (thus delivering proof of Blackett's theory). A mirror,

fixed to the compass needle, reflects a ray of light to a strip of photosensitive paper, recording the needle's motion on the paper.

A third instrument used on the *Galathea* measured the horizontal component of the magnetic field and was intended for the double sphere. It worked on more modern principles. An electric coil rotates 1500 turns per minute around a vertical axis and thus induces a current, the strength of which depends on the strength of the horizontal component of the magnetic field. The current, being extremely weak, is amplified and registered. In the lower part of the double sphere is the coil, made of non-magnetic materials. In the upper sphere are the motor and the amplifier. They must be kept at a distance of at least six feet from the coil or else they would influence the magnetic field around the coil.

A lot of technical difficulties had to be conquered before successful measurements could be taken. Apparently for no reason at all, the bronze sphere rotated like a spinning top when lowered into the sea and actually succeeded in untwisting the steel wire about 20,000 to 30,000 turns during an immersion. So the men put up a jointing arrangement 30 feet above the sphere and equipped it with a rudder. Then, finally, it stopped rotating. The two halves of the

bronze sphere did not fit tightly enough, and water seeped in under the enormous pressure. Not until our arrival at Singapore could the jointing surfaces be ground sufficiently accurate to keep the water out.

In the meantime the *Galathea* had reached the Tonga Trench. The technical problems had been overcome and they were going to make the all-decisive immersion to the bottom—30,000 feet below. Then a catastrophe happened: The big winch broke. The experiments had to be delayed just as the end was in sight. Not until they arrived at Los Angeles could the winch be repaired. Measurements were carried out in the Panama Bay at a depth of 15,000 feet. These investigations show that the magnetic field increases toward the bottom—a refutation of Blakett's theory. Because of influences from magnetic rocks they did not, however, get the final scientific proof. It lies waiting for us about 30,000 feet beneath the surface, in the darkness of the Tonga Trench.

For the first time in history it had been proved that there is life at depths greater than 18,000 feet. This is of great scientific importance and is undoubtedly the most sensational finding of the expedition. The basis of all life however is the production

(Continued to page 240)

Dr. Anton Bruun, leader of *Galathea* expedition, right, examines sea anemone with American Professor ZoBell

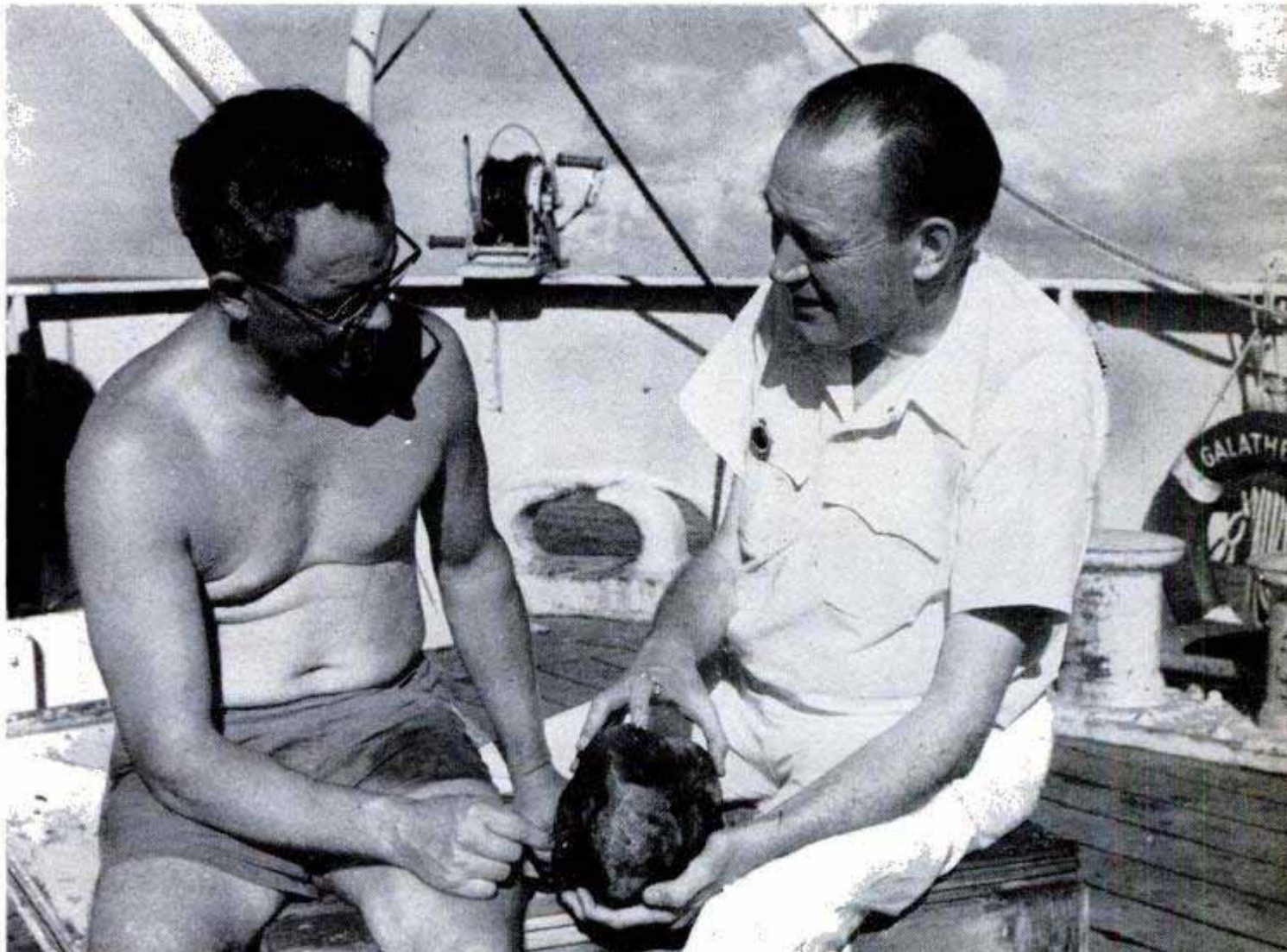



Army-Ration Heater Is Smokeless

Canned Army rations are heated in the field by a new fuel unit that burns without visible flame or smoke. The flexible heater is wrapped around a can of field rations and ignited with a match. The invisible flame heats even frozen food to the proper temperature within a few minutes. Ration heaters now in use must be shielded from the wind and also tend to generate smoke that might disclose the soldier's location. The new heating unit was developed by the Quartermaster Corps.

Oil Fuel Drums Reclaimed by Speedy Navy Process

Battered fuel barrels bound for the scrap heap are made good as new by a speedy reconditioning process in use at a Navy depot. Leaky, rusty and dented drums are first straightened on their ends by a machine that takes the kinks out of the rims. Then a "dedenter" literally blows the dents out of the drum with high-pressure air. Diamond-shaped links in a chain scrape away rust on the inside of the barrel before

a solution of hot caustic soda goes to work on it. Wire brushes flying around the outside of the drum clean off scale and loose paint. Leaks are plugged, paint is sprayed on and an infrared drying oven winds up the process for a cost of only one tenth as much as a new drum. Over a month's time, the treatment saved the Navy almost \$90,000. The process allows the drums to be stored in the open for 18 months without attention.

Ancient Cedars Form Memorial for Logging Industry

As a memorial to the industry upon which the city of Vancouver, B. C., was founded, residents have erected a huge commemorative arch made of three ancient cedar trees. The cedars, cut within the city limits, are expected to form a symbol of the logging industry for hundreds of years.

Cedar is noted for its resistance to rot, and the trees are mounted on concrete bases. The huge log forming the top of the arch came from a tree 120 feet tall and 12 feet in diameter near its base and weighs 30 tons. It is estimated that the log is more than 1000 years old.



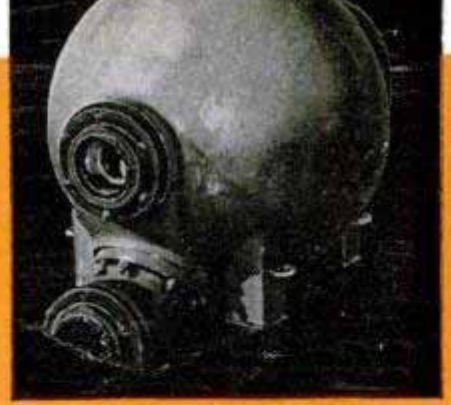

DEEP-SEA PHOTOGRAPHS



Allan Hancock Foundation photos

↑ Camera which took the photos was mounted in a 3000-pound steel ball with side opening for the lens and a lower one for the strobo-light

Above left, unknown kind of jelly-fish was photographed at a depth of 5620 feet. These strange, tentacled creatures live in total darkness

← Ocean bottom, 4356 feet below surface, reveals tentacles of unknown form of life, probably a wormlike creature with body buried in mud

IT HAS BEEN said that science knows more about the surface of the moon than of dark underwater areas that comprise more than 70 percent of the earth's surface. The Hancock Foundation of the University of Southern California has recently been peering into this vast unknown with the aid of a special underwater camera. The resulting photographs reveal organisms never seen by man. At some depths fish apparently carry their own lights like fireflies. Others probably swim with their enormous mouths open to collect as much organic debris as possible. Many are carnivorous, for large plant life and succulent algae do not exist below 600 feet. The camera was mounted in a 3000-pound steel sphere, with one opening for the lens and another for a strobo-light. A timer was preset to take one exposure every 30 seconds in hopes that the shutter would flash as sea life passed in front of the lens. This was an advance over the previous technique of lowering a camera for a single shot. The steel ball containing the photographic equipment, called a benthograph, was lost when it became hopelessly wedged in rocks 2100 feet below the surface of Santa Catalina Channel. However, it had already taken many photos including the two shown above. Photos of deep-sea basins, where the water circulates so slowly it becomes stagnant, show an abundance of worms, brittle-

stars and other creatures living in total darkness at 5000 feet. The photos prove that the ocean floor is bumpy from the burrowings of these animals. The scientists now are planning to build television into their next steel sphere to give them a camera-eye view of the ocean floor from the ship's deck.

Drawing shows equipment carried in the benthograph. The ball was lost in the rocks of a submarine canyon

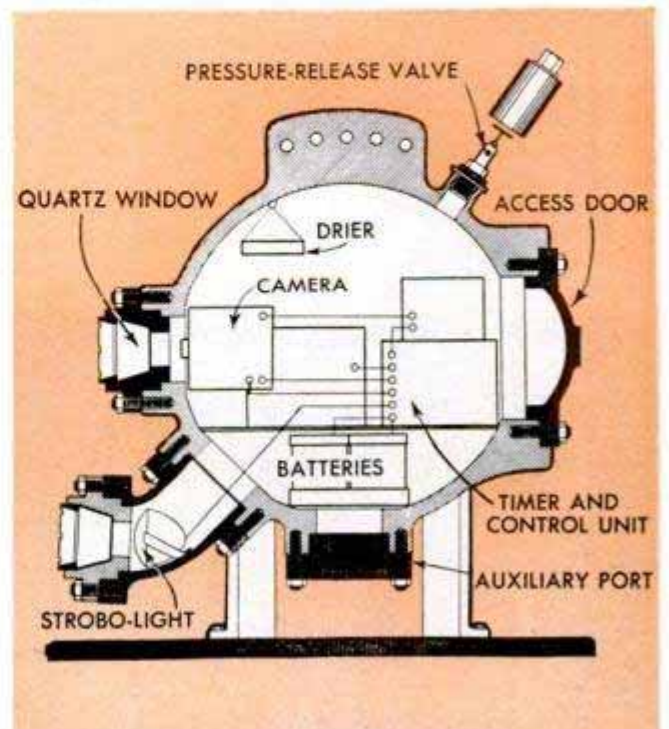

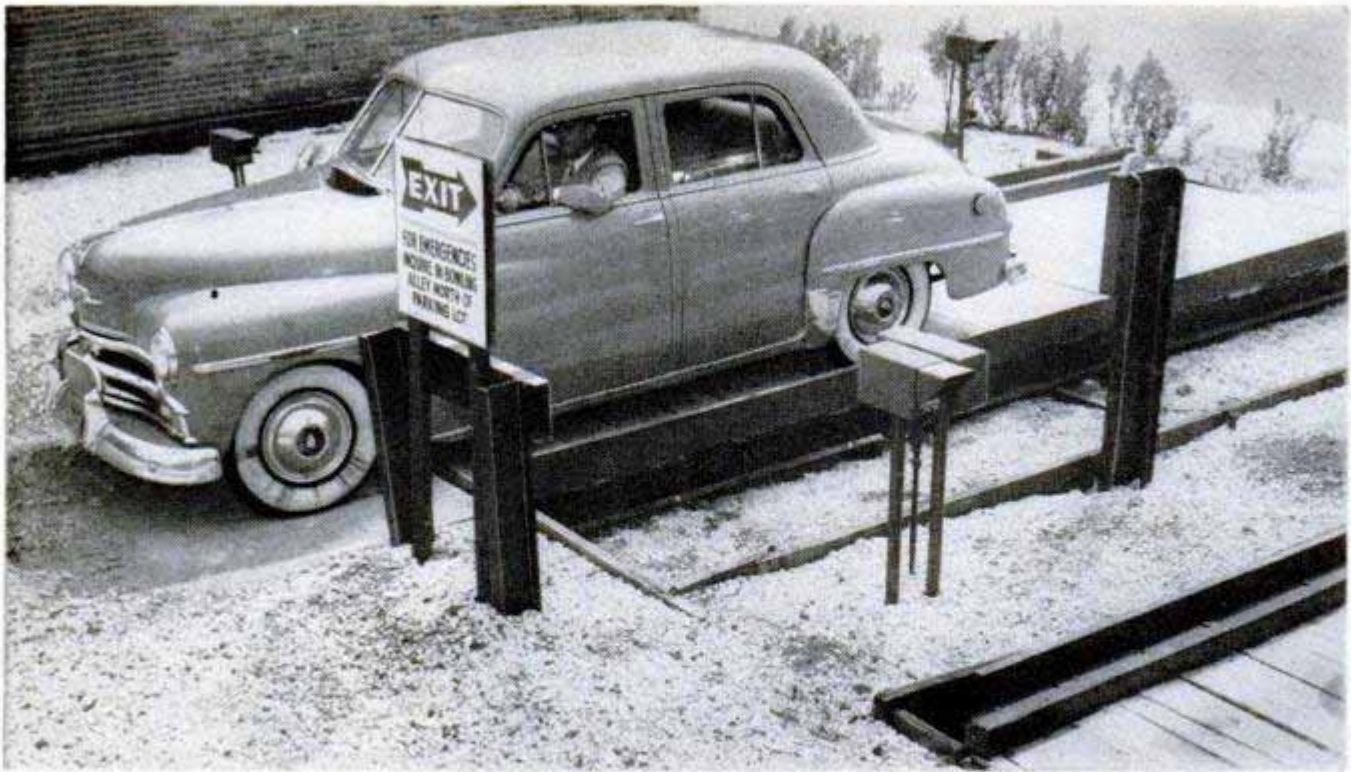

Parking Device Eliminates Need for Attendants

Guarding the entrance and exit of a parking lot, a completely automatic device collects parking fees, keeps a running count on the number of parked cars and prevents the entrance of more automobiles whenever the lot is full. An automobile coming into the lot rolls onto a flush platform, but is prevented from passing by a barrier in front of the car. The driver reaches out and deposits money in the coin box. This activates an electric motor that moves the

platform to the right of the barrier, allowing the car to enter and park. Signals from an electric eye cause the platform to move back to its original position, ready for the next automobile. The exit unit is identical with the entrance unit, a coin being necessary to activate the mechanism. A counting device set at the capacity of the lot flashes a "full" sign when that number is reached, stopping the operation of the entrance mechanism until a car leaves the lot.

Humidifier Uses Asbestos Wick to Double Moistening Capacity

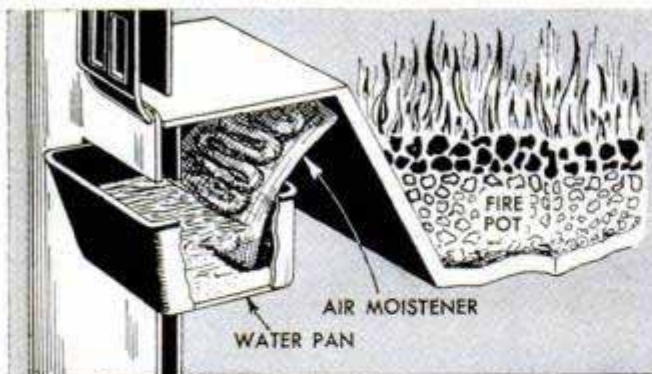

Made of asbestos wicking enclosed in bronze screen wire, a humidifier is attached to the water pan on warm-air furnaces with metal staples. It will not rust, rot or burn. This humidifier, or moistener, will increase the amount of water evaporated in the ordinary furnace pan two to three times, according to the manufacturer. The water-saturated wick, in an upright position at the back of the furnace pan, is fully exposed to the circulating air and heat from the fire pot.

Sandy Rubber Bounces At Low Temperatures

Developed for high-altitude airplane de-icing systems, a synthetic rubber, vulcanized and reinforced with fine sand, does not lose its bounce in extreme cold. Although most silicon-type rubbers snap when stretched more than twice their normal length, the new rubber will expand 600 percent without damage.

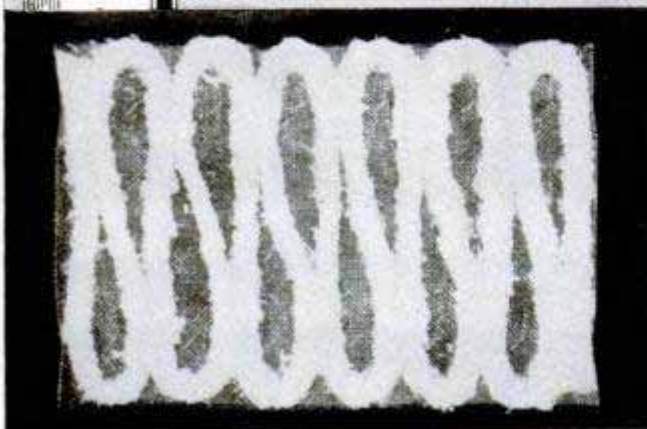

READ ABOUT ALL
THE '53 CARS

ALLSTATE

BUICK

Cadillac

CHEVROLET

Chrysler

DODGE

DeSoto

FORD

Henry J

HUDSON

Lincoln

Mercury

Nash

Packard

Plymouth

Pontiac

OLDSMOBILE

KAISER

Studebaker

Willys

Coming in February

one of the

Greatest Issues

in our history!

featuring a

GIANT AUTOMOBILE SUPPLEMENT

with

- 40 pages on automobiles
- Roundup of the '53 models
- 8-page album of full-color paintings
- Specifications of the new cars
- Floyd Clymer on motorcycles
- How to break in your new car
- Report on the Mexican Road Race
- Plus a host of other automotive features

on the newsstands January 27

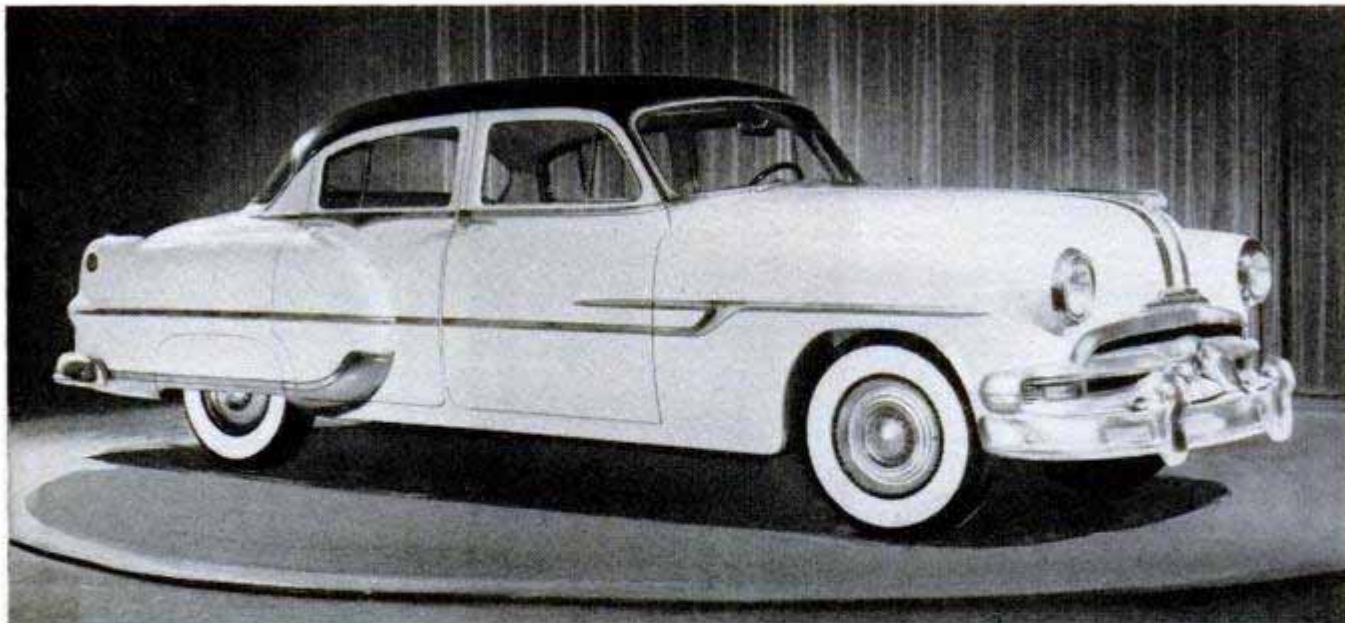

Pontiac retains its personality despite complete restyling. Famed chrome striping is changed only slightly

'53 Pontiac Provides First View of General Motors' Styling; Ford, Mercury Get Face Lifting; Packard Revives Clipper

FIRST OF THE General Motors' line to appear, Pontiac presents an all-new body for 1953. Also making news are Mercury, Ford and Packard—all basically unchanged from 1952. Packard revives its Clipper line, dropped before World War II.

Pontiac's 1953 bodies are roomier and on a longer (122-inch) wheelbase. A redesigned front suspension system makes high-speed turning easier and reduces tire scrub. To make slow-speed steering easier, but slower, the over-all ratio was boosted from 22 to 1 to 25 to 1.

The Pontiac 6 has been upped to 118 horsepower (compression: 7.7 to 1) by duplex carburetion and a new intake manifold, new camshaft and smaller combustion

chamber. Other changes include one-piece wrap-around rear window, one-piece curved windshield, a rear-fender fin and ignition-key starting. The rear door on four-door models is squared off at the top for easier access and unhindered side vision. In sedans, knee room is about two inches greater in the rear seat. Extras include power steering and automatic headlight dimming.

Mercury in 1953 has only identification changes from 1952. A chrome strip from headlight to taillight along each side increases the apparent length of the body. Some power has been added by changes in the muffler and exhaust system, but horsepower rating is unchanged.

Ford improved riding qualities for 1953.

Front-end road shock has been reduced drastically by improved springing and larger compression bumpers. The company claims 80 percent reduction in front-end impact over a two-inch bump at 40 miles an hour. Styling changes include a cleaner front grille, larger taillights and lower rear bumper.

Packard's new combustion chambers boost horsepower to 180 in the big model, 160 in the Clipper De Luxe and 150 in the Clipper. Compression ratios are 7.7 to 1 in the 150, 8 to 1 in the others. The Clipper sells from \$2500 to \$2800, the big Packard from about \$3000 to \$6900 giving the company two price lines for the first time since before World War II. ★ ★ ★

In the four-door Pontiacs, the rear doors have been squared off on the top to provide easier access and better passenger vision





To make the 1953 Mercury appear wider and lower, designers have given the bumper grille a new treatment. The long chrome side molding also makes the car seem lower and protects it from parking-lot scratches

Most of the Ford changes are invisible, as engineers improved the ride for '53. However, you will notice the cleaner front grille and the chrome stripe on the rear fender. Taillights are larger



In production again for the first time since before World War II, the Packard Clipper is in the medium-price field. The Clipper has both standard and de luxe models in two and four-door sedan styles

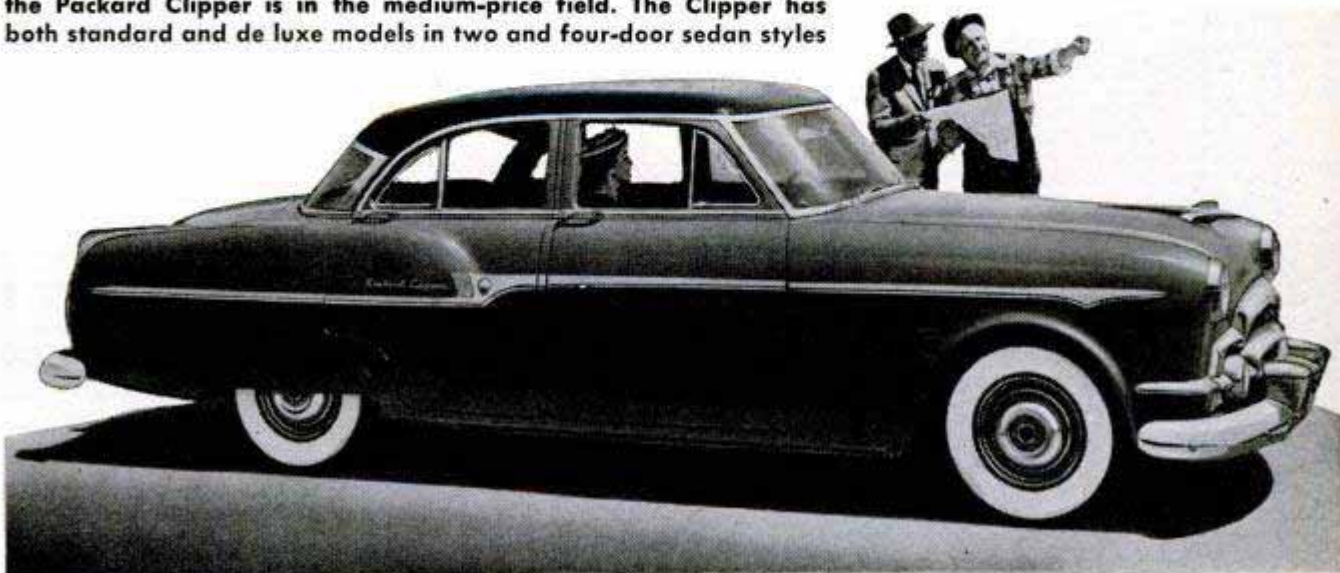

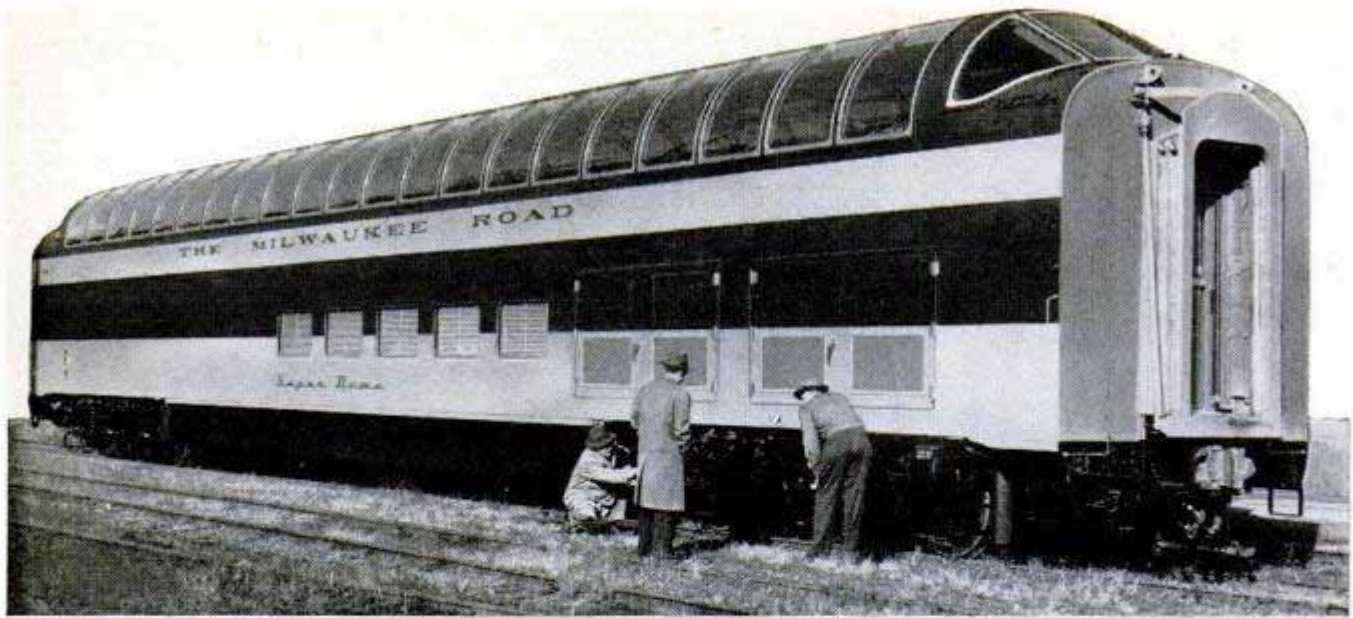

Double-deck Super Dome cars provide an unobstructed view from the upper level and snacks in the dining-lounge section below



Center aisle stretches the full length of spacious dome car with stairways at either end. The curved-glass window sections are five feet high. Seats have lower backs than the ordinary coach seats for better forward visibility and are nonreclining type



Super Dome Rail Car Seats 68 Passengers

FULL-LENGTH observation cars, called Super Dome, provide seats for 68 passengers and a dining and lounge section on a lower level accommodating 28 persons. Ten of the new cars are making their bow on the *Hiawatha* trains of the Milwaukee Road operating between Chicago, Milwaukee, St. Paul, Minneapolis, Seattle and Tacoma. The 42 curved window sections on each car measure five feet high and more than three feet wide. Stairways at either end enable the passengers to walk the full length of the car through the dome section. Passageways on the lower level permit passengers to reach other cars without having to walk through the dining-lounge section. Each double-deck car is air conditioned with refrigeration equipment that could produce 20 tons of ice a day. Unique features of the heating and cooling system are two "solar disks" atop the dome to supplement the regular thermostatic controls. These disks lower the temperature setting depending on the sun's heat. The cars weigh 200,400 pounds each and were built by the Pullman-Standard Car Mfg. Co. at a cost of \$320,000 apiece. Six-wheel trucks, which weigh 65,550 pounds and were designed for high-speed train service, support the cars. The cars are 85 feet long and the dome top is 15½ feet above the rails.



Detroit Listening Post

By Siler Freeman

ANOTHER BIG DAY of the new-model season dawns this month. Chevrolet will present its 1953 models and its answer to competition will be awaited not only by its dealers, but by its arch-rivals, Ford and Plymouth.

Something of a disappointment to Chevrolet's prospects is the fact that its V8 engine has not reached the stage where it can be offered even optionally. Only new engine in the GM line will be in Buick.

However, Ford prospects suffered the same disappointment and so did Plymouth. So the low-priced class stays on the same footing engine-wise for the time being.

But each is rushing ahead with plans for new power plants. Ford's is about the farthest along. Next is Plymouth's and again Chevrolet will have a chance to examine its competition's best before it goes into production.

What happens this month will probably tell the story of whether the auto industry will have a return to old-time competition or just a mild renewal. After the holiday letdown, plants will start building up stocks for the spring selling. Controls of some sort are still present and few auto-industry officials can see real competition until they can gear production to the market.

Controls are due to expire April 30. The general opinion is that they will be allowed to do so. Then the prewar rivalry that characterized the industry's strides will be much in evidence.

The new models unveiled so far and those that will complete the 1953 lineup this month show what has been done in anticipation of returning competition.

In cases where something new hasn't been added, the old has been improved. This will be true of two cars that will show this month. Both Chevrolet and Buick have improved their automatic transmissions. Both are of the same type, torque converters. Both have faced the same criticism from their users—smooth operation but uneconomical in the lower ranges. How well they have done to offset this criticism will be seen in their 1953 versions of the Powerglide and Dynaflo.

Charles A. Chayne, head of GM's re-

search engineering, has hinted at greater developments in the automatic-transmission field just ahead. He went to England to make these disclosures before several scientific societies. The developments have been carried on in great secrecy. How soon the corporation will be ready to disclose them is a matter only for guesswork.

Enthusiastic though its proponents are, air conditioning for cars this year will be limited both by price and production. GM will have the only unit available from its Frigidaire division and it will go not only into its higher-priced lines, but also into the Buick Super.

Inspection of the new models will show little improvement in the quality of the chrome. Despite the relaxation on the use of a slight coating of nickel over the copper before application of chrome, the thinness of the brightwork is apparent. Wider use of stainless steel is the only answer.

But the industry is continuing its search for better materials. Its war on corrosion is said to be progressing with new chemical rustproof treatments paying dividends. One of the metals under consideration for future use in cars is titanium. This is highly rust-resistant but also very expensive.

The increasingly popular sports car will get off to a good start this spring. Just what is in prospect will be seen in the GM show this month at the Waldorf-Astoria in New York City. Each division has its own version of what a sports car should look like. What the rabid sports-car devotee will pay is another thing. Only Buick has brought the price down to where it could attract some business so far.

Studebaker promises to give the sports-car fan a lift with its new sports line, scheduled for release in a month or so.

Not only will competition be rampant this year in the lower-price class but the luxury lines will clash in no unimportant manner. Packard's new management is determined to win back its old customers from Cadillac. Chrysler is undaunted by the latter's postwar popularity and wants a good slice. And Lincoln is making its own bid which showed definite progress last year and will be continued this year.

AVERAGE MILEAGE
OF CARS POLLED: 7969

AVERAGE OWNER REPORTS-
CITY 26.9 M.P.G.
COUNTRY 31.8 M.P.G.

MOST OWNERS
AGREE WITH THESE

THREE BEST-LIKED
FEATURES, POLL SHOWS

MOST FREQUENT
COMPLAINT: LOW POWER

ONLY 28% BOUGHT MINX
AS A "SECOND CAR"

39% HAVE TAKEN
LONG TRIPS

Clymer demonstrates the narrow
Minx body—62 inches over-all

POPULAR MECHANICS OWNERS POLL

(Conducted by Floyd Clymer)

10 months. Speedometer mileage: 10845

- I have owned a Hillman Minx Premium gasoline
- I use regular gasoline . Average gasoline mileage in city: 26 m.p.g.; in country: 33.3 m.p.g.
- Average gasoline mileage in city: 26 m.p.g.; in country: 33.3 m.p.g.
- Oil consumption: One quart every 2000 miles. I change oil every 2500 miles.
- Roadability at high speeds: Excellent Good Unsatisfactory
- Maneuverability in traffic: Excellent Good Unsatisfactory
- Acceleration: Excellent Good Adequate Poor
- What is most satisfactory cruising speed of your Hillman? 55 m.p.h.
- What is the top speed of your Hillman? 85 m.p.h. Don't know
- My main reasons for buying a Hillman Minx: Economy of maintenance, low purchase price, maneuverability in city traffic, appeal of foreign car in both body & mechanical design (4 forward speeds, etc.)
- Rate these points:

Visibility, forward	Like <input checked="" type="checkbox"/>	Acceptable <input type="checkbox"/>	Dislike <input type="checkbox"/>
Visibility, rear	Like <input type="checkbox"/>	Acceptable <input checked="" type="checkbox"/>	Dislike <input type="checkbox"/>
Riding qualities:	Like <input type="checkbox"/>	Acceptable <input checked="" type="checkbox"/>	Dislike <input type="checkbox"/>
Horsepower:	Like <input type="checkbox"/>	Acceptable <input checked="" type="checkbox"/>	Dislike <input type="checkbox"/>
Trunk space:	Like <input checked="" type="checkbox"/>	Acceptable <input type="checkbox"/>	Dislike <input type="checkbox"/>
Body styling:	Like <input checked="" type="checkbox"/>	Acceptable <input type="checkbox"/>	Dislike <input type="checkbox"/>
Quick steering response:	Like <input checked="" type="checkbox"/>	Acceptable <input type="checkbox"/>	Dislike <input type="checkbox"/>
- Specifically, what are your complaints on the Hillman? fast-wearing brakes, hard on spark plugs, wheels which tend to come loose.
- Would you buy another Hillman Minx? Yes Possibly No
- Is your Hillman the "second car" in your family? Yes No
- What major repair work have you had done? Brake re-lining
- Do you find parts and repair service readily available? Yes No
- How is your dealer service? Excellent Good Average Poor
- Give an overall rating for the Hillman: Excellent Good Average Poor
- Have you made any long trips (over 1000 miles) in the Hillman? Yes No

OWNERS

Comment: Good performance.

20. What specific improvements do you want in your next car? Smoother riding, long-wearing brakes, larger drums, automatic conversion to open car, locking glove compartment, single front seat.

This questionnaire will be tabulated fairly and your name held in strict confidence. Write additional comments on reverse side. Thank you.

Mail promptly to:
FLOYD CLYMER
Popular Mechanics Owners Poll
1268 So. Alvarado St.
Los Angeles 6, Calif.

Your name: _____
Street: _____
City & State: San Francisco 22, Calif.
Occupation: Radio Writer-Producer





More American in appearance than most British cars, the Minx is one of the top sellers among foreign makes

REPORT on the HILLMAN MINX

By Floyd Clymer

FOLKS WHO DRIVE British cars love to talk about their automobiles. Most of them have a few thousand words to say, pro and con, about details which are often completely ignored in replies from owners of American cars.

Drivers of English cars seem more mechanically minded than the operators of Detroit products, commonly referred to as "inverted bathtubs" by the foreign-car devotees. A Hermosa Beach, Calif., research engineer expressed this opinion when he gave as his reason for buying a Hillman Minx: "I detest those chrome-plated monsters that give 10 miles per gallon."

Not that owners of British cars aren't critical of their own vehicles. They can think of more things to crab about than the driver of a 1922 Saxon. One exuberant Hillman owner returned his questionnaire loaded with lavish praise for his car and wound up deploring in strong terms the absence of a cigarette lighter.

A building contractor-salesman in Amarillo, Tex., wrote: "After 13,000 miles in my Hillman, I feel qualified to add a few comments beyond the matters ticked off in your form. An owner who knows how to drive one of these low-torque, high-r.p.m. mills can get a world of satisfaction and, incidentally, a lot of fun out of a Minx. . . . If he's patient with this little car, he'll be amply rewarded in return. . . . One thing you should warn the prospective customers about is the fish-bowl aspect of driving a

The true test of a car begins when the owner takes the wheel. *Popular Mechanics* sent questionnaires to 1000 Hillman Minx owners. Here's what they have to say

Emergency-brake handle is convenient to use, but a few women wrote that they caught their skirts on it



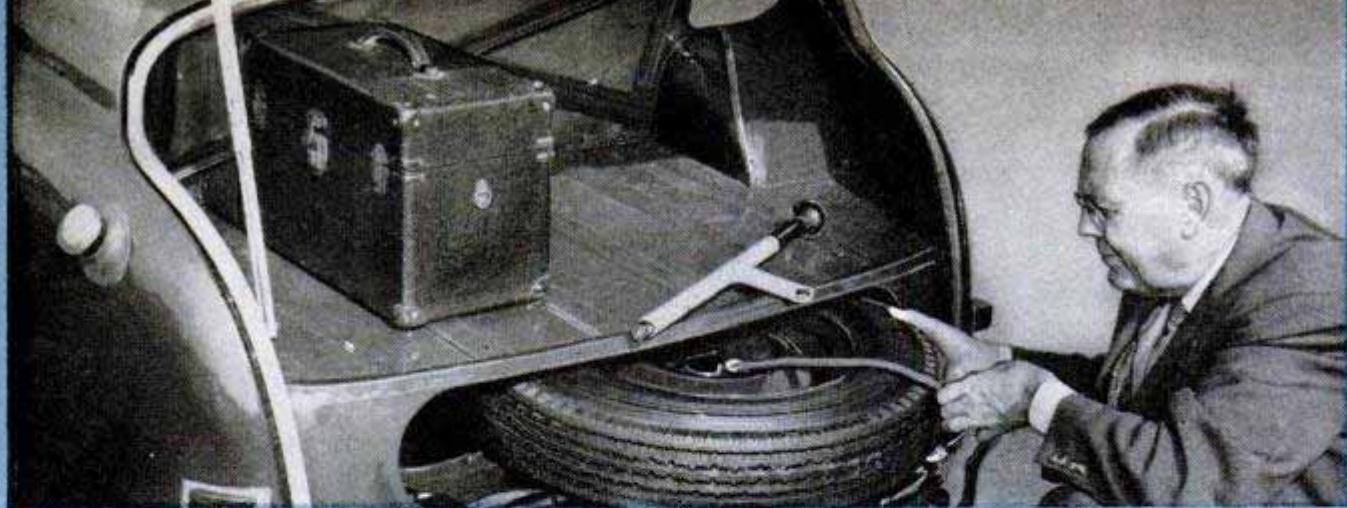

Trunk space is small but well organized. Spare tire rides beneath the floor and is pulled out with a strap

Percentages From PM Owners Poll

Average length of Hillman ownership.....	8.5 months
Average speedometer mileage reported.....	7969
Owners using regular gasoline.....	56%
premium (high test) gasoline.....	44%
Average gasoline mileage in country.....	31.8 m.p.g.
in city.....	26.9 m.p.g.
Average mileage for adding one quart of oil.....	1183
Average mileage for change of oil.....	1516
Owners rating roadability excellent.....	61%
good.....	35%
unsatisfactory.....	4%
Maneuverability excellent.....	91%
good.....	Over 8%
unsatisfactory.....	Less than 1%
Acceleration excellent.....	17%
good.....	40%
adequate.....	37%
poor.....	6%
Average cruising speed.....	52 m.p.h.
Average top speed.....	73 m.p.h.

- Chief purchase reasons (in order of popularity):
1. Gasoline and maintenance economy expected
 2. Maneuverability (ease of parking specifically)
 3. Original purchase price
 4. Size and compact design
 5. Styling features
 6. Belief in quality of construction or preference for British manufacturing

- Most frequent complaints:
1. Inadequate power for climbing hills, passing, etc.
 2. Rattles, poor body fitting or assembly
 3. Inadequate acceleration in traffic and at cruising speeds due to low power or improper gear ratios
 4. Shock absorbers and other suspension parts requiring too frequent attention or replacement
 5. Inadequate rear vision in convertible models
 6. Poor paint or chromium trim
 7. Unreliable or unattentive dealers or poor service
 8. Difficult starting of engine when cold — excessive choking required
 9. Arrangement of gearshift positions

Heater control is within easy reach, but speedometer, seen at right, is too far from driver, Clymer says



Comments on specified features:

	Like	Acceptable	Dislike
Visibility, forward.....	97%	3%	0%
Quick steering response.....	88%	10%	2%
Body styling.....	83%	15%	2%
Riding qualities.....	72%	26%	2%
Trunk space.....	55%	39%	6%
Visibility, rear.....	45%	39%	16%
Horsepower.....	30%	59%	11%

Owners who will buy another Hillman Minx..... 68%
 might buy another Hillman..... 23%
 will not buy another Hillman..... 9%

Owners who bought Hillman as "second" car..... 28%

Major repair work done (noted mainly from owners having over 15,000 miles on their cars):

1. Piston rings replaced or valves ground
2. Brakes relined
3. Shock absorbers rebuilt or replaced
4. Carburetor or fuel pump reworked or replaced

Owners finding parts and service readily available..... 84%
 Owners rating dealer service excellent..... 41%
 good..... 24%
 average..... 19%
 poor..... 16%

Owners having made trips of over 1000 miles in Hillmans..... 39%

Improvements desired in next car (in order of preference):

1. More horsepower
2. Increased rear vision
3. U. S. gearshift position and more positive shifting linkage
4. Tighter body fitting, better workmanship
5. Larger or heavier car (longer wheelbase, more interior space, etc.)
6. Increased acceleration at low speeds and at cruising speeds. Gear ratio changes frequently suggested

OVER-ALL RATING OF HILLMAN MINX

Excellent.....	50%
Good.....	41%
Average.....	6%
Poor.....	3%

British drivers must have small feet! The clutch, brake and accelerator pedals are too close for safe driving



Minx, or any imported job for that matter. One soon learns to ignore the stares, but there's something else more startling. The car seems to bring out the beast in everyone on the streets. I find that even little old ladies in big Caddies will try to outrag me at lights. One gets used to such things. Or the service-station attendant who looks under the hood and says, a little contemptuously, 'Sure a small motor.' And then, 'Hey! Is that the battery?'"

This sentiment was echoed by a Tucson, Ariz., Air Force sergeant, who said: "Big cars, no matter what age, cannot allow a Hillman to be in front of them—it brings out the maniac in most other drivers."

A Chicago art director wrote: "It's a swell little car; I have no complaint whatever except I would like to see more of them on the road. Easy to handle in traffic, holds the road well, easy to park, economical to operate. . . . I would like to see a wider range of car colors."

Only a few owners replying in the survey found the Hillman was too much of a change from standard cars in respect to wheelbase. One of these was an Everett, Wash., salesman, who said: "I drove my Minx less than three months before I went over a 90-foot embankment and completely demolished it. I blame the accident solely to not being used to the short wheelbase. Other than that, the car was paying for itself by less gas consumption. I did not buy a second one."

The principal reason why 21 percent of the owners bought a Hillman was price and fuel economy. The survey showed that Minxes average 26.9 miles per gallon in city driving and 31.8 miles per gallon in the country. This compares favorably with the MG. But it was revealed that many Hillman owners want to have their cake and eat it too: A majority wished for more horsepower. This was suggested so fre-

Minx tested by Clymer had European turn indicators that swing upward. Some have the U.S.-style blinkers



quently as to lose all novelty. Several owners, including a Huntington, Ore., railway electrician, suggested that a change in the third-gear ratio should be made to provide more speed in that gear.

Here are some things people like about the Hillman:

"Twelve-volt electrical system, leather upholstery, excellent heater and defroster system, electric windshield wipers, parcel shelf under dash."—Portland, Ore., auto-parts warehouseman.

"The four doors in the small body. . . . The car parks and turns much more easily than the ordinary one."—Inglewood, Calif., housewife.

(Continued to page 260)

ECONOMY TEST

HILLMAN MINX MARK V 4-DOOR SEDAN

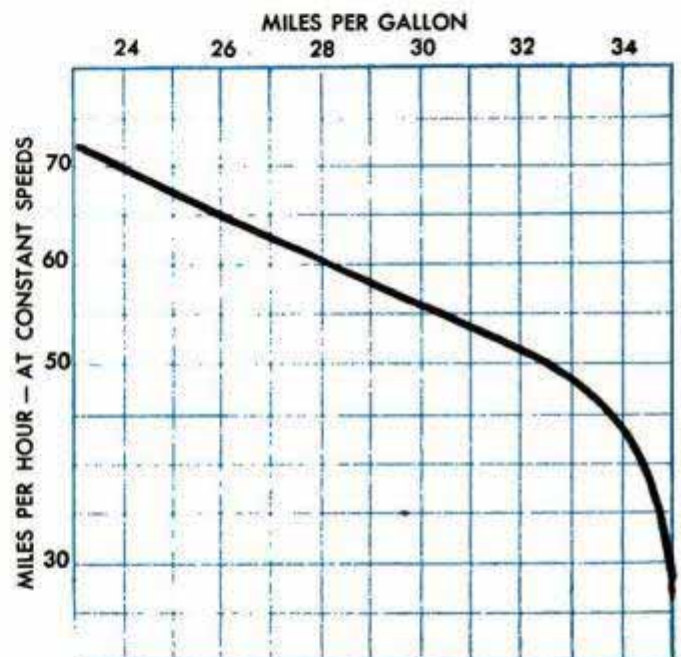

Miles Per Gallon

At constant 30 m.p.h.	34.9 m.p.g.
At constant 50 m.p.h.	32.6 m.p.g.
At constant 60 m.p.h.	28.3 m.p.g.
At constant 70 m.p.h.	23.8 m.p.g.
Los Angeles to Riverside, Calif., and return	30.6 m.p.g.
San Pedro to San Fernando Valley (city limits of Los Angeles), 60 miles through average traffic	27.3 m.p.g.

ACCELERATION TEST

HILLMAN MINX 4-DOOR SEDAN

¼ mile from zero	33.3 seconds
½ mile from zero	53.4 seconds
0 to 30 m.p.h.	7.9 seconds
0 to 60 m.p.h.	31.8 seconds

Maximum speedometer readings

1st gear — 22 m.p.h. 3rd gear — 54 m.p.h.
2nd gear — 33 m.p.h. 4th gear — 78 m.p.h.

Actual top speed about 6% less (speedometer variation).

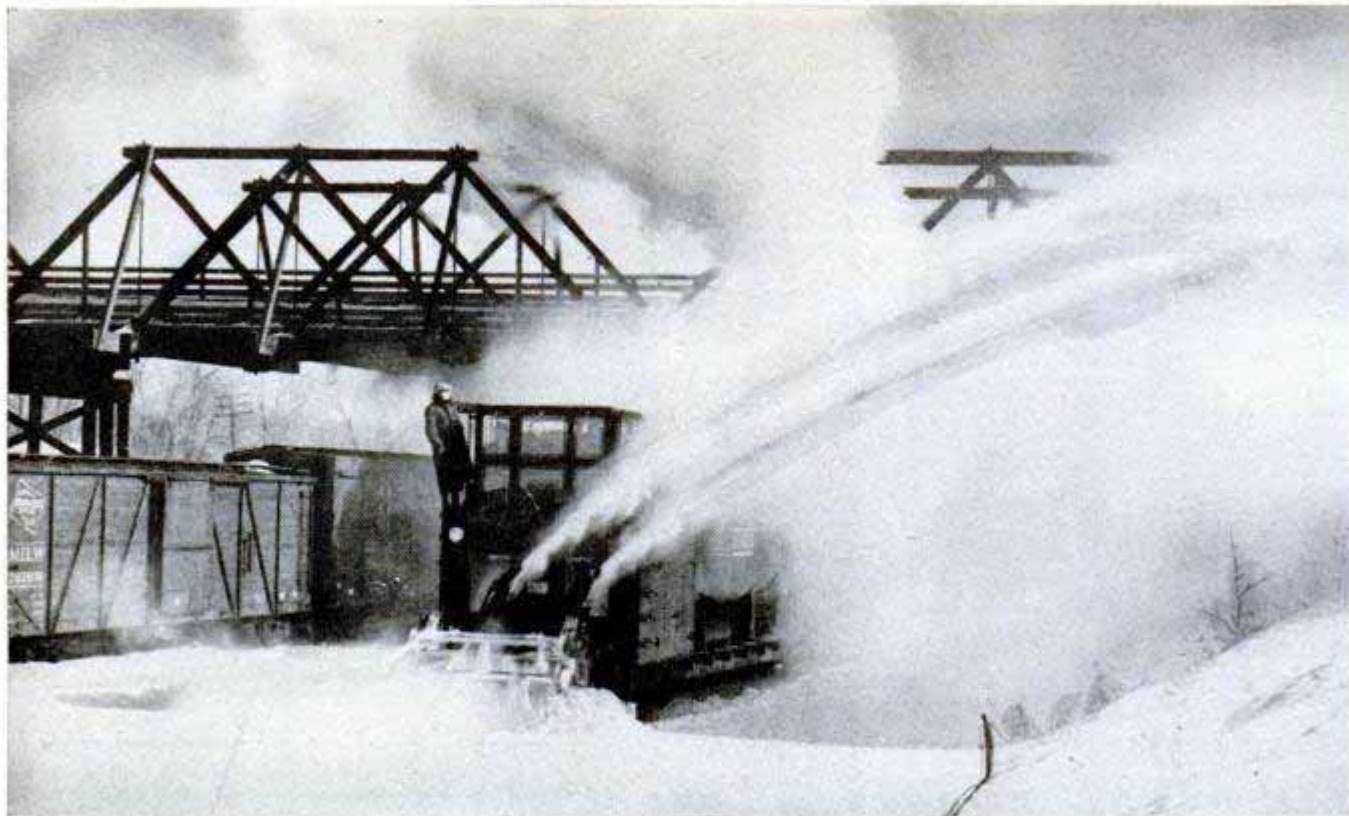

Railroad "Snow Eater" Plows and Melts

Gouging its way through drifts on a Northwest railway, a monster snow remover mounted on a 70-ton flatcar casts part of the snow aside and "eats" the rest. Tilted blades rotating in front of the plow blade break up the snow, which is thrown as far as 100 feet to the side by directional chutes or is carried back to a melting tank by conveyor. Fed into a 19,000-gallon chamber, it is melted by a steam-heated hot-water pressure spray and dropped later where it will not affect the rail operation. Both the crew and controls are housed in a high glass-sided cab which is located at the front of the machine.



Miniature French Auto

Appearing to be built around the driver, a French miniature car actually has room for one other passenger. The vest-pocket convertible is powered by a one-horsepower motor, has a top speed of 50 miles per hour and gets 35 miles to the gallon. It was displayed at a Paris auto show as one answer to the parking problem.

☐ Approximately 25,000,000 American automobiles are equipped with radios.

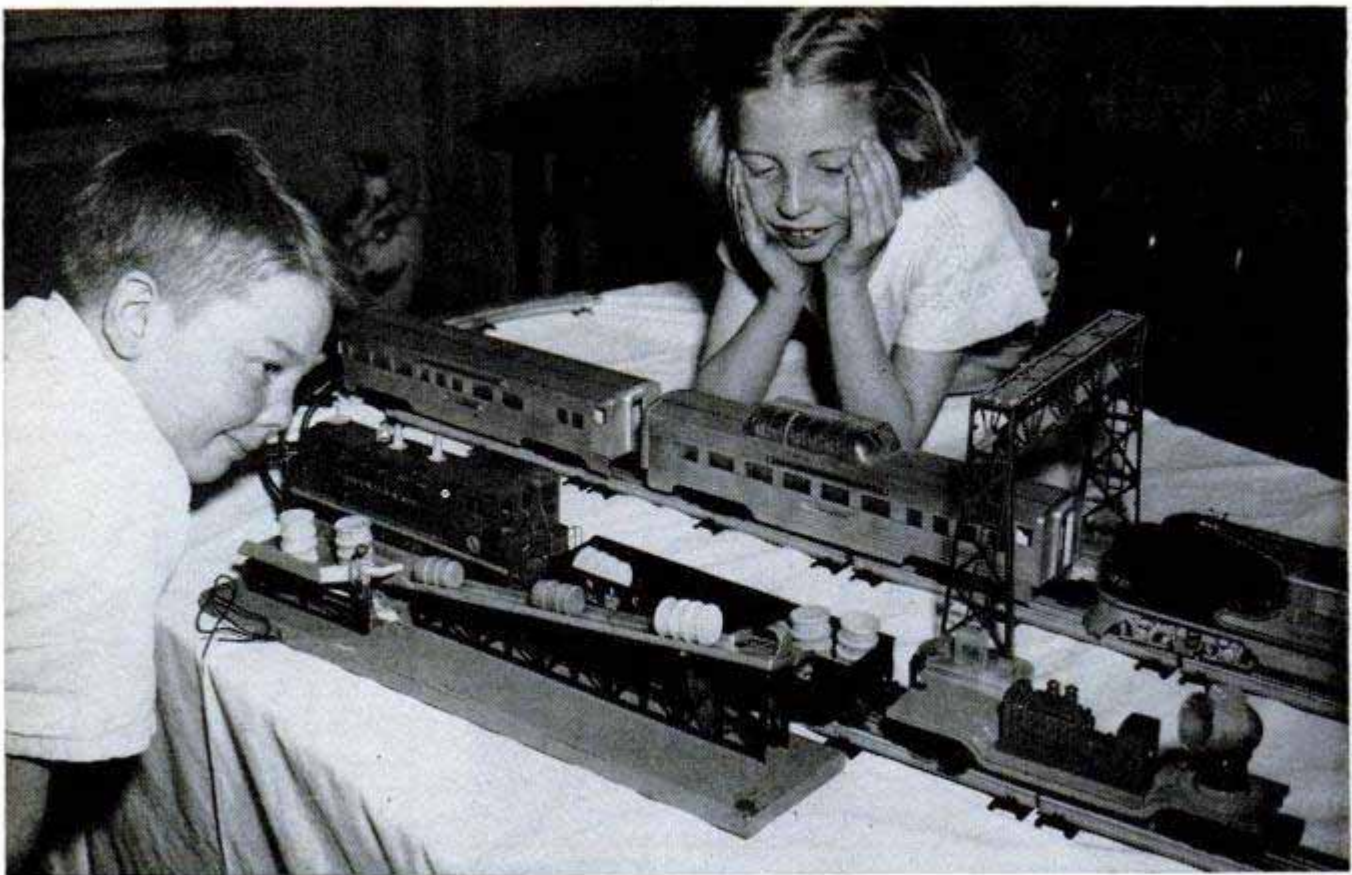

Miniature Railroaders Man Toy Switchyard

Miniature workmen man the switch tower and handle freight in a switchyard for model trains. As the train approaches, a switchman posted outside the tower room scurries inside to throw switches and alerts a watchman who descends a flight of stairs with a mail pouch, then climbs back upstairs once the train has passed. Barrels placed on a vibrating platform move within reach of a toy workman who topples each keg onto a conveyor which carries it up to a loading platform. From there it slides down a chute into a waiting railroad car.

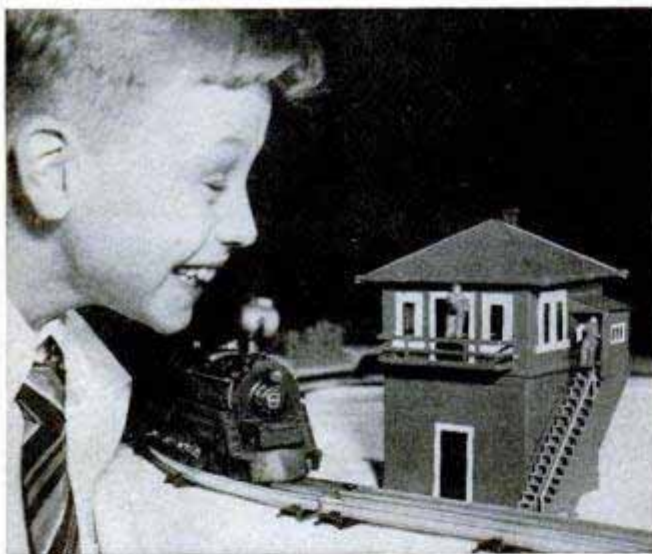

Flexible Swinging Gate Adjusts to Any Grade Level

Any swinging gate works, it seems, except when it's on a slope or you're trying to coax a lot of small livestock through it. Now, however, a new swinging gate has slats that are joined to the uprights at all places by single steel pins. Nonrigid, the gate "relaxes" into position. An adjustable guy wire allows the gate to hang flush on any kind of slope. Easily raised at one end to permit small livestock to squeeze under it, it can be quickly dropped to maintain one-way traffic. When the gate is opened, it permits the clearance of frozen mud or other obstructions.



Of the 2558 new locomotives put into service in the United States in the last year, 2537 were diesel, 18 steam and 3 electric.



First hydro-ski tests were made by the NACA on this modified D-558 model and proved that the water skis were practical for high speed and could be retracted. Model is shown coming in for landing on its skis

Hydro-Skis on Seaplanes Speed Take-Off

SEAPLANES in the near future may take off and land on retractable hydro-skis with small beaching wheels inside the skis. This will eliminate the need for beaching gear or mooring buoys because the plane will be able to roll up a ramp without assistance. Extensive hydro-ski tests have been made by the National Advisory Committee for Aeronautics, the Navy Bureau of Aeronautics and the Air Force. The first tests were made on models of the Douglas D-558 research plane. These revealed that smooth landings could be made at high speed on rough water. It was also discovered that the skis were small enough to be retracted, thus removing the air drag of conventional seaplane design. Edo Corporation made the first tests on a full-scale plane by installing a single hydro-ski on a fixed strut under a JRF-5 seaplane. The gear was operated from ice, snow and water. The plane makes a speedy take-off from water. During landing on rough water the hydro-ski presents only a small area for impact. As the plane decelerates the hydro-ski takes more of the load until it submerges and the plane floats gently on the water. The next step was the introduction of wheels slightly below the ski's planing surface so an airplane could be landed in water and taxied onto a beach. Wheel tests were made on an SNJ.



SNJ used in tests is equipped with ski gear and wheels. Here the plane has taxied out of the water for take-off from beach



Above, JRF-5 hydro-ski test plane has single ski on a fixed strut below hull. This plane was tested for multibase operations and additional skis were added (below) for use on snow and ice. The ice tests were too rough on the airplane





Streamlined tractor pulls the new hay baler, which will turn out three to eight bales per minute



Four-cylinder engine produces ample power to operate three-bottom plows in many types of soils. At end of the field or over grass strips the live-action hydraulic system will quickly lift the implements

Ford Tractor—'53 Model

GREATER POWER and a live-action hydraulic system are features of the '53 Ford tractor. It is larger, longer and heavier than its predecessors and the four-cylinder overhead-valve engine has been made more powerful by increasing the cylinder bore and shortening the piston stroke. Other features include a lever for implement-position control and constant-draft control, a throttle control for hairline speed adjustments, a selector which permits changes in the speed of the hydraulic system, and a live-power take-off attachment for continuous operation of implements whether the tractor is moving or standing still.

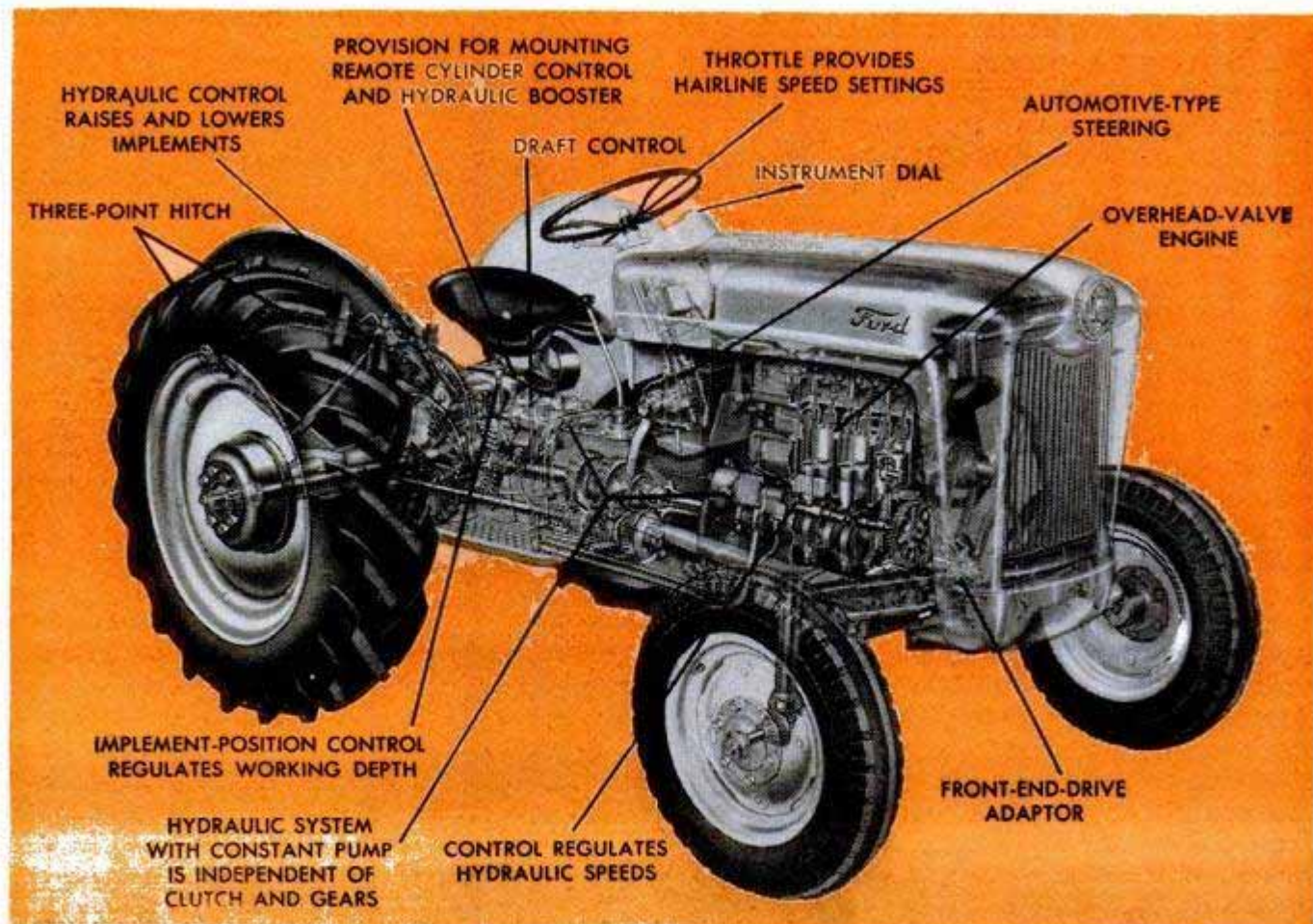



Official U. S. Navy photo

Light Beams Gauge Carrier Planes' Rate of Descent

Safe rates of descent for carrier-based aircraft are determined by a new shipboard instrument in a fraction of the time previously required. It sends out two beams of light which the approaching plane intersects and the instrument then records instantly the rate at which the plane is descending to the carrier deck. Prior to the installation and use of this instrument several days were necessary to compute the information acquired from photographic records.

Hot is the word for that spot in California's Mojave Desert where geologist Dr. Thomas Clements measured the air temperature three feet off the ground at 150 degrees Fahrenheit.



Swiveling Outboard Motor for Low-Cost "Yachting" Enthusiasts

Responding to the fast-growing popularity of outboard cruising, Martin Motors is introducing a 20-horsepower Blue Streak model. The versatile, heavier-duty motor is expected to answer the needs of "yachting on a budget" fans as well as those of fishing and racing enthusiasts. The 2-cylinder, 67-pound power plant can be swiveled into the boat for propeller inspection or overnight docking in shallow or salt water. The manufacturer claims its automotive-type valves allow smoother, faster acceleration. It has a removable steering handle and plug-in attachment for remote control.



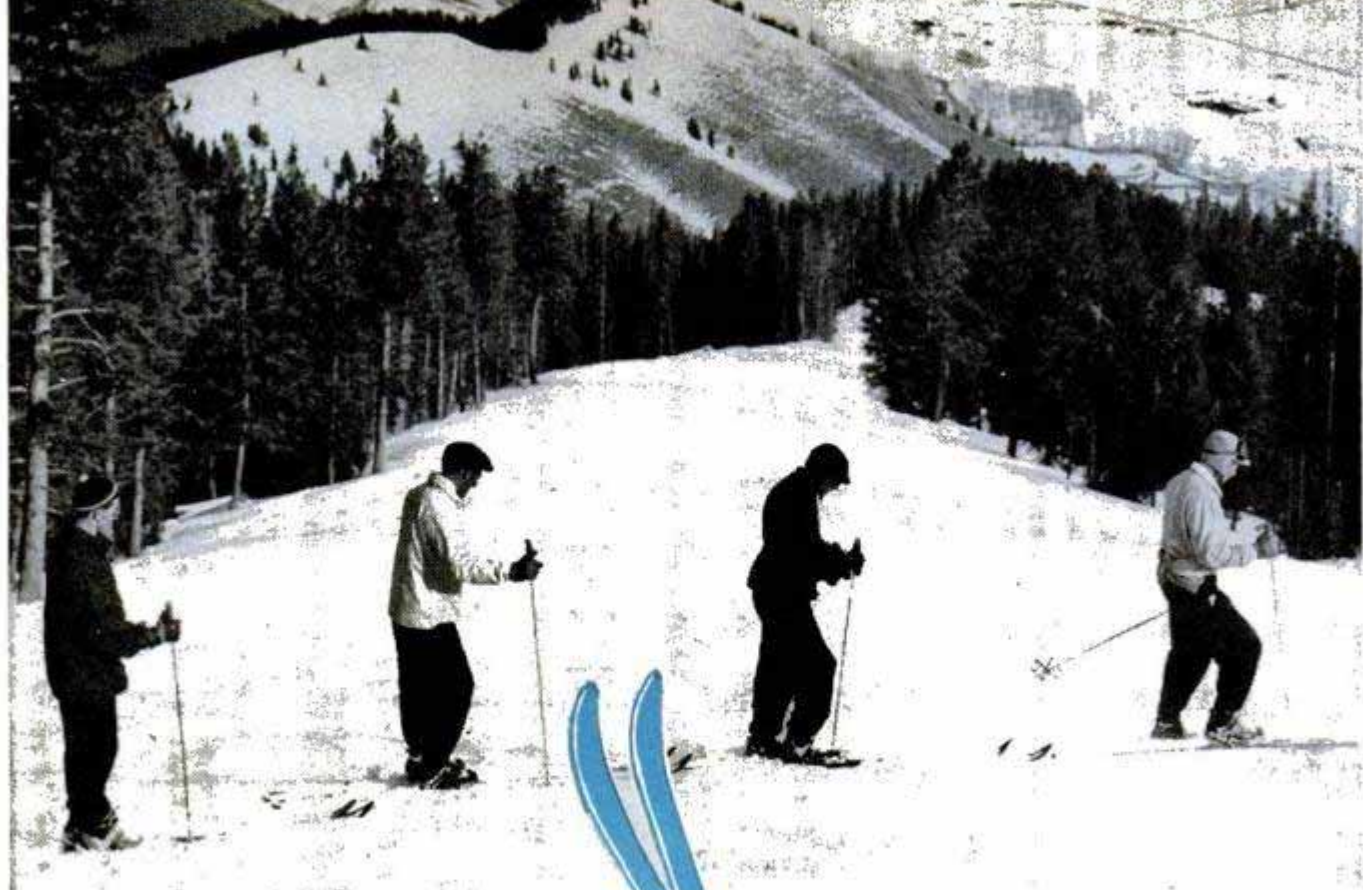

Sun Valley ski-patrol members pack trails high on 9250-foot Baldy Mountain after the season's first snow

HERE COMES the SKI PATROL!

By Norman Sklarewitz

CAUGHT IN THE WHITE FURY of last winter's paralyzing blizzards, the crack streamliner, *City of San Francisco*, lay half-buried in the drifting snow high in the Sierra Nevada mountains.

Inside, passengers huddled together as the second day of their strange imprisonment dragged on. Slowly fear as well as the cold began to creep into the coaches and Pullmans. Then suddenly someone glanced out across the bleak stretches of the Donner Summit Pass and saw a strange but wonderful sight.

Moving down the slope, heads bent against the savage winds, came a file of skiers. Minutes later they reached the stranded train, slipped off their heavy packs—and contact between the outside world and the 196 men, women and children aboard was completed.

In the rush of evacuation activities that followed, only a few people had time to wonder how it was that these few rescuers were able to reach the train when the best available mechanical equipment had failed. But those who noticed a small blue and orange insignia worn by most of the men had the answer. It was the mark of the National Ski Patrol.

Qualified as expert skiers, the patrolmen are out early to prepare the snow trails and runs before the lodge's guests are ready for classes

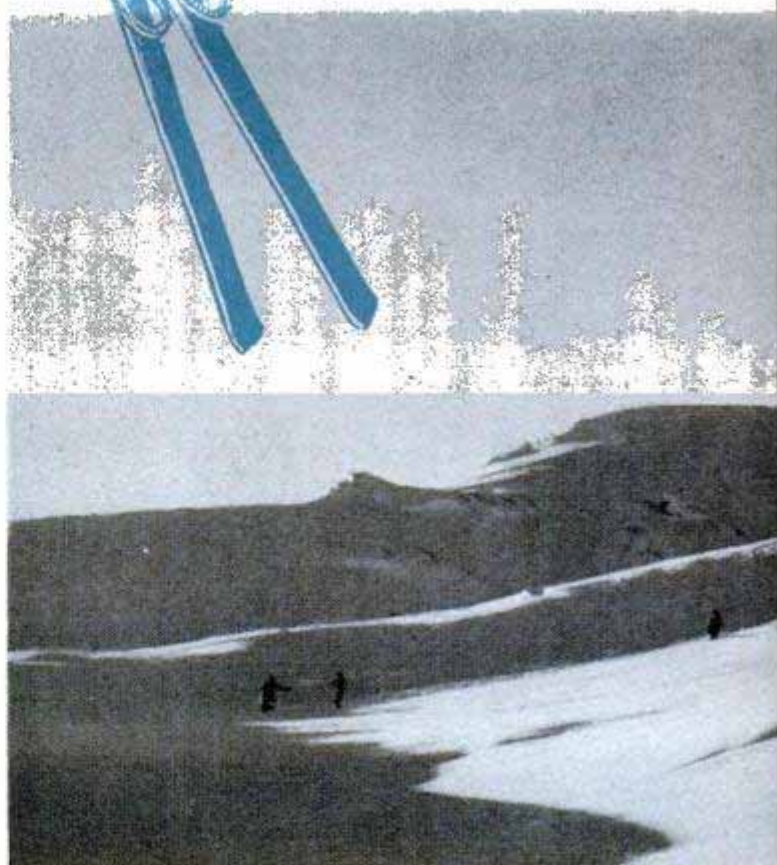

Across America's vast snow belt, the exploits of ski patrolmen would be almost legendary if they weren't so common. Here is an organization of only 4000 skiers who, in their brief history, have handled more than 36,000 accidents and saved 49 lives.

What's more, they've taken part in airplane-crash rescue missions in rugged wilderness areas of the Rockies . . . inched through blizzards in search of stranded motorists or lost hunters and carried out a constant program for winter-sports safety at hundreds of ski areas. And all this on an entirely voluntary basis!

This sounds like a lot of rugged adventure reserved only for a few hearty sportsmen. But, in reality, the Ski Patrol represents a cross section of American outdoor enthusiasts. And now the activities of the 500 local ski patrols are becoming increasingly important to the general public. During the past four years, skiing has attracted thousands of new fans. Week-end excursions by train, car and even airplane into snow areas are now common. Many new slopes and ski areas were opened last year alone.

While giving skiing a wonderful boost, all this activity has meant a greater need for safety supervision. As beginners and novices

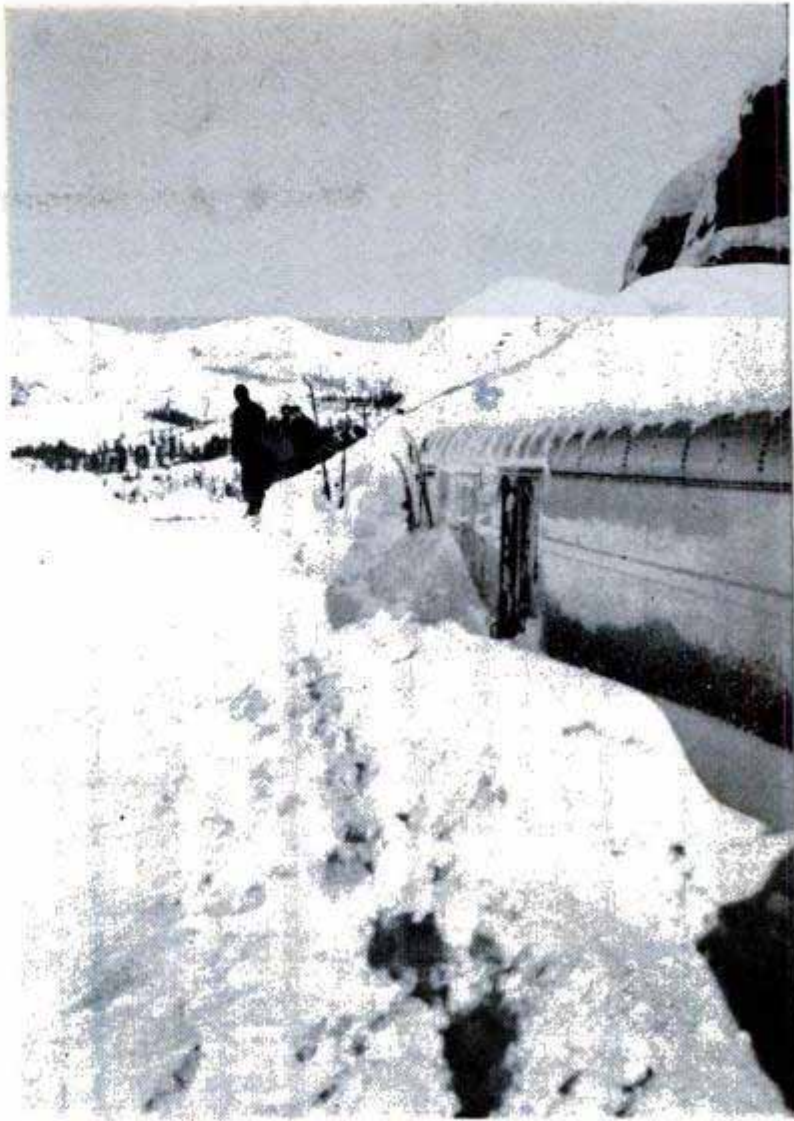

Reaching 196 men, women and children stranded in the crack streamliner, *City of San Francisco*, by a blizzard, above, was one of the National Ski Patrol's most dramatic rescue missions

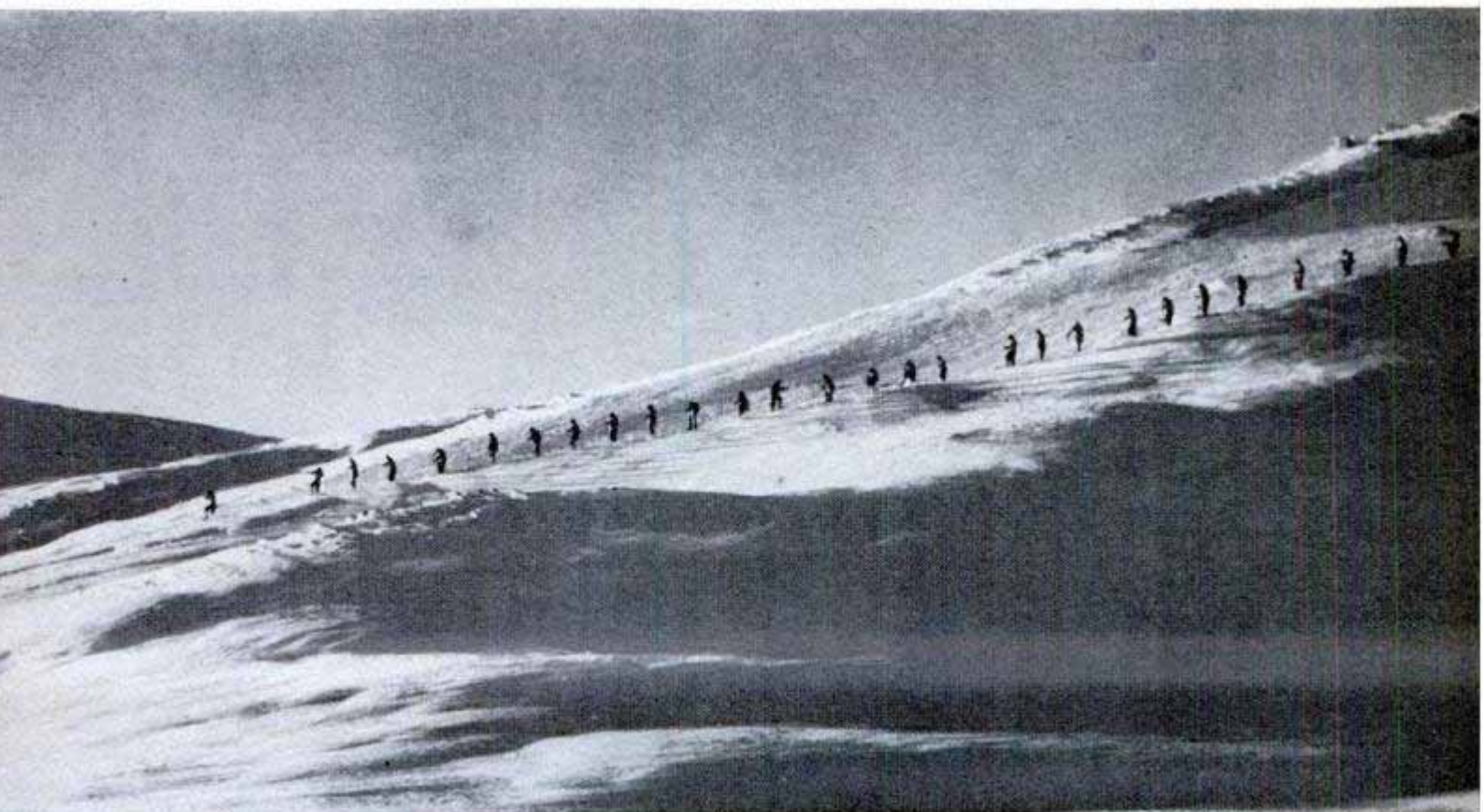



While a fur-coated patrol member stands by, a ranger gets a radio call for first aid for an injured skier

take to the slopes, adequate measures to protect them must be taken. This important responsibility has fallen on the shoulders of the Ski Patrol.

The National Ski Patrol System, Inc., as it is formally known, is certainly one of the most colorful groups of its kind in the nation. Its goal as stated officially is: "To

work towards greater safety and thus greater enjoyment in the sport of skiing." The headquarters is at Denver.

In order to carry out that objective successively, the group has branched out into a half dozen different fields. As a result, the NSPS is today an amazingly well-trained, well-equipped body of specialists. Civilian Defense agencies and the American Red Cross, in fact, now consider it one of their key units in disaster relief.

Depending upon the region in which a patrol operates, its members carry out rescue work under a variety of tough weather conditions and terrain. Out West, patrolmen (the term includes some 500 women) are expert mountaineers as well as skiers. They're trained in air-ground coordination and work closely with Civil Air Patrol and Air Force Rescue flights.

Farther east, patrols train for city emergencies when sudden winter storms block highways and cut power lines. In such cases, patrolmen are put at the disposal of local authorities. During a recent severe Midwestern winter, for example, transportation in a four-state area was crippled; all normal communications were out.

No sooner had the blizzard hit than ski patrols unlimbered their gear and reported to police stations, hospitals and state-police barracks. In Milwaukee, Wis., the situation was exceedingly critical. While the storm still raged, word came through that a farmer outside of town had fallen and broken

Moving a skiing-accident victim down the mountainside on a toboggan. All NSPS members have first-aid training



his arm. Roads were impassable but he needed help immediately. The Milwaukee Ski Club was ready for just such calls.

Joyce Pflieger pushed off to the lonely farmhouse and the injured man. She put his arm in a sling and stood by until a snow-plow brought a doctor.

About the same time, police radios got a desperate plea from another stranded community. There a man had suffered a heart attack. Fire-department rescue crews were giving him oxygen, but their supply was almost exhausted. Additional tanks were needed or the man would die.

Art Mariage, another Milwaukeean, got the report and swung into action. Two heavy tanks of oxygen were lashed to a toboggan and Art skied three miles cross-country pulling the load. The man's life was saved—and Art was later awarded the NSPS Purple Merit Star.

For all their heroic deeds and unselfish service to the sport, patrolmen work without pay or compensation of any kind. In fact, many sportsmen have expressed the opinion that the patrols carry far too much of a financial burden. When members ski, for example, they pay all their own expenses. Yet they are on call to the resort operator at any time.

Patrolmen even buy their own first-aid equipment and so have to ask that splints and bandages be returned after a patient has recovered!

Structure of the National Ski Patrol System is simple, but efficient. Edward F. Taylor at Denver is the national director. The country is then divided into seven regions—Eastern, Central, Northern Rocky Mountain, Southern Rocky Mountain, Intermountain, Far West and Pacific Northwest. Each is headed by a divisional chairman who directs the activities of the regions within his division.

Under the regional chairman come the sections and the various ski clubs which sponsor patrols. To be eligible for NSPS membership, each man or woman must first take and pass the

(Continued to page 254)



Ski patrolman Walter Kienzi clears the way beneath one of the chair lifts at Sun Valley. Patrolmen perform their heroic deeds and unselfish service without pay or compensation of any kind

Using skis as a brace on a steep mountainside, patrolmen bring an injured skier down safely and slowly. Interior of this versatile toboggan is a basket litter, which in many cases acts as a splint



Pocket Calendar Can Be Used for 307 Years

ON WHAT DAY of the week were you born? A new perpetual calendar will tell you—as it will tell you the day and date during any year from 1753 to 2059.

Claimed to be the fastest method yet devised for determining the day of the week in any year since the early part of the Gregorian calendar, the compact chart is the copyrighted brain child of Arthur A. Merrill, General Electric engineer in Schenectady, N. Y. It is simple to use and so uncluttered that all of the 3684 months represented on the calendar could be printed on the front and back of a wallet-size card and still be clearly legible.

The chart is divided into two sections. The first is a table that assigns a key letter to each of the 307 years that the calendar describes. The second section correlates these key letters with the 12 months of the

year to show how any month would be arranged in any year.

Here is how you find out on what day the Declaration of Independence was signed: The date was July 4, 1776. Starting with the left-hand table, go down the left column to the first three digits of the year, 177. Then go horizontally to the column under the fourth digit, 6, and you get the key letter H.

Now find July in the right-hand table. Move straight across the July line to the key letter H. Drop down the white channel below the column to the calendar that shows exactly how a July calendar page looked in 1776. You will discover that July 4, 1776, was Thursday.

In case you're interested: 1953 has three Friday the 13ths (Feb., Mar. and Nov.) and in the year 2000 you can plan a big holiday because Christmas falls on Monday.

- CALENDAR ... 1753 - 2059 -

To use:
 Go down column to first three digits of year, then across to column of fourth digit, and obtain Year Type Letter.
 Then find month, go straight across to Year Type Letter, then down to calendar.

175				A	B	C	K	F	G	A
176	I	D	E	F	N	B	C	D	L	G
177	A	B	J	E	F	G	H	C	D	E
178	M	A	B	C	K	F	G	A	I	D
179	E	F	N	B	C	D	L	G	A	B
180	C	D	E	F	N	B	C	D	L	G
181	A	B	J	E	F	G	H	C	D	E
182	M	A	B	C	K	F	G	A	I	D
183	E	F	N	B	C	D	L	G	A	B
184	J	E	F	G	H	C	D	E	M	A
185	B	C	K	F	G	A	I	D	E	F
186	N	B	C	D	L	G	A	B	J	E
187	F	G	H	C	D	E	M	A	B	C
188	K	F	G	A	I	D	E	F	N	B
189	C	D	L	G	A	B	J	E	F	G
190	A	B	C	D	L	G	A	B	J	E
191	F	G	H	C	D	E	M	A	B	C
192	K	F	G	A	I	D	E	F	N	B
193	C	D	L	G	A	B	J	E	F	G
194	H	C	D	E	M	A	B	C	K	F
195	G	A	I	D	E	F	N	B	C	D
196	L	G	A	B	J	E	F	G	H	C
197	D	E	M	A	B	C	K	F	G	A
198	I	D	E	F	N	B	C	D	L	G
199	A	B	J	E	F	G	H	C	D	E
200	M	A	B	C	K	F	G	A	I	D
201	E	F	N	B	C	D	L	G	A	B
202	J	E	F	G	H	C	D	E	M	A
203	B	C	K	F	G	A	I	D	E	F
204	N	B	C	D	L	G	A	B	J	E
205	F	G	H	C	D	E	M	A	B	C

JAN 31 d	E	L	G	N	D	K	A	H	C	J	B	I	F	M	31 d	JAN.
FEB. 28/29	B	L	D	K	A	H	E	L	G	N	F	M	C	J	28/29	FEB.
MAR 31 d	B	H	D	J	A	N	E	K	G	M	F	L	C	I	31 d	MAR.
APR 30 d	F	L	A	N	E	K	B	H	D	J	C	I	G	M	30 d	APR.
MAY 31 d	D	J	F	L	C	I	G	M	B	H	A	N	E	K	31 d	MAY
JUNE 30 d	A	N	C	I	G	M	D	J	F	L	E	K	B	H	30 d	JUNE
JULY 31 d	F	L	A	N	E	K	B	H	D	J	C	I	G	M	31 d	JULY
AUG 31 d	C	I	E	K	B	H	F	L	A	N	G	M	D	J	31 d	AUG
SEP 30 d	G	M	B	H	F	L	C	I	E	K	D	J	A	N	30 d	SEP.
OCT 31 d	E	K	G	M	D	J	A	N	C	I	B	H	F	L	31 d	OCT.
NOV 30 d	B	H	D	J	A	N	E	K	G	M	F	L	C	I	30 d	NOV.
DEC 31 d	G	M	B	H	F	L	C	I	E	K	D	J	A	N	31 d	DEC.

S M Tu W Th F S

1 2 3 4 5 6 7

8 9 10 11 12 13 14

15 16 17 18 19 20 21

22 23 24 25 26 27 28

29 30 31

S M Tu W Th F S

1 2 3 4

5 6 7 8 9 10 11

12 13 14 15 16 17 18

19 20 21 22 23 24 25

26 27 28 29 30 31

S M Tu W Th F S

1 2 3 4 5

6 7 8 9 10 11 12

13 14 15 16 17 18 19

20 21 22 23 24 25 26

27 28 29 30 31

Example
 July 4, 1776
 Year Type H
 Day of week Thursday

Copyright 1952
 Arthur A. Merrill

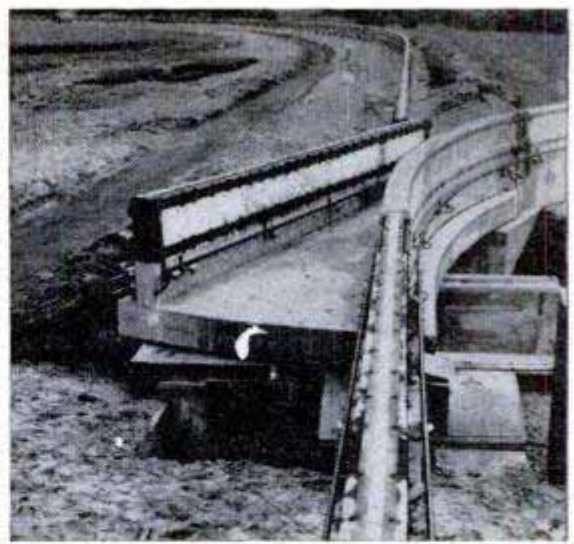

Racing at high speed, test train takes a curve which would normally demand slowing to 18 miles per hour. Switch consists of huge concrete platform containing two sections of rail which is turned by electric motors

Germans Develop Fast Monorail Train for High-Speed Travel

Zooming along its one rail like a wingless airplane, an experimental train under test near Cologne, Germany, is the working model for a machine designed to travel at 200 miles per hour. Built of light metal and constructed like an airplane, the train is shaped like a caterpillar with a deep notch cut along its middle. It is into this notch that the single rail fits, the train reaching down around the rail and gripping it from the sides. The track consists of one reinforced-concrete girder elevated from the ground on pillars over six feet high. But the girder carries five metal rails: One main rail on the top and two flat metal bands along each side. The top rail carries the main drive wheels and bears the weight of the train. Sets of guiding wheels run on the side tracks at right an-

gles to the driving wheels, maintaining safety at high speeds. The model, 40 percent the size of the projected train, travels at 90 miles per hour even around sharp curves. The full-scale train will travel on a series of connected reinforced-concrete blocks supported by hollow concrete pylons spaced 50 feet apart. Diesel or even jet engines may replace the electric motors now used. Suitable for cross-country or commuting service, the train is designed to carry the same passenger load as a normal express train at the same speed with one seventh the power. Work has started on a train with a different carriage which could be adapted to conventional rail systems. Pylons would support a girder down the middle of a regular rail section, the revised train riding eight inches above the ties.

Plastic Rotating Tray Places Artists' Tools Within Reach

Art and hobbycraft tools are kept within easy reach by a rotating receptacle recently placed on the market. Adapted for use in shop, den or studio, it is made of light durable plastic, is 7 inches high and 10 inches in diameter.

Whistle Aids Anesthesia

"Blow the whistle," instead of "breathe deeply," is the command now given children receiving gas anesthesia at Mayo Clinic. A whistle that fits into the exhalation side of a gas-anesthetic machine climbs in pitch as the youngster works to expire air through the machine. After a demonstration of how the whistle works, children become interested and instead of struggling, fall asleep while blowing the whistle. When the patient loses consciousness, the whistle is silenced by a plastic cap.



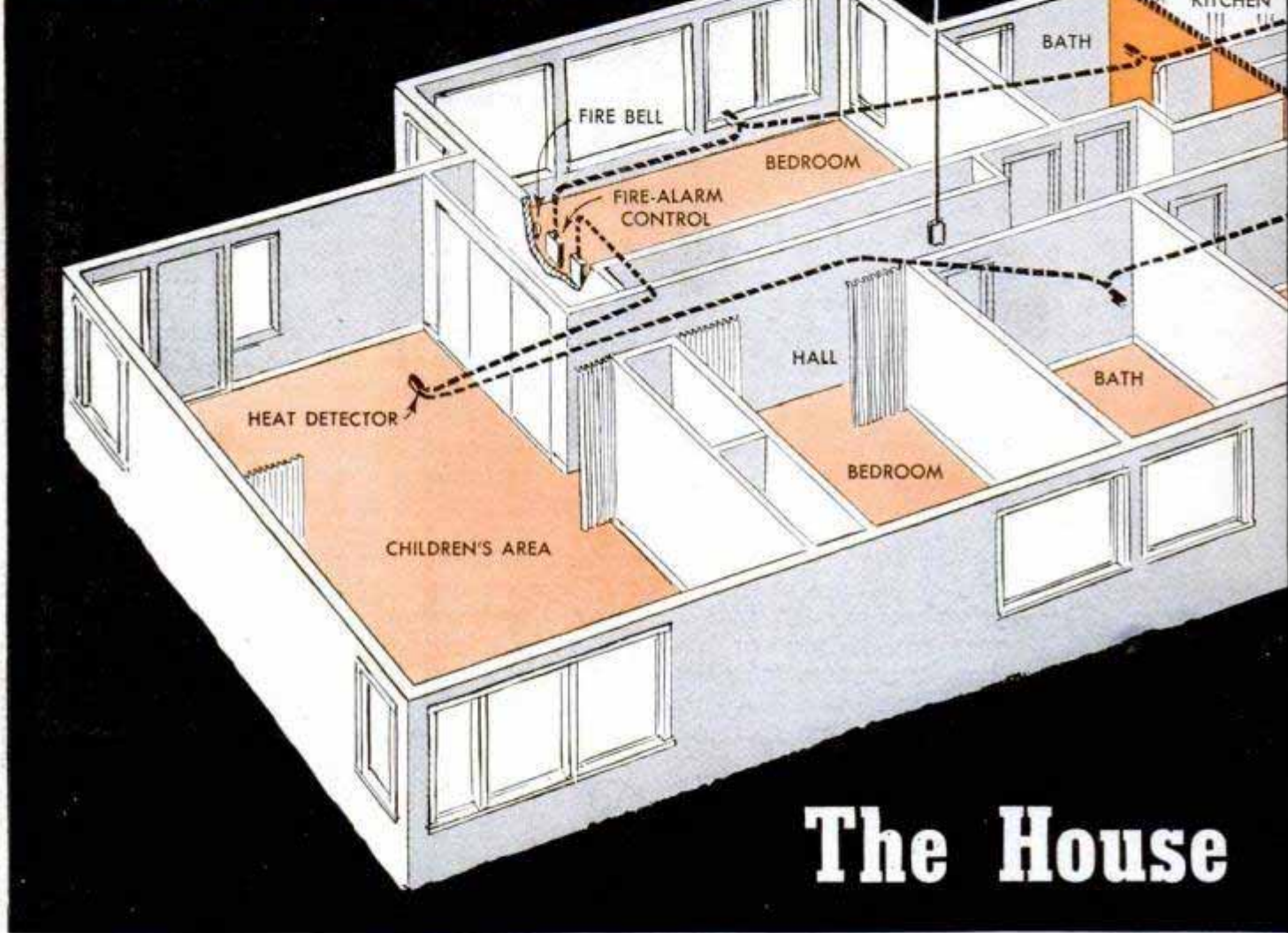

The House

A fire-insurance executive planned and built this fireproof home of ordinary materials—wood and stucco

By Richard F. Dempewolff

NESTLED AGAINST a wooded bluff in suburban Larchmont, north of New York City, sits a new home. To passers-by, J. Wendell Sether's flat-roofed, multiwindowed, frame-and-stucco dwelling is just one more attractive addition to the many houses that are mushrooming across the nation. But under its solar eaves, and behind its huge picture windows and angular walls, lie a host of hidden surprises.

You can take a blowtorch, hold it up against an ordinary pine-studded plaster wall in that house for more than an hour, and end up with only a two-inch black spot

for your pains. You could build a bonfire on the cellar floor, let it rage for an hour, and stand a good chance of facing a repair bill for only a few broken windows. But it's doubtful a fire would start in Mr. Sether's house and burn that long. Before creeping flames got far, automatic sprinklers, spotted around the cellar ceiling would let go at 160° and give any blaze a thorough wetting down. About the same time that the sprinklers went off, a bell upstairs would clang loud enough to awaken the dead. If everything missed, the fire might gain some headway downstairs, but a few

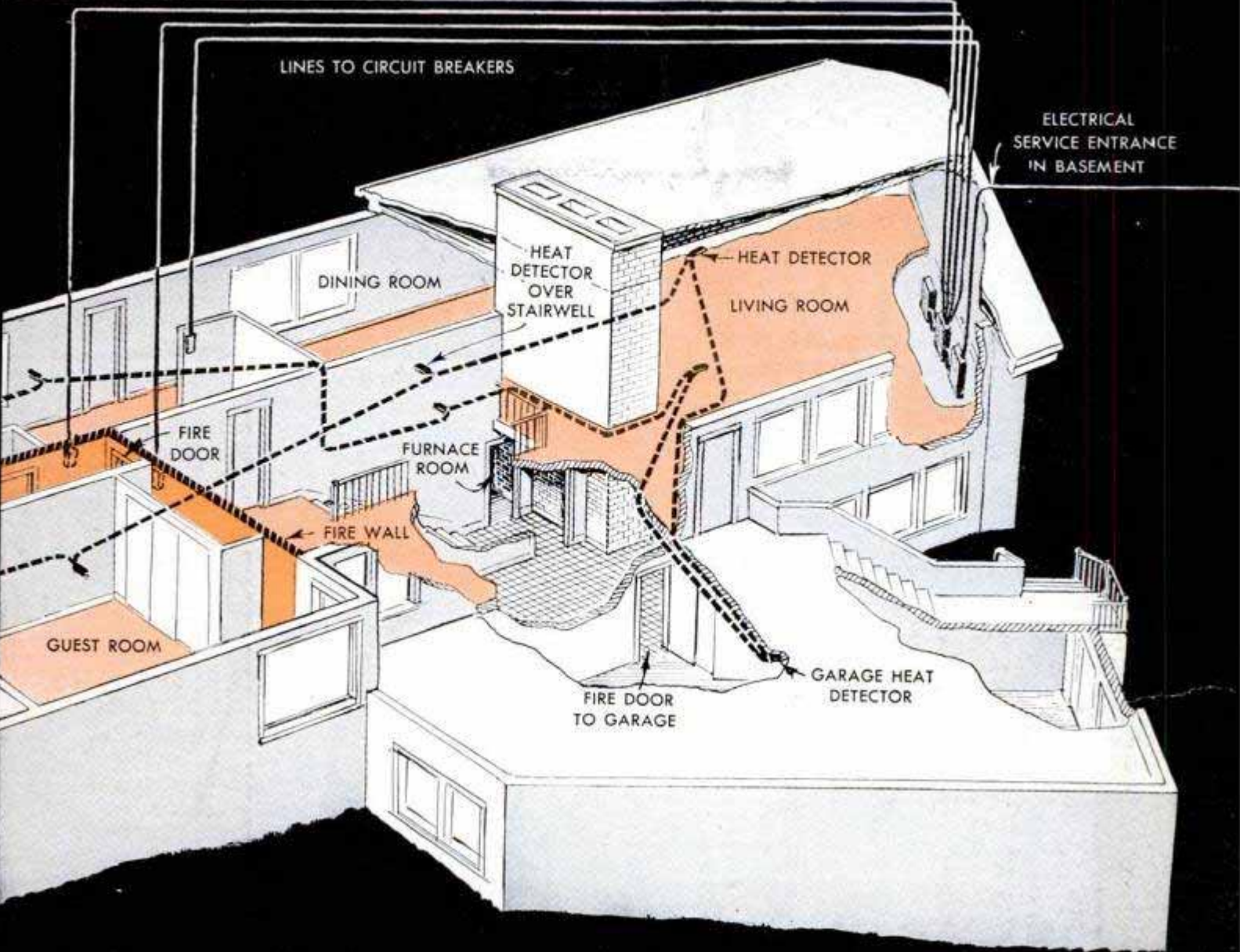

That Will Never **BURN** Down

House features fire doors and a bisecting fire wall

strategically placed fire doors would hold it back for one solid hour, preventing the flames from fighting their way into the stairwell. Suppose everyone was asleep and fire did manage to break all barriers and roar upstairs? It would bump into a fire wall capable of standing it off for another whole hour—and probably more.

Sether is a man with a job that would give most people the willies. Across his desk at the National Board of Fire Underwriters in New York pours a deluge of tragic reports. They are reports of dwelling

Sether adjusts bell on his bedroom wall that rings if fire starts anyplace in house, including garage

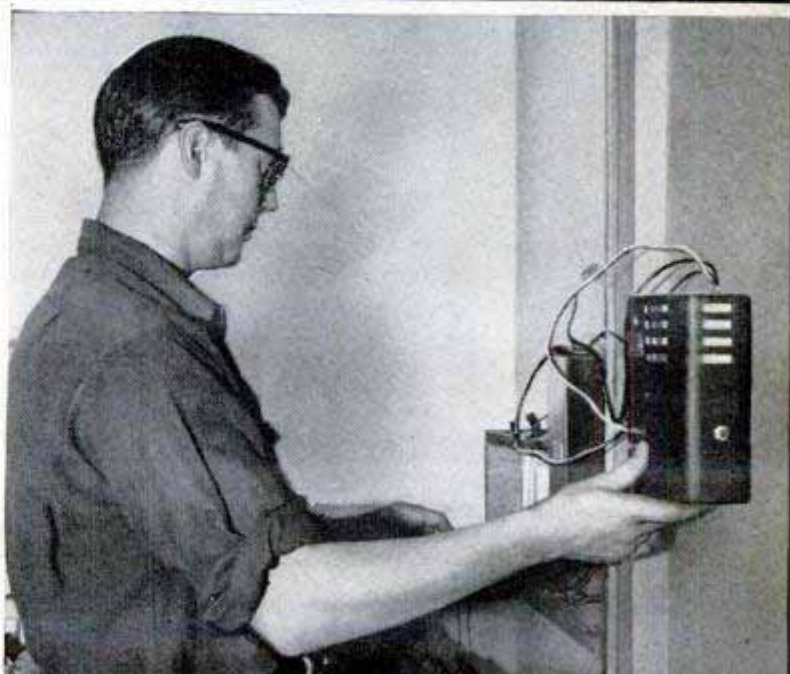



Sether sprays studs of fire wall with water-repellent chemical to protect the wood before painting them with fireproof paint which is water absorbent

Beams of basement ceiling are covered with metal lath and plaster. Both floor and the fire wall received high rating by Underwriters' Laboratories, Inc.

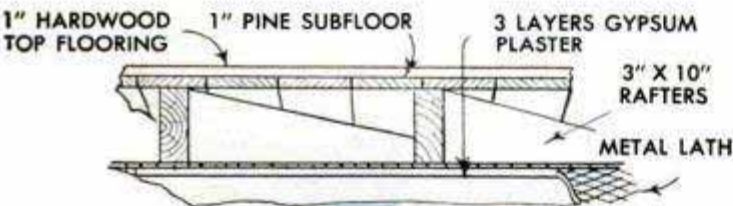

FLOOR BUILT FOR ONE-HOUR FIRE RATING

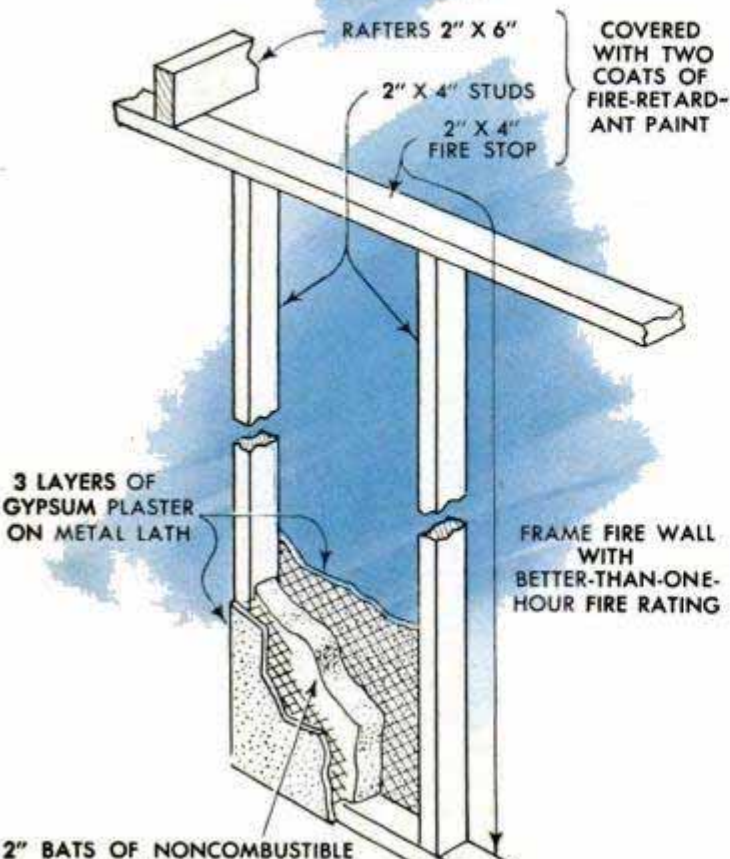

fires from all over the United States—vivid accounts of the roaring flames that damaged 293,776 homes last year and snuffed out 11,000 American lives. Since it is Sether's responsibility to study causes of fires in dwellings, and to help educate people in matters of firesafety, he decided to build a house that would be completely firesafe, but intensely practical—no blue-sky stunt. "Anyone," he says, "can build a house of steel framing and thick concrete that would be virtually fireproof. But how many folks will take the trouble to do it—even if they could afford it? Wood is more common. So is stucco. The trick was to make those materials as firesafe as possible."

Can it be done? The long, low home in Larchmont today is proof that it can. No special concessions were made in the architectural plans to assist in the fire-retardant features of the building. Designed for Sether by Edgar Tafel, it sits on the side of a bluff, and steps up in two levels. Garage and the playroom are downstairs. Living room, dining room, kitchen, two baths, master bedroom, guest room, a small extra bedroom, and a huge area that can be opened wide for play, or divided by movable partitions into two bedrooms for the children, form the main floor of the house.

"In most two-story homes," explains the owner, "a fire starting downstairs or in the cellar becomes disastrous in a matter of minutes. Open stairwells act just like chimneys, sucking heat and flames upward in a raging holocaust."

The grim efficiency of stairwell "flues" screams from the front pages every day, and Sether can pluck a hundred instances from his files in a few minutes—each one more grisly than the last. To prevent any such catastrophe in his home, Sether confined his stairs, from cellar to entry hall above, between two walls of concrete block covered with three coats of plaster. The stairwell is open at the top with a wrought-iron rail around the edge. But down below, the steps are completely bottled in. A blank wall faces the bottom step. Walls on either side of the landing have beautiful birch-finished flush doors opening out into the cellar areas. Another similar door, set in a concrete-block foundation wall, separates the garage from the cellar.

Though they look like plain wooden doors, these are actually fire doors—tested and awarded a one-hour fire rating by the Underwriters' Laboratories, Inc. A "one-hour rating" means this type of door has been put in the laboratories' furnace, one side held against a flame generating about 1700°, the other side facing the furnace door. At the end of an hour, the door was removed. A high-pressure water stream from a 2½-inch hose was then directed

at the charred door, and it stood the impact.

Though wood-surfaced, this type of door can stand off tremendous heat. It has a mineral core of incombustible hydrous calcium silicate, in a fiber binder. The edge, of solid birch, has been fireproofed under pressure. The frame is covered with $\frac{1}{16}$ -inch hardwood veneer, bonded to the core, with a decorative veneer on top of that.

"Any fire starting in the cellar or garage," Sether points out, "is going to have a tough time breaking through those barriers. As long as the doors are kept shut, the stairwell can never act like a chimney flue."

Downstairs, a few other precautions will discourage any fires. Sether admits that it isn't practical to put in special plumbing for sprinklers all over the house. But where water pipes run conveniently across the cellar ceiling it can be done cheaply. He has tapped pipes in the furnace room as well as other convenient spots (over his paint locker area, for instance) in the cellar ceiling. At the end of each outlet a little spout is fastened. Each spout has a nipple of fusible metal, and when the temperature reaches 160° the metal will melt and water will spray any fire beneath it.

Another vital factor in preventing fire from spreading through a multistoried frame house is the separation between the floors. Improperly constructed floors and walls can transmit heat and flames through a whole building in jigtime. It doesn't take long for temperature to soar up to 1000° above a confined fire.

What kind of flooring in a frame house would prevent a cellar fire from mushrooming? The floor of his firesafe house has a one-inch finish of red oak on a one-inch-pine subflooring. Ten-inch-deep air spaces between the beams provide an in-

ulating barrier. So far, that's pretty standard. The difference is in the cellar ceiling. Instead of leaving beams exposed, as they are in most homes, Sether has covered the entire cellar ceiling with metal lath and three coats of gypsum plaster. This forms an incombustible seal that flames and hot gases can't penetrate for a long while. The furnace-room ceiling has three layers of cement plaster, which gives it a 1½-hour rating. "It's more expensive," he admits, "but it could spell the difference between a house standing intact or burning down."

Across the entire building, dividing the sleeping section from the living quarters is a remarkable fire wall of standard frame construction. The only opening in it is another of those wood fire doors with a one-hour rating. When the partition studs were in, Sether painted them with two coats of a commercial fire-retardant coating that looks like white paint. Hold a blowtorch against it, and the paint blisters up to form an insulation barrier between its surface and the wood. After half an hour of this, you can scrape off the charred substance, hit the same spot with the torch again and the undercoat will blister up and do the same job. Studs painted with this material will cook a long time before they catch fire.

To insure firesafety in the wall, Sether plastered the fire-retardant paint around rafters and cross members above the studs as well as on the floor members beneath it. Into the stud spacings went two-inch bats of incombustible insulation. Each side of the partition was sealed by metal lath and three layers of gypsum plaster. "The Underwriters gave this type of wall a one-hour rating," says Sether, "but they didn't try for the limits. It will undoubtedly hold for a lot longer than that."

Blowtorch is applied to piece of laminated wood protected by fire-retardant paint used by Sether

After half-hour application of blowtorch, charred blisters are scraped off showing wood unscorched

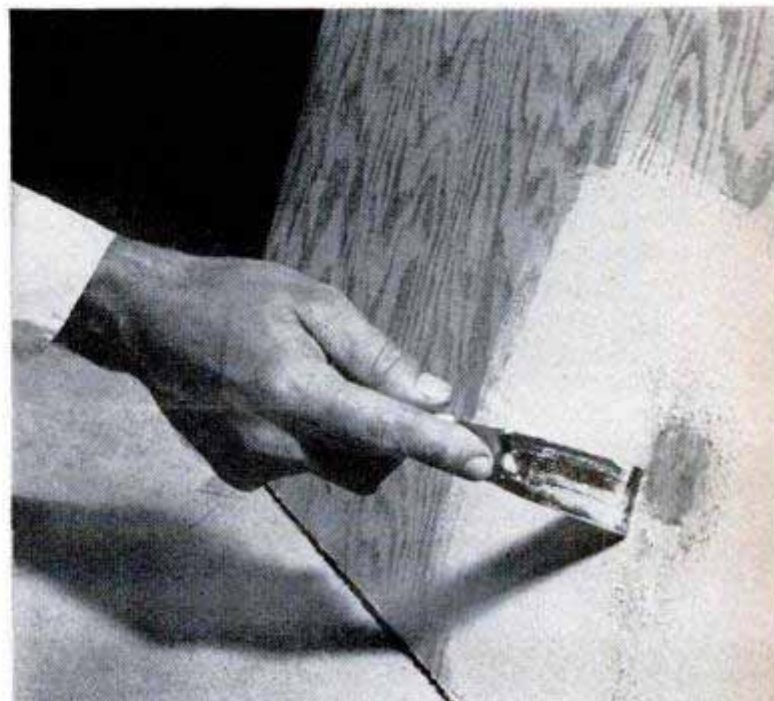



Heat detector on ceiling has bar of fusible metal that melts at 160 degrees and sets off fire alarm

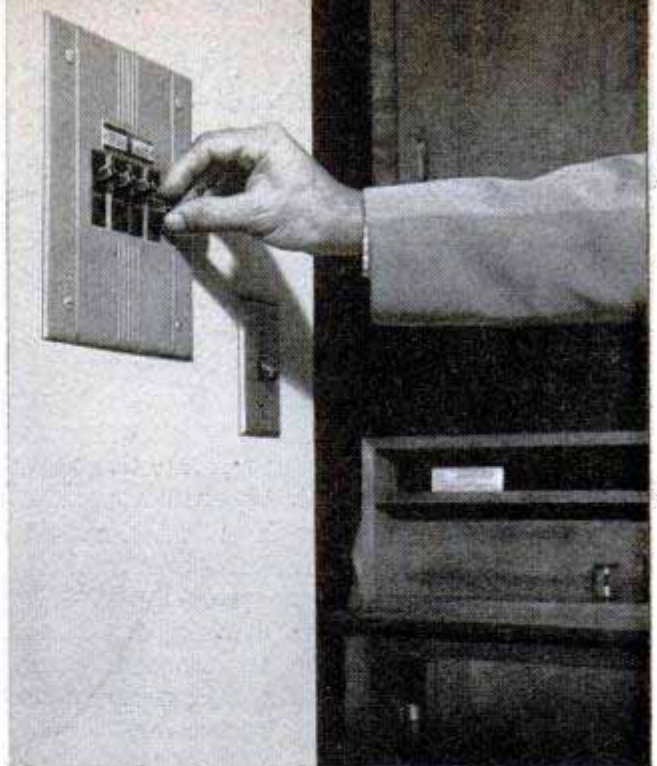

Circuit-breaker system eliminates need for a fuse box. Sether has five such switch panels in house

The only disadvantage to the paint is that it has moisture-absorbent qualities—a minor hazard. Sether solved it by spraying his studs and beams beforehand with a prepared chemical solution called Pentachlorophenol. This is a moisture repellent, and protects the internal timbers against any moisture the paint may attract.

There's another trick in this amazing house. If you look closely at the ceilings in every room, over the stairwell and in the garage, you can see little plastic and metal gadgets that look like miniature thermostats. In effect, that's just what they are. Down the center of each runs a bar of fusible metal. All are hooked together on a 24-volt system that works off the house current. A loud bell and a red light in the master bedroom are hooked into the circuit. When the circuit is intact, nothing happens. But if a fire should be burning anyplace in the house, the ceiling temperature in that room needs only get to 160° before the metal bar on the nearest detector melts. When it does, little springs on each end of the bar pull the stubs apart, breaking the circuit. Instantly, the red light in the bedroom glares, and the bell starts clanging away like mad. The efficient system is back-stopped by batteries to keep it functioning in case the house current fails.

A glance through the reports in Sether's files shows that thousands of dwelling fires each year are caused by defective electrical systems. "Faulty wiring," "pennies in the fuse box," "high-amp fuses" are frequent notations. No fuse box in this house will ever cause trouble. There is none.

Instead of feeding through one big box in the cellar, power lines come in to five

neat panels sunk in the walls of various rooms. Instead of fuses, the panels hold little circuit-breaker switches.

The draperies and upholstery materials in Sether's house are of spun glass fibers. Other decorative materials stress fire resistance. "Fabrics that can't be made of fire-resistant material," he says, "are easily treated at home. Four ounces of boric acid, plus nine ounces of borax in a gallon of water make a solution that can be used to spray, rinse or dip any fabric. Materials so treated can't support combustion."

What Sether has done is fine for anyone who's about to build a new house. But what if you already have a frame house? There are several things you can do.

Stairs from cellar to first floor can be blocked by a flush-type fire door instead of the flimsy, wood-paneled affair with which most homes are equipped. Similar doors, costing \$30 to \$40, may prevent fire from coming into your sleeping quarters.

A gypsum ceiling covering the cellar beams will add a tremendous firesafety factor to any house. Judicious use of that fire-retardant paint can make a good "fire wall" out of a strategically located partition.

"And any man," Sether points out, "can rig the same fire-alarm system I have. If he wants to buy it, the entire outfit—including wires, batteries, detectors, bell and light—costs about \$50. A circuit-breaker system would run about \$30.

A home containing all these features, according to Sether, would be just about as firesafe as a frame house could be. Even if flames should start, you and your family would have plenty of time to gather your wits and get away unscathed. ★ ★ ★

WANTED: 50,000 ENGINEERS

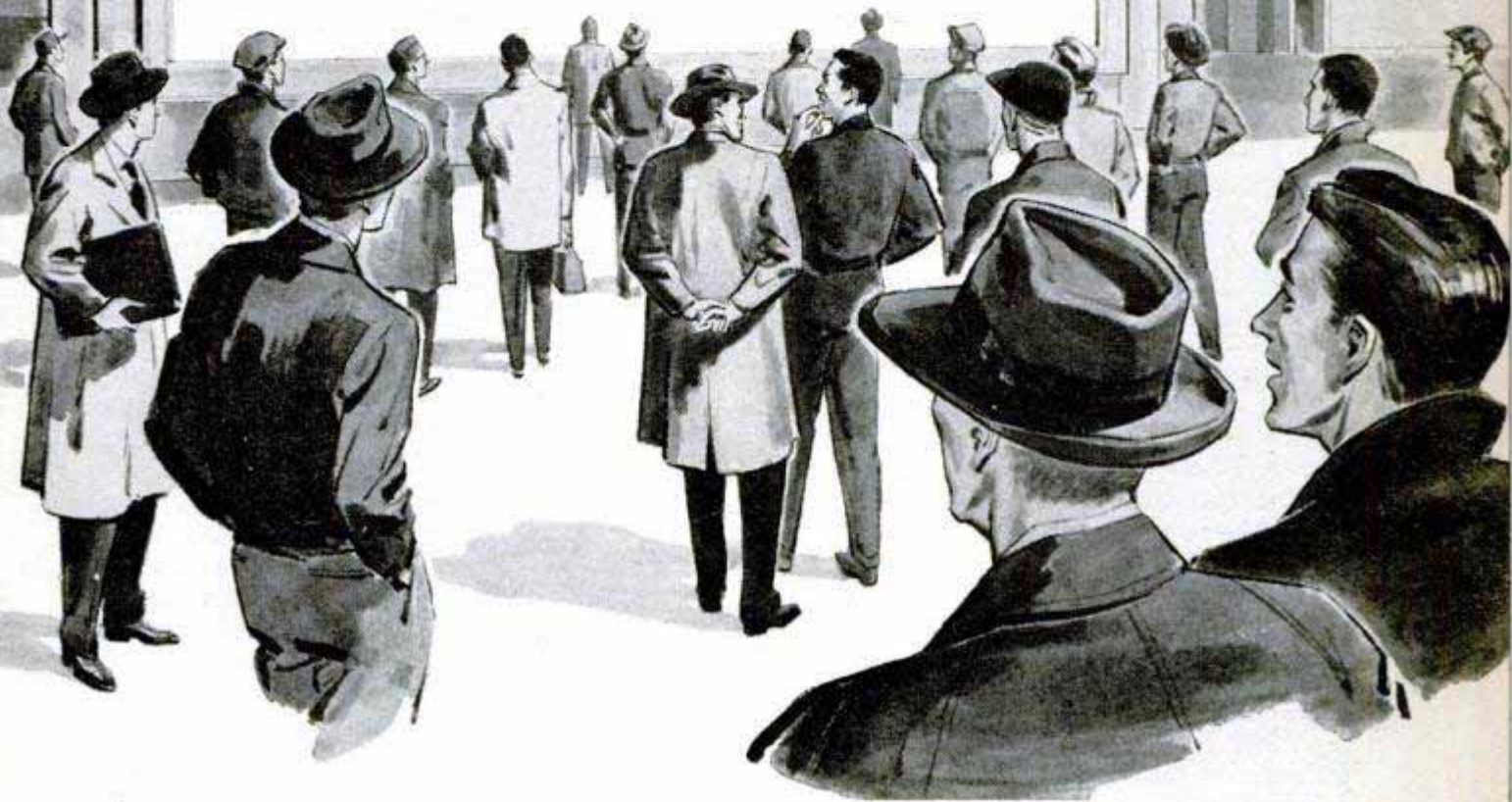

Here's a profession that's exciting, constructive and well-paid, yet authorities see no end to the shortage of trained men. Readers of this magazine may have particular abilities needed in this profession. Sample aptitude tests with this article help indicate such abilities

By Carey H. Brown

Chairman, Engineering Manpower Commission

IF YOU'VE EVER dreamed of designing or building great bridges, huge monuments to civilization in the far corners of the world, electronic wonders or rockets to probe outer space, your chances of making those dreams come true were never better. Provided, of course, that you have the basic qualities it takes to make an engineer. And provided, too, you have the time for four to six years of essential college work before you can create and build your first dream.

Right now America is crying for engineers—50,000 of them. Worried men with slide rules have figured that, with the rapid advance of scientific development in every field, an additional 30,000 engineers will be needed every year in industry alone. We're not even close to meeting that figure. By 1954, only 17,000 engineering students will

graduate. There are many reasons for this sad state of affairs. Unlike our wartime allies, we drafted into military service thousands of engineering students, many of whom never returned to the field. The low birth rate of the 1930s is now aggravating the engineering-manpower shortage.

But the important fact is that any young person today who has an aptitude for engineering and is willing to work hard to develop it is virtually assured of a fascinating job, a sound future, prestige and a salary few fields can match.

How good is it? The engineering students who graduated last June could pretty well pick their jobs from a variety of offers with starting salaries of \$300 to \$375 a month. In 10 years the good ones will be making two or three times that much. Many



of today's student engineers will have branched into scores of specialty fields and spread to the four corners of the world—from the pipe lines of Saudi Arabia to new mining developments under the rim of the Arctic Circle.

Just what is engineering? It has been called the art that makes pure science useful. The engineer takes the formulas of the scientist and puts them to work for mankind. He is far from an impromptu builder who goes to work willy-nilly with sketchy plans and reliance on his handy ingenuity. Engineers analyze, design and then supervise the building of nearly anything you can name—railroads, radios, bridges, rockets, dams, power plants, radar and television devices, engines, machines, industrial plants, pipe and transmission lines and thousands of other things too numerous to mention. Their work carries them over deserts, mountains, seas and snowbound wastes.

Here's how it works. If you were a civil engineer hired to build a bridge across the Amazon River, you would first learn exactly the functions your customer wanted that bridge to perform. You'd plan in general how it could be done. You would visit the site with a crew of surveyors. You would determine all the forces, in their maximum degree, that would be brought to bear on the structure—like floods, earthquakes, wind and the loads it should be designed to carry.

Several materials might do the job.

Should it be steel or masonry? For each you'd consider several possible arrangements. Should it be an arch bridge, suspension, truss or cantilever? After reconnaissance and selection of the site, followed by necessary investigations to acquire information on which to base the final design, you and your associates would spend weeks or months designing each separate part and making dozens of scale drawings. Then you'd draw up minute specifications and descriptions for the entire project as it would be in final form on the Amazon site. Nothing can be taken for granted. Every detail must be allowed for.

Finally, you might have to supervise the construction of your bridge, watch it grow through proper stages and satisfy yourself and your client that everything you put into it would do the job it was supposed to do.

From all this, you might gather that unless you were a big, tweedy, six-foot giant with a mathematical trap of a mind and a penchant for monstrous things and wide-open spaces, you couldn't be an engineer. This is not so. Engineering encompasses dozens of fields and myriad personalities. You can be fat, thin, tall, short, introvert or extrovert. And no matter what your particular bent, if you have an engineering-type mind, there's a niche you'll fit. You don't have to build a bridge or railroad; it may be a power plant, an oil refinery, a chemical plant, a steel mill or a mining project.

The profession breaks down into five big fields. There are electrical engineers who work in electronic devices, communications and electric-power generation, transmission and application. The mechanical engineer, alone or in cooperation with other engineers, designs and builds anything that can move or be moved—from monkey wrenches to steam engines. He produces airplanes, rockets, jet power plants, turbines. It is the civil engineer who turns his talent to the massive stationary monuments that decorate our modern landscapes—bridges, dams, superhighways, railroads, underwater tunnels, water systems and other structures. The chemical engineer takes what the chemist does in his laboratory and turns it to industrial use. He creates the plastic objects you use today, synthetic fibers and fabrics and a host of chemicals

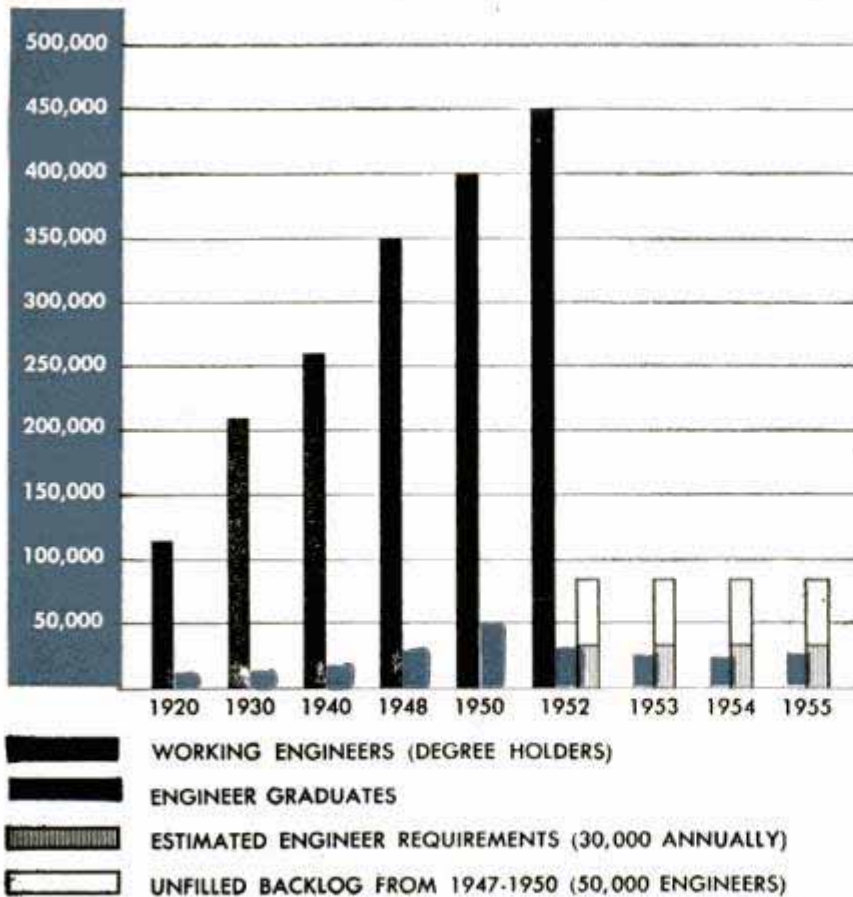

used in industry. Mining and metallurgical engineers find ways to get minerals from the earth and combine them to produce useful products like stainless steel and many other alloys that make the things you use every day. Others who have adopted a specialty may call themselves industrial engineers, manufacturing engineers, aeronautical engineers, petroleum engineers or other designations indicating their particular line of activity.

Closely related to the engineer, and working hand in hand with him, are the designers, draftsmen, detailers and surveyors. The surveyor is the chap you see on the site of a big construction project, peering through his tripod-mounted transit. This with his level, plane table, tape and photographic equipment are his principal tools. He's an outdoor-type fellow, usually. He maps the site terrain, lays out the site for the engineer, locates boundaries, sees that structures are at proper elevation and grade, searches deeds and records. Though it helps, an engineering degree is not a "must" for him.

Engineering aides are highly respected men, essential to the successful execution of engineering projects, whose principal training in most cases has been on the job. Though sometimes applied to junior graduate engineers, this term usually signifies a man whose technical training or experience falls short of qualifying him as an engineer. Many of them have one to three years' training in a technical school plus a vocational-high-school diploma. They might be called the "top sergeants" of the profession and often command handsome salaries, but few go on to executive positions because most companies now prefer graduate engineers in those spots.

Another fellow who may or may not have a degree is the draftsman. This highly skilled craftsman makes finished drawings from designs the engineer has roughed out. Some specialize in cartography, or map making. In other specialties, such as machine design, the engineer and the draftsman work side by side or their activities may merge. Unless the engineer's idea or design is translated into proper drawings and specifications and thence into an adequate structure or piece of equipment it's of little practical value. This illustrates the importance of the engineering aide, the technician and the draftsman to the engineering profession.

All this is fine, but how can you tell if you have the qualifications to be an engineer? There are a number of specific things that help make a good engineer. Ask yourself these questions, posed by Dr. A. Pemberton Johnson, project director of the

Educational Testing Service. Try to answer them honestly.

1. Were your high-school-mathematics grades in the top third of your class?

2. Were your grades in physics, chemistry and other science courses in the top third of the class?

3. Were your high-school English grades in the top half of your class?

4. Did you have sound habits of work and study?

5. Does your curiosity about things run high? (Do you wonder why radio signals are weaker in daytime than at night? Why fluorescent bulbs are tube-shaped instead of bulbous like standard lamps? Why aluminum is soft? Why concrete highways are made of slabs instead of in a continuous strip?)

6. Are you interested in improving things? If so, have you ever done something about making an improvement?

7. Are you honest with yourself and other people?

If you can answer "yes" to all these questions, you have some of the faculties it takes. But there are many more. Though a four or five-year undergraduate course in a good engineering school will give a man his necessary degree, many engineers go on to graduate work and all must be prepared for continual study to keep up with the rapidly advancing developments in the fields of science. Many use night schools and correspondence courses.

The tests on these pages are samples of the type that help show your ability to acquire and retain knowledge in fields that should interest a potential engineer. Designed by Mr. Johnson O'Connor, director of the Human Engineering Laboratory, Inc., and the Johnson O'Connor Research Foundation, Inc., they are parts of tests now in actual use. They are helping to screen future engineers for large concerns. If you do well on the samples shown here, it does not necessarily mean you should plunge into engineering but indicates an interest in that direction, and you may want to investigate further.

The best way to learn whether or not you have the basic engineering aptitudes is to take aptitude tests. These are designed to indicate your ability to visualize things in three dimensions; to determine the degree of your intellectual curiosity and creative imagination, and to determine your personality type. The answers are important for the prospective engineer to know. A quiet man with subjective personality and high creative ability does best in de-

(Continued to page 246)

The tests on these pages were designed and especially selected for *Popular Mechanics* by Johnson O'Connor, director of the Human Engineering Laboratory. Two types of test are used to probe a man's potential for engineering or any other profession: aptitude and knowledge. Today

some 15 different aptitudes are known and measurable at the Human Engineering Laboratory. These two pages show the proficiencies especially important to the engineer. The following three pages contain sample knowledge tests which you can take as an experiment in this type of testing.

FINGER DEXTERITY

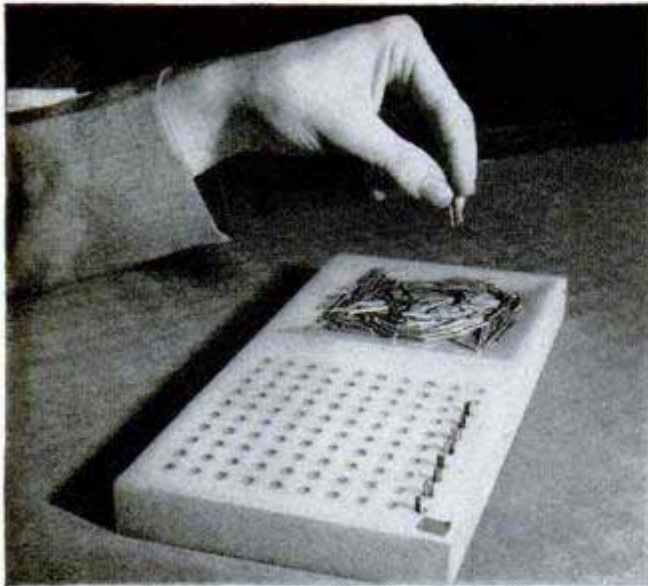

Finger dexterity represents a man's ability to carry out ideas with his hands. It is exhibited to a high degree by a mechanic, for example. This aptitude is particularly needed in engineering when coupled with good structural visualization. The photo shows how finger dexterity can be tested. The subject, seated at a table, is given the pegboard containing 100 holes. He is told to pick up three pins at a time and fit as many of them as possible in the plastic board in six minutes. The subject who fills 77 holes in the allotted time is judged fair in this aptitude. Over 83 holes filled is considered a high score and indicates finger dexterity to a high degree

TWEEZER DEXTERITY

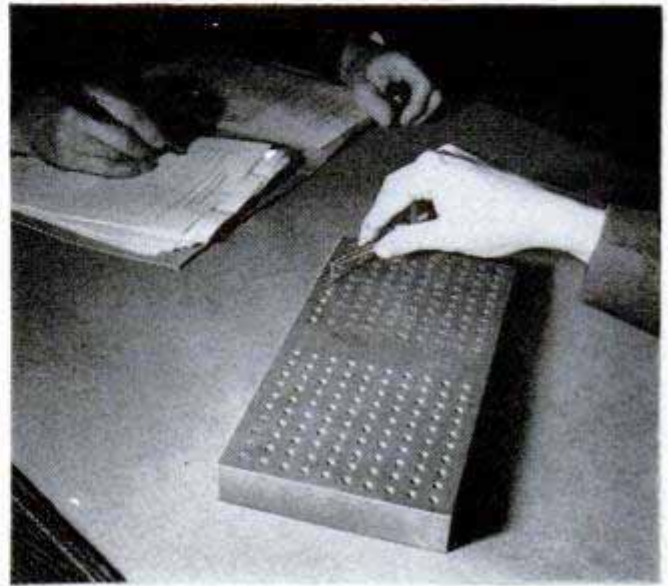

Tweezer dexterity is quite similar to finger dexterity, but has one basic difference in that the subject must manipulate some object in order to carry out his idea. It also is highly exhibited by the mechanic, who can perceive what is wrong with an automobile engine and then manipulate his tools with his hands to eliminate the trouble. In this test the potential engineer is given another pegboard and a pair of tweezers. He is told to pick up 100 pegs from one side of the board and drop them into holes in the other side. A highly dexterous person can move 100 pegs in 4.1 minutes to rate a good score in the test. This aptitude is valuable in miniature assembly work

INDUCTIVE REASONING



Inductive reasoning is the ability to see a fundamental law or relationship. The pure scientist rates extremely high in such ability. In each of these sample strips, three pictures are similar for a particular reason. In the top strip a child is common to three pictures; in the bottom strip it's a dog. To get the full benefit from this type of test the subject must determine the common factor in at least 60 strips of pictures at top speed. The strips grow more difficult—in the final strips the common factor is quite hard to find

STRUCTURAL VISUALIZATION

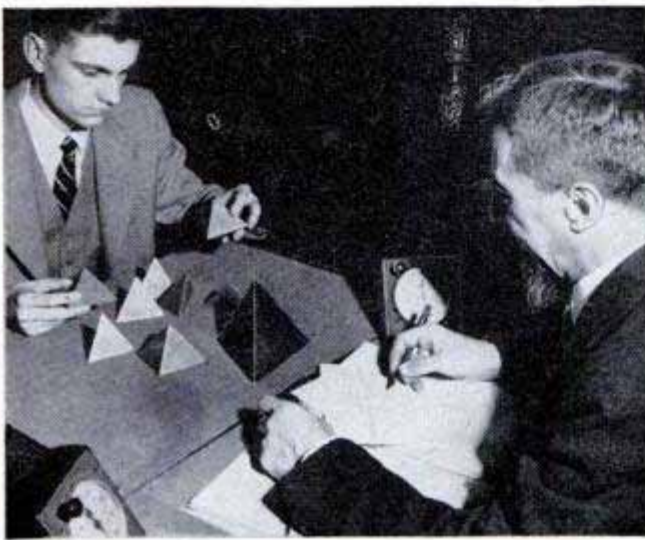
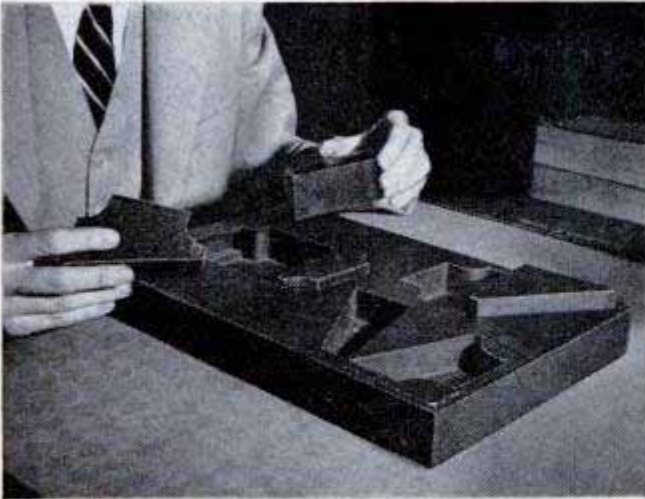

Structural visualization is the ability to see things in three dimensions. It has nothing to do with intelligence — persons of high intelligence sometimes have virtually no ability at structural visualization — but seems to be an inherited trait. This aptitude is usually tested with building blocks. In the upper-left photo the subject is fitting oddly shaped blocks into just as oddly shaped holes. If he has good structural visualization he'll do it in less than 2.8 minutes. Above, he is given blocks with black and yellow sides and told to build a big cube without any yellow showing. A good time for this test also is 2.8 minutes. At left his problem is to build a big pyramid by stacking up the little pyramids. If he does it in 8 minutes he has done well. Anything beyond 18 minutes is a very poor score. Student engineers who take the structural-visualization test shown here are permitted to try three times

NUMBER REASONING



Testing for this aptitude is still experimental. The subject is given a board marked off with symbols representing mathematical problems. He also is given numbered tiles. When the test begins he must arrange the tiles as fast as possible on the board to set up the problems and answers. His score is judged on how fast he can set up the correct problems

Tests shown on these pages are the most vital to the engineer, but there are many other aptitudes that may be important to his work. Tests of knowledge may also yield much valuable information, as knowledge itself may indicate certain aptitudes. Tests on the following three pages are samples of those given potential engineering students. You won't get a high score unless you have a deep interest in the fields that are important to engineers. And you probably aren't interested in these fields unless you already have some of the necessary aptitudes. However, if you do well on these tests it does not necessarily mean you are a potential engineer. It does mean that if you are interested in the field of engineering it would be well worth your while to take an entire series of such tests. In taking these sample tests you may want to compare your scores and answers with those made by a representative group of engineering students. The answers to the following tests appear on page 246, together with the scores of these students. If you were a top professional engineer you'd miss only a very few of the questions in these tests. A good score indicates you may have valuable engineering aptitudes. It might pay you to investigate your aptitudes further. These knowledge tests were designed and are copyrighted by Human Engineering Laboratories, Inc.

MORE TESTS ON FOLLOWING PAGES ♦

1. This machine, which creates power at Niagara Falls, is called:

- (eliminator) (antenna)
- (generator) (turbine)
- (spark-coil)

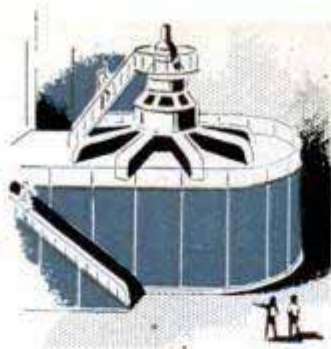

2. In this diagram, showing lines of light from a distant object to a camera film, the distance from the lens to the image being photographed is known as:

- (axis) (foot-candle)
- (penumbra) (incidence)
- (focal length)

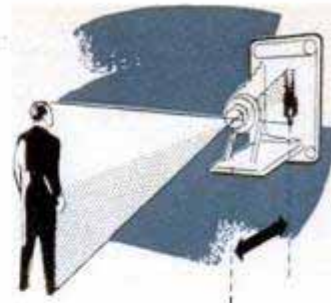

3. This instrument compares the candle power of two light sources. It is called:

- (camera) (photometer)
- (electric eye)
- (electrophorus)
- (stereoscope)



4. You'll find this device in most radios. It allows the flow of current in one direction only. Its name is:

- (switch) (audio)
- (rectifier) (fuse)
- (transmitter)



5. The temperature above which it is impossible to liquefy a gas, no matter how great the pressure, is called:

- (recalescence) (fusion)
- (critical) (boiling)
- (freezing)

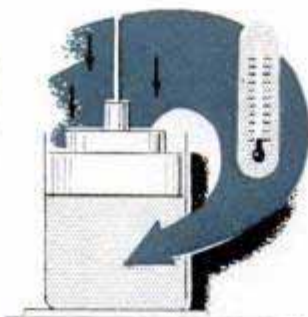

6. The spoon in the beaker containing fluid is about to be electroplated. It is called the:

- (cathode) (ion)
- (electrolyte) (anode)
- (positive electrode)

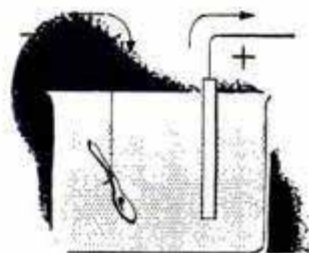

7. The particle with the smallest known mass is the:

- (electron) (atom)
- (ion) (proton)
- (alpha particle)



8. A famous pendulum is arranged to swing in the pattern indicated by the diagram, due to the earth's rotation. Such a pendulum is called:

- (compound) (simple)
- (ballistic) (Foucault)
- (Kator)



9. The instrument at right measures the sugar content of a solution. Its name is:

- (comparator)
- (polariscope)
- (spectroscope) (analyzer)
- (heliostat)

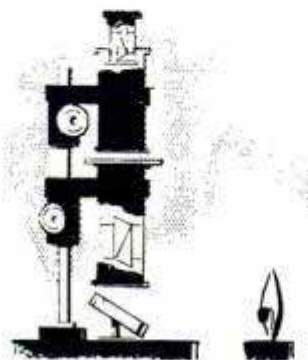

10. One ten-millionth of a millimeter is called:

- (Angstrom unit) (micron)
- (micrometer) (megohm)
- (millimicron)



1. The airplane shown at right can land on water or land. This type aircraft is called a:
 (monoplane) (biplane)
 (amphibian) (seaplane)
 (flying boat)

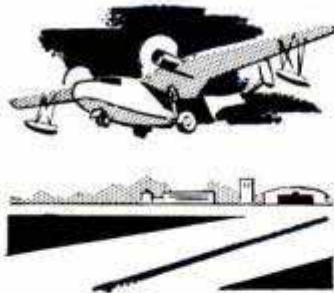

2. The angle indicated by the curved arrow is the one between the direction in which the plane is pointed and the direction in which it is moving. It is the:
 (angle of pitch)
 (trim angle) (drift angle)
 (flight-path angle)
 (wind-correction angle)

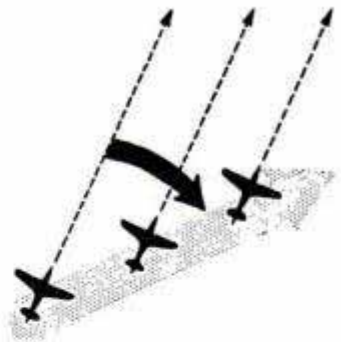

3. The current of air driven astern over the aircraft (shown by arrows at right) by the propeller is termed:
 (blade element)
 (downwash)
 (sweepback) (slipstream)
 (tail plane)

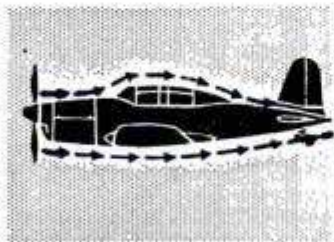

4. The diagrams right are cross sections of surfaces designed to obtain reaction from the air through which they move. Such a surface is called:
 (flap) (rib)
 (aileron) (airfoil)
 (strut)

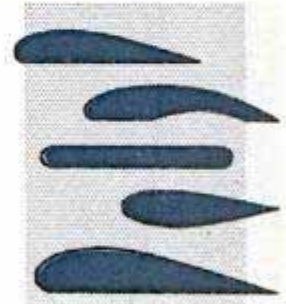

5. The long steel tubes indicated by arrows at right form the framework of a plane's body and are called:
 (spacers) (flanges)
 (spars) (longerons)
 (gussets)



6. The group of parts forming the aircraft assembly at right is known as:
 (rudder) (empennage)
 (stabilizer) (fin)
 (elevator)



7. The instrument shown at right measures the force or speed of the wind. Its name is:
 (nephoscope)
 (anemometer)
 (psychrometer)
 (computer)
 (air-speed indicator)



8. The climbing term diagrammed at right, in which the momentum of the craft is used to obtain a higher rate of climb, is called a:
 (chandelle) (wingover)
 (zoom) (Immelman)
 (pull-up)

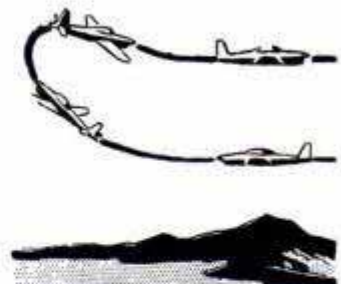

9. The fore and aft compression members of the internal bracing system of the aircraft shown at right are called:
 (stringers) (spats)
 (tabs) (compression ribs)
 (drag struts)

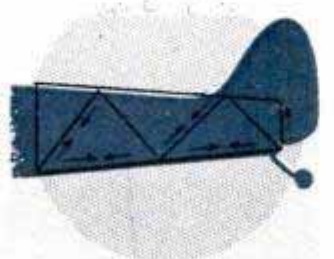

10. The point in the atmosphere at which the fall of temperature with increasing height abruptly ceases is the:
 (ionosphere)
 (stratosphere)
 (tropopause)
 (troposphere)
 (pressure altitude)

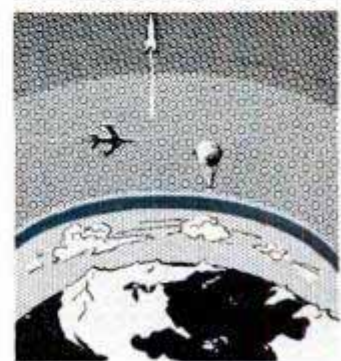

CHECK ONE ANSWER IN EACH ROW THAT BEST ILLUSTRATES THE TERM



1. TOPOGRAPHY
PHYSICAL CHARACTERISTICS



HEAD



INDUSTRY



MINERALS



TYPESETTING



2. SMALL ESTUARY
INLET



LAKE



PROMONTORY



PENINSULA



ISLAND



3. MORaine
MARSH



FOREST



GLACIAL DEPOSIT



LOW GROUND



NARROW GORGE



4. FLUVIAL DEPOSIT
RIVER



VOLCANIC



DUST



GLACIAL



CORAL



5. ALLUVIAL SOIL
ROCKY FORMATION

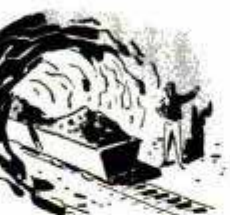

MINERAL



FERTILE

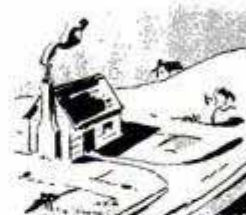

OVERWORKED



FLOOD DEPOSIT



6. NEOLITHIC AGE
PREFLOOD



PRIMITIVE MAN



GLACIAL



LATER STONE



CAVEMAN

Death-Ray Chamber Tests Atom Effects

PACKED with the killing power of half the radium on earth, a radiation chamber for test animals is lined with tubes through which shuttle samples of radioactive cobalt. The animal, which may be a pigmy mouse or a fat pig, is suspended in a cage in the middle of a tube-lined cylinder. In an adjoining exposure room, a robot magnetic arm operated by remote control picks up "hot" capsules of cobalt one by one and shoves them into pneumatic tubes. Carried through the tubes which form the "death cylinder," the cobalt shuttles back and forth, soaking the animal with rays from all directions. With the machine, scientists at the Naval Medical Research Institute can simulate the effects of atom-bomb radiation on the human body. The experiments, they hope, will lead to better methods of treating radiation sickness and may point the way to a means of defending the body from the deadly rays.

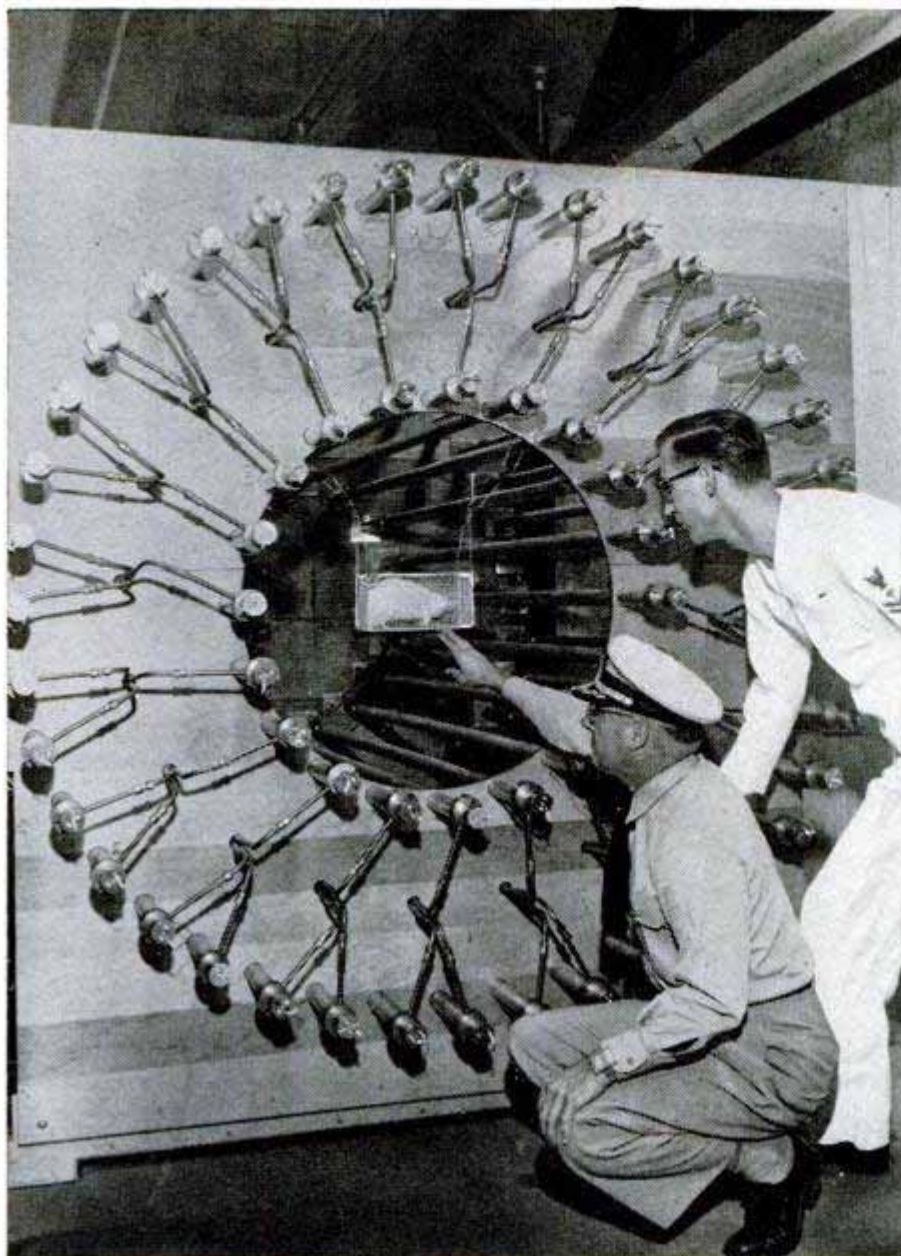

Radiation chamber is a cylinder within a cylinder. "Hot" cobalt inside tubes permits even radiation not possible with present X rays or radium

Operator standing outside concrete-encased exposure rooms manipulates controls of robot magnetic arm to insert cartridges of cobalt in pneumatic tubes

Arrangement of mirrors enables operator to see what he's doing. There are 60 tubes in all; each has to be loaded separately. Rays in loading room can kill

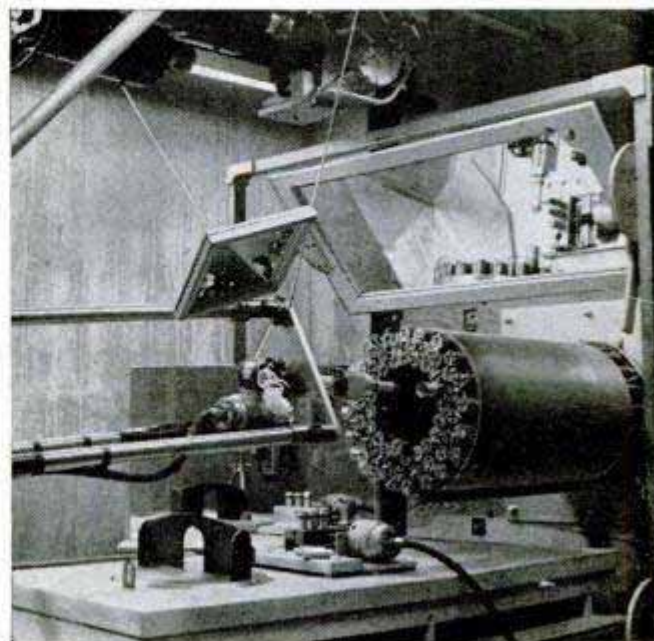
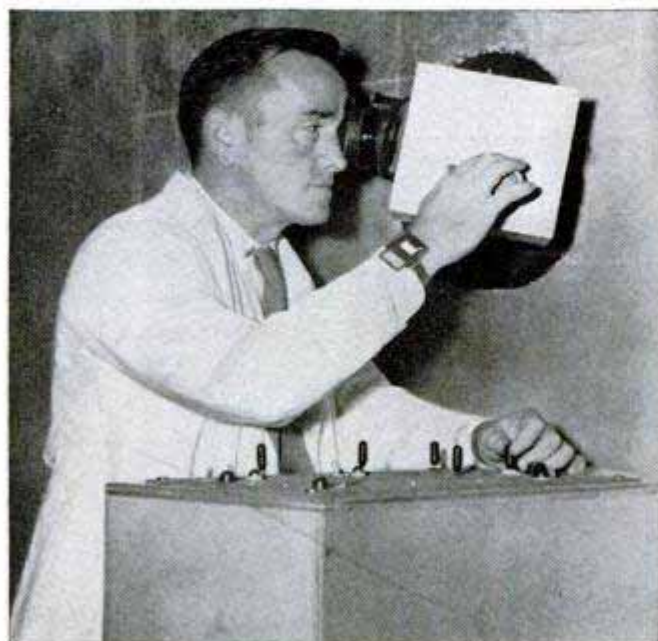

WHAT'S NEW FOR

Your Home



1

1. BATHTUB CLEANER takes the hard work out of a frequent household chore. Foam-rubber pad, molded to fit corners and rounded surfaces, is fitted to sturdy aluminum handle bent at an efficient angle

2. ELECTRIC-BROILER unit handles a large steak, yet is smaller than the average teakettle. Any pan or skillet serves as a drip pan, when topped by the broiler rack which is covered by the heating unit

3. TABLE TRAY of plastic fits any rectangular table, brings food down to youngster's level. Two trays, clamped by knobs to opposite ends of card table, keep refreshments handy, yet out of the way

4. PASTRY BOARD faced with clothlike rubber material prevents dough from sticking or tearing, contributes to flakiness. Concentric circles on tray serve as cutting guides for various-sized crusts

5. SIGN KIT allows anyone to make almost any kind of marker or sign with letters, numerals, boards and attachments supplied in knocked-down form. Kit is packed to order, includes everything but tools



2



3

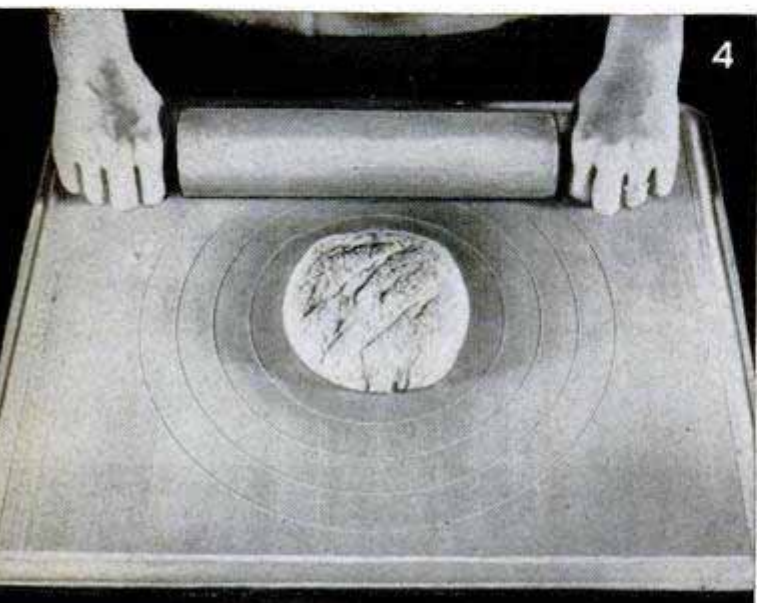

4

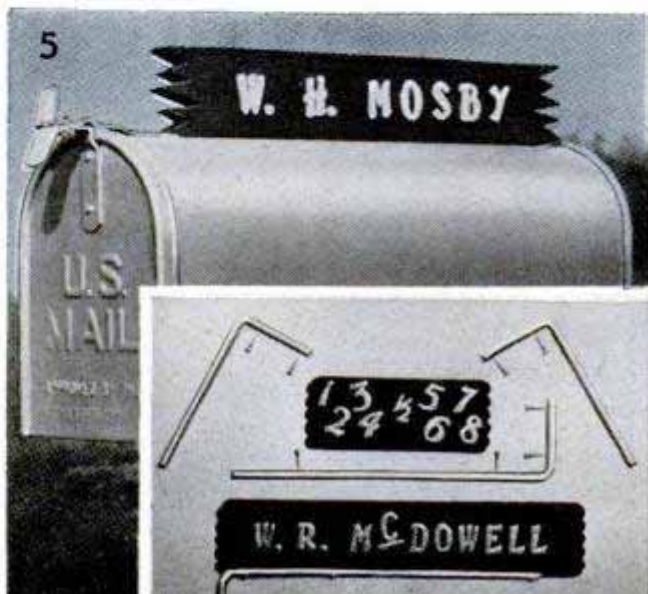

5



6. LUMINOUS PENDANT for pull cords is a miniature radium-lighted lantern that enables you to find lamp in complete darkness with a minimum of stumbling



7. SHUTTER KIT halves cost of movable interior or exterior shutters by allowing you to do your own assembling, trimming, finishing and installation. Everything but costly handwork is done at factory

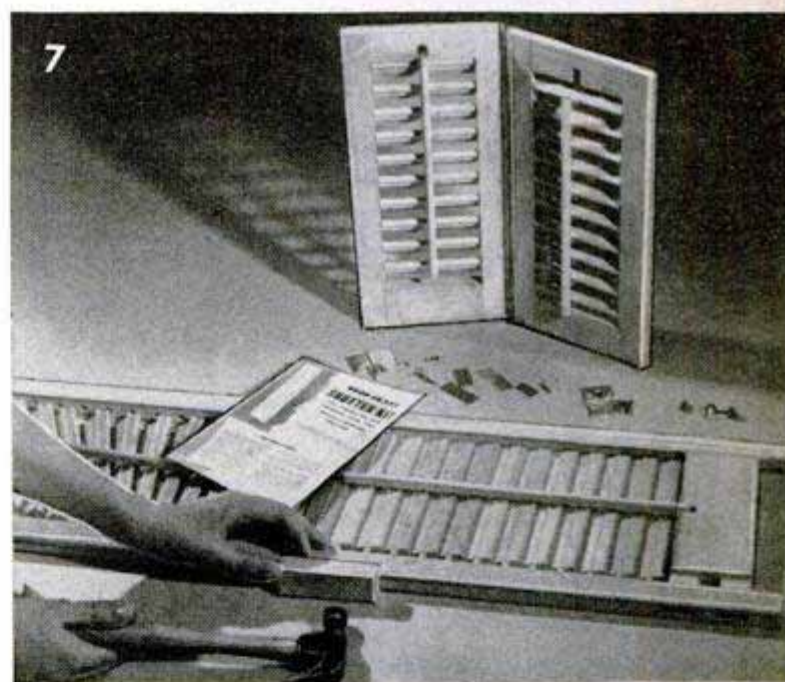

8. KNITTING SET allows speedy knitting with several kinds of yarn, eliminates tangling problem. Yarn is wound on spools fastened to the ends of clear plastic tubes, feeds up through tubes as needed

9. CLOTHESLINE REEL with tangle-free rope guide allows the stringing of up to 200 feet of taut line; keeps cord neat and clean when not in use. Light and durable, it is fitted with large, comfortable handles



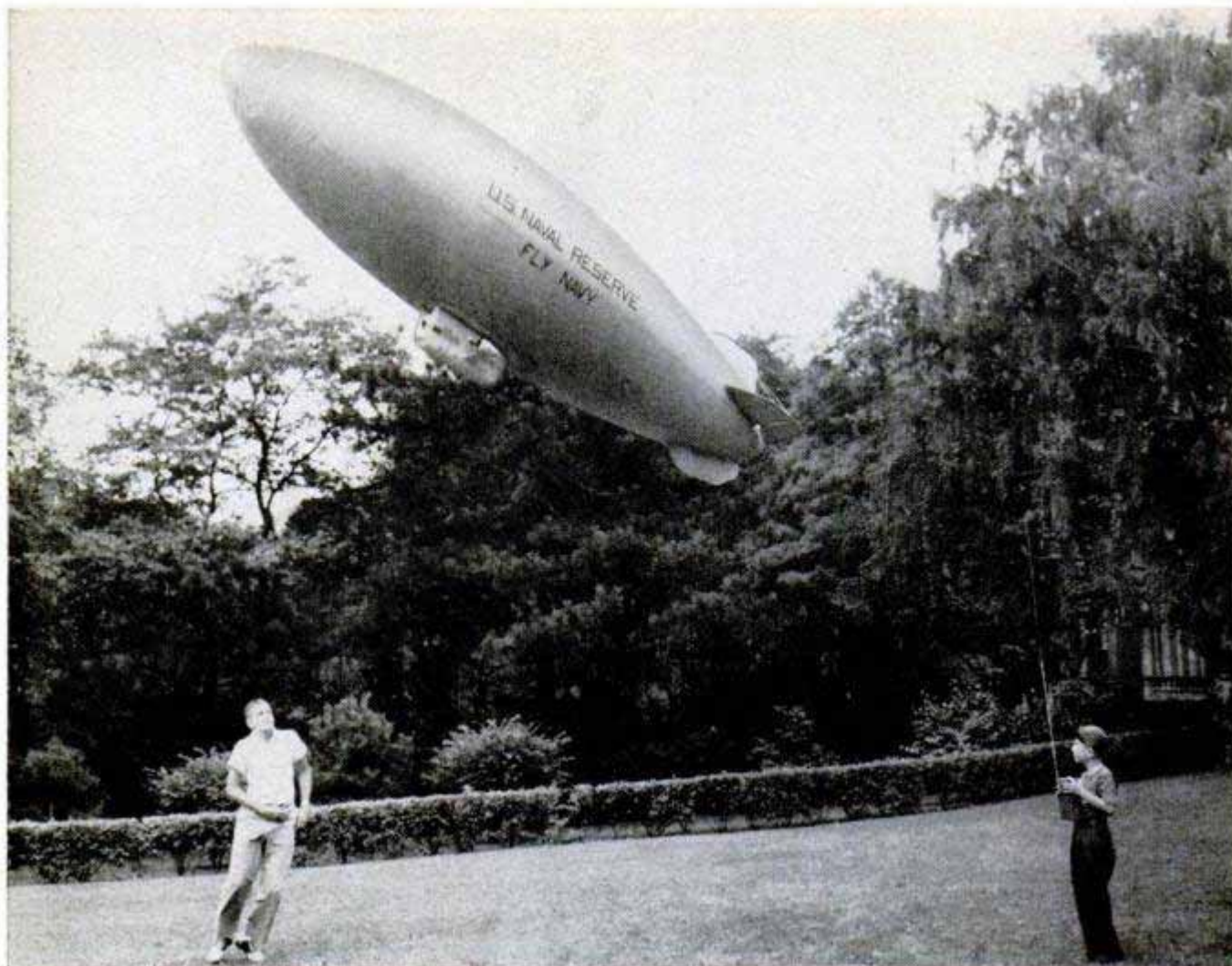

Radio-Guided Model Blimp Used in Navy Recruiting Program

Operated by radio signals, a 17-foot model of a Navy blimp cruises along at 12 miles per hour and can be controlled up to a mile from the transmitter. The airship was built under the direction of Navy officers and is being flown in various parts of the country

as part of the Navy recruiting program. A group of model-plane builders from Baltimore, Md., worked out the radio-control equipment, the fins and the two tiny gasoline engines which propel the small-size blimp.



Synthetic Asbestos Substitute

Possessing greater heat-resistant qualities than natural asbestos, a manmade ceramic fiber promises to ease the pinch on the critical imported material. The new fabric is made by melting aluminum and silica in an electric furnace and subjecting a stream of molten material to a blast of air. Result is a fluffy white cottonlike mass of fibers one fourth the thickness of fine silk and weighing two pounds per cubic foot. The fineness and random arrangement of the fibers make the material a superfilter for gases and liquids in chemical operations. Its resilience means that the product can be used for vibration damping and as a packing material for expansion joints. Specially processed aluminum-silicate fiber will be utilized for electrical insulation and as a replacement for asbestos in brake linings subjected to heavy loads.

Holding the slender "snake" in his hand, the Indian is set to hurl it down the rut

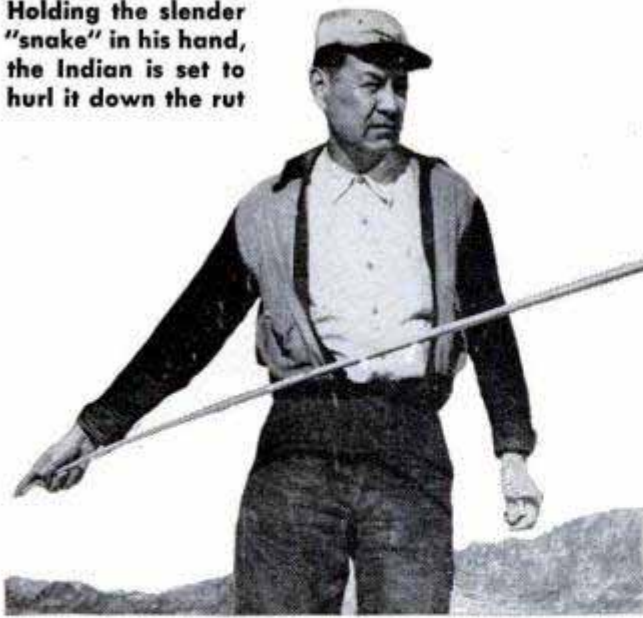

"Snakes" in the Snow

"HUN-YOU! Hun-you!"

That's the cry as braves of the Six Nations in Ontario, Can., hurl long wood "snakes" along a rut in the snow in a game that was old before the white man came to America.

The snake is a hickory wand made unbelievably smooth by patient labor. For a year, the wood is soaked in oil, then the head is weighted with lead and a finger groove is cut in the tail.

The track is made by dragging a sapling through the snow. Launched by a running heave, the snake slithers and slides effortlessly for nearly a mile before stopping.



Above, the hickory snakes must be flexible to follow the minor irregularities of the mile-long rut in the snow. Below, a short run is used to launch the snake





About 150,000,000 gallons of water a year are used in the Broken Hill zinc-lead mine



WATER LIFT FIGHTS AUSTRALIA DROUGHT

WHEN EIGHT YEARS of drought threatened Australia's great inland mining city of Broken Hill with disaster, the Iron Horse came to the rescue in the biggest rail water lift the world has known.

Across 40 miles of drought-stricken desert, fast express trains hauled a total of 250,000,000 gallons of water during six months of bone-dry weather. It took 1517 trains to haul the water and altogether they traveled 119,360 miles back and forth over the 40-mile stretch of trackage. The average speed of the trains was about 40 miles per hour.

Broken Hill, a city of 36,000 about 700 miles west of Sydney, has the title of "Australia's Money Mine" because of its fabu-

By J. W. Morris

lous zinc-lead production — a production, incidentally, which requires large amounts of water. The city produces more than \$50,000,000 worth of ore annually, providing residents with a high standard of living and Australia with a valuable source of income. Since zinc-lead production began at Broken Hill in 1884, more than \$500,000,000 worth of ore has been taken from the vein. It was this fabulous wealth that put the full resources of the government-owned railroad behind the water lift to assure continuous production.

When it became apparent that Stephens Creek reservoir, the city's main water-storage facility, was running dry in the long drought, railway engineers shipped heavy earthmoving equipment to Mount Gipps,

Diagrammatic map shows the 40-mile stretch of rails over which 250,000,000 gallons of water were hauled

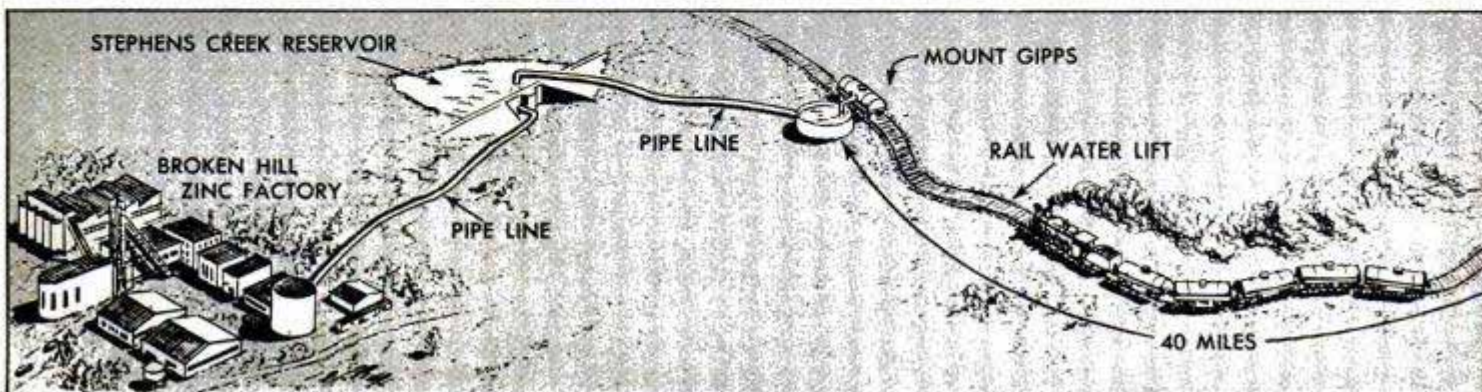

a previously unknown rail siding east of Broken Hill.

There, huge gravity tanks were built around a triangle of track. Within a week the work had been completed enough so that two trains could be handled simultaneously. Two days before the Stephens Creek reservoir failed, water trains were discharging water at Mount Gipps—a record of speedy construction and organization.

From the gravity tanks the water flowed 14 miles through a pipe line to the dusty, dry reservoir at Stephens Creek. From there it was carried by pipe to the city of Broken Hill.

The trains were filled at Horse Lake, another previously unknown railroad siding west of Menindee. Water from the River Darling was piped to Horse Lake to fill the special trains for their dash across the desert. These express trains operated on a round-the-clock basis with 14 trains of 10 cars each making a round trip a day. Only 72 men, including both train crews and administrative personnel, were used in the operation.

The water lift was discontinued when a new pipe line from Menindee to Broken Hill was completed. The incomplete section between Horse Lake and Mount Gipps had made necessary the railroad link. When this was finished, the water lift via rail was no longer operated.

All that remains today to attest to the unusual feat is a prolific growth of grass and shrubs around Horse Lake, the result of continuous wetting received as trains departed with dripping water tanks.



Broken Hill's main water reservoir at Stephens Creek looked as dry as the desert that surrounds it. Normally, 20 feet of water cover the sandy bed. Small hole in wall is the water-outlet valve



Water trains discharged into gravity tanks at Mount Gipps. From here the water flowed by gravity to Stephens Creek reservoir, 14 miles away. After leaving the reservoir, it filled the city water-supply mains

Filling the water tank cars at Horse Lake was carried out with no lost time. The daily quota of trains to be filled was 14 and the amount of water handled daily averaged about 1,500,000 gallons

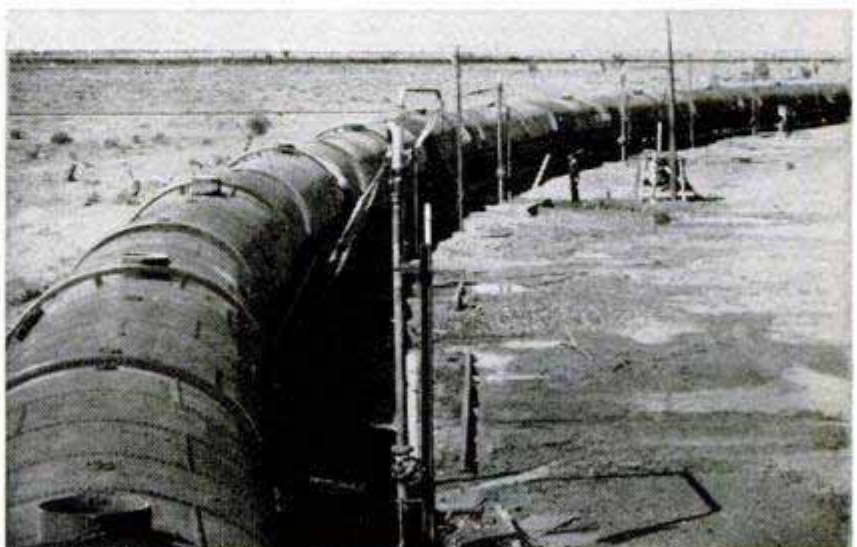
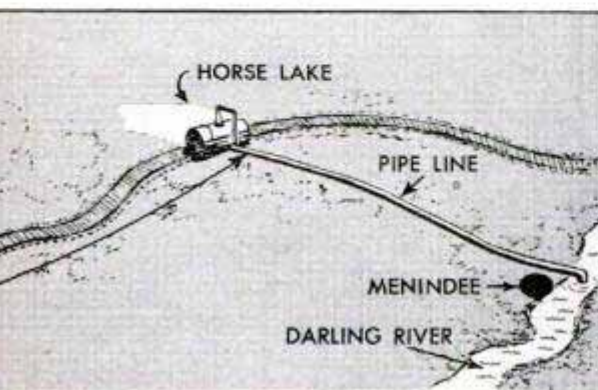

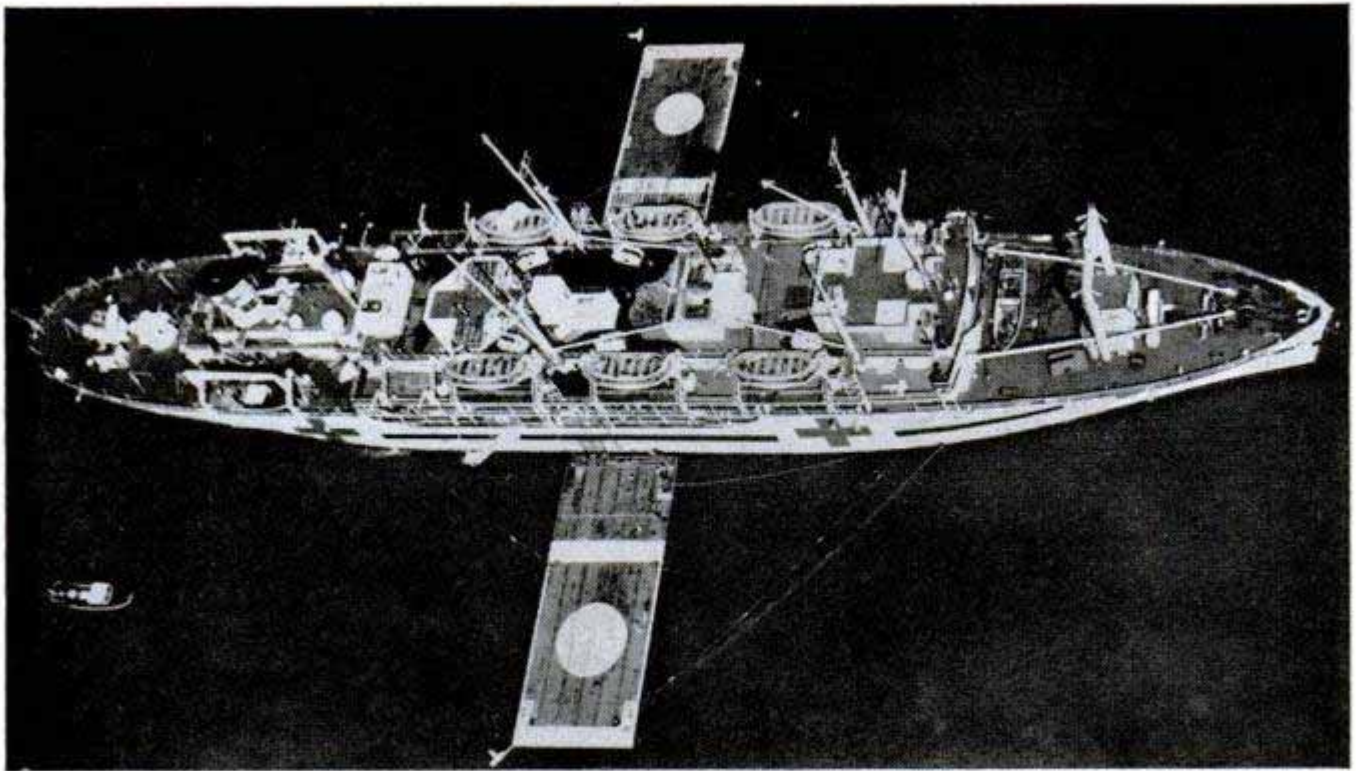

Hospital Ship Has Helicopter Landing Platforms

Helicopters carrying Korean battle casualties can now fly direct from the front lines to the USS *Haven*, a Navy hospital

ship. They land on platforms specially constructed and moored to take helicopters and move men into hospital quarters.

Window Sheeting Removes Glare From Sun's Rays



Sunlight without glare results when custom-cut Vinylite-plastic sheeting is applied to window panes. Moistened, and pressed on with a squeegee, the material is easily peeled off again and is reusable. Tough and strongly resistant to tearing, abrasion, scuffing and chemical damage, the sheeting can be washed indiscriminately. Available in eight shades, from frosted translucent to blackout black, the glare-cutting plastic may find wide use in hospitals, homes, offices and factories.

Woven-Wire Carpet Gives Better Traction for Auto Tires

When automobile wheels spin on icy pavements, small woven-steel-wire mats placed under the rear wheels give needed traction. The thin edge of the carpet is wedged firmly under the tire, and the car is started slowly. The multilayered 27 by 5-inch mat digs into ice and snow, and provides a rough top surface for the tire treads.

Rocket-Fuel Chemical Produced by Electric Method

By shooting high-frequency electric current through ammonia gas, chemists at the University of Utah have produced hydrazine, a chemical source of rocket fuel and the tuberculosis drug, isoniazid. Formerly

produced by chemical means only, hydrazine had to be dehydrated by expensive and difficult methods. The new dry process may open the way to manufacture of hydrazine on a commercial scale.

Gasifier Aids Motor Starting Under Arctic Conditions

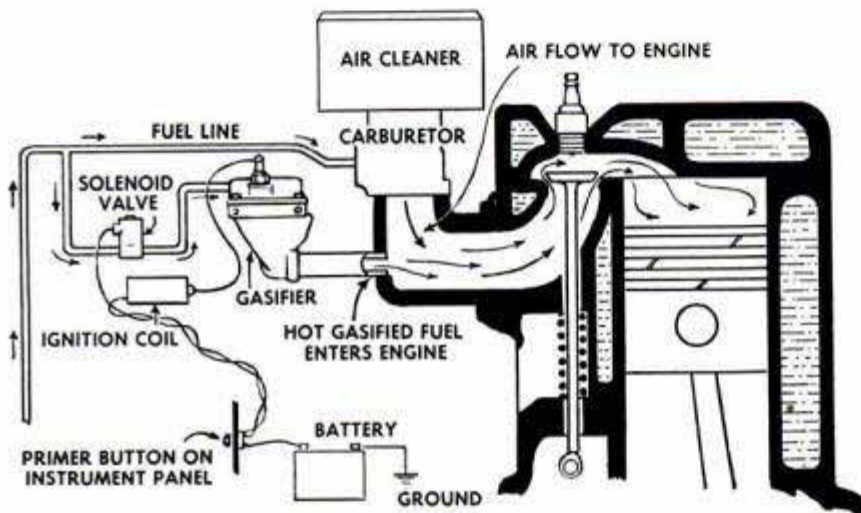
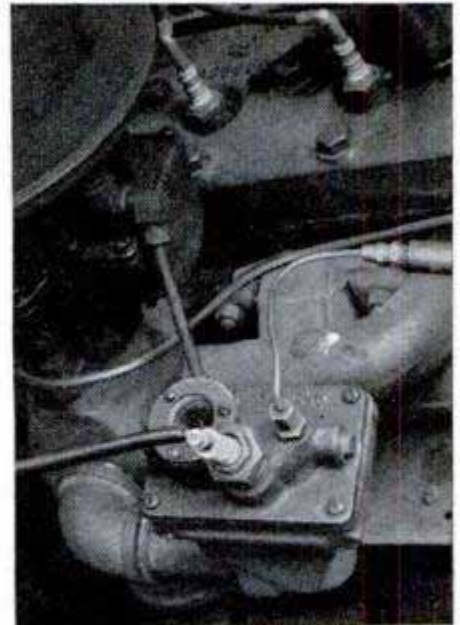
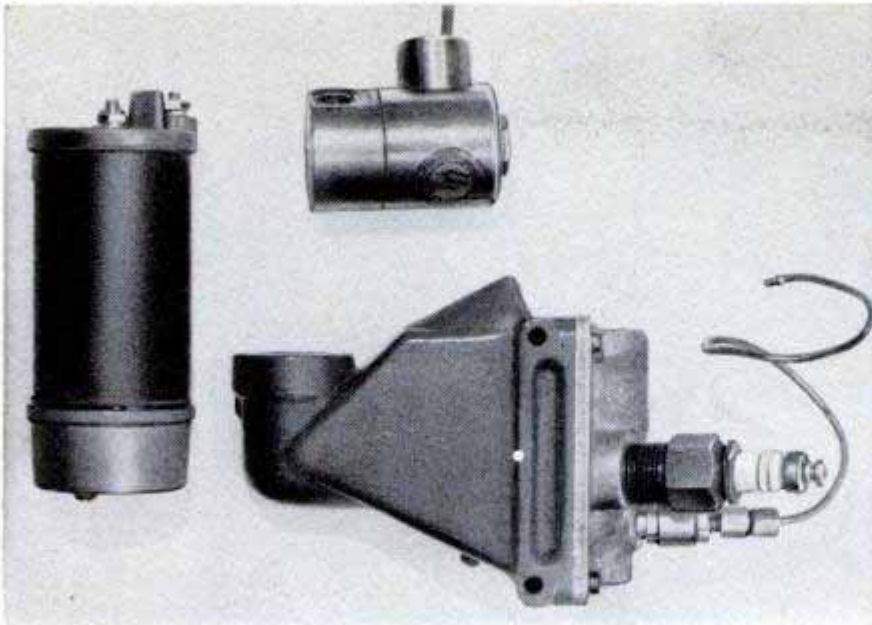

Three units (above, left) comprise the starting apparatus. At left is the ignition coil, above is the solenoid-electric valve, and at bottom right is the gasifier unit. Installation (above) in a regular car engine by sandwiching gasifier between manifold and carburetor or threading it directly into manifold below carburetor takes 15 to 45 minutes. Pressing of primer button (left) energizes system's solenoid valve and spark plug. Cold fuel is drawn from carburetor line, enters the gasifier. Part is burned; the rest, changed into hot vapor, enters intake manifold, mixes with carburetor air. Resulting rich, warm mixture enters combustion cylinder and is ignited

Enabling engines to start in less than 30 seconds at temperatures as low as -65 deg. Fahrenheit, a gasifier for piston engines may be used on Army vehicles operating in the Arctic. The device supplements the carburetor for starting only. It is essentially a fuel precombustion chamber with a conventional spark plug. A quantity of the fuel supplied is burned under controlled conditions to heat and vaporize the main portion. The resultant rich, warm gaseous

priming charge is drawn into the engine upon cranking to facilitate combustion independent of initial carburetor performance. After a few minutes of operation the gasifier enables the engine to operate satisfactorily in a normal manner. Simple to install, it needs no extra accessories for operation, such as an extra fuel tank, for it uses the same fuel as the engine. Adequate starting power is necessary for successful operation.

Cap Protects Rifle Sights Against Rain and Snow



Held tightly in place by a continuous band, a lens cap for rifle telescopic sights assures shooting accuracy even during a snow or rain storm. The lens cap can be detached quickly for a fast shot. A drip ring doubly seals the lens from all moisture.

☐ Forty-five percent of the cars on the road today have been driven more than 40,000 miles, according to the Automotive Manufacturers Association.

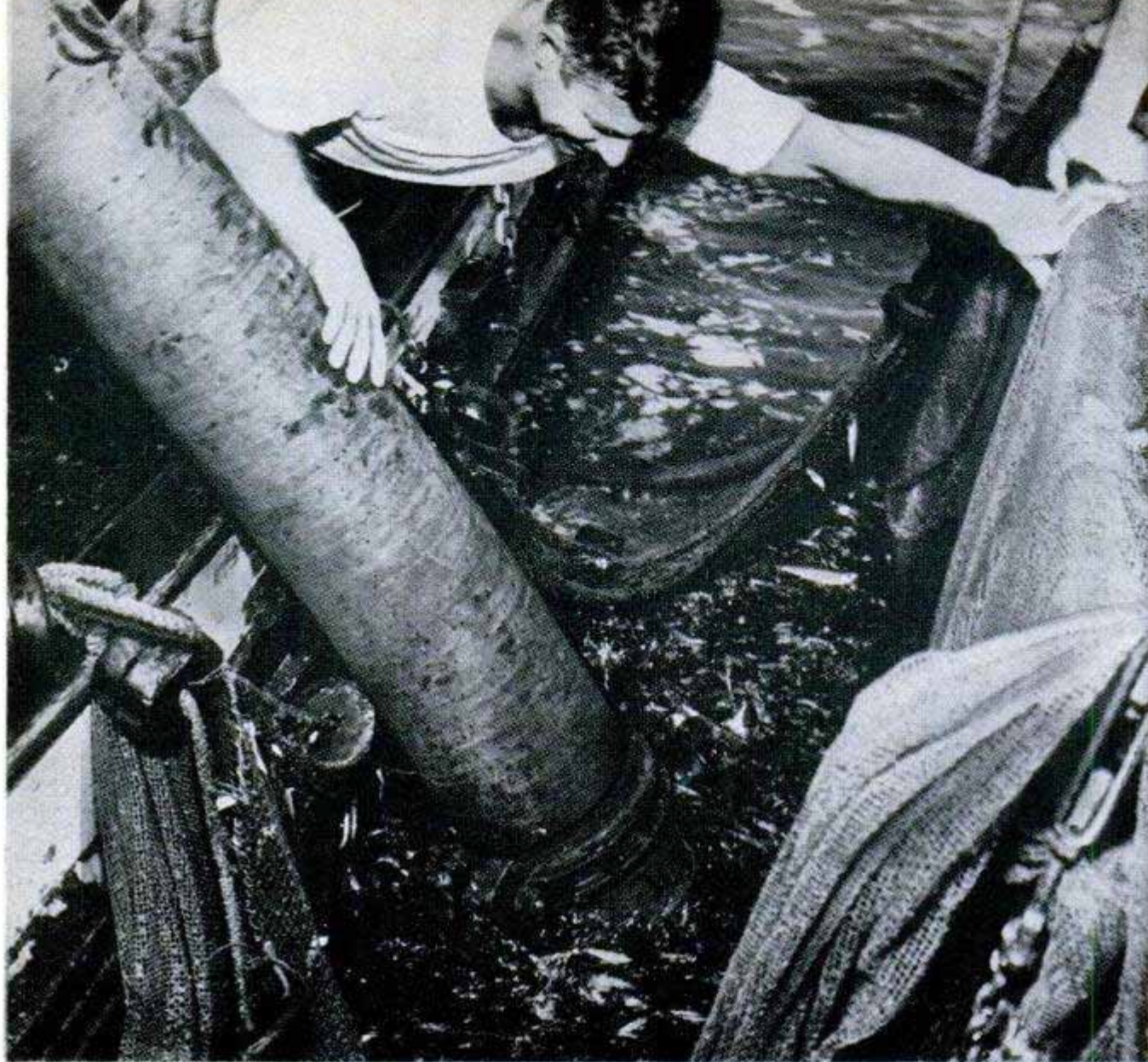

Anchovies are drawn up through the *El Redondo's* suction hose at a rate of 500 pounds of fish per minute

THE BOAT THAT INHALES FISH

By Shep Shepherd

EVER SINCE MAN has been keeping a record of his activities nets have been used for taking up schools of small ocean fish. Probably no other human enterprise has remained so long unchanged.

Along the southern California coast, from Pismo Beach to Ensenada, Mex., an industry has been growing steadily since sport fishing began in the Pacific in the early 1920s. Collecting live bait for sport fishermen is now an extensive business.

The small greenish-blue anchovy, four to six inches long, is the favorite bait fish, though sardines are sometimes used. The Pacific schools of anchovy and sardine have always been taken by net.

A school is located by watching either

the surface or the gulls. The presence of a flock of seagulls hovering over one spot is a sure sign of bait fish just under the surface. In their absence the boat cruises slowly about while a lookout scans the surface for signs of bait fish leaping from the water in an effort to escape game fish that are feeding on the school.

When a school has been spotted, the boat draws close, drops one end of a hundred-yard-long net over the stern and cruises in a circle. Several men on each end of the net then begin the laborious task of drawing in the net and transferring its contents to the bait tanks in the hold of the ship. It is here that the backbreaking work comes in. Large, long-handled dip nets are used.



Bringing the school in close to the boat is the only hard hand work that still remains in anchovy fishing

They hold as much as a man can lift. Slowly, a dip net at a time, the school is taken from the seine, passed from hand to hand until the last man dumps it into the hold.

All this is now changed. The long net is still used to trap the school, but there ends the old method. A second boat, the *El Redondo*, pulls in near the first with the net full of fish between. Over the side of the *El Redondo* goes a long, hard-rubber suction hose with a spreading mouth 18 inches wide. The ship's big marine engine starts a pump mechanism going that moves water

Once aboard, the fish ride a stream of water down the flume without so much as knocking off a scale

and bait fish aboard at a rate of 500 pounds of fish per minute.

Just before the fish hit the pump mechanism, where they would quickly be ground to bits, a rotary valve passes the fish out into a flume without so much as knocking off a scale. The fish ride a stream of water down the flume and into the holds.

The *El Redondo* has a capacity of between 80,000 and 100,000 anchovies. I watched her stow away that number in less than 15 minutes; that job by hand would require three hours of backbreaking toil.

Use of the hard-rubber suction hose spares the bait-boat crew tedious, backbreaking effort with dip nets



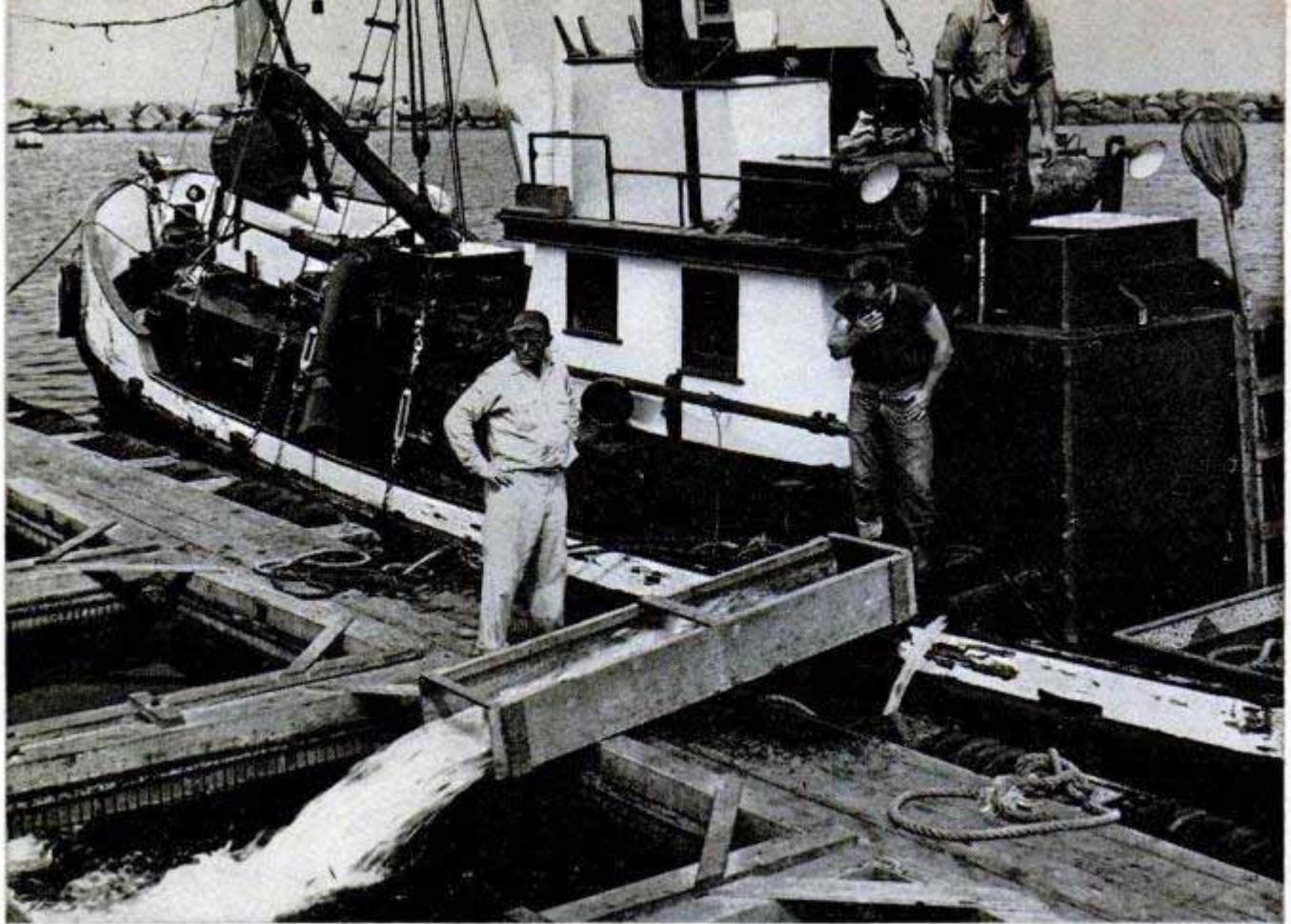

After loading up to 100,000 anchovies, the *El Redondo*, above, heads home and the catch is flushed out into holding tanks. Rotary valve, left, detours fish out of suction system before anchovies hit pump mechanism

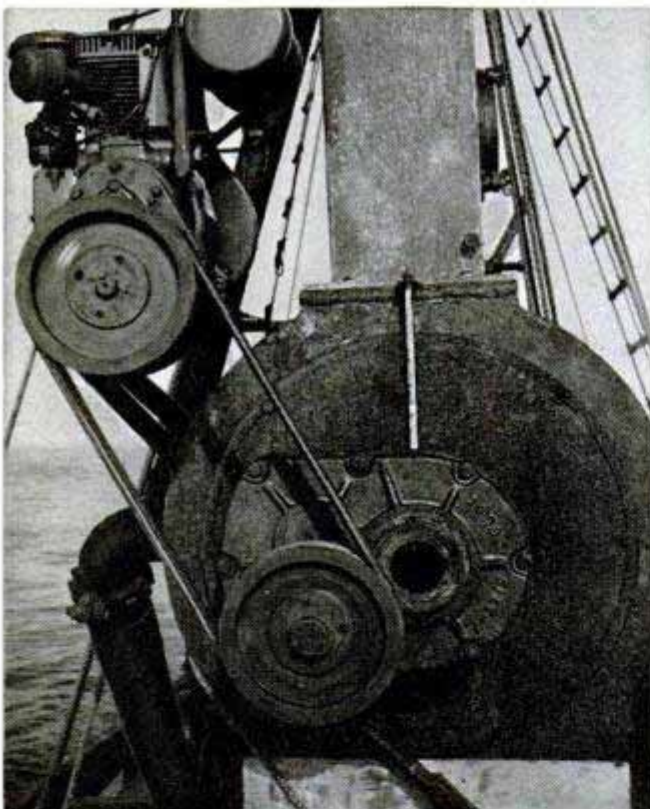

Once loaded the *El Redondo* cruises to holding tanks near port, where the sport-fishing boats call for the day's supply of live bait. Wooden flumes are fitted to outlets at the bottom of her holds. A lever opens the gates and the fish are flushed out into the holding tanks.

Loss of fish never exceeds two percent. Under the old system, in which the fish were not only lifted out of the water but crushed under the weight of their own fel-

lows in the dip nets, the loss ran as high as 20 or 25 percent.

Old-timers have detected another difference. An anchovy has a greenish cast in the water. When lifted out of the water in dip nets from seine to ship and from ship to tanks they change to a bluish tone and lose some of their speed and agility. With the new system they are never out of the water and retain their original spirit and color.

This idea of a bait boat inhaling fish was the brain child of Howard Kimmerle of Long Beach, Calif. He took the design to the Meletron Corporation of Los Angeles, builders of marine equipment, who assigned engineer Emmett Lowery to "iron out the bugs."

Lowery is continuing experimental work with an eye on the sardine industry. Though big canneries have mechanical means of unloading catches from purse seiners, the small canneries do not. With the depletion of the Pacific sardine fishery the small canneries are finding it difficult to buy cargoes because the skippers and crews don't like the manual labor involved in unloading at a small cannery. They face shut-downs unless they can attract commercial fishing boats to their docks.

With a rig similar to the one on the *El Redondo* they can now compete with the big fellows on even terms. ★ ★ ★

"Tilt Up" Method Hurries Building

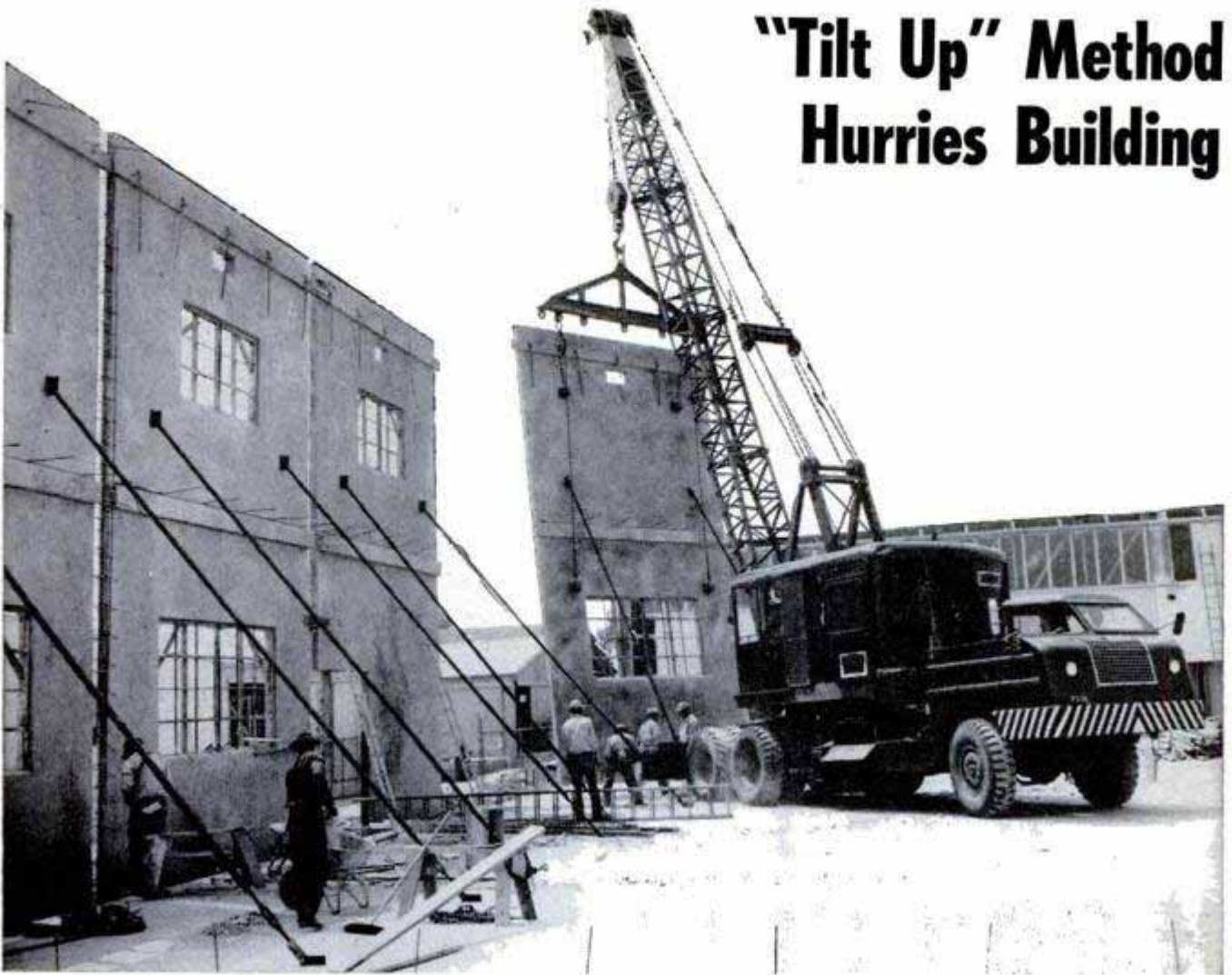

Precast 22-ton concrete wall panels are raised into place by huge crane. Slabs settle into prepared slots

TWO MONTHS of work were cut from the construction time of a two-story factory recently built in Burbank, Calif., by means of "tilt up" techniques. Rapidly becoming a favorite method of constructing large, reinforced buildings, the method is fast and said to be inexpensive. Wall sections are poured in forms lying on the previously cured concrete floor, then raised and moved into place by a crane. Adjoining sections are tied together by means of reinforced-concrete columns. The method avoids all use of the costly wooden frames formerly required. In the Burbank operation, each precast wall slab measured 20 by 31 feet, was 6 inches thick and weighed 22 tons. A single crane placed 15 of the slabs in a day. Usually confined to single-story construction, the use of tilt-up techniques at Burbank marked one of the first times that the cost-cutting method was applied to two-story buildings. Approximately 45,000 feet of floor space are contained in the factory.

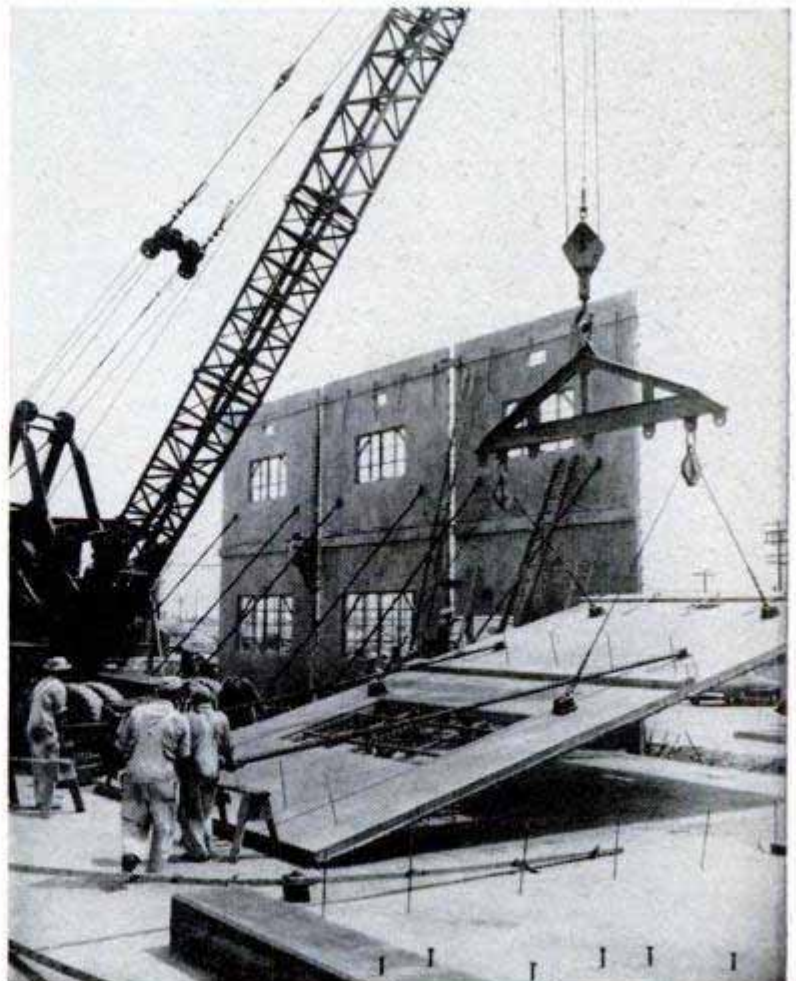

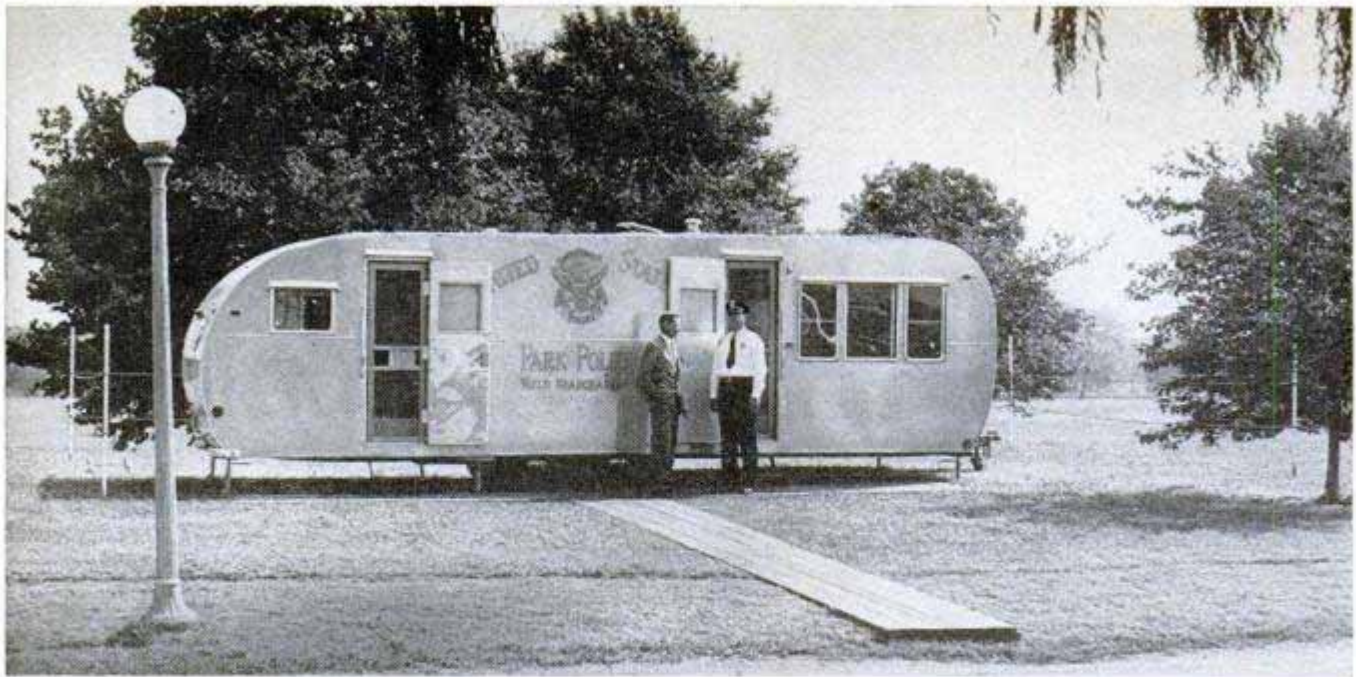

Washington's mobile police headquarters set up for action. Wheels in center allow easier maneuvering in transit

Rolling Hoosgow Serves Capital Police

WASHINGTON, D. C., claims the world's only hoosgow on wheels. An elegant aluminum trailer 30 feet long, it is furnished with such home comforts as a shower bath, Venetian blinds, electric refrigerator, screens on the windows and rugs on the floor.

Much more than a rambling jailhouse, it serves as a mobile headquarters for the National Capital Park Police. In addition to acting as a temporary brig for questioning or detention until the patrol wagon arrives, it is a valuable field center when police are on duty at parades and special events.

Equipped with a two-way, 60-watt radio transmitter and receiver, public-address system, telephone, typewriter, floodlights and general supplies, it is an emergency field headquarters from which park police could direct their operations.

After an air raid or at the scene of a major accident, police must move into the area, establish security measures, take initial steps in the matter of first aid, rescue work, traffic control, and assume a host of other duties. An air tragedy in 1949 in which two planes crashed and 55 people were killed convinced park police that a mobile headquarters was a necessity.

The trailer was built to rigid specifications. It is of sturdy construction and has a strong steel framework, suitably welded. The body is insulated with glass fiber on all sides, top and bottom. Axles and wheels

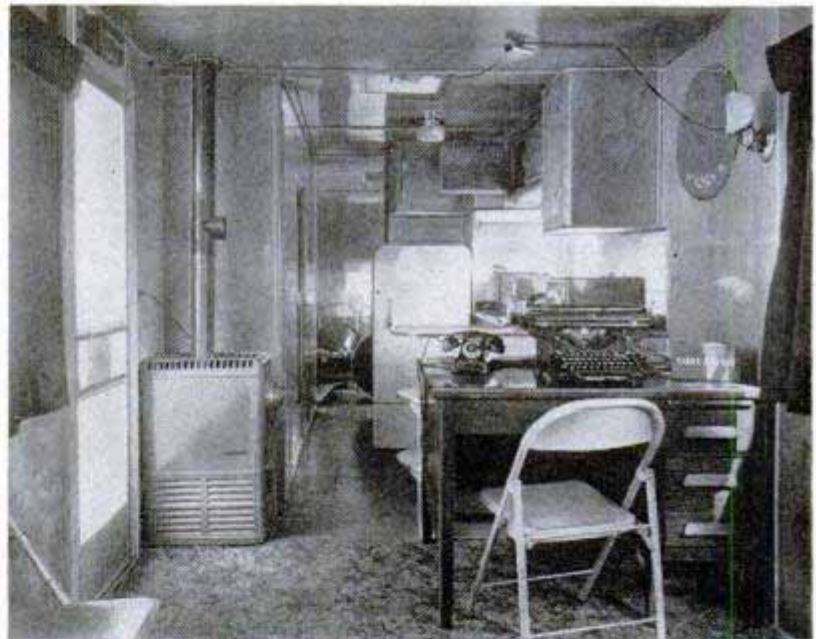

Interior of trailer is designed for efficiency plus comfort and proves an efficient center for directing police activities

were designed for brake equipment on all four wheels; brakes are operated electrically from the towing car. A separate, Jeep-drawn unit houses a 7500-watt, gasoline-powered generator to supply electric current when city power is not available. Stocked with emergency supplies of all kinds, from rubberized sheets and woolen blankets to hip boots, a woodman's ax and a pack-type acetylene torch, the unit is regarded as indispensable by the city's forward-looking police department.

Chemically treated for strength and absorbency, a new paper cleans dirt from windshields without leaving streaks.

Graham (M) Info. Co.

Austrian's Ski-Sail Permits Long Leaps

Leaps as long as 50 feet can be made on slight inclines with a ski-sail developed in Austria. In addition to increasing the skier's speed, the inventor claims it gives users the feeling of lying on air while in a perfect jump attitude. Called the Glockner Sail, it makes possible effortless leaps across rocks, snow-free patches of ground and other mountainside obstacles, as well as helping beginners maintain better balance. The greater speed made possible by the sail also permits the user to make more downhill runs daily. The leaps are made by adjusting the canvas sail, which is fastened to ski poles, held by the skier, and to his chest. It enables the user to turn and maneuver more easily.

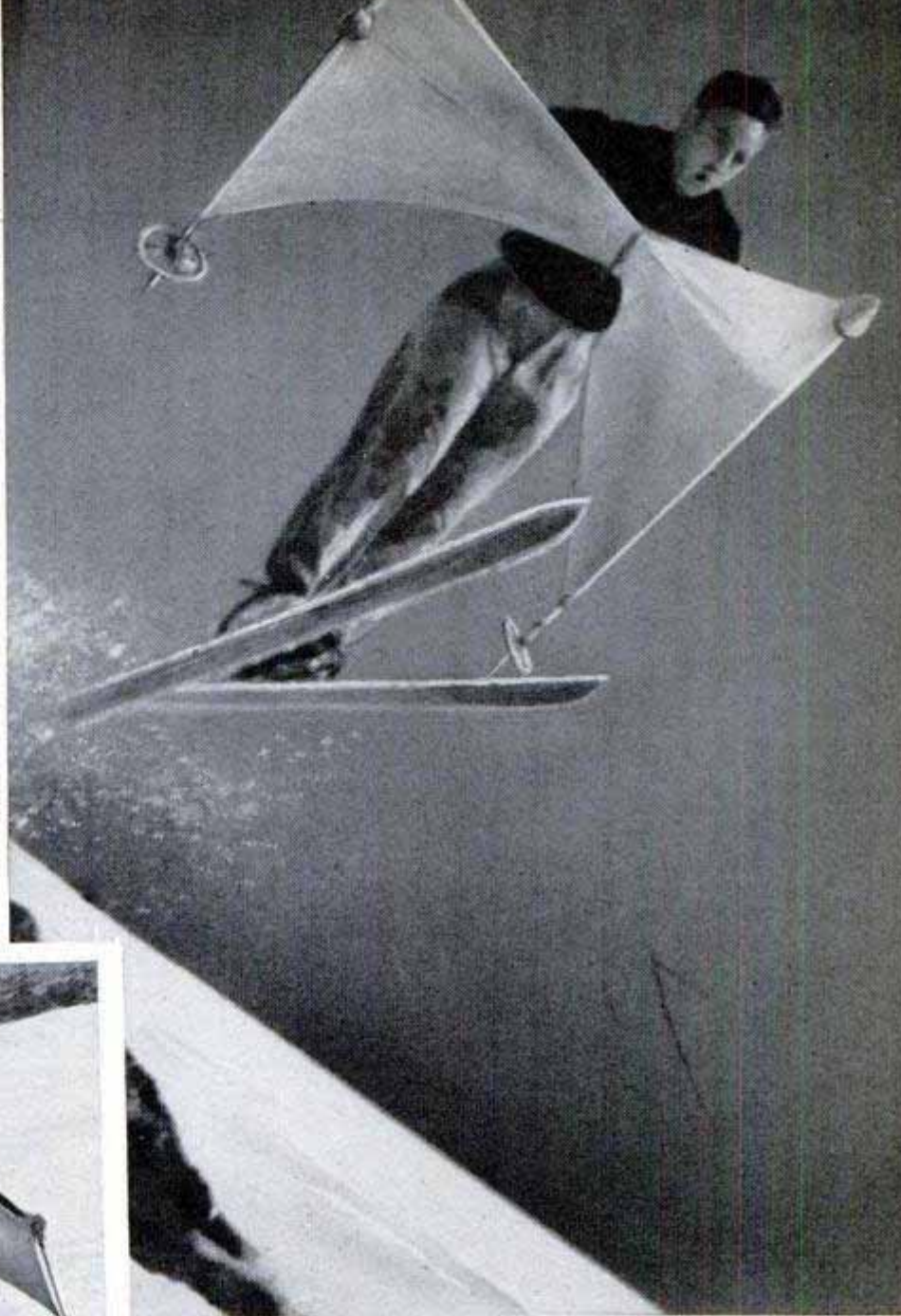

Leaning forward in good skiing form, a sportsman using a ski-sail "flies" effortlessly over a snow-slope obstacle

Faster downhill runs and turns are possible with the sail, which is attached to the skier's chest and poles

Chemical Technique Produces Metals From Low-Grade Ores

Through an entirely new process, metals are being refined with chemicals instead of by smelting or electrolysis. The technique shows promise of recovering metals from low-grade ores which can't be utilized economically at present. It also can produce virtually pure metals from scrap heaps. In the process, the ore is concentrated and then watered into a slurry. This flows into an autoclave—a tank where the metals are separated by heat, pressure and chemical agents. Different metals emerge as pure powders. The process requires a relatively moderate investment and authorities expect plants to be built right at the mines.



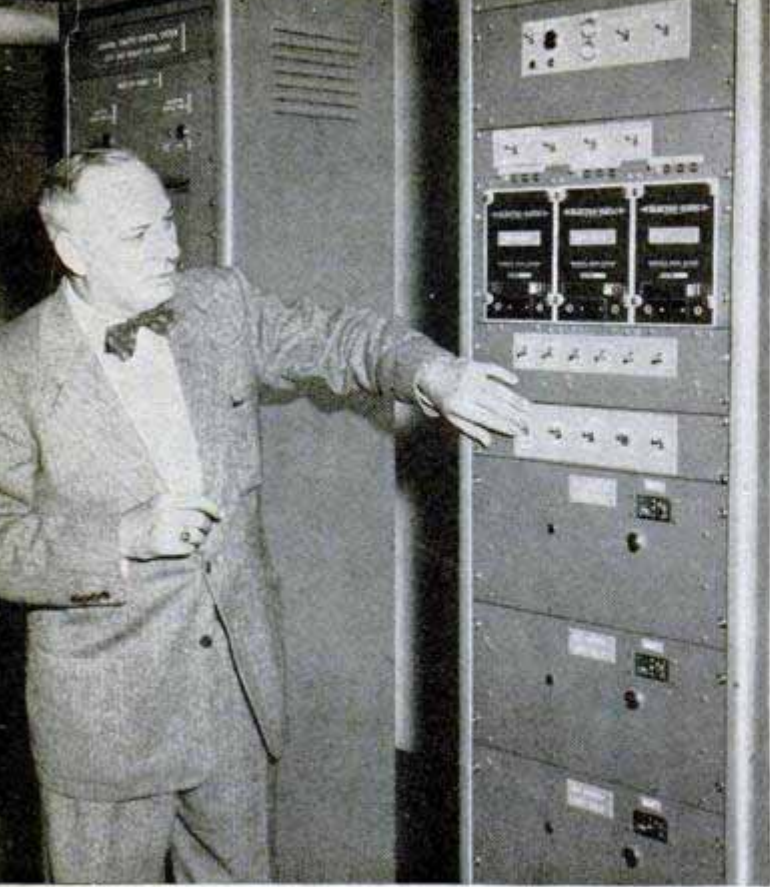

Henry A. Barnes, Denver traffic engineer, throws a switch on one section of his electronic "brain"

\$100,000 "BRAIN" KEEPS DENVER TRAFFIC ROLLING

DENVER HAS PUT its best brains to work on traffic problems and now has an electronic "brain" that promises to cut congestion to a minimum.

The mile-high city previously attracted national attention some years ago when it started a system that permits pedestrians to walk in any direction across intersections when the light says "walk."

Now, it has another solution—an electronic brain that detects and analyzes the traffic flow and relays its "conclusions" to traffic lights controlling 155 downtown intersections. Incidentally, it's a costly bit of "gray matter"—costing about \$100,000, plus another \$65,000 for installation. But

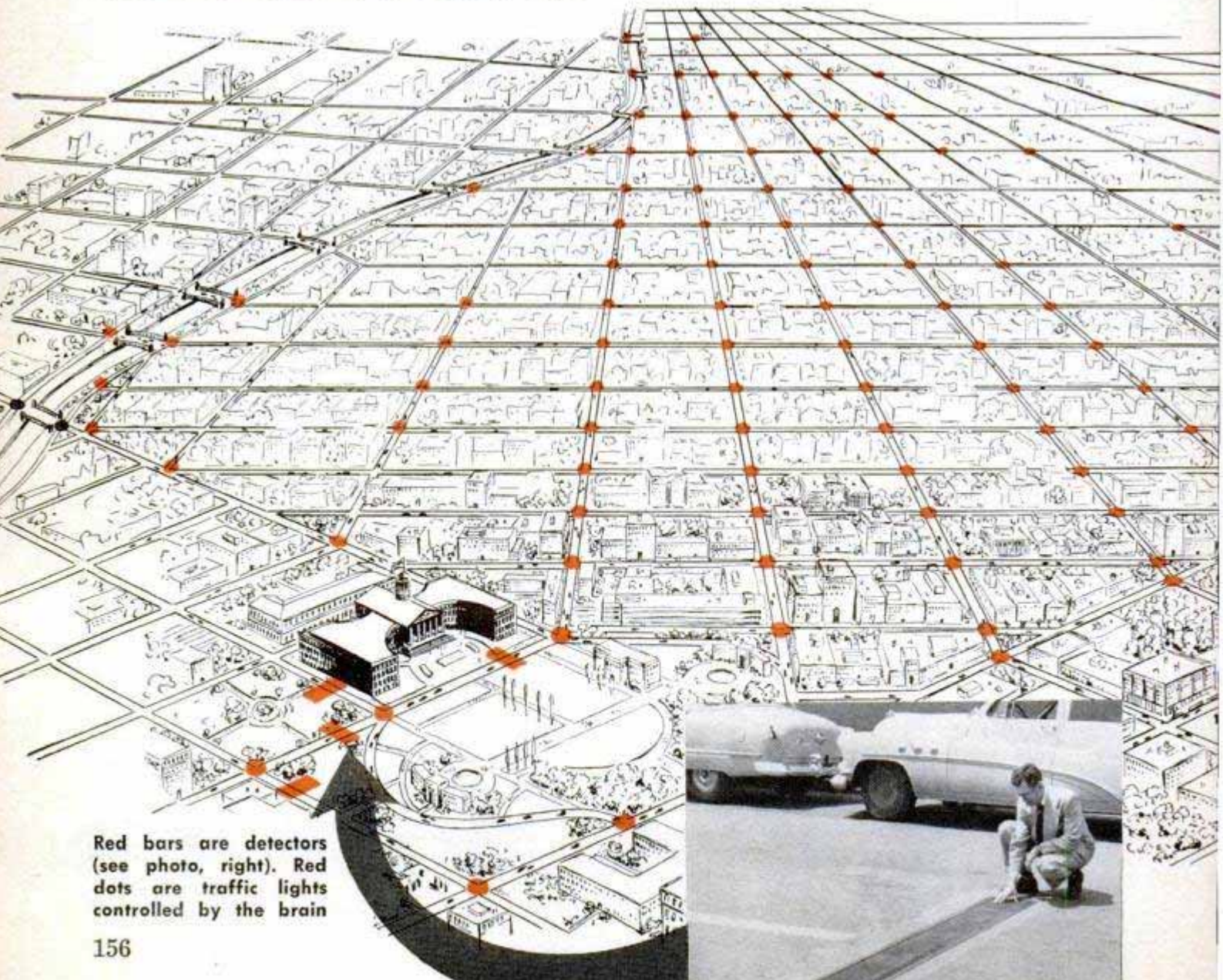

Red bars are detectors (see photo, right). Red dots are traffic lights controlled by the brain

that total is only a fraction of the net worth of the minutes wasted each day in traffic tie-ups across the city.

The brain does its analyzing by "studying" traffic as it rolls over four counters sunk in the streets around Denver's civic center. These counters or detectors notify the electronic brain inside the building how many cars are moving north, south, east and west. By projection, the brain translates this data into the precise signal-light cycling necessary to keep traffic from piling up anywhere in the 140-block area.

In theory, the lights are regulated to maintain an uninterrupted flow regardless of traffic conditions. The cycle can be reduced to as little as 40 seconds (for the red-yellow-green-walk cycle) when traffic is light. As more cars influence the brain, the cycle is lengthened until it takes 120 seconds for the cycle from green to green.

The brain takes traffic-flow samplings every six minutes and sets in the necessary changes immediately. If a sudden influx of traffic occurs in the downtown area, such as at the close of the work day, it takes no more than six minutes for the cycle corrections to be set in and operating over the

whole area where heaviest traffic is found.

The brain behind the brain is Henry A. Barnes, Denver traffic engineer, who feels that traffic congestion can't be treated with halfway measures. The electronic machine was conceived about five years ago by Barnes and his staff of eight electricians and electrical engineers. About five miles of wire are installed inside the control unit itself, while cables that connect the unit with the signal lights add up to about 1000 additional miles of wire.

When the brain (Barnes' staff members refer to it as "The Thing") has determined the direction and extent of traffic flow, it relays the instructions to each signal-control box. These electric instructions adjust the speed of tiny motors which govern the red-yellow-green-walk cycles of each light.

By the way, engineer Barnes, strangely enough, feels he is fighting a hopeless battle against congestion. The only solution to the problem, he says, is rapid and inexpensive mass transportation. Then, he claims, people will ride instead of drive to work—and, although he doesn't point this out, it would put his electronic "brain" out of work.

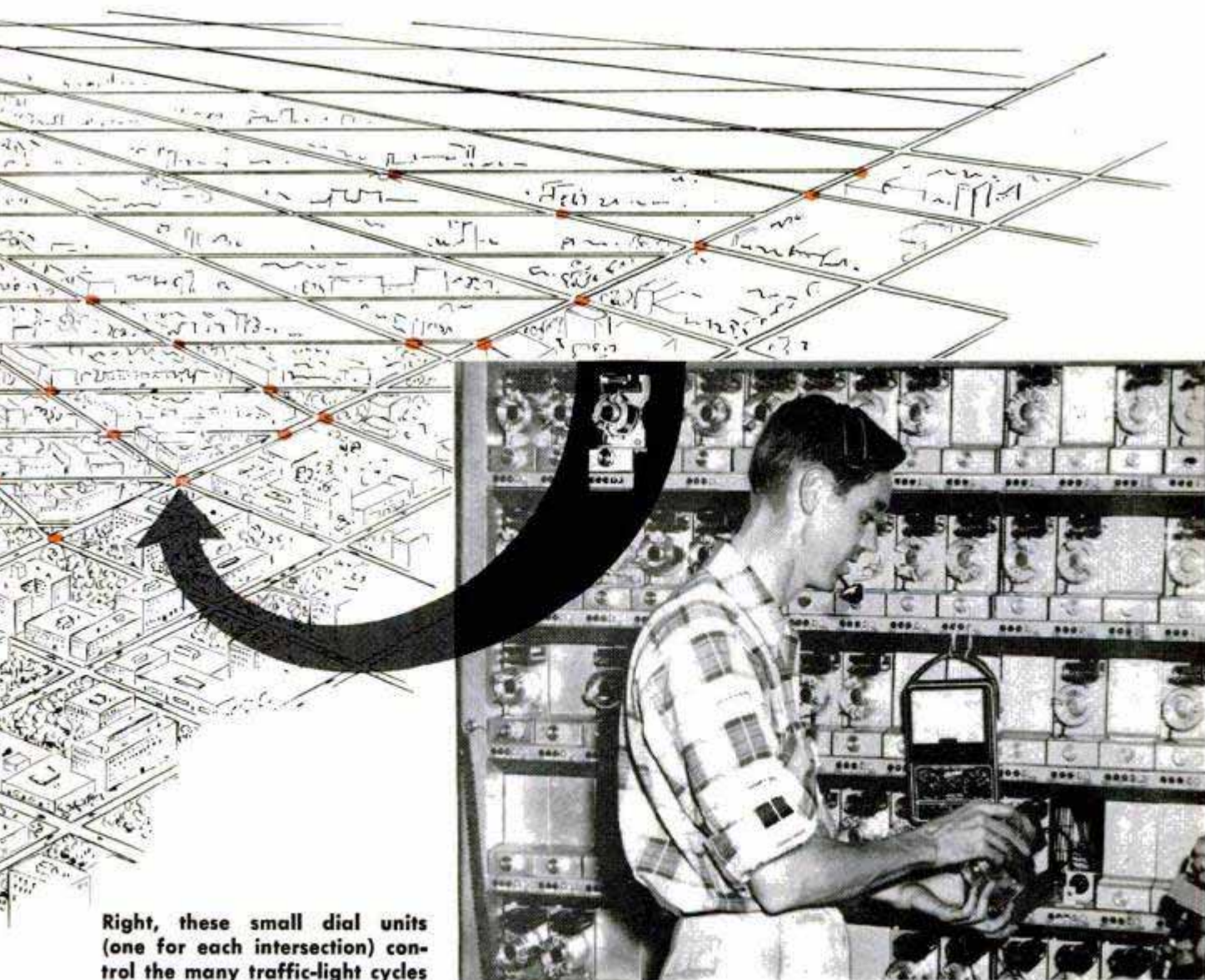

Right, these small dial units (one for each intersection) control the many traffic-light cycles



SOME PEOPLE collect dinosaur eggs as a hobby, others breed mink or raise fish-worms, but out in Cuyahoga Falls, Ohio, there's a man who since 1935 has been building a house for recreation. So far, it's more than 200 feet long, and you have to look twice to see it because one glance won't take it all in. Ezra Kauffman, now a

Hobby House 200 Feet Long

prosperous real-estate dealer, began the structure in the late depression when he didn't know where his next pound of nails was coming from. But he reasoned that no one ever finishes anything if he doesn't make a start. So he invested his last \$2.50 in



Solar Stove

Scientists of India have presented their prime minister with a solar cooking machine which they anticipate will be mass-produced in the near future. The cooker has a collapsible umbrella-shaped reflector which concentrates the rays of the sun on a pan containing the food to be cooked.



Vacuum Cast

All that's needed to apply a new medical cast to a patient is an air pump to create a vacuum. The cast can be used over and over again to immobilize patients undergoing X-ray and other types of treatment. It consists of a bag filled with tiny plastic granules. Because it is flexible, it can be pushed into exactly the right shape around the patient's torso.

☐ Crane operators in England get a close-up view of what is happening to the load by means of a television picture broadcast to a receiving set located in the control cab of the crane.



Under Construction Since '35

building tile and Depression Ranch was born. Over the years, working evenings and week ends, he added room after room until now the total is over 20. Kauffman estimates his expenses for materials and outside labor at less than \$8000. A main reason

for his low costs has been his habit of buying with an eye to the future, picking up a bargain sink here, a supply of low-priced lumber there. Out of the stock pile came materials for such additions as the present greenhouse, shuffleboard court, shooting gallery, five kitchens and 16 fireplaces. Building, of course, continues.

Junior-Size Jaguar

Most six-year-old boys are proud of a pedal-pusher automobile so it's no wonder that Gary Tiscornia of St. Joseph, Mich., beams as he drives around in a small, motorized version of the Jaguar. The car weighs 1000 pounds, has a 71-inch wheelbase and is powered by a Cushman motor-scooter engine. It is geared down to a top speed of 10 miles per hour. Patterned after his father's full-size Jaguar, the car was custom-built by professional body men.

Over 2000 government-owned patents, available without charge to any manufacturer under non-exclusive, royalty-free licenses, are listed in a new pamphlet prepared and issued by the Government Patents Board, U. S. Department of Commerce.



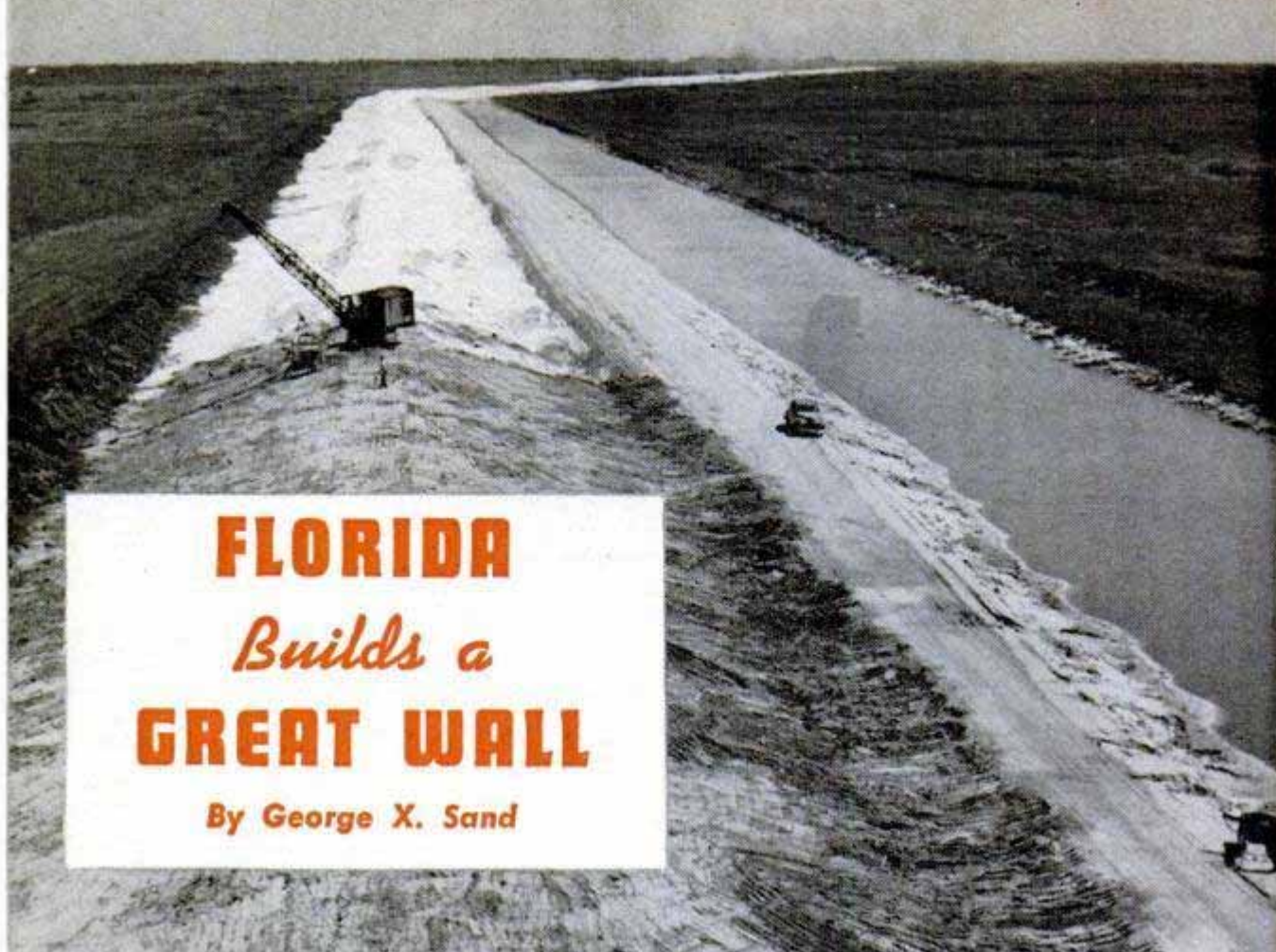

FLORIDA *Builds a* GREAT WALL

By George X. Sand

Draglines "dress" the top of Florida's 110-mile levee of earth and rock before replacing topsoil for grass

DOWN IN WATER-MENACED Florida the federal government is helping to build a protective dike which will be thicker and mightier than the Great Wall of China. It is the largest earthmoving operation this country has undertaken since the construction of the Panama Canal.

Flying over this peninsula state, one sees plenty of water; the Atlantic Ocean on one

side and the Gulf of Mexico on the other. However, it is not salt water that poses the problem: The flood menace comes from within. It is a threat that lurks constantly in the placid depths of Lake Okeechobee, second-largest body of fresh water within this country. It hides in the state's 225 rivers and 30,000 named lakes and countless streams and canals. Experience has shown

Behind the Everglades Experiment Station a fire rages along a 30-mile front during a long winter dry spell



that during the wet season, the four-month period during which practically all of Florida's annual 60 inches of rainfall takes place, a single intense hurricane with its wind-borne waters can add to the already heavy downpour to overtax quickly the canals and streams. Under such conditions fresh water inundates a vast area of flat lands in mid-Florida. Such floodwaters flowing southward by gravity, as well as eastward to the coast through intercepting canals, usually inundate everything in their path—farm, ranch or resort city.

An intense hurricane occurred in 1926 and again in 1928, when 2300 persons were drowned after Lake Okeechobee overflowed. To prevent the recurrence of such a disaster the federal government in 1935 constructed high perimeter levees and control locks at strategic points about the huge inland sea.

While these great levees performed the work for which they had been intended, they were not enough. The remainder of Florida continued to suffer alternately from flood and drought. In 1947 crop losses alone amounted to more than \$35,000,000 from a single hurricane and over 2000 homes were flooded in Dade County, where Miami is located.

Following the 1947 floods, the Corps of Engineers recommended to Congress a comprehensive project for Florida which, in addition to flood control, provided for water conservation, increased land use and prevention of salt-water intrusion into well fields of the large vacation cities in the coastal areas. It also included plans for what promises to be one of the largest fish and wildlife sanctuaries in America. Con-

During a flood northwest of Lake Okeechobee, prize Brahma cattle seek refuge on hill in Hendry County

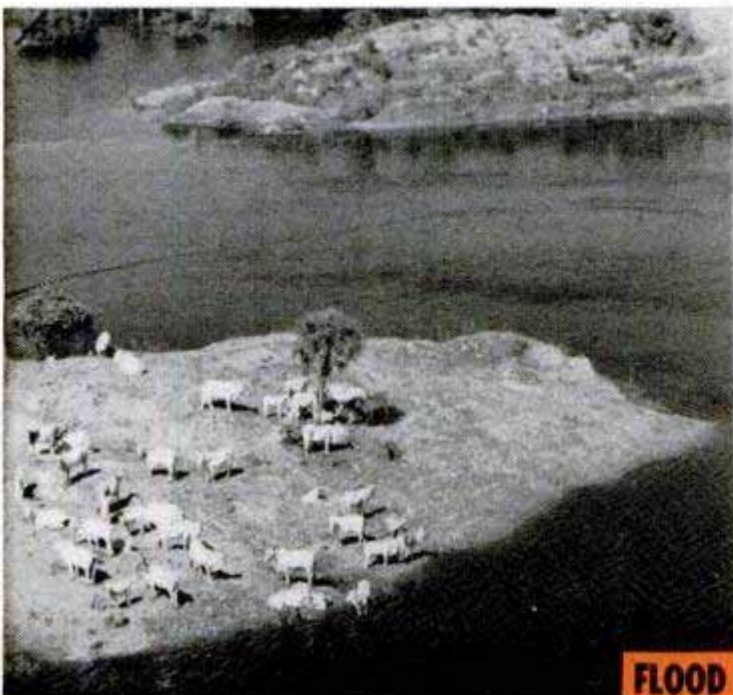

FLOOD

JANUARY 1953

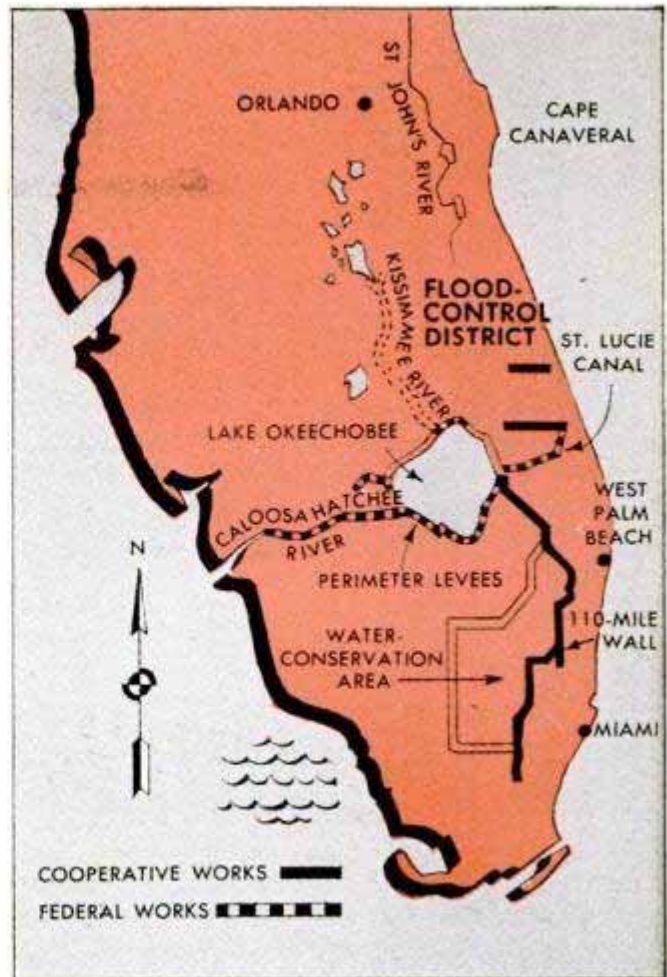

Levee indicated on map will hold back floodwater during rainy season and store it up for irrigation

gress approved this recommendation in 1948 as a federal-state cooperative project. It was put into effect by the Florida legislature in 1949.

The basic scheme of the cooperative project is to make use of the natural storage reservoir provided by Lake Okeechobee, along

Measuring rod below shows how topsoil has blown away and subsided since 1916—top figure on the rod



DROUGHT

161

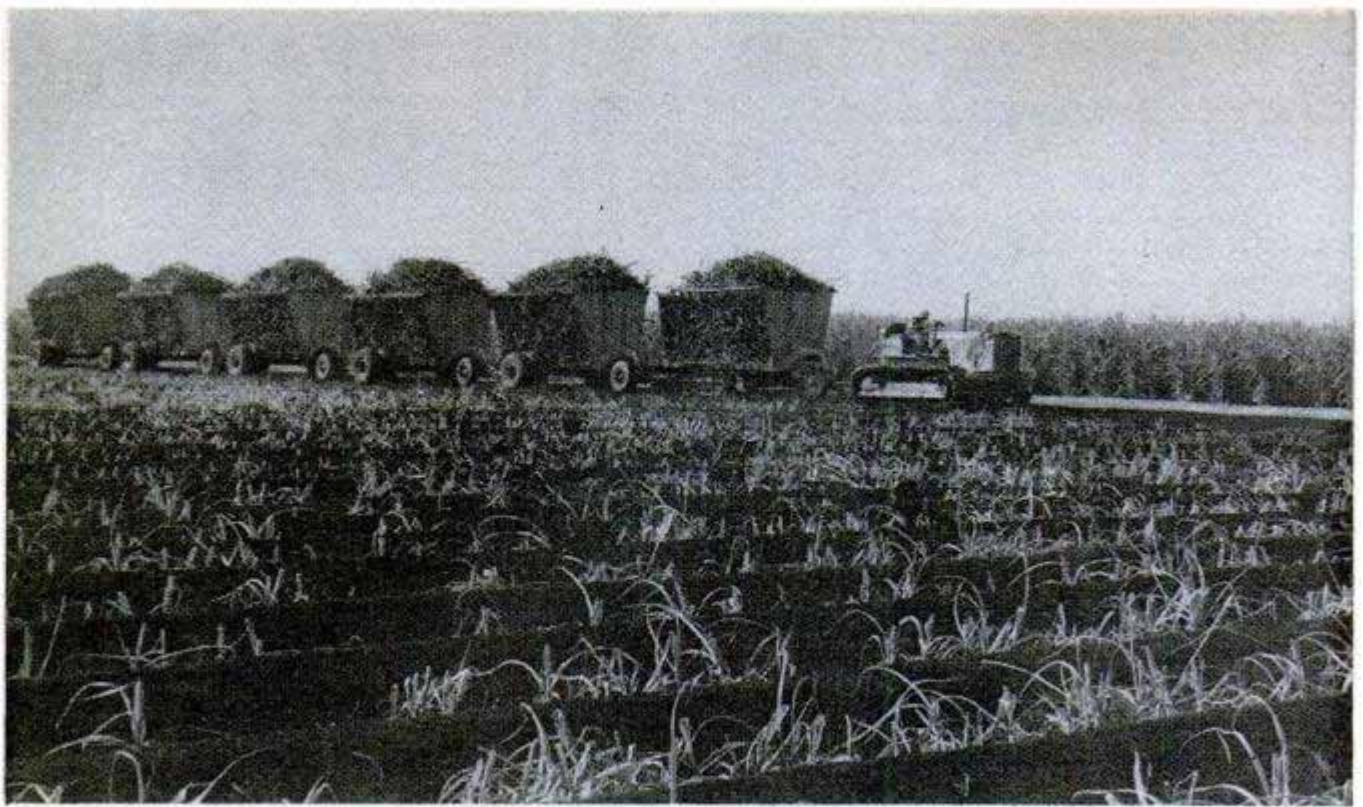

Three stages of sugar cane in Everglades—young cane in foreground, cut cane in carriers, ripe field beyond

with the Kissimmee River, which is its principal tributary, and the chain of smaller lakes that serves as headwaters for this river. Through construction of spillways at the improved outlets at each of the smaller lakes in the chain, water will be impounded for use during the dry season. During storm periods such storage of water in the upper Kissimmee valley will decrease flood heights along the lower river and hence lessen the peak flows into Lake Okeechobee. Similarly, the upper St. Johns basin with its associated lakes will be used to provide water storage during the rainy season and adequate water supply to adjacent agricultural and coastal city areas in dry spells.

Initial works, however, provide for flood protection for the lower east or "Gold Coast" cities and to this end men and machines are working night and day. Begun in January 1950, a 110-mile wall of earth and rock stands almost completed through the Everglades jungle region. Starting at Lake Okeechobee, it curves southeastward immediately behind the coastal area to a point just below Miami.

To build this great wall nearly 17,500,000 yards of soil are being excavated. Huge machines, like the 175-ton dragline with its 140-foot boom and 6-yard bucket, labor through the tropic swamp. To prevent such heavy machinery from settling into the muck the workmen must make up mats of five 40-foot lengths of 14 by 14-inch timbers bolted together. These mats are floated into position through the 10-foot-deep, 100-foot-wide borrow channel which the draglines leave in their wake as they construct the dike.

Normally the big draglines, each of which is capable of moving about 6000 cubic yards per day, work in pairs. First come the strippers, one working on the levee site, the other on what will be the channel. They strip off the vegetation, some of which will be used later as peat blanketing after the levee is dressed.

Next comes a pair of excavation draglines. Normally, two machines each dig one half the width of the channel to the desired depth, depositing the material on the levee site. Another pair of machines follows, one scooping up the piled dirt to shape the levee while the other spreads the original stripplings from the levee back to provide the soil for grass growth, thus saving the levee from erosion.

A representative levee is 10 feet high, 10 feet wide at the top and 86 to 96 feet at the base. A one-lane drive on its crown widens to 30 feet for a passing point every mile.

Watching the army of men battle against the problems of lengthening supply lines; the heat, insects and snakes; the big alligators that slide through the muddy sawgrass of the great swamp; listening to the roar of the dynamiters; the hiss of compressed air; the whir of skimming airboats carrying the engineers across the oozy bottom lands; the straining rumble of numerous tractors that had to be equipped with extended wooden support cleats before they could be used, one can't help sensing the irony behind this picture. For here man is busily attempting to restore the land to the condition in which he found it—before the water balance was upset through the

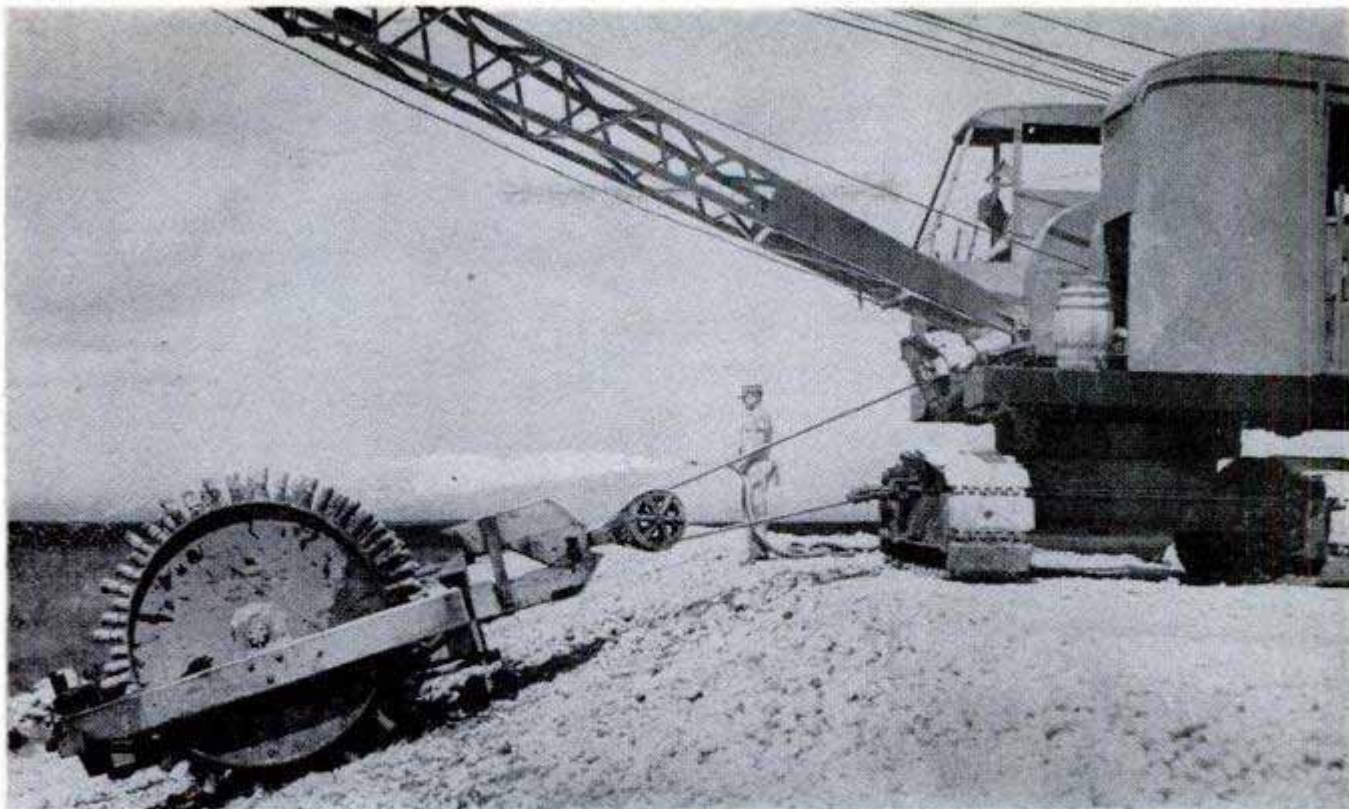

Sheep's-foot roller packs the earth firmly along sides and top of levee before the rich topsoil is replaced

use of poor or ill-advised drainage systems.

Early settlers of Florida found the rich Everglades mucklands covered by a thin sheet of water—the overflow from Lake Okeechobee. Crops planted in this rich layer of silt and organic decay, which was thousands of years in the making, would spring up almost overnight.

Drainage canals and ditches were feverishly dug. Men became rich from but a single lush harvest of oversized crops. But the jet-black earth, robbed of its normal high moisture content, began to dry up and blow away beneath the hot Florida sun. Huge muck fires developed which could not be controlled. Today, so severe has soil subsidence become, that a tall man can walk beneath some of the original Everglades homes that were built on piling foundations driven through the muck to rock. And, unless something is done, many of the soil scientists predict another 50 years will see the agricultural possibilities of this lush region exhausted.

The flood-control program has been engineered to safeguard against this possibility by maintaining favorable ground-water levels. Plans for Lake Okeechobee call for completing the levee encirclement originally begun for hurricane protection in 1935. Large pumping stations along the south shore will remove floodwaters from the agricultural lands during the storm season, storing them inside the big natural reservoir where they will be available during the dry season.

In addition, lying southeastward from the Lake Okeechobee agricultural area and

immediately westward from the great wall, there will be provided a second huge water-conservation area of some 1400 square miles—nearly double the size of the big lake itself.

This latter area will actually consist of three separate pools, divided by large levees housing big pumping stations, so that floodwaters may be absorbed and

(Continued to page 274)

Kenaf, an excellent substitute for jute, thrives in the black Florida soil of the Everglades region



Kansas City Weather Beacon Provides Latest Forecasts

Visible for 15 miles, a weather beacon mounted atop a 10-story building in downtown Kansas City, Mo., relays late weather forecasts to residents and visitors. Changing lights on the 78-foot-high stainless-steel shaft are controlled by an operator in contact with the United States Weather Bureau. Green means fair; orange (steady), cloudy; orange (flashing), rain; white (flashing), snow. When the circular-band lights on the tower flash from bottom to top, warmer weather is coming. Steady rings mean "no change" and downwards indicates cooler temperatures. Forecasts are good for 24 hours.

Warning Light on Dash Signals Wasteful Driving

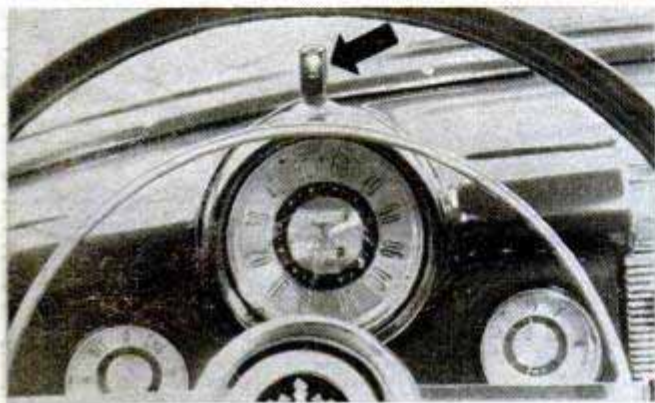

Operated by engine vacuum, a dash-mounted red light warns the driver when he is wasting gasoline by overacceleration. A small electric switch is attached to the intake manifold to control the indicator light. The lamp also informs the driver when he leaves the ignition turned on.

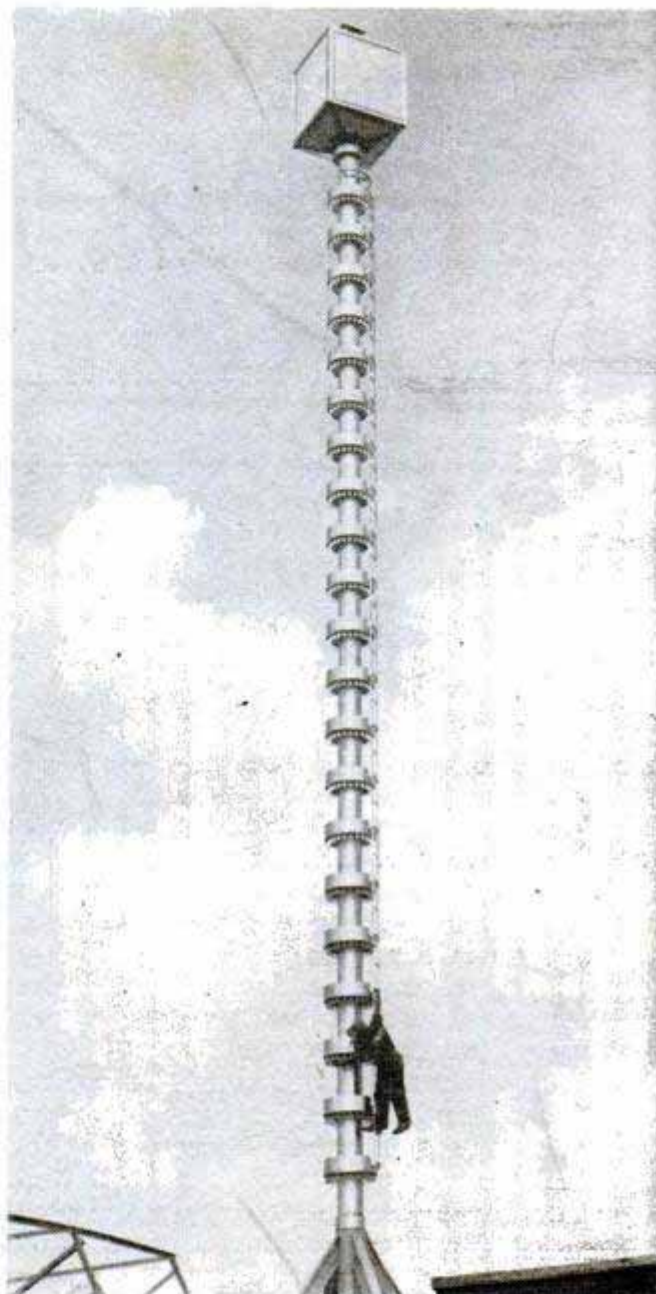

Rubber Valve Cap Shields Pipe-Line Workers From Chemical Leaks



Shaped like a bell, an acid-resisting Neoprene rubber cap which fits over pipe-line valves protects workers from leaks and sprays of dangerous chemicals. Installation can occur while the valve is in service. The valve wheel is removed, a hole for the valve stem is punched in the top of the "bell" and the shield is pulled down into place over the valve. The flexible lip at the bottom allows easy inspection of the valve or tightening of nuts. Made in three sizes, the shield is designed for valve sizes from three fourths to four inches.

If you do not find the information you need in the index on pages 12, 14 and 16, sources of further information are available without charge from *Popular Mechanics*. Write to the Bureau of Information, 200 East Ontario Street, Chicago 11, Illinois

the

POPULAR
MECHANICS

CRAFTSMAN

X 45



Olwen, her friend Marge Watling and I show how the built-in twin bench serves as conversation corner

Here's Glamour for **YOUR BASEMENT**

By James R. Ward

FREQUENT REQUESTS from two teenage daughters for a party room, plus questioning glances from their mother who hoped I would accept the challenge, led to this beautiful recreation room. Two family conferences gave us a start on planning, and also led to an agreement that building the room would be family project. This later proved to be a wise decision. It started a competitive interest in design and construction which kept the job going.

Judy, the 13-year-old, seemed to favor a miniature schoolyard complete with juke box in which all the "kids" could have Coke parties and hilarious times. Betty, the 18-year-old, being more grown-up, wanted a neat, modern room with radio, record player, television and plenty of dancing space. Olwen (Mrs. Ward) agreed with Betty, but also wanted a modern laundry and insisted emphatically that the room be easy to keep clean—an important factor to



Above, view toward south wall showing bench, bar and cabinet with the built-in radio and record player. Views below show approach to the stairway next to the laundry and built-in book shelves at the east wall



any mother. She also wanted plenty of storage space.

After consulting an architect and interior decorator, we decided on the room pictured on these pages. Reference to the color sketch on page 168 will give an idea of the plan as well as the appearance of the basement. The room is 25 x 25 ft. inside measurements. The wall at the lower left-hand corner is the north wall. This and the east and south walls are outside walls. In the west wall we incorporated closets. The closet at the southwest corner is a wardrobe type having sliding doors opening into the recreation room. This closet is mainly for use by guests. To the north of this closet is the doorway to the heating room and workshop. Two storage closets, separated by compartments for TV set and movie projector, complete the wall. Since the partition shuts off much of the heat coming from the boiler room it was necessary to provide an auxiliary heater for use during extremely cold weather. This was done by using a Coleman wall heater which you can see in the partition wall at the northwest corner.



Marge and Olwen enjoy a Canasta game while Judy serves from the folding buffet table on the south wall

When laying out a recreation room in your basement, any projections such as posts, pipes, etc., should be taken into consideration in the planning stage. Instead of trying to relocate them, it's better to build around them and use the free space of the resulting enclosures for storage, also incorporating the enclosures as part of the design. The electric and water meters and laundry tubs in our case are good examples. Instead of moving the tubs from the proposed recreation-room area we built the laundry room around them. In fact, the only change made in the original basement was to move three pipes. See lower photos on page 172. The gas, cold and hot-water pipes were moved over between the supporting timber and the heating pipes from the boiler and then enclosed.

Before starting construction there are several things to keep in mind. First is the electrical wiring. If your home does not have enough circuits at present, now is the time to install them. Also, all the

wiring for the basement room must be done at this time, including the laundry, which will need a 220-volt circuit if you install an electric clothes drier.

Before you start framing, the walls should be cleaned and patched if necessary. It also is a good idea to waterproof them. There are several waterproofing compounds on the market. We used Coprox. This compound penetrates into the pores of the masonry walls and seals them thoroughly. In addition to this, insulate the cold-water pipes. This is necessary to prevent moisture condensing on them and dropping onto the ceiling, which may damage its appearance or cause it to deteriorate.

Matchstick-type bamboo curtains hide windows but let sunlight filter through into the room



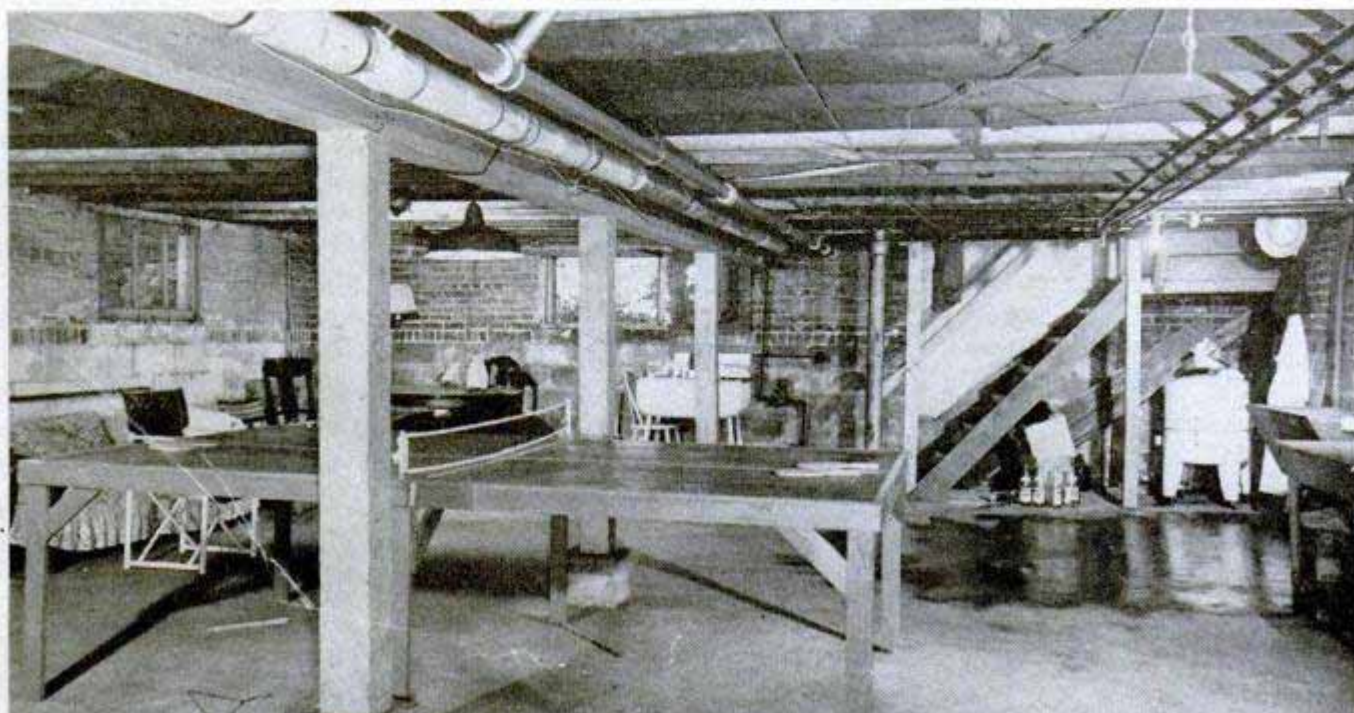
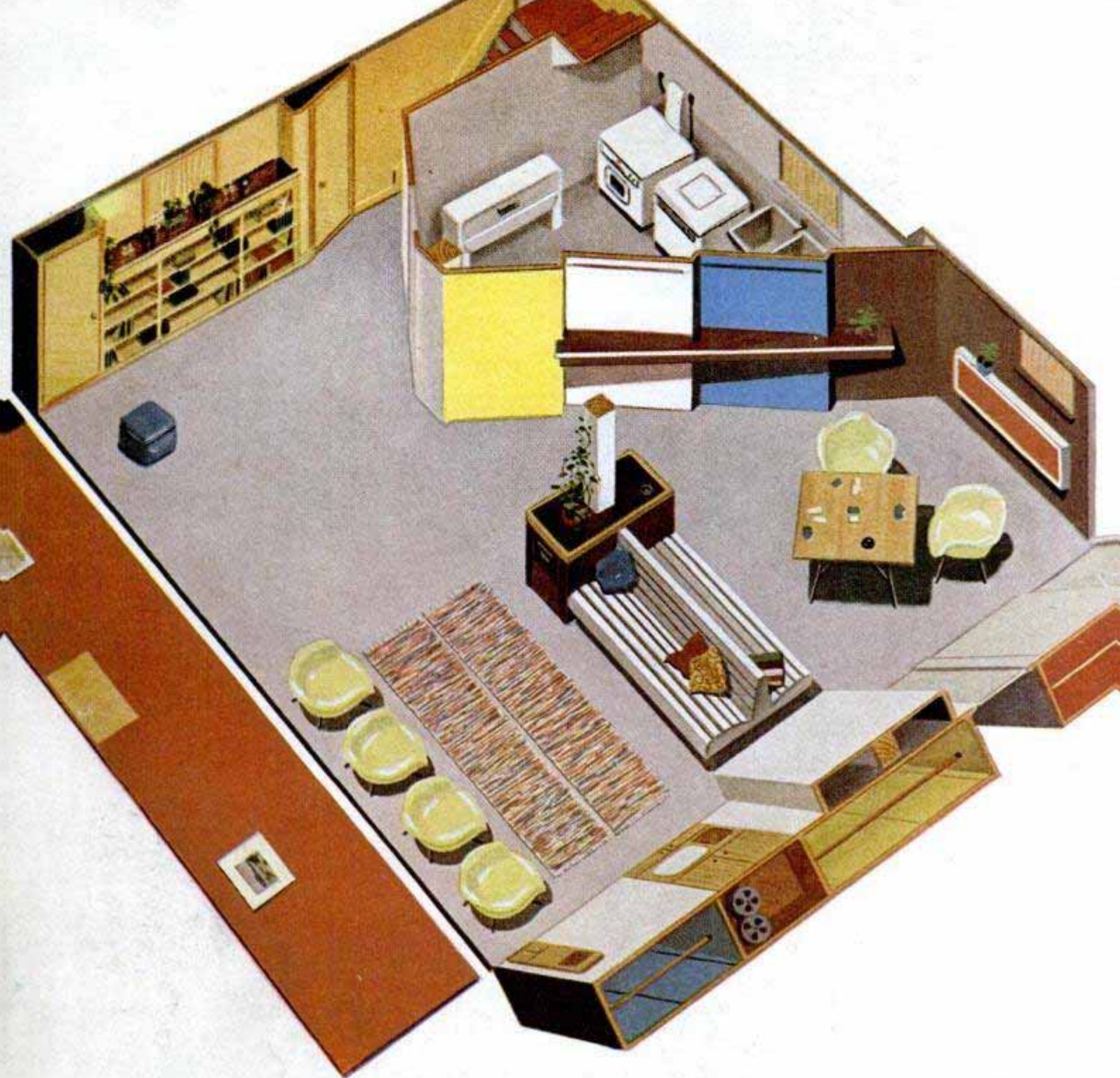

Since wall construction will be determined by the type of covering used, it will be necessary to decide on the covering before you order lumber for the walls. We wanted a room that could be changed in appearance by merely changing the color scheme. After investigating various wall coverings, we decided on gypsum wall-board. This produces a wall as smooth as a plastered one and can be decorated easily with water or oil paints. It is available in large rigid sheets that are easy to apply and is highly resistant to fire.

There are two ways of framing walls for the covering. One is to use furring strips and the other is to build a stud wall inside the masonry wall. We selected the latter method since our walls were concrete block up 4 ft. from the floor and brick the rest of the way. They also were uneven, which would have made it difficult to use furring strips. We used 2 x 3-in. studs and sills along the three outside walls, going to 2 x 4-in. stock for the partition walls. To build a wall of this type, anchor the sills to the concrete floor with lag screws and expansive sleeves, spacing the screws 6 to 7 ft. apart. Where the wall runs at right angles to the floor joists, nail headers to the under edges of the joists as nailing pieces

for the studs. In most cases, the studs should be set 16 in. on centers. However, if ½-in. gypsum board is used, you can space the studs 24 in. on centers.

Figs. 2, 3, 4 and 5 show how we framed the basement. No specific dimensions are given as these will be determined by your particular plan. Section C-C of Fig. 2 shows the window treatment. It will be necessary to bridge across, flush with the stud wall. To do this, we faced the studs adjacent to the windows and then filled in between the window casings and facings with filler strips, using window sills at the bottoms.

The two closets at the ends of the bookcase at the east wall were just a matter of running up studs for the wall covering. Fig. 3 shows the shelves that were built between the cabinets. We did this by first putting on the wall covering, which was gypsum grain board, then fitting the shelves over this, using cleats to support them in the center.

Like most people, we wanted a bar in the recreation room, but did not want it to be the dominating feature. The upper picture on page 166 shows how we built it into the laundry-partition wall. There are two small doors that can be raised when the bar is to be used for beverage purposes

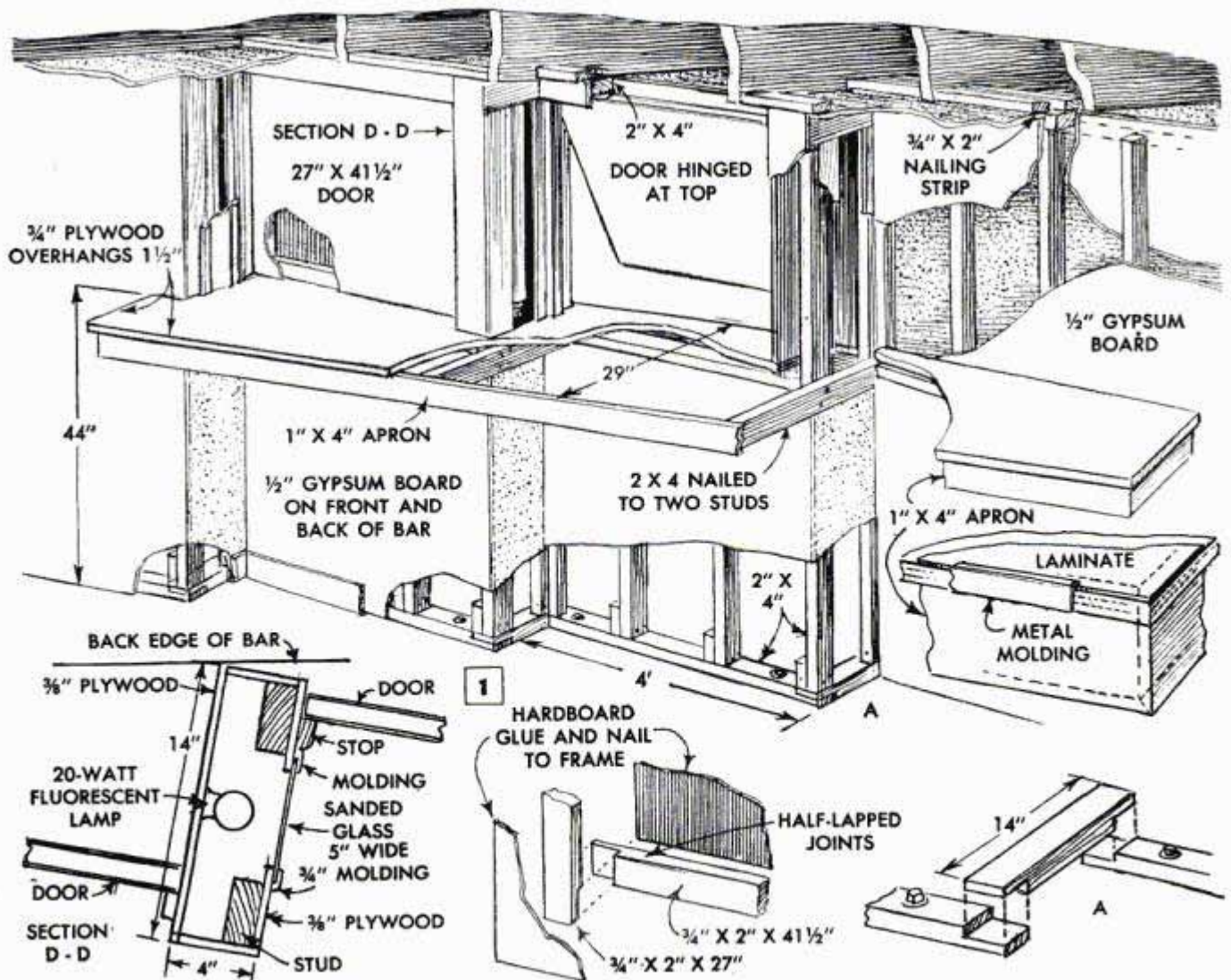

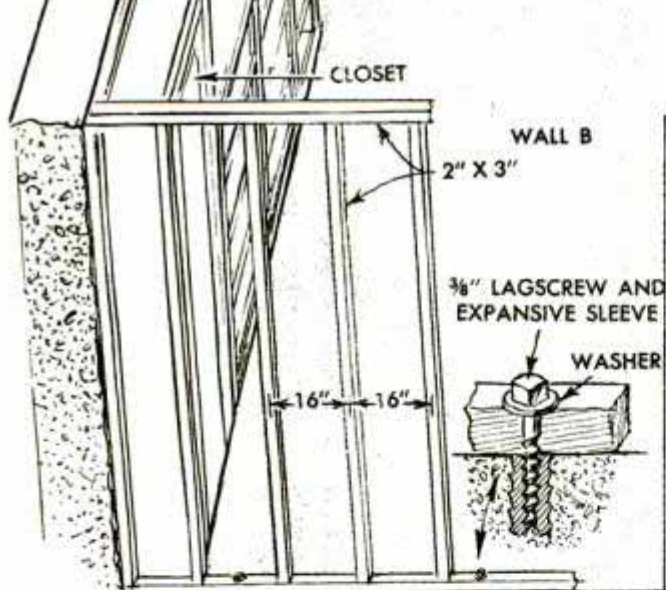
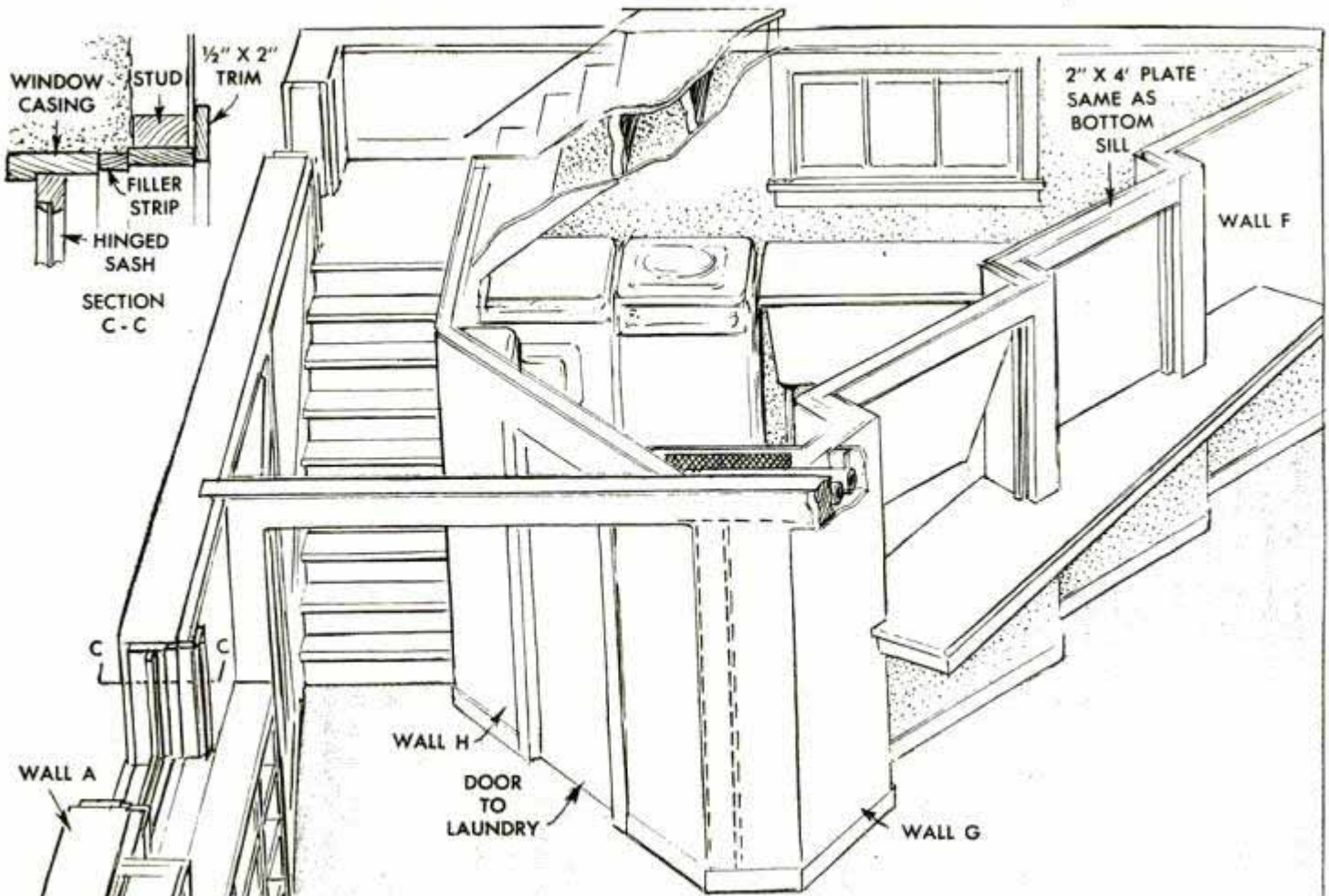

COLOR SCHEME

- | | |
|---------------------|----------------------|
| Wall A, grain board | Wall E, cocoa brown |
| Wall B, slate gray | Wall F, cocoa brown |
| Wall C, slate gray | Wall G, lemon yellow |
| Seat D, slate gray | Wall H, slate gray |

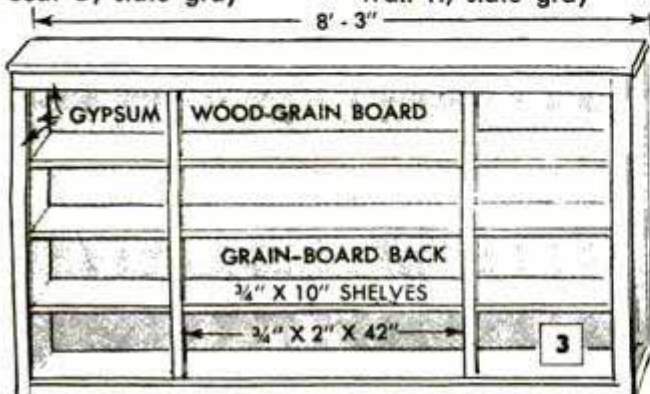

and closed when it is desired to use the bar top as a counter. Three vertical fluorescent lamps set into the wall directly above the bar top provide illumination. Fig. 1 shows the construction. The floor sill is built up, using half-lapped joints as shown at A. The ceiling plate at the top of the wall is a duplicate of the sill and is nailed to the under edges of the joists, after which the sill is bolted to the floor and the studs set in and toenailed in place.

Section D-D shows a down view of the three fluorescent lights. These are housed in boxlike compartments made of 3/8-in. plywood. The face side of each box is cut out to take sanded glass 5 in. wide. The glass is held in place by molding strips.

The upper parts of the bar at the ceiling also is faced with 3/8-in. plywood. The two small doors, which are hinged at the top to close the bar openings, are made by assembling a frame of 3/4 x 2-in. stock on each side of which is glued and nailed hardboard. This makes a very rugged door that will not warp. The upper left-hand photo on page 172 will give you an idea of the appearance of the bar at this stage of construction.

Fig. 5 shows an end view of the twin seat. Although at first glance this may

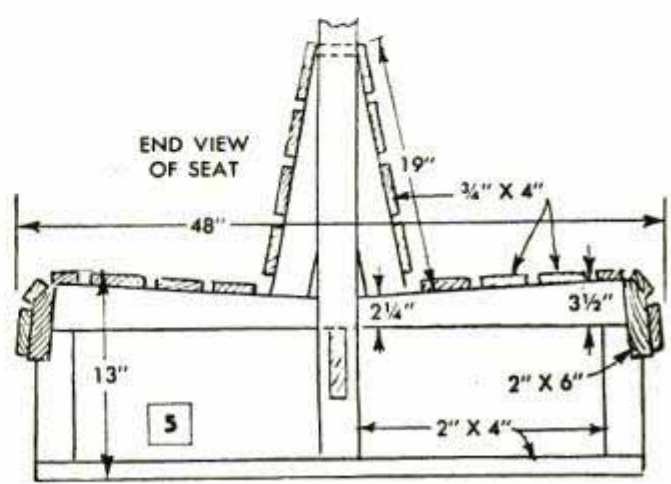
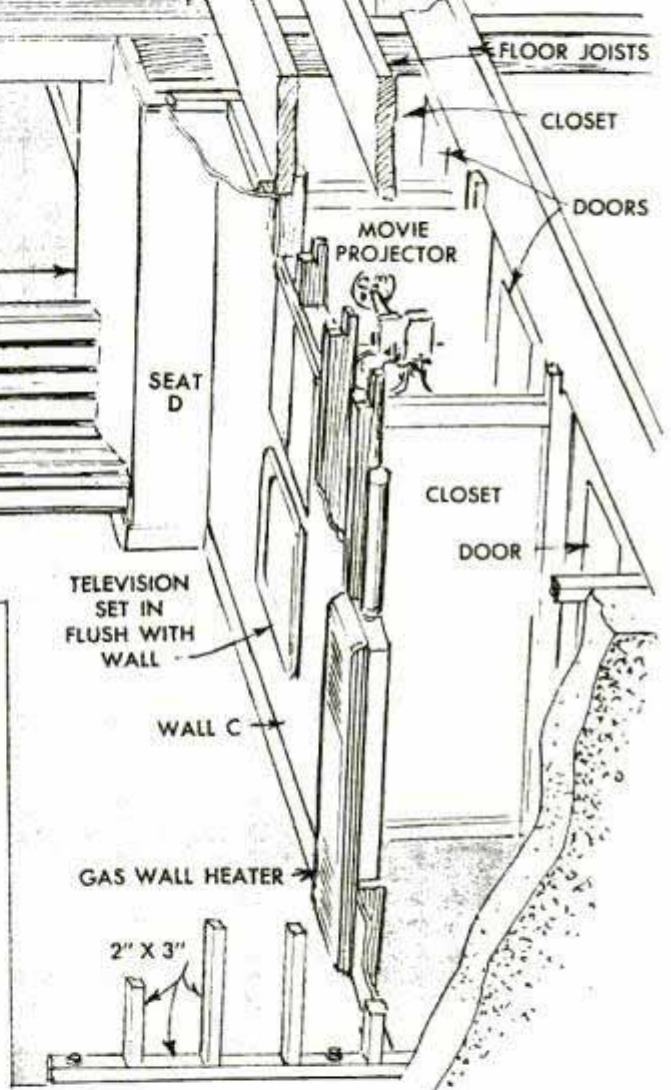
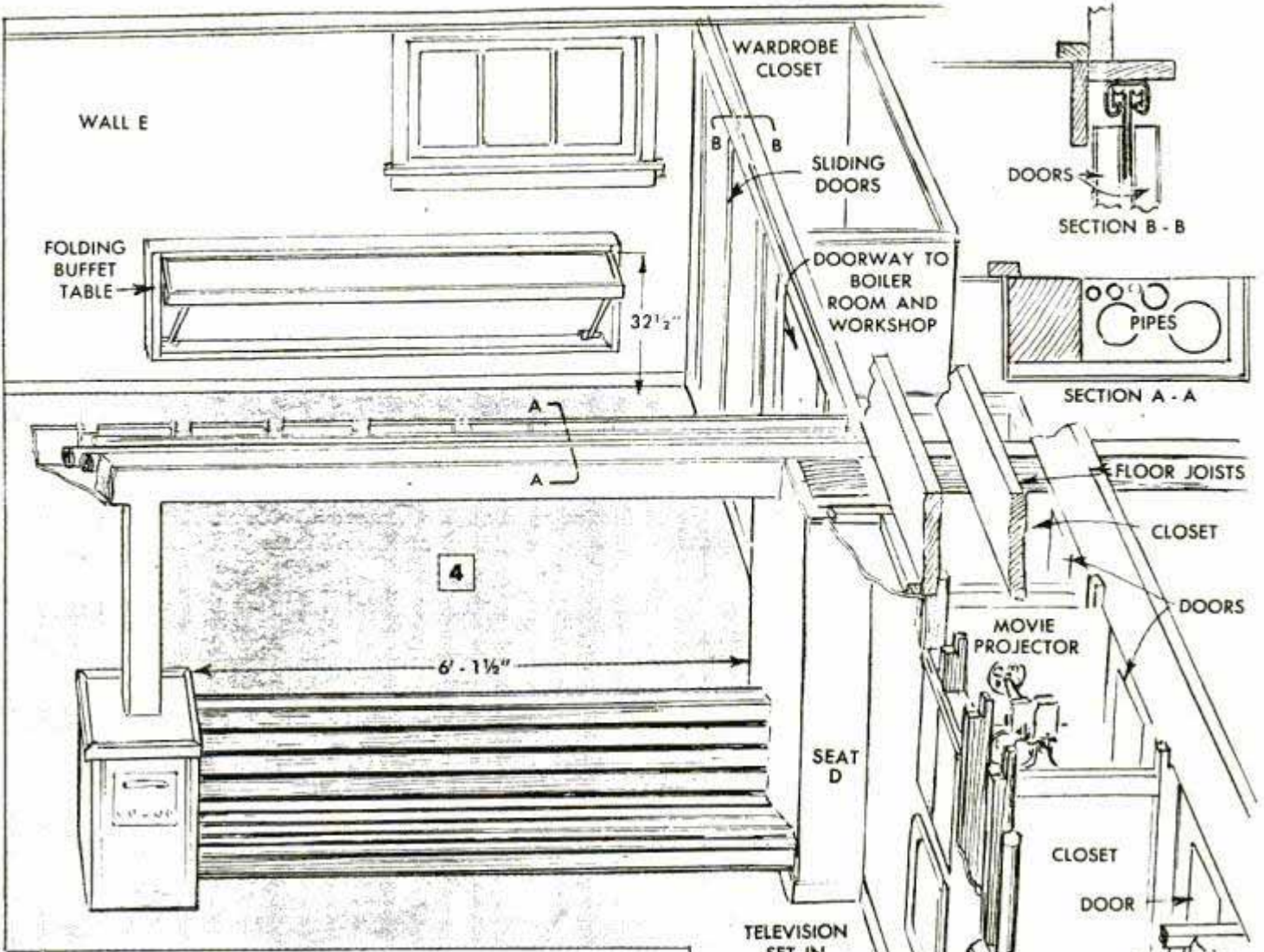

seem a little difficult to build it is quite easy to construct. The slats are $\frac{3}{4}$ x 4-in. clear pine and the supporting frame is made of 2 x 6s and 2 x 4s as indicated. It is supported entirely by the wall at one end and the cabinet around the post at the other end. Section A-A shows how the pipes—gas, hot and cold water and heating pipes—were assembled and then enclosed. Framing for the enclosure consisted of L-shaped members assembled from lengths of 2 x 4s and nailed to the center supporting beam and to the floor joists, the members being spaced the same as the joists. Two of these members can be seen in the upper-left corner of the upper-left photo on page 172. I also built a rectangular air duct around the heating pipes terminating it with outlets in the laundry and boiler rooms. The outlet in the laundry is covered with a grille and the one in the boiler room is fitted with a fan. Warm air from the boiler room is blown over the heating pipes into the laundry room to heat it. The fan operates only when laundry room is in use.

Section B-B shows how the sliding doors in the wardrobe closet were installed. These doors, as well as all others, were homemade and will be described next month.

The folding buffet table pictured in Fig.

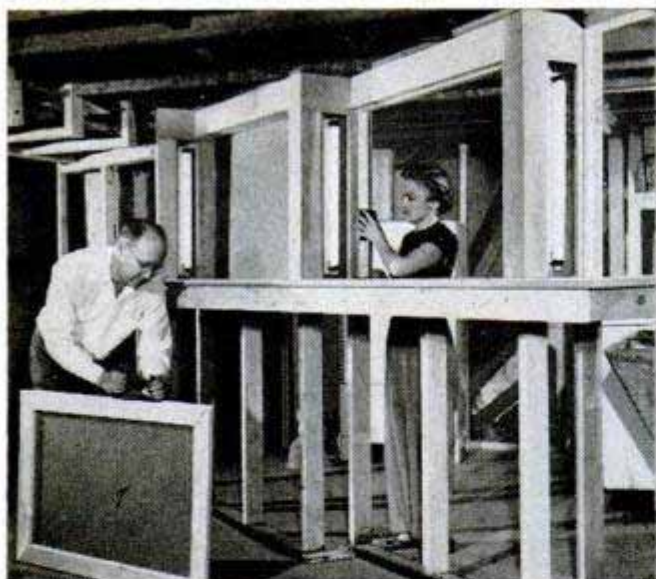

Olwen is busy with the sanding block while I fit the small doors before hinging them to ceiling plate



Continuing with the teamwork, Olwen fits a door latch while I install small wall studs in the shelf area

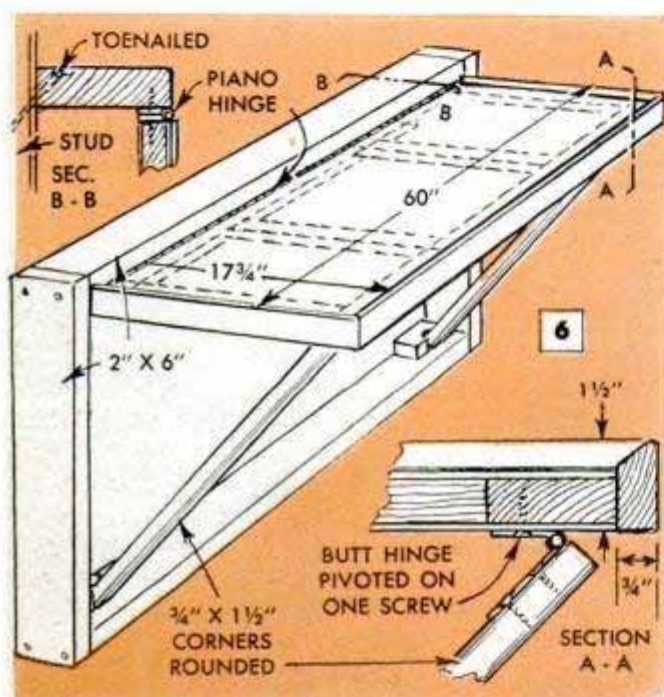

Construction details of folding buffet table that folds down against the wall when not in use for serving

6, consists of a frame made of 2 x 6s and toenailed to the wall studs after the wall covering is in place. The table top is assembled on a frame made of $\frac{3}{4}$ x 2-in. stock. The frame is covered on both sides with hardboard, after which the top surface is covered with laminate in a manner similar to the bar top. The table top is assembled into the large frame with a piano hinge. The molding around the edge of the top is made of oak. The supporting braces are hinged to the underside of the top, only one screw being used in the half of each hinge attached to the top, so that the braces can pivot and fold against the top when it is in the down position. After completing the wall framing, we framed the cabinet around the exposed supporting post. Next we built in the twin seat between the cabinet and wall in preparation for the wall and ceiling coverings which will be described next month.

(To be continued)

Gas and hot and cold-water pipes were moved from the position shown below to space between center supporting timber and heating pipes in lower-right photo. Pipe assembly was then enclosed to hide it

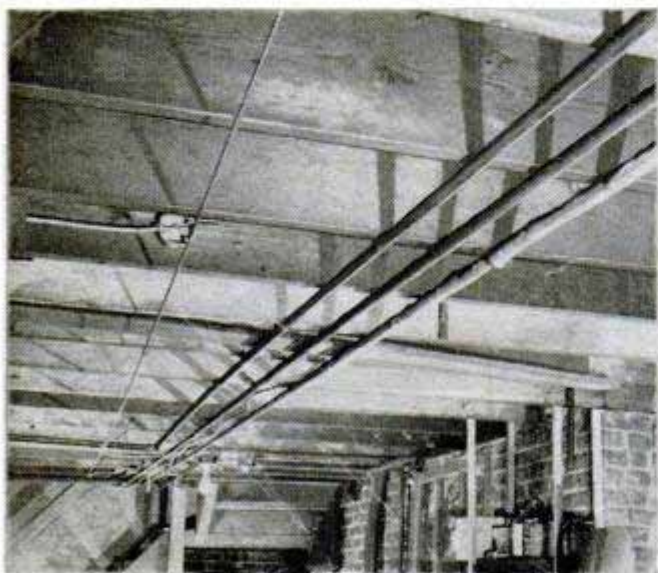

Cookbook Shelf Slides Underneath Cabinet

This shelf will hold a cookbook directly above a kitchen work counter for easy reading and, when not in use, will slide out of the way underneath a wall cabinet. The shelf is a $\frac{3}{8}$ -in. piece of plywood, $11\frac{1}{2} \times 14$ in., sawed in two 4 in. from one end, after which one of the severed edges is beveled at a 25-deg. angle to permit the shelf to support the book at an angle. A narrow strip is nailed to the lower edge to form a ledge for the book. Following this, the shelf sections are hinged together, with the beveled edge underneath, and edges that will move in grooves sanded and waxed. Grooved slides of 1 x 1-in. stock,

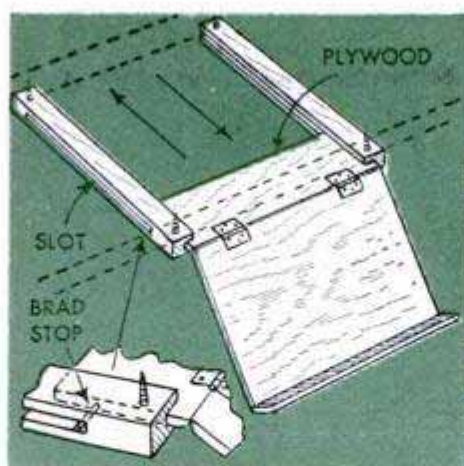

having blind slots in which brad stops work to limit movement of the shelf, are screwed to the underside of the wall cabinet.

Method for Creating Vacuum in Can to Retard Thickening of Paint



By creating a vacuum inside a partly used can of paint, one craftsman is able to retard the thickening of stored paint. To do this, the lid is pressed down tightly and a tiny hole punched in the center. Then a piece of inner tube is coated at one end with rubber cement and placed so the flap or uncoated portion covers the hole, thus providing a one-way air valve. Following this, a force cup is placed over the valve and worked up and down. When the cup will no longer fill and a slight dimple appears in the rubber directly over the hole, the maximum vacuum obtainable by this means is indicated. When the paint is to be used again, the valve should be pried up and removed to release the vacuum before the can is opened.

Durable Varnish Finish for Wooden Counter Tops

Varnish applied to a wooden counter top or other surface that receives hard usage must penetrate deeply to provide adequate protection. For best results, sand the surface and then use spar varnish that has been cut 50 percent with alcohol. Apply

it liberally until the wood will absorb no more. After allowing the varnish to dry for 48 hours, remove the gloss with sandpaper and flow on a full-strength coat of spar varnish. When this dries, apply a second coat.—E. L. Burgess, North Platte, Neb.

Know Your Hammer

is the first of a series of articles in which the editors of *Popular Mechanics* will describe and tell how to use all the most popular hand tools. Use of the wrong type of hammer, or incorrect use of a hammer often results in bent nails, damaged work or injured fingers. A hammer that balances well in your hand, has a correctly ground face and is designed for the job will enable anyone to avoid these mistakes. Read this story next month and use your hammer correctly.

PLASTIC WEBBING BRINGS

Reupholstering becomes so simple with a new woven plastic webbing that anyone can put new life back into old furniture. The webbing also provides home-workshop fans with a new crafting material which has unlimited uses



'EM BACK TO LIFE

By Wayne C. Leckey

DOES YOUR ATTIC harbor a furniture derelict—a shabby upholstered chair, perhaps, that has been cast aside for want of a new seat? Look what you can do with a new material, called plastic webbing, to bring these forgotten pieces back to life. A common pull-up chair, for example, can be transformed into a smart modern piece and, what's more, it is such an easy job that anyone can qualify. "Reupholstering" with plastic webbing is simplified to the point of interlacing the strips, drawing them taut and tacking the ends securely to the chair frame. Available in 150-ft. rolls, 2 in. wide, the webbing may be purchased by the foot and can be had in many different colors at leading department, hardware or upholstery-supply stores. It is strong and sagless, moisture and fade-resistant and cleans like new with soap and water.

By means of special metal fasteners, it's a simple trick to apply plastic webbing to tubular furniture. Here, holes are drilled at intervals through the inner wall of the metal frame to take studs on the fasteners which are designed to snap in the holes and draw the webbing taut. The details given below and on the facing page show how the webbing is applied.

The use of plastic webbing is by no means limited to reupholstering chairs. The clever home craftsman can use it to add a smart basket-weave treatment to the face of cabinet doors and speaker grilles, to cover bed headboards, clothes hampers, valance boards and folding screens, as well as tops of coffee tables and benches. ★ ★ ★

Information courtesy Martin Fabrics Corp.



COFFEE TABLE

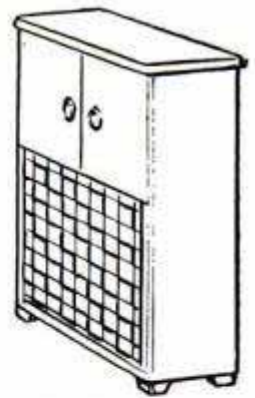

SPEAKER GRILLE

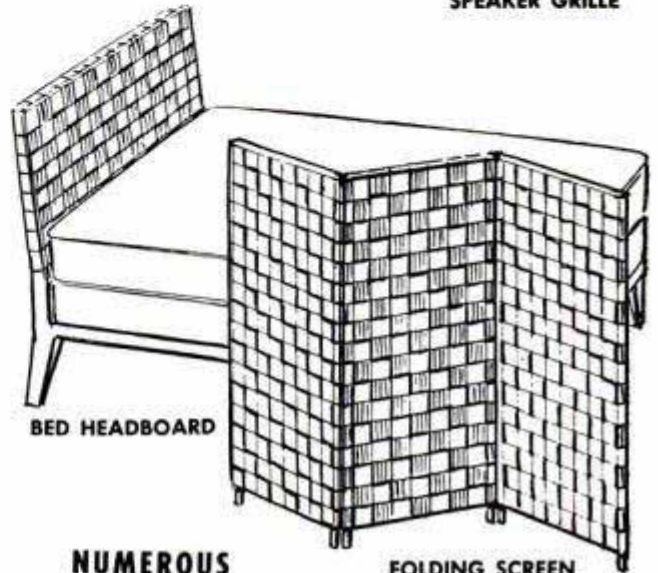

BED HEADBOARD

FOLDING SCREEN

NUMEROUS APPLICATIONS



UNDERSIDE VIEW

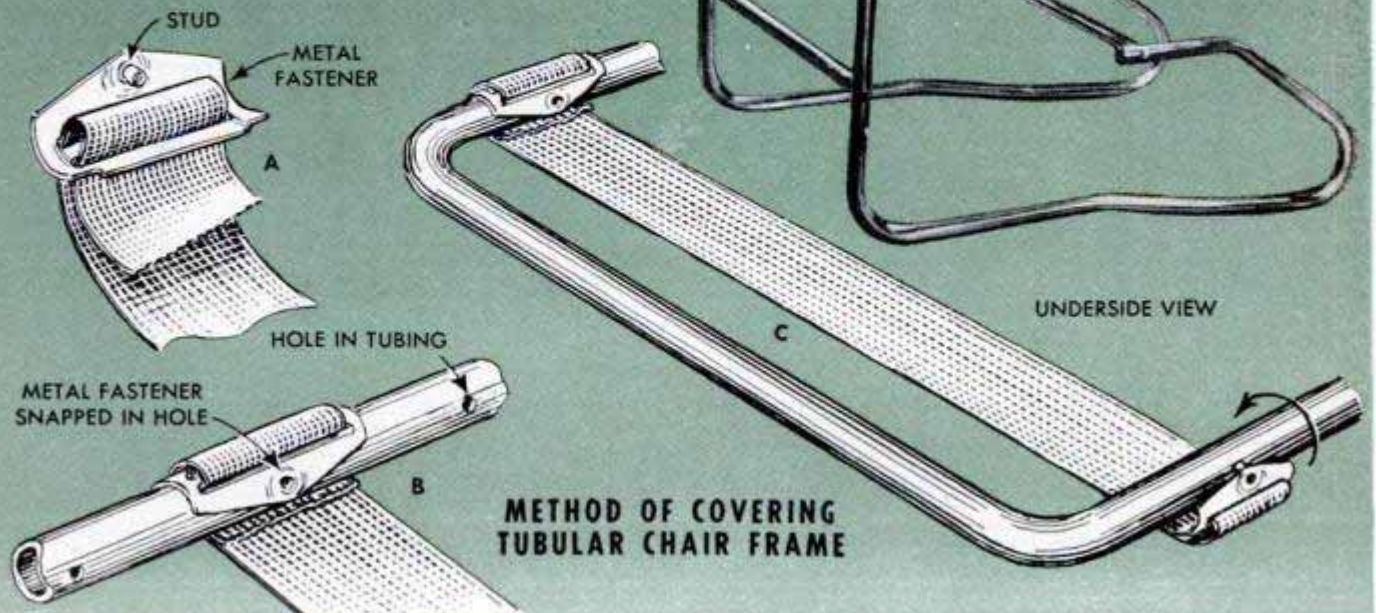

METHOD OF COVERING TUBULAR CHAIR FRAME

Ladder Secured to Slanting Roof Without Use of Nailed Brace



One homeowner avoided the use of nails in securing the base of a ladder placed on a slanting roof by anchoring it as shown inside another ladder laid flat on the roof and held in place with ropes. These were run from the supporting ladder to stout boards braced against the inside of windows near by. Another advantage of the arrangement is that the upright ladder can be moved along the supporting ladder as work progresses, thus eliminating the necessity of repeatedly securing the base each time the ladder is moved.

John L. Wilkin, Clifton, N. J.

Blanket-Roll Knot Is Slip-Proof

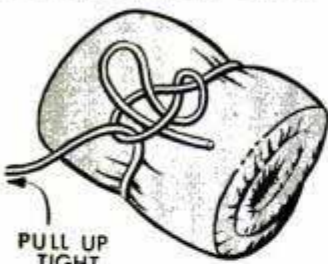

To tie a roll or bundle tightly, loop the cord as shown in the diagram and pull up tight. The knot will not slip back, and a half-hitch can be thrown over the projecting loop if desired. To untie, pull the loose end. A little practice will enable you to tie this knot quickly.

B. Franklin, Azusa, Calif.

Improved Mailing Labels

Mailing labels for packages and large envelopes can be made from wide gummed-paper tape. After cutting a piece of tape to the required length, wax paper is placed against the gummed side to prevent sticking and the tape is inserted in the type-

writer. When the completed label is removed from the machine, the wax paper is peeled from it with ease.

Robert Burgess, Grand Rapids, Mich.

Soles of Child's Shoes Taped For Play on Waxed Floors

Short pieces of adhesive tape applied to the soles of a child's shoes will help prevent injurious falls while walking or romping over freshly waxed floors. Cut the pieces slightly shorter in length than the width of the shoes and apply in the manner shown. The tape, which in no way will mar the floor, will remain effective for about a week, after which time it must be replaced.



Gene D. Legler, Houston, Tex.

Ax Handle Shock Absorber

If your ax handle becomes literally "chewed up" immediately behind the bit, nail a strip of rubber to the handle at this point. A strip cut from an old auto-tire casing is ideal for this purpose. As the handle is most likely to be damaged when



splitting stove wood and fence posts, this idea is especially desirable for that work.

Henry Josephs, Gardenville, Pa.

Wooden Doorstop Tips Flagstaff

Homemade flag-staffs have a neat and finished appearance when a wooden doorstop is used as a crown tip. These come provided with a permanently attached screw by which they may be fixed to the end of the pole. A coat of bronze paint applied to the stop before it is screwed to the pole adds to the appearance of the finished job.

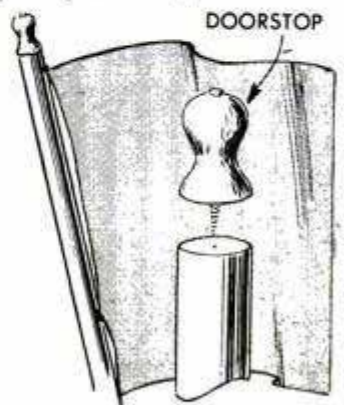



TERRARIUM LAMP

Plants growing in a lamp base are a decorative novelty that complements any type of home furnishings. Discarded jugs and bottles of clear glass, especially narrow-necked vases having value as antiques, can be made into attractive terrarium lamp bases by use of a special socket adapter available as a unit ready for installation. Adapter consists of a cork center-drilled for a short length of $\frac{1}{8}$ -in. pipe onto which a special lamp socket is screwed. Cork inserts are available in a wide range of sizes. Wild plants, such as wood violets and ferns, also certain slow-growing succulents, will take root and develop readily in a shallow bed of fine gravel, moss and rich soil mixed with leaf mold. Water the plants at regular intervals

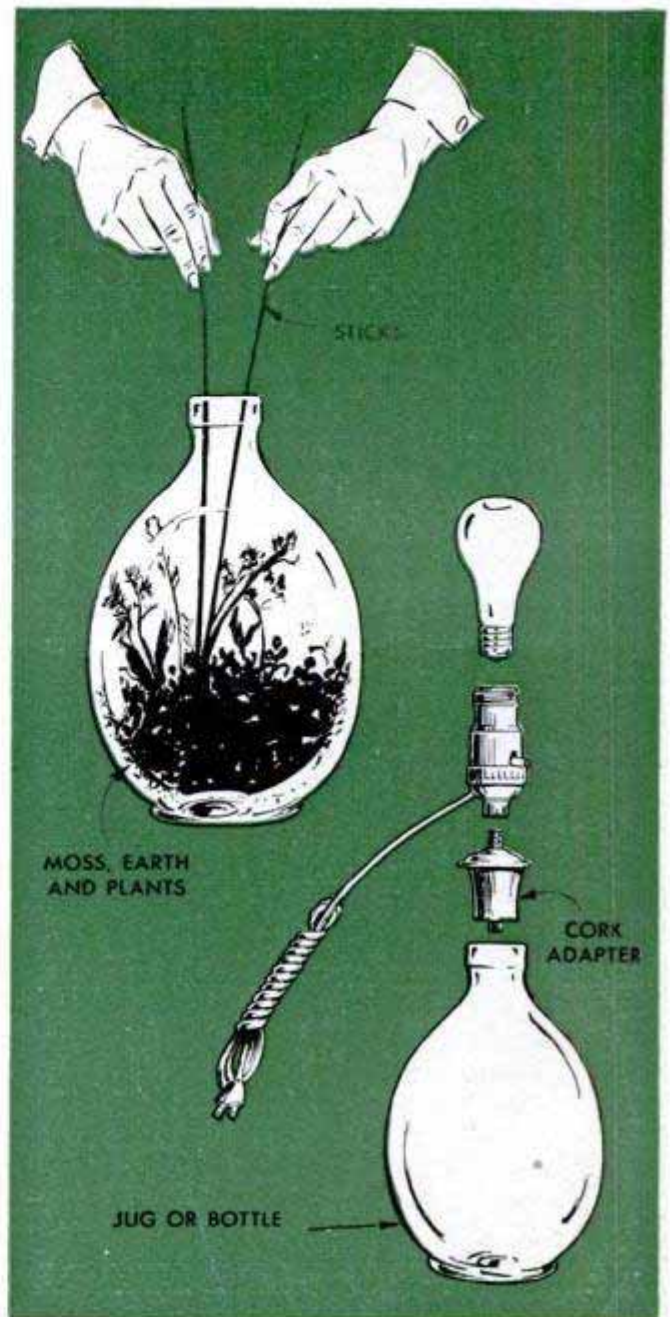

Abrasive Mounted on Sanding Disk With Photographic Tissue

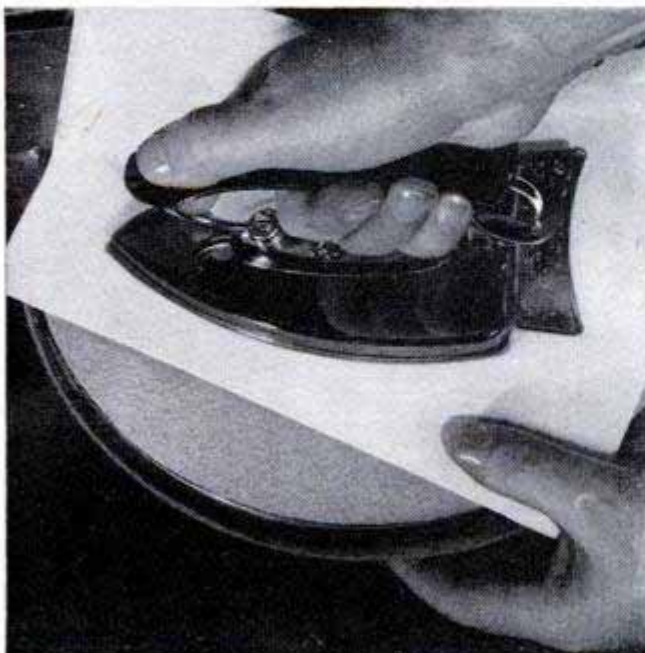

If an adhesive for attaching abrasive paper to a sander disk is not available, use a sheet of photographic mounting tissue as a substitute. Place the abrasive paper on the sanding disk with the tissue inserted between them and then press with a hot electric iron, using a piece of plain paper between the iron and the abrasive surface. The abrasive paper can be removed by heating with the iron to soften the tissue.

Coasters Improvised From Salt Box

The ends of round salt boxes, which usually are made water-resistant to prevent the absorption of moisture by the salt, provide durable, emergency coasters for glasses containing beverages. Cut off the ends so that a rim approximately $\frac{3}{8}$ in. wide remains. This may be deckled for a decorative effect.—Frank Shore, New York City.

Solving

HOME PROBLEMS

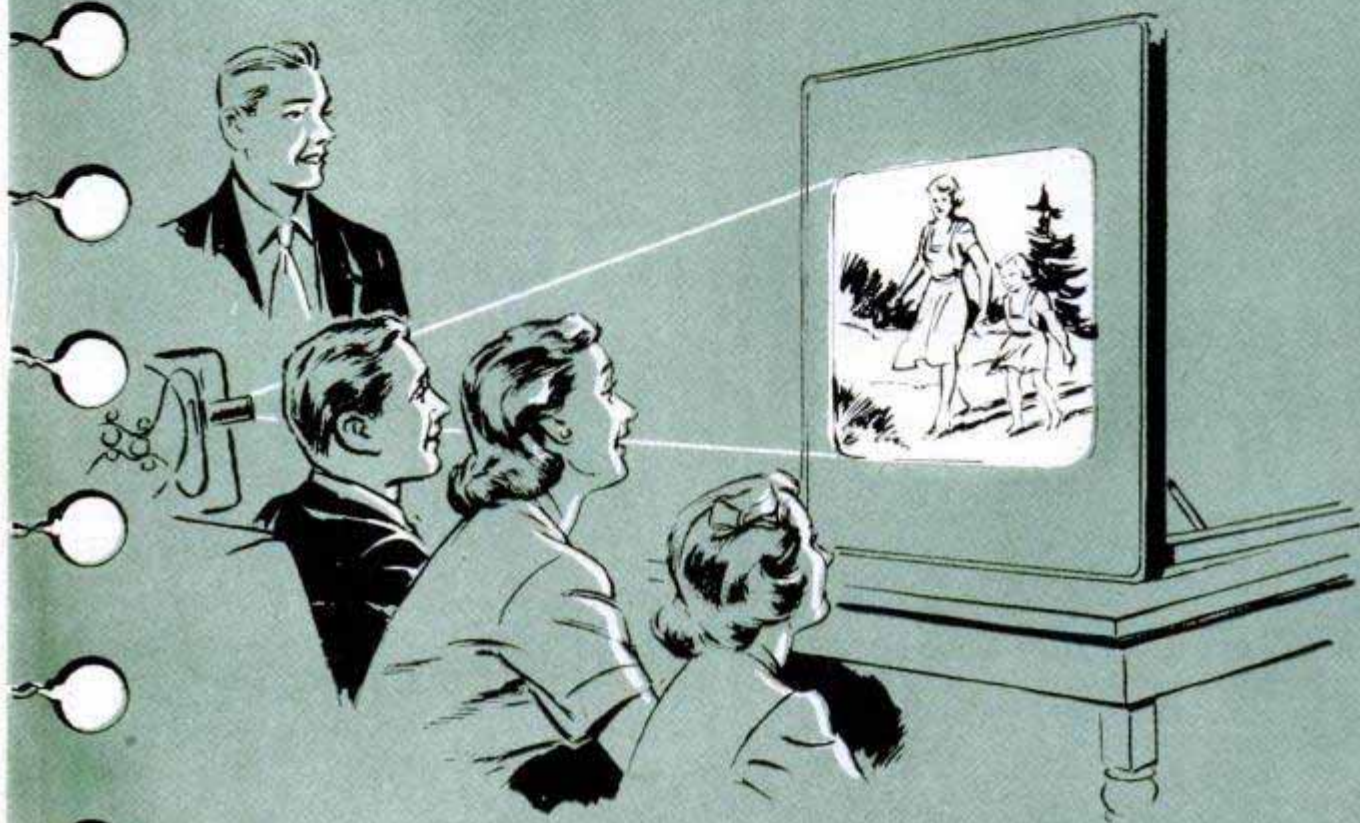

CARD TABLE doubles as home-movie screen when two legs are extended to hold it on edge. If top is dark-colored, it may be covered with paper or white sheeting

BAKING-POWDER CAN, perforated and fastened to underside of a closet shelf, provides container for mothballs. Lid of the can is screwed to the shelf

AN ORDINARY TEA STRAINER can be used to dampen ironing when clothes sprinkler has been mislaid. Just dip strainer in water and shake over clothes

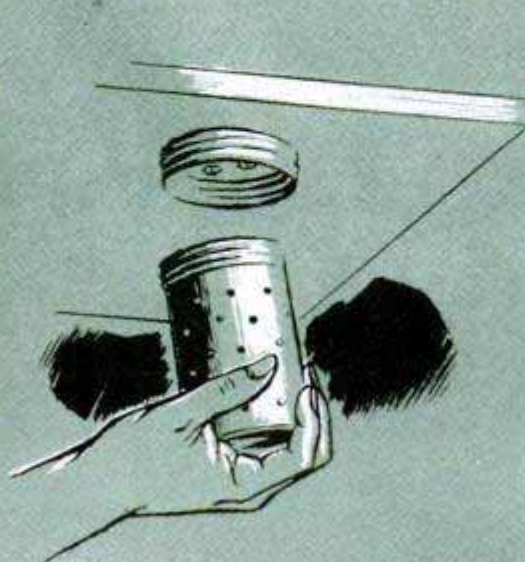



WATERING POTTED PLANTS is done neatly and quickly by setting one or more ice cubes in each planter. Placed on top of the soil, the cubes will water the plants as the ice melts

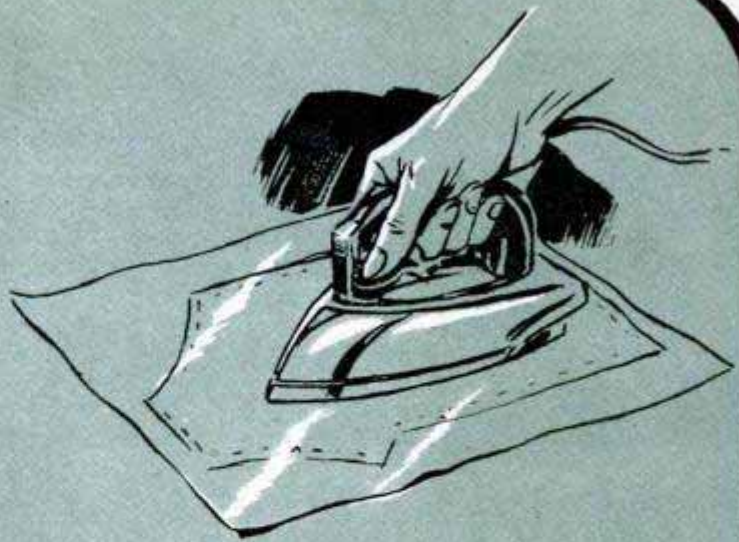

WHEN A DRESS PATTERN becomes so wrinkled that it is difficult to work with, place the pattern under wax paper and iron. This stiffens paper and smooths out wrinkles as well



SOFT INSULATION BOARD forms a handy backing when removing spots from garments. Placed under the fabric, the board absorbs the stain readily, eliminating much of the rubbing

IF BOTTLE CAP does not seal tightly because the cork or paper insert has been lost, wrap string around neck of bottle, as below. Cap will seat on string to make an effective seal

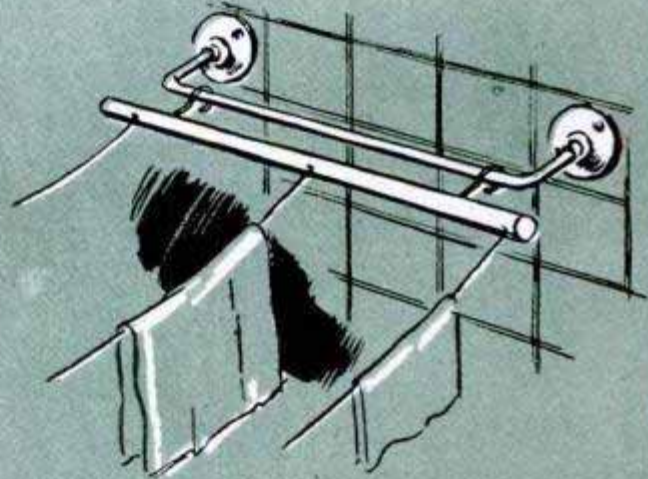

BATHROOM CLOTHESLINE is hung or removed in seconds by hooking it between two towel bars. Ends of the line are tied to a pair of drilled dowels which are fitted with screw hooks

NEXT TIME THE STAYS for your shirt collar are missing, don't waste time searching for them. Small hairpins inserted in the collar-stay pockets will hold collar wings in place





Piece of Chain in Clothesline Improves Airing of Garments

Sunning and airing of suits, coats and other clothing can be accomplished more quickly and efficiently if a length of chain is incorporated in the clothesline as shown. It then is a simple matter to space the hangers several links apart, thus assuring ample space between the garments for the passage of air.—Ed Packer, Chicago.

Wrapping Paper Cut to Length With Plywood Template



Finding that he needed to cut a number of sheets of heavy wrapping paper to exact size for a special job, one shipping clerk made a template that enabled him to do the trick quickly and without the necessity of measuring and cutting each sheet

individually. The template consists of two pieces of $\frac{1}{4}$ -in. plywood nailed together with a smaller piece sandwiched between them. The larger piece should be somewhat longer than the width of the paper and the combined width of the two pieces is made slightly less than the length of the paper sheet required. Then the paper is wrapped around the template to a dozen or more thicknesses and cut at one edge with a sharp knife as in the detail.

G. E. Hendrickson, Argyle, Wis.

Shield Guards Hunter's Bootlaces

To prevent snagging and knotting of his bootlaces when walking through briars and weeds, one hunter uses rubber shields made from pieces of inner tube. These are cut to the shape shown in the drawing, of a size to fit snugly around his boot tops. Each shield is held in place by an arrow-point tongue, cut in one end, which is inserted through a slot in the other end.



Ratchet Wrench Turns Square Bit

When it is necessary to drill in a tight spot that will not permit the use of a brace, a regular mechanic's ratchet wrench can be used in place of the brace to turn square-shanked bits. To start the bit, apply downward pressure on the wrench until the threaded spur enters the wood and pulls the cutting edges of the bit into the work.

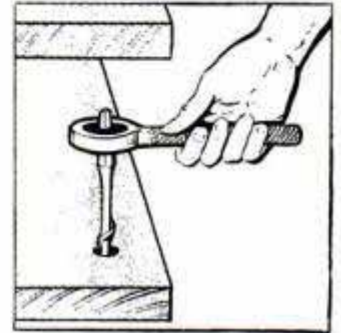

Caster Cups Hold Sewing Supplies

To provide handy containers for pins, needles, buttons and other sewing materials, keep a number of glass caster cups wherever sewing is done in the home. You'll also find them useful for holding dress patterns in place.

William Swallow, New York City.



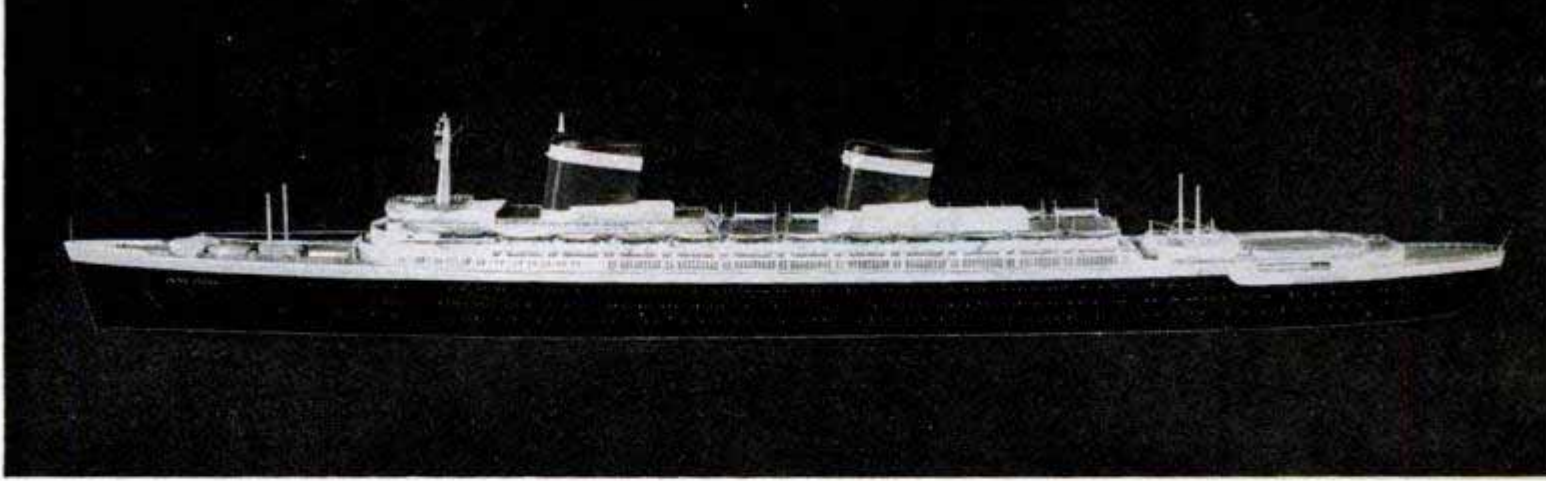

36-in. Model of the

Part II

SS UNITED STATES

WITH THE MODEL of the SS *United States* completed to the point discussed in Part I, which took the modelmaker through the carving of the hull, we are ready to add the four propeller housings. The stern profile drawing, below, is presented one half actual size to assist you in plotting the location of each housing on your hull. Both fore and aft housings are made in pairs; each carved alike, except for being shaped left and right hand. Each housing, you will notice, resembles a tapered three-sided wedge which is individually shaped to fit the hull. A hub is formed on the aft end of each housing to take a standard four-bladed propeller, approximately $\frac{1}{2}$ in. in diameter. The cross-sectional size at the aft end of the housing measures approximately $\frac{3}{8} \times \frac{1}{2}$ in. After

the housings are shaped to your liking, they are glued to the sides of the hull, each being placed in relation to station lines H and G. To make the housings look like an integral part of the hull, fillets of wood putty are neatly formed along the joints and later sanded smooth. The pattern for the rudder is given full size, ready for tracing on a piece of stiff cardboard or hardwood. After it is cut and glued in place, the rudder is made to look like it actually pivots by scoring the joint slightly with the point of a knife.

With the hull set aside for the moment, we can turn our attention to laying out the various decks that make up the superstructure of the ship. Here you are referred back to Part I and the patterns which were given for the wooden and metal decks. You will recall that these patterns are half size and

The shaded area in the sectional drawing below represents the hull sliced through at section line A-A

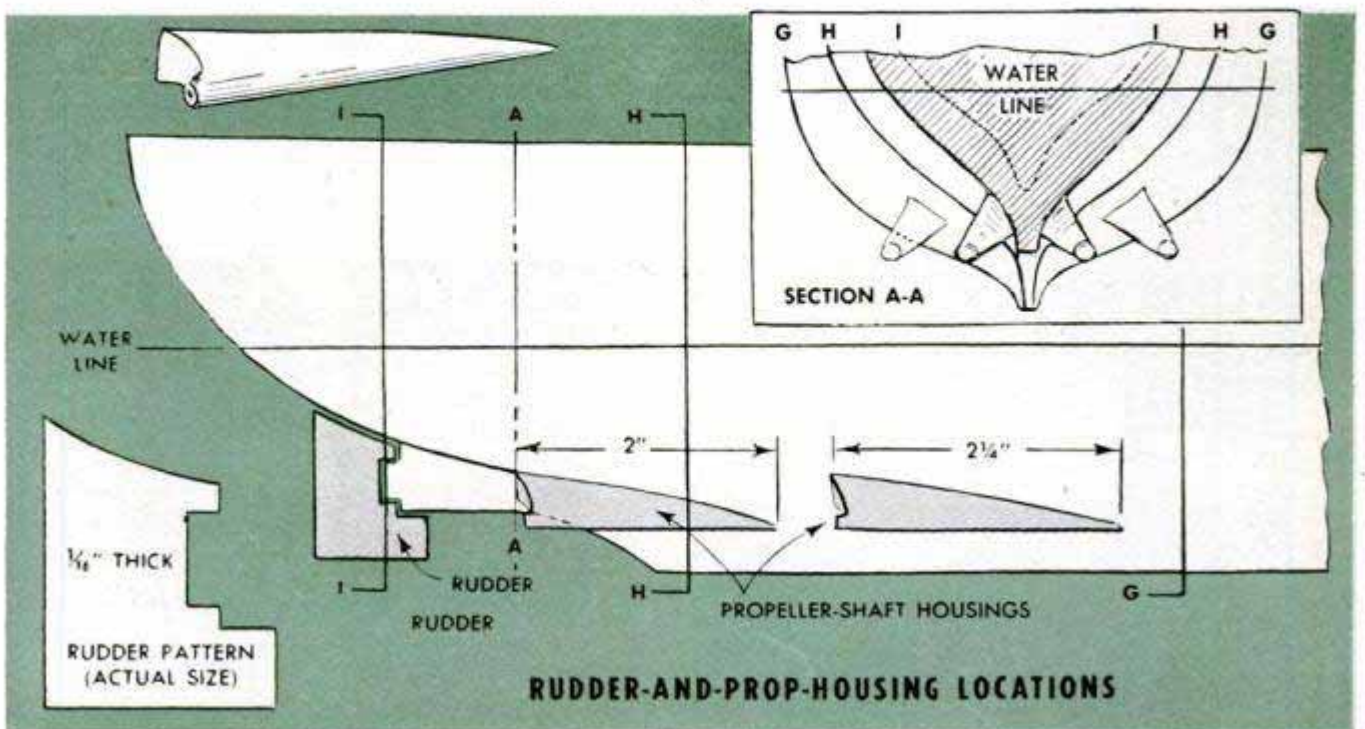

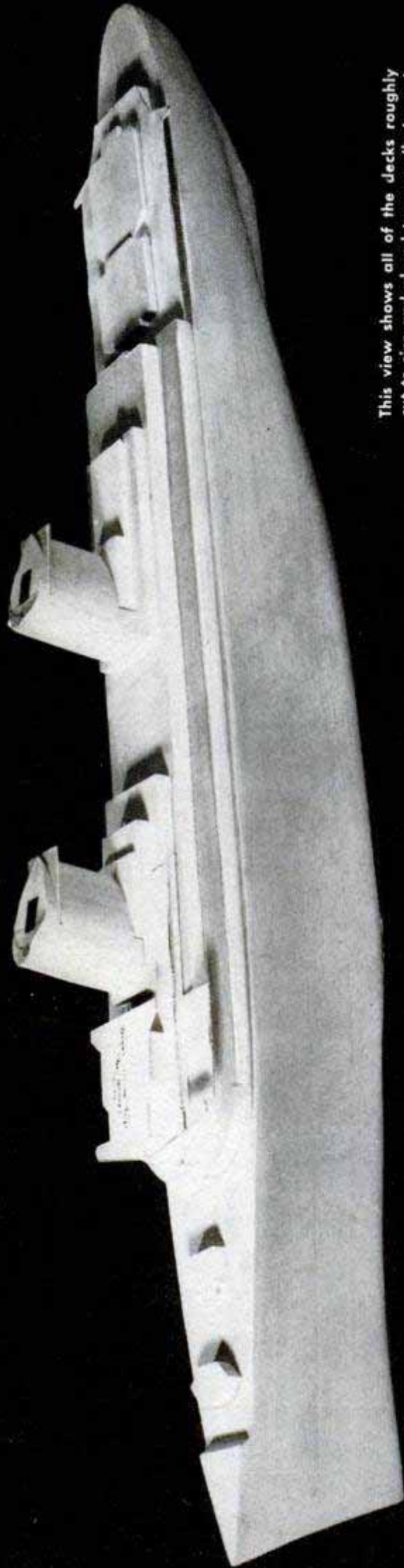

This view shows all of the decks roughly cut to size and placed temporarily in position on the hull. Later they will be finished individually before the final installation

are shown on $\frac{1}{2}$ -in. squares to permit you to enlarge them to full size. Actual-size patterns for these parts have been prepared for those not wishing to enlarge the magazine patterns. Not counting the stacks, some 18 separate pieces are required for the superstructure. The long promenade deck is cut from a piece of soft pine measuring $\frac{3}{8}$ in. thick. The fore end of this deck is undercut $\frac{1}{8}$ in. to set over the sheer step near station line C-C. The metal promenade deck, aft, is placed on top of the wooden upper deck which is butted against the sheer step between station lines G and F. If desired, the metal decks can be made of fiberboard, gluing rather than soldering the bulwarks to them. If metal is used, brass or any sheet metal will do as it is later painted. The long wooden sun deck tops the promenade deck. Note that the fore end of this deck is cut down to bring the metal sports deck flush with the surface. The sun deck and the raised promenade deck, which are placed on top of the metal promenade deck, are one piece. Notice that the sun deck is cut from $\frac{1}{2}$ -in.-thick cardboard or metal and overhangs the deck along each side. The fore sports deck, like the large sun deck, is cut down $\frac{1}{32}$ in. to permit the metal navigating bridge to set flush. The aft sports deck carries the aft-stack deckhouse, and both the aft and fore-stack deckhouses are cut from single blocks with steps cut where indicated to take the stacks themselves. Patterns for the two deckhouses located on the fore deck are given full size in the general assembly drawing on page 183. In addition to these, two raised hatches are required, one measuring $\frac{1}{8} \times \frac{3}{4} \times 1$ in. and the other $\frac{1}{8} \times \frac{9}{16} \times \frac{7}{8}$ in. Two flush hatches located aft on the plan view, Part I, are merely drawn on the deck surfaces. The pullapart assembly drawing of the decks will give a general idea of their relation but the plan view is used when permanently locating them on the hull. Later in the series of articles you will be told how each deck is finished individually, starting from the lower one, the promenade deck, and working on up.

Both of the sleek, raked stacks are alike, except that the aft one is somewhat smaller. Patterns for their teardrop shapes are drawn full size from the squared drawing and traced on soft-pine blocks, top and bottom. A stepped cut in the bottom of each stack allows them to fit over the edges of the deckhouses. The tops of the stacks are rounded all around and a recess is cut in the top of each one. Smoke-deflector fins, designed to deflect exhaust from upper decks, are added to each stack at the top. These can be of thin cardboard inserted in sawcuts made with a hacksaw blade or merely cut out to fit the contour of the

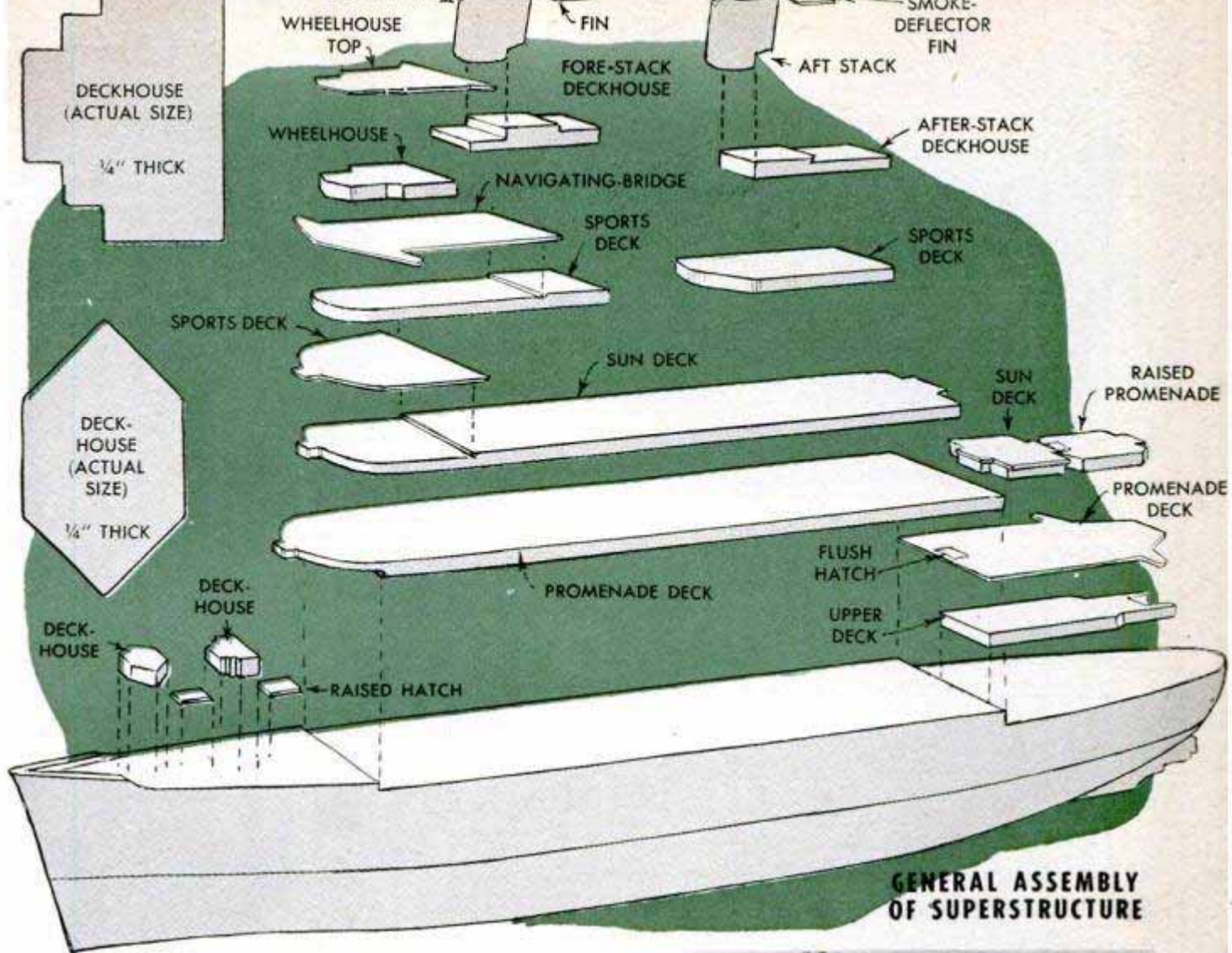

stacks and glued in position. Whistles, antenna brackets, tower and other stack fittings are added later. Of general interest in the construction of the actual SS *United States* is the fact that the stacks were riveted together with a total of 65,000 aluminum rivets. These were first tempered by heating, then stored in freezer chests and finally driven, ice-cold, a new departure in riveting. The mammoth twin stacks stand as high as a four-story house and spread the width of 10 parked automobiles. Traveling cranes hoisted them aloft in two sections and set them onto the hull while the ship was being built in dry dock. So much for

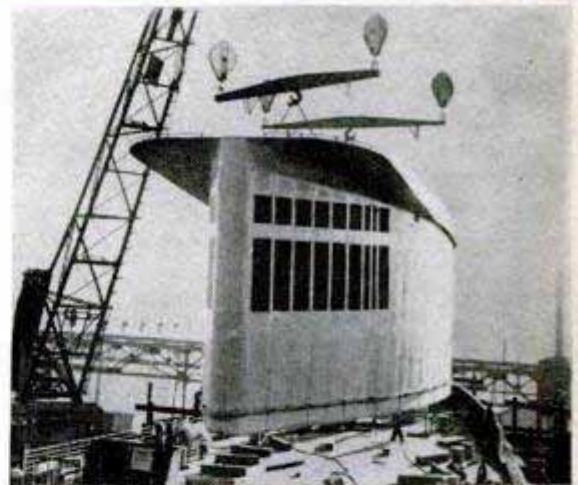

Prefabricated of aluminum, the stacks of the SS *United States* were set aboard by giant cranes as shown in these two photos. Towering 55 ft. high, the stacks are the largest and only all-aluminum ones in the world

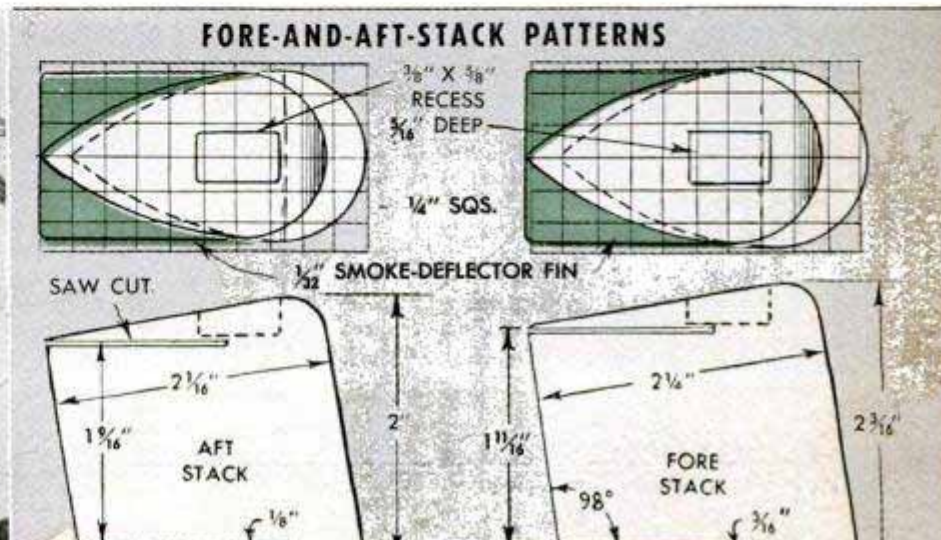
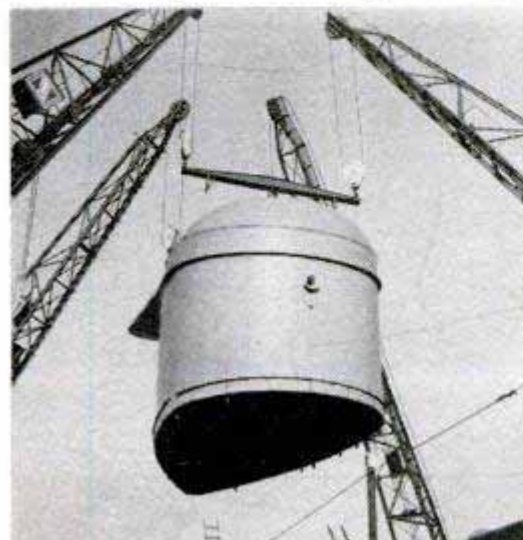

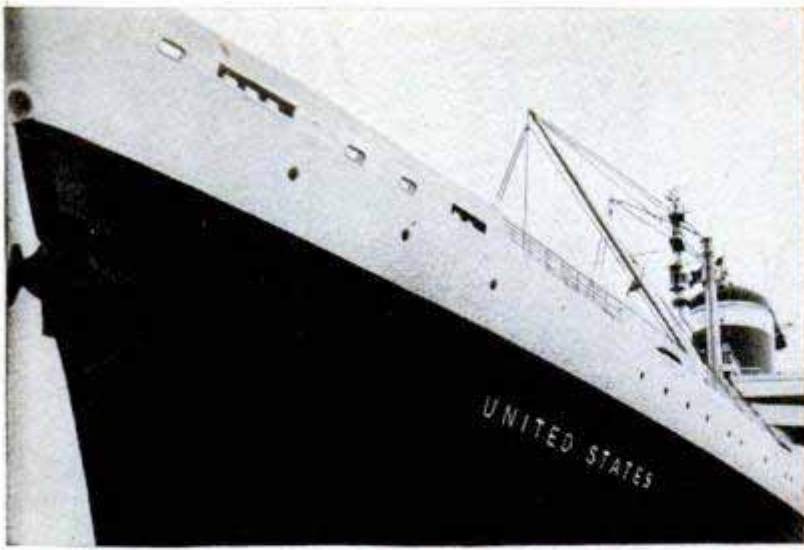

Although dwarfed by the bow, the Inconel metal letters in the ship's name are 2½ ft. high and stretch 51 ft. long

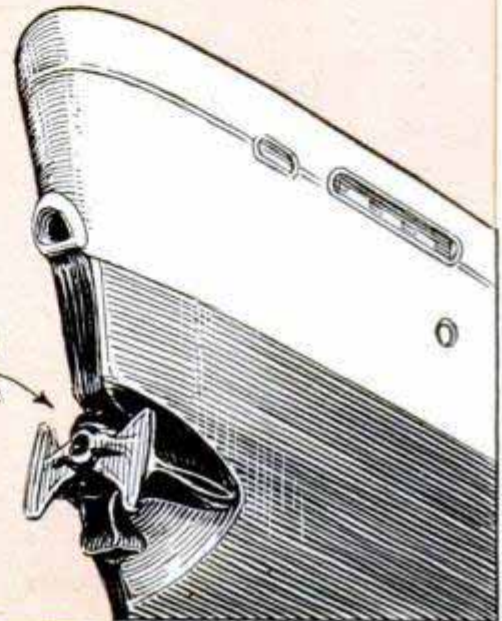
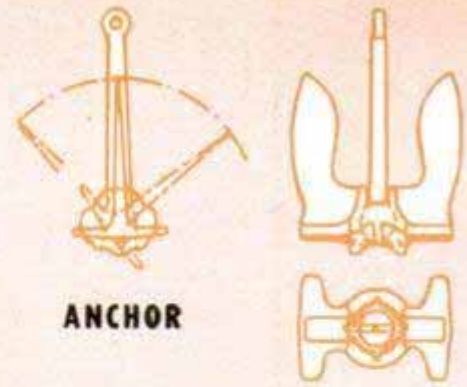
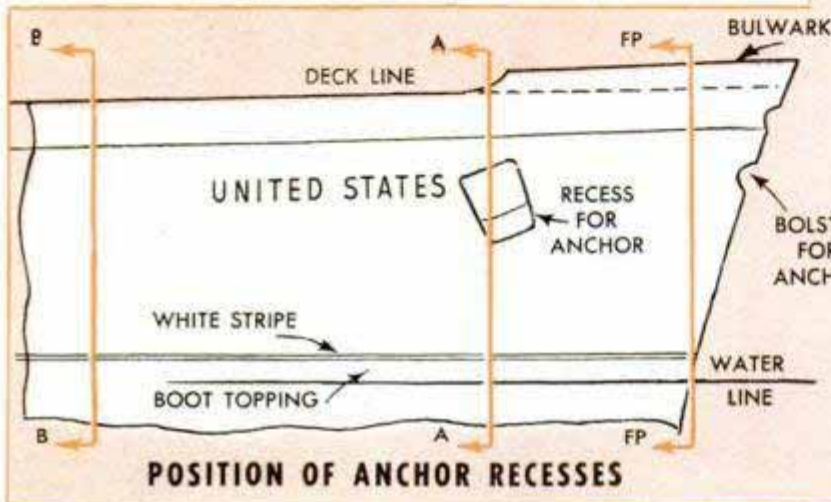

Using either brush or spray to apply the finish coats, the hull first is given four coats of sanding sealer, each one being left to dry for about an hour and then rubbed lightly with fine sandpaper. All nicks and other blemishes in the hull should be carefully filled with wood putty and sanded smooth

the superstructure for the present.

The SS *United States* is equipped with three anchors, one in the leading edge of the bow and one on each side of the hull at station line A-A. On the model, the side anchors are housed in shallow recesses chiseled in the hull. The size and location of the recesses are taken off the profile view, the measurements being doubled, of course, since the drawing is one half full size. The anchors can be purchased from model-supply houses, and in mounting them, holes are drilled in the hull for the shanks and the latter cemented in place. Bolster plates at the lower edges of the side-anchor recesses are cut to shape from thin cardboard and glued to the hull.

The hull now can be painted. If you are satisfied with the final sanding, give the hull four coats of sanding sealer to build up a smooth base for the paint. Let each coat dry and sand with 4/0 paper. As the water line establishes the line where the bottom paint ends,

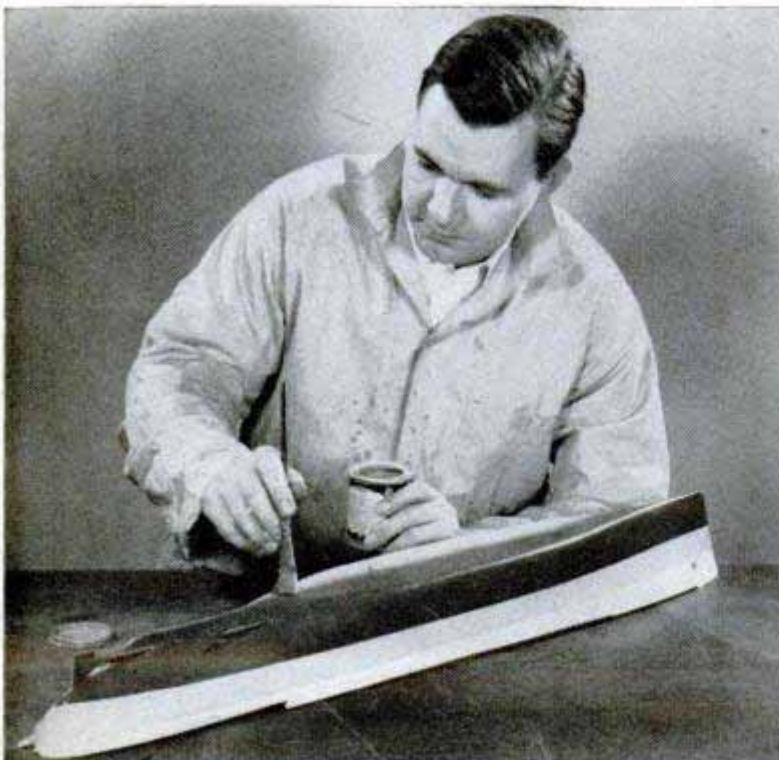

mask off the rest of the hull with tape and newspaper. If a spray gun is available, lay on several coats of red lacquer, rubbing each one lightly, when dry, with 4/0 waterproof paper. If the painting is done with a brush, use a quality four-hour enamel. Final painting of the hull above the water line is left until the portholes are installed. Placing some 775 portholes in both sides of the hull is a tedious job but they add tremendously to the detail of the model. In studying the outboard profile view in Part I, you'll note that the portholes are installed in four rows which run parallel with the sheer line. The spacing of the rows, as well as the portholes, is done best with a pair of dividers, doubling the spacing for each one as given on the half-size profile view, and then transferring it directly to the hull. The portholes are tiny eyelets about $\frac{1}{16}$ in. in diameter which can be purchased. A hole is drilled slightly undersize for each eyelet, after which it is tapped in place with a small pin punch. The spacing of the portholes is the same on both sides of the hull. The loading ports in the side of the hull are indicated with white lines scratched in the black paint.

(to be continued next month)



Adding the many portholes to both sides of the hull consists of drilling rows of undersize holes and pressing tiny eyelets into them. This is done before the hull is painted black above the water line.

Brackets on Basement Joists Aid Stretching of Clothesline

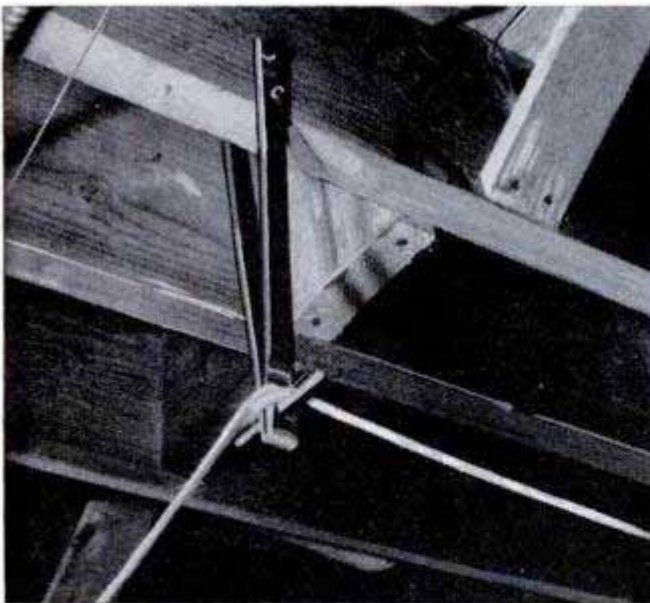

Hanging laundry in the basement will be less of a chore if brackets similar to the one illustrated are attached to joists to support a clothesline without sagging. The bracket is formed from a strip of flat steel, 24 in. long, which is bent double and drilled near the bend to take a $\frac{1}{16}$ -in. bolt. After the head has been removed from the bolt and a nut run all the way up on the threads, the bolt is inserted in the hole and a second nut run on and tightened to hold it in place. A tee or crossbar is thus provided, around which the clothesline may be looped, tied

or cinched when stretching. Arms of the bracket then are drilled near the ends, spread apart and slipped over the joist where it is nailed in place.

Tire-Chain Life Prolonged By Waterproofing Straps

By waterproofing the web straps on strap-on tire chains, moisture and road chemicals will not rot them. A mixture of paraffin dissolved in gasoline or benzine can be brushed on the straps, or they can be dipped in the solution. Caution must be observed in using either of these solutions, as they are highly flammable.



Folding Table Transported or Stored Easily

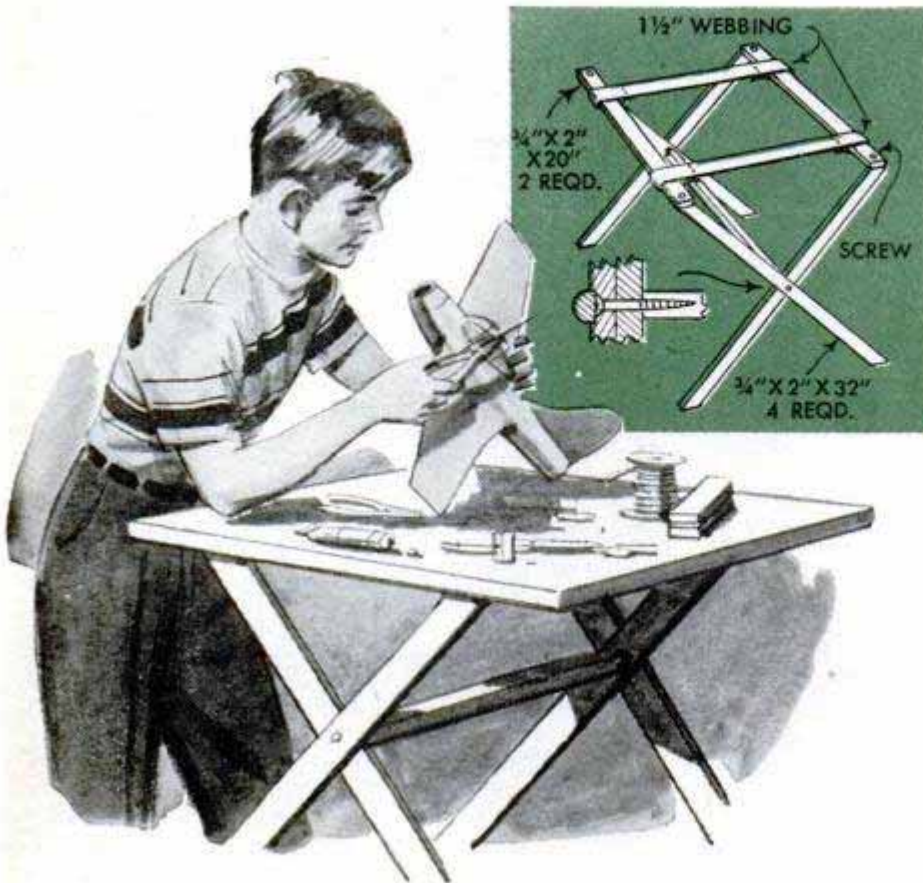

Here's a handy table which can be folded flat and stored easily in a closet. Consisting of a separate top that rests on a folding stand, the table not only will serve a variety of uses in the home but also may be carried along on outings. The top is plywood or hardboard, while the legs and cross-pieces are $\frac{3}{4}$ x 2-in. stock. A round piece, 1 in. in diameter, is used for a center brace. The legs are crossed and pivoted on screws driven in the center brace. The stand is braced in an open position by $1\frac{1}{2}$ -in. webbing which is passed around the crosspieces and stitched. Before the table is assembled, all pieces are sanded and finished with stain and shellac.

Linoleum Held Flat Against Floor by Friction Tape on Underside

To prevent the corners of a linoleum throw rug from turning up and cracking, apply strips of friction tape to the underside, extending at 45-deg. angles from each corner. The tape will not stick to the floor but is sufficiently tacky to prevent the rug from sliding about the floor. Pieces of tape also will come in handy for joining two of the rugs if desired. Simply invert two rugs and place them edge to edge. Then apply several strips of tape across the adjoining edges as indicated. This done, apply corner strips to the outer corners of each rug.

Mrs. T. F. Watts, Charlotte, N. C.

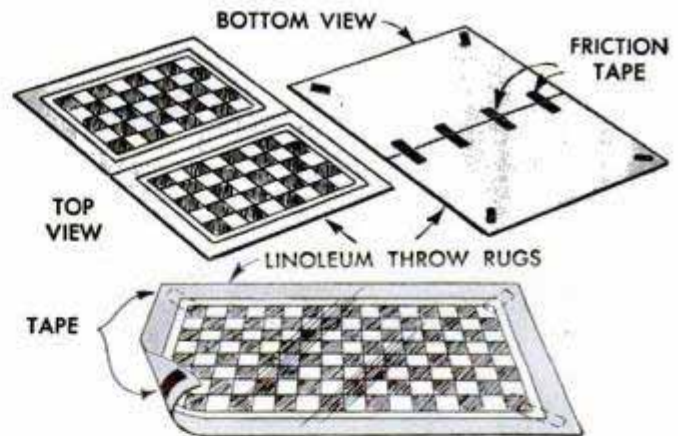

Tracing Wheel Perforates Plastic Lacing for Decorative Effect



Hobbyists who work with plastic lacing will find that a novel decorative effect can be obtained by running a tracing wheel over the lacing as indicated. Thumbtack the lacing to a flat surface and roll the wheel along the center of the strip. Then rub paint or crayon into the indentations and wipe off the excess. Several combinations of colors may be applied alternately, if desired, for varied effects.

☛ To prevent rusting and thereby extend the life of a garbage pail or can, paint it on the inside and apply a coat of wax.

Container for Small Drills From Old Fountain Pen



Instead of throwing away an old fountain pen, use it as a container for small drills. After unscrewing the point and removing the ink sack, wash the pen thoroughly and dry before using. —Norm Jacky, Fond du Lac, Wis.

Dividers Hold Toolbox on Roof

Confronted with the problem of anchoring a toolbox on a steep wood-shingled roof, one carpenter used his dividers as shown to

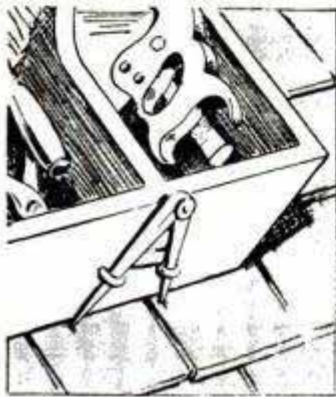

hold the box in position. After two staples had been driven into the end of the box, the prongs of the dividers were passed through them and pressed down until the points of both became firmly engaged in the wooden roof.

Rubber Strips Tighten Shelves Wedged Between Studs

Easily removed shelves for temporary use in a garage or tool shed are held securely between studs by placing a strip of inner tube at one end of each shelf before wedging it in place. Using 1 x 4 material, cut each shelf to fit a bit loosely between the studs.



Then place one end of each shelf against a rubber strip and drive down the other end with a mallet in the manner indicated. Finally, cut off the projecting end of each rubber strip flush with the joint.

White pine may be given an antique finish by staining it with strong tea diluted with water to the shade desired. When the stain has dried, cover it with two thin coats of shellac. Then wax and polish.

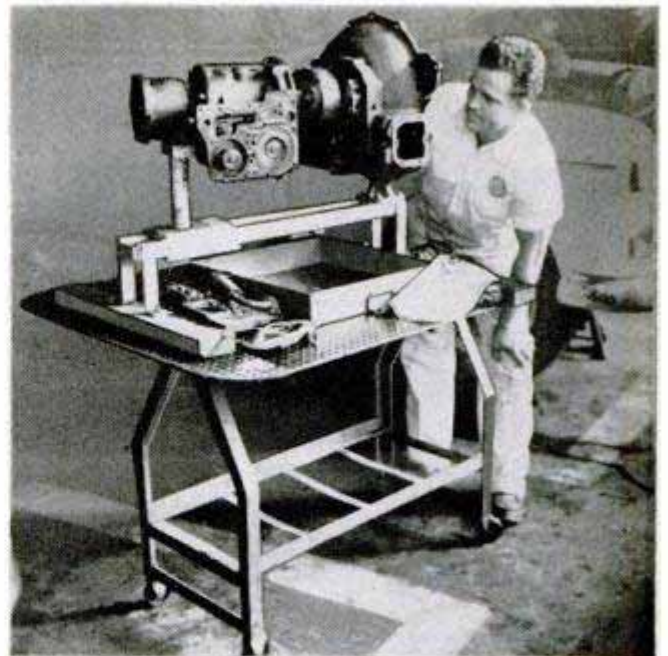

Portable Transmission Stand Reduces Overhaul Time

Instead of attaching an automatic-transmission overhaul rack to a workbench, one garage mechanic mounted it on a portable engine stand. This permits him to roll the repair equipment right to the car being serviced, thus saving considerable time and labor. The overhaul rack is bolted to a pair of 2 x 4s which, in turn, are clamped to the engine-stand table. In this way, the transmission rack may be removed quickly whenever the stand is needed for engine-repair work.

Clipped Magazine Articles Stored In Box-Type Letter File

Stapled together and filed alphabetically in a letter file of the type shown, magazine articles may be protected and kept readily available for future reference. The file, being of letter size, will accommodate pages from all but the largest magazines without the need for folding them.

Clyde L. Allison, Cadillac, Mich.

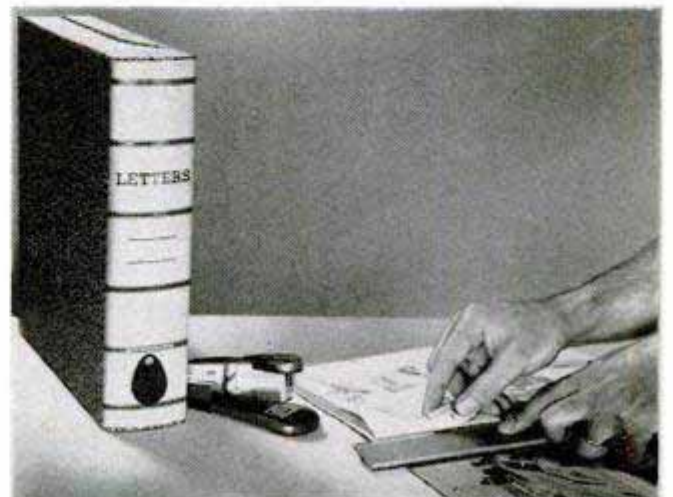

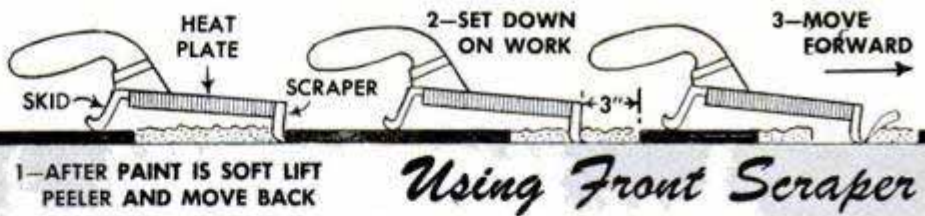
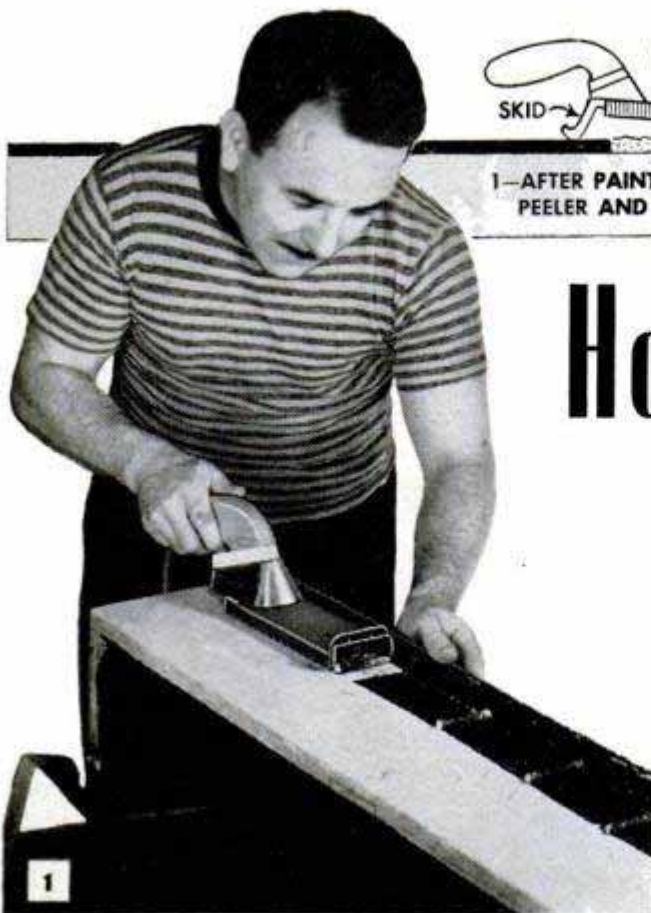

Using Front Scraper

How to UNPAINT!

By Sam Brown

SCRAPE, SAND, melt or burn it—you can take your pick from a wide variety of methods for removing paint finishes down to the bare wood. The efficiency of each method, however, depends primarily on the type and scope of the job to be done. For example, one method is ideal for flat, unobstructed surfaces but is practically useless on grooved or rounded surfaces such as moldings and baseboards. Naturally, the method selected should be one that is best suited to fill your particular needs. For this reason, if you lack previous experience, it is wise to do a small job first to learn which method you find the quickest and most satisfactory. The various methods to be considered are handscraping, hand sanding and power sanding as well as the use of a blowtorch, chemical paint removers and the recently developed electric paint peeler.

Electric paint peeler: Here is a tool that makes some unpainting jobs quite simple. This peeler will strip up to 20 coats of paint in one pass, cutting a ribbon 2 in. wide at the rate of 2 to 10 in. per minute. Exceptionally clean to work with but useful only on flat surfaces, the peeler consists of a simple heating element encased in a metal housing that is provided with a skid at one end for supporting it about $\frac{1}{8}$ in. above the paint. A scraper blade is provided at the other end for removing paint softened by the heating element. The unit may be used either with a front or rear scraper blade. The front scraper, shown in Fig. 1, is best for all-around work since it is controlled easily and permits working up to shoulders. Movement of the peeler with the scraper in front is illustrated at the top of the page, while Fig. 4 shows the proper

Electric paint peeler, above, shown with scraper mounted in front to permit working up to shoulders. Scouring of heating element with steel wool, center, removes paint accumulations. Rear scraper, bottom, is quicker and allows continuous forward scraping



Using Rear Scraper

2—MOVE FORWARD AND SET DOWN ON SOFT PAINT

3—PUSH FORWARD CONTINUOUSLY

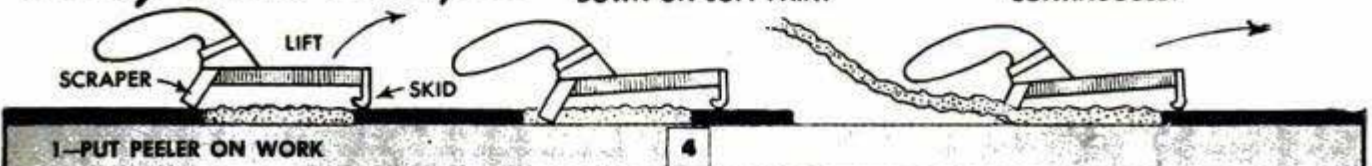



5

WAX FLOATS ON TOP

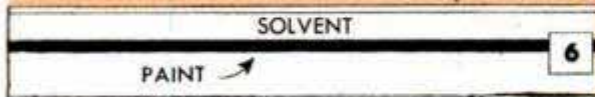

Chemical paint removers work well on almost any flat surface. Wax-base type is least expensive, but requires after-wash to remove wax residue. Paste type is best for vertical surfaces

movement with the scraper in the rear. Although the rear scraper, Fig. 3, is faster and permits continuous forward scraping, it will not cut up to a shoulder.

Paint removed by the peeler is dry and hard after leaving the tool and may be brushed away like dry sawdust. After approximately 10 min. of actual use, the bottom of the heating element should be scoured with steel wool, Fig. 2, to remove any paint accumulations which may have dried on the metal surface.

Chemical paint removers: Liquid paint-and-varnish removers are solvent mixtures which, when brushed on the work, soften the old finish and permit its removal with a cloth or putty knife. The various kinds of removers, which are described in Fig. 5, are divided into two categories: Those having a wax base and those that are wax-free (no-wash). A remover containing wax is used because it seals in the solvent, Fig. 6, so it will not dry out before the paint is softened. However, some of the wax sooner or later reaches the exposed wood and, if left on, causes poor drying and eventual peeling of the new finish. For this reason, it is necessary to wash off the wax residue with alcohol or other suitable solvent. A no-wash remover contains no wax and requires no solvent wash.

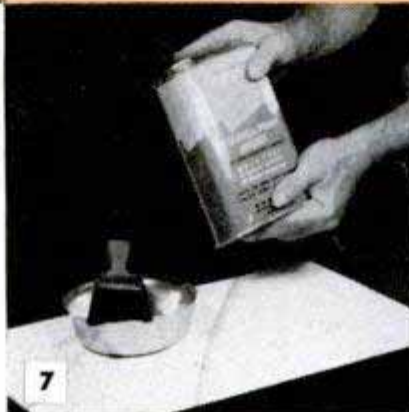

7

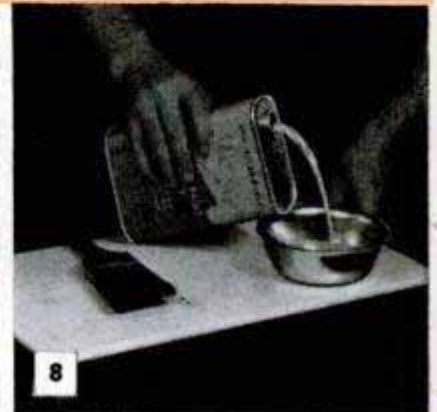

8

Left, always shake can before using, a "must" for wax-base removers. Right, use shallow container and pour only what you need



9

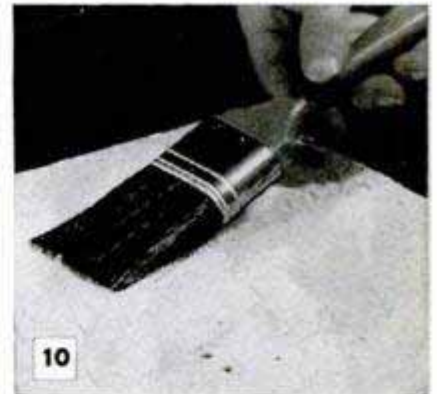

10

Left, apply remover with flat side of brush, but do not brush out. Right, let work stand until soft, then apply second coat if needed

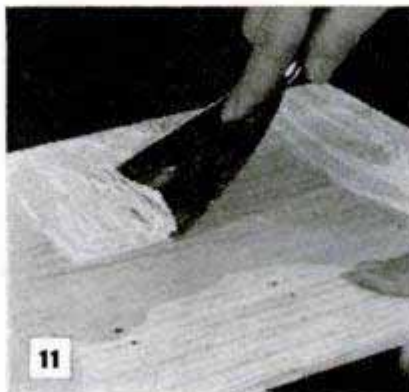

11



12

Left, remove softened paint with a dull putty knife. Right, use alcohol and rub with No. 2 steel wool in final cleanup operation



13

SAWDUST

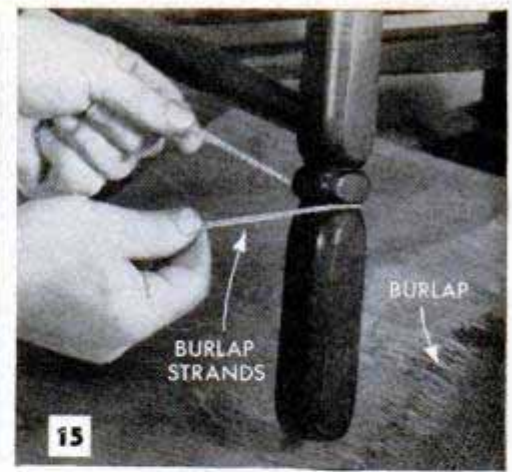

15



14

Above, using sawdust on final coat of remover. Above right, cleaning turnings with burlap strands. Left, burning of remover leaves powdered paint for easy scraping or sanding

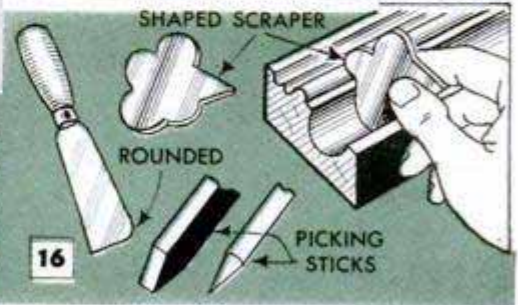

16



17

STIFF BRISTLE (FIBER) BRUSH

Above, using stiff brush on carved surfaces. Below, power sanding done with coarse belt minimizes loading tendency



18

Most liquid paint removers, unless otherwise specified, have a milklike consistency which is suitable for all level surfaces, but which will run when applied to vertical surfaces and drip when used overhead. The remedy for this is to use a heavy-bodied or paste type of remover. Figs. 7 to 12 show how paint remover is used for the average job. If no-wash remover is used, the final cleanup, Fig. 12, can be accomplished with a coat of the remover itself instead of alcohol. Most jobs require at least two coats of remover which either can be applied as separate coats or one on top of the other. Generally, if a paste remover is used, the proper technique is to keep piling on the remover until a test scraping shows that the paint has been softened down to the bare wood.

Some thick finishes require anywhere from 6 to 15 hrs. for softening, in which case the paste remover is best because it is made specifically for staying wet and active over long periods of time. The usual technique with the liquid-type remover, which must be removed and renewed frequently, is to apply a thick first coat, allow it to work for about 20 min. and then remove whatever paint has become soft. Used in the same manner, the second coat usually will cut through the average five or six-layer finish. Often, during second and third applications, the softened paint tends to become rather "gooey," a condition that can be remedied by sprinkling with sawdust, as in Fig. 13. This kink works best on the coat of remover that is expected to remove the last of the paint from the wood. Under this condition, the combined paint and sawdust mixture is scrubbed over the surface with a putty knife to dry-clean the wood. Another trick is to burn off the remover, Fig. 14, an operation that also works best on the final cleanup coat. However, this technique should be used outdoors only, and no more than a square foot of the surface burned at one time. The dry, powderlike film left by the burning yields readily to scraping or power sanding.

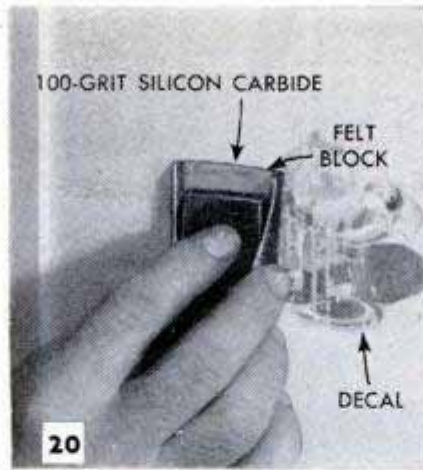

Left, applying 20-percent solution of muriatic acid to cut water-resin paint. Center, using 100-grit waterproof sandpaper to remove decals. Right, using electric peeler to remove paint on flat surfaces of door

A putty knife is the favored tool for removing softened paint. It is best to have two or three available—one with rounded corners to prevent gouging flat surfaces, one having square corners for working shoulders and another with corners rounded sufficiently for getting into moldings. The knife must always be kept clean for best results. On intricate surfaces such as carvings, the paint remover is applied with a stiff brush, as in Fig. 17, using short, jabbing strokes, after which it is removed in the same manner. Various picking sticks and contour scrapers, Fig. 16, can be made up as needed, while steel wool, burlap, moss, hair or wood wool often works better than a putty knife for the final cleanup. Fig. 15 shows the use of strands shredded from burlap for cleaning turnings.

Other methods: Various other methods that are used for removing paint in addition to those described, Fig. 22, include hand-scraping, hand sanding, power sanding and the use of a blowtorch. A dry, crisp finish is removed easily either by handscraping or power sanding. The one disadvantage of power sanding, Fig. 18, is that the friction created softens the paint and causes rapid glazing of the belt. This can be partially overcome by using a coarse sandpaper, employing a light, fast stroke and by not sanding any area twice in succession. The blowtorch is for professionals and should be used for house paint only. The torch is held in one hand while the other hand follows with a putty knife to remove the softened paint.

★ ★ ★

22 · UNPAINTING Job Specifications

AVERAGE WORK: For the average job use a chemical paint remover. Apply a heavy first coat to remove the bulk of the old finish. Then follow with a second coat of liquid remover and allow to dry overnight before refinishing. If a wax-base remover is used, a final cleanup with alcohol will be necessary to remove any traces of wax remaining on the work. As a further assurance of complete paint and wax removal, wash the surfaces with a mild caustic—a saturated solution of tri-sodium in warm water is recommended. Allow at least 36 hrs. for it to dry, sand with 3/0 paper and otherwise treat as new wood

DECALS: Decals may be removed easily with paint remover, but this also strips the finish underneath. To preserve the old surface, sand with 100-grit waterproof (silicon-carbide) sandpaper, Fig. 20, wrapping it around a felt or wooden block and using water for a lubricant

FINE FURNITURE: For best results, use paint remover for removing the finish from fine furniture, wiping off softened paint with burlap, wood wool or hair. It's wise to avoid the use of a scraper, putty knife or electric peeler in order to prevent possible damage to the wood

HOUSE PAINT: Use the electric paint peeler or a blow-torch for removing house paint. Paint removers are used sometimes, but in most cases are slow and expensive

WATER PAINT: Casein and resin-emulsion paints can be removed with a warm solution of household ammonia or muriatic acid, Fig. 19, using approximately 1 part chemical to 4 parts water applied with a stiff brush

WOOD FILLER: Wood filler, which normally will remain in wood, may be removed if necessary for a natural finish by applying a liquid paint remover and brushing well with a fine steel-wire brush. Sanding is also practical

WOOD FLOORS: Power sanding is the most common method for removing paint from wood floors. The job also can be done with a no-wash paint remover, working a 2 x 3-ft. strip at a time. Clean up with a commercial floor bleach and allow the floor to dry 24 hrs. before varnishing

WOOD STAIN: Paint removers will not remove wood stain. Bleaching is effective sometimes. Stain removers are obtainable which are especially effective for red mahogany



Supply Kit for Lettering Artist Mounted on Tripod Near Work

When lettering names or signs on office doors and windows, one lettering artist uses a camera tripod to support a box containing supplies close at hand. A hole was drilled in the bottom of the box, which was a metal one of the kind used for fishing tackle, and a nut soldered over it to take the tripod bolt.

Wire Screen Perforates Paper

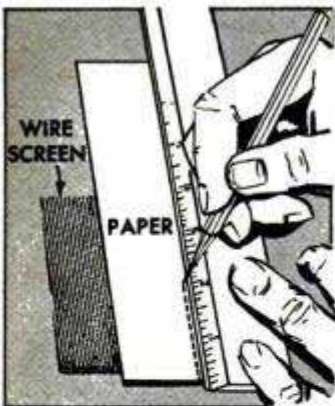

Sheets of paper can be perforated for tearing by ruling the sheets over a piece of screen wire. Slight pressure on a sharp pencil or stylus will score the sheets neatly. Use clean, unpainted screening for best results.

Repairing Damaged Linoleum

Small damaged areas in linoleum or asphalt-tile floors can be repaired quickly and permanently with the aid of a gasket punch. After cutting a circular piece containing the damaged portion with the punch, slip the blade of a putty knife under the edge of the piece and gently pry free. Then, again using the punch, cut an identical piece of matching design and grain if possible from any surplus tile or linoleum

on hand. If working with asphalt tile, warm the pieces with a blowtorch first to facilitate cutting. Next, scrape the old adhesive from the floor, apply fresh adhesive and install the patch. A gasket punch may be obtained at most refrigerator-supply houses.
P. Douglas Grewer, Alfred, N. Y.

Fruit-Box Boards Salvaged Intact By Sawing Off Ends of Boxes

To salvage wood from fruit crates and boxes without having it split when the nails are removed, one craftsman cuts off the ends of the boxes on his bench saw as indicated. Ends of boards remaining on box ends may be pried loose, the nails pulled and the box ends sawed or split into the sizes desired.

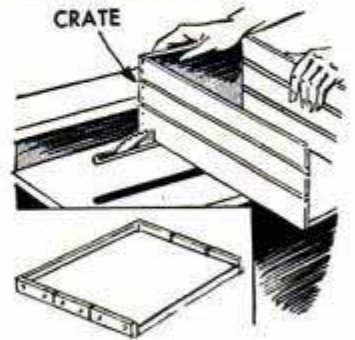

Tape Protects Floor Outlet When Remodeling Room

A strip of cellulose tape applied over the openings of an electric outlet in the floor of a room that is being remodeled will keep dust and bits of debris from getting into the plug. Leave the tape on until the work is finished and the dirt removed from the surrounding area.

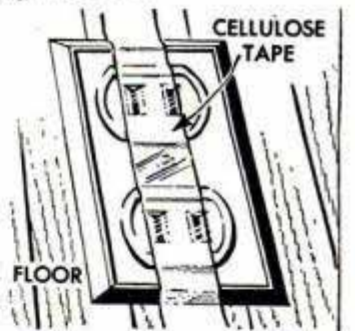

Joel Miles, Denver, Colo.

Bracket Serves as Doorstop

A slotted bracket of the type used to support the drop leaf of a writing desk will provide an ideal doorstop when mounted between the door frame and the top of the door. This arrangement has been found especially practical for doors having tile floors and baseboards.

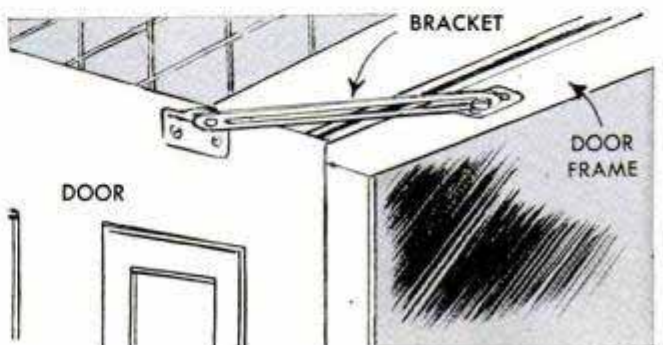

Modern Coffee Table to Brighten Living Room

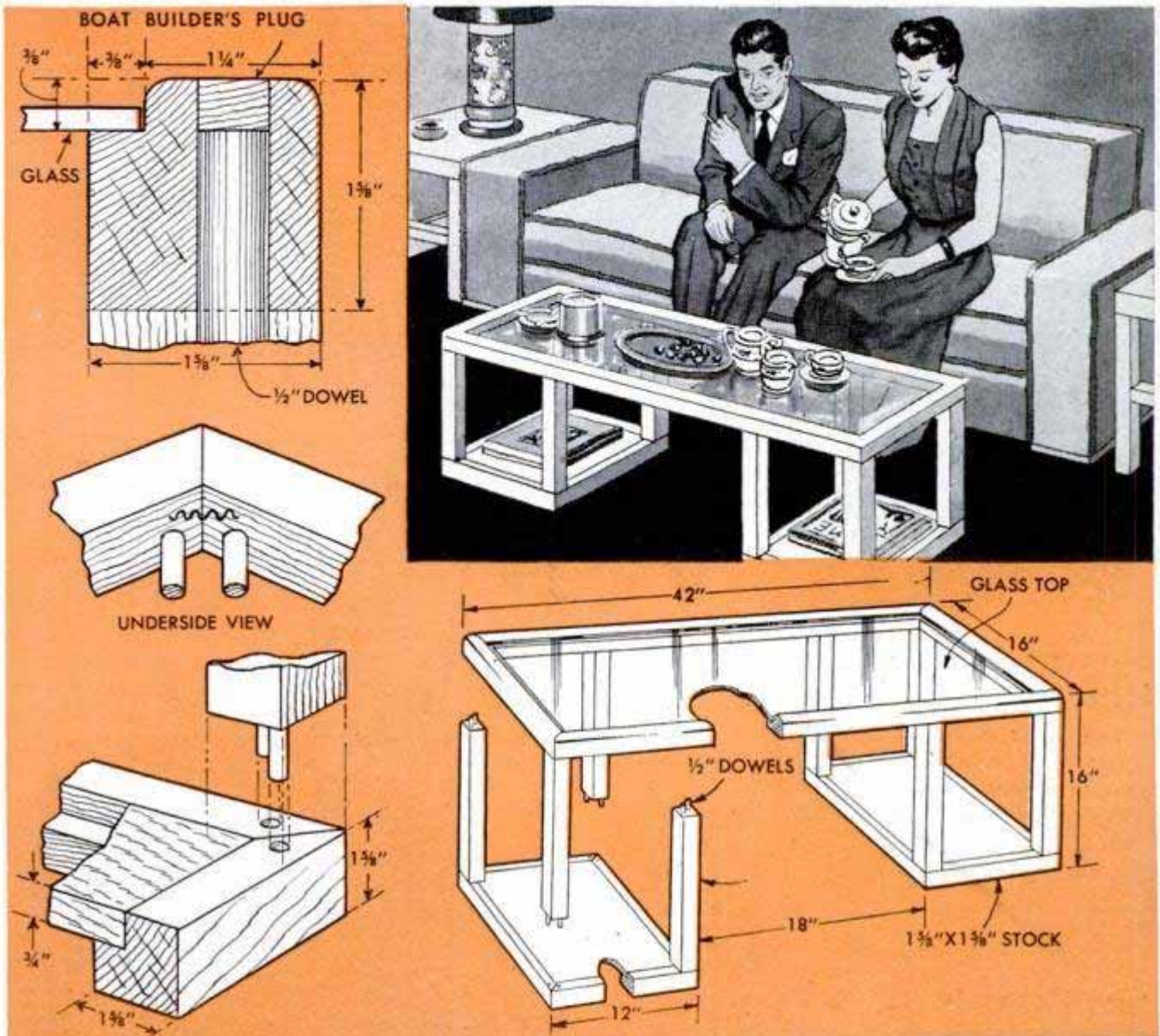

Featuring an attractive glass top that will never burn or stain, this handsome, open-design coffee table will fit into practically any room containing modern furnishings. The table is constructed almost entirely from $1\frac{5}{8} \times 1\frac{5}{8}$ -in. stock, while plywood is used for a shelf at each base of the unit. After members of the top frame have been mitered and joined together, the pieces are rabbeted along the inside top edge to take $\frac{1}{4}$ -in. plate glass as indicated. The operation is repeated with each of the base frames in order to accommodate the shelves. All joints are secured with dowels

and glue, while corrugated fasteners are driven into the underside of mitered corners for additional reinforcement. To attach the legs, two $\frac{1}{2}$ -in. holes are drilled through each corner of the top and base frames as well as the ends of each leg to receive dowels. After the dowels are inserted in holes in the top frame, boatbuilder's plugs are glued in place as shown, chiseled flush with the top side of the frame and sanded smooth. Then the entire unit is sanded thoroughly, given a coat of liquid sealer and, when dry, waxed or shellacked.
Hi Sibley, Nuevo, Calif.

Treatment for Violin Keys That Stick or Slip

Skilled instrument repairmen, in repairing sticking or slipping violin keys, first remove the keys and sandpaper them lightly to remove any gloss. Then they apply naphtha soap that is moist enough to smear like a heavy grease. Next the keys are returned to the proper holes and turned sev-

eral times. Remove keys again and apply a powdered chalk. Once again they are inserted and turned. The last time keys are taken out, most of the chalk and naphtha taken out, most of the chalk and naphtha should be repeated every few months.

Jesse A. Leason, St. Paul, Minn.



Modern uses of candles still afford the old-time charm of candlelight on the dinner table, and also as console displays for special social gatherings and birthday-cake ceremonies for young and old. Candles are available in a wide range of sizes, colors, lengths and shapes for every party occasion

CANDLE HINTS

One of the practical uses for candles is the coating of a shellac brush with the melted wax to keep it soft during intermittent use. Light the candle and hold it horizontally over the brush, permitting the melted wax to drip onto the bristles. When you are ready to use the brush again, scrape off the wax

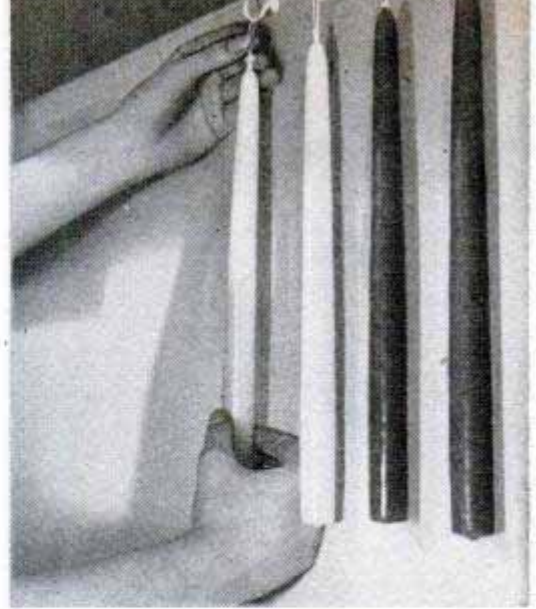

Long tapers stored loosely in a drawer are apt to become broken. It is better to hang them from hooks. Loops of thread tied to the wicks and slipped over the hooks will allow the tapers to hang straight and free. This prevents warping in warm weather



To assure that burning candles will stand upright in the holders, place two strips of adhesive tape crosswise on the lower end. Then press tightly into the holder until the free ends of the strips of tape are concealed

If candle is too large at base to fit holder, never pare it with a knife. Rather bring water to a rolling boil and dip the end of the candle intermittently until wax melts sufficiently for the end to fit holder tightly





Another way of fitting undersize candles to holders is to wrap a strip of corrugated cardboard around the base. This compresses when candle is forced into holder



Apply a thin coat of white shellac to candles to make them last longer. The shellac coating also helps to prevent excessive dripping of melted wax from the tip



Left, insect-repellent candles can be made by drilling holes 1 in. deep close to wick. Fill holes with citronella and coat with melted wax to prevent evaporation



Center, rub wax from a candle onto a Zipper to make it work easily. Right, melted wax from candles rubbed over the inside of breadboxes keeps them from rusting



Wax from used candles may be reclaimed by melting and pouring into a muffin tin. When hardened the wax disks are removed easily and stored for future use

Another trick that slows down the burning rate of tall candles is to make a conical-shaped hood of aluminum. This also prevents objectionable dripping



"Candles" on Cardboard Cake Formed With Dollar Bills



One father surprised his young daughter with a novel birthday "cake" made of cardboard and decorated with "candles" formed with dollar bills. The candles, each of which was topped with bright-colored paper cut in the shape of a flame, were mounted in holes made in the top of the cake to hold them in the shape desired. The cake itself, consisting of a single round piece and a long strip of cardboard, was assembled with cellulose tape and painted to represent a cake covered with frosting.

Wrapper Cut From Leftover Rolls Helps Identify Wallpaper Quickly



Before storing leftover rolls of wallpaper, wrap them in a piece of the paper before tying them together. With the design placed on the outside, the wrapper not only will identify the bundle but

also will help keep the rolls clean. Strips of cloth, used in place of cord to tie the bundle, will also help to prevent damage to the rolls.—H. Hanscom, Elmhurst, Ill.

Leveling Power-Tool Stands

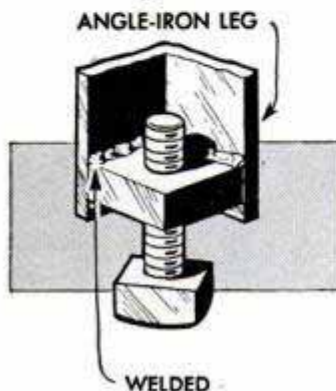

Power-tool stands having angle-iron legs are easy to level if the bottom of one or two of the legs is fitted with a square nut and a cap screw. Adjacent faces of the nut are welded in the angle formed

by the leg. The cap screw is turned into the nut, the weight of the stand resting on the head of the screw. The stand is adjusted by turning the cap screws on the legs until the stand is level. Jam nuts turned on the cap screws before mounting the screws on the legs may be used to lock the screws after adjustment.

Carmen Carson, Calgary, Alta., Can.

Tape Prevents Suction Loss Through Vacuum-Cleaner Units

Several layers of cellulose tape wrapped around the metal ends of a vacuum-cleaner hose and extension pipes will help to prevent loss of suction when the attachments are worn or loose. An application of tape to the fittings of new vacuum cleaners will increase their cleaning efficiency, since most attachments fit the machine somewhat loosely.



Lance Werner, Cleveland, Ohio.

Steel Wool in Blowtorch Cup Prevents Spilling of Gas

When packed in the priming cup of a blowtorch in the manner illustrated, a wad of fine steel wool will help prevent the spilling of gasoline in case the torch is moved while being preheated. The arrangement also speeds up heating of the torch inasmuch as the flame, which tends to be steadied by the presence of the steel wool in the priming cup, will burn more evenly and its heat will be concentrated directly beneath the burner casting.



Attractive Writing Desk for Child's Room

By I. M. Fenn

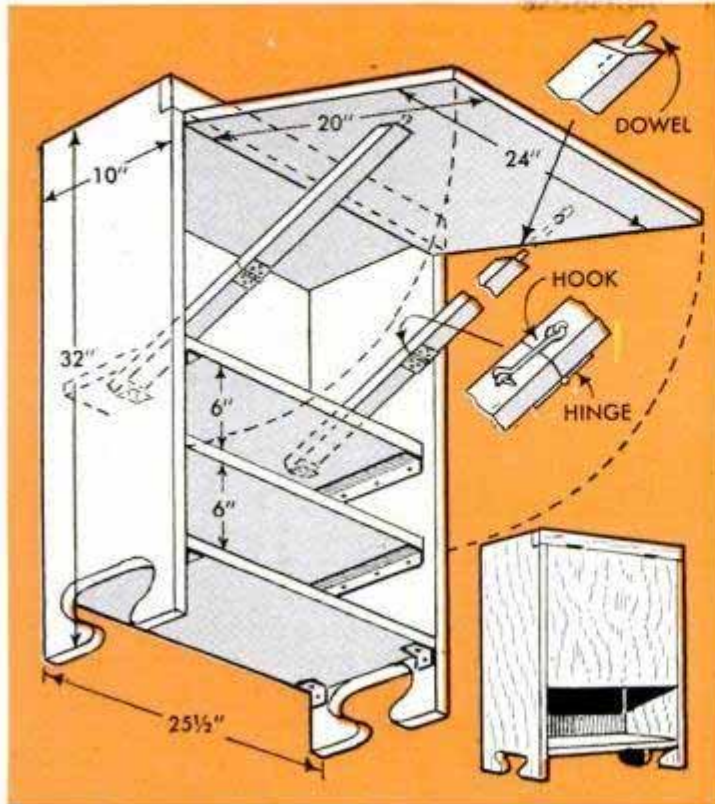

This combination writing desk and bookcase, which will be a welcome addition to any child's room, features a drop leaf that folds down to cover all but the bottom shelf, presenting the clean lines of a modern console-type cabinet. The desk may be built to the dimensions indicated, or tailored to fit the requirements of a particular child or teen-ager. All shelves, as well as the top and sides of the desk, are made from $\frac{3}{4}$ -in. stock, while plywood is used for the drop leaf. Also cut from $\frac{3}{4}$ -in. stock or scrap suitable for the purpose, the two-part braces are hinged in the middle and where they are connected to the top shelf. Support for the

drop leaf is provided by drilling two holes in the underside to receive dowels which are fitted in the upper ends of the braces. If desired, additional holes may be drilled to change the angle of the drop leaf for drawing purposes. After all pieces have been sanded smooth, they are assembled with glue and nails. The bottom shelf is joined to sides of the desk with metal angle brackets, while the other shelves rest on short lengths of steel angle for easy adjustment or removal. When completely assembled, the desk is finished with stain, shellac or paint to match other furnishings in the room.

Roof Cement Secures Shingles Against Strong Winds



Composition shingles can be protected against windstorm damage most easily, I have found, by applying a small amount of asphalt roof cement under each shingle to secure it to the one below. A putty knife is used to raise each shingle and then for applying the cement about an inch back from the edge. Although requiring more time to apply than the canned liquid tar usually sold with roll roofing, the cement remains tacky over a longer period, adapting itself readily to any over-all movement of the shingles such as that due to strong winds or to a heavy snow load.

Clinton R. Hull, Costa Mesa, Calif.

CHIP CARVING



DECORATING your woodshop projects with chip-carved panels and moldings will give them a new-found warmth and a handcrafted appearance that otherwise is hard to achieve. Although the finished product may look like the work of a highly skilled craftsman, chip carving is actually a series of simple geometric cuts—triangles, squares, diamonds and arcs—arranged in an all-over pattern, as in examples shown on these pages. You'll be surprised at the skill attained with very little practice.

Accurate layout is essential to a professional-looking job, and this should be done directly on the work with a straightedge and a sharp pencil. The work may be carved with a pocketknife having a sheep's-foot blade or with a pair of knives, one of which has an angular sticking blade and the other a splitting blade as shown below. The sheep's-foot type of blade is used for making both the sticking and splitting cuts.



SHEEP'S-FOOT KNIFE



STICKING BLADE



SPLITTING BLADE

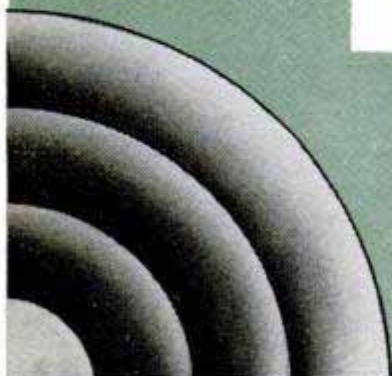
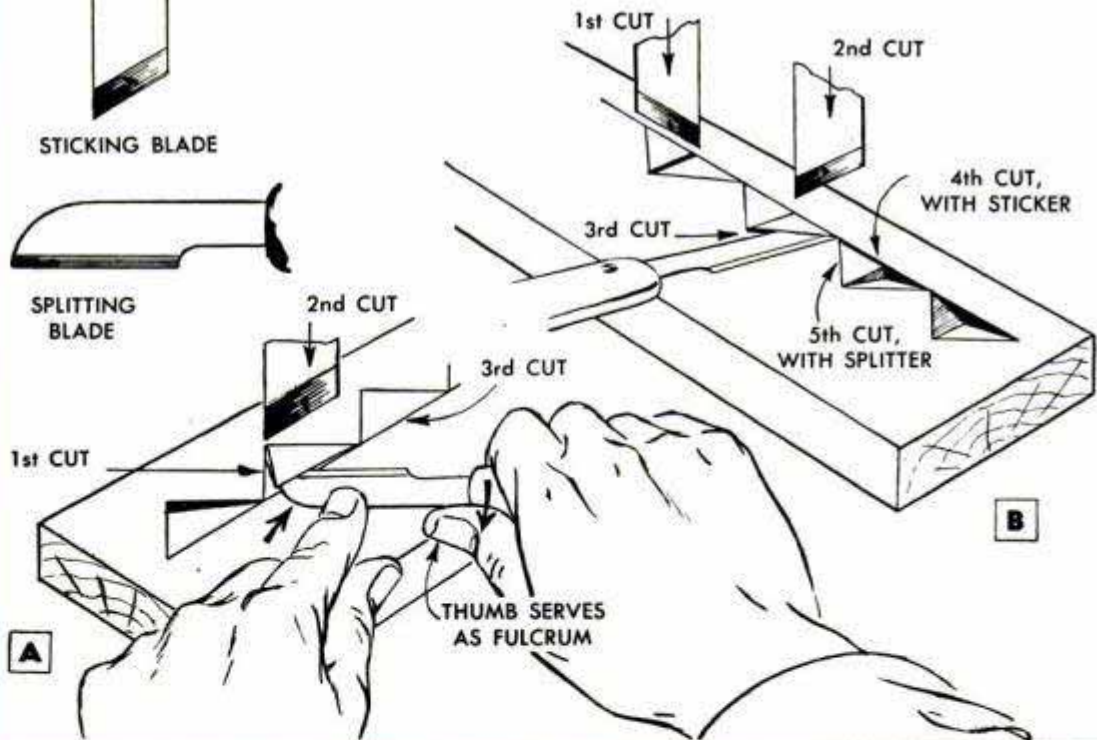
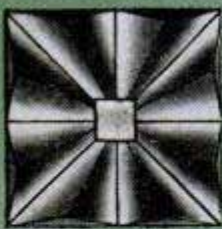

The pair of knives can be made from sections of hacksaw blades set in handles or fashioned from household paring knives of good-quality steel. The blades are ground to form a long bevel on both sides, the edge of the sticking blade being cut off at an angle before grinding. The blades should be honed to razor sharpness after grinding. It is necessary to keep them in this condition in order to produce satisfactory work. To renew the cutting edge, sharpen on an oilstone and hone the edge lightly on a hard slipstone. Then finish the edge by stroking across the palm of your hand or a piece of full-grain leather.

For the best chip-carving results, select a straight-grained wood that is free from knots, spongy spots and other defects. Basswood, poplar, mahogany, red gum and walnut are especially suitable.

Details A, B, C and D picture basic chip-carving cuts, the vertical cuts being made with the sticking blade and the stock removed with the splitting blade. Use both hands to hold and guide the knife. Note in detail A how the splitting knife is used to remove a triangular chip, the blade being pushed with the index finger while the thumb of the knife-holding hand serves as a

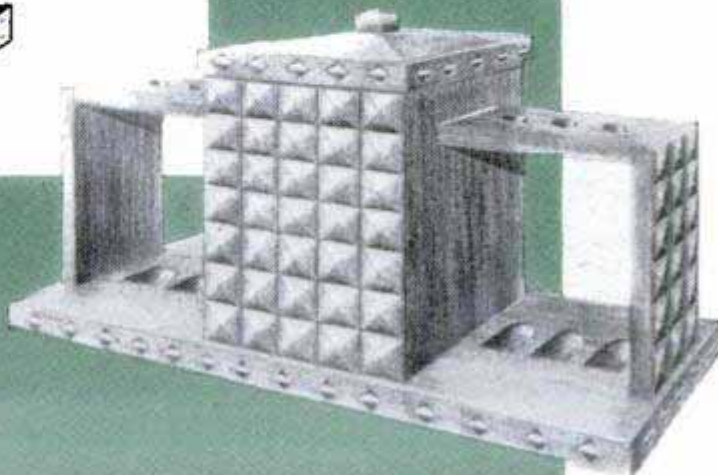
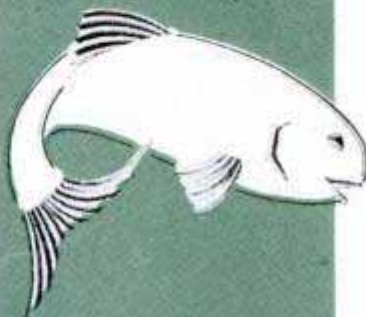
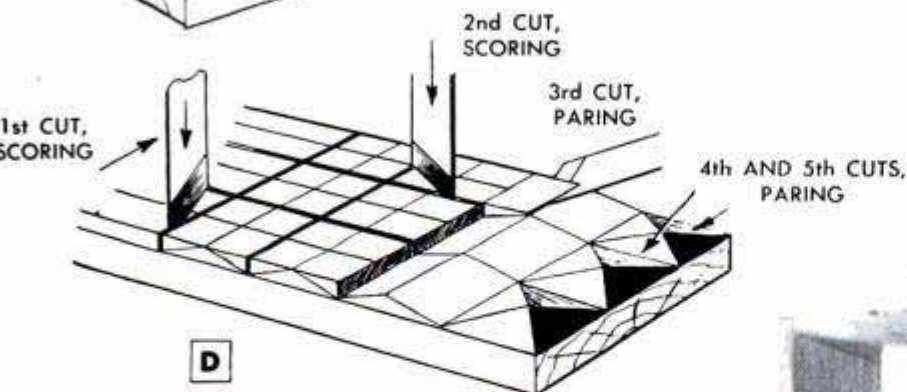
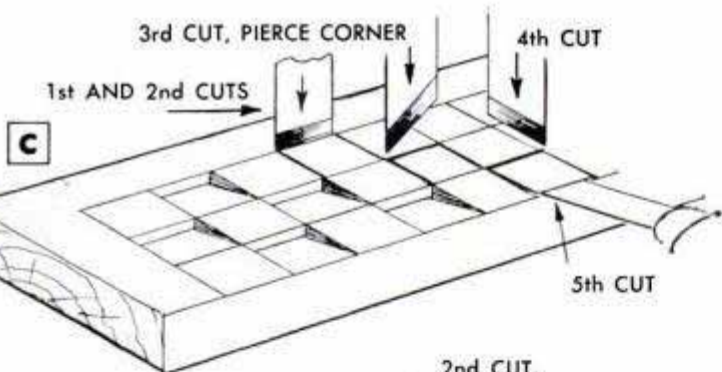

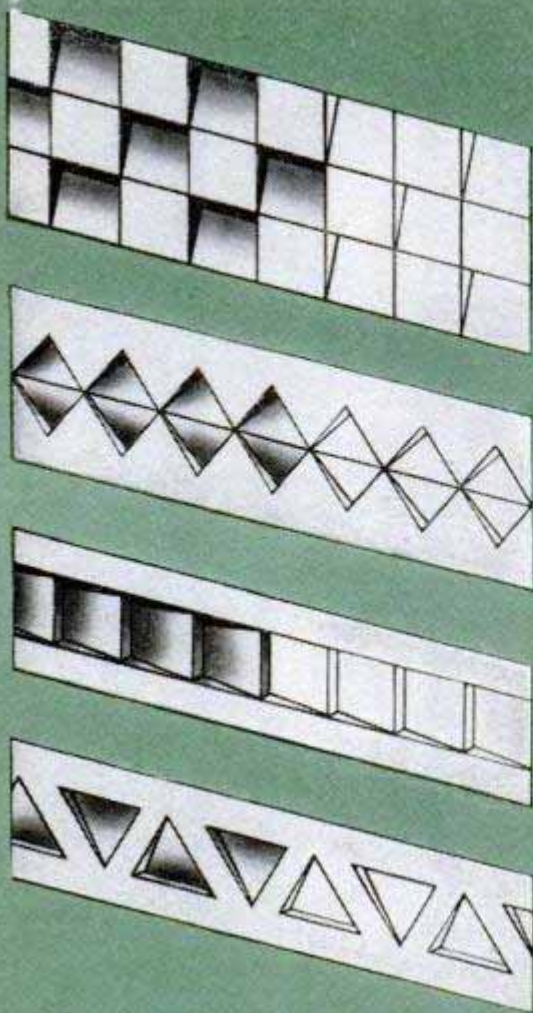

Attractive molding designs, above, are examples of chip carving in its simplest form

fulcrum. When making cuts as in details A and B, it is important to align the blade carefully with the opposite corner of the triangle in order to split the wood along the guide line. The paring cuts in details C and D may be made with either the splitting or sticking blade.

You can see from these illustrations that chip carving consists primarily of making two or three vertical cuts and then lifting out the chip. The sticking blade also is used to score the work for a series of cuts as in detail D. Try out the various patterns on scrap lumber to familiarize yourself with the different cuts before attempting to decorate a project. The designs shown on pages

Jewelry Box

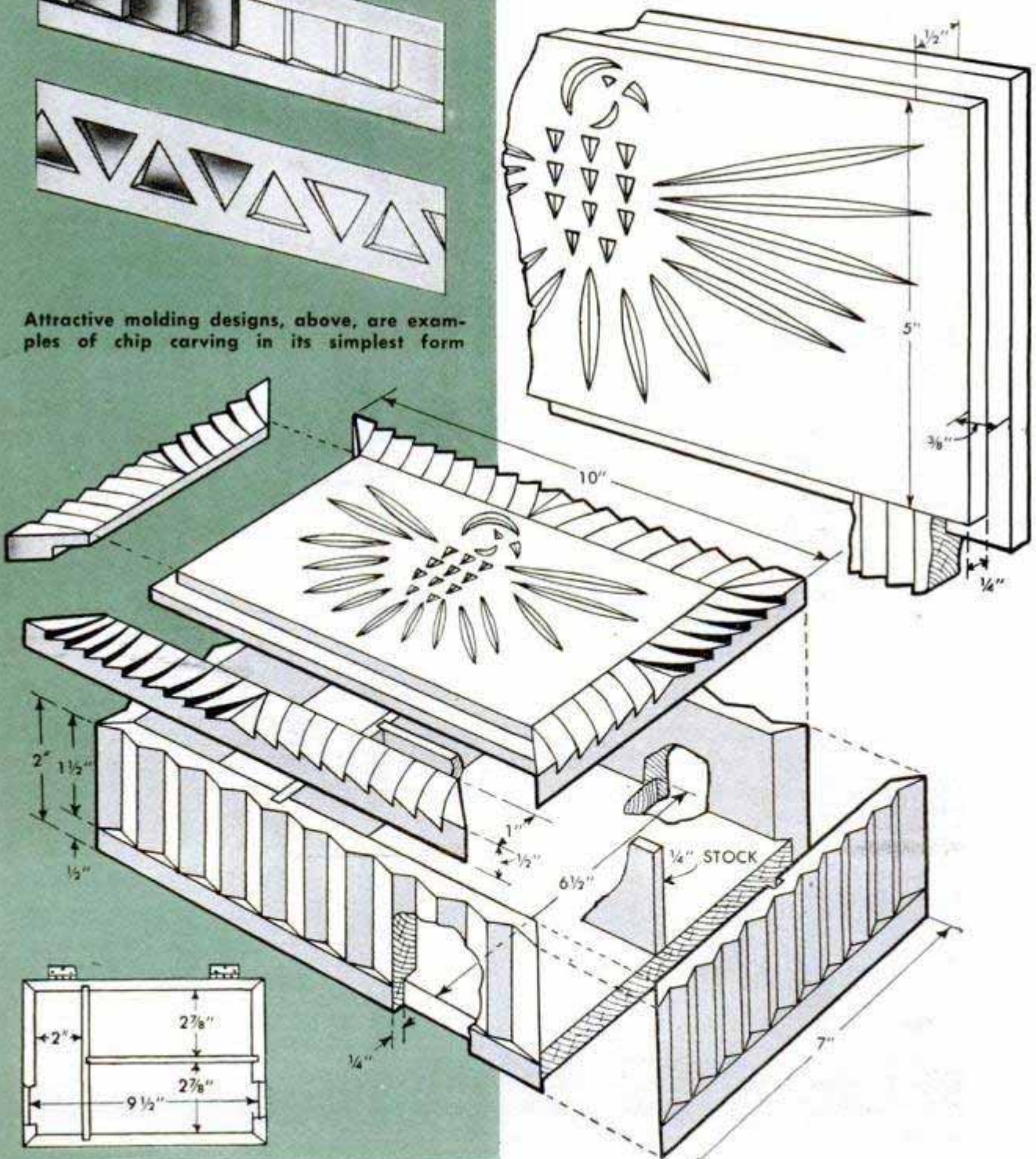

198 and 199 are simply more extensive applications of the same techniques employed in the basic cuts.

Before finishing the chip-carved piece, erase all pattern lines and sand the flat surfaces with fine sandpaper. The wood may be finished natural or stained to suit, applying two thin coats of clear shellac over the stain and sanding lightly between the coats. To protect the finish, coat the surface with a liquid wax. Apply the wax carefully with a brush so that it does not lump or cake in the carved depressions. Some craftsmen feel that shellac or varnish destroys the beauty of the carving and recommend that the work be finished merely with several

coats of furniture wax polished with a soft-bristle brush.

Jewelry box: Especially beautiful when made of $\frac{1}{2}$ -in. walnut or mahogany, this jewelry box utilizes the distinctiveness of chip carving to its fullest extent. The top consists of four outer sections mitered at the corners and fitted to the rabbeted center panel. The side members are carved as indicated and rabbeted along the lower edges. Corners of the side pieces also are mitered.

Cigarette dispenser: A real conversation piece, this novel cigarette dispenser is fairly ornate and yet achieves a modern appearance. The dispenser is designed so that the sliding cigarette drawer doubles as the bottom of the hopper. A $\frac{3}{8}$ -in. groove, just

Cigarette Dispenser

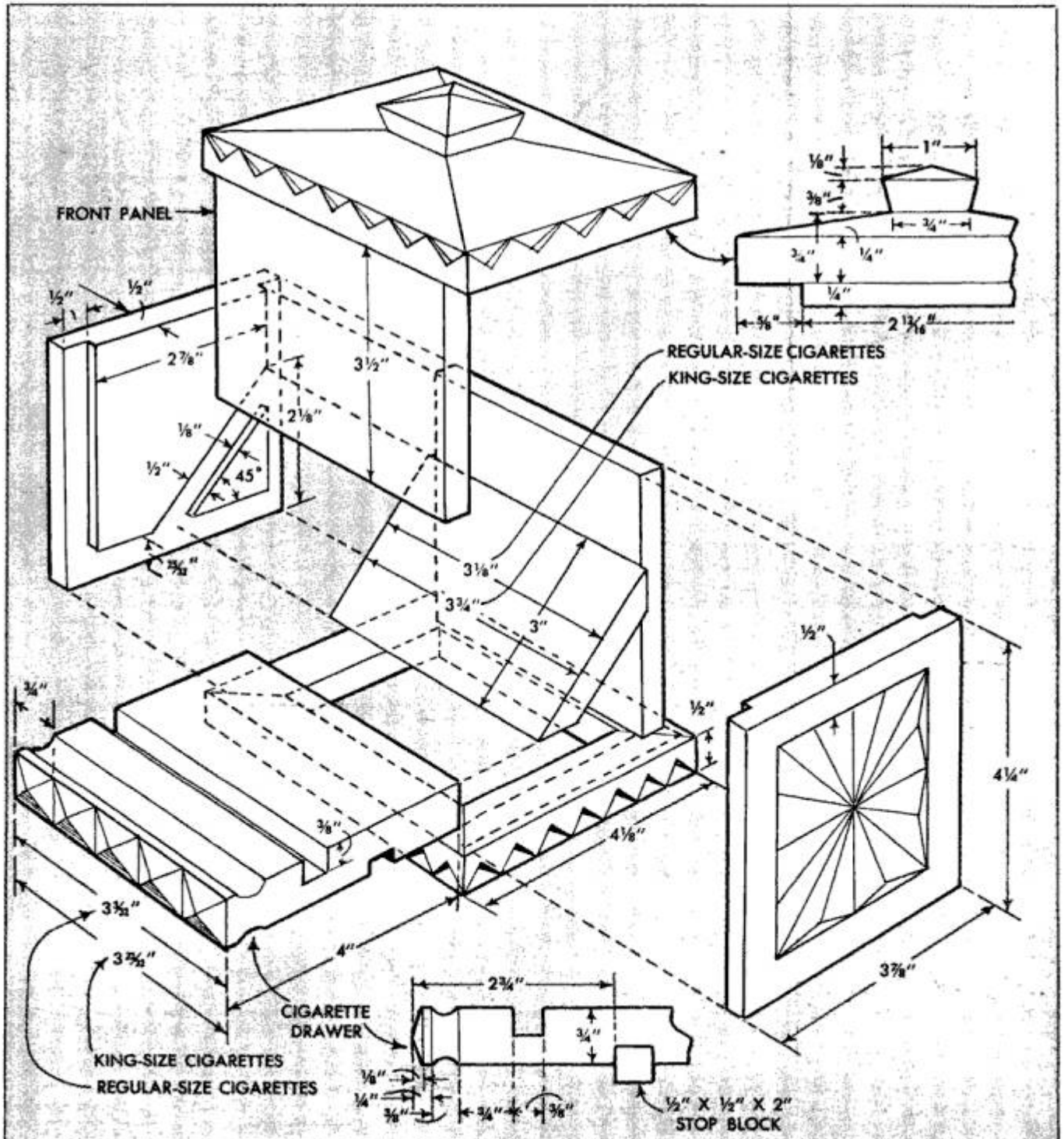

The raised and ornate borders, left, are produced with slight variations of basic chip-carving cuts

large enough to take a single cigarette, is cut in the upper face of the drawer, as detailed. A 2-in. stop block glued in a groove in the underside of the cigarette drawer engages the inner edge of the bottom frame to keep the drawer from being pulled out all the way. The front panel is glued to the rabbeted side panels and provides clearance at the bottom for the cigarette drawer.

Humidor-pipe rack: The chip carving on this combination humidor-pipe rack lends a touch of craftsmanship to an otherwise plain-looking project. The base is rabbeted for the edge molding and notched for the humidor front and back panels as well as the pipe-rack endpieces. Note that a 1½-in.-dia. hole is bored in the underside of the lid and filled with plaster of paris. Brads driven in the edges of the hole anchor the plaster in place. Keeping the plaster moist provides the necessary humidity inside the tobacco canister. ★ ★ ★

Humidor-Pipe Rack

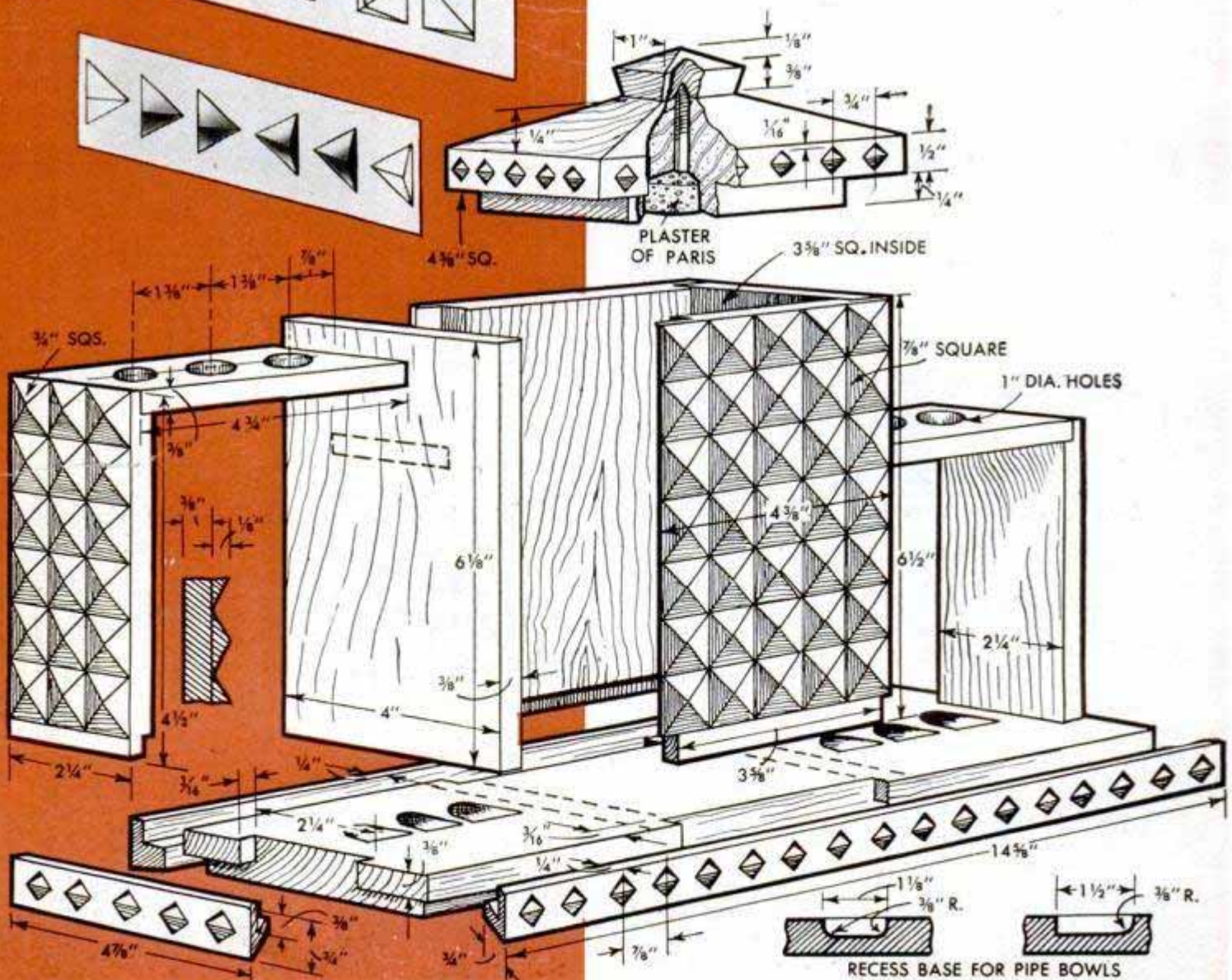

RECESS BASE FOR PIPE BOWLS

Alarm-Clock Spring Used in Scale for Chemicals

Useful to photographers, chemists and others who require accurate weighing of very small quantities, this sensitive scale is easily constructed from scrap materials. It is of the comparative type—that is, a known weight is placed on it and a reading taken. Then the material to be weighed is placed on the tray until it matches the reading. The sensitivity of the scale is shown by the fact that one grain will move the pointer from 1 to 2 in. when the arm is made from the balance-wheel spring of an alarm clock. For heavier work, larger springs may be used. The spring is crimped to allow the tray to be used in different positions. The tray is of lightweight

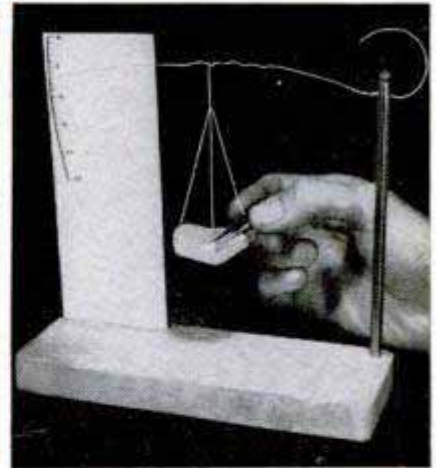
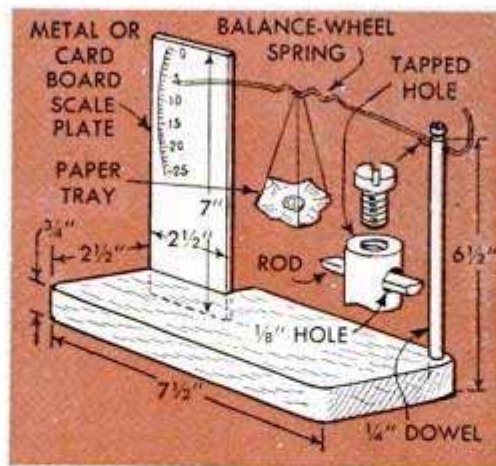

paper suspended by threads from the spring arm. A general curve is drawn on white cardboard or paper-faced metal, and this curve is calibrated as a scale. Divisions of any desired spacing may be used, but for accurate work they should be placed fairly close together.

Door Brace Made Easily From Pipe Strap

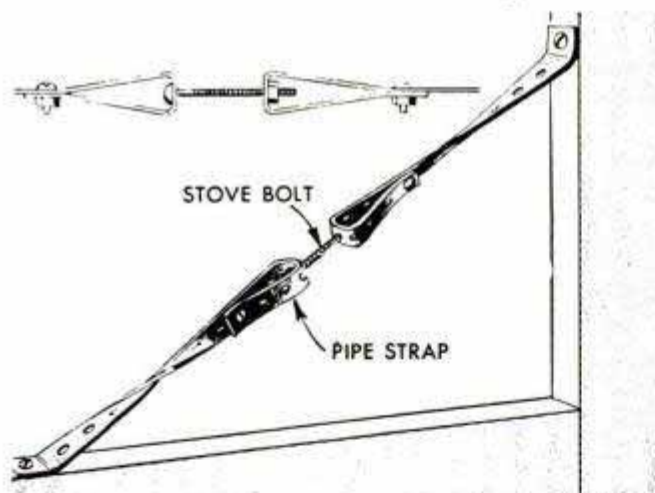

To eliminate sagging in a gate or large door, use a brace formed from pipe strap and several bolts. When cutting the pipe strap, be sure to allow enough extra length for forming "stirrups" at one end of each piece and for attaching the brace to the door or gate. Use pliers to bend the strap back on itself, allowing one of the jaws to square the end of the stirrup sufficiently to provide clearance for the bolt head or the nut, as the case may be. The ends are secured with 1/4-in. bolts. A 1/4-in. bolt, 1 1/2 in. long, is used for the adjusting bolt which, in use, is regulated with a screwdriver. Ends of the brace are screwed or bolted.

Graphite Mixed With Lighter Fluid For Out-of-the-Way Crevices

The problem of reaching inaccessible places for dry lubrication, which often proves difficult even with a pressure-type graphite gun, can be overcome by mixing the graphite with lighter fluid. This will allow the mixture to be flowed into hidden crevices where the liquid soon evaporates, leaving only a film of graphite. A clean fingernail-polish bottle will provide an ideal container for the mixture as well as furnish a handy applicator for the job. It's a good idea to shake the bottle before using the contents.—Ken Murray, Colon, Mich.

☞ To salvage putty that has become dry and hard, rub it through a screen and mix the resulting powder with linseed oil.



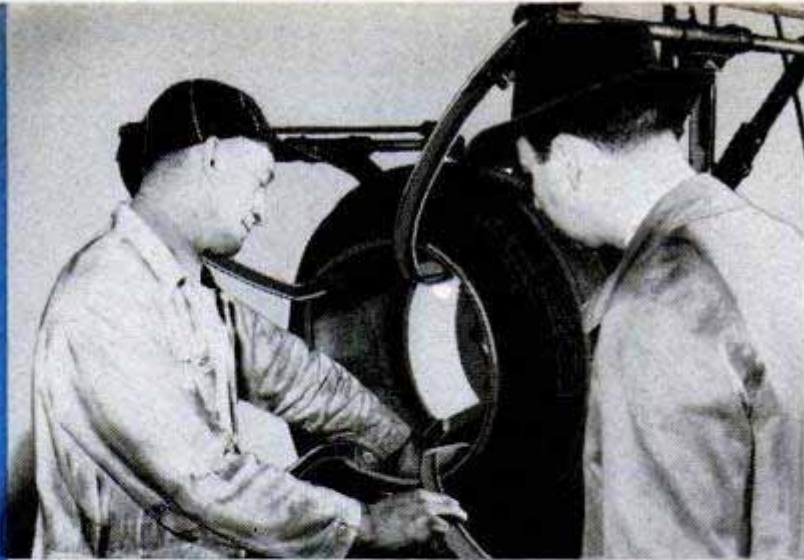
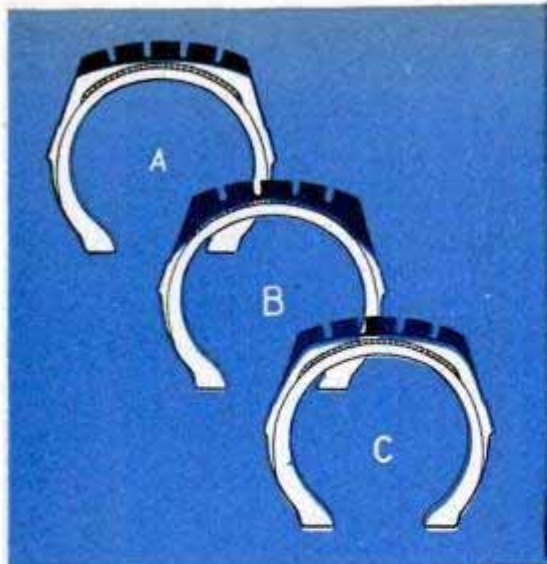

Above, the three types of new treads which may be put on a worn tire: Fig. A, the top-capped tire; Fig. B, showing tire fully recapped; Fig. C, retreaded tire

No retreading company will put on treads without thorough inspection. Here, spreader is used for inside inspection. Any casing break will reject tire

More Miles for Your Tires

By C. E. Packer

OF THE THREE big items of mileage expense—fuel, lubrication and tires—the latter is most often neglected by the economy-minded motorist as a means of reducing the cost per mile of driving. Actually, substantial savings can be had by taking care of tires during their normal life and by having them retreaded when they are worn smooth. They should be examined regularly for signs of undue wear, cracks, gouges and breaks, and any such damage should be repaired immediately. Special patches should be applied to small breaks and nail holes to prevent moisture from seeping into the cords, where it will cause interior rotting. Correct inflation has

much to do with the life of a tire. Low air pressure causes extreme flexing of the sidewalls, which will loosen the cords and cause separations between the cords and the outer rubber. A tire in this condition is beyond repair. It's a good habit to know what tires look like when properly inflated, and to check them by sight every time you buy gas. Screeching turns while driving and serious overloading of the car are responsible for bead separation, which also ruins a casing, and should be avoided. Finally, tires should be recapped as soon as the original tread is worn down. It is false economy to drive until the cords show through, for by then it may be too late to recap. But if recapped in time, a set of tires will give many more miles of safe service.

Pointer indicates bead separation which caused tire rejection. It may have been brought on by bad rims, poor mounting, overloading or hard driving on turns

Deep sidewall cracks, shown here, are result of old age and overexposure to weather and sun. This tire cannot be recapped because cracks extend into cords

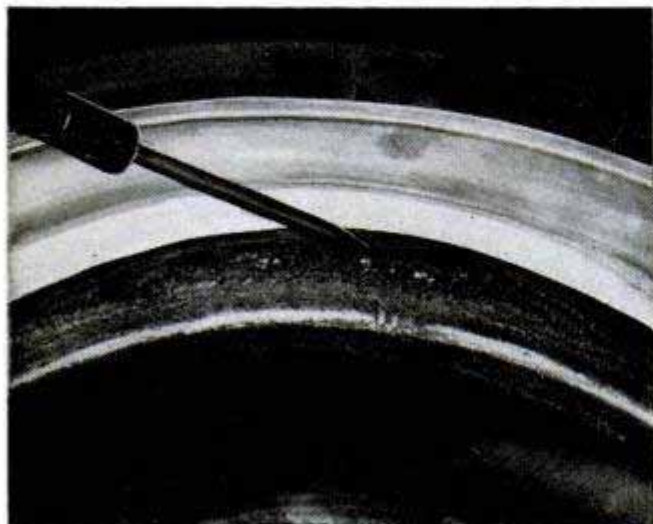

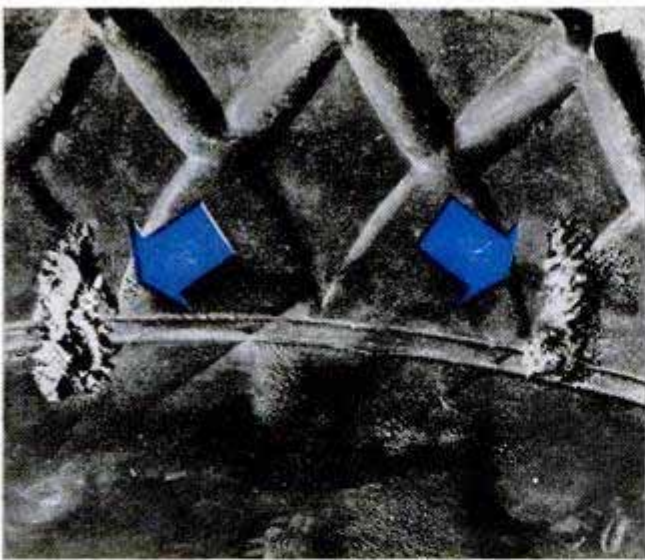

Gouges caused by tight snow chains or by striking curbs can be repaired with special patches. If they are not repaired, moisture will seep into the cords

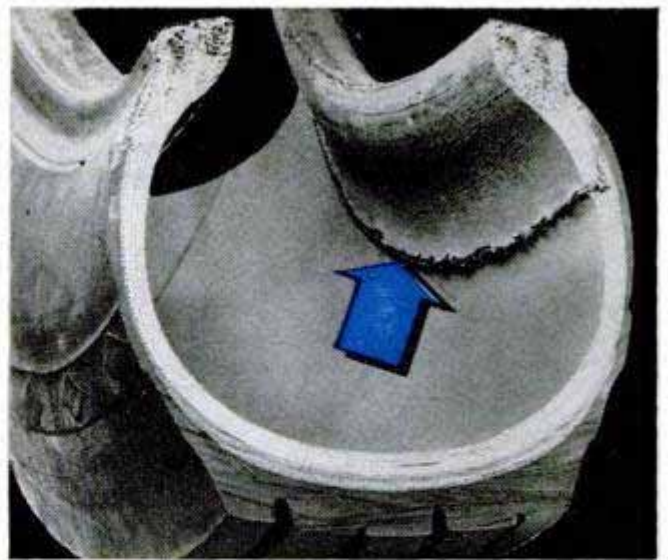

Broken cords resulting from overloading have ended the life of this light-truck casing. Money made by overloading was lost in rapid tire deterioration

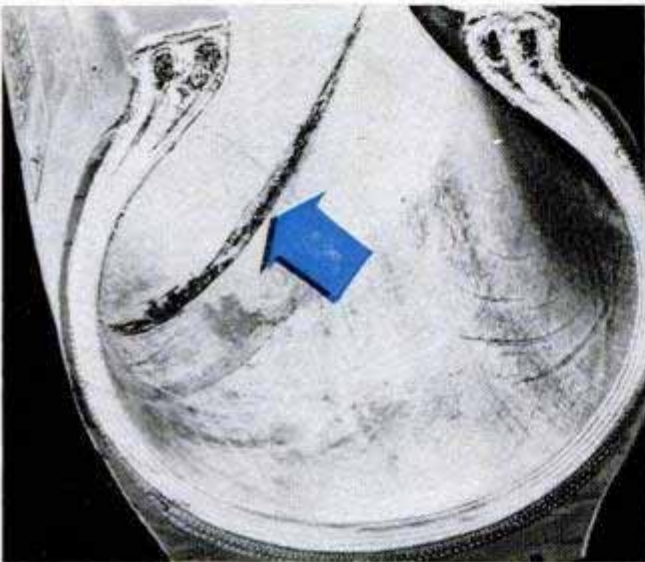

Damaged beyond repair by striking a bad hole in the street at too high a speed, this tire cannot be given a new tread. Slower, more cautious driving on rough streets can prevent casing breaks of this type

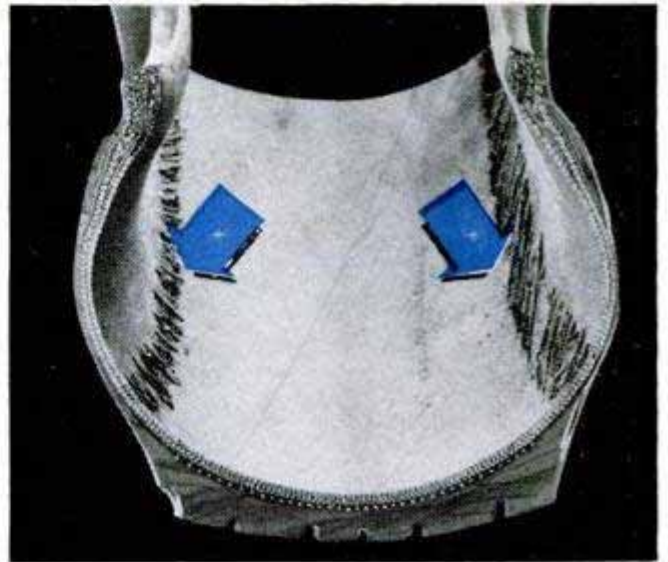

The owner of this tire forgot to check air pressure. The loosened cords in the sidewall are due to running for some distance with oversoft tires. Visual check of tires when buying gas will prevent this

A nail injury to tire casing is not serious and can be repaired. But if damage is neglected, it may lead to rotting of the cords by moisture or further tearing of the casing under adverse driving conditions

Nail hole pictured at left after being repaired with rubber carcass gum. Gum is also used to repair small gouges in exterior of casing, providing permanent repair. Special patches are used for larger cuts

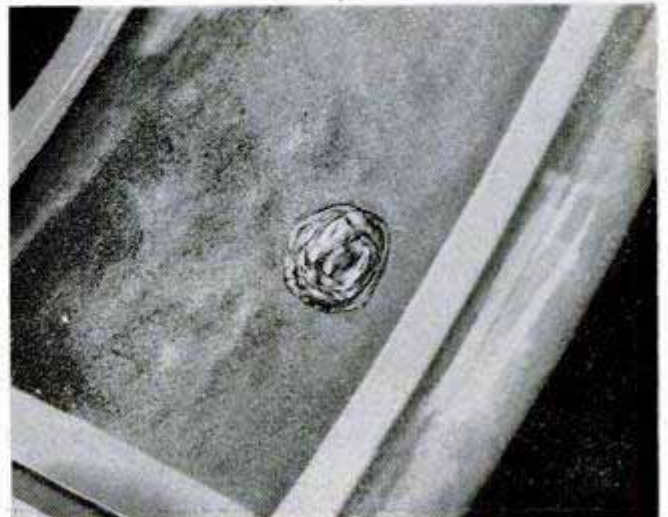
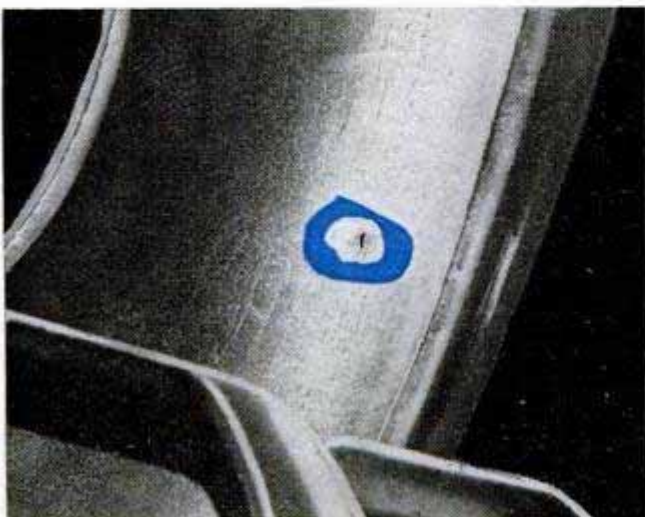



Prior to recapping, tire man removes all foreign matter from casing with a bradawl. Tacks and small nails which will eventually lead to punctures and slow leaks are frequently found embedded in casing



The outer surface of the casing is cleaned and roughened with a special rasp as the next step in the re-treading process. Careful preparation is essential for a job that will stand up satisfactorily in use

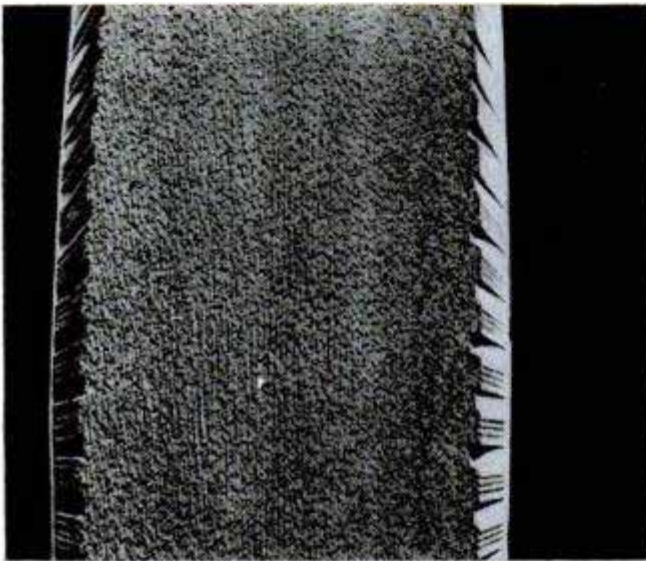

This photo shows the surface of a tire casing after it has been properly rasped and made ready for a coat of cement. With this job done correctly, the new tread will never tear away from the casing

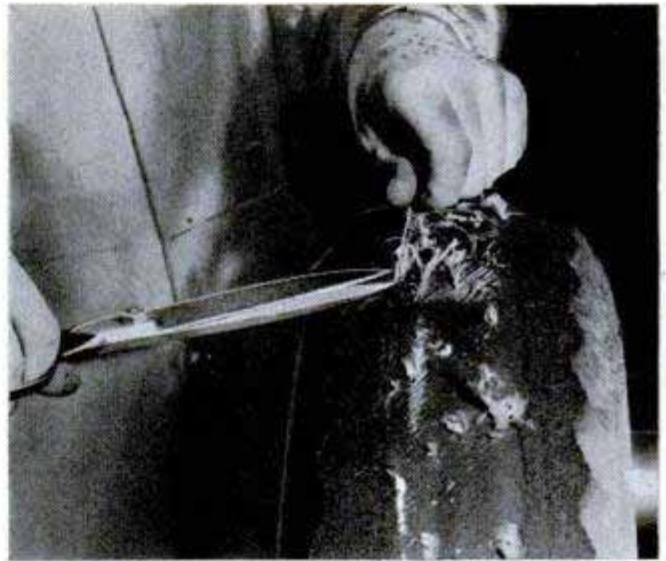

The owner of this tire drove it too far before deciding to recap. Some of the cords have been cut, but since they are only surface cords the tire may be saved. Deeper cutting would have ruined it

The rasped surface of the tire shown in the photo above is thoroughly coated with rubber cement, below, and strips of padding gum are applied to cover exposed cords. Successful recapping may now be done

The camelback or tread rubber is stitched down with a roller as it is applied to the prepared casing. Cement has been previously put on with a stippling action which works it down into roughened surface

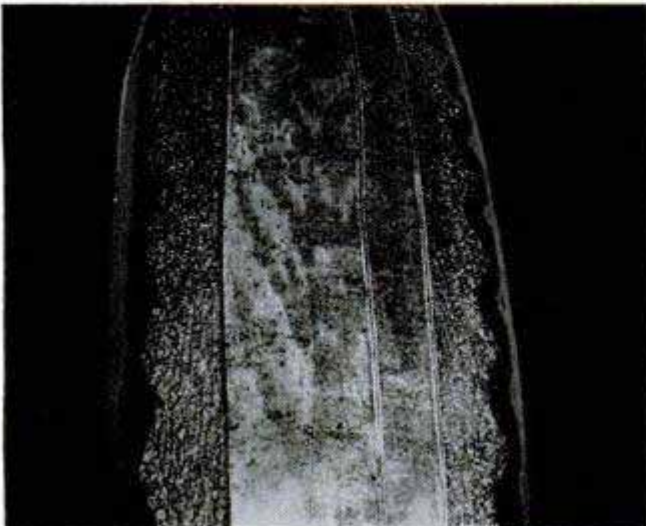

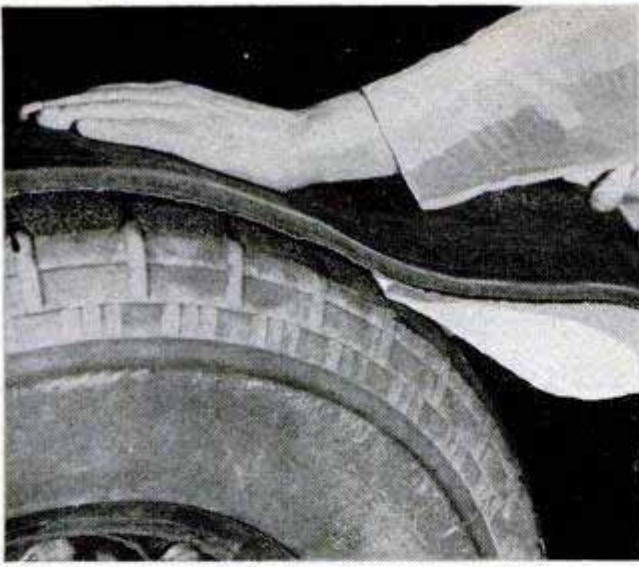

Camelback is carefully centered on casing since an off-center tread makes a lopsided, poor-wearing tire. Backing material is removed during application

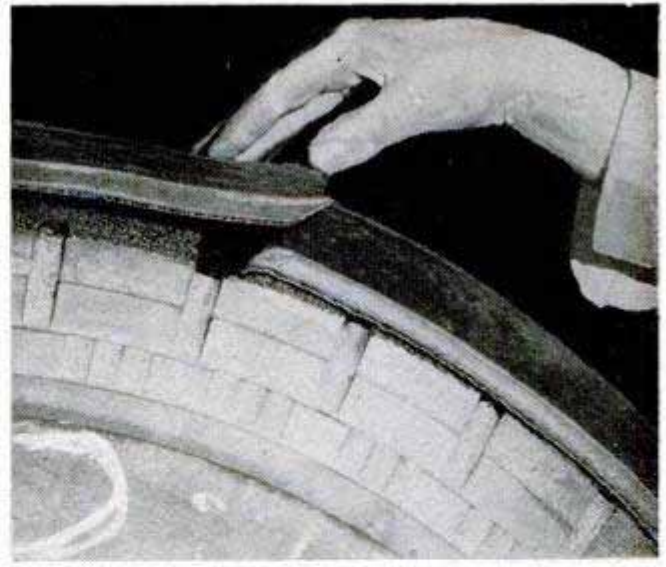

Beveled camelback is crowded into contact with starting end. The tread is kept tight, but is not stretched as it is applied. Cement bonds the ends

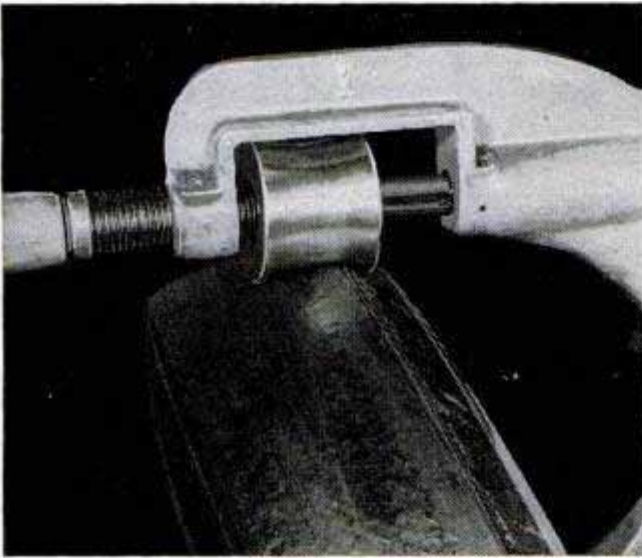

After camelback ends are spliced together, a smooth roller is used, first along the center and then on the edges, to bond the entire camelback so that it is smoothly in place on the casing. Curing is next



Prior to putting the casing in the mold, a vulcanizing inner tube is inserted in it. Care must be taken to see that the tube and the mold are the correct size for the tire. Otherwise buckling may occur

With a matrix to give the desired pattern to the tread, casing is carefully centered in the mold and clamped. Heat of the mold softens camelback rubber, while pressure is applied to force it into the matrix design

Fleet operators have found that a tire with a good casing can be recapped several times, and that the recapped tires match the service and performance of new casings. Operational costs thus can be cut sharply



Vent Holes in Reflector Help Cool Floodlights



When using photoflood lights for an extended period, you can lengthen the life of the bulb and prevent damage to the socket by providing the reflector with several

small vents to permit the escape of heat. This may be done effectively by drilling $\frac{1}{4}$ -in. holes around the neck of the reflector as shown.—Henry Truchelut, Atlanta, Ga.

Positive Connection for Flash Gun

Photographers who shoot a great deal of action with a flash gun either attached or removed from the camera, often lose that important shot because the flash-gun cord has accidentally become disconnected. You can prevent this trouble by allowing enough cord to reach the solenoid and then by tying a knot with the cord itself to some stationary part of the camera. In this way, the strain will come on the knot and not on the solenoid connection. Flash-gun cords tend to break at the solenoid when considerable off-the-camera flash work is done.

Robert C. Florian, Chicago.

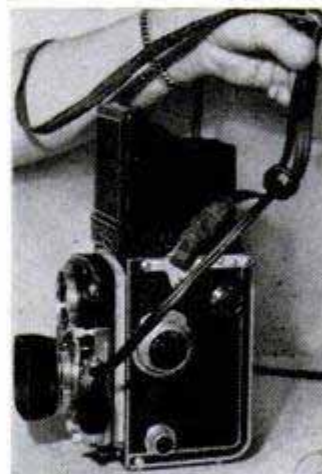

Popular Mechanics Bookshop

For Children of All Ages . . .

. . . there's exciting fun—and a real education—in *Mr. Wizard's Science Secrets*, a book by TV's famous Mr. Wizard, Don Herbert. In it he reveals more than 150 mystifying science experiments any child or adult can perform in his own home. There are no elaborate construction sets to buy—the only materials needed are everyday items found about the house. The amateur wizard can turn wine into water, pop popcorn with radiant energy, blow up a balloon inside a bottle, cause spectacular but entirely safe explosions, make his own home telegraph and telephone systems, cause water from a faucet to bend mysteriously. Here's a perfect gift for children of all ages, one that promises constructive entertainment for hours on end. The price is only \$3.00. Order from Popular Mechanics Press, 208 East Ontario St., Chicago 11.

For the Home Craftsman . . .

. . . there's a fascinating type of craftwork performed with the aid of the new "miniature home workshops." Portable electric tools, some of them so small they can be packed with two score attachments into a 12 x 16-in. box, can perform an amazing

variety of jobs, from grinding, sawing and routing to filing, carving and polishing. *Portable Electric Tools and How to Use Them* is the first, and authoritative, book on these miniature tools. If the master of the house already has a workshop full of man-sized power tools, he'll discover plenty of uses for these miniature precision instruments. And if he doesn't yet have room for a workshop, he'll learn how he can use a card table as a bench to turn out all but the most rugged types of work. Included in the book are numerous projects. Order now from Popular Mechanics Press, 208 East Ontario St., Chicago 11. The price is only \$2.00.

For the Hobbyist . . .

. . . there's a new craft technique that promises hours of enjoyment as well as substantial spare-time profits. It's called ornamental casting, and through it the hobbyist can cast practically any article in concrete, plaster, imitation marble or any other casting material. There are no expensive molds to buy, no high-priced materials. *Flexible Mold Making and Ornamental Casting* contains complete instructions, how-to-do-it photographs and copyrighted formulas. Order now for \$3.00 from Popular Mechanics Press, 208 East Ontario St., Chicago 11.

All books available from Popular Mechanics Book Department, 208 E. Ontario St., Chicago 11

Useful kinks for the CAMERA GADGET BAG

By M. G. Winterton

A PRACTICAL KINK for use with a camera gadget bag is to insert plastic panels inside the bag and outside pocket to protect photographic accessories and help maintain the bag's proper shape. Another idea, which eliminates opening the bag repeatedly, is to attach small zipper-type camera cases to the carrying-strap rings of the bag for filters, shades and other small accessories. Also, two straps sewed or riveted to the cover of the outside pocket will provide an ideal means for carrying a flash extension cord or a lightweight tripod. Leather wrist-watch straps are ideal for this purpose.

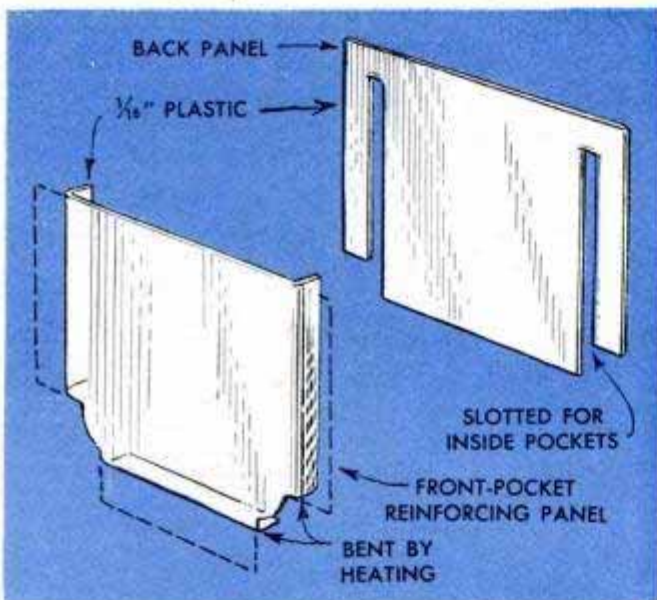

Above, panels are cut on jigsaw, after which front panel is heated in oven at 200 deg. F. for bending; below, camera cases attached to sides of gadget bag are handy for carrying frequently used accessories



Plastic panel inserted in outside pocket protects flash bulbs and prevents bending of flash reflector. Panel is heated in oven for bending it to fit pocket



Above, prongs of back panel are fitted into pockets inside gadget bag; below, wrist-watch straps sewed or riveted to cover of outside pocket are ideal for securing an extension cord or lightweight tripod



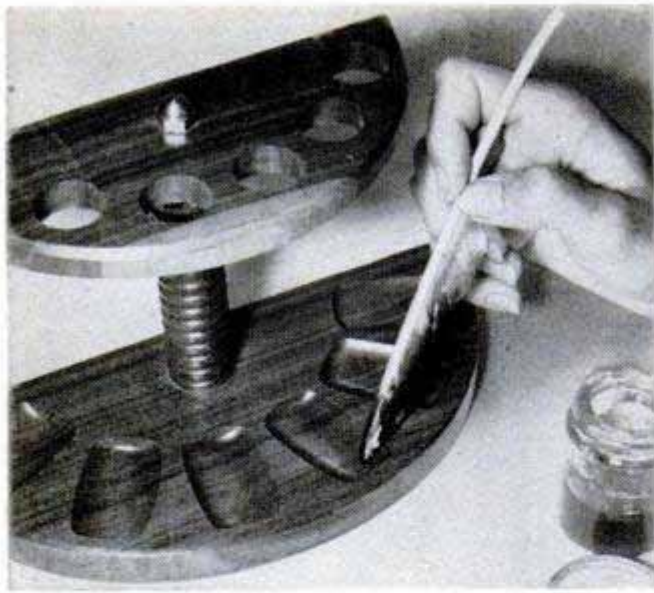

Touch-Up Brush From Feather

Ideal for getting into small cracks and corners, a quill feather is an excellent substitute for a small paintbrush when painting or varnishing small objects or touching up scarred furniture. The feather, a dozen or more of which may be obtained from the wing of a duck, not only holds paint or varnish well but will spread it evenly, rarely causing bubbles to form as frequently occurs when applying varnish. Furthermore, the feather can be cleaned and used over again if desired.

Don Shiner, Nescopeck, Pa.

Leather Squares Prevent Rolling Of Punch on Smooth Surface



To prevent round center punches from rolling when placed on a smooth surface, I cut square pieces of leather, punched holes in the center of each and forced them over the ends of the punches as

shown. If a thin piece of leather is not available, the squares may be cut from the sole of an old shoe.

Arthur Trauffer, Council Bluffs, Iowa.

Seat-Cover Shock Eliminated

The unpleasant electric shock which comes from static electricity built up on the surface of plastic seat covers in automobiles can be eliminated by grounding the seat covers. A simple method of doing this is to place four thicknesses of aluminum foil, such as can be purchased in a grocery store, between the seat cover and

the car cushion. On each side of the seat a piece of flexible lamp cord is attached to the foil and to the seat springs to ground the foil.—Doyce Pool, Plainview, Tex.

Repairing Loose Furniture Casters

If a caster fitted in a wooden leg of a piece of furniture has worked loose and frequently drops out, build up the sides of the hole with wood putty to secure it firmly in place once again. After removing



the caster, press a small quantity of the putty into the hole and clean away any excess. When the putty begins to set, grip the caster housing and twist the wheel a few times to free it for easy turning.

R. F. Donovan, Guttenberg, N. J.

Cup Stores Nails Under Shop Shelf

A common tin cup with a rolled lip can be used as a convenient drawer under a shop shelf in which to store nails, brads and other small parts. The lip slides in

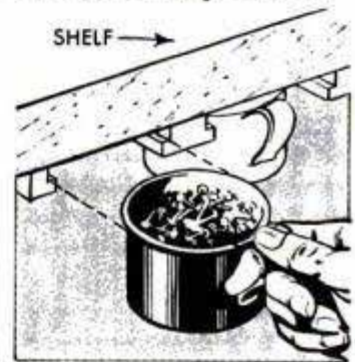

saw-slotted strips screwed to the underside of the shelf. The handle of the cup, facing out, is wide enough to be labeled to identify the contents of the cup.

Emergency "Stamp Pad" Provided By Typewriter Ribbon

If a stamp pad is not available, you may ink a rubber stamp for limited use on a typewriter ribbon. Simply place part of the ribbon on the roller as shown to provide a backing and then press the stamp against it several times.—John J. Rea, Urbana, Ill.



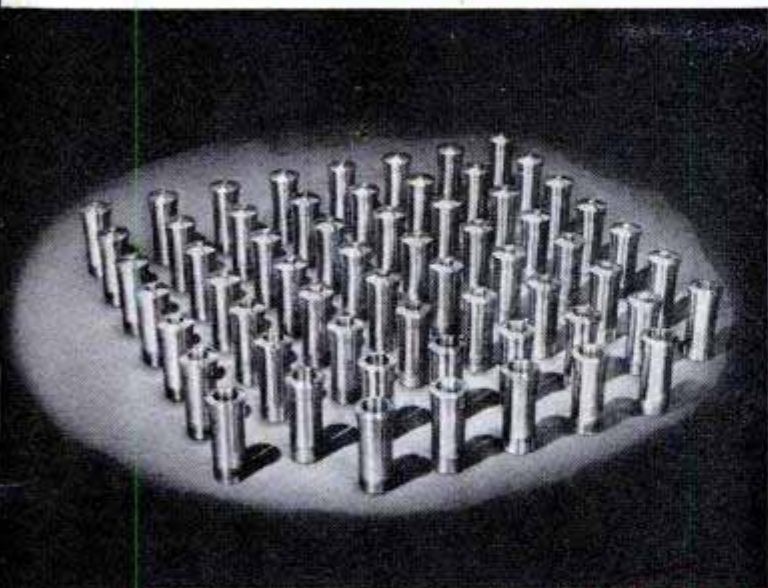

All photos courtesy South Bend Lathe Works

(SN 56)

COLLETS

for precision chucking

By E. R. Haan

ON SMALL lathe work where extremely close tolerances are required, collet chucks are not only more accurate than most types of larger chucks, but also are great timesavers. Common collets come in sizes ranging from $\frac{1}{16}$ -in. to 1-in. capacity, rising by $\frac{1}{64}$ in. or equivalent. They are furnished in fractional-inch, decimal-inch and metric sizes and are designed to hold round, square and hexagon-shaped work.

Assembly of parts: To set up a collet chuck of the draw-in type, first screw the nose cap onto the threaded end of the headstock spindle. Then insert the closing sleeve which projects inside the headstock spindle and accommodates the collet. To loosen the sleeve, back off the nose cap until it bears against the sleeve flange. A drawbar fitted with a handwheel extends through the headstock spindle and its tapped inner end screws onto the threaded end of the collet. Contacting surfaces of these parts should be free from chips, dust and excess oil to assure maximum accuracy. Turning the drawbar handwheel tightens or loosens the collet, the tapered, slotted head of which grips the work when it is drawn into the closing sleeve. It is important to select the proper-size collet for a job. Never use one that has a designated size of more than .005 in. smaller or larger than the diameter of the work.

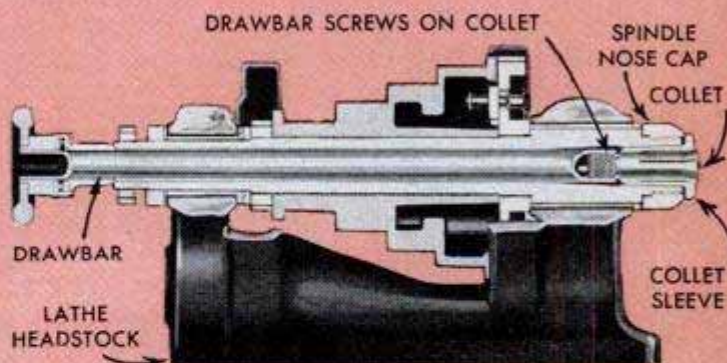
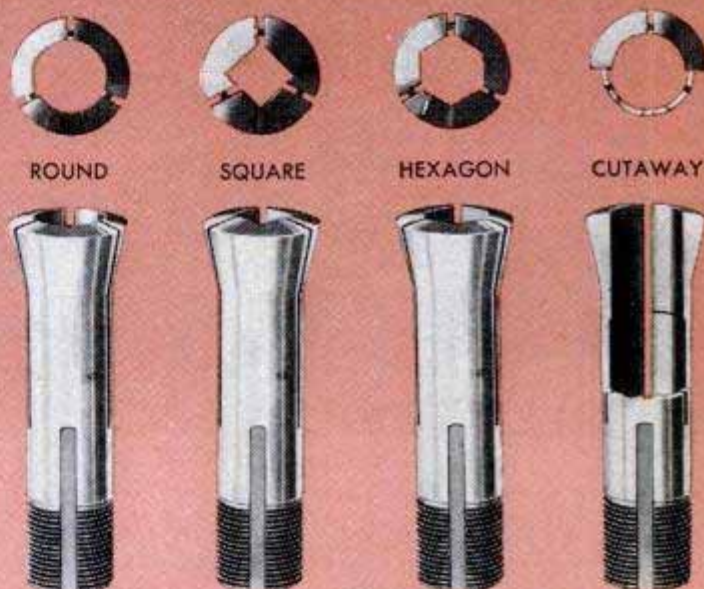
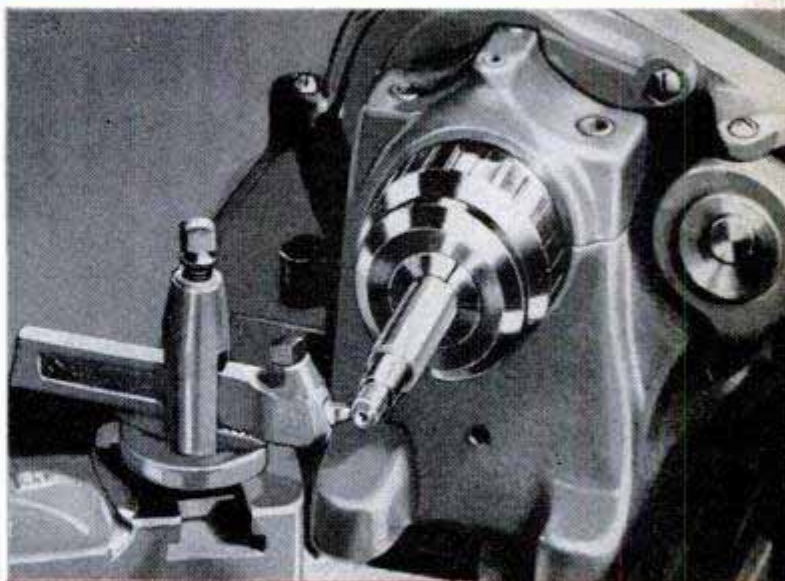

ASSEMBLY OF COLLET AND ACCESSORIES

Feeding stock for repeat operations: As the drawbar and collet are hollow, long stock can be fed through from outside the lathe headstock to the working position. The stock extending beyond the spindle always should be supported at the height of the spindle to prevent it from whipping. After the work has been machined and cut

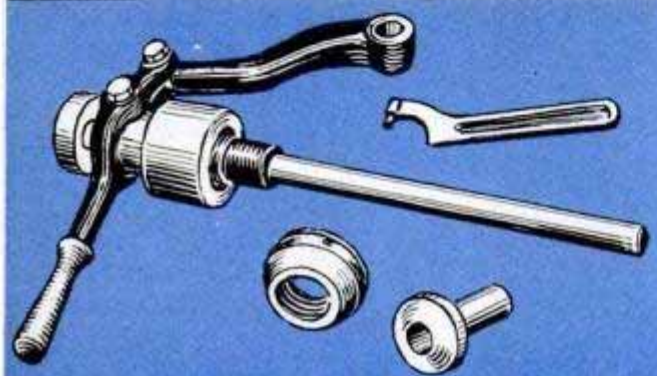
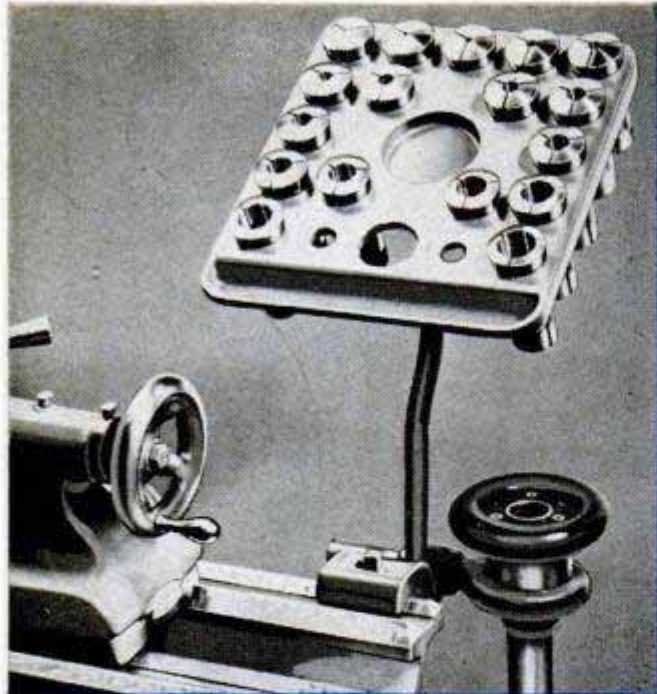

HAND-LEVER, DRAW-IN COLLET CHUCK

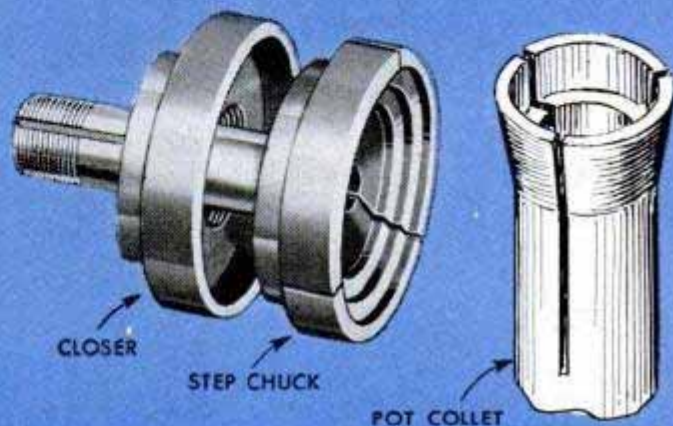

These lathe accessories enable the operator to handle lathe jobs requiring toolroom precision. Always keep valuable collets in a holder or specially designed box to prevent damage. Never store in drawers

off, the collet is loosened, the stock advanced and the collet retightened for the repeat operation. Although collets usually are made of steel, precision-ground, then hardened and tempered, you also can buy brass collets which have many practical applications. They can be machined readily for holding tapered or irregularly shaped work and cost less than steel collets, making them ideal for odd sizes that are used only occasionally.

Precautions for accuracy: To assure accuracy of chucking in collets, the stock must be of uniform size, free from mars and other surface imperfections that may affect the diameter and also free of chips and dirt. The collet and drawbar should be kept clean and free from oil. Don't tighten collets more than necessary to prevent the work from slipping while it is being machined in the lathe.

Collet storage: Where collets of various sizes are used daily, keep them at hand near the lathe on a rack of the type shown above. This can be obtained from the lathe manufacturer, or you can make one of hardwood. If collets are used only occasion-

ally, keep them protected from dirt and contact with other tools by storing them in a tight, strongly made hardwood box where the collets fit into marked wells for instant selection. Don't store collets in a drawer or box, or in contact with other tools, as scratches and mars destroy their accuracy.

Variations of collets: For increased production speed, you can make use of a hand-lever type of collet drawbar, Fig. 7, which permits opening and closing the collets without the need of stopping the lathe. A pot collet varies from a regular collet in that it is counterbored to form an inside shoulder that limits the depth to which short work can be inserted.

For holding disks, gear blanks and other narrow work, a step chuck and closer is a useful lathe accessory. It operates basically like a collet, the step chuck being slotted and forced shut when it is drawn into a tapered cup that acts in the same manner as the closing sleeve on a collet. Step chucks are made to order in various sizes in capacities from 2 to 6 in. They generally are supplied with a blank head which is machined by the user to suit the work.

Sliding Shield Protects Glass In Carpenter's Level

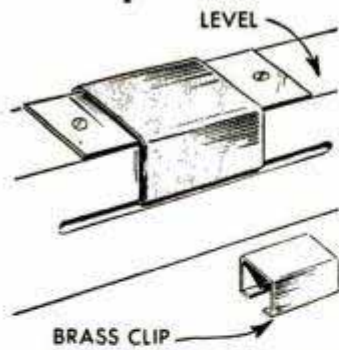

A good way to protect a glass in a carpenter's level against possible breakage when not in use is to fit a sliding shield over it. This can be shaped from a piece of thin brass.

The sides of the level should be grooved to provide a track for the shield. If spring brass is available, the shield should be made from this as it will better grip the sides of the level.

J. L. McClay, Pasadena, Calif.



Adjustable Stool for Mechanic From Jack and Brake Drum

To provide himself with an adjustable work stool for use while servicing car brakes, one mechanic welded a screw-type jack to a discarded brake drum and fitted the seat of a piano stool into the top of the jack. Adjustments in height are made easily by hand.—L. H. Houck, Jefferson City, Mo.

Farm-Machine Parts Assembled To Provide Small Concrete Mixer

Built from discarded farm-machine parts, an oil drum and steel angles and channels, this concrete mixer has several unusual features. The frame is constructed with one open end so that the unit can straddle a foundation form. Each fresh mix can be poured from the mixer directly into the form without a second handling of the material. Then the unit is moved to a new position over the form and the procedure repeated. The tilting frame which supports the drum and its driving mechanism is made by welding steel channels together to form the U-shape. A bevel gear and pinion taken from an elevator jack provide the reduction gear. This is driven through a salvaged chain and sprockets from a large flat-faced pulley mounted on a short shaft at one side of the frame. Use a small gasoline engine or electric motor to drive the unit.



Board Aids Cutting of Card Stock

One artist who had to make small price tags for various departments of a large store made this portable board to cut the cards as required. It consists of a hardwood board to which is attached a steel-edge ruler. Spacers are used at each end of the ruler to raise it above the board to permit insertion of the card stock. When mounted in this way the ruler provides a metal edge for guiding a razor to cut the stock.

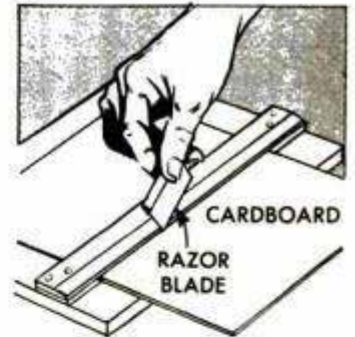

Improvised Plumber's Snake Fits Small Traps

A very flexible snake for cleaning small sink and lavatory traps can be made from the springs of two discarded window-shade rollers. Screw the ends of the springs together and solder them to make one 31-in. section. In one end of this section solder a piece of 1/4-in. rod to form a bit. When rotated in a hand drill, this snake can be worked well into the pipe.

T. K. Hastings, Los Angeles, Calif.

Fitting Nipples Into an Air Hose

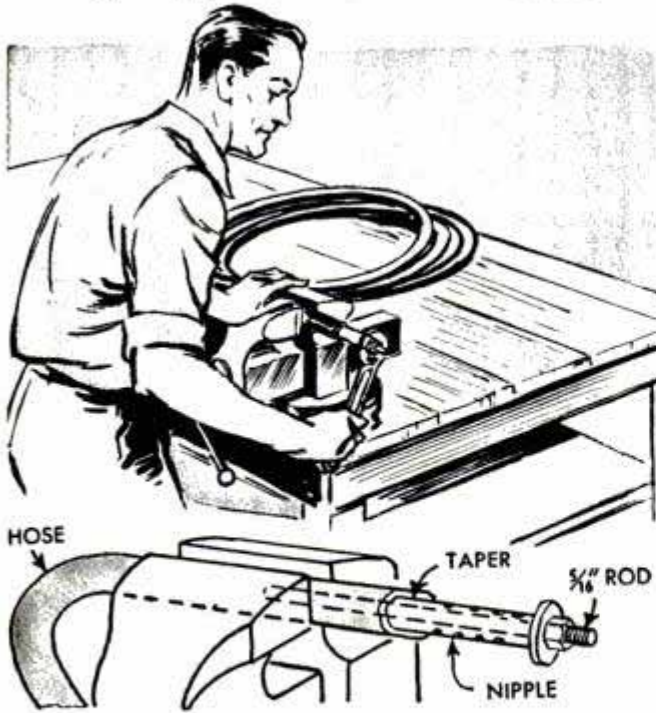

Because of the tight fit required, the task of fitting nipples into the end of a compressed-air hose often can be difficult. A rig to ease this job can be made from a threaded rod 10 in. longer than the nipple, and a nut and washer. The rod is threaded for half its length and inserted in the nipple, which has been ground to a taper on its entering end. The hose is placed in a vise with a little more than the nipple's length projecting from the jaws. The rod and nipple assembly is inserted in the hose so that the tapered end of the nipple is started into the hose. The vise jaws are tightened on the rod and a small wrench used to tighten the nut. As the nut tightens, it forces the nipple into the hose. A small clamp around the joint finishes the job.

H. B. McDermid, Norwood, Ohio.

Angle Irons Lengthen Vise Jaws

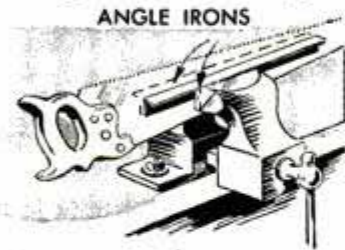

If you use a common bench vise to hold handsaws for filing, you can eliminate much adjusting of the vise to move the saw back and forth

by lengthening the jaws. Two lengths of angle iron placed in the vise as shown will increase the length of the vise jaws for this purpose.

Easy Method of Cross Hatching

When an artist or draftsman finds it necessary to cross hatch, the job may be simplified by inscribing a dotted line on a transparent angle, 1/8 in. in from the longest

side. Draw the first hatch line as usual on the work, then slide the angle over and align the inscribed line with the first hatch line to draw the second hatch line.

Leonard Lundberg, Marquette, Mich.

Predrilled Nut Protects Threads When Drilling Hole in Bolt

One mechanic having a number of bolts to drill to take cotter keys used a guide made from a nut and clamped it in a vise to help speed up



the work. The nut was drilled transversely, using a slightly larger drill than the one used for the holes in the bolts. In this way, the nut not only served as a drill guide, but also permitted the bolts to be held in the vise without damaging the threads.

Lathe Tool for Internal Slotting Is Used as Boring Bar

Originally designed to cut internal slots for grease seals, this lathe tool has since proven useful for other jobs, such as undercutting at the end of an internal thread or flush with the bottom of a blind hole. While the tool can be used frequently to do the work of a boring bar, it has two advantages over the latter, one being a lesser tendency to chatter, and the other its usefulness in starting a cut in a small hole. A 3/16-in. standard blank of high-speed steel was hand-ground to make the tool as detailed, the designated rake being intended only for cross-feeding. However, the tool can be made suitable for horizontal feeding, if desired, by grinding off the necessary rake angle.

Harry L. Truchelut, Atlanta, Ga.

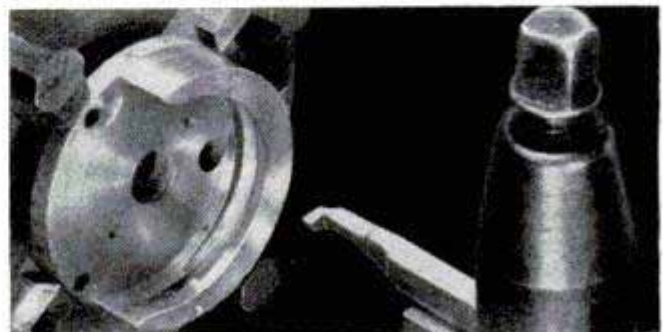
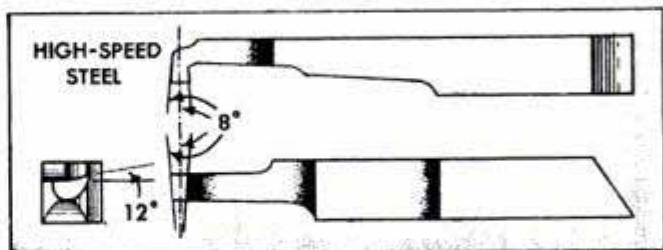

ADD A SHAPER

To Your Lathe

By R. Kielsmeier

FOR A FEW cents, plus some scrap lumber, you can add a practical shaper attachment to your lathe and thus equip your shop for decorating table and chair legs, fluting, beading and making ornamental moldings. The only cash outlay needed to build the attachment is for the floor flange which holds the shaper in the tool-rest holder. The base and back are made of $\frac{3}{4}$ -in. plywood, while the blocks on which the work rests are $\frac{1}{2}$ x 2 x $7\frac{3}{4}$ -in. hardwood. One of these blocks is split diagonally so it can be adjusted to compensate for full-width cuts that are made with a straight-face shaper cutter. Index marks are scribed along the junction line of the two halves of this block. At the time this is done, the left and right-hand blocks must be in perfect level alignment. Once the assembly is mounted on the tool-rest holder, the base is checked for alignment with the arbor. If the alignment is not true, shims are inserted between the floor flange and the base. Several holding blocks are made, as indicated in the detail, and clamped against the backboard to hold the work in position while shaping.

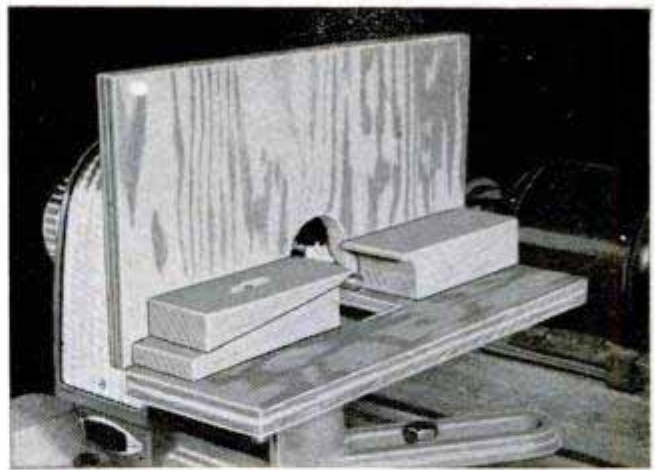

The completed shaper on the lathe and ready to go to work. Note that a shim is inserted under left block to compensate for saw cut when block is split

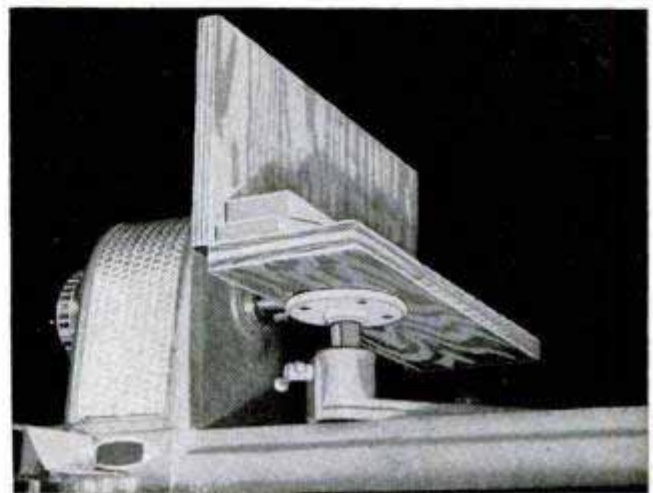

Diameter of floor flange and of pipe which threads into it depends on the size of the tool-rest holder

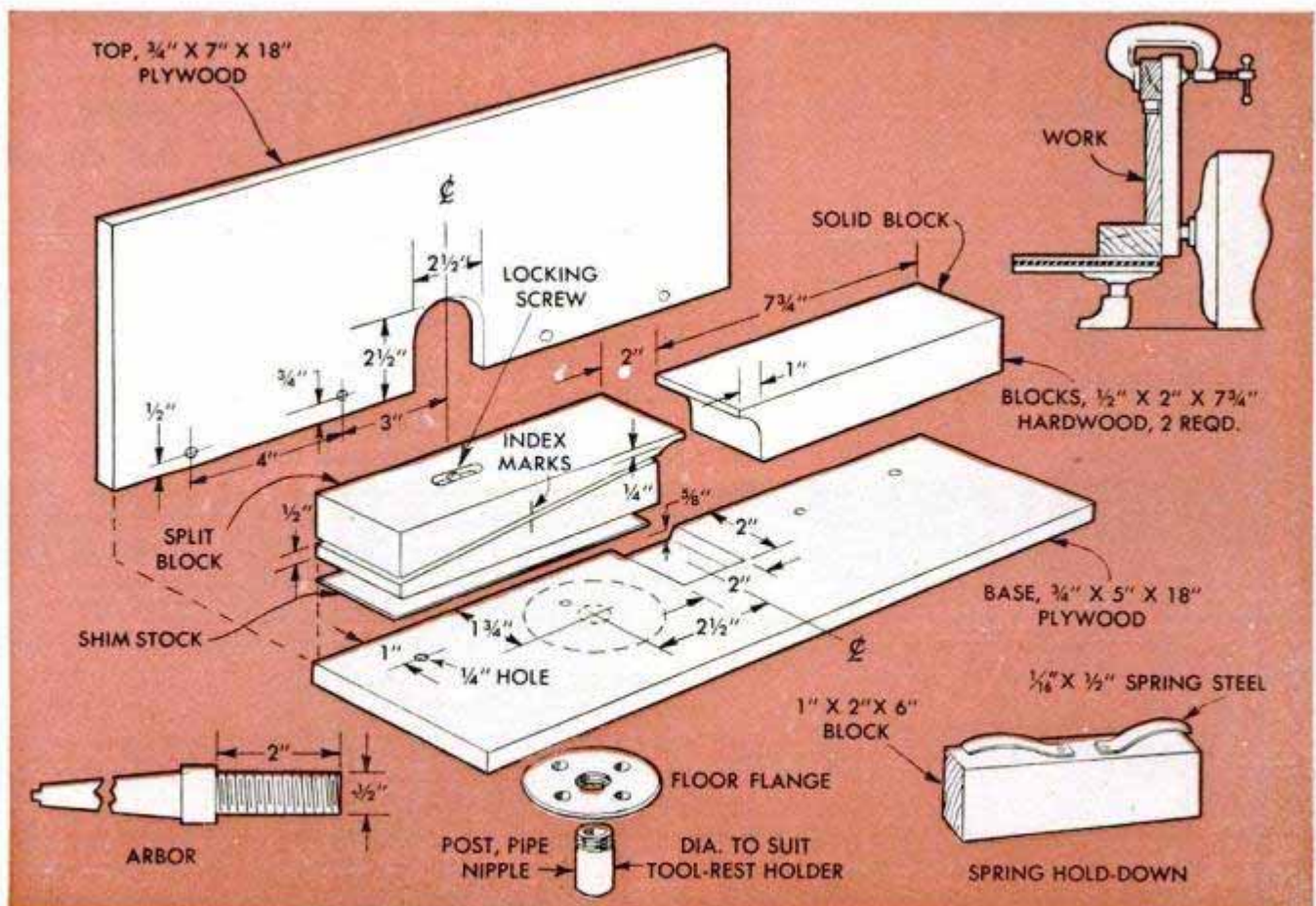

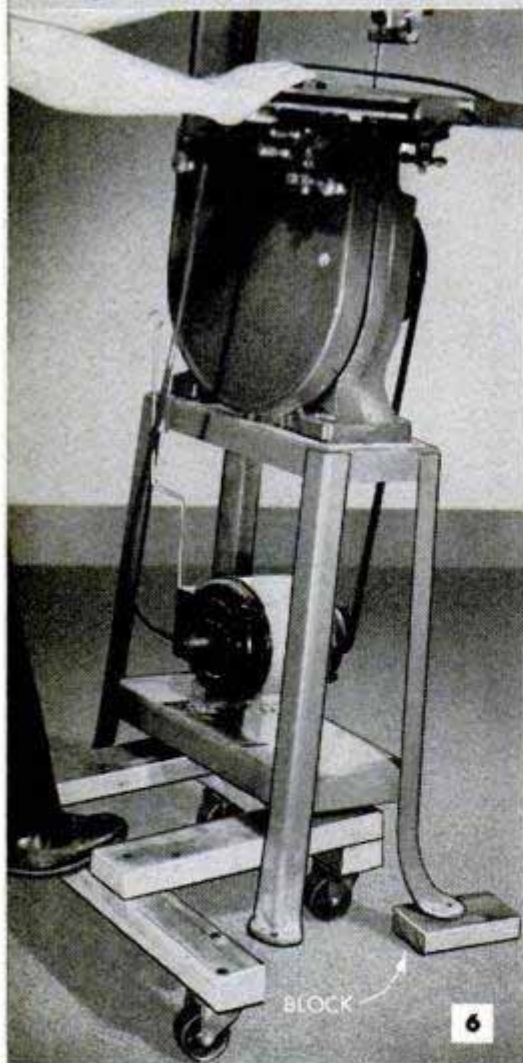
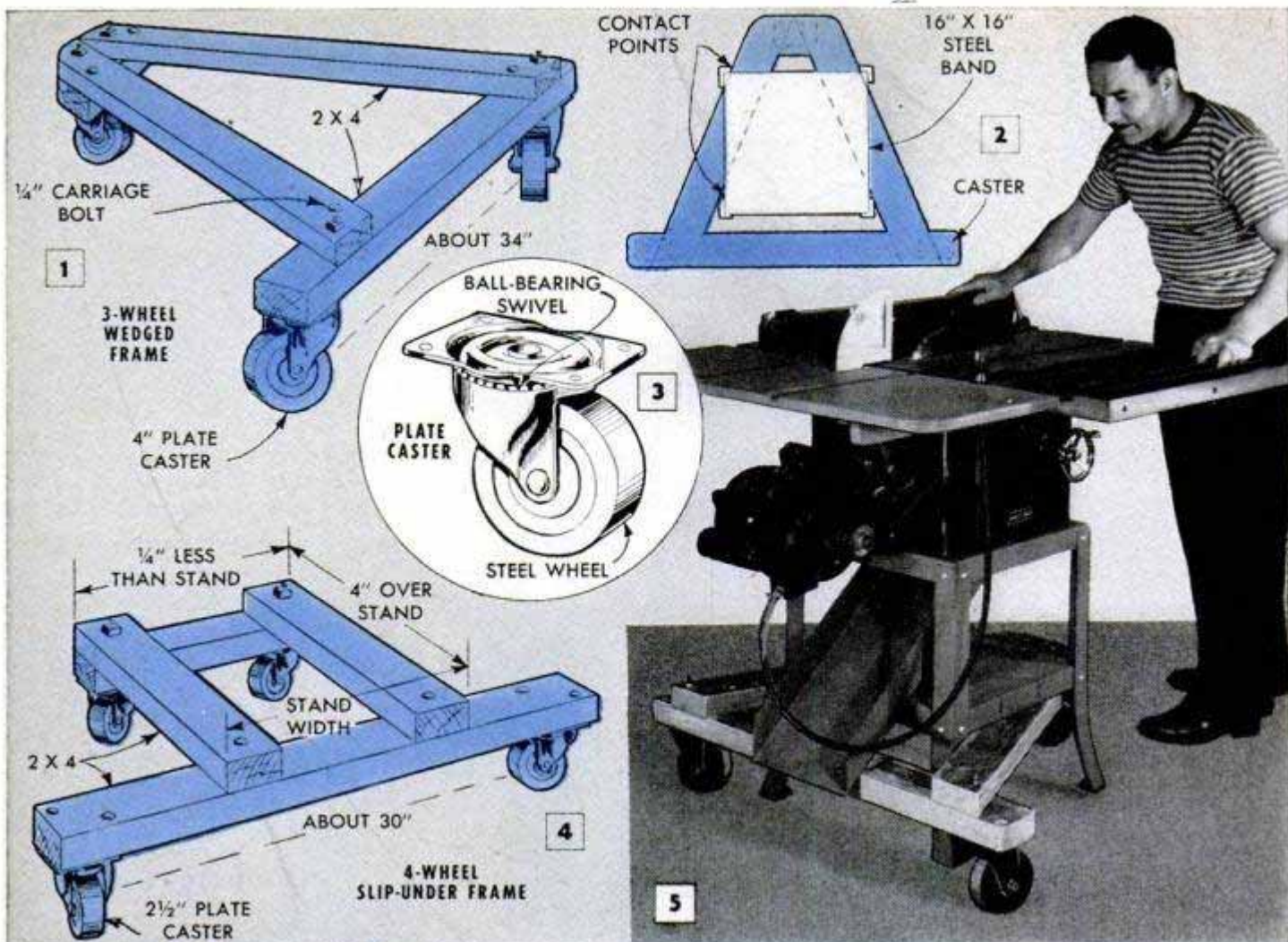

Wheels for your POWER TOOLS

By Sam Brown

FEW HOME SHOPS are big enough to provide ample work area for several power tools. When the space is limited, such machines as the bandsaw, shaper and circular saw must be moved to accommodate long stock. At best this is a difficult job and may result in damage to the machine and also the shop floor. A dolly fitted with three or four swiveling casters enables the operator to move the machine to the required position with a minimum of time and effort. Caster wheels of the types shown should be at least 2 in. in dia. and, better, 2½ or 3 in. If your shop floor is concrete and rough in spots, nothing less than 3 or 3½-in. wheels should be used in order to permit easy rolling, Fig. 9. The best wheel for a concrete floor is a steel wheel having a rubber or laminated-leather tire, such as is used in the installation shown in Fig. 5. Plain steel wheels are a good second choice although they are noisy on rough concrete. Plastic and composition wheels are satisfactory only if the floor is fairly smooth.

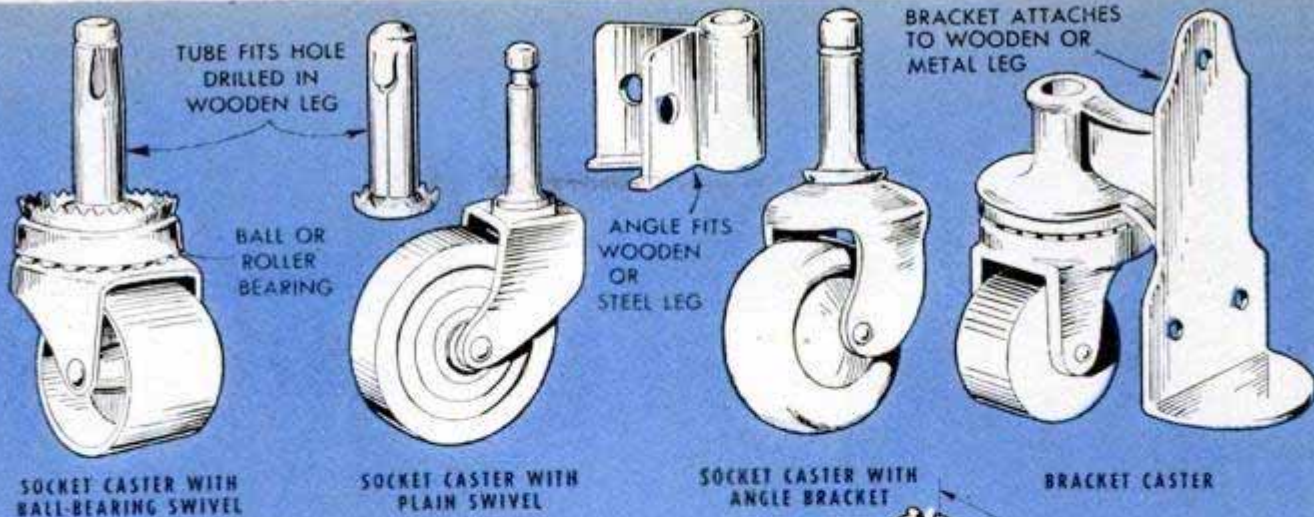

SOCKET CASTER WITH BALL-BEARING SWIVEL

SOCKET CASTER WITH PLAIN SWIVEL

SOCKET CASTER WITH ANGLE BRACKET

BRACKET CASTER

7

Casters for making power-tool dollies are available in a variety of styles and sizes. The average wheel size should be 3 in. for use on fairly smooth concrete floors. The retractable caster shown at the right is furnished as a unit having flat-faced brackets for bolting to any vertical surface

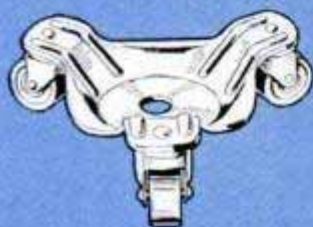

STOVE TRUCK CASTER

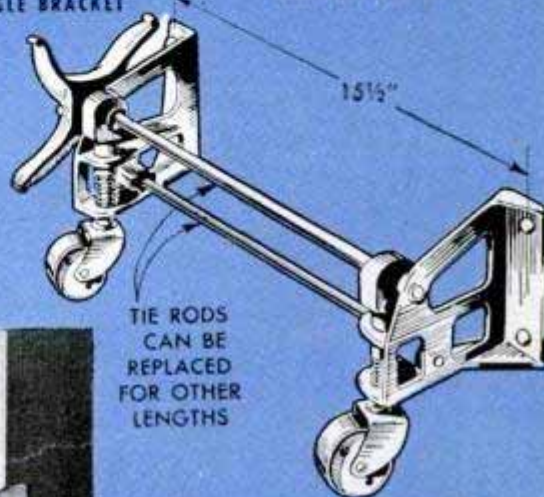

RETRACTABLE CASTER

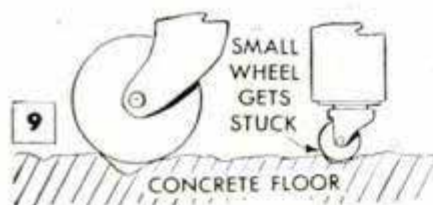

9



8

Probably the most useful style of wheel for a power-tool dolly is the plate caster, Fig. 3. This is available with wheels from 2 to 6 in. in dia. When the tool is mounted on a steel floor stand, the usual installation is to make a wooden framework which will fit under the lower shelf of the stand. The casters are then bolted to the framework. A typical installation, shown in Fig. 5, is made from 2 x 4-in. stock wedged between the legs of the stand as in Fig. 2. It must be fitted in place for assembly and cannot be removed without disassembling one side. The 4-in. wheels, Fig. 1, raise the stand legs about 1 in. above the floor when used under the 2 x 4-in. framework on the stand pictured. Some dollies made in this manner may require blocking to raise the stand or half-lapping of the frame to lower the stand to get the desired lift of $\frac{3}{4}$ or 1 in. above the floor.

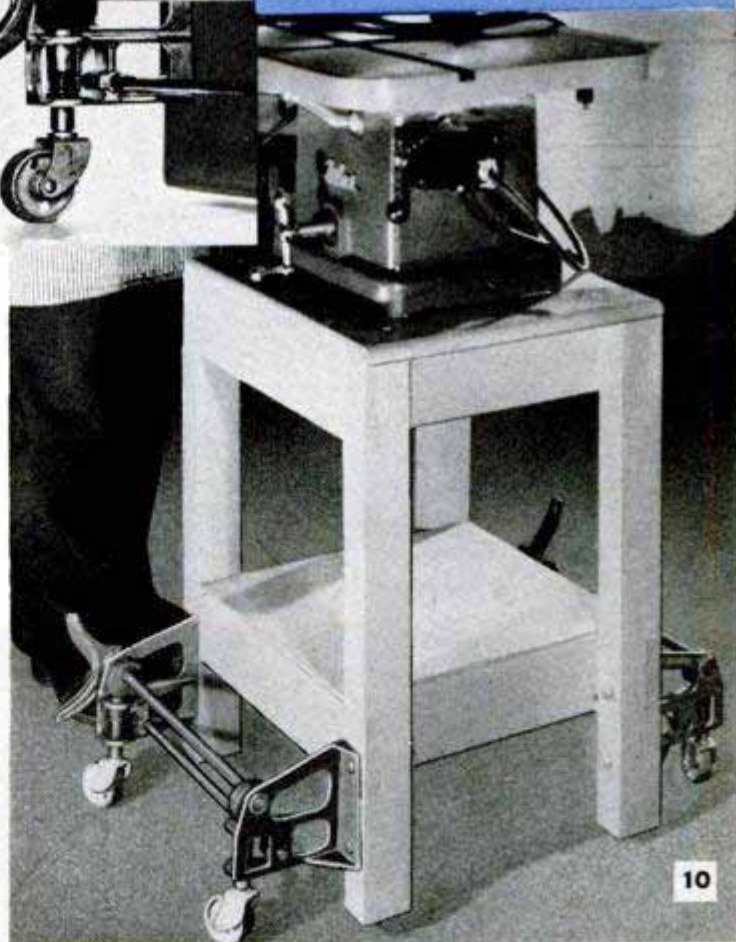

10

Although the retractable-caster units are best to use on a bench which permits attaching them inside the legs, they can be mounted on the outside of the legs as shown above

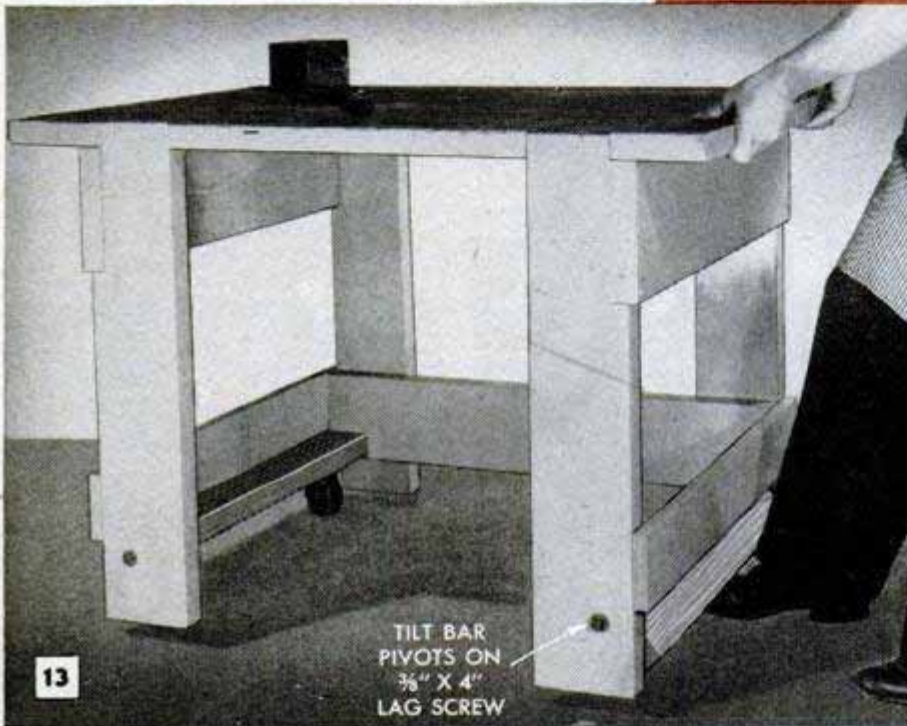
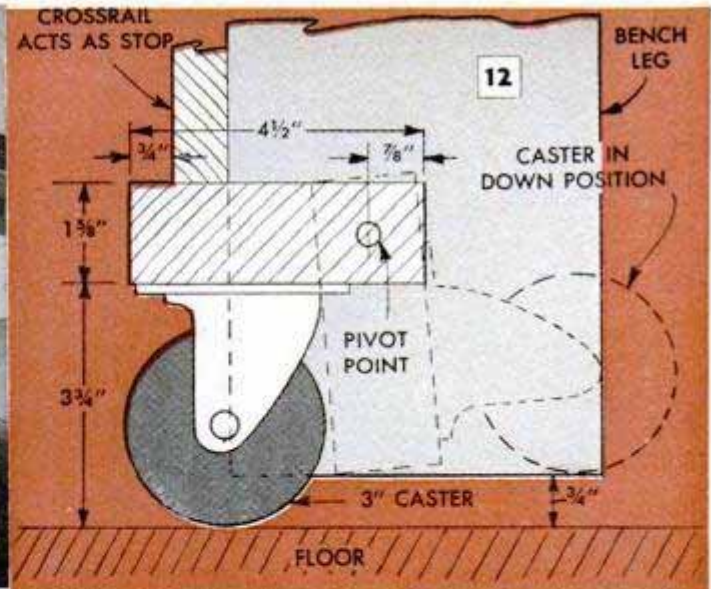
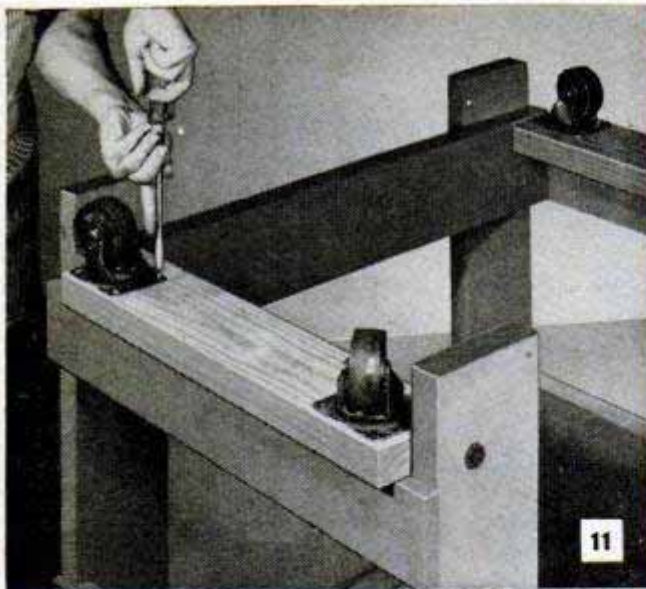

Simple retractable caster mounting can be made by pivoting a tilting bar between the legs of the machine stand. Casters are tilted to down position with foot

the casters inside the bench legs. However, an outside mounting, shown in Fig. 10, is quite satisfactory. This unit has an up-and-down movement of about $\frac{1}{2}$ in. and is operated by a treadle, Fig. 8. Socket casters, Fig. 7, are the easiest to fit when you want to fit wheels directly to the legs of a wooden stand. The angle-bracket caster is especially suitable for plain angle-steel stands. The bracket caster is a useful mounting for

A slip-under style of stand is shown in Figs. 4 and 6. This can be dimensioned to serve a number of tools. The unit is readily slipped under the machine after first blocking up the rear legs with blocks a little thicker than the distance the caster unit raises the legs above the floor, Fig. 6. It will be noted that in both of these units the machine rests on the wheels at all times. The legs do not touch the floor. This is a practical mounting when used on an average concrete floor as the machine will not roll under normal operating conditions. On a smooth floor, the two units shown operate satisfactorily with two wheels only, substituting plain raising blocks for the other caster or casters. In a two-wheel installation, the machine must be tilted wheelbarrow-wise to move.

Retractable casters, Figs. 7, 8 and 10, make good installations for any light power tool. The best installation of this unit is on a long bench, since this permits fitting

attaching to existing legs without increasing the height of the installation. Normally, wooden or angle-steel legs can be sawed off to compensate for added lift of the casters.

For larger machine stands or a small wooden bench, the simple tilt-bar type of retractable mounting, Figs. 11, 12 and 13, is satisfactory. The unit shown uses four 3-in. plate casters fitted to the underside of a tilting bar pivoted on lag screws. To set the wheel position, the end of the bench is raised slightly, Fig. 13, and the tilt bar is moved in or out with the foot. Two casters only can be used if desired, making a wheelbarrow-type unit which is readily wheeled to any location. ★ ★ ★

☞ When painting your home early in the morning, work on the east side first, and then on the other sides. The sun will quickly evaporate any moisture left on the east wall long before the other walls are free of moisture.

Loop Anchors Chalk Line

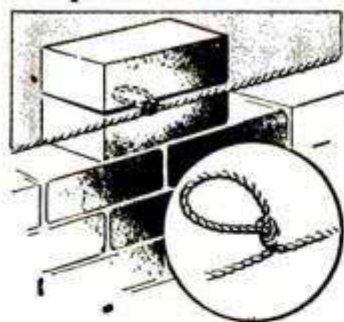

To keep his chalk line from sagging or from vibrating in a high wind when stretched across a long span of wall, one bricklayer ties a loop in the center of the line. This loop, an inch or

more in diameter, is then anchored between two loose bricks as shown in the drawing.

Drill Rack Supports Round Work For Boring Lengthwise



When drilling the end of wood, plastic or metal round stock, the problem of holding the stock firmly in a vertical position can be solved by inserting it in one of the holes in a

drill rack, using a hole that takes the work with a snug fit. With the rack on the drill press, the stock can be drilled, countersunk or tapped with reasonable accuracy.

Paul Fryar, Long Beach, Calif.

Wire Splices Soldered Quickly By Altering Tip of Iron

The soldering of wire splices can be accomplished more quickly if the tip of an electric soldering iron is altered slightly. First, remove the tip from the element housing by loosening the setscrew and then file or grind a deep groove near the blunt end similar to the one shown. After cleaning the tip of any solder or flux remaining from previous usage, insert the tip end in the housing and tighten the setscrew. Now heat the iron and lay the splice in the groove when ready to solder.

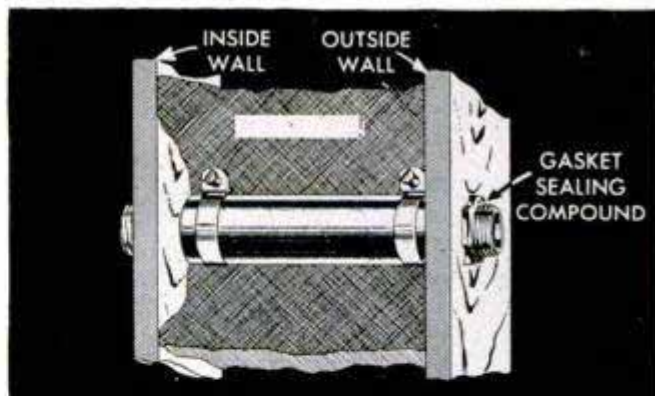

Sealed Refrigerator-Wall Duct

Condensation frequently forms on metallic pipe used as a duct for refrigeration tubing and electric wiring through the wall of a walk-in refrigerator. This moisture may rust the pipe or seep into the insulation, causing rotting and other damage. A duct made from a length of car-radiator hose and two pipe nipples will prevent this condensation. In making the installation, a pipe nipple with an inner locking nut is inserted outward through a hole in the outside wall. Calking compound is placed around the nipple on the outside and then a locking nut is tightened through the compound, making a leakproof joint. After the inner wall is erected, a locknut is screwed on the inside pipe nipple to hold the hose more firmly. With the tubing or wiring in place, ends of the duct are sealed with mastic and exposed parts are coated with aluminum paint.—Paul E. James and Chester P. Davis, Jr., Washington, D. C.

Preventing Clogged Spray Gun

If you have had a spray gun become clogged between application of lacquer coats, here is an idea you will appreciate. One amateur painter, experiencing this difficulty with a spray gun having a screw-type canister, solved the problem by using two canisters. Lacquer is kept in one, while the other is filled with thinner. Whenever a short interval between applications is anticipated, the canister containing lacquer is removed and replaced with the one containing thinner, after which a little of the thinner is run through the gun. In this way lacquer inside the gun is prevented from drying. The operation, which can be accomplished in a minute or less, saves considerable time that otherwise might be spent in dismantling and cleaning a clogged gun.—Leo F. Bowler, Jr., San Bernardino, Calif.

DRILL-PRESS TAPPING JIG

By Carl S. Bates



DESIGNED especially for the small production shop, this drill-press jig eliminates the bottleneck frequently caused by hand tapping a number of parts. By using the jig, the tap is automatically driven into the hole when the work is pressed against it, and then the tap is backed out by pulling the work away from it. This is accomplished by a pair of 7¼-in.-dia. hardwood disks mounted on a sliding shaft to reverse the direction of tap rotation when one or the other disk is held in contact with a rubber-covered driving spindle. The latter is tapered to match a bevel on the inside faces of the disks. Bearing blocks of hard maple are fastened to the base blocks with long stove bolts and the base is drilled to permit bolting to the drill-press table. Made to the dimensions given, the jig will handle taps up to ¼ in. If larger or coarse-thread taps are to be used, the diameter of the disks should be increased.

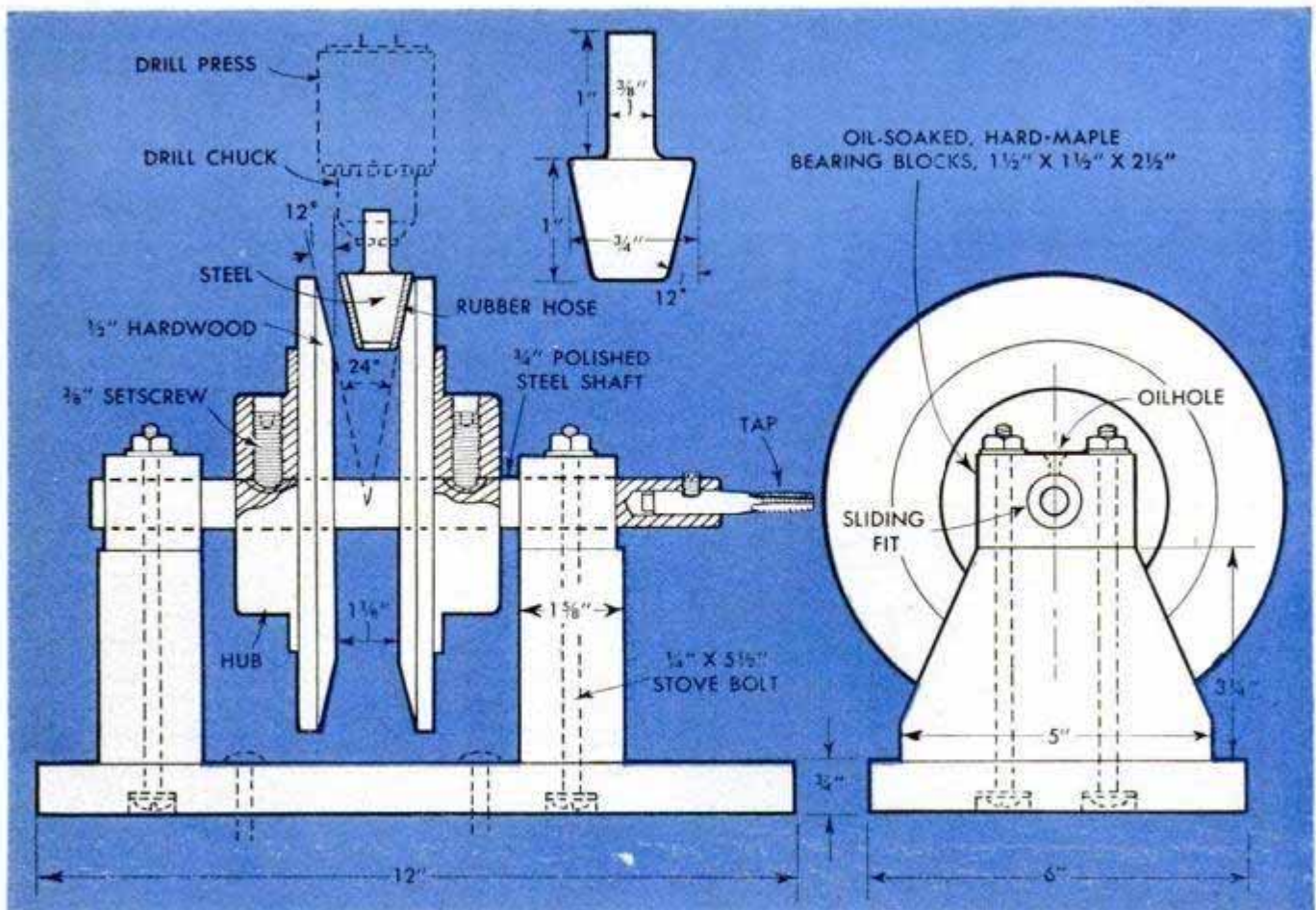

Tack Pocket From Old Rubber Toe

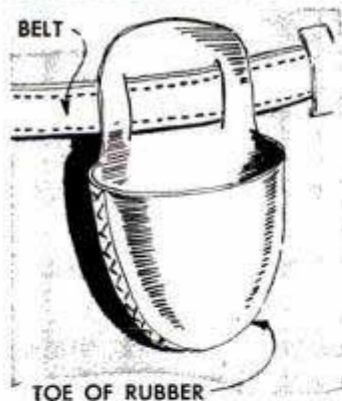

The toe piece cut from a discarded rubber can be utilized as a pocket to hold tacks for bill posting, carpet laying and other similar jobs. Slits in the tab end permit the pocket to be worn on the trouser belt, and the pocket remains

open for easy removal of the tacks. The fisherman who wades in a stream some distance from his bait can will also find this pocket handy for carrying live bait.

Mark Steel to Avoid Errors When Shaping or Planing

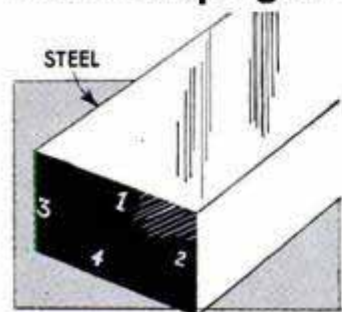

When shaping or planing steel bars, mistakes may be avoided if the faces being worked can be identified readily. This may be done by numbering them on one end of the bar being

worked, using layout ink or dye. This practice is particularly helpful to beginners in the shop or school machine-shop class, where grinding procedures specify that the direction be the same for each face.

R. M. Woodbury, Natick, Mass.

Thumbscrew on Tap Wrench Locks Handle in Position

The annoyance of having the handle on a tap wrench slip out of position may be eliminated by this simple locking arrangement. Simply drill and tap a hole in the end of the wrench to take a thumbscrew.

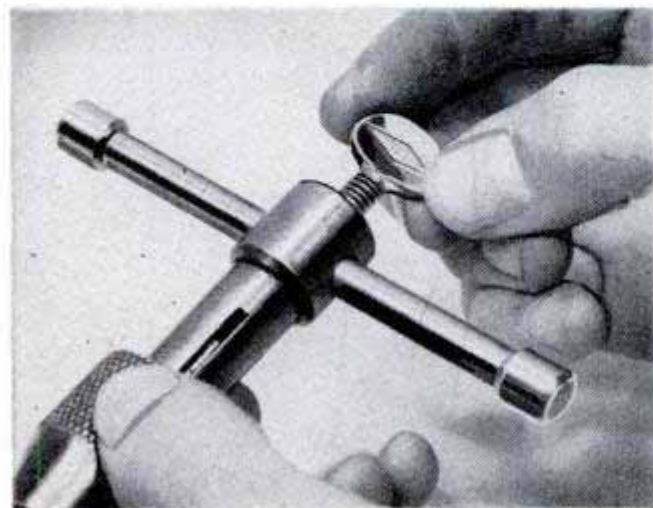

Pigeonhole Bolt Rack

This rack provides storage for 63 sizes of bolts, nuts and washers as well as screws and nails if desired. It was originally designed for use in a farm shop, but is equally useful in the home shop for storage of small parts that must be kept in order and readily available. It consists of a square frame of 1 x 4-in. stock, glued and screw-fastened at the corners. Shelves and dividers are cut from the same material. The back is of 1/4-in. plywood and the compartments are partially enclosed at the front by 3/8 x 1 3/8-in. strips of lattice stock nailed to the front edges of the shelves. Half-lap joints in the members are used to form the pigeonholes.

Jig Simplifies Right-Angle Welds

When welding work calls for a right angle, this jig allows the weld to be applied to the inside of the angle without breaking down the clamped setup, as is the usual procedure with ordinary welding jigs. Different sizes of the jig can be made to fit the work at hand. Care should be taken when using this jig to see

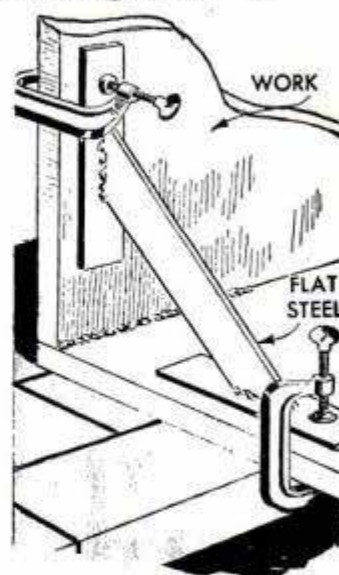

that the pieces to be welded together fit closely, with no air space between them.

L. E. Fannon, Huntington Park, Calif.

SHOPPING FOR TOOLS



1. EASILY HANDLED LEVEL of lightweight magnesium offers a dimensionally stable, accurate tool for the homeowner and carpenter. The die-cast I-beam construction produces a rugged tool that will withstand considerable rough usage. The level features moisture and dust-free bubble vials which contain a new vial fluid developed to withstand greater temperature extremes

2. ADJUSTABLE CLAMP combines best features and strength of C-clamp and toolmaker's parallel clamp. Ball-bearing trunnion eliminates distorting, twisting action and absorbs vibration to insure a firm, steady grip throughout milling, routing and shaping operations. Screw remains in horizontal position so jaws can be quickly adjusted. Available in five sizes from 1½ to 12 in.

3. MAGNETIC HOLDER for dial indicators and inspection lights attaches to any iron or steel surface, magnet with 50-lb. pull providing a firm grip. Holder pictured features swivel arm and thumbscrew for minute adjustments. Also available for lathe-carriage use, equipped with an inspection light or with a swivel clamp for holding flashlight or extension lamp

4. WATER-COOLED DIAMOND DRILL for ½-in. chuck will cut through masonry, glass or porcelain at the rate of 1 in. every few seconds and produces a clean accurate hole. Valve-fitted water sleeve is connected directly to the water line. A 10-ft. length of hose is supplied with adapter which will connect to any supply from a ½-in. pipe thread to a ¾-in. faucet

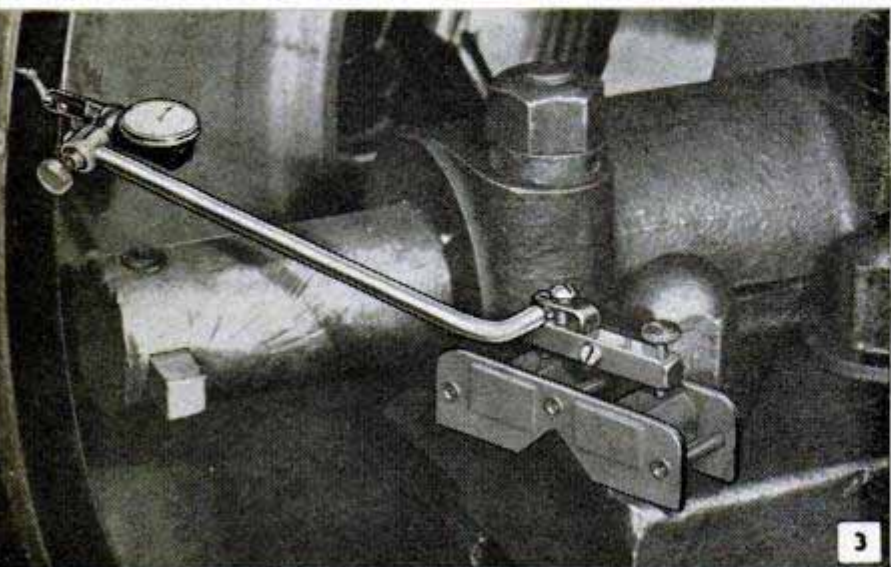
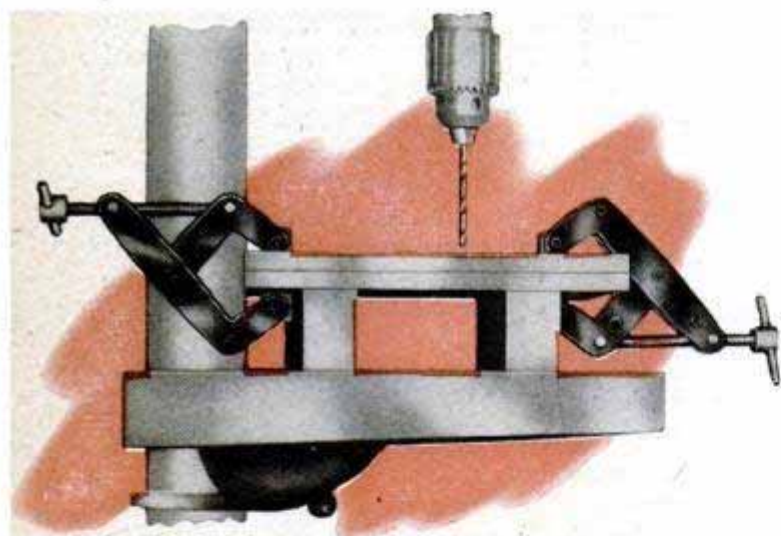



5. PORTABLE ELECTRIC SANDER features oversize bottom plate which extends beyond body to permit sanding in close quarters. Knob handle fastens to sides or front of housing and new holder simplifies changing sandpaper. Platen has orbit dia. of 3/16 in.

6. CEILING-TILE STAPLE GUN saves considerable time and labor when installing tongue-and-groove tile. Operator simply positions the gun tacker on tongue of the tile and then compresses the handle to drive a heavy 9/16-in. staple into furring strip

7. PAINTBRUSH HANDLE bends at almost any angle and remains in position until readjusted. Angle setting of handle permits thorough coverage of many hard-to-reach places that ordinarily are difficult to paint. Flexible cable joins wooden handle to brush ferrule

8. PRESET TIMING CONTROL on portable spot welder results in consistent and uniform welds on most common metals. Welder turns on when tips are closed to maximum pressure and stays on until time elapses. Draws average of 45 amp. on 220-volt, 60-cycle line

9. WOBBLE DADO SAW takes cuts up to 7/8 in. wide and 2 in. deep with a single adjustable blade. Pitch of 1/8-in.-thick blade is varied by loosening arbor nut and adjusting the hub gears with a socket-head wrench. Dado fits saws having 5/8 or 3/4-in. arbors

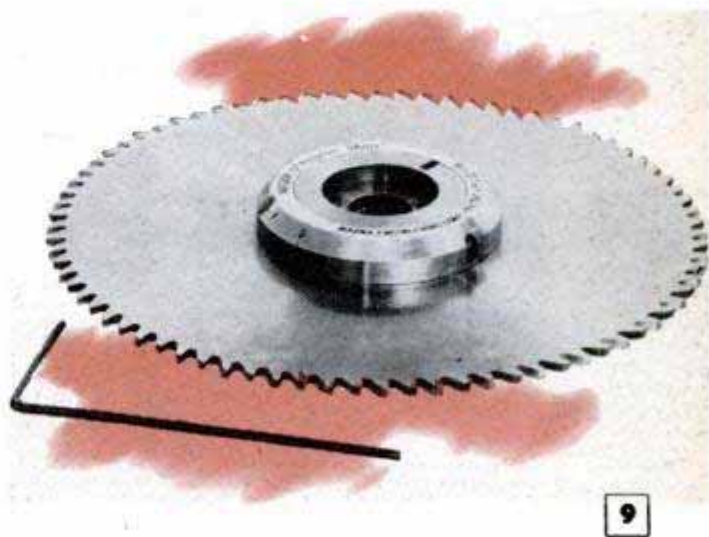
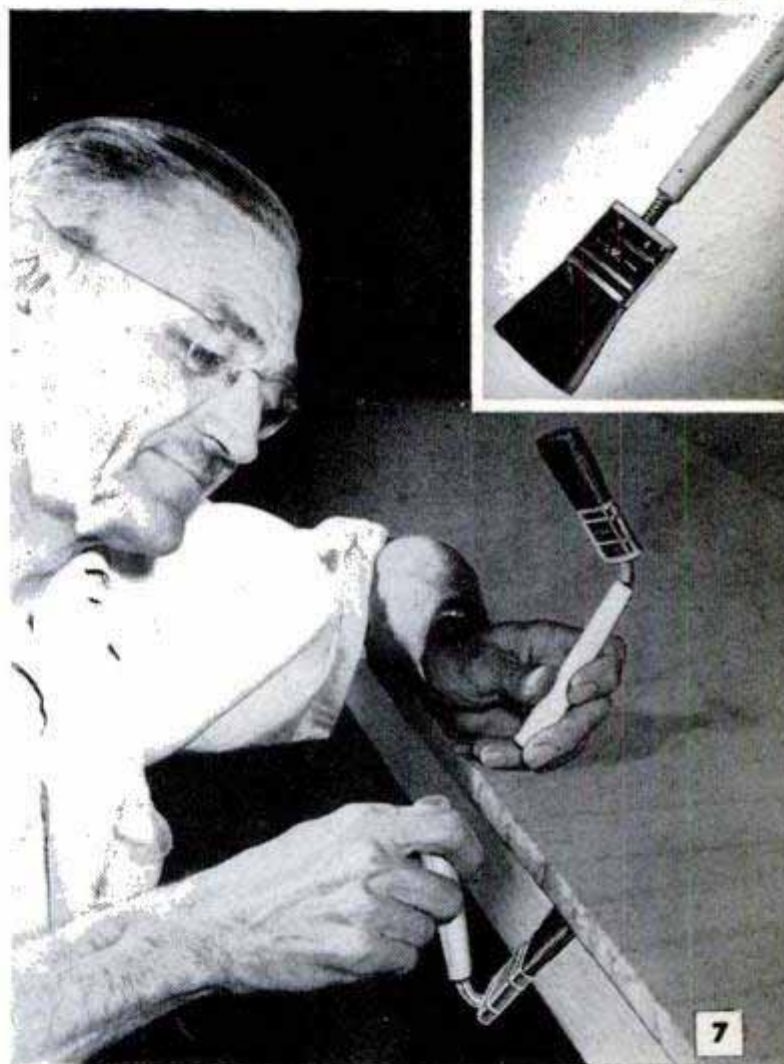
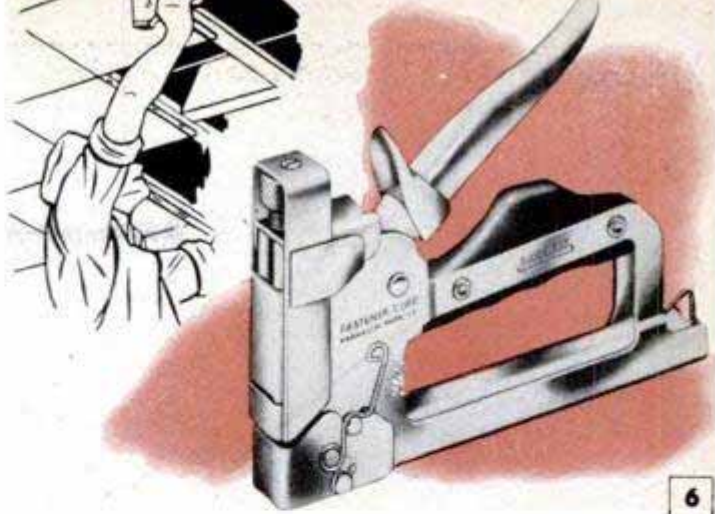

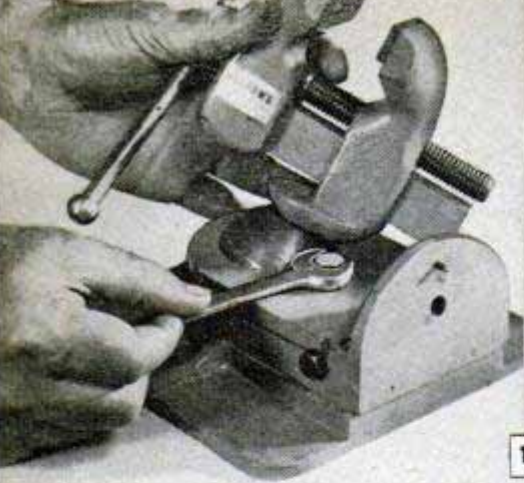

10



11

See letter in back of book

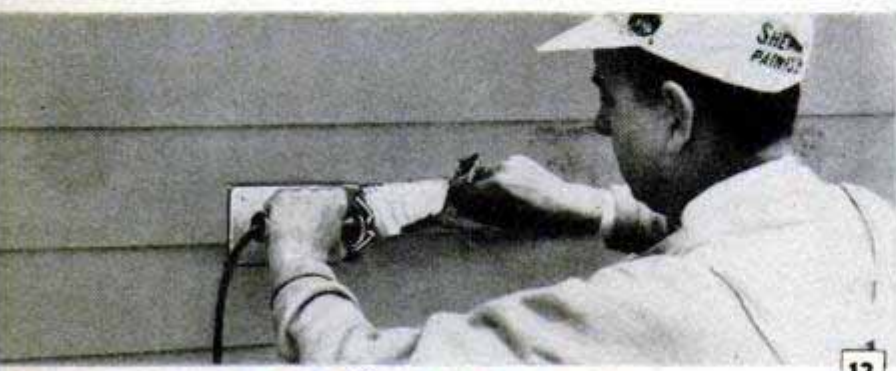

12



13

10. SWIVEL VISE holds work securely at any desired angle on drill press or milling machine. Vise is tilted by hand into position and held rigidly by a plate which clamps over the ball swivel. Machine bolt in base is loosened to relieve plate pressure for adjusting vise. Latter is supplied with a plate for drill-press and milling-machine use as well as a clamp for mounting on edge of a workbench. Vise is quickly changed from bench to machine work

11. HAND-TAPPING GUIDE automatically squares tap or reamer with hole to assure accuracy. As tool is held true at all times, guide eliminates the high percentage of tap and reamer breakage caused by twisting or bending out of alignment. Base of jig is ground square with guide sleeve and the tap holder works smoothly in the sleeve. Tools are inserted and removed easily as slotted guide base grips holder shank while handle is turned to loosen tap

12. ELECTRIC PAINT REMOVER operates quickly and economically through use of radiant heat. Designed for professional and home use, device consists of two skids under which a 1000-watt tubular heater is mounted. As remover is slid over surface, heat softens and blisters paint so it can be removed as rapidly as operator can scrape it off with a putty knife. Skids keep heat a safe distance from surface and reflectors keep the plastic handle cool

13. WOOD-BORING SET for 1/4-in. drill permits boring holes from 3/8 to 1-in. dia. to extreme depths; for instance, as much as a 27-ft. span of floor joists. Shank extensions, obtainable in 6 or 12-in. lengths, can be joined together without removing bit from work. A socket-head setscrew holds each extension in place. Front-rake design of the bits requires less horsepower, thrust and pressure than with ordinary bits and, at the same time, drills a smoother hole

Double-Swing Farm Gate Closed by Coil Spring

You won't have to set down a load you are carrying to open the yard gate if you hinge it to swing both ways and use a spring arrangement to keep it closed. This consists of a length of channel iron bent to the shape shown and welded to the top of the gate. To this is attached a coil spring, which is fastened to one of the fence posts close to the gate. Strength of the spring needed will be determined by the pressure required to close the gate. If small children are to use the gate frequently, the strength of the spring should not be so great that it presents a possibility of the gate flying back and injuring one of them as they pass through.



Steel Balls Drawn Through Tubing to True Diameter After Bending

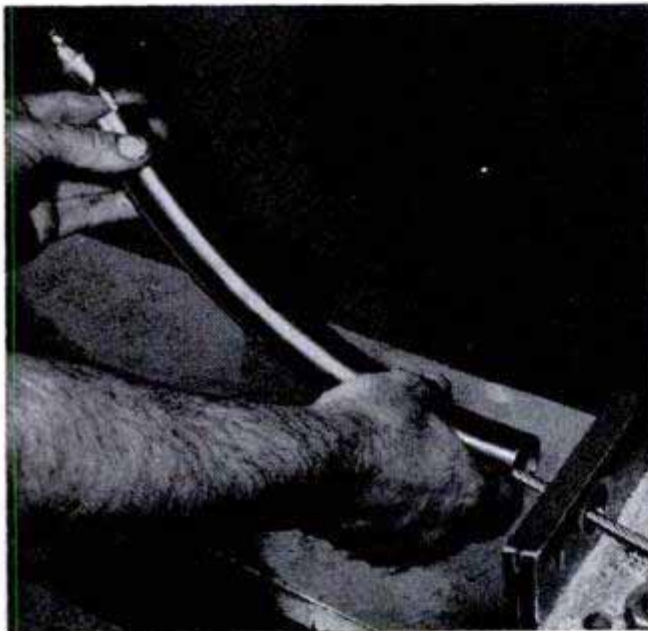

To restore tubing that has become distorted during a bending process to the exacting tolerances required by modern aircraft, one manufacturer developed a re-sizing operation in which steel balls are drawn through the tubing on a hydraulic cable-testing machine. From two to four egg-shaped balls in graduated sizes are used, each of which is drilled to take a short length of cable. After they have been coated with grease, the balls are connected to the machine by means of the cable and drawn through one at a time, starting with one of the smaller sizes and working up to one having the same diameter as the inside of the tubing. The operation, which is set up and performed by one person at the Texas Engineering & Manufacturing Company, Inc., has made possible tolerances as close as .001 in.

Grinder Mounted on Feeder Skids Saves Handling of Materials

By simply extending the skids of a cattle-size self-feeder, one farmer provided a sturdy mounting base for a burr-type grinder. In this way ground feed and supplements are blown directly into the feeder hopper, thus saving time-consuming handling of the materials. Note that an oil drum is mounted on the grinder frame just above the hopper. This serves as a container for supplements fed into the grinder by means of an improvised gate which covers a small opening cut in the bottom of the drum. By opening the gate to different positions the flow of supplements into the grinder can be closely controlled.

Electrician's tape wrapped around the handles of pliers for insulation will wear longer and the tool will be easier to handle if coated with household or model-airplane cement.—N. W. Byrne, Hamilton, Ont., Can.

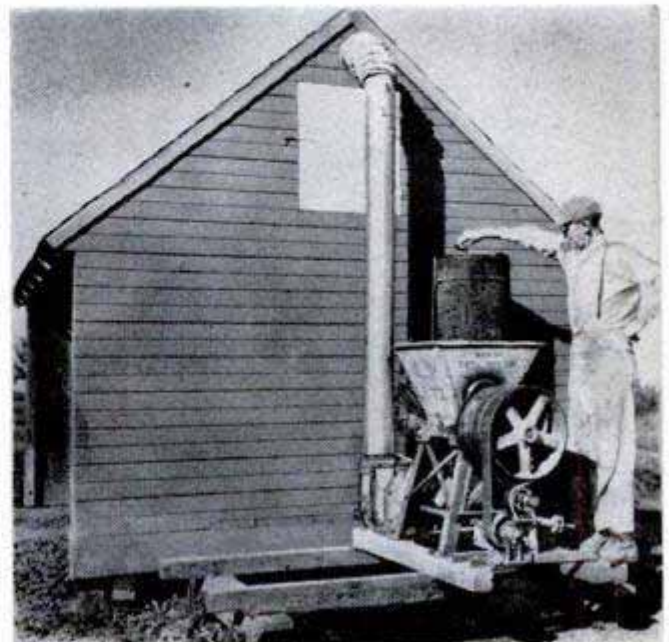

Rigid Stand for Power Grinder Made From Scrap Pipe

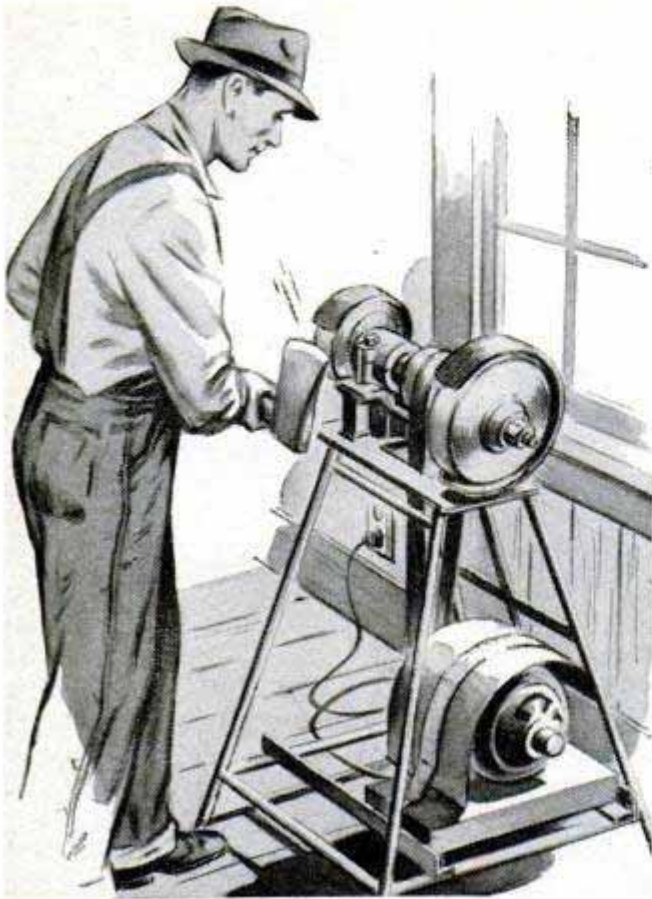

Lengths of scrap pipe, together with angle-iron braces for supporting an electric motor, were welded together to make this power-grinder stand for a farm shop. A piece of sheet metal was mounted over the motor as shown to protect it from abrasive particles. The grinder is connected to the current by means of a long cord, making it possible to move unit outdoors when necessary for work on large machinery.

A. M. Wettach, Mt. Pleasant, Iowa.

Loose-Pin Hinges Lock Workbench Securely Against Shop Wall

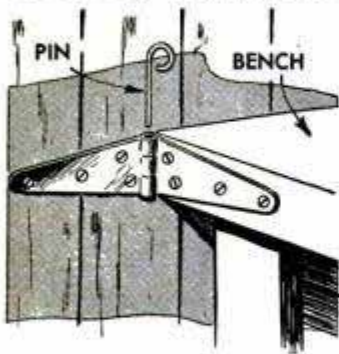

If your workbench has a tendency to be a little wobbly or for any other reason you would like to have it secured against a wall, yet have it so that it can be moved away easily, use loose-pin hinges as indicated.

Screw one leaf of each hinge to each end of the bench. Then screw the other leaves of the hinges to the wall and substitute pins bent from heavy wire or small rod stock for the pins that come with the hinges. The pins you make should have a loop

formed on the upper end to aid in withdrawing them easily. The best way to do the job is to screw the hinges to the bench and then move the bench into position and screw hinges to the wall. In this way you will be able to remove the pins and have the leaves in perfect alignment.

Leaky Fuel Tank Repaired While Still on Car

Small leaks in automobile fuel tanks can be repaired without removing the tank by using a 1/4-in. section of thin-wall conduit as a dam around the leak. Apply plastic auto-body solder to the outside surface of the conduit after it has been placed around the leak. When the solder is completely dry, plug the conduit section with a cork and cement the cork in place with more body solder.



Sprinkler Heads in Spraying Booth Protected by Paper Bags

Automatic sprinkler heads in paint-spraying booths may become fouled by hardened lacquer and paint. This condition can be prevented by fitting small, fragile, paper bags over the heads. In the event of fire, the bags will burst quickly and not interfere with the normal operation of the sprinklers.—Howard Nichols, Canton, Mass.

Shorted Auto Horn Disconnected

Embarrassing moments spent frantically hunting a screwdriver or pliers when an automobile horn becomes shorted and sounds accidentally can be avoided by inserting a small snap-in wire connector in the switch wire immediately next to the horn. Paint it a bright red and label so that anyone opening the car hood can see it.

Roger Johnson, Lusby, Md.

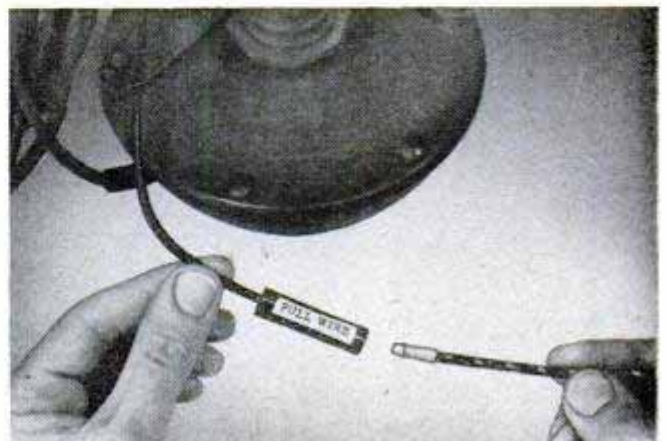

RADIO *Television* ELECTRONICS

COMMUNITY TV-ANTENNA SYSTEM

GOOD TV reception in Laconia, N. H., from Boston stations nearly 100 miles away presented what looked like insurmountable difficulties. These, however, have been overcome by RCA engineers with their Antenaplex system. It consists of a master TV-antenna tower on top of Mt. Belknap, the antenna being tuned to bring in the clearest possible signal from each of the stations. Diagram D shows the antenna tower, the amplifying system at the base, the series of line amplifiers down the mountain and through the town, and finally the booster amplifiers where the lines are tapped for the home customers.

Photo B shows the coaxial cable coming over and down the mountain to Laconia which dips like a saucer in the surrounding mountains. Up to this time TV reception there had been very poor; now the signals are clear, and all tall roof-top antennas have been eliminated. Photo A shows the system being tapped to bring the signal into a home in Laconia. The tower amplifier station appears in photo C.

The set owners' subscription price is fixed at \$169.00 for installation and there is a monthly charge of \$3.95. The old tall-mast antenna arrays formerly used in the neighborhood cost between \$75.00 and \$175.00.

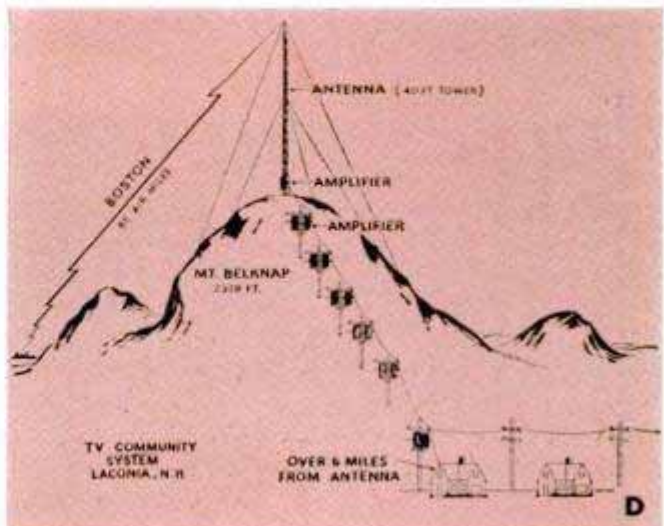
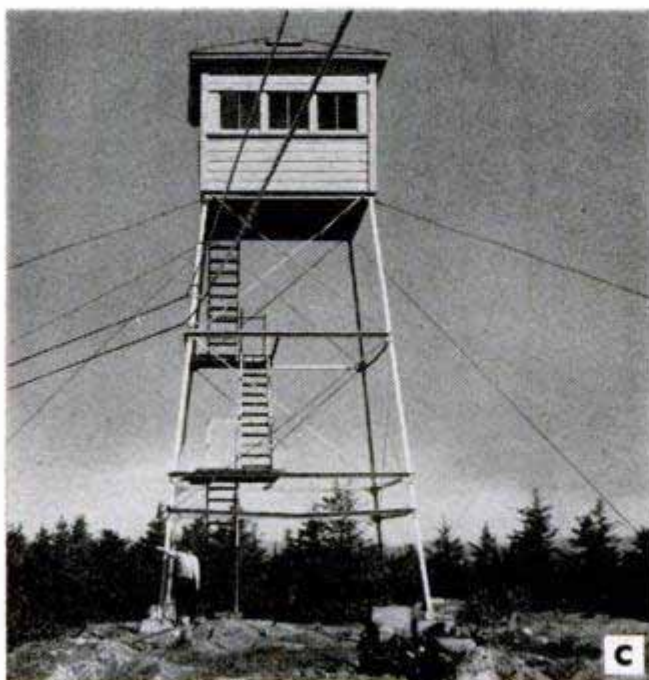
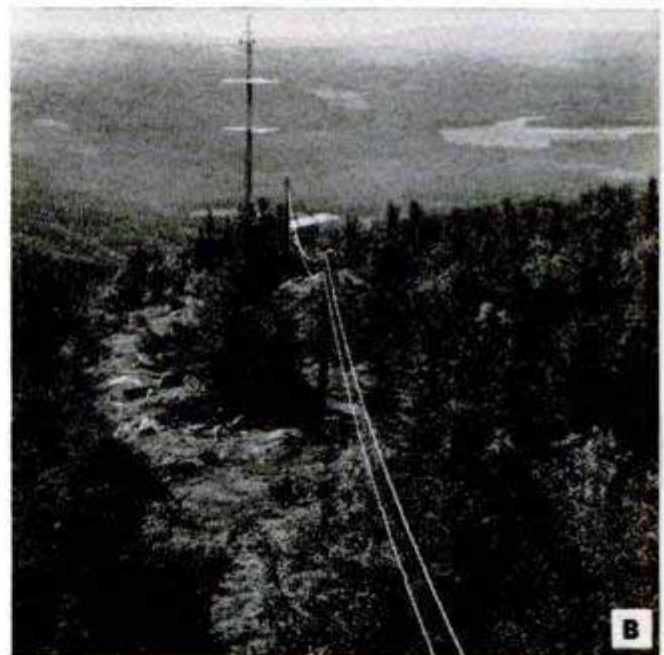



HOW TO MAKE YOUR TV

By John B. Ledbetter



EVERY TV-set owner is interested in making his picture tube last as long as possible. While the following information cannot guarantee that the tube will last forever, it will help to stretch its normal life as far as possible. When adjusting or operating your TV set, never turn the brightness control full on for any length of time. With large tubes of the 20 to 30-in. variety, only a few seconds at full brilliance will cause permanent damage to the screen coating, especially if the ion-trap magnet is not adjusted perfectly.

If you are not familiar with television circuits do not attempt to make any adjustments inside your set. High voltages as well as dangerous low voltages are present when the set is connected to a power-line outlet. The set manufacturer provides a safety interlock for this reason so that the rear cover cannot be removed for simple tube replacements, or any other reason, without automatically disconnecting the set from the power line, see photo A. All necessary adjusting and tuning controls for the average inexperienced TV-set owner are external.

A poorly adjusted ion-trap magnet can cause dark corners or shadows on the screen as indicated in Fig. 1. Poor focus, low brightness, or a slight off-centering of the picture may stem from the same cause. Check with your serviceman if any of these troubles are present.

Do not leave your TV set turned on while you visit with neighbors. If you leave the

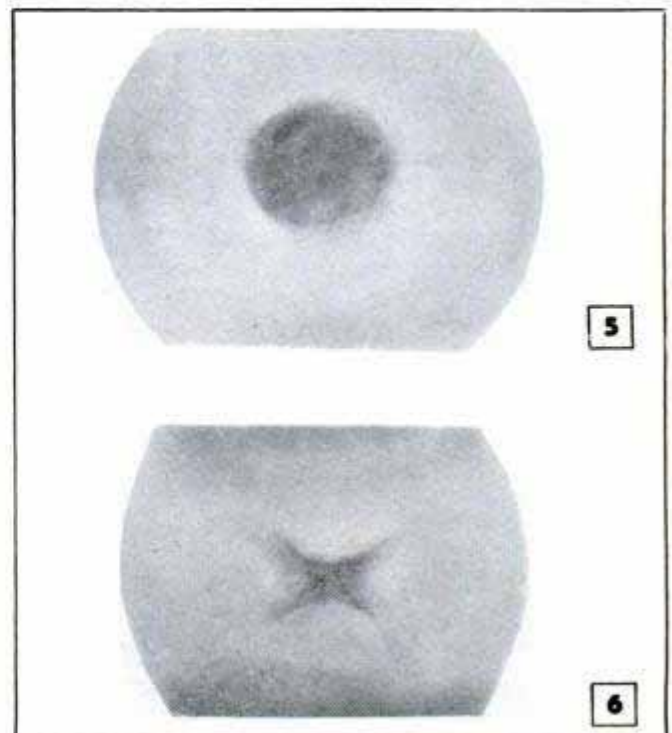
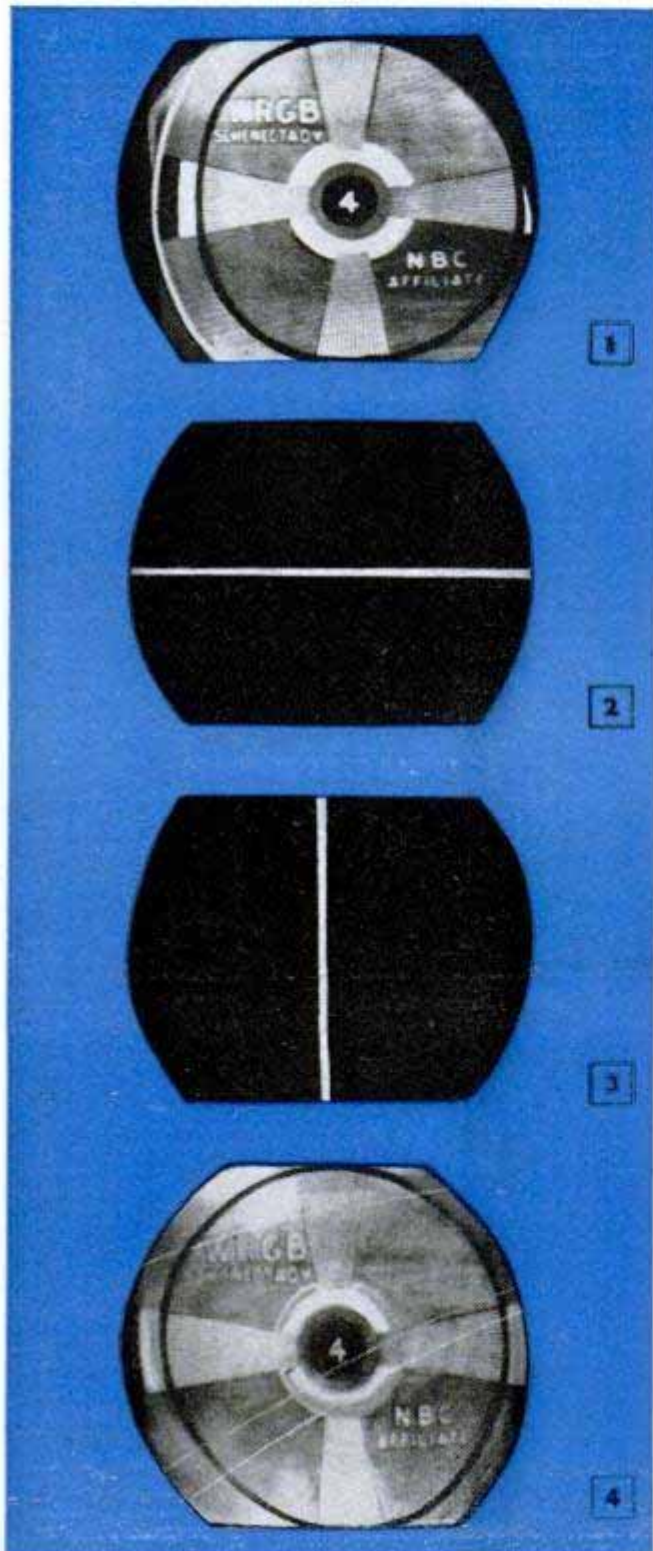

PICTURE TUBE LAST LONGER

room to answer the phone or doorbell, or if you listen to the sound only when busy in another room, turn the brightness control down. This will prevent burning a thin white line into the screen (Figs. 2 and 3) if one of the "sweep" tubes should fail. Some of the following picture-tube troubles will require checking by your serviceman, others you may be able to remedy for yourself. At any rate you will know where you stand if difficulties should arise.

Brightness in any picture tube will drop rather rapidly during the first 500 hours of use. Then it tapers off for the next 1000 to 1500 hours. If the drop is normal you do not notice it because it takes place so gradually that you automatically compensate by turning up the brightness control. Low brightness, Fig. 4, does not always mean that the picture tube has gone bad. More often than not, it is caused by some weak tube in the circuit, a defective filter condenser or resistor in the high-voltage section or simply by a heavy collection of dust and soot on the front of the picture tube and on the inside of the safety glass. This safety glass can be removed as illustrated in photo C, and special cleaning fluids are available from your TV dealer. The tubes to be checked are as follows: the high-voltage rectifier, horizontal oscillator, horizontal output and horizontal damper. (In most sets, these are numbered 1B3GT, 6BG-6G or 6CD6GT, 6SN7GT, 6V6G, 5V4G, 6W4G.) If these tubes are good, the serviceman should make the other checks previously mentioned. A bad resistor can make the picture "bloom" or change size and lose focus when the brightness control is turned up. A bad capacitor (condenser) may cause the picture to be dim or completely dark.

Ion spots, Figs. 5 and 6, are brown or amber in color and usually appear in or near the center of the screen. In this case there is nothing you can do except replace the picture tube, or put up with the trouble. If your set is within the warranty period, call your dealer or distributor as soon as you notice the discolored spot. Most distributors

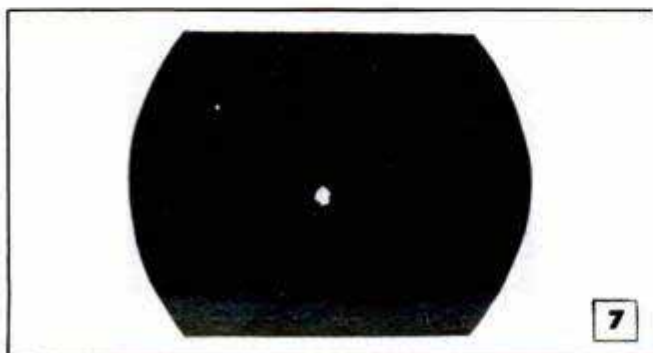
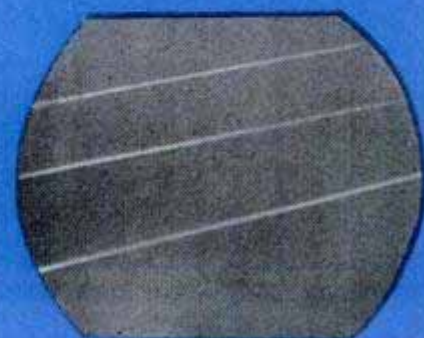

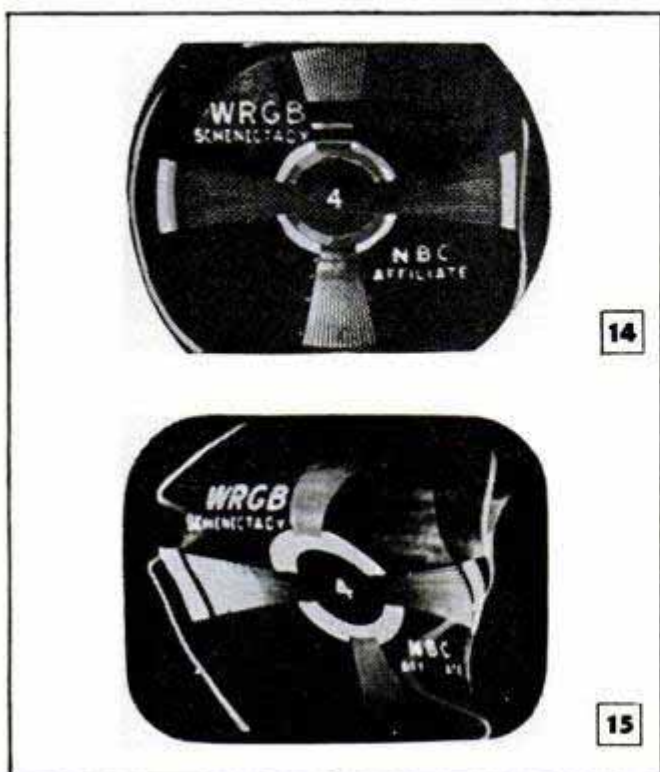
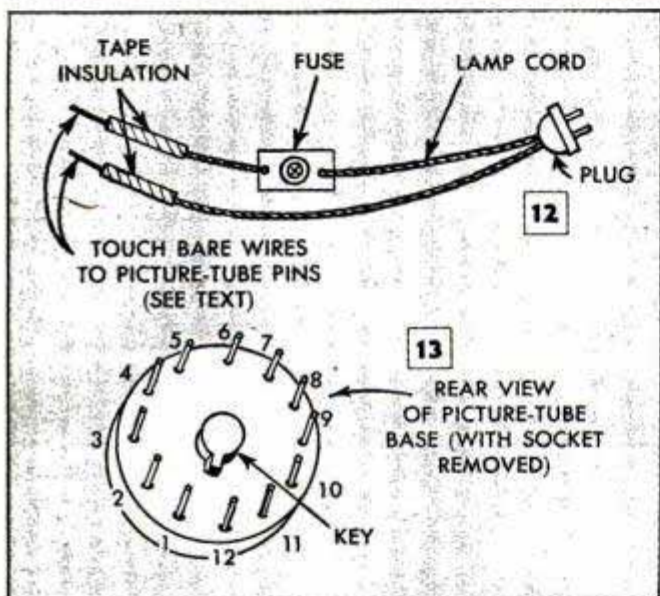
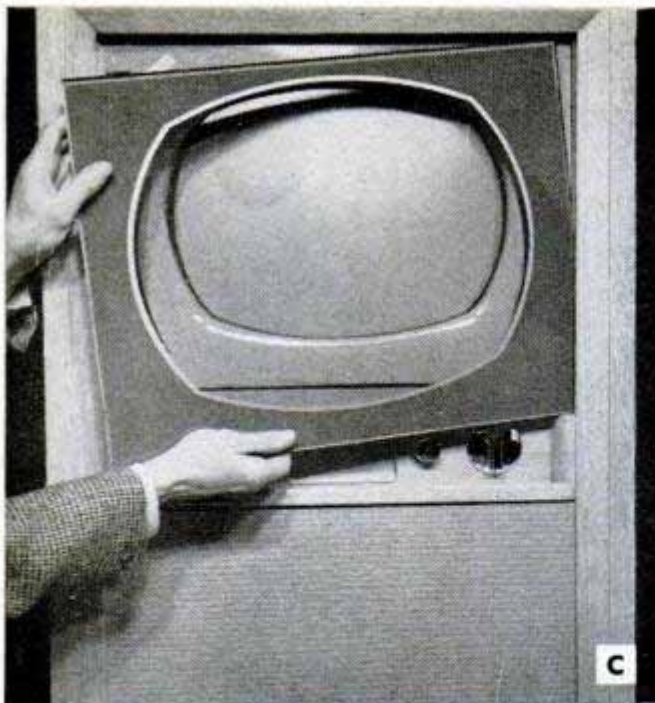

make a satisfactory adjustment if the spot is caused by an internal defect. Some picture tubes will give off flashes of light for a short while after the set has been turned off. This is not important and will not harm the screen. If a tiny, brilliant spot (Fig. 7) should remain on the screen after the set has been turned off, it may eventually burn or discolor the screen. You can prevent this by turning the brightness control full on after the set is turned off. Always be sure to return the brightness control to normal before the set again is turned on.

A shorted picture tube will make the picture resemble Figs. 4, 8, 9 and 10. Turning the brightness control full on will have no effect on the screen. In some TV-set models this effect can be due to a shorted capacitor across the brightness control. In other models, a shorted picture tube will leave the screen bright but with no picture, as in Fig. 11.

If the picture tube is still within the warranty period, contact your dealer immediately. If the warranty period has passed and you are reasonably sure that it is shorted, check with your serviceman.

The following test may be made by the experienced set owner, experimenter or student if he wishes to try it. It has cleared up many shorted tubes and, after all, if the warranty has run out, you have nothing to lose as the tube must be replaced if the short is not eliminated. The first step is to remove the power-line plug from the wall receptacle. Then take off the back cover of the set and remove the picture-tube socket. Its location is indicated by the arrow in photo B. The next step is illustrated in Figs. 12 and 13. Make up the test cord from an ordinary lamp cord as detailed in Fig. 12. The fuse in one of the leads should be of lower amperage than the house-line fuse and it is merely employed in case you accidentally short the two wires. Plug the lamp cord into a wall outlet after first making sure that the ends are not touching. Now locate pins 2, 11 and 12 on the picture-tube base, by checking their respective key positions as indicated in Fig. 13.

Note that the pins are numbered clockwise. Holding the lamp cord at the tape-insulated ends, place one lead on pin 11—then touch the other lead first to pin 2, then to pin 12 (do this several times if necessary). Just be sure that you do *not* connect the lamp-cord leads to pins 1 and 12 as this will burn out the tube. Many times this test has cleared the short and given the picture tube extra months or years of useful life.

When picture tubes become magnetized by a near-by speaker or other strong magnetic field, the typical effect is shown in Figs. 14 and 15. Metal-cone tubes can be demagnetized by your serviceman. ★ ★ ★

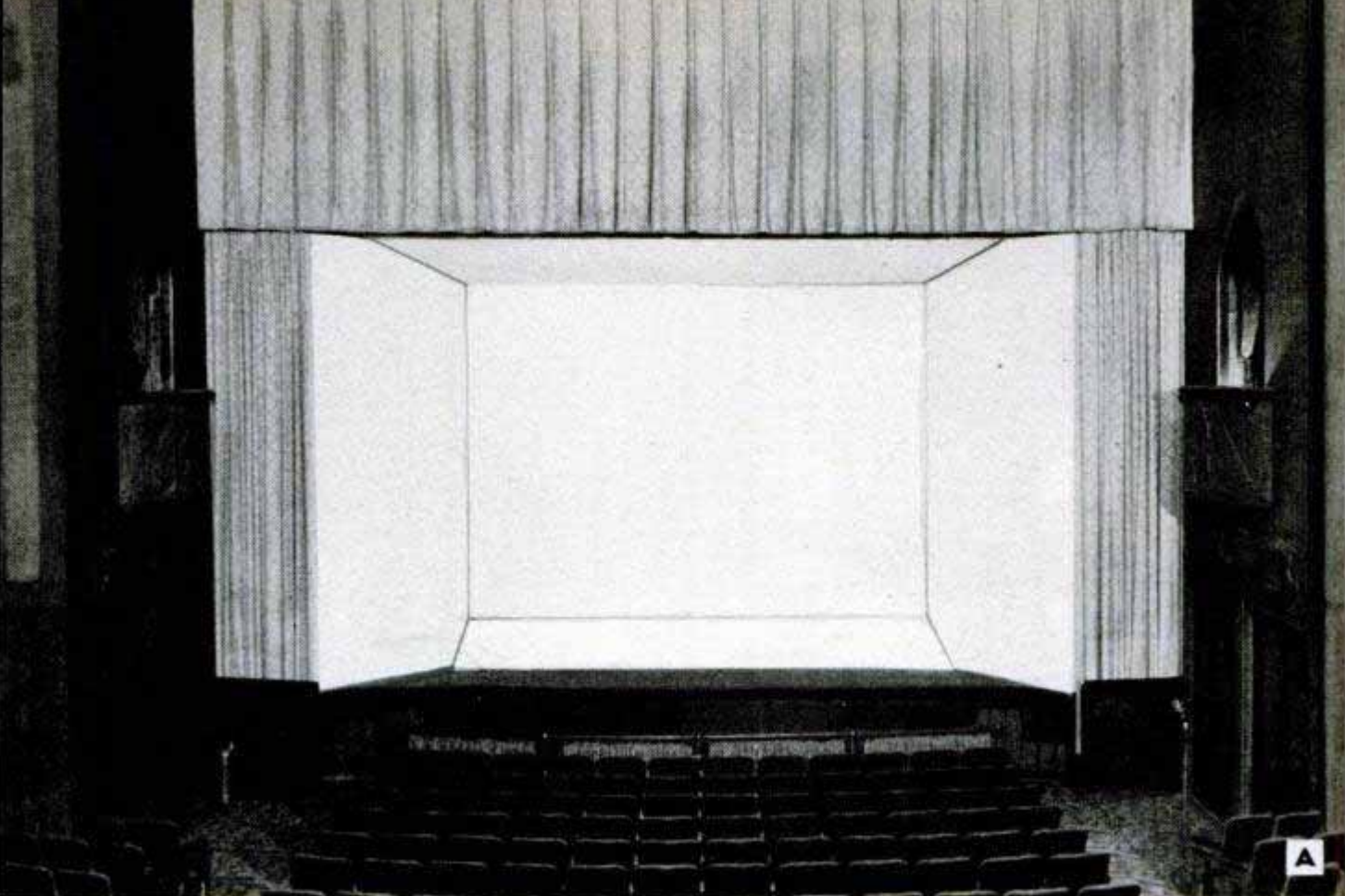

MOVIE SYNCHRO-SCREEN HEIGHTENS VISUAL IMPACT

PERHAPS one of the most important improvements in the pictorial presentation of motion pictures in 25 years is the new RCA wide-vision screen. This Synchro-Screen is a stage setting that utilizes a "surround" of screen-covered panels or wings at the sides, top and bottom. It is scientifically designed and assembled to produce an extension of the projected light, continuously synchronized in intensity and color with screen imagery. In other words, these panels pick up and reflect diffused light from the picture. When color pictures are shown, reflected hues appear on the wings and panel. This imparts to the viewer a new and dramatic sense of realism by making the action on the screen appear to occupy a larger portion of his field of vision.

Recently installed at the Palace Theater in Chicago, the first picture shown was the *Greatest Show On Earth*. When viewed by the audience, the optical impression was that of looking at a live scene. The picture appeared to be larger, less confined and more realistic as color is softer.

Photo A shows a theater installation; wing and panel details are given in Figs. 1 and 2. Reflection of light on the wings eliminates the sharply contrasting outline of the screen image and makes it appear to taper off in the outer portions.

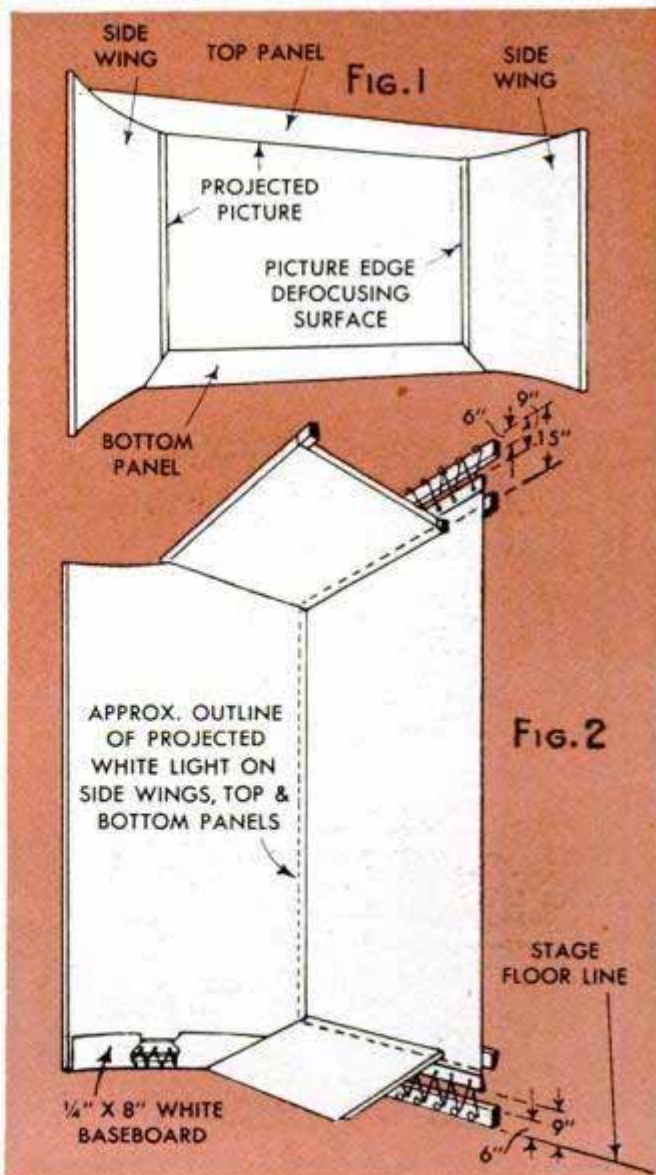

TELEVISION TODAY

INTEREST in the progress of television is international. Many countries will expand their TV stations and viewing audiences in 1953. A special hearing aid for deaf radio and TV listeners, shown in photo A, recently was demonstrated at the National Radio Show in London. Volume and switching are controlled by means of two knobs on the switch box connected either to the radio or to the TV set.

Here, in the United States, TV receivers are being built into the walls of new homes. One manufacturer of mantels includes a 17-in. TV sets of standard make in one of its mantel designs illustrated in photo B. The new UHF (ultra-high-frequency) TV stations will soon be on the air both in cities and in areas not now served by the standard VHF stations. These UHF signals require special antenna arrays for their reception. The one shown in photo C is claimed to cover all television channels, both standard VHF and the new UHF.

Many troublesome TV-interference problems will be solved in 1953. Manufacturers and servicemen are improving their products and techniques. Many set owners can help themselves and save time and money within reasonable limits. For example, if you are in an area where line voltage tends to increase up to 140 volts you can protect your set by plugging in a line-voltage ballast resistor between the TV set and the electric receptacle, as illustrated in photo D. Photo E shows a TV-picture-tube reactivator that is claimed to lengthen the useful life of worn and dim picture tubes that normally would be discarded.

The RCA tricolor picture tube, so important in the all-electronic color-TV system, appears in photo F. Basic improvements in these three-gun tubes have been made.

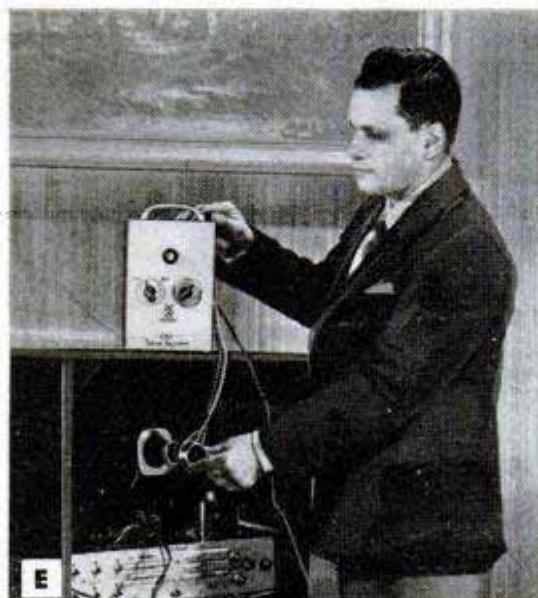
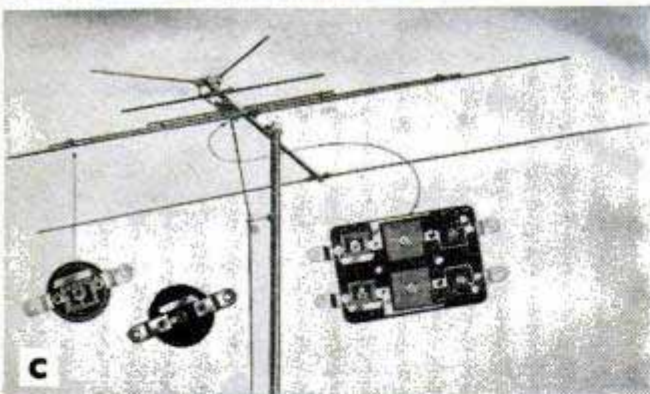



Using an electron tube developed by RCA, automotive engineers have perfected an instrument which automatically controls automobile headlights.

Out of the stars — a cure for headlight glare!

When RCA scientists developed an electron tube so sensitive that it could respond to flickering starlight, astronomers promptly put it to work in their studies of the Universe.

Called a *multiplier phototube*, RCA's invention now "takes to the road" in an instrument which will add to your safety in night driving. The multiplier phototube is now being used in an *automatic control for automobile headlights*.

Here's how it works. RCA's tube, in a new system, sits behind your windshield to "see" approaching headlights. A car comes, and instantly the multiplier phototube activates a

system which shifts your headlights to low beam—then returns them to high when the other car has passed. It's simple. It's completely automatic. And what's most important, it lets you keep your undivided attention where it belongs . . . *on driving your car*.

Development of the multiplier phototube is another example of how RCA research benefits you. RCA research assures you finer performance from any product or service of RCA and RCA Victor.

See the latest in radio, television and electronics at RCA Exhibition Hall, 36 West 49th Street, N. Y. Admission is free. Radio Corporation of America, RCA Building, Radio City, New York 20, N. Y.



RADIO CORPORATION OF AMERICA

World leader in radio—first in television

Adventure in Color Pictures

The world of miniature
color photography is
exciting . . . rewarding.
Here you can pick a
"team of two" to help
you discover it.



THERE'S nothing more satisfying than "shooting it in color" on Kodachrome Film, then staging grand color shows. On these pages you see expert Kodak miniature cameras for taking color shots . . . projectors and viewers for showing big images of the beautiful color slides you get. Let your Kodak dealer help you select a camera-and-projector "team" to fit your budget. Ask,

too, about full-color prints and enlargements from your slides.

. . . .
Latest in home projection is the brilliant new Kodaslide Highlux III Projector, shown above. Its 300-watt lamp, combined with a specially designed optical system including Kodak Projection Ektanon Lens, 5-inch $f/3.5$, gives top brilliance plus unsurpassed color purity and over-all definition. Three-way slide cooling—by baffles, a fan, and heat-absorbing glass. \$56.50 (including carry case with built-in fan).



New economy 35mm. camera —
The new Kodak Retinette Camera is a miniature beauty. Slips into small coat pocket. Fine three-element $f/4.5$ lens assures sparkling color slides. Has automatic film stop, counter, double-exposure prevention. 8 speeds to $1/300$. . . and a delayed-action setting. Built-in flash "synch." Only \$59.50.



New model of famous Retina Camera—The new Kodak Retina IIa Camera with Schneider Retina-Xenon $f/2$ Lens and Synchro-Compur Shutter, 1 second to $1/500$, is designed for action work in color. Single window for range finder and view finder; rapid lever-action film wind; automatic film stop; double-exposure prevention. \$164.10.



Moderate-price range-finder "miniature"—The new Kodak Signet 35 Camera features Kodak's finest lens—Ektar $f/3.5$ —for extra color brilliance. Speeds to $1/300$. Built-in range finder, flash "synch." Exclusive ball-bearing action for ultra-smooth focusing; automatic exposure counter; film stop; double-exposure prevention. \$92.50.



Kodak Pony 828 Camera (left)—Inexpensive color camera with color-corrected Kodak Anaston $f/4.5$ Lens; Kodak Flash 200 Shutter. Takes 8-exposure black-and-white, Kodachrome, and Kodacolor Film. Only \$31.15.



Kodak Pony 135 Camera (right)—Makes superb color slides on Kodachrome Film. Has automatic film stop and exposure counter. Uses all Kodak 135 Films, 20 or 36 exposures. A good buy at \$35.75.



Kodaslide Table Viewer, Model A (left)—Projector, screen, and slide changer in a single unit. Projects brilliant images in lighted room. Takes 75 cardboard or 30 glass slides. Images appear as push-pull plunger positions slides. \$97.50.



Kodaslide Table Viewer, 4X (right)—This budget-priced viewer enlarges slides four times on its built-in screen. Showings are effortless. \$49.50.



Kodaslide Merit Projector (left)—Features improved slide-feeding mechanism on top of projector, eliminating danger of jarring instrument. Includes Kodak Projection Ektanon Lens, 5-inch $f/3.5$. \$26.10.



Kodaslide Projector, Master Model (right)—Fast lenses, 1000-watt lamp can deliver more light to screen than any other 2 x 2-inch slide projector. Choice of 4 lenses. From \$169.00.

New Kodaslide Highlux II Projector (right)—This highly capable 200-watt projector is a companion product to the Highlux III. Features include Kodak Projection Ektanon Lens, 5-inch $f/3.5$; heat-absorbing glass for slide protection; two Lumenized condensers for uniform light distribution over the picture area. If, later, you wish to convert to 300-watt screenings, you can do so very easily. Simply purchase the Kodaslide Highlux Blower Case for \$19.20 and insert a 300-watt lamp (extra). Price of the Highlux II, \$36.50.



You can see this equipment, and many other interesting items, at your Kodak dealer's. Stop in any time and ask for a demonstration. His professional knowledge and experience will prove valuable in helping you make a selection that will best suit your needs.

Eastman Kodak Company, Rochester 4, N. Y.

Prices subject to change without notice and include Federal Tax where applicable.

Kodak

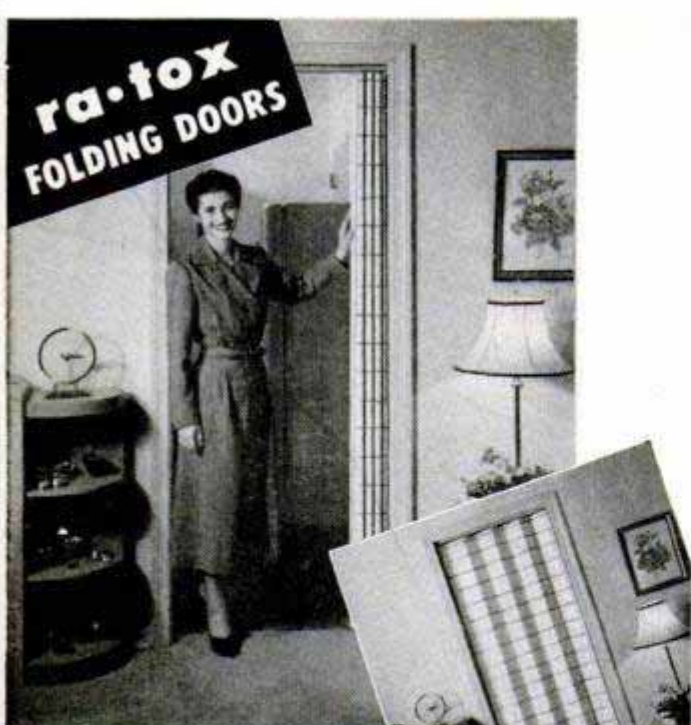

ra-tox
FOLDING DOORS

*The low
cost way*

**TO ADD MORE ROOM AND
BEAUTY TO YOUR HOME**

DO IT YOURSELF, IN A FEW MINUTES

When rooms are small or you can't set furniture right, replace swinging doors with RA-TOX Folding Doors . . . Swinging doors take up space while Ra-Tox Doors hang from the top of the door frame and fold to the side. With this one change you also replace the plainness of hinged doors with folding doors that add beauty to your entire home. Ra-Tox Doors are made of woven wood slats, "natural stain" finish or choice of smart, new colors.

AIR FLOW: Narrow slat construction lets air circulate through door. Permits air-flow for proper heating and air conditioning. Ideal for clothes closet ventilation . . . ends dampness and musty odors.

Supplied complete with hanging hardware. You simply screw overhead track to top of door frame and anchor molding to door jamb. Takes only a few minutes.

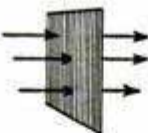

Here is a typical clothes closet. Ra-Tox Door eliminates cost of door wall. Hang Ra-Tox door from ceiling to floor. Easier to build closet interior. Ra-Tox Folding Doors supplied in any door or room divider size.

Used everywhere by builders and home owners. Easy to install. Low cost. Beautiful. See your lumber yard or building supply dealer . . . or write for Ra-Tox Folding Door Bulletin No. 706.

THE HOUGH SHADE CORPORATION

Ra-Tox Division

1066 JACKSON STREET

JANESVILLE, WISCONSIN



FOR WARDROBES



ROOM DIVIDERS



KITCHENETTE
CLOSURES

Clinic for Homemakers

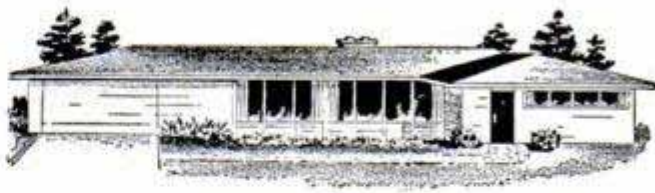

As a service to our readers in solving the hundreds of problems pertaining to a home—inside or out—the editors of *Popular Mechanics* invite you to present your problems to The Clinic Editor for help and advice. Address your questions to The Clinic Editor, *Popular Mechanics Magazine*, 200 East Ontario Street, Chicago 11, Ill.



Removing Decals

Q—How can I remove decal transfers from a painted wall? I have applied decals to the original paint job and now I want to remove them before painting the walls again. Also, is there any coating I can apply over the new paint so that the decals can be easily removed later on without damaging the paint on the wall?—G.T., W. Va.

A—You can remove decals from painted walls by applying a lacquer thinner, or reducer. However, unless care is used to apply the thinner only to the surface of the decal, the paint is likely to be damaged. Also, there may be an objectionable spot remaining when the decal is removed. A better way is to use the special felt pad supplied for removing decals without danger of damaging the paint film underneath. These are readily available at paint stores and come with full instructions for use. Although not recommended by the manufacturers of decals, you can make the transfers easier to remove simply by coating the spot where the decal is to be applied with paste wax. Apply only a thin film of wax and polish to a high luster before the decal is applied. Remove the decal by applying hot water.

Downspout Splashpads

Q—The downspouts on my new home empty directly onto the ground at the corners of the house as our local building code does not permit connecting them to a drain. How can I prevent water from the downspouts washing away the grade at the corners of the house? As it is, it will be impossible to seed the area.—C. H., Ill.



A—Anything that will spread the stream of water from the downspout will prevent washing of the soil. Some homeowners embed a large flat stone under the end of the spout elbow so that it slopes slightly away from the foundation wall. This will serve to break up and spread the stream when the quantity of water is not too great. A somewhat

(Continued to page 238)

Congress Pulleys

QUALITY COSTS YOU NO MORE!

Now you can get the finest quality pulleys from your local supplier. These are the Congress Pulleys used by most original equipment manufacturers — standard on Bendix, Frigidaire, Hamilton, General Electric and many other famous appliances. Congress Drives are electrolytically plated, diamond-bored and tested for trueness.

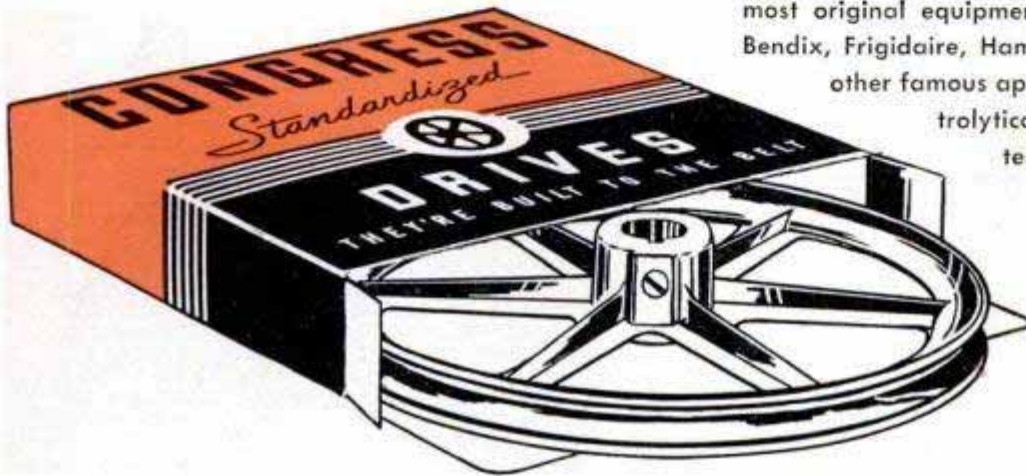

**The Complete Line
FHP to Heavy Duty**



Built to the Belt

**BUY
from
THIS
DISPLAY**



Take no substitute. Insist on Congress Pulleys and V-belts.



*Serving Industry
Since 1914*

CONGRESS DRIVES DIV.

Tann Corporation

DETROIT 34, MICHIGAN



Care and Feeding of Engines

BY S. P. CORP

BODIES NEED LUBRICATION, TOO

Body lubrication is necessary if you want a quiet car, because body noises are caused by dry surfaces rubbing together. To do a good job, you will require a can of light engine oil, a stick of lubricant or a grease pencil, and a tube of powdered graphite, all obtainable at any gas station or car dealer.

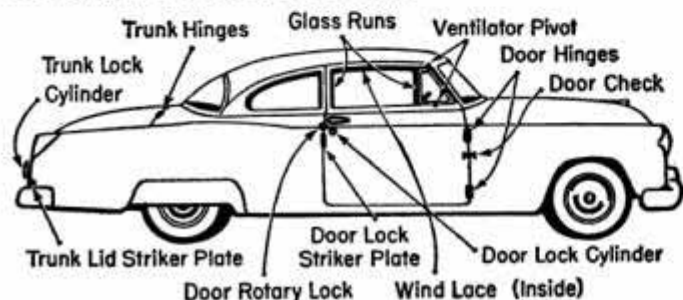

QUICK GUIDE TO BODY LUBRICATION

1. Refer to the diagram and apply a thin coating of graphite to all glass-run channels, working glass up and down until graphite is worked in. Insert end of graphite tube into key opening of door locks, squeezing tube to force graphite into working parts; also the trunk lock.
2. Use grease pencil to apply a thin coating on door lock striker plate and trunk lid striker plate. Open doors and apply grease pencil to each weather cord, the cloth covered tube around each opening, wherever it contacts the door. Friction between weather cord and door often causes door squeaks.

OIL HINGES AND FRONT SEAT TRACKS

3. Apply light oil to all door and trunk hinges, door checks, door rotary lock, and pivots on door and window ventilators.
4. Front seats are usually on tracks. A few drops of oil here will make seat move with less effort and more quietly.
5. When windows are hard to operate, remove door or window trim pad and apply grease to window regulators, using your grease pencil.
6. Part of your body lubrication job should be a careful check to see that drain holes in the bottom of each door are open, so that rain running down the windows can find its way out. Clogged drain holes can cause doors to rust out from the inside.

By following these simple instructions, you can keep the body of your car as quiet as when it was new.



WRITE FOR FREE BOOKLET

This new booklet, "MORE POWER, Less Gas, Less Oil," tells many facts about car care, and about new Sealed Power KromeX Ring Sets, engineered to fight heat, friction, abrasion, and corrosion in late-model cars and trucks. A postal card to Sealed Power, Dept. G-1, Muskegon, Mich., will bring your free copy. It can save you real money.

(Continued from page 236)

better block, or pad, can be made by building a pear-shaped form from 3-in. strips of sheet metal in an excavation from 6 to 10 in. deep. Fill the excavation to the bottom of the form strip with gravel and tamp firmly. The metal form should be curved to the desired shape and held with wooden stakes, the top edge of the form being about 1 in. above the level of the grade. Then fill with concrete and trowel the surface to a concavity of about 1 in. leaving the lower edge flat. Size can vary but ordinarily the pad should be about 18 in. wide and at least 36 in. long, with a 1-in. slope.



Soil Conditioners

Q—I'm wondering whether I should use one of the new chemicals that are said to loosen hard, cloddy soils. My garden plot is a stiff clay soil which becomes as hard as stone if it is worked when a trifle wet. I'm told that it should be plowed and left rough in the fall—that freezing and thawing will loosen the soil. Is this

right, and what about the chemical?—O. B., Ohio.

A—Soil conditioners aid in curing the condition you describe, but before they can do their best work, the plot must be plowed and worked when it is reasonably dry. Then the conditioner should be scattered and worked into the soil by repeated disking and harrowing, or deep raking, if the plot is small. Usually heavy, compact soils that tend to puddle and then harden after rains can be put in a good, friable condition by the addition of organic matter in the form of a green cover crop plowed under, the addition of compost or natural manures and whatever commercial fertilizers are required to supply adequate plant food. Many garden plots which have been plowed for many years develop what is known to agronomists as a "plow sole," which is a hard layer of compacted soil just below furrow depth. This tends to prevent normal movement of moisture and causes rapid drying of the topsoil.

Repairing Stonework

Q—I want to fill small, narrow cracks in stonework. Both the joints and the stone are affected. Small pieces of mortar have fallen out of the joints and there are several cracks in the stones which make the wall unsightly. How should I repair the wall?—J. O., Ark.

A—Broken mortar should be chipped and brushed from the joints and these repointed with new mortar, using a mason's pointing trowel. Narrow cracks in the individual stones can be filled with a mixture of litharge and glycerin. This should be mixed to a heavy paste and applied to the cracks with a stiff-bristled brush. If the stones are a dark-gray or reddish-brown color, the mixture can be colored to match by adding a small quantity of lampblack or red lead to the mixture.

Condensation in Water Heater

Q—I have a gas hot-water heater installed in the kitchen and vented to the chimney. When the heater is on, the pipe drips water. What is the cause, and how can I correct the trouble?—R. P., Calif.

A—One of the products of combustion is water vapor. This condenses on the surface of the vent pipe, which is cooler than the gases passing through it. Usually pitching the horizontal run of pipe at a greater angle will cure the trouble.

Correction

In our November 1952 issue the following appeared inadvertently: "Obtain a small quantity of muriatic-acid crystals" . . . This is incorrect. This acid is available only in solution; not in the crystal form.

New ...SHOPMASTER
PRESENTS THE SENSATIONAL
Universal
INDIVIDUAL COMBINATION
Power Tool

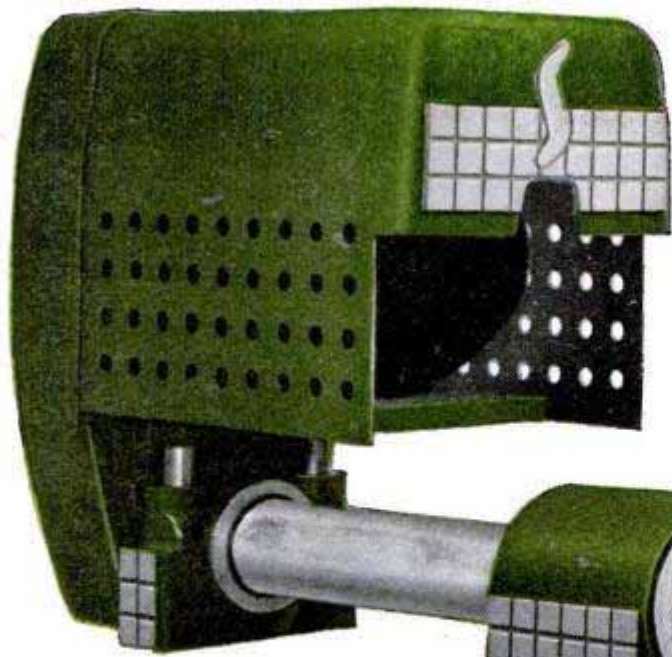

Patents Pending

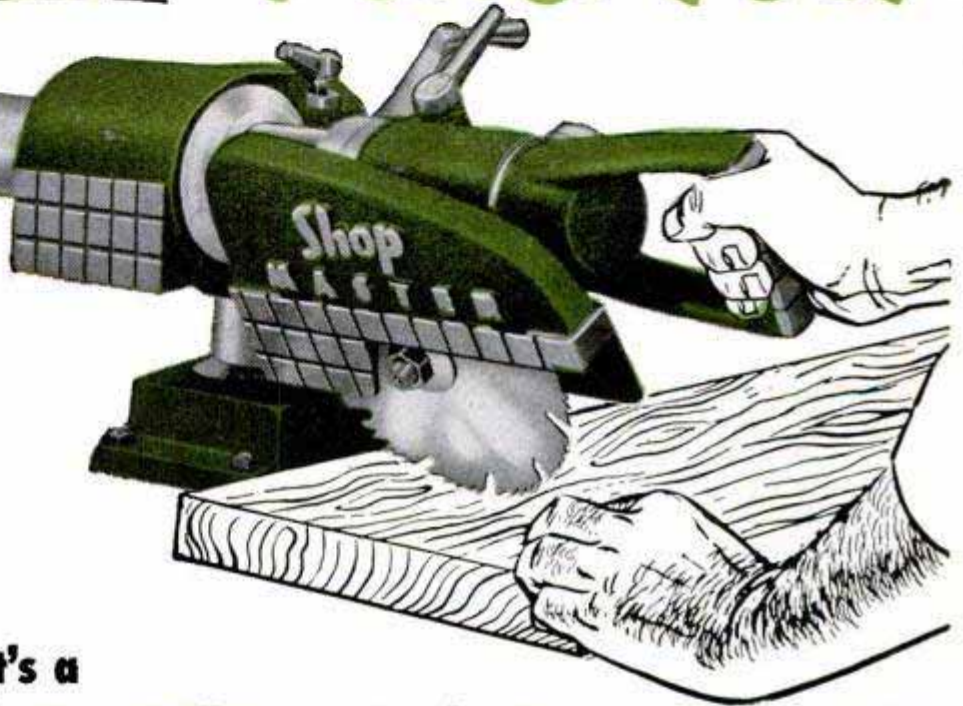

As Ball Bearing Circle Saw
 Mitres, compound mitres, cross-cuts, dados, rips, cups, grooves. 8" blade, 2 3/16" cut.

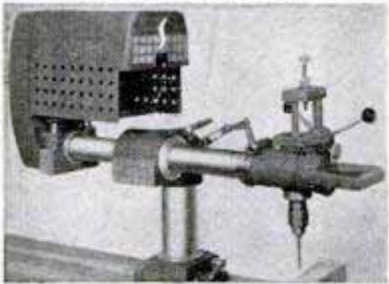

As Ball Bearing Drill Press
 3" stroke, 18" throat. Drill, rout or mortise at any angle, in 36" circle.

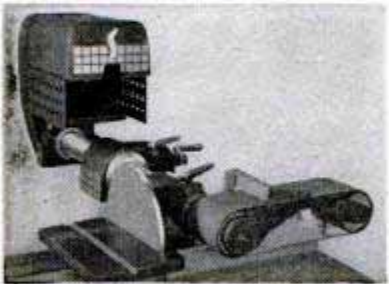

As Ball Bearing Sander
 Either belt or disc locks in vertical or horizontal position, or at any angle.

It's a
Circle Saw, Drill Press, Sander, Router, Shaper, Lathe

All in one

The most versatile and useful all-purpose woodworking power tool ever developed . . . a complete workshop in itself! Easy to convert . . . It's light, flexible and simple to operate, yet precision-built to finest professional quality.

All Moving Parts Glide on Ball Bearings

Moving parts glide smoothly, effortlessly on friction-free ball bearings. Easy-to-read calibrations permit quick, precise setting. Locks in any position. Beautifully finished with chrome-plated column crank, lock handles and shaft caps.

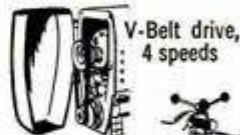

Powers other tools



Tools changed in seconds.*

Complete with saw, drill, disc and belt sander, and safety type chuck. Mounts on special table See other famous individual Shopmaster tools. Other tool accessories available.

\$249⁹⁵
 plus motor



Shopmaster, Inc., Dept. PM-1
 1214 Third Street South, Minneapolis, Minnesota
 Send information on new Shopmaster Universal Power Tool TODAY!

Name.....
 Address.....
 City..... State.....

(Continued from page 103)

of organic matter, carbohydrates, proteins, fats—in some form or other. And as animal life in many forms was found at greater depths than seven miles, there must be organic matter in these places. But where did it come from and in what quantities was it being produced? While animals break down organic matter to carbon dioxide and water, plants build up this material to carbon hydrates and other organic matters, which serve as food for fish, animals and human beings. It would, consequently, be of great importance to determine the production of organic matter in



Professor ZoBell used both feet and hands working to classify bacteria brought up from 30,000-foot depth

the sea. The *Galathea* people solved the problem. The production of organic matter in the sea has been investigated before, but the results have not been exact because the methods used—determination of the oxygen production of the plants—were by no means sensitive enough for the open sea. Therefore, it was imperative to develop a new method of greater sensitivity.

"The radioactive carbon isotopes, one of the first and biggest blessings of the atomic age, came to our rescue," says Dr. Steemann Nielsen, leader of this part of the expedition. In a few months he developed a method to determine the production of organic matter with the help of the carbon isotope C_{14} .

This new method was to give the most

(Continued to page 242)



—yours with these Wizards with Wood

Making something that needs finishing? Mending something that needs gluing? If it's made of wood ask for Firzite, Satinlac and Weldwood Glue. At hardware, paint and lumber dealers—or mail coupon for leaflets.

The Wood Glue you can rely on!



To make things or fix things, use Weldwood Glue for all wood-to-wood bonds. Makes joints stronger than the wood itself. Mixes easily with water. Stain-free, rot-proof...highly water-resistant!

WELDWOOD®
PLASTIC RESIN GLUE

Gets that blond or pickled effect—



Produce those magical "woody" effects — on hard wood or soft, plywood or solid lumber with White Firzite. For light pastel tones, tint with Colors-in-Oil. (On fir plywood stain jobs, tame that wild grain with Clear Firzite.)

WHITE FIRZITE®

Gets that Natural-Wood Finish



—without shellac or varnish. On furniture, panelling or woodwork, there's nothing like Satinlac. Brings out natural grain and color beauty of any plywood or solid wood. Avoids that "built-up look; will not turn yellow or darken with age. "Water-clear," easy to brush or spray, dries ready for next coat in 2 or 3 hours.

SATINLAC®

Pints, Quarts,
Gallons

United States Plywood Corporation,
Dept. 167, 55 West 44th St., New York 36, N.Y.
Send me free leaflets on Weldwood Glue, Firzite
and Satinlac.

NAME _____

ADDRESS _____

MARVEL keeps

NEW CARS NEW LONGER...

USED CARS IN USE LONGER...



Drivers in the know . . . know Marvel is the finest lubricant you can put into your crankcase and gas tank.

And that goes for both new cars and used cars. Age doesn't matter. What does matter is the way Marvel registers — in the lower service charges you shell out at inspection intervals.

Try a can of Marvel in your engine today. See if your car doesn't run better, longer . . . right from the start!

**MARVEL MYSTERY OIL—
THE MECHANIC'S CHOICE
FOR THIRTY YEARS**

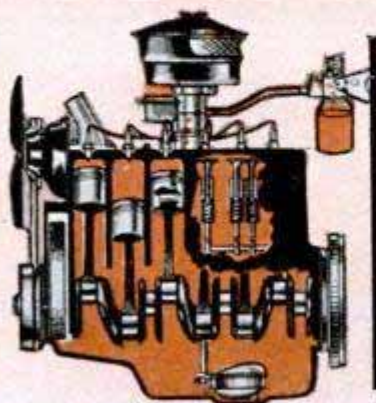

Marvel in the crankcase lays a strong, heat-resistant film of oil on all moving parts . . . eliminates hydraulic valve clatter . . . provides ring seal . . . cleans, cools and protects bearings and vital upper cylinder regions. The car runs for many more engine miles per dollar.

Install a Marvel Inverse Oiler for direct lubrication to the heart of the engine. Feeds in direct proportion to horsepower curve through inverse ratio to manifold vacuum. No other oiler works on this principle! Fully adjustable. Easy to install. Fully guaranteed.

For more information, write:
EMEROL MANUFACTURING CO., INC.
Dept. 113, 242 W. 69th St., New York 23, N. Y.



astounding results. The radioactive element had to be purchased from the United States. It is expensive, but very little is necessary. A quarter of a gram was more than enough for the entire expedition.

If you put a drop of sea water under a microscope you will find it crowded with microorganisms, no bigger than $\frac{1}{100}$ millimeter. They are plankton algae, tiny green and golden plants of the craziest shapes. They produce the organic material, the amount of which the *Galathea* expedition was to determine. In principle this is done in the same way as other biological experiments with isotopes. The plankton cannot detect the difference between natural carbon dioxide and radioactive carbon dioxide, of which the isotope C^{14} is a part. Carbon dioxide containing isotopes is added to the plankton-filled water and with a Geiger counter you measure how radioactive the plankton algae have become. Then the amount of assimilated carbon can be calculated and also the organic matter that has been produced.

The average production of organic matter along *Galathea's* route across the Indian Ocean is 100 milligrams of carbon per square meter of surface. At the western coast of Africa the production is four to five times higher. This may not sound like



A few creatures brought up from the ocean bottom off South Africa—none could survive surface pressure

(Continued to page 244)

UNCLE WALTER

IT SMELLS GRAND



HAS IT GOT AROMA?
MAN, AND HOW!

IT PACKS RIGHT



AND IT PACKS SO NEAT
IT RATES A BOW

IT SMOKES SWEET



IT'S THE PIPE-BLEND CHAMP
YOU MUST ALLOW

IT CAN'T BITE!

A BLEND OF CHOICE KENTUCKY BURLEYS,
EXTRA-AGED TO GUARD AGAINST TONGUE
BITE. SIR WALTER RALEIGH STAYS LIT
TO THE LAST PUFF — NEVER LEAVES A
SOGGY HEEL



*It costs
no more
to get
the best!*

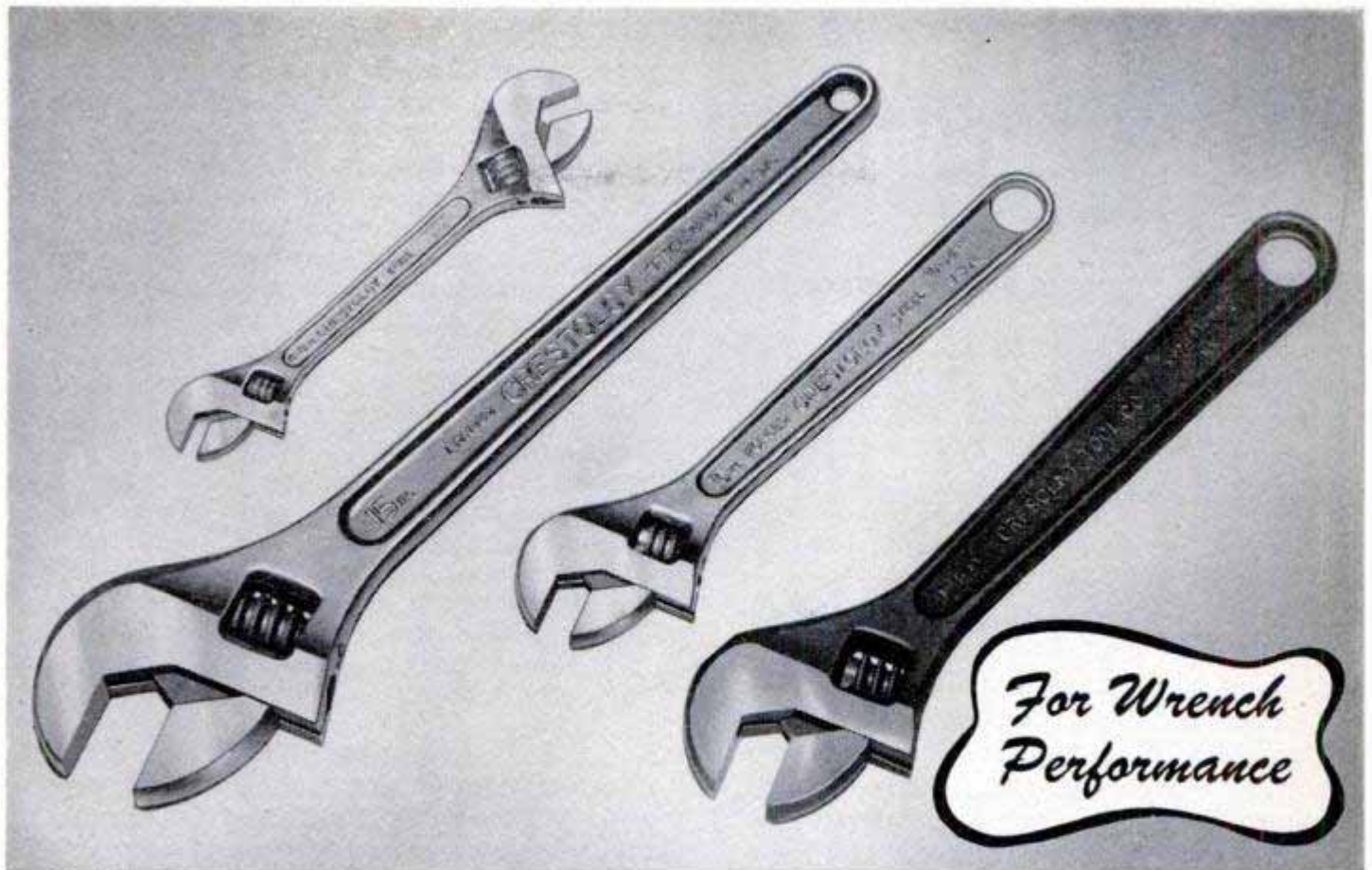

Choose **CRESCENT** or **CRESTOLOY**

● Since more Crescent and Crestoloy Adjustable Wrenches are sold today than any other brand, an explanation of the differences in these two famous Crescent tools may be appropriate.

CRESTOLOY Wrenches are forged from a special alloy steel permitting thinner, trimmer design with greater strength and less weight than conventional types. They are available in Single End patterns, 4" to 24" size. Double-end in four models combining 4-6; 6-8; 8-10; 10-12 inch sizes.

The 15", 18" and 24" sizes, available in Single End pattern only, are distinguished by their tapered handles. There is no stronger or finer Adjustable Wrench than **CRESTOLOY**.

CRESCENT Wrenches are forged from selected carbon steel and specially heat-treated to increase their toughness and durability. Due to their lesser cost and relatively great strength, they are widely used in industrial and service operations where thinness is not essential. Available in Single End Patterns, 4" to 18".

Both Wrenches represent the best in design and workmanship, and carry the same guarantee.

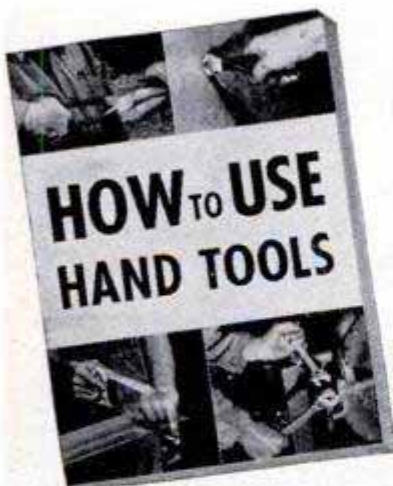

GET YOUR FREE COPY!

This new 20-page booklet provides many useful how-to-do-it ideas for both amateurs and professional mechanics, as well as basic information on the proper selection, use and care of hand tools. 93 illustrations. Write today.

CRESCENT TOOLS

Give Wings to Work

*Sign of the Artisan
Symbol of Excellence*



Crescent is our trade-mark, registered in the United States and abroad, for wrenches and other tools. Sold by leading distributors and retailers everywhere and made only by **CRESCENT TOOL COMPANY, JAMESTOWN, NEW YORK**

EASY WAY TO PEEL OFF OLD WALLPAPER



EASYOFF remover
saves up to \$15 per room

This is the simplest, most economical known method of removing wallpaper. You just mix EASYOFF with warm water and brush, sponge or spray on. It penetrates the paper and dissolves the paste,

so all the old wallpaper can be peeled right off. Will not injure wall surface or woodwork.

If your paint or wallpaper dealer doesn't have EASYOFF, mail \$1.00 for 6-oz. bottle that makes 3 gallons of remover—enough to remove paper from one large or two small rooms. Money-back guarantee.

THE KLEAN-STRIP CO.
2362 S. Lauderdale, Memphis 6, Tenn.
Makers of Highest Quality Removers



**INSTALLED
IN JUST 30 MINUTES**

Nova Roller Doors for passageway or storage space

Be modern — with handsome, silent, space-saving roller doors. Exclusive Nova construction features give you doors operating under fingertip control — built for year 'round use in any climate — light, strong, warp-resistant. Two or more doors enclose any opening. Each door comes complete in one carton and is quickly installed by one man. . . . These are hollow core, flush doors — regularly sold in the finest plywood or lumber — from birch and gum to imported mahogany, for any waxed, stained or painted finish your interior design may demand. Write today for fully illustrated literature. Department 19C, NOVA SALES CO., Trenton 3, N. J.



much, but in the total amount of sea water 40,000,000,000 tons of carbon hydrate are produced every year and that is as much as is produced by all the trees and plants on land.

These investigations may be of great practical value. They tell where fishing can be done on a big scale without harming the population seriously. And one day, perhaps, our technical skill may be so developed that we use these vast supplies of food more directly than by eating the fish.

Ornithologists also were on board the ship and they brought home many rare birds from their expeditions. Among other places, they investigated the island of Mindanao in the Philippines, where in some mountainous areas no white man had ever been before. Here they successfully proved a theory advanced by Dr. Ernst Mayer regarding development of species. It is known that new species can be developed by mutations but, according to the theory, if the mutation shall form a new race, it must take place in an isolated area. If it does not, the new characters will swamp out by being mixed too much. In an isolated area the mixing is limited and there is a greater chance that the mutation will form a new race. Theoretically, you would expect to find new species on an isolated island like this one and the ornithologists did find many such. For instance, they found a little bird which was exactly like its relatives from other parts of the world except for a small yellow spot on the throat.

Dr. Birket Smith, ethnologist, studied the Igorots, a partly unknown people living in the center of the island of Luzon in the Philippines. A few years ago the Igorots were heartless headhunters. Today they live in isolation, but Doctor Smith's good luck got him contact with these people as well as the chance to live with them and study their life and religious ceremonies.

The *Galathea* has brought home some fine results from its trip around the earth. It has been successful in many ways. The trip cost Denmark about \$1,000,000—a lot of money for a small country. Now the scientists are trying to raise new capital so that they can start again on new expeditions, new scientific investigations and new adventures. ★ ★ ★

Time Switch for Car Headlights

Seconds or minutes after you've left your car, its lights are automatically turned off by a control which fits on the dash panel. Designed to end stumbling in dark garages and dim side streets, it allows illumination for any time period up to five minutes.

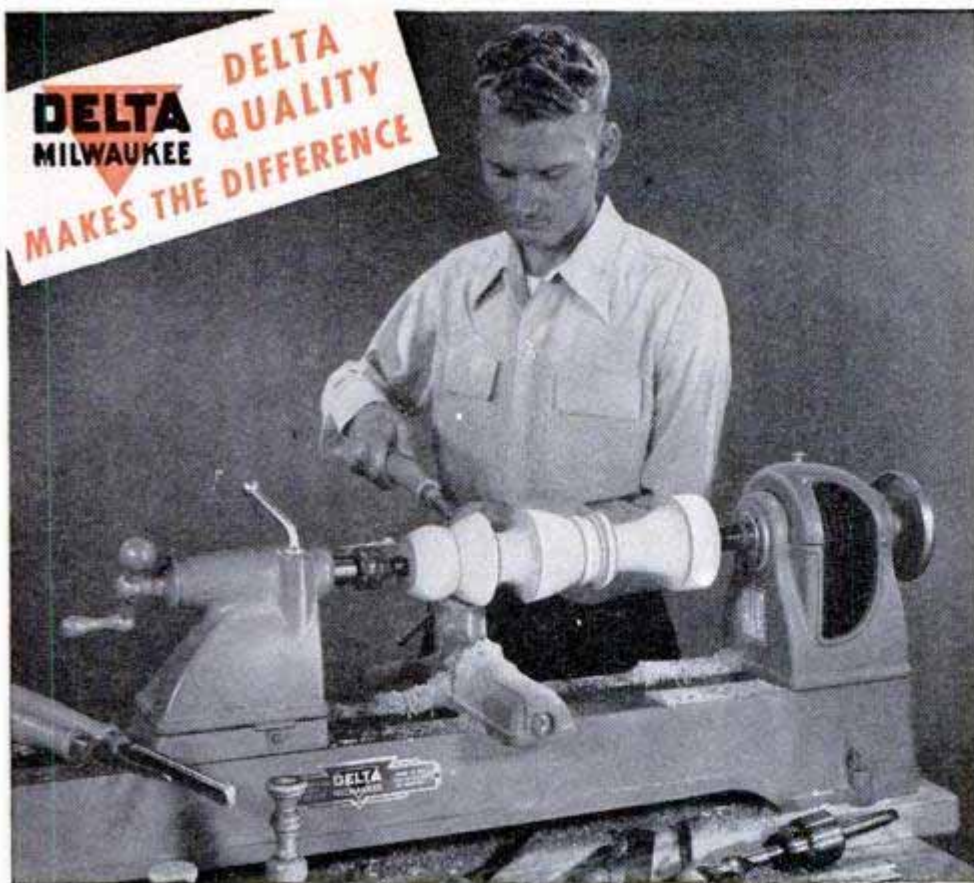

Know
the Fun of
Working
with a Fine
LATHE
Know the
Satisfaction
of owning a
DELTA

Check these outstanding quality features:

- heavily ribbed bed for strength and rigidity
- Timken tapered roller bearings carry the spindle
- double-row index mechanism built into headstock—invaluable for quick division of spindle or face-plate work
- No. 2 Morse Taper centers and other attachments for quick changes; heavy non-jamming thread on both ends of spindle permits use of either inboard or outboard face plates, grinding, polishing, or sanding accessories
- 3/8" hole through headstock for repetitive work on rods and dowels.
- graduated tail stock sleeve machined inside with a No. 2 Morse Taper and adjustable pointer for convenience in drilling work held in chuck
- handy lever locks tailstock to bed—ball lever at rear locks or unlocks tailstock sleeve in one easy movement
- set-over tailstock—easy to align—centers accurately
- slide rest and other attachments for light metal turning available at small cost
- 4 speeds—930, 1400, 2140, 3200 rpm

Make tables, chairs, lamps and scores of attractive items—do fine professional-looking work with a Delta Homecraft 11" Lathe.

A fine lathe means you can do work better, faster and easier. Yet a high quality machine doesn't mean high price—not when it is DELTA. Be sure to see this tool at your Delta Dealer's. Note its many quality features and its wonderful-value price.

Handy Deltacraft books teach you how to use power tools—give plans and instructions for many wonderful projects. Use the coupon.

MAKE INTERESTING PROJECTS LIKE THESE:



Graceful colonial table



Brilliant "zebra" bowl is simple



Turned wine set

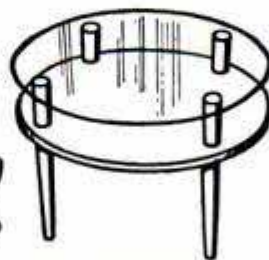

Smart glass-top coffee table

DELTA POWER TOOL DIVISION
ROCKWELL MANUFACTURING CO.
502A N. Lexington Avenue
Pittsburgh 8, Pa.

Please send the following:

- Delta Homecraft Catalog—10c enclosed.
- "Things to Make on Your Lathe"—25c enclosed.
- "Getting the Most Out of Your Lathe"—25c enclosed.

Name _____

Address _____

City _____ Zone _____ State _____



DELTA POWER TOOL DIVISION
ROCKWELL MANUFACTURING COMPANY
502A N. LEXINGTON AVENUE • PITTSBURGH 8, PA.

Save Time! Save Money!
Get this--
BIG NEW BOOK
The Woodworker's "Bible"



only
15¢

- 144 PAGES OF BARGAINS AND HELPFUL INFORMATION
- 1500 ITEMS AND IDEAS FOR THE WOODWORKER

Whether you're a beginner or an advanced wood craftsman--this famous big, new book will show you how you can make hundreds of valuable items in wood. It's literally filled with step-by-step instructions, how-to-do-it information, dozens of time and money saving hints and ideas, plus all kinds of projects you can make for fun or profit--at real bargain prices you can afford.

Guide for Amateur and Expert

Offers the world's finest selection of imported and domestic woods. Illustrates 32 rare and fancy woods in color...43 veneer designs...multi-colored bandings, inlays, overlays...275 scroll patterns... all kinds of tools, machinery, cabinet hardware, ornaments, mouldings. All woods properly seasoned, kiln dried, correctly graded. Quick delivery --a board or a carload. Everything guaranteed. Thousands of others all over the world have sent for this famous book. Mail coupon and 15c today --you'll be glad you did.

MAIL THIS COUPON--TODAY!

CRAFTSMAN WOOD SERVICE CO.
2729 S. Mary Street, Dept. A1
CHICAGO 8, ILLINOIS

Please send me Hunt's BIG, NEW time and money saving Catalog No. 19 for Woodworkers. Enclosed is 15c.

Name _____

Address _____

City _____ Zone _____ State _____

Wanted: 50,000 Engineers

(Continued from page 135)

sign. A hail-fellow-well-met, with low creative ability but objective personality will do better in construction.

Robust health is essential for the engineer whose work takes him into the field, where he must get around without handicaps on dangerous construction jobs. Long hours of work call for reserves of stamina. The engineer should be alert, persevering, reliable, willing to face staggering problems without quailing. He must get along with people, since his work will ordinarily require it. He must be forever curious about "things" and must have the ability to visualize the objects which he thinks of.

In answer to a request from the government two years ago, the Engineers Joint Council, which is made up of five major engineering societies, formed the Engineering Manpower Commission located beside

(Continued to page 272)

ANSWERS TO PHYSICS TEST

Answer	Percentage of Engineering Students With Correct Answer
1. generator	100
2. focal length	96
3. photometer	80
4. rectifier	73
5. critical	57
6. cathode	49
7. electron	44
8. Foucault	39
9. polariscope	22
10. Angstrom unit	20

ANSWERS TO AVIATION TEST

Answer	Percentage of Engineering Students With Correct Answer
1. amphibian	95
2. drift angle	72
3. slipstream	67
4. airfoil	58
5. longerons	53
6. empennage	49
7. anemometer	46
8. chandelle	25
9. drag strut	20
10. tropopause	6

ANSWERS TO GEOLOGY TEST

Answer	Percentage of Engineering Students With Correct Answer
1. physical characteristics	81
2. inlet	75
3. glacial deposit	35
4. river	34
5. flood deposit	27
6. later stone	26

**5 BIG POWER TOOLS
in ONE**



**8" TILTING
TABLE SAW**

**HORIZONTAL
DRILL PRESS**

GRINDER

30" LATHE

SANDER

RETAIL PRICE \$125.00

FACTORY TO YOU \$79.95

SUPERSHOP is a **PRECISION-BUILT WORKSHOP**. 100% ball bearing. All running parts precision ground. Big capacity. Extra rugged. Amazing value. Write for **FREE** catalog.

BUY ON EASY PAYMENTS

POWER TOOLS, INC.

143 YATES AVENUE
BELOIT, WISCONSIN

**VERTICAL
DRILL PRESS**

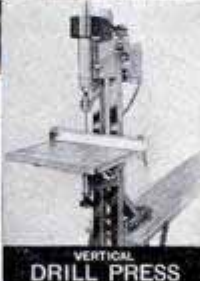

Thousands In Use

SMALL! POWERFUL!

America's finest low cost tractor. Ruggedly built. Easy to operate. No belts, no chains. Borg-Warner clutch, trans. and diff. 140 to 1 reduction. 40% more drawbar pull than ordinary tractors. 8-1/4 H.P. engine—gasoline or kerosene. 20 quick change implements. Write for complete details.

ENGINEERING PRODUCTS CO.
915-K1 Niagara Ct.
Waukesha, Wis.

ECONOMY TRACTOR

Buy the Mechanic's FIRST Choice

...EMPIRE LEVELS

For Home, Farm, all Trades



See Empire Levels at your dealer.



Empire No. 151 Aluminum Level: Adjustable vial cases, twin levels, plumbs, 45° vials — 24" — \$7.50.



**EMPIRE LEVEL
MFG. COMPANY**

10930 West Potter Rd., Dept. PM., Milwaukee 13, Wis.

Mortite **KEEPS THE COLD OUT**

SAVES FUEL AND MONEY

Cordlike and pliable, Mortite is the perfect weatherstripping. Goes on in a jiffy without tools or tacks. Keeps out wind, dust, dirt. Anyone can press it around windows, doors, transoms, baseboards. Weatherstrip a whole window for 29c—costs even less if you use the larger packages. Get Mortite at stores or write for circular. J. W. Mortell Co., 522 Burch St., Kankakee, Ill.



Handiest tool you can own
Starrett
COMBINATION SQUARE

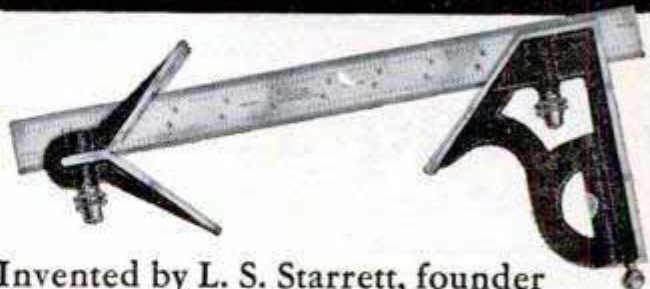

Invented by L. S. Starrett, founder of The L. S. Starrett Company, the combination square combines a rule, square, mitre, height gage, depth gage, level, center gage and scribe — eight handy tools in one! Latest models feature hardened precision ground steel blade with bold figures and sharp, easy-reading graduations; new type quick-reversing lock bolt; easy-to-clean black enamel finish on square and center head; built in level; hardened scribe. Available in 4, 6, 9, 12, 18 or 24 inch sizes, at your Starrett Tool Distributor's.



COMBINATION SETS

With reversible or non-reversible protractor head, square head and center head. 12, 18, and 24 inch sizes.

BEVEL PROTRACTORS

Reversible or non-reversible protractor head, built in level, hardened blade. 12, 18, and 24 inch sizes. Also Metric.



SEND FOR IT — ONLY 10¢

Starrett "Tools and Rules" Book shows the right tools for any measuring job. 50 pages, 100 pictures, helpful reference tables. Address Dept. AP



THE L. S. STARRETT COMPANY • ATHOL, MASS., U.S.A.

Starrett
TRADE MARK
REG. U.S. PAT. OFF.
SINCE 1880
WORLD'S GREATEST TOOLMAKERS

Buy THROUGH YOUR INDUSTRIAL DISTRIBUTOR
Prompt delivery
Dependable service
Quality products

MECHANICS' HAND MEASURING TOOLS AND PRECISION INSTRUMENTS
DIAL INDICATORS • STEEL TAPES • PRECISION GROUND FLAT STOCK
HACKSAWS, BAND SAWS and BAND KNIVES

STOP BURNING OIL!

RESTORE THE POWER
YOU BOUGHT



GET THAT "NEW CAR" PERFORMANCE WITH

Ring-Re-Nu

TRADE-MARK

MOTOR RECONDITIONER KIT

1-2 combination that cleans and reconditions your engine. Increases compression, eliminates piston slap, and reduces oil consumption.

Double Value Kit Contains

P. V. R. COMPOUND — when poured in carburetor, P. V. R. cleans your engine of gum, carbon and varnish. Frees rings, valves and pistons. Prepares your engine for...

RING-RE-NU — the amazing compound which when squeezed by tube on your pistons forms a pliable, self expanding lubricating seal on rings and pistons to compensate for wear. Good for 10,000 plus miles. Saves overhaul cost and oil bills.

Simple to install —

Nothing to dismantle. Will take you only a few minutes with our easy-to-follow instructions.

Order the Genuine **RING-RE-NU** — not a foreign import. Made in America for American engineered engines. Guaranteed not to harm your engine. Assures you of 10,000 plus miles of "new car" performance.



1 tube kit — good for all makes of cars (except those listed below) only

\$4.95

Postpaid R. D., Inc.

2 tube kit — for larger engines — Buick Roadmaster, Cadillac, Chrysler 8, LaSalle, Lincoln, Packard 8, Olds 88 and 98 — \$8.95 postpaid.

(\$1.00 deposit required on all C.O.D. orders)

10 DAY MONEY BACK GUARANTEE

Free descriptive folder available on request.

RICHIE DISTRIBUTING, INC.
11916 MADISON AVE., DEPT. A1
CLEVELAND 7, OHIO

Say You Saw It in
POPULAR MECHANICS

DRIVING COMFORT at its best! The New *Electric Throttle* With Foot Control

The Electric Throttle ("Speedselector") sets whatever speed you choose electrically — releases instantly at a touch on the toe-button, or by applying foot brake. Banish foot and back strain for good! Price, \$17.50 F.O.B. Check or C.O.D. Ten day money-back guarantee. Several State franchises open. Dealer inquiries invited. Give car, make, and year. Pays for itself in gasoline savings.

AN IDEAL GIFT ITEM

D & M MFG. CORP., Anderson, Ind.

INSTALL IT YOURSELF
Send for FREE Illustrated Folder



Headaches of a Jet Designer

(Continued from page 85)

version of an attack plane yet to be built.

Complexity, therefore, is not a sign of perfection. Engineers are frequently lauded for the intricacy and complexity of their designs. This is a grave error. True perfection is a matter of solving problems by avoiding them and applying ingenuity to achieve simplification.

What it all boils down to is this: America will remain superior in air power if our designers not only can outguess the enemy but also our procurement agencies. A newspaperman, they say, needs a nose for news. An airplane designer must detect future trends and anticipate what the Navy and Air Force will require 5, 10 or even 15 years from today.

If we designers guess wrong, all 155,000,000 of us in the United States will be reaching for the aspirin bottle. ★ ★ ★



German Iron Rest

Clamped to the ironing board at an angle, a metal bracket holds the iron on a series of rollers. Made and sold in Germany, the iron rest also has a guide to keep the cord from becoming snarled during use. The rollers permit the housewife to slide the iron in and out of the rest without lifting it.

☞ To spin the blades of an Alabama turbine-generator to the top speed of 942 miles per hour will take 90 minutes and to bring them to a stop will take 30 minutes.

**RELIEVES
HEADACHE
NEURALGIA
NEURITIS PAIN**

FAST



Here's Why...

Anacin® is like a doctor's prescription. That is, Anacin contains not one but a combination of medically proved active ingredients. Anacin is specially compounded to give **FAST, LONG LASTING** relief. Don't wait. Buy Anacin today.

SHEET METAL BRAKES

Angles, flanges, Pittsburgh locks, 24 G. steel, heavier aluminum. Cam locking, mount on bench, truck or floor stand. Truss braced-steel. Express collect. 30", 65 lbs., \$35.50. 36", 75 lbs., \$40.00. 48", 100 lbs., \$56.00. Portable stands, 32" hi. 35 lbs., \$8.00.



IRON BENDER forms hooks, angles, eyelets, etc. Capacity 1/4 x 2", 5/16 x 1 1/2". 10 parts, all steel, express collect. \$9.50
2 1/2" CURVE FORMER. Forms straight and tapering pipes 2" to 2 ft. in diameter, 16 gauge, express collect. \$9.50
(Immediate delivery. Order cash or C.O.D., or send for folder)

VYKE BRAKE CO., P-3016 Leavenworth, Omaha 5, Nebr.



Sport-Fun-Thrills!

Swing into the saddle of a powerful Harley-Davidson motorcycle — for a thrilling, action-packed ride. See your dealer, or send 25 cents for literature and copy of *Enthusiast Magazine*.

HARLEY-DAVIDSON MOTOR CO.
Dept. P, Milwaukee 1, Wis.

HARLEY-DAVIDSON
HYDRA-GARD

Get the handy
TORIT ACETYLENE BLOWPIPE OUTFIT
for soldering and all small jobs requiring heat

Consists of torch, 4 tips, soldering copper, hose, connections for acetylene tank, and instructions for use.

Ideal for garages, repair shops, home workshops, etc. Ask for free literature on Torit Outfit No. 23 or order now. Sent postpaid for only



\$12.00

TORIT MANUFACTURING CO.

273 Walnut St. • St. Paul 2, Minn.

World's Most Complete!
1953 ALLIED
TV & RADIO CATALOG

FREE!

Everything in TV & Radio
At Lowest Prices

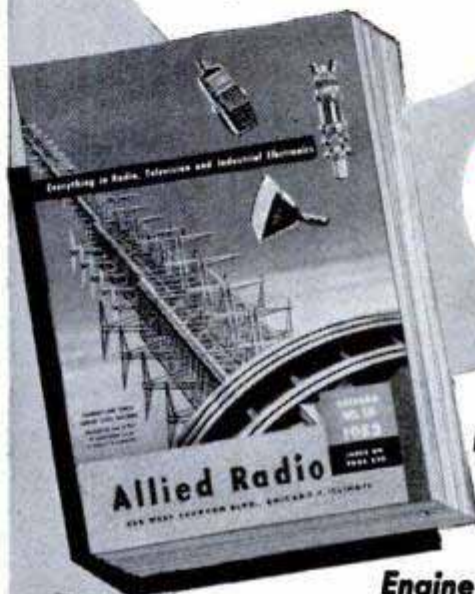

**236 PAGES
VALUE-
PACKED**

Everything for
**Experimenters,
Builders,
Amateurs,
Servicemen,
Engineers, Soundmen**

Send for ALLIED's big 236-page value-packed guide to *everything* in TV and Radio! Custom TV chassis, TV accessories, FM and AM radios, Amateur supplies, High-Fidelity Sound, P. A. Systems, recorders, test instruments, builders' kits—plus the world's largest stocks of electronic parts, tubes, tools and books. Get more for your money—send today for your **FREE 1953 ALLIED Electronics Catalog!**



SEND FOR
FREE
CATALOG

ALLIED RADIO

ALLIED RADIO CORP., Dept. 5-AA-3
833 W. Jackson Blvd., Chicago 7, Illinois

Rush FREE 1953 ALLIED 236-Page Catalog.

Name _____

Address _____

City _____ Zone _____ State _____

Experts (like you)...beginners, too... like SHOPSMITH better

than any other
power tool in
America!



.....

A
COMPLETE
Workshop!

Five superior tools
in the space of one!

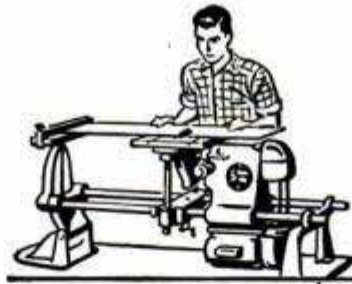

CIRCULAR SAW cross-cuts, rips, bevels or miters. Maximum depth of cut, 2 1/4". Depth regulated by built-in micro table-raising mechanism. Up to 48" between blade and fence!

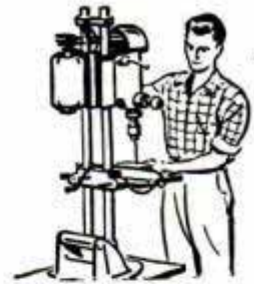

DRILL PRESS drills, routs, reams, mortises, countersinks wood, metal, plastic. Up to 27" between table and chuck. Saw fence miter gauge and tilting table provide automatic settings without special jigs.

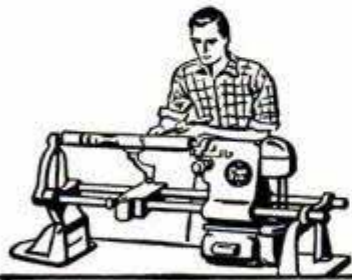

LATHE turns wood, plastics. Extra capacity—15" swing, 33" between centers. Tool rest slides parallel to work; is quickly adjusted, locked into position for any operation, including faceplate turning.



DISC SANDER is a precision tool you'll use often. No "chatter" when beveling thin pieces. Plain and compound miter sanding. 12" sanding disc is dynamically balanced ... installed instantly.



HORIZONTAL DRILL PRESS is ideal for pieces too big or awkward for vertical drill press. Length of work limited only by size of room. It's the *only* professional doweling tool available for the home workshop.

Complete 5-tool unit
 only \$189⁵⁰
 Motor* and bench extra

* Special SHOPSMITH motor; heavy-duty, 1/2-hp., ball-bearing, capacitor, 110 V, 60 cycles—\$34.50.

SHOPSMITH is America's largest selling power tool because it's a real *multi-purpose* tool that actually outperforms most saws, sanders, drills and lathes.

It offers hairline accuracy, tremendous capacity, important savings in money and space, and many quality features formerly found only in the most expensive professional tools. SHOPSMITH versatility means you have the proper tool, simplified adjustments and ready-made jigs for difficult or unusual operations, and to change from one tool to another takes less than 60 seconds.

SHOPSMITH is *not* a makeshift one-bench assortment of individual tools never designed to work together. It was designed from the beginning as a multi-purpose tool, and is time-tested, rugged, practical and completely flexible. Yet its cost fits the most modest budgets. Fill out and mail the coupon today for SHOPSMITH's colorful 16-page booklet. It's free!



Compare SHOPSMITH quality with any other power tool!

BALL-BEARING CONSTRUCTION. Spindle floats on *four* grease-sealed ball bearings. Spindle tip is induction-hardened, has reverse-tapered safety flat.

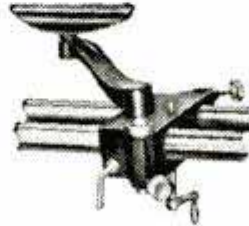
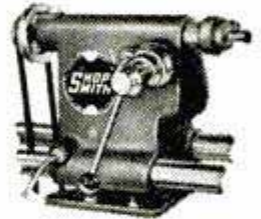

MACHINE-TOOL PRECISION. All moving parts are machined to precision tolerances. Headstock and carriage slide effortlessly on the ways.

HEAVY-DUTY CASTINGS. No stamped metal parts. Castings are fine-grain grey iron or rigidly ribbed, top-grade aluminum alloy.

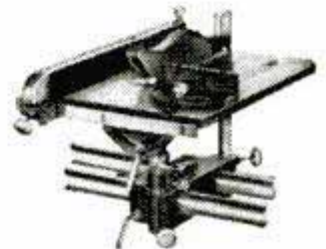

EXCEPTIONAL QUALITY THROUGHOUT. Because they are used for all major operations, parts are made with special care from top-grade materials.

FREE SHOPSMITH BOOKLET!

Gives complete details. 16 illustrated pages. Send coupon for your free copy.



MAGNA ENGINEERING CORP.

Dept. 102-B at factory nearest you:
 12819 Coit Rd., Cleveland 8, Ohio, OR
 Menlo Park, California

Please send me my free copy of the SHOPSMITH catalog and the name of my nearest dealer.

Name _____

Address _____

City _____ State _____

DOES DOZENS OF HOUSEHOLD JOBS



**Your All-Purpose
WELLER Gun**

Homecraftsmen —

Hobbyists—Here's your

most useful tool! Instant-heating

WELLER Guns cut rubber and composition floor tile—remove old putty from windows—repair rain spouting, radio and TV sets, furniture finishes, electrical wiring—heat-seal home-freezer packages—build model railroads—solder costume jewelry—re-groove auto tires. Dozens of other money-saving jobs, too. See dual-heat (high or low) WELLER Guns with low-cost replaceable tips at your Hardware Dealer.

• **Send for Literature.** New bulletin tells all about sharp-shooting WELLER Guns. Send for your copy today.

Weller SOLDERING GUNS

816 Packer Street, Easton, Pa.

Free to mechanics
DURO-CHROME
TOOL CATALOG

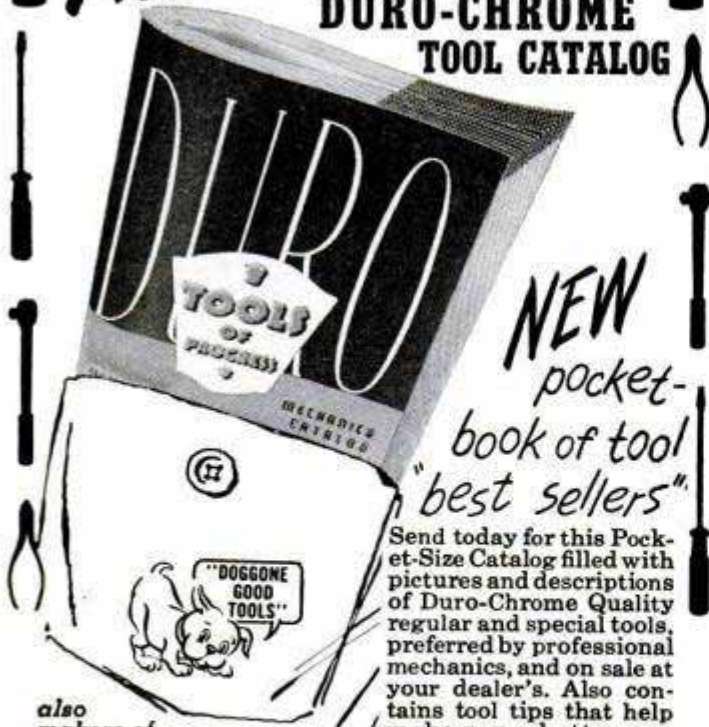

NEW
pocket-
book of tool
"best sellers"

Send today for this Pocket-Size Catalog filled with pictures and descriptions of Duro-Chrome Quality regular and special tools, preferred by professional mechanics, and on sale at your dealer's. Also contains tool tips that help make you a better mechanic. All yours without cost or obligation.

also
makers of
nationally advertised
DURO POWER TOOLS

clip this coupon now to get **FREE** copy
MAIL TO DURO METAL PRODUCTS COMPANY
2649 N. Kildare Ave. Chicago 39, Illinois.

Write your name and address in margin space.

Darkroom in the Desert

(Continued from page 94)

With this Jeep so equipped I have traversed very difficult terrain to reach remote areas, and with the portable darkroom it is quite simple to use the kitchenette of almost any motel to knock out a few prints.

Many times I have pitched camp here in the desert some 60 miles from the nearest town, and yet it has been possible to work efficiently and to live comfortably in camp with the Jeep equipped as it is. In fact, this setup has proved so successful for back-country operations that three different prospectors have offered me a higher price than originally paid for the Jeep complete with its box.

The Jeep is equipped with a 250-pound weight on the front end to help when using the four-wheel drive on steep slopes. ★ ★ ★

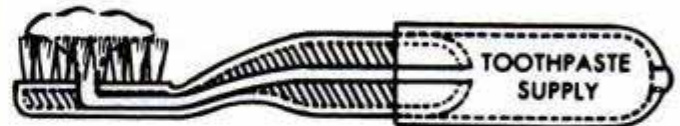

Loaded Toothbrush

Containing its toothpaste right in the handle, a hollow toothbrush feeds itself. Just a push and a twist of the plastic handle thrusts a supply of paste in among the nylon bristles. Covered like a fountain pen with a ventilated clip-on cap, it can be carried safely in the pocket, lunch box or suitcase. Made in four different pastel colors, it is about the size and shape of a fountain pen, and holds a six-to-ten day supply of toothpaste.

You Don't Need MUSCLES



... with a
**WISE-GRIP
WRENCH**



**Locks To
Work With
TON-GRIP**

Model 10-W, \$2.60

Leave your TOUGH fixin' jobs to Vise-Grip! A squeeze of the hand, and powerful jaws lock to work with Ton-grip. Won't slip! You can turn, twist, hold, bend, cut, ratchet. So E-A-S-Y, so FAST! 7" and 10", with or without cutter. Only \$1.85 to \$2.60 at your dealer.

Manufactured Only By



Dept. P-1 DeWitt, Nebr.



BUILD FINE GRANDFATHER CLOCK NOW

The simple sensible Red-i-Kut way as thousands have — **SAVE HALF. SHOP TESTED PLANS "SPIRIT OF THE CENTURY"** Narrow waist 83" tall or stately straight side **"SPIRIT OF AMERICA."** **EASY-TO-FOLLOW photopack PLANS** tell all—plus **BROCHURE** of heavy brass weight Westminster, tube chime, movements, gorgeous dials, 3/4" solid mahogany case kits. Send \$1.00 today — Both plans \$1.50 NOW.

KUEMPEL CHIME CLOCK CO., 26 Kuempel Bldg., Minneapolis 16, Minn.

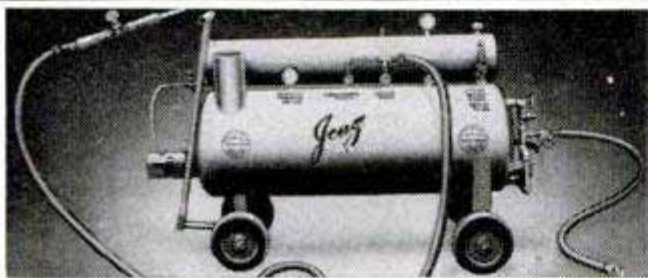

EARN \$6.00 PER HOUR

At a cost of 20c with the NEW JENZ SUPER CHIEF STEAM CLEANER. Portable—No moving parts—Cleans anything—Any place—Motors—Chassis—Machinery—Floors—Buildings—Oil Rigs, etc.—Oil fired—Economical—Fully tested and warranted. 75 lbs. steam in ten min.—Model 90. Complete **\$388.50** as illustrated.....

F.O.B. shipping point

HI-PURE LABORATORIES, Evansville, Ind.

Say You Saw It in Popular Mechanics

ELECTRICITY *Anywhere*

FOR PORTABLE, EMERGENCY OR HOME USE

ONAN Electric Plants generate 110-volt, 60-cycle current for homes, farms, cabins and resorts beyond the highline. Lightweight, portable plants cut costs, speed work for contractors. Standby plants protect units against power failure. 400 to 55,000 watts. Gasoline or Diesel-powered. Priced from \$219.00.

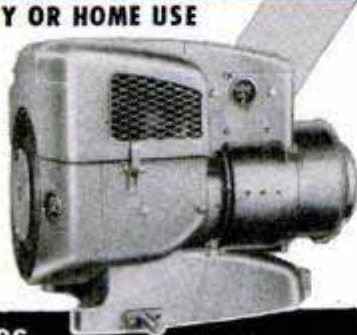

WRITE FOR CATALOG

D. W. ONAN & SONS INC.

5865 UNIVERSITY AVE., MINNEAPOLIS 14, MINN.

FOR SMOO-OO-THER WINTER DRIVING

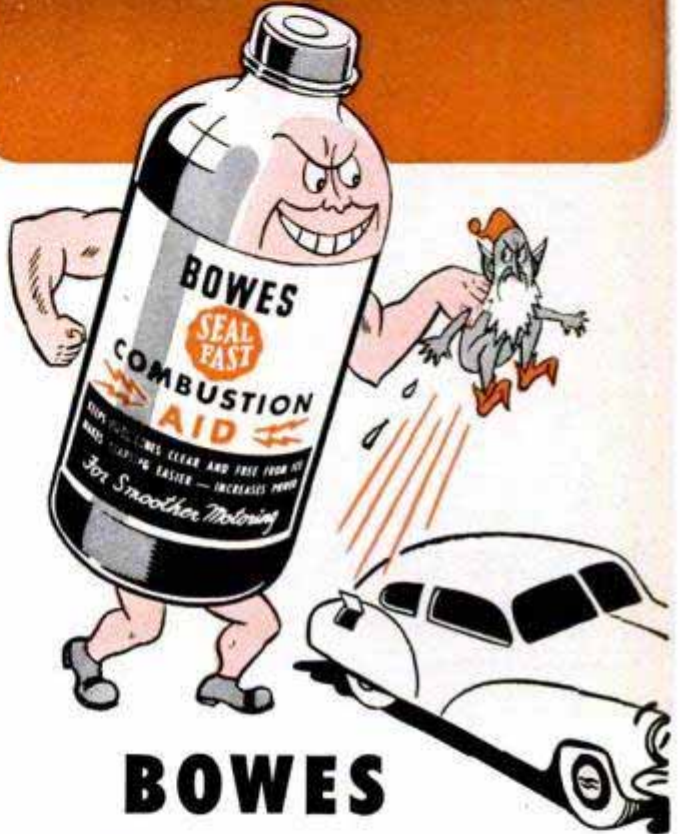

BOWES COMBUSTION AID

**KEEPS JACK FROST
OUT OF YOUR GAS TANK,
MAKES STARTING EASIER,
INCREASES POWER**

Be sure of quick, easy starting this winter! Bowes Combustion Aid absorbs the water in your fuel lines, keeps them free of gums and rust, softens and removes carbon. Easy to use . . . just put it in your gas tank . . . and have dependable, inexpensive cold weather protection! Your Bowes "Seal Fast" dealer can supply you.

**DRIVE IN
WHERE YOU
SEE THIS EMBLEM**



BOWES "SEAL FAST" CORP., INDIANAPOLIS 7, INDIANA

For Discriminating Users

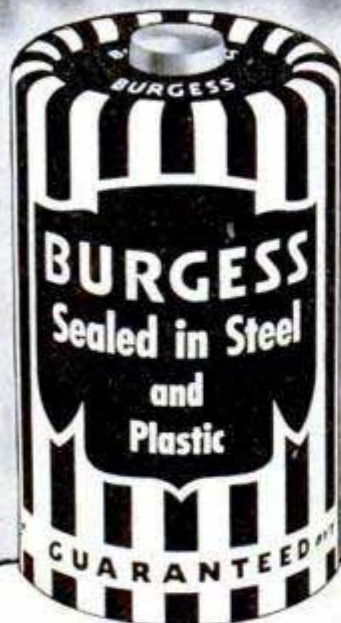

Scientists, explorers and engineers choose Burgess Batteries where lives depend on battery power, because they are recognized as best by the experts. Insist on using Burgess Batteries in your flashlight. Burgess Battery Company, Freeport, Ill.; Niagara Falls, Can.

A Quality Dry Battery For Every Purpose

SENSATION

SNOW-BLO

SAVES YOUR HEART!



Clears Walks and Driveways ... IN MINUTES

If you're one of the 9-million Americans with some form of heart trouble, SNOW-BLO is for you. Shoveling snow can overtax your heart and strain little-used muscles. But Sensation Snow-Blo gives you a new lease on life. Guide it down the walk and back to clear a 24" path . . . toss snow up to 20-feet away. For home or business, Sensation Snow-Blo provides quick, easy, low-cost snow removal. Get the facts today on gasoline and electric models.

SEND FOR FREE BOOKLET TODAY

Please send me FREE illustrated booklet describing the TIME and LABOR-SAVING SENSATION SNOW-BLO.

Name _____

Address _____

City and State _____

Sensation Mower, Inc. Box PM 1-53 Raiston, Nebr.

Here Comes the Ski Patrol

(Continued from page 125)

American Red Cross standard 18-hour first-aid course. Then he takes the advanced 12-hour course which concentrates on winter-sports accidents.

Once these requirements are met, the candidate is given a skiing test supervised by an examining committee. Here he must demonstrate his ability as a skier and execute various downhill runs and methods of ascent.

He must, for example, make at least a 200-foot vertical ascent and descent under complete control carrying a 15-pound pack and demonstrate his ability to handle a rescue toboggan. These are specially rigged with control ropes, straps, blankets, first-aid kits and brakes to control the downhill speed.

Upon completion of these rigid requirements, the patrolman is certified by his divisional chairman and becomes eligible to wear the distinctive rust parka and blue-and-orange shoulder patch of the National Ski Patrol System.

As a patrolman, a member can be part of several different types of groups. In certain regions, skiers patrol only their own area. These are considered local patrols. Others who move about from area to area are termed metropolitan patrols and they serve wherever they happen to be.

Any patrolman who distinguishes himself by active participation in NSPS may eventually be recommended for promotion to the honorary rank of national patrolman. Last year only 88 men and 8 women achieved this position.

By tenure standards, the Ski Patrol is a relatively young group. It had its beginning in 1938 when the idea of a trained rescue unit was advanced by C. Minot Dole, a New York insurance broker.

The patrols were just becoming well-organized when the threat of war moved over the country. Almost immediately the manpower and resources of NSPS were offered to military and Civilian Defense agencies. Gen. George C. Marshall, then Army Chief of Staff, saw the value of the system and outlined a suggested program.

It called for patrolmen to experiment with various types of field shelters such as might be used by military ski units. Also, the Army suggested that the patrol could furnish guides to Army units training in remote areas. Lastly a program for anti-aircraft and antiparachute warning services was implemented.

Just before the Pearl Harbor attack, Dole, who was chairman of NSPS, made

(Continued to page 256)

LESTO Electric HAND SAW

WITH PLANETARY GEAR

NO OTHER DOES

SO MUCH

SO FAST

SO WELL

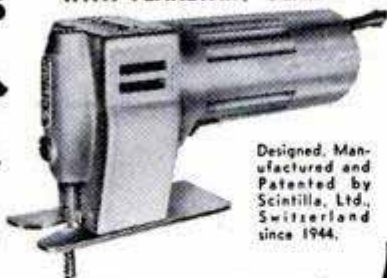

Designed, Manufactured and Patented by Scintilla, Ltd., Switzerland since 1944.

At Last — a rip, scroll, band, jig, crosscut, coping, and keyhole saw — all in one. Quick, easy, ideal for curves and fanciest shapes. Cuts inside holes without drilling starting hole. Users say there's nothing to equal it on wood, sheet metal, bone, plastics, hard rubber, cement sheets, pressed wood, etc. For factory, home workshop, carpenters, decorators, etc.

FREE Illustrated Literature. Write for Yours Today.

Sold & Serviced in Principal Cities Throughout U.S.A.

VICTOR J. KRIEG, Inc.

Sole U.S. Representative for Scintilla, Ltd., Switzerland
51 West 52nd St., New York 19, N. Y.

DO MORE PLANING JOBS WITH LOW-COST BELSAW \$215.00

AMAZING 12 1/4-IN. PLANER Does All Ordinary Planing Mill Jobs. Provides attachments for Jointing, Rabbeting, Tongue, Groove, Matching. 12 1/4 x 6-in. capacity, 3-knife solid round all-steel cutterhead. Power feeds at 24 feet per minute, 42 cuts per inch. Provides for full line of necessary attachments — Grind and Joint knives IN THE CUTTERHEAD WITHOUT REMOVING.



BELSAW MACHINERY CO.

1019 Field Bldg., 315 Westport Rd., Kansas City 11, Mo.

FREE BOOK

PROCESS 33 INSTANT PAINT BRUSH CLEANER

FREE CRAFT CATALOG



120 PAGES... Craft Supplies, Tools, Designs, Instruction Books from America's Largest, Most Complete Handcraft Stock.

Send for your free copy NOW!

GRIFFIN CRAFT SUPPLIES

5626-A Telegraph Ave • Oakland 9, Calif.

Say You Saw It in Popular Mechanics

MORE JOBS EASIER QUICKER

With Gear-Driven "RED-E" GARDEN TRACTORS



Buy Direct from Manufacturer and SAVE

NO BELTS! NO CHAINS!
Proven For Over 29 Years
NEW 1953 MODELS

Thousands of satisfied users say "RED-E" has solved their tractor problems. You too, will like its smooth, powerful, easy-to-operate, gear-driven action—with power turning clutch for 4 1/2 and 6 H.P. WALKING MODELS and automotive type differential for 8 1/2 H.P. RIDING MODEL. Our 2 and 3 H.P. Walking Models low as \$169.00. Attachments for plowing, sowing, cultivating, wood-sawing, snow-plowing, etc. **EASY TERMS**—Factory-To-You discount. Write for FREE Catalog.

RED-E TRACTOR CO. Richfield 345, Wisconsin

Most versatile folding rule—

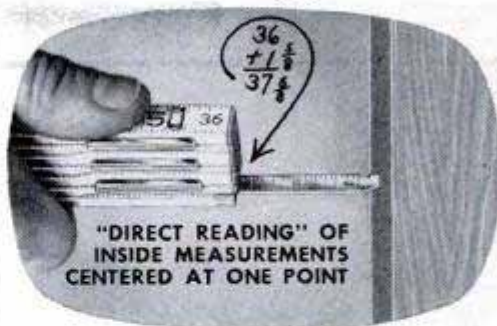

"DIRECT READING" OF INSIDE MEASUREMENTS CENTERED AT ONE POINT

NEW STANLEY "100 PLUS" EXTENSION RULE No. X226

Make no mistake, the new Stanley "100 Plus" Extension Rule is the handiest, most versatile folding rule you can buy.

Read it four ways — on inside measurements using slide, entire reading is centered at one point — no chance for errors; may also be used as an ordinary extension rule for inside measurements, and as a regular folding rule reading from either end.

Use it as a marking gauge for measurements in 2" and 4" multiples.

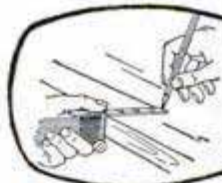

CHECK THESE "100 PLUS" RULE FEATURES:

- Easy to read Big Black Numbers on White Sticks.
- Square ends — butt flush with work.
- Opens to even inches at end of each stick.
- Handy for end-to-end measurements — opens in 6" multiples to full length, 72".
- 8-inch Brass slide removable for use as depth gauge.
- New plastic finish wears four times longer.
- Extra Thick Rock Maple Sticks graduated all edges.

For real rule value ask for the X226 at your hardware dealer's. \$2.65 each.

STANLEY TOOLS, New Britain, Connecticut
THE TOOL BOX OF THE WORLD

STANLEY

Reg. U.S. Pat. Off.

Hardware • Tools • Electric Tools • Steel Strapping • Steel



P1

TOY PATTERNS—6 for 25c

Ideal gifts for the youngsters.

Two sets — 6 full-size patterns in each.



P2

SEND TOY PATTERNS NOW!

Stanley Tools, 313 Elm St., New Britain, Conn.
(In Canada: Stanley Tool Co. of Canada, Ltd.,
313 Stanley St., Roxton Pond, Quebec)

Enclosed is..... Send Patterns checked

..... Patterns P1 (25c) Patterns P2 (25c)

Name.....

Address.....

City and State.....

INSULATE YOUR HOME

For As Low As

\$67.60*



"I did it myself in an afternoon"

Yes, you can insulate your home yourself and save \$50-\$100 installation costs. Zonolite vermiculite Insulating Fill easily pours from the bag between attic joists and sidewall studs—flows snugly around pipes, wiring, braces, eliminates money-draining heat leaks—keeps winter heat IN... summer heat OUT! Saves up to 40% on fuel. It's fireproof—snuffs out flame—termiteproof, rotproof, rodent-proof—permanent. Mail coupon today for FREE BOOKLET!

**(cost of insulating attic in average home)*



ZONOLITE COMPANY, Dept. PM-13
135 S. LaSalle St., Chicago 3, Ill.

Gentlemen: Please send me, free-of-charge, booklet HI-20, "Your Home—Its Comfort and Protection."

Name.....
Address.....
City..... Zone..... State.....

SEE YOUR LUMBER OR BUILDING SUPPLY DEALER

CAR HARD TO START?

Get EASY STARTING
... Smoother Engine
Performance... Save Gas!
with SENSATIONAL NEW
SISSON
Electrimatic
CHOKER



Positive, dependable electric choking gives quick, easy starts every time in any weather. Smoother warm-up... no stalling...no flooding...no seasonal adjustment! Fits any car equipped for automatic choking. \$5 complete.

INSTALL IT YOURSELF
Get FREE Illustrated Folder

Sisson Choke, 1652 Ohio Avenue
Anderson, Indiana

- Please send me FREE illustrated Electrimatic folder
- I enclose \$5 (check or money order) for one Choke
- Ship C. O. D.—I will pay postage

Car Make..... Year..... Cyl.....
Carburetor Make.....
Name.....
Address.....
City..... Zone..... State.....

arrangements through General Marshall for the patrol to process, check and clear applications for assignment to the mountain troops. As a result of the patrol's effort, the 87th Infantry Mountain Regiment, first in the United States Army's history, was established in November 1951.

More than 25,000 men were screened for duty with the outfit which became the 10th Mountain Division in 1942. The division served in the bitter campaigns of northern Italy and one of its members, Maj. George P. Hays, won the Medal of Honor.

During the war years, ski patrols in this country were also in action. In conjunction with the Second and Fourth United States Air Forces they initiated Air Force Winter Search and Rescue Units. In all, 52 missions were completed and eight known lives were saved. Ski Patrol members are still active as civilian instructors at the Mountain and Cold Weather Training Command Headquarters at Camp Carson, Colo.

Because there is much to be learned yet about ski safety, the NSPS has an extensive research program in effect. Through its medical chairman, Dr. Irvin E. Hendryson, reports on every accident attended are filed. These are then carefully checked and analyzed. Out of them have come recommendations on ski bindings, ski-tow safety devices and other vital aspects of sporting safety.

But still the most colorful and dramatic job of the Ski Patrol comes when the blue, early morning shadows cut across slopes of new-fallen snow. Then, high in the mountains of the West, in the tricky Midwestern hills or on the twisting trails of New England, the patrols move out.

In the first hours of daylight they reach the slope heights and begin to "break trail." Here they search for dangerous rocks uncovered by winds during the night and plant warning flags. Where avalanches threaten, they rope off the area or, in many cases, blast down the threatening cornice.

Medical caches high in the trails are checked and then the area is opened to the public. In more remote areas, telephone systems are available. Each time a patrolman passes one, he reports his position back to the lodge headquarters. As he skis for his own pleasure during the day, every patrolman is on the alert for accidents.

When one happens, help is rarely far away. In a matter of minutes, sometimes seconds, patrolmen bring up the rescue toboggan and begin to work against time. Shock sets in very quickly in cold climates so first aid must be given promptly. Then the descent, often down dangerous icy slopes, is made.

(Continued to page 270)

Only Sears
Gives you this Value!

CRAFTSMAN
REG. U. S. PAT. OFF.

**10-inch Tilting Arbor
Bench Saw**

Saw Only

\$92.00*

cash
Less guard, motor,
extensions, bench
\$9.50 Down



Complete Outfit

\$183.65*

cash
With guard, motor,
extensions, bench
and Powr-Panl
\$18.50 Down

Only \$8.50 down puts this CRAFTSMAN Saw in your shop!

Here's a whole shop-full of tools in one compact budget-priced unit . . . designed for men who insist on professional quality work. **Massive, extra heavy duty construction!** Extraordinary accuracy. Improved model, with rigid saw base, strong motor support and new pivot arm for smoother operation. New tension device between motor mounting plate and support reduces transmission of vibration and jumping of motor.

Table never tilts . . . work always lies flat! Motor, blade and arbor tilt together as a unit, any angle up to 45 degrees; belt never twists. Blade raises and lowers to vary depth of cut from 0 to 3 3/8 inches.

Sealed precision ball bearings; lubricated for life! 27x20-in. cast semi-steel table.

13 3/8-in. working area in front of blade! Rip fence usable on either side of blade clear to table edge. Single control lever locks fence at BOTH ends. 10-inch combination rip and crosscut blade (3/8-in. bore) gives full 3 3/8-in. depth of cut. Blade, miter gauge, stop rods, rip fence, machine and motor pulleys and V-belt included.

Complete Outfit as shown: Saw; saw guard assembly, CRAFTSMAN 1-H.P. 3450 R.P.M. capacitor motor (110-120 volt 60-cycle AC); 2 table extensions, tool bench; remote-control Powr-Panl. See this superb saw at your Sears Retail Store today!

**Prices slightly higher west of the Mississippi and south of the Ohio.*

CRAFTSMAN Hand and Power Tools by **SEARS, ROEBUCK and CO.**
Famous for fine quality . . . precision performance . . . low price!

CAMPBELL-HAUSFELD Spray Painting Outfits

*Outperform
them all!*

DO more and better painting in an hour than you can brush on in a day. Same compressor inflates tires, lubricates cars, tractors, implements.

4 models, precision built for trouble free service. Last a lifetime. Gasoline or electric power.



See them at your dealer
or write for literature,
giving his name.

**pressure
maid**

New Low Priced
Pressure Maid . . . dwarf
in size . . . giant in power.

THE CAMPBELL-HAUSFELD CO.
1046 RAILROAD AVE. HARRISON, OHIO

WOODS

get this **BIG Catalog**
without cost!

Loaded with how-to-do it articles on wood-finishing, veneering, making inlay pictures and cabinets. Contains 83 distinct inlay designs and borders, plus a wood identification panel of 60 different varieties. All shown in full natural color suitable for framing.



A MULTITUDE OF MATERIALS

Lowest Prices On

Veneers	Period Furniture Hardware
Inlays	Modern Picture Frame Molding
Lumber	Upholstery
Plywood	Hand and Electric Tools
Plans	Finishing Materials
Supplies	Decorative Metals
Plastics	Leather

Albert Constantine & Son, Inc.
Dept. PM-8, 797 E. 135th St., N.Y. 54

● VISIT US at our N.Y. Plant. Demonstrations every Saturday on making inlay pictures, wood finishing and other crafts. Everyone invited.

SEND THIS COUPON!

Albert Constantine & Son, Inc., Dept. PM-8
797 E. 135th St., New York 54, N.Y.

Enclosed find 50c (refunded on 1st order) for your copy of "Manual For Craftsmen" No. 52.

Name _____
Address _____
City _____ State _____

Bonanza in Bark

(Continued from page 89)

The plentiful cork in some Douglas-fir bark is not of much use in conventional Mediterranean cork uses, but it is an important part of several of the above products. Douglas-fir cork also contains the most wax of any bark fraction, the Oregon Forest Products Laboratory found. This wax, extracted from the bark by leaching with benzene, is used with imported carnauba or candelilla wax as a polish and for water-proofing. It can also be employed in some uses of beeswax.

The Oregon laboratory recently announced the development of new processes for the low-cost recovery from bark of vegetable tannin for tanning leather, waxes and pharmacological chemicals. Tannin is extracted from bark merely by dunking it in hot water several times and then evaporating the water. Douglas-fir tannin would substantially reduce the United States' need to import 70 percent of the 150,000 tons used here yearly. Most of the latter is quebracho bark from Argentina.

Four companies already have applied for licenses from the laboratory to climb on the "waste bark" bandwagon.

Removal of bark from logs is a tough job, especially if it is left on the wood for a long time after cutting. One manufacturer has built machines to "squirt" bark from logs. Two nozzles of a hydraulic debarker force as much as 750 gallons of water per minute against logs, at pressures up to 1200 pounds per square inch. Pressure needed for good bark removal varies widely with season of year, species of tree, method of log storage and type of area in which the tree grew. Even at these high pressures, it is sometimes necessary to run a log through the water debarker a second time. Increase of pressure might destroy the wood.

Another type of debarker presses the log so hard with a roller head, like rollers used to put crinkles on the edge of pies, that the bark just gives up trying to protect the log and sloughs off. Some foresters are tampering with the idea of poisoning trees and then waiting a year for the bark to fall off before felling them. ★ ★ ★

Supersonic Propeller Planes

Speeds up to 1000 miles an hour are expected of airplanes using a new turboprop engine and special propellers recently developed by the Curtiss-Wright Corporation. Turboprop engines use jet power to turn the propellers and the new one is said to be the most powerful yet built. The propellers can harness 20,000 or more horsepower.

HI-SPEED COPE-SAWDRILL-BIT *It* **DRILLS SAWS REAMS**
INTERNATIONAL TWIST DRILL CORP.



DRILL, SAW, REAM . . . metal, pipe, wood, plastic, Transite, etc. Use with any electric drill, slow drill press, lathe or milling machine. Drills own starting hole—upper part of bit is used to cut, saw or ream circles, ovals, squares or scrolls. Easy to operate. Ideal for carpenters, mechanics, electricians, plumbers, hobbyists, many others. Abrasive resistant, high speed steel. Flutes ground from solid. Will withstand severe continuous use without breaking. Resharpener at no charge. Takes place of up to \$50 in tools. 1/2" diameter, 2" cutting sections, total length 3 1/2". Also available specially designed for wood or metal and in 2 3/8" and 1 1/2" lengths. Write for details. Specify all-purpose bit. Shipped same day. Money-back guarantee. Dealer inquiries invited.

SEND CASH, CHECK OR MONEY ORDER
 Manufactured and distributed by:
INTERNATIONAL TWIST DRILL CORP.

only
\$3.95
 POST PAID

618 Wyandotte, Rm. 639, Kansas City 6, Mo.

CHOOSE FROM PROFESSIONAL QUALITY

WESTCRAFT TOOLS

AT WESTERN AUTO

HEAVY LOAD CAPACITY FINGER-TIP CONTROLLED WARNER TRAILER AXLES

14" x 2" Electric Brakes

New Never Used Surplus.

2" Sq. Solid Steel. Adaptable Also for Dual Wheel Mounting.

Comes complete with wiring . . . heavy duty haul or light load springs . . . spring saddles "U"-bolts and shackles . . . hubs and Timken bearings . . . truck wheels and brake controller for 2-ton load.
 60" Tread Straight Axle \$88.00
 72" Tread 4" Drop Axle \$116.00
 84" Tread 4" Drop Axle \$122.00
 All prices F.O.B. 40% deposit required with order.

Broadway Trailer Center
 U. S. HWY. 22, NORTH BRANCH, N.J.

LAWN ORNAMENT-NOVELTY PATTERNS

28 Lawn Ornament Patterns, 25c. Other Patterns: 15-20" high; Dutch Girl, Dutch Boy, Pirate, Bull Terrier, Mexican Girl, Mexican Boy, Dwarf, Penguin, Flower Girl, 15c each. 25 Novelty Patterns, 30c. All 62 Full Size Patterns, \$1.00.
 Strother Pattern Service, Dept. DD-8, Box 128, Belington, W. Va.

IDEAL LAWNMOWER SHARPENER

MAKE EXTRA CASH THIS EASY WAY!

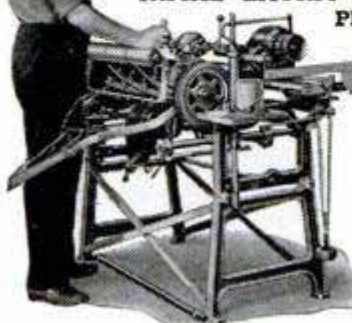

Plenty of mowers to grind in your community! IDEAL Model 300 grinds them all with ease and precision — assures your reputation for perfect workmanship. Sharpens all mowers — hand or power — without disassembling. Exclusive hook grinding method perfected by 50 years' experience. Get started now in this profitable business; write for FREE complete catalog today.

THE FATE-ROOT-HEATH COMPANY
 Dept. PM-1, Plymouth, Ohio

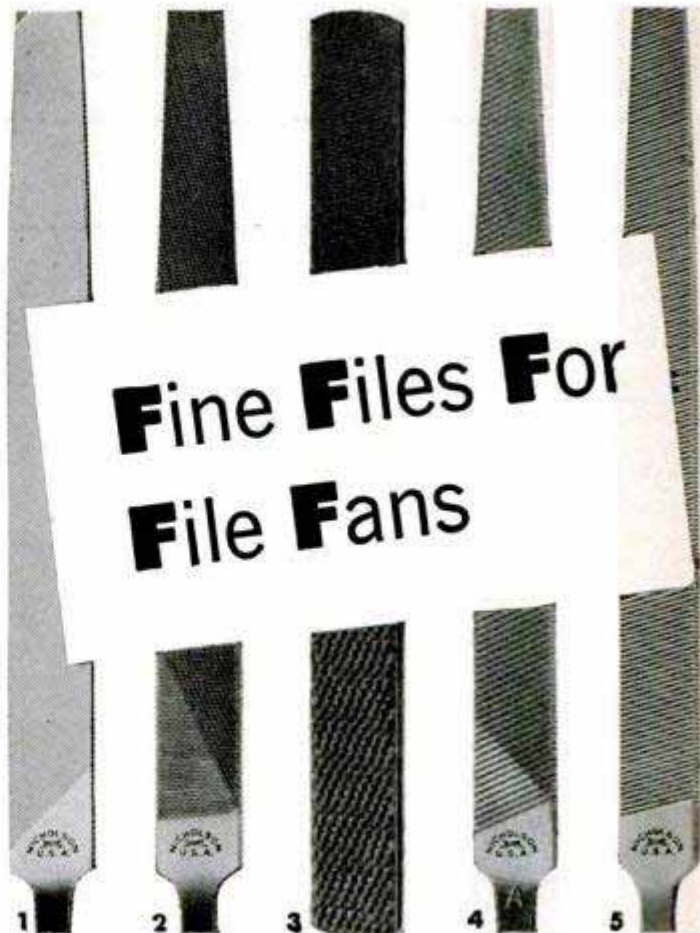

Fine Files For File Fans

Amateur and professional craftsmen get a special kick out of the unusual in the tools they add to their equipment. Here are some special files that will warm any tool user's pride. The Nicholson or Black Diamond trademark assures their practicality and quality. If your hardware dealer doesn't have them on hand, he can get them for you through his wholesaler.

1. **LATHE FILE** with teeth cut at a long angle to "slide" out the chips and prevent them from scratching work being smoothed in lathe.
2. **BRASS FILE** with special "non-clog" teeth cut for use on brass and other tough ductile metals.
3. **4-IN-HAND** file-rasp with two kinds of cutting surfaces on both half round and flat sides.
4. **ALUMINUM TYPE "A" FILE** for soft aluminum and aluminum alloy castings. Small teeth "scallop" break up filings, help clear out chips.
5. **LEAD FLOAT** with stubby "blade"-like teeth for "floating" or "shaving" away extra-soft metals, such as lead, babbitt, pure copper.

For free pamphlet, "Ten Special File Types," and free book, "File Philosophy," on kinds, use and care of files, write to —



NICHOLSON FILE COMPANY
 22 Acorn Street, Providence 1, R. I.
 (In Canada, Port Hope, Ont.)



NICHOLSON FILES FOR EVERY PURPOSE

1903 - GOLDEN ANNIVERSARY - 1953

SHAW
"DU-ALL"

Garden and Small Farm Tractors

STANDARD OF QUALITY FOR MANY YEARS

Rugged 1½ to 5 H.P. Walking Models
Do Everything in Gardening



5 H.P. Walking Model with 10-inch Plow

Fast and Easy

You can save yourself a lot of work with a Shaw Du-All, the garden tractor that has proved its efficiency and dependability for many years. Handle 6...7...10-inch plows with these stronger built, superior traction machines. Harrow, disc, plant, cultivate with Shaw quick mount tools. Use power take-off for many other jobs. Choice of 1½, 2½, 3 and 5 H.P. machines, with variable speeds, adjustable wheel widths, individual gang tool controls. None better than a Shaw Du-All for rugged work. Power turn models & power take-off attachments available.



CUT WOOD



MOW

Powerful 5..8 12 H.P. Riding Tractors



Cheapest Source of Power for Small Farm

12 H.P. Shaw Du-All with 12-in. Plow



RAKE



BULLDOZE

Plow 4 to 8 acres daily. Cultivate fast and at low cost. Use this larger Shaw Du-All for all small farm ground preparation and cultivation for mowing, raking, hauling, sawing, many other purposes. Simplified design and highly durable construction. High quality tools and all wanted power take-off attachments. Pulls 10...12...14-inch plows. Works between or astride 42-inch rows. Ideal machine for small farm or second tractor on larger acreage.

See Your Nearest Shaw Dealer for Demonstration

MAIL COUPON FOR FREE CATALOG

SHAW MANUFACTURING CO.
4501 Front St., Galesburg, Kansas
668-G N. 4th St., Columbus, Ohio

Please send me Free Catalog and Prices on Shaw Du-All Garden and Small Farm Tractors.

NAME _____

ADDRESS _____



Tire changing on a Minx is easy. The light car is easy to raise and the jack fits in a slipproof socket

Owners Report on the Hillman Minx

(Continued from page 115)

"Ease of handling, particularly for my wife; smart appearance for a small car and high quality of workmanship on interior." —Arcadia, Calif., hotel manager.

"My main reason for buying a Hillman: I wanted a sports car, my wife didn't. This is a compromise!" —North Hollywood, Calif., Air Force captain.

"I have no complaints on the Hillman.

(Continued to page 262)

Under the center hump of the front floor is a small dipstick for checking level of transmission lubricant

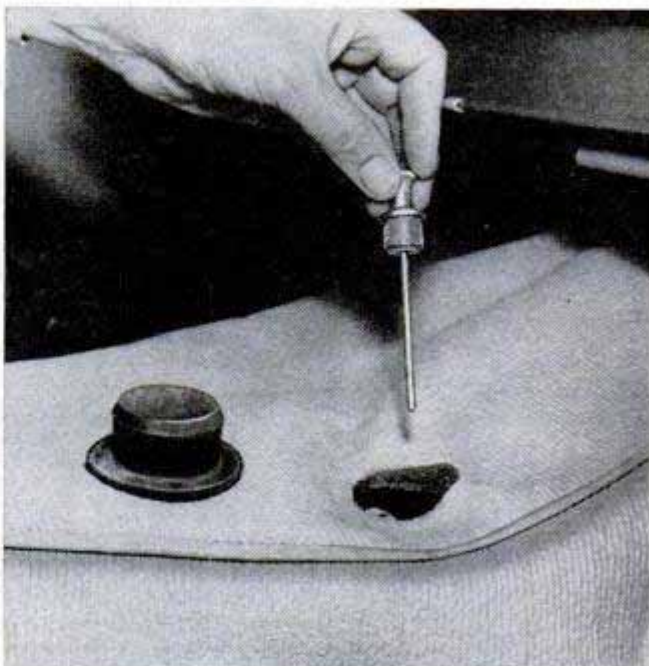

How To Clean Carburetors Right On The Engine



Here's the low-down on a new approach to an old problem: the why, when, and how of cleaning carburetors on the engine.



Disconnect and plug fuel line



ATOMIZER

A common cause of hard to locate engine-trouble and high gas consumption is the tiny speck of dirt or the microscopic gummy film that cuts carburetor efficiency. ... and dollars are

Complete carburetor cleaning no longer involves disassembly, soaking in solvent, re-assembly, and readjustment. On-the-engine carburetor cleaning does a complete job in less than 20 minutes; removes all dirt, muck, moisture, ... merely



PROTECT YOUR CAR

WITH

The Sensational Pneumatic Spring Booster

- For Overloads
- For Improved Roadability
- For Trailer Hauling
- For Sagging Springs

ECONOMICAL AND EASILY INSTALLED

Inflates with Air — Same as a Tire
Thousands in Use — Guaranteed

GIVE YOUR CAR A LIFT — WITH AIR LIFT

See Your Dealer or Write

AIR LIFT CO.

2330 W. MAIN STREET
LANSING, MICHIGAN



Didn't expect it to be a Rolls. It isn't. So what?" — San Mateo, Calif., advertising man.

"This car is a distinct pleasure to drive. I must continually check myself to keep from going too fast for the maximum cruising speed (60 to 65 miles per hour) of this wonderful engine." — Oregon City, Ore., paper-mill worker.

"I was tired of handling a large car and have no need or desire to hurry." — Seattle, Wash., retired executive.

"If this car had better rear springs and a better-made rear seat to give a better

1953 HILLMAN MINX (Mark V) SPECIFICATIONS

ENGINE

Type	4-cyl., L-head
Bore and stroke	2.56 in. x 3.74 in.
Piston displacement	77.20 cu. in.
Brake horsepower42 @ 4200 r.p.m.
Compression ratio	6.63 : 1
Transmission	4-speed synchromesh

GENERAL

Steering wheel, lock to lock	2½ turns
Turning radius	16 ft. 6 in.
Brakes	Hydraulic with riveted linings
Tire size	5.50 x 15
Recommended tire pressure	28 lb. f-
Shipping weight	

placements—
to correct trouble cur-
by carburetor cleaning.
“clean the carburetor
considered the sensible
to curing a rough-run-
ne. When should this be
the man whose car is
the sweet song of a per-
nning engine cleans the
or (1) at the first sign of
trouble; (2) with every
(3) at least twice a year.

disconnect the fuel line; use an
inexpensive “applicator” to feed
the cleaner into the carburetor;
then reconnect the fuel line.

Pennsylvania Refining Com-
pany, 2687 Lisbon Road, Cleve-
land 4, Ohio sells the new car-
buretor cleaner under the name
GUMOUT at \$1.50 a pint. The
applicator, which lasts indefinitely,
sells for \$4.75. The manufacturer
has prepared a helpful *Carburetor
Handbook*, which is sent free on
request.

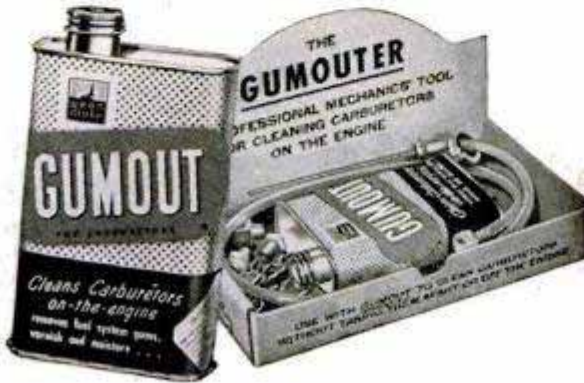

W-40 different cu
with **AMAZING, NEW**

Warren DADO SAWING
WASHERS

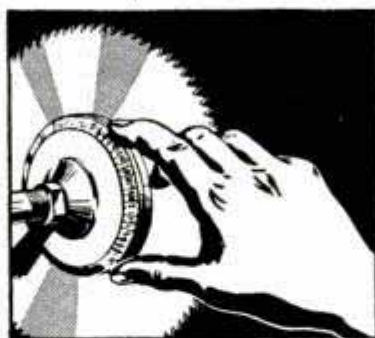

**ON YOUR
SAW BLADE!
NO Warp...
NO Wobble...
NO Burning!**

**ONLY \$4⁹⁵ PER
SET**

4 Washers Mean Perfect Balance

Make clean, smooth parallel grooves at any angle—no chewing, no sanding. Just dial your cut—no trick screws, no vibration, strengthens blade for straight cuts. Warren Washers greatest improvement in 30 years—and most copied—look for the name on the box and washers. It costs no more to get the best—WARREN, IT'S GUARANTEED! At your dealer or order direct. Give arbor size— $\frac{1}{2}$ ", $\frac{3}{4}$ ", $\frac{5}{8}$ ", 1"—sent postpaid.

Send for Free Booklet

WARREN DADO SAWING WASHERS CO.

Dept. 21 • Box 98 North End Station
Detroit, Michigan

Width, over-all .
Length, over-all .
Road clearance . .

IN

Front-seat width .
Rear-seat width .
Headroom, front .
Headroom, rear .
Legroom, front . .
Legroom, rear . .

Oil
Water
Gasoline

ride, it would
Antonio, Tex.

"I think if a
ican-made star
a car like a H
car every tim
ment officer.

As in every
cluded this q
are your com
random, here
responses:

"Battery loc
ice."—Alhamb

"Don't like
(Co

Millions Enjoy His Program Every Week on TELEVISION!
More Will Enjoy His New Popular Mechanics Book!



Make Boys and Girls Happy While They Learn

give them

Mr. Wizard's Science Secrets

by TV's Famous Don Herbert



FREE!

Name Stamped on Cover
in Gold Letters

Give Mr. Wizard's Science
Secrets as a gift with re-
cipient's name stamped in
gold FREE.

150 Mystifying Experiments With Everyday Things That Help in School and All Through Life!

Millions of children enjoy Don Herbert's science experiments on television. Now they can enjoy them more in his own brand-new book, *Mr. Wizard's Science Secrets*, with Mr. Wizard himself and his helpers, Willy and Betsy. Get this fascinating, entertaining and instructive book for your young people. Let them learn exciting scientific facts by doing Mr. Wizard's experiments themselves, using only simple materials, most of it in your kitchen and bathroom cabinets. Never before such a book. It entertains as it educates. It makes fun out of learning facts. Give your children—your friends' children—the educational advantages and joyous pastime which Mr. Wizard's book affords. See special gift offer—books will be personalized with recipients' names in gold FREE.



Above: Mr. Wizard in a demonstration of oxygen and combustion. Center: With helpers, Willy and Betsy, watching bottle fountain and action of carbon dioxide in bubbles. Willy and Betsy in a test that proves sound isn't so easy to locate. Hundreds of pictures like these in Mr. Wizard's book.

Some of 150 Projects and Experiments Explained and Pictured for Boys and Girls to Do at Home

Why salt melts ice.
Experiments with vacuum.
What is air, oxygen, atmospheric pressure?
What makes an airplane fly?
What is gravity?
Why does hot air rise?
What is steam?
Why does corn pop?
What are molecules?
What is carbon dioxide?
How to write with invisible ink.

How to make . . .
Static electricity
Water boil with an ice cube
Your own telephone with tin cans
Music boxes
Compasses
Your own telegraph set
Water boil in a paper box
Fire extinguishers
How to carry sound in your finger tips
And more than a hundred others

264 Fascinating Pages • 249 Illustrations — Made for This Book

Answers Hundreds of "How" and "Why" Questions

Mr. Wizard answers most of the questions children ask. They're all in his book. His answers and demonstrations are so fascinating that youngsters actually have fun learning the facts they should know and they never tire of learning. Parents and teachers will find the book a helpful treasure.

Science, Physics, Chemistry in Fascinating, Joyous Form

Mr. Wizard makes games out of science, physics and other subjects that keep young people occupied and interested for countless hours. He has special appeal to both boys and girls of all grammar school ages and imparts information that will be helpful to them now and throughout their lifetimes.

Order Today! Use Coupon to Get Mr. Wizard's Book. Include Name for FREE Gold Stamping.

Order this big, beautifully illustrated, printed and bound book now. It is the GIFT BOOK of the hour, with the added feature of the recipient's name in gold. Give it to all young people for birthdays, Christmas and other gift occasions—for merit awards—for good conduct—or just to help a boy or girl advance. Only \$3.00 postpaid. Order on the handy coupon.

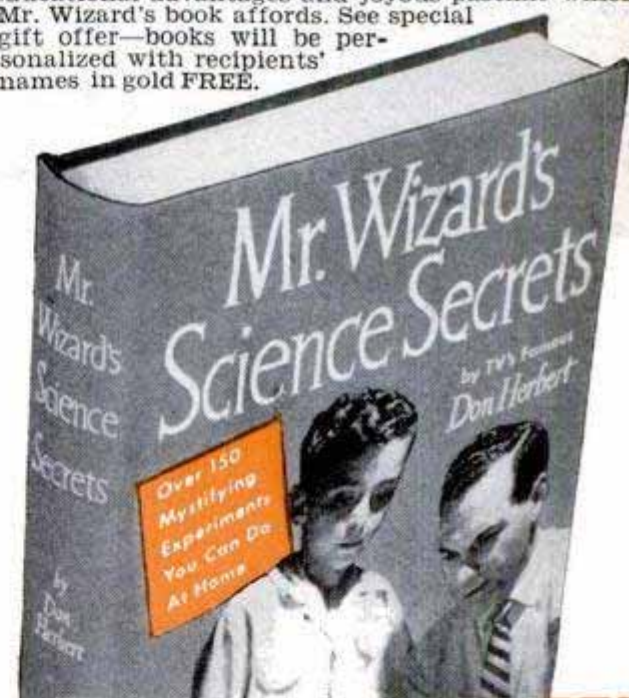

POPULAR MECHANICS PRESS, Dept. WS
200 East Ontario St., Chicago 11, Ill.

Please send at once, delivery prepaid, _____ copies of *Mr. Wizard's Science Secrets* at \$3.00 each. Stamp names in gold without extra charge under your special FREE offer. Remittance enclosed \$_____

Name _____

Address _____

City _____ State _____

Print name for gold stamping on this line. Use margin for extra names if required.

BIG MONEY

in your hands!



BE YOUR OWN BOSS! Men who are determined to get ahead in something for themselves will find this opportunity hard to beat! Where else can a man turn his own labor so quickly and easily into **BIG MONEY!** Earn as high as \$50 and more a day sanding floors with an easy-to-run American Machine—and **YOU ARE BOSS.** Prospects everywhere—old and new homes and remodeling. Pleasant indoor work—steady the year round. No schooling—no experience needed. Age makes no difference—men 18 to 80 are active and successful. Send coupon for “money-making” booklet entitled “Opportunities in Floor Surfacing”—enclose 25c in coin or stamps to cover handling.



AMERICAN FLOOR MACHINES

SEND

The American Floor Surfacing Machine Co.
535 So. St. Clair St.
Toledo 3, Ohio

Enclosed find 25c in stamps or coin for booklet “Opportunities in Floor Surfacing”, telling me how I can start my own floor sanding business.

Name _____

Street _____

City _____ State _____

(women catch skirts on it).” —Norwood, Ohio, housewife.

“The Hillman is wonderful for city traffic, but it is dangerous and hard to drive with poor steering.”—Milwaukee, Wis., insurance man.

“Inadequate hill-climbing ability.”—Portland, Ore., cabinetmaker. (This was mentioned frequently.)

“They would sell more Hillmans if a U.S.-type gearshift were used. As it is, the average driver is too confused when trying out a Hillman to really get the ‘feel’ of this fine car. I loaned mine to a friend who brought it back in 10 minutes. Too hard to find gears, he said.”—Los Angeles doctor.

“It shouldn’t be necessary to overhaul the car on an average of every 20,000 miles.” —Tacoma, Wash., maintenance worker.

“One bad feature about the ’52 Hillman is that the gas pedal is so close to the brake that when you apply the brake, acceleration is increased, causing confusion and possibly an accident.”—San Francisco registered nurse.

“Too small for a large family.”—Seattle, Wash., waterfront checker.

“Dust seeps into the car on country roads.”—Sherwood, Ore., housewife.

“The rear-view mirror should be higher. . . . The driver can’t see backward when three people are in the rear seat.”—Portland, Ore., housewife.

“Brakes do not hold up well; seats do not ‘breathe,’ causing lots of perspiration in hot weather.”—Baltimore, Md., musician.

“Car is geared too low for this flat country. First gear is hardly usable, second speed particularly too low.”—Ormond Beach, Fla., retired man.

“My only complaints are the uncooperative servicing facilities and the inadequate front bumpers, which are lower than on regular-size cars and the radiator grille gets dented if another car backs into it.”—New York City copy writer.

These were some typical suggestions for improvements:

“Why not a V4 or a V6 to increase the body capacity of a small car?”—Glendale, Ariz., machinist.

“Bigger trunk space if possible (although it is better than in most small European cars).”—New York press representative.

“Clutch and brake pedals should be farther apart. U.S.-style gearshift with fourth gear as an overdrive like Borg-Warner. Otherwise the car is excellent, a pleasure to drive and park. Economy is wonderful.”—Pasadena, Calif., contractor.

“Back seat should fold down so that

(Continued to page 266)



"WAS MY FACE RED"

... when I learned what a sucker I'd been for the oil change racket!

ARE YOU A VICTIM OF THIS SHAMEFUL HOAX?

That's what they all say when they learn the truth. Car owners like you, MILLIONS of them - all in the same boat and sinking hundreds of millions of dollars in UNNECESSARY OIL CHANGES every thousand miles or so. Well, you ask, "What's wrong with that? Doesn't everybody know you've got to change oil every 1000 miles because it gets dirty and full of sludge?" We ask, "Who told you THAT?" Shall we tell you?



\$14.95 VALUE
\$9.95

RIGHT COMBINATION

for Performance PLUS Economy LIFE-KLEEN - the permanent oil filter cartridge - and MIZER-X Refill. Remember - with this unit in your car - you change ONLY the REFILL . . . NOT the OIL!

the OIL COMPANIES—that's who! We say they're wrong, dead wrong! They won't admit it but they know it too. And they're not the only ones. The U.S. Air Force knows it. Leading Airlines know it. Taxi companies know it. Truck operators know it. Greyhound Bus Lines know it. We say it's about time YOU know it. How about it? Want to know the truth? It might embarrass you a little. It'll certainly make your face red with indignation. But, it will also show you how you can save hundreds of dollars now thrown away on oil changes and engine repairs due to faulty lubrication.

All it will cost you is 3 cents to get the answers

No obligation. Nothing to buy. Just mail the coupon! It's as simple as that. Of course, if you are in a hurry, if you want to avoid that next oil change, send \$9.95 now for the new invention that eliminates costly oil changes, and reduces engine wear. We'll send you LIFE-KLEEN—the PERMANENT Oil Filter Cartridge—plus TWO MIZER-X refills (Regular \$14.95 value)—on a 30 day MONEY BACK GUARANTEE. Don't confuse LIFE-KLEEN with any other type of oil filter cartridge on the market. LIFE-KLEEN is different . . . and BETTER! PROVED better by thousands of taxi, truck and fleet operators in millions of miles of actual performance. And by private car owners, one of which already reports going more than 40,000 miles without changing oil.

L-K FILTERS, INC.
Dept. M-1

26 North Fifth Street, Allentown, Pa.

L-K FILTERS, INC.

26 N. 5th St., Dept. M-1 Allentown, Pa.

I don't want your filter cartridge yet, but PLEASE SEND ME—FREE—"Facts About The 'Oil Change' Racket"—and complete information on how I can SAVE on oil bills and costly engine repairs.

Since I am taking no chance—thanks to your MONEY BACK GUARANTEE—send me one LIFE-KLEEN Permanent Oil Filter Cartridge—plus TWO MIZER-X REFILLS (Reg. Value, \$14.95) for only \$9.95. If not satisfied I will return unused within 30 days and you will pay the postage. Send information on dealer franchise.

Send C.O.D., I'll pay postage charges. Enclosed is \$9.95 for postpaid delivery.

NAME _____

ADDRESS _____

CITY _____ ZONE _____ STATE _____

MAKE & YEAR OF MY CAR _____

FILE SAWS THE RIGHT WAY

SUPER FILER No. 9



SO EASY with this new filing jig and jointer anyone can now sharpen any handsaw like new! When file hits hardened steel rollers teeth are finished and EXACTLY THE SAME HEIGHT. All teeth cut and saw runs true and smooth. Jig and instructions \$2.95 postpaid. FREE FOLDER.

SHARPEN YOUR CIRCULAR SAWS

The RIGHT WAY on your own saw table. Sharpens rip, cutoff, hollow ground and combination blades—6" to 10". Saws stay round with correct bevel. Precision made, easy to use. GUARANTEED. Only \$8.95. Includes \$3.00 Grinding wheel.

"TRU-CIRCLE" saw set automatically sets teeth at 10° or more. \$2.95

AT DEALERS OR POSTPAID

A.D. McBURNEY, 317 E. 4th St., Los Angeles 13, Calif., Dept. A-25

GREATEST SAVING EVER OFFERED!

U. S. GOV'T SURPLUS

"BARGAIN BOOK"

SAVE ON WINTER NEEDS!

It's loaded with bargains in genuine Gov't Surplus for farm-home-industry. Save up to 85% on clothing, hardware, sporting goods, etc. The "Book of the Year". Send 10c for yours today.

500 BARGAINS
• FARMS • SPORTS
• HOME • SHOP

FISLER SALES co.

723 WALNUT ST., DESK M-1, KANSAS CITY, MO.

MAIL TODAY Only **10¢**

send for FREE CATALOG



America's Foremost *money-making* **MECHANICS' TOOLS**

It's easy to own the same "pay-off" tools used and endorsed by America's top-earning mechanics throughout the automotive, aviation and industrial fields! Snap-on tools help you handle every repair job faster, easier, better. And they LAST . . . pay for themselves over and over again! Start building your own tool set now with basic Snap-on units—add others any time. Genuine Snap-on tools are never sold in stores—direct to users only. Mail coupon for free catalog.



SNAP-ON TOOLS CORPORATION
8062-A 28th Ave., Kenosha, Wisconsin
Send me free catalog of Snap-on tools.

Name _____

Address _____

City _____ Zone _____ State _____



**Take advantage of
your Black & Decker
Tool's amazing
versatility!**

**buy
B&D Utility
accessories**

RECEIVE a Black & Decker Utility Drill or Sander-Polisher for Christmas? Pleased as punch with the way it helps you build and repair things? Then you're in for more good news when you discover how many more times useful you can make it by buying Utility accessories! There's a whole raft of them to choose from—for everything from sharpening knives and making picture frames to polishing your car and shining up pots and pans. Try them at your hardware, appliance or department store!

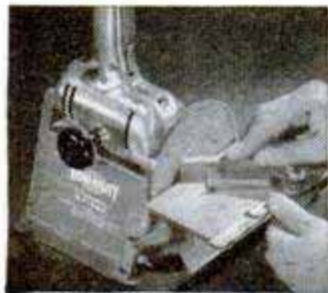

**Disc Sanding Table
only \$7.75**

Ideal for rapid, accurate sanding of picture molding, plastics and hobby parts. Easily handles small, odd-shaped, curved pieces.



Roto-Hone Attachment only \$10.95

Hones knives, chisels, plane bits, lathe tools to razor edge. Clamp and guide bar for accurate angle. Stone has rough and fine sides.

PLUS stands, auger bits, masonry bits, countersinks, wire wheel and cup brushes, sanding discs, lambswool bonnets, auto polish, electric wax, saw blades, protractors, etc. **WRITE TODAY** for free book of job tips to: **THE BLACK & DECKER MFG. Co., Dept. H1M, Towson 4, Md.**



Black & Decker
UTILITY TOOLS
PORTABLE ELECTRIC TOOLS

trunk can be reached from inside of car, and so that larger objects can be carried.” —Cedar Rapids, Iowa, store buyer.

“Should have no chrome instead of a minimum.” —Chicago anthropologist.

“If you could put an Austin A-40 motor in a Hillman body, you would have just about the perfect small car.” —Pennsylvania factory manager.

The survey showed that 28 percent of the owners use the Hillman as a second car, mostly to drive to and from work. Of all owners replying, 56 percent use regular gas, 44 percent premium. Oil consumption averaged one quart every 1183 miles, with a change of oil every 1516 miles. Hillman doesn't pretend to be a fast car, yet the average top speed reported was 73 miles per hour.

The question of dealer service and availability of parts is sometimes controversial for foreign makes. Hillman owners reported dealer service as follows: Excellent, 41 percent; good, 24 percent; average, 19 percent, and poor, 16 percent. Parts and service were found to be readily available by 84 percent of the owners—quite a high percentage.

On the horsepower question, opinions of mechanically minded Hillman owners followed that expressed by a New York City supervisor: “If the Hillman used the same horsepower as its larger brother, the Humber Hawk — 53 horsepower, I believe — it would be an ideal car.”

A Freeport, N. Y., electronics engineer wrote: “I am surprised at the tire, brake and clutch mileage obtained. They are better than four times that which I had on three previous cars.”

But not every owner was so enthusiastic. A retired man living in Mt. Vernon, N. Y., said: “I would not recommend this car for anyone who cannot do some of his own repair work or who is not near a reliable dealer.” A San Francisco insurance solicitor wrote: “I would say that the Hillman Minx is a wonderful little car in spite of the British dealers who do everything to leave a bad taste in your mouth. In five months of ownership, the car was in the shop more than three months while their mechanics fiddled around with it.”

A Salem, Mass., Army engineer was one of several who remarked that the speedometer is too far over on the right side of the dash. A Boston, Mass., publisher rated his Minx “excellent” but asked for “less Americanization in styling. There is no reason to imitate American styling.”

Now for my test of the Hillman Minx: The car tested was the Mark V four-door sedan, which accounts for about 75 percent

(Continued to page 268)

MOST POWERFUL SAW of its kind!

Very Quiet Operating!

CUTS 1" SOFT WOOD, THIN METAL, PLASTIC!
Ideal for Cutting TILE of Rubber, Linoleum, Metal!

Syncro's newest Electric Jig Saw—No. 201—is so powerful it cuts 1" soft wood—so quiet operating it's ideal for apartment as well as workshop use. Smooth cutting eliminates sanding! PORTABLE. Stroke adjustable! Arm adjusts for any length cut! Thousands used in schools, hospitals, homes. Get this sturdy, quality, precision-made tool with new BUILT-IN Reactance Electric Motor, only \$24.95 at dealers or postpaid from factory. Saw GUARANTEED by World's Largest Makers of this type saw!

NEW RED ROCKET JIG SAW!

Amazing! The new safe jig saw for children that cuts 1/2" soft wood, thin metal—SAFELY. Train your child to use tools safely with SYNCRO RED ROCKET. Motor Built-In. only \$14.95 dealers or postpaid from factory.



No. 801
\$14.95



Patented



No. 201
\$24.95

COMPLETE with new BUILT-IN Reactance Electric Motor

No Sanding Necessary . . . Sands as It Cuts!

Power Unit Guaranteed Against Burn-out during OWNERSHIP or Replaced FREE!

SYNCRO
Electric Jig Saws

SYNCRO CORPORATION, Dept. D-13, Oxford, Mich.

MAKE UP TO \$5 AN HOUR WITH

EASISHARP

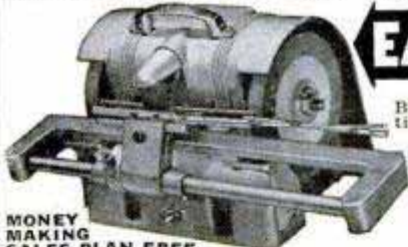

Big profits in your spare time sharpening scissors. We show you how to start making money immediately. This is your chance now to have your own business with Easisharp. Sharpen a pair of scissors in less than two minutes! A child can operate it. Weighs only 10 lbs. Every home, barber, tailor, dressmaker — everybody uses scissors and all need sharpening two to four times a year. Don't let some one else get ahead of you. Write immediately to

MONEY MAKING SALES PLAN FREE

SERR-EDGE MACHINE CO., 9731 Lorain Ave., Cleveland, Ohio

WOW! A Real Children's Motor Car THE EXCITING NEW *Powercar Jr.* ELECTRIC MOTOR DRIVEN



Auto Battery Powers Cars For Kids

The POWERCAR Junior drives up or down hills easily . . . is strong enough to tow several other children's vehicles . . . Mechanically the POWERCAR Junior steers and drives like a big car, weight is evenly distributed, close to the road, takes corners safely . . . has reverse shift for easy parking and maneuvering; the semi-pneumatic tires ease the jolts and take the bumps, yet need no air. Stops in a few feet when foot pressure is released. Positive action hand brake. Safe operating speed—no faster than a brisk walk. Satisfaction guaranteed or full purchase price returned. Send for free colorful literature and information about children's motor vehicles and Special Offer.

MYSTIC RIVER SALES COMPANY
Dept. P-1 Mystic, Conn., U.S.A.

Make 100% to 150% Profit!

MANUFACTURE BUILDING BLOCKS In Your Own Back Yard



AMAZING GENERAL BLOCK MACHINE
CAPACITY 1000 BLOCKS PER DAY
Only \$218 LESS MOTOR F.O.B. PLANT

SHIPPING WEIGHT 400 lbs.

Here is an outstanding opportunity for men of vision and small capital. Cinder and concrete blocks are in great demand. Millions used for homes, factories, public buildings. Sell all you produce at 100% to 150% mark-up.

PEAK BUILDING DEMAND!

The General Block Machine is amazingly practical, foolproof. Simple to operate indoors or outdoors. Rugged all steel construction. Vibrator mounted in sealed ball bearings. Produces up to 1,000 blocks per day. Superior 3 Core Type that meets all building code requirements. Can produce 4 x 8 x 16, 8 x 8 x 16, 12 x 8 x 16 blocks. All materials obtainable anywhere. All operating instructions and mixing formulas supplied. Full details FREE without obligation.

HOW TO BUILD YOUR OWN CONCRETE BLOCK HOME Only 1 Prepaid by Experts

Wonderful Book Written & Illustrated by Experts

GENERAL ENGINES CO.

DEPT. M-13 • 307 HUNTER ST. • GLOUCESTER, N. J.

Includes floor plans for 6 beautiful, easy to build concrete block bungalows. Shows ways to save money. How to lay blocks, lay out building lines, mix concrete, build steps, porches and concrete floors. Mail coupon at once with \$1.

Name
Address
City Zone . . . State . . .



make your *HANDS* ***MORE CREATIVE*** with **X-acto Knives and Tools**

Creative hands can be your greatest asset... X-acto knives and tools help the intelligent coordination of active minds and agile fingers... they can develop skill and dexterity in any art or handicraft you select.

Whether it's boat whittling, model airplanes, wood-carving, leathercraft, model railroads or any other handicraft, you can make your hands more creative with "designed-for-the-job" precision-engineered X-acto knives, tools and handicraft kits.

X-acto offers the complete line of handicraft knives, interchangeable blades, tools and attractive kits

From 25¢ to \$30.—at dealers everywhere.

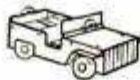

No. 82
X-ACTO KNIFE CHEST
\$4.20



Send 15c to cover postage
for our new illustrated
28-page Catalog.



X-acto Crescent Products Co., Inc.
440 Fourth Avenue, New York 16, New York

of Hillman Minx sales in the United States, the other 25 percent being convertibles with a scattering of estate cars, which we would refer to as station wagons. I put the car through severe tests in the desert, mountains and over winding trails in southern California.

The performance of the car, considering the size of its 42-horsepower four-cylinder engine (77.20 cu. in., about the size of a large American motorcycle engine), is exceptionally good and economy is outstanding (see economy chart). For a four-cylinder engine it is extremely smooth and free of vibration.

By American standards the Minx is indeed a small car, having a 93-inch wheelbase (7 inches shorter than the Henry J or Nash Rambler) and having an unladen weight, less gas and water, of 2072 lbs. for the sedan and 2093 lbs. for the convertible. Considering the size of the car there is a surprising amount of room—although, of course, not as much seat width as in conventional American cars.

The car rides well and 2½ turns of the steering wheel from lock to lock make it quickly maneuverable in traffic and when parking. Because of the short wheelbase and the narrow tread (48⅝ inch front and 48½ inch rear) the car has a turning circle of 33 feet. The ground clearance of the Minx is 7 inches.

It cruises along easily at 50 to 60 miles per hour and has a top speed of 76 to 78 miles per hour by speedometer, which I found to be fast by about 6 percent.

The best performance of the Minx is secured by revving up the engine, as its power is developed by high engine speed. The four-speed transmission is therefore desirable because the different ratios are necessary for best performances under various road conditions. The over-all gear ratios are well selected as follows: High, 5.22:1, third, 7.78:1; second, 12.89:1; first, 18.60:1, and reverse, 24.85:1.

The car has little tendency to roll or sway on corners and the suspension is excellent, modern in every respect as coil springing is used in the front and leaf springs in the rear. After driving the car a few miles, there is no feeling of being in an ultrasmall automobile.

The car's interior is well finished, with leather upholstery, which the British seem to prefer. There is a wide range of adjustment for the driver's seat. The flexible-spoke steering wheel eliminates vibration and is very comfortable. The clutch and brake pedals are small and mounted too close together. Also, the foot throttle is too close to the brake pedal.

(Continued to page 276)

SURPLUS MACHINE SHOP TOOLS AT PRICES YOU CAN AFFORD

HIGH SPEED STRAIGHT SHANK DRILLS



SET 30 selected H. S. Straight Shank Drills from 1/8" to 1/4" lengths up to 7". \$15 value, only... **\$2.98**

SET 100 HIGH SPEED DRILLS: 1/4" down. 19J 30 new std. H. S. Drills — 70 slightly used sharp drills, lengths up to 7". \$30 value. PPD. **ONLY \$7.98**

SET 12 different size H. S. straight shank Drills, 1/4" to 1/2". lengths up to 7". Only.... **\$3.98**

HIGH SPEED MORSE TAPER SHANK DRILLS



Reconditioned and sharpened—ready to go! Many drills with extra lengths of flute. Immediate delivery. These drills are priced as low as 25% of your present cost and shipped post paid to you.

Size	Twist	Price	Size	Twist	Price
1/4"	2 1/2"	Each	3/8"	3 1/2"	Each
1/4"	2 1/2"	.35	1/2"	4 1/2"	1.19
5/16"	2 1/2"	.40	5/8"	4 1/2"	1.19
21/64"	3 1/2"	.40	1-1/8"	5 1/2"	1.19
11/32"	3 1/2"	.43	1-1/4"	5 1/2"	1.19
23/64"	3 1/2"	.48	1-1/2"	5 1/2"	1.19
3/8"	3 1/2"	.48	1-5/8"	5 1/2"	1.19
25/64"	3 1/2"	.53	1-3/4"	5 1/2"	1.19
13/32"	3 1/2"	.53	1-7/8"	5 1/2"	1.19
27/64"	3 1/2"	.55	1-7/8"	5 1/2"	1.19
7/16"	3 1/2"	.55	1-7/8"	5 1/2"	1.19
29/64"	3 1/2"	.63	1-9/16"	5 1/2"	1.19
15/32"	3 1/2"	.63	1-9/16"	5 1/2"	1.19
31/64"	3 1/2"	.65	1-11/16"	5 1/2"	1.19
11/16"	3 1/2"	.75	1-11/16"	5 1/2"	1.19
33/64"	4"	.82	1-13/16"	5 1/2"	1.19
17/32"	4"	.82	1-7/32"	8 1/2"	1.19
35/64"	4 1/4"	.90	1-15/64"	7 1/2"	1.19
9/16"	4 1/4"	.90	1-9/32"	7 1/2"	1.19
37/64"	4 1/4"	1.00	1-19/64"	5 1/2"	1.19
19/32"	4 1/4"	1.00	1-5/16"	5 1/2"	1.19
39/64"	4 1/4"	1.06	1-21/64"	5 1/2"	1.19
41/64"	4"	1.19	1-3/8"	5 1/2"	1.19
21/32"	6"	1.19	1-25/64"	7 1/2"	1.19
43/64"	4 1/2"	1.31	1-13/32"	8 1/2"	1.19
45/64"	4 1/2"	1.31	1-27/64"	8 1/2"	1.19
47/64"	4 1/2"	1.44	1-7/16"	6"	1.19
23/32"	5"	1.44	1-29/64"	6"	1.19
47/64"	5"	1.57	1-15/32"	8"	1.19
49/64"	4 1/4"	1.64	1-17/32"	7"	1.19
25/32"	4 3/4"	1.64	1-35/64"	8"	1.19
51/64"	5 1/2"	1.85	1-39/64"	7"	1.19
13/16"	4"	1.85	1-21/32"	7"	1.19
53/64"	4"	1.91	1-27/32"	7 1/2"	1.19
27/32"	5 1/2"	1.91	1-7/8"	9"	1.19
55/64"	5 1/2"	2.02	1-29/32"	6 1/2"	1.19
7/8"	4 3/4"	2.02	1-31/32"	10.00	1.19
57/64"	5 1/2"	2.12	2-1/2"	7 1/2"	1.19
29/32"	4 3/4"	2.20	2-7/16"	11"	1.19
15/16"	5 1/4"	2.20	2-15/32"	13"	1.19
61/64"	4 1/2"	2.42	2-1/2"	11"	1.19
31/32"	4 3/4"	1.50	4"	9"	1.19

Large quantities available in every size. 5% DISCOUNT ON PURCHASES OF \$50 OR MORE. 10% DISCOUNT ON PURCHASES OF \$100 OR MORE.

1/4" TO 17/32" BITS—1/4" SHANKS
1/2" TO 1- 3/16" BITS—1/2" SHANKS
All Bits High Speed.



Add 10% to the price of any of the above Bits from 1/4" to 17/32" and you can have a 1/4" straight shank to fit your 1/4" Drill.
Add 10% to price of any above Bits from 1/2" to 1-3/16" and you can have a 1/2" straight shank to fit your 1/2" Drill.

H. S. TAPER SHANK CHUCKING REAMERS



SET 15 Different Size High Speed Morse Taper Shank 25J Chucking Reamers up to 1 1/2" With No. 1 and 2 tapers. New and used. Priced at only... **\$7.95**

SET 8 Different Size High Speed Morse Taper Shank 13J Chucking Reamers from 1/4" to 1". New and used. Priced at only... **\$6.95**

HIGH SPEED WOODRUFF KEY SEAT CUTTER

SET 5 different size cutters. Can be used as mounted milling cutter or circular saw. All with 3/8" and 1/2" shanks, widths up to 1 1/4", dia. up to 1". New and used. Ppd. **\$3.95**



6 SLITTING SAWS WITH MANDREL

SET 6 different 34J size high slitting saws, 5 pcs. 2 3/4" dia. x 1" arbor, plus 1 pc. 5" dia. x 1/2" arbor. Thickness from .040 to .071. Cuts wood, aluminum, brass, steel, etc. PLUS SPECIAL MANDREL which enables use of saws in 1/4" or 1/2" electric drill. \$25 value. PPD. Only... **\$4.95**



7 selected, sharp H. S. Slitting Saws as above to use on your own mandrel or milling machine. New and used. Ppd. A bargain at... **\$4.95**

DOUBLE-END END MILLS

SET 4 right hand H. S., 3/8" straight shank End Mills... **\$3.98**

New Rotary FILE MIX
7 different pcs., High Speed 1/4" shank, PPD... **\$4.49**



SET 14 different pcs., as above, PPD... **\$8.79**

HIGH SPEED HAND TAPS

SET 8 different size H. S. Std. Thread Hand Taps up to 5/8", including 2 Std. H. S. Pipe Taps. **\$2.95**



SET 40J 16 same as above... **\$4.80**

NEW 360° SWIVEL TYPE TOOL HOLDER AND BORING BAR

Here is a tool that will do the work of a left, right and straight tool holder, plus a boring bar, all for a fraction of its original cost, post paid to you.

- TOOL A takes a 5/16" sq. bit, or 5/16" dia. boring tool. Shank size 9/16"x1"x4 3/4". PPD. Only... **\$3.29**
- TOOL B takes a 3/8" sq. bit or 3/8" dia. boring tool. Shank size 5/8"x1-3/16"x5 3/4". PPD. Only... **\$3.95**
- TOOL C, Cut-off blade holder for 3/32"x 3/8" blade. Shank size 1/2"x1"x4 1/2". Can be changed to fit other size cut-off blades. PPD. only... **\$2.25**
- TOOL BIT SPECIAL: 12 H.S. 3/16" sq. x 2 1/2" new tool bits. PPD. **\$1.95**

NEW MOUNTED STONES

SET Mixture of 12 Mounted 27J ed Stones with 1/4" shanks. PPD... **\$2.95**



MOUNTED POINTS WITH 1/8" AND 3/32" SHANKS

Assortment of:
10 stones... **\$1.20**
25 stones... **\$2.75**
50 stones... **\$4.50**



NEW HIGH SPEED COMBINATION DRILL AND COUNTERSINKS

SET 8 selected sizes from A1 to F2 (3/8" drill x 1/8" body to 3/16" 2J drill x 7/16" body) 60° angle of countersink. New cost on these countersinks 75c to \$2.50 ea. Priced to you Ppd. at only... **\$3.98**



GENERATORS!

P1 GENERATOR 200-amp, 24-volt, continuous duty. Wt. 48 lbs. Special closeout price. F.O.B. Tulsa... **\$14.98**

E5A GENERATOR 50-amp, 12 volt continuous duty. Wt. 21 lbs. F.O.B. Tulsa. Only... **\$7.98**

These used, guaranteed serviceable aircraft quality generators are easily convertible for welders, power plants, boats, platers, etc.

H. P. MOTOR, 24-volt, 90-amp, double end ball-bearing shaft. Wt. 18 lbs. F.O.B. Tulsa, only... **\$7.00**



HYDRAULIC BARGAIN DEPT.

New Hydraulic Hose!!
2000-lb. Test

- Any length
- Std. Pipe Connections 1/4", 3/8", and 1/2" ID Available

1/4" hose has 3/8" male pipe connections.
3/8" hose has 1/2" male pipe connections.
1/2" hose has 3/4" male pipe connections.

Length in feet	Price 1/4" ID	Price 3/8" ID	Price 1/2" ID
1	\$.75	\$1.50	\$1.65
2	1.00	2.25	2.40
3	1.20	2.75	2.95
4	1.45	2.95	3.10
5	1.70	3.40	3.60
6	1.95	3.60	3.75
7	2.30	3.75	3.95
8	2.30	3.75	3.95
9	2.30	3.75	3.95
10	2.30	3.75	3.95

11 to 50-ft. lengths available at 15c per ft. for 1/4" ID Hose—30c per ft. for 3/8" ID Hose—40c per ft. for 1/2" ID Hose. Above prices quoted complete with fittings. Finest construction double wire internal braid. 1/4" ID Hose will carry 3 GPM at 1000 PSI. Use for hydraulics, steam, air, etc. Large quantities available at greatly discounted prices.

60 TO 1 GEAR BOX

5/16" dia. input shaft, 1/2" dia. output shaft with removable sprocket. Wt. 6 lbs. PPD... **\$6.49**

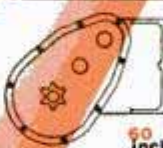

60 TO 1 GEAR BOX TRAINING

Includes 8 gears and 7 ball-bearings. Wt. 10 lbs. Ppd. **\$6.00**



NEW VICKERS MF9, 6 H. P. Hydraulic Motor

Unit is compact, powerful. Displaces .507 cu. in. per revolution, 6 gal. per min. at 3000 RPM, 1500 PSI. Positive displacement. Angle type. Rated at 6 H. P. Rotates either direction. Unit can also be used as a pump. Here is the finest hydraulic motor available at a fraction of its new cost of over \$200. Our price only... **\$19.95**

NEW VICKERS HYDRAULIC MOTOR, Serial No. MF 107130 B.C. F 2, cu. in. displacement per rev., 378, 3600 R.P.M. 1000 P.S.I. Unit similar to above only with smaller displacement and H.P. Only... **\$16.50**

NEW SURPLUS PRESSURE GAUGES

2 1/2" Dial. Following pressures available: 30"—0—60", 0 to 600#, 0—30", Your choice... **\$1.30**

4 1/2" Dial. Std. quality gauges; std. pipe connections. Finest brands. Retailing at \$7.00 and up. Following pressures available: 0 to 15", 30"—0—100", 0 to 100#, 0 to 160#, 0 to 200#, 0 to 700#, 0 to 800#, 0 to 1000#, your choice, only... **\$4.00**

Gauges suitable for steam, air, oil, gas and water. Discounts on quantities.



AUTO TEST VACUUM GAUGE, 4 1/2" Dial, 30"—0. You can pay up to \$14.00 for this gauge. PPD, only... **\$3.25**

AIR TANK—REGULATOR—MASK

• A4 Tank, 5" x 8", 104 cu. in. vol. 500 PSI... **\$1.50**

• Demand Type Regulator complete with 500 PSI pressure gauge. Fits above tanks... **\$1.50**

• Mask complete with 14" of hose. Outlet valve. Fits above regulator... **\$1.60**

Above equipment suitable for air tanks, compressors, respirators, diving units, etc.



BARGAIN TOOL & SHOP MIXES—PPD.

- 30 GRINDING WHEELS 1/4" arbor, 4" diameter max... **\$3.29**
- 2—8" WIRE WHEELS coarse and fine, 1" thick, 5/8" bore. Pair only... **\$2.29**
- SURPRISE MIX: Over 50 pcs for your 1/4" elec. drill including rotary files, drills, bits, reamers, grinding wheels and arbors for our customers who like pleasant surprises. Your money back if you aren't satisfied... **\$2.98**
- BEARING MIX: About 40 needle, ball and roller bearings, new and used. Up to 2 1/2" dia. approx. 5 lbs. Outstanding buy at... **\$2.95**

Write For Free Catalog Describing Thousands of Bargain Cutting Tools.

T & T TOOL 221 W. SECOND TULSA, OKLA.

WHAT DO YOU WANT?

A GOOD BUSINESS OF YOUR OWN?

A HIGH PAY SPARE-TIME JOB?

Then FOLLOW THIS PROVED SUCCESS PLAN!

Here is your chance to be your own boss, secure financial independence, build a future for yourself and your family in a profitable business in your own garage or basement. J. S. of Michigan writes, "I figure my profits (last season) at over \$1,000.00." Mr. C. H. R. of Ohio says, "This season I have taken in \$3,688.20." J. P. of Pennsylvania writes "I spent only 40c for a newspaper ad and have done nearly \$500.00 worth of business." Another owner writes, "I have had 4 mowers a day brought to me since last May . . . and do the grinding evenings at an average of \$2.50 each." Think of it! That's \$10.00 an evening in spare time. If you want to get ahead, make big money, be your own boss. Act Now. Write today for full details of our proved success plan.



ONLY ON THE UNIVERSAL LAWN MOWER GRINDER

can the inside face and edge of the stationary blade, and all reel blades, be ground to proper clearance

ALL IN ONE SET-UP

WITHOUT REMOVING ANY BLADE FROM THE MOWER

. . . that's why this business is simple, easy, and interesting. No experience or long hours of study are necessary. A leading National Magazine says, even an inexperienced worker can do a good job. We furnish complete instructions, everything you need to get started . . . But you must take the first step. Just fill in and mail the coupon below. Do it right now.

ROGERS MFG. CO., DEPT. M-13, LINDSEY, OHIO

SEND THIS COUPON NOW

ROGERS MFG. CO., Dept. M-13, Lindsey, Ohio
Please send me full details about the profit possibilities of Lawn Mower Sharpening.

NAME _____

ADDRESS _____

CITY _____ STATE _____

The patient is released to his companions for whatever further medical treatment or examination they wish to give and the patrolmen return to the slopes. By the end of the day when everyone else relaxes before the open fireplace, the patrolmen have one more important assignment—the "sweep" of the trails.

They are the last ones to ride the chair lift or tow rope to the trail tops. Then they move down, checking bad turns, following ski tracks that veer away from the main trail to be certain they returned. The run may be as long as two or three miles but the "sweep" is thorough; a skier's life may depend on being found in those few minutes.

Only when they finally assemble again at the lodge and the area is closed can the patrolmen settle back and join their friends in the companionship of this rugged sport. And though there has been strain and tension, even danger, in their day, few would trade places with the most carefree tourist.

For, in the lash of the wind and the sting of the swirling snows, they have found both the thrills and satisfaction that come to those who dedicate themselves to helping others.

★ ★ ★

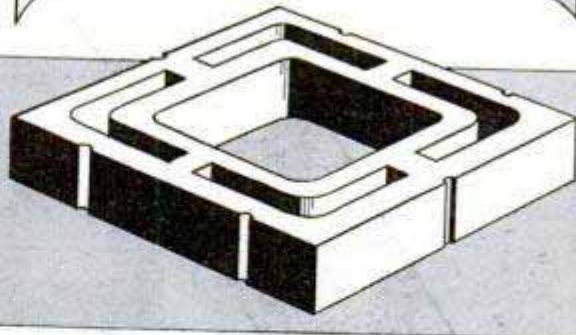
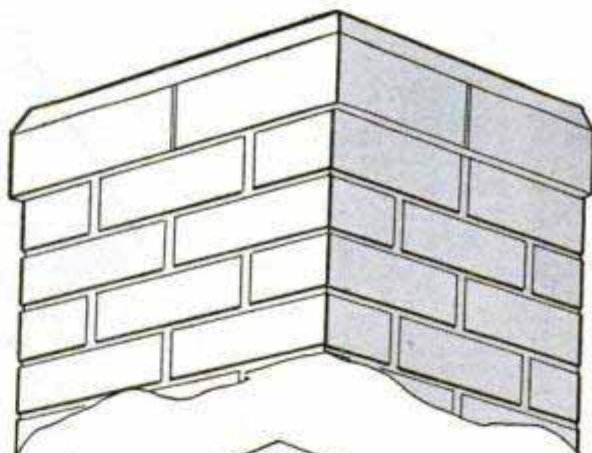

Chimney Blocks With Flue Liners

Building up a chimney is an easy job for even the amateur workman when special square blocks are used for this purpose. Made of concrete, the blocks are scored to give the appearance of brick and are fabricated with built-in flue liner, which reduces both cost and time required to put up a chimney.

Tough hobby jobs

made easy
with

PALMGREN

ROTARY TABLE

NOW ONLY

\$54⁵⁰

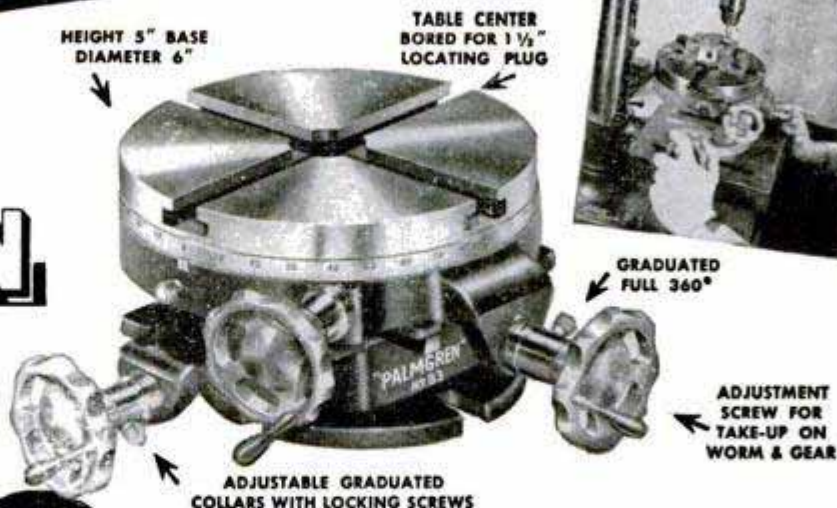

**The Only Table Having ROTARY FEED
Combined With DUAL CROSS FEEDS!**

It's sensational—in price, in construction, in performance. Makes your drill press a vertical milling machine. You can rout, straight or curved-rabbit-drill-sand or mortise. Also hundreds of other jobs such as milling slots, grooves, keyways, squares, hexagons, curves, flats, dovetails, indexing and laying out work.

Designed for use on Drill Press or Milling Machine, it will handle large tough jobs or small model parts on all types of metal and woodworking projects.

Built by Specialists for LIFETIME SERVICE

Precision built. Permits close tolerances. Rotary feed is calibrated in degrees-cross feeds in thousandths. Cross slides and feeds are 2 1/8" each side of center—4 1/4" overall. Adjustable gibs on cross slides—40 to 1 worm and gear ratio in rotary feed. 4 Bolt slots—2 lock screws.



No.	Base Keyway	Table T-Slots	Base Dia.	Table Dia.	Ht.	Wt.	Price
83	5/8"	5/8"	8"	6 1/4"	5"	28 lbs.	\$54.50
82	As above without ROTARY FEED					26 1/2 lbs.	39.75

CHICAGO TOOL and ENGINEERING CO.

Mfrs. of PALMGREN PRODUCTS for over 30 years

8415 SOUTH CHICAGO AVENUE

CHICAGO 17, ILLINOIS

OTHER "HOBB-E" TOOLS



"Hobb-E" ANGLE VISES
for quick accurate set-ups and any angle. Save hours of time. XI-VISE 1 1/2" Jaws \$4.95. No. 000-2 1/2" Jaws Only \$8.75



"HOBB-E" MILLING ATTACHMENTS
Mill on your lathe. Make T-Slots-Dovetails-Keyways, Etc. Fits any lathe. Graduated for rotary or vertical feeds. Attaches to tool post in 10 Seconds. No. 150-1 1/2" Jaws \$20.65. No. 250-2 1/2" Jaws \$27.25. No. 400-4 Jaws \$39.75



"Hobb-E" BENCH-DRILL PRESS VISES
A handy combination. Use on bench for hand work—slide vise off adaptor to use on drill press. Swivel bench Base—2 1/2" Jaws. V grooved for holding round pieces. Only \$12.95



"Hobb-E" DRILL PRESS VISES
Designed especially for Hobbyists, to make operations on small articles more convenient. No. 6—1 1/2" Jaws \$3.30. No. 30—2 1/2" Jaws \$5.50



"Hobb-E" HAND VISE
A handy device with unlimited uses in finishing operations. Grips smallest pieces for buffing or grinding without damage and safeguards hands and fingers. No. 15—1 1/2" Jaws Wt. 7 oz. Only \$2.15

Order Today!



Send for
**FREE
BOOKLET**

MAIL COUPON

USE THIS CONVENIENT COUPON!

CHICAGO TOOL and ENGINEERING CO.
8415 South Chicago Ave., Chicago 17, Ill.
Enclosed find { Check for \$_____ Please
M. O.

send items marked below:

No. _____ ROTARY TABLE
 No. _____ MILLING ATTACHMENT
 No. _____ DRILL PRESS VISE
 No. _____ ANGLE VISE SEND FREE
 No. _____ COMB. VISE "HOBB-E"
 No. _____ HAND VISE BOOKLET

NAME _____
 STREET _____
 TOWN _____ STATE _____
 PLEASE WRITE DEALERS NAME IN MARGIN

Save \$89.50

on this **PORTER-CABLE** combination!

STARTS

as a **ROUTER**



Router Complete with base and motor—\$49.50

BECOMES

a **PLANE**



By adding Plane Attachment — \$25.00

THEN

a **SHAPER**



By adding Shaper Table — \$24.00



Interchangeable Motor powers 3 tools . . . saves cost of 2 motors!

All 3 Tools for only \$98.50

For expert woodworking, build your home workshop around this Porter-Cable Tool combination—production tools used by Builders—and save \$89.50!

As a ROUTER—you can tongue, groove, rabbet, dovetail, do scrollwork, cut contours and beaded edges on wood, composition or plastic.

As a PLANE—you can shave off wood at high speed—taking cuts from $\frac{1}{64}$ " to $\frac{3}{32}$ " deep—without a wave or ripple! Attachment for sharpening right on the job.

As a SHAPER—you can edge irregular pieces; joint strips accurately, even narrow and short pieces; make hundreds of fancy cuts for cabinets, furniture, trim, toys, picture framing, molding, etc.

Purchased separately, all tools complete with motors would cost you \$188.00. But, with *one* Interchangeable Motor mounted in the proper attachments, you get all 3 tools for only \$98.50—a saving of \$89.50!

See this great money-saving combination at your Porter-Cable dealer's. Or mail coupon today for full details.

PORTER-CABLE Machine Co.
1441 N. Salina St., Syracuse 8, N. Y.
Send me full information about Porter-Cable Router, Plane and Shaper Combination . . . also name of nearest Porter-Cable dealer.

Name _____

Address _____

City _____

State _____

Manufacturers of SPEEDMATIC and GUILD Electric Tools
In Canada write: Strongridge, Ltd., London, Ont.

The Engineers' Club in New York City. The job of this commission is to work toward the alleviation of the engineering-manpower shortage. One way it is going about this is by interesting qualified young people in the engineering profession. Advice, encouragement and help to young people from all over is a part of the commission's function, and its New York office and its local delegates throughout the country follow through on hundreds of inquiries that come to their attention.

Our civilization today is permeated with engineering. A man with a recognized engineering degree can find his place almost anywhere, in scores of seemingly unrelated fields. Some engineers manage big businesses, like the presidents of many well-known companies. City managers and public-works directors in many cities are engineers. Government calls for more and more of them. Businessmen use engineers to survey and analyze markets or even to formulate plans for advertising and sales campaigns. Investment concerns turn to engineering advisors to evaluate the practical side of new manufacturing proposals. Industry is dependent upon the continued supply of qualified engineers.

Without proper preparation in high school—mainly in science and mathematics—entrance into an engineering college or a technical school is difficult. So if you think you want to be an engineer and set your sights on any one of these goals, start early and you'll get there if you have what it takes. ★ ★ ★

Plastic Pencil Case Snaps Into Binders

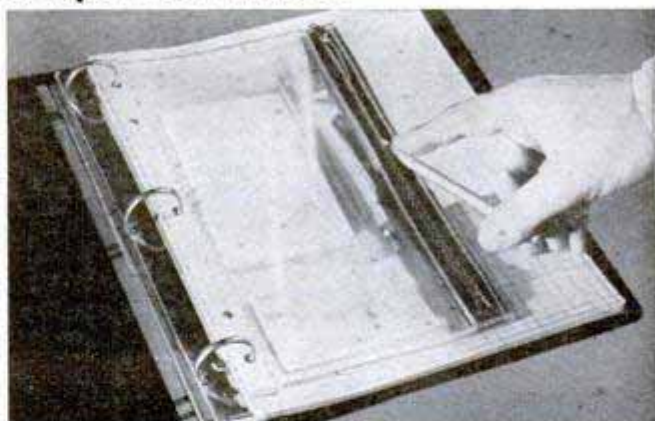

Pencils, erasers and drawing instruments are enclosed in a transparent-plastic pocket that fits into a loose-leaf binder. Holes punched in the sturdy inner edge fit standard two, three and five-ring binders. A slide fastener opens the outer edge of the five by ten-inch kit. Tear-resistant for long wear, the Vinylite-plastic case resists moisture, ink and scuffing.

Build A MODERN READY-CUT HOME! *Costs You Less!*

Shipped
Direct
from Our
Mill



Liberty Homes

*Save 30% to 40%
on Your New Home..*

\$3184



Don't pay several hundred dollars more than necessary when you build a home! Buy direct from our mill at our low factory price. We ship you the lumber cut-to-fit, ready to erect. Paint, glass, hardware, nails, etc., all included in the price—no extra charges. Plans furnished—also complete building instructions. No wonder our customers write us that we saved them 30% to 40%. Architecturally approved construction. (Not pre-fabricated.)

Visit a Liberty Home!

Many thousands of Liberty Homes have been built in all parts of the country. There is one near you that you can visit and inspect. Write us and we will give you its location.

**31 Designs to Choose From
AS LOW
AS . . . \$2180**

Recommended by Banks and
Building and Loan Associations

Handsome Big CATALOGUE

Pictures wonderful homes in colors at money-saving prices. Designs to suit everyone. Send 25c for catalogue today.

**BIG BOOK
of
House Plans
in Colors
25¢**

LEWIS MANUFACTURING CO.

1231 LAFAYETTE AVE.,
BAY CITY, MICH.

At Last! A PORTABLE Motor-Welder

9 TOOLS IN 1



Motor-Weld Model 1A
—recommended for hobby and home work. Comes as illustrated above, 110 volt, 60 cycle AC or DC. Four speeds and welds up to 3/8" steel. Uses up to 3/8" rod. (80 amps.) Ship. Wt. 40 lbs. F.O.B. Chicago, Ill. **\$54.75**

Battery charger attachment, \$5 extra.

HAS SELF-CONTAINED MOTOR GENERATOR JUST LIKE BIG PLANT UNITS

MOTOR WELD is the only known motor-generator type unit that has its Large Amperage Output, is self-contained, yet has light-weight "Pickup" Portability and sold at transformer price levels. Low cost, economical operation. No special wiring—just plug into any 110 volt AC or DC line (any cycle) and it's ready to use! Its portable POWER UNIT can be used to operate saws, grinders, etc. Other models (150-225 amp.—Cart Models, etc.) available.

Send for **FREE Literature**

10-DAY FREE TRIAL

**90-Day Warranty
On All Machines**

Send remittance with order; will ship C.O.D. (\$15 deposit)

Porto-Weld Model 2A
—recommended for repair, maintenance, and installation work. Comes as illustrated above, 110-220 V.-AC or DC. 7 welding ranges and welds up to 3/8" steel. Uses up to 3/8" rod. (150 amps.) Ship. Wt. app. 80 lbs. **\$98.50** F.O.B. Chicago, Ill.

Battery charger attachment, \$5 extra.



- ✓ WELDS
- ✓ BRAZES
- ✓ GRINDS
- ✓ SANDS
- ✓ POLISHES
- ✓ BUFFS
- ✓ BRUSHES
- ✓ POWER UNIT
- ✓ CHARGES BATTERIES

GENERATOR SALES CO. • 1627 N. Damen Ave. • Dept. B • Chicago 47, Ill.

What d'ya mean
replacement
rings?



● Of course you know oil-pumping usually means worn-out piston rings—but maybe you don't realize all that ring *replacement* means.

As your engine gets older, the cylinders wear tapered and out-of-round. The engine runs hotter because of accumulations in the cooling system. It needs more oil on the cylinder walls. Yet this extra oil must be kept under full control—so you get generous lubrication without a bit of waste.

This calls for a special type of piston rings—*replacement rings*.

Hastings makes replacement rings exclusively . . . devotes all its research, on the highways and in the laboratory, to the particular replacement problems of each make and type of engine . . . for re-ring, re-bore and re-sleeve.

Hastings rings are nationally known for their ability to stop oil-pumping, check cylinder wear, restore engine performance.

At the first sign of oil-pumping or performance drop-off, go to your motor specialist. If rings are the trouble he will gladly install a Hastings Steel-Vent replacement set. Truly the best money you can spend on your car.

HASTINGS MANUFACTURING COMPANY, HASTINGS, MICHIGAN
HASTINGS LTD., TORONTO

Piston Rings, Spark Plugs, Oil Filters, Casite, Drout

These are the rings that are **TOUGH** but oh so **GENTLE!**

Tough on Oil-Pumping
Gentle on Cylinder Walls

HASTINGS

**STEEL-VENT
PISTON RINGS**

Regular or Chrome-Faced

Motor Engineered

FOR CARS, TRUCKS,
BUSES AND TRACTORS



Florida Builds A Great Wall

(Continued from page 163)

distributed among the stations as occasion demands.

This 858,022-acre manmade water reservoir is ideally suited for fish and animal life. The first pool, having an area of 216 square miles, has been leased for 50 years to the United States Fish and Wildlife Service. The remaining two areas, 204 and 924 square miles respectively, will be administered by the Florida Game and Fresh Water Fish Commission.

Upon completion of the flood-control program, no longer should Florida's growing cattle industry (ranking thirteenth in the nation) be checked by flood and drought. No longer should emergencies arise such as that which confronted the lower-east-coast city of Fort Pierce in September 1951. Suffering from an acute water shortage, this city appealed to the Flood Control District for aid in recharging its well-field areas. Yet, before an emergency supply canal could be finished, Fort Pierce found itself under flood condition from abnormal rains!

Too, with provision made for adequate water control, there will be incentive for settlement of the vast ranges within the state that presently are regarded as wasteland. For example, in the Everglades agricultural area alone, there are 713,670 acres of land capable of long-term agricultural development. The presently developed area totals but 260,950 acres. This should inspire the planting of such extra crops as rice and such important fibers as ramie and kenaf.

The Florida project is an example of what intelligent state and federal cooperation can achieve in the salvation of great natural resources. ★ ★ ★

Spring-Action Weather Strip

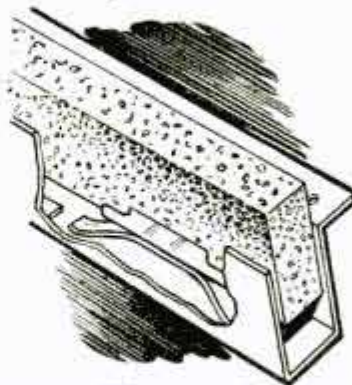

Steel springs in a new design of weather strip push a pad of felt against doors and windows to give a positive seal against air leakage. The springs are mounted in an aluminum channel beneath the felt strip. The weather strip is installed with screws and cadmium-plated nails, using only a hammer and screwdriver.

☐ Clothing is the latest item to be shipped and stored in steel containers—or cans—by the Air Materiel Command.



5 features prove:
BOLENS
 garden tractors
*serve you better
 save you work*
 all year 'round

2 1/2 H.P.
 Power-Ho De Luxe

Spare yourself the toil and trouble of hundreds of jobs around the yard, farm or garden. Let a Bolens tractor do the work *faster and easier*.

Compare feature for feature. It's proof of the labor-saving, money-saving advantages you get from a **BOLENS** — America's *first and finest* garden tractor line. There's a **BOLENS** to fit your needs and pocket-book. Ask your dealer for demonstration.



2 1/2 H.P.
 Super Handi-Ho



6 H.P.
 Ridemaster

Only Bolens offers so much for your money

1. *Quicker Hitching.* Patented Snap-Hitch for fast, easy attachment of all implements.
2. *Smoother Running.* Rolls on precision needle bearings. Driven by powerful engine.
3. *Simple to Operate.* Responds instantly to finger-tip controls. Perfect balance.
4. *Easier, Shorter Turns.* Proved most maneuverable by actual test.
5. *Longer Life.* Rugged, compact construction for years of trouble-free service.

7 tractor models
 111 tools and attachments
 5 rotary mowers
for countless jobs all year 'round

Please send name of nearest dealer and free illustrated literature.

Name _____

Address _____

City _____

Bolens Products Division
 Food Machinery and Chemical Corp.
 267-1 S. Park St., Port Washington, Wis.



BOYS-IT'S FREE!

...NEW, EXCITING 16-PAGE BOOK on magic and marvels of chemistry

Shows you how to amaze friends with eye-opening tricks of chemical magic... like changing water to blood and blood to stone. Tells you how to do many fascinating home experiments and shows you the big, new Chemcraft outfits. Describes fun, thrills, adventure you can have with a Chemcraft chemistry outfit of your own. Send now for free copy to Porter Chemical Co., 44 Prospect Ave., Hagerstown, Md.

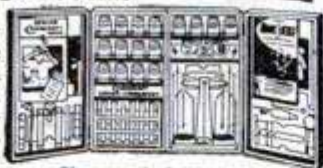

Chemcraft Senior Lab.

HEY FELLAS!
 ask Dad for **CHEM-CRAFT**

Build your own **SMITH Compressor**

Operates spray guns, rock drills, tampers, paving breakers, sandblasting... Uses only 1 gallon of gas an hour!



Save Money—build your own Smith Air Compressor! Famous the world over! Capacity 60 cu. ft.; pressure up to 100 lbs. per sq. inch. Just order the Smith Compressor Head and Accessories with complete instructions for assembling. All you need is a Ford Motor and shop facilities. Head equipped with high speed compressor valves; automatic unloading and idling.

Write for complete information!

GORDON SMITH & COMPANY, Inc.
 410 College Street • Bowling Green, Ky.



Make Your Own!

The Only Tool You Need Is A Screwdriver!

- BEAUTIFY YOUR HOME
- PROTECT IT FROM THE ELEMENTS

ASSEMBLE AMERICA'S Most Beautiful **CANOPIES AND WINDOWS**

IT'S EASY! Just do the top - the sides are ready. They're pre-treated, too, ready for paint.



WRITE FOR FREE MEASURING CHART AND LITERATURE

Save 50%

8974 St. Charles Rd. **Herbert's** St. Louis 14, Mo.



NAME _____

ADDRESS _____

CITY _____ ZONE _____ STATE _____

NEW 1953 BOAT KITS BY U-MAK-IT

30 Models 8 TO 23 FEET

**21 FT. OUTBOARD AND
INBOARD CABIN CRUISERS**

Roomy cabin sleeps 2. Includes full size toilet room, galley, sink & ice chest.

New



**18 FT. OUTBOARD AND
INBOARD CABIN CRUISERS**

Fast Vee bottom hull, speeds up to 25 M.P.H. Accommodations for 2.

New



ROWBOATS OUTBOARDS INBOARDS

8 to 14 Ft.

12 to 21 Ft.

16 to 23 Ft.

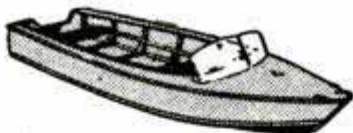

**NEW 1953
CATALOG**

48 PAGES, shows construction details. Incl. everything to build your own—hardware, engines, conversions, paint & color chart.

SEND 35¢ COIN TODAY

U-MAK-IT PRODUCTS

703P WHITTIER ST.
Bronx 59, N. Y. City

KIT BOAT OWNERS

Protect your boat with Fiberglas. Makes new & used boats permanently water-tight. Lengthens lifetime, strengthens construction, increases value & safety. SEND 10¢ postage for interesting booklet with detailed instructions.



EVER GLASTING
(U-MAK-IT PRODUCTS)

703P WHITTIER ST
BRONX 59, N. Y. CITY

The Lockheed hydraulic two-leading-shoe brake system is ample for the weight of the car, although excessive pedal pressure is needed. The hand brake is located between the door and the seat.

There are two open package compartments on the dash. The speedometer is located to the right of center, actually nearer the eyes of the passenger than of the driver. I would prefer it directly in front of the steering wheel, as the driver's eyes must be shifted considerably from the normal driving position to see it. The choke is manual. The starter is the pull-out type and requires too much effort to operate. The directional-signal lever is at the top of the steering-wheel hub and, on the new models, U.S.-type blinkers are used instead of the side-operating signals common in Europe.

The one-piece windshield is slightly curved and vision is satisfactory. The rear window could be enlarged for better rear vision. One feature I like is the quick-acting window crank handle; about one turn of the crank raises or lowers the window (United States engineers should not overlook the value of faster-operating window cranks).

Mounted directly back of the engine on the fire wall is a 12-volt battery. Heretofore 12-volt batteries have been somewhat inconvenient because of lack of charging equipment in some service stations. However, the 12-volt system is now coming into use on American cars, as it is better than the 6-volt system when a lot of electrical accessories are added.

The doors open and close easily and the body is solid. The frame and chassis are solidly welded in unit construction, which is good engineering.

The gearshift is confusing. Low gear is down and forward. Second gear is down and back. Third gear is up and forward, and fourth gear is up and back. Reverse position is rather difficult to get into as the lever must be pushed far down and pulled backward. The new driver and occasional drivers of the Minx naturally are confused. For the American market, the adoption of a standard United States gearshift would be advisable—with some provision for fourth speed to be operated by pushing the lever down and pulling back such as is now used for reverse.

The spare tire is carried in a compartment below the rear luggage space. Hillman offers a unique jack arrangement with permanent four-corner sockets built into the main frame assembly. A rigid arm on the jack fits into the corner sockets. It is a convenient arrangement.

(Continued to page 278)

MAKE ELECTRONICS WORK FOR YOU!

DON'T MISS
THIS
AMAZING OFFER



Here's the most comprehensive information ever published concerning the things you can do with crystal diodes. Complete instructions for building electronic door locks, charger for dry batteries, pocket stroboscope, door bell booster, remote control for electric trains . . . and scores of other devices. Don't delay, supply of these books is limited!

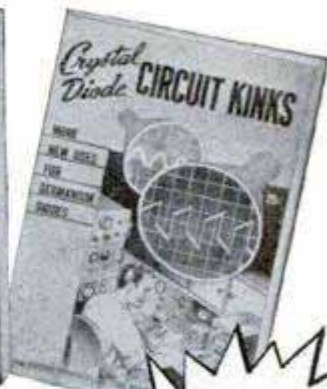
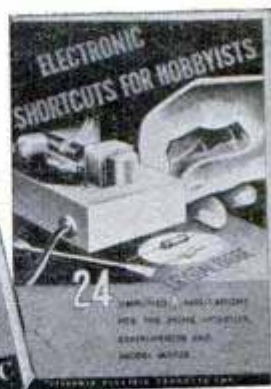
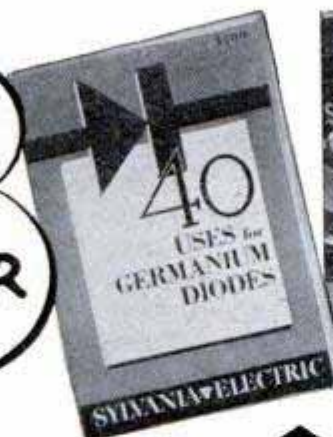

104 fascinating circuits . . .
Easy-to-follow diagrams and
instructions.

Three books
now only

50¢

Send your half-dollar now to:
Sylvania Electric Products Inc.,
Dept. 3E-3701, 1100 Main Street,
Buffalo, N. Y.

RADIO TUBES; TELEVISION PICTURE TUBES; ELECTRONIC PRODUCTS; ELECTRONIC TEST EQUIPMENT; FLUORESCENT TUBES, FIXTURES, SIGN TUBING, WIRING DEVICES; LIGHT BULBS; PHOTOLAMPS; TELEVISION SETS



SYLVANIA

Communication Problems Solved! with ARMY FIELD TELEPHONES & WIRE



EE8 Field Telephones

Factory Reconditioned
Like New

Ea. \$22.50 Per Pr. \$44.50
Guaranteed

Many other Phones, inter-com units—Telephone wires available. Write for FREE FOLDER

LORIS SALES, P. O. Box 1896—B1, Sacramento, California

Construction men, engineers, farmers, and industrial men everywhere are using portable Army Field Telephones for quick, dependable 2-way to 8-way communication. These phones were built to serve combat forces reliably under battlefield conditions. Simple to install. Just string this 2-conductor wire, attach phones, ring and talk any distance up to 17 miles! Powered by flashlight batteries. No maintenance required.

ACT NOW! LIMITED SUPPLY!

All prices FOB Sacramento. No COD. (Calif. residents add 3% for sales tax. Send check or money order.

TELEPHONE WIRE ALL PURPOSE—ALL WEATHER

This is genuine W110B Army Field Wire on original steel reels, with handle. Compressor 2x1 1/4 in. 2.8 CFM pressure to 100 lbs. Spray Gun, flat or round Spray, Quart Cup, Hose and Tire Chuck, Check Valve, Safety Valve, Completely Assembled, ready to run.

1-Mile reels (wt. 160 lbs.)	\$38.50
1/2-mile reels (wt. 80 lbs.)	\$19.50
Grade 1, unused, exc. condition . . . 1-mile	\$22.50
1/2-mile	\$12.50
Grade 2, unused, good cond. . . . 1-mile	\$17.50
1/2-mile	\$9.00

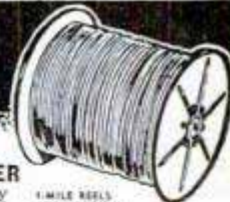

New MOTOR BARGAINS for Home, Farm & Industry



1/2 H.P.
3/4 H.P.
1 H.P.

Dayton, 3450 RPM
IND type . . . \$18.50
Westinghouse, DBL shafts, 1725 RPM \$22.50
Westinghouse, dbl. shafts, 3450 RPM \$23.50
Eicor, capacitor type ball brg., 1725 RPM \$32.50
General Electric, cap. ball brg. dbl. shafts, 1725 RPM \$34.50
General Electric, cap. type, 3450 RPM \$34.50
Eicor, 1750 RPM, cap. type \$52.00
Dayton, 3450 RPM, cap. type \$57.00
Dayton, 3450 RPM, cap. type, dbl. shaft \$62.50

All are 110 V. or 110/220 V. 60 cy. 1 ph. A.C. Motors. All Motor Prices are F.O.B.



Write for FAN CIRCULAR: Listing Blades, Guards, Motors, ALL SIZES: Attic, Window or Room Cooler.

16 TO 1 SPEED REDUCERS
For Display Table—Barbecue Spits—Toy Auto Gear Box—Experimental Uses, Etc. Gears Enclosed in Aluminum Housing. Bronze Gear. Hardened Worm. Input Shaft 1/4 in. Output Shaft 3/8 in. Speed Reducer \$3.95 Post Paid #R 161

C. MARSHALL SALES
3546 W. Fullerton Ave., Dept. P-1 Chicago 47



PORTABLE AIR COMPRESSORS NEW LOW PRICE 1/2 H.P. AIR COMPRESSOR OUTFIT FOR SPRAYING, TIRE INFLATION, ETC.

1/2 H.P. Heavy Duty 110-V, AC Motor—9x18 in. Stainless Steel 300 lb. test Tank mounted on Wheels, with handle. Compressor 2x1 1/4 in. 2.8 CFM pressure to 100 lbs. Spray Gun, flat or round Spray, Quart Cup, Hose and Tire Chuck, Check Valve, Safety Valve, Completely Assembled, ready to run.

Spray Outfit with 1/2 HP, 110-V AC Motor #A33 . . . \$67.50
you assemble #K33 . . . \$57.50
EXTRA HEAVY DUTY 1/2 HP AUTOMATIC AIR UNIT
Heavy Duty Repulsion Induction 1/2 HP AC Motor. Starts and Stops any desired pressure 50-150 lbs. Big Stainless Steel Tank 12x24 in.—500 lb. test. Precision 1/2 HP Air Compressor, 3 CFM, 150 lbs. Ball Bearing Rubber Tired Wheels. DeLuxe equipped Safety Valves, Check Valves, Auto Pressure Switch, Off Valve, Hose, Tire Chuck, Gauge, Heavy Duty Repulsion Induction 1/2 HP, 110/220-V, 1 ph. AC Motor. Assembled Unit #A55 . . . \$97.50
SAVE \$10.00—K.D. you assemble. Parts #K5 \$87.50 ABOVE OUTFITS SHIPPED F.O.B. CHICAGO
#275—Air Compressor Only, 1/2-1/2 HP, ppd. \$19.75
#22—Quart Spray Gun, 15 ft. Hose & Tire Chuck . . . ppd. \$10.50
Automatic Pressure Switch . . . ppd. \$5.50

Volume Blowers for Heating, Ventilating, Exhausting

Blowers for forced drafts, heating boots, exhausters, coolers, dryers and dust collectors. 110 volt A.C., 50/60 cycle motors.

*Midget Blower: 5 CFM 2 in. Wheel \$ 6.95
*75 CFM Blower: Postpaid . . . \$ 9.75
*150 CFM Blower: 4 inch Wheel . . . \$18.50
*250 CFM Blower: 5 inch Wheel . . . \$22.50
*600 CFM Blower: 6 inch Wheel . . . \$38.50
*1000 CFM Blwr: 8 inch Wheel . . . \$52.00
*1500 CFM Blwr: 9 inch Wheel . . . \$72.00
*These Blowers with Motors shipped Post Paid. Larger sizes are F.O.B.

KNOWN FOR THEIR FINER QUALITY

GENSCO

IMPORTED

SWEDISH TOOLS



WOOD CHISELS

Finest Swedish steel blades with unbreakable, machined plastic handles. Take and hold a better cutting edge. Sizes from 1/4" to 2" widths.

MORA HUNTING KNIVES

Seven models, all with leather sheaths. Hand forged, hand honed Swedish steel blades. Polished curly birch handles.



BUSHMAN BOW SAWS

Fastest cutting saw you can own for firewood and rough work. For campers, home owners, farmers, ranchers. 24", 30", 36", 42" sizes.

AT BETTER HARDWARE STORES EVERYWHERE

GENSCO TOOL DIVISION

GENERAL STEEL WAREHOUSE CO., INC.

1832 North Kostner Ave. • Chicago 39, Ill.

BRIKCRETE



**Local Manufacturers
Have Broad Opportunities**

Brikrete manufacturers operate compact, self-contained plants under franchise privileges in protected territories. Each is an independently owned unit in a country-wide chain, using local materials and local labor to supply the world's most modern masonry for local building needs.

Brikrete is rich in sales appeal because it is ahead in design, style, size, color, economy. Easily the preferred masonry. But because local production eliminates economic wastefulness, Brikrete can be sold at a lower-than-lumber price. Yet still allow a generous profit margin.

Brikrete offers much to men looking for a community enterprise on a nominal investment. We supply complete equipment; easy terms when desired. Liberal cooperation. Write today for Brikrete Book No. 2—while territory is still open.

BRIKRETE ASSOCIATES, INC.

4679 Division Avenue, S.
Grand Rapids 8, Mich. 82



The rear trunk lid is held up by a rod which works automatically. The lid appears somewhat flimsy when opened because it is supported on one side only. There is an amazing amount of luggage space, considering the size of the car. In contrast with American manufacturers, Hillman furnishes a starting crank and a fairly complete set of tools.

The driver who wants top speed and tremendous acceleration is not going to find the Minx a car to his liking. The owner who desires dependable economical transportation with the many advantages of the small car will find the Minx a real value and well worth owning.

The Hillman has a world-wide reputation and is extremely popular in all countries. It is manufactured by the Rootes Group, which also manufactures the Humber, Sunbeam-Talbot, Commer and Karrier commercial vehicles and heavy construction equipment (Vulcan). Our survey shows that this firm, which is the second-largest automobile-manufacturing group in England, now is firmly established in the United States, with dealers and service depots for parts and accessories located in almost every section. ★ ★ ★

**Flexible Radiator Hose
Fits Many Models**

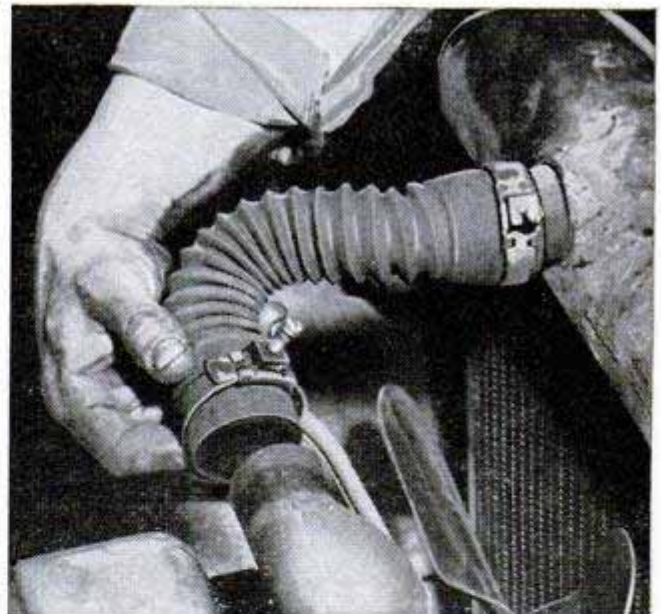

No cutting is necessary to install an accordion-pleated radiator hose that bends, compresses or stretches to fit almost any engine. Steel-coil reinforcing prevents crimping or collapsing and extends the useful life of the hose. Tapered at both ends, the flexible tubing saves installation time and permits repair shops to fit many models of cars, trucks and busses by carrying only a few sizes in stock.

POWER HYDRAULICS for Snow Plows

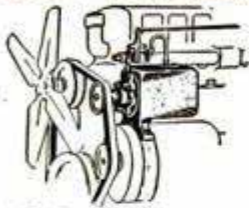

HY-LO-JACK
does the job
FASTER - EASIER

- Lifts average snow plow in 3 to 10 seconds.
- 1,000 lbs. per square in. pressure
- Quick, easy installation on new or existing equipment.
- Complete kit form, including the pump, tank, hose lines, etc.

★ Write for Circular. See your Road Machinery, Jeep or Farm Equipment dealer

Use on



TRUCKS



JEEPS



TRACTORS

MONARCH ROAD MACHINERY CO.

Quality Machinery since 1856

333 Front Ave., N. W., GRAND RAPIDS, MICH.

FINE TOOLS NEED FINE OIL!



• Lubricates



• Prevents Rust

• Cleans • Polishes

SOLD EVERYWHERE

3-IN-ONE Oil

READY CUT HOMES

\$2150 AND UP DIRECT FROM MILL

YOU SAVE the items which help make today's building cost expensive: high labor cost, contractor's profit and overhead, insurance, architect's fees. Cut-to-Fit eliminates usual lumber and material waste, also costly mistakes. Anyone can assemble. Simple, easy-to-follow plans furnished and each part numbered. Complete with all lumber, roofing, nails, glass, hardware, paint, doors, windows. Freight paid. Low-cost building plans sold separately if desired. 57 Homes and Floor Plans.

**5 EASY PAY PLANS
COLOR CATALOG**



INTERNATIONAL MILL & TIMBER CO.
Dept. P.M. 13 Bay City, Mich.

JANUARY 1953

Made
\$900
IN SPARE TIME

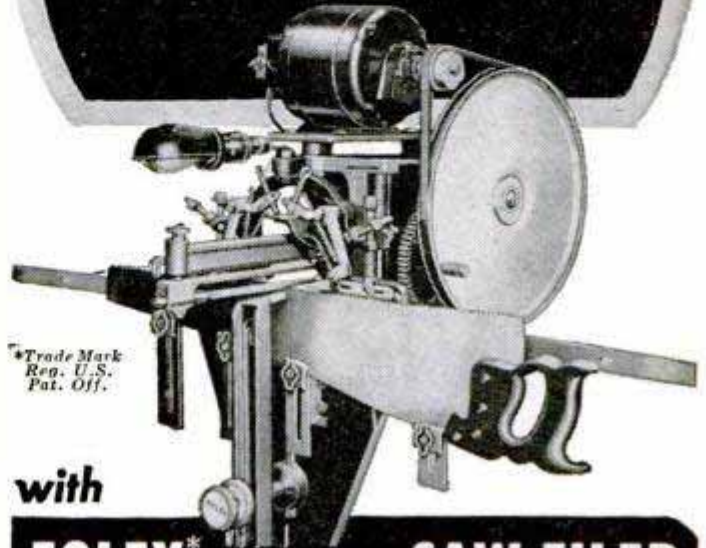

*Trade Mark
Reg. U.S.
Pat. Off.

with

FOLEY* automatic SAW FILER

"I did very well last year with my Foley equipment, sharpening about 950 saws in my spare time. About \$900 for me." **Leo H. Mix**

"I have done 4 or 5 thousand saws in my spare time in the 4½ years since I got the outfit, and they are all coming back." **Len Crego**

Make up to \$3 or \$4 an hour in Spare Time

With the high prices of food, clothing and everything else, just think what you could do with extra money every week! With a Foley Automatic Saw Filer you can file hand, band and circular saws better than the most expert hand filer. "The first saw I sharpened with my Foley Filer came out 100%" — writes Clarence E. Parsons. Cash business, no canvassing. No eyestrain, no experience needed.

FREE BOOK Shows How to Start

Tells just what to do to start your own spare time business in your basement or garage. Just think—with a small investment, no overhead, no stock of goods to carry, you can get right into a cash business. Send coupon today —no salesman will call.

Also see *Foley Lawn Mower Sharpener*, page 308 and *Foley Saw Retooler*, page 290.

Send for **FREE BOOK**

FOLEY MFG. CO.,
116-3 Foley Bldg., Minneapolis 18, Minn.
Send **FREE BOOK** — "Money Making Facts"

Name _____

Address _____



279

This is the wrench

that
saves
hours,
dollars,
materials

Now
Available!

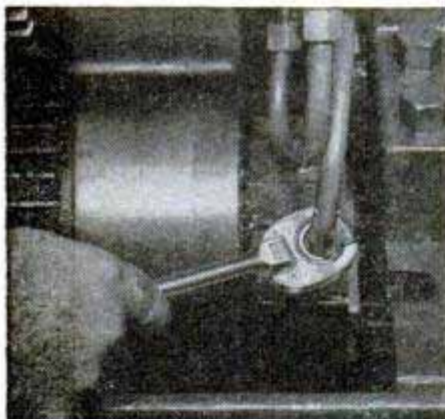
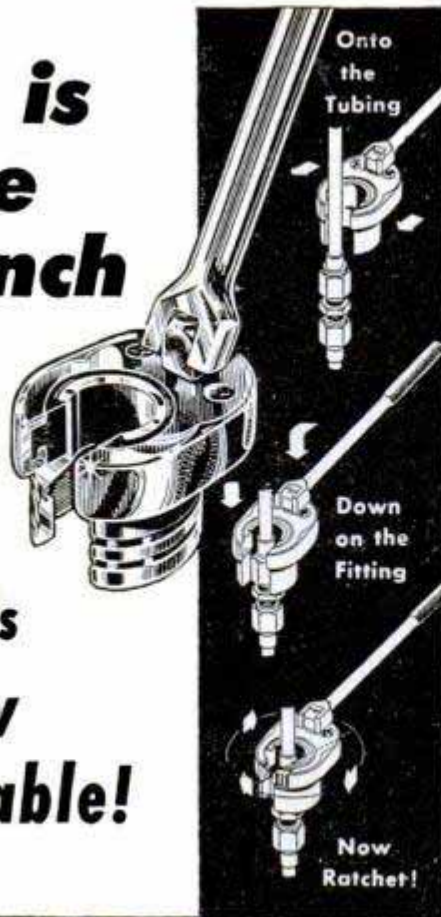

FOR PHENOMENAL
WRENCHING SPEED...

- AUTOMOTIVE
- HOME APPLIANCES
- REFRIGERATION
- PLUMBING
- NUTS WITH LONG STUDS
- FUEL LINES
- WATER AND GAS
- MARINE
- DIESEL
- AIRCRAFT
- INSTRUMENTS
- ... MANY OTHERS

TAC OPEN END RATCHET WRENCH

(socket type)

For the first time in tool history a wrench that passes *over* and around tubing, drops *straight down* onto fittings, then *ratchets* on or off as fast as your arm can swing. Limited clearance? The TAC functions from any conceivable direction, slips into "impossible" mazes, ratchets with as little as 7° arc of handle clearance. No other single tool can do all this!

All reports of resulting speed and ease seem incredible until you've tried the TAC yourself. Then you'll know why for years the Armed Forces have required our full production—until their primary needs were satisfied.

Now available to you, the Socket Type Open End Ratchet Wrenches are sold singly or in sets (consisting of several sockets, a ratchet head, square drive handle and enameled steel box.) 6 sets, 64 sizes of sockets from 3/8" to 4". Adaptors also available for allen heads, screwdriver, turnbuckle, and Spanner use.

Send for free catalog

TUBING APPLIANCE CO.

10321 ANZA AVENUE
Los Angeles 45, California



© 1951—TAC



Chemical Eggs Disinfect And Protect Poultry

Hens do not object to a novel disinfecting method involving chemical eggs. Developed by a retired Texas banker, the disinfectant eggs are formed of a mixture of DDT, calcium sulphate, naphthalene and hexachloride cast in an aluminum mold. The eggs are then placed in the nests and, according to the manufacturer, are as effective as sprays and powders. In addition, he says, hens do not object to the presence of the eggs as they do to being sprayed and dusted.

Some Scientists Believe H-Bomb Harnessed for Power

Can science harness the vast power of the H-bomb for industrial use? Some scientists believe the two big problems have been theoretically solved. A starting mechanism, producing extremely high temperatures, must be designed, and some form of control must be devised for the vast output of power that occurs when atoms of hydrogen are brought together to produce helium. The Italian government recently announced that Italian scientists already have succeeded in exploding hydrogen to make helium. Scientists of the Atomic Energy Commission are planning to test their theories in the laboratory. If they succeed they will have tapped a source of power far greater than the atomic reactors now being built, and will produce energy in almost the same manner as the sun.

Atlas

GREATEST VALUES IN METALWORKING TOOLS

*Look them over
- see for yourself!*

Lower cost . . . easier operation . . . better bearings for longer service — by every comparison Atlas metalworking tools give you more for your money! See for yourself — compare. Visit your Atlas dealer, or send for latest catalog. The low prices will surprise you!

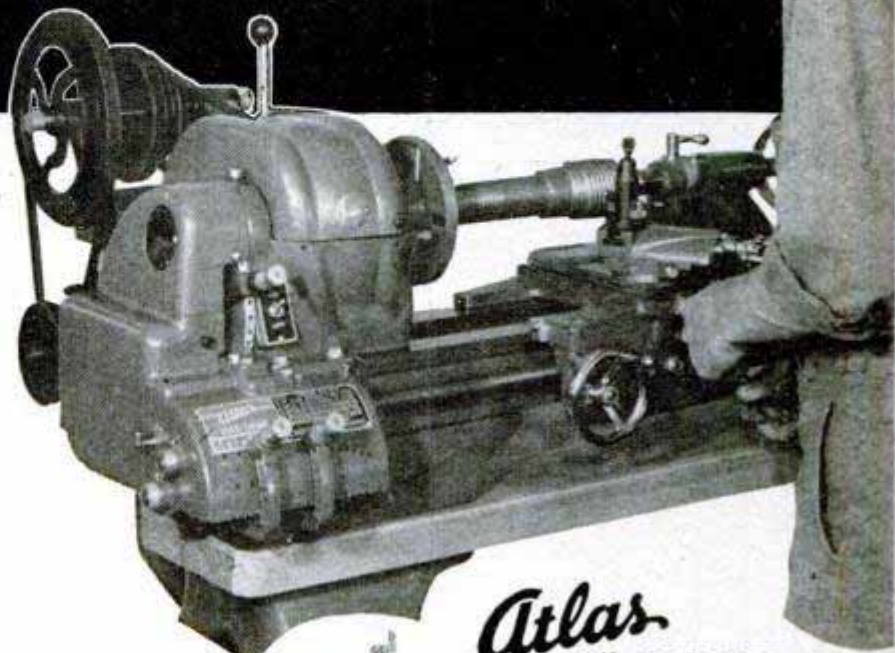

Atlas 7" SHAPERS

Handles all shaping within a 7" stroke. The only 7" shaper with Timken bearings, outside length of stroke adjustment, cast iron bull gear with 1" face.

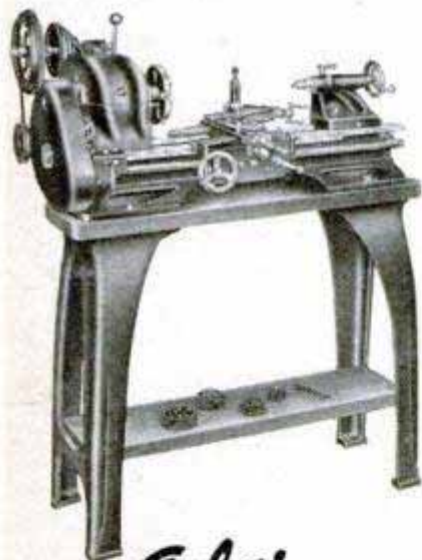

Atlas MILLING MACHINES

Performs the full range of milling operations . . . accurately, efficiently, and at low cost.

Atlas 6" - 10" LATHES

The only 10" lathes with Timken bearings! 16 speeds, instantly reversible power cross and longitudinal feeds, plus many other features. Precision 6" lathes also Timken bearing equipped!

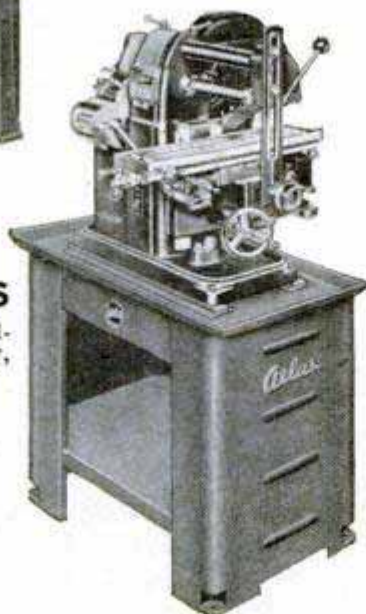
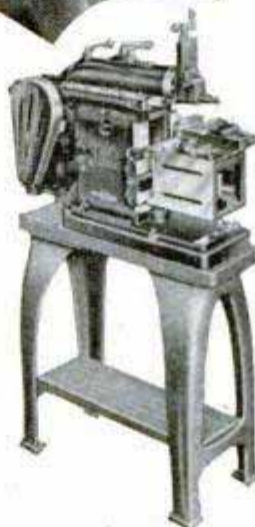

Atlas DRILL PRESSES

15" bench and floor drills — and 12 3/4" bench models — with "floating drive" and many exclusive features for greater accuracy, longer service life.



SEND FOR FREE CATALOG

I am interested in the following tools:

- | | | |
|------------------------------------|-----------------------------------|--|
| <input type="checkbox"/> 10" LATHE | <input type="checkbox"/> 6" LATHE | <input type="checkbox"/> DRILL PRESS |
| <input type="checkbox"/> MILLER | <input type="checkbox"/> SHAPER | <input type="checkbox"/> WOODWORKING TOOLS |

NAME _____

ADDRESS _____

CITY, STATE _____

ATLAS PRESS COMPANY

122 N. PITCHER ST. • KALAMAZOO, MICHIGAN

Atlas

DEPENDABLE QUALITY TOOLS SINCE 1911

**FOR FASTER, SCRATCH-FREE
SANDING USE DREMEL
STRAIGHT-LINE ACTION SANDERS**



Model
2000
\$24.50

Price includes sturdy steel storage case;
25 asstd. abrasives; 1 sheepskin pad.

WORLD'S FINEST FINISHING SANDER — Patented Straight-Line Action sands with the grain of the wood—eliminates cross grain scratches and orbital swirls. **MORE SANDING SURFACE PER DOLLAR** means more work done. Faster action (14,400 sanding strokes per min.); more than three times as fast as other type sanders! **POWERFUL**, high-speed, lifetime reciprocating motor (110 V. 60 cycle A.C.) **EASY, ONE-HAND OPERATION** less tiring on vertical and overhead operations. Sands into corners — other tight places. **TROUBLE-FREE USE** assured. Only two moving parts; never needs oiling. No armatures, brushes, gears or bearings to wear out and replace.

Professional Model 2000 is a favorite with carpenters, painters, contractors and family handymen! Ideal for finish sanding on flush doors, panelling, cabinets, etc. Superb for waxing cars, polishing furniture, etc.



A "must" for dry-wall joints.

Sands into tight corners.

Ideal for refinishing.

TRY THIS SIMPLE TEST: Sand a piece of wood by hand, using the four motions below. Note the slightest cross-grain action produces scratches and swirl marks. Sanding **with-the-grain** gives scratch-free satin finish. This test proves conclusively why professional craftsmen always sand with-the-grain—never cross grain.



FOR HOBBYISTS . . . HANDYMEN AND HOUSEWIVES

Lighter-capacity Model "A" is an all-purpose sander — polisher — massager. Takes the work out of polishing, sanding, etc. Effective body massager, too! Weight 2½ lbs., has 12 sq. in. (2⅜" x 5⅜") sanding pad surface. Price includes 6 abrasive sheets; 1 sheepskin; 1 felt pad. . . . **\$14.85**



FREE — 16 Page SANDING GUIDE

A "How-To-Do-It" booklet, full of helpful hints on sanding procedures, is packed free with each Dremel Sander. Extra copies available for \$.25.



SEE YOUR DEALER! If he can't supply, order direct on five day trial, money-back guarantee. Remit in full for postpd. shipment; or, send \$2. now, pay postman balance plus postage and C.O.D.
DREMEL MFG. CO., Dept. 113-A, RACINE, WIS.



Jet Power Pod Is Third Engine for Air Freighters

Extra power for take-off and emergencies is supplied Flying Tiger Line air freighters by a small jet engine pod that hangs from the aircraft's belly. Only 82 inches long and 25 inches in maximum diameter, it adds about a 10 percent "kick" to the total take-off power of either single engine on the C-46. An eyelid covering the intake scoop closes when the engine is not in use, eliminating drag. By pulling a switch, the pilot can immediately cut in the jet power in the event of an engine failure in flight. It uses gasoline from the main aircraft system.

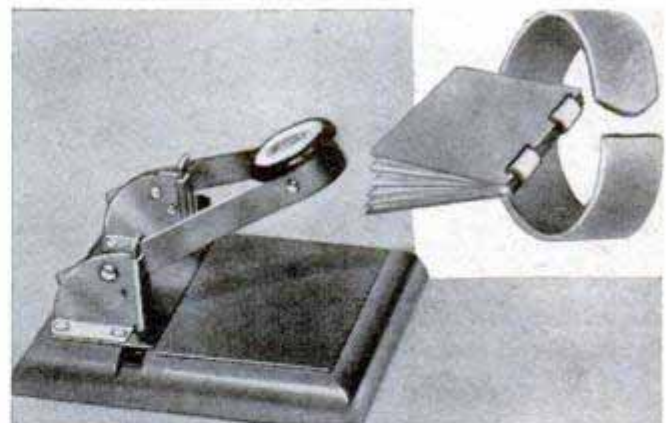

Binding Kit Makes Album

Photographs, recipes or other material can be bound into permanent or loose-leaf volumes quickly by a kit that includes a simple hand punch and binding tubes to complete 75 books. The photos are arranged in order and holes punched. The plastic binding tubes are then inserted in the holes and the album is complete.

STOP Faucet Leaks for years!

SNAP-IN

SWIVEL WASHER

FEATURED IN READER'S DIGEST . . .

This amazing faucet washer lasts 10 to 20 times longer than ordinary washers. Patented swivel action allows washer to seat tightly without grinding—practically eliminates wear. Genuine Neoprene face disc. Snaps into faucet stem—no special tools needed. Ask your hardware dealer for Snap-in Swivel Washers. 3 for 69c. Accept no substitute. If dealer cannot supply, send 69c and bibb washer-size to Snap Products Co., Division of Harrison Industries, 847 W. Harrison St., Chicago, Ill.

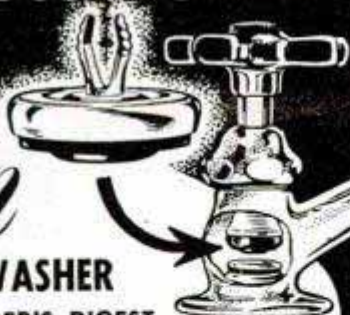

WELD-BRAZE CUT-SOLDER

4 Ways to Handle 1001 Repairs Around Home-Garage-Garden

Complete welder with Twin Carbon Arc Torch and all operating accessories to do all types of metalcraft work. Easy instructions for work on iron, steel, bronze, brass and aluminum. Plugs into any properly wired AC or DC line. Low cost pays for itself in money saved and earned. A wonderful practical gift of a lifetime. Order now!

only **\$14.75**

f.o.b. factory

Larger Models Available on request.

4 way welder

Yours on a money back
10 DAY TRIAL

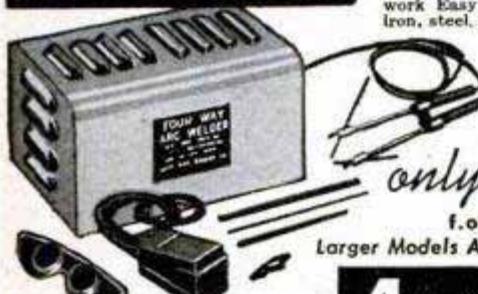

FOUR WAY WELDER CO.
2326 S. Michigan Ave.
Chicago 16, Ill., Dept. F2-AD

BUILD YOUR OWN Heathkit TEST EQUIPMENT

Heathkits are completely engineered instruments supplied unassembled. Every kit goes together smoothly and easily. All drilling, punching, and painting has already been done for you. All parts are furnished and are of highest quality.

Detailed construction manual shows clearly where each wire and part goes and tells exactly how to build the kit.

WRITE FOR
FREE CATALOG

HEATH COMPANY
BENTON HARBOR 17,
MICHIGAN

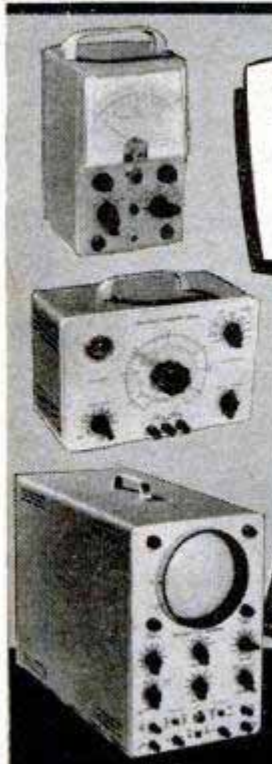

MOST PRACTICAL TOOLS YOU CAN OWN!

DREMEL Electric MOTO-TOOL

1001 USES AROUND THE HOME AND SHOP

Here is the fastest (27,000 r.p.m.) most powerful tool in its class—THE ORIGINAL POCKET-SIZE MACHINE SHOP. A jack of all trades around the workshop, it is indispensable for carving, drilling, grinding, and for sharpening tools, scissors, kitchen knives, garden tools, lawn mower blades, etc. More versatile than a 1/4" electric drill as it is so light weight (13 oz.) and handy for so many small jobs. Perfect for drilling small holes to hang pictures, installing cabinet hardware, hardwood trim. Powerful, 110 V. A.C.-D.C. motor. A tool built for years of lasting service.

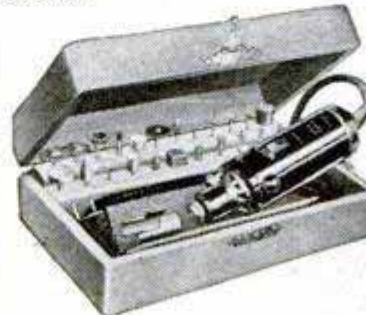

MOTO-TOOL NO. 2 Offers more convenience and long life features for the money than any other hand grinder. Thousands of satisfied users. Moto-Tool No. 2 (with 1 emery wheel point)
KIT NO. 2 Includes Model 2 Moto-Tool and 23 Accessories (High-Speed Steel Cutters, Grinding Wheels, Polishers). Packed in sturdy hardwood case

\$16.50
\$23.50

A PRECISION TOOL WIDELY USED IN INDUSTRY



For Sharpening Tools



Speeds Up Repair Jobs



Great for Hobbyists



AMAZING FOOT-A-MINUTE (7,200 Strokes Per Min.) CUTTING SPEED!



Only **\$5.85**
with 3 saw blades

FREE PLANS!



Make your own jig saw. Complete plans and six project patterns included FREE.

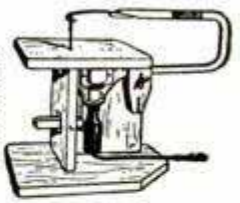

FAMOUS DREMEL ELECTRIC MOTO-SAW

Here is a genuine craftsman's tool with dozens of household and workshop uses. It is perfect for all sorts of coping and jig saw work making window valances, knicknacks, hobby projects, etc. High-speed, reciprocating-type motor easily cuts asphalt and rubber tile, also masonite and formica—wood up to 3/4". Perfectly safe for children—so easy to handle that women love to use it. Has only two moving parts, never needs oiling. A high quality tool used by craftsmen, tile layers, and carpenters.



Cuts scrolls like magic!

SEE YOUR DEALER! If he can't supply, order direct on five-day trial, money-back guarantee. Remit in full for postpd. shipment; or, send \$2 now, pay postman balance plus postage and C.O.D.

DREMEL MFG. CO. DEPT. 113-A RACINE, WIS.

Quieter, Smoother Operation...

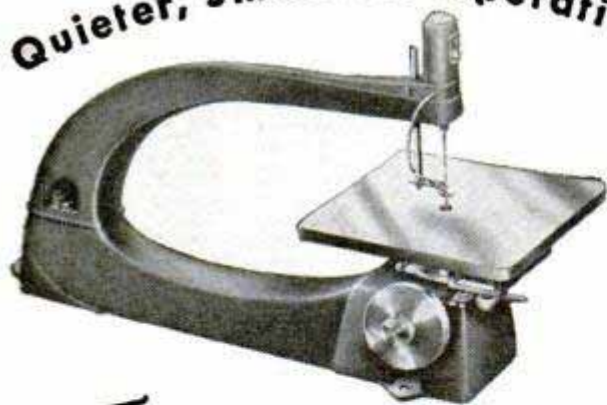

TOMLEE JIG SAW

- COMBINATION saber, jig saw and filing machine of truly advanced design. So safe and simple that a child can operate it. All manner of scrolls, angles, internal cutouts, etc. are easily handled in wood or light metal. Heavy cast frame, 15" and 18" sizes.

"How To Do It"



SHOP BOOK 25c
28-page Tomlee book shows what to make and how to make it with power tools. Send 25c in stamps or coin.

TOMLEE TOOL & ENGINEERING CO.
723 North Washington • Minneapolis 1, Minn.

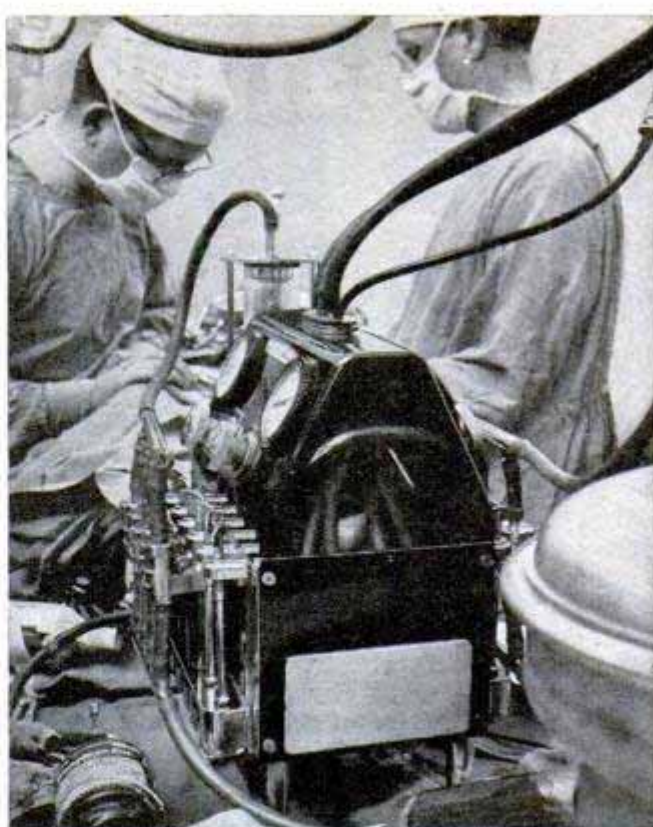

Mechanical Heart-Lung

Hitherto impossible heart surgery may be done successfully through use of a heart-lung mechanism developed in Detroit. It permits the entire heart or parts of it to be emptied of blood, enabling the surgeon to operate with full vision in a so-called "dry" field, rather than having to rely on the sense of touch. The unit took over complete maintenance of a 41-year-old man's blood supply for 50 minutes while his heart was opened and worked upon. Made of stainless steel, glass and rubber, the artificial heart is about 10 by 12 by 17. Air pressure, vacuum and electricity are supplied to its two independent pumps by a power source outside the operating room. It is portable and can be used anywhere that regular 110-volt a.c. is available. Co-operative research on the machine was sponsored by the Michigan Heart Association. General Motors Research Laboratories handled engineering and construction details as a public service.

Construction Takes Most Steel

Biggest user of finished steel in the 12 years prior to 1952 was the construction industry, which consumed 102,000,000 tons of the 737,000,000-ton total. The automotive industry was next, with 97,300,000 tons, 13.8 percent of the total. To warehouses supplying hundreds of thousands of small customers in different industries, however, went 115,000,000 tons, more than that used by any single industry.

Swedish Steel Chisels



SHARK BRAND

ESKILSTUNA, SWEDEN

Genuine Swedish Charcoal Steel hardened and tempered for two-thirds of the length of the blade — that's the big difference between SHARK BRAND Paring Chisels and the ordinary kind. You'll do better, faster, more accurate work easier with these finest of all chisels. They really stay sharp and are honed with an extra wide bevel for the professional carpenter or home workshop enthusiast.

Try one next time you're in a hardware store. Make sure it's SHARK BRAND. Sold singly or in sets with tough Curly Birch or unbreakable plastic handles.

Write for SANDVIK Folder
Dept. P-1

Sandvik Saw & Tool

Division of Sandvik Steel, Inc.

47 WARREN ST., NEW YORK 7, N. Y.

• SHOP by MAIL & PAY LESS at GROBAN'S •



LOGAN AIR CYLINDER
Item #350 — Double acting pneumatic cylinder, 6" bore, 6" stroke, 1 1/2" shaft. Adjustable cushions at both ends. Flange mounting at shaft end. Overall length closed 18". Ideal for use in 125 PSI systems. Shipping weight 40 lbs. F.O.B. Chicago. **39.50**



LOGAN 4-Way, Foot Operated AIR VALVE Item #59, Model 6520—Ideal for operating air vices, presses, air machinery, and other double acting pneumatic devices. Heavy cast construction. Standard 3/2" pipe thread ports. Overall dimensions 8 1/2" x 5 3/4" x 7 1/2". Gov't acquisition cost \$42.00. Shipping weight 28 lbs. An outstanding buy. F.O.B. Chicago. **15.00**

HEAVY DUTY HYDRAULIC and AIR EQUIPMENT

Large supply of new labor-saving, economical hydraulic equipment in many types and sizes. Use these positive, highly efficient smooth pressure hydraulics on presses, arbors, lifts, loaders, power control, positioning, brakes, plastic dies, auto frame alignment, etc.

ALL ITEMS UNCONDITIONALLY GUARANTEED

ITEM #42—Double action hydraulic cylinder, 4" bore, 18" stroke. Rated lift capacity with 1000 PSI line pressure is 2,300 lbs. Ship. wt. 30 lbs. F.O.B. Chicago. An Excellent Buy for **32.50**

ITEM #16C—Double acting hydraulic cylinder, 1 1/2" bore, 26" stroke. Will lift 1760 lbs. with 1000 PSI line pressure. Weight 8 lbs. A \$55.00 value. Now only **16.95**

Item #1036—Double acting hydraulic cylinder, 3" bore, 36" stroke, 1/2" pipe thread ports. 1 1/2" solid steel shaft. Overall length closed 49". Clevis mounting at base and shaft. **FEATURES** • Cup & Chevron Packing • All Welded Construction • Precision Ground and Honed Construction • 1/4" Seamless Steel Tubing Cylinder Case. Weight (net) 57 1/2 lbs. F.O.B. Chicago. **50.00**

PUMP PRESSURE (PSI)	LIFT CAPACITY (LBS.)
500	3535
1000	7069
1500	10604
2000	14138



Item #29KJ — Gear Type Hydraulic Pump. Ideal in industrial applications and for

operating all hydraulically powered farm implements including loaders, stackers, swathers, plows, etc. Delivers 1000 PSI (may be set at lower PSI if desired). 12 GPM at 400 RPM. Maximum operating speed 800 RPM—rotation counter clockwise. Has built-in relief valve, permanent or torque bar mounting, 1" diameter shaft, 3/4" pipe tap inlet, 1/2" pipe tap outlet. Shipping weight, 22 lbs. F.O.B. Chicago. **45.50**

Item #126 — Four-way, open center control valve with built in adjustable relief valve. Factory set at 1000 P.S.I., spring loaded neutral position, for use with one double acting cylinder. In neutral position cylinder is locked and pump unloaded. Fully balanced plunger type, smooth, positive, easy operation. Can be used as single unit or mounted in series of any combinations desired. Has 3/4" pipe thread inlet and outlet, 1/2" pipe thread cylinder ports. Newly manufactured to our specifications. Shipping weight 8 1/4 lbs. An outstanding buy! F.O.B. Chicago. **21.50**



WAR SURPLUS GENERATING PLANTS

Be Prepared

Immediate Delivery

Available for Immediate Delivery — Large Stock — Many Sizes from 350 Watts to 25 KVA



ITEM #183

Item #183 — 3000 to 4000 WATT GENERATOR SET — **FEATURES** — Power for your home or business. Simply connect to power panel or house circuit. • Constant voltage regardless of load. • Push button start or stop. • Easily made full automatic start or stop. **SPECIFICATIONS** — Sizes 19"x30"x48". Steel skids, weatherproof housing, requires no building. Wt. 725 lbs. • Hercules 4-cyl. 10 HP gasoline engine. Load governor, Oil filter, Quiet engine. • Hobart 115 volt, 60 cycle, muffer, 6-volt starter, generator. 3000 to 4000-watt generator. 2 or 3 phase power, 2 or 3 wire. • Panel contains oil gauge, voltmeter, ammeter, circuit breaker, voltage regulator, start button. Today's cost over \$1200.00. **SALE PRICE, 465.00**

Item #201—PE 95-G—10 KW—110/220 Volt 60 Cycle A.C.—Single Phase. Totally enclosed. Onan generator direct coupled to Willys Jeep, 4 cylinder, water cooled engine, push button start. Instrument control with engine and generator instruments, circuit breaker, controls, etc. Uses 6 volt car battery. (Battery not incl.) Skid mounted. Ship. wt. 1500 lbs. F.O.B. Chicago. **1295.00**

Item #301 — Model 125 to charge 6 and 12 volt batteries — 12 volts — 300 Watts; Heavy Duty Generator; Push button self-starter; 2 qt. gasoline tank in base; Ammeter; Generator cut-out; Concealed coil, etc.; Speed and charging rate control; Attractive orange finish; Weight 93 lbs.; Length 15 1/2", width 11 3/4", Height, 14 3/4". F.O.B. Chicago. **89.00**

TINY TIM BATTERY CHARGER

ITEM #301



NEW GROBAN MANUFACTURE

MODEL 251

Item #2510, 2500 watts, 115 volts, 60 cycles, single phase, A.C. electric generating plant, powered by dependable 6.5 H.P. Wisconsin engine — Two pole ball bearing belt driven high efficiency generator with heavy duty windings for high torque motor starting loads. Rated 3000 watts for intermittent service. Light weight portable rugged unit, easily transported to job site. Consumes 3 quarts of gas per hour at rated load. Dimensions: 24"x20"x24", ship. wt. 220 lbs. Complete with fused outlet box and voltmeter. F.O.B. Chicago. **349.00**

Item #2510



General Motors — Allison CENTRIFUGAL PUMP

200 GALLONS PER MINUTE

For Draining Basements
 Fire Fighting • Irrigation
 Fuel Transfer
 Swimming Pools
 Home Water Systems
 Dewatering
 Converted for high volume commercial, home, and industrial use. Standard 2 1/2" pipe thread inlet, twin 1 1/4" pipe thread outlets. Ball bearing supported 3/4" shaft. Easy priming. Rotation, counter-clockwise facing shaft. Gov't. acq. cost \$145.00. Complete with full instructions. Ship. wt. 35 lbs. F.O.B. Chicago. **39.50**

Suction Lift	Head Pressure	Gal. Per Min.	H.P.	R.P.M.
10'	75'	260	6.0	3500
10'	65'	200	5.2	3500
10'	40'	140	3.5	3500
10'	30'	100	3.0	2500

FREE 1953 CATALOG 48 pages, chock-full of unsurpassed War Surplus Equipment Bargains for farm, home, factory and workshop. Every item is unconditionally guaranteed. You save on everything! Write today.

HYDRAULIC SPEED REDUCER

(ITEM #115) WITH FINGERTIP CONTROL

USE FOR: • Reamer Drives • Midget Cars • Feed Mills • Canning Machines • Conveyors • Lathes • Milling Machines • Motor Boats • Cream Separators • Garden Tractors • Pumps

Variable output speeds from 0 to input speed available by moving control handle. Locking handle maintains setting. Use input power of 1/4 to 1 1/2 H.P. This Westinghouse-Oil Gear Unit consists of a variable displacement hydraulic pump feeding a fixed displacement hydraulic motor. Adjustable relief valves set at factory for 100 inch pounds of torque may be reset up to 180 inch pounds. Independent reverse control allows full output power and speed selection in either direction of rotation. Shafts measure 5/8" diam., include keyway. Input rotation is counter-clockwise facing shaft. Recommended input speed not to exceed 750 R.P.M. Over-all dimensions, 7 1/2"x7 1/2"x11 1/2". Gov't acquisition cost, \$428.00. Ship. wt. 31 lbs. Complete with 2 qts. of oil and full instructions. F.O.B. Chicago. **54.50**



NEW MODEL 353—DUAL RANGE

ARC WELDER

For Stationary or Portable Use
HEAVY DUTY RANGE TO 250 AMPS.
 New 'MAGIC TERMINAL' for Low Current 30 to 100 Amps.
 Ideal for
 • FARM
 • FACTORY
 • GARAGE
 • WORKSHOP
 Welds Anything From Auto Fenders To Tractor Frames

These precision engineered D.C. Arc Welders contain the highest quality War Surplus aircraft components built to exacting government specifications. They are light in weight, have oversized lifetime grease-sealed ball bearings, air cooled commutator, dial type rheostat for easy pin-point control, a high-low rheostat switch, reactor coil for even arc and the new 'MAGIC TERMINAL' low current welding range for welding lighter materials. Designed for many years of trouble-free service. Run welder from drive pulley or power take off of a tractor or Jeep, 7 1/2 HP electric motor or 10 HP gas engine at 2500 R.P.M. Uses two V belts or flat belt. Continuous output rating 200 amps. Intermittent welding rating 250 amps, 30 volts. This sensational price includes double V or flat belt pulley and complete operating instructions. Shipping weight 107 lbs. \$350.00 value. **119.50** F.O.B. Chicago. Item #65. Now only.



ORDER DIRECT FROM AD — SEND PAYMENT OR PURCHASE ORDER TODAY — SATISFACTION GUARANTEED

GROBAN SUPPLY CO. 1139 SO. WABASH AVE., CHICAGO 5, ILL. DEPT. PM-1

best
white tape
made

ONLY
98¢*



The new "Evans White-Tape" has everything you'll find in tapes costing over \$1.50—plus.

- snow-white blade with bold, legible, jet-black numerals and graduations. Graduated in 32nds for first 6 inches.
- sturdy die-cast case heavily chrome-plated, calibrated for quick reading inside and outside measurements.
- blade 1/2" wide made of finest high carbon steel—tempered—Bonderized—enamelled—baked.
- blade replaceable in seconds—without tools—without even opening case. And Evans replacement blades cost far less.
- every "Evans White-Tape" is unconditionally guaranteed.
- exclusive Evans automatic brake gives smoother push-pull action with absolutely no "creeping" of tape into case.
- underside is white, too. Mark with ordinary pencil, remove mark with flick of thumb.
- unheard-of low price*: 10-ft. \$1.49; 8-ft. \$1.19; 6-ft. 98¢. Prices higher in far west and Canada.

Evans & CO. • Elizabeth, N.J. • Montreal, Que. © 7623
Makers of Evans 6-ft. Folding Rule and "Folding Yardstick"

a
push
... and
you're
through



"YANKEE" No. 41
Automatic Drill

Drilling is an easy, one-hand job with the "Yankee" No. 41 Automatic Drill. Just push the handle and the drill point spins in. Return action spring clears chips. Magazine handle contains eight drill points, 1/16" x 11/64". See it at your Stanley dealer's today. North Bros. Mfg. Co., Dept. 4, 215 West Lehigh Ave., Philadelphia 33, Pa.

NORTH BROS. MFG. CO.
Philadelphia 33, Pa.

"YANKEE" TOOLS
NOW PART OF
STANLEY
THE TOOL BOX
OF THE WORLD



GIANT BALLOONS

They're really BIG. Genuine gov't. surplus weather & target balloons. Lots of fun for all the family, in backyard, for parties, picnics, dances, fairs, etc. Sure to attract a crowd for business events, conventions, exhibitions, trade shows. Used by lodges, civic groups, schools from coast to coast. These are terrific attention getters! Send for your **GIANT BALLOONS** today.
3 Ft. Dia. **49¢** — 6 Ft. Dia. **79¢**
13 Ft. Dia. **\$1.59**

• Add 10% for handling & delivery.

Eliminate Repair Costs
PROTECTO-ROD

motor keeps cool, saves radiator wear, gives engine longer life... a series of zinc & copper plates on a stainless flexible steel spring core that helps loosen scale deposits in old cars for easy flushing; keeps new motors completely scale and rust free. Just insert thru neck of radiator... not impaired by anti-freeze. Guaranteed. If not satisfied return for refund.

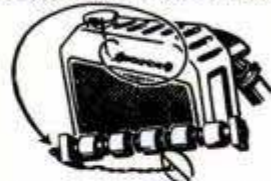

CARS — \$1.95 . . . for TRUCKS — \$3.25 Prepaid.

• Calif. Res. please add Sales Tax on all items.

WAR ASSETS DIV. VOLUME SALES CO.

Dept. M-1-53, 3930 Sunset Blvd., Los Angeles 29, Calif.



BRONZE FOUNDRY

Schools and Home Workshops

Make your own castings of aluminum, copper, bronze, silver. Foundry sets are available in three sizes including 2400 Deg. F. blast Furnaces. \$22.50; \$29.50; and \$42.00. f.o.b. Kansas City. Free Circular.

KANSAS CITY SPECIALTIES CO. P. O. Box 6022, Dept. P-1
KANSAS CITY, MO.

WONDER-PASTE
Paint Remover

The modern, easy way to strip paint, varnish, enamel, lacquer, etc. AT PAINT AND HARDWARE STORES

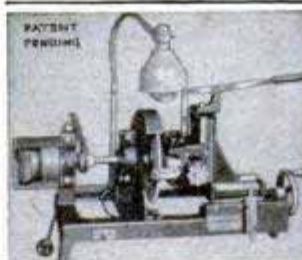

Start a NEW BUSINESS!

or Add to your present Repair Business
SHARPEN DULL PIPE WRENCHES

PIPE TAPS & DIES
"GUM" CIRCULAR SAWS
Write for Information

J. C. MOORE INDUSTRIES
BOX M 276 FREDONIA, PA.



UP TO 6 MILES MORE PER GALLON

Reported by Hundreds Using
MIRACLE ACTION TUR-B-LIZER

Carburetor specialists say Tur-B-Lizer is best patented improvement they have seen. Tested in over million miles of driving. Write for full facts or send \$3 for 6 cyl. type, \$4.50 for 8 cyl. Easily installed. Try Tur-B-Lizer in your car. If you do not notice immediate improved performance and gas savings claimed by users, your money will be refunded.

Mechanics—Salesmen: Make good money full or part time. Write for best territories now.

UNIVERSAL TUR-B-LIZER CO.
623 E. State St. Milwaukee, Wisc.



ELECTRIC LEAD POINTER

Designed for... **DRAFTSMEN, ARCHITECTS, RETOUCHERS, AND ARTISTS**

- NO MORE MESSY LEAD DUST
- HANDSOME, RUGGED BAKELITE CASE
- CONICAL OR WEDGE POINT OF ANY TAPER OR SHARPNESS IN SECONDS
- WILL NOT BREAK SOFT LEADS
- OPERATES WITH MOST STANDARD LEAD HOLDERS AND TAPERED WOODEN PENCILS
- PRECISION FEED

AVAILABLE AT YOUR DEALER OR DIRECT FROM FACTORY
WRITE FOR DESCRIPTIVE FOLDERS
SEND CHECK, MONEY ORDER, OR C.O.D.
GUARANTEED SATISFACTION OR MONEY BACK

VAN BILT MFG. CO.
BOX-1701 - LINCOLN, NEBRASKA

BULL DOG HITCHES



Heavy Drop Forge Steel Construction. Strong — Safety-Engineered Reliable

Model No. 1-B
NOW ONLY
\$4.95
Post Paid (when
paid in advance)

Made for trailers with up to 2,500 pounds capacity
1 3/4" dia. shank Fits 1 1/4" pipe tongue

HAMMER BLOW TOOL COMPANY
Wausau Wisconsin



AXLE ASSEMBLIES

Ideal axles for farm implements, carts and trailers of all kinds

\$58.01 Less Tires
F.O.B. Factory

Solid steel construction with springs and saddles—U-bolts and shackles—spring bolts and brackets—hubs and bearings and 15" or 16" Wheels—shipped complete, ready for use

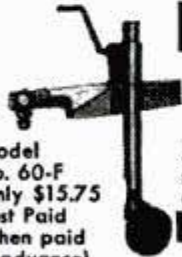

BULL DOG JACKS

Makes parking or hitching trailers and heavy farm implements an easy, one-man job

Model No. 60-F
Only \$15.75
Post Paid (when paid in advance)

All steel construction—heavy duty ball bearing swivel action... raise and lower with crank... complete with bracket, ready to install

HAMMER BLOW TOOL COMPANY
Wausau 13-A, Wisconsin

MONEY for MEN ALL FREE

THE PLASTEX Industry needs manufacturers on small scale and for big production of Lamin and Clock Stands, Art Goods and Novelties in Plastex and Marble imitation. Experience unnecessary. 1/2¢ material makes regular 10¢ store sellers. Rubber moulds furnished for speed production. Small investment brings good returns. We are now placing big Chain Store Orders with manufacturers. Ambitious men have chance for real prosperity. Our Free booklet will interest and benefit you.

PLASTEX INDUSTRIES, Dept. A
3400 Third Ave. New York 56, N. Y.

Tune in the **AUTO-LITE Show** { **"Suspense!"**
CBS Radio Mondays
CBS Television Tuesdays

BUTANE-PROPANE GAS ON YOUR CAR



Save up to 1/2 and get powerful Hi-Octane operation! Simple combination system (easily installed) can switch to gasoline instantly while running! Equipment for all cars—trucks.

SEND \$2.00 for our complete "How to do it" booklet, instructions, photographs and special prices. (refunded on parts order) **ORDER NOW — TODAY.**
LPG PRODUCTS CO., Dept. PM-1, KEARNEY, NEBR.

SPECIAL LIMITED TIME OFFER!

FREE
of extra cost

BUFFING COMPOUND
with **Dico Buffs**



Take this ad to your Hardware Dealer... buy one or more Dico Buffs (4" or larger)... and he will give you a tube of Dico TC6 Buffing Compound—*absolutely free.* "How-to-buff" Manual free with each packaged Buff, too. Take advantage of this offer today, because...

IT'S FUN TO BUFF AT HOME WITH DICO BUFFS and COMPOSITIONS

This authorizes you to supply Dico Compound from your stock, as offered above. Send this ad, with your name and address, and we will mail replacement stock, postpaid.

To Dico Dealers

DIVINE BROTHERS CO., Dept. B-153, Utica, N. Y.

JANUARY 1953

TIME SAVING TIPS

ALL YOU NEED IS A TUBE OF
DU PONT DUCO CEMENT

REG. U.S. PAT. OFF.

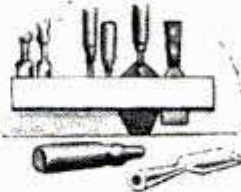

WHEN HANDLES COME OFF, put 'em back on to stay with "Duco" Cement. It's a must in the tool room.



LOOSE REAR-VIEW MIRROR? It'll hold fast if you put it in its place with strong Du Pont "Duco" Cement.



REPAIRS CHAIRS. Strong "Duco" Cement puts loose rungs in so they'll stay. Makes chairs sturdier.



LOSING YOUR GRIP? Anchor loose golf-club grips with "Duco" Cement. Good for tennis-racket grips, too.

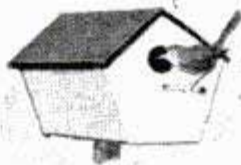

FOR THE BIRDS. Build an attractive birdhouse. You can make it strong and neat with "Duco" Cement.



COAT STRIPPED THREADS with "Duco" Cement for new gripping power. Perfect for emergency repairs.

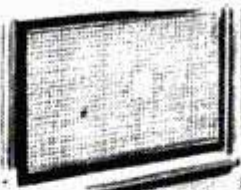

KEEP BUGS OUT by mending small tears in screens with strong, transparent, waterproof "Duco" Cement.



WATERPROOF MATCHES for camping trips. Dip them in easy-to-use "Duco" Cement, and wipe smooth.



A HOUSEHOLD
FAVORITE FOR 25 YEARS



BETTER THINGS FOR BETTER LIVING
... THROUGH CHEMISTRY

REG. U.S. PAT. OFF.

BUILD IT FIX IT with AMBROID



Ready-to-use
Fast drying
High tensile strength
Transparent
Waterproof

IT STAYS STUCK

Dries entirely by evaporation of the solvent. Quick setting—no distortion. Ideal for assembling, repairing, home crafts, electrical work, factory, workshop or household use. Send postcard for free literature.

Try Ambroid in your business, too. For over 40 years recognized as the leading industrial adhesive of its type.

Art galleries, museums, and leading industrial concerns, rely on AMBROID

TRY A TUBE TODAY—At most hardware stores and hobby shops. If your dealer cannot supply you, send 25c for big 2 oz. tube, postpaid. Money back guarantee.

AMBROID 303 FRANKLIN ST. BOSTON 10, MASS.

You CAN START A \$40 A DAY BUSINESS IN YOUR SPARE TIME

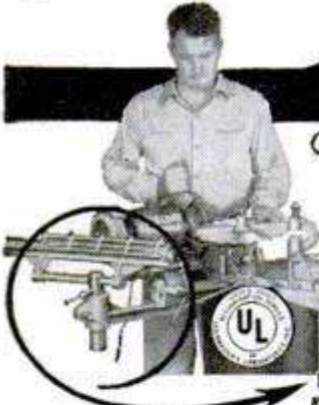

Andy Phillips says...
"MY BELSAW CIRCULAR SAW SHOP gives me BIG PROFITS at LOW expense . . . I can run 35 to 40 circular saws in an 8-hour day . . . That makes me \$40 cash."

NEW ATTACHMENT OFFERS "BIG EXTRA PROFITS!"

New precision attachment for sharpening planer and jointer knives, plane irons, wood chisels and drill bits brings you up to \$4 an hour from the first day.

You can start this REPEAT CASH business in your own home or garage while you are working at your regular job. Easy to operate, no experience needed. "Pays for itself from just 65 jobs." — Harvey Jensen

For as little as \$15 down payment, you can get your BELSAW CIRCULAR SAW SHOP rushed to you.

FREE book tells how

YOU can start making money the very day your BELSAW CIRCULAR SAW SHOP arrives. Earn \$4 to \$5 an hour in your SPARE TIME sharpening & setting circular saws for builders, lumber yards, factories... Plus BIG EXTRA CASH, precision grinding planer and jointer knives, plane irons, wood chisels and drill bits. Hundreds of jobs in your own neighborhood. No extra equipment needed, no canvassing. Send today for your Free copy of "Life-Time Security."



BELSAW MACHINERY CO
60-C Field Building Kansas City 11, Mo.

ELECTRIC MOTOR BARGAINS!

1/2 HP	1750 or 3450 RPM	19.75	1 HP	1750 RPM	52.00
1 1/2 HP	3450 RPM	47.50	2 HP	3450 RPM	65.00

All prices F.O.B. Every Motor Fully Guaranteed

Heavy Duty, Repulsion Induction and Capacitor Types, 110-220 Volts (except 2 HP which is straight 220), 60-cycle. Single phase, Standard Makes (G.E., Wagner, Leland, Westinghouse, etc.). Rush your order TODAY—large stock of motors—1 & 3 phase. 32-v direct current bargains. Prices f.o.b.

Paramount AIR COMPRESSOR

COMPARE Price—Features—Savings!

Reg. \$24.95, Ball bearing, piston-type compressor of revolutionary new design. Can't be matched as an all-purpose, low cost unit. New principle operates it on conventional 1/4 HP—BUT delivers MORE air than ordinary 3/8 HP unit. For professional paint spraying, tire inflating, insecticide and hundreds of other uses in shop, farm, home! Delivers 2 1/4 cu. ft. air per minute. Includes Tank—Air Gauge and Air Regulator for adjusting pressure from 0 to 100 lbs. Order now and SAVE! Satisfaction guaranteed or money back. We pay postage.

\$12.95 Post paid

ROBERTS ELECTRIC CO., 849 W. Grand, Dept. 48, Chicago, Ill.

WORLD'S LOWEST PRICED ADDING MACHINE

Vest Pocket Size FREE TRIAL

IDEAL FOR BUSINESS AND PERSONAL USE—GUARANTEED ACCURATE. Not a toy. Operates with only a finger flick. Adds, subtracts, multiplies, divides. Counts up to one billion. Pays for itself over and over. Ideal Gift—for Business, Income Tax and School use.

\$2.95 TOTAL COST SEND NO MONEY

MONEY BACK GUARANTEE. Send name and address. Pay postman only \$2.95 plus postage (Send full cash if outside U.S.) Beautiful rich-looking Leatherette Case included at no extra cost. Money back in 10 days if not delighted. AGENTS WANTED.

CALCULATOR MACHINE CO., (Mfrs.)
Dept. PM-1 Glenview, Illinois

ESHELMAN

MAKES WINTER JOBS EASIER

MAKES MONEY SELLING Eshelman Tractors Plowing Snow From Roads and Driveways

RAKES PLOWS CULTIVATES HARROWS HAULS SPRAYS SAWS DOZER MOWS CUTS ROLLS TILLS SNOW FLOW

1 1/2-3 1/2 H.P.

\$95 PLUS TOOLS

Also Snow Blowers Riding Tractors & Power Reverse Women can operate it. Free Catalog. Write nearest branch.

ESHELMAN CO.,
Dept. 51
119 Light St., Balto. 2, Md.
333 N. Michigan Ave. Chicago 1, Ill.
105 Lake St., Reno, Nev.

SpeedWay Speed Sander

SANDS, SMOOTHS, CLEANS, BUFFS, POLISHES

This motor-driven, all-ball-bearing, orbital motion finishing sander works any wet or dry abrasive—3 covers from standard sandpaper sheet makes it easy to finish or refinish furniture, woodwork, walls. Ask your dealer to demonstrate. Write for electric tool catalog.

SpeedWay Mfg. Co. 1863 SO. 52ND AVE. CICERO 50, ILLINOIS

\$34.50

Say You Saw It in Popular Mechanics

MODERN LAWN MOWER SHARPENER

Service departments of leading Lawn Mower manufacturers use the Modern Lawn Mower Sharpener. One lever moves lawn mower into grinding position. Gasoline and oil remain in engine while sharpening, no dismantling of wheels, roller or handle. The Modern is a precision bed knife grinder—no extra grinder to buy. Imitated but never equaled—Compare before you buy. If it isn't a Modern it can't be Modern (Prices subject to change without notice)

\$263.00 with motor F.O.B. PASADENA

WRITE FOR FREE BOOKLET 10D

MODERN MFG. CO.
160 N. Fair Oaks - Pasadena 1, Calif.



REAL DIESEL ENGINE

\$3.95

- for planes, boats, midget cars
- 7500 RPM; 1/7 HP; ht. 3 1/2"; wt. 5 oz.
- Precision machined for smooth operation

You just can't beat this price for a precision diesel engine! Streamlined, compact, easy to install. Thousands of satisfied users all over the world. Fast delivery if you ORDER TODAY! Send \$3.95 plus 25c postage. Engine is completely assembled, and includes all engine parts including: crankcase, crankshaft, connecting rod, piston, cylinder and carburetor.

ORDER TODAY! FAST DELIVERY!

GOTHAM HOBBY CORP. Dept. P, 107 E. 126th St. New York 35, N. Y.

PARTS FOR MILITARY TRUCKS

FOR JEEP, DODGE, CHEV., GMC, STUDEBAKER, 4 WHEEL DRIVE AND 6 WHEEL DRIVE. ALSO PARTS CATALOG. WRITE

NEW AXLES FOR TRAILERS

Surplus . . . H.D. axles suitable for building many types of trailers, farm wagons, etc. Standard width straight axle, 2 inch square, complete with Hubs, Timken bearings, 6 hole 750x20 or 825x20 wheels, without brakes, only (Dual Wheels \$15 extra) **\$69.50**

NEW JEEP TOPS AND CURTAINS

Military type, easily adapted to civilian type Jeep. Complete top & back curtains, side curtains, snapon doors, 5 windows. Waterproof, OD color. 25 lbs. FOB, KC. **\$59.50**

All Prices F.O.B. K.C. 25% dep. Required on C.O.D.'s
American Auto Parts Co., Inc.
1830 LOCUST ST. KANSAS CITY, MO.

BIG MONEY and your OWN BUSINESS in AUTOMATIC MERCHANDISING

Get started in the fabulous young business—automatic merchandising. Learn how small operators share in BILLION DOLLARS spent yearly in pennies, nickels, dimes for vended products. STUDY AT HOME so you can operate your own machines vending coffee, candy, sandwiches, other products. Write for amazing Reader's Digest reprint, "Insert Coin Here," the story of vending, SENT ABSOLUTELY FREE. Also how you can master secrets of selling merchandise automatically. RUSH NAME TODAY.
SUPERMATIC REPORTS, 1209 Calhoun, Dept. 21, Houston 3, Texas



LOOK FOR THIS SELF-SERVICE DISPLAY



Every fine Fuller steel screw driver and wood chisel has our famous unbreakable amber handle. Fully guaranteed. At hardware stores everywhere. Wholesale Distributors! Write for Catalog Pages & Prices.
FULLER TOOL COMPANY, INC., 3522 Webster Ave., Bronx 67
World's largest makers of Amber-Handle Tools
EXPORT SALES DEPT., JOHN H. GRAHAM CO.,
105 Duane Street New York, U. S. A.

Say You Saw It in Popular Mechanics

NEW POWER AUGER BIT

NEW LOW PRICES
Drills fast and perfectly in any wood. Twelve sizes from 5/16" to 1", all fit any 1/4" chuck. Knots and nails won't damage heat hardened cutting edges. Hexagon shank can't slip in chuck.
Sizes 5/16" & 3/8", 85c; 7/16" & 1/2", 90c; 9/16" & 5/8", 95c; 11/16" & 3/4", \$1.00; 13/16" & 7/8", \$1.05; 15/16" & 1", \$1.10. Set of six \$5.50.
Money back guarantee. Cash with order. We pay the postage.

85¢
5/16" or 3/8" SIZE

BARCLAY COMPANY, P. O. Box 883, Plainfield 9, N.J.

WAR SURPLUS AND OTHER BARGAINS SAVE UP TO 90%

LOW VOLTAGE CIRCUIT TESTER

Made for U. S. Ordnance Dept. to rigid specification. Portable steel hand-carrying unit is a self-contained trouble shooting device for making a complete and rapid check of the generator battery circuit, incl. any circuit & voltage regulators. Battery voltage, regulators, cut-out settings & generator performance easily determined. It's great for garages, mechanics, truck fleet owners, boat and marine mechanics. Can be used on any 6 or 12 volt system. Approx. Govt. cost \$175. NEW. Complete with instruction book, only **\$32.50**. Shpg. Wt. 20 lbs.



"HELIOS" ORIGINAL TOOLMAKERS VERNIER CALIPERS

ULTRA PRECISION—Imported for the really critical mechanic who must have the best. Recommended and used by experimental and research machinists at Lockheed, Douglas, Bendix, GM, RCA, GE. ALL NEW and at low, low prices . . . but quantity is limited! Model 51-Genuine Helios. Hardened lapped precision surfaces, 1/1000" and 1/10 mm graduations. Has handy slide roll and thumb lock. Quick accurate depth, A \$35 value, it's yours complete with leather carrying case for just **\$6.95**. Model 64-Helios 8". Glass hardened lapped jaws. Inside, outside measurements. 1/28" and 1/1000" verniers. Thumb guide and lock screw. A \$45 value at the amazing price of **\$7.50**. Model 65-Helios 8". Glass hardened lapped jaws. Inside, outside measurements. Thumb guide and lock screw. Valued at \$50, on sale while they last, for **\$8.50**. Model 76-Helios 8" Depth Gauge. Graduations 1/1000". Glass hardened. It's worth every bit of \$25, yours now from Airborne for **\$6.50**.

MICROMETERS

Chrome plated, precision engineered, carefully tooled to give long life. All new 0-1" capacity—**\$2.25** ea 1-2" capacity—**\$3.50**.



WILLARD WET PLATE BATTERY

Extra-long life, rechargeable battery. 2 V., 20 Amps. Great for portable radios, mobile units, bell circuits, alarm systems, rural telephones, Strobe bulbs, etc. Only 5" high. Visible ball float hydrometer built in Lucite case. Shipped dry (wt. 3 1/2 lbs.) . . . any battery service will supply standard battery electrolyte. Used singly or in multiples. ALL NEW! Now only **\$1.95** ea.



D. C. GENERATORS

Finest aircraft quality . . . heavy duty . . . lifetime grease-sealed ball bearings. Terrific for truck and marine use, for welders, plating, D. C. Appliances, lights, etc. Type P-1. Mfd. by Ford, General Electric, Westinghouse & Delco-Remy. Rated 200 Amps., 28 Volts, 2500 RPM., can be "reved" up to 300 Amps. Shpg. Wt. 53 lbs. Approx. Govt. Cost \$350 . . . New to you . . . **\$21.50**

MAKE YOUR OWN ARC WELDER

Complete make-up package consisting of one New P1 Generator 200 Amps, one reverse current relay, one voltage regulator and a wiring diagram chart showing conversion of Aircraft Generator to Arc Welder. Nothing else to buy. Special—**WHILE THEY LAST—\$32.50**

PUROLATOR OIL FILTERS

The perfect filter to keep motor oil or hyd. fluid clean at all times. Permanent type. No. G159J-32. Protect your pump, engine, midget racer or boat with this unit. To clean element, just turn handle. Inlet and outlet ports take pipe or straight threads up to 3/8" male pipe. Accommodates 16 GPM at 30 PSI. Mtg. brackets. Wt. 4 lbs. A \$15 value, NEW to you, with 2 FREE male reducer connectors for only **\$3.85**.

BERNZ-O-MATIC TORCH

Terrific for mechanics or hobbyists, for heating, burning, soldering or brazing. Compact, versatile torch for electricians, plumbers, painters, auto mechanics, dental technicians, jewelers, neon glass formers, plastic workers and radio repair men. Burns for 10 continuous hours. Replaceable fuel cylinder. No moving parts to get out of order. Burns in any position with non-varying flame of approx. temp. of 3660°. No hose connections to get in way. Always ready for use! 2 1/4" dia. 10" long. Absolutely safe, ICC approved. Wt. 2 lbs. NEW. An amazing value **\$6.95**. Extra fuel cylinders **\$1.95**.

HIGH SPEED DRILLS. ALL NEW. Fractional and numbered. Orig. value \$18. Nationally known brand. Assorted sizes. Set of 30 just **\$3.50**.
WIRE GAUGE DRILLS—From 45 to 60. Highest quality steel. You'll recognize the brand. Hard to get sizes valued at \$7.50. Airborne gives you a set of 12 for **\$1.75**

MAGNETIC BASE INDICATOR HOLDER

For all types of dial indicators with guaranteed lifetime ALNICO magnets. V-slotted base has a 45 to 50 lbs. pull, permits immediate application without clamps or special attachments and mountings can be made on cylindrical surfaces. For machinists, tool-makers and inspectors. Base 3 1/2" long by 1 1/2" wide. NEW. **\$3.50** ea.



Send 25c for 1952 catalog. Bargains for everyone. Check, Money Order or Cash. 25% deposit on C.O.D. orders. Prices F.O.B. Culver City, Calif., unless otherwise stated.

AIRBORNE SALES CO., INC., Dept. PM 153
8501 Stellar Dr. Culver City, Calif.

FLAMELESS . . . BLOW TORCH

FOR TEMPERATURES UP TO 750°

Blisters paint for easy removal; melts plastics for welding or shaping; softens asphalt or rubber tile for easy cutting; thaws gas lines, locks, radiators, plumbing; dries paints; aircraft fabric dope; ignition systems; heats small rooms; **ALL SAFELY AND WITHOUT FLAME** with the Mamco Heat Gun, 110-120 Volt AC or DC. Turbo type fan. Adjustable air intake. 8 Ft. heavy duty cord. Double jacketed heater housing. Complete... **\$28.50**

Master users include GE, Westinghouse, Am. Air Lines, Bethlehem Steel, U. S. Rubber, Bell & Howell & countless others.

TEN-DAY MONEY-BACK GUARANTEE
Send check or M.O. for P.P. shipments or \$5.00 deposit with balance C.O.D.

Handy hand sized, super-powered Roto-Master runs cool at 38,000 RPM. Mile-a-minute air torrent cools motor; micro-precision, lifetime lubricated ball bearings; 110-130V. AC or DC. Best hand tool in its class.

38,000 RPM—
USES CARBIDE BURRS

SPECIFY
3/32" or 1/8"
CHUCKING
CAPACITY



NEW! AMAZING!!



\$28.50 MASTER APPLIANCE MFG. COMPANY

404 4th Street, Racine, Wisconsin

\$32.50

earn
BIG PROFITS

Sharpening Hand Saws

The Foley Saw Retoother cuts perfect new teeth right over old ones in less than 1 minute, without removing saw handle. Saves you HALF your filing time. Takes all hand saws 4 to 16 points per inch. Relieves eye-strain. No experience needed.

FREE Foley Price Guide of saw sharpening charges. A valuable chart of actual prices. Send coupon today. No salesman will call.

FOLEY MFG. CO. 170-3 Foley Bldg., Minneapolis 10, Minn.

Send FREE Price Guide and Foley Retoother circular.

Name _____

Address _____

The SPEEDY STITCHER

Sews quick and strong, making new or repairing all sorts of leather and canvas articles—boots, shoes, coats, gloves, belts, saddles, golf bags. Ski, Football, Baseball, Skating, Hunting, Fishing, Camping togs, grain bags, burlap, etc.



Each stitcher comes ready to use with a reel of waxed thread and 3 needles, assorted sizes. Needles are carried in handle. A handy tool for home or on hunting, fishing or camping trips.

Price Postage prepaid \$1.00.

LYMAN BRADFORD CO.

Box No. 201 KINGSTON, MASS.

LUTHY AERO TYPE SPARK PLUGS

Aluminum Oxide Insulators

Material developed during World War II for high speed combat aircraft. Aluminum Oxide insulator cools very rapidly, is stronger, has greater resistance to moisture and reduces breakage to a minimum. Correct Gap setting and proper heat range for your automobile, truck, tractor, hot-rod and stock car.

Packed In Engineered Sets

PACKED IN SETS OF 6 OR 8 - CORRECTLY GAPPED FOR THE MODEL AND YEAR OF ALL CARS

ORDER YOUR SETS NOW

8 cyl. set
7.12

6 cyl. set
5.34



More R.P.M.

More Miles Per Gal.

Pat. App. For

3
P
o
i
n
t
e
r
e
c
t
r
o
d
e

Satisfaction Guaranteed

Longer Life More Economy
High Speed Performance

Luthy Aeronautical Sales Company

JACKSON, MICHIGAN (Canadian address, Box 394, Hamilton, Ontario)

Send me a set of _____ plugs. Enclosed is \$ _____ Check here if you want us to ship COD.

Name _____ Address _____

Year of Car _____ Make and Model _____



GIVE TRAFFIC JAMS THE SLIP WITH A HULL AUTO COMPASS



• Leave main highways at will, without losing bearings on strange side roads. A HULL gets you there the quickest, surest way. Write for local dealer's name, free literature.

HULL MFG. CO. P.O. Box 246-D-1 Warren, Ohio

Beaconlite \$6.95
ILLUMINATED
STREAMLINE \$4.95
STANDARD (not illus.)

Say You Saw It in
POPULAR MECHANICS

Surplus Bargains . . . SAVE UP TO 85%

HELIOS IMPORTED GERMAN PRECISION TOOLS

No. 213-A MICROMETER

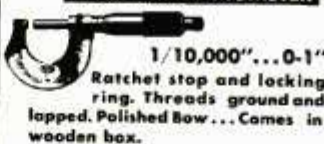

1/10,000" . . . 0-1"
Ratchet stop and locking ring. Threads ground and lapped. Polished Bow . . . Comes in wooden box.

Brand New! . . . \$12.95 ea. Postpaid

No. 64 VERNIER CALIPERS

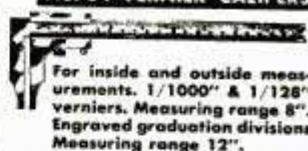

For inside and outside measurements. 1/1000" & 1/128" verniers. Measuring range 8". Engraved graduation divisions. Measuring range 12".

Brand New . . . \$9.95 ea. Postpaid

No. 65 VERNIER CALIPERS

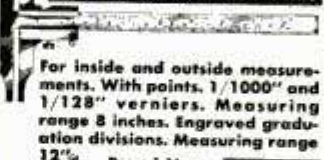

For inside and outside measurements. With points. 1/1000" and 1/128" verniers. Measuring range 8 inches. Engraved graduation divisions. Measuring range 12".

Brand New \$10.95 ea. Postpaid

No. 76 DEPTH GAUGE



Narrow measuring stock. 1/1000" and 1/128" verniers. Measuring range 8"; length of jaws 1 1/2". Measuring range 12"; length of jaws 3 1/2". Measuring range 4"; length of jaws 4". Brand New . . . \$7.95 Postpaid

SENSITIVE ALTIMETERS



Genuine U.S. Air Force and Navy sensitive altimeters made by Pioneer Instrument. Range 0-35,000 ft., calibrated in 20 ft. increments. Barometric pressure setting adjustment. No hook-up required ready for installation in auto or aircraft.

Used, Good \$12.95 ea.

ALL PRICES F.O.B. PASADENA UNLESS OTHERWISE QUOTED
PLEASE ENCLOSE FULL AMOUNT WITH ORDER

C and H Sales Company

Box 356-JM • East Pasadena Sta. • Pasadena 8, California

PAGE Garden Tractors

1953 MODELS More Work! Less Cost!

• 2 to 6 HP walking and riding machines • Over 60 attachments available! • Enclosed gear drive with reverse.

No belts — No chains! Also new one-wheel "Bantam" model

Low Prices — Easy Terms 25 years' experience behind every PAGE — fully guaranteed!

Free Catalog Shows over 60 attachments!



Plows, discs, tills, seeds, cuts grass and weeds, and many other jobs!

PAGE 1804 S. 81st St. Milwaukee, Wis.

THE NEW WATERBORG

MILLING ATTACHMENT FOR YOUR DRILL PRESS

MAKES AN IDEAL MILLING MACHINE FOR HOME AND SHOP

Do model work, tool making or experimental work in your spare time and earn extra money. Sturdy and accurate. Hardened and ground spindle, bronze spindle-bearing, bracket swings out of the way when not in use. 5"x12" table top, 10" longitudinal travel, 7" cross slide. Only \$77.75 complete with bracket for 13", 14", or 15" drill press, 17" bracket \$2.00 higher. Brackets or tables also sold separately. A few jobs will pay for the attachment. Illustrated Circular on request.

WATERBORG MACHINE CO. 2830 Rapids Drive Dept. PM-2, Racine, Wis.



LAWN MOWER SHARPENER



\$47.50

F.O.B. ROCK ISLAND ILLINOIS Free Literature

turn spare time into dollars

Order direct from **QUAD CITY PRODUCTS Company, Inc.** Box 42, Rock Island, Ill.

BUILD YOUR OWN TILTING ARBOR SAW!

Exclusive GIL-BILT Build-It-Yourself Features

- No machining—build easily with hand tools only
- No blueprint reading—step-by-step pictorial plans, full scale patterns, actual photographs
- Sturdy wood, aluminum, and steel construction
- Capacity and performance of commercial saws selling for \$60 and up

SAVE \$50 OR MORE

GIL-BILT 10-INCH TILTING ARBOR SAW



- 27x28 in. table, 13 1/2 in. capacity in front of blade
- 10 in. blade cuts 3 1/4 in. deep, tilts full 45 degrees
- Floor model 34" high, table always stays level

- New Departure ball bearing arbor, 5/8" precision shaft turned down for 5/8" bore blades, alum. housing, shipped ready to run
- Jackscrew and 4 1/2 in. dia. handwheel lowers and raises blade
- Cast aluminum miter gauge and self-aligning rip fence guide

GIL-BILT Metal Parts Kit includes Plans, ball bearing arbor, miter gauge and bar, rip fence guide, dado insert, lock knobs, jack screw mechanism and handwheel, and all other metal parts (less blade)..... \$21.95
Same Kit with 10" Combination Blade \$24.90
Same Kit with 8" Combination Blade \$23.90

GIL-BILT 8-INCH TILTING TABLE SAW

- 21x27 in. table tilts full 45 degrees, 13 in. capacity in front of blade
- 8 in. blade cuts from 0 to 2 1/2 inches
- New Departure ball bearing arbor, 5/8" precision shaft turned down for 1/2" bore blades, alum. housing, ready to run
- Cast aluminum miter gauge and self-aligning rip fence guide (same as above)



GIL-BILT Metal Parts Kit includes Plans, Ball Bearing Arbor, Miter Gauge and Bar, Rip Fence Guide, Machined Lock Knobs, Tilt Support Segments and All Other Metal Parts (less blade)..... \$15.95
Same Kit with 8" Combination Blade..... \$18.90

GIL-BILT 12-INCH BAND SAW

- Cuts to center of 24 inch circle
- Handles stock up to 6 inch thick
- 18x18 inch table tilts 45 degrees
- Lower wheel and drive pulley runs on sealed New Departure Ball Bearings; Upper wheel runs on two 5/8" bore Oilite Bronze bearings
- Upper wheel tension and tilt mechanism of cast aluminum, completely assembled
- Upper and lower blade guides, each has ball thrust bearing, self-lub bronze jaws
- Rigid cast aluminum wheels fully machined ready-to-install. Heavy rubber tires
- Uses standard 78 inch blades up to 3/8 in. wide
- Fully enclosed mechanism for utmost safety

GIL-BILT Metal Parts Kit includes Plans, rubber tires, aluminum wheels, 1/4 in. blade, ball bearing spindle, tilt mechanism, blade guides, table tilt segments, and all other metal parts..... \$21.95



GIL-BILT BELT SANDER

- 84 sq. in. sanding surface. Over 4 times the effective area of a 10 in. disc sander.
- Belt operates in either vertical or horizontal position, does all sanding operations.
- Driver drum and pulley turn on sealed New Departure ball bearings; tension drum turns on Chrysler Oilite bronze bearings.
- Spindle and tension mechanisms of cast aluminum, completely machined and assembled.
- Belt travels 1800 ft. per min. Over a MILE of straight sanding action every three minutes. Saves more "elbow grease" than any other tool.

GIL-BILT Metal Parts Kit includes Plans, 3 in. tension drum, tension mechanism, table tilt segments, rubber tires, cloth sanding belt, and all other metal parts..... \$16.95



NO DEALERS—ONE LOW FACTORY PRICE! Return in 10 days for refund of purchase price if not satisfied. Prices include postage within 300 miles. Over 300 miles add 5%. Send cash, check, or money order for parts kit, or send \$1.00 for Step-by-Step Plans and order kit later less cost of Plans. Plans sent postpaid anywhere in the world.

GILLIOM POWER TOOLS

P.O. Box 1-PA, Lambert Field, St. Louis 21, Missouri

COMPLETE PLANS only \$1.00 EACH

DRAINS Cellars, Wash Trays; CIRCULATES Oil; IRRIGATES Gardens!

ORIGINAL "Type P" Pump has 1,001 year 'round uses — home, shop, garden, farm. DRAINS cellars, cisterns, wash tubs, ditches, pools. IRRIGATES gardens, lawns, truck patches. SPRAYS crops, orchards. CIRCULATES oil, coolant. SUPPLIES water to elevated tanks from wells as deep as 25 feet. 2400 gals. per hr. capacity. 360 GPH 75' high, 1500 GPH from 25' well, 1" suction and 3/4" discharge ports fitted for hose. Use 1/8 to 1/2 HP motor or engine. 1/2" Stainless Shaft; Oil-less Bearing. DOES NOT CLOG OR RUST!

ONLY \$6.95 Motor coupling included.



WHICH OF THESE 5 PUMPING UNITS DO YOU NEED?

Easy to Assemble! Easy to Use!



TYPE C-4

Direct drive. Ideal for plumbing fixtures below sewer line. Complete with 1/4 HP motor, \$25.95. With-out motor, only \$11.25.

LITTLE GUSHER

Irrigates, drains, waters livestock, fights fires! Pumps 2000 GPH 25' high or 360 GPH 75' high. 2 HP engine with 3" power take-off V-pulley. Adjustable from 1700 to 4500 RPM. Portable. Complete with 1 1/2" Bronze Foot Valve. Dollar for dollar, pound \$69.00 for pound, the best pump value at

1 1/2" suction hose, \$1.25 per foot.

1 1/4" discharge hose, \$1.00 per foot.

BIG GUSHER

Pumps 7000 GPH. Complete with 3" of 2" suction hose and 2" foot valve.

2" suction hose, \$1.75 per foot.

1 1/2" discharge hose, \$1.25 per foot.

Low-Cost Accessories

All Bronze Foot Valve for 1" hose, \$3.45

1" Suction Hose, per foot..... \$.38

3/4" Discharge Hose, per foot..... \$.22

Money Back Guarantee

All prices POSTPAID if money order or check with order. West of Mississippi & Canada, add 50c for Type P; \$1.00 for other models.

LABAWCO PUMPS, Belle Mead 22, New Jersey.



TYPE D-3

Cleans 40' well or cesspool quickly! Drains, Irrigates, etc. Operates in any position. 400 GPH 40' high; 1400 GPH 20' high. 1/2 HP 3450 RPM ball-bearing motor, \$32.95.

Less motor \$12.85

TYPE D-4

Drains cellars, pools, boats. 1500 GPH 5' high; 600 GPH 13' high. Same as D-3 but with 1/4 HP 1750 RPM motor, \$27.45.

Less motor, \$12.85

AUTOMATIC SWITCH

for 24" sump, fits D-3 and D-4, \$4.60.

START YOUR OWN BUSINESS

Be Your Own Boss!

Make up to
\$15,000 easily
the first year

Write Big Profit Orders
for Combination Screen and
STORM-WINDOWS

You Easily Assemble the Ready-Cut Parts

Now, you can start making that big money you've always dreamed about—fast, easily—by assembling Knocked-down Storm Windows and selling them below normal cost to a waiting market. These redwood or aluminum windows are pre-cut to size, shipped to you ready for assembly and can be put together in thirty minutes or less.

Your profit is almost unbelievable! You make from \$12.00 to \$14.00 profit on each window—and still substantially undersell competition! Yes, here is your once-in-a-lifetime opportunity. With a little initiative you can be independent—and make up to \$15,000.00 year after year! Start in your basement or garage with an extremely small cash outlay. Then expand as the word gets around that you sell quality storm windows for less than competition!

Buckeye Storm Windows are made of the finest, kiln-dried redwood; also available in precision-machined aluminum. Shipped direct to you with easy-to-follow assembly instructions. Get the complete story NOW—and be on your way to independence in a sound business.



Many Choice Territories Still Available —

WRITE: free literature. Drop us a postcard NOW! We'll rush you complete information and price list.

Reserve Yours NOW!

THE BUCKEYE SCREEN & WEATHERSTRIP CO.
1380 South 22nd St., Columbus, Ohio



Brings
'split-second'
starting

to ANY CAR or TRUCK

STEWART-WARNER Electric



fuel pump

Get yours now! Get quick, sure "split second" starts for your car or truck—every time—in any weather! This Stewart-Warner Electric Fuel Pump feeds a steady flow of fuel to your carburetor the second you turn on the ignition. Operates independently of the engine. Saves your battery. Saves you from the trouble and embarrassment of a car that dies at every stop.

Easy to Install. Takes only minutes. Do it yourself or see your local Carburetor Shop or Service Garage.

Precision Built by

STEWART-WARNER

Instrument Division, Dept. N-13

1840 Diversey Parkway • Chicago 14, Ill.

2 DRILLS in 1



\$11.95
post paid

This attachment gives you two drills in one. It converts any 1/4 inch electric drill to 1/2 inch capacity. Reduction gears reduce the drill speed 5 to 1, the average speed of a 1/2 inch drill, and thereby increases the power. Absolutely indispensable for all shop work and home craftsmen.

G. M. CO. MANUFACTURING, INC.
1308 43rd AVE.
LONG ISLAND CITY 1, NEW YORK

Send check
or
Money Order
•
Satisfaction
guaranteed
•
Order
yours now



A NEW YEAR

of satisfaction can be yours with a Gerstner Chest. Free Catalog.

GERSTNER TOOL CHESTS
453 Columbia St. Dayton 7, Ohio



CUT BUILDING COSTS 2/3!
Make Your Own Concrete
BLOCKS and BRICKS
To Use or Sell

New superior moulds make absolutely square, true, easy-to-lay blocks which will pass any building code. Production is fast... easy. One durable \$30 machine will make four 5"x8"x12" blocks per minute—1,000 a day. Pays for itself in one day! Sell blocks for big profit... or save 2/3 building cost for yourself. POST CARD BRINGS FREE FOLDER.

ECONOMY MFG. CO.
DEPT. P STONE MOUNTAIN, GA.



**THE ONLY
SPARK PLUG
WITH PATENTED
CORALOX
INSULATOR**



CAN'T STALL WON'T RUN DOWN!

Now Freezing weather can't kill battery. Amazing chemical "Evercharge" instills new power... stops corrosion... triples battery's life so it never needs recharging. Run radio, heater, defroster. Can't run down! Must work or money back. Only \$1.00 postpaid.

B & B SALES, 5038 N. Winthrop, Chicago,

Say You Saw It in Popular Mechanics

Ball-Bearing SPEED WHEELS



JUVENILE WHEELS (No bearing, solid tires)

4"40e	6"65e
5"45e	7"75e
(Semi-pneumatic tire, ball bearing)			
8 x 1.25	1.85	10 x 1.25	2.20
8 x 1.75	1.95	10 x 1.75	2.30
8 x 2.00	2.20	10 x 2.00	2.65
12 x 1.75			

INDUSTRIAL WHEELS

Lug Base, Semi-Pneumatic tire			
5 x 1.75	3.65	10 x 2.00	6.10
6 x 2 SW	3.45	10 x 2.75	5.15
6 x 2.00	4.00	12 x 2.00	6.90
8 x 2.00	5.20	12 x 3.00	9.20
8 x 2.50	5.40	16 x 4.00	15.15
Smooth Base, Pneumatic tire and tube			
8 x 3.00	11.00	12 x 4.00	12.10
10 x 2.75	6.80	4.00 x 8	13.10
10 x 3.50	10.95	14 x 4.50	13.40

Dealers, Jobbers, and Manufacturers! Our new prices will interest you.

Available Now — CASTERS
Write for circulars on all wheels.
Prices F.O.B. our plant.
JIM BROWN TOY COMPANY
1095 HOME AVENUE AKRON 10, OHIO

INSTALL A "MILE-O-METER"

LEARN HOW TO SAVE GAS AND TUNE YOUR OWN MOTOR . . .

"Mile-O-Meter" on the dashboard registers miles per gallon faithfully at all speeds, under every driving condition . . . Will show what speed your engine delivers its maximum power. Can save you many gallons of gas . . . Provides constant check on engine condition — Warns you of operating imperfections for 31 different motor adjustments . . . Nationally advertised in leading magazines and newspapers . . . Can be installed in a few minutes . . . transferred from old to new car. Fine watch precision . . . Order yours today!



STD. Model
\$9.75
2 3/4" Dia. Ppd. Fed. Tax Incl.

HUGE 24 PAGE INSTRUCTION MANUAL AND MILEAGE CALCULATOR INCLUDED FREE!



Installation requires no experience . . . becomes a constant companion on every trip. Saves cost in a short time. This professional gauge is a must!

\$14.95 DELUXE MODEL with Chrome Ring
3 3/4" Dia. Ppd. Fed. Tax. Incl.

GALE HALL ENGINEERING Dept. 308

BOSTON 18, MASS.

DELUXE MODEL NOW ILLUMINATED

KING MIDGET

WORLD'S LOWEST PRICED
2 PASSENGER AUTO



JUST OUT — NEW CONVERTIBLE!
Operate it for 75c per week. Amazing performance. Surprising comfort. All steel construction. Ready to run or assemble it yourself.

self with our bolt together parts. Rider Agents wanted, earn your car free. Send 25c for detailed literature or \$1 (refunded first order) for actual assembly book and service manual filled with photos, drawings, specifications, etc.

MIDGET MOTORS MFG. CO., ATHENS, OHIO

60 POWER TELESCOPE \$3.95

VARIABLE EYEPIECE 20 x 40 x 60 — BRASS BOUND

NEW! Three telescopes in one, 3 different magnifications. 20 power for ultra-bright images with 40 and 60 power for extra long range. Guaranteed to bring distant objects, people, sports events, ships, moon, stars, etc. 60 times as close.



Most powerful for any where near the moon. ey. 5 sections. Closes to 1 ft. long. Contains 4 ground and polished lenses. Also used as a powerful compound microscope. Directions included. Mass production enables us to offer this instrument at amazing price of \$3.95 complete. Ready for immediate use. We pay postage. Get yours now.

CRITERION CO.
DEPT. PMB10 331 CHURCH ST.
HARTFORD 3, CONN.

Say You Saw It in Popular Mechanics



GRAVELY makes tough jobs EASY!

Powerful!

5-HP Gravely Tractor powers 21 tools—does every lawn, garden, and field job easier, better! All-gear drive, Reverse. New "Power vs Drudgery" Booklet FREE. Write for it today!



GRAVELY

BOX 163, DUNBAR, W. VA.

FIELD-TESTED FOR 32 YEARS

Arc Welding Pays Big

when you equip with **HOBART**

Welding is today's fastest growing trade. Every day, more and more individuals and firms use welding. New shops are badly needed in practically all towns. Pay and profits are top!

CASH IN ON THIS OPPORTUNITY

. . . by setting up your own welding department or shop today. One Hobart Welder puts you in business. It goes anywhere—handles any job—gives you faster, better, lower cost welds. Its 1000 combinations of heat and remote control make it easy for anyone to do the every day welding jobs. Available in choice of Electric or Gas Engine Drive models, portable or stationary. Check coupon today for details.

More welding capacity for your money

200 amp. "Bantam Champ" elec. drive DC welder

300 amp. elec. drive DC welder

Weld Anywhere with this 250 amp. "Pipeliner" gas drive DC welder

Welding Books

it will pay you to own.

- TEXT AND LESSONS BOOK. Covers every phase of welding. 544 pages, over 600 illus. . . . \$3.00
- LESSONS BOOK. Complete operator's training course. 200 pages, fully illus. . . . \$1.00
- PRACTICAL DESIGN. 100's of weld ideas in design form. 3 vols., 100 designs each. . . . 1 vol. \$3.50; set of 3. . . . \$10.00

HOBART trains you

Learn welding quickly, easily, in modern, non-profit school. Complete or brush-up courses. Best equipment. Experienced instructors.

Check coupon for free booklet on welding school!
Hobart Brothers Co., Box M-13, Troy, Ohio
"One of the world's largest builders of arc welders"

HOBART BROTHERS CO., BOX M-13, TROY, OHIO
Send complete details on items checked.

Electric Drive Welders Gas Drive Welders Hobart Trade School. Send books checked. Text and Lessons Lessons. Practical Design: Vol. 1 Vol. 2 Vol. 3 set of 3 vols. Cash enclosed C.O.D.

free Welder's Vest Pocket Guide

NAME _____
ADDRESS _____
CITY _____ STATE _____

ECONOMICAL! POWERFUL!
ELECTRIC MOTOR
GEAR BOX & POWER-PACK

EDUCATIONAL! FUN! SAFE!



ALL 3 FOR **\$2.98**

Add many hours of pleasure to your hobbies. Let this POWERFUL Motor Kit drive model trains, boats, planes, carousels, cars, construction sets, etc. Get this amazing Power Kit. The motor is powerful yet measures only 1 x 1 x 1 1/4 inches. Turns up to 6,800 r.p.m.'s and it's instantly reversible with the new POWER-PACK which holds two standard flashlight batteries. The Power-Pack gives you remote control operation too! PLUS the outstanding GEAR BOX which gives you ratios up to 81 to 1.

This is the swiftest little POWER UNIT ever made to run your model trains, turntables, fans, boats, draw bridges or whatever else you want to make GO. Imagine how many different ways you can hitch them up to run things... with gears... direct-drive and belt-drive arrangements. There's no end to their uses.

ORDER NOW! Be the first amongst your friends to own this POWERFUL MOTOR, GEAR BOX and POWER PACK for only \$2.98 (if batteries are desired, add 25c for two) All will be sent to you by return mail. When postman delivers it, pay only \$2.98 plus postal charges. If not completely satisfied, return it within ten days and your money will be refunded in full. ACT NOW! Send check or money order and save on postage!

ELECTRO-KRAFT CO.

Dept. M-1, P.O. Box 237
 Old Chelsea Station, New York 11, N.Y.

You Can Become an Expert
User of POWER TOOLS

Brand New Book Shows You How to Select and Operate Home Workshop Machines—How to Use All Popular Power Tools Efficiently in Your Home Workshop

Here's the book that tells and shows you how you can become an expert in the use of all power tools. It covers selection, use and operation of sanders, drill presses, band-saws, scrollsaws, lathes, shapers, jointers, metal working tools, accessories, etc. Tells how to use tools to make cabinet joints, moldings, compound angles; contains actual plans and instructions for a variety of fascinating projects. A special directory in the back of the book lists names and addresses of various manufacturers and sources of supply.



7 Day Money Back Guarantee
 Send only \$2.50 today for this big 144 page book with its more than 375 photos, drawings and diagrams. Return it within 7 days for a full refund if it is not entirely satisfactory.

POPULAR MECHANICS PRESS, Dept. 93
 200 E. Ontario St., Chicago 11, Ill.

Send at once my copy of POWER TOOLS AND HOW TO USE THEM. I may return it for a full refund in 7 days if it is not satisfactory.

NAME _____
 ADDRESS _____
 CITY _____ ZONE _____ STATE _____
 \$2.50 enclosed Send C.O.D. (Postage Extra)



BUILD YOUR OWN
POWER MOWER

With Parts We Furnish

Why break your back mowing field or lawn? Now anyone can save time, money and effort by building their own Power Mower. Build it to fit your needs, in a short time without special tools.

PULLS ITSELF, STEERS ITSELF

WRITE FOR FREE BUILDING INSTRUCTIONS—NO OBLIGATION!

T & H Mfg. Co., 811 E. 31 St., Dept. 112, Kansas City, Mo.

AUTOMATIC RETOOTHER

MAKES NEW PROFITS

for HAND SAWS

Cuts new teeth in 50 seconds — any size 4 to 16 points. Old teeth fall off as chips. Easy to operate. A perfect job.

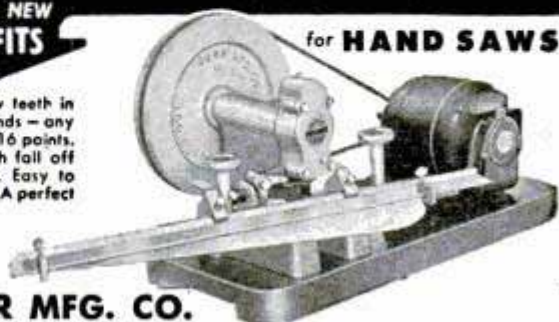

BURR MFG. CO.

DEPT. PM1 — 8933 VENICE BLVD., LOS ANGELES 34, CALIFORNIA

BIG LEATHER & CRAFT CATALOG!

1000's of items for Leatherscraft, Textile Painting, Copper Tooling, Kits, Projects, Tools, Supplies, Etc. Send 25c (refunded with 1st order) to:
RUSSO HANDICRAFT SUPPLIES Dept. 7-CD, 245 S. SPRING LOS ANGELES 12, CALIF.

HELPFUL BOOKS

Send post card asking for FREE catalog
 Popular Mechanics Press, 200 E. Ontario, Dept. 601, Chicago 11



HAVE MORE FUN TRAVELING

DINSMORE AUTO COMPASSES are a constant source of information, interest and education. Passengers love it! Saves time, worry. No back-track, driving with America's first and finest auto compass. Precision made and fully jeweled with micrometric compensator. Only \$5.49. ILLUMINATED. Send for name of nearest dealer.

FREE Folder on compasses for the hunter, camper, fisherman, sailor, plus a history of the compass, "Pants, knives and Compasses." Send for your copy today.



DINSMORE INSTRUMENT COMPANY 1802-21 Kelso St. Flint 1, Michigan

1/2" ELECTRIC DRILL \$2.95

ADAPTER takes all drill sizes to 1/2". Fits any small 1/4" Electric Drill — in just a second! Well-made and a Mighty Handy Tool!

DANIELS PRODUCTS CO.
 M-1-822 W. 22nd St., Kearney, Nebr.

Postpaid in U.S.A. Order Now

New Window Paint Roller
Keeps Paint Off Glass!

Now paint your window sash easily, quickly, neatly—with the Clever New Window Paint Roller. Just fill paint reservoir and roll paint on sash right up to the glass, smoothly, cleanly, without getting any paint on the glass. Dozens of other uses—for stripping, outlining panels, etc. Use indoors or out. Order Today!



Only **\$1.19**

SEND NO MONEY! Mail Order. Pay postman only \$1.19 plus C.O.D. and postage. Or send \$1.19 plus 10c for postage and handling. Money-Back Guarantee. Order NOW!
STRADER PRODUCTS CO.
 Dept. E-179 259 Strader Ave. Cincinnati 26, Ohio

BUY from C&H - you'll save and be sure!

POWER and HAND WINCHES

For — BOATS, TRUCKS, FARMERS, LOGGERS, CONTRACTORS, ETC.

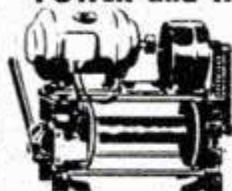

Hand winch, 3-1 ratio, 600 lb. pull, drum has 1 3/8" spool, 6" flange, takes 7 3/8" 3/16" cable, stop locking pawl, wgt. 26 lbs. \$16.95

Ball bearing Hand winch, low ratio 1-1, high ratio 3-1, 600 lb. pull \$29.50
Same as above with bronze worm gear, 12 to 1 ratio and handbrake \$39.50
1/2 HP electric ball bearing model; compact gear box, 12 rpm drum speed. . . \$135.00
3/4 HP, same as above, 3" drum. . . \$165.00
Heavy duty, 10-1 ratio, double drum model with jaw-type clutch, wgt. 280 lbs. \$49.95
CABLE, 1/4" preformed stainless steel aircraft, 100 ft. or less. 17¢/ft.
Over 100 ft. 15¢/ft.

BUILD YOUR OWN INCLINE or DUMB WAITER ELEVATOR



Get all the convenience of a dumb waiter elevator for store, shop, restaurant and home — or the convenience of an incline elevator on steep lake shores, hills, ravines, etc. at lowest cost. We furnish complete parts. Steel Car — Guide Rails — Worm Gear — Limit Switches — Electrical Control — Steel Cable. SEND 25¢ for completely diagrammed instructions with list of parts, kits and prices.

ALARM HORNS • SIRENS

Motor driven (not a vibrator). Heavy duty with great power and long life. Adjustable for high, medium or low tone, 110 v. AC current. Weather proof. For alarm or signal horn on boats, school yards, factories, air raid siren, etc. Lists at \$47. Our price NEW \$24.95



BOOSTER FANS fit any 8", 9", 10" furnace pipe. 1500 rpm motor with 6' cord, mounting frame, 7" blade. Motor 110 volt 60 cycle 1350 rpm. Easy to install. Silent operation. Warm those rooms with long runs. List \$11.95. price \$6.95

High Volume BLOWERS

Top performance for forced draft, ventilating, exhausting, cooling and drying, 110v. AC.
75 cu. ft. per min. \$10.95
150 cu. ft. per min. 13.95
300 cu. ft. per min. 17.95
500 cu. ft. per min. 36.00



CLUTCHES For Motor scooters, motor bikes, etc. Centrifugal action enables electric motors or small gas engines to handle heavy starting loads. 3" A belt pulley. NEW. 3/4" bore \$9.95; 1" bore \$10.95; 1 1/2" bore \$11.95.

CENTRIFUGAL Ball Throw-out CLUTCH. A or B belt pulley. 3/4" bore \$9.00; 1" bore \$11.00

FRICITION DISC CLUTCH

Twin disc throw-out type. Ideal for power link with gas engines and electric motors from 3/4 to 15 hp. 1-7/16" shaft bore — can be pushed to suit. Overall length 4", 5 1/2" plate with 6 mounting holes. Lists at \$44. Used like new. \$15.95



ELECTRIC HOT WATER HEATER

Heat water faster, easier with this immersion unit, 115 v. AC — 1250 watt Westinghouse or Chromalox element. Manual unit, \$42 value, \$6.95; thermostat Fenwall control \$3.95. Element with Fenwall thermostat \$8.95. 10 gal. steel tanks 12x21" — \$9.95; 8x42" — \$11.95; 18' cord #12/2 or 3 conductor with plug \$2.25.

RUBBER HOSE

Long wearing GOODRICH 2 ply 2" I.D., 25 ft. lengths worth \$25. Only \$4.95; 3 lengths for \$12.00.



SAVE OVER 50%

ON THESE BRAND NEW WAR SURPLUS POWER UNITS



BE PREPARED for any emergency!

300 WATT 110-220 volt AC. 60 cycle light plant powered by 1 HP gas engine, direct drive, mounted base, wgt. 40 lbs. Ideal for campers, P. A. systems, house trailers, etc. Equipped with handle for easy carrying. \$99.00
750-1000 WATT 110 volt AC. powered by Briggs & Stratton gas engine. \$169.00
1000-1200 WATT 110 volt AC. \$194.00
2000-2500 WATT 110 volt AC. 60 cycle, slow speed generator, 5.10 HP Briggs & Stratton gas engine, NEW. \$294.50
To make 110-220 add \$40. for transformer.
2500-3000 WATT 110 volt AC. 60 cycle, Lealand generator — runs at slow speed (1800 r.p.m.) for longer life. 8.25 HP Briggs & Stratton gas engine. You can rely on this plant for all average home needs — freezer, stoker, pump, hot plate, radio, etc. — and overloads from starting motors. Reconditioned and fully guaranteed. \$295.00. NEW. \$345.00
Plants same as above, built in 1951, with tools and spare parts. Lists at \$790. Our price \$426.
To make 110-220 add \$48. for transformer.
3000 WATT 110-220 volt with push button starter. Starter battery is automatically charged by plant. Gas engine same as in plant above. \$465.00
5000 WATT 120 volt, 60 cycle AC. Hercules 4 cyl. gas engine, Hobart generator, completely automatic, radio & TV filtered, power cable plug, exhaust pipe and manual. Lists at \$1800. Our price \$795. Extra parts & tools \$25. 150' reel 2-wire #6 rubber cable with connectors \$90. 150' reel 3-wire remote control cable & switch \$25. Plant complete with parts and 2 reels of cable \$895. To make plant 110-220 v. add \$75 for transformer.
7500 WATT 110 v. AC, 4 cyl. gas engine NEW. \$995.
10,000 WATT 110-220 v. AC, Reconditioned. \$1195. NEW. \$1495.
25,000 WATT 220 v. AC, 3 phase or 110-220 v. single phase. Reconditioned. . . . \$1995. NEW. \$2495.
35,000 WATT 110-220 v. AC, Diesel. Rebuilt. \$2995.
50,000 WATT 240 v. AC, 3 phase Diesel. NEW. \$5900.

ORDER DIRECT from this ad! All prices F.O.B. Milwaukee. 25% deposit required on all C.O.D. orders. No C.O.D.'s under \$10.00. Many other bargain items not listed. Write for our FREE CIRCULARS!

C&H ELECTRIC MACHINE CO. Inc.

434th W. Juneau Ave., Milwaukee 3, Wisconsin

Guided Missile Filter CAN NOW BE USED IN YOUR CAR!

Complete filter assembly (give make of car) \$12.95
Permanent Element only (To fit in your present filter case). \$6.95
(Give make and model of car and present filter.)
(Above prices postpaid or send \$1.00 deposit, balance C.O.D.)

STOP THROWING MONEY AWAY!
GOV'T. APPROVED OIL FILTER ELEMENT NEVER NEEDS REPLACING!
FULL 10 YEAR GUARANTEE!

The sensational "LIFETIME" oil filter forces all your oil through a porous bronze filter element which never wears out. It filters out dirt particles as small as 39/millionths of an inch as soon as your engine starts and allows no oil loss or bypass regardless of engine temperature. It saves the quart of oil soaked up by ordinary filter elements and does not absorb valuable, protective oil additives. "LIFETIME" pays for itself over and over by saving oil, engine repair, and ending the expense of stock filter element replacement. Fits all cars and light trucks. To clean, just rinse the bronze cartridge in gasoline.

STOP MOTOR

SKIP BUCK And MIS

with a dual point BREAKER PLATE

Replace your present stock (single point) ignition with a dual point breaker plate. It increases cam angle from 31 degrees to 36 degrees dwell and also increases coil saturation to full capacity. This plate produces a hotter spark . . . giving better mileage, easier starting and smoother performance. Features "super" size dual tungsten points. The only 8 cyl. plate available with 50 precision ball bearings. Fits: '37 to '52 Oldsmobile 8's, Pontiac 8, Buick 8, Studebaker V8, also Packard '51 to '52 (with Delco Dist.)
Postpaid. \$11.95

Also non-ball bearing dual point conversion plates for '49-'52 Ford 6, '37-'52 Chery, '49-'52 Ford V8 and Mercury, '50-'52 Lincoln: Specify. Postpaid. \$6.95

SAVE GAS

WITH A FUEL PRESSURE REGULATOR!

Stop: ✓ Power Loss ✓ Fuel Waste
✓ Flooding ✓ Stalling

MANY USERS CLAIM UP TO 25% BETTER MILEAGE as this revolutionary new accessory stops gas waste caused by fuel pump pulsation. It eliminates carburetor overflowing and fuel "surge." Stops the annoyance and danger of "motor cut-out." As this precision regulator s-m-o-o-t-h-s fuel flow, it also prevents vapor lock and percolating. It pays for itself ten-fold with gas savings, by eliminating frequent carburetor adjustment and by reducing engine and carburetor wear. Fits all cars and trucks. 15 day "money back" guarantee! \$7.95 postpaid. (Or send \$1.00, balance C.O.D.)

BEFORE AFTER

NEWHOUSE AUTOMOTIVE INDUSTRIES Dept. BX-1, 5805 E. Beverly Blvd., Los Angeles 22, Calif.
World's Largest Distributors of Speed-Power-Economy Equipment

The **NEW Model 50 UTILITY TESTER**
FOR REPAIRING ALL ELECTRICAL APPLIANCES-MOTORS
an all-around electrical trouble shooter



- Measures A.C. and D.C. Voltages, A.C. and D.C. Current, Resistances, etc.
- Will measure the current consumption while the appliance under test is in operation. The appliance or utility may be plugged directly into the front panel receptacle. A special pair of insulated clip-end leads is included for motors, etc.
- Incorporates a sensitive direct-reading resistance range which will accurately measure all resistances commonly used in electrical appliances, motors, etc. This range will enable continuity checks and tests for shorts and opens.
- Will test thermostats, radio tube filaments, bulbs, fuses, fluorescents, condensers, switches, field coils, circuit breakers, lighting systems, etc.

Handsome round cornered molded bakelite case $3\frac{1}{8}'' \times 5\frac{7}{8}'' \times 2\frac{1}{4}''$. Complete with all test leads and instructions.

\$13.90

SHIPPED ON APPROVAL
No Money With Order - No C.O.D.

Try it for 10 days before you buy. If completely satisfied send \$3.90 and pay balance at rate of \$2.00 per month for 5 months — No Interest or Carrying Charges Added. If not completely satisfied, return to us, no explanation necessary.

SUPERIOR ELECTRONIC CO., INC.
 Dept. D-45, 227 Fulton Street, New York 7, N. Y.
 Please rush 1 Model 50. I agree to pay \$3.90 within 10 days after receipt and \$2.00 per month thereafter.

Name _____
 Address _____
 City _____ Zone _____ State _____

Say You Saw It in Popular Mechanics



4 TOOLS IN 1
The Complete
METAL WORK SHOP
 FOR HOME AND PLANT

Patent No. 2053309

IT

- FORMS
- SHEARS
- PUNCHES
- RIVETS

INTRODUCTORY PRICE
 Only **\$6.95**

DELIVERED

BENCH TOOL that **FORMS, SHEARS, PUNCHES, RIVETS**—one small compact tool that is a complete metal workshop. Bending and forming dies make smooth sharp bends in either bar or rod stock. Hardened steel shearing jaws shears metals cleanly up to $\frac{1}{4}''$ thickness. An efficient punch press complete with $\frac{1}{8}''$, $\frac{3}{16}''$ and $\frac{1}{4}''$ punches. Rivets easily with punch press and rivet dies. Check must accompany order. No C.O.D.'s. Full immediate refund if not completely satisfied.

TATU CO., Dept. F5
 85 Columbia Dr. Williamsville 21, N. Y.

UP TO 2000 POWER!
MICROSCOPES... OPTICS

FROM \$14.95 OPTICS FROM \$1.00



UNHEARD OF VALUES IN PROFESSIONAL QUALITY OPTICAL INSTRUMENTS . . .

These fine instruments are used throughout the U.S. in laboratories, schools, colleges and physicians' offices

SEND FOR FREE 32 PAGE CATALOG

World's greatest values in hobbyists, students, and professional research microscopes, complete accessories, mechanical stages, eyepieces, prepared slides, dissecting microscopes, ore, mineral, gem microscopes, binoculars, telescopes, magnifying glasses of all types. Each item a bargain . . . money-back guarantee.



THE AKRON 4400 SUNSET BLVD.
 LOS ANGELES 27, CALIF.

1-P

NEW SAW SHARPENER

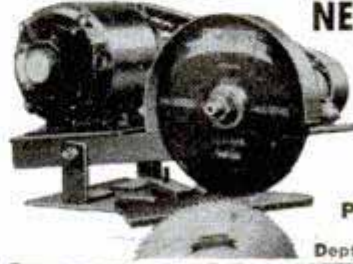

Improved #64 Hand Gummer sharpens all types circular saws 4" to 20" diam. Ideal for saw shops. Self-centering adjustment for quick, easy set-ups. Complete with $\frac{1}{4}$ HP motor, 1 grinding wheel & cord. \$79.50 FOB Portland. Wt. 70#. SEND FOR FREE LITERATURE.

P. T. HOBBS MACHINERY
 8375 N. INTERSTATE AVE.
 Dept. P.M.-61, PORTLAND 17, OREGON

Make Money Selling Eshelman Power Mowers Riding Tractors & Rotary Tillers

For **BETTER GARDENS**



ESHELMAN ROTARY TILLER

ONLY \$119.50

Turns virgin ground into a garden bed in one operation. Replaces plowing, discing, and cultivating. Women can operate it. Also POWER MOWERS & RIDING TRACTORS from \$95. Free Catalog. Write nearest branch:—**ESHELMAN CO., Dept. R-23**
 119 Light St., Balto. 2, Md.
 333 N. Michigan Ave., Chicago 1, Ill.
 105 Lake St., Reno, Nev.

Print Your Own

Cards, stationery, circulars, tags, labels, photo and movie titles, advertising, etc. Save money. **Print for Others, Good Profit!** easy rules sent. Raised Printing like Engraving, too. Sold direct from factory only. Write for free catalog of outfits and all details. **KELSEY PRESSES, M-37, Meriden, Conn.**

\$ Free Course! Big Profits! \$
Flocks & Sandblasts

Dual Purpose Spray Gun! Uses only 25 lbs. Air Pressure

- Thousands of uses in Home, Shop, Industry. Makes Auto Interiors Clean & New, Lines drawers, Marproofs lamp bases, Refinishes any object. All in colorful Flock. Etch & Frost windows, glassware, etc. Removes Paint & Rust from Autos. Tools. Guaranteed! Send \$24.75 or write for free information. Flocking supplies!

BLASTO SPRAY GUN MFG.
 Dept. PM-1, 7007 Haas Avenue, Los Angeles 47, Calif.

WAR SURPLUS BARGAINS!



WAR SURPLUS BARGAINS

\$500,000.00 INVENTORY for QUICK LIQUIDATION

Surplus items—hundreds of them for home, shop, factory, farm and outdoor use. New items, used items, reconditioned items—all at tremendous savings—all priced for quick sale.

Page After Page of Values
 This big catalog shows page after page of amazing money saving values. Write for your copy today. Send 10c to cover postage, mailing, etc. Write today!

SEND TODAY FOR YOUR COPY

10c

STARK'S Dept. PM 153 509 So. STATE STREET CHICAGO 5, ILLINOIS

GIGANTIC
SAVE-TO-70%

MAIL SALE

WAR SURPLUS
EXCESS INVENTORY
BANKRUPT STOCK

POWER PLANTS & GENERATORS

- Master Plants, 5KW, 115-230 v, 60-c, 4-cyl. engine, manual start. Costover \$1100. **\$531.70**
- Onan Plants, 5KW, 115-v, 4-cyl. push button start. Cost \$1400.00. **\$689.50**
- Onan Plants, 1-KW, 115-v, 60-c. Full automatic start-stop. Cost over \$500.00 **\$291.50**
- Burdex Plants, 2KW, 115-v, 60-c **\$279.50**
- Homelite Plants, 1.5KW, 115-v, 60-c. **\$199**
- Kato Generators, 5KW, 115-v, 60-c, with control panel, drive pulley, etc. 1800 RPM, 1 phase. Cost \$550. **\$259.50**
- Generators, 115-v, 60-c. Ball bearing, 500-w, **\$94.50**; 1000-w, **\$99.50**; 2000-w, **\$138.40**.

Write for Power Plant Catalog

HYDRAULIC BARGAINS

Build your own loaders, diggers, presses, plow lifts, etc. Lowest prices. Savings to 80%. See our "How to Build" catalog.

- Pump, 1000 lbs., 12 g.p.m., 400 r.p.m. **\$45.50**
- Cylinder, 2 3/8" bore, 19" stroke, 9000 lb. lift. List \$91.50. **\$18.49**
- Cylinder, 2" bore, 10" stroke, 3141 lb. lift. Sale **\$16.50**
- Control Valve, For single or double acting cylinders. Sale **\$17.98**
- Pressure Gauges, 1000 lb., 1500 lb., 2000 lb. **\$3.49**

Write for Hydraulic Data-Catalog

Winches - Hoists - Blocks

- Boat, dock, business hand winch, 1-4 gear ratio. Special **\$19.95**
- Farm-Truck-tractor heavy duty hand winch. Dual ratio 1-3, 1-9. Finest cast steel construction. Special **\$29.98**
- Chain Hoist, Lever type 3000 lb., **\$19.48**
- Truck Crane-Winch, Mounts on trucks and pick-ups. Special **\$84.60**
- Winch Cable, 1/4" super-flexible (4000 lbs. cap.) 50' with load hook **\$9.90**
- Army Snatch Block, 13,000 lb., **\$12.95**
- \$165 Airplane Winch. Beautifully made. Requires reducing gear. SALE **\$17.49**

BURDEN PAYS ALL SHIPPING CHARGES

SUPER CLOSEOUT BARGAINS

- Remote Motor Operated Channel Selector for TV sets, 110-v, 60-c, Regularly \$45. SALE **\$15.49**
- Dial (3 1/2") Thermometer (mantel) **\$1.49**
- Garden Tractors (2 h.p.) **\$119.50**
- Snow Blower for above tractor **\$29.50**
- Flexible Shaft (40") with chuck **\$3.95**
- Finest Gas Chain Saw (#325) **\$279.50**
- Plane Propellers (7" 6") (#151) **\$12.95**
- Search Lamp Bulbs 4,800,000 C.P. output! 24-volt (6 for \$7.49) 110-volt **\$1.95**

WATER PUMPS AND SYSTEMS

Save up to 60%. Ask us for expert advice on your problem. Pumps for wells, basements, weed spraying, septic tanks, garden irrigation, etc.

- Centrifugal Pumps, Cast iron, stainless steel shaft, bronze impeller, ball bearings. No. 75, 3/4" **\$18.90**; No. 100, 1" **\$28.90**; No. 150, 1 1/2" **\$35.60**
- Bronze Rotary Pumps, Low pressure, (25 lbs. max.) Self priming. No. 12, 1/2" **\$12.75**; No. 34, 3/4" **\$16.95**; No. 101, 1" **\$22.95**; Hi-Pressure type (150 lbs. max.) No. 612, 1/2" **\$14.50**; No. 634, 3/4" **\$20.95**; No. 610, 1" **\$27.95**
- Irrigation War Surplus Pump, 10,000 g.p.h. 2 1/2" intake, Two 1 3/4" outlets, Spe. **\$39.50**
- Burdex Shallow Well System, 110-volt, 60-c, 300 g.p.h., 40 lbs. pressure, fully automatic. Easy to install **\$69.50**
- Adj. Auto. Pressure Switch, **\$4.95**; 3/4" foot valve, **\$2.49**; pressure gauge 0-60 lbs. **\$1.89**; also hose, strainers, etc., at real savings.
- Hand Pump, Lever type, high capacity, Pump basements, tanks on farms, etc. Cost \$35. **\$27.60**

Write for useful Water Pump Data-Catalog

MISCELLANEOUS SURPLUS BARGAINS

- Surveyors Farm Level **\$37.95**
- Surveyors Level-Transit **\$77.50**
- Laboratory Small Microscope (200X) **\$13.95**
- Navy Inflatable Life Belts **\$1.09**
- Auto Illuminated Compass **\$6.95**
- Binoculars, Top Quality, 7x50 **\$42.95**
- NAVY Thermometer (5" dial) with 5' tube Shows outdoor temp., -40 to 120°. Cost \$49.50, SALE **\$9.85**

SPECIAL FOR THE MONTH

WESTERN ELECTRIC CITY TELEPHONES

• Genuine W.E. wall or desk phones, same as used on city telephone systems. Useful for inter-communication, private system, extension ringo, etc. Specify "wall" or "desk". Original cost over \$20.00. Pre-paid Sale, **\$4.99** each. Two for **\$9.69**.



Correspondence School Bargain

• Famous engineering school closes because of high operating costs. We offer limited quantity of complete courses, Radio or Electrical (27 fine lesson texts.) at fraction of regular tuition rate. Deal #1, Complete Radio or Engineering Course Texts, **\$5.95**. Deal #2, Combined Radio and Electrical Course Texts **\$9.95**

AIR COMPRESSOR UNITS

Paint, blow up tires, control termites, clean greasy engines, blow dust, etc. Build your own or buy ready-built units.

- DeLuxe Air Kit, Consists stainless tank 12"x24", finest 1-cyl. 3 cfm piston compressor, valves, gauge, fittings, hose, excellent paint gun, blow gun, pressure regulator, chuck and "How To Build Portable Outfit." Special **\$45.49**
- Economy Air Kit, Same as above except 6"x24" tank and no regulator or paint gun. Each **\$31.90**

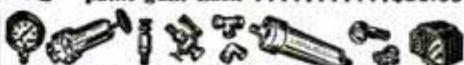

- Air Components, Top quality, 1-cyl. piston comp. **\$20.50**; 2-cyl. pis. comp. **\$49.50**; Adj. Auto. pressure switch, **\$4.95**; pressure regulator, **\$2.65**; Adj. safety valve, **\$1.95**; Pressure gauges, 0-160 lbs. **\$1.89**.
- Air Operated Power Grease Gun **\$23.95**

Write for interesting Air Data-Catalog.

ORDER FROM AD, or Write for 4 FREE Catalogs!
OUR 30-YEAR POLICY: • Everything Guaranteed Satisfactory
We Pay Shipping Charges in U. S.



BURDEN SALES COMPANY

817 "O" ST.

LINCOLN, NEBRASKA



LEARN WELDING TO MAKE AND SAVE MONEY

Complete Outfit and How - To - Do - It. Everything Needed to Get in Business.

DYNAMIC WELDER COMPANY

FASCINATING HOBBY...PROFITABLE BUSINESS

This is the time to cash in on big profits to be made doing welding for yourself or others, making valuable items of metal to use or sell. No experience or expensive equipment needed to get started in a profitable business of your own, full **FREE** or spare time. Write for full details.

15 E. 23rd Street Dept. D2-AD Chicago 16, Illinois

The New Improved Model 38-98 DYNAMIC POWER TOOL COMBINATION

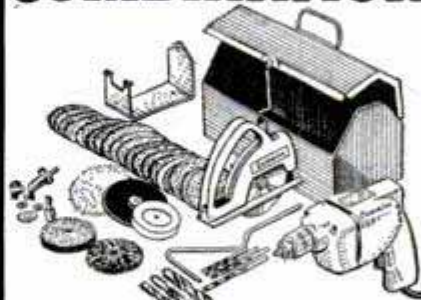

INCLUDES: Cummins 1/4" Pistol-Grip Electric Drill; Cummins Saw Attachment; Combination Saw Blade; Set of Drills; Lambs Wool Bonnet; 13 Sanding Discs; Steel Arbor and Attachments; Cloth Buffing Wheel; Grinding Wheel; Wire Wheel Brush; Steel Paint Mixer; Steel Bench Stand; Portable Steel Carrying Case.

Price of Dynamic Power Tool Combination complete is **\$29.95**

SHIPPED ON APPROVAL

No Money With Order - No C.O.D.

Try it ten days before you buy. If completely satisfied then send \$4.95 and pay balance at rate of \$5.00 per month for 5 months - No Interest or Carrying Charges Added. If not completely satisfied, return to us, no explanation necessary.

KAPNER HARDWARE, INC.

Dept. A-61, 2248 Second Ave., New York 29, N. Y.

'53 **Ford** The New STANDARD of the AMERICAN ROAD!

AJUSTRITE STOOL for Bench, Machine and Shop

Seat Adjusts 18 to 27 inches

Get just the right height for any job in woodworking, machine, tool or bobby shop. **SPLIT-SECOND ADJUSTMENT**—just lift the seat to desired height. No tools, bolts or nuts. **ALL METAL**—10 year **GUARANTEE**. Weight 15 lbs. Price \$12.50. Shipped C. O. D. or prepaid if cash with order.

AJUSTO EQUIPMENT CO. Dept. PM
2144 Madison Ave. Toledo 2, Ohio

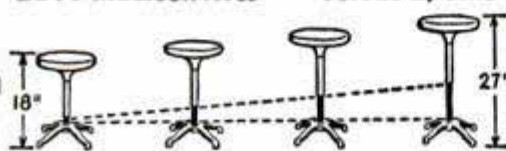

**A "Must" Book for Boys of All Ages and
the Greatest Gift Book of All Time!**

**POPULAR
MECHANICS**

BOY MECHANIC

Give the
Boy Mechanic
for Christmas
and other Gift
Occasions

FREE Any Name Stamped
in Gold on Cover
Any name you wish will be stamped in gold on the
cloth bound front cover FREE if you remit with order

NEW!

Fascinating! Educational!

How to Make Things That Work and Go!

This is it, fellows! Here's the exciting book you have been waiting for. Get the brand new Popular Mechanics **BOY MECHANIC** for yourself or be sure you get it soon for a gift. You know it's the fellow who can do things—make things that "work" and "go" who is the kingpin in every school and neighborhood. Enjoy this popularity yourself. Learn what to do—what to make—how to make it—with the **BOY MECHANIC**. Have fun with outdoor projects and gadgets; models of every type; your own scientific experiments and instruments; all kinds of craft work with wood, metals, plastic, etc; easy to make toys for yourself and others.

Something for Every Place, Time and Season

Think of it! More than 500 wonderful ideas you can use, selected by Popular Mechanics editors. Projects for the home workshop; in camp; on land and water and in the air. Projects for summer and winter and in between. More than 1100 pictures and diagrams show you exactly what to do and how to do it. It's a big, fascinating and helpful book that will give you hours and hours of fun and show you how to make so many of the things you have always wanted.

**A Grand Big
Book!**

**Beautifully Bound
in Library Cloth and
Personalized With
Your Name in Gold
on the Cover**



308 Pages

Packed with fascinating pictures and practical how-to-do-it information on outdoor projects, models and model making, spare time crafts, workshop fun, simplified science, toys, etc.

1100 Pictures

Photographs, Drawings, Diagrams, Plans and Construction Details. The most elaborately illustrated "What to Make" book ever printed.

**Rush Coupon
Today!**

Be the first in your neighborhood to get the **BOY MECHANIC** by mailing the coupon today. Only \$2.95 postpaid. And we'll stamp your name (or any other name if a gift) on the cloth bound cover in gold FREE if remittance accompanies order. Be sure to **PRINT** name for gold stamping and mail order today.



Model Airplanes, Railroads,
Ships, in Model Section



Fascinating Tin Craft,
from Indoor Crafts

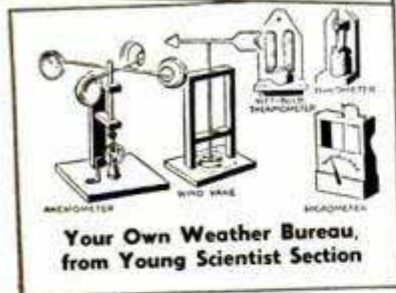

Your Own Weather Bureau,
from Young Scientist Section

Some of More Than 500 Articles in Boy Mechanic

Build a Soap Box Derby Racer — Coasting in a Sidewalk Jeep — Aero Driven Ice Boat — Eight Repair Kinks for Your Bicycle — Sea Scout Dinghy — Control Line Flying Model Planes — Model Racing Yacht — Model Railway Small-Space Track Layout — Leathercraft — Tin Can Craft — Useful Articles from Hammered Copper — Jackknife Animal Carving — Easy to Make Hand Puppets — Art With the Typewriter — Dog Quonset Hut — Bird Houses and Cages — Home Laboratory Short Cuts — Your Own Weather Bureau — Toy Electric Motors You Can Make — Fun With Common Gases — 100 Power Microscope — Six-in-One Puzzle — Magnetic Theatre — Turkey Hunt Dart Game. And hundreds of others.

**POPULAR MECHANICS PRESS, Dept. 111
200 E. Ontario Street, Chicago 11, Ill.**

Send me at once _____ copies of the **BOY MECHANIC** at \$2.95 each.

- Remittance enclosed. Stamp name in gold and send postpaid.
 Send COD. I will pay postman plus delivery charges.

Name _____

Address _____

City _____ State _____

Print name on this line for gold stamping. Use margin for additional names.

Design Draftsmen and Draftsmen

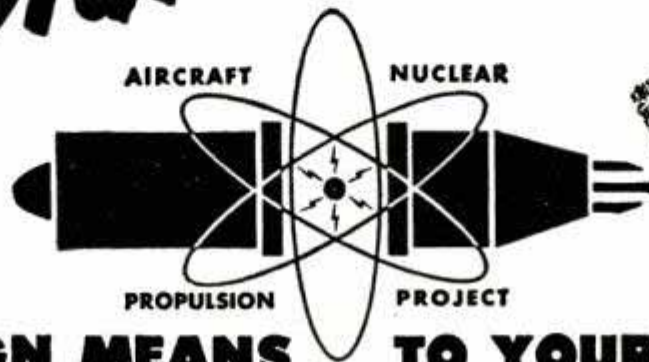

WHAT THIS SIGN MEANS TO YOUR FUTURE

Symbol of the atom, this sign is also of special significance to your future! For General Electric is now offering you a career opportunity in the great new field of the age — atomic power!

WORK ON THE DEVELOPMENT OF ATOMIC-POWERED AIRCRAFT ENGINES
AT

GENERAL ELECTRIC

Here is a young and expanding industry whose possibilities are unexplored. Enormous challenges still lie ahead. As one of the men who pioneer the industry now with General Electric, you can look forward to a future of progress and achievement.

Positions are now open with the Aircraft Nuclear Propulsion Project in the following fields:

AIRCRAFT POWER PLANTS	REACTOR DESIGN
CONTROLS & INSTRUMENTATION	TEST EQUIPMENT
TEST FACILITIES	INSTALLATION FACILITIES
TOOLS & DIES	JIGS & FIXTURES

G-E BRINGS THE FOLLOWING ADVANTAGES TO YOUR ATTENTION:

- New, progressive community on the outskirts of Cincinnati, the Queen City of America. Convenient to modern plant.
- Pension, health and life insurance. Company stock bonus plan.

Please write for application to: F. E. Reasoner, A.N.P. Project

GENERAL  **ELECTRIC**
P.O. Box 132, Cincinnati 15, Ohio

Careful, Son!

*those are mighty
important people
you're shooting!*



Don't be nervous when we tell you, sonny, but you're about to take a picture of the most important twosome in the world!

Sure it's your mom and dad... and that means they're pretty big people to you.

But thousands of folks you don't know look up to them with respect, too, and try in every way to win their friendship.

These other folks are the people who manufacture brand name products... who want every mom and dad to buy the things they make, again and again.

These brand-makers carry on continuous programs of research and product improvement,

employ scientists and testing engineers... all in an effort to make better products that will please more people.

That is what brand names mean... signs of the pride and responsibility of the firms that make the products. They tell you at a glance: these are made by manufacturers who care.

Read the advertisements in this magazine carefully and remember the brand names of the products you like. You save time shopping that way, get exactly what you want. Most important, you keep yourself the "boss" of the most productive industrial system in the world.

Yes, in the factories of the brand-makers, yours is the final word. Your free choice of branded products makes you the boss. You can keep it that way by demanding the brands you want.

Brand Names Foundation
INCORPORATED

A NON-PROFIT EDUCATIONAL FOUNDATION • 37 WEST 57TH STREET, NEW YORK 19, N. Y.

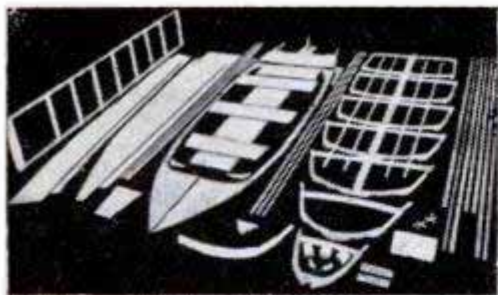

14-ft. DeLuxe Runabout Kit



8-ft. Pram Kit Boat—\$45



14-ft. Sportsman Kit Boat—\$139



17-ft. Kit Speedboat—\$449



14-ft. DeLuxe Runabout Kit Boat—\$178

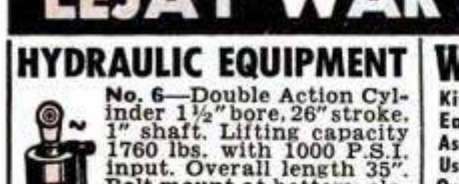

18-ft. Outboard Express Cruiser Kit Boat—\$595

SAVE 1/2 or more! Buy a new CHRIS-CRAFT KIT

for as little as \$45 full price!

Many more new kit models! Send for FREE catalog today!



10-ft. Pram Kit Boat—\$91



14-ft. DeLuxe Runabout Kit Boat—\$178



Model CC-650 Boat Trailer—\$129 (tax extra)
Complete line—300- to 2200-lb. capacities

EASY to assemble—fun, too! Precut Philippine Mahogany parts, Fir marine-plywood panels; brass fastenings; compound; decals; illustrated instructions. Also, new lifetime Chris-Craft Boat Trailers, priced from \$99 (tax extra). Mail coupon today! (Kit prices quoted f.o.b. factory, subject to change without notice.)

Chris-Craft Corporation, Algonac, Mich.



17-ft. Kit Speedboat—\$449

Chris-Craft Corporation, Algonac, Mich. **FREE!**
Send FREE Chris-Craft Kit Catalog to:
Name _____
Address _____
City _____ State _____

SAY YOU SAW IT IN POPULAR MECHANICS

LEJAY WAR SURPLUS AT CARLOT PRICES

HYDRAULIC EQUIPMENT

No. 6—Double Action Cylinder 1 1/2" bore, 26" stroke, 1" shaft. Lifting capacity 1760 lbs. with 1000 P.S.I. input. Overall length 35". Bolt mount at bottom, clevis at top. \$55.00 Value—now only..... **\$15.95**

No. 2—(As Illustrated) Double Action cylinder 4" bore, 18" stroke, 1 1/2" shaft, lifting capacity 12,500 lbs. with 1000 P.S.I. input. Overall length 30 1/2". Clevis mounting at bottom, threaded shaft at top. Cost Gov't. over \$300.00—Special.. **\$29.75**

No. HP4—Hand Pump with handle. Built in check valve—Capacity 2000 lbs. Pressure. \$55.00 Value... **\$11.25**

No. 211—Pesco Type pump for oil, water, air, 1" pipe thread ports. Splined self-aligning **\$15.25**

WELDER SPECIAL \$39.95

Kit Form Easily Assembled Use Your Own Generator



Powerful 200 ampere machine includes special mounting base and all equipment necessary for welder. **AW5 Kit — Complete \$39.95** as above **Same Kit including Generator and Arc Stabilizer \$77.90**

ACCESSORY KIT BARGAIN

EXTRA! A \$17.20 Accessory Kit Complete for only \$15.95! Includes Welding Helmet, Electrode Holder, 5 lbs. Ass't. Rods. Two 10 ft. Welding Leads with terminals and ground clip, plus Audel's Welding Guide. Sold with any Welder Kit... \$15.95
Special Price.....

TEACH YOURSELF! BOOK BARGAINS (Postpaid)

Used by Armed Forces Institute in World War II.

- 1. Electricity for Beginners.** Learn the electrical trade with this simple, well illustrated book. Over 400 pages of concise, clearly written information. Electricians earn big money. Complete **99c**
- 2. Machine Tool Operation.** Learn a high pay trade. Complete data on machine work of all kinds. Learn to be an expert machinist. Detailed and simple to understand. Over 500 illustrations and examples..... **99c**
- 3. Basic Mathematics.** Essentials of mathematics and arithmetic in simple form. This basic course essential as foundation for all trades. Simple review of arithmetic and mathematics in 1 concise book. Easily understood..... **99c**
- 4. Mathematics Essential to Electricity and Radio.** This course applies mathematics directly to electricity, radio. Practical and detailed with over 1,000 workable examples and illustrations..... **99c**
- 5. The Small Business.** Detailed and valuable information on how to set up your own business. Full of illustrations and general information on all types of small businesses. Easily understood and applied. Only..... **99c**

SPECIAL — Order all 5 above books ppd..... \$3.99

ORDER FROM THIS AD

MONEY BACK GUARANTEE—Send Check or Money Order—or small deposit and we will ship C.O.D. Catalog of additional Surplus Bargains, Sent FREE.

LEJAY MANUFACTURING CO., INC.

747 LEJAY BLDG., MINNEAPOLIS 8, MINN.
928-1st AVE. SO., C 47, SEATTLE 4, WASH.

The easy way to paint!

Speedy Sprayer

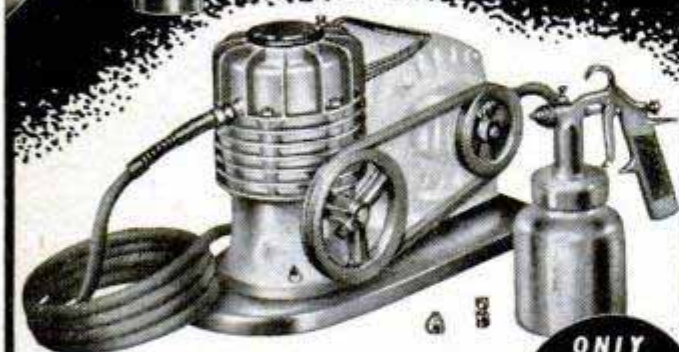

Favorite of home owners and craftsmen for 20 years! SPEEDY SPRAYER gives your work that professional paint finish everyone admires. Sprays paint, enamel, varnish, lacquer, etc. . . . 4 to 7 times faster than hand brushing! Lightweight, portable, uses any 1/4 H.P. motor. Improved diaphragm principle assures clean, oil-free air. You'll find dozens of time and money saving uses for SPEEDY SPRAYER, including spraying insecticides 2-4-D and DDT. Complete outfit, without motor, only \$32.50.

ONLY
\$32.50
LESS
MOTOR

At leading hardware, lumber, and auto supply dealers. FREE—write for handy booklet "How to Spray."

W. R. BROWN CORPORATION
2635 N. Normandy • Chicago 35, Ill.

ACE of ACES
in Low
Cost
Transportation!
Cushman

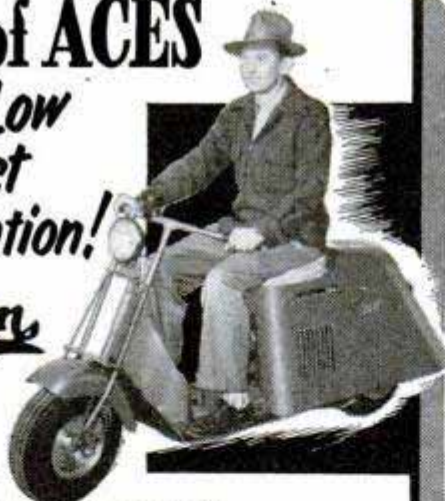

40 miles
per hour!

75 miles per gallon!

Cushman is the top card in the transportation deck. Ride it to work, on errands, deliveries, to school—hundreds of uses in both town and country. No traffic or parking worries, either. And total operating cost LESS THAN A PENNY PER MILE! Go CUSHMAN in 1953!

Write for free illustrated literature.
See your nearest Cushman dealer
for a FREE demonstration.

CUSHMAN MOTOR WORKS, INC.
Dept. PM-1, 900 No. 21 St., Lincoln, Nebraska



STICK with LEPAGE'S



LEPAGE'S INC., Gloucester, Mass.
GLUEMAKERS FOR 73 YEARS



G E A R S

In Stock - Immediate Delivery
Gears, speed reducers, sprockets, thrust bearings, flexible couplings, pulleys, etc. A complete line is carried in our Chicago stock. Can also quote on special gears of any kind. Send in your blueprints and inquiries.

Send for Complete Catalog No. 10
CHICAGO GEAR WORKS
440-50 N. Oakley Blvd., CHICAGO 12, ILL.

VARIABLE SPEED

HYDRAULIC POWER
TRANSMISSION



It has Infinite Speeds 0 to 550, Reverse, Automatic Overload Protection; Adjustable Torque up to 180 inch pounds. 3/4" Input and Output Shafts. It will handle 1/4 to 1 1/2 H.P. Motor. Case measures 7 1/2" long, 7" high 6 1/2" wide. VALUE OVER \$300. Shipping Wt. 25#. On C.O.D. Orders we require a 10% only \$54.50 Deposit. Fab. Chicago

DIRZIUS MACHINE SHOP "J" 1423-25 So. 52nd Ave., Cicero 50, Ill.

HEADQUARTERS for CARBIDE!

Write for Free Catalogue of Tools and Conversion Kits
TIME SAVER TOOLS, INC. MUNDELEIN, ILLINOIS



1953 EDITION

It's New! It's Different! Get world's largest Auto Accessory & Parts Catalog and save money. Over 50,000 items, including Hollywood Accessories, Hi-Speed Equipment, Rebuilt Engines, all parts and accessories for all cars & trucks. We have that Hard-To-Get part! Jam packed with bargains. Completely illustrated. (124 pages) Send 25c (refundable).

J. C. WHITNEY & CO., 1917-XP Archer Ave., Chicago 16, Ill.

LEATHERCRAFT
THE
"HE-MAN" HOBBY



Make Leather Items for Gifts, to Sell, or for Your Own Use

Get started now. LARSON Beginners' Kits of ready-cut projects require no tools or experience. Free instructions included. Make belts, gloves, moccasins, billfolds, woolskin animals and mittens, other attractive leather items. Also America's most complete stock for advanced hobbyists and professional craftsmen. SEND 10c TODAY for big illustrated catalog. **J. C. LARSON CO., 820 So. Tripp Ave. Dept. 2227, CHICAGO 24, ILLINOIS**

AIRPLANE WHEEL ASSEMBLIES



These wheel assemblies are all new, and of heavy duty construction. Depending on load desired to carry, they are ideal for House Movers, Farms, Trailers, Carts, Wheelbarrows, etc.

Complete with Wheel, Tire, Tube and Bearings

26:00 23:00 17:00 5:00x4 10 1/2x4

Size 26:00, 10 ply tire, smooth tread, uses tapered axle size 3 in. x 2 1/2 in. 10 1/2 in. wide. Overall height 26 in. Static Load 6,300 lbs. Weight 54 lbs., Price \$47.50 ea.

Size 23:00, 8 ply, smooth tread. This size complete with axle. Overall height 22 in., axle width 10 in. Static Load 4,700 lbs. Weight 70 lbs., Price \$37.50 ea.

Size 17:00, 6 ply, smooth tread. Uses tapered axle, size 2 in. x 1 3/4 in. 8 in. wide. Overall height 17 in. Static Load 2,000 lbs. Weight 18 lbs., Price \$17.50 ea.

Size 5:00 x 4, 6 ply, smooth tread. Uses straight 5/8 in. axle. 3 1/4 in. wide. Overall height 13 in. Static Load 1,800 lbs. Weight 8 lbs., Price \$12.50 ea.

Size 10 1/2 x 4, 6 ply ribbed tire. Uses straight 5/8 in. axle. 3 1/4 in. wide. Overall height 10 1/2 in. Static Load 1,200 lbs. Weight 8 lbs., Price \$9.95 ea.

Prices F.O.B. Chicago. Include approx. postage on orders paid for in advance. C.O.D. orders enclose 25%, balance sent C.O.D.

U. A. S. Corp. Dept. PM1 5637 W. 63rd Pl. Chicago 38, Illinois

PUMP WATER FAST!



DRAIN WASH TUBS, CELLARS, CISTERNS IRRIGATE—FILL TANKS—DRAW WELL WATER

Pumps 2800 GPH. 420 GPH at 75' High or 1600 GPH from 25' well. Sturdy, Rustproof Alloy Metal. Six Blade Impeller. Uses any 1/8 to 1/2 H.P. Motor. Will not leak or clog. Fits any garden hose. Immediate Money Back Guarantee. Send Check, M.O., or C.O.D. **895 IN U.S.**

MOORE MANUFACTURING CO. SWEDSBORO 1 NEW JERSEY

SPECIAL FOR HOBBYISTS, JEWELERS & WATCHMAKERS, TOOL & DIE MAKERS



SWISS NEEDLE FILES

Genuine Swiss files in all shapes for fine precision work. Full dz. 5 1/2" Pluto Brand needle files to a set.

ORDER BY MAIL TODAY!

STURDY TOOL & HARDWARE CO. Sole Distributors for U.S.A. 156 Chambers St., New York 7

ONLY **\$3.60** POSTPAID set of 12

Do MORE Jobs FASTER with "RED-E" Garden Tractors



Only **\$169.00**

Buy Direct Save Up To 25%

This new 2-wheel, 2-hp Walking Model is just one of RED-E's well-known, bargain priced Garden Tractors. Buy direct, as thousands have already done over the past 30 years. You'll save money—and you'll like RED-E's powerful, gear-driven action—easy handling—and smooth, dependable performance. A real "work horse." RED-E does more jobs faster and easier. 4 wheel, 8 1/2 H.P., Riding Model as low as \$510.00. Also attachments for plowing, sowing, cultivating, wood-sawing, snow-plowing, etc. **SPECIAL FACTORY-TO-YOU DISCOUNT—EASY TERMS.** Write for **FREE CATALOG** today!

RED-E TRACTOR CO. Richfield 377, Wisconsin



Get a Handicraft Workshop

and be Sure it's a Genuine



HANDEE

HANDEE—the original and finest "hand tool of 1001 uses." Dad, brother, uncle—anyone—will derive countless hours of pleasure from this versatile hand tool. Leatherworking, woodworking, plastic craft, metalworking, many types of home repair—**HANDEE** makes them all easy and enjoyable. Get a *genuine HANDEE*, the hand tool that has proven itself through years of service.

HANDEE Complete with 7 Accessories

There are years of relaxing fun and achievement ahead when you give a **HANDEE**. Powerful 25,000 r.p.m. motor. Works off any 110 v. AC-DC circuit. Take advantage of our liberal 10-day money-back trial offer. Order today.

No. 3009, Handee and 7 Accessories.

\$19⁹⁵



drill
grind
polish
sand
saw
cut
carve
engrave

HANDEE 53-Piece Set

Here is an unbelievably complete hobby and handicraft set to delight the heart of any one who appreciates the best. Complete accessories to drill, grind, polish, sand, saw cut, carve and engrave.

No. 3010—Handee 53-Pc. Set \$2750

Order yours today—**HANDEE** sent post-paid on 10-day money-back guarantee. Free Catalog.

CHICAGO WHEEL & Mfg. Co. Dept. PM-1, 1101 West Monroe St. CHICAGO 7, ILLINOIS

STOP CHANGING MOTOR OIL!

End this needless expense forever with

RECLAIMO Today's most advanced OIL RE-REFINING filter FOR CARS, TRUCKS, TRACTORS.

Continuously cleans and RE-REFINES motor oil as you drive by utilizing motor heat — keeps oil in high grade lubricating condition at all times.

"RECLAIMO"

- REMOVES SOLIDS (by filtration)
- REMOVES WATER (by distillation)
- PREVENTS Excess fuel dilution
- PREVENTS Acid and Sludge Formation
- ADDS Thousands of Miles to Engine Life

MAINTAINS Stable Viscosity **ELIMINATES** All Oil Changes
 FREE 32-page book "OIL FACTS" with bonafide \$1,000.00 offer on page 30. Gives you the complete "Reclaimo" story and details of our extraordinary 90-DAY NO-RISK TRIAL OFFER. Write for your copy today!

RECLAIMO MFG. CO., INC.

5083 Elston Ave., Dept. 53, Chicago 30, Ill.
 Wm. Schwalge, U.S. Pats. 1757223, 1834654, 2068473.

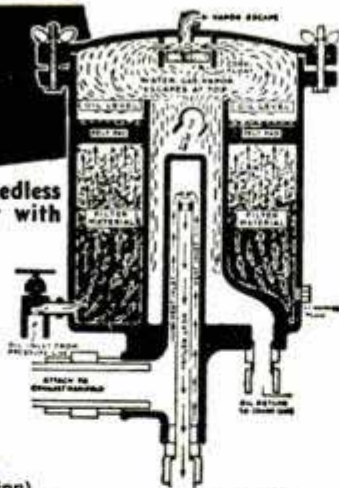

DEALERS WANTED

U. S. BUREAU OF STANDARDS, Bul. 86 States, "Oil does not wear out mechanically."

ACCURATE, low cost shooting



CROSMAN ARMS CO., Dept. 45, Rochester 20, N.Y.

POWER MOWERS & KITS FREE PLANS

LOW FACTORY PRICES DIRECT TO YOU



It's easy to build your own quality 18" or 20" mower with our LOW COST KITS, Parts, Engines. Free plans guide you. Parts finished, ready to use. Fully guaranteed. KIT shown includes: Front swivel unit with 8x1.75 wheel; Center Post and V-belt pulley; your choice of 18" or 20" cutting blade; 2 Rear rubber tired wheels size 10x1.75 with axles and brackets. Bolts, nuts included. All for \$31.95. Send check or money order for postpaid shipment or 10% down, balance C.O.D. Literature and Price List on request.



MANUFACTURERS OF AMERICA'S FINEST COMPLETE MOWERS. Write for Prices.

TRIANGLE MANUFACTURING CO., Box M-18, Fort Scott, Kansas

Say You Saw It in Popular Mechanics

107 TOOL SILHOUETTES

PUT YOUR SHOP IN ORDER! STOP HUNTING FOR TOOLS!

MAKE A TOOL BOARD that shows everyone where to replace tools. Simply cut out and apply with ordinary electric iron. New adhesive plastic is not affected by moisture. Your 107 "Tracers" include full size silhouettes of 2 saws, complete set of chisels, box end wrenches, open end wrenches, bits, clamps, pliers, cutters, etc. Face of "Tracers" is ready varnished for long life.

Mail Check, M.O. or C.O.D. to **TRACERS** 1970 MARSHALL RD., KIRKWOOD (22) MO.



Three Authoritative Books Every Fan Needs!

AUTOMOBILE RACING

Famous for authoritative, detailed information on auto racing, every type race car, rules, specifications, working drawings, plans, etc. No duplication. Every book is different.

AUTOMOBILE RACING, 6th Ed.

★ Championship cars, big cars, midgets, roadsters, Offenhauser dirt track car. Specifications on Indianapolis cars. Four-wheel drive details, front drive drawings. Plans for Ford 60 midget, roadster racer, data on engines, gear boxes, clutches, axle ratios, compression ratios, etc. Indianapolis rules and regulations. More than 100 illustrations. Only \$2.00.

Fast—How to Make Them Fast—How to Build Engines—How to Build Chassis—How to Build Bodies—Who Holds What Records—What the International Formula Is—What Midget Racing Rules Are—How World's Record Cars are Built—How to Speed Up Ford V8 Cars! Only \$1.00.

AUTOMOBILE RACING, 4th Ed.

★ Gives information on midgets, including three sets of working drawings and complete building instructions. Miller-Ford V8 Front Drive Racers are illustrated and described, also other big-time data featured. Only \$1.00.

AUTOMOBILE RACING, 5th Ed.

★ Tells you—Why the Fast Ones are POPULAR MECHANICS PRESS, Dept. 350, 200 E. Ontario St., Chicago

STOP JERKY STARTS! with an AUTOMATIC CLUTCH

END BELT SLIPPAGE—Get smooth pickup for your power mower, scooter or garden tractor with only throttle control.

PREVENT STALLING engine, cut belt wear, gain no-load idling. Quickly and easily installed on 1/2, 3/8, 3/4, 1" shafts. Every clutch factory tested.



See dealer or write for Folder PMI. V-PLEX CLUTCH DIVISION • Hagerstown, Indiana

FIX YOUR OWN...

PLYMOUTH or CHEVROLET

IT'S EASY!

Popular Mechanics Magazine has just published two new Owners Manuals covering all 1941 to 1952 models of Plymouth and Chevrolet cars. So accurate mechanics use them... so simple a woman can understand them.

Save money on your repairs. Prevent trouble. Enjoy care-free driving. Increase trade-in value. Avoid major repairs by fixing minor troubles before they get serious. Get sparkling performance at all times. Each manual has 272 pages, more than 350 photos, diagrams, tables, charts, breakdown drawings, plus clear, non-technical directions that make all repairs simple as ABC. Each Manual written by Ed Packer, one with assistance of Chrysler Corporation, the other with assistance from General Motors Corp. Shows you how to diagnose troubles by feel, sound, sight, smell and performance. Simple trouble shooting. Permanent repairs. Emergency repairs. Plus "How to get value from garages."

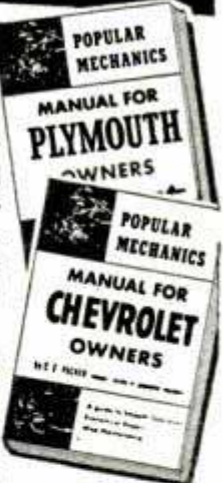

MONEY BACK IF IT DOESN'T SAVE MORE THAN THE COST!

One minor repair will save the cost ten times over. Read it. Then you decide. If you don't see that you'll save more than the cost, send it back for refund, SEND NO MONEY. Just send postcard. Be sure to specify whether you want PLYMOUTH or CHEVROLET Manual. Postman will deliver C.O.D. for \$3.50 plus postage. Or, to save postage cost, send \$3.50 with your order. Send today. Save its cost on your next repair.

POPULAR MECHANICS PRESS
 200 E. Ontario, Dept. 1810, Chicago 11, Illinois
 POPULAR MECHANICS



CAPE COD CHAIRS TRELLISES • ARBORS DUTCH WINDMILLS

Chairs style B-C-A PLANS 50c Ea., all 3 only \$1.00. 12 different trellis designs PLAN of all 12 only 50c. Unique PLAN only 75c. Unique 40" high Lighthouse having copper lantern, ideal for garden or on lake shore of summer home. Large detailed PLAN 75c. SPECIAL all plans above \$3.00 val. Only \$2.50. Send 10c for catalog Craftsman's Model Co. Dept. P48 DELAFIELD, WIS.

TOOLS AT WHOLESALE

PROFESSIONAL MECHANICS HAND TOOLS
Farm, Household and Special Tools
TOP QUALITY, FACTORY GUARANTEED
Write Today for FREE CATALOG
MECHANICS CO-OP
Dept. X Oakland 8, Calif.

MAGNETS OF ALL TYPES — 10c UP

AMAZINGLY POWERFUL!!
6 ounce horseshoe magnet—\$1.50.
Our Leader, 1 lb. magnet lifts 40 lbs. \$2.95. New alloy—will not weaken! Useful for lifting valuables from tanks, lakes, or rivers easily! 7 small magnets \$1.25 with list of many shop and home uses. Satisfaction guaranteed.
R. EYRICH, 1219 W. MEINECKE AVE., MILWAUKEE, WIS.

NEW INVISIBLE WOOD FASTENERS

Especially Designed for Countersinking
New type "CHEVRONS," 3/8" depth for hard and soft woods of thicknesses up to 2 1/2". Draws wood together. Just hammer in and countersink instantly with Chevrons Countersink. Illustration shows slots filled with putty. Prevents rust. At your dealer or send only \$1.00 for 100 "Chevrons" postpaid. Add 35c for countersinking tool. Money back if not delighted.
E. B. PACKARD CO., Inc., Dept. PM-12
139 CEDAR ST., NEW YORK 6, N. Y.

SILVER SOLDER TORCH & KIT \$7.95

JOINS ALL METALS PERMANENTLY
Do your own repairing. KIT includes one tube silver solder paste and 10 5-in. lengths silver solder alloy. Hot-test ALCOHOL TORCH known. 2700° F. flame. Operates in any position, indoors or out. Pint of special fuel included. Complete outfit ready for use \$7.95 postpaid. TORCH alone with pint of special fuel \$6.85. KIT alone \$1.65. Instructions included.
AMERICAN PRODUCTS CORP., 422 S. Dearborn, Dept. 3-A, Chicago

TRANSFORMER WELDER \$18.95 FOR QUINCY

Complete with everything. Ready to plug in. 110 volts A.C., 15-30 amps. 3 heats. Welds metal from 1/16" to 1/4" using 1/16" to 3/32" standard rods. Guaranteed unconditionally. 10-day trial. No C.O.D. We also make welder for 16-22 gauge metal, \$3.95; 1/8" metal \$6.45.
ESSAY MFG. CO., INC., Dept. 51, Quincy 69, Mass.

POWER HACKSAW \$52.75

LESS MOTOR
F. O. B. Benton Harbor
● Rugged cast iron construction. Wt. 56 lbs. bronze bearings. Draw cut. Auto. return lift. Auto. shut-off. Vise swivels 45°. Cap. 4"x4".
Send for full details and name of nearest dealer.
EXCEL MACHINE TOOLS BENTON HARBOR, MICHIGAN
Dept. PM-13

BATTERIES!—START

—a factory at home and re-cast junk batteries into new; latest achievement. We supply complete instructions and everything needed. Large daily profits!
BATTERY LABORATORIES, Dept. PM, Minneapolis 4, Minn.

SUPER DRILL GRINDER

Sharpens round shank drills from 3/32" to 1/2" in diameter, up to 6" long. Grinds old drills like new in 4 different point angles, using hand or power grinding wheels. Money-back guarantee. Only \$2.95
At Dealers or Postpaid
A. D. McBURNEY 317 E. 4th St., Dept. A-25
Los Angeles 13, Calif.

NOW! SAW 2x4's IN ONE EASY CUT WITH NEW LARGER 'ARCO-SAWS'



Amazing New Safecut Blade Allows Any 1/4" Drill To Whiz Thru Heavy Lumber, Wall-board, Plywood, etc.
At last, here are the first—the only—gear driven saw attachments to whiz thru 2x4's in one cut! Imagine, now you can build anything from bookcases to a bungalow with these sensational new saws. A moderately priced drill will do the job because of new "ARCO SAFECUT" Blade.

ONLY "ARCO" GIVES YOU THESE FEATURES:
5-inch Safecut Blade—cuts faster—uses 30% less power, Graduated Depth & Bevel Gages for cuts to 1 3/4"—bevels from 0 to 45°, Adjustable Rip Gage & Visual Guide, Sturdiest and Easily Adjusted Safety-Yoke keeps drill steady, Worm Drive Clamp releases drill in seconds, Precision Gear Box with Steel Gears, 90-DAY FACTORY GUARANTEE.
REPLACEMENT BLADES: Specify 5" Safecut, or Combination, or Rip, or Crosscut Style..... \$1.75

NEW! 'ARCO STAND 'N TABLE'

MAKES A WORKSHOP OUT OF EVERY 1/4" ELECTRIC DRILL!
HAS TILTING TABLE FOR Sanding, Grinding, Buffing, etc.

Sturdy Aluminum Castings hold complete unit vibration-free, allows operator to use both hands.
Consists of strong Drill Stand with Worm Drive Clamp and adjustable Table. Tilts to 45°, adjusts up or down for various jobs. Rubber cushioned Sander for beautiful sanding, can also be used in drill alone or drill press. 6 Sanding Discs and "Speed Cement."
No. 400 \$7.95
No. 401 "ARCO STAND" consists of Drill Stand & Worm Drive Clamp only..... \$2.75

NEW! 'ARCO SAFECUT' SAFETY SAWBLADES

The Safest, Fastest Cutting Sawblade Ever Made! Made of finest tempered tool steel. No "Kick-back" accidents—cannot drag hand into blade. Easily and quickly resharpened with ordinary handfile.
6-inch Blade..... \$1.75
7-inch Blade..... \$1.95
8-inch Blade..... \$2.15
Special Bores for Skill, Mall, B & D Saws—Add 30c
10-DAY MONEY BACK GUARANTEE ON ALL ITEMS
BUY THE BEST—see your hardware dealer now! Don't accept inferior substitutes—if not available send us check or M.O. (Postpaid), C.O.D.'s—postage extra.
DEALERS: Write for nearest jobber.

ARROW METAL PRODUCTS CO.

Dept. PM-1, 140 WEST BROADWAY, N. Y. 13, N. Y.

Amazing Midget Wrist Radio

\$2.98
Enjoy music, sports, programs with your own private, portable Wrist Radio! Use indoors or outdoors! Brings in local stations up to 50 miles! Worn like wrist watch, yet receives regular radio stations. Has super-sensitive crystal diode (worth \$1.95 alone!) & needs NO BATTERIES! NO TUBES! NO ELECTRICAL PLUG-INS! Lasts for years with NO EXPENSE! Built-in earphone. Complete with 2 clips. Just connect & set is ready for use. About 2 1/2-in. diameter, colorful plastic case, adjustable im. leather band. Only available at this low price while war-surplus diodes last so order now!
Complete Postpaid
NO BATTERIES! NO TUBES! NO ELECTRICAL PLUG-INS! Lasts for years with NO EXPENSE! Built-in earphone. Complete with 2 clips. Just connect & set is ready for use. About 2 1/2-in. diameter, colorful plastic case, adjustable im. leather band. Only available at this low price while war-surplus diodes last so order now! \$2.98
(2 for \$4.98) EACH COMPLETE POSTPAID ONLY.....
JOHNSON SMITH & CO., Dept. 642, Detroit 7, Michigan
Send 10c for catalog of 3000 novelties, gadgets, funmakers, etc.

Heike's 1953 Hobby Catalog-35c



Collector's Catalog of historical and scientific items. — Selling: 450 historical firearms — 20,000 Indian Relics — Collectors Cartridges — Coins — Confederate Money. — Revolutionary, Civilwar, Indian Wars, Flintlocks, percussion muskets, Swords, Bayonets, Pistols, Revolvers, Ramrods, Bullet Molds, Percussion Caps, Powder Flasks, Powderhorns, Blunderbusses, Civilwar Handgrenades, — Stagecoach Carbines, Winchester Rifles, Kentucky Rifles, Pepperboxes, Gun Barrels—Locks—Nipples.—**ARROWHEADS**, Tomahawks, Battle Axes, Gempoints, Spearheads, Peace Pipes, Arrow making Stones, Discoidals, Bannerstones, Gorgets.—**Steerhorns**, Buffalo Horns, Eagle Feathers, Deer Horns, Elk Antlers, Bo-wood, Blohorns, Mounted Squirrels, Pheasants, Ducks, Owls, Quails.—**AGATES**, Fossils, Minerals, Marine Shells, **Violin Wood** — Daguerreotypes, Ambrotypes, Scalping Knives, Duelling Pistols, Gold Dollars, Frontier Colts, etc., too numerous to mention.

SPECIAL: 5 Arrowheads, \$1.65—Tomahawk, \$3.88—Scalper, \$1.88 — Hammerstone, \$2.40 — Civilwar Musket, \$28.65 — Sword, \$16.40—Bayonet, \$1.98—Powderhorn, \$8.75—25 Indianhead Cents, \$1.98—Agate, Fossil, Rattler Geode, Galena, Pyrite, Gastropod, Brachipod, Molybdenum, Crinoid, Chalcopyrite, Barite rose, Petrified wood, each \$.48, all 13, \$5.00.

Send 35c for your profusely illustrated 1953 catalog today.
R. HEIKE, 153 M Street, Wenona, Ill.

Say You Saw It in Popular Mechanics



\$19.95

THE NEW *Regency* VB-1 Voltage Booster

Get peak performance from your TV set or any electrical device drawing 350 watts or less. This manually operated autoformer maintains full 117 volt power supply. Insures full size TV picture when low line voltage shrinks picture size.

Available at all Radio Dealers or write:
I.D.E.A., INC., REGENCY DIVISION
7900 Pendleton Pike, Indianapolis 26

BARRON Drill Press TOOLS



FOR WORKSHOP AND INDUSTRIAL USES...

Over 40 precision built woodworking tools and accessories... Hi-Speed Router Bits—Rotary Surface Sanders & Drum Sanders—Safety Shaper Cutters—Dovetail Cutters—Large Auxiliary Metal Tables—All Metal Shaper Fences—Spindle Adapters—Handy Bench Vises. Many other items indispensable for accurate, useful, versatile workshop use. Every tool sold on complete satisfaction or your money back. See your Barron Dealer. Ask for special folder — "24 Extra Uses for Your Drill Press."

ROTARY PLANER

Planes • Rabbits
Tenons • Panels
Routs • Bevels

Only \$7.50 COMPLETE

BARRON TOOL CO. INC.
365 Architects Bldg., Detroit 1, Mich.



MAGNETS

GENUINE ALNICO—NEVER WEAKENS

225^{lb.} PULL

AMAZING, PERMANENT MAGNETS—WILL NOT WEAKEN; NON-ELECTRIC

Retrieve guns, tackle, tools and other steel items from lake, river, plating tanks, drains or other hard-to-reach spots. Recover drills, taps, etc. from sweeping. Clear alley of harmful tacks, nails. Many other uses. Pays for itself quickly. **GUARANTEED.** Try any magnet one week. Money refunded if you are not well pleased.

- No. M-725 (Weights 54 oz.) Has pull of 225 lbs. on steel block..... \$15.00
- No. M-675 (Weights 49 oz.) Has pull of 175 lbs. on steel block..... \$10.50
- No. M-650 (Weights 41 oz.) Has pull of 150 lbs. on steel block..... \$ 8.50
- No. M-30 Hobbyist assortment of six small magnets..... \$ 1.50

Send Money Order or Check. We pay postage. No C.O.D.'s.
MIAMI MAGNET COMPANY 3240 N. W. 27th Ave. MIAMI 42, FLA.

WATERLOO METAL BOXES AND CHESTS

NEW SMALL PARTS CABINET

Metal bound. Baked green enamel. Green plastic drawers. Removable dividers. At hardware stores. Write for free catalog—complete Waterloo line of metal boxes and cabinets.
Waterloo Valve Spring Co., Waterloo, Ia.

NEW, IMPROVED CALCULATOR FOR WOODWORKERS only 25c

Instantly gives information on lumber, nails, concrete mixes, painting materials, etc. Convenient, simple to read. Just set dial for nail specifications, to convert linear to board feet, find bit sizes for screws, compare characteristics of woods. 6" diameter heavily varnished cardboard. Send 25c, no stamps, please to Greenlee Tool Co., 2101 Columbia Avenue, Rockford, Illinois.

AUTO OWNERS... GET SUMMER STARTING IN WINTER—SAVE BATTERIES SERVICE CALLS AND DELAYS!

E-Z-E START MOTOR OIL HEATER keeps motor oil warm for easy starting in the coldest weather. You replace your present oil measuring stick with an Anger E-Z-E Start Motor Oil Heater. It operates from any 110 volt lighting circuit, and it is as economical as a 50 watt light. Endorsed by present users and sold on a money back guarantee — \$7.95 postpaid. Send check or money order with make, model and year of car.

WRITE FOR FREE FOLDER!

ANGER MANUFACTURING CO.
Box R-4787 Redford Station • Detroit 19, Mich.

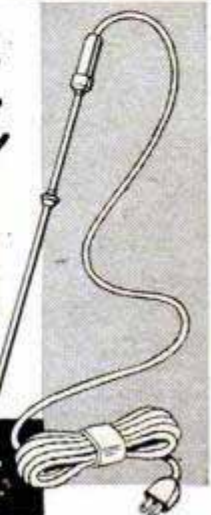

EXTENSION CORD



(Item 16) 40 ft. heavy duty, made of specially insulated No. 14 2-conductor wire. So tough that you can drive over it and yet flexible and easy to handle. Resists oil, grease or water. Extends electricity up to 400 ft. without voltage drop. Use indoors or out. Complete with heavy rubber plug and outlet. Wt. 2 1/2 lbs. Usually \$4.50—Special 40 ft. \$1.99
Comb: 2-40 ft. and 1-20 ft. (total 100 ft.)..... \$4.95
100 ft. length (one piece) \$4.85
WIRE ONLY (Item 50)
No fittings. 100 ft. \$4.00

HEATING & VENTILATING FAN

(Item 10) Easily installed in furnace pipes. Forces even heat to all rooms. Over range, removes kitchen smoke and odors. Powerful continuous duty motor, 110-120 v. A.C. Quiet, super efficient fan moves huge volume of air (400 to 600 c.f.m.) 5" Fan, wt. 5 lbs., \$6.85; 9" Fan, wt. 6 lbs., \$7.85; 10" Fan, wt. 7 lbs., \$8.85; 12" Fan, wt. 8 lbs., \$9.85.
HEAVY DUTY 12" fan, enclosed motor, suitable for spray booths, restaurant exhausts, poultry houses, and other difficult applications. Wt. 12 lbs. Item 10D. \$12.95



RUBBER HOSE

New genuine Neoprene Hose—outlasts ordinary rubber 3 to 1. Reinforced with super tough cotton cord piles. Flexible. Easy Flo brass couplings with standard pipe threads for quick connections. Included. Pump water for irrigation, stock tanks, home, barn, fire fighting, etc. Pump Gas or Fuel Oil. Save more than 60%.

In. Diam. 1" 1 1/4" 1 1/2" 1 3/4" 2"
Length 10 ft. 25 ft. 50 ft. 100 ft. 30 ft.
Price \$5.95 9.25 24.75 49.95 14.75

If specified we will send special hose for gas or oil at same prices.

32 Pc. SOCKET SET



32-pc. Socket Set (Item 59)
Highest quality gear, non-breakable sockets made by Husky. Beautiful, matched chrome alloy, absolutely the best. Complete range of 21 sockets from 1/4" thru 7/16" in 1/4" drive and 1/2" thru 1-1/16" in 1/2" drive; 2 extensions, reversible 1/2" ratchet, adaptor bit, slide head, all angle coupling, 2 end wrenches, 1/4" speeder handle and sturdy metal tool box. For prof. mechanics who want the best. Wt. 14 lbs. Easily worth \$41.50. While they last only..... **\$16.95**

45 Pc. SOCKET SET
(Item 205) Contains a complete set of sockets in 1/2" drive, 3/4" drive and 1/4" drive, plus all necessary extensions, handles, speeders, reversible ratchets, etc.; all uncond. guaranteed against breakage. Beautifully matched chromed thin wall alloy sockets in a sturdy handsome steel tool box. Wt. 17 lbs. List price \$62.90. **Factory Special..... \$26.95**

HYDRAULIC JACKS

(Item 208) Heavy duty, precision built, smooth, positive acting with built-in relief valve. Hi-Lift with screw extensions. Govt. surplus at a fraction of orig. cost. (Handle included.)
1 1/2 ton (Item 208) Wt. 11 lbs. **\$6.45**
3 ton (Item 208A) Wt. 15 lbs. **\$9.45**
5 ton (Item 208B) Wt. 17 lbs. **\$11.45**



FACTORY PRICES YOU PAY LESS THAN 50% RETAIL

SATISFACTION UNCONDITIONALLY GUARANTEED
HI-LINE 6000 WATT PLANT

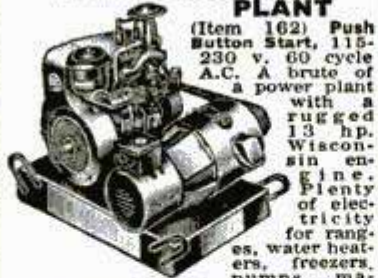

(Item 162) Push Button Start, 115-230 v. 60 cycle A.C. A brute of a power plant with a rugged 13 hp. Wisconsin engine. Plenty of electricity for ranges, es, water heaters, pumps, machinery, etc. Affords both 110 and 220 volts. Ideal where heavy current is needed. Wt. 590 lbs. Easily worth \$995.00. With self starter. Factory price... **\$645.00**
Generator and control box only, belt driven. Use your own engine or tractor. Wt. 240 lbs. (Item 163) Factory price. **\$345.00**

HEAVY DUTY D-C ARC WELDER



Use as portable or shop welder. Up to 300 amps. Senior model. Made for years of trouble-free, continuous service. Will handle light or heavy jobs. Easily welds up to 3/4" plate using 1/4" rods. Built-in air cooling system. Arc is easy to strike and hold, because of specially designed arc stabilizer. Hi-to switch and dial control gives wide range of welding heats. Run welder at 2600 rpm. with tractor, jeep or 15 hp. gas engine, or 7 hp. elec. motor. Complete with instructions, gear, and double V belt or flat pulley. You can pay more, but you can't buy a better welder. Wt. 110 lbs. **\$99.75**
\$400 value at.....

DUAL CONTROL MODEL same as above but with built-in dual rheostat for low heat soldering. **\$119.50**
WELDING KIT, Two 10 ft. leads, welding helmet, electrode holder, ground clamp. Sold only with welder at..... **\$10.50**
Write for prices on A.C. Arc Welders.

HEAVY DUTY POWER CABLE
#12-2 Cond.—stranded, very flexible, rubber covered, special outside conductor for grounding power tools, etc. Finest heavy duty power cable made. 50 ft. (Wt. 8 lbs.) Item 199. **\$6.95**
100 ft. (Wt. 16 lbs.) Item 200 **\$12.95**

COMMANDO MOTOR BIKE

Speed to 40 M.P.H. Travels on Any Kind of Road. Amazing 5 Yr. Guarantee
The Commando Motor Bike is new throughout. Advanced engineering—Automatic Clutch provides quick acceleration and easy hill climbing—yet motor idles at will when you stop. No belts or chains. Rugged lightweight 2-cycle engine delivers dependable power with long life. Transmits power direct to rear wheel with modern Dynarator. Easy automatic pedal or pull starting. Special control permits pedalling if desired. Perfect balance and comfort. Anyone can ride a Commando Motor Bike—safe and easy. Rear mounting of motor eliminates hard steering, dirt, fumes and heat. Really trouble-free! Rugged heavy duty cycle, custom built by famed Schwinn. Ride for health and pleasure; ride to work or school; make deliveries. Order now. Easy payments available. Ask for free circular.
Commando Motor Bike Town & Country Cruiser Model...
1 cyl.—1 1/2 hp. motor, complete—no extras to buy..... **\$199.50**
Commando Motor Bike Super Chief Model... Motor cycle-type 24" wheels; large flange-type brakes; heavy spring fork; powerful Commando twin cylinder 3 hp. motor. Complete—no extras to buy..... **\$249.50**

EXTRA! Convert your own pedal bike into a motorized miracle in one hour with a Commando Motor. Complete with easy-to-follow fittings and instructions. Commando Captain Bike Motor, single-cylinder, 1 1/2 hp., Wt. 35 lbs. Complete—nothing else to buy. Item C90. Factory Price **\$125.00**
Deluxe Twin-Cylinder Commando General Bike Motor, 3 hp., Wt. 42 lbs. Item C91. Factory Price..... **\$149.50**
Dealers: Send for our special proposition.

PORTABLE LIGHT PLANTS



350 watts—115 v. D.C. powered by a sturdy, easy-starting 1 1/2 hp. Briggs engine, perfect for lights, radios, razors, etc. in cabins or trailers. Use standard light bulbs. Built-in control box with receptacle—just plug in. Weighs only 65 lbs. Item 273. Reg. price \$190.50. **\$99.75**
A terrific value at.....
PUSH BUTTON START A.C. PLANT
500-700 watts—115 v.—60 cyc. A.C. Powered by a rugged 2 hp. easy-starting Briggs gas engine. No wiring necessary, just plug in and operate. Plenty of current for any oil burner, freezer, brooder, emergency lights, etc. which require up to 700 watts. Ideal for Civil Defense, Fire Depts., trailers and camps. Complete with Voltmeter and built-in winding to charge 6 v. auto batteries. Item 24. Wt. 85 lbs. Fully Guaranteed. Be Prepared if war or storm knocks out power lines. Reg. \$275 value..... **\$143.50**
1000-1200 Watt Plant (Item 45) same as Item 24 but larger generator and engine... **\$199.50**

GIANT 2000-2500 WATT PLANT

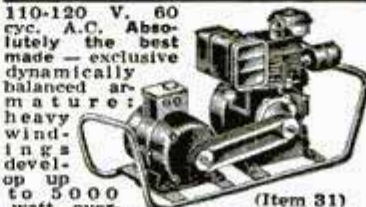

110-120 V. 60 cyc. A.C. Absolutely the best made—exclusive dynamically balanced armature; heavy windings developed up to 5000 watt overload for motor starting. Skid-mounted—portable. Powered by easy starting Briggs or 6 hp. Wisconsin engine—complete with all accessories; engine easily disconnected for other uses. Big outlet box, voltmeter, no wiring necessary. Ample current for all purposes. Factory warranty and complete instructions included. Wt. 220 lbs. Reg. price \$585.00. Special at..... **\$299.50**
With Electric Self Starter. **\$359.50**
GENERATOR ONLY and control box. Drive it with your engine or tractor. **\$169.50**

3000-3500 WATT PLANT
(Item 198) 110-220 v.—60 cyc. A.C. with Wis. Engine, push button start. Wt. 370 lbs. Heavy duty..... **\$399.50**
Generator only for belt drive, Wt. 115 lbs. (Item 198A)..... **\$239.50**



New Automatic Transmission
Mileage Up to 150 per Gallon

CARRY-AIR (Item 52) Stainless steel tank—capacity 500 cu. in. at 400 lbs. press. complete with inlet and shut-off valves, press. gauge, detachable air hose, tire chuck. Fill at any service station. Carry air for tire inflation, blowing out lines, spray painting, insecticides, etc. One emergency pays back cost. Wt. 10 lbs. Worth \$20.00. Our price..... **\$8.95**
(Item 55) With big double tank (1000 cu. in.)..... **\$11.95**
(Item 58) Tank only, 500 cu. in. (no fittings)..... **\$5.95**



MASTER SNOW BLOWER

No Pushing — Self-Propelled
It's a lawn mower
It's a power sickle
It's a cultivator
It's a plow
It's a bulldozer
It's a rotary tiller

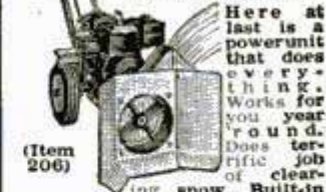

Here at last is a powerunit that does everything. Works for you year round. Does terrific job of clearing snow. Built-in power takeoff to drive pumps, saws, generators, etc. Safety clutch—can't burn out. More versatile and efficient than tractors costing twice as much. Basic self propelled 2 hp. tractor—Briggs or Clinton engine. Only **\$119.50**
Tractor shown with snow blow attachment.
Snow Blow..... **\$39.50**
Lawn Mower Hitch..... **\$4.50**
Cultivator..... **\$8.75**
Rotary Tiller..... **\$42.50**
Sickle Bar-Mower..... **\$42.50**
Bulldozer..... **\$11.25**
Freight prepaid to most areas. Easy payment plan available.

MASTER AIR COMPRESSOR



(Item 209) High pressure type for large volume of air for heavy duty service. For paint spraying, inflating truck and auto tires, greasing, and the hundreds of other jobs done by compressed air. Piston type. 2" bore compressor with built-in air filter. Master built with hi-strength alloys and precision bearings. Stainless steel tank, 12"x24", 2100 cu. in. cap. Safe up to 500 lbs. Equipped with automatic switch that starts and stops motor to maintain desired pressure (up to 150 lbs.) and check valve, safety valve, gauge, shut-off valve, 20 ft. air hose and tire chuck. Beautifully balanced on ball bearing wheels and rubber tires. Low factory prices.
With 1 1/2 hp. 110 v. A.C. motor (Reg. \$175.00) (Item 209)..... **\$98.50**
With 1 1/2 hp. motor (Reg. \$199.50) (Item 209A)..... **\$119.50**
With 2 hp. Briggs Gas Engine (Reg. \$109.50) (Item 209B)..... **\$109.50**
Write for price of compressor only. A complete line of spray guns and air tanks available.

Variable Speed Selector



Heavy duty, made by S. F. GOODRICH for industrial use. Provides instant speed changes for any drive. For machine tools, dryers, printing, conveyors, production lines, hoists—any operation requiring variable speed. Ideal for midcut autos. Employs reliable "trouble free" planetary system. No hydraulic power losses or creeping. Infinite range, smooth operation, easy installation (data included). 3 sizes: 1 1/2 hp. wt. 36 lbs.; 1-2 hp. wt. 55 lbs.; 2-3 hp. wt. 105 lbs. Reg. list \$228, \$252 and \$332. Our prices... **\$79.50, \$89.50 and \$114.50.**

Factory Prices on Catalog Items

Send 10c for BIG 1953 catalog. Hundreds of bargains.

Prices f.o.b. Factory. 10 day Money back guarantee. Send check or Money Order
MASTER MECHANIC MFG. CO., DEPT. 79-B Burlington, Wis.

Schupack's AMAZING TOOL BARGAINS! ALL BRAND NEW MERCHANDISE

112 PIECE ASSORTMENT \$3.95
FOR ELECTRIC GRINDER
 \$10.00 VALUE — ONLY! **Post-paid**

Here's what you get! Mounted Stones on 1/2" mandrel, Drum Sander, Sanding Sleeves for sander, Rotary Cutters, Wire Scratch Brush, Bristle Brushes, Circular Saw, Buffing Wheel, Grinding Wheel, Rubber Polishing Wheel, Cut-off Wheels, Rubber Cylinder, Mandrels to fit above tool, Assorted Sanding Discs, Sharpening Stone, etc.

18 ROTARY CUTTERS \$5.85
 \$13.50 Value **Post-paid**

Illustrated 1/2" actual size

Assorted sizes cutter on 1/4" or 3/32" shank. Will fit all hand grinders. Ideal for cutting wood, metal, or plastic. Brand new.

12 MINIATURE CUTTERS \$1.00
FOR CUTTING WOOD, PLASTIC, OR METAL **Post-paid**

Actual size. Assorted shapes on 3/32" shank. For die makers, home workshop, etc.

7 HIGH SPEED TWIST DRILLS \$1.00
 15 DRILLS FOR ONLY \$2.00! Order Today! **Post-paid**

7 Popular Sizes—up to 1/4" Brand new. Ideal for home or shop use. Fits all standard chucks.

5 DRILLS FROM 1/4" to 1/2" DIAMETER—\$1.95

SURPRISE VALUE 100 Pieces \$1.00
FOR ELECTRIC GRINDERS **Post-paid**

Grinding Wheels, Cut-off Wheels, Sanding Discs, Mounted Stones, Sharpening and Honing Stones, Rotar Cutting Burs, Abrasive Cartridges, Mandrels, and many other items.

Free!

For a limited time only, and while supply lasts, we will give the items below absolutely FREE with every order for \$6.00 or more. Value of these FREE items is \$3.25.

- 3 Grinding Wheels 1 1/2" to 3 1/2"
- 1 Cut-Off Wheel 3" Dia.
- 2 Buffing Wheels 3" & 4" Dia.
- 2 Felt Pol. Cylinders

Every item in this ad, including the FREE items, is BRAND NEW FINEST QUALITY merchandise, sold with the Schupack guarantee of satisfaction. To get this FREE Offer clip this ad to order. All mdse. postpaid in U.S.A.

1953 Illustrated Catalog 10c

FLEXIBLE SHAFT — ONLY \$4.95 **Post-paid**

Fits all electric drills & hand power tools. 35 3/4" long. Oilite bearings. Core of specially wound, high carbon steel wire in flexible steel casing. Will accommodate tool shafts up to 1/4" dia. For lathes, electric drills, etc.

2 DRUM SANDERS \$1.50 **Post-paid**

With 12 Bands in Assorted Grits. 1 1/2" dia. x 1" long on 1/2" arbor with 12 Bands

ONE DRUM, 1" DIA. x 1" LONG ON 1/2" ARBOR WITH 6 EXTRA SLEEVES \$1.00 **Post-paid**

12 MOUNTED WHEELS \$2.95 **Post-paid**

and points on 1/2" Mandrel.

For grinding on plastic, wood soft and hard metal. Regular \$5.40 List. Val. 12 wheels on 1/2" Mandrel \$3.60

18 MOUNTED POINTS ON 3/32" MANDREL \$2.50

18 GRINDING WHEELS \$1.00 **Post-paid**

and rubber polishing wheels up to 1" dia. For grinding & polishing metals, plastic, wood. With one 3/32" mandrel.

10 CUT-OFF WHEELS 1 1/2" DIA. WITH 1/2" MANDREL \$1.00

20 ABRASIVE ROLLS, cloth, and 1/4" mandrel \$1.00 **Post-paid**

for grinding, sanding, deburring metal, plastic, wood or rubber. ONLY....

ADAPTER CHUCK \$1.50 **Post-paid**

With 2 interchangeable collets, opening from 3/32" to 9/16" on 1/2" mandrel. Price each only

2 CIRCULAR SAWS \$1.50 **Post-paid**

ON 2 MANDRELS — ALL AT ONE LOW PRICE

1" diameter saws on 1/2" Mandrels. For cutting wood, plastic, or soft metals. Order at once! Send Check or Money Order.

SCHUPACK SUPPLY CO., 7331 COTTAGE GROVE AVE., DEPT. M-38 CHICAGO 19, ILL. SEND CHECKS OR M. O. NO COD'S PLEASE

Made \$2,600 LAST SEASON

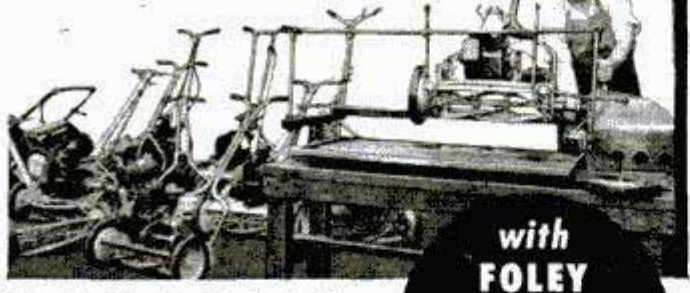

99c Profit On Each Dollar

It costs less than 1c per mower for electricity and material. The Foley sharpens all blades and cutter bar together just like lawn mower manufacturers do it. Start in spare time in basement or garage. The Foley handles up to 3 or 4 mowers per hour—prices run \$1.50 to \$3.00 for hand mowers—\$5.00 to \$8.00 for power mowers.

FREE—VALUABLE ILLUSTRATED BOOK shows how to sharpen all leading makes of power mowers. Foley prices are low — easy payments available. **FREE PLAN** tells how to start. Send coupon today—no salesman will call.

with FOLEY LAWN MOWER SHARPENER

"Last year we sharpened and repaired about 1000 lawn mowers for a net profit of \$2600," says E. G. "In 1939 I bought a Foley Lawn Mower Sharpener," writes W.T.J., "the best investment I ever made. I have made a good living for my wife and self, and have put money in the bank besides."

SEND FOR FREE BOOK

FOLEY MFG. CO., 107-3 Foley Bldg. Minneapolis 18, Minn.

Send FREE BOOK and FREE PLAN on Foley Lawn Mower Sharpening business.

Name _____

Address _____

NO FROZEN PIPES

When You Use WRAP-ON ELECTRIC HEATING CABLE

Protects to 35° Below Zero

No more worry, expense or inconvenience from frozen pipes! Just wrap plastic coated cable around exposed or shallow underground pipes and plug into 115 volt outlet. Maintains low heat — like electric blanket. Uses only small current. Thermostat turns on only when needed. No radio or TV interference. Low prices — complete with connections. Satisfaction or money back.

G-Q Electric Seed Bed Heater. Seeds are up in 30 hours—root cuttings in 6 days. You cut germination time 2/3—transplant 2 weeks sooner. Uses house current. Thermostat control. Easy installation. Write for catalog and FREE folder on seed bed construction.

GRO-QUICK SALES
 11143-2 MORANG AVE., DETROIT 24, MICH.
 Tuxedo 5-5828

Free Catalog

NEW—Sensational! GEIGER COUNTER

"The SNOOPER"
LOW PRICE ONLY \$24.95
COMPLETE

Find a fortune in uranium with this new, super-sensitive Geiger Counter. Get one for atom bomb defense. So small it fits in the palm of the hand or in the hip pocket, and yet more sensitive than many large, expensive instruments. Weighs only 1 1/4 lbs. Uses flashlight battery. Low price includes earphone, radio active sample, instructions. Sold with ironclad moneyback guarantee.

ORDER YOURS TODAY—Send \$5.00 with order or payment in full to save C.O.D. Write for free catalog on larger, more elaborate Geiger Counters, metal locators and our Scintillator Counter.

Dealer Inquiries Invited **PRECISION RADIATION INSTRUMENTS**
 2235 PM So. La Brea, L.A. 16, Calif.

Why Pay List Prices? BUY WELLWORTH PRODUCTS ... SAVINGS UP TO 50%

PORTABLE SPRAY OUTFIT

1/3 H. P. HEAVY DUTY MOTOR



Paint Sprayer mounted on 7 1/2 x 25 inch tank, 1/3 H.P. 110 V. 60 cy. Heavy duty motor, 10 ft. cord and plug, V belt drive, Piston type Compressor with 2 Compression rings, 1 oil ring, 2 inch Bore, 1 3/4 inch stroke, displacement 2.86 C.F.M. at 60 lbs. pressure. Safety valve. External and internal atomizing gun, fan, round and angle spray nozzles; quart cup; maintains 35 to 40 lbs. working pressure. Oil and water extractor, 20 ft. heavy duty two-braid air hose with leakproof fittings. Complete with carrying handle. Wt. 75 lbs.
Special Price
Complete Outfit..... **\$67.50**
Spray Gun Sold Separately... **\$12.95**

Regular Price... **\$125**

2000-2500 WATT LIGHT PLANT

Heavy Duty Windings

110 v., 60 cy., A.C., takes starting overload up to 5000 watts. Floating Base for Automatic Belt Adjusting, 2-Groove Engine Pulleys, V-Belts, Bolts, etc. 5 H.P. Wisconsin or Briggs & Stratton Model 14 Engine. Voltmeter, 2 plug-in receptacles. Portable Tubular Steel Skid Type Carrier. Dim.: L 34 5/8" x W 17" x H 20". Wt. 180 lbs. List

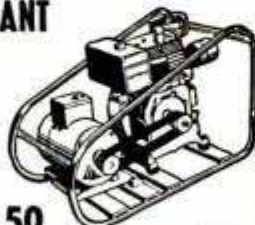

\$299.50

Generator only, with voltmeter, 2 plug-in receptacles. Ship. Wt. 75 lbs..... **\$169.50**
500 WATT GENERATOR, Wt. 55 lbs..... **\$99.50**
5000 to 6000 W. GENERATOR, 110/220V. Wt. 225 lbs..... **\$325**
5 K.W. Signal Corps Light Plant, List price \$2200... **\$895**



"Wellworth" BLOWER BARGAIN

Quiet operating. Double wheel inlet, double width blower. For heating, ventilating, cooling, air washing, exhausting and forced draft. DIMENSIONS: 10" wheel; outlet 13 1/8" x 11 3/8"; inlet 8 3/4". Height 19". Width 18". Depth 16 1/2". C.F.M. 1/4" S.P. 1600; outlet vel. 1575. Wt. 45 lbs. **\$27.50**

With belt and variable speed pulleys, \$2.50 extra. Same Blower, complete, with 1/4 H. P. Motor **\$45.00**



RED SEAL CONTINENTAL GAS ENGINE

Red Seal, 2 HP with 6 to 1 reduction gear. Operates at 450 R.P.M. For lawn mowers, scooters, garden tractors, pumps, compressors, generators, etc. List Price **\$79.50**. Shipping wt. 54 lbs. **\$47.50**
SPECIAL PRICE..... **\$47.50**
Same engine, 3600 r.p.m., **\$47.50**
With 2 1/2 H.P. motor..... **\$62.50**

AUTOMATIC COMPRESSOR UNIT WITH 22 GALLON TANK

1/3 H.P. heavy duty capacitor motor. 110 volt A.C., 2" bore, 1 3/4" stroke, 60 cycle, 2x1 3/4 inch piston type compressor, splash feed lubrication. 14"x32" tank, automatic pressure switch, CFM 2.8 at 100 lb. pressure, or 150 lbs. pressure for intermittent duty. Check valve, safety valve, 20 ft. air hose with air chuck for inflating tires. V. belt drive. Mounted on 2 wheels, ball bearing, with 2"x8" semi-pneumatic tires. Portable with handle. Shipping wt. 150 lbs.



With 1/3 h.p. motor
Regular price \$175
\$98.50

With 1 1/2 h.p. gas engine
\$124.50

Regulator, gauge and filter included at no extra cost.

Larger size compressor units furnished with same tank and accessories described above:
with 2 1/2 x 2 Compressor, 1/2 h.p. motor, 3.24 c.f.m., wt. 175 lbs..... **\$136.50**
with 2 1/2 x 2 Duplex compressor, 1 h.p. motor, 7.35 c.f.m., wt. 200 lbs..... **\$225.00**

WELLWORTH AIR COMPRESSORS

Aluminum piston, stainless steel valves, 3 piston rings, bronze bearings, splash lubrication. Intake muffler, V-belt, cast iron fan cooling flywheel.



Model W800 COMPRESSOR 2" x 1 3/4". 2.8 c.f.m.
Operates with 1/4 HP or 1/2 HP motor up to 150 lbs. Weight 20 lbs. **\$20.50**
Special price.....

MODEL 200 COMPRESSOR
2 1/2" x 2". 2.55 to 4.80 c.f.m. up to 150 lb. pressure. Operates with 1 1/2-3/4 HP motor. **\$27.95**
Special Price.....
Shipping wt. 24 lbs.

MODEL W7 COMPRESSOR
2 cylinder 2 1/2"x2", 5.10 to 8.50 c.f.m. up to 150 lb. pressure. Operates with 3/4-1-1 1/2 HP motor. **\$54.50**
Special Price.....
Shipping wt. 45 lbs.



LELAND GENERATORS

2500 to 3000 watts, 110 v. 60 cy. single phase 1800 r.p.m., self excited. Fungus treated for long life. 1951 model. Brand new, in original factory crate. Ship. wt. 135 lbs. **\$195**
List **\$425**. SPECIAL PRICE.....

See our Catalog for Terrific Bargains in Light Plants and Generators.

PRICES F.O.B. CHICAGO. MONEY BACK GUARANTEE. SEND CHECK OR MONEY ORDER TODAY. PROMPT SHIPMENT. WRITE FOR FREE CATALOG.

GEAR HEAD MOTORS 110V., AC

Right angle gear head—1/30 h.p. 6 RPM **\$11.95**
Right angle gear head—1/20 h.p. 135 RPM **9.50**
Bottom type gear head—1/30 h.p. 1250 RPM **10.25**



WELLWORTH TRADING CO.

1832 S. Wabash Ave., Dept. D-153, Chicago 16, Ill.
Cable address "WELLTRADCO"



C1 COLORCRETE

Drab or dirty masonry—concrete, stucco, etc., becomes gleaming white. Or there's a range of sparkling colors—ivory, cream, pink, blue, green, and 25 more. Colorcrete is fused to masonry surfaces under pneumatic pressure. Stays put and stays beautiful. Highly water resistant. Used for more than a quarter century.

There's Profit-Appeal in Stucco Spraying

The business of applying Colorcrete is a community enterprise, with special appeal to men of limited capital. Equipment is compact, simple to operate, practically wear-proof. Work is easy, interesting and rich in profit potentials. Broad opportunities for development. We supply all equipment and full instructions.

No experience or special ability needed. Write or wire today for the Opportunity Book.

COLORCRETE INDUSTRIES, INC.
570 Ottawa Ave.
Holland, Mich.



FASTER THAN \$100 ENGINEER INSTRUMENTS!

Packed in husky carrying case 12 x 11 1/4 x 3 1/4"



UP TO 50 FEET OR MORE LEVELALL

Regular 50 Feet **\$8.95**

THE NEW, IMPROVED WATER LEVEL FOR SIMPLEST ONE-MAN OPERATION

Deluxe 75 Feet **\$12.95**
Heavy Case

FOOTINGS FOUNDATIONS GRADINGS

Anything you need level LEVELALL does it

LEVELALL
87B Webster Street
Rockland, Mass.
Dealer inquiries invited

LEVELALL
87B Webster St., Rockland, Mass.
Mail me _____ Levelall instruments at \$8.95
Mail me _____ Deluxe Levelall at \$12.95
you guarantee satisfaction or money back upon return of Levelall within ten days.
 Send C.O.D. I will pay postman full purchase price plus delivery charge on arrival.
 Full purchase price is enclosed. Send postpaid. (Postage prepaid on orders in U.S.A. only.)

Name _____
Address _____
City _____ Zone _____ State _____

INSIDE-OUTSIDE VERNIER CALIPER

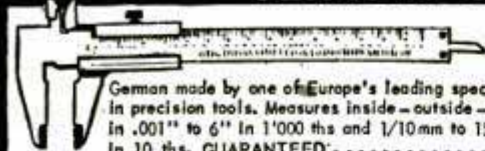

German made by one of Europe's leading specialists in precision tools. Measures inside - outside - depth in .001" to 6" in 1/1000ths and 1/10mm to 150mm. In 10ths. GUARANTEED.....

9.75
NEW

STAND MAGNIFIER

Handy stand magnifier with universal adjustment. Over-all height: 6". Has a powerful, clear magnifying lens. **1.99**

MAGNETIC BASE INDICATOR HOLDER

Time saver for precision checking. Magnetic base fits curved or flat surface. Has 45-50 lb. pull. 6 1/2" stainless steel rod which is mounted in ball socket to permit universal settings. **3.50**

NOTE: We have complete line of instruments, depth gauges, inspection mirrors, etc. Write Today!

REPAIR KIT



An all-purpose kit! 6 useful tools - a fine steel trimming knife - pair of genuine WISS heavy duty scissors - a steel roller for cementing seams in fabric, wallpaper, etc. Two 12" half round files - a wire burnishing brush. Complete in cloth case. Ideal for wallpaper and linoleum. A 9.50 VALUE **3.29**

BENCH CLAMP

Carpenters, wood workers, cabinet makers - you need this one! Opens to 8" with 2-3/4" thumb screw. All steel, sturdy & dependable. Handy for clamping, glueing, assembling, etc. **1.59**

CLAMP-ON-ANYWHERE LAMP



One of the handiest lights you can own! Clamps on anywhere. Has a fully adjustable ball swivel which allows light to move freely. May be used with ordinary bulb, photoflood or photoflash lamps. Also used as reading lamp, work lamp, patio floor, etc. Socket assembly includes clamp, adjustable swivel, cord and plug. LAMP ALONE **1.39**

Spot Reflector (5" diameter) or Parabolic Flood Reflector (9" diameter) } **1.09 EACH**

PALLEY SUPPLY CO. SEE OPPOSITE PAGE

U.S. NAVY PHONE SET



Used by the Navy for flight deck and gunnery control. An ideal emergency communication system because they require no power supply. Perfect for office-to-shop, house-to-garage or barn, or any point-to-point within a 1/2 mile radius. These sets are fully Sound Powered. Each set includes 2 phones on chestplate, 2 headsets, button switches & approx. 35 ft. of cable. **10.95 PR.**

One phone and headset..... **5.95 EACH**

BELT KIT for TOOLS



For the Mechanic, Electrician, Machinist, Radio & TV technician, etc. Made of bark tanned, top grain cowhide and worn on the belt. Saves wear & tear on clothing. A convenient, handy place to carry all small tools. Re-inforced with rivets.

A - ELECTRICIAN'S, 7 POCKET KIT - Holds tape, pencil, tools, etc. **3.49**

B - EXTRA CAPACITY KIT - Main pocket is 1 1/2" box type, 2 extra pockets. **3.19**

C - METAL WORKERS KIT - Has 5 pockets & hammer holder. Roomy. **3.39**

D - GENERAL UTILITY KIT - Has just 1 large pocket for all uses. **1.79**

E - FLASHLIGHT HOLDER KIT - Handy holder for 2 cell lights. **1.09**

F - RADIO & TV INSTRUMENT KIT - 1 large & 2 small pockets. **2.79**

CUNO OIL FILTER



An aircraft type oil filter which can easily be adapted to autos, etc. Will keep oil clean without a cartridge replacement. Can be installed in minutes. Has two mounting braces. Lge size, 5/8" tube ports.

A real SURPLUS BARGAIN. **6.95**

HAND TOOLS KIT



WAR SURPLUS MIX. Four hand tools plus an Army Cinder Scoop for your fireplace. The tools alone are worth for more than our price but we throw in the Cinder Scoop FREE! Tools include a Hammer Punch, Chisel-Hammer, Stake Driver and 17" Stanley Screwdriver. All have crucible cast steel heads & hardwood handles. For heavy work around home, machine shop, garage, ranch, farm, etc. **2.89**

UTILITY BAG



Room to carry ammo, flashlight, compass, camera, maps, food, first aid kit, etc. Made of Heavy O.D. canvas. Has a wide, adjustable shoulder strap. Two rings on each side for tying on extra equipment. Inside has two large compartments. Cover straps down. Size: 12" x 7" x 4". **1.29**

PALLEY'S DEPT. PM-4, 2263 E. VERNON AVE., LOS ANGELES 58, CALIF.



FIRST CHOICE OF SKILLED CRAFTSMEN

HOLD-E-ZEE

THE ORIGINAL AUTOMATIC GRIP SCREWDRIVERS



Gripper Recedes into Handle

Models for All Types of Screws

At Leading Dealers Everywhere

Upson Bros., Inc. Rochester 14, N. Y.

Build your own JET ENGINE!



SEND NO MONEY

Order these plans today

1. JET PROPELLED BICYCLE, Assemble your own. Photo and instructions, \$1.00.
2. HOW TO MAKE EXPERIMENTAL JET ENGINES. Seven sheets drawings with information and instructions \$2.95.
3. BOTH OF ABOVE in one order \$3.75. SEND NO MONEY. Order both at once \$3.75 C.O.D. in USA plus c.o.d. postage. Send check or Money Order and we pay postage. Get other information too. Rush Order.

J. HOUSTON MAUPIN, Dept. 55, Tipp City, Ohio

make your own Gems 29.50 F.O.B.



The Gem Maker comes complete with all necessary equipment, including a super-charged diamond blade for sawing, and all wheels for grinding, shaping and polishing; also complete instructions. The complete equipment as shown, less motor and belt, for only \$29.50, f.o.b., Burlington, Wisconsin. Write today for information and literature.

B&I MANUFACTURING CO. Dept. S Burlington, Wis.



START YOUR OWN BUSINESS With A Route of nut, candy or gum Vendors. No experience or training necessary. Earn at once, highest profits, easy operation. No age limits. Full or part time. For complete information how anyone can become financially independent send for CATALOGUE 100 to **RAKE**

609-P Spring Garden St., Philadelphia 23, Penna.

ONE-MAN SAWMILL LOW \$50.00 AS... 50.00 DOWN



Take BELSAW Portable Sawmill right to the trees - turn out valuable lumber for local yards - do "custom sawing" for neighbors. BELSAW lasts a lifetime. No crew needed. Power with old auto engine. Beginners get excellent results. Send postcard for FREE BOOK, "How To Make Lumber."

BELSAW MACHINERY CO

711 8117 Field Bldg. 315 Westport Rd, Kansas City 11, Mo.

FREE Garden Tractor CATALOG

3 outstanding models plus all attachments including sickle bar, plow, cultivator, and rotary saw. Designed for rough, hard service. Many exclusive features. Ideal for farm, club, estate, or small plot. Write for catalog.

Quick Mfg., Inc. 3257 E. Main St., Springfield, O.

Springfield GARDEN TRACTOR



100-200 300 POWER MICROSCOPE

Has a triple objective revolving turret. Extra fine micro adjustment. Adjustable plane sub-stage mirror. Body inclinable through 90° for microprojection. In dovetail hardwood wood case. **1395**

600 POWER MICROSCOPE

Has all the features needed for the finest work. Comes with 3 eyepieces (5x, 10x, 15x) Triple revolving turret has 4x, 10x, achromatic objective lenses. Gives power combinations from 20x to 600x. Also has a square 90° inclination stage. Two side plane & concave substage mirrors. Solid base, precision construction. A regular \$150 val. **OUR PRICE complete with special! 7495** **WOOD CASE.**



POCKET MICROSCOPE

A Palley Bargain! Has extremely sharp 50 power magnification. Compact, clips into pocket, 4 lens compound optical system. New examine insects, stamps, minerals, gems, etc. Comes ready to use. **349**



20 POWER TELESCOPE

Top quality import. Coated Lenses. Bright, clear image & wide field of view. **895**

EYE LOUPES

An indispensable aid in fine inspection work. Available in 2x, 2-3/4, 3-1/4, 4 and 5 power. **99c**

Surplus JEEP CANS

FOR RESERVE GAS SUPPLY. Holds 5 GAL. Has screw top and will take standard flexible nozzle. **139** **FLEXIBLE NOZZLE . . . 49c**

MARCHING COMPASS

Officer's type with prismatic hair-line guide for sighting distant objects and at the same time reading degree of setting. Accurate & dependable. Has a jewel mounted needle-luminous dial for night reading. **ONLY 395**



POCKET HAND WARMER

The perfect GIFT for servicemen, family or friends. Will maintain temperature of 100° from 16-24 hours by radiation. Uses pocket-warmer fluid, lighter fluid or white gas as fuel. Metal chrome finish with velvet pouch. For hunter, fisherman, skier, etc. **225**



LEATHER MITTENS

Sheepskin lined. Leather outer cover. Ideal for all types of winter work. Small - **269** Med. - Large. **PR.**



Air Corps Type LEATHER CAP

Special! For Hunter, Comber, Farmer. All leather with soft chamois lining. Has turn-down ear flaps, covered with warm sheepskin for added ear protection. Leather covered, long billed visor. Sizes: Small, Med., Large. **259**



SHEEPLINED BOOTS

A REAL BARGAIN! All NEW! 100% waterproof & designed to be worn with or without shoes. Lined throughout, including tongue, with soft fleece sheepskin. Water repellent leather uppers with waterproof rubber lowers. Heavy non-skid tread on soles. Full zipper closure. Height approximately 12". **SMALL, MED., LARGE 1395**



RICOH FLEX VI CAMERA MAKE YOUR OWN POWER UNIT



Acclaimed as "The Buy of the Year" by a nationally famous research publication. It's an ideal 'family' camera for indoor or outdoor use. Simple to load and operate. Comes with a genuine leather, ever-ready case. **38.50**

Compare These Features with those of Cameras Selling for Twice As Much...

- *All Metal Body, Leather Covered
- *ASA synchronized shutter.
- *Speeds 1/25, 1/50, 1/100 & 8.
- *Built-in focus magnifier.
- *Depth of field scale.
- *Comes with genuine leather Case.
- *Twin, Matched, Color Coated Lenses.
- *Shut coating, single lever shutter action.
- *Built-in Flash Synchronizer.
- *Precision Coupled Focusing.
- *Takes 8 & W or Full Color.
- *Uses No. 130 film. 12 exp.

10 DAY FREE TRIAL MONEY BACK GUARANTEE



Here's a unit PACKED WITH BRUTE FORCE! Does all those hard, heavy jobs that ordinary power tools cannot handle. Easily made from a vacuum cleaner type motor, a gear reduction drive and a few homemade parts. Can be used for turning large nuts & bolts, digging post holes, drilling large holes in wood or metal, driving power tools and machinery, lifting, pulling, pushing and any job where a slow speed with high torque is required. **YOU CAN'T STALL IT!** Lightweight and easy to handle. Has 1,000's of uses in the home, garage, shop, factory, etc. We supply assembly instruction with each complete unit. **ORDER YOURS TODAY!**

4 TAKE-OFF DRIVE UNIT



All four drives turn in unison from the common power input. Drive is adaptable to use with 9/32" flexible drive shafts and accessories. Has many uses where from one to four take-offs are desired. This item is worth at least twice our price. **375**

606 DELCO MOTOR



1/50 HP, 24V, DC, 1/6 amp. turns 3000 RPM. Has adj. overspeed contactor to stabilize and control speed - **495**

SURPLUS MOTOR



No. 500 - Used - 1/2 HP - 27v, DC-AC. This motor can be readily adapted to deliver up to 1/2 HP on 110 volts AC, by the simple method of rearranging armature brush-leads. Free diagram with each order. Supply is limited. **595**

SAMSELL MOTOR

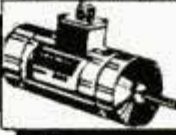

27 volts, 16 amp. 1 1/2 HP, reversible, series wound motor, 3800 RPM, shaft 9/32" diam. 12" coline. 4-1/8" x 2-3/8". **NEW - ONLY 395**

RADIO MIX



A veritable "treasure chest" for "ham" operators and experimenters. Contains: Headset, Mike Buttons, Transformer, Wire, Insulators, Switches, Condensers, Rheostats, Terminals, Jump Cable, etc. Approx. 8 packed lbs. for **ONLY 249**

Signal Corps TELEGRAPH KEY



The new model J5A with ball type flame-proof, metal key. Perfectly balanced to permit positive contact with minimum effort. An ideal instrument for "ham" or professional use. A BUY at **NEW 189**

RADIO SPEAKERS



Ideal for small radios, intercom systems, test equipment, etc. **ALNICO - Permanent magnet type. 4" diam. 2 wire hook-up. NEW 249** **DYNAMIC SPEAKER - 10" with plug-in and transformer. 295** **PERMANENT MAGNET SPEAKER - 12" diameter, 2 wire hook-up. 425**

230 PAGE CATALOG

1000's of ITEMS! Fully ILLUSTRATED! For the MECHANIC, SPORTSMAN, HOBBYIST, HOME OWNER, etc. War Surpl. - - Factory Closeouts and General Merchandise Values! Save on Hardware, Hand and Power Tools, Gadgets, Sports Equipment, Hydraulics etc. SEND 25c for HANDLING & MAILING.

Palley's
ORDER BY MAIL
GADGETEER'S HEAVEN!
SAVE UP TO 85% ON WAR SURPLUS

ORDER FROM THIS AD All prices F.O.B. Los Angeles. Pay by M.O. or check. P.O.'s accepted from D & B firms. 1/3 deposit with C.O.D.'s.

9 PIECE DRAWING SET

Suitable for the architect, student, draftsman, artist, etc. Contains 9 separate pieces including: one 5 1/2" divider, one each: - 3 1/4" bow divider, bow pencil & bow pen with wheel adjustment & reversible needle point; one 4 1/2" ruling pen with extra holder; capsule of extra leads. All in a 2 Hop, velvet lined pocket book case. **ONLY 598**

GENUINE ARMY TYPE 8-9 PARKA

Outside made of extra heavy mountain cloth with full Beaver Fur, Parka Hood which completely protects the head and face. Hood has adjustment for perfect fit. Lined chin protector and button-down neck closure. Coat is full cut with an elastic inset for snug fit. Has two, deep slash breast pockets and two roomy side pockets. Waist length zipper is covered by an outer, button down storm flap. Body is lined in double thick, 100% wool with quilted rayon covering. O.D. color. In SMALL MEDIUM; LARGE sizes. **2850**



"Blue Bunny" FLYING SUIT

For WINTER SPORTS, HUNTING or "BUNDLING". As coveralls for cold OUTDOOR or FARM WORK. It is 100% woven wool with an extra flannel innerlining for double warmth and utility. Has wiring so fine, flexible, it does not interfere with movements. Can be used with or without heating or can be plugged into car, tractor or Truck battery. Sizes 36 thru 44. **495**



New

SOUTH BEND Pedestal GRINDER

A ruggedly built grinder that will give long, dependable service under hard usage. Ideal for production, maintenance and toolroom work. Pedestal mounting of motor provides greater work clearance at grinding wheels and protects motor. Also, removes load and weight of wheels from motor bearings and practically eliminates vibration. Amply powered. Send coupon for full information.



SPECIFICATIONS

Wheel Sizes: 8" (½ h.p. motor), 10" (¾ h.p. motor). Spindle: Approximate speed 2450 r.p.m. Sealed ball bearings. Motor: Standard 2875 r.p.m. 50 cycle or 3450 r.p.m. 60 cycle, also D.C. Over-all Dimensions: 49½" high, 18" wide, 20½" deep (10" Grinder ½" wider).

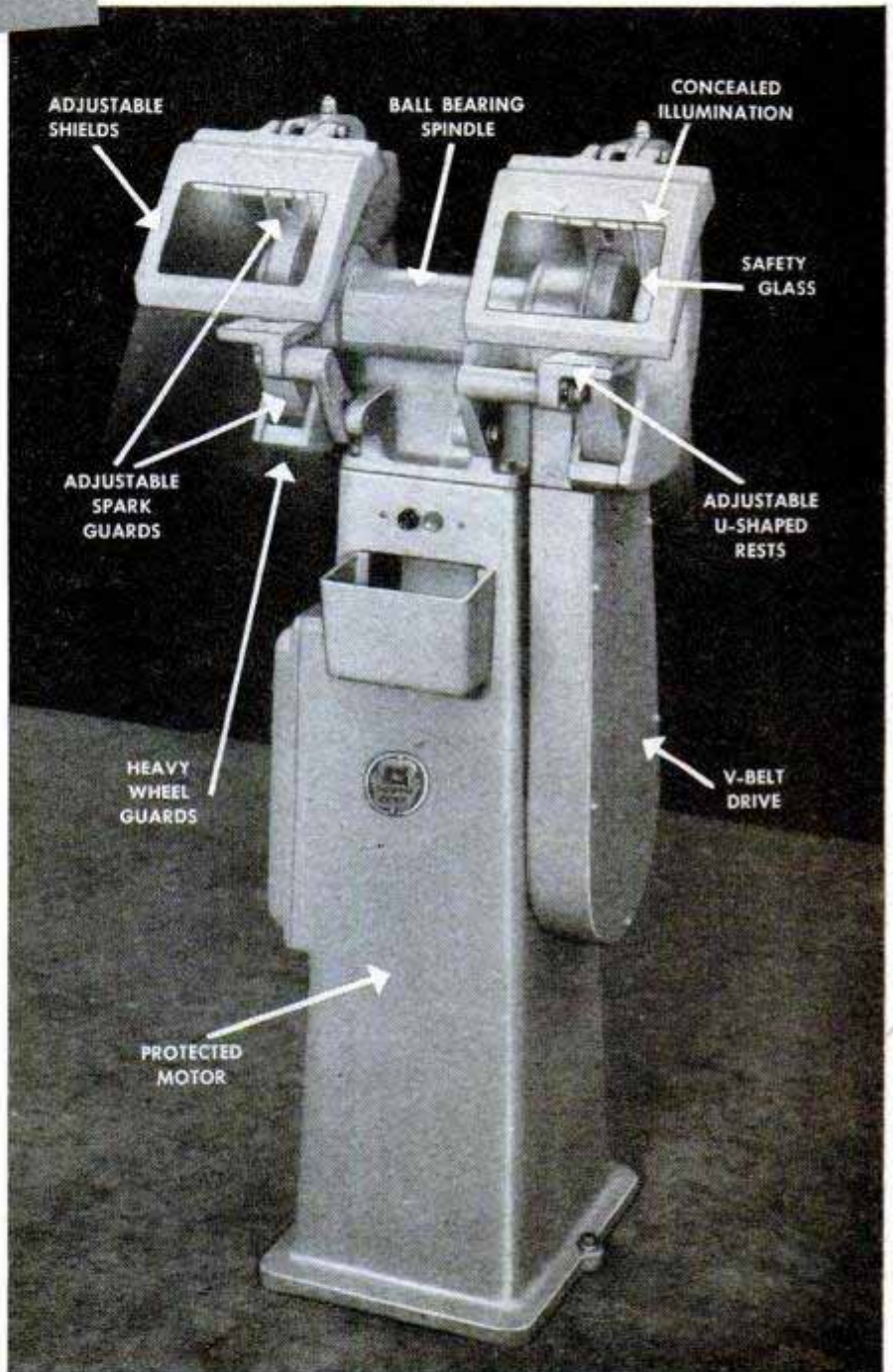

SEND INFORMATION CHECKED:

SOUTH BEND GRINDER

TOOLS & ATTACHMENTS



9" and 10" BENCH LATHES



10" to 16-24" FLOOR LATHES

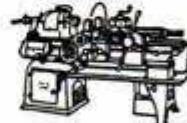

½" and 1" Collet TURRET LATHES



14" DRILL PRESSES



7" BENCH SHAPERS

Name _____

Company _____

Street _____

City & State _____

Building Better Tools Since 1906 • SOUTH BEND LATHE • South Bend 22, Indiana



Here's the First NEW idea in plier design in years...

THE NEW No. 420

CHAN NEL LOCK

PLIER

TRADE MARK REG.

U. S. PATENT OFFICE

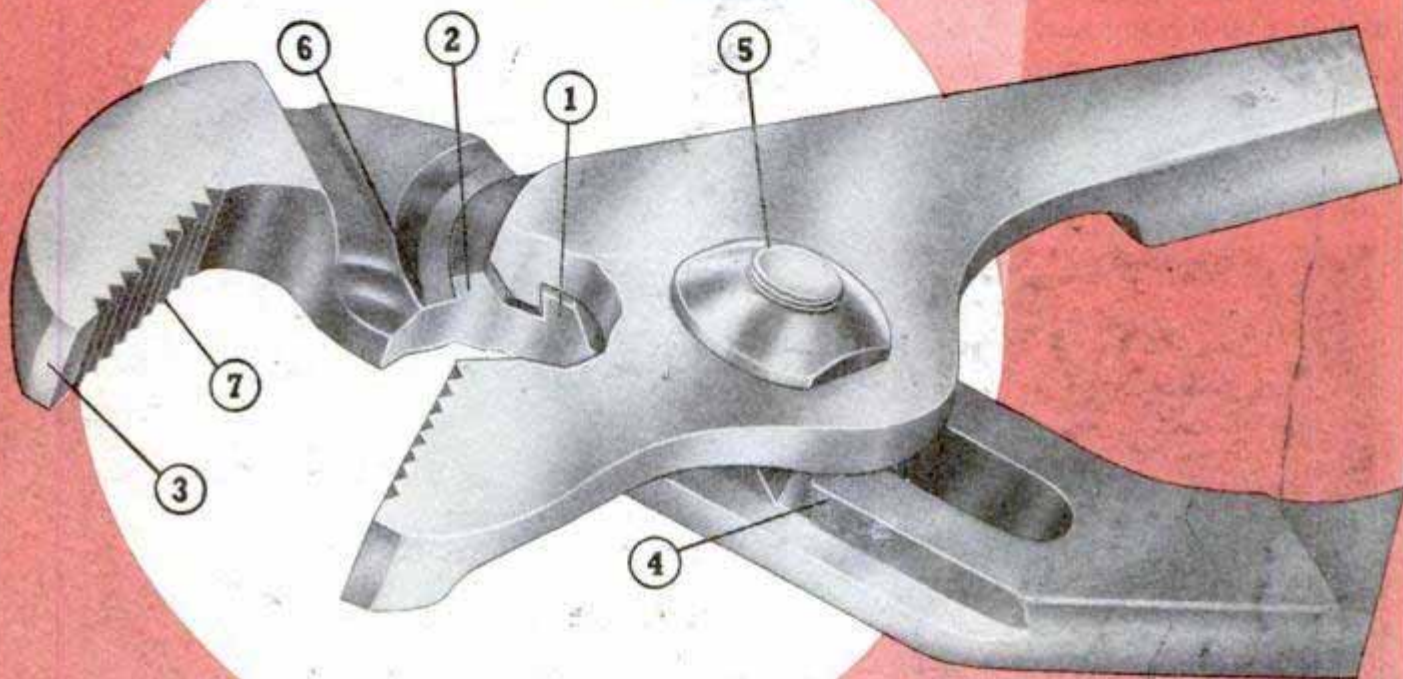

Look at these NEW features . . .

1. Interlocking principle positively prevents slipping under any load . . . the heavier the job, the greater the interlocking action.
2. New type wide base lugs provide maximum cross section strength . . . cannot shear.
3. New nose design provides greater utility for gripping small objects.
4. Patented design of tension edge provides more strength and eliminates stress concentration at channels.
5. New interlocking design minimizes stress on joint bolt.
6. Precision machined interlocking surfaces provide perfect fit, thus distributing pressure evenly.
7. "Rite Angle" teeth guarantee maximum bite and minimum wear.

Here's the new, improved Channellock Plier—bringing to you new features which offer more positive gripping, greater strength and longer wear. The undercut interlocking channel is the first really new idea in plier design in years. Engineering skill has developed a plier with new patented features which give you the newest, strongest, most practical plier you can buy. Here is a plier that will last for years! Channellock Pliers—made only by Champion DeArment Tool Co., Meadville, Pa.

Send for your Catalog today.

Channellock pliers are listed in the Yellow Pages of most Telephone Directories under "Tools"



THE PLIER DESIGN THAT OBSOLETEs ALL OTHERS

Only **CHAMPION DeARMENT** makes

CHAN NEL LOCK



CHAMPION DeARMENT TOOL CO.

MEADVILLE, PA.

What? No built-in shower?



MORE HEAD ROOM

IMPROVED VISION

103° WINDSHIELD WIPER ACTION

BETTER ANGLE STEERING COLUMN

SOUND-DEADENING WELDED STEEL CONSTRUCTION

MORE ROOM FOR COMFORT

FULL FOAM RUBBER BACK

REO

best truck buy for '53



THE IMPROVED REO CAB GIVES YOU THE SMOOTHEST, SAFEST RIDE IN AMERICA!

You can't blame truck drivers for expecting more of a Reo. Reo's NEW CAB gives you more of the vital features you need for greater driving comfort and safety. New! More head and leg room. New! Full foam rubber back. New! External rear vision mirrors. New! Full 30" door opening. New! Dual electric windshield wipers that won't slow down or stop, with 103° cleaning area. New utility compartment, cab corner pockets...and many more improvements! Climb into the cab of a Reo and put it through its paces. Test all the new features. When you're through, you'll know the only truck for you is REO! (P.S.—If you want action, tell the boss man to check the Reo dealer on Reo Gold Comet Engine power and economy.)

REO MOTORS, INC., LANSING 20, MICHIGAN

REO Builds The Amazing

EAGER BEAVER

Truck For The U.S. Army.