

AND



POPULAR MECHANICS

MAGAZINE

WRITTEN SO YOU CAN UNDERSTAND

REG'D. TRADE MARK, GREAT BRITAIN, NO. 410426

PRINTED IN U.S.A.

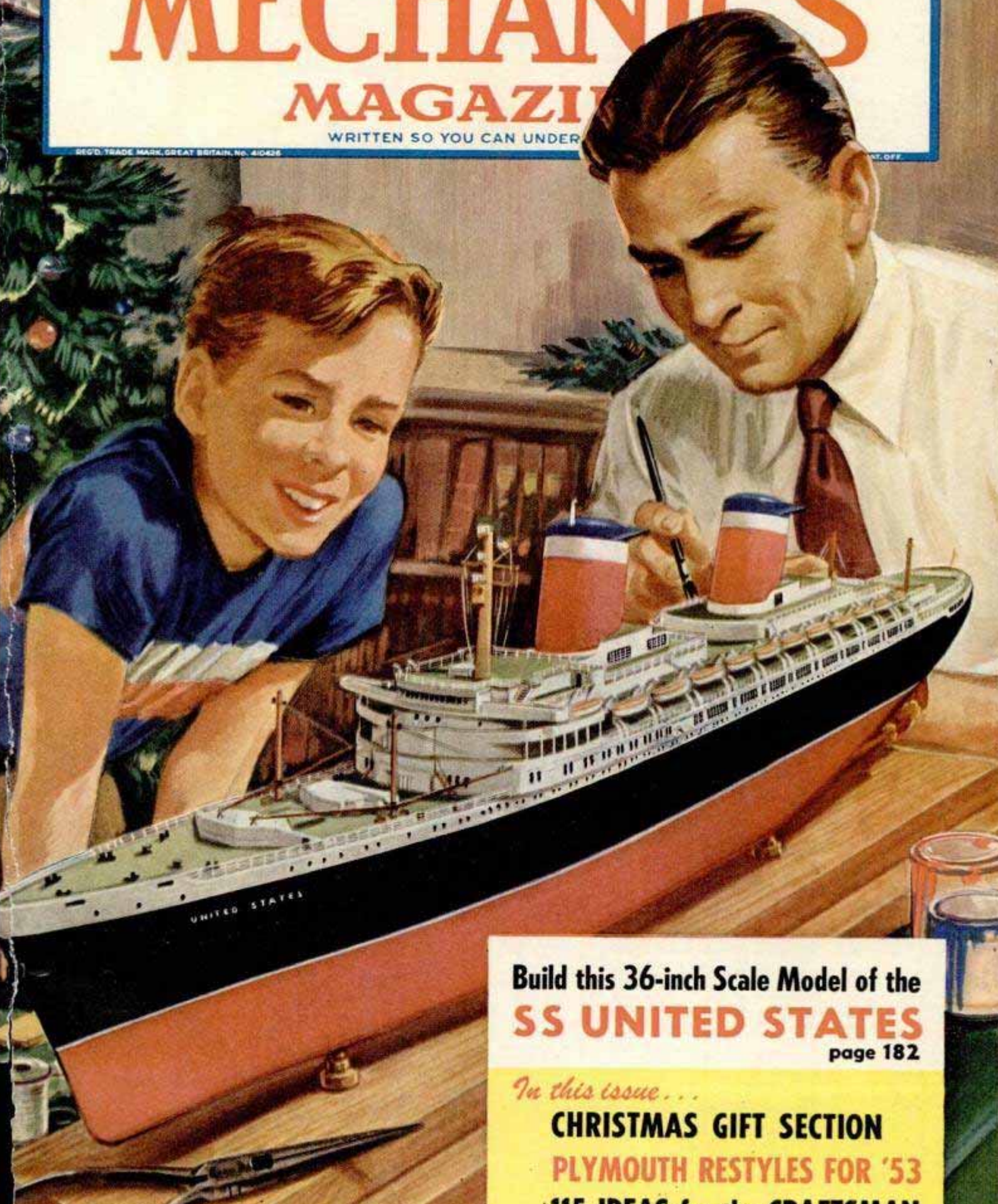

Build this 36-inch Scale Model of the
SS UNITED STATES

page 182

In this issue...

CHRISTMAS GIFT SECTION

PLYMOUTH RESTYLES FOR '53

45 IDEAS FOR THE CRATCHMAN

GET THIS BOOK NOW!

How to plan her dream kitchen

NO OTHER home improvement could mean as much for your family as a famous Youngstown Kitchen.

You save time and work every day in the most used room of all. And your house is immediately worth more, to you and to someone else who might want to own it.

Best of all, a genuine steel Youngstown Kitchen is priced for your budget and easy to install.

Send the coupon and just 10c today for full-color, 24-page book that tells how you can plan, decorate and pay for your dream kitchen . . . and how you can start enjoying it *now!*



The Youngstown Kitchens Electric Sink is only one of many advances in kitchen planning, including Jet-Tower* Dishwasher, which does dishes faster and better than the old-fashioned by-hand method. Food Waste Disposer banishes garbage forever.



There are over 60 sizes and styles of Cabinet Sinks, base and wall cabinets, utility and variety units to choose from. These help make your kitchen dream come true.

*Reg. U. S. Pat. Off.

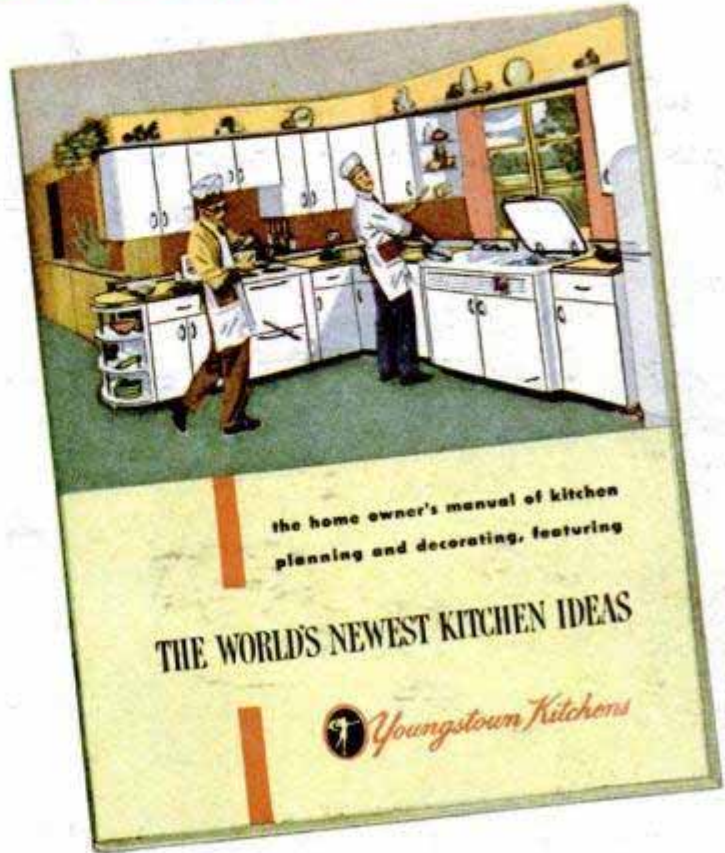

Send for this book prepared by kitchen-planning experts. You'll learn how to plan and decorate your dream kitchen and how easy it is to pay for.



Youngstown Kitchens

MULLINS MANUFACTURING CORPORATION • WARREN, OHIO
Youngstown Kitchens are sold throughout the World
Call Western Union, Operator 25, and without charge get the name of a nearby dealer.

Mullins Manufacturing Corporation
Dept. PM-1252, Warren, Ohio

Send 24-page book in color, "The World's Newest Kitchen Ideas." I enclose 10¢ for mailing. (No stamps, please.)

I am interested in: Kitchens Dishwashers
Food Waste Disposer

NAME (Please print) _____

ADDRESS _____

CITY _____

ZONE _____

COUNTY _____

STATE _____

© 1952 Mullins Manufacturing Corporation

WORLD'S MOST EXCLUSIVE CLUB ADDS 12 NEW MEMBERS!



TROY RUTTMAN



JIM RATHMANN



SAM HANKS



DUANE CARTER



ART CROSS



JIMMY BRYAN



JIMMY REECE



CLIFF GRIFFITH



JACK McGRATH



JIM RIGSBY



JOE JAMES



BILL SCHINDLER



Tops in professional prestige among racing drivers is membership in the Champion 100-Mile-An-Hour Club.

Since 1935 just 62 have qualified by completing, *without relief*, the full 500 miles in the famed Indianapolis Memorial Day Classic at an average speed of 100 miles per hour or better.

Champion Spark Plugs were the confident choice of 56 of the 62 club members. This almost unanimous preference by the racing elite points an emphatic fact for every performance-minded motorist: for championship performance in *your* car, you need Champion Spark Plugs.

CHAMPION SPARK PLUG COMPANY, TOLEDO 1, OHIO
FOLLOW THE EXPERTS—CHOOSE THE SPARK PLUGS

CLUB ROSTER

- | | | |
|------------------|----------------|---------------------|
| Emil Andres | Sam Hanks | Jim Rathmann |
| Billy Arnold | Mack Hellings | Jimmy Reece |
| Bob Ball | Ralph Hepburn | Jim Riggsby |
| Henry Banks | Bill Holland | Floyd Roberts |
| George Barringer | Ted Horn | George Robson |
| Cliff Bergere | Jimmy Jackson | Mauri Rose |
| Walt Brown | Joe James | Paul Russo |
| Jimmy Bryan | Andy Linden | Troy Ruttman |
| Bob Carey | Doc MacKenzie | Bill Schindler |
| Duane Carter | Johnny Mantz | Wilbur Shaw |
| Joie Chitwood | Rex Mays | Russ Snowberger |
| Hal Cole | Jack McGrath | Jimmy Snyder |
| George Connor | Lou Meyer | Babe Stapp |
| Art Cross | Zeke Meyer | Stubby Stubblefield |
| Bill Cummings | Chet Miller | Joel Thorne |
| Lewis Durant | Lou Moore | Louis Tomei |
| Dave Evans | Duke Nalon | Luigi Villorosi |
| Myron Fohr | Mike Nazaruk | Lee Wallard |
| Fred Frame | Johnny Parsons | Frank Wearne |
| Chet Gardner | Kelly Petillo | Howdy Wilcox |
| Cliff Griffith | Ray Pixley | |

CHAMPIONS

USE!

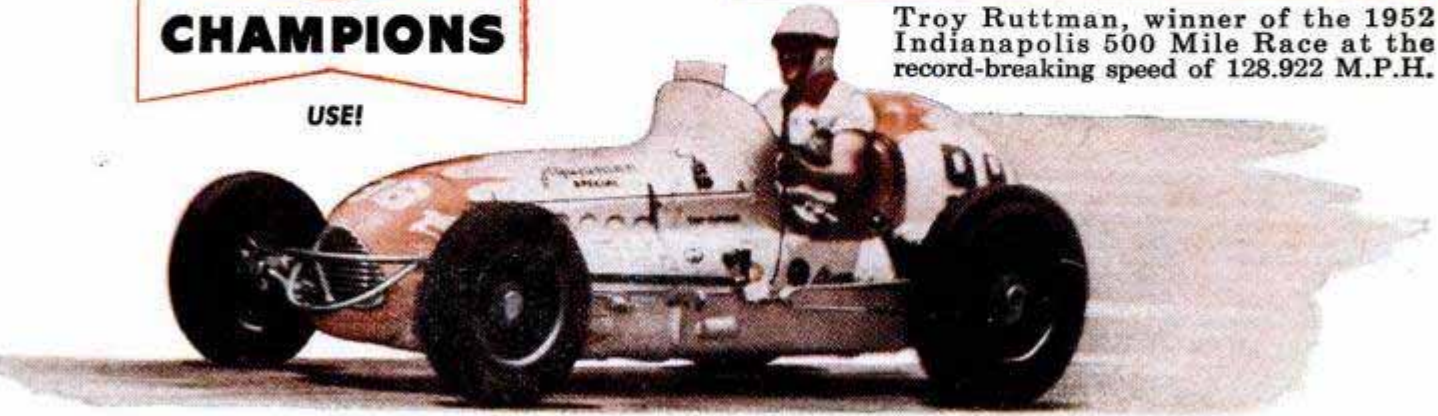

Troy Ruttman, winner of the 1952 Indianapolis 500 Mile Race at the record-breaking speed of 128.922 M.P.H.

Get the most for your money INSTALL YOUR OWN KENTILE FLOOR



Mrs. William A. Loock Jr. shows you how easy it is to install long-lasting Kentile



Here Mrs. Loock is finding the center of the floor. Next, she'll spread Kentile Adhesive over half the floor before laying the tiles in place.



With half the floor installed, Mrs. Loock spreads Kentile Adhesive to cover remaining half. Then it's simply a matter of putting tiles in place until entire floor is completed.

HERE'S America's most popular floor-covering for homeowner installation... low-cost, easy-to-lay, long-wearing. Dirt and stain-resistant... gleams like new with occasional, no-rub waxings. Don't make the mistake of buying floor-coverings with just a colored surface that wears off with use. Kentile's 26 wear-proof colors go right through each tile—its durability is assured by this written guarantee. (If you prefer, your Kentile Dealer will install your floor.)

KENTILE
GUARANTEE
FOR SELF-INSTALLED KENTILE

Kentile, Inc. will provide new tile without charge for any Kentile that wears out... and on which colors wear off... during your own occupancy of your home wherein you have installed Kentile. This guarantee does not apply to damage caused by improper handling, or failure to follow the instructions for installation and maintenance available at your Kentile dealer's.

Only Kentile Dealers offer you these low-priced Guaranteed Kentile Floors

*Price quoted is for a Kentile Floor approximately 8' x 10' installed by you. Your Kentile Floor may cost less or slightly more, depending on size of room, colors and freight rates. See your local Kentile Dealer... he's listed in the classified phone directory under FLOORS. In Canada, T. Eaton Co., Ltd.

Write for your FREE Kentile Color Book showing all the colors of low-cost Kentile and easy-to-follow instruction booklet

KENTILE, INC., 58 2nd Ave., Dept. G-10, B'klyn 15, N. Y.

KENTILE®

The Asphalt Tile of Enduring Beauty



POPULAR MECHANICS

Popular Mechanics Magazine

Registered in U. S. Patent Office and Canada

H. H. WINDSOR, Founder

H. H. WINDSOR, JR., Editor and Publisher



this month's cover

CHRISTMAS is a time for many things—the sparkling gaiety of a special tree and the deep, rich tones of church chimes ringing out the age-old hymns. Best of all, perhaps, Christmas is a time when members of a family draw quietly together again, when a good, warm feeling goes with every family activity. Our cover shows a scene that soon will be duplicated in thousands of American homes, in one way or another. Dad and son are working as a team on a special project, one they can't seem to find time for during the rest of the year. It could be almost any project, but in this case it's something extra special—a 36-inch model of that new queen of the seas, the *SS United States*. On page 182 is the first of a series of articles on building this beautiful model. The series includes complete plans for the ship, from the keel to the crown of the supersmokestacks. It's a project well worthy of any father-son team. Why not launch it during the holiday season?

Published monthly by Popular Mechanics Company, 200 E. Ontario St., Chicago 11, Ill. H. H. Windsor, Jr., president; William Harrison Petridge, vice-president; D. F. Windsor, vice-president and secretary-treasurer; H. H. Windsor III, vice-president; Clover L. Perkins, advertising manager; Alan M. Deyoe, circulation manager. Single copy in the United States and Canada, 35 cents; subscription rates in United States and possessions, Canada, Philippines and countries of the Pan-American Postal Union, 1 year \$3.50; 2 years, \$6.00; 3 years \$8.00. To all other countries add \$1.00 a year over United States prices for overseas postage. If you plan to move, notify us at least 30 days in advance so you will not miss an issue. Give both your old and new addresses. Entered as Second Class Matter, September 15, 1903, at the Post Office at Chicago, Illinois, under Act of March 3, 1879. Entered as Second Class Matter at Post Office Dept., Canada. Registered as Second Class Matter at the Post Office at Mexico, D. F., Mexico, June 20, 1950. Copyright 1952 by Popular Mechanics Company. Copyright under International Copyright Union. Copyright in France. All rights reserved under Pan-American Copyright Union. Printed in the United States of America.

Volume 98

DECEMBER 1952

Number 6

Address all communications to:
200 East Ontario Street, Chicago 11, Illinois

Managing Editor.....Roderick M. Grant
Assistant Managing Editor.....Wayne Whittaker
Shop Notes and Crafts Editor.....James R. Ward
Radio-Television, Electronics Editor.....Frank L. Brittin
Associate Editor, Aviation.....Aubrey O. Cookman, Jr.
Associate Editor.....Clifford B. Hicks
Associate Editor, Automotive.....Arthur R. Railton
Assistant Shop Notes and Crafts Editor.....Wayne C. Lecky
Assistant Editor, Makeup.....John C. Dalen
Automotive Correspondent.....Siler Freeman
Art Director.....Frank Beatty

Assistant Editors

W. Clyde Lammy
Theodore A. Daum
Eastern Editor.....Richard F. Dempewolf
Empire State Bldg., Room 2906, New York City 1
Western Editor.....Thomas E. Stimson, Jr.
302 23rd St., Santa Monica, Calif.
London Manager.....Douglas W. Wedderspoon
Eagle House, Jermyn St., London S. W. 1, England
Director, Bureau of Information.....Allan Carpenter
200 E. Ontario St., Chicago 11

IN THIS ISSUE

The Magic of Silent Sound - - - - -	65
Flippy Rings the Bell - - - - -	72
They Make Candy by the Ton - - - - -	81
The Owners Report on the Henry J and the Kaiser - - - - -	88
We're Blasting Holes in the Iron Curtain - - - - -	94
Plymouth Restyles for '53' - - - - -	104
Thursday Night Is Railroad Night - - - - -	112
They Built Him a Farm in a Day - - - - -	118
Do Your Christmas Shopping Here - - - - -	126
Playing Safe With Atomic Rays - - - - -	137
"Talking" the Smoke Eaters Through Town - - - - -	142

For the Craftsman

Selecting Your Christmas Tree - - - - -	149
Tree Decorations in Other Lands - - - - -	150
Jigsaw a Merry Christmas - - - - -	152
How to Make a Hunting Knife - - - - -	167
36-in. Model of the <i>SS United States</i> - - - - -	182
Direct-Drive Belt Sander - - - - -	195
How to Use Your Dado Head - - - - -	202
Shopping for Tools - - - - -	208
Radio, TV and Electronics - - - - -	211
Clinic for Homemakers - - - - -	220

Other items, and manufacturers of available products described, are listed on pages 12, 14 and 16

Millions Enjoy His Program Every Week on TELEVISION!
More Will Enjoy His New Popular Mechanics Book!



FREE!

Name Stamped on Cover
in Gold Letters
Give Mr. Wizard's Science
Secrets as a gift with re-
cipient's name stamped in
gold FREE.

give
them

Mr. Wizard's Science Secrets

by TV's Famous Don Herbert



150 Mystifying Experiments With Everyday Things
That Help in School and All Through Life!

Millions of children enjoy Don Herbert's science experiments on television. Now they can enjoy them more in his own brand-new book, *Mr. Wizard's Science Secrets*, with Mr. Wizard himself and his helpers, Willy and Betsy. Get this fascinating, entertaining and instructive book for your young people. Let them learn exciting scientific facts by doing Mr. Wizard's experiments themselves, using only simple materials, most of it in your kitchen and bathroom cabinets. Never before such a book. It entertains as it educates. It makes fun out of learning facts. Give your children—your friends' children—the educational advantages and joyous pastime which Mr. Wizard's book affords. See special gift offer—books will be personalized with recipients' names in gold FREE.



Above: Mr. Wizard in a demonstration of oxygen and combustion. Center: With helpers, Willy and Betsy, watching bottle fountain and action of carbon dioxide in bubbles. Willy and Betsy in a test that proves sound isn't so easy to locate. Hundreds of pictures like these in Mr. Wizard's book.

Some of 150 Projects and Experiments Explained and Pictured for Boys and Girls to Do at Home

- | | |
|--|--|
| Why salt melts ice. | How to make . . . |
| Experiments with vacuum. | Static electricity |
| What is air, oxygen, atmospheric pressure? | Water boil with an ice cube |
| What makes an airplane fly? | Your own telephone with tin cans |
| What is gravity? | Music boxes |
| Why does hot air rise? | Compasses |
| What is steam? | Your own telegraph set |
| Why does corn pop? | Water boil in a paper box |
| What are molecules? | Fire extinguishers |
| What is carbon dioxide? | How to carry sound in your finger tips |
| How to write with invisible ink. | And more than a hundred others |

264 Fascinating Pages • 249 Illustrations — Made for This Book

Answers Hundreds of "How" and "Why" Questions

Mr. Wizard answers most of the questions children ask. They're all in his book. His answers and demonstrations are so fascinating that youngsters actually have fun learning the facts they should know and they never tire of learning. Parents and teachers will find the book a helpful treasure.

Science, Physics, Chemistry in Fascinating, Joyous Form

Mr. Wizard makes games out of science, physics and other subjects that keep young people occupied and interested for countless hours. He has special appeal to both boys and girls of all grammar school ages and imparts information that will be helpful to them now and throughout their lifetimes.

Order Today! Use Coupon to Get Mr. Wizard's Book. Include Name for FREE Gold Stamping.

Order this big, beautifully illustrated, printed and bound book now. It is the GIFT BOOK of the hour, with the added feature of the recipient's name in gold. Give it to all young people for birthdays, Christmas and other gift occasions—for merit awards—for good conduct—or just to help a boy or girl advance. Only \$3.00 postpaid. Order on the handy coupon.

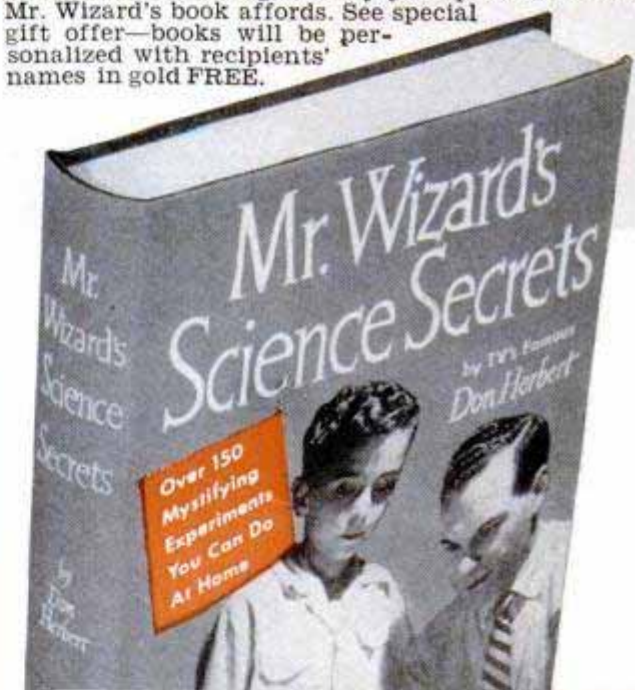

POPULAR MECHANICS PRESS, Dept. WS
200 East Ontario St., Chicago 11, Ill.

Please send at once, delivery prepaid, _____ copies of *Mr. Wizard's Science Secrets* at \$3.00 each. Stamp names in gold without extra charge under your special FREE offer. Remittance enclosed \$_____

Name _____

Address _____

City _____ State _____

Print name for gold stamping on this line. Use margin for extra names if required.

FASTEN IT FASTER

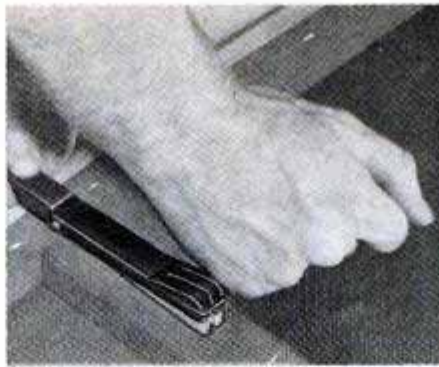

PLASTIC SCREENING can be tacked to frames quickly and easily with *Bostitch B-8* used as tacker.

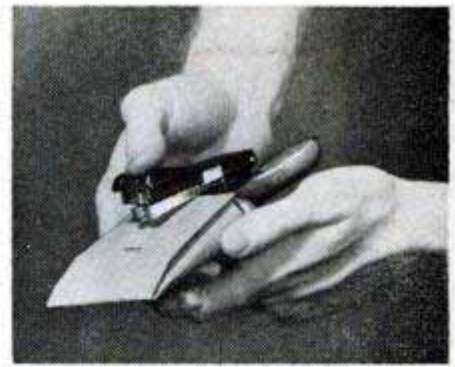

PUT WRAPS on your paint brushes between jobs. *Bostitch B-8* has removable base for getting into tight places.



STOP HEAT LOSS by covering warm air ducts with asbestos paper. *Bostitch B-8* makes it an easy, one-night project.

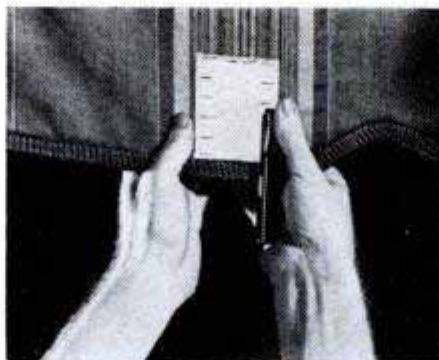

TORN CANVAS on awnings or furniture can be mended by stapling parts with *Bostitch B-8*.

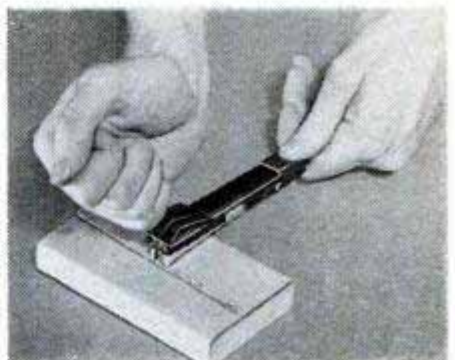

SANDING BLOCKS are easy to make when you tack sandpaper to blocks of scrap lumber with *Bostitch B-8*.

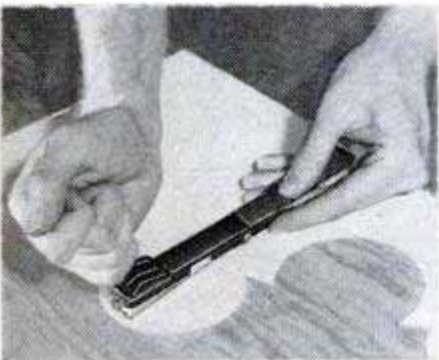

KEEP PATTERNS IN PLACE by stapling them to material to be cut. Lift them easily with *Bostitch B-8's* staple remover.



\$2.85

Slightly higher in the West and Canada

IT'S A STAPLER!
IT'S A TACKER!
IT'S A STAPLING PLIER!
IT'S A STAPLE REMOVER!

Bostitch gives you the only fasteners with staple remover attached.

with the ***Bostitch B-8***
WITH REMOVER

The Bostitch B-8 is one of 800 Bostitch staplers and stitchers made for home, office and industrial use. For help in solving production line or shipping room fastening problems, write: BOSTITCH, 552 Mechanic St., Westerly, R.I.

BOSTITCH[®]
AND FASTER
fastens it better with wire

QUIT STALLING!

USE

PYROIL

There's nothing more annoying than having your car stall in the midst of busy traffic — or the first time out in the morning — or anytime. There's an easy and economical way to avoid stalling. It's the Pyroil way. Pyroil, with its special property of making ordinary oil cling to metal surfaces, assures a constant ready flow of necessary lubrication at all time. A few ounces of Pyroil in your gas tank — a pint of Pyroil in the crankcase means easy starts, even after being parked all night. Pyroil prevents sludge and gummy deposits. Pyroil eliminates friction between piston walls and cylinder surfaces.

If you want to "quit stalling" — add Pyroil — add miles to your car.

Pyroil for Aircraft Engines

Use Aircraft Pyroil B for lubricating oil, Aircraft Pyroil A for gasoline.

GIVEN! An attractive Pyroil metal savings bank — takes coins up to 50¢ pieces. **MOTORISTS**, it's yours for the asking — sent postage paid.

Manufactured and Guaranteed by Pyroil Company, 177 Pyroil Bldg., La Crosse, Wisconsin

Canadian Distributors: Central Purchasing Agencies, Ltd., Toronto, Ontario



PYROIL COMPANY
177 Pyroil Bldg., La Crosse, Wisconsin

I want my car to last and run properly. Please tell me more about Pyroil and how it can accomplish this for me.

Name _____

Address _____

City or Town _____ State _____



in this corner.....

THE EDITORS



Letter to the Editor:

In Floyd Clymer's test of the '52 Lincoln (PM, Oct. 1952) he mentioned that the hand brake was at the right side and hard to apply. The hand brake may be hard to apply, but it is not on the right side!

Rod Smith,
Butte, Mont.

Correct, sir, the brake is on the left!—
Editor.

Wooden Lungs for Polio Victims

During a visit to Hillsboro, Ore., Gov. Earl Warren of California and his daughter Nina, a recovered polio patient, examined with interest one of the hundreds of



"wooden lungs" built from *Popular Mechanics* plans. More than 1200 civic and fraternal groups in the United States and abroad requested the plans, which were furnished free, after an article describing the construction appeared in the magazine's January 1952 issue. The lung was designed for emergency use in the treatment of infantile paralysis. It was designated as the "project of the year" by the United States Junior Chamber of Commerce, with 678 local bodies building lungs for their communities. Other organizations actively participating were Lions clubs, American Legion posts, Boy Scout troops, lumber merchants' association, the National Association of Letter Carriers and police and fire departments. Typical of many projects was that of the Hillsboro Junior Chamber of Commerce. After its directors voted to build the lung and received the plans, a workshop was set up in the garage of member Theodore F. Oberlander, project chairman. For the next two months 21

(Continued to page 8)

Accountancy Home-Study

made interesting and practical
thru problem method

YOU know as well as we do that Accountancy fits many men for positions that pay four and six and ten thousand dollars a year—gives many other men unusual opportunity to start a profitable growing business of their own.

You probably realize also that the accounting profession faces the greatest opportunity it has ever had.

The only question is—just how practical is it for *you* to train yourself adequately in Accountancy through home study?

And the answer lies in the LaSalle Problem Method.

For this modern plan of training not only makes Accountancy study at home thoroughly practical but makes it interesting as well.

And here's how:

You Learn by Doing

Suppose it were your privilege every day to sit in conference with the auditor of your company or the head of a successful accounting firm. Suppose every day he were to lay before you in systematic order the various problems he is compelled to solve, and were to explain to you the principles by which he solves them. Suppose that one by one you were to work those problems out—returning to him every day for counsel and assistance—

Granted that privilege, surely your advancement would be far faster than that of the man who is compelled to pick up his knowledge by study of theory alone.

Under the LaSalle Problem Method you pursue, to all intents and purposes, that identical plan. You advance by solving problems.

Only—instead of having at your command the counsel of a single individual—one accountant—you have back of you the organized experience of a great business training institution, the authoritative findings of scores of able accounting specialists, the actual procedure of the most successful accountants.

Thus—instead of fumbling and blundering—you are coached in the solving of the very problems you must face in the higher accounting positions or in an accounting practice of your own. Step by step, you work them out for yourself—until, at the end of your training, you have the kind of ability and experience for which business is willing and glad to pay real money.

One-Tenth of All C.P.A.'s Are LaSalle Trained

If you want still more proof, remember that over 3500 C.P.A.'s—approximately one-tenth of all those in the United States who have passed the difficult examination for this coveted degree—are LaSalle alumni.

And knowing these facts, ask yourself if there can be any further question about the practicability of this training for you—ask rather if the real question is not about the size of your own ambition and the quality of your determination.

For Accountancy is no magic wand for the lazy or the fearful or the quitter—it offers success only to the alert adult who has the courage to face the facts and the will to carry on till the job is done.

If you are that individual, the coupon below, filled out and mailed, will bring you free the information that may open up to you the future of which you have dreamed—ability and income and success. Is it not worth getting that information?

LASALLE EXTENSION UNIVERSITY

CHICAGO 5, ILLINOIS *A Correspondence Institution*

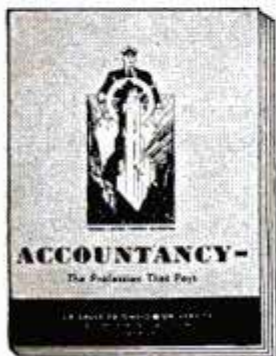

LaSalle Extension University A Correspondence Institution

Dept. 1264-HR, 417 S. Dearborn St., Chicago 5, Ill.

Please send me, free of all cost or obligation, your 48-page illustrated book "Accountancy, the Profession That Pays," telling about the profession of accountancy and your training for success in that field—also "Ten Years' Promotion in One"—a book which has helped many men.

Name.....Age.....

Address.....

City, Zone, State.....

Other LaSalle Opportunities

- C.P.A. Coaching
- Bookkeeping
- Law: LL.B. Degree
- Business Management
- Salesmanship
- Traffic Management
- Foremanship
- Industrial Management
- Stenotypy
(Machine Shorthand)

This One



OAYB-UBB-9DAU

YOU SHAVE CLEANER IN 1/2 THE TIME

"Get it over with" fast with Schick Injector, world's only razor specially engineered to give you "Twice Over" smoothness with "Once Over" Shaving!



No movable parts that get out of adjustment, no detachable parts that can be dropped or misplaced. Specially designed to "fit" your face—under nose, around lips!

Today, get your complete razor kit:

- ★ Gold-Plated Razor
 - ★ 12 Scalpel-sharp "Gold Pack" Blades
 - ★ Handy Travel Case
- Big \$1.75 Value. Now Only

98¢

Only razor offering these 4 advantages

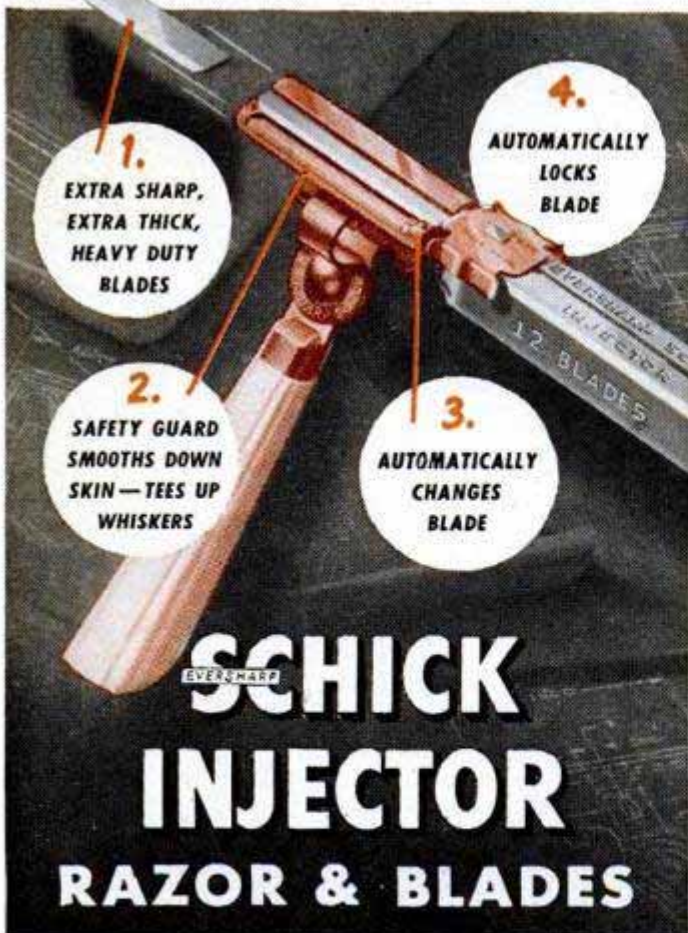

©1952, Eversharp Inc 350 Fifth Ave., N. Y. C

(Continued from page 6)

of the members, almost all of them inexperienced craftsmen, put in a total of 327 hours building the lung. The entire cost of materials was \$187.55. On completion the lung was presented to Washington County and it is now constantly available for its lifesaving role at the county hospital.

Letter to the Editor:

Right up to the last minute of the day before Christmas the thousands of Associated Press Teletype machines all over the country pound out their news dispatches for newspapers and radio and television commentators. But with the start of Christmas Day the news releases dwindle and finally the machines stop their clicking.

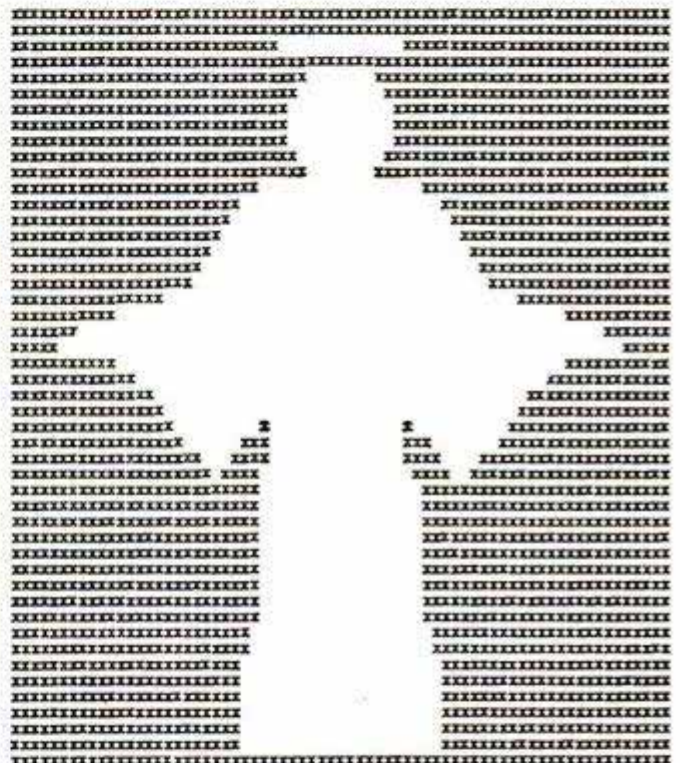

Then a bell rings, the machines start to chatter again and this time strange messages that never get into any newspaper start coming across the wires.

Usually the message is in the form of an intricate drawing, carefully tapped out with the letter X. As soon as one operator finishes, another starts.

These messages are Christmas greetings from one operator to another. There are huge Santa Clauses, stars, sacred silhouettes, Christmas trees and dozens of others, all bearing messages of good will.

Considering the limited equipment which the operators must use, most of the X-drawings are works of art. Actually, many days of planning, and careful counting of spaces go into the messages.

All of them follow the same motif; most contain messages of cheer found on an

(Continued to page 10)

ARE THESE MISTAKES HOLDING YOU BACK?

If you're not getting ahead as fast as you'd like, check these possible reasons. Find out why you're not a success and what you can do about it.

- YES NO
- Do you put things off?** To get anywhere you have to make a start.
 - Do you really want to succeed?** Isn't there something you want enough to work for it? Marriage, a new home, money for your family—all depend on your advancement.
 - Are you unwilling to give up temporary pleasures?** Some people think more of a good time now than of promotion and higher pay later on.
 - Are you too lazy to plan ahead?** You've got to manage your life, plan for success and stick to it.
 - Are you afraid of responsibility?** In a bigger job you'll have to make decisions, act, be somebody.
 - Are you short on courage?** It takes grit and determination to set a course and stick to it.
 - Is your education limited?** The good jobs go to men who know—men with sound training in their field. I. C. S. offers you that training.
 - Do you think you can't afford specialized training?** College may be too expensive, but home study lets you earn while you learn, at 1/10 the cost.
 - Do you hesitate to find out where to get training?** If you shy off from taking the first step, you'll never achieve success.

One out of three who read this page and check their shortcomings will do something about it. Two will stay in the rut. One will plan for self-improvement and stay with it till he gets there. Are you the one?

I. C. S. has helped train nearly 6 million men and women for better jobs. Among its 391 courses there's one that can help you succeed. I. C. S. lessons are clear, direct, authoritative. They give you bedrock facts and theory with practical application. Studying at home you can progress at your own speed, have the advantage of individual instruction. Choose the course you need from the list below, and *mail the coupon today!* We'll send you full information plus free book, "How to Succeed."

INTERNATIONAL CORRESPONDENCE SCHOOLS



BOX 5552-L, SCRANTON 9, PENNA.

Without cost or obligation, send me "HOW TO SUCCEED" and the booklet about the course BEFORE which I have marked X:

- | | | | | |
|--|---|--|---|--|
| <p>ART</p> <ul style="list-style-type: none"> <input type="checkbox"/> Commercial Art <input type="checkbox"/> Magazine and Book Illustrating <input type="checkbox"/> Cartooning <input type="checkbox"/> Show Card and Sign Lettering <input type="checkbox"/> Fashion Illustrating <p>AUTOMOTIVE</p> <ul style="list-style-type: none"> <input type="checkbox"/> Automobile, Mechanic <input type="checkbox"/> Auto-Elec. Technician <input type="checkbox"/> Auto Body Rebuilding and Refinishing <input type="checkbox"/> Diesel—Gas Engines <p>AVIATION</p> <ul style="list-style-type: none"> <input type="checkbox"/> Aeronautical Engineering Jr. <input type="checkbox"/> Aircraft Engine Mechanic <input type="checkbox"/> Airplane Drafting <p>BUILDING</p> <ul style="list-style-type: none"> <input type="checkbox"/> Architecture <input type="checkbox"/> Arch. Drafting <input type="checkbox"/> Building Contractor <input type="checkbox"/> Estimating <input type="checkbox"/> Carpenter and Mill Work <input type="checkbox"/> Carpenter Foreman <input type="checkbox"/> Reading Blueprints <input type="checkbox"/> House Planning <input type="checkbox"/> Plumbing | <ul style="list-style-type: none"> <input type="checkbox"/> Heating <input type="checkbox"/> Steam Fitting <input type="checkbox"/> Air Conditioning <input type="checkbox"/> Electrician <p>BUSINESS</p> <ul style="list-style-type: none"> <input type="checkbox"/> Business Administration <input type="checkbox"/> Certified Public Accountant <input type="checkbox"/> Accounting <input type="checkbox"/> Bookkeeping <input type="checkbox"/> Stenography and Typing <input type="checkbox"/> Secretarial <input type="checkbox"/> Federal Tax <input type="checkbox"/> Business Correspondence <input type="checkbox"/> Personnel and Labor Relations <input type="checkbox"/> Advertising <input type="checkbox"/> Retail Business Management <input type="checkbox"/> Managing Small Business <input type="checkbox"/> Sales Management <input type="checkbox"/> Salesmanship <input type="checkbox"/> Traffic Management <p>CHEMISTRY</p> <ul style="list-style-type: none"> <input type="checkbox"/> Chemical Engineering <input type="checkbox"/> Chemistry <input type="checkbox"/> Analytical Chemistry <input type="checkbox"/> Petroleum—Nat'l Gas <input type="checkbox"/> Pulp and Paper Making <input type="checkbox"/> Plastics | <p>CIVIL, STRUCTURAL ENGINEERING</p> <ul style="list-style-type: none"> <input type="checkbox"/> Civil Engineering <input type="checkbox"/> Structural Engineering <input type="checkbox"/> Surveying and Mapping <input type="checkbox"/> Structural Drafting <input type="checkbox"/> Highway Engineering <input type="checkbox"/> Reading Blueprints <input type="checkbox"/> Concrete Construction <input type="checkbox"/> Sanitary Engineering <p>DRAFTING</p> <ul style="list-style-type: none"> <input type="checkbox"/> Aircraft Drafting <input type="checkbox"/> Architectural Drafting <input type="checkbox"/> Electrical Drafting <input type="checkbox"/> Mechanical Drafting <input type="checkbox"/> Structural Drafting <input type="checkbox"/> Sheet Metal Drafting <input type="checkbox"/> Mine Surveying and Drafting <p>ELECTRICAL</p> <ul style="list-style-type: none"> <input type="checkbox"/> Electrical Engineering <input type="checkbox"/> Electrician <input type="checkbox"/> Electrical Maintenance <input type="checkbox"/> Electrical Drafting <input type="checkbox"/> Electric Power and Light <input type="checkbox"/> Lineman <p>HIGH SCHOOL</p> <ul style="list-style-type: none"> <input type="checkbox"/> High School Subjects | <ul style="list-style-type: none"> <input type="checkbox"/> College Preparatory <input type="checkbox"/> Mathematics <input type="checkbox"/> Commercial <input type="checkbox"/> Good English <p>MECHANICAL AND SHOP</p> <ul style="list-style-type: none"> <input type="checkbox"/> Mechanical Engineering <input type="checkbox"/> Industrial Engineering <input type="checkbox"/> Industrial Supervision <input type="checkbox"/> Foremanship <input type="checkbox"/> Mechanical Drafting <input type="checkbox"/> Machine Design-Drafting <input type="checkbox"/> Machine Shop Practice <input type="checkbox"/> Tool Design <input type="checkbox"/> Industrial Instrumentation <input type="checkbox"/> Machine Shop Inspection <input type="checkbox"/> Reading Blueprints <input type="checkbox"/> Toolmaking <input type="checkbox"/> Gas—Electric Welding <input type="checkbox"/> Heat Treatment—Metallurgy <input type="checkbox"/> Sheet Metal Work <input type="checkbox"/> Sheet Metal Pattern Drafting <input type="checkbox"/> Refrigeration <p>POWER</p> <ul style="list-style-type: none"> <input type="checkbox"/> Combustion Engineering <input type="checkbox"/> Diesel—Electric <input type="checkbox"/> Electric Light and Power | <ul style="list-style-type: none"> <input type="checkbox"/> Stationary Steam Engineering <input type="checkbox"/> Stationary Fireman <p>RADIO, TELEVISION, COMMUNICATIONS</p> <ul style="list-style-type: none"> <input type="checkbox"/> General Radio <input type="checkbox"/> Radio Operation <input type="checkbox"/> Radio Servicing—FM <input type="checkbox"/> Television <input type="checkbox"/> Electronics <input type="checkbox"/> Telephone Work <p>RAILROAD</p> <ul style="list-style-type: none"> <input type="checkbox"/> Locomotive Engineer <input type="checkbox"/> Diesel Locomotive <input type="checkbox"/> Air Brakes <input type="checkbox"/> Car Inspector <input type="checkbox"/> Railroad Administration <p>TEXTILE</p> <ul style="list-style-type: none"> <input type="checkbox"/> Textile Engineering <input type="checkbox"/> Cotton Manufacture <input type="checkbox"/> Rayon Manufacture <input type="checkbox"/> Woolen Manufacture <input type="checkbox"/> Loom Fixing <input type="checkbox"/> Finishing and Dyeing <input type="checkbox"/> Textile Designing <p>HOME ARTS</p> <ul style="list-style-type: none"> <input type="checkbox"/> Dressmaking and Designing <input type="checkbox"/> Cookery <input type="checkbox"/> Tea Room Management |
|--|---|--|---|--|

Name _____ Age _____ Home Address _____

City _____ State _____ Working Hours _____ A.M. to _____ P.M.

Occupation _____

Special tuition rates to members of the Armed Forces. Canadian residents send coupon to International Correspondence Schools Canadian, Ltd., Montreal, Canada



AUDELS T.V. RADIO SERVICE LIBRARY

2 VOLS. \$6 COMPLETE \$1 A MO. PAY ONLY 1 MO.
HERE IS LATE INFORMATION IN A HANDY FORM FOR RADIO & TELEVISION REPAIRMEN, SERVICEMEN AND STUDENTS
IT PAYS TO KNOW!

AUDELS T.V.-RADIO SERVICE LIBRARY presents the important subjects of Modern Radio, Television, Industrial Electronics, F.M. Public Address Systems, Auto, Marine & Aircraft Radio, Phonograph Pick-Ups, etc. Covers Basic Principles—Construction—Installation—Operation—Repairs—Trouble Shooting. Shows How to get Sharp, Clear T.V. Pictures, Install Aerials—How to Test. Explains Color Systems & Methods of Conversion. 1001 Facts—Over 1260 Pages—625 Illustrations of Parts & Diagrams—Valuable for Quick Handy Reference & Home Study. Tells How to Solve T.V. & Radio Troubles—Answers T.V. & Radio Questions.

Get this information for Yourself, 7 DAY TEST—ASK TO SEE IT!

MAIL ORDER

AUDELS, Publishers, 49 W. 23rd St., New York 10, N.Y.
 Mail AUDEL'S T.V. RADIO SERVICE LIBRARY 2 Vols. \$6 on 7 days free trial. If O.K. I will remit \$1 in 7 days and \$1 monthly until \$6 is paid. Otherwise I will return them.

Name _____
 Address _____
 Occupation _____
 Employed by _____ P12

AUDELS Carpenters and Builders Guides 4 vols. \$6



Inside Trade Information for Carpenters, Builders, Joiners, Building Mechanics and all Woodworkers. These Guides give you the short-cut instructions that you want—including new methods, ideas, solutions, plans, systems and money saving suggestions. An easy progressive course for the apprentice and student. A practical daily helper and Quick Reference for the master worker. Carpenters everywhere are using these Guides as a Helping Hand to Easier Work, Better Work and Better Pay. To get this assistance for yourself, simply fill in and mail FREE COUPON below.

Inside Trade Information On:
 How to use the steel square—How to file and set saws—How to build furniture—How to use a mitre box—How to use the chalk line—How to use rules and scales—How to make joints—Carpenters arithmetic—Solving mensuration problems—Estimating strength of timbers—How to set girders and sills—How to frame houses and roofs—How to estimate costs—How to build houses, barns, garages, bungalows, etc.—How to read and draw plans—Drawing up specifications—How to excavate—How to use settings 12, 13 and 17 on the steel square—How to build hoists and scaffolds—skylights—How to build stairs—How to put on interior trim—How to hang doors—How to lath—lay floors—How to paint.



AUDELS, Publishers, 49 W. 23rd St., New York 10, N.Y.
 Mail Audels Carpenters and Builders Guides, 4 vols., on 7 days' free trial. If O.K. I will remit \$1 in 7 days and \$1 monthly until \$6 is paid. Otherwise I will return them. No obligation unless I am satisfied.

Name _____
 Address _____
 Occupation _____
 Employed by _____ P12

WHAT ALL AUTO MECHANICS WANT TO KNOW

1800 PAGES

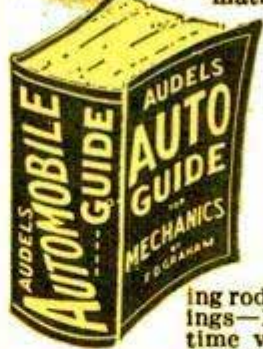

This Big Practical Book gives full information with working diagrams covering the principles, construction, ignition, service and repair of modern cars, trucks and buses.

Diesel Engines, Hydramatic & Fluid Drives Fully Explained.
 A complete Guide of 1800 pages, with over 1500 illustrations showing inside views of working parts, with instructions for service jobs.

IT PAYS TO KNOW

How to fit pistons—How to locate engine knocks. How to fit connecting rod bearings—How to service main bearings—How to recondition valves—How to time valves—How to adjust fan belts—How to adjust carburetors and chokes. How to rebuild a clutch—How to service automatic transmissions—How to service brakes—How to adjust steering gear—How to cope with ignition troubles—How to service distributors—How to time ignition—How to "tune up" an engine.



\$4 COMPLETE • PAY \$1 A MO. TO GET THIS ASSISTANCE FOR YOURSELF SIMPLY FILL IN AND MAIL COUPON TODAY.

Step up your own skill with the facts and figures of your trade. Audels Mechanics Guides contain Practical Inside Trade Information in a Handy Form. Fully illustrated and Easy to Understand. Highly Endorsed. Check the book you want for 7 DAYS FREE EXAMINATION. Send No Money. Nothing to pay postman.

MAIL ORDER



AUDELS, Publishers, 49 W. 23 St., NEW YORK 10, N.Y.

Please send me postpaid for FREE EXAMINATION books marked below. If I decide to keep them I agree to mail \$1 in 7 Days on each book or set ordered and further mail \$1 monthly on each book or set until I have paid price, otherwise I will return them.

- AUTOMOBILE MECHANICS GUIDE, 1800 Pages \$ 4
- TRUCK & TRACTOR GUIDE, 1299 Pages 2
- DIESEL ENGINE MANUAL, 575 Pages 4
- MACHINISTS HANDY BOOK, 1650 Pages 4
- WELDERS GUIDE, 400 Pages 1
- BLUE PRINT READING, 416 Pages 2
- MATHEMATICS & CALCULATIONS, 700 Pages. 2
- SHEET METAL PATTERN LAYOUTS, 1100 Pages. 4
- SHEET METAL WORKERS HANDY BOOK, 388 Pgs. 1
- MECHANICAL DRAWING GUIDE, 160 Pages 1
- MECHANICAL DRAWING & DESIGN, 480 Pages 2
- AIRCRAFT WORKER, 240 Pages 1
- TELEVISION SERVICE MANUAL, 384 Pages. 2
- RADIOMANS GUIDE, 914 Pages 4
- ELECTRONIC DEVICES, 216 Pages 2
- ELECTRIC MOTOR GUIDE, 1000 Pages 4
- ELECTRIC WIRING DIAGRAMS, 272 Pages 1
- ELECTRICIANS EXAMINATIONS, 250 Pages. 1
- ELECTRIC POWER CALCULATIONS, 425 Pages. 2
- HANDY BOOK OF ELECTRICITY, 1440 Pages. 4
- ELECTRIC DICTIONARY, 9000 Terms 2
- ELECTRIC LIBRARY, 7000 Pages (12 Book Set) 18
- MARINE ENGINEERS HANDY BOOK, 1258 Pgs. 4
- SHIPFITTERS HANDY BOOK, 250 Pages 1
- REFRIGERATION & Air Conditioning, 1280 Pgs. 4
- MILLWRIGHTS & MECHANICS GUIDE, 1200 Pgs. 4
- POWER PLANT ENGINEERS GUIDE, 1500 Pages 4
- ENGINEERS & FIREMANS EXAMS, 525 Pages 1
- PUMPS, Hydraulics & Air Compressors, 1658 Pgs. 4
- ENGINEERS LIBRARY (3 Book Set) 9
- MECHANICAL DICTIONARY, 950 Pages 4
- GARDENERS & GROWERS GUIDES (4 Book Set) 6
- CARPENTERS & BUILDERS GUIDES (4 Book Set) 6
- PLUMBERS & Steamfitters Guides (4 Book Set) 6
- MASONS AND BUILDERS GUIDES (4 Book Set) 6
- PAINTERS & DECORATORS MANUAL, 450 Pgs. 2
- HOUSE HEATING GUIDE, 1000 Pages 4
- OIL BURNER GUIDE, 384 Pages 1

Check NOW!

You Can Look Over Any Guide In Your Own Home — Start the Easy Payments If Satisfied

MAIL THIS TODAY

Name _____
 Address _____
 Occupation _____
 Employed by _____ P12

Are you flirting with fire?



Neglected wires cause automobile fires—burn up hundreds of cars, trucks, and buses every day!

Year after year, National Safety Council figures tell the same story: fire reports list “defective wiring” as the cause of as high as 92% of all vehicle fires.

DON'T FLIRT WITH FIRE! See that your wires and cables are checked *today*. Not only to prevent fire, but to prevent hard starting, poor engine performance, battery failure. When replacing wiring, insist on genuine Crescent Wiry Joe Wire and Battery Cables. There are none better!



Write now for this valuable free booklet!

THE CRESCENT COMPANY, Inc.
Pawtucket, Rhode Island

Please send me my free copy of “The Effect of Defective Wiring on Car Performance.”

NAME _____

ADDRESS _____

CITY _____ ZONE _____ STATE _____



WHERE-TO-BUY-IT INDEX

Source of supply appears after items commercially available

AUTOMOTIVE

Detroit Listening Post.....	87
Plymouth restyles for '53.....	104
400-horsepower Chrysler V8 hits 170 m.p.h. on speedway.....	108
"Wing flap" brakes German sports car.....	132
Truck engines start quickly when preheated by hot-air flow.....	148

AUTOMOTIVE ACCESSORIES

Cross-link rollers give long life to automobile tire chains (Roll-O-Matic Chain Co., 200 Wyandotte St., Kansas City, Mo.).....	110
Automobile cigarette lighter doubles its use as flashlight (Cuno Engineering Corp., 4612 S. Vine St., Meriden, Conn.).....	125
Plastic sheet keeps windshield of parked car ice-free (Central States Paper & Bag Co., 5221 National Bldg., St. Louis, Mo.).....	125
"Windmill" device on windshield protects nighttime driver from glare.....	141
Traction tire clip replaces conventional auto chains.....	141

AVIATION

Jet-bomber pilots learn job on the ground (Link Aviation, Inc., Binghamton, N. Y.).....	71
Pop-out samplers accurately check airplane's rate of icing.....	78
Hydraulic lift parks airplanes in small carrier-deck areas.....	79
Air ferry for cars and motorists ready for cross-channel service.....	80
"Clipped" plane has retractable wings.....	102
Air patrols check ground radar.....	110
All-metal lightweight flies over 100 m.p.h.....	123
Britain's jet-driven flying boat starts flight tests.....	125
Airplanes of glass?.....	144

HOBBIES AND NOVELTIES

Diminutive "overstuffed" furniture pieces make novel pipe racks.....	70
Wren house (W. R. Vermillion Co., 2205 Grand Ave., Kansas City 8, Mo.).....	127
It's fun to be fooled.....	134
Reindeer for hire.....	146

HOUSE AND HOME

Catchup dispenser (Squeezit Corp., Morris Heights 53, N. Y.).....	126
Table hopper lamp (Sylvia Robinson, 12 Forster Parkway, Mt. Vernon, N. Y.).....	126
Personalized labels (The Camp, Hartford, Conn.).....	126
Book rack (Salisbury Artisans, Salisbury, Conn.).....	126
Butter warmer (Susi Press Co., 200 Hill St., Whitinsville, Mass.).....	126
Fold-away tray (Village Store of Lake Placid, Lake Placid 5, N. Y.).....	127
Flower holder (Carmel Work Center, Box T-1, Carmel-by-the-Sea, Calif.).....	127
Coffee caddy (Design Lab., Studio "A," Box 8332 University Park Station, Denver 10, Colo.).....	127
Magnetic pot holder (Magnex, 1573 S. Josephine, Denver 10, Colo.).....	127
Small projector (Willoughbys, 110 W. 32nd St., New York City 1).....	128
Economy grill (Fletcher Enamel Co., Dunbar, W. Va.).....	129
Blackboard chair desk (Durex Co., Box 672, Chicago 90).....	131
Friction latch and lock (Specialty Industries, 5848 Northwest Highway, Chicago 31).....	242
Lathering cup fits on tube (Conway Products, Box 385, Lemon Grove, Calif.).....	250
Door hinge needs no mortise (No-Mortise Hinge Corp., Bound Brook, N. J.).....	266

INDUSTRY

Hydraulic spike yanker.....	70
"Railroad" planer smooths large laminated-wood trusses.....	70
Coal miners carried by ski hoist on way homeward.....	79
Accelerated drying method for painted and varnished products.....	79
Buttermaking minus churns.....	116
Thermometer traces ills of ailing oil wells.....	133
Sewage "farms" promise valuable feed and chemical products.....	148

SPORTS AND RECREATION

Locking gun rack (Yield House, North Conway, N. H.).....	128
Bait box (Parker Plastic Products, Box 13162, Houston, Tex.).....	128
Sportsman's muff (Pacific Products Co., 1604 S.W. 10th Ave., Portland, Ore.).....	128
Sunmat (Sunmaster, 709 E. Yanonali St., Santa Barbara, Calif.).....	129
Champ "skates" through streets of Paris on a pair of wheeled skis.....	132

TOYS

Miniature switchboard buzzes and rings for junior operators.....	110
Bat Bak (Merylie Trading Corp., 100 E. 21st St., New York City 10).....	130
Freight station (Lionel Corp., Irvington, N. J.).....	130
Fix-it truck (Guarantee Products Co., 950 S. Lincolnway East, South Bend, Ind.).....	130
Electric car (Mystic River Sales Co., Mystic, Conn.).....	130
Toy fire engine (Charles W. Doepke Mfg. Co., 1947 Emerald Ave., Rossmoyne, Ohio).....	130
Toy vehicle kits (Northwestern Products Co., 200 Fifth Ave., New York City).....	131
Toy house kit (Allied Toy Co., 180 Casper St., Valley Stream, N. Y.).....	131
TV showhouse (Dyer Products Co., Canton, Ohio).....	131
Small-size vacuum cleaner for junior housekeeper (Kenlee Industries, 2817 N. Clark St., Chicago 10).....	262

(Continued to page 14)

INVENTORS

Learn how to protect your invention. The U. S. Patent Laws provide that any new and useful art, machine, article of manufacture, or composition of matter, or any new and useful improvement thereof, may be patented if the act of invention is involved. Therefore, every inventor with a valuable invention should take advantage of the Patent Laws and proceed for patent protection in order to safeguard his rights.

A patent gives the inventor the exclusive right to prevent others from making, using, or selling the invention claimed in the patent for a period of seventeen years.

The Patent Laws were enacted for the benefit of the inventor to give him protection for the features of his invention which are patentable. These features must be properly and concisely set forth and claimed in a formal application for patent, in order to comply with the requirements of the Patent Laws. For that reason, unless the inventor is familiar with patent matters, he should engage a competent registered patent attorney or agent to represent him. We are registered to practice before the U. S. Patent Office and are prepared to serve you in the handling of your patent matters.

A specially prepared booklet entitled "Patent Guide for the Inventor", containing detailed information with respect to patent protection and procedure, together with a "Record of Invention" form will be promptly forwarded to you without obligation upon request.

CLARENCE A. O'BRIEN & HARVEY JACOBSON

Registered Patent Attorneys

21-M DISTRICT NATIONAL BUILDING

WASHINGTON 5, D. C.

IMAGINE THEIR JOY

when they found they could play this easy-as-ABC way!



Learned Quickly at Home

"I didn't dream I could actually learn to play without a teacher. Now, when I play for people they hardly believe that I learned to play so well in so short a time."

*H.C.S., Calif.



Plays at Dances

"Your lessons have been most satisfactory. I can play all of the popular songs. I have earned money playing at dances."

*E.N.J., New York

What Instrument Would You Like to Play?

JUST name your instrument and we'll show you how you can learn to play it—quickly, easily, in spare time at home. Never mind if you don't know one note of music from another—don't worry about "special talent." And forget all you've ever heard about music being hard to learn.

The truth of the matter is that thousands now play who never thought they could! Yes, men and women everywhere have discovered this amazingly easy way to learn music at home. Now they are enjoying the thrilling satisfaction of playing the piano, violin, guitar, saxophone or other favorite instruments. Some of them are playing in orchestras and over the radio; others are teaching music, making money in spare or full time. And thousands are having the time of their lives playing for their own enjoyment and the entertainment of their friends.

No tedious study and practice, no tiresome exercises. You learn to play by playing—start right in with the melody of a simple tune! It takes only a few minutes a day; the cost is trifling. Does it sound too good to be true? Mail the coupon and get the FREE PROOF!

Easy as A-B-C



SEND FOR FREE PROOF

Fascinating illustrated booklet answers all your questions; free Print and Picture Sample shows how method works. If interested, just mail coupon to U. S. School of Music, Studio B3012, Port Washington, N.Y. (900,000 Students—Our 55th Successful year.)

*Actual pupils' names on request. Pictures by professional models.

FREE! Print and Picture Sample

U. S. School of Music, Studio B3012, Port Washington, N. Y.

Send me Free Book and free Lesson-Sample. No salesman is to call upon me. I'm interested in playing (name instrument).....

I do I do not—have instrument now.

Name..... (please print)

Address.....

(Continued from page 12)

MISCELLANEOUS

Antique "flaming" organ displayed by London museum.....	71
Government hires large percentage of scientists.....	71
Shock-absorber rope prevents fatal falls by workers.....	78
One-man sub prowls sea bottom.....	107
Twenty years added to average lifespan.....	110
Navy uses plastic patches to repair ship pipe lines.....	117
Rain makers seed clouds with salt particles or water droplets.....	123
Church services held in outdoor theater.....	124
Fountain pen (Imperial Pen Co., 225 N. Michigan Ave., Chicago 11).....	128
Tool chest (Stanley Tools, New Britain, Conn.).....	129
Blower seeds unsightly embankments.....	136
Finger-size stomach camera developed by Japanese scientists.....	144
Nazi assault boats employed to wage war on beetles.....	144
Electronic "stop watch" splits second into millionths.....	145
Steel framing material quickly assembled in various shapes.....	145
Forecast 1000-mile rocket.....	148
Electric-heater thermostat.....	148

Craftsman and Shop Notes Index

AUTOMOTIVE

Signal light warns driver when parking brake is set.....	156
Method for improving service of worn distributor points.....	171
Sections cut from casing replace worn tire-chain links.....	176
Extending auto-battery life.....	190
Bleeder screw releases air lock in car-heater line.....	200
Excessive rotor gap reduces spark.....	200

CHRISTMAS IDEAS

Make your own tree ornaments.....	161
Shelf attached to window sill without use of nails.....	170
Dry soapsuds used as snow on Christmas tree.....	170
Yule tree in picture-window bay "framed" by balsam branches.....	170
Soaped candles burn brighter.....	170

HOBBIES AND NOVELTIES

Make Fido a dog tag.....	163
Decorative wood-putty book ends "cast" in plaster molds.....	174
Tie clasps and barrettes in colorful plastic.....	177
Imitation bamboo picture-frame molding formed by burning wood with hot wire.....	189

HOUSE AND HOME

Silverware chest.....	157
Refinishing marred furniture.....	160
Weighted key stays in door lock.....	162
Improvised frozen-food containers.....	162
Solving home problems.....	164
Repairing loose doorknobs.....	166
Partitioning helps to keep drawers orderly.....	171
Lawn-furniture legs preserved by asbestos roof coating.....	174
Sagging bedspring repaired temporarily by crimping wire links with wrench.....	181
Packaged cereals kept crisp when stored near hot-water heater.....	185
Dummy windows on garage doors relieve blank-wall effect.....	185
Folding ironing board for travel can be packed in suitcase.....	189

JIGS, GAUGES AND FIXTURES

Emergency candleholder from old light fixture.....	162
Floor lamp wired into circuit produces electrical tester.....	162
Spring contacts on voltmeter speed testing of dry cells.....	189
Jar covers and wood from crate used to make letter scales.....	197

METALWORKING

Tape marker on threading chart indicates lathe gear setting.....	160
Androns of welded pipe lengths beaded to simulate logs.....	176
Emergency crimping of stovepipe.....	185
Tiny ladle used in modelmaking made from thimble and wire.....	190
Drill and tap stand.....	201
Glass window on bandsaw guard permits safe view of work.....	207
Cutting metal in your jigsaw.....	210

OFFICE, SHOP AND STORE

Reflector for workshop light provided by wash basin.....	162
Cutlery trays provide drawers for small-parts cabinet.....	166
Rubber-stamp aligning guide assures even print.....	176
Improvised stencil cutter.....	180
Gymnasium locker laid on side provides workshop storage bin.....	186
Felt dauber applies layout ink.....	197
Mechanics signal work status with colored lights.....	200
Tape holds line of rubber type ready for repeated use.....	200

PHOTOGRAPHY

Storage rack for cut-film holders.....	191
Inexpensive winder speeds loading of film-cartridge reel.....	191
Test line keeps flash guns firing.....	192
Toning down scratches and abrasions on old negatives.....	193
"Deckle" edges for snapshots.....	194
Spreader tightens clamp-on lamps.....	194

(Continued to page 16)

IMPORTANT NOTICE—It is the intention of this magazine to provide its readers with information regarding the latest developments in the mechanical arts. We take no responsibility as to whether the disclosures contained in our articles are covered by patents and advise readers to investigate this subject before making, using, or selling any of the products, machines, or processes described in order to avoid possible liability for patent infringements.

INVENTORS

If you believe that you have an invention, you should find out how to protect it. The first step is to have a search made of the prior pertinent U. S. patents. If a report on this search indicates that the invention appears patentable you can apply for a patent, and the specifications and claims should be prepared.

The firm of McMorrow, Berman & Davidson, with offices in Washington, D. C., is qualified to take the necessary steps for you. We can make a preliminary search on your invention, advise you whether we think it can be patented, and prepare your application for patent.

Unless you are fully familiar with the U. S. Patent Laws, we recommend that you engage the services of a Registered Patent Attorney to protect your interests. The patent laws are *your* laws. A patent gives you the right to prevent others from making, using or selling the invention claimed in your patent for a period of 17 years.

Use these patent laws for your protection. Investigate whether your invention can be patented. If you have what you believe to be an invention, we suggest that you have this firm make a search for you.

Send for a copy of our Patent Booklet entitled "How To Protect Your Invention," containing information about patent protection and patent procedure. Along with this we will also send you an "Invention Record" form, for your use in writing down and sketching details of your invention. We will mail them promptly. No obligation. They are yours for the asking.

McMORROW, BERMAN & DAVIDSON

Registered Patent Attorneys

PATENTS • COPYRIGHTS • PATENTS

135-E VICTOR BUILDING, WASHINGTON 1, D. C.

RECREATION

Partitioned box and marbles provide rainy-day game.....156
 Playroom xylophone158
 Curtain for show in home hung with safety pins.....160
 Rings and bull's-eye on paper plate provide easy-to-make target190

TOOLS

All-purpose clamp175
 Worn masonry drills salvaged to provide chisels and punches 181
 Grass cutter (L. Woodford, 3310 Kauffman Ave., Vancouver, Wash.)208
 Combination saw-setting machine (Belsaw Machinery Co., Dept. S-321, 315 Westport Road, Kansas City, Mo.).....208
 Small-bore dial gauge (Standard Gage Co., Inc., Poughkeepsie, N. Y.)208
 Push-pull steel rule (Kipco Industries, 1910 Corunna Ave., Owosso, Mich.)209
 Saw-edge protector (Dyer Products Co., 2nd St., S.W., Canton, Ohio)209
 New milling machine (E. R. Bachmann, 27-11 41st Ave., Long Island City 1, N. Y.)209
 Five-piece saw set (Weill Specialty Co., 1650 E. 38th St., Brooklyn, N. Y.).....209
 Tiny electrically operated sprayer (Burgess Vibrocrafters, Inc., 180 N. Wabash Ave., Chicago 1)209
 Safety saw guard (Frank N. Bretthauer, ~~1000 Broadway, N. Y. 17~~)209

WOODWORKING

Cutting wedges on a power saw.....156
 Dowels keep wood from splitting when bandsawing wheels....160
 Plan of the month—Christmas tree stands.....172
 Thin stock taped together for multiple bandsawing.....174
 Mass production in the basement shop.....178
 This plywood wardrobe "grows" with child.....187
 Slotted block aligns stock on circular saw.....197
 Giant "nursery" gate closes truck parking lot.....201

WORKSHOP HINTS

Eraser "bumpers" on coping saw protect work from chucks..166
 Protecting ends of drill bits.....166
 Glazier points driven with putty knife.....180
 Steel wool tamped in hole tightens loose screw.....180
 Method for cutting glass produces even separation.....185
 Bench saw pinch-hits as "joiner".....186
 Talcum powder applied to glass furnishes "bite" when marking190
 Handy shop dispenser.....198
 Altered wrench socket grips spark plug.....207
 Sanding disks trimmed easily with sharpened hacksaw blades 210
 Centering a worn shaft.....210

MISCELLANEOUS

Oil drum aids removal of tree stump.....156
 Carlock secured by curtain hook.....166
 Cans protect exposed dock piling and serve as channel markers174
 Sturdy rack for gasoline drum made from old auto-wheel rim 177
 Removing oil stains.....177
 Straining paint quickly.....180
 Tire cushions boat on car top.....180
 Threaded end of bolt filed to take nut easily.....180
 Proper treatment of fishing tackle prevents deterioration in storage181
 Longer life for razor blades.....181
 Rewire ornamental lamps easily.....186
 Rubber tip checks sliding umbrella.....186
 Cleaning and handling of plastics important to final appearance188
 Safety latch for suitcase.....190
 Treatment for scuffed suede gives shoes new look.....196
 Firmer support for fence posts.....207
 Hollow punch from steel tube aids in removing plasterboard. 207
 Metal lath attached to cornice with softboard spacers.....207

Radio-Television, Electronics

Periscope eye for TV cameras.....211
 TV receiver has unitized chassis (Setchell-Carlson, Inc., 330-5th Ave., N., New Brighton, Minn.).....211
 TV converter for UHF channels (Radio Corporation of America, RCA Victor Division, Camden, N. J.).....211
 Table-type all-channel TV antenna (K-G Electronics Corp., 3059 N. Sheffield Ave., Chicago 14).....211
 TV set in automobile (Arcraft Mantel and Television Co., 1811 W. Liberty Ave., Pittsburgh 26, Pa.).....211
 Children's record player has automatic start and stop.....212
 Projection-TV installations in the home (Arcraft Mantel and Television Co., 1811 W. Liberty Ave., Pittsburgh 26, Pa.) 215

☞ South America and South Africa probably were once joined by a broad land bridge, Dr. Kenneth Caster of the University of Cincinnati told members of the International Geologic Congress, citing similarities in certain geologic features.

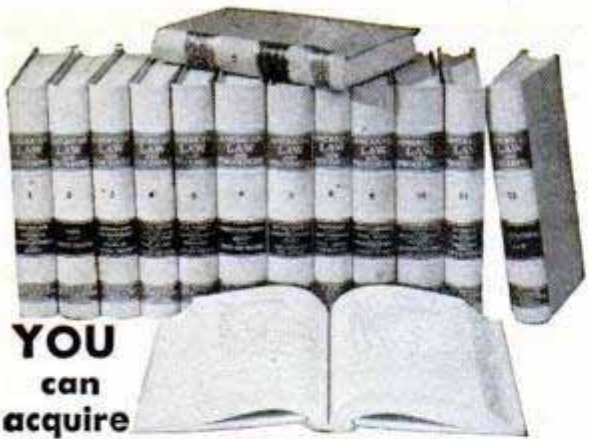

YOU
can
acquire

LAW NIGHTS AT HOME!
L. L. B. DEGREE

LaSalle's famous Law Library—used as reference in many Law libraries and Law offices—has enabled thousands to master Law surprisingly fast, in spare hours at home, for business and professional advancement.

These 14 remarkable volumes, compiled by leading professors and lawyers, cover the whole basic field of Law in condensed, orderly, simplified manner.

You advance rapidly with this great library, plus special lectures furnished. We guide you step-by-step with personalized Problem Method of instruction . . . you learn by doing—handling legal problems—not by memorizing rules.

Send for two FREE 48-page booklets, "Law Training for Leadership," and "Evidence," answering questions about Law and its value to you, and telling how LaSalle Law graduates are winning rapid advancement in business and public life. Mail coupon below. No obligation.

LA SALLE EXTENSION UNIVERSITY
A Correspondence Institution

417 S. Dearborn St. Dept. 1264-L Chicago 5, Ill.

Send me your two FREE booklets described above, without obligation.

Name..... Age.....
 Street.....
 City, Zone & State.....

**THE HANDIEST PAIR
OF LEGS IN THE
WORLD!**

**MAKE XMAS TRAIN
PLATFORMS, TABLES,
WORK BENCHES, etc.**

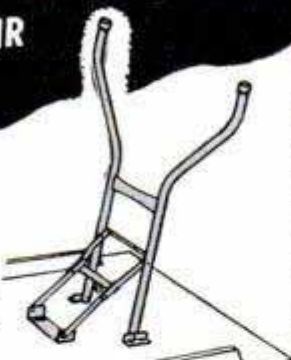

Atlas STEEL FOLDING UTILITY LEGS

For home, office or factory! It's easy to bolt or screw them to wood, masonry or other materials. Hold over 600 lbs., fold easily, lock into position for safety. Complete with bolts, folding mechanism. Money-back guarantee!

-  TABLES
-  TRAIN PLATFORMS
-  WORK BENCHES

please specify **\$9.95** pr. postpaid
height desired (on C.O.D. orders
26, 30 or 34" you pay postage
(3 sets, \$25)

INSTITUTIONAL SALES CO.

Dept. D. 4932 Portico St. Phila. 44, Pa.



Success Comes Sooner THIS FAMOUS WAY

IT may be true that there is no single "magic formula" for success—but I.C.S. training comes mighty close to it. For example, a recent survey showed that, **IN JUST ONE 120-DAY PERIOD, MORE THAN 1900 I.C.S. STUDENTS WERE PROMOTED TO BETTER JOBS!**

If you want success to come sooner to you—if you want to get ahead faster in your present field or to break into a new one which is more profitable or more interesting—then I.C.S. is ready to help you. **AND THE COST TO YOU IS ONLY A FEW CENTS PER DAY!**

SURVEY SHOWS
That in Just One
120-Day Period Over
1900 I.C.S. Students
Were Promoted to
Better Jobs!

Today's Exciting Opportunities

In industry after industry, the crying need today is for trained men. The electronics industry, for example, is expanding so rapidly that already it is producing 20 times as much as 12 years ago. There are 80,000 jobs waiting for engineers of all kinds—but only 20,000 men qualified to fill them. Radio and television needs 170,000 new technical workers. There is a tremendous shortage of trained manpower in the chemical field. Electricity generation is due to expand 40% in the next 3 years.

Right at home, in your own most convenient spare time, you acquire the additional training you need to

increase your earning power. You have 391 courses from which to choose—and one or more of our 203 expert instructors gives you the individual, personal attention which helps you get ahead faster. And the cost is small because I.C.S. is so large—5,918,632 students so far!

FREE—2 INTERESTING BOOKS

The coupon below, without cost or obligation, will bring you our Free Book about the subject you're interested in. You'll also receive, free, our book on "How to Succeed"—a 36-page gold-mine of valuable advice telling Why People Fail, How to Pick Your Goal, How to Develop Your Hidden Talents, etc. To take full advantage of today's job opportunities mail coupon NOW.



INTERNATIONAL CORRESPONDENCE SCHOOLS



BOX 5551-L, SCRANTON 9, PENNA.

Without cost or obligation, send me "HOW TO SUCCEED" and the booklet about the course BEFORE which I have marked X:

- | | | | | |
|--|--|--|--|--|
| <p>ART</p> <p><input type="checkbox"/> Commercial Art</p> <p><input type="checkbox"/> Magazine and Book Illustrating</p> <p><input type="checkbox"/> Cartooning</p> <p><input type="checkbox"/> Show Card and Sign Lettering</p> <p><input type="checkbox"/> Fashion Illustrating</p> <p>AUTOMOTIVE</p> <p><input type="checkbox"/> Automobile, Mechanic</p> <p><input type="checkbox"/> Auto-Elec. Technician</p> <p><input type="checkbox"/> Auto Body Rebuilding and Refinishing</p> <p><input type="checkbox"/> Diesel—Gas Engines</p> <p>AVIATION</p> <p><input type="checkbox"/> Aeronautical Engineering Jr.</p> <p><input type="checkbox"/> Aircraft Engine Mechanic</p> <p><input type="checkbox"/> Airplane Drafting</p> <p>BUILDING</p> <p><input type="checkbox"/> Architecture</p> <p><input type="checkbox"/> Arch. Drafting</p> <p><input type="checkbox"/> Building Contractor</p> <p><input type="checkbox"/> Estimating</p> <p><input type="checkbox"/> Carpenter and Mill Work</p> <p><input type="checkbox"/> Carpenter Foreman</p> <p><input type="checkbox"/> Reading Blueprints</p> <p><input type="checkbox"/> House Planning</p> <p><input type="checkbox"/> Plumbing</p> | <p><input type="checkbox"/> Heating</p> <p><input type="checkbox"/> Steam Fitting</p> <p><input type="checkbox"/> Air Conditioning</p> <p><input type="checkbox"/> Electrician</p> <p>BUSINESS</p> <p><input type="checkbox"/> Business Administration</p> <p><input type="checkbox"/> Certified Public Accountant</p> <p><input type="checkbox"/> Accounting</p> <p><input type="checkbox"/> Bookkeeping</p> <p><input type="checkbox"/> Stenography and Typing</p> <p><input type="checkbox"/> Secretarial</p> <p><input type="checkbox"/> Federal Tax</p> <p><input type="checkbox"/> Business Correspondence</p> <p><input type="checkbox"/> Personnel and Labor Relations</p> <p><input type="checkbox"/> Advertising</p> <p><input type="checkbox"/> Retail Business Management</p> <p><input type="checkbox"/> Managing Small Business</p> <p><input type="checkbox"/> Sales Management</p> <p><input type="checkbox"/> Salesmanship</p> <p><input type="checkbox"/> Traffic Management</p> <p>CHEMISTRY</p> <p><input type="checkbox"/> Chemical Engineering</p> <p><input type="checkbox"/> Chemistry</p> <p><input type="checkbox"/> Analytical Chemistry</p> <p><input type="checkbox"/> Petroleum—Nat'l Gas</p> <p><input type="checkbox"/> Pulp and Paper Making</p> <p><input type="checkbox"/> Plastics</p> | <p>CIVIL, STRUCTURAL ENGINEERING</p> <p><input type="checkbox"/> Civil Engineering</p> <p><input type="checkbox"/> Structural Engineering</p> <p><input type="checkbox"/> Surveying and Mapping</p> <p><input type="checkbox"/> Structural Drafting</p> <p><input type="checkbox"/> Highway Engineering</p> <p><input type="checkbox"/> Reading Blueprints</p> <p><input type="checkbox"/> Concrete Construction</p> <p><input type="checkbox"/> Sanitary Engineering</p> <p>DRAFTING</p> <p><input type="checkbox"/> Aircraft Drafting</p> <p><input type="checkbox"/> Architectural Drafting</p> <p><input type="checkbox"/> Electrical Drafting</p> <p><input type="checkbox"/> Mechanical Drafting</p> <p><input type="checkbox"/> Structural Drafting</p> <p><input type="checkbox"/> Sheet Metal Drafting</p> <p><input type="checkbox"/> Mine Surveying and Drafting</p> <p>ELECTRICAL</p> <p><input type="checkbox"/> Electrical Engineering</p> <p><input type="checkbox"/> Electrician</p> <p><input type="checkbox"/> Electrical Maintenance</p> <p><input type="checkbox"/> Electrical Drafting</p> <p><input type="checkbox"/> Electric Power and Light</p> <p><input type="checkbox"/> Lineman</p> <p>HIGH SCHOOL</p> <p><input type="checkbox"/> High School Subjects</p> | <p><input type="checkbox"/> College Preparatory</p> <p><input type="checkbox"/> Mathematics</p> <p><input type="checkbox"/> Commercial</p> <p><input type="checkbox"/> Good English</p> <p>MECHANICAL AND SHOP</p> <p><input type="checkbox"/> Mechanical Engineering</p> <p><input type="checkbox"/> Industrial Engineering</p> <p><input type="checkbox"/> Industrial Supervision</p> <p><input type="checkbox"/> Foremanship</p> <p><input type="checkbox"/> Mechanical Drafting</p> <p><input type="checkbox"/> Machine Design-Drafting</p> <p><input type="checkbox"/> Machine Shop Practice</p> <p><input type="checkbox"/> Tool Design</p> <p><input type="checkbox"/> Industrial Instrumentation</p> <p><input type="checkbox"/> Machine Shop Inspection</p> <p><input type="checkbox"/> Reading Blueprints</p> <p><input type="checkbox"/> Toolmaking</p> <p><input type="checkbox"/> Gas—Electric Welding</p> <p><input type="checkbox"/> Heat Treatment—Metallurgy</p> <p><input type="checkbox"/> Sheet Metal Work</p> <p><input type="checkbox"/> Sheet Metal Pattern Drafting</p> <p><input type="checkbox"/> Refrigeration</p> <p>POWER</p> <p><input type="checkbox"/> Combustion Engineering</p> <p><input type="checkbox"/> Diesel—Electric</p> <p><input type="checkbox"/> Electric Light and Power</p> | <p><input type="checkbox"/> Please send information about I.C.S. employee training for companies.</p> <p><input type="checkbox"/> Stationary Steam Engineering</p> <p><input type="checkbox"/> Stationary Fireman</p> <p>RADIO, TELEVISION, COMMUNICATIONS</p> <p><input type="checkbox"/> General Radio</p> <p><input type="checkbox"/> Radio Operation</p> <p><input type="checkbox"/> Radio Servicing—FM</p> <p><input type="checkbox"/> Television</p> <p><input type="checkbox"/> Electronics</p> <p><input type="checkbox"/> Telephone Work</p> <p>RAILROAD</p> <p><input type="checkbox"/> Locomotive Engineer</p> <p><input type="checkbox"/> Diesel Locomotive</p> <p><input type="checkbox"/> Air Brakes <input type="checkbox"/> Car Inspector</p> <p><input type="checkbox"/> Railroad Administration</p> <p>TEXTILE</p> <p><input type="checkbox"/> Textile Engineering</p> <p><input type="checkbox"/> Cotton Manufacture</p> <p><input type="checkbox"/> Rayon Manufacture</p> <p><input type="checkbox"/> Woolen Manufacture</p> <p><input type="checkbox"/> Loom Fixing</p> <p><input type="checkbox"/> Finishing and Dyeing</p> <p><input type="checkbox"/> Textile Designing</p> <p>HOME ARTS</p> <p><input type="checkbox"/> Dressmaking and Designing</p> <p><input type="checkbox"/> Cookery</p> <p><input type="checkbox"/> Tea Room Management</p> |
|--|--|--|--|--|

Name _____ Age _____ Home Address _____

City _____ State _____ Working Hours _____ A.M. to _____ P.M.

Occupation _____

Special tuition rates to members of the Armed Forces. Canadian residents send coupon to International Correspondence Schools Canadian, Ltd., Montreal, Canada.

We teach you FREE!



We put you in Business!

HERE'S THE BIG OPPORTUNITY FOR YOU! Learn a new and fascinating occupation AT THE SAME TIME! a wonderful hobby... and MAKE MONEY AT THE SAME TIME! OPERATE AT HOME OR IN A SMALL SHOP! AND... the complete Instructions... books, lessons and personal guidance COST YOU NOTHING! We teach you FREE how to make the most beautiful jewelry you have ever seen: door-knobs imbedded with interesting objects, nite-lites, book-ends, coasters, name-plates, ash trays, paper weights, statues, figurines, souvenirs, novelties, gadgets, etc. . . . an endless variety of high-quality, highly saleable products out of LIQUID MARBLE, TRANSPARENT GEM-LIKE LIQUID PLASTIC, CERAMICS, PLASTER, COMPOSITIONS, STONE, ETC.! All without tools or machinery! The manufacture of these lovely objects is as easy as pouring water out of a glass! And—you learn how ABSOLUTELY FREE! The only limitation is your own IMAGINATION! No special talents or experience are required!

You get more than the FREE INSTRUCTIONS! We also show you methods of selling your finished work . . . even selling part of it to us! Start on a shoestring! And overnight, become established in one of the most fascinating and profitable occupations in existence!

Just send 25c for our big catalog, "CASTING MATERIALS, MOLDS, ETC." — and you're on your way! Along with the catalog we will include the book, "THE ART AND BUSINESS OF CASTING" absolutely FREE! And—surprising details on an amazing, exclusive Plasticast offer guaranteeing your success! DON'T DELAY! This could be the most important step of your lifetime! WRITE TODAY!

PLASTICAST CO. (DEPT. C)

P. O. Box 6737
Chicago, 80, Ill.

(WRITE TO
NEAREST
ADDRESS)

P. O. Box 987
Palo Alto, Calif.

CANADIAN CUSTOMERS: Send 35c for catalog to Canadian Ind. PLASTICS, 1056 1/2 W. Pender St., Vancouver, B. C.



SEND
NO MONEY
•
MORE THAN
4000 PAGES
•
2750
PICTURES

**9 BIG COMPLETE BOOKS
BUILDING, ESTIMATING, CONTRACTING**

Examine this Up-to-Date Edition for 10 days. See how these nine books supply easily understood training that will help you to get a better job and make more money, or start a profitable business for yourself. Think what a BIG help it will be to have them handy for use in solving all sorts of building problems.

Learn to draw plans, estimate, do all-new construction and modern remodeling to meet fast growing demand. More than 4000 pages of practical, pay-raising information with 2750 helpful illustrations, on such subjects as blueprint reading, concrete forms, masonry, carpentry, steel square, electrical wiring, plumbing, heating, painting, and hundreds more.

In our more than 50 years we have never offered more complete building information. Send the coupon TODAY.

(A year's consulting privileges with our engineers now given with these books without extra cost.)

**AMERICAN TECHNICAL SOCIETY—Publishers Since 1898
Dept. G919, Drexel Ave. at 58th St., Chicago 37, Ill.**

I would like to examine your 9-Volume Set of Building, Estimating, Contracting Books. I will pay the delivery charges only, but if I choose I may return them express collect. If after 10 days' use I prefer to keep them, I will send you \$3 plus postage and pay the balance at the rate of only \$4 a month until \$34.80 has been paid.

Name _____
Address _____
City _____ State _____

Please attach letter giving employer's name and address (if self-employed give business man reference). Men in service please give home address.

(Continued from page 10)

transmission. A mechanic in the local Chevrolet garage told me that on Sept. 19, 1952, three Chevrolets with V8 engines and one straight 6 Chevy with a new automatic transmission stopped at the garage for repairs. The straight 6 had broken a connecting rod. The four were on their way back to Flint, Mich., from Denver, Colo., where they had tested the cars on Pikes Peak and other rugged terrain.

Below are the facts that I could find out about the four cars:

1. The new transmission had the letters on the indicator quadrant arranged in a different manner and there was an extra position marked S. . . .

2. The V8 engines "looked like baby Cadillac engines."

3. The tail pipe on the V8s had been changed to the right side.

4. Some of the mechanics had rides in the V8s and according to them the V8s had plenty of pickup. One Chevrolet engineer got the V8 up to 100 m.p.h. on the speedometer. This was accomplished on a curving and hilly stretch of highway.

All the above facts are true so far as I know. I did not see the cars myself, but the mechanics are reliable.

Harold Cooney,
(Student in mechanical engineering, State University of Iowa, Iowa City, Iowa.)

According to our reports, the V8 won't be ready for the 1953 Chevrolet line. — The Editor.

Letter to the Editor:

Regarding the "Owners Report on the '52 Lincoln" (PM, Oct. 1952) and referring to the center-fill gas tank, it does not take much ingenuity to place the cap so it will hold the license plate down while the gas is being put in the tank. Now, the location of the battery: The proper place for a heavy unit like the battery is as low as practicable considering the road clearance of the car. Why impair the stability of the car by placing this weight as much as three feet from the road as is done in some cars? I enjoy articles by Floyd Clymer.

Frank M. Hogan,
Blaine, Wash.

Letter to the Editor:

I wish to inform you that I received the beautiful scroll on which *Popular Mechanics* placed Nikola Tesla. I wish to thank you personally as well as in the name of the State Committee for the Commemoration of the Tenth Anniversary of Tesla's death and the 100th Anniversary of Tesla's birth,

(Continued to page 20)

LEARN

ELECTRICITY AND ELECTRONICS

ON REAL EQUIPMENT
IN THE GREAT SHOPS
OF **COYNE**



RADIO-TELEVISION

Plays a Vital Roll in Nation's Defense

HIGHER RANK— HIGHER PAY— IN ARMED FORCES

Coyne Training will help you forge ahead in the Army, Navy, Air Force. And you'll be all set for a good future when you leave the service.



The tremendous growth of this new field is almost unbelievable. TV has been given the "go-ahead" in 1227 new communities, with 1845 new stations to be built. Unusual opportunity to get in on ground floor. RADIO-TELEVISION and ELECTRONICS are vital to our Defense Program. And they offer a world of opportunities for a real future when the emergency is over. Train quickly on actual equipment at Coyne by practical-technical methods. Get big Free Book today.

ELECTRICITY—

The Power Behind Our Defense Program

A great opportunity field and vital to Defense. Thousands of trained Electrical and Electronics men needed in good jobs with a real future when the emergency is over. Why be satisfied with a "no future" job? Get Free Book that tells how thousands have prepared quickly for Electricity and Electronics at Coyne.

TRAIN QUICKLY AT COYNE FOR VITAL FIELDS

ELECTRICITY-RADIO-TELEVISION-ELECTRONICS-VITAL in Industry and Armed Forces. TRAIN QUICKLY for better rating, if drafted—vital job in Industry, if not. Trained men whether 16 or up to 50 needed. Many men with physical handicaps can qualify. Prepare now for steady, well paid, essential jobs in A FIELD THAT ALSO OFFERS A REAL FUTURE WHEN THE EMERGENCY IS OVER.

WE TRAIN YOU IN CHICAGO

We do not teach by mail. All training is given in our Great Training Shops in Chicago, plus necessary theory. No advanced education or previous experience needed.

APPROVED FOR VETERANS— FINANCE PLAN FOR NON-VETS

Non-vets enroll now, pay most of tuition after graduation. If you need part-time work to help out with living expenses while at Coyne, we'll help you get it. Special plan for men of Draft Age.



1 You are TOLD the how and why of each job.



2 You're shown how to do typical jobs by trained instructors.



3 You DO practical job YOURSELF on equipment.

Mail Coupon for Big FREE BOOK

Whether you prefer Electricity or Television-Radio, train on actual equipment, at Coyne. Fill in and mail coupon TODAY. Paste it on a postcard if you wish. A big fully illustrated booklet and complete details will come by return mail. No salesman will call.

B. W. COOKE, President

COYNE SCHOOL

ATECHNICALTRADE INSTITUTE
CHARTERED NOT FOR PROFIT
Established 1899
500 S. Paulina Dept. 92-72H
Chicago 12, Illinois

ELECTRICITY ★ TELEVISION ★ RADIO ★ REFRIGERATION ★ ELECTRONICS

B. W. COOKE, President

COYNE SCHOOL
500 S. Paulina St., Chicago 12
Dept. 92-72H

Send your BIG FREE BOOK and details of your training offer. This does not obligate me and no salesman will call. I am interested in

ELECTRICITY TELEVISION-RADIO

NAME.....

ADDRESS.....

CITY.....STATE.....

EARN MORE IN DRAFTING



More
Opportunities
for
Employment
and
Promotion

"Here I am at work making good money as a draftsman. I'm glad I sent the coupon to Chicago Tech for that Free Trial Lesson and found out how easy it is to learn Drafting in spare time at home. Today I feel secure in my job because the draftsman's work comes first on any new project. And, in addition, draftsmen can't be replaced with machines. What's more, I feel I'm slated for promotion and more pay, because I see so many draftsmen advancing to high-pay jobs."

LEARN IN SPARE TIME — AT HOME!

(or at the College in Chicago)

A few hours of pleasant home study every week—that's all. No interference with your present job. All the tools you need; drawing outfit included. With Chicago Tech's help, you train yourself step by step. This tested method—developed over 48 years of C.T.C. progress—prepares men quickly for good positions in industry.



FREE INFORMATION—SEND COUPON

To prove to you how easy it is to learn Drafting at home by the Chicago Tech method, we will send you this FREE TRIAL LESSON. No charge for this lesson, now or later. Fill out and mail coupon, or send post card today.

CHICAGO TECHNICAL COLLEGE

S-250 Tech Bldg., 2000 So. Michigan Ave.,
Chicago 16, Illinois

Mail me FREE Lesson with information about big opportunities in DRAFTING.

Name _____ Age _____

Address _____

City _____ Zone _____ State _____

ENGINEERING DEGREE IN 27 MONTHS

Big Demand for Graduates

Aeronautical, Chemical, Civil, Electrical, Mechanical and Radio Engineering (inc. TV and Electronics)

Hundreds of young men are earning B. S. ENGINEERING DEGREES annually in this recognized institution — year around operation. New terms start quarterly. Many students earn a major part of their college expenses in this large industrial center.

Low tuition. Competent instruction. Thorough, intense, practical program. Modern, well-equipped laboratories including new physics laboratory and modern wind tunnel. Individualized instruction emphasized.

Government approved for G.I.'s. Engineering preparatory courses. Students from 48 states and 21 foreign countries. Enter December, March, June, September. Send coupon for free catalog and full information. Enroll now.

SEND COUPON TODAY

INDIANA TECHNICAL COLLEGE

5122 E. Washington Boulevard
Fort Wayne 2, Indiana

Please send me free information on B.S. Engineering Degree in 27 months as checked.

Aeronautical, Chemical, Civil, Electrical,
 Mechanical, Radio-Television

Name _____

Address _____

(Continued from page 18)

also in the name of the Nikola Tesla Institute of which I am the president.

The citation will be placed in the Nikola Tesla Museum in Belgrade which is now in the process of organization. I am sure that as Tesla's admirers it will interest you to know that all of his papers are now here in the Tesla Museum and that they contain a priceless record of the historic development of the electrical era. As soon as all his papers are sorted this will be material for years of study and research.

Sava N. Kosanovic,
Minister of State,
Belgrade, Yugoslavia



Publisher Visits Aberdeen

Secretary of the Army Frank C. Pace, Jr., (right) greets H. H. Windsor, Jr., publisher of *Popular Mechanics* at first public demonstration of the Army's new 11-inch mobile gun which will fire atomic shells. In the demonstration at Aberdeen Proving Ground one of the 85-ton guns fired a conventional shell which exploded in view of the spectators on the reviewing stand.

Letter to the Editor:

Here's a curiosity that may interest you: A Swiss manufacturer replaces the gasoline engine of a Willys Jeep with a 6-cylinder, 35-horsepower diesel engine. Total cost of the Jeep with diesel is \$2750; with standard gasoline engine \$2500. Both prices apply in Switzerland.

Peter Wildermuth,
Ruti, Switzerland

☐ A new kind of bullet to replace the traditional tracer bullet has been invented by Peter P. Alexander of Beverly, Mass. He has discovered that bullets made of an alloy of lead and zirconium burst into flame on impact with the target.

GET SHOP-METHOD HOME TRAINING

for **SUCCESS** in Today's Top Industries!



SEND COUPON
TODAY
for **FREE**
BOOK and
COMPLETE
SAMPLE LESSON!

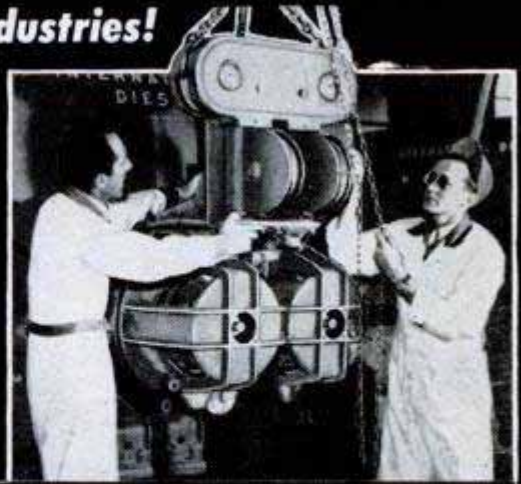

RADIO-TELEVISION & ELECTRONICS OR AUTOMOTIVE-DIESEL & ALLIED MECHANICS

Like a business of your own... or a good job with a big firm... and get paid for what you know? Shop-Method Home Training in Radio, Television, Electronics will bring you the job... money... you've always wanted. 105 million Radios, 3100 stations... 16 million TV sets, over 100 TV stations... many more, now Govt. restrictions are off. Defense industries want trained men for interesting, good pay jobs. Get into this opportunity-making industry... advance fast. Find out how... mail coupon... **TODAY!**

I GIVE YOU STANDARD PARTS! INCLUDING TUBES!

—they are yours to keep. You actually learn by doing, build generators, receivers, a big Super-Het radio.



THIS PROFESSIONAL FACTORY-MADE MULTI-TESTER IS YOURS!



Valuable equipment every Radio-TV man needs. Yours to keep!

INVESTIGATE NOW!



LET NATIONAL SCHOOLS of Los Angeles, California, a Resident Trade School for almost 50 years, train you at home for today's unlimited opportunities. Pick your industry—mail coupon below now!

EARN EXTRA MONEY WHILE YOU LEARN!

I show you how to earn extra money *while learning!* Many men have paid for their entire course in this way. You can, too. Remember: Shop-Method Home Training covers *every phase* of the industry—in an interesting step-by-step way. Why wait—take the first step to success—mail the coupon today!

DRAFT AGE? Training helps you get the service branch you want, advance fast. That means higher pay and grade, more prestige—right away! Don't take a chance—mail coupon *now!*



Want to be your own boss... or get into booming industries? 8 million older cars need big, profitable services and repairs. Farm machinery is going Diesel. Defense industry begs for more and more trained mechanics for high-pay jobs. National Schools Shop-Method Home Training prepares you for all Automotive, Diesel, Allied Mechanics opportunities. Helps you get the security, good pay you've always wanted. Send coupon for your Free Book and Sample Lesson now!

I GIVE YOU THE TOOLS OF YOUR TRADE!

Big professional-quality kit of tools of your trade—and all-metal tool box. All yours to keep—part of your course; they help make your training more practical—start you off right!



NATIONAL SCHOOLS

LOS ANGELES 37, CALIFORNIA

Established 1905

In Canada: 193 East Hastings Street
Vancouver 4, B.C.



APPROVED FOR
G. I. TRAINING

**DON'T
PUT IT OFF
GET THE
BIG SALARY
YOU'VE
ALWAYS
WANTED!**

MAIL TODAY—YOU'RE "ON YOUR WAY"!

NATIONAL SCHOOLS, Dept. B-122
4000 S. Figueroa Street
Los Angeles 37, California

Mail in envelope
or paste on
postal card

I want to "get going"! Send me Free Book I checked and Free Sample Lesson. I understand no salesman will call.

- My Future in Radio-Television & Electronics
 My Future in Automotive-Diesel & Allied Mechanics

NAME _____ AGE _____

ADDRESS _____

CITY _____ ZONE _____ STATE _____

VETS! Check here if released from service less than 4 years ago.



THE GREATEST
POWER ON
EARTH!

The Magic of Mind

WERE the great personages of the past victims of a stupendous hoax? Could such eminent men of the ancient world as Socrates, Pericles and Alexander the Great have been deluded and cast under the spell of witchcraft—or did the oracles whom they consulted actually possess a mysterious faculty of foresight? That the human mind can truly exert an influence over things and conditions was not a credulous belief of the ancients, but a known and demonstrable fact to them. That there exists a wealth of infinite knowledge just beyond the border of our daily thoughts, which can be aroused and commanded at will, was not a fantasy of these sages of antiquity, but a dependable aid to which they turned in time of need.

It is time you realized that the rites, rituals and practices of the ancients were not superstitions, but subterfuges to conceal the marvelous workings of natural law from those who would have misused them. Telepathy, projection of thought, the materializing of ideas into helpful realities, are no longer thought by intelligent persons to be impossible practices, but instead, demonstrable sciences, by which a greater life of happiness may be had.

One of America's foremost psychologists and university instructors, says of his experiments with thought transference and the powers of mind—"The successes were much too numerous to be merely lucky hits and one can see no way for guessing to have accounted for the results." Have you that open-minded attitude of today which warrants a clear, positive revelation of the

facts of mind which intolerance and bigotry have suppressed for years? Advance with the times; learn the truth about your inherited powers.

Let this free book explain

The Rosicrucians (NOT a religious organization) have been leaders in introducing the ancient wisdom of mental phenomena. Established throughout the world for centuries, they have for ages expounded these truths to those thinking men and women who sought to make the utmost of their natural faculties. Use the coupon below—avail yourself of a pleasing book of interesting information which explains how you may acquire this most unusual and helpful knowledge.

The ROSICRUCIANS (AMORC)

USE THIS COUPON

Scribe: M.E.S.
The Rosicrucians, AMORC
San Jose, California

I am sincerely interested in knowing more about this unseen, vital power which can be used in acquiring the fullness and happiness of life. Please send me, without cost, the book, "THE MASTERY OF LIFE," which tells me how to receive this information.

Name _____

Address _____

State _____

Now IN YOUR OWN HOME Learn

TELEVISION RADIO

the Amazingly Effective
D.T.I. WAY

**—with the aid of BOTH
HOME EQUIPMENT
and HOME MOVIES**

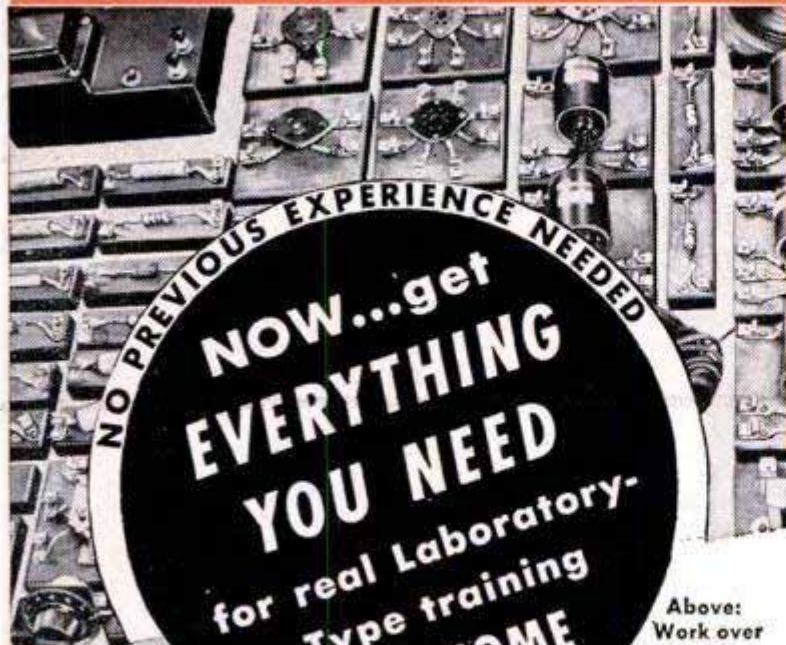

NO PREVIOUS EXPERIENCE NEEDED
**NOW...get
EVERYTHING
YOU NEED**
for real Laboratory-
Type training
AT HOME

Above:
Work over
300
fascinating
experiments
with this
equipment

You
KEEP
all test
equip-
ment



1. Build over 300 fascinating experiments from 16 BIG SHIPMENTS of Electronic-Radio parts which you KEEP.
2. Build valuable commercial-type test equipment—as shown to the left—which you KEEP. This includes a quality OSCILLOSCOPE—a must for Television work.
3. Use a 16 mm. movie projector and new series of Hollywood produced instructive movies—a wonderful aid to help you grasp important fundamentals faster...easier...better.
4. Enjoy well-illustrated, easy-to-read lessons with handy FOLD-OUT diagrams.
5. Get an honest-to-goodness EMPLOYMENT SERVICE to help you get a good job after graduating—or assistance in starting your OWN SALES AND SERVICE BUSINESS. Mail coupon today for the complete details.

What will mailing the coupon below do for YOU? Just this! You'll find out about one of today's most remarkable...practical ways to prepare to get into America's amazing billion dollar opportunity field of TELEVISION-RADIO-ELECTRONICS. You'll see how to get into fascinating work that pays well...that offers one of America's most promising futures...that enables you to start your own business almost "on a shoe string," if you prefer this to a job opportunity.

And above all, you'll get some GOOD NEWS especially welcomed by men anxious to earn REAL MONEY in this thrilling field. For you'll see that NOW you can get the kind of practical, laboratory-type training so desirable for making real progress in Television-Radio-Electronics...and WITHOUT LEAVING HOME.

You'll see that DeForest's Training, Inc. sends everything needed to set up your own HOME LABORATORY. You get and keep the same type of basic electronic equipment used in our modern Chicago Training Laboratories. You get home training that includes the knowledge and experience gained from training thousands of students first hand in Chicago. And to top it all, you use DTI's amazingly effective and exclusive home training aid—INSTRUCTIVE MOVIES. But why not get the complete story? Mail coupon today for information-packed literature.

MODERN LABORATORIES
If you prefer, get all your preparation in our new Chicago Training Laboratories—one of the finest of its kind. Ample instructors, modern equipment. Write for details!

MILITARY SERVICE!

If you're subject to military service, the information we have for you should prove very helpful. Mail coupon today.

**Get BOTH of these colorful,
information-packed folders
FREE**

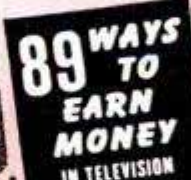

Mail Coupon Today



Build and Keep this 17-INCH TV RECEIVER—OPTIONAL after completing regular training at moderate added cost.

New "black" RECTANGULAR TUBE



DeFOREST'S TRAINING, INC.
AFFILIATED WITH
De Vry Technical Institute
CHICAGO 14, ILLINOIS

DeFOREST'S TRAINING, INC., Dept. PM-12-I
2533 N. Ashland Avenue, Chicago 14, Ill,

I would like valuable, information-packed folders showing how I may get started toward a good job or my own business in Television-Radio-Electronics.

Name _____ Age _____
Street _____ Apt. _____
City _____ Zone _____ State _____

Learn **ELECTRIC** APPLIANCE REPAIR IN YOUR Spare Time at Home



START YOUR OWN BUSINESS

WITH A POTENTIAL MARKET OF 50,000,000 CUSTOMERS

New shop-method, home training system gives you electrical know-how that used to take years to learn. Learn at home by building valuable testing kits, repairing your own and neighbor's appliances. If it is not unusual for appliance repairmen to charge on the basis of \$5.00-\$8.00 an hour.

FREE ILLUSTRATED BOOK Shows you how you learn every phase of electrical appliance. How to make money while you learn. Write today for your FREE copy.

CHRISTY TRADES SCHOOL, Dept. D-1303
4432 North Kedzie Ave. Chicago 25

Learn this Profitable Profession



**IN 90 DAYS
AT HOME**

Money-Making Career Open to Men and Women, 18 to 60

Hundreds of men and women between 18 and 60 make \$10 to \$20 in a single day giving scientific Swedish Massage and Hydro-Therapy treatments. There is big demand from doctors, hospitals, sanatoriums and clubs. Graduates earn large full time income from these or in private practice in their own offices. Others make good money from home treatments given in spare time. Learn this interesting money-making profession in your own home, through our home study course. Same instructors as in our nationally known resident school. You can win independence and prepare for future security by qualifying for your Graduation Certificate. Course can be completed in 3 to 4 months. Many earn while they learn. Begin your training at once.



NEW 32-PAGE BOOKLET FREE

Fill in the coupon below (please print name and address) and mail it for your FREE copy of 32-page Information Booklet. If you act at once we will include Anatomy Charts and Success Booklet which supply additional information you should have. All will be sent postage paid.

THE COLLEGE OF SWEDISH MASSAGE
Dept. 264R, 41 E. Pearson St., Chicago 11, Illinois

Please send me FREE and postpaid New 32-Page Illustrated Booklet, Anatomy Charts and Success Booklet at once.

Name _____ Age _____
Address _____
City _____ State _____

SAVE UP TO 50%
AND MORE

OUT OF PAWN
TIME PAYMENTS
ARRANGED

GENUINE DIAMONDS

VALUES FROM \$10
TO \$10,000

Send for
Illustrated
FREE
Catalog

All diamonds reset in brand new modern mountings. Sold with a written iron-clad money back guarantee. Over 100,000 satisfied customers have bought diamonds from Berman's.

Our Reference - Your own Bank or any Mercantile Agency

Berman's Diamond Loan Bank

Dept. P - BERMAN BLDG., BALTO. 1, MD.

Diamonds from estates, banks, unclaimed, pledges offered at substantial savings.

SHORTHAND in 6 Weeks at Home

Famous Speedwriting Shorthand, 120 wpm. No symbols; no machines; uses ABC's. Easiest to learn, write and transcribe. Low cost. 150,000 taught by mail. For business and Civil Service. Also typing. 30th year. Write for FREE booklet to:

Speedwriting

Dept. 1512-2, 55 W. 42 St., New York 36 (R)

PLAY GUITAR IN 7 DAYS OR GET MONEY BACK

Let Ed Sale, top Radio Guitarist, teach you to play a song the very first day, and any song by ear or note in 7 days! His famous book contains 52 photos, 87 chord charts, etc. Shows how to tune, keep time, build chords, bass runs, dance chords, swing, etc., plus 110 Popular Songs, words and music. Surprise friends, relatives. Popularity and fun galore. **SEND NO MONEY!** Just name and address to Ed Sale and pay postman \$1.98 plus C.O.D. postage (or send \$2 with order and I pay postage. Same guarantee). **ED SALE, Studio 1903, BRADLEY BEACH, N. J.**



Bar Bells

Buy Direct From Factory

Write for free booklet
and price list

\$8.95
up

INDEPENDENT IRON WORKS
2416 East 23rd Street, Dept. B
Los Angeles 58, Calif.

LAW FREE BOOK



Your FREE copy of "The Law-Trained Man" shows how to gain prestige and greater earnings through Blackstone home law study. All instruction material furnished including 16-volume Law Library written by 65 well-known law authorities. Lawyers, judges among our graduates. LL.B. degree. Low cost; easy terms. Write today.

BLACKSTONE COLLEGE OF LAW 225 N. Michigan Ave. Dept. 59, Chicago 1, Ill.

A Correspondence Institution Founded in 1890



Thrilling Work **COLORING PHOTOS**

Fascinating vocation learned at home by those with aptitude. Thrilling pastime. National method brings out life-like colors. Free booklet.

NATIONAL PHOTO COLORING SCHOOL
835 Diversey Pkwy., Dept. 1359, Chicago 14



7 DAY FREE TRIAL
Return and Pay Nothing if Not Completely Satisfied

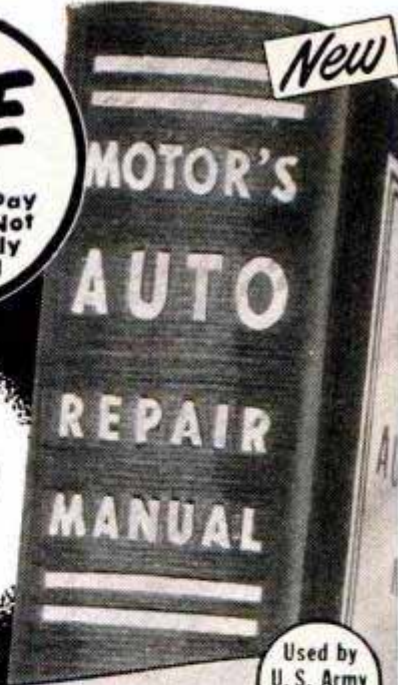

Used by U. S. Army and Navy

NOW! You can easily Fix ANY Car in less time-- and do a better job too!



MOTOR's Manual paid for itself on the first 2 jobs, and saved me valuable time by eliminating guesswork." — W. SCHROEP, Ohio

Here's the Quick, Easy Way to Repair ANY CAR BUILT SINCE 1935. Step-by-Step Instructions by Factory Experts, Over 2400 "How-to-do-it" Pictures, Over 200 "Quick Check" Tables Make it "Easy as Pie" For Even a Beginner To Do A First-Rate Job.

NO auto repair job is tough when you've got MOTOR's brand-new BIG AUTO REPAIR MANUAL. Shows how to save work on "ornery" jobs. Helps you make MORE MONEY by doing more jobs in less time. Try this amazing book FREE for 7 days.

Want to fix anything from carburetor to rear end, Jeep to Cadillac, shaky '35 to shiny '52? Here's the quick, easy, right way—the way factory experts advise. Just look up make, model, and job in quick index—and go to it. Clear, ILLUSTRATED instructions lead you step by step through whole job.

NO OTHER MANUAL LIKE IT!

The engineer-editors of MOTOR Magazine collected and "broke down" over 170 official

factory shop manuals for you—spotted all the vital repair information you need—dove-tailed it all together into ONE handy, easy-to-understand book.

EVERYTHING YOU'LL NEED TO KNOW

MOTOR's Manual takes nothing for granted. Starts at the very beginning; tells how to identify all 851 car models. More than 2400 easy-to-follow Photos, Drawings, Diagrams guide you step-by-step right thru each operation. Over 800 big pages crammed with Factory Specifications and Adjustment Tables, Tune-up Charts, Tables of Measurement and Clearances, Overhauling and Replacement facts. Automatic Transmissions (including New Dual-Range Hydra-Matic), Engines (including New De Soto, Lincoln, Ford Engines), Ignition, Generators, Carburetors, Brakes, Overdrives, and much MORE!



"Instructions so clear have no trouble learning anything about any car. Now working as mechanic in big plant." — SAM ORDONEZ, Cal.



"I have become foreman of my garage—thanks to help of your Manual." — ELMER HENSLER, Wis.

COVERS 851 MODELS — ALL THESE MAKES

- | | | |
|-----------|-----------|--------------|
| Buick | Ford | Nash |
| Cadillac | Frazer | Nash Rambler |
| Chevrolet | Henry J | Oldsmobile |
| Chrysler | Hudson | Packard |
| Cord | Kaiser | Plymouth |
| Crosley | Lafayette | Pontiac |
| De Soto | La Salle | Studebaker |
| Dodge | Lincoln | Terraplane |
| | Mercury | Willys |

Same FREE Offer on NEW MOTOR'S TRUCK & TRACTOR REPAIR MANUAL

New Edition covers EVERY job on EVERY popular make gasoline truck and farm tractor made from 1936 thru 1952! Over 2267 pictures, 930 pages, 300,000 facts. All types of Gasoline Engines, Fuel Systems, Governors, Lubrication, Ignition, Starters, Generators, Clutches, Axles, Brakes and more! For FREE 7-DAY TRIAL, check box in coupon.



Try Book FREE 7 Days

SEND NO MONEY! Just mail coupon! When the postman brings book, pay him nothing. First, make it show you what it's got! Unless you agree this is the greatest time-saver and work-saver you've ever seen—return book in 7 days and pay nothing, owe nothing. Mail free trial coupon today! Address MOTOR Book Dept., Desk 1P, 250 West 55th St., New York 19, N. Y.

MoTor Published by MOTOR, The Leading Automotive Business Magazine.

MAIL COUPON NOW FOR 7-DAY FREE TRIAL

MOTOR BOOK DEPARTMENT
Desk 1P, 250 West 55th Street, New York 19, N. Y.

Rush to me at once: (Check box opposite book you want)

MOTOR's New AUTO REPAIR MANUAL. If O. K. I will remit \$1 in 7 days, (plus 35c delivery charge), then \$2 monthly for 2 months, and a final payment of 95c a month later. Otherwise I will return book postpaid in 7 days. (Foreign price, remit \$8 cash with order.)

MOTOR's New TRUCK AND TRACTOR REPAIR MANUAL. (Described at left.) If O. K. I will remit \$2 in 7 days, and \$2 monthly for 3 months, plus 35c delivery charge with final payment. Otherwise I will return book promptly. (Foreign price, remit \$10 cash with order.)

Print Name.....Age.....

Address.....

City & Zone No.....State.....

SAVE 35c delivery charge by enclosing WITH COUPON check or money order for full payment of \$5.95 for Auto Manual (or \$8.00 for Truck Manual). Same return-refund privilege applies.

No Shop
Needed

Operate YOUR OWN Business



Clean & Mothproof rugs, upholstery IF NOW EMPLOYED:

You can operate in spare time and build up a permanent profitable full-time business

Can you qualify? . . . If you are dependable, honest and willing to work, send for FREE Booklet explaining how you can become "your own boss" in a growing business of your own. You'll use proven successful methods of established DURACLEAN Dealers. Service rendered "in the home," offices and public buildings. Easy to learn.

DURACLEAN cleans by absorption! No scrubbing. No soaking or shrinkage. Fabrics dry in just a few hours. Dirt, grease and many unsightly spots vanish as if by magic . . . colors revive. Upholstery and floor covering last longer. Results often almost unbelievable.

DURAPROOF kills moths and carpet beetles. Makes material resistant to both! Another year 'round service. **DURAPROOF** to our knowledge, is the only mothproof service backed by a National Money Back, 4 YEAR WARRANTY for your customer's protection.

These services are Nationally Advertised! Leading furniture and department stores recommend **DURACLEAN** Dealer's service. Almost every building in your territory houses a potential customer. Even auto dealers buy your service to revive upholstery in used cars.

Some dealers establish a shop or an office after business has grown. Others continue to operate from their own home. Alert dealers can average \$4.50 hourly gross profit on service they render and \$3 on EACH of their servicemen at National Price Guide charges.

Territories are limited! Write immediately for FREE 16-page illustrated Booklet. Easy Terms. No obligation. Write TODAY!

Duraclean Co., 2-16D Duraclean Bldg., Deerfield, Illinois

150 DIAGRAMS and HOW TO READ THEM

150 DIAGRAM BOOK

FREE

For Examining Coyne's Great 6-Volume Set On

ELECTRICITY

This valuable book of 150 Electrical and Radio wiring diagrams, with charts and instructions, is yours FREE merely for examining Coyne's 6-Volume Set, Applied Practical Electricity on 7-day's free trial. This 6-Volume Set COVERS EVERYTHING ELECTRICAL from home appliance repairs to advanced AC-DC motors and equipment, plus the great field of INDUSTRIAL ELECTRONICS. Thousands of diagrams and photos . . . written so both "beginners" and "old-timers" can easily understand.

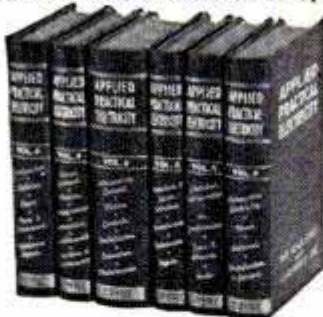

7-DAY'S FREE TRIAL — SEND NO MONEY

Send for 6-Volume Electrical Set on 7 day's FREE TRIAL. We'll include Shop Prints Book FREE. If you keep the set, send just \$3 after 7 days and \$3 a month until \$19.70 plus postage is paid (cash price: \$18.70). Or return the set in 7 days and owe nothing. Either way, Shop Prints Book is yours to keep, FREE! Mail coupon Now!

FREE COUPON { NOT AN ORDER — JUST A REQUEST TO SEE BOOKS

Educational Book Publishing Division
COYNE ELECTRICAL & TV-RADIO SCHOOL
500 S. Paulina St., Dept. C2-R6, Chicago 12, Ill.
Rush 6-Volume Electrical Set for 7 day's FREE Trial per your offer. (Include Shop Prints Book FREE.)

Name _____ Age _____

Address _____

City _____ Zone _____ State _____

Check here if you are enclosing \$18.70. We pay postage. 7-day Money Back Guarantee.



HIGH QUALITY—LOW COST USED TIRES EVERY TIRE FULLY GUARANTEED

Don't risk your life on tires of inferior quality. Saftyres are dependable first quality used tires—the best! Equip your car with SAFTYRES.

BETTER GRADE PASSENGER TIRES One Year Written Guarantee plus Free Tube with each Passenger Tire

600-16 \$5.59	600-15 \$5.59	820-15 \$7.50
600-16(6) 6.50	650-15 5.59	670-16 6.95
650-16 5.79	710-15 6.50	550-16 5.95
640-15 5.95	760-15 6.75	550-17 5.75
670-15 5.95	700-15 5.59	475-19 5.75
700-16 7.59	750-16 12.25	760-16 7.75
	550-15 5.59	

10% off
ON 2 OR
MORE
TIRES

FREE TUBE WITH EACH PASSENGER TIRE

MUD AND SNOW TIRES

TWO YEAR WRITTEN GUARANTEE

600-16 \$6.95	900-16 \$12.95	750-20 Reg. \$12.50 Spec. \$15.95
650-16 7.50	650-16(6) 9.50	650-15 \$6.50

EXTRA VALUE TRUCK TIRES

ONE YEAR WRITTEN GUARANTEE

600-20 \$10.75	750-20 \$14.50	825-20 \$21.50	1100-20 \$26.95
650-20 11.75	32x6 (8) 11.75	900-20 19.50	1100-22 24.50
700-20 12.50	32x6(10) 12.50	1000-20 20.00	750-20(10) 18.00

Complete line of High Mileage Tires in stock. Write for price list for sizes not listed. Take off 10% on orders for two or more tires. All prices F.O.B. Richmond, Va.

MAIL ORDERS PROMPTLY FILLED. Send check or money order with this ad. **SAFTYRE CO., Inc.** "FOR THAT SAFE TIRE" Dept. PM, 1801 E. Broad Street, P.O. BOX 2254, RICHMOND, VA.



FREE STAMPS

Including Famous Berlin Bear Stamp—used by Russians as propaganda to show "The Russian Bear" rebuilding Berlin. We'll also include 225 other stamps—all DIFFERENT—ALL FREE—to introduce our special bargain approvals. PLUS a FREE copy of our helpful, informative book, "How to Collect Stamps." Rush name, address, and 10c to help cover postage and handling to: LITTLETON STAMP CO., Dept. PM-12, Littleton, N. H.

ENGINEERING DEGREE IN 27 MONTHS

INDIANA TECHNICAL COLLEGE

B. S. DEGREE. Aeronautical, Chemical, Civil, Electrical, Mechanical and Radio Engineering (inc. TV and Electronics). Drafting, 1-yr. G.I. Gov't approved. Low rate. Earn board. Large industrial center. Students from 48 states, 21 countries. Demand for graduates. Enter December, March, June, September. Write for catalog, 16122 E. Washington Boulevard, Fort Wayne 2, Indiana.

LEARN WATCH REPAIRING

AT HOME. By our modern and original system of instruction you can learn every part of the **WATCH REPAIRING TRADE AT HOME.** Prepare yourself for a well-paying position or start in business after completing our course of instruction. Good watch repairers are in demand and generally earn very good salaries. For particulars apply to the **WISCONSIN SCHOOL OF WATCH REPAIRING**, 759 N. Milwaukee, Dept. 12, Milwaukee 2, Wis.

MAKE EXTRA MONEY PLASTICS LEARN AT HOME

LEARN HOW TO MAKE fast-selling PLASTIC NOVELTIES FURNITURE JEWELRY SIGNS TOYS LAMPS

There are RICH OPPORTUNITIES for MEN and WOMEN with "know-how" in Plastics. Interstate's new Plastics course tells and shows how to make hundreds of fast selling items out of Plastics. Gives complete training in fabrication, casting, lamination, molding, internal carving, etc., in simple, easy, step-by-step language and pictures. Plastics and Fabricating Kits for 23 valuable Plastic items come with training at no extra cost. **START A PLASTICS BUSINESS OF YOUR OWN.** No other industry holds such promise for the future. You can make big money manufacturing novelties, toys, signs, etc., in your own home in spare or full time. Don't wait! Learn NOW how Interstate's Plastics Training qualifies you for success in the Plastics field.

PLASTICS AND SUPPLIES FURNISHED FOR 23 VALUABLE PROJECTS

INTERSTATE TRAINING SERVICE
Dept. C3N Portland 13, Oregon



**TRAIN FASTER—TRAIN BETTER—TRAIN EASIER
 IN 10 MONTHS—OR LESS—FOR
RADIO-TELEVISION
 Our 21st Year Training Men for Greater Incomes and Security in Radio-Television**

**I SEND YOU
 18 BIG KITS**
 of Radio Television parts and equipment. Much of your training will be actual construction and experimentation . . . the kind of truly PRACTICAL instruction that prepares you for your Radio-Television career.



Frank L. Sprayberry
 President
 Sprayberry Academy
 of Radio

NEW! NO OBLIGATION PLAN

**You Have No Monthly Payment Contract to Sign
 Pay For Your Training as You Earn and Learn**

You can get into Radio-Television, today's fastest growing big money opportunity field, in *months* instead of years! My completely new "package unit" training plan prepares you in as little as 10 months or even less! *No monthly payment contract to sign—thus NO RISK to you!* This is America's finest, most complete, practical training—gets you ready to handle any practical job in the booming Radio-Television industry. Start your own profitable Radio-Television shop . . . or accept a good paying job. I have trained hundreds of successful Radio-Television technicians during the past 21 years—and stand ready to train you, even if you have no previous experience! Mail coupon and get all the facts—FREE!



**Valuable Equipment Included
 With Training**

The new Sprayberry "package" plan includes many big kits of genuine, professional Radio-Television equipment. You perform over 300 demonstrations, experiments and construction projects. You build a powerful 6-tube 2-band radio set, multi-range test meter, signal generator, signal tracer, many other projects. All equipment and lessons are *yours to keep* . . . you have practically everything you need to set up your own profitable Radio-Television service shop.

Earn Extra Money While You Learn!

All your 10 months of training is IN YOUR HOME in spare hours. Keep on with your present job and income while learning. With each training "package" unit, you receive extra plans and "Business Builder" ideas for spare time Radio-Television jobs. New television stations everywhere, open vast new opportunities for trained Radio-Television Technicians—and those in training. If you expect to be in the armed forces later, there is no better preparation than practical Sprayberry Radio-Television training.

YOU BUILD the Television set and the powerful superhet radio receiver shown above IN ADDITION to the other test units shown here. (Many are not illustrated.)

Approved for Veterans under the G. I. Bill

**SPRAYBERRY ACADEMY OF RADIO 111 NORTH CANAL ST.
 Dept. 10-R, Chicago 6, Ill.**

**MAIL COUPON
 TODAY!
 NO OBLIGATION**

**I invite you to get all the facts —
 FREE TO YOU 3 BIG
 RADIO-TELEVISION BOOKS**

Rush coupon for my three big Radio-Television books: "How to Make Money in Radio-Television." PLUS my new illustrated Television Bulletin PLUS an actual sample Sprayberry Lesson—ALL FREE. No obligation and no salesman will call. Mail coupon NOW!

**SPRAYBERRY ACADEMY OF RADIO, Dept. 10-R
 111 North Canal St., Chicago 6, Ill.**

Please rush to me all information on your 10-MONTH Radio-Television Training Plan. I understand this does not obligate me and that no salesman will call upon me. Be sure to include 3 books FREE.

Name..... Age.....
 Address.....
 City..... Zone..... State.....



NEW LOW PRICES
on these powerful **NEW 1953**

MIDWEST TELEVISION

Super Powered for "FRINGE" AREAS

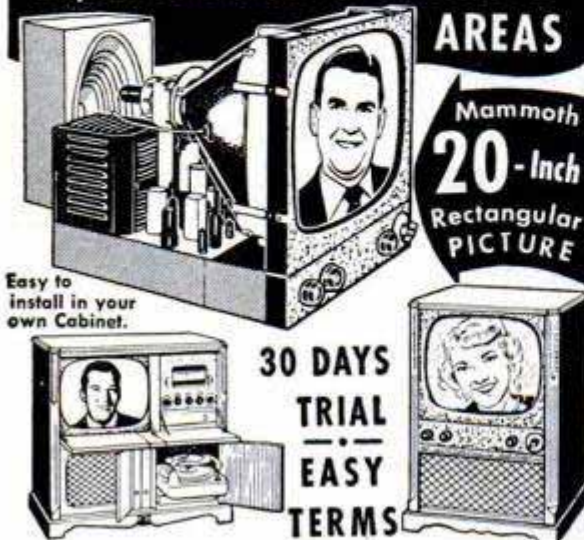

Easy to install in your own Cabinet.

Mammoth
20-Inch
Rectangular
PICTURE

30 DAYS TRIAL EASY TERMS

Midwest offers a sensational new 1953 line of beautiful consoles and complete chassis for easy installation in your own cabinet. Mammoth 20-Inch Television at low Factory Prices, and on 30 Days Trial.

Buy **DIRECT** from the **MIDWEST** Factory and **SAVE!**

SEND THIS COUPON For FREE MIDWEST 1953 Catalog	MIDWEST RADIO & TELEVISION CORP.
	Dept. 25D, 909 Broadway, Cincinnati 2, Ohio
	NAME _____
	ADDRESS _____
	CITY _____ ZONE _____ STATE _____

UNLIMITED OPPORTUNITIES IN ENGINEERING

DEGREE IN 27 MONTHS

Study Engineering in this world-famed school, established 1884. Demand for our graduates exceeds supply. Growing shortage of engineers. No field offers greater opportunities for responsible, lucrative positions.

Bachelor of Science Degree in Mechanical, Civil, Electrical, Chemical, Aeronautical, Radio (Television) Engineering; Business Administration and Accounting. Also 36-weeks certificate course in Surveying and Drafting.

Personalized Instruction. Accelerated courses. Non-essentials eliminated. For ambitious, earnest students. Earn your degree in the shortest possible time. Preparatory courses. Placement service.

Extensive Campus. Well equipped, new and modernized buildings; up-to-date labs. Low cost. New terms start quarterly. Enter September, January, March, June.

Write today for free catalog and special information.



TRI-STATE COLLEGE

4122 College Ave., ANGOLA, INDIANA

Tool and Die Design Training

\$8,000 to \$15,000 YEARLY INCOME!

ACME training has been fully proved in practice through its fine resident schools. Acme graduates report outstanding promotions, resulting in higher salaries. Progress is sure and easy through Acme's famous "COPE" System. Prepare yourself **IN YOUR SPARE TIME** for a secure position of responsibility and high earnings, and qualify at a time when you will have every opportunity to rise to a position in the \$8-15,000 per year salary bracket. Be successful — Go Farther Faster!

Detailed information upon request.

ACME SCHOOL OF DIE DESIGN

(Correspondence Division, Dept. M)
8 N. JEFFERSON STREET DAYTON 2, OHIO



Ships & the Sea Magazine

You'll enjoy this big popular magazine. It's packed with sea-going pictures, salty yarns, charts, articles & model ship department. 50c at larger stands. **Special Offer!** Send \$1 for 3-month trial. Act now!

Ships and the Sea Magazine Dept. 1572B, Milwaukee 3, Wis.

LEARN CARTOONING at home in spare time

Simplified Landon Picture Chart Method makes progress quick, exciting, easy. Former Landon students include creators of "Steve Canyon," "Freckles," "Out Our Way," "Winnie Winkle," "Regular Fellers," "The Neighbors," "Strange as it Seems" and many others. Earn while learning. Rush 10c for Picture Chart (to test your ability) and full details. Please state age.



Landon School of Cartooning, 5212 CTS Bldg., Cleveland, O.

FOR SPARE TIME PROFITS OR A FULL TIME CAREER

LEARN UPHOLSTERING

Learn at home in months! Earn spare time money — or start a shop! Easy lessons show how. Tools and materials to build ottoman included. Low terms. Write for valuable booklet today!

COMMERCIAL TRADES INSTITUTE, Dept. U 2-12
1400 Greenleaf Avenue • Chicago 26, Illinois



GROW MINIATURE TREES

Grow authentic, LIVE dwarf trees!
Fascinating hobby! Fabulous profit!

SEND FOR FREE SEED & INSTRUCTIONS!

MINIATURE NURSERY CLUB
Dept. 5-D, P. O. Box 18696, Rimpau Sta.
Los Angeles 19, California

ESSENTIAL IN PEACE OR WAR

AVIATION

- MASTER A & E MECHANIC
- PILOT AND SPECIALIST
- DRAFTING AND DESIGN

The aviation industry urgently needs properly trained young men for essential civilian aviation positions. Embry-Riddle offers maximum training in minimum time. Fully accredited 6-month to 2-year courses in all aeronautical phases also aid rapid military advancement if called to armed forces. Thorough, practical instruction backed by 25 years' experience training today's aviation leaders. Complete school campus. Training authorized under G.I. Bill. Enroll today!

Illustrated catalog, address:
Registrar, Dept. 99, Miami 30, Fla.



TRAIN IN MIAMI -- AIR CAPITAL OF THE WORLD

TURN RIGHT

Get on the Road to a

Better Job-Brighter Future with RIGHT Training

—then You Can Really GO!

AMERICAN SCHOOL, Dept. G945, Drexel at 58th, Chicago 37, Ill.

Without obligation, please send **FREE** and postpaid, full particulars about the subject checked below.

- | | | |
|--|---|---|
| <input type="checkbox"/> Accounting | <input type="checkbox"/> Drafting—Building Trades | <input type="checkbox"/> Plastics Engineering |
| <input type="checkbox"/> Air Conditioning | <input type="checkbox"/> Drafting—Machine Trades | <input type="checkbox"/> Plumbing—Practical |
| <input type="checkbox"/> Architecture & Building | <input type="checkbox"/> Electrical Engineering | <input type="checkbox"/> Private Secretary |
| <input type="checkbox"/> Automotive Technician | <input type="checkbox"/> Electricity—Practical | <input type="checkbox"/> Refrigeration |
| <input type="checkbox"/> Better Foremanship | <input type="checkbox"/> Electronics—Industrial | <input type="checkbox"/> Retail Merchandising |
| <input type="checkbox"/> Bookkeeping | <input type="checkbox"/> High School Courses | <input type="checkbox"/> Salesmanship—Outside |
| <input type="checkbox"/> Business Management | <input type="checkbox"/> Machine Shop Operations | <input type="checkbox"/> Sheet Metal Work |
| <input type="checkbox"/> Contracting | <input type="checkbox"/> Mathematics & Slide Rule | <input type="checkbox"/> Tool Making |
| <input type="checkbox"/> Diesel Technician | <input type="checkbox"/> Mechanical Engineering | |

NAME..... OCCUPATION.....
 HOME ADDRESS..... AGE.....
 CITY..... STATE.....

START NOW by checking, filling in and mailing this coupon. You'll get full information — No cost, No obligation!

• *Today*, make the **BIG** decision of your life. Choose the career you want and take the first easy step toward your goal. Learn how you can get the training that can put you in the bigger pay class and give you security in the years ahead. Find out how, in spare time at home, you can qualify for work you prefer, and higher pay. Or if you are already in the work you like, find out how you can win quicker promotion and a larger income.

Backed by 55 Years of Training Know-How

Since 1897 American School has helped many thousands of ambitious people toward success by providing specialized training for

commercial and technical advancement. Its study program for *you* has been prepared by experts in the subject you select and the school will give you guidance every step of the way. In time you might otherwise waste and at a cost you can afford you can prepare at home and really **GO** on the *right* road.

Don't Delay YOUR Start

Give serious thought to the list of training courses listed above. Pick the opportunity that interests you, check it and add your name and address. (Check more than one if you are undecided which appeals most.) Then clip and mail the coupon. Full information will be supplied without cost or obligation.

PRACTICAL, EFFECTIVE HOME STUDY TRAINING SINCE 1897

AMERICAN SCHOOL, Dept. G945, Drexel at 58th, Chicago 37, Ill.

THE SOONER YOU START, THE SOONER YOUR GOAL CAN BE REACHED



Men!

Reading This Message Could Be the Most Important 40 Seconds In Your Life

From every indication Auto Body and Fender Repair work will continue to be one of America's Big Income fields. Here at U.E.I. we're training men for it—a proven plan that combines spare-time, home study and actual shop practice. Men from coast to coast have successfully completed the U.E.I. course in Auto Body and Fender Repair—many earned money while learning—many now have their own shops. What about you? Isn't this the time for you to see what this big-pay field offers you? Do this: Mail the coupon below and we'll send you our big, descriptive book, "Opportunities." It's Free—Mail the Coupon.

UTILITIES ENGINEERING INSTITUTE, Chicago 14, Illinois
Founded 1927

UTILITIES ENGINEERING INSTITUTE,
2523 Sheffield Ave., Dept. XC-16, Chicago 14, Illinois
Please send, Free, Your Book "Opportunities".
NAME (print) AGE.....
ADDRESS
CITY..... (Zone).... STATE.....
 Check here for information if you are under 17.

BUILD A \$15,000 A YEAR FUTURE!

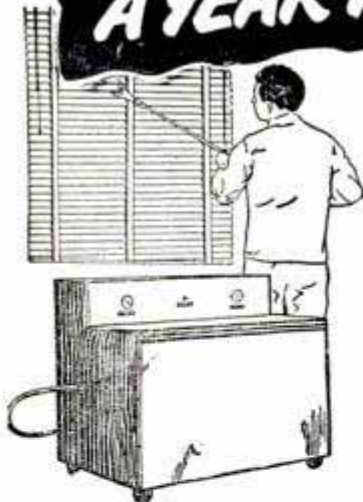

IN THE EXCITING NEW BUSINESS OF LAUNDERING VENETIAN BLINDS

There is big money to be made cleaning Venetian Blinds and a permanent, fast growing, Lifetime Business, besides.

An amazing new kind of business of your own in a field that is growing like mad. Millions of Venetian Blinds need laundering at regular intervals.

With our new patented machine, you can start small—using your basement, garage or utility room to begin with. You can expand as your business increases by leaps and bounds. Income up to \$200.00 daily already being made by others. Small investment for equipment starts your own lifetime business—and monthly payment plan permits you to pay for it as you grow.

FREE Get all the facts about this sensational new kind of machine that launders blinds so fast that your charges are unbelievably low. People would rather send blinds to you than do the work themselves. Yet, you make 700% profit on every blind you clean. Get names of successful owners near you. Get details of the full amazing plan without obligation. Be first in your territory to start a business that has brought \$15,000 PROFITS the first year to others. Wire today or send name on postcard.

VENETIAN BLIND LAUNDRY EQUIPMENT CO. INC.
442 N. SENECA ST. DEPT. 1012 WICHITA 12, KANSAS

EAR NOISES?



If you suffer from those miserable ear noises and are Hard-of-Hearing due to catarrh of the head, write us NOW for proof of the wonderful, palliative relief many people have reported after using our simple home treatment. **NOTHING TO WEAR.** Many past 70 reported such relief in hearing and ear noises. **SEND NOW FOR PROOF AND 30 DAYS TRIAL OFFER.**

THE ELMO COMPANY
DEPT. 3PM9 DAVENPORT, IOWA

STOPS FOGGY WINDSHIELDS NEW Chemical Mitt



Amazing Discovery! Autoists wild over new FOG-STOP Windshield Cleaner. Simply glide over windshield chemically-treated Mitt—at once glass sparkles crystal clear. Blurry mist, frost, sleet, snow disappear like magic. Stops fogging. *Sells like wild!*

SAMPLES FOR AGENTS Sample offer sent immediately to all who send name at once. Hurry. Postcard will do. **SEND NO MONEY—just your name.** KRISTEE CO., Dept. 694, AKRON 8, OHIO



SEND FOR THIS FREE!

Make money. Know how to break and train horses. Write today for this book **FREE**, together with special offer of a course in Animal Breeding. If you are interested in Galting and Riding the saddle horse, check here () Do it today—now.

BEERY SCHOOL OF HORSEMANSHIP
Dept. 11012 Pleasant Hill, Ohio

BECOME AN EXPERT IN TRAFFIC

Traffic men earn \$4,000 to \$10,000 and up. Thousands of firms need experts on rates, tariffs, regulations. We train you thoroughly in spare time at home for executive traffic jobs. Personal training under traffic authorities. Placement counsel and help. Write for free 48-page book "Traffic Management—the Fast Growing Profession."

LASALLE Extension University, 417 So. Dearborn St.
A Correspondence Institution Dept. 1264T Chicago 5, Ill.

RUPTURED?

Get Relief This Proven Way

Why try to worry along with trusses that gouge your flesh—press heavily on hips and spine—enlarge opening—fall to hold rupture? You need the Cluthe. No leg-straps or cutting belts. Automatic adjustable pad holds at real opening—follows every body movement with instant increased support in case of strain. Cannot slip whether at work or play. Light. Waterproof. Can be worn in bath. Send for amazing **FREE** book, "Advice To Ruptured" and details of liberal truthful 60-day trial offer. Also endorsements from grateful users in your neighborhood. Write:

CLUTHE SONS, Dept. 31, Bloomfield, New Jersey.

Now YOU can PICK your JOB with a BIG PAY Future in INDUSTRY

TOOL ENGINEER
TOOL & DIE DESIGNER
MACHINE DESIGNER
INDUSTRIAL ENGINEER
INDUSTRIAL DRAFTSMAN
MASTER MACHINIST
TOOL & DIE MAKER

Industry is expanding so rapidly there are more good paying jobs than there are trained men to fill them. Shortages of Draftsmen, Designers, Tool Engineers, Machinists, Tool & Die Makers are so widespread that you can pick one of these high paid key jobs -- and then look forward to a lifetime of Achievement and Security!

Yes, you can pick your job now --- and fill it when you are trained and qualified, and that is why you should mail the coupon at once for Allied's FREE books. Find out NOW about Allied's tested plan that has been training successful men for a quarter century.

The enormous present day expansion of our American Industry has brought about an acute shortage of Draftsmen, Tool and Die Designers, Tool Engineers, Machinists and Tool and Die Makers. With ALLIED training you can take your place in these important industrial fields!

APPROVED FOR VETERANS

ALLIED is approved by Industry, the American Society of Tool Engineers, Department of Education and Registration, the Department of Public Instruction -- State of Illinois and the Veterans Administration.

Accredited by the Central Schools Association.

Free employment service and housing assistance all through your training period and after your graduation. Our industrial contacts cover the U. S. A.

ALLIED TRAINED MEN GET
GOOD PAYING KEY JOBS



GRADUATE IN DEMAND

"Believe me, it really gives you a feeling of satisfaction to be able to pick your employer instead of having to go wherever you can to get a job...."

Dave Nickels, Dundee, Ill.

PRACTICAL TRAINING

"I am employed as an aircraft draftsman and junior engineer. Thanks to Allied and the excellent instruction I received there...."

R. Clugston, Joliet, Ill.

EMPLOYER IMPRESSED

"My employer was impressed with my practical knowledge and drafting skill. Both of these I learned at Allied having never worked in the die design field...."

Frank E. Myers
Maywood, Ill.

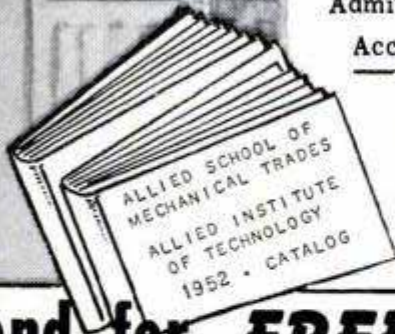

ALLIED SCHOOL OF
MECHANICAL TRADES
ALLIED INSTITUTE
OF TECHNOLOGY
1952 • CATALOG

send for **FREE BOOKS**

ALLIED SCHOOL
of Mechanical Trades
1338-42 S. Michigan Ave.
Chicago 5, Illinois



ALLIED SCHOOL of MECHANICAL TRADES
ALLIED INSTITUTE of TECHNOLOGY
1338-42 S. MICHIGAN AVE., Dept. PM-12
CHICAGO 5, ILL.

GENTLEMEN.

I WANT TO GET INTO IMPORTANT INDUSTRIAL TRADES AND PROFESSIONS.

SEND ME WITHOUT OBLIGATION YOUR FREE BOOKS EXPLAINING ALLIED'S COURSE OF INSTRUCTION.

I AM INTERESTED IN RESIDENT TRAINING.

I AM INTERESTED IN HOME STUDY TRAINING.

I AM ELIGIBLE I AM NOT ELIGIBLE FOR TRAINING UNDER G. I. BILL.

Name _____ Age _____

Address _____

City _____ State _____

Give ME 15 MINUTES A DAY To Prove I Can make YOU a NEW MAN!

That's all I want — just 15 minutes a day to prove I can give you a powerful body of

might and muscle—with my quick "Dynamic-Tension" method. Mail coupon below—and I'll

send you, absolutely free, my new book, "Everlasting Health and Strength." Reveals secrets that changed me from a 97-pound weakling to winner of title, "World's Most Perfectly-Developed Man." Shows how I can build you a champion body the same easy way!

I've taken thousands of flabby, no-muscle men and given them big, powerful muscles, increased measurements, amazing strength, vitality, pep. My natural Dynamic-Tension method develops real men—tones up the entire body, inside and out!

Send NOW for free copy of my book filled with pictures and body facts. Find out how I can make you the husky, big-muscled NEW MAN you can be! Mail coupon TODAY.

CHARLES ATLAS, holder of title "World's Most Perfectly-Developed Man."

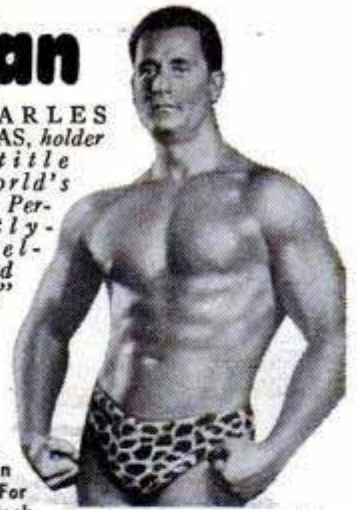

Mail Coupon Now For Free Book

**CHARLES ATLAS, Dept. 8Z,
115 East 23rd Street, New York, N. Y.**

Send me your Free Book which proves how "Dynamic Tension" can make me a NEW MAN.

Name Age

Address

City State

WATCHMAKING FREE Sample Lesson

Shows how to clean watches by hand or machine. It's fun . . . profitable too! An exciting hobby or fascinating career. Chicago School of Watchmaking offers complete home study training in professional watch repairing at amazing low cost. All equipment included at no extra charge. No experience needed. Send coupon today! No obligation.

CHICAGO SCHOOL OF WATCHMAKING

1608 N. Milwaukee Ave., Dept. 1112, Chicago 47, Ill.

SEND FREE SAMPLE LESSON Veteran

Name

Address

City Zone State

The Steady Pay Profession Good Times or Bad!

SCIENTIFIC CRIME DETECTION

FOLLOW
THIS MAN
Operator
No. 38



It Is Easy to Learn!

I will teach you this fascinating science during your spare time at home. It pays to be an expert in Finger Printing, Firearms Identification, Police Photography and Criminal Investigation. I have trained hundreds of men and women now successfully serving in identification bureaus throughout America. You, too, may quickly prepare yourself to become a well-paid valued officer of the law, often sharing in the generous rewards offered for wanted criminals.

FREE! OVER 800

"BLUE BOOK OF CRIME"

This book is full of exciting information on scientific crimedetection. It will show how you can get started in a grand career. Now, at amazingly low cost. Clip coupon Now...Mail it today.

of all Identification Bureaus in the U. S. employ students and graduates of I. A. S. A majority of these men are heads of Bureaus. Many of them knew nothing about crime detection before training with me. Now they have steady jobs, good salaries and a fine future. Write today for full particulars and free book. Give age. No salesman will call.

INSTITUTE OF APPLIED SCIENCE

(A Correspondence School since 1916)

1920 Sunnyside Ave., Dept. 1359, Chicago 40, Ill.

INSTITUTE OF APPLIED SCIENCE
1920 Sunnyside Ave., Dept. 1359, Chicago 40

Gentlemen: Without any obligation on my part, send me the "Blue Book of Crime," and complete list of Identification Bureaus employing your students or graduates, together with your low prices and Easy Terms Offer. (Literature will be sent ONLY to persons stating their age.)

Name Age

Address R. F. D.

City State

Develop Hidden Earning Power STUDY LAW

at home! LL.B. Degree

Qualify yourself in spare time for advancement, greater earnings, business success. Now, more than ever, legal ability is in demand! Easy-to-understand step-by-step lessons and text material furnished — invaluable for permanent reference. Over 40 years expert instruction. 114,000 students enrolled. Easy payments. Find out now, at no cost, how study of law can help you. Write today for FREE Book "Law and Executive Guidance."

AMERICAN EXTENSION SCHOOL OF LAW

Dept. PM-57, 646 N. Michigan Ave., Chicago, Ill.

NOTICED POPULAR MECHANICS' SHOPPING SECTION YET?

It's called "Shopping for Living and Giving" . . . immediately precedes the editorial section.

You can do your shopping by mail—the easy way —by consulting these pages of selected novelty merchandise. Your family and friends will admire your original gifts—unusual buys that ordinarily would take hours of time . . . miles of walking.

For smart buys, watch for the "Shopping for Living and Giving" section in every issue!

Say You Saw It in POPULAR MECHANICS

Buy DIAMONDS at Wholesale Prices

Benefit from Loan foreclosures and Estate Liquidations. Values from \$50. to \$10,000.

Write Dept. A

CITIZEN'S
Diamond Brokers

195 Mitchell St.
Atlanta, Ga.



Est. 1914

Become an ELECTRICAL or MECHANICAL ENGINEER IN 36 MONTHS

- ★ Bachelor of Science Degree
- ★ Engineering Associate Certificate, 12-18 Months
- ★ Service Preparatory Courses, 3-12 Months

The growing shortage of trained engineers and technicians offers greater opportunity for ambitious young men. By 1955 there will be at least two positions for every graduate. Enroll NOW and earn your B. S. Degree in 36 months. Each of three levels of study is complete in itself. Technician courses can also be applied as one-third of the degree program. Faculty of specialists. Military, practical or academic training evaluated for advanced credit. Terms open JANUARY, APRIL, JULY, OCTOBER.

CHOOSE FROM THESE 15 PROGRAMS

- General Preparatory Course — 3 Months
- SERVICE LEVEL — 6 to 12 Months**
 - Electrical Service
 - Welding Operator
 - Refrigerator Service
 - Heating Service
 - Radio-Television Servicing Course
- TECHNICIAN LEVEL — 12 to 18 Months**
 - Radio and Television
 - Electrotechnics
 - Welding
 - Electronics
 - Air Conditioning
 - Mechanical
- ENGINEERING LEVEL — 36 Months — B. S. Degree**
Choice of functional electives: Production Sales or Research. • ELECTRICAL ENGINEERING — ELECTRONICS OR POWER MAJORS. • MECHANICAL ENGINEERING.

MILWAUKEE SCHOOL OF ENGINEERING

NONPROFIT • FOUNDED IN 1903

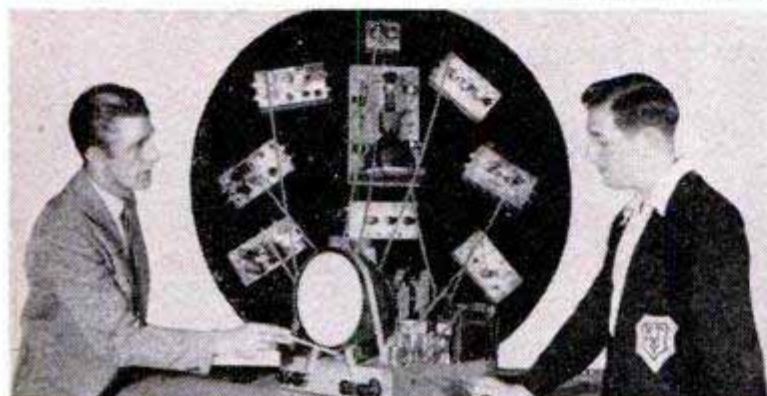

Milwaukee School of Engineering
Dept. PM 1252, 1025 N. Milwaukee
Milwaukee 1, Wisconsin

Without obligation, send catalog and information on.....
(Name of Course)

Name.....Age.....

Address.....

City.....Zone.....State.....

If veteran, indicate date of discharge



DRAW for MONEY... BE AN ARTIST!

LEARN AT HOME IN SPARE TIME —
Train for Profitable Career

Commercial Art, Designing, Cartooning — one complete, practical course. Step-by-step method teaches beginners quickly. For 38 years W.S.A. has been preparing graduates for good-paying art jobs in Advertising, Television, Newspapers, Art Studios, etc. TWO ART OUTFITS furnished. Low tuition; easy terms.

TRIAL PLAN offered — mail coupon today for FREE illustrated booklet — "Art for Pleasure & Profit."

WASHINGTON SCHOOL OF ART
Studio 1212F, Washington 5, D. C.

Please send me full information and your free book, "Art for Pleasure & Profit."

Name.....Age.....

Street.....

City.....Zone.....State.....

Course G.I. Approved for Eligible Vets



Get into.. PLASTIC LAMINATING AT HOME!

Get ORDERS and CASH from your mailman—do work in SPARE TIME at home —or expand into FULL TIME business. Send coupon for Free facts about the newest and most fascinating of all home operated businesses. For the first time a simplified machine brings the fabulous profits of Plastic Sealing and Plastic Laminating within the reach of the small operator. Anyone can learn to operate the machine with a few minutes practice—then with our Magic Mail Plan can get mail orders pouring in daily with cash in every envelope. No canvassing—no selling. We even

Make \$20 to \$30 a Day by..
MAGIC MAIL PLAN!

supply the circulars you mail to bring back cash and orders. Don't waste a minute. Rush your name. We'll send you FREE and postpaid, pictures, prices, details, and all the facts you need to start. Mail coupon or send name on postcard. No charge. Warner Electric Co., 1512 Jarvis Av., Dept. L-10 W, Chicago 26, Ill.

Make Thousands of Beautiful Art Creations

COSTUME JEWELRY • CIGARETTE BOXES
TRAYS • CANDLESTICKS • COASTERS
LAMP BASES • BOOK ENDS...ALL IN
SPARKLING COLORED PLASTIC



THIS MAN... is taking out of the machine a Plastic Sealing Job — ordered by mail — only 11c in material cost brings back \$2.58 in cash by mail. Capacity of machine: \$25.00 profit per hour of operation.

WARNER ELECTRIC CO., 1512 Jarvis Av.
Dept. L-10-W, Chicago 26, Ill.
At no cost to me, please rush complete details postage prepaid. I am under no obligation.

Name.....

Address.....

City.....Zone.....State.....

No Waiting to LEARN
START NOW TO EARN!
 This BIG BOOK SHOWS HOW
THIS IS YOUR BIG OPPORTUNITY!

Never before has a more helpful book been printed for those planning a business of their own. Gathered in this large illustrated volume are the formulas, recipes, facts and secrets that have contributed so largely to America's great industrial progress. Capitalize on this information for making most any conceivable product without experience, special equipment or previous knowledge of chemistry or manufacturing.

The experts who compiled this book are authorities, and present this information in simple, understandable language. They also give you wholesale supply sources for needed materials, short cuts and methods for the most profitable results.

10,000 IDEAS SECRETS FORMULAS
 924 BIG PAGES ILLUSTRATED

FORTUNES FROM A SINGLE IDEA

Hundreds of good paying businesses have been built on a product made from a simple recipe. Choose from any of the 162,000 Adhesives and 10,000 formulas of which the following are only a very few: Adhesives, Alloys, Anti-Freeze Solutions, Cosmetics, Beverages and Liquors, Candy, Gum, Casein, Celluloid, Ceramics, Cheese, Cleaning Preparations, Concrete, Copper, Cotton, Dentifrices, Depilatories, Dyes, Embalming Fluids, Enameling, Glass, Glazes, Gold, Household Formulas, Inks, Insecticides, Iron, Jewelers' Formulas, Lacquers, Laundry Preparations, Leather, Linoleum, Lubricants, Manicure Preparations, Marble (artificial), Metals, Mirrors, Oils and Ointments, Paints, Paper, Perfumes, Photography, Polishes, Powders, Remedies for Man, Beast or Fowl, Rubber Products, Refrigerants, Soaps, Solder and Soldering, Tooth Cements, Transfers, Transparencies, Varnishes and Thousands of others for making all sorts of profitable and practical things.

ALSO

We include Free—our new book of helpful money-making information: — "The More You Know the More You Can Earn—Easier," and "Quicker."

BEAT THE HIGH COST OF LIVING

Homemakers and business men make substantial savings with this comprehensive book. It is an accepted authority by chemists, schools, industry, etc. and is the largest and most comprehensive book of its kind ever issued. Nothing else like it in existence. A single formula has been worth a thousand times this book's small cost to countless owners. Cramped with money-making ideas. Invaluable for reference. Ideal for Factory, Home, Farm, Office or Workshop. As necessary as the dictionary and more useful for manufacturers, chemists and salesmen who put up products for profit.

POSTPAID
\$3.98
 ANYWHERE IN THE WORLD

\$3.98 postpaid anywhere. (Send \$1., pay balance C.O.D., U. S. only). Immediate same-day shipment. Safe Delivery Guaranteed.
ADAMS BROWN COMPANY BOOKS OF APPLIED SCIENCE
 Dept. 101, Chestnut Hill 67, Massachusetts, U. S. A.

A "GOOD HAND" HELPS YOU SUCCEED!
LEARN TO WRITE WELL

Handwriting quickly improves with our easy-to-understand picture lessons! Put your spare time to good use; send today for FREE BOOKLET: "How to Become a Good Penman," or check volume wanted below at \$1 each: Business Writing Artistic Writing Card Writing Bird & Design Flourishing Engraving Alphabets. COMPLETE SET \$4.50. Ask for price list of penman's supplies.

TAMBLYN SCHOOL OF PENMANSHIP
 S.A. Ziller, Pres., 442 Ridge Bldg., Kansas City, Mo., USA

Only 10¢ writing. 33rd YEAR

FULLY GUARANTEED TIRES COST LESS!

Nationally famous FIRESTONE, GOODRICH, U. S. ROYAL, GOODYEAR, and other makes. Every tire selected and inspected for your safety.

FREE TUBE WITH EVERY PASSENGER TIRE			
New Tread Tires Guar. 24 Mos. (Mud & Snow Tires \$1. Extra)			
550x16 7.98	600x16(6) 9.98	650x20(8) 19.95	700x16(6) 14.48
550x17 7.98	650x15 9.98	640x15 8.98	710x15 10.48
600x15 7.98	650x16 10.48	670x15 9.98	760x15 11.48
600x16 7.98	650x16(6) 12.48	700x15 11.48	820x15 12.98

GOOD TIRES GUARANTEED 12 MONTHS			
600x16 4.14	700x16 5.14	32x6(8) 8.84	825x20 14.24
650x16 4.54	670x15 4.74	32x6(10) 10.84	900x20 13.34
650x15 4.34	650x20 7.84	750x20(8) 8.54	1000x20 14.14
700x15 4.64	700x20(8) 8.94	750x20(10) 9.94	1100x20 16.14

AAA PREMIUM GRADE GUARANTEED 18 MONTHS			
550x15 5.48	700x15 5.98	760x15 5.58	750x20(10) 14.98
600x16 5.28	700x16 6.78	55x17 5.48	825x20 18.68
600x16(6) 5.58	700x16(6) 7.98	600x20 9.78	900x20 18.98
640x15 5.68	750x16(6) 8.98	650x20 10.88	1000x20 19.98
650x16 5.78	800x15 6.88	700x20 12.88	1000x22 21.98
650x16(6) 6.98	820x15 7.48	32x6(8) 10.48	1100x20 20.98
650x15 5.98	710x15 6.09	32x6(10) 12.48	1100x22 21.98
670x16 6.18	550x18 5.98	750x20(8) 12.98	1100x24 23.98

MILITARY SPECIAL AA Guaranteed 12 Months—		NEW TREAD GUAR. 24 MOS.	
900x16 10.69	1000x20 19.98	600x16 8.98	
750x20 10.98	1100x20 21.98	600x16(6) 9.98	
AAA GUARANTEED 18 MONTHS		700x15(6) 15.95	
900x16 14.98	750x20 16.48	750x20(8) 24.98	

PENNA'S LARGEST STOCK Largest stock of used tires in the East. Thousands of satisfied customers. Write for sizes not listed. MONEY ORDER OR CHECK WITH ORDER. NO C.O.D.'s

PYRAMID TIRE CO.
 1333-35 North 5th St.
 Dept. M., Phila. 22, Pa.

New Low Cost Electric Water Heater Gives You HOT WATER AUTOMATICALLY From Your Present Tank!



- No dirt, grime, soot, flame!
- SAFE! Every part UL approved!
- Install in 10 Minutes, or less!
- No new tanks or plumbing required!
- Works automatically—saves on fuel bills!

Complete—Ready to Plug In — Only **\$19.95**

New, UL approved LECTROMATIC changes gas, coal or oil-burning water heater into modern ALL-ELECTRIC unit! Turns on automatically when needed, shuts off automatically when water is heated. To install, simply shut off water. Remove plug from water tank. Screw LECTROMATIC into opening (as shown), then PLUG IN! Plenty of hot water all day long. Uses only 1/4-1/2¢ electricity per gal. of hot water. Temp. adjustable from 100 to 180 degrees. Save postage. Send check or money order for \$19.95 now. Money back in ten days if not delighted. Full one year guarantee! ORDER NOW!

COLLOID EQUIPMENT CO., INC. Dept. PM-12, 50 CHURCH STREET NEW YORK 7, N. Y.

Learn REFRIGERATION AND AIR CONDITIONING

FREE! PLAN FOR YOUR SUCCESS

EXTRA CASH NOW — Spare time at home — Earn while you learn by doing with Easy Home Course. START YOUR OWN BUSINESS — No Experience Needed. Special tools & equipment furnished. Send for FREE BOOK — TODAY!

MECHANICS TRAINING SCHOOL—Dept. P-5212
 7217 South Broadway • Los Angeles 3, California

FREE BOOK

Model Railroading is Fun!

Read about it in picture-packed Model Railroader magazine. **Special Offer!** Send \$1 (\$1.75 value) for special 3-month subscription plus new 64-page "Introduction to Scale Model Railroading." Limited. Act today!

Model Railroader Magazine Dept. 1572C, Milwaukee 3, Wis.

WORLD'S MOST COMPLETE PHOTOGRAPHIC CATALOG

90 Illustrated Pages with everything photographic... Tape Recorders, Audio Equipment, Scientific Instruments, Binoculars, etc.

Send 10¢ in Coin or Stamps 25¢ Back on your First Purchase!

PEERLESS CAMERA 415 LEXINGTON AVE., WRITE TO NEW YORK 17, N. Y. DEPT. 102

Quick, EASY Way to REPRODUCE any Object

Make exact duplicates of trays, lamp bases, medals, figurines, vases, etc., right at home over night! New RUBBER MOLD method needs no heat curing. No special skill or tools required. Make perfect reproductions of objects of clay, plasteline, wood, metal, glass, in any quantity! Cost will be only few cents. Send for Brochure 42 which gives exact step-by-step instructions anyone can understand and follow. Send 10¢ for it today to **SCULPTURE HOUSE, 304 West 42nd Street, New York 36, N. Y.**

CASH SPARE TIME!

Turn spare hours, evenings, weekends into Money! Take orders from friends, neighbors, others for world-famous Stark Fruit Trees, Shrubs, Vines, Roses. Enormous demand for new Quick-Bearing Apple, Pear, Peach, other trees. U. S. Patent Loaders including sensational DWARF trees. SUCCEED with 137-year-old company.

FREE Giant MONEY-MAKING Sales Outfit It's yours—FREE. Send no money. No experience needed. GIANT DEMONSTRATION OUTFIT PLUS beautiful natural color Photo Plate Book sent at once. Rush name, address—start earning quick!

Stark Bro's Desk 5563, LOUISIANA, MISSOURI

Learn BAKING At Home

Baking is one of America's high industries in wages. Nearly depression-proof. Thorough basic home course lays sound foundation. If you have aptitude, write for FREE BOOKLET: "Opportunities in Commercial Baking."

NATIONAL BAKING SCHOOL
 835 Diversey Parkway Dept. 1359 Chicago 14, Ill.

AMAZING NEW TRAINING PLAN

NOW... YOU CAN BECOME A LICENSED* TV TECHNICIAN
LICENSED TV MEN MAKE MORE MONEY

Leonard C. Lane,
 B.S., M.A.
 President of Radio-Television
 Training Association,
 Exec. Dir. of Pierce School
 of Radio and Television

**AT NO EXTRA COST!
 YOU GET A ROUND TRIP TO
 NEW YORK CITY**

FROM ANYWHERE IN THE U.S. OR CANADA—I pay your way to New York and return, PLUS 2 FREE weeks, 50 hours of advanced instruction and shop training at the PIERCE SCHOOL OF RADIO & TELEVISION. You use modern electronics equipment, including student-operated TV and Radio stations. You go behind the scenes of New York's big Radio-TV centers, to study first hand. And I give you all this AT NO EXTRA COST! (Applies to complete Radio-TV course only.)

Only RTTA makes this amazing offer.

EXTRA FEATURES THAT MEAN MORE MONEY FOR YOU!

Thousands of new job opportunities will be available for you right in your own state, now that the government has lifted restrictions on new TV stations. My simple, successful methods can PREPARE YOU NOW to take your place in America's booming TELEVISION and Electronics industries... help you get the success and happiness that you always wanted out of life. You learn the practical, easy way by using actual parts and equipment in the 15 big Radio-TV kits I send you, including a COMPLETE TV RECEIVER... yours to build and keep.

My Advanced Training Prepares You For Better Jobs Then, after you finish your training for a position as a full-fledged TV Technician—where you can write your own ticket and choose from dozens of fascinating careers—I don't stop there! I continue to train you—AT NO EXTRA COST—to qualify for even better pay in the BETTER JOBS that demand FCC licenses, with my...

FREE* FCC COACHING COURSE
 PREPARES YOU AT HOME FOR YOUR
 FCC LICENSE
 THE BEST JOBS IN TV AND RADIO
 REQUIRE AN FCC LICENSE
 Given to every student at NO EXTRA COST after
 TV Theory and Practice is completed.

Earn Extra Money in Spare Time

Make as much as \$25.00 a week in your spare time while learning—repairing Radio-TV sets. Many of my students pay for their entire training from spare time earnings almost from the very beginning... start their own service business.

FREE EMPLOYMENT ASSISTANCE. My vocational adviser will show you how you can have a good-paying career in the locality of your choice.

**SET-UP YOUR OWN HOME LABORATORY
 WITH THE 15 BIG TELEVISION-RADIO
 KITS WE SEND YOU (At No Extra Cost)**

**YOU BUILD
 AND KEEP
 ALL THESE
 UNITS**



—INCLUDING BIG SCREEN TV RECEIVER,
 plus Super-Het Radio Receiver,
 R.F. Signal Generator, Combination
 Voltmeter-Ammeter-Ohmmeter,
 C-W Telephone
 Receiver, AC-DC
 Power Supply.
 Everything
 Furnished
 Including
 All Tubes.

NOW! Advanced FM-TV Training
 For Men Who Know Radio
 Prepares You For Higher Pay Jobs
 In A Few Months
 COMPLETE theory and practical training
 course... complete with kits
 including large screen TV receiver.
 FCC License Coaching Course Included FREE.

VETERANS!

**MAIL COUPON
 TODAY**

MY SIMPLE
 METHODS
 MAKE SUCCESS
 EASY!

**THIS SCHOOL FULLY AP-
 PROVED TO TRAIN VETER-
 ANS UNDER NEW G. I. BILL!**
 If discharged after June
 27, 1950 — CHECK COUPON
 BELOW!



I GET MY GRADUATES GOOD PAYING JOBS

"As Merchant Ship Radio
 Officer, I receive \$867.
 for 40-day trip. Your
 training helped me get
 this fine position."
 —Stanley Nawrocki

I now hold a fine air-
 lines position at La-
 Guardia Field, New York
 City, thanks to your ex-
 cellent training."
 —Joseph Rosenberg

"Your excellent instruc-
 tion helped me get my
 present job as an air-
 port radio mechanic for
 American Airlines."
 —Eugene E. Basko

"Thanks to your train-
 ing, I qualified for a
 good job as a Receiver
 Tester at Federal Tele-
 phone and Radio."
 —Paul Frank Seier

Many others working at NBC, RCA, CBS, Dumont, Philco,
 Emerson, Admiral and other leading firms.



**BOTH
 FREE
 New
 Illustrated
 Book plus
 Sample
 Lesson**

NO SALESMAN WILL CALL!

Mr. Leonard C. Lane, President
 RADIO-TELEVISION TRAINING ASSN.
 1629 Broadway, Radio City Station
 New York 19, N. Y. Dept. M-12

Dear Mr. Lane:

Mail me your NEW FREE BOOK and SAMPLE
 LESSON that will show me how I can make BIG
 MONEY in TELEVISION. I understand I am un-
 der no obligation and no salesman will call.

Name _____ Age _____
 Address _____
 City _____ Zone _____ State _____

I am interested in: Radio-TV Advanced FM-TV
VETERANS: If qualified under new G.I. Bill, check
 here

RADIO-TELEVISION TRAINING ASSOCIATION

1629 Broadway, Radio City Station, New York City 19, N. Y.
 Approved as a Correspondence School
 under the laws of the State of New York

INVENTORS

Your first step—if you consider your invention to be something of importance—is to have a search made of pertinent, prior U. S. patents. If our search report indicates probable patentability of your invention, you may apply for a patent which gives you the right to exclude others from making, using or selling your invention as claimed for a term of 17 years.

This firm is registered to practice before the U. S. Patent Office and is available to assist in the preparation of the necessary drawings, specification and claims.

Ask for a copy of our instructive booklet "Patent Protection for Inventors" and our convenient "Evidence of Invention" form. No obligation.

VICTOR J. EVANS & Co. *Merlin M. Evans*
REGISTERED PATENT ATTORNEY
730-P MERLIN BUILDING, WASHINGTON 6, D. C.

INVENTORS

IF YOU WISH TO PROTECT YOUR INVENTION, You should take steps to protect it by a U. S. Patent. Write me for "INVENTION RECORD" form

CARL MILLER
REGISTERED PATENT ATTORNEY
WOOLWORTH BLDG., 35th FLOOR, 122A
NEW YORK CITY



PATENTS

C. A. SNOW & CO.

REGISTERED PATENT ATTORNEYS
WRITE FOR INFORMATION TO
428 SNOW BUILDING, WASHINGTON 1, D. C.



INVENTORS

Send for PATENT INFORMATION Book and INVENTOR'S RECORD without obligation
GUSTAVE MILLER
122-PM WARNER BUILDING
WASHINGTON 4, D. C.

REGISTERED PATENT ATTORNEY
Patent Attorney & Advisor
U. S. NAVY DEPT. 1930-1947
ASSOCIATE EXAMINER
U. S. PAT. OFF. 1922-1929
PATENT LAWYER

INVENTORS

I shall be pleased to furnish you, upon request, with full information relative to patent procedure—without any obligation on your part.

PATRICK D. BEAVERS
Registered Patent Attorney
934 Columbian Building Washington 1, D. C.

MONTH AFTER MONTH, YEAR AFTER YEAR, YOU SEE OUR AD. CHECK AND DOUBLECHECK BEFORE YOU BUY ANYWHERE!
1 Are These Tires "Family-Safe?" Our Families Use Them.
2 Are They Recaps? Ours Are Not (Except Passenger Snow-Tires)
3 Will I Get Goodyear, U. S. & Famous Brands? From Us, You Must!
4 Is The Guarantee Unconditional? See Our Fine Offers Below.
5 Can Good Tires Be Bought Cheaper? It's Dangerous To Pay Less.
6 Is A Tube Included Free? Yes, We Do. See OUR Free Tube Offer.

GOODYEAR Firestone

GODDICH, U. S. ROYAL, GENERAL & OTHERS, (NO, NOT RECAPS) DOUBLE WARRANTY & UNCONDITIONAL GUAR. ON PASS. TIRES

Our Policy is to select your tires so carefully, as if our very future depended on the service given by that particular tire.

FREE TUBE WITH EVERY GOOD GRADE & FINEST GRADE PASSENGER AND TRUCK TIRE

GOOD GRADE 20 MONTHS GUARANTEE BOND		FINEST GRADE 30 MONTHS GUARANTEE BOND	
600-16 \$4.02	820-15 \$5.30	600-20 \$ 6.92	32x8-8 11.52
650-16 4.40	700-15 4.22	650-20 7.52	32x8(10) 9.80
700-16 5.00	670-15 4.40	700-20 8.40	900-20 13.10
650-15 4.00	710-15 4.60	750-20 8.40	1000-20 13.62
760-15 4.90	550-19 6.54	825-20 13.92	1100-20 13.94

THIS GRADE MADE THE "BLATT" NAME WORLD FAMOUS.		30 MONTH GUAR. TRUCK TIRES	
600-16 \$5.12	700-15 \$4.82	700-20 \$9.92	700-20 \$13.52
600-16(6) 5.92	475-19 5.08	700-15(6) 9.92	750-20(8) 12.92
650-16 5.92	840-15 5.02	700-17 10.62	750-20(10) 17.52
650-16(6) 6.92	670-15 5.22	750-16 9.62	750-20(10) 17.52
700-16 6.52	710-15 5.72	750-15 13.22	825-20 18.22
700-16(6) 8.72	760-15 5.92	750-17 11.52	900-20 17.22
750-16 7.02	800-15 6.62	700-18 15.92	1000-20 18.52
525-18 4.92	820-15 6.72	600-20 10.22	1200-20 21.52
550-17 4.52	760-16 6.62	650-20 10.60	1000-22 17.52
650-15 5.12	450-21 5.08	32x8(8) 13.52	1100-22 20.42

Buy the "Right" Truck Tires for "Your" Job.
Std. Guar. 20 Mos. Rugged Guar. 32 Mos.
MILITARY MUD-SNO TREAD
750-20Std \$10.08 750-20Rg. \$14.52
900-16Std 10.58 900-16Rg. 15.08
750-16Rg. 17.64 600-16Std 6.48 600-16Rg. 9.95

FACTORY RETREAD SNOW-TIRES. 30 MONTH GUARANTEE. "New Tire Traction"
GOOD YEAR, FIRESTONE & OTHERS
670-15 \$8.50 600-16 \$8.50 710-15 \$8.50 650-15 \$11
760-15 \$8.50 700-15 \$8.50 800-15 \$11

BLATT BLATT BLDG., GIRARD & LANCASTER AVES. DEPT. PM, PHILADELPHIA 31, PA.
SEND CHECK OR MONEY ORDER & THIS AD.
Shipments RUSHED Down South, Far-West & Up North

INVENTORS

Whether an invention is patentable can be substantially determined by a search of the U. S. Patent records. Without obligation, write for information explaining the steps you should take to secure a patent.

JOHN N. RANDOLPH
Registered Patent Attorney
201 Columbian Building, Washington 1, D. C.

CARBURETOR TOO RICH MAKES MOTORIST TOO POOR

Car owners who are wasting money, getting poor gas mileage due to over-rich mixtures, will be pleased to learn how to save gasoline by VACU-MATING OVER-RICH MIXTURES. Vacu-Matic fits all cars, trucks and tractors. Automatic and operates on the supercharge principle. Easily installed in a few minutes.
SALESMEN WANTED! Big Profits

For FREE particulars, how you can install one on your own car for introducing, just send your name and address on a postcard to VACU-MATIC, 7617-1964 W. State St., WAUWATOSA, WIS.

"How to Make Money with Simple Cartoons"

A book everyone who likes to draw should have. It is free; no obligation. Simply address **FREE BOOK**
CARTOONISTS' EXCHANGE
Dept. 912D Pleasant Hill, Ohio

ELECTRIC APPLIANCE REPAIRMEN

Find all the sources of supply for parts on all ELECTRIC APPLIANCES... Washing Machines, Vacuum Cleaners, Ranges, Sewing Machines, Small Appliances, etc.
The Only Publication Especially for the Appliance Repairman
SEND ONLY 20¢ IN STAMPS OR COINS FOR SAMPLE COPY
ELECTRIC APPLIANCE SERVICE NEWS
Dept. M-30 176 W. Adams St. Chicago 3, Ill.

**MOST FAMOUS
KNIFE
IN HISTORY!**

Renowned from Dieppe to the Yalu by Anglo-American fighting men of two wars, this priceless collector's item is fast becoming a legend. Named the "Fairbairn," this beautiful knife of finest Sheffield steel was made for British ordnance in England. It was issued to Commando and Ranger units exclusively. Your knife shipped in original leather sheath for belt and boot. An authentic souvenir which will increase in value from year to year. Overall 12". Brand new. Send check, cash or m.o. (For U.S., A.P.O. and F.P.O., air mail, add 80c per knife.) Dealers inquire.



AN IDEAL GIFT
FOR THE
SERVICEMAN
\$300
EACH
POSTPAID

Calif. resid. add 3% state tax.
Pasadena Firearms Co.,
Dept. 66
972 East Colorado St.
Pasadena 1, Calif.

**COME TO THE
UNIVERSITY OF HOUSTON
FOR YOUR
TECHNICAL AND VOCATIONAL
TRAINING**

ONE OF AMERICA'S LARGE AND MOST MODERN UNIVERSITIES

Select from these fascinating fields

- | | |
|---|---|
| <input type="checkbox"/> Aeronautics | <input type="checkbox"/> Industrial mechanics |
| <input type="checkbox"/> Air conditioning and refrigeration | <input type="checkbox"/> Drafting |
| <input type="checkbox"/> Automobile trades | <input type="checkbox"/> Machine shop |
| <input type="checkbox"/> Body and paint | <input type="checkbox"/> Welding |
| <input type="checkbox"/> Mechanics | <input type="checkbox"/> Woodworking |
| <input type="checkbox"/> Upholstery and trim | <input type="checkbox"/> Photography |
| <input type="checkbox"/> Diesel | <input type="checkbox"/> Radio |
| <input type="checkbox"/> Electricity | <input type="checkbox"/> Stationary Engineering |
| <input type="checkbox"/> Electronics | <input type="checkbox"/> Television |

PREPARE FOR YOUR FUTURE NOW . . . with the very latest methods and equipment, at the modern University of Houston School of Technology. For entrance: high school diploma, or over 18 and ability to profit from instruction. Beautiful campus—250 wooded acres in Houston, Texas—the city of tomorrow. Full college activities . . . sports . . . social life. Day or night, short or longer courses. Cooperative work and study programs . . . earn part of tuition and expenses with part-time job in your own career field, while you learn. Personal vocational counselling. Diploma or B.A.S. degree on completion—and job placement assistance. Feb., June, Sept., semesters. G.I. approved. —V. A. on campus. Send for Free illustrated brochure now!



EZEKIEL W. CULLEN BUILDING

University of Houston, School of Technology
Dept. 1C2—HOUSTON 4, TEXAS

Without cost or obligation, please send me fully-illustrated brochure and full particulars. I am interested in subject marked X above.

Name Age
Address
City State

When You LEARN By KCSW's Outstanding Method

You Can Earn More in WATCHMAKING

LEARN PROFITABLE WATCHMAKING AT HOME
KCSW's HOME STUDY COURSE includes actual work projects as well as theory. Earn extra money as you learn repairing clocks and watches.
"BE A BETTER WATCHMAKER WITH A BETTER FUTURE; LEARN BY KCSW HOMESTUDY."

KANSAS CITY SCHOOL OF WATCHMAKING
1218 Admiral Blvd. Kansas City 6, Missouri



ITALIAN ACCORDIONS

Hand Made. Very Best. Buy Direct from Factory Representative at lowest wholesale prices and Save Money. Send Name and Address for FREE catalog.

ITALIAN ACCORDION MFG. CO.
7600 Cottage Grove Ave., Dept. PM-12, Chicago 19, Ill.

TOOL & INDUSTRIAL ENGINEERING

DEGREE IN 36 MONTHS

Bach. Degree in Tool Engineering. Curriculum includes Mechanical Drafting, Tool & Die Designing. Facilities cover large and modern Machine Shops, Drafting and Engineering Laboratories. Approved by the American Society of Tool Engineers. G. I. Approved. Largest industrial center in the world. Free employment assistance and housing. 100% Placement of graduates. Year around classes. Write for catalog PMA-12.

ALLIED INSTITUTE OF TECHNOLOGY

(Div. Allied School of Mechanical Trades)
1338 SO. MICHIGAN AVE., Dept. PMA-12, CHICAGO, ILL.

REAL ESTATE

BE A BROKER

PAYS BIG! SEND FOR FREE, BIG, ILLUSTRATED CATALOG NOW! Graduates report making substantial incomes. Start and run your own business quickly. Men, women of all ages, learn easily. Course covers Sales, Property Management, Appraising, Loans, Mortgages, and related subjects. **STUDY AT HOME** or in classrooms in leading cities. Diploma awarded. Write TODAY for free book! No obligation.

WEAVER SCHOOL OF REAL ESTATE (Est. 1936)
Suite 300 Law Bldg. Dept. PM Kansas City, Mo.



SHOPPING FOR GIFTS?

For the perfect selection, consult POPULAR MECHANICS' "Shopping for Living and Giving" section, immediately preceding editorial. You'll get lots of helpful ideas here.

Each item is carefully selected for its appeal and originality for richer living and giving. In this display of handsome new merchandise, there's an appropriate item for every taste.

Save hours in those busy days before Christmas! Shop by mail in POPULAR MECHANICS' "Shopping for Living and Giving."

Learn to MOUNT Birds and Animals



To All Men & Boys!
Here is FUN and PROFIT!
Send Coupon for Free Book

Tells all about **Taxidermy**, and how you can learn at home to mount life-like **Birds, Animals, Game-Heads, Fish**. Save your valuable trophies. Decorate your home and den. Learn genuine **Chrome Tanning** for harness and sole leather buckskin and fine furs. Mount **Common** specimens, squirrels, rabbits, owls, even frogs. Into marvelous craft-work groups, both useful, humorous. Wild game not necessary. Marvelous hobby. Fascinating.

BIG PROFITS Turn your spare time to cash. Have a sideline profitable business. Mount game trophies for sportsmen; sell your own mounts; save money and **Make Money** with expert tanning. Learn by mail from old reliable school with 400,000 graduates. **Investigate Now.** Send coupon or letter or post card **Right Now** for this marvelous **FREE BOOK**. There is no cost or obligation. Please state your **AGE**.

FREE BOOK

Northwestern School of Taxidermy,
2512 Elwood Bldg., Omaha, Neb.

Gentlemen:—Please send me your **FREE 48-page** booklet explaining **Taxidermy**. (Please print plainly and state **age**. Use postal card if more convenient.)

Name _____ Age _____

Address _____



SAVE \$65 ON THIS LUXURIOUS \$100 CONTOUR CHAIR

Everything needed for only **\$34.95**

PUT IT TOGETHER IN ONE EV'G!

Scientifically correct design for restful, healthful relaxing. Adjusts for perfect sitting or reclining comfort. Proved beneficial to heart, nerves, most popular chair in every home. Firestone foam rubber and washable, pliable genuine Duran upholstery. Would cost \$100 or more in any store. Ideal Gift. Shipped all ready to put together in less than one evening. No cutting, no drilling, no skill needed. A woman can do it. Order now! Everything needed for only **\$34.95 f.o.b. Balto.** State color wanted: forest green, royal blue, ruby red, walnut brown. Enclose \$5 deposit, pay balance on arrival. Money back guaranteed if not delighted.

BESTE CRAFT CO., Dept. 6, Balto. 14, Md.



Make money selling and assembling contour chairs for friends

new, easy way to.. STRIPE with PAINT

Do Perfect Paint Striping at Home with New Kind of PAINT STRIPING TOOL

This Master Painters' Striping Tool makes it easy to do expert striping on furniture, bikes, model planes, autos, signs, toys, linoleum, wallboard, etc. Makes plain, painted walls look like tile. Paint straight lines... curved... circular or evenly spaced parallel lines the same way a professional painter does. Simply fill Tubular-Glass Paint Fountain with any color paint and wheel tip feeds paint evenly. Tips interchangeable—jaws split apart for easy cleaning. Tool complete with tips for 1-16 in. stripe only \$1.00 postpaid. Other complete tools with 1-64, 1-32, 3-64, 5-64, 3-32, 1-8 inch tips, \$1.50 ea. Extra tips — 75c each.

COMPLETE KIT with tool and 7 tips, \$5.00. Here's the handiest tool in your whole painter's kit. C.O.D.'s post. coll.

DEALERS Paint Striping Tool packed in attractive display cartons of 1 doz. Fast, profitable seller. Write for illus. circular, discounts.



Just the tool you've been waiting for! New **PAINT STRIPING** tool gives "professional" results every time, yet simple and easy to use as a fountain pen. Adjustable guide keeps lines straight as an arrow. Just as easy to make curves or free hand designs. Adds new beauty and finished look to everything you paint. Send dollar today.

WENDELL MFG. CO., 4234 N. Lincoln Ave., Dept. 3-W, Chicago 18, Ill.

Build the MONOGRAM SUPERKIT F-51 Mustang

16 to 26 Plastic Parts in Each Kit

ONLY **89c**



17 Other Thrilling Models — Flying and Solid • Jet Power Racers • Ships

Here's thrilling fun for all kids 8 to 80 years old. Genuine **SUPERKIT** scale model airplanes including the famous **F-51 Mustang** shown above. Easiest of all to build yet most detailed models ever produced. Kits contain completed wings with double airfoil, smooth carved bodies, precision-cut balsa parts, plastic 3 and 4 bladed props, pilots, canopies, cannon, rockets, bombs, display stand and other plastic parts. Complete catalog of 18 planes, including jets, 5 jet power race cars and 5 U.S. fighting ships **FREE** in every kit. Be sure you get **Monogram Models**.

MONOGRAM MODELS, Dept. 19, 3421 W. 48th Place, Chicago 32

WHAM-O SPORTSMAN*

\$1.50

35-LB. PULL!

HITS LIKE A RIFLE— KILLS RABBITS, SQUIRRELS.

Powerful, silent, accurate.

For hunting, target, routing pests.

Sportsman's choice sold world over!

HUNTING SLINGSHOT

Heavy duty 7" ash stock.

40 steel balls, extra rubber, target.

GUARANTEED. At dealers, or send \$1.50 to

Wham-O Mfg. Co. Box 8T, South Pasadena, Calif.

* Professional model of Nat'l Slingshot Assn.

Broken or Loose FALSE PLATE?



Fix it Yourself EASILY in a Few Minutes

Your plates may become broken or loose just when you need them most. With **FIX-IT-KIT** you can repair your own broken plates. Also tightens loose fitting plates, easily. Get permanent comfort with professional material. Complete instructions. Satisfaction guaranteed or your money refunded. **Order Now** at a new low price only **\$2.95** postpaid — or sent C.O.D.

Make Plates Like New

DENT-FIX DENTAL PRODUCTS, Dept. PM-12, P.O. Box 674, Kansas City 8, Missouri



SILVER SOLDER TORCH & KIT \$7.95

JOINS ALL METALS PERMANENTLY Do your own repairing. **KIT** includes one tube silver solder paste and 10 5-in. lengths silver solder alloy. **Hottest ALCOHOL TORCH** known. 2700° F. flame. Operates in any position, indoors or out. Pint of special fuel included. Complete outfit ready for use **\$7.95** postpaid. **TORCH** alone with pint of special fuel **\$6.85**. **KIT** alone **\$1.65**. Instructions included.

AMERICAN PRODUCTS CORP., 422 S. Dearborn, Dept. 3-K, Chicago

TASOPE PHOTO-ENGRAVING PLANTS



Establish your own profitable **PHOTO-ENGRAVING** business. Make cuts for newspapers, printers, and advertisers. Make etched name plates, plaques etc. Instructions furnished, no experience necessary. Sold direct from factory since 1931. First five hundred cuts sold locally or by mail will pay for plant and pay you well for your time. Write for **FREE** catalog.

Material Cost Of This Cut 3/4c
Selling Price \$1.00 And Up

TASOPE DEPT. PMS, AURORA, MO.

Complete Training in Spare Time at Home

BIG OPPORTUNITIES IN

Mechanical Engineering

Mechanical Drafting

Machine Shop Operations

• Yes, long years of on-the-job experience can raise your pay, **BUT** with *right* training, in spare time at home, you can climb faster—go farther—increase earnings quicker. Opportunities for trained men are great in the rapidly expanding mechanical fields. If you want to reach ever higher levels get full information on the practical training offered by this 55-year-old career school. Write **MECHANICS, PLEASE** and your name and address on a post card and mail it now, to—

AMERICAN SCHOOL, Dept. M945, Drexel Ave. at 58th St., Chicago 37, Ill.

NEW AUTOMATIC DEFROSTER

ONLY
\$7.95

**YOU MAKE UP TO \$4
ON EVERY FAST SALE!**



Millions of defroster attachments sold at \$12.50. Now — with new guaranteed **HOLWIN** at \$7.95 sales breaking all records. Men selling as many as 10 and 12 a day — right now. Your profits big — as high as \$4.00 cash on every sale. Converts any old style refrigerator into automatic defroster in 10 seconds. Just plug in. Terrific demonstrator. Women crazy for it at this price. Sell 4 out of 5 calls.

NO CHARGE for complete selling kit and offer of sample demonstrator. Rush name. If you've ever sold anything you'll clean up with **HOLWIN**. All mailed Free. Send name today for \$140-a-week opportunity. **DEFROSTER SALES CO.,** 415 N. LaSalle, Dept. H-8-W Chicago 10, Ill.

FREE SEND NAME
Rush name for free sales kit and offer of demonstrator sample. Sales skyrocketing. Send name. Get in on big money.

Learn ACCOUNTING Business Administration

Bookkeeping, secretarial and allied subjects at home in your spare time or attend nationally approved resident school. Write for **FREE Success Book** giving complete information about courses, plans, rates and employment opportunities.

Hills BUSINESS UNIVERSITY AND EXTENSION SCHOOL
619 W. MAIN ST. OKLAHOMA CITY 2, OKLAHOMA

KIT BOAT OWNERS

Protect your boat with **Fiberglas* Boat Armor**. New ready mixed laminator eliminates measuring and mixing, assures perfect job. No experience necessary, easy to apply.

Boat Armor makes new and used boats watertight, lengthens lifetime, strengthens construction, increases value, adds to appearance and safety. Ideal for decks and cabin roofs.

RUSH 10¢ postage for interesting, illus. booklet, and detailed instructions.

*T.M. Reg. O. C. Fiberglas Corp.

EVER GLASTING (U-MAK-IT PRODUCTS) 703P WHITTIER STREET BRONX 59, N. Y. CITY

CHRISTMAS GIFTS

UNITED "Seal of Quality" etched only into UNITED'S "Best-By-Test" **UNI-COATED*** Binoculars. Your guarantee of satisfaction. Insist on it!



UNITED Bargain offerings are all **BRAND NEW** top quality **UNI-COATED*** Binoculars with precision ground optics, lightweight metal bodies. Achromatic and Moisture-Dust proofed!

16x50 (illustrated) is the ultimate in a fine precision made binocular. Tremendous power — yet Easy to hold, Easy to focus for it weighs only 27 oz.! Objective lens is 50 mm (2" across)!



UNITED'S CHRISTMAS SPECIALS

- 6x 4 1/2 oz. Pocket size (3" long) now... **\$16.95**
- 6x30 15 oz. Economy priced 4 1/2"x6"... **27.95**
- 7x All chrome, palm sized masterpiece... **19.95**
- 7x35 Sturdy — all round use 5"x6 1/2"... **45.50**
- 7x35 **CENTER FOCUS**. Great performer... **49.50**
- 7x35 German 14 ounce! **CENTER FOCUS**... **57.50**
- 7x40 **CENTER FOCUS**: A great value... **52.50**
- 7x50 "Day and Night" glass. 31 oz.!... **36.00**
- 7x50 **CENTER FOCUS**. 6 3/4"x7 1/4"!... **39.50**
- 8x30 An! all purpose glass. 18 oz.!... **32.50**
- 8x30 German World's Lightest! (11 oz.!) **CEN. FOC.**... **39.50**
- 8x40 **MORE POWER** Yet only 5 1/2"x6 3/4"... **54.50**
- 8x40 **CENTER FOCUS**. Perfect balance... **62.50**
- 10x Pocket Model weighs only 7 1/2 oz.!... **24.95**
- 10x30 Compact Power for it weighs only 18 1/2 oz. **39.50**
- 10x50 **CENTER FOCUS** Super! 27 oz. **59.50**
- 12x50 **CENTER FOCUS** Tremendous power (27 oz.) **67.50**
- 20x56 German 9 1/2"x8"! Weighs 27 oz.! **Cen. Foc.** **99.50**
- 15x-40x American Wollensak 6 in 1 Telescope. **COATED!** 9" closed 27" extended. 18 oz.! **NO. FED. TAX.**... **30.75**

20 POWER



A 20 power **UNI-COATED*** telescope. Easy to hold and focus for it weighs only 7 1/2 ounces. Pocket size (8 3/4" closed, 13 1/2" extended). Threaded fittings throughout! All Metal. Achromatic. Ideal for accurate range checking, nearby or distant viewing, etc. Federal Tax Free!

\$8.95

UNI-COATED* Assuring buyers that applications of magnesium fluoride have been applied to the interior sides of the **VITAL** front and rear **ACHROMATICS** assuring users brighter, clearer, sharper images than ever before.

FROM 3 CONTINENTS come UNITED'S "BEST-BY-TEST" binoculars. Above are from America, Germany, and where not indicated, from American influenced Japan where skilled German optical craftsmen tutored local optical workmen in advanced techniques. It explains why the quality is so **HIGH** and the price so **LOW**.

30 DAY FREE TRIAL—If not fully satisfied, return for full refund. Cash orders prepaid. C.O.D.'s require \$2.00 deposit. Add Federal Tax. Prices all include handsome genuine leather case and straps!

FREE 3 color 40 page catalog listing over 60 different models. UNITED, Zeiss, Hensoldt, etc. from \$14.95

AIR MAIL For speedier Christmas delivery Add \$1.00 for pocket size binoculars and 20x telescope; \$2.00 for 6x, 8x, and 15x-40x Telescope; \$3.00 all others.

UNITED BINOCULAR CO., United Bldg., 9043 S. Western Ave. Dept. ARF-5708 CHICAGO 20 DEALERS WANTED Display Sales Rooms open Mon.-Fri. 9:00-3:30

LEARN MEAT CUTTING AT NATIONAL

Pay After Graduation



The steady dependable trade of Meat Cutting taught easily in 8 short weeks. **YOU LEARN BY DOING** under actual meat market conditions in big modern school at Toledo.

For beginners or men with experience. Get a profitable store of your own. Remember, **PEOPLE MUST EAT!** Big pay jobs. Free employment help. Thousands of successful graduates.

Buying, cutting, percentage, pricing, advertising, selling, etc. A complete retail meat education. National School established over 25 years. Get National training **NOW**. Pay your tuition in easy weekly payments

after you graduate. Send coupon for **FREE** 52 page school catalog — **TODAY**. G.I. approved.

National School of Meat Cutting, Inc., Dept. 50M, Toledo 4, Ohio

Send me your **FREE** school catalog on National Training at Toledo in Meat Cutting, Meat Merchandising and Self Service Meats. No obligation. No salesman will call.

Name _____ Age _____

Address _____

City _____ State _____

Approved for training Korean Veterans

AMAZING IMPROVED ELECTRIC SPRAYER MAKES HOME PAINTING EASY

Why wear yourself out using Expensive old-fashioned brushes. **Mistifier Sprayer** quickly, smoothly and evenly sprays glossy enamels, lacquers, insecticides, mothproofers and oils. All in one self contained unit that requires no compressor, motor or accessories. All metal non-corrosive parts makes this unit a LIFE-LONG useful tool. Sturdily constructed weighs only 2 lbs., uses standard replaceable Mason jar. Spray volume is adjustable, 80 POUNDS PRESSURE, fingertip control. AC-110 volts. **FOR PAINTING, SPRAYING, DISINFECTING, MOTH PROOFING.** Mistifier Sprayer works wonderful when painting wicker and all other furniture, cars, metal cans, partitions, concrete



10 DAYS
FREE
TRIAL
Unconditionally
Guaranteed

ONLY
995
Complete—
No Extras
to Buy

We Guarantee that Mistifier Sprayer will apply paint smoothly, quickly, easily — or return it within 10 days for full purchase price refund. Only \$9.95 Postpaid or sent C.O.D. plus postage. Full instructions. Order Now.

IMPERIAL SALES, Dept. 5-589
480 Lexington Ave., New York 17, N. Y.



SPRAY FURNITURE



PAINT AUTOS

brickwork, rough wood, boats, wagons, screens, cabinets, venetian blinds. Wonderful for Mothproofing clothes, rugs, drapes, storage closets, etc. Mistifier is Safe and Easy to use.

WHAT GOOD IS A TIRE WITHOUT A TUBE?
TUBE GIVEN WITH EVERY TIRE AT NO EXTRA COST



Why Pay More!

WINTER SPECIALS—AT LOW PRICES
SAVE TIME — SAVE MONEY — SEND THIS AD
GOOD USED TIRES — NOT RECAPS
20 YEARS AT THIS ADDRESS
Be Wise—A TRIAL OF ONE TIRE WILL CONVINCE YOU.
VETS AND SERVICE—10% off ON EVERY MEN MAY TAKE TIRE
20 MONTHS WRITTEN GUARANTEE

600-16 \$4.12	820-15 \$5.32	600-20 \$7.02	32x8(8) \$8.52
650-16 5.52	700-15 4.52	650-20 7.82	32x6(10) 9.82
700-16 5.02	670-15 4.42	700-20 8.42	900-20 13.12
650-15 4.32	710-15 4.62	750-20 8.52	1000-20 13.72
760-15 4.92	550-17 4.42	825-20 14.62	1100-20 13.82

EXTRA SPECIAL — 30 MONTH WRITTEN GUARANTEE

600-16 \$5.32	475-19 \$4.82	700-15(8) \$8.92	700-20 \$11.02
600-16(6) 6.42	640-15 5.02	750-16(8) 10.72	750-20(10) 15.42
650-16 5.82	670-15 5.52	700-17 9.92	750-20(8) 15.02
650-16(6) 7.32	710-15 5.72	750-17 11.72	825-20 18.32
700-16 6.42	760-15 6.02	750-15 13.92	900-20 17.22
750-16 9.22	800-15 6.52	825-15 12.92	1000-20 17.72
525-18 4.72	820-15 6.82	600-20 10.22	1000-22 19.42
550-17 4.72	670-16 6.32	650-20 10.22	1100-22 20.42
650-15 5.32	760-16 7.12	32x6(8) 11.12	1100-22 20.42
700-15 5.42	700-16(6) 7.62	32x6(10) 11.72	1100-22 20.42

White Walls \$1.00 extra Military treads 750-20 16.12

Thousands of tires shipped all over U.S.A. All tires shipped F.O.B. Phila. Send Check or M.O. with this ad. Dept. 2.
STANDARD 834 N. Broad St., Philadelphia 30, Pa.

I GAINED 53 LBS. OF SHAPELY POWER-PACKED MUSCLES

— says Roger Hirsch, N. Y. —

NOW **2** Which of these? **ME'S** is YOU? BEFORE

"That 112 lb.—6 ft. spindle-armed Sissy at right was ME a few short weeks ago", says Roger Hirsch. Look at him NOW! I gave him 53 lbs. of MIGHTY MUSCLES, added 6½ inches to his CHEST, 3 inches to each ARM! They don't call him SKINNY any more!

NO! I don't care how skinny or flabby you are. All I want is 10 minutes a day in your home to make you over by the same method I turned myself from a wreck into a Champion of Champions. You'll become an ALL-ROUND, ALL-AMERICAN, HE-MAN, A WINNER in everything you tackle—or my training won't cost you one cent.

ROGER HIRSCH was a 112 lb., 6 ft. WEAKLING. Look at him NOW!

SEND ME ONLY **10¢** for all **5** PICTURE-PACKED HE-MAN BUILDING Courses and also get both **FREE** 1. PHOTO BOOK OF STRONG MEN 2. A MUSCLE METER

JOWETT INSTITUTE, Dept. 220 Fifth Ave., New York 1, N. Y. PM-212

Dear George: I enclose 10c for which please send me on trial all 5 picture-packed HE-MAN Building Courses, FREE Photo Book, and Muscle Meter.

NAME..... AGE.....
(Please print plainly. Include Zone Number)
ADDRESS..... No C.O.D.'s
CITY..... STATE.....

"Win This 15" Silver Trophy as I did."
— Roger Hirsch

\$5000.00 in PRIZES

DRAW MY HEAD

YOUR DRAWING JUDGED & ANSWERED

1st & 2nd Prizes Complete \$130.00 ART COURSES

80 other VALUABLE PRIZES

Take this test and try for a thrilling prize. Discover if you have profitable Art talent. You may gain a lifetime of happiness and high earnings if you mail your drawing today. Amateurs only. Our present students not eligible. Copy this girl 4" to 6" high in pen or pencil, and mail to us. None returned. Winners notified. New \$5000 contest each month. Your drawing will be entered in Contest for month in which we receive it. Send your drawing now and include your name, address, age and occupation. Enter today.

WALLER ART EXCHANGE, Studio 175, 1000 N. CHARLES ST. BALTIMORE-1, MD.

MASTER MIND!

Learn Short-Cut Mathematics

Juggle figures, do baffling number tricks. Make people gasp at your marvelous lightning-quick mind. Multiply 4 figures by 4 figures without using old-fashioned multiplication! Big cloth-bound volume; fully illustrated course.

Sharpen up Your Brain Power

Includes worked-out problems, answers, etc. Sensational bargain, only \$1.95, postpaid or COD plus postage. Satisfaction guaranteed or refund. Order this amazing "Short-Cut Mathematics" today!

NELSON-HALL CO., 210 S. Clinton St. CHICAGO 6, ILL. \$1.95 Complete

Secrets of VENTRILOQUISM Now Revealed!

Easy to learn in 60 to 90 days with our Home Study Course. RESULTS GUARANTEED. Make Money! Be Popular! Have Fun! Big Opportunity! Radio, Television, Stage Appearances! For FREE Information regarding price and terms, WRITE. You must state your age. Dummy Catalog 25c.

FRED MAHER SCHOOL OF VENTRILOQUISM
Box 36, Studio L Kensington Station Detroit 24, Michigan

New Jet Engine Burns Gasoline

Powers Your Models

FASTER IT MOVES, THE MORE POWERFUL THE THRUST! New fun & thrills for model makers & experimenters. Ram jet M.E.W. 601 rocket engine has no moving parts. Runs on regular gasoline. (Not a CO2 unit). Gives powerful, continuous thrust lasting 3 minutes. Maximum thrust lasts 1½ min. Easy to start & re-fuel. Lasts indefinitely. Aluminum tail pipe, brass fuel metering nozzle, steel compression tank. With booster tank. 5¾-in. long; 1½ oz. Complete, ready to run. Use alone or in pairs (2 for \$5.45) Each Postpaid. **\$2.98**

JOHNSON SMITH CO., Dept. 637, Detroit 7, Michigan
Send 10c for Big Catalog of 3000 Novelities, Funmakers, Gadgets, etc.

MEN - WOMEN!

Paint it with Suede!

**SPRAY ON
RAINBOW COLORS**

for PROFIT and Pleasure...

**A SENSATIONAL NEW HOME BUSINESS!!
A NEW INDUSTRY... A NEW MIRACLE FINISH!!
MAKE \$500 to \$1000 PER HOUR and more!**

Flok-Kraft Covers:

Fabric, Metal, Glass, Plaster,
Wood, Plastic or *any surface!*

PROFESSIONAL SECRETS CAN BE YOURS

At last the carefully guarded secrets of this amazing miracle finish can be yours. Huge profits are waiting to be tapped in this tremendous new field. Flok-Kraft gives a velvety, luxurious surface to radios, lamps, toys, signs, store displays, figurines, auto dash boards—actually a thousand and one items to be seen on every hand can easily and quickly be beautified, enriched, increased in value with Flok-Kraft. Make old objects beautiful and saleable. Make new things worth more with this soft, rich covering that can be applied to any surface, even if old and worn.

YOU CAN LEARN IN A FEW DAYS

Yes, you can learn in a few days to start making money—big money! Make to \$5.00—yes! even \$10.00 and more per hour. Everything you need is furnished, including fully detailed instructions that are complete and easy to understand. Every point is explained to show you how to start on the road to big money, full or spare time.

WE FURNISH EVERYTHING YOU NEED TO START

In addition to the full step-by-step instructions you get a complete set of materials and equipment that enables you to start at once. A few cents worth of materials can mean many dollars in returns to you. You can make big profits, spare or full time—add to your income from your regular job or begin to build your own successful future with a full time business of your own and do it all right in your own home! A corner of your basement, garage, service porch, kitchen or living-room is all the space you need to start.

GRASP THIS LIFETIME OPPORTUNITY TODAY

This is one too good to miss. Fill out the coupon below and mail it today for full free details. I'll arrange to send you the complete outfit—everything you need to start—for leisurely, no-risk examination right in your own home. You owe it to yourself to investigate. Write now for full, free details, samples, etc. Fill out and mail the coupon below Do it today! Everything I send you is FREE.

SEND NO MONEY—MAIL COUPON NOW!

COAST INDUSTRIES, Dept. 2C
1004 S. Los Angeles St., Los Angeles 15, California
Gentlemen.

Please rush me FREE details, sample, etc., I understand that everything you send is free and that I'll be under no obligation now or ever.

NAME _____
STREET _____
CITY _____ STATE _____

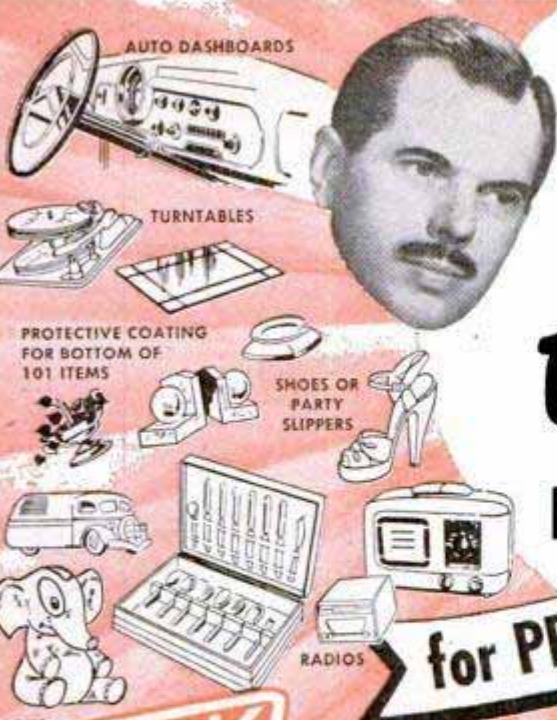

Read What Others Say About Flok-Kraft

"Received the flok-kraft outfit and everyone that saw it is very enthused. I only had it about thirty minutes and got an order for a hundred dollar job." Mr. C. H. Maryland.



"... I have received my order of Flok and Adhesives and believe me, I'm very pleased and happy as I've made myself MORE than the cost of my supplies already, and I've still got more jobs to do." Cpl. G. W., S. Carolina



"Got \$52.50 for those 7 trunk interiors for about 4 hours work. \$7.50 per trunk." J. O., Mo.



"... pleased with your course and I'm being swamped with work to do." W. F.,



YOURS TO EXAMINE WITHOUT RISK!!

Examine in your own home—then decide. The complete instructions, the full starting kit of materials and equipment and full details on how you can open your own business, spare or full time—EVERYTHING will be sent you to EXAMINE AT OUR RISK!

FLOK-KRAFT and DEFENSE

This amazing miracle finish is of inestimable value for use on hundreds of defense products. Flok-Kraft offers you a way to big, extra money, assisting manufacturers in many lines as well as filling a big demand on the home front.



**FREE!
Booklet,
Sample,
Plan!**

Coast Industries, Dept. 2C
1004 Los Angeles St., Los Angeles 15, Calif.

Your Best - WATER & SHOCK RESISTANT

Watch Value is...

LIBERTY



It's also Thinner, Smaller, Anti-magnetic, Strong and Handsome! A dependable "always on time" companion for work or play. Luminous Dial. Sweep second Hand. Unbreakable Crystal. Leather Strap. Additional Styles from \$6.50 to \$11.95. Glo-Gold Finish from \$8.95 to \$12.50.

At friendly stores most everywhere.

LIBERTY WATCH CORP., NEW YORK 18, N. Y.

LEARN UP-TO-DATE

APPLIANCE REPAIR



MAKE GOOD MONEY at HOME!

A MODERN BIG PROFIT ONE-MAN BUSINESS CAN BE YOURS AT HOME - SPARE OR FULL TIME. New visual "shop-practice" method quickly shows you how to repair Home Freezers, Refrigerators, Vacuums, Garbage Disposals, Automatic Washers and Dryers, Motors, Fluorescent Lights, Fans, Irons-yes, even House and Industrial wiring. You can set up shop in your garage, basement, porch or attic, wherever you have a little bench space. No costly leases-no big overhead-no need to hire others-no selling-we show you how to make business come to you.

BIG MONEY-SECURE FUTURE-INDEPENDENCE. Hundreds of plain-as-day "How-to" photos and drawing make it easy. F. V. in N. Y. says: "I made \$800 in 3 months while studying." T. E. H. in W. Va. says: "Made \$14 a day while learning."

NO PREVIOUS EXPERIENCE NEEDED. You will get, in addition to complete instructions, my book, "How to Open Your Own Electric Appliance Business." It shows you how to start small and grow big. Everything furnished to help you build your own Big Profit business at home. Yes! We even supply you with appliance tester and tools! Write today for this amazing new Home Business Plan-It's FREE! Send no money-just your name and address.

PACIFIC TRAINING SCHOOL, Dept. P-5212.
7217 S. Broadway, Los Angeles 3, California.

SENSATIONAL OPTICAL BARGAINS



IMPORTED 20X TELESCOPE AND TRIPOD
Machined threaded fittings throughout. Weighs 7 ounces. 6 3/4" closed length. 13 1/2" open length. Achromatic objective lens low reflection coated on inside. Makes excellent spotting scope. Swivel-head tripod is collapsible. 9" high.
Stock #50,007-H (with tripod) \$12.95 Postpd.
Stock #50,006-H (without tripod) \$8.95 Postpd.

SLIDE PROJECTOR SETS Consists of all unmounted lenses you need to make the following size projectors:
Stock #4029-H-35 mm \$2.85 Postpaid
Stock #4038-H-2 1/4"x2 1/4" \$3.35 Postpaid
Stock #4039-H-2 1/2"x3 1/2" \$3.35 Postpaid

SIMPLE LENS KITS -Include plainly written, illustrated booklet showing how you can build lots of optical items. Use these lenses in photography and for dozens of other uses in experimental optics, building TELESCOPES, low power Microscopes, etc.
Stock #2-H-10 lenses \$ 1.00 postpaid
Stock #5-H-45 lenses 5.00 postpaid
Stock #10-H-80 lenses 10.00 postpaid

Order by Stock No.
Send Check or
M. O.

We Have Literally Millions of War Surplus Lenses and Prisms for Sale at Bargain Prices. Numerous Types of Instruments, Tool Write for FREE CATALOG-H.

EDMUND SCIENTIFIC CORP., Barrington, N. J.

'How to MAKE MONEY with Simple CARTOONS'



A book everyone who likes to draw should have. It is free; no obligation. Simply address

FREE BOOK

CARTOONISTS' EXCHANGE
Dept. 912A Pleasant Hill, Ohio

STUDY INDUSTRIAL DESIGN

You can train at Art Center School in California with practicing-professionals for upper-level jobs in INDUSTRIAL DESIGN. Recent graduates have been added to the staff at General Motors, Chrysler, Raymond Loewy, Henry Dreyfuss, etc. Majors in transportation, general product design, structures, community development, furniture design, packaging, display. 4-year degree courses. Learn to combine imaginative design with technical proficiency, coordinate utility and beauty. Stimulating environment. Field trips. Advantages of mild Southern California climate and nearby holiday spots. Coed. Placement service. Write for catalog.

ART CENTER SCHOOL, Edward M. Adams, Director
5353 WEST THIRD STREET, LOS ANGELES 5, CALIFORNIA



BOYS! MAKE YOUR OWN RADIO

Make your own simple, tubeless, batteryless Crystal Radio. SEND 25c for a GENUINE MELOMITE CRYSTAL with complete illustrated instructions for making your own set. Crystal sent postpaid with instructions and our own publication, "THE MAGIC CRYSTAL" which is full of news, diagrams, questions and answers of interest.

SEND 25c FOR YOUR CRYSTAL TODAY!

ALVA ALLEN RADIO Dept. PM-12 Clinton, Mo.

Macmillan Ring-Free Motor Oil

will increase gasoline mileage an average of 8%. For further information write R. S. Macmillan, President,

MACMILLAN PETROLEUM CORPORATION
530 West Sixth Street Los Angeles



BE A LOCKSMITH

Learn Locksmithing and Keymaking from Experts in Your Spare Time at Home!

Locksmiths in big demand! No layoffs, no slow seasons! Age no disadvantage. Year-round, steady income in this permanent, respected field. Full or part time. Practical, illustrated lessons show how to make money even while learning! All materials, special tools supplied. FREE BOOKLET.

INSTITUTE OF LOCKSMITHING, Dept. P-37
15 PARK AVE. RUTHERFORD, N. J.
Lic. & Approved State of N.J. VA Approved

SAY YOU SAW IT IN POPULAR MECHANICS

Learn PHOTOGRAPHY at Home

Splendid opportunities. Prepare in spare time. Practical basic training. Long-established school. Send for free book, "Opportunities in Photography." No obligation.
AMERICAN SCHOOL OF PHOTOGRAPHY, 835 Diversy Pkwy., Dept. 1359, Chicago 14, Ill.

EARN BIG MONEY!

GROW "LIVING" MIDGET TREES!

AT HOME — SPARE TIME — NO EXPERIENCE NEEDED!

It's new! Amazing! At last, the secret of growing miniature (MING) trees can be yours. FULL GROWN, dwarf trees—only a few inches high. Beautiful miniature fir, orange, oak, Chinese elm, peach, pine, cypress—any kind! All BLOOM and even BEAR FRUIT. All perfect healthy specimens—but miniature in size! Make costly home decorations and expensive centerpieces. (SOLD FOR OVER \$1,500 EACH.) Big demand. Costs only pennies—takes only minutes per week. IT'S EASY! Fun! A new fascinating hobby—a new fabulous \$\$\$ business. Send for free secret plan details and real seed.

HELP US FILL HUGE DEMAND

These trees are being demanded by STORES · CLUBS · HOTELS · FLORISTS · HOUSEWIVES · INTERIOR DECORATORS · COLLECTORS · HOBBYISTS—Big Money Opportunity for you.



HOW TO LEARN GROWING SECRETS

\$ BOTH SEED FREE

MAIL TODAY FOR FREE SEED AND PLAN!

NATIONAL NURSERY GARDENS, Dept. M-12
8463 South Van Ness, Inglewood 4, California
Rush me FREE PLAN and SEED IMMEDIATELY!

Name _____
Address _____ Zone _____
City _____ State _____

POWERFUL MIDGET MOTOR

DRIVES MODEL PLANES, BOATS, CONSTRUCTION SETS, Etc.

WITH AMAZING SPEED! RUNS ON FLASHLIGHT BATTERIES!

BOYS! MODEL-MAKERS! Get this new MIGHTY MIDGET D.C. Electric motor. It's a honey! Looks and runs just like a big one. Motor is powerful yet measures only 1 x 1 x 1 1/4 inches; weighs one ounce! Turns up 6,800 r.p.m.'s. REVERSES instantly. Motor is in durable plastic housing. Comes complete with two 1 1/2 volt batteries in clip holder, transparent plastic gear box—PLUS extra gears and pulleys for working out your own ratios. No shocks, sparks or shorts. And no transformer is needed. Endless hours of fun. Educational, too! Money back guarantee! Send no money. Order today. Pay postman only \$2.98 plus postage when delivered. Or send \$2.98 with order and we will pay postage. Complete instruction booklet.

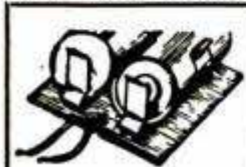

Runs on Ordinary Flashlight Batteries!



Multi-Ratio Gearbox Included! Plus Extra Gears & Pulleys!



ONLY \$2.98

IMPERIAL SALES CO., Dept. M-590

114 East 47 St. • New York 17, N. Y.

500 TRICKS MAGIC TRICKS

IT'S FUN TO DO MAGIC

Be popular! Amaze—mystify—entertain! For 30 years Douglas has satisfied customers all over the world. Now, you can enjoy this fascinating hobby. Only 10c brings our Catalog 500 Tricks, containing brand new tricks for pocket, parlor, stage. Join in the fun — send 10c today!

Douglas Magicland, Dept. A, Dallas, Texas

Say You Saw It in Popular Mechanics



Start As High As \$3,795.00 A YEAR

Trains & Travel Magazine

Get this interesting and exciting picture-packed, magazine. Read about fascinating places and railroads that reach them! 50c at larger stands.

Special Offer! Send \$1 for 3-month subscription. Act now!

Trains & Travel Magazine Dept. 1572A, Milwaukee 3, Wis.

KEEP AQUARIUM WATER Spring-Sparkling Clear!

For crystal beauty and healthy fish equip your aquarium with a famous "Scattergood Filter" set! Keeps water clean, odorless. Eliminates water changing. Easy to attach, operate. Performs perfectly for years! A FINE GIFT!

COMPLETE AQUARIUM FILTER SET NO. 1
Filtering Outside Filter, Superflo Air Lift, Restart Siphon, bulb, 10' air hose, 1 lb. SCACO activated carbon, Thiberg air pump and all instructions. (\$18.45 val.) **15.95**

FREE: Decorative 1/2 lb. pc. of petrified wood with each order this month only!

MONEY-BACK GUARANTEE!
WRITE FOR FREE FOLDER!

CLEARWATER AQUARIUM CO.
P.O. BOX 3617, PHILA. 25, PENNA.

MEN—WOMEN
Postoffice Clerks-Carriers
Railway Postal Clerks
Stenographers
Accountants
Immigrant Inspectors
Typists
Customs Inspectors
Many Other Early Jobs

FRANKLIN INSTITUTE
(Not Government Controlled)
Dept. R-83,
Rochester 4, N. Y.

Gentlemen: Rush to me, FREE of charge, list of U. S. Government big pay jobs. Send FREE 32-page book describing salaries, vacations, hours, work, etc. Tell me how to qualify for one of these jobs.

COUPON

Veterans Get Preference

MAIL COUPON TODAY SURE

Name _____

Street _____

City _____ Age? _____

Last Week I Made \$259⁹²



RAY BARTA

with Science's New Midget Miracle
PRESTO Fire Extinguisher—So reported RAY BARTA
of Wisconsin. Many others "cleaning up"—so
can YOU! Over a Million Already Sold!



Science's
New Midget
Miracle
"PRESTO"

AMAZING new kind of fire extin-
guisher. Tiny "Presto" (about size
of a flashlight!) does job of bulky extin-
guishers that cost 4 times as much,
are 8 times as heavy. Ends fires fast
as 2 seconds. Fits in palm of hand.
Never corrodes. **Guaranteed for 20
years!** Sells for only \$3.98!

Show it to civil defense workers, own-
ers of homes, cars, boats, farms, etc.,
and to stores for re-sale—make good in-
come. H. J. Kerr reports \$20 a day. C.
Kama, \$1,000 a month. Write for **FREE**
Sales Kit. No obligation. **MERLITE IN-
DUSTRIES, Inc.**, Dept. 512, 201 East 16th
St., New York 3, N. Y. **IN CANADA:**
Mopa Co., Ltd., 371 Dowd St., Montreal
1, P. Q. (If you want a regular Presto
to use as a demonstrator, send \$2.50.
Money back if you wish.)

STUDY TO BE A DOCTOR of Psychology or Metaphysics

Obtain a Ps.D., Ms.D., or Ph.D. degree. Be a Teacher, Lecturer, or
Accredited Practitioner. Teach others how to achieve Health, Happiness
and Contentment. Chartered by State. Write for **FREE** book telling how.

THE NEOTARIAN COLLEGE OF PHILOSOPHY

Desk 8, Pickwick Building Kansas City 6, Missouri

APPROVED FOR KOREAN VETS AND ALL G.I. BILLS

Drafting—Design. Aircraft, Mechanical, Electrical, Architectural, Structural,
Building Construction Estimating, Blueprint Reading, Mathematics—
Refresher & Higher, Surveying. Prepare for Licenses—Professional Engi-
neer, Architect, Stationary Engineer, Refrigeration, Electrician.
MONDELL INSTITUTE, 230 West 41st St., N.Y. 36, N.Y.
40 Years Preparing Thousands for Technical Engineering Positions.

100 BEST Woodworking Projects



SELECTED FOR YOU BY POPULAR MECHANICS EDITORS

Enjoy the fun—the pride—of making things. Get
100 BEST WOODWORKING PROJECTS, complete with
simplified instruction, plans, diagrams and more than
400 how-to-do-it pictures. Make all kinds of furniture,
baby carriages, clocks, lamps, book shelves, fireplaces
and other useful articles at little or no cost. Send
only \$2.00 with name and address. Money back if
not pleased.

POPULAR MECHANICS PRESS, Dept. PM6, 200 E. Ontario St., Chicago 11

Enjoy the Fascinating Story of the Horseless Carriage in

It's thrilling, fascinating, informative.
From the very first gasoline-propelled
buggy to the cars of today and the
atomic auto of the future. The first
cars—the men who made them—the
scrambled start and development of
the fabulous auto industry—the story
of auto racing. 166 thrilling action
pictures—old-time cars—racing cars—
early auto advertising—automotive
oddities. Listing of 2000 U. S. autos
included. Ideal gift book. Cloth bound,
only \$3.00 by mail. Money back if
not pleased. Paper covered edition
\$1.00 at newsstands.



POPULAR MECHANICS PRESS, Dept. PM15, 200 E. Ontario St., Chicago 11

YOUR HIGH-PAYING interesting career in TELEVISION

starts here! HOME STUDY COURSE

with one of America's largest schools

There's a place for YOU in the
tremendous, billion-dollar Television,
Radio & Electronics industry! It's
so easy to get started with the
famous CRESCENT SCHOOL course.
Learn in your spare time . . . illus-
trated, simplified lessons and kits
to practice on. No previous train-
ing needed. Send for **FREE** sample
lesson . . . make this day the day
you started on your way to a
brilliant career!



Complete parts kits
included. Build your
own TV SET!



**APPROVED FOR KOREA VETS
SEND COUPON TODAY!**

CRESCENT SCHOOL Dept. 812
500 Pacific Street, Bklyn. 17, N. Y.

Sirs: Rush your **FREE** sample lesson and full details about
the CRESCENT SCHOOL Home Study Course — at no
obligation to me!

NAME _____
ADDRESS _____
CITY _____ ZONE _____ STATE _____

YES! SEND



directly
to my door
every month

I am enclosing
 \$3.50 for 1 year
 \$8.00 for 3 years

name _____
address _____
city _____ zone _____ state _____
A-122

Hand this order to your newsdealer or send it to
POPULAR MECHANICS
200 East Ontario St. Chicago 11, Ill.

**WORLD'S
BEST
WANT AD
MEDIUM**

CLASSIFIED Advertisements



Advertisements in this section 85 cents per word, each insertion, minimum 10 words, payable in advance.

To be inserted under proper classification, copy must be in our office the 20th of the second month preceding date of issue

F. W. Johnson, Manager, Classified Advertising

Popular Mechanics Magazine, 200 East Ontario Street, Chicago 11, Illinois

YOU'LL PROFIT

By reading and answering the classified ads in this section. Hundreds of opportunities for you to make and save money

AUTOMOBILES. MIDGET CARS

BUY Racing heads, dual manifolds, hot coils, etc., without money. Information free. Newhouse Automotive Industries, Los Angeles 22.

MOTORISTS — Alcohol-water injection increases performance up to 25%. Automatic unit only \$5.95. Free literature. Vaporizer Co., Box 7033-M, Los Angeles 37, California.

"HOW To Soup Up Your Car" handbook plus speed equipment catalog. Send 25c. Almqvist Engineering, Milford 6P, Pennsylvania.

1952 SUPERIGNITIONER: Starting; mileage; pep. \$4.50. EG Mfg., Elmsford, N. Y.

ONE Dollar may save you \$500.00! Read 1953 edition "Save Up to 20% on Any New Car Purchase." \$1.00. Rotacop, P.O. Box 461, Palo Alto, Calif.

MAKE Repair your own auto body Polyester-Fiberglas. Catalog 10c. Airmailed 35c. Gem-O-Lite, Box 6861M, North Hollywood, California.

FREE Motor magazines; automobile literature, old, new and foreign; glossy photos, dealer books, shop manuals—Offered with non-profit organization. Write today; get on free mailing list. Auto Maniacs, Stockbridge, Mich.

"120 WAYS To increase Gasoline Mileage." Plus performance figures all cars. \$1. Holloway Publications, Bijou, Calif.

SAVE—California custom accessories headquarters. Buy direct from original designers. Chrome dash panels, electric push button door-trunk conversions, fender skirts, dual mufflers, lowering kits, speed-dress up equipment. 40 page catalog, hundreds of photos—25c. Eastern Auto, 3319A South Grand, Los Angeles 7, Calif.

SPEED Equipment from the world's largest firm. 25c for huge catalogue. Newhouse Automotive Industries, Los Angeles 22.

POWERCAR Junior — Real children's auto! See details under "Motorcycles, Bicycles."

AUTO SUPPLIES AND EQUIPMENT

REFLECTIVE Sheeting. Reflectorize rear auto bumpers for safer night driving. In. x 5 ft. strip—\$1.00. Grant Products, Box 112, Somerville, N. J.

NEW Automatic thief chaser burglar alarms. Guaranteed to stop auto thieves. Easily installed. Free literature. Novak Manufacturing Company, 3131 West 13th, Gary 1, Indiana.

JEEP Station wagon blueprints \$2.00. Craftsman Books, Box 1153, Milwaukee 1, Wis.

ELECTROPLATE Auto parts, novelties, mirrors. Easy, inexpensive home processes. Free booklet. Tyco Metals, Box 13231-BG, Houston 19, Texas.

MOTORIST—A new tested and proven gas saver only 25c. Ganus Enterprises, 1815-B Fairview Ave., Augusta, Ga.

ALL Cars—Remove rust from bumpers and fenders with Rustygon. Trial bottle \$1.00. Lowell Laboratories, Lowell, Mich.

LACHAPPELLE'S Treatment. (Patented.) For a better motor for \$3.00. Free data. Ferns Products, 8120-B Walnut Dr., Los Angeles 1, Calif.

SEDAN Delivery owners. Simple plans for folding rear seat. Snaps up with one hand. Folds completely below floor. Inexpensive—easily built. Plans \$2.00. Plander Seat Plans, Lang Bay, B. C., Canada.

LACHAPPELLE'S Treatment. Agents distribution, warehouse. Dillon, Box 323, Bridgeport, Ohio.

HAND Brake warning lite complete with flasher. Fits all cars. Saves brakes, clutch, and gas. \$3.95 postpaid. Daron Products Company, Box 45, North Quincy, Mass.

REMANUFACTURED Motors. Most makes \$75.00 up. Exchange or outright. Auto Parts Service, West Salem, Ohio.

LACHAPPELLE'S Treatment. Canadian distribution. Master, Box 3, Station C, Hamilton, Ontario.

END Oil changing! Refine your oil as you drive! Refinol antiquates all other oil filters. Free book on saving your car or tractor motor. International Refinol Company, Pure Oil Bldg., 35 East Wacker Drive, Chicago 1, Illinois.

AUTOMOTIVE Books, manuals. Engine, transmission, carburation, ignition, electrical. Free list. Modern, Box 4704, Kansas City, Mo.

AUTO Parts 1920 up. No catalog. Bill's Auto Parts, Valley Falls, Rhode Island. We buy parts from old cars.

MOTORIST Save gasoline by vacuumating overrich mixtures. Fits all cars. For free particulars write Vacuumatic, Dept. 1965, Wauwatosa, Wis.

OIL-Vuer, vital link between oil filter and motor. Annealed glass dome cuts oil inspection to seconds. Easily attached to all filters with external lines. Thousands in use. \$4.95 postpaid or send \$1.00. balance c.o.d. Guaranteed. Rogers Automotive Supply Company, Box 23, Station C., Pasadena, California.

LACHAPPELLE'S Treatment. Cuban distribution. Luis Izaguirre, San Carlos 178, Cienfuegos.

HYDRAULIC Jack repair kits. Repair your own. Send for prices. Jack Parts Company, 2000 South Claiborne, New Orleans, La.

GM71 Discarded injector parts wanted. Bares, 7120 Carnegie, Cleveland, Ohio.

SPEED Equipment. Edelbrock, Offenhauser, Navarro heads, manifolds, Winfield cams, dual ignition points. Chev. 37-51, Ford 49-51. Deeptone mufflers, headers, dual muffler sets, Mallory coils, distributors. Speed catalogue 25c. Urzi's Auto Supply, San Jose, California.

"HELL'S Bells" in your automobile! For kids "16-60." Electrifying "clatter" commands attention, provokes amazement! It's new! Free literature. "Winco," Box 9525, Dallas, Texas.

HOW To buy speed equipment without money. No selling. Information free. Newhouse Automotive Industries, Los Angeles 22.

NEW And used guaranteed parts for civilian and army cars and trucks. Largest stock in America. Mail orders. Pioneer Auto Wrecking Co., 734 W. 13th Ave., Denver, Colorado.

CHEVROLET Owners: Stop tappet noise with Kaye Tappet Silencers. Quality product. Easy to install. Money-back guarantee. Complete set \$5.95 postpaid. Kaye Products, 1321B So. Layton Blvd., Milwaukee, Wis.

BRUSH Plating outfits connect to a battery. No tanks or shop required. Free particulars. Gunmetal Co., Ave. J., Decatur, Ill.

AUTO Parts and accessories. Briggs Automotive Engineering of Chicago, P.O.B. 3454 Merchandise Mart, Chicago 54, Ill.

WE Sell reconditioned guaranteed transmissions for all cars—\$24.00. Auto Transmission Co., 5805 Kingsway Pl., Brooklyn 34, N. Y.

BE Independent, save money. Grind crankshafts without disassembling engine. New hand operated tool \$3.75. Literature. D. McGee, 719 Cascade, Wenatchee, Wash.

"WATER Injection." Airflow needles. Economy methods. Free illustrated information. Neher Industries, La Verne, Calif.

NEVER Change your oil! Full details free. Thousands of users. New oil filter. Dept. TI, Henderize, Inc., 5667 Freeport Blvd., Sacramento, California.

ANTI-Fog cleans windshields, prevents fogging, guaranteed. 6 oz. bottle \$1.00; sprayer 25c extra. Kem Kraft Products, 1416 Croes Ave., 72, New York City.

AMAZING New automatic safety starter switch. Starts car from neutral when ignition key is on. Most adaptable to cars with automatic transmission. Anyone can install in a few minutes. Fully patented. Send \$9.95 to Automoto Corporation, 1840 N. Michigan Ave., Saginaw, Mich.

AUTO TRAILERS

BUILD Streamlined house trailer. Telescopes small for towing. Other models. Information, pictures 10c. Comstock Trailers, 585, Parsons, Kansas.

BUILD Your own trailer! Plans for all kinds. Illustrated catalog 10c. Jim Dandy, 125-M, Wausau, Wisconsin.

MOTORCYCLES, BICYCLES, MOTORSCOOTERS AND SUPPLIES

40 RECONDITIONED Harley-Davidson motorcycles. Large stock of parts and accessories, good chromium parts. Complete motor rebuilding by H-D factory trained men. Bill Theide, The Motorcycle Man, 7577 West Lake Street, River Forest, Ill.

WHIZZER Bike motor \$7; Briggs \$5; Harley single motor \$10. Harley twin motor \$10; midget car chassis \$65. Four airplane tires \$3. (Mailorder only). Send 25c for catalogue Number Fifty listing the above and hundreds of bargains in new and used motorscooters, midget cars, motors, parts, plans for homebuilders, etc. (35c by first class mail). Midget Motors Directory, Athens, Ohio.

NSU Motorcycle, motorbikes, 1953 NSU-Lambretta motorscooters. Seven models (100cc-500cc). Fast parts service. Ask for folder. Some dealerships open. Butler & Smith Trading Corp., 117 West 63rd St., Dept. P, New York, N. Y.

POWERCAR Junior — Real children's electric auto. Plenty of power for hills, towing wagons, etc. Catalog free. Mystic River Sales, Dept. P-12, Mystic, Conn.

CUSHMAN Wizard speed camshafts \$6.50 exchange. Weber Cams, 4200 Whiteside, Los Angeles, California.

BINOCULARS, TELESCOPES, MICROSCOPES, MAGNIFIERS

SAVE! Save! New binoculars! Free catalog. Free book, "How to Select Binoculars." Write today! Bushnell's, 43-M42 Green, Pasadena 1, Calif.

REFLECTOR Telescope kits—Precision eyepieces, mirror cells, diagonal holders, tubing, other optical bargains. Free illustrated bulletin. Esco Products, 911 Willow Ave., Hoboken, N. J.

POWERFUL Telescopes easily made. Lenses, erector, focusing tube, instructions for making 40X, 100X, 200X and 400X telescope \$6.00. Telescopic Cameras, Manorville, N. Y.

CHRISTMAS Specials: 20X telescope \$9.75; triple objective 300X microscope with wooden case \$14.75. Many other bargains. Send for free list. Nassau Optical Co., 9 W. Greenwich Ave., Roosevelt, L. I.

GIANT 100 Power complete telescope and tripod. (10,000 area magnification.) No upside down images. \$10.00 f.o.b. factory. Carl James, Manorville, N. Y.

SAVE, Buy direct—Wholesale prices. Get free illustrated binocular buyers guide. F-E Binoculars, Dept. 1, 2251 W. Pico Blvd., Los Angeles 6, Calif.

GIANT Astronomical telescope complete with 6 ft. tripod. 45X and 100X (10,000 area magnification) eyepieces and sun projector lens. Full power, clear vision guaranteed. \$15.00 f.o.b. factory. Suffolk Science Service, Dept. BT, Riverhead, New York.

AMAZING Prices, binoculars, telescopes, microscopes. Free trial. Folder, "Binocular Selecting," optical catalog free. Prentiss Importers, Mercury Bldg., West Los Angeles 25, Calif.

GIANT 100 Power telescope easily made for pleasure or profit. Instructions, 5 lenses, wholesale list, profit suggestions \$3.00. Carl James, Manorville, N. Y.

WAR Surplus bargains. Binoculars, telescopes, sextants, millions of lenses, prisms, reticles, eyepieces, objectives, etc. Mail 10c for big "Catalog CH." Send \$1.00 for Stock CH—10-piece lens kit and big instruction booklet. Edmund Scientific Corp., Barrington, N. J.

TELESCOPES, Microscopes, binoculars, books. Buy, sell, repair. Rasmussen-Reece, Amsterdam, N. Y.

SAVE! Free 36 page, 3 color binocular catalog. 60 different models. United Binoculars, (A-4508), 9043 S. Western, Chicago 20.

REFLECTING Telescopes, 60X, completely assembled \$29.75. Guaranteed observatory clearness. Free information. Skyscope, 475 Fifth Avenue, New York 17.

POWERFUL Astronomical telescopes easily made. Perfect lenses and instructions: 100X \$3.00; 100X and 200X \$4.00; 100X, 200X and 400X \$6.00. Full power, clear vision guaranteed. Instructions alone 10c. Suffolk Science Service, Riverhead, N. Y.

BINOCULARS, Telescopes, microscopes. Our 20th year of leadership in optical values. Bargain catalog free. Brownscope Co., 24 West 45th Street, New York.

BUILD Your own microscope. 200 power. Complete castings, mounts, lenses, screws, instructions. Kit \$14.75. Free illustrations. Esco, 911 Willow Ave., Hoboken, N. J.

PETS—DOGS, BIRDS, RABBITS, HAMSTERS, ETC.

COTTON-Tail rabbits, frogs, for sale. Vol Brashears, Berryville, Arkansas.

RAISING Guinea pigs, profitable. Free booklet. Taylors, B426A, Hapeville, Ga.

MONKEYS Are the best pets—Intelligent, easily trained, inexpensive. Send 10c for catalog. Tropical Hobbyland, 1525R Northwest 27th Avenue, Miami, Fla.

FAMOUS Angoras, Chinchillas, White Giants! World's most profitable rabbits. Finest heavy-producing prize-winners. Catalog free. P. M. Grinsteeds, Edwardsville, Illinois.

HAMSTERS—Virgin stock; young, \$3.00 pair; fully developed, \$4.00 pair. Adirondack Hamstery, Prospect 2, New York.

RAISE Rabbits. Good markets. Literature free. Tayco Rabbitry, Hapeville, Ga.

BEAUTIFUL Pure white pedigreed police puppies. Ansonia Kennels, Mose, N. Dak.

REGISTERED St. Bernard puppies. Mrs. Dorothy Poling, R2, Elida, Ohio.

WHITE German Shepherd puppies. Theatrical dog tricks. Knoff, Pewaukee, Wisconsin.

BIG Profits raising pet hamsters in garage or basement. Write for free information. Southern Hamstery, Box M685, Gaffney, S. C.

CHINCHILLAS Rented. We pay \$300.00 each for raising. Write: R. Rau, Rt. 2, Jeannette 3, Pennsylvania.

EARTHWORM Raising pays worthwhile profits! Illustrated 23-page booklet explains raising, feeding, packing, marketing. 25c. Ozark Worm Farm-J, Willow Springs, Missouri.

GOLDEN Hamsters, Bear strain. Pedigree stock. Breeders, laboratory or pet stock. Shipped express anywhere. Price list free. Charles E. Bowser, Smoke Run, Pennsylvania.

700 BRED Mink—booklet, pen plans 20c. Lake Ontario Mink Ranch, Gravel Road, Webster 4, N. Y.

PANDA Hamsters, write for folder. Everett Engle, Farmersburg, Indiana.

SPORTSMEN: 200 Pointers, Setters, Straight Cooners, combination hunters, rabbit and fox hounds. Reasonable. List free. Ramsey Creek Kennels, Ramsey, Ill.

STANDARD Rabbit Journal, B-241-M, Milton, Penna. Year \$1.00, sample dime, beginner's manual 25c.

YOUNG Parrots—Make fine talkers. Herb Miller, 1911-N, Lubbock, Texas.

EARN Up to \$400 monthly raising Angora or New Zealand rabbits. Plenty markets. Particulars free. White's Rabbitry, Newark, Ohio.

HAMSTERS—Golden or spotted. Cages and equipment. Free illustrated details. Lakeview Hamster Colony, Newfield, New Jersey.

BOOKLET "Treatise on Breeding and Raising Canaries"—\$1.00. Audubon Publishing Co., 3449-PM N. Western, Chicago 18, Illinois.

MAKE Big money! Raise Chinchilla rabbits. Cash markets supplied. Write today! Rockhill Ranch, Sellersville 15, Penna.

MINK Raising information free. Complete. Lake Superior Mink Farm, Superior, E.E.I. Wisconsin.

A Practical beginning to successful rabbit raising. 48 page illustrated booklet. Dime. American Rabbit Breeders Association. 36 AR & CBA Bldg., Pittsburgh, Penna.

RAISE Mink: Free booklet, pen plans, inside "secrets," feed, care. Mink are money makers. Investigate today. Lawrence Molgard, Brigham City 12, Utah.

PLANTS, SEEDS, NURSERY AND GARDEN SUPPLIES

FRUIT Trees! Stark Bro's sensational new "Dwarfs." Also standard size, exclusive patented, trade-marked varieties produce abundant, larger, better apples, peaches, pears. All fruit faster growing, quicker bearing. Also beautiful ornamental trees and shrubs. Get giant new colorphoto catalog free. Stark Bro's., Dept. 30063, Louisiana, Missouri.

PLANT The grass you never have to cut. Lawn sample, planting directions \$2.00 postpaid. Midget Grass, 3370-N 53, Milwaukee 16, Wis.

WE Sell on the installment plan. Best varieties peach and apple trees, low as 12c; grapevines 5c; shrubs 13c; evergreens 15c. Berries and plants. Catalog free. Benton County Nursery, Box 542, Rogers, Arkansas.

FARMS, FARM LANDS, REAL ESTATE

UNITED Farm Agency's big free winter catalog of farm and country real estate bargains can help you plan soundly for your future security in the country. Good pictures, many states, easy terms, many equipped, hay and feed included. For special service, state requirements, desired location. Write for your catalog today. It's free! United Farm Agency, 1408-PM Consumers Bldg., Chicago 4, Ill.

FARM And business catalog free! Big new edition. Hundreds of bargains from \$1000 up. Maine to Florida. West's, M-12, Pittsburgh 17, Penna.

FLORIDA—5 Acres high dry land near beaches, raise fruits and vegetables. Only \$495.00, \$10.00 down, \$10.00 month. Information write G. B. Potterfield, Owner, Union Bldg., Dept. P, Charleston, W. Va.

FLORIDA Highway ranches—\$345. Pay \$15 monthly. Most desirable, large country estates. High, dry and gently rolling, on paved highway. In famous Panama City pleasure resort area. World's finest beaches. Beautiful lakes. Wonderful fishing, hunting. Grow fruits, berries, vegetables, flowers, poultry. Cheap electricity. Ideal for happy, economical living in new, desirable community. Fine investment. Write today for free booklet. Wendell Wood, Box 873, Houston, Texas.

FLORIDA—Beautiful lake front camp and homesites across from Ocala National Forest, Lake County. Good fishing and hunting. Ideal for the sportsman. Price \$295 up, easy monthly payments. Write for free literature. Grace and Euclid Parker, Box 5, Paisley, Florida.

FLORIDA—New Lake County development adjoining Ocala National Forest. Best fishing, hunting. Safe from bombs. Nice homesites \$245 at \$10 monthly. Folder free. Howard Vernor, DeLand, Florida.

CALIFORNIA Ranch lands. 50c to \$5 acre minimum bid. Farm-ranch-hunt-fish-retire. 10c brings illustrated land catalog, outline maps. Tax Land Sales, Box 2350 BW, Hollywood 28, Calif.

\$5.00 MONTHLY Buys 40 acres near town; price \$200.00. Free list. Box 425-P, Carthage, Missouri.

FARM-Ranch opportunities. Favorable conditions, Washington, Minnesota, Montana, Idaho, Oregon, North Dakota. Literature, farm descriptions. Specify which state. J. W. Haw, 119 Northern Pacific Ry., St. Paul 1, Minn.

HOMESITES \$300—Convenient payments. California's finest garden section. On Morro Bay's scenic shores. Wonderful fishing, boating, bathing. Fertile soil, softest water, temperate climate, congenial community. Free literature. Richard Otto, Department M, San Luis Obispo, Calif.

MAKE Money in Texas. Get yourself a fine tract near Houston for only \$245.00. Pay \$10 cash and \$10 monthly. Fastest growing city and second largest seaport in U. S. Huge \$100 million steel plant. World's greatest oil producing, refining, chemical, manufacturing and shipping center. Many are making phenomenal profits here and you can too. These beautiful tracts located in Houston's desirable southside suburbs with all-weather streets, electricity, schools, bus service, etc. Insured title. Write today for maps, pictures. Full information free. Bailey Wood, Owner, Box 6223, Houston 6, Texas.

STROUT Catalog mailed free! Farms, homes, businesses. 31 states. Coast-to-coast. Over 3400 bargains. World's largest. Our 52nd year. Strout Realty, 7-M So. Dearborn St., Chicago 3, Ill.

POULTRY, FARM SUPPLIES

KNOW How to raise poultry for profit. Read Poultry Industry. Every issue packed with helpful hints and practical suggestions. Latest articles on breeding, feeding and management. Subscribe now, 1 year 50c, 3 years \$1.00. U. S. funds or checks payable at a New York or Boston bank. Poultry Industry, Dept. PM, 376 Boylston St., Boston 16, Mass.

RAISE Turkeys the new way. Write for free information explaining how to make up to \$3000 in your own backyard. Address—National Turkey Institute, Dept. 3, Columbus, Kansas.

POULTRY Farmers—Broiler growers—Turkey raisers read the new American Poultry Journal for latest ideas and greater profits. 12 months, 50c. Special offer, 4 years, \$1.00. American Poultry Journal, 182 North Wabash, Chicago.

PROFITABLE OCCUPATIONS

OPPORTUNITIES In aviation—Openings, salaries, method of applying. Booklet written by specialists with 24 years experience. \$1.00. Horizons Unlimited, Box 933, International Airport, Miami 48, Fla.

\$10,800 PROFITS! Your own mailorder business! No capital risk! "Success plan" (worth \$2) free! Write today! Treasury, 149 Storer, New Rochelle L-6, New York.

MAKE. Sell artificial flowers, corsages, chenille dolls, jewelry. Starting kits, fibre, leaves, shellcraft, rhinestones, sequins, findings. Wholesale catalog, 10c. Profit-krafts, 4508T232 Lorain Ave., Cleveland 2, Ohio.

WORK For Uncle Sam! \$3000.00 to \$14,800.00. Write. National Service Co., Box 1718, Washington 13, D. C.

UP To \$200 weekly! Work home, start spare time, small capital. Free book "301 Unique, Successful Businesses" tells how. Deumant Publications, 85-R Deumant, Kenmore 23, N. Y.

"HOW To Make Money With Simple Cartoons"—A book everyone who likes to draw should have. It is free; no obligation. Simply address Cartoonists' Exchange, Dept. 912-CP, Pleasant Hill, Ohio.

FOREIGN Employment construction men, building trades, helpers, office men, others interested in foreign projects. High wages, quarters, transportation. Send \$1 for foreign construction compendium and application forms. Foreign Service Bureau, Dept. PM-12, Metuchen, New Jersey. (Not an employment agency—no fees.)

WANT A diesel job? New opportunities to increase income. Higher pay. More money. We can help you qualify. Tools. Shop method home training. Write today! Diesel Tractor, Heavy Equipment Division, Interstate Training Service, Dept. 3N, Portland 13, Oregon.

SEND For big, new 1952 illustrated catalog that will show you how to turn your spare time into cash—making quick-selling, highly profitable lamps. Every home a prospect. Hundreds doing it, you can, too. No experience or special tools required. Catalog No. 7 contains 56 pages filled with shades, shade frames, figurines and bases, oil lamp converters, boring compound, and dozens of similar items. Also all kinds of sockets, cords, pipes, harps, finials, bases, and hundreds of other parts—everything you need. Special 8-page section shows 6 beautiful lamps in kit form, ready to assemble. You buy wholesale, sell at retail. Make big profits. Send 25c today for new 1952 catalog and wholesale price list, you'll be glad you did. The 25c will be refunded on your first order. Gearon Co., Dept. 500-B-12, 27 S. Desplaines, Chicago 6, Ill.

"FROG Raising!" New book tells how! Illustrated literature free. Broel-B, 1035 Marlborough, Detroit 15, Michigan.

WANTED! Home producers! By manufacturers in our clearing house service. Become a sub-contractor, casting plastic products for these companies. Thousands of easy-to-make items required. Cash in at home, without previous experience. For details write Plastic Service, Dept. PM, East Boston 28, Mass.

CLAYCRAFT (Profitable). Instructions 50c. Mrs. Ruth H. Painter, Jadwin, Mo.

WHOLESALE Catalog! Nationally advertised products, 80% discounts! 25c. Modern Wholesale, Columbus 1, Kansas.

TYPISTS—Profitable home business. Complete copyrighted information, 50c. Gaunt, 827-A Irving Pk., Chicago, Ill.

SECRET Investigation. Experience unnecessary. Investigators' particulars free. Write Wagoner, 125-M West 86th, New York 24.

MUSHROOMS Grown boxes, barrels. Manureless process 50c. Spawn \$1.00. Gordons, 553 William, Winnipeg, Manitoba.

CANADA'S Huge industrial expansion creates labor shortages. Send \$1.00 today for our monthly "Construction Worker's Bulletin" which lists construction jobs under way and pending, oil companies drilling and immigration regulations. National Surveys, P.O. Box 402, Vancouver, B.C., Canada.

\$46 FROM Square foot plywood: Jigsaw necessary. Write: Woodarts, PM-254, Bridgewater, Mass.

FOREIGN And Latin American employment. 1953 "Foreign Service Directory" gives up-to-minute facts on military and civilian construction, government jobs, major oil listings, aviation, transportation, steamship lines, mining, importers, exporters, how-when-where to apply, application forms, hot list firms hiring. \$1.00 postpaid. Global Reports, Box 883-P, Hollywood 28, Calif.

OVERSEAS Jobs. Big pay, transportation, expenses. Clerical, professional, mechanical workers. Most all trades. Latest listings airline, construction, manufacturing, oil, steamship companies, government agencies, many other opportunities. Up to date information on securing employment, contracts, income tax, application forms. \$1.00. Overseas Jobs, Box 335-A4, Baton Rouge, La.

ALASKA! Last American frontier. \$1.00 brings 1953 business directory and government map. Military and civilian construction; homestead and highway facts; mining, aviation, fur farming, grazing, timber, travel directions. List of firms hiring. How to apply. Alaska Opportunist, Box 883-P, Hollywood 28, Calif.

CONSTRUCTION Job list. Published monthly. \$1.00 Dempster's Construction Scout News, Dept. 268-JR, Bridgeport, Ill.

FOREIGN Jobs. Contracts underway and soon starting in Africa, South America, Canada, England, Europe, South Pacific, Middle East, Mexico and Alaska. Send \$1.00 for foreign job news, information, application forms, etc. DCS Foreign Job News, Dept. 268-JS, Bridgeport, Ill.

SAIL Ho! Be a merchant seaman. Enjoy world travel. Big pay. Send now for free information. Seaways, Box 1231, Baltimore 3, Maryland.

ALASKAN Jobs! Over 100 new construction contracts with names, addresses companies hiring. Thousands needed. Highest wages. Military, private construction, mining, fishing, lumbering, aviation, railroads, homesteading. Skilled, unskilled workers. Write today. Our information accurate. \$1.00 complete. Alaskan Opportunities (PM), Box 362, Kenmore, Washington.

MEN—Women. "Everybody likes candy." Learn to make professionally. Tools and supplies. (Our 42nd. year.) Ragsdale Candies, D6, East Orange, New Jersey.

GROW Mushrooms. Cellar, shed, and outdoors. Spare, full time, year round. We pay \$3.50 lb. We paid Babbitt \$4,165 in few weeks. Free book. Washington Mushroom Ind., Dept. 99, 2954 Admiral Way, Seattle, Wash.

MAKE Flexible molds! Cast plaques, bookends, figurines! Free sample! H. Tooker, 630-M Chestnut, Hamilton, Ohio.

RAISE Pheasants on the \$100 week plan. Little capital and space can make you independent. Free details. Great Central Game Management System, Columbus 1, Kansas.

\$40.00 WEEKLY Made growing mushrooms, fresh, dried. Dominion patent 331583. Free spawn. North American, 169P Yonge, Toronto, Canada.

BE The Popular Mechanics representative in your neighborhood and earn big profits in your spare time. Write Popular Mechanics Magazine, Room 408M, 200 E. Ontario St., Chicago, Ill.

BIG Profits screen printing mottoes. Simple! Fascinating! J. Jones, Box 321, Meridian, Mississippi.

SOILLESS Gardening (Hydroponics) easy, profitable. Free literature. Earl Riley, Red Bluff, Calif.

FREE Book "505 Odd, Successful Businesses." Work home. Expect something odd! Pacific, Oceanside, Calif.

BOOKS, PERIODICALS, PICTURES, POSTCARDS

BOOKS—Government surplus. Textbooks, including International Correspondence Schools Home Study Pamphlets. On half million volumes. Bargain prices. Free catalog. Long's College Book Co., Dept. PM, Columbus 1, Ohio.

"THE Modern Clock." All about clock repair. 502 pages. 173 illustrations. \$4.95, postpaid. 10-day return privilege. North American, Dept. 12M, 2018 North Ave., Chicago 47, Illinois.

NEW And used books, sets, technical, others. Complete stock. Crist Book Shop, 381 Wabasha, St. Paul, Minn. Books since 1900.

SAM Bass, Life of—Famous train robber, facsimile original 1878 edition, w/actual photos, pp. \$1.50. Frontier Bookshop, 8102 Lockheed, Houston, Texas.

OUT Of print books. Send wants. Book Finder, Cincinnati 30, Ohio.

PENNSYLVANIA Dutch dictionary. 20,000 words. English into Dutch. \$2. Edwin Danner, Spring Grove, Penna.

ART—Craft books, supplies. Catalog 10 cents. Artcraft, Baldwin, Maryland.

NATIONAL Geographic Magazines. 1888-1952. Periodical Service, Box 465-PM Wilmington, Delaware.

BOOKHUNTERS! All subjects. Send wants! Jaher Book Service, 620-P East 17th Street, New York 57.

MAGAZINES (Back dated)—Foreign, domestic—Arts, books, booklets, subscriptions, etc. Catalog 10c (refunded). Cicerone's, 86-22 Northern Blvd., Jackson Heights, N. Y.

BOOK "Breeding of Parakeets" and cage-bird magazine—\$1.00. Audubon Publishing Co., 3449-PM N. Western, Chicago 18, Illinois.

BOOKHUNTERS! Scarce, unusual, miscellaneous books supplied. Atlantic Book Service, Lawrence Avenue, Charlestown 29, Massachusetts.

FREE Giant Popular Mechanics 40 page Golden Anniversary Book Catalog! Over 400 books. Workshop planning. Home building. Household repairs. Projects. Motoring. Sports. Photography. Money-making opportunities. Machinery, inventions. Crafts. Hundreds more. Many not available in stores. Send postcard today. Popular Mechanics Press, Dept. 110, 200 E. Ontario, Chicago 11, Ill.

SEND Comically insulting cartoon postcards to people you dislike. Three styles. 12 for \$1.00 money order. J. W. Bard, Box 12021, Houston 17, Texas.

MINIATURE Locomotive, bi-monthly magazine about live steam model railroads—Tells "how-to" build, pictures of engines, cars, track set-ups, club news. Exciting, educational family hobby. Send \$3.00. Miniature Locomotive, Box 305F, Reseda, Calif.

SPARETIME Profits taking subscriptions, all magazines. Wholesale catalog free. Cassell Agency, Westfield 2, New Jersey.

GAMES, TOYS, NOVELTIES

OUTSTANDING Gift for any occasion—A pegleg cribbage board. New, unique, patented. It will be treasured a lifetime. Regulation size but may be expanded for three or six players. Highest quality, selected maple, superbly finished, gift boxed. Satisfaction guaranteed. Amazing value for only \$2.95 postpaid. Sparhawk Co., South Portland 7, Maine.

Q-Bicles—Provocative game requiring strategic thinking, spacial vision. \$1. Haynes, 2500 Wisconsin, Washington, D. C.

SLINGSHOT Parachute, perfectly balanced, strong perlon umbrella, hours of fun for youngsters and grownups. \$1. National Traders, Ltd., 6411 Hollywood Blvd., Hollywood 28, Calif.

MAGIC TRICKS, PUZZLES, JOKER NOVELTIES

200 ELECTRIC Stunts, 110 volts, \$1.00. Kutting Sons, Los Altos, Calif.

MAGIC—Jokes. Big magician's catalog 10c. Top Hat, 529A Main, Evanston, Ill.

VENTRILOQUISM Selftaught. My quick, easy instructions, 25c. "Ventriloquist," CalAllen, Texas.

GENUINE Wood nickels, trick and magic catalog, all for 35c. Fun 'n Magic, 511-P North St. Marys, San Antonio 5, Texas.

WE Supply every noted magician. Large professional catalog \$1.25. Holdens, P220 West 42nd Street, New York.

TRICK Of the year. "Magic money-maker." Fool everybody. Only \$1.25. Literature, free gift 35c. Rothleder, 102PMT Cathedral Station, New York 25.

PROFESSIONAL Catalog, 180 pages, 25c. Williams, 900 Plymouth, Ellwood City, Penna.

MAGIC Catalog and lists 10c. Sterling Magic Co., Royal Oak, Mich.

PROFESSIONAL Catalog and free trick 35c. Terry's Magic Studio, 6606 Durycourt, Brooklyn 19, New York.

512-PAGE Catalogue of 2500 tricks, pocket, parlor, stage. World's finest magic. Send \$2.00 for catalogue (refunded first \$8.00 order). Kanter's, M-1311 Walnut, Philadelphia 7.

FREE Trick and large illustrated catalog 35c. Lerro Magic, 8111 Fifth Avenue, Brooklyn 9, N. Y.

BIG Fun kit! Tricks, jokes, novelties, books. Real gay stuff. Howls galore. \$1.00. Johnson, 414 McRae, Wilmington, N. C.

NO. 29 Edition catalog. 500 tricks now ready. Send 10c for your copy, containing latest in good magic for pocket, parlor, stage. Douglas Magicland, Dept. 1, Dallas, Texas.

COINS, TOKENS, CURRENCY

BARGAINS At auctions. \$50,000 sold monthly. Free catalog. Hollinbeck Coin, Des Moines, Iowa.

COIN Collector's largest magazine, wooden nickel and foreign money 10c. Lawrence Brothers, Anamosa, Iowa.

OLD Money wanted. Will pay \$100 for 1894 dime, S. mint. \$50 for liberty head nickel (not buffalo). Big premiums paid for all rare coins. Send 4c for large coin folder. May mean much profit to you. Numismatic Co., Dept. 20, Fort Worth, Texas.

GRAB-Bag 75 U.S. coins. 1/2 cent to half dollar \$7.50. Fairway, Box 121, Rye, N. Y.

COIN Collector's Magazine. Largest independent, over 1000 pages per year. Sample copy 30c; \$3.00 per year. Hewitt, 7320-J Milwaukee Ave., Chicago 31.

GET Profit and pleasure in collecting old coins. Send 10c for 56 page illustrated coin catalog. You'll be delighted with it. Send for it now. B. Max Mehl, 370 Mehl Bldg., Fort Worth Texas. Largest rare coin establishment in U. S. Established 52 years.

FREE! How to keep coin records. Coin-dex, Box P-288, Flushing, N. Y.

WHAT Are your coins worth? Amazing Fell's new 1952 United States coin book. Everything on every single coin minted—Worth, value, how to sell, speculating, investment; other valuable facts. Cloth-bound. 150 illustrations. Send no money. Pay postman only \$1.50 (plus postage) or \$1.50 postpaid (refundable). Order now! Fell Publishers, 386-M7 4th Ave., New York City 16.

40 DIFFERENT Selected coins, \$1.00. Oddehon, Box 482, St. Louis, Mo.

WATCHING Your change for valuable coins? Our copyrighted Spotter identifies them instantly! 25c. Premium Coin Spotter, Box 2583, Carmel, California.

CONFEDERATE Bill, Indian and white cents, two and three cents, 1883 nickel; only \$1.00. Edgar, 18 Twain St., Baldwin, N. Y.

FREE! Foreign coin, banknote and coin collectors illustrated catalog to approval service applicants. Send 3c postage. Tatham Coinco, Springfield 30, Mass.

5-IN-1 Special, \$1.00. 1893 Columbian half dollar; coin album; wooden nickel; check list and coin catalog. Ben's, PM Dept., 31 North Clark, Chicago 2.

SET Japanese invasion notes for United States, \$2.00. Burma note and coin catalogue, 25c. Shultz, Salt Lake 10, Utah.

STAMP COLLECTING

SENSATIONAL—Fifteen different complete pictorial sets only 10c with sparkling bargainful approvals. Dresel, Box 270-a Cathedral Station, New York 25, N. Y.

100 BRITISH Empire, all different 10c; jumbo approvals by countries. Charles Chase, 152 Court St., Portsmouth, N. H.

\$1.00 CATALOG Value, foreign, 25 stamps 10c. C. W. Ritchie, Watertown, So. Dak.

PACKETS World-wide. Special 1000, \$1.00; 2000, \$2.25; 3000, \$5.00; 5000, \$13.00; 10,000, \$45.00. Russell, Box 2011D, Natural Bridge, St. Louis 15, Mo.

WONDERFUL Offer — 7 complete mint sets only 10c with approvals. Reich (M26), 1033 Lawrence, Chicago 40.

OUTSTANDING Booklet! Easy way stamp collecting! Send dime today! "Stamps By Mail," 2133 Lunt, Chicago 45.

ILLUSTRATED U. S. and Confederate states catalogue free. Stone, 45 Bromfield, Boston 8, Mass.

EGYPT #240, The scarce pound stamp, 25c with approvals. Royal Stamp Company, Tamaqua, Penna.

100 DIFFERENT U. S. 25c, 500 different worldwide 50c. Approvals. Hegenbarth, 1545 Ardmore, Chicago 26.

FREE—100 Different. Approvals. Case, 14161 Forrer, Detroit 27, Mich.

FREE Sport stamp and story featuring Diagoras, Olympic victor. M. Voker, 232a East 77th, New York 21.

BARGAINS! Stamps low as 1/4 catalog. Lucas, Box 387M, Lombard, Illinois.

AMAZING Offer! 200 United States stamps — including commemoratives, airmails, high denominations to \$5.00, only 10c to approval applicants! Illustrated bargain lists free. Mystic Stamp Co., Dept. 80, Camden, New York.

50 MINT — Including Monaco bicolours, given approval applicants. Broadmoor Co., Pittsburgh 34, Penna.

TRIANGLES! Latest Hungary, San Marino bicolours (8); free to approval buyers. William Deem, Ravenswood, West Virginia.

635 SCANDINAVIA \$1.00. Multifarious mixture. Nielsen, 2076 Tupper, Montreal, Canada.

WORLDWIDE Mixture! 400 interesting, colorful stamps 25c. Garrow, Chula Vista, California.

FREE! Marino flower airmail triangles. Approvals. Tipex, 2388 Westcliffe, Walnut Creek, Calif.

TRIANGLE Sets—New 1952 San Marino flowers, colorful Hungary bird triangles, giant Monaco Prince Rainier set. Only 10c with approval sets. Universal Stamp Co., Box 145, Boston 1, Mass.

UNITED States! 58 different including commemoratives, airmails, 10c approval applicants. Sunset, Box 47, Southgate, Calif.

UNITED States mint specials! Tipex, Cipex souvenir sheets, 778-81, 948-50c; flags complete—\$1.00. Want lists filled. Brooks, 2352F East 23rd Street, Brooklyn 29, New York.

FREE Packet with United States and foreign on approval. Hoyt, Hudson, New Hampshire.

FIFTY Different United States; commemoratives, airmails, etc. All for 10c. Ed. Keller, Library 1, Penna.

200 DIFFERENT Triangle, airmail, pictorials, etc.; 10c. Carlton's, Tujunga, Calif.

111 STAMPS From 111 countries \$1.11. U. S. presidents 1c to \$5, 32 values. Complete \$2.00. No approvals. John Bosse, 536 Rush St., Chicago 11, Ill.

OLD U. S. on approval. Low prices. MacG., 2905 Observatory, Cincinnati 8, Ohio.

AFRICAN Stamps free with approvals. Melrose Distributors, 6 Rockland Street, Melrose, Mass.

UNBEATABLE! Over 100 different with triangles, Liberia, Tangier, Morocco, etc. Free with approvals. Reeve, 576-C Crawford, Windsor, Ont., Canada.

127 DIFFERENT U. S. commemorative stamps for \$1. G. H. Pritchard, 1306 Good Hope, Cape Girardeau, Mo.

MIXTURE Of 1000 stamps 50c. Murray Specialties, Box 904, Plainfield, N. J.

STAMP Mixtures \$3.95 per kilo. Your choice: Austria, Belgium, Czechoslovakia, Denmark, Finland, France, Germany, Great Britain, Italy, Norway, Spain, Sweden, world-wide. 3 kilos \$10.50, ten \$30, postpaid from Sweden. Fairbrook, 133-21 Blossom, Flushing, N. Y.

FISH, Lion, earthquake triangles, Belexlands 25 different, all 5c. Approvals. Hathaway, Box 211-P, Hempstead, N. Y.

UNITED States, 10 large commemoratives 3c, approvals. Wineholt, Woodbine, Penna.

SHOEBOX Full of stamps \$2.50. Terrific value! Nelson Exchange, Rye, N. Y.

MINT Five pound British Colony stamp, guaranteed genuine, face value \$25, just 25c to introduce our famous approvals. Viking, 130-ZZ Clinton St., Brooklyn, N. Y.

1c BARGAINS. 75,000 Different stamps in books of 1000—Only 1c each sent on approval. References please. B. Sir, 228 Woodstock Street, Crystal Lake, Illinois.

NEED Higher wages? Not when buying our stamps. Try our books of 1000 at 1c and 2c each, or economy U. S. approvals. Clark Stamp Co., Dept. P-6, Muskegon Heights, Mich.

U.S. Illustrator catalog free. Ernest Lush, 9627 Martindale, Detroit 4, Mich.

COMPLETE Mint famous Americans, \$4.50. Approvals. Lou Allmendinger, Warner, N. H.

GIGANTIC Collection free. Includes triangles, early United States, animals, commemoratives, British Colonies, high value pictorials, etc. Complete collection plus big illustrated magazine all free. Send 5c for postage. Gray Stamp Company, Dept. PM, Toronto, Canada.

EXCHANGE Stamps universe. Particulars free. Exchangers, Bry 126, Seine, France.

YOU Stretch your dollar when buying our mounted 1c and 2c foreign approvals. Also U. S. at bargain prices. Don't delay, write today. Roseland Stamp Co., Dept. 10-C, Spring Lake, Michigan.

FREE Complete set of famous Americans, flags, parks and presidentials to approval buyers. Send 3c for 15 of the above stamps plus full particulars. Triboro Stamp Company, 145 Nassau Street, Dept. 112, New York 38, N. Y.

MINT King George coronations from 5 different British Colonies only 10c with approvals. Walter Welles, Box 1246-R, Church St. Station, New York City 8.

STAMPS On approval. One cent each. Packets: 500 different \$1.00; 1,000, \$2.00; 2,000, \$5.00; 5,000, \$15.00 C. Wessbecher, Kirkwood, Missouri.

VALUABLE Airmail book plus gorgeous world-wide airmail collection 10c. Includes \$10,000 stamp, zeppelin, scarce triangle, many others with beautifully illustrated book, only 10c with choice approvals and bargain lists. Jamestown Stamp Co., Jamestown 708, New York.

1000 UNITED States mixed. Guarantee 170 varieties. \$1.05 insured. Quaintance, Box 178F, Upper Sandusky, Ohio.

FREE! Abyssinia to Zanzibar packet plus 2 Monaco triangles, to new approval applicants. Moulblow, Box 278A, East Northport, N. Y.

ROOSEVELT Set and gauge 5c with approvals. Jeffrey Stamps, Box 223, Forest Hills 75, New York.

250 STAMP Hinges and 15 different Switzerland free with approvals. Jaydee, 218 Dickinson S.W., Grand Rapids 7, Mich.

9 CANADIAN Commems 9 cents, approvals. McGuffin, Beck San 7, London, Canada.

1000 LUXOR Hinges, five cents. With approvals. Lush, 9627 Martindale, Detroit 4, Mich.

POPULAR Sets on approval. Write today. Samples and illustrated folder. W. Langford, 53 Durham Road, San Anselmo, California.

U. S. Army and Navy heroes on stamps; 10c with United States approvals. Locust, Box 205-T, Harmon-on-Hudson, New York.

200 EXOTIC Japan stamp—10c. Kenmore, Milford K57, N. H.

COMMEMORATIVES, 100 Mixed U. S., 25c. Ray Worth, 321 S. Cicero, Chicago 44.

50 DIFF. U.S.A. and 100 diff. foreign, 10c to approval applicants. Kem, 670 W. Florence, Los Angeles 44, Calif.

312 MIXED U. S. only 10c to "Gold Nugget" approval applicants! Nothing like them. Kessel's, Folsom, California.

FREE! Powerful magnifying glass for 5c post. Bargain lists and approvals. Jamestown Stamp Co., Dept. 207, Jamestown, New York.

NUDES Set; colorful approvals—10c! Atlas, 2830-M Eisenhower, Racine, Wis.

GREAT Free offer — Weird mosquito stamp, thrilling bicycle race, gorgeous orchid, colorful native drummer, gigantic diamond airmail, stamp albums, all to our approval buyers. Bell Stamp Service, Dept. S-4, Bell, California.

FREE, 25 British Colonies, illustrated lists, real stamp bargains, more free packets, sets. Stoll Stamp Service, 2632 Burnett, Louisville 10, Kentucky.

ALBUM! Capacity over 1000 stamps! Only 10c! Stampmart, Hartford 1, Conn.

850 MIXED U. S. Old-New, 25c. Lists. Weatherby, Medina, Ohio.

AN Extra bonus — Your choice latest Scotts Albums; catalogue and available philatelic accessories. Realize — you get these extra bonuses when you buy from our better foreign approvals. Write today for full particulars sent with trial approval selection. Americas' Stamp Service, Riverside 9, Calif.

500 MIXED Stamps and surprise packet for 10c with approvals. Fahsing, Dept. PM, Atascadero, California.

TEN Dandy sets, 10c to approval applicants. Faszold, 423c Cameron, St. Louis Co. 15, Mo.

1,000 UNIQUE Colorful attractive mounted stamps 1c-2c each. Rushed. Niagara Stamp Co., Niagara-on-the-Lake 71, Can.

"SNAKES," Rhinoceros, giant, pygmy, emu, kangaroos, koalabear, kookaburra and other fierce jungle beasts given if you request our exciting approvals. Niagara Stamp Co., Niagara-on-the-Lake 51, Can.

100 DIFFERENT France 10c. Approvals. Aronson, 91 Marion, Brookline 46, Mass.

300 STAMPS For only 10c.—This mammoth value includes airmails, pictorials; stamps from strange countries cataloguing up to 25c each! Also approvals. Mystic Stamp Company, Camden 80, New York.

FLAG Stamp—Free with hygrade U. S. approvals. Wenigman, 1933 Patterson, Chicago 13.

FREE "Stamp Finder." Tells instantly country to which any stamp belongs. 32 pages profusely illustrated. Garcelon, Calais 17, Maine.

200 DIFFERENT Including Roosevelt triangle, 5c to approval applicants. M. Avalon Stamp Company, Springfield, Mass.

STAMPS Wanted. Collections, duplicates, surplus stock, mint and used. Good grades only. Buy outright if bargain. What have you? Write us details. Vanroy Shirk, Lebanon, Penna.

1/2-1-2c APPROVALS. Bargains galore! Cole, 43A Rinewalt, Buffalo 21, N. Y.

40 DIFFERENT U. S. commemoratives, airmails 25c. Seidenberg, 944, Appleton, Wis.

FREE Sample—Interesting, informative, illustrated! National Stamp News, Anderson, South Carolina.

POLAR Bear triangle, giant George Washington, six colored Ecuador, Arctic triangle, first American commemorative, Corsica, Devils Island, others. Everything free with approvals. Capital Stamps, Little Rock 2, Ark.

FREE—Illustrated catalog! Kenmore, Milford, C-57, N. H.

FREE. Scott's International Album. Other big premiums. Full particulars with approvals. Raymax, 68-Z Nassau St., New York 38.

DIFFERENT 500, 35c; 1000, \$1.00; 2000, \$2.00; 5000, \$10.00 with approvals at wholesale to clear. K. S. Holmes, London, Can.

U. S. Price list free. P. Wetterquist, 1635-13th Avenue, Rockford, Illinois.

100 DIFFERENT Spain 25c. Penny approvals included. Reed, Box 980, Chicago 90, Ill.

50,000 STAMP Grabbags 25c each. Anderson, 630B Bingham, Reading, Penna.

307 ALL Different—Only 15c! Beautiful collection: commemoratives, triangles, high values, bicolored stamps, etc. Garcelon, Calais 400, Maine.

NICARAGUA Sports, Costa Rica agriculture sets 10c with approvals. Seminole Stamps, Box 1138-P, Coral Gables 34, Fla.

50%-75% DISCOUNTS! Approvals from 33,000 collection—1/2c up! Schur, Box 235, Buffalo 12, N. Y.

WOW! 203 All different Germany 10c! Zeppelins, semipostals, airmails, high values, etc. to new customers. Jamestown Stamp, Jamestown 512, New York.

WORLD'S Largest stamp (7 1/2 x 14 inches). A real curiosity! Retail for 50c, only 3c to approval applicants. Tatham Stamp Co., Springfield 30, Mass.

77 DIFFERENT United States—25c. Approvals. Utechts, 1143-D North Keeler, Chicago 51.

WE Give you—Mammoth International albums, Scott's catalogues, hinges, complete accessories, when you buy our wonderful foreign approvals. Don't write unless you intend to buy. But don't buy elsewhere without comparing our more generous offers. Bargain Stamps, Santa Ana, California.

SINGLES, Sets, packets. Illustrated price lists 10c (refundable). D. Babineau, 7 Clifford St., Biddeford, Maine.

BIRD Triangles 10c with approvals. Lincoln Stampco, 8820 Aberdeen, Chicago 20.

OLD Scarce U.S. seconds on approvals. Slight imperfections, lowest prices. Herfield, Clintonhill Sta., Newark 8, N. J.

UNITED States approvals—Select, used, mint. Kingsbury, South Woodbury 2, Vt.

PENNY Approvals and advanced material. "Sunny," 1267 Tutwiler, Memphis 7, Tennessee.

81 MULTI-Colored flags of the world; only 15c. Kenmore, Milford P-57, N. H.

100 DIFFERENT U.S. 25c, approvals. Buckeye, Box 53, Mansfield 2, Ohio.

50 DIFFERENT U.S. commemoratives. 50 different foreign. Both \$1.00. Hager, Box 10, Buffalo 11, N. Y.

ITALIAN Social Republic complete set with approvals. Pomykala, 3110 W. 40, Chicago 32, Ill.

FREE Bahawalpur Jubilee set with approvals. Lighthouse, Box 1516B, Colorado Springs, Colorado.

1000 U.S. Foreign stamp mixture 25c. Book Nook, Willmar, Minnesota.

110 DIFFERENT Hitlers, Roosevelt, Liberia, Haiti, etc. with approvals 10c. Buckey, 208 Ludlow Bldg., Dayton 2, Ohio.

SHEPARD Stamp news. One year 20c. Sample free. Box 1147, Chicago.

5 GERMANY Pictorial sets. Free to approval buyers. Pleasure Stamps, 1865P 52nd, Brooklyn 4, N. Y.

FREE! Big illustrated catalog listing everything for the stamp collector. Approvals. Harrisco, 202 Transit Bldg., Boston 17, Mass.

200 UNIVERSAL Different, 10c. 1000, \$1.00. Approvals. Seifert Stamps, Box 1672, Reading, Penna.

1000 MIXED U.S. coils, airs, etc. 25c. Sibley, Mendon, Mass.

FREE! Big United States stamp catalog! Invaluable guide and check list. Hundreds of illustrations. Approvals. Harrisco, Boston 17-W, Mass.

START Your own stamp business. Send for free circular. Donald Shepard, Box 1147, Chicago.

ANTIQUES, RELICS, INDIAN GOODS, CURIOS

6 PERFECT Ancient arrowheads \$2.00. Fine grooved tomahawk \$3.00. List free. Lear's, Glenwood, Arkansas.

4 PERFECT Arrowheads \$1.00; perfect pipe \$2.50, \$5.00; tomahawk \$3.00; knife 50c. Catalog 10c. H. Daniel, Lamar, Ark.

PRECIOUS STONES, MINERALS

"GENUINE" Red Arizona rubies (garnets). Send quarter for packet. Bitner's, Box 1025, Scottsdale, Arizona.

QUARTZ, Agate, jasper, and catalog. 25c. Gemco, Elkhart Lake 2, Wisconsin.

GEMOLOGY Books, catalog 10c. Atlantic Books, Lawrence Avenue, Charlestown 29, Massachusetts.

GEMSTONES, Mineral specimens. Every variety. Lowest prices. Postcard brings free booklet. Plummer's, 4720 Point Loma Ave., San Diego 7, Calif.

FIND Tungsten, mercury, uranium with Mineralight. Free brochure. Write Dept. PM8 Ultra-Violet Products, South Pasadena, California.

GEMS, Precious and semi-precious, genuine, from world-wide sources. Deal direct, no overhead, save money. Catalog 10c. Hill Co., 5450-G Portland Rd., Salem, Oregon.

GEMS And minerals, beautiful magazine tells how to cut and collect. Brochure and book list free. Gembook Co., Palmdale, Calif.

HOBBIES AND COLLECTIONS

BUTTERFLIES, Real. 20 beautiful assorted tropical butterflies \$2.00. American Butterfly Co., 3706 Rosedale Road, Baltimore 15, Maryland.

50 DIFFERENT Army embroidered patches \$1. Other bargains. Insignia Mart, 703A Broadway, New York 3, N. Y.

WANTED Cigarette, tobacco, cards. Write Charles Bray, East Bangor, Penna.

TYRANOSAURUS, Solid metal, royal bronze finish, 3" size \$1.00. Models, stamps, hobby supplies. Variety Hobbies, 1117 Cass St., Joliet, Illinois.

BIG Packet foreign campaign ribbons. Colored catalogues. \$1.00. Medcrafts, 421 6A St. N.E., Calgary 2, Canada.

AMAZING Hobby—Collect authentic armed forces insignia, ribbon bars, embroidered patches, naval rates; fascinating assortment of 57 for only \$1; special gift free with order. Pritt Co., Dept. M-12, 16 West 27th Street, New York City.

NEW—15 Different match covers 10c. Box 202, Rochester 1, N. Y.

LEATHERCRAFT Is fun. Your friends enjoy receiving leather gifts. You will enjoy making them. Tools, designs, supplies on hand. Free catalog. Tandy Leather. Box 397-C, Tulsa, Oklahoma.

UNUSED Matchbook covers—100 different \$1.00 36-page catalog 25c. Charles Edelman, 1311C East 84, Cleveland 3, Ohio.

INVENTING Can be an interesting and profitable hobby. Write for complete particulars. Institute of American Inventors, Dept. 40-E 631-E St. N.W., Washington 4, D. C.

NEVER Before at such low prices. Jewelry parts. Findings and parts assorted \$2.50 lb.; 5 lbs. \$8.50. Imported beads assorted \$1.50 lb.; 5 lbs. \$6.00. High luster pearls assorted \$2.00 lb.; 5 lbs. \$8.50; 100 imported stones assorted \$1.50; 1000 assorted \$5.00. Merchandise Distributing, 19-B East 16th Street, New York 3, N. Y.

CAMERAS, PHOTO SUPPLIES

HUMOROUS—Old time color slides for home projection. Illustrated list free. Universal, Box 629A, Beverly Hills, Calif.

STEREO Camera, viewer, mounts. Complete \$20.00. Easy to operate. Guaranteed. Color or B&W. Keys Stereo, 3823 East 7th, Long Beach 4, California.

WHOLESALE Photographic supplies. Cameras, films, projectors, enlargers. Write for free catalog. Capitol Photo Supplies, 2428 Guadalupe, Austin, Texas.

PHOTOMURALS. Your negative or ours. Catalogue 25c. Photomammoth Murals, Dept. M, 12048 Vanowen Street, North Hollywood, California.

BASS Says: Trading since 1910. Used but good as new buys: 8mm. B&H, Sportster \$52.50; 16mm. Keystone A-7, F:2.5 lens \$37.50; Voigt. 35mm. Vito II, flash shutter, Skopar F:3.5, like new \$38.50; Kodak Reflex F:3.5 lens, like new \$88.50; Contax I, F:2.8 Sonnar \$87.50; 3 1/4 x 4 1/4 Speed Graphic, Skopar F:4.5, Ibsor shutter, \$52.50. Satisfaction guaranteed. Bass Camera Co., Dept. AG, 179 W. Madison St., Chicago 2.

FREE Photographic bargain book packed with hundreds of sensational values in still and movie cameras, lenses and latest accessories. Super savings for you in new and used equipment. No money down—Up to 15 months to pay. Liberal trade-in allowances, too, on your own equipment. Write now for your free copy to Central Camera Co., Dept. 9M, 230 S. Wabash Ave., Chicago 4, Ill. (Photographic Headquarters since 1899).

PHOTO FINISHING

OVERSIZE Prints no extra charge. 8-exposure roll, 30c. 12-exposure, 45c. 16-exposure, 55c. Reprints oversize 4c. Finest quality. Mail Order Photo Service, Box 297, Watertown, Wisconsin.

SINCERE. Only you can give a quality 5x7 double-weight matt enlargement in salon mount—\$1.00. From picture, \$1.50. E. B. McGowan, Box 2906, Brentwood 17, Missouri.

8 CONTACTS 30c, Jumbos 40c. 12, 45c; Jumbos 55c. Reprints 4c; Jumbos 5c. Western Photo, Dept. PM-122, Box 298, San Francisco 1, Calif.

SATISFACTION Guaranteed! Eight jumbo size prints mounted in album, 35c—12 to 16 exposure rolls, 50c. Free mailers, quick service, finest developing, finishing. Photo Christmas cards our specialty. Crown Studios, Box 1223-PM, Dallas, Texas.

GIANT Glossy prints (3 1/2" x 5"); fast service. Mail us your holiday films. 8 exposures, 30c; 12 exposures, 45c; 16 exposures, 60c. Triman, 335 East Utica, Buffalo 8, N. Y.

FINEST Copies of any picture. 8x10 with billfold size \$2.00 postpaid. Originals returned unharmed. Ferguson, P.O. Box 317, Rio Linda, California.

12 JUMBOS 25c, 16 Jumbos 35c. from any size roll or negatives, with this ad. Skrudland S, Lake Geneva, Wis.

20 FORMULAS. Make developers, fixers, hardeners, 50c. Formulas, 31 Farleigh Cres., Hamilton, Ontario, Canada.

PHOTOSTAMPS. Finest quality. Free samples. Photostamps, Box 4216-M, Jacksonville, Florida.

AMATEURS. Wholesale finishing. Lists 3c. Photocraft, Dept. AF, Monticello, Ark.

JUMBO Prints! 8 or 12 exposure roll developed and printed 39c. 1 day service. Quality guaranteed. Dean Studios, Dept. P, Omaha, Nebraska.

GIANT Size deckle album prints. 8 exposure roll, 35c. 12 exposure 50c. Send money. Free mailers. Dowl Photo Co., P.O. Box 2077, Ft. Worth, Texas.

ENLARGEMENTS! Eight 5 x 7's or five 8 x 10's, \$1.00. Wilart Enlargers, Box 967, Little Rock, Ark.

16 PRINTS Or 8 jumbos from roll or negatives, 25c with this ad. M. Skrudland, Box 486, Daytona Beach, Florida.

CUSTOM Photo finishing guaranteed. 8 exposures 35c; 12, 50c. Bound in beautiful plastic ringed album. Special! 35mm. 36 exposure \$1.00. Free mailer. Flash Foto, Box 36M, Brooklyn 4, N. Y.

FAST—Same day service! 8 oversized prints in attractive plastic-bound book only 35c; 12-50c; 16-60c. Satisfaction guaranteed. Free exposure guide with first order. Pic-Sure, Box 899-B, Philadelphia 5, Penna.

6 OR 8 Picture roll 35c, 12 or 16 picture roll 55c. Each roll printed and developed. Handy album pack. If you fail to get pictures on your film a new roll will be sent you without extra cost. Send coin with roll. No c.o.d.'s. Mailing containers sent free. DeLuxe Film Service, Box 1268-A, Shreveport, Louisiana.

BEAUTIFUL Enlargement from each picture on 8 exposure roll 35c. Cut Rate Photos, Dept. B-4, Janesville, Wis.

TWO Beautiful prints from each picture on 8 exposure roll 35c. Thirty-one years of satisfied customers. Quick service. Lens Photos, Dept. J-4, Janesville, Wis.

GREAT News! Our famous Century jumbo oversize finishing at contact prices. Our Chicago plant, with new improved equipment, exclusive with Century, produces sensationally magnificent quality work. Any 8-exposure roll finished deluxe style only 40c. 12-exp., 55c. 16-exp., 70c. 36-exp., \$1.50. Oversize reprints 5c each. Free mailers. Send us your next order, you will be delighted with results. Century Photo Service, Box 5208, Chicago 80, Ill.

UNBEATABLE For quality and price. You will be surprised and pleased with the beautiful results from our celebrated jumbo oversize finishing. Low prices, same as contact. 8-exp. roll superfine finish only 40c. 12-exp., 55c. 16-exp., 70c. 36-exp., \$1.50. Oversize reprints 5c each. Send us your order, you will be delighted. Free mailers. Mallbag Film Service, Box 5440A, Chicago 80, Ill.

TWO Prints each good negative. 8-exp., 45c; 12-exp., 65c; 16-exp., 85c; reprints 4c. Mayfair Photo Service, Box 617-K; Toledo, Ohio.

MOTION PICTURES AND SOUND EQUIPMENT

MOVIES' Biggest bargain—"Santa Claus Punch and Judy," brand new, first quality prints—150' 8mm., \$1.98; 300' 16mm. silent, \$2.98; 300' 16mm. sound, \$11.95. (Postage each reel: 8mm., 15c; 16mm., 25c). Used 100' 16mm. Panoram musicals, six for \$4.99 plus 25c postage. Used 16mm. sound cartoons, sports, musicals, travels, comedies, features at but a fraction of their cost new. Real buys in screens, reels, splicers, editors and other accessories and supplies. Good used 16mm. sound projectors—Ampros, Bell & Howells, Victors, frequently available at \$129.95. Get on the list for Blackhawk's big free monthly catalog. Blackhawk Films Inc., 1217 Putnam Bldg., Davenport, Iowa.

NEW 8MM. full color movie film, 25 ft. double roll including superspeed processing, postpaid, \$3! Guaranteed! 16mm. mag. 50 ft. \$6. 16mm. 100 ft. \$8.50. 35mm. 20s for stills \$2.75. Federal Film Corporation, Dept. 14, Rochester 3, N. Y.

WILD Life films. Exciting, dramatic action in the natural habitat of animals of forest and plain. 8mm. or 16mm. in beautiful color or B & W. Also 2" x 2" color slides. Write for free illustrated literature. Wild Life Films, 5151A Strohm Ave., North Hollywood, California.

FREE Movies. Thousand subjects. Interesting. Entertaining. Latest directory, 50c. National Cine, 500 Dayton Ave., Toms River, N. J.

BARGAINS 8-16-35 Shorts, features, quality sound, silent films, equipment, new, used reels, cans 5, \$1.00. 1600' 50c. Outdated still, movie film. Free film library membership. Catalogs available. Inquiries welcomed. Mogull's, 112 W. 48, New York.

5000 NEW-Used 8-16mm. silent-sound films. International-B, 2120 Strauss, Brooklyn 12.

"ENTIRE Life Story of Christ" 8 mm., 16mm., sound and silent, purchase or rent. Hemenway Film, 31 Church St., Boston 16, Mass.

WE Have it! Send 10c for special listings and sample film strip. Reyelle, Box 12, Dept. PM, Hammels, N. Y.

BARGAINS 16MM. sound films. Also for exchange. Bedner, 5300 So. Talman, Chicago.

8-16MM. Silent-sound films. Complete rental library. All latest subjects. Free catalogue, sample film 10c. Garden Film, 317 West 50th, New York 19.

RENT 16MM. sound films, 50c reel. Large selection; free catalog. Film Service, 128 Chestnut St., Roselle Park, N. J.

GUARANTEED Fresh 8mm. roll, magazine; 16mm. roll, magazine movie films. Color. b&w. Free catalog. ESO-S, 47th Holly, Kansas City 2, Missouri.

MOVIE Camera film: 8mm. roll \$1.50, 16mm. 100' \$3.00. Free processing. Better Films, 742 New Lots, Brooklyn, N. Y.

TAPE Recorders, tapes, accessories. Unusual values. Dressner, 624-M East 20th Street, New York City 9.

SYNCHRONOUS Magnetic recorder professional quality. Magnetic Recorders Co., 7120-A Melrose Ave., Los Angeles 46, Calif.

MUSIC AND MUSICAL INSTRUMENTS

SONGWRITERS! Outstanding, convincing offer. Hibbeler, C-5, 2157 N. Avers, Chicago 47.

SWISS Musical movements. Excellent quality. \$2.50. Spielman, 131 West 42nd, New York 36.

ACCORDIONS New and used. Student or professional. World's finest makes at the lowest prices anywhere! Save 50% and up! Trade-ins taken. House of Accordions, 10 Conway Rd., Shelburne Falls, Mass.

MUSIC Arranged. Songs printed. Frank Wildt, Music Publisher, Lancaster, Penna.

SONG Poem writers! Get the facts first. Send for free booklet, "Songwriting Secrets," and outstanding offer. Melody House, Dept. PM2, Box 19007 LaTijera Sta., Los Angeles 43, Calif.

AMAZING. Songs written for \$5.00, complete cost. Send lyrics with remittance immediately. E-Z Publishers, 1133 Broadway, New York 10.

1952 ACCORDIONS — Wholesale. Free catalog, American Accordion Center, 5329 Belmont, Chicago.

ELECTRIC Guitars, accordions, amplifiers, wholesale, free catalog. Carvin, Baldwin Park, Calif.

POEMS Wanted for musical setting on percentage basis. Broadcast consideration. Sooner Song Co., 22-PM North West 8th, Oklahoma City 2.

ACCORDIONS—Save 50% and up. Cash or terms. New and used. All brands. Wholesale to everyone. Free catalogue. Del Principe, 29 South Cicero, Chicago 44, Ill.

POPULAR Songs. How to write and sell them. Write for free booklet Successful Songwriting. Gateway Songs, Box 2470, Hollywood 28, Calif.

SONGWRITERS! Protect your ideas! Hold all songs; poems! Write for Safe Correct Procedure first! Song Service, Dept. P, 333 W. 56th St., New York 19, N. Y.

SONGWRITERS! Send poems, songs. Music Service, 243 West 72nd St., PM, New York 23.

WANTED! Poems for musical settings. Write Songwriters' Service, Clifton, N. J.

POEMS Wanted to be set to music. Free examination. Send poems. McNeil, Master of Music, 510-PM S. Alexandria, Los Angeles, California.

WRITE Songs. Big money and reputation. Write for information. J. Gordon Pub. Co., 4700 South California Avenue, Chicago.

SENSATIONAL Free booklet, "How To Write And Sell Songs." Get the facts first. Poems examined free. Reliable Music Service, Box 430-P, Hollywood 28, Calif.

POEMS Wanted for musical setting. Send poems for free examination. Five Star Music Masters, 630 Beacon Bldg., Boston, Mass.

FREE Collaboration, new plan. Details. Turner, Box 2201-PM, Bridgeport 8, Conn.

RADIO AND TELEVISION

BUILD 15 Radios—Only \$1.30 each. Experience unnecessary. Home radio and TV course includes trouble shooting and servicing lessons, radio principles, code instructions, practical radio building and repairs. You build and keep receivers, transmitters, amplifiers, test equipment and code oscillator. All parts, tools, instructions supplied, including radio tester and electric soldering iron. Send for big, new time and money saving catalog and radio TV repair guides. Enclose 25c. Progressive Electronics Co., 497 Union Ave., Dept. PM-25, Brooklyn 11, N. Y.

FREE 236 Page 1953 television-radio-electronic catalog! World's largest stocks, lowest prices. Complete supplies for builders, experimenters, amateurs, servicemen. Latest television, radios, phonos, recorders, sound equipment. Thousands of parts, tubes, test instruments, books, diagrams. Top quality money saving values. Get yours now! Allied Radio Corp., 833 W. Jackson Blvd., Dept. 34-M-2, Chicago 7, Ill.

NEGATIVE Resistance makes crystal set selective, distance-getting, loudspeaker radio. Instruction 30c. Serco, X261D, Waltham, Mass.

COMPLETE Instructions. How to check and repair radios. Only \$1.00. Slate's Radio Service, Corsicana, Texas.

24 PAGE Plans "18 Long Distance Crystal Sets," 25c; including "Radiobuilder," catalog. Laboratories, 1131-C Valota, Redwood City, California.

SHORT Wave. With a soldering iron convert your radio for less than \$5. Free details. Write Rathert, 4661 Loughborough, St. Louis 16, Missouri.

CUSTOM Radios for 1952 Fords, \$44.50. Nordic Radio Co., Box 582, Evanston, Ill.

BUILD Inexpensive electronic multimeter, instructions \$1.00; component tester, instructions \$1.00; particulars free. Technological Developments, 475-L Fifth Ave., New York 17, N. Y.

BUILDER'S "Pictorial Construction Plans." Free list. Alena, Box 24, Astoria 6, New York.

KITS — Radio, television, crystal how books. Free list B. Govt. release rare fixed Western Electric crystal detector IN26, \$1.98. Murray Barron Ind., Box 74, West Englewood, N. J.

FLASHLIGHT Battery radio, plans 25c. Boscia, 39 Spencer Road, Rochester 9, N. Y.

CLEARCO Crystal radio kit \$1.50; preassembled \$1.75. Free catalogue. Clearco Crystal Co., Box 1857, Milwaukee, Wis.

ENJOY Zingo color television screen now. Send only \$1.50. Give screen size. Zingo Products, Johnstown 7, New York.

TELEVISION Interference filters. Price \$2.75. Steil's Co., Box 1104, Sioux City, Iowa.

MAKE Simple, tubeless, batteryless, distance-getting crystal radios. Crystal and illustrated instructions 25c postpaid. Allen, 427-P, Clinton, Mo.

TV And FM antennas. Yagi, conical, bow-tie, mounts, accessories. Lowest prices. Wholesale Supply Co., Lunenburg 1, Mass.

BUSINESS OPPORTUNITIES

CONVERT Hand mowers to power mowers. Do it now, this winter. Sell the Handy-Dandy conversion kits. Easily installed on 16 to 20" mower. Use any small gasoline or electric motor. Quick delivery. Kits purchased with or without engines. Also new garden cultivator. Cultivates 3" deep. Attachments available: weed cutter, lawn mower, snow plow, and rotary snow brush. Discount to dealers. LeClaire Manufacturing Company, LeClaire, Dept. PM, Iowa.

AMAZING New moth-resistant genuine crushed redwood cedar compound with DDT! Prevents moth damage. Makes fragrant cedarized closets, applied like paint, laboratory tested. Hardware, paint, building supply dealers, contractors buy quantities. Exclusive distributors. Tremendous profit potential! Low priced; attractively packaged. Write for details, Cedarco, 90B Summit, Brookline, Mass.

\$5 AN Hour and more possible in your home. You can paint it with suede. Fabulous new business. Spare or full time. Spray on rainbow colors. Auto dashboards and trunks, signs, radios, toys, figurines, lamps, etc. Beautified with amazing new 3rd dimensional plush-like finish with touch-appeal as well as eye-appeal. I'll send you complete, step-by-step plans and equipment, including high-velocity spray gun for no-risk examination in your own home. Send no money, just name and address. Coast, 1004-AW S. Los Angeles St., Los Angeles 15.

FREE Valuable catalog. Over 2000 select businesses, farms, ranches and income properties for sale thruout West. Contains prices, addresses, etc. Write us what and where you want to buy and we'll advise sellers of your requirements. No salesman, no commission to pay. Write for free catalog No. 76. National Business & Property Exchange, 4101 West 3rd St., Los Angeles 5, Calif.

SEVERAL Mailorder money making homework offers. Jenkins, PM, Lucasville, Ohio.

LIQUID Marble—Colorful, glossy! Molded, brushed, sprayed! Cast novelties, statuary, colored tiles. Flexible molds. Composition floors. Particulars free. Marbleizing Service, Edwardsville, Illinois.

MAKE \$6.73 Every time you sell one—And they're amazingly easy to sell! We have new adding machines in original factory cartons you can sell for only \$14.95 and you make 45%. They're executive model portables, precision built with automatic clearance, direct subtraction, fully guaranteed. Send for life size color photo with full details. Write today to Lightning Adding Machine Co., Inc., Dept. P-24, 1260 West Second Street, Los Angeles 26, Calif.

START A buying service. Buy wholesale thousands nationally advertised products. Make big profits selling at sizeable discounts. Send postcard for details. American Buyers' Service, 627-R Linden, Buffalo, N. Y.

"PROFITABLE Decorating business." Fascinating! Instructive. Only \$1.00. Fran Council, Box 150-M, Wildwood, New Jersey.

MAKE Perfumes at home. Write, "Carey Laboratories," 1914 Chouteau, PM-12, St. Louis 3, Missouri.

UP To \$200 weekly! Work home, start spare time, small capital. Free book "301 Unique, Successful Businesses" tells how. Deaumont Publications, 79-R Deaumont, Kenmore 23, N. Y.

LEARN Sewing machine repair. Electrify, rent, trade, sell. Make up to \$125 week spare time. New machines, motors, etc. wholesale. Details free. Taylor Service, Hamilton PM-12, Ohio.

ADVERTISING Book matches—Cash in on big demand; sell union label matches. Cuts for all businesses and political parties. Free powerhouse selling kit, low prices, protection guaranteed on repeat orders. Cash commissions. Superior Match Co., Dept. MX-1252, 7530 Greenwood, Chicago.

START Your own business on credit. Your own boss. 1586 of our dealers sold \$5,000 to \$27,500 in 1951. We supply stocks, equipment on credit, 200 home necessities. Sales experience unnecessary. Pleasant, profitable business backed by world-wide industry. Write Rawleigh's, Dept. L-U-PPM, Freeport, Ill.

IMPORT-Export! Opportunity, profitable, world-wide, mail-order business from home, without capital; or travel abroad. Established World Trader ships instructions for no-risk examination. Experience unnecessary. Free details, Mellinger 2C, Los Angeles 24.

LEARN Silk screen printing; invisible reweaving; repair dolls; make rubber stamps. Rubber for molds, new low prices. Large catalogue free. Universal, Box 1076-A, Peoria, Ill.

EARN Money spare time, homework. Experience unnecessary. Literature free. Claude Wiese, 1516 Franklin, Waterloo, Iowa.

GROW Plants, flowers. Details free. Shiffers, Box 129, Millersburg, Penna.

ABC Shorthand in one week \$2. Returnable. 215P West 91, New York 24, N. Y.

START Your own mail order business with hundreds of repeat, sales proven, hobby-craft items. No stock to carry, no shipments to make. We pack and ship for you. For details and instructions send 25c. Mail Order Service, Dept. PM25, 845 S. Wabash, Chicago 5, Illinois.

FREE Illustrated instructions on casting figurines, novelties, etc., using latex molds. Earn money at home. Make your own molds with our latex for few cents. Lowest prices. Write Major Chemical & Latex Co., 23 Allerton Street, Boston 19, Mass.

SILK Screen printing offers great opportunities. Inexpensive course teaches everything. Typcrafters, 510-H West Susquehanna, Philadelphia 22, Penna.

SELL Printing by mail! We fill orders. Free plans, samples. Sutton Printing, Box 853-G, Waycross, Georgia.

PARTNERS Wanted. Patented appliances. Dr. Roberts, 111 N. Stevens, Valdosta, Ga.

PRACTICAL Spare and full time business plans. Particulars free. Write: Plans, Box 447, Park Ridge, Ill.

LARGE Wholesaler of nationally advertised appliances, cameras, watches, etc., will help you start your own business with investment of under \$20. No selling involved. Free details. Cam Company, 1717-PM 58th St., Brooklyn 4, N. Y.

LIQUID Latex for flexible rubber moulds. Complete instructions. \$2.50 qt., \$9.00 gal. prepaid. Eastern Latex Laboratories, Box 153, Mattapan 26, Mass.

PROFITABLE Ideas—"176 page book" \$1.00. General Sales Service, 423 Brobst, Shillington, Penna.

SAWDUST. Turn it into cash. Twenty methods. Instructions 50c. Charles Company, 12-DAR, Norwood, Ohio.

PROFITABLE Home business, electroplating novelties, giftwares, auto parts, mirrors. Easy, inexpensive home processes. Free booklet. Tyco Metals, Box 13231-MJ, Houston 19, Texas.

BOOKKEEPERS Earn \$1000 month operating Bookkeeping-Tax Consultant Service. Details free. Universal, Box 664-M, Springfield, Missouri.

"MAKE Perfume" catalogue free. "International," 6347 Parnell-PM-12, Chicago 21, Illinois.

WHERE To buy at wholesale 100,000 articles. Free list. Also extra-income information. Maywoode, 1133 Broadway, New York.

RAISE Chinchillas for profit. New "Easy-Pay" plan helps you start at low cost. Registered N.C.B.A. breeding stock. Write Kryders Chinchillas, Sturgis 1, Michigan.

SAW Reconditioning simplified. Literature free. Zapart, 586-PM Manhattan Ave., Brooklyn 22, N. Y.

\$50 PROFIT Per day possible using simple machine in your garage making concrete drain tile. Details free. Ceeten Products, Cornella, Georgia.

GET Hundreds money making, new business ideas. Amazing. Details free. 5538 Lexington, Mail Service, Chicago 44.

BUY At wholesale, catalogue of radios, watches, toys, appliances; nationally advertised. 25c. Refunded with first order, particulars free. Zen Publications, East Marion, Elkhart, Indiana.

NEWSPAPERS. Turn them into cash. Eighteen methods. Instructions 50c. Charles Company, 12-DAS, Norwood, Ohio.

START A trading post in your town. Interesting literature 10c. J. Angelski, P.O. Box 378, Wooddale, Ill.

ALL Profit—Making, selling, installing important heating specialties. Details free. Harrington, Box 103MH, St. Matthews, Ky.

START Home mailorder business. Details. Gedgard, Box 798-T, New York 1, N. Y.

START Home perfume business. No equipment. Everything furnished. Emly Enterprises, Box 319-P12, North Hollywood, Calif.

REPEAT Sales guaranteed, cheapest, best glass, dishwashing liquid for taverns. Riesen, 419 Vliet Street, Milwaukee 12, Wis.

RAISE Fishworms. Breeders 100, \$1.00. Guaranteed instructions, \$1.00. Postpaid. Literature free. Dixdok, Kent, Ohio.

FREE Demonstrator offer. Power mowers. '53 models. Appoint dealers-agents. Permanent. Rotacut-51, Excelsior Springs, Mo.

START Fascinating home mailorder business. Exciting sample, details free. M. Rienzi, 24-B North 7th, Newark 7, New Jersey.

HOW To raise capital. True amazing plans. Free details. Everett Hale, P.O. Box 997, Newark 1, New Jersey.

COLOR Concrete with chemicals. Marble-glaze cement benches, pottery, garden ornaments. Home — shop. 10c brings sample, pictures. Hollywood Cementcraft, 8527-R Wonderland, Hollywood 46, Calif.

SPECIALIZED Magazines covering your field of interest help you to greater success. Get latest copies through our easy-to-get-acquainted service. Hundreds of business, trade, professional, educational, sport, hobby, stationery, store display, sign, textile, tobacco, window display, woodworking, writer and others covering all interests. Send for list today. It's free. Commercial Engraving Publishing Company, 34C North Ritter, Indianapolis 19, Indiana.

ORCHIDS! Grow them for profit or pleasure. Complete, illustrated instruction book 50c. Samuel Presner (Orchidologist), Box 4550-PM, Coral Gables, Florida.

MONEYMAKING Mailorder plan. 25c. George Lenhoff, Box 201-M, Lincoln 1, Nebraska.

SENSATIONAL. New. Make fastest selling costume jewelry at home, from marine and botanical life; transformed into exquisite "ceramic" gems. In lovely pastels and gold leaf, orange blossoms, pansies, starfish, etc. 500% profit. Write Jewelry by Jullum, Box 460, Ft. Lauderdale, Fla.

EARN Income by mail. Spare time. Success assured. Investment small. Reho, Box 21A, Whitsett, Penna.

LET Others sell for you. Earn steady from home. No mail order. Full set up service from idea to success. Free information. Hermes Company, 152 West 42 Street, New York.

HAND Tools — Nationally advertised. Jobber prices. 2000 item catalog 25c. Midwest Sales, 3219 W. 117th, Cleveland, Ohio.

OPEN A cigar store. We supply. Cigarco. Caguas, Porto Rico.

READ "Your Own Mailorder Business." Proven, tested, guaranteed, 25c. E. Merrill, Box 242A, Bangor, Maine.

CAN The boss! Make building plastic of waste. Flooring, plaster, stucco. Beautiful, durable, economical. Bays Laboratory, Oklahoma City 9.

START Business without capital! Reliance, 15-A Park Row, New York 38, N. Y.

MAKE Money at home mailing cards, circulars. Everything furnished. Start at once with almost no investment. Paton, Box 55-C, New York 23, N. Y.

MAKE Green dyed lycopodium Christmas wreaths. Fascinating production course. Supplies. Enclose 25c for sample corsage. Lycopodium Foundation, St. Paul 8, Minn.

BITS Of plywood; jigsaw. Exceptional income. Literature free. Woodarts, PM-153, Bridgewater, Mass.

CO-Partners wanted—Share in big time profits publishing-selling new book with terrific possibilities. Foreman, 351-H, Fairmount, Jamestown, N. Y.

MAKE \$15,000-\$50,000 Yearly your own business. Get exclusive franchise for amazing new "Lambert-Line" of air sanitizing, deodorizing, disinfecting chemicals and equipment needed in every office, home, store, factory. Moderately priced, fast easy sales, steady repeats. Excellent profits. Permanent. Opportunity unlimited. Write today for free facts. Lambert Research Laboratories, Dept. 212, St. Louis 16, Mo.

START A Venetian blind laundry. Profit opportunity for lifetime business. New machine method. Free booklet on request. F. C. Co., 442 N. Seneca, Wichita 12, Kansas.

VENDING Machines—A post card may bring you the opportunity you are waiting for. No experience necessary. Stamps, nut, candy, gum and others. Small investment. Write Schoenbach Enterprise, Dept. 11, 1645 Bedford Ave., Brooklyn 25, N. Y.

MAKE Gifts, novelties, jewelry, from sea shells, fish scales, plastics! Wholesale, illustrated catalog 10c. Giftcrafts, Box 4550-PM, Coral Gables, Florida.

YOUR Own business without investment. Be an authorized agent for magazines and take care of new and renewal orders in your territory. Experience not necessary. We furnish all supplies free. Write for our catalog. Subscription Service Company, P. O. Box 2070, Birmingham, Alabama.

PROFITABLE Home business. Make fast-seller chenille monkey trees, dolls, flowers. Terrific holiday demand. Information free. Velve, Bohemia 16, N. Y.

LIQUID Rubber, make flexible molds. Free sample. Chaney, 1130 E. 16th St., Jacksonville 6, Fla.

YOU Can have a steady lasting income with my copyrighted system in the mail-order business, right at your own home. Write me. I'll tell you how. F. Little, R.D. 1, Glenshaw, Penna.

NATURAL Molding latex. Extra thick. Free sample. W. Wooley, 115-A Donald, Peoria, Ill.

TO \$35.00 Weekly. Spare time, home operated, mailorder business. Successful "beginner's" plan. Everything supplied. Lynn, 10420-M National, Los Angeles 34, Calif.

RAISE Fishworms. Easy, profitable. Complete instructions 25c. Huffman Worm Ranch, Rives Junction, Mich.

BIG Money in your own business. Details free. How, Box 684-A, St. Louis, Mo.

FIX Typewriters. Free booklet describes our modern, inexpensive home-study course. Factory methods taught. Write: Typewriter, Building 1, Tarentum, Penna.

\$25 WEEKLY Working two hours daily. No canvassing. No manufacturing. Lycke, Box 2471-A, Cleveland 12, Ohio.

RESILVERING Mirrors, formula 50c; two-way lookout mirrors, (No one sees you), 50c; coppered mirrors, 50c. All \$1.00. Nelko-Mir, Box 3462-J, Chicago 54.

FIGURINE Molds and many others, liquid rubber, statuary plasters, flock finishes, Glo-candle wax, etc. Illustrated catalog and "Plastercraft" manual free. Blue Rapids Supply, Blue Rapids, Kansas.

START Home manufacturing business. Make cleaners, soaps, polishes, cosmetics. Free literature. Kemix, Park Ridge, Ill.

MAKE Money at home as renewal headquarters for all magazines. Big Christmas sales profits now. Liberal commissions. Supplies furnished. Write for free catalog. McGregor Magazine Agency, Dept. 500B, Mount Morris, Ill.

ESCAPE Wage slavery. Easily. Operate your own profitable lifetime business. Free literature. Corley, H186 Ackerman, Clifton, New Jersey.

VENDING Machines earn big money! An investment as low as \$10.50 will start you in this fascinating, profitable business that can lead you to the road of success and independence. Routes can be established and operated in either full or spare time with no experience needed. Write for full details and our free catalog illustrating our nut, candy, gum and stamp vendors; also pin ball machines, music boxes, etc. Write immediately to Parkway Machine Corporation, Dept. 7, 715 Ensor Street, Baltimore 2, Maryland.

HOME Business opportunity mailing literature to new mothers. Everything furnished. Big earnings. Orders filled. Delray, Box 3852M, Columbus 13, Ohio.

MAIL Selling opportunities galore! Free! Wehner, Box 142-A, Roxbury 19, Mass.

HOW And where to obtain capital? Free details. Star Service, Wapakoneta, Ohio.

SELL By mail to automobile owners. Millions of prospects. Fast selling items. Everything furnished. Write: Eastern, Box 142-P, Dorchester 24, Mass.

BIG Profits making new greaseless doughnuts. Start in kitchen. Wholesale to grocers and cafes. Free plans. M. Ray Company, 3605 South 15th Ave., Minneapolis 7, Minnesota.

BIG Money and fun growing live miniature Ming trees on your window sill. Write for free rare tree seed and plan. National Nursery Gardens, 8463 South Van Ness, Inglewood 4, California.

MAKE Money spare or full time, casting metal toys and novelties. Big wholesale and chain store demand for autos, soldiers, ashtrays, banks, etc., keeps manufacturers busy. Production moulds furnished for up to 100 and more castings per hour. No experience or special place necessary. Write for information and illustrations of patterns needed. Metal Cast Products Co., Dept. A, 1696 Boston Road, New York 60, N. Y.

FLEXIBLE Rubber moulds for plaster and Marblite figurines. Sample and large illustrated catalog 25c, refunded on first order. K-C Novelties, Dept. 23, Easthampton, Mass.

WHY Not make extra dollars repairing zippers? Excellent profits uncrowded field. Details free. Texas Specialty Company, 204-B Texas, Texarkana, Texas.

SELL By mail to women—Real merchandise. Everything furnished, orders filled. Big profits. Charles, Box 32-S, New York 63, N. Y.

NEW Exceptionally profitable plans, ideas for home operated mail business. Rush name. Miller, 1772-P Carlyon Road, East Cleveland 12, Ohio.

MAKE Flexible molds! Cast plaques, bookends, figurines! Free sample! H. Tooker, 630-R Chestnut, Hamilton, Ohio.

21 POPCORN, Candy apple formulas, proven money-makers. Send \$1 today for formulas, catalog of money-making ideas. Concession Supply, 3916 Secor, Toledo, Ohio.

RECAST Old batteries into new. Latest achievements. Battery Laboratories, Minneapolis.

READ "Advance"—The voice of mail order. Offers money-making opportunities, sources of supply, personal guidance, etc. Issued monthly. Sample copy 35c. Yearly subscription \$2.00. Advance Publishing Company, 313 East 21st Street, Suite 450, New York 10, N. Y.

GOOD Paying business silvering mirrors, plating autoparts, reflectors, bicycles, bathroom fixtures, etc., by late method. No tanks or shop required. Outfit furnished. Free booklet. Gunmetal Co., Ave. H, Decatur, Illinois.

POPCORN And potato chip equipment. Long Eakins Company, 5260 High, Springfield 99, Ohio.

BUY Wholesale. Thousands articles. Supply directory, 10c. Idealco, Park Ridge, Illinois.

EARN Extra money! "Homeworker Magazine" tells how. Sample 25c. Sizemore, Box 7, 4917 Kostner, Chicago 30.

BOOKKEEPERS, Keep books, small firms spare time. Manual latest technique by C.P.A., \$3.00. Modern Business, Box 406, Youngstown 1, Ohio.

EXTRA Money—No selling, operate vendors. Amazing profits, details free. Silver King, Suite 220, 622 Diversey, Chicago 14.

BUY It wholesale! Manufacturers, distributors offer 850,000 items. Literature free. Olsen, 1231-A East Third St., Duluth 5, Minn.

OPERATE Profitable mail order business. Write Walter Service, 4159-A East 112th, Cleveland 5, Ohio.

EARTHWORM Breeding? First, get unusual story. "An Earthworm Turned His Life." Free. Earthmaster, Dept. 14, El Monte, Calif.

INCOME From local information. No selling. Write Neherco, La Verne, Calif.

DOLLARS In personalized baby record books. Sell by mail. Use same literature we do. No-Co-Ro, Oakland 6, Calif.

MADE \$24,500 Using money making plans from Schemer Magazine, world's oldest mailorder publication. Box 275M, Canfield, Ohio. Year \$2.00. Sample 20c.

MINK Raising information free. Complete. Lake Superior Mink Farm. Superior, EEL, Wisconsin.

COPUBLISH Leading m.o. paper. Latest copy Mail Sale Advertiser, details, dime. Vanroy Shirk, Lebanon, Penna.

COLORGLAZED Concrete pottery made without molds. Patented method. Cemetery products, novelties, tiles. Basement leak-sealing. Money-making projects. Booklet, details free. Men only. National Potteries Company, Grand Rapids, Minnesota.

\$100 WEEKLY Commissions taking magazine subscriptions. Details. Courier, 40-69A 97th Street, Corona 68, New York.

THIMBLE-Knife. Fits finger. Cuts, rips everything. Amazing device. Fast seller. Great profit. Write Tom Noble, Old Greenwich, Connecticut.

FREE Particulars "Profitable Home Business Projects" plus wholesale sources 740,000 items. Cottage Industries, Omaha 12, Nebr.

EARN Money with typewriter; sewing machine! Spare time! Details free. Edwards, 3915-PM, 12th, Des Moines 13, Iowa.

GET Dollar orders in your mail. Keep 90c. Everything supplied. Genmerco, Box 142-D, Dorchester 24, Mass.

PROFITABLE Mail selling; twelve tested plans. Write: Edwards, Box 1067, Allen Park, Michigan.

RUBBER Molds! New catalog illustrating over 100 professional molds, 10c. Castcraft Studios, 508-P Marion St., Brooklyn 33, N. Y.

HOME Mail business! We supply exclusive product, advertising, everything. Experience unnecessary. Start low as \$150. Terrific potentialities. Write: NMD Agency, Box 88-D, Dorchester 22, Mass.

FREE Book "505 Odd, Successful Businesses." Work home. Expect something odd! Pacific, Oceanside, Calif.

EXCELLENT Earnings, repairing sewing machines as a business. Details free. Joseph Alexander, 313 8th Ave., N. Y. 1.

CHINESE Raised art. Fantastic profits. Easy enjoyable hobby. Details free. Modern Aids, 248 South Main, Jamestown, N.Y.

MILLER'S Modern manufacturing formulas make fast-selling products that get the business and pay. Fifty years supplying the best. Literature free! Miller, Research Chemist, Tampa, Florida.

MAKE Fast-selling repeat order products at home. No machinery. Everything furnished. Write, Shepard, 455-D West 34th, New York 1, N. Y.

MOLD Making liquid rubber; sample pint, with instructions, \$2.00 postpaid. Plastercraft Supply Company, 3051 St. Clair Avenue, Cleveland 14, Ohio.

\$50.00 AN Hour, spare time. Johnson, Box 351-B, Ithaca, New York.

EARN 400% Selling attractive low priced watches. Free salesmen's sample. Result Sales, 580 Fifth Ave., New York 36A.

MONEYMAKING OPPORTUNITIES

BE Independent, be secure, have your own profitable business—Earn \$20.00 and more a day making beautiful, fast-selling lamps at home. No equipment needed. Illustrated course teaches you quickly. Course, parts catalog, wholesale price list—only \$2. Gearon Co., Dept. 200-B-12, 27 S. Desplains, Chicago 6, Ill.

"HOW To Make Money With Simple Cartoons." A book everyone who likes to draw should have. It is free; no obligation. Simply address Cartoonists' Exchange, Dept. 912-CC, Pleasant Hill, Ohio.

\$100-\$200 WEEKENDS. No selling or manufacturing. Brennan, 4025-Z Lankershim, North Hollywood, Calif.

BE Your own boss! Free book "301 Unique, Successful Businesses" tells how. Start spare time, small capital, work home. Deumant Publications, 83-R Deumant, Kenmore 23, N. Y.

\$10,800 PROFITS! Your own mailorder business! No capital risk! "Success plan" (worth \$2) free! Write today! Treasury, 149 Storer, New Rochelle PM-6, New York.

GROW Miniature dwarfed trees. Instructions 50c. Metro, Box 103-D, Berwyn, Ill.

HOW And where to buy wholesale. Thousands articles. Free details. Write United, Box 87-M, Detroit 2.

MONEYMAKING Is easy and fun when you sell the wonderful trick. Hypnotizer. Try it. Sample \$1. Moneyback guarantee. Hypnotizer, 208 Iini Way, Aiea, Oahu, Hawaii.

HOW To make \$25 daily at home and over \$8,000 from half acre plus 999 dollar maker tips. Only \$2 postpaid. Baults Cottage Industries, Box 646, Hermiston, Ore.

XMAS Special ball pen, 100 double edge razor blades; guaranteed \$1.00. Payne, 5426 5th Ave., Los Angeles 43, Calif.

SELL Titania gems; \$9.75 carat wholesale. More brilliant than diamonds. Free catalogue. Diamonte, 1404-M Mitchell, Oakland 1, California.

NAME-Address labels; 500, 48c postpaid. Easy \$1.00 seller. Circulars furnished. Linolabels, Topsham, Maine.

"NEWSPAPER Clipping Bureau." Instructions 25c. Shroder, 803 Wisconsin, Peoria 4, Illinois.

\$100-\$200 WEEKENDS. No selling or manufacturing. Brennan, 4025-Z Lankershim, North Hollywood, Calif.

PROFITABLE Year-round income upholstering automobiles. Diagrammed instruction manual shows easy way to make and install seat covers, door panels, headlinings, tops, etc. Only \$2. Free literature. Purifoy Upholstery Service, 602-AA South State, Jackson, Mississippi.

NEW Business plan free. No canvassing. Swain, 553 Wilder, Lowell, Massachusetts.

SELL Books, merchandise, by mail. Everything furnished! Free details. Paragon, Box 5, Providence 8, R. I.

SERVICEMEN, Agents, dealers wanted. Sell television wavetraps \$2.75. Sample \$2.00. Steils Co., Box 1104, Sioux City, Iowa.

WANT Profits? Investigate new promotional program. Good income. Particulars 25c. Sales Dealer, 326 W. Park, Pleasantville, New Jersey.

FREE Advertising! Thousands new, unusual products! Operate profitable giftware-home products mailorder business. Free success plan! Write H. F. Seidel, 7070 Hollywood Blvd., Hollywood 28, Calif.

EARN Money sparetime, 101 plans 25c. Commonwealth, 5708-A Carothers, Cincinnati 27, Ohio.

WIN Contest money. General Contest Bulletin gives hundreds of tips. Lists current contests and rules. Sample 25c. General Contests, 1609½ East 5th, Duluth, Minnesota.

TIE-Breaker picture puzzles exposed, \$2.00. Wenograd, Box 1495, Philadelphia 5, Penna.

SCHUHMACHER Matmakers. Convert old tires into dollars. Devote full or spare time. S and S Patents, Inc., 1307 North Clark St., Chicago 10, Ill.

EARN Money evenings, copying and duplicating comic cartoons for advertisers. Adservice, Argyle 1, Wisconsin.

MAKE Money—Sewing and assembling at home. Liebig Industries, Beaver Dam 10, Wisconsin.

50,000 ARTICLES Wholesale. Source directory, dime. Nelko, Box 3462-DR, Chicago 54.

BE Appointed State Notary Public now! Details: Stationers, Helotes, Texas.

PUBLISH Your own magazine. Hand-some 52 page format, well edited, illustrated. Cost low as \$1.00 month. Brings you prestige, profits. 25c brings sample, details. National, Ord, Nebr.

READ Progressive Mailtrade, the magazine that tells how to make money by mail. Dime brings sample and special offer. Progressive Mailtrade, Box 357, Sheboygan, Wisconsin.

PROFITS—Free radio advertising. Pay commission only on orders received. Over 400 radio stations active. Free information. Mishek, 2, Waseca, Minn.

300% PROFIT Making and selling seamless wallets. Only scissors needed. Send \$1 for pattern. Barcklow, Box 33, Westville, N. J.

FREE Book "505 Odd, Successful Businesses." Work home. Expect something odd! Pacific, Oceanside, Calif.

SPARETIME Profits taking subscriptions, all magazines. Wholesale catalog free. Cassell Agency, Westfield 2, New Jersey.

LEARN Watch-clock repairing at home. While learning we fix your watches—clocks. Special bonus offer. Inquire Modern Technical Supply, 55-PM West 42nd Street, New York 36.

FORMULAS, PLANS, ETC.

BOOKS—10,000 Formulas, \$3.98. Materials handbook—properties, uses, 8800 materials, \$8.50. Descriptions. Booklist free. Handbooks, libraries, others. K. Paulin, Loudonville, Ohio.

SECOND Printing, improved version, spectacular chemical fireworks experiments manual. Complete setups, formulas, instructions, still \$1.00 postpaid. Chemi-Technix Laboratories, 568G Riley, Buffalo 8, N. Y.

ANY Formula. Jack, Consulting Chemist, 5138 Gainer Road, Philadelphia 31, Penna.

REAL Manufacturing formulas. Lists free. Cummings, Chemist, Gordon Ave., Syracuse 4, N. Y.

FORMULAS: All kinds. Latest, best. Literature free. Kemixal, Park Ridge, Ill.

TESTED Formulas. Interesting descriptive booklet free. Pont, Box 635-PM, Terre Haute, Indiana.

MILLERS Modern manufacturing formulas make fast-selling products that get the business and pay. Fifty years supplying the best. Literature free! Miller, Manufacturer's Chemist, Tampa, Florida.

PLASTICS

HI-Profits—Gifts, jewelry. Free catalogue, details. Pilot Plastics, 67-B Fulton St., New York 38, N. Y.

LEARN Plastics at home. Small cost—Spare time. Dime brings sample plastic, three experiments, full details. Plastic Projects, Box 5151, Detroit 35, Mich.

FREE List—Jewelry findings, lucites, plexiglas, internal carving drills, dyes, supplies, pens, emblems, medallions, insignia, chain, ear wires, many others. Caraday, Box 71, Ryder Sta., Brooklyn 34, N. Y.

PLASTICS. Lucite, Plexiglas, acetates, complete supplies. Retail-wholesale prices. Catalog 10c. Airmailed 35c. Gem-O'-Lite, Box 6861K, North Hollywood, California.

"WORKING With Plexiglas," 70 page illustrated instructions with material catalog \$1.00 postpaid. Plastic's, Box 1812, Salt Lake City 10, Utah.

NEW Liquid casting plastic. Clear, colors. Embed flowers, insects, coins. Saw, drill, carve. Free folder shows fine things you can make at home; sell at big profit. Write today. Castolite, Dept. P-101, Woodstock, Illinois.

INTERNAL Carvers increase profits, make television or night lights. Now available, plastic lamp base completely wired, with slot in top to illuminate your carved plaque. Available in opaque black, translucent ivory or pink. Send for sample and prices, \$1.25 postpaid. Arata, Roberts and Browne, Inc., Towaco, N. J.

WILDLIFE Internally carved plastics. Wholesale literature 10c. Cosmopolitan Plasticrafters, Box 176, New York 8.

PLASTIC. Sheets, rods, tubes, etc. Free list. Plastic Supply Co., 2901 N. Grand Blvd., St. Louis 7, Mo.

LUCITE. Plexiglas. Any size sheets, masked. Square foot (12 x 12) cost, 1/16", \$1.20; 1/8", \$1.40; 3/16", \$1.75; 1/4", \$2.08. Include 10% postage. Almac Plastics, 230 Fifth Ave., New York 1, N. Y.

MANUFACTURERS of a complete line of internal carvings. Special introductory offer; \$1.00, jewelry set and keychain. Crystal Floral Company, Bound Brook, New Jersey.

CHEMISTRY

AMAZING New book of science. Experiments, formulas and catalogue of laboratory supplies. Only 25c. National Scientific Co., Dept. 16, 2204 W. North Ave., Chicago 47, Illinois.

SAVE Money! Supplies catalog, 20c, refundable. Laboratory Sales, Box 161-E, Brighton, Mass.

SECOND Printing, improved version, spectacular chemical fireworks experiments manual. Complete setups, formulas, instructions, still \$1.00 postpaid. Chemi-Technix Laboratories, 568G Riley, Buffalo 8, New York.

LABORATORY Apparatus, chemicals, microscopes, complete chemistry sets, minerals, uranium ore. 10c brings catalog. Porter Chemical Company, Hagerstown 1, Maryland.

NEW Idea chemical and apparatus outfits for home experimenting. Photo-scales, microscopes, chemicals, biological and laboratory supplies in small quantities. Catalog 25c. Established 1931. John H. Winn, 124A West 23rd Street, New York, N. Y.

CHEMICALS And apparatus for industrial, analytical, and private laboratories. Catalog 20c. Dept. M-50, Biological Supply Co., 1176 Mt. Hope Ave., Rochester 20, N. Y.

ILLUSTRATED Catalog: Chemistry, mineralogy, biology 10c. Tracey Laboratories, Evanston, Illinois.

SPECTROSCOPE For quick chemical analysis \$3.00. Kutting Sons, Los Altos, Calif.

AGENTS WANTED

CHANCE To earn \$25 to \$50 daily, sell stores or door to door, sensational new item, no competition, nothing like it in America. Full time or sideline. Write for free information. Please don't write from California. State fully covered. The A.P. King Company, 1745 Jefferson, Napa, Calif.

BUY Wholesale thousands nationally advertised products at big discount. Sent free "The Wholesale Plan." American Buyers' Service, 629-R Linden, Buffalo, New York.

BE Your own boss! Free book "301 Unique, Successful Businesses" tells how. Start spare time, small capital, work home. Deumant Publications, 81-R Deumant, Kenmore 23, N. Y.

MAKE \$10 To \$15 in just 2 hours. New automatic license plate holders. Sells on sight to any car dealer. Change plates in just 5 seconds. Write for particulars. The Pace Co., Box 513, Topeka, Kansas.

DISTRIBUTORS. Men's, women's Plastikwear raincoats. Write Yale Clothing, Meriden, Conn.

STRANGE "Dry" window cleaner. Sells like wild. Replaces messy rags, liquids. Simply glide over glass. Samples sent on trial. Kristee 154, Akron, Ohio.

BEST Source for nylons. Fields Hosiery, 99-D Chauncy St., Boston, Mass.

SELL Harmar's French fried popcorn to stores and taverns. Fast repeater. Harmar Products Co., Hammondsport, N. Y.

PRINTING—Stationery, envelopes, cards, labels. Free catalog, samples. Sutton Printing, Box 853-W, Waycross, Georgia.

VITAMINS! Big easy profits. Sales plan free. Exclusive state franchises available. Each tablet contains 35 ingredients. \$3 thirty day supply \$1.50. VimVite, 2910PM Beverly, Los Angeles 4, California.

FAST Selling novelties. Write Jay Sales, 5621 N. Clark, Chicago, Ill.

ABSOLUTELY Free—Sales kit. Sell personal initialed buckles with belts, cap badges, tie clasps, etc. Choose from 3000 emblems. Hook-Fast, Box 1425PM, Providence, R. I.

BIG Profits selling new sensational cellulose Handi-Kleeners. Retail \$1.19. Free information. Fields, #310 Railway Exchange, Kansas City, Missouri.

YOUR Photo on stamps! 300% profit. No investment. Free samples, details! Special offer! Send photo (returned unharmed) and 65c for sheet of 100 photo-stamps. National Photostamp, 1418-M, 3 Ave., New York City.

SPARE-Time earnings as representative. No selling. Knight, 19217 Schoolcraft, Detroit, Mich.

INVEST 2c And make huge profits with costume jewelry. Perfect reproductions of \$500.00 items. Quick sellers. Ideal for Xmas. Year-round appeal. Write immediately for free catalogue. Fain's Wholesale Jewelers, 93 Nassau St., New York, N. Y.

BUY Wholesale. 25,000 items. Catalogue 25c. Matthews, 1472-B2 Broadway, New York City 36.

IMPORTED Colorful deluxe Scottish wool scarfs, stoles and squares. Lovely gifts. Winter necessities. Undersell competitors. Big commissions. Babrok Importers, Troy, N. Y.

1 CENT Each in quantity. Beautiful miniature toys. Terrific profits. Sell stores, mail order, homes. Send \$1.00 for 50 assorted samples. Money back guarantee. Morael Manufacturing Co., Box 115-M, Rockaway Park 94, New York.

NEW Plastic ties. (Ready tied 4-in-hand.) Unique, attractive, long lasting. Fast sellers anywhere. Send \$1.00 for sample or \$7.20 dozen. Leader Plastic Products, Capac 1, Michigan.

ATTENTION Jobbers, dealers, agents. We manufacture plastic aprons, table cloths, shower caps, car windshield protectors, etc. All types of soft plastic sold by the yard. Write for free catalogue. Lion Manufacturing Company, Dept. P-1244-5th St. N.E., Washington, D. C.

RESTORE TV picture tubes. Big "demand" profits. TV, 484 Massachusetts Ave., Buffalo, New York.

\$200 WEEKLY. New invention. Amazing 4-second Presto emergency tire chains, fit all modern auto wheels. National advertising building big demand. 3 sales daily to oil stations, dealers, etc., make \$200 or more weekly. Territory going fast. Write Presto Chain Co., Dept. P-16, Des Moines 2, Iowa.

"FOG-Stop" windshield cloth. Instantly removes blurry mist, frost, sleet, snow. Stops windshield fogging. Samples sent on trial. Kristee 153, Akron, Ohio.

MAKE Money at home or in field sales, full or spare time. Sell subscriptions to leading magazines. Liberal commissions. Big Xmas season profits. Supplies furnished. Write Paramount Reading Club, 512 Palace Bldg., Minneapolis 1, Minn.

YOUR Own business—Used suits \$1.50, overcoats 65c, mackinaws 35c, shoes 12 1/2c, ladies coats 30c, dresses 15c. Enormous profits. Catalog free. Moro, 558-AA Roosevelt, Chicago 7.

EARN \$100 Weekly spare time! 350 new plastic items for party demonstrators, canvassers! No experience needed. Free catalog! Write "Plastics," Roosevelt 6, N. Y.

SELL Big money maker to men and women. Easy handwork makes fast-selling useful articles. Sample free. Sunmade Company, Brockton 64, Mass.

BIG Profits selling ties. \$2.00 values, \$6.50 dozen. Free catalog. Empire Cravats, 648 Broadway, New York 12.

TAKE Large unit orders for wool uniforms, caps, shirts, ties, wallets, personal initialed buckles with belts, cap badges, 3000 emblems. Send for free outfit now! Hook-Fast Co., Dept. PM, Roanoke, Va.

BE A money maker. Represent magazines year around. Wonderful home work. Big Christmas profits now. Liberal commissions. Everything furnished. Write for free catalog. McGregor Magazine Agency, Dept. 500A, Mount Morris, Ill.

SCHOOL Seniors—Earn sensational profits selling classmates America's most beautiful graduation name cards. Largest selection. Outsell all others. Free sample kit. Printcraft, Dept. M, 1509 Maple St., Scranton 5, Penna.

AGENTS—300% Profit selling genuine gold window letters; stores and offices. Free samples. Metallic Sign Letter Co., 431-D North Clark, Chicago.

GOLD Lacquered and silver sign letters. Windows, doors, trucks. Standard sizes. Penny and up samples. Atlas-P, 544 West 79th, Chicago 20.

MEXICAN Feather pictures. High profit! Fast sellers! Adelphi, Box 57-B, Belle-rose 6, N. Y.

\$50 WEEKLY Selling finest razor blades, other items. Free details. Edisans, Box 274, Far Rockaway, N. Y.

CALIFORNIA Sweet smelling beads. Sensational sellers. Free particulars. Mission, 2328PM West Pico, Los Angeles 6, Calif.

EXCELLENT Sideline for printing and advertising salesmen. Decalcomania name plates in small quantities. Great demand. Also, make money with our line of automobile initials and sign letters. Free samples. "Ralco" XL-Roxbury, Boston 19, Mass.

AGENTS: Stamping names on key protectors. Sample 25c. Stamping outfits, checks, social security and name plates. Hart Mfg. Co., 303 Degraw St., Brooklyn, N. Y.

SALESMEN, Distributors, fast selling costume jewelry direct from factory. Big picture catalog, free. Pickcraft, M19 Bank, Attleboro, Massachusetts.

MEXICAN Feather pictures. Sell on sight; 200% profit! Free details. Sample 20c stamps. (No coins.) Sylviap, Apartado 9036, Mexico City.

BUY Wholesale—Catalog appliances, jewelry, etc. E. C. Ellison, 409 Hazel Street, Warren, Penna.

FREE Wholesale catalog—Costume jewelry, watches, premiums, giftware. Very low prices. S. Canterman, Oglethorpe St., Pittsburgh 1, Penna.

SENSATIONAL Gamebird ashtray set terrific seller! Dollar brings sample, wholesale catalog. Lovan, Box 694-FW, Canton, Ohio.

PRINTING, Salesbooks, envelopes. Free illustrated catalog. Ersko, Dept. PM, Bronx 72, New York.

SALESMEN—DISTRIBUTORS

MAN To earn \$500 month up. National company. Exclusive territory. Full or part time. Prospects everywhere. \$10 sale earns you \$6. Write Superior Products Inc., Dept. 108, 3410 Main St., Kansas City, Mo.

ADVERTISING Book matches—Cash in on big demand; sell union label matches. Cuts for all businesses and political parties. Free powerhouse selling kit, low prices, protection guaranteed on repeat orders. Cash commissions. Superior Match Co., Dept. M-1252, 7530 Greenwood, Chicago.

SELL Better nutrition to families with inadequate vitamin and mineral diets and become financially independent. Send today for proof of earnings and free nutrition booklet. Vitmora Co., Dept. PM-12, 109 So. Adams Street, Glendale 5, Calif.

AD Matches! Sell amazing designs—20, 30, 40 and 240-light book matches. Bigger spot cash commissions; every business a prospect. Low prices for high quality. Repeats. Start without experience; men, women; full, part time. Buy nothing! Sales kit furnished. Match Corp., Dept. PM-36, Chicago 22, Illinois.

OPERATE "Escalator" mailorder system selling our products or any products. Fastest, most revolutionary mailorder system known. Write: Selbyco, Decalor 163, IN.

POSITIVELY Make \$50.00 a day and up selling brand new item going to every type of food and beverage store, factories, laboratories, hospitals, etc. Samples furnished. Utility Durawear, 53 West Jackson Blvd., Dept. PM-12, Chicago, Illinois.

NEW Jobs open in selling! Send name, address for five free issues of Opportunity Magazine's money-making guide, listing hundreds of companies who'll pay you well, full or part-time. No experience needed. Opportunity, 28 E. Jackson, Dept. 17, Chicago 4, Ill.

EDUCATIONAL AND INSTRUCTION

PIANO Tuning pays. Learn this profitable profession at home. Our Tunometer and mechanical aids make learning easy. No knowledge music necessary. Diploma granted. Largest and oldest school—55th year. G.I. approved. Write for booklet. Niles Bryant School, 78 Bryant Bldg., Washington 16, D. C.

COMPLETE Your high school at home in spare time with 55-year-old school. Texts furnished. No classes. Diploma. Information booklet free. American School, Dept. X945, Drexel at 58th, Chicago 37, Ill.

NEW Analytic, guaranteed method teaches algebra instantly. Send \$1. Ziem-bek, 6123 Orchard, Dearborn, Mich.

BOOKKEEPERS! Increase your earnings! Operate your own simplified "Dollar-A-Week" bookkeeping and tax service. Full or spare time. Details free. No obligation. Ellis, Box 200-N, Cedar Grove, North Carolina.

INCREDIBLE! Unprecedented! Look under "Miscellaneous!" Bijou, Box 1727-MZ, Hollywood 28, California.

HIGH School—No classes. Study at home. Spare time. Diploma awarded. Write for free catalog HF-27, Wayne School, 2527 N. Sheffield, Chicago 14, Ill.

WELDING Training pays at Hobart Welding School, Box M-1222, Troy, Ohio. VA contract. Best equipment. Catalog free.

WANT A diesel job? New opportunities to increase income. Higher pay. More money. We can help you qualify. Tools. Shop method home training. Write today! Diesel, Tractor, Heavy Equipment Division, Interstate Training Service, Dept. 3N, Portland 13, Oregon.

BOOKKEEPING—Complete self-check course with solutions only \$9.95. Consultation service with certified public accountant. Write for information, or send 50 cents for bookkeeping adaptability test including grading service. P. D. Lipscomb, 6609 Avondale Drive, Oklahoma City, Okla.

PREPARE For civil service examination, and you can pay for course after securing position. Write, Free School Department, Kokomo, Indiana.

BECOME Expert draftsman. Booklet free. Monroe Institute, PM-12, Alton, Ill.

ESTIMATING Building construction. Home study course. For full particulars write, Quantity-surveyor, 1016 Coolidge Drive, San Gabriel, California.

SMASH That worry habit with new "Human Behavior Control" plan. Users praise it. Request amazing free lecture today. No obligation. Personal Psychology, Inc., Box 1924-E, Louisville 1, Ky.

\$4 TO \$10 Hour spare-time in billion-dollar adjustment field. Qualify now! Write today. Universal Schools, M-63, Box 8202, Dallas 5, Texas.

FEET Hurt? Others do. Correct weak feet, and fallen arches. We teach the making of arch supports from individual impressions of feet and foot culture. This is a streamlined low priced course. Puts you in a business profession. Archoprac-tic Institute, Dept. A, Columbus Junction, Iowa.

3800 LATEST Used correspondence courses. Catalog \$1.00. Cartoonist \$3.95. EG, Elmsford, N. Y.

IT'S Fun learning a language by Lingua-Phone. At home, in leisure time, quickly, easily master Spanish, French, German, Russian, Japanese, Norwegian, Portuguese—29 languages by Linguaphone Conversational Method. Send for free book. Lingua-Phone Institute, 8312 Radio City, N. Y. 20.

PHOTOGRAPHY For pleasure or profit. Learn at home. Practical basic training. Long established school. Write for booklet. American School of Photography, 835 Diversey Parkway, Dept. 3437, Chicago 14, Illinois.

PREPARE For career in private investigation or public law enforcement work. Write for free Booklet "P." National Detective Academy, 257 South Spring St., Los Angeles 12, Calif.

HOME Study course, drugless therapy. Free literature. Institute of Drugless Therapy, Tama, Iowa.

MEDICAL Laboratory technicians in great demand. We train you in your own home. Catalogue free. Imperial Technical Institute, Box 973-J, Austin, Texas.

SECRET Investigation. Experience unnecessary. Investigators particulars free. George Wagner, M125 West 86th, New York 24.

INVESTIGATOR Training. Phillips Secret Service System, 1917-B North Kenneth, Chicago 39.

MIDLAND Linotype School, Charles City, Iowa. Civilian and Veteran Courses. Free placement. Established 1909.

USED Correspondence courses and books sold and rented. Money back guarantee. Catalog free. Courses bought. Lee Mountain, Pisgah, Alabama.

BE A real estate broker. Study at home or in classrooms in leading cities. Write for free book today. Weaver School of Real Estate, 304 Law Bldg., Kansas City, Mo.

FOR An extremely profitable lifetime business, operate a collection agency. Quickly learned. Write Cole Associates, Syracuse 2, N. Y.

OIL Coloring photographs can be a fascinating hobby or profitable sideline for those with artistic talent. Learn at home. Easy simplified method. Send for free booklet. National Photo Coloring School, 835 Diversey Parkway, Dept. 3448, Chicago 14, Illinois.

USED Correspondence courses and educational books bought, sold, rented, catalog free. Educational Exchange, Summerville, Ga.

PLAYS, STORIES, MANUSCRIPTS

I Want new writers to cash checks of \$1 to \$100 offered daily. The easiest way to write for pay. No previous experience necessary. Free details. Saunders M. Cummings, 6840 Odin St., Studio 11, Hollywood 28, Calif.

NO Luck finding a book publisher? Write for free Booklet PM. Vantage Press, 120 W. 31, New York.

BEGINNING Writers: Get \$1 to \$20 checks daily writing simple children's stories, articles, poetry in your sparetime. Experience unnecessary. Our instructions reveal how. Details free. W. Herman, 7016 Euclid, Cleveland 3, Ohio.

SPECIAL SERVICES

MINE Search perpetrated by former state geologist. Rare opportunity for land owners. Short search and preliminary report for mineral deposits at low rates. Only by appointment from 3 days to 1 month. A small mine discovery at this time can clear your financial problems. Prospecting & Geophysical Office, 38-14, 218th Street, Bayside, Long Island, New York.

SAVE Electrician's fees. Six different house circuits explained with simple easy to follow directions. Send \$2.00. Wiring Services, Box 445, Dept. 1, Roseville, Mich.

DON'T Know where to find merchandise you want? We do. 25c coin. Orr's Catalogue Service, Box 1575, Rapid City, South Dakota.

MEXICO Postmark. Letters, cards remailed 25c. 5-\$1.00. Francisco Madis, Montemorelos, N.L., Mexico.

LETTERS Remailed from any city, U.S.A., 25c; 6 for \$1.00. Tucson help-wanted columns, \$1.00. Belco, Box 3133, Tucson, Arizona.

BARROW, Alaska—Letters remailed from 350 miles north of Arctic Circle, on Arctic Ocean, northernmost post office on North American continent. Post mark. Top of the world, land of darkness and midnight sun. True Eskimo country. Colorful local scenery stamped on your mailing envelope. 50c or 3-\$1.00. Address your outside envelope: Air Mail, A. A. Nobles, Barrow, Alaska.

REMAILING From Chicago 25c. Other cities 75c. Personal and business address. C. Mack's Mailorder, 5656 N. Hermitage, Chicago.

YOU Need a Chicago office address. On your letter. Your mail, parcels, telegrams, received, forwarded. Faultless, P-677 Milwaukee Ave., Chicago 22.

LETTERS Mailed from New York, \$2 monthly. International Bureau, Box 157-GPO, New York City.

LETTERS Remailed 25c. Hobkirk, Box 1637, Wichita, Kansas.

BOSTON Letters remailed 25 cents coin. Also private receiving address. Replies forwarded. Monthly rates. Employment columns and business opportunities airmailed \$1.00. International Mailings, Box 144, Boston, Mass.

MIMEOGRAPHING—Manuscript typing—Samples. L. Sartin, Box 185, Galax, Va.

SANTA Claus postmark! Surprise friends! Your stamped, addressed Xmas cards remailed from Santa Claus, Ind. \$1.00 per doz. Howell, 1680 South Elliott, Evansville 13, Indiana.

LOS Angeles letters remailed 25c each; 6, \$1.00, month \$2.00. Los Angeles classified columns airmailed 75c. Sunland Studios, 1624½ Magnolia, Los Angeles.

CARTOONING, COMMERCIAL ART, SHOWCARD WRITING, SIGN PAINTING

"HOW To Make Money With Simple Cartoons." A book everyone who likes to draw should have. It is free; no obligation. Simply address Cartoonists' Exchange, Dept. 912-C, Pleasant Hill, Ohio.

WINDOW Display is interesting, profitable sideline. Easy with instructional kit. Write Larry Vandeman, Box 104, Hinsdale, Illinois.

GAG Writers, cartoonists needed. Beginners welcome. Cartoonists' Markets, LaHabra, Calif.

ARTISTIC Back dated art magazines. Eight \$1.00. Wonderful art courses and other bargains. Catalog 10c. Art Book Shop, Arnold 8, Missouri.

PAINT Signs for profit. Biggest complete course, with 324 illustrations, \$5 postpaid. Descriptive circular free. Matthews, 2325 Cass, St. Louis 6, Mo.

WHERE To sell cartoons, gags, by mail. Best-paying market lists, 35c airmailed. Byford, Dandridge, Tenn.

HOW To draw and sell cartoons. Write for free trial lesson! Kirk's Art Exchange, Dept. 12C, 2821 Idalia, El Paso, Texas.

LEARN Sign painting at home. Test lesson free. Ben Kerns, Box 812-P.M., Greenville, S. C.

CHALK Talks. Laugh producing program, \$1.00. Catalog 10c. Balda The Cartoonist, Oshkosh, Wisconsin.

CARTOONS Make money. Complete course plus selling helps, \$3. Cartoons, 3601 N. Meridian, #102, Indianapolis, Ind.

9 ALPHABET, 3 Numeral pattern sets and raised wood letter catalog, \$1.00. Sign Letter Distributors, P.O. Box 101, Mineola, N. Y.

ADVERTISING AGENCIES, LETTER WRITERS, FOR ADVERTISERS

MAILING Lists. Several classifications. Reasonable prices. Ralph Underhill, Beebe, Arkansas.

ATTENTION Swappers, traders, \$3.00 puts your 30 word ad in "The Texas Trader." Rio Hondo, Texas.

WANT Ads placed. Southern dailies list free. National Advertising Agency, 516 N. 21 St., Birmingham 3, Ala.

ADVERTISE: 24 Words, 100 Canadian newspapers \$5.50. Lists free. Advertising Bureau, 10511-C Springfield, Chicago 43.

ADS Placed in out of town newspapers and magazines. Low rates. Catalogue free. Ideas that pay. Baker Advertising Agency, Successors Ankrum Agency, 189 W. Madison, Chicago 2.

ADVERTISERS! Reach nearly 18,000,000 readers. 25 Sunday national key newspapers, 18 words, \$59.00. "Terrific pullers." 20 popular newspapers, \$11.50. Free booklet. Special—One inch display 2,-821,198 circulation, \$51.10. Newmark's Advertising Agency. (Established 1893), 217-7th Ave., New York 11.

MAILING Lists; \$5.00-1000 up. Write Dixie Service, King, N. C.

RUBBER STAMPS AND OFFICE SUPPLIES

RUBBER Stamps, any kind, style, size or quantity. Real money saving prices. Postal brings catalog. Postage refunded. Esco, 12 Print, 8 Holt, Dayton-7, Ohio.

10 BALLPOINT Pens \$1.00 postpaid. Cheaper than refills. Money back guarantee. Sorry no c.o.d.'s. Calpen Company, P.O. Box 3164, San Francisco 19, Calif.

2-45c; 3-65c; PAD 40c; Signature \$2.35. Stamp-Right, Wauwatosa, Wis.

RUBBER Stamps made. Free style list. Criterion, Box 2326, Denver 25, Colo.

LINE 25c; 2-45c; 3-65c. Stamp Works, Auburn, Nebraska.

SHIPPING Supply kit. Terrific buy. Smith's, 1040 South Westlake, Los Angeles 6.

TYPEWRITERS, DUPLICATORS, OFFICE DEVICES

MIMEOGRAPH Ink, \$1.00 pound; stencils, 12, \$1.35. Natmarch, 1975-AM, Little Rock, Ark.

RECONDITIONED Typewriters, printing devices, office machines, equipment. DixieGraph, King, N. Car.

BARGAINS In safes, filing cabinets, typewriters. Hamilton Safe Co., Beloit, Wisconsin.

PRINTING, MULTIGRAPHING, MIMEOGRAPHING GUMMED LABELS

100 LETTERHEADS, 100 Envelopes \$1.50 postpaid. Angel Gonzalez, 945 Fox Street, Bronx 59, N. Y.

FREE Samples. Business cards (raised letters), 10 styles, colors, lowest prices. Fast service. All-Trades, 304P Chestnut Street, West Hempstead, N. Y.

250 LETTERHEADS With matching envelopes \$3.25; immediate service; 500 beautiful raised printing business cards, \$2.95. Springman-King Co., Brownsville, Texas.

1000 EMBOSSSED Business cards, \$3.95 prepaid. Free samples. Earl Radaker, Anderson College, Anderson, Indiana.

100 8 1/2 x 11 LETTERHEADS, 100 Envelopes \$2.00. Benneville Printing, Box 1931, Pittsburgh 30, Penna.

TWO-Color 8 1/2 x 11 letterheads, 100 — \$1.50. Samples. D'Yarmett Printing, Newark, Ohio.

PRINTING—Lowest prices, free samples. Weeks, 342 Woodcrest, Nashville 11, Tenn.

125 8 1/2 x 11 LETTERHEADS And 125 envelopes \$2.00 postpaid. 24 hour service. Samples free. Catalpa Press, 5519 N. Clark, Chicago 14, Illinois.

1000 EMBOSSSED Business cards \$3.70. Ortiz, 1050 Fox Street, New York 59.

100 ENVELOPES. Printed 2-colors \$1.25. Box 523, Rochester 2, N. Y.

PHOTOGRAVINGS At about 1/2 price. Send for free price list. Billings, Box 4951, Los Angeles 1, Calif.

FINE Printing—Prompt service, prepaid. Wide selection of type styles, colors, etc. Cuts furnished. Samples-prices free. Wilcox, Nicholls, Georgia.

1000 BUSINESS Cards \$2.50 prepaid. Samples free. Reliable Print Shop, 905 E. Jefferson, Louisville 6, Ky.

MIMEOGRAPHING—Letters, pricelists, formulas, instructions. Lowest prices. Lem's Letter Shop, 5710 Stanton, Detroit 8.

125 8 1/2 x 11 LETTERHEADS And 125 6 3/4 envelopes \$2.00, postpaid, 250 of each \$3.50. Going Print Shop, Box 1544A, Muskogee, Oklahoma.

500 3 1/2 x 2 1/4 FOUR Line gummed stickers 50c. Red border \$1.00. Moritz Printery, Saginaw, Mich.

1000 QUALITY Business cards, \$4.00 postpaid. Felco, Box 1300, San Francisco.

NEED Printing? Request samples, prices. Gooch, 202PM, Hernando, Miss.

500 EACH Letterheads, envelopes—\$7.75. Wainright Printers, Toms River, N. J.

100 PRINTED Business envelopes or letterheads \$1.00. Salesbooks \$3.00. Broadbrook, Botsford, Conn.

PRINTING That pleases. Send copy for estimate. Samples, prices. Mercury Press, Box 69M, Marengo, Iowa.

PRINTING OUTFITS AND SUPPLIES

PRESSES, Type, cabinets, supplies. List for stamp. Lincoln Press Company, 220-N Hartwell, Fall River, Mass.

DO Your own printing. Save money. Simple rules. We supply everything. Print for others; good profit. Raised printing like engraving too. Have home shop. Details free. Kelsey Presses, V-11, Meriden, Connecticut.

PRESSES, Supplies, paper. Catalog 10c. Custom, Box 211-P, Springfield, Missouri.

MAKE Your own self-molding rubber printing cuts. Plexirubber, Argyle 1, Wis.

PRINTING Presses, type, supplies. Lists 3c. Turnbaugh Service, Loysville, Penna.

PATENT ATTORNEYS

INVENTORS—If you consider your invention to be something of importance, take steps to protect it with a United States Patent which gives you the right to exclude others from making, using and selling your invention as claimed. "Patent Protection for Inventors" outlines steps to take to secure patent protection. Mailed promptly without obligation. Victor J. Evans & Co., Merlin M. Evans, Registered Patent Attorney, 731-P Merlin Building, Washington 6, D. C.

FREDERICK A. Zoda—Registered Patent Attorney, 202-B Kellogg Building, Washington 4, D. C., offers services.

C. A. Snow & Co.—M427, Snow Building, Washington 1, D. C. Registered Patent Attorneys. Write for information.

INVENTORS—If you believe that you have an invention, you should find out how to protect it. The firm of McMorrow, Berman & Davidson is qualified to take the necessary steps for you. Send for copy of our patent booklet "How to Protect Your Invention" and "Invention Record" form. No obligation. McMorrow, Berman & Davidson, Registered Patent Attorneys, 1346 Victor Building, Washington 1, D. C.

INVENTORS: Learn how to protect your invention. Special booklet "Patent Guide for the Inventor" containing detailed information concerning patent protection and procedure together with "Record of Invention" form will be promptly forwarded to you upon request—without obligation. We are registered to practice before the U. S. Patent Office and prepared to serve you in the handling of your patent matters. Clarence A. O'Brien & Harvey Jacobson, Registered Patent Attorneys, 21B-K District National Building, Washington, D. C.

PATENTS. "Proof of Invention" free. E. E. Vrooman, Registered Patent Attorney, 507 McKim Building, Washington 5, D. C.

"INVENTOR'S Guide" free. Frank P. Ledermann, Registered Patent Attorney, 154 Nassau Street, New York.

REGISTERED Patent attorney offers services. Sanders, 6430 Evans, Chicago 37, Ill.

INVENTORS—For "Invention Record" form, contact Carl Miller, Registered Patent Attorney, Woolworth Building, New York.

INVENTORS: When you are satisfied that you have invented something of value write me, without obligation, for information as to what steps you should take to secure a patent. Write Patrick D. Beavers, Registered Patent Atty., 935 Columbian Bldg., Washington 1, D. C.

INVENTORS: Without obligation, write for information explaining the steps you should take to secure a patent. John N. Randolph, Registered Patent Attorney, 203 Columbian Bldg., Washington 1, D. C.

CANADA—Ramsay Company Registered, 273 Bank Street, Ottawa, Canada.

FOR INVENTORS

INVENTORS—If you believe that you have an invention, you should find out how to protect it. The firm of McMorrow, Berman & Davidson is qualified to take the necessary steps for you. Send for copy of our patent booklet "How to Protect Your Invention" and "Invention Record" form. No obligation. McMorrow, Berman & Davidson, Registered Patent Attorneys, 1346 Victor Building, Washington 1, D. C.

INVENTORS—If you have a valuable invention, you are advised to authorize a preliminary search through appropriate classes of United States patents. This firm is registered to practice before the Patent Office and is available to make such search and report to you concerning the probable patentability of your invention. Instructive booklet with "Evidence of Invention" form sent upon request. Victor J. Evans & Co., 732-P Merlin Building, Washington 6, D. C.

INVENTOR, Seeking sales distributor. We are looking for new item on exclusive national sales basis. Our sales organization now selling nation's leading jobbers, department stores, chains, mail order firms. We assume financial risk of carrying accounts, stock, and ship from our own warehouse. Strong financial and business references. Unusual success with new lines. Schneider-Lorscheider Company, Waukesha, Wisconsin.

INVENTORS—Send for free patent information book and inventor's record. Registered Patent Attorney. Associate Examiner, Patent Office 1922-29; Patent Attorney & Advisor, Navy Department 1930-47. Gustave Miller, 122A Warner Building, Washington 4, D. C.

PATENT Analyses and reports. Research and development. Arthur F. MacConochie, Mechanical Engineer, University Post Office Box 1362, Charlottesville, Virginia.

CASH For your idea, 280 manufacturers need inventions, patented or unpatented. List free. Invention Bureau, 208M Clinton, Oak Park, Ill.

"STRAIGHT Talk," how, where, what—Usable, copyrighted, idea to sale information. Eliminates loss, disappointment. \$2 postpaid. Satisfaction guaranteed. Inventor, Box 60, Doniphan, Missouri.

INVENTORS: Cash-in on your ideas and inventions. Join the National Inventors Institute, 4097 East 131st St., Cleveland 5, Ohio. Only \$5.00 per year. Write for your free copy of "Inventioneering."

INVENTORS! For "Copyright, Design & Patent Guide" contact Mr. Metzler, 11 West 42nd, New York 18.

PATENT Searches \$5.00. 48-hour service. Protection forms free. Write Raymond L. Smith, Patent Searcher, 622 Sheraton Building, Washington 5, D.C.

PATENT Searches \$5.00, including patent copies. Same careful, reliable searches conducted for patent attorneys. 48 hour airmail service. "Record of Invention" free. Competent experienced investigators. Capitol Patent Service, Box 664-P, Washington 4, D.C.

"INVENTOR'S Guide" free. Frank P. Ledermann, Registered Patent Attorney, 154 Nassau Street, New York.

PATENT Searches \$5.00. Protection forms free. Patent drawings prepared. Write Patent Engineering Service, 711 14th Street, N.W., Washington 5, D.C.

PATENT Searches \$5.00. 48-hour service. For free record of invention forms write Miss Ann Hastings, P. O. Box 176, Washington 4, D.C.

INVENTORS: Learn how to protect your invention. Special booklet "Patent Guide for the Inventor" containing detailed information concerning patent protection and procedure together with "Record of Invention" form will be promptly forwarded to you upon request—without obligation. We are registered to practice before the U. S. Patent Office and prepared to serve you in the handling of your patent matters. Clarence A. O'Brien & Harvey Jacobson, Registered Patent Attorneys, 21A-K District National Building, Washington, D. C.

INVENTORS: Without obligation, write for information explaining the steps you should take to secure a patent on your invention. John N. Randolph, Registered Patent Attorney, 202 Columbian Bldg., Washington 1, D. C.

SEARCHES—Put your patent searches in the hands of a registered patent attorney or agent, as he qualifies to give a worthwhile patentability report. Record of invention form upon request and information on patent protection. Patrick D. Beavers, Registered Patent Attorney, 936 Columbian Bldg., Washington 1, D. C.

INVENTORS — For "Invention Record" form, contact Carl Miller, Registered Patent Attorney, Woolworth Building, New York.

INVENTORS: If you have an invention for sale, patented or unpatented, write Institute of American Inventors, Dept. 40A, 631-E St. N.W., Washington 4, D. C.

PATENT Searches, \$5.00, including patent copies. Same reliable search as conducted for patent attorneys. Free protection forms. 48 hour service. Patent Service Institute, 945-A Pennsylvania Avenue, Washington 4, D. C.

INVENTIONS WANTED

INVENTORS—If you have a patent application pending in the patent office or if your patent has already been granted, we can help you market your invention through our nationwide contacts. Write today for complete information, free. Patent Promotion Company, Box 1225, Washington, D. C.

INVENTIONS Wanted, Patented; unpatented. Tremendous manufacturers lists. Global Marketing Service, 1404 Mitchell, Oakland 1, California.

INVENTIONS Wanted, Patented, pending only. Inventors Patent Exchange, Hartford 1, Conn.

CASH Buyers for ideas and inventions. Write National Inventors Institute, 4097 East 131st St., Cleveland 5, Ohio.

MARKETING Aid — Nation wide. Patented, patent pending. Booklet free. Market Contacts, 719-A2 Magnolia, Tupelo, Miss.

INVENTIONS Wanted, Patented or patent pending. 21 years experience promoting inventions. National Service Bureau, 3120 Meramec, St. Louis 18, Mo.

INVENTIONS Promoted. Patented or unpatented. Established 1911. Write Adam Fisher Company, 61 Enright, St. Louis, Mo.

INVENTORS: Hundreds of manufacturers have requested our assistance in locating marketable new products. Complete information free. Institute of American Inventors, Dept. 40-D, 631-E St. N.W., Washington 4, D. C.

PATENTS FOR SALE

FOR Sale—Patent No. 2484170. Lock for inside or outside micrometers. Harry Kenslake, Pomona Park, Fla.

INVENTORS: Test the commercial value of your patented or unpatented inventions, quickly and inexpensively. Write for free information. Institute of American Inventors, Dept. 40-B, 631-E St. N.W., Washington 4, D. C.

FREE, 2 Toy patents with purchase injection mold for manufacturing patented plastic toy. Reasonable offer accepted. Neilson, 313 West 47th Street, New York City.

MANUFACTURING

DESIGNERS, Manufacturing rubber, plastics, machine parts. Free estimate, immediate delivery. Harry Smith Specialties, Box 9378, Akron, Ohio.

MODELS — Small lot manufacturing. Metals, plastics, etc. Milburn, Burlington, Kentucky.

MODELS, MODEL SUPPLIES

FAMOUS Model catalogs: Ships, Fittings, Hints, 169 pgs. 50c; Worlds Tinplate Trains, 148 pgs. 50c; HO, O Trains—Manual, 140 pgs. 50c. Each includes 50c refund coupon. Also Collectors Soldiers 25c; Old Time Autos, 15c; 100 model projects, 10c. Polk's, Dept. M-22, 314 5th Ave., New York City 1.

POWER Models. Unusual steam, gasoline and traction engines. Metals, tools, accessories. Catalog 50c. Chas. Cole, Ventura, Calif.

BUILD Miniature homes with our accurately scaled materials. Send 25c for booklet and samples. Architectural Model Materials, Inc., Dept. M122, 4208 Armitage Avenue, Chicago 39.

LIONEL and American Flyer catalogs, 20c. Shannon's, 503 Franklin, Nutley, N. J.

STEAM Locomotives, 1½", 1", ¾", ½" ¼" scales. Castings, rail, steam fittings! Thorough drawings with instructions. Catalog 50c. Little Engines, Wilmington, California.

STOP! Before you buy electric trains, send for 4-color illustrated reference guide to Lionel and American Flyer trains and all available accessories. Packed with information, track-layout ideas, wiring diagrams. New! Different! Only 50c. Hobby House Inc., Dept. BZ, 800 Huron Road, Cleveland 15, Ohio.

WORLD'S Finest illustrated catalog-handbooks. Railroads 92 pages 35c. Airplanes, boats, crafts, hobbies, tools 60 pages 25c. No stamps. Print name. E and H Model Hobbies, Room 70, 130 W. Cheltenham Avenue, Philadelphia 44.

MINIATURE Gasoline, steam and locomotive engines; finished or rough castings. Catalogue 25c (50c if airmail). Far East Patternmakers Guild, Shinjuku Post Office Box 36, Tokyo, Japan.

SHIP Models—Most complete line in New England. Kits, fittings, plans, books, tools, engines, motors. Illustrated catalog 25c. James Bliss & Co., Inc., Dept. SM, 342 Atlantic Ave., Boston 10, Mass.

SHIP And yacht model fittings; blueprints. Send 25c for illustrated catalog No. 27—listing hundreds of items. A. J. Fisher, 1002-1 Etowah Ave., Royal Oak, Mich.

SHIP Models and yacht supplies complete. Large 64 page catalogue 30c. Bill Wild's, 510 East 11 St., New York City 9.

ILLUSTRATED Lionel catalog, 10c; American Flyer, 10c; H. O. gauge, 10c. Ben's PM Dept., 134 North Dearborn, Chicago 2.

HOME CRAFTSMEN

GLITTERBIRDS Easily made. Beautiful Christmas tree, table decorations. Literature free. Sample kit 25c. Miles Crafts, 3220-PM Fish Avenue, New York 69, N. Y.

FLORIDA Cypress. New adventure in lamp making. Particulars 25c. Craft-Mart, 316-A West Oakwood, Bucyrus, Ohio.

OUR Biggest leather and craft catalog yet! 1000's of items. Send 25c (refunded with first order). Russo Handicraft Supplies, Dept. 12C, 245 S. Spring, Los Angeles, California.

SWISS Music movements, finest make, lowest price. Ask for leaflet. Helax Company, 218 West 72 Street, New York.

LAMP Size cypress knee \$1.00. Cy Products, Ella Street, Lafayette, La.

JIGSAW Owners attention! Start earning money at home cutting out wooden novelties and souvenirs. Write H. Cook, Dept. A, 4407 S. Normal Ave., Chicago 9, Illinois.

LEATHERCRAFT For pleasure or profit. Make easy-to-assemble purses, belts, gloves, woolskin toys, 100 other items for gifts or to sell. Send 10c today for big catalog. Largest leathercraft stock in U. S. J. C. Larson Co., 820 S. Tripp, Dept. 2750, Chicago 24.

16 NEW Lawn chairs, 22 picnic tables, benches, trellises, etc. All 38 plans with necessary full size patterns, \$1.00. Mastercraft, 123M, 7041 Olcott, Chicago 31, Ill.

ENVY Of all. New, beautiful, simple, inner-locking magazine rack. Saw and assemble. No glue, nails, screws used. Modern or early American patterns. 50c each, 75c both. No stamps. Bud, Box 214, El Segundo, Calif.

NEW Engraving, carving pantograph attachment for hand motor tools, "Dupliscaler." Sample plastic engraving 25c. Desco Distributors, 6334-A Sepulveda, Van Nuys, Calif.

LEATHERCRAFT: Tanned deerskins. Season's first shooting. Full skins. Fawns \$2.95. Does \$3.95. Bucks \$4.95. ½ skins, ½ price. Worth triple. Limited supply. First come, first served. A. Frank, 45 Vesey, New York City 7.

93 "ORIGINAL Idea" jig saw patterns \$1.00. Professional drawing, quality printing. Full size shelves, toys, lawn ornaments, novelties. Walker Studio PM-12, 4343 Lindell, St. Louis 8, Mo.

89 FULL Size jig saw patterns of beautiful shelves, ornaments, toys, novelties. Plus "How, Where to Sell." Only \$1.00. Mastercraft, 124M, 7041 Olcott, Chicago 31, Illinois.

SHELLCRAFT—Quality supplies. Complete kit \$3.00. St. Petersburg Novelty, Box 56, St. Petersburg, Florida.

WHITTLE Kit—White pine jigsawed figure (buffalo, kitten, dog, horse, or bird). "Popular Mechanics Whittling Book" instructions. \$1.00. Additional figures, 75c. Featherfoot Industries, King St., Wabash, Indiana.

ATOMIC Saw. Fits ¼" drill motor. 6" blade cuts 2x4. Willard's, Canoga Park 13, Calif.

SAVE Dollars. Mahogany, maples, birch, walnut, oak. Free price list. Dart Sales, 3812 Atlantic Avenue, Brooklyn 24, N. Y.

KNOCKDOWN Cedar chests, Lumber and veneers. Free price list. Giles & Kendall Company, Huntsville, Ala.

90 ALL New, full size lawn ornament and novelty patterns, up to 20" high. Only \$1.00. Mastercraft, 122M, 7041 Olcott, Chicago 31, Illinois.

NO Cost for materials, make vases, jars, fishbowls, ashtrays from bottles now thrown away. Cut bottles where you want with the aid of electricity. Save money on plastic work by adding only plastic covers. Equipment costs only few dollars at local hardware stores. Send 25 cents for instructions. Edward A. Smith, 102 Monroe St., Brooklyn 16, N. Y.

FREE—Form furniture patterns. Corner shelves \$1.00. Twelve other articles \$2.00. Echoacres, Box 184, La Grange, Ill.

TRY Leathercraft. It's new. It's easy. It's educational. Make your own belts, billfolds, purses, hats, dresses, blouses, from durable low-priced leathers. Free catalog tells how. Tandy Leather, Box 397-C, Tulsa, Oklahoma.

WILD Animals! Ancient locomotives! Six-foot train! 34 quality jigsaw wall patterns. 50c! Pauls Plans, 2233A N. 35, Milwaukee 8, Wisconsin.

100 FULL Size jig saw patterns up to 20" high, only \$1.00. Pattern Service, Medway 9, Mass.

LEATHERCRAFTERS: Illustrated catalog of materials, tools, kits, 10c. Art Leather, 411 Joseph Ave., Rochester 5, New York.

AMAZING New and sensational offer. Make costume jewelry at home from natural marine and botanical life: orange blossoms, pansies, starfish, etc. Free information. Write Jewelry by Julium, Box 460, Ft. Lauderdale, Fla.

LEATHERCRAFT, Copper tooling, textile painting, beadcraft, shellcraft. Many other crafts. Big free catalog shows everything you need. Kit Kraft, 7373 Melrose, Hollywood 46, California.

TOOLING Copper, flock, finishes, free instructions. Bestcraft, Dept. M, 949 Kenwood Ave., Inglewood, Calif.

FREE Seashell catalog. Shellcraft instruction book 35c. "Secors," Bradenton Beach, Fla.

FREE Blueprint Catalog! Hundreds of projects—Motor scooter, furniture, toys, birdhouses, radios, garden furniture, power tools, boats, work benches, home freezer, many more! Send postcard to Popular Mechanics Press, Dept. 103, 200 E. Ontario, Chicago 11, Ill.

VIOLIN Makers, amateurs, professionals. Fine tone European wood. Supplies. Tools. Patterns. Instructions. Illustrated catalogue 10c. Refunded. Premier Violin Supplies, Dept. VZ, 430 South Broadway, Los Angeles 13, California.

STENCILS, 15 Assorted for textiles, furniture, etc., \$1.00. Catalog 300 designs 25c, refundable first order. Marion Specialties, Box 141, Halesite, N. Y.

LEATHERCRAFT—New stylecraft folder free. New kits illustrated. Filigree belts, billfolds, purses, etc. Send 25c new catalog. Refunded first order. Apache Leather Co., 2804 East Washington St., Phoenix, Arizona.

MINIATURE Furniture kits. Colonial reproductions. Solid cherry. Catalog 20c. Culver Miniatures, 194 61st St., Dept. A, Niagara Falls, N. Y.

30 LAWN Ornament patterns. Ready cut. Full size. Color indicated. \$1.00 postpaid. Lincoln Craft Studio, Columbia, Conn.

LEATHERCRAFT, Tremendous stock of leather, tools, supplies, and kits. In leather business over forty years. Send 10c for big catalog. Sax Bros., 1111 No. 3rd, Dept. PM, Milwaukee 3, Wisconsin.

FREE Information. How to make money with jig saw. Write Jigsawers, 117-M Worth, New York 13.

"TOPS" In everything for leathercraft. Low priced kits, leathers, tools, lacing. Catalog 10c. Crown Leathers, 22 Spruce Street, New York 38.

LEATHER, Tools, lacings, supplies. Free catalog. National Handicraft, 199 William St., New York 7.

NEW! "100 Best Woodworking Projects"—144 page Popular Mechanics book with 100 special projects for every member of the family. Furniture, toys, novelties, many more. Send \$2.00 to Popular Mechanics Press, Dept. 105, 200 E. Ontario, Chicago 11, Ill.

PERSONALIZE—Decorate glassware. Etch designs and monograms easily and safely in three minutes with Etchall. Send \$1.00 for trial kit. Etchall, Inc., Columbia 4, Missouri.

BEAUTIFUL Large illustrated catalog of leathercraft supplies for the craftsman. Send 25c coin or stamps (refunded with first order). Nicewarner Leather Co., Craft Division, Dept. M1, 14-16 E. Chestnut St., Columbus 15, Ohio.

REFINISH Your own furniture. \$1.00. Krafters, Box 86, Hubbard, Ohio.

WATER Softener builders. Tanks, zeolite, tops, yokes. McCarthy Company, 2930 W. Burleigh St., Milwaukee, Wis.

SAVE Thousands of dollars. Build your own home. Book and plans for Popular Mechanics Ranch-Type House ready now! Six rooms and carport for \$5000; add breezeway, garage, extra bedroom \$2500. No experience needed. Book shows you how. Get copy today. Step-by-step instructions, hundreds of photos, drawings. Mail \$3.50 to Popular Mechanics Press, Dept. 101, 200 E. Ontario, Chicago 11, Ill.

MAKE IT YOURSELF

BUILD Drill machine, motor mounting, printing press, etc. Particulars free. Hamilton, 2301 Hill, Alexandria, Louisiana.

FIRE Film Christmas decorating kit. 4 different colors, red, green, blue, orange. Activating blacklight plus instruction manual. \$4.95 postpaid. Nucleon, 2046 Lindy, St. Paul, Minnesota.

WATER Your lawn or irrigate your farm automatically. Go on vacation. Waters every day and also skips days. Turns itself on and off. Simple kit picture and easy to get part list \$1.00. Refundable. Watering Kits, 113 N. 21 St., Montebello, Calif.

PLANS—Enlarger, print dryer, foot-switch. \$1.00 ea., 3 for \$2.00. GF, Box 186, Mt. Prospect, Ill.

BUILD Your own machinery. Handbook describing plans filled with workshop "tips" 25c (refundable). Satisfaction guaranteed. Kimo, Box 307-P, New York 19.

GRANDFATHER Clock easily built. Big savings. See ad on page 239.

STREAMLINED, Built-in kitchen cabinets fit any kitchen. Illustrated manual describes designing and construction. All for \$1.00. Thornbert Company, Newton, Iowa.

BUILD With concrete, fieldstone, earth. Movable form system cuts costs. Construction simplified. Free literature. Smith, PM, Box 36, Eagle Creek, Oregon.

BUILD Inexpensive concrete blockmaker. Motor, hand. Write: C. Lee, Mountain View, Oklahoma.

FREE Handbook. Build sawmills, block machines, freezers, tractors, scooters. Nichols Company, Purvis 2, Miss.

MAKE Your own "Stone-Veneer." Economical. Easily made, quickly applied. Looks like genuine stone. Transforms any home into one of excellent beauty. Formulas, illustrations, patterns. Alburg, Box 17, Carrollton, Mich.

SEND 25c Today for new large catalogue of supplies for 21 popular crafts. Dept. D-11, Dearborn Leather Company, 8625 Linwood Avenue, Detroit 6, Michigan.

BUILD Your own "tractor." Free information. Eltraco, D-I, Camptonville, California.

100% IMPROVED Floor furnace performance. Plans \$1.00. Ostrom, 608 30th, Richmond 2, Calif.

300 PROJECTS You can make—In Popular Mechanics 32-page Blueprint catalog. Send 3c stamp for copy. Popular Mechanics Press, Dept. 106, 200 East Ontario St., Chicago 11, Ill.

HOMES You can build for \$4500 to \$7046. Books that take you through every step. Popular Mechanics Famous Concrete Block House, \$2.00. Your Home and How to Build It Yourself, \$3.00. Ranch Type House You Can Build, \$3.50. Also full-sized builder's plans for each home at nominal price. Popular Mechanics Press, Dept. 102, 200 E. Ontario, Chicago 11, Ill.

WATCHES, OLD GOLD, JEWELRY

WATCHMAKING—Learn. Material, instructions for start and wholesale precision tool supply catalog, all \$1.50. Refund not satisfactory. Stewart's, 727 Market, St. Louis 1, Mo.

WATCHMAKERS—Jewelers' complete informative catalogue 20c. Bengale Company, Culver City, California.

EXTRA Money for you between now and Christmas. Make smart looking jewelry that sells fast. We supply rhinestones, jewelry settings, cameos, sequins, beads. Send 10c for illustrated catalog. J & M Novelties, Dept. CP-3, Griffith, Indiana.

7 JEWEL Watch at bargain price. 5 year guarantee. \$6.95 plus 10% tax. Send to: Lake Products, Dept. E, 149 Broadway, New York, N. Y.

GRANDFATHER Clock movements, Swiss musical units. Clockmaker's, cabinetmaker's inquiries invited. Pierlot, 1010 South Fir, Inglewood 1, California.

10 HIGH-Grade Swiss ladies' and gents' wristwatches needing minor repairs. \$18.00. Write for prices. B. Lowe, Holland Bldg., St. Louis 1, Mo.

WATCHMAKERS' Journal contains instructive articles for watchmakers and beginners. \$1.00 year. Sample copy 20c. Dean Co., Box 3218, Daytona Beach, Fla.

HEIRLOOM Cuckoo clocks repaired. Beach's Clock Clinic, 205 S.E. 16th, Portland 14, Ore.

NEW Bulova watches. Free illustrations. Buy now for Christmas. Save. Fast Jewelry, Dinuba, Calif.

JEWELRY Making can be a profitable hobby—Send 20c for our latest illustrated catalog. Milady-Fair Co., G.P.O. Box 1328, New York City.

HIGHEST Cash paid for old, broken jewelry, gold teeth, watches, silverware, diamonds, spectacles, platinum. Free information. Satisfaction guaranteed. Rose Smelting Company, 29-A East Madison, Chicago.

OLD Gold wanted. Highest prices paid on old or broken watches, diamonds, spectacle frames, dental gold and platinum. Cash by return mail. Information free on request. Alamo Watch Company, Second Floor, Melrose Building, Houston 2, Texas.

UNREDEEMED Diamond, 1-carat, \$295. 30-day refund. Free catalog. Broff's Diamond Loan Association, 411 Smithfield, Pittsburgh, Penna.

5000 JEWELRY Styles, you can easily make yourself—Pins, earrings, bracelets, rings, matched ensembles. Instructions and catalog 10c. Barrys, 124 Ardsley Court, Newark, N. J.

WATCHMAKERS! Beginners! Watches; movements. Descriptive list. Box 150, Chicago 90, Ill.

TOBACCO, SMOKERS' SUPPLIES

100 CIGARS, \$4.75 postpaid. Packed 25 in vacuum tin, all Havana filler, money-back guarantee. Others. Ace Mail Order Co., East Orange 1, N. J.

FOR THE HOME

"TERMITES And Their Control." Treat them yourself and save hundreds of dollars. Send \$1.00 for booklet. Money back guarantee. J. R. Wynne & Co., 426 Transportation Bldg., Cincinnati 2, Ohio.

OF INTEREST TO WOMEN

POULTRY Carving shears, 10 1/2", superior quality, shiny chrome, serrated keen-cutting blade, bone cutter, safety lock, staghorn handle, superb gift, \$4.95 (value \$8.95), refund guarantee. Also: toe and fingernail nippers, 5 inches, chromed steel, \$2 (value \$4.25). National Traders Ltd., 6411 Hollywood Blvd., Hollywood 28, Calif.

FOR SALE—MISCELLANEOUS

RAZOR Blades, 100 for \$1.00. Free samples. Box 167, Moorhead, Minnesota.

100 DOUBLE Edge razor blades, \$1.00 (bill). Good quality, Cohen, 141 Bristol St., Brooklyn 12, New York.

FREE Catalog on government surplus bargains from country's largest surplus organization specializing in outdoor, sporting goods, clothing, camping equipment. Tents, rubber boats, tarpaulins, hundreds of other items. Rockaway Sales Co., Route 6, Rockaway 7, New Jersey.

SAVE Money on army, navy and factory surplus. Write today for new 60-page illustrated catalog. Tennusa Sales Co., Dept. C, 1451 Market, Chattanooga, Tenn.

WANTED—MISCELLANEOUS

I Will pay half price for your good, uncancelled, current, U.S. "stuck" postage stamps—1c, 2c, 3c. Geo. T. Robinson, 1029 Madison Avenue, Daytona Beach, Florida.

SCRAP Mercury (quicksilver) containers supplied—Tantalum, bismuth, tungsten. Metallurgical Products Company. Established 1909, 35th and Moore Sts., Philadelphia 45, Penna.

WE Buy used plating equipment. Send description. Hollywood Bronze Supply, Dept. 22, 1624 East First Street, Los Angeles 33.

PERSONAL

BORROW By mail. Loans \$50 to \$600 to employed men and women. Easy, quick. Completely confidential. No endorsers. Repay in convenient monthly payments. Details free in plain envelope. Give occupation. State Finance Co., 323 Securities Bldg., Dept. U-14, Omaha 2, Nebr.

LETTERS Retailed 25c. Private receiving address \$2.00 month. McLaughlin, 369 Welch, Columbus 7, Ohio.

FLORIDA Letters retailed 25c. Employment columns, business opportunities St. Petersburg, Miami air-mailed \$1.00 each. W. Eastlake, 5808 Mangrove St. N., St. Petersburg, Florida.

LETTERS Retailed 25c. Help wanted and business opportunities columns \$1.00. Ask for rates private receiving address. Roy Berlin Co., 257 So. Spring St., Los Angeles 12, Calif.

BIBLE Reveals exact date of time of the end. Free. Write: Harvest, Jefferson City, Missouri.

BE The Popular Mechanics representative in your neighborhood and earn big profits in your spare time. Write Popular Mechanics Magazine, Room 408M, 200 E. Ontario St., Chicago, Ill.

LETTERS Remailed 25c. Also private residence receiving address available. Monthly rates. Shanks, Box 3110-D, San Francisco 19, California.

LETTERS Remailed from New York, 25c. Gleason, Box 25, New York 72, N. Y.

HERE'S How and where to borrow \$50.00 to \$300.00 by mail. Confidential. Free particulars. Postal Finance Company, Dept. 45, Sioux City, Iowa.

MEXICAN Law practice. Reliably conducted. Box 1736, El Paso, Texas.

ENDLESS Energy, "Secrets of Tiredness," \$1.00. Eidetic Foundation, Fairhope, Alabama.

"HOW Can I find out?" You can! Information confidentially developed. Any matter, person, problem. Worldwide. Officially licensed. Established 1922. William Herman, 170 Broadway, New York City.

LETTERS Reairmailed from Havana \$1. Jose Rabade, Apartado 3404, Havana, Cuba.

SKINNY? Amazing bodyweight gains possible! Proven method. Write Cambria, Box 26-N, Cambria Heights 11, N. Y.

MISCELLANEOUS

LEATHERCRAFT. Everything needed by beginners, advanced hobbyists and professional leatherworkers. Largest stock of supplies in U. S. Moderate-priced tooling leathers, top quality calfskins, tools, supplies, kits. Send 10c for big catalog. J. C. Larson Co., 820 S. Tripp, Dept. 2751, Chicago 24.

SURPRISE Gift. Only \$1.00 postpaid. Refund if not delighted. Wennerstrom, Box 69-B, Auburn, Mass.

DANDY Bird house. New, different. Details. The Yankee Doodle, Box 75-A, West Thornton, New Hampshire.

PERSONALIZED Cocktail mixers. Your name engraved on colorful plastics. 2 dozen \$1.00 postpaid. Hickey & Durham, 822 8th Ave., Flint, Mich.

MEDICAL "Scrapbook" reprints 190 thrilling news items on latest wonder drugs, cures, lifesaving knowledge! Free literature! Bijou, Box M8-1727, Hollywood 28, Calif.

I Buy, sell or trade anything of value. Over 10,000 items in stock. If not in stock, I can get it for you new or used. Joe's Trading Post, P.O. Box 378, Wooddale, Ill.

DID You ever need a screw, but did not know its size? Handy steel gauge automatically tells it. Ideal gift! Only \$2.00. Paas Research Laboratory, 13 Dogwood Road, West Orange, N. J.

PREVENT Check tampering. Protect your checks with Chekmate. Bank approved. \$2.95 ppd. Nina Skidmore, 121 Pine, Elizabethton, Tenn.

ROOTICATE Destroys root growth in drains and sewers. Very inexpensive and effective. Write for details. Electric Sewer Cleaning Co., Allston 34, Mass.

TRADING Saves. Send list of your trade items. Receive latest bargain packed swap bulletin. All for 25 cents. Print name, address. Traders Exchange, 714 American Bldg., Seattle 4, Wash.

LET'S Trade ties. Send yours with \$1.00. Receive others. Ernest Winings, Box 886-B, Trenton, N. J.

CHRISTMAS Ties, hand sewed only \$2 each, 3 for \$5. Ties, 705 Charlotte, Detroit, Mich.

SMASH That worry habit with new "Human Behavior Control" plan. Users praise it. Request amazing free lecture today. No obligation. Personal Psychology, Inc., Box 1924-M, Louisville 1, Kentucky.

CACTUS Candy, delicious, healthy, fresh, concentrated Arizona sunshine, shipped in sealed cans, \$1 per lb. National Traders Ltd., 6411 Hollywood Blvd., Hollywood 28, Calif.

300 BIG Mails guaranteed. Samples, plans, offers, propositions, 12 months listing, \$1.00 (refundable). Wright Publications, 2270 Hubbard, Memphis 8, Tenn.

EXPERIENCED Roof repairs. Franchise protection. Luster-Kote, 19417 Derby, Detroit, Michigan.

MAKE Your own tooth powder, shaving cream, hand lotion, shampoo, cold cream, etc. Eight formulas, easy instructions, \$1.00. Kem Industries, Box 1032, Stockton, Calif.

RECEIVE Mammoth mails, magazines, catalogs! Three months 25c. Two years \$1.00. Waddell's Directory, 341-B East 76th, New York 21.

CLEAN Brushes fast! Simple system 25c. coin. Wasson, Box 133, Wyncote, Penna.

OUTDOOR Toilets, cesspools, septic tanks cleaned, deodorized with amazing Paw Paw Odorless. Tried and proved effective by over 150,000 worldwide customers. Easy, safe, economical to use. Saves digging, pumping. Satisfaction guaranteed or money back. Postcard brings free details. Burson Laboratories, Dept. B-27, Chicago 22, Illinois.

RECEIVE Magazines, samples, catalogues. Mails from everywhere. Offers, hundreds. Get listed 25c. Rorick, Box 86, Cincinnati 26, Ohio.

FREE Blueprint Catalog! Hundreds of projects—motor scooter, furniture, toys, birdhouses, radios, garden furniture, power tools, boats, workbenches, home freezer, many more! Send postcard to Popular Mechanics Press, Dept. 103, 200 E. On-

STUDY Wildlife, game warden, fish, park, forestry and patrol service. Details free. Write Delmar Institute, D11, Whittier, Calif.

YOUR Leather jacket renovated expertly. Free circular. Berlew Mig. Co., Dept. 8, Freeport, N. Y.

LEATHER Jackets repaired. New knit, zippers or relined. Work fully guaranteed. Jackets made to order. Free circular. Taubers, 689 Mission, San Francisco 5, Calif.

GOLD, Silver, metal detectors. Geiger counters for uranium. Mineralights. Sensational new fully guaranteed models. None finer. Information free. Detectron Co., 5631 Cahuenga Blvd., North Hollywood, California.

TREASURE—M-Scope Geiger counters, mineral locators. Why buy something inferior when you can buy the best at a lower price? Backed by years of experience. Fully guaranteed by factory. Detects minerals, metals, gold, silver, coins. Payment plan available. Proven superior performance. Free 16 page illustrated booklet. Fisher Research Lab., Inc., Palo Alto, California.

MECHANICAL Train sets complete with tracks only \$4.95 postpaid. Free toy catalog. Write, Bedford Sales, 769 First St., Secaucus, N. J.

GENUINE Buckskin jackets, gloves, moccasins. Send 50c for buckskin pouch and illustrated catalogue. Berman Buckskin Co., Dept. 55, Minneapolis, Minn.

BOOKS Found! Any author, old or new. Rush titles wanted; no obligation. International Bookfinders, Box 3003-PM, Beverly Hills, California.

PANNING Gold lesson and catalogue. Beginners supplies, books, "maps where to go" free. Old Prospector, Box 729D1, Lodi, Calif.

TREASURE Finders for gold, silver and minerals. Money back guarantee, best available. Also Geiger counters for uranium prospectors, free information. Write Goldak Company, 1541 West Glenoaks, Glendale 1, Calif.

BEAUTIFUL Handmade ties, \$1.25 each or 3 for \$3.00. Laure Girard, Thompson St., East Haven, Conn.

SELECTIVE Metal and mineral detector. Revolutionary design. Distinguishes metals from black magnetic sands. Readily detects metals under salt water. Also Geiger counters and mineralights. Free literature. Gardiner Electronics Company, 2018 N. Dayton, Phoenix, Arizona.

HEARING Aid batteries, wholesale. Free list. HABS, Box 51, York, Penna.

FIX YOUR FORD *and SAVE*

Brand new handbook for owners and mechanics by Bill Toboldt, Editor, Motor Service Magazine. Covers all Ford V-8's and 6's, 1932 to 1952. Gives you the know-how of hundreds of Nation's top Ford service men. Includes repair and service short-cuts and kinks, tune-up specifications, how to increase gas and tire mileage, make car run better, last longer, worth more. Hot rods and speed-ups too. Simplified. Packed with pictures. If you drive a Ford you need this book. Clip this ad and mail with name, address and \$2.50. Money back in 5 days if you want it.

Goodheart-Willcox Co., Dept. 190, 1321 S. Michigan Ave., Chicago 5

GET UP TO 40% OFF!

BUY IT WHOLESALE!

START A BUYING SERVICE at home, spare time. Get big-name merchandise for clients (and yourself) at up to 40% and more below the regular list price. Make fat commissions. Folks eagerly buy through you to get sizeable discounts. Send postcard for details.

AMERICAN BUYERS' SERVICE, 631R Linden Ave., Buffalo 16, N. Y.

HE-MAN VOICE!

★ **STRENGTHEN** your voice this tested scientific way. Yes—you may now be able to improve the **POWER** of your speaking and singing voice . . . in the privacy of your own room! Self-training lessons, mostly silent. No music required.

FREE BOOK Write TODAY for Eugene Feuchtinger's great booklet "How to Develop a Successful Voice." It's absolutely FREE! You must state your age, mailed postpaid in plain wrapper. No sales man will call. Send your name and age **RIGHT NOW!** Perfect Voice Institute, 210 S. Clinton St., Studio MY-2, Chicago 6, Ill.



 **x-acto**®

HOBBY KNIVES and TOOLS

SEND 15¢ TO COVER POSTAGE FOR NEW ILLUSTRATED 28-pg. CATALOG

X-ACTO CRESCENT PRODUCTS CO. INC., 440 FOURTH AVE., N. Y. 16, N. Y.

GIVE! **A MILLION THRILLS!**

High Power BINOCULARS

30 DAY FREE TRIAL

Finest Precision Optics
Featherlight
Guaranteed Savings
Money Back Guarantee
Easy Pay Plan
Compare Before You Buy!
Dealer Name on Request.

FREE BOOK & COLOR CATALOG

BUSHNELL Binoculars Bushnell Bldg., Dept. M52
Pasadena 1, Calif.

33 Models \$9.95 UP

FREE BOOK AND COLOR CATALOG

NAME _____ CITY _____

ADDRESS _____ STATE _____

Free!

SPARE TIME!

Sensational! New HOME-BUSINESS!

PRINT WITHOUT A PRINTING PRESS!

OR ANY SPECIAL EQUIPMENT



WHAT IS SCREEN PRINTING?

It's a revolutionary new method of printing - WITHOUT an expensive printing press. This amazing new development lets you print 25, 50, 100, 500, or even 1,000 copies in many cases, FOR LESS THAN YOU CAN PRINT ON A \$5,000 PRINTING PRESS. Just put anything under a screen and take out beautiful products of printing—no expensive plates or "cuts" needed. No big overhead. Never has such an opportunity been offered the spare-time person who wants to make "Extra Income" in his home.

PRINT IN COLORS—EVEN NEW FLUORESCENTS

It's easy to print in luminescent, "glowing" fluorescent colors, too. Screen-Print lets you print on paper, cardboard, leather, glass, wood, plaster, fabrics—anything!

NO ART NECESSARY—EASY TO LEARN

Beautiful printing can be produced WITHOUT doing any art work.

A BUSINESS OF YOUR OWN

Be your own boss. Operate from the corner of your kitchen or garage. Build a successful future with a few cents worth of materials. Screen-Printing is the opportunity to establish a spare-time business without sacrificing job or pay check.

THERE'S \$\$\$ IN ADVERTISING!

Here's your chance to GET INTO ADVERTISING—one of the largest paying businesses in America. Most Screen-Printing is used for advertising purposes. Materials cost you 10%—you can earn 90%—few businesses offer this high profit.

HUGE DEMAND! ENORMOUS PROFITS!

Millions of shops, stores, theaters, markets - almost any business needs Screen-Printing done for them. Make \$10 to \$20 profit on each dollar of cost on some jobs. Here's...

YOUR "Chance of a Lifetime" OPPORTUNITY to "cash-in" on this new printing method not generally known. We supply everything you need! A complete ready-made BUSINESS PLAN guides you every step of the way. This all can be yours—at our risk. Don't waste a minute - mail coupon NOW! TODAY! - and get all the FREE FACTS and ACTUAL SAMPLE

AMAZING NEW PRINTING SECRETS CAN BE YOURS

For Pleasure & Profit. Once you learn the closely guarded printing secrets of Screen-Print there's virtually no limit to how much "extra money" you can earn. SPARE-TIME WORK—FULL-TIME PROFITS.



PRINT ADVERTISING DISPLAYS FOR STORES, GAS STATIONS, THEATRES, MARKETS—EVERYWHERE!



PRINT SIGNS, BANNERS, POSTERS, LABELS, ETC. FOR EVERY BUSINESS, LARGE OR SMALL



PRINT CLOTH, GEAR, WARE, NOVELTIES, LAMPS, CALENDARS, DRAPERIES, PAPER, ETC.

FREE

MY BOOKLET AND ACTUAL SAMPLE OF SCREEN-PRINTING. TELLS ALL THE FACTS ABOUT MY HOME-BUSINESS OPPORTUNITY PLAN.



FREE BOOKLET AND REAL SAMPLE MAIL TODAY!

SCREEN-PRINT CO., Dept. 2C
1010 So. Los Angeles Street Los Angeles 15, Calif.
Dear Mr. Nowak: Please rush me booklet, facts, sample and entire Home-Business Plan. All this is FREE. No salesman will call. I am under no obligation now or ever.

Name _____
Address _____
City _____ Zone _____ State _____

THE EASY WAY TO DRILL & SAW

Powerful Cummins #190 Electric DRILL & SAW KIT

Factory Guaranteed

Includes 1/4" Drill (1700 RPM, 115 V. AC-DC); 4" Saw Attachment (Adjustable); 1/4" Capacity Jacobs Chuck; 3 Steel Twist Drills; Horizontal steel drill stand, which converts drill into bench grinder, buffer, polisher, sander, etc. Attractively packaged. Instructions included.

Postage 50c additional. 30% sales tax in N.Y.C. Send check or M.O. COD's, \$5 deposit.

Only \$19.95
\$27.95 Value

DANDY FOR HOME & SHOP USE
10 day money back guarantee

GOLDEN ELK PRODUCTS CO.
12 East 41st St., N.Y.C. (17), HA 9-7810

Hand Guide!

OZMENT (INVENTOR), 34-P, ST. LOUIS, MO. (BX665)

GREAT PROFITS

MAKE YOUR OWN RUBBER MOLDS

X.L. RUBBER MOLDS
will realize your great profits quickly!
WRITE FOR NEW FREE CATALOG

YOU can EASILY learn to cast thousands of perfect plaques, book ends, figurines, ash trays, etc. IT'S EASY, FUN, PROFITABLE!
X.L. Rubber, Pts. \$2.50; Qts. \$4.00 (postage extra). Models and enough for 3 molds \$1.50 prepaid.

Address Dept. 2
3403 S. Madison St.
Muncie, Ind.

SEND FOR FREE FACTS

CARTOONING

HAVE FUN! MAKE MONEY! Cash in on your sense of humor AT HOME—BY MAIL. No experience needed to start. Write today FOR FREE TRIAL LESSON and full particulars.
Moon Gag Cartoon School, Dept. F, Fall Creek, Wis.

Become a MENTAL SUPERMAN OVERNIGHT!

Floor everybody! No studying! Revolutionary MEMO-PROP does all your thinking! It's uncanny! Unprecedented! FULL MONEY-BACK GUARANTEE! For FREE LITERATURE write: BIJOU HOLLYWOOD STUDIO, BOX 1727-M1, HOLLYWOOD 28, CALIFORNIA.

Learn TATTOOING At Home

Earn extra MONEY—Tattoo blood types and designs in your community. Splendid opportunity in every town. Prepare in spare time. Practical instructions. Send 25c for details and list of Tattoo Supplies. No obligations.
2815 SCHOOL OF TATTOOING • 728 Leslie, Rockford, Ill.

WELD YOUR WAY AHEAD!

Learn Arc and Gas Welding In Spare Time

Your opportunities are greater when you learn to use this great tool of modern industry. Training in welding opens the door to many key industries. Now you can train at home with UEI's practical course. Includes techniques, metallurgy, blueprints, shop practices, other important phases.



Write For FREE Facts! You can follow home-study training with actual shop practice. High school diploma not necessary. Write NOW!

UTILITIES ENGINEERING INSTITUTE
2523 Sheffield Ave., Dept. WC-1, Chicago 14, Ill.

**Shoot your own
TALKING PICTURES!**

...with the New "Cine-Voice"
16mm Sound-On-Film Camera.
\$695.00, money-back guarantee.



Write for free illustrated folder.

BERNDT-BACH, Inc. 7333 Beverly Blvd., Los Angeles 36, Calif.

16mm SOUND-ON-FILM EQUIPMENT SINCE 1931

1 **ROLL-O-KITE**

Amazing new spool-type kite that spins as it flies. Unusual performance. Quick and easy to assemble. Fun to fly. Requires no tail or other complicated adjustments. Light but durable. Flies up to 1/2 mile high.

COMPLETE kit in colorful gift package includes all ready-cut parts, flying string, instructions, plus hours of inspiring fun. Measures 18 x 7 in. Choices - red, blue or yellow.

ROLL-O-KITE CO.
LOMITA, CALIFORNIA
P.O. BOX 182 * DEPT. 20

POST PAID

Learn Modern Appliance and Electrical Servicing
Revolutionary New Method **YOUR SPARE TIME!**
shows you how—at home—in

We send you complete Home Training Kits and latest Engineered Test Equipment. You can actually earn **BIG MONEY WHILE LEARNING!** Many men are making \$2.50-\$3.00 and more **PER HOUR!** RUSH name and address for big **FREE** book and full details — **WRITE TODAY!**

ADVANCE TRADES INSTITUTE Dept. 401
5944 NO. NEWARK AVE. CHICAGO 31, ILL.

LOCKSMITHING & Key Making

PRACTICAL UP-TO-DATE COURSE—ONLY \$4.95

Easy-to-learn modern information for self-instruction. How to work on locks, de-code, make master-keys, repair, install, service, etc. For every handyman, home owner, carpenter, mechanic, service station operator, fix-it shop, hardware dealer, gunsmith, 53 plain illustrated lessons. **FULL PRICE ONLY \$4.95. SEND NO MONEY.** Easy terms. Write for **FREE BOOK** about this money making profession that is not affected by machine age.

Just pay postman plus C.O.D. postage. Or send \$4.95 with order, we'll ship postpaid. Satisfaction guaranteed or refund.

NELSON-HALL CO., 210 S. Clinton Ct., Dept. MY-2, Chicago 5, Ill.

Learn MECHANICAL DENTISTRY AT HOME!

To make Crowns, Plates, Bridgework, etc., for Dentists. Easy practical way to learn mechanical dentistry at home in spare time. **FULL EQUIPMENT OF TOOLS AND MATERIALS INCLUDED WITH COURSE.** Low tuition. Easy terms. Write for **FREE BOOK** about this money making profession that is not affected by machine age.

McCARRIE SCHOOL OF MECHANICAL DENTISTRY
207 N. Broad St., Dept. 10, Philadelphia 7, Pa.

When is wood glue really WATERPROOF?

ANSWER: when it meets Military Specification tests for gluing wood for marine use.

Cascophen is a resorcin resin—the only cold-setting glue that passes these tests and is nationally available in small packages!

Use Cascophen for permanent wood bonds on boats, outdoor furniture, fishing tackle, archery and other wood sports equipment. Write for free descriptive folders. The Borden Co., Chemical Div., Dept. PM122, 350 Madison Avenue, New York 17, N. Y.



IF IT'S *Borden's* IT'S GOT TO BE GOOD!

CHRONOGRAPH & CALENDAR **ONLY \$7.95 PLUS TAX**

The watch with the **"MECHANICAL BRAIN"**

ONLY \$7.95 PLUS TAX

Buy DIRECT from IMPORTER!

A truly thrilling gift for any man—the watch with the "Mechanical Brain" that gives accurate timing and is fun to use. **NEW, DIFFERENT, IMPRESSIVE!** It's a magnificent, precision-built watch, **PLUS** a **CHRONOGRAPH, TELEMETER, TACHOMETER** and a **CALENDAR** watch too!

- TIMES HORSE RACES
- TIMES AUTOS
- TIMES AIRPLANES
- TIMES SPORTS
- TIMES PHOTOGRAPHY
- TIMES WORK OPERATIONS
- TIMES LAB EXPERIMENTS
- TIMES PULSE BEATS

Also Measures **DISTANCES** covered by planes, cars, athletes, etc! Yes... all this and it's an **AUTOMATIC CALENDAR** too! The date pops up in the tiny window every day! Easy to operate with 2 push-buttons: One to start, another to stop watch. **Everyone** wants this super watch! Students, soldiers, aviators, sailors, race fans, sportsmen, photographers and all men of action!

SEND NO MONEY. Pay only **\$7.95** plus 80c tax & postage on delivery. This low price made possible because you buy direct from the importer. **5 Day Trial—money back guarantee.** Unlimited Service Guarantee Certificate, exclusive of parts. **FLEX-O-MATIC** Band & Gift Box included. Supply limited! Order now!

Thoresen's 140 Fifth Ave. Dept. 6-N-250 New York 11, N.Y.

GREER SHOP TRAINING
2230 So. Michigan Blvd. Chicago 16, Illinois

Leader in Practical Training for 50 Years

Gain success by learning a trade offering security and high pay—go into business for yourself.

Get the "Know-how" at Greer

You learn in our new, large, modern shops by working with latest tools and equipment of the trade — tear down, inspect, repair and rebuild... under supervision of experts. Greer founded 1902. Over 51,000 successful grads. Part time, full time, day and evening. E-Z terms. Mail coupon today.

CLIP COUPON . . . MAIL TODAY

Greer Shop Training—2230 South Michigan Chicago 16, Illinois Desk 213

Please send information about trade checked:

In our Chicago Shops:

- Body, fender Repair
- Diesel Mechanics
- Welding—Arc, gas
- Tool & Die
- Refrigeration & Air-conditioning
- Machine Shop
- Piano tuning

G.I. appr. for Vets dischgd. after 7-25-47

Or learn at home—extension courses:

- Diesel
- Refrigeration
- Plastics

Name _____
Address _____
City _____
State _____ Age _____



WATERPROOF RAIN SUIT
New Low Price \$3.98
One Piece Rainsuit

Lightweight & Durable. Elasticized Cuffs and Ankles. Full length Zippered Front. Will withstand all types of Weather for both MEN & WOMEN—For all sports & work outdoors. Will not crack, peel or mildew. Attached Hood with Drawstrings. Full Rain Protection Head to Toe.

FOLDS TO POCKET SIZE PACKAGE
• FISHERMEN • SCOUTS • GOLFERS
• CAMPERS • HUNTERS • HIKERS
Send only \$3.98 for each Rain Suit you order: Enclose Check or Money Order. Or sent C.O.D.

DILO SALES CO., Dept. RS-467, 480 Lex. Ave., N. Y.

PORTABLE GARAGE
\$6.75



VINYL PLASTIC USE IT ANYWHERE!
• Goes wherever your car goes • Folds compactly • Keeps rain, snow, dust, salt air, sun or sleet away • Protects your car's finish • Durably constructed of vinyl plastic that is long wearing and tough • Nylon threads for extra security • Spring-tite, elasticized bottom, holds securely in all kinds of weather • Fits all makes and models • Direct from manufacturer • Enclose check or money order for \$6.75, or sent C.O.D.

10-DAY MONEY BACK GUARANTEE
MARDO SALES CORP.
480 LEXINGTON AVE., DEPT. G-467, NEW YORK 17, N. Y.

Famous 15 and 17 Jewel BULOVA WATCHES \$16.95 PLUS TAX
PRACTICALLY WHOLESALE TO YOU



UNLIMITED WRITTEN GUARANTEE

Were Up to **\$59.50** ALSO CHOICE OF
SAVE \$42.55 • BENRUS • GRUEN
• WALTHAM OR
• ELGIN WATCHES

You get these unredeemed UNLIMITED guaranteed Bulova and other movements in latest style Yellow Gold Cases at this sensationally low price because we bought out SURPLUS STOCKS of leading New York and Md. jewelers. Order now while they last. Specify make preferred and whether men's or ladies'! Only \$16.95, plus \$1.70 tax. Order right now.

FREE TRIAL OFFER! WEAR AT OUR RISK!
Money back guarantee in 10 days if not delighted!

SEND ONLY \$1 with order. Pay balance C.O.D. plus postage. Or we pay postage if you enclose \$16.95 plus \$1.70 tax.

UNLIMITED Guaranteed—17 Jewel Swiss
WRIST WATCH
Worn by Army, Navy & Marines
Originally \$59 Plus \$1.50 TAX
\$14.95
New Incablock, Shock-Protected
WATER-DUST PROOF

FREE! Handsome Expansion band with orders. AIRMAIL XMAS DELIVERY GUARANTEED.
MARYLAND DISTRIBUTORS, Dept. 418
561 E. BALTIMORE ST., BALTIMORE 2, MD.
Write for Free Watch and Diamond Ring Catalog — Practically Wholesale Prices.

High School at Home

Many Finish in 2 Years

No classes. No time wasted going to and from school. Progress as fast as your time and abilities permit. Standard H. S. texts supplied. Thousands enroll each year in this 55-year-old school. Send for FREE descriptive booklet.

AMERICAN SCHOOL, Dept. H945
Drexel at 58th St., Chicago 37, Ill.
Without obligation, please send FREE descriptive booklet.

Name _____
Address _____

MAKE MONEY 90 WAYS IN PHOTOGRAPHY



EARN WHILE YOU LEARN AT HOME
Famous low-cost LEARN-BY-DOING method and INDIVIDUAL attention trains you quickly at home—for profitable, action-packed career, or steady, spare-time income. Big FREE book gives full facts on more than 90 money-making opportunities in photography. Our 43rd year. Write TODAY! Also Resident Courses. Approved for Veterans.

New York Institute of Photography
DEPT. 49, 10 WEST 33 ST. NEW YORK 1, N. Y.

SEND FOR FREE BOOK

REPAIR YOUR TELEVISION SET WITH EASE AND MAKE MONEY IN YOUR LOCALITY
We Guarantee To Show You In Minutes Without Experience . . . We Show You How to quickly locate and change all defective tubes with complete safety in your set and other sets. How to repair 90% of troubles. . . . SEND ONLY \$1.00 ANTEE
ANDERSON TV SHOP, 5146 No. Broadway, Dept. P., CHICAGO 40

BE YOUR OWN BOSS!

EARN UP TO \$200 WEEKLY
Work home! Start in your spare time. Only small capital needed. Book "301 Unique, Successful Businesses" gives all details. Send postcard for your FREE copy today.
DEUMANT PUBLICATIONS, 81-PM Deumant, Kenmore, N. Y.

RADIO Engineering. All phases radio & electronics theory & practice; television; FM; broadcasting; servicing; aviation, marine & police radio. Prepare for high pay; 18-month course. Graduates in demand by major companies. Enter Jan., March, June, Sept. Regular campus life. Write for catalog.
VALPARAISO TECHNICAL INSTITUTE, Dept. D, Valparaiso, Ind.

SENSATIONAL NEW PRODUCT

PREVENTS RUST IN: • AUTO RADIATORS • FURNACE HUMIDIFIERS
RUST BAR
Nature's own method of preventing rust now discovered by man. A small, magic metal 3 inch bar that absorbs rust-making gases. Rust destroys—RUSTBAR keeps destructive rust out! Send only \$1.00 for a RUSTBAR, postpaid, today!

GENERAL ENGINEERING CO., Box 205, Cinti. (24) Ohio

Become a Doctor of PSYCHOLOGY

Win the degree of Ps.D. Learn the secret of contentment, happiness. Solve mental worries. Experience the revelation of truth. Chartered college. Individual help. Write for FREE book. **COLLEGE OF UNIVERSAL TRUTH, 5153-B North Clark St., Chicago.**

Say You Saw It in POPULAR MECHANICS



OVERHAUL YOUR MOTOR in 10 minutes

STOP BURNING OIL, STOP PISTON SLAP
15,000 Mile Performance Guarantee!
1st Step — CLEANSE WITH "MOTOR PURGE"—In the FIRST step of the famous Motor Renew Kit treatment, the "Purge" formula cleans, quiets and frees rings, valves and pistons from efficiency and power robbing carbon, gums and varnish. Pour this miracle solvent into the cylinders, run your motor and watch the combustion residue billow out of your exhaust pipe.
2nd Step—RENEW WITH "COMPRESSION SEAL"—RESTORE COMPRESSION . . . GET NEW POWER, SPEED AND ECONOMY with "Compression Seal"! As the SECOND step of the Renew treatment, squeeze this self expanding mineral compound into your cylinder where it can fill worn spots (which cause compression leaks) between cylinder walls and pistons. Thus it restores compression . . . cuts oil-gas waste and eliminates costly engine overhaul and ring jobs.
100% MONEY BACK GUARANTEE!
Free Auto Manual with each order. Kit treats all cars and trucks. \$6.95 Postpaid (or send \$1 deposit, bal. C.O.D.)
CONSOLIDATED ENGINEERING, Dept. PMK-12
10407 W. Washington Blvd., Culver City, Calif.



Gay Christmas Earrings—Surprise her with this wonderful stocking stuffer. Bubbles of holiday excitement—earrings as gay and gala as New Year's Eve! Wee Christmas balls, gayer than the tree itself, to dangle 'bout her head. And to make it an extra merry holiday, ear-ring your guests, too. Glittering bright in red, green, gold, aqua. Pair \$1.00—2 pairs for \$1.75, tax included and postpaid. Check or money order only. No c.o.d.'s. World Ideas, Dept. Q-1, 21-20 33rd Ave., Long Island City 6, N. Y.

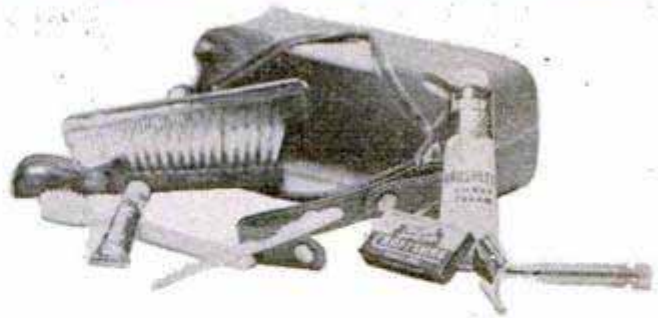

Carry-Kit—Ours (and yours) exclusively in top grain cowhide. Compact, completely equipped: Hair brush, comb, razor, blades, brushless shave cream, nail file, tooth brush, toothpaste. Fully lined. Perfect gift. Made to last a lifetime. You don't need a size to fit the guy who's lucky enough to get it. \$6.95 ppd. The Rowland Brandwein Co., Dept. 12-PM-2, 143 E. 35 St., New York 16, N. Y.



Books for the Craftsman—With designs by furniture stylist John Bergen, 100 Beautiful Pieces of Furniture You Can Build tells how to build furniture for the home at big savings. Price \$3.00. Power Tools and How to Use Them, a guide to selection and operation of homeshop tools. Price \$2.50. Popular Mechanics Press, 200 E. Ontario St., Chicago 11, Ill.



Corkeroo Pipe—Lighter, sweeter smoking than a corn cob! Big genuine cork bowl is lined with "Meeracle," a material like costly meerschaum. Bamboo stem, with hard-rubber mouthpiece. Never burns out—lasts a lifetime. Weighs less than an ounce. Send check or money order, no C.O.D.'s. 3 for \$1.15 ppd. Bell Industries, Dept. M-12, 21 East 22nd St., New York 10, New York.



Orchids Anyone Can Grow—You can easily grow exquisite "Butterfly Orchids" anywhere indoors. From Spring through Summer they'll bear as many as 200 exotically fragrant miniature white orchids with purple throats. Crown of 10 or more bulbs is mounted on highly decorative oak slab, ready to hang or set anywhere. Fun to grow, and a delight to give or to own. Simple growing instructions are provided. Only \$2.00 ppd. Max Schling Seedsmen, 614P Madison Ave., New York 22, N. Y.

Orchids Anyone Can Grow—You can easily grow exquisite "Butterfly Orchids" anywhere indoors. From Spring through Summer they'll bear as many as 200 exotically fragrant miniature white orchids with purple throats. Crown of 10 or more bulbs is mounted on highly decorative oak slab, ready to hang or set anywhere. Fun to grow, and a delight to give or to own. Simple growing instructions are provided. Only \$2.00 ppd. Max Schling Seedsmen, 614P Madison Ave., New York 22, N. Y.

Americana—Portfolios of full color prints of Early American locomotives, fire engines, automobiles, carriages, 6"x8". Eight diff. prints to each attractively packaged gift portfolio. Ideal for framing, mounting on lampshades, baskets, etc. \$1.50 ea. Special, all 4 sets \$5 ppd. Croyden Co., 516 5th Ave., New York 36, N. Y.

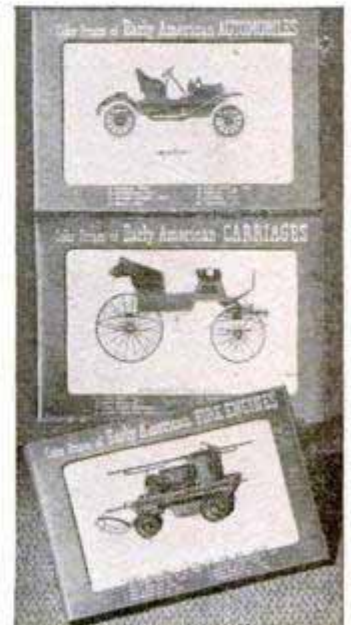

Give him mild and tasty

Prince Albert

**America's largest-selling
smoking tobacco**



Give him a big one-pound tin of Prince Albert—choice, crimp cut tobacco! Prince Albert's gaily decorated gift package needs no wrapping — you just write your message on the built-in card! Give P. A. to your friends who roll their own cigarettes, too!

*The
National
Joy
Smoke!*



Now they're drilling wells,
pumping oil, peering through
metals, treating your aches
and pains with

POPULAR MECHANICS

DECEMBER
1952

WRITTEN SO YOU CAN UNDERSTAND IT
VOL. 98 NO. 6

The Magic of SILENT SOUND

By *Thomas E. Stimson, Jr.*

FANTASTIC, almost incredible, things are being done with sound waves pitched so high, or so low, that we can't hear them.

With ultrasound we can look inside castings and forging and examine them for flaws as easily as if they were made of ice. The same high-frequency vibrations are used by physicians to treat patients. Sometimes an arthritic patient finds much of his disability vanishes after a 10-minute treatment that he didn't even feel or hear.

Infrasound, an uncanny form of energy only recently investigated, can perform many heavy tasks. Prof. F. J. Converse of California Institute of Technology is using infrasonic energy to compact loose beach

sands into roads that can support heavy truck traffic.

Our ears detect sound waves that vibrate from about 20 to some 20,000 cycles per second. Vibrations above that band are ultrasonic; those below are infrasonic.

Recently at Ventura, Calif., petroleum engineers watched a thing that seemed positively supernatural—a drilling rig that was "making hole" a mile beneath them without any of the usual commotion.

No big machinery was in motion. The

Patient's arm is being treated with ultrasonic therapy. Crystal in the transducer head vibrates at one megacycle per second



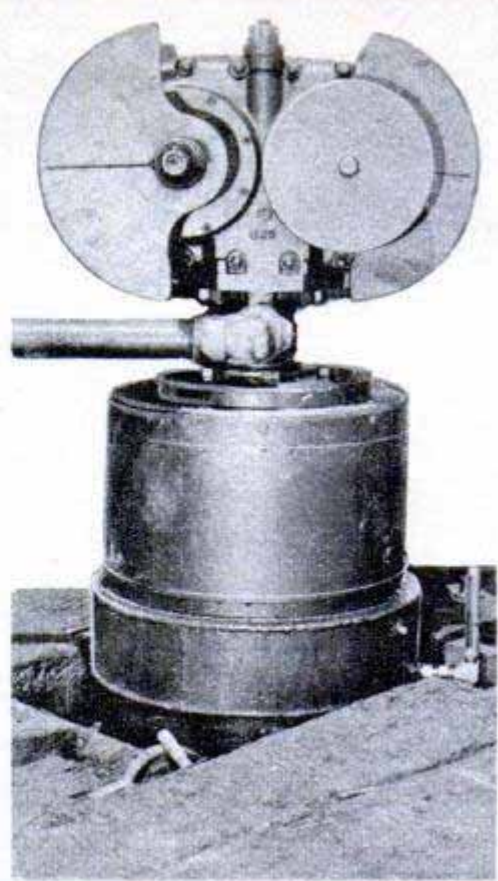
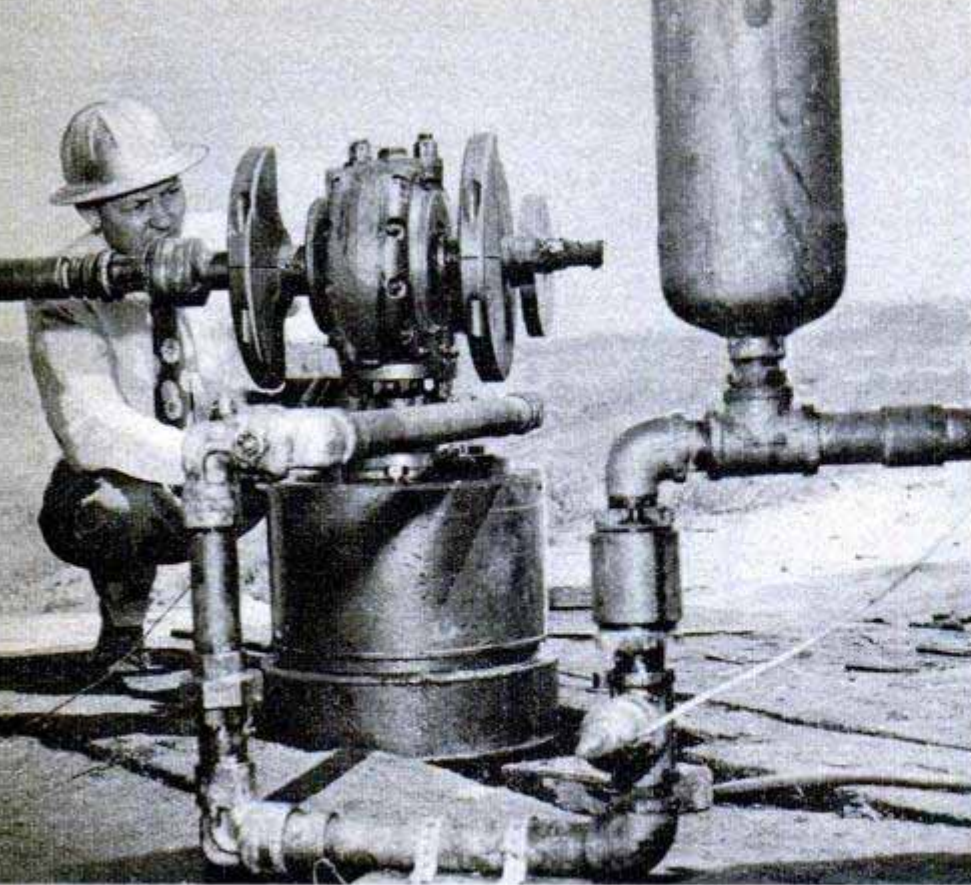

Left, infrasonic vibrations cause this pump to bring oil from deep wells. Wave generator, center, consists of two weights, shown more clearly at right, geared to exert vertical thrust as they are rotated by an engine

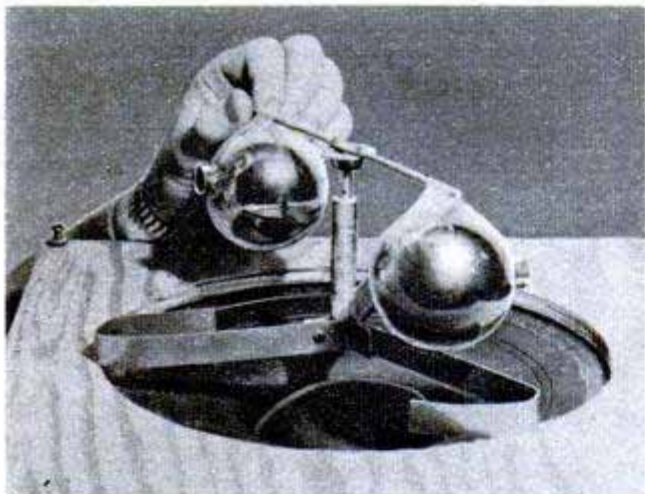

rotary table was standing still and yet the drill pipe was dropping steadily into the hole. The only noise that could be heard was the clank of the mud pump as it circulated a stream of mud down into the well and forced up to the surface the debris of the drilling process.

What the engineers were watching was a sonic drill that may revolutionize the science of drilling for oil.

The apparatus uses infrasonic energy to fatigue and break up the formation ahead of the drilling bit. Sound waves do the work cheaper, produce straighter holes and eliminate most of the tedious "round trips"

Above, when loudspeaker below these balls produces intense sound, jets of air issue from openings in balls, making the pivoted arm rotate. Below, 1400-horsepower siren is at the opposite end of a long wave-guide tube

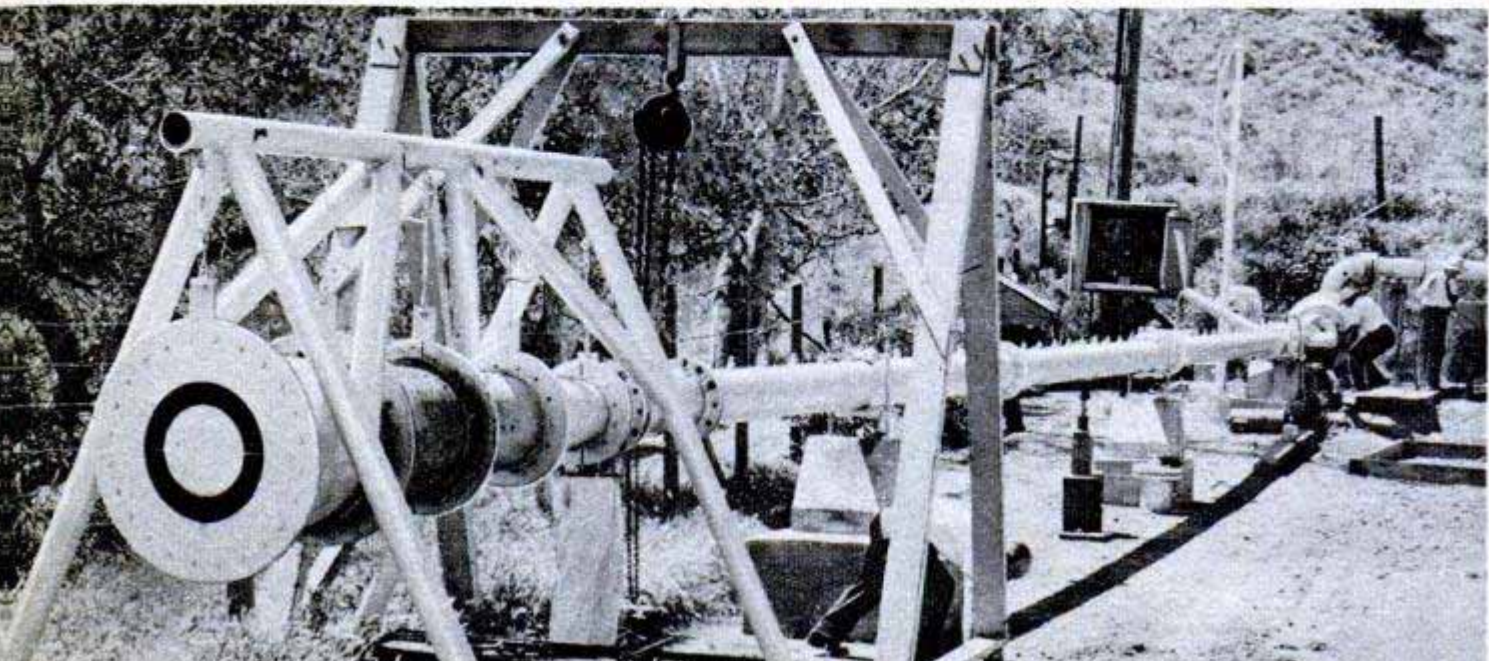

necessary to replace a worn or damaged bit.

One of the amazing things about the drill is the tiny amount of power required to drive it. All the energy it needs comes from the movement of the mud that is circulated down into the well. And yet the acoustic drill smashes its way through solid granite, a heartbreaking rock for most drillers, as rapidly and easily as an ordinary rotary bit cuts through soft shale.

Not all of the bugs have been worked out of the drill to date, but already it appears that extreme depths that have been unattainable for sheer mechanical reasons will soon be easy to reach.

On the same day that the engineers watched sound waves drilling a well, they inspected an acoustic pump, a simple device that imparts infrasonic energy to the tubing of an oil well. Presto! The oil flows out of the well almost with gusher force.

The sonic pump consists merely of a pair of weights arranged something like out-of-balance flywheels. They rotate in opposite directions and in phase with each other so that both exert vertical thrust at the same time. Attached to the top of a string of oil-well tubing that hangs free in the well, this generator puts elastic wave energy into the tube. The resulting resonant action produces rapid elongations and contractions of each end of the tube.

In effect, the bottom of the tube reaches down into the oil, traps some of the oil above the first of a series of check valves, lifts the oil, then reaches down for another gulp. Each stroke is only a little more than an inch long but the end of the tube makes 10 strokes per second. The net result is a pump that lifts hundreds of barrels of oil a day.

It's a pump that works by sound because, by definition, sound waves are "periodic disturbances in an elastic medium." All such vibrations, no matter whether they occur at the rate of one per second or

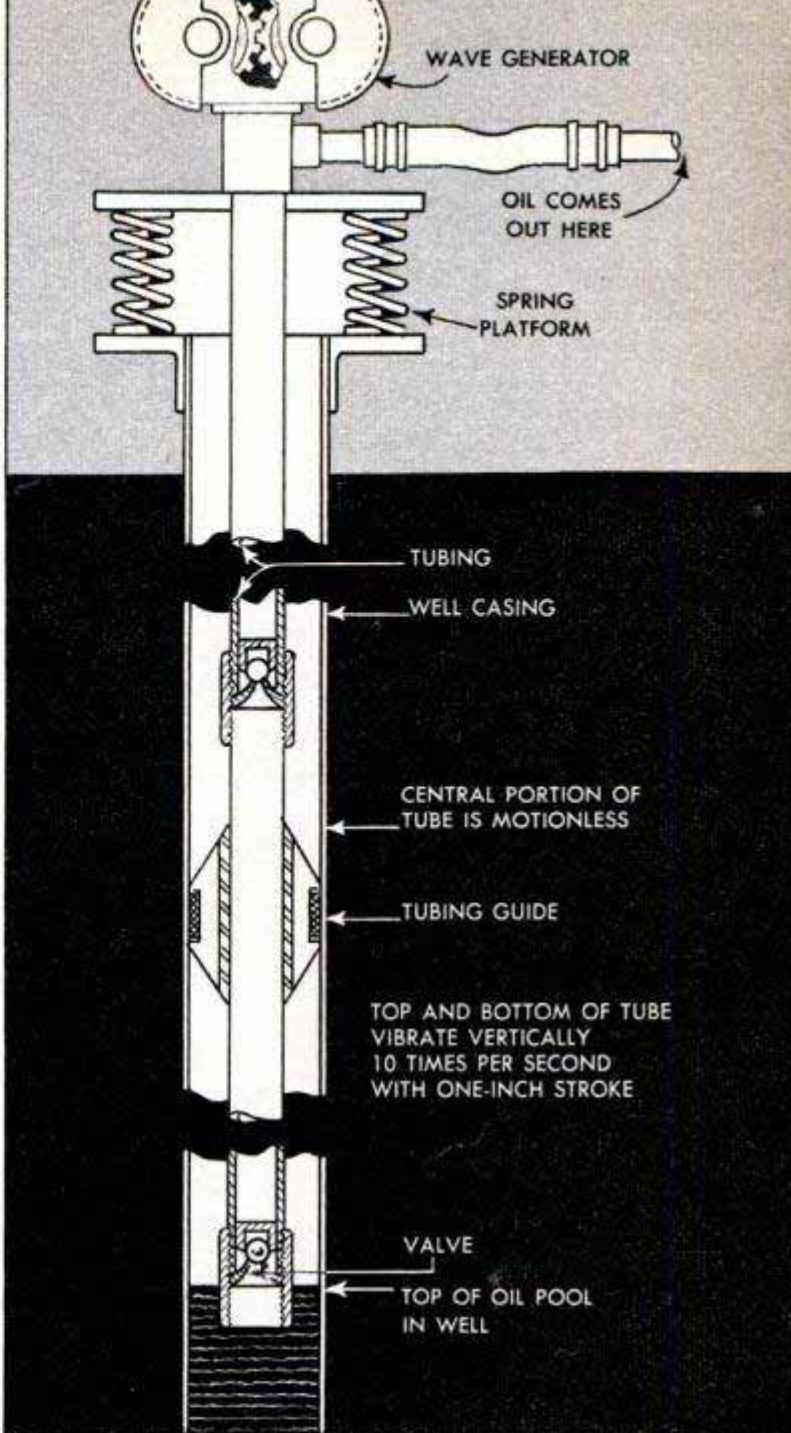

As tube in sonic pump vibrates, its open end dips in and out of the oil, lifting it an inch per vibration

Below left, ultrasonic photo of steel-bar exterior. Right, interior of forged aluminum bar "seen" sonically
Electro Circuits, Inc., photos

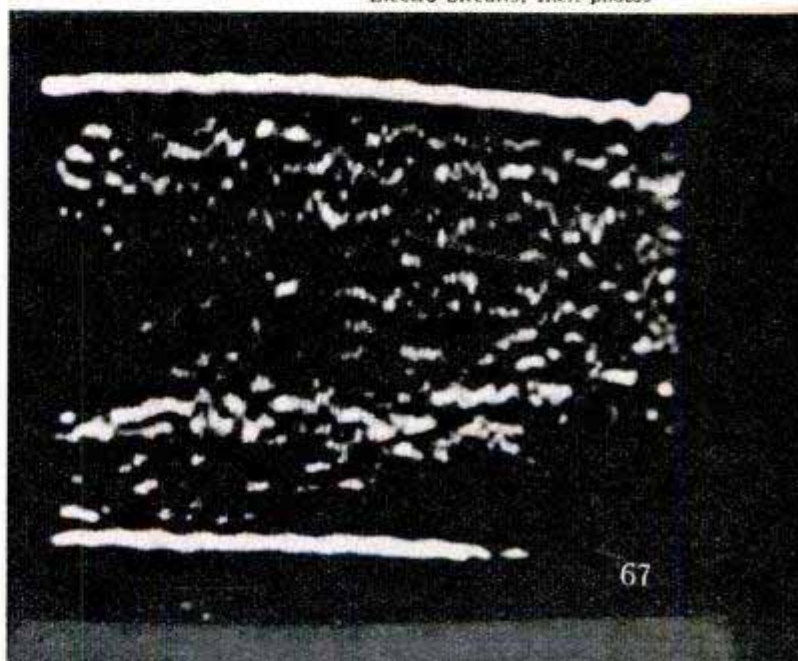
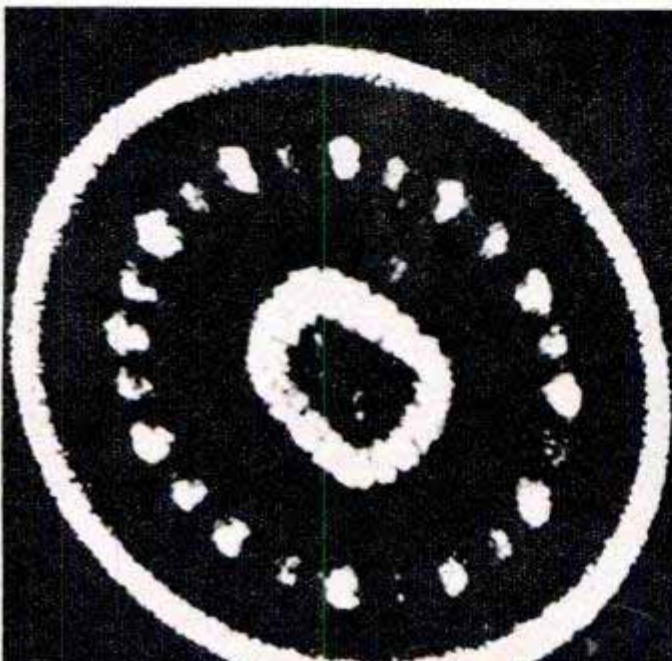

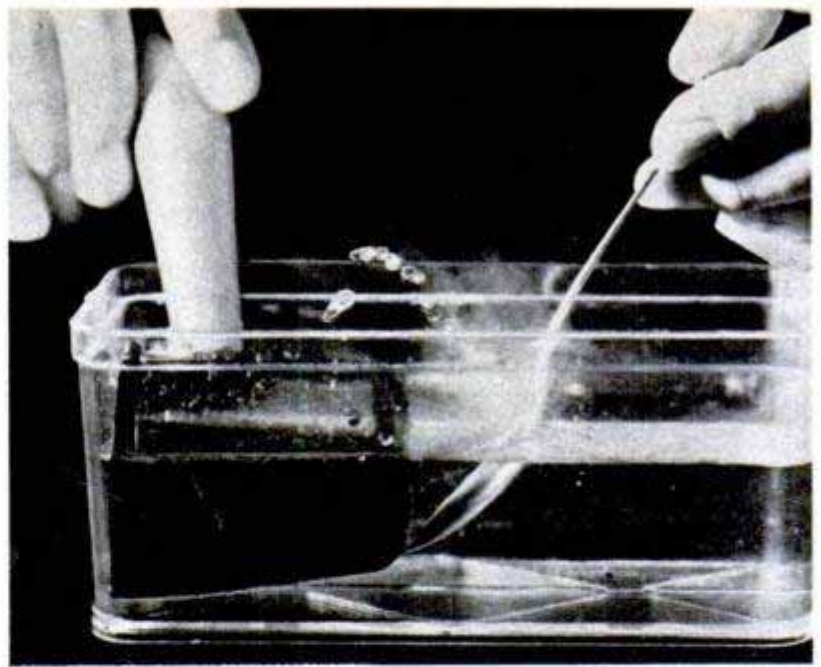
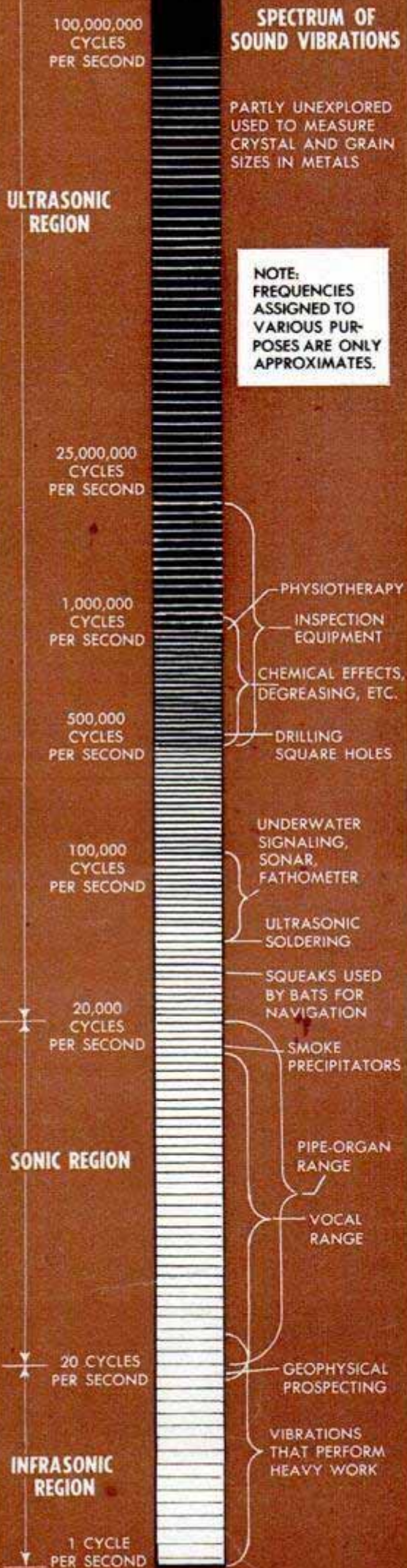

Electro Circuits, Inc., photo

Transducer in water at left emits one megacycle per second. Energy bounces from bowl of spoon, causing column of water to jump up

millions of times per second, follow the same acoustic principles.

The "Soundrive Pump" and the "Soundrill" stem from research by Albert G. Bodine of Los Angeles, a pioneer investigator of infrasonic energy. Important as they appear to be, they are mere peanuts compared to another use that Bodine foresees in the near future for infrasound.

These low-frequency waves hold the promise of doubling the amount of oil that can be extracted from the ground. By conventional methods no more than 25 to 35 percent of the oil is obtained from any petroleum deposit. All the rest remains locked or clogged up in the rocklike sands. Today it appears that infrasonic energy can be used to vibrate the formations, or heat them up, to release once again as much oil as we have

Below, interiors of metal pieces are checked ultrasonically with transducer at end of tube. The inspection must be done underwater

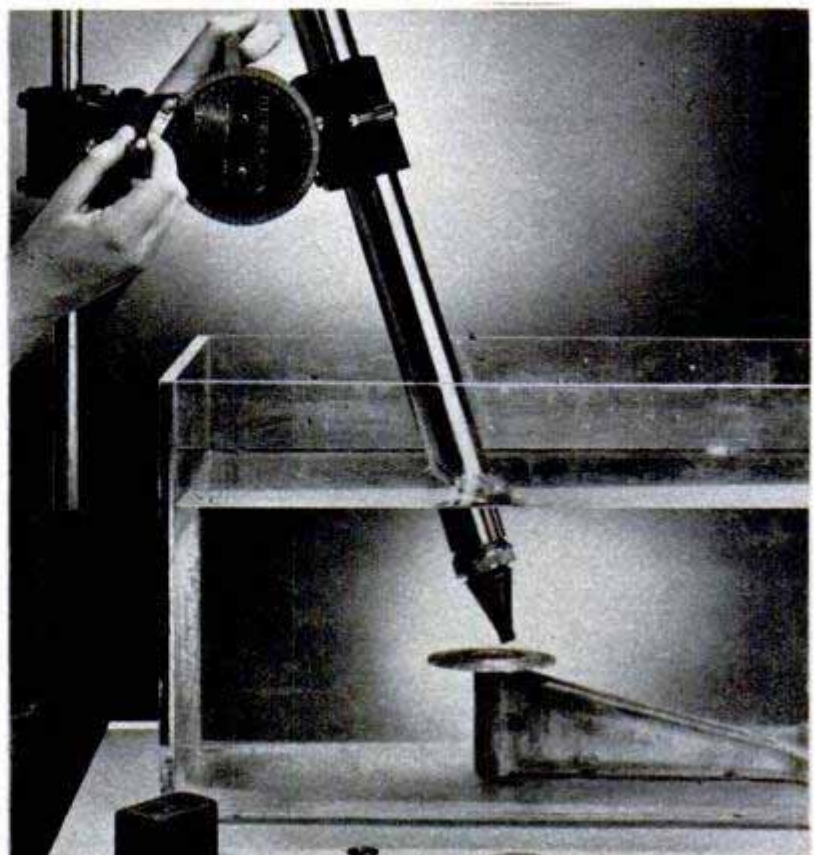

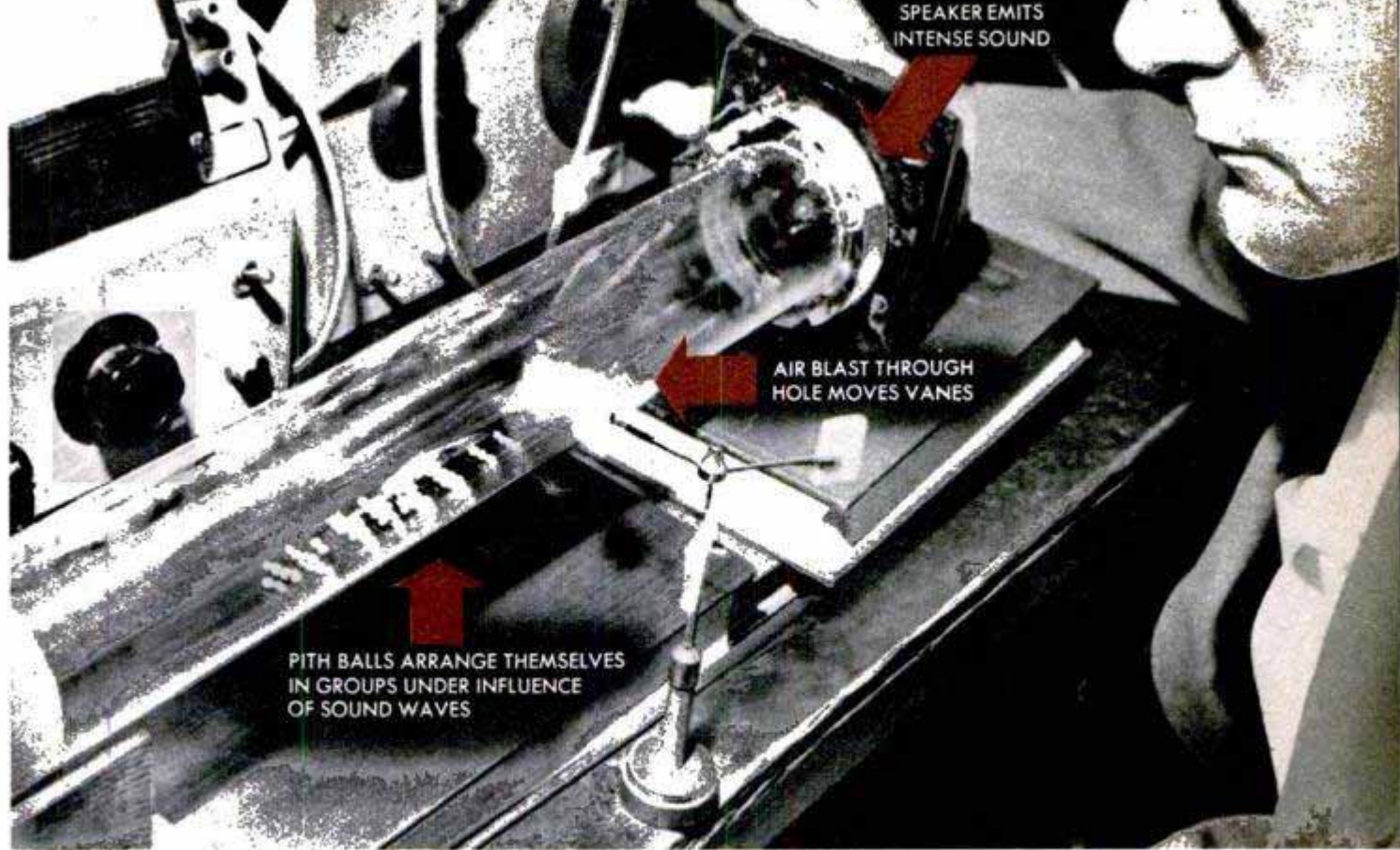

Intense sound causes pith balls to assemble in clumps and forces jet of air from hole in sealed plastic tube

been getting. In a sense, oil would be melted out of the rock.

"The sonic pump in its present form vibrates the surrounding rock to some extent and unclogs it, enabling more oil to flow," Bodine says. "Now we are designing new pumps that will transmit some of their energy into the formation at the same time they do the pumping job. Experiments with cores of oil sands indicate we can

about double the total production of oil from any deposit."

Among other activities, Bodine is making a basic study of the entire science of high-amplitude sound in cooperation with Drs. R. W. Leonard and I. Rudnick of UCLA for the Office of Naval Research.

One of their tools is one of the world's most powerful sirens, located in a remote

(Continued to page 248)

Simple shapes with flat surfaces are checked out of water. Coating of oil on surface transmits ultrasonic waves



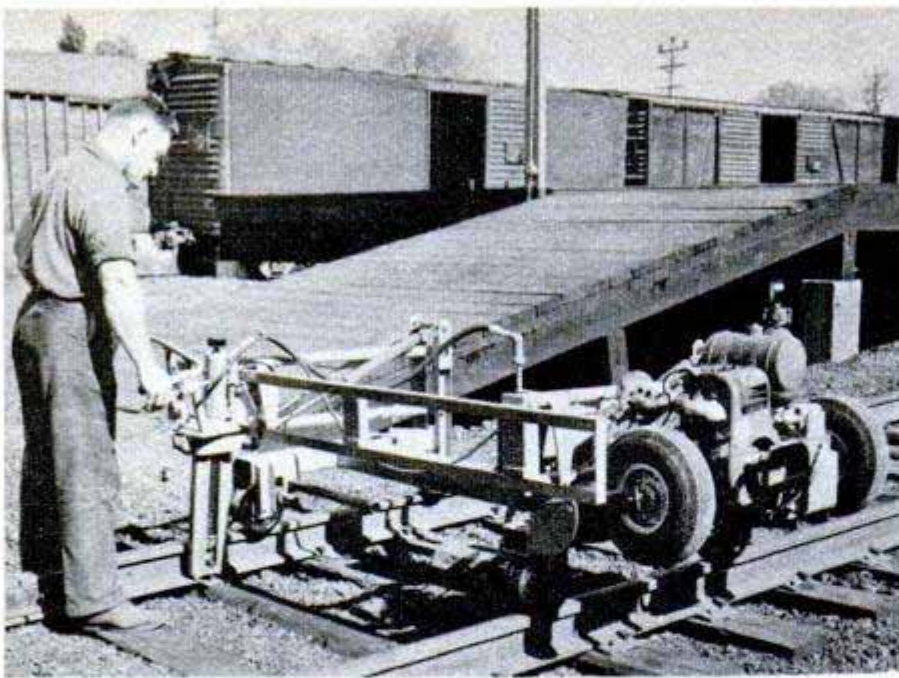

Hydraulic Spike Yanker

Railroad maintenance is aided by a unit that pulls spikes from ties at a speed of 8 to 12 a minute by a gasoline-powered hydraulic machine. The pulling mechanism, mounted on counterbalanced arms, is quickly swung from one rail to the other. One man operates the machine and, despite its 685 pounds, can lift it on and off the rails alone, as the unit is equipped with two set-off wheels and lift pipes.

"Railroad" Planer Smooths Large Laminated-Wood Trusses

Huge beams and trusses made of laminated wood ride four-wheeled flatcars through a big planer that trims and smooths the rough surfaces. The "railroad" planer speeds the finishing operation considerably, replacing hand sanders. The largest beam handled by the planer, built for a dredge, measured 90 feet long, 12 inches thick and tapered in width from 52 to 36 inches.

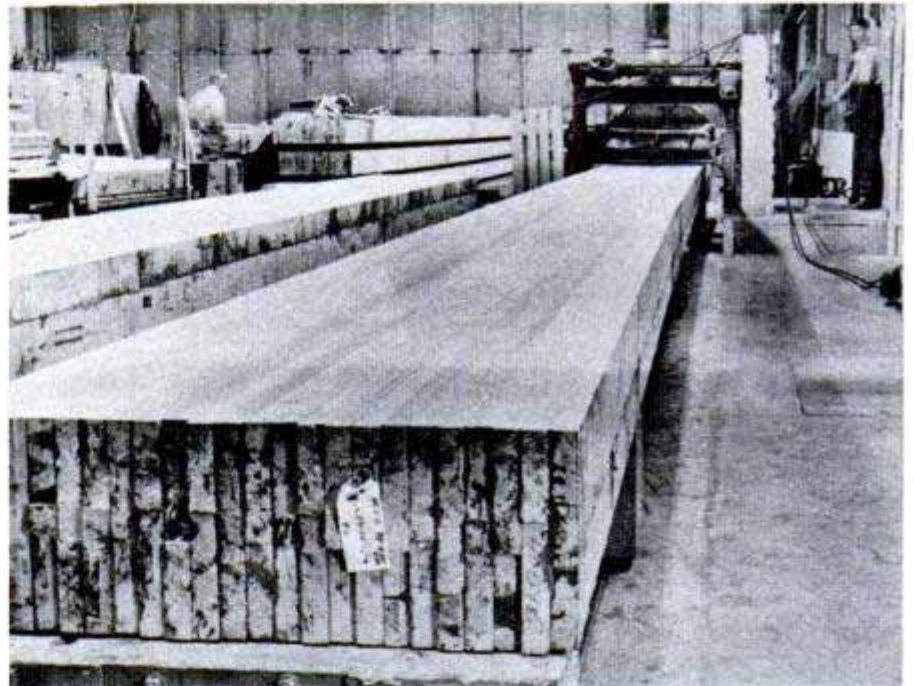

□ Nearly 1,000,000,000 pounds of carbon black are added to rubber each year to improve tires.

Diminutive "Overstuffed" Furniture Pieces Make Novel Pipe Racks

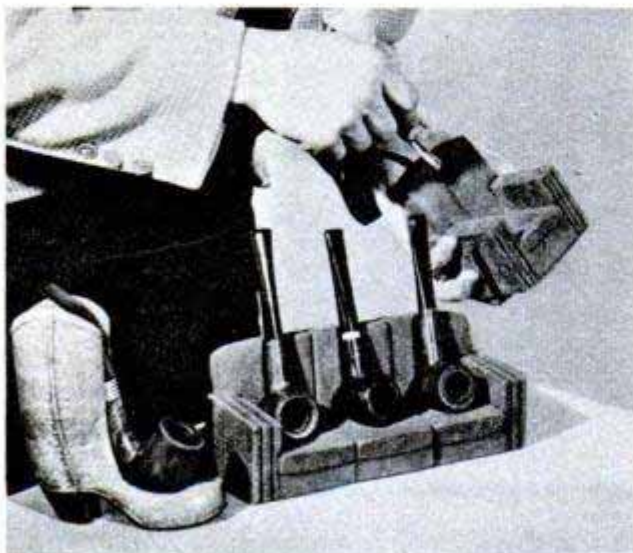

Miniature pieces of "overstuffed" furniture made from scrap lumber are grooved to serve as decorative racks for pipes. Built by industrial-arts students at the University of Idaho, the smoker's accessories are painted with colorful enamel. While the enamel is still wet, flock of the same color is blown on to give the appearance of mohair. Other designs include a cowboy-boot pipe rack.

If you do not find the information you need in the index on pages 12, 14 and 16, sources of further information are available without charge from *Popular Mechanics*. Write to the Bureau of Information, 200 East Ontario St., Chicago 11

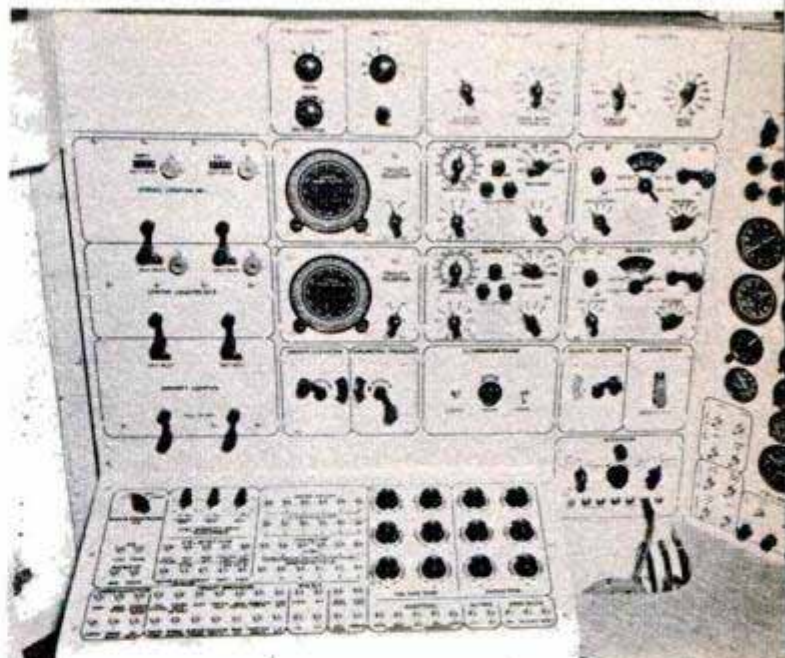
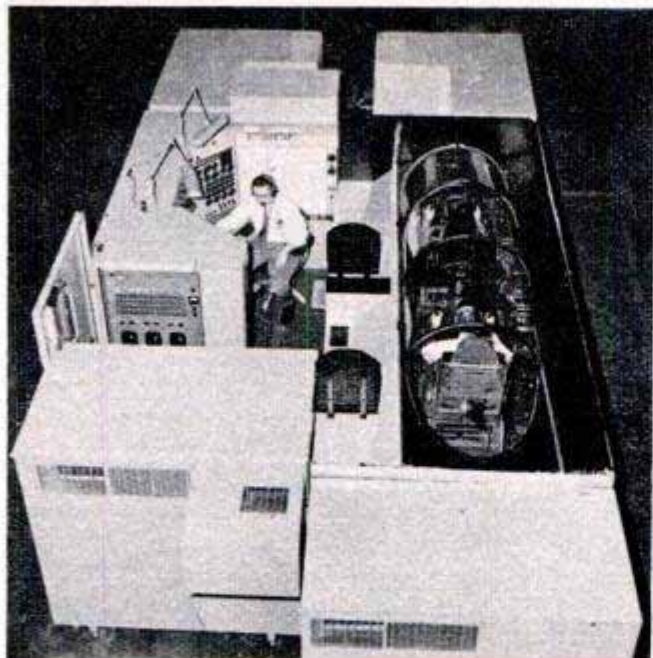

Jet-Bomber Pilots Learn Job on the Ground

Crewmen for the Air Force's fastest jet bomber will be schooled for the job in an electronic simulator that provides 1001 required training steps. The Link-built trainer, with a single motor-generator power supply and miniature electronic units, weighs and costs only a fraction of an actual B-47 airplane. It duplicates both normal and emergency engine, flight and communications operations, as well as assisted take off (ATO) and procedures for refueling in the air. A buzzer warns the

pilot of an impending stall, for example, but movement of the controls and built-in buffeting provide identical conditions of the in-flight stall. Sitting before a myriad of lights, switches, push buttons and instruments, an instructor sets up and controls each flight, introducing problems and conditions as the occasion demands. His console is directly opposite the trainer unit, which is an inch-for-inch duplication of the jet aircraft's cockpit with exact placement of the controls and equipment.

Antique "Flaming" Organ Displayed by London Museum

Gas flames regulate pitch of an unusual organ owned by the London Science Museum. Over 77 years old, the Pyrophone produces notes with glass tubes, inside of which are controlled gas flames. Invented by physicist Frederick Kastner, the instrument was played at a recent meeting of the Royal Society of Arts. The music it produces was described as "celestially beautiful."



Government Hires Large Percentage of Scientists

Scientists directly employed by the federal government in technical work number 90,980—over 15 percent of the nation's total supply. Slightly over half—46,673—are engineers. Physical scientists are next with a total of 16,308; biologists number 14,793. Medicine and dentistry account for 6100 employees and all other groups of scientists add up to 7106.



Equipped with a special harness and a towline, Flippy serves as the motive power for a mermaid's surfboard ride. Below, dog takes a ride, too. Right, the porpoise leaps through a small hoop



Below, the agile porpoise soars up out of the water to hurdle a fish net. Trainer taught him to leap over the net for a reward of fish, then jump over a rope and finally sail through the paper hoop

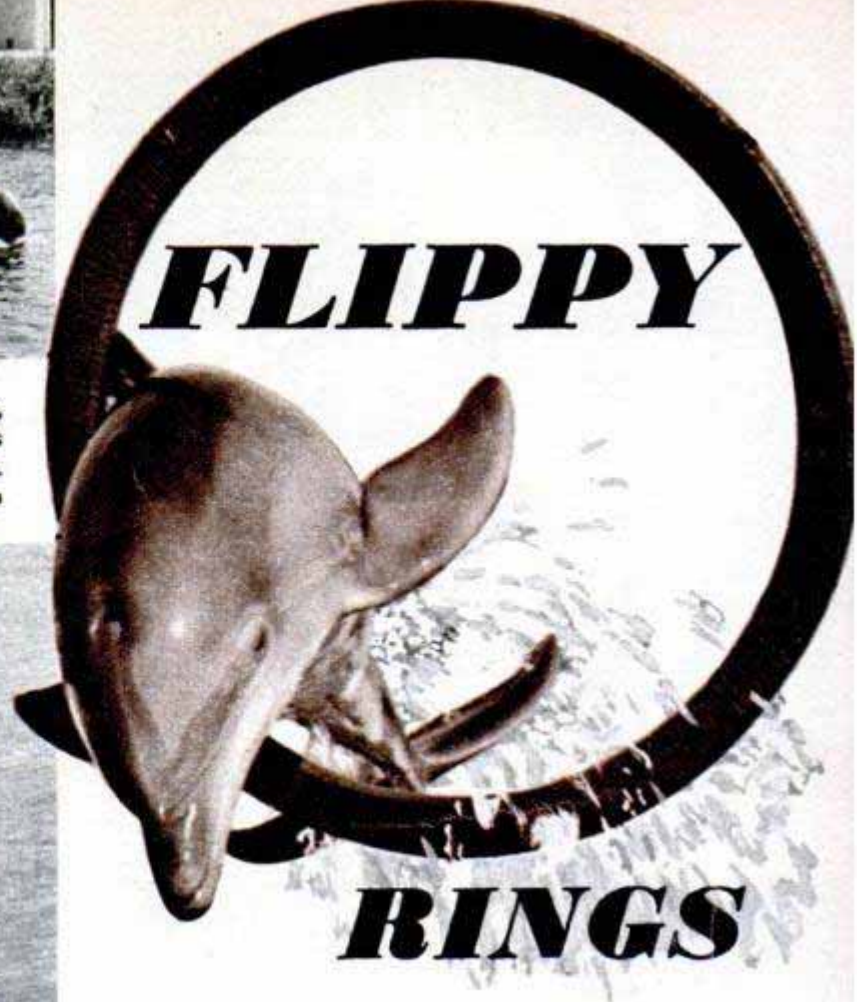

Keepers of the deep-sea zoo at Marineland, Fla., have a salty picnic with their performers. Porpoises, they say, are practically people

VISITORS TO the big Marine Studios on the white Florida beach some 20 miles south of St. Augustine thought they were seeing things recently. In a small estuary behind the big tanks, a girl and a dog bounded over the wavelets on a surfboard at the end of a towline. On the pulling end of the line was a seven-foot porpoise named Flippy. With great heaves of his ponderous body, he arched clear of the water, tugging the surfboard and occupants at a lively clip.

Every evening in a "private" pool behind the Marineland tanks this same finny phenomenon goes through a repertoire of stunts and tricks no porpoise in history has ever done before. At voice or hand commands from a trainer, Flippy leaps through a paper hoop, flings his seven-foot, 350-pound body into the air, grabs a ball hanging on a string and rings a bell with it. He can hoist a flag the same way. He'll leap up to catch a ball or stick tossed to him and bring it back to the trainer. Another Flippy stunt is to sit halfway out of



In huge tanks of Marineland, denizens of the deep live in natural surroundings while the visitors — and scientists — watch them

At gesture from his trainer, Flippy heaves himself six feet into air to grab rubber ball and ring the bell

THE BELL

By
Richard F. Dempewolf

water and swim back a few feet in vertical position every time the trainer flicks his hand. He'll also do figure-S turns back and forth through a small hoop held under the water.

Flippy, who is a bottlenose dolphin, is not just a trick animal like a trained seal. He's not even on exhibit at Marineland. He is one of a host of marine experiments being conducted at the world's most remarkable deep-sea zoo, where scientists peer through portholes to watch the private lives of marine denizens. Flippy is proving that porpoises have a brain development so advanced that it may compare with that of the dog and the chimpanzee.

Learning the secrets of the deep and its denizens at Marineland has called for pioneers with plenty of ingenuity and determination.

Actually, Marineland was conceived in an African jungle by a trustee of the American Museum of Natural History and a Hollywood cameraman, Douglas Burden. Burden was herding tigers, elephants, monkeys and other jungle beasts into a stockade for the filming of the movie *Chang*.

It set Burden wondering why the same thing couldn't be done

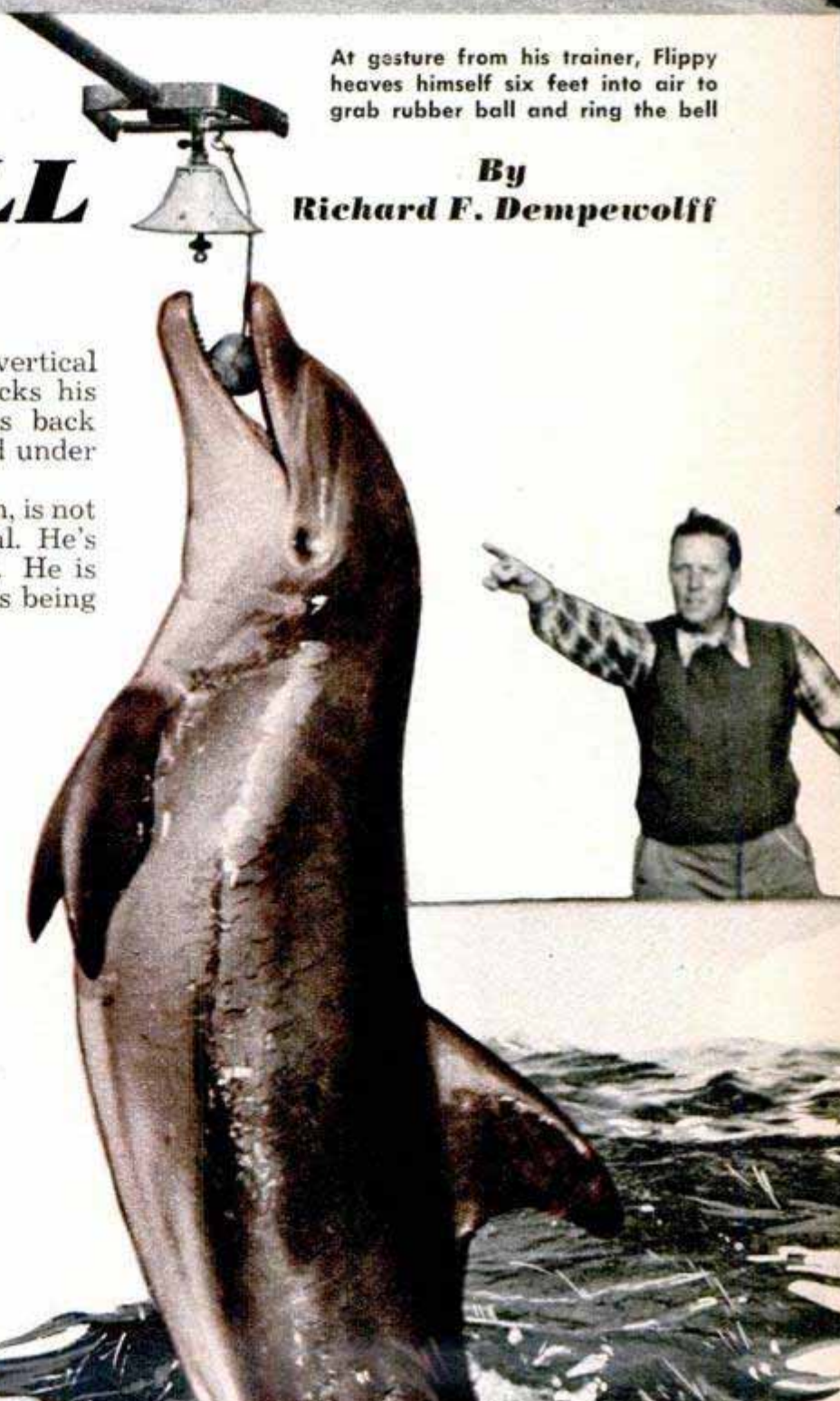

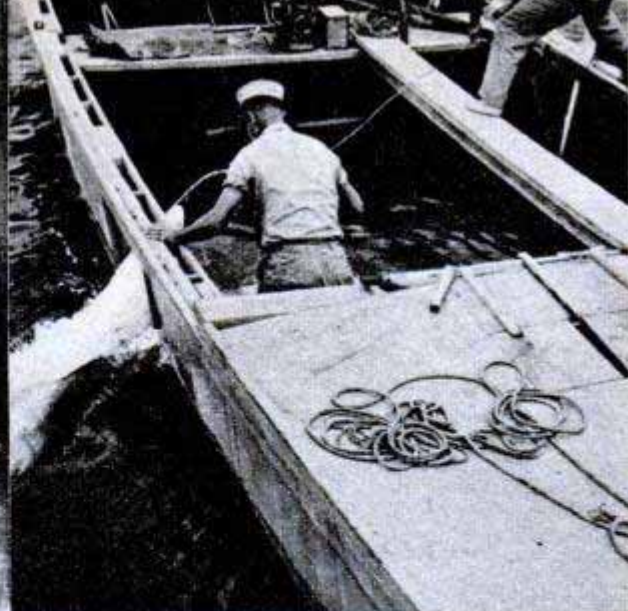

Shark, caught in the deep sea, is hauled into live well of the barge. Left, upon arrival at oceanarium, diver must walk the shark around tank to restore its "breathing"





One snap of this character's jaws could sever an arm. Collectors remove dangerous "hooks" from his mouth

with denizens of the deep. He visualized an enclosed chunk of ocean where briny creatures of all kinds would live, love and fight together just as they would in the open sea. The baby ocean would be surrounded by steel and concrete walls, perforated by crystal portholes, so the sea creatures could be observed and photographed underwater. Back home, Burden and Ilya Tolstoy, grandson of the famous writer, put their heads together, drew plans and set out to sell their idea. From a dozen magnates and wealthy sportsmen they raised the money. At last, in 1938, a huge, white, fortresslike structure rose out of the coquina sand. Within four years Marineland boasted a population of 26 human and 15,000 finny citizens.

Inside the multitiered shell surrounding

Collector stands ready to drop tail snare over a curious porpoise. Tongs snap shut, tightening rope

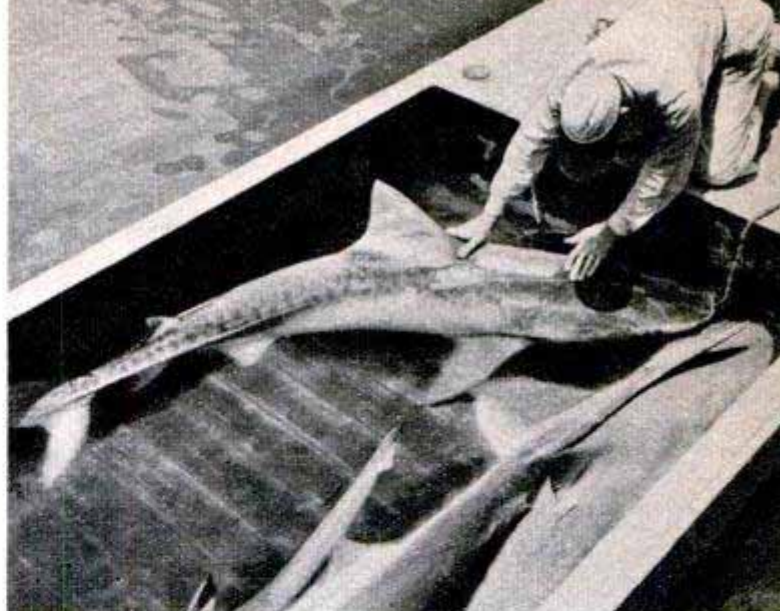

Attendants push sharks around barge's well so water will pass through the gills to prevent suffocation

the sea corral, a visitor walks into a jade-green world. He is in the enclosed outer perimeter of two giant steel and concrete tanks. A rectangular one, 100 feet long, 45 feet wide and 18 feet deep connects by flume with a circular "minisea" 75 feet in diameter and 12 feet deep. In the honeycomb of passageways surrounding the tanks, 200 heavy-glass portholes pierce the inner walls at every conceivable level. Through them glows the cool green of sea water and past them move the ghostly forms of sea giants.

Myriad schools of bright-colored tropical fish scoot around the sand bottom, hiding from big predators in the hollows of a seven-ton coral reef. Sea fans and plumes wave gently as marine creatures brush them. In the circular tank, undulating

Visitor holds out a mullet from the feeding platform and porpoise leaps six feet out of water to snatch it





Webbed sling is worked under the body of a porpoise that's just been caught, and odd animal is hoisted into big tank with a crane. Drawing below shows complete layout of Marineland

500-pound porpoises send little fish scooting for cover. Big manta rays skirt the ribs of an old shipwreck as they flap slowly along the bottom. From a jagged, eight-ton rock ledge, a monstrous moray eel pokes his ugly head.

It's one thing to have a gigantic fish bowl full of deep-sea goliaths, and another to keep your monsters in good shape. Divers stalk, slow-motion, along the coquina bottom several times a day, scattering pieces of fresh mullet. Each porpoise alone gobbles 20 pounds of fish each day. But in spite of being well-fed, big fellows sometimes eat the little fellows. "Once we put a tiger shark in with the porpoises," one of the men reveals. "The big dolphins ganged up on him and took turns ramming him in the gills with their snouts. In no time the shark was dead."

All this, plus mortality from natural causes, means the highly specialized fishing crew employed by the studios is kept busy corralling replacements and finding new rare

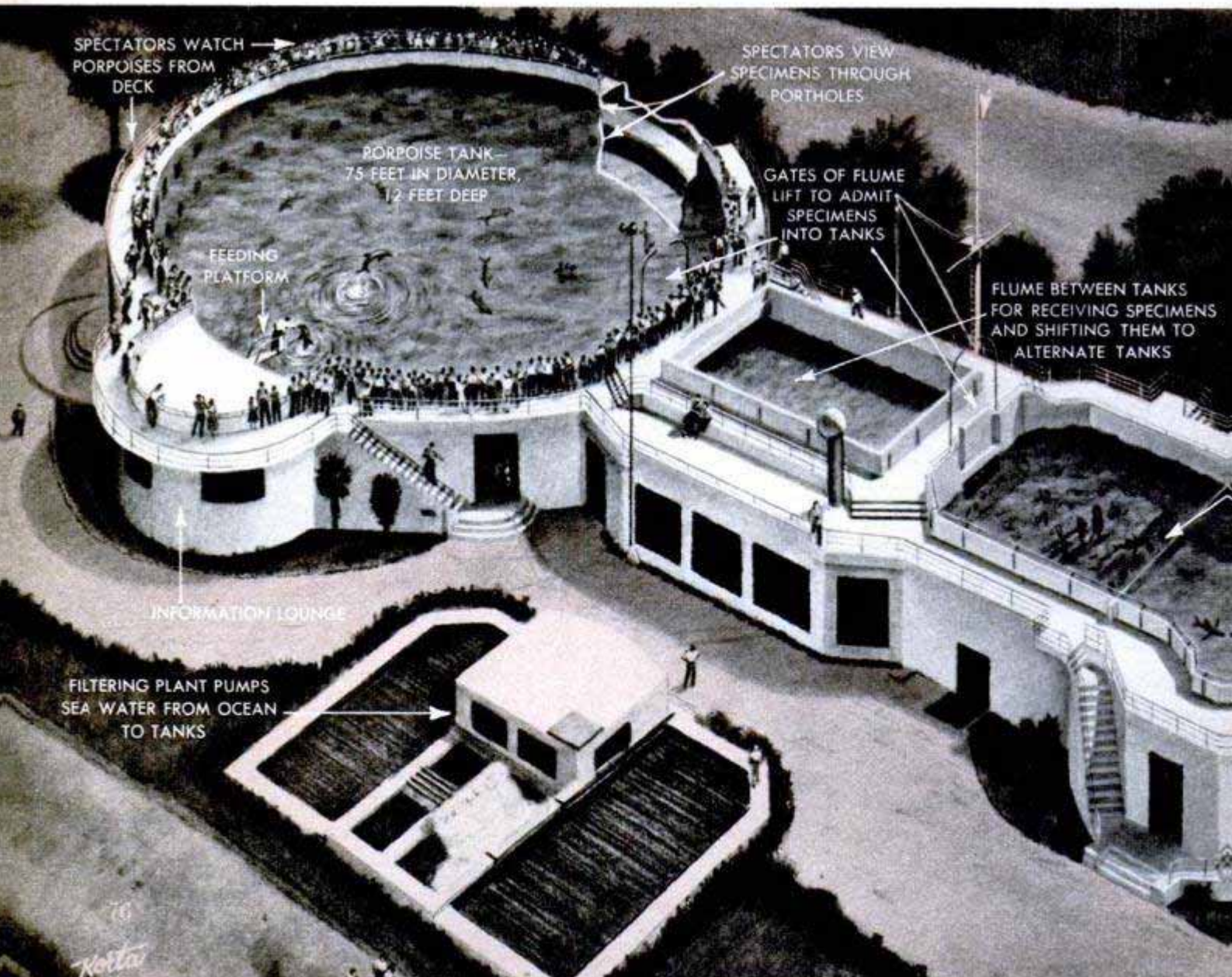

specimens. To do their job, these pioneers have had to develop ingenious devices and stunts. Their fleet consists of a dinghy, a 32-foot barge and a 28-foot skiff. The barge has the 14-foot "live well" in its center for carrying specimens to the studios. The men haul specimens aboard simply by pulling them into the well through a big door in the side of the barge.

One of the niftiest devices used by the collectors is the odd tail snare or lasso for catching the spotted porpoise without injuring him. This 10-foot fast-swimming character with a built-in grin is mighty elusive. His weak spot is a sense of curiosity that leads him to investigate any boat in sight.

The snare is a long pole with a rig like a pair of open ice tongs on the end of it. It holds a loop of rope. While Mr. Porpoise frolics beside the boat, a collector drops the snare right above the animal's wide, horizontal tail fin. Presto! The tongs snap shut, flipping the loop of rope around the tail, and Mr. Porpoise is in trouble. The rope hinders his driving mechanism which, unlike that of most ocean dwellers, propels him with an up-and-down motion. Soon he's tired enough to be hauled alongside.

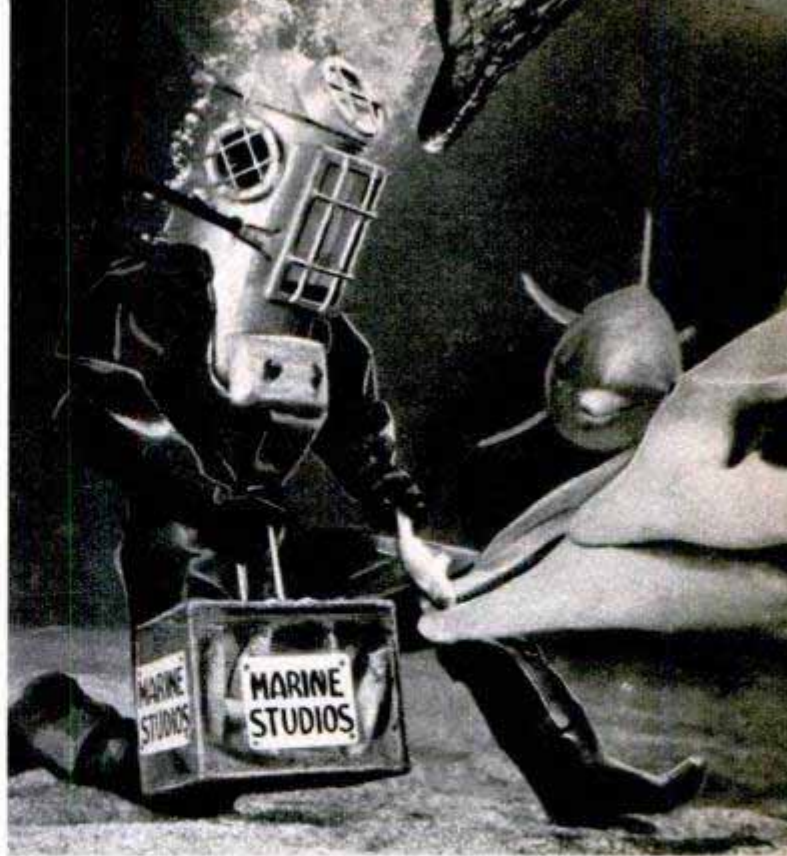

The 50,000 finny citizens of Marineland are fed several times daily by divers carrying baskets of fish



WINDOWS AT ANGLE GIVE UNDERSIDE VIEW

SPECIMEN TANK -
45 FEET WIDE, 100 FEET LONG,
12 TO 18 FEET DEEP

Big 10 and 12-foot sharks at Marineland are another matter. For them the crew has designed special steel hooks, 10 inches long and $\frac{1}{4}$ inch thick, which they fasten with chains to a heavy line several hundred feet long. Hooks are spaced every five fathoms. The line is baited with chunks of fish or horsemeat, anchored at each end, marked with buoys and tossed over the side. Later the lines are hauled up and 15 to 25 monsters, weak from their struggles, are dragged into the live well of the barge.

Until recently, crews doped these big fellows before tinkering with them. A big hypodermic syringe with a needle almost half the size of a soda straw was attached to the end of a special harpoon. As the shark was pulled alongside, a harpooner

(Continued to page 234)

Ugly 1500-pound manta ray was trapped in a net and towed fishing barge around the ocean for six hours

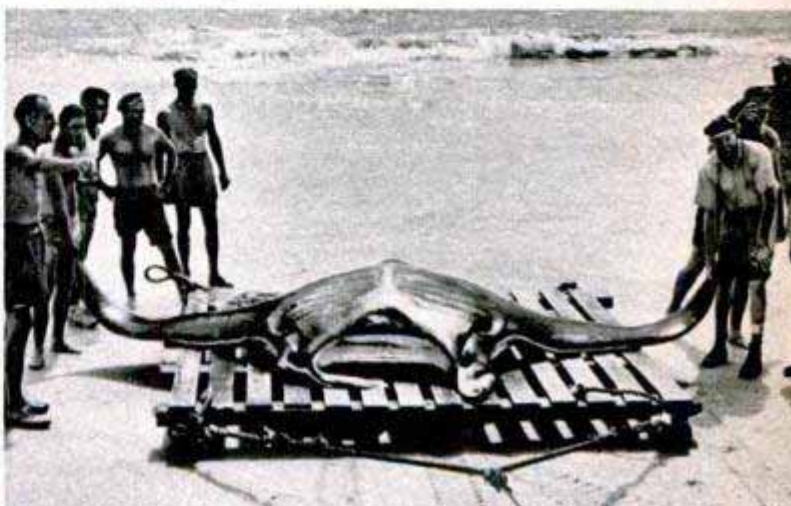

Pop-Out Samplers Accurately Check Airplane's Rate of Icing

Automatic ice-gathering devices are being used to test icing conditions on the Air Force's F-89 all-weather interceptor. Believed to be the first ever developed, they each contain four sections measuring $\frac{1}{8}$ to 3 inches in diameter and pop out from the plane's nose when the radar operator pulls a switch on a special control panel. They revolve for a half minute, receiving an even coating of ice, then retract into special refrigerated chambers. After the flight, the cylinders are removed and the amount and thickness of the ice coat are carefully measured.



Shock-Absorber Rope Prevents Fatal Falls by Workers

Steeplejacks, steelworkers and others who work at dangerous heights can protect themselves from fatal falls by a safety device invented in France. It consists of a shock-absorbing rope which takes up the force of a free fall without injury to the worker. Eight rubber tubes are the absorb-

ing mechanism. As tension is exerted, each tube is stretched successively. In tests in France, free falls of as much as 10 feet have been stopped within 3 feet without injury to the worker. The shock-absorbing section is in a bag worn by the worker or placed where the rope is anchored.

Left, rope has 10 rubber strips to absorb shock. Right, packed in a bag, the rope is anchored above worker

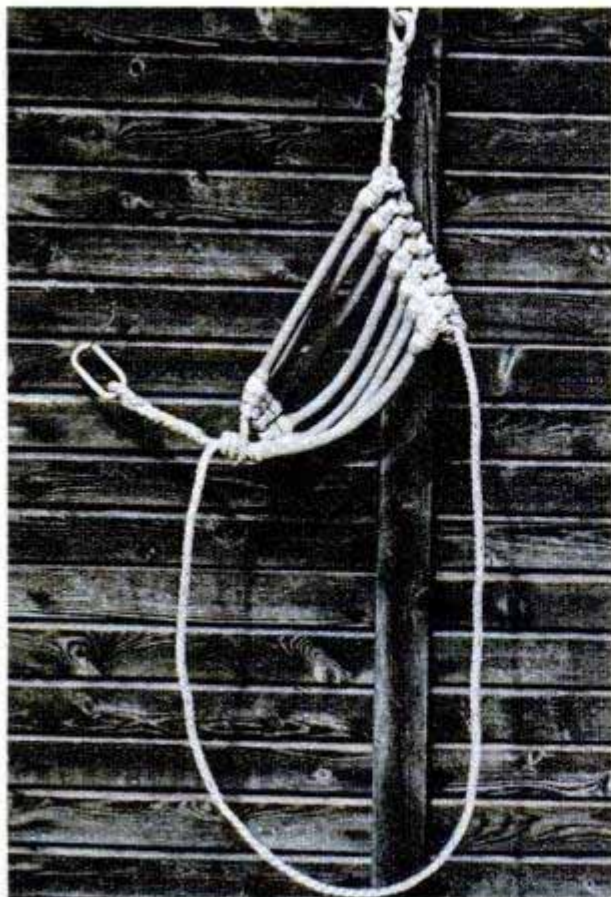

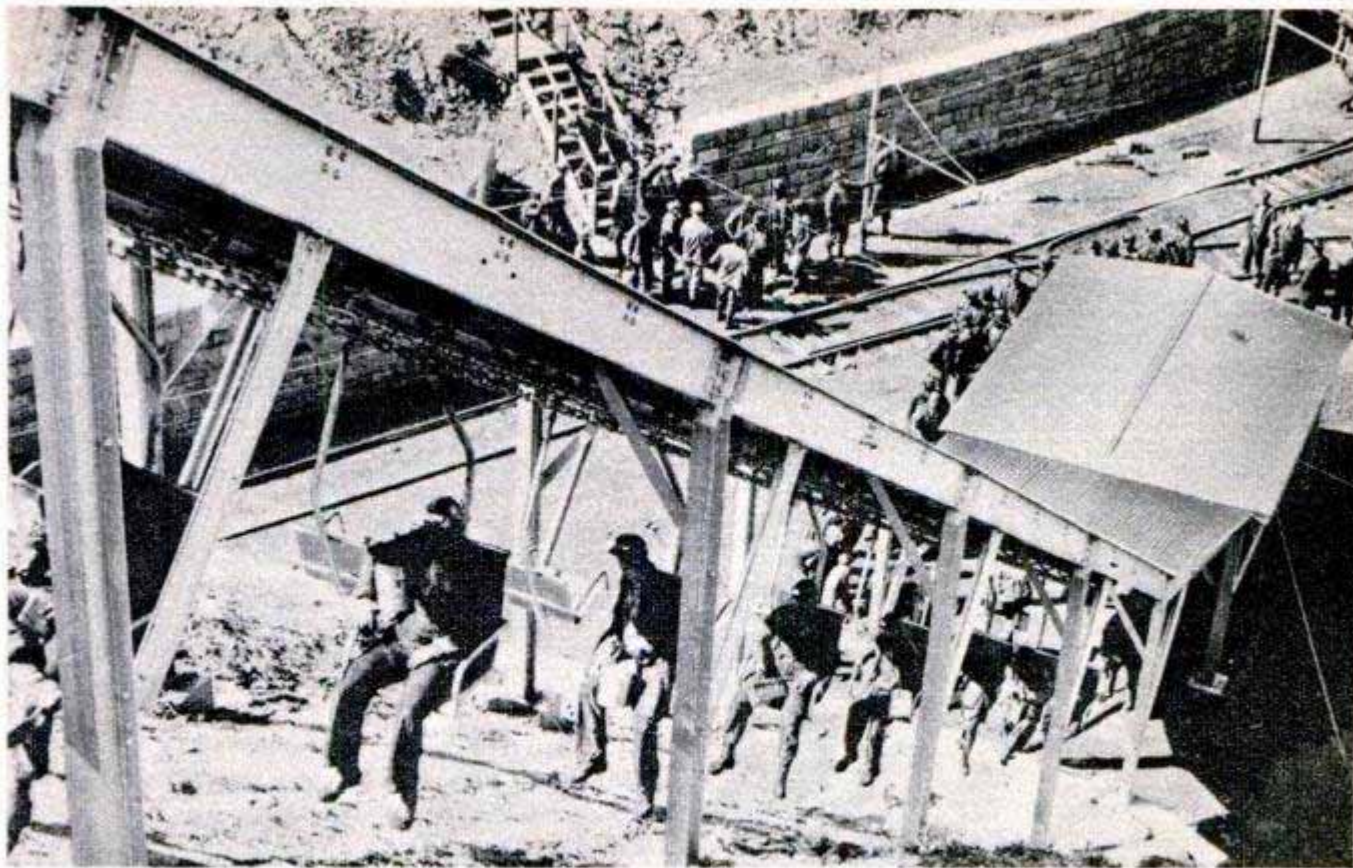

Coal Miners Carried by Ski Hoist on Way Homeward

Coal miners at a shaft near Gary, W. Va., are literally "given a lift" at the end of a hard day's work. They are transported in

style to the mine's exit level by means of a chain-belt seating device similar to those used by skiing enthusiasts.

Hydraulic Lift Parks Airplanes in Small Carrier-Deck Areas

Initial tests are being made aboard a carrier of a new hydraulic lift to maneuver planes into small parking areas. The motor-driven English device enables one man to move a six-ton airplane about with ease. The lifting end is put under either the tail wheel or nose wheel, which it locks in a circular pallet and raises. The aircraft is towed or pushed on its main landing wheels. Push buttons on the handle control lifting and lowering operations.



Accelerated Drying Method for Painted and Varnished Products

Almost instantaneous drying of many paints, inks and varnishes is accomplished with a process using sulphur-dichloride vapor. Conventional industrial drying methods take hours, but the new method does the job in from two to twenty seconds. The vapor reacts with pigmented oils as coated materials are passed through an enclosed drying chamber on an endless belt. After

treatment in the chamber, materials are dust and tack free and can be handled, stacked, packaged or given a second coat. Recently developed by Illinois Institute of Technology researchers, the process has high industrial value because it speeds up production and cuts down storage space. It can be used in the manufacture of linoleum, furniture, appliances and license plates.

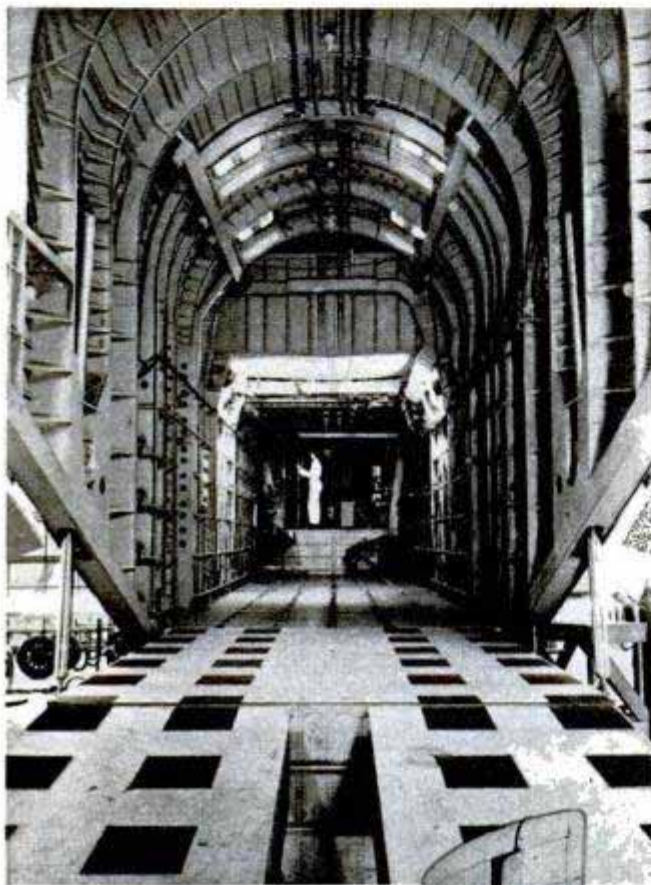
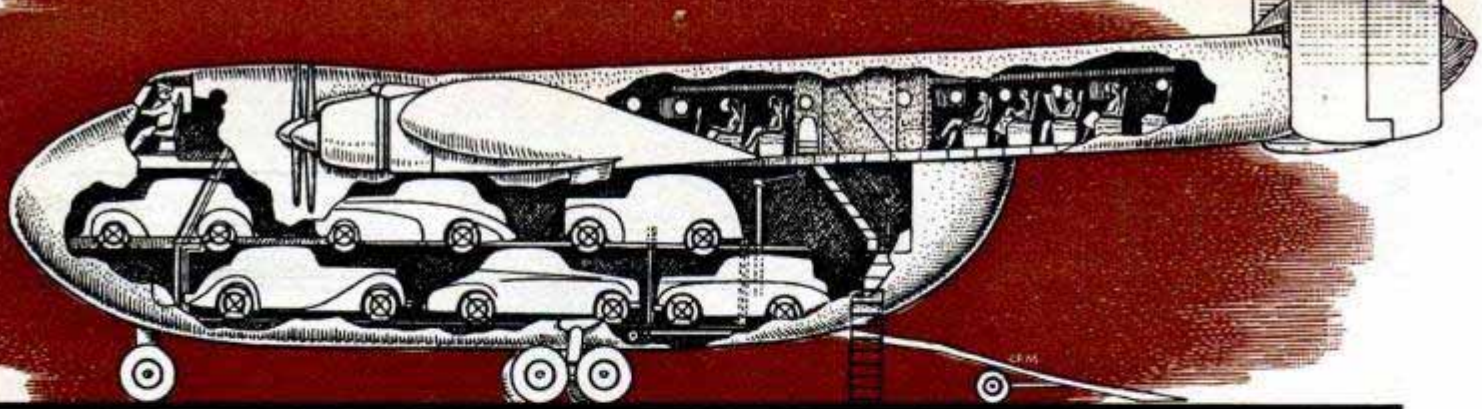

Top, cross-section view of ferry, showing location of cars and passengers. Above, interior of 55-ton airplane

Even large busses, below, can enter through freighter's wide, outward-opening doors under craft's high tail

Car-and-Motorist Air Ferry For Cross-Channel Service

Up to 8 automobiles and 42 passengers will be carried on a triple-decker freighter airplane scheduled to begin flights in England next year. It will enable tourists to fly with their cars on ferry trips between the British Isles and Europe. The aircraft's two lower decks will house cars and other vehicles, with the passenger cabin and crew compartment occupying the third level. The cars will be loaded through two large doors at the rear of the four-engine, 55-ton aircraft, after being pulled singly up the ramp by a winch. An elevator will lift the first vehicles to the second deck where they will be slid forward on rails into position. All the cars will be locked in place for the flight. The complete loading operation for freight and passengers will take 20 to 25 minutes. There will be enough space for motorcycles and bicycles to be stowed along one side of the lower deck. The aircraft, a modification of the Blackburn Universal Freighter, already in operation, will cruise at about 180 miles an hour.

Blackburn and General Aircraft, Ltd., photos

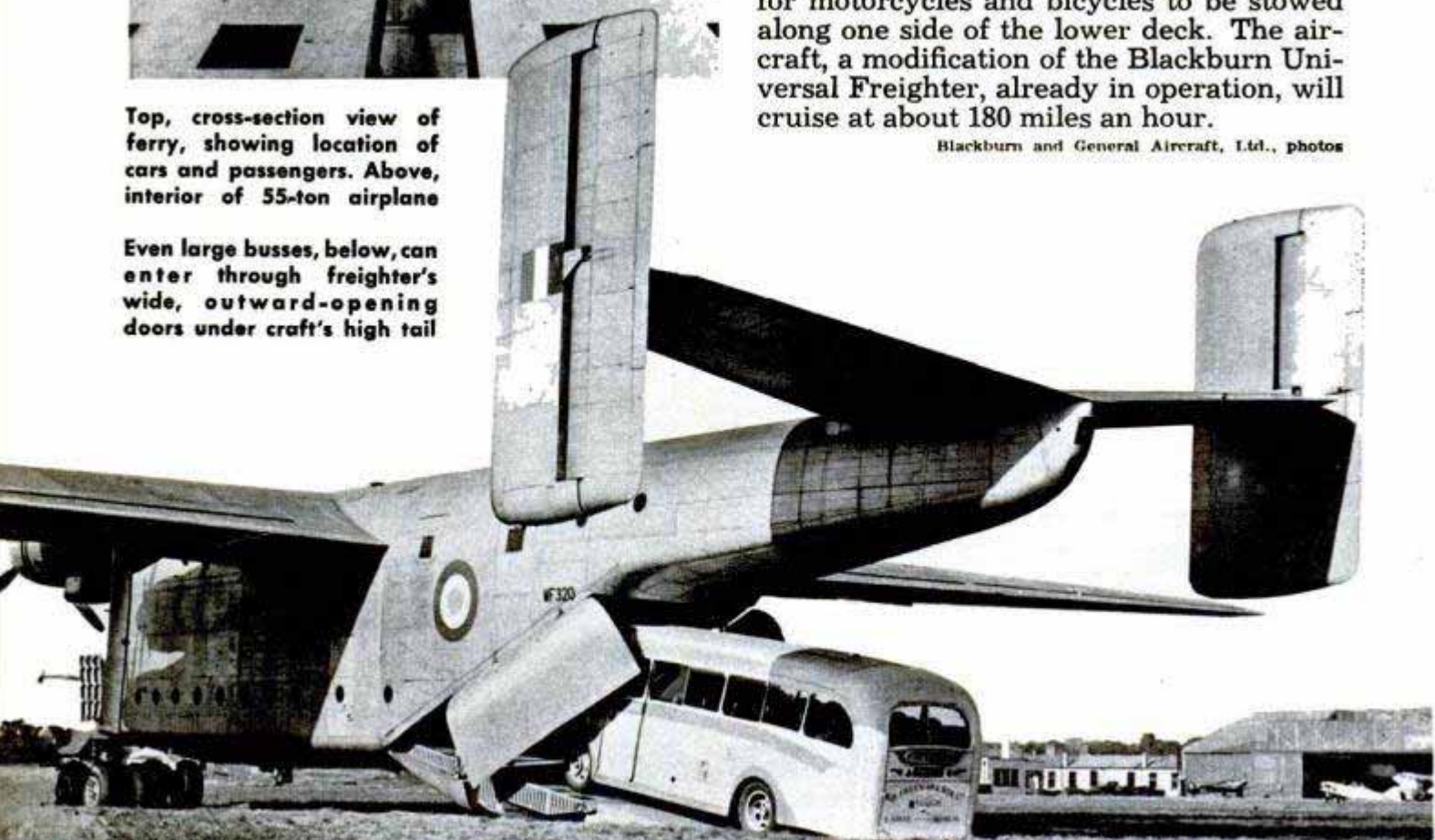



Photo from Knott's Berry Farm

It's a big decision—how to spend that nickel. A few confectioners still specialize in real old-time candies

They Make Candy by the Ton

By
Clifford B. Hicks

HIGH ATOP a huge factory in Chicago is the fairy-tale kingdom of a man with a unique and appealing profession. So appealing, in fact, that if he were only known to the nation's small fry he'd outdazzle all manner of cowboys, puppets and spacemen.

This is America's largest sweet-tooth factory—a full 17 acres of luscious sights, smells and tastes—and here Otto Windt plies a unique trade in the high little office: he's actually paid to taste candy, day in and day out.

Windt is a tall, energetic and thin man (surprisingly thin, considering his work) who serves as the factory's chief candy technician. His pleasant duties are twofold: He sees that every batch of sweetness emerging from the tantalizing depths of the

Candymakers "swing the batch" by looping it over arms of a mechanical puller, which gives right texture





Candy is tumbled in big drums to give it an outer coating, to color it or to polish it to a high luster. Process is called panning. These are candy eggs with a long "shelf life," already in production for Easter

factory is taste-tested; and he dreams up luscious new candies to tempt the palates of 125,000,000 candy-eating Americans. Five days a week Windt is surrounded by the tempting, vagrant odors of maple sugar, melted butter, roasted nuts, pungent spices, sharp cinnamon and rich chocolate. He tastes hundreds of types of candy during the week.

Candy-technician Windt practices an art that is surprisingly modern, yet the history of candy itself goes back to antiquity. You can bet your bottom bonbon that the cave-

man soothed his sweet fang with honey swiped from Pleistocene bees. The Romans, in their day, cooked up a concoction of honey, poppy seeds and nuts, thereby innocently inventing the forerunner of the modern nougat. In the 14th century, Venetians started toting back from the Orient a strange substance which we now call sugar. But modern candies didn't really get their start until the 19th century when pharmacists discovered the trick of coating pills with sugar.

Today candy is literally a billion-dollar

On hot, leather-topped table, candymaker works out effective design. "Rope" will be pulled, cut into pieces





"Sugarheads" work on cut-rock—the kind with the picture in the middle. Soft, thin layers of red, white and blue candy are assembled into an intricate mass



Design is stretched out, then mounted in a big pillow of white candy. The trick is to "draw" the picture lengthwise so it will appear in cross section of candy



Final step is wrapping the entire mass in a thin red blanket. The resulting "log" is slowly pulled from one end to form "rope" about the size of man's finger

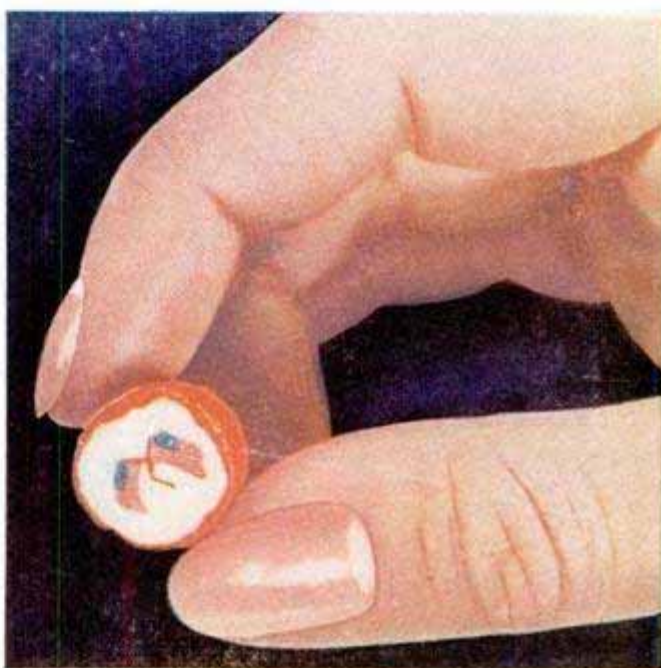

When rope is chopped into pieces, design appears in miniature in the center. In this case, candy-eater will find 13 stripes, suggestion of stars on each flag

business. In this country, it's estimated, the candy-eaters stow away an average of 20½ pounds apiece each year, a grand total of about 2,500,000,000 pounds!

To satisfy the tremendous demand, our confectioners produce some 2000 different kinds of candy. Yet the old-timers in the business will tell you there hasn't been a really new species of sweetness for a good many years. The old-fashioned licorice whips, buttons, "mothballs" and jawbreakers are the forebears of today's candies. Here and there you can still purchase the old-timers. Knott's Berry Farm at Buena Park, Calif., goes to fantastic lengths to stock old-fashioned candies for its little—and big—customers.

Perhaps the outstanding example of an old candy with a new appearance is the remarkable confection turned out by Charles Slagle at his Candy Butcher Shop in San

Francisco. Hanging from racks in the shop are all kinds of sausages, ham, bacon, cold cuts and other meats. Actually these meats are old-fashioned marzipan candy, pressed into shape in molds and beautifully painted with vegetable coloring.

Slagle's brother, Robert, is a competitor in the fancy-candy business in San Francisco. His specialty is candy fish—realistic rainbow trout, packed in a fisherman's creel.

Otto Windt, the man with the enviable job, plies his unique trade for one of the world's largest candymakers, E. J. Brach & Sons. As chief candy technician he dreams up new candy combinations and directs the laboratory of control, which sees that every bite of candy leaving the factory measures up to rigid standards.

The laboratory's 20 technicians check every manufacturing operation in the building frequently. No one in the factory



Tons of different candies are churned in this mechanical bin, then packaged as party mixes. Below, wrong picture for a candy story? No, those cold cuts all are marzipan candy, hand-painted to resemble meats

Photo from Slagle's Candy Butcher Shop

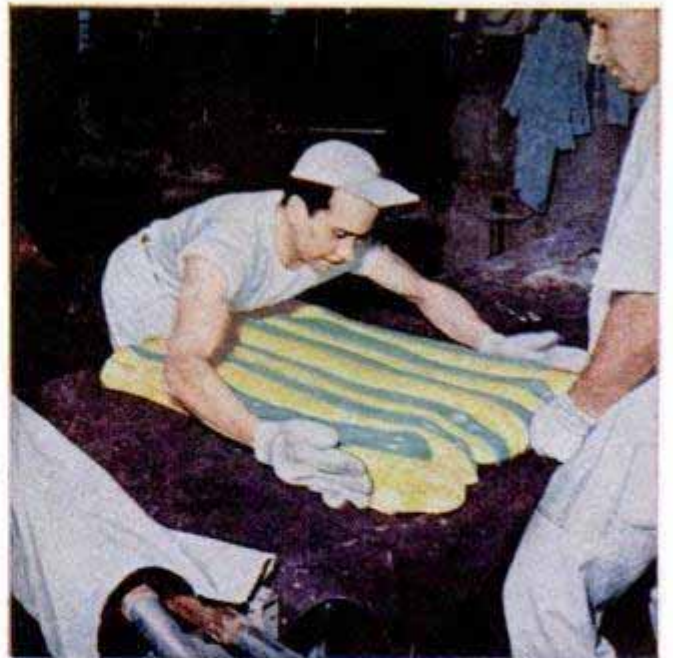

Alternate-colored strips are assembled on a table. Possible designs for candy "pillows" are endless

Big "mogul," below, revolutionized candymaking. Cycle starts as starch flows to empty trays, ends when candy tumbles from trays, which go on for a new load

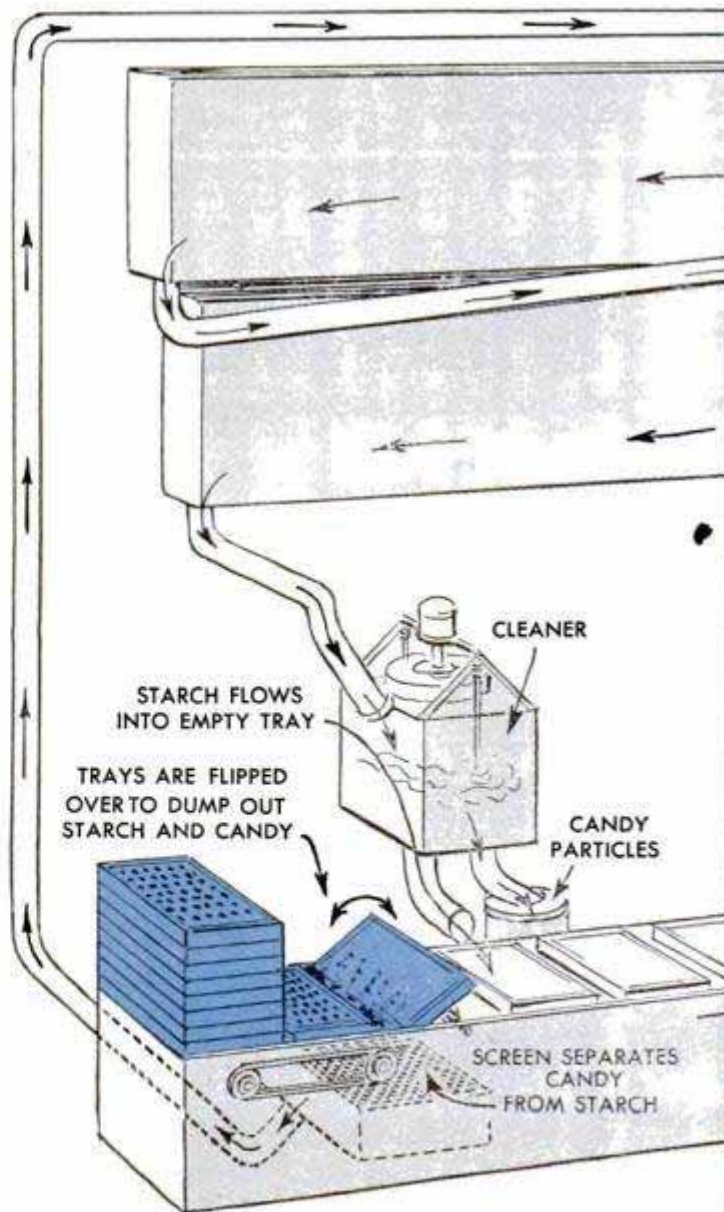

knows when an inspector will appear at a particular candy line, scoop up a sample and take it with him to the laboratory for examination. Every peanut coming into the plant is X-rayed and any goober that shows the slightest variation is discarded.

But a mechanical taster just hasn't been invented, so the final exacting test of the candy is left to the sensitive palate of the technician, who wraps his lips around luscious chunks of fudge, nougat and caramel day in and day out. It's no strange sight to see this same taste-tester stop by the retail candy store in the factory to buy a couple of pounds of assorted gumdrops for his week-end pleasure. That, perhaps, demonstrates the unique appeal of candy: no one ever gets tired of it.

In performing the second part of his job—dreaming up new candy combinations for Brach's—Windt shops for confections all over the world.

The candy business, despite its hauntingly pleasant end product, is among the most fiercely competitive industries in existence. Candymakers have a sharp eye and sensitive tongue for detecting new

candies that seem to strike the public fancy anywhere in the world. Occasionally a promising treasure is found in the product of a small confectioner. Such an item may be picked up and analyzed; then, perhaps, a new big-volume candy will be born.

Though there's been little that's genuinely new in end products, there's been a real transformation in the candy industry in the past 50 years. Brach's itself is a fine illustration of that change.

Back in 1904 Emil J. Brach and his sons, Edwin and Frank, started their "Palace of Sweets" with a cooking vat, a couple of pouring tables and a few starch boards. Just about everything was done by hand, and it was a sweet day when they turned out 100 pounds of candy.

Today Brach's may ship out a million pounds of candy in 24 hours. Some of the figures are significant: It takes 20,650 acres in cane and beets to produce the company's sugar intake; 20,250 acres of corn to make the corn syrup; the full production of 2750 dairy cows to meet milk requirements.

Obviously this landslide of ingredients couldn't be converted into tantalizing candies if the manufacturing process were still a hand operation.

Every conceivable mechanical aid is used in the factory. Hydraulic pumps shoot peanut butter and fruit fillings into the heart of hard candies. Glistening stainless-steel kettles—vacuum cookers—turn out 300-pound batches of sweets. Huge mixers stir cream centers to velvety smoothness, and miles of conveyor belts carry ingredients,

(Continued to page 244)

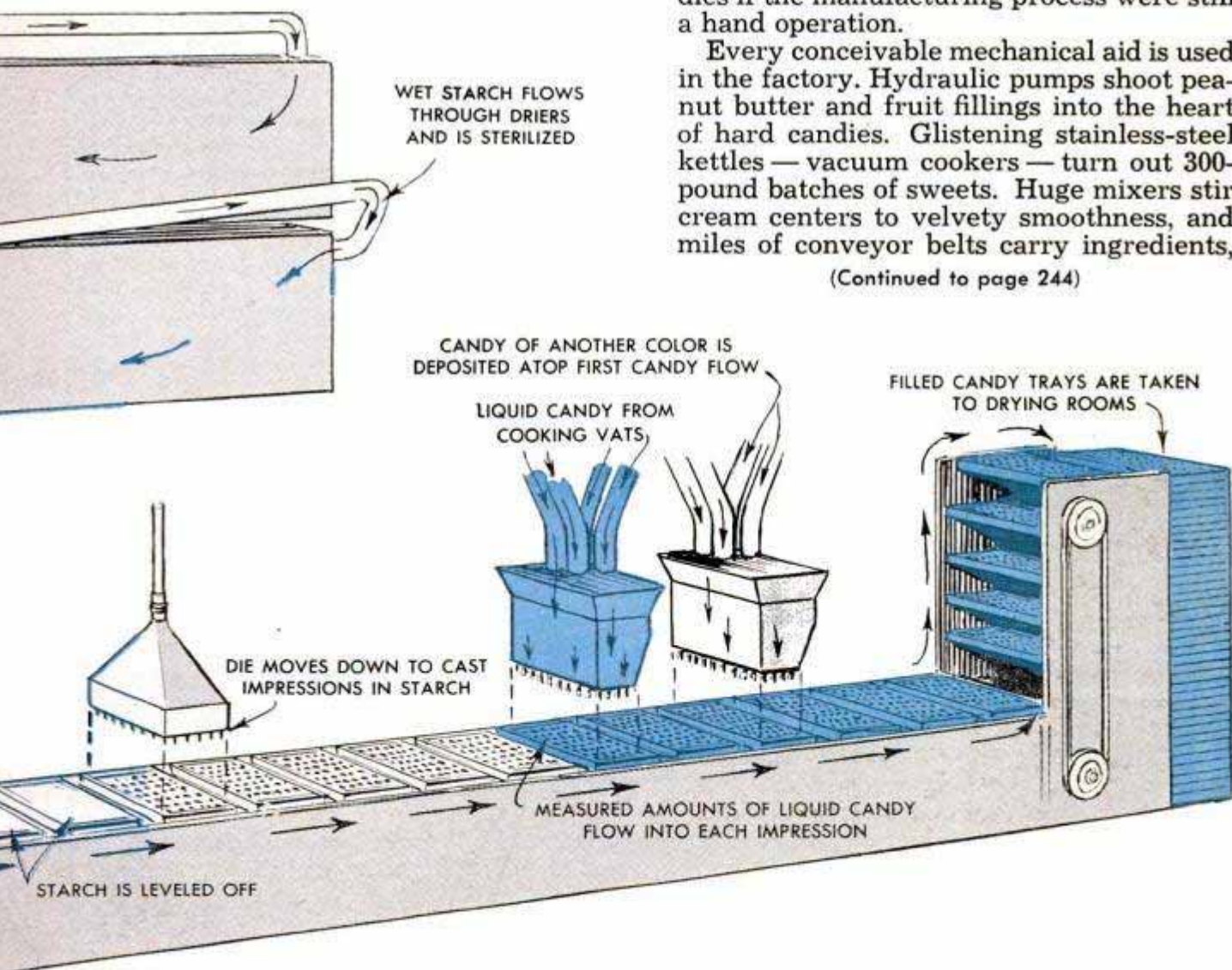

THE MOGUL—ASSEMBLY LINE FOR CANDY

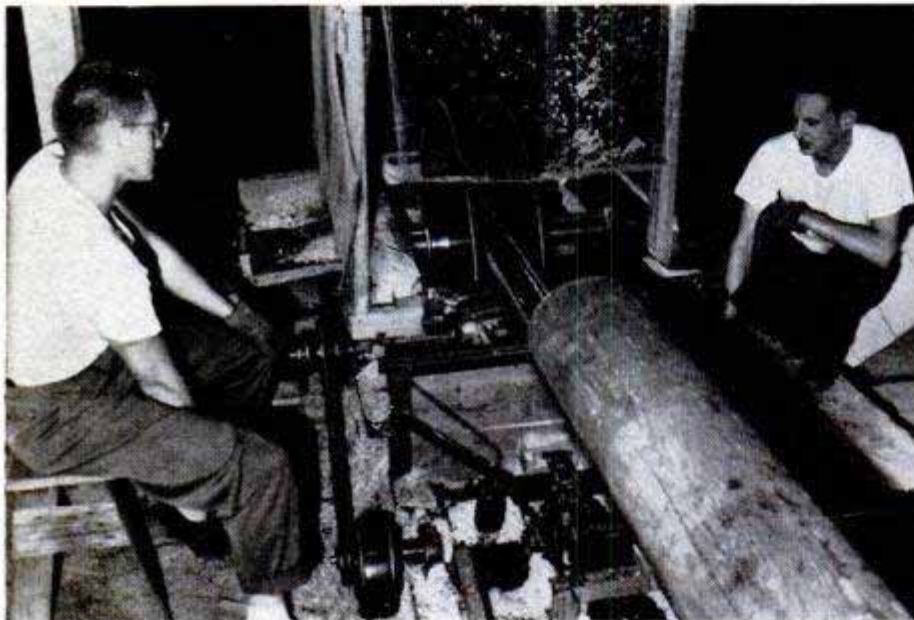
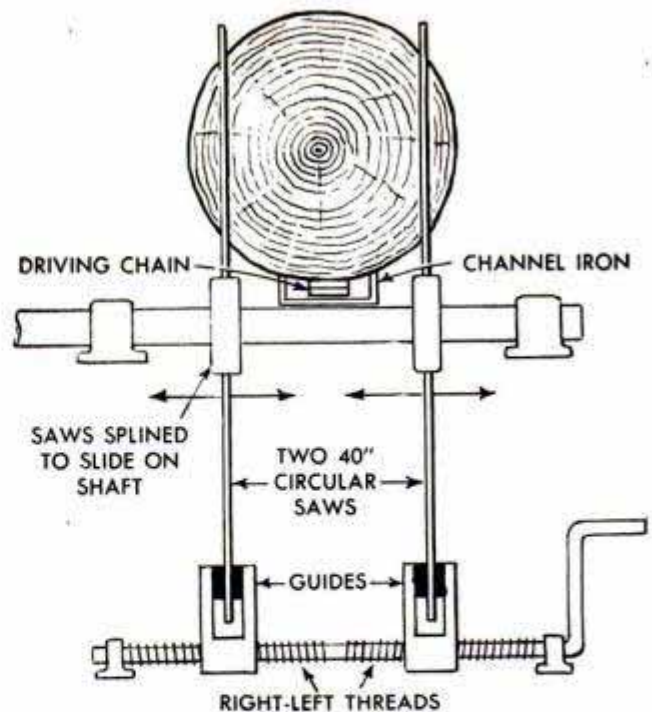
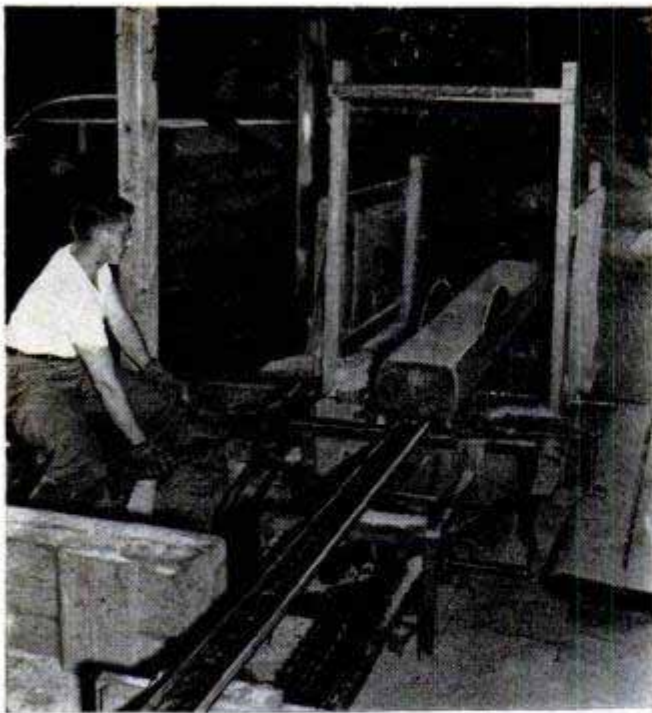

Auto transmission on reduction gear enables Macpherson (above, left) to reverse conveyor chain after the first cut and bring log through from other direction. Cores average eight to ten feet

Parallel saws (above) rest on guides anchored to a threaded shaft. Turning of crank adjusts width of cut. Conveyor chain is mounted in channel iron at exact midpoint between circular blades

Preparing to "square off" log, Macpherson (left) operates the conveyor-chain controls while Wolff turns crank to adjust the blades for proper cutting width. Mesh protects eyes from sawdust

Junior-Size Sawmill Turns Firewood Into Lumber

INGENUITY has paid off handsomely for John Macpherson and Milt Wolff of Portland, Ore., who literally built a sawmill in the basement of an apartment house! The two young men became interested in the peeler cores of local plywood mills, where huge lathes peel veneer layers from the best fir logs available. A peeler core, about one foot in diameter, can't be lathed further and in the past has been sold as fuel. The young men realized that the lumber in the cores was excellent and would immediately be purchased by finishing mills if the logs were squared into timbers. They designed a complete junior-size sawmill and built it in the basement of an apartment building. After testing it, they moved the mill to the outskirts of Portland and went into business. The entire mill cost less than \$1000, and in the

first month of its operation, running only evenings and week ends, it grossed \$1350. The head rig of the mill consists of two 40-inch circular saws splined to the same shaft. A powered link chain passes between the blades. A small log simply is rolled into place between the saws, the two blades are adjusted for the width of the cut, and the chain pulls the log through the mill. The log then is given a quarter turn, the drive chain reversed, and a second pass made. Result: A squared timber. Without help, the two men produce more than 1000 board feet of lumber per hour, averaging a net of \$7.00 per hour apiece.

U. S. telephone service has doubled during the last 10 years and almost a million people are waiting for new installations, according to company officials.



Detroit Listening Post

By Siler Freeman

THE RUSH of new models slows somewhat this month with only three scheduled—Pontiac, Ford and Mercury. All three will come out during the first half of December.

Pontiac will be of the utmost interest. Because General Motors' styling policy overlaps in several divisions, the 1953 Pontiac will provide the first clue as to what the new Chevrolet will look like.

The battle between the two rivals, Ford and Chevrolet, will be charged with unusual vigor next year—a year experts say will provide the first real competition since 1940. Ford's changes will not be extensive. They will be "identification" changes mainly. Mercury's too will not go beyond that.

The industry is buzzing about the revival of the sports-car market. Kaiser-Frazer's announcement of a plastic-bodied sports roadster was followed by Nash's that it has decided to build its ultralight car, heretofore labeled only as the NXI.

As stated in this column previously, George W. Mason, president of Nash, has never abandoned the idea of a small, economical yet smart-looking car to supplement his Rambler line. But it has undergone major changes since it was first shown to test public reaction.

The new Nash small car will have an 85-inch wheelbase rather than 80. It will seat three instead of two and will be powered by a 42-horsepower engine instead of an 18 or 36. It will be built in England, as originally planned. Left by the wayside is the \$1000 price tag for which Mason was shooting. No price has been given, but no doubt it will be almost double that when it hits the American market.

K-F's plastic roadster will be in the \$2000-to-\$2500 class. It will weigh 200 to 300 pounds less than the Henry J.

Studebaker, leading independent, is keeping very quiet about its 1953 models. But that doesn't mean inactivity at South Bend. Reports are that it will again set a style trend, as it did postwar. Its new car is said to have a foreign look, principally like the British Jaguar. It will be a little hard to get into, but will have plenty of room inside.

Stepping up engine horsepower and compression ratios isn't posing a fuel problem yet. The national average is now 90 octane on premium gasoline, with 93 to 94 in the Midwest. Oil-industry experts say the power race will have to pause for a while after this year. They do not see much of a step-up in octane ratings immediately because of the huge expense involved.

Compression ratios for the first time will go above 8 to 1 in the 1953 models. Unless engineers can build "mechanical" octanes into their power plants, the 10-to-1 ratios envisioned for ordinary cars will still be a few years away.

Lead, of course, has eased up in price, but that alone is not enough to bring 100-octane fuel. However, it has insured continuance of present supplies of premium gasoline.

One long-term mechanical change to be noted in the 1953 models is the use of 12-volt batteries. Cadillac, Oldsmobile and Buick will have them and Chrysler will be forced to adopt them for its air-conditioning systems. Use of the 12-volt battery saves copper and is more efficient. It is expected to spread throughout the car and truck field within the next year.

Dodge amazed the experts by holding the price line after a complete retooling for its 1953 body and engine. Often in the industry, slight ornamentation changes have brought forth requests that OPS boost price ceilings. Dodge's move is encouraging.

More than ordinary interest will be centered on the new Chevrolet and Buick lines, due in January. Both have changed their automatic transmissions to an important extent. The two GM divisions are using the torque-conversion principle and have found their customers slightly querulous for various reasons. The improvements will be watched carefully when they get in the hands of the public.

Buick will have another sports car in addition to its Skylark at the big GM show in New York next month. So will Cadillac and Olds. Although no announcement has been made of plans for production other than for the Skylark, orders will be written at the Waldorf display.

29% USE PREMIUM GAS EXCLUSIVELY

69% HAVE CONVENTIONAL TRANSMISSIONS

THE POPULAR MECHANICS MOTOR SURVEY
AS CONDUCTED BY FLOYD CLYMER

- 1- I am the owner of a 1952 Henry J. Corsair 4 Corsair 6 Vagabond 4 6
- 2- It is equipped with: Conventional transmission Speedometer with overdrive
- 3- I have owned it approximately 3 months. I use premium (high test) gasoline Regular Reasonably so
- 4- Do you obtain the gasoline economy you expected? Yes No m.p.g. - country driving: 26
- 5- Average gasoline mileage: 1500-2000 miles. I do do not add oil between oil changes.
- 6- I change oil every 22 months. I do do not add oil between oil changes.
- 7- Roadability and handling qualities are: Excellent Good Unsatisfactory
- 8- Maneuverability in traffic seems to be: Excellent Good Unsatisfactory
- 9- Acceleration is: Exceptional Very Good Average Poor No
- 10- In your Henry J, do you have the feeling of driving a "small" car? Yes No

ONLY 9% GET LESS THAN THEY EXPECTED

JUST AVERAGE, POLL SHOWS

11- Here are my main reasons for purchasing a new Henry J: I wanted to get a new car at what a good second hand car would cost - inexpensive upkeep *except for rear

- 12- My comments on the features:
 - Visibility, front and rear: Like Dislike Acceptable
 - Riding qualities in general: Like Dislike Acceptable
 - The 100-inch wheelbase: Like Dislike Acceptable
 - The body styling in general: Like Dislike Acceptable
 - Curb clearance for opening of doors: Adequate Too High Too Low
- 13- Specifically, what do you dislike about your new Henry J? Should be at least 6 in. more leg space in rear seat. Also should have larger rear window. Not enough room in rear seat. When base should be about 110.
- 14- Would you buy another Henry J? Yes Possibly No
- 15- Has the fact that the Kaiser-Frazer factory pays retail prices to your dealer for warranty repair work or service benefited you? Yes Partially No
- 16- Have you found Kaiser-Frazer dealer service better or worse than service from dealers in other makes you have previously owned? Better Worse About the same
- 17- How do you rate your Henry J, generally? Excellent Good Average Poor

ONLY 14% ADD OIL BETWEEN CHANGES

SLIGHTLY BELOW AVERAGE

48% EXCELLENT 39% GOOD

LOUDEST GRIPES--
1. REAR SIDE WINDOW CAN'T BE OPENED
2. REAR WINDOW TOO SMALL

89% WANT NO MORE HORSEPOWER

GENERAL INFORMATION

- 18- What type of engine would you prefer in your next new car? In-line V-type
- Number of cylinders: 4 6 8 Valves: Side Overhead
- 19- Are you satisfied with the horsepower rating of your Henry J (68 or 80 h.p.)? Yes No
- Approximately what H.P. rating would you like in your next new car? 90-100
- 20- What specific improvements would you like in your next car? larger rear window
- 21- Based on your present experience, which transmission would you prefer: Conventional Automatic (What kind? about 110" wheelbase - more space between front and back seats)

This questionnaire will be tabulated fairly, and your name will be held in strict confidence; we request that you attend to each question listed. Thank you.
Please mail promptly to:

FLOYD CLYMER,
1268 SO. ALVARADO ST.
LOS ANGELES 6, CALIF.

My name: [Redacted]
Address: [Redacted]
City & State: Chicago, Ill.
Occupation: printer

(Please write other personal comments)
This is my second Henry J. - I especially like the fold-forward backseat. It makes a good bed for the kids (we have a mattress for it) whenever we travel. With the 3 features I disliked about it corrected, the Henry J, to me, would be the perfect family car.

CLYMER TESTS THE KAISER

Floyd Clymer tested the Henry J in February 1951. This month, he puts its big brother through the paces. Read what Clymer found out about the Kaiser, beginning on page 91

The



Slightly longer than last year's, the 1953 Corsair has a restyled interior, an almost unchanged exterior

OWNERS REPORT on the HENRY J

The true test of a car begins when the owner takes the wheel. *Popular Mechanics* sent questionnaires to 1000 Henry J owners. Here's what they say about their cars

By Floyd Clymer

UNDoubtedly one of the most-discussed cars on the American market is Kaiser's lightweight (2350-pound) Henry J. An amazing number of Henry J owners are enthusiastic boosters and a large percentage have high praise for the car, while the percentage of dissatisfied owners is quite small; in fact, only 3 percent said they would not buy another Henry J; 31

percent might buy another Henry J and 66 percent said they will do so.

Most owners are well pleased, such as a Southbridge, Mass., automobile serviceman who wrote: "I work on all makes and models of cars day in and day out; I have driven everything from a Model A Ford to Lincolns and Cadillacs. Some of the big cars may give a little better ride and go a

Despite the slanted rear deck and small lid, there is considerable luggage space in the small Henry J

Most owners use regular gas, are satisfied with gas mileage. Sloping back window makes rear vision poor



Percentages From PM Poll

Owners of Corsair models.....	56%
Vagabond models.....	44%
Owners of 4-cylinder models.....	51%
6-cylinder models.....	49%
Conventional-transmission cars.....	69%
Overdrive-equipped cars.....	31%
Use regular gasoline.....	71%
premium gasoline.....	29%
Get gas mileage expected or more.....	56%
reasonably near expected mileage.....	35%
less than expected.....	9%
Average gasoline mileage in country*	
4-cylinder.....	27.8 m.p.g.
6-cylinder.....	26.1 m.p.g.
*Owners of overdrive-equipped models report approximately 2 m.p.g. higher gas mileage (country driving only)	
Average gasoline mileage in city	
4-cylinder.....	24.3 m.p.g.
6-cylinder.....	23.3 m.p.g.
Average mileage before oil change.....	1332
Owners who do not add oil between changes.....	86%
Roadability excellent.....	63%
good.....	36%
unsatisfactory.....	1%
Maneuverability excellent.....	82%
good.....	18%
unsatisfactory.....	0%
Acceleration exceptional.....	24%
very good.....	53%
average.....	22%
poor.....	1%
Owners who note no feeling of driving a small car.....	78%

OWNERS' RATING OF HENRY J

Excellent.....	48%
Good.....	39%
Average.....	12%
Poor.....	1%

Below, with a 17½-foot turning radius, the 100-inch-wheelbase Henry J is easy to maneuver in tight spots. Chalk lines emphasize how sharply front wheels turn



GENERAL INFORMATION

Owners preferring the following on next car:	
In-line engine.....	74%
V-type engine.....	26%
Six cylinders.....	64%
Four cylinders*.....	19%
Eight cylinders.....	17%
Side valves.....	55%
Overhead valves.....	45%
No increase in horsepower desired.....	89%
Conventional transmission with overdrive.....	50%
Conventional transmission only.....	30%
Automatic transmission.....	20%
(*37% of the owners of 4-cylinder models would prefer a similar engine in their next cars.)	
Will buy another Henry J.....	66%
Might buy another Henry J.....	31%
Will not buy another Henry J.....	3%
Dealer service about the same as that of other makes.....	55%
better.....	30%
worse.....	15%
Chief purchase reasons (in order of popularity):	
1. Economy of operation	
2. Original price	
3. Styling features	
4. Driving ease (roadability and handling)	
Improvements desired in next car (in order of preference):	
1. Increased vision to rear	
2. Better body workmanship	
3. Rear side windows which crank up and down	
4. Increased seating and/or riding comfort	
Most frequent objections:	
1. Rear side windows do not crank up and down	
2. Inadequate rear vision (small rear window)	
3. Body fitting, poor assembly or workmanship	
4. Inadequate leg or seating room in rear	
5. Undue vibration or noise from engine or drive mechanism	
6. Car too small, short or lightweight	

little faster, but the Henry J, in my estimation, will stand up to most of them in durability and performance."

The replies from Henry J owners include some brickbats, too. "Specifically, what do you dislike about your new car?" is a question always included in our surveys, and here is a random sampling of Henry J dislikes:

"After the usual parking-lot adventures, the bumpers are wrinkled like an accordion."—Cleveland physician.

"The rear windows won't roll down."—This complaint was common among the owners. (I agree.)

"Frequent breaking of door glass."—South Carolina naval-base employee.

"The 'grasshopper' rear end."—Philomath, Ore., newspaper worker.

"No dome light or armrests."—Greenville, Tenn., electric-lift operator. (The 1953 car has a dome light in all models.)

"Should have a lock on the driver's door."—Astoria, L. I., housewife. (I agree.)

"Clutch and brake pedals should be a

(Continued to page 230)

CLYMER TESTS THE KAISER

THE CAR I TESTED was the 1952 Kaiser Manhattan four-door sedan with Dual-Range Hydra-Matic Drive, powered with the 115-horsepower, six-cylinder, 7.3 to 1 high-compression engine which Kaiser calls Supersonic.

The test was for 1090 miles in southern California, Arizona and Nevada over desert, mountains and back roads. I could not make the engine overheat. The only trouble I had was a vapor lock that occurred twice in the heat of the desert. Some cold water poured on the gas line and fuel pump took care of it. The exhaust manifold is too close to the fuel pump, which causes this trouble. (Engineers should climb high mountains like Pikes Peak some time, as the same trouble occurs on many cars climbing long, steep grades at high altitudes. This suggestion applies not only to Kaiser engineers but to all engineers.)

The new Kaiser is one of the finest handling cars I've ever driven and roadability is excellent. I once said that earlier Kaiser cars had a nearly perfect combination of balance and weight distribution and now I find the 1952 model is even better than previous ones. The car is very stable at high speeds and on curves.

The self-centering, easy operating brakes are excellent and stand abuse. Vision is as



Clymer says that though it's no road locomotive, the Kaiser has good power in low gears for steep grades

Announced too late for testing, the 1953 model is little changed outside. Horsepower has been boosted to 120 compared with 115 in the '52 model. The new Kaiser retains sleek continental lines and good visibility

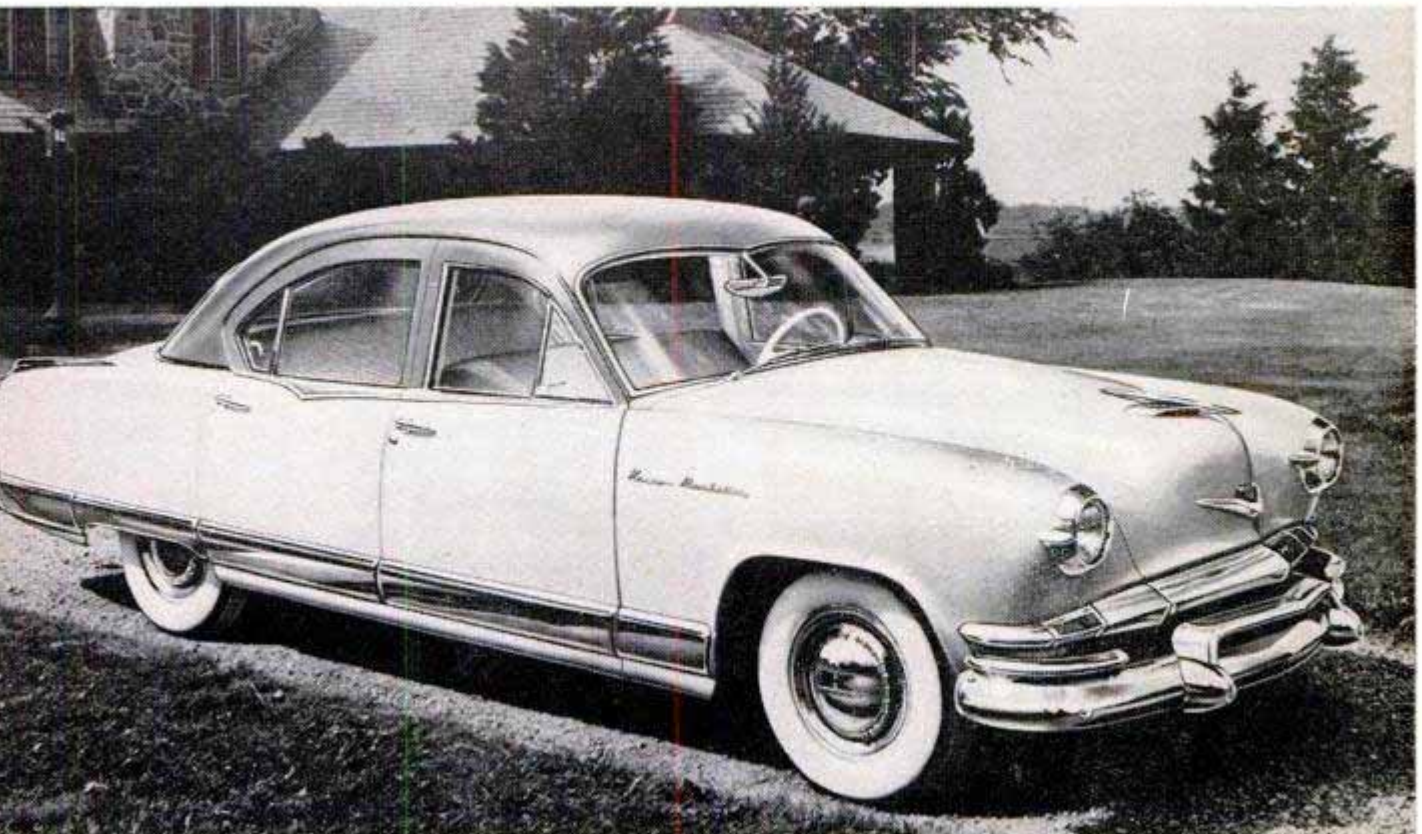

**ECONOMY TEST — 1952 Kaiser Manhattan
Dual-Range Hydra-Matic Drive
MILES PER GALLON**

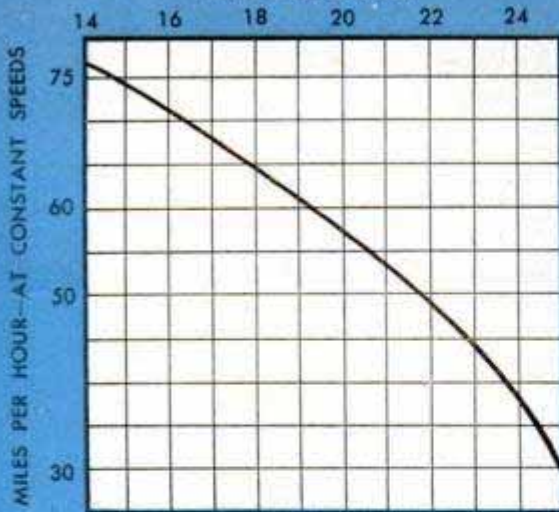

At constant 30 m.p.h.....	24.9 m.p.g.
At constant 50 m.p.h.....	21.8 m.p.g.
At constant 60 m.p.h.....	19.2 m.p.g.
At constant 75 m.p.h.....	14.5 m.p.g.

CROSS-COUNTRY MILEAGE

Los Angeles to San Diego (coast route, considerable traffic).....	17.2 m.p.g.
San Diego to Phoenix, Ariz.....	19.8 m.p.g.
Phoenix to Los Angeles, via Las Vegas, Nev.....	21.9 m.p.g.

Premium gasoline of various brands was used to Phoenix.
Regular gasoline used on return trip. Satisfactory but some pinging.

¼ mile from zero	Drive range 3 only.....	22.30 sec.
	Drive and Low ranges.....	21.90 sec.
½ mile from zero	Drive range 3 only.....	34.80 sec.
	Drive and Low ranges.....	33.90 sec.
0 to 30 m.p.h.	Low range only.....	5.80 sec.
0 to 60 m.p.h.	Drive range 3 only.....	18.90 sec.
	Drive and Low ranges.....	17.10 sec.

Top speed by speedometer..... 95-98 m.p.h.
Actual top speed about 7% less (speedometer variation)

good as if not better than any other American car. Steering is easy but there is some road shock transmitted from wheels to the steering wheel. Some large persons will find the steering wheel too low. The ratio is quite good and five turns of the steering wheel from lock to lock is satisfactory. The ride is smooth; the front end is stiffer and has less tendency to "bottom" when hitting hard bumps at high speed than previous models. Wheelbase is 118½ inches, which makes for a good-sized car.

The driving position is most comfortable and I found it an excellent car for long-distance driving. Roominess is an outstanding feature of Kaiser cars. Body lines are low and rakish.

The Kaiser engine is smoother than in earlier models and, while slightly underpowered by present horsepower standards, it gives a satisfactory and economical performance. Top speed is good — 95 to 98 miles per hour by speedometer (which, like most others, is fast by about 7 percent). The car has good power in lower gears for steep grades.

The engine gives good economy for its moderate size (226.2-cubic-inch displacement) and my tests produced excellent mileage (see Economy Chart).

The Hydra-Matic transmission needs no comment and its operation on Kaiser cars is the same as on General Motors makes. Borg-Warner transmissions, with or without overdrive, are also available on all Kaiser and Henry J models.

The body is built by Kaiser and is wide and roomy, yet there is no feeling of bulk or awkwardness in handling the car. I can't quite make up my mind what Kaiser's "Anatomic" design is or what it means, but I do know it gives a comfortable ride regardless of the name. It is easy to get in and out through the large doors. Door handles are of the pull type, operate easily and are attractive. Doors open and close nicely.

The foam-rubber cushions and seats are excellent. Seats are wide (approximately 64 inches in front, 63 inches in the rear) and afford a comfortable and roomy ride for three passengers in front or rear.

The instrument panel has a vinyl-covered crash pad which has some value in a crash. The instruments are well located. Brake pedal and

(Continued to page 224)

Child is visible when only 7½ feet from bumper, several feet closer than on most other cars



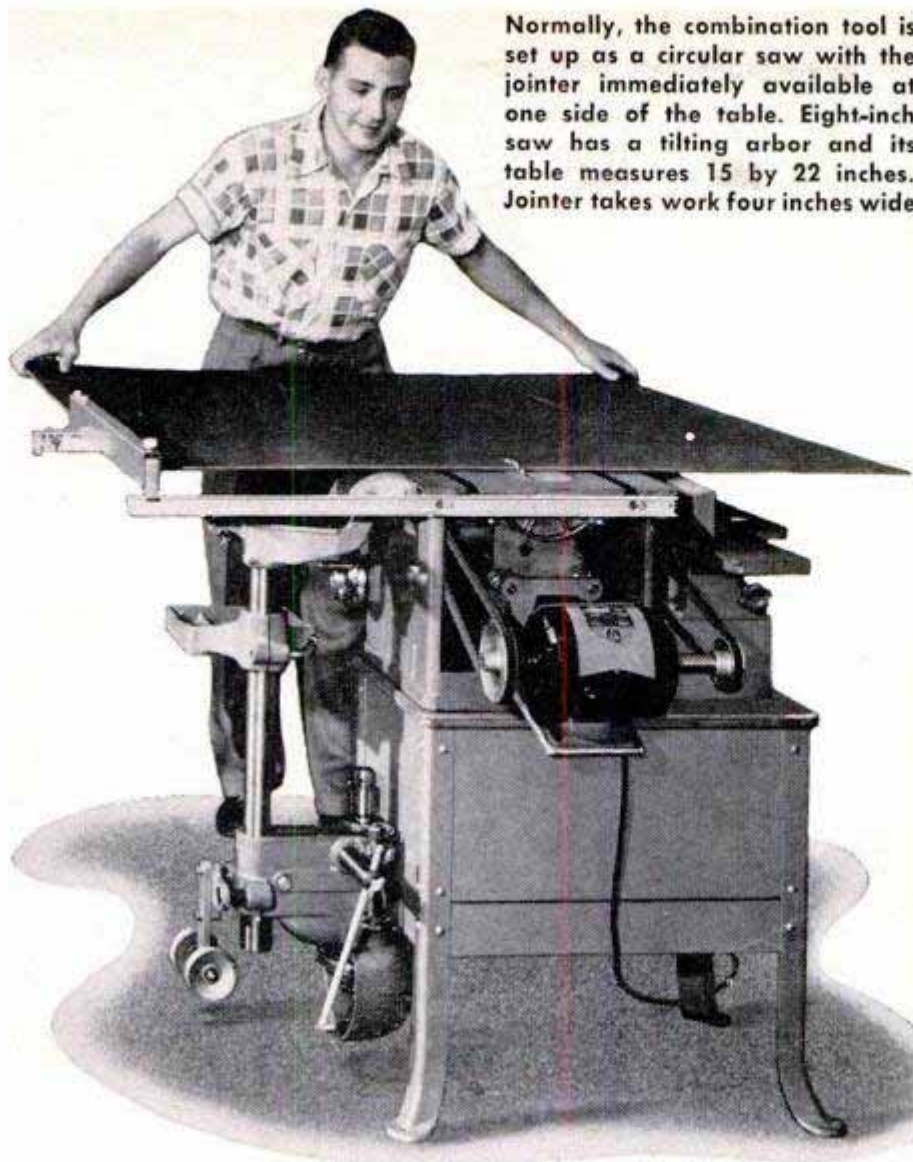

Normally, the combination tool is set up as a circular saw with the jointer immediately available at one side of the table. Eight-inch saw has a tilting arbor and its table measures 15 by 22 inches. Jointer takes work four inches wide

All-in-One Power Workshop Combines Four Basic Tools

FOUR BASIC TOOLS—the ones most often used by home craftsmen—are combined in a single power workshop measuring only three feet square. Built into the unit, manufactured by Delta, are a tilting-arbor circular saw, a jointer, a drill press and a disk sander. A special feature of the new combination tool is that it can be broken down into four individual tools, each mounted on its own stand and powered by its own motor. This enables the owner to set up a full-scale workshop when additional space is available. In normal operating position the power shop is set up as a circular saw and a jointer. Work can be moved directly from one of these tools to the other. It takes less than one minute to change the tool for operation of the drill press, and about 30 seconds for operation of the sander. With the attachment of a molding head and 27 cutters, the saw can be used to turn out all conventional shapes of molding. The jointer handles work up to four inches wide.

Top right, compound mitering—cutting two angles at once—is easy with saw's tilting arbor. Center above, jointer cuts a square edge for good joint, also can be used to cut bevel edge and rabbet. Right, sander puts finished edges on curved surfaces. Below, it takes less than a minute to swing drill press into place

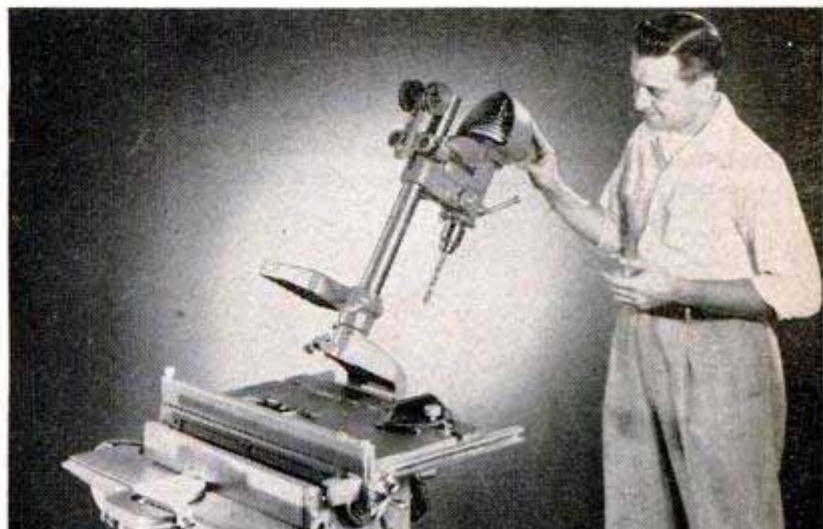
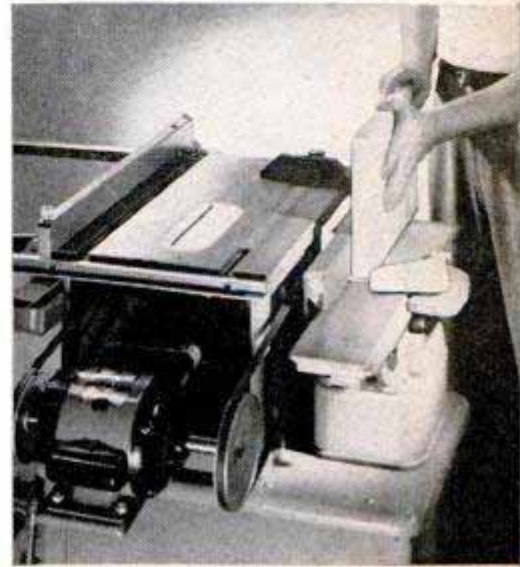



Plastic balloons carrying leaflets penetrate Iron Curtain in spots where radios are jammed. The word "svoboda" is Czech for "freedom"

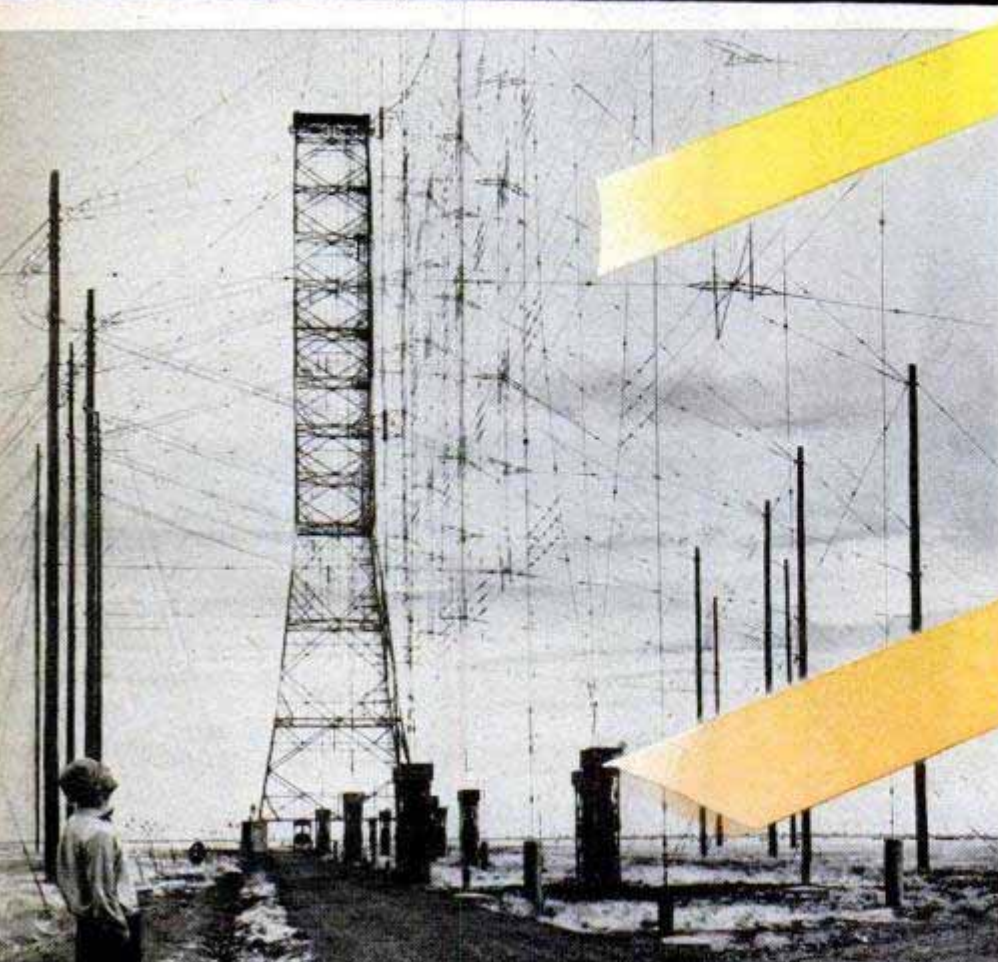

Curtain antenna on West Coast is one of several Voice of America installations in the U.S.A. which beam programs to specific targets

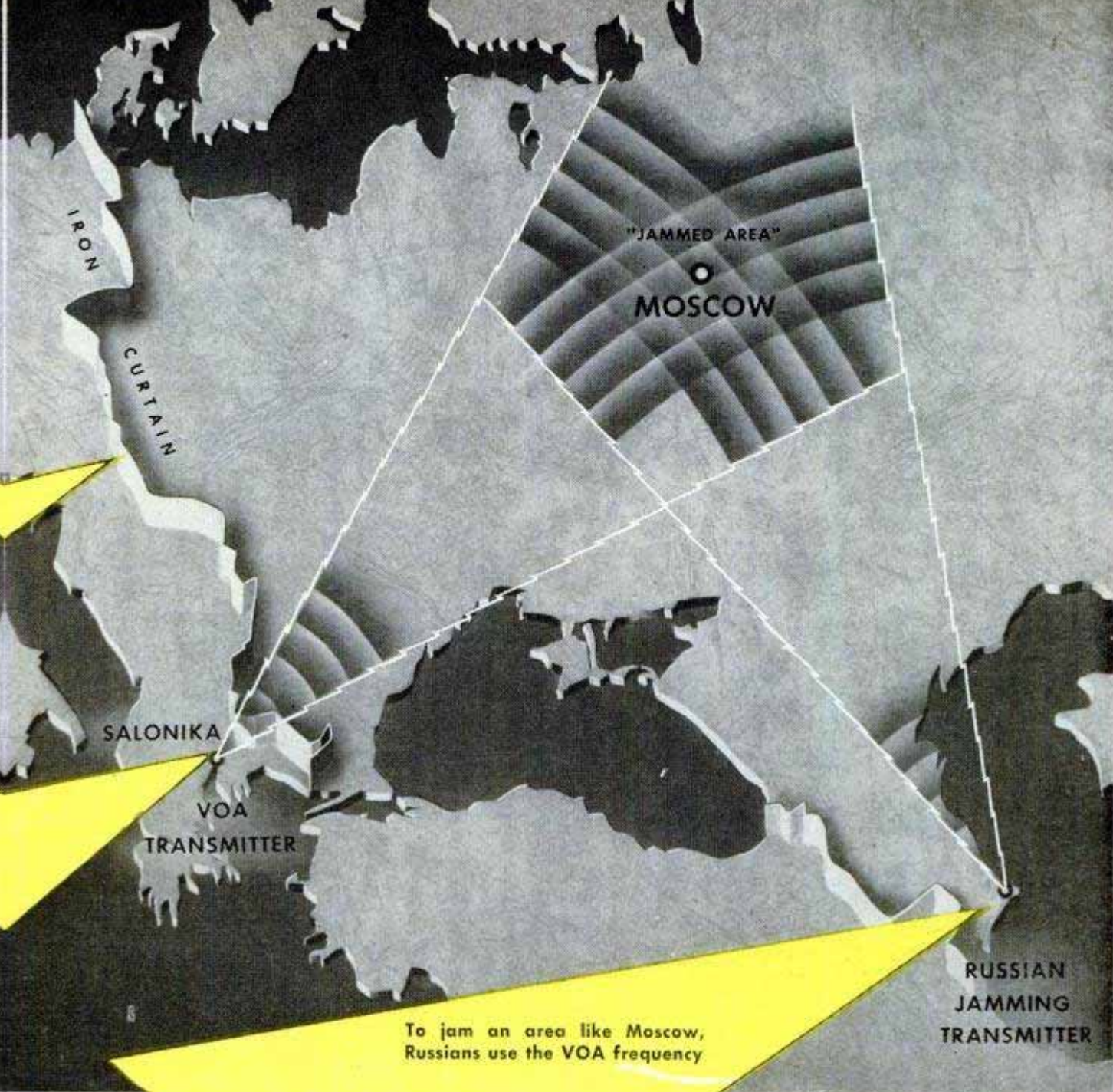

WITH SEAGOING RADIO STATIONS, SKYSCRAPING SPIDERWEBS AND SQUARE BALLOONS . . .

We're Blasting Holes in the Iron Curtain

MARINERS, hugging the coastal route between Panama and Vera Cruz a few months ago, saw something out on the gray Caribbean that looked as though a chunk of the Navy's lighter-than-air base at Lakehurst, N. J., had torn loose and gone to sea. High above a strange ship, and attached to it by a heavy cable, a big blimp soared like a fat bird on a leash.

The craft's deck bristled with a startling array of 30-foot antennas. Some resembled giant fishing rods. Others looked like upside-down steel towers with pointed ends anchored to the deck. Amidships, a massive steel landing platform for the blimp reared above the deck line.

It was the *Courier*, Voice of America's new roving radio transmitter, testing the



Coast Guard cutter *Courier* is the Voice of America's seagoing radio broadcasting station with giant 150,000-watt transmitter



On board *Courier*, turntable for recordings stays level even when the ship rolls

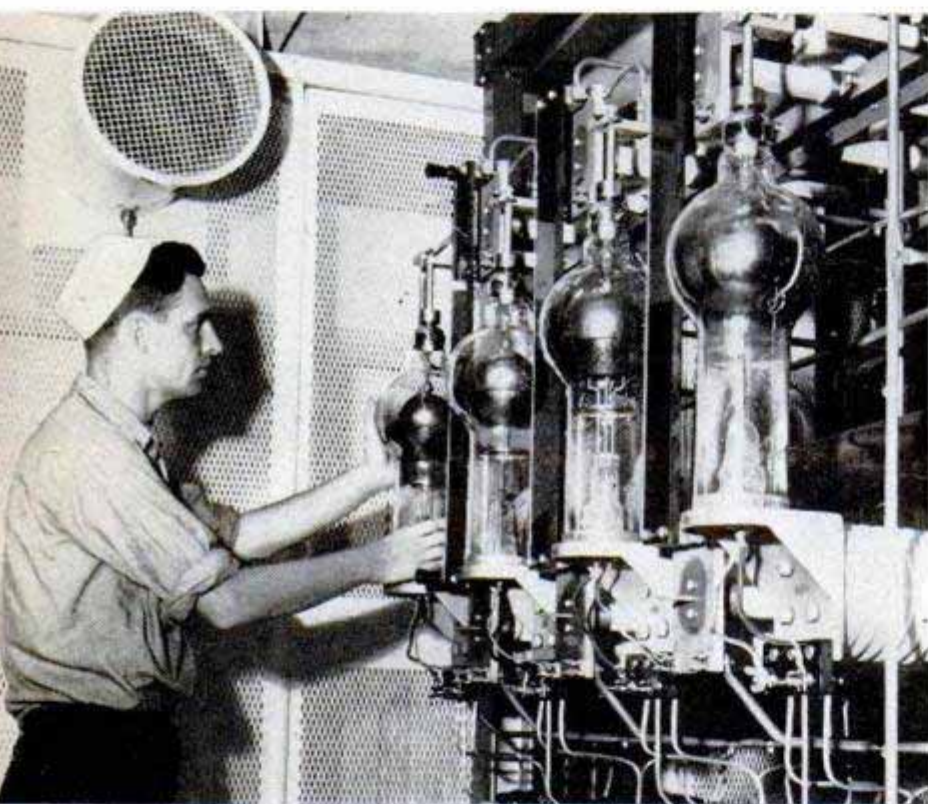

Huge condenser tubes in ship's transmitter room are shock-mounted

Engineer in main control room on *Courier* faces water-cooled tubes



carrying power of her electronic voice. Converted from a 5800-ton Navy A-K, she's one of a hatful of new tricks—including such things as vast webs of steel for blasting radio messages around the world; great flights of message-carrying pillow-shaped plastic balloons for hurdling communist boundaries; matchbox-sized radio sets for Red-dominated listeners—all helping to pull the drawstring on the Iron Curtain.

Manned by the Coast Guard for the State Department, the *Courier* is the first "combat" ship for Operation Vagabond—a proposed fleet of wandering supertransmitters that will roam the seas and lob verbal broadsides into Red-dominated countries from convenient harbors. Already, she has begun to play the biggest game of international radio tag in history. If necessary, she could operate under way, originate special programs from aboard and beam them out on a "skyhook" antenna that she flies from her helium-filled captive balloon. But most of the time, Capt. Oscar C. B. Wev, her skipper, will slip her in and out of undisclosed friendly European ports. She'll pick up Voice programs from the States and beam them on assigned frequencies deep into Soviet and satellite countries. Whenever Russian monitors locate her frequency and try to jam her off the air, she can simply haul down her

skyhook, up anchor, and set up business in a new location.

How well she works was revealed during her Caribbean shakedown. For six weeks her crew of 80 coastguardsmen, including nine radio officers and three Voice engineers, blasted the air waves with both relayed programs and special Latin broadcasts originating in the ship's own compact studio in the wheelhouse. Disk recordings were played on the special seagoing turntable, suspended so that the platter is always level, like a compass, no matter how the ship tosses on the seas.

"We broadcast to 10,000,000 listeners in Mexico," says Paul Tabailoux, one of the Voice supervisors on board, "and 160,000 in Panama City. But our mail shows we were picked up as far off as Scotland, Spain, Hawaii, New Zealand, England and France."

Packed into the *Courier's* 338-foot hull are a generating plant and radio station more powerful than many a big shore-based transmitter. Deep in an after hold, engineers roam through an air-conditioned electronic maze of switches, dials and glowing tubes. A 150,000-watt medium-wave transmitter will beam radio signals out across 1000 miles of space. In another long corridor banked by gleaming dial panels, operators stand on a cork runway to control two 35,000-watt short-wave transmitters capable of lobbing an anticommunist

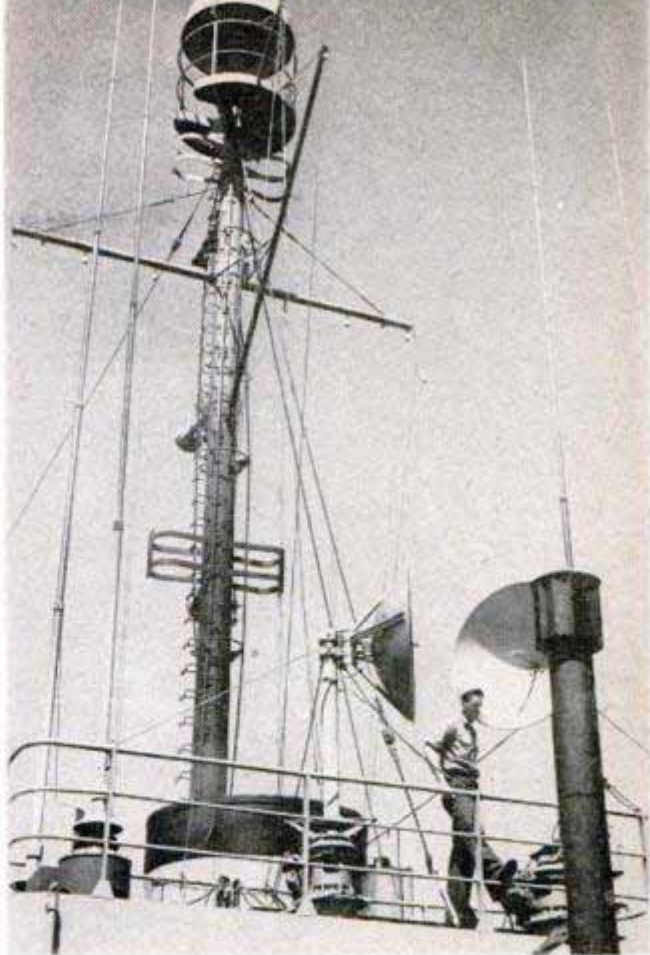

Forest of antennas towers above *Courier* deck. Tall mast houses radar; long rods are receiving antenna

Below, captive balloon supports Voice of America antenna. Here it is shown fully inflated on flight deck of *Courier*. Balloon can soar 900 feet in air

U.S. Coast Guard photo

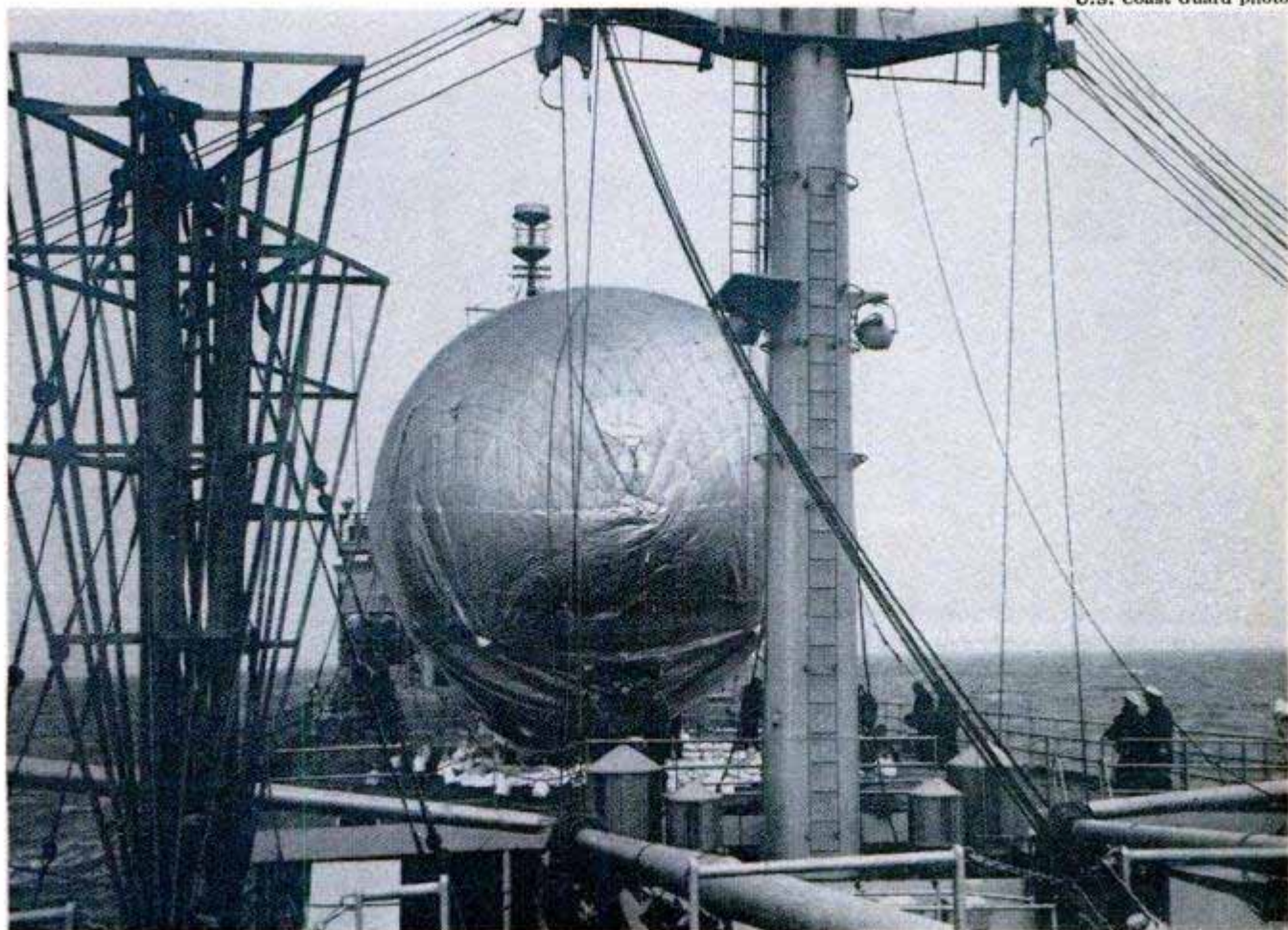

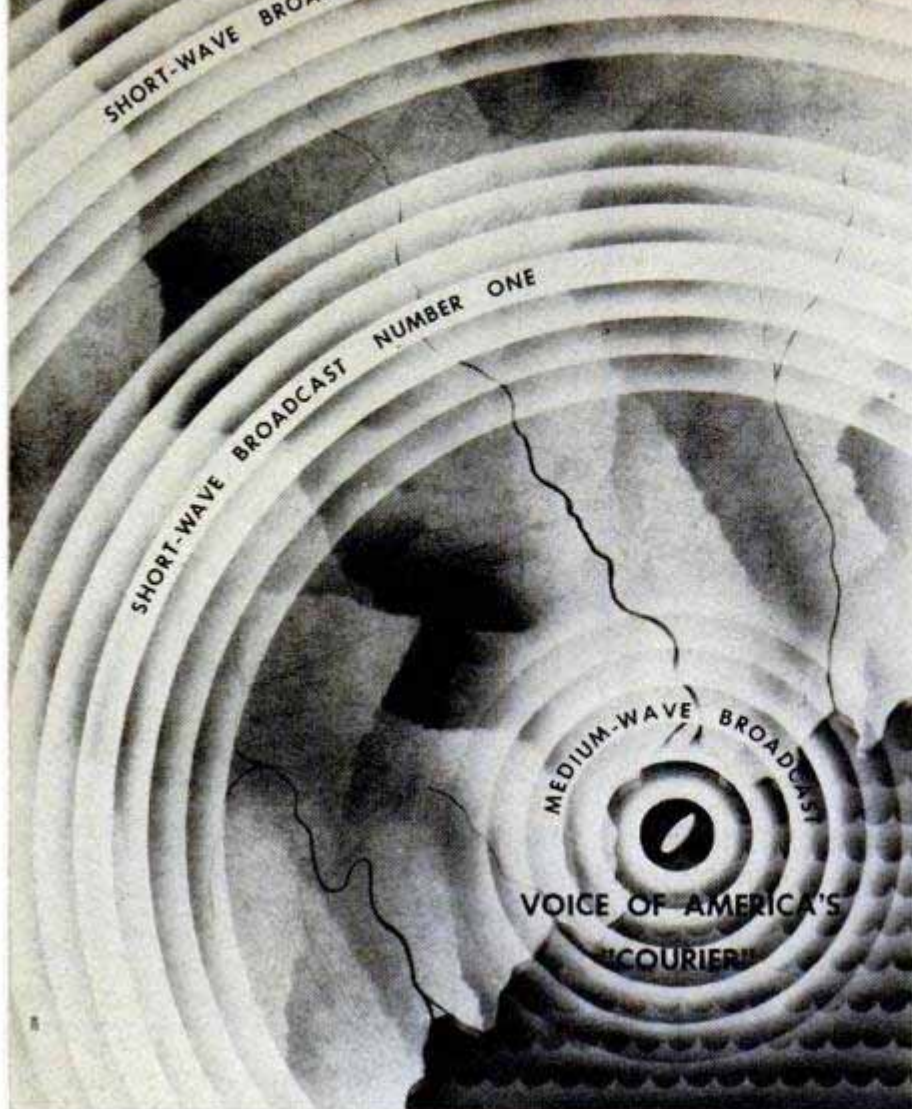
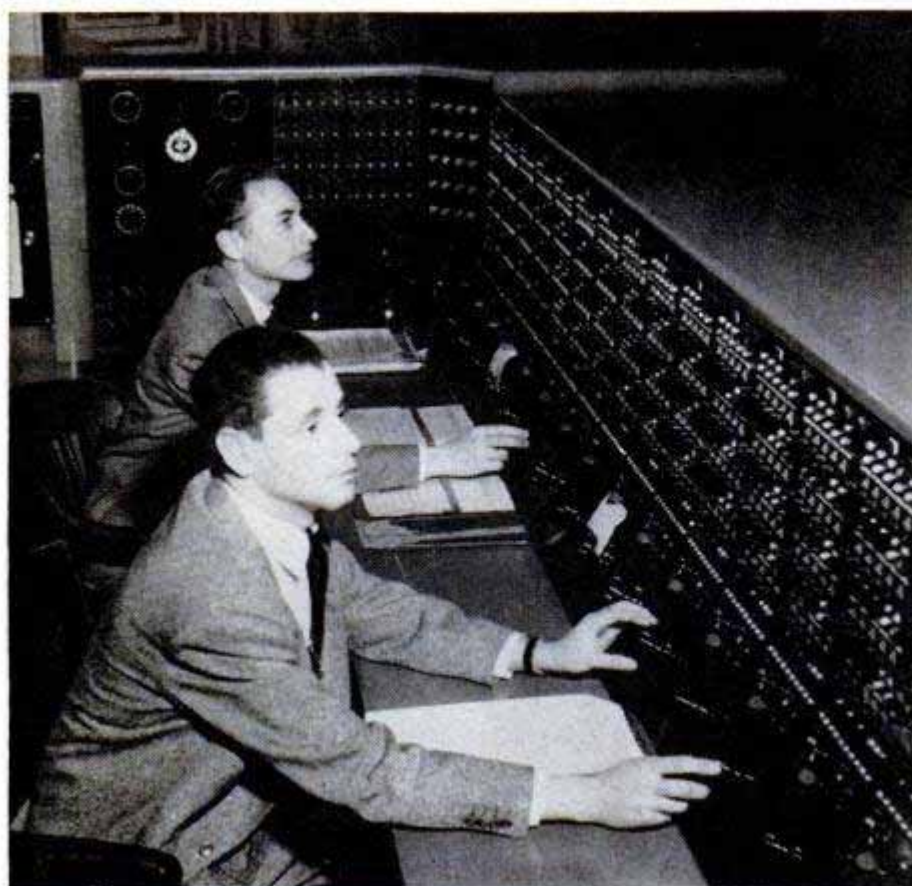

Diagram shows how Courier can transmit three broadcasts simultaneously

Voice of America's master control board handles 20 programs at one time and is the "gateway" for incoming and outgoing programs of the service



radio broadside clear around the world. Ship-to-shore and radioteletypewriter transmitters fill in the corners. Most of this delicate equipment sits on an eight-inch concrete platform measuring 20 by 40 feet, which is floated on cork slabs to absorb vibration from the ship's engines when she's under way.

In a 30-foot-high dungeon buried amidships, a battery of monster transformers hum in a low pitch. They are among the biggest ever to go to sea. Another hold houses three diesel generators capable of whamming 1,500,000 watts of power to the transmitters.

"With everything going, it would get seething hot down below and blister the paint," says Tabailoux. "So we have a special air-cooling system." The tubes are cooled by distilled water rushing through big porcelain water jackets around each tube base. The water takes heat from the tube and carries it to a heat exchanger, where fresh sea water cools it again. Then it returns to the tubes for another load of heat.

Oddest part of the ship is her 100-foot steel flight deck, sitting atop her well deck like a vast multi-legged table surrounded by a forest of antennas. The long whip-type rods are receiving antennas. Short wave goes out over the strange cornucopia-shaped steel towers. The skyhook, carried aloft by the blimp, is for medium-wave broadcasts.

Launching the skyhook at sea is a spectacular undertaking. Coastguardsmen, trained at Lakehurst, scramble around the flight deck like circus hands raising a big top, as they wrestle with the endless square yards of heavy

rubberized fabric. "The bag measures 69 feet long and 35 feet high, inflated," Tabailleux points out. "And there's only a 90-foot clearance between the masts."

The *Courier* carries six of the big bags, plus 600 bottles of helium to fill them. A big winch lofts the blimp and its antenna 900 feet in the air.

Tremendous insulators protect everything around the flight deck—for good reason. "During operations," Tabailleux explains, "the flight deck is so hot with frequency that men on it become charged. If you held a fluorescent lamp in your hands, it would light up."

Actually, the *Courier* is just one more verbal artillery piece in a battery that is blasting holes in the Iron Curtain with barrages of truth. In 1942, a tiny Voice of America squeaked its first news program from Station WLWO in Cincinnati to BBC, where it was fanned out to listeners in Germany and Italy. Today, a virtual storm of facts, figures and home truths bombards an estimated 353,290,000 potential listeners around the world in 46 languages. More than 50 program-hours a day on 70 frequencies pour out of New York studios to any of 38 short-wave transmitters located in the United States. Voice-controlled

(Continued to page 256)

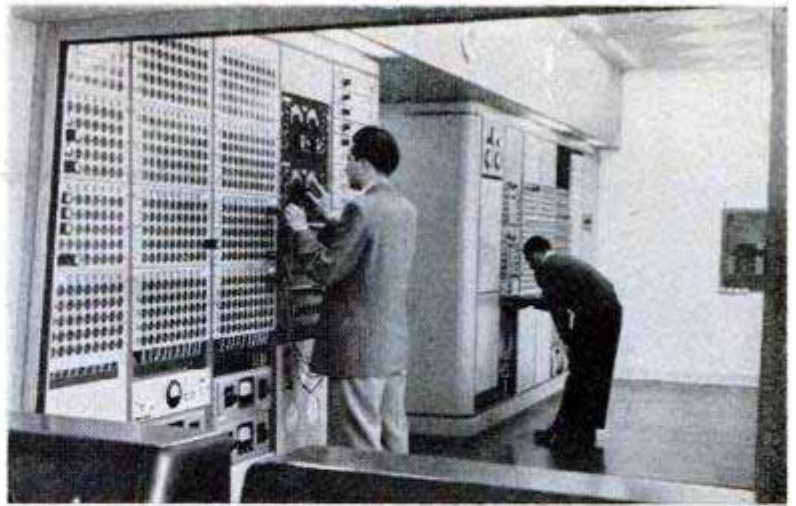

Radio Free Europe operates from this master control room in Munich. Below, RFE worker monitors an Iron Curtain broadcast



Map of the world shows how Voice of America transmitters literally blanket the world with radio coverage by bouncing signals from U.S. transmitters to networks of relay stations on both sides of the hemisphere

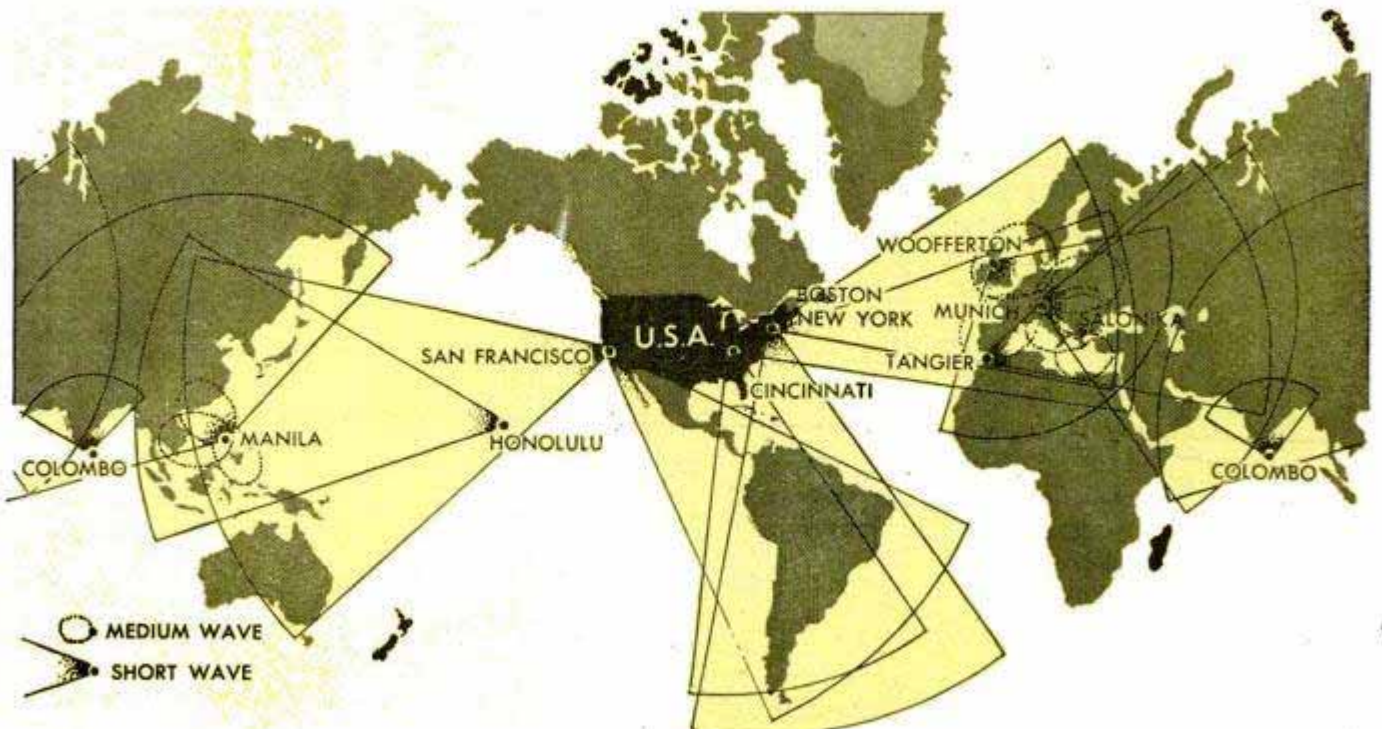

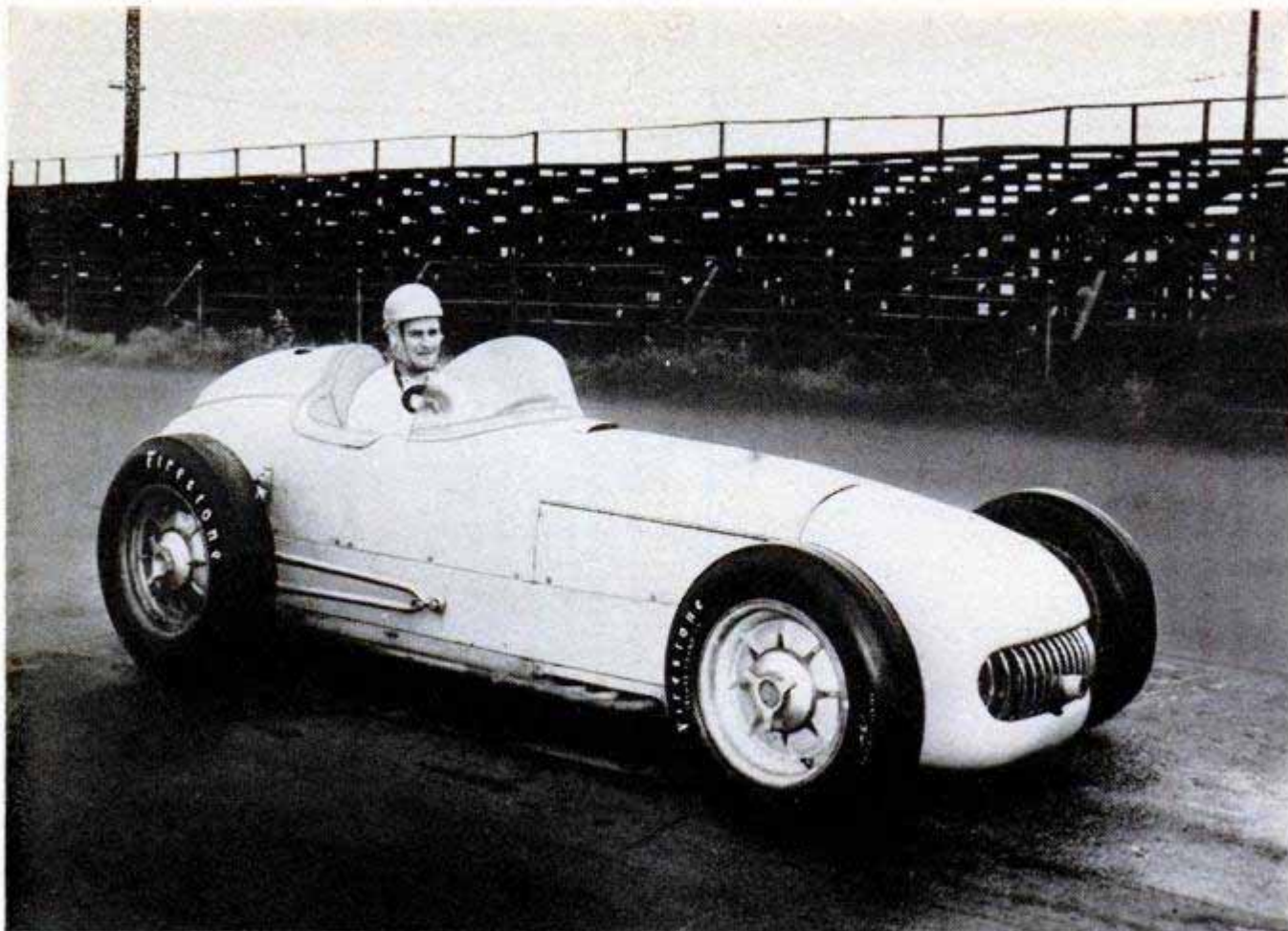

Driver Joe James covered 140 miles at an average of 135 miles per hour in the Chrysler-powered racing car

400-Horsepower Chrysler V8 Hits 170 M.P.H.

by David A. Wallace

President, Chrysler Division, Chrysler Corporation

BECAUSE of the extraordinary performance of a modified Chrysler V8 FirePower engine in recent tests conducted by the Firestone Tire and Rubber Company on the Indianapolis Motor Speedway, public interest has been aroused to a point where further details of the design of this power plant are in demand. Installed in a conventional racing chassis owned by Roger G. Wolcott of Indianapolis, this FirePower engine, in trials aggregating over 900 miles, drove the car farther and faster at sustained high speeds than ever before had been seen on this track, the scene of the 500-mile Memorial Day race.

The car was clocked at a rate of 137 miles per hour for one lap, at 170 miles per hour on the straightaways and at 135.02 miles per hour for 100 miles, which beats the existing record of 133.068 miles per hour for this distance in the 500-mile race. And not a single thing was done to the engine, even to the changing of a spark plug, in all the grueling 900 miles of testing, the greater part at speeds bettering 133 miles per hour.

There was no change in the basic design

of the engine to accomplish these extraordinary feats of speed, stamina and reliability, except that it was necessary to use a dry sump to accommodate the low road clearance (three inches) of the racing car to avoid holding the oil on the sides of the crankcase when rounding the turns, as might be the case with a wet sump.

It is on the basis of this performance that I call this the "ultimate" engine. I believe it embodies the ultimate potentialities of the reciprocating type of engine for use in driving motor vehicles.

Normally, it is necessary when seeking to increase horsepower and torque in an automobile engine to make major design changes. These generally involve changing bore and stroke to produce even as little as 25 more horsepower. But the flexibility of the Chrysler FirePower engine is such that horsepower may be more than doubled without changes in weight, bore or stroke and with only minor changes in compression ratio, carburetion and fuel. It is possible to have an engine with an output of approximately 150 horsepower with

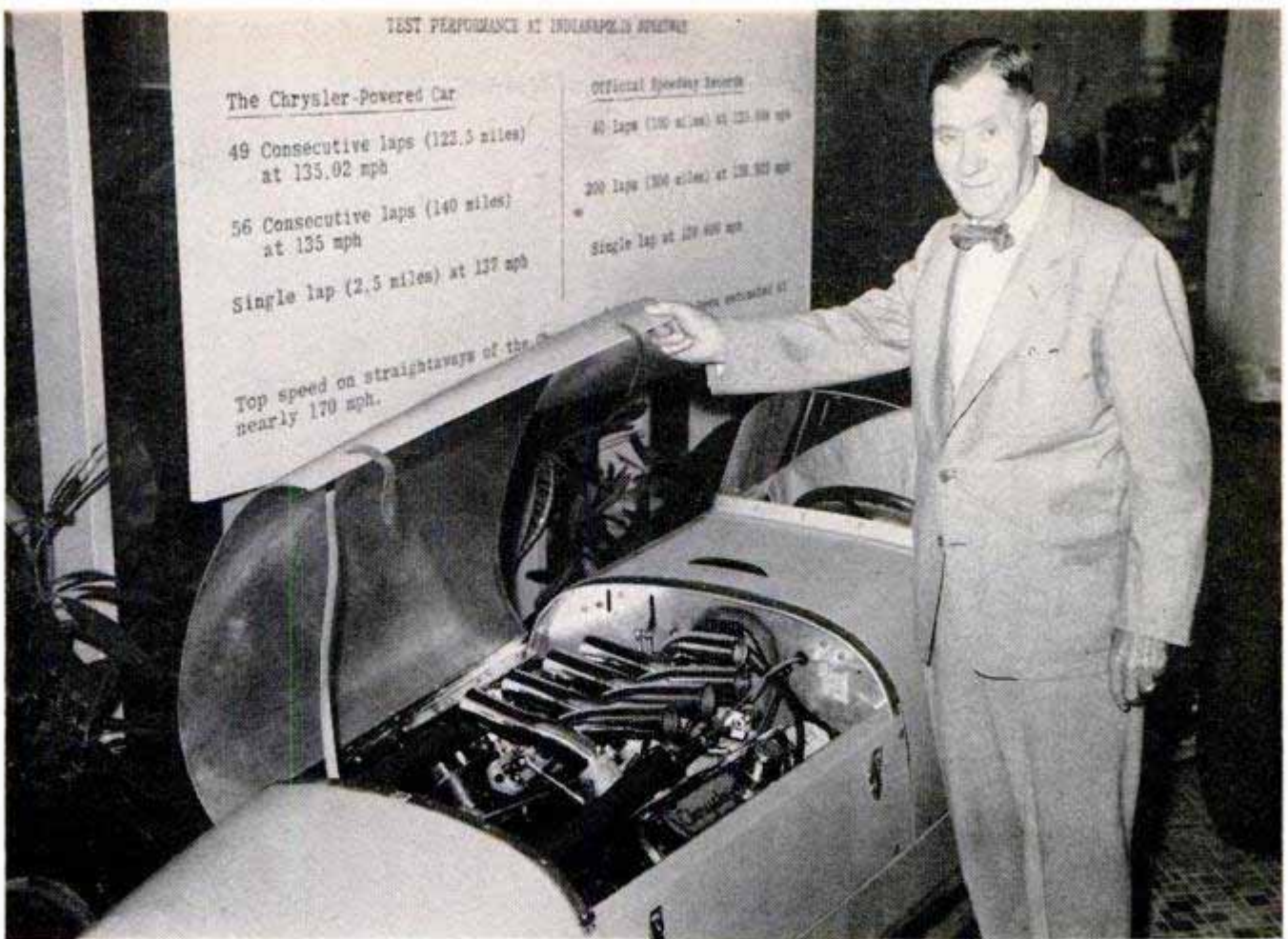

President Wallace, Chrysler Division, holds open the hood to uncover the engine he describes in this article

a compression ratio of 6 to 1 and then, by changes in compression, carburetion and fuel, to increase this progressively to over 400 horsepower, which was the output of the power plant used in the Indianapolis test car. Torque increases are commensurate with power increases in these steps.

The compression change requires only a slight increase in the length of the piston. The carburetion may be changed from a single carburetor, as in the stock FirePower, to a two or a four-barrel carburetor. Open or closed fuel injection will give the increased volumetric efficiency required by the higher horsepower.

In this "ultimate" engine, the increase in output from 150 to over 400 horsepower is accomplished without a supercharger and there are no changes necessary in bearings, rings or other important features. Hydraulic or solid tappets may be used, the solid type being adaptable to racing engines as their noisier operation is not a factor.

The hemispherical design of the combustion chamber is the basis for the extraordinary performance. The location of the spark plug in the center of the combustion chamber provides uniform burning of the fuel and all of the pressure when the charge is ignited is exerted directly on the piston.

There is no loss due to pockets or other uneven surfaces in the combustion cham-

ber. The hemispherical design makes it possible to obtain the highest rate of cooling or absorption of heat. This design also permits placing the valves on each side of the chamber which, in turn, means that maximum valve sizes may be used to obtain the horsepower desired. Various types of camshafts may be used to increase volumetric efficiency, but this a minor change that may be required only in engines with an output of above 250 horsepower.

The adaptability of the FirePower engine was illustrated in a report by James C. Zeder, vice-president and director of engineering and research of Chrysler Corporation. Mr. Zeder listed six minor changes required to raise the horsepower from 180 to 310 (with premium fuel) for use in the Chrysler experimental K-310 sports car:

Valves and ports were enlarged; a two-runner intake manifold replaced the production type; four single carburetors

(Continued to page 286)

Indianapolis Speedway Performances

CHRYSLER-POWERED RACER	OFFICIAL SPEEDWAY RECORDS
49 laps (122.5 miles) at 135.02 miles per hour	40 laps (100 miles) at 133.008 miles per hour
56 laps (140 miles) at 135 miles per hour	200 laps (500 miles) at 128.922 miles per hour
Single lap (2.5 miles) at 137 miles per hour	Single lap (2.5 miles) at 139.600 miles per hour

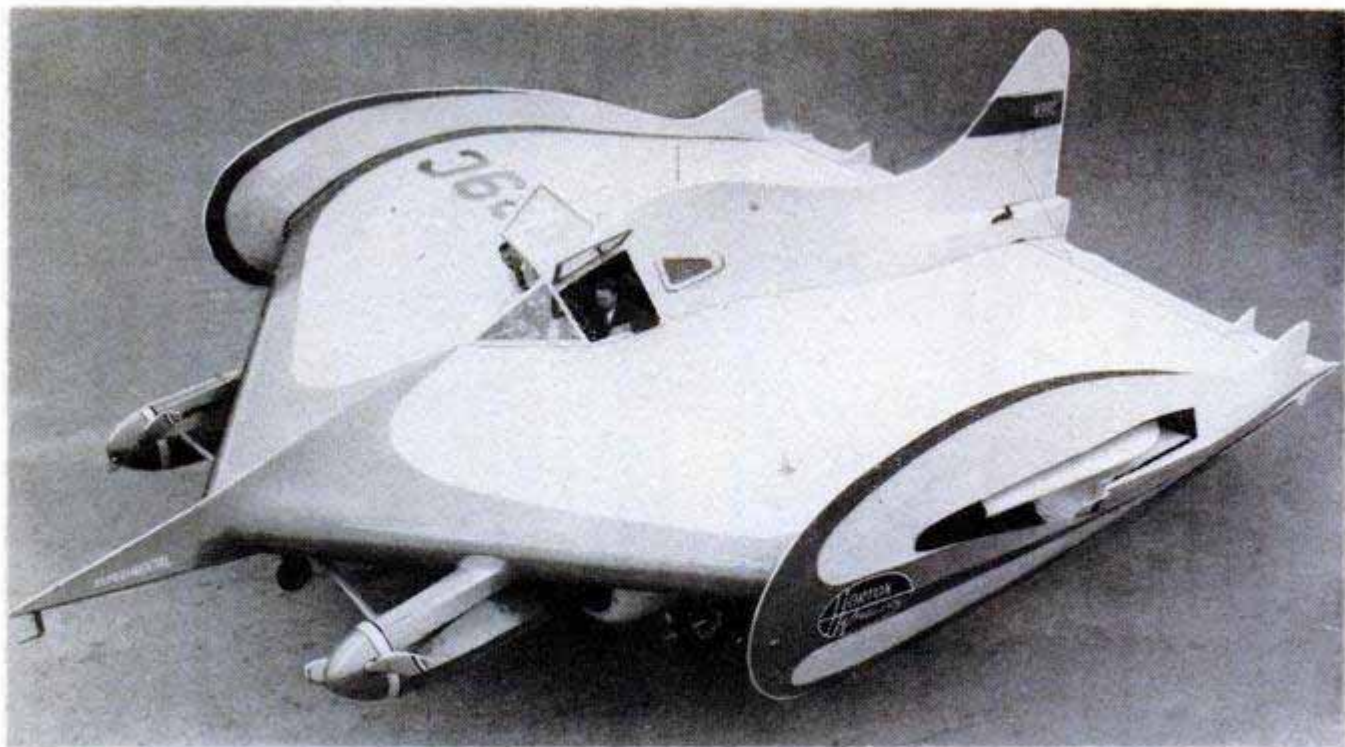

Wings of the wedge-shaped plane disappear into the fuselage for parking. They are extended during flight

'Clipped' Plane Has Retractable Wings

SKIMMING ALONG the runways of the Orange County Airport, near Los Angeles, Calif., a strange "clipped wing" airplane has been undergoing high-speed taxi tests. The odd, wedge-shaped craft is the project of William E. Horton, a 36-year-old aircraft engineer. Although it's dubbed the Horton Wingless, the experimental plane has wings which retract into the fuselage.

His new idea, according to Horton, is to prevent high-pressure positive air surrounding the plane in flight from mixing with low-pressure air flowing over the upper portion of the fuselage. To accomplish this, Horton has built two "sealers"—

graceful streamlined fins—along the sides of the broad fuselage. Normal aircraft wings extend eight feet beyond the sealers and can be retracted for parking. The sealers, Horton says, produce multiple centers of pressure to give the plane much greater lift with 100 percent increase in pay load and range.

The plane is built around the engines, main spar and landing gear of a twin-engine Cessna monoplane. It is powered by two 225-horsepower engines and measures 26 feet from sealer to sealer and 40 feet from tip to tail.

After a series of taxi tests the plane will

During experimental taxi tests in preparation for flight tests, the Horton Wingless soars 20 feet into the air



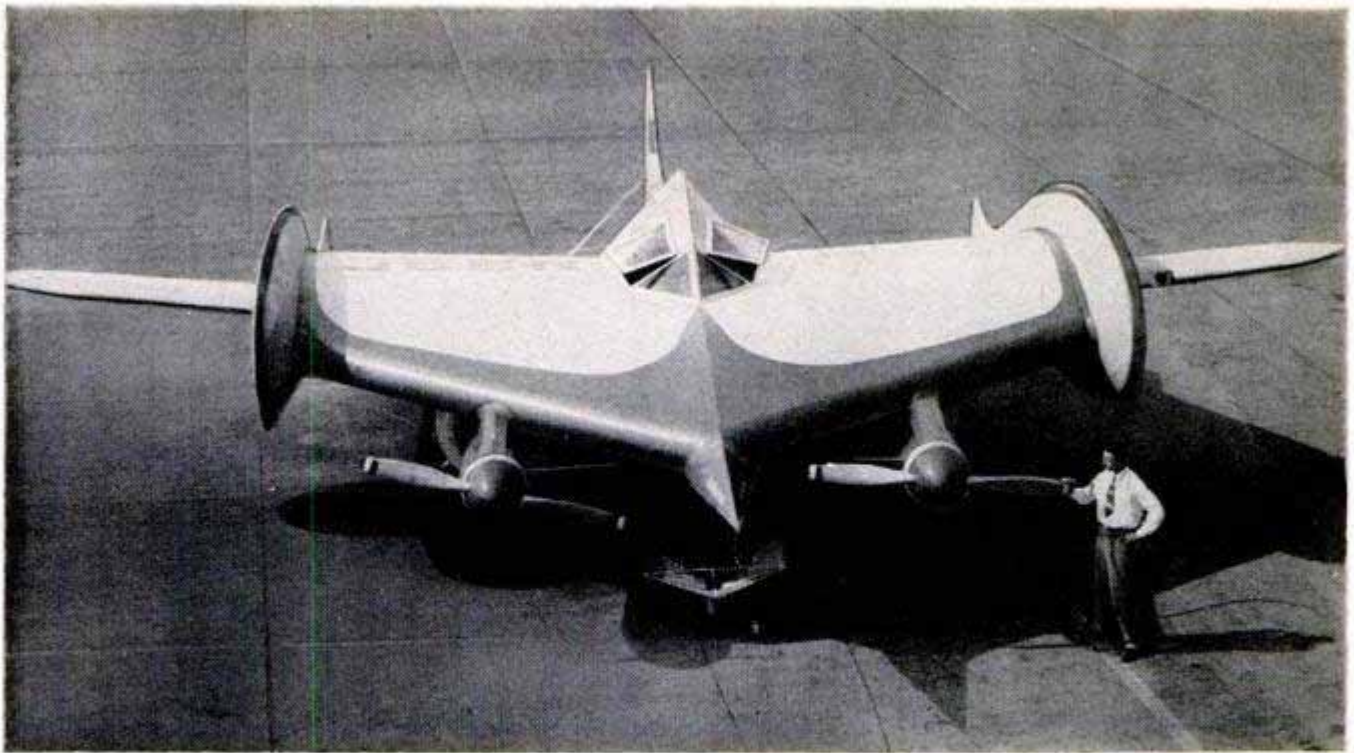

Odd plane, representing an investment of \$50,000, is built around the engines, main spar and landing gear of a conventional light monoplane. The inventor says the finlike "sealers" trap air to increase the lift

be put through its paces in experimental flights.

Horton has discussed the odd fuselage design with aerodynamicists. "They all tell me it won't fly," he says, and then describes the high-speed taxi test in which it soared 20 feet off the runway.

"The Horton Wingless takes off at 45 miles per hour with a power setting of 1800 revolutions per minute," the inventor reports. "The craft has very good landing and take-off characteristics and its performance during the taxi tests has been excellent." ★ ★ ★

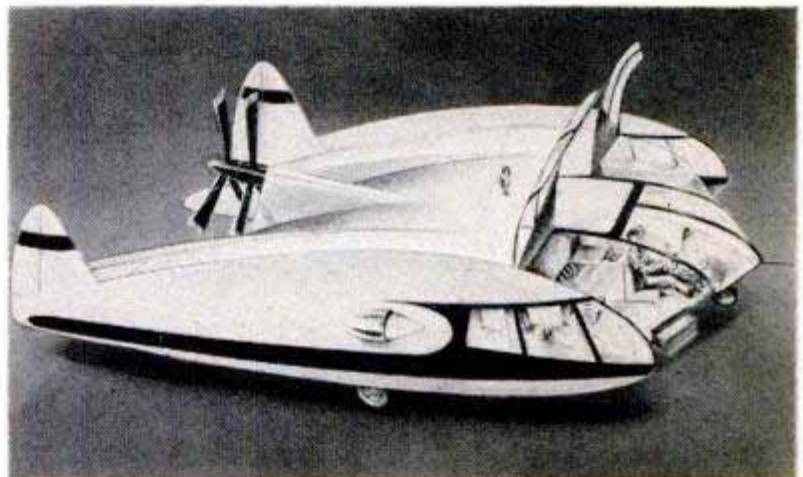

Inventor visualizes this kind of wingless plane for businessmen

Horton, seated in plane, is sure he has discovered a way of increasing a craft's efficiency with "sealers"

Taxi wheel makes the plane easy to steer and park on ground. Mechanism folds into fuselage in flight

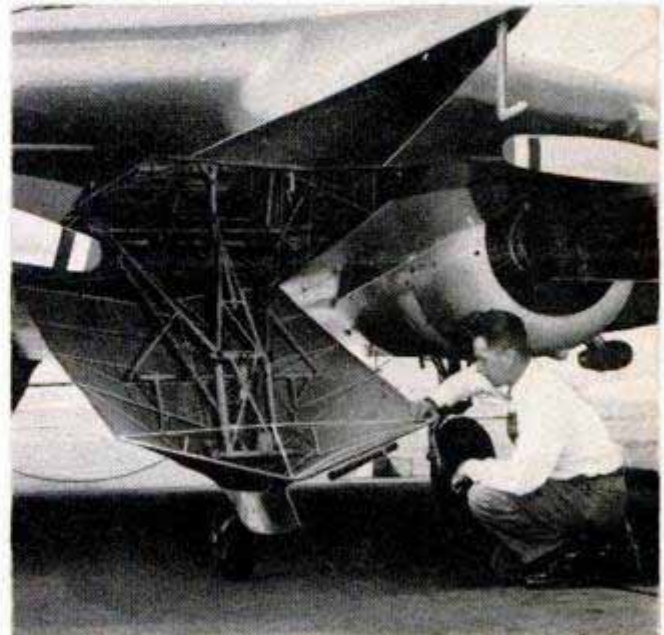

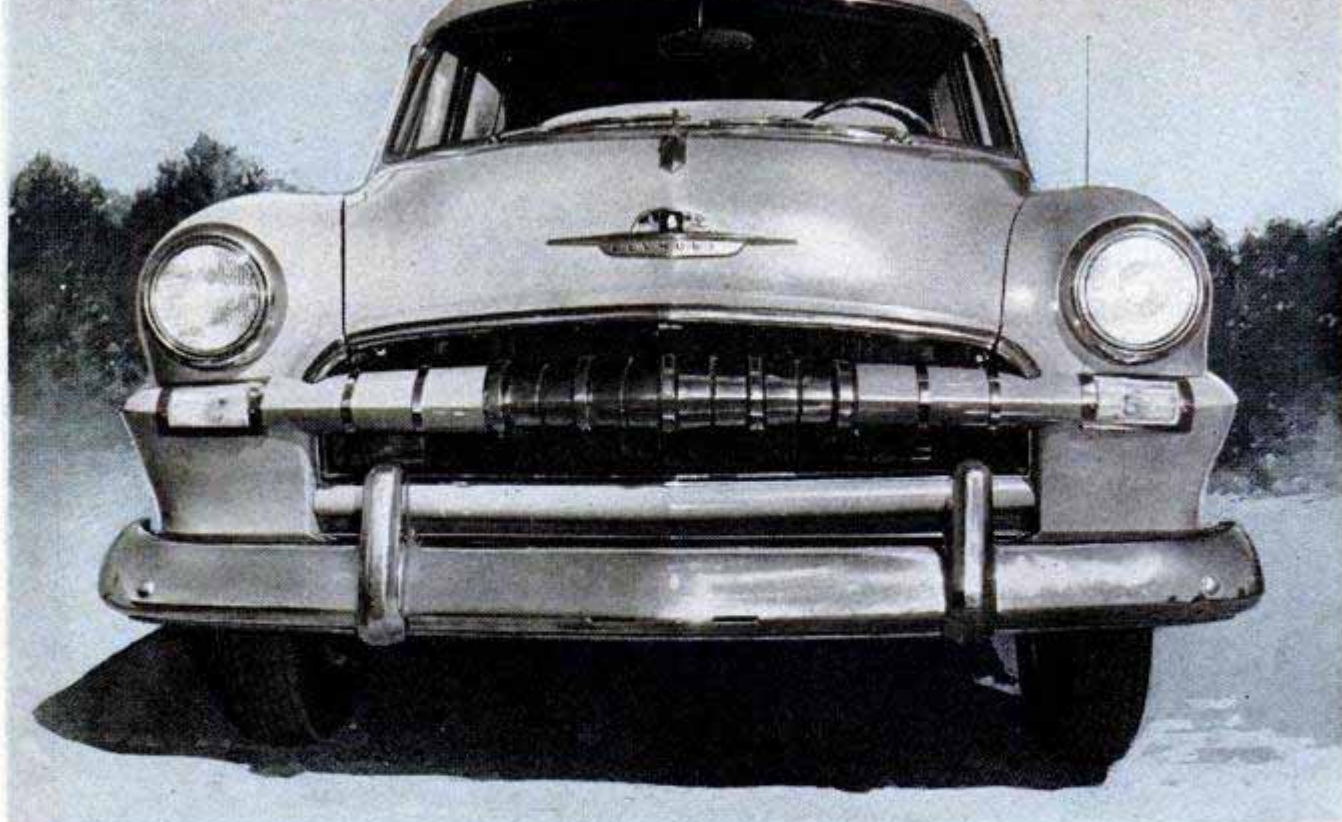

Wider and lower, the new Plymouth no longer has the boxy look that many critics complained of last year

PLYMOUTH RESTYLES FOR '53

REMEMBER the old movie plot about the "plain Jane" secretary—the brainy, efficient gal who does three girls' work but gets nary a glance from the boss? Then about the middle of the picture she tosses away her horn-rims, gets a new hairdo, a new wardrobe, and presto! the boss not only gives her a glance, but marries her as the show ends!

Well, that's the 1953 Plymouth story—with a few changes. This year, the dependable, solid Plymouth is busting out with a style that promises to make heads turn. Yet beneath the whistle-drawing lines is the engineering for which Plymouth is famous.

Completely new from bumper to bumper, the 1953 Plymouth body is lower, but not so low as to be uncomfortable. It is only about an inch lower over-all than last year, but skillful designing makes that inch seem like six. Chair-height seats have been retained, although they have had to be lowered slightly.

Engine-wise, there are few changes. It's the same basic power plant, but its compression ratio has been upped to 7.1 to 1 (last year's: 7.0 to 1) by slight changes in combustion-chamber volume. This, plus other small design changes, has increased power to 100 horsepower instead of last year's 97.

You won't hear any more complaints about Plymouth lacking stability on curves.

By a nonparallel control arm for the front-wheel suspension system, Plymouth has raised its roll center closer to its center of gravity, thus increasing stability. By moving the rear axle forward on the rear spring and increasing the rear-spring width to two inches, designers have virtually ended rear-wheel hop, even when accelerating on washboard roads or in sand. It is also claimed that the new axle location decreases the tendency of rear wheels to spin when starting on ice or snow.

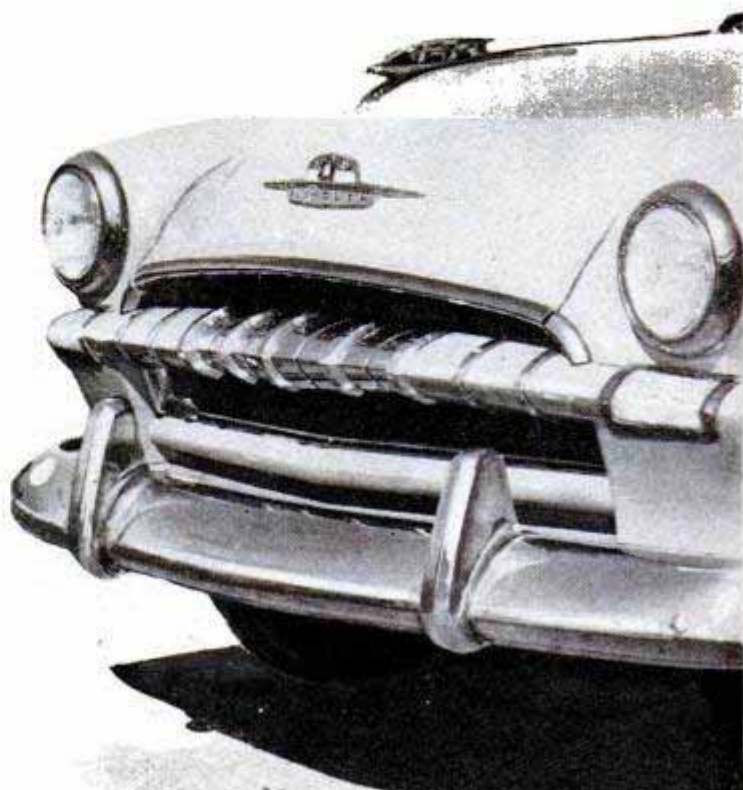

This latter claim remains to be proved because at the time *Popular Mechanics* tried out the 1953 Plymouth, there wasn't a square inch of snow for miles—the temperature being in the top 80s. No acceleration or economy tests were made on the factory sample car (such tests will be made later by Floyd Clymer on assembly-line production models), but a road-handling test definitely did prove that the engineers weren't overstating the case for stability. Two severe S-turns (both as flat as a bowling alley) were easily navigated at between 55 and 60 without tire screech or fighting of the wheel. Fast driving (up to 60) over a blacktop "dipsy doodle" country road proved that the car won't pitch. On a washboard-gravel stretch, acceleration was steady and turns were made without wheel hop that wastes power and lowers traction.

The car is shorter than the 1952 regular models. It has a 114-inch wheelbase instead of last year's 118½. (There is no 111-inch Concord this year.) The shorter wheelbase plus better balance throughout the chassis make the car handle beautifully. Engineers at Plymouth say there is no one specific reason for the much-improved handling qualities—they are the result of many changes in suspension and steering elements.

Now for the styling. It's clean and has little gingerbread or nonfunctional chrome. Incidentally, for those who like extra chrome, it's available at extra cost.

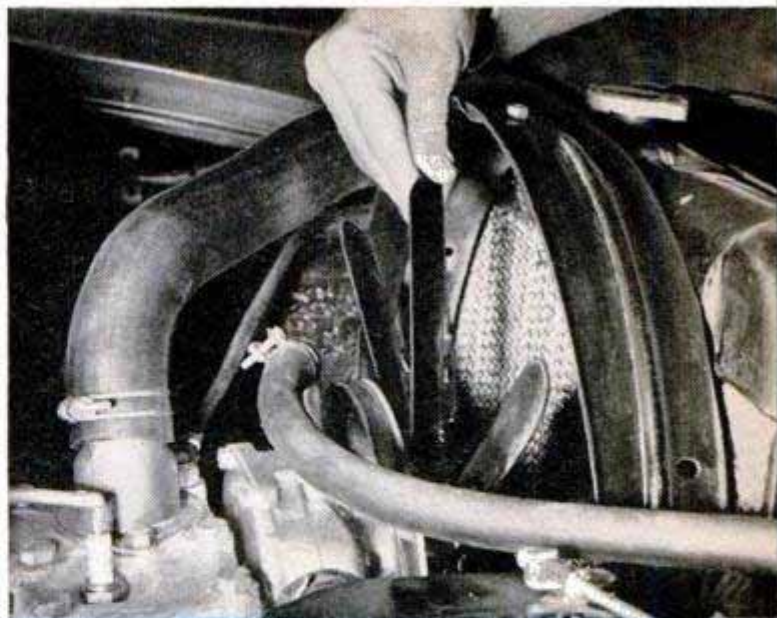

Lowering the hood line forced engineers to turn to a smaller six-bladed fan that is shrouded to prevent air recirculation. The new fan runs more slowly and therefore is quieter at high speeds

By
Arthur R. Railton

Even on a de luxe Cranbrook, decorations have been kept straightforward. The absence of the separate rear fenders makes the car appear longer although it has a slightly shorter wheelbase than 1952

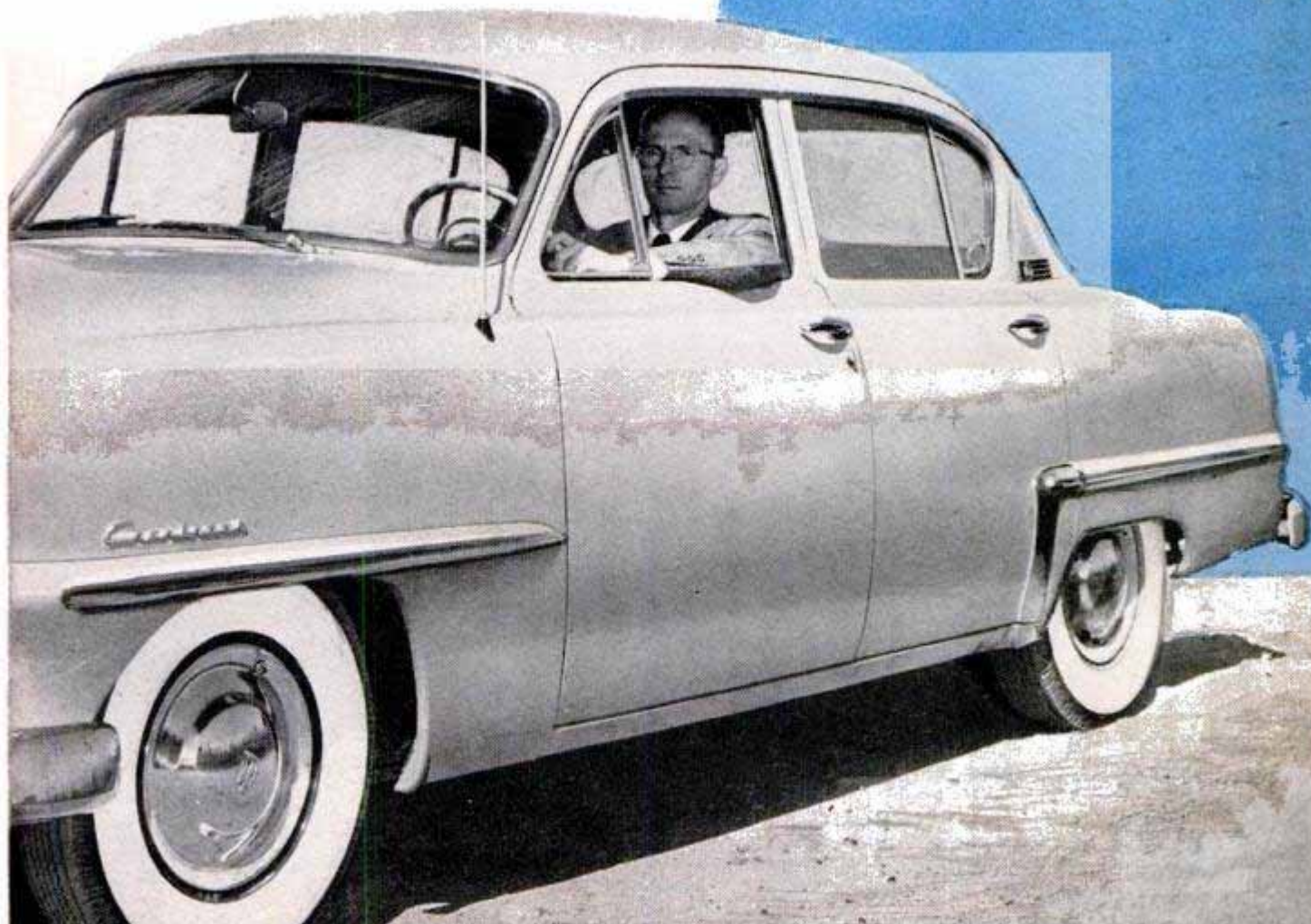



Driver convenience has been improved by mounting the glove compartment in the center of the dashboard



There's more trunk room and the lid is wider. That is the gas filler cap you see on the left rear sill



Above, the rear door of the '53 Plymouth is much wider at the top so a back-seat passenger can see out without leaning forward—a real innovation

Below, superimposed on a photo of a 1953 Cranbrook is the dotted outline of the same model in the '52 line. New car appears much lower than it really is

The body appears much lower than it really is because vertical lines have been softened or eliminated.

The curved, one-piece windshield is virtually distortion free. It has no sharp sweepback on the ends. Instead it has a nearly constant curve over its full width eliminating annoying side distortion.

Rear fenders are part of the body this year. The rear deck has been broadened and the trunk lid made larger. Statisticians claim there is almost 30 percent more room in the trunk, although it is doubtful that it will hold that much extra luggage.

Pushing the engine forward a distance of 2½ inches adds legroom inside the body and, by making a sharper jump-up in the frame at the rear axle, designers have provided more hiproom and cushion space in the back seat.

Here's a list of other improvements: The glove compartment is now in the center of the dash so the driver can reach it easily; gasoline filler pipe is on the rear sill to the left of the license plate; the dashboard has been curved forward slightly to add knee-room in the front seat; on two-door models, the driver's portion of the front seat is wide enough so that two persons can sit undisturbed as the other section tilts forward for entry of rear-seat passengers; trunk-lid hinges are mounted at the extreme outer ends where the hinge mountings can't gouge luggage or packages. ★ ★ ★

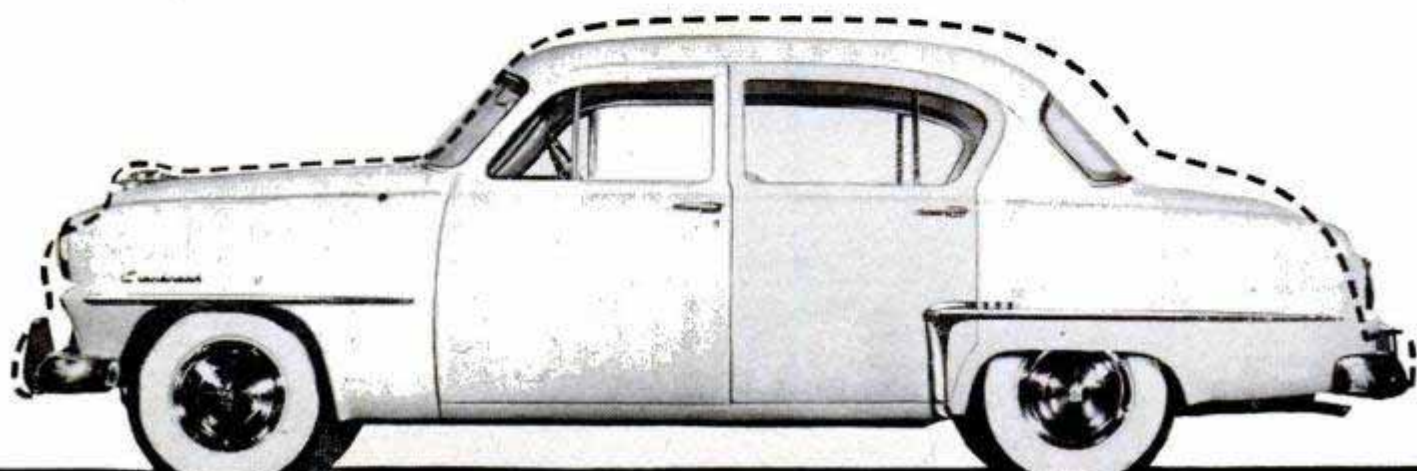

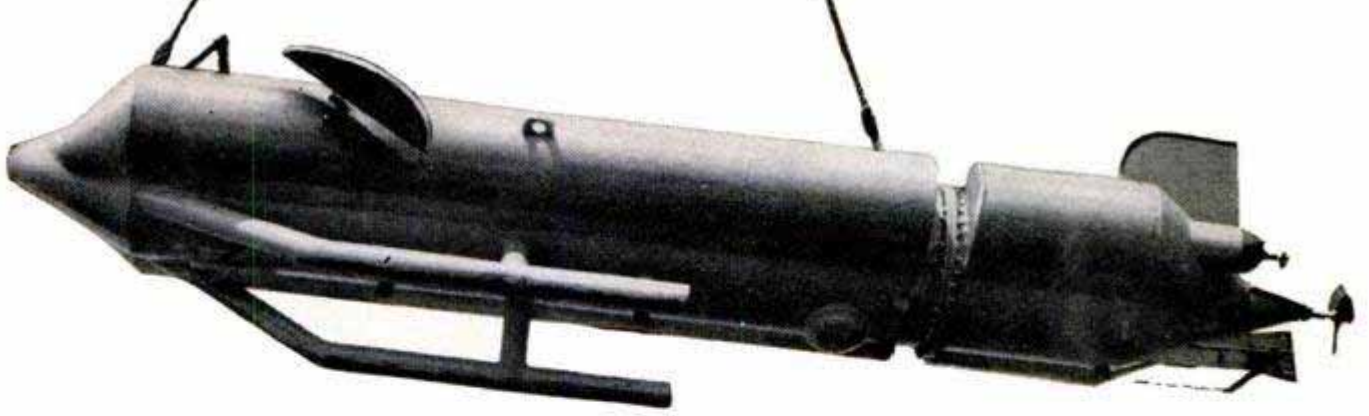

One-Man Sub Prowls Sea Bottom

OFF THE CALIFORNIA coast, a unique one-man submarine is being put through its paces. Designed for salvage work and exploration, the odd craft enables a diver to prowl the ocean bottom independent of surface facilities. Wearing full or partial diving gear, he controls the submarine from an open cockpit. If he wishes to park his vehicle on the sea floor, he can flood the tanks, connect a 30-minute air supply to his suit and walk away. While cruising, he is supplied with enough oxygen for several hours of submersion. On the surface, a 35-horsepower gasoline engine drives the boat at a speed of 15 knots. Underwater, a 24-volt battery system takes over for a speed of 3 knots. Twenty-two feet long, the submarine consists of a main cylinder, containing cockpit, engine, charging plant and battery motors, and smaller outboard blisters which carry fuel, compressed air and flooding tanks. Steel-tube runners beneath hold an emergency air supply. A compressed-air antishark gun mounts on front.

Steel-tube runners which support craft when it is resting on ocean bottom contain an emergency air supply compressed to a pressure of 800 pounds. Large central propeller (below), which is powered by gasoline engine, drives submarine on surface. Small outboard propellers are battery-driven for underwater travel

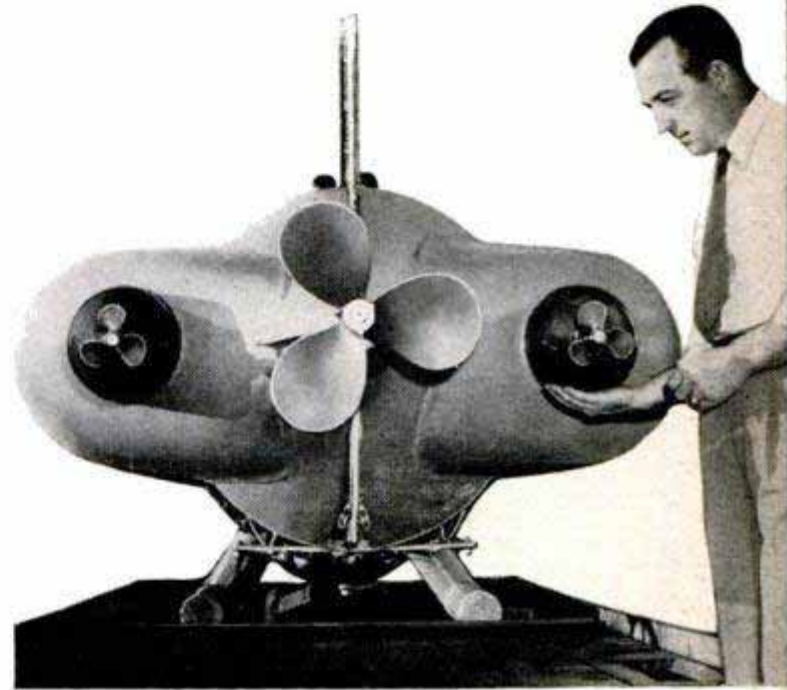

Sub operator rides in an open cockpit containing steering wheel, engine controls, air and water valves





This year's Chrysler emphasizes style and the Imperial sedan is an example of simple, uncluttered elegance

All-New Bodies Spark the 1953 Chrysler, DeSoto Lines; Lincoln Gives Its V8 Engine a 205-Horsepower Punch

NEW CARS, vintage of 1953, continue to make news. Among those showing this month are Chrysler, DeSoto and Lincoln. The first two offer completely new bodies, while Lincoln, after its recent body restyling, has put its energy into adding muscle to its V8 engine.

Exterior beauty is the Chrysler keynote with the whole line, from Windsor to Crown

Imperial, emphasizing style. Lower by 1½ inches, shorter by 4 inches, wider by 1¼ inches, the new cars have sleek and smooth lines. Despite exterior modifications, interior dimensions are virtually unchanged.

Chrysler features a 12-volt electrical system in its V8 models. Complete power steering and power braking are available. Compression ratios are the same—7 to 1

Sweptback rear fender is biggest change in the all-new Chrysler body. All models have wrap-around rear window





Lincoln restyled its front end for 1953, but top news is in its 205-horsepower engine. This is the Capri

for the six and 7.5 to 1 for the 180-horsepower V8.

All models have one-piece curved windshield and wrap-around rear window. Extra-cost items for the sports enthusiast are 60-spoke chrome-plated wire wheels. The gas filler cap has been moved to the rear below the trunk lid and new pull-type handles open the doors.

Wheelbases are as follows: 125½ inches for the Windsor 6 and the New Yorker V8; 133½ inches for the Imperial V8, and 145½ inches for the Crown Imperial V8.

Also in the news this month is another member of the Chrysler family, the DeSoto. Its redesigned body bears a strong resemblance to its big brother. Continued is the 160-horsepower FireDome V8 as well as the older six. Both series are available with full power steering.

The wider and lower rear deck makes the car appear longer than its 125½-inch wheelbase would indicate. Over-all length is now 213⅞ inches, five inches longer than in

1952. It, too, has switched to a one-piece curved windshield. An interesting and practical feature is the reflection-free panel over the top of the dashboard.

Another debutante is the 1953 Lincoln with the 205-horsepower engine—the most powerful production engine in an American car today. The overhead-valve V8 was given added horsepower by improved carburetion and manifold plus an exhaust system that lessens back pressure. Also involved in the “soup up” is a mechanical spark control that supplements the regular vacuum advance. Top speed in excess of 112 miles per hour is claimed. Acceleration is improved, with the manufacturer stating that it will zoom from 0 to 80 miles per hour in less than 23 seconds.

In addition to power steering and power braking, Lincoln has a four-way motor-driven front seat that can be adjusted up and down like a barber chair as well as forward and backward. Two push buttons do the trick. ★ ★ ★

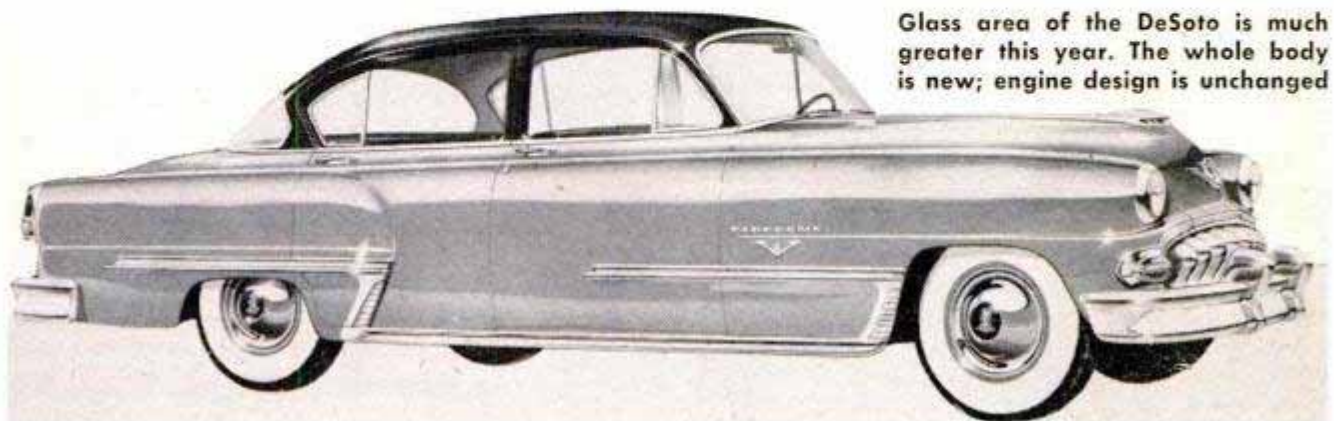

Glass area of the DeSoto is much greater this year. The whole body is new; engine design is unchanged

Miniature Switchboard Buzzes and Rings for Junior Operators



Vocational training for the small fry starts early in a household equipped with a toy switchboard which duplicates many features of a real instrument. The unit buzzes, rings and provides connections for as many as nine "calls." It was exhibited at a press preview of the Toy Guidance Exhibit in New York.

Air Patrols Check Ground Radar

Flying "detectives" of the Civil Aeronautics Administration are constantly checking the efficiency of ground-based electronic instruments that control traffic over 70,000 miles of federal airways. About 85 patrol planes are equipped with special instruments to pick up all signals given out by the radio-range stations and airports with instrument-landing systems. The new omnidirectional radio ranges must likewise be kept operating with courses true to within 2.5 deg. Finding electrical interference, which may come from a new barn, metal silo or bridge in the area, is often more difficult than remedying it.

Cross-Link Rollers Give Long Life to Automobile Tire Chains

Cross links can now be fastened on automobile tire chains with a roller assembly that allows the cross link to rotate and wear more evenly. There is also another advantage. The assembly is spring loaded so you can slip off a broken cross link and install a new one in a few minutes without tools. The turning action means better traction as well as longer wear because the links rotate in the opposite direction to the wheel when touching the pavement. Complete roller-equipped chain sets are available for passenger cars and light trucks. Heavy-duty roller assemblies are sold separately for large truck chains.



Wanted: 50,000 Engineers

They're not only wanted, they're desperately needed in American engineering projects, from new mines under the rim of the Arctic Circle to atomic-energy laboratories scattered across the country. Next month Carey H. Brown, Chairman of the Engineering Manpower Commission, takes a look at the broad field of engineering and its requirements. Supplementing his story are several aptitude tests—questions and answers with more than 60 illustrations—to help any reader determine whether he may have a mind particularly suited to engineering. Don't miss this story—the tests are fun as well as revealing. The civilian industry in the United States alone needs 30,000 engineering graduates a year—11,000 more than the estimated number of 1953 graduates of engineering schools.

Twenty Years Added To Average Lifespan

Medical progress in the last half century has contributed to an increase in life expectancy from 47.3 years to 67.6 years, according to officials of the American Medical Association. At the same time, the leading causes of death have changed. In 1900, pneumonia caused 12.9 percent of all deaths, tuberculosis 10.4 percent and heart disease 8.5 percent. Fifty years later, heart disease caused 32.6 percent of all deaths, cancer 13.6 percent (an increase from 3.6 percent), and cerebrovascular disorders 9.1 percent. Since 1900, the percentage of persons over 65 has doubled, partially due to the use of preventive medicine.

Machine Mixes and Sprays Base Coats of Plaster on Wall

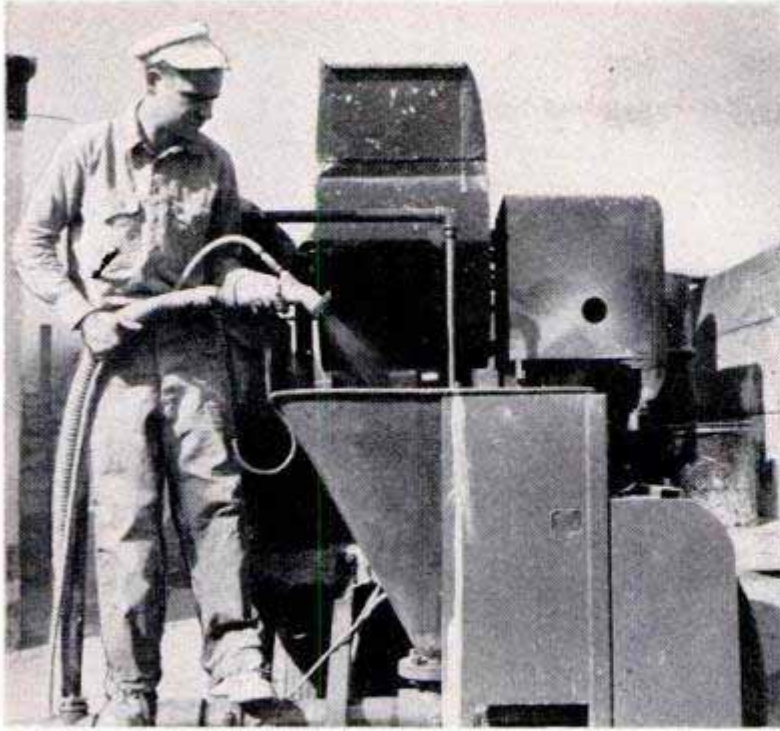

Left, workman prepares machine for a mix. Right, a stream of compressed air forces plaster against the wall

Plaster is sprayed on walls by an electric machine that enables one man to apply 60 cubic feet of base coat an hour, whereas with the hawk-and-trowel method he would average about 90 cubic feet a day.

Used only for the first two coats, the machine pumps plaster from a hopper to a nozzle where compressed air sprays the mixture on walls and ceilings. A switch at the nozzle controls the flow.

Popcorn Production Line Supplies Chain of Theaters

Enough popcorn to drown the sound in 140 movie houses is mass-produced at a single plant supplying a large chain of West Coast theaters. In a room where the temperature is maintained at 70 degrees and the air is changed at the rate of 500,000 cubic feet every minute, six big rotary poppers convert over 100,000 pounds of raw corn every month. Sorting, popping, culling, seasoning and sacking are all handled mechanically. The atomic-age version of the old-fashioned corn popper also mixes the seasoning of coconut oil and butter concentrate; applies it evenly to the corn; tosses out imperfect grains; transfers them to a stamping machine and produces poultry feed. When operating at full capacity, the poppers burn 1,500,000 British Thermal Units of gas every hour, enough to supply a small city.

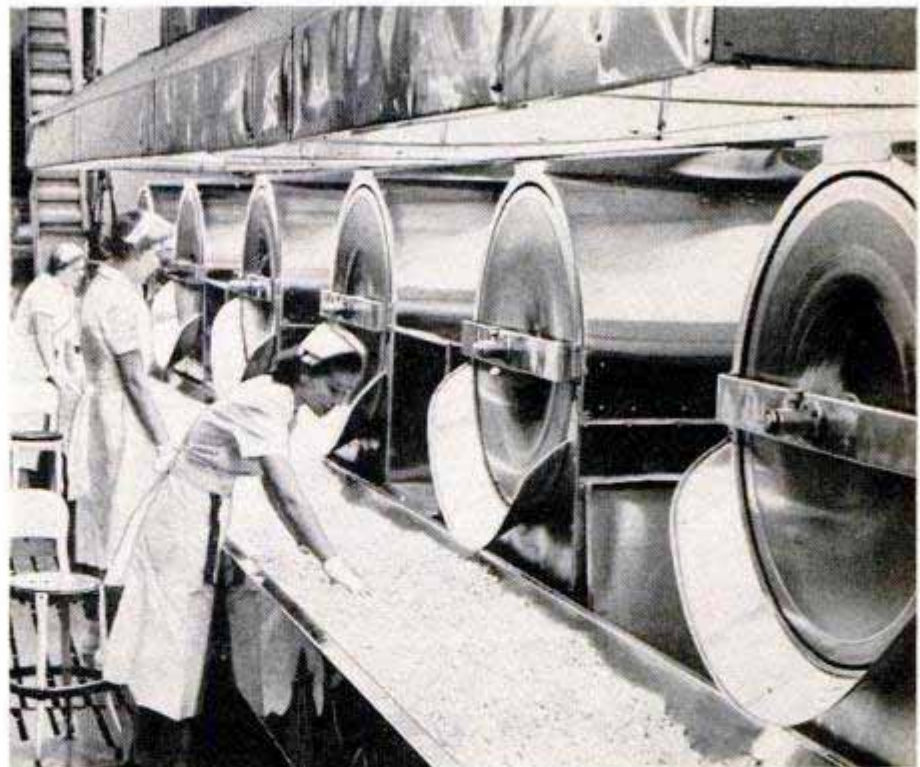

Improved combat medicine and surgery have reduced the mortality rate among United Nations soldiers wounded in Korea to 23 per 1000 as compared with 45 per 1000 in World War II.



Children of all ages come to watch the modelers' two-hour public sessions

THURSDAY NIGHT IS RAILROAD NIGHT

in the old Pelham Manor, N.Y., railroad station where you'll find a gathering of indoor railroaders running their model trains on a layout almost a mile in length

by Daniel Rubin

Schematic diagram of the Eastern Lines. Lights along the way chart progress of trains over the system

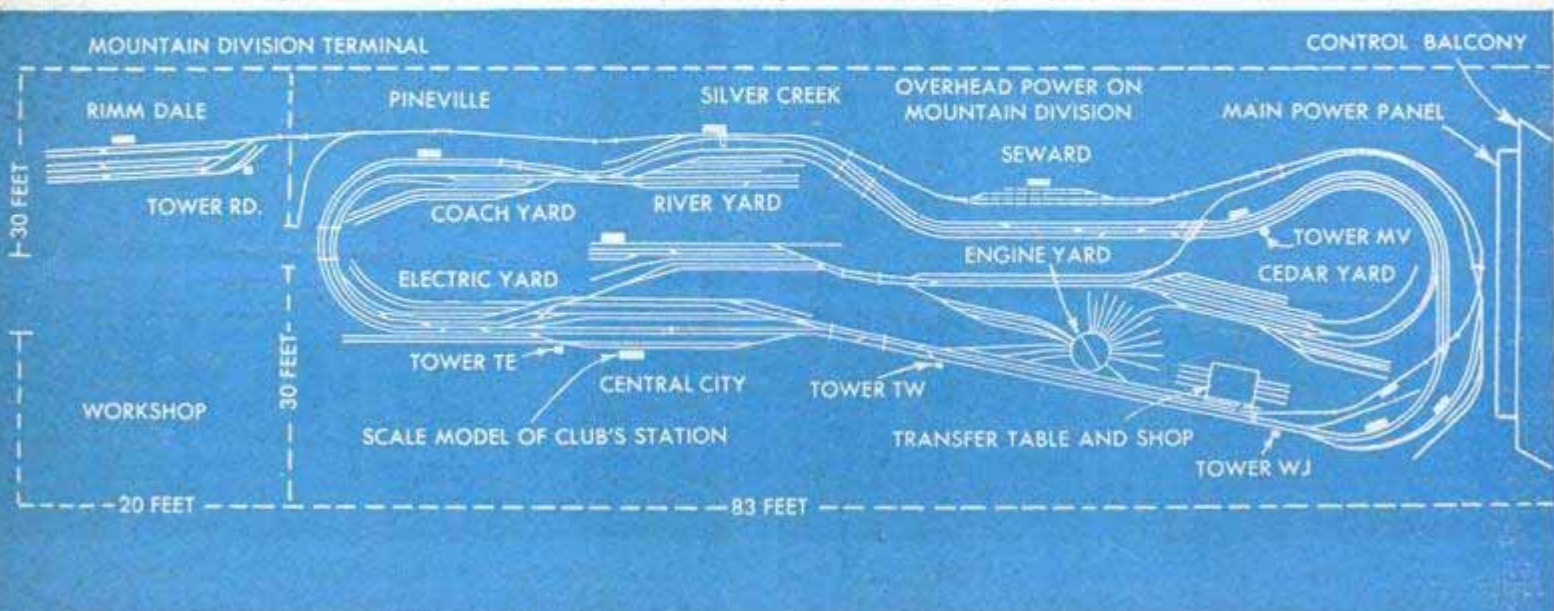

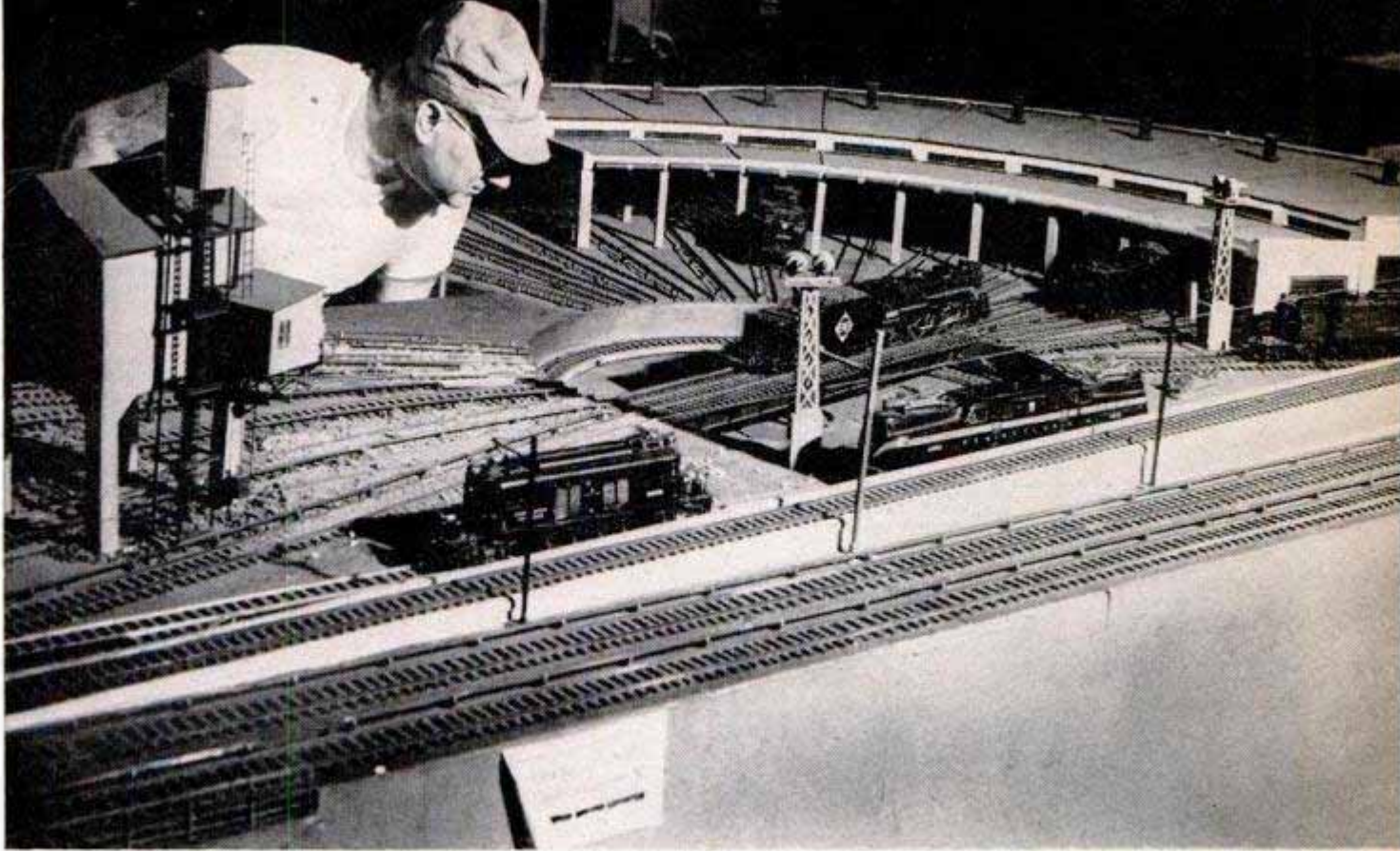

All the members have specific assignments during operations. Here the roundhouse foreman is busy at his job

ALMOST 30 YEARS AGO in New Rochelle, N. Y., six men were having trouble with their wives. The same kind of trouble, for it seems that these men—Rollin Meyers, James See, George Barkley, A. Q. Smith, Robert Ward and E. P. Alexander—were busily engaged in building railroad pikes in their homes.

As these model railroads expanded to monopolize more and more of their attics and cellars, the wives began to object—strenuously and vocally. So began the Westchester Model Club. The men moved to Mr. Alexander's attic and in a short time, with all their equipment pooled together,

again ran out of space. They moved to a loft and from there, in 1934, to the present site—the old Pelham Manor, New York, New Haven & Hartford Railroad station. There are now over 3500 feet of O-gauge cold-rolled-steel track.

The rolling stock, all built to exact scale, consists of about 500 freight and 150 passenger cars and over 75 locomotives, among them the American, Atlantic, 10-wheelers, Pacific, Mountain, Hudson, Niagara, Consolidation, Mikado, Berkshire, Santa Fe, switchers, electric and diesels, although 80 percent of these had no commercial kits available and had to be built by hand.

It takes a sharp eye to tell this miniature, one of 75 locomotives on the line, from the full-size article



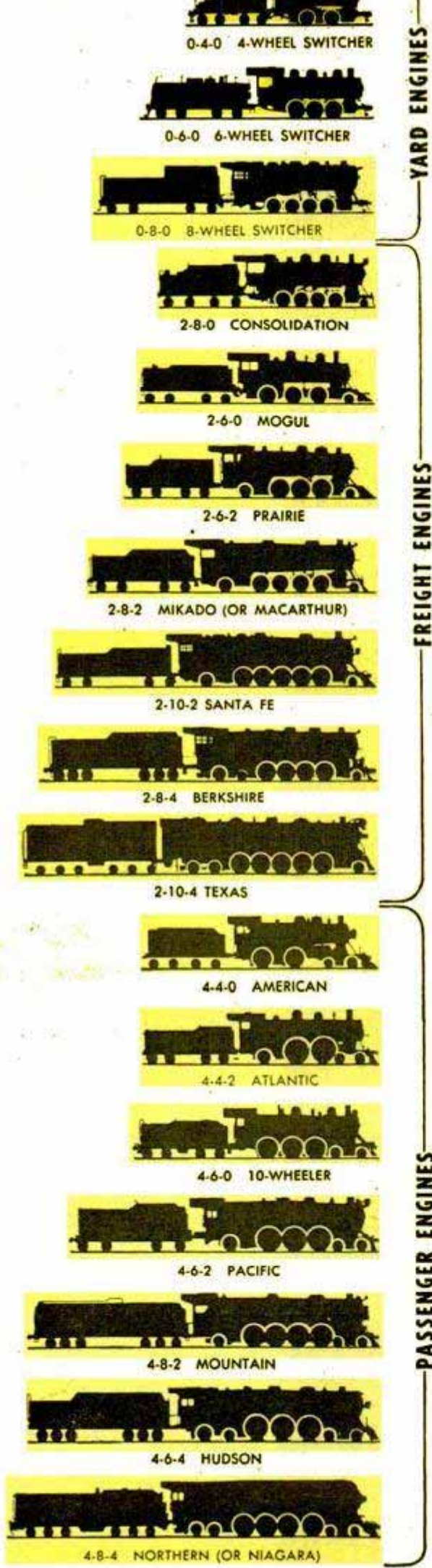

A machine shop equipped with a lathe, miller, drill press, shear and brake, is at one end of the station and is in constant use. The members are always building or repairing their equipment.

The line, with limited and express trains that make a scale speed of 70 miles per hour requires at least 20 men to operate it. The superintendent of operations supervises the entire system; the trainmaster checks operations and specifies all extra trains to be run and awards demerits for infractions of operating rules. There are also dispatchers, towermen, engineers, conductors, a yardmaster and a round-house foreman.

An interesting angle of the layout which makes it different from others is that it is run as a straight line rather than a circuit. The train will be put together in one yard, brought out on its line and run from one point to another, finally ending up in another yard. While the tracks, of necessity, are laid out in an oval, the trains are not run around and around.

They also follow a strict timetable, keeping the dispatcher busy. A telephone system connects all towers with the dispatcher, whose job it is to keep trains rolling right on time, to contact the towerman to set the switches and color-light signals and to give the conductor orders for picking up and dropping cars.

The system has two running rails and an outside third rail for power pickup. The Mountain Division gets its current from overhead wires. The line, running on 22-volt direct current with about two amperes per engine, can handle up to five trains in each direction. Over 50,000 feet of wire are used for power, signals, switch controls and for lighting model houses, stations, platforms and telephones.

The landscaping of the line is unique in that its mountains, made of a mixture of plaster of paris and asbestos over 1/2-in. wire mesh, blend into hand-painted landscapes on the backdrop scenery. The station is made of broken stones and cement, giving a realistic touch. The grades on the main line do not exceed two percent and on Mountain Division, three percent.

All members own pieces of rolling stock and some have pikes at home, so the trains are either taken home or left in the lockers at the station.

The club affords members a place to follow their hobby and stimulates interest in model railroading. ★ ★ ★

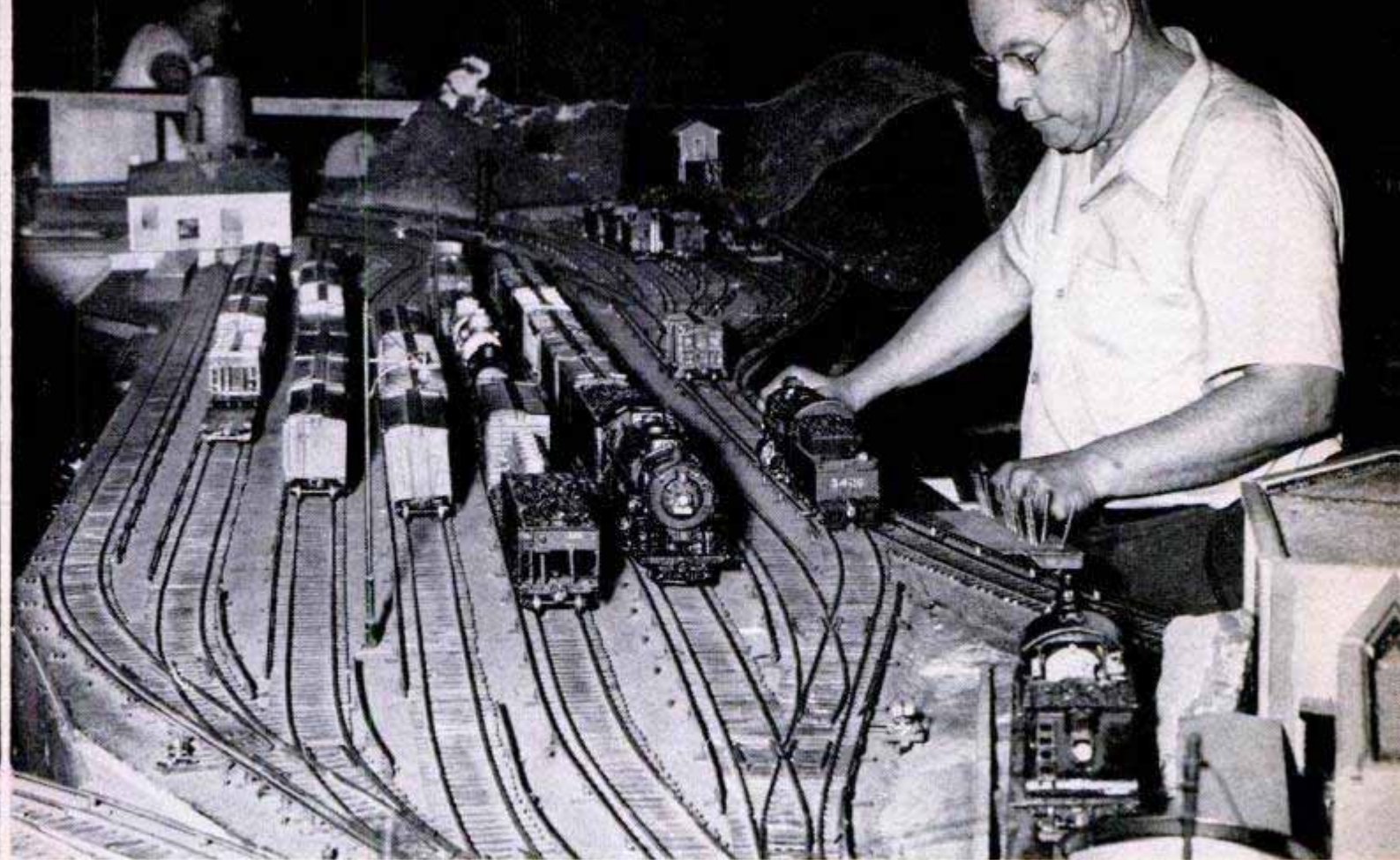

With a modern Gulliver supervising the operation, a model locomotive is run through a series of switches

Part of the Mountain Division is shown at right, as a 10-car fast freight roars around a main-line curve.

Only part of the 700-odd pieces of rolling stock is kept in club's station. Most of it is stored at home

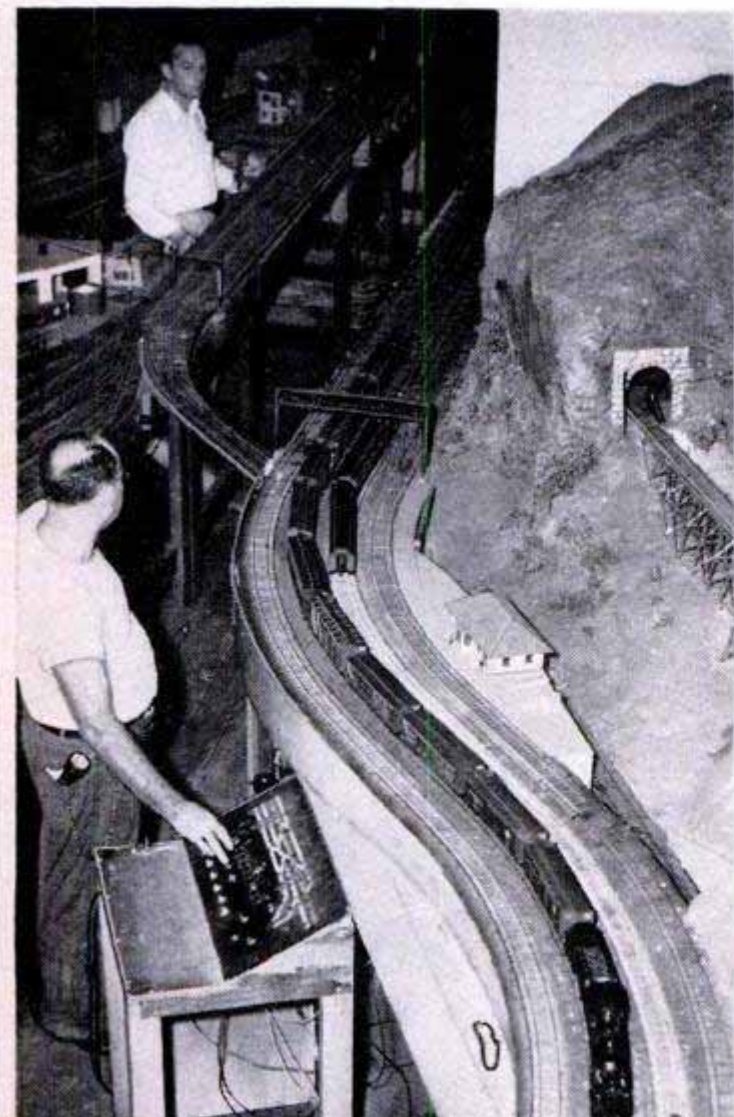

Inside the clubhouse building is its exact replica. Architect for the Pelham Manor station was Stanford White, designer of the original Madison Square Garden



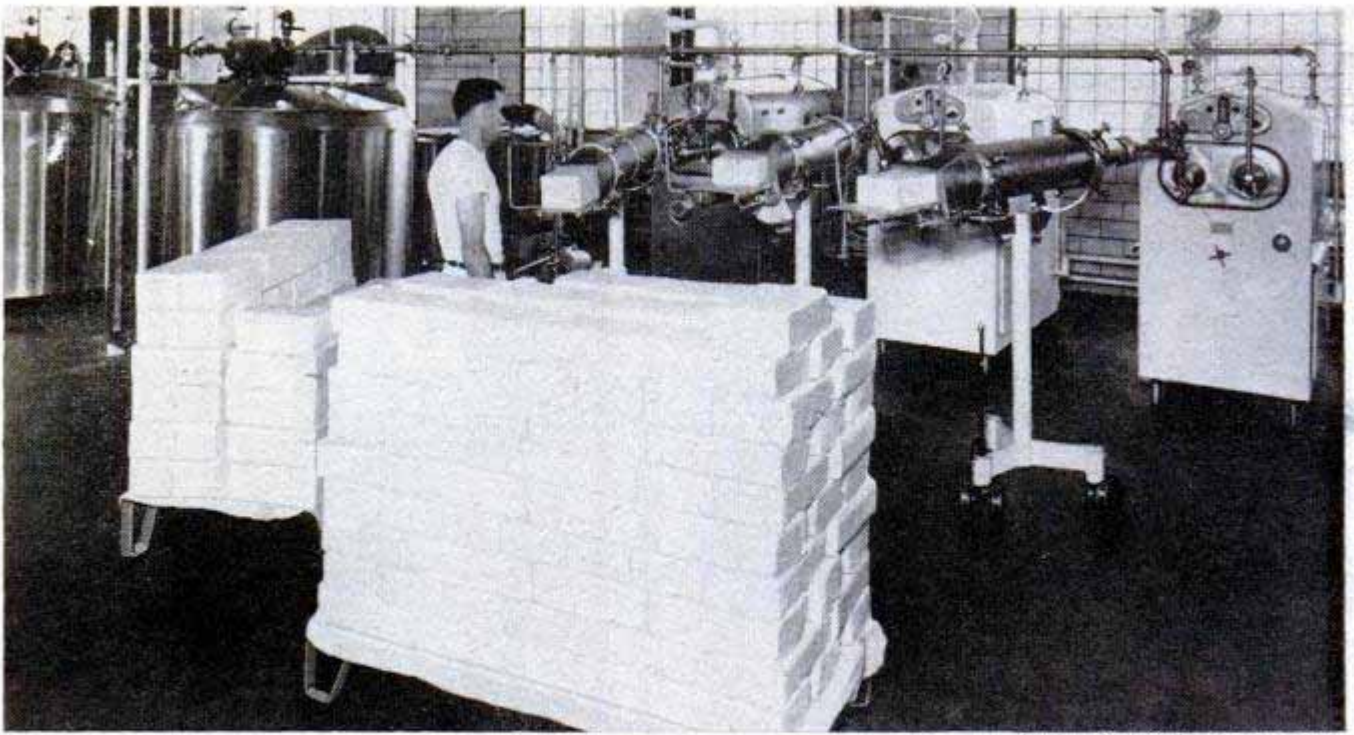

Cherry-Burrell Corporation photo

Continuous buttermaking machines turn out large blocks (above) or standard one-pound pats (below, right)

Buttermaking Minus Churns

UNTIL RECENTLY, buttermaking hadn't changed much since the days of Grandma's oaken churn. By the same, slow process, mammoth churns were agitated to separate the buttermilk and cause particles of butterfat to stick together. Now, in a new continuous process, cream is reduced to the necessary concentration of butterfat by centrifugal action, quickly heated and cooled to coalesce the particles, pasteurized, salted and turned into finished butter.

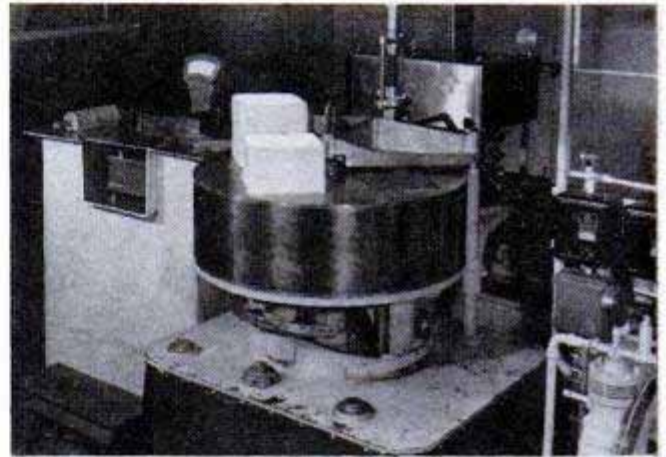

Workers remove huge slab of butter from standard churn. Up to three tons were produced in a single batch

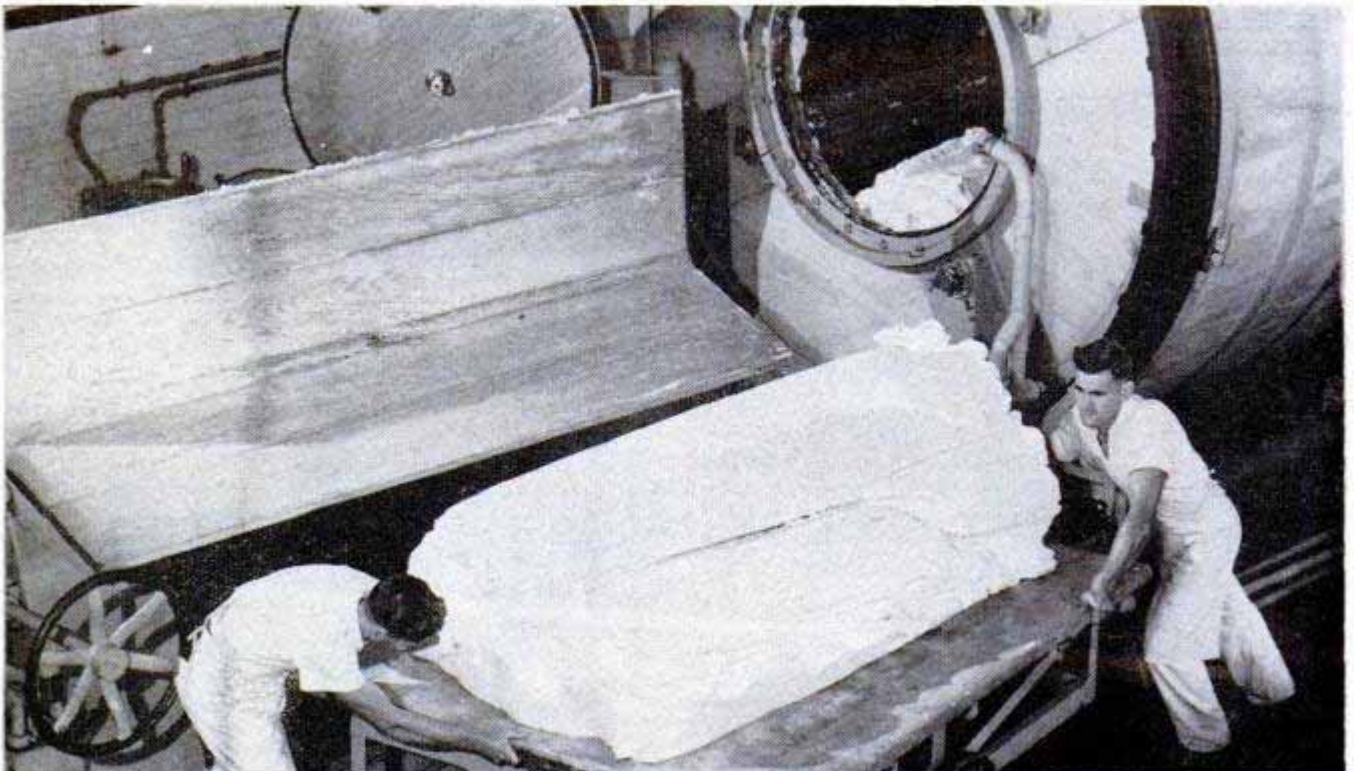

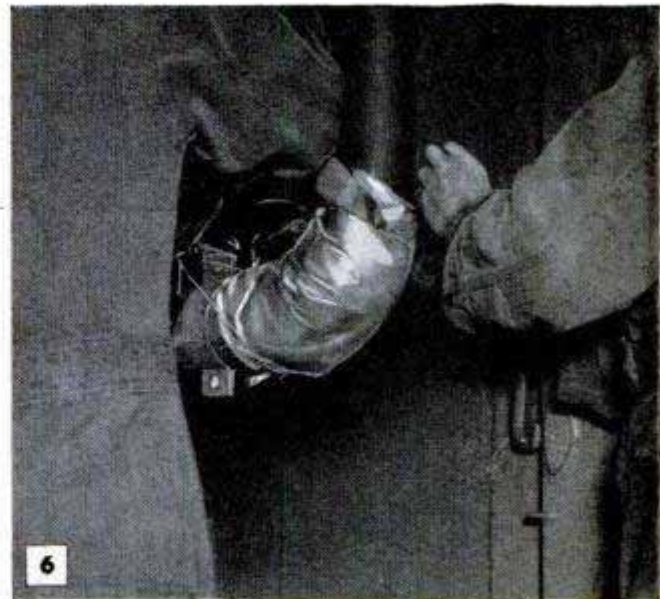
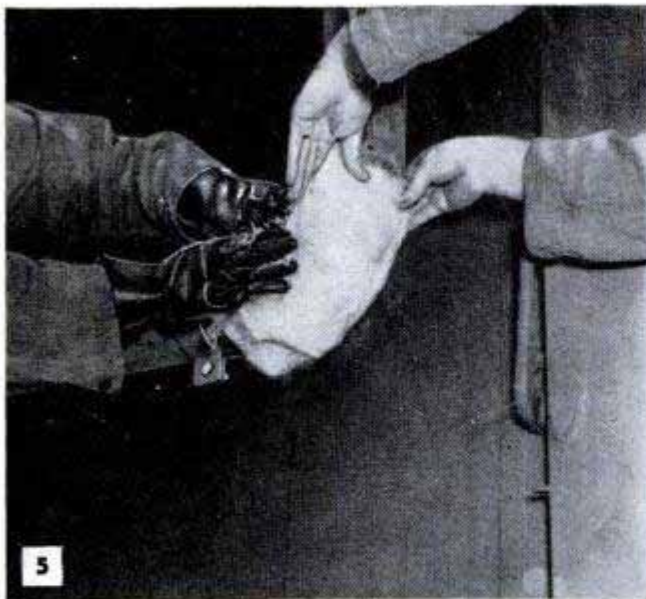
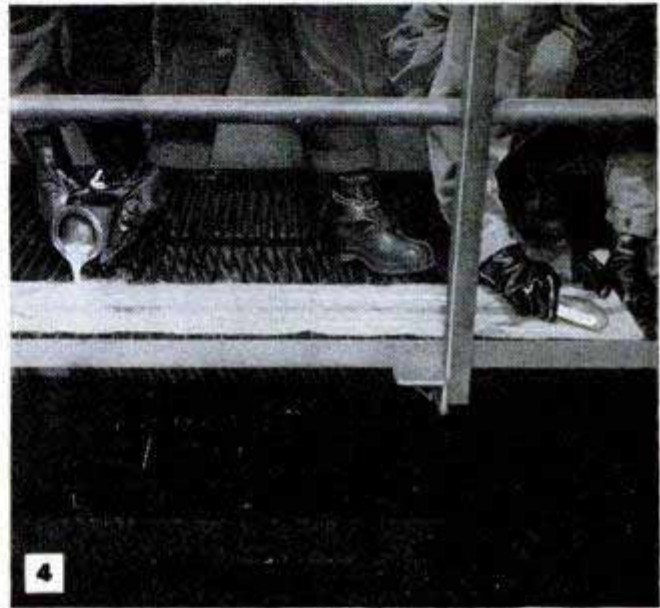
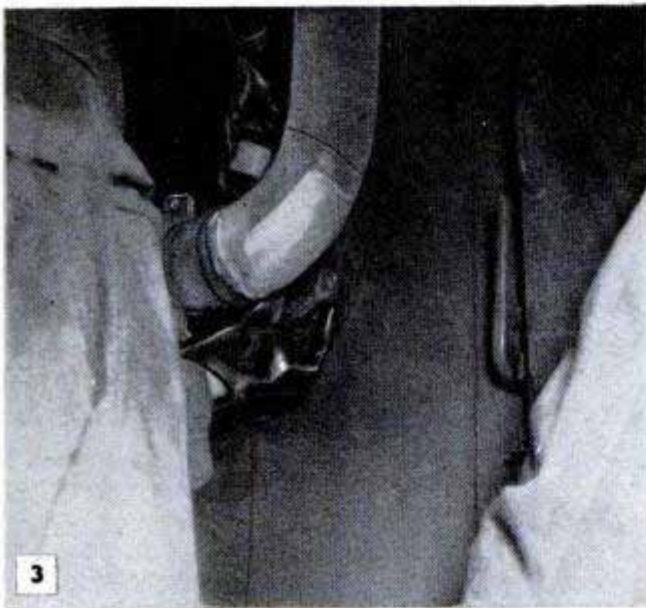
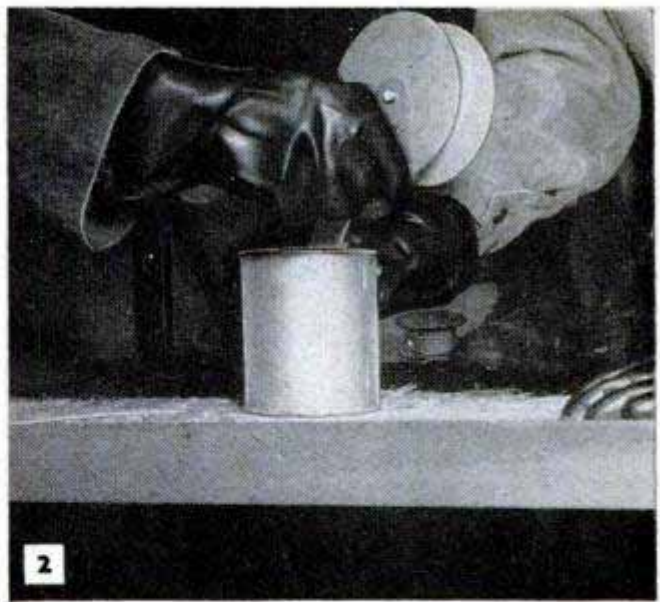
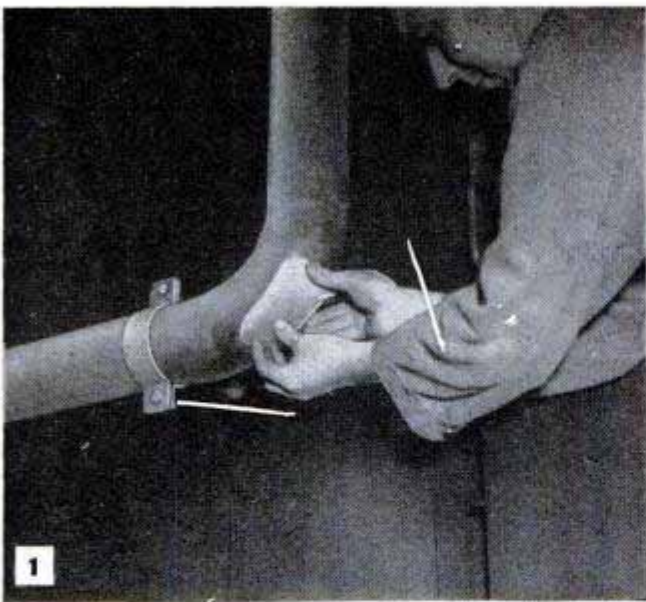

Navy Uses Plastic Patches to Repair Ship Pipe Lines

Quick emergency repairs of shipboard pipe lines are made with a new plastic patch developed by the U. S. Navy. Even completely severed ends of pipe can be joined tightly. A small patch (1) is put over the hole. Glass tape is then coated (2) with a liquid

plastic and wrapped tightly (3) around the pipe. A section of glass matting is then coated (4) with the remaining liquid plastic and applied (5) over the tape. Paper is wrapped around the patched area (6) to confine the liquid resin during the curing

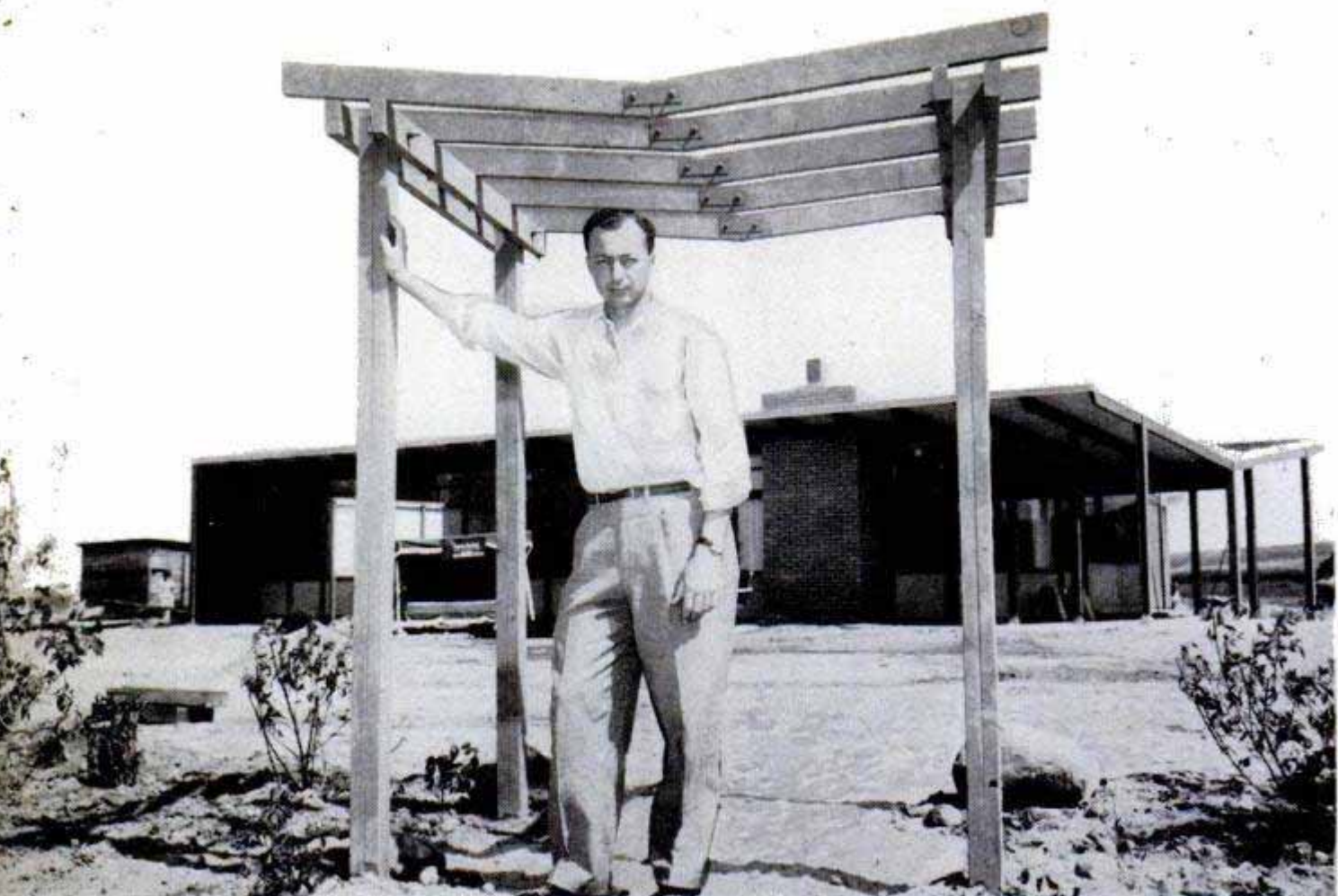

Meet Don Dunn, lucky owner of the \$75,000 farm, complete with modern home, which was built in just 22 hours

THEY BUILT HIM A FARM IN A DAY

ON A WINDY day a few months ago, a cyclone of activity struck a plot of barren ground in the Columbia basin of Washington.

In 22 hours, a \$75,000 farm grew from raw and rough land which had yielded only sagebrush, cheat grass and boulders the day before. This farm-in-a-day was complete with a furnished, seven-room home, machine shed, garage and shop, cattle loafing shed and chicken house; fences, young trees, shrubs and grape arbor; 80 leveled, fertilized, planted and irrigated acres; an

array of gassed-up, greased-up machinery; a cow and baby chicks under a glowing brooder.

And it all went as a gift to a lucky but deserving 30-year-old GI named Donald Dunn. Behind the new farm was more than a year of expert, scientific planning. Five of the West Coast's top architects studied farmers' needs and habits before designing the model home. The entire farmyard was planned for convenience, serviceability and attractiveness. The crops planted were carefully selected as the best for the par-

Through the morning big land planes scraped down high spots on the farm while other machines fertilized

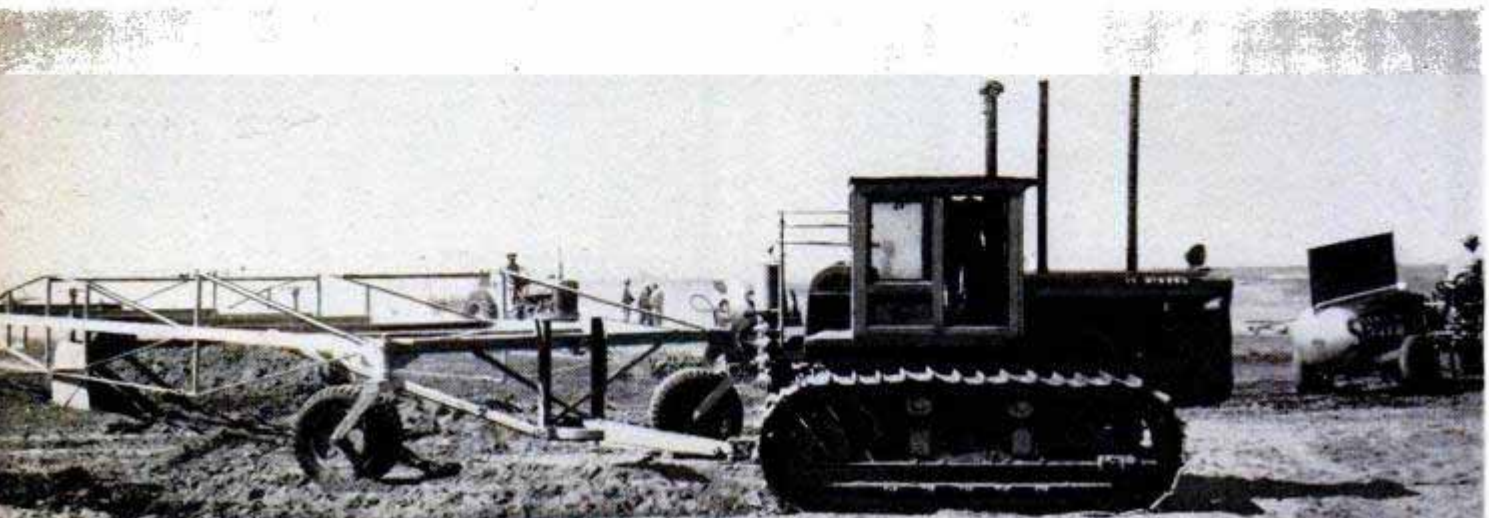



Exposed beams and cedar walls give a rustic but comfortable touch to the living room of the new farm home

ticular acres involved in Dunn's free farm.

The story of Dunn and the farm-in-a-day begins at 10 p.m. July 8, 1951, about four miles southeast of Marion, Kans.

The rain started coming down then—hard. It had been raining off and on for days, and most of Dunn's 400 rented acres were already flooded. The house was on high ground, but . . .

"Looks bad," Don told his wife, Vernetta. "We better get out of here fast."

Don drove their truck and Vernetta the car with their two daughters. The girls tried to find their kittens but there wasn't time.

With rain coming down in vertical waves, the Dunns pulled into Marion, already

jammed with farm refugees. No electricity, no water, no telephone service. Just martial law.

By morning, 12 more inches of rain had poured down on the flooded area. Don learned that a neighboring family was caught out there in the Kansas sea. He offered to guide a rescue boat.

"Our boat passed over hedges I knew were 10 and 12 feet high," said Don. "We found my neighbors huddled on a little high patch of ground. The kids were holding their hands over their ears so they wouldn't hear the cries of drowning sheep—sheep they had raised as a 4-H project. It's things like that you remember longest about a flood."

More than 300 workers swarmed over sagebrush land to build the home, other buildings and plant the crops



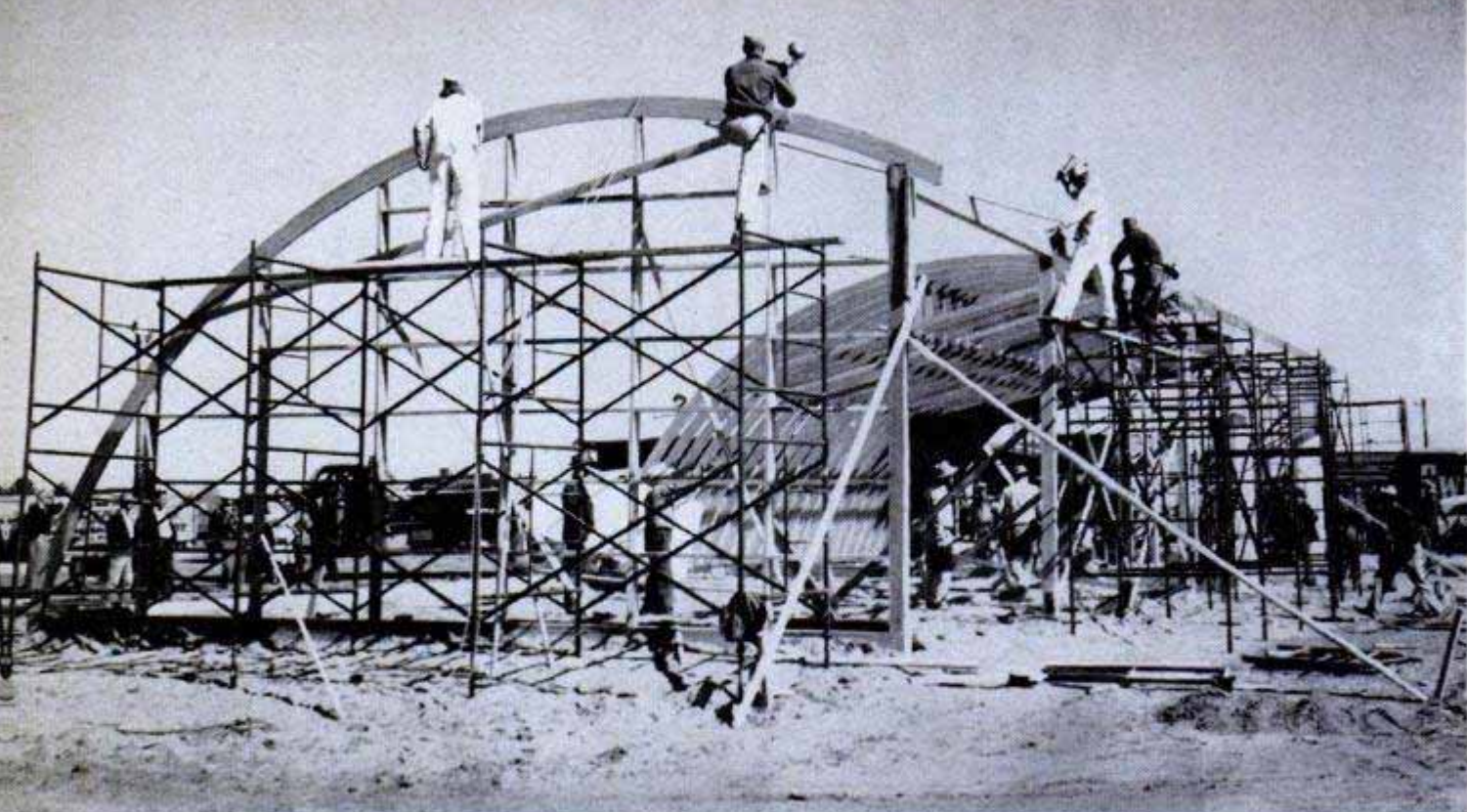

As fast as carpenters nailed up a beam or board on one of the buildings, other workers rushed in to paint it

Three days later Don managed to get back to his own farm. His beef and dairy cattle had found refuge on high ground. But of 350 chickens only two were left—perched high in a tree. Grain in steel storage bins was watersoaked and worthless. Hay in the barn was slimy with mud. Farm machinery was badly damaged.

And the house. Some furniture had floated away, some had fallen apart and the rest was just a muddy mess.

The Dunns tried cleaning up for two weeks, but the task was hopeless. They

Volunteers lay up the fireplace, which was built in the dining room so the farmer could enjoy it at mealtime or relax by it without taking off his work clothes

held a sale and cleared \$18,000. This paid off all their debts — \$17,500 worth. Then Don borrowed \$2000 from a friend, bought a truck, loaded the family in it and headed west.

He had heard about some Bureau of Reclamation projects with homestead possibilities for veterans. But he wasn't lucky—not then. He took a job selling farm equipment in Yakima, Wash.

On the afternoon of April 14, 1952, a representative of the Veterans of Foreign Wars called at the little house the Dunns

Kitchen has a maximum of natural lighting, provided by the "butterfly" roof. Farm wife can see the fireplace, fields and playground through picture windows





Dining room looks out on the barnyard, but a solid-paneled fence cuts off view of the usual farm litter

had rented. He had a telegram. The telegram said that Donald D. Dunn had won the contest conducted through the nation by the VFW to select a worthy veteran of World War II to receive a farm to be built in a day. The farm was to celebrate the coming of water to the Columbia basin from the vast new storehouse behind Grand Coulee Dam.

"I still wake up in the middle of the night—wondering," said Dunn. "I was just one of millions of GIs. Didn't even rate the Purple Heart."

Maybe not, but he earned three battle stars in 10 months of the toughest combat dished out in the European theater. Of 36 tank drivers in his original outfit, he and another were the only two not killed or wounded. But the lack of a Purple Heart wasn't held against the fighting sergeant.

The man who was to get the farm had to be not only a top-notch GI, but a top-notch farmer. When Don's record was looked over among thousands, it just naturally stood out. With virtually no capital when he was discharged in 1946, Don rented 160 acres next to the land where he had been reared. He had done an outstanding job with Herefords in 4-H work, and Marion merchants were glad to stake him to any equipment he needed.

The 160 Kansas acres prospered as they never had before. Don rented 260 more acres to raise dairy and beef cattle, feeder lambs and sometimes hogs. He did custom baling for neighbors. Then the rains came.

At one second past midnight on May 29, 1952, aerial bombs were set off at the site of the new Dunn farm in the Columbia basin,

and more than 300 carpenters, bricklayers, electricians, plumbers and general helpers went to work.

There had been "farms in a day" before throughout the nation, but never on such a scale. This was big, like the Columbia basin which covers 1,029,000 acres—a new land empire as large as the state of Connecticut. It's big like Grand Coulee Dam, the world's greatest mass of concrete, which this year will bring water to more than 66,000 acres and thereafter to 70,000 additional acres yearly until eventually 13,000

All the furnishings and appliances for the house were provided. Dunns even found food on cupboard shelves





There's lots of wardrobe-closet space throughout the house. Home was built on a concrete slab, is expandable

neighboring farm units are to be served.

In predawn, work on house and farm buildings was done under floodlights. The sun rose on completed frames. The only major preliminary work on the house was the pouring of a concrete slab for the floor so the slab would be dry for construction workers.

William C. Bell of Seattle, managing director of the Western Retail Lumbermen's Association, was general coordinator of the construction phase of the farm. Heavy beams and a few other major pieces of lumber had been previously cut to size, but otherwise everything was done on the spot.

A bandsaw powered by a three-horse-

power motor rolled to the site on a trailer. Wesley Nelson of Moses Lake, who manned the saw, stuck with it from midnight until 5:30 p.m.

As a carpenter banged in the last nail on a board, a painter appeared beside him with a brush and an electrician notched a hole for wiring. Timing was good, but not perfect.

"I wouldn't recommend a house, let alone a whole farm, in a day as a regular diet," said Bell, midway in the construction. "I'm enjoying every minute of this, but the minutes are expensive. Speed makes for waste in both labor and materials."

(Continued to page 238)

One month after he moved in, Dunn inspects his crops, raised on land cleared, fertilized and seeded in a day



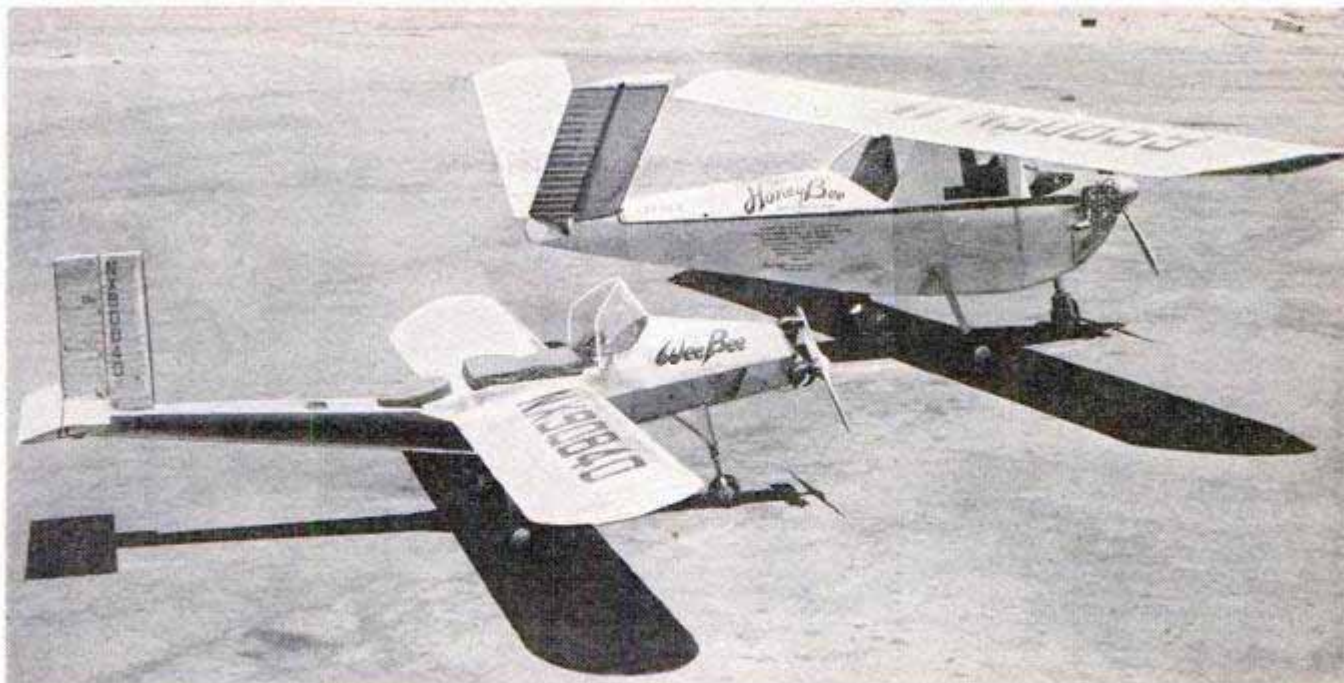

There is only a slight size difference between Honey Bee, rear, and older, midget Wee Bee in the foreground

All-Metal Lightweight Flies Over 100 M.P.H.

All metal, a 550-pound airplane built for low-cost personal flying cruises at well over 100 miles per hour. Called the Honey Bee, it has a 28-foot wingspan and is 17 feet long. A 65-horsepower engine gets the single-place craft off the ground at about 45 miles per hour and needs only 500 feet of runway. In power-on stalls it has been flown down to 35 miles per hour. Some of the Honey Bee's structural features are a spring-steel tricycle landing gear, a steerable nose wheel, hydraulic brakes and a butterfly tail. Production is expected to start early in 1953. The Honey Bee's simplicity is reflected in the equivalent of only 60 working days required for its design and construction, a low figure for an experimental plane.

As easy to enter as an automobile, new plane is a single-seater



Rain Makers Seed Clouds With Salt Particles or Water Droplets

Two rain-making recipes are being tested in the Pacific; one recommends adding water as needed to clouds, the other involves seasoning them with salt. Australian experimenters claim to have emptied cumulus clouds of their water simply by spraying droplets of the right size into the base of the cloud. The theory of these experiments is that droplets of a certain size must be present in a cloud before little drops form into big ones and rain results. In recently conducted Hawaiian experi-

ments, oceanographer Alfred H. Woodcock is proceeding on the theory that microscopic salt particles form the nuclei of raindrops over the ocean and that there is a relationship between the amount of salt in rain and the intensity of rain. Salt particles are carried hundreds of miles inland, and may play an important role in the formation of rain over land, he believes. Woodcock's plan is to seed clouds with the proper salt particles in order to induce a forced precipitation in these areas.



Houston Chronicle Rotogravure Magazine photos

Sunday services at the drive in are popular. Largest congregation was last Easter when over 2000 attended

Church Services Held in Outdoor Theater



Above, parents bring small children without fear that they will cause a disturbance. Below, a steady stream of cars roll in for the early morning service

Texas churchgoers on their way to work or play attend Sunday morning services right in their cars at a drive-in movie theater that becomes a house of worship once a week. The services, which attract an average of about 200 cars each week, also appeal to invalids who find it difficult to attend regular church services. One Easter morning service attracted 525 autos. Leading the services is the Rev. E. W. Matthias of St. John's Lutheran Church, Galena Park, who got the idea after reading about drive-in Easter morning sunrise services. Now the movie-theater service is a regularly scheduled part of the Texas church's program. It does not replace the regular services, which are conducted in the church building right after the drive-in meeting is adjourned.





Photo courtesy Sanders-Roe, Ltd.

Britain's Jet-Driven Flying Boat Starts Flight Tests

Flight tests have begun for Britain's giant flying boat, the Princess, under construction since 1946. In military use the aircraft will be able to fly 200 troops 3500 miles nonstop. With 10 jet-driven propeller units, she will be able to cruise at about

380 miles per hour and fly as high as 40,000 feet. The 140-ton Princess has a 219-foot wingspan and is 148 feet long. Three million rivets and more than 2½ miles of longitudinal members went into the construction of the large hull.

Plastic Sheet Keeps Windshield of Parked Car Ice-Free

You don't have to spend minutes on a frosty morning scraping stubborn ice off your windshield when you have protected it with a plastic shield. There is nothing to tie or adjust. The polyethylene-plastic sheet with a sewed-on cloth edge for strength is merely draped across the windshield and held tightly by shutting the doors on its ends. It does not become brittle, even at 60 below zero, nor will it adhere to the windshield.



Automobile Cigarette Lighter Doubles Its Use as Flashlight



If you want a light for a cigarette or for reading a map, you can get either from a new car accessory that is a combination flashlight and cigarette lighter. There is no installation problem. You merely insert it in the lighter socket on the dashboard. It operates as a cigarette lighter in the conventional manner. A small switch turns on a light bulb that shines its beam away from the driver's vision.

☞ In Mexico, in 1535, Cortez established the first sugar mill in North America.



PIN-UP

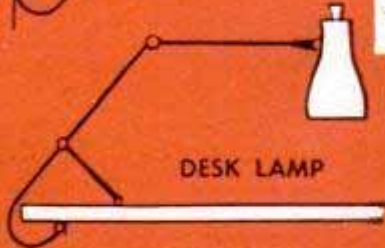

DESK LAMP



BED LAMP

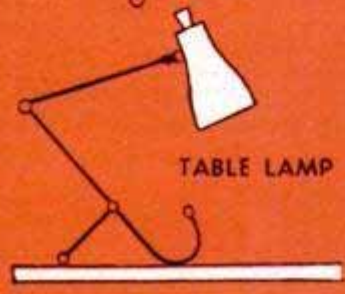

TABLE LAMP

TABLE HOPPER lamp is an ideal gift for the student or anyone who is fussy about lighting. The lamp has a spotlight bulb and can be used on a wall, table or bed as shown in the illustration at left



DO YOUR Christmas



PERSONALIZED LABELS carry name and address on cellulose tape — ideal for books, tools, records, etc. **CATCHUP DISPENSER** below is of red or yellow plastic in the shape of a tomato. All it takes is a squeeze

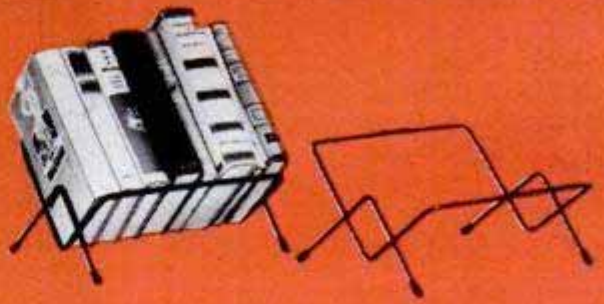

BOOK RACK made of wrought iron in black finish lends modern touch. It's 11 inches long. **BUTTER WARMER** for the table is heated by candle and is also handy for sauces or hot syrups



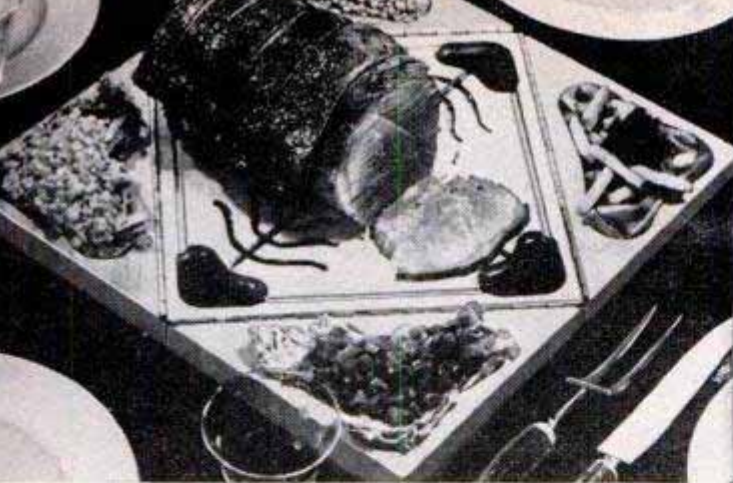

FOLD-AWAY TRAY made of wood has spikes to hold meat firmly and corner wells for vegetables. It measures 17 inches square open, 12 when closed



WREN HOUSE comes in seven pieces which can be put together without nails or glue



Shopping HERE

For the **HOME**—
and the woman
who runs it

Six pages of timely new Christmas gift ideas for the home, the youngsters, and the man of the family



FLOWER HOLDER is incorporated in bowl at left with slots in the top to support any short-stemmed flowers. A good gift for pansy or nasturtium growers. The vase can also be used as a centerpiece with candle in the top

MAGNETIC POT HOLDER clings to metal sides of kitchen range, refrigerator or steel cabinet. Laundering will not rust or injure the magnet insert in any way

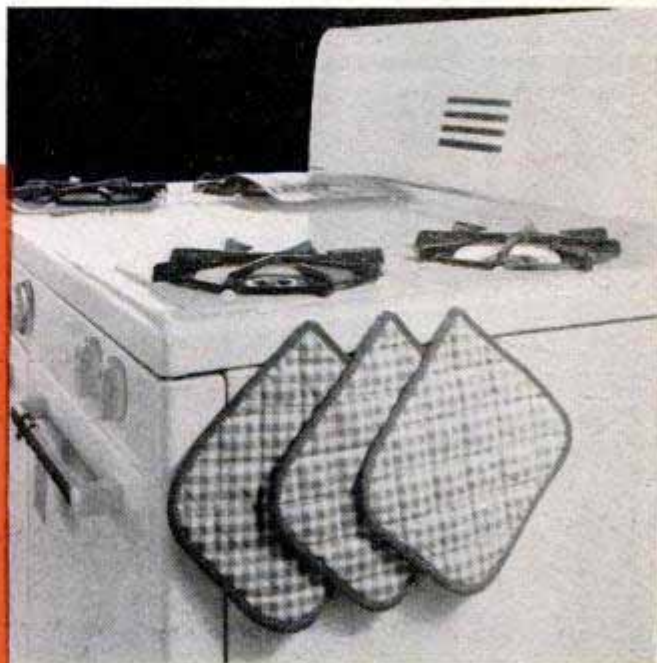

COFFEE CADDY at right consists of a quart vacuum bottle held in a wrought-iron frame. This makes an excellent gift for the family that serves on the terrace. It is also handy for buffet suppers and parties





BAIT BOX made of plastic and cylindrical in shape is just the thing for a fisherman who likes something different. The lattice-work openings provide proper circulation of water when the box is tied to the belt of a fisherman or a boat. It will accommodate 12 to 15 minnows or crawfish



LOCKING GUN RACK holds six guns in "show position" and offers a new safety feature for the home. The drawer under the rack holds ammunition, hunting and cleaning gear. One key unlocks drawer and guns. The locking rod is polished brass and the rack itself is available in honey-tone knotty pine or mahogany. The rack is 24 by 40 inches

DO YOUR Christmas

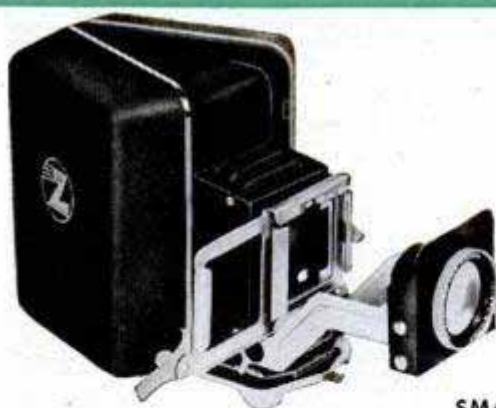

SMALL PROJECTOR handles 35-mm and bantam-slides and projects up to 10 feet wide. It weighs under two pounds. **FOUNTAIN PEN** above at right carries its own spare point that can be changed easily — actually two pens in one. One of the points writes medium bold, the other medium fine. **MUFF** for sportsmen contains a heating unit that provides a constant 120-degree heat. It straps around the waist either over or under a coat and weighs only eight ounces. Also recommended for postmen, policemen and ice-hockey spectators



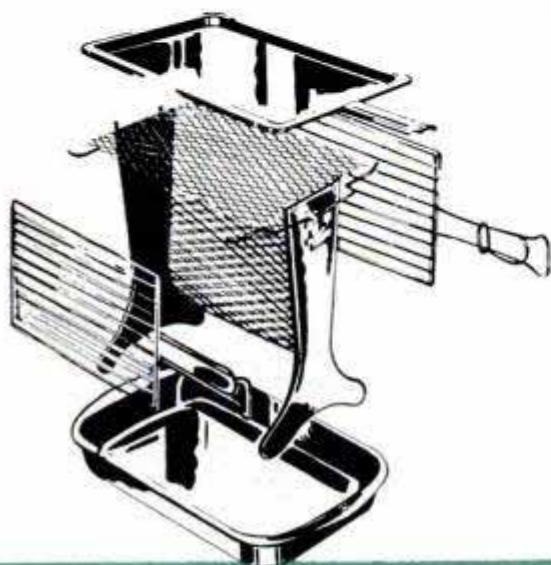
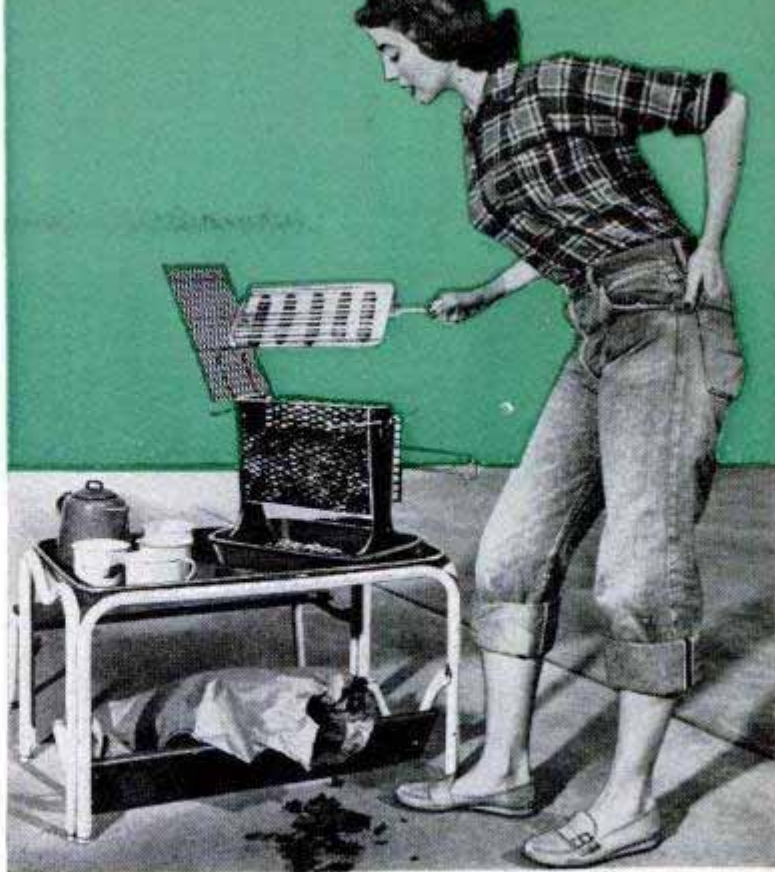

ECONOMY GRILL barbecues, broils or fries and is said to use less charcoal than flat grills. Vertical firebox makes it possible to cook on either side. The steel frying pan (in upper left photo) can also be used to control the draft on fire

Shopping HERE

For the man— and
the outdoorsman—
in the family

TOOL CHEST of varnished oak will bring a sparkle to the eye of every craftworker. It contains 29 tools, has divided drawer and a lock. A feature of the set is a roll-up door. Steel clips hold tools in proper places

SUNMAT has handy pockets for clothing or towels and two locking Zipper pockets for valuables. Features of the mat include weighted corners, printed gameboard in the center, Zipper opening for a beach umbrella

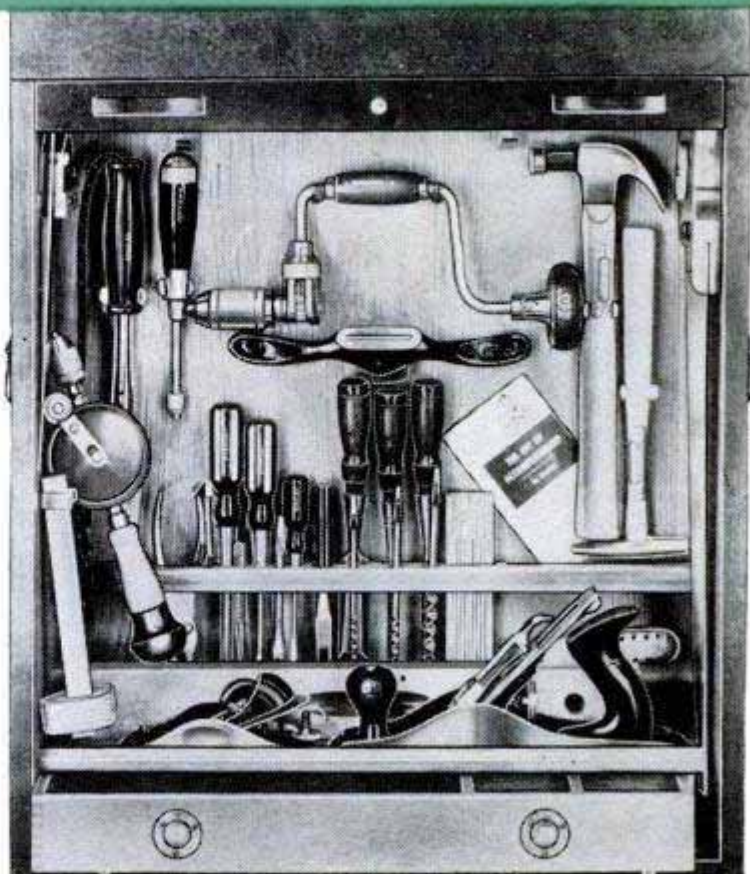

ELECTRIC CAR weighs 90 pounds and can pull load of 200 pounds, including the two-passenger trailer shown at right. The car is powered with an automobile battery which drives an electric motor. It is ruggedly built. **TOY FIRE ENGINE** below does everything but stop traffic. It's a scale model of a big American-LaFrance engine and has detachable ladders, a hose that unwinds and pumps a stream of water



BAT BAK is the name of the game being played by the young man below. It might also be called one-man table tennis for a novel backboard lobs the ball back or returns it at a fast clip just like a live partner, depending on how fast the small ball is hit



DO YOUR *Christmas*



FIX-IT TRUCK at right is a dream come true for the junior mechanic. It has a repair kit for changing wheels and a lift jack that really works. **FREIGHT STATION** for small trainmen stands 5½ inches high. With only a slight push of a button two baggagemen zip in and out on the loaded cars

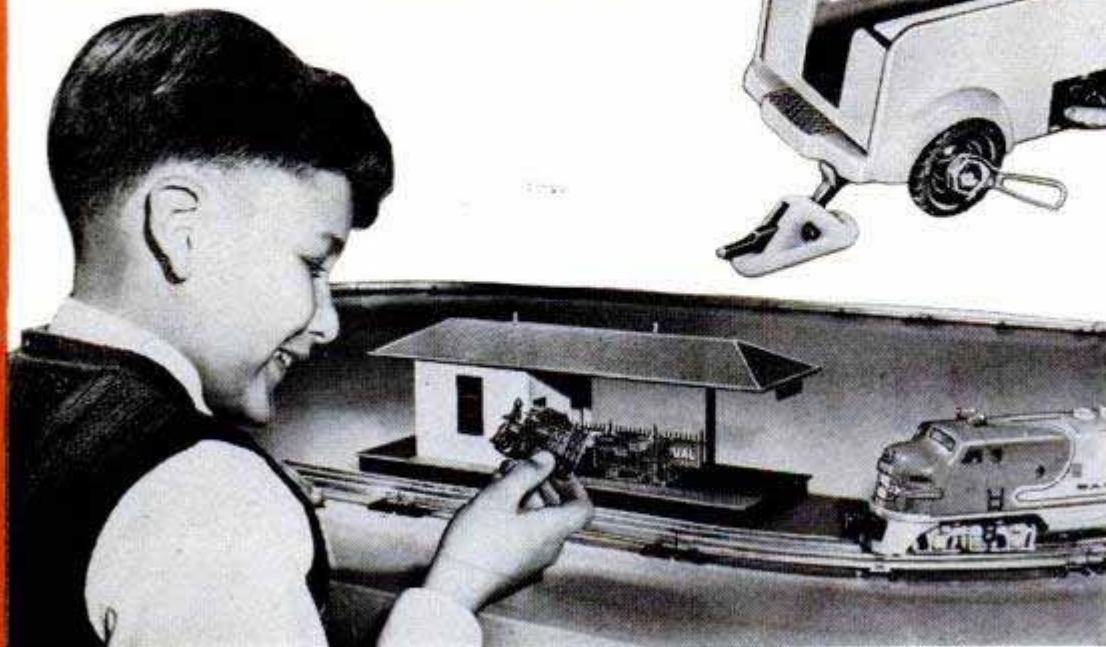
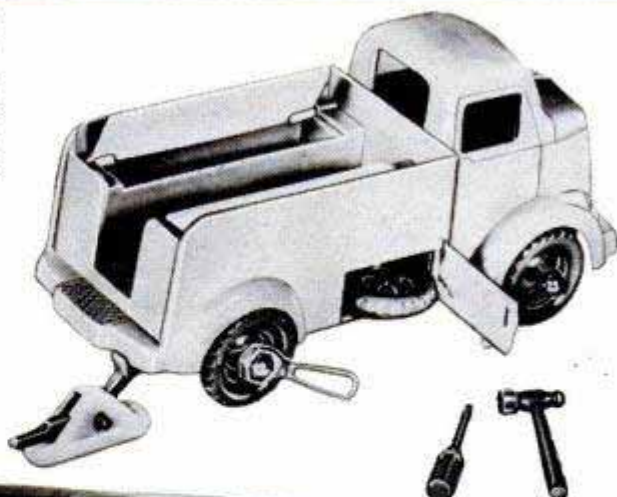

TV SHOWHOUSE below is made of cardboard and stands 40 inches high and is deep enough to accommodate a junior-size puppet operator. Children enjoy imitating other TV acts with the box. It requires no tools for assembling and folds neatly into a small unit for storage in a special carton. This gift encourages the small fry TV watchers to exercise imaginations



600 BRICKS, one bag of mortar, six windows and seven doors come with this model kit that makes building a house almost like the real thing. The miniature bricks can be broken like real bricks and they can be set with either permanent-type mortar or mortar that will dissolve in water. Shingles and foundation are made of cardboard. Houses are just the right size for electric-train scenes

Shopping **HERE**

For the youngsters



STAGECOACHES, covered wagons and other ancient vehicles of the Old West are built from interlocking parts made of metal or plastic. The vehicle kits are designed for use by very young children

BLACKBOARD CHAIR DESK can be reversed at meal-time to form an enamel table for lunch. Both frame and tray top are of smooth enamel and the blackboard has a black slate finish. Height from ground to seat is nine inches; weight is 18 pounds



"Wing flap" on Mercedes boosts braking power of the car on turns at high speed without dangerous decrease in traction



"Wing Flap" Brakes German Sports Car

Borrowing an idea from dive-bomber designers, German road racers installed a "wing flap" atop a Mercedes 300 SL for better braking on curves. The brake acts by greatly increasing wind resistance. Normally carried in a horizontal position, the hinged flap is pushed into a vertical position by the wind when it is released. It operates independently of the wheel brakes. Although the flap was installed on the Mercedes for the world-famed Le Mans 24-hour race, its use was limited to practice runs over the course. It was not used in the race which, incidentally, was



won by another Mercedes-Benz with an average speed of 96.4 miles an hour for 24 hours, covering a distance of 2314.9 miles.

Champ "Skates" Through Streets of Paris on a Pair of Wheeled Skis



Not even the lack of snow and being in the heart of one of the world's largest cities can stop a true ski enthusiast. But Paris gendarmes looked twice when French Olympic ski champion Henri Oreiller, who is also a singer-guitarist and composer, gaily "slalomed" down the Champs Elysees on a pair of wheeled skis.

Sources of available products described in this issue are listed on pages 12, 14 and 16. Sources of further information on other articles are given in the WHERE-TO-FIND-IT LIST, available from Bureau of Information, *Popular Mechanics*, 200 E. Ontario St., Chicago 11

Thermometer Traces Ills of Ailing Oil Wells

MEN IN the oil industry watch an oil well's temperature as closely as a doctor watches a child's fever. But an oil well need not be sick before an engineer reaches for his thermometer. And normal may be 300 to 400 degrees Fahrenheit. One use of the instrument is to locate the top of a cement plug after casing has been cemented. Plugs are placed to keep unwanted material, usually salt water, from flowing through the well bore. As cement sets, it gives off heat, and a thermometer lowered slowly into the bore soon after cementing shows precisely at what depth the heat is first noted. This defines the top of the plug and tells whether the cement has reached the proper point up and outside the casing. Another use of the thermometer in oil-field work is to help locate casing leaks. In these instances it points an accusing finger at the spot of the leak for there is usually an abrupt change in temperature at the break.



As the instrument is lowered a counter registers its depth. Below, inserting the temperature chart



Putting thermometer into a bore. Below, up from the depths, metal strip is a record of well's temperature

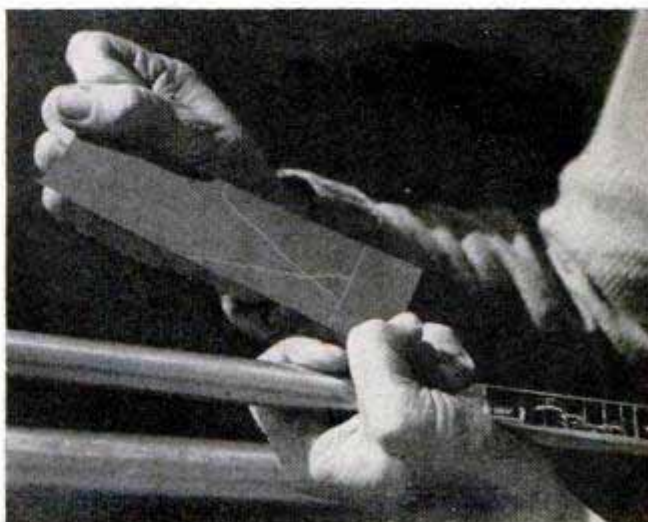



LADY WINDERMERE'S FAN:

1. (a) Deal cards into four piles of eight cards each, placing consecutive cards on different stacks. (b) Select a pile, split it, and show four cards in each hand to spectator who mentally picks one card and indicates the hand it is in. 2. Indicated half is placed under other four cards, one full pile placed on top, two other full piles placed on bottom of deck. 3. Repeat step 1 (a), dealing cards face up, from top of deck. Spectator indicates which pile his card is in. Selected card is fifth from top in pile indicated by him. Speed helps disguise the trick. Cards may also be dealt face down and "fanned" toward spectator



IT'S FUN TO BE FOOLED



... but it's more fun to know. And it's easier than you may think. Here are some simple, effective bits of card magic you can perform with a borrowed deck

MERRY-GO-ROUND: If you'd like to pose as a clairvoyant but don't want to waste your time boning up on black magic, learn this stunt. Ten cards are laid face down on

a table; when you are out of the room, a friend moves several cards from left to right. Upon your return, you will be able to tell him the number of cards he moved.

1. Lay out first 10 cards of a suit in order of numbering. Notice that position numbers used run in the opposite direction. 2. Spectator secretly moves cards, one at a time, from the left end to right end of row. After first move, number of

card at far right is number moved. 3. Its number plus the position number of the indicator card after the next move. This formula holds indefinitely. The number of the indicator card plus its position num-

ber tells you where to look for the indicator card next time. Subtract 10 if the total sum is over 10. Limit cards moved each time to nine. Cards must be moved in order. Mystery is heightened if cards are face down even at start of trick

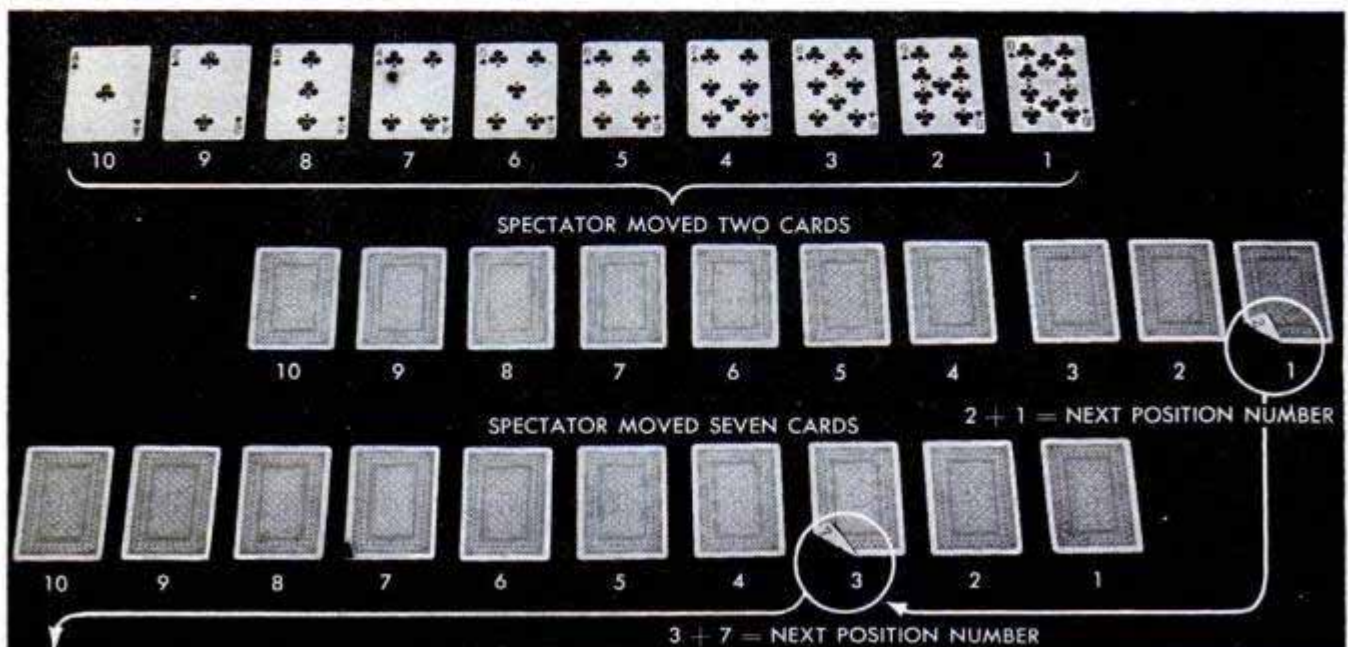



WHISPERING QUEEN:

1. Invite spectator to shuffle deck. Run cards, face up, from one hand to other, withdrawing queen of spades who will shortly "whisper" name of selected card. Remember the bottom card.
2. Ask spectator to cut deck into two piles approximately 39 and 13 cards each. 3. Determine his accuracy by counting smaller deck into a new pile, reversing order to bring down bottom card to top. Ask him to note top card of smaller deck, insert it in pack, and shuffle deck. Hold the queen of spades to your ear, pretending that she is whispering mystery card you already know. Then name spectator's card. This trick lends itself well to diversionary tactics. Compliment spectator on his rare cutting ability; maintain patter



WHISPERING QUEEN: Some tricks are based upon the use of an accomplice. Dishonorable, some say—but in the above case a cardboard informer is your announced helper—and her only real purpose is to allow you to spot the bottom card. It's simple but effective.

26th CARD KEY: Here's a trick that can be repeated and still remain a mystery to some of the most acute observers. Basis of the stunt is the discovery of the key card, which is 26th from the top. The spectator's chosen card is always the 25th one past the key 26th card.



26th CARD KEY:

1. With cards face up, count deck into another pile, remembering 26th card from bottom of new deck. Turn over deck, tell spectator to cut two thirds of deck to make pile B, half of pile B to make pile C. 2. Pile C is shuffled by spectator, who chooses a card and places it on top of pile C. Trickster drops pile A onto C and pile AC onto pile B. Spectator cuts the deck. 3. With deck face up, find key card. Silently count toward bottom of deck. Card 25th past key card is spectator's. If there are less than 25 cards below key, finish count from top. You may learn the identity of the key card by any means at your disposal, of course, but the easiest ruse is to say "I want to make sure that I have 52 cards," then counting them out and making a note of the 26th card from the top. When you're looking for key card, pretend you're actually having difficulty finding spectator's chosen card

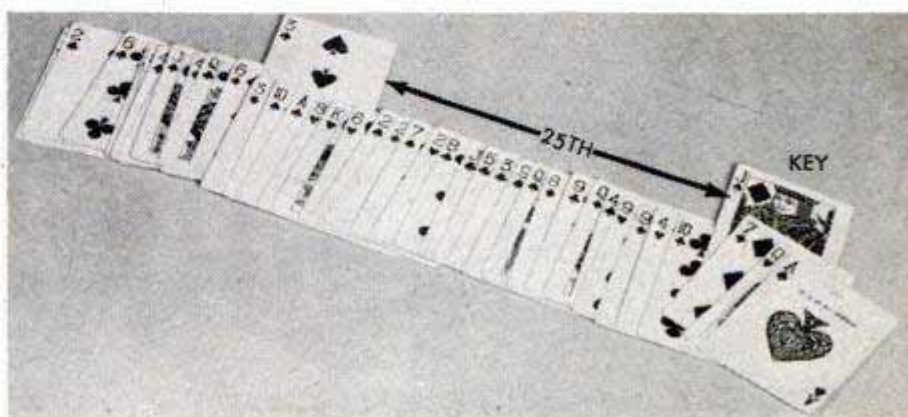
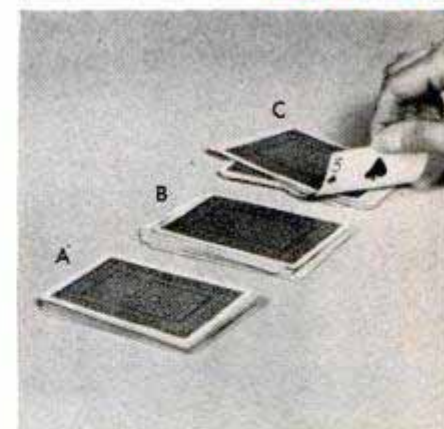



Guiding the flexible blower tube, workmen distribute grassing mixture across a sharply inclined slope

Blower Seeds Unsightly Embankments

TWO Canadians have perfected a machine that gives unsightly embankments a "facial treatment," no matter how steep, jagged and broken they are. Blowing topsoil, fertilizer, oat, grass and clover seed, and peat moss, it seeds up to 1800 square feet an hour. A week ahead of seeding operations, peat moss, oat seed and topsoil are machine mixed and set aside in piles to germinate. At first signs of seed growth, the mixture is fed to a second machine mounted on a blower-truck unit. Grass seed, more topsoil, fertilizer and clover seed are added and dropped through a trap into a long, flexible blower tube, through which the complete mixture is sprayed. Repeated sprinklings prevent the mixture from being blown away.

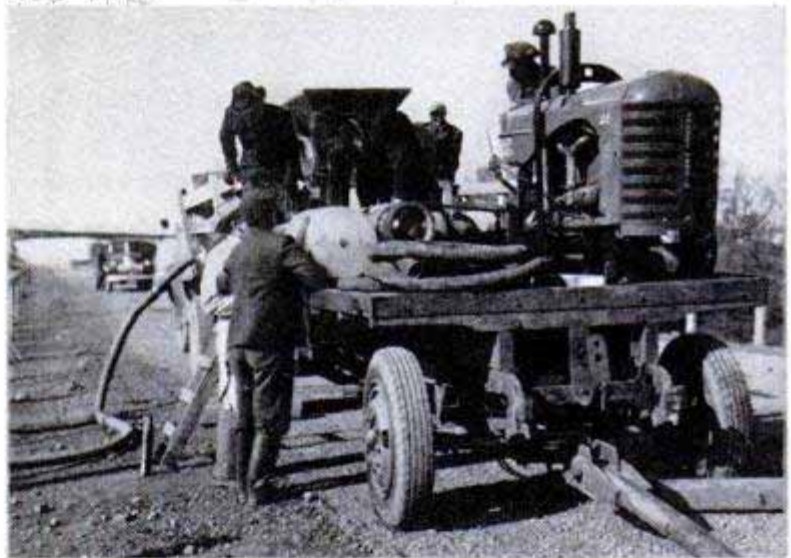

All the equipment used for the initial grassing experiment in Canada was carried on a flat-bed truck. Below, the mixture of topsoil, fertilizer, oat, grass and clover seed, and peat moss is drawn upward by a worm gear and blown out through hose

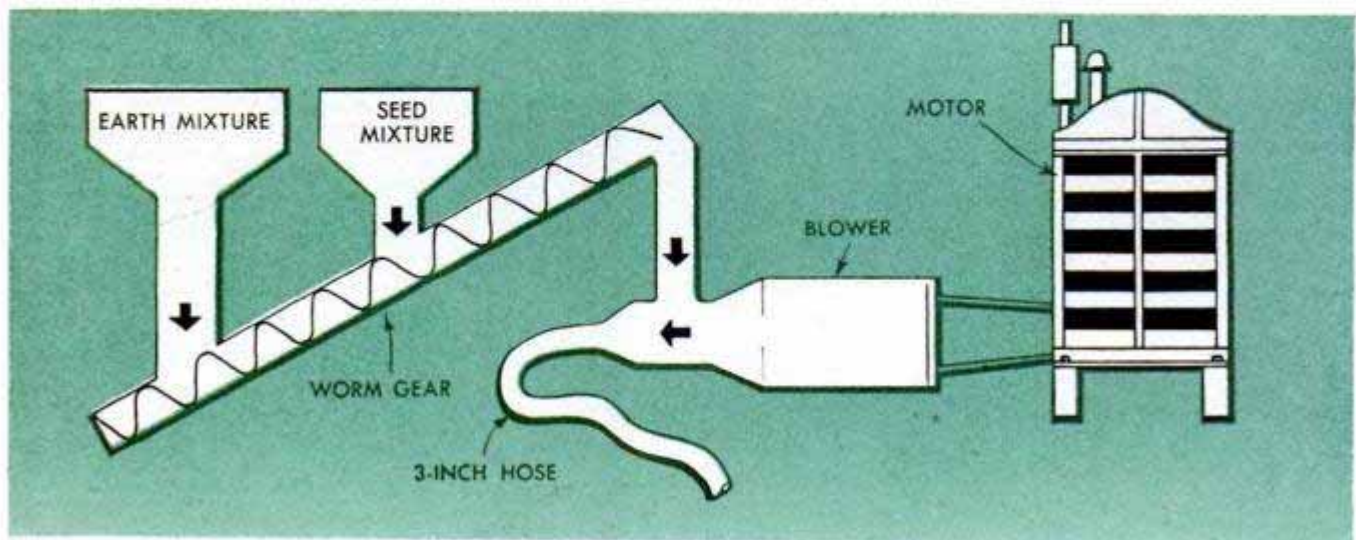

PLAYING SAFE

with

ATOMIC RAYS

By Rafe Gibbs

NOT LONG AGO four atomic scientists—three men and a woman—were working behind closed doors on an experiment with fissionable (atom-splitting) material in the Argonne National Laboratory at Chicago. During that experiment, an accident occurred—just what happened is a secret known to the few. But the four scientists looked tensely at one another. They knew. They had been overexposed to atomic radiation.

Days of hospitalization . . . wondering . . . waiting . . . Then, on June 20, came the announcement from Dr. Robert J. Hasterlik, director of the laboratory's health division: "Tests show the four have recovered, and can return to work. But they will be checked from time to time to be doubly sure."

This story is not told here to emphasize that radioactive material is dangerous. It can be! But the point in the Argonne case is that such occurrences among thousands of workers throughout the nation now dealing daily with radioactive materials are quite rare.

If not put under control, an unstable man can be dangerous. Same with unstable isotopes. Some men are just naturally unstable, and some get that way. Isotopes likewise. Both humans and isotopes sometimes "blow their tops." Safeguards in the nation's atomic plants are many—weirdly intricate and startlingly costly. Take one item. A non-coloring-glass window for a radioactive room, measuring 54 by 24 inches and 3 feet thick, costs \$8000. You can get an ordinary windowpane that size—but not so thick—

Approaching a marked boundary, the man behind mask is checking an atomic-plant area for radiation

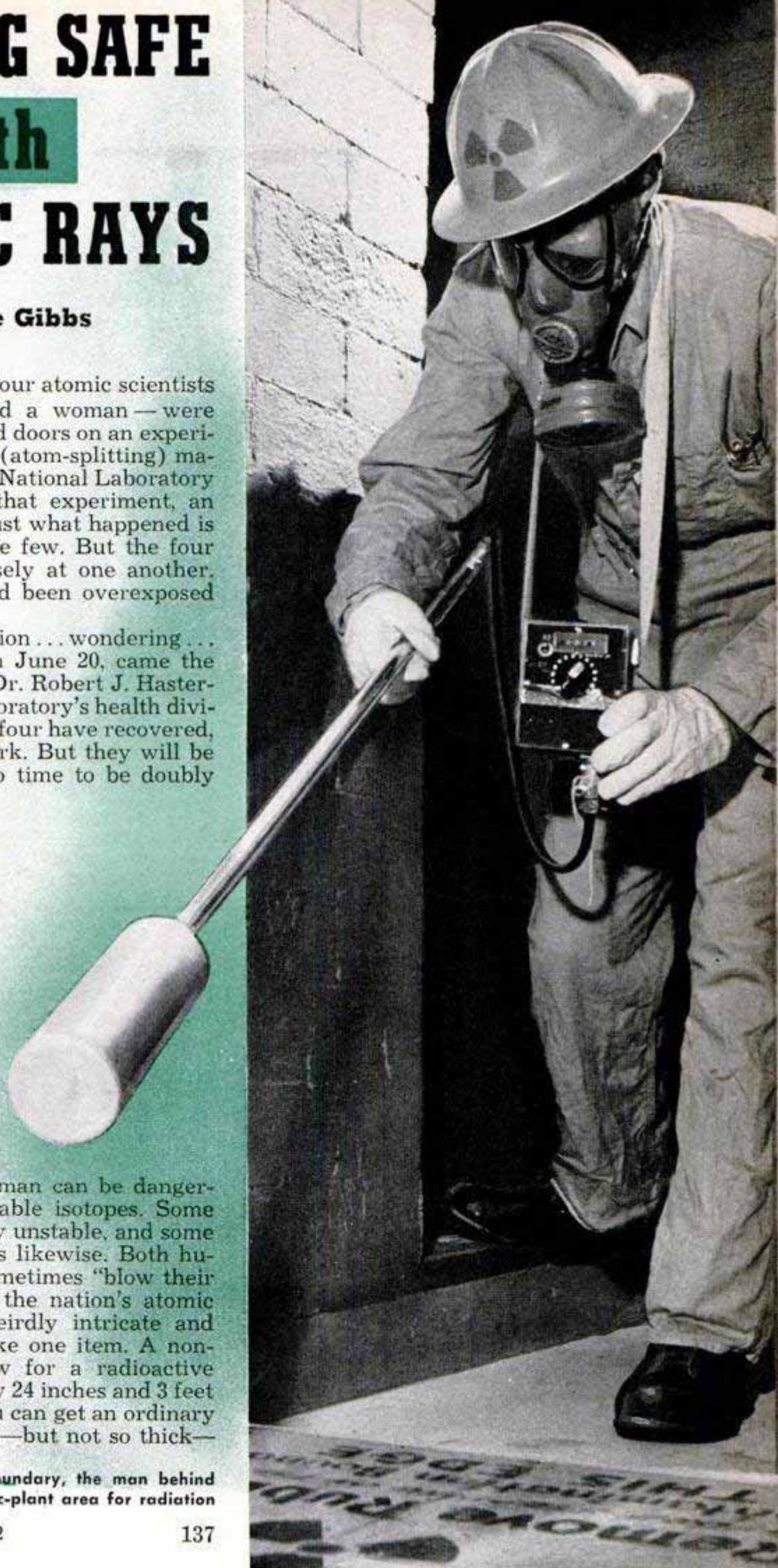

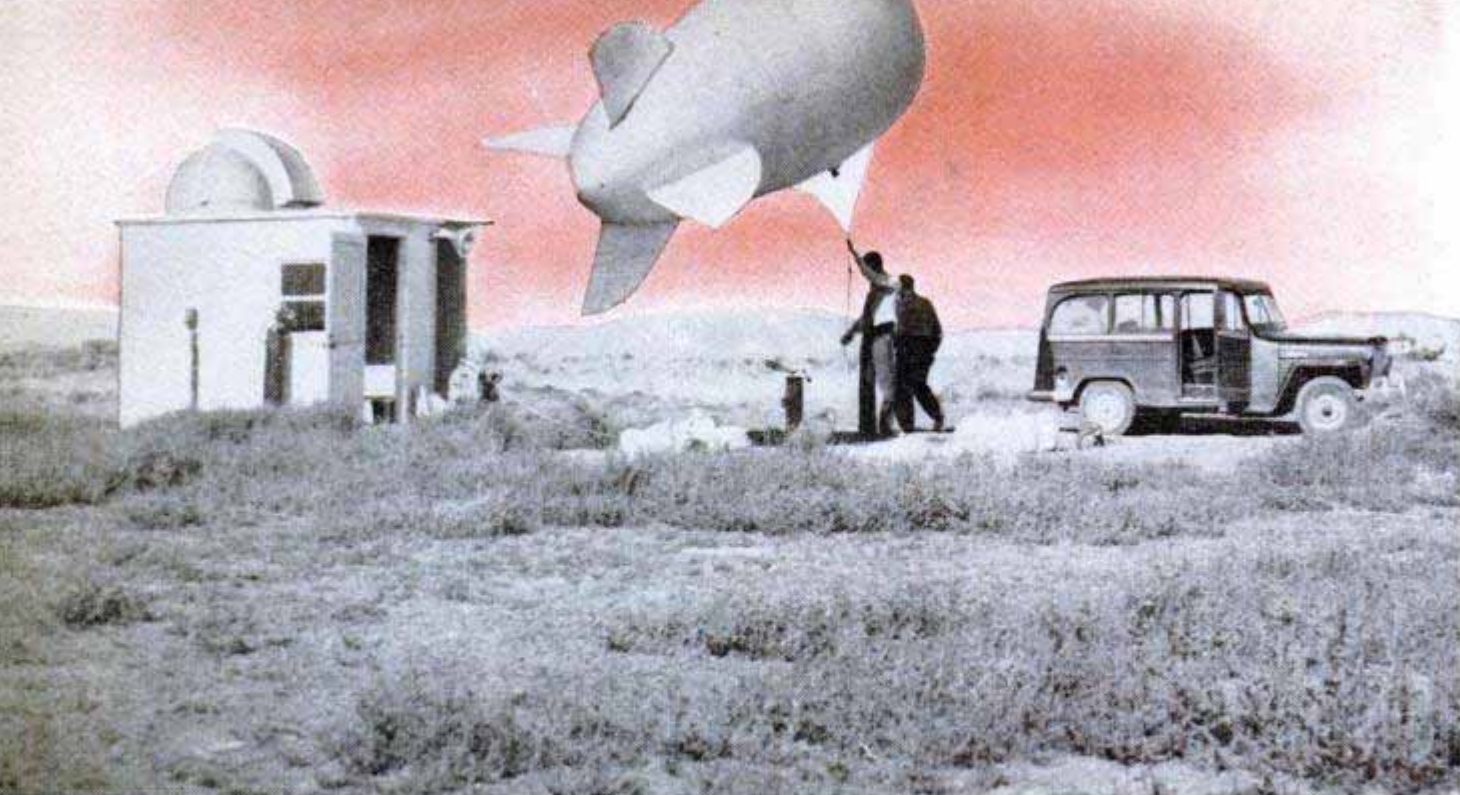

To learn if the weather is right for an atomic test, a balloon is sent up to check wind and air factors

at the local hardware store for about \$1.

And some of the persons who work in atomic-energy plants go through motions that are almost out of this world. Let's take the case of Joe who works at Hanford, the place out on the semidesert lands of Washington where they deal in wholesale radiation. Some installations handle radioactive material by the gram. Hanford handles it by the ton—more than all that handled by all other places in the nation put together.

Well, Joe used to be a bus driver, but he's a "canyon operator" now. "Canyons" are the names given to massive and isolated concrete structures on the 488,000-acre Hanford project area—the places where they work with the hot stuff. Each Hanford canyon contains enough concrete to build 30 miles of highway.

The personnel experts figured it takes a steady man to drive a bus—the kind who would make a good canyon operator. And

Left, a pump draws air through filter paper and around a Geiger counter in continual checks on radioactivity. Acid squirted from a plastic bottle by mechanical hands, shown at right, washes "hot" tools in a sealed room

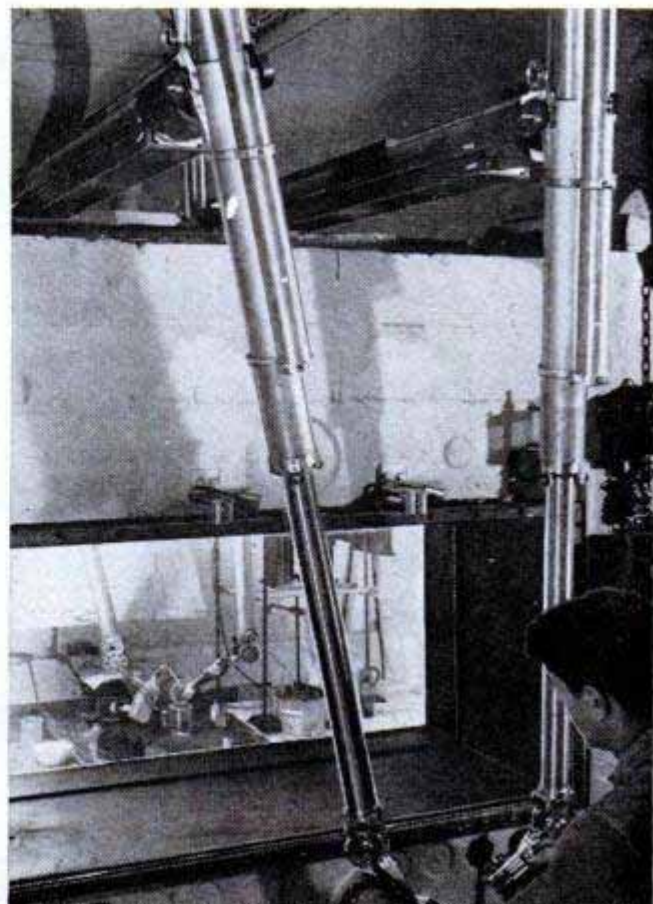



Long-handled tongs, mask, heavy rubber gloves and a film badge on pocket help guard against overexposure

Joe wanted the job because the pay is higher, and he has three youngsters. Joe has a modest house in near-by Richland, and while there he leads a pretty average life. When he leaves home for work at the Hanford project in the morning, however, he is no longer Mr. Average.

The husky guard at the plant gatehouse knows Joe. "Hello, Joe," he says. "Kids get-

ting over the measles all right? Here are your checker-uppers."

The guard hands Joe three small objects. There are two "pencils" (pocket ionization chambers) and Joe's personal film badge. Joe must never be without these three items while in a canyon. When he leaves at night he will turn them in. The pencils will be checked immediately to determine

Air from tank on this man's back is breathed and expelled from suit to keep contaminated air from entering

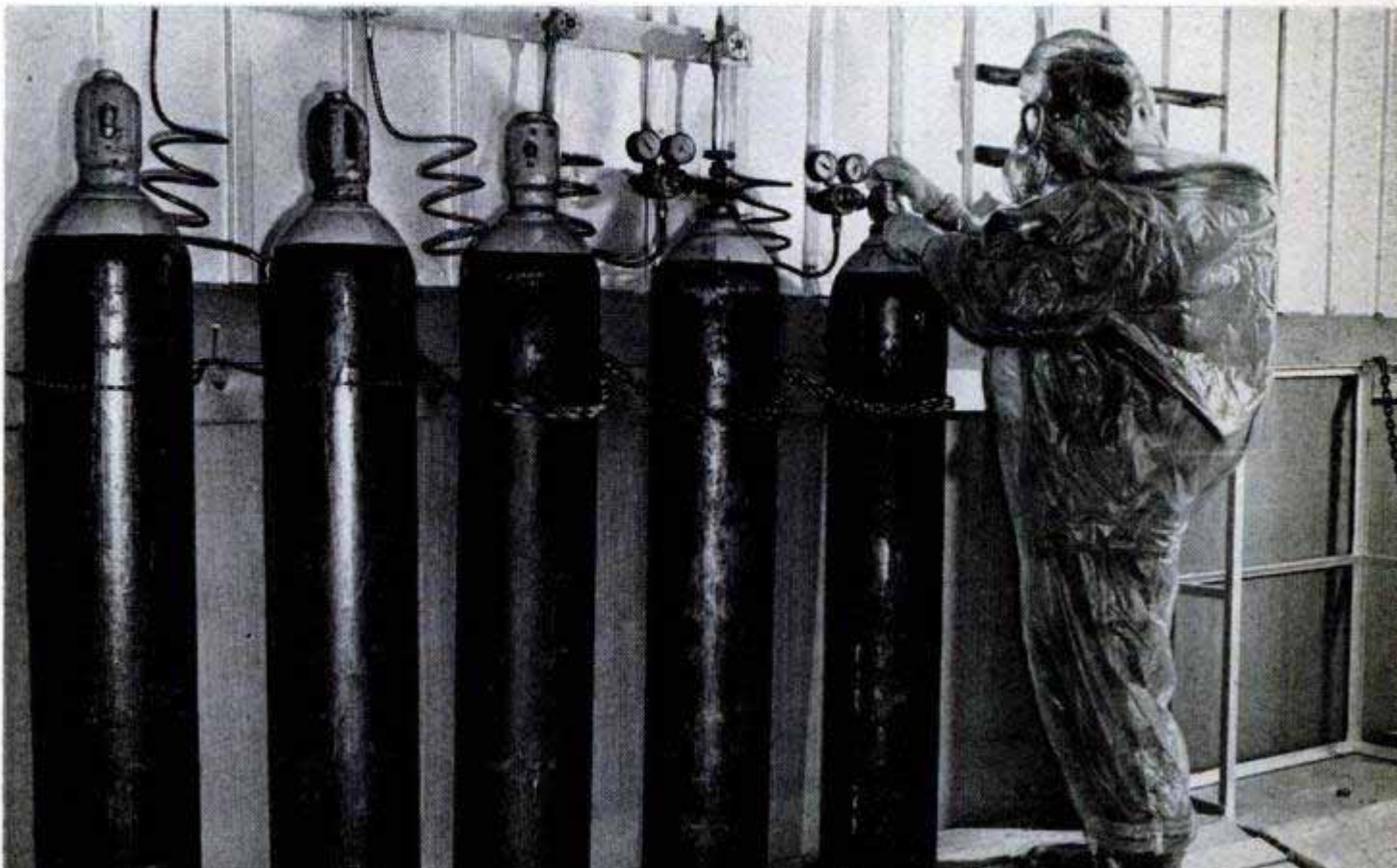



Samples of plant life are taken, left, to determine radiation in vicinity of tests. With three-dimensional television, right, dangerous experiments can be conducted remotely thanks to accurate depth perception

his amount of radiation exposure; the film badge is checked at the end of the week.

Joe's wife, Ella, always packs him a lunch in a bucket. This he leaves in the plant lunchroom. He is not allowed to take it with him out to his canyon work site. There, Joe can neither eat nor smoke because of the possibilities of getting radioactive particles in his mouth. But the lunchroom is "clean"—in the usual sense, and also in the sense that it is monitored continuously for radioactivity.

Joe now enters a canyon-plant building which handles one stage of the chemical processing of radioactive materials that will eventually go into an atomic bomb. At his post, Joe stands in front of a panel with a lot of gauges—watches these closely, of course—and turns valves.

When Joe turns those valves things hap-

pen in a thick-walled, sealed-up room. Acids are added to the batch of material with which Joe is working, the material is transferred from one vessel to another, wastes are run off. Joe knows every second what is happening inside that room where death would come to any man who entered. A meter detects any unusual vibration of moving equipment. A loudspeaker even brings him the strange process noises.

And Joe is happy at his work. He feels safer than he did driving a bus. Scientific minds, which have upset the world with atomic-energy development, are now working overtime to devise more and better safeguards. One is the use in atomic goggles of glass containing cadmium, making them safe, transparent absorbers of neutrons, the penetrating particles of atomic fission. The

(Continued to page 252)

Using a beta-gamma counting device, the technician at left records the scale reading on coveralls worn by an atomic scientist. A worker coming off the job, right, checks to learn if he has a "hot" foot from radiation





Simple tire clamps may replace conventional chains as standard equipment. Only one is needed per tire



Traction tire clamp, easily placed on wheel after car is stuck, enables automobile to work itself free

Traction Tire Clip Replaces Conventional Auto Chains

Incredibly simple in design but efficient as it is easy to put on, a clamp that fits over an automobile tire gives certain traction in ice, mud or snow. In tests, a car stuck in mud up to the differential was fitted with the clips and worked itself free in less than a minute. The clamp can be attached while

the automobile is stuck, and can be placed anywhere around the tire. It will not fly off at speeds of 40 to 45 miles per hour on a paved roadway. No tools are needed to install or remove the clip, which is manufactured in three sizes to accommodate the requirements of all sizes of automobiles.



"Windmill" Device on Windshield Protects Nighttime Driver From Glare

Someone is always trying to solve the glare problem for the night driver — now an Italian inventor has a novel solution. Mounted on the top rim of the windshield, the device consists of eight opaque plastic sections each containing a narrow slit.

When rotated by a tiny electric motor, the sections form a slotted disk that interrupts the driver's vision and reduces the excessive light that causes glare. When not in use, the device folds like a fan out of the driver's line of vision.



Controlled traffic lights make sure that this equipment arrives when it is needed

“Talking” the Smoke Eaters Through Town

STOP WATCH IN HAND, I watched a trial run of Columbia, S. C. firemen. Fifteen seconds, they said, would see them out of bed and on their way down the street.

They hopped, skipped and jumped into boots and pants, shot down the firehouse pole and onto the truck with two seconds to spare.

More miraculous, I thought, as the truck lurched to a stop, the rig had moved through nine intersections busy with daytime traffic and reached a fire a mile away in 69 seconds! Little wonder Columbia's fire loss is small and its insurance rate is among the lowest in the South.

How do they do it? The secret lies in the city's new fire station, fully equipped with the latest electric devices which synchronize every necessary movement and eliminate delay along the line.

Heart of the system is a remote-control wiring installation developed by General Electric engineers. With its help, a man sitting at the switchboard can turn on or

By
Raymond Schuessler

As fire trucks sped along a mile-long route, traffic lights blinked and sirens screamed to open the way

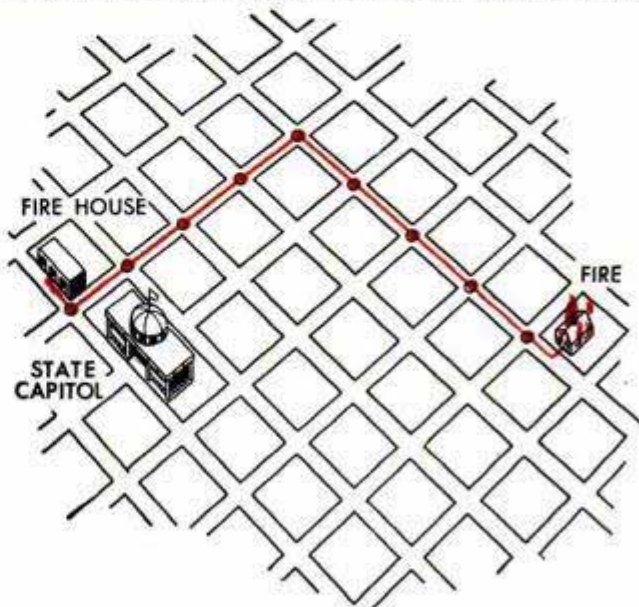



Control operator receives fire reports, alerts men, opens doors and switches traffic lights to clear route

off every light in the firehouse, open and close its eight doors and control every city traffic light.

With ordinary traffic-control methods, it would have taken us two and a half minutes to cover the mile-long route we had taken. In a flash fire, the delay of a few seconds could mean losing a whole building and some of the people in it.

When a fire report comes in, the switch-board operator turns on all lights, alerts fire fighters by loudspeaker, gives instructions and opens doors by remote control.

As the vehicles move through town, the radio man on the lead truck tells the control room what intersection he's approaching. The control operator turns the proper switch, starting a siren at the corner and turning the traffic light to flashing amber. Traffic comes to a stop and the fire trucks race through. The last piece through the crossing radios "cut," the siren stops and traffic returns to normal. With such traffic control, apparatus from the main station can reach the farthest part of the city in five minutes, one third the former time. ★ ★ ★

Approaching intersection, lead truck radios station; traffic halts as light blinks and corner siren sounds





Copyright Presse-Seeger

Nazi Assault Boats Employed to Wage War on Beetles

Waging an all-out war on the cockchafer, a beetle destructive to vegetation, German forestry workers are using former Nazi assault boats to spray the banks of the Danube and Tsar Rivers. Bavarian offi-

cialists say there are 3,000,000,000 beetles in the invasion, the largest such insect threat in German history. The spray being used is a combination of DDT, poisonous exterminating gases and fire.

Finger-Size Stomach Camera Developed by Japanese Scientists

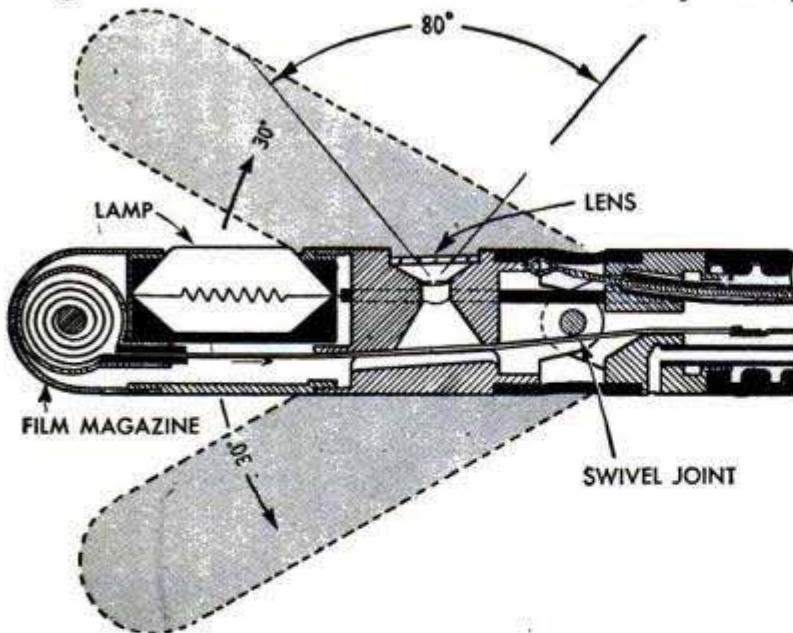

Doctors can take photographs of the inside of the stomach with a tiny camera that carries its own light supply. The camera and 16-candlepower lamp are attached to the end of a rubber tube. Film is loaded in the camera in a tiny magazine. Thirty pictures can be made in five minutes.

Airplanes of Glass?

Glass, more resistant to the searing skin-friction temperatures of supersonic flight than most metals, is being urged as the material for airplanes of the future. Glass-plastic laminate—not ordinary window glass—is the material under consideration. Thomas E. Piper of Northrop Aircraft points out that "the airplane of the future could have glass wings, ailerons, stabilizers and an all-glass fuselage. It would be fastened with glass rivets and supported by lightweight titanium and stainless-steel structural members."



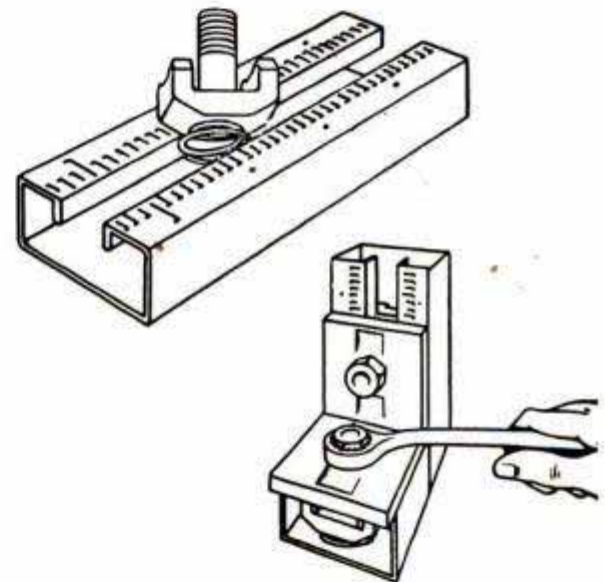
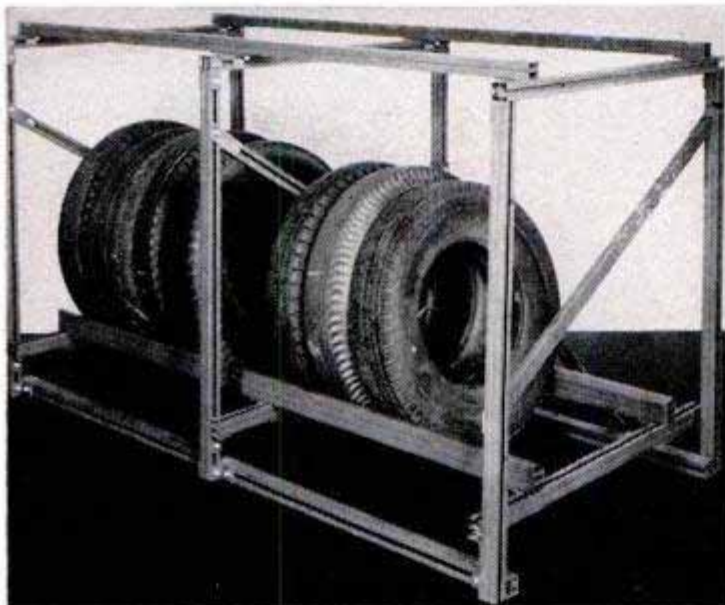
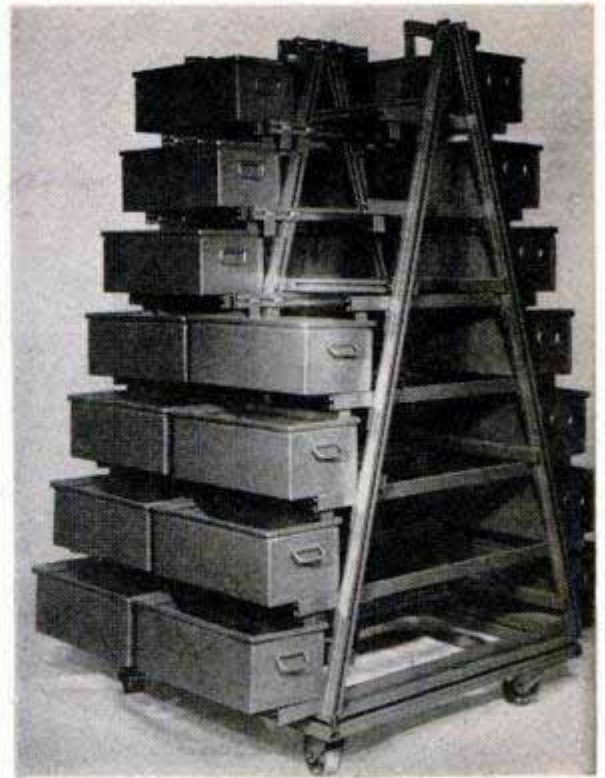
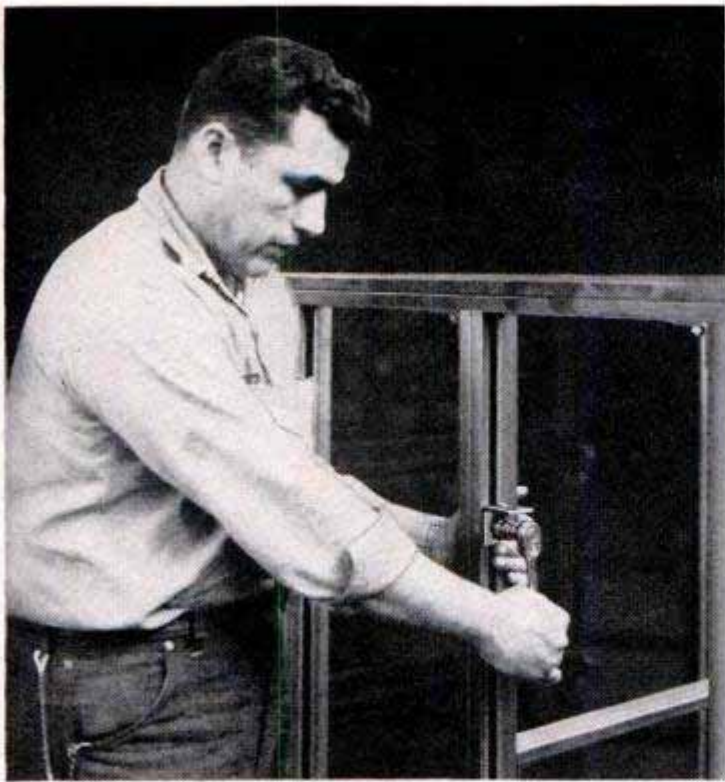

Steel Framing Material Quickly Assembled in Various Shapes

Although it has only three basic units, a steel framing material can be assembled to form a multitude of shapes with no tools except a wrench. The three units are a channel frame (available in several sizes), a spring-loaded bolt and a serrated fitting (also available in different sizes and shapes). These parts can be fitted together

to form racks for service stations, supports for conduits and overhead radiators, legs for benches or racks for basement storage. A ribbing along the slot in the channel frame meshes with the serrations on the fittings to assure a nonslip joint that prevents sideways. The channel frames can be cut to size with a hacksaw.

Electronic "Stop Watch" Splits Second Into Millionths

Capable of slicing a single second into 8,000,000 parts, a new "stop watch" measures elapsed time by means of electronic counters. However, you probably wouldn't want to take the timer to a sporting event; its hair-splitting accuracy is most suited to timing relay contacts, camera

shutters, measuring geophysical vibrations, projectile velocities and telemetry frequencies. Nor would you carry this stop watch in your pocket; it is contained in two cabinets four cubic feet in volume. The lower cabinet houses the power-supply unit; the upper case contains the computer.



Having a short, powerful body, the reindeer is not the sleek gazelle common in Christmas decorations

Reindeer
For Hire

EVERY CHRISTMAS parade has Santa Claus dispensing good cheer, but his hard-working deer, Dasher, Prancer and company never seem to get into the act.

They never do, that is, except in Texas, where youngsters thrill each year to the sight of real live reindeer pulling Santa and his pack of presents.

This Christmas treat is on Grady Carothers, Goldthwaite cattle rancher who imported some reindeer from Alaska several years ago. He has trained them to haul a sleigh (which has to roll along on wheels

hidden between its runners, Texas weather being what it is) and now he gets so many requests for his animals that he's building up a herd of them.

Annually, he buys a few more from Eskimos near the Bering Sea and flies them to his Texas ranch. It takes only a couple of days to haul the animals from the land of ice and snow to one of cactus and sagebrush, but it will take much longer to make them love it! In summer, Carothers has to keep them cool with a huge fan and a water spray in their covered corral. ★ ★ ★

Something look confused here? No wonder, as cowboys help Santa train his reindeer on a dusty ranch in Texas





In hot weather, the broad-antlered reindeer pant like dogs. Their cloven hoofs crackle and pop as they walk

Four rubber-tired wheels make up for snow shortage in Texas

Below, the reindeer take part in up to four parades a day, being hauled from town to town in this trailer

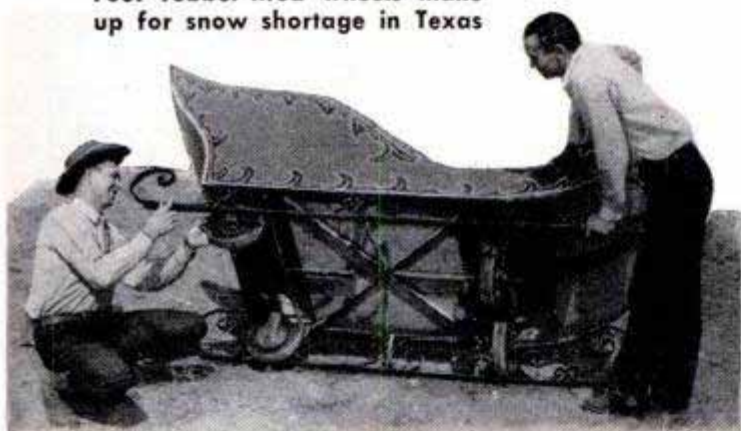

Below, to keep the animals cool, a giant fan and a water spray lower the temperature in their corral

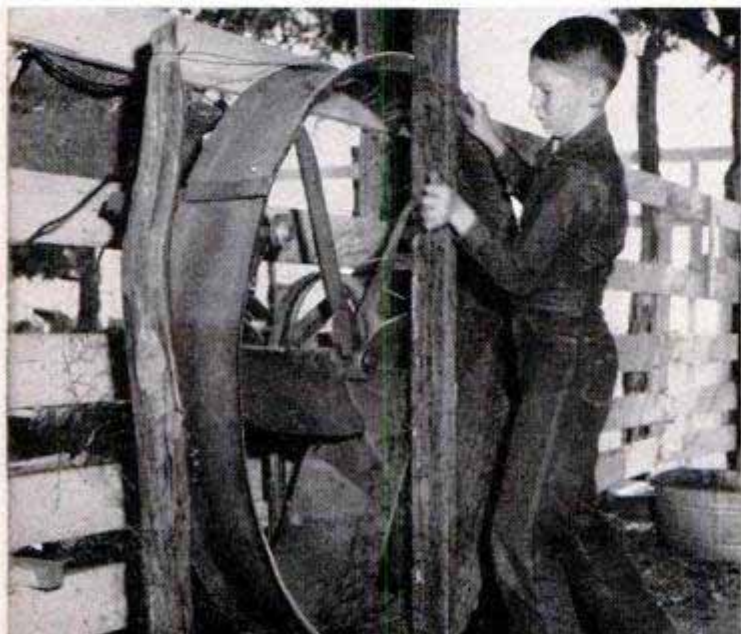

Truck Engines Start Quickly When Preheated by Hot-Air Flow

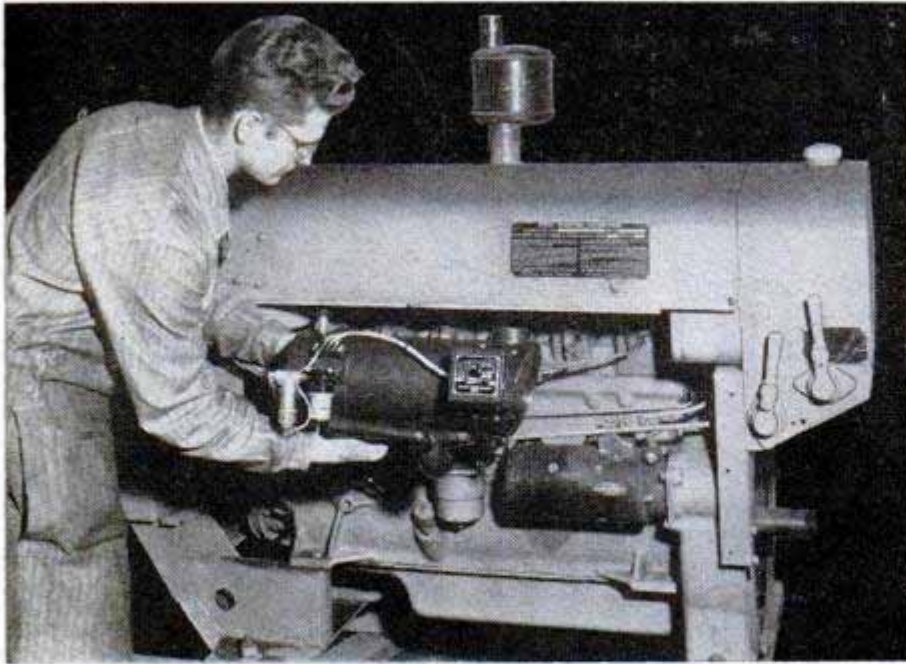

Above, mechanic holds preheater in its approximate position on an engine. Hot-air ducts, shown by diagram below, carry heat to battery and block

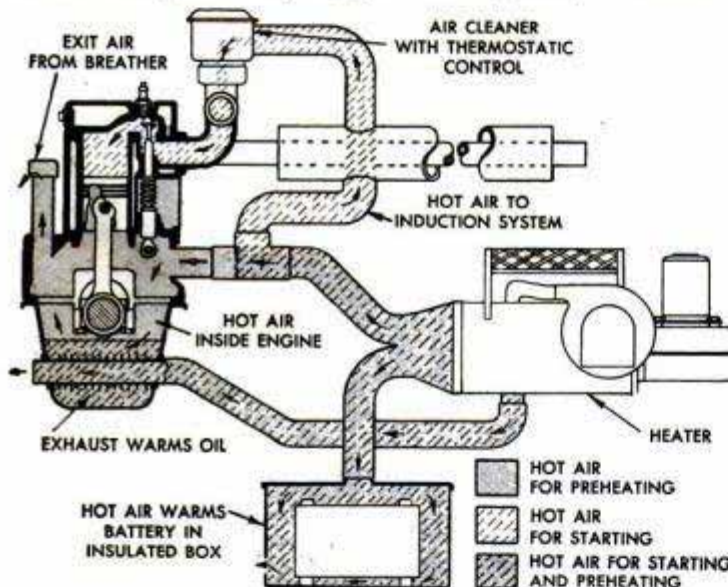

Quick starts are assured at temperatures as cold as 65 degrees below zero by an engine preheater that pours hot air into the block to warm lubricants and make fuel ignite more quickly. Clean air, heated to about 400 degrees Fahrenheit, is circulated through the engine and around the battery. In 10 to 20 minutes the engine is warm enough to start easily. During the starting operation, the heated air is introduced into the engine's air-induction system for faster ignition. These heaters can be used on either diesel or gasoline engines and are at present designed only for trucks and

other heavy equipment. Once the engine has been started the heater output can be used to heat personnel, to defrost the windshield or to keep cargo from freezing in sub-zero weather.

Forecast 1000-Mile Rockets

Within five years, multistage rockets will be able to roar 1000 miles into space, Naval Research Laboratory engineers predict. Single-stage rockets will go half that distance. Already, they point out, the Wac Corporal, Viking, Aerobee and V-2 sounding rockets have carried seven tons of instruments 140 miles into the sky.

Electric-Heater Thermostat



You can make any electric heater completely automatic by plugging it into a recently developed thermostatic unit. Completely self-contained, it requires no wiring. The compact attachment includes a sensitive thermostatic control which is easily set for any desired temperature, a built-in receptacle, and a standard six-foot cord which connects to the nearest wall outlet. The unit will maintain a constant room temperature.

Sewage "Farms" Promise Valuable Feed and Chemical Products

Sewage "farms" where waste will be turned into valuable livestock feed and industrial chemicals are suggested by research at the laboratories of the University of California. Algae growing in the oxidation ponds would convert sewage to algae almost completely in a day. The single-celled aquatic plants contain up to 50 percent protein, and would reclaim the valuable nutrient elements now being poured into the sea in huge quantity. Besides providing feed for domestic animals, the dried algae could furnish raw materials for chemicals, fats, alcohol, oils, synthetic fibers, hormones and drugs. The method is said to be simpler, faster, and less expensive than present methods of disposal.

the

POPULAR
MECHANICS

CRAFTSMAN



THE MANY VARIETIES of evergreens sold during the yuletide season pose the annual problem of just which tree is best for indoor decoration. Variations in types, sizes and shipping costs determine to some extent the selection of trees on the market in any given locality, but the symmetrical Douglas fir usually is first choice. Tradition has it that the first Christmas trees were firs.

Evergreens are identified principally by variation in the needles (foliage), but as a rule the shape and appearance of the tree distinguish the fir from the pine. The form of the Douglas fir usually is a long pyramid and the shape is uniform on all sides. The pines available for Christmas trees generally are less symmetrical, the branches are less regularly spaced along the trunk and the needles grow in "bundles" of two to five, the length depending on the variety. The Douglas fir may be identified by its soft, flat needles and the buds at the ends of the branches which cause the needles to curve gracefully during development. Like the true firs, the needles

are borne singly on the branches. They range from 1 to 1½ in. long and are blunt tipped, unlike needles of the pines, spruce and certain of the cedars, which are sharp pointed. In a general way you can tell the difference by touching the ends of the needles; if they are pointed and prickly to the touch, the tree is a spruce. If the needles are in bundles, the tree is one of the pines. If they are soft and blunt, the tree is one of the firs.

A tree selected for use in the home should be from 4½ to 7 ft. in height, the foliage should be of uniform color, and the branches must be sufficiently strong to bear the weight of ornaments. In general the foliage of the spruce, hemlock and most of the pines is less durable than that of the firs. The trunk should be straight and the central leader, or tip, of the tree should be erect and sufficiently rigid to support an ornament. Firs are especially desirable in this respect. Immediately after purchase cut off the trunk diagonally about 3 in. from the end and place in a water-filled container.

Tree Decorations in

By *Norb Hildebrand*

The decorations pictured are part of an annual display of traditionally trimmed Christmas trees that is featured by the Chicago Museum of Science and Industry

FROM AN ORIGIN lost in the obscurity of Old World tradition, the Christmas tree has become an almost universal testimony of joy in the birth of Christ and, though popular tradition ascribes the first Christmas tree to Germany, almost every Christian country has a legend in its folklore to account for the honored role given the "evergreen" at Christmas time. A natural evolution in the decoration of the trees has resulted in the decorations assuming characteristic national features, first of the economic and cultural life of each country and, in more recent times, of the influence wrought by the constantly shrinking boundaries of geography and commerce.

The uniqueness and simple beauty of the original themes can be recaptured for your family tree by incorporating some of the decorations used in other lands. Homemade decorations are the rule in this case, and it is surprising what scissors, paste, colored paper and a few other common materials plus a little imagination can accomplish.

Perhaps the most unusual decorations are those of Lithuania, where straw from the fields is strung with needle and thread to form intricate geometric designs, bell towers, bird cages and a host of religious symbols. The same effect may be achieved by substituting soda-fountain straws, and

the finished ornaments will, with reasonable care, last for many years. As a still further adaptation, colored-plastic drinking straws may be used to combine the new with the old to make a colorful and unique display to which every member of the family may contribute.

The "straw" bird cages are ideal for housing fragile eggshell birds so loved by the people of Poland who use empty eggshells as the basis for all kinds of ornaments. Heads, arms, legs and wings of colored paper are glued to the shells to simulate men, animals and birds. The fresh egg is emptied by punching a pinhole at each end and forcing out the contents by blowing into one of the holes. Gay chains made by interlocking rings of colored paper continue the Polish tradition. Colored paper is used extensively all through the Balkan countries, and you will find that many varieties of decorations can be fashioned from crepe and metallic-finish papers.

People of the Scandinavian nations express an intense personal patriotism by trimming their trees with paper chains made in the national colors and by draping long garlands of miniature flags in colorful spirals on the tree. This idea may be adopted effectively in America by trimming the tree entirely in red, white and blue along

Polish



Danish



Lithuanian



Other Lands

with miniatures of the Stars and Stripes. The color harmony can be carried out with the lights as well as the ornaments. In addition to colored-paper ornaments, Danish trees include a massed display of checkered-paper bags which may be used to hold the hard candies and nuts that the children love to find.

One of the most exquisite trees is that traditional of France, the charm of the ornaments lying in the simplicity of their shape and color. Large white snowballs of cotton or foam plastic, silver-paper cornucopias filled with hard candies, and an abundance of tinsel are the only ornamentation. Yet, the effect of white spheres, silver cones and sparkling tinsel against the dark green of the tree is something fairy-like and fragile. The effectiveness of such simplicity is heightened by using lights of only one color.

According to tradition, the German tree first was trimmed with nothing but candles. Christmas cookies were added and then apples, oranges and popcorn balls until a well-stocked German tree soon became a thing of beauty to make both eyes and mouth water.

One of the simplest and most effective methods of decoration is the old British custom of trimming the tree exclusively with Christmas cards. These may be fastened with colored cord to make long garlands or hung individually from ribbons.

In Japan, the Christmas tree takes on an oriental motif, with tangerines, kimono-clad dolls, fragile glass-blown ornaments and little rice wafers known as "sembei." The latter contain fortune-telling slips of



Checkered-paper bags featured on Danish tree are just the thing for holding Christmas candy and nuts

paper to be read during holiday festivities.

The American Christmas tree, like the nation, is a reflection of all people of all traditions. But, America has also, in a sense, made an important contribution to the Christmas-tree tradition—that of the electric light bulb, which today blossoms forth in all sizes, shapes and colors, giving light and sparkle to the tree regardless of how it may be decorated. ★ ★ ★

British

Yugoslavian

Lithuanian



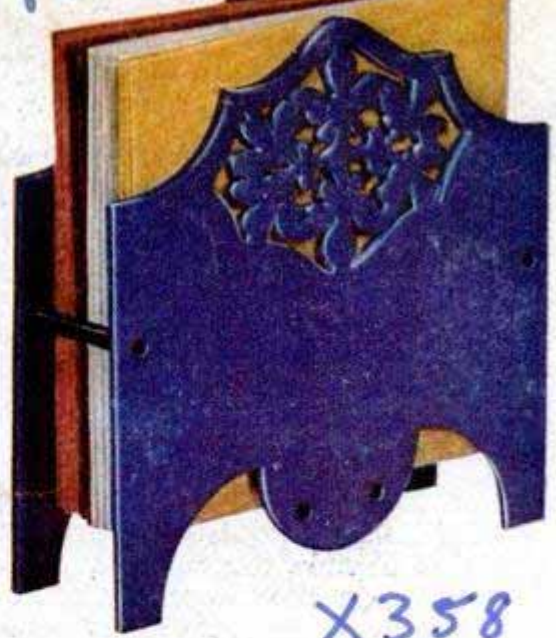

X358

JIGSAW *a Merry*

By Albert P. Belanger

These original designs are presented as a special Christmas project for the craftsmen who enjoy working with wood or plastic. The intricate patterns offer excellent jigsaw practice for the beginner as well as a challenge to the skill of the "old hand"

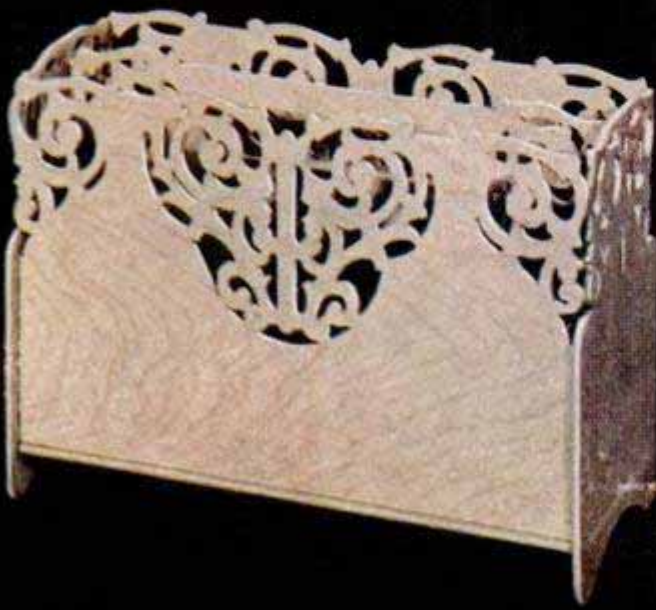

clude these beautiful scrolled pieces in your Christmas workshopping list. Made of colorful opaque plastic or hardwood-veneered plywood, any of the novelties pictured will form a long-remembered gift. Or, if you would like the basement shop to start producing a little extra cash, turn out the items in quantity and retail them through local gift shops and department stores. Their eye-catching originality means quick sales throughout the year as well as during the holiday season.

To produce the pieces in any appreciable quantity, multiple cutting of identical parts is a necessary timesaver. Although plywood panels can be tacked together, plastic sheets should be held by cellulose tape and pins as in the detail on page 155 to prevent cracking. Locate the pins only in waste stock at the corners of the sheets.

The plastic flower basket consists of two similar parts, one of which incorporates a handle. Both parts are notched to form a



Christmas

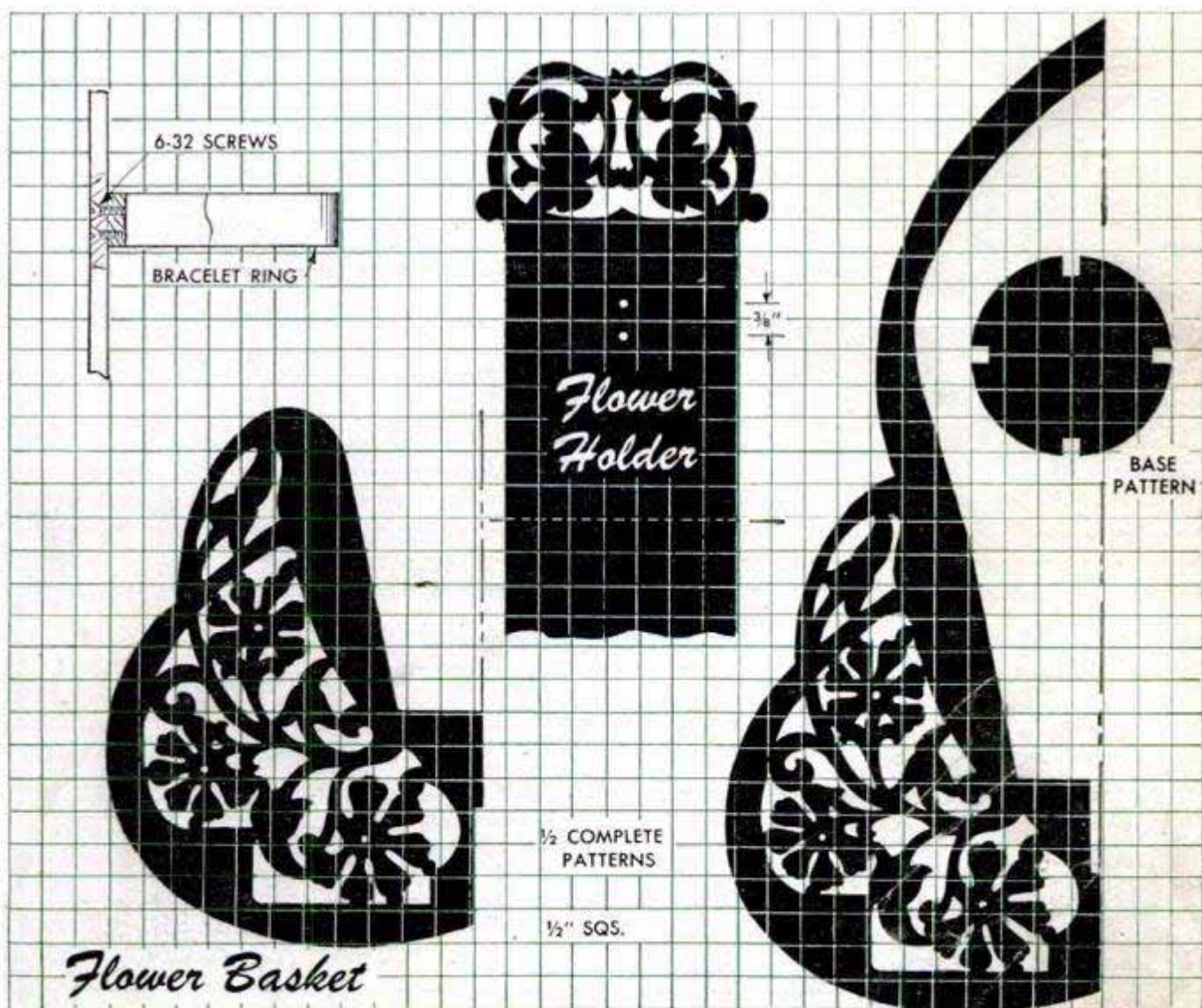



1/2 COMPLETE
PATTERN FOR
HANDLE

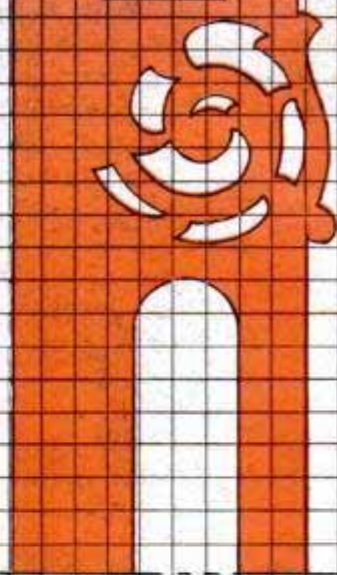

Magazine Rack

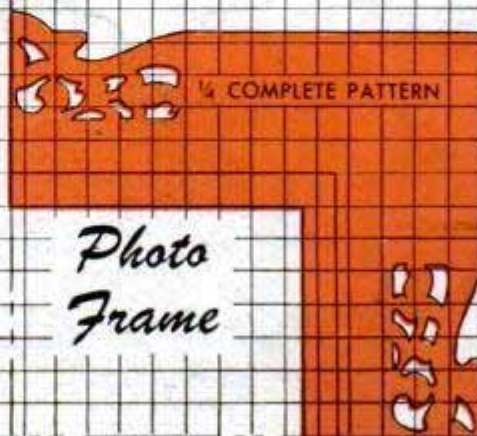
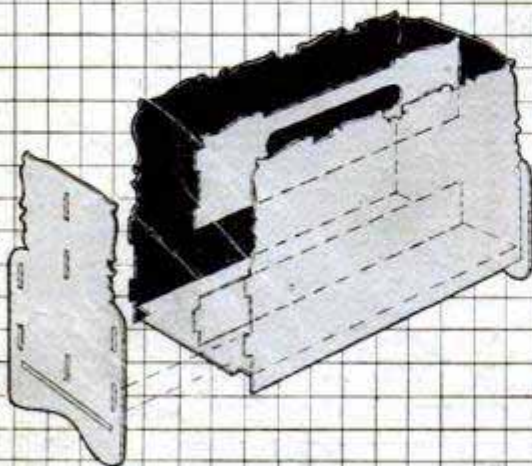
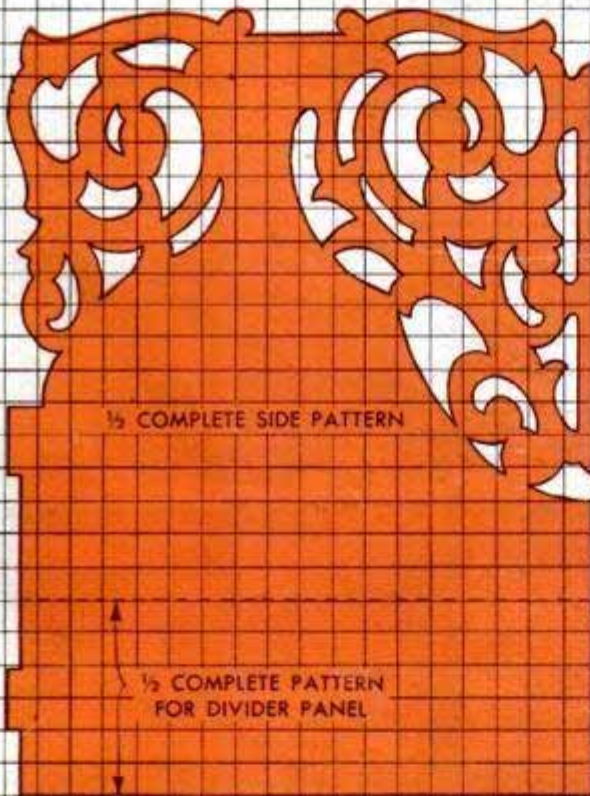

*Photo
Frame*

half-lapped joint at the center and are held in position with a notched spacer disk. The wall-bracket flower holder is simply a scrolled panel fitted with a plastic bracelet ring. The latter is fastened to the panel with two countersunk screws, the holes in the plastic being drilled slightly undersize so that the screws will tap the plastic as they are driven.

The magazine rack is made of $\frac{1}{4}$ or $\frac{3}{8}$ -in. plywood and assembled as in the lower left-hand detail on page 154. Note that the tabs in the side members are pinned in the slots in the endpieces with brads driven through the edges of the endpieces.

Plywood, overlaid with a $\frac{1}{2}$ -in. border of veneer around the center cutout, is used for the picture frame shown below. Glue the veneer in place before cutting out the center of the frame, as this will serve as a guide for the saw blade. Add four strips of $\frac{1}{2} \times \frac{3}{4}$ -in. stock to the rear of the frame, spacing the strips around the center cutout about $\frac{1}{2}$ in. from its edge. After inserting the glass, picture and backing, drive a few brads into the strips against the backing. The plastic frame shown in the color photo is simply a jigsawed panel, the glass and picture being held with cellulose tape.

Attractive napkin holders may be jigsawed from plywood or plastic according to the squared pattern at the right or similar to the one pictured on page 152. The sides of the holders are joined with four $\frac{1}{4}$ -in. plastic or hardwood dowels which are located to form a trough for the napkins. ★ ★ ★

Picture frame of $\frac{1}{4}$ -in. plywood is overlaid with contrasting veneer border. Either plywood or plastic is used for distinctive napkin holder to right of frame

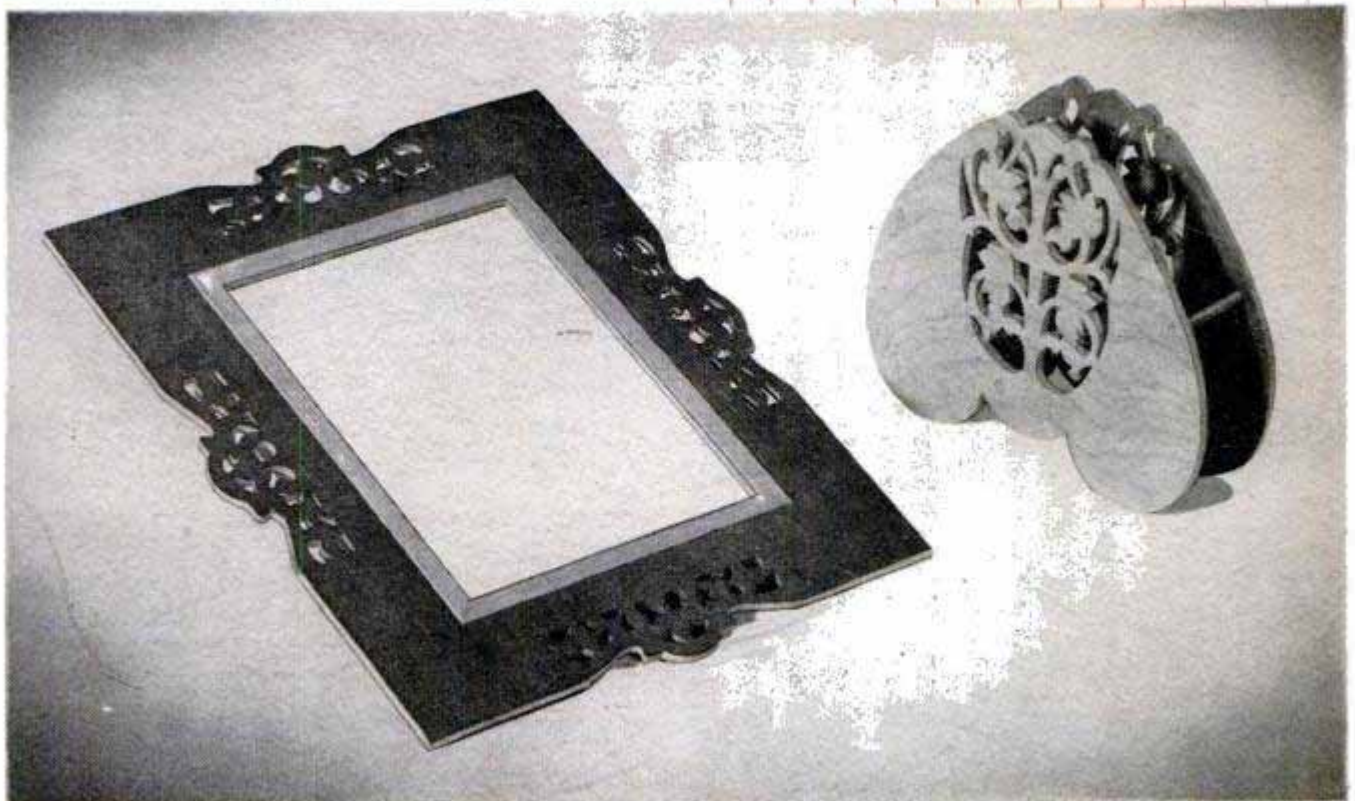
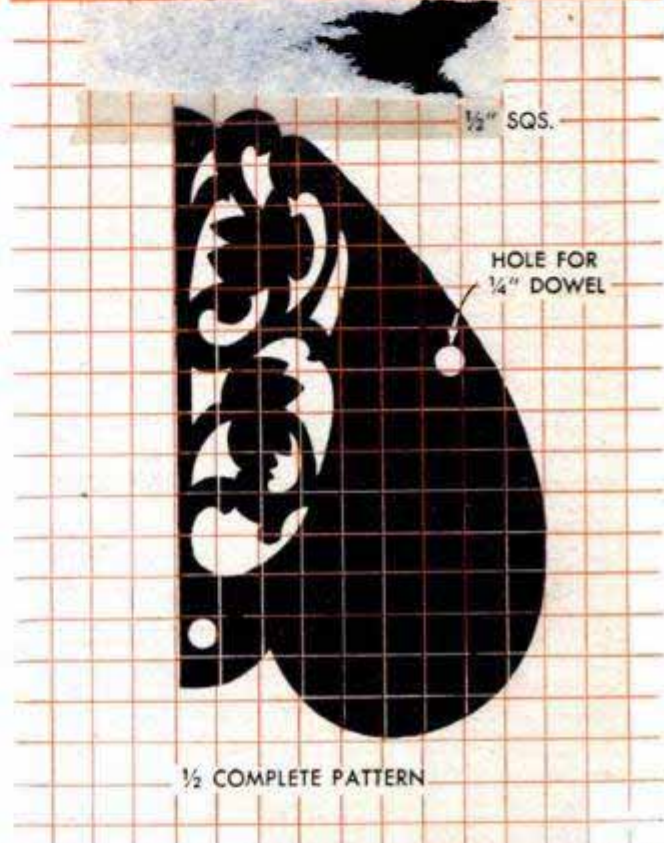
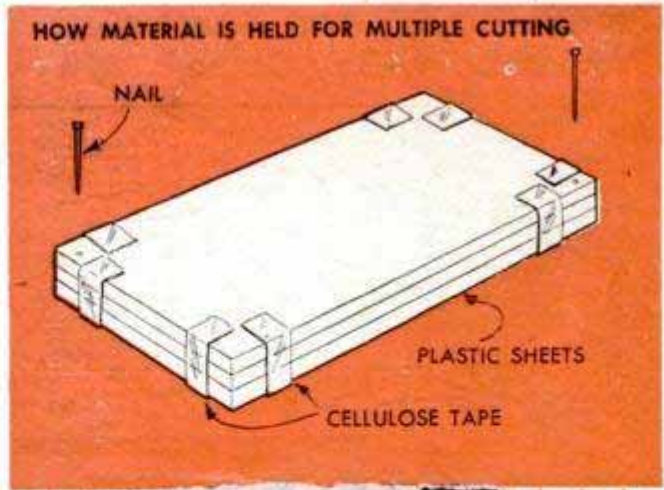

Partitioned Box and Marbles Provide Rainy-Day Game

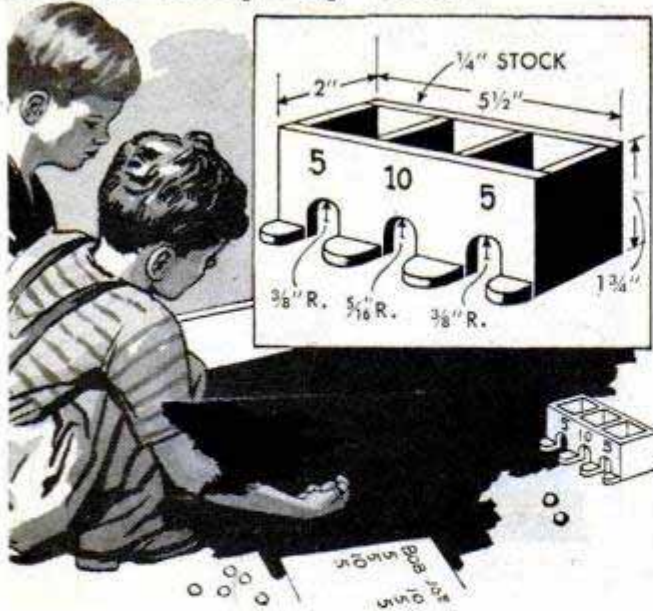

Here is a marble game assembled from scrap wood that children can enjoy indoors on rainy days. A box of the dimensions shown in the illustration is put together with glue and nails. It then is stained or painted and numerals placed above the three openings for scoring purposes. The game is scored by rolling glass marbles into the openings in the box.

I. M. Fenn, Chicago.

Cutting Wedges on a Power Saw

The difficult job of cutting wedges accurately on a circular saw is simplified with this jig, which will enable you to cut wedges that are perfectly true. The jig consists of a piece of 2 x 6 about 2 ft. long. The shape of the desired wedge is cut in one edge of the jig, after which the blocks from which the wedges are to be cut are placed in the jig and run across the saw as pictured. If you want both wedges to be exactly alike, don't forget to allow for the thickness of the saw blade when cutting the jig. In use, the jig is placed be-

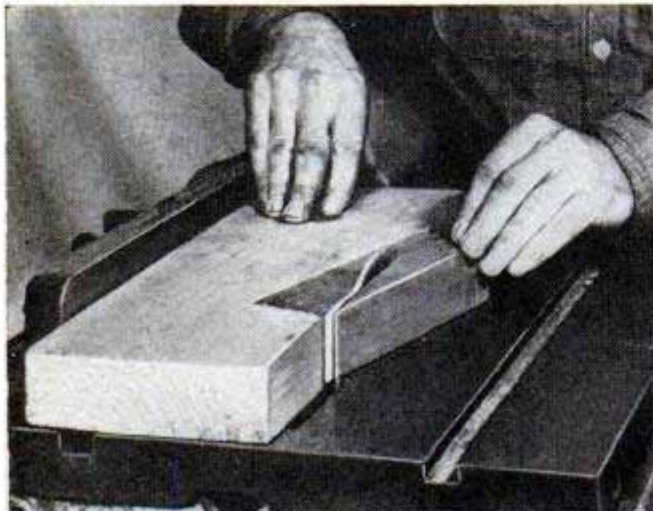

tween the saw and the rip fence, allowing just enough space for the jig to clear the saw. Blocks from which the wedges are to be cut should be prepared beforehand, after which each one is run over the saw.

Michael Ligocki, Gary, Ind.

Oil Drum Aids Removal Of Tree Stump

One way of removing a tree stump quickly is by placing over it an old oil drum having both ends removed, after which dry grass, twigs and branches are piled around inside and then ignited. Kerosene may be poured over the fuel if desired to hasten burning. If the drum rests flat on the ground, as when burning a small stump with roots unable to support the drum off the ground, holes must be cut around the bottom edge to provide the necessary draft. When burned continuously, stumps treated in this manner usually are charred sufficiently within 48 hours to allow removal with an ax and spade.

Signal Light Warns Driver When Parking Brake Is Set

The nuisance of inadvertently driving with the parking brake on is eliminated by this neat and practical warning light. As soon as the driver turns the ignition key the light reminds him the brake is on. The items needed to assemble the light are a small automobile plunger-type switch, a socket, a 6-volt bulb and a bracket. The switch is held by the bracket which in turn is fastened to the parking-brake bracket at

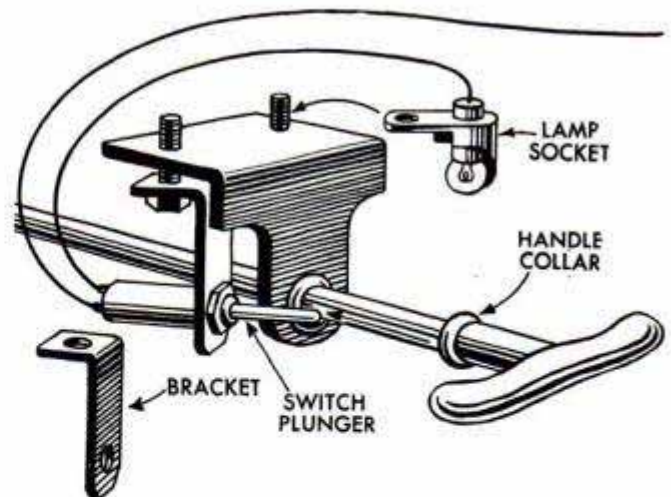

an angle so that the brake handle strikes the plunger when brake is released. When the brake is pulled to the "on" position, the plunger is released, lighting the bulb. The light also is mounted on the parking-brake bracket. The switch is wired into the ignition circuit on the "cold" side, or side that carries no current when the ignition key is turned off.—Otto Merker, Chicago.

SILVERWARE CHEST

By Elma Waltner

AN ATTRACTIVE chest for fine silverware, with carved initials to add to its custom appearance, is an interesting project for the home craftsman. The chest accommodates service for 12 and is made of contrasting woods, such as maple and mahogany. Box and lid are $\frac{3}{8}$ -in. solid stock, while the bottom is plywood fitted between the sides of the box. Strips of maple mitered at the corners serve as the lid border. Small holes are drilled at intervals through the width of these strips to permit driving finishing nails edgewise through the strips into the centerpiece. The holes are put-
 tied before finishing the lid. Assemble the box with glue and finishing nails and sand thoroughly. Trace the monogram on the lid and make an outlining cut $\frac{1}{16}$ in. deep around the letters. Use a curved carving chisel to work down the background around the monogram. Narrow slots are cut in the center divider. Felt or velvet lining is held in place by a light application of glue. Note that 14 pockets are sewn to the lid lining before it is glued. Apply paste wood filler to the mahogany parts and finish with varnish.

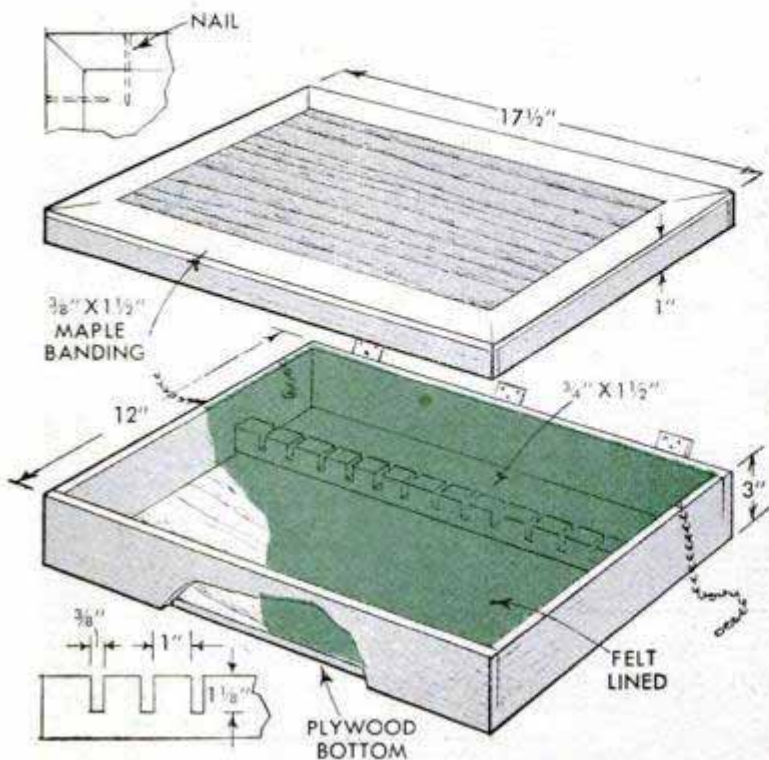
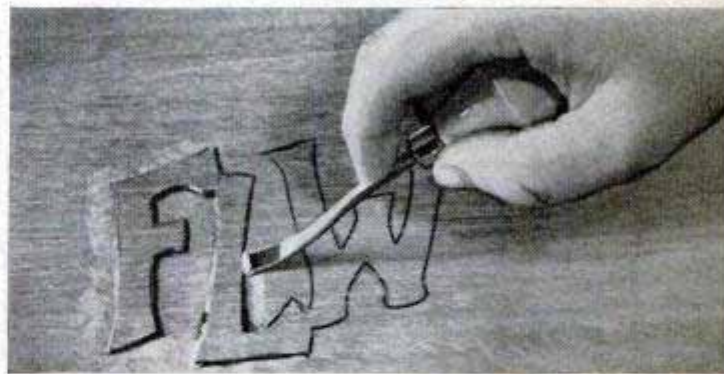
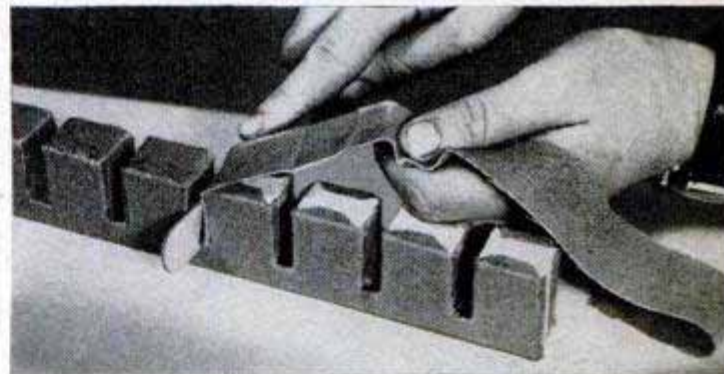

PLAYROOM XYLOPHONE

By Walter E. Gustafson

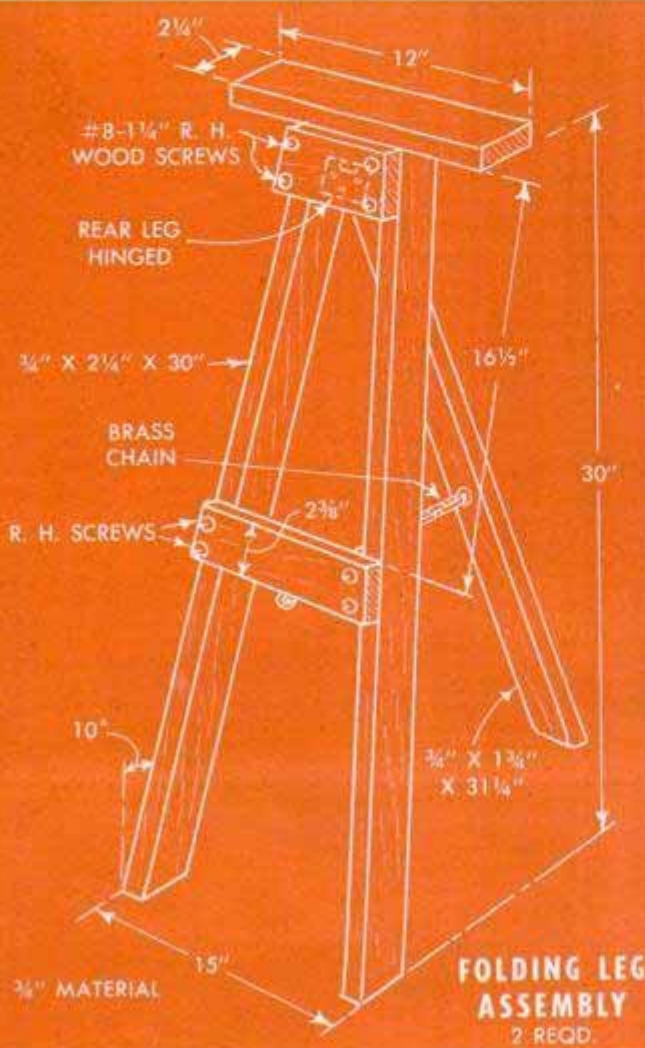

BUDDING YOUNG ARTISTS with musical leanings will have plenty of fun with this xylophone—especially when dad builds it in his basement workshop. It's not intended for professional use or advanced musical reproduction, but it does provide a means of acquiring manual skill and training for young ears in recognizing the notes of the musical scale. The keyboard includes two complete octaves, B to B, and all keys are located on one frame. Building the collapsible leg units and the keyboard frame requires only simple "sawhorse carpentry," but assembling and tuning the keys call for more time and care. The keys are ripped to the exact sectional size given, but are cut only to approximate lengths from the shortest to the longest. Use selected birch which is dry, straight-grained and sound. Each key must be tuned separately with a pitch pipe, and to do this make the tuning frame detailed on the opposite page.

Then make two hammers, or mallets, by drilling 1/4-in. holes in 1-in.-dia. wooden balls. Fit 12-in. lengths of 1/4-in. dowel as handles. Locate and drill transverse holes through all the keys as in the side view below. Place each key on the tuner as in the detail and rap it lightly with the mallet. Trim the end of the key about 1/32 in. and test again. Continue in this manner until the tone is true with the pitch pipe. Keep

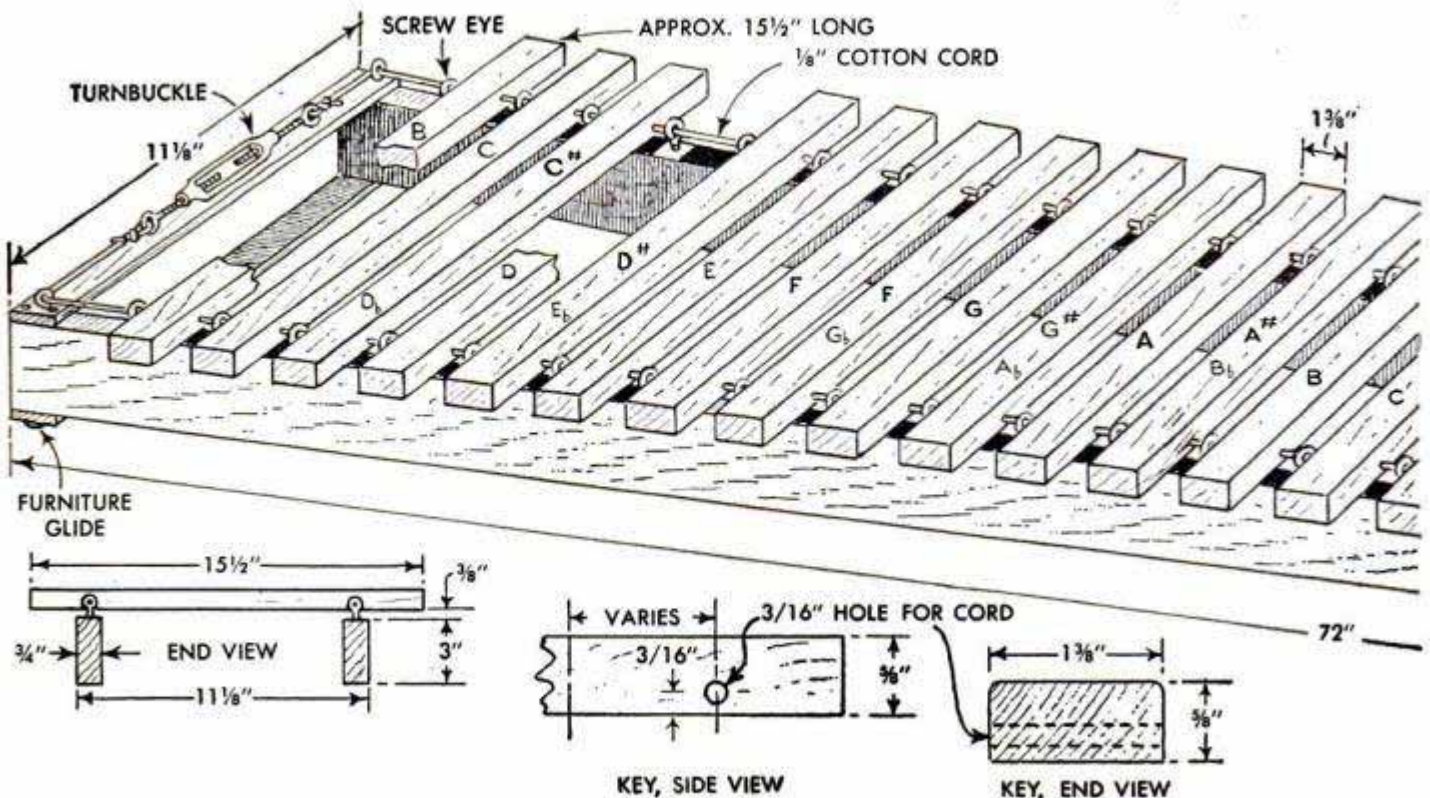



the keys in order as they are tuned. There will be some variation in response in keys cut from the same piece of stock, and in some instances it may be necessary to make substitute keys which may be trimmed and tuned to the pitch required. If you take off too much stock when tuning, lay the key aside and use it for the next higher note. When all keys have been tuned, they are strung one by one on a cord running through screw eyes turned into the frame. Join the ends of the cord with a small turnbuckle so that proper tension of the cord can be maintained. Glue strips of felt to the top edge of the frame underneath the ends of each key. ★★★

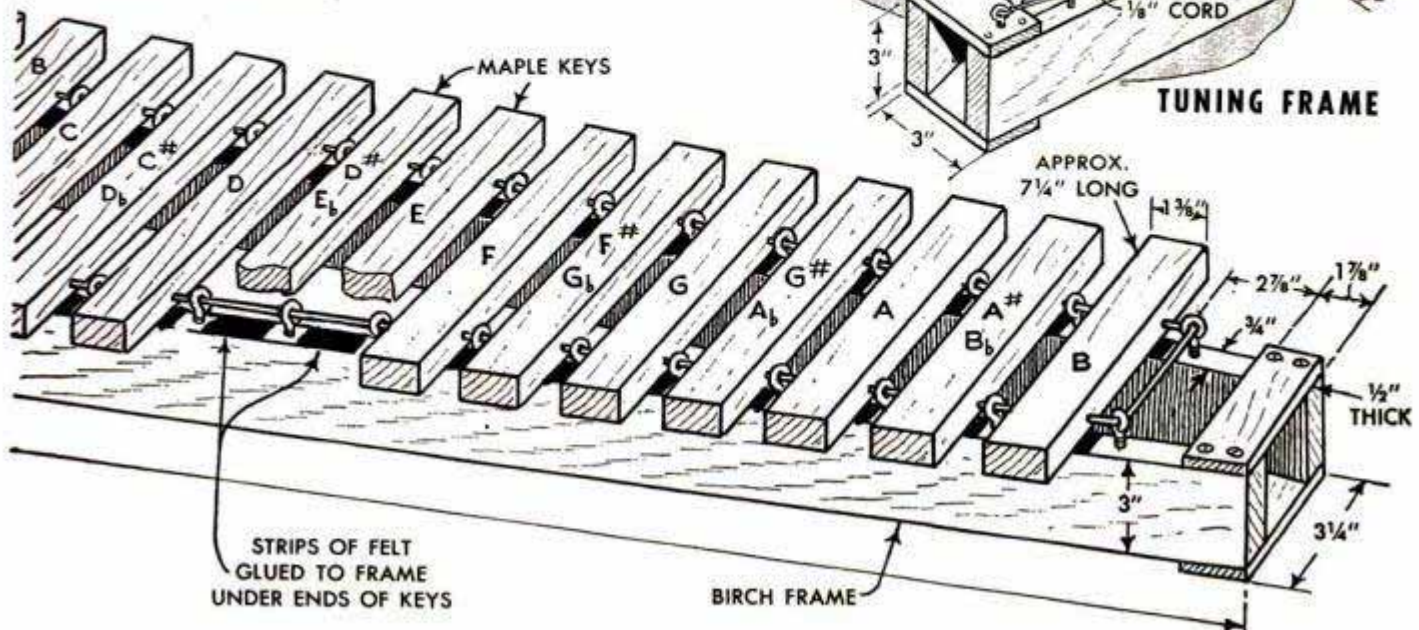
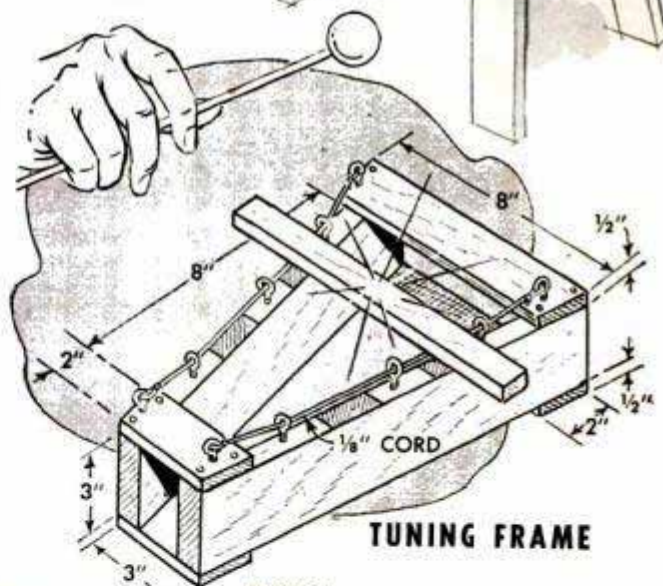

Curtain for Show in Home Hung With Safety Pins



Whenever children get the urge to put on a show indoors, you can forestall the appropriation of most of your shower-curtain hooks for hanging an improvised curtain by supplying them with several dozen large safety pins. The pins may be strung on a supporting wire through the eyelets in the coiled ends and then pinned to bed sheets or light blankets.

William Crouch, Eddystone, Pa.

Dowels Keep Wood From Splitting When Bandsawing Wheels

When cutting out large wooden wheels for lawn furniture, as well as work of a similar nature, I found that the wood has a tendency to split occasionally. After some experimentation, I discovered that this can be overcome to a great extent by drilling holes through the stock and inserting dowels as shown. A long electrician's drill is

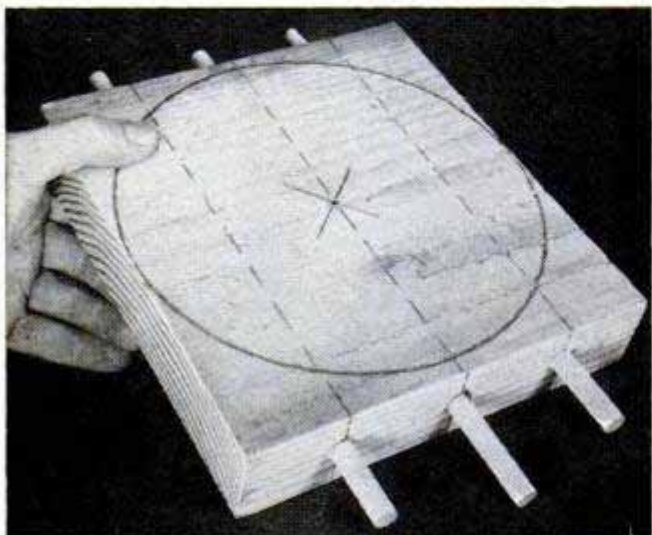

used for making the holes, after which $\frac{3}{8}$ -in. dowels, which I found most suitable for 2-in. stock, are glued in place. When the glue dries, the stock is cut on a bandsaw and, after any irregularities around the ends of the dowels have been filled with wood putty, sanded smooth.

Refinishing Marred Furniture

A professional-looking refinishing job can be done on scratched furniture by using pigmented touch-up stain. First, sand the piece very lightly with 4/0 sandpaper. The purpose of this is to roughen the old finish so that the new finish will adhere properly. After dusting, apply the stain which is available at most paint stores. Then wipe off the stain immediately with a clean, dry rag and apply one or more coats of good clear varnish or clear shellac, allowing time for each coat to dry hard. To produce a rubbed, satinlike finish, saturate a rag with furniture polish and go over the entire surface. Sand lightly to remove dust nibs, using very fine sandpaper dipped in oil to prevent scratching. Lastly, remove the excess oil with a soft, dry cloth.

Francis Henry, Pottsville, Pa.

Tape Marker on Threading Chart Indicates Lathe Gear Setting

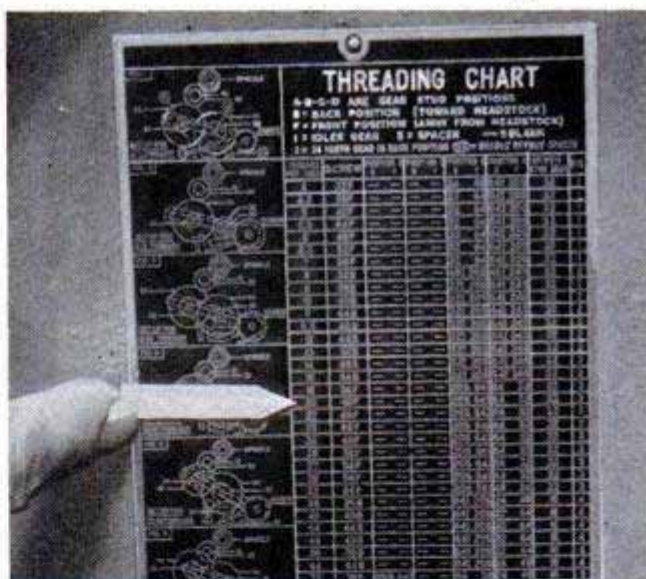

When getting ready to use a lathe fitted with change gears, an operator frequently has difficulty recalling what thread-cutting or carriage-feed setting the lathe is geared for. This usually requires the time-consuming job of checking the gears with the threading chart. One way of eliminating this problem is to place an adhesive-tape marker at the proper point on the threading chart when the gears are set, thus making it possible later to tell at a glance how the lead screw is geared the next time the tool is used.—R. Hanscom, Elmhurst, Ill.

Make Your Own TREE ORNAMENTS

IF YOU'RE TIRED of trimming the Christmas tree with the same ornaments year after year, you will find these Tide-covered novelties a refreshing change. The ornaments are made by coating a variety of common items with a mixture of Tide and plastic starch as described in the sequence A to D, below. Best results are had by applying the mixture when the humidity is low so the ornaments will dry quickly. The icing will keep for several days in a covered container. Use such items as clothespins, pipe cleaners, drinking straws, cardboard cutouts, pretzels and nuts for basic props and cover the icing with sign-maker's glitter or paint with fingernail polish. Various types of trim, such as silver or gold dust, sequins, beads, ribbons and rhinestones should be collected before icing the props.

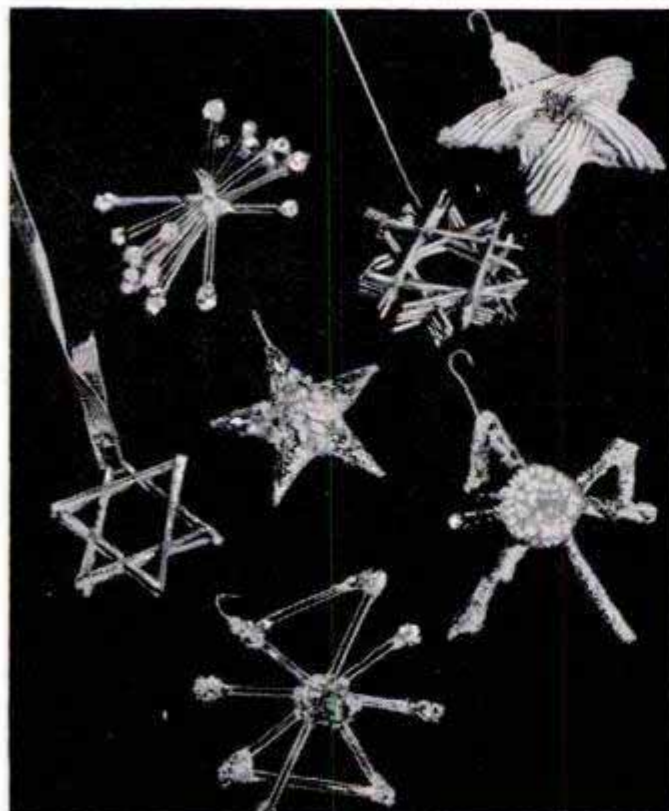
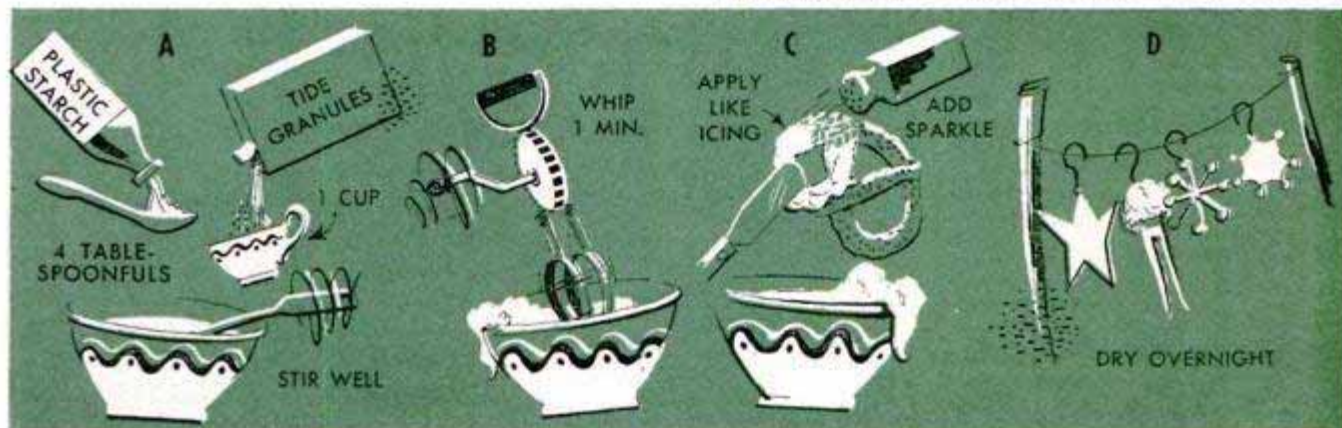

Reflector for Workshop Light Provided by Wash Basin

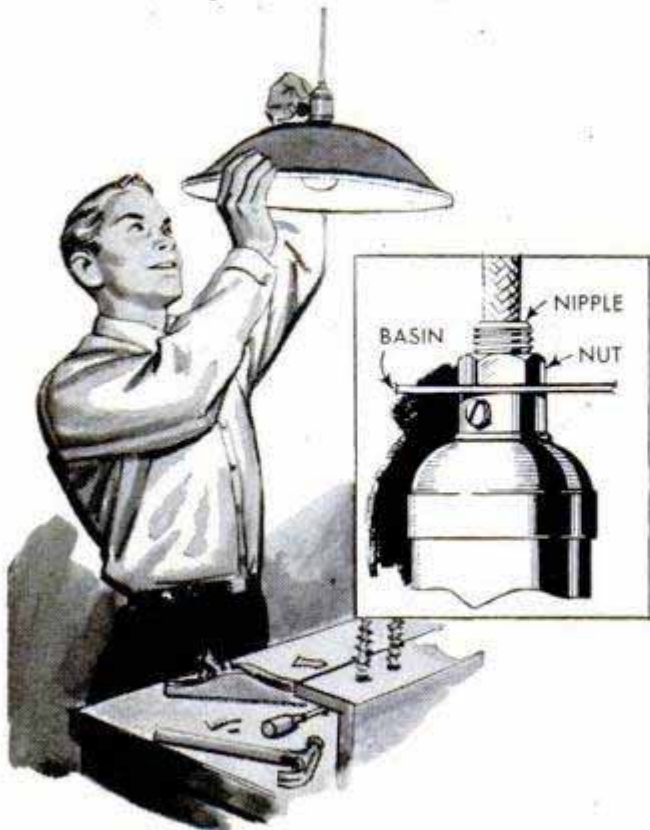

An old wash basin, having a hole punched or drilled in the center for installation of a socket and hung in an inverted position, will provide an ideal reflector for a drop-light over a workbench or table. The detail indicates how the socket is held in position by means of a nut and a short, $\frac{1}{8}$ -in. pipe nipple.—A. E. Fenn, Chicago.

Weighted Key Stays in Door Lock

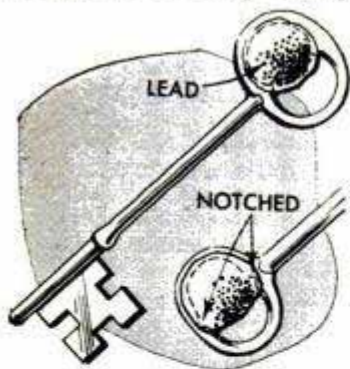

Keys of mortised door locks are less likely to be dislodged if the handle ends are weighted. To do this, a small round piece of lead such as a split-shot fish-line sinker is peened into the handle to serve as a weight. Thus weighted, the key is off balance and will stay in place even when the door is slammed.

Thomas Trail, Catonsville, Md.

Improvised Frozen-Food Containers

Both quart and pint-size milk cartons can be put to good use as packages for home-freezing food. The staple which fastens the top of the carton is removed and the carton filled with the food to be frozen. Then the top is folded back along the origi-

nal creases to close it tightly, and the carton tied with a single wrapping of strong string.
John Krill, North Lima, Ohio.

Emergency Candleholder From Old Light Fixture

A porcelain lamp socket of the type shown can be converted to an excellent candleholder for emergency use. Remove the chain and wrap one end of a piece of stiff wire around the neck to serve as a handle. Fasten the free end of the wire to the socket with a small machine screw, first forming an eye in the end and passing the screw through a mounting hole in the socket.

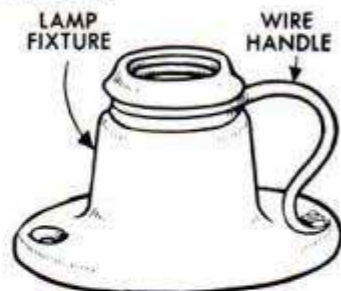

Frank Shore, New York City.

Floor Lamp Wired Into Circuit Produces Electrical Tester

For occasional electrical tests, a floor lamp can substitute for a bank of lamps. Most floor lamps have three stages on the center bulb and switches for turning on one, two, or all three of the side lamps as well. By using two 50-watt and one 25-watt side bulbs in conjunction with the center bulb, current values up to 425 watts, in steps of 25 watts, can be set up. Above this total, larger bulbs should be used in the side sockets. The wiring harness shown will put the lamp in series with the device to be tested.

Keith Heryford, Cedarville, Calif.

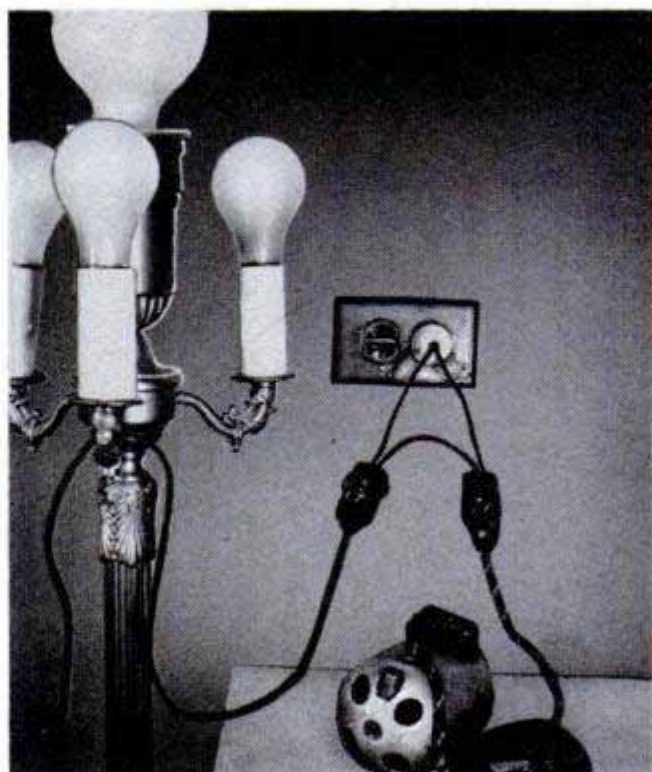

Make Fido a DOG TAG

By Walter E. Burton

ETCHED identification tags for dog collars, and name plates for luggage and sports equipment, can be made with sheet metal and materials usually found in the home. Plates are cut from 14 or 16-ga. aluminum, copper or brass. The blank tag is shaped and polished with fine abrasive cloth. Then the polished side is coated with a thin layer of candle wax. Wax from candles containing beeswax adheres to the metal best. Scribe the outline of letters to be etched, cutting through the wax to the metal, then widen the lines and work in details. Use a soft brush to remove wax particles. Put the tag, waxed surface up, in a dish and cover the scribed characters with etching fluid, confining the liquid to a pool on the waxed plate. Etching acid for aluminum is a strong lye solution. For copper or brass, a solution is made by slowly adding 1 part concentrated nitric acid to 3 parts water. The time required for etching varies so that limits cannot be given, but tags in the photos were etched in 30 min. Bubbling of the solution on the scribed lines indicates its action on the metal. When the pool is covered with bubbles, draw it off with a dropper and replace with a fresh solution, several changes being necessary to complete the job. After etching, rinse plate thoroughly in clean water and warm it to permit wiping off the wax. To make the letters more prominent, they can be filled with a pigment. Aluminum tags require no other finishing. For copper and brass, polish and then coat with clear lacquer.

To make lettering more prominent, black lacquer may be brushed into letters. Lacquer remaining on surface is removed with abrasive cloth after drying

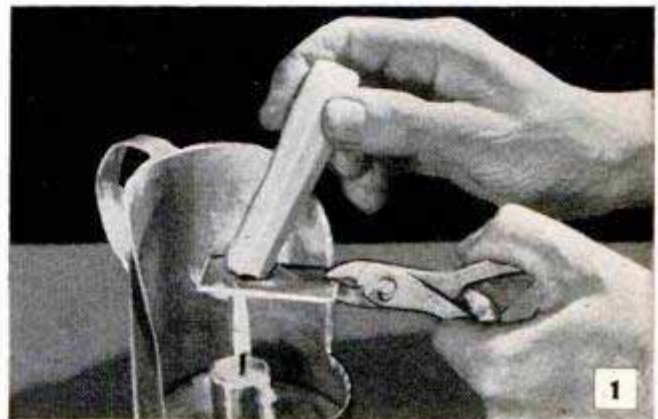

Tag is heated while wax is applied to warm surface

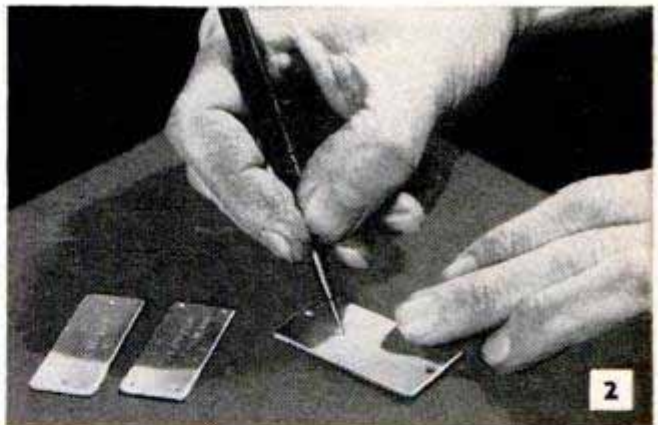

Scriber used above is phonograph needle in automatic pencil. Below, medicine dropper is used to apply etching solution to the waxed surface of the plate

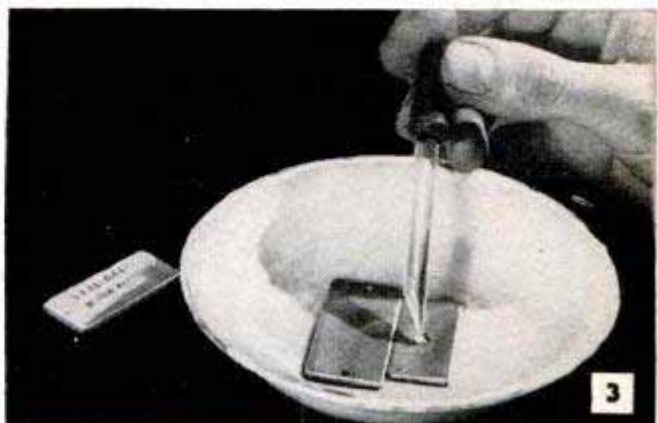
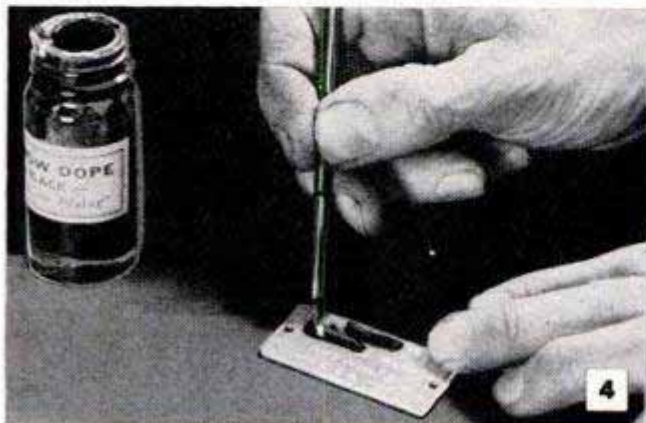

Solving HOME PROBLEMS

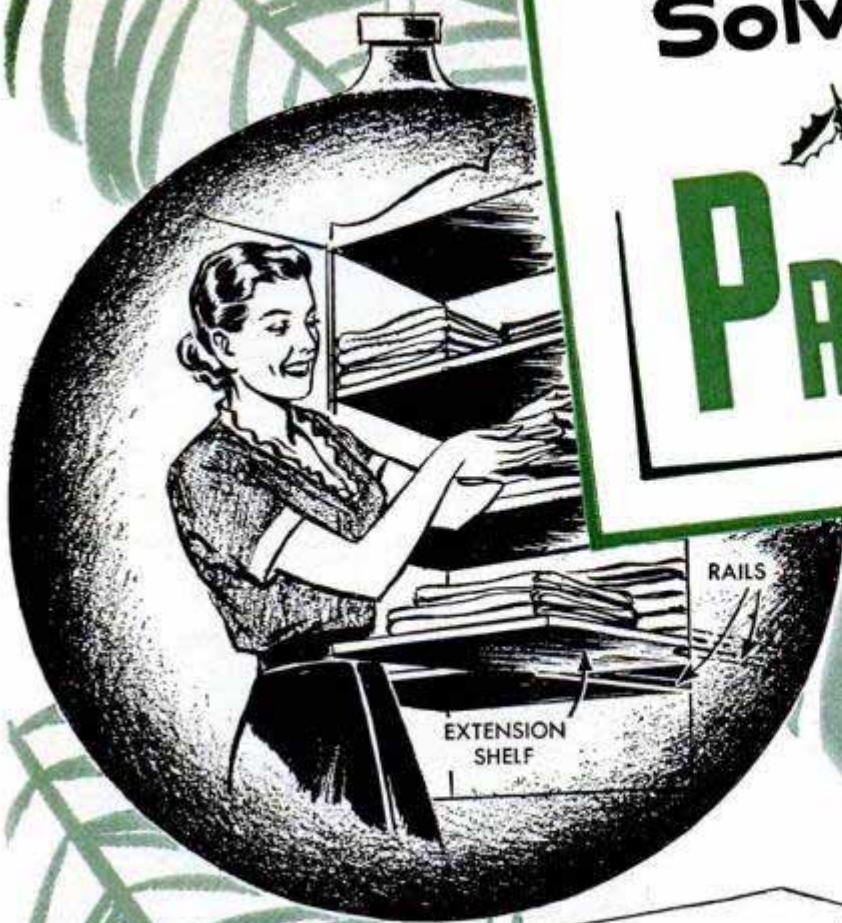

EXTENSION SHELF IN LINEN CLOSET forms convenient place to stack freshly laundered linens for sorting. Extension panel slides on cleats fastened to closet wall and underside of a fixed shelf

TRIMMING ENDS OF WORN BRISTLES at a 15-deg. angle transforms old paintbrush into an excellent sash brush. By tapering bristles to a chisel edge, cutting-in corners of window sash is no problem

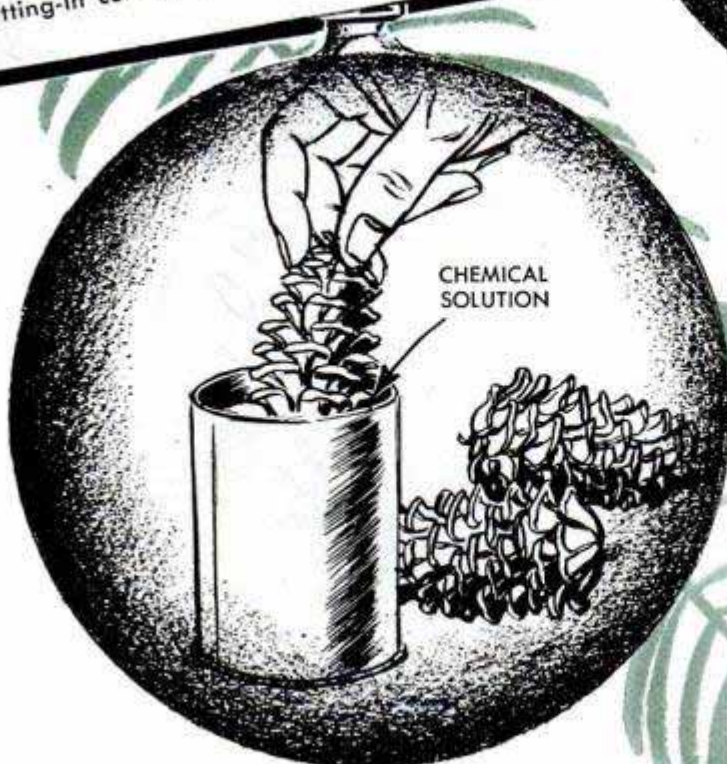

SOAKING PINE CONES in chemical solutions produces colored flames when cones are burned in fireplace. Dry cones thoroughly, soak in chemical and allow to dry before burning. Strontium nitrate produces red flames; barium nitrate, apple-green; copper nitrate, emerald green; calcium chloride, orange; potassium nitrate, yellow; potassium chlorate, violet; lithium chloride, purple

ILLUMINATED CHRISTMAS-TREE DECORATIONS are made by fitting glass ornaments with flashlight bulbs. Wired as shown at the right, 6 to 10 bulbs are connected in series to a standard doorbell transformer

WARM-AIR REGISTER installed in guest closet, below, dries and prewarms garments for winter comfort. Use 4 x 6-in. register and leave 1/2-in. clearance at bottom of closet door to permit circulation of warm air

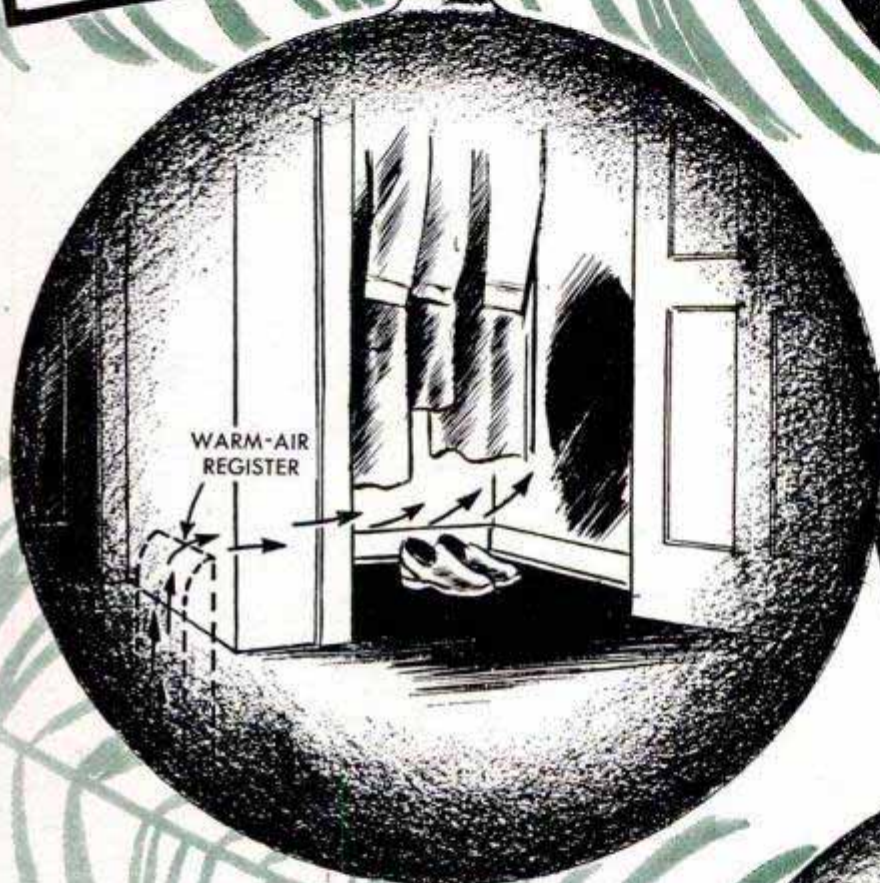
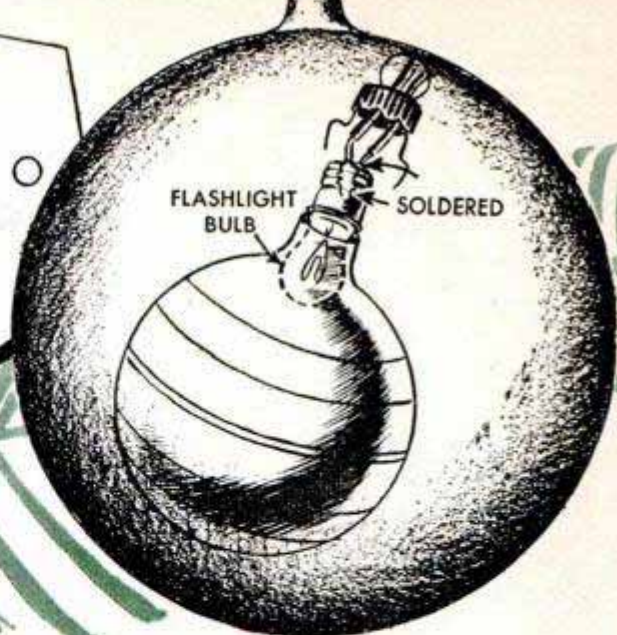

ATTRACTIVE COASTERS below, are made by partially covering tin cans with sheet cork and decorating them with colored cloth tape. Top is removed from can with rotary opener and burr filed off. Outside of can is rubbed with steel wool and polished before applying the cork

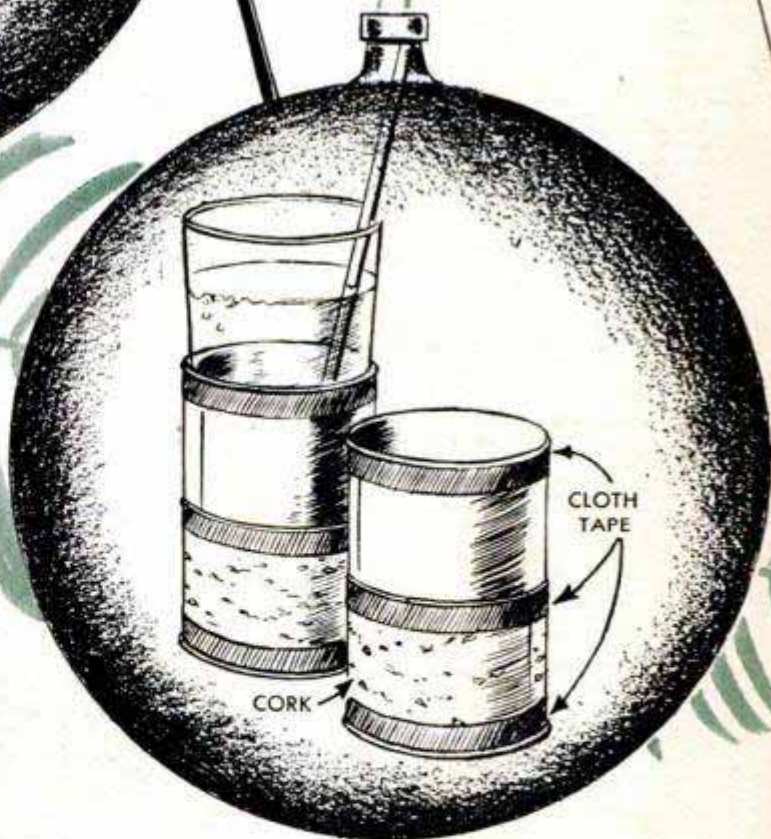

CLEAN SHOEBRUSH is excellent for polishing or dusting beaded, carved or fluted portions of furniture, as the bristles reach into narrow depressions that an ordinary polishing or dust cloth would miss

Cutlery Trays Provide Drawers For Small-Parts Cabinet

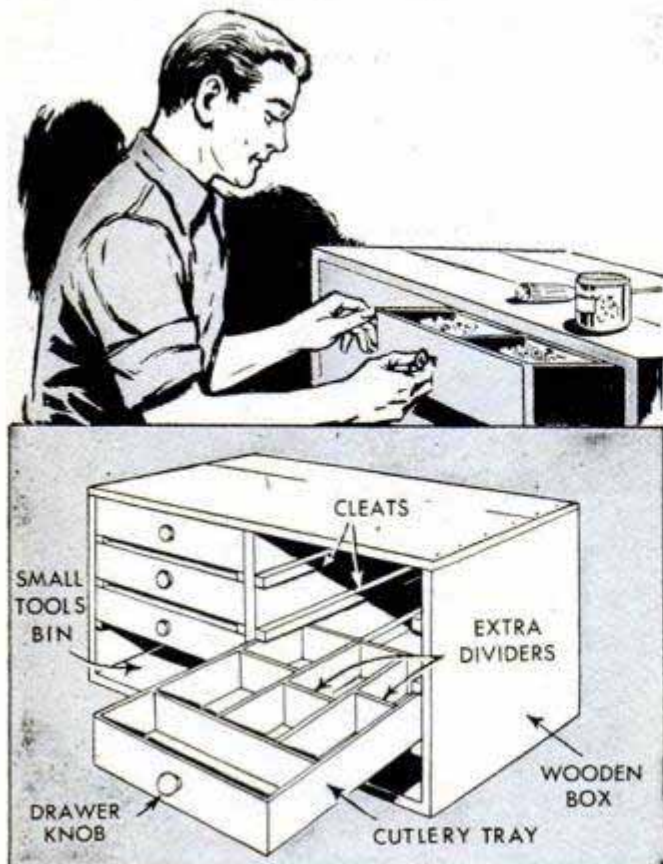

Constructed from scrap materials and virtually "built around" a number of wooden cutlery trays that provide ready-made drawers at small cost, this practical workshop cabinet will come in handy for storing screws, bolts and other small parts. An orange crate or other wooden box from a local grocer serves as the cabinet itself. Either a single or double row of trays may be installed in the cabinet, depending on whether the box is used on its side or in an upright position. Drawer slides are formed by nailing cleats to the center partition and the ends of the box, and if desired, space may be left at the bottom of the box for storing hand tools. The glued joints of the trays should be reinforced by nailing and the separators also should be nailed in place. To complete the job, drawer knobs are added to the trays and the entire cabinet painted.

Edward J. Speer, Southport, Conn.

Repairing Loose Doorknobs

When a doorknob of the screw-on type will not stay tight, the usual trouble is that the threads have become worn and the setscrews no longer will hold the knob. To repair them economically, take out the original setscrews and replace with socket-head setscrews. Then assemble the knobs on the door and tighten the setscrews so that they will mark the shaft. Now remove

the knobs and make a deep center-punch mark in the center of each of the marks formed by the setscrews. Then reassemble the knobs, making sure the screws are tightened over the indentations in the shaft.

William Macklin, Serath, Sask., Can.

Oarlock Secured by Curtain Hook

Common shower-curtain hooks can be used effectively to secure oarlocks in their sockets. They snap out quickly when you desire to remove the oars from the boat, and provide a convenient loop for attaching stringers of fish to the boat.

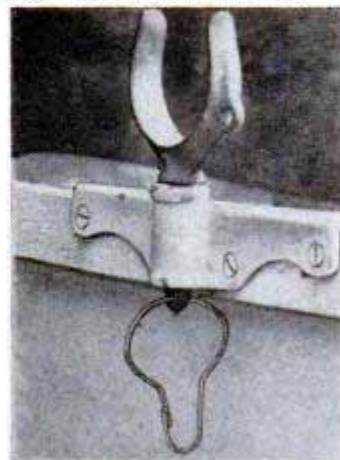

Eraser "Bumpers" on Coping Saw Protect Work From Chucks

When cutting thin stock with a coping saw, you can lessen the possibility of marring the work with the blade chucks if rubber "bumpers" are placed at each end of the blade. Simply drill holes lengthwise in two pencil erasers and slip them over the ends of the saw blade as shown.

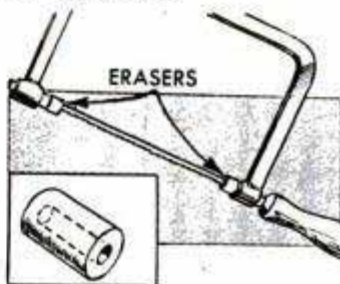

Protecting Ends of Drill Bits

To protect the cutting ends of drill bits stored in a toolbox or drawer, one carpenter simply slips rubber crutch tips over them. The tips, which are available in assorted sizes, may be purchased in almost any hardware or ten-cent store. Rubber slip-on erasers are ideal for drills in small sizes.—Andy Vena, Philadelphia, Pa.

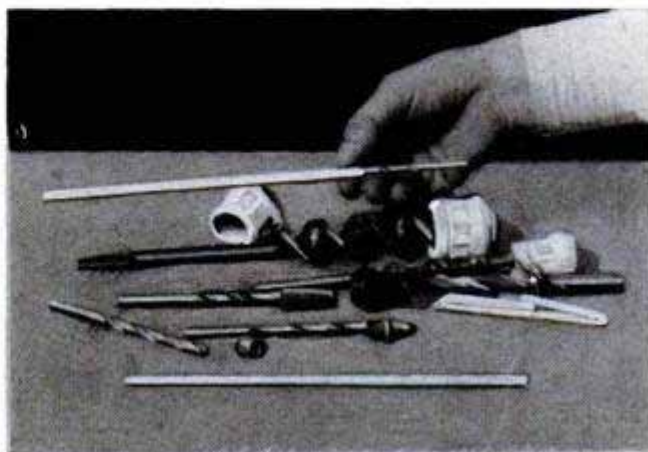



Custom-Make Your **HUNTING KNIFE**

WHEN PREPARING for long and difficult trips afield, hunters, trappers and explorers often discard other less essential equipment in favor of the all-purpose hunting knife. An experienced camper alone in the woods would rather lose his tent than the hunting knife in his belt sheath. He can get along without the former; the latter is indispensable.

Although knifemiths usually select Swedish steels because of their stability and extremely fine grain, for the finest hand-forged custom blades, you can make a reasonably good hunting knife from a large mill file. Probably the next best material is an oil-hardening tool steel, as it has a better response to tempering and a more uniform soundness of structure than does the average file.

Photos on these pages showing the essential steps in knife making were taken in the workshop of W. D. Randall, noted knifemith who began making knives as a hobby and now is in the business of hand-forging them in various styles that class among the finest made. In the photo above Randall-made knives are shown in styles



Above, one of the first steps in making a knife is heating the blank in a blacksmith's forge. Below, after heating, the blank is hammer-forged on an anvil to draw the blade to the rough form for grinding



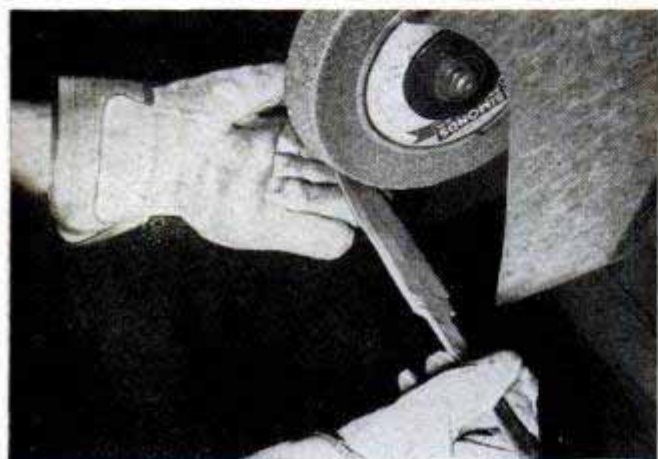
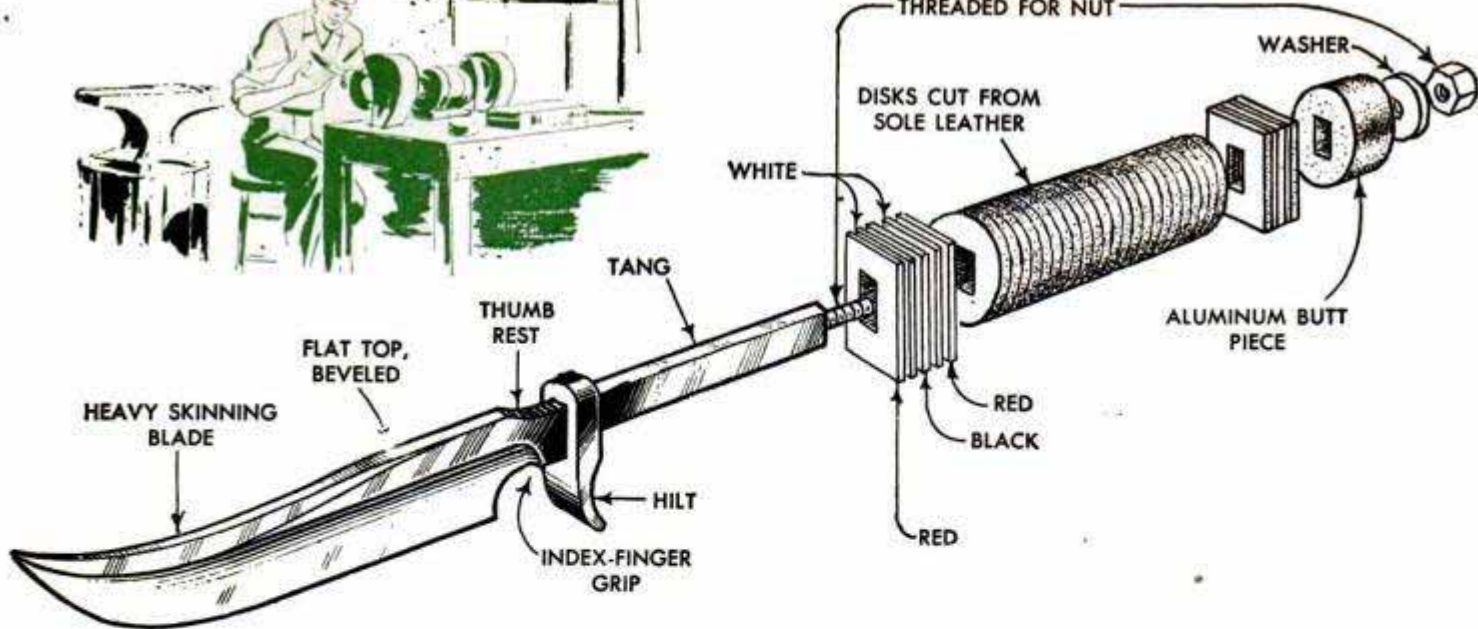

Above, rough-grinding the blank on a coarse emery wheel. Below, polishing blade on stitched cloth buff



and blade lengths suitable for all purposes.

In making a blade in any of the three styles detailed below, the blank is first ground to form the tang to sectional size and to shoulder the offsets for the hilt. If a file is used, it ordinarily is annealed before grinding. Then the rough is heated to a cherry red in a blacksmith's forge (heating also can be done in a coal-burning furnace) and hammer-forged on an anvil as in the lower photo on the preceding page. Forging in this manner draws the bevels to the rough shape and gives an edge thickness of about $\frac{1}{32}$ in. Then the blade and tang are finished to exact size by freehand grinding on a coarse wheel as in the upper photo at the left. The edge bevels are ground to form a cutting edge and the narrow back bevels are ground in to shape the blade to contour. This operation requires extreme care to get the lines of the blade ground true. Note that in the photo the operator is wearing heavy leather gloves to protect his hands from injury. He also wears industrial-type goggles.

Next the blade is hardened by heating it cherry red and immersing instantly in tempering oil. On some steels it is necessary to repeat this process in order to equalize internal stresses. Use low heat in succeeding steps—about 450 deg. When properly

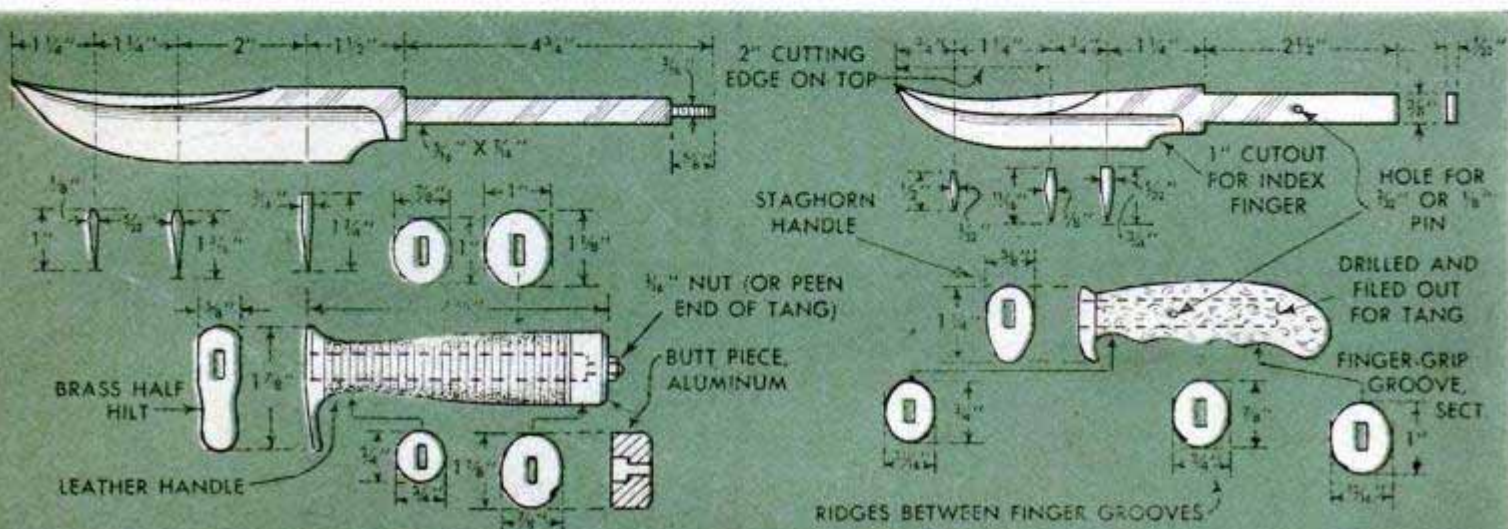

tempered the blade appears a straw-blue color and can be cut with a file. From this point on, special care must be used to avoid drawing the temper. True the bevels by slow, light grinding on a medium-fine wheel, checking the results continually by eye until all surfaces of the blade show a true reflection when viewed in oblique light. Before honing and buffing, the reflections will be rather dull, but they will enable you to spot irregularities in the surfaces. While grinding the blade to final contour, true up the tang and fit the hilt and butt piece. In the knives pictured and detailed, the hilt is of brass and the butt piece of aluminum. The hilt is filed to the rough shape before fitting to the tang. Final finishing of the blade is done on a hone as in the lower right-hand photo, and the fine scratches left by the final grinding are removed by buffing on a stitched buff as in the lower photo on the opposite page. The buff should be charged with polishing rouge of the type specified for steels.

Although ivory, staghorn and even certain metals are used for handles, ordinary top-grain cowhide is recommended for hunting knives. The lower center photo at the right compares the rough with the finished leather handle. Details below and on the opposite page give sizes of the leather disks. Note that the latter are oval in rough shape and that the center holes are cut rectangular to fit the tang snugly. Five $\frac{1}{16}$ -in. fiber squares in three colors are fitted on the tang next to the hilt. Then follow with the leather disks and three or five fiber squares. Cement each disk and square to the one preceding. Then attach the butt piece firmly in place by peening the tang projection. Rough to size and shape with a coarse rasp as in the upper center photo at the right. Then finish the hilt and the entire handle with a medium emery wheel and finally bring to a high polish with a stitched cloth buff charged with polishing rouge. When buffing be careful not to heat the leather handle unduly. The shape of the handle is optional. Grind it to a form that suits your finger grip. ★ ★ ★

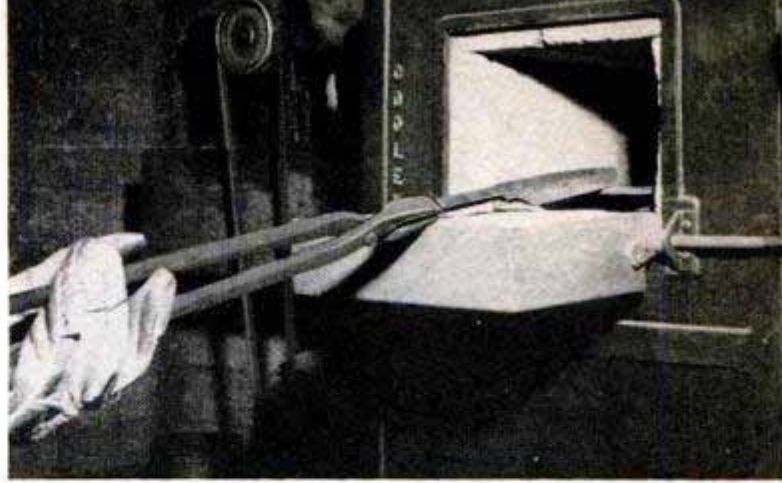

In the tempering process the blade is heated in an electric furnace which permits close control of temperatures so essential to proper tempering of steel



Leather handle is roughed out with a coarse rasp and the hilt and butt piece are filed to the rough shape. Finish with emery wheel and a stitched buff

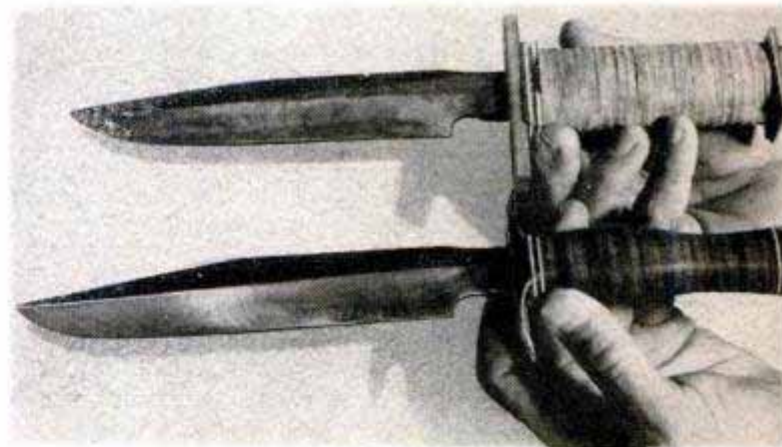

Above, the rough and finished handles of the all-purpose knife. Below, honing the blade by hand on a three-part professional-type hone. Note blade angle

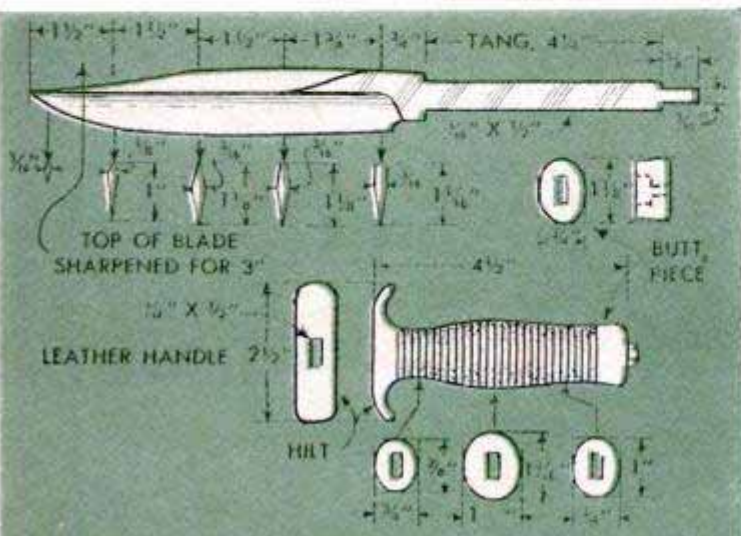

Shelf Attached to Window Sill Without Use of Nails



A decorative Christmas candle or a flowerpot that is too wide to rest on the window sill may be supported on a simple shelf which is held in place by the window lift. The shelf consists of a wooden block of a thickness to fit under the lift and having a length suitable for the object which it is to support. The block is notched on one end for the lift and beveled at the other for decorative purposes. A top from a tin can or a scrolled wooden block may be used to hold the objects set on the shelf. In use, raise the window slightly, place the block in position and lower the window so that the lift rests in the slot.

A. J Stephenson, Detroit, Mich.

Soaped Candles Burn Brighter

Here's a method of improving Christmas candles. Dip your hands into a thick mixture of soapsuds, or rub them on a wet bar of soap, and roll the body of the candle between the palms until it is well coated with soap. When dry, the soap-coated candles will not smoke or drip and will tend to burn brighter.

Yule Tree in Picture-Window Bay "Framed" by Balsam Branches

To add to the effectiveness of a table-top Christmas tree placed in a large picture-window bay almost as wide as the living room itself, my husband constructed a wooden frame extending just beyond the top and sides of the bay to which balsam branches were tied. The branches, which were tied in an upright position and overlapped sufficiently to conceal the frame,

converged upon the center of the cross-piece where a cluster of pine cones was attached. Tops of the branches were sprayed with artificial snow to high light portions of the branches. The frame was constructed from 1 x 2 stock with a braced piece extending out from the base of each upright member to hold the frame against the wall. The frame was painted to match the color of the branches.

Mrs. Evelyn B. Daum, Chicago.

Dry Soapsuds Used as Snow On Christmas Tree

For a "white" Christmas this year, spread whipped, dried soapsuds on the branches of your yuletide tree. It's inexpensive and will add a most realistic snow effect. Also it's clean, making no mess while on the tree, nor when the tree is taken down. Empty a box of any soap flakes or soap powder into a deep bowl, add a small amount of water and whip until the suds seem dry and are of the consistency of cream. Spread newspapers under the tree and apply the suds from the top branches down with a tablespoon. For a lighter "snowfall," apply the suds along the tops of the branches with your fingers. Sprinkle soap flakes over the branches before the suds are dry to get a sparkling, fresh-fallen effect. The whipped suds will "drift" enough to look natural, and will dry overnight to a stiff, non-tacky finish that will stay in place indefinitely. The treatment also may be used on holly wreaths and other decorations, and can be applied to the corners of windows and mirrors to give a drifted-snow effect. Later, a damp rag will remove it from the glass.

Tom Riley, Portland, Ore.



Partitioning Helps to Keep Drawers Orderly

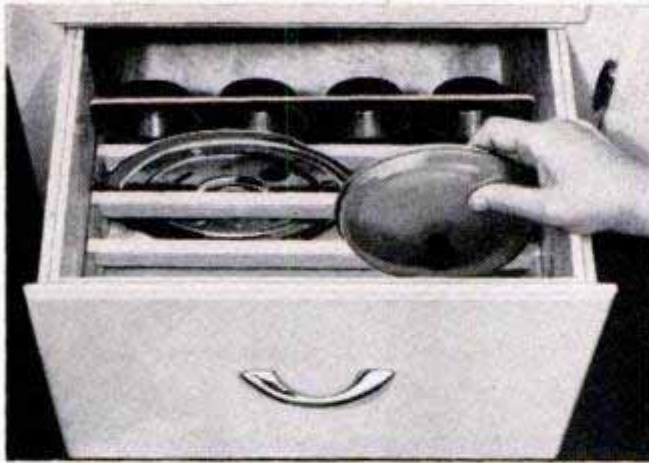

By Elma Waltner

Good partitioning can eliminate the clutter in drawers in which small items are stored in your home. Each article can be found quickly when needed, with no more fumbling. The left-hand photo shows a drawer having vertical compartments for pot lids, piepans and other flat kitchenware. The partitions in this drawer can be made by fitting square strips into notched side rails as shown, or by fastening pairs of notched cleats to the drawer sides and slipping solid panels into the notches. The Lazy Susan pictured in the detail is designed for use in drawers in which articles stored at the back are difficult to reach. Revolving the tray quickly brings the desired item to the front of the drawer. The base disk is of $\frac{3}{4}$ -in. stock cut to a diameter $\frac{1}{2}$ in. less than the width of the drawer. The side band is a sheet-metal strip 1 in. less than height of the drawer. A small disk of $\frac{3}{4}$ -in. stock is slotted to receive plywood dividers to form six preshaped sections. Small compartments may be built into any drawer by making the dividers from $\frac{1}{4}$ -in.

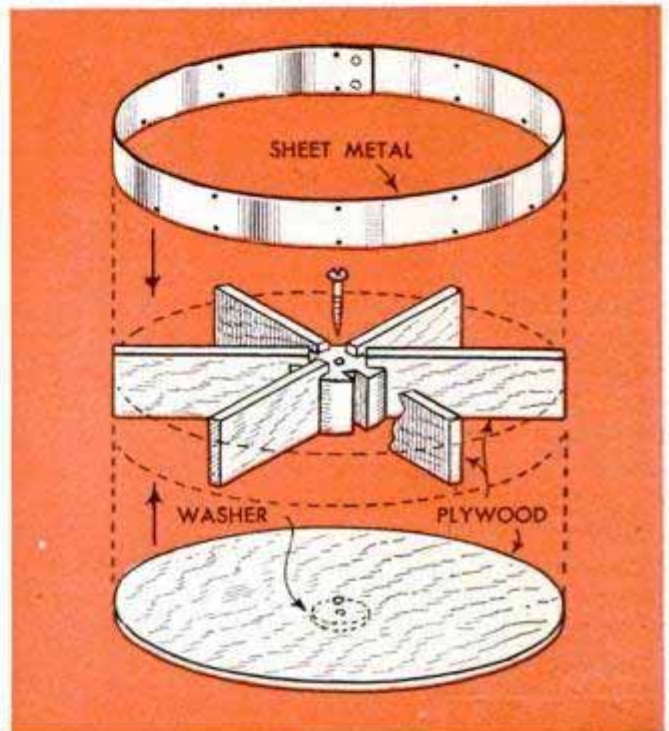

stock, $\frac{1}{2}$ in. narrower than the inside height of the drawer. These dividers are interlocked with half-lapped joints to form a crisscross pattern.

Method for Improving Service of Worn Distributor Points

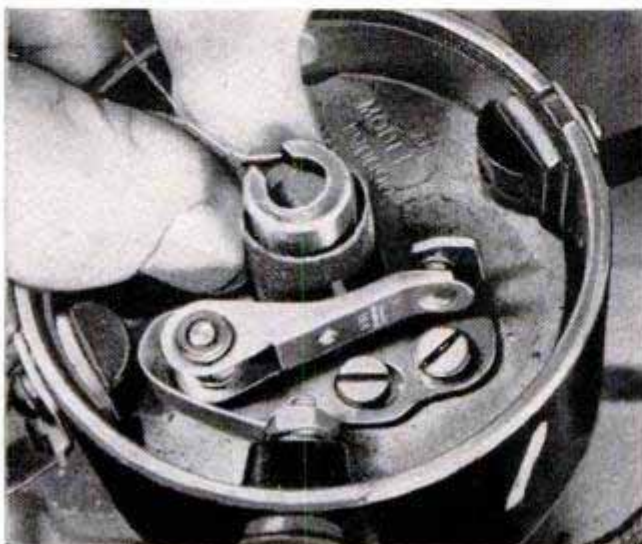

If the breaker-point arm of a distributor becomes slightly out of line or worn where it is pivoted, the end of the fiber block probably will only contact partially the curved surface of the cam. This will result in excessive wear of the block which, in turn, not only will cause further misalignment of the points but also will affect, perhaps critically, the gap interval between them. One way to correct this condition temporarily is by wrapping a strip of fine sandpaper around the cam and rotating manually to grind the end of the block to fit the contour of the cam, after which the gap between the points should be reset. Finally, remove any abrasive particles that have become dislodged from the sandpaper.

PLAN of the MONTH



These Christmas-tree stands are Santa-approved and you'll have time to build one or more before the holiday. All are designed to hold the tree rigidly upright and provide a constant water supply. Stand pictured at left and detailed below, features a lighted base with scrolled gallery and spring-tensioned holder for clamping the tree trunk securely. Holder is shown in section and plan views at lower left. Lights are controlled by single-pole toggle switch

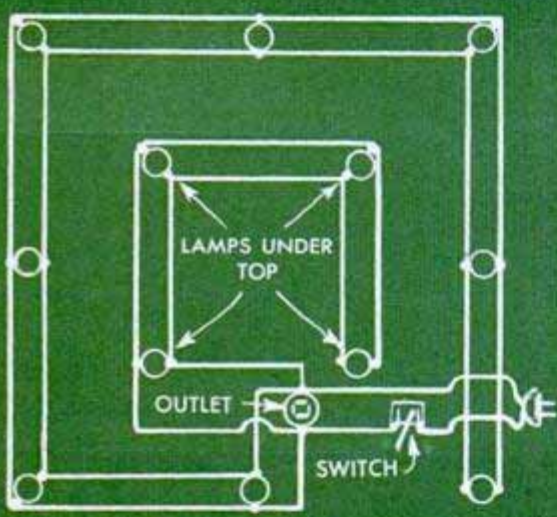

WIRING DIAGRAM

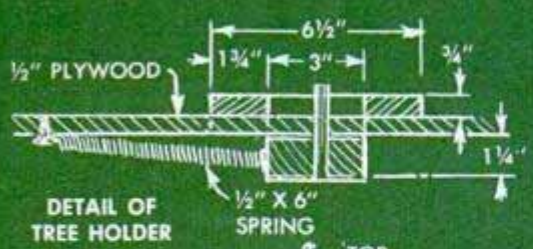
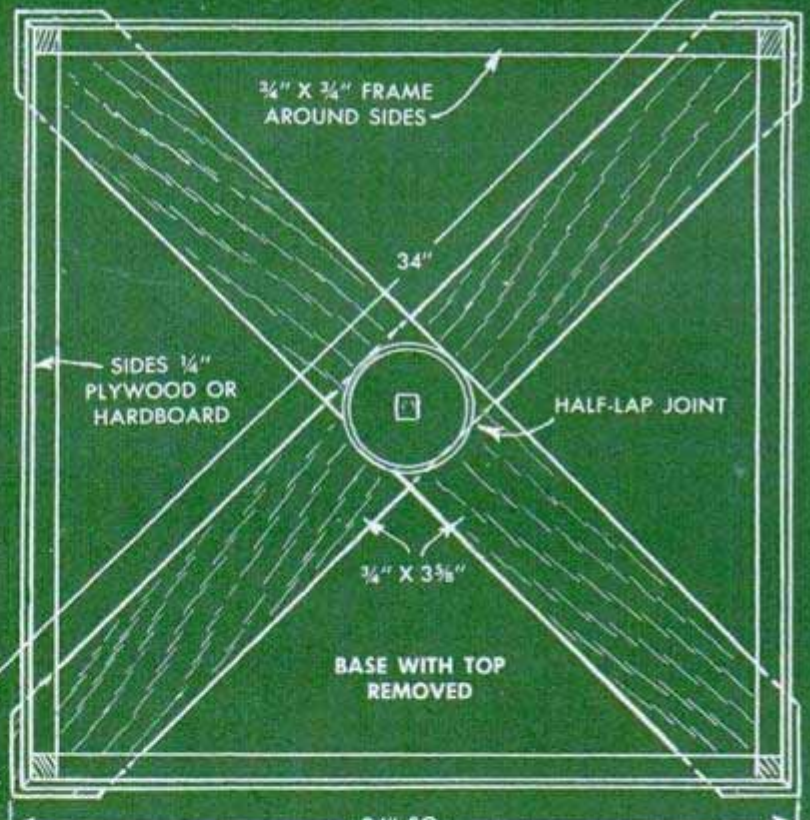

DETAIL OF TREE HOLDER

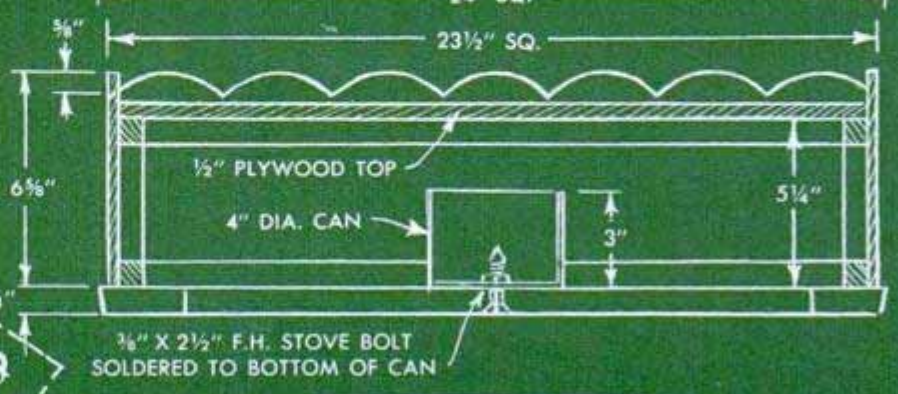
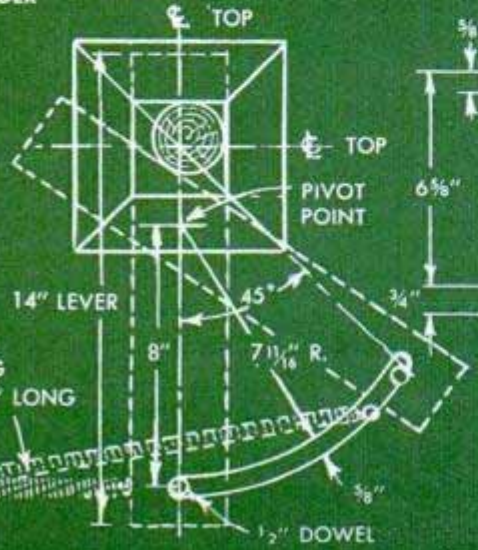

3/8" X 2 1/2" F.H. STOVE BOLT SOLDERED TO BOTTOM OF CAN

DECORATIVE CUT-OUT FOR SIDES 3/4" SQS.



FASTEN COLORED GLASS OR PLASTIC BEHIND CUTOUT

...Christmas Tree Stands

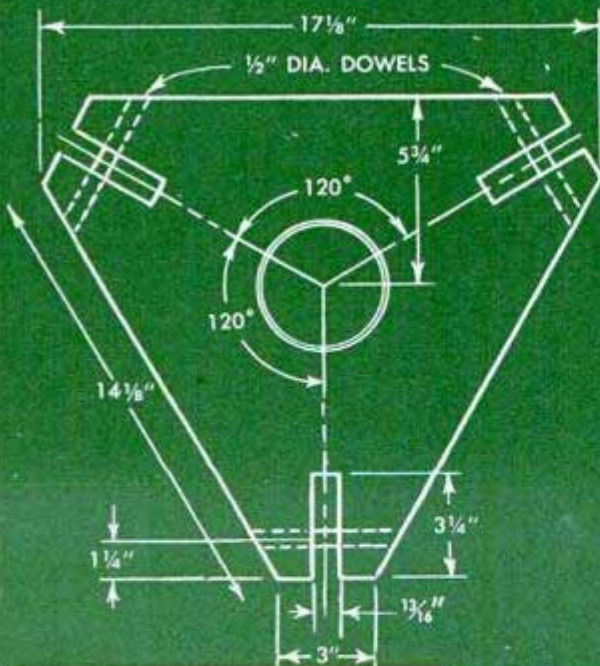
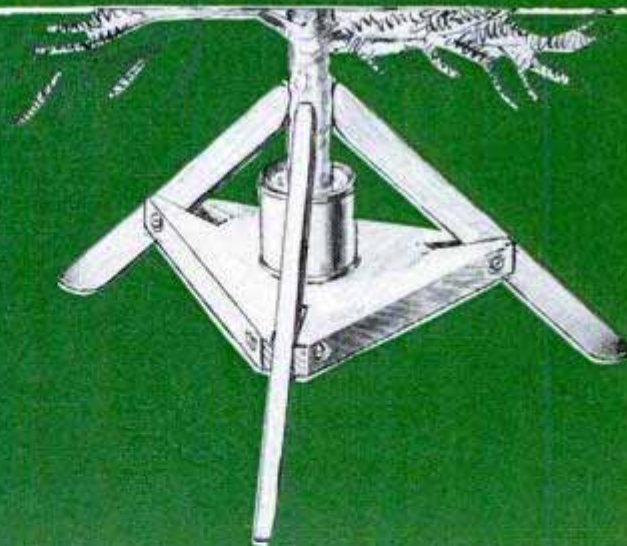
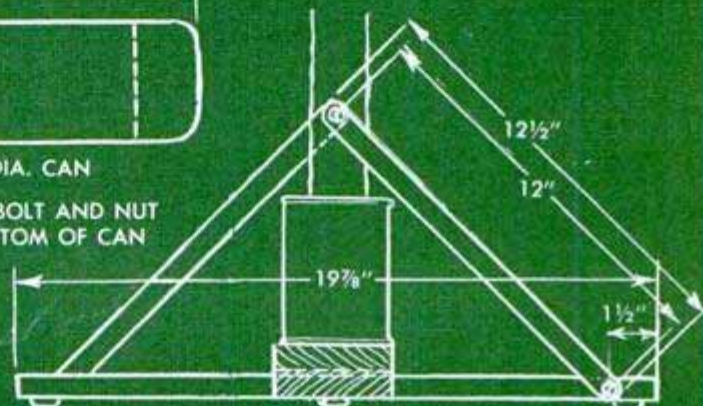
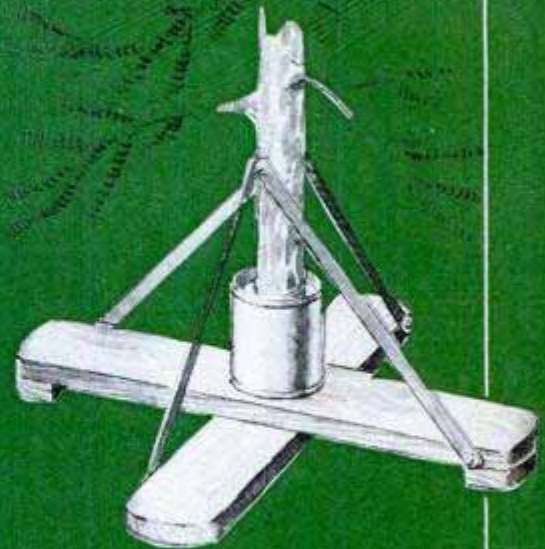
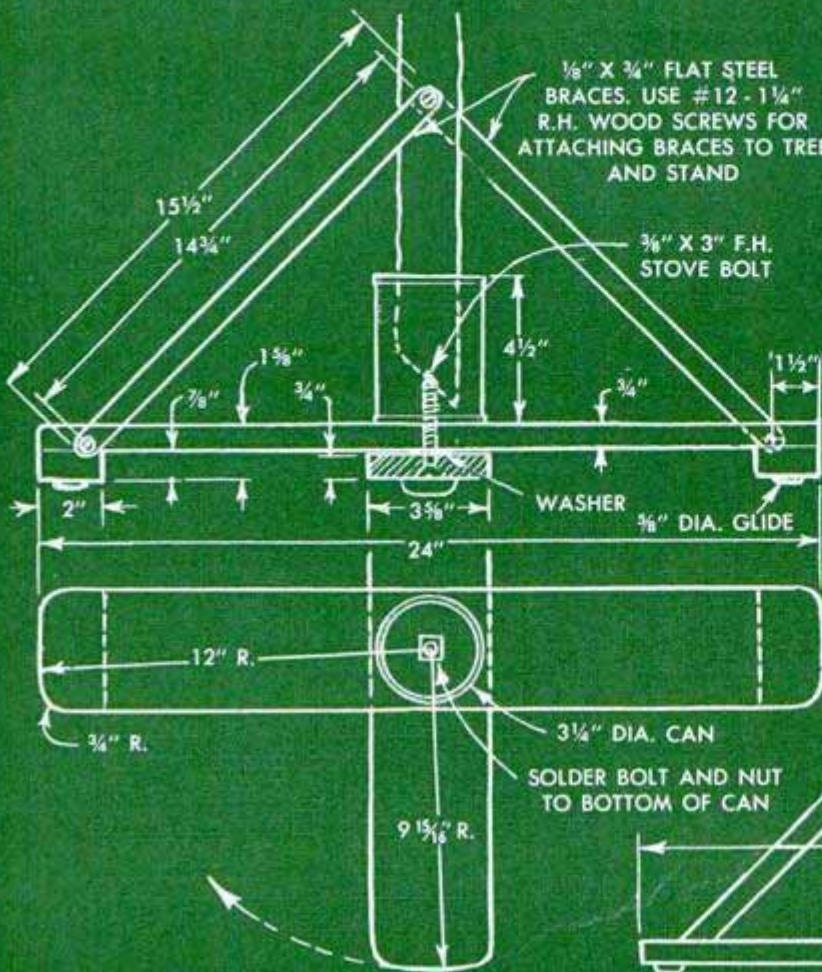

Stands like those above can be assembled in one evening. In the upper design, flat-steel braces are screwed to the tree trunk. In the lower one, three legs pivoted to a triangular base support the tree trunk. Weight of the tree forces upper ends tightly against trunk

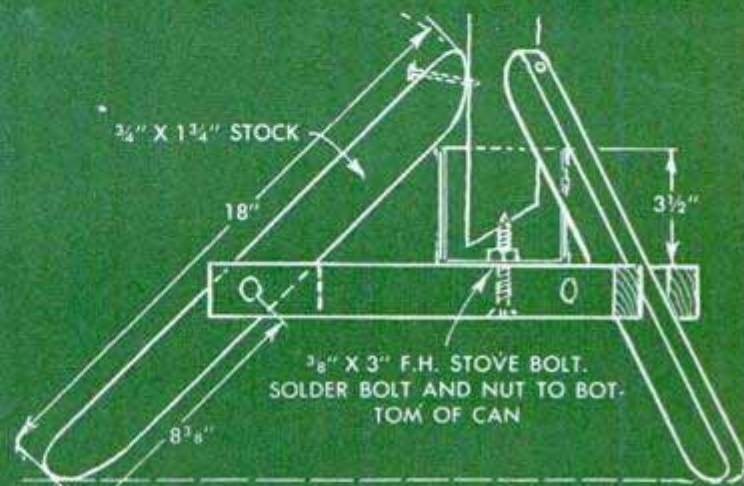

Decorative Wood-Putty Book Ends "Cast" in Plaster Molds



Let your own hands be the models for these unusual book ends that will be attention-getters wherever they are used. All that's needed to make them is a cake tin, petroleum jelly, wood putty and a small quantity of plaster of paris. After coating one hand with the jelly, mix the plaster to a thick, creamlike consistency and pour in the pan to a depth of at least 2 in. As the plaster begins to set, press the palm of the hand, with fingers together, as well as part of the wrist halfway into the substance, keeping it there until the plaster hardens. When ready to make the other half of the mold, coat the entire face of the completed half with the jelly and also the back of the hand if necessary. Then, after mixing more plaster, again place the hand in the depression in the completed half and pour plaster over it. As soon as the plaster has set firmly, use a knife or a wall scraper to pry apart the two halves. The next step is to coat the inside surfaces of the mold halves with the jelly, afterward pressing wood putty into the depressions until it is approximately $\frac{3}{16}$ in. thick. When the putty has hardened thoroughly, remove the halves and join together with glue, first adding putty wherever necessary to effect a smooth joint. After repeating the operation with the other hand, sand both replicas, shellac or paint in the color desired and mount with glue on two L-shaped wooden pieces in the manner shown.

Bess Ritter, New York City.

Lawn-Furniture Legs Preserved By Asbestos Roof Coating

The legs of wooden lawn furniture will last longer and have a neater appearance if their bases are given an application of asbestos roof coating. Turn the furniture

upside down and paint about 5 in. of the leg. After this has dried thoroughly, apply a second coat. Be sure that the end pores of the wood are completely filled.

T. F. Watts, Charlotte, N. C.

Cans Protect Exposed Dock Piling And Serve as Channel Markers

The end grain of wooden piling used for dock structures and channel markers is constantly exposed to the elements, causing the wood to rot. Tin cans afford excellent protection against this rotting. The cans must be large enough to fit over the ends of the piling, though a tight fit isn't necessary, and should be painted

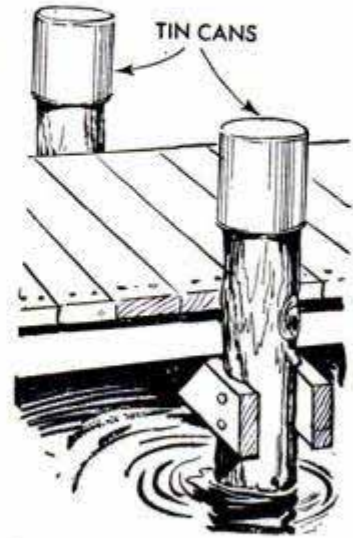

inside and out with a good marine paint before being put into use. Some resort owners use painted cans to identify the channels leading to their particular cottages, while others achieve a novel effect by having cans of many different colors on their docks.

Thin Stock Taped Together For Multiple Bandsawing

When bandsawing quantities of thin stock that are to be cut into identical shapes, the job may be speeded up by taping a number of pieces together for sawing at one time. The pattern is taped to the top piece to serve as a guide. Pieces of hardboard are shown secured with masking tape while being cut into window scrapers.

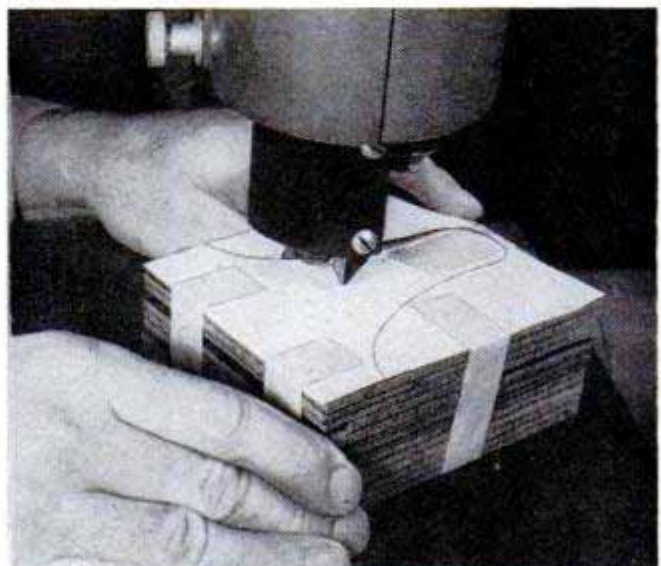

ALL-PURPOSE CLAMP

By Martin D. Koehler

For those hard-to-hold articles when you wish for a third hand, this all-purpose clamp will prove invaluable. The base construction is shown in the diagram. To complete, add a photoflood-reflector clamp

$\frac{3}{4}$ " X 5" X 8 $\frac{1}{2}$ "
WOODEN BASE

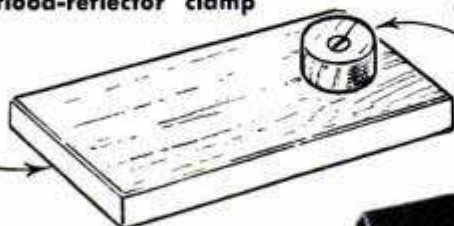

1 $\frac{1}{2}$ " O.D. X 5"
BRASS TUBE

WOODEN DISK,
SNUG FIT
INSIDE TUBE



Below, left, clamp holds plans or instruction book for modelwork. Below, right, clamp provides fixture for soldering small wire parts

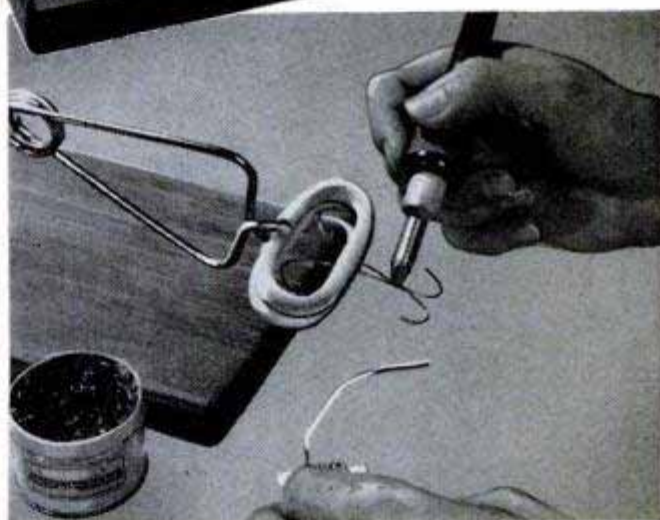

In left-hand photo below, "third hand" substitutes as glue clamp for small work. Center photo, flash-extension units are held in almost any position required by photographer. Lower, right, for portrait or table-top photography, clamp holds cardboard reflector as it can be adjusted at various angles to light shadows



Sections Cut From Casing Replace Worn Tire-Chain Links

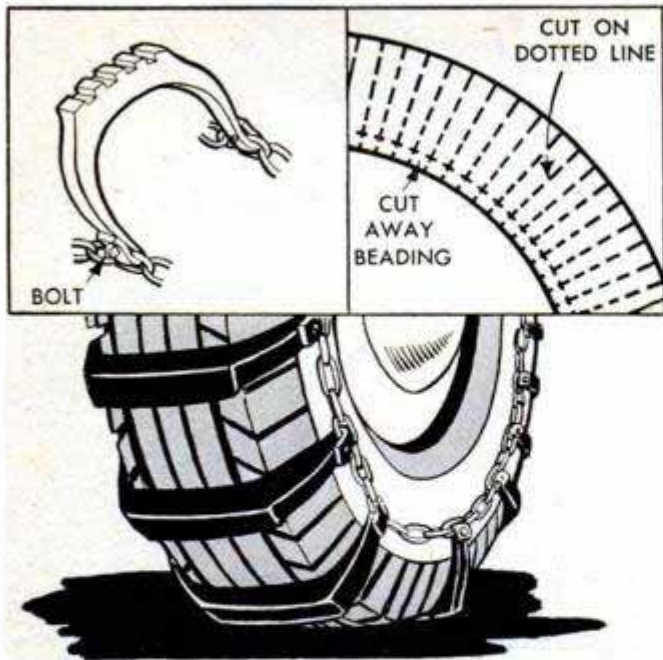

When tire chains have become worn to the extent where some of the links have separated and no longer are effective, a repair job providing chains more durable than the original ones can be done with the use of an old tire casing. First cut the wire bead from both sides of the tire. Then cut the carcass of the tire into strips $1\frac{1}{4}$ in. wide, which will pass through the side links of the chain. After the strips are cut, remove the cross links from the chain one at a time, and as you remove these, replace with rubber "links." To fasten, pass the rubber strip through the side link of the chain and bend it back with an inch of overlap. Drill or punch a hole through both layers and bolt together with stove bolts, placing the heads on the inside. These rubber chains give better traction and are much quieter in operation than the steel chains.—Walter J. Swontek, Bedford, Ohio.

Andirons of Welded Pipe Lengths Beaded to Simulate Logs

In constructing this pair of simulated-log andirons, an apprentice welder can get practice and, at the same time, produce an interesting addition to his home. The main columns are cut from 4-in. pipe while the stub "branches" are of $1\frac{1}{4}$ -in. pipe. After these are assembled, enough bead should be run on the sides of the pipe to give them a rough-bark appearance. Facings for the beveled ends of the pipe sections are cut from $\frac{3}{8}$ -in. plate and growth rings are etched on the plate to give a cut-log effect. The shanks which hold the fuel are made of square bar stock. After the rough edges are ground off, the entire andiron is given a final polishing with a wire brush and emery cloth.—O. A. Fitzgerald, Moscow, Idaho.



Rubber-Stamp Aligning Guide Assures Even Print

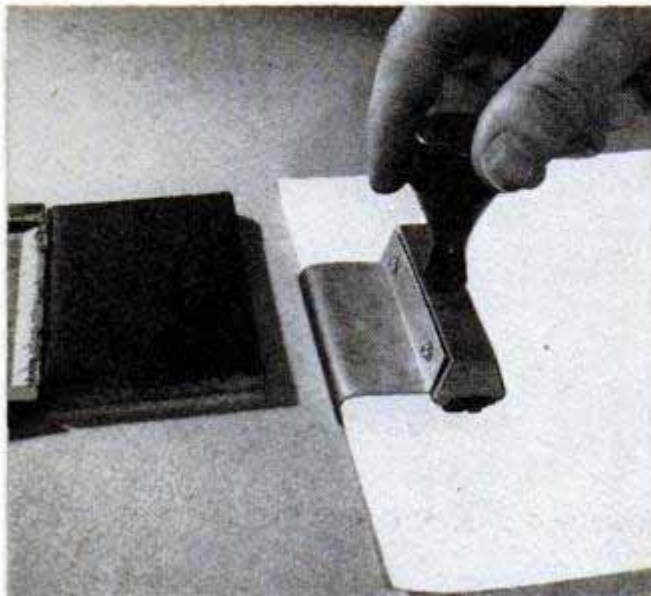

Rubber stamp impressions always will be made at the same distance from the edge of the paper, and in perfect alignment, if this simple attachment is used. It consists of a piece of sheet metal of the same width as the stamp, bent S-shape and screwed to the back of the stamp. If desired, keyhole-type slots may be made in the metal guide so it can be slipped off and on without removing the screws. The guide also assures clean impressions, as the stamp is always lowered in a level position that avoids blurring.—Ken Murray, Colon, Mich.

☞ Earthenware that imparts a clay taste to food can be conditioned to prevent this by boiling it in water about 15 min. Soak the earthenware until the water cools.

Tie Clasps and Barrettes in Colorful Plastic

Matching monogrammed clasps for the whole family, tie clasps for the male members and barrettes for mother and daughter, can be made of bright plastic in one evening. A piece of plastic $\frac{1}{8} \times \frac{1}{2} \times 6$ in. is needed for the adult tie clasp, while the junior clasp is formed from a piece $\frac{1}{8} \times \frac{1}{2} \times 4\frac{1}{4}$ in. The edges are filed smooth, sanded with fine sandpaper and finally buffed with steel wool. Remove the paper backing from the plastic just before bending, then heat over a hot plate until pliable. The senior tie clasp is bent $3\frac{1}{4}$ in., and the junior clasp $2\frac{1}{4}$ in., from one end. The tip of the shorter end is bent slightly to facilitate clipping to the shirt. Chromium-plated initials are cemented in place to finish the job.

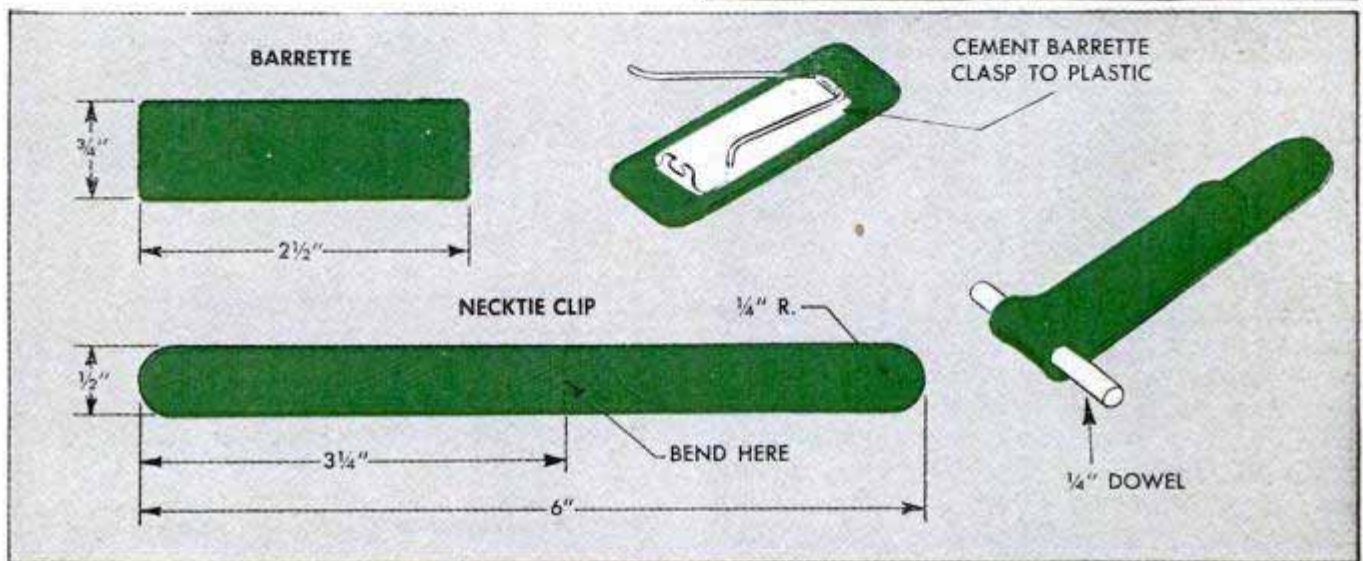
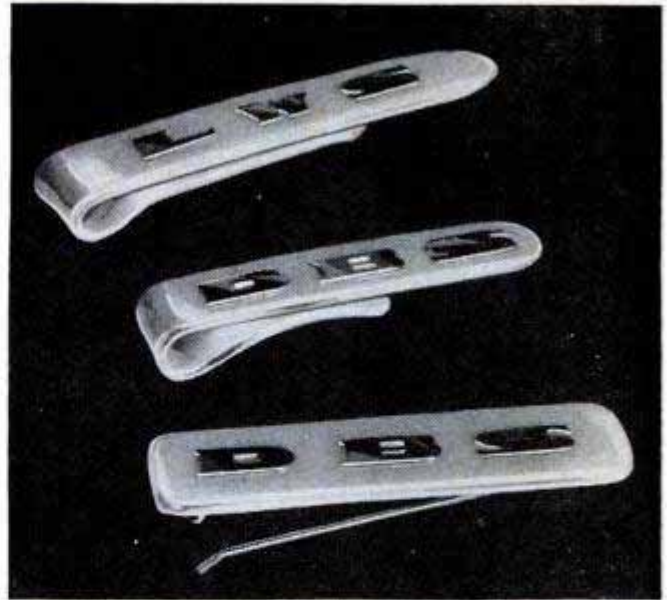

Sturdy Rack for Gasoline Drum Made From Old Auto-Wheel Rim

This neat-appearing rack for holding a gasoline drum was made by cutting old auto-tire rims into smaller sections and welding them in the manner shown. The



supports are joined together by pieces of flat steel which are welded to the lower sections, or legs, of the rack. The legs are prevented from sinking into the ground by setting the rack on short planks. However, if the barrel is to remain in the same position indefinitely, it is a good idea to pour a small concrete slab for the purpose. A coat of aluminum paint or a regular metal paint will improve the appearance of the rack.

A. M. Wettach, Mt. Pleasant, Iowa.

Removing Oil Stains

When a garment becomes spotted with sewing-machine oil, cover the oil spots immediately with fuller's earth, putting it on thickly and allowing it to stand overnight. The next morning, when the fuller's earth is brushed off with a soft brush, the stain should have disappeared. In some stubborn cases, however, the treatment may have to be repeated.

MASS PRODUCTION

In the Basement Shop

By John D. Arnold

IF YOU PLAN to put your workshop on a profitable basis, tooling up to mass-produce a certain item for the Christmas rush will help you to compete effectively with the local gift trade. Simple cutting setups, assembly jigs and short-cut finishing methods may be combined to produce a better item at a faster rate and greater profit. The small chest shown on the opposite page illustrates what can be accomplished when bandsaw and shaper operations are combined to produce a cover and legs that appear to be separate units but which actually are formed from a single boxlike unit.

The box is made by cutting sides and endpieces to the size desired, after which the sides are rabbeted on both ends to fit the endpieces. Then the sides and endpieces are grooved on the inside to take the bottom and stacked, with their respective patterns placed on top as shown, in open-box jigs for bandsawing. Following this, the pieces are placed in a right-angle jig to assure squareness when assembling the chest with glue and brads. The brads should not be driven where they might interfere with subsequent shaper operations. Then a top is cut to the proper size and secured with glue only, as the upper portion of the box is to be cut free to provide a cover.

After the chest has been given a preliminary sanding, the cutters are adjusted in place on the shaper and test pieces run through to determine the proper depth and setting. When the bottom molding and groove have been cut, a small surface bead and molding are cut near the top edge in a similar manner. Then, after a final light sanding, the cover is cut from the body on a line just above the surface bead, after which mortises for the hinges are cut with a dado head.

With the arrangement shown at the right, it's easy to produce small disks or wooden wheels for toys. To overcome the problem of removing severed pieces, the regular saw insert is replaced with a wooden insert having a rectangular opening adjacent to the blade. A sheet-metal chute attached to the underside of this insert directs the pieces into a box underneath the saw table. A stop is clamped to the table as shown to assure duplicate cuts, while a fence attached to the miter gauge aligns the stock properly with the blade. ★ ★ ★

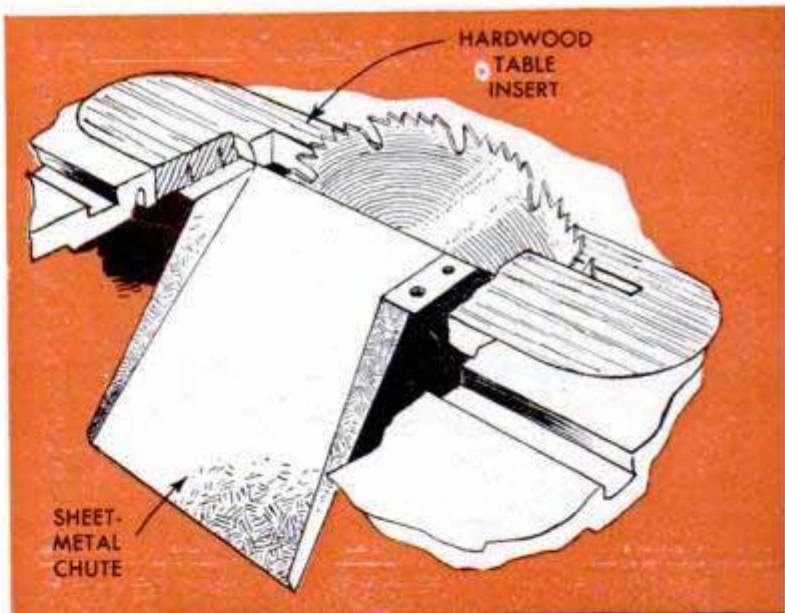



Completed chest, above right, illustrates how leg detail suggests separately molded and mounted units

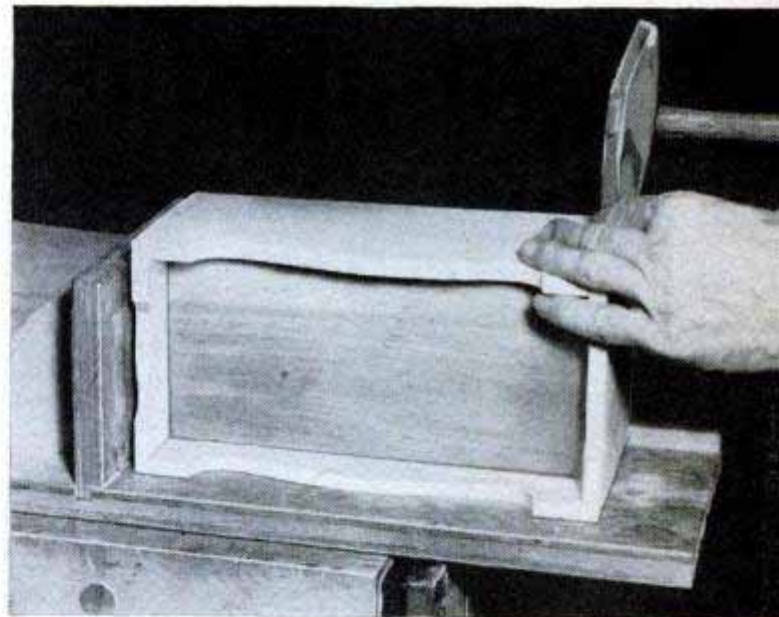
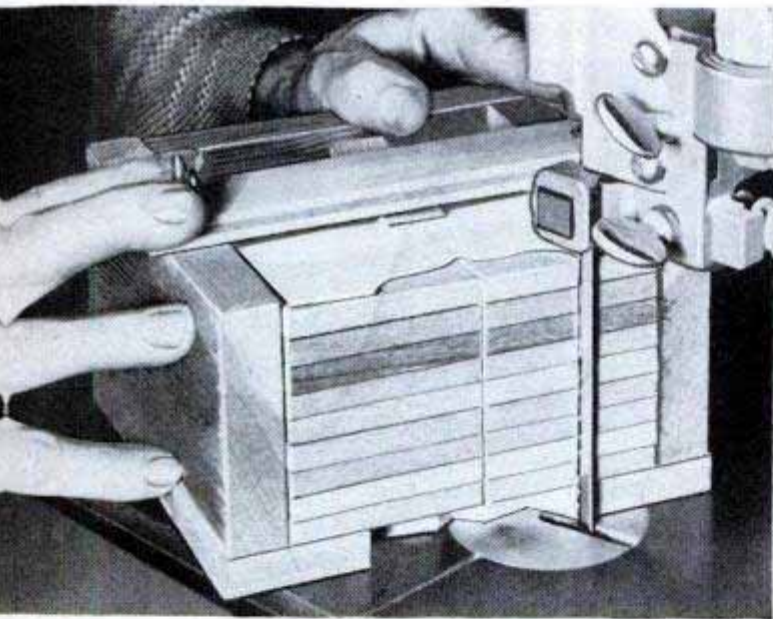

For multiple bandsawing, chest endpieces are held in open-box type of jig with pattern placed on top

Above, the sides and endpieces being assembled with glue and brads when trued in right-angle jig

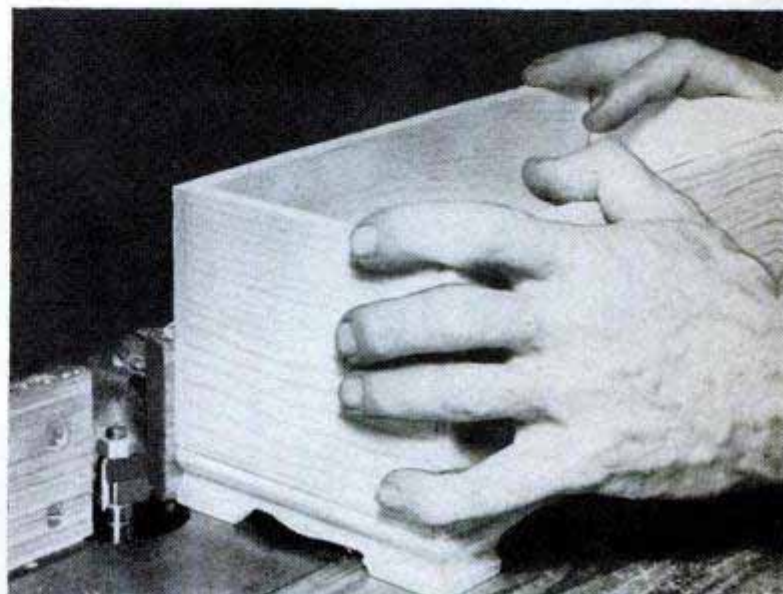
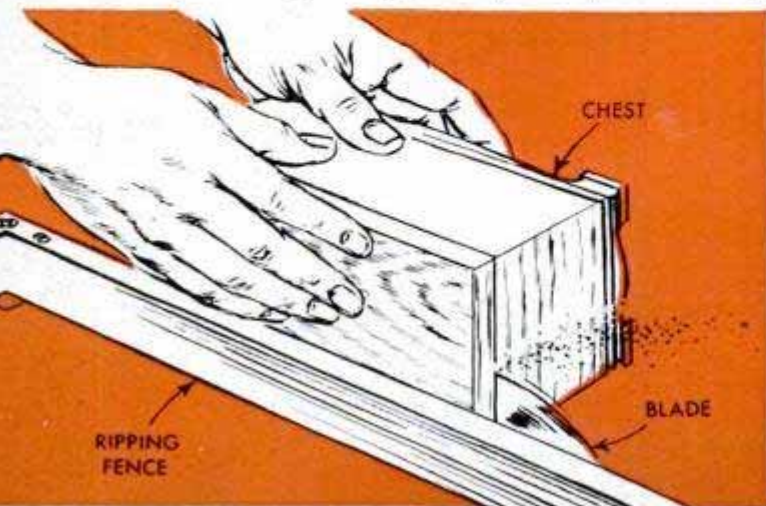

Above, cutting lid from chest on circular saw; at right, shaping groove and molding in one operation

Tire Cushions Boat on Car Top

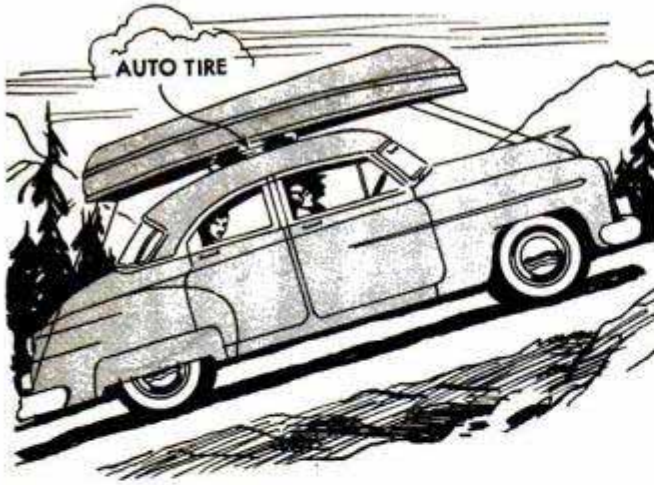

An old tire placed on the roof of your car is a good substitute for a special boat-carrying rig. Place tire in the center of car top and tie the boat to the four corners of the car. Boat will balance itself on the tire without touching the top at any point. For light boats one or two inflated inner tubes will do the job with the added advantage that your family can use them as floats.

A. R. Finley, Altadena, Calif.

Straining Paint Quickly



Time can be saved in straining paint by placing a circular-shaped piece of screen wire cut to the same diameter as the inside of the paint can on top of the paint. Then, by pushing the screen down slowly with a

brush or stick, the skin and also any hardened lumps or particles in the paint are forced to the bottom of the can. After the job has been finished, the screen can be removed with a wire hook and cleaned for reuse.—Ken Murray, Colon, Mich.

Threaded End of Bolt Filed To Take Nut Easily

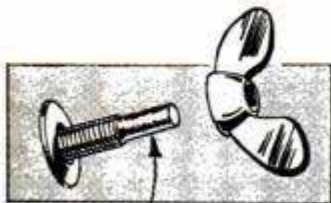

Where parts are assembled and disassembled frequently the problem of quickly starting square, hex, or wing nuts is solved by filing

away several threads at the end of each bolt. The threads should be filed down so that the nut will slip easily over the smooth

end. When assembling parts simply slip the nut over the end of the bolt until it engages the threads and then spin it home.

Arthur Trauffer, Council Bluffs, Iowa.

Improved Stencil Cutter

You'll find it a simple matter to draw neat ruled lines on a duplicator stencil with a discarded glass cutter. Held against a straight-edge in the manner shown, cutter wheel will leave a clear line on the stencil.

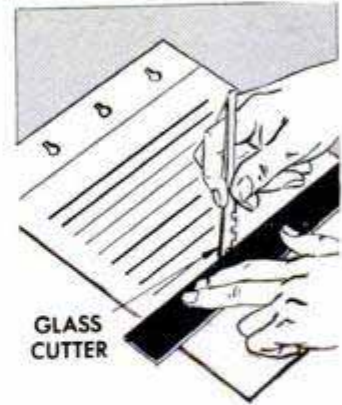

Glazier Points Driven With Putty Knife

If a driver is not available when replacing a pane of glass, you will find a putty knife helpful for driving glazier points. Hold the tool against the edge of the point as illustrated and tap it lightly with a hammer.

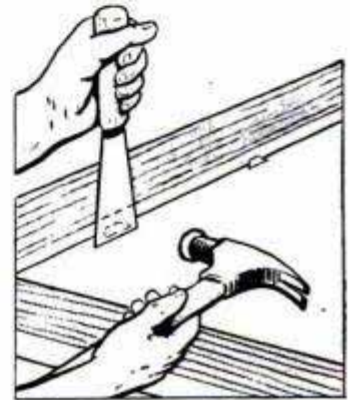

Steel Wool Tamped in Hole Tightens Loose Screw

To tighten a wood screw that has worked loose, tamp steel wool into the hole and then replace the screw. If steel wool is not available, try using a piece of scouring pad, slivers of tin or other thin-gauge sheet metal.—J. W. Rocke, Atkinson, Neb.

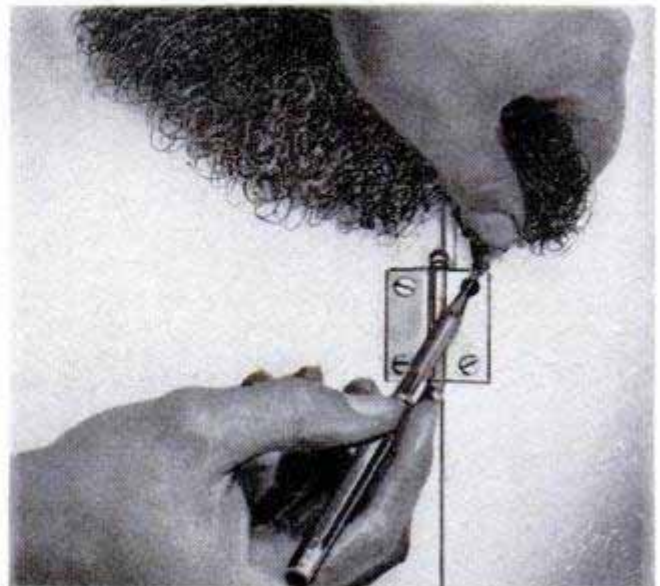

When a bedspring of the type shown sags badly, it may be repaired temporarily in most cases by crimping the individual wires and replacing any coil springs that have become stretched. Pliers, or better still, an adjustable open-end wrench and a screwdriver are all that you need for the job. The wrench is used to grip the wire while the screwdriver is inserted through the hole in the wrench handle to provide a T-handle for twisting the wrench. — Max Alth, New York City.

Sagging Bedspring Repaired Temporarily By Crimping Wire Links With Wrench

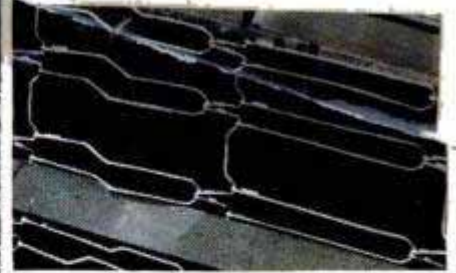

Worn Masonry Drills Salvaged To Provide Chisels and Punches

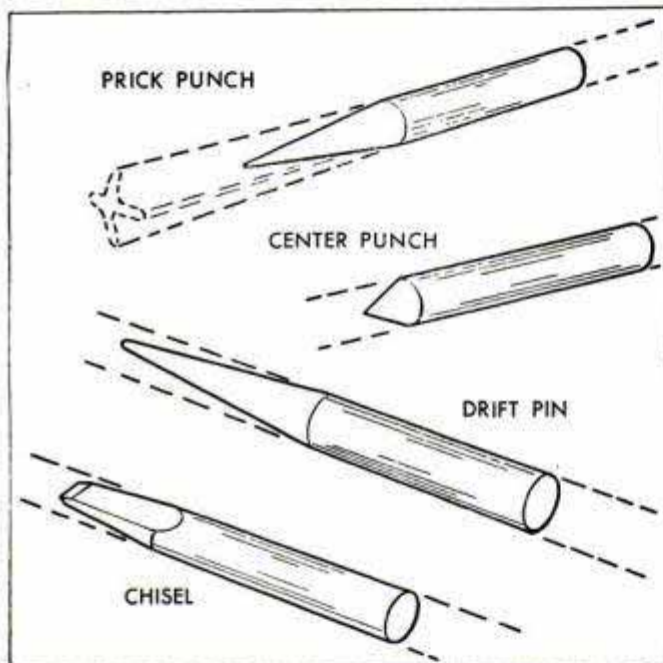

Useful tools, such as chisels, driftpins and punches, can be made from worn masonry drills. Using a hacksaw, I first remove the cutting head from the drill, leaving a shank 10 in. long with which to work. A full-length piece may be tapered and shaped on a grinder to form either a cold chisel or a driftpin. A similar length can be cut in half and the two shorter pieces shaped into center and prick punches. To speed cutting of the metal, saw around the piece and then break it in two. When pointing the metal, be sure to wet the grindstone with water from time to time.

D. A. Walker, Nashville, Tenn.

Proper Treatment of Fishing Tackle Prevents Deterioration in Storage

Fishermen having large selections of trout and bass flies can mothproof them by dipping each fly in kerosene before storing. To prevent rubber baits from rotting, put them in a can of tire talcum. Wash and dry wooden plugs and metal spoons and then give them a coat of floor wax. Rub a little grease over all fishhooks, or dip them in a rust-preventive liquid. Wash fishing lines in clear, cold water and, after drying them thoroughly, wind them loosely around a large cardboard tube or can. Disassemble the reels and clean the parts in gasoline. Next, wipe the parts dry and reassemble, applying a few drops of reel oil to the level-wind mechanism, end bearings and gear shaft. When finished, store the reel in a cloth bag. After assembling the fishing rods, insert small corks in the agate guides and hang the rods vertically by the tips. All tackle should be stored in a dry place.—R. A. Jenkins, St. Louis, Mo.

Longer Life for Razor Blades

Appearing in its initial stages as nothing more than brownish stains, the rust that forms on the cutting surfaces of a razor blade and eventually dulls it can be retarded to a certain extent by drying the blade thoroughly each time the razor has been used. One easy way to accomplish this is by storing the blade between folds of a blotter when not in use. The blotter may be kept on a shelf of the medicine cabinet and the folds held together by placing a jar or a bottle on top of them.

C. E. Mitchell, Chicago.

☐ To remove whitish heat stains from furniture, dip a soft, moist cloth in cigarette ashes and rub the marred finish gently.

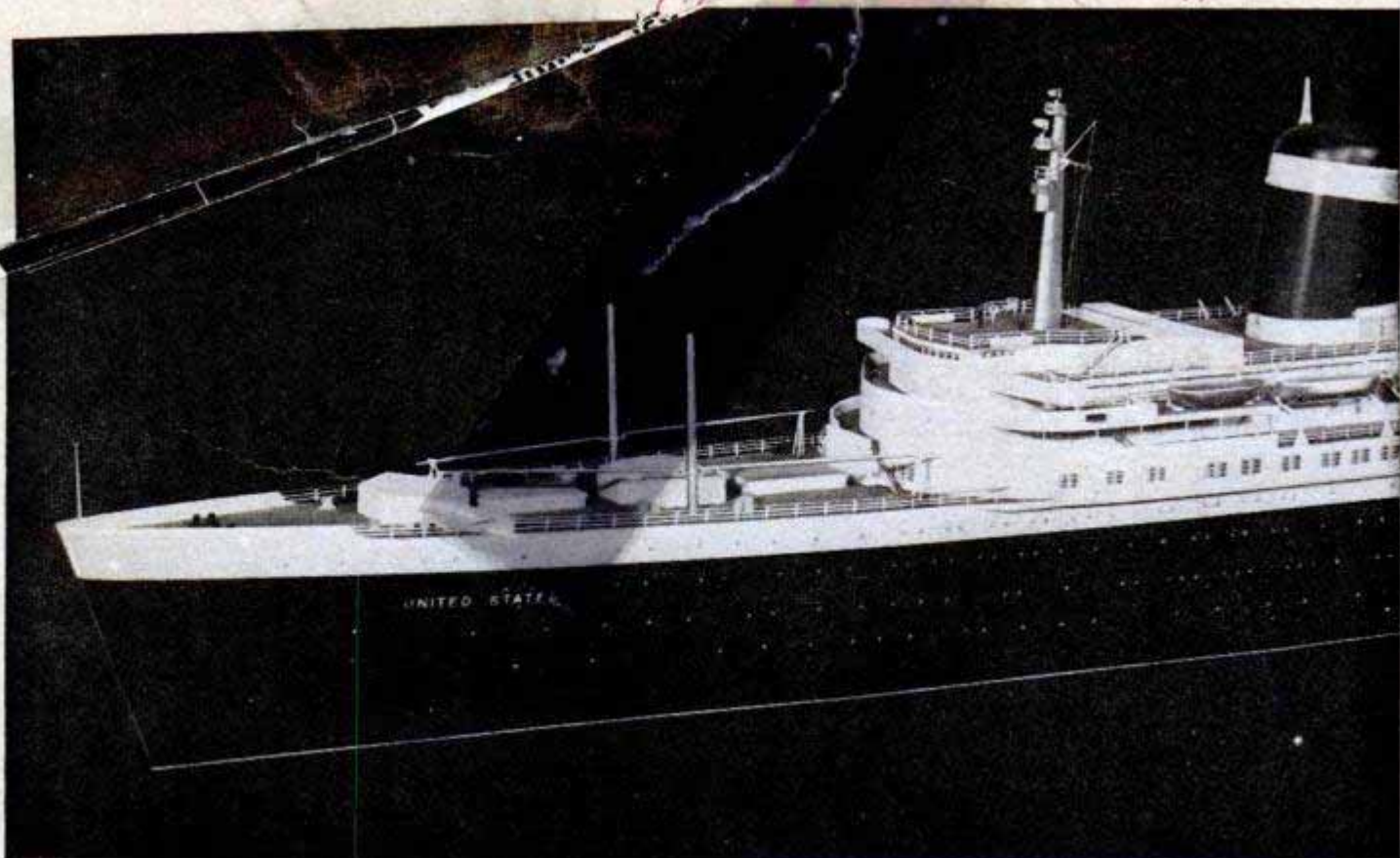

36-in. Model of the

PART I

By Wayne C. Leckey

MODELMAKERS throughout the world have been eager to start modeling the new speed queen of the seas — the SS *United States*. To fulfill their requests, the editors of *Popular Mechanics* commissioned Mr. Robert G. C. Fee, model engineer at the Newport News Shipbuilding and Dry Dock Co., builders of the actual ship, to prepare the necessary plans. *Popular Mechanics*, herewith, is proud to present the first in a series of exclusive construction articles on building a 36-in. scale model of America's mighty superliner.

A blue-ribbon winner in her maiden Atlantic crossings, the *United States* established a record-breaking eastward run of 3 days, 10 hrs. and 40 min., knocking off some 10 hrs. running time between New York and Southampton at an unheard of speed of 41 land miles per hour. Combining aluminum with steel to help reduce her weight and increase her speed, the *United States* weighs some 30 gross tons less than her famous British rivals, the *Queen Mary* and the *Queen Elizabeth*. While built in a record-breaking time of only 1031 days from some 1,200,000 blueprints, the combined man-hours were enough to construct 6000 average-size homes.

You have a choice of building a water-line model as pictured at the top of the page or a keel model as detailed in the plans. The model to be described includes the entire hull, but if a water-line model is preferred, it's a simple matter to omit the lower half of the two-part hull and work from the water line up. In either case, the completed model is mounted on a finished baseboard, the keel-type model being supported by two brass turnings, while the water-line model is screwed to the base.

After acquainting yourself with the general construction of the model, begin by

SHIP'S DATA

Length over-all	990' - 0"
Beam	101' - 6"
Height from keelson to stack	175'
Number of decks	12
Propulsion	Steam turbine
Horsepower	118,500
Screws	Quadruple—9' blades
Speed	30 knots plus
Gross tonnage	51,500
Passengers	2000
Troops in wartime	14,000
Crew	1000
Operated by	United States Lines
Built by	Newport News Shipbuilding and Dry Dock Co., Newport News, Va.
Designed by	Gibbs and Cox, Inc., Naval Architects, New York City
Keel laid	February 8, 1950
Launched	June 23, 1951
Maiden voyage	July 3, 1952

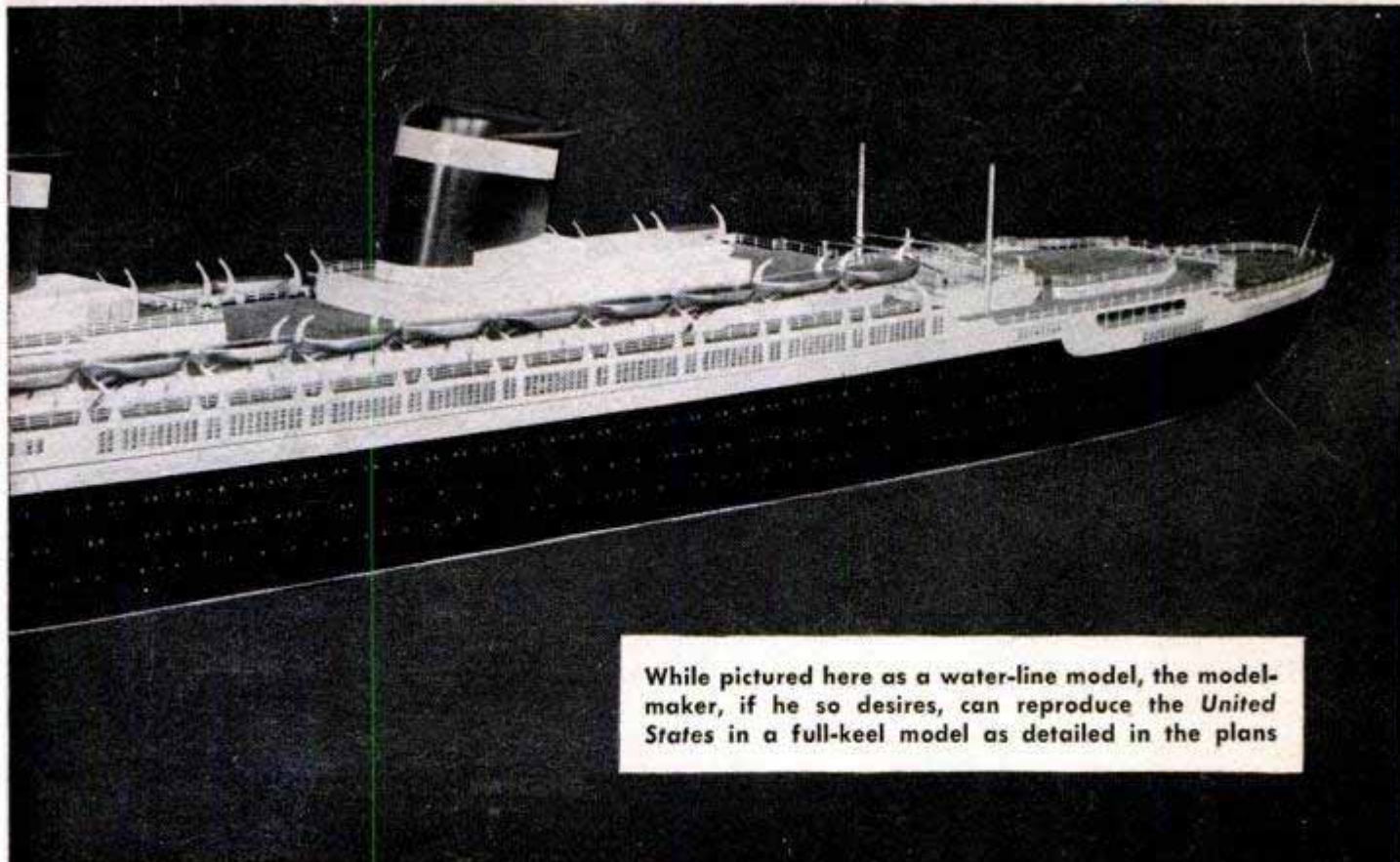

While pictured here as a water-line model, the model-maker, if he so desires, can reproduce the *United States* in a full-keel model as detailed in the plans

Reprinted WTM 54 + Book for Boop

SS United States

drawing full size the three templates required to lay out the lines of the hull, namely: the profile, deck and water line. These are presented one half actual size with important contour lines being shown on squares for easy enlargement. Only half-patterns are actually required of the deck and water-line templates, as they may be flipped over on each side of the centerlines to draw the complete outline. Make the templates of fairly stiff cardboard and

strive to maintain the same sweeping lines as shown in the half-size patterns. For reference in positioning the templates on the block, draw the water lines as well as the station lines on the templates and letter each one. Full-size patterns of the templates, ready for tracing, are available for those who do not wish to make their own.

The blank block from which the hull is carved consists of two separate blocks. Use sugar pine for these and, if necessary, build

Although shorter in over-all length than the *British Queens*, the *United States* can outdistance her rivals



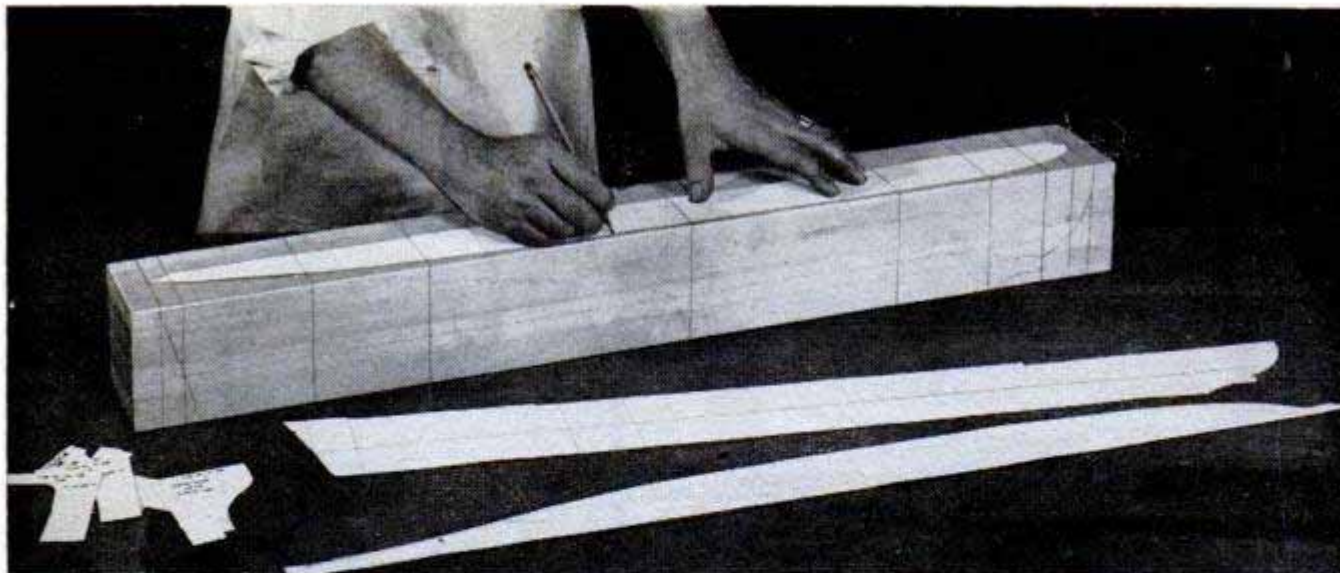

After stations and center lines are marked on the blank for the hull, outlines of the templates are drawn

up each one to the required thickness from two or more pieces. A resin-type glue is recommended in gluing the pieces together, and it's best to clamp the work. When the glue has dried, the two blocks are aligned and clamped together without glue, and holes for two registering $\frac{3}{8}$ -in. dowels are bored through the upper block and part way into the lower one. The dowels allow the two sections of the hull to be taken apart and later replaced in exact alignment. The joint between the two blocks represents the water line of the hull.

Next, the complete block is marked with a centerline along the top and bottom, and the station lines are drawn across the top and down one side of the block. In tracing the outline of the deck template on the top of the block, carefully align the centerline

of the template with the centerline on the block and draw around the template with a sharply pointed pencil, checking to see that the station lines correspond on both the template and the block. It's a good idea to use tabs of cellulose tape to hold the template in position on the block. To draw the complete outline, simply flip the template over, again aligning it with the centerline on the block. After the deck pattern is traced, the water-line template is also traced on top of the block in the same manner, positioning it in line with respective station points. Finally, the lower section of the two-part hull is removed and the same water-line template is traced on the top of the lower section. Then the two blocks are placed together again for rough sawing.

Bringing the rough-cut deck and water lines to exact line is done neatly and accurately on a disk sander

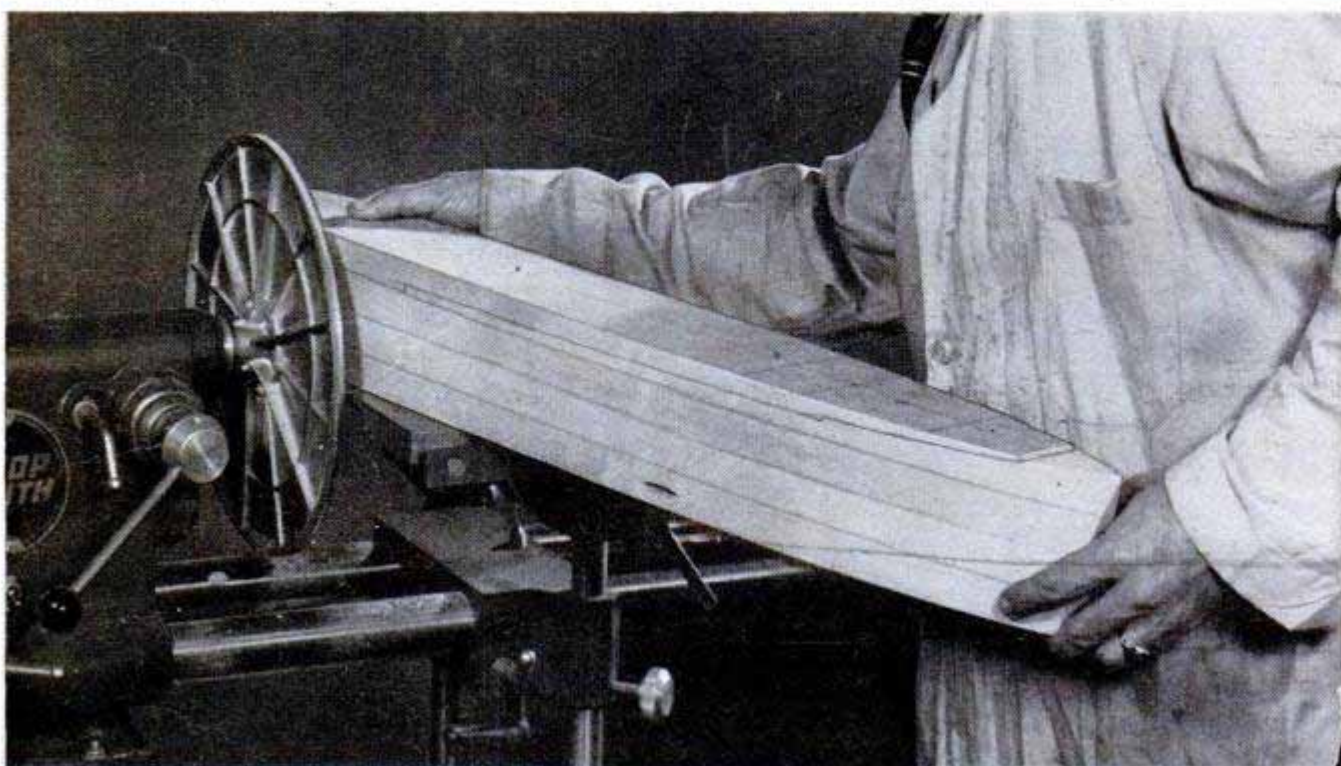

Rough-sawing the blank to the general lines of the hull is done most easily with a bandsaw. The block is placed on its side and the deck sheer line is cut first. Then the waste piece is tacked back on to re-establish the deck and water-line outlines. Next, with the block on its side, the bow and stern profile cuts are made, sawing carefully to line. After this, the two sections of the hull are again taken apart. It is important to note before sawing the deck outline, that since the hull has a tumble home (inward rake) at station E-E, the water-line outline must be followed at points where it overhangs the deck outline. If you have a disk sander, you can cut outside the line roughly and then bring the block down to line nicely on the sander. Finally, the water-line outline on the top of the lower section is cut and sanded to line. This establishes the exact shape of the hull at the water line and also the depth that the hull is carved at the various sta-

tions along the water line. The two sections of the hull now can be glued together permanently, clamping them for a tight joint.

Ten different cardboard templates are required to check the progressive carving of the hull contour. These are given in actual size on page 184B for tracing directly on cardboard, each respective template being used at the same station point on each side of the hull. Supporting the hull in an inverted position for carving is best done by screwing a scrap block to the deck and then clamping the block in a bench vise. The rough hull is gradually brought down to the proper contour by carving it a little at a time and then checking repeatedly with the respective template. Start at station E-E and work each way. In using each template, hold it vertically and even with the centerline on the bottom of the hull and align the water-line mark on the template with the water line of the hull. Several hand tools, such as a small block plane,

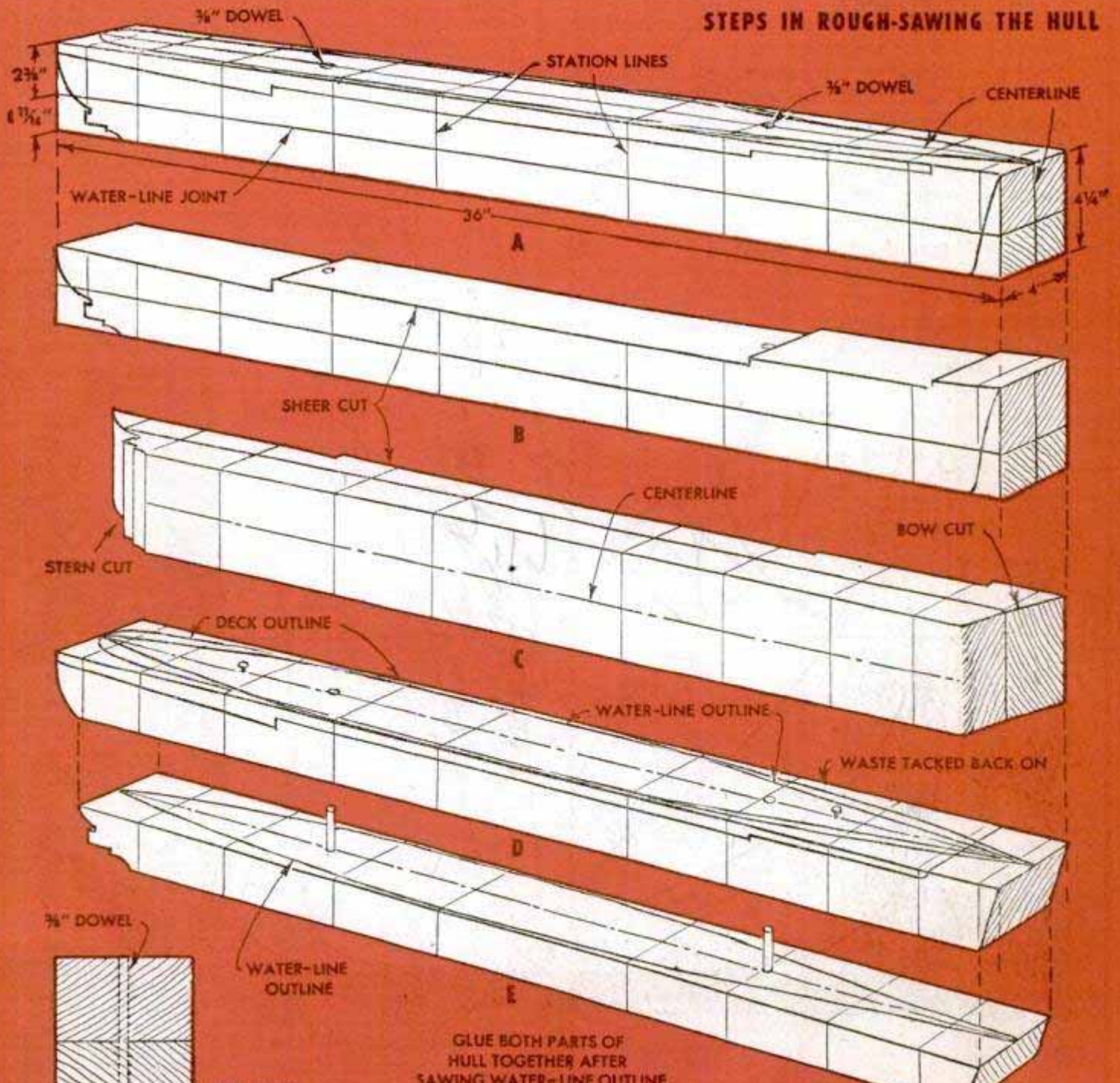



Cardboard contour templates are used to check the lines of the hull as it is carved. These are held at respective station points on each side of the hull. Carving is done with hull supported upside down

gouges, chisel and wood rasp, as well as coarse sandpaper, all are helpful in shaping the lines of the hull to coincide with the templates. Remember that the tumbler home at station E-E makes the hull wider at the water line than at the deck at this point. Try to obtain smooth, flowing lines between station points. When the hull is carved to your satisfaction, give it a good final sanding with 4/0 paper.

Part II will describe cutting the various lifts comprising the superstructure, adding the propeller-shaft housings and rudder, shaping the stacks, installing anchors and painting the hull with an initial coat of sealer.

(Continued next month)

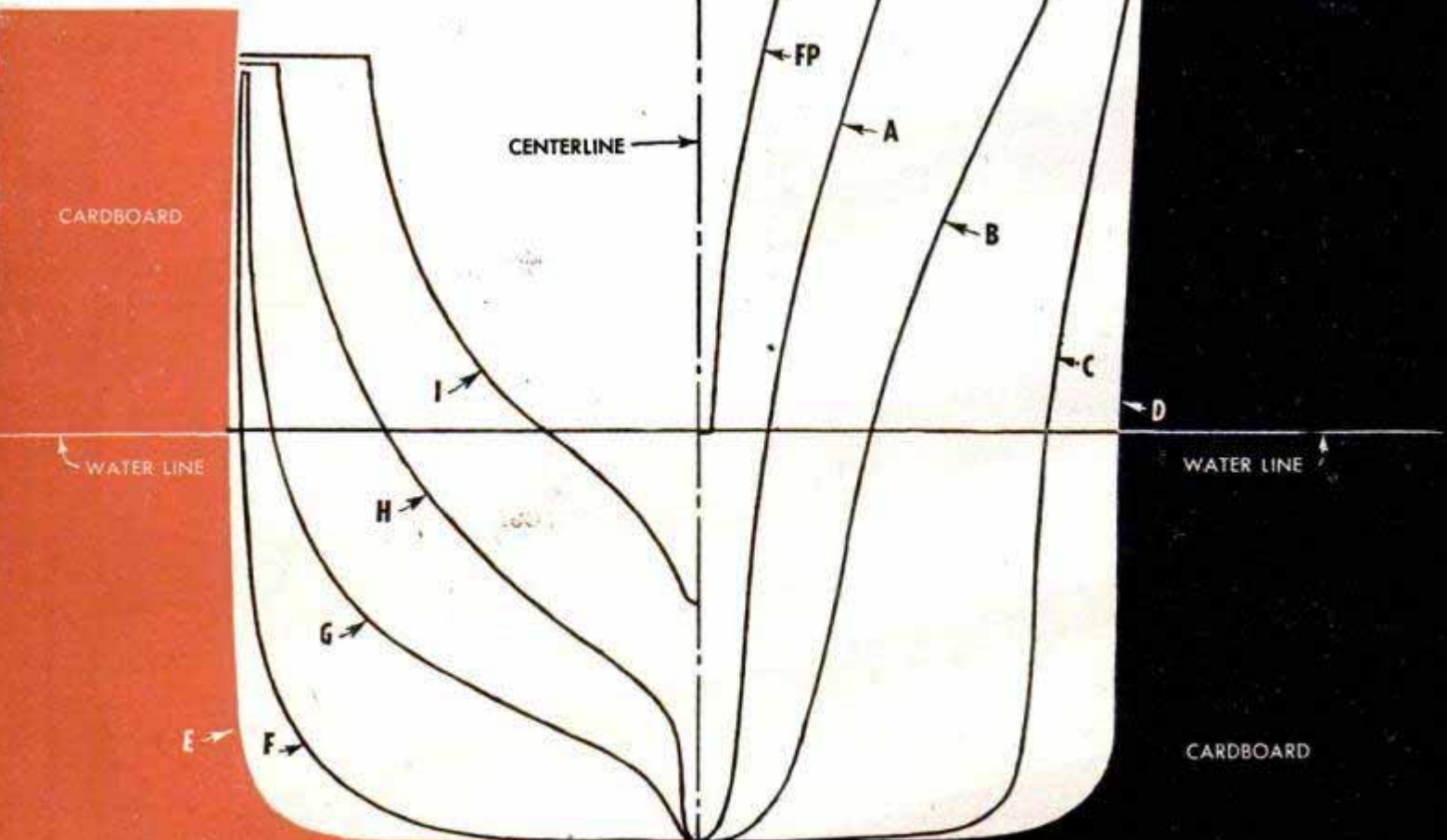

TEMPLATES ON THIS SIDE OF CENTERLINE USED AT STATIONS E-E AND AFT

TEMPLATES ON THIS SIDE OF CENTERLINE USED FORWARD OF STATION E-E

HULL PAINTING SCHEDULE

Boot topping Red
 Stripe above boot topping White
 Hull above stripe (to paint line)..... Black
 Hull above paint line..... White

SUPERSTRUCTURE

Deckhouse sides White
 King posts, booms, spars, staffs, mast on stack Aluminum
 Breakwater and hatch coamings White
 Radar tower Aluminum
 Stack above band Blue
 Stack band White
 Stack below band (to paint line)..... Red
 Stack (paint line to deck)..... White

DECKS AND TOPS OF HOUSES

Upper deck Dark green
 Promenade deck, sun deck..... Dark green
 Hatch covers (forward) Light gray
 Hatch covers (aft)..... Dark green
 Top of forward deckhouses..... White
 Sun deck Dark green
 Sports deck Dark green
 Navigating bridge, wheelhouse, after-stack deckhouse, forward-stack deckhouse Dark green forward, aft white
 Wheelhouse top (aft of rail area)..... Dark green
 Wheelhouse top (within rail area) White
 Tops of houses White

FITTINGS AND MISCELLANEOUS

Rail (cap) Aluminum
 Rail and stanchions (other than cap)..... White
 Bitts Black
 Winches Medium gray
 Capstans Medium gray
 Anchors Black
 Lifeboats Aluminum
 Boat davits White
 Inclined ladders (stringers) White
 Inclined ladders (treads) Dark green

The monotonous, blank-wall effect of solid garage doors can be remedied easily, without cutting into the door itself, by attaching dummy windows similar to those shown in the illustrations. A frame to accommodate the simulated window sash is constructed from 1 x 2 stock, while the "panes" of the windows themselves are 1/8-in. hardboard framed in 3/4 x 1 1/4-in. pine, edged with a molding. To add a decorative note, 3/8-in. battens are used above the windows and at the sides. If the windows are to be set apart individually, imitation shutters may be included for a pleas-

Dummy Windows on Garage Doors Relieve Blank-Wall Effect

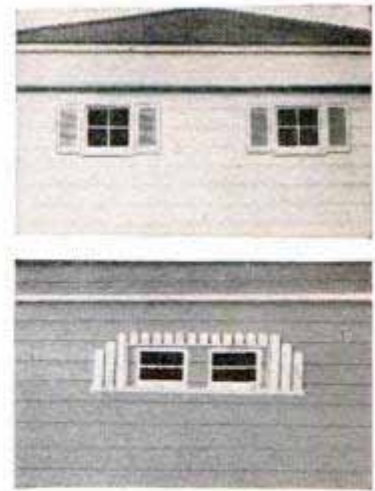
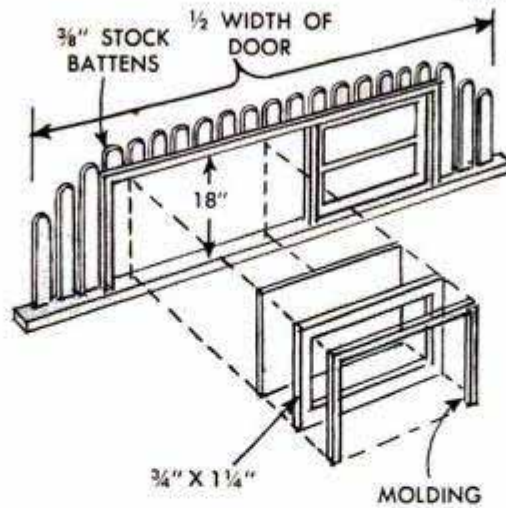

ing effect. If the windows are to be set apart individually, imitation shutters may be included for a pleas-

ing effect. If painted light blue and set in a white frame, the hardboard will suggest real glass.—Hi Sibley, Nuevo, Calif.

Method for Cutting Glass Produces Even Separation

Several years ago I cut glass by a method which usually resulted in the glass separating unevenly. After resting the glass on a smooth surface, I would place a straight-edge in position and score the glass, often going over it several times. I then would raise the glass and tap the underside along the scoring until it cracked. The disappointing results led me to order the glass cut where it was purchased—until a crafts-

man told me of the method he uses. Now, when ready to score the glass, I start the cutter at the far edge and draw it toward me in one, unhesitating stroke. I then raise the glass and tap the edge only where it is scored. As soon as the glass cracks slightly, I grasp it on both sides of the score and, by employing a slight twisting motion of the wrists, snap apart the two pieces.

Frank Vavrina, Washington, D. C.

Packaged Cereals Kept Crisp When Stored Near Hot-Water Heater



Owners of ranch homes and other dwellings which include utility rooms have an ideal means of keeping dry cereals crisp at all times. One homeowner simply hangs cereal packages over screw hooks on the inside of the door to the hot-water heater enclosure. Another method of hanging the packages is to use large paper clamps, one leg of which is screwed to the door or wall near the hot-water heater. Warm dry air that circulates in the heater compartment will keep the cereals dry and crisp.

Ed Packer, LaJolla, Calif.

Emergency Crimping of Stovepipe

When installing new stovepipe and later, when replacing worn gutters, I found that uncrimped scrap pieces could be salvaged by crimping them with a pair of needle-nose pliers. By alternately gripping and twisting the edge around the circumference of the pipe, the diameter can be reduced sufficiently to allow the end to be fitted into a mated piece.

William Bernard, Cincinnati, Ohio.

Gymnasium Locker Laid on Side Provides Workshop Storage Bin

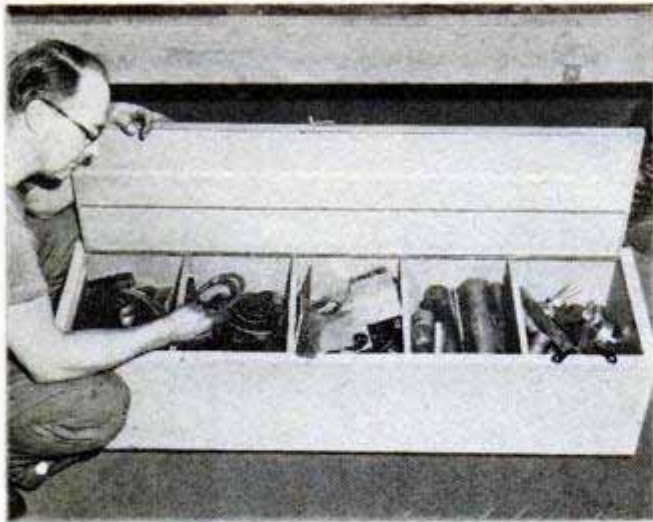

Laid on its side as shown, a gymnasium locker provides L. V. Grover of Los Angeles, Calif., with a handy bin in which metal parts and leftover materials are stored. The original shelves, which serve to divide the bin into compartments, were left intact, although one or two may be removed to form larger compartments if necessary. Casters were fitted to the underside of the box so it can be rolled under a workbench out of the way.

Tom E. Stimson, Jr., Santa Monica, Calif.

Bench Saw Pinch-Hits as "Jointer"

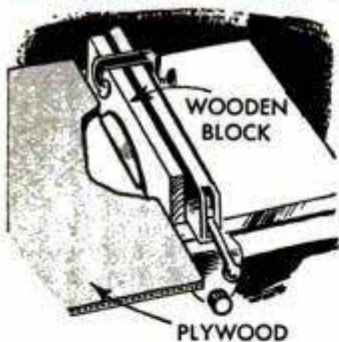

If you don't have a jointer and are confronted with the task of edge-planing plywood panels, a slotted block, employed as a depth stop will permit your bench saw to do the job. As shown in the

sketch, a block of $\frac{3}{4}$ -in. stock is trimmed to height of the saw fence. Then, using the fence as a guide, the block is lowered onto the saw blade to cut an arc one half the thickness of the blade in the side of the block. The block is clamped to the saw

That finishing touch . . .

You can give many woodworking projects a distinctive "old craftsman" appearance by chip-carving them with a neat, geometric design. Chip carving produces beautiful results, yet it's one of the easiest forms of wood carving. The requirements are simple: two homemade knives and a small package of patience. Next month's issue will contain a fully illustrated feature on chip carving—how to make the tools, lay out and chip away the design, and finish the wood. Don't miss it.

fence after which the edge of the plywood is guided along the block. This allows a skimming cut to be made by the exposed portion of the blade.

Rewire Ornamental Lamps Easily

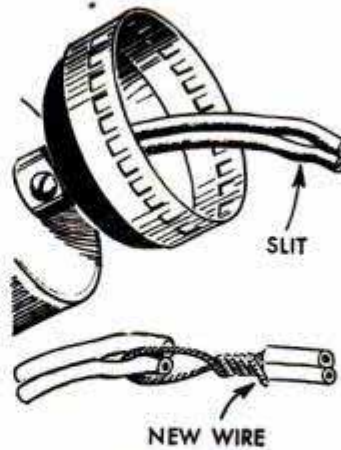

An ornamental table or floor lamp can be rewired quickly by using the old wire to pull the new wire through the base and socket. Pull up enough of the old wire to trim it off and cut a slit between the two wires about $\frac{1}{2}$ in. from the end. Bare

about 2 in. of the new wire and taper the insulation down to the wire. Twist the bared wire tightly, pass it through the slit in the old wire and fasten it securely in a loop. By pulling on the old wire at the lamp base, the new wire will follow through without catching.

J. L. McClay, Pasadena, Calif.

Rubber Tip Checks Sliding Umbrella

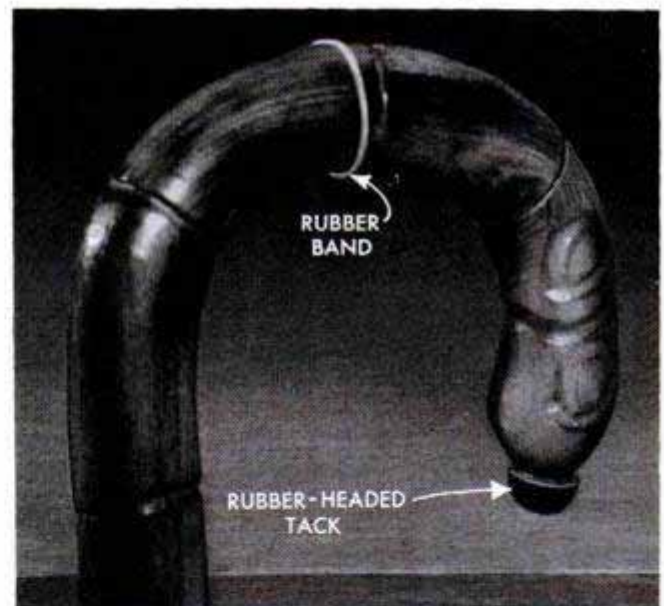

A rubber-headed tack driven into the end of the curved handle will help prevent an umbrella or cane hung on the edge of a table or chest from slipping off. Likewise, the addition of a small rubber band around the handle will keep an umbrella or cane from sliding off the rounded back of a chair.

☐ Holes or short tears in canvas may be repaired by using rubber cement to apply patching material. Weight the patch for several hours to be sure that it adheres.



This Plywood **WARDROBE**

"grows" with child

By Charles and Bertram Brownold

HERE'S AN attractive wardrobe that your child can use from the time she is old enough to hang up her own clothes until she is a young lady. The clothes-pole section of the wardrobe is expanded to suit the height of the youngster by raising the storage shelf and the attached clothes pole along with it. Five $\frac{1}{2}$ -in.-sq. cleats are screwed to each side of the cabinet so that the shelf may be raised in stages from a height of $2\frac{1}{2}$ or 3 ft. to a point which utilizes the full height of the cabinet for hanging clothes.

The appeal of the wardrobe to the youngster is enhanced by a blackboard mounted on the face of the double doors, and appropriate decoration may be added by fastening jigsawed letters and numerals to the doors, as shown in the upper right-hand photo. If desired, decals may be substituted for the jigsawed overlays or the doors left plain. The decoration can be changed easily to suit the varying interests of the child through the years.

The wardrobe is made primarily of plywood, as in the detail on the following page, although hardboard may be substituted for the door, back and top panels. The $\frac{5}{8}$ -in. plywood sides and the $\frac{1}{4}$ -in. back panel extend 1 in. below the top edge of the scrolled base. Top and bottom front rails consist of two lengths of $\frac{1}{4}$ -in. plywood, which are glued together as in the sectional details, or single lengths of $\frac{1}{2}$ -in. plywood rabbeted as indicated. The $\frac{5}{8}$ -in. bottom panel rests on cleats screwed to the inside of the base so that the top of the panel is flush with the top edge of the front rail. Corners of the base rails should be mitered if you intend to stain or varnish the wood. However, if the finished cabinet is to be painted, butt joints may be used, filling them with wood putty and sanding before painting.

The door panels are mounted on frames of $\frac{1}{4} \times \frac{3}{4}$ -in. stock. Note how the frames are positioned so that the double doors overlap when closed. The frames serve as dust stops at the top, bottom and center of the doors, and dust stops may be provided along the side of each door by tacking felt weather stripping to the edge of the side

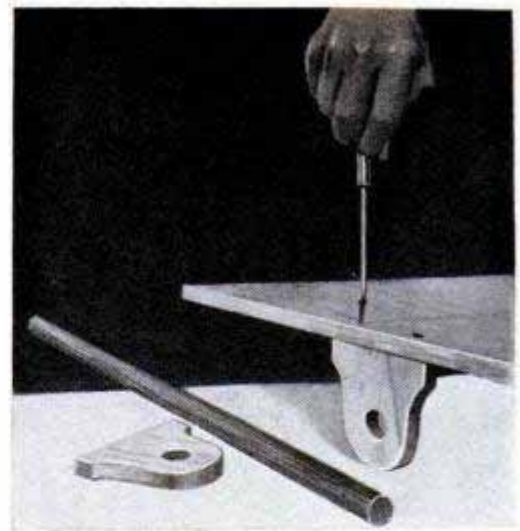
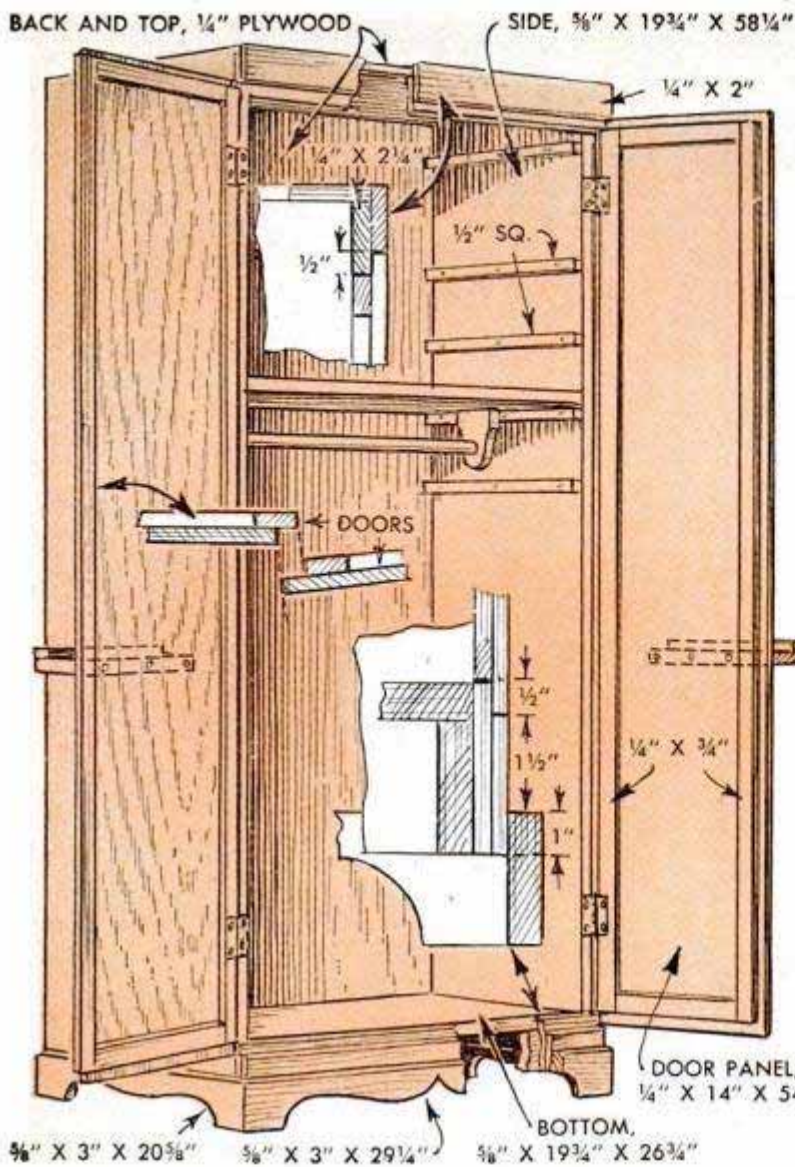

Clothes-pole brackets are screwed to underside of shelf, above. Jigsawed letters, below, decorate doors of wardrobe



panel. Cut away the felt over the hinges so it does not keep them from closing. The two door handles double as a blackboard rail when the door is closed.

A plywood or hardboard blackboard can be made in one piece, set on the combination rail-handle and lifted off when the doors are to be opened. Or, it may be made in two pieces and fastened permanently to the doors. Cover the board with blackboard paint or three coats of flat-black wall paint. If you wish, a blackboard or slate of suitable size can be purchased, and its wooden frame painted to match the ward-

robe or the decorative jigsawed overlays.

Wooden clothes-pole brackets are fastened to the underside of the shelf as in the upper right-hand photo. These are located just far enough from the edges of the shelf to clear the cleats on the sides of the cabinet. Before obtaining a length of dowel for the clothes pole and drilling the holes in the brackets, check the hangers used for the child's garments to be sure that the diameter of the dowel is not too large for the hangers. The brackets may be redrilled to take a heavier dowel when the weight of the clothing makes this necessary. ★ ★ ★

Cleaning and Handling of Plastics Important to Final Appearance

When making articles of acrylic plastic, you can enhance their natural beauty by cleaning and handling them properly. These plastics are covered with a masking paper when purchased and, to prevent excessive scratching of the surface while working, this masking should not be removed until the last possible moment. When the masking is removed an electrostatic charge which attracts dust is built up on the surface of the plastic. This charge

can be removed by wiping the plastic with a damp chamois. However, don't use a dry cloth as this will increase the charge. To wash a plastic surface, use soap and water and a grit-free chamois or sponge. Remove grease and oil with kerosene or white gasoline but don't use ethyl gasoline, lacquer thinner or carbon tetrachloride as these will soften the surface. Next apply wax to cover minor scratches and buff with a soft, dry cloth.—H. Suter, Daytona Beach, Fla.

By rounding the face of molding and then burning it at 3-in. intervals to represent joints, one craftsman produced "bamboo" picture-frame molding that closely resembles the real thing. Finished with light maple stain, the scorched grooves make the deception nearly perfect. The "branding iron" consists of a stiff wire shaped to fit over the molding, but formed slightly narrower. The wire is heated red hot and pressed against the wood to burn a shallow groove on three sides. The frames may be finished with either a coat of flat-

Imitation Bamboo Picture-Frame Molding Formed by Burning Wood With Hot Wire

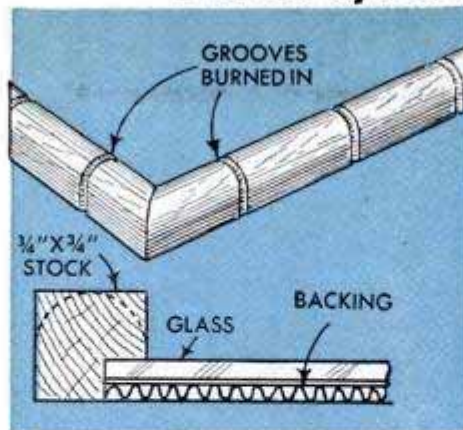

drying varnish or clear shellac that is rubbed with fine steel wool and then waxed.

C. E. Verrill, Pasadena, Calif.

Spring Contacts on Voltmeter Speed Testing of Dry Cells



By adding two spring-brass strips to the terminals of a small voltmeter, you can use it for instant checking of dry cells without using lead wires or prods. A hole is drilled near the end of each strip for bolting to the meter terminals and the ends of the strips are bent at right angles in order to contact the top and bottom of a standard flashlight cell. Cells will be easier to insert if ends of the strips are bent up slightly with a pliers. Smaller cells can be tested by squeezing the strips between the thumb and forefinger to make the contact. Large dry cells which have both posts on the top also can be tested in this manner.

Folding Ironing Board for Travel Can Be Packed in Suitcase

Small enough to go into a suitcase, yet strong enough for all ironing needs, this ironing board makes a good traveling companion. The board is $\frac{3}{4}$ -in. marine plywood, 10 x 24 in. The corners of the board are rounded, and one end is tapered to 5 in. For steadiness, the 4-in. high legs are the full length of the board. To allow garments to slide over the board, the legs are cut in an anvil shape. The cutback from the narrow end of the board is 10 in., but from the rear is only $5\frac{1}{2}$ in. The legs are hinged to the board so there is a $\frac{3}{8}$ -in. gap between them when they lie flat, to allow storage space for a spreader used to hold the legs of the board in the open position. The spreader is a 9-in. metal rod with a $\frac{1}{2}$ -in. right-angle bend at each end, and is inserted in holes drilled 2 in. from the front of each leg. When the board is folded, the ends of the spreader are inserted in holes in the underside of one leg. A pad on top of the board is covered with cloth that is tacked in place.—Ed. Packer, Chicago.

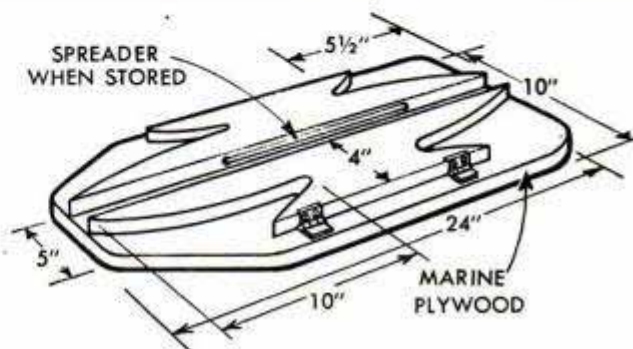
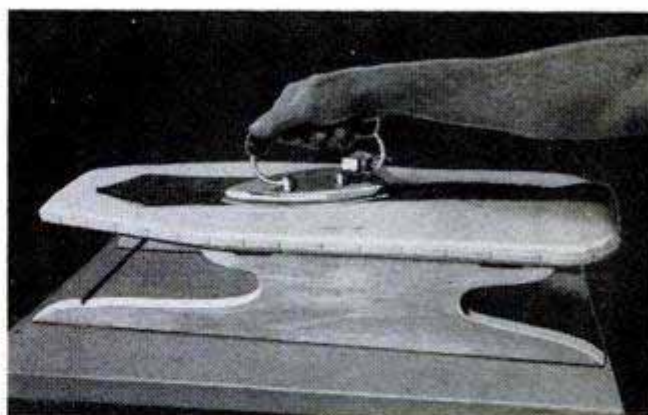

Rings and Bull's-Eye on Paper Plate Provide Easy-to-Make Target



The backs of paper plates will make ideal targets for air-rifle practice, since no backing is required as there is with paper targets. Simply draw the rings and bull's-eye on the bottom of the plate and nail to a tree or building as shown.

Safety Latch for Suitcase

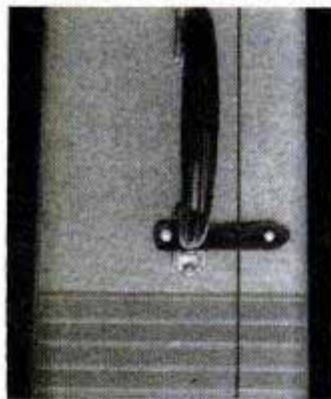

Your suitcase or overnight bag will not fall open unexpectedly if you equip it with the simple leather catch shown in the photo. The catch is a 3-in. strap cut from an old belt or a woman's shoe and punched at both ends. Attach

the strap to the body of the suitcase with a roundhead machine screw and nut, and then set a similar bolt in the suitcase lid with two nuts, one on the inside and the other on the outside of the lid. Slip the end of the strap over the bolt head to lock the case. It may be necessary to slit the strap at the hole to accommodate the head.

Mrs. T. F. Watts, Charlotte, N. C.

Extending Auto-Battery Life

Automobile-battery life can be extended considerably if the battery is cleaned and refinished every six months. Remove the battery from the car and plug the small vents in the caps with match stems. Then thoroughly wash the entire casing. If corrosion is difficult to remove, use a soda-water solution to clean it. After this clean-

ing, any small cracks such as those frequently caused by overtightening of the mounting bolts will be discernible. Mend them by applying a soldering iron to the cracked area until sufficient melting of the hard-rubber casing occurs to fill the crack. Finally, coat the casing with rubber paint of the type used on tires. The battery will look like new and unnecessary damage by corrosion to both the battery and battery cables will be avoided.

Jack Ray, Los Alamos, N. Mex.

Tiny Ladle Used in Modelmaking Made From Thimble and Wire

Finding an ordinary ladle too large for pouring lead into small castings, one modelmaker used a thimble and a short piece of stiff wire to make a tiny ladle suitable for the purpose. After the rim was crimped to form a pouring spout, a hole was drilled in one side of the thimble to take the end of the wire handle. To anchor the wire in the hole, a short tenon was filed on the end of the wire to permit peening it over on the inside of the thimble.—Lewis Booker, Louisville, Ky.

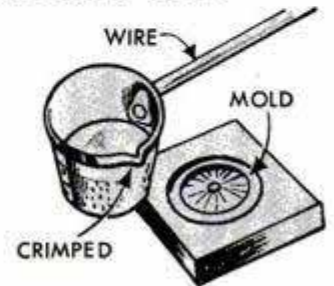

Talcum Powder Applied to Glass Furnishes "Bite" When Marking

When using a grease-type marking pencil such as the type designed for writing on glass or other slick surfaces, it sometimes is almost impossible to make a mark on some jars or bottles, even when they have been washed with soap and water. A simple trick for overcoming this condition is to dust a little talcum powder on the glass. One or two applications will supply sufficient abrasive on the glass to assure positive results with the most detailed markings.



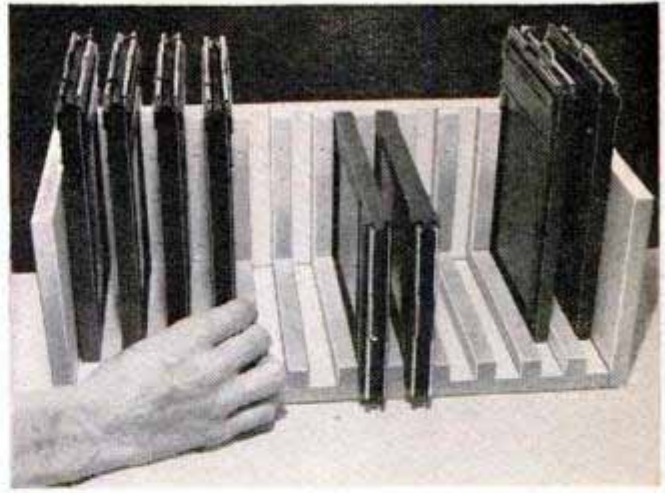
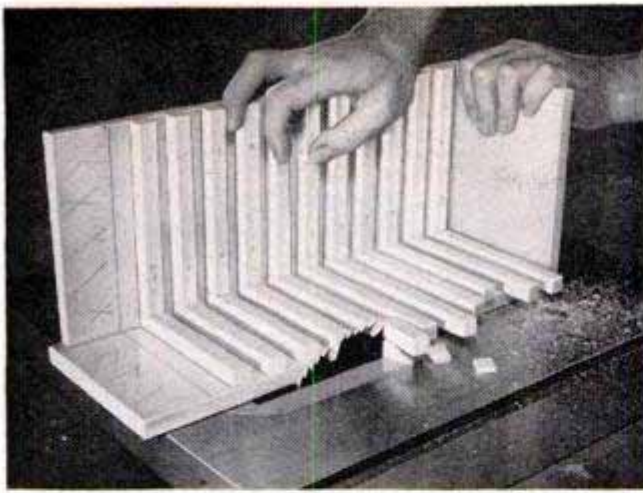

STORAGE RACK

FOR CUT-FILM HOLDERS

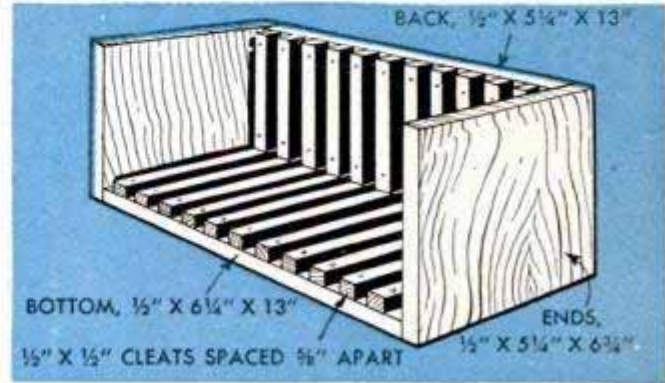

The problem of keeping track of cut-film holders, as well as that of storing them, was solved easily for one photographer by the construction of a rack from scrap $\frac{1}{2}$ -in. stock. The rack, which is nothing more than a box lacking the top and one side, is fitted with cleats spaced $\frac{5}{8}$ in. apart. Ends of the side and bottom originally are cut longer than is required to simplify finishing the last slot accurately. After the box is assembled with glue and nails, $\frac{1}{2} \times \frac{1}{2}$ -in. cleats are nailed to the side and bottom,

using a spacer $\frac{5}{8}$ in. wide. The cleats, also cut slightly longer than required, are later trimmed evenly on a power saw in the manner shown. Following this, the side and bottom are trimmed and the remaining end attached. In use, loaded 4 x 5 holders are placed in the left side of the rack, while empty ones are stored in the center. Holders containing exposed film may be placed upright in the right side of the rack as indicated in upper right-hand photo.

Walter Haase, Hartford, Conn.

Inexpensive Winder Speeds Loading of Film-Cartridge Reel

This simply constructed 35-mm. bulk-film winder, for use either in a darkroom or inside a changing bag, can be made inexpensively in practically any home workshop. Made from $\frac{3}{4}$ -in. stock, the base is slotted to form two 3-in. prongs, each of which is drilled in the center to take a $\frac{3}{8}$ -in. dowel. A small piece of sheet metal, drilled near one end and slotted at the other as shown, is bent to hold the reel from a film cartridge and attached to the base with screws.—John J. Rea, Urbana, Ill.

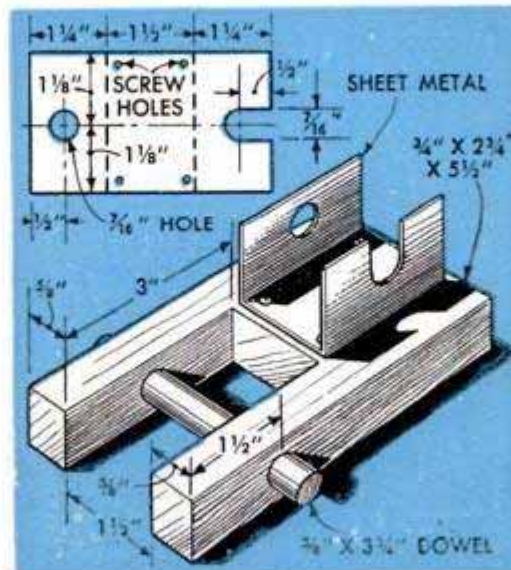

In use, roll of film is placed between prongs of the base and a dowel inserted to hold in place. Film is engaged in reel slot and wound with right hand. Single notch cut in rim of reel permits counting each turn

TEST LINE KEEPS FLASH GUNS FIRING

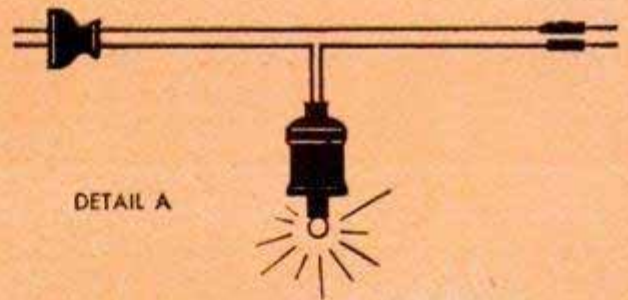
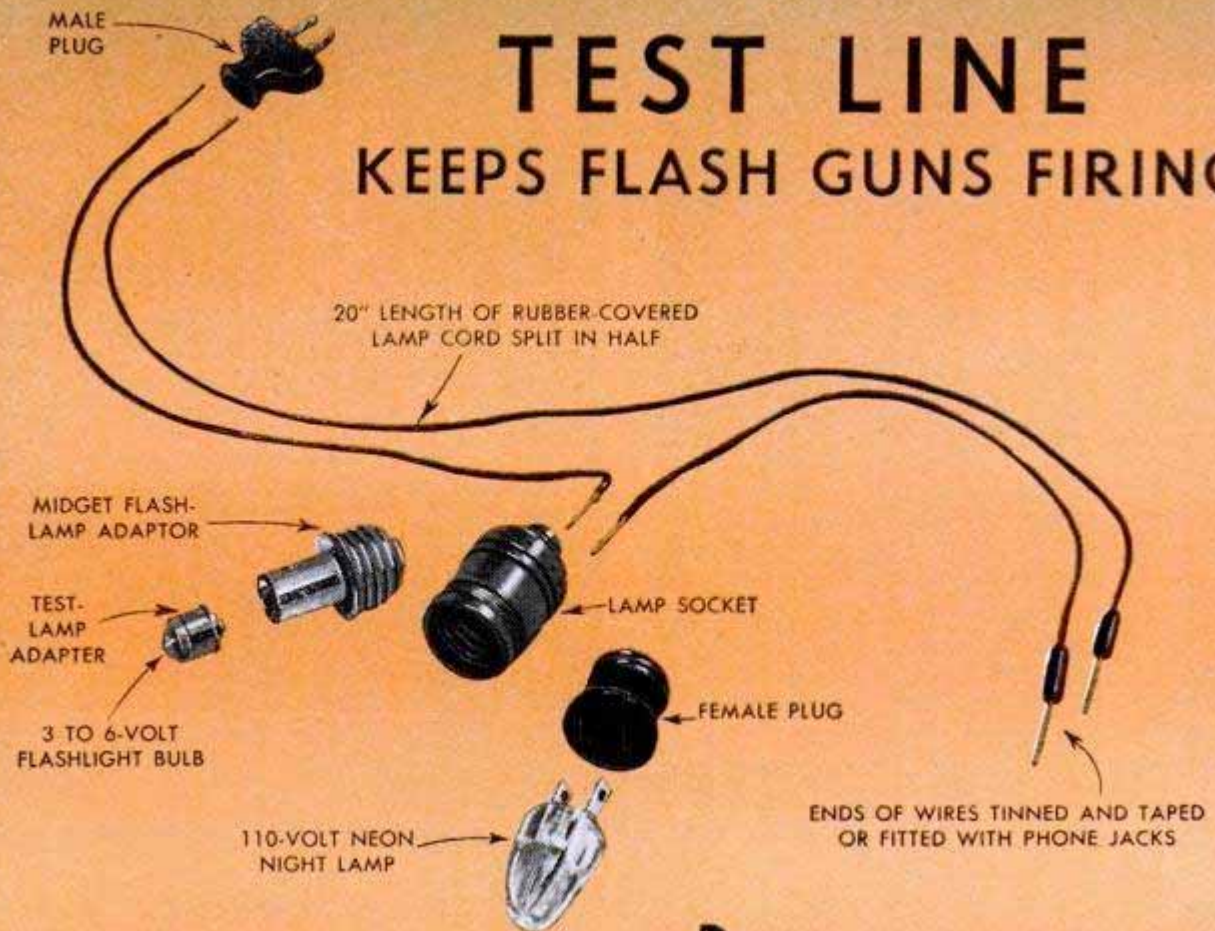

By Frank P. Fritz

ALTHOUGH a good photographer tests all of his equipment before leaving home, trouble may occur on the job. This simple "series" test cord, with essential accessories, will locate quickly circuit breaks and point out flash failures. All the necessary parts to assemble the test cord, as well as the method of assembly, are indicated in the diagram above. Series wiring means that all elements in the circuit must be connected to complete the cycle of current. Thus, in detail A above, when the test cord is plugged in, the phone jacks would have to touch, completing the circuit, before the test lamp would light. The methods of trouble shooting with this test line are described in the photo captions. Note also that flash-bulb cord polarity may be tested with this.

To test flash-gun switch and flash socket, insert test lamp in gun and push button. If the test lamp lights, that portion of the gun is good. Then test sockets on the side of the gun, as they may be bad



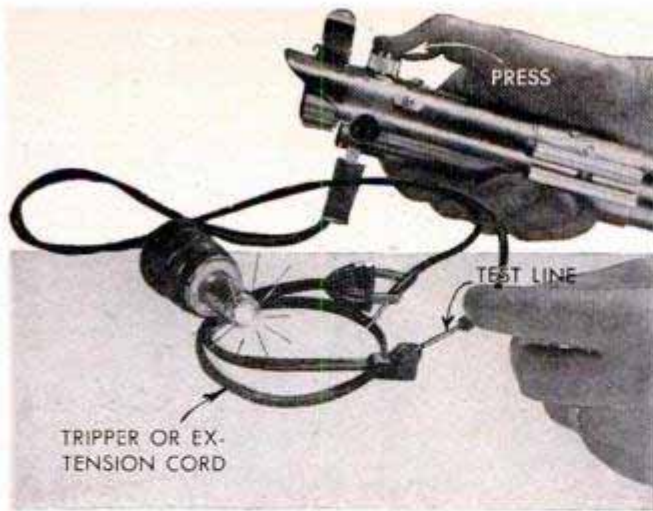

To test cords, tripper, side light and extension, insert male plug in flash-gun socket. Insert bare wire in one side of cord plug, touch other end of cord with other bare wire. If lamp does not light, touch other side of plug. If lamp lights, that side of line is good. Test other side of cord in same fashion

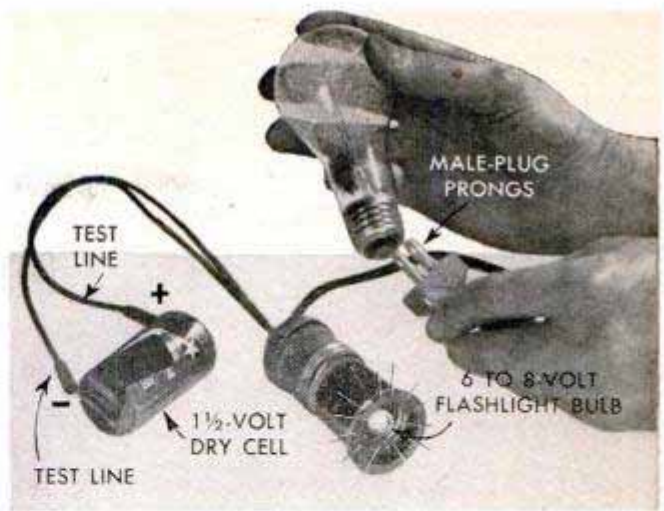

To test flash bulbs, fasten test cord to plus and minus ends of a flashlight dry cell. Touch prongs of male plug to base of flash bulb so that one prong touches base and other touches side of base. If test lamp lights, flash bulb is good. Do not test the flash bulbs on a 110-volt current as they will flash

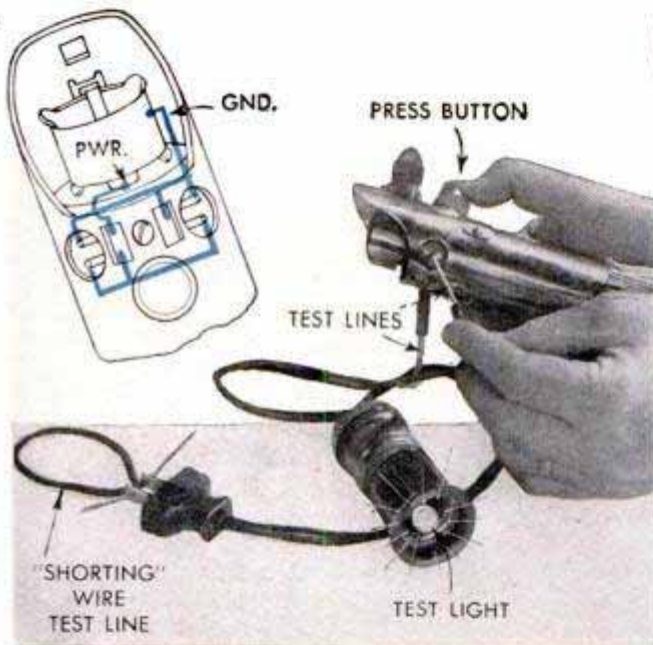

To test flash-gun sockets, connect prongs of male plug with short wire. Insert test wire in one side of plug receptacle on flash gun. With other test wire, touch bottom prongs of sockets. If test lamp lights, connections are good. Repeat test, using other plug receptacle and top prongs of flash-gun sockets



To test side lights, insert male plug in power on flash gun. Insert one test wire in socket receptacle and touch bottom socket prongs with other wire, touching flash-gun button to apply power. Lighted test lamp indicates good connections. Move test wire to opposite receptacle to test top prongs of sockets

Toning Down Scratches and Abrasions on Old Negatives

The use of oil from the human skin for toning down fine scratches and abrasions on old negatives is a common practice among professional photo finishers. Unlike petroleum jelly, which often proves sticky and difficult to handle, oil obtained by rubbing the finger across the forehead, nostrils, or bridge of the nose is so fine that it is barely visible and will not pick up lint as do heavier oils. It is applied directly to the negative with the finger in a brisk rubbing motion across the abrasion. In those cases

where it is necessary to use petroleum jelly, the jelly should be applied and removed with lens-cleansing tissues. The tissues are more absorbent than cloth and will leave less lint. In removing the jelly from the negative, wipe off as much as possible to eliminate any stickiness.

Robert Florian, Chicago.

☐ To simplify changing of storm and screen doors, replace regular hinge pins with pins having an eye formed in the upper end.

"Deckle" Edges for Snapshots

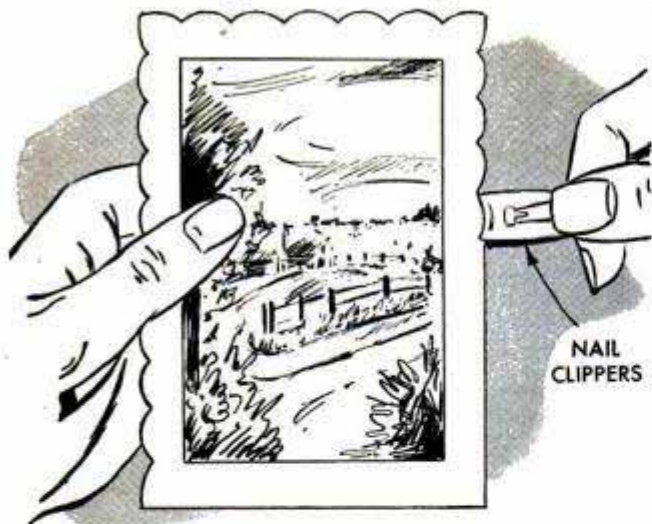

Here's a simple, quick way to give snapshots attractive scalloped edges similar to those provided by a professional photo finisher. Ordinary fingernail clippers, used in

the manner illustrated, is all that is necessary to do the job.

George Kapitan, New York City.

Spreader Tightens Clamp-On Lamps

The clamp-on type of photoflood lamp is often found to be weak in spring pressure so that it does not clamp securely. To exert extra clamping pressure, notch a small strip of wood or plastic to fit over the widest part of the wire arms.



By forcing this strip toward the narrow end, outward pressure is exerted on the arms to bring additional clamping pressure on the jaws. Friction holds the strip in place.

Popular Mechanics Bookshop

"What Can I Make, Dad?"

That's a question every father has heard hundreds of times. Too often it's left unanswered. A man leans over his bench, intent on a project, while a boy stands at his side begging for something to do with his own inexperienced hands. For 40 years *The Boy Mechanic* has been the standard handbook for young craftsman. Now it's available in a completely new edition that contains 500 fascinating projects, 500 answers to that old question, "What can I make, Dad?" *The Boy Mechanic*, by the editors of *Popular Mechanics*, tells in easy-to-read instructions, photos, diagrams and drawings how to make all kinds of things. Here's a fine, practical introduction to almost any hobby—chemistry and metalwork, engineering and carpentry, archery and carving. Price is \$2.95 from Popular Mechanics Press, 208 E. Ontario St., Chicago 11.

Adventure!

There's real excitement in the parade of American history—especially when it's told in terms of prairie schooners and canal boats, stagecoaches and balloon ascensions. You'll live the adventures of all kinds of fascinating people from the Daniel Boone trail blazers to the pioneers of jet transportation in *Popular Mechanics Picture History of American Transportation*. Here's a book that traces the movement of our people down the first Indian trails, along the waterways and across the prairies in a long train of Conestoga wagons. You'll find some humorous memories of local transportation

—cable cars, horse-drawn streetcars and early subway systems. You'll ride the trains of America, from the little wood-burning Tom Thumb of 1830 to the streamlined giants of tomorrow. You'll drive the Duryea brothers' first horseless carriage and join the parade of American automobiles. And you'll watch the development of American aviation, from the time George Washington watched a balloon ascension in 1793 to the road of a modern jet plane. Here are 320 pages of American history told in exciting text and more than 100 photographs, drawings and diagrams. The price is \$5.00 from Popular Mechanics Press, 208 E. Ontario St., Chicago 11.

A Time of Magic

Christmas is the excitement of youngsters hanging up their stockings, the warm memories of an old-timer, the wrapping of secret workshop projects. It's the spicy smell of fruit cake and the stickiness of popcorn balls. It's hanging your heart on an evergreen tree along with all the decorations saved from other years. You'll find thrilling fun for all the family in *Popular Mechanics Christmas Handbook*. Here are gift projects for everyone, decoration ideas for holiday hostesses, instructions for making beautiful greeting cards and advice on selecting and decorating your Christmas tree. It's time now to start planning your holiday season, and here's a book you'll use for many years. Clothbound, it's only \$2.00 from Popular Mechanics Press, 208 E. Ontario St., Chicago 11.

All books available from Popular Mechanics Book Department, 208 E. Ontario St., Chicago 11

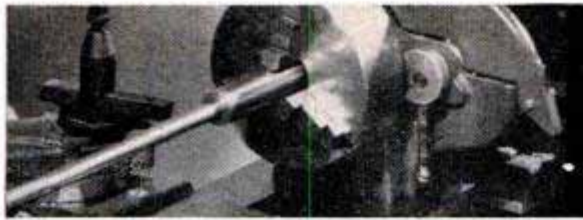

SHOP NOTES

Direct-Drive BELT SANDER

By Hugh Smiley, Jr.

FOR LITTLE more than the cost of a motor, you can have a direct-drive belt sander that is especially designed for freehand sanding. It will smooth and polish irregularly shaped pieces in a fraction of the time required to finish them by hand. A $\frac{1}{8}$ or $\frac{1}{4}$ -hp., 1750-r.p.m. motor is adapted to support a column and base by replacing the top housing bolts with longer ones that will extend about 2 in. beyond the motor housing. The base is drilled to fit over the ends of the two bolts, spacers being used to hold the base away from the housing. Nuts are turned on both bolts to bear tightly against the motor frame inside the end bell to relieve undue strain on the housing.

After the base is mounted on the motor, make the head-assembly plate, spring arm and offset idler-pulley shaft as in the detail on the following page. Then fasten the head assembly to the upper end of the column with socket-head setscrews. Don't weld the column to base plate until pulleys have been made and can be temporarily set up to check alignment.

The pulleys are made of fine-grained hardwood, and can be given a "factory" finish by cementing a thin aluminum disk to each face. Note in the detail

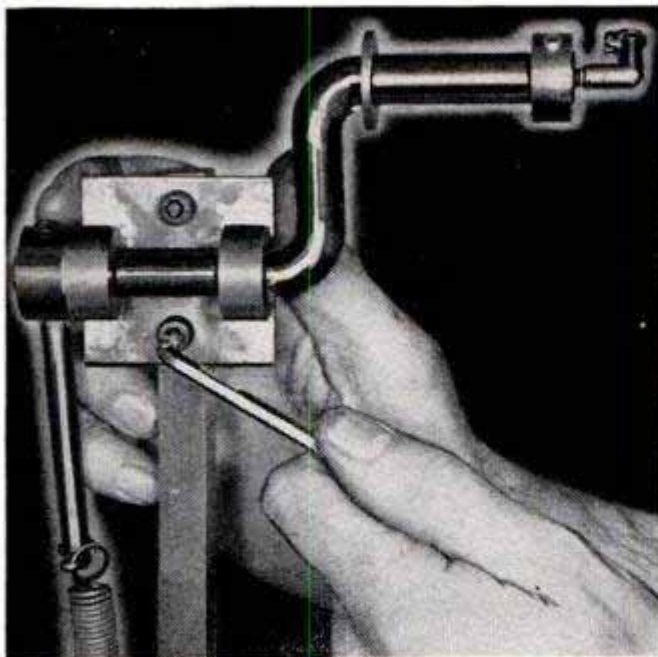

Head assembly is attached to top of the column with socket-head setscrews. Note oil cup at end of shaft

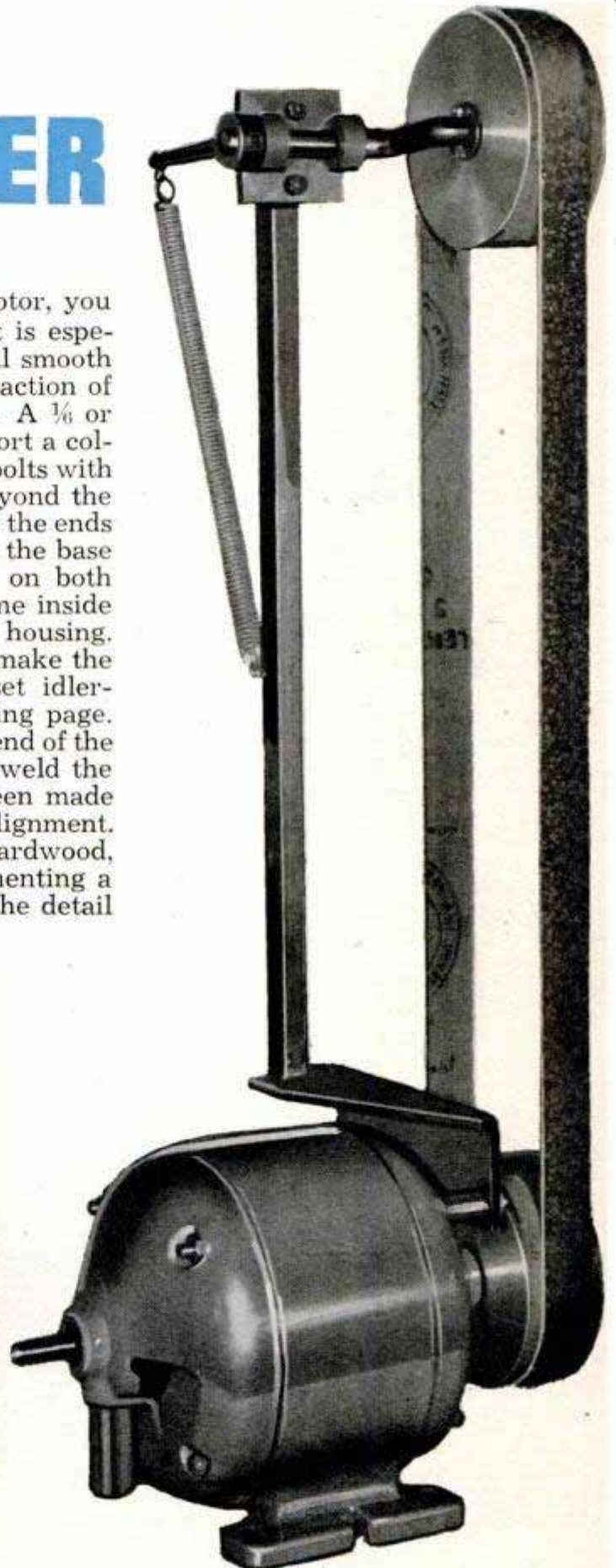

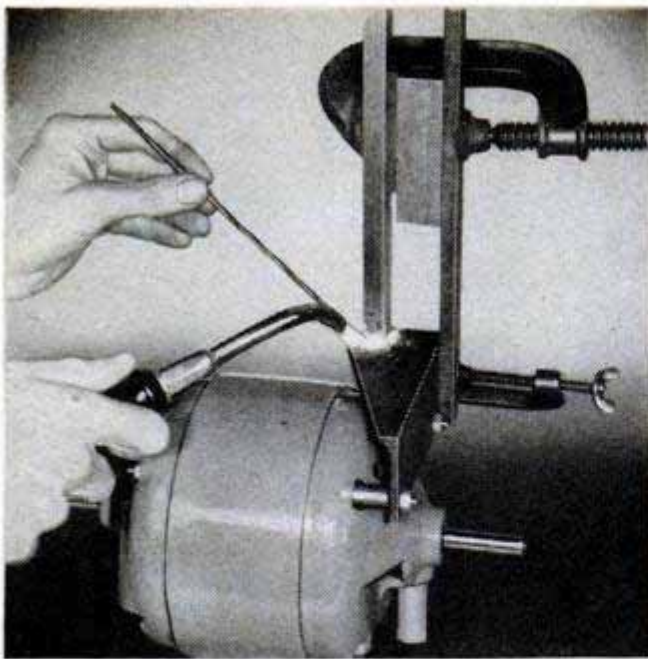

Column is held in position for welding by clamping to temporary vertical support and required spacers

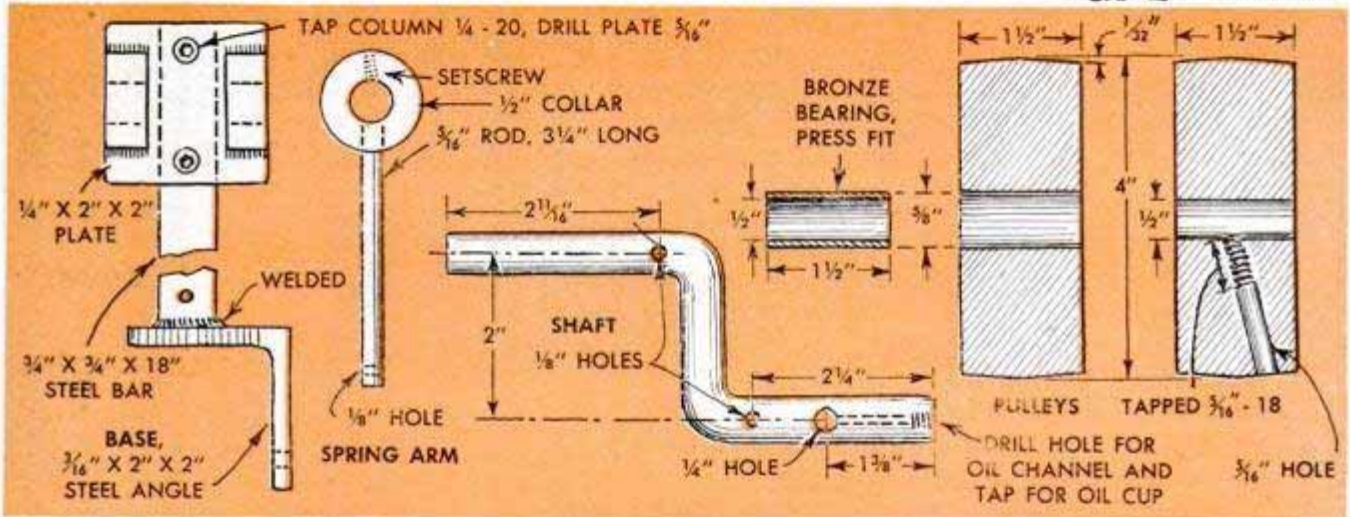
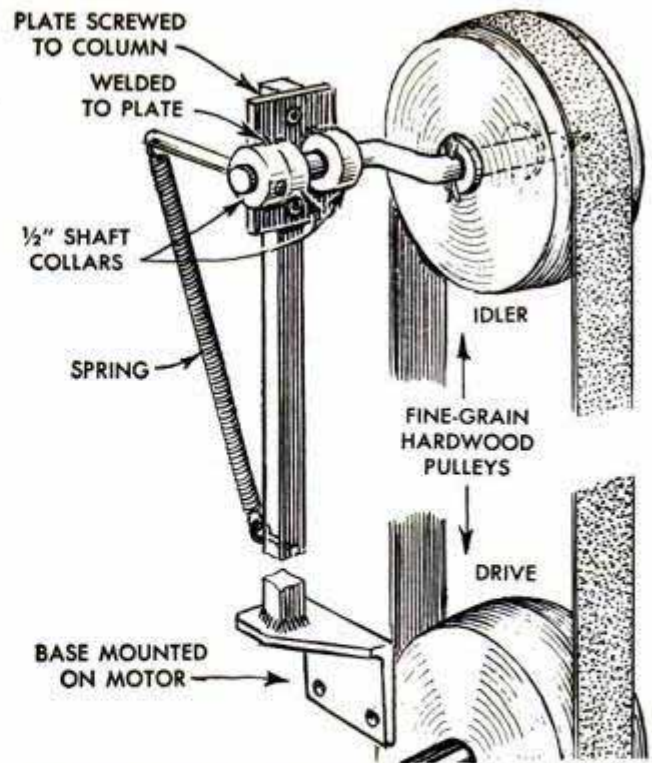

how the pulleys are crowned $\frac{1}{32}$ in. to keep the belt running in the center of the pulleys. The idler pulley is fitted with a bronze bearing and the driving pulley is locked to the motor shaft with a socket-head setscrew. In the latter case, the setscrew is turned into an undersize hole drilled at an angle in the pulley.

Before permanently mounting the idler pulley, insert a $1\frac{1}{8}$ -in. piece of pipe cleaner into the oilhole drilled and tapped in the end of the shaft. Pack the intersecting $\frac{1}{4}$ -in. hole with felt, and keep the felt pressed in place until the pulley is slid over it. Screw a small oil cup into the tapped hole and fill with SAE 20 oil.

The sanding belts are made from 1-in. cloth-backed abrasive belting. The belting is cut diagonally so that the splice is at an angle of 45 deg. or more. Allow a $\frac{1}{4}$ -in. overlap and, before cementing the ends of the belt together, scrape all abrasive material from the lapped portion of the belting to obtain a smooth joint.

With enough spring tension to keep the belt from slipping, turn the motor by hand to see if the belt runs in the center of the pulleys. If not, the pulley alignment can be corrected by shimming either side of the base plate with thin washers or by cutting down the length of one or both of the spacers. Spring tension is adjusted by loosening the spring-arm setscrew and moving the arm in relation to the offset section of the shaft. ★ ★ ★

Treatment for Scuffed Suede Gives Shoes New Look

After suede shoes become scuffed and old looking, they can be given new life by rubbing them with a clean cloth dipped in vinegar. Rub the scuffed parts especially well. Allow the shoe to dry thoroughly, then brush vigorously with a suede brush. As a result of this treatment, the scuffed places will disappear and the shoes once again will look like new.

Slotted Block Aligns Stock on Circular Saw

Every craftsman is aware of the difficulty and uncertainty of aligning a pencil mark on wide stock with either the side or center of a circular-saw blade. This guide block assures an accurate cut every time. Place the block against the end of the crosscut guide which is nearest the saw blade. Holding the block tightly against the guide, run it into the saw blade until the cut is about $\frac{1}{2}$ in. deep. To use, pencil the dimension line on the stock, place the piece against the crosscut guide and bring up the block against the end of the guide as pictured. Then align the pencil mark with either the center or the side of the slot in the block. In some cases it will be more convenient to align the mark with the side of the slot rather than attempt to center it.

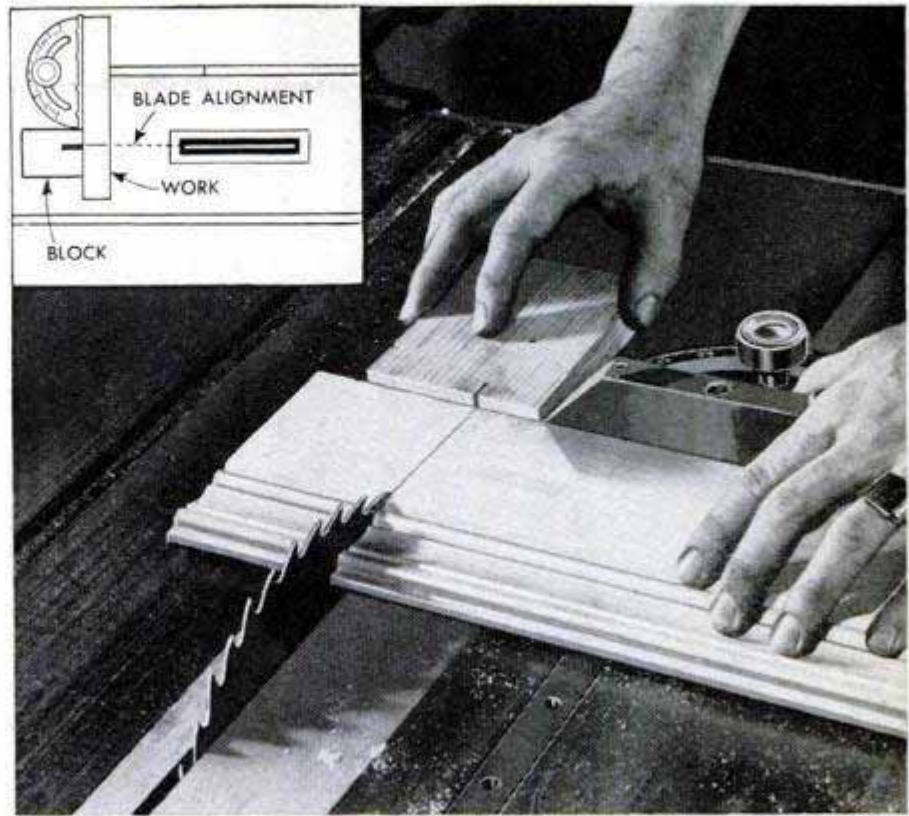

Make the cut as illustrated and the piece will be the length required.
Mrs. Carolyn Clark, Chicago.

Jar Covers and Wood From Crate Used to Make Letter Scales

Having an occasional need for a letter scale, I made one from two fruit-jar covers and a few pieces of scrap wood. After a piece had been cut to serve as a base, two short pieces were nailed upright near the ends to provide stops, while a slightly long-

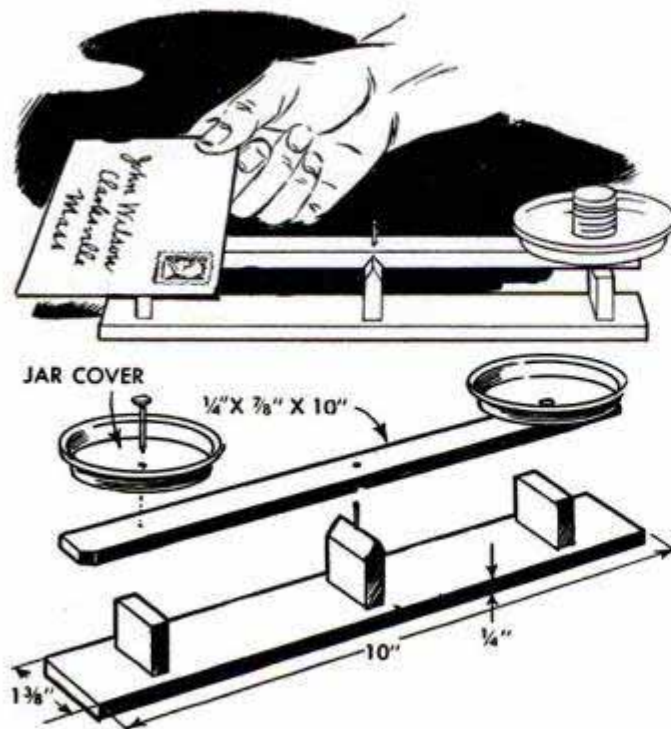

er one was nailed in the center of the base. The longer piece was beveled on top to form a pivot for the balancing bar, with a brad driven in the edge as shown. I made the bar narrower than the base and, after nailing the lids to the ends, measured the piece carefully to determine the exact center. I then cut a shallow groove across the underside of the bar at the center point and drilled a small hole through the center of the groove so the bar could be slipped over the brad. Copper pennies, weighing about $\frac{1}{8}$ oz., or eight to the ounce, are used in place of regular weights. It was discovered later that the scale also is handy for weighing cooking ingredients.

P. Casperson, El Cajon, Calif.

Felt Dauber Applies Layout Ink

When cleaned thoroughly, the felt dauber from a discarded liquid-shoe-polish bottle will come in handy for applying layout ink used in engraving plants and machine shops more smoothly than the ordinary inking brush. In addition, the polish bottle is a good container for the fast-drying ink, since the wooden stopper effectively prevents evaporation.

L. E. Fannon, Huntington Park, Calif.

A 1/4-in. plywood back is attached with screws. The cabinet is hung with two loose-pin butt hinges so that it may be removed from the wall if necessary. Next a length of 1/4-in. pipe is cut to fit between the top and bottom members of the cabinet. The ends are threaded for flanges. Then six lengths are cut from 1/4-in. pipe and the ends threaded. One end of each is fitted with a cap and each cap is drilled and fitted with a bullet-type catch as in the detail. Next, six pipe tees are reamed so that they slide over the pipe column and the arms are screwed into the tees. Now, with six collars of a size to fit over the pipe column you're ready to assemble the unit. First, screw a flange onto one end of the column and tighten it, then slide one of the arms over the column and follow with a collar. Proceed in the same manner with the remaining five arms. Note that each collar has a setscrew and can be locked at any point on the column. Screw on the other flange and mount in wall cabinet. When mounting be sure that bullet catches engage the cover piece with sufficient friction to hold arms in place. ★ ★ ★

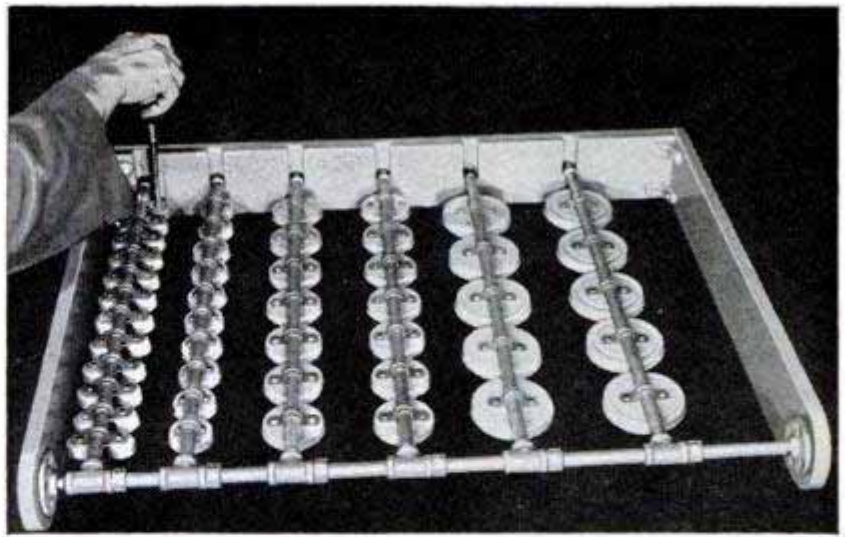

Covers of the glass jars are attached to the pipe arms with pipe hangers. Conduit hangers serve for the smaller jars. Note how free ends of arms enter slots cut in end piece of the hanging cabinet

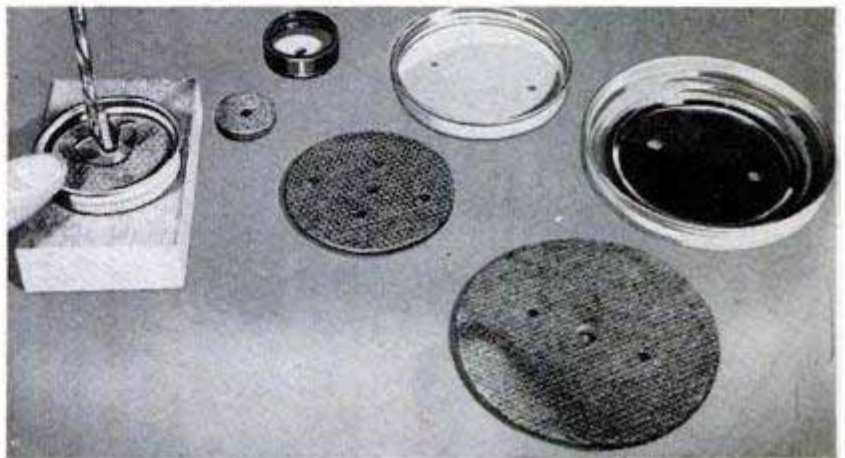

Covers of glass jars are reinforced with disks cut from hard-pressed board. Holes for the stove bolts holding the covers to the hangers are drilled accurately in the simple jig shown at the left in the photo

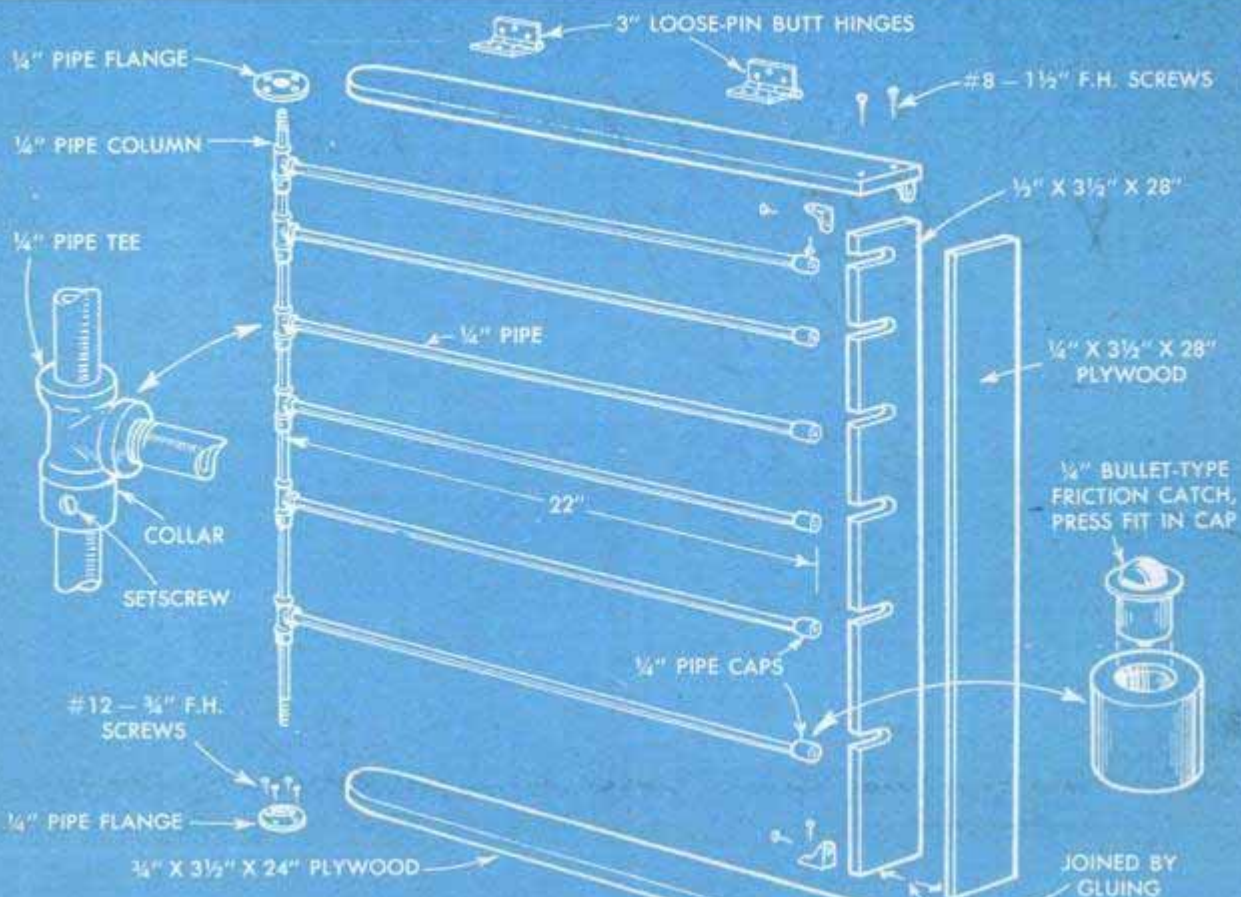

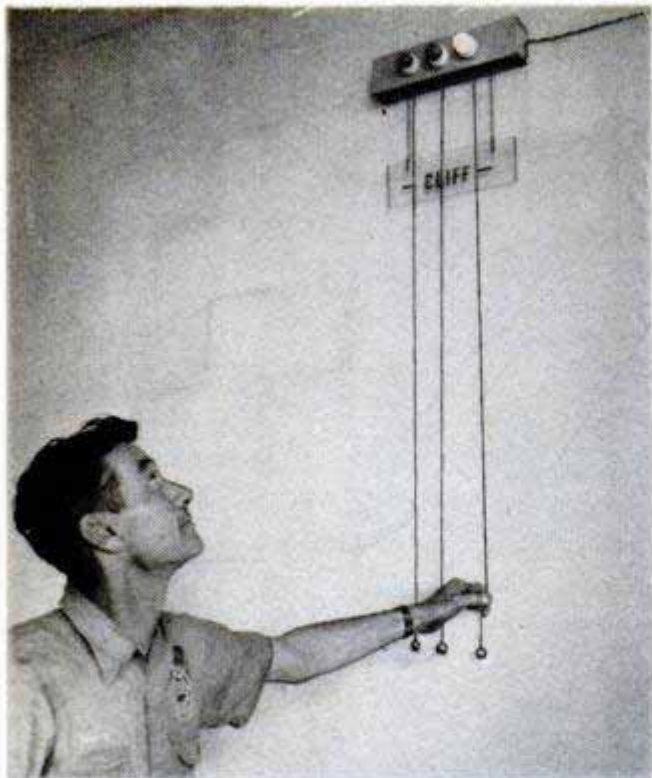

Mechanics Signal Work Status With Colored Lights

To enable the service manager to tell at a glance from almost any part of the garage the work status of each mechanic, one garage owner installed high above each work stall a set of three lights of different colors. These are controlled separately by long cords hanging within easy reach. Red, yellow and green bulbs are used, each having a different meaning. If a mechanic is busy and expects to remain so for an indefinite period, the red light is kept on. A yellow light, on the other hand, is a signal that a mechanic is nearly finished with a job and soon will be ready for another. If the green light is shining, it means the mechanic has finished and is idle. The system not only frees the manager from making frequent check ups in person of the work progress of each mechanic, but also allows him more time for other duties.

Tape Holds Line of Rubber Type Ready for Repeated Use

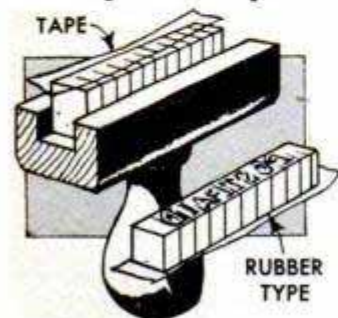

To simplify changing lines of type in rubber stamps, one shipping clerk sets each line in the holder with bottom ends of the type up. A narrow strip of cellulose tape then is applied to hold the line assembled so that it can be used when needed without resetting the type each time. This

method is better than using rubber cement or glue to hold the type as the tape may be removed at any time and the type redistributed without need of special cleaning.

G. E. Hendrickson, Argyle, Wis.

Bleeder Screw Releases Air Lock In Car-Heater Line

On many cars, draining and re-filling the water jacket results in an air lock in the top of the car heater. Although manufacturers have drilled small holes in the heater-out-



let pipes to permit releasing this air lock, the hoses must be loosened and moved aside to expose the holes, often damaging the hoses and causing leaks. One mechanic solved the problem by drilling and tapping a hole in the tubing just beyond the hose and fitting it with a machine screw. A washer cut from gasket material seals the opening, and the screw simply is removed to bleed the air from the line.

Clinton R. Hull, Costa Mesa, Calif.

Excessive Rotor Gap Reduces Spark

When a car misses regularly on acceleration from any speed and when ordinary ignition checks fail to show anything wrong, careful auto mechanics check the gap between the rotor and the contacts in the distributor cap. An excessively wide gap, as shown in the left-hand view, can cause the miss but it isn't always easy to locate the "weak" plug resulting from this defect. To check the rotor gap, place a small quantity of wax on each contact and replace the cap. After turning the engine over several times with the starter, remove the cap, whereupon a close examination will reveal the low contact. If the gap varies more than a few thousandths of an inch from the others, it should be replaced.



DRILL and TAP STAND

By Karl Greif

The convenience of selecting tap and body drills without consulting a chart makes this stand a worth-while project. Lay out the top section on $\frac{1}{16}$ -in. aluminum and cut to size, relieving the corners for end overlap. Before bending, pilot-drill the hole positions. Stamp the drill sizes and fill with a marking pencil. Bend the inside shelf ends to make a sliding fit, slip into place and drill the rivet holes. Rivet the bottom plate into position. Using a drill press, drill holes through the top and shelf successively, using the drills to be stored.

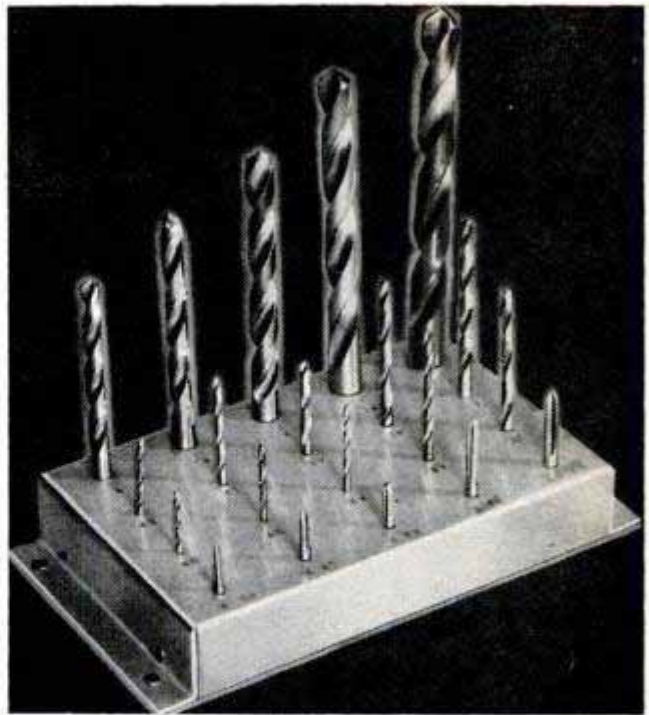

Combining popular tap sizes with tap and body drill for each size, this stand is fine school-shop item

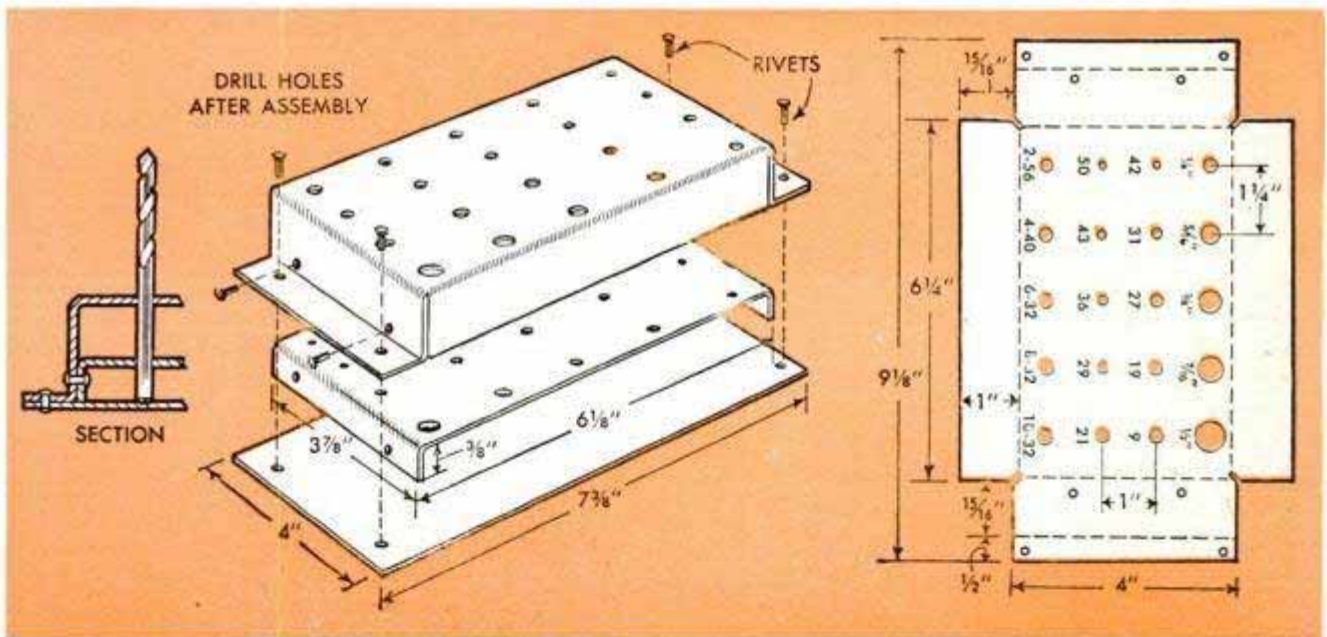

Giant "Nursery" Gate Closes Truck Parking Lot

The accordion-type nursery gate has grown up. Now made of 10-ft. 2 x 4s, it is swung across the driveway of a commercial parking area to keep unauthorized vehicles from passing through. The 4-in. pivot bolts at the top and bottom are located 12 in. from the ends of the boards. The center pivot bolts are 5 1/2 in. long, since they also must hold 23-in. lengths of chain that regulate the uniform opening of the gate. At the fixed end of the gate, the lower 2 x 4 is pivoted in an angle iron. At the top, a carriage bolt in the 2 x 4 slides in a 24-in. slot formed by two strips of flat steel screwed to a 2 x 6. Two casters sliding in a groove ease gate opening and closing.

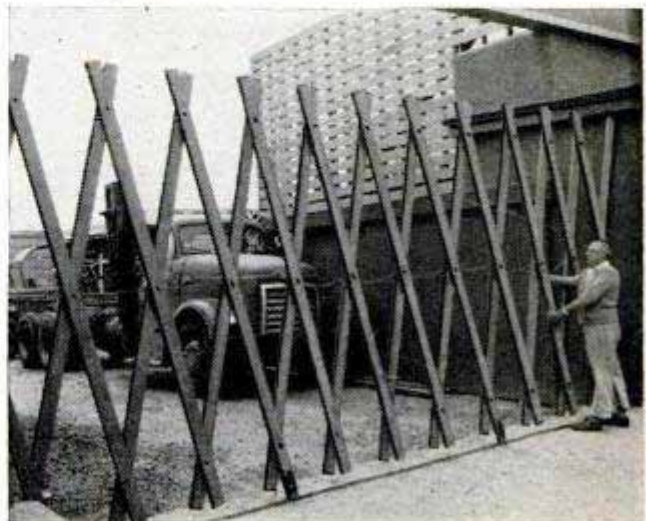

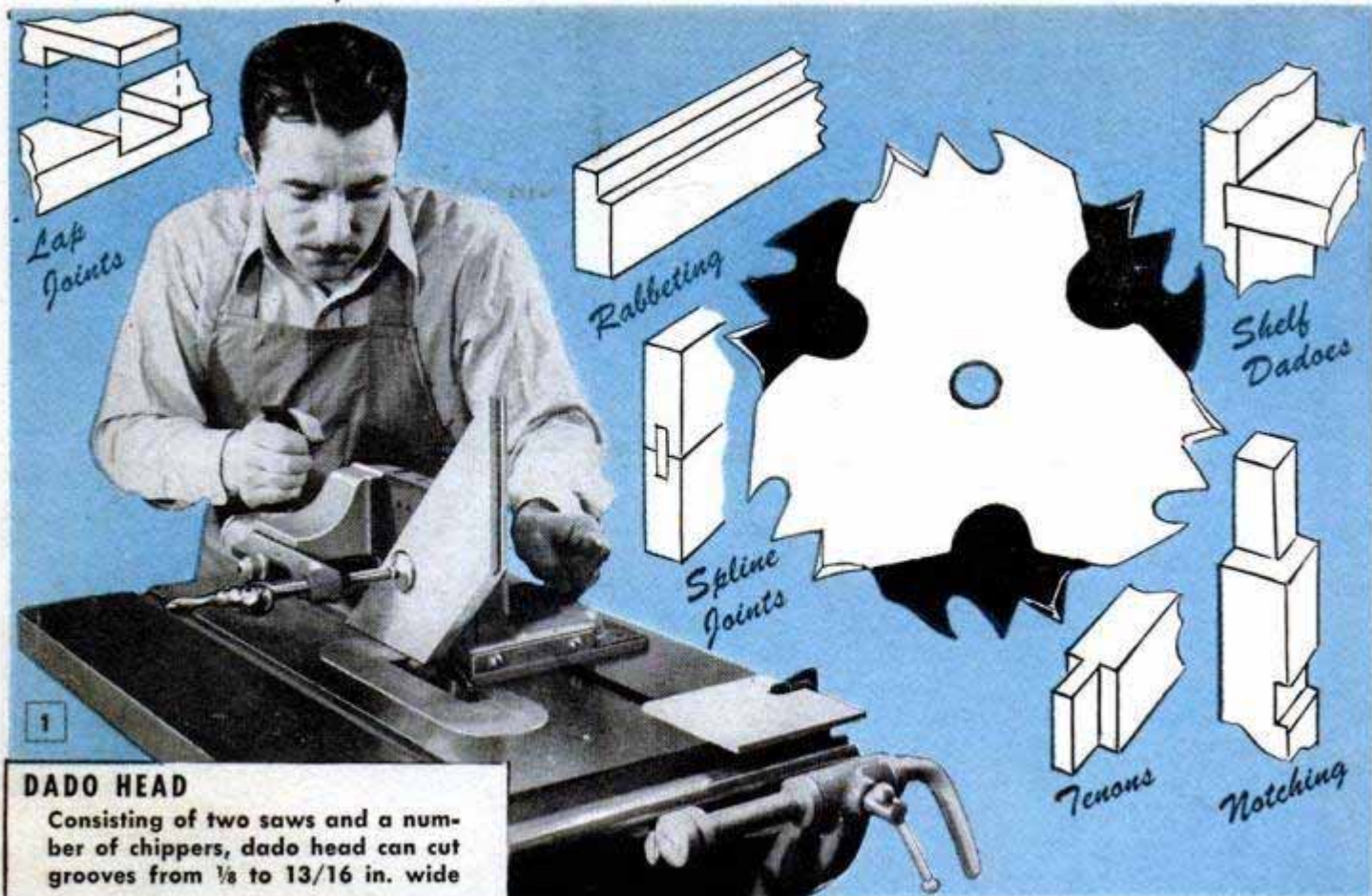

DADO HEAD

Consisting of two saws and a number of chippers, dado head can cut grooves from $\frac{1}{8}$ to $\frac{13}{16}$ in. wide

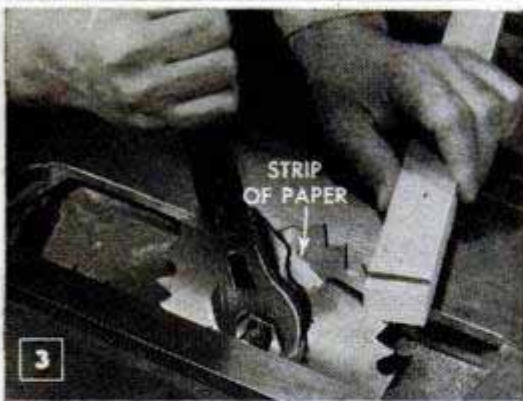

How to Use Your DADO HEAD

By Sam Brown

WHEN PURCHASING a dado head for your power saw, you can select from several styles. The spring-set head, shown in the photos at the left, has the advantage of low cost and easy maintenance. If you have an 8 or 10-in. saw, a 6-in. dado head is the proper size to use. Each blade of a dado saw commonly cuts a $\frac{1}{8}$ -in. kerf, while the addition of chippers increases the width of cut to $\frac{13}{16}$ in. by sixteenths. One saw plus one $\frac{1}{16}$ -in. chipper can be used to make a $\frac{3}{16}$ -in. groove. In any combination, the chippers next to the saws should be arranged to fall in saw gullets, Fig. 2. When mounting a dado head put the saws and chippers on the arbor one at a time, keeping the chippers evenly distributed around the circle. To remove the head, take off the outside saw, spin the chippers together and remove in one group. Two saws together will cut a $\frac{1}{4}$ -in. groove. This can be increased slightly by inserting paper between the saws, Fig. 3. Gummed paper washers, Fig. 4, also can be used.

Cutting duplicate dados: Fig. 6 shows the best method of duplicating dados when the cuts are not regularly spaced. Make the first piece by cutting the dados to pencil marks. Use this piece as a pattern and nail it to a second piece. Now, with a nail

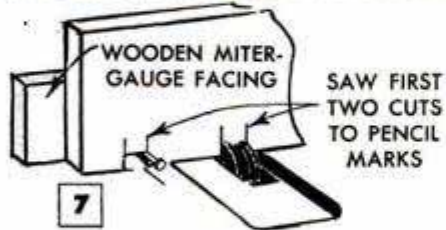
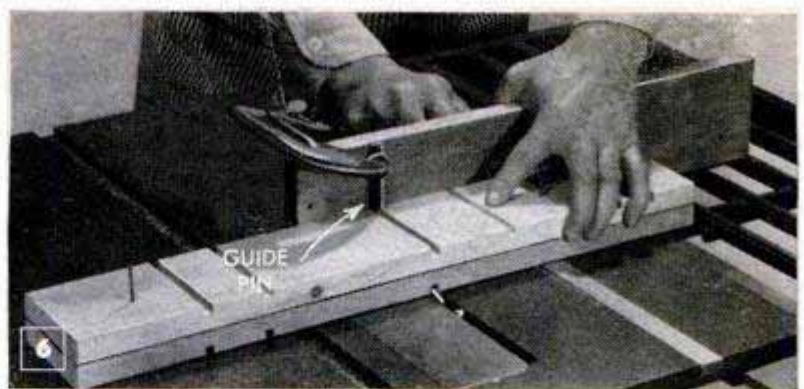
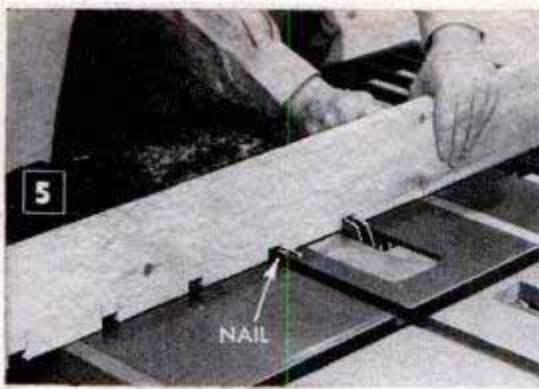

DUPLICATE DADOES

By using first piece as a pattern, duplicate dados can be cut. This pattern is nailed over other pieces to be dadoed and cuts are located with a guide pin. Left, equally spaced dados are worked by fitting nail guide in first of two cuts made to pencil marks. By setting each cut in turn to this guide pin, as many evenly spaced cuts as needed may be made

or wooden guide pin to engage the pattern, the second piece can be cut to duplicate the first. When cuts are spaced regularly, the first two cuts on the first piece are made to pencil marks. Then, with the dado head engaged in the second cut, a nail is placed along the edge of the first cut and driven into the miter-gauge facing, Fig. 7. By setting each cut to this guide pin, as many evenly spaced cuts can be made as desired, Fig. 5.

Blind dados: Accurate work on blind dados requires the use of stops, Fig. 8. These are located, as in Fig. 9, with the work placed alongside the saw which is set at the required cutting depth. A back stop, Fig. 10, is useful as it locates the cut and prevents any kickback when the work is lowered over the saw. When dadoing one

or two pieces, it is practical to work to pencil marks instead of using positive stops.

Corner joints: The dado head is used to make several kinds of corner joints, the most popular being the simple rabbet joint shown in Figs. 11 to 13. The dado-head setup should be a little wider than the thickness of the work, Fig. 11. For short-run work a narrower setup can be used, making the rabbet in two passes. The dado-and-rabbet joint, Fig. 14, is popular for drawer backs. In short-run work, piece B is cut with the work flat on the table, using the same setup as for part A but changing the depth. This has a disadvantage in that any variation in work thickness will affect the thickness of the tenon. To assure a constant tenon width, the cut should be made with the tenon side against the fence,

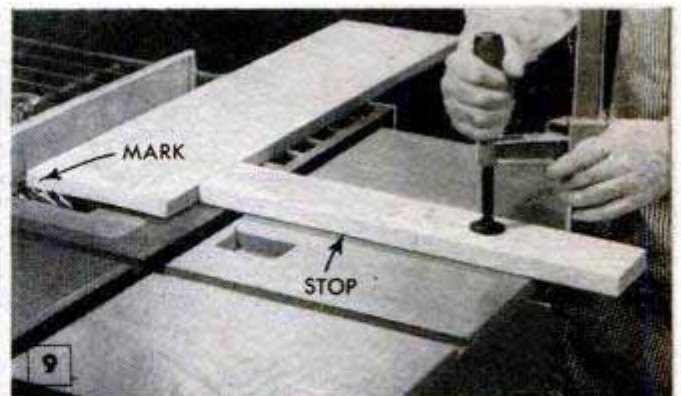
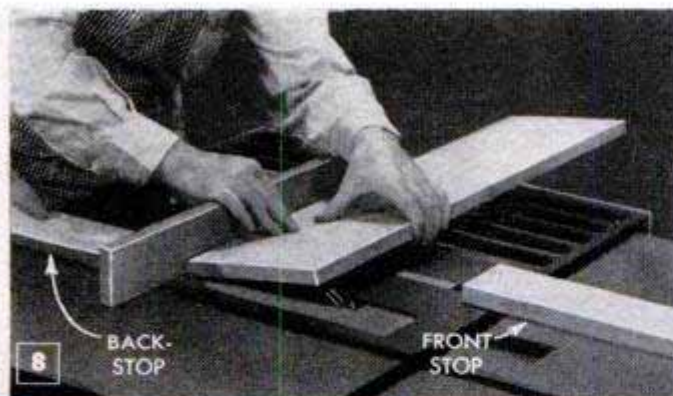

BLIND DADOES

Grooves stopped short of one or both ends of the work are called blind dados or gains. Stops assure accuracy and the starting stop also prevents kickback when work is lowered onto the dado blade. For offhand work it is more practical to work to pencil marks instead of using positive stops



Dado Corner Joints

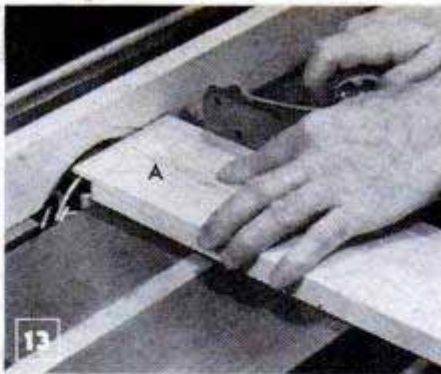
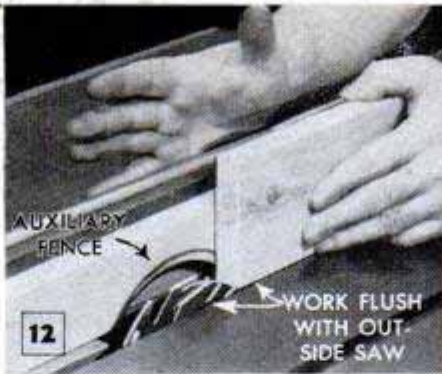
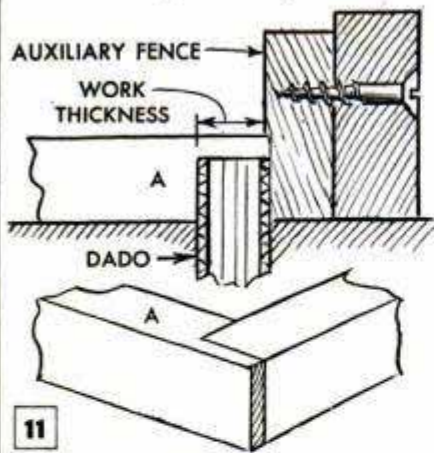

RABBET JOINT

Rabbet joint is useful and easy to make. Only part A is cut. Fig. 12 shows fence, used as stop, being set to work thickness. A faster setup is made with stop clamped to miter-gauge facing or saw table

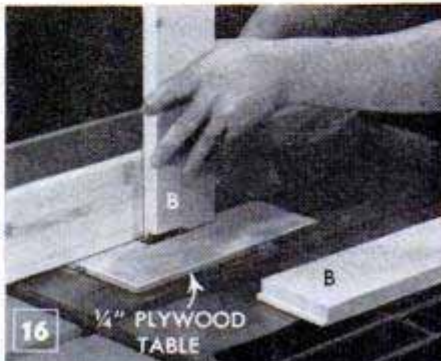
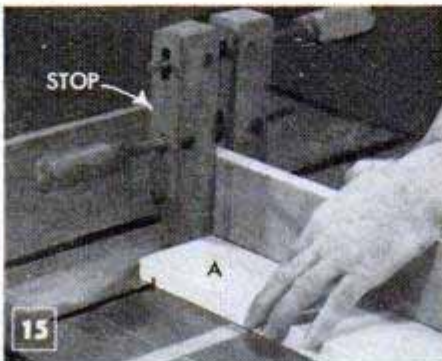
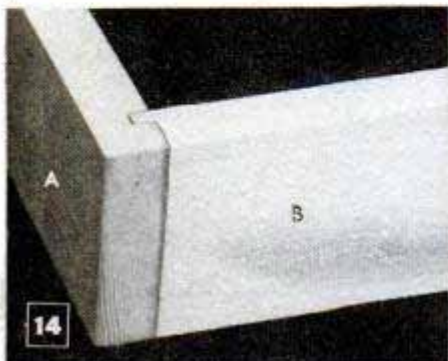

DADO AND RABBET

Dado and rabbet uses 1/4-in. dado for 3/4-in. stock. Part A should be cut first. For one or two joints, Part B is worked flat on the table. For production runs, an end cut, Fig. 16, is more accurate

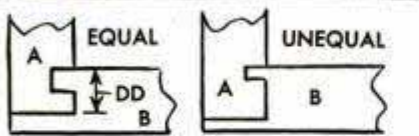
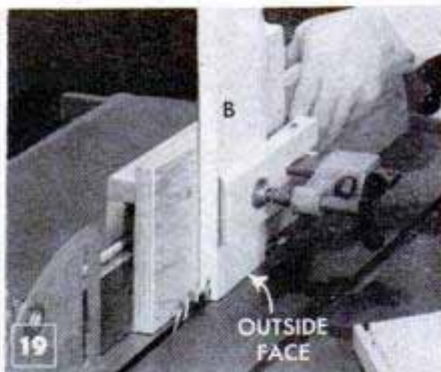
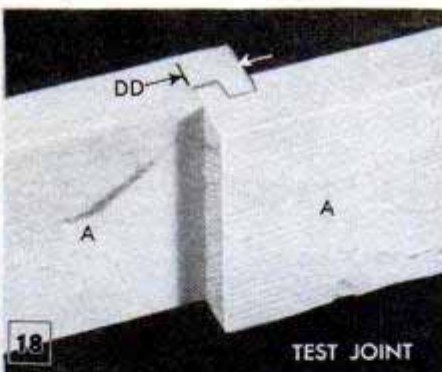

DOUBLE DADO

Double dado with equal dados is easiest to set up but unequal construction is stronger. Double-dado spacing is maintained by using tenon jig as stop for piece A and as work-holding device for piece B

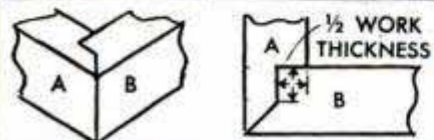
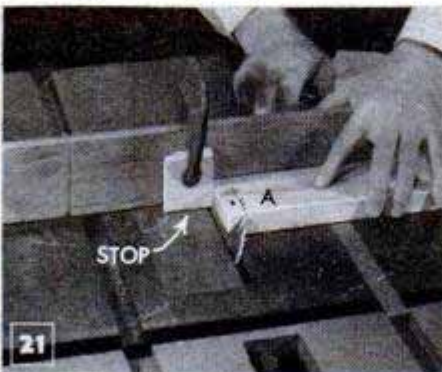
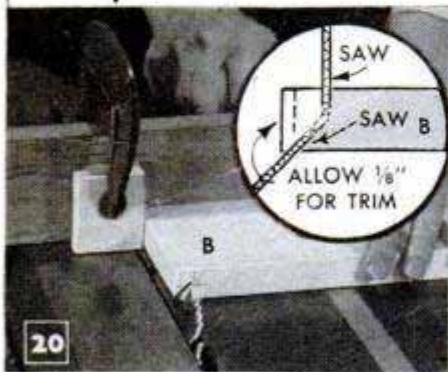

RABBET AND MITER

To get a clean miter, rabbet and miter should allow 1/8 in. per joint overlength. Part B is cut entirely by sawing. Part A is sawed at 45 deg., after which dado head is used to cut rabbet, Fig. 22

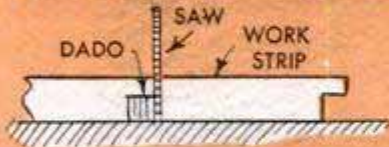
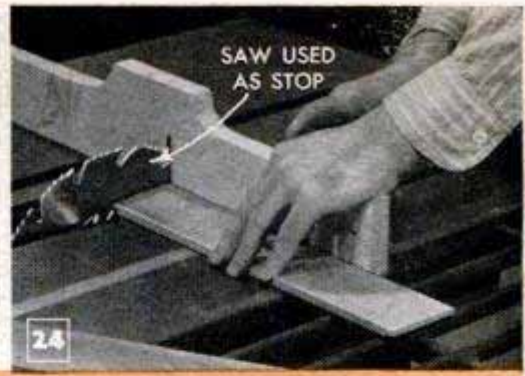
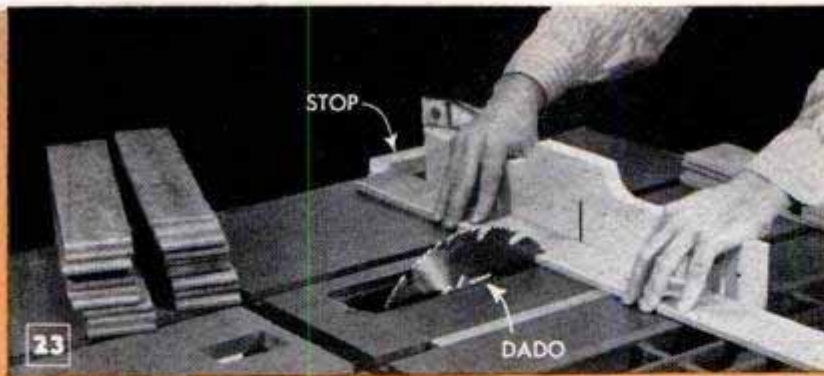

STRIP CUTTING OF RABBET JOINT

Strip cutting of rabbet joint is useful timesaving technique for mass cutting. Combined saw and dado cut work to length and make rabbet in one pass. Rabbet at opposite end of piece is cut by using saw blade as stop

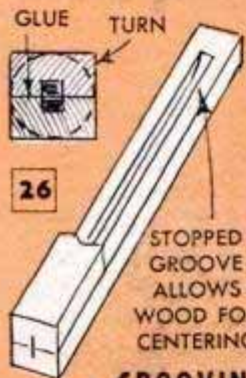
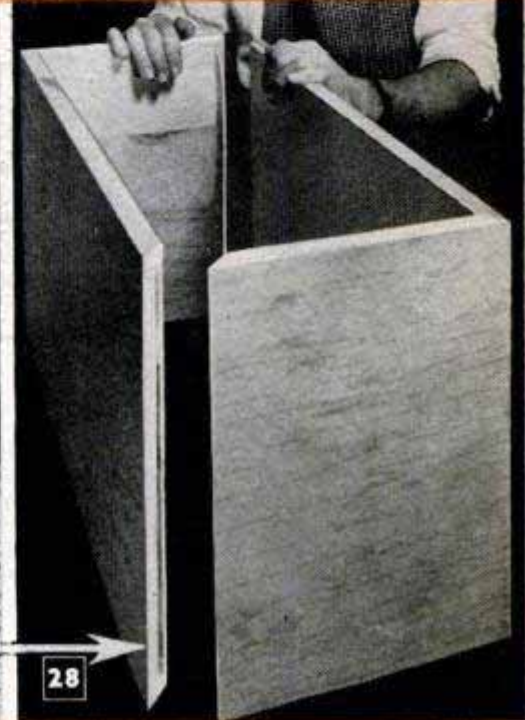

GROOVING

Lamp-table construction features grooving with $\frac{3}{8}$ -in. dado for wiring groove and single saw for splined miters. In grooving for spline keep the cut well to inside for maximum strength

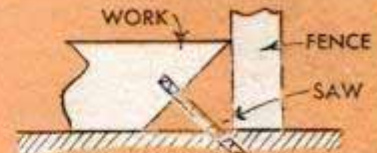

Fig. 16. If an auxiliary table or insert is used, cuts of this kind can be made free-hand. *Caution:* Never freehand narrow work over the regular dado insert because the large opening may let the work drop through to the table. The double-dado and rabbet-and-miter joints shown in Figs. 17 to 22 are useful dado joints, but are subject to variations both in proportions and working methods. Methods of cutting them are learned more readily by practice than by reading, and working methods often depend on the number of pieces to be cut. Time can be saved by combining a saw with the dado head, Figs. 23 and 24, to cut the work to length and make the rabbet in one pass.

Grooving: Grooving is just another name for dadoing, although it is used specifically

for narrow cuts or cuts with the wood grain. A typical application is the wiring groove for a lamp, Figs. 25 to 27. When turning the work after gluing, many workers prefer a blind groove, Fig. 26, so that the ends of the work will present solid stock for lathe centering. After the piece is turned, it is a simple matter to drill in an inch to connect with the grooves. The splined miter joint, Fig. 28, is commonly grooved with a single dado saw, keeping the cut well to the inside for maximum strength, as shown in the diagram. The cut usually is stopped at both ends, using stops as previously described for square cutting.

Angular notching: The angular notch provides a simple means of fitting table legs, Fig. 29. It is poor practice to attempt this freehand or with makeshift support



ANGULAR NOTCHING

Simple jig holds work at required 45-deg. position for angular notching. It is poor practice to attempt this cut freehand or with makeshift support blocks jammed under the work

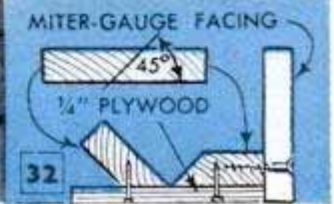
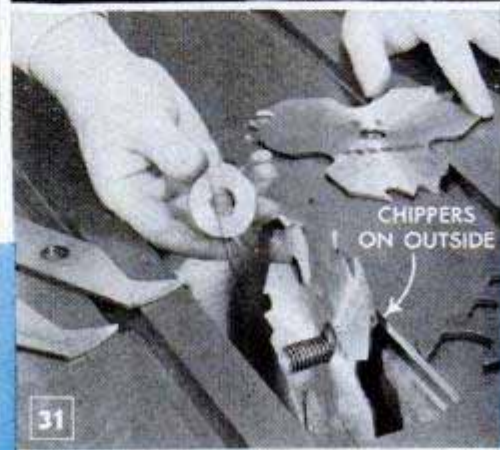
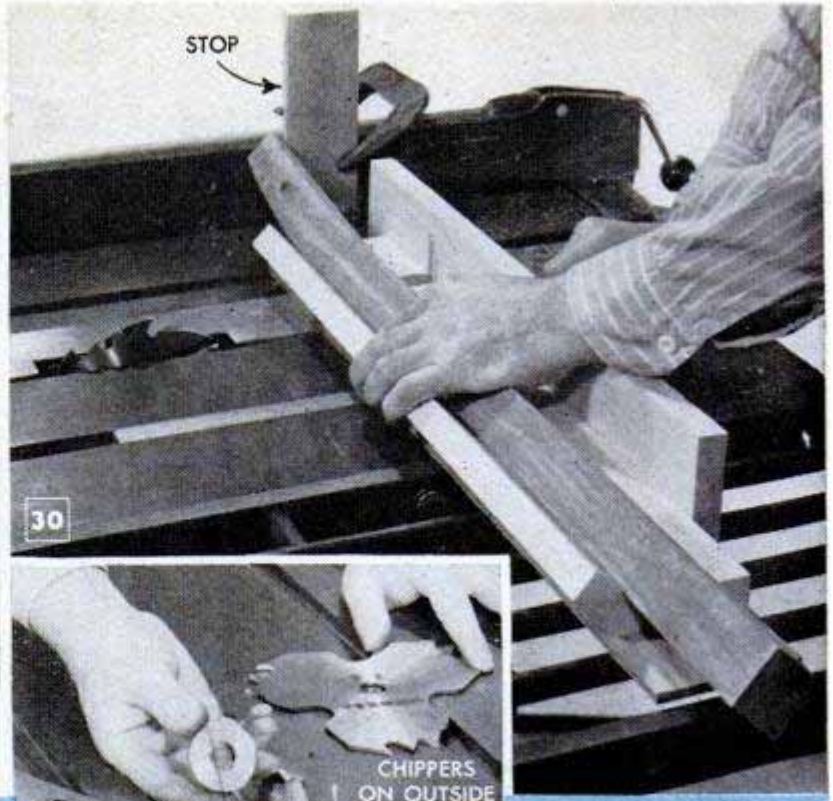

TONGUE-AND-GROOVE

Tenons and tongue-and-groove joints can be cut with dado saws spaced by suitable hardwood collar

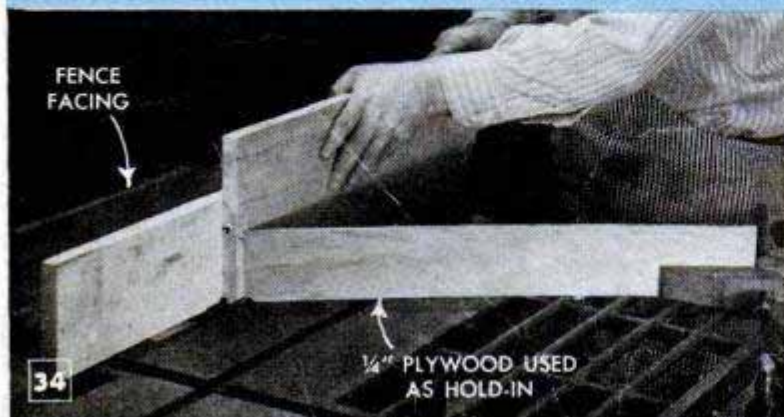
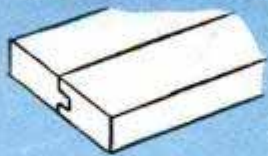

blocks jammed under the work. Take time to do the job right by ripping a piece of $\frac{3}{4}$ x 4-in. stock at a 45-deg. angle and nailing the two parts over a plywood base, Figs. 32, to provide a rigid holding device for the work.

Tenons: A quick way to make tenons is to work the stock flat on the saw table and cut away the waste wood from either side by turning the work over. Like all work using this reversal method, the thickness of the tenon will vary with the work thickness; hence this method is practical only when using wood of uniform thickness. For tenoning a number of pieces, a setup with a spacing collar between the saw blades does an excellent job independent of work thickness. This reverses the usual dado setup, since the saws are on the inside and the chippers outside, Fig. 31. The tenoning operation is shown in Fig. 33. Obviously, the same arrangement will work for the tongue of the tongue-and-groove joint, Fig. 34. The spacing collar can be metal or hardwood and should be thicker than the desired tenon by the amount of set on the saws. ★ ★ ★

Firmer Support for Fence Posts

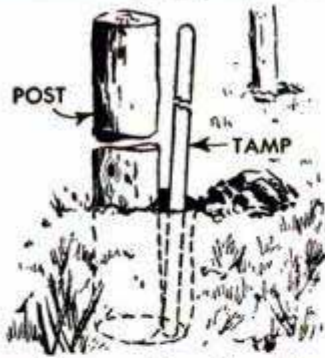

When setting a fence post, one farmer has found that a post will be supported more firmly if placed against one side of the hole instead of in the center. Positioning the post in this manner not only provides it with a solid backing against the undisturbed earth at the side of the hole, but also allows plenty of room for tamping loose earth around the post.

Metal Lath Attached to Cornice With Softboard Spacers

Where the type of building construction requires the application of stucco to porch ceilings and cornices, many builders first apply metal lath to assure a permanent job. In order to space the lath the proper distance from the nailing strips, one builder uses small squares cut from insulating board. The squares are attached to the joists or nailing strips with waterproof glue mixed to a fairly heavy consistency.

Edwin Love, Palmdale, Calif.

Glass Window on Bandsaw Guard Permits Safe View of Work

Designed to protect a bandsaw operator from flying particles while at the same time providing an unobstructed view of the work, this box-shaped guard consists of two sheet-metal sides that support a piece of $\frac{1}{4}$ -in. safety glass in front of the blade. The sides are joined together behind the blade by two strips of metal which connect the top and bottom edges and are riveted in place.—Bill West, Arlington, Va.

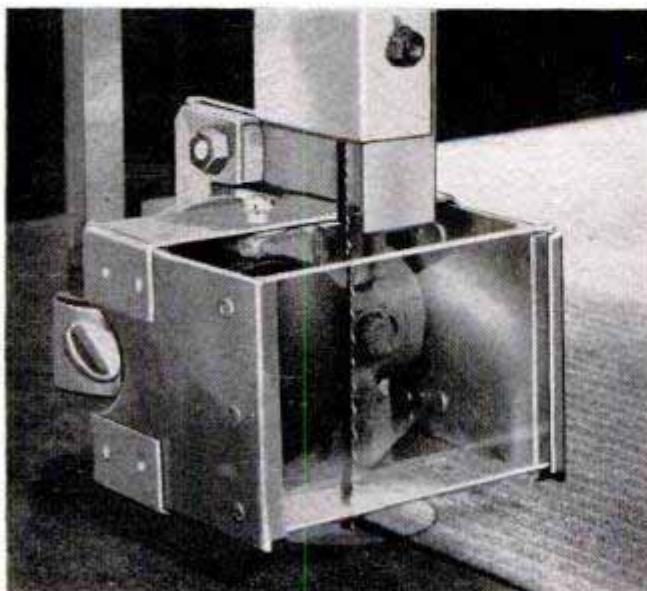

Hollow Punch From Steel Tube Aids in Removing Plasterboard

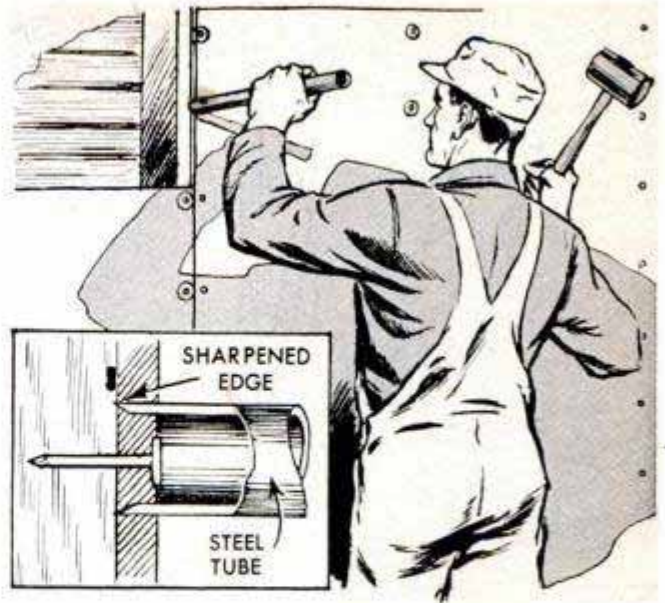

If you find it necessary to remove a section of a plasterboard wall during construction, you can do it neatly without damaging the plasterboard by using a steel tube sharpened at one end. Serving as a hollow punch, the tube is placed over the nailheads and struck sharply. A short length of rigid electrical conduit makes an excellent punch. To replace the plasterboard, the sheets simply are fitted over the nail-and-plaster projections on the studs and renailed.—B. Franklin, Azusa, Calif.

Altered Wrench Socket Grips Spark Plug

To simplify the removal of spark plugs from cylinder heads having deep plug recesses, one mechanic altered a thin-walled wrench socket so that it grips the body of the plug after it is unscrewed. First, he ground a notch in the wall of the socket near the open end, cutting deep enough to form an oval opening in the wall. Then he ground a concave groove entirely around the wall of the socket in line with the notch. The groove seats a length of tempered wire, one end of which is bent back on itself to form a short lug. This is inserted in the open notch and the wire ring is then snapped into place in the groove in the same manner as a retaining ring. When the socket is pushed over the plug, the lug catches below the spark-plug shoulder and holds it in the socket so that it is withdrawn easily from the recess in the cylinder head.

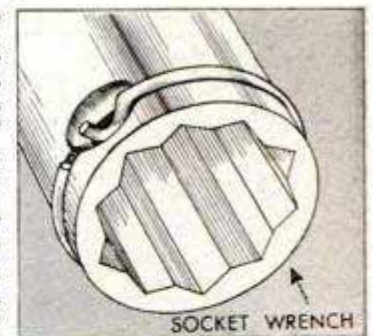



1

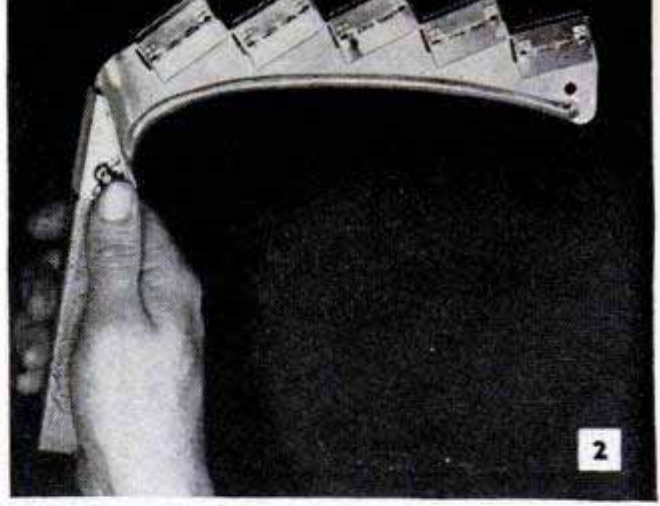

2



3

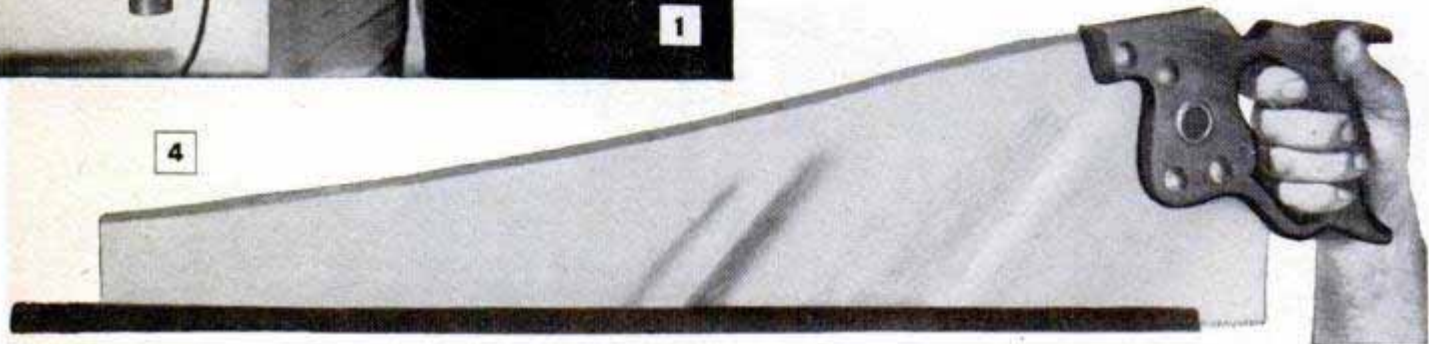

4

SHOPPING

1. COMBINATION SAW-SETTING machine doubles as a sharpening machine for planer and jointer knives, hand-plane irons, wood chisels and other tools. Set up in varying combinations it will joint, gum, bevel-grind and set all types of circular-saw blades from 4 to 48 in. in dia. Will grind planer and jointer knives up to 24 in. in length by changing setup

2. GRASS CUTTER utilizes the keen edge of safety-razor blades to shear grass with an easy motion of the hand and arm. Blade holder is similar to a sickle except that the cutting edges are on the outside instead of on the inside as in the conventional tool. Just the thing for trimming grass in hard-to-get-at places around trees, shrubbery and along walks

3. SMALL-BORE DIAL GAUGE is designed for accurate inspection of small-dia. bores measuring from .250 to .375 in. It is designed to check tolerances up to .005 in. Utilizes interchangeable "centering size" disks which attach to the head of the instrument and are locked securely in place by means of a knurled clamping nut. Dial is hooded for maximum protection

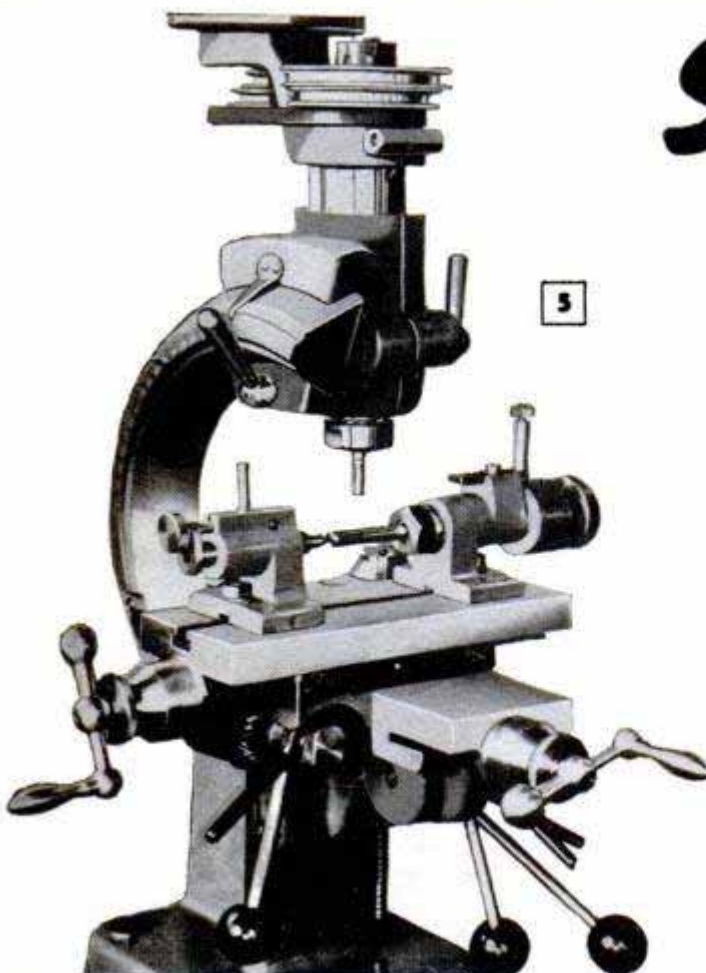

5

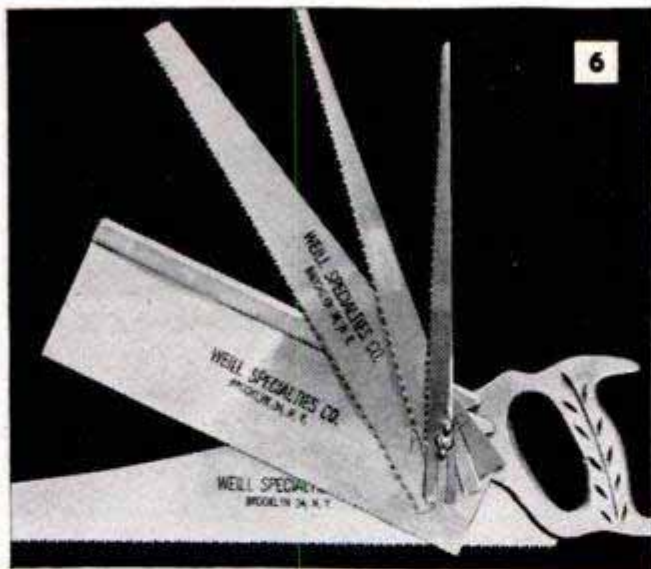

6

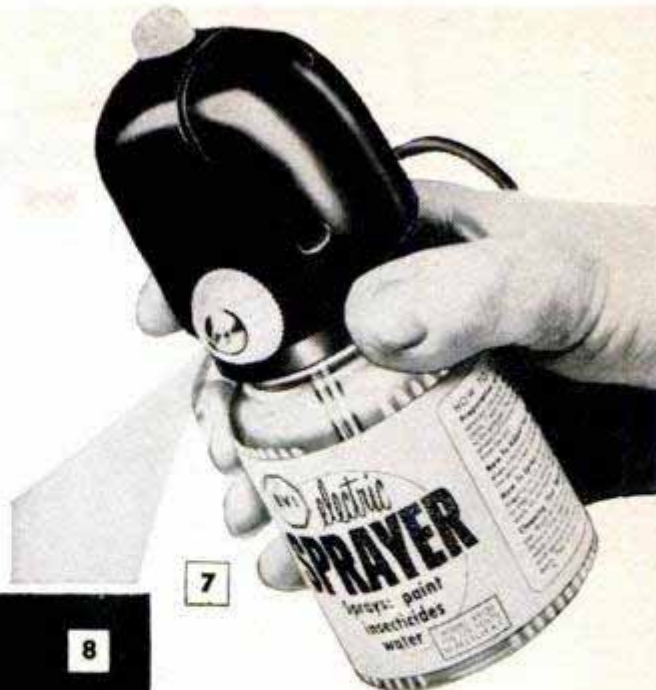

7

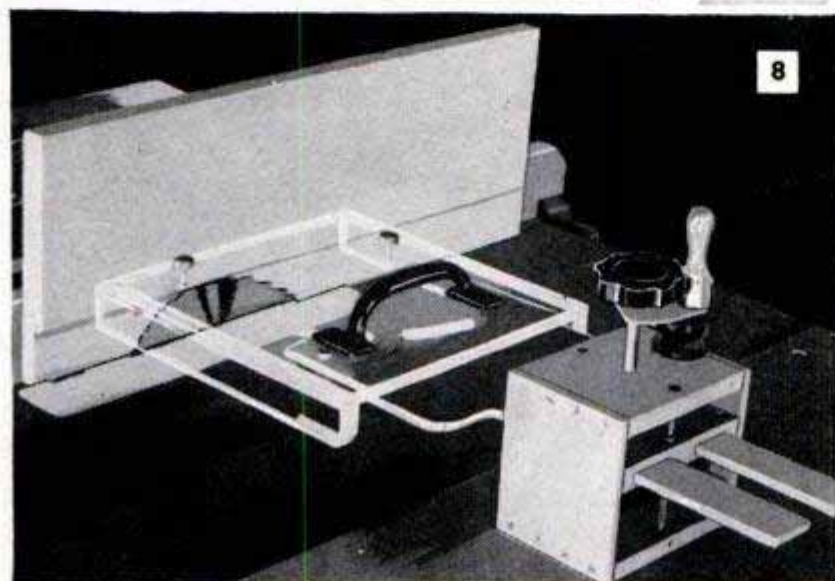

8

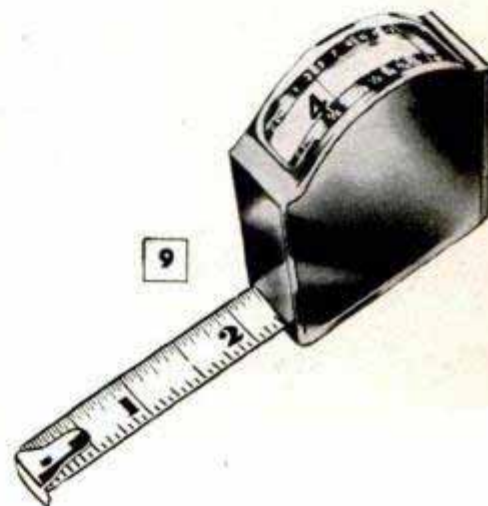

9

FOR TOOLS

4. **SAW-EDGE PROTECTOR** is made from plastic and is designed to protect handsaws from dulling when they are carried in a toolbox. Impervious to oil, gasoline and sunlight. Simply slide it over the saw teeth. The protector is held in place by friction which is sufficient to cause it to grip the sides of the blade securely. Made for all ordinary handsaws

5. **NEW MILLING MACHINE** has milling-spindle assembly which can be locked in any position between vertical and horizontal. Tools are held in spindle by collets, the maximum bore of which is 13/32 in. A universal 3-jaw chuck can be used instead of the collets when the nature of the work permits. Table travel longitudinally is 4 in. and vertical movement is 4½ in.

6. **FIVE-PIECE SAW SET** makes an ideal Christmas gift for the man of the house. The five blades are made of alloy steel and are hardened and polished. Set includes 16-in. panel saw, 12-in. backsaw, 15-in. pruning saw, 12-in. compass saw and a 10-in. keyhole saw. All blades lock securely into the natural-finished hardwood handle and are slotted for easy insertion

7. **TINY ELECTRICALLY OPERATED SPRAYER** is just the thing for modelmakers and for touch-up work around the house with paints and enamels. Is controlled by a finger-tip switch and operates on 110-volt, 60-cycle current. Sprayer is held in the hand rather than by a handle, thus giving close control of the application of paints, enamels, lacquers and certain insecticides

8. **SAFETY SAW GUARD** is made of clear plastic so that work can be seen at all times and is so designed that the guard itself exerts a downward pressure on work. Nearly all common circular-saw operations can be performed with the guard in normal position. Can also be used as an overriding fence for angular work. Should prove useful in school shops

9. **PUSH-PULL STEEL RULE** gives accurate dial readings showing measurements to fractions of an inch under a vernier "window" where they are easily read. Dial face is white with black figures and is calibrated with all fractions to 1/16 in. Rule is equipped with cleaning and oiling pads to keep it in good condition and to prevent rusting while it is in use

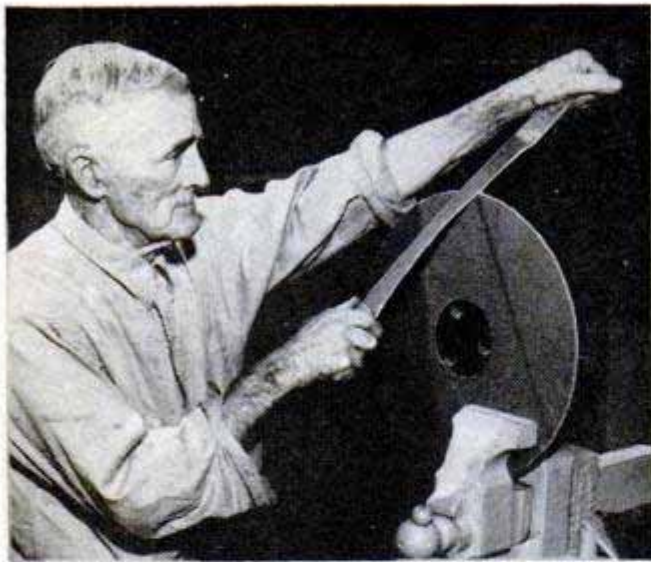

Sanding Disks Trimmed Easily With Sharpened Hacksaw Blades

Discarded power hacksaw blades are utilized effectively by one manufacturer for trimming sanding disks to the exact size of the backing plates. The operation, which formerly had been accomplished with wood rasps, wore out two or three rasps a week. In the preparation of a saw blade, the toothed edge of the blade is sharpened and the ends wrapped with tape to serve as handles. With the tool used like a draw-knife, the operation now requires only half the time formerly required, provides neater edges on the disks and practically eliminates any possibility of wear on the backing plates.

Centering a Worn Shaft

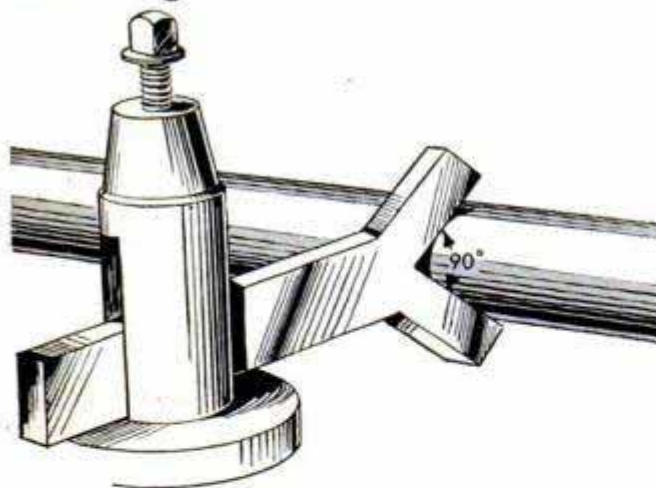

In job machine shops specializing in repair work, the machinist often encounters the problem of centering a badly worn shaft in the lathe in preparation for truing up the bearing surfaces. This is especially difficult when the shaft has been worn out of round, or where it is necessary to true the journals concentric with that portion of the shaft on which a rotating cutter-head or other part is mounted. One ma-

chinish does this job accurately with the simple centering fork shown in the detail. This is made from a piece of tool steel. Arms of the fork forming a 90-deg. angle are welded or brazed to the body and all surfaces are machined and ground true. The device is mounted in the lathe tool post with the bottom of the vee on the horizontal center line of the lathe. Then the work is mounted with one end on the live center and the fork is brought into a position to bear on the unworn surface of the shaft. Chuck a center reamer or center drill in the tailstock, start the lathe and feed the center drill into the work, holding the latter in place in the fork with the left hand.—H. B. McDermid, Norwood, Ohio.

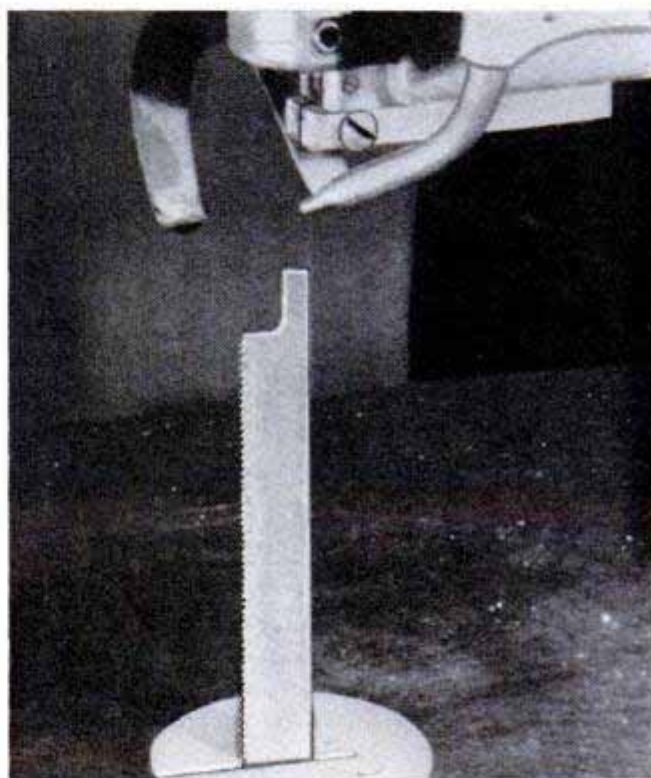

Cutting Metal in Your Jigsaw

Anyone having only an occasional job of sawing metal will find that it can be done easily on a jigsaw. All that's necessary is to convert 6-in. pieces of hacksaw blade so they can be clamped in the chucks of the jigsaw. This is done by grinding the ends of the pieces to fit the chuck. Blades most suitable for use are those made of high-speed steel, which give long service and produce clean, straight cuts. Be sure to mount the blades so that the cutting is done on the down stroke. This is necessary in order to cause the pull to come on the motor and not on the spring that raises the blade in most jigsaws. Before this method can be used, however, the speed of the jigsaw must be reduced approximately 50 percent. This is done by changing the sizes of the pulleys on both the jigsaw and the motor.—Herbert R. Pfister, New York City.

TELEVISION TODAY

KEEPING an eye on new television equipment today is like trying to watch all the performers in a three-ring circus. One of the outstanding devices that ABC-TV engineers have recently introduced is the "Periscope Eye" shown in photo A. This attachment gives their TV cameras an extended view over the heads of crowds and into places previously closed to television.

The "Unit-ized" television chassis, illustrated in photo B, consists of a base and eight compact plug-in units, each individually tested to maintain uniformity and simplify maintenance. The domelike high-voltage unit is sealed against humidity to prevent arcing.

Another recent addition to high-gain indoor TV antennas is the one illustrated in photo C. It is claimed to tune all 12 VHF-TV channels and employs the following TV antenna principles: helix coil, folded dipole, straight dipole and delta-match transformer. One of the new all-channel UHF selectors is shown in photo D. It is designed for use with existing TV receivers to bring in the UHF programs as soon as they are available in your area.

TV is generally illegal in cars. However, this photo E installation passed rigid Pennsylvania motor-vehicle inspection because it cannot be operated when car is in gear.

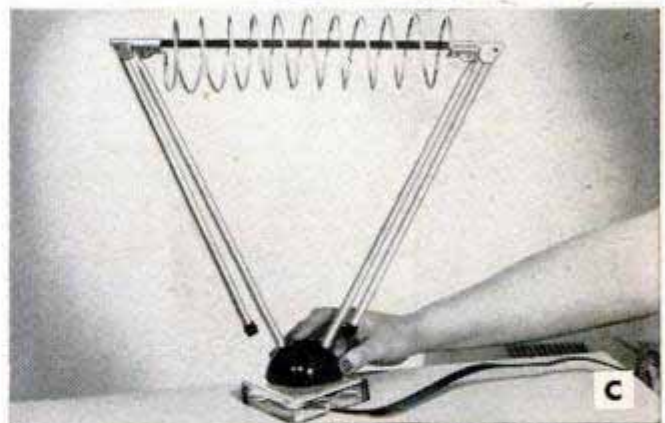
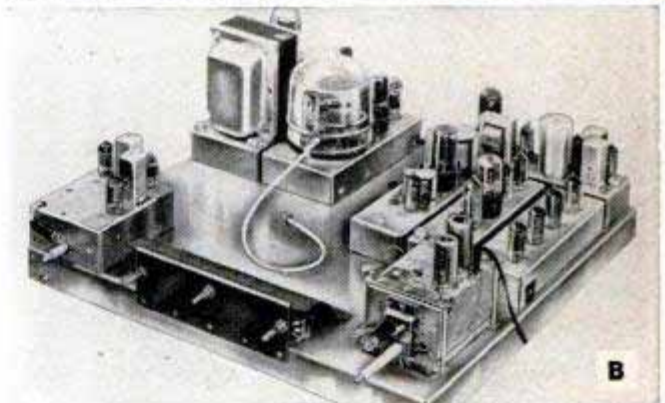
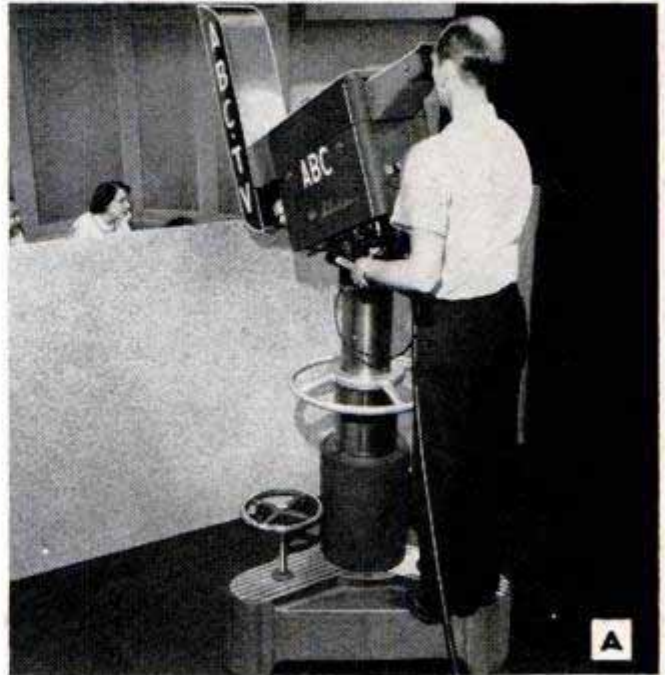



CHILDREN'S RECORD PLAYER



SURPRISE the small fry at your house this Christmas with a simple record player. Not just an ordinary player—but one that you can build yourself; a phonograph that practically starts and stops itself. It employs a quick-heating 3V4 miniature tube in the audio amplifier for instant warm up and starts playing just as soon as the operator lifts the pickup arm from its rest. After the record has been played, the arm is replaced on the stop pin which opens the line switch and shuts off the amplifier and the turntable motor. There are no controls except for volume. The bottom of the cabinet is covered with a pressed hardwood panel to keep out little fingers.

The completed unit is shown in photo A. An underside view, with bottom cover removed, appears in photo B. All construction details for the cabinet and sheet-metal chassis base for the amplifier are given in Fig. 2. A pictorial wiring diagram for the audio amplifier appears in Fig. 1; the component parts are shown in their relative positions under the base, and all wiring details are indicated. The leaf-spring switch may be the Unimax MXT-1 leaf-spring hinged type shown in photos D and C or any similar variety. This switch is mounted

RESISTORS

- R1=27-OHM, ½-WATT CARBON
- R2=10,000-OHM, ½-WATT CARBON
- R3=2500-OHM, 5-WATT WIRE-WOUND
- R4=150-OHM, ½-WATT CARBON
- R5=25,000-OHM, ½-WATT CARBON
- R6=68-OHM, ½-WATT CARBON
- R7=1-MEGOHM VOLUME CONTROL LINEAR TYPE, WITHOUT SWITCH

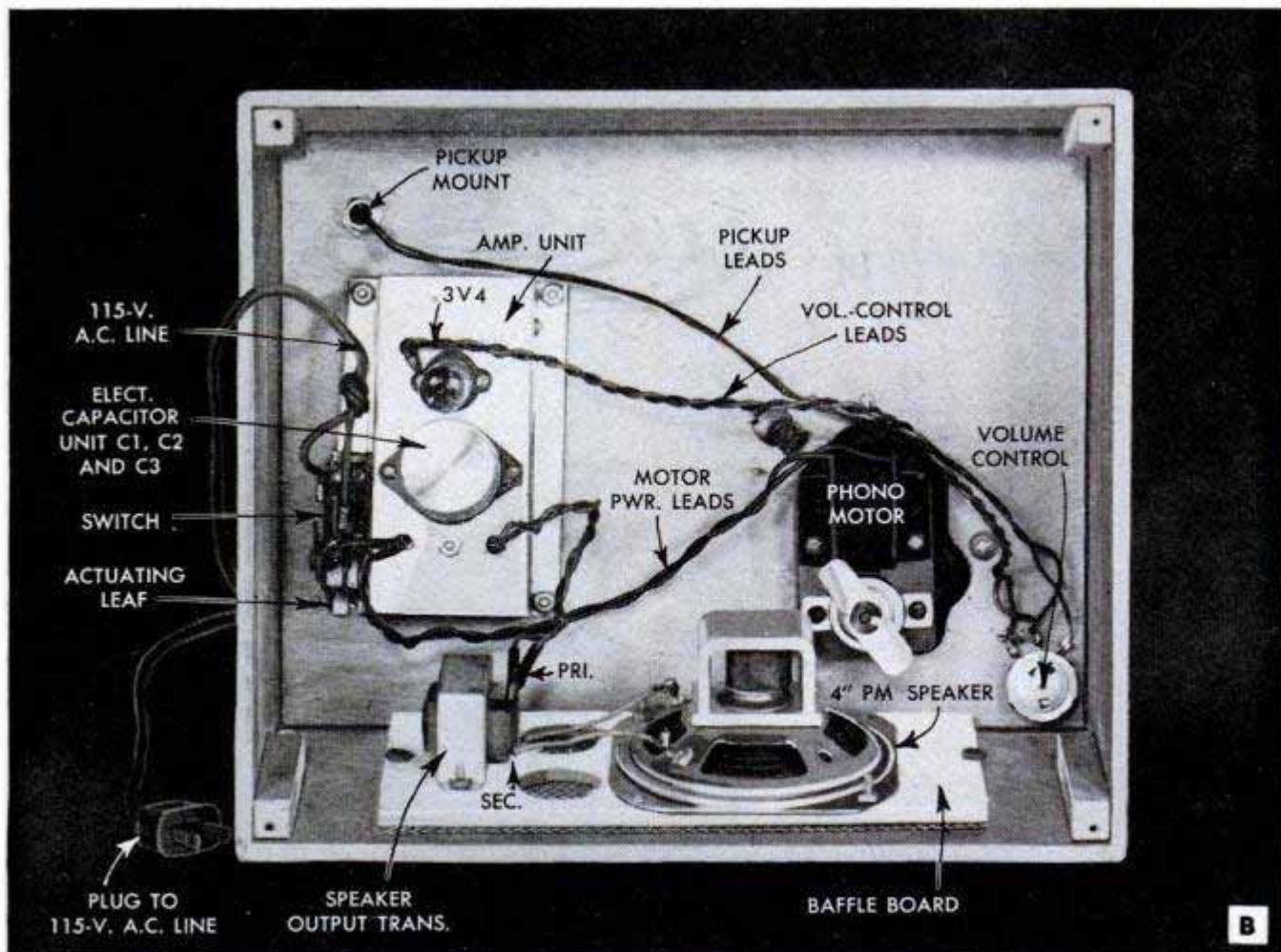

HAS AUTOMATIC START AND STOP

on the chassis base by means of two 6-32 machine screws as shown in Fig. 1; the proper connections appear in the underside view below. The switch is normally closed with the connections shown and opens when the actuating leaf is depressed by the weight of the pickup arm. The wooden disk, detailed at upper left, pushes the stop pin through a hole in the top of the cabinet located directly above the actuating leaf of the switch. The mounting holes for the chassis base are made slightly oversized so that the base can be shifted a little if necessary to bring the leaf directly under the hole.

The schematic circuit diagram is given in Fig. 3. Capacitor values are listed in Figs. 1 and 3. A chart of the resistor values appears on page 212. The miniature tube socket is preferably of the shock-mounting type. All parts for the amplifier are available from any radio parts house. A selenium rectifier does away with the usual rectifier tube. The chassis base can be formed from a piece of sheet aluminum bent to shape in a vise between blocks of wood. Drill the necessary holes with a hand drill and enlarge them to size with a tapered reamer. A keyhole saw will be required

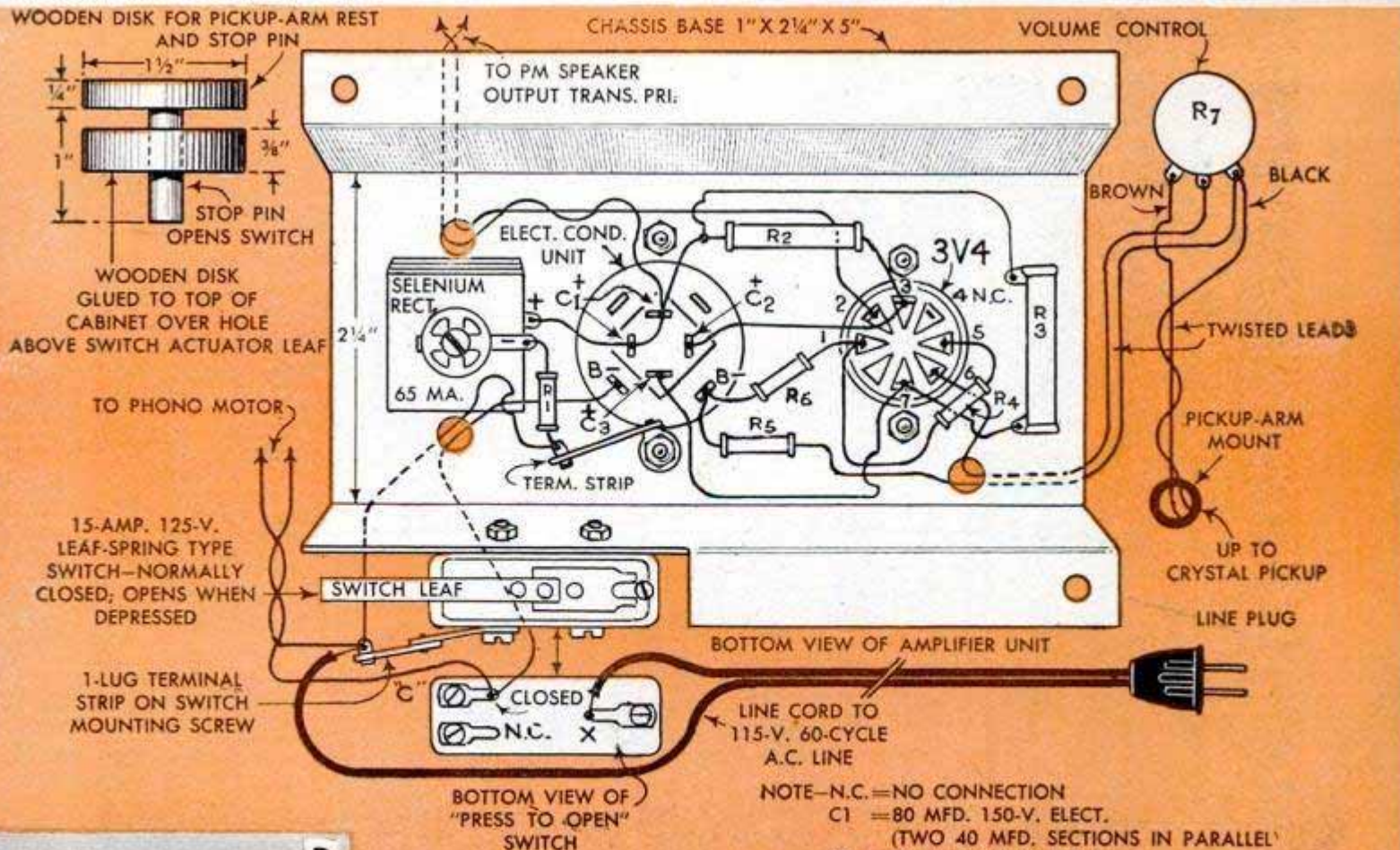
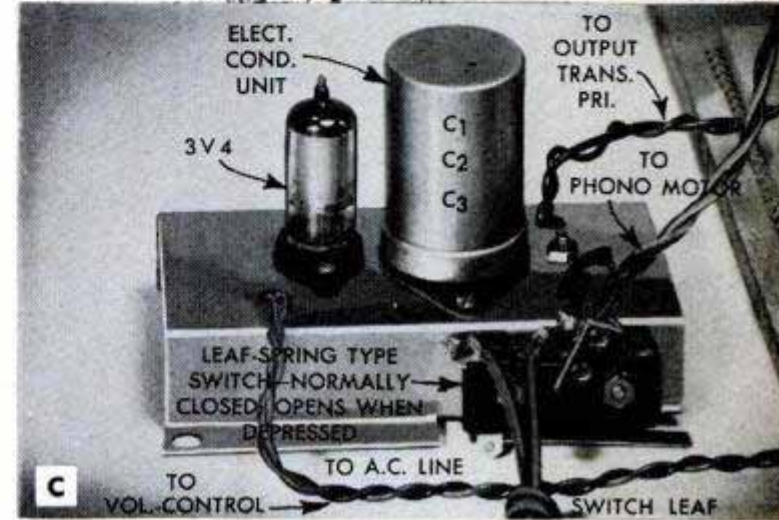

- NOTE—N.C.—NO CONNECTION
 C1 = 80 MFD. 150-V. ELECT.
 (TWO 40 MFD. SECTIONS IN PARALLEL)
 C2 = 40 MFD. 150-V. ELECT.
 C3 = 50 MFD. 25-V. ELECT.
 ALL ABOVE CAPACITORS IN EITHER
 A 3 OR 4-SECTION METAL CAN

FIG. 1



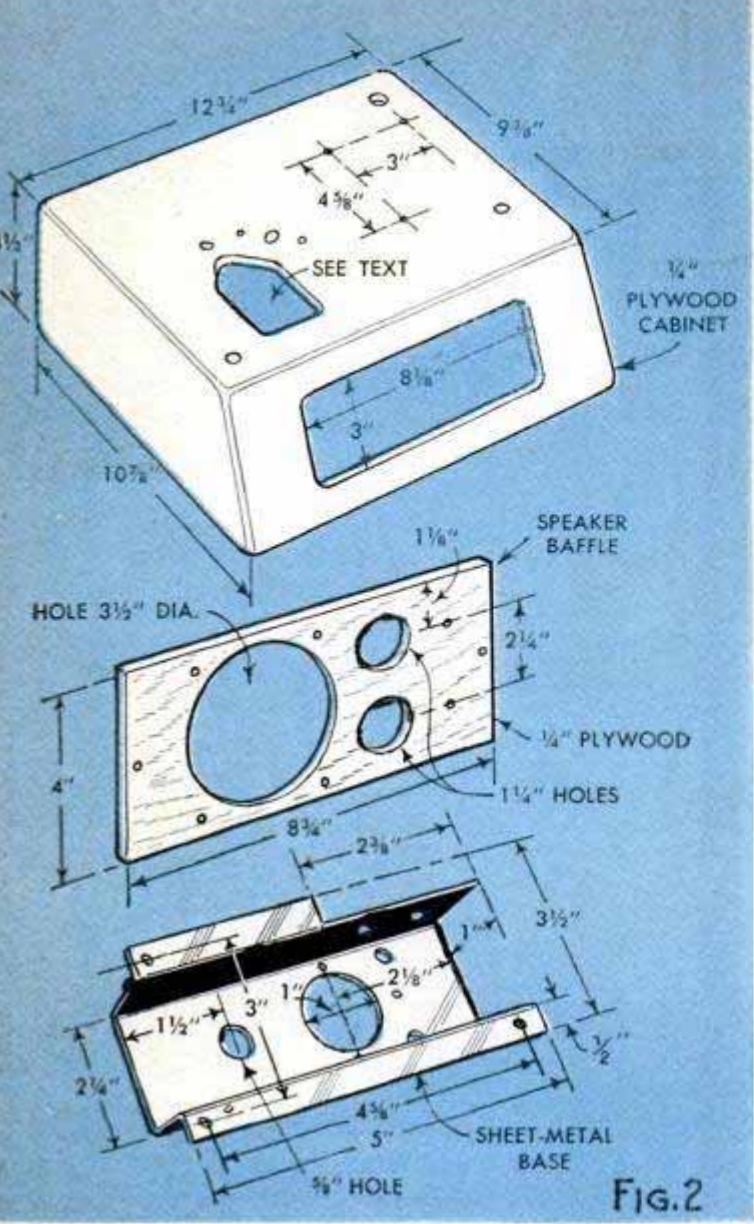

FIG. 2

to cut the openings for the speaker in the 1/4-in.-plywood baffle and cabinet. The two extra holes in the baffle are for necessary ventilation. The speaker output transformer is also mounted on this baffle which is fastened with wood screws behind the cut-out in the front of the cabinet. The cutout section is backed up with either gold or tan grille cloth.

Use rosin-core wire solder for all circuit connections and make every soldered connection carefully. No. 20 hookup wire with push-back insulation can be used for all circuit wiring. The terminal lugs on the 7-pin miniature tube socket are rather small and close together so careful soldering at this socket is important. Use a small iron and only enough solder to make a good connection.

The phono motor and 8-in. turntable can be either an Alliance or General Industries inexpensive 78 r.p.m. rim-driven type, complete with mounting plate. The size of the motor-mounting hole in the top of the cabinet in Fig. 2 will depend upon unit used.

Bolt all parts attached to the cabinet and speaker baffle securely. After the wiring is completed, attach the bottom cover to the cabinet corner blocks with wood screws. The plywood cabinet may be given a coat of bright-red or yellow enamel, dressed up with appropriate decals and mounted on rubber feet. Detailed student material list R-415 is available from Popular Mechanics Radio and Electronics department upon receipt of ordinary letter postage. ★ ★ ★

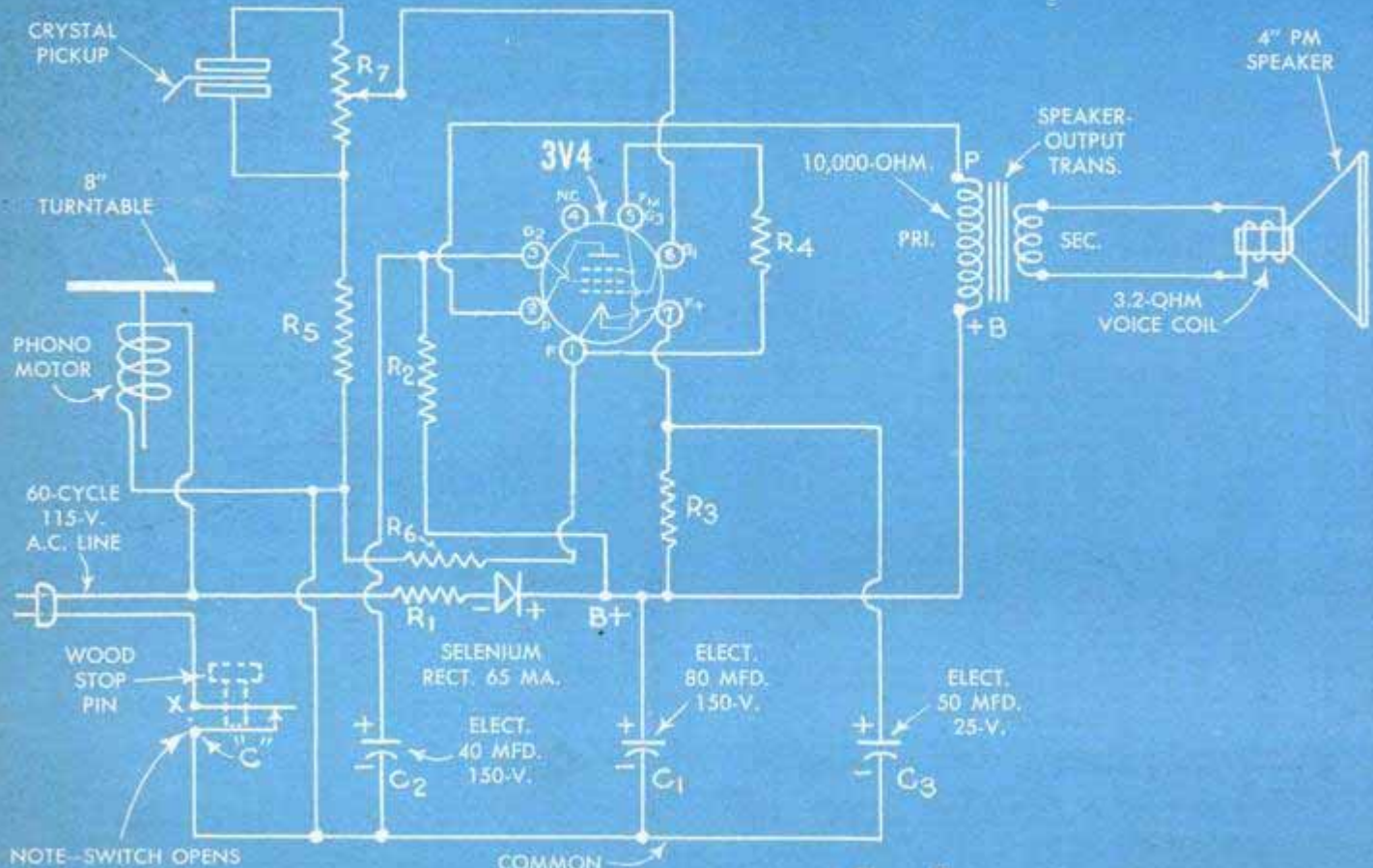

FIG. 3

NOTE—SWITCH OPENS WHEN STOP PIN IS DEPRESSED.

Projection-TV Installations In the Home

LIFE-SIZE television now is available for your living room, den or that basement game room you have been planning. Imagine TV pictures 3 ft. high and 4 ft. wide. Smaller picture screens (30 x 40 in.) are being built into walls with the projection equipment behind the screen.

A Pittsburgh, Pa., firm is installing these projection sets in that area, and similar installations have been made elsewhere. This firm combines an RCA model 630 TV receiver with the North American Phillips "Protelgram" lens system. These are custom-built into the units shown in the inset photo A, and photos D and E. In photo A the projection unit is housed in a modern end table and photo B shows the unit mounted in the ceiling in the white box. Reverse projection behind the screen is employed in the living room shown in photo C.

In installation A, the picture is projected directly onto the screen from the inconspicuous end-table unit on which a lamp is placed, at the right. The cabinet projection unit, photo D, may be placed on the floor or at any hidden point in the room. Portable units, photo E, are available for indoor or outdoor viewing, and for use in classrooms or wherever you wish to set up a screen in exactly the same manner that you would show home movies. The large cabinet houses the TV set and speaker, while the smaller cabinet holds the projection unit. With these units the picture size can be adjusted from 2 x 3 ft. to 8 x 10 ft. if desired. These new units may be separated up to 35 ft. permitting control from a remote, tamperproof location.

The self-contained projection unit, photo D, employs a 42-tube TV chassis and the picture is adjustable from 12 to 48 sq. ft.

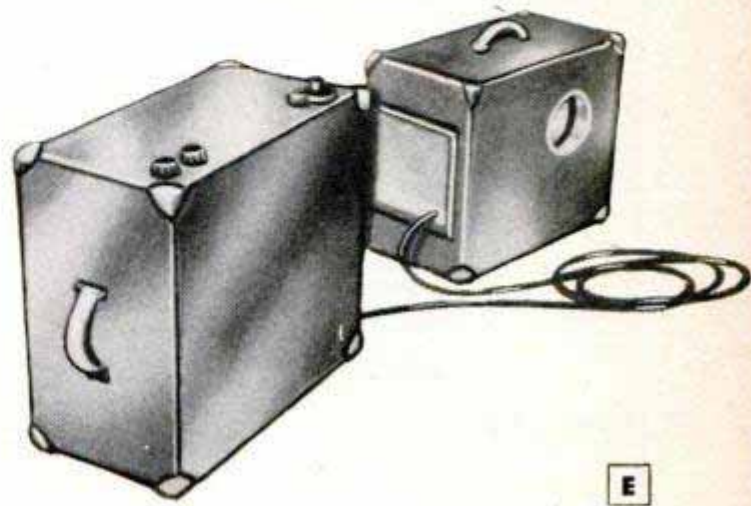
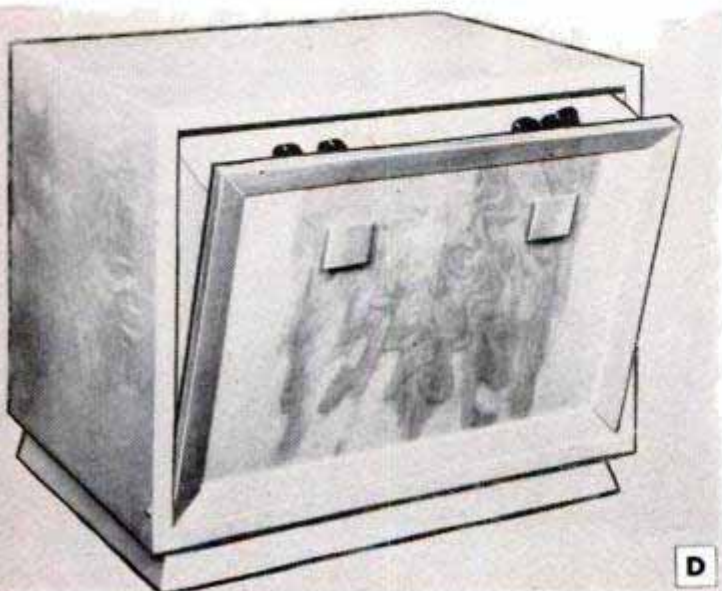



SERVICE HINTS FOR PORTABLE RADIOS

By Harry F. Leeper

WINTER SPORTS are more fun if you take along your portable radio. You can keep in touch with weather reports and football-game broadcasts in almost any location provided you have not neglected to check over your set after returning from your summer vacation. Many battery-operated portables are set aside and given very little attention between trips. Never leave batteries in the set over long periods when not in use as they will deteriorate.

Portable radios of the type shown in photo A often have the loop antenna underneath the battery compartment. Some manufacturers provide a support to hold the batteries above the antenna wires, but it is always a good idea to slip a piece of cardboard between the batteries and the loop as insurance against possible trouble. If your radio is a three-way portable type, photo B, and it refuses to operate on the battery circuit, make sure that you have good contact at the line-cord plug before you decide that the batteries are dead. Move the plug a little with the set turned on and tune in a local station. If a signal then is received, remove the plug and bend the prongs slightly so they will make better contact. Use either tape or a rubber band to hold the folded line cord so that it will fit into its compartment, as illustrated in photo C. If you expect to use the set on an indoor power line, it is a good idea to take along an extension cord as outlets in cabins and motels are not always at convenient locations. A cord of the type shown in photo D provides two handy outlets.

Battery clips and terminals, if broken and replaced, should be marked for correct polarity as indicated in photo E.

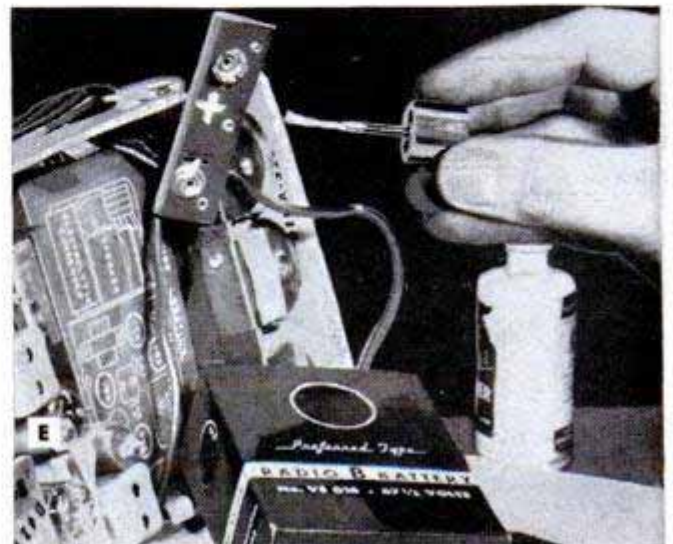
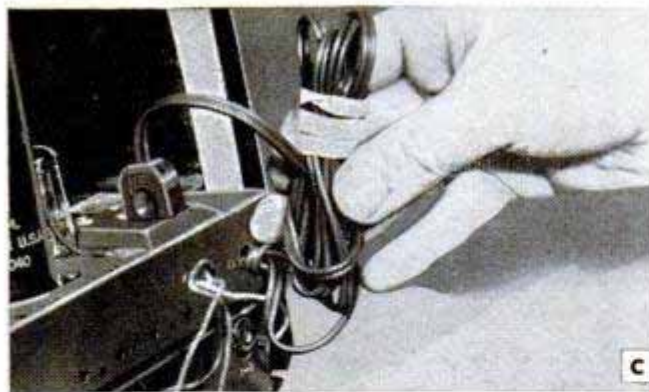
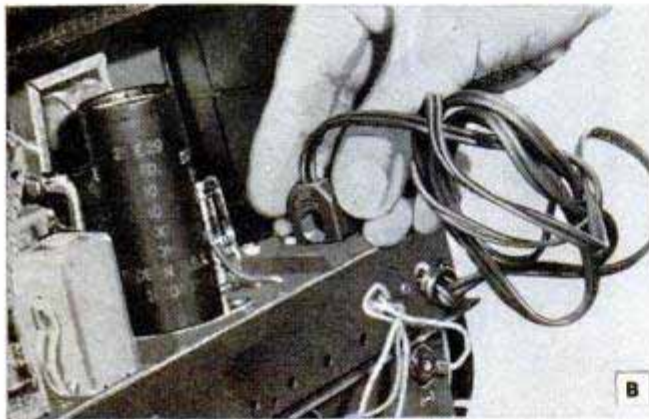
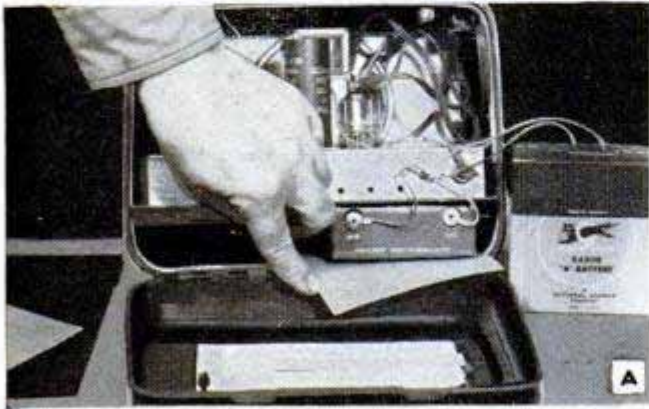

For Real Railroading right at home...

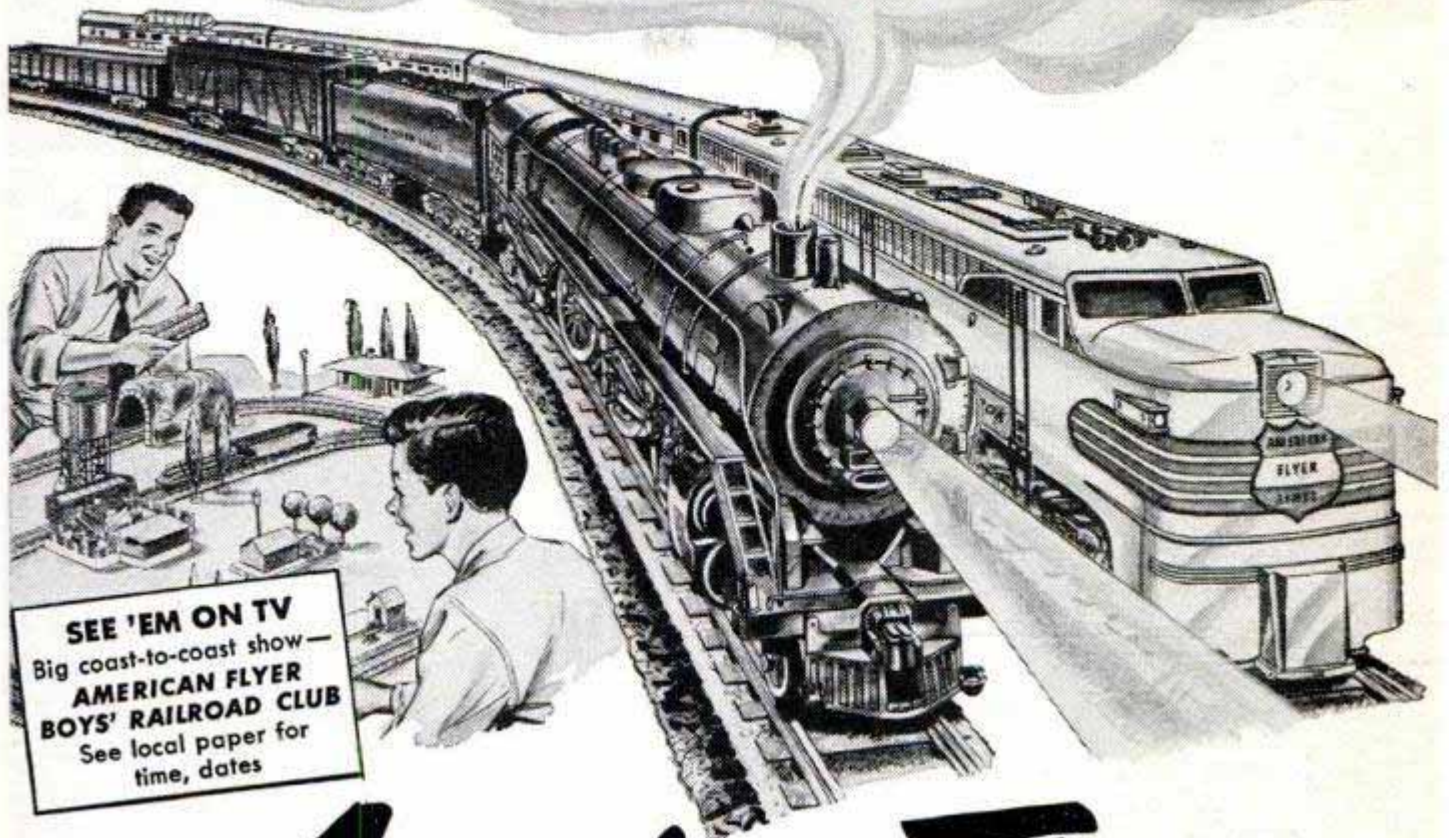

SEE 'EM ON TV
Big coast-to-coast show—
AMERICAN FLYER
BOYS' RAILROAD CLUB
See local paper for
time, dates

American Flyer

**The scale model electric trains that
run on REAL 2-RAIL TRACK**

If it's realism and authentic action you like—you want an American Flyer! No other electric train so truly captures the romance and adventure of railroading. Superb engineering and meticulous attention to detail make American Flyer Trains outstanding. It's almost as if a magic wand had been waved

over real-life locomotives and cars, reducing them to $\frac{3}{16}$ inch scale! Proportions and colors are perfect—and everything is there, right to the last rivet! A whole new world of fun begins on Christmas Day with an American Flyer Train. Why not pass the word to Dad, right now?

**THIS BIG
EXCITING
TRAIN
BOOK
—YOURS FOR ONLY 10¢**



**GILBERT HALL OF SCIENCE
304 ERECTOR SQUARE, NEW HAVEN 6, CONN.**

I enclose 10¢ for which send me immediately the huge 48-page Train Catalog filled with full-color pictures of AMERICAN FLYER Trains and accessories, PLUS Gilbert Erector sets, Chemistry sets, Magic sets, Tool sets and Puzzles.

NAME.....
STREET.....
CITY.....ZONE.....STATE.....

This offer good in U.S.A. only

AMERICAN FLYER TRAINS ARE MADE BY A. C. GILBERT, MAKER OF WORLD-FAMOUS ERECTOR



Easy-to-use materials for printing pictures—ideally suited for beginners. Kodacraft Printing Kit, \$4.95.



Basic essentials for developing and printing pictures, including roll-film tank. Kodacraft Photo-Lab Outfit, \$8.75.



Complete developing, printing equipment, incl. metal printer. Kodacraft Advanced Photo-Lab, \$14.10.



For efficient print drying. Counteracts tendency of prints to curl. Use it over and over. Kodak Blotter Roll, \$2.88.



Easy to use, load, and pour. Takes 620-120, 616-116, and 127 roll films. Kodacraft Roll-Film Tank, \$2.53.

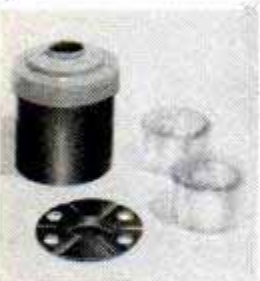

For simultaneous development of two rolls of 828 or 135 film. Kodacraft Miniature Roll-Film Tank, \$2.53.

Save time—Shop here for the photo fans on your Christmas list

These two pages give you some idea of the many useful and inexpensive gift ideas at your photo dealer's. Visit him soon. He'll be glad to help you choose just the right gift for every photo fan on your shopping list.



Permits loading and processing of 35mm. films to be carried out in daylight. Kodak Day-Load Tank, \$9.30.

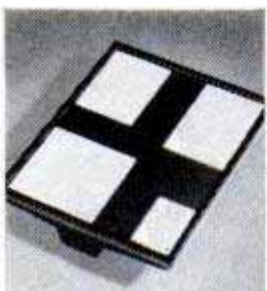

New-type printing frame of steel construction. Includes a set of masks. Kodacraft Printing Frame, \$1.29.

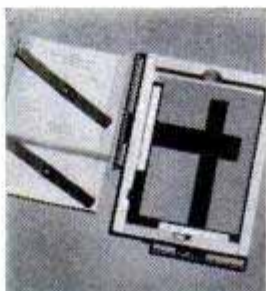

Adjustable—accepts all sizes of negatives up to 4 x 5 1/2 inches. Kodak Auto-Mask Printing Frame, \$2.79.



Converts ordinary tray to efficient, trouble-free washer for prints or films. Kodak Automatic Tray Siphon, \$4.50.



Frees both hands for handling equipment and material in the darkroom. Kodak Utility Footswitch, \$10.00.



Tilting base, minute and split-second hands, large dial. Covers intervals to 60 minutes. Kodak Timer, \$7.20.

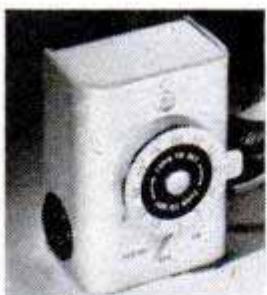

Gives precise timing in contact and projection printing, 1 to 57 seconds. Kodak Electric Time Control, \$13.50.



Handsome chemical-resistant plastic housing protects all working parts. Kodak Chemical Scales, \$9.90.



Cool, Circline fluorescent lamp, integrating-sphere lamphouse are prominent features in each enlarger. Kodak Hobbyist Enlarger (left), \$44.00, complete with f/6.3 lens. Versatile Kodak Fluorolite Enlarger (right), \$99.50, without lens.

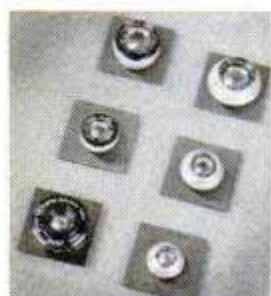

Lenses for the Fluorolite Enlarger range from 50mm. f/4.5 "Ektanon" to 4-inch f/4.5 "Ektar." From \$14.00.

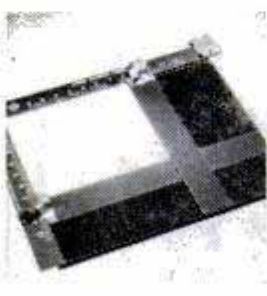

For accurate masking of enlargements—use it with any vertical enlarger. Kodak Masking Easel, 11 x 14, \$9.60.



For determining correct printing time—saves both paper and time. Kodak Projection Print Scale, \$1.15.



Feature-packed view-type camera—permits one-to-one close-ups. Kodak Fluorolite Camera Combination, \$60.00.



Permits use of 35mm. film with Fluorolite Enlarger or Recomar-type cameras. Kodak 35mm. Film Adapter A, \$45.00.



Includes three cups for darkroom work with both papers and films. **Brownie Darkroom Lamp Kit, \$1.75.**



New darkroom safe-light that provides direct or indirect illumination—or both. **Kodak 2-Way Safelamp, \$4.50.**



Can be used either from a drop cord or in a wall plug. Includes safelight filter. **Kodak Darkroom Lamp, \$4.70.**



Attaches to wall, shelf, bench. Includes switch, cord, safelight filter. **Kodak Adjustable Safelight Lamp, \$7.40.**



Expertly made, offers sound protection together with smart appearance. **Kodak carrying case. From \$2.65.**



Adapts de luxe model Kodak Tourist Cameras to take Kodachrome Film. **Kodak Tourist Adapter Kit, \$13.25.**



Permits use of economical Bantam-size (828) color films. **Kodak 828 Adapter for Kodak Reflex Cameras, \$4.59.**



Automatically trips shutter, permits photographer to get into picture. **Kodak Auto-Release, \$3.86.**



Provides dependable "flash" for most internally synchronized cameras. **Kodak Stand-Standard Flashholder, \$8.25.**



Sensational new battery-condenser flash system. **Kodak Ektalux Flashholder (Standard Bracket), \$29.75.**



Condenser-type power for dependable "flash." **Kodak B-C Flashpack, \$2.95 (without 22½-volt battery).**



Twelve-inch reflector focuses readily from wide to narrow light beam. **Kodak Vari-Beam Clamplight, \$10.50.**



Permits close-range picture taking with most fixed-focus cameras. **Kodak Close-up Attachment, \$1.63.**



Now a filter designed for inexpensive box cameras—emphasizes clouds. **Kodak Cloud Filter, \$1.72.**



Provides an excellent means of darkening the sky and clouds in color pictures. **Kodak Pola-Screen, \$6.75.**



Shades the camera lens and reduces sky flare—attaches directly to adapter ring. **Kodak Lens Hood. From \$1.65.**

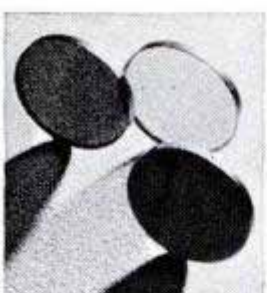

Popular yellow (K2), red (A), and green (X1) filters to fit most cameras. **Kodak Wratten Filters. From \$1.65.**



Two compartments hold 4 filters, adapter ring, lens hood. **Kodak Combination Filter Cases, \$4.25, \$4.95.**



New-type slide-feeding mechanism, cool operation, elevating device. **Kodaslide Merit Projector, \$26.10.**



2 x 2 projector and screen in a single unit. Usable in fully lighted room. **Kodaslide Table Viewer, 4X, \$49.50.**



Projector, screen, slide changer in one unit. **Kodaslide Table Viewer, Model A, \$97.50.**

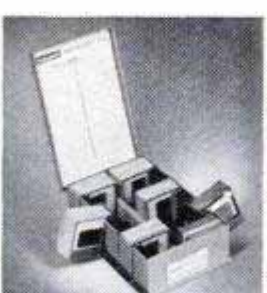

Compartments for 240 cardboard or 96 glass slides. **Kodaslide Compartment File, \$3.94.**

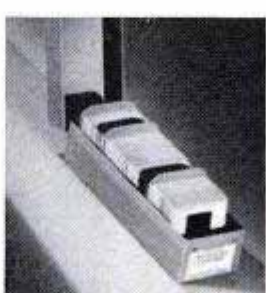

Protects 140 cardboard or 55 glass slides—keeps them organized. **Kodaslide File Box, \$1.57.**

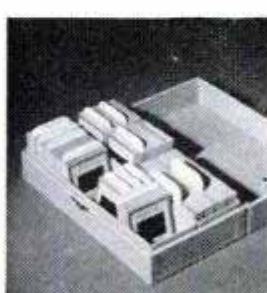

Holds 360 2 x 2-inch or 160 stereo slides. **Kodaslide Flexo File, \$1.25.**

Prices subject to change without notice and include Federal Tax where applicable. Consult your dealer.

EASTMAN KODAK COMPANY, ROCHESTER 4, N. Y.

Kodak
TRADE-MARK



Care and Feeding of Engines

BY S. P. CORP

POOR TIMING WASTES GAS

Your ignition distributor interrupts the primary circuit for correct timing of the spark, advancing the timing as your engine accelerates. A vacuum distributor advance connected to the distributor governs timing for sudden loads on the engine, such as fast acceleration.

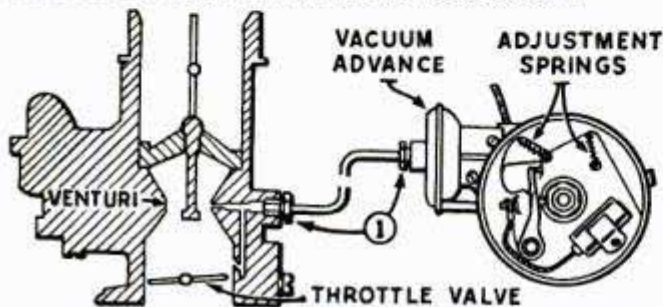

VACUUM DISTRIBUTOR ADVANCE HOOK-UP

A small pipe line connects this vacuum advance to the carburetor, which furnishes the vacuum. Should this line become clogged, poor engine performance and low gas mileage can result. An engine may backfire and fill this line with gasoline, which would clog it.

To correct, loosen nuts at each end of pipe marked (1), remove pipe from fittings, and blow it clear. **Caution:** When replacing, turn nuts halfway by hand before using a wrench, as threads are very fine and can be crossed, causing an air leak. It is a good idea to have the vacuum advance unit checked for diaphragm leaks, to protect gas economy.

ONE CAUSE OF HARD STARTING

Your car radio uses a resistance unit to remove ignition interference. This is installed in the high tension lead from ignition coil to the center of the distributor cap. Being a carbon resistance unit, its resistance increases with age and heat from the engine.

Such increased resistance interferes with current to the spark plugs and can cause hard starting, also a high speed miss. As a rule, the correct resistance is marked on the outside of the unit. It can be removed and checked by any radio service man. Remove it by pulling the wires out of each end and placing the coil wire back into the distributor cap.

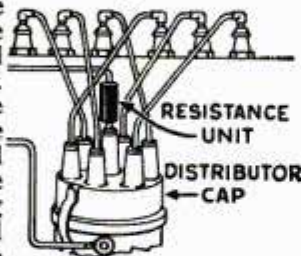

With unit removed, check starting of engine. If trouble is corrected, get a new unit. Car radios require such a unit for good operation.

GET VALUABLE BOOKLET FREE

"MORE POWER, Less Gas, Less Oil," a new booklet on car care, is yours for the asking. It tells about new Sealed Power KromeX Ring Sets. Write Sealed Power, Dept. G-12, Muskegon, Mich.



Clinic for Homemakers

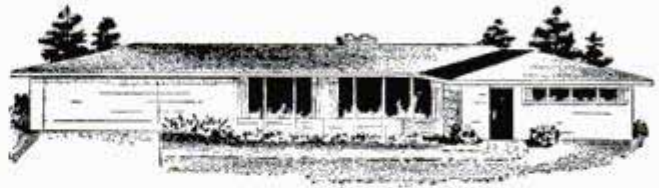

As a service to our readers in solving the hundreds of problems pertaining to a home—inside or out—the editors of *Popular Mechanics* invite you to present your problems to The Clinic Editor for help and advice. Address your questions to The Clinic Editor, *Popular Mechanics Magazine*, 200 East Ontario Street, Chicago 11, Ill.

Removing Stump

Q—Recently I cut down two large trees in my yard and now I'm faced with the problem of removing the stumps. I'd considered attempting to dig them out, but have hesitated because of the labor involved and the unavoidable damage to the lawn. Is it practical to burn them out and if so, how do I go about it?

M.A., Tenn.



A—Eliminating a stump by burning is a rather tedious job as a fire must be maintained over a period of time and generally the smoke is objectionable. The usual procedure is to drill several 1-in. holes deep into the stump and repeatedly fill these with kerosene until absorption ceases. Then place wood or other material around the stump, ignite it and add fresh fuel to keep the fire burning until the kerosene-soaked wood ignites and burns freely. As a rule the stump can be burned out to a point well below ground level. Where smoke is objectionable another method produces fairly satisfactory results, although it takes more time. Drill holes in the stump in the same manner as described and fill the holes with the packaged chemicals sold by hardware stores for making compost. These speed up normal decay to a fraction of the time ordinarily required.

Paint Defects

Q—What causes checking, blistering and wrinkling of paint when applied to wooden siding?

R.T., Colo.

A—Checking generally means short, narrow breaks in the paint film. As a rule both checks and cracks (longer and larger cracks) are the result of shrinking and hardening of the paint film so that it no longer has sufficient elasticity to resist atmospheric changes. Moisture penetrating the walls from the room side is a common cause of blistering paint. Moisture in the form of vapor will penetrate all common building materials except barriers, and eventually will collect under the paint film. Moisture in the form of excess humidity may have as its source steam from the preparation of food in the kitchen, laundering and shower bathing. In new homes slow drying of plaster is a cause of paint blistering on exterior walls. A common cause of wrinkling is the application of a heavy finish coat over undercoats which are not thoroughly dry. It should be understood that only the more common causes of paint defects are given above. There are, of course, other causes.

(Continued to page 222)

WHAT? YOU INSULATED YOUR HOUSE YOURSELF?

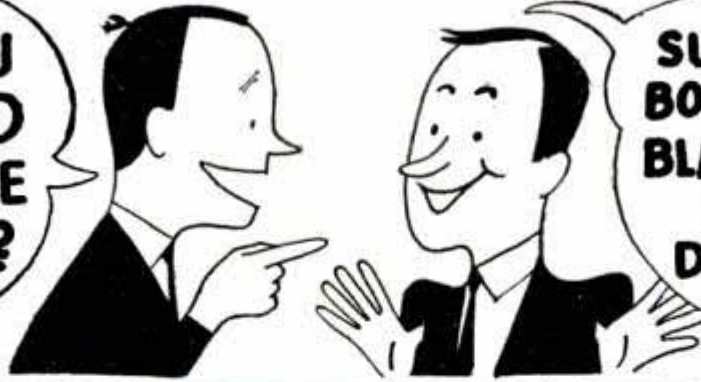

SURE-WITH GOLD BOND ROCK WOOL BLANKETS-AND WHAT A DIFFERENCE!

WITHOUT INSULATION THE FURNACE HEAT WAS GOING RIGHT UP THROUGH THE ROOF.



SO I PUT FIREPROOF GOLD BOND ROCK WOOL BLANKETS IN THE ATTIC. IT SURE WAS EASY!



IN THE UNFINISHED PART, I JUST LAID THE BLANKETS WITH THE VAPOR BARRIER DOWN!



IN THE WALLS AND CEILING OF OUR ROOM I USED 8 FOOT BLANKETS LIKE THIS- IT WAS A CINCH.

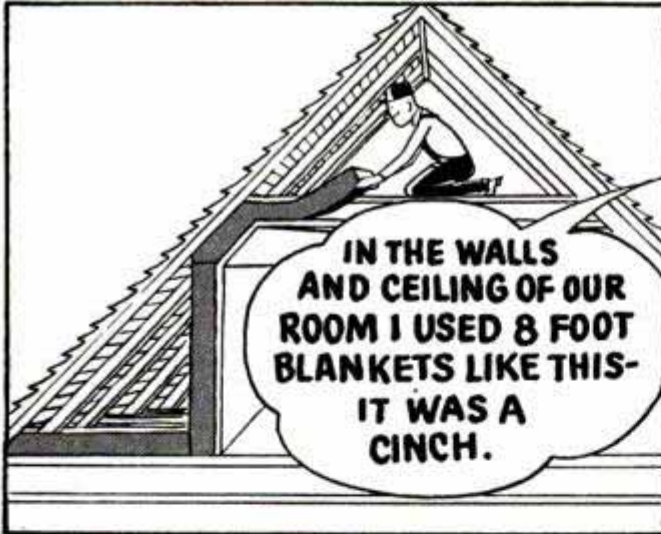

MY GOLD BOND LUMBER AND BUILDING MATERIAL DEALER FIGURED THE WHOLE JOB - SHOWED ME EXACTLY HOW TO DO IT...

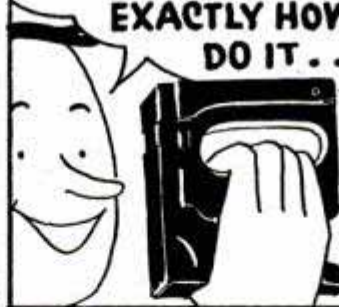

EVEN SUPPLIED A STAPLING GUN- (NAILING IS EASY, TOO!)

BUILD BETTER WITH Gold Bond BUILDING PRODUCTS

MY FUEL SAVINGS HAVE MORE THAN PAID THE COST. THE WHOLE HOUSE IS WARMER IN WINTER AND MUCH COOLER IN SUMMER! WHY DON'T YOU SEE YOUR GOLD BOND DEALER ABOUT INSULATING NOW!

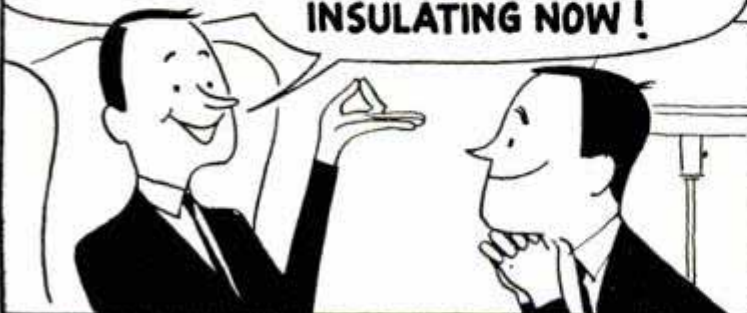

LOOK FOR THE STRIPED PACKAGE



NATIONAL GYPSUM CO. BUFFALO 2, N. Y.

ADD-A-ROOM NOW! with Gold Bond BUILDING PRODUCTS

Do it yourself with



Speed Way Speed Tools

Build, repair, install, finish or refinish—at your convenience, at low cost. Powerful SpeedTools take the drudgery out of work, help you do "professional" quality work in a hurry.

No. 150 SpeedSander

An all-ball-bearing, orbital-motion, finishing sander with powerful 3450 r.p.m., A.C. induction motor and cast aluminum body. **\$34.50**

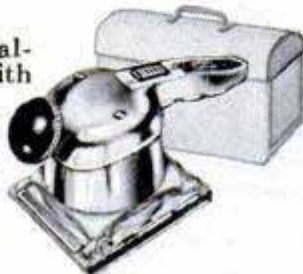

150-K SpeedSander Kit

The Sander with Accessories including: deep contour pad, finishing plate, felts for free abrasives and wet rubbing, lamb's wool bonnet, 90 sheet abrasive covers, etc. in fitted steel carrying case. **\$49.50**

No. 1000 SpeedSaw

1/4 H.P. Universal Motor, cast aluminum housing, safety shut-off switch. Cuts all angles to 45°, any depth to 1 1/8" **\$29.95**



SpeedDrills

(for metal or wood)

Extra power, high speed, electric drill with cast aluminum cases, and geared chucks.

No. 200-J 1/4" SpeedDrill **\$19.50**

No. 400

1/2" SpeedDrill **\$39.50**

also other sizes, types.



Drill Kits

Several fast selling kits. Painters and Householders Kit (illustrated) is typical. It has: 1/4" Hornet Drill, Abrasive Discs and rubber backer plate, grinding wheel, wire brush, buff, etc. In attractive display carton. **\$19.95**

Write for catalog



Speed Way MANUFACTURING CO.
1863 So. 52nd Ave. • Cicero 50, Illinois

Attaching Knotty Pine To Basement Walls

Q—I'm planning a basement recreation room to be finished in knotty pine. According to the plan the boards must be attached to the masonry walls. I'm told that the best method is to install studding and nailing members inside the masonry walls, but the space available is comparatively small and this construction would reduce the size of the room. Isn't there a way to attach the boards directly to the masonry?—T.U., Ky.



A—Yes, one way is to drill holes in the masonry walls with a star drill and insert screw anchors. Then attach wooden furring, or nailing strips, by driving screws through the strips into the soft-metal anchors. The strips can be spaced from 18 to 36 in. apart. If the wall slopes slightly, then the thickness of the strips will have to be varied so that the boards will stand perpendicular. Another method utilizes the metal fasteners which are attached to the wall with a special adhesive. These are located at measured levels on the wall and equally spaced. A nail is welded to each metal plate with the point projecting. When the adhesive is dry, the furring strips are centered on the projecting nail points and then tapped with a hammer causing the nail points to enter and pass through the strip from the back. When the strip is in place, the nail points are clinched tightly to hold the strip securely. The knotty-pine boards are then nailed or screwed to the strips.

Sweating Masonry Walls



Q—My home is built of concrete blocks and for the last two winters I've been troubled by the walls sweating. Moisture seems to collect near the ceilings and drops run down the walls. Paint and wallpaper are being damaged and unless I can find and cure the trouble there's no use of re-decorating. I've looked

in the low attic for leaks but there seems to be none. What is causing this and how do I cure it?—A.B., N.Y.

A—You did not describe the wall construction. That makes it difficult to judge, at this distance, but basically the trouble is due to an excess of moisture in the air inside the house. Variations in the temperature of the air and the walls will cause the moisture to condense on the inside surfaces of the walls, which are colder. The trouble is more pronounced where the plaster is applied directly to the masonry without proper insulation and the installation of a vapor barrier. If this is so in your case, then the only remedy that can be considered effective is to attach wooden furring strips to the walls, apply insulation and a vapor barrier and then plaster over metal lath or a plaster base. Some types of insulation made especially for installation between furring strips have a vaporproof membrane attached to the room side. In order for this to be fully effective care must be used when installing to assure a moistureproof seal. Follow the manufacturer's instructions in all details. The insulation tends to prevent penetration of cold to the inner surface of the wall, and this means that the temperature of the walls on the room side remains at more nearly the temperature of the air. In some cases reducing the humidity of the air in the rooms will prove helpful in minimizing condensation. Some homeowners have found that a kitchen ventilating fan operated each day will reduce the humidity by removing cooking vapors and excess moisture from the weekly laundering.



MILE-O-METER

REG. U. S. PAT. OFF

No Finer Gift

FOR THE MAN WHO OWNS A CAR

Mile-O-Meter is the most practical and fascinating gift any motorist can receive. It mounts permanently on the dashboard (with no holes to drill) and indicates continuously both "miles per gallon" and overall motor condition, warning clearly when minor adjustments are necessary to prevent costly breakdowns and repairs. Fully guaranteed on a firm "money-back if not satisfied" basis. Endorsed by leading automotive associations. Really simple to install. Fits all cars. Mile-O-Meter is the perfect gift for the man who owns a car.

SAVE GAS

CUT MILEAGE COSTS

THE PERFECT GIFT

MONEY-BACK GUARANTEE

EASY TO INSTALL

ILLUMINATED

FITS ALL CARS



Save Three Ways with MILE-O-METER

Save on Gasoline — because Mile-O-Meter makes it easy to drive economically.

Save on Repairs — because Mile-O-Meter continuously indicates the performance of your engine.

Save on Tune-Up — because Mile-O-Meter shows you how to make 31 different motor adjustments quickly and easily.

AND . . . Mile-O-Meter takes only a few minutes to install. Accurately measuring the manifold vacuum, Mile-O-Meter "translates" this important information for you by an easy-to-read calibrated dial. It's the most important investment you can make for overall driving economy. Pays for itself over and over again.



You'll save when you drive by instrument instead of instinct . . . when you drive with a Mile-O-Meter on your dashboard.



Mile-O-Meter is beautifully gift-wrapped, with all accessories included. A gift card will be enclosed at your request. We mail anywhere in the USA on the same day order is received. When payment is enclosed, we pay postage. Add 35c for special delivery.

(C.O.D.'s accepted.)



\$14.95
Ppd.

Deluxe Illuminated Model 3 1/4" dia Fed. Tax incl.

\$9.75
Ppd.

Standard Model 2 1/4" dia. Fed. Tax incl.

Order from GALE HALL ENGINEERING Dept. 283
107 Northampton St., Boston 18, Mass.

Please send . . . Deluxe . . . Standard Mile-O-Meters at \$

Name _____

Address _____

City _____ State _____

Check enclosed C.O.D. Gift Wrapped (free) Gift Card (if desired)

Send check or M. O. . . . shipped prepaid (add 35c for special delivery). C.O.D.'s accepted (plus postage).

FREE! Huge 24-page Motorist's Manual and Instruction Booklet PLUS Mileage Calculator.

Enjoy the Thrills of Short-Wave at a Down-to-Earth Price

FROM hallicrafters

Here is a radio that strides the world at the touch of a dial. Now you can hear historic world events direct, hear the BBC, Paris, Australia, exciting ship-to-shore broadcasts, amateurs from all over the world, the Voice of America, Russian propaganda, police calls, and in addition you get powerful long distance, broadcast-band reception.

Here is a radio that gives you superior short-wave and standard broadcast reception, yet costs no more than you'd expect to pay for an ordinary radio. Only Hallicrafters skill and know-how, the experience gained in years of producing more military type radio communications equipment than all other manufacturers combined, could produce this set. See it. Hear it—hear what you've been missing.



HALLICRAFTERS
MODEL S-38C Only **\$49⁵⁰**

hallicrafters

WORLD'S LEADING PRODUCER OF PRECISION
COMMUNICATIONS RADIOS

Clymer Tests the Kaiser

(Continued from page 92)

throttle locations are good. The hand-brake lever is operated by the right hand. Starter is push-button type. The "bin type" glove compartment is convenient but I don't like the idea, as articles fall out too easily when it is opened and too much slamming is required to close it. The windshield is two-piece and curved. It is extremely high and wide, affording excellent vision as corner posts are very narrow. Rear vision likewise is excellent, but the rear-vision mirror does not offer full use of the large rear window. Ventilation is good and controlled for either or both sides by separate knobs. The heater is excellent and its controls operate easily.

The hood is counterbalanced, easy to open and close and is locked from the inside. The luggage compartment is ample, but not so large as that in the first Kaiser cars when the body was higher. The spare tire lies flat in a well on the floor with a metal cover. The cover lock could stand much improvement. When a flat occurs, luggage must be removed before the tire can be taken. It's a space-saving idea, but not a practical one.

Even in the dusty and rough desert the car developed no rattles, squeaks or dust leaks and in 100 miles of rain no water came in, which indicates better assembly than in earlier Kaiser models.

The new Kaiser took all the abuse I gave it and came through in good shape. I would rate it a good, sound, reliable and economical car.

In his cars, Henry J. Kaiser offers many fine features, some of which are better than those found on competing makes, yet it is hard for some people to see anything good in a Kaiser. I've said many times and say again that Kaiser products are far better than most people think they are. In spite of opinions of some nonowners, you'll find Kaiser owners rate among the highest in praise of their cars. If you don't think so, just ask the next 10 Kaiser or Henry J owners you meet how they like their cars. By and large, they are real boosters and some are fanatical in praise of Kaiser. Of course, you'll also find a few "knockers" among the owners.

Some say Kaiser is an "assembled" car, and in early days some sort of stigma seemed to be attached to the word "assembled." It is true that Kaiser is an assembled car, but so are all the others. These are the days of specialists and even the larger makers no longer make all the units used in their cars.

Kaiser probably builds as much of his

(Continued to page 228)

The Perfect Christmas Gift For Any Man

All-Purpose WELLER GUN

**Does Dozens of Money-Saving Jobs
Plus All Types of Soldering**

With this instant-heating electric tool, he'll repair metal equipment, spouting and toys—fix radios, TV, appliances and wiring—heat-seal home freezer packages—build model railroads—make costume jewelry—regroove tires. Weller Guns with finger-tip heat control and prefocused spotlight are available in Christmas Gift packages at your Hardware Dealer

WRITE FOR BULLETIN telling all about Weller Guns.

Weller

**SOLDERING
GUNS**

816 Packer Street, Easton, Pa.



cuts rubber or composition floor and wall tile



removes old, hard putty from windows



repairs furniture scratches with stick-wax

**WATERLOO
METAL
BOXES
AND
CHESTS**

Santa's 1st Choice
for Hobbyist and Shopman

Craftsmen in every phase of automotive, radio, electrical, or industrial work choose Waterloo boxes. Why? ... Because they are designed to meet the exacting requirements of tool experts ... because they are unmatched for lightness, strength and beauty. They feature:



• GABLE TOP TOOL BOX



• SMALL PARTS CABINET



• HEAVY DUTY
CARPENTER'S BOX



• GENERAL UTILITY BOX



• MECHANIC'S BOX

• Embossed metal Reinforced corners Automatic trays Heavy draw bolts.

• Piano type hinges. Water shed Green baked enamel electrostatically applied

• Lifetime handles ... double edges.

See these boxes now at your Hardware Dealer ... or write for free catalog.

**WATERLOO VALVE SPRING
COMPRESSOR CO. • WATERLOO, IOWA**

America's most complete line

Saving money for industry . . . giving greater pleasure in the home workshop
 Designed with plus-performance and features professional craftsmen want

Man! Look at these big, rugged, streamlined beauties . . . and look at their amazing low prices! No wonder Sears lead all America in power tool sales! All are precision-built by the most expert, efficient manufacturing methods known. All are laboratory tested . . . and GUARANTEED to give you complete satisfaction or your money back!

CRAFTSMAN and DUNLAP Power Tools come in a complete range of types and sizes for industrial or home workshop use. Buy with confidence! See these sensational extra-value tools at your nearest Sears Retail Store TODAY! Compare them feature-by-feature with ANY others . . . and prove to yourself that Sears Power Tools give you more for your money!

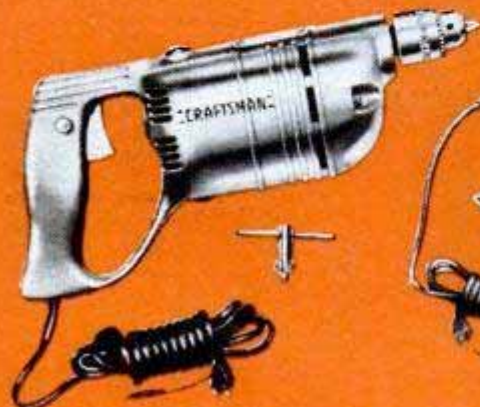

CRAFTSMAN 1/2-inch Electric Drill
\$25.95 Cash \$3.00 Down

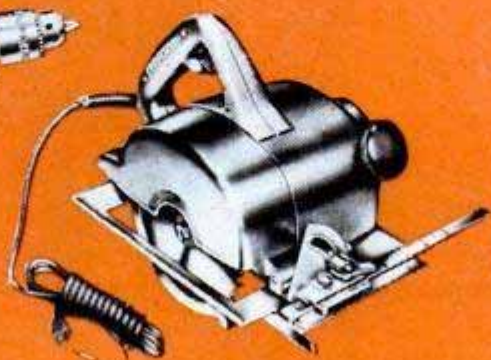

CRAFTSMAN 6 1/2-inch Electric Hand Saw
\$55.00 Cash \$5.50 Down
 Without case



CRAFTSMAN Ball Bearing Capacitor Motor
\$28.00 Cash \$3.00 Down
 1/2-H.P. 1750 R.P.M.



DUNLAP 1/2-inch Electric Drill
\$34.95 Cash \$3.50 Down



CRAFTSMAN Disc Sander-Polisher
\$36.50 Cash \$4.00 Down
 Without case



CRAFTSMAN Wood Shaper
\$54.00 Cash \$5.50 Down
 Without motor



CRAFTSMAN Rotary Tool Outfit
\$26.95 Cash \$3.00 Down
 Complete 54-piece set



CRAFTSMAN Sander-Polisher
\$16.95 Cash \$2.00 Down
 Without case



DUNLAP 1/4-H.P. Electric Grinder
\$29.95 Cash \$3.00 Down

CRAFTSMAN and **DUNLAP** Tools by **SEARS, ROEBUCK and CO.**
REG. U.S. PAT. OFF.

of fine quality Power Tools!

Compare them yourself! We don't think you can match these values anywhere!
Just a small down payment on Sears Easy Terms puts one or more in your shop!



Free!

1953 CRAFTSMAN Power Tool Catalog! Get yours NOW from the Hardware Department of your nearest Sears Retail Store!



CRAFTSMAN 8-inch Tilting-Arbor Bench Saw

\$60.00 Cash \$6.00 Down

Less guard, motor, extensions



CRAFTSMAN 3-Drum Belt Sander

\$58.95 Cash \$6.00 Down

Without case



CRAFTSMAN Ball Bearing Drill Press

\$75.00 Cash

Without motor \$7.50 Down

CRAFTSMAN Metal Turning Lathe

\$47.50 Cash \$5.00 Down

Without motor

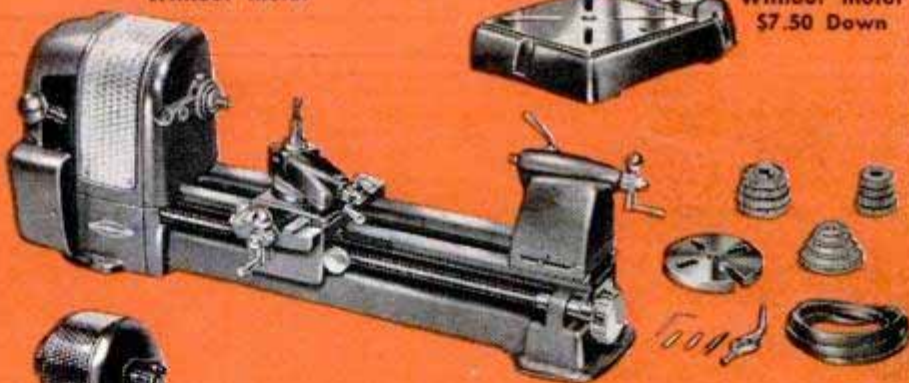

CRAFTSMAN 18-inch Jig Saw

\$32.50 Cash \$3.50 Down

Without motor



CRAFTSMAN Ball Bearing Wood Lathe

\$46.50 Cash

Without motor \$5.00 Down



CRAFTSMAN 3-wheel Band Saw

\$53.00 Cash \$5.50 Down

Without motor



CRAFTSMAN 4 1/2-inch Jointer-Planer

\$50.00 Cash \$5.00 Down

Without motor

Your nearest Sears Retail Store will furnish you with exact selling prices which will not exceed O.P.S. ceiling prices.

Famous for fine quality... precision performance... low price!

car as many others, inasmuch as he builds his own bodies. Although the engine carries the Kaiser-Frazer name, it sometimes is referred to as a Continental, which certainly carries no stigma; thousands of taxis that require stamina in engines use the same unit.

Borg-Warner supplies Kaiser with transmissions, as it does Ford, Lincoln, Mercury, Studebaker, Packard, Nash and Willys, including transmissions for such trucks as Reo, Mack, Ford, International, Buda, Diamond T and others.

For clutches Kaiser went to Borg & Beck, which supplies Chrysler, DeSoto, Dodge, Plymouth, Nash, Studebaker and others. When Kaiser engineers wanted a steering gear, they went to Gemmer (in business 42 years) which supplies all Chrys-

(Continued to page 230)

1952 KAISER-FRAZER SPECIFICATIONS

ENGINE

	Kaiser	Henry J "6"	Henry J "4"
Type	6-cyl., L-head	6-cyl., L-head	4-cyl., L-head
Bore and stroke	3 ¹ / ₁₆ in. x 4 ³ / ₈ in.	3 ¹ / ₈ in. x 3 ¹ / ₂ in.	3 ¹ / ₈ in. x 4 ³ / ₈ in.
Piston displacement	226.2 cu. in.	161 cu. in.	134.2 cu. in.
Brake horsepower	115 @ 3650 r.p.m.	80 @ 3800 r.p.m.	68 @ 4000 r.p.m.
Compression ratio	7.3 : 1	7.0 : 1	7.0 : 1
Transmission	3-speed conventional.	Conventional with overdrive unit optional on all models. Dual-Range Hydra-Matic optional on Kaiser only.	

GENERAL

Steering ratio	25 : 1	24 : 1	24 : 1
Steering, lock to lock	5 turns	4 ¹ / ₄ turns	4 ¹ / ₄ turns
Turning radius	19 ft.	17 ft. 6 in.	17 ft. 6 in.
Brakes	Hydraulic with riveted linings—all models.		
Tire size	6.70 x 15	5.90 x 15	5.90 x 15
Recommended pressure	24 lb. front 24 lb. rear	24 lb. front 20 lb. rear	24 lb. front 20 lb. rear
Weight (unladen)	3171 lb.	2350 lb.	2300 lb.
Wheelbase	118 ¹ / ₂ in.	100 in.	100 in.
Tread, front	58 in.	54 in.	54 in.
Tread, rear	58 ³ / ₄ in.	54 in.	54 in.
Height, over-all	60.25 in.	61.90 in.	61.90 in.
Width, over-all	74.875 in.	69.38 in.	69.38 in.
Length, over-all	211 ¹ / ₈ in.	177 ² / ₃₂ in.	176 ² / ₃₂ in.
Road clearance	8 in.	7 ¹ / ₂ in.	7 ¹ / ₂ in.

INTERIOR DIMENSIONS

Front seat width	63.18 in.	57.38 in.	57.38 in.
Rear seat width	63.12 in.	56.75 in.	56.75 in.
Headroom, front	35.69 in.	35.41 in.	35.41 in.
Headroom, rear	33.69 in.	33.10 in.	33.10 in.
Legroom, front	45.31 in.	43.44 in.	43.44 in.
Legroom, rear	39.56 in.	37.18 in.	37.18 in.

CAPACITIES

Oil	5 qt.	5 qt.	4 qt.
Water	13 qt.	9 qt.	10.8 qt.
Gasoline	17 gal.	13 gal.	13 gal.

Built for economy-minded hobbyists who demand . . .

QUALITY PLUS!

SHOPMASTER

8" TILTING ARBOR SAW

A new Shopmaster tool at a new low price. Durable construction of rugged cast aluminum alloy with large table working surface. Has visible and convenient operating mechanism. It's an excellent all-around tool for the new hobbyists' workshop.

\$49⁹⁵

Slightly lower Zone 1

NEW MITRE GAUGE STOP ROD INCLUDED











SEALED FOR LIFE BALL BEARINGS

MASSIVE CAST CONSTRUCTION

SIMPLIFIED TILTING CONTROLS

FREE Complete catalog of the famous quality Shopmaster tools.

<p>Other famous SHOPMASTER TOOLS</p>	 <p>20" TILTING TABLE JIG SAW</p>	 <p>TABLE SIZE SPINDLE SHAPER</p>	 <p>20" TABLE SIZE SABER SAW</p>	 <p>12" DRILL PRESS</p>	
	 <p>BELT AND DISC SANDER</p>	 <p>10" SWING WOOD TURNING LATHE</p>	 <p>12" TILTING TABLE BAND SAW</p>	 <p>10" TILTING ARBOR SAW</p>	

1214 THIRD ST. SOUTH • MINNEAPOLIS, MINNESOTA



Eager power

Thrilling speed

Great stamina

It's got EVERYTHING

HARLEY-DAVIDSON

HYDRA-GLIDE®

Years ahead in design. Miles ahead in power. It's loaded with features that make it the best motorcycle that ever came down the road. The improved 55 HP, 74 OHV motor has engineering advances few automobile engines can boast... hemispherical combustion chambers, hydraulic valve lifters and rotating valves. That means power to thrill you, speed to dazzle you, performance under any condition that makes you proud you own this most wanted of all motorcycles.

Try a ride today. See your Harley-Davidson dealer and take a buddy along. Or send 25¢ for illustrated literature and a copy of the Enthusiast magazine, filled with exciting action pictures and stories. Harley-Davidson Motor Co., Dept. P, Milwaukee 1, Wisconsin.



HARLEY-DAVIDSONS
win national events
Peoria T. T. Championships
45" Class — 1st
80" Class — 1st
National Class C Hillclimb
1st in all 4 events!

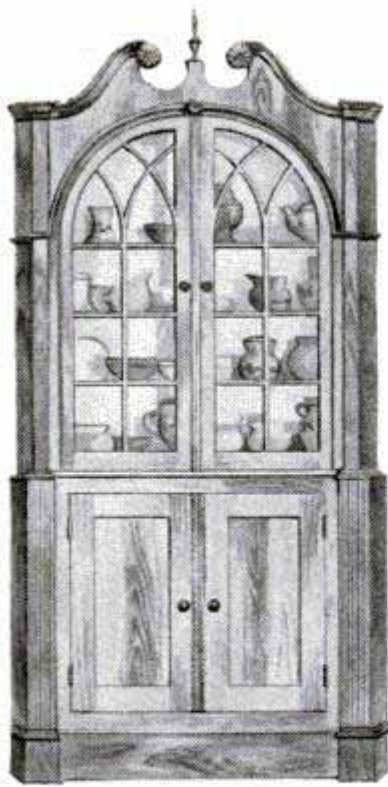

Make tomorrow's heirlooms
with beautiful

WESTERN PINES*

Craftsmen of today choose the mellow, rich woods of the Western Pines for fine furniture and cabinetwork that will be cherished treasures in years to come!

When you make this handsome pine cupboard, for instance, you will find these straight-grained, soft-textured woods remarkably responsive, easy-to-work, cutting to clean edges and contours, shaping easily on the turning lathe. Waxed, then rubbed to a shiny sheen, every inch will glow with lasting loveliness!

Whether you do fine cabinetmaking, build a bunk bedroom, or remodel a kitchen, you can't choose better than these naturally beautiful Western Pines!

FREE IDEA PACKET NO. 540

contains helpful how-to-do-it suggestions and furniture work plans, including one for the cupboard illustrated.† Also a copy of the colorful booklet, "Enchanting Homes of Western Pines," with 71 illustrations. Write today to WESTERN PINE ASSOCIATION, Dept. 540-N, Yeon Building, Portland 4, Oregon.

†This cupboard from *The Cabinetmaker's Treasury*, published by The Macmillan Company.

These are the Western Pines

* IDAHO WHITE PINE
* PONDEROSA PINE
* SUGAR PINE

ler-built cars, Packard, Hudson, Nash, Mercury and Lincoln. Ford makes its own Gemmer-design gears under arrangement with Gemmer.

Carter carburetors are standard on all Kaiser cars. Carter also is used in Studebaker Champions, some Cadillacs, Hudson, Nash, Oldsmobile, Packard, Willys, Plymouth, DeSoto, Chrysler, Pontiac and Buick.

Other units such as speedometers, rear axles, shock absorbers, radiators, body hardware, batteries, plugs, springs, frames, bumpers, fan belts, universal joints and other items are supplied to Kaiser by specialists in their respective fields and many of them supply all or some units for most of the other car makers. ★ ★ ★

Owners Report on the Henry J

(Continued from page 90)

little farther from the steering column."—Three Rivers, Mich., accountant.

"Rear window is not high enough for rear-view mirror."—Ashtabula, Ohio, truck driver.

"The body should be about 18 inches longer, without an increase in wheelbase, for more room between front and rear seats."—Kankakee, Ill., farmer. (Owners of all makes of small cars register this complaint, as do owners of many club coupes in larger cars.)

"Kaiser should have brought out the present better-finished Henry J at first. Many formed a bad opinion of the first cars because of lack of refinement and needed accessories that now are available. It's a great car and far better than most people think."—Atlanta, Ga., bus driver.

But most replies were favorable.

An Astoria, Ore., Navy employee wrote: "This car surprises everyone by the room and power it has. I believe people under-rate it. I've owned two and will buy a new one when it comes out next year."

A Detroit plumbing contractor was one of several who said, "The Henry J makes an excellent second car in the family. I use mine for business purposes."

"Room in the Henry J is fantastic. Three can ride in the front seat in comfort. I feel relaxed and not cramped on many long trips I take. Economy is fine, engine smooth. I'd like rear windows that open."—Glendale, Calif., salesman.

A Mesa, Ariz., insurance agent, a Dallas, Tex., golf professional and an Aurora, Ill., serviceman were among those who said that water leaks in under doors and around the windshield and rear glass.

A Worcester, Mass., man wrote: "I drive heavy trucks for a living and don't care to

(Continued to page 232)

Want the greatest Christmas ever?

COME RIGHT OUT AND ASK YOUR FAMILY FOR THE

DELTA SHOP

...DOES 98% OF HOME-SHOP JOBS

Here's a one-motor combination shop that makes sense—the four most-used regular Delta Homecraft tools in a unit that takes only a 3-foot square—built around a husky 8" circular saw with tilting blade. Plus a big-capacity 4" jointer, versatile 11" drill press, sturdy disc sander. Not a group of attachments, no time-wasting setting-up and adjusting. Ready to work! Nothing to compare with it—for big value, small size and best of all, LOOK... only **\$209.95*** including the steel stand.

Later, if you have more room for a bigger shop, it's easy to separate your Deltashop into individual tools. Or you can build the DELTASHOP tool-by-tool as your funds permit.

*Motor and motor accessories extra.



Another
ROCKWELL
Product

OR MAYBE YOUR SHOP NEEDS ONE OF THESE FINE TOOLS...

DELTA Homecraft 11" LATHE

for the expert who loves turning. Make furniture,



lamps, toys, hundreds of excellent projects.

\$57.25

DELTA Homecraft 10" BAND SAW

for inside and outside curve cuts, and for cutting stock too thick for the circular saw. For hardwood, too—and plastics, light metals.



\$46.95

DELTA Homecraft 16" SCROLL SAW

Do intricate patterns and delicate cutting like marquetry, fine fret work, inlays, veneers, jig saw puzzles. A wonderful tool for starting your youngster's shop training.



\$37.95

Special!

A DELTASHOP GIFT CERTIFICATE

Here's the ideal way to present this ideal gift for any man—get an attractive DELTASHOP Gift Certificate Box from any Delta dealer.



HAPPY NEWS FOR A MODEST CHRISTMAS BUDGET...

GIVE A DOWN-PAYMENT—What gift so appropriate for a family that watches the dimes, as a down-payment on a DELTASHOP! Delta dealers have an easy-payment plan, actually the tool soon pays for itself.

DELTA
MILWAUKEE

DELTA POWER TOOL DIVISION

Rockwell MANUFACTURING COMPANY

502P NORTH LEXINGTON AVENUE • PITTSBURGH 8, PENNSYLVANIA

There's a Delta Power Tool for Your Job.

do much driving on my day off, but this little car really is a pleasure to drive around in traffic. I don't need a heavy eight-cylinder job to shop or drive back and forth to work."

"It is a small car, yet large enough to hold a family with four children," wrote a New York City telephone repairman. A Eugene, Ore., truck operator commented, "I like the way the rear seat lays down because I have four small children and when they get tired they can lie down."

"The Henry J is a fine family car, giving ample comfort with a minimum of the luxury items which never were needed in the operation of a car," said a Johns Island, S. C., rural mail carrier.

"Easiest car to handle I've ever driven. Wonderful in traffic and easy to park. Can beat 9 out of every 10 cars in getaway from traffic lights. It's really a Model A for economy."—Denver, Colo., contractor.

"A 13-gallon gas tank seemed a joke to me when I bought the car. Now I find it ample and once for a test I filled the tank and drove until the tank ran dry at 332 miles. I can't travel 220 miles on a tankful with a larger car I own. My kids like our Henry J better than the big car."—Denver, Colo., salesman.

One interesting response from quite a few owners, including a Cambridge,

Mass., teacher and a Yonkers, N. Y., insurance man, was the wish that Kaiser would build the Henry J as a convertible. A San Antonio, Tex., Air Force officer wrote, "It is a rugged little car and will deliver excellent performance. I am an auto fan and wish that K-F would put out a real sports car built on the Henry J wheelbase—just don't let the price get out of hand." (K-F recently announced it would build 1000 sports cars on the Henry J chassis, using a glass-fiber body.)

One controversial issue in connection with the Henry J—that of its resale value—was discussed by some owners. A Dayton, Ohio, machinist wrote, "The cost of operation over the period of a year will more than make up the difference in the resale of the car." An Indianapolis carpenter said, "Henry J owners should be assured that the resale value will justify their investment, contrary to popular criticism that the dealers don't give a satisfactory allowance when purchasing a Henry J."

A woman's reaction came from an Ontario, Ore., beauty operator, who said, "I like my Henry J very much. It's one car in which I don't have to sit on a pillow to see out when driving."

A South Boston, Mass., truck driver thinks that Kaiser-Frazer should check up

(Continued to page 268)

DO IT TODAY! SWITCH TO

MILD

KENTUCKY CLUB



"Look! Another man switched to Kentucky Club—the thoroughbred of pipe tobaccos."

Notice how much better your pipe tastes—how much fresher your mouth feels when you switch to Kentucky Club.

Look for the blue tin with the picture of the red-coated rider. Send for free catalog showing fine pipes and how to get them at big savings. Mail Pouch Tobacco Co., Wheeling, West Va. Dept. 96





and get
**GIVE MILLERS FALLS
 TOOLS THIS CHRISTMAS**

A basic tool for every handyman. Millers Falls No. 77A Hand Drill. \$3.30



A beautiful new tool with unbreakable glossy red "Tenite" head and handle. No. 1950 Bit Brace. \$4.80



Makes light work of hundreds of jobs. Millers Falls amazing new No. 966 Sander-Polisher. \$37.50



Cuts Most Anything — most anywhere. Millers Falls No. 725 "Nest of Saws." \$2.95



Handiest way ever to bore small holes. No. 100 Automatic Drill. \$4.00



Passport to fun and a profitable hobby. Millers Falls No. 106 Carving Tool Set. \$4.60



A tradition among fine planes. Millers Falls No. 14 Jack Plane. \$8.30



For men who like to do things fast. No. 29X Screw Driver with 4 attachments. \$3.80

At hardware stores everywhere, you'll find these and many other fine Millers Falls tools in colorful Christmas boxes. They're perfect gifts for the men and boys on your list. Wonderful, too, to receive yourself. Pick out the ones you'd like and drop a hint to your family. They'll appreciate the tip. Free circular on request.

*Prices slightly higher in the West
MILLERS FALLS COMPANY
 Greenfield, Mass.



The Mark of Superiority

MORE JOBS
EASIER — QUICKER
 You'll like the smooth, powerful, gear-driven, easy operating action of the 4½ or 6 H.P. WALKING MODEL with power turning clutch or the 8½ H.P. RIDING MODEL with automotive type differential. Our 2 and 3 H.P. Walking Models low as \$169. Attachments for plowing, sowing, cultivating, wood-sawing, snow-plowing, etc. Write for FREE Catalog New 1953 Models on Easy Terms — special Factory-To-You discount. **RED-E TRACTOR CO., Richfield 338, Wis.**

with **'RED-E' GARDEN TRACTORS**

Fully Guaranteed **BUY DIRECT** from Manufacturer and Save

*When winter winds begin to blow
 And the air is filled with rain or snow
 Streets are slippery, visibility is low*

Night driving made SAFE

LUMA-RIM, the brilliant reflective wheel trim, lets drivers of on-coming cars SEE YOU BEFORE IT IS TOO LATE, when crossing street, or roadway, or pulling away from curb at night. Precision die cut in the form of a circle, from the finest reflective material. Cemented to the flat portion of the wheel rim, will retain its bright red glow for years. Reflects light from any angle. Best insurance against being hit at night. Nationally advertised product of par excellence. Complete set **\$2.95** for four wheels, postpaid. Made for 15" and 16" rims. Order by tire size. © L-R Corp. 1952.

LUMA-RIM CORP., Pacific Bldg., Dept. D-2, OAKLAND 12, CALIF.

Make Your Own!
 The Only Tool You Need Is A Screwdriver!

- BEAUTIFY YOUR HOME
- PROTECT IT FROM THE ELEMENTS

ASSEMBLE AMERICA'S Most Beautiful CANOPIES AND WINDOWS

IT'S EASY! Just do the top - the sides are ready. They're pre-treated, too, ready for paint.

WRITE FOR FREE MEASURING CHART AND LITERATURE **Save 50%**

8974 St. Charles Rd. **Herbert's** St. Louis 14, Mo.

NAME _____
 ADDRESS _____
 CITY _____ ZONE _____ STATE _____



Ideal to Give or Get!
SARGENT PARALLEL-
ACTION PLIER No. 102
the mechanical hand

Grips like a vise
Cuts wire easily
Holds nuts like a wrench
Gets into tight spots
Unkinks wire



Give a Sargent Parallel-Action Plier for Christmas... the favorite tool of mechanics, sportsmen, farmers and handymen everywhere. Finished in bright Nickel and available in 4½", 5½", 6½" and 8" lengths, in special Christmas boxes at your hardware dealer. For further details, write Dept. 20M.



Builders Hardware
 and Fine Tools
 since 1864

Sargent and Company

New York • NEW HAVEN, CONN. • Chicago

Show this advertisement to your favorite Santa.

Flippy Rings the Bell

(Continued from page 77)

would give him the needle. Then the fish could be handled like a log. Today the needle is kept around only as a precaution. "We've found that sharks give up quickly after a short struggle on the hook," one Marineland explains.

Despite all their fancy equipment Marineland fishermen still rely on nets, rods and reels for much of their work. Big loggerhead turtles weighing more than 300 pounds are harpooned through the flipper by men in the dinghy who sneak up on them while they're snoozing on the surface.

When the men wanted some specimens of big gray porpoises which they'd seen chasing a school of fish up a near-by inlet, they stretched a net across the inlet mouth and waited for the tide to go out. As the porpoises headed seaward, a second net was dropped behind them and the two worked slowly together. Though two big fellows leaped 10 feet into the air to clear the net tops and escape, several others were trapped.

Incredible things have been caught in the big nets. One day as the skiff's winch began hoisting it, the net took off. For six hours the boat was pulled all over the ocean before that catch could be hauled in. In the center was a 1500-pound manta ray measuring a full 12 feet from wing tip to wing tip.

Rays are tough customers even in junior sizes. Everyone stands clear when a three or four-foot sting ray comes into the live well. As it passes through, one man must stand ready to perform the dangerous job of removing the poisonous barbs from its tail so it won't injure other specimens in the well—not to mention the people on deck.

A pigmy sperm whale once was sighted near a beach by fishermen who notified the studio. Marineland crews went out by sea and by land. The sea crew maneuvered the big fellow shoreward until he beached himself. Then with block and tackle he was hoisted aboard the truck and hauled off to the tanks.

Most of the small, brilliantly colored tropical reef fish in the oceanarium aren't native to near-by waters. They come from the Keys and the Bahama Islands, and so must be transported overland. To do this job the men have devised a rolling aquarium. Built on the back of a semitrailer, the rig consists of six removable canvas tanks that hang on a framework of racks. A built-in circulating and aerating system provides plenty of oxygen and moving water via

(Continued to page 236)

POWER HYDRAULICS for Snow Plows



HY-LO-JACK
does the job
FASTER - EASIER

- Lifts average snow plow in 3 to 10 seconds.
- 1,000 lbs. per square in. pressure
- Quick, easy installation on new or existing equipment.
- Complete kit form, including the pump, tank, hose lines, etc.

★ Write for Circular. See your Road Machinery, Jeep or Farm Equipment Dealer

MONARCH ROAD MACHINERY CO.
Quality Machinery since 1856
327 Front Ave., N. W., GRAND RAPIDS, MICH.

Use on



TRUCKS



JEEPS



TRACTORS

Mortite

KEEPS THE COLD OUT

SAVES FUEL AND MONEY

Cordlike and pliable, Mortite is the perfect weatherstripping. Goes on in a jiffy without tools or tacks. Keeps out wind, dust, dirt. Anyone can press it around windows, doors, transoms, baseboards. Weatherstrip a whole window for 29c—costs even less if you use the larger packages. Get Mortite at stores or write for circular. J. W. Mortell Co., 522 Burch St., Kankakee, Ill.



INSURED TIRE SERVICE POPULAR BRANDS

FREE INSURANCE POLICY given with each used tire sold. We guarantee the amount of service you pay for.
Tube Given Free with Each Used Passenger Tire Upon Request

SPECIAL! Deduct 10% on orders for Two or More used tires
YOU CAN'T LOSE!!

Super Quality — Rugged Performance — 15 Months Insured Service	
600x16 \$4.55	670x15 \$5.25
650x15 4.95	670x16 5.35
650x16 5.45	700x15 5.40
700x16 5.55	700x16 5.55
710x15 5.45	820x15 6.45
760x15 5.95	820x17 4.75
Supreme Quality. Nothing Finer — 30 Months Insured Service	
450x20 5.95	450x21 6.25
600x16 5.65	650x15 5.75
650x16 5.85	670x15 5.95
700x16 7.75	700x15 5.75
750x16 12.50	710x15 6.50
550x17 5.75	760x15 6.95
525x18 5.45	820x15 7.50
640x15 5.75	475x19 5.75
600x16 10.95	670x16 11.75
600x15 11.45	700x15 13.95
640x15 11.45	700x16 14.95
650x15 11.95	710x15 13.95
650x16 11.95	760x15 14.95
670x15 11.95	820x15 15.95

SNOW TIRES
NO CHAIN PROBLEMS
"Worry-Proof" Driving
NEW TIRE GUARANTEE

MIDLAND TIRE SALES 1141 W. Randolph St., Dept. PM-5, Chicago 7, Ill.
Speedy shipments on Mail Orders. Insurance Policy sent with each order. Deduct 10% on orders for 2 or more used tires. Send CHECK or MONEY ORDER. No COD's.

A Man's Gift!



For that man among men who works with his hands. He's always wanted power tools, but he's been too unselfish to buy them for himself. Give him a PET Power Tool for Christmas!

Mirror finished 1/4" drill
Pistol grip, trigger switch, lock with instant release. Model 1950-HM. In gift box, **\$19.95**



Gold-tone finished 1/4" drill. This will make him whistle! Tops in looks and performance. Model 1950-HB. In gift box, **\$20.95**

Chromium and satin finished 1/4" drill. High quality, yet low in price. Pistol grip, trigger lock. Model 77-HC. In gift box, **\$14.95**



High-luster finished Zip-Sawer Jr. Converts any 1/4" drill into a portable saw. Rips, cross-cuts, trims. Model ZP-1. In gift box, **\$7.95**

35-pc. attachment set. Fits any 1/4" drill. Sands, grinds, sharpens, waxes, polishes. Nine drills, too. Model AP-10. In gift box, **\$7.95**



Favorite of "DO-IT-YOURSELFERS"

Look for the PET Christmas Tree Display at your dealer's!

PORTABLE ELECTRIC TOOLS, INC.
320 W. 83rd St., Dept. PM-122, Chicago 20, Ill.
In Canada: Portable Electric Tools, Ltd., Toronto, Ontario

hoses and tubes that run along the framing.

There are plenty of problems involved in maintaining the big fish bowl and its pernickety inhabitants. One of the toughest customers was a giant manta ray that refused to eat. Finally, under the direction of the late Arthur MacBride, ichthyologist curator of the studio, the men wedged open his two-foot mouth with studding timbers while one brave fellow thrust his arm in—up to the shoulder—to jam great handfuls of fish down his gullet.

That wasn't the end of it. The ray never got used to captivity. He flopped ceaselessly around the tank's bottom perimeter day and night. The porpoises, who sleep in fitful 15 to 30-second intervals near the surface, were so nervous they didn't get any sleep. They finally moved to the center of the tank and adjusted themselves to new sleeping grounds, while the ray kept making his rounds until he finally expired of sheer nervous exhaustion.

Another problem fish was the 400-pound black grouper, hauled up from the deep off St. Augustine. Accustomed to tremendous pressures of the ocean bottom, he swelled like a balloon when he hit the thin upper waters. By the time he reached the studio he was so full of air he bobbed on the surface like a cork.

Ichthyologist MacBride solved this one

by climbing into a diving suit, submerging beneath the ugly fish and puncturing its air sac with a hypodermic needle. It's been in perfect health ever since.

Perpetual problem children, but most fascinating of all the specimens are the porpoises. These uninhibited deep-sea extroverts have an impossible sense of humor. For years a gannet named Gabby inhabited the edge of the circular tank for the scraps he could filch at feeding time. Now and then, floating truculently on the surface, he'd let out a hoarse croak and bounce several feet skyward without moving a wing. Cause of this phenomenon was not Gabby, but one of the porpoises who periodically sneaked up under him and gave him a flip with the tail.

The big fellows also occasionally snatch a feather from a pelican's tail and carry it down to the water inlet where they let it go, watch it soar off with the current, chase it and repeat the performance. A rubber inner tube from a motor scooter is a favorite plaything. Several other porpoises play catch with the customers, flipping the ring back to people who'll toss it to them from the balcony. Their aim is hot, too.

The porpoise's playful attitude has its drawbacks in the tanks. One porpoise had a queer habit of upending a 300-pound

(Continued to page 264)

UNCLE WALTER

IT SMELLS GRAND



SNIFF A WHIFF —
IT SMELLS RIGHT JOLLY!

IT PACKS RIGHT



CUT TO PACK JUST RIGHT, BY GOLLY!

IT SMOKES SWEET



A MERRY SMOKE — *Sir Walter Raleigh!*

IT CAN'T BITE!



SIR WALTER RALEIGH'S BLEND OF CHOICE KENTUCKY BURLEYS IS EXTRA-AGED TO GUARD AGAINST TONGUE BITE. THE LARGE SIZE CANISTER OF SIR WALTER RALEIGH — IN A BEAUTIFUL YULETIDE PACKAGE — MAKES THE PERFECT CHRISTMAS GIFT!

Just in Time for Xmas Giving!



ORIGINAL Heirloom Toys
"more than just toys"

Authentic Wild West scale models that will be cherished by youngsters, treasured by collectors of Americana; also desired as distinctive decorative touch! Constructed in cast iron . . . made to be handed down from generation to generation!

Buckboard (A) has green body, flaming red wheels. Stagecoach (B) has red body, yellow wheels. Covered Wagon (C) deep blue, white canvas cover, yellow wheels. Ebony black horses. Detachable front wheel sections and drivers. About 3 lbs., 12" long, 4 1/2" high.

Add 20c per item for sending west of Mississippi. Send check or money order, no c.o.d.'s. Satisfaction Guaranteed or money refunded AT ONCE.

3.95 EACH

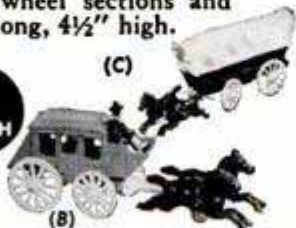

Heirloom Toys

3623 N. Lawrence St., Phila. 40, Penna.

PRECISION CALIPER



This Trade Mark guarantees highest quality

MODEL #30-78 With set screw accurately fixing position of the slide



M-Z-B PRECISION CALIPERS made by the leading European precision tool craftsmen. Guaranteed highest accuracy for any kind of precision work. Chrome steel, spring-tempered, glass hard on all measuring surfaces. For measuring inside, outside, thread and depth. To read .001" and 1/128", 8" overall, 6" graduation.

The following models have the famous M-Z-B cam lock which guarantees fixed and never shifting setting when pressure lock is released.

- #30-61 Chrome Steel .001" & 1/128" \$14.00
 - #30-64 Chrome Steel .001" & 1/20mm \$14.00
 - #30-62 Stainless Steel .001" & 1/128" \$16.50
 - #30-65 Stainless Steel .001" & 1/20mm \$16.50
- Leather cases supplied free of charge with each Caliper. You pay postage on C.O.D. Money back guarantee. Other models up to 12" available. Send for our catalog of fine imported pliers.

\$9.75 POST PAID

INTER-CONTINENTAL TRADING CORP.

90 WEST STREET • NEW YORK 6, N. Y.

Can You Run a Local Dunbrik-Dunstone Plant?

More local plants are needed. You can be one of a national chain. Simple, compact equipment. Moderate investment. 100%—150% mark-up on basic costs. Broad protection and liberal co-operation.

Outstanding Manufacturing Opportunity for Right Man



Tie in with today's demand for smart, colorful, low-cost masonry for homes and other buildings. Dunbrik-Dunstone has beauty, strength, modernity. Easily America's finest masonry, with tremendous appeal to building owners.

Yet costs less than lumber because locally manufactured from local materials by local labor for local consumption.

W. E. Dunn Mfg. Co.
600 W. 24th St., Holland, Mich.



Write for descriptive book "Blueprints for Profit."

DUNBRIK-DUNSTONE

HOW TO...

SET UP or KNOCK DOWN

SAWHORSES FAST!

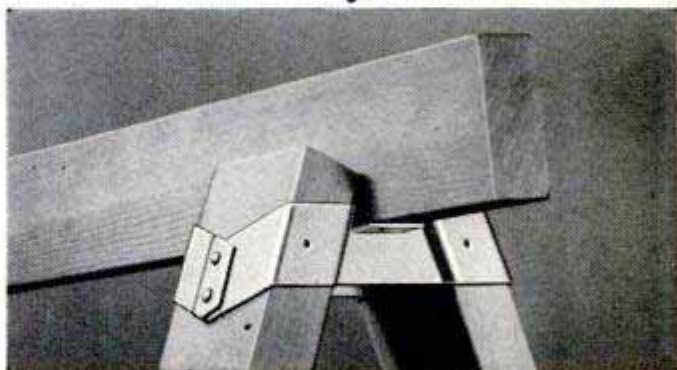

Use Strong, Lightweight

NU-WAY SAWHORSE BRACKETS

Set up or knock down sawhorses in jig time! Carry them in your car . . . or store them easily . . . the modern way—the NU-WAY!

Practical, simple, time-saving NU-WAY Brackets are inexpensive . . .

ONLY \$1.50 PAIR (one pair makes up one Sawhorse).

See your Hardware, Paint or Lumber Dealer NOW! If he does not carry Nu-Way Brackets, send check or money order for \$1.50 per pair (postpaid) to:



Work Benches



Scaffolding



Hobby Tables

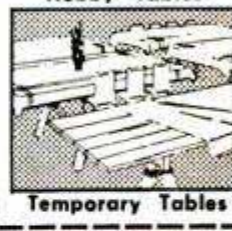

Temporary Tables

THOMAS PRODUCTS CO., 8490 Lyndon, Detroit 21, Mich.

SEND me _____ pairs NU-WAY Sawhorse Brackets.

I enclose \$_____ in check or money order.

My name _____

Address _____

City and State _____

My favorite Dealer is:

Store Name _____

Address _____

City, State _____



YOUR LIFE MAY DEPEND ON USING THE RIGHT BRAKE FLUID

Just keeping enough fluid in the brake system is NOT the answer if you want good brakes . . . and SAFETY!

There are many brake fluids which can be dangerous . . . some, freezing point too high or boiling point too low . . . no water absorption . . . no rust protection . . . no lubricating qualities . . . ingredients which cause distortion of rubber parts and formation of sticky gums . . . and . . . some that won't properly mix with fluid presently in brake system.

Don't Take Chances . . . INSIST ON

BOWES BRAKE FLUID



Certified to meet or exceed
SAE Specifications

**IF YOU WANT TO STOP IN TIME . . .
SEE YOUR BOWES DEALER
FOR SAFE
BRAKE FLUID!**

BOWES "SEAL FAST" CORP., INDIANAPOLIS 7, IND.

They Built Him a Farm in a Day

(Continued from page 122)

The house was pegged as a \$19,000 job, but under such fast-moving circumstances it probably would cost several thousand more. Here, everything was donated—from land to lumber to groceries in the cupboards and on the shelves.

All labor was voluntary. A large delegation of workers came from the air base at Moses Lake, and not all were buck privates, either. At one time a brigadier general, three colonels, one lieutenant colonel and a major were toting lumber. The general, H. W. Bowman, who was a farm boy long before he became commander of the base, wound up milking a donated cow.

At 4 a.m., 70 pieces of heavy equipment and 34 tractors started churning across the land that had gone back to the wild after wheat crops failed on it 30 years ago. Giant levelers came first, then disks, harrows, fertilizing equipment and seeders.

But all this was just part of the big show. The house intrigued most visitors. Paul Kirk, Seattle architect, was chairman of the committee which designed it.

"Notice the fireplace," he says. "It's in the dining room—not the living room. In the winter, a farmer comes in cold from chores. An open fire makes the meals more pleasant. That was true of the pioneer cabin a hundred years ago. And the fireplace can be seen from the kitchen. A farm wife spends most of her time in the kitchen, and likes to look at an open fire, too.

"Another thing—the farmer doesn't like to shuck off his work clothes in the evening, so he sits in the dining room instead of the living room. You can't move the farmer—at least not in his habits—so we moved the fireplace. The living room is the wife's plush part of the house—a place that can be kept in order for entertaining visitors."

The Dunn home has two bathrooms. One is near the back door of the house. When the dusty or muddy farmer comes into the house, he doesn't have to track up the whole place getting to his bathroom.

Many homes built today have 35 percent of their space more or less wasted in halls. The Dunn home has only 15 percent in halls.

Built on a concrete slab, the house allows for easy access to the outside. The slab-floor construction also makes for economy.

In exterior design, the house with its "butterfly" roof and large picture windows has the modern touch. One-story with no basement, the building is sprawling, ranch-like and has expandability for the years to come.

(Continued to page 240)

NO BLIND SPOTS . . .



FULLY GUARANTEED

USERS ARE BOOSTERS

WHEN YOU DRIVE WITH

Wyd-Vue

Pano-scopic REAR VIEW MIRROR



Full 100° rear and side vision with Wyd-Vue Mirror.

Dangerous limited vision with standard mirror.



SALES AGENTS WANTED

Gives complete panoramic vision around your car, BOTH SIDES as well as rear • Reduces danger of side and rear collisions • Makes driving many times . . .

EASIER—SAFER—PLEASANTER!

Scientifically designed • A series of five integrated, optically true mirrors, rubber mounted in attractive 22 gauge steel frame finished in soft black vinyl.

EASY TO INSTALL • FITS ANY CAR

No holes to bore, no special tools • Simple brackets easy to apply and adjust.

ONLY **\$795**
Transp. prepaid
Save C.O.D. charges
Send check or money order.

ARGYLE FAIR, INC., 1029 W. Argyle, Chicago 40, Ill.

ELECTRICITY *Anywhere*

FOR PORTABLE, EMERGENCY OR HOME USE

ONAN Electric Plants generate 110-volt, 60-cycle current for homes, farms, cabins and resorts beyond the highline. Lightweight, portable plants cut costs, speed work for contractors. Standby plants protect units against power failure. 400 to 55,000 watts. Gasoline or Diesel-powered. Priced from \$219.00.

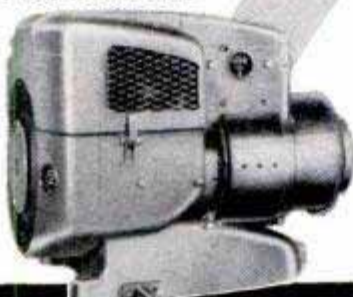

WRITE FOR CATALOG

D. W. ONAN & SONS INC.

5864 UNIVERSITY AVE., MINNEAPOLIS 14, MINN.

BUILD FINE GRANDFATHER CLOCK NOW

The simple sensible Red-i-Kut way as thousands have — SAVE HALF. SHOP TESTED PLANS "SPIRIT OF THE CENTURY" Narrow waist, 83" tall or stately straight side "SPIRIT OF AMERICA," EASY-to-FOLLOW photopack PLANS tell all—plus BROCHURE of heavy brass weight Westminster, tube chime, movements, gorgeous dials, 3/4" solid mahogany case kits. Send \$1.00 today — Both plans \$1.50 NOW.

KUEMPEL CHIME CLOCK CO., #4 Kuempel Bldg., Minneapolis 16, Minn.

Say You Saw It in Popular Mechanics

Take it easy with this... **2 H.P. SNOW BLOWER**

Powerful!
Adjusts to dry or wet snow!

one of 15 attachments available with

GEORGE

LAWN & GARDEN TRACTOR

TRACTOR ONLY WITH 2 H.P. ENGINE

\$11950

SNOW BLOWER

\$2950

14 OTHER TOOLS

\$4.50 to \$42.50

F.O.B. SULLIVAN



Health Saver, Money Saver, 12 months a year! Fully guaranteed! Compare with others at \$50 to \$75 more. Write for folder 34.

GEORGE GARDEN TOOL DIV. Community Industries Assn. Sullivan • Illinois

Give him the tool he wants!



NEW

B&D Utility No. 44 Sander only \$46.95

For the man who wants a Professional Sander

—Many exclusive features! Orbital motion insures a "satin-smooth" finish; 10 times faster than hand-sanding. Priced below comparable tools!

For the man who wants a Tool of 1001 Uses



B&D Utility 5" Sander-Polisher only \$32.95

—Extra-powerful, extra-speedy. Comes complete with 1/4" Jacobs drill chuck, sanding discs, polishing bonnet, rubber pad, wax, auto polish! Also grinds, sharpens, etc.

For the man who wants his First Power Tool



B&D Utility 1/4" Electric Drill only \$22.95

A handy, high-quality tool at a popular price! Drives many low-cost attachments to drill, sand, polish, grind, sharpen.



Bob Davis says: Whether you're giving a gift or buying for yourself, choose the brand experts prefer... **BLACK & DECKER** . . . and get a real tool, not a toy! Write TODAY for free book of job tips to: **THE BLACK & DECKER MFG. Co., Dept. H12M, Towson 4, Md.**



Black & Decker

UTILITY TOOLS

PORTABLE ELECTRIC TOOLS

GET THE WORLD'S LEADING TV & RADIO CATALOG

FREE

236
VALUE-
PACKED
PAGES

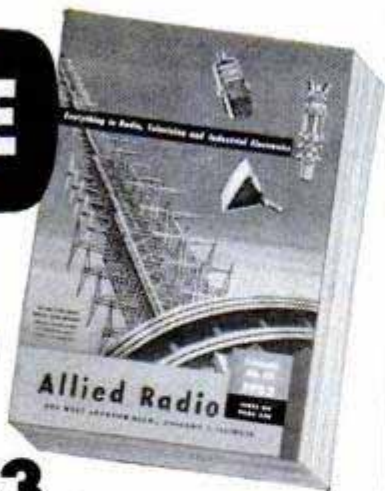

1953 ALLIED BUYING GUIDE

Save on Everything
in TV & Radio!

**Everything for Experimenters,
Builders, Amateurs, Service-
men, Engineers and Soundmen**

Get the big 236-page 1953 ALLIED Catalog featuring the world's largest selections of latest top-quality electronic equipment at lowest, money-saving prices. See the newest in TV, home radios, Amateur Equipment, Hi-Fidelity sound, P.A. systems, recorders, test instruments, builders' kits—plus thousands of parts, tubes, tools and books. Get more for your money from the World's Largest Radio Supply House. Send today for your FREE 1953 ALLIED Catalog!



FREE
CATALOG

SEND FOR IT TODAY

ALLIED RADIO

ALLIED RADIO CORP., Dept. 5-MM-2

833 W. Jackson Blvd., Chicago 7, Illinois

Rush FREE 1953 ALLIED 236-Page Catalog

Name _____

Address _____

City _____ Zone _____ State _____

Too often yard layout and landscaping are done as an afterthought. Not so on the Dunn farm. The house was first located according to the prevailing winds and to take advantage of the view. The front door of the house faces the parking lot, but the driveway is downwind to help keep dust out of the house. The play yard for the children was placed so that it can be seen from the kitchen window.

The barnyard litter is not seen from the house—a fence takes care of that. The sheds have the same colors as the house and blend with it, rather than detract from it.

Soil tests had been run and it was known just what the land needed. That was more than the first settlers knew. When dry-land wheat crops, after seven healthy years, suddenly refused to grow, the farmers figured it was just due to lack of rain. They were short on water, all right, but also on nitrogen.

"The native vegetation in these parts is mostly cheat grass," explains D. M. Harris, former county extension agent in the basin. "There's no lush growth such as that on virgin soil of the coast to return nitrogen. And where there are excessive heat and insufficient moisture, nitrogen escapes in the form of gas. What little nitrogen there was in the basin's virgin soil the early wheat farmers took out in seven years. To grow a decent crop on arid soils such as we have here, a man should fertilize the land every year."

The livestock of the early settlers didn't do so well, either. The farmers failed to recognize that it is necessary to put minerals in the soil to increase minerals in plants to increase minerals in animals.

Fertilizer was put on the Dunn farm that first day in three modern forms—pellets, powder and gas. The injection into the soil of NH_3 (anhydrous ammonia) is a new gift of science to ailing soil. The gas—81 percent nitrogen—is derived from a cracking process with the use of natural gas and electricity. It is shot six to eight inches beneath the surface.

Sprinkler irrigation was provided for 30 acres and natural flow for 50. It was determined that the gravelly soil condition of 30 acres would be more productive under the sprinkler system. Actually the farm covers 120 acres, but only 80 were considered valuable for crop production. The remaining 40 acres have been set aside for pasture.

Crops planted consisted of alfalfa, 15 acres; Kenland red clover, with oats as a companion crop, 12; legume-grass pasture, 6; red Mexican chili beans, 31; potatoes,

(Continued to page 242)

LOOKING FOR THE "DIFFERENT" CHRISTMAS GIFT?

GIVE A **BECKER** PRESSURE-TYPE **SPRAY GUN**

Completely portable, ruggedly built—no electric cords or hoses to bother with. Powered by inexpensive CO₂ cartridges, which spray up to one container full (21 oz.) — Not a toy — used widely in industry — sprays paint, insecticides, varnishes, enamels, moth-proofing. Dozens of uses around home, cottage or business — anywhere you want to take it! Complete instructions packed with each unit.

If your dealer can't supply, send \$15.95, we ship postpaid — or \$2. now and pay postman balance plus postage and COD. Money back if not delighted after 5 days' trial.

SULLIVAN-BECKER CO.
Dept. 112-M Kenosha, Wis.



ONLY **\$15.95**
with 3 cartridges



MONEY for **MEN** ALL DATA **FREE**

THE PLASTEX Industry needs manufacturers on small scale and for big production of Lamp and Clock Stands, Art Goods and Novelties in Plastex and Marble imitation. Experience unnecessary. 1/2c material makes regular 10c store sellers. Rubber moulds furnished for speed production. Small investment brings good returns. We are now placing big Chain Store Orders with manufacturers. Ambitious men have chance for real prosperity. Our Free booklet will interest and benefit you.

PLASTEX INDUSTRIES, Dept. A
3400 Third Ave. New York 56, N. Y.

\$750 BUILDS 4 ROOMS & BATH! **WHY PAY RENT?**



For Seven Hundred Fifty Dollars and 30 days of your spare time, you can build yourself this Beautiful Home. Living Room 11x15, Front bedroom 9x11, Back bedroom 10x12, Kitchen 9x11, Bath 5x8, Hall 3x4. Wind out steel casement windows. Concrete block, stuccoed, illustrated pictures, step by step instructions, blueprint and material list. \$1.00. Money back guarantee. **L. H. FARROW, Dept. C**
Box 645 Columbus 16, Ohio

HASTINGS STEEL-VENT PISTON RINGS The best money you can spend on your car!

HAPPY RAILROADING!

Dad & Son Authentic **ENGINEER CAPS**

Here's railroad romance brought right into your own electric train layout! Genuine **ENGINEER CAPS**—same kind real engineers wear when highballing thousands of surging horsepower over the shining rails! Your son (or daughter) will be delighted—you'll feel in command of a 6-unit diesel yourself! Get a set **now** for Christmas. Wonderful gifts for others, too! Bright blue striped denim with authentic **FRISCO** Railway insignia! Sizes Large and Small, \$1.25 each. Set of 2 only \$2.00! Postpaid. **Order today—supply limited!** Sorry, no C.O.D.'s. Send cash, check or money order; state sizes. Money-back guarantee!

SET OF 2 ONLY **\$2.00**



PREMIER SALES COMPANY
102 South Meramec • St. Louis 5, Missouri

Starrett TOOLS FOR SMALL WORK



PRECISION SCREWDRIVERS NO. 555

Precision made by Starrett craftsmen for aircraft and electronic instrument mechanics, model makers, watch and instrument repairmen, office machine servicemen, jewelers, opticians, etc. Six sizes (.025", .040", .055", .070", .080", .100" blades) with hexagon swivel top, knurled handle. Replaceable blades held in quick-acting, firm-lock chuck. Grooved ends identify size. See them at your Starrett Tool distributor's.

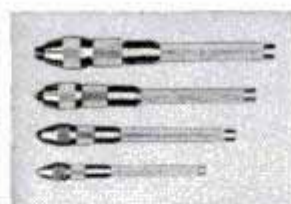

Starrett PIN VISES

Ideal for holding small parts, stock or tools. Four different sizes with range from 0 to .200 inches. Available separately or set of four in red, plastic case.

NO. 240

SEND FOR IT — ONLY 10¢
Starrett "Tools and Rules" Book 50 page booklet shows the right tools for any precision measuring job. 100 pictures plus helpful reference tables. Send only one dime. Address Dept. AP.



THE L. S. STARRETT COMPANY · ATHOL, MASS., U.S.A.

TRADE MARK

Starrett

REG. U.S. PAT. OFF.

SINCE 1880
WORLD'S GREATEST TOOLMAKERS

THROUGH YOUR INDUSTRIAL DISTRIBUTOR

Prompt delivery
Dependable service
Quality products

MECHANICS' HAND MEASURING TOOLS AND PRECISION INSTRUMENTS
DIAL INDICATORS • STEEL TAPES • PRECISION GROUND FLAT STOCK
HACKSAWS, BAND SAWS and BAND KNIVES

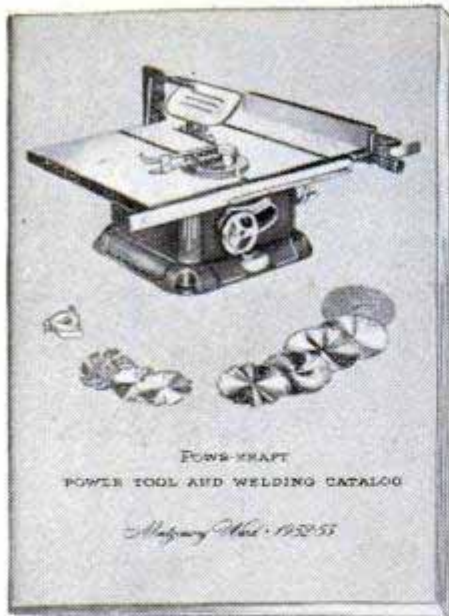

FREE

WARDS 1952-53 POWR-KRAFT POWER TOOL AND WELDING CATALOG

48 PAGES OF POWER TOOLS and accessories for the beginner, advanced hobbyist and for production shops. Includes wood and metal working equipment, portable electric tools, welding supplies, motors. Famous brands such as Mall, Shopsmith, Beaver, Globe, and Dumore, plus full line of Wards Powr-Kraft tools. Send for this FREE Catalog today!

SPECIAL GET-ACQUAINTED OFFER



Until Jan. 15, 1953
Workshop Dispenser
\$1.00 Postpaid

Send for our new 1952-53 Power Tool Catalog and we'll send you this handy 8-jar workshop dispenser for only \$1, Postpaid. Complete with mounting bracket.

Montgomery Ward

CHICAGO • ALBANY • BALTIMORE • DENVER
FT. WORTH • KANSAS CITY • OAKLAND
PORTLAND, ORE. • ST. PAUL

Clip and mail coupon to nearest city above—NOW!

MONTGOMERY WARD, Dept. WM-PM12

- Please send me Wards free 1952-53 Powr-Kraft Power Tool and Welding Catalog.
- I am enclosing \$1.00. Send me Workshop Dispenser and Wards free Power Tool Catalog.

Name..... (Please PRINT Plainly)

Street Address or
Route and Box No.

Post Office..... State.....

10; corn, 5. Beans, corn and potatoes were selected as "cash crops" to give Don quick operating revenue. The rest are soil-building crops planned to fit a rotation pattern.

"U. S. Department of Agriculture officials tell me I should gross \$12,500 this year," said Dunn. "Doesn't hardly seem possible. Still, the experts figured prices conservatively."

John L. Toevs, chief of the land development branch for the Bureau of Reclamation, adds: "For years this land, without irrigation water, was good only for grazing cattle and sheep. As grazing land, it returned five or six cents an acre. As crop land, the returns will run better than \$150 an acre."

The transformation was completed at 10 p.m.—a total of 22 hours. What did old-timers in the area think about it?

"Just short of a miracle," said Paul Donaldson of Ephrata, who homesteaded at Moses Lake in 1905. "Took a good man three days to grub sagebrush with a hoe off just one acre in the old days. And to build a shack—just a frame shell, mind you—a week or more."

Most 1952 settlers in the basin, however, have not had Don's luck. Several of his new neighbors are building homes by their lonesome. But strangely enough, on the big day they were over helping Don. ★ ★ ★

Friction Latch and Lock

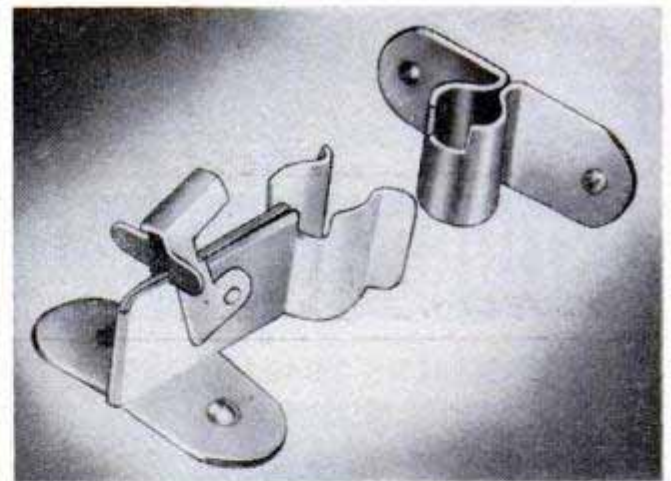

Neat in appearance and easy to install, a simple friction latch is designed for safety and long life. Consisting essentially of a tubular-steel piece which fits a matching clip and is secured by a locking finger, it can be used on any light swinging piece. Effective in preventing sag in a screen door, it may also be used to latch storm windows, basement windows, gates, storage cabinets and built-in ironing boards.

☐ If you have average vision, you can see about 500,000 different colors.

**RELIEVES PAIN OF
HEADACHE • NEURALGIA
NEURITIS**

FAST

The way
thousands of
physicians
and dentists
recommend



Anacin® relieves headache, neuralgia, neuritis pain fast because Anacin is like a doctor's prescription—that is, Anacin contains not just one, but a combination of medically proven, active ingredients in easy-to-take tablet form. Thousands have been introduced to Anacin through their own dentist or physicians. If you have never used Anacin, try these tablets yourself for incredibly fast, long-lasting relief from pain. Don't wait. Buy Anacin today.



**BUILD
YOUR OWN
MACHINE TOOLS
CASTINGS - DRAWINGS**



Catalog with complete construction drawings of this bench milling machine or six inch shaper 25 cents per set postpaid or send one dollar for drawings of shaper, three millers and three lathes. Refund on castings order.

POOTATUCK CORPORATION, 100 Sammis Pl., Stratford, Conn.

**More Local Plants Needed
to Make Cement Drain Tile**

Hundreds of local plants are selling millions of dollars' worth of cement drain tile every year. But demand is getting bigger, and opportunities are open for hundreds more.

Farm drainage, reclamation projects, highway construction—these and other sources are creating a large market. It can be most economically supplied by compact, local plants.

Outstanding Manufacturing Opportunity

Champion drain tile machine is deliberately designed to supply compact, low-investment, tile-making equipment. Makes finest tile possible—dense, truly round, and shale proof. Better than clay tile, yet can sell for less because local production saves freight and distribution cost. But project possibilities are high. Business requires no previous experience—no skilled labor—no special building. Equipment available on easy terms. Full information on the cement tile business and equipment are given in the Drain Tile Book—free on request.



Concrete Equipment Company

E3 522 Ottawa Ave., Holland, Michigan

Give Your Boy the
Christmas Joy that
grows through
the years...



**Send For 1952
LIONEL TRAIN
Catalogue Offer**



EVERY BOY and model rail-roader will want this thrilling 36 page, full color Lionel catalog. Greatest R. R. show on earth.

PLUS this new official R. R. Rule book with signals and everything. It's illustrated, authentic from A to Z. Great fun!

PLUS this new model R. R. town building kit. Stores, gasoline station, etc. to set up a main street around the R. R. station.

LOOK! GET A REAL
ENGINEER'S CAP
LIKE THIS FOR YOUR
SON, GRANDSON OR
NEPHEW. SEE SPECIAL
OFFER BELOW!



EXTRA SPECIAL OFFER



Official Engineer's Cap, in striped denim, plus 5 R. R. insignia emblems to wear on it, together with Catalog, Rule Book and Building Kit all for only 50¢!



**ALL For
50¢**

LIONEL TRAINS

P. O. Box 9, Dept. U, New York 46, N. Y.

- I enclose 25¢ for catalog offer below—
 1. The new 36 page full color Lionel Catalog
 2. Rule Book (including signals) for Model Railroaders
 3. Model R. R. Town Building Kit—Stores, etc.

OR

- I enclose 50¢ for catalog offer above plus engineer's cap

Check cap size here Small Medium Large

Name.....

Address.....

City..... Zone..... State.....

**2 OFFERS
CHECK
1**

SUPER TV ANTENNAS & ACCESSORIES AT BARGAIN PRICES

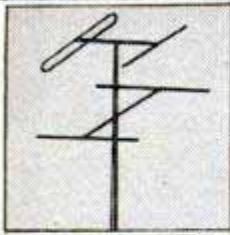

Save up to 50%. Pre-Assembled Antennas Direct from Distributor. Quality Materials—Easy to erect by anyone. Needed in all fringe areas. Select yours now, note better reception.

HI-LO TV ANTENNAS

High or Low reception Famous make—complete, ready to install. Widely used. Gives good results everywhere. Reg. \$11.95 Now \$6.95.

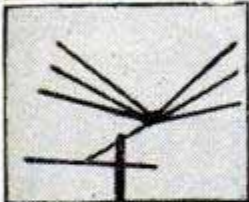

CONICAL TV ANTENNAS

Widely used Hi-Gain broad band. Exceptionally Popular Country or City Areas. Reg. \$11.95 Now \$6.95.

YAGI TV ARRAYS

Finest on market Fringe & Ultra fringe areas. Highly directional, closely tuned, all channels, 2 to 13 — Cuts

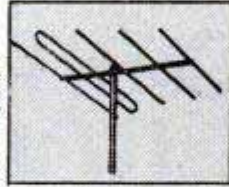

interference, noise & ghost reflections. Individual array for each channel.

For Channels 2-3-4-5-6

Reg. \$21.95 Now \$11.95

For Channels 7-8-9-10-11-12-13

Reg. \$12.95 Now \$7.95

EASY TO USE TV BOOSTER

All fringe area residents can boost signals and get better reception, clearer picture with Lexington Booster. Performs all channels. Only 1 simple dial attaches to any TV set in jiffy. A \$39.95 Value. Only \$18.95



INDOOR V ANTENNAS

Double 3 Sectional 40 inch telescopic brass elements. Attractive heavy duty base. Portable. Reg. \$6.95 Now \$2.95

GUARANTEED STANDARD BRANDS of TV and RADIO TUBES

40% off on quantities of 10 or more. \$5 deposit, with order, mention tube selection or model of TV or Radio Set. FACTORY GUARANTEED.

BRAND NEW TV CATHODE RAY TUBES

Nationally known brand in Original New Factory Cartons.

10"	\$18.75	19" Metal or Glass	\$37.00
12"	23.75	20"	35.50
16" Glass	27.00	21"	39.95
16" Metal	28.25	24"	69.00
17"	25.50		

300 OHM POLY. WIRE \$2.00 per 100 FEET.

OUR NEW DX-630 CHASSIS GIVES TV RECEPTION UP TO 200 MILES

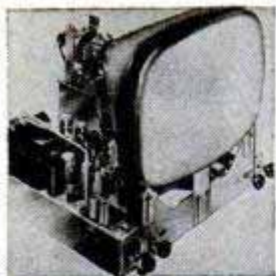

1953 MODEL — Actual Field Tests prove this best chassis with **CASCADE TUNER** on market for areas up to 200 miles away from station.

HAS 4 MICROVOLT SENSITIVITY—10 times any other TV receiver. Picks up distant stations without use of booster or special arrays—and with less noise. Operates any tube including 24", greater brilliance, improved keyed AGC circuit (eliminates flickering and fading). Best materials with high factor of safety to insure trouble-free operation. STD. RTMA

GUARANTEE Free Replacement of defective parts or tubes for 90 DAYS. Completely factory-wired chassis ready to operate with 12" P.M. Speaker, Hardware & Knobs.

Price incl. Excise Tax..... **ONLY \$169.50**

ORDER TODAY—Price Subject to Change

QUANTITIES LIMITED. Mail Check or Money Order today or 50% deposit. Pay bal. C.O.D. Mention item and channels you have.

TELEVISION CLINIC

Dept. P12, 442 East 86th St., New York 28, N. Y.

They Make Candy by the Ton

(Continued from page 85)

candies and packaging materials to workers throughout the plant.

The machine that really revolutionized candymaking was the big "mogul," an assembly line that turns out everything from cream centers for chocolates to chewy little Santas for the Christmas trade. To see how it works, watch it turn out a holiday candy.

Sugar and corn syrup, egg white and fruit flavors first must be blended into liquid candy in a 1000-pound steam cooker. At that moment the mogul snatches up large trays and fills them with a soft starch paste. Now a die descends into the starch, casting as many as 720 little Santalike depressions in each tray as it marches past. Farther down the line each tray pauses a fleeting moment beneath 120 little spigots that release liquid candy into the individual molds. If Santa is to have a white beard and a fur collar, white candy drops first, filling the bottom design of the mold. Farther on, the trays pause again and red candy pours in to fill the depression. The machine automatically stacks the candy-filled trays, which are whisked away to huge drying caverns.

Perhaps 24 hours later the trays are wheeled out again, snatched up once more by the mogul, and flipped end over end. Candy and starch cascade out. The starch is drawn away by vacuum, the tray marches on for another load, the candy is deposited on a belt and moves off for its final polish. The mighty mogul can turn out more than 5,000,000 little Santas in an eight-hour day, enough to please a good many expectant tots come Christmas morn.

Bill Melody, vice-president and factory manager, is the man who supervises the vastly complicated array of equipment at Brach's. From him, candymaking sounds simple.

"Sugar and glucose are the basic ingredients of virtually every candy," explains Melody. "You just add confectioner's starch to make gum work such as jellybeans and gum drops. You add milk to make caramels. You vacuum the basic mixture for hard candies. You beat it to produce chocolate centers. You table it and cut it into slabs to make fudge."

Naturally it isn't that simple. Economical production is the real secret of today's candymaking. Yesterday the itinerant candymaker wandered from city to city, selling secret recipes to local confectioners. "Today," says Melody, "I imagine we could duplicate just about any candy on the face of the earth here in our lab. But we still

(Continued to page 246)

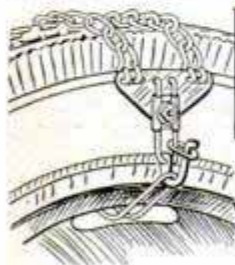

Kon-veen-yunt

EMERGENCY TIRE CHAINS

Put On Your Tire in 10 Seconds Gets You Out of Trouble "Quik"

Wonderful new emergency tire chains widely used throughout the United States. Designed for simplicity of adjustment. No buckles or swollen straps to fuss with or break — ALL STEEL and twice as strong as strap type. Fits all passenger cars except Buick. All prices F.O.B. Richmond, Va. ORDER TODAY—SATISFACTION GUARANTEED. Mail orders promptly filled. Send check or money order with this ad. PLEASE indicate tire size. Set of 4 Chains **only \$5.98**

KON-VEEN-YUNT TIRE CHAINS
P. O. Box 283-B Richmond, Va.

SATISFACTION GUARANTEED



The Greatest Dollar for Dollar Value
On The Power Tool Market Today...

SHOPMASTER

20" TILTING TABLE JIG SAW

\$29⁹⁵

Now... for the first time... you can get a 20" Tilting table jig saw for the same price as 16" and 18" saws. Yes... a 20" working area on cuts to center of 40"... built with the same recognized high quality and rugged construction features of all other famous Shopmaster Tools. Here is one of the necessary tools for your home workshop... built to professional standards... but priced for the hobbyist.

Free complete catalog of the famous quality Shopmaster tools and accessories...
Write Department PM17
1214 Third St. South • Minneapolis, Minnesota

Other famous
SHOPMASTER
TOOLS

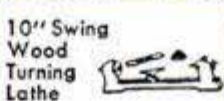
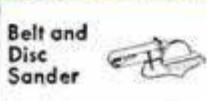

BE A FROGMAN!



Join the new national FROGMAN CLUB today. All you have to do is send \$1.00—be sure to include your name and address—and here's what you get:

- 1) A miniature pair of Frog Feet. Can be worn on key chain, lapel or hung on windshield as lucky charm.
- 2) An attractive membership card.
- 3) A Frogman decal to be used on your windshield, bicycle or notebook.
- 4) A booklet on "How To Swim Underwater" and "The Supreme Sport of Spearfishing".
- 5) Periodic bulletins on the latest developments in Frogman equipment and news.
- 6) Complete catalog of Frogman equipment available for purchase.
- 7) A free coupon for \$1.00, which can be used toward the purchase of a pair of regular size Frog Feet, \$6.95 or equivalent in value. This is redeemable at your local sporting goods dealer, drug store, auto supply store or toy departments. If no such dealer available in your area, we will handle direct.

BE A FROGMAN — Send your dollar today!

National Frogman Club

1428 Maple Avenue, Dept. PM-7, Los Angeles, 15, Calif.

MAKE Big MONEY WITH THE

Universal LAWN MOWER GRINDER!

Enjoy a profitable lawn mower sharpening business of your own. No previous experience needed. Place a hand or power mower on the UNIVERSAL GRINDER. With only ONE SET-UP you quickly grind the stationary blade and all the reel blades to proper clearance WITHOUT REMOVING A SINGLE BLADE from the mower.

PROOF
G. Spurlock, of Arkansas, writes: "I have my Universal Grinder two months and made a net profit of \$227.00".
C. E. Hardy of Miss, writes: "I am doing a fine business with the Universal Grinder. I spent 40c for a newspaper ad and have done nearly \$500.00 of business." Write today for FREE FACTS about Big Profits in Lawn Mower Sharpening.



ROGERS MFG. CO. DEPT. M-122 LINDSEY, OHIO

DECEMBER 1952



Send for this BIG NEW Hunt's WOODWORKERS CATALOG NO. 19

NEW LOW PRICES ONLY 15c

Offers greatest selection of fine domestic and imported woods—and hundreds of woodworkers items at bargain prices!

You'll save time and money with this big, new catalog. Contains everything wood craftsmen needs. Shows 32 rare and fancy woods in color...43 veneer designs...275 scroll patterns...multicolor inlays, overlays, bandings...all kinds of tools, machinery, cabinet hardware, ornaments, mouldings...and pages of valuable tips, ideas, information, instruction. Send for your copy NOW. Only 15c—refundable on your first order.

- 144 PAGES
- QUICK DELIVERY
- on maple, poplar, oak, mahogany, red cedar, cherry, walnut, and many others—
- all properly seasoned and kiln dried.

MAIL THIS COUPON—TODAY!

CRAFTSMAN WOOD SERVICE CO.
2729 S. Mary St., Dept. A12
Chicago 8, Illinois

Send me the big, new, money-saving Catalog No. 19. Enclosed is 15c—refundable on my first order.

Name _____
Address _____
City _____ Zone _____ State _____

**Throw Away
Nicotine***

**ENJOY CARE-FREE
FILTERED SMOKING**



in

MEDICO

Crest \$3 *Finest Medico ever made.
Exquisite Burgundy Finish*

MEDICO V. F. Q. — \$2 *With NEW NYLON BIT.
Exclusive! Guaranteed Bite-Proof!
Odorless! Tasteless! Cushion Bite!*

MEDICO MEDALIST — \$1.50

* When filter turns brown—in Medico Pipes or Cigarette Holders—throw it away, with nicotine, juices, flakes, tars it has trapped. Insert a fresh filter for cooler, cleaner and dryer smoking. Imported Briar.



Box of
10 filters—10¢

Wide variety of styles and sizes.
Write Medico Pipes, Inc., N.Y. 22, for Booklet M

MEDICO CIGARETTE & CIGAR HOLDERS — \$1

**THE
NEW
DART
RULE**

with
"clear vision" design
the
perfect gift



6 ft. 8 ft. 10 ft.
\$1.25 \$1.50 \$1.75

DART MFG. CO. MASON, MICHIGAN

might not know the secret of manipulating it in a large mass, or might not solve the mechanical problem of producing it at an attractive price."

There's one place that the art of the old-time candymaker still shows up. It's in the manufacture of cut-rock, the candy "with a picture in the middle."

Shelby Young has been a "sugarhead," a hard-candy artist, for 42 years. His work begins after the batch has been cooked up and dumped on a table. When the candy arrives it is a shimmering green, and Young and his assistant "swing the batch" by looping it over the arms of a big mechanical puller. The four arms of the machine pull the candy into a smooth, velvety mass, changing the color from green to white.

Young may decide at this point to place two crossed American flags, occupying less than a quarter inch of space, in the center of the candy. He slices off part of the snow-white candy, then further divides the slice into smaller batches, some of which he colors red and blue. Next he stretches each batch into a long thin strip and cuts up the strips.

Now he's ready to "draw" his picture. Very carefully he places the red, white and blue strips on the rolled-out layer of white candy. The seemingly impossible part of the job is that, although he is working lengthwise on the mass of candy, the finished flags will appear in cross section. It's as though an artist painted a picture that could be viewed from the edge of the canvas. Within three minutes Young has completed his picture and wrapped it in blankets of white and red candy.

He rolls this 300-pound "log" onto a canvas litter and, with the help of his assistant, carries it over to the spinning machine. Here another man takes over, pulling it until one end of the log is a "rope" about a half inch in diameter. This he feeds into his machine, which pushes the rope through cutting blades. The knives chop it off into pieces about a half inch long. There, in the center of each piece, appear two American flags, their staffs crossed, 26 stripes a hair-line wide, two vivid but infinitesimal fields, and even a suggestion of stars on each field.

By now Young and his fellow workers have turned out the last of their Christmas candies and are working into another season, for the candy industry must work well ahead of the demand. The sharp, haunting flavor of a Christmas cane may soon be giving a good many adults an aftertaste of their own childhood. At the very moment they are savoring the cane and its memories, the candymakers will be turning out billions of Easter eggs in their pot-licker's paradise. ★ ★ ★

FOR EASIER SCRATCH-FREE SANDING USE DREMEL STRAIGHT-LINE ACTION SANDERS

Christmas Gift Idea!

Here's a gift the whole family can enjoy and really use. Give the handyman of the house a Dremel heavy-duty Model 2000—a professional tool for sanding dry-walls; refinishing woodwork, furniture, paneling; polishing furniture, cars, etc. Dremel Model "A" is a family favorite for polishing, buffing, dozens of household duties and hobby projects; also a relaxing massager. For gifts that will really be used and appreciated, give Dremel Electric Sanders.



Only Dremel Offers All These Features:

WORLD'S FINEST FINISHING SANDER — Patented straight-line (with-the-grain) action duplicates craftsmen's hand-sanding motion . . . the only way to be sure of super-smooth, scratch-free finishes . . . no gouging, no cross-grain swirls or scratches.

MORE SANDING SURFACE PER DOLLAR — You can't beat a Dremel for work! Largest sanding pad surface per dollar cost. Faster action (14,400 working strokes per minute) . . . more than three times as fast as most sanders!

EASY, ONE-HAND OPERATION — Light weight; less tiring for vertical or overhead sanding; higher speed means less down-pressure required for effective sanding.

SANDS INTO CORNERS — Rectangular, over-size sanding pad permits sanding into corners, other tight places.

TROUBLE-FREE USE — Only 2 moving parts; never needs oiling. No armatures, brushes, gears or bearings to wear out and replace.

POWERFUL — High-speed lifetime reciprocating motor (110 v. 60 cycle AC).

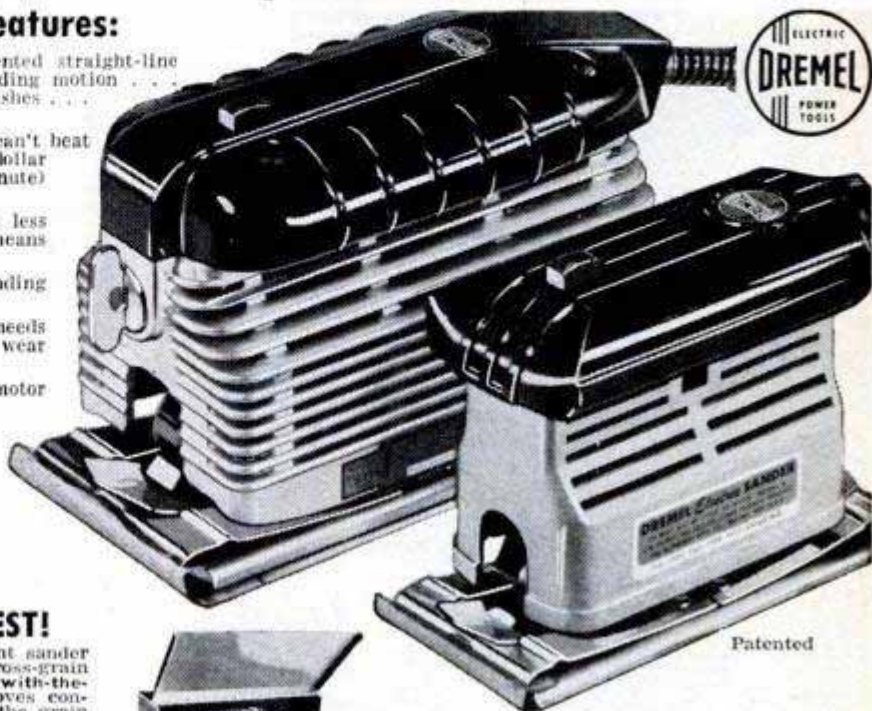

Patented



FREE SANDING GUIDE

A handy, 16-page "How-to-do-it" booklet containing helpful hints on sanding and refinishing procedures packed FREE with each Dremel Sander. Extra copies, 25¢.

MAKE THIS SIMPLE TEST!

Sand a piece of wood, by hand, using the four different sander motions illustrated below. Note how the slightest cross-grain action produces scratches and swirls . . . how sanding with-the-grain leaves a scratch-free, satin finish. This test proves conclusively why professional craftsmen always sand with the grain of the wood . . . never cross grain. YOU BE THE JUDGE! If you are not 100% convinced that Dremel straight-line action is the finest, most effective sanding method known, we sincerely don't want you to buy.



A "must" for sanding dry-wall joints. Fast—cuts refinishing time in half. Sands right into tight corners. Prepares furniture for repainting.

MODEL 2000

Heavy-duty model; 21 sq. in. (3 1/4" x 7") sanding base. Price includes sturdy steel storage case (left) with handy carrying handle; 25 asst'd. abrasives; 1 sheepskin pad. **\$24.50**

MODEL "A"

Household and hobby model (above, right); 12 sq. in. (2 3/4" x 5 3/4") sanding base. Price includes 6 abrasives; 1 sheepskin pad; 1 felt pad. **\$14.85**

GRINDS • CARVES • DRILLS • ROUTS • ENGRAVES • SHARPENS

DREMEL Electric MOTO-TOOL



FASTEST, MOST POWERFUL TOOL IN ITS CLASS —APPROX. 27,000 R.P.M.

Most practical tool a man can own—more powerful than any similar tool you can buy. Works well in wood, plastics, and metal. For home maintenance jobs you'll wonder how you got along without it. For model making it's a must. And for general shop operations it saves time and money. Compare it, try it, buy it. You be the judge. **Check These Important Features:** Oilless sealed bearings • Dynamically balanced armature • Shockproof, Bakelite housing • Dust-filtered air cooling system • Sturdy 110-120 V., A.C.-D.C. motor • Wt. only 13 oz. • A precision tool widely used in industry for many years.



KIT NO. 2 Includes Model 2 Moto-Tool and 23 Accessories (High-Speed Steel Cutters, Grinding Wheels, Polishers). Packed in sturdy hard-wood case. **\$23.50**

KIT NO. 1 Includes Model 1 Moto-Tool and 34 Accessories (Steel Cutters, Grinding Wheels, Polishers, etc.). Packed in attractive lacquer-finished wood case. **\$17.50**

MOTO-TOOL NO. 2 Offers more convenience and long life features for the money than any other hand grinder. Thousands of satisfied users. Moto-Tool No. 2 (With 1 emery wheel point) **\$16.50**



SEE YOUR LOCAL DEALER: Dremel Tools are sold at better dealers everywhere. If your dealer can't supply, order direct on a five-day trial, money-back guarantee. Remit in full, and we will ship post-paid. Or, send only \$2.00 now, pay postman balance plus postage and C.O.D. fee.

DREMEL MANUFACTURING CO.

Dept. 112-M

RACINE, WISCONSIN

**Now! Paint 7 inches
in one stroke**



**NEW
FLEET WING**

WALL COATER

made by

Pittsburgh Plate Glass Co.

**ONLY
\$3.69**
with pan

This new brush from the Pittsburgh Plate Glass Co., covers a full 7" with each stroke! And what a smooth, even finish you get on walls and ceilings—thanks to Pittsburgh's new wonder-bristle, NEOCETA—developed especially for painting.

What's more, the Fleet Wing features a new type of paint brush construction (see right). That's why it's so lightweight... easy to handle... why you can paint for hours without any drip or splatter. See this—and other Pittsburgh brushes—at your paint dealer's! Or, write for information to: Pittsburgh Plate Glass Co., Brush Div., Dept. P-12, 3221 Frederick Ave., Baltimore 29, Maryland.

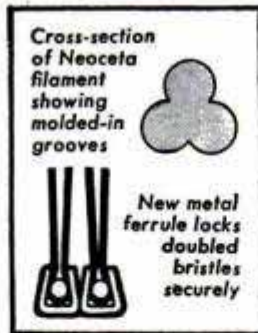

COMPLETELY DIFFERENT CONSTRUCTION utilizes doubled filaments of NEOCETA, bound in metal ferrules, to produce rows of four bristles each. Molded-in grooves in each filament provide above average paint carrying capacity.

There's a Pittsburgh brush for every home and industrial use

**PAINT & VARNISH BRUSHES
POWER-DRIVEN BRUSHES**



PITTSBURGH BRUSHES

BRUSHES • PAINTS • GLASS • CHEMICALS • PLASTICS

PITTSBURGH PLATE GLASS COMPANY

The Magic of Silent Sound

(Continued from page 69)

canyon where its penetrating screech is dissipated among the surrounding hills.

A pair of 700-horsepower aircraft engines compresses the air that is driven through the siren's chopper wheel, which is spun by a third power plant. Attached to the siren is an 80-foot wave guide tube, inside of which are microphones that measure such phenomena as standing waves and turbulence. With this noisemaker the research people are testing new kinds of sound-abatement devices, among other things. There's a suggestion that new attenuators have been developed that would rob a jet engine of much of its roar and at the same time increase its power.

Meanwhile, at the upper end of the sound spectrum, practical applications are resulting from the many years of research during which high-frequency sound was little more than a scientific curiosity.

Tiny ultrasonic drills are being used by jewelers to drill square holes, or holes of any shape desired, through metal, ceramics, or even precious stones. Ultrasound is used in hastening some chemical processes, in degreasing and in other jobs in which vibrations are a help.

At Lockheed Aircraft Company, engineers have devised a "sonodizer" or ultrasonic soldering iron that cleans the oxide coating from a metal while the metal is in contact with the molten solder, allowing a bond to take place before the surface re-oxidizes. Metals soldered with this device include stainless steel, chromium plate, various types of aluminum and even metalized phenolic plastics.

Ultrasonic washing machines vibrate dirt particles from clothes, doing a better job than conventional machines. High-frequency waves in the audible range trap smoke particles, reducing the soot and dirt that escape from industrial plants.

There are two fields in which ultrasonics is becoming very important. In Europe, physicians have been using the high-frequency sound waves in treating painful diseases of the joints, neuralgic conditions and other ills. Enthusiastic reports have been made and American medical men are now studying the same field. They are moving with caution because of a feeling that more research should be done to learn if there are any possible injurious side effects to the treatments.

The other field in which ultrasonics is growing rapidly is that of inspecting metals for interior flaws. A beam of high-frequency sound behaves something like radar

(Continued to page 250)

**PREPARE NOW FOR
POWER FAILURE!**

WAR SURPLUS GENERATING PLANTS

Available for Immediate Delivery — Large Stock — Many Sizes from 350 Watts to 25 KVA



Item #183 — 3000 to 4000 WATT GENERATOR SET — FEATURES —
Power for your home or business. Simply connect to power panel or house circuit. • Constant voltage regardless of load. • Push button start or stop. • Easily made full automatic start or stop. **SPECIFICATIONS —** Sizes 19"x30"x48". Steel skids, weatherproof housing, requires no building. Wt. 725 lbs. • Hercules 4-cyl. 10 HP gasoline engine. Load governor. Oil filter. Quiet muffler. 6-volt starter, generator • Hobart 115 volt, 60 cycle, 3000 to 4000-watt generator. Furnishes either single or three-phase power, 2 or 3 wire. • Panel contains oil gauge, voltmeter, ammeter, circuit breaker, voltage regulator, start button. Today's cost over \$1200.00. **SALE PRICE, 465.00**
F.O.B. Chicago.

Item #334—Power unit PE-77D is a compact electric generating set consisting of a 1-cylinder, 4 starting (rope) Briggs & Stratton gasoline engine, directly connected to a d-c self-exciting generator. The engine is rated 1.3 horsepower at 2650 revolutions per minute and operates 5 hours on one gallon of gas. The generator is rated 0.35 KW, 250/350 watts, 115 volts, 2.2 amperes direct current. Plug in to double receptacle for easy connection. **F.O.B. Chicago... 115.00**



LOGAN AIR CYLINDER Item #350 — Double acting pneumatic cylinder, 6" bore, 6" stroke, 1 1/2" shaft. Adjustable cushions at both ends. Flange mounting at shaft end. Overall length closed 18". Ideal for use in 125 PSI systems. Shipping weight 40 lbs. **F.O.B. Chicago... 39.50**



LOGAN 4-Way, Foot Operated AIR VALVE, Item #59. Model 6520—Ideal for operating air vices, presses, air machinery, and other double acting pneumatic devices. Heavy cast construction. Standard 1/2" pipe thread ports. Overall dimensions 8 1/2" x 5 3/4" x 7 1/2". Gov't. Acquisition cost \$42.00. Shipping weight 28 lbs. An outstanding buy. **F.O.B. Chicago... 15.00**

Item #16C—Double acting hydraulic cylinder, 1 1/2" bore, 20" stroke. Will lift 1760 lbs. with 1000 PSI line pressure. Weight 8 lbs. A \$55.00 value. Now only **16.95**

General Motors — Allison CENTRIFUGAL PUMP 200 GALLONS PER MINUTE

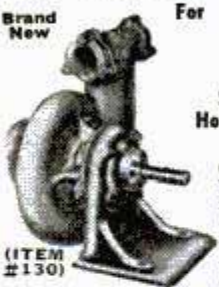

For Draining Basements
Fire Fighting
Irrigation
Fuel Transfer
Swimming Pools
Home Water Systems
Dewatering

Converted for high volume commercial, home, and industrial use. Standard 2 1/2" pipe thread inlet, twin 1 1/2" pipe thread outlets. Ball bearing supported 3/4" shaft. Easy priming. Rotation, counter-clockwise facing shaft. Gov't. acq. cost \$145.00 Complete with full instructions. Ship. wt. 35 lbs. **F.O.B. Chicago... 39.50**

FREE 1953 CATALOG
48 pages, chock-full of unsurpassed War Surplus Equipment Bargains for farm, home, factory and workshop. Every item is unconditionally guaranteed. You save on everything! Write today,



Item #301
Automatic shutoff; Push button self-start; 2 qt. gasoline tank in base; Ammeter; Generator cut-out; Concealed coil, etc.; Speed and charging rate control; Attractive orange finish; Weight, 93 lbs.; Length, 15 1/2"; Width, 11 3/4"; Height, 14 3/4". **F.O.B. Chicago... 89.00**

Item #300 — Model C18 — 3 KW — 110 Volts D.C. This mighty mite develops 3 KW — 28.5 amps. D.C. Standard Delco generator direct coupled to a Model ZEP Briggs and Stratton 1 cylinder, 5-7 HP, air cooled, rope starting gas engine. Instruments include voltage control rheostat and voltmeter. Wt. 275 lbs. **F.O.B. Chicago... 295.00**

Tiny Tim Battery Charger
Item #301 — Model 125 to charge 6 and 12 volt batteries—12 volts—300 Watts; Heavy Duty Generator; Automatic shutoff; Push button self-start; 2 qt. gasoline tank in base; Ammeter; Generator cut-out; Concealed coil, etc.; Speed and charging rate control; Attractive orange finish; Weight, 93 lbs.; Length, 15 1/2"; Width, 11 3/4"; Height, 14 3/4". **F.O.B. Chicago... 89.00**

Item #178—350 watt—110 volt —60 cycle A.C. direct coupled to 1 cylinder Mideo engine. Shpg. wt. 116 lbs. **F.O.B. Chicago... 125.00**

Item #201—PE 95-G—10 KW—110/220 Volt 60 Cycle A.C. Single Phase. Totally enclosed. Omni generator direct coupled to Willys Jeep, 4 cylinder, water cooled engine, push button start. Instrument panel with engine and generator instruments, circuit breaker, controls, etc. Uses 6 volt car battery. (Battery not incl.) Skid mounted. Ship. wt. 150 lbs. **F.O.B. Chicago... 1295.00**

MANY WAR SURPLUS ITEMS

Shop by Mail and Pay Less at GROBAN'S

ORDER DIRECT FROM AD

ALL ITEMS GUARANTEED

HEAVY DUTY HYDRAULIC and AIR EQUIPMENT

Large supply of labor-saving, economical hydraulic equipment in many types and sizes. Use these positive, highly efficient smooth pressure hydraulics on presses, arbors, lifts, loaders, power control, positioning, brakes, plastic dies, auto frame alignment, etc.

Item #6—Double action hydraulic cylinder. 3" bore, 24" stroke, will lift 7070 lbs. with 1000 PSI line pressure. Steel barrel, 1 1/4" stainless steel shaft. Ship. wt. 26 lbs. **F.O.B. Chicago... 28.00**

Item #1036—Double acting hydraulic cylinder, 3" bore, 36" stroke, 1/2" pipe thread ports, 1" solid steel shaft. Overall length closed 49", clevis mounting at base and shaft. **FEATURES —** Cup & Chevron Packing • All Welded Construction • Precision Ground and Honed Construction • 1/4" Seamless Steel Tubing Cylinder Case. Weight (net) 57 1/2 lbs. **F.O.B. Chicago... 50.00**

PUMP PRESSURE (PSI)	LIFT CAPACITY (LBS.)
500	3535
1000	7069
1500	10604
2000	14138



Item #29KJ — Gear Type Hydraulic Pump. Ideal in industrial applications and for operating all hydraulically powered farm implements including loaders, stackers, swathers, plows, etc. Delivers 1000 PSI (may be set at lower PSI if desired). 12 GPM at 400 RPM. Maximum operating speed 800 RPM—rotation counter clockwise. Has built-in relief valve, permanent or torque bar mounting, 1" diameter shaft, 3/4" pipe tap inlet, 1/2" pipe tap outlet. Shipping weight, 22 lbs. **F.O.B. Chicago... 45.50**

Item #126 — Four-way, open center control valve with built in adjustable relief valve. Factory set at 1000 P.S.I., spring loaded neutral position, for use with one double acting cylinder. In neutral position cylinder is locked and pump unloaded. Fully balanced plunger type, smooth, positive, easy operation. Can be used as single unit or mounted in series or any combinations desired. Has 3/4" pipe thread inlet and outlet, 1/2" pipe thread cylinder ports. Newly manufactured to our specifications. Shipping weight 8 1/4 lbs. An outstanding buy! **F.O.B. Chicago... 21.50**



HYDRAULIC SPEED REDUCER

(ITEM #115) WITH FINGERTIP CONTROL

USE FOR: • Reamer Drives • Midget Cars • Feed Mills • Canning Machines • Conveyors • Lathes • Milling Machines • Motor Boats • Cream Separators • Garden Tractors • Pumps



Variable output speeds from 0 to input speed available by moving control handle. Locking die. Locking handle maintains setting. Use input power of 1/2 to 1 1/2 H.P. This Westinghouse-Oil Gear Unit consists of a variable displacement hydraulic pump feeding a fixed displacement hydraulic motor. Adjustable relief valves set at factory for 100 inch pounds of torque may be reset up to 180 inch pounds. Independent reverse control allows full output power and speed selection in either direction of rotation. Shafts measure 5/8" diam., include keyway. Input rotation is counter-clockwise facing shaft. Recommended input speed not to exceed 750 R.P.M. Over-all dimensions, 7 1/2" x 7 1/2" x 11 1/2". Gov't acquisition cost, \$428.00. Ship. wt. 31 lbs. Complete with 2 qts. of oil and full instructions. **F.O.B. Chicago... 54.50**

NEW MODEL 353—DUAL RANGE ARC WELDER

For Stationary or Portable Use
HEAVY DUTY RANGE TO 250 AMPS.

New 'Magic Terminal' for Low Current 30 to 100 Amps.



Ideal for
• FARM
• FACTORY
• GARAGE
• WORKSHOP

Welds Anything
From Auto Fenders
To Tractor Frames

These precision engineered D.C. Arc Welders contain the highest quality War Surplus aircraft components built to exacting government specifications. They are light in weight, have oversized lifetime grease-sealed ball bearings, air cooled commutator dial type rheostat for easy pin-point control, a high-low rheostat switch, reactor coil for even arc and the new 'MAGIC TERMINAL' low current welding range for welding lighter materials. Designed for many years of trouble-free service. Run welder from drive pulley or power take off of a tractor or Jeep, 7 1/2 HP electric motor or 10 HP gas engine at 2500 R.P.M. Uses two V belts or flat belt. Continuous output rating 200 amps. Intermittent welding rating 250 amps, 30 volts. This sensational price includes double V or flat belt pulley and complete operating instructions. Shipping weight 107 lbs. 350.00 value. **Item #65. Now only... 119.50** **F.O.B. Chicago**

ORDER DIRECT FROM AD — SEND PAYMENT OR PURCHASE ORDER TODAY — SATISFACTION GUARANTEED

GROBAN SUPPLY CO. 1139 SO. WABASH AVE., CHICAGO 5, ILL. DEPT. PM-12

Thinking of Building a Boat?



Plan 21—20' Sloop



Plan 25—13½' Runabout



Plan 24—7'9" Dingy



Plan 23—9' Skiff

Choose One of These Easy-to-Build Designs

PLANS AND INSTRUCTIONS ONLY 10¢ EACH

PLAN NOW to log a season full of boating pleasure by building one of these sturdy Exterior plywood boats. Each is designed by a top naval architect. Each is planned with plywood to make it easy to build, light, strong and durable. Big sheets speed work . . . add strength and rigidity . . . eliminate caulking and open seam troubles. Exterior plywood (identified by EXT-DFPA® on panel edge) is bonded with 100% waterproof marine adhesives. Your lumber dealer now sells it at new low prices. See him soon.

Exterior-Type (EXT-DFPA®)

Douglas Fir Plywood
© Douglas Fir Plywood Assn.



MAIL THIS COUPON TODAY!

Douglas Fir Plywood Association (Good USA Only)
Dept. 912, Tacoma 2, Washington

Please send plans checked. I enclose 10c for each.

Plan 21 Plan 23 Plan 24 Plan 25

Check here and enclose additional 10c for 40 page catalog listing source of 250 plywood boat plans, 50 plywood boat kits.

Name.....

Address.....

City.....Zone.....State.....

and is reflected back from all surfaces, as between metal and air. Thus the front and rear surfaces of a metal bar, as well as any voids between the surfaces, are revealed.

Ultrasonic inspection of metals is faster and simpler than X-ray inspection and can penetrate to depths far beyond the scope of most X-ray machines. Until recently, however, ultrasonic inspection was limited to simple shapes such as solid bars or axles. This was because the transducer head that contains the quartz crystal had to be held in flat contact with the metal, since sound waves of extremely high frequency do not travel through air.

Today a new technique devised by Donald C. Erdman of Electro Circuits, Inc., has changed all that. By placing both the transducer and the part to be inspected under water, Erdman can examine even a complicated shape and detect at once on a cathode-ray tube, the size, location and depth of any interior flaws. Douglas Aircraft Company is inspecting all castings and forgings by this method.

One of Erdman's latest developments is a transducer head that is coupled to a solid stream of water. This allows metal to be inspected for flaws without immersion. The combination transducer and water jet will be able to examine every inch of the welds of an oil-storage tank or pipe line and detect all weak spots. This is only one of the new uses to which ultrasound is being put as an inspection technique. ★ ★ ★

Lathering Cup Fits on Tube



Convenient to use, an attachment for a tube of shaving cream provides a cup for "whipping up" plentiful lather from a minute quantity of cream. The cup has a universal rubber fixture to fit all tubes. The cup also acts as a stand for storing.

Atlas **FINEST QUALITY TOOLS**

Engineered and Built to Serve You a Lifetime!



Atlas
10" FLOOR
SAWS

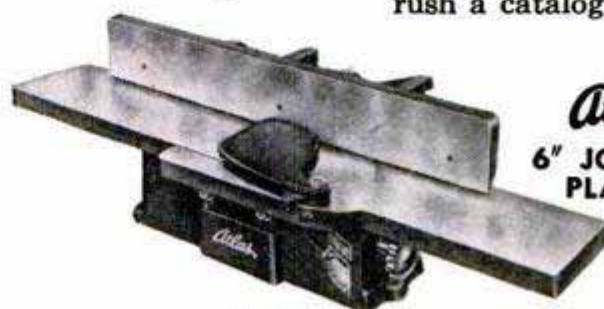

Atlas
6" JOINTER-
PLANER

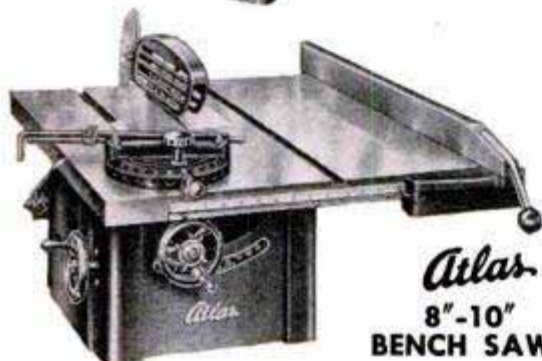

Atlas
8"-10"
BENCH SAWS

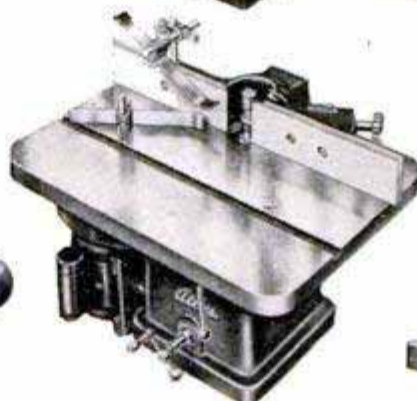

Atlas
SPINDLE
SHAPER



Atlas
BELT & DISC
SANDER

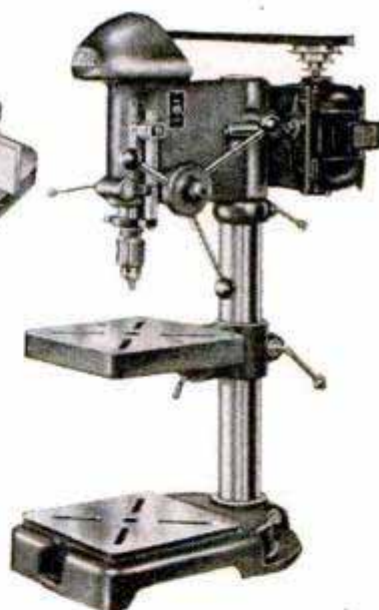

Atlas 12 $\frac{3}{4}$ "-15"
BENCH DRILL PRESS

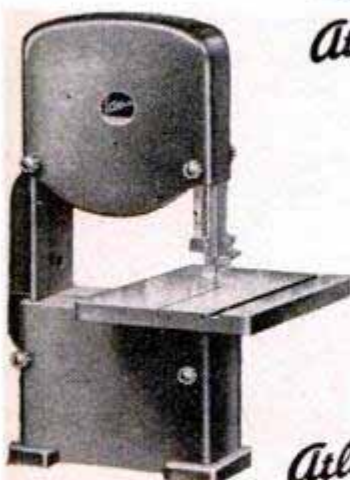

Atlas 12" BAND SAW



Atlas
12" WOOD LATHE

Atlas

12" WOOD LATHE

ATLAS PRESS COMPANY
1224 N. Pitcher St., Kalamazoo, Mich.

Atlas

DEPENDABLE QUALITY TOOLS SINCE 1911

USE THIS COUPON FOR FREE CATALOG!

ATLAS PRESS COMPANY: 1224 N. Pitcher Street,
Kalamazoo, Michigan. Please send your latest Wood-
working Catalog.

NAME _____

ADDRESS _____

CITY _____ STATE _____

This is the wrench

that
saves
hours,
dollars,
materials

Now
Available!

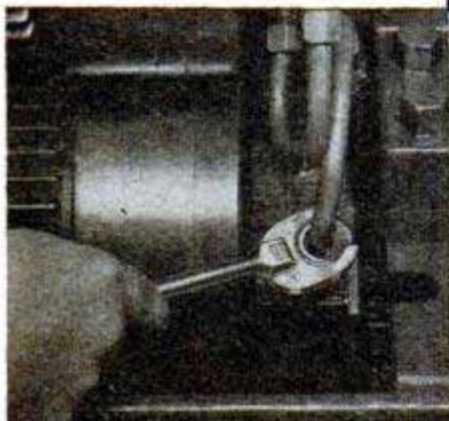
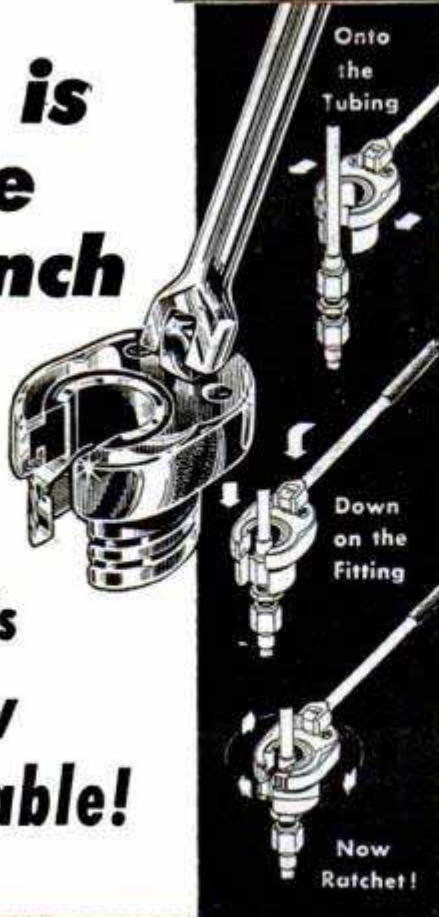

FOR PHENOMENAL
WRENCHING SPEED...

- AUTOMOTIVE
- HOME APPLIANCES
- REFRIGERATION
- PLUMBING
- NUTS WITH LONG STUDS
- FUEL LINES
- WATER AND GAS
- MARINE
- DIESEL
- AIRCRAFT
- INSTRUMENTS
- ... MANY OTHERS

TAC OPEN END RATCHET WRENCH

For the first time in tool history a wrench that passes over and around tubing, drops straight down onto fittings, then ratchets on or off as fast as your arm can swing. Limited clearance? The TAC functions from any conceivable direction, slips into "impossible" mazes, ratchets with as little as 7° arc of handle clearance. No other single tool can do all this!

All reports of resulting speed and ease seem incredible until you've tried the TAC yourself. Then you'll know why for years the Armed Forces have required our full production—until their primary needs were satisfied.

Now available to you, the Socket Type Open End Ratchet Wrenches are sold singly or in sets (consisting of several sockets, a ratchet head, square drive handle and enameled steel box.) 6 sets, 64 sizes of sockets from 3/8" to 4". Adaptors also available for allen heads, screwdriver, turnbuckle, and Spanner use.

Send for free catalog

TUBING APPLIANCE CO.

10321 ANZA AVENUE
Los Angeles 45, California



© 1951—TAC

Playing Safe with Atomic Rays

(Continued from page 140)

new glass will also be used in peepholes in atomic installations.

Unlike Joe, some workers—especially scientists conducting experiments—must actually see every detail of what is going on behind the walls. To take care of this need, Argonne developed a three-dimensional-television technique. Ordinary television suffices in the most routine experiments, but in some highly intricate studies it falls short. With three-dimensional, or stereotelevision, the operator can transport his hands and eyes to a remote point and carry out manipulations normally and naturally. It maintains the combination of manual dexterity and depth perception.

With the "master slave" manipulator developed by atomic researchers, almost any operation can be performed that human hands can do—while the scientist is shielded from a quick trip to the hospital by those thick, concrete walls. The scientist merely takes hold of a couple of handles which are connected to mechanical hands inside a radioactively hot room. Since these hands are "slaved" to the master handles, they move just as the scientist moves his own hands.

And now the men of unusual mechanical know-how have gone one step further. They have developed an electrically operated, push-button slave manipulator. A technician, trying the device for the first time, grinned: "Look, ma! No hands!"

Operators who work with the mechanical hands day in and day out get so that they can do tricks with them—pointing and even wagging a "finger." But, though they may become casual, they don't become careless. They know fully the deadly wallop that can be packed in radiation.

A superhot job was coming up. A laboratory "cave" was to be used for testing uranium specimens that had been irradiated in a reactor. The specimens were not only intense gamma-radiators, but they also contained plutonium, one of the most dangerous substances, medically speaking, ever manufactured by man. It comes by its name honestly, for Plutonia is a place anciently regarded as an entrance to infernal regions.

The workers, not desiring to toy with any infernal possibilities, first rolled out the seven-ton concrete door of the cave on railroad tracks. Then, they carefully went over every inch of the cave with detecting devices to be sure no contaminating radiation from previous jobs had been left around.

Next, new equipment was laid out. And this equipment had to be placed not only so

(Continued to page 254)

SURPLUS MACHINE SHOP TOOLS AT PRICES YOU CAN AFFORD



HIGH SPEED STRAIGHT SHANK DRILLS

SET 30 selected H. S. Straight Shank Drills from 1/8" to 1/4", lengths up to 7". \$15 value, only... **\$2.98**

SET 100 HIGH SPEED DRILLS: 1/4" down, 19H 30 new std. H. S. Drills - 70 slightly used sharp drills, lengths up to 7". \$30 value. PPD. **ONLY \$7.98**

SET 12 different size H. S. straight shank Drills, 1/4" to 1/2", lengths up to 7". Only... **\$3.98**

HIGH SPEED DRILLS

1/4" to 17/32" WITH 1/4" SHANKS!
SET 6 different size H. S. Drills, 1/4" to 17/32" shanks. PPD. **\$2.98**

SET 10 of above, 36H PPD. **\$4.95**
Sets 35H and 36H will fit any 1/4" drill.

HIGH SPEED DRILLS

1/2" to 1-3/16" WITH 1/2" SHANKS!
5 Drills for less than the price of one new Drill!

SET 5 different size H. S. Drills
32H 1/2" to 1-3/16"..... **\$7.95**

SET 10 different size H. S. 33H Drills 1/2" to 1-3/16"..... **\$14.50**
These new and used H. S. precision Drills with 1/2" shanks can be used in a 1/2" elec. drill or a 1/2" capacity lathe or drill press.

HIGH SPEED MORSE TAPER SHANK DRILLS

SET 9H 15 Different Size High Speed Morse Taper Shank Drills up to 9/16" with No. 1 and 2 tapers. New and used. \$50 value. Priced at only..... **\$6.49**

SET 20 Different Size High Speed Morse 10H Taper Shank Drills from 1/2" to 1". New and used. \$70 value. Priced at only..... **\$12.95**

SET 10 Different Size High Speed Morse Taper Shank Drills from 1/2" to 1 1/4". New and used. \$50 value. Priced at only..... **\$9.95**

SET 8 Different Size High Speed Morse Taper Shank Drills from 1" to 2" with No. 3, 4, and 5 tapers. New and used. \$125 value. Priced at only..... **\$29.95**

NEW MOUNTED STONES

SET 12 Mixture of 27H Mounted Stones with 1/4" shanks. PPD. **\$2.95**



HIGH SPEED WOODRUFF KEY SEAT CUTTER

SET 5 different size cutters. Can be used as mounted milling cutter or circular saw. All with 3/8" and 1/2" shanks, widths up to 1 1/2" dia. up to 1". New and used. PPD. Priced at only..... **\$3.95**



New Rotary FILE MIX

7 different pcs., High Speed 1/4" shank. PPD. **\$4.49**



SET 14 different pcs., as above, 22H PPD. **\$8.79**

H. S. TAPER SHANK CHUCKING REAMERS

SET 15 Different Size High Speed Morse Taper Shank 25H Chucking Reamers up to 1 1/2" with No. 1 and 2 tapers. New and used. Priced at only..... **\$7.95**

SET 8 Different Size High Speed Morse Taper Shank 13H Chucking Reamers from 1/4" to 1". New and used. Priced at only..... **\$6.95**



GENERATORS!

P1 GENERATOR 200-amp. 24-volt, continuous duty. Wt. 48 lbs. Special closeout price. F.O.B. Tulsa. **\$14.98**

ESA GENERATOR 50-amp, 12 volt continuous duty. Wt. 21 lbs. F.O.B. Tulsa. Only..... **\$9.98**

These used, guaranteed serviceable aircraft quality generators are easily convertible for welders, power plants, boats, platers, etc.

2 H. P. MOTOR 24-volt, 90-amp. double end ball-bearing shaft. Wt. 18 lbs. F.O.B. Tulsa. only..... **\$7.00**

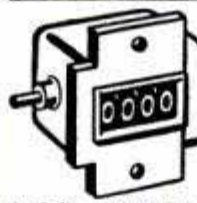

NEW VEEDER ROOT COUNTERS

(non-reset type)
A counter for punch presses, motor RPM, gadget experimentation, etc. 3 digit, clock-wise rotation type..... **\$1.49**
4-digit, clock-wise rotation type .. **\$1.89**
5-digit, clock-wise rotation type .. **\$2.49**
5-digit, ratchet type .. **\$2.89**

Money-Back Guarantee On RECEIPT of Merchandise. All mdse. mixture of new and reconditioned unless specified new. All orders (Except those specified F.O.B. Tulsa) are shipped Post Paid, saving you up to 25% on total delivered cost!

Write For Free Catalog Describing Thousands of Bargain Cutting Tools.

HYDRAULIC BARGAIN DEPT.



New Hydraulic Hose!!
2000-lb. Test

Length in feet	Price 1/4" ID
1	5.75
2	1.00
3	1.20
4	1.45
5	1.70
6	1.95
7	2.30
8	2.55
9	2.80
10	3.00

• ANY LENGTH
• 1/4" STD. PIPE CONNECTIONS
1/4" Hose has 1/4" male pipe connections. 11 to 50-ft. lengths available at 20¢ per foot. Above prices quoted complete with fittings. Finest construction double wire internal braid. Carries 3 GPM at 1000 PSI. Discounts on large quantities.

PESCO HYDRAULIC GEAR TYPE PUMP

Rated at 3 GPM, 3750 RPM, 1500 PSI, 1/2" drive spline. Gov't cost over \$90. Yours for only..... **\$9.49**



BARGAIN TOOL & SHOP MIXES-PPD.

- 30 GRINDING WHEELS 1/4" arbor, 4" diameter max..... **\$3.29**
- 2-8" WIRE WHEELS coarse and fine, 1" thick, 5/8" bore. Pair only..... **\$2.29**
- 300 SPRINGS all types and sizes..... **\$1.79**
- SURPRISE MIX: Over 50 pcs. for your 1/4" elec. drill including rotary files, drills, bits, reamers, grinding wheels and arbors for our customers who like pleasant surprises. Your money back if you aren't satisfied..... **\$2.98**
- BEARING MIX: About 40 needle, ball and roller bearings, new and used. Up to 2 1/2" dia. approx. 5 lbs. Outstanding buy at..... **\$2.95**
- RIVET MIX: 5 lbs. assorted rivets: cherry, explosive, etc. Hundreds of rivets..... **\$2.29**

6 SLITTING SAWS WITH MANDREL

SET 6 different size high speed Slitting Saws, 5 pcs. 2 3/4" dia. x 1" arbor, plus 1 pc. 5" dia. x 1/2" arbor. Thickness from .040 to .071. Cuts wood, aluminum, brass, steel, etc. PLUS SPECIAL MANDREL which enables use of saws in 1/4" or 1/2" electric drill. \$25 value. PPD. Only... **\$4.95**



7 selected, sharp H. S. Slitting Saws as above to use on your own mandrel or milling machine. New and used. Ppd. A bargain at..... **\$4.95**

Print Your Own

Cards, stationery, advertising, etc. Save money. Print for others, good profit; easy rules sent. Raised printing like engraving, too. Sold direct only. Write for free details. Kelsey Presses, F-37 Meriden, Conn.

TORIT ACETYLENE BLOWPIPE OUTFIT

for soldering and all small jobs requiring heat

Consists of torch, 4 tips, soldering copper, hose, connections for acetylene tank, and instructions for use.

Ideal for garages, repair shops, home workshops, etc. Ask for free literature on Torit Outfit No. 23 or order now. Sent postpaid for only.....

\$12.00

TORIT

MANUFACTURING CO.

273 Walnut St. • St. Paul 2, Minn.

T & T TOOL 221 W. SECOND TULSA, OKLA.

LUTHY AERO TYPE SPARK PLUGS

Aluminum Oxide Insulators

Material developed during World War II for high speed combat aircraft. Aluminum Oxide insulator cools very rapidly, is stronger, has greater resistance to moisture and reduces breakage to a minimum. Correct Gap setting and proper heat range for your automobile, truck, tractor, hot-rod and stock car.

Packed In Engineered Sets

PACKED IN SETS OF 6 OR 8 - CORRECTLY GAPPED FOR THE MODEL AND YEAR OF ALL CARS

ORDER YOUR SETS NOW

PACKED IN GIFT BOXES FOR XMAS

8 cyl. set	6 cyl. set
7.12	5.34

Satisfaction Guaranteed
Longer Life More Economy
High Speed Performance

Luthy Aeronautical Sales Company
JACKSON, MICHIGAN (Canadian address, Box 394, Hamilton, Ontario)

Send me a set of ___ plugs. Enclosed is \$___ Check here if you want us to ship COD.

Name..... Address.....
Year of Car..... Make and Model.....

3 Point Electrode

More R.P.M.
More Miles Per Gal.
Pat. App. For

GIFT...

**most desired
by camera fans!**

The Meters
Most
Photographers
Use

Delight him Christmas morning with a genuine WESTON...the meter he really wants. It will assure perfectly exposed pictures and real photographic enjoyment throughout the years. See both WESTON models at your local camera store.

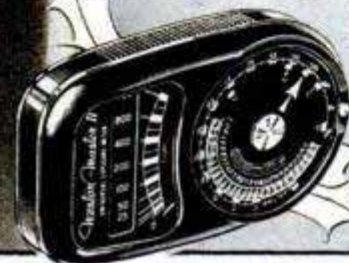

**WESTON
EXPOSURE
METERS**

WOODS

get this **BIG Catalog**
without cost!

Loaded with how-to-do it articles on wood-finishing, veneering, making inlay pictures and cabinets. Contains 83 distinct inlay designs and borders, plus a wood identification panel of 60 different varieties. All shown in full natural color suitable for framing.



A MULTITUDE OF MATERIALS Lowest Prices On

Veneers	Period Furniture Hardware
Inlays	Modern Picture Frame Molding
Lumber	Upholstery
Plywood	Hand and Electric Tools
Plans	Finishing Materials
Supplies	Decorative Metals
Plastics	Leather

Albert Constantine & Son, Inc.
Dept. PM-7, 797 E. 135th St., N.Y. 54

● VISIT US at our N.Y. Plant. Demonstrations every Saturday on making inlaid pictures, wood finishing and other crafts. Everyone invited.

SEND THIS COUPON!

Albert Constantine & Son, Inc., Dept. PM-7
797 E. 135th St., New York 54, N.Y.

Enclosed find 50c (refunded on 1st order) for your copy of "Manual For Craftsmen" No. 52.

Name _____
Address _____
City _____ State _____

that it could be easily handled by the slave manipulator, but so that the mechanical hands could reach any piece of equipment accidentally dropped. Crevices or blind spots had to be eliminated.

Some of the apparatus was enclosed in a clear-plastic case, known as a "dry box." Where instruments passed into this case, rubber bellows were attached to prevent the escape of dust. Plutonium-bearing uranium had to be sawed in the case, and the dust would be heavy.

With everything set up, the scientists were still not satisfied until they had conducted a dry run with a dummy specimen. Then the real stuff was rolled in—specimens encased in a heavy lead pot. The massive door to the cave was wheeled back in place, the man at the master slave manipulator peered through his three-foot window, picked up a mirror inside the cave with one mechanical hand and a pair of tongs with the other, extracted a uranium specimen, and set about his routine studies.

When an atomic bomb is set off in Nevada's wastelands, mobile testing units fan out to points within a radius of 500 miles. Typical report after a 1952 bomb blast: During a six-hour period when readings were highest in areas 200 to 500 miles away, a man would have received a total exposure of about 1/10 the amount of radiation he would get during the fraction of a second necessary for a chest X ray.

All of which goes to prove that distance is still the best safeguard from harm when an atomic bomb goes off.

Doctors know pretty well what happens in the human body when it is overexposed to radiation, but they are still looking for a first-rate cure.

Considered highly important is the post-war medical discovery that there is a substance in the spleen and other parts of mice that seems to prevent many deaths after overexposure—of mice. Unanswered yet is the question of just how effective the substance would be on human beings.

This mystery substance has also been found recently in other animal materials, such as marrow. Dr. Charles L. Dunham of the Atomic Energy Commission said there is hope for finding great quantities of the substance in the nation's slaughterhouses. Or, once it is isolated and analyzed, it may be manufactured synthetically.

Meanwhile, all the precautions being taken to prevent overexposure are worth every last million they cost. ★★★

☞ Farmers in the U. S. own more trucks than any other group in the world with a total of 2,300,000, according to the Automobile Manufacturers Association.



"New" living room . . . with permanently beautiful Weldwood paneling on walls and squares of Striated Weldtex on ceilings.



Weldwood paneling helps to give this multi-purpose "family-room" permanent beauty . . . for interior Weldwood Plywood is guaranteed for the life of a building.



Weldwood paneling on walls and repeated colors keep bedroom in harmony with other rooms on the first floor.

They built a **New home** inside an **Old house**

... with the aid of Weldwood® Plywood

THE George Montgomerys loved their old farmstead in Harrison County, Missouri. It had been their home for 25 happy years.

But . . . they sometimes wondered whether the bad features of the old homestead outweighed the good ones . . . cracked plaster, protruding chimneys, skimpy closets (and the *lack* of them). Would it be better to build a *new* home with the inner beauty and conveniences they so much wanted?

The Montgomerys chose to build . . . *not* a new house . . . but a *new home* INSIDE their old house.

They decided Weldwood Plywood was the perfect solution for the walls. Because it is genuine wood paneling it is beautifully decorative, permanent, crackless.

The living room, bedroom and family walls were covered with rich-looking Weldwood birch panels and squares of distinctive Striated Weldtex® on the ceilings.

Panels in the living room are of Weldwood Plankweld®, the edge-grooved, pre-finished panel that is proving such a favorite with discriminating home owners. (They're so easily and quickly installed by the man of the family.)

The Montgomerys (and their friends) are delighted with the beauty and livability that Weld-



Mr. and Mrs. George Montgomery, of Pattonsburg, Missouri . . . happy in their "new-old" home.

wood Plywood gives to their "new" home.

"And," enthused Mrs. Montgomery, "since Weldwood beauty is said to increase with age, I guess that my major interior decorating problems are also settled . . . *for life!*"

With Weldwood Plywood, you can give *your* home more room, lasting warmth, beauty and economy. Visit a distributing unit of United States Plywood Corporation or U. S.-Mengel Plywoods, Inc., or your lumber dealer. Or mail coupon for complete information.

There is a Weldwood Plywood for every purpose. Look for the Weldwood trademark.

Weldwood® PLYWOOD

Product of United States Plywood Corporation
World's Largest Plywood Organization



UNITED STATES PLYWOOD CORPORATION

Box 61, New York 46, N. Y.

PM-12-52

Enclosed find 10¢ for booklet, "Beautiful Wood for Beautiful Homes," showing ideas in full color for beautiful Weldwood paneled rooms.

Name _____

Address _____

City _____ Zone _____ State _____

Merry Christmas!

STANLEY TOOLS

A Christmas "natural" to warm the heart of any man or boy! Give Stanley Tools . . . complete sets in chests or tools in Christmas boxes. Buy them at your hardware dealer's. Look for the famous **STANLEY** trade mark.

STANLEY TOOLS, NEW BRITAIN, CONN.

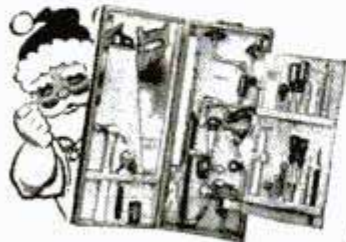

HOBBY HOUSE SET
No. 910 — A top-notch group of tools to make any man or boy feel proud.
\$72.50*

OTHER CHESTS AND SETS
FROM **\$23.75* UP**



"YANKEE" PUSH DRILL
No. 41 — None better for boring small holes in wood or plastics. 8 Drill Points in handle.
\$5.25*



STANLEY SCREW DRIVER SET No. X3000M — Five drivers for home use, and a handy kit to hold them.
\$2.80*



STANLEY BIT BRACE No. X1250 — Well-made for tough boring jobs. Beautifully finished.
\$4.25*



STANLEY CHISEL SET No. X64 — 1/4", 1/2", 3/4" and 1" with plastic handles and a kit to hold them.
\$10.50*

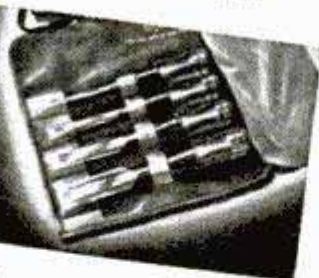

*Western Prices Slightly Higher

SEND FOR THIS BOOK—IDEAL FOR CHRISTMAS GIVING . . . \$2.00
Stanley Tools, 3122 Elm St., New Britain, Conn. In Canada: Stanley Tool Co. of Canada, Ltd., 3122 Stanley St., Roxton Pond, Quebec.

THE TOOL BOX OF THE WORLD



Reg. U.S. Pat. Off.

Hardware • Tools • Electric Tools • Steel Strapping • Steel



We're Blasting Holes in the Iron Curtain

(Continued from page 99)

relay stations in Tangier, Munich, Salonika, Ceylon, Hawaii, Manila and England bounce them in fan-shaped patterns that blanket the whole Soviet-dominated part of the globe and much of the rest of it. Some programs are rebroadcast via medium wave over 100 Latin American stations, and about 120 stations in Western Europe.

Besides Voice of America, Radio Free Europe, a privately financed outfit, began in July, 1950, to blast the trumpets of democracy to all who dare listen behind the Iron Curtain. Using a network of 11 stations, more than 1000 hours of hot dope is lobbed into Soviet satellite countries every week, via big transmitters in the Frankfurt, Munich and Lisbon areas. One half-mile-long antenna not only magnifies the power of transmitters, but can pin-point verbal bombshells with accuracy.

Unhampered by the touchy diplomatic problems that beset the State Department's Voice of America, RFE doesn't have to pull punches. Recently, citizens of Red-controlled Bratislava in Czechoslovakia were tipped off to a snake in their midst:

"Hello, Bratislava! Radio Free Europe calls the citizens of Bratislava! In a moment you will hear names of Bolshevik informers and agents of police. In the office of the National Reconstruction Fund is employed one Comrade Absolonova. We are warning you against this person as emphatically as possible. She is a dangerous agent of the communist police. Her task is to recruit for the State Security Police new agents and informers among young people. . . ."

In words of one syllable, the announcer revealed the woman's techniques. So damaging was the effect that Comrade Absolonova no longer does business in Bratislava. There are many other examples like this one.

Radio Free Europe gets information from many sources, including anticommunists who escape, and also through the mails. Despite communist censorship, plenty of mail gets through to "Box 62-20" in Munich, RFE's mailing address which is continually publicized via radio.

Although a nuisance most of the time, the bouncing characteristic of short waves sometimes can be useful. By calculating the bounce between earth and ionosphere, Voice engineers at the Salonika transmitter, for instance, can make the signal plop right down on Moscow in a checkerboard pattern that irritates the Politburo. The

(Continued to page 258)

General Salvage Co. SURPLUS Bargain-SALE!

BUY DIRECT FROM THIS AD

BUILD YOUR OWN ARC WELDER OR LIGHT PLANT



Westinghouse D-C GENERATOR
 Save \$250 to \$500
\$15.50 Instruction included. Rated 200 Amps. 28 Volts. 2500 R.P.M. Ship. Wt. approx. 50 lbs. Stock No. 707.

PRICE F.O.B. K. C., MO.
 CONVERTS TO ARC WELDER 200-250 AMP.
 OR LIGHT PLANT CAP. LOAD 5000 WATTS

Stock No. 711 D. C. Generator R-1 Jack & Heinz, rated 300 Amp. 30 Volts. Gov't cost \$300.00. Instruction for converting to welder or light plant incl. Also instructions and diagram for converting the R-1 or P-1 generator to Combination Welder **\$25.50** and Light Plant included.

Carbon Pile Generator Voltage Regulator For use with 24 or 32 Volt D.C. Generators. Also recommended for the P-1 and R-1 type generators in "build your own" **\$6.95** Light plant. Postpaid.

R-21 HEAVY DUTY RHEOSTAT Brand New for regulating voltage on ELECTRIC WELDERS, model trains, electric blankets, lights, control photoflood lamps, etc. Rated 16-32-ohms. Size 3 1/2" x 2 1/2" postpaid. **\$6.95**

WEAVER HYDRAULIC HAND PUMP New With Built in Check & relief valve. For oil or Hydraulic Fluid. Rated 1000 P.S.I. **\$12.95** postpaid \$75.00 Value.

VALUABLE GEARS BARGAIN SPEED REDUCER. 10-1 ratio 90 degree angle 1/2" splined shaft with 3 mounting holes rated 2 H.P. **\$5.95** postpaid

SENSATIONAL SELSYNS - Two or more connected together work on 110V A.C. For controlling distance operation, etc. In- **\$7.95** Postage instructions incl.

CUNO OIL FILTER New. Aircraft type filters without cartridge replacement. Turn handle & cartridge is clean. 3/8" inlet & outlet ports **\$4.95** postpaid instructions incl.

Send CHECK OR M. ORDER. PRICES F.O.B. KCMO EXCEPT when marked POSTPAID U.S.A.

ELECTRIC MOTORS
 Stock No. 700 1/2 HP. 27 VDC R.P.M. 4000. Shaft ext. 2 1/4", variable speed, applicable for 110V. A.C. by simple rearranging armature brush leads. Instruction incl. **\$5.95**
 Stock No. 4949 is 1/4 H.P. 24 V. D.C. 2000 R.P.M. Mfg. by Pesco applicable for 115 V. A.C. Instructions incl. Base mounted. **\$3.50**
DELCO MOTOR 6 Volt DC handles 8" fan blade. Shaft is 1/2" in dia., 1 1/2" long. Size 5"x3" two mounting studs. 1200-2000 RPM New **\$2.35** (add 50 cents postage)

ECLIPSE MOTOR & GEAR UNIT
 Brand New including 24V. D.C. Motor. Gear ratio 4:1, can be adapted for 2:1, 40:1 & 20:1. Ideal GARAGE DOOR OPENER, HOIST, PUMP JACK, HAY-LIFT, LAWN MOWER DRIVE, DRIVE FOR POST DRILL, etc. Gear unit applicable for 110 A.C. Diagrams & instructions incl. Gov't cost \$221.00. Wt. 23 lbs. **\$9.95** f.o.b. KCMO.

BEAM ROTATOR MOTOR
 Brand New with instructions for use on 110V. 60 cycles. Powerful geared motor for TV aerials, ham. FM, etc. Light weight, rugged. For ventilating louvers, furnace dampers, and check drafts. **\$7.95** \$35.00 value.

VACUUM AIR HYDRAULIC PUMP for water, oil, as automobile drain case pump. 3/4" pipe thread ports Splined self aligning shaft 150 G.P.H. Stock #75 In- **\$12.95** struction incl. wt 12 lbs.

PESCO CENTRIFUGAL HEAVY DUTY PUMP Including built in motor. Applicable for 24 V. D.C./A.C. or 110 V. A.C. The motor is explosion proof constructed for gasoline fuel, oils, water, fuel booster, etc. 3/4" hose connection. Rated capacity 400 G.P.H. Instructions incl. Gov't cost \$172.00 **\$9.95** Stock #659

PESCO LARGE VOLUME UTILITY PUMP For Water, Oil, Insecticides, etc. including built in relief and by pass valve. Capacity 400 G.P.H. 1/2" drive spline shaft. 3/4" pipe inlet and outlets. Engineering data incl. (Stock #600) **\$7.95** postpaid only

HYDRAULIC PRESSURE GAUGE Range 0 to 2000 P.S.I. Connections are 1/8" **\$3.50** postpaid

Stratopower Constant Displacement Pump
 For operating Hydraulic cylinders, hydraulic motors on tractors, Bulldozers, Construction machinery, Lift trucks. For fuel or oil transfer, etc. Delivers up to 400 G.P.H. at 3750 R.P.M. Rated 1250 to 1400 P.S.I. 3750 to 4500 R.P.M. HAS BUILT IN RELIEF AT HEAD. \$100.00 value. Engineering data and instr. **\$15.50** incl. Stock #37. Wt. 8 lbs.

HYDRAULIC CYLINDERS Stock No. 512 Double action hydraulic cylinder 2 1/2" Bore, 4" Stroke, Dia. 3/4" shaft including built in Hydraulic control valve which may be operated with rod or lever. Clevis mounting. Overall length shaft retracted 14". **\$75.00** f.o.b. value. Wt. 9 lbs. **\$8.95** KC, Mo.

Stock #11—Double action 1 1/2" Bore, 6" Stroke, 3/4" Dia. shaft. Clevis mounting base and shaft end. Capacity 1160 lbs. with 1000 P.S.I. **\$9.95** post-input. \$50.00 value.

Stock #303—Double Action 2" Bore, Stroke 1 1/2". Dia. shaft 1 1/2". Overall length shaft retracted 23". 2000 lbs. capacity with 1000 PSI gives 2800 lbs. with our STRATOPOWER PUMP. 4" Bore, 10 3/4" Stroke, 1-5/16 dia. Shaft, clevis mounting. Ideal for farm, shop and road machinery. **\$25.50** f.o.b. Gov't. cost \$300.00

HYDRAULIC CONTROL VALVE—Adel precision #B-10329 for controlling 2 single action or 1 double action cylinder including toggle lever. When lever is released it returns to the neutral position and **\$8.95** Postlocks cylinder. New

VICKERS UNLOADING VALVE Brand New—By passes full amount output of the pump while the cylinder is not in operation. Takes starting load off of electric motor driving the pump. 1/2" AC TUBE PORTS **\$8.95** postpaid (3/4"-18) thread. Price

FOUR WAY VALVE Solenoid operated on 24 volt D.C. Applicable for 115 V. A.C. Off in neutral position. For operating double action hyd. cylinders, remote control, etc. Has 1/4" tube ports. Instructions incl. #324 **\$8.95** postpaid
HYD. PRESSURE & relief valve 3000 P.S.I. 3/4" ports **\$4.95** postpaid

GENERAL SALVAGE CO., 2922 E. 27 St., Dept. 722, Kansas City, Mo.

STEBBINS 1/4" Electric DRILL

92nd Anniversary
SPECIAL
 Reg. \$19.50 **\$14.95**



Husky, lightweight. Packs terrific power and speed—2500 RPM! Die-cast aluminum case, chassis; air-cooled. Special high-torque motor. Self-aligning, oilless bearings. Ball thrust bearing, with Jacobs geared chuck.

Illinois residents add 2% occ. tax. Cash orders postpaid. Include \$5 deposit with C.O.D.'s

STEBBINS HARDWARE CO.
 Chicago's Oldest and Largest
 15 W. VAN BUREN · DEPT. M · CHICAGO 5, ILL.

NEW—Sensational! GEIGER COUNTER



"The SNOOPER"
 LOW PRICE ONLY **\$24.95**
 COMPLETE

Find a fortune in uranium with this new, super-sensitive Geiger Counter. Get one for atom bomb defense. So small it fits in the palm of the hand or in the hip pocket, and yet more sensitive than many large, expensive instruments. Weighs only 1 1/4 lbs. Uses flashlight battery. Low price includes earphone, radio active sample, instructions. Sold with ironclad moneyback guarantee.

ORDER YOURS TODAY—Send \$5.00 with order or payment in full to save C.O.D. Write for free catalog on larger, more elaborate Geiger Counters, metal locators and our Scintillator Counter.

Dealer Inquiries Invited **PRECISION RADIATION INSTRUMENTS**
 2235 PM So. La Brea, L.A. 16, Calif.

CAR HARD TO START?

Get EASY STARTING ... Smoother Engine Performance ... Save Gas! with SENSATIONAL NEW **SISSON Electrimatic CHOKE**

Positive, dependable electric choking gives quick, easy starts every time in any weather. Smoother warm-up... no stalling...no flooding...no seasonal adjustment! Fits any car equipped for automatic choking. \$5 complete.



Sisson Choke, 1652 Ohio Avenue Anderson, Indiana

- Please send me FREE illustrated Electrimatic folder
- I enclose \$5 (check or money order) for one Choke
- Ship C. O. D.—I will pay postage

Car Make _____ Year _____ Cyl. _____
 Carburetor Make _____
 Name _____
 Address _____
 City _____ Zone _____ State _____



Gift...for a MAN

For the man who likes tools — 3 fine UTICA Adjustable Wrenches in the popular 6", 8" and 10" sizes.

Attractively boxed in festive Christmas wrapping — for brother, dad, hubby, son, Uncle Pete and any home workshopper or handy man.

Top quality—drop forged—extra-hardened on jaw surfaces for 10 times longer wear.

At your tool dealer's.



IT PAYS TO BUY QUALITY TOOLS

and the world's best tools are made in U.S.A.



4 TOOLS IN 1

The Complete
METAL WORK SHOP
FOR HOME AND PLANT

Patent No.
2053309

INTRODUCTORY PRICE
Only
\$6.95

DELIVERED

BENCH TOOL that **FORMS, SHEARS, PUNCHES, RIVETS**—one small compact tool that is a complete metal workshop. Bending and forming dies make smooth sharp bends in either bar or rod stock. Hardened steel shearing jaws shears metals cleanly up to 1/4" thickness. An efficient punch press complete with 1/8", 3/16" and 1/4" punches. Rivets easily with punch press and rivet dies. Check must accompany order. No C.O.D.'s. Full immediate refund if not completely satisfied.

TATU CO., Dept. F4
85 Columbia Dr. Williamsville 21, N. Y.

IT

- FORMS
- SHEARS
- PUNCHES
- RIVETS

RFE's transmitter near Lisbon is aimed to take two bounces off the ionosphere, one off the Mediterranean and then spray itself all over the Russian satellite countries on the other side.

Biggest radio problem for the West's broadcasters is the Russian "jam session." Over an estimated 1250 stations, all beamed as closely as possible to same frequencies as the Voice, BBC, RFE and other Western radio, the Reds continually broadcast the greatest barricade of pure noise ever created in the history of man.

The best way for the Russians to clobber a broadcast would be to build a station of equal power right next door to the one they're after. Since they can't do this, they build one of equal power at the same distance from the target area. Another stunt, used in Moscow, is to blanket an area with a whole battery of low-power transmitters, all belching their raucous chatter at once. This is "saturation" jamming.

Besides jamming, the Reds have contrived other stunts to foil us. Radio sets sent in for repairs to communist-controlled shops have their short-wave bands removed before going back to the owners. And in some areas, all radios are wired to central receivers, manned by commies, of course, who select programs that the people may hear.

What are we doing about this massive counterattack? Relay stations continually switch frequencies on their medium waves and aim their short-wave broadcasts at new targets. Whenever this happens, a big Russian jamming transmitter must be torn down, relocated and start its operations from scratch. With the *Courier* and her sisters moving from place to place around the periphery of Europe, it's going to be tougher than ever for the jammers to jump often enough and fast enough to keep our voice from being heard.

Beauty of the *Courier* is that she can sit in a harbor and hit three targets at once in wide concentric circles—medium wave covering near-by areas, one short wave planting its programs beyond it and the other skipping off the ionosphere.

Appropriations for two more ships even more powerful than the *Courier* already have been made, according to news reports. With a whole fleet of jack-rabbit super-transmitters spattering the straight side of the news into Red territory from all directions, Russia's jammers will be spread pretty thin.

Right now, without Operation Vagabond, monitoring reports indicate that 25 percent of Voice broadcasts get through to Moscow, where jamming is roughest. Sixty to eighty

(Continued to page 260)

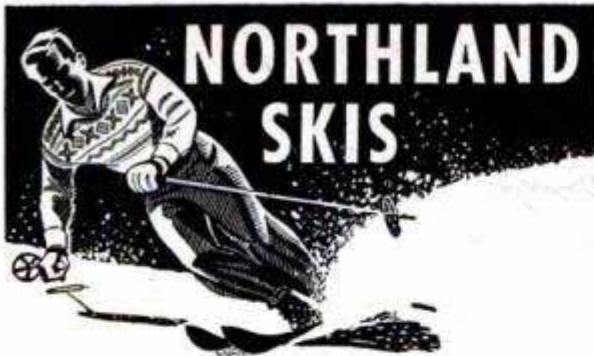

NORTHLAND SKIS

Choice of Champions

Beyond doubt, Northlands will make you a better skier — give you confidence — add to your enjoyment. Follow the lead of the world's leading skiers. Ask for, and get, Northlands.

Ski the professional way. Send for Northland's illustrated ski manual. Free in U. S. A.

NORTHLAND SKI MFG. COMPANY
95 NORTHLAND PARK • NO. ST. PAUL 9, MINN.

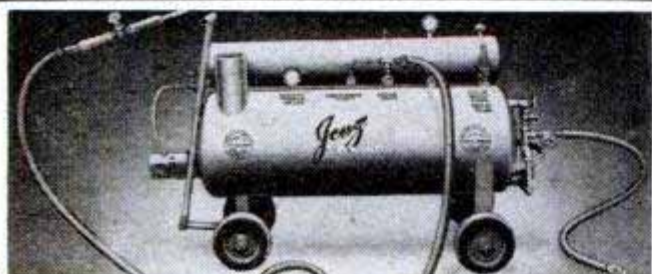

EARN \$6.00 PER HOUR

At a cost of 20c with the NEW JENZ SUPER CHIEF STEAM CLEANER. Portable—No moving parts—Cleans anything—Any place—Motors—Chassis—Machinery—Floors—Buildings—Oil Rigs, etc.—Oil fired—Economical—Fully tested and warranted. 75 lbs. steam in ten min.—Model 90. Complete as illustrated..... **\$388.50**

F.O.B. shipping point

HI-PURE LABORATORIES, Evansville, Ind.

Make Garden Masonry for Spare-Time Profits

Millions of homes can use these Ornamental products—urns, vases, flower boxes, bird baths, lawn seats, flagstones, etc. Easily made of sand and cement. Permanently glazed in a range of smart colors. Distinctive—attractive—quick selling.



Eye-Appeal Makes for Cash-and-Carry Sales

Selling prices allow 200% to 300% mark-up on basic costs. Only a small investment needed for supply of molds. Easily set up in shed or garage. Write immediately for catalogue OM and price list.



Colorcrete Industries, Inc.
710 Ottawa Ave., Holland, Mich.



Make Every Day Christmas For Him —

buy SIOUX

QUALITY

ELECTRIC TOOLS

Throughout the World, Automotive, Aviation and Industrial Plants have used Sioux Tools for over 38 years.



1/4" DRILL TOOL SET—For the Home Shop, for Drilling, Grinding, Wire Brushing, Cleaning, etc.... **\$41.55**

No. RC-1822

★ ★ ★

1/2" ELECTRIC DRILL—For Home Shop, Builder and Craftsman. Light Weight, Rugged, Handles easily in any position.... **\$42.50**



No. RC-1832

★ ★ ★

1/4" ELECTRIC DRILL—Pistol Grip Type. Equipped with Hex Key Chuck. Capacity in steel up to 1/4", in hard wood 1/2"..... **\$22.95**

\$22.95

No. RC-1885

★ ★ ★

POLISHER-SANDER—For the Farm, the Craftsman and the Home. Will sand or polish all kinds of surfaces... **\$29.25**



No. RC-1865

★ ★ ★

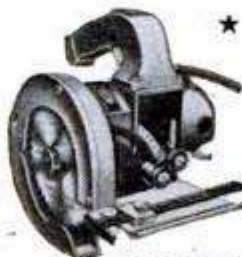

ELECTRIC HAND SAWS—Portable—Professional. 6 1/4"-8 1/2". Wood depth cut 2" to 2 7/8". One hand operation—perfectly balanced. Faster, easier, better, Profit-Makers. For 6 1/4" shown..... **\$61.95**

No. RC-1806

WRITE US for complete details on full line of SIOUX Quality Electrical Tools, and name of nearest Dealer.



ALBERTSON & CO., INC.

SIOUX CITY, IOWA, • U. S. A.

Congress Pulleys

Standard equipment on Bendix, Frigidaire, Hamilton, General Electric and many other appliances

YOU PAY NO MORE for CONGRESS QUALITY

Congress quality costs no more! Insist on the drive preferred by most original equipment manufacturers. There is a difference! Congress Drives are electrolytically plated, diamond-bored and tested for trueness.

Buy Congress V-Belts and Pulleys from your local supplier.



LOOK FOR THIS DISPLAY

You'll see it at leading suppliers throughout the United States.

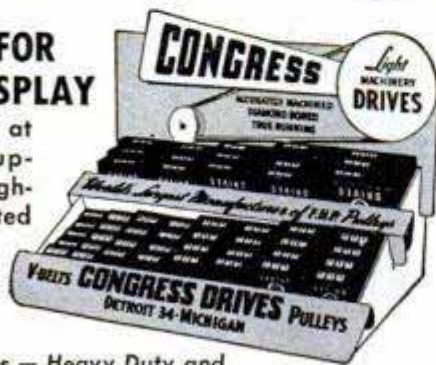

Q-D Sheaves — Heavy Duty and Steel Cable V-Belts—FHP Drives

CONGRESS DRIVES DIVISION

TANN CORPORATION

World's Largest Manufacturer of FHP Pulleys
DETROIT 34, MICHIGAN

Greatest tool values CATALOG FREE

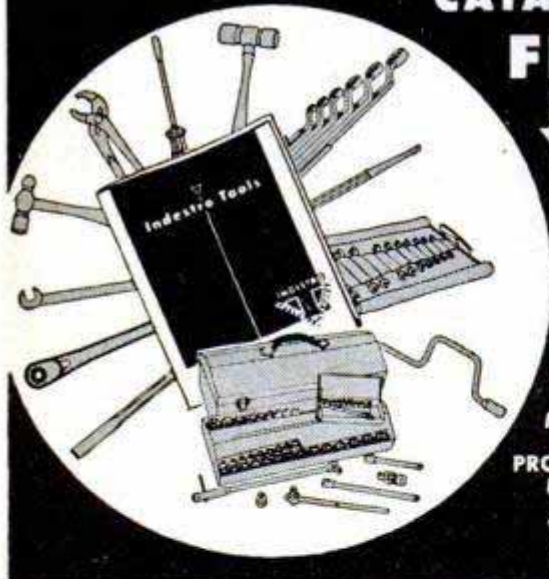

AUTO SERVICE MEN

FARM MECHANICS

PROFESSIONAL MECHANICS

WORKSHOP HOBBYISTS

This brand-new book gives you full information on High-Quality, Low-Price Indestro Tools your dealer can supply. The very newest designs in regular or special hand tools, tool sets and complete tool chests; every tool finely made, properly heat-treated, ground and polished for years of satisfying service. Insist on Indestro, the choice of professional shop men.

send coupon for INDESTRO catalog

FILL OUT AND MAIL NOW FOR FREE COPY

Send to INDESTRO MANUFACTURING CORP.
N. Kildare at Schubert, Chicago 39, Ill.

Write your name and address in margin space

percent get through elsewhere. Such evidence spurs our engineers to even greater efforts to outwit Russian countermeasures. For nearly a year, crews of men have been crawling like spiders across 10 gigantic wire webs they are weaving on six sites between New York and San Francisco. Each net, strung for a distance of two city blocks between a pair of small Eiffel towers rearing some 290 feet skyward, is a "curtain antenna," capable of blasting short-wave programs through interference. They increase signal strength some 14 times.

Another stunt is to beam signals by slow Morse code, which can be heard through any jamming. It's slow enough so that anyone with a Boy Scout handbook can translate the signal.

A new gadget called a "heterodyne filter" is going into all the Voice's relay bases. The little filter knocks down some jamming noises without cutting down on the program signal as did the former crystal filters.

How are we getting around Russia's fiendish "wired radio" circuits? Right now, in the Red sector of Berlin, Western-minded citizens can stick an ear through the Iron Curtain by picking up the phone and dialing a certain number. Tape recordings of newscasts made by RIAS (Radio in American Sector) automatically greet them.

And there are other ways of getting word to the enslaved people. At six a.m. one August morning in 1951, the people of Red-dominated Czechoslovakia looked up to find their sky full of strange balloons, slowly descending on their woods, in their village streets and back yards. Soon after, thousands of leaflets fell from the clouds announcing that Operation Winds of Freedom was under way.

The stunt was pulled by the Crusade for Freedom, the United States citizens' group which raises funds for RFE. Plastic pillow-shaped balloons, about five feet square, carried a payload of 200 single-sheet messages sealed in a pocket. Hydrogen gas, slowly leaking through the transparent plastic, allowed the pillows to come to earth after specific flying time, determined by the amount of gas in them. Thus, RFE engineers, gauging wind speed, could aim them at specific targets.

Other round, synthetic-rubber balloons, about five feet in diameter, each carried 2200 sheets of messages loose inside the bag. Carried eastward by prevailing winds, they would rise until they burst, permitting the leaflets to flutter down over many square miles. One balloon shower hit the fair grounds at Prague. Leaflets were

(Continued to page 262)

HERE'S HOW TO SAY—
MERRY CHRISTMAS
 and a
SAFE NEW YEAR
 (for many years to come)

GIVE HIM A

Big Beam



Model No. 166

with SEALED BEAM Bulb
 Whether he's fixing a flat at the side of the road, or going on a pre-dawn fishing trip, or just puttering around the basement... his Big Beam will mean added protection against the hazards of darkness.

ONLY
\$750
 less battery

At leading hardware, sporting goods, and department stores, or write to—

U-C LITE MFG. CO., 1066 W. Hubbard St., Chicago 22, Illinois

2-BEDROOM HOME \$890
 BUILD YOUR OWN



Living room 12x14. Master bedroom 10x12. Nursery-den 10x11. Kitchen 7x10. Bath 5x8. Concrete block built. Blue prints, material lists, exact instructions for 3 designs.

Complete \$1 ppd.

SUNNY-CAL HOMES, Box 309-D Hollywood 28, Calif.

HI-SPEED COPE-SAWDRILL-BIT DRILLS SAWS REAMS
INTERNATIONAL TWIST DRILL CORP.

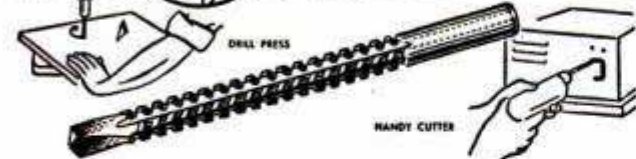

IDEAL AS A XMAS GIFT

DRILL, SAW, REAM... metal, pipe, wood, plastic, Transite, etc. Use with any electric drill, slow drill press, lathe or milling machine. Drills own starting hole—upper part of bit is used to cut, saw or ream circles, ovals, squares or scrolls. Easy to operate. Ideal for carpenters, mechanics, electricians, plumbers, hobbyists, many others. Abrasive resistant, high speed steel. Flutes ground from solid. Will withstand severe continuous use without breaking. Resharpener at no charge. Takes place of up to \$50 in tools. 1" diameter, 2" cutting sections, total length 3 1/2". Also available specially designed for wood or metal and in 2 1/2" and 1 1/2" lengths. Write for details. Specify all-purpose bit. Shipped same day. Money-back guarantee. Dealer inquiries invited.

SEND CASH, CHECK OR MONEY ORDER
 Manufactured and distributed by:
INTERNATIONAL TWIST DRILL CORP.

618 Wyandotte, Rm. 638, Kansas City 6, Mo.

only
\$3.95
 POST PAID



For all the
 home-workshoppers
 on your Xmas List—

a pair of
SIMONDS
SI-CLONE
SAWS

(IN ATTRACTIVE GIFT PACKAGE)

Here's how to please industrious friends... give 'em a bright gift-wrapped pair of Simonds guaranteed quality woodworking saws: A No. 60 Combination Saw for general-purpose work... and a Planer Saw for extra-smooth cutting. A choice of 8" or 10" diameter is offered with 5/8" round centerhole to fit most makes of table saws. On sale at hardware and department stores, saw shops and woodworking machinery dealers.

at these **LOW** Combination **PRICES**

2-8" Saws \$6.10
 (1 No. 60 and 1 Planer)

2-10" Saws \$10.60
 (1 No. 60 and 1 Planer)

These saws have 5/8" round centerhole

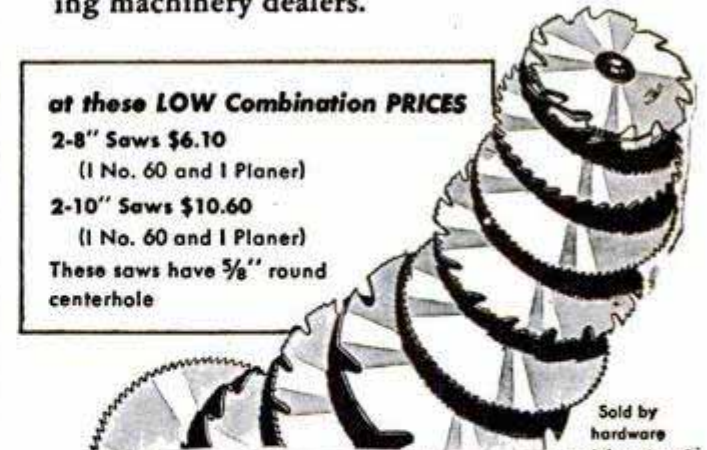

Sold by hardware and department stores saw shops, etc.

SIMONDS
SAW AND STEEL CO.
FITCHBURG, MASS.

Factory Branches in Boston, Chicago, San Francisco and Portland, Ore. Canadian Factory in Montreal, Que.

STOP THAT OIL EATER!



GET NEW CAR PERFORMANCE WITH PISTON SEAL WITHOUT COSTLY OVERHAULING

Piston Seal—the amazing compound that forms a self expanding, pliable lubricating seal around pistons that compensates for wear. Eliminates oil burning, restores power and compression. Can be applied in a few minutes.

GOOD FOR 10,000 MILES



SIMPLY REMOVE SPARK PLUG AND SQUEEZE

FOR COMPLETE, FREE DETAILS WRITE TO

RICHIE DISTRIBUTING CO. 11916 Madison Ave., Dept. M, Cleveland 7, Ohio

STOP FURNACE LEAKS

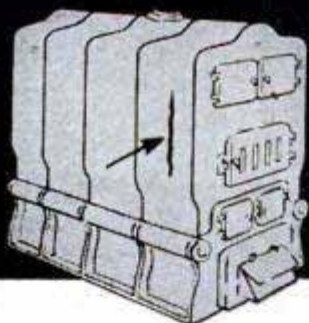

Cut this winter's fuel bills. Seal *tight* every heat-wasting crack, opened seam and other leak in your furnace, boiler, tank, radiators and piping — as professional repair men do — with Smooth-On No. 1 Iron Cement. Keep a can of Smooth-On handy for tightening loose parts and many other repairs around your home. Buy Smooth-On No. 1 in 1¼-oz., 7-oz., 1-lb. or larger sizes at your hardware store. If they haven't it, write us.

FREE Repair Handbook

40 pages of ingenious, tested, short-cut repairs. Simple directions. 170 illustrations. Write today for YOUR free copy of the Smooth-On Handbook. 50 379

SMOOTH-ON MFG. CO., Dept. 37M
570 Communipaw Ave., Jersey City 4, N. J.

Do it with
SMOOTH-ON
THE IRON REPAIR CEMENT OF MANY USES



snatched by eager people and spread throughout the countryside before the Reds knew what had happened.

Best of all was Moscow's reaction. In a broadcast via Radio Moscow, the Reds screamed: "Our people will not be affected by experimental balloons, filled with press manure issued by our exiles . . . everything brought to us by Western winds is just filth and dirt. But this will not disturb us and make us panic. We will not sit here indifferently. . . ."

The louder Moscow screams, the happier are the faces in organizations like the Voice of America and Radio Free Europe. Unless they are being hurt, the communists don't talk. "Their complaints," says an RFE spokesman, "are the surest measure of our success." ★ ★ ★

Small-Size Vacuum Cleaner For Junior Housekeeper



Designed for the junior miss of the family, a miniature vacuum cleaner operates just like mother's model. The only difference is size. Powered by a 110-volt electric motor, it's right up to the minute in construction features. The pint-size cleaner has an automatic handle-controlled on-and-off switch; electric headlight and a 10-foot cord. It is safe for youngsters to use.

BRIKCRETE



Local Manufacturers Have Broad Opportunities

Brikrete manufacturers operate compact, self-contained plants under franchise privileges in protected territories. Each is an independently owned unit in a country-wide chain, using local materials and local labor to supply the world's most modern masonry for local building needs.

Brikrete is rich in sales appeal because it is ahead in design, style, size, color, economy. Easily the preferred masonry. But because local production eliminates economic wastefulness, Brikrete can be sold at a lower-than-lumber price. Yet still allow a generous profit margin.

Brikrete offers much to men looking for a community enterprise on a nominal investment. We supply complete equipment; easy terms when desired. Liberal cooperation. Write today for Brikrete Book No. 2—while territory is still open.

BRIKRETE ASSOCIATES, INC.

4679 Division Avenue, S.
Grand Rapids 8, Mich. 82

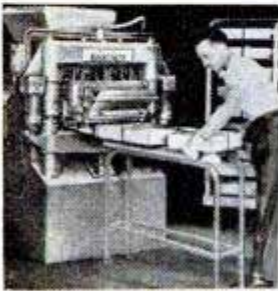

KING MIDGET

WORLD'S LOWEST PRICED
2 PASSENGER AUTO



Drive it for 75c per week. Amazing performance. Surprising comfort. All steel construction. Ready to run or assemble it yourself with our bolt together parts. Rider agents wanted, earn your car free. Send 25c for detailed literature or \$1 (refunded first order) for actual assembly book and service manual filled with photos, drawings, specifications, etc.

MIDGET MOTORS MFG. CO. ATHENS, OHIO

PAGE Tractors

Do The Job Faster—Easier—At Less Cost!

DOES
TILLING,
PLOWING,
DISKING,
Dozens of
other jobs



Rugged 1953 riding, walking, models 2 to 6 HP. All gear drive with reverse. Over 60 attachments! No belts, no chains. Fully Guaranteed!

Over 25 years' experience

Free Catalog—

PAGE 1804 S. 81st St.
Milwaukee, Wis.

BOYS-IT'S FREE!

...NEW, EXCITING 16-PAGE BOOK
on magic and marvels of chemistry

Shows you how to amaze friends with eye-opening tricks of chemical magic... like changing water to blood and blood to stone. Tells you how to do many fascinating home experiments and shows you the big, new Chemcraft outfits. Describes fun, thrills, adventure you can have with a Chemcraft chemistry outfit of your own. Send now for free copy to Porter Chemical Co., 43 Prospect Ave., Hagerstown, Md.



Chemcraft Senior Lab.

HEY FELLAS!
ask Dad for **CHEMCRAFT**

HERE'S BIG NEWS!

AT
BETTER
HARDWARE
STORES
EVERY-
WHERE

'ARCO
SAW'

NEW LARGER MODEL
CUTS thru 2x4's with
QUICK CUTTING
5" 'ARCO SAFECUT'
SAWBLADE.

\$9.95
UP

AVAILABLE
IN FOUR MODELS
TO MEET EVERY NEED!
(See Complete Price List
Below)

ATTACHES IN ONE
MINUTE TO ANY
1/4" ELECTRIC DRILL

CUTS 8 TIMES FASTER
THAN A HANDSAW!

Now, here is the first gear driven saw attachment for electric drills that will go through 2x4's in one easy cut. Comes equipped with a 5-inch "ARCO SAFECUT" Sawblade—the smoothest, fastest cutting sawblade made. Whizzes through lumber, plywood, wallboard, etc.

ONLY "ARCO" GIVES YOU THESE FEATURES:

5-inch "ARCO SAFECUT" SAFETY SAWBLADE—uses 30% less power, allows small drill to cut thru heavy wood. Precision Graduated Depth & Bevel Gages for cuts to 1 3/4" in depth, bevells from 0 to 45°. Adjustable Rip Gage for accurate strips. Adjustable Visual Guide (not shown) for straight & bevel cuts. Sturdiest, Most Easily Adjusted Safety-Yoke or absolute safety, keeps drill steady & vibration-free. Worm Drive Clamp releases drill in seconds for other work. Precision Gear Box with Steel Gears. Self-lubricating Lifetime Bearings. 90-DAY FACTORY GUARANTEE.

No. 455 "ARCO-SAW" (shown above) with ALL GAGES & 5" SAFECUT Blade. MAX CUT: 1 3/4"..... **\$12.50**

No. 454 "ARCO SAW". Same as above, less gages. Has accurate Visual Guide. MAX. CUT: 1-15/16"..... **\$10.95**

No. 445 "ARCO-SAW with ALL GAGES & 4" "HYCARBON" Crosscut Blade. MAX. CUT: 1 1/4"..... **\$11.50**

No. 444 "ARCO-SAW". Same as No. 445, less gages. Has accurate Visual Guide. MAX. CUT: 1-5/16"..... **\$9.95**

REPLACEMENT BLADES: Specify Safecut, } 5" BLADE..\$1.75
or Combination, or Rip, or Crosscut Style. } 4" BLADE..\$1.60

NEW! 'ARCO STAND 'N TABLE'

MAKES A WORKSHOP OUT OF
EVERY 1/4" ELECTRIC DRILL!

HAS TILTING TABLE FOR
Sanding, Grinding, Buffing, etc.



Sturdy Aluminum Castings hold complete unit vibration-free, allows operator to use both hands.

No. 400
\$7.95

Consists of strong Drill Stand with Worm Drive Clamp and adjustable Table. Tilts to 45°, adjusts up or down for various jobs. Rubber cushioned Sander for beautiful sanding, can also be used in drill alone or drill press. 6 Sanding Discs and "Speed Cement."

No. 401 "ARCO STAND" consists of Drill Stand & Worm Drive Clamp only..... **\$2.75**

NEW! 'ARCO SAFECUT' SAFETY SAWBLADES



The Safest, Fastest Cutting Sawblade Ever Made! Made of finest tempered tool steel. No "Kick-back" accidents — cannot drag hand into blade. Easily and quickly resharpened with ordinary handfile.

6-inch Blade..... **\$1.75** 7-inch Blade..... **\$1.95** 8-inch Blade..... **\$2.15**

Special Bores for Skil, Mall, B & D Saws — Add 30¢
10-DAY MONEY BACK GUARANTEE ON ALL ITEMS

BUY THE BEST—see your hardware dealer now! Don't accept inferior substitutes—if not available send us check or M.O. (Postpaid). C.O.D.'s—postage extra.

DEALERS: Write for nearest jobber.

ARROW METAL PRODUCTS CO.

Dept. PM-12, 140 WEST BROADWAY, N. Y. 13, N. Y.

Say You Saw It in Popular Mechanics

CRESCENT TOOLS

Give Wings to Work

ASK YOUR
HARDWARE
DEALER

FREE PLAN

Tells How to Start
Your Own Business

FILING SAWS



Saws come from 20 and 30 miles

"I rented a two-car garage and have all the work I can do. Some days I start 6:30 in the morning. I get work 20 and 30 miles from my place of business." — Charles H. Smith.

Each Saw Filed Brings Six More

"Each saw I filed got me six more and business has been picking up that way since a year ago. If it keeps up I will have to buy another Foley Saw Filer." — William C. Baldwin.

FOLEY FILED SAWS BRING NEW CUSTOMERS

Here is a steady repeat CASH business you can start in your own basement or garage in your spare time. Every saw you sharpen with the machine accuracy of the Foley Saw Filer is an ad that brings you more customers. S. M. Hollingshead wrote to us: "I am doing very well with my Foley Filer, and I am glad I invested in your machinery. It is very satisfactory and works very well in the small community in which I live."

You can file all hand saws, also band and cross-cut circular saws on the Foley Saw Filer. The adjustments are simple — there is no eyestrain — and you can start right away to turn out perfect cutting saws. "The first saw I sharpened with my Foley Filer came out 100%. I think it is a marvel of perfection." — writes Clarence E. Parsons.

FREE Book Shows How to Start

"MONEY MAKING FACTS"

explains how you can get business from hardware stores, home owners, farmers, carpenters, schools, mills, factories, etc. Just think — with a modest investment, no overhead, no stock of goods to carry, you can start right in on a cash business that will help pay the rent, buy groceries, or a new car. Start now — send coupon today. No salesman will call.



Send for **FREE BOOK**

FOLEY MFG. CO., 1216-2 Foley Bldg.
Minneapolis 18, Minn.

Send me free book "MONEY MAKING FACTS."

Name _____

Address _____

trunkback turtle with his snout and shoving him back and forth from wall to wall, just for laughs. Divers, who usually submerge to scrub down the oceanarium walls, are constantly on the alert for Algy, a young porpoise who likes to poke their helmets with his snout or nibble at their heels with his teeth.

Once in a while a porpoise does himself in with his antics—like the one that picked on a shark. Every few times around the porpoise would dive on the shark and playfully jam the shark's head into the sandy bottom. Finally the shark caught his tormentor napping. The porpoise was found on the surface one morning, his stomach ripped open from end to end.

Scientists have long suspected that the porpoise is pretty smart. One porpoise brain was found to be bigger than man's, and had many convolutions. At Marine Studios, several experiments are under way to find out just how smart he is.

F. Glenn Wood, Jr., curator of the studios, listens with an underwater microphone to the animals "talking" to each other. He's learned that the silence of the deep isn't so silent at all—especially around porpoises, who chatter constantly in the depths. They whistle through their blowholes, make a noise like a Bronx cheer, bark like dogs, cry like babies, yelp like puppies, creak like an old gate and snap their jaws together with a shot that sounds like a firecracker.

Most interesting experiment of all, though, is Flippy. When caught in a nearby estuary, he was just about two years old, six feet long and weighed 150 pounds. Today, two years later, he's half again that size. Under the charge of Adolph Frohn, a famous animal trainer, he's been proving beyond doubt that porpoises are smart.

Frohn began by teaching him to take food gently from his hand. Gradually, via hand signals which the porpoise discerned quickly, he learned to barrel-roll and retrieve a stick thrown into the water. In a short time he was swimming through a hand-held loop under the water.

Teaching the animal to jump out of the water and hurdle an object took some time. At first, coaxed with a promise of mullet, he found he had to jump over a fish net stretched across the pool to get his reward. Later a rope replaced it. Then Frohn built a six-foot hoop suspended over the water and the porpoise leaped through it. Today, at a gesture from his trainer, Flippy goes through a three-foot hoop held about three feet above the water and breaks through a paper mask that covers it.

It was tough teaching the unique pupil

(Continued to page 266)

JUST IN TIME FOR XMAS

Giant BALLOONS



Genuine govt. surplus weather & target balloons. Have fun or make money with 'em. Great sport in back yard or for parties, picnics, dances, fairs, etc. Great attention getters, it'll bring the crowds to business events, conventions, exhibitions, trade shows; for lodges, civic occasions or school functions. Thousands of satisfied customers from coast to coast! Order now at these low prices.
3 ft. Dia. 49c — 6 ft. Dia. 79c
13 ft. Dia. \$1.39

* On above items add 10% for handling and delivery



20 POWER TELESCOPE

Magnifies 5 1/2 times. Much more power than binoculars used officially by the U.S. Armed Forces. Easy to hold, easy to focus, light weight, fits into pocket. Perfect for indoor or outdoor sports, vacationing, trips, aboard ship, on rifle range or hunting; or just plain spotting. Fine optically ground achromatic lenses, fully coated to give clear, brilliant image at great distances. Rustproof chrome tube. Don't confuse this with a cheap toy. It is all-metal, precision-machined. Closed, only 6 5/8"; extends to 15 1/4". Unconditional money-back guarantee if returned in 10 days. Our special import makes this modest price possible (a \$30.00 value), prepaid and tax free, only **\$8.95**

* California residents please add sales tax.

WAR ASSETS DIV. VOLUME SALES CO.

Dept. M-12-52 3930 Sunset Blvd. Los Angeles 29, Calif.

PUMP WATER FAST!



DRAIN WASH TUBS, CELLARS, CISTERNS IRRIGATE—FILL TANKS—DRAW WELL WATER

Pumps 2800 GPH. 420 GPH at 75' High or 1600 GPH from 25' well. Sturdy, Rustproof Alloy Metal. Six Blade Impeller. Uses any 1/8 to 1/2 H.P. Motor. Will not leak or clog. Fits any garden hose. Immediate Money Back Guarantee. Send Check, M.O., or C.O.D. **8.95** U.S.

MOORE MANUFACTURING CO.
SWEDESBORO | NEW JERSEY

HAVE MORE FUN TRAVELING



DINSMORE AUTO COMPASSES are a constant source of information, interest and education. Passengers love it! Saves time, worry. No back-track, no wrong turns. Quickly installed. You'll enjoy every minute of driving with America's first and finest illuminated auto compass. Fully jeweled with micrometric compensator. If your dealer cannot supply, order direct. Only \$5.49 postpaid.

FREE Folder on compasses for the hunter, camper, fisherman, sailor, plus a history of the compass. "Pants, knives and Compasses." Send for your copy today.



DINSMORE INSTRUMENT COMPANY

1802-43 Kelso St. Flint 1, Michigan

15-inch Swing

Four inches more than other heavy-duty lathes. 33" between centers. Extra features. Compare SHOPSMITH! It's a saw, sander, vertical and horizontal drill, too. Write for free catalog.

SHOPSMITH, Dept. 227-B
12819 Coit Rd., Cleveland 8, O.



SAVE 50% - THOUSANDS HAVE ASSEMBLED

\$42 UP PACKAGED BOAT KITS

World's most complete line . . . dinghies, skiffs, inboards, outboards, racers, cruisers. Assemble your own boat . . . it's easy, it's fun! See how they're built, how they perform.

SEND 25c FOR NEW 1953 CATALOG

BOAT PLANS PATTERNS

Over 50 modern plans and full size patterns. Racing classes, cruisers, inboards, outboards, sail boats. By famous designers. 6' to 30'. DESIGN CATALOG 35¢. Design Catalog and boat building handbook, \$1.00

CUSTOM-CRAFT - DEPT. 7 - BUFFALO 7, N. Y.

You can get the
"Big Pay"
welding jobs
with HOBART

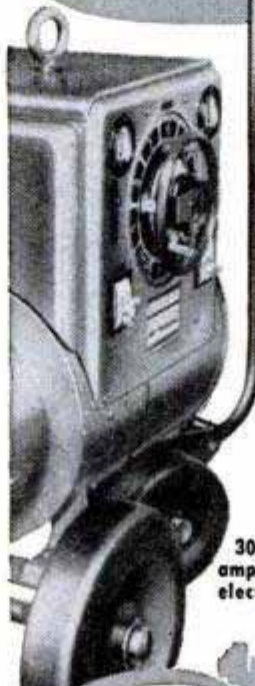

Never before has the demand for good arc welding been so great nor the profits so large. Shops furnishing dependable welding work are badly needed in every town.

Cash in on this opportunity now! Be independent, add to your income, set up your own welding department or business with Hobart. With average mechanical ability, you'll soon be earning Hundreds of Dollars of extra profit monthly doing every kind of job for factories, builders, farmers, etc.

Hobart Welders assure better, stronger, faster, lower cost welds. That's why they're used in America's leading industrial and production plants where quality is a must. They go anywhere—handle any job—give you 1000 combinations of heat—plus remote control—which means easier welding. Choice of Electric or Gas Engine Drive models, portable or stationary. Check coupon for details.

300 ampere electric

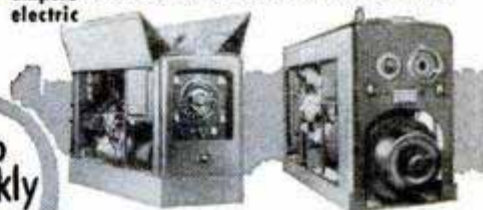

Learn to weld quickly at **HOBART Trade School**

300 amp. gas drive 250 amp. gas drive
Modern, non-profit school. Complete or "brush-up" courses. Best equipment, thorough training, experienced instructors. Learn by doing. Check coupon for booklet.



Improve your welding technique!
TEXT AND LESSONS BOOK. Covers every phase of welding 544 pages, 600 illus. . . . **\$3.00**
LESSONS BOOK. Complete operator's training course. 200 pages, fully illus. . . . **\$1.00**
PRACTICAL DESIGN. Hundreds of welding ideas in design form. 3 vols., 100 designs each . . . 1 vol., \$3.50; set of 3, \$10.00.

HOBART BROTHERS CO., Box M-122, Troy, O.
"One of the world's largest builders of arc welders"

HOBART BROTHERS CO., BOX M-122, TROY, OHIO

Send complete details on items checked.

- Electric Drive Welders Gas Drive Welders
- Hobart Trade School. Send books checked:
- Text and Lessons Lessons, Practical Design: Vol. 1 Vol. 2 Vol. 3 set of 3 vols. Cash enclosed C.O.D.



FREE!
Welder's Vest Pocket Guide

Name _____

Address _____

City _____ State _____

TOMLEE

TILT ARBOR

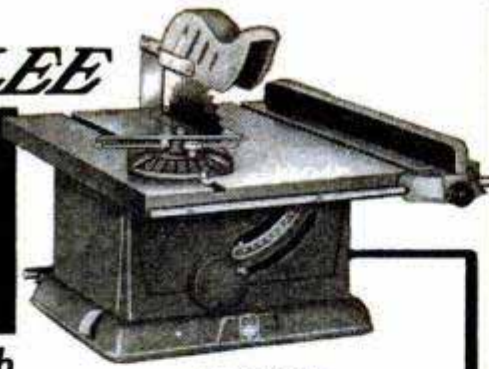

The Saw with

ALL THE FEATURES!

The Tomlee is a rugged cast iron precision tool with enormous capacity—made even greater by the addition of table extensions. A single hand wheel controls the depth of cut. A second knob regulates a rapid tilt mechanism and locks the sealed ball bearing arbor in any position up to 45 degrees. A large accurate tilt gauge assures perfect angle cuts. It's the most flexible, easy to operate circle saw on the market today . . . you'll be proud of the professional look obtained when you use a Tomlee. Standard equipment includes a saw guard, splitter, mitre gauge, fence, motor pulley, belt, floating motor base, blade and instructions. Feature-for-feature, you can't beat a Tomlee!

Get the 28-page Tomlee Home Workshop Book . . . shows what to make and how to make it . . . yours for 25c in stamps or coin.

rips,
cross-cuts,
mitres,
rabbets,
dados



TOMLEE TOOL AND ENGINEERING CO.
723 North Washington • Dept. B • Minneapolis 1, Minn.

to ring his own dinner bell. But now, at a command (and often without it), he leaps from the water, grasps a ball suspended from a pole and gently tugs it with his teeth. The ball is connected to the bell.

Last year, the porpoise was moved from his tank to a big lagoon, where Frohn put a harness on him. With a few months of intensive training Flippy had learned to pull the surfboard on which a girl, a dog, or both would ride.

Flippy's tutelage is going even further. Right now the trainer is teaching him to obey voice command alone. Two tiny holes behind every porpoise's eyes carry sound to his brain.

"Catch!" shouts Frohn. Flippy stands on his tail and backs off across the pool, waiting for the trainer to toss a ball, which he catches on the fly and returns to his owner's hand.

When someone remarked that if the porpoise got any smarter he'd soon be talking, the trainer answered: "He does talk, but we're too dumb to know what he's saying."

And, in a way, that sums up the mission of all the keepers of this deep-sea zoo—to help fathom and translate the language of the unexplored deep and its inhabitants, about which so little is known. ★ ★ ★



WYTEFACE
TRADE MARK
STEEL TAPES

No squinting, no guessing when you use WYTEFACE Steel Tapes. Jet black markings (foot numbers in red) on a white background. Easier to read in any light. Faster, more accurate measurements. Rust-resisting, hard to kink, simple to clean.

Protected by U. S. Patent 2,089,209

K+E

"I'll take the WHITE one every time!"

KEUFFEL & ESSER CO.

Door Hinge Needs No Mortise



No recess is needed for a new-type hinge. It is screwed directly to the door and frame, eliminating all mortising and chiseling. The outer, larger leaf of the hinge is screwed to the frame; the smaller, inner leaf is screwed to the door. When the door is closed the smaller leaf fits into the larger one. The hinge is self-aligning and self-gapping, and is available in three standard sizes.

EASE COLD MISERY



AT ALL
DRUG STORES
+
45c and
75c SIZES

Take Tabcin

BRAND Reg. U. S. Pat. Off.

BUY DIRECT — SAVE 25%



Only **\$14.95** F.O.B. Rock Island, Illinois

All metal Wood Lathe with large 8" swing. 24" between centers. 3-speed head stock. Order today or write for FREE Literature!

QUAD CITY PRODUCTS COMPANY
P. O. Box 42, Rock Island, Illinois



**THE ONLY
SPARK PLUG
WITH PATENTED
CORALOX
INSULATOR**

DRAINS Cellars, Laundry Tubs; CIRCULATES Oil; IRRIGATES Gardens

Original "Type P" Pump has 2400 GPH capacity. 360 GPH 75' high, or 1500 GPH from 25' well. Use any 1/8 to 1/2 HP motor. DOES NOT CLOG. 1" intake; 3/4" outlet.

Postpaid if cash with order. (West of Miss. add 50c.) Motor coupling included. MONEY BACK GUARANTEE. Also Gear Pumps in all sizes.

LABAWCO PUMPS, BELLE MEAD 7, N. J.

MODERN LAWN MOWER SHARPENER

Service departments of leading Lawn Mower manufacturers use the Modern Lawn Mower Sharpener. One lever moves lawn mower into grinding position. Gasoline and oil remain in engine while sharpening, no dismantling of wheels, roller or handle. The Modern is a precision bed knife grinder—no extra grinder to buy. Imitated but never equaled—Compare before you buy. If it isn't a Modern it can't be Modern (Prices subject to change without notice)

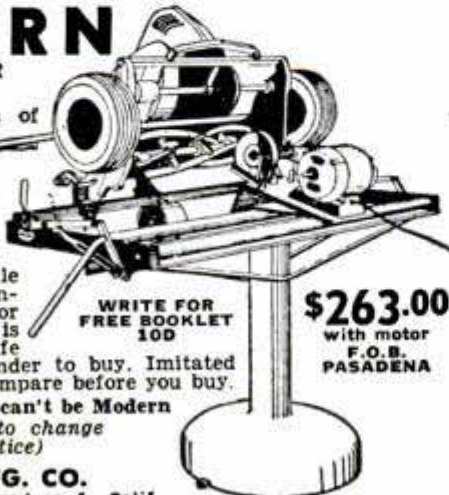

WRITE FOR
FREE BOOKLET
100

\$263.00
with motor
F.O.B.
PASADENA

MODERN MFG. CO.
160 N. Fair Oaks - Pasadena 1, Calif.

The NEW Model 50 UTILITY TESTER FOR REPAIRING ALL ELECTRICAL APPLIANCES-MOTORS an all-around electrical trouble shooter



- Measures A.C. and D.C. Voltages, A.C. and D.C. Current, Resistances, etc.
- Will measure the current consumption while the appliance under test is in operation. The appliance or utility may be plugged directly into the front panel receptacle. A special pair of insulated clip-end leads is included for motors, etc.
- Incorporates a sensitive direct-reading resistance range which will accurately measure all resistances commonly used in electrical appliances, motors, etc. This range will enable continuity checks and tests for shorts and opens.
- Will test thermostats, radio tube filaments, bulbs, fuses, fluorescents, condensers, switches, field coils, circuit breakers, lighting systems, etc.

Handsome round cornered molded bakelite case 3 1/8" x 5 7/8" x 2 1/4". Complete with all test leads and instructions.

\$13.90

**SHIPPED ON APPROVAL
No Money With Order — No C.O.D.**

Try it for 10 days before you buy. If completely satisfied send \$3.90 and pay balance at rate of \$2.00 per month for 5 months —No Interest or Carrying Charges Added. If not completely satisfied, return to us, no explanation necessary.

SUPERIOR ELECTRONIC CO., INC.
Dept. D-42, 227 Fulton Street, New York 7, N. Y.

Please rush 1 Model 50. I agree to pay \$3.90 within 10 days after receipt and \$2.00 per month thereafter.

Name _____
Address _____
City _____ Zone _____ State _____

Say You Saw It in Popular Mechanics

FASTER THAN \$100 ENGINEER INSTRUMENTS!

Packed in husky wooden carrying case 12 x 11 3/4 x 3 3/4".



UP TO 50 FEET OR MORE

LEVELALL

THE NEW, IMPROVED WATER LEVEL
FOR SIMPLEST ONE-MAN OPERATION

**FOOTINGS
FOUNDATIONS
GRADINGS**

Anything you need level
LEVELALL does it

Regular
50 Feet
\$7.45

Deluxe
75 Feet
\$12.45
Heavy Case

Inquire — your dealer or by mail Post Paid, send Check or M.O.
Will ship C.O.D. you pay charges.

LEVELALL • 87 WEBSTER ST. • ROCKLAND, MASS.
DEALER INQUIRIES INVITED

Give a Hobby for Christmas

and be Sure
it's a Genuine



HANDEE

HANDEE—the original and finest “hand tool of 1001 uses.” Dad, brother, uncle—anyone—will derive countless hours of pleasure from this versatile hand tool. Leatherworking, woodworking, plastic craft, metalworking, many types of home repair—HANDEE makes them all easy and enjoyable. Make this Christmas last for years—give a *genuine* HANDEE, the hand tool that has proven itself through years of service.

HANDEE Complete with 7 Accessories

There are years of relaxing fun and achievement ahead when you give a HANDEE. Powerful 25,000 r.p.m. motor. Works off any 110 v. AC-DC circuit. Take advantage of our liberal 10-day money-back trial offer. Order today.

No. 3009, Handee and 7 Accessories.

\$19⁹⁵

drill
grind
polish
sand
saw
cut
carve
engrave



HANDEE 53-Piece Set

Here is an unbelievably complete hobby and handicraft set to delight the heart of any one who appreciates the best. Complete accessories to drill, grind, polish, sand, saw cut, carve and engrave.

No. 3010—Handee 53-Pc. Set \$27⁵⁰

Order yours today—HANDEE sent post-paid on 10-day money-back guarantee. Free Catalog.

CHICAGO WHEEL & Mfg. Co.
Dept. PM12, 1101 West Monroe St.
CHICAGO 7, ILLINOIS

on its dealers in regard to service. His shift jammed between first and second and his dealer couldn't repair it; he did so himself. Furthermore, in cleaning the car he found that the windshield had been sealed for leaks in two places with chewing gum.

“The Henry J is exceptionally easy to handle in the city or on the highway and has excellent visibility,” wrote a Medford, Ore., lumberman. “It is a comfortable car to drive (I am 6 feet 1 inch in height). The 100-inch wheelbase makes it easy to park parallel to the curb and also makes it an easy car to handle in mountain driving.”

In the opinion of an Evansville, Ind., aircraft worker, “It is an economical and stylishly designed small car. However, if the new models could be so constructed as to eliminate rattling, rumbling sounds and to keep the front wheels in alignment, I would be more satisfied.”

The very smallness of the Henry J is a decided advantage in the minds of many owners, such as a Berkeley, Calif., photocopier who wrote, “If I had wanted a tank I'd have bought a tank.”

Wrote a Greenwich, Conn., beautician, “The back window is large enough but on too much of a slant to give good visibility. Otherwise, the car is perfect.”

“The Henry J is the most underrated car in America to those who have never driven or ridden in one. I've ‘converted’ hundreds of skeptics who were ‘knockers.’ A ride will surprise anyone. If the Henry J were built by one of the Big Three, they couldn't build enough,” Los Angeles mechanic.

“The Henry J is a dream to handle. Brakes are fine, roadability excellent, easy ride. Remarkable performance and economy that surprises all.”—Pomona, Calif., farmer. (Sixty-three percent of owners said roadability is excellent, 36 percent said good and 1 percent said unsatisfactory.)

Since I first tested the Henry J from Detroit to Los Angeles about two years ago I've driven one about 8000 miles. My opinion of this remarkable little car has not lessened and has, in fact, become more favorable. In that test I noted little evidence of “small car” feeling in driving it and 78 percent of the owners reporting feel the same way; 74 percent liked the 100-inch wheelbase and only 2 percent disliked it. Ninety-one percent said they got the gas mileage they expected, or near it. Most remarkable, however, is that 87 percent of the reporting Henry J owners said the car was good or excellent, 12 percent said average and only 1 percent said it was poor—a remarkable tribute from owners. Surprisingly, more owners (51 percent) had the four-cylinder rather than the six-cylinder models. ★ ★ ★

The Smoke
Curls Up
The
Chimney!

Miniature Barbecue Fireplace ASHTRAY

Shown in LIFE, TIME, NEW YORKER



It's novel, different, attractive, useful—and a real conversation piece for home or office! Built, colored, textured to look like actual field-stone outdoor barbecue fireplace. The smoke curls up the chimney with remarkably realistic effect. Holds generous supply of cigarettes and matches. Metal fireplace grill

lifts out for easy cleaning. Also makes an unusual planter or incense burner. An ideal gift! Order today.

SEND NO MONEY—just mail order. Pay postman only \$1.98 plus postage and C.O.D. charges—or send \$1.98 and we pay postage. Money back if not delighted. Mail order NOW.

LEWIS PRODUCTS, Dept. 511

173 W. MADISON ST.

CHICAGO 2, ILL.

FORCED AIR

INSTALL IT YOURSELF AND SAVE UP TO \$200
CONVERT YOUR GRAVITY FURNACE TO MODERN QUICK FORCED AIR HEAT. INSTALL McLARTY FANS IN YOUR COLD AIR PIPES. NO SHEET METAL WORK REQUIRED. SIMPLE ELECTRIC CONNECTIONS. LOWEST COST SYSTEM TODAY.

McLARTY SYSTEMS 2607 DICKMAN RD.
BATTLE CREEK, MICHIGAN
In Canada Write
WINNIPEG SUPPLY & FUEL
WINNIPEG, MANITOBA

FREE CIRCULAR

START YOUR OWN BUSINESS With A Route of nut, candy or gum Vendors. No experience or training necessary. Earn at once, highest profits, easy operation. No age limits. Full or part time. For complete information how anyone can become financially independent send for **CATALOGUE 100** to

RAKE

609-P Spring Garden St., Philadelphia 23, Penna.

BE YOUR OWN BOSS!!!

Make big money! Get ahead in something for yourself! Be a floor surfacing contractor and sand both new and old floors. No experience needed. High earnings, steady work with a future! Write for booklet "Opportunities in Floor Surfacing," enclosing 25 cents in coin or stamps to cover handling

AMERICAN

FLOOR SURFACING MACHINE CO.
335 So. St. Clair Street - Toledo 3, Ohio

BeMaCo Dependable

AUTOMATIC SAW SET

Sets 400 teeth per minute on hand or band saws 4 to 16 point. Hammer and anvil action sets teeth accurately and uniformly. . . . No tooth breakage. Does a perfect job. Used profitably by saw shops everywhere and saw manufacturers. Every machine guaranteed!

FAST - ACCURATE - DEPENDABLE

★ INCREASES PROFITS

BEAVER MFG. CO.

Saw Machine Div. #1-C
800 SO. ISIS AVE. • INGLEWOOD, CALIF.

WAR SURPLUS AND OTHER BARGAINS SAVE UP TO 90%



PUROLATOR OIL FILTERS

The perfect filter to keep motor oil or hyd. fluid clean at all times. Permanent type, No. G159J-32. Extract your pump, engine, midget racer or boat with this unit. To clean element, just turn handle. Inlet and outlet ports take pipe or straight threads up to 3/4" male pipe. Accommodates 16 GPM at 30 PSI. Mtg. brackets, Wt. 4 lbs. A \$15 value, NEW to you, with 2 FREE male reducer connectors for only \$3.85.

10" long. Absolutely safe, ICC approved. Wt. 2 lbs. NEW. An amazing value \$6.95. Extra fuel cylinders \$1.95.



BENZ-O-MATIC TORCH

Terrific for mechanics or hobbyists, for heating, burning, soldering or brazing. Compact, versatile torch for electricians, plumbers, painters, auto mechanics, dental technicians, jewelers, neon glass formers, plastic workers and radio repair men. Burns for 10 continuous hours. Replaceable fuel cylinder. No moving parts to get out of order. Burns in any position with non-varying flame of approx. temp. of 3660°. No hose connections to get in way. Always ready for use! 2 1/2" dia. 10" long. Absolutely safe, ICC approved. Wt. 2 lbs. NEW. An amazing value \$6.95. Extra fuel cylinders \$1.95.

"HELIOS" ORIGINAL TOOLMAKERS VERNIER CALIPERS



ULTRA PRECISION—Imported for the really critical mechanic who must have the best. Recommended and used by experimental and research machinists at Lockheed, Douglas, Bendix, GM, RCA, GE. ALL NEW and at low, low prices . . . but quantity is limited! Model 51—Genuine Helios. Hardened lapped precision surfaces. 1/1000" and 1/10 mm graduations. Has handy slide roll and thumb lock. Quick accurate depth. A \$35 value, it's yours complete with leather carrying case for just \$6.95. Model 64—Helios 8". Glass hardened lapped jaws. Inside, outside measurements. 1/28" and 1/1000" verniers. Thumb guide and lock screw. A \$45 value at the amazing price of \$7.50. Model 65—Helios 8". Glass hardened lapped jaws. Inside, outside measurements. Thumb guide and lock screw. Valued at \$50, on sale while they last, for \$8.50. Model 76—Helios 8" Depth Gauge. Graduations 1/1000". Glass hardened. It's worth every bit of \$25, yours now from Airborne for \$6.50.



BENDIX HYDRAULIC PUMP AND MOTOR

Pump has 1" connections, built-in relief valve, adjustable up to 1500 lbs. Max. capacity 6 GPM. 1 1/2 H.P. 24-volt motor. 4000 RPM. Can be used on 12 or 36 volts. Govt. cost approx. \$350—our price —NEW—\$14.95.

WILLARD WET PLATE BATTERY

Extra-long life, rechargeable battery. 2 V., 20 Amps. Great for portable radios, mobile units, bell circuits, alarm systems, rural telephones, Strobe bulbs, etc. Only 5" high. Visible ball float hydrometer built in Lucite case. Shipped dry (wt. 3 1/2 lbs.) . . . any battery service will supply standard battery electrolyte. Used singly or in multiples. ALL NEW! Now only \$1.95 ea.



HYDRAULIC HAND PUMP

Handle operated. Operating pressure 1500 PSI. Telescope extension handle for greater leverage. NEW. A \$75 value. Now only \$9.95.



RIVET SETS Universal type, case hardened tips. Set of dies will head up only brazier or round head rivet from 1-1/8" to 1/4". With adapters for air gun or hand use. All new—cost Govt. approx. \$27.00. Complete 15 piece set (wt. 2 lbs.) . . . \$5.00.



D.C. GENERATORS

Finest aircraft quality . . . heavy duty . . . lifetime grease-sealed ball bearings. Terrific for truck and marine use, for welders, plating, D. C. Appliances, lights, etc. Type P-1. Mfd. by Ford, General Electric, Westinghouse & Delco-Remy. Rated 200 Amps., 28 Volts, 2500 RPM., can be "revved" up to 300 Amps. Shpg. Wt. 53 lbs. Approx. Govt. Cost \$350 . . . New to you . . . \$21.50



RIGHT ANGLE ACTUATOR

Has worm gear drive in 6 to 1 ratio. Thrust shaft and 9/16" dia. and travels 12", forward or reverse on Arme Worm Thread. Drive shafts on either side of housing are 3/8" dia. with 16 splines. Overall length 25", width 4". Ideal for pushing, pulling or lifting. Sealed, self-lubricating chamber. Shpg. Wt. 5 lbs. Govt. Cost \$150. NEW . . . \$4.95 ea.

MICROMETERS

Chrome plated, precision engineered, carefully tooled to give long life. All new 0-1" capacity—\$2.25 ea 1-2" capacity—\$3.50.

Send 25c for 1952 catalog. Bargains for everyone. Check, Money Order or Cash. 25% deposit on C.O.D. orders. Prices F.O.B. Culver City, Calif., unless otherwise stated.

AIRBORNE SALES CO., INC. Dept. PM1252
8501 Stellar Dr. Culver City, Calif



MAKE HIS FIXIN'

FUN!

with this most Useful gift of them all!

No. 10-W
\$2.60



WISE-GRIP
WRENCH

Does MORE Jobs EASIER than any other Tool!

A useful gift, a MAN'S gift — to make him an Expert Fixer! Vise-Grip locks to work with Ton-Grip. Won't slip! Turns, twists, pulls, cuts, ratchets. A whole tool kit in one trim tool! 7" and 10", with or without cutter. Only \$1.85 to \$2.60 at your hardware dealer.

Manufactured **PETERSEN** Only By **WISE GRIP MFG. CO., INC.**
Dept. P-12 DeWitt, Nebr.

PLEASE SEND ME



for the time checked.
I am enclosing . . .

1 year \$3.50
2 years \$6.00

name _____
address _____
city _____ zone _____ state _____ C-122

Hand this order to your newsdealer or send it to
POPULAR MECHANICS
200 East Ontario St. Chicago 11, Ill.

FREE 10 DAY TRIAL

New WRIST WATCH with Amazing MECHANICAL BRAIN
• It Remembers • Tells Time • Tells Date!
Measures Speed. Measures Distance. Records up to 12 Hours. OVER 40 QUALITY FEATURES. Precision Jeweled. Imported Swiss Movement. Accurate.
Push-Button Stop & Start. Red Sweep-Second Hand. Unbreakable Crystal. Triple Chrome Plated Case. Shock Resistant. NITE-VUE RADIUM GLOW DIAL. Anti-Magnetic. Times Shop work. Times Photography. Times Sports. Times Races. Times Lab. work. Times Planes. Smart Expansion Band Included.
Includes 1 year guarantee and Service Certificate.
Compare it at \$50.00
SPECIAL OFFER \$8.95
Plus 90c Fed. Tax

SEND NO MONEY
Pay postman plus postage or send cash, check, or money order. We pay postage. Keep 10 days. Return for full refund of purchase price if not fully satisfied.

YOUNG PRODUCTS, Dept. 717
3605 ELMHURST, DETROIT 4, MICHIGAN

NEW FAST LIGHT WEIGHT TRENCHER

Portable DITCH-WITCH digs 4" to 6" deep, even ditches to 42" depth in every type soil. Complete unit — self propelled — outdigs 8 men. 3 economical, rugged models. Write for illustrated literature.
THE CHARLES MACHINE WORKS
Perry, Oklahoma

Snap-on Tools
THE CHOICE OF BETTER MECHANICS

4000 fine tools, available direct from factory to user. Snap-on catalog free — send for it today.
Snap-on Tools Corporation
8062-L 28th Ave., Kenosha, Wis.

\$2.95 EACH OR 2 FOR \$5.00!

Upright Telephone complete with cord in Tested and Guaranteed condition. For Inter-communication or extension. Complete list of telephone parts, inter-communication sets, switchboards, handsets, magneto and dial telephones, etc. Write for list.
TELEPHONE ENGINEERING CO.
608 REGAL BLDG. SIMPSON, PA.

RUBBER STAMPS Direct to You!

Handle mounted, made-to-order, rubber stamps. Low prices. Rapid service. Write FREE catalog type styles.
WALLACE STAMP CO. 844 Venice Blvd. Dept. P12 Los Angeles 15, Calif. **FREE CATALOG**

USE SAND-NO-MOR ABRASIVE BLOCK

Removes old wood finishes. Smooths wood and plaster.
"Won't clog" — 100% usable
35c ea. EASY TO USE — VERY FAST
9" x 2" x 2" ea.
FINE FOR FURNITURE — BOATS — PLASTER — DRY WALLS
If your dealer can't supply — send \$1.00 for THREE INTRODUCTORY SAND-NO-MOR blocks.
Address: Carter Products Co., Box 1924, Columbus 16, Ohio

BETTER MILEAGE—INCREASED POWER
with Miracle Action Tur-B-Lizer reported by hundreds!

Carburetor specialists say Tur-B-Lizer is best patented improvement they have seen. Tested in over million miles of driving. Write for full facts or send \$3 for 6 cyl. type, \$4.50 for 8 cyl. Easily installed. Try Tur-B-Lizer in your car. If you do not notice immediate improved performance and gas savings claimed by users, your money will be refunded.
Mechanics—Salesmen: Make good money full or part time. Write for proposition.
UNIVERSAL TUR-B-LIZER CO.
623 E. State St. Milwaukee, Wis.

ELECTRIFY your SEWING MACHINE

NEW LOW PRICE!
\$10.50 1 YR. GUARANTEE

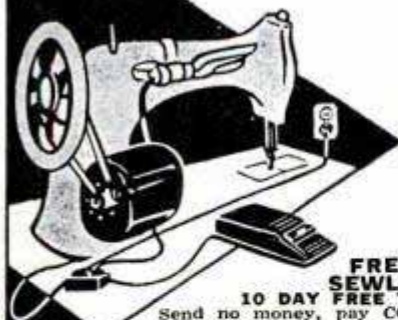

Buy direct from manufacturer and save! Kit comes fully wired, installed in a jiffy. Fits all machines! You get all-new parts:

- Motor & Bracket
- AC-DC 115v 60c
- Multi-speed foot control
- Cord set & block
- Easy instructions
- Steel pulley & belt

FREE . . . reg. \$2.95 chrome SEW-LITE given with every kit.

10 DAY FREE TRIAL - ORDER NOW!

Send no money, pay COD or send money order and we'll pay postage. Please state whether wheel on your machine turns toward you or away from you. Shipping wt. 6 lbs.

SENIOR SEWING MACHINE CO.
 Dept. PM-41 BKLYN 5, N. Y.

BOX 40



WORLD'S LOWEST PRICED ADDING MACHINE

\$2.95 Vest Pocket Size FREE TRIAL
 IDEAL FOR BUSINESS AND PERSONAL USE - GUARANTEED ACCURATE. Not a toy. Operates with only a finger flick. Adds, subtracts, multiplies, divides. Counts up to one billion. Pays for itself over and over. Ideal Gift - for Business, Income Tax and School use. **MONEY BACK GUARANTEE.** Send name and address. Pay postman only \$2.95 plus postage. (Send full cash if outside U.S.) Beautiful rich-looking Leatherette Case included at no extra cost. Money back in 10 days if not delighted. AGENTS WANTED.

CALCULATOR MACHINE CO., (Mfrs.)
 Dept. PM-12 Glenview, Illinois

Build your own JET ENGINE!



Order these plans today

1. JET PROPELLED BICYCLE. Assemble your own. Photo and instructions. \$1.00.
2. HOW TO MAKE EXPERIMENTAL JET ENGINES. Seven sheets drawings with information and instructions \$2.95.
3. BOTH OF ABOVE in one order \$3.75. **SEND NO MONEY.** Order both at once \$3.75 C.O.D. in USA plus e.o.d. postage. Send check or Money Order and we pay postage. Get other information too. Rush Order.

J. HOUSTON MAUPIN, Dept. 55, Tipp City, Ohio

SHEET METAL BRAKES

Angles, flanges, Pittsburgh locks. 24 G. steel, heavier aluminum. Cam locking, mount on bench, truck or floor stand. Truss braced-steel. Express collect \$3.00. 35 lbs., \$35.50. 36" 75 lbs., \$40.00. 48" 100 lbs., \$56.00. Portable stands, 32" hi. 35 lbs., \$8.00.



IRON BENDER forms hooks, angles, eyelets, etc. Capacity 1/4 x 2", 5/16 x 1 1/2". 10 parts, all steel, express collect \$9.50
24" CURVE FORMER. Forms straight and tapering pipes 2" to 2 ft. in diameter. 16 gauge, express collect \$9.50 (Immediate delivery. Order cash or C.O.D., or send for folder)

VYKE BRAKE CO., P-3016 Leavenworth, Omaha 5, Nebr.

Say You Saw It in Popular Mechanics

FILE SAWS THE RIGHT WAY

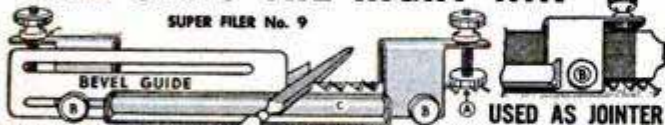

SO EASY with this new filing jig and jointer anyone can now sharpen any hand saw like new! When file hits hardened steel rollers teeth are finished and EXACTLY THE SAME HEIGHT. All teeth cut and saw runs true and smooth. Jig and instructions \$2.95 postpaid. FREE FOLDER.

SHARPEN YOUR CIRCULAR SAWS

The RIGHT WAY on your own saw table. Sharpens rip, cutoff, hollow ground and combination blades—6" to 10". Saws stay round with correct bevel. Precision made, easy to use. **GUARANTEED.** Only \$6.95. Includes \$3.00 Grinding wheel.



"**TRU-CIRCLE**" saw set automatically sets teeth at 10° or more. \$2.95

AT DEALERS OR POSTPAID

A.D. McBURNEY, 317 E. 4th St., Los Angeles 13, Calif., Dept. A-24

New 1953 Edition!!

FREE 32 PAGE MICROSCOPE CATALOG



COMPLETE 10 PIECE MICROSCOPE SETS AS LOW AS \$6.95

World's greatest values in microscopes, accessories, prepared slides, magnifying glasses, telescopes and binoculars. Professional quality equipment at prices everyone can afford. Send for it!!! An introduction to the priceless, never ending adventure of the invisible world of the microscope - a thrilling hobby that leads directly to many fascinating careers.

★ Christmas Delivery Guaranteed

ON MODELS ILLUSTRATED BELOW AND CATALOG PURCHASES IF YOUR ORDER IS POST MARKED BEFORE DEC. 15.

40 TO 600 POWER!!

In 15 Different Combinations*

MODEL #635 MICROSCOPE

\$29.95 Ppd.



In fitted hardwood case. As illustrated with 15X eyepiece, 10X, 20X, and 40X achromatic objective lenses (allowing 150X, 300X, and 600X) **less mechanical stage. Every feature needed for advanced university, pre-med, medical school use

Set of Extra Eyepieces \$9.95 Ppd. MODEL #240

4X, 6X, 8X, 12X in fitted hardwood case * Giving a total of 15 different combinations from 40X to 600X. Ground • Polished • Achromatic.

MODEL #240 MECHANICAL STAGE FOR MODEL 635 \$14.95 Ppd.

Allows calibrated slide movement microscopically right, left, up or down.

100-200-300 POWER

Model #300 Microscope \$14.95 Ppd

Select your 100, 200 or 300 power on the triple revolving turret for scientific work with the microscope. A lifetime bargain for students, schools, amateurs, labs. Ground, polished, achromatic lenses. All metal, precision construction. We doubt that you will find a comparative optical instrument for less than three times this amazing low price.

MONEY-BACK 10-day guarantee on all items. Send Check, cash or money order. C.O.D.'s 20% deposit required. Calif. residents add 3% state tax.

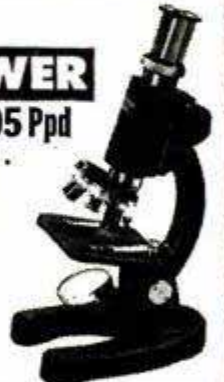

the AKRON 4400 SUNSET BLVD. LOS ANGELES 27, CALIF.

OPTICAL DEPT.

12-P

Give the Best...WISS!



for all sheet metal cutting

WISS Metal Master Compound Action Snips

#M-3 Easily cuts 18 gauge sheet metal. Cuts curves and circles as well as straight. Ideal for the home workshop. \$4.25. Rubber grips recommended, 60¢ extra.

WISS "Hy-Power" Pruners

#908 Pruning shears cut easily and cleanly. Non-pinching pistol grip handles. Soft anvil keeps knife blade sharp indefinitely. Choice of professionals. \$2.50

WISS Combination Snips

#V-13 Solid steel, with gray japanned handles. Cuts curves and irregular shapes with ease. Handy pocket size. 7" long. Accurately tempered jaws and strong bolts. \$1.85.



Prices slightly higher
Denver and West



Quality for more than a Century

J. WISS & SONS CO. • NEWARK 7, N.J.

DO IT EASIER - FASTER - BETTER

with a **SHAW**
"DU-ALL"

WALKING OR RIDING TRACTOR

1½ to 5 H. P. Walking Models

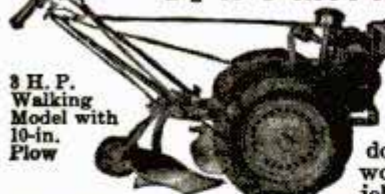

3 H. P. Walking Model with 10-in. Plow

Do Everything in Gardening

Handle 6, 7, 10-inch plows...cultivate, plant, mow, bulldoze, cut trees, saw wood, do many other jobs fast and easy. 1½,

3 and 5 H. P. machines with variable speed transmission, adjustable wheels, plenty of plant clearance. Power turn models and power take-off attachments available.

Powerful 5 to 12 H. P. Riding Tractors
Handle Work on Good Sized Farm

Also ideal for second tractor on large acreage. 5, 8, 12 H. P. models plow 4 to 8 acres daily, plant, cultivate, mow and rake, do many other jobs. Works astride or between 42-in. rows.

12 H. P. Shaw Du-All with 12-in. Plow



Power take-off pulley and attachments available.

FREE catalogs and best values you'll find anywhere, by return mail. See a Shaw dealer. Write

SHAW

MANUFACTURING CO.
4512 Front St., Galesburg, Kansas
668-G N. 4th St., Columbus, Ohio

5 Year Written Guarantee NEW \$13⁹⁵
17 JEWEL INCABLOC WATCH WAS \$50 NOW ONLY

DROP IT! WET IT! BANG IT!

Incabloc shock proof. Waterproof. Dust-proof. Tested best in Army and Navy Service. Anti-magnetic. Imported accurate Swiss lever movement. Sweep second hand. Radium dial.

10 DAY FREE TRIAL SAVE \$36 IN BANKRUPT FACTORY STOCK SELLOUT

Wear at our risk. Money back if not pleased. SEND NO MONEY. Pay postman plus tax and postage. Or enclose \$13.95 plus \$1.40 tax for men's watch, and we ship prepaid. (Ladies' model \$18.95 plus \$1.70 tax). Order now. Receive \$2 expansion band free with prepaid order. Xmas watches airmailed.



SAVE \$36

STANLEY SALES CO., Dept. P-12, Long Island City 4, New York

French STYLE DUELING SWORDS SET OF TWO \$3.98

Once used in deadly combat—now an exciting sport! Learn right at home. Fun—safe—educational. These swords are made of fine blue spring steel, polished metal



heavy duty

guards, turned handles, rubber safety tips. Fencing teaches quick thinking, develops coordination, posture. Since the Middle Ages, Europeans have enjoyed the sport of dueling. *Now advocated by U.S. colleges. Set includes two swords and the booklet, "The Art of Fencing". Special price. MONEY BACK IF NOT COMPLETELY SATISFIED

At sporting goods dealers or send \$3.98 to TECHRITE CORP., Box 12H, South Pasadena, Calif



NEW! EXCITING!
JET EXHAUST CUT-OUT

Now your car can sound off those exciting, dynamic tones — easily controlled mechanically from your dashboard. Channel your exhaust through special pipes or muffler without removing your original muffler. Easily installed. MONEY BACK GUARANTEE. Send \$1.95 check, cash, money order (postpaid) or C.O.D. plus postage to: FUR SALES, 1031 E. 63rd St., Chicago 37, Ill. Dept. PM Dealer inquiries invited

LEARN TO THROW THE BOOMERANG

A Fascinating Sport and Unique Gift

SEND FOR YOURS TODAY

Flight Tested—Guaranteed to Return Golden Red, Jade Green or Natural with Story and Instructions \$2.00 ea.

CARVED by Postpaid COL. JOHN M. GERRISH 4409-M S.W. Parkview Lane, Portland 1, Ore.

PARTS FOR MILITARY TRUCKS

FOR JEEP, DODGE, CHEV., GMC, STUDEBAKER, 4 and 6 WHEEL DRIVE. ALSO PARTS CATALOG. WRITE GIVING MAKE OF TRUCK

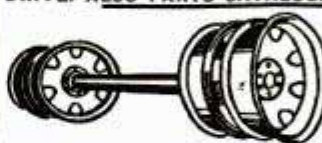

TRAILER AXLES

(Surplus) Heavy Duty axles suitable for building of many types of trailers, farm wagons, etc. Standard width straight axle, 2 inch square and is complete \$69.50

with Hubs, Timken bearings, 6 Hole 750x20 or 825x20 wheels, without brakes, only..... Dust Wheels..... add \$15.00 extra

NEW JEEP TOPS and CURTAINS

Military type, easily adapted to civilian type Jeep. Complete top & back curtain, side curtains, snap-on doors, 5 windows. Waterproof, OD color. 25 lbs. FOB, K.C. \$59.50

ALL PRICES QUOTED GOOD 30 DAYS FOB, KANSAS CITY 25% DEPOSIT REQUIRED ON ALL ORDERS

American AUTO PARTS CO. INC. 1830 LOCUST - DEPT. PM KANSAS CITY, MISSOURI



Announcing the NEW...POPULAR MECHANICS MAGAZINE LIBRARY FILE

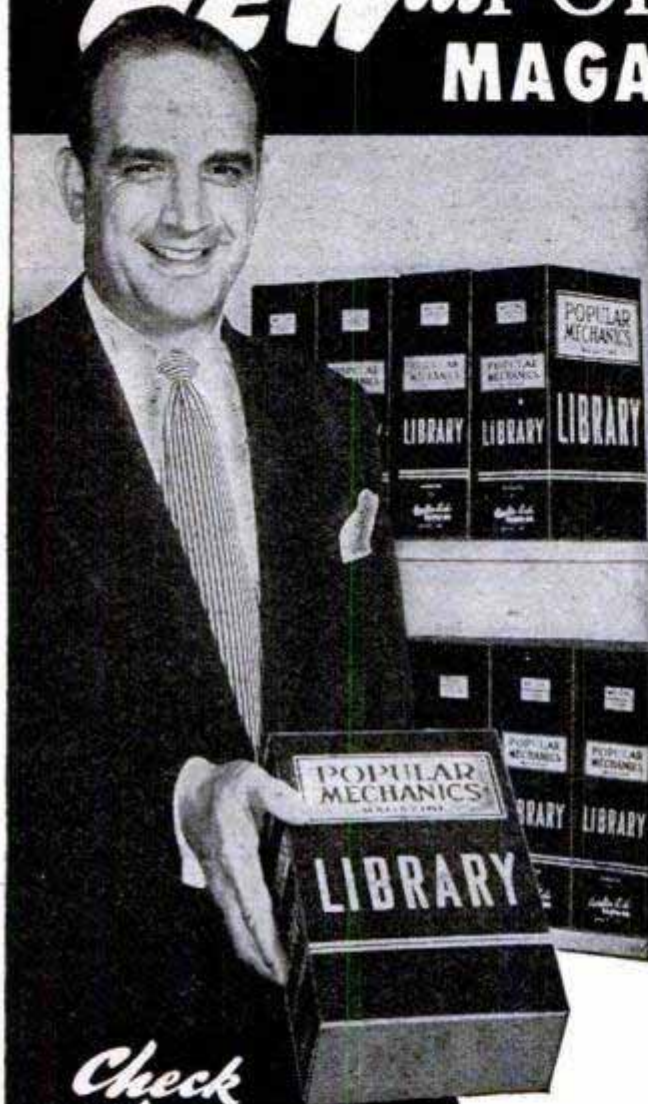

Check these Outstanding Features

- 1 Convenient size, measures 6 $\frac{3}{4}$ " wide, 3 $\frac{1}{4}$ " thick x 10" high. Ideal for tabletop, shelf or bookcase storage.
- 2 Special Reference Index Form, printed on back, records exact location of selected articles, diagrams and other information.
- 3 Date Label Stickers—enough to index ten years issues, furnished FREE.

NEW! NOVEL! INEXPENSIVE!

Never before so much convenience and utility at such a low price. So act now. Place your order today!

INGENIOUS CUSTOM-BUILT STORAGE FILE

A Sensational Popular Mechanics Value Scoop!

Now you can preserve every issue of Popular Mechanics Magazine in orderly, chronological sequence ... indexed and ready for instant reference! Made of high quality kraft fibre board, printed in rich colors and constructed to look like an attractively bound book, Popular Mechanics Magazine Library Files enhance the reference value and double the usefulness of your collection of Popular Mechanics Magazines.

Serviceable, convenient, handsome in appearance, Popular Mechanics Magazine Library Files make every volume and article instantly accessible. No more hunting for the issue or special data you want. No misplaced copies. A "must" for every reader of Popular Mechanics. Order now for immediate delivery. Use the handy coupon below.

PER SET OF 2
(Set holds 12 issues)

Only

70¢

POSTAGE PAID

5 SETS \$3.10
ONLY

10 SETS \$6.00
ONLY

POSTPAID

Best of all, production economies by the distributor service organization appointed by us to serve your needs—plus our large volume purchases—makes the phenomenally low cost of the Libraries possible.

USE THIS COUPON...Mail Today

POPULAR MECHANICS MAGAZINE, Dept. PL
200 East Ontario Street, Chicago 11, Illinois

P12-52

Please rush PREPAID _____ sets Popular Mechanics Magazine Library Files.

(QUANTITY)

Remittance for \$ _____ is enclosed.

(AMOUNT)

PRICES — 1 set (2 files) Holds 1 yr's. issues only \$.70
5 sets (10 files) Holds 5 yr's issues only \$3.10
10 sets (20 files) Holds 10 yr's issues only \$6.00

Includes Prepaid Parcel Post anywhere in U.S. and Possessions

Name _____

Address _____

City _____ Zone _____ State _____

BUILD YOUR OWN POWER TOOLS—TILT/ARBOR SAW

Exclusive GIL-BILT Build-It-Yourself Features

- No machining—build easily with hand tools only
- No blueprint reading—step-by-step pictorial plans, full scale patterns, actual photographs
- Sturdy wood, aluminum and steel construction
- Capacity and performance of commercial saws selling for \$60 and up

BANDSAW
BELT SANDER
SAVE \$50.
OR MORE

GIL-BILT 10-INCH TILTING ARBOR SAW



- 27x28 in. table, 13 1/2 in. capacity in front of blade
- 10 in. blade cuts 3 1/4 in. deep, tilts full 45 degrees
- Floor model 34" high, table always stays level

- New Departure ball bearing arbor, 3/4" precision shaft turned down for 5/8" bore blades, alum. housing, shipped ready to run
- Jackscrew and 4 1/2 in. dia. handwheel lowers and raises blade
- Cast aluminum miter gauge and self-aligning rip fence guide

GIL-BILT Metal Parts Kit includes Plans, ball bearing arbor, miter gauge and bar, rip fence guide, dado insert, lock knobs, jackscrew mechanism and handwheel, and all other metal parts (less blade).....\$21.95
Same Kit with 10" Combination Blade \$24.90
Same Kit with 8" Combination Blade \$23.90

GIL-BILT 12-INCH BAND SAW

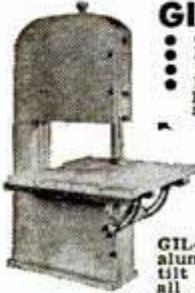

- Cuts to center of 24 inch circle
- Handles stock up to 6 inches thick
- 18x18 inch table tilts 45 degrees
- Lower wheel and drive pulley runs on sealed New Departure Ball Bearings; Upper wheel runs on two 3/8" bore Oilite Bronze bearings.
- Upper wheel tension and tilt mechanism of cast aluminum, completely assembled.
- Upper and lower blade guides. Each has ball thrust bearing, self-lub bronze jaws.
- Rigid cast aluminum wheels fully machined ready-to-install. Heavy rubber tires.
- Uses standard 78 inch blades up to 3/8 in. wide.
- Fully enclosed mechanism for utmost safety.

GIL-BILT Metal Parts Kit includes Plans, rubber tires, aluminum wheels, 1/4 in. blade, ball bearing spindle, tilt mechanism, blade guides, table tilt segments, and all other metal parts.....\$21.95

Return Kits in 10 days for refund if not satisfied.
(Prices include postage within 300 miles. Over 300 add 5%)
Also available—Plans and Parts Kit for 18" Band Saw, Belt Sander and 8" Tilt/Table Saw. Order Plans at \$1.00 each—Sent postpaid anywhere in the world or write for FREE descriptive catalog.

GILLIOM POWER TOOLS P. O. Box 1-PM, Lambert Field St. Louis 21, Missouri

WONDER-PASTE Paint Remover

The modern, easy way to strip paint, varnish, enamel, lacquer, etc. AT PAINT AND HARDWARE STORES

Adjustable PIPE JAWS fit any standard vise

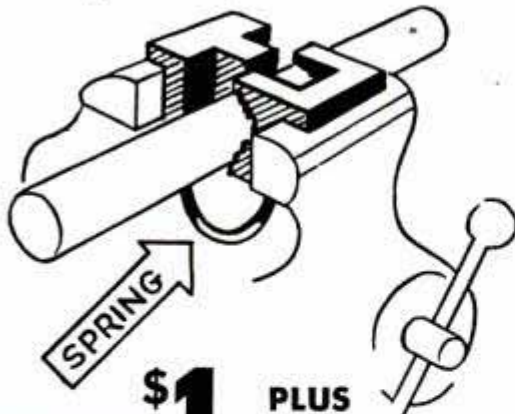

If your hardware dealer cannot supply you, write direct.

\$1 PLUS POSTAGE 20c

A handy and useful tool for home or shop. Fits any standard vise. Sturdy spring holds them snugly against vise jaws. 1/8" to 2" pipe or round stock. Can be used in vertical, horizontal or any angular position.

H. A. JOHNSON — Box 62 PM. Fruitvale Station Oakland, Calif.



EARN BIG MONEY...

RAISE RARE Tropical Fish

NEW SPARE TIME HOME-BUSINESS FOR PLEASURE AND \$\$\$ PROFITS

Wonderful opportunity! No experience needed—no expensive equipment to buy. It's easy and fascinating to breed "Tetras" that LIGHT-UP like neon signs; "Gourami" that are 12 DIFFERENT COLORS; "Fighting Fish" that FIGHT UNTIL DEATH; "Rosy Tetras" that are TRANSPARENT; "Danio" that are STRIPED LIKE A ZEBRA—hundreds of fascinating rare varieties. SOME SELL FOR \$50 EACH & MORE! Takes only minutes per day. WE SUPPLY EVERYTHING YOU NEED. HELP US FILL HUGE DEMAND from homes, interior decorators, clubs, hotels, pet stores, flower shops, schools, etc. Fabulous Profits! FREE Illustrated Plan & Details. RUSH name and address to:

Free HOME-BUSINESS PLAN

TROPICAL FISH BREEDERS OF AMERICA DEPT. D12, LOS ANGELES 15, CALIF.

TOOLS AT WHOLESALE

PROFESSIONAL MECHANICS HAND TOOLS
Farm, Household and Special Tools
TOP QUALITY, FACTORY GUARANTEED
Write Today for **FREE CATALOG** **MECHANICS CO-OP**
Dept. X Oakland 8, Calif.



SPORTONE MUFFLERS

- Ford & Chevrolet.....\$ 4.45
 - All other popular cars..... 5.45
 - V-8 Dual Sets..... 15.95
 - Chromed Silentips..... 2.95
- (Please state make & year of car on all orders.)

SANDÉE MUFFLER CO.
5643 Corryne Place • Culver City, California



Treasure and Minerals

Easily located with new Lightweight M-Scope Detector. Superior performance, lowest price, monthly payment plan.

FREE LITERATURE
FISHER RESEARCH LAB., INC.
PALO ALTO CALIF.

VARIABLE SPEED HYDRAULIC POWER TRANSMISSION

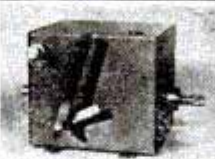

It has Infinite Speeds 0 to 550, Reverse, Automatic Overload Protection; Adjustable Torque up to 180 inch pounds, 5/8" Input and Output Shafts. It will handle 1/4 to 1 1/2 H.P. Motor. Case measures 7 1/2" long, 7" high 6 1/2" wide. VALUE OVER \$300. Shipping Wt. 25. On C.O.D. Orders we require a 10% only \$54.50 Deposit. Fob. Chicago

DIRZIUS MACHINE SHOP "1" 1423-25 So. 52nd Ave., Cicero 50, Ill.

POWER MOWERS & KITS FREE PLANS



LOW FACTORY PRICES DIRECT TO YOU
It's easy to build your own quality 20" mower with our LOW COST KITS, Parts, Engines. Free plans guide you. Parts finished, ready to use. Fully guaranteed KIT Shown Above includes: Front Swivel unit with 8 x 1.75 wheel; Center Post and V-belt pulley; 20" cutting blade; 2 Rear rubber tired wheels size 10 x 1.75 with axles and brackets. Bolts, nuts included. All for \$31.95. Send check or money order for postpaid shipment or 10% down, balance C.O.D. Literature and Price List on request.



MANUFACTURERS OF AMERICA'S FINEST COMPLETE MOWERS. WRITE FOR PRICES.

▼ **TRIANGLE MANUFACTURING CO., Box M-17, Fort Scott, Kansas**

GIGANTIC EXPANSION MAIL SALE

WAR SURPLUS EXCESS INVENTORY BANKRUPT STOCK

POWER PLANTS & GENERATORS

- Master Plants, 5KW, 115-230 v, 60-c, 4-cyl. engine, manual start. Costover \$1100. **\$531.70**
- Onan Plants, 5KW, 115-v, 4-cyl., push button start. Cost \$1400.00 **\$689.50**
- Onan Plants, 1-KW, 115-v, 60-c. Full automatic start-stop. **\$291.50**
- Burdex Plants, 2KW, 115-v, 60-c. **\$297**
- Homelite Plants, 1.5KW, 115-v, 60-c. **\$199**
- Kato Generators, 5KW, 115-v, 60-c, with control panel, drive pulley, etc. 1800 RPM, 1 phase. Cost \$550. **\$259.50**
- Generators, 115-v, 60-c. Ball bearing, 500-w, 594.50; 1000-w, \$134.90; 2000-w, \$159.50.

Write for Power Plant Catalog

HYDRAULIC BARGAINS

Build your own loaders, diggers, presses, plow lifts, etc. Lowest prices. Savings to 80%. See our "How to Build" catalog.

- Pump, 1000 lbs., 12 g.p.m., 400 r.p.m. **\$45.50**
- Cylinder, 2 3/4" bore, 19" stroke, 9000 lb. lift. List \$91.50. **\$18.49**
- Cylinder, 2" bore, 10" stroke, 3141 lb. lift. Sale **\$16.50**
- Control Valve, For single or double acting cylinders. Sale **\$17.98**

Write for Hydraulic Data-Catalog

Winches - Hoists - Blocks

- Boat, dock, business hand winch, 1-4 gear ratio. Special **\$19.95**
- Farm-Truck-Contractor heavy duty hand winch. Dual ratio 1-3, 1-9. Finest cast steel construction. Special **\$29.98**
- Chain Hoist. Lever type 3000 lb. **\$19.48**
- Truck Crane-Winch. Mounts on trucks and pick-ups. Special **\$84.60**
- Winch Cable, 1/4" super-flexible (4000 lbs. cap.) 50' with load hook. **\$9.90**
- Army Snatch Block, 13,000 lb. List \$19.40. **\$12.95**
- \$165 Airplane Winch. Beautifully made. Requires reducing gear. SALE. **\$17.49**

ORDER FROM AD, or Write for 4 FREE Catalogs!

OUR 30-YEAR POLICY: • Everything Guaranteed Satisfactory • We Pay Shipping Charges in U. S.

BURDEN PAYS ALL SHIPPING CHARGES

SUPER CLOSEOUT BARGAINS

- 10-Piece Stainless Steel top quality kitchen knife set, rosewood handles. \$10.50 value. SALE **\$5.49**
- Genuine Mail \$325 Chain Saws. **\$281.50**
- Electric Chain Saws. **\$98.90**
- World's Finest (\$225) Stainless Steel 7-Row Weed Spray Outfit. **\$129.50**
- Plane Propellers, (\$151.50) Beautiful polished hardwood, 7'6" long. Snow sleds, ice boots, den decoration. **\$12.98**
- Search Lamps, G. E. Plane landing. Tremendous 4,800,000 c.p. output! 2-mile range. 24-volt (6 for \$7.49.) 11-volt. **\$1.95**

WATER PUMPS AND SYSTEMS

- Save up to 60%. Ask us for expert advice on your problem. Pumps for wells, basements, weed spraying, septic tanks, garden irrigation, etc.
- Centrifugal Pumps. Cast iron, stainless steel shaft, bronze impeller, ball bearings. No. 75, 3/4", **\$18.90**; No. 100, 1" **\$28.90**; No. 150, 1 1/2", **\$35.80**.
- Bronze Rotary Pumps. Low pressure. (25 lbs. max.) Self priming. No. 12, 1/2", **\$12.75**; No. 34, 3/4", **\$16.95**; No. 101, 1", **\$22.95**;
- Hi-Pressure type (150 lbs. max.) No. 612, 1/2", **\$14.50**; No. 634, 3/4", **\$20.95**; No. 610, 1", **\$27.95**.
- Irrigation War Surplus Pump, 10,000 g.p.h. 2 1/2" intake, Two 1 3/4" outlets, Spe. **\$39.50**
- Burdex Shallow Well System, 110-volt, 60-c, 300 g.p.h. 40 lbs. pressure, fully automatic. Easy to install **\$69.50**
- Adj. Auto. Pressure Switch, \$4.95; 3/4" foot valve, \$2.49; pressure gauge 0-60 lbs. \$1.89; also hose, strainers, etc., at real savings.
- Hand Pump. Lever type, high capacity, Pump basements, tanks on farms, etc. Cost \$35. **\$27.80**

MISCELLANEOUS SURPLUS BARGAINS

- Inspection Magnifier Reading Glass. **\$2.97**
- German Pocket Microscope (25 power) **\$3.49**
- Binoculars, Best quality 7x50 coated. **\$47.50**
- Immersion Heater, 110-v, 750-w. **\$3.89**
- Engineers Hand Level. **\$5.84**
- Navy Life Saver Inflatable Belts. **\$1.09**
- Timber and Brush Eng. Driven Spray-Kill Outfit. List \$267.00. SALE. **\$163.50**

Write for useful Water Pump Data-Catalog

SPECIAL FOR THE MONTH

NAVY WEATHER BUREAU THERMOMETER

• Finest precision direct reading instrument. Shows outside temperature on large 5" attractive easy-to-read indoor dial. Flexible 5" tube connects to outside brass enclosed sensitive element. Reads -40° to 120° F. Wonderful unit for factory, home, farm, etc. Original cost \$49.50. SALE **\$9.85**



Correspondence School Bargain

• Famous engineering school closes because of high operating costs. We offer limited quantity of complete courses, Radio or Electrical (27 fine lesson texts.) at fraction of regular tuition rate. Deal #1, Complete Radio or Engineering Course Texts, **\$5.95**. Deal #2, Combined Radio and Electrical Course Texts **\$9.95**

AIR COMPRESSOR UNITS

Paint, blow up tires, control termites, clean greasy engines, blow dust, etc. Build your own or buy ready-built units.

• Deluxe Air Kit. Consists stainless tank 12"x24", finest 1-cyl. 3 cfm piston compressor, valves, gauge, fittings, hose, excellent paint gun, blow gun, pressure regulator, chuck and "How To Build Portable Outfit." Special **\$45.49**

• Economy Air Kit. Same as above except 6"x24" tank and no regulator or paint gun. Each **\$31.90**

• Air Components. Top quality. 1-cyl. piston comp. \$20.50; 2-cyl. pis. comp. \$49.50; Adj. Auto. pressure switch, \$4.95; pressure regulator, \$2.65; Adj. safety valve, \$1.95; Pressure gauges, 0-160 lbs. \$1.89.

• Air Operated Power Grease Gun... **\$23.95**

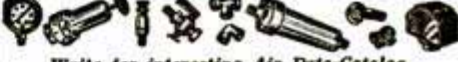

Write for interesting Air Data-Catalog.

FREE CATALOG

BURDEN SALES COMPANY

816 "O" ST.

LINCOLN, NEBRASKA



A PRECISION-BUILT ELECTRONIC UNIT with 1000 USES

It seems impossible... giving away a 110V AC, UL approved, Electronic Unit completely wired and housed in a beautiful plastic case. What! the sensitive plate relay alone is worth more than the \$2.49 we're asking. If you were to consider the many uses to which it can be modified and to study the list of parts below, you will then understand the terrific buy we're offering and rush to send in your order today.

- 1-115V-6.3V Filament Transformer
- 1-S.P.S.T. Sensitive Plate Relay
- 1-S.P.S.T. Switch
- 4-Paper Tubular Condensers
- 1-Electrolytic Condenser
- 1-Potentiometer

LOADED WITH VALUABLE STANDARD PARTS

- 6-Carbon Resistors
- 7-Wire Wound Resistors
- Pilot Lamp, Dial Assembly
- 3-Tube Sockets
- Plastic Cabinet 5 3/4"x5x3 1/4"
- Knobs, Feet & Assorted Hardware
- Schematic Diagram

FOR ONLY

\$2.49 POST-PAID

WORTH 5 TIMES THIS PRICE

MANUEL KLEIN CO. 948 CHAMBER ST., NEW YORK 7, N. Y. RECTOR 2-6460

IDEAL FOR SERVICEMEN, HAMS, ENGINEERS, TINKERS, HOBBYISTS AND ELECTRONIC STUDENTS

CASH IN YOUR SPARE TIME!

BIG MONEY IN OWN BUSINESS

YOU CAN MAKE UP TO \$40 a DAY sharpening and setting circular saws for factories, builders, lumber yards—with

NEW BELSAW COMPLETE CIRCULAR SAW SHOP. Low Cost, only \$15 down, sharpens 4 to 5 saws an hour. No experience needed! Instructions Furnished. Send Postcard Today for FREE BOOK. BELSAW MACHINERY CO. 3704 Field Bldg. Kansas City 11, Mo.



AMAZING NEW POCKET SIZE RADIO!

NO TUBES, BATTERIES OR ELECTRIC "PLUG-INS" NEEDED. "TUNES IN" MOST LOCAL RADIO STATIONS WITH STATIC-FREE CLEAR TONE. Has new perma-crystal diode and TINY SELF-CONTAINED SPEAKER PHONE—A marvelous real tiny pocket size radio to take with you anywhere you go — FOR REAL FUN AND ENJOYMENT. GUARANTEED TO WORK and should last for years! SEND \$1.00 (Cash, M.O., Ck.) and pay postage or send \$4.99 for p.p. delivery. COMPLETE ready to play. By mail only from: Midway Company, Dept. PPM-12, Kearney, Nebr.

CUT-TO-FIT HOMES CUT BUILDING COSTS

ORDER NOW

SAVE UP TO 1/3

CHOICE OF 57 DESIGNS

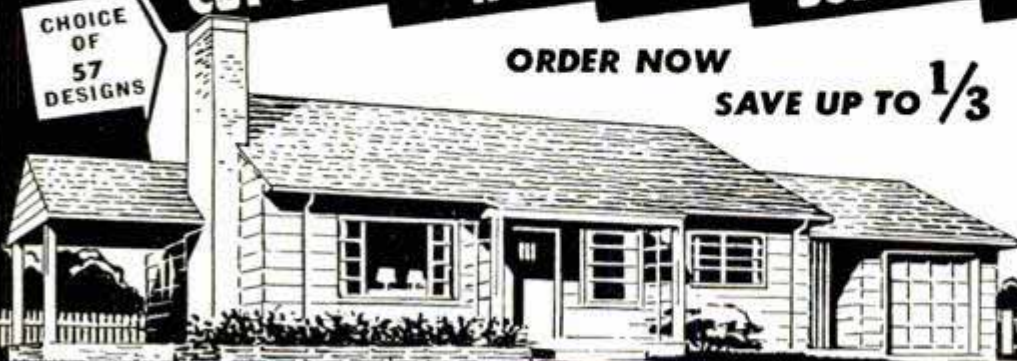

Build your own home and save the builders' profit—plus savings in lumber and labor with Sterling Ready-Cut-Homes. Anyone can assemble with simple, easy to follow plans furnished. Every house complete with all lumber, roofing, nails, glass, hardware, paint, doors and windows marked ready to erect. Freight paid. Complete building plans ready for filing at low cost. Sold separately if desired. Write today!

PRICED FROM \$2150 up

Five Easy Payment Plans

Send 25c for NEW COLOR CATALOG

INTERNATIONAL MILL AND TIMBER CO. DEPT. P.M. 122 BAY CITY, MICHIGAN

50 YEARS OF FORDS

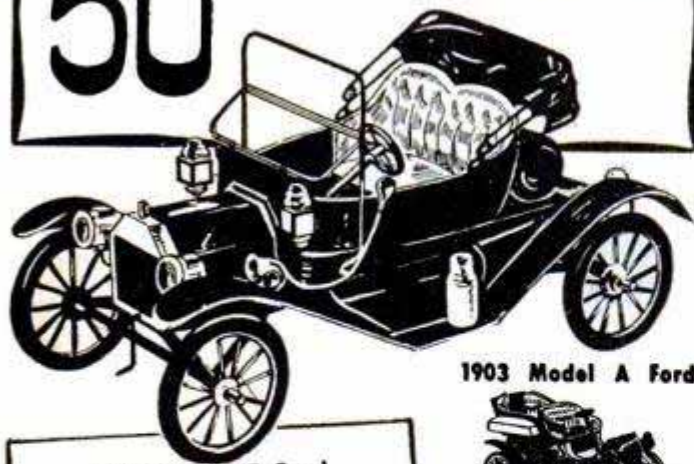

1903 Model A Ford

1910 Model T Ford

One of the most popular cars of its day. Now in kit form, authentic in every detail. Yours for easy building with prefabricated parts. Complete with instructions. \$2.50
Kits sold at Hobby, Toy or Department stores, or write us. Add 25¢ for postage and handling.



"First in the Ford family"
Complete Kit - - \$2.50

1909 Model T Ford



Built for Economy and Dependable performance.
Complete Kit \$2.95

OLD TIMERS SCRANTON HOBBY CENTER
DEPT. 14 SCRANTON 10, PA.

SPEEDLINER

14 FT. MODEL KB-14 SHOWN HERE



BOAT KITS

Assemble Yourself... Have Fun... Save 1/2

Get a kit designed by builders of famous Speedliners and save about 1/2. Easy-to-follow illustrated instructions. No special tools needed. Boat building experience not necessary. Transom and frames furnished completely assembled, other parts carefully cut to size. Screws and glue furnished. Only finest materials - Philippine mahogany lumber and finest boat grade fir plywood furnished. See your local Speedliner dealer for ready-built boats and boat kits.

OR SEND COUPON TODAY!

General Marine Co.
St. Joseph, Mo.
Dealerships available in some territories

Championship BOATS

Built for strength, speed and safety. 25 seaworthy ready-built models. See your Speedliner dealer or send coupon.

PLYWOOD

High quality Philippine Mahogany marine plywood available in any quantity. Manufactured in our own plywood division. Sheets up to 48" wide, scarfed to any length. Write for prices.

General Marine Co.
6th and Oak Street

Dept. 556
St. Joseph, Mo.

- Please send me FREE your complete catalog on Speedliner Boats and information and prices on your full line of Speedliner Boat Kits.
 Send prices on Speedliner plywood.

Name _____
Address _____
City _____ State _____

EVEREST & JENNINGS

Folding WHEEL CHAIRS

- Easy-handling
- Comfortable
- Made stronger to last longer!
- Accessories and modifications available.

FOLDS TO 10 INCHES

See your dealer or write for catalog

EVEREST & JENNINGS

761 No. Highland Ave., Los Angeles 38, Calif.

ONE-MAN SAWMILL

LOW \$50.00 AS... \$5.00 DOWN

Take BELSAW Portable Sawmill right to the trees—turn out valuable lumber for local yards—do "custom sawing" for neighbors. BELSAW lasts a lifetime. No crew needed. Power with old auto engine. Beginners get excellent results. Send postcard for FREE BOOK, "How To Make Lumber."

BELSAW MACHINERY CO.
8117 Field Bldg. 315 Westport Rd, Kansas City 11, Mo.

Anybody Handy With Tools Can Build

LEATHER LOUNGES FOR KITCHENS AND RESTAURANTS

Frames, springs, filling, construction simplified.

Send \$5.00 for complete plans and instructions, or 10¢ for brochure.

STEFAN GALENSKI
Designer & Manufacturer
2221 BROADWAY
BUFFALO 12, NEW YORK

BUILD ARC WELDER FROM OLD GENERATOR

For Light or Heavy Work. 75-200 amps. No previous experience needed. Complete PLANS 35c, Electrical & War Surplus Catalog Included. Or, Catalog, FREE.

LEJAY MANUFACTURING CO.
1347 LeJay Bldg., Minneapolis 8, Minn.

NEW SAW SHARPENER

Improved #64 Hand Gummer sharpens all types circular saws 4" to 20" diam. Ideal for saw shops. Self-Centering adjustment for quick, easy set-ups. Complete with 1/4 HP motor, 1 grinding wheel & cord. \$79.50 FOB Portland. Wt. 70#. SEND FOR FREE LITERATURE.

P. T. HOBBS MACHINERY
8375 N. INTERSTATE AVE.
Dept. P.M.-61, PORTLAND 17, OREGON

IDEAL LAWNMOWER SHARPENER

MAKE EXTRA CASH THIS EASY WAY!

Plenty of mowers to grind in your community! IDEAL Model 300 grinds them all with ease and precision — assures your reputation for perfect workmanship. Sharpens all mowers—hand or power—without disassembling. Exclusive hook grinding method perfected by 50 years' experience. Get started now in this profitable business; write for FREE complete catalog today.

THE FATE-ROOT-HEATH COMPANY
Dept. PM-12, Plymouth, Ohio

I'm going to name him Champ, Dad!

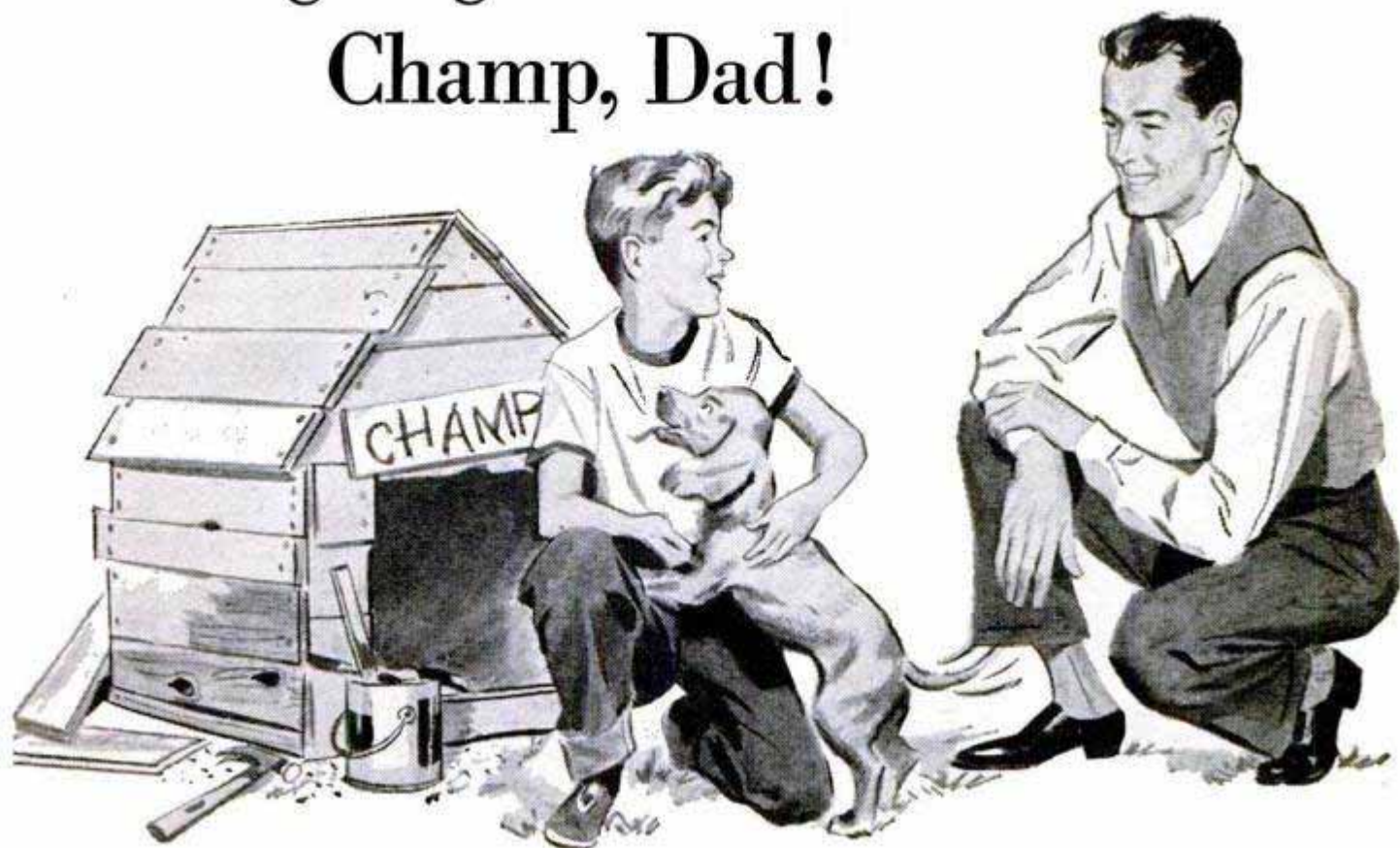

Yes—pups, people or products—names play a very important part in our everyday lives.

Today, our standard of living is greatly enriched by our system of competing brand names.

What do these names mean to you? A great deal, because they really make you—and every consumer—the *boss*.

When a manufacturer proudly signs his name to his product, he knows that he has to win your faith in that name.

Only through satisfying you, can he be sure that you will buy again—and again!

That's the main reason why manufacturers of branded and advertised products carry on continuous programs of research and product improvement. That's why winning your favor is the full time job of thousands of scientists and testing engineers, and the sole purpose of laboratories and experimental plants in every division of industry where trade-marking is practiced.

Yes, in the factories of the brand-makers, yours is the final word. Your free choice of branded products makes you the boss of the greatest manufacturing system in the world:

Brand Names Foundation

INCORPORATED

A NON-PROFIT EDUCATIONAL FOUNDATION • 37 WEST 57TH STREET, NEW YORK 19, N. Y.

Comfort

by the
FISTFUL!

...Yours in

WOLVERINE Pigskins

Genuine Pigskin! They dry soft—stay soft! They're tanned that way by the exclusive Wolverine triple tanning process. Extra wear, and plenty of it, on any work-glove job. Just wear a pair and see!



A NEW PAIR
FREE
IF THEY DRY OUT
HARD OR STIFF!

FREE

2-Way Comb

Who's your dealer? Just write us and we'll tell you and also send you, **FREE**, a handsome Wolverine 5-inch colored plastic comb that folds away to a 2" by 2 1/4" compact for purse or pocket. Offer limited to Continental U.S. only.

WOLVERINE ROCKFORD, MICHIGAN
Department JG-12

P & C Hot Forged Tools

make tough jobs **EASY!**

Built by master craftsmen, P & C tools are "muscle saving" and "fun to use." They get into small openings, fit nuts and screws snugly, balance perfectly in the hand. And special analysis alloy steels plus scientific heat treating makes them stay on the job longer. Look for the P & C rotary tool display unit and get "the best tools money can buy."

Write for new handy pocket catalog, complete data on some 300 P & C Tools.

P & C



P & C Hand Forged Tool Co.
Box 5926-H-Portland 22, Oregon



THE WORST WRONG TURNS OCCUR AT DEAD-ENDS

● Driving the exact opposite of the right direction usually starts at a dead-end turn. You **CAN'T** make this common error with a **HULL AUTO COMPASS**. Write for local dealer's name, free literature.

HULL MFG. CO. P.O. Box 246-D-12,
Warren, Ohio

Beaconlite \$6.95
ILLUMINATED
STREAMLINE \$4.95
STANDARD (not illus.)

Expert's Painting Tips - FREE

Lifetime of experience with aluminum paint, yours free—write for free 24-page illustrated book. Tells how to buy and apply right kinds of aluminum paint. We don't make paint but have prepared this to help you get best results. Just write for "Paint it Bright."

ALUMINUM COMPANY OF AMERICA,
1718M GULF BLDG., PITTSBURGH 19, PA.



MARVEL Mystery Oil

- Frees Sticky Valves
- Stops Hydraulic Valve Clatter

Buy it at your favorite gas station



GERSTNER Tool Chests

Always preferred by good Machinists and Tool-makers for their good tools. Free Catalog.

GERSTNER TOOL CHESTS
452 Columbia St. Dayton 7, Ohio



REAL LEATHER NAVY HELMET NO HOOKS, TUBES OR HOLES

Brand new NAVY helmet of rich Cordovan Brown leather lined with soft warm fleece. Detachable chin strap. Ideal for flyers, cyclists, farmers, hunters. Children love them! Cost Gov't. \$10.00 Small, medium, large sizes. Send cash, chk.; 25% dep. plus postage on COD. Money back guarantee.

\$2.00 pp
GRAND-HAWTHORNE SURPLUS
1439 S. E. Grand, Dept. PM12-52
Portland, Oregon

ARC WELDING FOR PROFIT OR PLEASURE

60 LBS. OF READY MADE PARTS

Only \$24.95

BUILD YOUR OWN HEAVY DUTY WELDER SAVE BUY ONLY NECESSARY PARTS

All necessary parts Ready-Made and easy to assemble. You can do all around welding on steel, cast iron and other metals after only a few hours practice. Illustrated instruction manual included. Sold on 30 Day Money-Back Guarantee! Free plans for building case.

FREE: Write today for fully illustrated Pamphlet S-11

ATOMIC ARC WELDER CO. Gives 100% penetration. Welds are stronger than original metal.
1039 So. 19th St., OMAHA, NEBR.

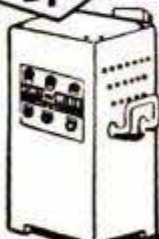

ELECTRIC MOTOR BARGAINS!

1/4 HP Split Phase 110 Volts..... 10.75



1/2 HP 1750 or 3450 RPM 19.75
 1 1/2 HP 3450 RPM 47.50
 2 HP 3450 RPM 65.00
 3 HP 3450 RPM 77.50

Every Motor Fully Guaranteed

All prices F.O.B. Immediate Delivery
 Heavy Duty, Repulsion Induction and Capacitor Types. 110-220 Volts (except 2 and 3 HP which are straight 220), 60-cycle. Single phase. Standard Makes (G.E., Wagner, Leland, Westinghouse, etc). Rush your order TODAY—large stock of motors—1 & 3 phase. 32-v direct current bargains. Prices f.o.b.



Paramount AIR COMPRESSOR COMPARE Price—Features—Savings!

Reg. \$24.95. Ball bearing, piston-type compressor of revolutionary new design. Can't be matched as an all-purpose, low cost unit. New principle operates it on conventional 1/4 HP—BUT delivers MORE air than ordinary 1/2 HP unit. For professional paint spraying, tire inflating, insecticiding and hundreds other uses in shop, farm, home! Delivers 2 1/4 cu. ft. air per minute. Includes Tank—Air Gauge and Air Regulator for adjusting pressure from 0 to 100 lbs. Order now and SAVE! Satisfaction guaranteed or money back. We pay postage.

\$12.95 Post paid

ROBERTS ELECTRIC CO., 849 W. Grand, Dept. 40, Chicago, Ill.

ask your dealer for

Red Devil
 putty knives and
 wall scrapers



THE CRAFTSMAN'S
 WELL-TEMPERED FRIEND

RED DEVIL TOOLS, IRVINGTON 11, N. J., U. S. A.

BIG LEATHER & CRAFT CATALOG!

1000's of Items for Leathercraft, Textile Painting, Copper Tooling, Kits, Projects, Tools, Supplies, Etc. Send 25c (refunded with 1st order) to:

RUSSO HANDICRAFT SUPPLIES Dept. 6-CD, 245 S. SPRING LOS ANGELES 12, CALIF.

64" FLEXIBLE SHAFT WOVEN WIRE CORE

USE AS
 ELECTRIC
 DRILL

REAL BARGAIN—cannot be duplicated for \$15.00. Coupling fits 3/4" motor shaft; other end fits standard chuck. Durable, heavy. Use it for grinding, polishing, buffing, drilling, etc. Chuck for same only \$1.25. Send check or money order and we will ship P.P. prepaid. Money refunded if not satisfied.

only **\$5.95**

HARRY W. RETTEW 400 West Avenue
 Jenkintown 5, Pa.

MAGNETS

OF ALL TYPES — 10c UP
 AMAZINGLY POWERFUL!!

8 ounce horseshoe magnet—\$1.50.
 Our Leader, 1 lb. magnet lifts 40 lbs. \$2.95. New alloy—will not weaken! Useful for lifting valuables from tanks, lakes, or rivers easily! 7 small magnets \$1.25 with list of many shop and home uses. Satisfaction guaranteed.
 R. KYRICH, 1219 W. MEINECKE AVE., MILWAUKEE, WIS.

Foley Filer Users—Attention!!

Save on File Expense! Improve Your Workmanship!
 Sharpen More Saws With Each File!

"FLOATING ROLLERS" will solve these problems for you! "FLOATING ROLLERS" replace saw carrier clips and have a tension spring which holds the carrier snug to the lower rollers, eliminating irregular size teeth, carrier play, etc., which must be remedied before precision work can be accomplished. Many other features make the "FLOATING ROLLERS" a MUST investment for you. Easily attached in five minutes.

For Model F-16, F-24 or F-61 Foley Filer, equipped with carrier rollers, \$7.50 per set.

Order a set today for 30-days trial. If not satisfied in any way, return them and your money will be refunded. Save COD and postage charges by sending check or money order with order, or write for further information.

NOW AVAILABLE—The Stadick Automatic Saw Setter for Foley Filers. A card will bring further information.

STADICK MANUFACTURING CO.
 Box 73, New Ulm, Minnesota

Here's the GIANT NEW 1953

HI-BRED

FIREBALL

The Most Powerful Flashlight in the world
 NOW WITH 15 CELL PERFORMANCE

- Mile Distance Spot Beam
- World's Finest Flashlight
- Solid Brass Case Will Never Rust
- New Giant Die Cast Reflector
- Uses 6 Batteries With Special Bulb
- 15 Cell Power Because Of HI-BRED Design and New Reflector
- Absolute Money-Back Guarantee

CAMPING

Penetrates deep woods like daylight. Makes enough light for entire tent at night. See shoreline from boat at great distance. Use as powerful boat headlight. Ideal fishing light.

COON HUNTING

Reaches highest tree with blinding spot beam to search out the most elusive coon as though he were on a sapling. Uses ordinary batteries but makes them last more than twice as long. Most amazing light ever made!

EXCLUSIVE WITH US

Can only be bought by mail direct from us. Get the genuine FIREBALL! Money back if not satisfied.

\$4.99 Add 25c ea. 2 FOR spec. packing **\$9.50**

6 EXTRA BULBS.....\$1.00
 EXTRA REFLECTOR .. 1.19
 SHOULDER SLING 1.39
 HEAVY DUTY, LONG-LIFE BATTERIESSIX for 90c
 HI-POWER BATTERIESSIX for 75c

DEALERS WANTED

DOG SUPPLY HOUSE,

P. O. Box 4465 Box P-12
 Detroit 28, Mich.



The New Improved Model 38-98

DYNAMIC POWER TOOL COMBINATION



INCLUDES: Cummins 1/4" Pistol-Grip Electric Drill; Cummins Saw Attachment; Combination Saw Blade; Set of Drills; Lambs Wool Bonnet; 13 Sanding Discs; Steel Arbor and Attachments; Cloth Buffing Wheel; Grinding Wheel; Wire Wheel Brush; Steel Point Mixer; Steel Bench Stand; Portable Steel Carrying Case.

Price of Dynamic Power Tool Combination complete is \$29.95

SHIPPED ON APPROVAL

No Money With Order — No C.O.D.

Try it ten days before you buy. If completely satisfied then send \$4.95 and pay balance at rate of \$5.00 per month for 5 months — No Interest or Carrying Charges Added. If not completely satisfied, return to us, no explanation necessary.

KAPNER HARDWARE, INC.

Dept. A-57, 2248 Second Ave., New York 29, N. Y.

Please rush 1 Dynamic Power Tool Combination. I agree to pay \$4.95 within 10 days after receipt and \$5.00 per month thereafter.

Name.....
 Address.....
 City..... Zone..... State.....

FREE

16-PAGE BOOKLET

Shows how to make your home DRAFT-PROOF

This new free booklet is crammed with useful information:—it tells why good weather stripping is so important to home owners, describes characteristics of various kinds of weather stripping, tells how to trace drafts, and suggests how to weather-strip doors, windows, storm windows, etc., effectively with **INNER-SEAL**. Illustrated throughout.



Bridgeport **INNER-SEAL** WEATHER STRIPPING

has exclusive, patented construction—live sponge rubber bead with woven-in spring wire tacking strip. Neoprene coated. It's tough, flexible, resilient, snug-fitting, easy to install, has many handyman uses. Ask your hardware or building supply dealer for your copy of "Why & How to Weather-Strip," or write direct to Dept. P12, Bridgeport Fabrics, Inc., Bridgeport 1, Connecticut.

BRIDGEPORT FABRICS, INC., BRIDGEPORT 1, CONN.

SANTA SAYS:

"A WONDERFUL HOBBY WORKSHOP GIFT!"



NOW 40 DIFFERENT CUTS ON YOUR SAW WITH **Warren** DADO SAWING WASHERS

Cut clean, accurate, parallel grooves—40 widths, any angle. No chatter, burning, chewing—or sanding. Eliminates vibration—strengthens blade. No screws to fuss with. Simply dial width with Micromatic adjustment. Leave on blade for straight cuts. Sizes to fit your arbor— $\frac{1}{2}$ " , $\frac{5}{8}$ " , $\frac{3}{4}$ " , 1". A perfect gift for woodworkers. See your dealer or write.

Send for Free Booklet

ONLY **\$4.95** PER SET

WARREN WASHERS CO.

BOX 98 • DEPT. 32 NORTH END STATION • DETROIT • MICH.

2 DRILLS in 1

\$11.95 post paid

Send check or Money Order • Satisfaction guaranteed • Order yours now

This attachment gives you two drills in one. It converts any $\frac{1}{4}$ inch electric drill to $\frac{1}{2}$ inch capacity. Reduction gears reduce the drill speed 5 to 1, the average speed of a $\frac{1}{2}$ inch drill, and thereby increases the power. Absolutely indispensable for all shop work and home craftsmen.

G. M. CO. MANUFACTURING, INC.
1308 43rd AVE.
LONG ISLAND CITY 1, NEW YORK

30x40 Projection Screen \$6.89

beaded, portable, tripod model

Customers examining the screen in our store ask unbelievably: "Is it really beaded? Does the low price include tripod and screen?" But after learning what they get, they admit that they expected to pay 100% to 150% more! Yes, you pay far below wholesale price for a first rate screen, equally suited for movie (8mm or 16mm) and slide projection. Crystal-beaded pyroxilin surface actually adds brilliance to your films and slides, makes them seem to come to life! Screen raises and lowers on elevating rod, metal can has beautiful scratchproof finish, carrying handle sets for balanced carrying, sturdy, plated tripod has protective rubber tips. Thousands of our screens are in use by churches, clubs, colleges and amateurs.

OTHER SIZE BEADED (40x40" . . . \$8.19 37x50" . . . \$9.64
TRIPOD SCREENS (50x50" . . . \$11.89 52x70" . . . \$24.95

Prepay in full or send \$1.00 deposit with C.O.D. orders. Shipment is made Railway Express, shipping costs collect (or you prepay for 11 lbs. pp. and ins. for 30x40, 40x50 screens).

SPIRATONE, 49 West 27th St., Dept. PM, New York, N. Y.

I WILL SAVE YOU UP TO 90%

Send for my new, 32 pg., illustrated **BLUE BOOK OF BIG BARGAINS** for mechanics, farmers, gadgeteers, outdoorsmen. My prices unbelievably low.

WAR SURPLUS BARGAIN FREE!

KARL ORT, Dept. P.M., York, Pa.

A REAL MINIATURE OUTBOARD MOTOR

Here's something for loads of fun at a low price! A genuine, precision-made "IMP" OUTBOARD MOTOR only 4 $\frac{3}{4}$ " high. It's SAFE! It's not a TOY! It's PRE-TESTED! It runs on regular flashlight batteries! It attaches to boat models! Replacement parts are always available. **\$3.50** POSTPAID ONLY.

Send check or money order to

HOBBYSPOrts Box 104, Flushing, N.Y.

MADE RITE CORPORATION

Trailer Running Gear

58" 2 TON AXLE \$8.00 RETAIL SPECIAL PRICE TO DEALERS PAT PENDING

F. O. B. 6454 EPWORTH BLVD. DETROIT 10, MICHIGAN

Say You Saw It in **POPULAR MECHANICS**

HURRICANE EXHAUST CUT-OUT

Now control your exhaust tone from a dash control button. Cut back into your original muffler in restricted areas at will. This especially engineered Cut-Out enables you to install special pipes and mufflers without removing the original muffler. We originated this top quality performer, with exclusive deep seat below pipe line to assure tight exhaust seal. The angled outlet permits freer flow to auxiliary pipe. Made of heavy plate steel, designed for easy installation. Thousands in use. Sent post paid for only \$6.95 check or money order. Satisfaction guaranteed or your money back.

ST. LOUIS PRODUCTS CO. Box 24-AM Normandy 21, Mo.

PRACTICAL GIFT FOR THE HOBBYIST and HOME FIXER

EAGLE "66" BRASS OILER WITH NEW SHUT-OFF SPOUT TIP!

Prevents dripping, leakage!

A necessity for every work bench! Deluxe, modern design, pistol grip all-brass Eagle Pump Oiler—delivers one drop or a full stream. Easy finger control operation. SPARK-PROOF.

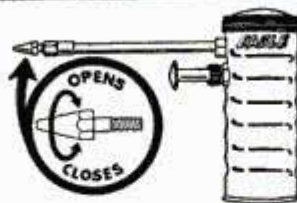

Buy one at your dealer's, or if he does not have it, write to:

EAGLE MFG. CO.
Wellsburg, West Virginia

HOBBYISTS! SHOPMEN! *Special* ONLY \$54.50

PALMGREN "HOBB-E" Rotary, Index, Milling Table

Ideal for Model Parts or Shop Work

Mill-Grind-Drill-Index-Rout curved or straight-Rabbit and Mortise on drill press or lathe. 8" Table, 4" Cross Feed, 360° Rotation, Accurately Graduated. Bolts to table. Order NOW! SAVE \$100. Only \$54.50. Less Rotary Feed \$39.75. Write for "HOBB-E" Tool Circular.

CHICAGO TOOL and ENGINEERING CO.
8365 South Chicago Ave. Chicago 17, Ill.



MANUFACTURE BLOCKS

Easy to start your own profitable business. General high speed, low cost Concrete Vibrator Block Machine produces 1000 blocks in 8-hour day. All sizes and shapes. Complete details FREE. Mail \$1 for wonderful book, "How to Build Your Own Concrete Block Home."

Only \$218
Less Motor



GENERAL ENGINES CO.

307 HUNTER ST., M-122 GLOUCESTER, N. J.

IMPORTANT See our display advertisement as well as editorial appearing in the September, October and November issues of Popular Mechanics on Carbide Tips. Write immediately for catalog and further details.

TIME SAVER TOOLS, INC.

DEPARTMENT 12 MUNDELEIN, ILLINOIS

LEATHERCRAFT and many other crafts

SHELLCRAFT • easy to do
TEXTILE PAINTING • profitable too
Send for FREE **BIG CATALOG TODAY**
• complete supplies • everything you need

KIT KRAFT • 7373 Melrose Ave., Dept. 29, Hollywood 45, Calif.

Say You Saw It in Popular Mechanics



DRILLS HOLES in GLASS

Now it's easy . . . By hand or electric or breast drill . . . No skill needed . . . New scientific steel development . . . SMITH GLASS DRILL . . . Only one of its kind . . . Drills any thickness in glass, ceramics, concrete, tile or plastics, etc. Follow simple instructions. Safe, fast and effortless, even by hand. 1/8", \$2.50; 1/4", \$2.75; 3/8", \$3.00; 1/2", \$3.50; 5/8", \$4.00; 3/4", \$5.50; 1", \$8.00. Postpaid. Specify whether for hand, breast or electric drill use. Money back guarantee.

Smith Engineering
1918 Bay Avenue Glen Ridge 4, N. J.



"HAZ-BIN, JR." Has Everything!

HANDIEST CABINET EVER BUILT
FOR STORING SMALL PARTS

32-DRAWERS (96 compartments)

15 3/8" high \$12.95
6" deep
12 1/2" wide

Contents visible! Unconditionally guaranteed, crystal-clear plastic drawers. Strong all-steel cabinet has individual drawer guides. Baked-on silver-gray hammer finish. Sent complete with index cards, removable lengthwise and crosswise drawer dividers, rubber feet.

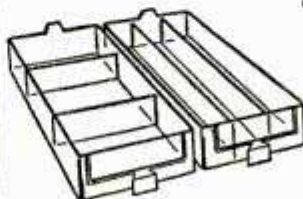
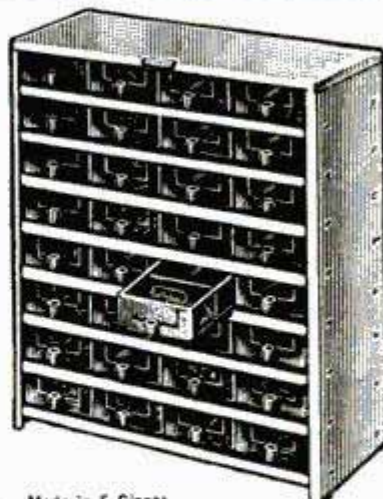

Made in 5 Sizes:

- J-64 64 drawer (192 compartments) \$24.95
- J-48 48 drawer (144 compartments) 20.95
- J-32 32 drawer (96 compartments) 12.95
- J-24 24 drawer (72 compartments) 10.95
- J-16 16 drawer (48 compartments) 7.75

Drawer size for all models—
2 3/4" wide, 1 3/8" deep
5 7/8" long. Movable dividers separate each drawer into 3 compartments.

SEND FOR FREE DESCRIPTIVE FOLDER

Post paid if full payment with order —
Otherwise C. O. D., f. o. b. Akron, Ohio

Add 3% Sales tax if Ohio order

10 Day FREE Trial! Money Back Guaranteed!

Mfgd. by **AKRO-MILS, INC.** P. O. BOX M-989
AKRON 9, OHIO

START A BUSINESS this Quick Way

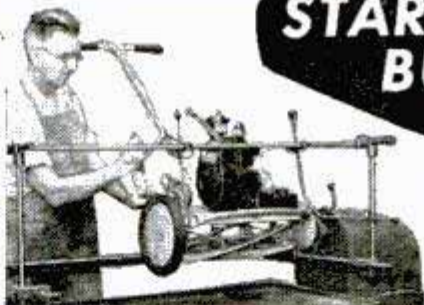

"I have taken in 100 mowers in 5 weeks since I got my Foley", says George C. Wise.

FOLEY LAWN MOWER SHARPENER

Start in spare time and make a quick CASH PROFIT. The Foley handles up to 3 or 4 mowers per hour—prices run \$1.50 to \$3.00 for hand mowers, \$5.00 to \$8.00 for power mowers. You make 99% profit!

FREE VALUABLE ILLUSTRATED BOOK shows how to sharpen all leading makes of power mowers. Foley prices are low—easy payments available. **FREE PLAN** tells how to start. Write today—no salesman will call.

FOLEY MFG. CO., 1207-2 Foley Bldg., Mpls. 18, Minn.

Chrome Rusty? WIPE IT OFF!

Works on Any Hard Metal

Not harmful to hands, auto body or painted surfaces.

Simply apply with damp applicator and wipe rust off (no matter how bad) while still wet. Amazing and capable, no labor involved, no scratching. More than enough in a bottle of WIPE OFF to clean all of your car's chrome.

WIPE OFF has been used in bulk by the country's leading car dealers, now available for the individual. Send for an eight ounce bottle of WIPE OFF and join the throng of satisfied users.

Enclosed One dollar. Send by return mail bottle of WIPE OFF

Print Name _____

Address _____

City _____ State _____

Woods Chemical Co., Inc., 584 W. DeLavan, Buffalo 22, N. Y.

BUY from C & H
HUNDREDS of SENSATIONAL BARGAINS!
you'll save and be sure

BOOSTER FANS fit any 8", 9", 10" furnace pipe. 1500 rpm motor with 6' cord, mounting frame, 6" blade. Motor 110 v. 60 cycle 1350 rpm. Easy to install. Silent operation. Warm those rooms with long runs. List \$11.95. Our price \$6.95

High Volume BLOWERS
 75 C.F.M. \$10.95
 150 C.F.M. \$13.95
 300 C.F.M. \$17.95
 500 C.F.M. \$36.00
 Top performance for forced draft, ventilating, exhausting, cooling, drying, 110v. AC.

"Janitrol" AIRCRAFT HEATERS

Warms up fast—just the thing for heating trucks, buses, garages, etc. Has an output of 50,000 BTU's per hr., 24 volts DC. Length 23", diameter 13", weight 14 lbs. Original cost \$130. Our price, NEW \$19.95

LIGHT PLANTS

300 Watt 110-220 volt AC. Wgt. 40 lbs.—portable \$9.95
 750-1000 Watt 110v. AC Briggs & Str'n. eng. \$169
 1000-1200 Watt 110v. AC only \$194.00
 2500-3000 Watt 110v. AC Slow speed (1800 rpm) Lealand generator for longer life. Recond'nd and fully guaranteed \$295. NEW \$345
 Plants built in 1951 with tools & spare parts. \$425.
 3 KW Plant, 120 v. 60 cycle AC. Lists at \$1800. Our Price \$795. Extra parts & tools \$25. 2 reels of cable & switch \$115. Plant, cable & parts complete \$895.

54 to 1 BOSTON Speed Reducer

Reduces speed of ordinary 1750 rpm electric motor to 33 rpm. Lists at \$55.00. Our price \$29.50

80-1 ratio Gear Reducer

Double reduction, reduces 1/6 to 1/2 HP electric motor's 1750 rpm to 22 rpm. Reg. \$45.00, NOW \$22.00

RUBBER HOSE

Long wearing GOOD-RICH 2 ply 2" I. D. 25 ft. lengths worth \$25. Only \$4.95. 3 lengths for \$12.00

SENSATIONAL POWER HAND WINCH VALUES

For—BOATS, TRUCKS, FARMERS, LOGGERS, CONTRACTORS, ETC. Hand winch, 3-1 ratio, 600 lb. pull, drum has 1 1/2" spool, 6" flange, takes 75' of 3/16" cable, stop locking pawl, wgt. 26 lbs. \$16.95
 Ball Bearing Hand winch, low ratio 1-1, high ratio 3-1, 600 lb. pull. \$29.50
 Same as above with bronze worm gear, 12-1 ratio and hand-brake \$39.50
 1/2 HP electric ball bearing model; releasing brake starts motor, brake on—motor off; compact gear box, 12 rpm drum speed \$135.00
 3/4 HP, same as above, 3" drum. \$165.00
 Heavy duty 10-1 ratio, double drum model with jaw type clutch, wgt. 280 lbs. \$49.95
 CABLE, 1/4" preformed stainless steel aircraft, 100 ft. or less 17¢/ft. Over 100 ft. 15¢/ft.

SEND TODAY FREE CATALOG Hundreds of \$5 saving buys. These are a few of the many items at sensationally low prices!
 Pumps Grinders Drop Cords Generators Fire Pumps Saws Clutches Air Tanks

C & H ELECTRIC MACHINE Co. Inc.

434m W. Juneau Ave., Milwaukee 3, Wisconsin

TALK-SING-PLAY OVER YOUR RADIO
 with the real Radio Mike! Attaches in a jiffy—full instructions given! Swell for "parties"—"cut in" on or "kid" regular network programs or put on your own broadcasts! Amaze your friends—real fun. Beautiful Metallic Plastic 6 in. high!
12 RADIO BROADCAST LESSONS GIVEN with each mike
SEND NO MONEY Just pay postman \$3.99 COD plus postage or send \$3.99 and we pay postage! Radio Mike is available only from us by mail—guaranteed.
 Midway Co., Dept. MPM-12, Kearney, Nebr.

Increase gas mileage!

FREE TRIAL IN YOUR CAR

ABOUT 1/2 MILLION NOW IN USE. Most users who write us swear by them and some report up to 25% more mileage. Many comment on Smoother Motor, Easier Starting, Faster Pick-Up, Better Idling. But some swear at them with "No Improvement" and fire "the little stinkers" back—proving Ganes can and do sometimes fail completely. So we invite you to try "the little stinkers" at "no cost." to see what they will do for you. Make NO deposit. Send NO money. Pay postman NOTHING. TRY BEFORE YOU BUY—10 DAY FREE TRIAL OFFER. You, or your service station, can quickly install them.
 USE GANES 10 DAYS—Check for increased gas mileage which must average 2 or more extra miles per gallon. At the end of ten days send us only \$1.50 per Gane Needle or else send them back and owe nothing! Just send your name, address and the year and make of your car to:
OCTA-GANE, Inc. Dept. MG-12, 605 1/2 W. Las Tunas San Gabriel, Calif.



BUILD IT yourself!

... FOR AS LITTLE AS 42.50 — FULL PRICE!

• Enjoy building your own boat. It's EASY... it's FUN, you save half or more! Cal-Kit "home-assembly" boat parts are factory pre-cut. Anyone can build a Cal-Kit Boat, without special tools. Send for Brochures on complete line. LAMINATED FIBER GLASS... all weather boat protection... optional with all Cal-Kit Boat units. Also available for any boat.



CALIFORNIA KIT BOAT CO.
 742 So. Hill St. • Dept. 106 • Los Angeles 14, Calif.

SUPER DRILL GRINDER



Sharpens round shank drills from 3/32" to 1/2" in diameter, up to 6" long. Grinds old drills like new in 4 different point angles, using hand or power grinding wheels. Money-back guarantee... only \$2.95
 At Dealers or Postpaid

A. D. McBURNEY 317 E. 4th St., Dept. A-24 Los Angeles 13, Calif.

PRINT YOUR OWN POSTCARDS with the GEM Stencil Duplicator. Save Money. Hundreds of uses. FREE TRIAL — Write for Gem Outfit, complete with all supplies and Book of Ideas; sent postpaid. After 10 days pay only \$9.50 or return GEM. Unconditional guarantee. BOND EQUIPMENT CO., Dept. 135, 6633 Enright, St. Louis 5, Mo.

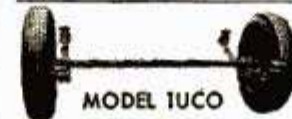

AXLE ASSEMBLIES

Ideal axles for farm implements, carts and trailers of all kinds

\$65.29 Less Tires F.O.B. Factory

Solid steel construction with springs and saddles—U-bolts and shackles—spring bolts and brackets—hubs and bearings and 15" or 16" Wheels—shipped complete, ready for use

HAMMER BLOW TOOL COMPANY

Wausau 13L Wisconsin

POWER HACKSAW \$52.75

LESS MOTOR F. O. B. Benton Harbor

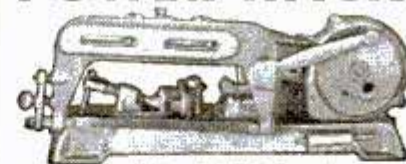

• Rugged cast iron construction. Wt. 56 lbs. bronze bearings. Draw cut. Auto. return lift. Auto. shut-off. Vise swivels 45°. Cap. 4"x4".

Send for full details and name of nearest dealer.

EXCEL MACHINE TOOLS Dept. PM-122 BENTON HARBOR, MICHIGAN

make your own Gems 29.50

The Gem Maker comes complete with all necessary equipment, including a super-charged diamond blade for sawing, and all wheels for grinding, shaping and polishing; also complete instructions. The complete equipment as shown, less motor and belt, for only \$29.50, f.o.b., Burlington, Wisconsin. Write today for information and literature.

B & I MANUFACTURING CO. Dept. S Burlington, Wis.

Say You Saw It in Popular Mechanics

Surplus

New and Used!

Pneumatic Rivet Hammers Pneumatic Drills
 Pneumatic 1/2" Impact Wrenches

\$10.00 AND UP

C.O.D. Satisfaction Guaranteed

BROWN TOOL MFG. CO. 9422 TRENTON ST. LOUIS 14, MO.



MOST POWERFUL SAW of its kind!

Very Quiet Operating!

CUTS 1" SOFT WOOD, THIN METAL, PLASTIC!

Ideal for Cutting TILE of Rubber, Linoleum, Metal!

Syncro's newest Electric Jig Saw—No. 201—is so powerful it cuts 1" soft wood—so quiet operating it's ideal for apartment as well as workshop use. Smooth cutting eliminates sanding! PORTABLE. Stroke adjustable! Arm adjusts for any length cut! Thousands used in schools, hospitals, homes. Get this sturdy, quality, precision-made tool with new BUILT-IN Reactance Electric Motor, only \$24.95 at dealers or postpaid from factory. Saw GUARANTEED by World's Largest Makers of this type saw!

NEW RED ROCKET JIG SAW!

Amazing! The new safe jig saw for children that cuts 1/2" soft wood, thin metal—SAFELY. Train your child to use tools safely with SYNCRO RED ROCKET. Motor Built-In, only \$14.95 dealers or postpaid from factory.



No. 801
\$14.95



Patented

No. 201
\$24.95

COMPLETE with new BUILT-IN Reactance Electric Motor

SYNCRO
Electric Jig Saws

No Sanding Necessary
... Sands as It Cuts!

Power Unit Guaranteed Against Burn-out during OWNERSHIP or Replaced FREE!

SYNCRO CORPORATION, Dept. D-122, Oxford, Mich.

MAKE ANY SIZE FOLDAWAY TABLE, WORK BENCH ETC.

with **FOLDAWAY** TUBULAR STEEL FOLDING LEGS!

COMPLETE 30" LEGS \$7.98 PLUS POSTAGE

FOR 12" WEIGHT OR SHIPPED EXPRESS COLLECT ORDER TODAY!

SHIPPED COMPLETE, READY TO FASTEN TO YOUR TOP IN A MINUTE • FOLDS FLAT, EASY TO CARRY AND STORE • RUBBER TIPPED • MAKE A SMART PING PONG TABLE, BATHROOM ENTRANCE, DISPLAY, MODEL TRAIN, PICNIC OR BANQUET TABLE

FREE CIRCULAR

THE DIAMOND MFG. CO. Dept. P.M. 1100 ALTAMONT AVE. SCHENECTADY 7, N. Y.

XMAS TREE FLOCK white only \$1.25 lb. Fireproof adhesive \$0.55 quart. \$1.55 gallon. Special prices and equipment to volume users. Flock equipment and supplies all colors in rayon \$1.45 lb. Adhesive tinted to match for all purposes \$1.25 quart. Electric Flock Gun, jet type, complete. A.C. D.C. \$21.50. All shipments prepaid.

ELSTON PAINT & SUPPLY COMPANY
4181 Elston Avenue Chicago 18, Illinois

WAR SURPLUS BARGAINS

WAR SURPLUS BARGAINS

\$500,000.00 INVENTORY FOR QUICK LIQUIDATION

Surplus items—hundreds of them for home, shop, factory, farm and outdoor use. New items, used items, reconditioned items—all at tremendous savings—all priced for quick sale.

Page After Page of Values

This big catalog shows page after page of amazing money saving values. Write for your copy today. Send 10c to cover postage, mailing, etc. Write today!

SEND TODAY FOR YOUR COPY **10c**

STARK'S Dept. PM 1252 509 So. STATE STREET CHICAGO 5, ILLINOIS

SAVE MONEY • SAVE FUEL • BE WARMER

STORM WINDOWS

OF GENUINE **DUPONT** CELLULOSE ACETATE

- CLEAR AS GLASS No cloudy vinyl plastic effect—but as transparent as the windows it covers.
- INSTALL IN MINUTES . . . FROM INSIDE Scissors and Scotch tape are all you need. No climbing ladders for outside installation! No marring of window sills with tacks. Simply tape on . . . as easy as mending a page!
- PERMITS AIRING OF ROOMS Just lift off tape when open window is desired . . . Replace when window is closed.

5 WINDOWS for \$6 POSTPAID



100% AIRTIGHT — Used by the U.S. Gov't. Fit any window. Roll size 36" x 288". Sheets easily taped together to cover wider windows. Completely waterproof . . . Instructions furnished. They'll pay for themselves many times over in fuel savings alone. Fill in and mail the coupon TODAY.

SEND NO MONEY!

Pay Postman YOUR MONEY BACK IN FULL IF RETURNED IN 10 DAYS

T. C. TOR, 2113 Bellevue St. Phila. 40, Pa., Dept. PM 3

GENTLEMEN: Please ship immediately () rolls (ea. roll 36" x 288") — at \$6. per roll of TOR Plastic Storm Windows . . . ea. roll enough for five average size storm windows — with instructions.

() I will pay postman \$. . . plus few cents postal collection fee.

() Am enclosing payment herewith (saving collection cost)

Name

Address

City

ONLY ONE SALE CAN PAY YOU UP TO
\$16.50 A DAY!



Showing Car Owners
 America's Greatest
 Auto Seat Cover
 Values Including

BAMBOO

NEWEST SEAT COVER SENSATION

BIG MONEY FULL OR SPARE TIME

Want extra money—plenty of it day after day? Then rush your name and address at once for Free Sample Outfit that will start you taking orders from car owners everywhere for Key expertly tailored Auto Seat Covers. **EXCLUSIVE NEW PATTERNS** to fit every make and model car. No one can compete with you, in wide choice, in quality—and in expert tailoring that makes covers fit like a pair of gloves—and when you quote prices that are only a fraction of what the customer expects to pay, brother! You make money hand over fist writing up the fast orders! Line includes nationally advertised sensations like **BLACK EBONY** Saran, beautiful **BAMBOO**, brilliant **FIESTA**, colorful **BULL FIGHTER PLAIDS**, plus many other exclusive patterns to choose from, all at unbelievably low prices.

Rush Name for FREE Outfit!

Give **MAKE, YEAR** and **MODEL OF YOUR CAR**. No experience needed. Make all the extra money you need easily just by showing! Every car owner a "hot" prospect. **YEAR AROUND STEADY PROFITS**. No investment to make. Actual seat covers given to producers for **OWN USE!** Write for Free Selling Kit valued at \$2.00 and actual samples **TODAY!**

KEY PRODUCTS CORP., Dept. 412

800 N. Clark St.

Chicago 10, Illinois

STOP THAT GAS HOG!

REDUCE:

- POWER LOSS
- FUEL WASTE
- FLOODING
- STALLING

**NEW FUEL REGULATOR
 CUTS GAS COSTS UP TO 25%**

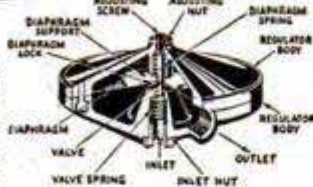

Many users claim up to 25% better mileage with this revolutionary new accessory as it stops gas waste caused by excessive fuel pressure. This new precision regulator eliminates carburetor flooding and fuel surge due to erratic fuel pump operation. Installs easily in the fuel line between the fuel pump and the carburetor. Gane-Master smooths fuel flow, prevents vapor lock, stops the annoyance of stalling, flooding and fire danger. It is made of durable highly polished aluminum alloy. Features a highly sensitive large diameter diaphragm pressure-spring balanced for extreme accuracy. Gane-Master fuel pressure regulator pays for itself many times over . . . by gas savings . . . by eliminating frequent carburetor adjustment . . . by reducing engine and carburetor wear! Easy and foolproof to install. Fits all makes of cars and trucks. 30 day money-back guarantee.



Gane-Master Fuel Pressure Regulator

COMPLETE UNIT **\$5.95** Postpaid

(Or send \$1.00 deposit, balance C.O.D.)

Dept. BX-12
 5801 E. Beverly Blvd.
 Los Angeles 22, Calif.

ENGINE PRODUCTS CO.

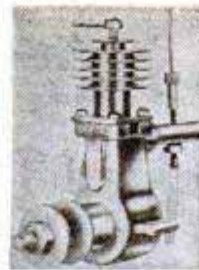

Our 553rd Advertisement

REAL DIESEL ENGINE

\$3.95 • for planes, boats, midget cars
 • 7500 RPM; 1/7 HP; ht. 3 1/2"; wt. 5 oz.
 • Precision machined for smooth operation

You just can't beat this price for a precision diesel engine! Streamlined, compact, easy to install. Thousands of satisfied users all over the world. Fast delivery if you **ORDER TODAY!** Send \$3.95 plus 25c postage. Engine is completely assembled, and includes all engine parts including: crankcase, crankshaft, connecting rod, piston, cylinder and carburetor.

ORDER TODAY! FAST DELIVERY!

GOTHAM HOBBY CORP. Dept. P, 107 E. 126th St. New York 35, N. Y.

FREE CRAFT CATALOG



120 PAGES... Craft Supplies, Tools, Designs, Instruction Books from America's Largest, Most Complete Handcraft Stock.

Send for your free copy NOW!

GRIFFIN CRAFT SUPPLIES

5626-A Telegraph Ave • Oakland 9, Calif.



OWN WORLD'S FINEST CRYSTAL RADIO

\$8.95 COMPLETE Money Back Guarantee KIT

Plays anywhere. Needs no tubes, batteries or electric current. Gets distant stations clearly. Head phones, aerial kit included. Nothing else to buy. Assembled in minutes. Big 5"x4 1/2"x6 3/8" table model size. Send \$1.00 deposit now, we'll mail C.O.D. for balance. Ideal for Christmas Gift giving. Order NOW!

JAEGER & CO.

P. O. BOX 246J SKOKIE, ILL.

FREE BOOKLET

New Household products. Wide variety . . . many uses for home and farm. Some products just from Patent Office. Excellent gifts.

SEND TODAY KEEP INFORMED

WHAT'S NEW PRODUCTS

1931-C 3rd AVE. BESSEMER, ALA.

Make Money Selling
ESHELMAN
 Car
 Snow Plows
 & Plowing
 Snow From
 Roads &
 Driveways



CLEAR SNOW PLOW
 CLEARS ROADS & DRIVEWAYS

Fits any car, jeep, truck. Attached in 2 minutes. Clears snow 24" deep and full width of car. Light weight, sturdy. Order by mail. Or send for Folder.

\$79.95 COMPLETE

Eshelman Co., Dept. 5-612
 119 Light St., Balto. 2, Md.



WARN HUB CAP MAKES 2 JEEPS OUT OF 1

Ends front wheel drag on all 4-wheel drive Willys and Dodge vehicles

Willys \$20.00
 Dodge \$23.00
 Ppd. U.S., Canada

Saves gas up to 5 miles per gallon, tire wear, front axles, increases speed and power. Stops shimmy—front wheels coast out of gear! 4-wheel drive handles, performs, climbs like 2-wheel. Install or remove **WARN HUB CAPS** in 10 minutes. Polished aluminum, guaranteed. Rush check, M.O., or C.O.D. Write for circular.

WARN MFG. CO., P. O. Box 6064A, Seattle 88, Wash.



Clark EXPANSIVE BIT

CUTS BETTER • COSTS LESS!

Accurate, fast; cuts smooth holes in hard or soft wood. Chrome vanadium steel blades, all chrome body. No. 250, 1/2"-1 1/2", \$1.89; No. 251, 3/8"-3", \$2.19. **GUARANTEED.** At your dealer or write Dept. PM12

ROBERT H. CLARK COMPANY • Beverly Hills, California

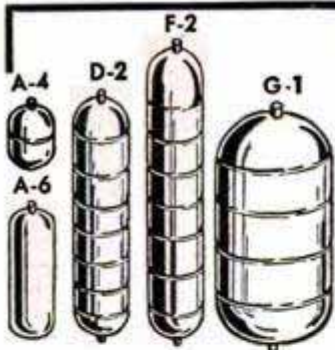

STEEL AIR TANKS

Steel pressure tanks suitable for compressors, pneumatic units, gases, hydraulics, and liquids. Rated at 500 lbs. per square inch pressure. 1/4" standard pipe thread openings on tank ends as shown.

	Size	Wt. Lbs.	Internal Volume	Price
A-4 Carbon Steel — New	7 1/2" x 5 1/4"	1 1/2	104 cu. in.	\$1.50
A-6 Carbon Steel — New	14 1/2" x 5 1/2"	3 1/4	280 cu. in.	3.50
D-2 Stainless Steel — New	24" x 6"	5	500 cu. in.	5.50
D-2A Carbon Steel — New	24" x 6"	5	500 cu. in.	4.50
F-2 Stainless Steel — New	45" x 6"	11	1000 cu. in.	9.50
F-2A Carbon Steel — New	45" x 6"	11	1000 cu. in.	8.50
G-1 Stainless Steel — New	24" x 12"	18	2100 cu. in.	11.50
G-1A Stainless Steel — Used	24" x 12"	18	2100 cu. in.	9.50

Prices F.O.B. Chicago. Include approx. postage on orders paid for in advance. C.O.D. orders enclose 25%, balance sent C.O.D.

U. A. S. Corp. Dept. PM12, 5637 W. 63rd Pl. Chicago 3, Illinois



CAPE COD CHAIRS TRELLISES • ARBORS DUTCH WINDMILLS

Chairs style B-C-A PLANS 50c Ea., all 3 only \$1.00. 12 different trellis designs PLAN of all 12 only 50c. A-PLAN only 75c. Unique

40" high Dutch Windmill Detailed PLAN only 75c. Unique 40" high Lighthouse having copper lantern, ideal for garden or on lake shore of summer home. Large detailed PLAN 75c. SPECIAL all plans above \$3.00 val. Only \$2.50. Send 10c for catalog

Craftsman's Model Co. Dept. P47 DELAFIELD, WIS.

60 POWER TELESCOPE \$3.95

VARIABLE EYEPIECE 20 x 40 x 60 — BRASS BOUND

Three telescopes in one. 3 different magnifications. 20 power for ultra-bright images with 40 and 60 power for extra long range. Guaranteed to bring distant objects, people, sports events, ships, moon, stars, etc. 60 times as close.



Most powerful for anywhere near the money. 5 sections. Closes to 1 ft. long. Contains 4 ground and polished lenses. Also used as a powerful compound microscope. Directions included. Mass production enables us to offer this instrument at amazing price of \$3.95 complete. Ready for immediate use. We pay postage. Get yours now.

CRITERION CO. 331 CHURCH ST. HARTFORD 3, CONN. DEPT. PMB9



You'll be happier
in a **FORD**



Revolutionary!

SQUARED CIRCLE SAW BLADE

YOU CAN RIP AND CROSSCUT FASTER WITH THIS SENSATIONAL "SQUARE" SAW BLADE

No other saw blade like it! Unique design reduces number of teeth to minimum...means less friction... keeps blade and motor cooler. Fewer teeth to sharpen. Blade has hard chrome finish...stays sharp longer. Available in all standard round arbors and to fit most portable electric saws.

5-7/8" or 6" ... \$4.45 7" or 7-1/4" ... \$4.95
7-1/2" or 8" ... \$5.90 8-1/4" ... \$6.30
9" or 10" ... \$7.50

ABOVE PRICES POSTPAID. (C.O.D. POSTAGE EXTRA)

SEE YOUR DEALER OR WRITE DIRECT

CLARK & SAWYER, INC.

2012 E. Seventh St. • Los Angeles 21, Calif.



Gift
Wrapped

The black head
and red
handle
—exclusively
PLUMB

in brightly colored
cellophane sleeves.
Please him with a
Plumb Tool — the
gift he'd choose, the
present he'll use.



The Plumb Axe for
your outdoorsman
—it will last a
lifetime.

Man or boy, he'll
appreciate this
Plumb
Hatchet.



Quality Comes **FIRST**
PLUMB
is **FIRST** in Quality

PLUMB

HAMMERS • HATCHETS • AXES • FILES

9 HANDY TOOLS IN 1 Outstanding MOTOR-WELD

1. WELDS
2. BRAZES
3. GRINDS
4. SANDS
5. POLISHES

Has four speeds and welds to 3/16" steel. Uses up to 3/32" rod. (75 amps.).



MOTOR-WELD MODEL 1-A
Comes as illustrated above.

6. BUFFS
7. BRUSHES
8. MOTOR DRIVE
9. QUICK BATTERY CHARGER

Ship. Wt. 40 lbs.
Price F. O. B.
Chicago, Ill. **\$54.75**

Quick Battery
Charger Attachment. \$5.00 Extra.

Here's an economical Combination Tool that's vitally important to any shop—garage—service station—plumber—holler man—farmer—or home workshop. MOTOR-WELD has a SELF-CONTAINED MOTOR GENERATOR just like the large industrial units—just plug into any 110 volt AC or DC line and it's ready for use. Easy to take to the job. Can be used straight or reverse polarity. Its PORTABLE power unit can be used to operate saws, planers, sanders, etc. MOTOR-WELD Machine starts an arc easier than most welders—especially with 1/16" rod on light gauge metal. Other models available (150 amp.—225 amp.—Cart Models, Etc.).

Send for FREE Literature
30 DAY WARRANTY ON ALL MACHINES
10 DAYS FREE TRIAL

Send remittance with order: will ship C.O.D. (\$15. deposit)

GENERATOR SALES COMPANY

1627 N. DAMEN AVE., DEPT. A CHICAGO 47, ILL.



TEST Circuits,
Fuses, Outlets
easily, quickly, safely.
Shockproof. Pull fuses
10 to 100
Amp.

\$2.75

\$1.50 add'l for 2 ft.
leads. At dealers . . . or
order direct from us.
Mailed POSTPAID

STAR FUSE CO., 233 Canal St., New York 13, N. Y.

SEND ME



every month so I am sure to
see each new issue. Here's

- \$3.50 for 1 year
 \$8.00 for 3 years

name _____

address _____

city _____

zone _____

state _____

B-122

Hand this order to your newsdealer or send it to

POPULAR MECHANICS
200 East Ontario St. Chicago 11, Ill.

400-Horsepower Chrysler V8 Hits 170 M.P.H.

(Continued from page 101)

replaced the dual type used in production engines; valve timing was modified to keep intake and exhaust valves open longer; a streamlined exhaust manifold replaced the production type; pistons were projected slightly into the combustion chamber.

It has been declared by Pres. L. L. Colbert of Chrysler Corporation that this company has no desire to enter into a speed-horsepower race. He expresses the hope that such a race may be averted. But with

SPECIFICATIONS

CHRYSLER FIREPOWER INDIANAPOLIS ENGINE

Horsepower: More than 400 @ 5200 r.p.m.
Block: Standard Chrysler FirePower
Head: Standard except for larger ports
Bore and stroke: Standard, 3 1/16-in. bore; 3 5/8-in. stroke
Displacement: Standard, 331 cu. in.
Crankshaft: Standard forging, improved alloy
Connecting rods: Standard design, strengthened
Engine bearings: Standard, commercial, Dodge truck
Rocker arms and push rods: Standard
Tappets: Mechanical Camshaft: Modified
Pistons: Standard, with domed head
Gaskets: Standard Ignition: Magneto
Oil supply: Dry sump
Clutch and transmission: Meyer & Drake
Rear-axle ratio: 3.03 to 1 Chassis: Kurtis-Kraft

this ultimate hemispherical combustion chamber engine, it is obvious that we fear no challenge. Already we have demonstrated that we can go far beyond anything ever before attempted for passenger-car service and we are confident that we have by no means reached the limit of this power plant's possibilities.

It should be understood that higher horsepower for the mere sake of higher speed is not the objective of Chrysler Corporation engineers. The top speed of cars equipped with the FirePower engine is not so much greater than that of comparable displacement cars of an earlier date. We have instead used the potential of the new engine to attain vastly improved low and cruising-speed performance, economy, sturdiness and dependability.

The maximum-torque figure, which is the engineer's index of normal-speed performance, is 16 percent higher in the new engine than in the 135-horsepower straight eight that preceded it, and it is attained at higher engine speed, giving far greater acceleration in the highway cruising range.

There is no question that such agility at normal cruising speeds is a real contribution to road safety. A car which can accelerate swiftly from 40 to say 50 or 60 miles an hour is a car that can whisk itself from impending trouble that would bring disaster to a car of lesser capacity. ★ ★ ★

SHARPEN CIRCULAR SAWS LIKE AN EXPERT



Precision filing easy without experience. Two simple adjustments. Keeps hollow-ground, cross-cut, combination blades true cutting. Fits 6" to 12" blades with 1/4" to 13/16" centers. Complete with file. Money back guarantee. Cash with order, prepaid. (COD postage extra.) Order today. **\$6.95**

\$6.95

ANOTHER SPEEDCOR TOOL
The Speed Corp. PM-12
512 N.E. 73 Ave., Portland 16, Oregon

NEW INVISIBLE WOOD FASTENERS

Especially Designed for Countersinking
New type "CHEVRONS," 3/8" depth for hard and soft woods of thicknesses up to 2 1/2". Draws wood together. Just hammer in and countersink instantly with Chevrons Countersink. Illustration shows slots filled with putty. Prevents rust. At your dealer or send only \$1.00 for 100 "Chevrons" postpaid. Add 35c for countersinking tool. Money back if not delighted.

E. B. PACKARD CO., Inc., Dept. PM-11
139 CEDAR ST., NEW YORK 6, N. Y.

DO MORE PLANING JOBS WITH LOW-COST BELSAW

AMAZING 12 1/4-IN. PLANER Does All Ordinary Planing Mill Jobs. Provides attachments for Jointing, Rabbeting, Tongue, Groove, Matching. 12 1/4 x 6-in. capacity, 3-knife solid round all-steel cutterhead. Power feeds at 24 feet per minute, 42 cuts per inch. Provides for full line of accessory attachments—Grind and Joint knives IN THE CUTTERHEAD WITHOUT REMOVING.
BELSAW MACHINERY CO
1019 Field Bldg., 315 Westport Rd., Kansas City 11, Mo.

JUST OUT!
1953 EDITION
It's New! It's Different! Get world's largest Auto Accessory & Parts Catalog and save money. Over 50,000 items, including Hollywood Accessories, Hi-Speed Equipment, Rebuilt Engines, all parts & accessories for all cars & trucks. We have that Hard-To-Get part! Jam packed with bargains. Completely illustrated. (124 pages) Send 25c (refundable).
J. C. WHITNEY & CO., 1917-XP Archer Ave., Chicago 16, Ill.

PROCESS 33 INSTANT PAINT BRUSH CLEANER

NEW, IMPROVED CALCULATOR FOR WOODWORKERS only 25c
Instantly gives information on lumber, nails, concrete mixes, painting materials, etc. Convenient, simple to read. Just set dial for nail specifications, to convert linear to board feet, find bit sizes for screws, compare characteristics of woods. 6" diameter heavily varnished cardboard. Send 25c, no stamps, please to Greenlee Tool Co., 2112 Columbia Avenue, Rockford, Illinois.

GEARS
In Stock - Immediate Delivery
Gears, speed reducers, sprockets, thrust bearings, flexible couplings, pulleys, etc. A complete line is carried in our Chicago stock. Can also quote on special gears of any kind. Send in your blueprints and inquiries.
Send for Complete Catalog No. 10 CHICAGO GEAR WORKS
440-50 N. Oakley Blvd., CHICAGO 12, ILL.

RETAIL PRICE \$125.00
FACTORY TO YOU \$79.95
SUPERSHOP includes precision-built 8" tilting table saw, vertical and horizontal drill press, 30" lathe, sander, grinder. 100% BALL BEARING. Write for FREE catalog, full details, trial plan. Easy Pay Plan.
POWER TOOLS, INC.
142 YATES AVENUE
BELOIT, WIS.

I need 500 Men

To Wear and Show
Made-to-Measure SUITS



Pay No Money—Send No Money

My values in made-to-measure suits are so sensational, thousands of men order when they see the actual garments. I make it easy for you to get your own suit to wear and show—and to **MAKE MONEY IN FULL OR SPARE TIME!** My Plan is **Amazing!** Just take a few orders at my low money-saving prices—that's all—and get your own personal suit, and make money fast taking orders. You need no experience. You need no money now or any time. Just rush your name and address now for complete facts and **BIG SAMPLE KIT** containing 150 ACTUAL woolen samples. It's **FREE!** Send your name and address **TODAY!**
STONE-FIELD CORP., Dept. P-816
532 S. Throop Street, Chicago 7, Ill.

BUTANE-PROPANE GAS ON YOUR CAR

Save up to 1/2 and get powerful Hi-Octane operation! Simple combination system (easily installed) can switch to gasoline instantly while running! Equipment for all cars—trucks.
SEND \$2.00 for our complete "How to do it" booklet, instructions, photographs and special prices. (refunded on parts order) **ORDER NOW — TODAY.**
LPG PRODUCTS CO., Dept. PM-12, KEARNEY, NEBR.

NOW! Give your Car That Look of the Future!

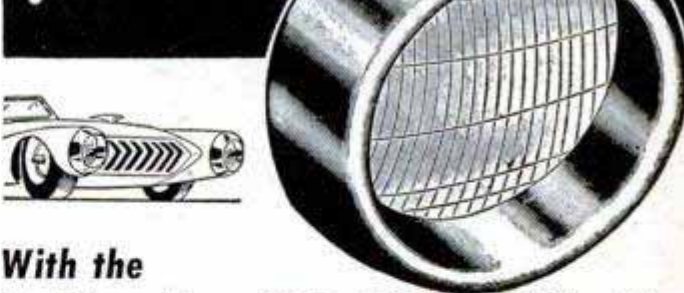

With the Exciting, New "BIG EYE" Headlite Rims

Here it is! The New Sports Car Sensation... the "Big Eye" Headlite Rims that will give your car that new, modern look. Easily installed—no holes to drill. One style rim fits about 85% of all cars with round rims.
FITS:
Buick1949-52
Cadillac1948-49
Chevrolet1949-52
Chrysler1949-52
Dodge1949-52
De Soto1949-52
Ford1941-48
Hudson1949-52
Kaiser-Frazer .1947-52
Mercury1941-48
Nash1949-52
Oldsmobile ..1948-52
Plymouth1949-52
Packard1948-52

- Gives a sensational, racy look to old cars and new cars.
- Gleaming triple plate chrome and beautiful gold metallic plastic.

CHROME, Per Pair.....Postpaid \$5.95
GOLD METALLIC PLASTIC, Per Pair Postpaid \$2.95

TOPAZ SALES CO., Dept. PM
203 S. Michigan Ave.
Chicago 16, Ill.
Enclosed find check or money order for \$5.95 for 1 pr. Chrome "Big Eye" Headlite Rims \$2.95 for 1 pr. Gold Metallic Plastic "Big Eye" Headlite Rims
Name _____
Address _____
City _____ State _____

FREE CATALOG OF GOV'T SURPLUS

Complete Power Tool Accessory Set



100 pieces \$4.98

Post. & Hand. 50c
for all 1/4" capacity
Electric Drills and
Motor Chucks. Kit
Contains: Grinding
Wheels, Drills, Reamer,
Mounted Stones,
Polishing Compound,
Buff, Arbors, Rotary
File, Steel Cutters,
Circular Saws, Cutoff
Wheels, End Wire

Brushes, Polishing Wheels, Honing Stones, Sanding Cloth and
Paper, Wire Wheels, Sanding Discs, and other useful items.

ELECTRIC Handi-Sprayer

Latest! The only PRECISION-BUILT
Sprayer of non-corrosive materials on
the market today! WITH A LIFE
TIME SERVICE GUARANTEE.

Features adjustable SWIVEL nozzle.
Ideal for use with Paint, Varnish, Lac-
quer, Insecticide, Disinfectants, Water
and Water Based Chemicals. 110 volt,
A.C. only.

898

Post. &
Hand. 50c



PENCIL SHAPED true tempered TOOLS



ideally suited for working in almost
every medium Metal, Plastic,
Wood, Leather, Clay, Stone, etc. Our
set of 8 NEW GOV'T SURPLUS DEN-
TAL INSTRUMENTS worth almost \$20.00, yours for only 1.98

150 PIECE grinding, polishing, buff-
ing and sanding Kit for only 98¢



Post & Hand. 20c

Kit contains: 3/4" Circular Saw with Mandrel, 2 Mounted Stones,
2 Burs, 2 Honing Stones, Unmounted Grinding, Rubber, Cut Off
and Felt Wheels and Cylinders, Cloth and Paper Sanding Discs,
and 2 Mandrels to accommodate the unmounted items.

BARGAIN MIXES—All New Merchandise	Add Post & Hand.
Set of 12 New Files up to 14".....	\$2.99 50c
10 ass't Taps up to 5/8".....	1.98 25c
15 ass't Drills up to 5/16".....	98c 20c
6 ass't Round Dies 11/16" to 2" outside dia.	1.98 25c
5 ass't Taper Pin Reamers 1/4" shanks.....	1.98 25c
\$10.00 list value of Abrasive cloths.....	98c 25c
100 ass't 1/8" and 3/32" shanks mounted stones and steel cutters....	9.98 50c

Dental Specialty & Sales Co., Dept. PM12 P.O. Box 692, Great Neck, N.Y.



MAGNETS 225 lb. PULL

GENUINE ALNICO—NEVER WEAKENS

AMAZING, PERMANENT MAGNETS— WILL NOT WEAKEN; NON-ELECTRIC

Retrieve guns, tackle, tools and other steel items from lake, river,
plating tanks, drains or other hard-to-reach spots. Recover drills, taps,
etc. from sweeping. Clear alley of harmful tacks, nails. Many other
uses. Pays for itself quickly. GUARANTEED. Try any magnet one
week. Money refunded if you are not well pleased.

No. M-725 (Weights 54 oz.) Has pull of 225 lbs. on steel block.....	\$15.00
No. M-675 (Weights 49 oz.) Has pull of 175 lbs. on steel block.....	\$10.50
No. M-650 (Weights 41 oz.) Has pull of 150 lbs. on steel block.....	\$ 8.50
No. M-30 Hobbyist assortment of six small magnets.....	\$ 1.50

Send Money Order or Check. We pay postage. No C.O.D.'s.
MIAMI MAGNET COMPANY 3240 N. W. 27th Ave.
MIAMI 42, FLA.

HANDY-DAPTER \$3.00

PREPARED IN U.S.A.
CONVERTS ANY 1/4" CHUCK TO 1/2"
IN A JIFFY. PROVIDES MORE USES FOR YOUR HAND OR ELECTRIC DRILL,
DRILL PRESSES, LATHE, FILE SHAPERS, ETC. ORDER DIRECT FROM:
CRAFTSMAN'S SUPPLY CO. 128 ARIZONA ST.
ALBUQUERQUE, NEW MEXICO

NEW GLUE INJECTOR COMPLETE WITH DRILL

Drill in handle makes a
tiny hole to heart of joint
— plunger forces glue
through hollow tip and hole
into and around joint under great
pressure. Mends furniture and toys quickly, cleanly and without dis-
assembly. Model Worker's Dream. Satisfaction Guaranteed. \$1.50
ppd. Sorry no COD's.

ARTCRAFT PRODUCTS CO., Box 867P, Cleveland 22, Ohio

SPECIAL! ELECTRIC TRAIN!

Finest American Flyer "Santa Fe" Passenger Train
2 ft. Diesel — Alum. Finish Cars — Whistle —
Interior Lighting.
List Price \$69.50—OUR PRICE... \$59.50
Send Check or M.O. to: **WEST SALES CO.**
Dept. A., P.O. Box 54 P. Stuy. Station, N.Y. 9, N.Y.



BARRON Drill Press TOOLS



FOR WORKSHOP AND
INDUSTRIAL USES...

Over 40 precision built woodworking tools
and accessories... Hi-Speed Router Bits—
Rotary Surface Sanders & Drum Sanders
—Safety Shaper Cutters—Dovetail Cutters—
Large Auxiliary Metal Tables—All Metal
Shaper Fences—Spindle Adapters—Handy
Bench Vises. Many other items indispensable

ROTARY PLANER

Planes • Rabbits
Tenons • Panels
Routs • Bevels

Only \$7.50
COMPLETE

for accurate, useful, versatile work-
shop use. Every tool sold on com-
plete satisfaction or your money
back. See your Barron Dealer.
Ask for special folder — "24
Extra Uses for Your Drill Press."

FREE
Workshop
Guide &
Catalog

BARRON TOOL CO. INC.
365 Architects Bldg., Detroit 1, Mich.

INCREASE COMPRESSION AS MUCH AS 126%

with Fisher's Compression SEAL

• Stop Burning Oil & Check Piston Slap!



Amazing new discovery. Fisher's Compression
SEAL, has been tested and approved by
a leading independent laboratory. Guar-
anteed to increase your car's compression, re-
duce oil consumption and check piston slap
or your money back! Easy to apply. Simply
squeeze a small amount into each cylinder
bore. This self-expanding compound then
seals the excessive clearance between piston
and cylinder wall, thus allowing you to
enjoy former operating efficiency. Lasts
10,000 miles. \$25,000 insurance policy
assures you it cannot harm the finest en-
gine. Only \$3.95 postpaid. Acts while you
drive, costly ring or rebore jobs may not
be necessary. Free folder. Send cash, check
or M.O. Dealers, a postcard will send our
representative to your door.

\$3.95 PPD.

ADVANCED ENGINEERING Box 7013, Dept. PM-12
Los Angeles 37, Calif.

BE YOUR OWN BOSS

Make Hundreds of \$ Spare or Full Time Work

NO EXPERIENCE NEEDED

Here is the ideal business with no previous
experience or large investment required and
no high-priced equipment to buy. A business
that will return dollars for the pennies you
invest.

YOU CAN CAST ANYTHING

With *Flexible Mold Making and Ornamental
Casting*, an amazing fact-packed book, you
learn how you can cast practically any ar-
ticle in concrete, plaster, imitation marble
or any other casting material using a mar-
velous new process. You can make ash trays,
novelties, garden and lawn ornaments and
hundreds of other highly profitable items
that cost you but a few cents and sell for as
much as \$5.00 and more. Why you can even
make true-to-life full-sized busts of your
neighbors and friends.

NO EXPENSIVE MOLDS TO BUY

Why buy high-priced molds from others?
Learn how you can make your own molds
quickly, easily and inexpensively with ma-
terials that can be used over and over. You
get copyrighted formulas, complete instruc-
tions and detailed how-to-do-it photographs
as well as complete sources of supply for
the few inexpensive materials you need. This
is the only book printed in America today
that contains instructions for making pro-
fitable papier-mache casts.

MONEY BACK GUARANTEE

Start on your road to extra income and in-
dependence today. Send only \$3.00 for your
copy of *Flexible Mold Making and Ornamental
Casting*. Complete satisfaction guaran-
teed or your money refunded within seven
days.

POPULAR MECHANICS PRESS, Dept. 46
200 E. ONTARIO ST., CHICAGO 11, ILL.

You can make
simply and
cheaply



BUSTS



GARDEN URNS



NOVELTIES



TILE



STATUARY

**A "Must" Book for Boys of All Ages and
the Greatest Gift Book of All Time!**

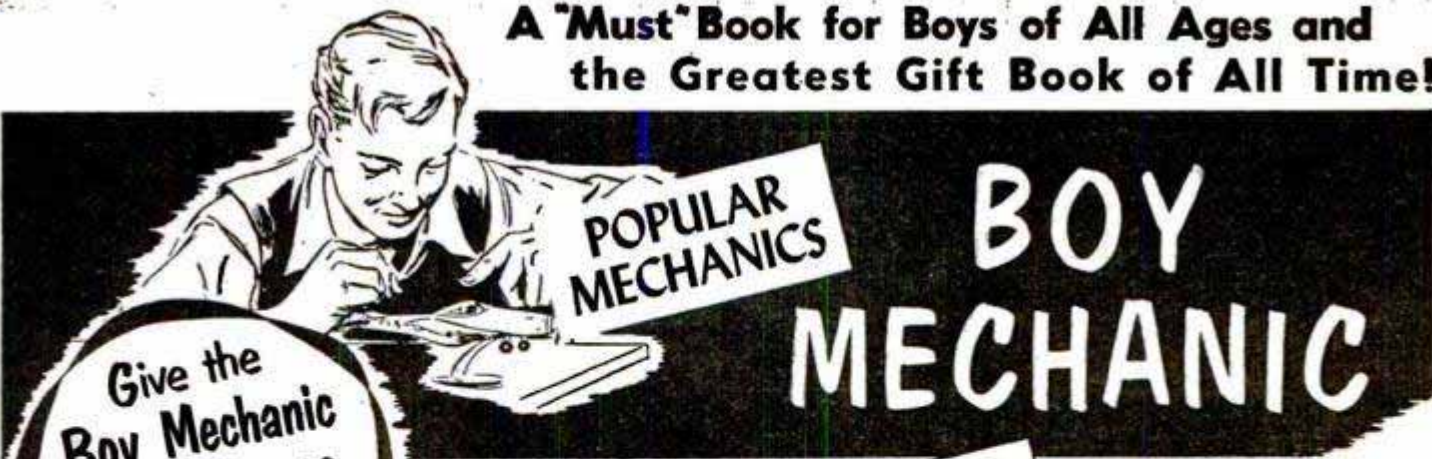

**Give the
Boy Mechanic
for Christmas
and other Gift
Occasions**

**FREE Any Name Stamped
in Gold on Cover**
Any name you wish will be stamped in gold on the
cloth bound front cover FREE if you remit with order

NEW!

Fascinating! Educational!

How to Make Things That Work and Go!

This is it, fellows! Here's the exciting book you have been waiting for. Get the brand new Popular Mechanics **BOY MECHANIC** for yourself or be sure you get it soon for a gift. You know it's the fellow who can do things—make things that "work" and "go" who is the kingpin in every school and neighborhood. Enjoy this popularity yourself. Learn what to do—what to make—how to make it—with the **BOY MECHANIC**. Have fun with outdoor projects and gadgets; models of every type; your own scientific experiments and instruments; all kinds of craft work with wood, metals, plastic, etc; easy to make toys for yourself and others.

Something for Every Place, Time and Season

Think of it! More than 500 wonderful ideas you can use, selected by Popular Mechanics editors. Projects for the home workshop; in camp; on land and water and in the air. Projects for summer and winter and in between. More than 1100 pictures and diagrams show you exactly what to do and how to do it. It's a big, fascinating and helpful book that will give you hours and hours of fun and show you how to make so many of the things you have always wanted.

A Grand Big Book!

**Beautifully Bound
in Library Cloth and
Personalized With
Your Name in Gold
on the Cover**



308 Pages

Packed with fascinating pictures and practical how-to-do-it information on outdoor projects, models and model making, spare time crafts, workshop fun, simplified science, toys, etc.

1100 Pictures

Photographs, Drawings, Diagrams, Plans and Construction Details. The most elaborately illustrated "What to Make" book ever printed.

**Rush Coupon
Today!**

Be the first in your neighborhood to get the **BOY MECHANIC** by mailing the coupon today. Only \$2.95 post-paid. And we'll stamp your name (or any other name if a gift) on the cloth bound cover in gold FREE if remittance accompanies order. Be sure to **PRINT** name for gold stamping and mail order today.

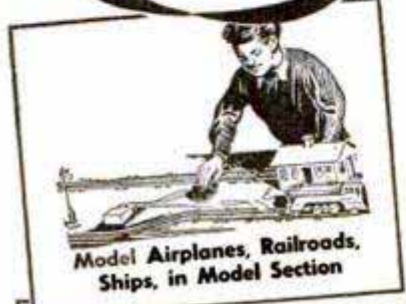

**Model Airplanes, Railroads,
Ships, in Model Section**



**Fascinating Tin Craft,
from Indoor Crafts**

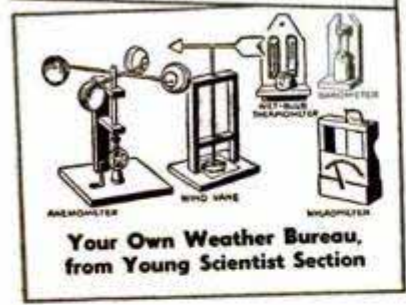

**Your Own Weather Bureau,
from Young Scientist Section**

**Some of More Than 500
Articles in Boy Mechanic**

Build a Soap Box Derby Racer — Coasting in a Sidewalk Jeep — Aero Driven Ice Boat — Eight Repair Kinks for Your Bicycle — Sea Scout Dinghy — Control Line Flying Model Planes — Model Racing Yacht — Model Railway Small-Space Track Layout — Leathercraft — Tin Can Craft — Useful Articles from Hammered Copper — Jackknife Animal Carving — Easy to Make Hand Puppets — Art With the Typewriter — Dog Quonset Hut — Bird Houses and Cages — Home Laboratory Short Cuts — Your Own Weather Bureau — Toy Electric Motors You Can Make — Fun With Common Gases — 100 Power Microscope — Six-in-One Puzzle — Magnetic Theatre — Turkey Hunt Dart Game. And hundreds of others.

**POPULAR MECHANICS PRESS, Dept. 111
200 E. Ontario Street, Chicago 11, Ill.**

Send me at once _____ copies of the **BOY MECHANIC** at \$2.95 each.

- Remittance enclosed. Stamp name in gold and send postpaid.
- Send COD. I will pay postman plus delivery charges.

Name _____

Address _____

City _____ State _____

Print name on this line for gold stamping. Use margin for additional names.



**NO WIRES! TALK! SING!
GAGS! THRU YOUR RADIO!**

**Portable Home
TRANSMITTER
Only \$9.95**

Own this amazing broadcast outfit. Complete short range transmitting station in miniature! Broadcasts without wires to any radio within 75 ft. Sound quality marvelously clear and life-like. Your voice comes thru radio as from a local station.

Microvox is simple, easily operated. Watch-like precision and a high-fidelity microphone . . . an instrument you'll be proud to own!

**HUNDREDS OF USES IN HOME,
BUSINESS, SCHOOL, OR CLUB**

Sing, play instruments, make sound effects, use records. All the family can listen. Have Quiz Shows, Dramatics, Round Table Discussions. Fool family and friends with fake broadcasts. Practice music and voice control **Right Over Your Own Radio!** Microvox can pay for itself many times over as an Intercom, Baby Listener or Public Address System in small auditorium.

- Includes:
- Vacuum Tube
- Switch
- Tuner
- Microphone
- 22½ Volt &
- 1½ Volt Batteries
- Condenser
- All Self-Contained

24 Hour Trial

Full instructions accompany each Microvox. Send only \$1. Pay postman \$8.95 plus small COD postage (or remit \$9.95 and we pay postage). **ABSOLUTELY GUARANTEED** on money-back basis.

FREE—SOUND EFFECTS MANUAL with each Microvox (limited time only). Over 25 ways to make startlingly realistic **SOUND EFFECTS** . . . fire, storm, crash, pistol, etc. Learn the Radio Sound Effects business. A world of fun. Don't delay. Send your name, address and \$1 now.

MICRO-SOUND CO., Dept. PMD
737 N. Michigan, Chicago 11

**All the Family
Listens on Your
Own Radio**



**SHAPE-AWL
CONVERTS ANY
DRILL PRESS!**

DO IT ALL with the SHAPE-AWL!

This new precision-engineered converter saves countless man-hours and dollars as it transforms any make or model drill press to a **MULTI-PURPOSE** machine in a few minutes. Operates in inverted position, too! Shapes any material with any standard shaping file! Die sinking made easy!

DESIGNED FOR RUGGED USE. Shape-Awl and its accessories are designed and built to exacting standards for precision work. It is made of high quality Duralmetal with 2 preloaded ball bearings, and has only 3 precision steel moving parts.

QUALITY GUARANTEE. The Shape-Awl is fully guaranteed to produce fast, accurate and superior work.

SPECIAL OFFER! Professional Model (1¾" stroke) complete with all fittings for your press. . . **\$37.50** ppd.
Home Workshop Model (1" stroke) all fittings. . . **\$29.95** ppd.
FREE set of 6 files with either model! Send Cash, Check or Money Order Today!

HOW TO ORDER Give Make, Model & Spindle Dimensions of your drill press. For presses with removable Chuck Taper Spindle state number of Jacobs or Morse Chuck Taper.

Dealer Inquiries Invited . . . Big Discounts on Quantity Orders!

FREE LITERATURE ON REQUEST!

Burla ENGINEERING

Dept. PB-12, 140 N. La BREA AVE., LOS ANGELES 26, CALIF.

SAW Metals, Plastics or Wood!

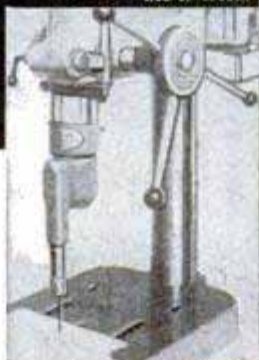

SLOT Keyways Faster!



FILE Fast & Accurate



**New POPULAR MECHANICS
CRAFTSMAN LIBRARY**



Start your workshop library with these four brand new volumes—the first books of the Popular Mechanics Craftsman Series. Other books to be published under this series are: Woodworking, Cabinetmaking, Metalworking and Plastics.

**Planning Your Home
Workshop**



How to plan and set up the kind of home workshop you have always dreamed of having. The editor, Sam Brown, will show you the easy, low-cost way to set up a home workshop your friends will envy. Whether you work in cramped quarters or have plenty of room this book will show you how to make use of every inch of space. Includes floor plans, wiring layouts, power tool hook-ups and shop furniture you can build. Special buyer's directory and many interesting projects. 128 pages. 250 photographs. 100 scale drawings. **\$2.50**

**Radio-TV Electronics
Handbook**

By F. L. Brittin, Radio-TV Editor, *Popular Mechanics*.



How to service radio and TV sets. Instructions and diagrams for building receivers, transmitters, phones, record player, etc. Glossary of parts, symbols, color codes. 160 pages. Hundreds of illustrations. **\$2.50**

**100 Beautiful Pieces of
Furniture You Can Build**



Build lovely modern furniture for every room of your home. Complete suites for living, dining and bedroom—occasional and odd pieces. Many exclusive designs by John Bergen, famous furniture stylist. Scaled diagrams and plans. 144 pages, 48 in brilliant full color. **\$3.00**

**Power Tools and
How to Use Them**

By W. Clyde Lammey, Asst. Crafts Editor, *Popular Mechanics*.



Get the most from your power tools. Covers selection and use of power tools; what you can do with the tools in the form of exciting projects, which tools to start with, which ones to add as you go along and how to use them. 144 pp. 375 illus. **\$2.50**

POPULAR MECHANICS PRESS, Dept. 18
200 E. Ontario St., Chicago 11, Illinois

Send the books checked below:

- Planning Your Home Workshop \$2.50
- 100 Beautiful Pieces of Furniture You Can Build \$3.00
- Remittance Enclosed (Send postpaid)
- Power Tools and How to Use Them \$2.50
- Radio-TV Electronics \$2.50
- Send C.O.D. (Postage extra)

NAME _____

ADDRESS _____

CITY _____ ZONE _____ STATE _____

CIRCULATING OIL HEATER

(Item 77) Circulating Heater. Modern, attractive cabinet heater with built-in powerful fan. Heats floors and all rooms evenly. Dim. 19 x 17 x 30 in. 7 in. Breeze pot and economizer heat baffles every bit of heat. 30,000 B.T.U. Ideal for 2-3 rooms, trailers, cottages, etc. Lifetime aluminum cabinet, built-in oil tank. Detroit inlet valve easily connected to outdoor tank if desired. Highest quality. Underwriters Lab. approved. Wt. 60 lbs. Built to sell for \$89.00. Sale price..... **\$39.50**



POTTER'S WHEEL

Power Driven - Foot pedal speed control. New compact modern design. Precision built to meet exacting requirements of professional artists—the finest wheel ever built. Mechanism fully enclosed for safety and to exclude moisture and clay. Foot-controlled variable speed drive provides instant, smooth speed range of 30 to 150 rpm. Equipped with adjustable arm rests. Easy to operate—even for handicapped persons. Reversible 10" throwing head—back side recessed for casting plaster bats. Motor 18x18" throwing table; wedging wire attached; removable water cup inside. Heavy bronze bearings pre-lubricated, sturdily built for long, dependable service. Use 1/4 hp motor (not incl.). Shipped fully assembled—just mount wheel and motor on table or sheet of 3/4" plywood. Self storing—tip up on edge. Wt. 45 lbs. List price \$125.00. Factory special..... **\$64.50**
1/4 HP 115 V. A.C. Motor for Potter's Wheel, wt. 27 lbs. (Item 258)... **\$15.00**

32 Pc. SOCKET SET

32-pc. Socket Set (Item 59) Highest quality guar. non-breakable sockets made by Husky. Beautiful, matched chrome alloy absolutely the best. Complete range of 21 sockets from 1/4" thru 7/16" in 1/4" drive and 7/16" thru 1-1/16" in 1/2" drive; 2 extensions, reversible 1/2" ratchet, adaptor bit, slide head, all angle coupling, 2 end wrenches, 1/4" speeder handle and sturdy metal tool box. For prof. mechanics who want the best. Wt. 14 lbs. Easily worth \$41.50. While they last only..... **\$16.95**

45 Pc. SOCKET SET (Item 203) Contains a complete set of sockets in 1/2" drive, 3/8" drive and 1/4" drive, plus all necessary extensions, handles, speeders, reversible ratchets, etc.; all uncond. guaranteed against breakage. Beautiful matched chromed thin wall alloy sockets in a sturdy handsome steel tool box. Wt. 17 lbs. List price \$82.90. Factory Special..... **\$26.95**

HYDRAULIC JACKS

(Item 208) Heavy duty, precision built, smooth, positive acting with built-in relief valve. Hi-Lift with screw extensions. Govt. surplus at a fraction of orig. cost. (Handle included.)
1 1/2 ton (Item 208) Wt. 11 lbs..... **\$6.45**
3 ton (Item 208A) Wt. 15 lbs..... **\$9.45**
5 ton (Item 208B) Wt. 17 lbs..... **\$11.45**



GET BEDROCK FACTORY PRICES SAVE TO 85% ON GIFTS

ELECTRICAL VALUES YOU CAN'T MISS!

HI-LINE 6000 WATT PLANT

(Item 182) Push Button Start, 115-230 V. 60 cycle A.C. A brute of a power plant with a rugged 13 hp. Wisconsin engine. Plenty of electricity for ranges, water heaters, pumps, machinery, etc. Affords both 110 and 220 volts. Ideal where heavy current is needed. Wt. 590 lbs. Easily worth \$995.00. With self generator and control box only built driven. Use your own engine or tractor. (Item 183) Factory price. **\$345.00**

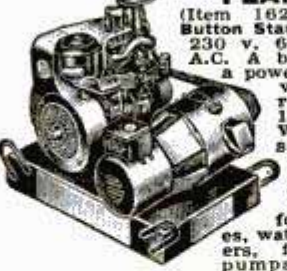

PORTABLE LIGHT PLANTS

350 watts—115 v. D.C. powered by a sturdy, easy-starting 1 1/2 hp. Briggs engine. Perfect for lights, radios, razors, etc. in cabins or trailers. Use standard light bulbs. Built-in control box with plug-in receptacle—just plug in. Weights only 65 lbs. Item 273. Reg. price \$199.50. A terrific value at..... **\$99.75**



HEAVY DUTY D-C ARC WELDER

Use as portable or shop welder. Up to 300 amps. Senior model. Made for years of trouble-free, continuous service. Will handle light or heavy jobs. Easily welds up to 3/4" plate using 1/4" rods. Built-in air cooling system. Arc is easy to strike and hold, because of specially designed arc stabilizer. Hi-lo switch and dial control gives wide range of welding heats. Run welder at 2600 rpm. with tractor, jeep or 15 hp. gas engine, or 7 hp. elec. motor. Complete with instructions, guar. and double V belt or flat pulley. You can pay more, but you can't buy a better welder. Wt. 110 lbs. **\$99.75**

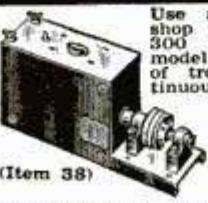

DUAL CONTROL MODE—same as above but with built-in dual rheostat for low heat soldering. **\$119.50**
WELDING KIT. Two 10 ft. leads, welding helmet, electrode holder, ground clamp. Sold only with welder at..... **\$10.50**
Write for prices and information on A.C. Arc Welders.

PUSH BUTTON START A.C. PLANT

500-700 watts—115 v.—60 cyc. A.C. Powered by a rugged 2 hp. easy-starting Briggs gas engine. No wiring necessary, just plug in and operate. Plenty of current for any oil burner, freezer, brooder, emergency lights, etc. which require up to 700 watts. Ideal for Civil Defense, Fire Depts., trailers and camps. Complete with Voltmeter and built-in winding to charge 6 v. auto batteries. Item 24. Wt. 85 lbs. Fully Guaranteed. Be Prepared if war or storm knocks out power lines. **\$143.50**
Reg. \$275 value.....
700-800 Watt Plant (Item 44) same as Item 24 but larger engine..... **\$169.95**
1000-1200 Watt Plant (Item 45) same as Item 24 but larger generator and engine... **\$199.50**

GIANT 2000-2500 WATT PLANT

110-120 V. 60 cyc. A.C. Absolutely the best made—exclusive dynamically balanced armature. heavy windings developed up to 5000 watt over. (Item 31) load for motor starting. Skid-mounted—portable. Powered by easy starting Briggs or 6 hp. Wisconsin engine—complete with all accessories; engine easily disconnected for other uses. Big outlet box, voltmeter, no wiring necessary. Ample current for all purposes. Factory warranty and complete instructions included. Wt. 220 lbs. Reg. price \$585.00. Special at.... **\$299.50**

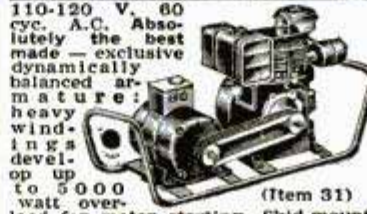

79 Pc. CARPENTER'S TOOL SET

Professional quality. A complete set of Master Mechanic tools featuring the famous Stanley brand. All neatly arranged in a beautiful sturdy 32" hvy. steel tool box. Set includes: Powerful 1/4" Electric Drill (optional), 3 Stanley Wood Chisels, 20" Spring Steel Saw, Steel Bench Vise, Tin Shears, 9 Drill Bits, Sharp, cutting Stone, 8" Plane, 2" Stanley Level, Hacksaw, Stanley Rule, 5 Double End Wrenches, 13 Ass'd. Hacksaw Blades, Stanley Hand Drill, 10" Vise Wrench, Comb. Square, Stanley Hammer, Stanley Ratchet Brace, Coping Saw, 7 Coping Saw Blades, Steel Wrecking Bar, 4 Screw Drivers, Offset Screw Driver, Nail Set, 4 Ass'd. Files, 8 Pc. Allen Wrench Set, Auger Bit Set and many other tools. Worth at least \$10.00 if purchased separately. Save cost of tools on one or two jobs. A terrific value. Item 242. Wt. 41 lbs. (without Electric Drill)... **\$39.50**
TOOL BOX ONLY—Wt. 15 lbs. Item 243)... **\$8.95**



Automatic Electric WATER HEATER

(Item 76) Immersion type 115 v. AC — 1250 watts. Convert your present tank to modern automatic hot water heater. Long life Westinghouse or Chromalox element screws into std. 1 1/4 in. opening in tank. Adjustable thermostat keeps water at desired temp. Can also be used in washing machine or tub. Wt. 8 lbs. Heater element and thermostat regularly \$49.50. Special..... **\$14.95**
Heater only, for manual temperature control. Wt. 3 lbs..... **\$7.95**

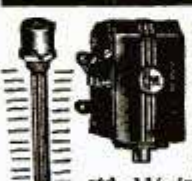

HEATING & VENTILATING FAN

(Item 10) Easily installed in furnace pipes. Forces even heat to all rooms. Over range, removes kitchen smoke and odors. Powerful continuous duty motor, 110-120 v. A.C. Quiet, super efficient fan moves huge volume of air 600 to 600 cfm. 8" Fan, wt. 5 lbs., \$6.85; 9" Fan, wt. 6 lbs., \$7.85; 10" Fan, wt. 7 lbs., \$8.85; 12" Fan, wt. 8 lbs., \$9.85. Heavy-duty 12" fan, enclosed motor, suitable for spray booths, restaurant exhausts, poultry houses, and other difficult applications. Wt. 12 lbs. Item 10D..... **\$12.95**



MASTER SNOW BLOW

No Pushing — Self-Propelled
It's a lawn mower
It's a power sickle
It's a cultivator
It's a plow
It's a bulldozer
It's a rotary tiller

Here at last is a powerunit that does everything. Works for you year round. Does terrific job of clearing snow. Built-in power takeoff to drive pumps, saws, generators, etc. Safety clutch—can't burn out. More versatile and efficient than tractors costing twice as much. Basic self propelled 2 hp. tractor—Briggs or Clinton engine. Only **\$119.50**
Tractor shown with snow blow attachment.
Snow Blow..... **\$29.50**
Lawn Mower Hitch..... **\$4.50**
Cultivator..... **\$8.75**
Rotary Tiller..... **\$21.50**
Sickle Bar-Mower..... **\$42.50**
Bulldozer..... **\$11.25**
Freight prepaid to most areas. Easy payment plan available.



MASTER AIR COMPRESSOR



(Item 209) High pressure type for large volume of air for heavy duty service. For paint spraying, inflating truck and auto tires, greasing, and the hundreds of other jobs done by compressed air. Piston type, 2" bore compressor with built-in air filter. Master built with hi-strength alloys and precision bearings. Stainless steel tank, 12"x24", 2100 cu. in. cap. Safe up to 500 lbs. Equipped with automatic switch that starts and stops motor to maintain desired pressure (up to 150 lbs.) and check valve, safety valve, gauge, shut-off valve, 20 ft. air hose and tire chuck. Beautifully balanced on ball bearing wheels and rubber tires. Low factory prices. With 1 1/2 hp. 110 v. A.C. motor (Reg. \$175.00)..... **\$98.50**
(Item 209)...
With 1 1/2 hp. motor (Reg. \$199.50)..... **\$119.50**
(Item 209A).....
With 2 hp. Briggs Gas Engine (Reg. \$199.50)..... **\$109.50**
(Item 209B).....
Write for price of compressor only. A complete line of spray guns and air tanks available.

Variable Speed Selector

Heavy duty, made by S. F. GOODRICH for industrial use. Provides instant speed changes for any drive. For machine tools, dryers, printing, conveyors, production lines, hoists — any operation requiring variable speed. Ideal for midget autos. Employs reliable "trouble free" planetary system. No hydraulic power losses or creeping. Infinite range, smooth operation, easy installation (data included). 3 sizes: 1/2-1 hp. wt. 36 lbs.; 1-2 hp. wt. 55 lbs.; 2-3 hp. wt. 105 lbs. Reg. list \$228, \$252 and \$352. Our prices... **\$79.50, \$89.50 and \$114.50.**



Factory Prices on Catalog Items

Send 10c for BIG 1953 catalog. Hundreds of bargains

Prices f.o.b. Factory. 10 day Money back guarantee. Send check or Money Order
MASTER MECHANIC MFG. CO., DEPT. 57B Burlington, Wis.

FIX YOUR OWN... PLYMOUTH or CHEVROLET

IT'S EASY!

Popular Mechanics Magazine has just published two new Owners Manuals covering all 1941 to 1952 models of Plymouth and Chevrolet cars. So accurate mechanics use them...so simple a woman can understand them.

Save money on your repairs. Prevent trouble. Enjoy care-free driving. Increase trade-in value. Avoid major repairs by fixing minor troubles before they get serious. Get sparkling performance at all times. Each manual has 272 pages, more than 350 photos, diagrams, tables, charts, breakdown drawings, plus clear, non-technical directions that make all repairs simple as ABC. Each Manual written by Ed Packer, one with assistance of Chrysler Corporation, the other with assistance from General Motors Corp. Shows you how to diagnose troubles by feel, sound, sight, smell and performance. Simple trouble shooting. Permanent repairs. Emergency repairs. Plus "How to get value from garages."



MONEY BACK IF IT DOESN'T SAVE MORE THAN THE COST!

One minor repair will save the cost ten times over. Read it. Then you decide. If you don't see that you'll save more than the cost, send it back for refund. SEND NO MONEY. Just send postcard. Be sure to specify whether you want PLYMOUTH or CHEVROLET Manual. Postman will deliver C.O.D. for \$3.50 plus postage. Or, to save postage cost, send \$3.50 with your order. Send today. Save its cost on your next repair.

POPULAR MECHANICS PRESS
200 E. Ontario, Dept. 1810, Chicago 11, Illinois

"SOUNDCRAFTERS"

New HIGH FIDELITY
F. M. - A. M. RADIO

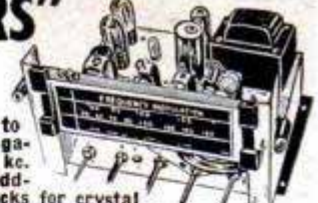

13 Tubes give you features and power to spare. FM tuning range 88-108 megacycles. AM tuning range 535-1650 kc. 14 Watt 6V6 Push-Pull Amplifier. Added RF Tube on FM. Separate input jacks for crystal and reluctance pickups. Will accommodate two speakers (i.e. 1—12" & 1—5" for very high notes—Extra \$2). Its wide range, 30-15,000 cycles, has an excellent Tone Control System using separate Bass and Treble tone controls. Tuner and Amplifier on one chassis makes installation very easy. AM Band has interstation noise control suppression. Phono Motor outlet provided COMPLETE, READY TO PLUG-IN including all tubes with a 10" or a 12" High Quality Speaker. Multi-colored slide rule dial. AM Loop Antenna. Knobs, etc. Size 12 3/4 x 10 1/2 x 7 3/4 High. RCA Licensed. New Merchandise. Original Factory Cartons. Immediate Delivery. Fully Guaranteed. Order Yours Today by Mail or Come in for a Free Demonstration. \$10.00 on C.O.D. Orders.
JAN ELECTRONIC DIST. CO. 222 FULTON ST., DEPT M NEW YORK 7, N. Y. **\$67.50** List \$139.50

Crosman for Christmas

WRITE FOR CATALOG

HIGH-POWERED .22 CAL. PNEUMATIC RIFLE

At dealers everywhere

Rifled barrel, military stock, adjustable sights, bolt action, wt. 4 lbs. 10 oz.

\$13.50

CROSMAN ARMS CO., Dept. 45, Rochester 20, N. Y.

ELECTRIC WELDER

AC or DC 110 Volts



"The Little Marvel" All-Metal welder. 5-year written guarantee. Welds 3/8" thick metal or money back. Repairs tanks, tools, fenders, machine parts, etc. Comes complete with everything—rods, unit, eye shield, and directions. We also make a welder for 16 to 22 gauge metal. \$3.95 complete. Transformer welder \$18.95. On C.O.D., postage extra.

\$6.45 Complete

ESSAY MFG. CO., Inc., Dept. 51, Quincy 69, Mass.

BRONZE FOUNDRY

Schools and Home Workshops

Make your own castings of aluminum, copper, bronze, silver. Foundry sets are available in three sizes including 2400 Deg. F. blast Furnaces. \$22.50; \$29.50; and \$42.00. f.o.b. Kansas City. Free Circular.

KANSAS CITY SPECIALTIES CO. P. O. Box 6022, Dept. P-12 KANSAS CITY, MO.

The QUICK-WAY to SHARPEN

CIRCULAR SAWS

A Preferred Gift for Homecraftsmen



Do it yourself—save time and money. The new QUICK-WAY Index Plate Circular Saw Sharpener makes your own power table a precision saw sharpener. Guarantees accurate grinding and spacing of every tooth. Complete unit only \$10.50 postpaid, including patented Index Plate block for mitre, and \$3.00 grinding wheel... Nothing else to buy! Send check, cash or money order. We pay postage. Write for free booklet "How to Sharpen Circular Saws".

QUICK-WAY Saw Company
11 Riverside Corning, N.Y.

Model 6-12P \$16.50

FURNITURE for YOUR BEDROOM

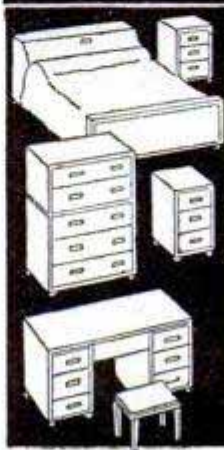

SAVE MONEY, be the envy of your neighbors by making this beautiful bedroom suite yourself! Only a power saw and jointer are needed to turn out this smart suite, featuring bed with storage space, three-piece vanity with cosmetic compartment and makeup mirror, Mr. and Mrs. dresser, and twin night stands with drawers. Letters demanding detailed plans poured in after this furniture was pictured in Popular Mechanics Magazine. Now the 4 plans are ready—easy-to-follow scale drawings—and they're yours for only \$2.00! Send for a complete set today.

POPULAR MECHANICS PRESS
200 EAST ONTARIO STREET, CHICAGO 11, ILL.

1/2" ELECTRIC DRILL \$2.95
ADAPTER takes all drill sizes to 1/2". Fits any small 1/4" Electric Drill—in just a second! Well-made and a Mighty Handy Tool!
DANIELS PRODUCTS CO.
M-12-822 W. 22nd St., Kearney, Nebr.
Postpaid in U.S.A.
Order Now

Say You Saw It in Popular Mechanics

WELD-BRAZE CUT-SOLDER

4 Ways to Handle 1001 Repairs Around Home-Garage-Garden

Complete welder with Twin Carbon Arc Torch and all operating accessories to do all types of metalcraft work. Easy instructions for work on iron, steel, bronze, brass and aluminum. Plugs into any properly wired AC or DC line. Low cost pays for itself in money saved and earned. A wonderful practical Gift of a lifetime. Order now!



only **\$14.75**

f.o.b. factory
Larger Models Available on request.

4 way welder

Yours on a money back
10 DAY TRIAL

FOUR WAY WELDER CO.
2326 S. Michigan Ave.
Chicago 16, Ill., Dept. F2-NC

Why Pay List Prices? BUY WELLWORTH PRODUCTS . . . SAVINGS UP TO 50%

PORTABLE SPRAY OUTFIT

1/3 H. P. HEAVY DUTY MOTOR



Paint Sprayer mounted on 7 1/2 x 25 inch tank, 1/3 H.P. 110 V. 60 cy. Heavy duty motor, 10 ft. cord and plug, V belt drive, Piston type Compressor with 2 Compression rings, 1 oil ring, 2 inch Bore, 1 3/4 inch stroke, displacement 2.86 C.F.M. at 60 lbs. pressure. Safety valve. External and internal atomizing gun, fan, round and angle spray nozzles; quart cup; maintains 35 to 40 lbs. working pressure. Oil and water extractor. 20 ft. heavy duty two-braid air hose with leakproof fittings. Complete with carrying handle. Wt. 75 lbs.
Special Price \$67.50
 Complete Outfit
 Spray Gun Sold Separately . . \$12.95

Regular Price . . \$125

AUTOMATIC COMPRESSOR UNIT WITH 22 GALLON TANK

1/2 H.P. heavy duty capacitor motor. 110 volt A.C., 2" bore, 1 3/4" stroke, 60 cycle, 2x1 3/4 inch piston type compressor, splash feed lubrication. 14"x32" tank, automatic pressure switch. CFM 2.8 at 100 lb. pressure, or 150 lbs. pressure for intermittent duty. Check valve, safety valve, 20 ft. air hose with air chuck for inflating tires. V. belt drive. Mounted on 2 wheels, ball bearing, with 2"x8" semi-pneumatic tires. Portable with handle. Shipping wt. 150 lbs.



With 1 1/2 h.p. motor
 Regular price \$175
\$98.50

With 1 1/2 h.p. gas engine
\$124.50

Regulator, filter and gauge included at no extra cost.

2000-2500 WATT LIGHT PLANT Heavy Duty Windings

110 v., 60 cy., A.C., takes starting overload up to 5000 watts. Floating Base for Automatic Belt Adjusting, 2-Groove Engine Pulleys, V-Belts, Bolts, etc. 5 H.P. Wisconsin or Briggs & Stratton Model 14 Engine. Voltmeter, 2 plug-in receptacles. Portable Tubular Steel Skid Type Carrier. Dim.: L 34 3/8" x W 17" x H 20". Wt. 180 lbs. List \$375

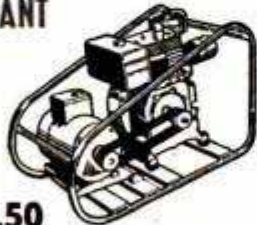

\$299.50

Generator only, with voltmeter, 2 plug-in receptacles. Ship. Wt. 75 lbs. \$169.50

500 WATT GENERATOR, Wt. 55 lbs. \$99.50

5000 to 6000 W. GENERATOR, 110/220V. Wt. 225 lbs. \$325

Leland Generator, 2 1/2 K.W., list price \$375. \$195

5 K.W. Signal Corps Light Plant. List price \$2200. \$895

CONTINENTAL GAS ENGINE



Red Seal. 2 HP with 6 to 1 reduction gear. Operates at 450 R.P.M. For lawn mowers, scooters, garden tractors, pumps, compressors, generators.

etc. List Price \$79.50. Shipping wt. 54 lbs. **\$47.50**
 SPECIAL PRICE
 Same engine, 3600 r.p.m., \$47.50
 With 2 1/2 H.P. motor . . . \$62.50

WIS. GAS ENGINE



Big Saving. 1952 model. A.K.N. 4 to 6 H. P. Wt. 75 lbs. List Price \$110.
\$89.50

PRICES F.O.B. CHICAGO. MONEY BACK GUARANTEE. SEND CHECK OR MONEY ORDER TODAY. PROMPT SHIPMENT. WRITE FOR FREE CATALOG.

COMPRESSORS SOLD SEPARATELY

- 2" bore, 1 3/4" stroke, wt. 16 lbs. \$20.50
- 2 1/2" bore, 2" stroke, wt. 24 lbs. \$27.95
- 2 1/2" bore, 2" stroke, Duplex, wt. 45 lbs. 54.50



"Wellworth" BLOWER BARGAIN

Quiet operating. Double wheel inlet, double width blower. For heating, ventilating, cooling, air washing, exhausting and forced draft. DIMENSIONS: 10" wheel; outlet 13 1/8" x 11 3/8"; inlet 8 3/4". Height 19". Width 18". Depth 16 1/2". C.F.M. 1/4" S.P. 1600; outlet vel. 1575.
\$27.50
 LESS MOTOR AND DRIVE
 With belt and variable speed pulleys, \$2.50 extra. Same Blower, complete, with 1/4 H.P. Motor \$45.00

GEAR HEAD MOTORS, 110V., AC

- Right angle gear head—1/30 h.p. 6 RPM 1/4" shaft, 3 1/2 lbs. \$11.95
- Right angle gear head—1/20 h.p. 195 RPM 3/16" shaft, 2 lbs. 9.50
- Bottom type gear head—1/30 h.p. 1250 RPM 3/8" shaft, 2 lbs. 10.25
- Same motor without gear head—1/10 h.p. 12,000 RPM 3/16" shaft, 2 lbs. 6.95 Right Angle

WELLWORTH TRADING CO.

1832 S. WABASH AVE., Dept. D-1252, CHICAGO 16, ILL.
 Cable Address "WELLTRADCO"

Popular Mechanics Home Improvement Help!



Now Ready! Brand new 1953 edition of USEFUL IDEAS. 160 pages of help for better homes and better living. Things to do and make for the home; for recreation; for fun and profit; tips and ideas that have made and saved hundreds of dollars for others. Special features show how to hang wallpaper, refinish Venetian blinds, dry wet basements, etc. Hundreds of pictures. Pictorial cover edition only 50 cents by mail or at your news dealer.

POPULAR MECHANICS PRESS, Dept. PM4, 200 E. Ontario St., Chicago 11

SAY YOU SAW IT IN POPULAR MECHANICS



Before You Buy Your Trailer—READ...

TRAILER TOPICS MAGAZINE

It brings you the latest in Trailer Coaches—Equipment—Accessories—Trailer Trips—Trailer Parks and many other interesting monthly features at only—\$3.00 for 2 years.

(6 MONTH TRIAL SUBSCRIPTION \$1.00)

TRAILER TOPICS MAGAZINE (Room 1577)
 28 East Jackson Blvd., Chicago 4, Ill.

HELPFUL BOOKS

Send post card asking for FREE catalog
 Popular Mechanics Press, 200 E. Ontario, Dept. 601, Chicago 11

BUILD YOUR OWN Heathkit TEST EQUIPMENT

Heathkits are completely engineered instruments supplied unassembled. Every kit goes together smoothly and easily. All drilling, punching, and painting has already been done for you. All parts are furnished and are of highest quality.

Detailed construction manual shows clearly where each wire and part goes and tells exactly how to build the kit.

WRITE FOR FREE CATALOG

HEATH COMPANY

BENTON HARBOR 17, MICHIGAN

Schupack's AMAZING TOOL BARGAINS! ALL BRAND NEW MERCHANDISE



SURPRISE VALUE
100 Pieces
FOR ELECTRIC GRINDERS
 Grinding Wheels, Cut-off Wheels, Sanding Discs, Mounted Stones, Sharpening and Honing Stones, Rotary Cutting Burs, Abrasive Cartridges, Mandrels, and many other items.

\$1.00
 Post-paid

FLEXIBLE SHAFT — ONLY \$4.95



Fits all electric drills & hand power tools. 35 3/4" long. Oilite bearings. Core of specially wound, high carbon steel wire in flexible steel casing. Will accommodate tool shafts up to 1/4" dia. For lathes, electric drills, etc.

\$4.95
 Post-paid

112 PIECE ASSORTMENT \$3.95



FOR ELECTRIC GRINDER
 \$10.00 VALUE — ONLY
 Here's what you get! Mounted Stones on 1/4" shank, Drum Sander, Sanding Sleeves for sander, Rotary Cutters, Wire Scratch Brush, Bristle Brushes, Circular Saw, Buffing Wheel, Grinding Wheel, Rubber Polishing Wheel, Cut-off Wheels, Rubber Cylinder, Mandrels to fit above tool, asst'd. Sanding Discs, Sharpening Stone, etc.

\$3.95
 Post-paid



2 DRUM SANDERS \$1.50
 With 12 Bands in Assorted Grits. 1 1/2" dia. x 1" long on 1/4" arbor with 12 bands

\$1.50
 Post-paid



18 ROTARY CUTTERS
 \$13.50 Value
 Illustrated 1/2 actual size
\$5.85
 Post-paid

\$5.85
 Post-paid

Assorted sizes cutter on 1/4" or 3/32" shank. Will fit all hand grinders. Ideal for cutting wood, metal, or plastic. Brand new.

12 MOUNTED WHEELS and points on 1/8" Shank. **\$2.95**



Post-paid
 For grinding on plastic, wood, soft and hard metals. Regular List Value \$8.40.

18 MOUNTED POINTS ON 3/32" SHANK \$3.60

12 MINIATURE CUTTERS \$1.00



FOR CUTTING WOOD, PLASTIC, or METAL. Actual size. Asst. shapes on 3/32" shank. For die makers, home workshop, etc.

\$1.00
 Post-paid

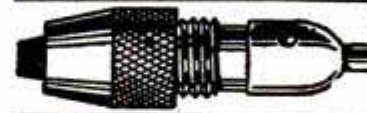

ADAPTER CHUCK
 With 2 interchangeable collets, opening from 3/32" to 0, on 1/4" mandrel. Price each only.

\$1.50
 Post-paid



2 CIRCULAR SAWS \$1.50
 ON 2 MANDRELS — ALL AT ONE LOW PRICE

\$1.50
 Post-paid

1" diameter saws on 1/4" Mandrels. For cutting wood, plastic, or soft metals. Order at once!



20 ABRASIVE ROLLS, \$1.00
 cloth, and 1/8" mandrel for grinding, sanding, deburring metal, plastic, wood or rubber, ONLY.....

\$1.00
 Post-paid

7 HIGH SPEED TWIST DRILLS \$1.00



15 DRILLS FOR ONLY \$2.00! Order Today! 7 Popular Sizes — up to 1/4". Brand new, ideal for home or shop use. Fits all standard chucks.

\$1.00
 Post-paid

5 DRILLS FROM 1/4" TO 1/2" DIAMETER — \$1.95

NEW ILLUSTRATED CATALOG 10c.

SCHUPACK SUPPLY CO., 7331 COTTAGE GROVE AVE., DEPT. M-37 CHICAGO 19, ILL. SEND CHECKS OR M. O. NO COD'S PLEASE

Earn **BIG MONEY WITH YOUR PICK-UP TRUCK!**
HAUL FACTORY WORKERS ETC. WITH Dixie Tallyho



Dixie Tallyho makes your pick-up truck into a station wagon. Top and sides of heavy-duty duck vinyl plastic coated both sides. Heavy-duty zippers close sides weather-tight. Clear plastic windows will not crack. Seats up to 8 comfortably. Tubular steel frame, vinyl coated fabric covered seats, top reinforced with hardwood slats. Order direct from factory and save \$68.00. Your price direct from factory is \$145.00. We pay freight if check accompanies order. Act now!

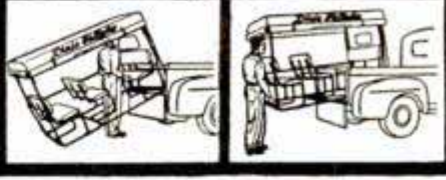

★
LIGHT WEIGHT — ONE PERSON CAN LOAD OR UNLOAD IN ONE MINUTE OR LESS

DIXIE TALLYHO, INC.
 Dept. P
FAIRBURN ★ GEORGIA

New MOTOR BARGAINS for Home, Farm & Industry

1/2 H.P.
 Dayton, 3450 RPM IND type . . . \$16.50
 Westinghouse, DBL shafts, 1725 RPM \$22.50
 Westinghouse, dbl. shafts, 3450 RPM \$23.50
3/4 H.P.
 Eicor, capacitor type ball brg., 1725 RPM \$32.50
 General Electric, cap. ball brg. dbl. shafts, 1725 RPM \$34.50
 General Electric, cap. type, 3450 RPM \$34.50
1 H.P.
 Eicor, 1750 RPM, cap. type \$52.00
 Dayton, 3450 RPM, cap. type \$57.00
 Dayton, 3450 RPM, cap. type, dbl. shaft. \$62.50
1 1/2 H.P.
 Westinghouse, ball brg. cap. type, 1725 RPM \$67.50
 Dayton, 3450 RPM, rep. ind. \$67.50
2 H.P.
 Dayton, 3450 RPM, rep. ind. \$75.00
 Leiland, 1725 RPM, rep. ind., ball brg. \$89.00
 Above Special Prices are F.O.B.

ALL NEW MOTORS WITH ONE YEAR FACTORY GUARANTEE
 All are 110 V. or 110/220 V. 60 cy. 1 ph. A.C. Motors.
 Write for FAN CIRCULAR: Listing Sides, Guards, Motors, ALL SIZES: Attic, Window or Room Cooler

C. MARSHALL SALES
 3546 W. Fullerton Ave., Dept. P-12 Chicago 47

PORTABLE AIR COMPRESSORS
 NEW LOW PRICE 1/2 H.P. AIR COMPRESSOR OUTFIT FOR SPRAYING, TIRE INFLATION, ETC.
 1/2 H.P. Heavy Duty 110-V. AC Motor—9x18 in. Stainless Steel 300 lb. test Tank mounted on Wheels, with handle. Compressor 2x1 1/4 in. 2.8 CFM—pressure to 100 lbs. Spray Gun, flat or round Spray, Quart Cup, Hose and Tire Chuck, Check Valve, Safety Valve, Completely Assembled, ready to run.
 Spray Outfit with 1/2 HP, 110-V AC Motor #A33 . . . \$67.50
 SAVE \$10.00—1/2 HP Outfit K.D. you assemble #K33 . . . \$57.50
EXTRA HEAVY DUTY 1/2 HP AUTOMATIC AIR UNIT
 Heavy Duty Repulsion Induction 1/2 HP AC Motor. Starts and Stops any desired pressure 50-150 lbs. Big Stainless Steel Tank 12x24 in.—500 lb. test. Precision 1/2 HP Air Compressor, 3 CFM, 150 lbs. Ball Bearing Rubber Tired Wheels, DeLux equipped Safety Valves, Check Valves, Auto Pressure Switch, Off Valve, Hose, Tire Chuck, Gauge Heavy Duty Repulsion Induction 1/2 HP, 110/220-V. 1 ph. AC Motor. Assembled Unit #A55 . . . \$97.50
 SAVE \$10.00—K.D. you assemble. Parts #K55 \$87.50
 ABOVE OUTFITS SHIPPED F.O.B. CHICAGO
 #275—Air Compressor Only, 1/2-1/2 HP, ppd. \$19.75
 #22—Quart Spray Gun, 15 ft. Hose & Tire Chuck . . . ppd. \$10.50
 Automatic Pressure Switch . . . ppd. \$5.50

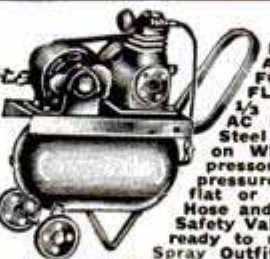

Volume Blowers for Heating, Ventilating, Exhausting

Blowers for forced drafts, heating boosters, exhausters, coolers, dryers and dust collectors. 110 volt A.C. 50/60 cycle motors.
 #Midget Blower: 5 CFM 2 in. Wheel . . . \$ 6.95
 #75 CFM Blower: Postpaid . . . \$ 9.75
 #150 CFM Blower: 4 inch Wheel . . . \$18.50
 #250 CFM Blower: 5 inch Wheel . . . \$22.50
 #600 CFM Blower: 6 inch Wheel . . . \$38.50
 #1000 CFM Blwr: 8 inch Wheel . . . \$52.00
 #1500 CFM Blwr: 9 inch Wheel . . . \$72.00
 *These Blowers with Motors shipped Post Paid. Larger sizes are F.O.B.



PALLEY BARGAINS

SAVE UP TO 85% ON WAR SURPLUS

ORDER BY MAIL!

2-WAY INTERCOM PHONES

Install this set of desk telephones for perfect, two-way communication between any two points up to 100 ft. This handsome set comes in a blue enamel finish. Has 2 phones, wire and simple hookup instructions. Operates on ordinary flashlight batteries. Here is the ideal set for use room to room, garage to house, barn to house, darkroom to outside, office to office or shop. Stock is limited! **ORDER TODAY! 750**

RADIO MIX

Ideal for 'ham' operators, experimenting, etc. Mix contains: Headset, mike, button, trans. wire, insulators, switches, condensers, rheostats, terminals, jump cable, etc. **249**

RADIO HEADSET

HS-30U - Two magnetic type receivers in watertight brass case. Soft rubber inserts in each receiver to fit into wearers' ear. Pliable steel head band. Ideal for communications, divers, workers in noisy compartments, etc. **NEW. 329**

COMPLETE UNIT

MAKE YOUR OWN POWER UNIT

Here's a unit PACKED WITH BRUTE FORCE! Does all these hard, heavy jobs that ordinary Power Tools cannot handle. Easily made from a vacuum cleaner type motor, a gear reduction drive and a few homemade parts. Can be used for turning large nuts & bolts, digging post holes, drilling large holes in wood or metal, driving power tools, & machinery, lifting, pulling, pushing, or any job where a slow speed with high take-off is required. **YOU CAN'T STALL IT!** Lightweight, easy to handle. Has 1000's of uses in the home, garage, shop, factory. We supply complete instructions.



MOTOR 325



GEAR BOX NEW 1295 USED 675

3 SPEED TRANSMISSION



Converts a high speed, low power input into low speed, high power take-off. Has 2 take-off shafts at 4 to 1 and 16 to 1 ratios. Gear box has a worm drive, bronze gears and a throw-out clutch. Will operate in either forward or reverse directions. Adaptable to many uses on power machinery. **1995**



90° TRANSMISSION

Has 1 1/2 to 1 gear reduction through bevel gears. Pre-lubricated bearings in dust proof housing. - A Positive lever control clutch. Size: 7" x 6". - 3/4" take-off shaft. **395**

PRESSURE TANKS



G-1 Type - Stainless Steel, shatterproof & rustless. Has reinforcing ribs and is pressure tested up to 400 PSI. Has high safety factor. Both ends have 1/4" pipe ports. Ideal for use as a buoy, drinking water supply, underwater fishing, diving, painting, cooking, or spraying. G-1 - 12 1/2" x 2" ONLY **1095** D-2 Tank - 500 cu. in. cap. **395** A-4 Tank - 104 cu. in. cap. **195**

AMAZING BERNZ-O-MATIC TORCH

It makes the old "blow-torch" obsolete. Here is a self-contained fuel & burner unit that does a job where intense heat from a concentrated flame is necessary. It is absolutely SAFE! (ICC approved). Has a replaceable fuel cylinder of high quality steel. PENCIL FLAME Type - with 10 hour cylinder and (1) burner unit **ONLY 695** EXTRA FUEL CYLINDERS. **195**

HAMMER-PUNCH

Designed for use by blacksmith, foundry, metal shop, etc. Made of forged steel with tapered punch tip. Has Hammer head for pounding or striking. Punch is 5/16" dia. Weight: 1-1/2 pounds. Complete with hardwood handle. **69¢**

RADIO ANTENNA REEL

For tuning beam antenna, opening and closing doors, etc. Powered by 1/8 HP, 24V, GE motor, engaged to a gear reduction only when electrical contact is made. Operates in either direction. Ideal for an auxiliary power take-off. Has 150 RPM at take-off. **NEW 875 USED 675**

RIGHT ANGLE SPINDLE DRIVE or GEAR BOX

Has 19-3/4" stroke at 1 to 1 ratio. 7/8" input and take-off shafts may be shortened if desired. Input shaft has universal joint. Has a threaded mount stud with tapered roller bearing adaptable to swivel mount. **795**

ELECTRIC ACTUATOR

Fast Linear Actuator - Has hundreds of uses for any mechanical device needing controlled two way action. Will open, close, raise or lower doors, windows, gates, etc. Has a 8500 RPM, 1/8 HP series wound motor. Operates on 24V DC current. Gives 4-1/2" stroke in 13 1/2 secs. Compression and tension loads up to 750 lbs. Has adjustable micro switch for limits of travel. Overall length retracted is 11 inches. **795**

EASTMAN ACTUATOR

Has a 1/8 HP, 24V, DC, 10,000 RPM motor & push-pull actuator. Actuator has a 4" travel through a reduction gear box. Has adjustable limit switches and forward and reversing reversing relays. Overall length extended, 20"; retracted 15 1/2". **1295**

GEAR HEAD MOTORS

Heavy duty, G.E. motor. 2 HP, 24V, DC, 125 amp, reversible motor to drive a reduction gear unit giving 36 to 1 ratio at take-off. Unit will operate on 6 or 12 volts. 36 to 1 G.E. (306 shaft RPM) **1095** 28 to 1 Eclipse (137 shaft RPM) **EACH** 30 to 1 Eclipse (110 shaft RPM)

GHM-529 Gear HEAD MOTOR

- Gear 24 volt DC, 7.6 amp, series wound reversible motor with overload clutch. Motor turns 11,000 RPM driving thru a 11 to 1 gear reduction box which turns the final take-off shaft 1000 RPM. Adjustable limit switches control limit of travel. Take-off shaft adapts to flex or rigid drive. Size: 10" x 4". **995**

FIRE EXTINGUISHER

Kiddle Lux - CO2 Type. Built to Gov't specifications. Has heavy, shatter-proof case. Recent hydrostatic test. Reconditioned and fully charged. **LIKE NEW!** All are **READY FOR INSTANT USE!** 3 1/2 lb. size with Swing Nozzle **\$14.95** 7 1/2 lb. size with Horn **21.75** 10 lb. size with new Squeeze Grip Handle & 3 1/2 ft. flex hose with Horn **27.75** 15 lb. size with Wheel Control **35.75** 15 lb. size with Squeeze Grip Handle, 4 ft. flex hose, Plastic Horn **39.95**

MAKE YOUR OWN HYDRAULIC REMOTE CONTROL

The ideal remote control for hundreds of uses such as throttle controls, engine & motor controls, switches, machinery, on large & small boats, in shop or factory, etc. Eliminates messy cables, pulleys, wire & rope connections. Gives positive, full range, instant action. Kit has two No. 3 Hydraulic Cylinders, shut-off valves, bleed valves and all fittings. The two cylinders are connected by tubing (any length) and filled with oil. When Master is moved the Slave responds equally in movement and pressure. Master may be used with many slaves by simple adaptation. Hydraulic Copper tubing for use with above unit **18¢ run ft.** Complete assembly instructions furnished with each kit. **KIT ONLY 1795**

GADGET MIXES

RADIO MIX - Rivets, Spacers, Bolts, Screws, Gears, Wheel Bearings, Springs and Clamps. **19**
BEARING MIX - Approx. 20 Needle, Ball & Roller bearings. New and Used. Sizes: 1/2" to 4". Some cost **159** Gov't \$10 apiece. 5 lbs. **ONLY**
FILE MIX - 10 assorted Files. 4" to 12". Includes Vixens, Half Rounds, Mills, Bastards, etc. in seconds and used but good condition. One vixen alone is worth our price for the entire mix. **99¢**

32 POSITION SWITCH

Was used as a bomb selector switch. Has 32 separate contact points through 1 common lead. Ideal for use in radio, experimental work, electronics, shops, factories, etc. - Has 32 post, Amphenol connector plug. Uses 12-24 volts current. In all metal case. **395**

AGASTAT-TIME DELAY RELAY

A 24 volt solenoid is held from a fraction of a sec. to 15 seconds by a Time Delay mechanism. When coil is energized it operates a double pole, single throw relay switch. Can be used on electric locks; animated signs, labs, etc. Fully adjustable by set. **225**

230 PAGE CATALOG

1000's of ITEMS! Fully illustrated! For THE MECHANIC, SPORTSMAN, HOBBYIST, HOME OWNER, etc. War Surplus - Factory Closeouts and General Merchandise Values! Save on Hardware, Hand & Power Tools, Gadgets, Sports Equipment, Hydraulics, etc. **SEND 25¢ for HANDLING & MAILING.**

WESTINGHOUSE AIR COMPRESSOR

1000's now in use for spraying, inflating, air tools, in garages, laboratories, shops & on trucks, tractors, jeeps, etc. Lightweight but powerful. Operates on 1/2 HP, gas or electric motor. Runs in either direction. Delivers approx. 3.27 CFM at 600 RPM or 6.54 CFM at 1200 RPM. Has 2" bore, 1-1/2" stroke. We also have available motors, tanks & fittings to adapt this unit. **2395**

LEATHER BELT KITS

Made of bark tanned, top grain cowhide. Designed to wear on your belt. So convenient and handy to carry your small tools. Sturdy and durable - reinforced with rivets. For use by mechanics, technicians, etc. "A" - ELECTRICIAN'S KIT - 7 Pocket. Equipped for tools, tape pencil, etc. **349** "B" - RADIO & TV REPAIRMAN'S KIT Has one large and two small pockets. **279**

PIANO HINGE

1 1/2" x 5 3/8" Cad. Plated Steel **.589** 1 3/4" x 7 1/2" Aluminum **1.29** 3 1/2" x 5 1/4" Stainless Steel **1.98**

AIRCRAFT CABLE

Rust resistant, alloyed steel. Extra flexible. Pre-formed, 7 x 19 strand. On reels. 1/16" - 4 1/2 ft. (7x7) 7/32" - 11 1/2 ft. 5/64" - 5 ft. (6x7) 1/4" - 12 1/2 ft. 3/32" - 5 1/2 ft. (7x7) 9/32" - 15 ft. 1/8" - 7 ft. 7x19 5/16" - 16 1/2 ft. 5/32" - 7 1/2 ft. 3/8" - 18 ft. 3/16" - 10 1/2 ft. 1/2" - 20 ft. Stainless Steel Cable - Pre-Formed 1/16" - 7 ft. 5/32" - 20 ft. 1/8" - 18 ft. 3/16" - 23 ft. Bronze Cable - Not Pre-Formed 1/16" - 5 ft. 5/16" - 23 ft. 1/4" - 17 ft. 1/2" - 38 ft.

ELECT. GYRO

50,000 RPM Motor is an integral part of balance wheel. Has double-end shaft to drive precision tools or machinery at precise, controlled speeds. Ball bearing mounted. High or low voltage. Ideal for experimental work, labs, hobbyists, technicians, etc. **495**

PALLEY SUPPLY CO. 2263 EAST VERNON AVENUE DEPT. PM-12 LOS ANGELES 58, CALIF.

Cuts Machining Time

SOUTH BEND 12 SPEED LATHE

The wide range of spindle speeds on this new lathe cuts machining time because the operator quickly selects the right speed for each operation. Push-button control provides a fast change from any high speed to the corresponding low speed. This versatility is further increased by 48 choices of longi-

tudinal and cross feeds which insure maximum efficiency on every job. Also, you will find that its accuracy and ease of operation make your tough jobs easy. Send the coupon for complete information about this new lathe.

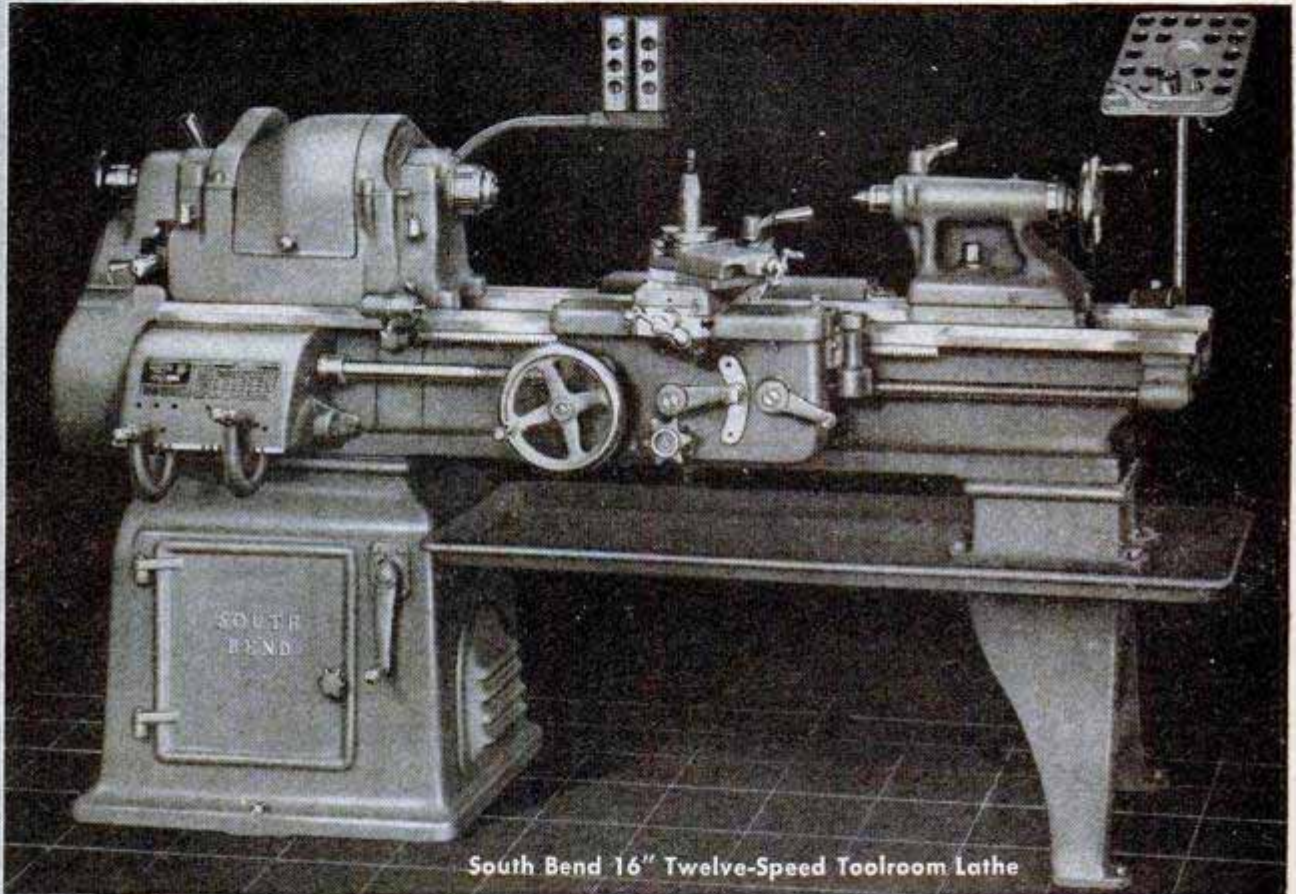

South Bend 16" Twelve-Speed Toolroom Lathe

SPECIFICATIONS

Spindle Speeds (approx.) Direct: high range 300, 550, 945; low range 150, 278, 475. Back gear drive: High range 32, 70, 118; low range 20, 33, 60.

Spindle Bore — 1 $\frac{3}{8}$ ".

Swing over bed and saddle wings — 16 $\frac{1}{4}$ ".

Swing over saddle cross slide — 9 $\frac{5}{8}$ ".

Distance between centers — 33 $\frac{1}{4}$ ", 45 $\frac{1}{4}$ ", 57 $\frac{1}{4}$ ", 81 $\frac{1}{4}$ ", 105 $\frac{1}{4}$ ".

Collet Capacity — 1" maximum.

Longitudinal Feeds — 48 R.H. of L.H., .0015" to .0841".

Cross Feeds — 48, .0006" to .0315".

Thread Pitches — 48, 4 to 224 per inch.

SEND INFORMATION CHECKED:

TOOLS & ATTACHMENTS



9" and 10" BENCH LATHES

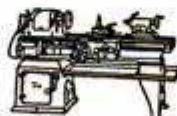

10" to 16-24" FLOOR LATHES



$\frac{1}{2}$ " and 1" Collet TURRET LATHES



14" DRILL PRESSES



7" BENCH SHAPERS

Name _____ Company _____

Street _____ City & State _____

Building Better Tools Since 1906 • SOUTH BEND LATHE • South Bend 22, Indiana



Which battery do you want in your car?

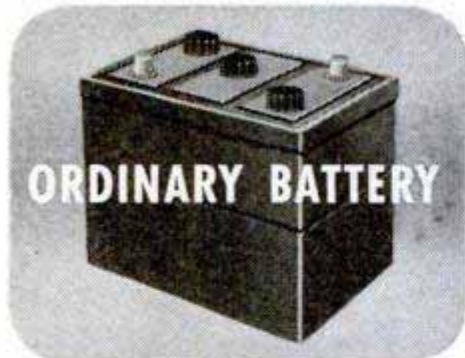

ORDINARY BATTERY

1. In ordinary batteries, small particles keep flaking off positive plates . . .

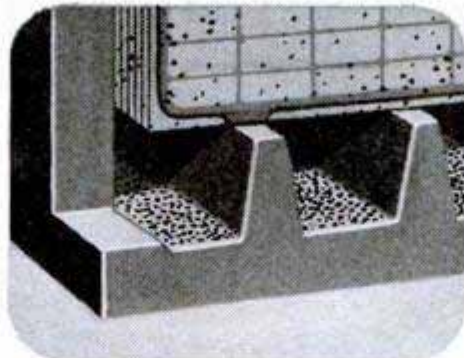

2. so ordinary design batteries must have large sediment wells at bottom of case to hold these particles.

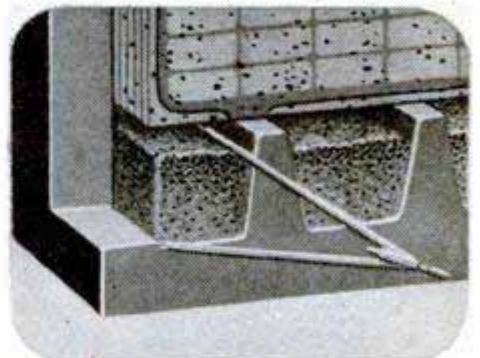

3. Even these sediment wells in ordinary batteries aren't big enough to hold flaking particles from positive plates . . .

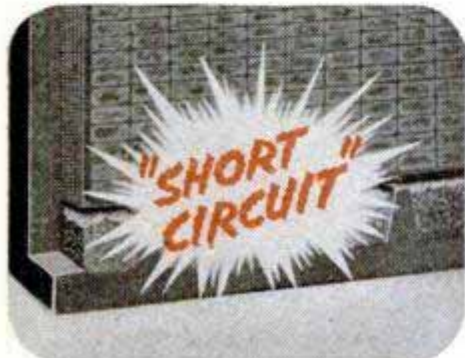

4. so particles pile up and short circuit plates, causing failure.



5. But in the Auto-Lite "Sta-ful" Battery, every positive plate has a Fibre-glass retaining mat protecting it . . .

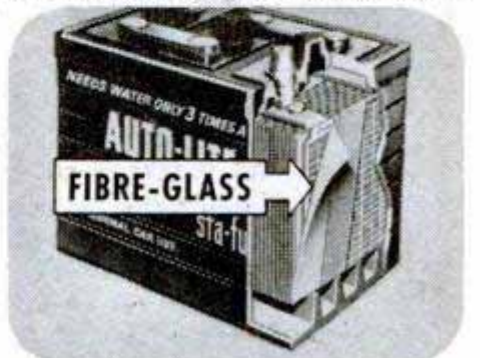

6. to hold the active materials in place to reduce shedding and flaking.

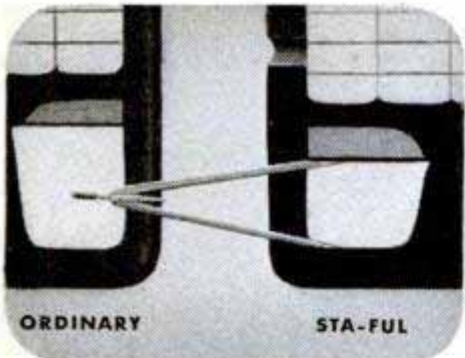

7. Side-by-side view shows that the Auto-Lite "Sta-ful" Battery doesn't need the extra space at bottom that ordinary design batteries do. So extra space . . .

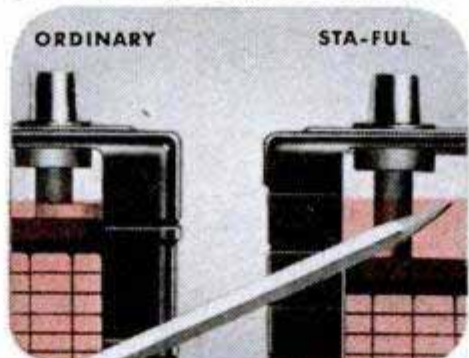

8. in "Sta-ful" Battery is moved to top where it holds more electrolyte, giving room for over 3 times the liquid reserve in the "Sta-ful" as in ordinary batteries.

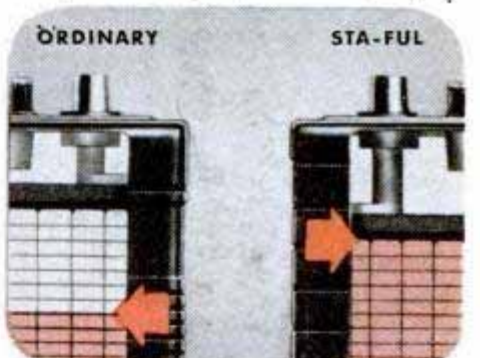

9. Here's proof of performance! Equal water evaporation shows how the Auto-Lite "Sta-ful" extra reserve keeps plates covered and active.

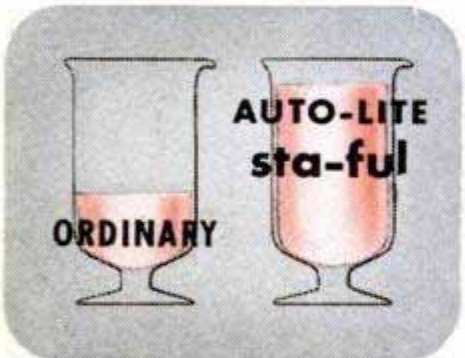

10. That's why "Sta-ful" needs water only 3 times a year in normal car use. Auto-Lite "Sta-ful" Batteries give longer life, too, in tests conducted according to minimum life cycle standards.

AUTO-LITE BATTERY CORPORATION
Toledo 1 Ohio



AUTO-LITE

sta-ful

*...needs water
only 3 times a year*

IN NORMAL CAR USE

WITH **PRESTONE** BRAND ANTI-FREEZE

**You're
SET**

Just put "Prestone" anti-freeze in and forget it till spring! No "boil-away" worries... no repair bills—its special inhibitors give the world's best protection against rust, clogging and foaming.

**You're
SAFE**

High compression engines and efficient car-heaters make non-evaporating anti-freeze more important now than ever. There's not one drop of boil-away alcohol or methanol in "Prestone" anti-freeze.

**You're
SURE**

With "Prestone" brand anti-freeze in your car, you're sure you've bought the best. It's America's No. 1 brand. No other anti-freeze gives your car the same complete protection. It's guaranteed!

No other anti-freeze gives your car the same complete protection



\$375
PER GALLON

\$100
PER QUART,
IN QT. CANS

One shot lasts all winter

NATIONAL CARBON COMPANY • A Division of Union Carbide and Carbon Corporation
30 East 42nd Street, New York 17, N.Y.

The terms "Prestone" and "Eveready" are registered trade-marks of Union Carbide and Carbon Corporation